

Electronic Design 12

VOL. 17 NO.

FOR ENGINEERS AND ENGINEERING MANAGERS

JUNE 7, 1969

Don't take insulation for granted. Choose it carefully, or you may doom an otherwise sound design. This holds true whether you are specifying connectors, buying PC

boards or designing radomes. But what are the differences between insulating materials? And how do you select the best type for an application? It's easy. See p. 65.



Pulse problems change and change and change and change.....and

so does the 1900 pulse system

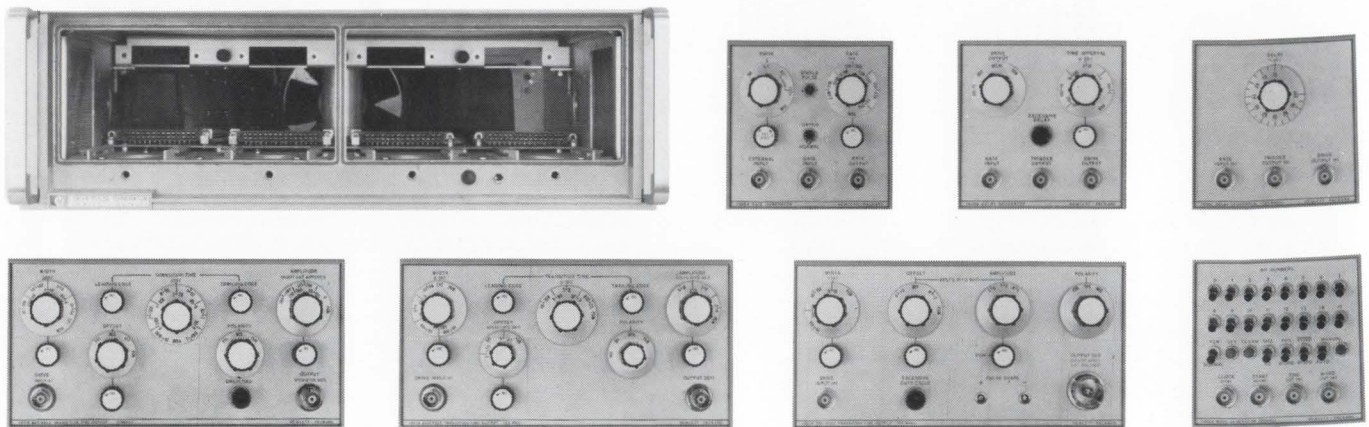

HP's brand new solution for people with pulse problems is a set of multi-purpose building blocks. You put what you want in your pulse generating system. With the HP 1900 Pulse System, you start with a standard mainframe that contains only power supplies and optional programming wiring.

Where do you go from there? That's up to you. HP is currently offering seven different functional plug-ins with more to come later. You can start with a relatively simple system and add to it as your needs change. Even complex pulse systems can be formed easily by using several mainframes and appropriate plug-ins.

Just to give you an idea of the capability of the 1900 system, here is a very brief description of the 7 existing plug-ins and some of their capabilities. And, keep in mind that the optional programming wiring allows you to make the 1900 completely automatic!

HP 1905A Rate Generator—provides output triggers variable in fre-

quency from 25 Hz to 25 MHz; it includes a pushbutton for single pulse triggers. (\$200)

HP 1908A Delay Generator—delays or advances pulses up to 25 MHz over a range of 15 ns to 10 ms and includes a double pulse mode. (\$200)

HP 1910A Delay Generator—pulses up to 125 MHz can be delayed from 5 to 100 ns in 5 ns steps. It has a 3 ns risetime and sufficient output to drive two variable transition time output plug-ins. (\$150)

HP 1915A Variable Transition Time Output—varies pulse risetime and falltimes from 7 ns to 1 ms and output currents from 40 mA to 1A, amplifies RZ or NRZ word formats. (\$1600)

HP 1917A Variable Transition Time Output—varies pulse risetime and falltimes from 7 ns to 500 μ s, amplifies RZ or NRZ word formats, 0.2 to 10 V amplitude at frequencies up to 25 MHz. (\$525)

HP 1920A Pulse Output—provides very fast 350 ps fixed risetime and 400 ps falltime with variable width and 0.5 to 5 V amplitude. Reversible

polarity and offset capability. (\$1750)

HP 1925A Word Generator—provides 2 to 16-bit words, RZ or NRZ format at frequencies to 50 MHz. Has remote programming and pseudo-random noise sequence generation capabilities. (\$850)

Two mainframes—are available to let you select the one that best meets your power requirements. Price: HP 1900A Mainframe, \$750; HP 1901A Mainframe, \$450.

Put together the system that best fits your needs. No other pulse system will do so much, so well—at such an economical cost! For more information, contact your local HP field engineer. Or, write to Hewlett-Packard, Palo Alto, California 94304. Europe: 1217 Meyrin-Geneva, Switzerland.

089/8

HEWLETT  PACKARD
SIGNAL SOURCES



Close your DVM credibility gap

...with the new 1822 Digital Voltmeter Calibrator

How well do you trust your DVM? Is its calibration still right? How about its linearity? Is the reading subject to hysteresis? Are you sure what effect input loading has on accuracy? How about the DVM's susceptibility to interfering voltages?

How do you find out? You could tear down your setup and drag your DVM to the standards lab for calibration. But wouldn't it be nice if the standards lab could come to you for a change?

We think we've worked out a way to bring the mountain to Mohammed and get those DVM calibration jobs done with the new GR 1822 Digital Voltmeter Calibrator. Here's an instrument that doesn't need the security blanket of standard lab conditions to do its job — it can come to you. And, conveniently too. All calibration functions are incorporated into one, small, easily transportable instrument.

All you have to do is bring the 1822 to your DVM, select a test voltage range, connect in your DVM, and push a button. Then, sit back and watch while an automatic test program takes your

DVM progressively through its decades. Select input loading or interfering voltages as desired. That's all there is to it. The testing method is in accordance with proposed USASI procedures for DVM's and Ratio Meters (USAS C39-6; soon to be released).

The 1822 is not limited to DVM testing. Anything that measures, transmits, or transduces analog voltages can be checked. And, the 1822 can be remote programmed for use as a systems calibration device.

The 1822 may create a credibility gap between you and your DVM's. But only for a little while. Then you'll swear by DVM's and not at them.

SPECIFICATIONS

DC Calibrating Voltages: 100 μ V to 1111.1 V in 7 decade ranges.

Voltages Available in Each Range: 0.11111, 0.22222, 0.33333, etc., to 1.1111. Zeros can be substituted if desired in the last four, two, or one digits (i.e., 0.30000, 0.33300, or 0.33330). Standard cell output can also be selected (1.018700 to 1.019100 V, adjustable to match standard).

Voltage Accuracy: Six-month accuracy is \pm (30 ppm of voltage + 10 ppm of full range + 3 μ V), except on 1-kV range which is \pm (50 ppm of voltage + 10 mV).

Warmup and Stability: Output essentially within above accuracy after 15-minute warmup from cold start. Stability over a 24-hour period is within \pm (20 ppm of voltage + 2 μ V).

Interference Voltages Available: 1, 10, 100 V \pm 10%, dc or peak ac. Choice of common-mode ac and dc (low terminal to case) and normal-mode ac (algebraically added to output). AC voltage is from line or can be provided externally (5-V pk).

Output Impedance: Less than 0.2 Ω above 1 V and 200 Ω below 100-mV in "zero"-ohm position; 1-k Ω , 10-k Ω , or 100-k Ω outputs, switch selectable.

Programmability: Internal automatic program sequences voltages from 1/10 of full scale to full scale and back down again. Maximum voltage range is switch selected. Program begins at maximum range, then drops a range and repeats the program. Process continues until range reaches either a 1-V or 1-mV preselected minimum, or until told to stop. In addition, functions controlling output range, digits and zeros can be remote programmed by switch closure or by "on" signal.

Price: \$2800 in U.S.A.

For complete information, write General Radio Company, West Concord, Massachusetts 01781; telephone (617) 369-4400. In Europe: Postfach 124, CH 8034, Zurich 34, Switzerland.



GENERAL RADIO

This newest of 13 data generators from Datapulse fires 16-bit words at clock rates from 10 Hz to 75 MHz. At \$2715, it's the first (and only) economical high-speed data generator.

Our Model 212 is fast enough to challenge your most advanced digital circuits, and variable enough to simulate nearly any input requirement. Baseline zero level can be independently adjusted from +2v to -2v on both the "positive true" and "negative true" outputs. The "true" level of each output is adjustable to 5v from the baseline, and word complement is available by front panel switch.

Model 212 is only the fastest. Other Datapulse data generators produce words up to 100 bits long, have as many as 13 channels, and provide NRZ and/or RZ outputs. Applications range from PCM simulation to pattern sensitivity testing with pseudo-random data. Prices start at \$680.

Our catalog will give you the whole story of the types, models, and options available. Contact Datapulse Division, Systron-Donner Corporation, 10150 W. Jefferson Blvd., Culver City, Calif. 90230. Phone (213) 836-6100.

A fast talker to test your hottest logic circuits

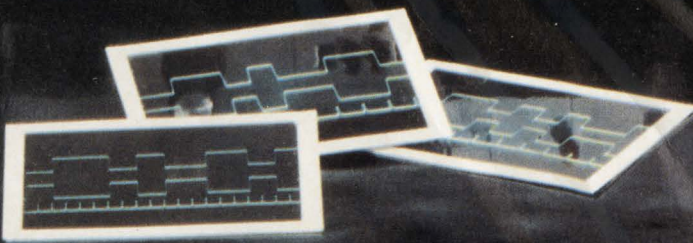
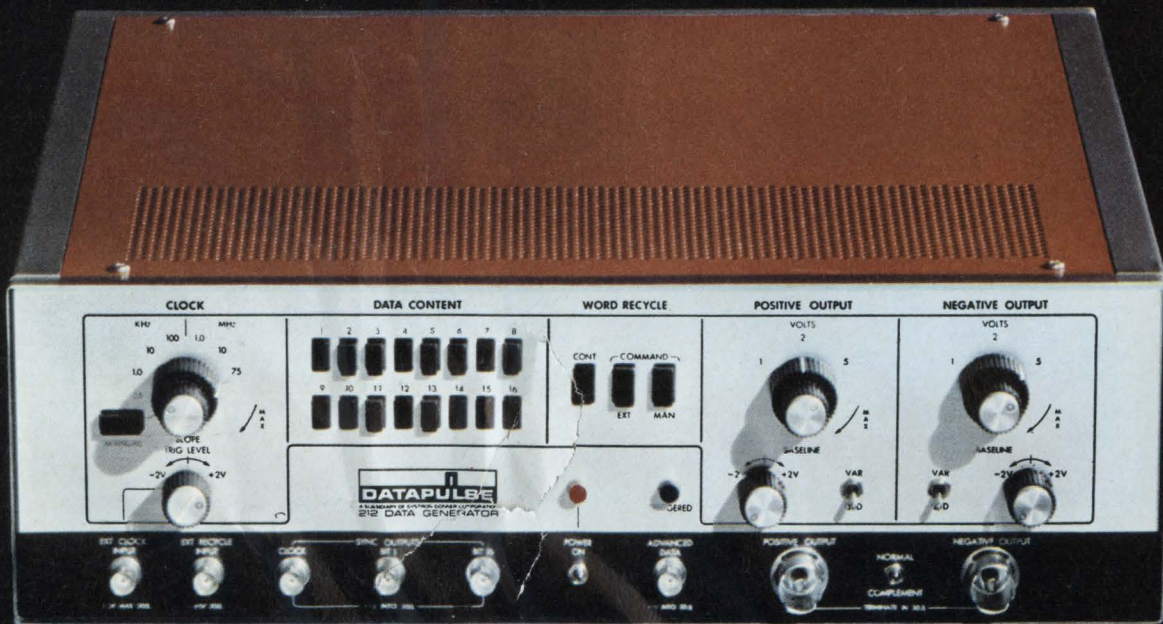

DATAPULSE
DIVISION
SYSTRON  DONNER

Another first. One of 144 Systron-Donner instruments

- | | |
|--------------------------------|-----------------------------|
| Electronic counters | Digital voltmeters |
| Pulse generators | Digital panel meters |
| Microwave frequency indicators | Microwave signal generators |
| Digital clocks | Laboratory magnets |
| Memory testers | Data acquisition systems |
| Analog computers | Microwave test sets |
| Time code generators | |
| Data generators | |

NEWS

- 21 News Scope
- 25 **Telemetry, the road map of the future**
Driver-guidance system, to be tested next year by U. S. Bureau of Public Roads, would give continuous directions by audible and visual signals
- 28 Laser-acoustic delay line reverses time functions
- 30 Ovshinsky displays futuristic thin-film devices
- 32 **Capacitor designs aim for IC compatibility**
Temperature-resistant and beam-lead tantalum devices in chip form have been developed for wide semiconductor use
- 39 Washington Report
- 44 Sidelights of the Issue
- 47 **Editorial: It's the alumni's turn to demonstrate**

TECHNOLOGY

- 65 **Insulating materials: a Special Report**
- 66 Smart designers keep pace with insulating materials
- 69 Thermosetting plastics
- 76 Ceramics, ceramoplastics and glasses
- 82 Thermoplastics
- 93 Elastomers
- 100 **Design—don't experiment—with ferrite beads.** Get more predictable performance from filters by learning how these inductors work.
- 106 **Go graphic with capacitive input filters.** Computer-generated curves allow you to optimize your designs in cost and performance.
- 112 **How to investigate a company**—or what every engineer and his manager should know about an annual financial report.
- 122 Ideas for Design

PRODUCTS

- 141 **Components:** Low-profile circular power resistors triple ratings.
- 144 **Instrumentation:** Compact digital panel meter programs from rear.
- 148 **ICs & Semiconductors:** Fifteen milliwatts power bright LEDs.
- 154 Data Processing
- 160 Modules & Subassemblies
- 164 Packaging & Materials
- 168 Production
- 170 Microwaves & Lasers

Departments

- 14 Designer's Datebook
- 173 Evaluation Samples
- 174 Design Aids
- 178 Application Notes
- 180 New Literature
- 186 Books
- 190 Advertisers' Index
- 192 Information Retrieval Service

COVER PHOTO: a micrograph of bismuth A, courtesy of Union Carbide Corp.

**The deepest source
for answers to ceramic
magnet questions.**

INDIANA GENERAL

We make it easy for the design engineer.



Try drawing on Indiana General. After all, we introduced ceramic magnets commercially in the U. S. And since our engineers work for the pioneer in the field, they've a knowledge of ceramic magnet materials and technology that your engineers just can't be expected to match.

Besides materials, where can we help you? In design assistance.

Production capacity. New applications. Costs. Plus the broadest materials range anywhere. We can often ship the type, size and shape you want right off the shelf.

Or, maybe we can send you something a little more animated. Like our engineers, who conduct magnet seminars frequently all over the country. If you'd rather stay home and curl up with a good book, try "Ceramic Permanent Magnet Motors," by our James Ireland. It's the definitive work on design. Just what you'd expect from a vice president of the corporation that gave ceramic PM motor design its start.

For some lighter reading on what we can do for you with ceramic magnets, write for our Indox manual, or bulletins.

Mr. C. H. Repenn, Sales Manager
Indiana General Corporation
Magnet Division
Valparaiso, Indiana 46383

Let's see if your ceramic magnet knowhow can make it easier for me. Please send me the following magnet literature:

- Indox Ceramic Magnets manual
- Catalog (stock) Indox Magnets
- Designing DC Motors with Indox Permanent Magnets
- Ceramic Magnet Axial Gap Synchronous Drives.

NAME _____ TITLE _____

COMPANY _____

ADDRESS _____

CITY _____ STATE _____ ZIP _____

PRE-ENGINEERED POWER!

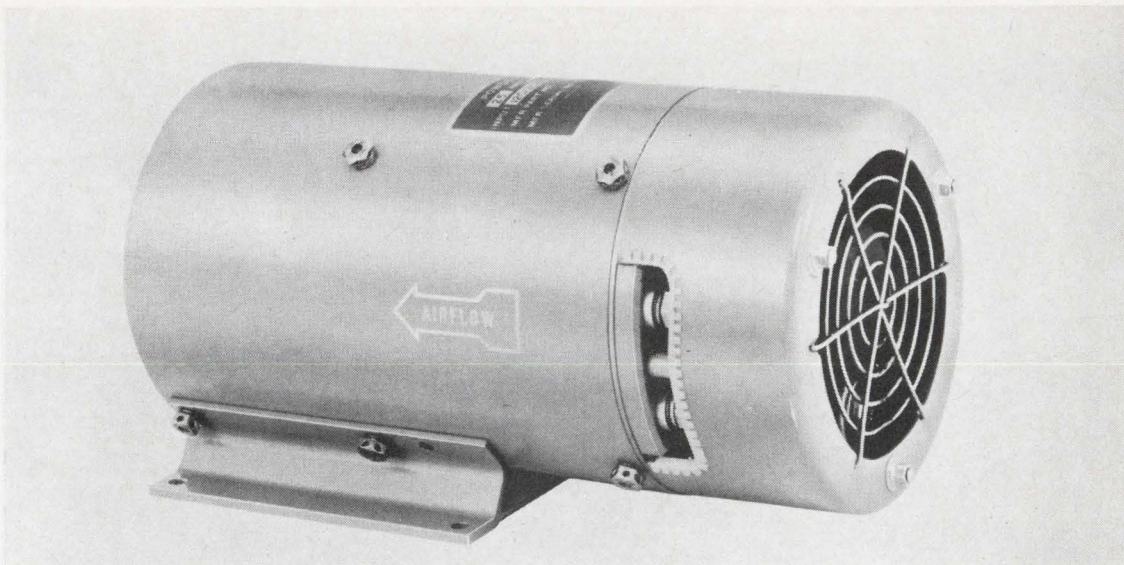

28G5P 47-65 Hz input (also style 28GP for 400 Hz), high-efficiency 28 V.D.C. output; lightest, most compact static unit.

Here are two readily available ways to get dependable 28 V. D. C. high-current power

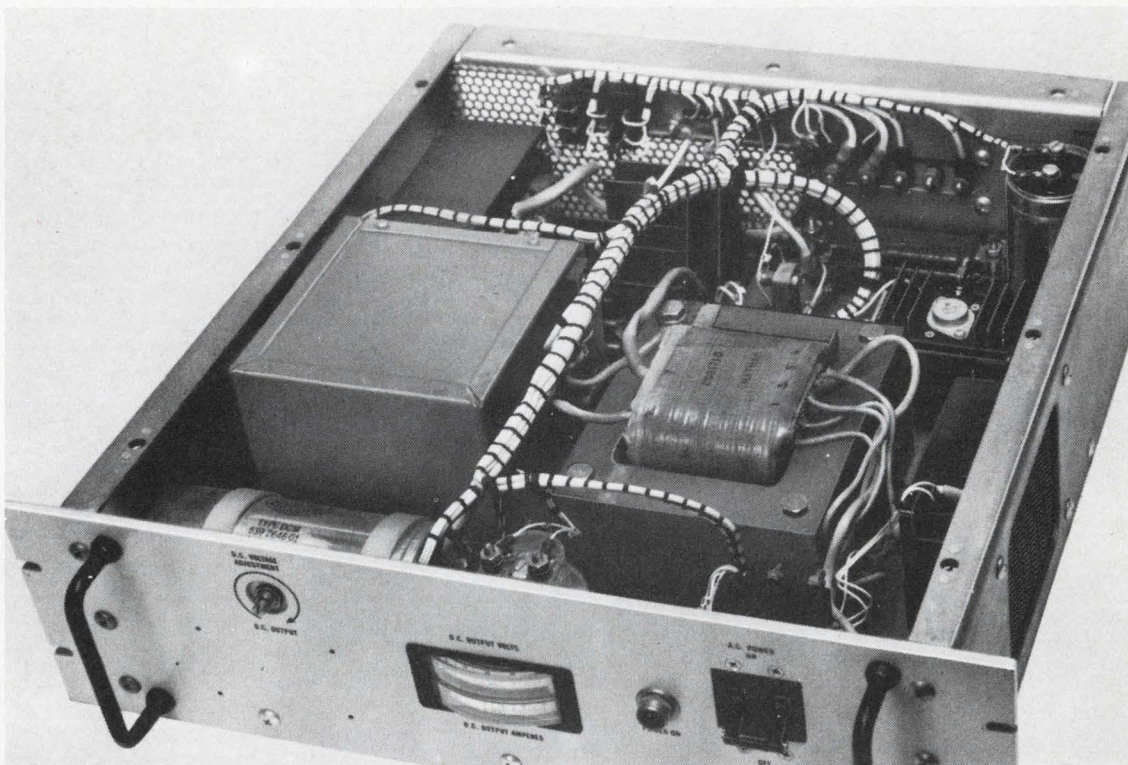

CR27.5 High-current, adjustable, 1% regulation, 28 V.D.C. output, 50-60 Hz unit. Withstands substantial overloads.

Tung-Sol pre-engineered standard power supplies meet lots of special requirements. You'll find they offer many cost/efficiency/size-weight/availability advantages. No more shoe-horning in at the last minute with a make-do power unit. No more high-cost custom or do-it-yourself designs. In all likelihood, Tung-Sol's done it before ... and can meet the specific requirements of your circuitry.

Tung-Sol pre-engineered power supplies reflect unique production abilities and in-house capabilities in solid-state components, transformers and electromagnetics which contribute added performance-value to your equipment. Units meet EMI and MIL Specs.

Talk to one of our experienced factory engineers. He's backed by a versatile line of pre-engineered, readily available, standard power supplies. Tung-Sol Division, Wagner Electric Corporation, 630 West Mt. Pleasant Ave., Livingston, N.J. 07039. Telephone (201) 992-1100.

TUNG-SOL*

Helps you do more
...with less

*Registered trademark Wagner Electric Corporation

**Small, compact size,
yet large capacity;
long life.**

HP RELAYS — Here is a new series of high power, high reliability relays designed with the user in mind. Complete standardization and design simplification have made it possible to deliver this high performance line in all quantities at prices that will demand the attention of the experienced relay buyer.

HC RELAYS, HM RELAYS — HC relays are new, extra long life, AC or DC miniatures. The HM relays are DC types, and are offered in a wide range of voltages. Both types are interestingly priced, especially when performance is considered.

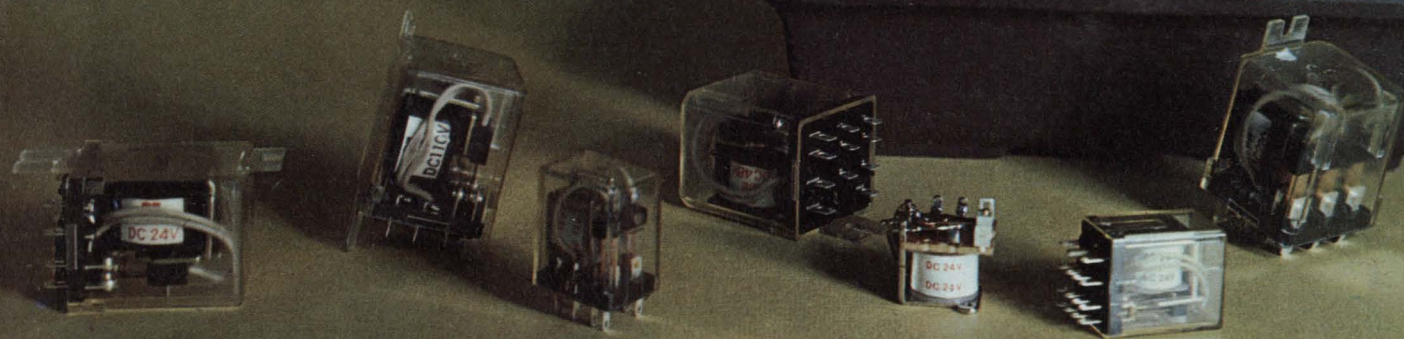

HP RELAYS



HP2-S

S-series — for direct solder tab connection or used with AMP-connectors.



HP2-R

R-series — for plug-in to standard sockets.

FEATURES: UL Approval Long life, high reliability, superior contact performance. DPDT, 3PDT & 4PDT types available at all voltage levels. Both solder and plug-in types available for AC and DC HP applications at 6, 12, 24, 48, & 120 volts. Complete standardization & simplification allow minimized sizes and lowest prices. Totally interchangeable with U.S. components, including pin configurations.

SPECIFICATIONS:

Max. switch-off current10A AC
 Max. switch-on current20A AC
 Max. contact current10A
 Max. contact voltage250V AC
 Max. contact power120W
 (at DC 24V), 2.5 KVA
 Max. pull-in/drop-out time15 ms
 Shock resistance10G
 Mech. lifeOver 10,000,000

HP 3 RELAYS

Brand new series — 3-pole versions of HP relays, for both AC & DC high power applications.

HC RELAYS



HC 4

4C contact arrangement



HC 2

2C contact arrangement

Especially designed to meet market demand for EDP, computer, process control and many other applications.

FEATURES: UL Approval Extra-long life: Mechanical — 10⁸ / Electrical — 10⁵ High reliability — gold flashed silver-cadmium oxide contacts. Compact size — 1.2 cu. in. AC & DC types Large control capacity: 3A for 4C, 5A for 2C.

SPECIFICATIONS:

Shock vibration resistance10-5G, 55 Hz
 Coil voltage6 to 115 VAC, 6 to 110 VDC
 Pull in/Drop out time13/10 ms
 Temperature range-50° to +50°C
 Coil power @ 25°C:
 AC=1.20V amps nom.; 0.77V amp min.
 DC=0.90 watt nom.; 0.58 watt min.

HM RELAYS

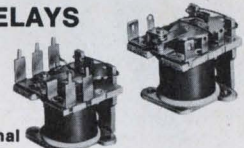

P terminal

S terminal

FEATURES: Minimum 15g contact pressure High life Low price Contact material: gold flashed silver SPDT types available with both P and S terminals at 3V, 6V, 9V, 12V, 18V, 24V, 35V, 42V, and 60V.

SPECIFICATIONS:

Max. switch-off current3A
 Max. switch-on current10A
 Max. contact current6A
 Max. contact voltage250V
 Max. contact power90W/1 KVA
 Mechanical life20,000,000
 Pull-in/Drop-out time12/8 ms
 Vibration resistance5G, 55 Hz

Call or write for details:



REMVAC COMPONENTS, INC.

37-55 61st Street, Woodside, Long Island, New York 11377 • (212) TW 9-6100

Agents for U.S. sales of components manufactured by Matsushita Electric Works, Ltd.

Got a switching problem? Perhaps an ordinary slide or rocker switch is what you really need. Or a standard switch with merely a slight modification. Stackpole can do more with a simple slide or rocker switch than you ever thought possible. Here are just a few examples. Look them over. Consider how you could be utilizing these versatile, yet economical and rugged devices. Stackpole makes more slide and rocker switches than anybody in the world. And makes them better!

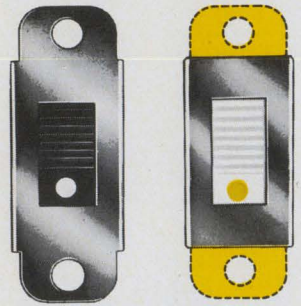

CASE MODIFICATION SAVES COSTLY PRINTED CIRCUIT BOARD SPACE

Space savings of up to 35% are possible by this simple case modification. Printed circuit terminals on the switch permit fast, simple insertion into the circuit board either manually or automatically. Also note that a hot stamped yellow dot was included to indicate ON position.



PLUG-IN CAPABILITY REDUCES ASSEMBLY TIME

The addition of wire leads with quick connectors provides a package that can literally be plugged into the unit. Any of the currently popular quick connection devices can be used. Leads can be specified to any length.

DOUBLING THE SWITCHES CAN HALVE THE COST

By ganging two slide switches, Stackpole saves this customer the time required to make two additional solder connections in the unit. Ganging can also solve complex switching function problems efficiently. This single operating knob controls the "on/off" of two separate functions in a floor polisher.

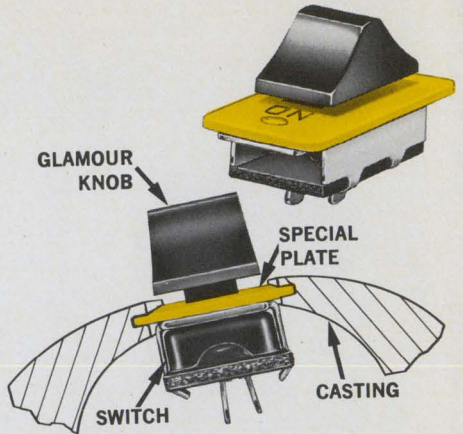
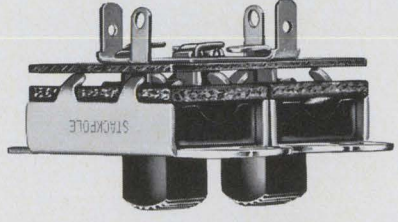

CASTING CAPTURE SIMPLIFIES APPLIANCE SWITCH MOUNTING ON CAST METAL OR MOLDED FRAMES

Simple attachment of a special metal mounting plate to a slide switch provides an effective, yet economical means of capture mounting the switch between two halves of a housing. The plate is inscribed so that the glamour cap provides visual indication of switch position by hiding one side while exposing the other. This modification is particularly applicable for power tools and appliances utilizing cast metal or molded frames.



MINOR CHANGES CAN MEAN MAJOR SAVINGS

This inexpensive slide switch was "adapted to a customer's individual application" simply by means of a slightly modified case. This particular case was adapted to include elongated mounting centers. Also incorporated into this design was a yellow notation spot to visually indicate whether the switch is in the ON or OFF position.

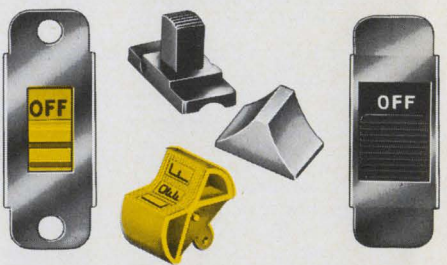

GLAMOUR CAPS... GREAT WAY TO TOP OFF A SWITCH DECORATIVELY, FUNCTIONALLY

Glamour caps for slide switches and custom knobs for rocker switches are two highly versatile means of adding sales appeal to any item. Shapes are almost infinite. So also are the colors. Lettering, "on-off," "high-low," etc., can be hot stamped in various colors.

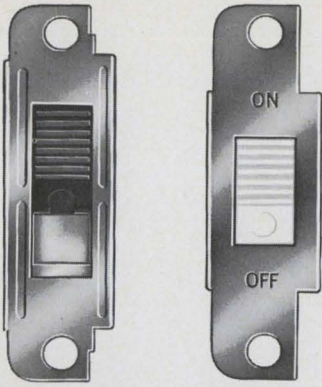

**INTERCHANGEABLE SWITCH CASES
ELIMINATE NEED FOR CHASSIS
DIFFERENTIATION BETWEEN MODELS**

Special case design for the single-pole, single-throw version of this slide switch makes it interchangeable with the double-pole, 3-position switch with regard to mounting dimensions. This simple modification permits the customer to utilize the same chassis for two different models of the same product.

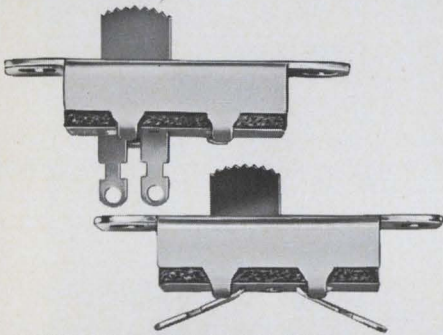

MOUNTING DEPTH A PROBLEM?

Simply rotate the terminals on the switch, make your connection and then fold the terminals flush against the base plate. This modification reduces the space requirement to a depth of less than 3/8" from the mounting surface.

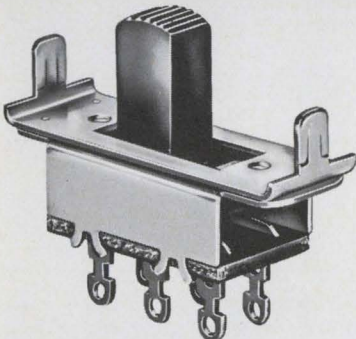

**TWIST-TAB MOUNTING SAVES
TIME AND MAKES CENTS**

The attachment of a twist-tab mounting plate to a slide switch can save many pennies as opposed to time necessary for mounting with a rivet or nut and bolt. A simple twist securely mounts switch in place. Elongated trigger used in this application in no way hampers or alters sliding action or touch.

**PRE-WIRING GETS YOUR
PRODUCTION TEAM INTO
THE HARNESS FASTER**

Switches provided with the wire harness already attached can save many hours of in-plant assembly time. Cross jumpering for reversing circuits is available as shown. Harnesses may be color coded and leads specified in any lengths.

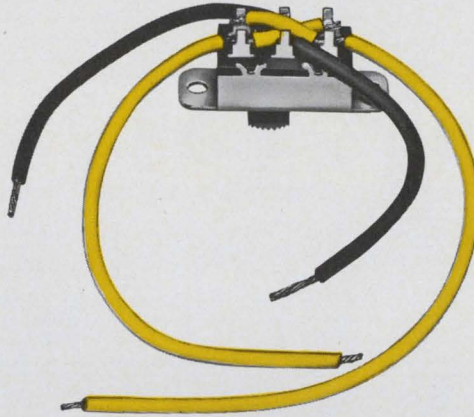

**END-TO-END MOUNTING CUTS
ATTACHMENT TIME AND
MATERIALS IN HALF**

Slide and rocker switches are available with case alterations for mounting end to end by use of a single rivet rather than two rivets per switch. Thus, attachment materials and effort are halved.

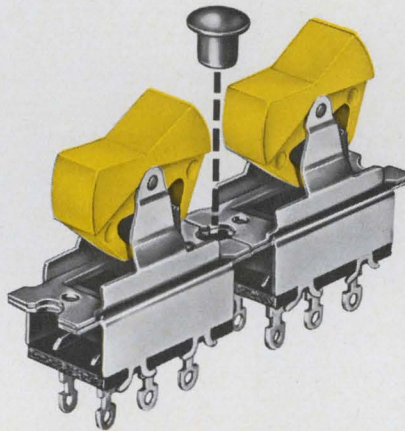

This is Stackpole "Contronics." Effective, efficient current control through the use of rather simple, highly reliable, yet economical Stackpole slide and rocker switches. These are but a few examples. If you can utilize this type switch, why not discuss it with us. We might just have an idea that'll turn you on. Stackpole Components Company, P. O. Box 14466, Raleigh, N. C. 27610. Phone: 918-828-6201.



Free. The only book you'll ever need to specify superior quality, economy and performance in slide and rocker switches. Bulletin 78/79-101. Send for your copy today.

**CUSTOM DESIGNED SWITCHES...
IDEAL SOLUTION FOR THE VERY
SPECIALIZED SWITCHING PROBLEMS
ON MODERN DEVICES**

Just in case our regular switches won't handle your switch problem, even if they're modified, Stackpole engineers will design and produce a switch specifically for your needs. Here are some cases in point.

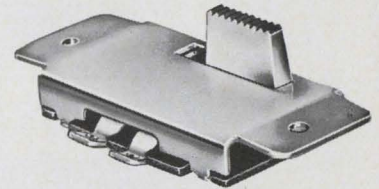

**DESIGNING SMALL AND NEED A
CUSTOM SLIDE SWITCH TO MATCH?**

Imagination, coupled with know-how and experience, created this amazingly slim slide switch. Notice the low profile, off-center knob location and slide-mounted terminals. High reliability was a must. Low cost was desirable. The client got both.

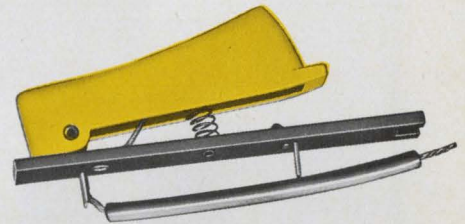

**KNIFE STYLE SWITCH DESIGN
PROVIDES FAST, SAFE AND
POSITIVE CONTROL OF ELECTRIC
CARVING KNIFE**

Working closely with the client's product design team, Stackpole engineers developed this highly efficient and safe switch. Life and safety were just as important as product beauty and customer appeal. Note the addition of the wire lead that cuts assembly time and costs.

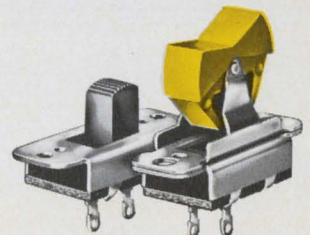

Capacitors

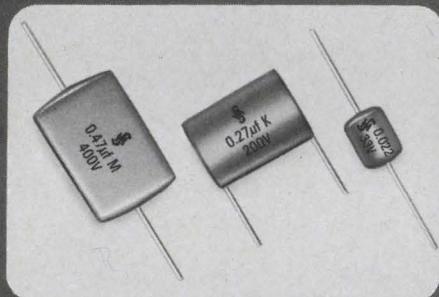

POLYESTER—33-630 V d.c., 1000 pF—0.47 MF

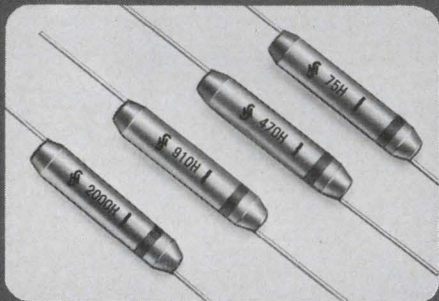

POLYSTYRENE—33-630 V d.c., 1-25,000 pF

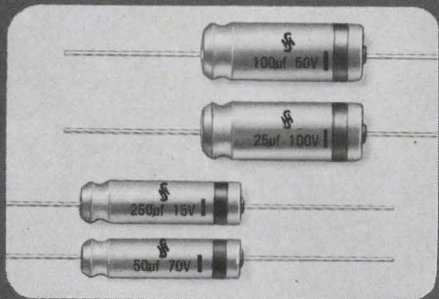

ALUMINUM ELECTROLYTICS
3—100 V d.c., 0.5—10,000 MF

*A Full Range of Capacitance
And Voltage Ratings In
Four Types--Designed With
Your Application In Mind.*

You can rely on Siemens to provide a wide range of precision built capacitors. High performance units that are available now in four major types designed to match your circuit requirements.

In addition, you can call on Siemens experienced engineers to assist you with your application problems involving the capacitors shown, as well as: Tantalum and Polycarbonate capacitors, Ferrite materials, Semiconductors, and many other products.

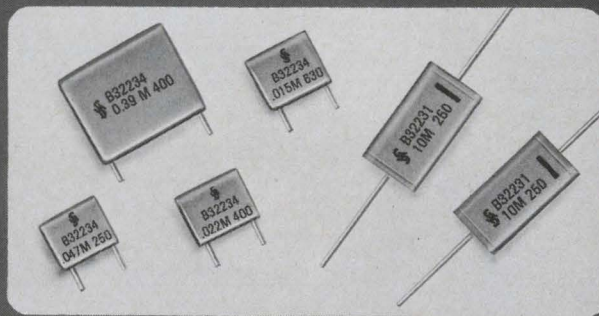

METALLIZED POLYESTER
100-630 V d.c., 0.01—10 MF

For technical information or assistance, contact:

Siemens America Incorporated, Components Division
685 Liberty Avenue, Union, New Jersey 07083 (201) 688-5400

"A tradition of craftsmanship and service since 1847"

Rogan Control Knobs For Quality Control

From electronic test equipment to appliances ... from communications equipment to amplifiers ... to almost every type of electrical application required today. Rogan offers the added advantage of *unlimited color* possibilities—molded material, or decorative inlays. It's the Rogan Knob that is selected when quality is the specification—and pricing the consideration. It's the Rogan name that makes the Rogan knob the designers' No. 1 choice in knobs.

Write today for new full color catalog or see us in Sweets or Thomas Micro catalog. Outline your requirements for quotation and free knob sample.

Rogan
BROTHERS, INC.

8019 N. Monticello Ave. Skokie, Illinois 60076

Phone: (312) 675-1234

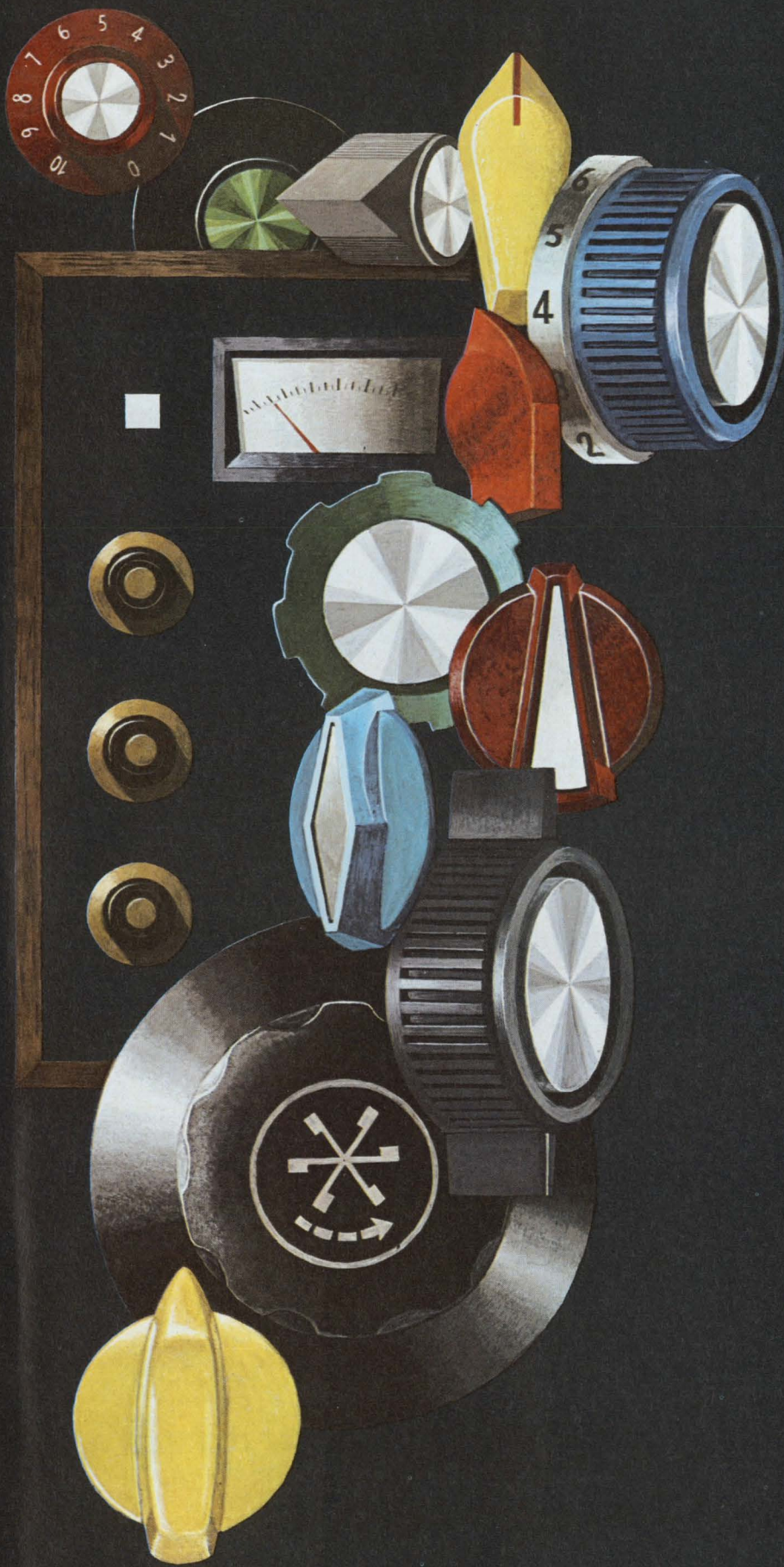

Pick the
BEST IC
for the job

Problem: Four DC to 30 kHz signals from high impedance sources must be summed into a $2k\Omega$, 100 pF load. The output is to be a guaranteed minimum ± 12 volts over the full frequency and military temperature range. The logical choice would be a Radiation RA-909. But amplifier offset current drift must not exceed $2 \text{ nA}/^\circ\text{C}$. Pick the Best IC for the job.

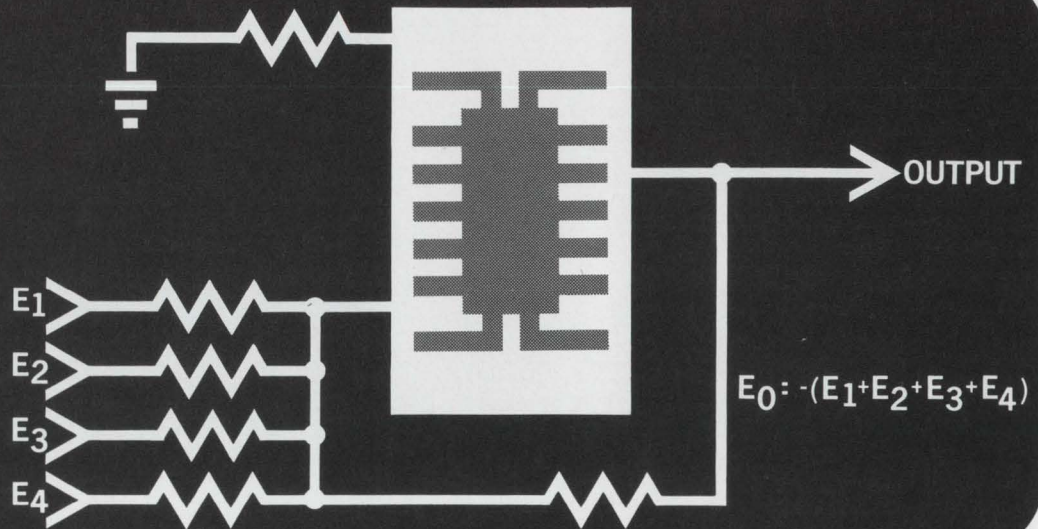

the **BEST** Solution:

THE NEW RA-909A COMPENSATIONLESS OPERATIONAL AMPLIFIER

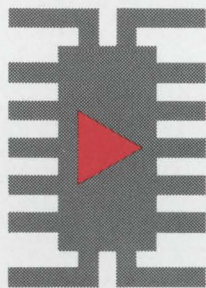

Drift error is very low in the new dielectrically isolated compensationless RA-909A. Between -55°C and $+25^\circ\text{C}$ offset current drift is a low $2 \text{ nA}/^\circ\text{C}$. From $+25^\circ\text{C}$ to $+125^\circ\text{C}$...an even lower $0.5 \text{ nA}/^\circ\text{C}$! And Radiation guarantees less than $15 \mu\text{V}/^\circ\text{C}$ offset voltage drift over the military temperature range. Compare this performance with any 709 type op amp over this extremely wide operating frequency range. You'll pick the Best op amp for the job. The RA-909A.

Like the RA-909, no external compensation is needed. Dielectric isolation and good circuit design eliminates the need for compensation. The RA-909A is in both a TO-99 package and a TO-86 flatpack configuration. A direct replacement for 709 type op amps.

Contact your nearest Radiation sales office. Let us help you pick the Best IC for the job.

WE MAKE THE **BEST** IC FOR THE JOB



RADIATION
INCORPORATED
SUBSIDIARY OF HARRIS-INTERTYPE CORPORATION
MICROELECTRONICS DIVISION

RADIATION SALES OFFICES: P. O. Box 476, Lexington, Mass. 02173, (617) 862-1055 • 600 Old Country Road, Garden City, N.Y. 11530, (516) 747-3730 • 2600 Virginia Avenue N.W., Washington, D.C. 20037, (202) 337-4914 • P. O. Box 30667, Dallas, Texas 75230, (214) 231-9031 • 6151 W. Century Boulevard, Los Angeles, California 90045, (213) 670-5432 • P. O. Box 37, Melbourne, Florida 32901, (305) 727-5430 • International Sales: Marketing Department, P. O. Box 37, Melbourne, Florida 32901, (305) 727-5412

INFORMATION RETRIEVAL NUMBER 10

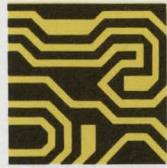

for intradyné SYSTEMS

At **Intradyné**...a new generation of microwave devices and sub-systems with superior performance characteristics is being manufactured in **production quantities** and with **high repeatability** using a Computer Controlled Network Analyzer in design, evaluation and checkout. Printout data can include VSWR, reflection coefficient, attenuation and gain, phase linearity, group delay, coupling and h,y,s and z parameters...**for every unit**. The Intradyné-owned analyzer can complete...with high accuracy...the equivalent of **6 man days in one hour!** The voltage tunable sources and the miniature coupler described are typical **Intradyné** computer-assisted designs.

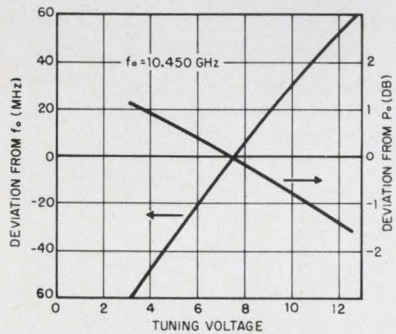
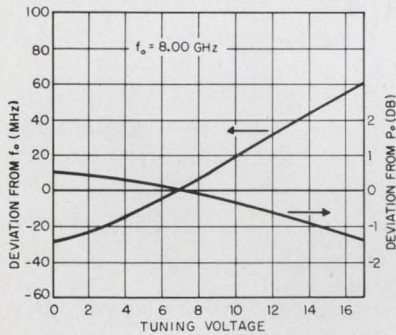

VOLTAGE TUNED OSCILLATOR

(Actual Size)

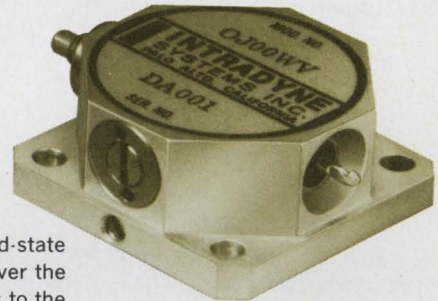

Now available...a series of voltage tuned, solid-state oscillators suitable for flight hardware that cover the frequency range from 8 to 12 GHz. The curves to the left show frequency and power output deviations with varying voltage.

- FREQUENCY:** 8.0 to 12.4 GHz.
- BANDWIDTH:** 200 MHz, mechanical.
50 MHz, voltage tuning.
- POWER OUTPUT:** To 50 milliwatts.
- TEMPERATURE STABILITY:** .. 0.35% max. 0.25% typ.
- DELIVERY:** Stock to 45 days ARO.



**INTRADYNE
SYSTEMS, INC.**

470 San Antonio Road,
Palo Alto, Calif. 94306
(415) 328-7840

To your specifications within short engineering cycles: Miniature, high-rel multi-function assemblies incorporating ferrite devices, couplers, mixers, bandpass filters.

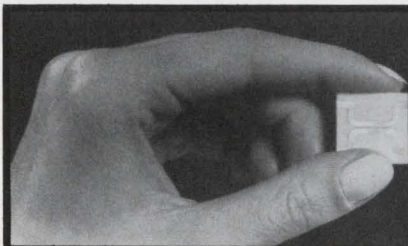

Computer
Analyzer
printout
of sub-
miniature
broad-band
10 db
coupler

FREQ.	VSWR 1	VSWR 2	VSWR 3	VSWR 4	LOSS DB	ISOLATION DB	COUPLING DB
2000.0	1.05	1.03	1.02	1.05	-5	-28.0	-11.0
2300.0	1.06	1.05	1.03	1.06	-5	-27.2	-10.4
2600.0	1.10	1.09	1.07	1.08	-7	-26.8	-10.1
3000.0	1.14	1.13	1.11	1.10	-7	-25.4	-10.0
3300.0	1.11	1.10	1.11	1.10	-7	-25.3	-10.0
3700.0	1.06	1.05	1.10	1.09	-5	-26.8	-10.3
4000.0	1.00	1.02	1.06	1.05	-6	-27.8	-10.7

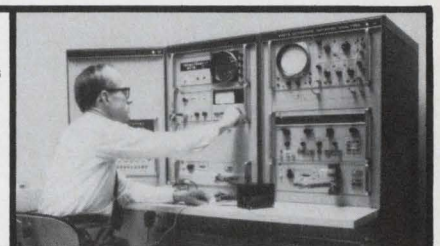

BULOVA has the Servo Amp you need, or else...

(or else we make it!)

You see, we're specialists in servo electronic components, which means we don't compete with you for your systems customers. It means we have what is probably the largest line of servo amplifiers under one roof. And, it means we have a quick response capability to design the right servo component to your specs. Our specialization means one more thing — skilled efficiency in production to provide you servo units at the right price . . . at the right time.

Being servo specialists, we know the specs for motors, resolvers, motor-tachs, and synchros, but we don't make them.

We do make —

- Servo amplifiers (AC and DC)
- Resolver booster amplifiers
- Modulators
- Demodulators
- Stepper motor logic
- Pre-amplifiers
- Error signal detectors
- D.C. power supplies
- Card amplifiers

— to mention a few.

Learn about all of them. And, be sure to ask about our servo amps from 3.5 watts to 40 watts output, in sizes as small as 1/3 cubic inch! Call 212-335-6000, see EEM Section 4900, or write —



BULOVA SERVO PRODUCTS

Electronics Division of the Bulova Watch Co., Inc.
61-20 Woodside Ave., Woodside, N.Y. 11377 (212) 335-6000

Go Bulova, and leave the designing to us!

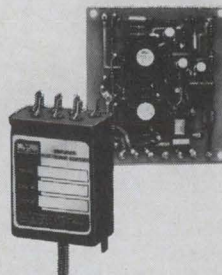

Designer's Datebook

JULY 1969						
Sun	Mon	Tue	Wed	Thu	Fri	Sat
		1	2	3	4	5
6	7	8	9	10	11	12
13	14	15	16	17	18	19
20	21	22	23	24	25	26
27	28	29	30	31		

AUGUST 1969						
Sun	Mon	Tue	Wed	Thu	Fri	Sat
					1	2
3	4	5	6	7	8	9
10	11	12	13	14	15	16
17	18	19	20	21	22	23
24	25	26	27	28	29	30
31						

For further information on meetings, use Information Retrieval Card.

July 7-11

Nuclear & Space Radiation Effects Conf. (Philadelphia) Sponsor: IEEE, NASA, et al., E. A. Burke, Air Force Cambridge Research Lab., Hanscom Field, Bedford, Mass. 01730

CIRCLE NO. 400

July 20-25

Engineering in Medicine & Biology (Chicago) Sponsor: IEEE, L. Stark, Univ. of Illinois, Chicago. 60612

CIRCLE NO. 401

Aug. 5-7

Joint Automatic Control Conference (Boulder, Colo.) Sponsor: IEEE, G-AC, W. E. Schiesser, Dept. of Chemical Engineering, Lehigh Univ., Bethlehem, Pa. 18015

CIRCLE NO. 402

Aug. 12-15

International Photoconductivity Conference (Palo Alto, Calif.) Sponsor: ONR, American Physical Society, Robert J. Keyes, Massachusetts Institute of Technology, Lincoln Laboratory, Lexington, Mass. 02173

CIRCLE NO. 403

Aug. 19-22

Western Electronic Show & Convention (WESCON) (San Francisco) Sponsor: IEEE, WEMA, T. Shields, WESCON, 3600 Wilshire Blvd., Los Angeles, Calif. 90005

CIRCLE NO. 404

Aug. 24-27

Electronic Materials Technical Conference (Boston) Sponsor: AIME, Edward L. Kern, Metallurgical Society of AIME, 345 E. 47th St., New York, N.Y. 10017

CIRCLE NO. 405

**We've taken out
all the levers, cams,
pivots, ratchets,
black boxes and assorted
moving parts.**

**And replaced them
with these.**

These little black chips represent the world's first application of an integrated circuit as a keyboard switching element.

Actuated by a magnet on the key plunger, the integrated circuit delivers a digital output which is fed into the encoding matrix of the keyboard. Codes are thus transmitted electronically instead of mechanically as in conventional keyboards.

This all solid state keyboard has no mechanical linkages. No electromechanical parts. No moving contacts. No black boxes. The bounce-free output eliminates the need for any special circuitry to adapt it to your equipment.

And the price is down as much as the technology is up. In production quantities, a mere \$100 buys an all solid state, assembled and encoded keyboard. Also the inherent reliability of the all solid state design helps you beat the economics of servicing equipment in remote locations.

MICRO SWITCH can supply all standard key and custom arrays. Block or offset. Encoding of any 8-bit code (or less); hexadecimal; Baudot, BCD; USACII

mono-mode, dual-mode and tri-function; plus EBCDIC and custom codes.

Our handy "Condensed Keyboard Guide" briefly discusses keyboards and options to give you an idea of the broad offering that we already have available. MICRO SWITCH application engineers are ready to work with you in developing the most economical keyboard designs to meet your precise format and encoding needs.



MICRO SWITCH

FREEPORT, ILLINOIS 61032
A DIVISION OF HONEYWELL

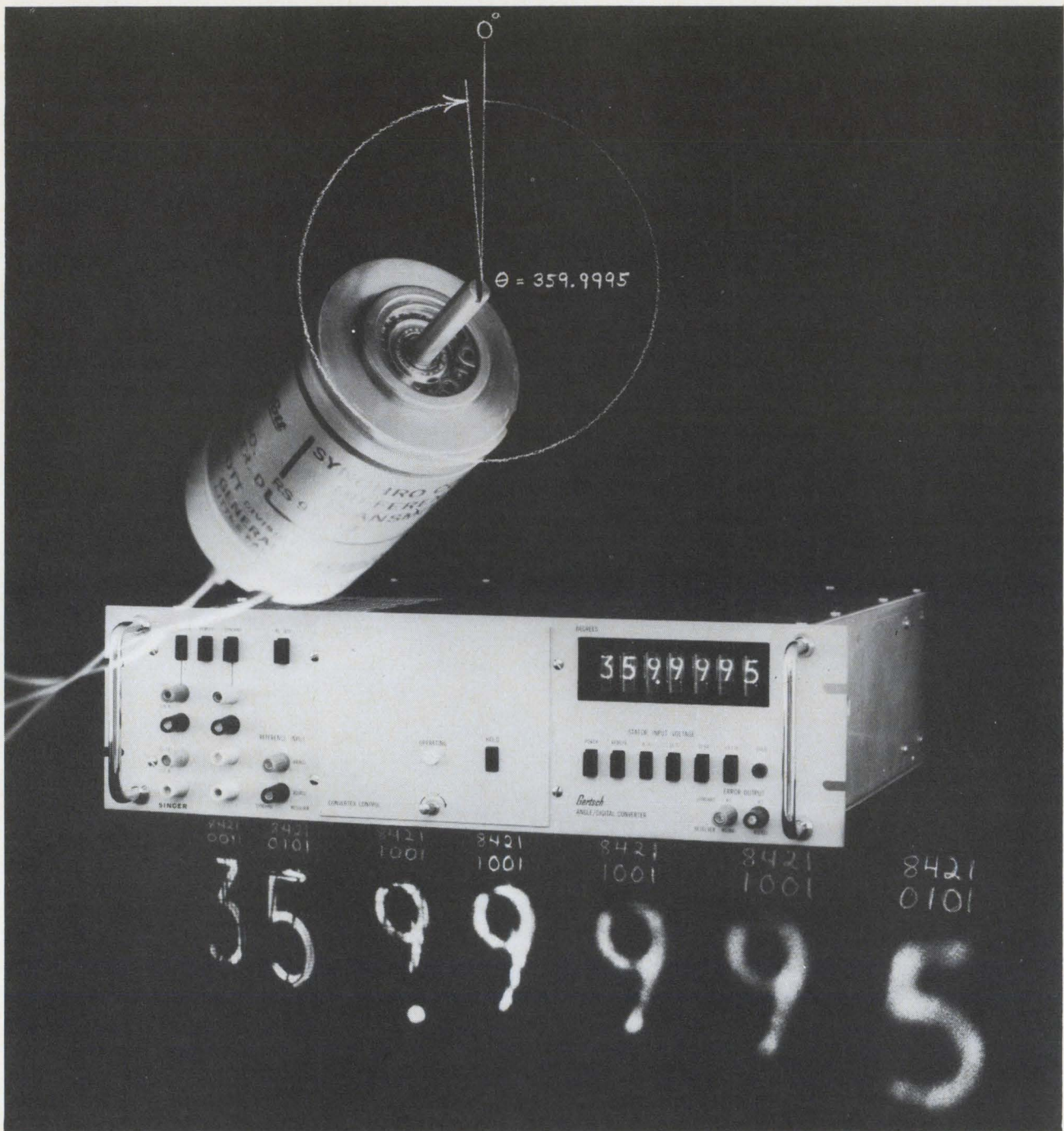

Instant angles – Instant interface with Gertsch

Whenever you need 0.001° synchro/resolver measurement accuracy in less than 250 milliseconds with computer compatibility, look to the versatile converter from Singer. Series ADC Angle/Digital Converters adapt to most all synchros and resolvers.

Protection against application obsolescence is provided by use of front-panel plug-in converter control. For example, when the Model ADC-1 main-frame is equipped with a **Model CC-1** plug-in, the instrument functions as a 0.001° synchro/resolver-to-digital converter. However, when the same main-frame is equipped with a **Model CC-7** plug-in, the unit becomes a digital-to-synchro/resolver converter (digital CT). Several plug-in, main-frame combinations are possible now, with more promised in the future!

Is 0.001° (3.6 seconds-of-arc) too accurate for your application? A 0.01° main-frame (ADC-2) is also available at reduced price.

Regardless of which combination you select, you are assured of:

- Computer compatibility, 5V logic levels with current sink inputs and BCD outputs.
- 45° Self-Test from front or rear panel, at any time you want.
- One-Megohm input impedance.
- Isolated inputs and outputs.
- 0 to 50°C operating range
- Immunity to noise, harmonics, and phase shift.

INFORMATION RETRIEVAL NUMBER 14

For a demonstration, or for full technical details, call your local Singer Instrumentation representative or contact us directly at The Singer Company, Instrumentation Division, Gertsch Operation, 3211 S. La Cienega Blvd., Los Angeles, California 90016 (213) 870-2761.

SINGER
INSTRUMENTATION

INFORMATION RETRIEVAL NUMBER 228 ►

Heard the new word in D/A converters? It's MINIDAC ...and it means just what it says.

A miniature, high speed / high performance digital-to-analog converter ... completely self contained in a tiny encapsulated package.

High speed? The fastest! In fact, MINIDAC switching time of just 200 ns means that only your logic or analog circuitry limits system speed. As for precision, you can choose 8, 10, or 12 BIT resolution, (BCD or BINARY), with $\frac{1}{2}$ LSB linearity.

This kind of size and performance is clearly something NEW ... The secret? An exclusive current switching technique which yields the very ultimate in switching speed, practically eliminates switching transients and supplies a current output for maximum flexibility in driving all kinds of analog circuitry.

Perhaps the most significant feature of this unique design is economy. MINIDAC is priced for the OEM ... The 12 BIT version just \$130.00 (100 lot), 8 BIT models are under \$100.00. And remember, MINIDAC is a complete D/A converter!

Where to use it? You name it! High speed flicker-free displays ... digitally programmed test instrumentation ... all kinds of computer interface applications. Add a few components (logic and comparator) and your MINIDAC becomes a precision high speed A/D converter. The hard part is done for you ... switches, reference, resistor networks are all included with performance tested and guaranteed!

Check the specs on the back, then ask for an in-your-plant evaluation. Just use the instant action reply card ... no obligation, of course.

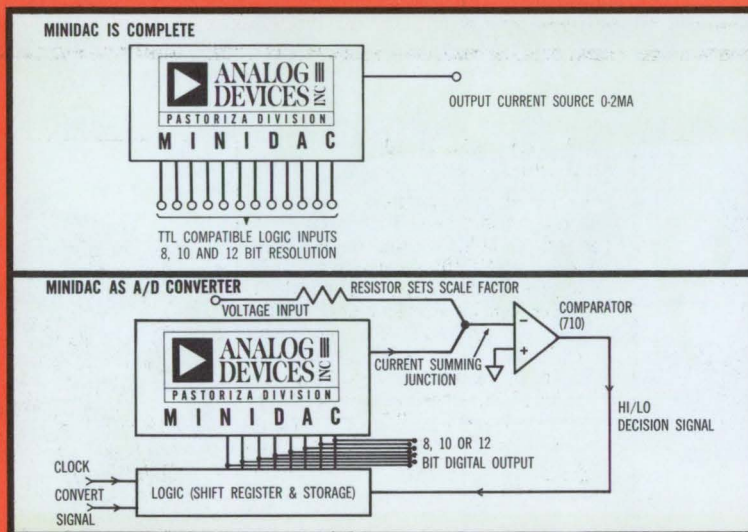

The MINIDAC module includes all critical components for high speed conversion ... reference supply, precision resistor network and 8, 10 or 12 high speed solid state switches. Input is compatible with DTL and TTL logic, output is current source for maximum flexibility.

MINIDAC becomes a high speed A/D converter by addition of Op-Amp comparator and shift register logic. Accuracy, linearity and resolution depends on precision components sealed in MINIDAC. Speed is limited only by comparator response and external logic speed. Complete 12 BIT conversion in 8 μ sec is possible with 710 Type Comparator.

\$130.
12 BIT MINIDAC
(MDA-L,
100 LOT)

BUSINESS REPLY MAIL
NO POSTAGE STAMP NECESSARY IF MAILED IN THE UNITED STATES

POSTAGE WILL BE PAID BY



221 FIFTH STREET • CAMBRIDGE • MASSACHUSETTS 02142

FIRST CLASS
Permit No. 39342
Cambridge, Mass.

SPECIFICATIONS

INPUT CHARACTERISTICS

Input logic levels DTL, TTL, ETC.

MECHANICAL DIMENSIONS

MDA-U75" x .75" x 1.5"	
MDA-L	2.0" x 2.0" x 0.4"	
Power Supply	±15VDC	
Price (1-9)	MDA-L	MDA-U
8 BIT	\$140	\$195
10 BIT	\$165	\$230
12 BIT	\$195	\$250

OUTPUT CHARACTERISTICS

Output current range Zero to +2mA
 Maximum output voltage 2 Volts
 Zero offset 20 nA (0°C to 70°C)

ACCURACY / RESOLUTION

Digital Resolution 8, 10, or 12 BITS
 Linearity ½ LSB @ 25°C
 Temperature Coefficient 20 PPM /°C
 Settling Time to 0.05% 200 ns
 Switch Signal Coupling Less than ½ LSB

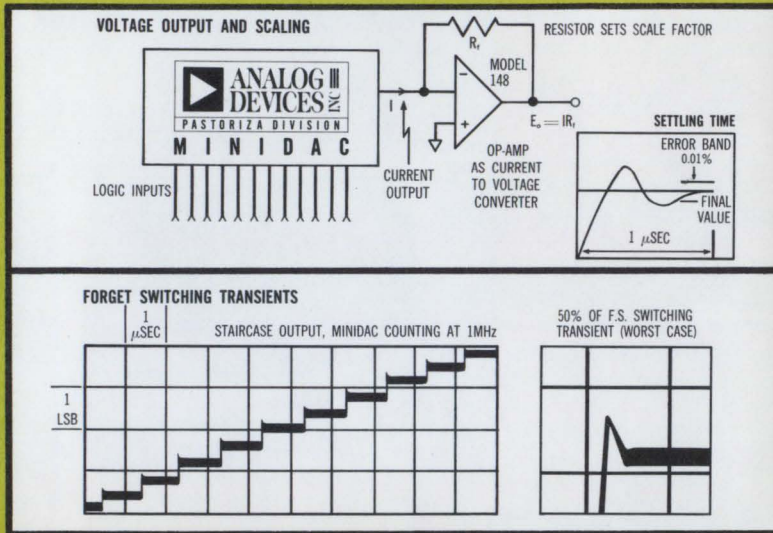

Follow MINIDAC with high speed Op-Amp for voltage output or to set scale factor. Analog Devices model 148 settles to 0.01% in less than 1 μsec.

Exclusive current switching technique keeps switch signal coupling well below ½ LSB... important for high speed applications where "glitches" (usually generated by conventional voltage switching converters) cause ambiguous data, damage associated circuitry. Besides low amplitude, transient width is less than 40 ns.

A/D CONVERTERS

FASTEST A/D CONVERTER YET!

Model ADC.F is the fastest A/D Converter commercially available, actually makes a complete 10 BIT conversion in less than 1 μs. High data rates usually require sample and hold units preceding the converter... not necessary with the high conversion rate of the ADC.F. Input voltage range is 0-10 Volts and the output supplies 10 parallel binary bits at TTL logic levels. The plug-in module is completely self contained including logic, switches, resistors, comparator and reference. Models are available with either 8 or 10 bit resolution.



LOW COST / HIGH SPEED A/D CONVERTER

The ADC-U is a complete, successive approximation type A/D converter built around the MINIDAC module. This combination of MINIDAC and commercially available components yields a unit which features high speed and low cost. A wide variety of input ranges is available and a choice of 8, 10 or 12 BIT resolution is offered. Conversion time is just 8 μ sec for the 12 BIT model, even faster for 8 and 10 BIT versions. P.C. card packaging is intended for the OEM, and so is the price... just \$795 for the complete 12 BIT version.

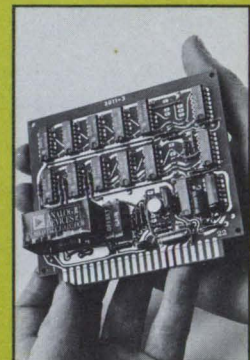

221 FIFTH STREET • CAMBRIDGE • MASSACHUSETTS 02142 • (617) 492-6000 • TWX: (710) 320-0326

INSTANT ACTION REQUEST

Please send Pastoriza Product Catalog

My interest is for:

- Information Only
- Immediate Application
- Anticipated Application

Special Requirements

Please send literature on model

- ADC-F ADC-U MDA-L MDA-U

Please arrange demonstration of MINIDAC

- MDA-L 8 BIT BINARY
 MDA-U 10 BIT BCD
 12 BIT

FREE CATALOG



This new 24 page catalog features many new products, contains complete specifications on our entire line of converters, multiplexers, sample-and-hold modules, etc. Get your copy free, use the "instant action" card.

Name	Title	
Company	Dept./Mail Station	
Address	Phone	
City	State	Zip

We have ways with arrays.

- Ways that will simplify your digital system designs!
- Ways to provide custom MSI circuits without delay!
- Ways to save you money, too!

Late last year, we introduced the XC170, a 128-Bit Read Only Memory array. Now, it has been programmed to produce four standard functions that all incorporate the advantages of arrays — low cost and custom design flexibility.

The four new standard functions are:

- MC4038 — Inverting/Non-inverting One-of-Eight Decoder — has a 3-Bit Binary address with inversion control which selects the desired word for the 8-Bit output

and exhibits address times of less than 45 nS.

- MC4039 — Seven-Segment Character Generator — for the direct operation of low-voltage lamp indicators.
- MC4040 — Binary to Two-of-Eight Decoder — a 4-Bit Binary number selects 2-of-8 output bits.
- MC4041 — Single-Error Hamming Code Detector and Generator — a programmed 128-bit

ROM for a variety of error detection and correction applications.

Those are for standard applications!

In addition, for your special requirements, all you need to do is send us your program on a key-punched computer card. We will manufacture a circuit to your exact specifications from the XC170 array — rapidly, and with minimal development costs!

By using computer-aided design and mask-making facilities, you can be assured of rapid turn-around time. And, because the bulk of the development costs are already absorbed in the production of the basic unit-cell or array, your costs can be as little as 2% of the normal cost of custom MSI circuits. For example, the MC4038-41 devices are priced at \$5.60 each (100-up) — in the 16-pin plastic dual in-line package.

To find out more about Our Way With Arrays, send for the data sheets on the MC4038-41 devices. And, for more complete information about our Custom MSI capabilities, write: P.O. Box 20912, Phoenix, Arizona 85036.

-where the priceless ingredient is care!



MOTOROLA
Integrated Circuits

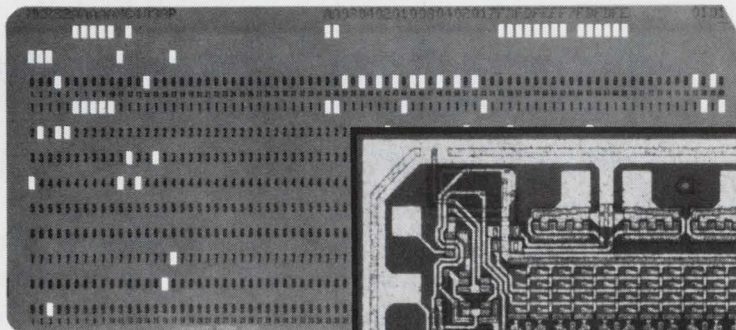

Your computer card and a logic table are all that's needed to computer-customize XC170 or another of Motorola's custom-standard arrays.

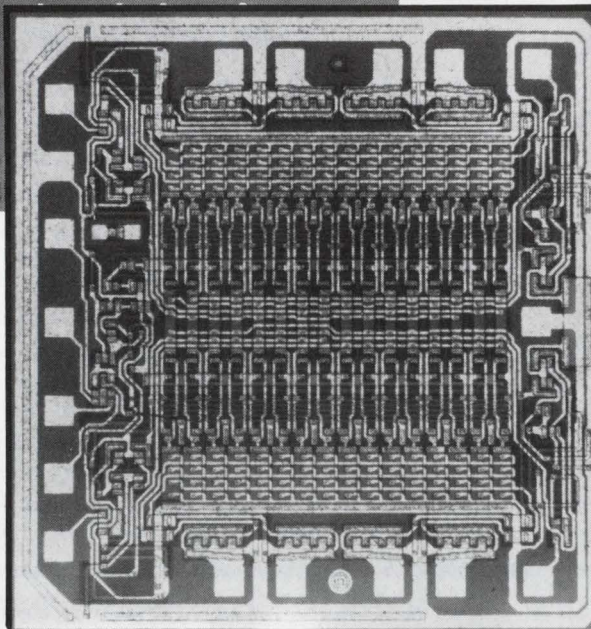

INFORMATION RETRIEVAL NUMBER 15

...want a complete proportional power controller?

Sprague VECTROL® Series VPC OFFERS OUTSTANDING PERFORMANCE

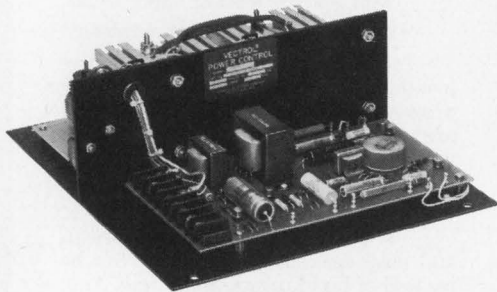

INFORMATION RETRIEVAL NO. 823

No snap-on . . . smooth phase control from zero. Easily adapted to closed-loop systems. Operates into primary of transformer or resistive load. Full-wave balance within 1°. High power . . . 1-100 KVA (A-C or D-C output). Protection networks . . . dv/dt . Adjustable to all standard inputs. Solid state trigger. Soft start. Current limit, operational amplifier, reference voltage, and zero voltage switching available as separate options.

45V-9136

Tiny in size...Giants in volume efficiency!

Type 160D, 161D

Solid-Electrolyte Tantalex® Capacitors for hearing aids and ultra-miniature circuits

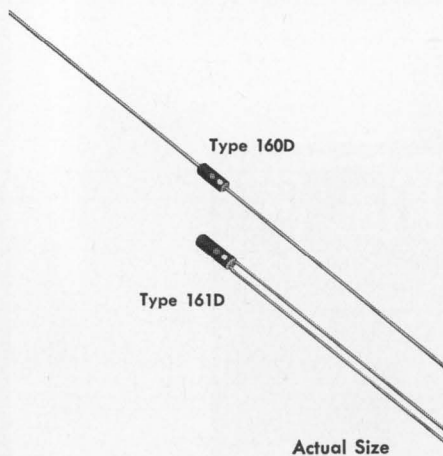

INFORMATION RETRIEVAL NO. 824

Tiny Type 160D/161D Tantalex Capacitors are sealed within a polyester film tube with tightly-bonded epoxy fill, so the assembly is both electrically insulated and highly resistant to moisture. They are available with axial leads as well as in single-ended construction.

Offering extremely high capacitance per unit volume (for example: 0.25 μ F @ 20 VDC in a case only .065" D. x .125" L.), Tantalex Hearing-aid Capacitors let you select from a broad range of ratings in five different case sizes.

48C-9125

For complete technical data on Series VPC Power Controllers, write for Engineering Bulletin 1014. For the full story on Type 160D/161D Capacitors, write for Engineering Bulletin 3515D. Address Technical Literature Service, Sprague Electric Company, 347 Marshall St., North Adams, Mass. 01247.



Sprague' and '®' are registered trademarks of the Sprague Electric Co.

THE BROAD-LINE PRODUCER OF ELECTRONIC PARTS

News

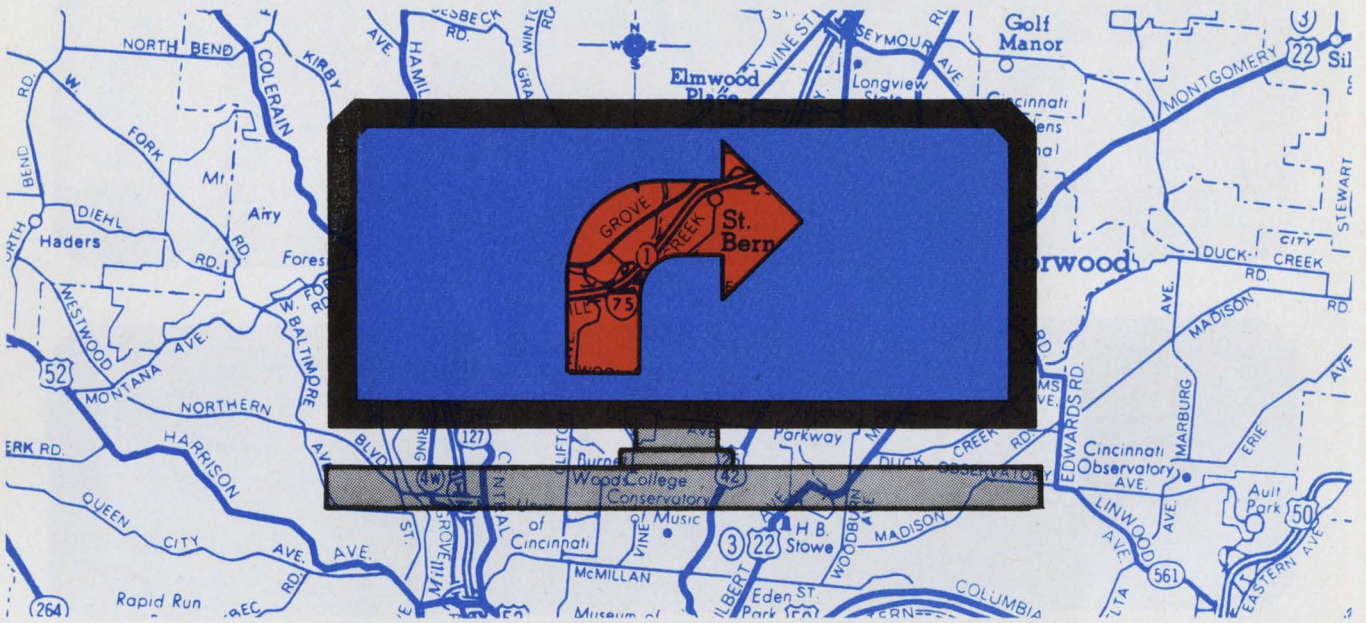

An electronic automobile guidance system now under development may permit drivers

to reach any point in the United States fast and without the use of road maps. p. 25.

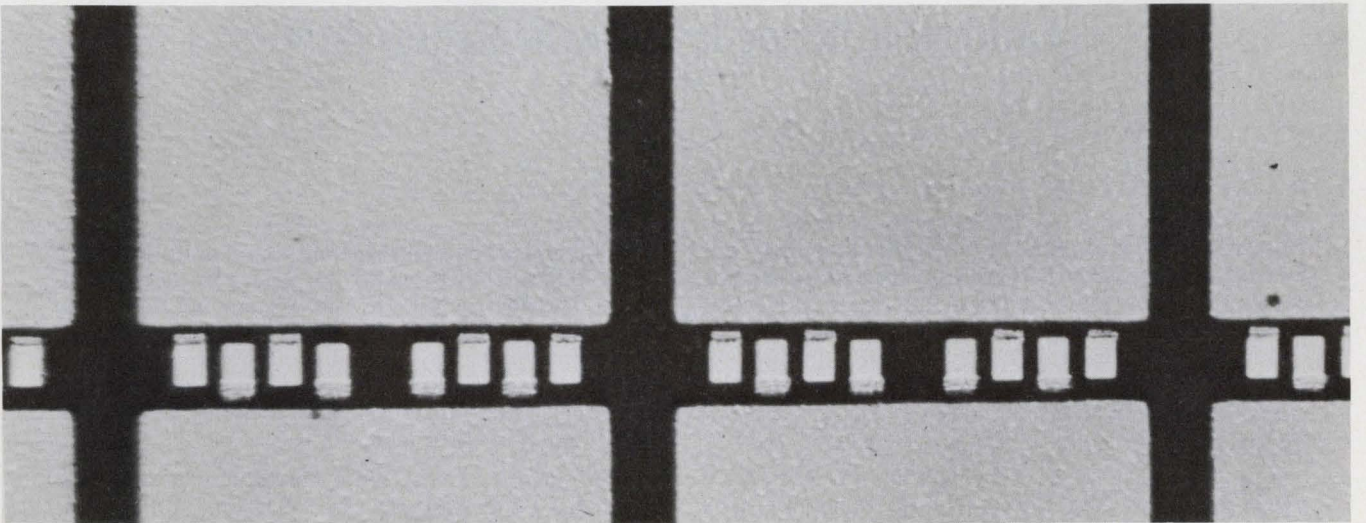

Capacitor manufacturers are developing new lines of high-temperature-resistant beam-

lead devices in chip form for a wide range of semiconductor applications. p. 32.

Also in this section:

Ovshinsky displays futuristic thin-film device. p. 30

Laser-acoustic delay line reverses time function. p. 28

News Scope, p. 21 . . . Washington Report, p. 39 . . . Editorial, p. 47

This readout tube never tells a lie

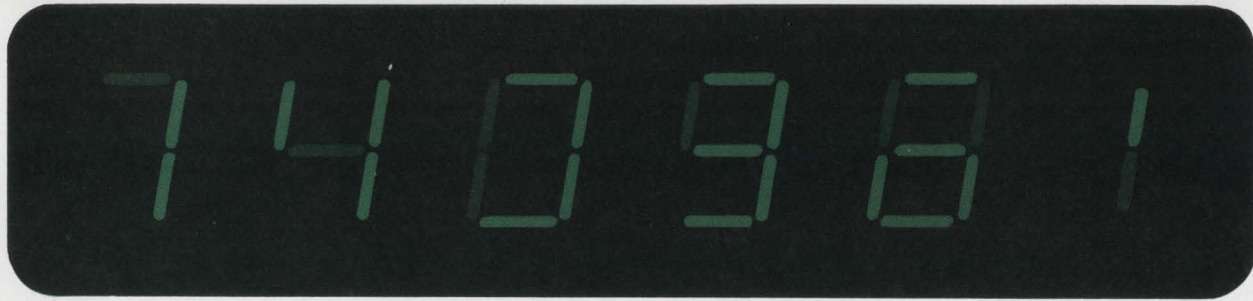
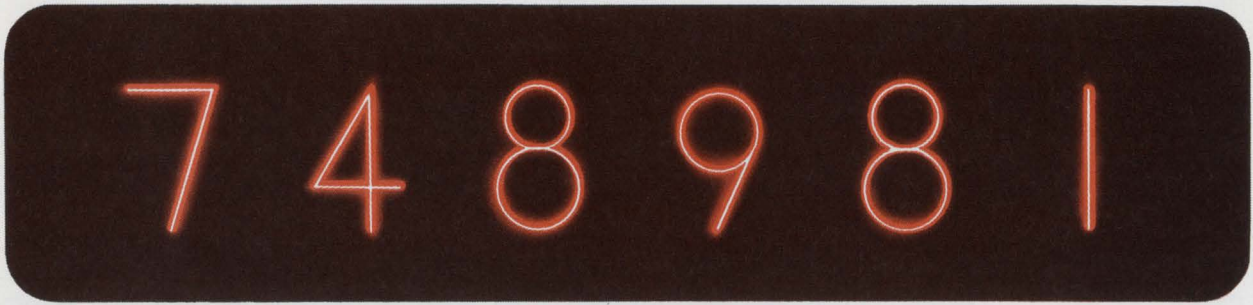

Others do

(and you never know when they fail)

Whatever data you input, a NIXIE® tube reads out. Exactly! You always have reliably accurate readouts, with no risk of a 1 when there should be a 7, a 0 instead of an 8, or a 3 instead of a 9. Rather than tell a lie, honest NIXIE tubes give you no reading ... protect you against false readouts caused by multiple segments that break down, blank out ... and don't indicate that they're wrong. You never know when they are faulty.

Selecting a readout display involves more than truth, so weigh every aspect. Check NIXIE tubes for their unmatched reliability, their proven long life (over

200,000 hours), natural readability, and uniform brightness (200 ft. lamberts, with no chance of partial fade-outs). See how only NIXIE tubes are unaffected by static charge ... meet mil specs ... offer unsurpassed packaging and design flexibility (no extra top leads required for decimals). All this, in the most complete and advanced line of tubes and accessories. No wonder NIXIE tubes lead the field.

For information, call or write: Burroughs Corporation, Electronics Components Division, P.O. Box 1226, Dept. N5, Plainfield, N. J. 07061; tel. (201) 757-5000.



View above display from 6 ft. distance for complete realism

the leader
in the world of displays

Burroughs 

Airlines seek visual enhancement systems

The nation's airlines are looking for electronic equipment to give pilots a high-fidelity real-world picture of the ground during rain, snow and fog.

This new technology, called "visibility enhancement," was explored in Washington, D. C., recently by experts from government and the aircraft industry.

At the meeting, sponsored by the All Weather Operations Committee of the Air Transport Association, a number of different approaches to the development of visual-enhancement equipment were described:

- Low-light-level television that would convert near infrared radiation to the visible state and intensify visual information. A real-time picture of the landing strip peaked in the visible region would be shown on a direct-view image intensified or the CRT of a TV set.

- Radar systems using frequencies at 16 GHz and 35 GHz for the monitor and 35-GHz band for the antenna that would provide high-resolution mapping of the approaching runway on a radar display.

- Holographic displays that would use the principle of wave-front reconstruction photography to show the pilot a three-dimensional virtual image of a runway.

- Night-vision devices that would operate from light passed through an objective lens and focused on an image intensifier tube or photoelectric cell. These devices require some light and an unobstructed visibility path between aircraft and airport.

- Infrared systems. These have greater resolution capability than radar, but they are subject to transmission losses due to scattering and absorption. Placing IR radiators in the vicinity of the runway is a possibility.

- Lasers, which operate generally in the visible or the IR region. These remain to be evaluated. Clouds, rain, fog and turbulence tend to degrade laser signals, but laser frequency might be varied to obtain best penetration under specific weather conditions.

Which systems are best? Capt. S. G. Granger, Director of Flight Operations-Research and Development, Trans-World Airlines, told *ELECTRONIC DESIGN*, "It's still too early to say, although the radar approach looks most promising."

Who will use the new system? About 5000 domestic, foreign, and business aircraft, and perhaps as many as 20,000 military aircraft, form a potential market for visual-enhancement equipment.

Such equipment would be a separate system in a plane and is not proposed to replace, or even to be added to, present landing systems.

As to cost, Capt. Francis L. Wallace, Project Director, Reduction and Minima Program, Pan American World Airways, makes a relative comparison: "When we modified our autopilot and instrument panels to meet FAA Category 2 requirements, it cost roughly \$65,000 per plane."

(Category 2 refers to conditions where the runway visual range is 1200 feet and the pilot's decision height to land or abort is 100 feet above the landing zone.)

It has been estimated that radar visual-enhancement equipment would cost about \$30,000 per plane. Infrared equipment, at the present state of the art, could range from \$100,000 to \$200,000.

Defense Department pushes satellite communications

The Defense Dept.'s budget request for satellite communications

in fiscal 1970 is \$149 million—more than twice last year's budget. And its request for detection and defensive techniques and systems in space is \$169 million. These are the more significant figures in a total projected military space R&D budget of over \$2.2 billion—up \$128 million over last year. These figures came out during recent testimony of Dr. John S. Foster, Director of Defense Research and Engineering, before the Senate Committee on Aeronautical and Space Sciences.

Other major outlays requested are as follows: the Manned Orbiting Laboratory program, \$528 million; navigation, \$25 million; ground-support systems, \$263 million; basic and applied research and component development, \$147 million; vehicle development, \$61 million; and for general support associated with these programs, \$868 million.

The Defense Dept., said Foster, will step up development of new ground terminals for the operational Defense Satellite Communications System. It will also update subsystems in existing terminals supporting the network. He noted that TRW, Inc., received nearly \$38 million to begin development of a synchronous strategic communications satellite last March.

Foster observed also that the three military services are preparing a joint development plan for the operational version of the Tactical Satellite Communications System. Hughes Aircraft developed the experimental TACSATCOM spacecraft, which was placed into a synchronous orbit last February.

Technology seen as spur to U.S. social progress

Can citizens of cities, states, and nations participate, as individuals in their own homes, in "town hall" meetings via Community Antenna Television? Gen James M. Gavin, chairman of the board of Arthur D. Little, Inc., thinks they can with proper organization—and perhaps a government-subsidized opinion-recording device.

In his keynote address to the Spring Joint Computer Conference in Boston, Gavin told computer engineers that their technology offers

News Scope

CONTINUED

real hope for social progress.

"When people are as well informed as they are today," he says, "they want action at a rate comparable to the rate at which they acquire information. And they want to participate in decisions."

The computer and electronics industry can offer such an opportunity, according to Gavin. "It would be a very simple matter to permit people to register their point of view from their own homes—and gather the data at central information gathering stations," he says. "A device, subsidized by government funding, could be provided with each TV set, for instance, which would permit individuals to express their views on an issue."

Gavin doesn't see this as a voting system, but merely as an opportunity for citizens to express their point of view with respect to national problems as they would at a town hall meeting.

"But feedback from citizens is not enough," says Gavin. He also wants a governmental structure specifically designed to deal with social problems—a cabinet post with responsibility for domestic affairs. A critical duty of the structure would be to acquire vast amounts of data that "defines and delineates the problems."

He adds, "... the computer industry to date has concentrated on hardware and mathematical languages. It has grown up in isolation from our country's critical social problems.

"Now it is faced with an obligation to make the contribution to social progress that it is capable of—and computer engineers must find the way."

Oceanographic ships need better computers

Seaworthy computers are needed for naval oceanographic vessels. The computers built for the new USNS John G. Keller are considered the best in service today, but although they have not even been installed, they are already consid-



The USNS John Gilbert Keller, the Navy's newest oceanographic vessel, is 208 feet long and carries about \$1 million worth of electronic equipment.

ered to be inadequate. They are not expected to fully solve the environmental problems a computer has at sea.

These problems involve salt spray, temperature extremes, humidity and general rough handling.

The biggest problem for oceanographic ships, according to Captain T. K. Treadwell, USN, Director of the U.S. Naval Oceanographic Office in Washington, D. C., is data processing. "What we want," he says, "is equipment that is compact, easy to operate, very reliable and extremely environmentally resistant." Capt. Treadwell is very concerned about the amount of downtime, which cuts into data-gathering time. Data quality control is a problem also. As he puts it, "being able to tell when the data that you have is no

good—and throwing it out."

Capt. Treadwell feels that "the electronics industry has done a good job so far. The equipment being installed on the Keller is almost fully automated," he says, "and is a tremendous improvement over what we've had in the past."

But designers still have a long way to go to adapt computers for oceanographic work.

On May 22 the Keller received her bronze name plaque and ceramic oceanography plaque. She was sent into service prematurely, due to the present lack of naval oceanographic ships in service. Her function will be primarily to gather information that will aid naval navigation. Such information will include depth of water, position of the shoreline, ocean currents, and type of bottom.

Lockheed loses out—subcontractors suffer

Cuts, by the Army, of Lockheed Aircraft Corp.'s Cheyenne helicopter production contracts means the loss of subcontracts for some 500 firms.

What of the subcontractors? Congressman Barry Goldwater, Jr., who represents part of the San Fernando Valley in Los Angeles, is "extremely concerned over the loss of jobs due to the cut."

The jobs lost at this juncture are almost entirely production personnel. Very few design engineers will be directly affected.

However, the Cheyenne research and development contract is also in danger, and its loss would have a much more profound effect on the engineering community.

Daniel J. Houghton, Lockheed chairman, called the cancellation of

the Cheyenne production contract "not justified" and confirmed that the company will "take appropriate legal action to protect our financial position on this contract."

New CRT operates in bright sunlight

A new high-contrast cathode-ray tube using a black phosphor screen, is said to operate in bright light with better resolution than conventional picture tubes. The tube, called the Sigmaconf, is manufactured by Electrovision Industries, Inc., El Segundo, Calif. It has a "multi-persistent" capability that makes it possible to combine TV and radar displays on the same tube. Other applications include computer read-out, electro-optical high-speed printing, and video recording.

New ways in digital automation with:

- Shaft Encoders, 34 types
- Synchro-to-Digital Converters, 6 types
- Analog-to-Digital Converters, 10 types
- Solid-State Digital Modules, 136 types

FREE ... 58 Pages

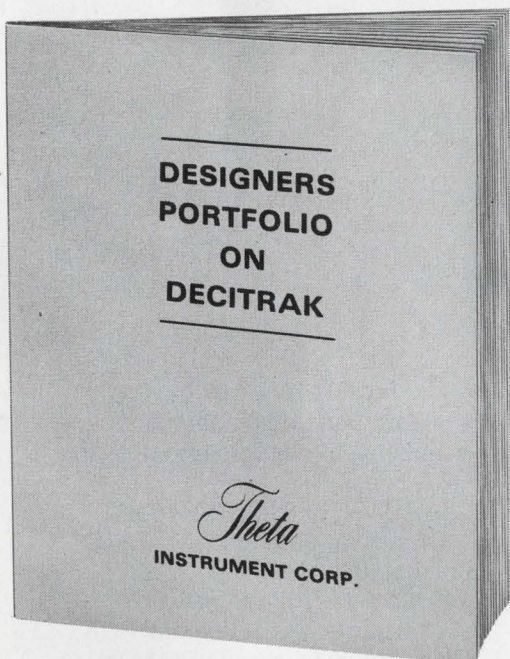

Includes copy of
"A Primer on Shaft Encoders"

We call it the DECITRAK[®] SYSTEM

Selecting from hundreds of off-the-shelf digital transducers and circuits, we assemble a remarkably low-cost, customized digital system for control/display/logging. DECITRAK can perform as simple a job as providing remote digital display of antenna pedestal position. Or, as impressive a task as the precise control of massive prime movers in response to punched-card commands.

Need a computer interface? A code converter? A typewriter driver? Set-point controls? Let a Theta Application Specialist tailor a system to your specific needs from the field-proven line of DECITRAK digital components.

More than 1,000 of these systems are now in use in nuclear installations, satellite tracking stations, wind tunnels, and aboard ships.

Theta

INSTRUMENT CORPORATION

FAIRFIELD, NEW JERSEY 07006 • PHONE: 201-227-1700 • TELEX: 138353

INFORMATION RETRIEVAL NUMBER 17

These RCA Triacs will turn you on

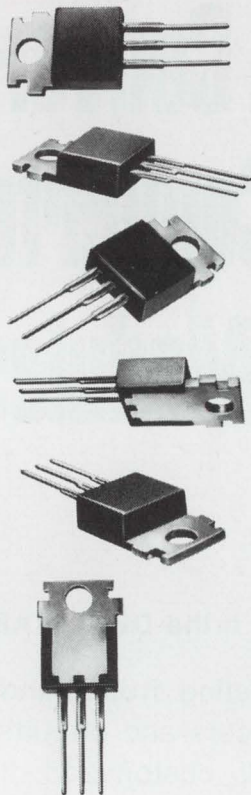

Choose New RCA 8 Amp Triacs for On-Off or Variable Phase Control of Power Into Resistive or Inductive Loads

Now's the time to think in terms of more than electro-mechanical controls and turn on with Triacs! Not just any triac—but the new RCA-40668 and RCA-40669. Both feature the unique RCA hermetic chip in the popular, easy-to-mount RCA VERSAWATT package . . . and at prices that are just as popular.

Use the RCA-40668 for 120 V per 1-kW capability, the RCA-40669 for 240 V per 2 kW. With either, look what you get:

- Commutating dv/dt capability of 10 V per μs (typ.) permits operation into inductive loads.
- Critical rate of rise of off-state

voltage—300 V per μs (typ.) for 40668 and 250 V per μs (typ.) for 40669—minimizes false triggering caused by line transients.

- 100 A single-cycle in-rush current capability handles start-up surge loads readily.
- 8 A (RMS) capability at a case temperature of 80°C.
- 4 modes of gate control allow design flexibility and simplicity with either positive or negative DC logic.

For relay replacement, relay protection, motor speed controls and the like—in switching or phase control applications—for use in such devices as comfort control

systems, vending machines, appliances—turn to and turn on with RCA Triacs.

The RCA-40668 for 120 V per 1-kW operation is just 98¢ (1,000 units) and the RCA-40669 for 240 V per 2-kW capability is \$1.10 (1,000 units). See your local RCA Representative or your RCA Distributor for details. For technical data, write RCA Electronic Components, Commercial Engineering Section RG6-1, Harrison, N. J. 07029.

RCA

Telemetry, the road map of the future

Driver-guidance system to be tested by U.S. next year would point the way electronically

Charles D. LaFond, Chief Washington News Bureau

Drive cross-country without a map and reach your destination on time? Visionaries in the U. S. Bureau of Public Roads say it could happen by the late 1970s.

The proposal, which is under study, is an outgrowth of research that is seeking down-to-earth, civilian uses for telemetry developed by the military and NASA. As envisioned by planners, the map-less drive across the country might work something like this:

You are in San Francisco, driving to Washington, D. C., and are unfamiliar with the route. You get behind the wheel, get out a special route destination booklet and locate "Western Ave.-River Rd." You find the locator letters "DCXSMB" and then rotate five thumb dials on a control box on the dashboard of the car to insert the destination code.

And you are on your way. Once you leave San Francisco, a heads-up display on the windshield, augmented by beeps and visual instructions, automatically give continuous, precise directions to your destination in Washington.

Contracts have been let

The Office of Research and Development in the Bureau of Public Roads has let a number of contracts in the last several years to develop the hardware and prove the feasibility of such a concept. An operational test of the system is planned next year in Washington.

Other applications for telemetry are being explored in such fields as oceanography, law enforcement, the oil and gas industry and earth resources satellite programs.

At the recent National Telemetering Conference and Exposition, held in Washington, only two technical papers dealt with military projects. The rest concentrated on civilian applications. One

paper, "Industrial Scientific and Commercial Applications," presented by Erwin S. Teltscher, an engineer with Digicom, Inc., Roslyn, N.Y., described 44 civilian applications in seven major categories:

- Environmental data analysis and control by telemetry.
- Telemetry in the service of urban problems.
- Telemetry for safety, safety testing and warning systems.
- Telemetry for industrial testing.
- Application of telemetry to service industries and industrial processes.
- Industrial and service indus-

try applications of telemetry via a synchronous satellite.

- Remote control and manipulation by telemetry.

A 3-part road system

Details of the road telemetry network, called Electronic Route Guidance System, were revealed by the Dept. of Transportation in an extensive exhibit at the Washington conference.

The system consists of three major subsystems:

1. For the vehicle, a transceiver and antennas, destination encoder and a visual display with an audible signal.
2. Triggering-communications loop antennas for each lane.

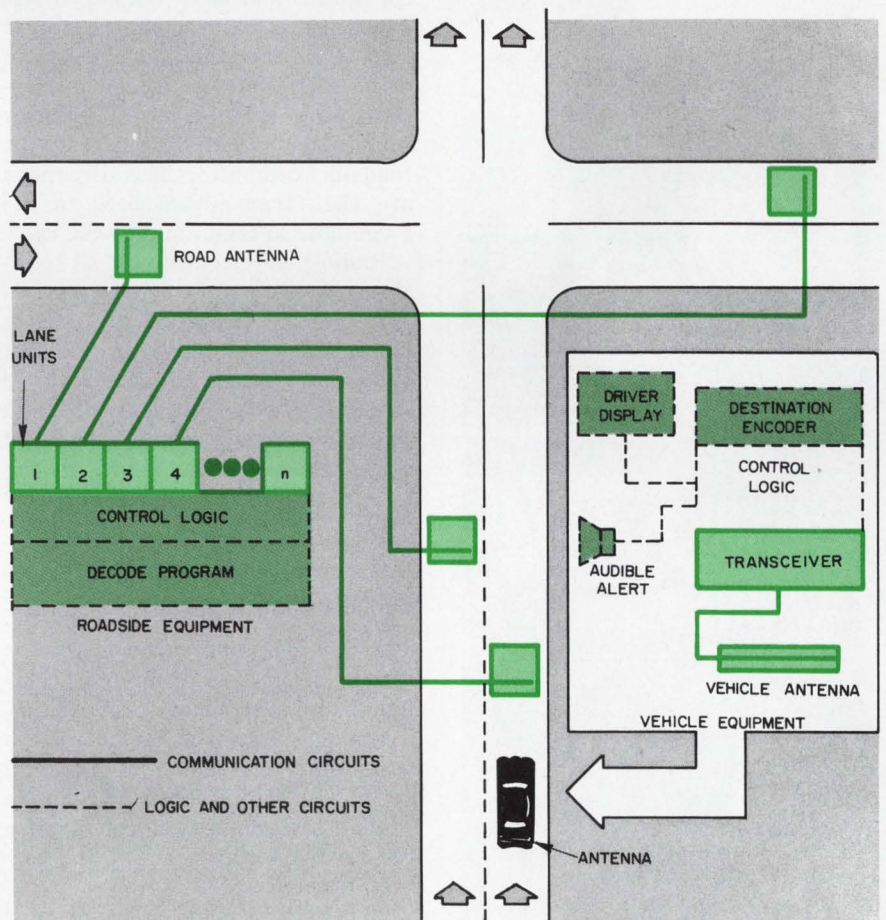

A driver approaching an instrumented intersection transmits a destination code to a roadside unit via a road antenna. The unit interprets the code, compares it with stored data and then transmits appropriate instructions to the driver, either to continue straight ahead or change directions at the next intersection.

(Telemetry, continued)

3. On the roadside, destination decoders—computers with stored instructions to drivers—and transceivers.

The lane antennas and roadside decoder-transceivers would be spotted at frequent intervals along each controlled route.

In operation, once the driver has selected his destination code from a directory, the rest of the operation is automatic. When the car approaches an instrumented intersection, a loop antenna in the road lane activates the vehicular unit. The equipment in the car transmits the destination code to the roadside unit via the lane communications loop.

The roadside unit interprets the code, compares it with stored data and then transmits appropriate instructions to the driver—either to continue straight ahead or to change direction at the next inter-



Electronic automobile guidance system now under development will enable drivers to avoid urban traffic congestion.

section. The instruction received in the vehicle is accompanied by a beep warning signal and visual directions.

Millisecond operation cited

The entire sequence, according to Stanley Metalitz, assistant director for R&D in the Bureau of Public Roads, takes but a few milliseconds to complete; a driver need not slow down to receive his instructions. Since the system is "destination oriented," a driver missing an instruction need only continue to the next instrumented intersection to correct any mistake.

The wire-loop antennas in the vehicle and road lanes are essentially the same. Each pair is mounted in mutually perpendicular planes. In a given pair, the larger horizontal loop is for communications; the vertically oriented loop in the road and in the vehicle is for the triggering circuit.

The road trigger loop is always energized, and as a vehicle passes, a voltage is induced in its trigger loop to initiate the transmission of destination data to the communications loop in the lane. The latter relays the signal by cable to the roadside computer. The directions are then transmitted back to the large lane antenna and to the car.

Radio-link circuitry is all-solid-state. Transceivers in the vehicle and on the roadway are nearly identical, operating with a 2-watt output at 170 kHz. Vehicle receiver sensitivity is set at 140 mV, and the road receiver sensitivity at 70 mv. The triggering signal in the lane, from road to vehicle, is at 230 kHz.

Recalibration avoided

To avoid regular maintenance or recalibration, the communications link is asynchronous—that is, timing marks must be included with the signals to establish the framing of the incoming transmission so that the demodulator can sample the received waveform at the correct time.

The PCM transmissions are at a rate of 2000 bits a second. The reference timing mark precedes each data bit and also serves to change the state of the transmitter carrier to either on or off.

Metalitz says that the present system is designed to handle up to 16 vehicles simultaneously. Each lane of a roadway has its own pair of triggering and communication loops. The lane loops are offset by 7 feet each, so that in the worst case (16 vehicles passing simultaneously) the total delay of instruction transmissions for all vehicles is 24.3 ms. This is based on a maximum vehicular speed of 75 mph.

The staggered lane loops prevent the transmission of misinformation to a vehicle, and the low transmitter power prevents local interference. Developers indicate, however, that for the system to work properly, drivers must exercise lane discipline.

The bureau estimates the cost of vehicular equipment as about the same as that for a car's automatic transmission. For highway equipment, the cost is estimated to be comparable to that for an intersection signal system.

Major contractors involved

The Philco Corp. of Philco-Ford, Palo Alto, Calif., one of the early researchers of the system under contracts totaling \$225,000, produced a six-character coding scheme last year designed to cover major highways in the entire country.

General Motors Research Laboratory and the Delco Div. of GM in Detroit, developed the prototype hardware for both roadside and vehicular equipment tests. They have worked on the program for the last two and a half years under contracts totaling \$500,000.

Serendipity Inc., McLean, Va., under a contract totaling nearly \$150,000, has performed studies to determine the human engineering aspects of vehicular displays.

Standard Kollsman Industries, Inc., Philadelphia, is developing a heads-up display for possible use in the system.

The Washington test next year, to be supervised by the Traffic Operation Office of the Bureau of Public Roads, will cover 100 intersections. Each intersection will be instrumented, and easily removable equipment will be provided for temporary installation in 50 vehicles, according to Metalitz. ■■

Throw the book at us.

If your customers are throwing the book at you about MIL-STD-883, stop ducking.

We can lick your problem.

Because Signetics is one company that understands 883. And designs to it. In fact, we've been gearing up for this hard-nosed testing for the past five years.

For instance, if you need an immediate source for those hard-to-get 5400's to MIL-

STD-883, try us. In fact, Signetics can spec just about anything you want—DCT, DTL, TTL, MSI or linear; you name it.

Go ahead: really throw the book. We won't even flinch.

P.S. Speaking of books, we've got a package deal: a 5400 handbook, along with a guide that spells out what 883 is all about. Yours for the writing.

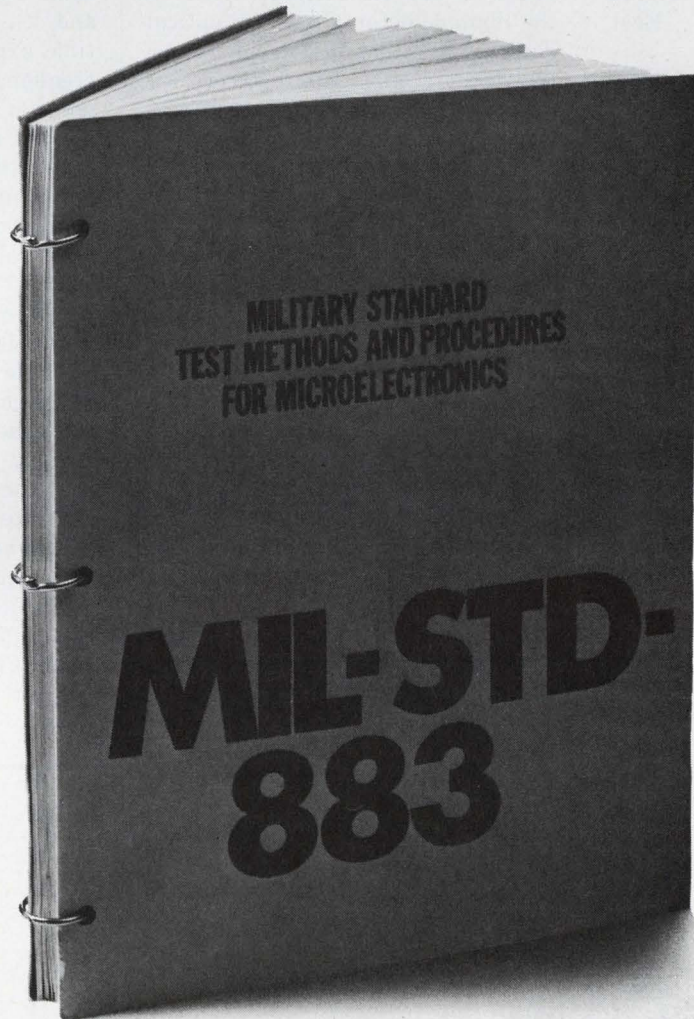

Signetics

Signetics Corporation/811 E. Arques Ave., Sunnyvale, Calif. 94086/A subsidiary of Corning Glass Works

INFORMATION RETRIEVAL NUMBER 19

Laser-acoustic line reverses time functions

Sweeping a beam along a transparent delay bar can also compress and expand microwave signals

Michael J. Riezenman
Technical Editor

Studies of the interaction between a laser beam and an acoustic wave have led to a device that can reverse a time function in real time. The same device can also expand or compress the time functions and provide the continuously variable delays needed in radar signal processing.

The device, called a laser-acoustic delay line—or LAD line, by most researchers in the field—has been developed by United Aircraft Research Laboratories of East Hartford, Conn.

Speaking at the IEEE Microwave Symposium in Dallas last month, Dr. Michael J. Brienza, chief of applied laser technology for the company reported that the device was the only practical means he knew of for reversing a time function in real time.

Because a LAD line can delay and reverse signals in real time, it can perform auto- and cross-correlations in signal-processing radars and sensitive receivers. For example, the line makes it possible to delay and reverse a transmitted pulse so that it can be correlated with a received signal for good performance in a noisy or jamming environment.

The main component of the LAD line is a transparent acoustic delay bar as shown in Fig. 1. The elec-

trical-to-acoustic transducer at the input launches a sound wave in the transparent bar. As the wave travels along the bar it acts as a moving diffraction grating and scatters the laser beam passing through it. It also frequency-shifts the laser beam by an amount equal to the sound frequency.

Actually, since the optical-acoustic interaction is not 100 per cent efficient, only a part of the beam is frequency-shifted; the rest of it is unchanged. Thus, the scattered light can be combined with some of the unscattered light in the photodetector. Since the optical detector is intensity-dependent, the two light signals are heterodyned together to produce an output signal at the input frequency.

Signal processing with a mirror

In the operation just described, the rotating mirror (Fig. 1) is assumed to be stationary. Its position merely determines the point at which the laser beam crosses the transparent bar and thus determines the delay of the system.

However, to really appreciate some of the tricks that the LAD line can perform, we must consider what happens when the mirror is rotating. When it rotates in the direction of the arrow, the laser beam will move up the delay bar as shown. If the scan velocity of the laser beam is V_l and the acous-

tic velocity in the delay bar is V_s , then the frequency and time duration of a pulse applied to the input will be shifted as follows:

$$\begin{aligned} f_o &= f_i a \\ t_o &= t_i / a \end{aligned}$$

where $a = 1 - V_l/V_s$. The input and output frequencies are f_i and f_o , respectively, and the input and output pulse durations are t_i and t_o , respectively. The scan velocity, V_l , is defined positive in the direction of V_s .

Clearly for $V_l < 0$, the output signal is compressed in time and upshifted in frequency. When V_l is positive, the results will depend upon the relationship between V_l and V_s . For $V_s > V_l$, the output is time expanded and downshifted in frequency. The amount of time expansion and frequency shifting increases as V_l approaches V_s until, when they are equal, the output frequency becomes zero and the time expansion increases to the limit set by the length of the bar.

For $V_l > V_s$, the output signal is reversed in time since the laser beam is actually overtaking the acoustic pulse from the rear. If V_l is chosen so that $2V_s > V_l > V_s$, then the output signal will be expanded V_s . For $V_s > V_l$, the output is $2V_s$, the output will be compressed and upshifted. In the interesting case where $V_l = 2V_s$, the output is a perfect time-reversed replica of the input pulse (Fig. 2). It is in this mode of operation that the LAD line will probably have its biggest impact. ■■

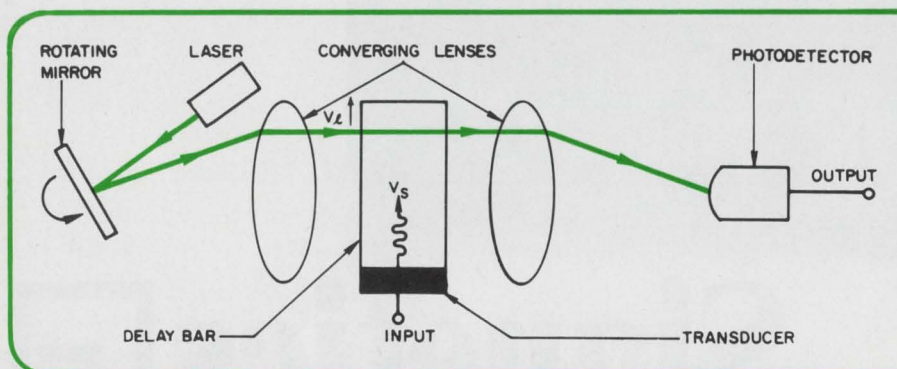

1. Exact time reversal can be obtained with this LAD line setup if the laser scan velocity, V_l , is exactly twice the sound-propagation velocity, V_s .

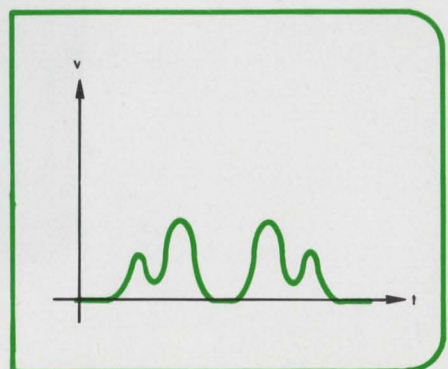

2. Textbook pictures like this can be achieved in real time with a LAD line.

Plug it in, get microwaves out.

We sell black boxes. Complete self contained microwave sources. We make the tradeoffs, handle the interfaces, take the responsibilities. You provide 117 Vac or 28 Vdc, and you get rf out—milliwatts to watts at frequencies from 1 to 60 GHz.

Based on 20 years' experience building and interfacing tubes for the most severe environments, we've developed rugged power supplies for our oscillators. We've designed versatile modular parts: filters, regulators, modulators, attenuators, and so on. And we have the finest line of field proven klystrons and other microwave



oscillators on the market. Plus the knowhow to adapt or develop whatever else might be necessary to meet your requirements. So talk to us about what you need at any of more than 30 Electron Tube and Device Group Sales Offices throughout the world or contact our Low Power Microwave Operation, 611 Hansen Way, Palo Alto, California 94303.

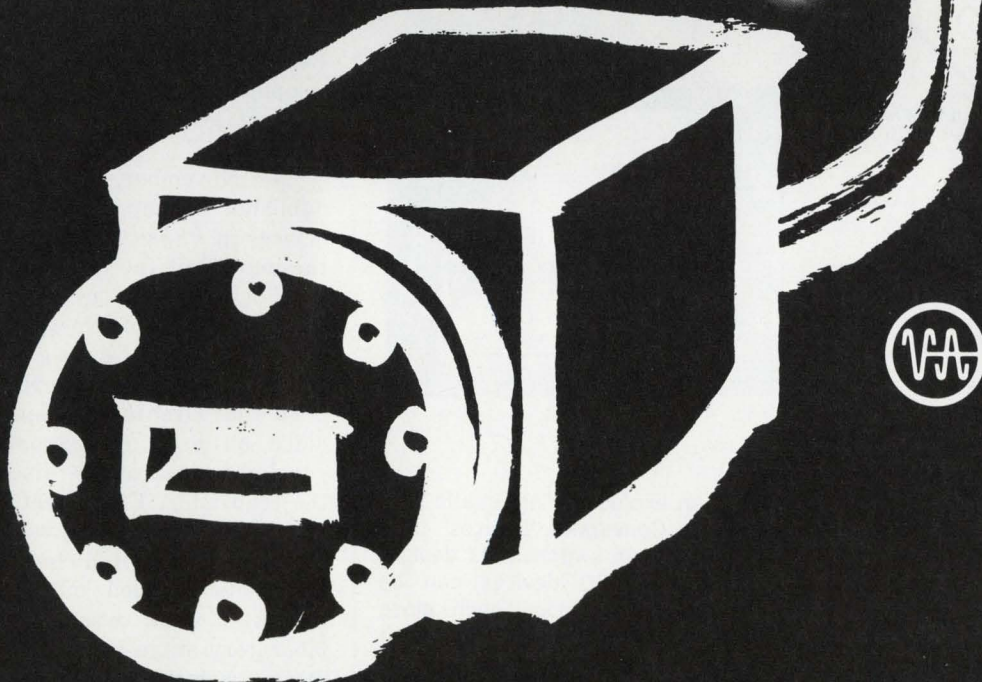

Ovshinsky displays futuristic thin-film device

But amorphous semiconductors are still a long way from mass production, researcher concedes

John N. Kessler
News Editor

For years, Stanford R. Ovshinsky, president of Energy Conversion Devices, Troy, Mich., has insisted that he could develop commercial devices made of amorphous solids, but his company has been reluctant to sell samples to researchers in industry without an involved contractual agreement. At the Symposium on Semiconductor Effects in Amorphous Solids in New York City, Ovshinsky lifted part of the veil that he has placed over his work. He showed the 300 attending scientists photographs and drawings of thin-film switching and memory devices that his company has developed. Their operation is based on the rapid change in conductance that occurs in amorphous materials with an applied electric field.

Ronald G. Neale, vice president

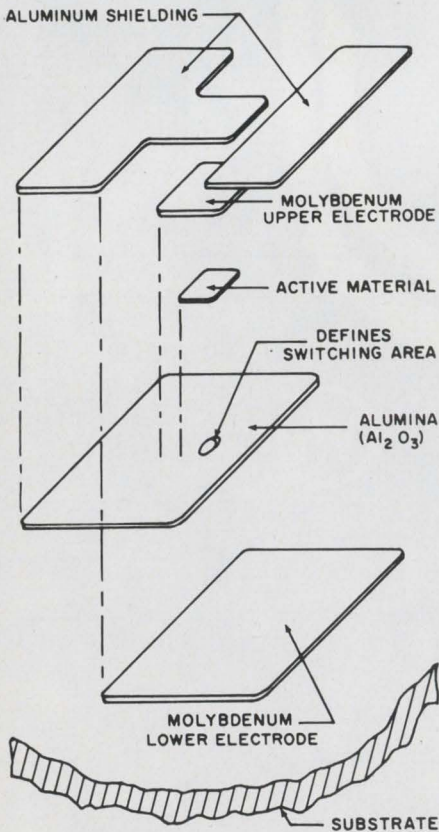

of operations for Energy Conversion Devices, called the new thin-film structures a "material and production evaluation run." But he would not predict when mass production might begin.

If reproducible devices can be mass-produced, a likely first application would be a read-only memory that would require no holding voltage to keep it in the "on" state. It would also be electrically alterable by the customer, thus avoiding rewiring at a factory.

The use of amorphous devices for electroluminescent devices is even more speculative. Potentially there is a large market for CRTs for television, message boards and other displays.

As for using the negative resistance characteristics of these devices to make oscillators and amplifiers, it's too early to make predictions.

From a commercial standpoint,

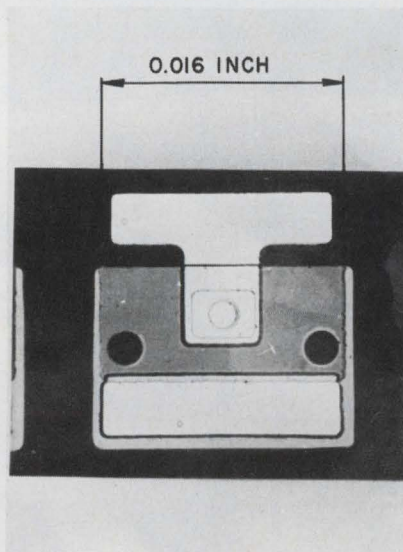

At left: An exploded diagrammatic view of Energy Conversion Devices' thin-film amorphous switch. It is designed so that 2500 devices can be fabricated on a 1 × 1-inch glass substrate. **Above:** The same switch magnified. The device is for evaluation only and is not commercially available at present, the company's officials emphasize.

there are at least four problems to be dealt with so far as Ovshinsky's new devices are concerned:

1. Although the switching time is short—150 picoseconds—the delay time before switching varies from about 0.5 to a few microseconds.

2. The devices suffer from lack of reproducibility, although Energy Conversion Devices and its consultants insist this is an interim problem.

3. The phenomenon of switching and memory effect is not peculiar to the glassy materials that Ovshinsky is primarily working with.

4. Any new devices will have to be compatible in electrical characteristics with existing devices.

Ovshinsky himself appeared more cautious than usual at the symposium, sponsored by the Picatinny Arsenal and the Army Research Office. Both he and his vice president of operations made it clear that a number of problems must be solved before mass production of devices can start.

"There is no question in my mind," he told *ELECTRONIC DESIGN*, "that amorphous materials will make an impact, probably in the computer field and the display field. But like any other important development, it's going to take years and not going to be accomplished all at once."

Last November, when Ovshinsky published a paper on amorphous devices in *Physical Review Letters*, the journal of the American Physical Society, a flurry of publicity sent the stock of Energy Conversion Devices flying to dizzy heights. Newspaper stories speculated that Ovshinsky's devices heralded an era in electronics comparable to that of the discovery of the transistor. Flat-screen TV and pocket-sized computers were among the applications predicted. Then, as the facts trickled out—that Ovshinsky's work was still in the laboratory stage and nowhere near mass production—the stock tumbled to more realistic levels. Speculators lost millions, and detractors

began to say that the "Ovshinsky effect" appeared to be more financial than physical.

At last week's symposium, however, Ovshinsky got a respectful hearing. Morrell H. Cohen of the University of Chicago, a consultant to Energy Conversion Devices, said that the reliability of amorphous devices was not entirely dependent on the development of a mathematical model, as some scientists have contended.

"What is needed," said Mr. Cohen, "is a mix of empirical information and good experiments."

"What one has to do is get enough of the qualitative understanding to know which way things go when you vary the various device parameters of a device configuration, the electrode materials and so forth. That kind of information is being collected very rapidly, and I think—and now I speak as a theoretical physicist—that adequate commercial reliability is quite likely to beat the theoretical physicists to the punch—in the sense that there will be a reliable device before the mathematical model."

Other scientists report

Nearly a fourth of the papers presented at the Symposium—13 out of 51—came from Energy Conversion Devices. Most of the rest were reports from workers at universities. A scattering of scientists represented some of the larger companies: Bell Telephone Laboratories, General Electric, Lockheed, Corning Glass, Xerox, and IBM.

A. D. Pearson of Bell Laboratories reviewed his early investigations of numerous semiconducting glass systems. In these studies, which were first reported in 1962, Pearson observed memory, switching, and negative resistance effects. Pearson suggested that the change in conductivity involved a thermal effect.

Pearson, Ovshinsky and others have patents covering amorphous materials and devices. But so far as possible patent disputes are concerned, Ovshinsky says there are none. "There are no patent contentions between me and anyone else," he told ELECTRONIC DESIGN, "Scientific work is based on what you do, and patents are a matter of record. ■■"

Nytronics Inductors are ahead of their time!

Nytronics continuous research and development have produced standardized quality inductors with the superb precision and stability to meet the demanding requirements of tomorrow's circuitry. Yours today — delivered off the shelf from a large inventory. Pioneering is a Nytronics speciality!

WEE-DUCTOR — Magnetically shielded with inductance range 0.1 to 180,000uH, designed to MIL-C-15305, Grade 1, Class B. Encapsulated Envelope: 0.157" dia. x 450" max. length.

SUPER WEE-DUCTOR/90537 TYPE — Manufactured in accordance with MS90537, Molded Magnetically shielded with inductance range 0.1 to 100,000uH ±10% tolerance. Molded Envelope: 0.163" diameter x 0.410" length.

WEE WEE-DUCTOR — Magnetically shielded with inductance range 0.1 to 1,000uH. Designed to MIL-C-15305. Encapsulated Envelope: 0.125" diameter x 0.335" max. length.

DECI-DUCTOR — Subminiature with inductance range 0.1 to 1000uH. Designed to MIL-C-15305, Grade 1, Class B. Molded Envelope: 0.100" diameter x 0.250" length.

S-M-L INDUCTORS — Non-shielded with inductance range 0.1 to 10,000uH. Designed to MIL-C-15305, Grade 1, Class B. Molded Envelope: "S" Type — 0.188" diameter x 0.44" length, "M" Type — 0.25" diameter x 0.60" length, "L" Type — 0.31" diameter x 0.90" length.

VARIABLE INDUCTOR — Unshielded with adjustable range 0.1 to 4700uH. Designed to meet MIL-C-15305, Grade 1, Class B. Encapsulated Envelope: 0.400" diameter x 0.500" length. Vertical or Horizontal mounting.

WEE V-L — Magnetically shielded adjustable range 0.1 to 100,000uH. Designed to MIL-C-15305, Grade 1, Class B. Epoxy Molded 0.300" diameter x 0.400" length.

ADJUSTOROID — Adjustable toroid available in nominal values from 0.01Hy to 12Hy. This unit provides stepless adjustment in a completely hermetically sealed package.

Nytronics off-the-shelf inventory also includes a wide range of capacitors, delay lines, and resistors. Write today for complete engineering data.



NYTRONICS, INC.

The quality line of standard components

Essex Electronics Division

550 Springfield Ave., Berkeley Heights, N.J. 07922 (201) 464-9300 TWX: 710-984-7977

INFORMATION RETRIEVAL NUMBER 20

Capacitor designs aim for IC compatibility

High-temperature and beam-lead tantalum devices in chip form developed for wide semiconductor use

Lucinda Mattera
New Products Editor

On the theory that if you can't lick 'em, join 'em, capacitor manufacturers are emphasizing compatibility rather than competition with the snowballing semiconductor industry.

At the 1969 Electronic Components Conference in Washington, D.C., the capacitor industry, with an eye on the blossoming use of hybrid circuit modules, unfolded a new manufacturing program aimed at direct substrate compatibility with integrated circuits. At the same time it disclosed exciting new applications for ceramic capacitors.

Introduced for the first time at the conference were:

- Solid tantalum chip capacitors that can withstand the same high temperatures as ceramic chip capacitors, and offer higher capacitance in less space.

- Beam-lead tantalum chip capacitors that are directly compatible, on the substrate, with silicon integrated circuits and have the extra of improved volumetric efficiency over ceramic devices.

- New alumina ceramic capacitors that can be used in rf transmission applications.

Fail-safe tantalum chip capacitors

Boasting as much immunity to high-temperature exposure as monolithic ceramic capacitors, a new family of solid tantalum chip capacitors was described in a paper by David Maguire, group product manager, Electronics Div., Union Carbide Corp. Previous limitations, caused by the breakdown or outgassing of the silver paint used to contact the counterelectrode, are eliminated by a new solid copper counterelectrode system.

Maguire explains that the solid tantalum chip capacitor consists of a series of layers. Tantalum metal is the positive electrode on which the dielectric layer of tantalum pentoxide is formed. The counterelectrode consists of manganese dioxide impregnated into the pores of the tantalum pentoxide, and a layer of colloidal carbon or graphite making a connection to the manganese dioxide.

Since carbon cannot be soldered, silver paint is normally used to contact the counterelectrode. But this painted silver layer is destroyed at processing temperatures of about 800°C.

Another temperature problem often occurred in assembling thin-film circuit modules because organics within the sealed package must be prevented from contaminating the semiconductor die. During the baking of these packages for purification, the silver-paint layer could be destroyed if the packages were not sealed; on the other hand, the silver paint tended to outgas if the packages were sealed.

Union Carbide solved both problems by eliminating the silver paint and applying pure copper directly to the counterelectrode.

According to Maguire, the tantalum capacitor is now as easy to use as the monolithic ceramic unit, with the added advantage of increased volumetric efficiency and lower costs.

"Tantalum," he notes, "generally becomes cheaper, over ceramic, once past the 0.1- μ F point. At 1 μ F, the tantalum chip costs 20% less than an equivalent ceramic unit. With sufficient volume, this

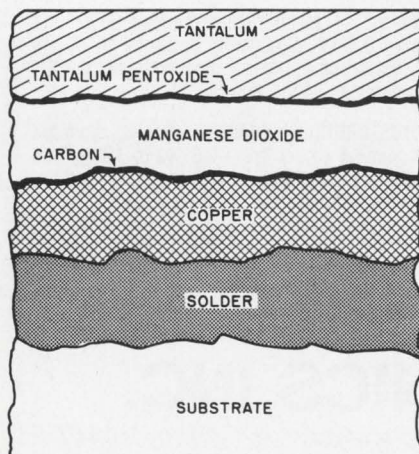

New solid tantalum chip capacitors, shown mounted, replace painted-on silver with pure copper.

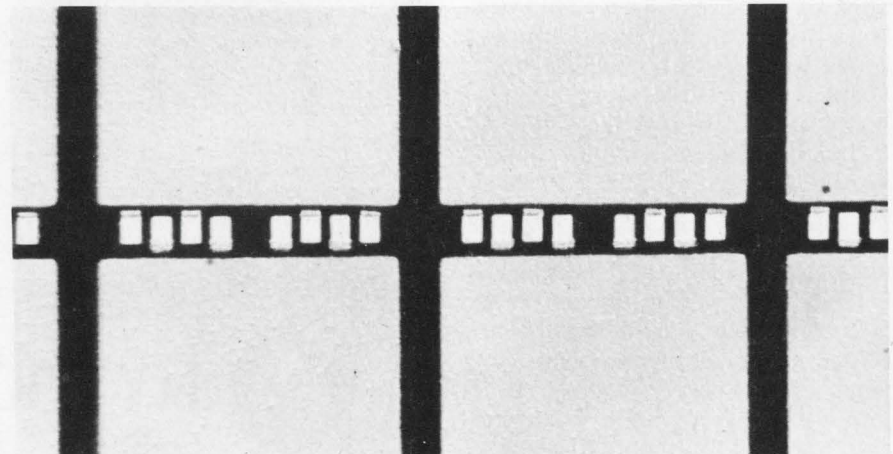

Beam-lead thin-film tantalum capacitors offer complete on-the-substrate compatibility with integrated circuits. Only 2 mils thick, these new chips also improve volumetric efficiency over ceramic devices via tantalum.

Get sine, square and triangle functions—and positive and negative going pulses, positive and negative going ramps—in the new HP 3310A. And there's more! You'll have these seven functions over a decade of decades—0.0005 Hz to 5 MHz.

All this capability is packed into a package only 7¾" wide, 4½" high, 8" deep! With the 3310A Function Generator performing many of the functions of the pulse generator, ramp

generator, bias box and amplifier on your bench—think about the clutter you eliminate...the instant access you'll have to all these signals.

With the dc offset capability of the 3310A, you can put any of the functions where you want them—easily and without biasing. And, with the choice of high or low level output, you can get clean low level signals without an external attenuator. You get a maximum of 15 V peak-to-peak into 50 Ω—and that's plenty of power to eliminate most needs for external amplification.

Add to this the external frequency control capability which allows you to sweep over a 50 to 1 range or tie the 3310A into a system—the price

of only \$575—solid-state reliability—and you know the HP 3310A is more than a function generator!

Order your HP 3310A today from your nearest HP Sales Office. For full specifications, write to Hewlett-Packard, Palo Alto, California 94304. Europe: 1217 Meyrin-Geneva, Switzerland.

HEWLETT *hp* PACKARD
SIGNAL SOURCES

099/9

This One Is More Than A Function Generator!

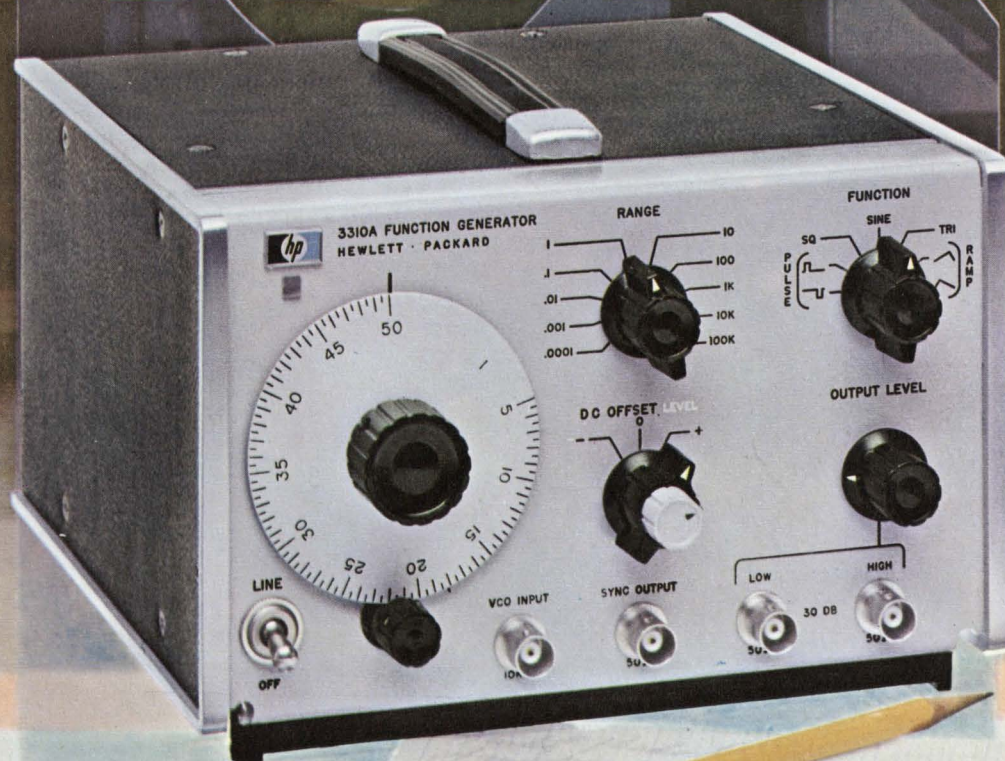

(New capacitors, continued)

cost difference could be even more pronounced."

Maguire expects a large growth in the tantalum chip capacitor market within the next year because of the removal of temperature limitations. "The market is so small now," he says, "that the growth could involve an order of magnitude increase."

Beam-lead chips go to tantalum

Another paper outlined the advantages, characteristics and processing of beam-lead tantalum thin-film capacitors. Co-authors W. Wesolowski and M. Tierman, of Sprague Electric Co., describe the new devices as combining the ruggedness of beam leads with improved volumetric efficiency through the use of tantalum.

"Up to now," says Wesolowski, development engineer, Thin Film Dept., "the design engineer has not really had anything compatible to put together with silicon integrated circuits in the form of a capacitor. Ceramic monolithics are big fat things, many mils thick. This tantalum chip capacitor is only 2 mils thick, the size of a beam-leaded silicon integrated circuit. The same sort of bonding operations that handle the silicon integrated circuit will handle this."

According to Wesolowski, the use of tantalum means very high capacitance per unit area. He notes that working voltage is the trade-off for capacitance. For example, at 50 Vdcw, capacitance is about 0.4 pF per square mil, climbing to 1.5 pF per square mil at 12 Vdcw.

Over the working voltage range

of 12 to 50 Vdcw, capacitance varies from 100 to 3000 pF for a 60 by 60 mil chip. Other possibilities include a device rated at 2 Vdcw and 10,000 pF, or 15 individual capacitors on a single chip.

The beam-lead configuration, Wesolowski indicates, allows the user to array the chips "very close to the original precision dimensions on the wafer." He expects the ultimate cost per chip to be under \$1 for 150 pF at 50 Vdcw or for 600 pF at 12 Vdcw.

When questioned about the possibility of going to a solid tantalum approach, Wesolowski commented, "We feel that our approach, for its capacitance range, yields comparable volumetric efficiencies. Even the layering or sputtering of tantalum would just complicate a process that is complicated to begin with. It is only because ours is a real batch process that you wind up with a relatively inexpensive chip."

Ceramic capacitors broaden uses

While new types of capacitors are appearing on the market, some exotic uses have been developed for standard multilayer ceramic capacitors. Donald Hamer, director of Research and Development, Materials Research Lab., Erie Technological Products, Inc., mentioned for the first time new high-voltage high-current multilayer alumina capacitors for rf transmission applications. With their heavy silver leads, these new devices minimize series resistance as well as inductance. Current ratings range from 8 to 20 A at 30 MHz and maximum peak rf voltages vary from 1.5 to 10 kV at 2 MHz. Capacitance values go from 3 to 750 pF, while power ratings are

7.5 or 10 kVA.

"There is nothing sacred about the planar construction of the multilayer ceramic capacitor," notes Hamer. Discoidal capacitors—circular discs with a center hole—can be used in low-inductance feed-through applications where high capacitance is desired to pass low frequencies. Curved bank constructions are also possible.

With a working voltage rating of 200 V per mil, ceramic capacitors, even in chip form, can be used in many high-voltage applications. The monolithic multilayer ceramic capacitor, for instance, minimizes the problem of surface arc-over. Hamer explains that this is because "the electrodes are neatly and cleanly encapsulated in an excellent insulation material, the dielectric itself." In addition, individual electrode edges are surrounded by a material with a uniform dielectric constant and reduce electric field intensity at these points.

Hamer foresees a steady price drop of 20 to 30% per year for multilayer chip capacitors. This means that a low-capacitance chip currently selling for about 6¢ will eventually cost only 2¢. It is at this price breakpoint that Hamer feels the automotive and consumer markets will be attracted. He also expects volumetric efficiency to improve by a factor of three or four in the next 10 years.

Where to get papers

The proceedings of the 1969 Electronic Components Conference contains all the papers presented. It is available for \$7 from the Order Dept. of the IEEE, 345 E. 47th St., New York, N.Y. 10017. ■

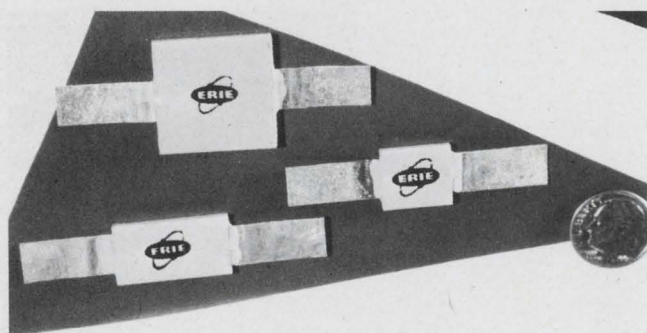

Designed for rf transmission applications, a new line of multilayer alumina capacitors handle currents as high as 20 A at 30 MHz and voltages up to 10 kV at 2 MHz.



Curved-bank ceramic capacitors are highly complex in their construction. Both single-layer and multilayer devices can be intricately formed.

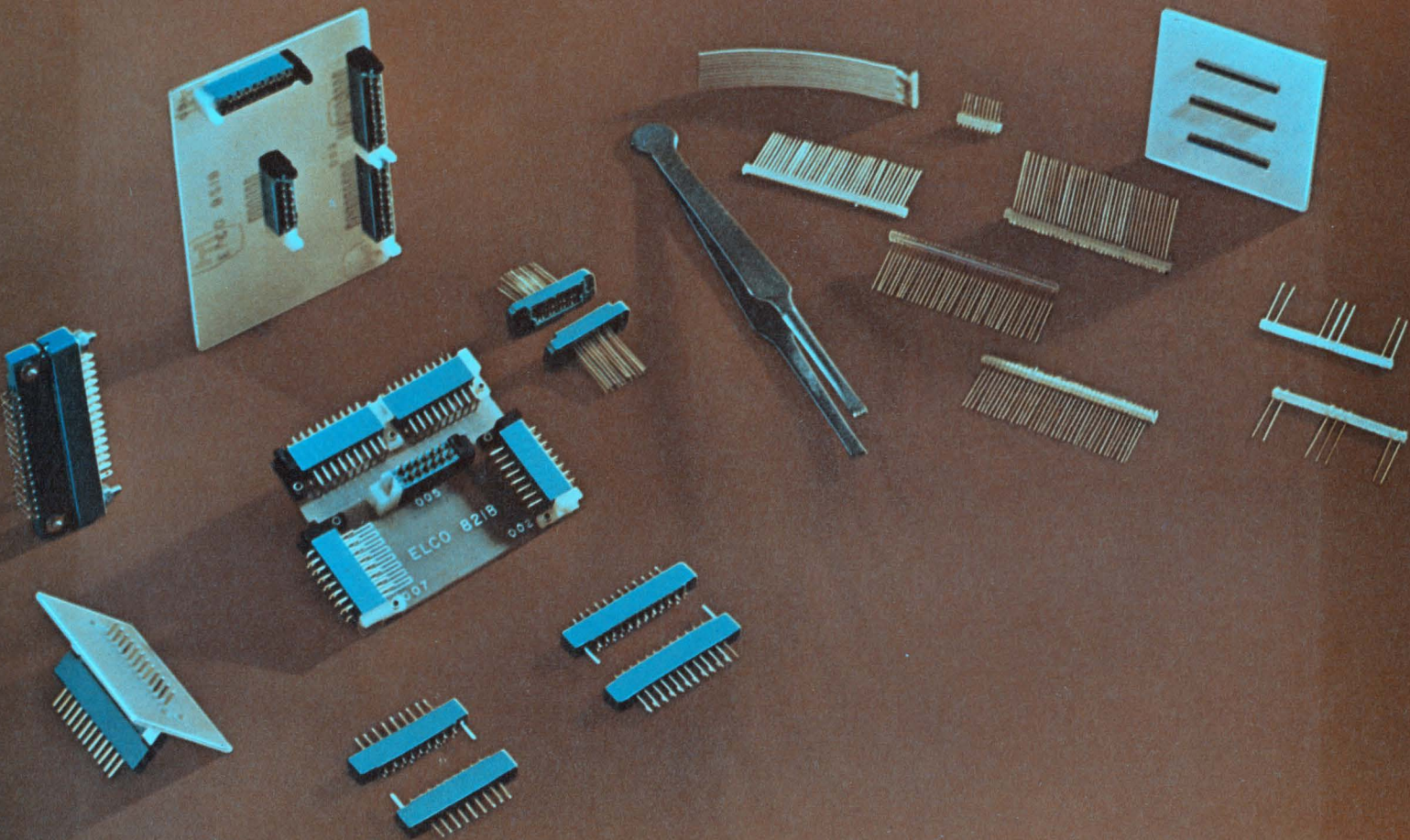

Miniature, subminiature connectors, yes.

Miniature, subminiature contacts, no.

Microelectronics can give you a pain in the tweezers. You have to be perfect. And you have to be perfect in places so small that a flea would have trouble scratching his back.

Actually, the electronics part isn't too hard, what with piezoelectric this's and thin-film that's to work with.

But, inevitably, there comes the day when all the this's and that's have to be put together. It's a problem. Mechanically. Electrically.

You don't want to put a big fat plug on a skinny little mini-circuit.

So you need miniature or subminiature connectors. Those we have. By the catalogfull.

But you sure don't need undernourished contacts. You need all the strength you can get, all the hang-togetherness you can get.

Those we give you. Every miniature in our catalog is made with our patented Varicon™ contacts (you probably already know about them). Our newer sub-miniatures are made with Bi/Con™ contacts (which

is sketched at the left).

See the four mating surfaces?

Four mating surfaces, coined so that they're exceptionally hard and smooth.

Four mating surfaces, held together snugly by the spring-like action of the design. And by the innate characteristics of the phosphor-bronze.

Four mating surfaces, strengthened by a reinforcing web.

Four mating surfaces, on a contact that floats in its insulator to make sure that the four mating surfaces mate.

No comparably sized contact can match the Bi/Con's dimensional, electrical, and mechanical characteristics.

And no subminiature contact can match the Bi/Con's incredibly low price, either.

For more information, write, wire, call or TWX us for our Microelectronics catalog.

Elco Corporation, Willow Grove, Pa. 19090.
(215) 659-7000. TWX 510-665-5573.

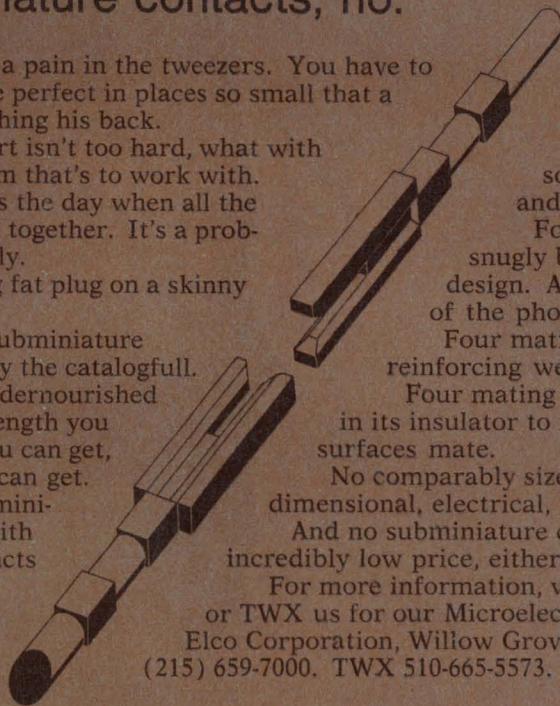

ELCO Varicon® miniatures
Bi/Con® subminiatures





We make components for guys who can't stand failures.

You can't court-martial a capacitor or a resistor for refusing to carry out orders. But at Corning we make our capacitors and resistors for guys who are demanding enough to wish that they could.

We make components that give you an extra measure of performance. Components that let you make sure your system will deliver all you designed into it. Because like you and the guys who use your equipment, we can't stand failures either.

Take our glass capacitors, for instance. There's only one reason why they've been designed into the Surveyor, Minuteman, Gemini, Apollo, Saturn, Titan, Syncom, Sparrow, Hawk and a number of other major aerospace and missile projects. With our glass capacitors, their circuit designers could get the proven stability and reliability that these important systems demanded.

U.S. Air Force tests have established that our glass capacitors deliver much better stability and much higher insulation resistance than ceramic and mica capacitors.

And take our precision tin

oxide resistors. They're the best of the metal film class. Because the resistive tin film is completely oxidized and molecularly bonded to the glass substrate, our tin oxide resistors are impervious to moisture and environmental degradation. No other resistor can deliver the same stability and reliability over load life. They offer guaranteed moisture resistance across all ohmic values to set a standard of reliability that can't be matched by metal film, wire wounds, carbon comps or metal glaze resistors. After a 56-day-long heat test in an environment of extremely high humidity, our tin oxide resistors showed a resistance change of just 0.2 per cent. And in an ambient temperature test—now in its ninth year—not one of the 600 tin oxide resistors being tested has exceeded a resistance change of 1.5 per cent.

But don't only think of Corning for military and other precision applications. We've got something to offer when economy and value are the prime considerations. At Corning we've been active in improving these important capacitor

and resistor characteristics, too.

We've developed the Glass-K™ capacitor to give you the volumetric efficiency and economy of monolithic ceramic capacitors, but with the much improved stability and reliability that a glass dielectric can add.

In resistors, our tin oxide resistors already offer long-term economy over metal film, precision wire wound and metal glaze resistors. And our new C3 resistors, in addition to giving you a small case size, compete costwise with carbon comps.

At Corning we make components for guys who can't stand failures. Guys like your most important customers. Guys like you. So, next time you're designing a system, reach for your CORNING® capacitor and resistor catalogs and call your local Corning authorized distributor for off-the-shelf delivery. They'll help you design-in that extra measure of performance.

If you don't have our catalogs, ask your Corning distributor for copies or drop us a line at: Corning Glass Works, Electronic Products Division, Corning, New York 14830.

CORNING
ELECTRONICS

The Standard of Excellence

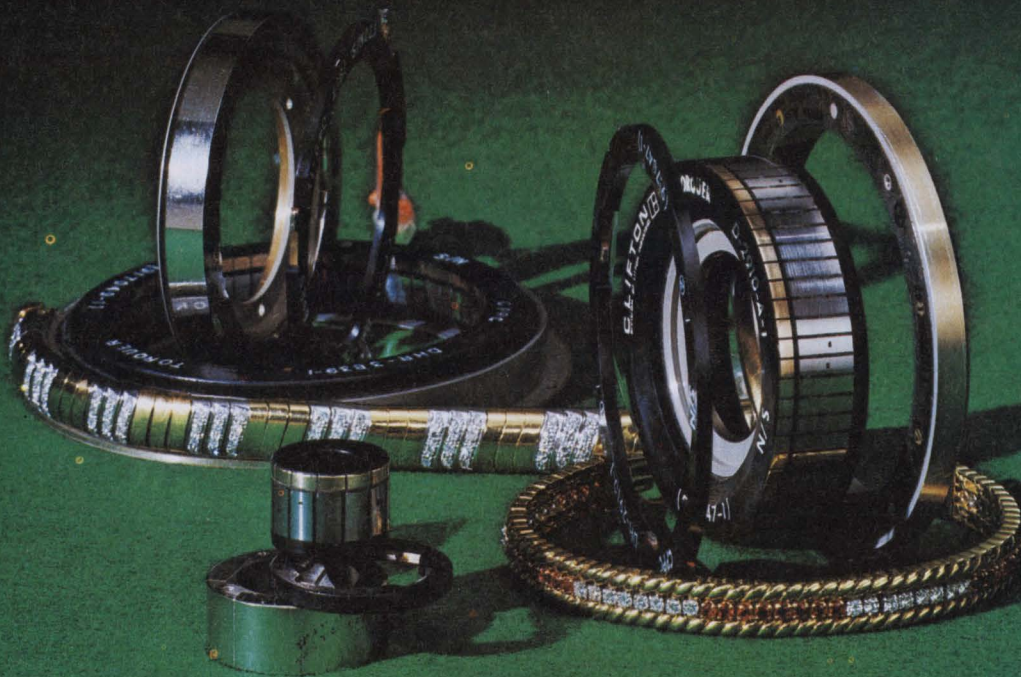

Torquers by Clifton

What makes Clifton torquers inherently excellent? We feel it's materials technology.

Of course, quality fabrication and electrical design are extremely important too. But Clifton long ago mastered the hollow shaft "pancake" configuration and the designing of optimum performance rotating components. It's our materials engineers who have provided our designers with the space-age materials and techniques which enable us to set a very high standard in torquers.

Consider the following characteristics.

□ DOUBLE INSULATED HI TEMP (200°C) MAGNET WIRE minimizes leakage current, gives superior insulation characteristics.

□ MOLDED BRUSH BLOCK ASSEMBLY. Brush blocks are completely interchangeable. Brush position on commutator is optimized.

□ BRUSHES MECHANICALLY FASTENED TO BRUSH SPRING IN ADDITION TO SOLDERING assures optimum brush alignment during soldering operation and a good mechanical and electrical bond between spring and brush.

□ STABLE HI TEMP MOLDING MATERIAL minimizes the movement of the windings under temperature variations. Material will not crack, thereby eliminating voids, exposed windings, dirt or humidity traps.

□ SOLID GOLD ALLOY COMMUTATOR insures consistent

low brush contact resistance over the life of the unit. Problems encountered in plating, such as gold migration and corrosive salts are eliminated.

□ SPECIAL MAGNETIC MATERIAL ALLOY permits higher torque per unit of volume, higher torque to inertia ratio, and will not corrode under high humidity.

Clifton's torquers are operational now in many of our nation's critical defense programs. Why not get Clifton excellence in your program too! Call your Local Clifton Sales Office or 215 622-1000.

CLIFTON 
DIVISION OF LITTON INDUSTRIES

Bracelets by J. E. Caldwell Co., Philadelphia—\$5600.



Cheyenne axed—more victims to follow?

With the cancellation of the Army's AH-56A Cheyenne helicopter production contract, Defense Secretary Melvin R. Laird revealed a new posture in his department. Not only is Defense not through with program cuts, but increased use of R&D in military projects before commitment to full-scale production is indicated. The attitude is, in other words, a retraction from the McNamara policy of single or total package procurement, in which one contractor was awarded a contract for R&D test and evaluation, and initial production—with, usually, an option clause calling for follow-on production.

The Army originally had planned to buy 375 of the highly advanced armed helicopters. The cancellation—a \$1 billion potential loss to Lockheed-Calif. Co.—was felt at once by the mother firm, Lockheed Aircraft, with a sharp drop in its stock value. The reverberations are reflected through the aerospace industry, as prime contractors fear for the safety of other programs currently being reviewed by the Pentagon.

Other programs under critical review include the F-14 and F-15 fighter aircraft, the S-3 (SX) antisubmarine aircraft, the entire navy shipbuilding program, the Army's Main Battle Tank (MBT-70) and Sheridan tank, plus several missile programs including the Navy's Condor air-to-surface weapon.

Rumors that the Cheyenne programs would be cancelled on May 16 began during the recent annual American Helicopter Society meeting in Washington. The day came and went with no action by the Defense Department, and the industry began to breath a little easier. However, the following Monday, May 19, the announcement was made. The Army declared that Lockheed was in "default for not living up to the performance terms of the contract." D. J. Houghton, Lockheed chairman of the board, quickly called the action "unfair" and said there would be a heavy personnel layoff, but indicated that his firm will fight the action in court. In Congress, Rep. Otis G. Pike (D.-N.Y.), a vigorous

Washington Report

CHARLES D. LAFOND
WASHINGTON BUREAU

critic of the Cheyenne program, declared he was delighted with the cancellation but indicated "it's a great tragedy that the action didn't occur at least \$1/4 billion ago."

Expenditures on the program are confused. The Army says it has spent \$90 million for R&D, but Rep. Pike estimates \$193.5 million. The Army estimates total production costs—including spares, ground support equipment and other associated items—at \$798 million, while Rep. Pike figures the production would cost \$1.06 billion.

In addition to the production contract cancellation, Army Secretary Stanley R. Resor revealed that a "cure notice" also may be issued on the remaining R&D portion of the contract. This would, in effect, detail present deficiencies in the Cheyenne effort and require Lockheed to indicate its plan to correct all technical problems. Such a cure notice, issued on April 10, was a precursor of the production contract cancellation.

Are Polaris subs safe from attack?

Complete confidence that our Polaris missile-carrying submarine fleet cannot be tracked by the Soviet navy was expressed by Rear Adm. Levering Smith, director of the U. S. Navy's Strategic Systems Projects. In an interview with Jim Ottaway, Jr., publisher of the New Bedford, Mass., *Standard Times*, the admiral also indicated his skepticism over reports that the Soviet Union informed the U. S. of the location of the nuclear submarine Scorpion, which sank last May while returning from the Azores.

Not only does the admiral claim that Soviet submarines cannot track and follow our nuclear submarines at present, but he also stated his belief that the new-generation Russian submersibles also will not be able to do the job. He is quoted as saying that the Soviet navy has "no specific new antisubmarine warfare methods" that would make the Polaris fleet vulnerable. He also

denied the practicability of satellite detection of submarines while submerged.

But others in Washington do not share the admiral's confidence. This reporter talked with several Navy officials, who requested anonymity. They observe that, while U.S. intelligence reports have not revealed any far-reaching advances made by the Soviet Union in long-range sonar detection, there was evidence that its scientists are making a concerted effort in such research. They indicate that the Soviet navy has dramatically increased its design capability for the production of quiet, deep-diving, long-endurance attack submarines.

They also see no reason why the Soviet Union could not develop an underwater-launched submarine-to-submarine missile equivalent to our Subroc. They argue that the apparent strategy of the Soviet navy today is defensive and thus is pushing to expand the Russian nuclear attack-submarine forces. In belying Soviet tracking skills, Adm. Smith referred to reports, never confirmed by the Navy, to the effect that the Soviets informed this country of the Scorpion's location. These stories appeared this year in *Parade* magazine and in the Washington, D.C., *Evening Star* editorial page in a column by James J. Kilpatrick.

RCA shows family of ground terminals

A family of five super-high-frequency ground terminals, ranging in size from a 1-1/4-ton transportable shelter to a man-pack receiving unit, was demonstrated in Washington last month by RCA's Defense Communications System Division. The equipment was developed for use with the experimental Tactical Satellite Communications spacecraft now in synchronous orbit (in line with the center of the U.S.). RCA won a contract from the Army Satellite Communication Agency, Fort Monmouth, N.J., in the summer of 1967 to develop the five terminals. The other self-contained units, to be carried by jeep, aircraft, and team pack, are two-way communication systems. The fifth unit is a new pack capable of receiving only.

While a reasonable amount of uniformity has been used in the various terminal designs, all have different capabilities to fit the varying demands of tactical operations. For example, the AN/TSC-80 transportable shelter includes a low-noise, uncooled, parametric amplifier, built-in self-test circuitry and considerable modulation-signal flexibility. It operates on fm voice with both high and low deviations and a variety of digital modes. The terminal includes a 500-watt-output transmitter, a receiver, a four-foot-diameter paraboloidal-reflector antenna (with a ring focus feed), a teleprinter and a reperforator.

At the other extreme the compact AN/TRR-30 man-pack terminal includes all the necessary equipment for receiving digital messages. Completely solid-state, and making heavy use of integrated circuits, it has a rugged low-noise tunnel-diode amplifier at the front end.

NASA asks for Earth Resources proposals

In preparation for a launch in late 1971 or early 1972, of a spacecraft for the Earth Resources Technology Satellite System, NASA has requested 12 U. S. firms to submit proposals. Two spacecraft are involved, and requests are made both for the definition and design of the spacecraft and for the study of a supporting ground data-handling system. Responses are due by June 18 at Goddard Space Flight Center, Greenbelt, Md.

Present plans call for the first spacecraft to be used for R&D for the test of sensors and of techniques used in collecting data. (The second spacecraft is for backup in case the first one fails.) Later data analysis is planned to check the effectiveness of an earth survey from space.

The first space vehicles must be designed for at least a one-year operating lifetime. This, says NASA, will provide the coverage necessary to judge the effectiveness of year-round observations of the same surface area of the earth.

The vehicle, weighing roughly 1000 pounds, will be placed in a circular, near-polar orbit at about a 500-mile altitude. The launch trajectory is intended to make the path sun-synchronous—that is, the sun will be directly behind the spacecraft during daylight orbit. As the craft passes over the earth in each revolution, it should view a segment about 100 miles wide.

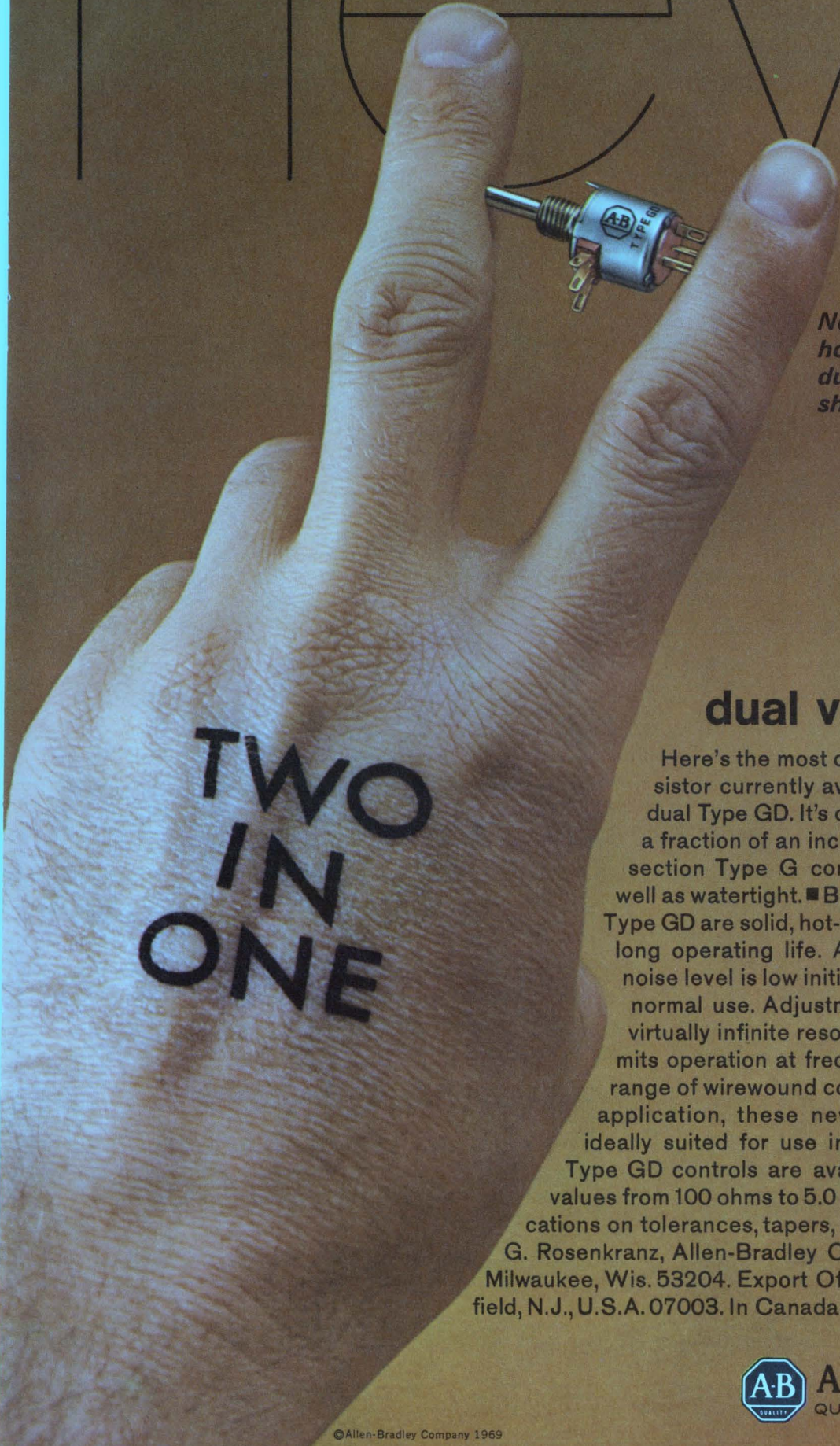
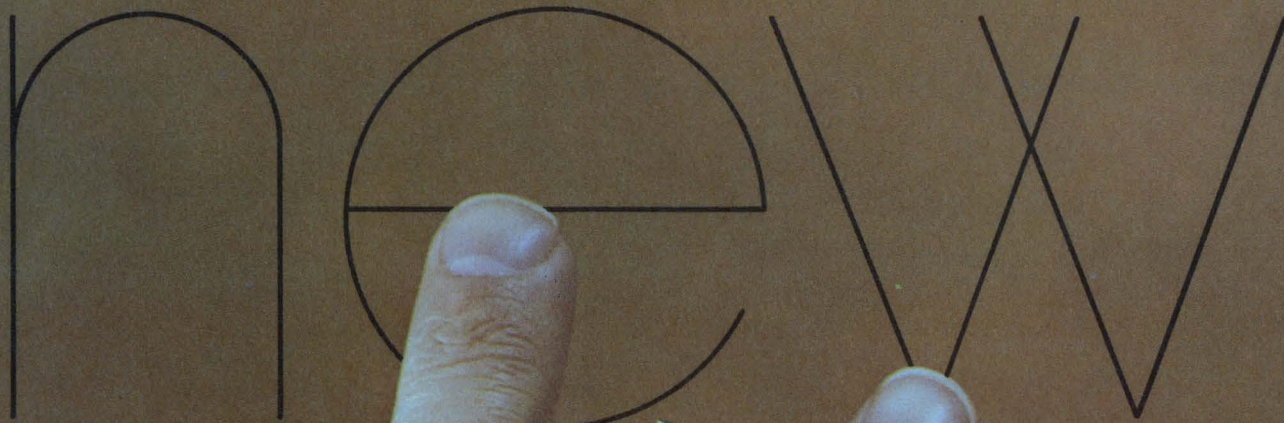

New Allen-Bradley hot-molded Type GD dual variable resistor shown actual size

**TWO
IN
ONE**

Allen-Bradley hot-molded dual variable resistor

Here's the most compact two section variable resistor currently available—the new Allen-Bradley dual Type GD. It's one-half inch in diameter and only a fraction of an inch longer than the popular single section Type G control. The case is dust-tight as well as watertight. ■ Both resistance tracks in the dual Type GD are solid, hot-molded elements, which provide long operating life. As with the single Type G, the noise level is low initially and actually decreases with normal use. Adjustment is smooth at all times with virtually infinite resolution. And low inductance permits operation at frequencies far beyond the usable range of wirewound controls. ■ In addition to standard application, these new dual Type GD controls are ideally suited for use in compact attenuators. ■ Dual Type GD controls are available with nominal resistance values from 100 ohms to 5.0 megohms. For complete specifications on tolerances, tapers, and options, please write Henry G. Rosenkranz, Allen-Bradley Co., 1201 South Second Street, Milwaukee, Wis. 53204. Export Office: 1293 Broad Street, Bloomfield, N.J., U.S.A. 07003. In Canada: Allen-Bradley Canada Limited.



5 GE silicone problem solvers.

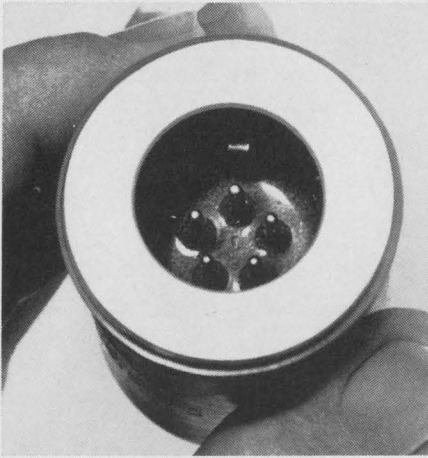

Invisible seal against moisture. Translucent GE RTV-615 silicone rubber used on this underwater connector assures clear identification of terminals, and improved dielectric strength under high voltage. RTV has excellent electrical properties.

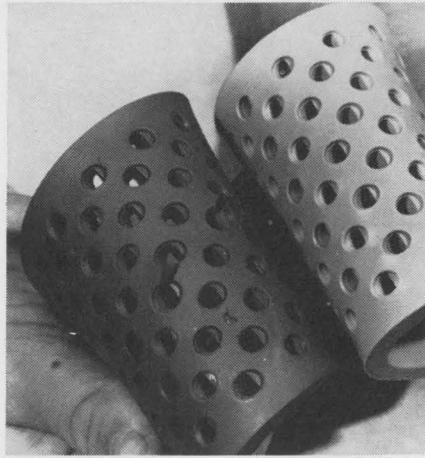

Mold life doubled. New RTV-630 silicone molds last twice as long as conventional silicones in molding epoxy parts for electronic modules. Tear strength of 100 psi (die B) makes "630" the toughest RTV yet... without sacrificing flexibility.

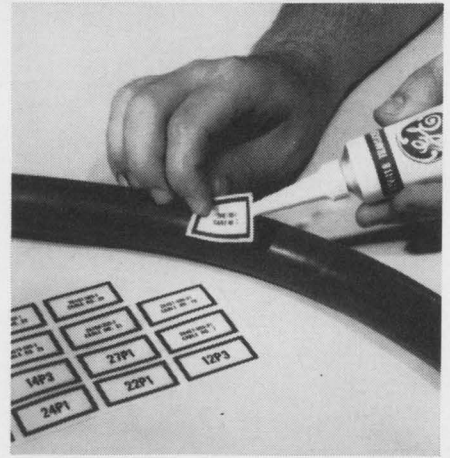

Durable marking labels made of GE silicone rubber withstand temperature extremes, aging, moisture, chemicals, fire. RTV adhesive/sealant keeps flexible labels in place permanently on cable, industrial equipment.



Beats heat and cold. Electrical heating strip on pipes keeps temperatures constant, indoors and out. GE silicone rubber "jacket," sealed with RTV, has high dielectric strength, resists aging, corona, from -65° to 600° F.



Cheaper than gaskets. GE RTV-109 silicone rubber seals plate assemblies of food slicer to keep juices out. Non-toxic, inert RTV-109 is applied easily, forms permanent, moisture-proof bond. Contact GE for FDA data on RTV-109.



And 500 others waiting in the wings.

Chances are you're wrestling with a design problem that could be solved with a GE silicone.

But *which* GE silicone? We have over 500 varieties to choose from. And thousands of success stories to back them up.

Let's make a deal. You tell us what your problem is, and we'll help you solve it.

Without fail.

Write to Section L6311, Silicone Products Department, General Electric Company, Waterford, New York 12188.

GENERAL  **ELECTRIC**

INFORMATION RETRIEVAL NUMBER 26

INFORMATION RETRIEVAL NUMBER 27 ►



Here's your answer to shock and vibration problems

■ Allen-Bradley Type R adjustable fixed resistors are unexcelled for holding precise settings through extreme conditions of shock and vibration. This unusual ruggedness is the result of a manufacturing process—perfected and used only by Allen-Bradley—which hot molds the resistance and collector elements, terminals, and insulating material into an almost indestructible component. Thus, the controls can be mounted by their own rugged terminals *without* additional support.

The solid resistance track assures such smooth control that it approaches infinite resolution. Its smoothness cannot be compared with the abrupt wire-wound turn-to-turn resistance changes which may cause circuit transients. Since Type R controls are essentially non-inductive and have low distributed capacity, they can

be applied in high frequency circuits where wire-wound controls are impractical. The Type R molded enclosures are both dustproof and watertight, permitting encapsulation after adjustment.

Allen-Bradley Type R controls are suitable for use from -55°C to $+125^{\circ}\text{C}$ and are rated $\frac{1}{4}$ watt at 70°C , 300 volts max. RMS. Available as standard in total resistance values from 100 ohms to 2.5 megohms with tolerances of $\pm 10\%$ or $\pm 20\%$. As special, can be furnished down to 50 ohms. Technical Bulletin B5205 contains complete specifications. Please send for your copy today: Allen-Bradley Co., 1201 South Second Street, Milwaukee, Wis. 53204. Export Office: 1293 Broad Street, Bloomfield, New Jersey, U.S.A. 07003. In Canada: Allen-Bradley Canada, Ltd.

Allen-Bradley Type R Adjustable Fixed Resistors—Shown actual size

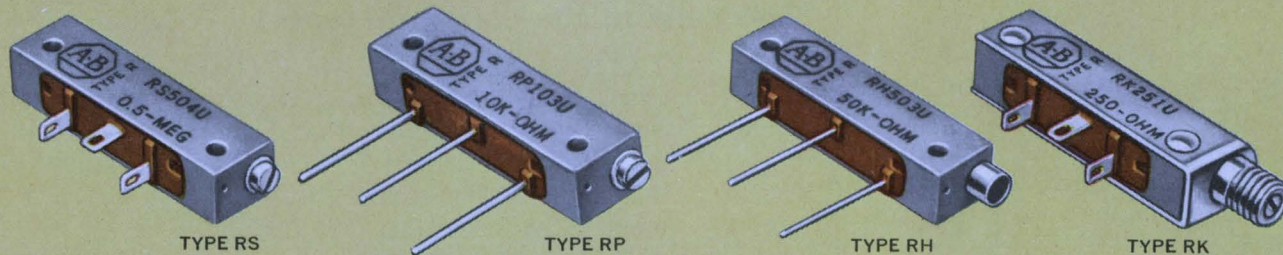

TYPE RS

TYPE RP

TYPE RH

TYPE RK



ALLEN-BRADLEY
QUALITY ELECTRONIC COMPONENTS

18.6 MHZ SELECTIVE LEVEL METER... EXCEPTIONAL ACCURACY... THE SPM-6

A field instrument with laboratory accuracy was our objective — a selective level meter with —100 dBm sensitivity and a phase locked, digitally indicated frequency setting to 18.6 MHz that could operate from rechargeable batteries or from the power line in a field environment.

To accomplish it we developed a new automatic calibration system which continually readjusts the amplifier circuits to

compensate for warm up drift, attenuator errors, frequency response errors and the majority of other causes of measuring uncertainty. The result is level measurements 5 to 10 times more accurate than can be made by most precision "laboratory" type instruments. The SPM-6 is, consequently, used in the lab and on the production line as much (and maybe more) than in the field.

Our philosophy is to produce only the finest measuring instrument current technology allows and to back them up with comparable service.



Wandel & Goltermann West Germany

represented in U.S.A. by W & G INSTRUMENTS, INC. 6 Great Meadow Lane, Hanover, N. J. 07936 • Tel: (201) 867-8700



Materials analysis, the easy way

Charles A. Harper, the materials specialist, is back in *ELECTRONIC DESIGN* again after a little more than a year's absence. This time Charlie has taken the knotty subject of insulating materials and made it simple. In Charlie's words, "The report should enable the electronic designer to zero in on the best material candidates and cut through all of the confusing names, especially in plastics, where confusion is so easy." The report stresses material capability and performance rather than chemical characteristics.

When not attending to his duties with Westinghouse Electric Corp.'s Aerospace Div., where he is a Fellow Engineer, Charlie is busy leading technical sessions on materials or writing magazine articles or books. His report is adapted from a chapter he wrote in "Handbook of Electronic Packaging," published by McGraw-Hill.

The front cover of this issue (photo courtesy of Union Carbide Corp.) shows a micrograph of bismuth A, used in a variety of electronic applications. The title page of the report—a collection of raw insulating materials—was photographed by Bill Alvarez of *ED*'s art staff.

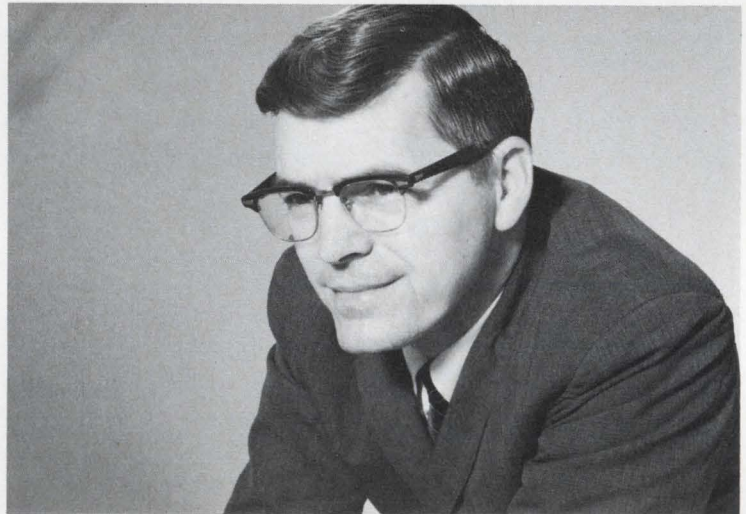

Author Harper presents his material in a way that is particularly meaningful and useful to the electronic engineer.

The case of the company report

ELECTRONIC DESIGN's own sleuth can be found investigating a company financial report on p. 112. Why? Because our editors believe that design engineers and their managers will benefit from reading and analyzing annual reports. The article will clue you in on what a financial statement can tell you.

As an added attraction, a section called "Annual Reports" makes its debut on page 119. Happy detecting!



Cimron leapfrogs the DVM industry —and there's a reason!

A number of reasons, to be exact! The all-IC Model 6753 is the next generation in digital multimeters—the lowest-priced autoranging instrument that will read DC from 100 nanovolts to 1099.9 volts and DC ratios. A fast-tracker, too—ideal for systems work. The closed loop tracking logic continually samples output at the rate of 14 readings a second, with accuracies of $\pm 0.001\%$ full scale $+0.005\%$ of reading. Like to learn about automatic desensitization? repetitive mode? out-of-range indication? Just ask how they can

help you. Important to you is the basic design, featuring optional IC plug-ins to extend capability which you can install yourself without technical service! Options include a 4-range AC converter with 10 microvolt sensitivity, a 5-range ohms converter, remote programmability, five print-out options. You can't beat the base price of \$2990! Cimron *customer concern* continues to provide what you really need at the lowest possible price. Write Cimron, Dept. C-145, 1152 Morena, San Diego, Calif. 92110.

LEAR SIEGLER, INC.



CIMRON DIVISION

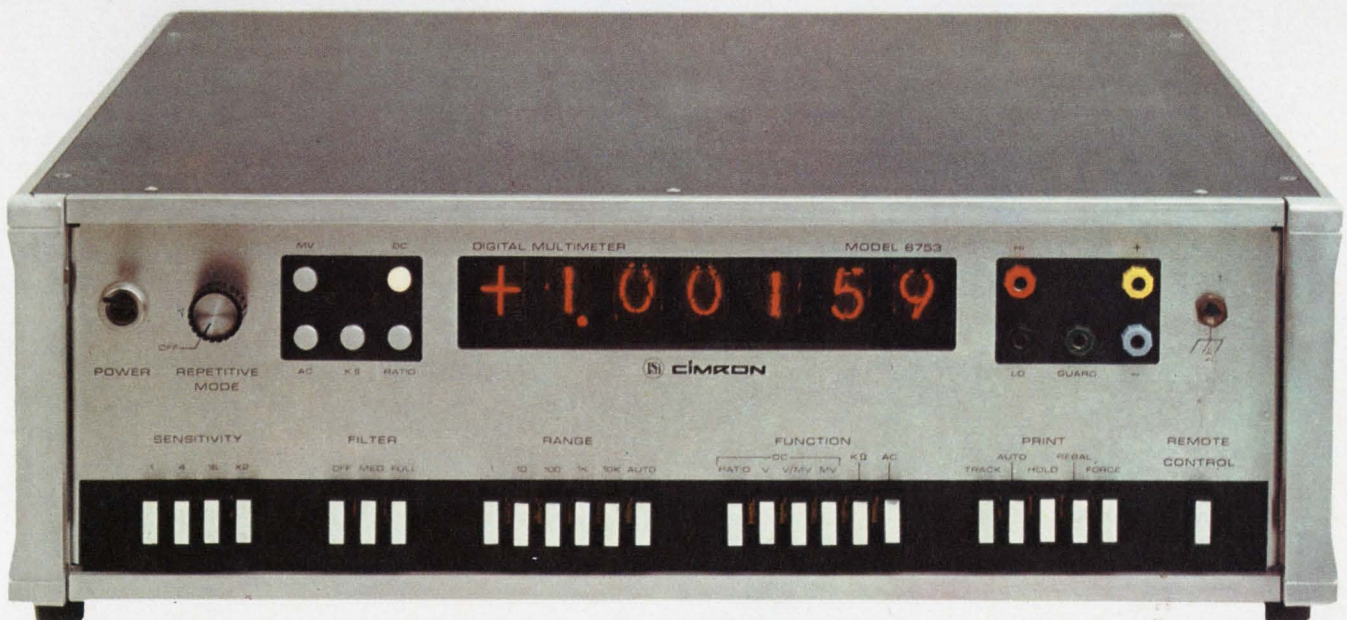

INFORMATION RETRIEVAL NUMBER 29

True to our tradition, we've got something great to tell you about this month.

Raytheon now has an op amp that draws less power than any other you can buy. Anywhere. It works within specifications with supplies as low as ± 3 volts. We call it the RM4132, and it's sitting on our distributors' shelves, right now, waiting for you to come and give it a home.

This graph plots power and current against supply voltage, and we guarantee that 150 μW figure at ± 3 V! Maximum input bias is 10 nA, max input offset current is 2 nA, with no more than 0.1 nA/ $^{\circ}\text{C}$ drift.

It has typical unity-gain frequency response of 150 kHz. And small signal open loop gain is 94 dB minimum.

Don't let your system run down.

Our new RM4132 microwatt op amp keeps your cells young and active.

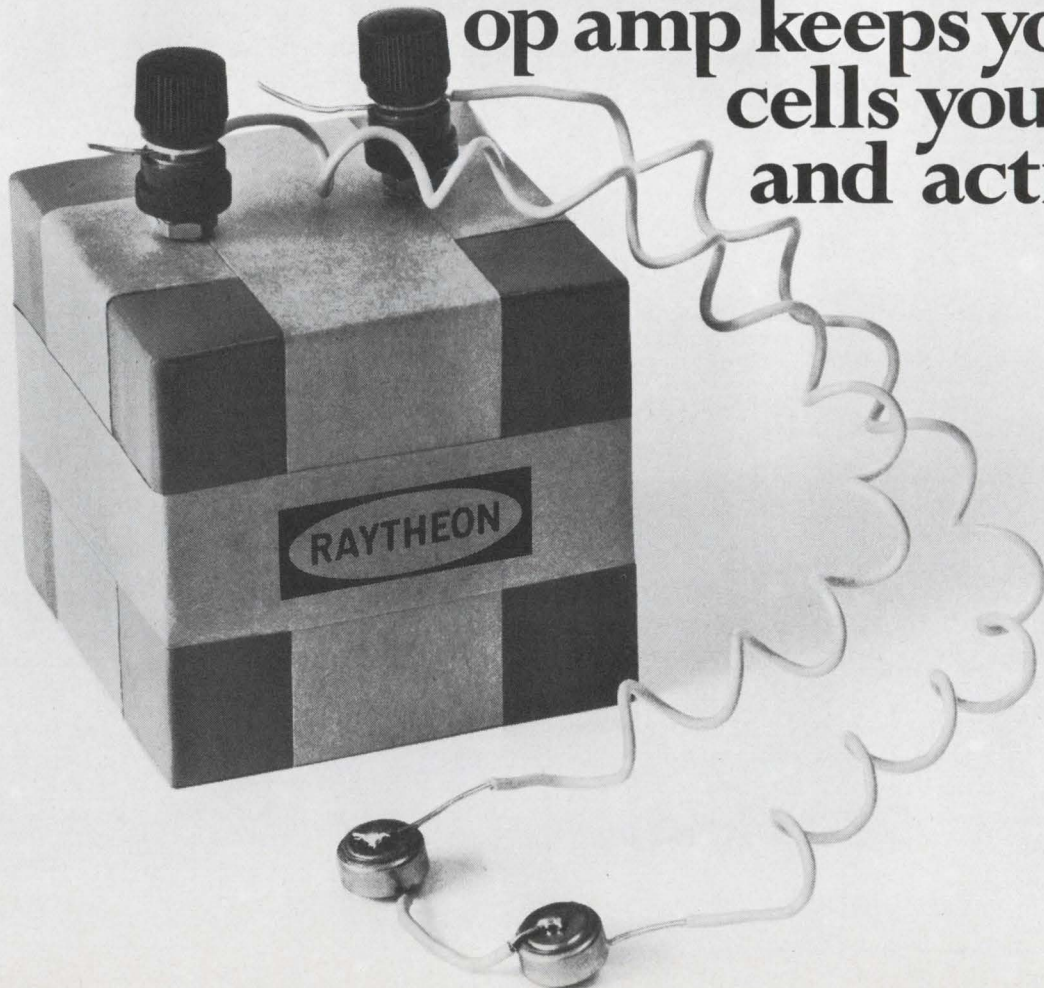

The RM4132 is internally frequency compensated. It's pin-for-pin compatible with the 709, 741, 107, 4131 and like that.

And the full military version costs only \$30 for 100-999.

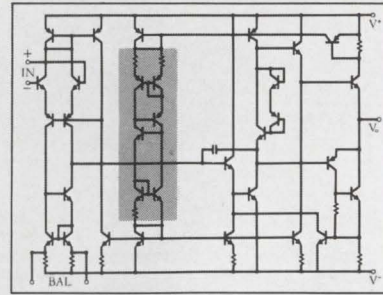

How do we do it? It's simple. This patent-pending little current regulator holds the amplifier quiescent current to 20 μA from ± 3 to ± 20 volts, and never

shows more than $\pm 10\%$ current variation across our whole -55 to $+125^{\circ}\text{C}$ temperature range. And those little bitty batteries seem to last forever.

So immortalize your system with an RM4132 from the company that's getting the ideas and delivering the goods. Raytheon Semiconductor, Mountain View, California. (415) 968-9211.

Publisher

Hugh R. Roome

Editor

Howard Bierman

Managing Editor

Frank Egan

Technical EditorsMilton J. Lowenstein
Michael J. Riezenman
Raymond D. Speer
Stella Lawrence**Management and Careers Editor**

Richard L. Turmail

News EditorsRalph Dobriner, Chief
John N. Kessler**Washington News Bureau**

Charles D. LaFond, Chief

Military/Aerospace Editor

John F. Mason

East Coast Editor

Jim McDermott

West Coast EditorsElizabeth deAtley
David N. Kaye**New Products Editor**

Lucinda Mattera

Copy Editor

Marion Allen

Editorial ProductionDollie S. Viebig
Phyllis Gura**Art Director**

Clifford M. Gardiner

Art Assistant

William Kelly

Technical IllustratorsWilliam Alvarez
Rita Jendrzewski
Lynn E. Thompson**Production Manager**

Thomas V. Sedita

Asst. Production Manager

Helen De Polo

Production AssistantsBernard Wolinsky
Carl A. Merkin**Circulation Manager**

Nancy L. Merritt

Information Retrieval

Genate Piccinetti

EDITORIAL



It's the alumni's turn to demonstrate

Is your engineering school making today's headlines?

Mine is. I'm a graduate of the City College School of Engineering in New York, class of '44.

I've been concerned, and I know many of you share the same emotion, with the growing unrest and disorders on campuses throughout the country. Our newspapers, magazines and TV screens display vividly the growing conflict between radical and conservative, black and white, student and faculty, youth and Establishment—and now between the engineering student and his liberal arts schoolmate.

Why does the engineering student demonstrate against the closing of colleges, while his liberal arts friend fights to keep them shut? A recent series of interviews at CCNY and Columbia point to some fundamental differences in behavior and attitude between these two types of students:

- The engineering student is aware of his career commitment. As stated by Wesley J. Hennessy, dean of Columbia School of Engineering: "Engineering students know where they're going. They're not trying to find themselves. They've never been lost. They've made their decision to join the Establishment, usually long before they leave high school. Liberal arts students look upon their four years at college as a time to find themselves."

- The engineering student admits he is more conservative than his liberal arts schoolmate. But, as one student complained: "Just because you believe in existing law, that makes you a conservative. If you believe in throwing bricks, you're a liberal."

- The engineering student cannot risk missing daily classroom lectures or laboratory experiments and still hope to pass. Liberal arts students admit that a flurry of activity toward the end of the term is often sufficient to achieve passing grades.

A rather pessimistic theory was offered by Columbia's Prof. Samuel Eilenberg, who suspects that liberal arts students feel the world is being taken over by a complex technology and that anyone who is not expert in technology will become a second-rate citizen. This attitude, he believes, has fostered antagonism between the two groups.

Are there solutions for the campus problems? Sure—about as many sure-fire ones as there are so-called experts anxious to get their names in print. Judges, policemen, businessmen, politicians, housewives—everyone seems to be getting into the act.

There are dedicated faculty and administrative officials who can provide workable solutions. Why not spend some time reviewing the status of our alma maters and take a position. If we don't like what they're doing, let's tell them. And if we are solidly behind them, let's give them our encouragement to solve this pressing problem.

But don't sit back and lament that sad bunch of college kids. They may turn up as your new boss 10 years from now.

HOWARD BIERMAN

The wreckless rechargeable.

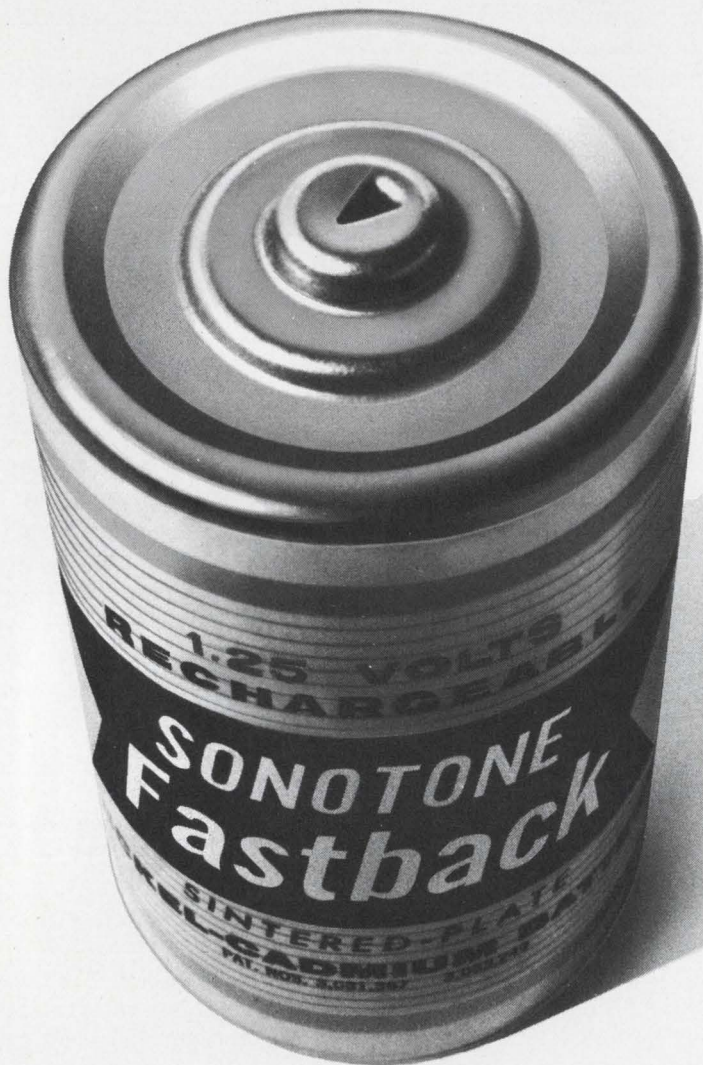

Sonotone's Fastback[®] battery won't wreck itself. Even under fast charging. Over and over and over again.

Sonotone's new nickel-cadmium sealed cell is called the Fastback because it gets back into action *fast*. In just five minutes, it gets enough charge to start a lawn mower or to operate a camera. So your product goes to work today... not tomorrow.

The Fastback's safe, too. In laboratory tests, it's been deliberately overcharged for months at the 3-hour rate. Without overheating or blowing its top. Even after that, it delivers full rated output under load.

And there's no need for expensive, bulky external charging apparatus. All

the charging capability is built right into the Fastback. Already, the Fastback's found its place in many consumer products. Should it be in yours? Find out by writing for full specifications and performance charts. Sonotone Corporation, Battery Division, Elmsford, New York 10523.

CLEVITE **SONOTONE**

And you can take your time turning off as well as on.

We weren't satisfied with giving you just a 120-second time delay. Or merely providing delay-on relays. So we've added both delay-off relays and 300-second relays to a line that was already the most complete in the industry.

Our solid-state line includes four full-size models with time delays adjustable from 0 to 300 seconds; there are delay-on and delay-off forms in both $\pm 2\%$ and $\pm 10\%$ accuracy ratings.

Delay-on units can be supplied for remote time-interval adjustment, making

them ideal for use on control panels, or where space or environment prevent direct access.

Where size is a factor, select our delay-on miniature model, adjustable 0 to 120 seconds with $\pm 2\%$ accuracy.

Check our low-cost thermal line, too. Available in plug-in and panel-mount models. Rated 2 amps resistive.

Don't delay in ordering our time-delay units. Call your Cutler-Hammer Sales Engineer or Stocking Distributor soon.

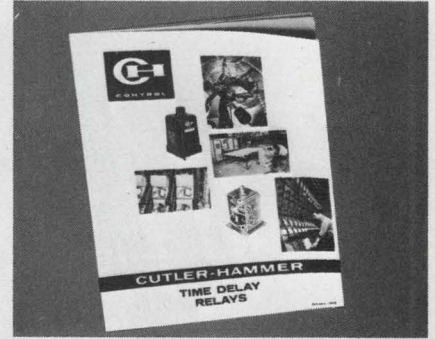

Circle the Reader Service Number below for our free catalog.

Now we offer the 300-second break.



CUTLER-HAMMER

SPECIALTY PRODUCTS DIVISION, Milwaukee, Wis. 53201

INFORMATION RETRIEVAL NUMBER 32

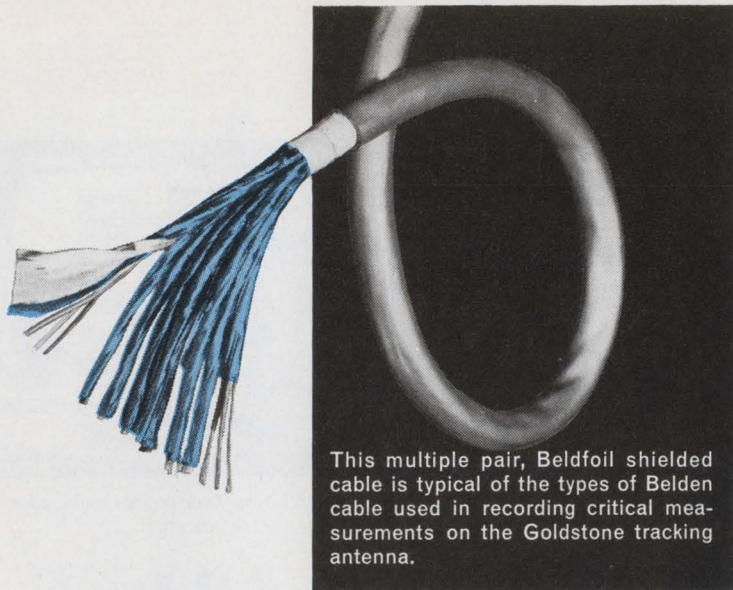

This multiple pair, Beldfoil shielded cable is typical of the types of Belden cable used in recording critical measurements on the Goldstone tracking antenna.

BELDFOIL* SHIELDED CABLE

SOLVED

CRITICAL NASA INSTRUMENTATION PROBLEM!



The unique insulating properties of Belden's exclusive Beldfoil shielding provides 100% protection against "cross-talk" and spurious signal impulses in highly sensitive circuit applications. That's why NASA used Beldfoil cable for its Goldstone Tracking Station. ■ In this massive 210 foot diameter antenna, built to track lunar and planetary probes, Belden Beldfoil shielded cables carry instrumentation signals from sensitive structural detectors to an instrumentation facility nearby. Every measurement of critical structure deflection, angular position, structure temperatures, and bearing pressures are recorded and analyzed prior to tracking operations. ■ Get the same precision analyzation in your critical instrumentation. Specify Belden Beldfoil shielded cable —the only cable providing 100% isolation.

*Belden Trademark Reg. U.S. Pat. Off.



FOR COMPLETE INFORMATION
CONTACT YOUR BELDEN
DISTRIBUTOR.

B-1-6A,

BELDEN CORPORATION • P.O. Box 5070-A • Chicago, Illinois 60680 • Phone 312-378-1000

INFORMATION RETRIEVAL NUMBER 33

INFORMATION RETRIEVAL NUMBER 34 ►

Oh, you'll put it together, all right, and after a while, it'll work, more or less. Then you'll take the prototype to engineering for board design, get it back, attach the components, test it, make a few compromises, try it again. What you have then is an engineering model.

Then the manufacturing design. Back to engineering for debugging. More testing. Parts procurement. Incoming inspection. Telephone calls. Late deliveries. More testing. Heartache.

Final release and the module is ready for manufacture. Maybe.

All this time, an already designed, fully debugged, guaranteed, computer-tested, solid state module sits on Digital's shelf. Fifty engineers in offices around the country wait for your call to help. Application notes, installation drawings, catalogs sit in our mail room.

Power supplies, hardware, racks are piled high in the stock room.

M Series modules are the most complete, fully compatible, fast, all IC, TTL, inexpensive solid state logic available anywhere. With a few million modules in our recent history, and a few million dollars worth of test equipment, we really know how to put them out.

Read all about them in the new Logic Handbook. Free.

digital
COMPUTERS · MODULES



Hold it, right there.

DIGITAL EQUIPMENT CORPORATION,
Maynard, Massachusetts 01754. Telephone:
(617) 897-5111 / Cambridge, Mass. / New
Haven / Washington, D.C. / Parsippany, Palisades
Park, N.J. / Princeton, N.J. / Rochester, N.Y. / Long
Island, N.Y. / Philadelphia / Pittsburgh / Cleveland /
Dayton / Huntsville / Cocoa, Fla. / Chicago / Denver /
Ann Arbor / Salt Lake City / Houston / Albuquerque /
Los Angeles / Palo Alto / Seattle. INTERNATIONAL,
Carleton Place and Toronto, Ont. / Montreal,
Quebec / Edmonton, Alberta, Canada / Reading and
Manchester, England / Paris, France / Munich and
Cologne, Germany / Oslo, Norway / Stockholm,
Sweden / Sydney and West Perth, Australia.

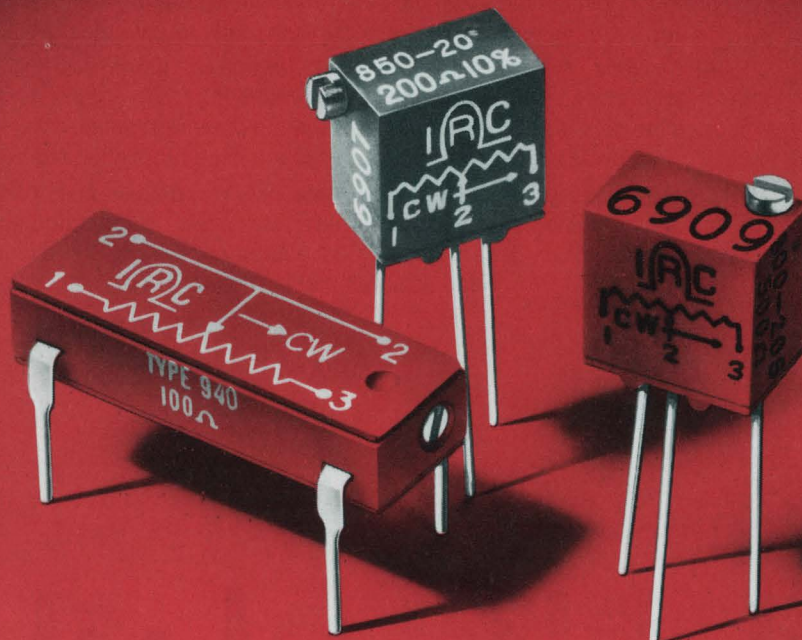

Space-saving trimmers

DIP construction matches IC size. Cuts assembly costs.

5/16" doubles performance of 1/4" trimmer—cuts cost almost in half.

IRC's new precision wirewound trimmer in dual-in-line package simplifies PC board layout. Pin spacing is the same as the popular TO-116 size integrated circuit. It is fully compatible with high-speed automatic inserting equipment.

The sealed, moisture-resistant units meet the environmental requirements of MIL-R-27208. Maximum height is only .200 inches. 1 watt @ 40°C. 10Ω to 20K. ±10% tolerance. TC is ±50ppm/°C.

Pin spacing of these 5/16" square trimmers matches the 1/4" square unit. Only .062" larger on each side, they can cut your cost almost in half and give you three times the power rating of the 1/4" and 40% better resolution.

Two types are available—precision wirewound and infinite resolution Metal Glaze. Both are fully sealed and impervious to common industrial solvents because of a silicone rubber shaft seal and epoxy bonding at all seams.

For data and prices, see your IRC Industrial Distributor or write IRC St. Petersburg Division of TRW INC., 2801 72nd Street, North, St. Petersburg, Florida 33733



DIVISION OF TRW INC.

INFORMATION RETRIEVAL NUMBER 36

Two Leads To Low Cost — High Performance For Volume Tuning Diode Applications

Device	C _T , Diode Capacitance = 4.0 Vdc, f = 1.0 MHz pF			Q, Figure of Merit V _R = 4.0 Vdc, f = 50 MHz	TR, Tuning Ratio C ₂ /C ₃₀ f = 1.0 MHz		
	Min	Nom	Max		Min	Typ	Max
MV2101	6.1	6.8	7.5	450	2.5	2.7	3.2
MV2102	7.4	8.2	9.0	450	2.5	2.8	3.2
MV2103	9.0	10.0	11.0	400	2.5	2.9	3.2
MV2104	10.8	12.0	13.5	400	2.5	2.9	3.2
MV2105	13.5	15.0	16.5	400	2.5	2.9	3.2
MV2106	16.2	18.0	19.8	350		2.9	3.2
MV2107	19.8	22.0	24.2	350		2.9	3.2
MV2108	24.3	27.0	29.7	300		3.0	3.2
MV2109	29.7	33.0	36.3	200		3.0	3.2
MV2110	35.1	39.0	42.9	150		3.0	3.2
MV2111	42.3	47.0	51.7	100		3.0	3.2
MV2112	50.4	56.0	61.6	100		3.0	3.3
MV2113	61.2	68.0	74.8	150		3.0	3.3
MV2114	73.8	82.0	90.2	100		3.0	3.3
MV2115	90.0	100.0	110.0	100		3.0	3.3

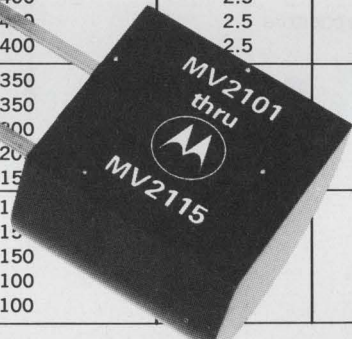

High Q Assures Sharp Response, Low Prices Assure Top Economy

High performance electronic tuning for FM radio and TV, AFC, and general frequency control plus large-volume industrial applications is now a practical, preferable reality with Motorola's new MV2101 — MV2115 series EPICAP* tuning diodes.

It's practical because the two-lead plastic Unibloc* package is economical both at purchase and in use. Prices are low, and the package design is perfect for high-speed automatic production line handling.

It's preferable because assured minimum Q's up to 450 provide sharp response at high frequencies and high, controlled tuning

ratios allow tuning over wide frequency ranges.

They offer all standard nominal capacitance values from 6.8pF to 100pF and uniform capacitance vs. voltage change from 2 thru 30 volts.

It's reality because devices are available off-the-shelf from your franchised Motorola Semiconductor Distributor or your Motorola Sales Office. Motorola's virtually unlimited plastic tuning diode production capacity can match your volume requirements. Inquire today.

*Trade-Mark Motorola, Inc.

- where the priceless ingredient is care!



MOTOROLA Tuning Diodes

Motorola Semiconductor Products Inc., P.O. Box 20912 / Phoenix, Arizona 85036

INFORMATION RETRIEVAL NUMBER 37

We spent a bundle developing these filters and capacitors.

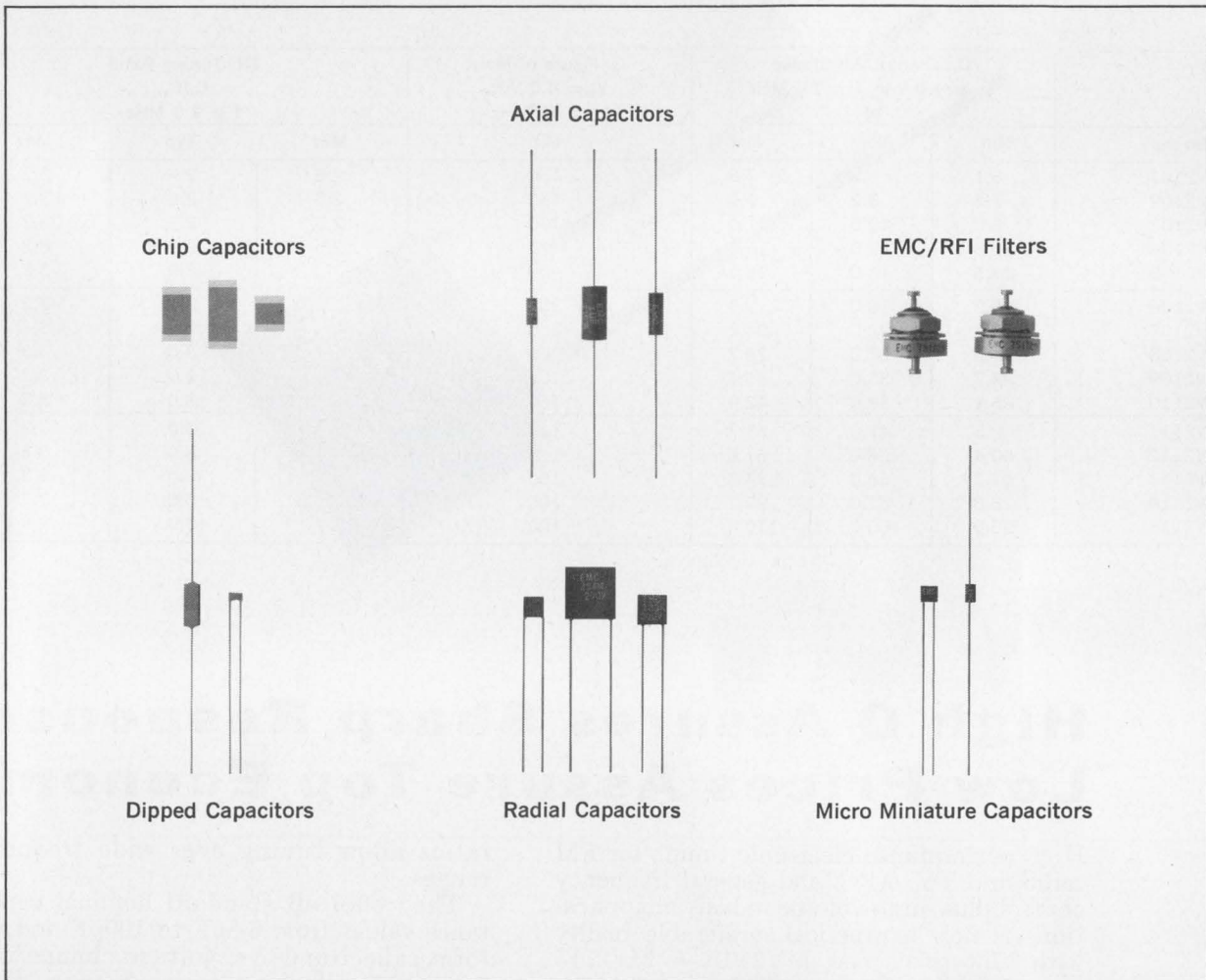

Information about them is free.

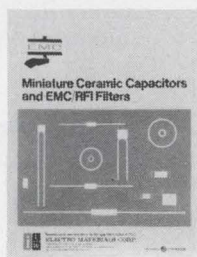

Represented by COMPAR

i t w **Electro Materials**
Division Illinois Tool Works Inc.
11620 Sorrento Valley Road, San Diego, California 92121
Phone (714) 459-4355, TWX 910 322-1130

INFORMATION RETRIEVAL NUMBER 38

INFORMATION RETRIEVAL NUMBER 39 ►

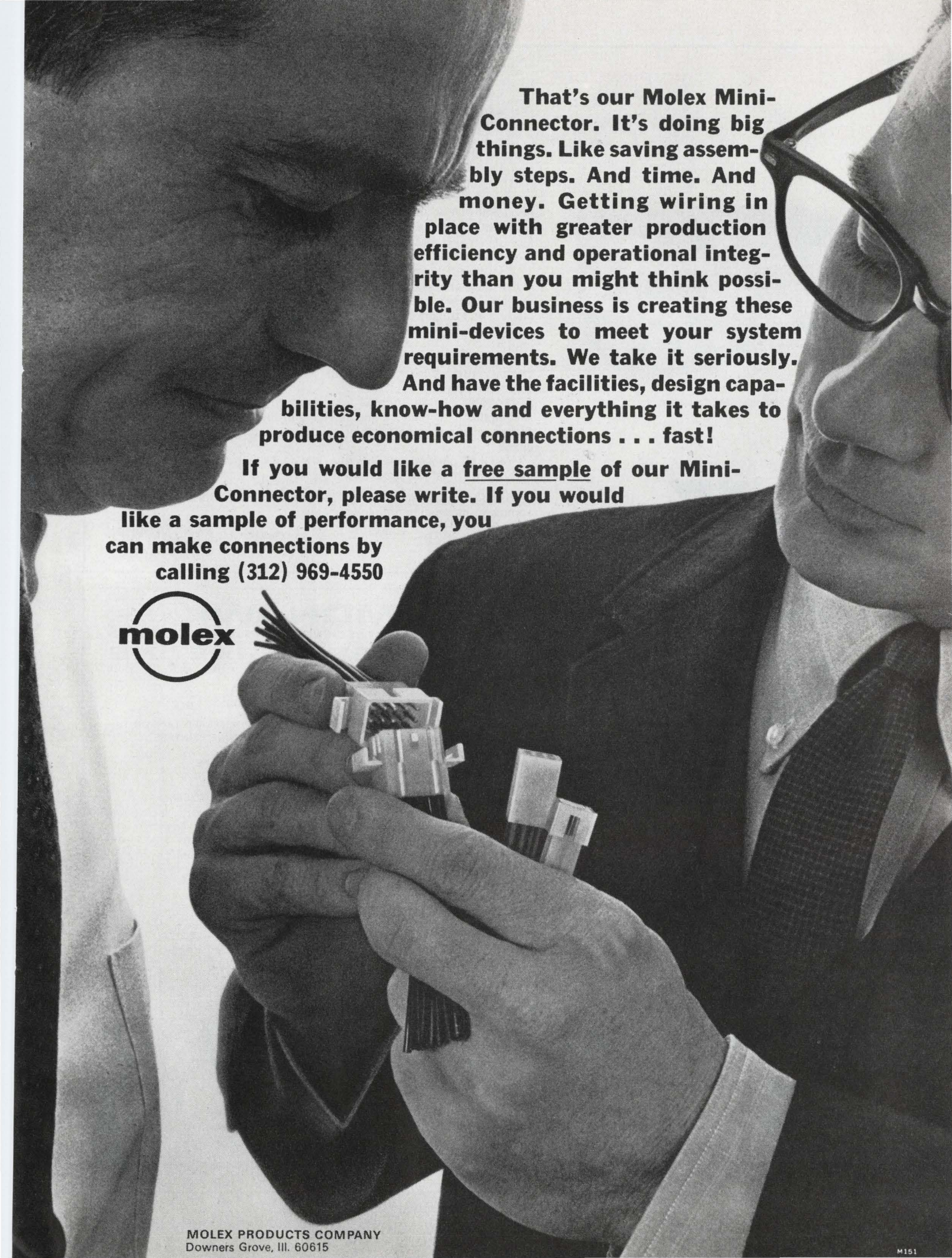

That's our Molex Mini-Connector. It's doing big things. Like saving assembly steps. And time. And money. Getting wiring in place with greater production efficiency and operational integrity than you might think possible. Our business is creating these mini-devices to meet your system requirements. We take it seriously. And have the facilities, design capabilities, know-how and everything it takes to produce economical connections . . . fast!

If you would like a free sample of our Mini-Connector, please write. If you would like a sample of performance, you can make connections by calling (312) 969-4550



**BIG PRINT-OUT
CAPACITIES
COME IN SMALL
MDS PACKAGES**

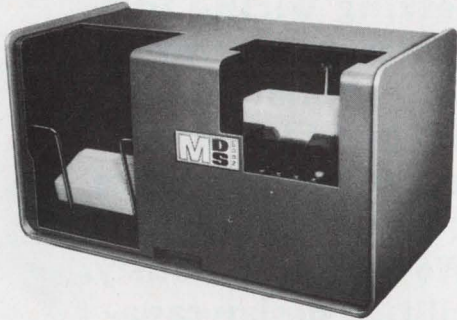

MDS Series 6002 Card Reader

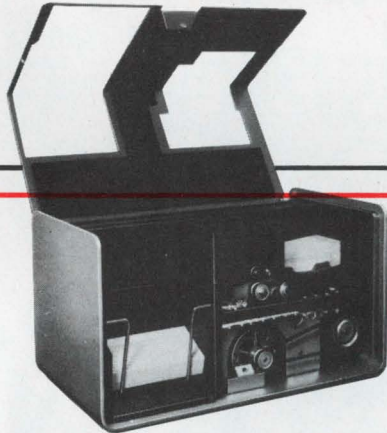

Compactness of 6002 Card Reader mechanism is shown (cover raised). Unit measures only 12½" high x 12½" wide x 23" long.

Requiring less than 2 square feet of space (a trifle larger than a typewriter), the low-cost MDS Series 6002 Card Reader offers many plus features common to more expensive models. Thus it is ideal for peripheral use with small computers or in remote terminals and data communications systems.

Input and output hoppers each hold 500 cards, face-up, and can be replenished during operation. No adjustments are necessary for different types of cards.

The same reliable, proven picker/reader head used in larger MDS Card Readers is used in the 6002, combining picker mechanism, a pneumatic picker throat, photoelectric read station and metering capstans in a single, precision-built assembly. This enables simple interface and flexible operation when combined with end-fed reading and pick-on-demand card processing.

Cards are driven through the read station by metering capstans which also provide 16 precise clock pulses for each column of card motion. These signals . . . and those from sensors which detect the leading and trailing edge of the card . . . enable highly accurate column registration ($\pm 0.0054"$) as well as a check of known vs. measured card length.

The 6002 80-column Card Reader is available with or without logic circuitry (Series 6001 is without) and with options accommodating 51-column cards.

Modular design enables fast, easy interchangeability for many assemblies. Maintenance and servicing problems are minimal . . . MDS sealed units are noted for their ability to withstand rugged, prolonged usage.

You'll be pleased with this true, low-cost compact Card Reader and its built-in "plus" features.

Ask for: MDS folder-file on the low-cost 6002 Reader . . . more complete information and specifications.

FOR MORE — MEET YOUR MAN FROM MDS

MOHAWK MDS
DATA SCIENCES CORPORATION
OEM MARKETING
P.O. BOX 630 • PALISADE ST. • HERKIMER, N.Y. 13350
Telephone 315/866-6800

Every MDS office is an OEM Marketing office

DIGITAL STRIP PRINTERS • BUFFERED TAPE UNITS
HIGH-SPEED AND LOW-SPEED LINE PRINTERS
CARD PUNCHES AND READERS
PAPER TAPE PUNCHES AND READERS

REGIONAL MANAGER OFFICES

Atlanta, Ga. Tel. 404/261-8036
Waltham, Mass. Tel. 617/891-4430
Des Plaines, Ill. Tel. 312/298-4141
S. San Francisco, Calif. Tel. 415/761-0750

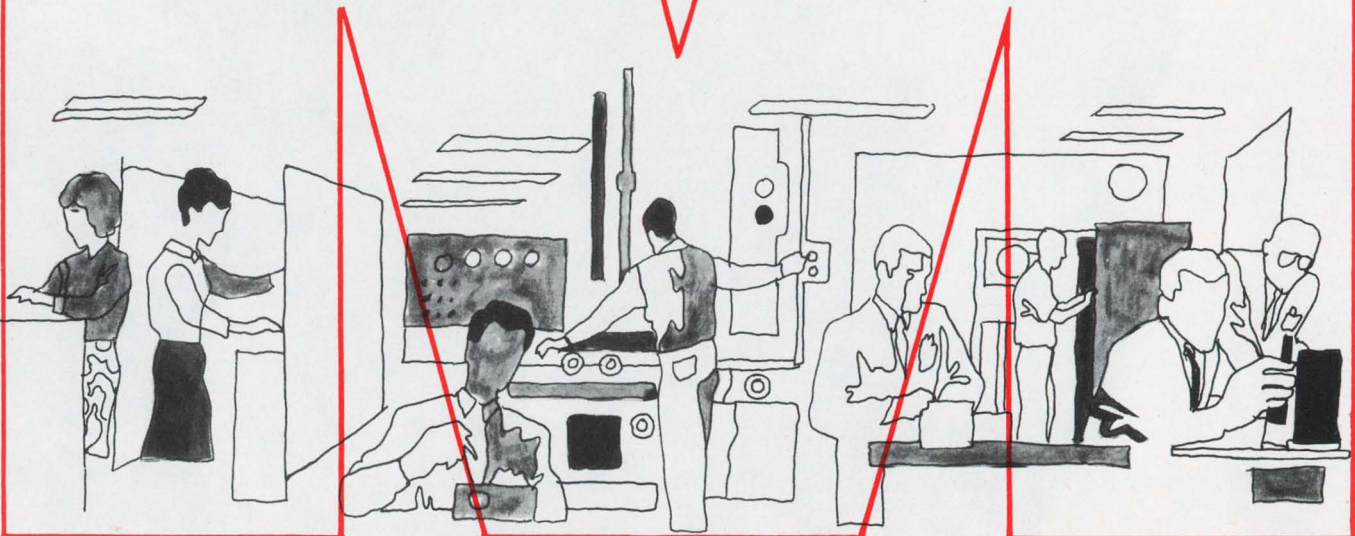

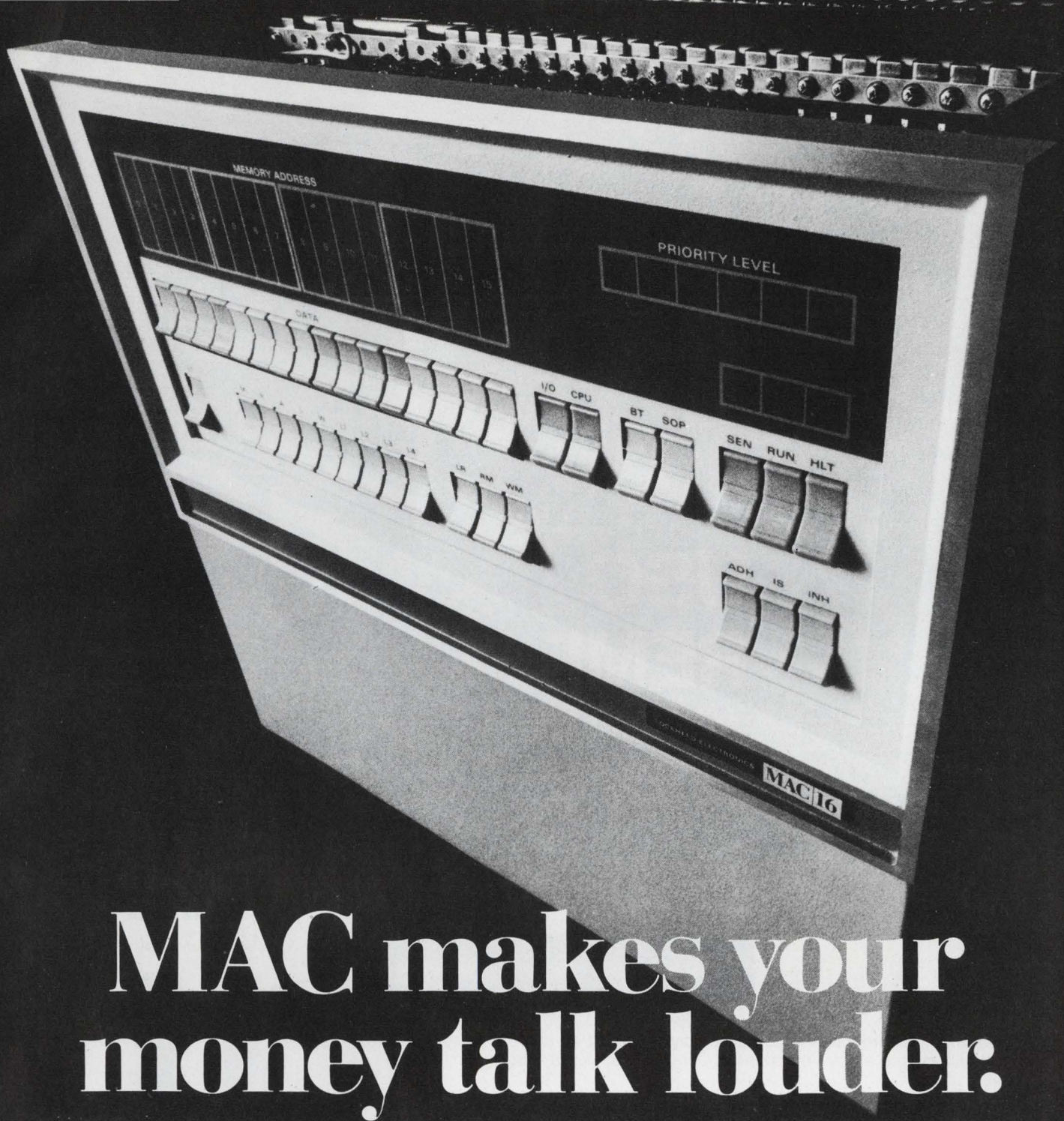

MAC makes your money talk louder.

Putting out \$11,950 for MAC won't make you a big spender. Just a smart one. With MAC in the middle of your real-time system, you've scored.

First, the price is a steal. And it includes teletype. Which makes you a hero with the comptroller — he knows you're watching the shop instead of budget-busting.

Then, you spike the chance of later hang-ups. If the system needs stretching or changing, MAC is capable, flexible and expandable.

Where else, for instance, can \$11,950 buy a basic 4K memory of 16-bit words expandable to 64K with 8K in the mainframe? At 1 μ sec cycle time? With 72 basic hardware instructions? And who else gives you options

you want but can't always get, like hardware multiply/divide, automatic bootstrap, and direct memory access channel? Plus an I/O bus with 255 device addresses, and 4 hardware priority interrupt levels, expandable to 64?

That's bare-bones hardware. But MAC also has the gamut of third-generation software — ready now — including some eye-opening Lockheed exclusives.

Put it this way: If there's a bigger pack of computer value than MAC anywhere near the price, we haven't been watching the shop.

Write to MAC, Lockheed Electronics Company, Data Products Division, 6201 East Randolph Street, Los Angeles, California 90022.

LOCKHEED ELECTRONICS COMPANY
LEC A Division of Lockheed Aircraft Corporation

USC REMI* JOINS THE NAVY

*REmovable REEntrancy Miniature Connector

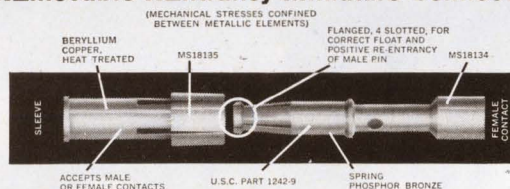

US Components
Printed Circuit Connectors
RWG-37F (Actual size) WG-37M (Actual size)

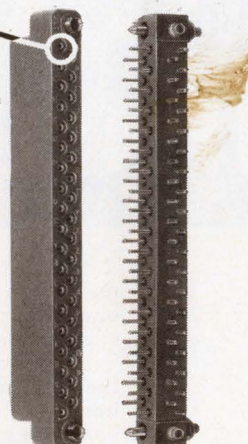

A modern Navy torpedo is a complex seagoing craft in itself. It requires an extremely reliable electro-mechanical "crew" to seek out and destroy enemy subs.

When Westinghouse Electric Corporation was assigned the job of building the wire-guided Mark 48 torpedo, it selected USC REMI* two-unit printed circuit connectors RWG-37F and WG-37M to serve on board. Westinghouse designed these USC REMI* connectors into its vital analog and amplifier circuits of its intricate guidance systems.

Major manufacturers such as Westinghouse know connectors can make a big difference in how well a completed product or system performs. That's why they specify USC where ER** helps simplify designs, save space, enhance reliability and reduce assembly costs.

Makes USC connectors worth investigating, doesn't it?

**USC Established Reliability can do!

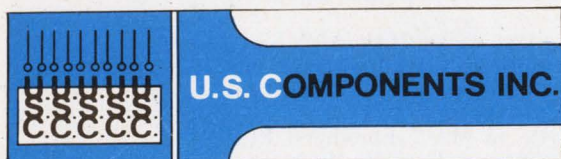

No. of Contacts: 37
Wire Sizes Accommodated: Female Connector, AWG #14 to #30 and MIL-W-16878A #16 to #37. REMI Contacts are ordered separately. Crimping by MIL-T-22570A (WEP) Class I or II tools.
Military Specifications: (Contacts) MIL-C-23216, MIL-C-26636, MS3190. (Connectors) MIL-C-23353, MIL-C-21097. (Latest revisions) U. S. Patent No. 2,979,689 •

1320 ZEREGA AVENUE • BRONX, N.Y. 10462 or use TWX: 710-593-2141 • Tel. 212-824-1600 TELEX: 1-2411 • or Cable: COMPONENTS N.Y.K.
See what is new at NEPCON U. S. COMPONENTS booth 635, Philadelphia, June 10-12.

INFORMATION RETRIEVAL NUMBER 42

INFORMATION RETRIEVAL NUMBER 43 ►

SUPER PIN

Actual Size



Model E-150 PIN Modulator

Model E-150P PIN Controller

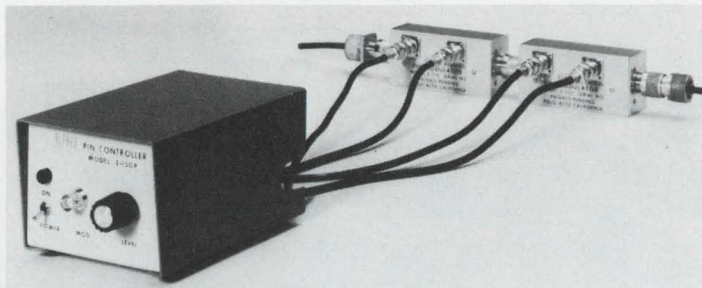

Full 250 MHz to 12.4 GHz attenuation and modulation in a single unit for only \$550.

That's the basic story of the Alfred PIN Modulator, Model E-150. For less than half of what you would pay elsewhere, the Model E-150 provides electronically controllable attenuation in one unit from 250 MHz to 12.4 GHz with wide dynamic range and low SWR at all attenuation levels.

Both input and output are matched at all attenuation levels. Because of its compact size, the unit is well suited to both laboratory and systems applications. The E-150 replaces four single band units for maximum economy and flexibility.

The Model E-150P PIN Controller provides control and power signals for one or two PIN modulator units. In this way attenuation or modulation can be

varied continuously with the E-150P front panel controls and electronically by applying a control signal to the E-150P MOD jack. Two E-150 units can be operated in series to give increased attenuation and dynamic range. The PIN Controller provides both local and remote operation.

Price of the Model E-150 is \$550; Model E-150P, \$175. To arrange a demonstration and secure complete technical information, please call your Alfred sales engineer (listed in EEM and EBG) or write us directly. Please address Alfred Electronics, 3176 Porter Drive, Palo Alto, California 94304. Phone: 415-326-6496. TWX: 910-373-1765.

ALFRED ELECTRONICS

Our private stock isn't private any more.



Motorola's Frequency Control Products are now on the market.

They say that if you want a thing done right, you do it yourself. And so we did. For thirty years, we've been designing and manufacturing our own

frequency control components. Because they had to be good enough to use in our own products.

We've been selfish long enough. Now our precision crystals, oscillators, filters, and tone modules are available to designers and manufacturers throughout the electronics industry. And if the mile-long list of components

isn't long enough, our designers and engineers are ready to go to work on custom projects.

For additional information on existing products and design potentials, write to Motorola Communications & Electronics Inc., 4501 W. Augusta Boulevard, Chicago, Illinois 60651. Ask for Bulletin TIC-3401.



The Readable Little Meters

You can even read the littler little one at arm's length.

(Actual sizes)

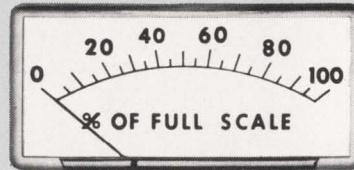

The littler little one.

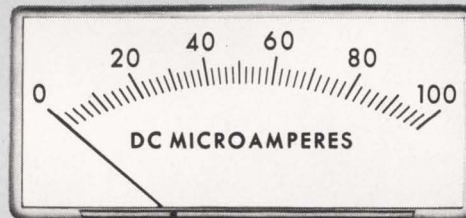

The bigger little one.

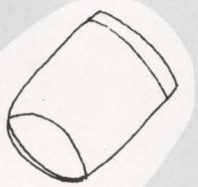

Put your left thumb here.

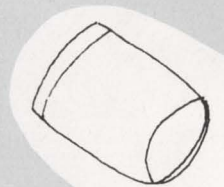

Put your right thumb here.

Honeywell's new Series 80T Panel Meters take up about half the panel space of full-size meters.

But hold this ad out at arm's length and see how easy the meters are to read. (How we ever got such large scales on such small faces without cluttering them, only our designers know.) And we've set the dial up front, so you can see it clearly, even from an oblique angle.

Behind the small face is Honeywell's unique taut-band mechanism - with about

50% fewer parts than a pivot-and-jewel. (One of the parts that's missing is the old space-consuming plastic barrel on the back of the meter.)

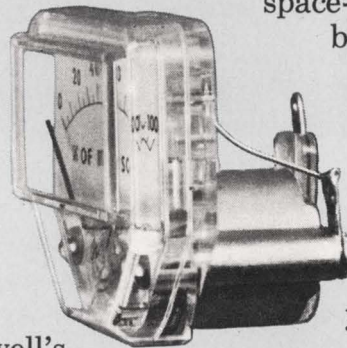

The new Series 80T Panel Meters come in 33 standard ranges. And they cost no more than pivot-and-jewel meters. So you don't have to pay a lot to get a little.

(We'd like to send you a catalog. Write Honeywell Precision Meter Division, Manchester, New Hampshire 03105.)

It takes all kinds of meters to make the Honeywell line.

Honeywell

Technology

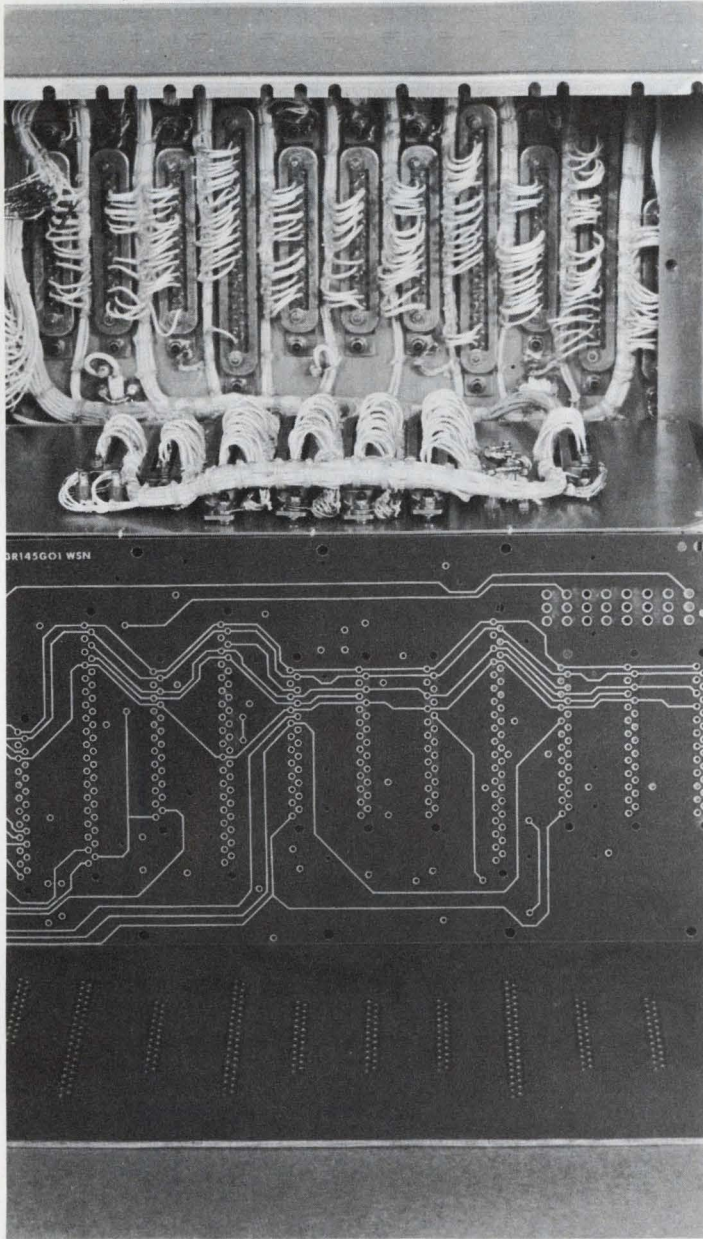

Electric insulating materials are as important to equipment design as they are numerous. But help for the bewildered designer is at hand. p. 65



Be your own sleuth. Learn how to spot seven clues to value in any company's annual report. p. 112

Also in this section:

Design—don't experiment—with ferrite beads. Learn how they work. p. 100

Go graphic with capacitive input filters. Use computer-generated curves. p. 106

Ideas for Design. p. 122

Hybrid I.C. Active Filters

under **\$30** *per pole pair!*

and off-the-shelf delivery!

KTI Model FS-20 Hybrid UNIVERSAL Active Filters.

Band-pass, high-pass and low-pass outputs simultaneously.

Any desired form of the second order transfer function.

Complex zeros anywhere in the S-plane.

Multi-loop negative feedback for added stability.

F_c and Q of basic unit can be tuned by adding external resistors.

Frequency range from D.C. to 50 kHz.

Q Range from 0.1 to 500.

Voltage gain is adjustable to 40 dB.

Supply voltage from ± 9 to ± 15 V with 250 mW power consumption.

Size: 0.804" x 0.366" x 0.474"; 14 pin DIP.

Price:

1 - 5	\$47.00	26 - 99	\$37.00
6 - 10	\$42.00	100 - 999	\$35.00
11 - 25	\$39.00	1000 - 2000	\$28.00



K I N E T I C T E C H N O L O G Y , I N C O R P O R A T E D

17465 Shelburne Way/Los Gatos, California 95030/(408) 356-2131/TWX: 910-597-5390

The name to remember for Hybrid Integrated Systems and Active Filters . . .

Send more information on

- FS-20 Put Me On Your Mailing List
 All Active Filters Hybrid Subsystems

Name _____

Company _____

Address _____

City _____

State _____ Zip _____

My application is

An ELECTRONIC DESIGN Special Report

Insulating Materials

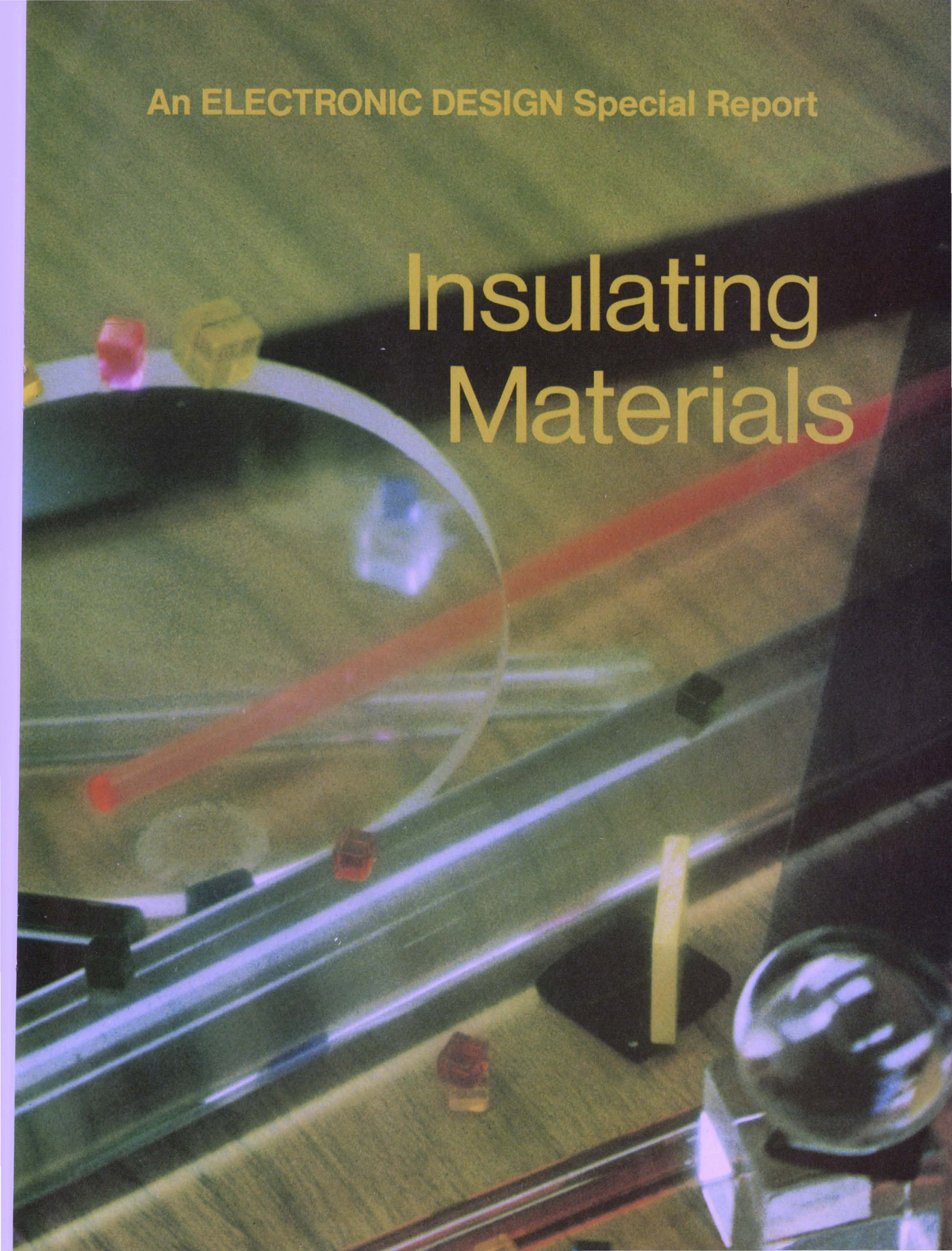

Smart designers keep pace with insulating materials

Acknowledgement: This report is adapted from a chapter of the *Handbook of Electronic Packaging*, Charles A. Harper, Editor, McGraw-Hill Book Co., New York, N.Y., May 1969.

Things are getting tougher all the time for electronic components and equipment. Not only must they perform increasingly sophisticated functions, but they have to do so under multifarious conditions—such as exist in outer space, under the sea, or even under the hood of a car. As a consequence, materials of all types are becoming increasingly important in the design of advanced electronic equipment. And whether the designer likes it or not, the success of his equipment or systems is affected just as much by the materials he chooses as by the circuits and design techniques he employs.

This is especially true for electrical insulating materials, which are being used more and more to meet a widening range of functional objectives. When a designer selects a connector, a circuit board, a plastic IC, or even wire and cable, he is not just specifying parts to implement his design, he is also choosing insulating materials. And no longer will *any* insulating material do. There are simply too many types available—each with its own characteristics, advantages and disadvantages.

In essence, then, it is essential for electronic design engineers to be aware of the state of the

art of insulating materials, and this Special Report is offered as an aid. It presents useful, basic design and selection guidelines in understandable and, for the most part, nonchemical terminology. For ease of use, the material is broken down into the following categories:

- Thermosetting plastics.
- Ceramics, ceramoplastics and glasses.
- Thermoplastics.
- Elastomers.

Dielectric and thermal properties define operation

Although insulating materials have many important properties and characteristics, which are discussed in detail in this report, there are two basic categories which should be mentioned at this time. These are dielectric characteristics and thermal classification.

The primary dielectric, or insulating, characteristics are dielectric strength, resistance and resistivity, dielectric constant, power factor and dissipation factor, and arc resistance. The definitions of these terms, and their significant features, are given in Table 2. (See page 68.)

Thermal classifications of electrical insulating materials are particularly important in modern electronic systems, which often have to operate at elevated temperatures. Most electrical properties of insulators are a function of temperature. Depending on the material, these properties may vary gradually in a given direction with temperature, may alternate to some degree over a temperature range, or may change drastically beyond a critical temperature region.

Written by **Charles A. Harper**, Westinghouse Electric Corp., Baltimore, Md.

For example, resistance and resistivity values generally decrease as temperature increases. Dissipation factor and dielectric constant on the other hand generally increase with temperature, although for many plastics they increase rapidly beyond a critical temperature region, which is different for each material.

In addition to the stability of electrical properties with temperature variation, physical stability as a function of temperature is also an important factor in analyzing the performance of insulating materials. This physical stability, together with the electrical stability, often is expressed by the *continuous-use temperature*. Although this rated value implies no specific property at the stated temperature, it is generally accepted that a material will perform without major physical or electrical instability at the specified continuous-use temperature.

Another widely accepted temperature classification system is the IEEE thermal classification of electrical insulating materials, shown in Table 1. A material properly rated into one of these classifications can be expected to operate continuously and reliably, in an electrical insulating application, up to the maximum operating temperature of its classification for a predetermined period (usually 20,000 hours but sometimes up to 100,000 hours). It should be noted that this system implies performance only as electrical insulation and does not necessarily cover satisfactory mechanical performance. The IEEE classification system has especially wide use in rating wire insulation, as shown by the typical curves of Fig. 1.

Table 1. IEEE thermal classifications

IEEE class*	Typical materials
90	Cotton, silk, paper, lowest-temperature plastics.
105	Cotton, silk, or paper, impregnated or coated, or immersed in dielectric liquid, and low-temperature plastics.
130	Mica, glass fiber, asbestos, epoxies, polyesters, melamines.
155	Mica, glass fiber, asbestos, epoxies, modified polyesters.
180	Silicones, mica, glass asbestos, polyimides, TFE fluorocarbons.
220	Glass or asbestos-reinforced silicones, polyimides, TFE fluorocarbons, and ceramoplastics.
Over 220	Mica, porcelain, glass, quartz, ceramics.

*IEEE class designations correspond to rated temperature (degrees C) for each class.

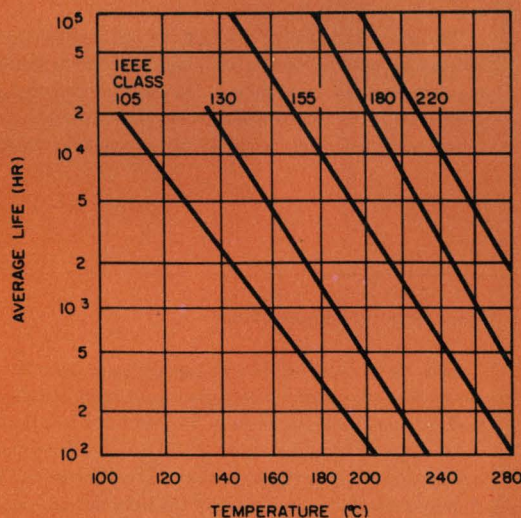

1. Typical life curves for IEEE thermal classes of insulated magnet wire.

Table 2. Basic electrical insulation properties

Property and definition	Significance of values
<p>Dielectric strength</p> <p>All insulating materials fail at some level of applied voltage for a given set of operating conditions. The dielectric strength is the voltage an insulating material can withstand before dielectric breakdown occurs. Dielectric strength is normally expressed in voltage gradient terms, such as volts per mil. Normally, breakdown occurs at a much higher volt-per-mil value in very thin pieces (a few mils thick) than in thicker sections (1/8 in. thick for example).</p>	<p>The higher the value the better the insulator. Dielectric strength of a material (per mil of thickness) usually increases considerably with decrease in insulation thickness. Materials suppliers can provide curves of dielectric strength vs thickness for their insulating materials.</p>
<p>Resistance and resistivity</p> <p>Resistance of an insulating material, like that of a conductor, is the resistance offered by the conducting path to passage of electrical current. Insulating materials are very poor conductors, offering high resistance. For insulating materials, the term "volume resistivity" is more commonly applied. This is the electrical resistance between opposite faces of a unit cube for a given material at a given temperature. The relationship between resistance and resistivity is expressed by the equation $\rho = RA/l$ where ρ = volume resistivity in ohm-cm, R = resistance in ohms between faces, A = area of the faces, and l = distance between faces of the piece on which measurement is made. This is not resistance per unit volume, which would be ohm/cu cm—although this term is sometimes erroneously used.</p> <p>Other terms are sometimes used to describe a specific application or condition. One such term is surface resistivity which is the resistance between two opposite edges of a surface film 1-cm square. Since the length and width of the path are the same, the centimeter terms cancel. Thus, units of surface resistivity are actually ohms. However, to avoid confusion with usual resistance values, surface resistivity is normally given in ohms/sq.</p> <p>Another broadly used term is insulation resistance which, again, is a measurement of ohmic resistance for a given condition, rather than a standardized resistivity test.</p>	<p>The higher the value, the better for a good insulating material. The resistance value for a given material depends upon a number of factors. It varies inversely with temperature, and is affected by humidity, moisture content of the test part, level of the applied voltage, and time during which the voltage is applied.</p> <p>When tests are made on a piece that has been subjected to moist or humid conditions, it is important that measurements be made at controlled time intervals during or after the test condition has been applied, since dry-out and resistance increase occur rapidly.</p>
<p>Dielectric constant</p> <p>The dielectric constant of an insulating material is the ratio of the capacitance of a capacitor containing that particular material to the capacitance of the same electrode system with air replacing the insulation as the dielectric medium. The dielectric constant is also sometimes defined as the property of an insulation which determines the electrostatic energy stored within the solid material. The dielectric constant of most commercial insulating materials varies from about 2 to 10, air having the value 1.</p>	<p>Low values are best for high frequency or power applications, to minimize electrical power losses. Higher values are best for capacitance applications.</p> <p>For most insulating materials, dielectric constant increases with temperature, especially above a critical temperature region which is unique for each material. Dielectric constant values are also affected (usually to a lesser degree) by frequency.</p>
<p>Power factor and dissipation factor</p> <p>Power factor is the ratio of the power dissipated (watts) in an insulating material to the product of the effective voltage and current (volt-ampere input), and is a measure of the relative dielectric loss in the insulation when the system acts as a capacitor. Power factor is nondimensional and is a commonly used measure of insulation quality. It is of particular interest at high levels of frequency and power in such applications as microwave equipment, transformers, and other inductive devices.</p> <p>Dissipation factor is the tangent of the dielectric loss angle. For the low values ordinarily encountered in insulation, dissipation factor is practically the equivalent of power factor, and the terms are used interchangeably.</p>	<p>Low values are favorable, indicating a more efficient system, with lower power losses.</p>
<p>Arc resistance</p> <p>Arc resistance is a measure of an electrical breakdown condition along an insulating surface, caused by the formation of a conductive path on the surface. It is a common measurement with plastic materials, because of the variations among plastics in the extent to which a surface breakdown occurs. Arc resistance is measured as the time, in seconds, required for breakdown along the surface of the material being measured. Surface breakdown (arcing or electrical tracking along the surface) is also affected by surface cleanliness and dryness.</p>	<p>The higher the value, the better. Higher values indicate greater resistance to breakdown along the surface due to arcing or tracking conditions.</p>

Thermosetting plastics

As the name implies, thermosetting materials—or thermosets as they are sometimes called—are cured, set or hardened into a permanent shape. This curing is an irreversible chemical reaction, known as cross linking, which usually occurs under heat. For some thermosetting materials, however, curing is initiated or completed at room temperature. Even here, though, it is often the heat of the reaction that actually cures the plastic material.

Although the cured part can be softened by heat, it cannot be remelted or restored to the flowable state that existed before curing. Hence, these plastics are normally more thermally stable than are thermoplastics, which are covered later.

Application information for thermosetting plastics is presented in Table 3. Included are listings of the major application considerations for each material class, the forms in which the material is available to the designer, and typical suppliers and product trade names. This information should help the designer make a coarse selection of candidate materials. Final selection can then be made from actual design values (Tables 4 and 5), which give the important electrical, physical, mechanical and thermal properties of the thermosetting materials.

It should be mentioned that much tailoring of materials can be done by suppliers, and better than average compounds exist for nearly any

Table 3. Major application considerations for thermosetting plastics

Material	Major application considerations	Common available forms	Typical suppliers and trade names*
Alkyds	Excellent dielectric strength, arc resistance, and dry insulation resistance. Low dielectric constant and dissipation factor. Good dimensional stability. Easily molded.	Compression moldings, transfer moldings	Allied Chemical Corp. (Plaskon), American Cyanamid Co. (Glaskyd)
Aminos (melamine formaldehyde and urea formaldehyde)	Available in an unlimited range of light stable colors. Exhibit hard glossy molded surface, and good general electrical properties, especially arc resistance. Excellent chemical resistance to organic solvents and cleaners and household-type cleaners.	Compression moldings, extrusions, transfer moldings, laminates	Allied Chemical Corp. (Plaskon), Monsanto Co. (Resimene); American Cyanamid Co. (Cymel for melamine; Beetle for urea)
Diallyl phthalates (DAP) (allylics)	Unsurpassed among thermosets in retention of properties in high humidity environments. Also, have among the highest volume and surface resistivities in thermosets. Low dissipation factor, and heat resistance to 400°F or higher. Excellent dimensional stability. Easily molded.	Compression moldings, extrusions, injection moldings, transfer moldings, laminates	FMC Corp. (Dapon); Allied Chemical Corp. (Diall)
Epoxies	Good electrical properties, low shrinkage, excellent dimensional stability and good to excellent adhesion. Extremely easy to compound, using nonpressure processes, for providing a wide variety of end properties. Useful over a wide range of environments. Bisphenol epoxies are most common, but several other varieties are available for providing special properties.	Castings, compression moldings, extrusions, injection moldings, transfer moldings, laminates, matched-die moldings, filament windings, foam	Shell Chemical Co. (Epon); Celanese Co. (Epi-Rez); Dow Chemical Co. (D.E.R.); Ciba Products Co. (Araldite); Union Carbide Corp. (ERL); 3M Co. (Scotchcast)
Phenolics	Among the lowest-cost, most widely used thermoset materials. Excellent thermal stability to over 300°F generally, and over 400°F in special formulations. Can be compounded to a broad choice of resins, fillers, and other additives.	Castings, compression moldings, extrusions, injection moldings, transfer moldings, laminates, matched-die moldings, stock shapes, foam	Union Carbide Corp. (Bakelite); Hooker Chemical Corp. (Durez)
Polyesters	Excellent electrical properties and low cost. Extremely easy to compound using nonpressure processes. Like epoxies, can be formulated for either room temperature or elevated temperature use. Not equivalent to epoxies in environmental resistance.	Compression moldings, extrusions, injection moldings, transfer moldings, laminates, matched-die moldings, filament windings, stock shapes	Pittsburgh Plate Glass Co. (Selectron); American Cyanamid Co. (Laminac); Rohm & Haas Co. (Paraplex)
Silicones (rigid)	Excellent electrical properties, especially low dielectric constant and dissipation factor, which change little up to 400°F and over.	Castings, compression moldings, transfer moldings, laminates	Dow Corning Corp. (DC Resins)

* This listing is only a very small sampling of the many possible suppliers. No preferences are implied or intended.

Table 4. Room-temperature electrical properties of thermosetting plastics

Property	Alkyd		Melamine		Urea cellulose	Polyester glass
	Mineral filled	Glass filled	Cellulose filled	Glass filled		
Volume resistivity 50% RH (ohm-cm)	10 ¹³ -10 ¹⁵	10 ¹⁵	-	2.0 x 10 ¹¹	10 ¹² -10 ¹³	10 ¹² -10 ¹⁵
Dielectric strength (V/mil) Short time, 1/8-in. Step-by-step, 1/8-in.	350-450 300-350	350 300	350-400 250-350	170-300 170-240	300-400 220-300	345-420 275-390
Dielectric constant 60 Hz 1 kHz 1 MHz	5.1-7.5 5.0-6.2 4.6-5.5	5.7 5.4 5.2	6.2-7.6 6.0-7.5 4.7-7.0	9.7-11.1 - 6.6-7.5	7.0-9.5 7.0-7.5 6.8	5.3-7.3 4.68 5.2-6.4
Dissipation factor 60 Hz 1 kHz 1 MHz	0.009-0.06 0.007-0.03 0.006-0.04	0.010 0.007 0.008	0.019-0.033 0.013-0.034 0.032-0.060	0.14-0.23 - 0.013-0.015	0.035-0.043 0.025-0.035 0.25-0.35	0.011-0.041 - 0.008-0.022
Arc Resistance (s)	75-190	180	95-135	180	80-150	120-240

Property	Diallyl phthalate		Epoxy		Phenolic		Silicone	
	Mineral filled	Glass filled	Mineral filled	Glass filled	Wood flour filled	Glass filled	Mineral filled	Glass filled
Volume resistivity 50% RH (ohm-cm)	10 ¹³ +	10 ¹³ -10 ¹⁶	>10 ¹⁴	>10 ¹⁴	10 ⁹ -10 ¹³	7 x 10 ¹²	10 ¹⁴	10 ¹⁰ -10 ¹⁴
Dielectric strength (V/mil) Short time, 1/8-in. Step-by-step, 1/8-in.	395-420 390-400	395-450 395-400	300-400 300-400	300-400 300-400	200-400 100-375	140-400 120-270	200-400 380	200-400 125-300
Dielectric constant 60 Hz 1 kHz 1 MHz	5.2 4.8-5.3 3.9-4.0	4.3 4.1-4.4 3.4-4.5	3.5-5.0 3.5-5.0 3.5-5.0	3.5-5.0 3.5-5.0 3.5-5.0	5.0-13 4.4-9.0 4.0-6.0	7.1 6.9 4.6-6.6	3.5-3.6 - 3.4-6.3	3.3-5.2 3.2-5.0 3.2-4.7
Dissipation factor 60 Hz 1 kHz 1 MHz	0.03-0.06 0.03-0.10 0.02-0.04	0.01-0.05 0.004-0.009 0.009-0.014	0.01 0.01 0.01	0.01 0.01 0.01	0.05-0.30 0.04-0.20 0.03-0.07	0.05 0.02 0.012-0.026	0.004-0.005 - 0.002-0.005	0.004-0.03 0.0035-0.02 0.002-0.02
Arc resistance (s)	140-190	125-180	150-190	120-180	Tracks	To 190	250-420	150-250

Table 5. Physical and mechanical properties of thermosetting plastics

Property	Diallyl phthalate		Silicone		Epoxy		Alkyd and polyester		Phenolic		Melamine	
	Mineral filled	Glass filled	Mineral filled	Glass filled	Mineral filled	Glass filled	Mineral filled	Glass filled	Flock filled	Glass filled	Flock filled	Glass filled
Mold shrinkage, in./in.	0.004-0.006	0.002	0.006-0.007	0-0.005	0.001-0.008	0.001-0.002	0.004-0.010	0.002-0.006	0.004-0.009	0.0001-0.001	0.006-0.007	0.001-0.004
Specific gravity	1.50-1.60	1.55-1.70	1.81-2.82	1.68-2.0	1.6-2.06	1.8-2.0	1.60-2.30	1.8-2.3	1.32-1.45	1.75-1.95	1.50-1.55	1.8-2.0
Tensile strength, psi	3000-8000	5000-10000	3000-3500	4000-5000	5000-7000	-	3000-8000	4000-10000	6500-9000	5000-10000	7000-9000	5000-10000
Compressive strength, psi	18000-25000	20000-30000	15000-18000	10000-15000	18000-25000	-	18000-25000	20000-30000	22000-36000	17000-26000	30000-35000	20000-35000
Flexural strength, psi	6000-10000	10000-20000	7000-8000	10000-14000	10000-15000	-	6000-10000	12000-20000	8500-12000	10000-16000	13000	15000-23000
Impact strength (ft-lb/in. of notch) (1/2 x 1/2 in. notched bar izod test)	0.30-0.50	1.0-10.0	0.26-0.35	3-15	0.25-0.40	-	0.30-0.50	1.5-16.0	0.24-0.60	10-50	0.4-0.45	4.0-6.0
Water absorption (24 hr, 1/8 in. thickness), %	0.2-0.3	0.1-0.3	0.13	0.1-0.2	0.1	0.05-0.095	0.05-0.05	0.06-0.28	0.3-1.0	0.1-1.2	0.16-0.3	0.09-0.21
Thermal conductivity, 10 ⁻⁴ cal per sec per sq cm per °C per cm	7.0-10.0	7.0-10.0	-	7.51-7.54	7-18	7-10	7.0-15.0	7.0-10.0	4-7	-	-	11.5
Thermal expansion, 10 ⁻⁵ per °C	2.0-3.0	2.0-3.0	-	0.8	2.5-5.0	1.1-3	3.5-5	2.5-3.3	3.0-4.5	1.6	-	1.5
Resistance to heat, °F (continuous)	350-450	350-500	>600	>600	300-500	330-500	300-350	300-350	360-500	350-500	250	300-400

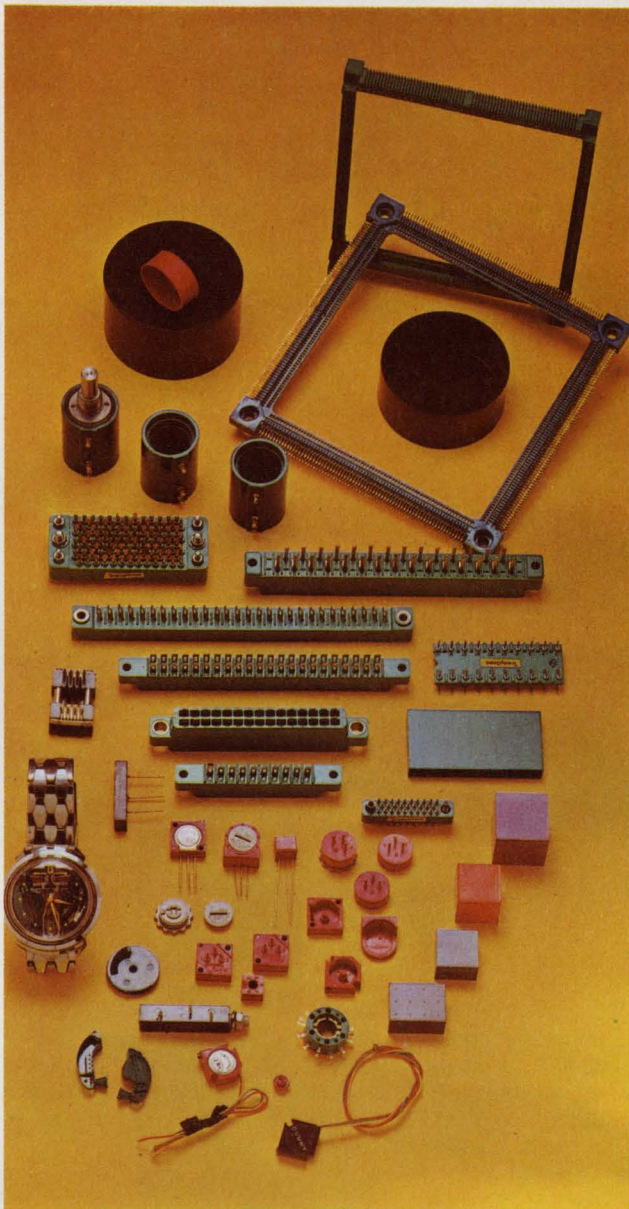

Diallyl phthalate is used in a variety of electronic parts, including connectors, memory frames and equipment housings. (photo courtesy FMC Corp.)

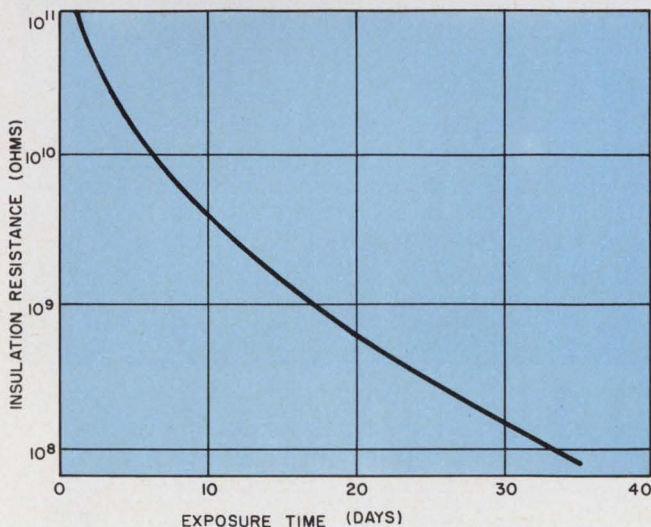

2. Effect of 95% humidity at 60°C on the 500 Vdc insulation resistance of an alkyd molding compound.

given design feature. Further, material improvements are constantly being made. Hence, consultation with suppliers is always advised in cases where any doubt exists.

As shown in Table 3, the principal thermo-setting materials are the

Alkyds	Phenolics
Aminos	Polyesters
Diallyl phthalates	Silicones
Epoxies	

Alkyds are good for molded parts

Alkyds are widely used for molded electrical parts, since they are easy to mold and economical to use. Molding dimensional tolerances can be held to within ± 0.001 inch per inch. Post molding shrinkage is small. Their greatest limitation is in extremes of temperature (above 350°F) and in extremes of humidity. In these respects silicones and diallyl phthalates are superior—silicones especially with respect to temperature, and diallyl phthalates with respect to humidity. The electrical insulation resistance of alkyds decreases considerably in high, continuous humidity conditions, as shown in Fig. 2.

Alkyds are chemically somewhat similar to polyester resins. Normally, the term alkyds is used to denote liquid resins, or low-pressure molding compounds. Alkyd molding compounds are commonly available in putty, granular, glass-fiber-reinforced and rope form.

Aminos are durable

Amino molding compounds are economical to mold, and they result in parts that are hard, rigid, abrasion-resistant, and have high resistance to deformation under load. They can be exposed to sub-zero temperatures without embrittlement, and have excellent electrical insulation characteristics. In addition, they are unaffected by common organic solvents, greases and oils, and weak acids and alkalis.

Of the two major types of aminos, namely melamines and ureas, melamines are superior to ureas in resistance to acids, alkalis, heat and boiling water, and are preferred for applications involving cycling between wet and dry conditions or rough handling. Both provide excellent heat insulation, and temperatures up to the destruction point will not cause parts to lose their shape.

When amino moldings are subjected to prolonged elevated temperatures, a loss of certain strength characteristics occurs. Some electrical characteristics are also adversely affected. Arc resistance of some industrial types, though, remains unaffected after exposure at 500°F.

Ureas are unsuitable for outdoor exposure, while melamines experience little degradation in

electrical or physical properties after outdoor exposure, although color changes may occur.

Diallyl phthalates shine at high temperatures

Diallyl phthalates are among the best of the thermosetting plastics with respect to high insulation resistance and low electrical losses. They maintain these favorable properties up to 400°F or higher, and in the presence of high humidity environments. This makes them an excellent choice for use in environmental-type connectors (Fig 3). Diallyl-phthalate resins are also easily molded and fabricated.

There are several chemical variations of diallyl-phthalate resins, but the two most commonly used are basic diallyl phthalate (DAP) and diallyl-isophthalate (DAIP). The primary application difference is that DAIP will withstand somewhat higher temperatures than will DAP.

The excellent dimensional stability of diallyl phthalates is demonstrated in Fig. 4, which compares them to other materials at various temperatures. The excellent electrical properties of diallyl phthalates are shown in Figs. 5 through 8.

Epoxies are extremely versatile

For electronic applications, epoxies are among the most versatile and widely used plastics. This is primarily because of the wide variety of formulations possible, and the ease with which they can be used. Formulations range from flexible to rigid in the cured state, and from thin liquids to thick pastes in the uncured state. Conversion from the uncured to the cured state is made by

use of hardeners and/or heat.

The main uses of epoxies in the electronics field are for embedding applications (potting, casting, encapsulating and impregnating) and in laminated constructions, such as metal-clad laminates for printed circuits and unclad laminates for various types of insulating and terminal boards.

Epoxies are available for the most part as liquid or solid resins, and as powdered molding compounds. The molding compounds are widely used to mold boxes for electronic modules, and



3. Miniature connector uses a glass-filled diallyl phthalate (DAP) molding compound to provide insulation between all of the 61 pins. Designed by Microdot, the multi-pin insert has a recommended working voltage of 750 V rms. (photo courtesy FMC Corp.)

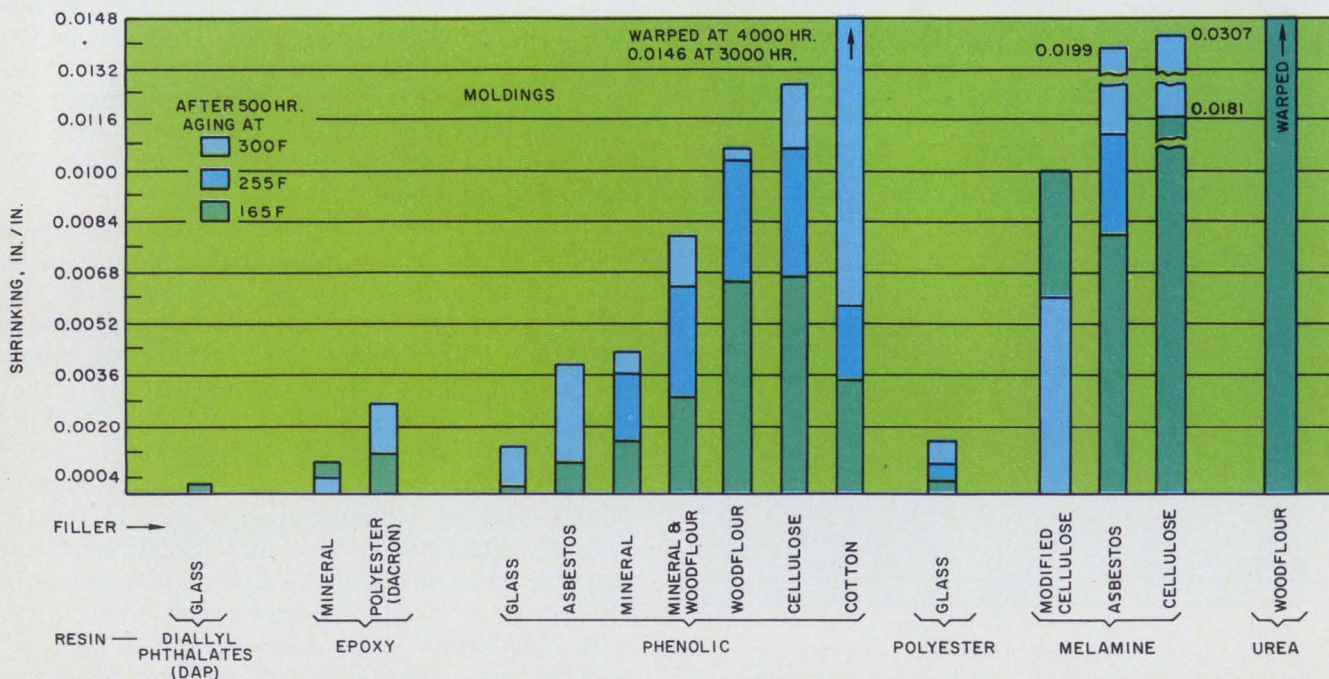

4. Shrinkage of various thermosetting molding materials as a result of heat aging.

even more widely to directly mold modules by the transfer molding technique (Fig. 9). They are also used for transfer and compression molding of many other types of electrical parts. The liquid resins find their broadest use in embedding applications and in the fabrication of laminate boards. Advanced multilayer circuit boards are almost exclusively based on epoxies.

In addition to their versatility and good electrical properties, epoxies are also outstanding in their low shrinkage, their dimensional stability and their adhesive properties. Their shrinkage

is often less than 1%, and the "as-molded" dimensions of an epoxy part change little with time or environmental conditions, other than excessive heat. Because of the low shrinkage and good strength properties of epoxies, cured epoxy parts resist cracking—both upon curing and in thermal shock—better than most other rigid thermosetting materials.

Based on the excellent bonds that can be obtained to most substrates with epoxy resins, epoxy formulations are broadly used as adhesives in electronic-equipment applications. Even when not specifically used as adhesives, epoxies have bonding properties that often provide a better seal around inserts, terminals and other interfaces than do most other plastic materials.

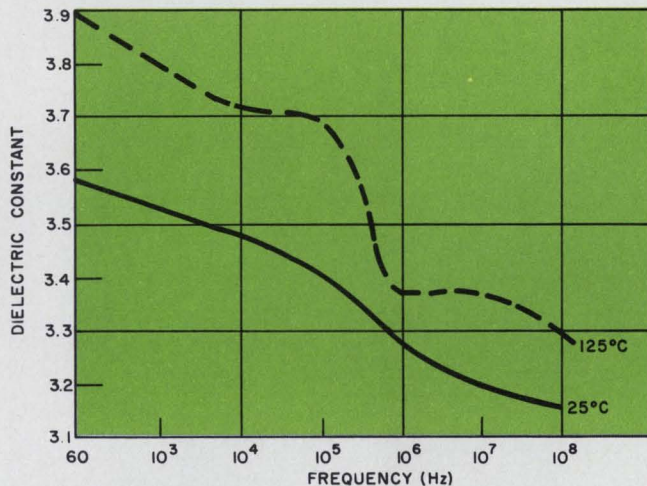

5. Effect of frequency and temperature on the dielectric constant of unfilled diallyl phthalate.

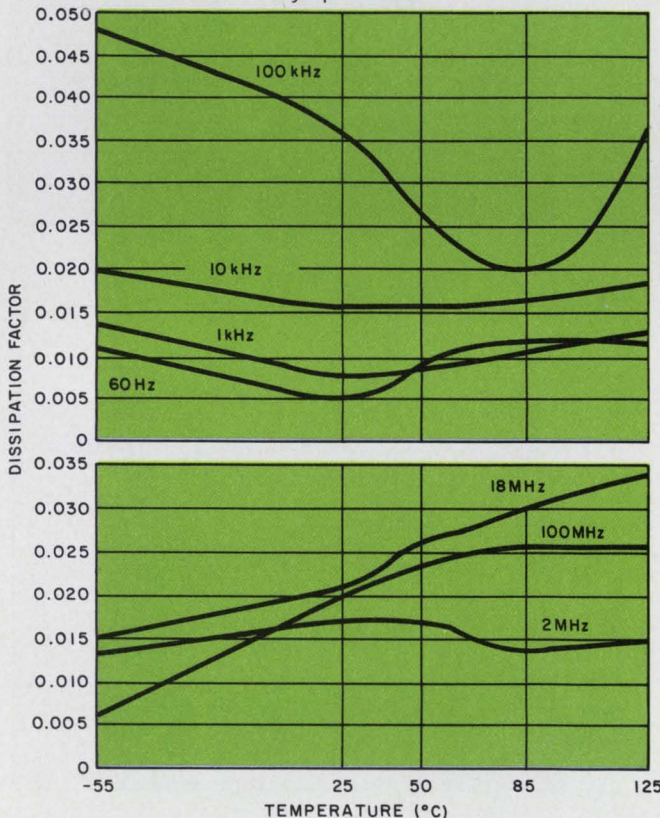

6. Effect of frequency and temperature on the dissipation factor of unfilled diallyl phthalate is shown for a frequency span of 60 Hz to 100 MHz.

Phenolics have widespread general-purpose use

Phenolics are among the oldest and best known general-purpose molding materials. They are also among the lowest in cost and the easiest to mold. An extremely large number of phenolic materials is available, based on the many resin and filler combinations. Though phenolics are broadly used for general-purpose insulating uses, it should be noted that many special-purpose electrical grades are now available, including low-loss types.

While it is possible to get various grades of phenolics for different applications, they are, generally speaking, not equivalent to a diallyl phthalate and epoxies in resistance to humidity, shrinkage, dimensional stability, and retention of electrical properties in extreme environments. Phenolics are, however, quite adequate for many applications where the electrical requirements

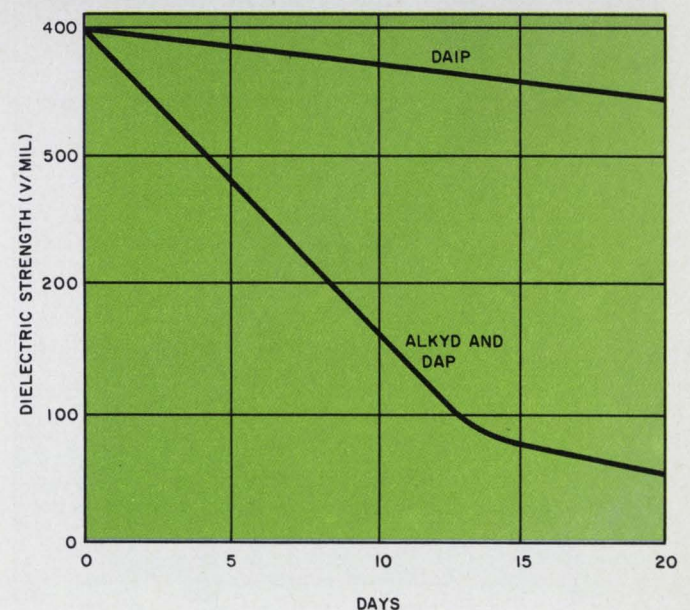

7. Effect of heat aging at 400°F on the dielectric strength of diallyl phthalate (DAP), diallyl isophthalate (DAIP) and alkyd molding materials.

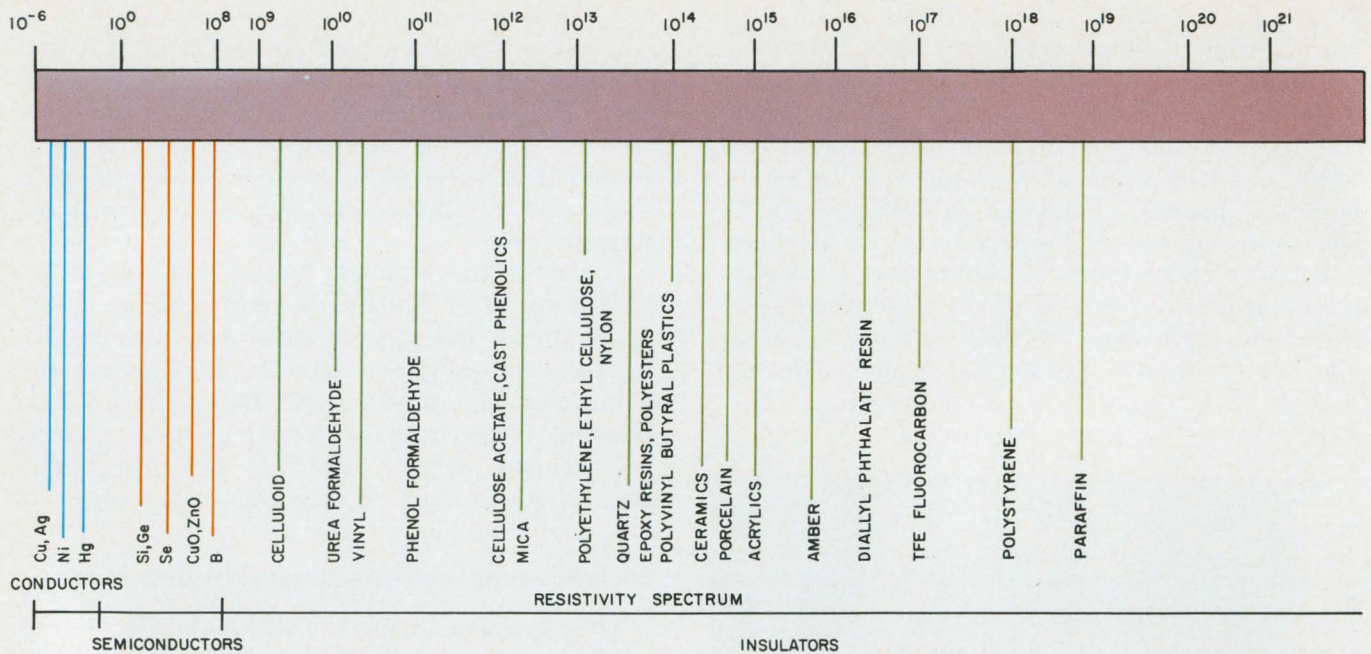

8. Resistivity spectrum for a variety of engineering materials shows that diallyl phthalate, TFE fluorocarbon and polystyrene rate highest among insulating materials,

all having resistivities in excess of 10^{16} ohm-cm. The values shown, which are expressed in ohm-cm, are for the case of unfilled resins.

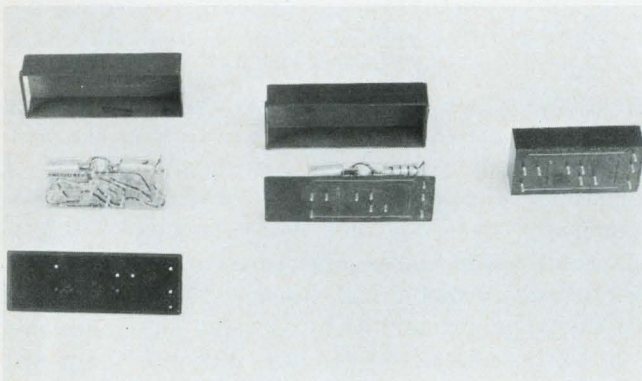

9. Epoxy molding material can be used for module cases (left), as well as for directly molded modules (right). (photo courtesy Westinghouse Electric Corp.)

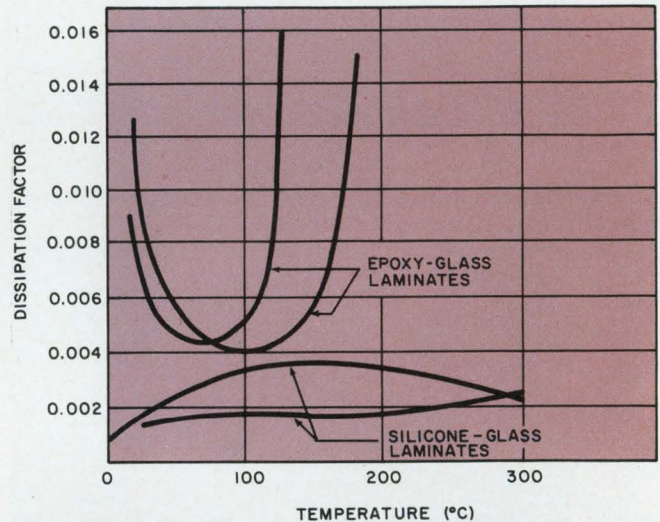

11. Dissipation factor vs temperature for silicone-glass and epoxy-glass laminates.

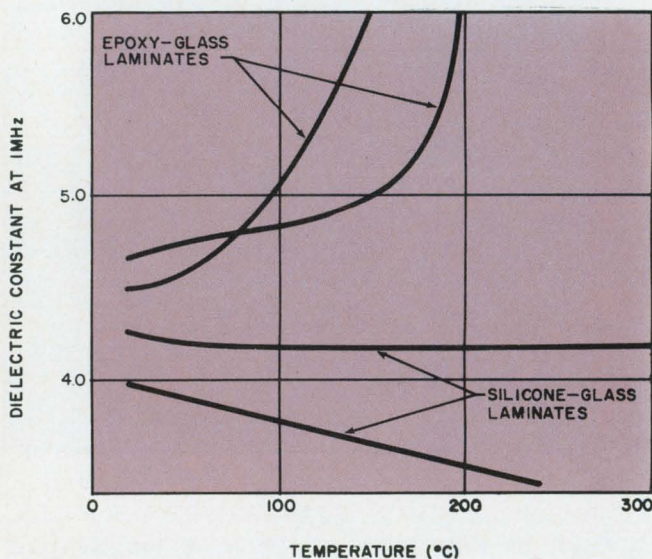

10. Dielectric constant vs temperature for silicone-glass and epoxy-glass laminates.

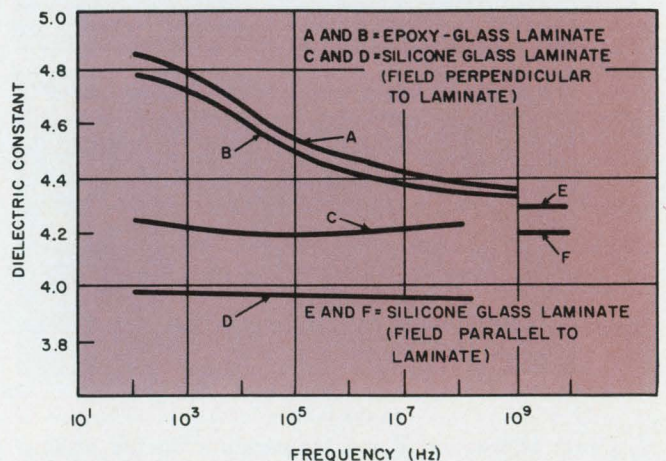

12. Dielectric constant vs frequency at room temperature for silicone-glass and epoxy-glass laminates.

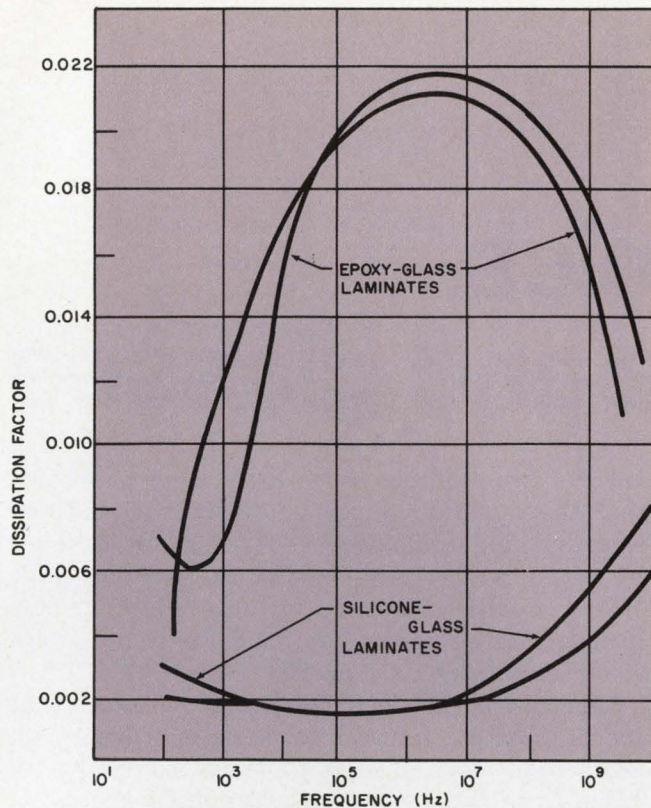

13. Dissipation factor vs frequency at room temperature for silicone-glass and epoxy-glass laminates.



14. Four spiral antennas used for space-vehicle applications take advantage of the low-loss properties of silicone laminates. The antennas, made by Westinghouse, consist of copper strips, etched to form a spiral pattern, and bonded to a silicone-glass laminate. (photo courtesy Dow Corning Corp)

are not too severe. Further, the glass-filled, heat-resistant grades are outstanding in thermal stability up to 400°F and higher.

Polyesters compete with epoxies

Polyesters are versatile resins that, from a chemical standpoint, are similar to the alkyds and from a handling and application standpoint are much like the epoxies. They are available in forms ranging from low-viscosity liquids to thick pastes or putties. The liquids are used for embedding applications and laminated products, much like the epoxies, and the pastes are used for molding applications.

The major advantages of polyesters over epoxies are lower cost and lower electrical losses for the best electrical-grade polyesters. Some important disadvantages of polyesters, as compared to epoxies, are lower adhesion to most substrates, higher polymerization shrinkage, a greater tendency to crack during cure or in thermal shock, and greater change of electrical properties in a humid environment.

Silicones resist temperature aging

Silicones are thermosetting polymers that can be classified as elastomers, when the cured product is rubberlike, classified as embedding materials, when the basic plastic form is a castable liquid (either rubberlike or rigid), or classified as molding compounds, especially low-pressure transfer molding compounds for electronic module embedment. They find wide usage, not only in electronic packaging, but for laminated products, molded parts and adhesives.

The most important properties of silicones for electronic applications are excellent electrical properties, which do not change drastically with temperature or frequency over the materials' safe operating temperature range. This is shown in Figs. 10 through 13, which compare epoxy and silicone laminates. In addition, silicones are among the best of all plastic materials in resistance to temperature-aging effects. Usable temperatures of 500°F - 700°F are possible with available silicone materials. Hence, silicones are very well suited for high-temperature electronic applications, especially those applications requiring low electrical losses.

The mechanical properties of silicone molding compounds are not as stable with increasing temperature as are the electrical properties. Most mechanical properties, however, are stable in other extreme environments, such as humidity and vacuum. This has led to the wide use of silicones both in military and space applications. A good example of silicone design capabilities for extreme conditions is shown in Fig. 14.

Ceramics, ceramoplastics and glasses

Ceramics, ceramoplastics and glasses are inorganic, electrical insulating materials that offer some special design features to the electronic designer. All of these materials have higher temperature capabilities and greater dimensional stability than plastics. However, they differ from each other in important engineering and application respects.

Ceramics must be chosen for electrical properties

Like plastics, ceramics are good electrical insulators, although they have much better thermal conductivity than do plastics. This characteristic makes ceramics very useful in applications requiring electrically insulated heat sinks. Ceramics do not, in general, have low dielectric constants, and do not rate as well as many plastics in this respect.

In addition to their good thermal and electrical properties, ceramics offer greatly improved dimensional stability over most plastics—especially at slightly elevated temperatures. This is true in both thermal expansion and physical distortion properties, such as flatness and warpage. Although ceramics are generally harder and more brittle than plastics, they can often be machined, assembled, and fabricated with comparative ease. Further, ceramics can be metalized or coated and thus fabricated into many useful electronic items.

Ceramics are widely used as substrates for thick and thin film circuits, and for electronic packages, such as integrated-circuit flat packs. In addition, certain ceramic materials—notably those based on titanates such as barium titanate—can be made with a controlled dielectric constant over a wide range, making possible their use as capacitors.

Included in the broad category of ceramic materials are aluminas, steatites, forsterite, zircons, titania, titanates, cordierite, lava, magnesia, magnesium silicate, silicon carbides, zirconia, beryllia, porcelain, mullite, spinel, quartz and boron nitride. Some of these ceramics are available in

various compositions and degrees of purity so that the materials must be fairly well defined when making comparisons. Also, some of these ceramics, while good insulators, do not have other properties required for high-reliability performance of electronic equipment in extreme environments, such as humidity.

Hence, it is the electrical-quality ceramics that are of greatest interest to electronic designers. Basic properties of some of these are shown in Table 7. Variations of dielectric constant and dissipation factor with frequency and temperature are shown in Fig. 15 for one alumina and one beryllia. These two types are among the most widely used ceramics in electronics.

Aluminas are harder, stronger and more resistant to wear than most other ceramics and are better electrical insulators, especially at higher temperatures and higher frequencies. These properties are responsible for their widespread use in avionic radomes (Fig. 16). Although aluminas are usually in the form of dense ceramics, they can also be obtained in porous forms, which are easily outgassed and find wide use as electron-tube insulators.

Steatites are usually easier to manufacture into final product form than the aluminas, and therefore are generally more economical. For many years they were the top performers in technical ceramics, and they still have a wide field of usefulness. In many applications it is worthwhile to study the characteristics of steatites (Table 6) to see if they meet the needed performance requirements. This may help prevent the needless use of a more expensive ceramic.

Forsterite serves well where the primary requirement is for very-low-loss insulators. It is somewhat difficult to form and frequently requires grinding to meet close dimensional requirements. The high coefficient of expansion matches that of several metals, but at a sacrifice in thermal shock resistance.

Titania has high mechanical strength and great hardness. It is excellent for mechanical applications requiring wear and chemical resistance. It

Table 6. Properties of representative ceramics*

Property	Steatite	Forsterite	Zircon	Cordierite	Lava (natural stone) grade A, aluminum silicate	Alumina	Beryllia ⁽³⁾
	MgO · SiO ₂ Alsimag 665 L-533	2MgO · SiO ₂ Alsimag 243 L-723	ZrO ₂ · SiO ₂ Alsimag 475 L-514	2MgO · 2Al ₂ · O ₃ 5SiO ₂ Alsimag 701		Al ₂ O ₃ Alsimag 753 L-724	BeO Alsimag 754 L-623
Water absorption, %	0	0	0	0.02-1	2-3	0	0
Specific gravity	2.7	2.8	3.7	2.3	2.3	3.85	2.88
Safe temperature at continuous heat	1000 °C	1000 °C	1100 °C	1200 °C	1100 °C	1650 °C	1600 °C
Hardness, Moh's scale	7.5	7.5	8	8	6	9	9
Thermal expansion, 25-300 °C	6.9 x 10 ⁻⁶	10 x 10 ⁻⁶	4.3 x 10 ⁻⁶	2.4 x 10 ⁻⁶	3.3 x 10 ⁻⁶	7.1 x 10 ⁻⁶	6 x 10 ⁻⁶
Thermal conductivity, 300 °C ⁽¹⁾	0.006	0.008	0.012	0.008	0.005	-	0.28
Dielectric strength, 60-cycle ac, volts/mil	230	240	220	225	80	230	240
Volume resistivity, ohm/cm							
25 °C	>10 ¹⁴	>10 ¹⁴	>10 ¹⁴	1.0 x 10 ¹⁴	>10 ¹⁴	>10 ¹⁴	>10 ¹⁴
100 °C	1.0 x 10 ¹⁴	5 x 10 ¹³	2 x 10 ¹³	2.5 x 10 ¹¹	6 x 10 ¹¹	>10 ¹⁴	>10 ¹⁴
Dielectric constant, 1 MHz, 25 °C ⁽²⁾	6.3	6.2	8.8	5.3	5.3	9.4	6.4
Dissipation factor, 1 MHz, 25 °C ⁽²⁾	0.0008	0.0004	0.0010	0.0047	0.010	0.0001	0.0001
Loss factor, 1 MHz, 25 °C ⁽²⁾	0.0050	0.002	0.009	0.025	0.053	0.0009	0.0006

(1) Conversion factor figures are in cal/(cm) (s) (cm²), one of which equals 2902 Btu/(in.) (hr) (ft²) (°F.)

(2) AlSiMag 243, 475, and 665 measured wet at 1 MHz, after immersion in water for 48 hr (MIL-I-10A).

(3) In working with beryllia ceramics, personnel should avoid exposure to dust- or fume-producing operations, such as sawing and grinding, in moist atmospheres at high temperatures. Specialized equipment is necessary to prevent the dispersal of the dust and fumes into the air.

*Courtesy American Lava Corp.

Table 7. Properties of some representative glass-bonded micas*

Property	Units	Machining grades, sheets and rods			Custom injection molded grades		
		Mykroy 750	Mykroy 1100	Mykroy 1116	Mykroy 761	Mykroy 777	Mykroy 1001
General:							
Specific gravity	-	3.3	3.2	3.2	3.6	3.9	3.1
Moisture absorption	-	Nil	Nil	Nil	Nil	Nil	Nil
Max. continuous temp.	°F	750°	1100°	1100°	750°	790°	1100°
Coefficient of expansion	x 10 ⁻⁶ °F	5.6	5.2	5.2	6.0	5.1	5.0
Electrical:							
Volume resistivity	ohm-cm	10 ¹³	10 ¹⁴	10 ¹⁴	10 ¹⁴	10 ¹⁴	10 ¹³
Dielectric, 1/8 in.	volts/mil	350	400	400	350	350	400
Dielectric constant	1 MHz	7.1	7.50	7.4	8.2	9.2	6.8
Dissipation factor	1 MHz	0.0014	0.0012	0.0019	0.0011	0.0016	0.0011
Loss factor	1 MHz	0.0099	0.016	0.014	0.009	0.015	0.008
Surface resistivity, dry	ohm	10 ¹⁶	10 ¹⁶	10 ¹⁶	10 ¹⁵	10 ¹⁵	10 ¹⁵
Surface resistivity, wet	ohm	10 ¹⁰	10 ¹¹	10 ¹²	10 ⁹	10 ¹⁰	10 ⁹

*Courtesy Molecular Dielectrics, Inc.

Table 8. Properties of representative commercial glasses*

Type of glass	Coefficient of expansion per °C, 0-300 °C	Density, g/cm ³	Refract. index, sodium D line	Electrical properties			
				Log ¹⁰ vol res., ohm-cm		Dielectric properties 1 MHz, 20 °C	
				250 °C	350 °C	Power factor	Dielectric constant
Silica glass (fused silica)	5.5 x 10 ⁻⁷	2.20	1.458	12.0	9.7	0.0002	3.78
96% silica glass, 7900	8 x 10 ⁻⁷	2.18	1.458	9.7	8.1	0.0005	3.8
96% silica glass, 7911	8 x 10 ⁻⁷	2.18	1.458	11.7	9.6	0.0002	3.8
Soda-lime, elect lamp bulbs	92 x 10 ⁻⁷	2.47	1.512	6.4	5.1	0.009	7.2
Lead silicate, electrical	91 x 10 ⁻⁷	2.85	1.539	8.9	7.0	0.0016	6.6
Lead silicate, high lead	91 x 10 ⁻⁷	4.28	1.639	11.8	9.7	0.0009	9.5
Aluminoborosilicate apparatus	49 x 10 ⁻⁷	2.36	1.49	6.9	5.6	0.010	5.6
Borosilicate, low expansion	32 x 10 ⁻⁷	2.23	1.474	8.1	6.6	0.0046	4.6
Borosilicate, low electrical loss	32 x 10 ⁻⁷	2.13	1.469	11.2	9.1	0.0006	4.0
Borosilicate, tungsten seal	46 x 10 ⁻⁷	2.25	1.479	8.8	7.2	0.0033	4.9
Aluminosilicate	42 x 10 ⁻⁷	2.53	1.534	11.4	9.4	0.0037	6.3

*Courtesy Corning Glass Works

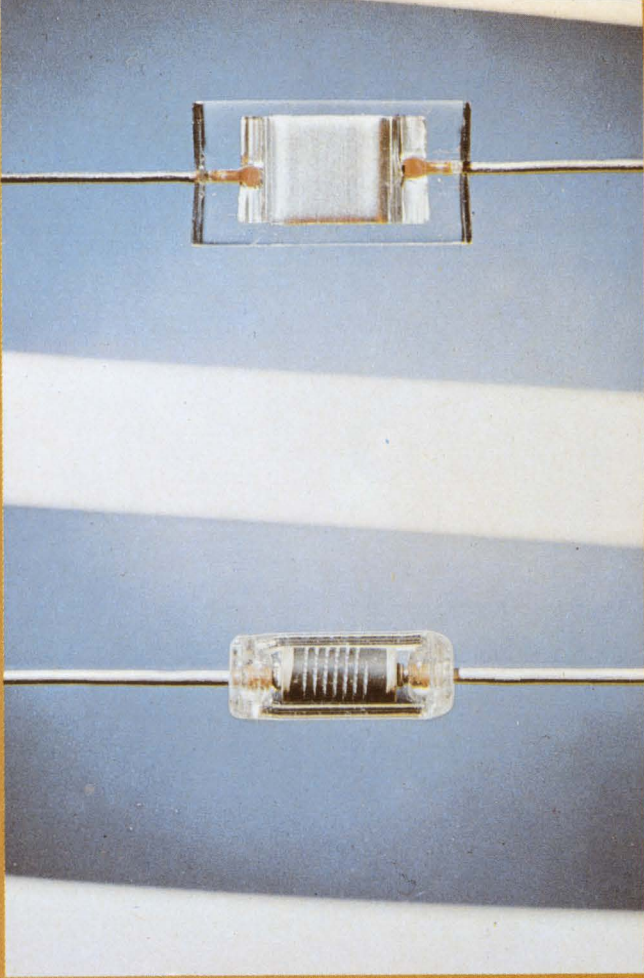

Glass is used as a sealer for this resistor and capacitor. The resistor element itself is a glass rod onto which a tin-oxide film is fused. (photo courtesy Corning Glass)

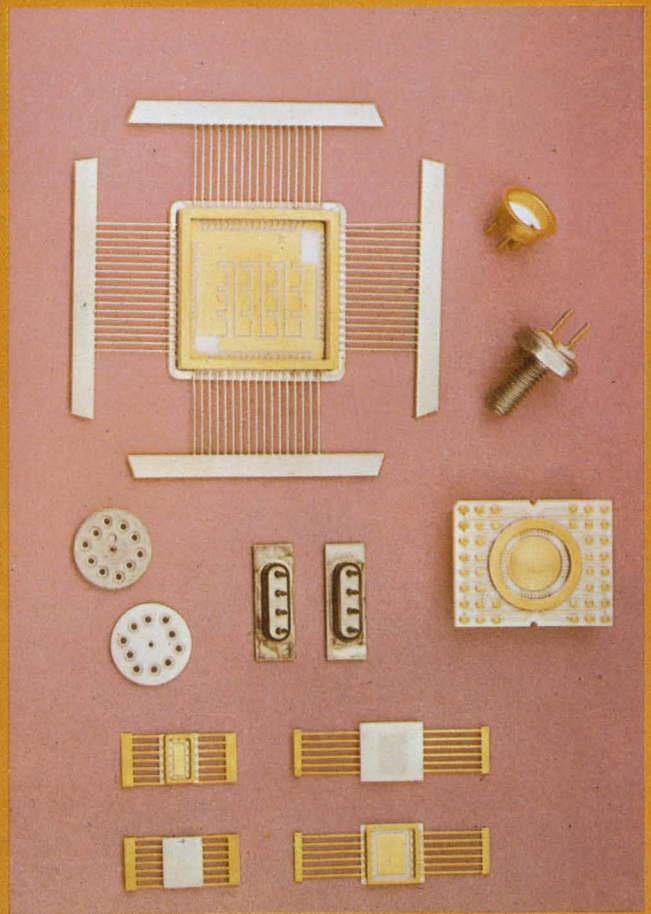

Applications for metalized ceramics include microcircuit packaging and power-transistor header discs. (photo courtesy of Coors Porcelain Co.)

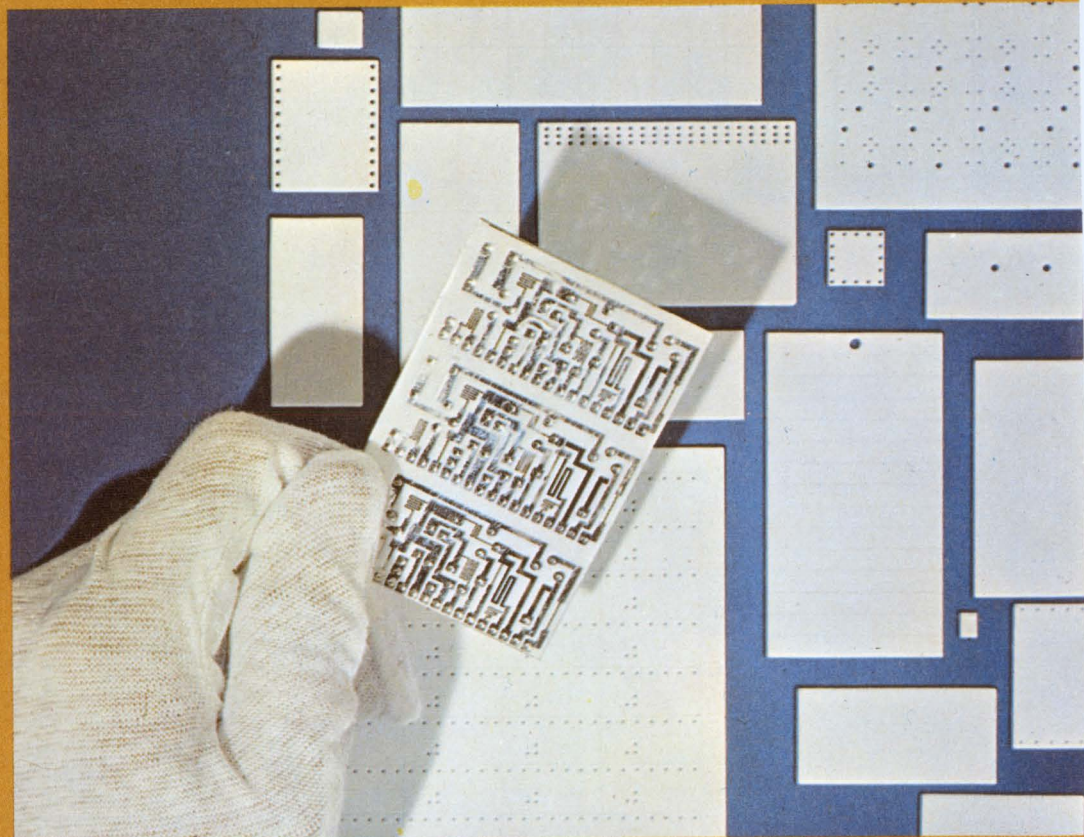

Alumina is widely used as a substrate for thick- and thin-film circuits. Here, a substrate with circuitry already deposited is shown above a field of bare substrates. (photo courtesy of Coors Porcelain Co.)

also lends itself to close-tolerance work, and is often produced in controlled finishes measured in micro-inches. Normally an excellent electrical insulator, titania can be processed to become a partial conductor to assist in control of static electricity.

Cordierites have a low coefficient of expansion and excellent resistance to heat shock. They are used mostly in the extruded form for insulators in products such as heating elements and thermocouples. They also lend themselves to dry pressing.

Lava is a mined natural mineral (aluminum silicate or magnesium silicate), which can be machined and then kiln-fired with little change in size. It has good electrical properties and good heat resistance. It is often used in prototypes, or where small quantities of a technical ceramic are needed.

Magnesia (magnesium oxide) ceramics are principally used as crushable ceramics for metal-sheathed heaters, range units, etc. Magnesias are available in medium purity for commercial uses, or in extremely high purity to meet certain AEC specifications.

Beryllia, or beryllium oxide, is a material that insulates electrically as a ceramic does but conducts heat as a metal does. Its thermal conductivity is 62% that of copper, compared to aluminum's 55% and steatite's 0.9%. A component insulated with beryllia, therefore, is isolated electrically, although thermally it is the same as though the component were grounded. Beryllia is unique among practical insulators in this respect, although the diamond exhibits this same combination of properties.

Care must be taken when machining beryllia because of possible toxicity problems with beryllia dust. Usually, though, the supplier can either machine for the user or advise on machining.

Boron nitride is useful for a variety of electronic applications. It has excellent high-voltage resistance properties (Fig. 17), and is used in wafers for thermal conductivity mountings, coil forms, waveguide windings, etc. Since there are variations in the moisture absorption of boron nitride materials, the appropriate grade should be chosen for a given design objective.

Ceramoplastics combine attractive features

Ceramoplastics are inorganic materials that can be molded or processed like plastics, but which have properties more closely resembling ceramics. The useful application temperatures for ceramoplastics lie between those of plastics and ceramics.

The most common form of ceramoplastic is glass-bonded mica. This is composed of finely powdered mica, natural or synthetic, bonded with

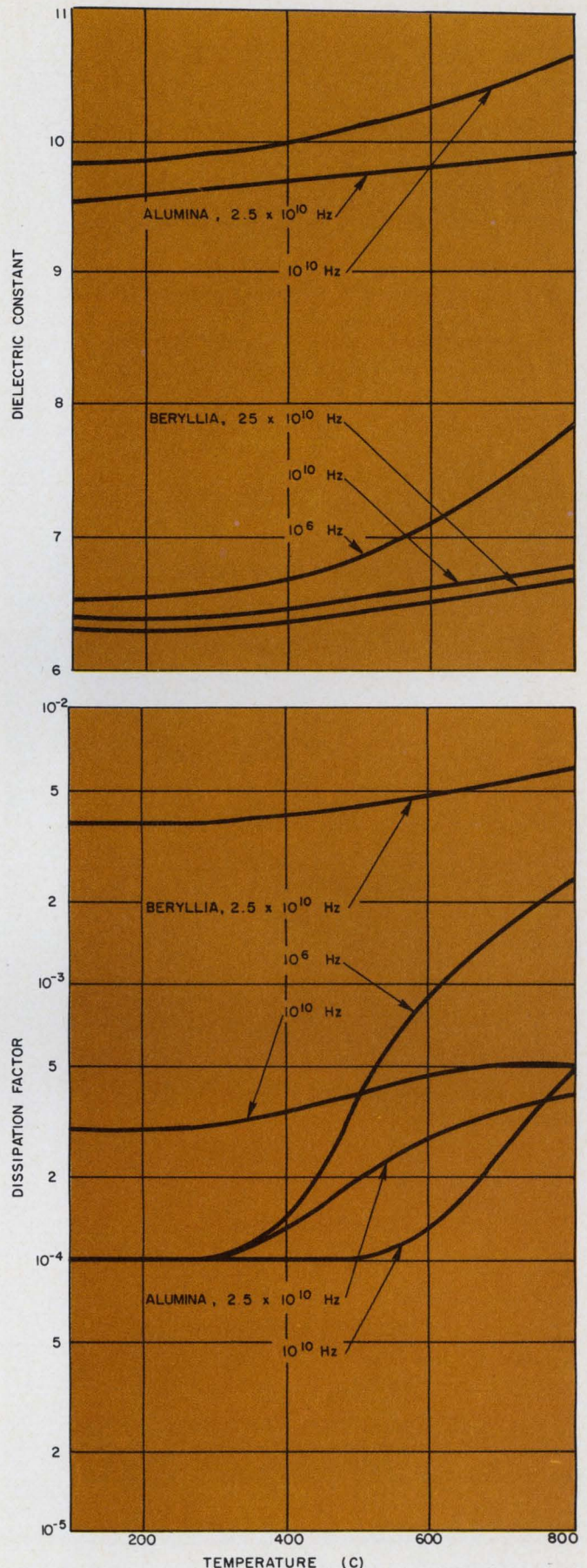

15. Effect of temperature on electrical properties are shown for a 99.5% alumina (Alsimag 753) and a 99.5% beryllia (Alsimag 754), which are among the most widely used ceramics. (photo courtesy of American Lava Co.)

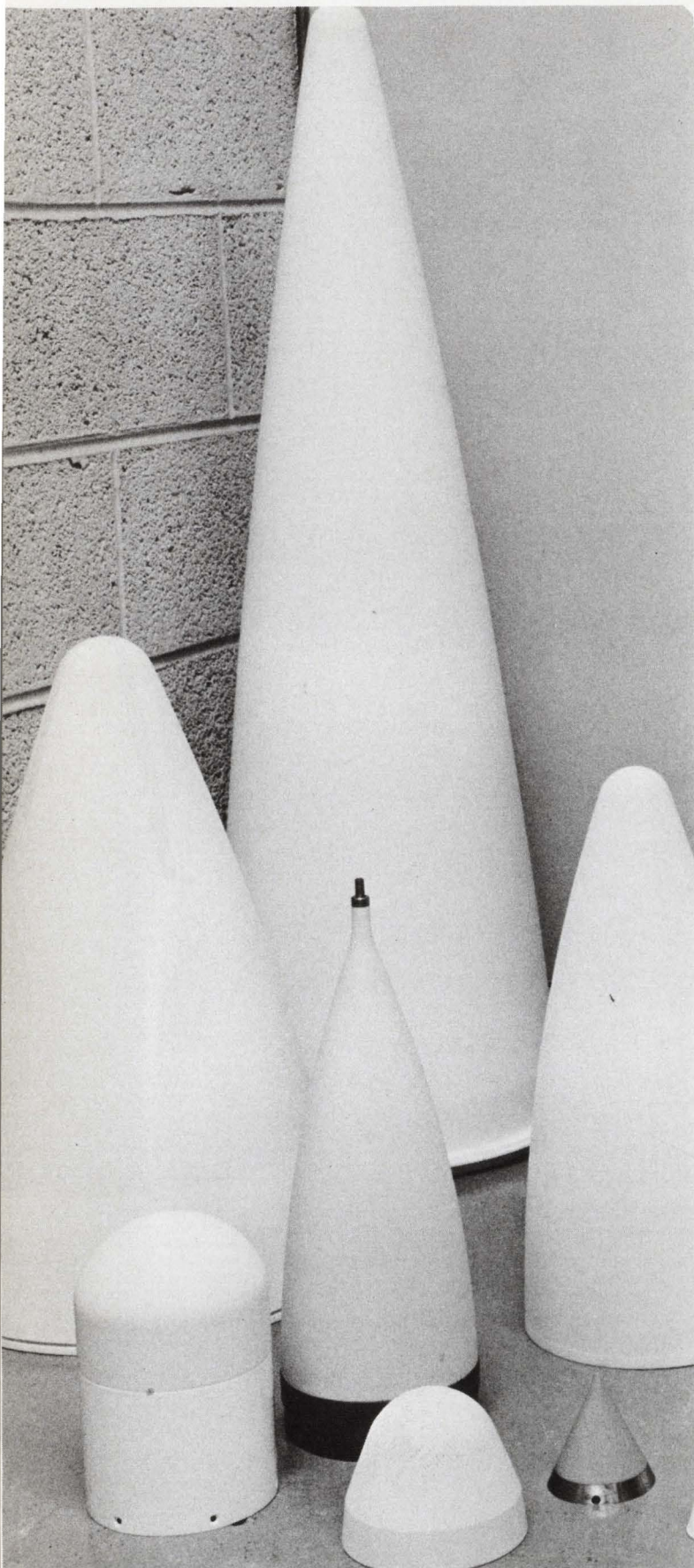

16. Alumina is used in many styles of radomes. The material is transparent at microwave frequencies and has very high temperature capabilities. It can also be manufactured to very close tolerances. (photo courtesy Coors Porcelain Co.)



17. Dielectric strength capabilities of boron nitride are demonstrated by detouring a 10,000-volt arc with a 1/32-inch thin strip of the material.

special glasses. To achieve certain properties, ceramics, glasses, and inorganic fibers or fillers may be combined. (Fig. 18).

Molding of glass-bonded mica parts is performed at relatively high temperatures, commonly in the 1000 to 1500°F range. Close tolerances can be held, however, even in complex shapes or with inserts. Glass-bonded mica is available in custom-molded shapes, or in sheet or bar stock.

The important properties of some representative machining grades and some representative molding grades of glass-bonded mica are shown in Table 7. Outstanding features of the material are as follows:

- Higher thermal endurance.
- Arc resistance.
- Radiation resistance.
- Low thermal expansion.
- Moldability, with delicate insert inclusion.
- Excellent electrical values.

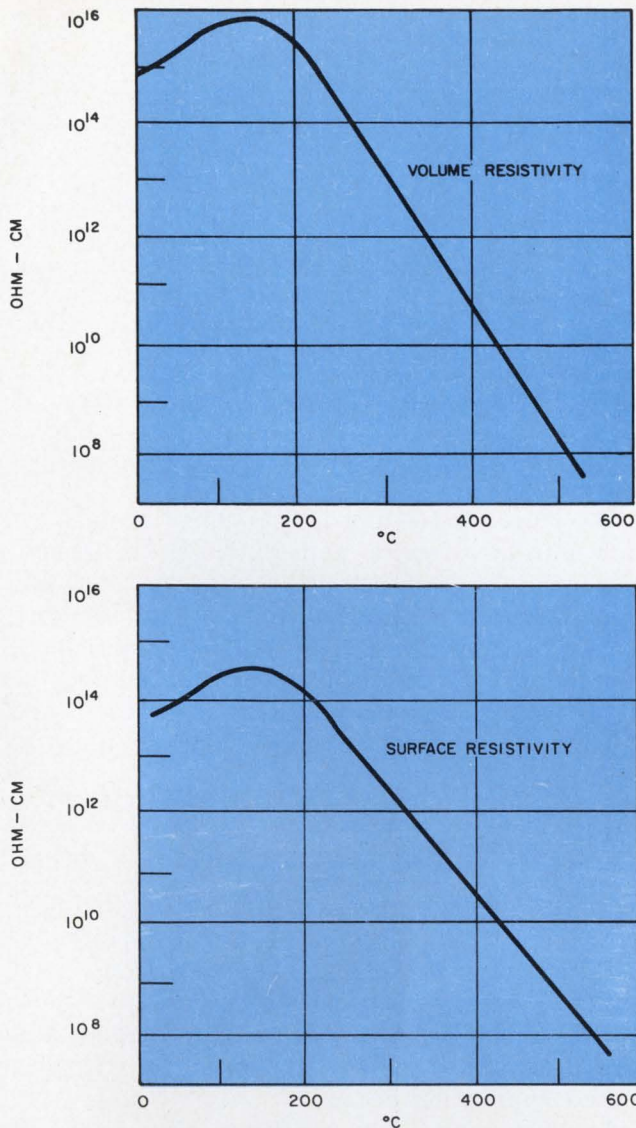

18. Resistivity as a function of temperature is shown for a representative glass-bonded mica. Values for both volume resistivity and surface resistivity are given.

- Machinability, which is better than ceramics, with no firing after machining.
- Corona resistance (in finished parts).
- Moldability with true hermetic seal.
- High dimensional stability.

Another, especially useful, property of glass-bonded micas is their relatively low linear coefficient of thermal expansion, especially among moldable products.

There are various electrical grades of glass-bonded micas, and some grades have relatively stable values of dielectric constant and dissipation factor up to frequencies of 8500 MHz or higher, and up to 250 to 350°C. Their resistivity, like that of plastics, decreases with temperature.

Types of glasses abound

Glasses come in hundreds of varieties, each with distinguishable property differences, but

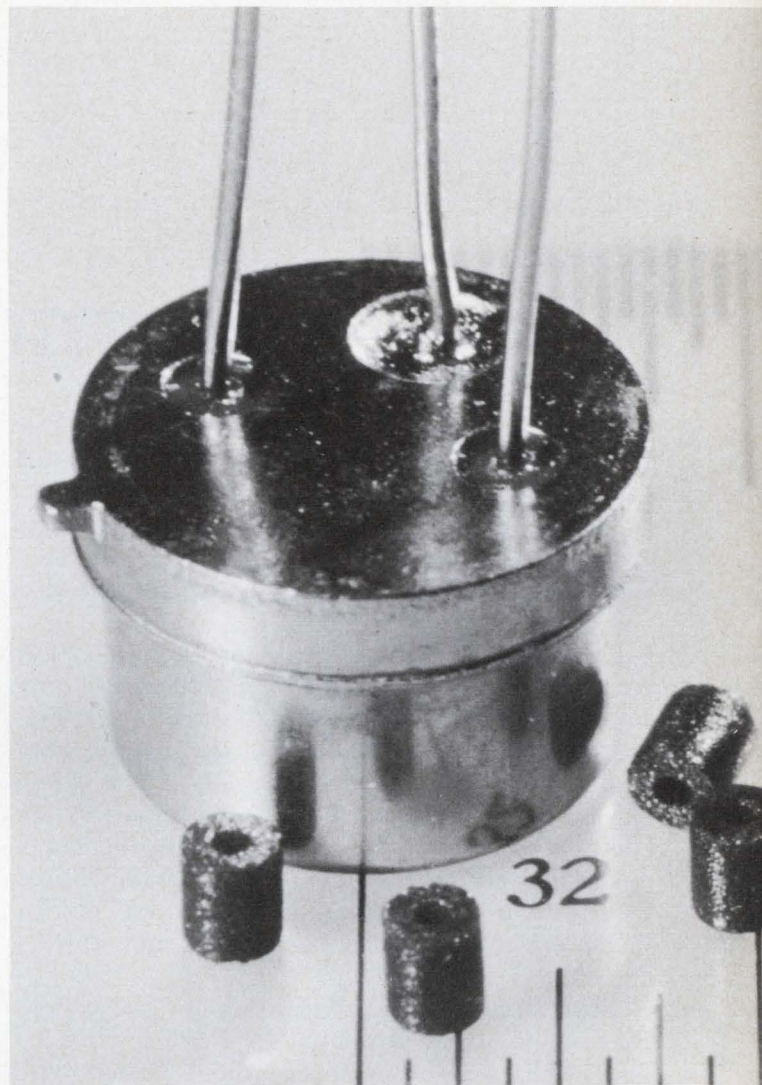

19. An example of the role of glasses in modern electronics is Corning Code 9013 lead-free glass, which is used for its constant dielectric properties.

only some of these are of importance for electronic use. Properties of typical glasses are given in Table 8. The data given includes electrical, mechanical and physical characteristics.

In glasses, current is carried by the migration of ions, as in electrolytics, rather than by free electrons, as in the case of metals. For this reason mobile ions, such as sodium ions, have a significant influence, and resistivity values tend to decrease with an increase in the sodium content.

Resistivity, dissipation factor and dielectric constant of glasses are affected by temperature, with the resistivity decreasing and the dissipation factor and dielectric constant increasing at higher temperatures.

An example of how glasses can be tailored as insulation for modern electronic equipment is shown in Fig. 19, which illustrates the use of lead-free glass in transistor headers.

Thermoplastics

Thermoplastics differ from thermosets in that they do not cure or set under heat. When heated, thermoplastics merely soften to a flowable state in which, under pressure, they can be forced or transferred from a heated cavity into a cool mold. Upon cooling they harden and take the shape of the mold.

Thermoplastics can be remelted and rehardened by cooling many times. However, thermal aging, brought about by repeated exposure to the high temperatures required for melting, causes eventual degradation of the material and so limits the number of re-use cycles. Essentially, then, all thermoplastics are processed by being heated to a soft state, and then shaped by applying pressure and being cooled. Common techniques include injection molding, extruding and thermoforming.

Basic applications information for the various thermoplastics is presented in Table 9. Physical and mechanical properties of the different types are listed in Table 10, and electrical properties are detailed in Table 11.

ABS plastics offer good mechanical properties

ABS plastics are derived from acrylonitrile, butadiene, and styrene. They offer hardness and rigidity, without brittleness, and at moderate cost.

While ABS plastics are used largely for mechanical purposes, they also have good electrical properties, which are fairly constant over a wide range of frequencies. These properties are affected little by temperature and humidity over the materials' rated operating temperature range.

Acetals are moderately attractive electrically

The acetals resemble nylon in appearance. They are good insulators, having relatively low dissipation factors and dielectric constants over their rated operating temperature range. All of the electrical properties of acetals are largely retained under exposure to high humidity and

water immersion.

The most outstanding properties of acetals are high tensile strength and stiffness, resiliency, good recovery from deformation under load, and toughness under repeated impact. In addition, acetals have low static and dynamic coefficients of friction, and are usable from the standpoint of their mechanical properties over a wide range of environmental conditions.

Acrylics shine for optical uses

Acrylics, which are also known as polymethylmethacrylates, are primarily known for their exceptional clarity and excellent light transmission. This optical clarity, together with their good electrical and mechanical properties and their ready availability in a wide range of shapes and forms, makes acrylics attractive for various special application areas.

Acrylics have high resistance and excellent tracking characteristics, which make them a good choice for certain high-voltage applications, such as circuit breakers. In addition, they are one of the few plastics that exhibit an essentially linear decrease in dielectric constant and dissipation factor with increase in frequency (Fig. 20).

Mechanically, acrylics are strong, rigid and resistant to sharp blows. Their physical properties are not affected by outdoor weathering, and they do not become exceptionally brittle at low temperatures.

Cellulosics susceptible to extreme environments

Cellulosics have relatively good electrical insulating properties, although the properties vary depending on the specific type and formulation of material. A definite disadvantage of the cellulosics is that they are not as resistant to extreme environments as are many other thermoplastics. They are, therefore, not used too frequently in electronic applications. Cellulose acetate is generally useful in the approximate temperature range of -25 to $+175^{\circ}\text{F}$, while the top tempera-

Table 9. Major application considerations for thermoplastics

Material	Major application considerations	Common available forms	Typical suppliers and trade names*
ABS (acrylonitrile-butadiene-styrene)	Extremely tough, with high impact resistance. Can be formulated over a wide range of hardness and toughness properties. Special grades available for plated surfaces with excellent pull-strength values. Good general electrical properties, but not outstanding for any specific electric applications.	Blow moldings, extrusions, injection moldings, thermoformed parts, laminates, stock shapes, foam	Borg-Warner Corp. (Marbon Cycolac); Monsanto Co. (Lustran); Goodrich Chemical Co. (Abson)
Acetals	Outstanding mechanical strength, stiffness, and toughness properties, combined with excellent dimensional stability. Good electrical properties at most frequencies, which are little changed in humid environments up to 125°C.	Blow moldings, extrusions, injection moldings, stock shapes	Du Pont, Inc. (Delrin); Celanese Corp. (Celcon)
Acrylics (polymethyl-methacrylate)	Outstanding properties are crystal clarity and resistance to outdoor weathering. Excellent resistance to arcing and electrical tracking.	Blow moldings, castings, extrusions, injection moldings, thermoformed parts, stock shapes, film, fiber	Du Pont, Inc. (Lucite); Rohm and Haas Co. (Plexiglas)
Cellulosics	There are several materials in the cellulosic family, such as cellulose acetate (CA), cellulose propionate (CAP), cellulose acetate butyrate (CAB), ethyl cellulose (EC), and cellulose nitrate (CN). Widely used plastics in general, but not outstanding for electronic applications.	Blow moldings, extrusions, injection moldings, thermoformed parts, film, fiber, stock shapes	Eastman Chemical Co. (Tenite); Dow Chemical Co. (Ethocel-EC); Celanese Corp. (Forticel-CAP)
Chlorinated polyethers	Good electrical characteristics; but most outstanding properties are corrosion resistance and good physical and thermal stability by thermoplastic standards.	Extrusions, injection moldings, stock shapes, film	Hercules Powder Co. (Penton)
Ethylene-vinyl acetates (EVA)	Excellent flexibility, toughness, clarity, and stress-crack resistance. Somewhat like a tough synthetic rubber or elastomer. Not widely used in electronics. Comparatively low resistance to heat and solvents.	Extrusions, injection moldings, thermoformed parts	U.S. Industrial Co. (Ulathrene); Du Pont, Inc. (Alathon); Union Carbide Corp. (Bakelite EVA)
Fluorocarbons			
a. Chlorotrifluoroethylene (CTFE)	Excellent electrical properties and relatively good mechanical properties. Somewhat stiffer than TFE and FEP fluorocarbons, but does have some cold flow. Widely used in electronics, but not quite so widely as TFE and FEP. Useful to about 400°F.	Extrusions, isostatic moldings, injection moldings, film, stock shapes	3M Co. (Kel-F); Allied Chemical Corp. (Plaskon CTFE)
b. Fluorinated ethylene propylene (FEP)	Very similar properties to those of TFE, except useful temperature limited to about 400°F. Easier to mold than TFE.	Extrusions, injection moldings, laminates, film	Du Pont, Inc. (Teflon FEP)
c. Polytetrafluoroethylene (TFE)	Electrically one of the most outstanding thermoplastic materials. Exhibits very low electrical losses, and very high electrical resistivity. Useful to over 500°F and to below -300°F. Excellent high-frequency dielectric. Among the best combination of mechanical and electrical properties but relatively weak in cold-flow properties. Nearly inert chemically, as are most fluorocarbons. Very low coefficient of friction. Nonflammable.	Compression moldings, stock shapes, film	Du Pont, Inc. (Teflon TFE); Allied Chemical Corp. (Halon TFE)
d. Polyvinyl fluoride	Mostly used as a weatherable, architectural facing sheet. Not widely used in electronics.	Extrusions, injection moldings, laminates, film	Du Pont, Inc. (Tedlar)
e. Polyvinylidene fluoride (PVF ₂)	One of the easiest of the fluorocarbons to process. Stiffer and more resistant to cold flow than TFE. Good electrically. Useful to about 300°F. A major electronic application is wire jacketing.	Extrusions, injection moldings, laminates, film	Pennsalt Chemicals Corp. (Kynar)
Ionomers	Excellent combination of toughness, solvent resistance, transparency, colorability, abrasion resistance, and adhesion. Based on ethylene-acrylic copolymers with ionic bonds. Not widely used in electronics.	Film, coatings, injection moldings	Du Pont, Inc. (Surlyn A); Union Carbide Corp. (Bakelite)
Nylons (polyamides)	Good general purpose for electrical and nonelectrical applications. Easily processed. Good mechanical strength, abrasion resistance, and low coefficient of friction. There are numerous types of nylons; nylon 6, nylon 6/6, and nylon 6/10 are most common. Some nylons have limited-use due to moisture-absorption properties. Nylon 6/10 is best here.	Blow moldings, extrusions, injection moldings, laminates rotational moldings, stock shapes, film, fiber	Du Pont, Inc. (Zytel); Allied Chemical Corp. (Plaskon); Union Carbide Corp. (Bakelite)
Parylenes (polyparaxylene)	Excellent dielectric properties and good dimensional stability. Low permeability to gases and moisture. Produced as a film on a substrate, from a vapor phase. Such vapor-phase polymerization is unique in polymer processing. Used primarily as thin films in capacitors and dielectric coatings. Numerous polymer modifications exist.	Film coatings	Union Carbide Corp. (Parylene)
Phenoxies	Tough, rigid, high-impact plastic. Has low mold shrinkage, good dimensional stability, and very low coefficient of expansion for a thermoplastic. Useful for electronic applications below about 175°F. Useful in adhesive formulations.	Blow moldings, extrusions, injection moldings, film	Union Carbide Corp. (Bakelite Phenoxy)
Polyallomers	Thermoplastic polymers produced from two monomers. Somewhat similar to polyethylene and polypropylene, but with better dimensional stability, stress-crack resistance, and surface hardness than high-density polyethylene. Electronic application areas similar to polyethylene and polypropylene. One of the lightest commercially available plastics.	Blow moldings, extrusions, injection moldings, film	Eastman Chemical Products, Inc. (Tenite)
Polyamide-imides and polyimides	Among the highest-temperature thermoplastics available, having useful operating temperatures between about 400°F and about 700°F or higher. Excellent electrical properties, good rigidity, and excellent thermal stability. Low coefficient of friction. Polyamide-imides and polyimides are chemically similar but not identical in all properties. They are difficult to process, but are available in molded and block forms, and also as films and resin solutions.	Films, coatings, molded and/or machined parts, resin solutions	Du Pont, Inc. (Vespel fabricated blocks, Kapton film, and Pyre-M.L. Resin)

* This listing is only a very small sampling of the many possible suppliers. No preferences are implied or intended.

Table 9. Major application considerations for thermoplastics (continued)

Material	Major application considerations	Common available forms	Typical suppliers and trade names*
Polycarbonates	Excellent dimensional stability, low water absorption, low creep, and outstanding impact-resistance. Good electrical properties for general electronic packaging application. Available in transparent grades.	Blow moldings, extrusions, injection moldings, thermoformed parts, stock shapes, film	Mobay Chemical Co. (Merlon); General Electric Co. (Lexan)
Polyethylenes and polypropylenes (polyolefins or polyalkenes)	Excellent electrical properties, especially low electrical losses. Tough and chemically resistant, but weak to varying degrees in creep and thermal resistance. There are three density grades of polyethylene: low (0.910-0.925), medium (0.926-0.940), and high (0.941-0.965). Thermal stability generally increases with density class. Polypropylenes are generally similar to polyethylenes, but offer about 50°F higher heat resistance.	Blow moldings, extrusions, injection molding, thermoformed parts, stock shapes, film, fiber, foam	Du Pont, Inc. (Alathon Polyethylene); U.S.I. Chemical Co. (Petrothene Polyethylene); Allied Chemical Corp. (Grex H.D. Polyethylene); Hercules Powder Co. (Hi-Fax H.D. Polyethylene); Hercules Powder Co. (Pro-Fax Polypropylene); Eastman Chemical Co. (Tenite Polyethylene and Polypropylene)
Polyethylene Terephthalates	Among the toughest of plastic films with outstanding dielectric strength properties. Excellent fatigue and tear strength and resistance to acids, greases, oils, solvents. Good humidity resistance. Stable to 135–150°C.	Film, sheet, fiber	Du Pont, Inc. (Mylar)
Polyphenylene oxides (PPO)	Excellent electrical properties, especially loss properties to above 350°F, and over a wide frequency range. Good mechanical strength and toughness. A lower-cost grade (Noryl) exists, having somewhat similar properties to PPO, but with a 75–100°F reduction in heat resistance.	Extrusions, injection moldings, thermoformed parts, stock shapes, film	General Electric Co. (PPO and Noryl)
Polystyrenes	Excellent electrical properties, especially loss properties. Conventional polystyrene is temperature-limited, but high-temperature modifications exist, such as Rexolite or Polypenco crosslinked polystyrene, which are widely used in electronics, especially for high-frequency applications. Polystyrenes are also generally superior to fluorocarbons in resistance to most types of radiation.	Blow moldings, extrusions, injection moldings, rotational moldings, thermoformed parts, foam	Dow Chemical Co. (Styron); Monsanto Co. (Lustrex); American Enka Corp. (Rexolite); Polymer Corp. (Polypenco Q-200.5)
Polysulfones	Excellent electrical and mechanical properties to over 300°F. Good dimensional stability and high creep resistance. Flame-resistant and chemical-resistant. Outstanding in retention of properties upon prolonged heat aging, as compared to other tough thermoplastics.	Blow moldings, extrusions, injection moldings, thermoformed parts, stock shapes, film sheet	Union Carbide Corp. (Polysulfone)
Vinyls	Good low-cost, general-purpose thermoplastic materials, but not specifically outstanding electrical properties. Greatly influenced by plasticizers. Many variations available, including flexible and rigid types. Flexible vinyls, especially polyvinyl chloride (PVC) widely used for wire insulation and jacketing.	Blow moldings, extrusions, injection moldings, rotational moldings, film sheet	Diamond Alkali Co. (Diamond PVC); Goodyear Chemical Co. (Pliovic); Dow Chemical Co. (Saran)

*This listing is only a very small sampling of the many possible suppliers. No preferences are implied or intended.

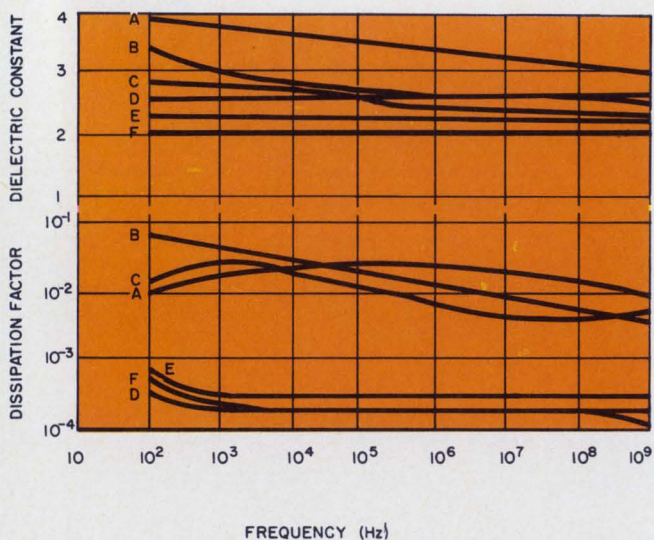

20. Effect of frequency on dielectric constant and dissipation factor of several thermoplastic materials is shown under room-temperature conditions. A, nylon; B, acrylic; C, CTFE fluorocarbon; D, polystyrene; E, polyethylene; F, TFE fluorocarbon.

ture limit for special cellulosics will normally not exceed 200°F.

Toughness and transparency, at moderate cost, are probably the outstanding characteristics of cellulosics.

Chlorinated polyether has limited electronic use

Chlorinated polyether is better known for its use in piping and hardware in the chemical processing industry than for its use in electronic applications. Nevertheless, it does have properties that can be useful in the electronic area. Both the dielectric constant and dissipation factor do not change much over the frequency range of 60 to 5×10^7 Hz, nor are they much affected by immersion up to 20 hours in boiling water. The dissipation factor, though, does increase considerably over the temperature range of 73 to 250°F. The dielectric constant increases only to about 3.5 at 250°F.

The mechanical creep properties of chlorinated polyether are generally good, with the percentage creep remaining below 4% after over 10,000 hours of a sustained 2000 psi load at 75°F.

Fluorocarbons are extremely important

Due to their excellent electrical properties, which are relatively unaffected by most of the extreme environments encountered by modern electronic systems, fluorocarbons are extremely important to the electronic designer. Probably the most widely used fluorocarbon is polytetrafluoroethylene, or TFE fluorocarbon. This was the original fluorocarbon, and is still known to many as Teflon. Correctly speaking, however, Teflon is the trade name for Du Pont TFE and FEP fluorocarbon only.

Although all fluorocarbons have excellent electrical properties, TFE and FEP fluorocarbons, in particular, have low dielectric constants and dissipation factors, which change little with frequency or temperature. The dielectric strength of TFE and FEP resins is high, and it does not vary with temperature and thermal aging. Initial dielectric strength is very high, as measured by the ASTM short-time test, and, as with any material, the value drops as the thickness of the specimen increases (Fig. 21).

Material life at high dielectric stresses is dependent on corona discharge. As shown in Fig. 22, the absence of corona permits very high voltage stress without damage to either TFE or FEP resins. Changes in ambient relative humidity or in the physical stress imposed upon the material do not diminish life at these voltage stresses.

Surface arc resistance of TFE and FEP resins is high and is not affected by heat aging. When these resins are subjected to a surface arc in air, they do not track or form a carbonized conducting path. When tested by the procedure of ASTM D495, they pass the maximum time of 300 seconds without failure.

Volume resistivity greater than 10^{18} ohm-cm and surface resistivity greater than 10^{16} ohm-sq for both FEP and TFE resins are at the top of the measurable range. Neither resistivity is affected by heat aging or temperatures up to the recommended service limits.

TFE fluorocarbon is the most commonly used fluorocarbon in electronic packaging. It is a semi-soft plastic that exhibits some cold flow properties, as well as considerable thermal expansion. This expansion is linear with increasing temperature (Fig. 23).

One of the most recent, and expanding, uses of fluorocarbons in current electronic design is the use of FEP fluorocarbon as flexible circuits or wiring, as shown in Fig. 24. The electrical properties, resistance to extreme electronic sys-

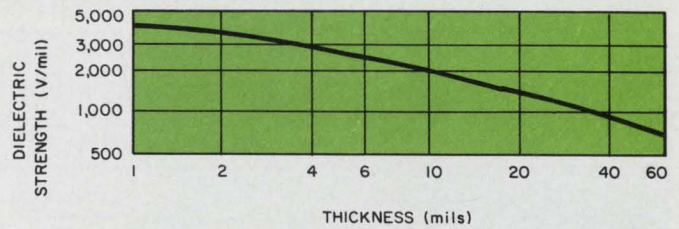

21. Short-time dielectric strength of TFE fluorocarbon vs thickness of test sample.

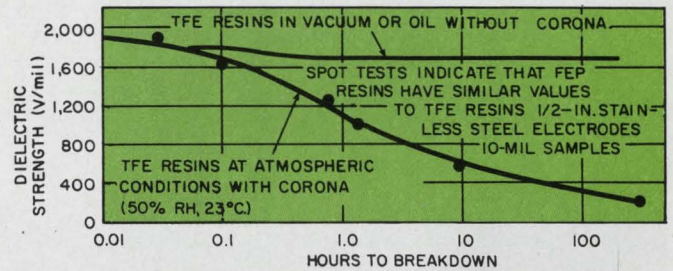

22. Insulation life vs continuously applied voltage stress for TFE and FEP fluorocarbons.

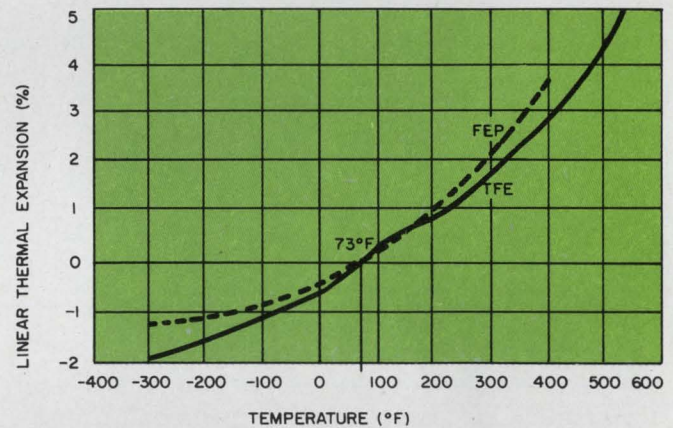

23. Linear thermal expansion of TFE and FEP fluorocarbons as a function of temperature.

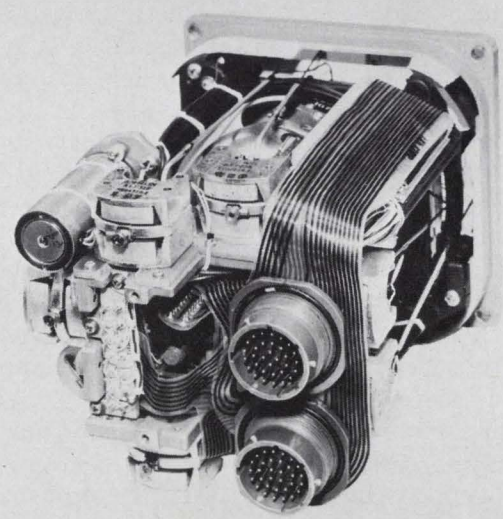

24. Capabilities of FEP flexible printed circuits for compact applications are apparent from the Sperry Phoenix Attitude Director Indicator, viewed here from the rear. (photo courtesy DuPont Corp.)

Table 10. Physical and mechanical properties of thermoplastics

Material	Coefficient of thermal expansion, (in./in.) (°C x 10 ⁻⁵)	Thermal conductivity, (cal/(cm ²) (s) (°C) (cm) x 10 ⁻⁴)	Water absorption 24 hr, %	Flammability (in./min) 0.125 in.	Specific gravity	Price range per lb	Heat resistance, continuous, °F
Acetal	0.25	1.6	0.25	1.1	1.410-1.425	\$0.65	185
ABS	3-10.5	4-9	0.2-0.5	1.0-2	1.01-1.07	\$0.33-0.43	160-235
Acrylic	-	1.4	0.3	9-1.2	1.18-1.19	\$0.455-0.75	130-195
Acrylic, high impact	6.5-10.5	4.0	0.2-0.3	1.1-1.2	1.11-1.18	\$0.525-0.70	140-195
Cellulose acetate	8-18	4-8	1.7-4.4	0-2	1.22-1.34	\$0.40	140-175
Cellulose acetate butyrate	11-17	4-8	0.9-2.2	0.5-1.5	1.15-1.22	\$0.62	140-175
Cellulose propionate	11-16	4-8	1.2-2.8	0.5-1.5	1.16-1.23	\$0.62	140-175
Chlorinated polyether	8	3.13	0.01	Self-extinguishing	1.4	\$2.50	250-275
Ethyl vinyl acetate	10-20	8	<0.01	Slow burning	0.93-0.95	\$0.2775-0.3575	120-170
Chlorotrifluoroethylene	5-7	4-6	Nil	Nil	2.09-2.14	\$4.70	390
Fluorinated ethylene propylene	8.3-10.5	5.9	<0.05	Nonflammable	2.16	\$5.60-9.60	400
Polytetrafluoroethylene	5.5 (25-60°C)	6	0.01	Nonflammable	2.13-2.18	\$3.25	500
Nylon 6	4.6-5.8	5.9	1.5	Self-extinguishing	1.13-1.14	\$0.86-1.19	250
Nylon 6/6	8.1	5.8	1.3	Self-extinguishing	1.13-1.15	\$0.84-0.875	250
Nylon 6/10	10	5.5	-	Self-extinguishing	1.07-1.09	\$1.26	220
Polyallomer	8-11	2-4	0.4	Slow burning	0.90-0.906	\$0.28	250
Polycarbonate	6.7-7	4.6	0.15	Self-extinguishing	1.2	\$0.90-3.05	250
Polyethylene, low-density	10-20	8	<0.05	Slow burning	0.910-0.925	\$0.1525-0.29	140-175
Polyethylene, medium-density	10-20	8	<0.05	Slow burning	0.926-0.940	\$0.17-0.235	150-180
Polyethylene, high-density	10-20	1.9-3.3	<0.01	Slow burning	0.941-0.965	\$0.18-0.32	180-225
Polyethylene, high molecular weight	13	8	<0.01	Slow burning	0.93-0.94	\$0.26-0.50	180-225
Polyimide	-	-	0.32	-	1.43	-	500-600
Polypropylene	3.8-9	2.8-4	<0.01	Slow burning to nonburning	0.90-1.24	\$0.19-0.55	250
Polystyrene	6-8	8	0.03-0.05	0.5-2.5	1.05-1.06	\$0.145-0.245	150-190
Polystyrene, high-impact	6.5-8.5	1-3	0.05-0.10	0.5-2.5	1.04-1.06	\$0.16-0.27	130-180
Polyurethane	10-20	7.4	0.60-0.80	Slow to self-extinguishing	1.11-1.26	\$1.19-1.60	190
Polyvinyl chloride (flexible)	7-25	3-4	0.15-0.75	Self-extinguishing	1.15-1.80	\$0.16-0.455	150-175
Polyvinyl chloride (rigid)	5-10	3-5	0.07-0.40	Self-extinguishing	1.33-1.58	\$0.21-0.42	160-165
Polyvinyl dichloride (rigid)	7-8	3-4	0.07-0.11	Self-extinguishing	1.50-1.54	\$0.50-0.53	195-210
Styrene acrylonitrile (SAN)	7	3	0.23-0.28	0.4-0.7	1.07-1.08	\$0.26-0.30	170-210
Ionomer	12-13	5.8	0.1-1.4	0.9-1.1	0.94-0.96	\$0.47-0.49	140
Phenoxy	3.2-3.8	-	0.13	Slow burning, self-extinguishing	1.17-1.34	\$0.75-1.00	-
Polyphenylene oxide	5.2	-	0.06	Self-extinguishing	1.06	\$1.15	250
Polysulfone	3.1-10 ⁻⁵ in./in. °F	1.8 Btu/(hr) (ft) (°F) (in.)	0.22	Self-extinguishing	1.24-1.25	\$1.00-1.25	300

tem environments (especially humidity), and formability by melt bonding techniques make FEP ideal for this application.

Nylon is a good general-purpose insulation

Nylon is widely used for general-purpose electrical and electronic applications, since it is very easily processed and has excellent all-around electrical and physical properties. It is not, however, outstanding in any of the extreme environments required for many advanced electronic systems, nor is it recommended for high-frequency, low-loss applications (Fig. 20).

Since all nylons absorb moisture, this characteristic must be considered when using or designing with them. They will absorb anywhere from 0.5% to nearly 2% moisture after 24 hours of water immersion.

Nylon, like all thermoplastic materials, exhibits some creep when subjected to stress. The extent depends on stress level, temperature and time. A part that is subjected to long-time stress must be designed accordingly, so that deformation with time is not excessive for the application and so that fracture will not occur. For

nylon, most cold flow takes place during the first 24 hours. This is a useful checkpoint for testing parts under load.

Nylon parts having exceptional wear characteristics and dimensional stability can be made by a special compression and sintering process. In addition, various fillers such as molybdenum disulfide and graphite can be incorporated into nylon to give special low-friction properties. Nylon can also be reinforced with glass fibers to give it considerably added strength. One application of glass-reinforced nylon is shown in Fig. 25.

Parylenes can be deposited as insulating films

Parylene is the generic name for members of a thermoplastic polymer series developed by Union Carbide. These polymers are unique in that they are polymerized in the vapor phase, and deposited as films on some substrate material. They can also be deposited onto a cold condenser, then stripped off as free film; or they can be deposited onto the surface of objects as a continuous, adherent coating in thicknesses ranging from 0.2 micron (about 0.008 mil) to 3 mils or more. Deposition rate is normally about 0.5 micron per

Table 11. Electrical properties of thermoplastics

Material	Volume resistivity, ohm-cm	Dielectric constant, 60 Hz	Dielectric strength, (st),* 1/8-in. thickness, volts/mil	Dissipation or power factor, 60 Hz	Arc resistance, s
Acetal	1-10 ¹⁴	3.7-3.8	500	0.004-.005	129
ABS	10 ¹⁵ -10 ¹⁷	2.6-3.5	300-450	0.003-.007	45-90
Acrylic	>10 ¹⁴	3.3-3.9	400	0.04-.05	No tracking
Acrylic high impact	10 ¹⁶ -10 ¹⁷	3.5-3.7	450-480	0.04-.05	No tracking
Cellulose acetate	10 ¹⁰ -10 ¹²	3.2-7.5	290-600	0.01-.10	50-130
Cellulose acetate butyrate	10 ¹⁰ -10 ¹²	3.2-6.4	250-400	0.01-.04	-
Cellulose propionate	10 ¹² -10 ¹⁶	3.3-4.2	300-450	0.01-.05	170-190
Chlorinated polyether	1.5 x 10 ¹⁶	3	400	0.01	-
Ethyl vinyl acetate	1.5 x 10 ⁸	3.16	525	0.003	-
Chlorotrifluoroethylene	10 ¹⁸	2.65	450	0.015	>360
Fluorinated ethylene propylene	>10 ¹⁸	2.1	500	0.0002	>165
Polytetrafluoroethylene	>10 ¹⁸	2.1	400	<0.0001	No tracking
Nylon 6	10 ¹⁴ -10 ¹⁵	6.1	300-400	0.4-0.6	140
Nylon 6/6	10 ¹⁴ -10 ¹⁵	3.6-4.0	300-400	0.014	140
Nylon 6/10	10 ¹⁴ -10 ¹⁵	4.0-7.6	300-400	0.04-0.05	140
Polyallomer	>10 ¹⁶	2.3	500-1000	0.0001-0.0005	-
Polycarbonate	6.1 x 10 ¹⁵	2.97	410	0.0001-0.0005	10-120
Polyethylene, low-density	10 ¹⁵ -10 ¹⁸	2.28	450-1000	0.006	Melts
Polyethylene, medium density	10 ¹⁵ -10 ¹⁸	2.3	450-1000	0.0001-0.0005	Melts
Polyethylene, high-density	6 x 10 ¹⁵ -10 ¹⁸	2.3	450-1000	0.002-0.0003	Melts
Polyethylene, high molecular weight	>10 ¹⁶	2.3-2.6	500-710	0.0003	Melts
Polyimide	10 ¹⁶ -10 ¹⁷	3.5	400	0.002-0.003	230
Polypropylene	10 ¹⁵ -10 ¹⁷	2.1-2.7	450-650	0.005-0.0007	36-136
Polystyrene	10 ¹⁷ -10 ²¹	2.5-2.65	500-700	0.0001-0.0005	60-100
Polystyrene, high-impact	10 ¹³ -10 ¹⁷	2.5-3.5	500	0.003-0.005	60-90
Polyurethane	2 x 10 ¹¹	6-8	850-1100	0.276	-
Polyvinyl chloride (flexible)	10 ¹¹ -10 ¹⁵	5-9	300-1000	0.08-0.15	-
Polyvinyl chloride (rigid)	10 ¹² -10 ¹⁶	3.4	425-1040	0.01-0.02	-
Polyvinyl dichloride (rigid)	10 ¹⁵	3.08	1200-1550	0.018-0.0208	-
Styrene acrylonitrile (SAN)	10 ¹⁵	2.8-3	400-500	0.006-0.008	100-150
Ionomer	>10 ¹⁶	2.4-2.5	1000	0.001	-
Phenoxy	2.75-5 x 10 ⁻⁵	4.1	404-520	0.0012-0.0009	70
Polyphenylene oxide	10 ¹⁷	2.58	400-500	0.00035	75
Polysulfone	5 x 10 ¹⁶	2.82	425	0.008-0.0056	122

*Short-time.

minute (about 0.02 mil). On cooled substrates, the deposition rate can be as high as 1.0 mil per minute.

Parylenes are good dielectric materials, with the basic member of the series, Parylene N, having a dielectric constant of 2.65 and a dissipation factor that increases from 0.0002 to 0.0006 over the range of 60 Hz to 1 MHz. Another parylene, namely Parylene C, has a dielectric constant of 2.9-3.1 and a dissipation factor of 0.012-0.020 over the same frequency range.

Parylenes can be used both at elevated and cryogenic temperatures, although long-term (10-year) service in air is limited to about 140 to 175°F, depending on the type of polymer involved. Barrier properties to most gases is reported superior to many other films.

Polyethylenes, polypropylenes and polyallomers

Polyethylenes are among the best known plastics and come in three main classifications, based on density: low, medium, and high. These density ranges are 0.910 to 0.925, 0.925 to 0.940, and 0.940 to 0.965, respectively.

Polypropylene is chemically similar to poly-

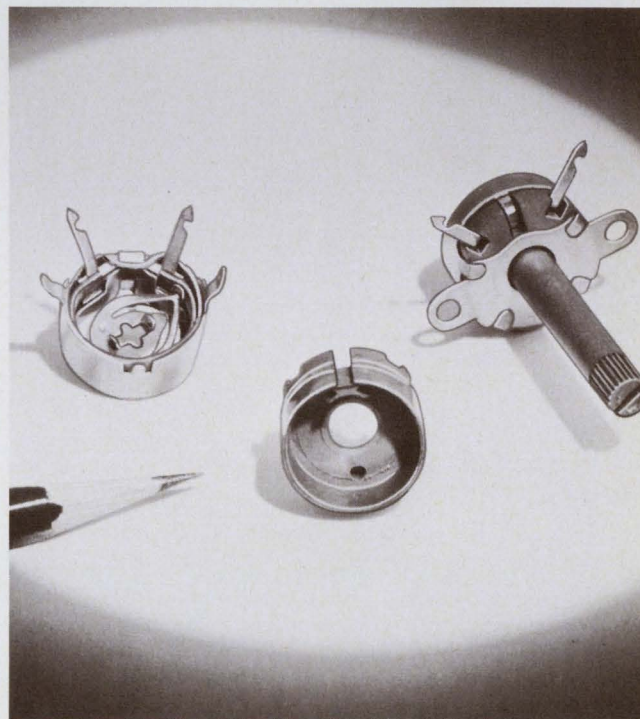

25. The rotor in this high-temperature rotary selector switch is made from glass-reinforced nylon. Dimensional stability and high-temperature resistance are the key factors in this application. (photo courtesy CTS Corp.)

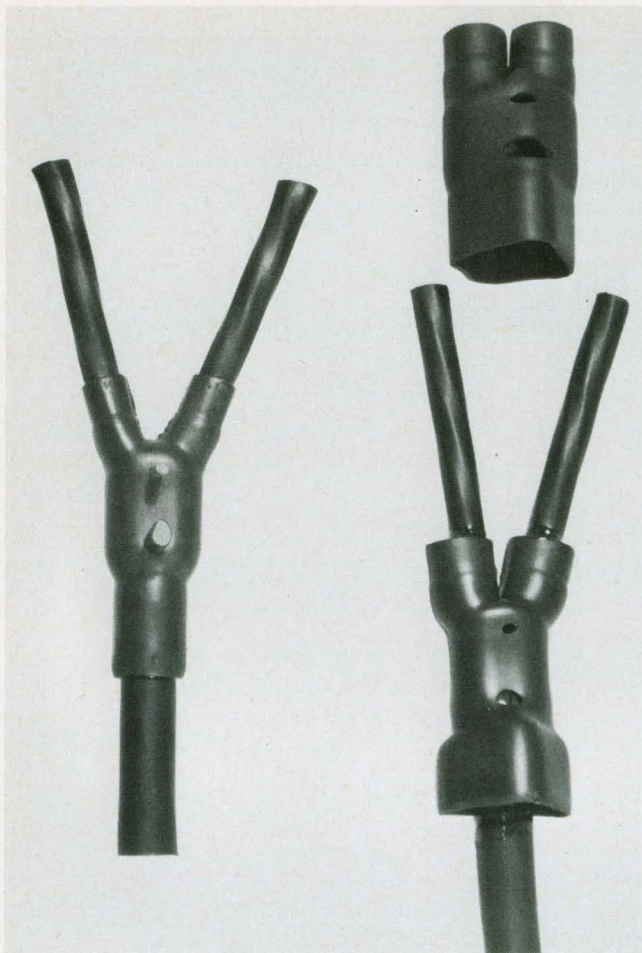

26. Irradiated, cross-linked polyolefins find use as heat-shrinkable cable boots. After being set in place, the oversized boot is heated, shrinking tightly around the cable. (photo courtesy Rayclad Tubes, Inc.)

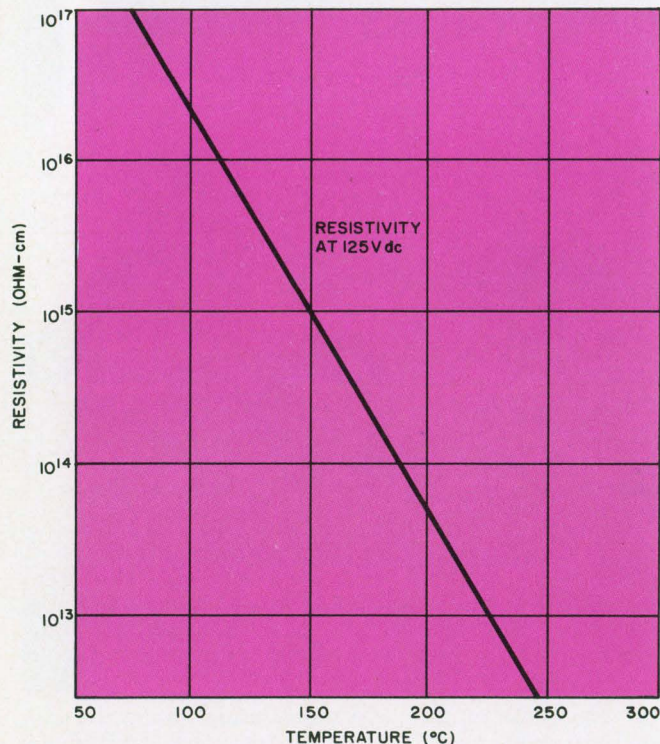

27. Important electrical properties of polyimides as a function of temperature.

ethylene, but has somewhat better physical strength at lower density—namely, 0.900 to 0.915.

Polyallomers are crystalline thermoplastic polymers produced from two or more different base materials, such as propylene and ethylene. They offer selective mechanical advantages, such as rigidity, impact strength, and resistance to abrasion and fluxural fatigue. Selective processing advantages also exist in flow characteristics, softening point, stress-rack resistance and mold shrinkage.

The electrical properties of polyethylenes and polypropylenes are similar and equally excellent over the operating temperature range of the materials. The dielectric constants and dissipation factors of both remain very low over a wide range of frequencies. This is shown in Fig. 20 for polyethylene.

All polyethylenes are relatively soft, although hardness increases with density. In general, also, the higher the density the better are the dimensional stability and physical properties, particularly as a function of temperature. Thermal stability of polyethylenes ranges from 190°F for low-density material up to 250°F for the high-density material. Thermal stability of polypropylene ranges from 250°F to over 300°F.

Cross-linked polyolefins are heat-shrinkable

While polyolefins, such as polyethylenes, etc., have many outstanding characteristics, they tend

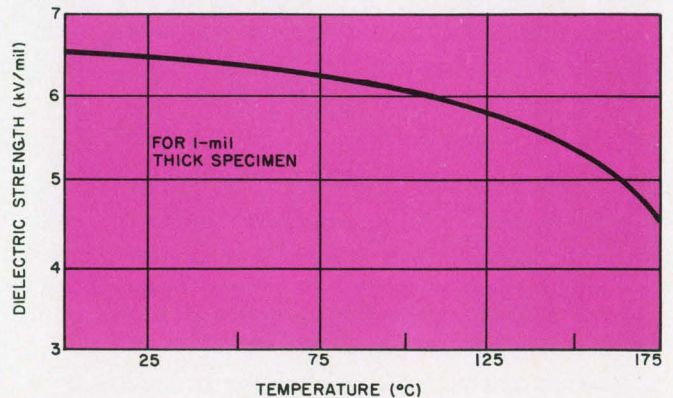
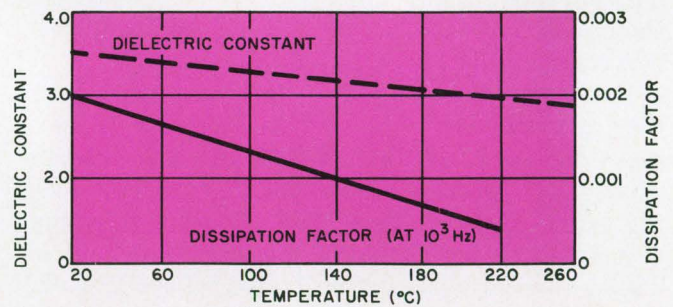

to creep or cold flow under the influence of temperature, load and time, as do all thermoplastics to some extent. To improve this and other properties, considerable work has been done on developing cross-linked polyolefins—especially polyethylenes. The cross-linked polyethylenes offer improvements in thermal performance of up to 25°C or more. Cross linking has been achieved primarily by chemical means and by ionizing radiation, and products of both types are available.

Radiation cross-linked polyolefins have gained particular prominence in a heat-shrinkable form. This form is achieved by cross linking the extruded or molded polyolefin, using high-energy electron-beam radiation, heating the irradiated material above its crystalline melting point to a rubbery state, mechanically stretching it to an expanded form (up to four or five times the original size), and cooling the stretched material. Upon further heating, the material will return to its original size, tightly shrinking onto the object around which it has been placed. Heat-shrinkable boots, jackets, tubing, etc. of this type are widely used (Fig. 26).

Irradiated polyolefins also find considerable use in wire and cable jacketing applications especially where minimum wire weight is a primary requirement.

Polyamide-imides and polyimides are comers

These two groups of plastics have some outstanding properties for electronic applications and are therefore gaining rapidly in importance. Generally, polyamide-imides and polyimides are characterized by high temperature stability, good electrical and mechanical properties (which are generally stable to higher temperatures than those for most plastics) and dimensional stability in most environments.

While their electrical properties are not as good as those of TFE fluorocarbons, polyamide-imides and polyimides are nevertheless good electrical performers, and are better than TFE fluorocarbons in mechanical and dimensional stability properties. This provides advantages in many high-temperature electronic applications. Polyamide-imides and polyimides are also useful at very low (negative) temperatures.

The electrical properties of polyimides as a function of temperature are shown in Fig. 27.

A potentially weak point of polyamide-imides and polyimides is moisture absorption in high humidities, with its attendant effects on physical and electrical properties. This characteristic varies with the material and its condition, and it should be investigated for any given application.

The thermal stability of these polymers is

outstanding, as shown by the data for insulating coatings on magnet wire given in Fig. 28. Some amide-imides are chemically etchable, especially in caustic solutions, and this provides some unique electronic design opportunities.

Molded polyimides have good wear and low friction properties, which can be improved even more by addition of fillers, such as graphite or molybdenum disulfide. The use of such fillers, however, slightly degrades other physical properties.

Polycarbonates combine useful properties

Polycarbonates have an excellent combination of properties for use in electronic applications. Their basic electrical properties are very good (Fig. 29) and remain reasonably stable up to about 150°C, as well as in high humidity environments. The dielectric constant value changes little up to nearly 10⁸ cycles, whereas the power factor or loss factor does increase somewhat in this frequency range.

Mechanically, polycarbonates excel in impact strength, heat resistance under load, dimensional stability, creep resistance, outdoor weatherability and low-temperature strength. The Izod notched-impact strength is approximately four times better than that of nylons or acetals. The useful upper temperature limit of polycarbonates, from the standpoint of their mechanical properties, is 250°F or higher, slightly exceeding that of acetals and exceeding that of nylons by a larger margin.

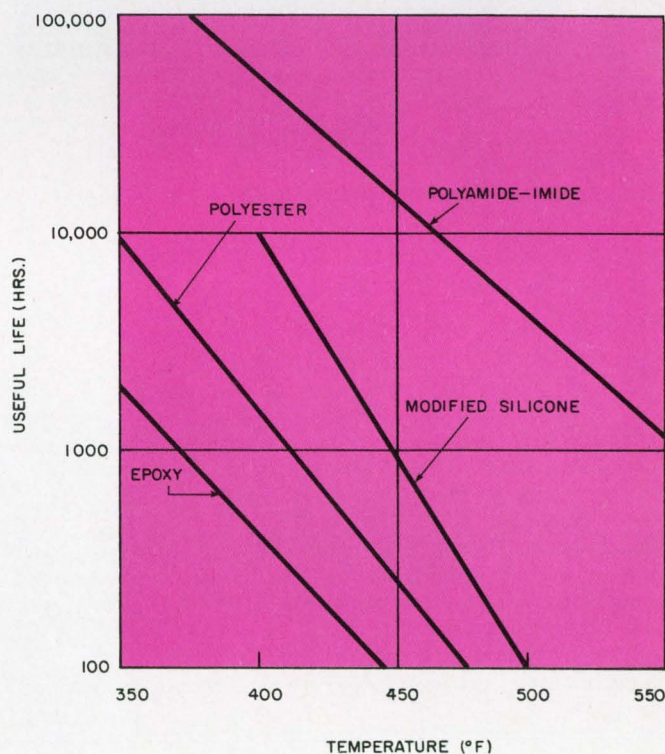

28. Thermal life of amide-imide wire enamels compared to other electrical insulation coatings.

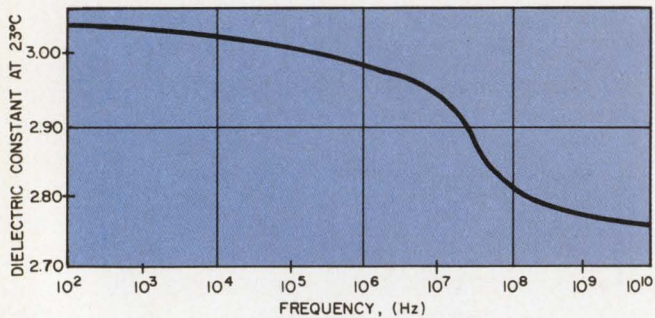
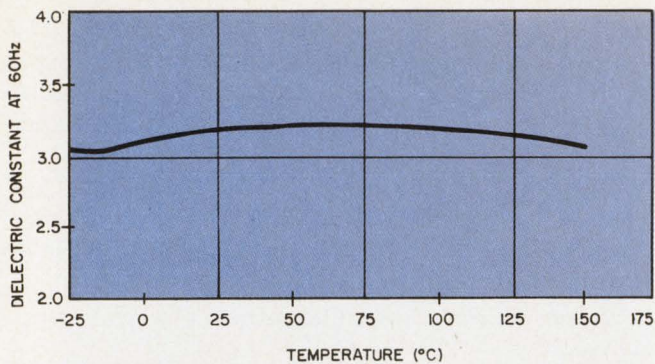

DIELECTRIC CONSTANT

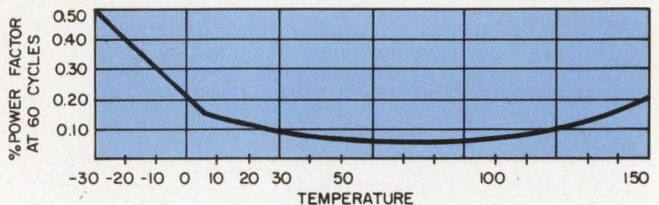
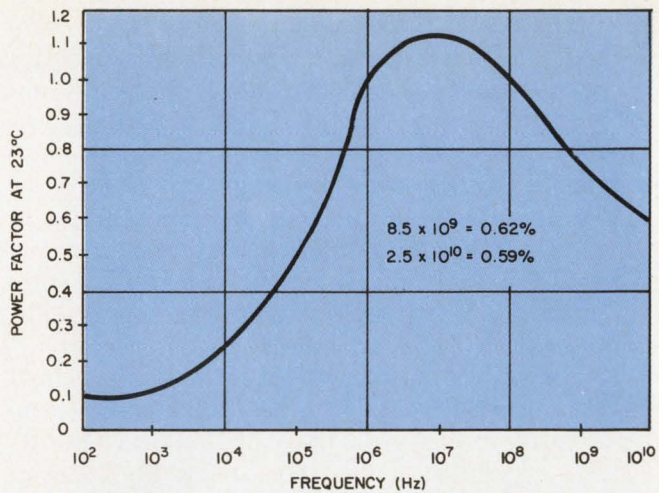

POWER FACTOR

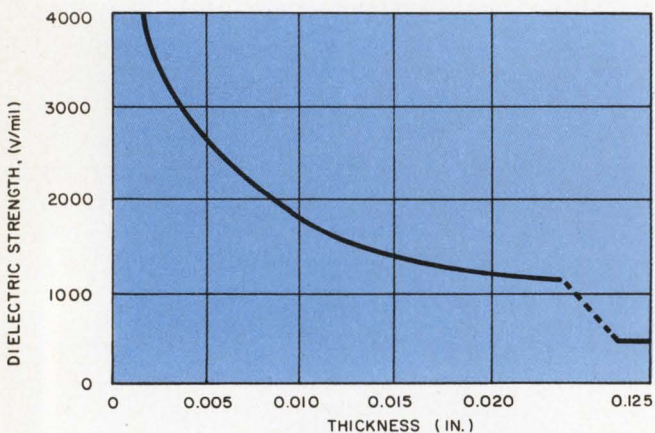

DIELECTRIC STRENGTH

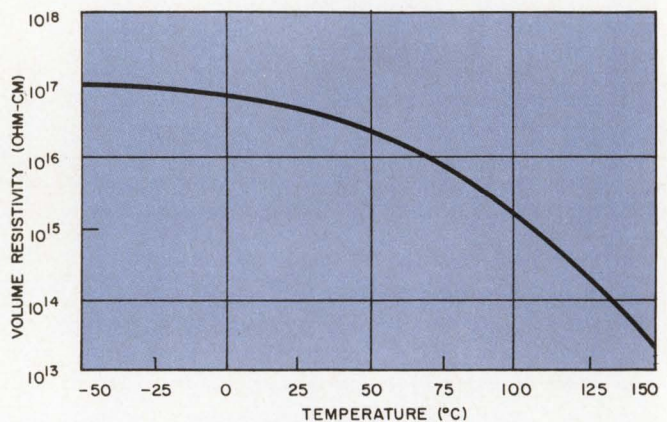

VOLUME RESISTIVITY

29. Important electrical properties of polycarbonates.

30. **Glass-reinforced polycarbonate** is used in the body housing and shaft hubs of this H. H. Controls Co. optical shaft encoder. Dimensional stability over the operating temperature range and light weight were two major factors in this application. (photo courtesy Fiberfil, Inc.)



Polycarbonates are also available in glass-reinforced compositions (Fig. 30).

Polyphenylene oxides are relatively new

The polyphenylene oxides represent another relatively new and important class of plastics that are very useful for electronic applications. They are products of General Electric Co. and are known as PPO and Noryl. Polyphenylene oxides have good all-around mechanical and electrical properties, with some of the PPO materials being especially good in their combination of mechanical properties and high-frequency electrical properties. For electronic application purposes, polyphenylene oxides would compete with acetals, polycarbonates, polysulfones and nylons (polyamides).

The electrical properties of polyphenylene oxides remain relatively constant with frequency and temperature over the material's rated temperature range. The electrical properties are also relatively unaffected by humidity. The effects of frequency and temperature on dissipation factor for polyphenylene oxide and other materials are shown in Fig. 31.

The heat deflection temperature of the polyphenylene oxides ranks high among the more rigid thermoplastics. Polyphenylene oxides also rate well in tensile strength vs temperature, tensile modulus and tensile creep. Water absorption is relatively low, as is the attendant change in dimensions and weight associated with water absorption. Impact strength, however, is not as good as that of polycarbonates at elevated temperatures.

Polystyrenes used widely at high frequencies

Polystyrenes are an important class of thermoplastic materials for the electronics industry because of their very low electrical losses. They have excellent dielectric strength and resistivity properties, as well as an exceptionally low dissipation factor and dielectric constant. Their mechanical properties are adequate, although they are somewhat temperature-limited, having normal temperature capabilities below 200°F. Polystyrenes can be cross-linked to produce higher temperature materials, as noted in Table 9, but these are somewhat brittle.

The low dissipation factor and dielectric constant of polystyrene as a function of frequency are shown in Fig. 20. (When referring to the illustration, it should be noted that the dielectric constant of some polystyrenes increases rapidly above $10^9 - 10^{10}$ Hz). This low dissipation factor, coupled with the relative rigidity of polystyrene compared to polyethylene and TFE, gives polystyrene advantages in many electronic applica-

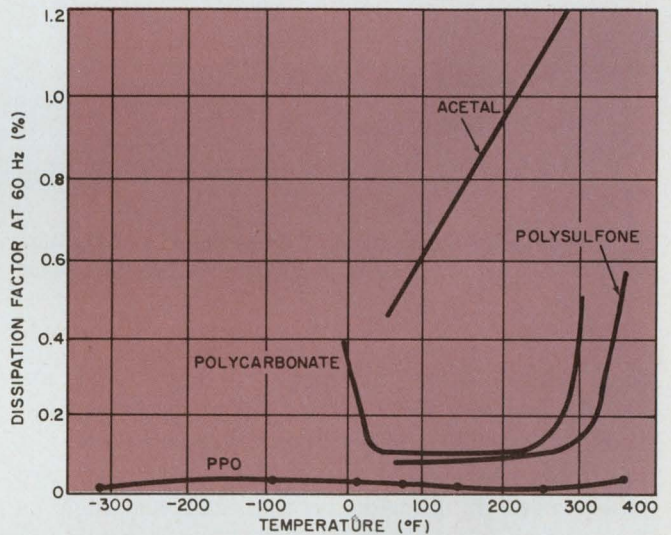
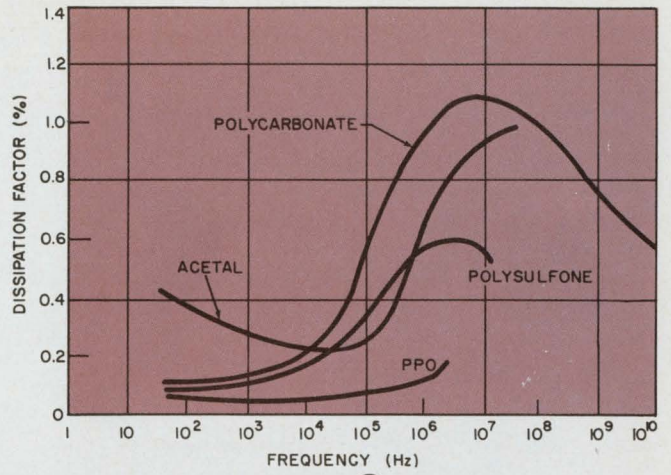

31. Effect of frequency on dissipation factor (A), and of temperature on 60-Hz dissipation factor (B) of several engineering thermoplastics.

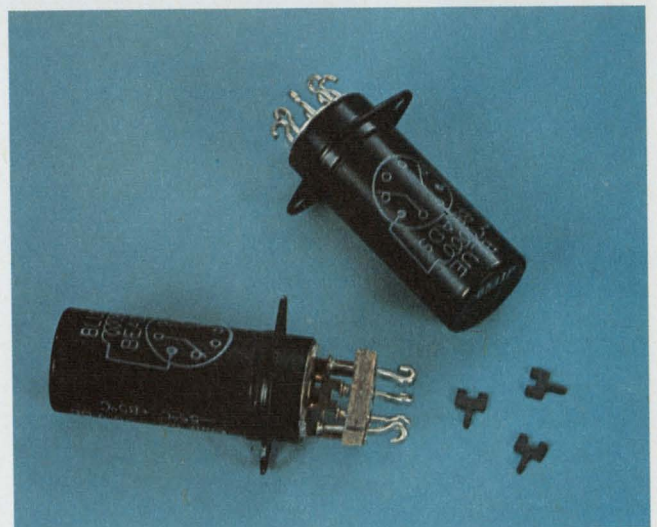

Polyimide resin has replaced a filled phenolic composition in the actuator portion of this Allied Control Co. relay. (photo courtesy E. I. Du Pont de Nemours)

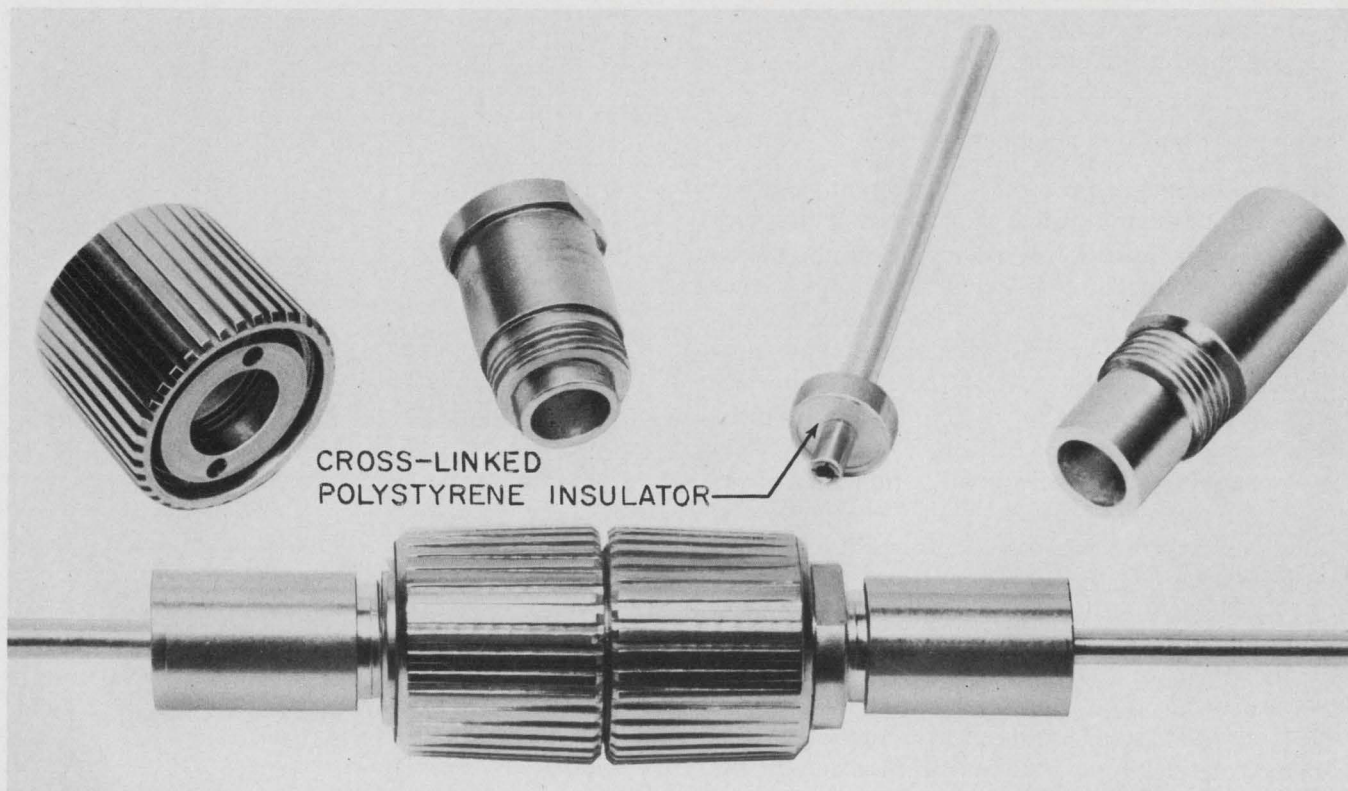

32. **Low-loss insulator** made of cross-linked polystyrene, indicated by arrow, is used in this Amphenol microwave

connector. (photo courtesy Brand-Rex Division, American Enka Corp.)

tions that require material hardness and extremely low electrical losses, particularly at high frequencies. The cross-linked polystyrenes are especially serviceable here. These materials are widely used in microwave applications, such as the connector shown in Fig. 32.

Polysulfones maintain properties after heat aging

Polysulfones are relatively new and very useful thermoplastics for electronic design applications. They have excellent strength vs temperature properties, good electrical properties (though not outstanding for high frequency) and outstanding strength retention over long periods of aging up to 300°F or over. The electrical properties of polysulfones are maintained to approximately 90% of their initial values after exposure at 300°F one year or more. The properties are generally stable up to about 350°F, and under exposure to water or high humidity.

The dissipation factor vs frequency as well as temperature for polysulfones is shown in Fig. 31. The dielectric constant of the material is approximately 3.1 up to 10⁶ Hz, and decreases slightly at 10⁷ Hz.

The heat-deflection temperature of polysulfones rates high among engineering thermoplastics, as does the flexural modulus vs temperature. The tensile-strength properties of polysulfones are generally similar to those of polycarbonates

and polyphenylene oxides, as are the dimensional changes due to absorbed moisture. The retention of strength properties after prolonged heat aging is perhaps the most outstanding feature of polysulfones.

Vinyls are useful—but not outstanding

Vinyls are good general-purpose electrical insulating materials, although not outstanding from an electronic applications viewpoint. Perhaps their biggest use in electronics is as insulation for hookup wire and as sleeving.

There are many grades and types of vinyls, but the special electrical grades are the ones that should be considered for electronic applications. In addition to the various basic classifications, vinyls may be rigid, flexible or foamed. Further, they may be filled in many ways, alloyed with other plastics, or plasticized with various plasticizers.

Some vinyls have unusual resistance to corrosive chemicals, such as plating baths, etc. One convenient-to-use form of vinyl is the polyvinylchloride dispersion which is available in liquid form and solidifies upon application of heat. Hence, these dispersions can be used for casting, potting and dip-coating applications—somewhat like RTV silicones except that they have considerably different properties. Properties favor silicones, and costs favor the vinyl dispersions.

Elastomers

At one time, when natural rubber and a few synthetic rubbers constituted the primary types of rubberlike materials in use, the term "rubber" was used predominantly to describe this group of materials. However, thanks to developments in the field of polymer chemistry, numerous rubberlike materials have been developed whose chemical composition bears no resemblance to the chemical composition of either natural rubber or the early synthetic rubbers. These newer materials often exhibit vast improvements over the early rubbers in many respects, while still being basically rubberlike or elastic in character. The term "elastomer" has, therefore, come to be used to encompass the broadened range of such materials.

The ASTM definition of an elastomer is "A material which at room temperature can be stretched repeatedly to at least twice its original length and upon immediate release of the stress will return with force to its approximate original length."

There are currently over a dozen recognized classes of elastomers, a number of which are useful in electronic assemblies. These are often used for cushioning materials, for vibration damping, and for gasketing and sealing, as well as for applications where rubberlike properties coupled with some selected combination of mechanical, electrical or fluid-resistant properties are required.

Elastomers are sometimes known by their popular name, sometimes by their chemical name and sometimes by the ASTM designation or some other previously used symbol. Table 12 is a cross reference of these various identifications. Further, there are ASTM-SAE application classifications for various elastomers. These are:

- Type R—non-oil-resistant
- Type S—resistant to petroleum chemicals
 - Class SA—very low-volume swell
 - Class SB—low-volume swell
 - Class SC—medium-volume swell
- Type T—temperature-resistant
 - Class TA—high and low temperature-resistant
 - Class TB—hot air and oil-resistant

The properties of elastomers may be defined and specified in a manner similar to that commonly used for plastics. In addition, though, there are some other properties of particular value in identifying these materials. One of these is hardness, and in fact, is often the primary description used in identifying the characteristics of an elastomer.

The hardness of an elastomer is related to its degree of vulcanization, or cure, and to the presence or absence of filler materials. The softer the rubber, the lower the hardness as normally measured by means of a durometer test. A comparative hardness guide is shown in Fig. 33.

Compression set is another property often specified for elastomeric materials. According to ASTM test D-395, compression set is the residual decrease in the thickness of a test specimen observed after 30 minutes of rest following the removal of a specified compressive loading applied under established conditions of time and temperature.

Elongation and tensile strength are also often used to describe elastomers. Elongation is the amount the material is stretched at the moment of rupture. The amount of force necessary to rupture the material is the tensile strength, which is normally expressed in terms of the original cross section of the specimen tested.

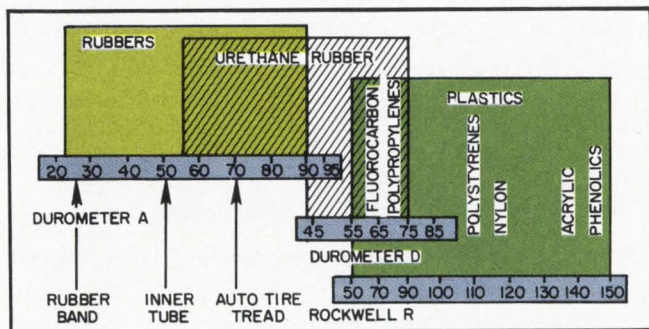

33. Hardness comparison for various elastomers and plastics.

Table 12. Nomenclature and major property considerations for elastomers

ASTM D 1418 designation	Tradename or common name	Chemical description	General properties
NR	Natural rubber	Natural polyisoprene	Excellent physical properties; good resistance to cutting, gouging and abrasion; low heat, ozone, and oil resistance. Electrical grades have excellent electrical properties at room temperature.
IR	Synthetic natural	Synthetic polyisoprene	Same general properties as natural rubber; requires less mastication in processing than natural rubber.
CR	Neoprene	Chloroprene (polychloroprene)	Excellent ozone, heat, and weathering resistance; good oil resistance; excellent flame resistance. Not as good electrically as NR or IR. However, the combination of generally good electrical and environmental properties make CR very suitable for electrical wire and cable jackets.
SBR	GRS, Buna S	Styrene-butadiene	Good physical properties; excellent abrasion resistance; not oil, ozone, or weather resistant. Electrical properties generally good but not outstanding in any area.
NBR	Buna N, Nitrile	Acrylonitrile-butadiene	Excellent resistance to vegetable, animal, and petroleum oils; poor low-temperature resistance; electrical properties not outstanding.
IIR	Butyl, chlorobutyl	Isobutylene-isoprene, Chloro-isobutylene-isoprene	Excellent weathering resistance; low permeability to gases; good resistance to ozone and aging; low tensile strength and resilience. Electrical properties generally good but not outstanding.
BR	Cis-4	Polybutadiene	Excellent abrasion resistance and high resilience; used principally as a blend in other rubbers.
—	Thiokol (PS) (Thiokol chemical)	Polysulfide	Outstanding solvent resistance; widely used for potting of electrical connectors.
R	EPR, EPT	Ethylene propylene, Ethylene propylene terpolymer	Good aging, abrasion, and heat resistance; not oil resistant. Good general electrical properties.
CSM	Hypalon (HYP) (Du Pont)	Chlorosulfonated polyethylene	Excellent ozone, weathering, and acid resistance; fair oil resistance; poor low-temperature resistance; not outstanding electrically.
SIL	Silicone	Polysiloxane	Excellent high- and low-temperature resistance; low strength; high compression set. Excellent electrical properties; especially good stability of dielectric constant and dissipation factor at elevated temperatures.
—	Urethane (PU)	Polyurethane di-isocyanate	Exceptional abrasion, cut and tear resistance; high modulus and hardness; poor moist-heat resistance. Generally good electrical properties. Special high-quality electrical grades are available.
—	Viton (FLU)	Fluorinated hydrocarbon	Excellent high-temperature resistance, particularly in air and oil. Not outstanding electrically.
ABR	Acrylics	Polyacrylate	Excellent heat, oil, and ozone resistance; poor water resistance. Not outstanding for or widely used in electrical applications.

Two other important design characteristics of elastomers are low-temperature stiffening and high-temperature service limits. Data for these limits are given in Table 13 and Fig. 34, respectively.

As with plastic materials, a broad range of properties can often be obtained with any given type of elastomer by compounding or modifying the basic material. Some representative electrical data ranges for the various elastomer classes can nevertheless be shown, as in Table 14.

Chlorosulfonated polyethylene has special uses

This unique elastomer has outstanding resistance to oxidizing chemicals, heat, abrasion, sunlight and weathering. It is almost completely inert to ozone, and it is one of the few elastomers that can be compounded in any color or shade. The electrical properties of chlorosulfonated polyethylene are generally good but not outstanding. The combination of excellent physical properties and good insulating properties make the

material a promising candidate for special insulation applications.

Ethylene-propylenes are on the upsurge

EP elastomers, whose usage is on the increase, are general-purpose synthetic rubbers having broad end-use potentials similar to those of natural rubber and SBR. The EP elastomers are highly resistant to attack by ozone, have excellent heat resistance, low-temperature flexibility (down to -70°C) and electrical properties—particularly as used in high-voltage cabling and insulation. Applications of EP elastomers include insulation for wire and cable.

Fluorocarbons rate only fair electrically

These specialty elastomers are relatively high-cost materials that have excellent resistance to chemicals and temperature extremes. Their mechanical properties are comparable to those of other synthetic rubber materials. Significant

Table 13. Stiffening temperature and brittle points for elastomers

Elastomer	Stiffening temp. (°F)	Brittle point (°F)
Natural rubber	-20 to -50	-70
SBR	-10 to -50	-80
Butyl	0 to -40	-75
Polysulfide	-10 to -40	-65
Buna N	+15 to -35	-70
Neoprene	0 to -30	-60
Chlorosulfonated polyethylene (Hypalon)	-30 to -50	-60
EPR and EPT	-20 to -50	-80
Polybutadiene (Cis 4)	-35 to -60	-90
Silicone	-50 to -90	-100
Fluorocarbon	+15 to -25	-55
Polyurethane	-5 to -25	-60

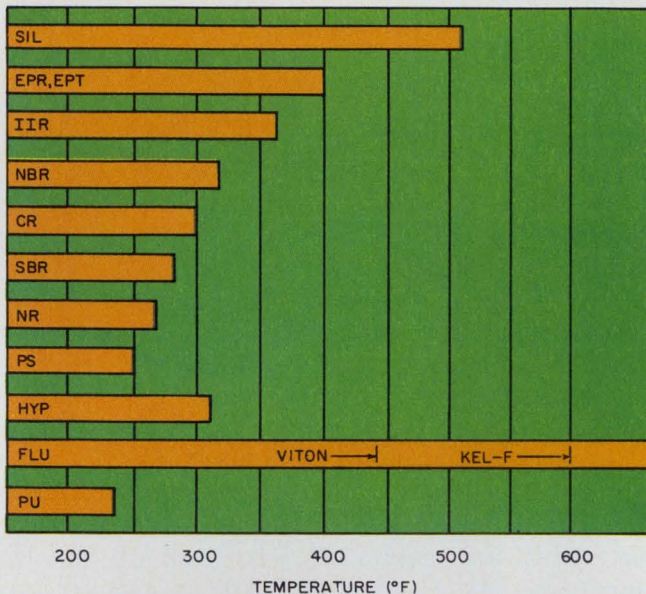

34. **High-temperature service limits for elastomers.** See Table 12 for the trade names or common names of these elastomers.

properties of fluorocarbons are good physical performance at 200°C and higher; resistance to most oils, chemicals, solvents and exotic fuels at 200°C and above; good mechanical properties; excellent resistance to ozone, oxygen and weathering; and fair electrical characteristics.

Nitriles are highly oil-resistant

The nitriles, which are among the most widely used elastomers, are known for their good oil resistance, and particularly for retention of tensile strength and abrasion resistance after immersion in oils. They have a lower and more temperature-sensitive resiliency than natural rubbers. Many different blends of the two basic chemical ingredients (acrylonitrile and butadiene) are available, and the proportion of each affects the properties of the end product.

The higher the acrylonitrile content of the rubber, the higher its tensile strength and its resistance to solvent attack and thermal degradation, and the lower its compression set. The higher the

butadiene content, the greater the resilience and low-temperature flexibility of the end product. Most commercial nitrile rubbers contain 20 to 40% acrylonitrile. The presence of acrylonitrile introduces a molecular polarity that degrades electrical properties, compared to SBR and butyl rubber.

Polyacrylates have good physical properties

Acrylic elastomers, or polyacrylate rubbers, are primarily noted for resistance to high temperatures, oxidation, sunlight and ozone. They are particularly resistant to sulfur-bearing oils, even at temperatures of 175°C and higher. These elastomers do not have outstanding electrical properties, but they are used as wire insulation where environmental resistance properties are also important.

Polychloroprenes are most resilient

Polychloroprenes, or neoprenes, are the most resistant of all synthetic rubbers, and among the best known. They are flame-resistant and relatively inert chemically, as well as generally superior to natural rubber in resistance to oxidation, sunlight, and to solvent attack by mineral and vegetable oils. Polychloroprenes are generally inferior to natural rubber in tensile and tear strength and in electrical properties. Principal electrical uses of polychloroprenes are wire insulation and cable jackets.

Polysulfides broadly used for connector potting

Polysulfide rubbers have good electrical properties at room temperature, excellent resistance to ozone, oil, and solvents, and good resistance to gas permeation. Compared with most elastomers, they have relatively low mechanical strength and high cold flow. Optimum operating temperature of polysulfides is below 100°C, but they can be used as high as 125°C if lesser physical and electrical properties are acceptable. The electrical properties of polysulfides can be improved by the addition of epoxy resins. This, however, increases hardness.

Polysulfide rubbers are available as solid materials, which are processed similarly to natural rubber, as softened crude rubber stock, and as liquids. They are broadly used for low-voltage potting or sealing of connectors.

Polyurethanes have unexcelled abrasion resistance

Polyurethane, or urethane, elastomers have excellent mechanical strength and are unexcelled among elastomers in abrasion resistance. They have high tensile and tear strength and good re-

Table 14. Typical electrical properties of elastomers

Material	Dielectric constant 10 ⁶ Hz	Power factor x 10 ² , 10 ⁶ Hz	Volume resistivity, ohm-cm	Surface resistivity, ohms	Dielectric strength, volts/mil
Natural rubber	2.7-5	0.05-0.2	10 ¹⁵ -10 ¹⁷	10 ¹⁴ -10 ¹⁵	450-600
Styrene-butadiene rubber	2.8-4.2	0.5-3.5	10 ¹⁴ -10 ¹⁶	10 ¹³ -10 ¹⁴	450-600
Acrylonitrile-butadiene rubber	3.9-10.0	3-5	10 ¹² -10 ¹⁵	10 ¹² -10 ¹⁵	400-500
Butyl rubber	2.1-4.0	0.3-8.0	10 ¹⁴ -10 ¹⁶	10 ¹³ -10 ¹⁴	400-800
Polychloroprene	7.5-14.0	1.0-6.0	10 ¹¹ -10 ¹²	10 ¹¹ -10 ¹²	100-500
Polysulfide polymer ⁽¹⁾	7.0-9.5	0.1-0.5	10 ¹¹ -10 ¹²	-	250-325
Silicone	2.8-7.0	0.10-1.0	10 ¹³ -10 ¹⁷	10 ¹³	300-700
Chlorosulfonated polyethylene ⁽²⁾	5.0-11.0	2.0-9.0	10 ¹³ -10 ¹⁷	10 ¹⁴	400-600
Polyvinylidene fluoride-co-hexafluoroisopropylene ⁽³⁾	10.0-18.0	3.0-4.0	10 ¹³	-	250-700
Polyurethane ⁽⁴⁾	5.0-8.0	3.0-6.0	10 ¹⁰ -10 ¹¹	-	450-500
Ethylene propylene terpolymer ⁽⁵⁾	3.2-3.4	0.6-0.8	10 ¹⁵ -10 ¹⁷	-	700-900

(1) Thiokol, Thiokol Corp. (2) Hypalon, DuPont, Inc. (3) Viton A, DuPont, Inc. (4) Adiprene, DuPont, Inc. (5) Nordel, DuPont, Inc.

sistance to ozone. Their resistance to solvent attack by oils is between that of neoprene and nitrile rubbers.

The electrical properties of polyurethanes are good but not exceptional. Like polysulfides, they can be blended with epoxies to improve electrical properties.

Silicones are attractive for many uses

Silicone rubbers are among the best known and most widely used elastomeric materials in the electronics industry. They have excellent electrical properties (Fig. 35), including low electrical losses and good resistance to corona discharge. They also have excellent stability of electrical and elastomeric properties over the temperature range of -60 to above +260°C.

Bibliography:

American Lava Corporation, technical data bulletin, Alsimag Ceramics
 Chottiner, J., "Dimensional Stability of Thermosetting Plastics," *Materials and Design Engineering*, New York: Reinhold Publishing Corp., Feb. 1962.
 Coors Alumina and Beryllia, technical data bulletin, Coors Porcelain Company.
 Dapon Diallyl Phthlates, technical data bulletin. FMC Corporation.
Design Data for Teflon Fluorocarbon Resins, technical data bulletin, DuPont, Inc.
 Dow Corning Silicones, technical data bulletin, Dow Corning Corporation.
 Harper, C. A., "Electrical Insulating Materials," *Machine Design*, September 28, 1967.
 Harper, C. A., *Handbook of Electronic Packaging*, New York: McGraw-Hill Book Co., 1969.
 Harper, C. A., *Plastics for Electronics*, Chicago: Kiver Publications, Inc., 1964.
 Hauch, J. E., "Heat Resistance of Plastics," *Materials in Design Engineering*, New York; Reinhold Publishing Corp., April 1963.
 Lexan Polycarbonate Resins, technical data bulletin, General Electric Co.
 Mathews, J. P. "Elastomers," *Machine Design*, August 19, 1965.
 Mykroy Glass-Bonded Mica, technical data bulletin, Molecular Dielectrics, Inc.
 National Boron Nitride, technical data bulletin, Union Carbide Corporation.

The main advantage of silicone rubber in electrical applications is that it retains its good electrical properties, such as dielectric strength, power factor and insulation resistance at elevated temperatures where other insulation degrades.

Silicone rubber's fatigue life under continuous stress is high. Organic polymers comparable to silicone rubber in initial dielectric strength exhibit a far more rapid decrease in this characteristic when subjected to voltage for a prolonged period of time.

Properly compounded and cured silicone rubber has excellent resistance to moisture absorption. As a consequence, excellent electrical characteristics are maintained under humid service conditions. Also, surface breakdown and arc resistance are high. ■■

Noryl Thermoplastic Resins, technical data bulletin, General Electric Co.
 Parry, H. C., et al, "High Humidity Insulation Resistance of Resin Systems", *SPE Journal*, Society of Plastics Engineers, Oct. 1957.
 Parylene Product Data, technical data bulletin, Union Carbide Corp.
 Plaskon Plastics and Resins, technical data bulletin, Allied Chemical Corp.
 Polysulfone, technical data bulletin, Union Carbide Corp.
 Raychem Irradiated Polyolefins, technical data bulletin, Raychem Corp.
 Riley, M. W., *Selection and Design of Plastics, Materials and Methods*, New York: Reinhold Publishing Corp., June, 1957.
 Shand, E. B., *Glass Engineering Handbook*, New York: McGraw-Hill Book Co., and Corning Glass Works, Corning, N.Y. 1958.
 Silastic Silicone Rubbers, technical data bulletin, Dow-Corning Corp.
 Silicone Rubbers, technical data bulletin, General Electric Co.
 Staff Report, "Thermoplastics Materials Properties," *Plastics World*, October 1966.
 Stalwart Rubber Selector, technical data bulletin, Stalwart Rubber Co.
Teflon for Electrical and Electronic Systems, technical data bulletin, DuPont, Inc.
 Vespel Polyimide Resins, technical data bulletin, DuPont, Inc.

Union Carbide / San Diego proves again that great technology breeds great products



MULT6 MOS IC MULTIPLEXER

The MULT6 (UC 6410) features exceptionally low leakage ($I_{DSS} = 200 \text{ pA}$), exceptionally low capacitance ($C_{RSS} = 1.0 \text{ pf}$), high voltage breakdowns (-40 V). 6 MOS P-Channel enhancement transistors on a single chip. The last word in reliability for multiplexers, decommutation, logic, interfacing. Or use as a group of six electrical switches for a variety of functions.

(For information circle 231)

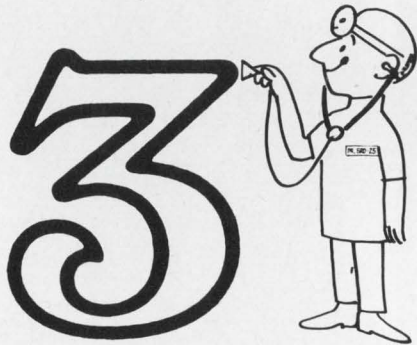

SRD-25 MOS IC SHIFT REGISTER

The new MOS Dual 25 Bit Dynamic Shift Register (UC7330) that solves your DTL and TTL interface problems. The only FULLY BIPOLAR COMPATIBLE shift register available today. Inputs can be driven by DTL or TTL. Output can drive DTL or TTL. Union Carbide's low threshold P-Channel technology assures low voltage power supplies ($V_{DD} = -10 \text{ V}$, $V_{GG} = -16 \text{ V}$), low power dissipation (typ. 0.4 mw/bit at 1 mHz).

(For information circle 233)



ROM1K MOS IC READ ONLY MEMORY

The world's best 1024-bit static MOS Read Only Memory, the UC6500. Three dimensional on-chip decoding. Four efficient word and bit organizations. Static operation. Bipolar compatible output. Low access time, less than $1.0 \mu\text{sec}$. Full MIL operating temperature range, -55°C to $+125^\circ\text{C}$. Chip inhibit capability. Dip or flat pack. And it's as fast as core, costs less than core, uses less power than core, and is 50 times denser than core.

(For information circle 232)

ALL FROM UNION CARBIDE, THE DISCOVERY COMPANY

Union Carbide's Electronics Division is a total supplier to the Electronics Community. For more information on Semiconductors, IC's and Modular Operational Amplifiers (circle 234), Capacitors (circle 235), Crystal Products (circle 236), Laser Systems (circle 237), and Water Quality Instruments (circle 238).

ELECTRONICS DIVISION
SEMICONDUCTOR DEPARTMENT



P.O. Box 23017, 8888 Balboa Avenue, San Diego, California 92123
TWX: 910-335-1211. Tel.: (714) 279-4500.

Plastic ICs

IN TOUGH ENVIRONMENTS



95% humidity off Louisiana coast



90°F / 90% humidity in jungle

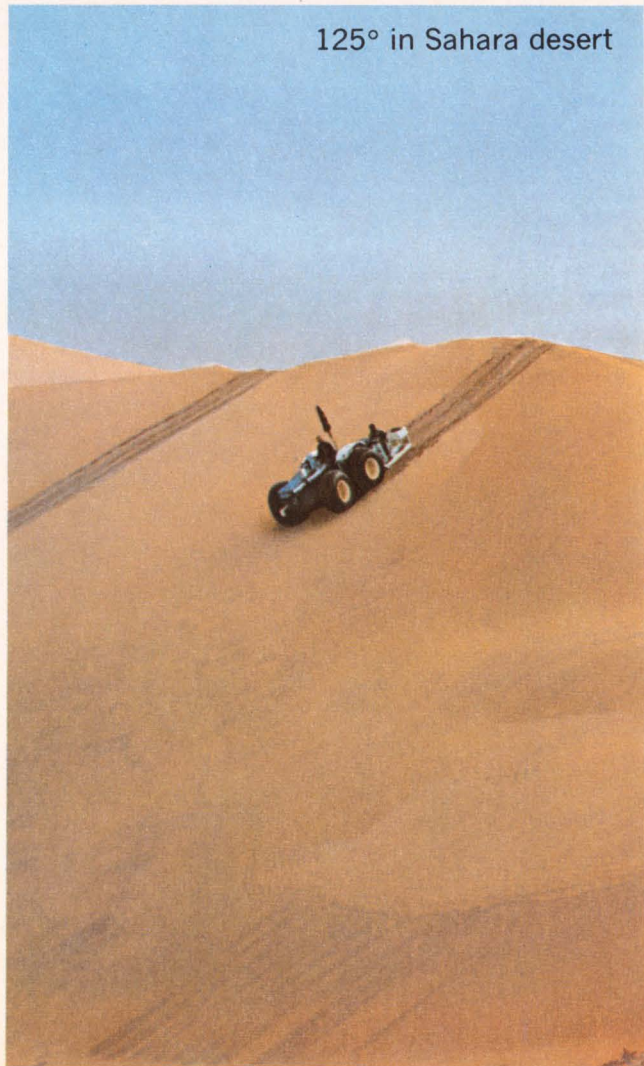

125° in Sahara desert



- 50°F at Northslope, Alaska

What do these oil exploration sites have in common?

Tough environments and reliable TI plastic ICs.



Conquering the elements is a major requirement of electronic equipment used in geophysical service... where tough environments demand rugged equipment and components.

Storage temperatures range from -50°F in the arctic to more than 150°F in the desert, operating temperatures from freezing to a searing 130°F .

Tropical rains and salt spray send humidities soaring to 100%.

Modules have even been submerged while crossing jungle streams.

And just transporting the equipment to job sites requires battle with some of the roughest terrain in the world.

Rugged TI plastic ICs have won this battle with heat, cold, humidity and

shock. Approximately 800 TI plastic ICs are used in each of the 150 DFS-III's™—digital seismic field systems—sold by TI's Industrial Products Group to geophysical crews on every continent and ocean. With DFS-III, these field workers instantly collect important seismic data in computer format to help uncover possible oil traps far below the earth's surface.

Out of the 100,000 plastic ICs in service on DFS-III field units, less than 0.03% have failed in up to three years duty. This performance has made DFS-III the industry standard for reliability.

Performance of TI plastic ICs has also established new standards of reliability for many other equipments. Over 1700 TI customers have combined the reliability and low cost of plastic

ICs to the benefit of their systems. Both the number and the diversity of plastic IC applications are growing dramatically.

Reliability Summary



For the latest information on the performance you can expect from TI plastic ICs, send for the new Reliability Summary just off the press.

Circle 246 on the Reader Service card for your free copy... or write direct to Texas Instruments Incorporated, Post Office Box 5021, MS 980, Dallas, Texas 75222.



TEXAS INSTRUMENTS
INCORPORATED

Don't experiment with ferrite beads - - design with them. Get more predictable high-frequency performance by learning how these inductors work.

Ferrite bead inductors, as many designers know, provide a convenient means for adding high-frequency insertion loss to a circuit. They are small, introduce no dc losses and are installed simply by slipping them onto component leads.

But their use originated by trial and error, and it is still largely that, since there are no handbooks to explain just how the beads work. Can the circuit performance be predicted with some degree of reliability? Yes, if designers understand the equivalent circuit analysis of ferrite beads.

R and L are frequency dependent

Ferrite beads can provide up to 10 dB of insertion loss over the frequency range of 1 MHz to 1 GHz. When inserted on a line, a bead has an equivalent circuit of a resistance in series with an inductance (Fig. 1). The values of both R and L depend heavily on the line frequency and current. The line current is the lesser of these two considerations, since it must be kept below about 5 A to avoid saturation of the bead.

To calculate R and L , refer to Fig. 2. (All symbols are defined in the box.) The total flux, ϕ , within the ferrite core on a wire results from integration over the core volume, or

$$\phi = \int_0^s \int_{r_1}^{r_2} B ds dr = (\mu_r \mu_0 I s / 2\pi) \ln(r_2/r_1).$$

For the bare wire in air without the bead ($\mu_r=1$ for air),

$$\phi_0 = (\mu_0 I s / 2\pi) \ln(r_2/r_1),$$

So the change in flux due to placement of the ferrite bead on the wire is:

$$\Delta\phi = \phi - \phi_0 = (\mu_0 I s / 2\pi) (\mu_r - 1) \ln(r_2/r_1).$$

The corresponding inductances (for $n=1$) of the ferrite plus wire (L), the bare wire (L_0) and the ferrite alone (ΔL) are:

$$L = \phi / I = (\mu_r \mu_0 s / 2\pi) \ln(r_2/r_1),$$

$$L_0 = \phi_0 / I = (\mu_0 s / 2\pi) \ln(r_2/r_1), \text{ and}$$

$$\Delta L = L - L_0 = (\mu_r - 1) L_0.$$

The change in impedance due to insertion of the ferrite core is

$$\Delta Z = j\omega\Delta L = j(\mu_r - 1) L_0.$$

Because of losses in the magnetic material, the effective relative permeability, μ_r , must be expressed in complex form (this is explained in detail later):

$$\mu_r = \mu' - j\mu''$$

So a complex ferrite impedance results; namely

$$\begin{aligned} \Delta Z &= j\omega(\mu' - j\mu'' - 1) L_0 \\ &= j\omega L_0(\mu' - 1) + \omega\mu'' L_0 \\ &= j\Delta X + \Delta R \end{aligned}$$

where

$$\Delta R = \mu''\omega L_0 = \text{effective resistance}$$

$$\Delta X = (\mu' - 1)\omega L_0 = \text{effective reactance.}$$

The equivalent resistance and inductance of a ferrite bead can be measured by winding a single coil turn around the bead. The lumped impedances are then determined with either a Maxwell-Schering bridge or a mutual inductance bridge to yield the impedance of the bead plus the line, or

$$Z = R + jX.$$

As long as only a single ferrite bead is involved (rigorously speaking, as long as the line length through a bead or an array of beads does not become a significant portion of a quarter wavelength), line impedance (Z_0) can be ne-

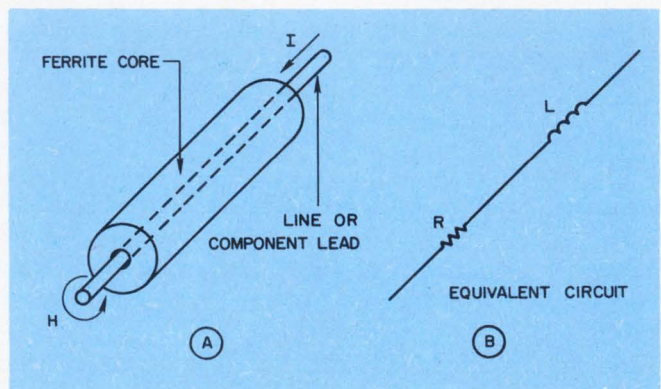

1. Ferrite bead inductors (A) have the simple equivalent circuit shown in (B).

Robert B. Cowdell, Manager, Systems Engineering, Genisco Technology Corp., Compton, Calif.

glected. The measurement therefore effectively determines the contributions to resistance and reactance due to the ferrite bead.

Complex permeability is convenient

When voltage is applied to a single-turn coil around a ferrite bead, a phase difference exists between the applied ac field and the resulting magnetization within the core. This suggests treating the core permeability as a complex vector quantity (as previously mentioned). The real part gives rise to inductance, while the imaginary part is associated with a residual core loss (the damping effect within the core causes energy dissipation). Measured data (Fig. 3) shows the variation in ΔR and ΔX with frequency for an actual ferrite bead. The real and imaginary parts, μ' and $-j\mu''$, respectively, of the permeability, μ_r , then follow from:

$$\mu'' = \Delta R / \omega L_0$$

$$\mu' = \Delta X / (\omega L_0 - 1)$$

where L_0 is accessible from calculation or measurement.

A sample permeability calculation for the bead inductors depicted in Fig. 3 follows. For the example, $\mu_0 = 4 \times 10^{-7} \text{H/m}$, bead length is 0.118 in. ($0.118 \times 2.54/100$)m, and from Fig. 1,

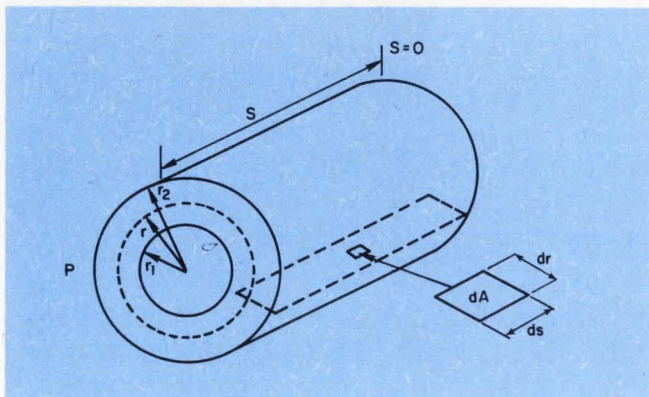

2. Total flux within a ferrite bead is found by integration over the bead volume.

Symbol definitions

- H = magnetic field intensity at core radius r for $n = 1$ turn
 $= 1/2 \pi r$
- B = magnetic flux density at point with radius r
 $= \mu H \mu_r \mu_0 H$, where
 μ_0 = absolute permeability in air
 μ_r = relative permeability
- ϕ = BA = total flux at radius r , with A = core cross section
- $d\phi$ = $B ds dr$ = flux through differential area element dA
- L = inductance
- Z = impedance
- R = resistance
- X = reactance
- ω = frequency
- I = ac line current
- $j^2 = -1$
- $()_0$ = refers to quantities without the ferrite core.
- Δy = refers to a differential change of a quantity, y , due to the ferrite core.

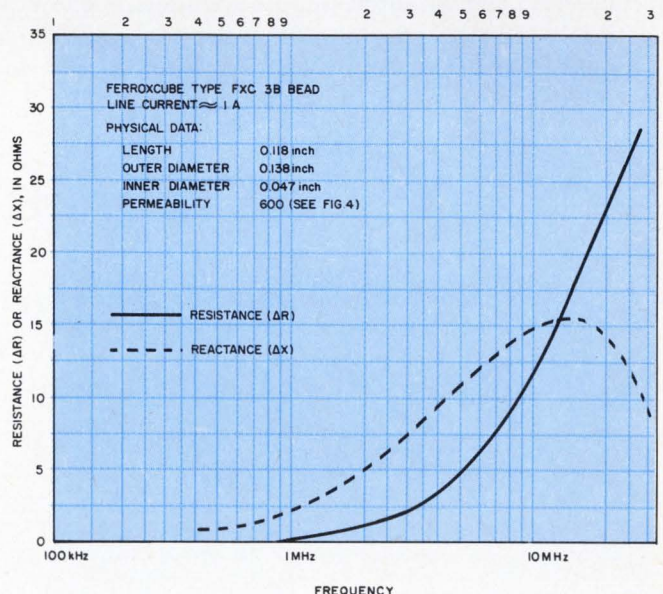

3. Resistance and reactance measurements vs frequency for a ferrite bead can be plotted in graph form and then used to determine bead permeability.

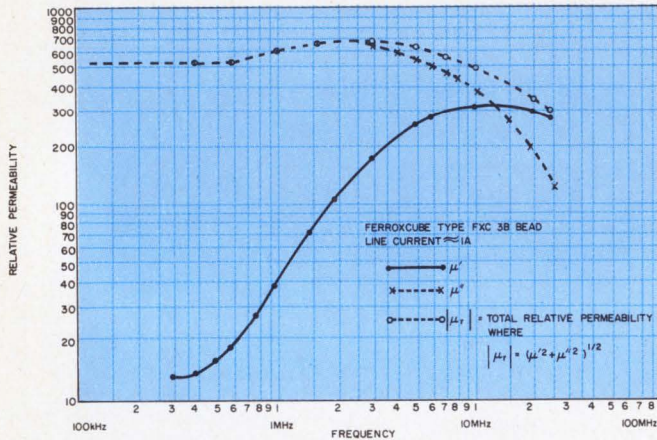

4. Total bead permeability, μ_T , consists of a real component, μ' , and an imaginary component, $-j\mu''$.

$\ln(r_2/r_1) = 1.04$. Hence,
 $L_o = (\mu_o s / 2\pi) \ln(r_2/r_1) = 600 \mu\text{H}$
 and from Fig. 3, at 5 MHz,
 $\Delta R = 4.8 \Omega$ and $\Delta X = 11 \Omega$.
 Substituting, therefore,
 $\mu'' = \Delta R / 2\pi f L_o = 256$
 $\mu' = \Delta X / 2\pi f L_o = 583$.

The variation of complex permeability with frequency, as computed in this manner, is shown in Fig. 4. Note that this data assumes a specific value of line current. The permeability, as a

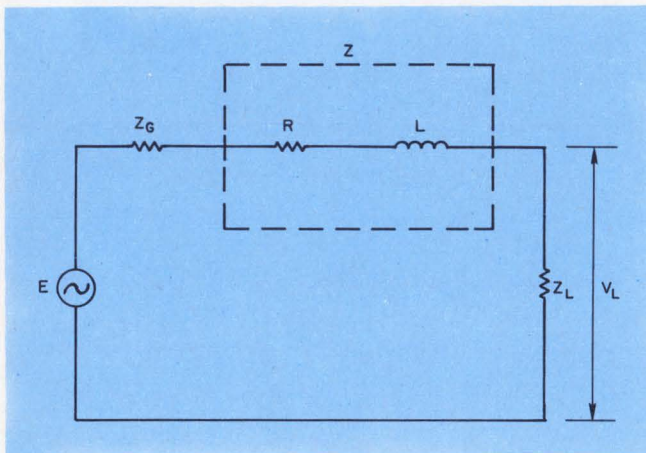

6. When a bead is placed on a line, the impedance, Z , of the bead and line adds to the existing circuit impedances, Z_G , and Z_L .

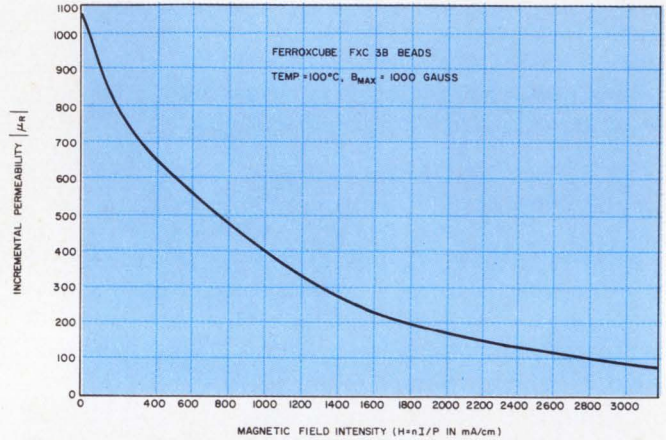

5. Line current, I , has a significant effect on the permeability of a ferrite bead.

function of frequency, changes drastically as line current increases, as shown in Fig. 5.

Note from Fig. 5 that for a single-turn coil, the magnetic field intensity is given by $H = I/P$, where $P = \pi(r_1 - r_2)$ is the average length around the periphery of the ferrite bead. With $r_1 = 0.47$ in. and $r_2 = 0.138$ in., $P = 1.47$ cm. For the beads depicted in Fig. 4, the curves show that the permeability should not be less than 530 in the effective operating range for best performance. Figure 5 therefore demonstrates that H cannot be larger than about 713 mA/cm. The allowable line current, I_{max} , thus turns out to be:

$$I_{\text{max}} = H_{\text{max}} P = (713)(1.47) = 1050 \text{ mA.}$$

This means that the permeability values of Fig. 4 are true as long as the line current does not exceed 1 A. For larger line currents, permeability decreases rapidly. Consider, for example, $I = 3$ A; then $H = I/P = 2045$ mA/cm, and Fig. 5 shows a drop in permeability from 530 (for 1 A current) to 175.

Insertion loss can be calculated

The insertion loss ratio (ILR) of a circuit containing ferrite beads is the ratio of load voltage with (v_o) and without (v_L) the inserted circuit (Fig. 6):

$$\begin{aligned} ILR &= (E/v_o) / (E/v_L) = v_o/v_L \\ &= (Z_G + Z_L) / (Z_G + Z_L + Z) \end{aligned}$$

And if load and source impedances are matched, say, at 50Ω , then $Z_G = Z_L = 50$.

Therefore,

$$ILR = 100 / (Z + 100)$$

Every ferrite bead strung on a wire introduces a series impedance $\Delta Z = \Delta R - j\Delta X$. If n beads are used, and if the highest frequency is low enough to keep the electrical line length below a significant fraction of a quarter wavelength, then the total series impedance of the n beads is $n\Delta Z = n(\Delta R - j\Delta X)$.

As an example, consider 30 Ferroxcube FXC 3B beads. Total length is $30 (0.118 \text{ in.}) (0.254 \text{ m/in.}) = 0.241 \text{ m}$. With 10 MHz as the highest frequency under consideration, the corresponding wavelength is 3 m, and line length represents $(0.241/3) = 0.08$ wavelength, which is much less than a quarter wavelength. For 10 MHz, Fig. 3 shows measured values of $\Delta R = 12.2 \Omega$ and $\Delta X = 15 \Omega$; hence, $\Delta Z = 30 (12.2 - j15) = 366 + j450 \Omega$. With these numbers, we can now determine

$$IRL(\text{dB}) = 20 \log_{10} \left| \frac{100}{Z + 100} \right| = -16.3 \text{ dB}$$

This yields one point on a curve of ILR vs frequency, which is plotted on Fig. 7. The slope of the measured ILR curve in Fig. 7 has abrupt changes at 350 and 650 MHz. At 350 MHz, line length has become slightly larger than a quarter wavelength; while at 650 MHz, line length is a half-wavelength.

How many beads?

The use of ferrite beads for increased insertion loss has obvious limitations, as a quick estimate will readily show. Suppose the number is increased from 30 (in the previous example) to 300. The insertion loss at 10 MHz then increases from -16.3 dB to -35.4 dB . However, the frequency of minimum attenuation has now decreased by a factor of 10, from 350 MHz to 35 MHz. The comparison is shown in Fig. 8.

As a practical rule, ferrite strings should be kept short, and should be limited approximately to the 1 to 100 MHz frequency range. Long bead lengths cause severe insertion-loss degradation. ■■

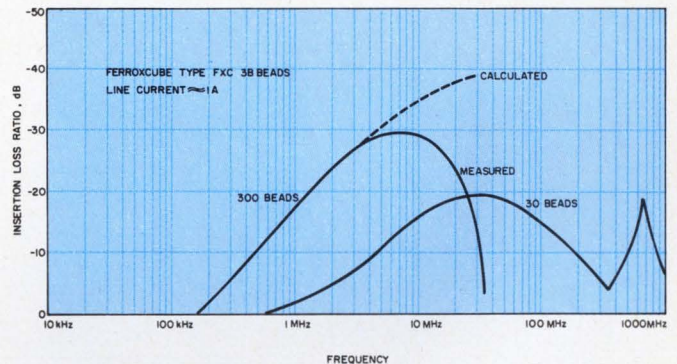

7. Insertion-loss ratio of 30 beads strung on a line is very frequency-dependent.

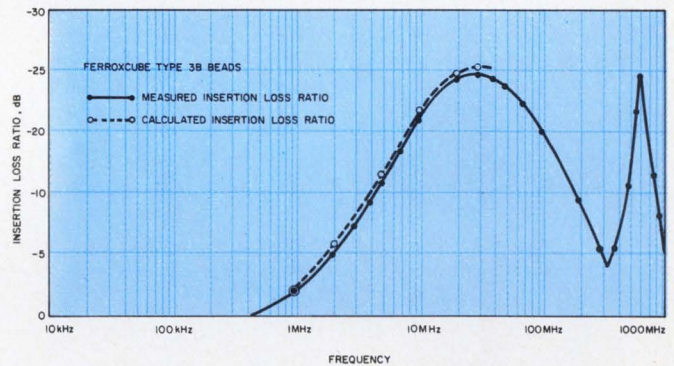

8. Increasing the number of beads on a line shifts the insertion-loss vs frequency curve lower in frequency.

Test your retention

Here are questions based on the main points of this article. Their purpose is to help you make sure you have not overlooked any important ideas. You'll find the answers in the article.

1. What are ferrite bead inductors used for?

2. What are the effects of line frequency and current on the characteristics of ferrite beads?

3. Why is there a practical limit to the number of ferrite beads that can be added to a line?

Dow Corning presents four new star performers on the electronic circuit.

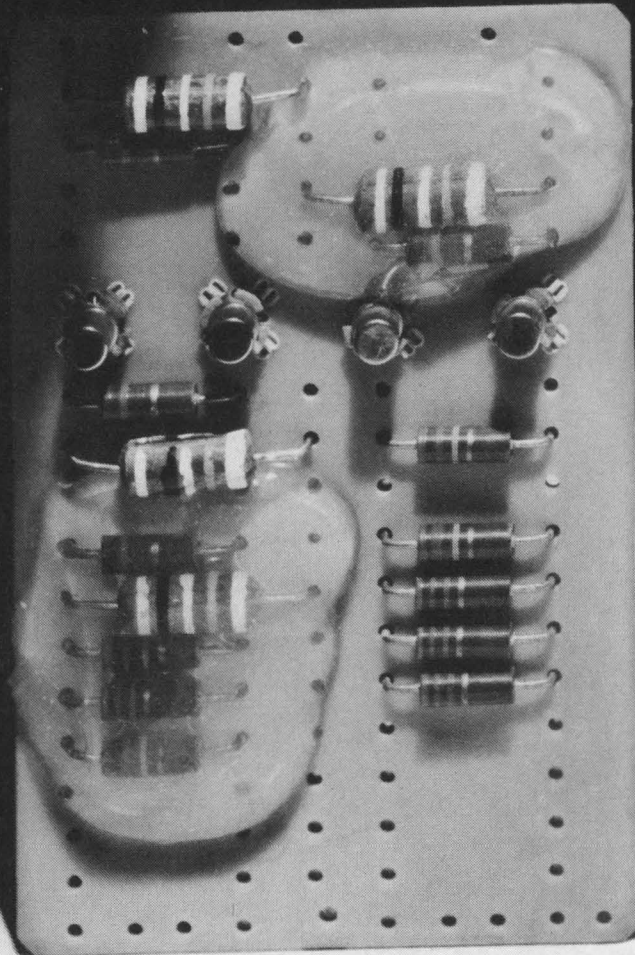

Now you see it

New Dow Corning® 3144 noncorrosive RTV adhesive/sealant is translucent to clear. You should see the job it does for corrosion-sensitive electrical or electronic equipment. It's a high-strength adhesive, too, cures at room temperature, and remains stable when the heat's on (long term to 250°C, short term to 300°C).

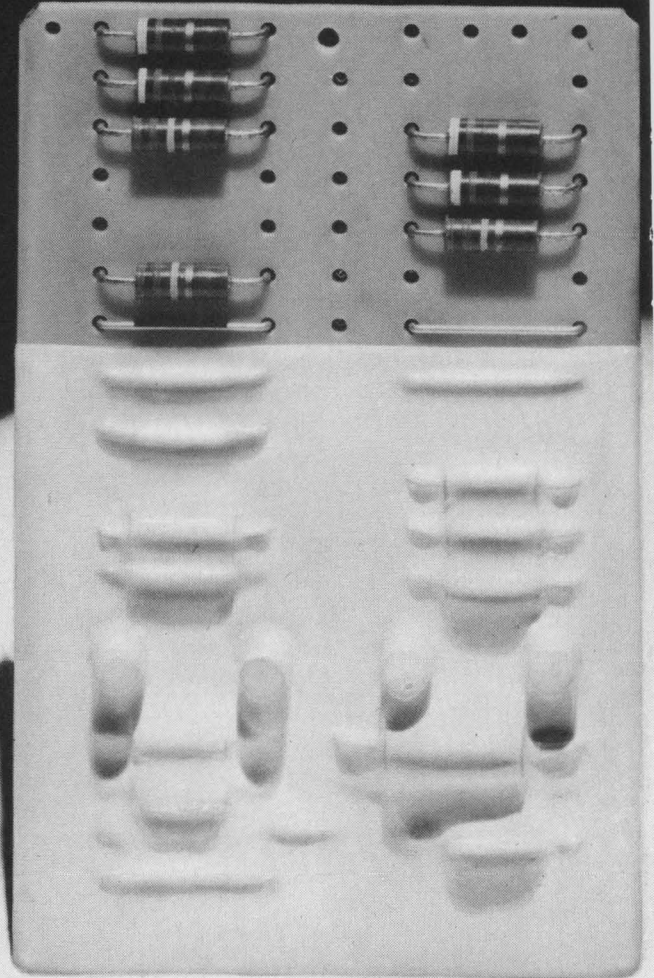

Now you don't

In case you have something to cover, use new opaque (white) Dow Corning® 3141 noncorrosive RTV coating. A new cross-linking prevents the buildup of corrosive by-products during cure. It's easily processed, easy to repair, and stays rugged in harsh environment.

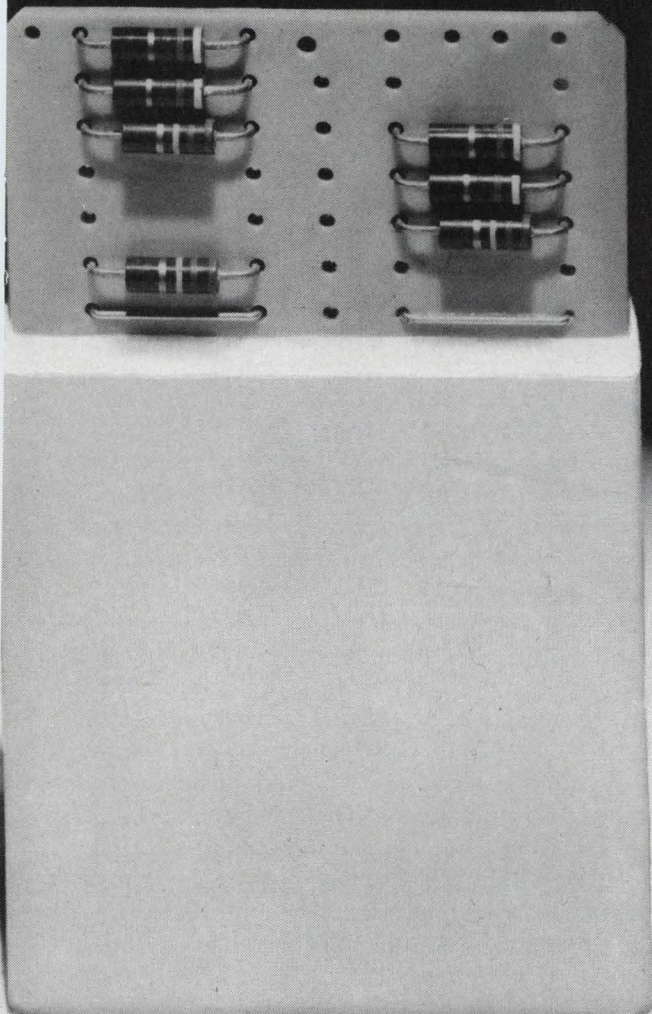

Effective immediately

New Dow Corning® 3101 low-density potting and encapsulating resin is ready for service right after cure. No postcure is necessary. And it cures in unlimited thicknesses in 24 hours at room temperature. It's great for potting aerospace electronic systems or for anywhere you need low-density and reversion resistance.

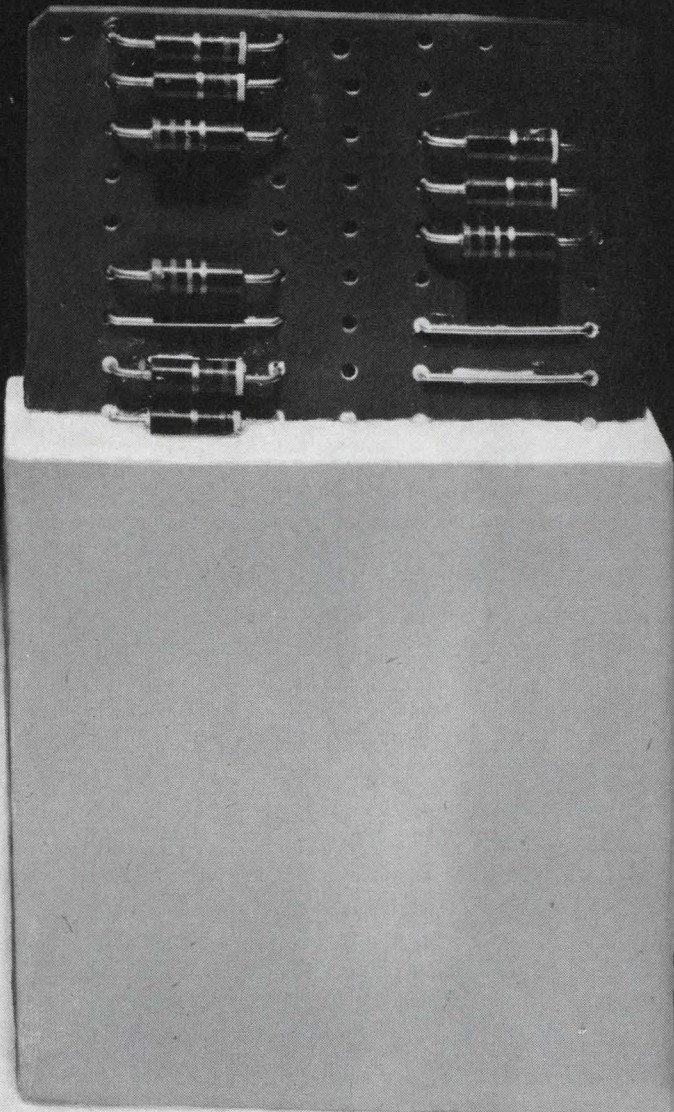

Set for life

New one-part, premixed, Sylgard® 3150 encapsulating resin lives a long life in extreme environments. It's a white, one-part, free-flowing low-viscosity encapsulant that heat cures in deep sections and is compatible with almost all material used in electronic assemblies.

There are many more encapsulants, coatings, and adhesive/sealants where these came from. Learn about them. On your letterhead, write Dept. B-9300, Dow Corning Corporation, Midland, Michigan 48640.

*Electrical/Electronic
materials from*

DOW CORNING

DOW CORNING

Go graphic with capacitive input filters.

Computer-generated curves allow you to optimize your designs in terms of both cost and performance.

The simple, capacitive input filter is widely used in dc power supplies. It is relatively inexpensive and lightweight, and has a minimum number of components (Fig. 1). Unfortunately, in the design of such a filter, the exact solution of output voltage as a function of load resistance and filter capacitance is quite complex, owing to the nonlinear characteristics of the power supply rectifiers.

This problem can be overcome, and capacitive input filters designed quickly and easily, by using the graphical solutions presented in Graphs 1 and 2. The data was synthesized on a computer for the case of a full-wave power supply having a driving-source frequency of 60 Hz and a driving-source output resistance of 1 ohm (Fig. 2). The data can also be used for power supplies having other frequencies and output resistances.

In Graph 1, the solution for minimum and maximum output voltage, in per cent of peak applied voltage, is plotted as a function of equivalent load resistance, (R_{eq}), and of equivalent filter capacitance, (C_{eq}). The minimum voltages are shown by solid lines, and the maximum voltages by dashed lines. For any particular solution, the difference between the minimum and maximum voltages is the ripple voltage.

To use Graph 1 for frequencies other than 60 Hz and driving-source resistances other than 1 ohm, corresponding values of R_{eq} and C_{eq} are found, as follows:

$$R_{eq} = R_{load}/R_1 \quad (1)$$

$$C_{eq} = (R_1 C_{filter}) (f/60), \quad (2)$$

where R_1 is the driving-source resistance, and f is the frequency.

In Graph 2, the solution for peak capacitor charge current, in terms of an equivalent charge resistance (R_{chg}), is plotted as a function of equivalent load resistance and equivalent filter capacitance. To determine the peak charge current, R_{chg} is found from Graph 2, and then inserted into the equation

$$I_{peak} = (V_{peak}/R_{chg}) (1/R_1) \quad (3)$$

where V_{peak} is the peak input voltage to the power supply.

The solutions presented in Graphs 1 and 2 are exact solutions (within the accuracy of the graphs) for a capacitive input power supply, and assume ideal diodes. Since a real diode develops a finite voltage drop, the voltage drop across the diodes (rectifiers) should be subtracted from the peak applied voltage before using the graphs. Similarly, since the diodes are in series with the driving source, the forward resistance of the diodes should be added to the output resistance of the driving source (transformer, etc.) before using the graphs.

It should be noted here that the graphs not only enable the designer to quickly and accurately determine the required component values for a given power supply; they also allow him to optimize the design of the supply in terms of cost and performance. As an example, it is evident from Graph 1 that adding additional capacitance to a filter capacitor will decrease the output ripple voltage; when, however, the filter capacitance exceeds the value of capacitance at the knee of the curves, an additional increase in capacitance will not cause an equivalent decrease in ripple voltage. The designer therefore can quickly evaluate the performance of a power supply in terms of filter capacitance and of its cost.

Examples demonstrate use of graphs

The use of Graphs 1 and 2 are clearly demonstrated by the following two examples:

Example 1

What is the minimum output voltage, ripple voltage, and peak charging current for a capacitive input power supply (Fig. 1) having the following characteristics:

V_{input}	= 35 V rms
$f_{applied}$	= 60 Hz
R_o (transformer)	= 0.30 Ω
R_o (diode)	= 0.05 Ω
R_{load}	= 10 Ω
C_{filter}	= 5000 μ F

The solution is obtained as follows:

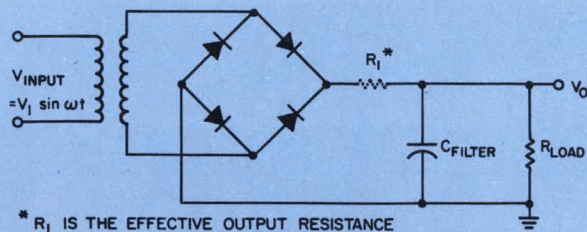

* R_1 IS THE EFFECTIVE OUTPUT RESISTANCE OF THE TRANSFORMER PLUS DIODES.

1. Basic capacitive input filter is conceptually very simple. But the nonlinearity of the power supply rectifiers makes the exact solution of output voltage as a function of load resistance and filter capacitance quite complex.

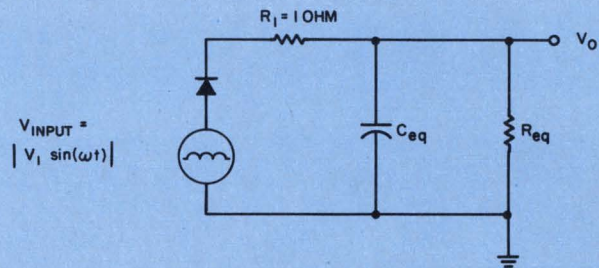

2. Equivalent circuit of capacitive input power supply is based on a driving source output resistance of 1 ohm and a frequency of 60 Hz. Solutions can be obtained for other values also, as explained in the text.

- a. Determine the driving source output resistance, R_1 , from the output resistances of the transformer and diodes. Then normalize the load resistance and filter capacitance, using Eqs. 1 and 2.

$$R_1 = R_o (\text{transformer}) + 2 \times R_o (\text{diode}) \\ = 0.30 + 2 \times 0.05 = 0.40 \text{ ohm}$$

$$R_{eq} = R_{load} / R_1 = 10 / 0.40 = 25 \text{ ohms}$$

$$C_{eq} = R_1 C_{filter} (f/60) = 0.40 \times 5000 \mu\text{F} \times \\ (60/60) = 2000 \mu\text{F}$$

- b. Using the values obtained for R_{eq} and C_{eq} , read $V_{max} (\%)$ and $V_{min} (\%)$ from Graph 1. Then, compute the peak source voltage, and the minimum and maximum output voltages.

$$V_{max} (\%) \cong 89.5\% \quad (\text{Graph 1, dashed lines})$$

$$V_{min} (\%) \cong 80\% \quad (\text{Graph 1, solid line})$$

$$V_{peak} = (1.414 \times V_{input} - 1.5^*) \\ = (1.414 \times 35 - 1.5) = 48 \text{ volts}$$

$$V_{max} = V_{max} (\%) \times V_{peak} = 0.895 \times 48 \\ = 43 \text{ volts}$$

$$V_{min} = V_{min} (\%) \times V_{peak} = 0.800 \times 48 \\ = 38.4 \text{ volts.}$$

* (Approximate voltage drop across the diodes.)

- c. Determine the ripple voltage directly from V_{max} and V_{min} .

$$V_{ripple} = V_{max} - V_{min} = 43 - 38.4 = 4.6 \text{ volts}$$

- d. Calculate the peak capacitor charge current through the diodes from Eq. 3, after obtaining the equivalent charge resistance from Graph 2.

$$R_{chg} \cong 7 \text{ ohms}$$

$$I_{peak} = (V_{peak} / R_{chg}) (1 / R_1) = (48 / 7) (1 / 0.4) \\ = 17.15 \text{ A}$$

Example 2

What is the minimum filter capacitance for a capacitive input power supply (Fig. 1) having the following requirements:

The minimum input voltage into a following transistorized regulator must be greater than 24 V. The input resistance of the regulator

is 8 ohms. In addition, the power supply characteristics are:

$$V_{applied} = 35 \text{ V rms}$$

$$f_{applied} = 400 \text{ Hz}$$

$$R_o (\text{transformer}) = 0.4 \Omega$$

$$R_o (\text{diode}) = 0.05 \Omega$$

The solution is obtained as follows:

- a. Determine the driving source output resistance, R_1 , from the output resistances of the transformer and diodes; then, normalize the load resistance using Eq. 1.

$$R_1 = R_o (\text{transformer}) + 2 \times R_o (\text{diodes}) \\ = 0.40 + 2 \times 0.05 = 0.5 \text{ ohm}$$

$$R_{eq} = R_{load} / R_1 = 8 / 0.5 = 16 \text{ ohms}$$

- b. Calculate the peak source voltage. Then calculate the required minimum voltage, in per cent, of peak source voltage.

$$V_{peak} = (1.414 \text{ V} - 1.5^*) = (1.414 \times 35 - 1.5) \\ = 48 \text{ volts}$$

$$V_{min} (\%) = (V_{min} \times 100\% / V_{peak}) = 2400\% / 48 \\ = 50\%$$

* (Approximate voltage drop across the diodes.)

- c. Using the values for $V_{min} (\%)$ and R_{eq} obtained previously, read C_{eq} from Graph 1.

$$C_{eq} \cong 480 \mu\text{F} \quad (\text{Graph 1, solid lines})$$

- d. Using Eq. 2, calculate the minimum required filter capacitance for V_{min} equal to 24 V.

$$C_{filter} = (C_{eq} / R_1) (60 / f) = (480 / 0.5) (60 / 400) \\ = 144 \mu\text{F}$$

- e. Calculate the peak charge current through the diodes from Eq. 3, after obtaining the equivalent charge resistance, R_{chg} , from Graph 2.

$$R_{chg} \cong 6.8 \text{ ohms}$$

$$I_{peak} = (V_{peak} / R_{chg}) (1 / R_1) = (48 / 6.8) (1 / 0.5) \\ = 14.1 \text{ A}$$

(The data upon which this article is based were obtained while the author was with the Space Systems Division of Hughes Aircraft, El Segundo, Calif.)

(Continued on next page.)

Graph 1

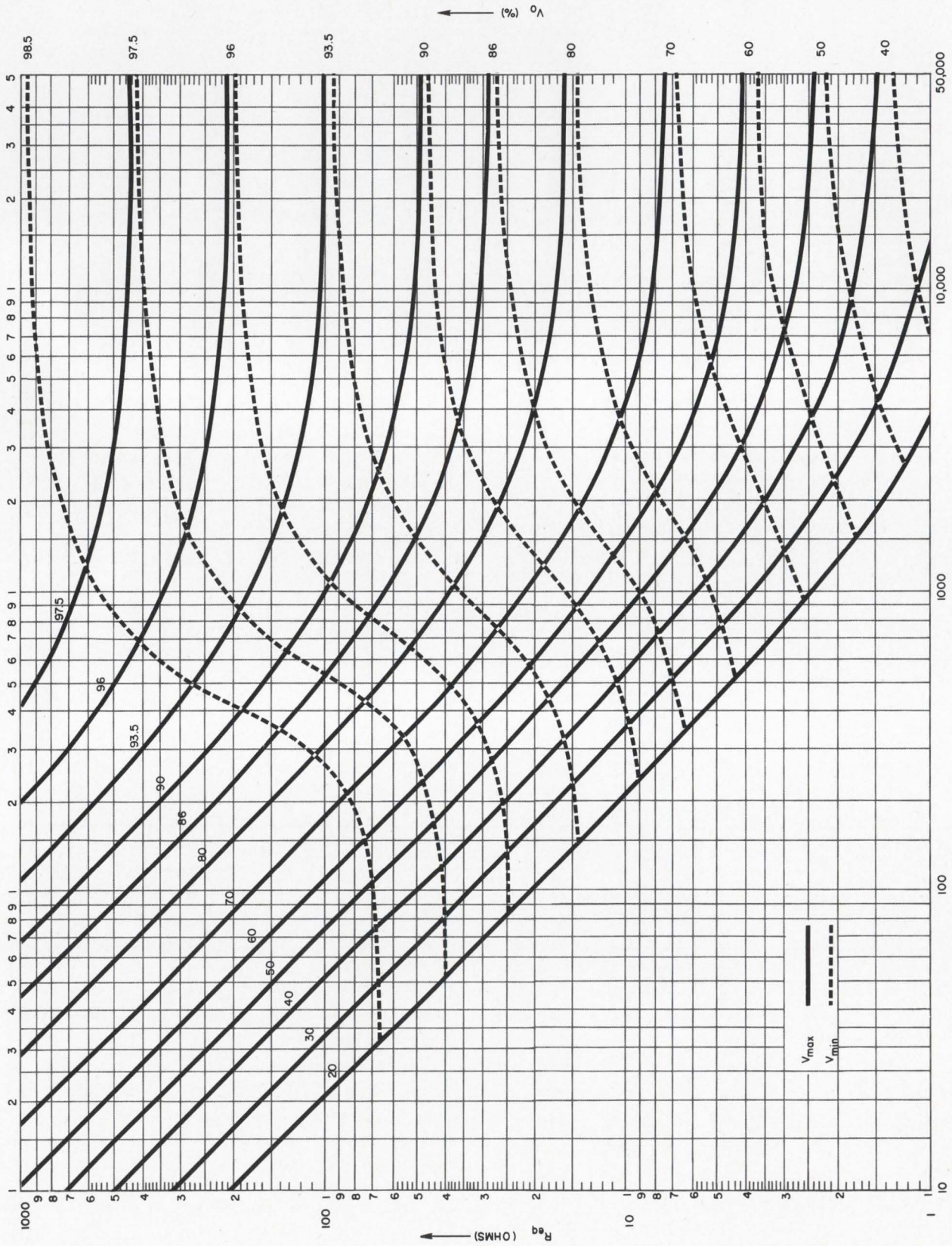

Graph 2

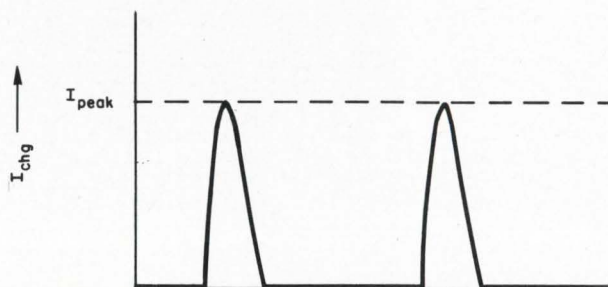
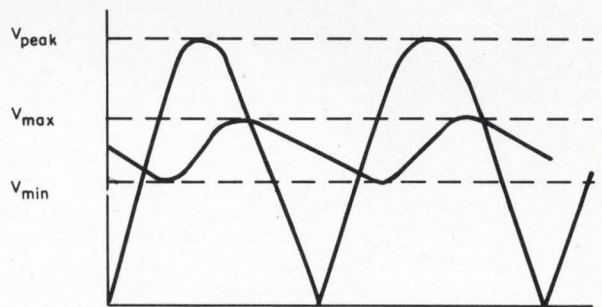
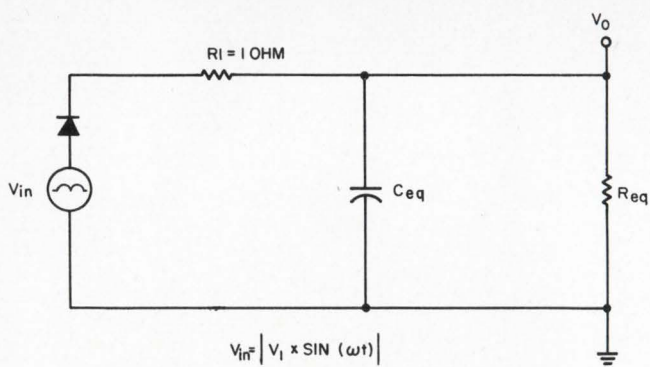
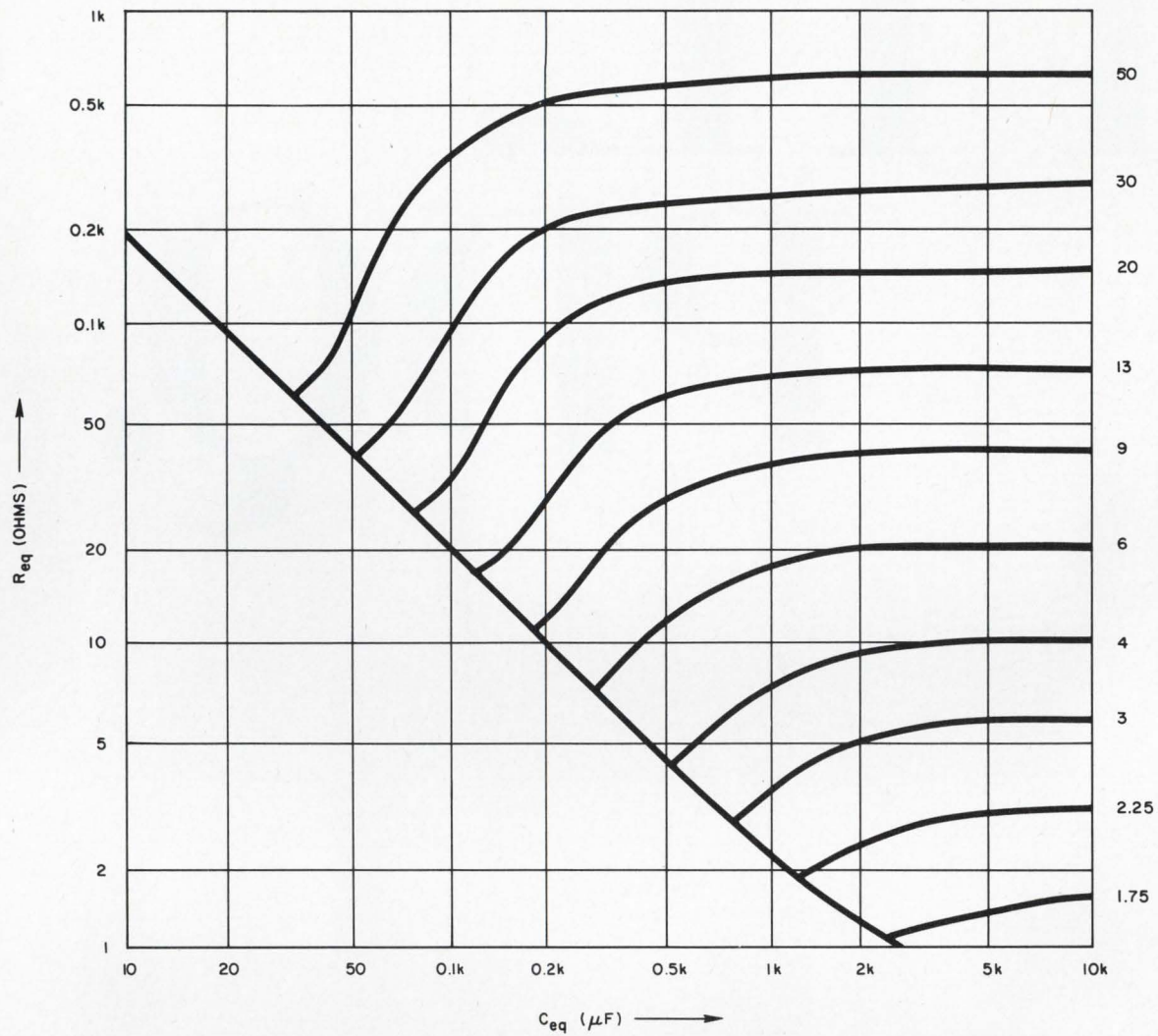

$$R_{eq} = \frac{R_{load}}{R_1}$$

$$C_{eq} = (R_1 C_{filter}) \left(\frac{f}{60} \right)$$

$$I_{peak} = \left(\frac{V_{peak}}{R_{chg}} \right) \left(\frac{1}{R_1} \right)$$

**TTL.
PDAQ.**

RSVP: Your National distributor

Gates

DM8000N (SN7400N)	Quad 2-Input, NAND gate
DM8001N (SN7401N)	Quad 2-Input, NAND gate (Open Collector)
DM8003N (SN7403N)	Quad 2-Input, NAND gate (Open Collector)
DM8010N (SN7410N)	Triple 3-Input, NAND gate
DM8020N (SN7420N)	Dual 4-Input, NAND gate
DM8030N (SN7430N)	Eight-Input, NAND gate
DM8040N (SN7440N)	Dual 4-Input, Buffer
DM8050N (SN7450N)	Expandable Dual 2-Wide, 2-Input AND-OR-INVERT gate
DM8051N (SN7451N)	Dual 2-Wide, 2-Input AND-OR-INVERT gate
DM8053N (SN7453N)	Expandable 4-Wide, 2-Input AND-OR-INVERT gate
DM8054N (SN7454N)	Four-Wide, 2-Input AND-OR-INVERT gate
DM8060N (SN7460N)	Dual 4-Input expander
DM8086N (SN7486N)	Quad Exclusive-OR-gate

Flip Flops

DM8501N (SN7473N)	Dual J-K MASTER-SLAVE flip flop
DM8500N (SN7476N)	Dual J-K MASTER-SLAVE flip flop
DM8510N (SN7474N)	Dual D flip flop

Counters

DM8530N (SN7490N)	Decade Counter
DM8532N (SN7492N)	Divide-by-twelve counter
DM8533N (SN7493N)	Four-bit binary counter
DM8560N (SN74192N)	Up-down decade counter
DM8563N (SN74193N)	Up-down binary counter
DM8520N	Modulo-n divider

Decoders

DM8840N (SN7441N)	BCD to decimal nixie driver
DM8842N (SN7442N)	BCD to decimal decoder

Shift Registers

DM8570N	Eight-bit serial-in parallel-out shift register
DM8590N	Eight-bit parallel-in serial-out shift register

Miscellaneous

DM8200N	Four-bit comparator
DM8210N	Eight channel digital switch
DM8220N	Parity generator/checker
DM8820N	Dual line receiver
DM8830N	Dual line driver
DM8800H	Dual TTL to MOS translator
DM8550N (SN7475N)	Quad latch

TTL devices for industrial applications. Stocked in depth—available immediately, through National distributors. For our TTL Specification Guide and pricing, write or call National Semiconductor, 2975 San Ysidro Way, Santa Clara, California 95051. (408) 245-4320. TWX: 910-339-9240. Cables: NATSEMICON.

National/TTL

P.S. We've got low power TTL too. Meets 883 mil standards; off-the-shelf availability.

How to investigate a company, or what every engineer and his manager should know about an annual financial report



Richard L. Turmail
Management & Careers Editor

You're an engineer and you have a problem to solve:

- You're about to be offered a job but you don't have a clue as to whether your prospective employer's administrative policies belong in the space age or the ice age, whether he's financially solvent or on the brink of bankruptcy.

- You want to invest in the stock market, but inexperience is making you a "Milquetoast." You can entrust your money to a stockbroker, but you'd feel more secure if you knew something about the art of investing.

- You'd like to supplement your vocabulary with terms like "liquidity ratio" so that the next time the office conversation turns to the stock market, you can make an intelligent contribution.

Where can you find the information you need to size up your employer, speculate on the stock market, and translate the language of investing? As Sherlock Holmes was given to say, "The answer is elementary, my dear Watson." For the solution to your problems is in knowing how to analyze a financial report.

Security analysts are able to determine the strengths and weaknesses of a company by analyzing its "balance sheet" and "income statement." But before you can subject a company to analysis, you must discover the "what," "why," and "how" of a financial report.

What is a financial report?

An abbreviated version of a balance sheet is shown at top right. It represents the financial picture of a company as it appeared on one particular day of operation. The complete report (on

p. 116) including the income statement which shows how much business the company does, portrays a corporation's financial progress growing out of the soundness of its operations.

Why a report?

During the days when a town's business was the chief topic of conversation, there was little justification for detailed financial reports. The annual meeting was attended by all of the shareholders, who lived conveniently near their investment. But as corporations expanded, capital needs increased, and the number of share owners grew beyond the boundaries of a particular region, the expense or trouble of attending an annual meeting hardly seemed worthwhile. As a result, an age of greater financial disclosure was launched.

At the turn of the century, the Stock Exchange persuaded the first industrial company to publish an annual statement. One after the other, companies wanting to qualify for listing on the Exchange brought out their annual reports. Today, according to the New York Stock Exchange, more than 1200 leading corporations distribute an estimated 40 million copies of these reports to the press, company employees, schools of business administration, investment firms, other financial organizations, and—most important—to those people who own shares in American business.

(continued on page 114)

The trading floor of the New York Stock Exchange, where speculators bid for securities on the premise of a favorable company analysis.

Typical Electronics Corporation, Inc.

(Abbreviated Balance Sheet)

	<u>1967</u>	<u>1966</u>		<u>1967</u>	<u>1966</u>
Assets			Liabilities		
Total Current Assets	\$ 48.4	\$ 44.2	Total Current Liabilities	\$ 21.6	\$ 18.6
Total Other Assets	5.5	4.6	Reserves	3.6	2.5
Total Fixed Assets	105.2	93.4	Long-Term Debt	26.0	20.0
Less Accumulated Depreciation	<u>-27.6</u>	<u>-25.0</u>	Total Stockholders' Investment	80.3	76.1
Adjusted Total Fixed Assets	77.6	68.4			
Total Assets	\$131.5	\$117.2	Total Liabilities and Stockholders' Investment ...	\$131.5	\$117.2



How to read a report

When analysts scrutinize a financial report, they actually read between the lines in order to make value judgments. Before this is feasible, however, one must discover what the lines themselves mean. Like all other professions, accounting has a specialized vocabulary. The following list defines the terms used in a financial report.



Clues to Investing Terms

Terms

Definitions

Assets

Current Assets	that which may readily be turned into cash
Cash	in the till, on deposit in the bank
Marketable Securities	investment of excess cash in securities that may be sold quickly when cash is needed
Accounts Receivable	amounts owed the company by its customers and others
Inventories	raw materials, goods in process of manufacture, finished goods
Prepayments	unexpended insurance, unused rentals
Good will, Patents, Trademarks	intangibles: the value varies considerably from one company to the next
Fixed Assets	that which is not intended for sale, and is used over and over again, such as land, buildings, machinery and equipment

Liabilities

Current Liabilities	all debts that fall due within the coming year
Accounts Payable	money owed to regular business creditors
Notes Payable	money owed to a bank
Accrued Expenses Payable	unpaid amounts of wages, interest on funds borrowed, fees to attorneys, insurance premiums, pensions, etc.
Long-Term Liabilities	debts due after one year from the date of the report

Stockholders' Equity

Capital Stock	shares in the proprietary interest in the company
Preferred Stock (cumulative)	shares having preference over other shares as regards dividends or in distribution of assets in case of liquidation or both. . . "cumulative" means that, if the dividend is not paid, it accumulates in favor of the shareholder
Common Stock	shares on the books at a par or stated value (market value is determined by sellers and buyers)
Capital Surplus	contributed assets, premium received from sales of stock over the par value
Earned Surplus	past retained earnings not paid in dividends

Statement of Income

Depreciation and Depletion	provision from income for the reduction of the service life of machinery and buildings and the use of minerals in mines
Operating Profit	the remainder after deducting expenses from sales, but before interest charges and taxes
Interest Charges	amount required for interest on borrowed funds

How to analyze a report

There are no pat findings from the analysis of a financial report. A divergence of opinion exists even among the experts. For example: It was reported in the February issue of *Management Review* that some analysts believe that when a company is comprised of a number of firms, a single financial report has little significance. Others were reported to believe that the facts of a company's growth provide a better foundation for analysis than the data gathered from the company "satellites."

More light was shed on the area of disagreement by this analyst's comment: "A majority of companies should be analyzed apart from their industries . . . [for example] Drugs are considered a growth industry, yet 50% of the drug companies aren't growing."

Another analyst was quoted as saying, "An electronics corporation cannot succeed if its research and development program lags behind its competitors'. In the computer business, entire computer systems are outdated within a year or two as a result of R&D."

Because the operations and policies of companies differ, analysts are forced to devise "slide rules" to make meaningful appraisals.

You cannot expect to analyze a company as well as the man who earns his living at it. But you can get more out of a financial statement by applying ratios that focus attention on significant relationships in the statement of income and the balance sheet.

The New York Stock Exchange published an approach to this method of analysis. It is called "The 7 Keys to Value," and these are the keys:

1. Pre-tax Profit Margin

This is the ratio of profit, before interest and taxes, to sales. It is expressed as a percentage of sales and is found by dividing the operating profit by sales. It is usually assumed that an increase in sales will help widen the profit margin.

2. Current (or working capital) Ratio

This is the ratio of current assets to current liabilities. A 2-for-1 ratio is the standard, meaning that for each \$1 of current liabilities, there are \$2 in current assets to back it up. A gradual increase in the current ratio usually is a healthy sign of improved financial strength. But a ratio of more than 4 or 5 to 1 is regarded as unnecessary, and may be the result of an insufficient volume of business to produce a desirable level of earnings. The ability of a company to meet its obligations, expand its volume, and take advantage of opportunities is often determined by its working capital.

3. Liquidity Ratio

This is the ratio of cash and equivalent (marketable securities) to total current liabilities. It

is also expressed as a percentage figure, and it results from dividing cash and equivalent by total current liabilities. This ratio is important as a supplement to the current ratio because the immediate ability of a company to meet current obligations or pay larger dividends may be impaired despite a higher current ratio. A decline in the liquidity ratio often takes place during a period of expansion and rising prices because of heavier capital expenditures and larger accounts payable. If the decline persists, the company may have to raise additional capital.

4. Capitalization Ratios

These are the percentages of the total company investment allotted to each type of investment. Specifically, the capitalization is made up of long-term debt, preferred stock, common stock, and surplus. Usually, the higher the ratio of surplus to common stock, the more assured is the position of the common stock, since there are fewer prior claims on corporate income in the form of debt securities or preferred stock. Companies in stable industries, such as electric light and power, may with safety have a higher proportion of debt financing than most industrial companies.

5. Sales to Fixed Assets

This ratio is computed by dividing the annual sales by the value before depreciation and amortization of plant, equipment and land at the end of the year. It is important because it helps determine whether or not the funds used to enlarge productive facilities are being spent wisely. A sizable expansion in facilities should lead to larger sales volume.

6. Sales to Inventories

This ratio is computed by dividing the year's sales by the year-end inventories. The so-called "inventory turnover" is important as a check on whether or not the enterprise is investing too heavily in inventories. Because inventories are a larger part of the assets of a merchandising enterprise than of most manufacturing companies, this ratio is especially worthy of note in the analysis of a retail business. A high ratio denotes a good quality of merchandise and correct pricing policies. A definite downtrend may be a warning signal of poor merchandising policy, poor location, or "stale" merchandise.

7. Net Income to Net Worth

This ratio is derived from dividing net income by the total of preferred stock, common stock and surplus accounts. It supplies the answer to the vital question: "How much is the company earning on the stockholders' investment?" A large or increasing ratio is favorable. In a competitive society an extraordinarily high ratio may invite more intense competition. An increase due to "inventory profits" may be short-lived because of rapid changes in commodity prices.

(continued on page 116)

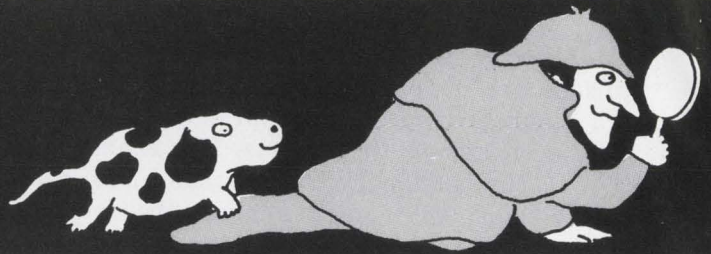

Ready for Analysis

Now that you have adopted an investment vocabulary, and understand the "keys to value," you have a working knowledge of how to "investigate" a company. If you are ready to test your powers of detection, apply what you have learned to the complete financial report of Typical Electronics Co., Inc., by answering the questions at the right.

Typical Electronics Corporation, Inc., and Consolidated Subsidiaries

Balance Sheet — December 31, 19__

	<u>1967</u>	<u>1966</u>		<u>1967</u>	<u>1966</u>
Assets			Liabilities		
Current Assets			Current Liabilities		
Cash	\$ 9.0	\$ 6.2	Accounts Payable	\$ 6.1	\$ 5.0
Marketable Securities, at Cost (Market Value)	—	2.0	Notes Payable	1.0	.8
Accounts Receivable	12.4	11.4	Accrued Expenses Payable	3.6	3.3
Inventories	<u>27.0</u>	<u>24.6</u>	Federal Income Tax Payable	9.6	8.4
Total Current Assets	\$ 48.4	\$ 44.2	Dividends Payable	<u>1.3</u>	<u>1.1</u>
			Total Current Liabilities	\$ 21.6	\$ 18.6
Other Assets			Reserves	3.6	2.5
Surrender Value of Insurance	\$.2	\$.2			
Investments in Subsidiaries	4.7	3.9	Long Term Liabilities		
Prepayments6	.5	First Mortgage Bonds, 5% Interest Due 1975	26.0	20.0
Goodwill, Patents, Trademarks	—	—			
Total Other Assets	\$ 5.5	\$ 4.6	Stockholders' Equity		
Fixed Assets			Capital Stock		
Buildings, Machinery & Equipment (at cost)	\$104.3	\$ 92.7	Preferred Stock, 5% Cumulative, \$100 Par Value Each: 6,000 Shares	\$ 6.0	\$ 6.0
Less Accumulated Depreciation	<u>-27.6</u>	<u>-25.0</u>	Common Stock, \$5 Par Value Each; 300,000	18.3	18.3
	\$ 76.7	\$ 67.7	Capital Surplus	9.6	9.6
Land	<u>.9</u>	<u>.7</u>	Earned Surplus	46.4	42.2
Total Fixed Assets	\$ 77.6	\$ 68.4	Total Stockholders' Equity	\$ 80.3	\$ 76.1
Total Assets	\$131.5	\$117.2	Total Liabilities and Stockholders' Investment	\$131.5	\$117.2

7 Clues to Value

	<u>1967</u>	<u>1966</u>
Statement of Income		
Sales	\$115.8	\$110.0
(less) Costs and Expenses:		
Cost of Goods Sold	74.8	73.2
Selling, General, Administrative Expenses	14.2	13.0
Depreciation and Depletion	<u>4.2</u>	<u>3.5</u>
	\$ 93.2	\$ 89.7
Operating Profit	22.6	20.3
Interest Charges	<u>-1.3</u>	<u>-1.0</u>
Earnings before Income Taxes	\$ 21.3	\$ 19.3
Provision for Taxes on Income	<u>-11.4</u>	<u>-9.8</u>
Net Income for the Year	9.9	9.5
Dividend on Preferred Stock	<u>-3</u>	<u>-3</u>
Balance of Income Available for Common Stock	9.6	9.2
Statement of Earned Surplus		
Balance at Beginning of Year	\$ 42.2	\$ 37.6
Add — Net Income for the Year	<u>+9.9</u>	<u>+9.5</u>
	\$ 52.1	\$ 47.1
Less Dividends Paid on		
Preferred Stock3	.3
Common Stock	<u>5.4</u>	<u>4.6</u>
Balance at End of Year	\$ 46.4	\$ 42.2

1. Which year had a pre-tax profit margin of 19.5%? Evaluate.
2. The 1967 current ratio was 2.24 to 1. What was the ratio for the previous year? Evaluate both years.
3. What per cent was the liquidity ratio for 1967? Evaluate.
4. What were the capitalization ratios for 1966? Evaluate.
5. Which year has a higher ratio of sales to fixed assets? Evaluate.
6. Which year had a sales-to-inventories ratio of 4.3? Evaluate.
7. What was the net income-to-net worth ratio for each year? Evaluate.

(answers on next page)

Only the Beginning

While interpreting the facts and figures of a financial report helps you determine the soundness of a company's operation and the attractiveness of its securities, it has been suggested by stock brokers Merrill Lynch, Pierce, Fenner and Smith, Inc., that selecting common stocks for investment requires careful study of factors other than those you can learn from financial statements. The economics of the country and the particular industry must be considered; the management of the company must be studied and its plans for the future assessed. These facts must be gleaned from the press or the financial services, or supplied by a research organization.

If you want to become a serious student of investing, knowing how to read and analyze a financial report is only the beginning. What you have uncovered here, however, may help you to determine what kind of company you may be getting into, what a financial statement can tell you, and, of course, to speak intelligently on such keys to value as "liquidity ratio." ■■

Answers to questions on report analysis.

1. 1967. Good. Profit margin widened. It is usually assumed that material increase in sales will help widen the profit margin. Certain costs are fixed, i.e., they do not rise or fall in the same proportion as changes in volume. Such costs are interest, rent and real property taxes. Ordinarily, because of their fixed costs, profits tend to increase and decline more rapidly percentage-wise than sales.

2. 2.38 to 1. Fair. The company did not improve its position in this regard because it used substantial funds to increase its plant and equipment. The ratio could have been better if the company had spent less for additions to its productive facilities, or had raised more funds for this purpose through the sale of securities, or paid less in dividends. This particular case illustrates why the entire annual report and financial statement must be examined.

3. 41.7%. Fair. A decline in the liquidity ratio often takes place during a period of expansion and rising prices because of heavier capital expenditures and larger accounts payable. If the decline persists, it may mean that the company will have to raise additional capital.

4. Long-term debts	20.8%
Preferred stock	6.3%
Common stock and surplus	72.9%

Unchanged. The common-stock ratio was some-

what smaller than in the previous year, because of the issuance of additional debentures during the year. Since the surplus was also larger, due to reinvested earnings, the change was slight and the common-stock equity remained high.

5. 1966. Bad. In 1967 the company's ratio of sales to fixed assets amounted to approximately 1.1 to 1 compared with 1.2 to 1 in the previous year. Fixed assets are shown both as a gross figure and as a net figure, i.e., before and after accumulated depreciation. Sometimes the details appear in a footnote to the balance sheet which sets forth the costs of the buildings, machinery, equipment and land. For our computation we have used the gross figure for all fixed assets, \$105.2 million in 1967 and \$93.4 million in 1966. The ratio is low, which is not good for an electronics company that ordinarily has a larger sales volume in relation to plant investment.

6. 1967. Fair to bad. The company's sales-to-inventories ratio in 1967 was approximately 4.3 to 1 compared with 4.5 to 1 in 1966. This decline would have resulted from purchases of raw materials in anticipation of an increase in prices of a falling off in sales toward the end of the year.

7. 1966, 12.5%; 1967, 12.3%. Unchanged. According to general surveys of all manufacturing corporations in the United States, a return of over 10% appears to be better than average. Although the later year shows a 0.2% deficit from the preceding year, it is not as significant as the return on the stockholder's investment.

Company evaluation? Since the answer to that question would depend on what you plan to do with the information, we'll do the honorable thing leave the decision to you.

References:

1. "Understanding Financial Statements — 7 Keys to Value", New York Stock Exchange, September, 1968.
2. F. V. Huber, "How Security Analysts Size Up a Company's Strength", *Management Review*, February, 1969, pp. 32-37.
3. "How to Read a Financial Report", Merrill Lynch, Pierce, Fenner and Smith, Inc., February, 1968.

For those engineers who would like to read and analyze the financial reports of various electronics companies, ELECTRONIC DESIGN introduces a new section titled, "Annual Reports." (See opposite page.) Starting with the June 21st issue, "Annual Reports," which includes such information as the company's net sales, net income and total assets, will appear in the products section of the magazine. To receive a complete financial report, the reader can circle the information retrieval number.

Annual Reports

Aerospace Corp., P.O. Box 95085, Los Angeles, Calif: military systems and equipment; net income, \$75,092,122; contact fees, \$2,619,095; total assets \$9,998,319.

CIRCLE NO. 378

Airpax Electronics, P.O. Box 8488, Fort Lauderdale, Fla: industrial controls and instruments; net sales, \$6,833,337; net income, \$322,178; net income per share, 73¢; total assets, \$3,975,766.

CIRCLE NO. 379

Applied Magnetics Corp., Santa Barbara Main Plant, 75 Robin Hill Rd., Goleta, Calif: magnetic and ferrite heads, memories, components; net sales, \$11,971,406; net income, \$1,033,693; assets, \$5,584,704.

CIRCLE NO. 380

Astrosystems, Inc., 6 Nevada Drive, New Hyde Park, N.Y: computer peripheral equipment, test systems, instruments; net sales, \$2,905,885; net income, \$235,900; assets, \$1,554,509.

CIRCLE NO. 381

Cohu Electronics, Inc., 5725 Kearny Villa Rd., San Diego, Calif: instruments, cameras, environmental test equipment; net sales, \$9,289,986; net income, \$294,378; assets, \$6,325,003.

CIRCLE NO. 382

Cubic Corp., 9233 Balboa Ave., San Diego, Calif: computer peripherals, data processing, navigation, guidance and communications systems; net sales, \$6,259,000; net income, \$202,000; assets, \$2,934,000.

CIRCLE NO. 383

Damon Engineering, Inc., 115 Fourth Ave., Needham Heights, Mass: filters, medical instruments, plastics; net sales, \$15,708,708; net income, \$1,045,462; total assets, \$6,954,266.

CIRCLE NO. 384

Dearborn Computer Corp., 100 W. Monroe St., Chicago, Ill: computer leasing, offshore drilling, marine equipment; total revenues \$10,613,000; net income, \$1,250,000; total assets, \$90,041,000.

CIRCLE NO. 385

Harris-Intertype Corp., 55 Public Square, Cleveland, Ohio: communications and information handling equipment, integrated circuits; net sales, \$277,772,000; net income, \$281,309; assets, \$199,544.

CIRCLE NO. 386

IMC Magnetics Corp., 570 Main St., Westbury, N.Y: air transportation products, motors, airmovers; net sales, \$9,396,340; net income, \$455,887; total assets, \$4,342,679.

CIRCLE NO. 387

Indian Head Inc., 111 W. 40th St., New York City: information handling, textiles, consumer glass containers, automotive hardware; net sales, \$369,531,000; net income, \$12,072,000; assets, \$248,782,000.

CIRCLE NO. 388

International Business Machines Corp., Armonk, N.Y: data processing services, computers, business machines; gross income, \$6,888,549,209; net earnings, \$871,497,991; total assets, \$6,743,431,161.

CIRCLE NO. 389

North Atlantic Industries, Inc., Terminal Drive, Plainview, N.Y: interfaces for computers and automatic test equipment; net sales, \$3,312,301; net income, \$211,173; total assets, \$1,894,526.

CIRCLE NO. 390

RCA, 30 Rockefeller Plaza, New York City: defense, aerospace, consumer products, components, broadcasting, communications, publishing; net revenues, \$3,129,020,000; net profit, \$154,047,000; assets \$1,356,287,000.

CIRCLE NO. 391

Republic Corp., 9601 Wilshire Blvd., Beverly Hills, Calif: components, packages, plastics, hardware, marketing services, film processing; net sales, \$142,670,000; net income, \$9,157,000.

CIRCLE NO. 392

Rogers Corp., Rogers, Conn: electrical insulation, elastomers, plastics, sealing materials; net sales, \$19,804,000; net income, \$520,000; total assets, \$9,933,000.

CIRCLE NO. 393

Siliconix Inc., 1140 W. Evelyn Ave., Sunnyvale, Calif: semiconductors, integrated circuits, semiconductor test equipment; net sales, \$7,905,498; net income, \$846,263; total assets, \$4,956,713.

CIRCLE NO. 394

Statham Instruments, Inc., Statham Industrial Park, 2230 Statham Blvd., Oxnard, Calif: medical, industrial and aerospace transducers and instruments; net sales, \$12,049,390; net income, \$130,480; assets, \$11,930,170.

CIRCLE NO. 395

Systron-Donner Corp., 1 Systron Drive, Concord, Calif: sensors, instruments, systems/controls; net sales, \$28,851,282; net income, \$2,015,522; total current assets, \$12,903,963.

CIRCLE NO. 396

Varian Associates, 611 Hansen Way, Palo Alto, Calif: instruments, microwave equipment, data processing, electrographics; net sales, \$170,755,000; net income, \$3,443,000; assets, \$168,155,000.

CIRCLE NO. 397

The Versatile 100 KHZ Astroverter

It's an ADC

It's a Multiplexer

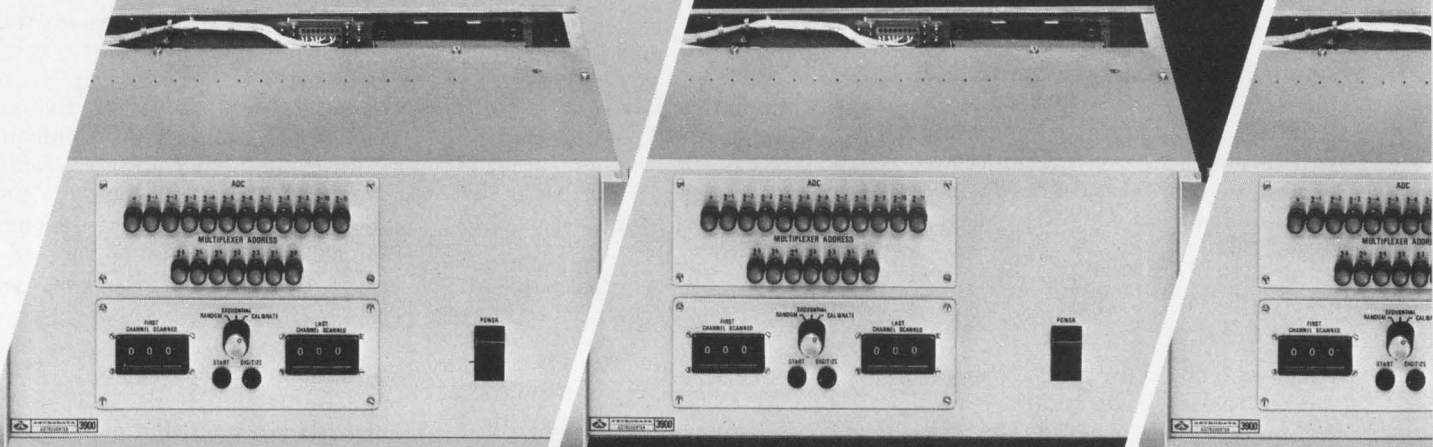

Absolutely—and it's a *high speed* ADC, with 5 μ sec. word conversion and a double-buffered output of 11 binary bits and sign. Two plug-in cards contain all the timing, bit selection and comparator circuitry required, leaving plenty of room for additional functions. For detailed ADC information, circle number 211.

Add two more plug-in cards and you have a high-speed 16-channel multiplexed ADC. And you can have as many as 128 channels if you desire. Switching and settling time of less than 5 μ sec., with 5 μ sec. digitizing, provides a total thru-put rate of 100 kHz. Get more information by circling number 212.

The Astroverter is also a high-speed oscilloscope, meters and DAC. Plug-in cards provide reference and DAC formats of 8, 11, 12 bits plus signs; up to 14 DAC channels can be mounted for extensive DAC capability. Circle number 213 for complete details.

**It's a
DAC**

**It's Simultaneous
Sample & Hold**

**It's a
New
Concept
in Data
System
Packaging . . .**

The Astroverter is an extremely flexible, high-speed, low-cost data acquisition instrument comprising a 7" rack-mounted chassis, with built-in power supply, and 16 card slots to accommodate a large family of interchangeable plug-in cards. With these cards, you can "design" virtually any type of data system—and probably still have room left for future expansion.

What's *your* system need? General purpose computer peripheral devices? Hybrid computer system interface? Acquisition for industrial process control systems? Whatever it is, you'll find that the Astroverter offers

the versatility, speed, reliability and economy necessary to meet virtually all your operational requirements. One of the most welcome features of the Astroverter is its surprisingly *low cost*.

Whichever configuration you select, you'll find the price hundreds of dollars under other available and probably slower models. Then there's economy in expansion. You don't buy another

instrument . . . you merely buy another card. Get the complete story today about the versatile, high-speed, low-cost Astroverter. Write or call

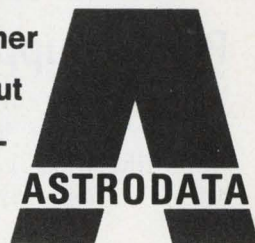

ASTRODATA

For simultaneous sample and hold, the Astroverter can be configured with up to 16 Sample and Hold Amplifier cards in a single package. The card features $\pm .01\%$ accuracy, $\pm .01\%$ settling time (in 4 μ sec.) and DC to 100 kHz frequency response, with a 50 nanosecond aperture. Circle number 214 for detailed information.

C for driving recorders. nce, control r 14 binary cards may ick-look" or com-

Series control technique cuts tuning power requirements

Current-variable inductors are excellent components for use as tuning elements in electronically tuned circuits. However, in applications where power requirements are critical, the current required to tune the inductors can often prohibit their use. Up to 100 mA at 2 to 6 volts is common with one such type of inductor.

With the tuning control circuit shown, it is possible to operate two or more control windings in series across the supply voltage and still have independent control of the currents. It is assumed that other considerations require a supply voltage of twice the maximum control winding voltage or greater. The total current required by all windings is the same as for only one winding. Thus, with two windings, the maximum current required is reduced to 1/2; with three windings it is reduced to 1/3, and so forth—as compared to the use of separate parallel tuning controls. For the circuit shown, the control windings require 60 mA each; using the series control circuit therefore reduces the maximum current from 120 mA to 60 mA.

As shown in the diagram, each control winding is connected as the collector load of one side of a differential amplifier. Resistors R_1 and R_2 should be about equal to the resistance of the control winding. The tuning controls, R_3 and R_4 , actually control the relative bias on the differential transistor pairs, thus changing the current through the control windings. Resistors R_5 and R_6 provide negative feedback to keep constant the sum of the currents through each pair of transistors.

Q_5 serves as a constant-current generator, with the maximum tuning current being set by R_7 . In this example, the maximum current was set at 60 mA. The current in either winding could then be adjusted from 0 to 60 mA, with

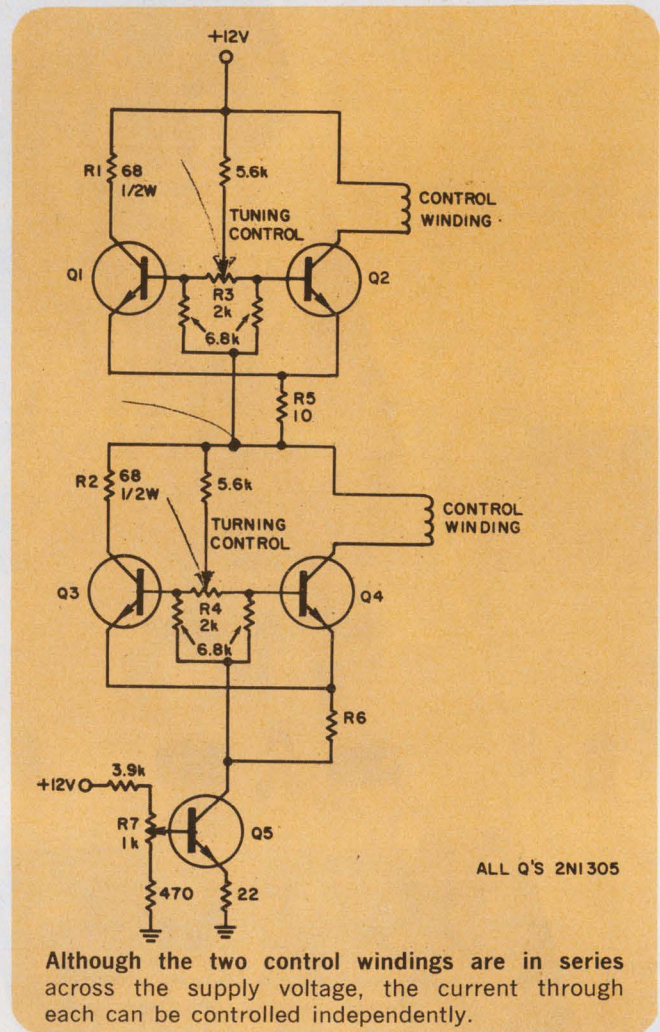

Although the two control windings are in series across the supply voltage, the current through each can be controlled independently.

negligible effect on the current in the other winding.

Merle E. Converse, Senior Research Engineer, Southwest Research Institute, San Antonio, Tex.

VOTE FOR 311

Power supply crowbar can be adjusted precisely

Crowbar circuits are often used in power supplies to protect loads against overvoltage conditions like those caused by a shorted series regulator. Voltage adjustability and continuous power

drain are frequently important considerations in the design of such circuits. With the crowbar arrangement shown, overvoltage protection can be provided at voltage levels between 4 and 25 V.

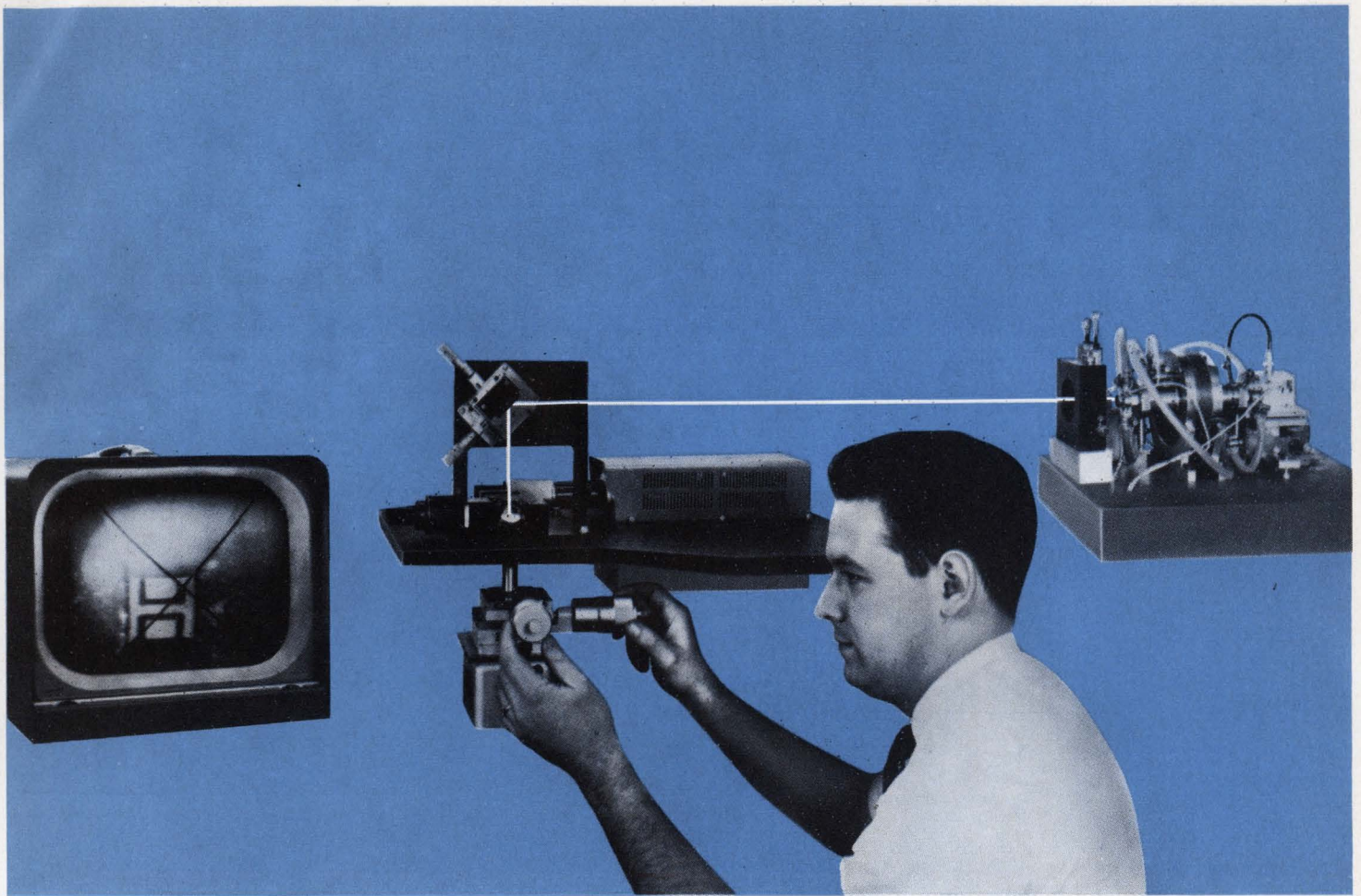

Micromachining with the laser

Bell Laboratories engineers M. I. Cohen and B. A. Unger have developed experimental techniques for using lasers in certain delicate thin-film integrated circuit work: machining circuit patterns, making "gap" capacitors, trimming tantalum thin-film resistors and monolithic quartz resonators, and cutting masks for circuit fabrication.

Our experimental system (above) combines a solid-state YAG (yttrium aluminum garnet) laser, manual positioning of the circuit, and television observation. The optical part of the system was developed by Western Electric's Engineering Research Center, located at Princeton, New Jersey.

The high spectral purity of the continuous-wave YAG laser, invented at Bell Laboratories, lets us focus the light to a very small spot for precision cuts

less than 5 microns (1/5 mil) wide and resistor trimming accurate to better than 0.1 percent. And, through Q-switching, the YAG laser produces high peak power at high repetition rates—over 1,000 pps—giving us the cutting speed necessary for practical circuit work.

Laser beams pass through any transparent atmosphere or material and can be accurately concentrated onto tiny areas. With the proper wavelength, we can machine components inside a transparent encapsulation without damaging it. Also, since we can regulate cutting depth, we can "micromachine" thin films without harming underlying materials.

To make capacitors, for example, Cohen and Unger use a laser to cut (vaporize) a narrow gap between conductors. In gold conductors on sapphire or alumina substrates, they have cut gaps

from 5 microns to 600 microns wide with good control.

Similarly, Bell Labs engineers have adjusted thin-film quartz crystal resonators to frequencies as precise as one part in 10^8 . The laser vaporizes part of the thin-film electrode, raising the resonator frequency to the desired value.

By removing hairline shorts, we have also repaired expensive integrated circuits that could not be reclaimed by standard techniques.

Pioneered at Bell Laboratories and Western Electric, laser micromachining is already in pilot and volume production use at Western Electric and other major integrated circuit manufacturers.

From the Research and Development Unit of the Bell System—



Bell Labs

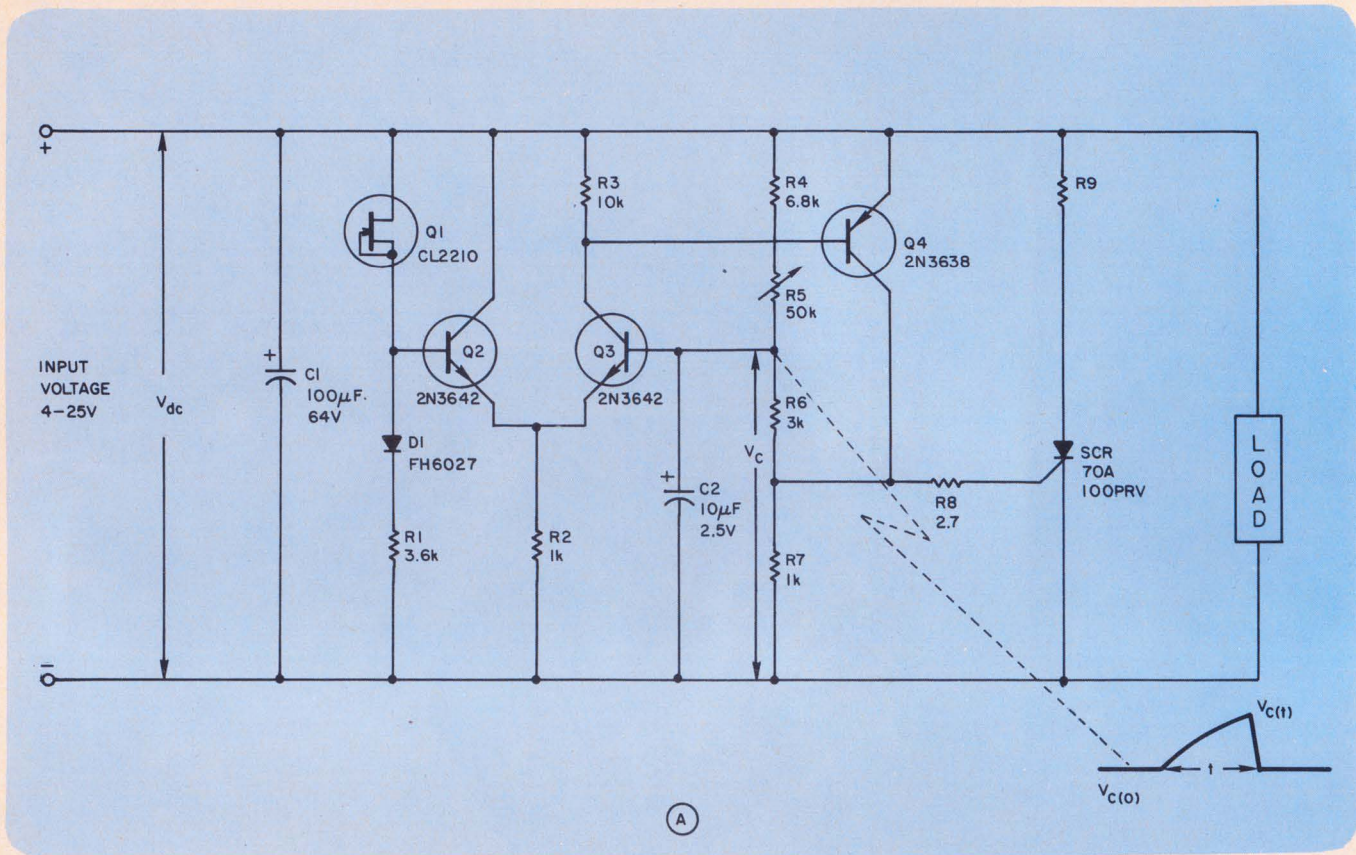

The range can be extended up to 60 V (the breakdown voltage of Q_1) by using transistors with higher voltage ratings. The power required by the circuit is less than 1.5 mA, continuous drain from the power supply being protected.

In operation, Q_1 supplies a basically constant current of 0.24 mA for drain-to-source voltages in the range 1.5 to 60 volts. The temperature coefficient of this current is $0.55 \mu\text{A}/^\circ\text{C}$, which is compensated for by the negative temperature coefficient of the voltage across diode D_1 .

The crowbar turns on as soon as the base voltage of Q_3 , which is equal to $4.0/(R_5+10.8)$ of V_{dc} exceeds the base voltage of Q_2 (determined by $I_D R_1 + V_D = 1.36 \text{ V}$). Conduction is then transferred from Q_2 to Q_3 , turning the SCR on, and establishing a virtual short circuit (1.0 V for the SCR used here) across the load. Positive feedback from the collector of Q_4 to the base of Q_3 ensures sufficient SCR gate current (50 mA for the large, low-cost, SCR used here). The crowbar turn-on voltage varies by less than $0.025\%/^\circ\text{C}$ over the temperature range of 20°C to 55°C , as seen from the accompanying curves (b).

The lower overvoltage limit at which the crowbar will be activated depends upon various characteristics of the monitored supply—in particular its response to sudden line and load changes. Capacitor C_2 permits the lower limit of the over-

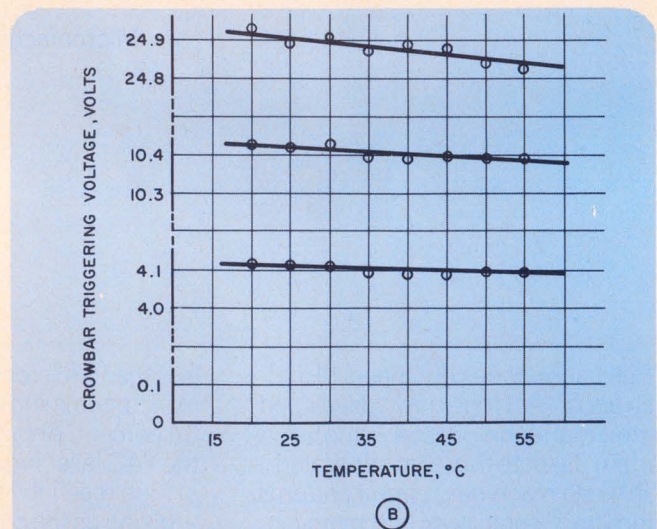

The SCR turns on, providing crowbar protection for the load, when the base voltage of Q_3 exceeds that of Q_2 (A). This turn-on voltage is exceptionally stable with temperature (B).

voltage margin to be adjusted to within 0.4% of the normal value of V_{dc} . Consequently, considering both the effects of temperature over the range indicated and an allowance for supply noise, overvoltages as small as $(35)(0.00025) + 0.004 = 1.3\%$ of the normal value of V_{dc} can

R.M.S. VOLTS -- the scale says -- but what about the circuits behind that scale?

All of us have been making rms readings of ac voltages for years. We know we have, it says so right on the front of the meter.

If someone were to ask what we mean by rms voltage, we could quickly explain the concept of "root mean square." In the interest of accuracy we might add that the rms voltage indication on most meters is true only for a sinusoidal wave. Unfortunately, most measurements are not made on true sinusoidal waves. However, for many applications, average responding meters are adequate.

But it would seem logical, where accuracy is important, to use a meter that measures true rms voltage no matter what the wave shape—a true rms voltmeter.

Why isn't this done more often? Well, until recently, most true rms voltmeters were expensive, limited

in capability and rather slow responding.

Now Hewlett-Packard has adapted the thermocouple concept used in standard laboratories; added protective amplifiers to insure overload protection (800 V p-p); and reduced final-value step function response to less than 5 seconds.

When you combine these features with a low price of \$525, it adds up to the HP 3400A—the first practical true rms voltmeter for general use in the 10 Hz to 10 MHz range. And, a high crest factor (ratio of peak to rms) allows you to measure noise and other non-sinusoidal wave forms at a ratio of 10:1 full scale or 100:1 at 10% of full scale. You get accurate noise and pulse measurements — without having to make non-standard corrections.

The 3400 isn't just a fine true rms

voltmeter—although that's plenty in itself. It can also be used as an ac/dc converter and a current meter. Typical dc output accuracy is 0.75% of full scale from 50 Hz to 1 MHz. Use the HP 456A AC Current Probe (\$225) and you get quick dependable current measurements. The 456A probe has a 1 mA to 1 mV conversion allowing direct readings up to 1 amp rms.

So, if all your measurements aren't made on true sinusoidal wave shapes and if you like direct accurate rms voltage indication no matter what you're measuring, it's time to check into the HP 3400A true rms voltmeter. For more information, contact your local HP field engineer. Or, write to Hewlett-Packard, Palo Alto, California 94304. Europe: 1217 Meyrin-Geneva, Switzerland.

099/19

HEWLETT  **PACKARD**

ANALOG VOLTMETERS

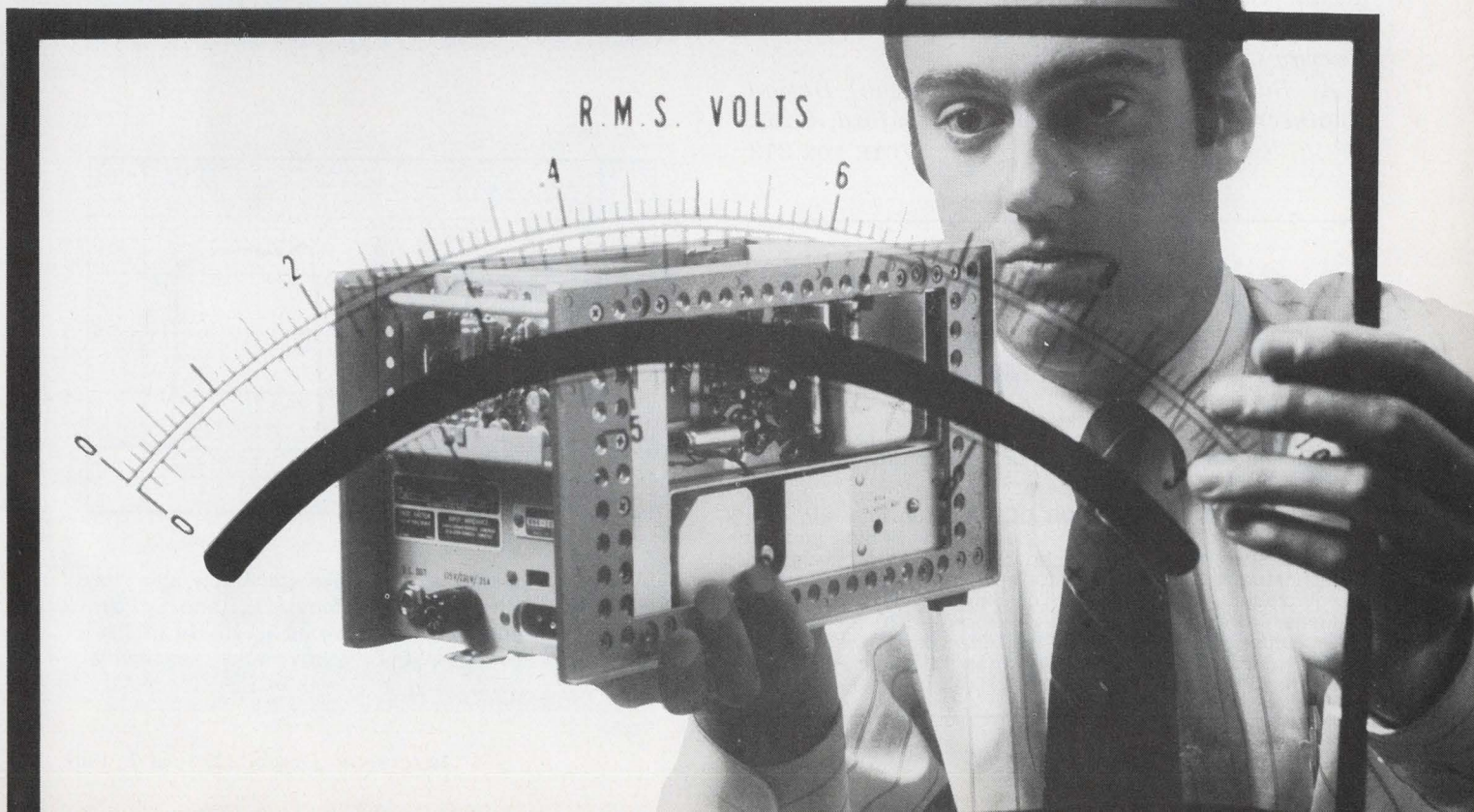

be detected and will operate the crowbar.

Unfortunately, C_2 masks short transient over-voltages of duration t , where

$$t = 2C_2(R_4 + R_5) \times \left[\frac{V_c(t) - V_c(0)}{2(V_{dc} + \Delta V_{dc}) - V_c(t) + V_c(0)} \left(\frac{1 + R_4 + R_5}{R_6 + R_7} \right) \right]$$

This expression for a rectangular pulse transient of duration t and amplitude just equal to the overvoltage margin is obtained by applying Kirchoff's Voltage Law to the network R_4, R_5, R_6, R_7, C_2 , and integrating and expanding the logarithmic function in series form. In the expression, ΔV_{dc} is taken as being equal to $[V_c(t) -$

$V_c(0)] [1 + (R_4 + R_5) / (R_6 + R_7)]$, since we are looking for the maximum transient duration maskable by C_2 . Substituting $V_c(t) = 1.36$ V and $V_c(0) = 1.30$ V, it is found that $t = 6.2$ ms for $V_{dc} = 4.1$ V. Therefore, the supply filtering must be guaranteed to prevent impulses of duration larger than 6.2 ms.

An appropriate resistance, R_9 , can be connected as shown if problems arise regarding current overload of the power supply or its meters when the crowbar is operated.

D. Protopapas, Graduate Student and K. C. Smith, Associate Professor, University of Toronto, Canada.

VOTE FOR 312

2-MHz square-wave generator uses two TTL gates

A simple 2-MHz square-wave generator can be built with two TTL NAND-gates, two resistors, and two capacitors. With the values shown (a), the circuit generates a 2-MHz symmetrical square-wave (b). Changing capacitors C_1 and C_2 to $0.01 \mu\text{F}$ results in a frequency of 500 Hz. For the particular integrated circuits and power supply voltages (5.0 V), the reliable operating range of $R_1 = R_2$ is 2 k Ω to 4 k Ω .

The circuit is used as a clock source for a digital system.

This work is supported by the U.S. Atomic Energy Commission.

A. Barna, D. Horelick, A. Johnson, Design Engineers, Stanford University, Stanford, Calif.

VOTE FOR 313

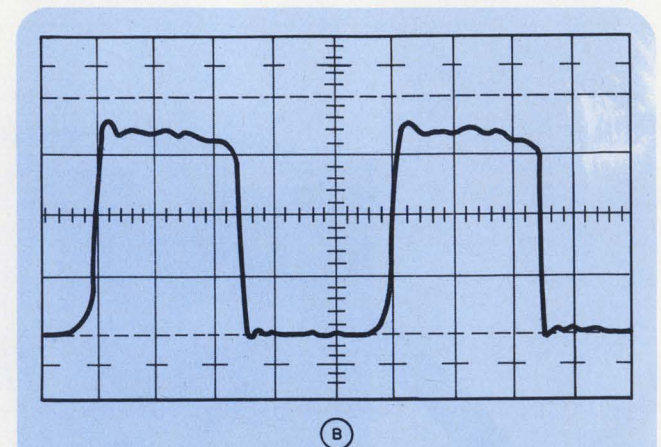
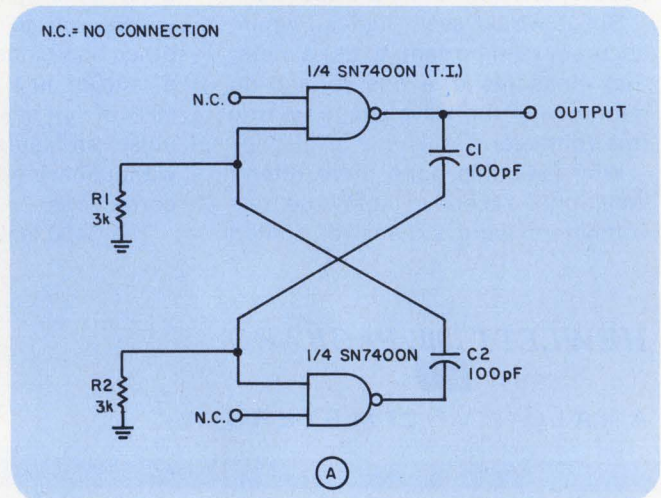

Frequency of the square-wave generator can be changed by changing the values of C_1 and C_2 . Output waveform from the circuit is shown in (b). Sweep speed was $0.1 \mu\text{/div}$ and sensitivity 1 V/div.

VOTE

VOTE! Go through all Idea-for-Design entries, select the best, and circle the appropriate number on the Reader-Service-Card.

SEND US YOUR IDEAS FOR DESIGN. You may win a grand total of \$1050 (cash)! Here's how. Submit your IFD describing a new or important circuit or design technique, the clever use of a new component or test equipment, packaging tips, cost-saving ideas to our Ideas-for-Design editor. You will receive \$20 for each accepted idea, \$30 more if it is voted best-of-issue by our readers. The best-of-issue winners become eligible for the Idea Of the Year award of \$1000.

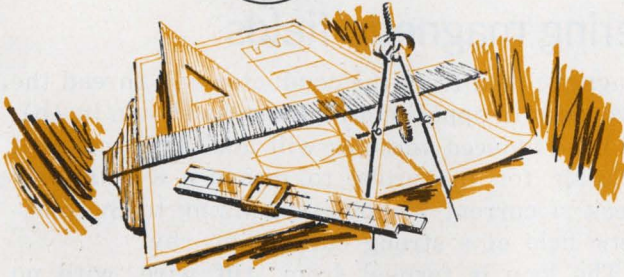

5 more electronic components tailored for designers

General Electric components are engineered for reliability and cost effectiveness. No other manufacturer offers such a wide selection of quality electronic components as General Electric. Specify GE in your designs.



General Electric's programmable UJT lets you control the key parameters

GE's D13T is a programmable unijunction transistor (PUT) with characteristics (η , R_{BB} , I_P , I_V) that can be selected to fit your circuit. Just two circuit resistors give the D13T1 and T2 programmability which permits the designer to:

- reduce a risk of thermal runaway
- use PUT in battery and other low-voltage circuits
- use base 2 as low impedance pulse output terminal
- use PUT in high volume applications.

Especially suited for long-interval timers, D13T2 features very low leakage and peak point currents. D13T1 is for more general use in high gain phase controls and relaxation oscillators.

Both are 3-terminal planar passivated PNP devices in the low-cost plastic TO-98 case. Circle number 221.



Pin-sized Lodex magnet

New—Lodex® permanent magnets in microminiature sizes

When designs call for tiny (even less than 1 millimeter) permanent magnets, GE has the answer. GE can produce powerful microminiature magnets at low cost—and in complex configurations, too.

The magnets are made of proved Lodex material that consists of elongated single domain iron cobalt particles bonded in a lead matrix and pressed to final dimensions at room temperature without the use of high temperature fabrication or heat treatment. This exclusive process makes it possible to produce Lodex magnets in very small or intricate shapes meeting extremely tight physical and magnetic tolerances.

Close piece-to-piece physical and magnetic uniformity often eliminates the need for final testing of the end product. These GE magnets are often the perfect answer for such precise applications as reed switches or magnetic pick-ups.

For more information, circle number 222.

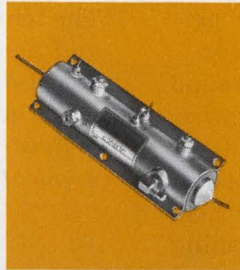

New transmitter design gives high performance to IFF and ATC transponders

GE's new C2003C transmitter is a Microwave Circuit Module (MCM) containing a master oscillator and power amplifier using planar ceramic triodes.

It is just one of many MCM's now available from GE to help reduce design cycles, provide retrofit and lead to improved system performance.

Other benefits include: meets performance and military requirements of the transmitter portion of IFF transponder significantly smaller than earlier designs permits two transmitters to function in space formerly used by one light-weight simplified heat sinking excellent frequency stability with wide variations in antenna VSWR.

For more technical information on this and other MCM's from General Electric, circle magazine inquiry number 223.



actual size

GE makes the only 150-grid relay that performs the AND-logic function

GE's 3SBR 4-pole relay is the only one available that performs the AND-logic function without any additional circuitry or components. Nine different input conditions control the relay's operation.

The 3SBR is another addition to GE's proved family of 150-grid relays for mil spec applications. It features all-welded construction, small size and a low profile—only 0.32" high. The 3SBR is available with a choice of coil ratings, mounting forms and headers.

For more technical data, circle number 224.

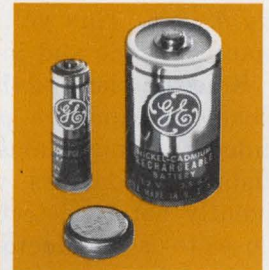

Rechargeable nickel-cadmium batteries give design flexibility—long life

Get lasting battery power and versatility suitable for many industrial and consumer applications. Types include sealed, pressure-relieved and vented cells. Custom designs to your specifications are also available.

Nominal ratings range from 0.1 amp-hours to 4.0 amp-hours in sealed cells and up to 160 amp-hours in vented types at the one-hour rate.

GE nickel-cadmium cells feature unique construction providing a very high discharge rate capability.

See how GE's proved line of nickel-cadmium batteries can increase your circuit performance. For more information, circle magazine reader card number 225.

LOOK TO GENERAL ELECTRIC—your best source for more in electronic components.

ELECTRONIC COMPONENTS SALES OPERATION

GENERAL  ELECTRIC

285-52

Rf current probe is immune to interfering magnetic fields

In working with high-frequency antennas it is very important to know the current distribution within the antenna elements as well as in nearby conductors. A simple current probe, which measures relative rf current magnitudes without breaking the conductor, is ideal for this purpose.

When the probe (see a) is held next to an rf current-carrying conductor, the magnetic field of the conductor induces a voltage in the figure-eight loop. This voltage is detected by the germanium diode and indicated on a dc voltmeter.

Since one half of the figure-eight loop is wound clockwise, and the other half counterclockwise, induced voltages arising from external fields of distant conductors will cancel out and consequently not be detected. When the probe is held close to a conductor, however, the encircling

magnetic field from the conductor will thread the two loops in opposite directions, as shown in (b), and the induced voltages will add. This makes it possible for the probe to measure a relatively weak rf current without responding to the magnetic field of a strong current nearby.

The loop is formed from stiff wire, with no dimensions being critical; the two loops, of course, must be approximately equal in area. The components (germanium diode, capacitor and two resistors) can be mounted on a masonite board or on similar insulating material.

An actual probe is shown in c.

Frederick W. Brown, Design Engineer, Communications Research, Idyllwild, Calif.

VOTE FOR 314

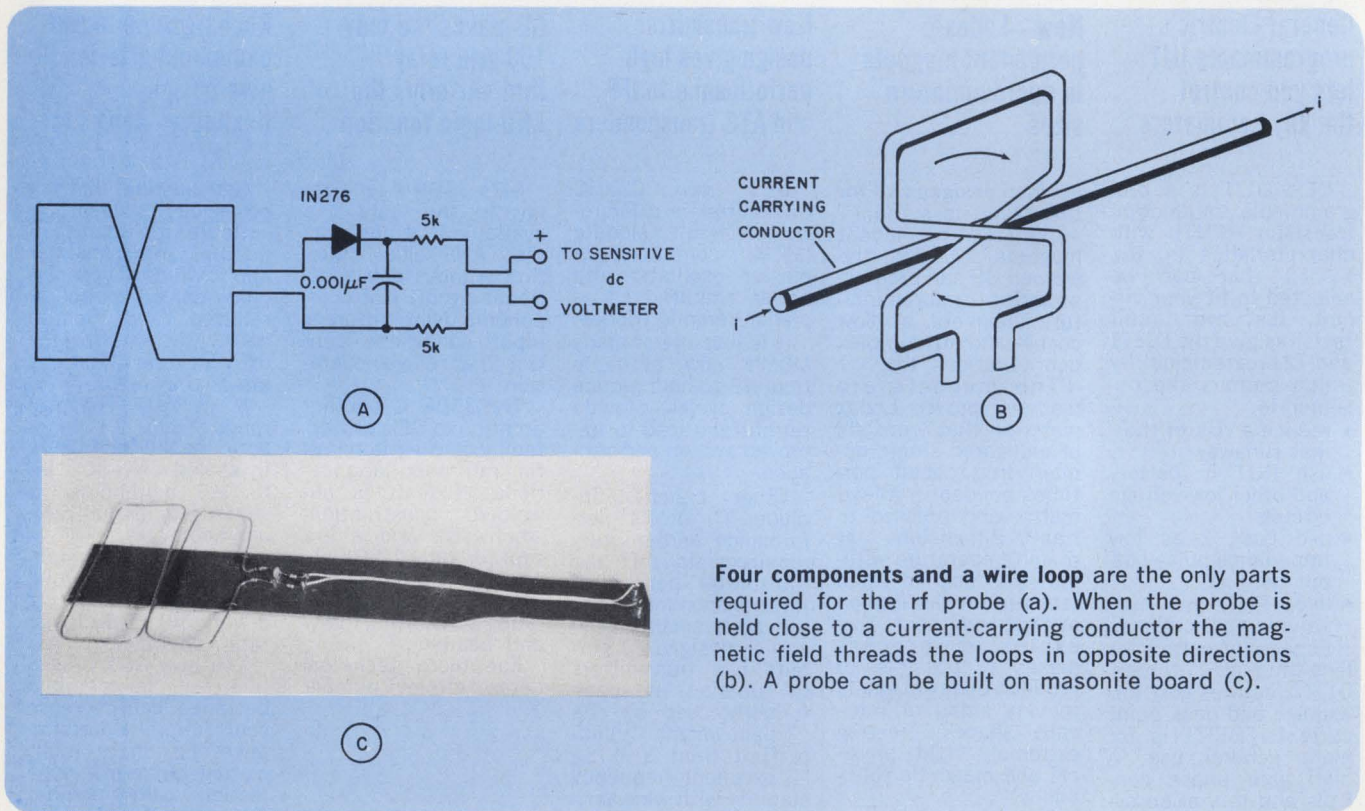

Four components and a wire loop are the only parts required for the rf probe (a). When the probe is held close to a current-carrying conductor the magnetic field threads the loops in opposite directions (b). A probe can be built on masonite board (c).

IFD Winner for February 15, 1969

L. Dunbar, Assistant Section Chief, Grumman Aircraft Engineering Corp., Calverton, N.Y. His Idea "Use your slide rule as a quick dB calculator and a wire table" has been voted the Most Valuable of Issue Award. Vote for the Best Idea in this Issue.

IFD Winner for February 1, 1969

Alan M. Hansel, Senior Development Engineer, E. F. Johnson, Waseca, Minn. His Idea "Complementary Schmitt trigger has zero output-offset voltage" has been voted the Most Valuable of Issue Award. Vote for the Best Idea in this Issue.

Versatility you can use in THERMISTOR PROBES

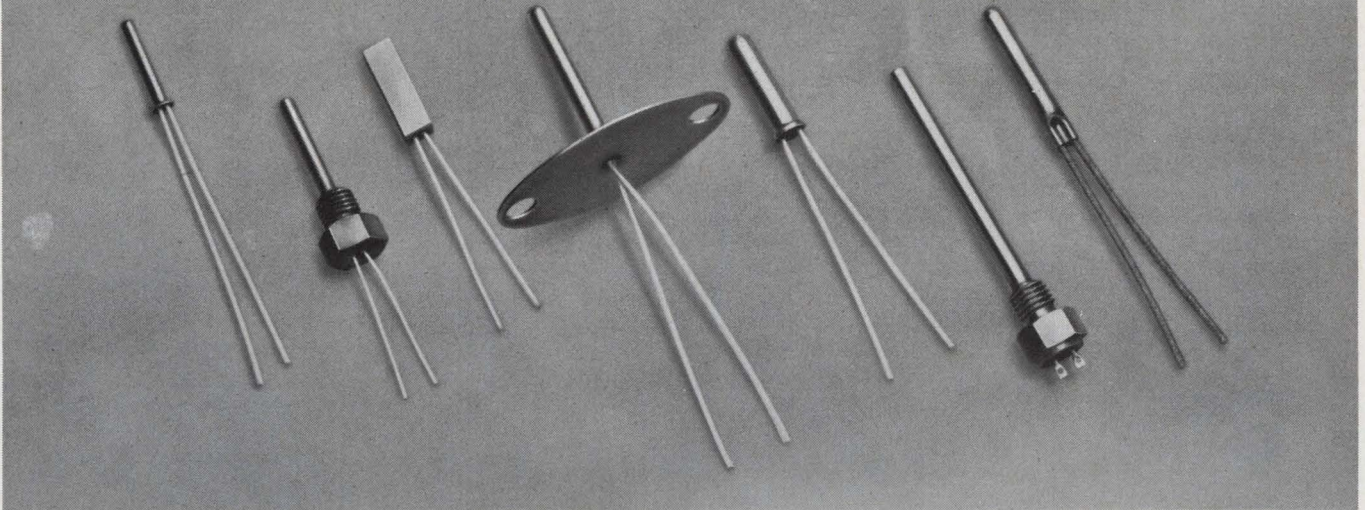

for temperature measurement

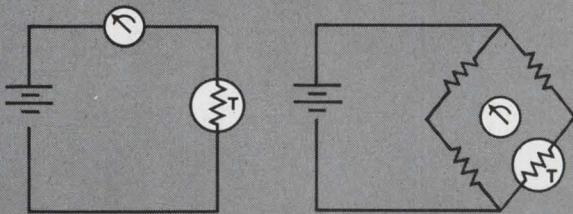

Circuit A

Circuit B

Combining high temperature sensitivity with high signal level, thermistors are ideally suited for temperature sensing. In circuit A, as the temperature of the thermistor increases, its resistance decreases, allowing more current to flow. If additional sensitivity is required, a bridge circuit like that shown at B may be used.

for liquid level detection

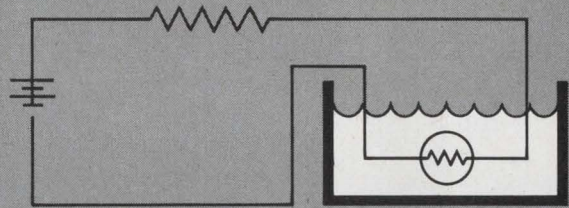

The thermistor is slightly self heated by passing a small current through the unit. The heat developed in the unit is dissipated more rapidly in the liquid than when the thermistor is above the liquid. The resulting change in body temperature results in a change in resistance. This in turn causes a change in the current in the circuit which can be detected by a relay or other means.

KEYSTONE TYPE	THERMISTOR RESISTANCE					
	0°C	25°C	37.8°C	104.4°C	150°C	232°C
370603-62.66-71-S	282.6	100	62.66	8.825	3.308	.8910
370603-119.1-85-S	631.2	200	119.1	14.01	4.800	1.174
370603-375.3-95-S	2132	650	375.3	39.48	12.76	2.826
0503-630-71-S	2750	1K	630.0	88.80	33.26	8.800
370603-1145-103-S	6733	2K	1145	111.1	33.78	6.607
370603-2801-120-S	18.23K	5K	2801	233.6	64.42	11.18
370603-4452-125-S	29.74K	8K	4452	356.2	96.61	16.29
060337-6266-71-S	28.26K	10K	6266	882.5	330.8	89.10
060337-11910-85-S	63.12K	20K	11.91K	1401	480.0	117.4
0503-16920-112-S	105.3K	30K	16.92K	1511	426.4	83.20
060337-37.53K-95-S	213.2K	65K	37.53K	3948	1276	282.6
0503-55.3K-125-S	361.0K	100K	55.30K	4420	1153	189.6
060337-114.5K-103-S	673.3K	200K	114.5K	11.11K	3378	660.7
060337-280.1K-120-S	1.823 meg	500K	280.1K	23.36K	6442	1118
060337-445.2K-125-S	2.974 meg	800K	445.2K	35.62K	9661	1629
050446-556.5K-125-S	3.717 meg	1 meg	556.5K	44.52K	12.08K	2037

All parts 260°C Max. operating temperature.

The probes illustrated above include stainless steel, aluminum, and chrome plated materials in a variety of configurations. Any thermistor listed at the left can be provided in one or all of the above illustrations. In addition, a variety of other designs are available. These probes are used in conjunction with solid state circuitry for liquid level measurement, and for use as sensors to measure temperature of liquids or surface temperatures. For full particulars, write, detailing your proposed application. Keystone Carbon Company, St. Marys, Pa. 15857.

Keystone
First

IN CREATIVE THERMISTOR TECHNOLOGY

INFORMATION RETRIEVAL NUMBER 52



THE C

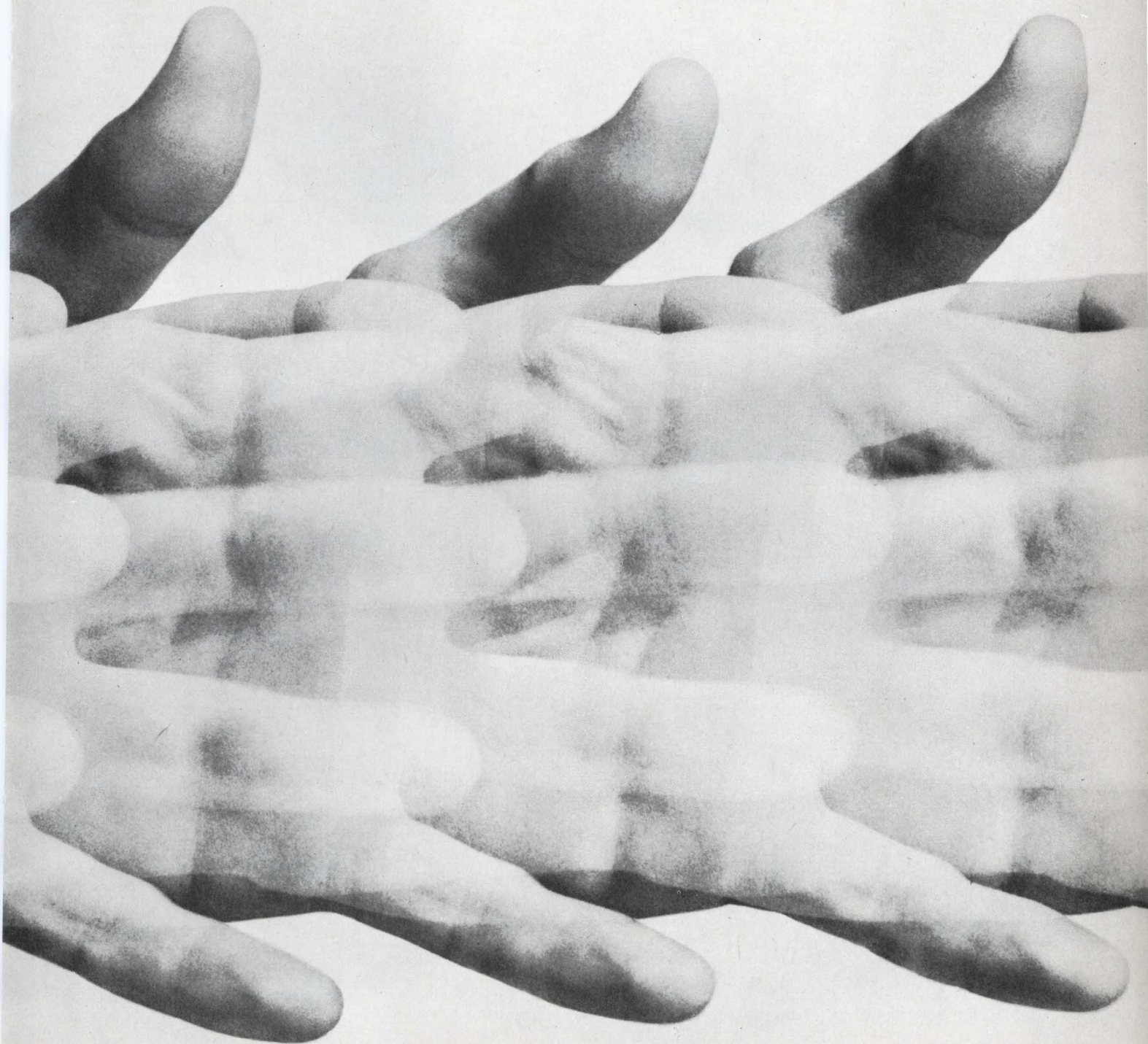

WREATH

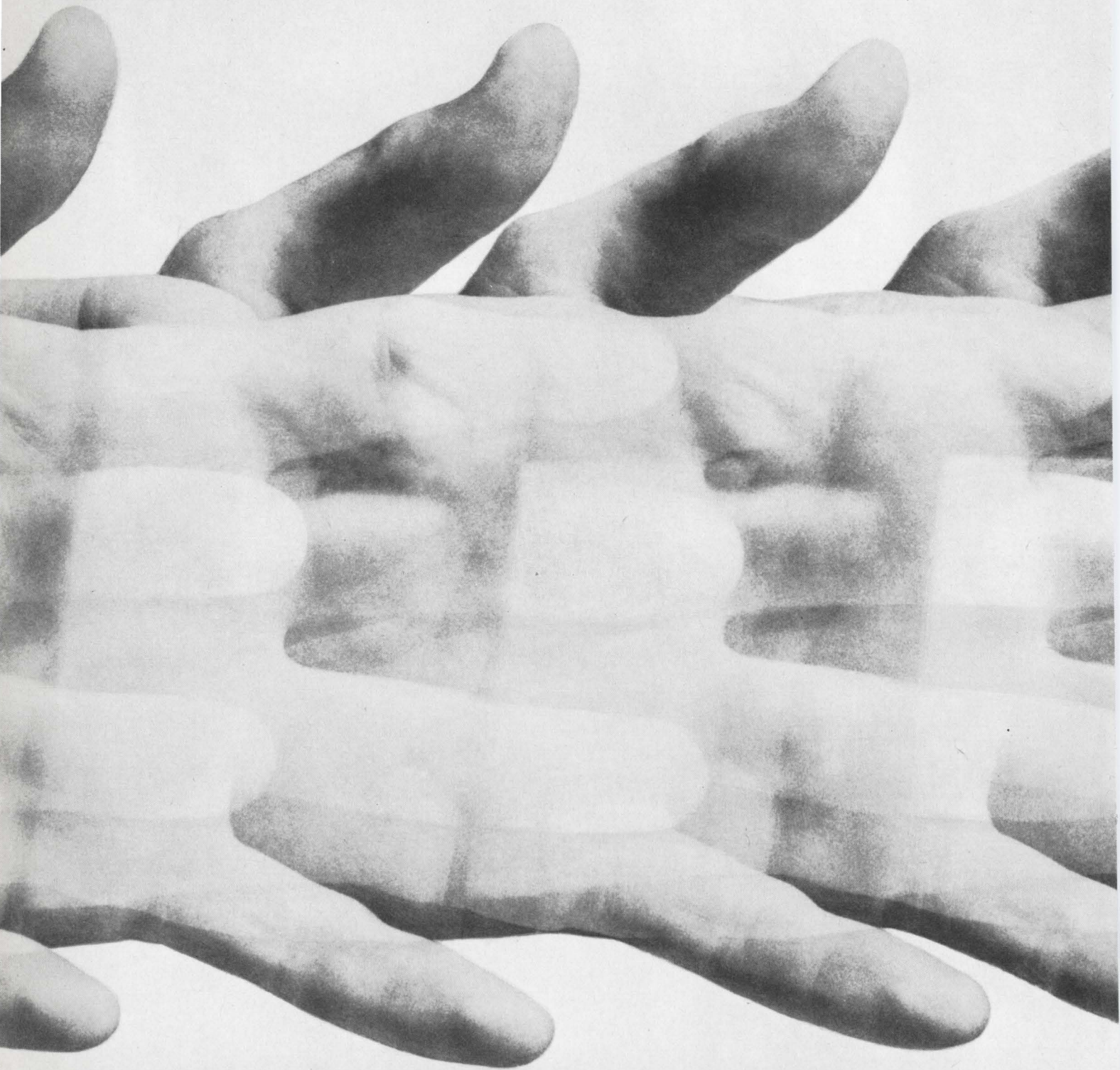

FAIRCH

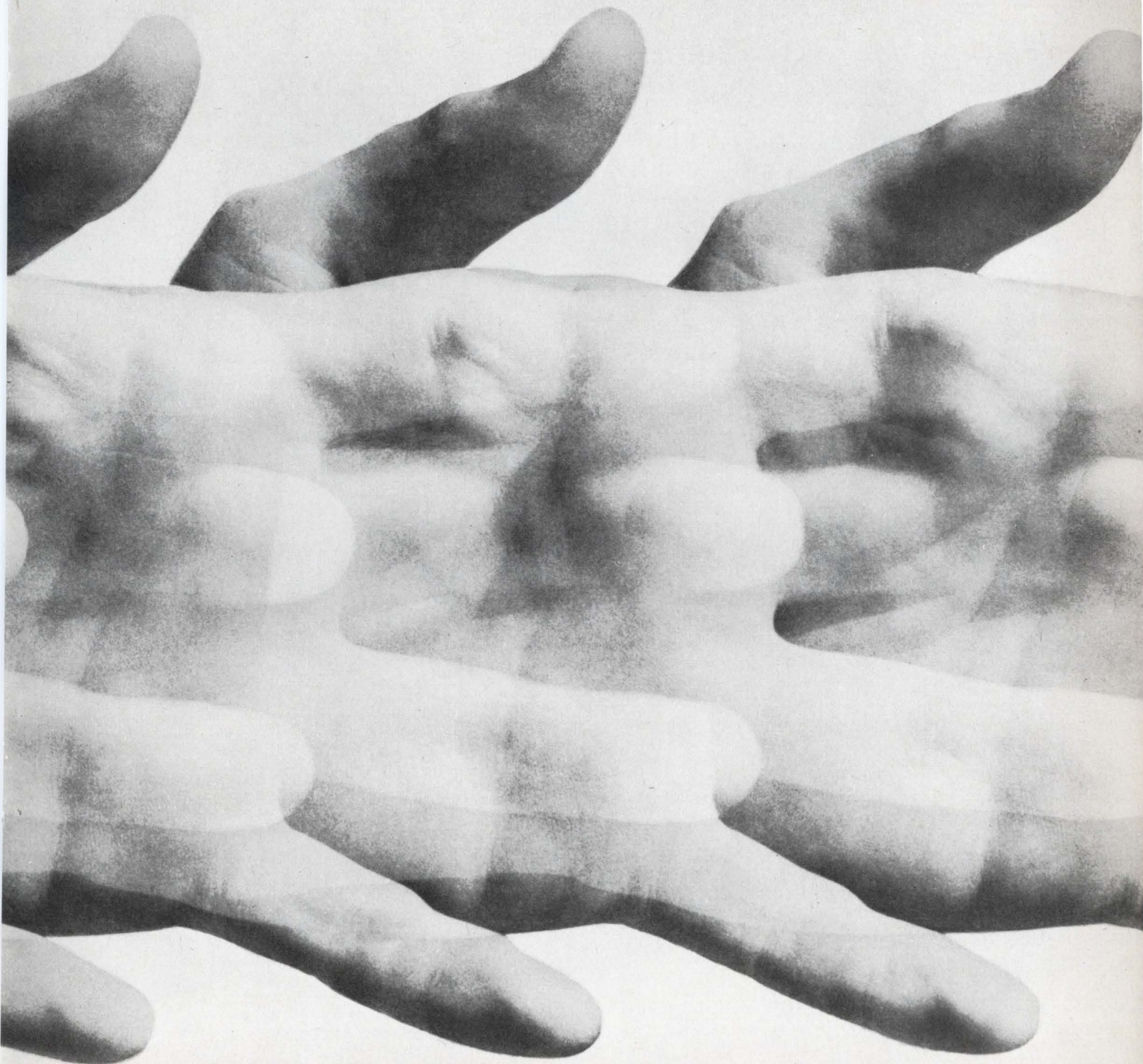

CHILD PO

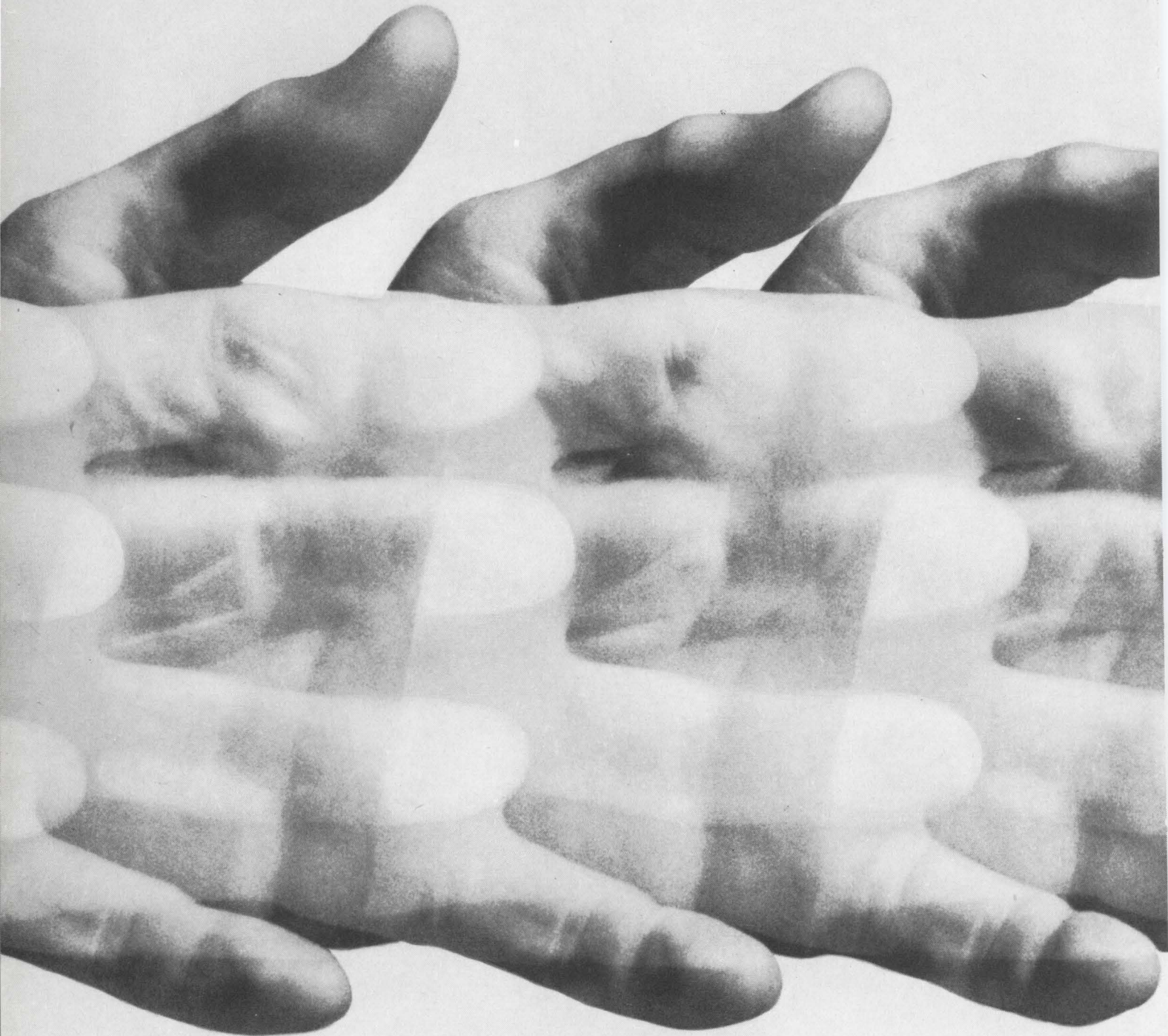

OWER

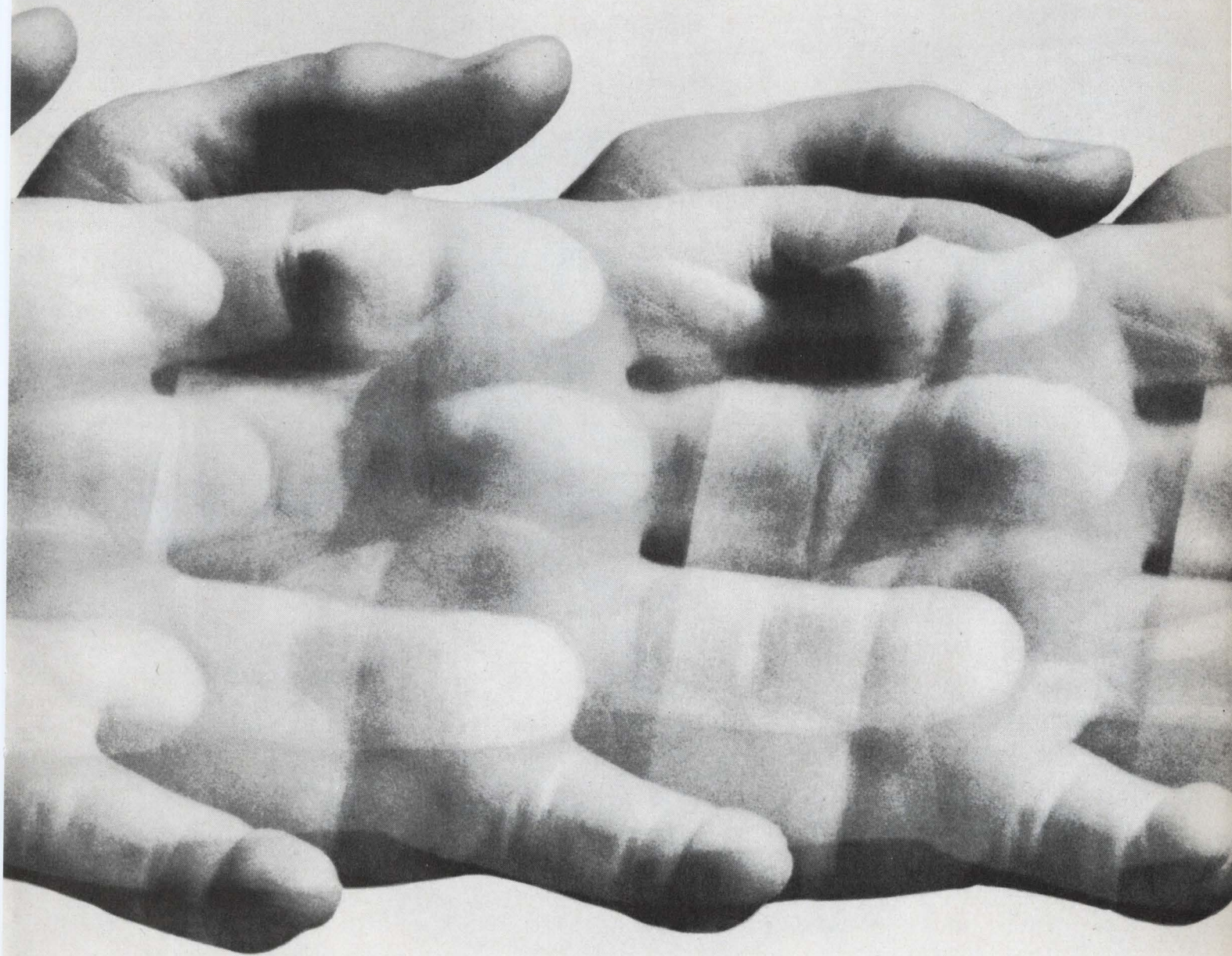

GRAB

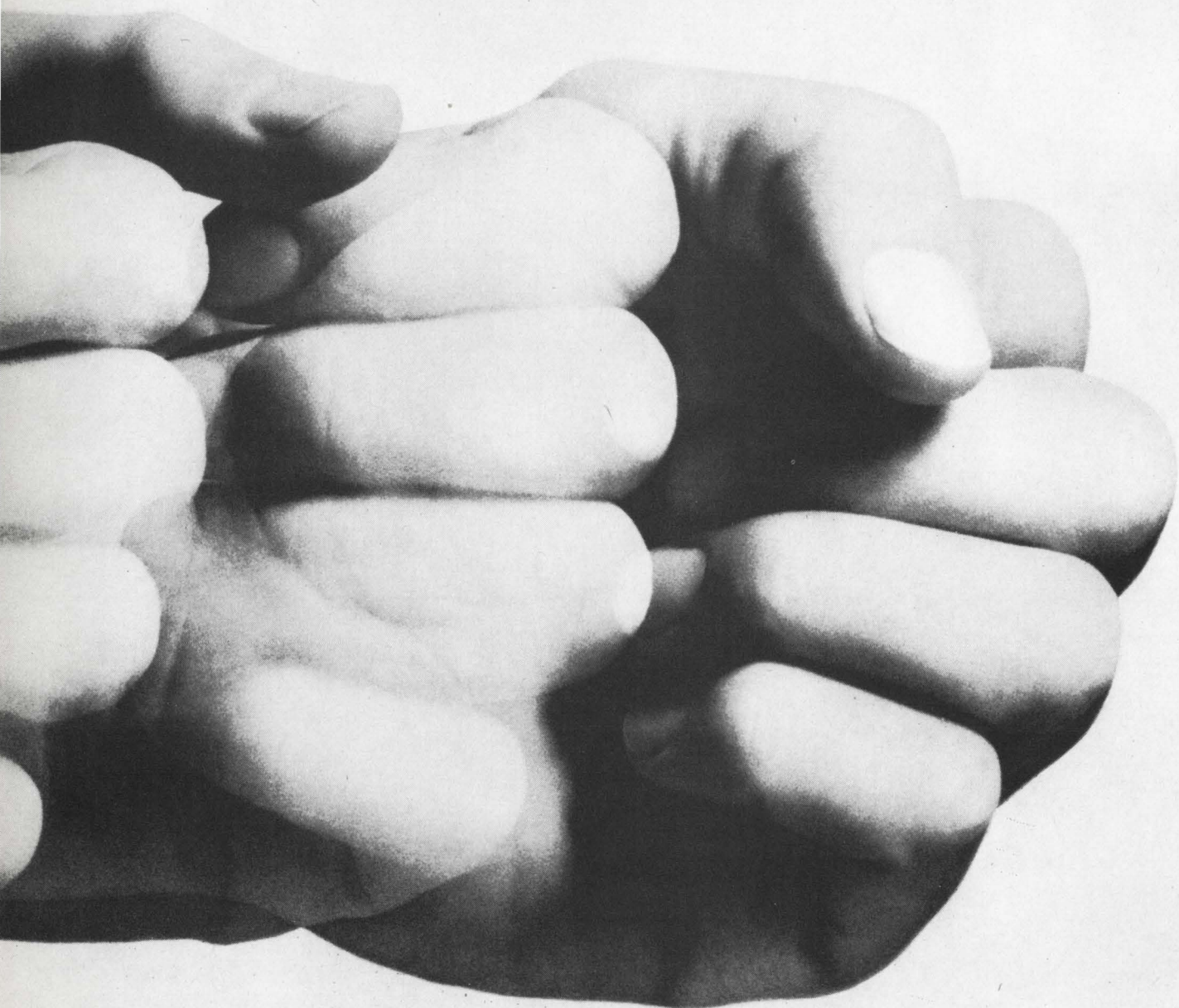

We're out to brute force the power business.
Across the board: NPNs. PNP's. NPN/PNP
complementary pairs.
High voltage devices. Devices no one else
can make.
And second-source devices we can make
better than anyone else.
Every month you'll see new power products.

Competitively priced. Available in volume,
off distributor shelves.
All on the preannounced schedule below.
To make a public announcement like this,
you've got to be either superconfident or crazy.
Crazy, we're not.

The Great Fairchild Power Grab is on.

JULY

NPN POWER SWITCHES AND AMPLIFIERS



THE GREAT FAIRCHILD POWER GRAB

AUGUST

PNP COMPLEMENTARY POWER SWITCHES AND AMPLIFIERS

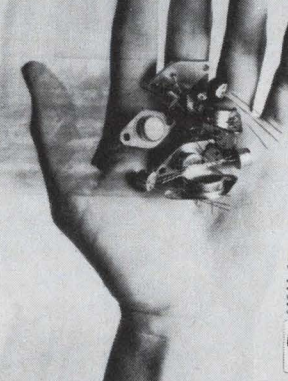

THE GREAT FAIRCHILD POWER GRAB

SEPTEMBER

NPN/PNP COMPLEMENTARY POWER SWITCHES



THE GREAT FAIRCHILD POWER GRAB

OCTOBER

TO-66/TO-3 PLASTIC POWER TRANSISTORS



THE GREAT FAIRCHILD POWER GRAB

NOVEMBER

HIGH VOLTAGE PLASTIC POWER AMPLIFIER TRANSISTORS



THE GREAT FAIRCHILD POWER GRAB

THE GREAT FAIRCHILD POWER GRAB



We frame up some of the biggest people in the industry.



Our lead frames are used by most of the major semiconductor manufacturers.

And there are good reasons why.

They've learned that they can depend on Sylvania. For a quality product. For fast service in large production quantities. (We turned out more than 100-million frames last year).

We make lead frames for all types of semiconductor packages—flat packs,

dual-inline packages and plastic encapsulated types.

We make them out of nickel, steel, Rodar,[®] and other glass-sealing alloys.

We make them fast and we make them accurate.

And we're the only supplier that can give you a choice of photo-chemical machined parts or die-stamped parts. Whichever suits your needs the best.

That's why some of the biggest people in the industry like being framed up by us. Wouldn't you?

Sylvania Metals & Chemicals, Parts Division, Warren, Pa. 16365.

SYLVANIA
A SUBSIDIARY OF
GENERAL TELEPHONE & ELECTRONICS

Products

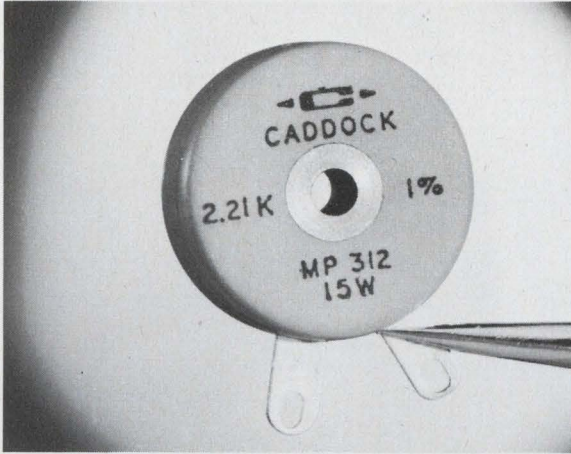

Low-profile disc power film resistors triple ratings and halve space. p. 141.



Data terminal prints up to 1200 words per minute over standard lines. p. 154.

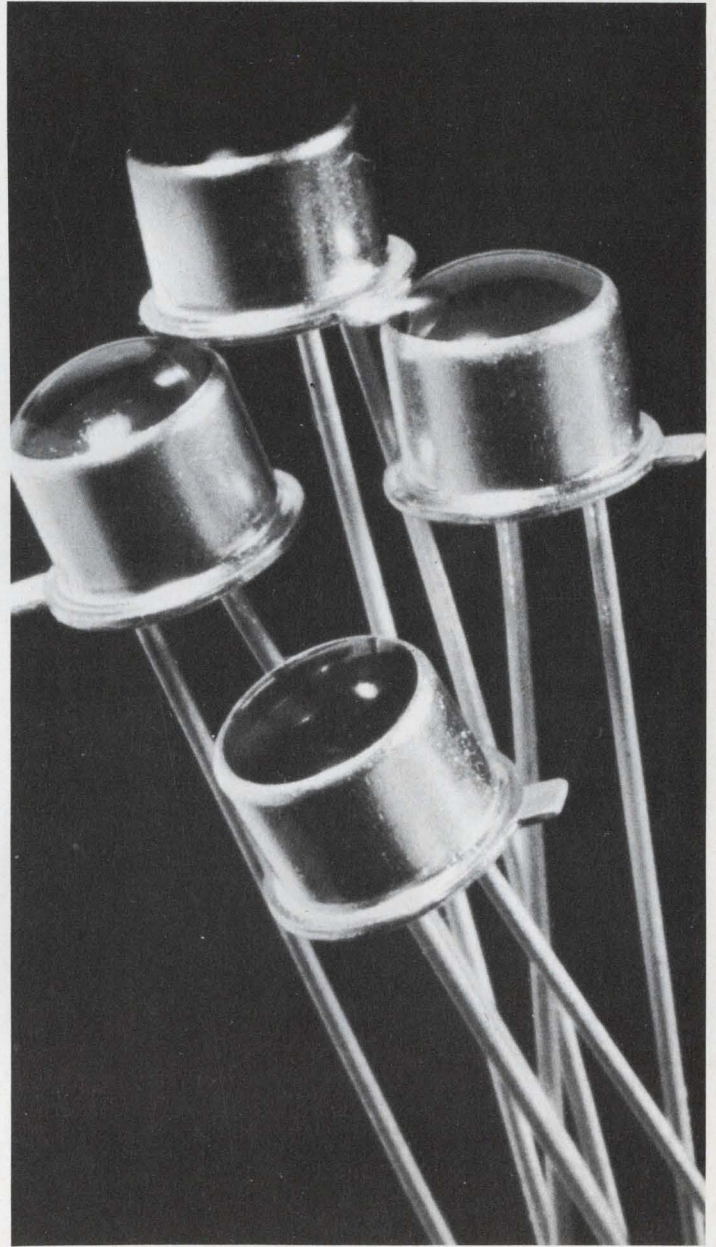

Light-emitting diodes develop brightness of 120 foot-lamberts with 15-mW drive power. p. 148.

Also in this section:

Indicator lamp with built-in reflector acts like miniature spotlight, p. 141.

Low-cost compact 2-1/2-digit panel meter can be programed from the rear, p. 144.

Under-\$10 operational amplifier delivers 5.5 mA at ± 11 V, p. 160.

Design Aids, p. 174 . . . **Application Notes**, p. 178 . . . **New Literature**, p. 180.

TRW Presents Low Frequency Varicaps®



High Capacitance...High Q...Low Noise

New TRW Varicaps make direct low frequency electronic tuning possible for the first time...from the high end of the broadcast band to 5 MHz and beyond.

Three high capacitance, single chip devices are available; PQ2150 at 150 pF, PQ2300 at 300 pF, and PQ2500 at 500 pF. All have less than

1 μ A leakage, Q factor greater than 150, and 5:1 capacitance ratio over a 2 to 90 V sweep.

Ideal for electronic tuning in receivers, ADFs, NAVCOM systems, low frequency VCOs, TCXOs, and field strength instruments, these single element Varicaps provide inherent low noise and high stability.

Contact any TRW Distributor for complete information. TRW Semiconductors is a Subsidiary of TRW INC.

TRW®

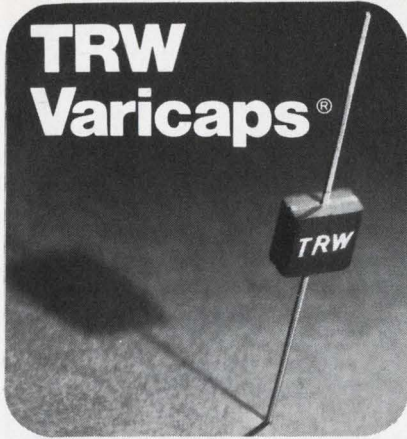

Immediately available from TRW distributors

CALIFORNIA—Los Angeles Area

AVNET CORPORATION
10916 Washington Blvd. (213)870-6141
Culver City, Calif. 90230 (213)836-4711

K-TRONICS, INC.
5645 E. Washington Blvd.
Los Angeles, Calif. 90022 (213)685-5888

SANTA MONICA BELL ELECTRONICS
CORP.
306 E. Alondra Blvd.
Gardena, Calif. 90247 (213)321-5802

WESTATES ELECTRONICS CORP.
20151 Bahama Street
Chatsworth, Calif. 91311 (213)341-4411

CALIFORNIA—San Francisco Area

ELMAR ELECTRONICS INC.
2288 Charleston Road
Mountain View, Calif. 94091 (415)961-3611

KIERULFF ELECTRONIC INC.
3969 E. Bayshore Road
Palo Alto, Calif. 94303 (415)968-6292

DISTRICT OF COLUMBIA
ELECTRONIC WHOLESALERS, INC.
2345 Sherman Avenue NW
Washington, D.C. 20001 (202)483-5200

CRAMER ELECTRONICS, INC.
692 Lofstrand Land
Rockville, Md. 20850 (301)424-2700

FLORIDA

CRAMER/FLORIDA, INC. (305)566-7511
4141 N. E. 6th Avenue (305)947-6517
Ft. Lauderdale, Florida Enterprise 1776

ELECTRONICS WHOLESALERS, INC.
345 Graham Avenue
Orlando, Florida (305)841-1550

MASSACHUSETTS

CRAMER ELECTRONICS, INC.
320 Needham Street
Newton, Mass. 02164 (617)969-7700

NEW JERSEY

EASTERN RADIO CORP.
312 Clifton Avenue
Clifton, New Jersey 07015 (201)471-6600
New York, New York (212)CH4-2268

NEW YORK

CRAMER/ESCO INC.
96-10 23rd Avenue
Elmhurst, New York 11369 (212)478-4000

TERMINAL-HUDSON
ELECTRONICS, INC.
236 W. 17th Street
New York, New York 10011 (212)234-5200

OHIO

ELECTRONIC MARKETING CORP. (EMC)
814 W. 3rd Avenue
Columbus, Ohio 43212 (614)299-4161

PENNSYLVANIA

ALMO INDUSTRIAL ELECTRONICS INC.
Roosevelt Blvd. at Blue Grass Rd.
North East, Industrial Park
Philadelphia, Penn. 19114 (215)676-6000

TEXAS

HALL-MARK ELECTRONICS CORP.
9100 Markville Drive
Dallas, Texas 75231 (214)231-6111

TRW

Available from all other TRW distributors
coast-to-coast.

COMPONENTS

Power film resistors circle out heat effects

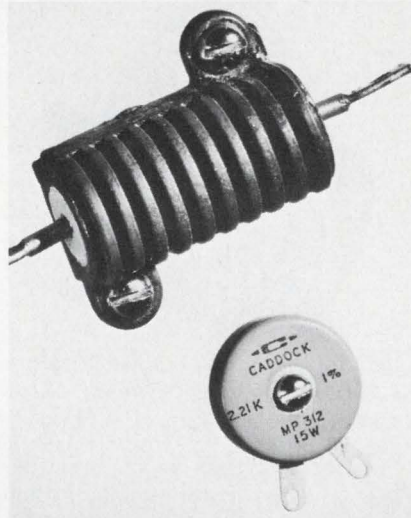

Caddock Electronics, 3127 Chicago Ave., Riverside, Calif. Phone: (714) 683-5361. P&A: \$3.60 or \$4; 2 to 3 wks.

Maximizing heat transfer efficiency with a low-profile laminar disc configuration, series MP chassis-mounted power resistors can handle three times the power in less than half the space of conventional units. Model MP312 is a 15-W device that is half the size of previous 5-W resistors; model MP330 is a 30-W unit, only slightly larger than its 15-W counterpart.

Using a complex oxide resistive film called Micronox, the new resistors embody a radical new design. A ceramic washer with the Micronox film is placed on an aluminum disc that has a center post for screw mounting.

Contact is made with radial solder lugs, or with Teflon leads, and the entire structure is then molded with silicone. The bottom surface of the aluminum disc, however, remains exposed to transfer heat.

The solder-lug MP312 and its leaded sister, the MP311, have a maximum voltage rating of 600 V, and measure 0.6 in. in diameter by 0.188 in. high. The solder-lug MP330 and the leaded MP329 are rated at 1000 V. Their size is 0.85 in. in diameter by 0.25 in. high.

Resistances range from 10 Ω to 200 k Ω for the solder-lug versions, and from 50 Ω to 200 k Ω for the leaded units.

CIRCLE NO. 250

Miniature spotlight builds in reflector

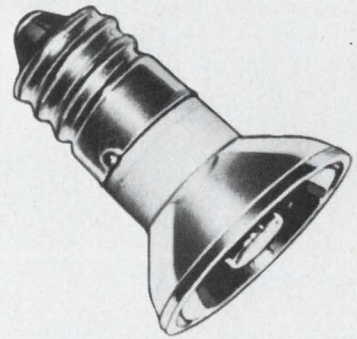

Chicago Miniature Lamp Works, 4433 N. Ravenswood Ave., Chicago. Phone: (312) 784-1020. P&A: 52¢; stock.

Designated as CM38 Reflect-O-Lite, a new indicator lamp produces a controlled area of light output through the use of a built-in parabolic reflector. Available in standard 12-, 60- or 120-V models, the unit mounts in standard lamp holders and comes with a bayonet or candelabra base.

CIRCLE NO. 251

Coaxial T-3/4 lamp operates from ICs

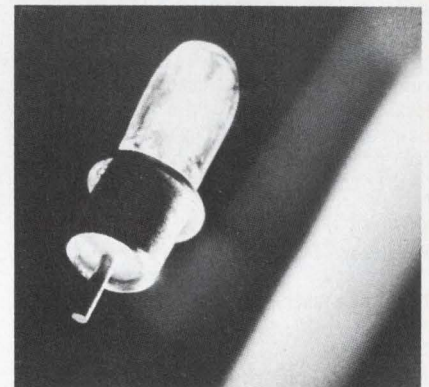

Lamps, Inc., 17000 S. Western Ave., Gardena, Calif. Price: 88¢.

Only 0.093 in. in diameter, a new subminiature coaxial-contact lamp can be driven directly by ICs without buffer transistors. This unsupported-filament T-3/4 lamp uses a coaxial base for fast positive-contact installation without soldering. It is available in 1.5-V ratings with amperage of 0.01 or 0.015 A, and in 5-V ratings with amperage of 0.02, 0.06, 0.075, 0.08 or 0.115 A.

CIRCLE NO. 252

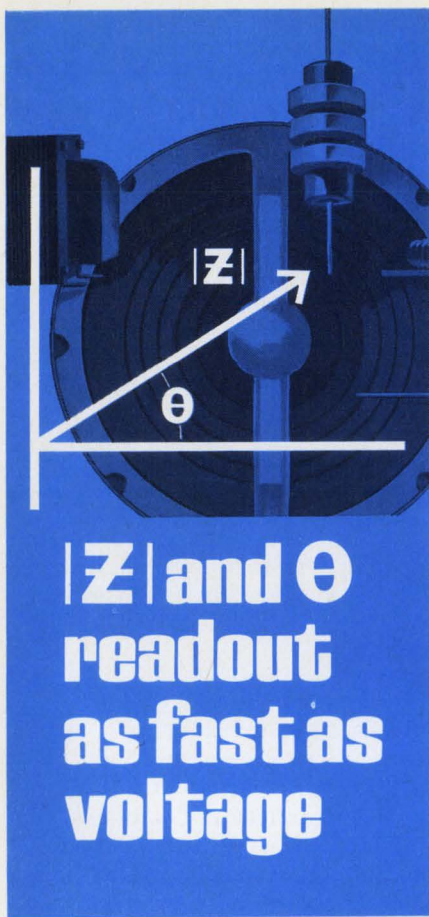

**|Z| and θ
readout
as fast as
voltage**

The Hewlett-Packard 4800A Vector Impedance Meter quickly displays the impedance characteristics of any passive device or circuit. There's no nulling or balancing — no calculations to make. Just select the impedance range, set the desired frequency and read out impedance and phase directly.

Application Note 86 describes many applications of the 4800A Vector Impedance Meter. For your copy and complete specifications, contact your local Hewlett-Packard field engineer or write: Hewlett-Packard, Green Pond Road, Rockaway, N.J. 07866. In Europe: 1217 Meyrin-Geneva, Switzerland.

Pertinent Specifications:

Frequency Range: 5 Hz to 500 kHz, continuous.
Impedance Range: 1 ohm to 10 megohms.
Phase Range: 0 to $\pm 90^\circ$.
Price: \$1650.

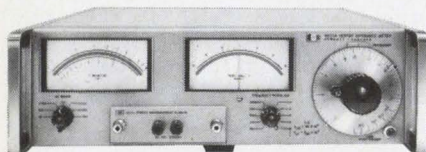

HEWLETT *hp* PACKARD
IMPEDANCE INSTRUMENTS

1094

INFORMATION RETRIEVAL NUMBER 55

COMPONENTS

Ac/dc stepping motor moves 200 times/rev



IMC Magnetics Corp., 570 Main St., Westbury, N.Y. Phone: (516) 334-7195. Price: \$40.

Useful as either an ac or dc device, a new motor achieves 200 steps per revolution in 1.8° increments when used as a dc stepper. As an ac synchronous motor, Tormax 200 can provide 72 rpm for a 60-Hz input and maintain remote devices in synchronism. As a dc stepper, it performs at rates as fast as 550 steps per second with a potential of over 1000 steps per second.

CIRCLE NO. 253

Molded wafer switches end contact problems

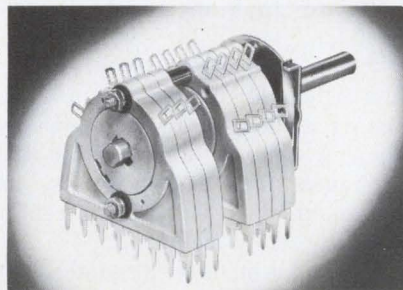

Standard Grigsby Co., div. of Standard Kollsman Industries, Inc., 920 Rathbone Ave., Aurora, Ill. Phone: (312) 897-8417. P&A: 40¢ to \$3; 6 to 8 wks.

Using a new snap-lock rotor construction, series SKPC PC-board wafer switches eliminate the often faulty mechanical pressure linkage between stator and switch contact paths. These eight-terminal molded switch wafers with plug-in PC-board terminals have a one-piece metal stator contact path from the printed-circuit termination into the switching point.

CIRCLE NO. 254

LOOKING FOR THOSE HARD-TO-GET SPECIAL AND DISCONTINUED TRANSISTORS?



2N128	2N672	2N930	2N1135	2N1656	2N2163	2N2380
2N207	2N673	2N935	2N1135A	2N1663	2N2164	2N2380A
2N207A	2N674	2N936	2N1158	2N1676	2N2165	2N2398
2N207B	2N675	2N937	2N1158A	2N1677	2N2166	2N2399
2N223	2N696	2N938	2N1177	2N1683	2N2167	2N2400
2N224	2N697	2N939	2N1178	2N1711	2N2168	2N2401
2N225	2N698	2N940	2N1179	2N1726	2N2169	2N2402
2N226	2N699	2N941	2N1199	2N1727	2N2170	2N2410
2N227	2N699A	2N942	2N1199A	2N1728	2N2175	2N2451
2N231	2N706	2N943	2N1200	2N1742	2N2176	2N2478
2N232	2N706A	2N944	2N1201	2N1743	2N2177	2N2479
2N240	2N706B	2N945	2N1204	2N1744	2N2178	2N2487
2N317A	2N708	2N946	2N1204A	2N1745	2N2180	2N2488
2N344	2N709	2N947	2N1219	2N1746	2N2181	2N2489
2N345	2N768	2N960	2N1220	2N1747	2N2182	2N2537
2N346	2N769	2N961	2N1221	2N1748	2N2183	2N2538
2N352	2N770	2N962	2N1222	2N1748A	2N2184	2N2539
2N353	2N771	2N963	2N1223	2N1749	2N2185	2N2540
2N355	2N772	2N964	2N1267	2N1750	2N2186	2N2651
2N386	2N773	2N965	2N1268	2N1752	2N2187	
2N387	2N774	2N966	2N1269	2N1753	2N2199	2N2699
2N393	2N775	2N967	2N1270	2N1754	2N2200	2N2710
2N395	2N776	2N976	2N1271	2N1785	2N2217	2N2795
2N396	2N777	2N977	2N1272	2N1786	2N2218	2N2796
2N396A	2N778	2N979	2N1300	2N1787	2N2218A	2N2904
2N408	2N779	2N980	2N1301	2N1788	2N2219	2N2905
2N428	2N779A	2N982	2N1411	2N1789	2N2219A	2N2955A
2N495	2N779B	2N983	2N1416	2N1790	2N2220	2N2906
2N496	2N784A	2N984	2N1427	2N1864	2N2221	2N2906A
2N499	2N794	2N1024	2N1428	2N1865	2N2221A	2N2907
2N499A	2N795	2N1025	2N1429	2N1866	2N2222	2N2907A
2N501	2N796	2N1026	2N1436	2N1867	2N2222A	2N2954
2N501A	2N785	2N1027	2N1467	2N1868	2N2274	2N2966
2N502	2N828	2N1028	2N1472	2N1893	2N2275	2N2967
2N502A	2N834	2N1034	2N1478	2N1905	2N2276	2N3011
2N502B	2N835	2N1035	2N1494	2N1917	2N2277	2N3015
2N503	2N846	2N1036	2N1494A	2N1918	2N2278	2N3133
2N504	2N846A	2N1037	2N1495	2N1983	2N2279	2N3134
2N534	2N846B	2N1118	2N1496	2N1984	2N2280	2N3135
2N535	2N858	2N1181A	2N1499	2N1985	2N2281	2N3136
2N535A	2N859	2N1181B	2N1499A	2N1986	2N2282	2N3317
2N535B	2N860	2N1119	2N1499B	2N1987	2N2360	2N3318
2N536	2N861	2N1122	2N1500	2N1988	2N2361	2N3319
2N588	2N862	2N1122A	2N1606	2N1989	2N2362	2N3320
2N589	2N863	2N1123	2N1607	2N1990	2N2368	2N3321
2N597	2N864	2N1124	2N1608	2N2048	2N2369	2N3322
2N598	2N865	2N1125	2N1608	2N2086	2N2369A	2N3342
2N599	2N924	2N1128	2N1613	2N2087	2N2374	2N3343
2N600	2N926	2N1129	2N1623	2N2088	2N2375	2N3344
2N601	2N927	2N1130	2N1643	2N2147	2N2376	2N3345
2N670	2N928	2N1131	2N1654	2N2148	2N2377	2N3346
2N671	2N929	2N1132	2N1655	2N2162	2N2378	

SPECIALS: T1750 through T2340
I.C.'S: 702, 709C, 710, 711

YOU JUST FOUND THEM!

All 100% tested . . . guaranteed
& at the Industry's lowest prices.
Write for new catalog and compare



LANSDALE
Transistor & Electronics, Inc.

COLMAR, PENNA. 18915 • 215-855-9002

INFORMATION RETRIEVAL NUMBER 56
ELECTRONIC DESIGN 12, June 7, 1969

Sixteen tiny lamps
fit into 1 sq in.

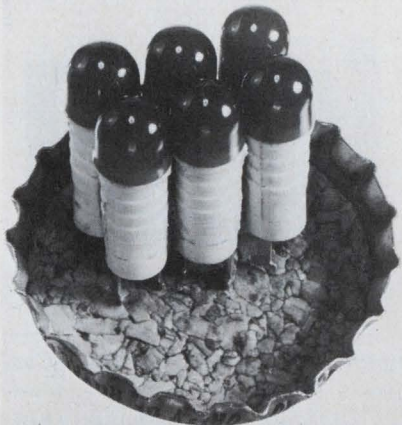

Marco-Oak Industries, Oak Electro/Netics Corp., P. O. Box 4011, Anaheim, Calif. Phone: (714) 535-6037.

A new microminiature indicator light with a slide-based replaceable T-1 lamp is so tiny that 16 units can be mounted in a square inch. QT-Lite is available as a press-fit unit that can be serviced from the front panel without tools, or as a right-angle printed-circuit-terminal unit.

CIRCLE NO. 255

Subminiature pot
is 0.35% linear



New England Instrument Co., Kendall Lane, Natick, Mass. Phone: (617) 873-9711.

A new 1/2-in.-dia precision rotary conductive-plastic potentiometer meets the high-accuracy requirements normally satisfied by larger units. Absolute standard linearities can be 0.35%, with special linearities as close as 0.15%. Resistance ranges from 250 Ω minimum to 130 k Ω maximum, and power rating is 1/2 W.

CIRCLE NO. 256

THE BARDEN
501

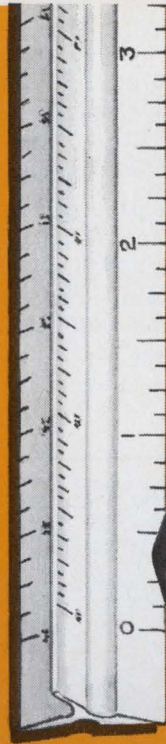

MINI
SIZE

mighty performance

The new Barden Model 501 voltage regulator offers localized regulation throughout your system. No more supplementary filters, power transistors or capacitors are required! They are built into the 1 $\frac{5}{8}$ " square case.

With a minimum of 70% efficiency from no load to full load at any rated voltage (8-40V), the 501 has low dynamic impedance, only 50 MV peak-to-peak output ripple; logic controllable on-off, heavy internal filtering, and high transient response. Completely overload protected with self-recovery capability. Ask for free literature.

barden

A DIVISION OF INTERDYNE
2217 PURDUE AVE. • LOS ANGELES, CALIFORNIA 90064
Telephone (213) 477-3511

Signal conditioner equalizes data lines

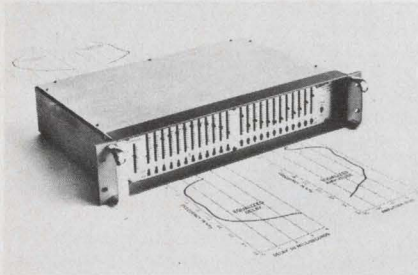

Acton Laboratories, Inc., sub of Bowmar Instrument Corp., 531 Main St., Acton, Mass. Phone: (617) 263-7756. Price: \$635.

Independently equalizing both amplitude and delay, a new line conditioner is designed for use in restricted-bandwidth information channels. Model 478A can condition any practical voice channel used for high-speed data transmission.

CIRCLE NO. 257

Low-cost compact DPM programs from rear



Digilin Inc., div. of Dura-Containers, Inc., 6533 San Fernando Rd., Glendale, Calif. Phone: (213) 246-8161. P&A: \$139; 3 wks.

Selling for only \$139, a new compact digital panel meter can be programed, from the rear panel, to measure dc voltage, current or resistance. Offering a 2-1/2 digit readout with 100% overrange, model 250 has an accuracy of $\pm 1\%$ of reading, ± 1 digit.

Using practically all-IC circuitry, the new meter achieves its price-performance breakthrough with a totally new sampling technique; the input is sampled and the display is changed 60 times per second.

Two stacked circuit boards inside the housing accommodate all components. One board contains the digital circuits, while the other has the analog circuits and the constant-current supply. As a result of this compact construction, the new meter occupies only 3.12 in. behind the panel. In addition, it is only 4.38 in. wide by 3.13 in. high.

Numeric plug-in Nixie-type tubes provide the digital readout, besides a numeral "1" indicator. Memory storage circuitry allows a non-blinking display.

The 250 DPM has a maximum range of 1000 V for voltage, 10 A for current and 100 k Ω for resistance. Maximum sensitivity is 10 mV, 100 nA and 10 Ω , respectively.

Automatic zero adjustment eliminates drift and assures accuracy plus stability. Because of its self-contained power supply, the unit can operate directly from any ac line source. Response time is 20 ms.

CIRCLE NO. 258

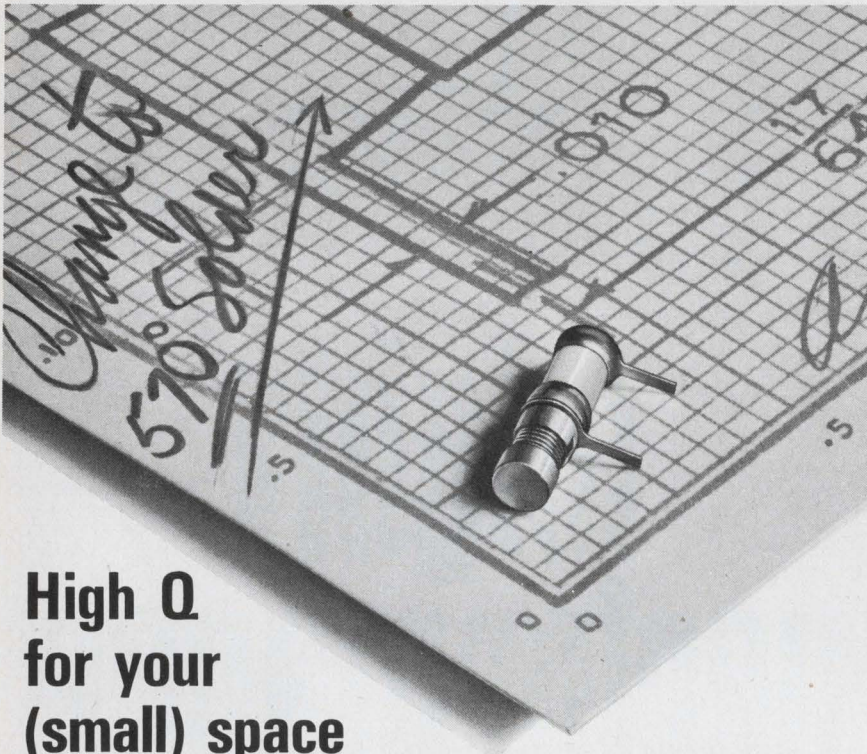

High Q for your (small) space requirements!

The Johanson 4700 Series Variable Air Capacitors provide, in micro-miniature size, the extremely high Q important in demanding aerospace applications. In addition, the ultra-rugged construction of the 4700 Series capacitors assures highest reliability in the most critical environments.

- Available in printed circuit, turret and threaded terminal types.
- Meets Mil Specs for salt spray requirements.
- Features 570° solder, which prevents distortion and is not affected by conventional soldering temperatures.

SPECIFICATIONS

Size: 1/8" diameter, 1/2" length
Q @ 100 MC: > 5000
Q @ 250 MC: > 2000
Capacity Range: 0.35 pF to 3.5 pF
Working Voltage: 250 VDC
 (Test voltage, 500 VDC)
Insulation Resistance: > 10⁶ Megohms
Temp. Ranges: -55°C to 125°C
Temp. Coefficient: 50 \pm 50 ppm/°C

WRITE TODAY FOR FULL DATA.

Johanson

MANUFACTURING CORPORATION

400 Rockaway Valley Road, Boonton, N. J. 07005 (201) 334-2676

INFORMATION RETRIEVAL NUMBER 58

ANOTHER BOURNS FIRST...

10 MIL-SPEC TRIMPOT® POTENTIOMETERS

MIL-R-27208



RT10



RT11



RT12

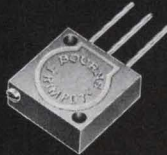

RT22



RT24



RT26*

MIL-R-22097



RJ11



RJ12

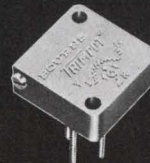

RJ22



RJ24*

AVAILABLE FROM YOUR LOCAL BOURNS DISTRIBUTOR!

Bourns is the world's largest manufacturer of Adjustment potentiometers with 22 years of leadership. Bourns is also the largest manufacturer of MIL-Spec potentiometers backed by a total of 10 RT and RJ models in our line.

The 6 RT and 4 RJ models not only meet the specifications of MIL-R-27208 and MIL-R-22097, but each is designed and manufactured to consistently exceed each facet of these requirements.

As in the past, you can depend on Bourns to deliver the potentiometer you need. In this tradition of service, we now offer the MIL-Spec unit you may need for your next critical application with 10 RT and RJ models.

Full data is available from the factory, local field office, representative or your stocking distributor.

* Not yet stocked in depth by distributors.



BOURNS, INC., TRIMPOT PRODUCTS DIVISION
1200 COLUMBIA AVENUE, RIVERSIDE, CALIFORNIA 92507
714 684-1700 • TWX: 910 332-1252 • CABLE: BOURNSINC

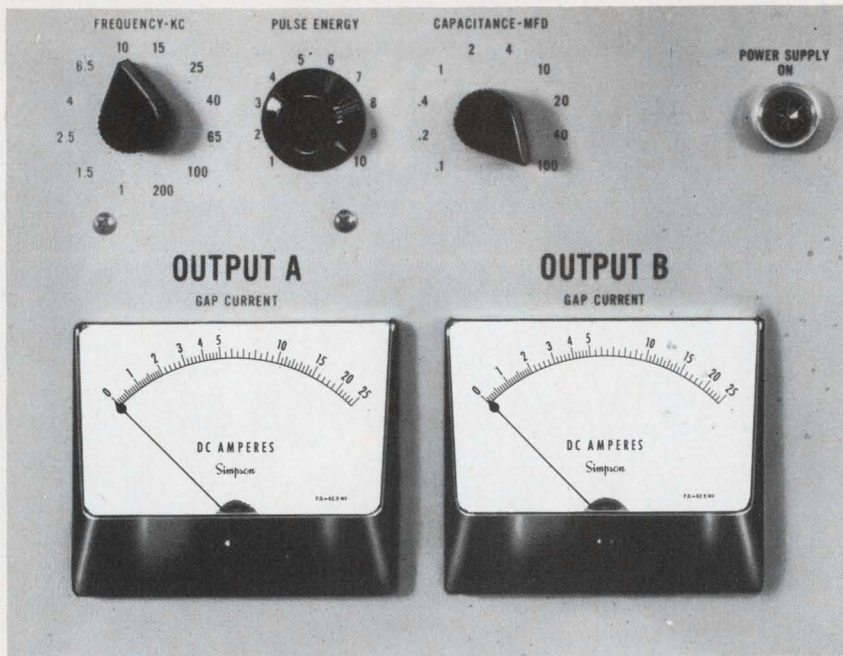

the sure way to let
customers know you
care about quality...

Simpson panel instruments on your equipment

Simpson's advanced self-shielding annular and core magnet construction provides optimum torque-to-mass ratio. Rugged Taut Band and Pivot & Jewel movements can withstand punishing shock and vibration. Your assurance of an instrument that will *stay* accurate. No wonder so many manufacturers with reputations to protect (or build!) specify Simpson.

Over 1,400 stock ranges, sizes, and types. Get "off the shelf" delivery from your local electronic distributor.

For special needs contact your local Simpson Representative. He's ready to help.

Simpson ELECTRIC COMPANY



5200 W. Kinzie Street, Chicago, Illinois 60644 • Phone (312) 379-1121

EXPORT DEPT.: 400 W. Madison Street, Chicago, Illinois 60606. Cable Simelco
IN CANADA: Bach-Simpson Ltd., London, Ontario • IN INDIA: Ruttonsha-Simpson Private
Ltd., International House, Bombay-Agra Road, Vikhroli, Bombay

INSTRUMENTS THAT STAY ACCURATE

INFORMATION RETRIEVAL NUMBER 60

INSTRUMENTATION

Transmission test set checks out noise too



Hewlett-Packard, 1501 Page Mill Rd., Palo Alto, Calif. Phone: (415) 326-7000. P&A: \$625, 8 wks.

Replacing two or more voltage-measuring instruments, a new test set reads telephone transmission levels as well as message-circuit noise. Actually a voltmeter designed for telephone transmission quality measurements, model 35558 has wide bandwidth for transmission-level measurements and is rms-responding for noise measurements. Noise-weighting filters and impedance-matching transformers are built into the instrument.

CIRCLE NO. 259

Phase instrument has 40-dB range

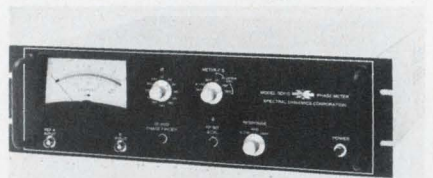

Spectral Dynamics Corp., P. O. Box 671, San Diego, Calif. Phone: (714) 278-2501. P&A: \$995; 1 wk.

A new phase meter, model SD110, features 40-dB dynamic range and a continuous frequency range from 5 Hz to 1 MHz. Over its 40-dB amplitude range (at 400 Hz) the meter provides an absolute detection accuracy of ± 0.75 degrees. Signals as low as 30 millivolts are accepted, and offsets up to ± 150 volts dc on each signal unusual feature of the instrument is a Δ CAL front-panel adjustment. An input can be accommodated. An

CIRCLE NO. 260

Digital clock/calendars use ICs and Nixies



Chrono-log Corp., 2583 W. Chester Pike, Broomall, Pa. Phone: (215) 356-6771. Price: from \$1040.

Costing approximately half as much as an equivalent transistor instrument, series 30,000 low-cost digital clock/calendars with Nixie display and buffered BCD outputs incorporate all-IC circuitry. The new instruments are available in over 7000 different combinations of options. This permits selecting a unit that will meet the requirements of virtually any system needing a digital output of time and date.

CIRCLE NO. 261

Programmable system measures 10-MHz inputs



Singer Instrumentation Div., Ballantine Operation, 915 Pembroke St., Bridgeport, Conn. P&A: from \$1950.

Offering both ac and dc converter capability coupled to a digital readout module, a new programmable measuring system is capable of making ac measurements to 10 MHz with a full-scale sensitivity of 10 mV. All panel functions are remotely programmable, and outputs can be interfaced with any analog or digital computer system. The readout is a four-digit display, plus overrange; automatic polarity sensing is standard.

CIRCLE NO. 262

The Heavyweight says reduce system costs

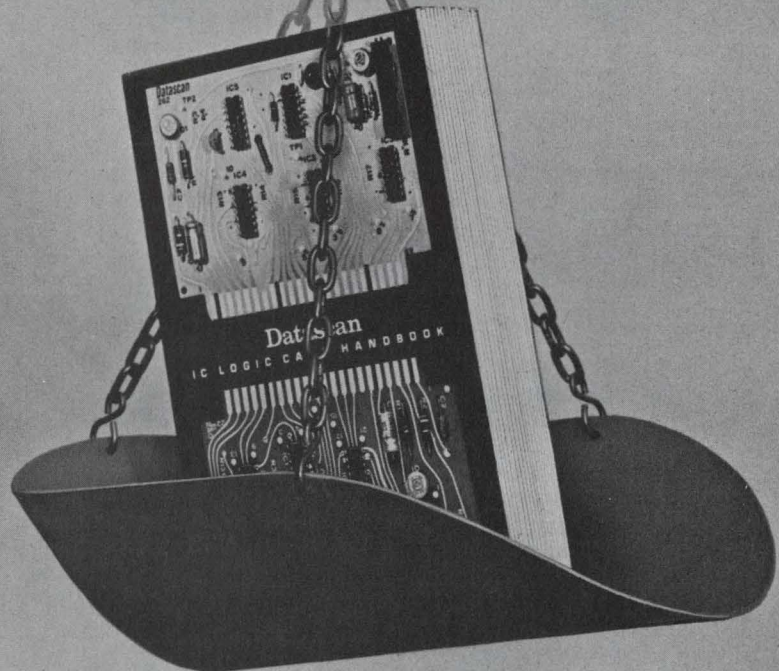

There are hundreds of pages in our new I.C. Logic Card Handbook to help you lower costs — not just card costs but **total system costs**. As an example — there are probably more function-cards illustrated and all with Dynamic Decoupling*, than in any other single logic card source. Function cards means less cards, less back plane wiring, less testing — and **less system costs**.

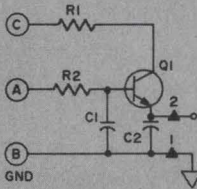

*Dynamic Decoupling™ is a Datascan exclusive — it's a circuit right on the card which eliminates high and low frequency noise for extremely reliable system operation. You get a clean 5V DC power bus **on each card** — reducing system costs by eliminating system debugging.

Our many services to reduce costs start with letting you know what we have to offer — **get your own copy of Datascan's new Logic Card Handbook** — and see all the DTL, HTL (for high noise environment) and TTL circuits you don't have to design.

Datascan

DATASCAN, INC.

1111 Paulson Avenue, Clifton, N. J. 07013 • Telephone 201-478-2800

903

INFORMATION RETRIEVAL NUMBER 61

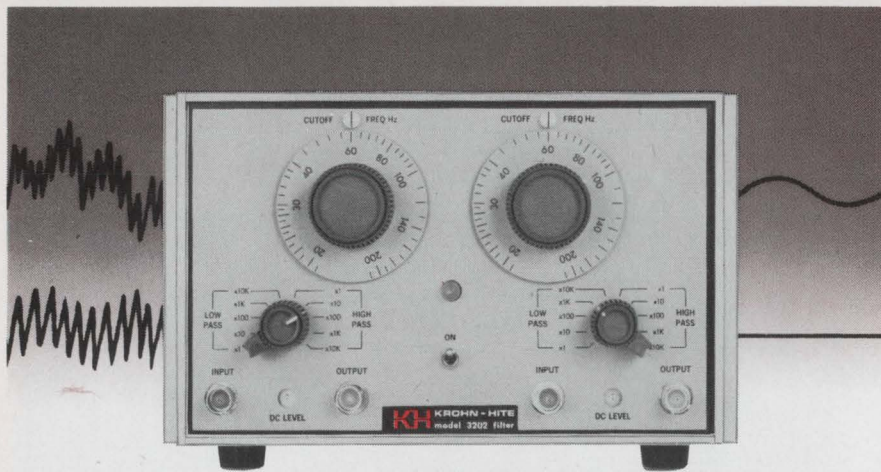

**Best way
to get rid of
unwanted
signals**

K-H multifunction filter.

Model 3202 all solid state filter with two independent channels gives you continuously adjustable high-pass, low-pass, bandpass or band reject functions over a 20 Hz to 2 MHz frequency range; provides the flexibility essential for complex frequency or time domain measurements.

Check these exclusive features. See for yourself why the Krohn-Hite Model 3202 is such an exceptional value at \$795.

FUNCTIONS: Low-pass — direct coupled with low drift. High-pass — upper 3 db at 10 MHz. Bandpass — continuously variable. Band rejection — variable broad band or sharp null.

TWO RESPONSE CHARACTERISTICS: (1) Fourth-order Butterworth or (2) simple R-C (transient free).

ZERO-db INSERTION LOSS: All-silicon amplifiers provide unity gain passband response. 24 db per octave slopes per channel extend to at least 80 db.

90-db DYNAMIC RANGE: Low hum and noise (100 micro-volts) eliminate costly preamplifiers.

There's more. Write for complete data. Contact your Krohn-Hite Representative for an eye-opening demonstration.

OVERSEAS SALES OFFICES: BELGIUM, C. N. Rood s. a.; DENMARK, SC Metric A/S; FRANCE, Antares; GERMANY, Nucletron Vertriebs-GMBH; HOLLAND, C. N. Rood n. v.; ITALY, Dott. Ing. Mario Vianello; SWEDEN, Telemstrument; ISRAEL, R.D.T. Elect. Eng. Ltd.; JAPAN, Shoshin Shoji Kaisha, Ltd.; AUSTRALIA, Sample Electronics (Vic.) Pty., Ltd.

KH KROHN-HITE CORPORATION

580 Massachusetts Ave., Cambridge, Mass. 02139, U.S.A.
Phone: (617) 491-3211 TWX: 710-320-6583

Oscillators / Filters / AC Power Sources / DC Power Supplies / Amplifiers

INFORMATION RETRIEVAL NUMBER 62

Low-power LED brightens output

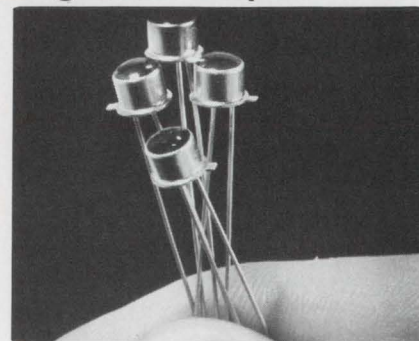

Hewlett-Packard, 1501 Page Mill Rd., Palo Alto, Calif. Phone: (415) 326-7000. P&A: \$4.90; stock.

With only 15-mW drive power (10 mA at 1.5 V), a new gallium-arsenide-phosphide light-emitting diode achieves a typical brightness of 120 foot-lamberts. Useful as a panel and circuit-status indicator, type 5082-4400 produces a bright red light with a wavelength of 660 nanometers. Allowable power dissipation is 85 mW continuous.

CIRCLE NO. 263

Dynamic register varies its length

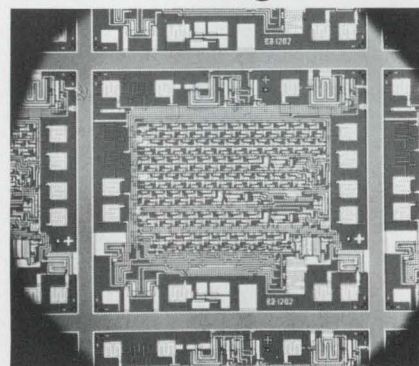

Electronic Arrays, Inc., 501 Ellis St., Mountain View, Calif. Phone: (415) 964-4321. P&A: \$16; stock.

Said to be an industry first, an electronically adjustable dynamic MOS shift register can have a fixed or variable register length between 1 and 64 bits. This is implemented by the logic state of six register-length control inputs, while data input and output leads remain fixed. Model 1203 operates up to 1 MHz with a single-phase 9-V clock; model 1202 operates up to 3 MHz with a two-phase 24-V clock.

CIRCLE NO. 264

Introducing a new model— the AT-701A



See all the people who came to see our new Model AT-701A. Are you in the photo?

AT-701A, as you've probably guessed, is an improved version of our fabled, pioneering Model AT-701. Based, like the other S. S. White systems—the Model LAT-100 (the \$6,000 system) and the Model AT-704 (the 4,000 per hour system)—on the proven Airbrasive® method for clean, shockless, and noiseless removal of resistance material, without altering the substrate. Precise electronics monitor resistance during the trimming cycle, give 'stop' command when preset value is reached.

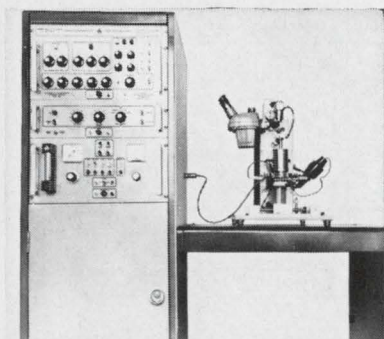

Yes, it sells for less, but be a good chap and read the text of the ad anyway... please?

Accuracy with the AT-701A is guaranteed at $\pm 0.5\%$, with 0.1% frequently attainable. Capacity is up to 600 trims/hour; tolerances may be set from 0 through $\pm 11\%$ with resolution of 0.1% . Final resistance values can be programmed through 5 digits and four multipliers giving four ranges from 0 to 10K and through 0 to 10M.

In fact, in performance, the AT-701A is exactly similar to its non-A predecessor, though it looks a bit different. What's interesting about it, though is this:

It sells for a lot less money.
(The number to call (collect) is 212-661-3320. Ask for Hal Skurnick.)

Output of the Model AT-701A can be doubled via a new optional rotary feeding table. Table features automatic gripping of substrates up to 2" x 2", automatic indexing and positioning of sub-

strate for trim. Operator has merely to drop in untrimmed substrates and pick out the trimmed ones. Doubles production.

Modesty prevents our saying that the AT-701A, with its carousel feeder stole the IEEE show; it does not prevent our saying that many who came to visit us actually looked at the machine (instead of the pretty girls). If you missed the Show, you'll be

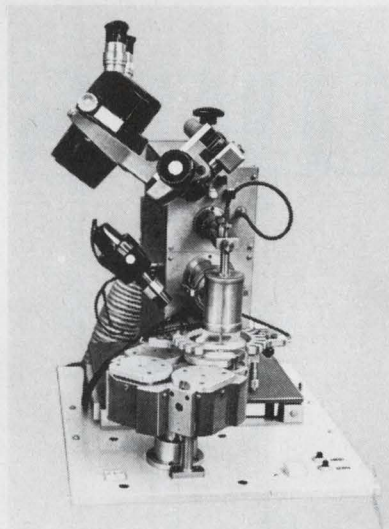

New turntable for the Model AT-701A really zonks up feeding speed, output. By how much we don't know yet, but we estimate that it will double system's output.

happy to know that we will again be demonstrating the AT-701A at the Nep/Con show, June 10, 11, and 12, at the Coliseum.

S. S. White Division, Pennwalt Chemicals Corp., Dept. 28, 201 East 42nd Street, N.Y., N.Y. Tel.: 212-661-3320

PENWALT
S.S. WHITE
INDUSTRIAL PRODUCTS

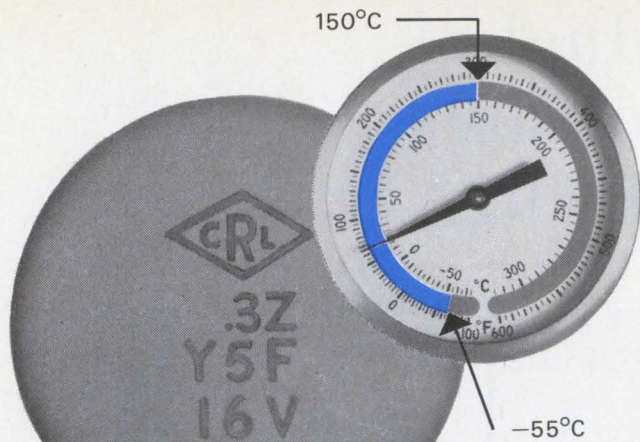

Centralab gives transistor circuits longer, more reliable performance with NEW 16, 25 & 50 volt Ultra-Kaps[®]

Centralab engineers have achieved a new degree of temperature stability in semiconductor type, low voltage ceramic disc capacitors with their development of temperature-stable Ultra-Kaps. The 16 and 25 volt units can hold a maximum capacitance change of $\pm 4.7\%$; 50 volt units as little as $\pm 7.5\%$.

Ultra-Kaps also exhibit other superior performance characteristics, such as low impedance; high capacitance density; and operation to temperatures as high as 150°C , as low as -55°C . In 50v ratings average dissipation factor is as low as 1.5% ; leakage resistance of 1000 megohms, min.

the stable ones

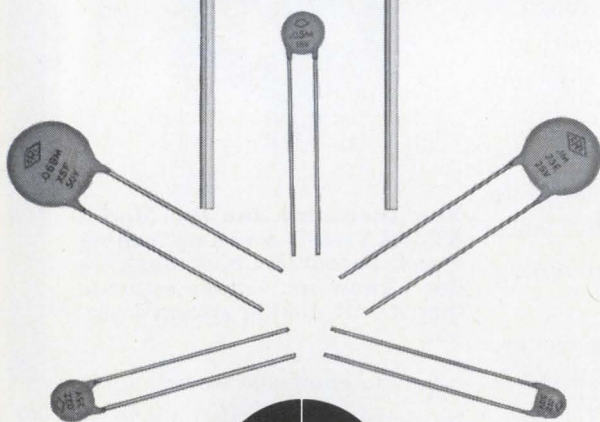

Ultra-Kaps are ideal for use in transistor circuits because they are operable to a frequency of 1 MHz. And they're still low cost units that replace more expensive mylar and "Hi-K" ceramic capacitors. On quantity orders, they're priced as low as $2\frac{1}{2}$ cents each with delivery as short as 4 to 5 weeks. We can send you samples immediately for your evaluation.

Don't let your design plans melt away because of inferior capacitor performance. Get the ultimate, Centralab's stable Ultra-Kaps.



CENTRALAB

Electronics Division
GLOBE-UNION INC.
5757 NORTH GREEN BAY AVENUE
MILWAUKEE, WISCONSIN 53201

Max. Diameter	16 volt		25 volt		50 volt	
	Max. Cap. MFD	Min. I.R. Megohms	Max. Cap. MFD	Min. I.R. Megohms	Max. Cap. MFD	Min. I.R. Megohms
.290	.02	5.0	.015	65.0	.01	1000
.390	.033	3.0	.022	45.0	.015	1000
.405	.05	2.0	.033	30.0	—	—
.485	—	—	—	—	.022	1000
.515	.068	1.5	.05	20.0	.033	1000
.590	0.1	1.0	.068	15.0	.047	1000
.690	0.15	0.65	0.1	10.0	.05	1000
.760	—	—	—	—	.068	1000
.820	0.2	0.5	0.15	6.5	—	—
.920	0.3	0.33	0.2	5.0	0.1	1000

*Thickness: .156 inches maximum

Lead spacing: Discs less than .500" diameter, nominal lead spacing is .250"
Discs .500" and larger, nominal lead spacing is .375"

M-6901

FOR MORE INFORMATION AND/OR DESIGN ASSISTANCE, WRITE CAPACITOR SALES MANAGER, CENTRALAB.

INFORMATION RETRIEVAL NUMBER 64

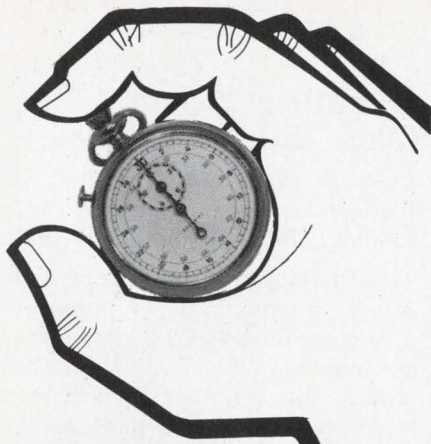

Need CENTRALAB ULTRA-KAPS® RIGHT NOW?

Your Centralab Industrial Distributor has these new products for immediate delivery at factory prices. He can furnish these and thousands of other Centralab components from stock. He will serve you promptly and efficiently.

For a complete directory of Centralab Industrial Distributors, mail coupon today.

Advertising Department
Centralab, Electronics Division, Globe-Union Inc.
5757 North Green Bay Ave., Milwaukee, Wis. 53201

Name _____
Title _____
Company _____
Address _____
City _____
State _____ Zip _____

DISTRIBUTOR PRODUCTS



CENTRALAB
Electronics Division
GLOBE-UNION INC.

5757 NORTH GREEN BAY AVENUE
MILWAUKEE, WISCONSIN 53201

DI-6908

INFORMATION RETRIEVAL NUMBER 65

ELECTRONIC DESIGN 12, June 7, 1969

ICs & SEMICONDUCTORS

MOS memory clocks itself

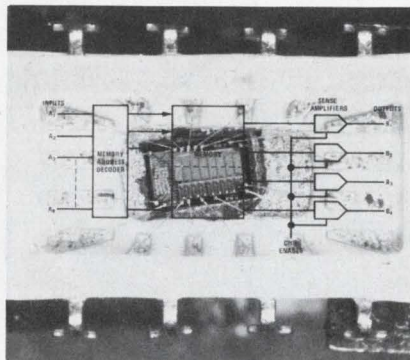

National Semiconductor Corp.,
2950 San Ysidro Way, Santa Clara,
Calif. Phone: (408) 245-4320.
P&A: \$54; 6 wks.

Arranged as 256 four-bit words, a new 1024-bit MOS read-only memory requires no external clock because of its on-chip dc-coupled logic. Completely compatible with DTL or TTL circuits, model MM521 has non-volatile data storage and operates in less than 1 μ s. Gate protection diodes are used on all inputs to protect against static charge build up.

CIRCLE NO. 265

Dual npn transistors hold noise to 3 dB

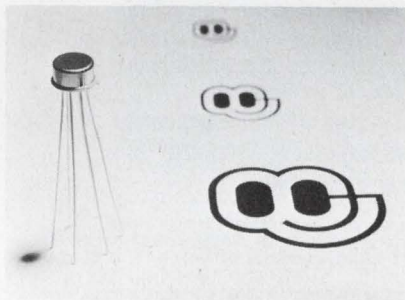

Qualidyne Corp., 3699 Tahoe Way,
Santa Clara, Calif. Phone: (408)
738-0120. Price: \$1.75 to \$7.30.

Featuring low noise, close matching and high voltage breakdown characteristics, a new series of npn dual transistors offer maximum noise figures of 3 dB at 1 kHz and breakdown voltages as high as 60 V. Types 2N2913 to -20 have a tracking accuracy of 10 μ V/ $^{\circ}$ C at 100 μ A. Current gain is 150 minimum at 10 μ A. They are packaged in six-lead TO-5 metal cans.

CIRCLE NO. 266

Applications Power*



PUTTING CURRENT- LIMITER DIODES TO WORK

Problem: How to improve the performance of this bipolar series voltage regulator and reduce circuit complexity?

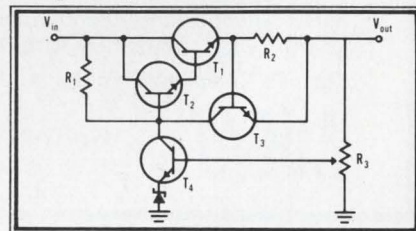

Solution: Replace the darlington pair with a FET and a CL diode.

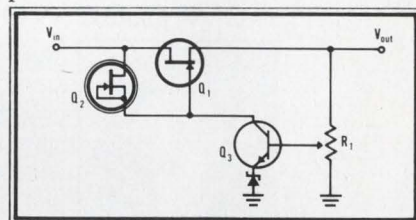

Increases in V_{OUT} are inverted and amplified by Q3. The increased V_{GS} on Q1 reduces the supply current, decreasing output voltage. Current-limiter Q2 (1) acts as a load for Q3 and (2) when the output is short circuited it limits the forward bias current of Q1, limiting the short circuit output current to the I_{DSS} of Q1. The use of the FET increases circuit power gain, reducing ripple, and increasing regulation.

For immediate applications assistance call the number below; ask for extension 19.

Siliconix
incorporated

1140 W. Evelyn Ave. • Sunnyvale, CA 94086
Phone (408) 245-1000 • TWX: 910-339-9216

*Applications Power: A broad product line and an in-depth applications team waiting to serve you.

HIGH DENSITY IC PACKAGING PANEL

Modular Type

INCREASES FLEXIBILITY
IN PROTOTYPING,
PRODUCTION AND
FIELD SERVICE.

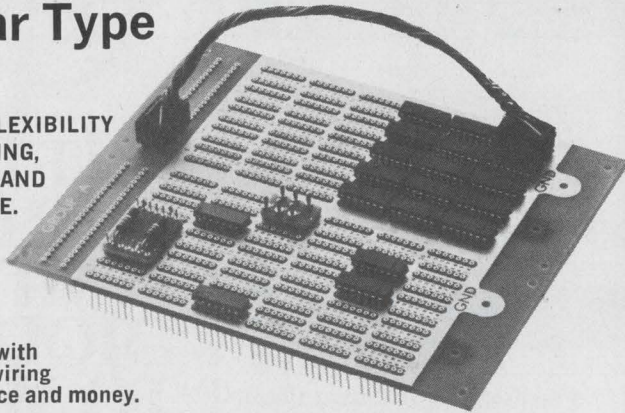

**P Series Panel with
Point to Point wiring
saves time, space and money.**

- Available in multiples of 30 IC pattern sections up to 180 patterns.
- Two pins of each pattern tied directly to power and ground planes. Different numbers available for different pin assignments.
- IC pattern also accepts I.O. plugs and adaptor plugs for discrete components.
- Excellent contact retention and low contact resistance.
- Wire Wrap terminations with Tri-level connection length.

Request Complete IC Folder

AUGAT
INC.

Tel: 617-222-2202
31 Perry Ave., Attleboro, Mass. 02703

INFORMATION RETRIEVAL NUMBER 66

HOW ELSE WOULD YOU DO IT . . . ?

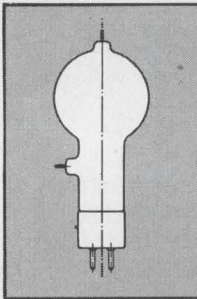

Many of the leading manufacturers of power tubes (and other electronic components) rely on Tempilaq^o to determine operating-temperature characteristics of their products . . . recommend it to their customers as a practical and accurate means of monitoring. Here is what some original equipment manufacturers say about Tempilaq^o in their technical literature:

- "Considering the importance of tube temperatures, every design engineer should familiarize himself with the use of Tempilaq^o or some other similar substance. Measurements of this kind yield basic information sometimes obtainable in no other way."
- "Cooling of power tubes, inductors and other components under operating conditions needed to be carefully evaluated. Tempilaq^o temperature indicators proved to be a practical method of checking the operating temperature of these critical items."
- "Your products are officially recommended in our Service Bulletin to insure proper operation of our tubes . . . as well as being extensively employed in our production and research facilities."
- "The maximum seal temperature of 250°C is a tube rating and is to be observed in the same manner as other ratings. The temperature may be measured with temperature-sensitive paint, such as Tempilaq^o."



Tempilaq^o . . . a simple quick-drying coating, can be applied to glass and other smooth surfaces — frequently provides the only practical means of determining temperatures of electronic tubes and other components.

- 103 certified temperature ratings, available in closely spaced intervals.
- Accuracy within one percent of the stated rating.
- Response delay of a thin coating: a few milliseconds.
- Change of appearance on melting irreversible.

Write to: ADVERTISING DIVISION

Tempil^o
DIVISION OF BIG THREE INDUSTRIAL GAS & EQUIPMENT CO.
132 WEST 22nd Street, NEW YORK, N. Y. 10011
Phone: 212-675-6610 TWX: 212-640-5478

INFORMATION RETRIEVAL NUMBER 67

ICs & SEMICONDUCTORS

Miniature zeners take 250-W surge

Unitrode Corp., 580 Pleasant St., Watertown, Mass. Phone: (617) 926-0404. P&A: from \$3.90; stock.

With voltage ratings from 10 to 220 V, a new series of miniature 5-W zener diodes can absorb surges as large as 275 W. Types JAN IN4958 through JAN IN4990 have tolerances of 5% and meet all the requirements of MIL-S-19500/356. The metallurgically bonded units have a fused-in-glass voidless construction that does not use plastic.

CIRCLE NO. 267

High-speed TTL ICs delay only 7 ns

RCA/Electronic Components, 415 S. Fifth St., Harrison, N. J. Phone: (201) 485-3900. Price: \$1.45 to \$4.55.

Providing 16 logic functions with a choice of two temperature ranges, a new digital high-speed TTL IC family of 48 diversified types offers basic gate propagation delays of 7 ns with an average power dissipation of only 11 mW. Series CD2400 circuits have input clamp diodes to prevent false triggering due to ringing and low impedance. Darlington output circuits provide high-capacity drive capability with balanced rise and fall delay times.

CIRCLE NO. 268

Transistors and ICs resist radiation damage

Texas Instruments Inc., Components Group, P.O. Box 5012, Dallas, Tex. Phone: (214) 238-2011.

Ten new radiation-tolerant semiconductor devices include: two silicon small-signal transistors, 2N5332, 2N5399; two silicon power transistors, TIXP39, TIXP40; five DTL integrated circuits, RSN-15930, RSN15932, RSN15944, RSN15945, RSN15962; and one IC operational amplifier, RSN52709. All the circuits use dielectric isolation, thin-film NiCr resistors, optimized component geometries and layouts, oxide passivation, and aluminum interconnect systems.

CIRCLE NO. 269

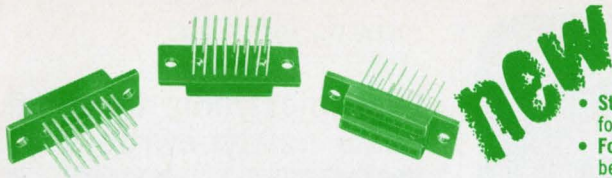

DUAL-IN-LINE IC SOCKETS

14 and 16 CONTACT SOCKETS

- Styles for PC board or chassis mounting in the smallest overall size — ideally suited for prototype, test or production packaging.
- For all 14 and 16 lead IC packages with leads on .1" centers in row and .3" between rows.
- Accepts any package with round, square, rectangular, hollow or solid leads with a cross section of .008" to .023" and .090" minimum lead length.
- Large funneled lead entry holes with closed entry low insertion force contacts provide fast easy insertion.
- All styles have a .315" x .155" open-thru center section and a recess at either end to allow for a variety of package extraction methods.
- Contacts are captivated within the socket body and cannot be accidentally pulled or pushed out.
- Choice of Contact Terminations suitable for soldering into PCB's, or hard wiring of up to 3 wires per terminal.

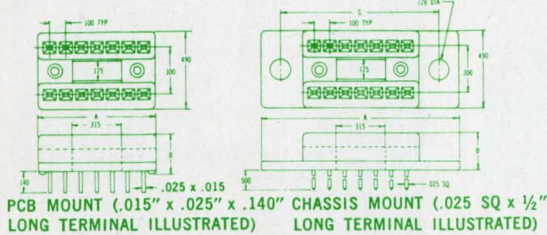

24 and 36 CONTACT SOCKETS

Part No.	No. of Contacts	A	B
IC-246	24	1.3"	.5"
IC-366	36	2."	1."

Tolerances: Decimals $\pm .005$ "; Fractions $\pm \frac{1}{64}$ "
— unless otherwise specified

Part No.	No. Contacts	Termination	A	B
IC-143-SW	14	.025" SQ x 1/2" Long	.750"	.260"
IC-163-SW	16	.025" SQ x 1/2" Long	.850"	.260"
IC-143-S1	14	.015" x .025" x .140" Long	.750"	.250"
IC-163-S1	16	.015" x .025" x .140" Long	.850"	.250"

Part No.	No. Contacts	Termination	A	B	C
IC-143-CW	14	.025" SQ x 1/2" Long	1.275"	.240"	1.025"
IC-163-CW	16	.025" SQ x 1/2" Long	1.375"	.240"	1.125"
IC-143-C1	14	.015" x .025" x .140" LONG	1.275"	.230"	1.025"
IC-163-C1	16	.015" x .025" x .140" LONG	1.375"	.230"	1.125"

- For all 24 and 36 lead IC packages with leads on .1" centers in row and .6" between rows.
- All styles have a recess at either end to allow for a variety of package extraction methods.
- Contact Terminations suitable for soldering into PCB's, or hard wiring.

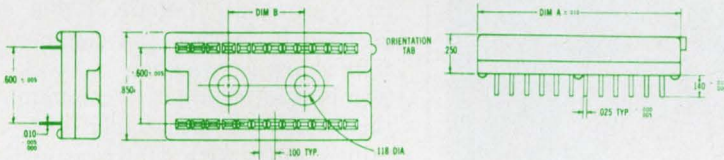

**Robinson
NUGENT
INCORPORATED**

802 EAST EIGHTH STREET NEW ALBANY, INDIANA
AREA CODE: 812-945-0211 47150

INFORMATION RETRIEVAL NUMBER 68

NEW!

\$20⁰⁰ each

PROBE HEAD ASSEMBLY

DESIGNED FOR THICK AND THIN FILM APPLICATIONS

FEATURES:

- "Snap-in" probe point
- Magnetic base
- 6-1 ratio joystick for fine positioning
- Height and pressure adjustment

Request Probe Head Assembly Bulletin 1068

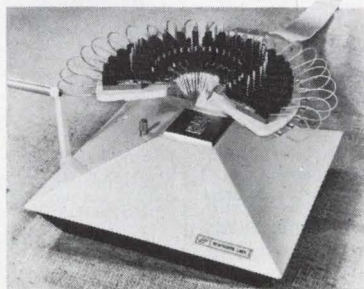

Also available . . . the New **MP-0200 Microcircuit Prober** accommodates up to 34 Probe Head Assemblies on pre-wired ring. Features include an automatic vacuum system for substrate hold-down; an interchangeable chuck and a shielded double flat cable interface with connectors. Rate: 700-900 substrates/hour.

WENTWORTH LABORATORIES INC.
ROUTE 7, BROOKFIELD, CONN. 06804 — (203) 775-1750

INFORMATION RETRIEVAL NUMBER 69

ELECTRONIC DESIGN 12, June 7, 1969

DiGiCATOR[®]

Numeric Readouts and Decoder/Drivers

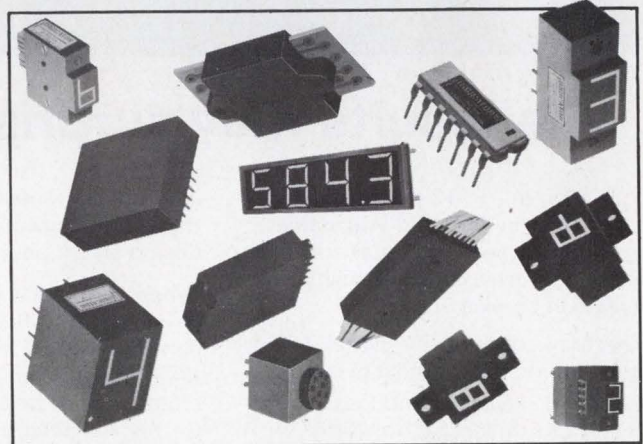

YOUR SOURCE FOR THE MOST EXTENSIVE LINE OF:

BAR-MATRIX DISPLAYS AND DECODER/DRIVERS

★ MIL-SPEC AND COMMERCIAL
OFF THE SHELF DELIVERIES

DISCON CORPORATION

1150 NORTHWEST 70th STREET • FT. LAUDERDALE, FLORIDA 33309
PHONE: (AREA CODE 305) 933-4551

INFORMATION RETRIEVAL NUMBER 70

153

Fast electronic terminal ousts teletypewriters



General Electric Co., Specialty Control Dept., Waynesboro, Va. Phone: (703) 942-8161.

Through the use of a unique printing concept, a new electronic data communications terminal achieves speeds of 10, 15 and 30 characters per second—two to three times faster than other similar equipment. TremiNet 300 can be used in private and commercial time-sharing systems, as well as terminal-to-terminal communications. It is a completely self-contained unit, with all transmitting and receiving electronics contained in a single package about the size of an office typewriter.

CIRCLE NO. 270

Computer terminal prints 1200 words/min



Teletype Corp., 5555 Touhy Ave., Skokie, Ill. Phone: (312) 676-1000.

Capable of printing up to 1200 words per minute, a new high-speed terminal operates 12 times faster than conventional data communications equipment. Called Inktronic, the unit can operate over regular telephone lines, despite its very fast speed. Since it requires only voice-grade channels, computer time sharing is expected to be a large application.

CIRCLE NO. 271

try these **BERLOX[®]** packages for

**SIZE
PERFORMANCE
RELIABILITY
THERMAL
CONDUCTIVITY**

the results may surprise you.

40 pin plug-in . . . 42 pin flat pack . . . 36 pin dual in-line . . . you name it, Cermetrol Division can make it, with built-in features and reliability you only find in beryllia:

- Thermal conductivity equal to, or better than, that of most metals
- Excellent dielectric and loss characteristics. Integral bonding with metallized circuitry
- Capability of greater packaging density because of super heat dissipation

These advantages are available to design engineers because of the unique

inherent characteristics of beryllia, and the technological skills of Cermetrol design and manufacturing specialists.

When you face a problem of heat—in power output, miniaturization, package density, system reliability, the maximum in radiation hardening and cost effectiveness, take a long, hard look at Cermetrol metallized devices.

A new technical brochure gives you all the details—just ask for it. Better yet, let Cermetrol Division specialists become involved with your problems from the start.

10995



CERMETROL DIVISION

National Beryllia

Haskell, N.J. 07420 Telephone: 201 • 839-1600

CORP.

INFORMATION RETRIEVAL NUMBER 71

Disc-drive synchronizer downs errors to 100 ns

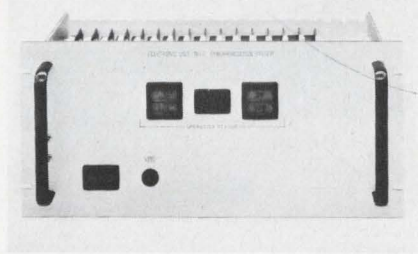

Sequential Information Systems, Inc., 66 Saw Mill River Rd., Elmsford, N. Y. Phone: (914) 592-8810.

Providing precise speed/phase and indexing control of magnetic disc files, a new system permits an unlimited number of individual disc drives to be synchronized with a time displacement error between drives of less than 100 ns. Model DS360 disc-drive synchronization system couples individual drives with an external reference frequency that can be derived from the main computer clock.

CIRCLE NO. 272

Industrial computer is IBM compatible

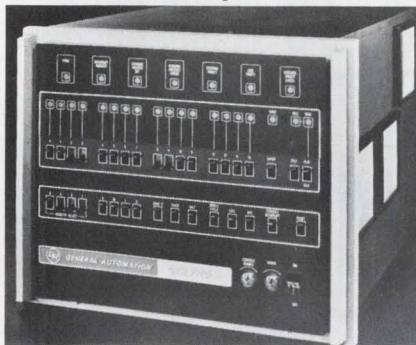

General Automation, Inc., Automation Products Div., 706 W. Katella Ave., Orange, Calif. Phone: (714) 633-1091. P&A: from \$20,000; summer, 1969.

Aimed at the burgeoning industrial automation market, the new 18/30 computer, which is fully compatible with the IBM 1800 and 1130 systems, can process over 400,000 instructions per second. This new computer will function as the supervisory computer system for automation projects in many industries. Its processor has a 960-ns memory that is available in sizes up to 32k words.

CIRCLE NO. 273

san fernando electric manufacturing company

Electronic components
of proven reliability

Aluminum Electrolytic Capacitors

The rugged CAPACITORS by West-Cap that have built-in reliability and durability. Because of their all-welded construction they will withstand more vibration and shock. The elements are made from 99.99% pure etched aluminum foil sealed in high grade aluminum cases.

SERIES WHC Computer Grade Electrolytic.



A superior line of energy storage and filter electrolytics which meet all the specifications set by MIL-C-62. In addition, this series will meet all the standard telephone quality standards set by the telephone industry. This electrolytic will meet the most exacting ripple standards.

**Ratings: 200 mfd to 100,000 mfd
from 5 VDC to 150 VDC
Voltages in excess of 150 VDC
to 500 VDC on special order**

SERIES MAC Axial Lead Electrolytic.

They are available in miniature size with 1/4" x 5/8" case and larger.

**Ratings: 2 mfd to 70,000 mfd
from 3 VDC to 150 VDC**

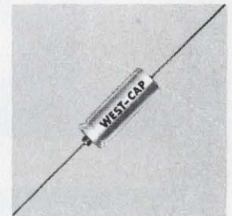

The manufacturing process is completely quality-controlled in West-Cap's modern new facility in the Tucson International Airport Industrial Park. This facility was designed and equipped primarily for the manufacture of high quality electrolytic capacitors at competitive prices.

Call your representative of West-Cap high reliability components, or contact West-Cap Arizona, where service and quality count.

WEST-CAP ARIZONA

SUBSIDIARY OF SAN FERNANDO ELECTRIC MANUFACTURING CO.
2201 EAST ELVIRA ROAD, TUCSON, ARIZONA 85706

INFORMATION RETRIEVAL NUMBER 72

ELECTRONIC MOTOR SPEED CONTROLS

The most complete source of every type: SCR, Variac, Transistorized, Ferrite, 172 models. 1/1000 to 150 H.P. From .01 RPM to 15,000 RPM. Low-cost and feature packed models: 1000:1 range, reversing, braking, speed readout, remote control, positioning, feedback, 0.25% reg. Custom controls and systems. Thousands of motors, controls; hundreds of accessories, clutches, brakes, timers, etc.



FREE CATALOG

28 pages of variable speed motor controls

BB MOTOR & CONTROL
CORP. • 96 Spring Street, New York, N.Y. 10012
Phone (212) 966-5777

INFORMATION RETRIEVAL NUMBER 73

**PUNCH, NOTCH,
SHEAR, BEND, RIVET,
GROOVE, RIP, CRIMP
circuit boards**

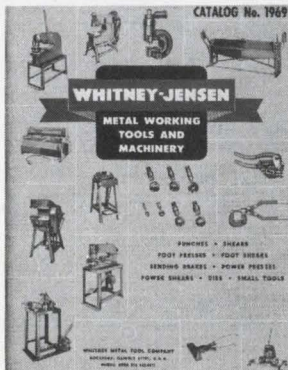

Sheet metals of all kinds and gauges can be worked and formed with ease using Whitney-Jensen hand tools. You have great flexibility of application when breadboarding or designing prototypes.

Free Ninety pages of information on metalworking tools are yours for the asking. Hand, bench, floor, manually operated, foot-operated and power tools are detailed along with standard and special dies.

WHITNEY METAL TOOL COMPANY
2833 HUFFMAN BLVD.
ROCKFORD, ILLINOIS 61101

WHITNEY-JENSEN

INFORMATION RETRIEVAL NUMBER 74

DATA PROCESSING

Data instruments perform at 180 kHz



Raytheon Co., Computer Operation,
2700 S. Fairview St., Santa Ana,
Calif. Phone: (714) 546-7160.
Price: \$5800 to \$8200.

Combining a multiplexer, a sample-and-hold amplifier and an analog-to-digital converter, three new instruments with 12-bit formats offer throughput rates of 90 kHz, 135 kHz and 180 kHz. Mini-verter units can operate in a short-cycle mode for higher throughput at fewer bits resolution. All the instruments are capable of both sequential and random-address operation.

CIRCLE NO. 274

CRT display terminal has I/O compatibility



Delta Data Systems Corp., 613 W. Cheltenham Ave., Philadelphia. Phone: (215) 224-0700. P&A: \$4500 to \$7000; 90 days.

A new low-cost CRT display terminal features full computer-systems input/output and video compatibility. The Delta 1 video display terminal uses the same type of input/output logic circuitry as do small computer systems. In its graphics mode, the unit can display lines, circles, curves and characters.

CIRCLE NO. 275

ELECTRONIC DESIGN 12, June 7, 1969

Where the action is...

is where you need Tungsten and sintered metal contacts

Especially if the action calls for heavy duty performance. H. A. Wilson special powder metallurgy processes make possible contacts of sintered metals that cannot be alloyed. Tungsten offers the properties needed for higher voltages and currents. Contacts in rivet form, steelbacks, faced screws, discs, washers, and special shapes. Assemblies are available riveted, hot upset, welded and brazed.

Let the H. A. Wilson Technical Service Department advise you as to the best form, type and size of contact . . . type of material, method of attaching, and best spring to use.



ENGELHARD

ENGELHARD INDUSTRIES DIVISION
ENGELHARD MINERALS & CHEMICALS CORPORATION
2655 U. S. ROUTE 22, UNION, NEW JERSEY 07083

35

INFORMATION RETRIEVAL NUMBER 75



give...so more will live

HEART FUND

SNOB KNOB



The first new styling innovation in fifteen years!

900 Series Snob Knobs come in four bright, handsome models. Spun aluminum cap. Spun aluminum inlay. Decorative metallic ring. And Black. From 1/2" to 1 3/4" diameter.

Kurz-Kasch is known as the quality knob source by electronics manufacturers the world over. If you're not familiar with the outstanding Kurz-Kasch line, we'll send you a complete catalog. And if you're just anxious to see the new Snob Knob, we'll send you a free sample.



Kurz-Kasch, Inc.

Standard Parts Division • 1415 S. Broadway
Dayton, Ohio 45401 • Phone 223-8161

INFORMATION RETRIEVAL NUMBER 77

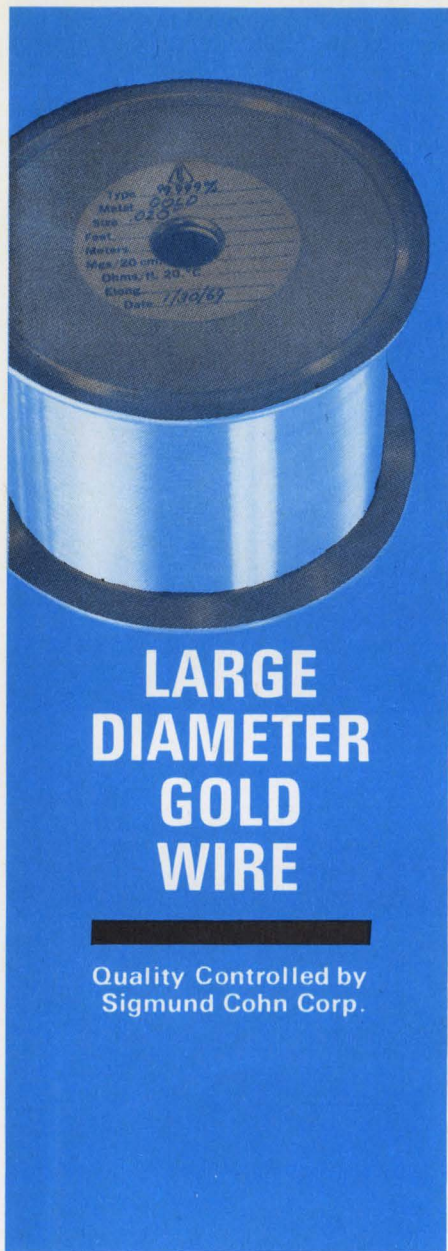

LARGE DIAMETER GOLD WIRE

Quality Controlled by
Sigmund Cohn Corp.

For years, we have specialized in very small sizes of Gold bonding wire... We also manufacture large sizes of Gold wire, such as .010" and .030" etc... Our personnel apply the same care and precision in producing large sizes as in the fabrication of finer wire... This control is maintained in all critical areas—diamond die selection, heat treatment and final cleaning... Result: you can be sure of maximum uniformity—both chemically and physically—in the ultimate performance of your product.

SIGMUND COHN CORP.

121 So. Columbus Ave.
Mt. Vernon, N.Y. 10553

Since 1901 914-664-5300

INFORMATION RETRIEVAL NUMBER 78

DATA PROCESSING

Self-equalized modem delivers 9600 bits/s

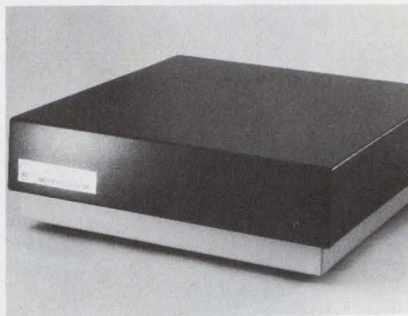

International Communications Corp., sub. of Milgo Electronic Corp., 7620 N. W. 36th Ave., Miami, Fla. Phone: (305) 691-1220. P&A: \$11,500; December, 1969.

Transmitting information at the rate of 9600 bits per second, a new high-speed data set can operate over voice-grade telephone lines without requiring complex automatic equalizers. The new modem, model 5500/96, achieves this performance with a unique narrow-band design.

CIRCLE NO. 276

Video terminal is IBM compatible

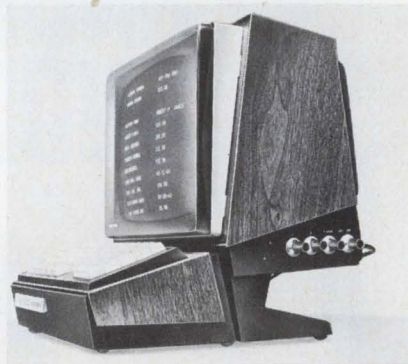

Ultronic Systems Corp., Mt. Laurel Industrial Park, P. O. Box 315, Moorestown, N. J. Phone: (609) 235-7300. Price: \$5000.

Said to offer dramatic savings over other currently available systems, a new low-cost general-purpose alphanumeric display system is both hardware- and software-compatible with IBM System-360 units. Videomaster 7000, which includes a display monitor and a standard alphanumeric keyboard, can present 960 displayable characters on its 74-in.² screen.

CIRCLE NO. 277

TRYGON HAS THE POWER



to deliver new Liberator slot range systems power in rack-mount and modular units..from \$105

Now the Liberator wide-slot line is even wider. We've added new LVS low-power modules in voltage ranges from 2.5-5.5V to 115-161V, and up to 2.1 amps, at prices as low as \$105. Optional rear mounting OV protection module. Plus new low-price LHS half-rack power supplies with ratings to 115-161V and up to 25A; and up to 70A with the L3R/L5R Liberator Rack series.

- All silicon design—precision performance
- 0.01% regulation—high stability
- Low noise for IC and systems applications
- ¼ and ½ rack; full rack; modular and metered models
- Adjustable current limiting and foldback protection—OV protection option
- Integral meter and control options
- Convection cooling—no temperature derating to 60° C
- Remote sensing and programming

Liberators offer the ultimate in systems versatility when combined in any of TRYGON'S five mix-n-match rack adapters. Up to 7 DC outputs—more performance versatility—combine any of these with TRYGON'S famous Series 1 Module Power Supplies.

For full details on these and many more, write today for your free copy of Trygon's brand-new Liberator Power Supply Brochure.

TRYGON POWER SUPPLIES

111 Pleasant Avenue, Roosevelt, L.I., N.Y. 11575
Trygon GmbH 8 Munchen 60, Haidelweg 20, Germany
Write for Trygon 1969 Power Supply Handbook.
Prices slightly higher in Europe.

INFORMATION RETRIEVAL NUMBER 79
ELECTRONIC DESIGN 12, June 7, 1969

Microfilm console reads and displays

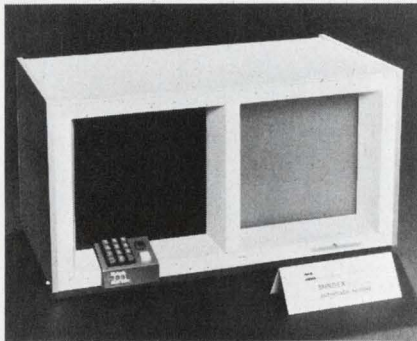

Microfilm Data Systems, Inc., Suite 1507, Palo Alto Office Center, Palo Alto, Calif. Phone: (415) 327-6495.

In a single cabinet, a new electronic console combines the advantages of a high-density microfilm reader with a computer display terminal. Called the Mindex, the automatic computer reader/terminal looks like a dual-screen television set. This ultrafilm (high-density microfilm) viewer also features automatic keyboard retrieval controls.

CIRCLE NO. 278

Disc pack coating resists static charges



3M Co., 3M Center, St. Paul, Minn. Phone: (612) 733-7297.

A new conductive coating for Scotch Brand 911 disc pack, which is compatible with all IBM 2314 drive systems, minimizes the development of static charges that cause phantom errors and collection of dust and contamination. The build-up of these charges is particularly critical in the 2314 systems because of the reduced thickness of the air-bearing film between the flying head and disc surface.

CIRCLE NO. 279

Eliminate the Middleman

A sure way to eliminate the middleman in your instrument servo system.

We're not LION! We know a sure way to eliminate the Middleman in your servo system. Gearing mechanisms between the power supply and final output shaft become obsolete and unnecessary when you use an Inland torque motor mounted directly on the output shaft. Pounce on your gear backlash error and associated "dead zones" by "going direct".

Being frameless, Inland torque motors can be designed-in as an integral part of your equipment. "Pancake" type construction is ideal since the motor can be fitted into a minimum space on or around the shaft to be driven. The results are the highest possible servo stiffness and accuracy.

Our Inland Sales and Engineering staff are experts in eliminating the Middleman. Drop us a line and let us show you how to use Inland torque motors in *your* special servo problem.



INLAND MOTOR

CORPORATION
OF VIRGINIA
RADFORD, VIRGINIA
703-639-3973

DIVISION OF **KOLLMORGEN**



INFORMATION RETRIEVAL NUMBER 80

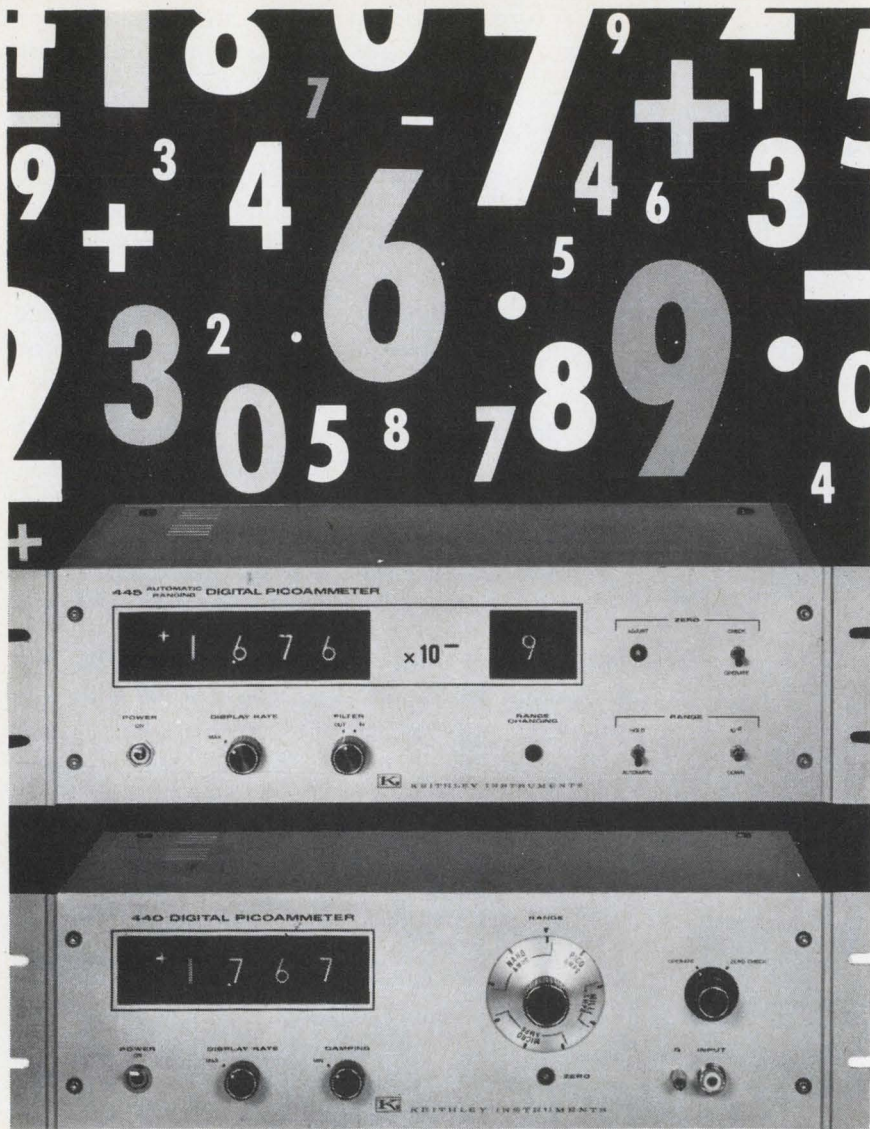

MEASURES MILLIAMPERES TO PICOAMPERES AND NARROWS THE GAP BETWEEN PRICE AND PERFORMANCE

See the first digital picoammeter above? It's our new \$1495 autoranging Model 445. It simplifies measurements from 10^{-2} ampere f.s. to 10^{-9} ampere and provides both analog and BCD outputs. The second is the Model 440, new too. At \$995, it features 10^{-2} to 10^{-10} ampere f.s. current ranges, has an analog output and an option for BCD.

Both picoammeters are packed with convenience features designed to minimize operator error and maximize performance. Stable to 0.5% of full scale per week, they make low level measurements accurate to 0.2% almost routine. And provide variable display rate to 24 readings per second. But isn't that what you'd expect from a firm with years of analog picoammeter design experience? And an industry-wide reputation for quality? Like Keithley.

See if you don't agree we have the best digital approach to picoampere level measurements. Call your Keithley Sales Engineer for demonstration and details. Or contact Keithley Instruments, Inc., 28775 Aurora Rd., Cleveland, Ohio 44139. In Europe: 14 Ave. Villardin, 1009 Pully, Suisse. Prices slightly higher outside the U. S. A. and Canada.



KEITHLEY

INFORMATION RETRIEVAL NUMBER 81

MODULES & SUBASSEMBLIES

Low-cost amplifier supplies 5.5 mA



Data Device Corp., 100 Tec St., Hicksville, N.Y. Phone: (516) 433-5330. P&A: \$9.75; stock to 3 wks.

Costing only \$9.75 each, series D-2 operational amplifiers guarantee a minimum output of 5.5 mA at ± 11 V. Voltage drift is $10 \mu\text{V}/^\circ\text{C}$ and current drift is $0.2 \text{ nA}/^\circ\text{C}$. At rated load, dc open-loop gain is 90 dB; frequency for full output is 50 kHz. All units have input overvoltage protection and output short-circuit protection. Unity-gain frequency is 1.5 MHz.

CIRCLE NO. 280

Thick-film network enhances Q factor

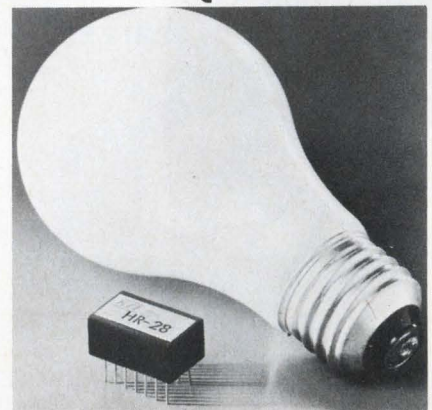

Kinetic Technology Inc., 17465 Shelburne Way, Los Gatos, Calif. Phone: (408) 356-2131. P&A: \$12; 2 wks.

Useful from dc to 500 kHz, a new negative resistor is a Q-enhancement device designed for use with LC networks in telephone and tone signaling applications. Model HR-28 operates from a single supply and contains two identical thick-film active networks in a DIP configuration. Negative resistance values range from 4 to 300 k Ω .

CIRCLE NO. 281

**need
quality diodes
or arrays fast?...**



**...we ship our guaranteed
products the day
they're ordered!**

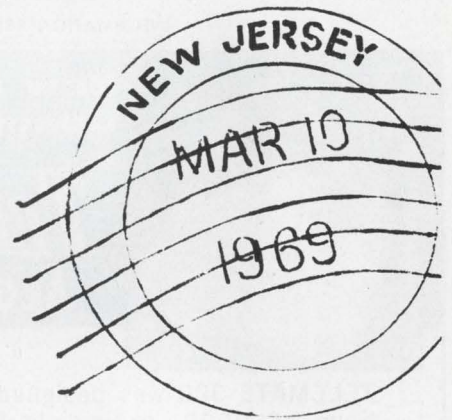

The performance of our products — our laser diodes, our laser diode arrays, our pulse power supplies, and our crystal and epitaxial wafers — is the highest in the industry. We guarantee this. Our prices are the lowest in the industry. Our delivery is the quickest in the industry. And we have the broadest line of gallium-arsenide laser diode arrays.

Performance? You'll find that specifications listed on our data sheets are conservative ratings.

For example, our LD11 single element gallium-arsenide laser diode will, on the average, emit 8 watts. Yet our data sheet cites a conservative 5 watt minimum. And both our LD11 and LD12 single element gallium-arsenide laser diodes are superior to any other diodes available at operation temperatures ranging from —196 degrees C to 70 degrees C. Typically there is no time delay in the emission of laser radiation with respect to the drive current.

Furthermore, these laser diodes are so rugged you can step on them — without affecting their performance.

What does this high performance, low price, ruggedness and immediate delivery mean to you?

It means you now have a source which supplies you with ruggedly packaged diodes that you can operate with a lower cost pulser — while obtaining higher peak power and higher average power — throughout a longer operating life. At lower cost to you. With no waiting for delivery.

- Single Element Gallium-Arsenide Laser Diodes
- Gallium-Arsenide Laser Diode Arrays
- Laser Diode Pulse Power Supplies
- Laser Grade Gallium-Arsenide Crystal and Epitaxial Wafers

*The power at 55°C is typically 60% of the 25°C power value.
For a 5 watt output the derating is 70 milliwatts per °C, while at 10 watts
it is 150 milliwatts per °C.*

TYPICAL PERFORMANCE DATA

		+25°C	+55°C
		1KHZ, 200ns 3 x Ith	1KHZ, 200nsec 2 x Threshold
LD11	Peak Power Threshold	8 Watts 25 Amperes	5 Watts 40 Amperes
LD12	Peak Power Threshold	3 Watts 12 Amperes	2 Watts 20 Amperes

LASER 
LABORATORIES

205 Forrest Street, Metuchen, New Jersey 08840

For technical or application information
call (201) 549-7700

A Subsidiary of The United Corporation

INFORMATION RETRIEVAL NUMBER 82

MATCHED DIODES

Pairs and quads in EIA registered type numbers to customer specifications. Types IN430, IN4307, IN4242, and IN4243 are stocked in depth. Special (low cost) packaging eliminates chance of mixing high value matched devices. Plug-in or custom packages designed for special needs. Components exceed environmental requirements of Mil-S-19500.

For even closer matching tolerances, Burns & Towne has designed the BMQ and BMP series.

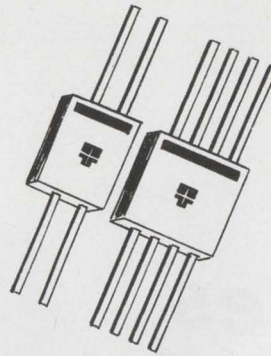

B & T Quad Type	B & T Pair Type	Max. Forward Voltage Drop	ΔV_f —55°C to +100°C .1 MA to 10 MA	PIV @ 5 μ a	Reverse Current		Power Dissipation
					25°C	100°C	
BMQ 75	BMP 75	1.0v @ 100 ma	± 5 mv	75 v	.1 μ a @ 30 v	100 μ a @ 30 v	250 mw
BMQ 100	BMP 100	1.0v @ 100 ma	± 5 mv	100 v	.1 μ a @ 40 v	100 μ a @ 40 v	250 mw
BMQ 150	BMP 150	1.0v @ 100 ma	± 5 mv	150 v	.1 μ a @ 60 v	100 μ a @ 60 v	250 mw
BMQ 200	BMP 200	1.0v @ 100 ma	± 5 mv	200 v	.1 μ a @ 100 v	100 μ a @ 100 v	250 mw
BMQ 250	BMP 250	1.0v @ 100 ma	± 5 mv	250 v	.1 μ a @ 125 v	100 μ a @ 125 v	250 mw

* 10Nsec @ IR=1.0ma. IF=10ma. RL= 100 Ohms



BURNS & TOWNE INC.

18 GRANITE STREET • HAVERHILL, MASS. 01830 • (617) 373-1501

INFORMATION RETRIEVAL NUMBER 83

MODULES & SUBASSEMBLIES

Wideband op amp slews at 600 V/ μ s

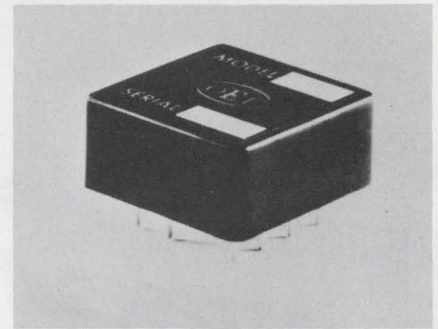

Optical Electronics Inc., P.O. Box 11140, Tucson, Ariz. Phone: (602) 624-8358. P&A: \$95; stock.

With full output slewing of ± 600 V/ μ s over video frequencies, a new operational amplifier settles to 0.1% of final output amplitude within 55 ns. Model 9186B has a minimum open-loop gain of 60 dB, a gain-bandwidth product of 1000 MHz, and a common-mode rejection of 70 dB at 1 MHz. Applications include high-speed d/a converters and integrators, as well as wideband amplifiers.

CIRCLE NO. 282

New and Better Communications with . . .

TELEMATE 300 ACOUSTICAL COUPLER



TELEMATE 300 was designed and developed to specifications of DACC, a time-sharing computer company that knows the needs of users.

That's why Telemate 300 is more compact, more reliable and elegantly styled.

Top Quality • Competitively Priced

- Easily portable
- Data Rate: 300 Baud
- Carrier and on/off lights
- Highly selective tuned oscillator circuit
- Half/full Duplex
- Triple tuned circuitry
- AGC circuit
- Acoustic isolation min. 20 db
- Teletype or EIA Interface
- Optional: Carrying case, originate/answer, cable interface, loud speaker and RS 232B

FULL WARRANTY • WRITE FOR BROCHURE



Use TELEMATE 300 with your telephone and/or your teletype system. Comes in walnut and attractive office decorator colors.



DACC

DIRECT ACCESS COMPUTING CORP.

Communications Equipment Group

24175 Northwestern Highway
Southfield, Michigan 48075

313/358-5000

High-output amplifier maintains 5×10^5 gain



Analog Devices, Inc., 221 Fifth St., Cambridge, Mass. Phone: (617) 492-6000. P&A: \$36 or \$46; stock.

Delivering ± 20 -V output swing at 20-mA rated full-load current, a new differential amplifier sustains its open-loop dc gain of 500,000. Model 163 has a 50-kHz full-power inverting response, 6-V/ μ s slewing rate and 0.6-nA/ $^{\circ}$ C maximum bias current drift. Voltage drift is ± 5 μ V/ $^{\circ}$ C for model 163K and ± 20 μ V/ $^{\circ}$ C for model 163A.

CIRCLE NO. 283

INFORMATION RETRIEVAL NUMBER 84

Thick-film regulators supply 250 mA output

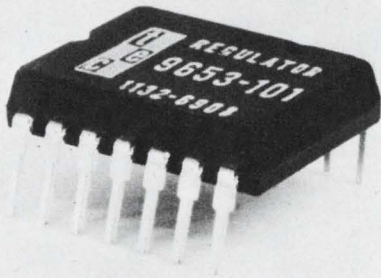

Transformer Electronics Co., P. O. Box 910, Boulder Industrial Park, Boulder, Colo. Phone: (303) 442-3837. Price: \$27.50 to \$29.50.

Without external pass devices, four new dual-in-line hybrid thick-film voltage regulators develop a maximum output current of 250 mA. Models VR1050, VR1150, VR120 and VR2150 offer fixed voltages of 5, 15, 20 and -15 V respectively. Typical load regulation, no load to full load is $300 \mu\text{V}$; typical line regulation, for inputs of 22 to 40 V, is 2 mV.

CIRCLE NO. 284

Analog multiplier errs but 2%

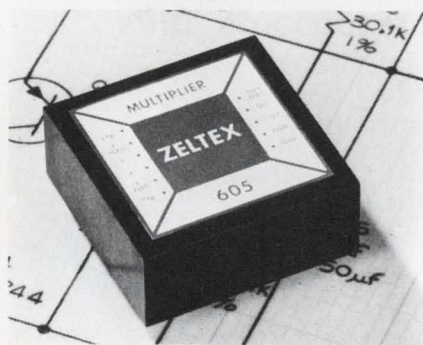

Zeltek, Inc., 1000 Chalomar Rd., Concord, Calif. Phone: (415) 686-6660. P&A: \$48; stock.

With no external amplifiers or components, a new self-contained four-quadrant multiplier has a maximum error of only 2% (200 mV at ± 10 -V output). The addition of four external trim potentiometers to model 605 reduces error to 1% maximum. Output noise is only 1 mV rms from dc to 100 kHz. The unit can perform multiplication, squaring, division and square-root operations.

CIRCLE NO. 285

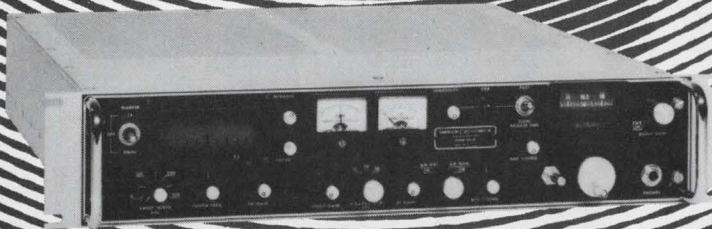
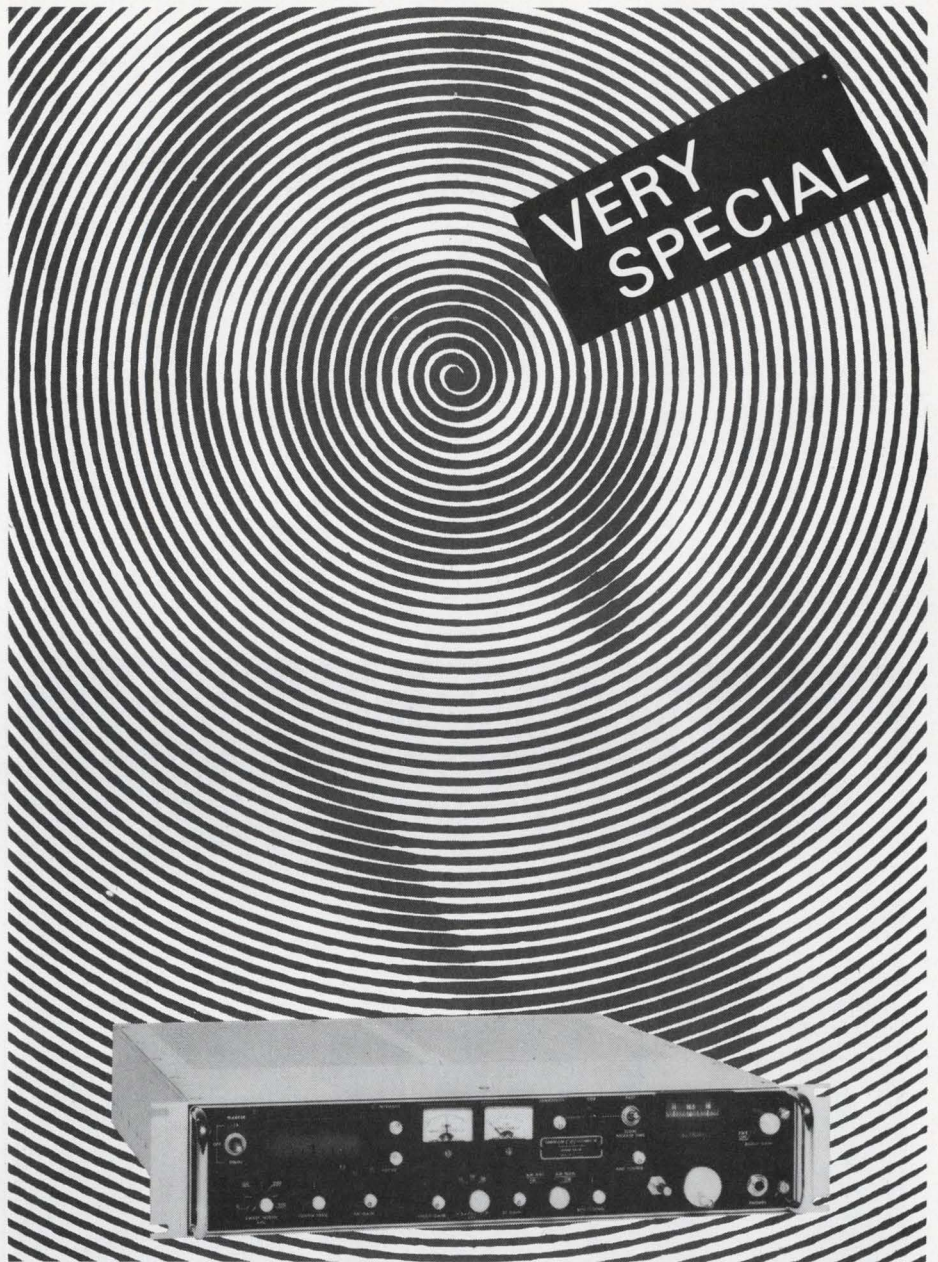

W-J's new Type 555 VHF Receiver offers a wealth of special features in a unit designed for specialized surveillance and monitoring applications.

It receives AM, FM and CW signals in the 90 to 180 MHz range and, since FM signals normally encountered in this band are of low deviation, incorporates a high slope FM detector. Separation of closely spaced signals in this congested band is accomplished by IF filters with very steep skirts. A 50 kHz wide band position is provided by a crystal filter. Mechanical filters provide bandwidths of 10 kHz and 20 kHz.

The receiver includes an integral signal monitor with a dispersion adjustable from

0 to 300 kHz and a resolution of 2.5 kHz. The monitor has a center frequency marker to indicate the center of the IF band for precise tuning. Markers are provided in 50 kHz increments on both sides of the center frequency marker for accurate determination of spacing of interfering signals.

Other features: a carrier operated relay and an independently variable beat frequency oscillator, plus Digital Automatic Frequency Control capability when the receiver is connected to an external counter such as W-J's DRO-302A.

There's more! Ask the receiver specialists at Watkins-Johnson Company's CEI Division, 6006 Executive Blvd., Rockville, Md. 20852.



WATKINS-JOHNSON

CEI DIVISION

World's largest selection of receiving equipment for surveillance, direction finding and countermeasures.

INFORMATION RETRIEVAL NUMBER 85

Diversified Glass-to-Metal Hermetic Seals like these...

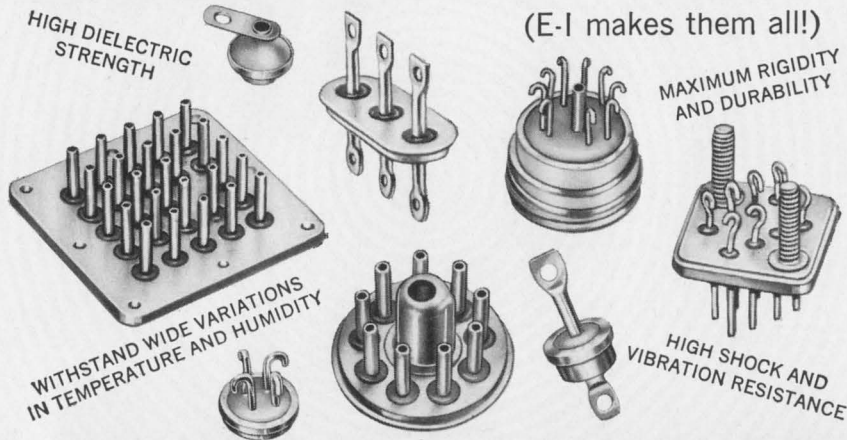

Require Highly Specialized Engineering Capabilities...

(E-I has the know-how!)



Specify E-I Sealed Terminations for Unusual Service Applications!

How does E. I. produce a quality line of hermetic seals? The answer is simple. A stringent program of testing and control! Above is shown an optical comparator being utilized to measure wire terminals for use in a hermetic seal. Testing in this manner assures that the finished hermetic seal will comply with all your requirements.

Available in thousands of standard types, E-I seals can be produced in 'specials' to meet particular component or equipment requirements.

Technical literature edited for the engineer/designer/specifier, and containing complete data and information, is available on request.

- Sealed Terminations
- Multiple Headers
- Transistor and Diode Bases
- Semiconductor Bases
- Compression-type Threaded End Seals
- Plug-in Connectors
- Vibrator Plug-in Connectors
- High Voltage Glass-bonded Ceramic Seals
- Hermetically-sealed Relay Headers
- Special Application Custom Seals
- Custom Sealing to Specifications



Electrical Industries

A Division of Philips Electronics and Pharmaceutical Industries Corp.
Murray Hill, N. J. 07971 — Tel. (201) 464-3200

Patented in U.S.A., No. 3,035,372; in Canada, No. 523,390; in United Kingdom, 734,583; other patents pending.

INFORMATION RETRIEVAL NUMBER 86

Liquid-crystal kits simplify handling

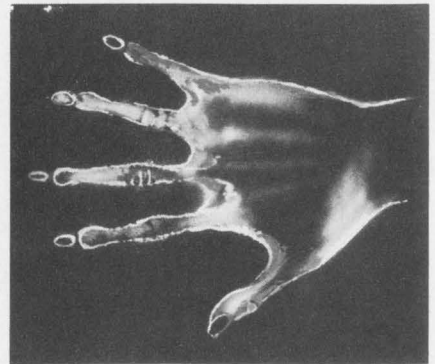

Edmund Scientific Co., 380 Edscorp Building, Barrington, N.J. Phone: (609) 547-3488. Price: \$4 or \$10.

Eliminating formerly messy processes as well as the danger of contamination, two new kits of encapsulated liquid crystals consist of tiny micron capsules that contain the liquid crystals and six mylar sheets. Each mylar sheet covers a specific temperature range. One kit, model 71143, has 6 by 12 in. sheets; the other, model 60756, has 4 by 6 in. sheets.

CIRCLE NO. 286

Solderless socket breadboards DIPs

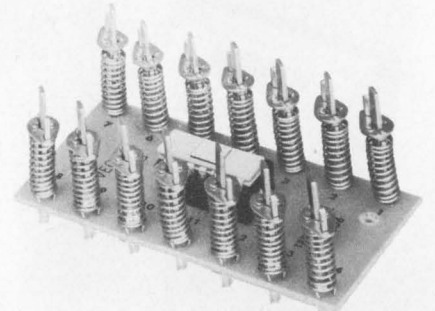

Vector Electronic Co., Inc., 12460 Gladstone Ave., Sylmar, Calif. Phone: (213) 365-9661. Price: from \$3.95.

Designed for prototype work with 14-pin DIP integrated circuits, a new IC breadboard socket allows solderless connections to any terminal pin. Model 570G consists of an epoxy glass wafer on which is mounted a 14-pin dual-in-line socket with terminals soldered to two adjacent rows of solderless spring-type terminals.

CIRCLE NO. 287

IC breadboard accepts discretes

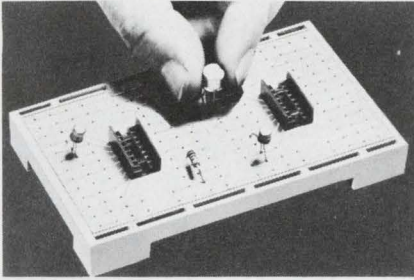

Intratec Div., British Aircraft Corp. (U.S.A.) Inc., 399 Jefferson Davis Highway, Arlington, Va. Phone: (703) 684-6404.

A new breadboarding kit uses standard push-in carriers to accommodate all types of IC packages as well as discrete components; double-leaf spring contacts permit components to be used again. Typical layouts of four 10-lead TO-5 packages or two DIP stations are provided for by 208 numbered contact points. Two models are available, the μ -DeCA and the μ -DeCB with two DIP sockets.

CIRCLE NO. 288

Water-soluble flux stays chloride-free

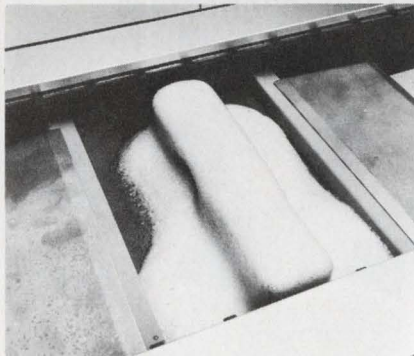

London Chemical Co., Inc., 240 Foster Ave., Bensenville, Ill.

Completely free of chloride, a new water soluble soldering flux is particularly useful in applications involving critical copper soldering. Its outstanding rinsability in water-wash after-soldering cleaning systems eliminates white spots and chemical dimpling on printed surfaces. Organo-flux AM-C-4 can be applied by dipping or brushing.

CIRCLE NO. 289

We did it!

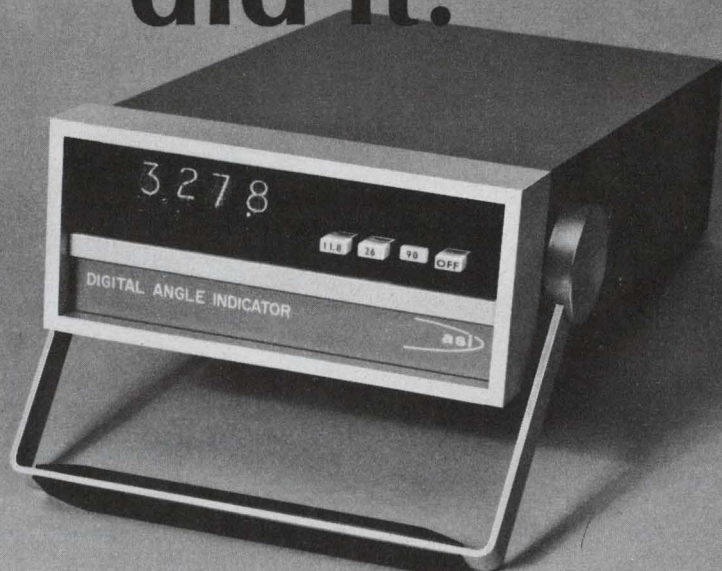

for under \$1500

- All Solid State - No Moving Parts
- Digital Output
- 0.1° Resolution and Accuracy
- High Readability

AstroSystems Digital Angle Indicator is a solid state all electronic device for measuring and displaying angle inputs from remote synchro or resolver inputs. For the first time, a low cost, high reliability, solid state angle indicator is available that does not use gears, motors, synchro receivers or any other rotating components. This rugged, versatile, reliable instrument is ideal for system, ground support and laboratory applications. Some of the outstanding features of this new unit are: **Ultra Reliability**—Accuracy guaranteed for one year without calibration or periodic adjustments. **High Readability**—Large inch-high characters on Nixie® tube readout. **High Input Impedance**—200K. **Versatile**—Accepts synchro or resolver inputs at 11.8, 26 or 90 volts line-to-line. **Low Audible Noise**—No motors or gears. **High Slew Speeds**—100°/second. **Digital Output**—A four decade BCD digital output available.

astroSystems, inc. 6 Nevada Drive, New Hyde Park, New York 11040 516/328-1600 TWX 510/233-0411. West Coast Office 4341 Commonwealth Avenue, Fullerton, California 92633 714/523-0820.

asi

astroSystems, inc.

Try a new reliable source



Start by writing for a free catalog

Automatic Coil, with nearly 20 years of experience, is a reliable source of standard RF coils, transformers, toroids and filters. And an innovative source of custom designed components and assemblies. Write for free catalog. AUTOMATIC COIL CO., div. of Designatronics, Inc., 76 E. Second St., Mineola, N.Y. 11501/(516) 741-7070.

INFORMATION RETRIEVAL NUMBER 88

DOES A 10000 PERM FERRITE TURN YOU ON?

Contact Us About
Our New MN100 Ferrite

ceramic magnetics, inc.

87 FAIRFIELD ROAD • FAIRFIELD, N. J. 07006 • (201) 227-4222

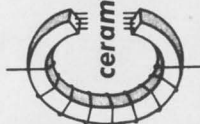

INFORMATION RETRIEVAL NUMBER 89

REED RELAYS

Certifiable to
MIL-R-5757/29B

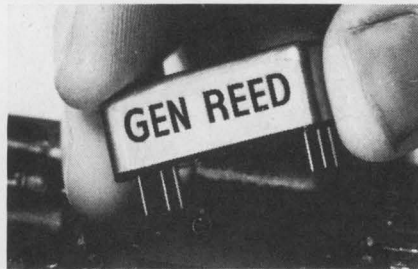

- Choice of 14 basic Form A, Form C, and combinations of A and C capsules in three standard-size metal cases.
- Coils: 6, 12, and 26.5 volts, or to specifications.
- Printed circuit type pin on standard 0.1-inch grid spacing, in standoff insulating header.
- All units magnetically and electrostatically shielded.
- Resists humidity, vibration, and shock.
- Fast operate time; long life; high reliability.

Ask for Bulletin GR-5.



19 Walnut Ave. (Box 858), Clark, N.J. 07066
Tel. 201-382-7373

INFORMATION RETRIEVAL NUMBER 90

PACKAGING & MATERIALS

Non-corrosive silicones come ready to use

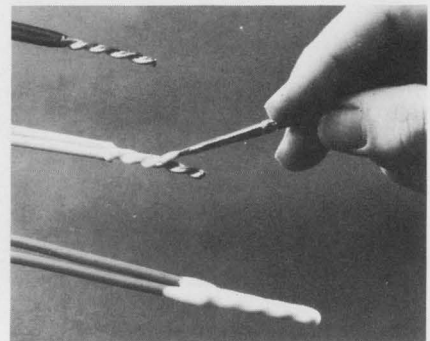

Dow Corning, Engineering Products Div., Midland, Mich. Phone: (517) 636-8510. Price: \$8.80 or \$11/lb.

Two new ready to use silicone insulating materials feature a room-temperature curing system (24 hours) that does not give off corrosive by-products. Type 3141 RTV coating is a white liquid rubber for use as a conformal coating or potting material. Type 3144 RTV adhesive/sealant is a translucent high-strength nonflowing material for sealing, mounting, insulating and bonding.

CIRCLE NO. 290

Small connectors are 14-pin DIPs

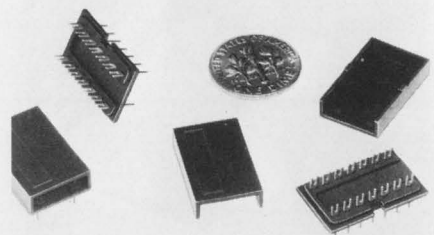

DPA, 1600 N. Arrowhead Ave., Suite 9, San Bernardino, Calif. P&A: 75¢; stock to 2 wks.

Accommodating wires as large as AWG #24, new miniature 14-pin connectors plug into dual-inline IC sockets with standard 0.1 by 0.3-in. grids. The new DIP connectors may be used for mounting discrete components from pin to pin, as well as for connecting wires. All pins are gold-plated.

CIRCLE NO. 291



Electrical Engineers:

Join a small, hard-hitting logic design team at IBM.

Here's your chance to really get involved with designing the logic for sophisticated new systems for both military and commercial projects.

New Engineering Center

Here at IBM's new Communications and Engineering Sciences Center, near Washington, D.C., we work in small groups. This allows each member to dig into the project from the very beginning—from sitting down with the customers before we begin to conducting the maintenance training after we finish.

The entire group is involved with everything from hardware design to systems acceptance and program management.

You should have a degree in electrical engineering. Experience in logic design, digital systems or some other data processing area would be helpful.

Projects now underway

Several high-priority projects are already underway. They range from an advanced reservations system for commercial airlines to highly classified ground-based military systems.

We are also helping to develop greater mission capability for the post-Apollo period.

Why choose IBM?

Today's major growth industry is information handling and control. And IBM is a leader in that field. This growth environment can bring out the best of your talents and abilities, because in a growth company like IBM you can work constantly toward greater achievement. This means more opportunities to achieve distinction and personal recognition.

So if you're a problem-solver who wants a personal sense of achievement and recognition for your hard work in an exciting growth company, consider IBM.

Call or write

If you are an Electrical Engineer and want to join a small, hard-hitting team, call Jim Dunn at (301) 921-7724 collect any weekday between 9 and 4:30. Or, send a brief letter or resume to him at IBM Corporation, Federal Systems Division, Dept. CD1073, 18100 Frederick Pike, Gaithersburg, Maryland 20760.

An Equal Opportunity Employer

IBM®

New from the **SPEC-TROLL!**

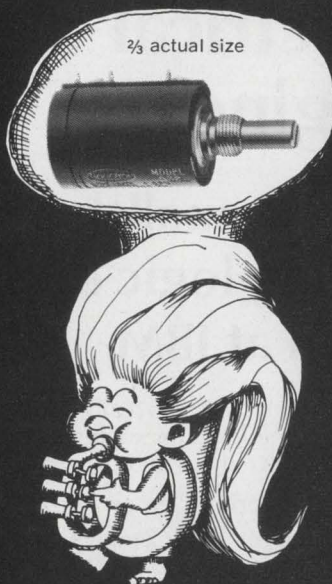

A 10-TURN INDUSTRIAL WIREWOUND POT WORTH BLOWING OUR HORN ABOUT!

Selling for only \$4.39 in quantity, our new Model 532 features "designed-in" reliability to give you top pot performance at bargain prices. The 532 offers:

- Longer element for "tighter" resolution.
- Precious metal contacts for minimum noise characteristics.
- Improved vibration-resistant slider design and dual slip ring contacts.
- Rugged mechanical stops for dependability.
- Passivated stainless steel shaft.
- A tough industrial design that can handle most of the requirements associated with MIL-R-12934.

Brief Specs

Size:	7/8" diameter
Resistance Range:	15 ohm to 180K
Resistance Tolerance:	±5%
Independent Linearity:	±0.25%
Power Rating:	3 watts @ 40°C

The model 532 is available through your local Spectrol distributor. For full specs, circle the reader service number. Qualified respondents may obtain a sample *free of charge* through their Spectrol representative.



Spectrol Electronics Corporation
A subsidiary of Carrier Corporation
17070 East Gale Avenue
City of Industry, Calif. 91745
Phone: (213) 964-6565
TWX: (910) 584-1314

INFORMATION RETRIEVAL NUMBER 91

PRODUCTION

IC lead bender is air-operated

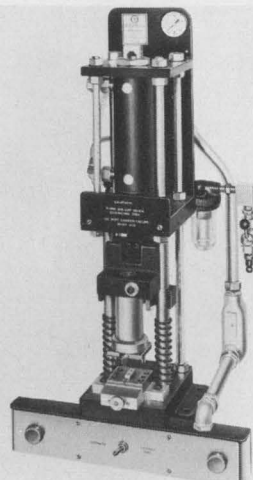

*D-Vel Research Laboratories, Inc.,
555 Bedford Rd., Bedford Hills,
N. Y. Phone: (914) 666-3455.*

Model 100-AC air-operated integrated-circuit lead bender achieves production rates of several hundred pieces per hour with little or no operator fatigue. The new bending press operates from 80 to 100 pounds of shop air pressure and can be supplied with self-contained pushbutton control for maximum operator safety or with a foot valve.

CIRCLE NO. 292

Flatpack cutter trims each lead

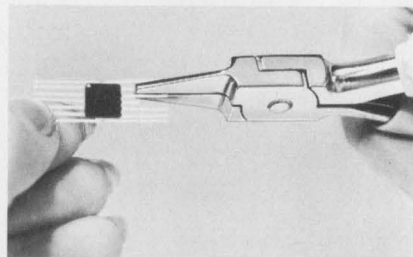

*ETM Corp., 144 W. Chestnut Ave.,
Monrovia, Calif. Phone: (213)
359-8102.*

With a tip width of 0.062 in., a new narrow-end cutter can trim individual flatpack leads to desired lengths. Its narrow tip allows adequate clearance between adjacent leads. Model 1018 can cut leads as large as 0.006 by 0.02 in. There is a stop screw in the shank to prevent overpressure.

CIRCLE NO. 293

VITREOSIL[®] INDUSTRIAL WARE

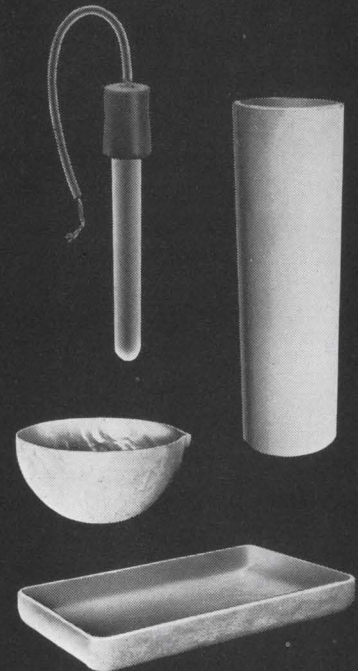

Whether you're concentrating, evaporating, or crystallizing acid solutions . . . or melting, sintering, or heat treating metals, Thermal American VITREOSIL Industrial Ware is your best bet.

VITREOSIL is exceptionally resistant to thermal shock (having a coefficient of expansion of: 0.45×10^{-6}), chemical reactions at high temperatures, has high dielectric strength, high purity, and extreme resistance to catalytic action. It is available in the forms of crucibles, dishes, trays, tanks, retorts, pots, tubes and pipes, and can also be fabricated in other configurations for specific requirements. It is light in weight and suitable for operating temperatures between 1000°C and 1300°C.

For complete technical and application data, write or phone.

79

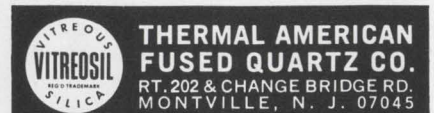

INFORMATION RETRIEVAL NUMBER 92
ELECTRONIC DESIGN 12, June 7, 1969

Modular system draws in 3-D

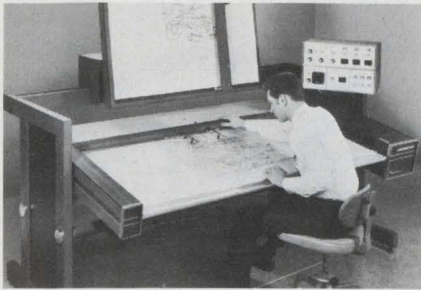

Perspective Systems, Inc., 4400 Seventh Ave. South, Seattle, Wash. Price: \$18,750 to \$29,325.

Directed by an analog computer, the Illustromat 1200 drawing system creates a wide variety of drawings — axonometric, perspective, and three-dimensional stereo — as an operator traces two orthographic (blueprint) views. Built with a modular design, the new unit can be expanded into a more highly automated graphics system, with such sophisticated features as memory storage and playback, three-axis digitizer, and interface capability with existing digital systems.

CIRCLE NO. 294

Beam-lead bonder accepts flip-chips

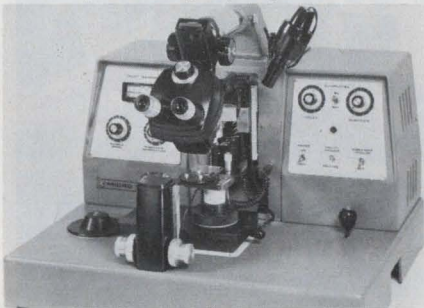

Micro Tech Mfg., Inc., a sub. of Sprague Electric Co., 703 Plantation St., Worcester, Mass. Phone: (617) 755-5215.

Developed for both the laboratory and the production line, the 1190 bonder can handle beam-lead devices, flip-chips or conventional eutectic die devices with substrates up to 2 in. square. Many adjustable operating features include wobble tool speed, angular rotation, pressure, tool temperature and substrate temperature controls.

CIRCLE NO. 295

Leasametric has it ...everywhere!

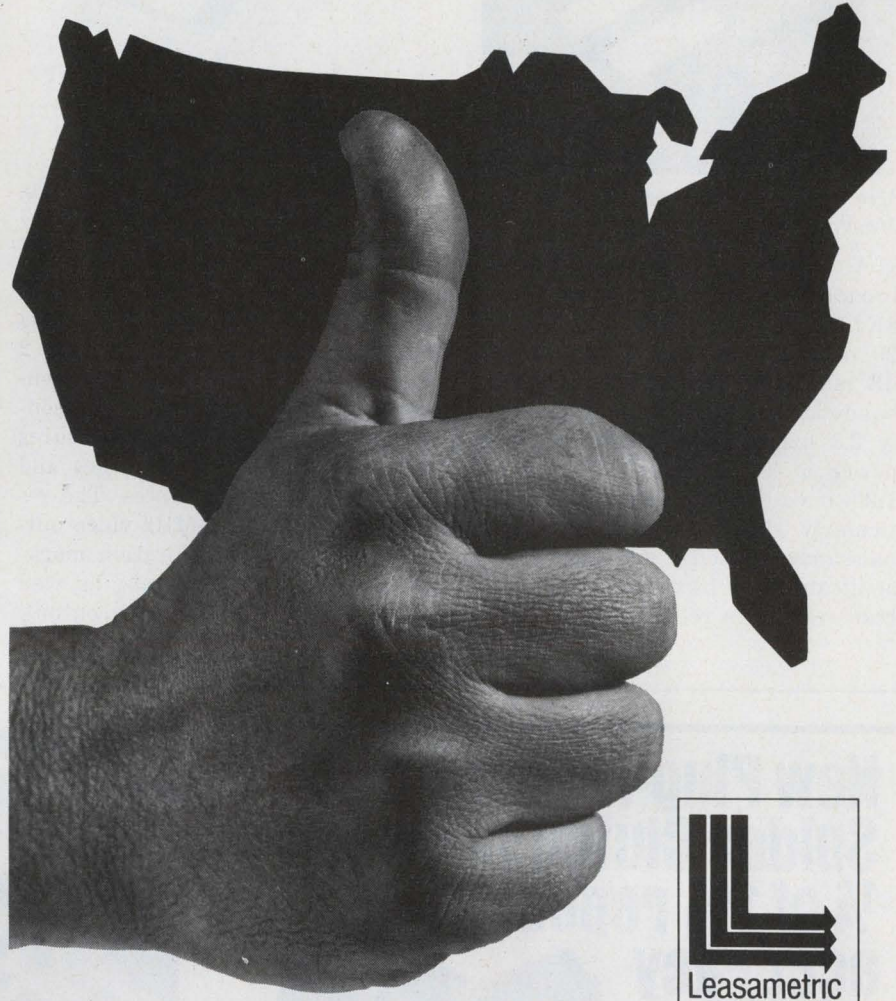

Rent or lease electronic instruments
from 36 offices coast-to-coast. Immediate delivery.
Call us first!

For more facts call any one of our regional offices, or send for the 1969 Leasametric catalog.

Alabama	(Huntsville)	(205) 881-3294	New York	(Albany)	(518) 489-4777
California	(Los Angeles)	(213) 837-8181		(Binghamton)	(607) 723-9661
	(San Diego)	(714) 291-1391		(Buffalo)	(716) 473-2115
	(San Francisco)	(415) 347-3067		(Comack, L. I.)	(212) 732-0001
Connecticut	(Hamden)	(203) 248-4174		(Poughkeepsie)	(914) 561-4510
Florida	(Orlando)	(305) 293-5202		(Rochester)	(716) 473-2115
Illinois	(Chicago)	(312) 774-6440		(Syracuse)	(315) 471-7274
Indiana	(Indianapolis)	(317) 243-6681		(Utica)	(315) 732-3775
Mass.	(Waban)	(617) 969-9881	North Carolina	(Charlotte)	(704) 333-7743
Michigan	(Detroit)	(313) 886-2280	Ohio	(Cleveland)	(216) 261-5440
Minnesota	(Minneapolis)	(612) 920-7080		(Dayton)	(513) 426-5551
Missouri	(Kansas City)	(913) 381-5852		(Tulsa)	(918) 622-3753
	(St. Louis)	(314) 839-9100	Oklahoma	(Willow Grove)	(215) 922-3270
	(Wichita)	(316) 682-4140	Pennsylvania	(Pittsburgh)	(412) 371-9449
New Jersey	(Newark)	(201) 444-0662	Texas	(Houston)	(713) 622-2820
				(Richardson)	(214) 231-4846
				(San Antonio)	(512) 226-4342
			Washington, D. C.	(Silver Spring)	(301) 593-4900

INFORMATION RETRIEVAL NUMBER 93

Xb-band circulator handles 10-kW peak

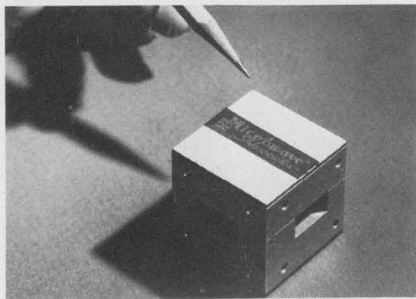

Microwave Associates, Burlington, Mass. Phone: (617) 272-3000.

A high-performance Xb-band broadband circulator, the MA-8K267, features high isolation of 20 dB max., with low loss of 0.3 dB max over the 5.85- to 8.2-GHz bandwidth. Weighing approximately 2.3 lbs., this model has a peak power of 10 kW and a VSWR of 1.20 max. The MA8K267 is particularly suited for use in reconnaissance systems or laboratory applications where broadband transeiving is required.

CIRCLE NO. 296

Superhet receiver covers 1 to 2 GHz

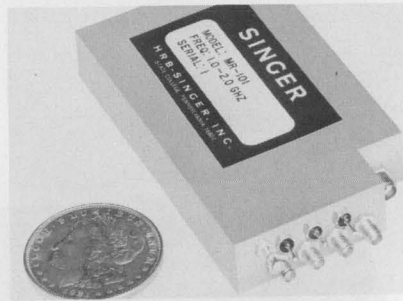

HRB-Singer, Inc., Science Park, State College, Pa. Phone: (814) 238-4311.

A solid-state, automatically swept superheterodyne receiver covers the frequency range from 1 to 2 GHz. Using microstrip circuit techniques, the over-all receiver is contained in a package that measures 2-1/4 by 4-5/8 by 3/4 inches and weighs less than 6 ounces. The receiver provides a 1-MHz video output with crystal calibration markers at 125-MHz intervals, as well as a 10-MHz crystal video output.

CIRCLE NO. 297

Spdt coaxial switch handles 18 GHz

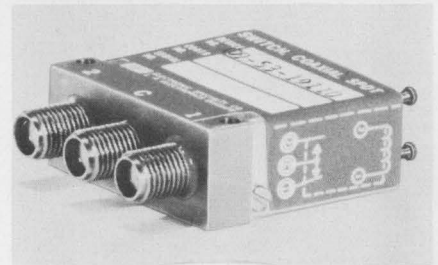

Electronic Specialty Co., 4561 Colorado Blvd., Los Angeles. Phone: (213) 246-6767.

Excellent rf performance is combined with very broad bandwidth in a lightweight, subminiature spdt coaxial switch. The 09-53 series switches have excellent VSWR (1.25:1 at 12.4 GHz), and provide high interchannel isolation from 0 to 18 GHz (60 dB min at 11 GHz and 55 dB to 18 GHz), Standard rf connectors are of the OSM type and project from a single surface (OSSM-type connectors are also available).

CIRCLE NO. 298

New Plug-In Timer with Spider Clutch provides 1/4 of 1% repeat accuracy

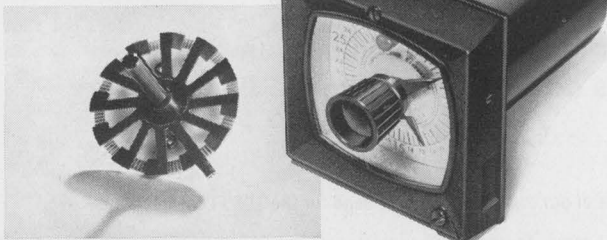

Spider is the name of our revolutionary clutch which provides our new Series GP Plug-in Timers with 1/4 of 1% repeat accuracy.

The patented Spider Clutch, an exclusively new feature of Series GP, incorporates the high accuracy of infinite engagement clutches with the mechanical integrity of toothed clutches. The Spider insures non-slip

repeat accuracy that's unequalled by any other positive engagement, motor-driven timer.

Series GP is completely interchangeable with most of today's widely used plug-in type delay/interval timers. Priced as low as \$29.10 (500-999 units). For additional information, ask for bulletin 310. Call 201-887-2200.

SINGER
INDUSTRIAL TIMER CORPORATION
U.S. HIGHWAY 287, PARSIPPANY, N.J. 07054



Designers Choice

What's best for your logic system design? CAMBION's Logic Manual tells you all you need to know about CAMBION DTL, TTL, HTL circuits, full MIL capability, complex functions, all types of cards for use in industrial controls, computers, A-to-D converters; interfacing instrumentation, and automatic check-out systems.

CAMBION's new Wire-Wrap* Products and Service Brochure covers our prototype and production wire-wrap activity . . . plus sockets, cards, files and racks for the designer developing his own cards. Get these two free catalogs today. Cambridge Thermionic Corporation, 463 Concord Avenue, Cambridge, Massachusetts 02138. Phone: (617) 491-5400. In Los Angeles, 8703 La Tijera Boulevard 90045. Phone: (213) 776-0472.

*Registered Trademark of Gardner-Denver Co.

Standardize on
CAMBION[®]
The Guaranteed Electronic Components

X-band adapter joins waveguide to microstrip

Tek-wave, Inc., Raymond Rd., Princeton, N.J. Phone: (609) 921-8910.

The first commercially available waveguide-to-microstrip adapter operates in X-band over 10% bandwidths. VSWR is 1:25 maximum when terminated into a 1.03 load. The adapter is for launching 50- Ω microstrip circuits on 0.025-in. Al_2O_3 ceramic substrates. The new transition completely eliminates the need for intermediate coax fittings normally necessary to accommodate conventional connecting devices.

CIRCLE NO. 334

Glass laser system has extended life

American Optical Corp., Technical Products Div., Southbridge, Mass. Phone: (617) 764-3211. P&A: \$8388; 4 months.

A glass laser system provides 10 to 100 times the flashlamp life of comparable ruby laser systems. It allows operators to achieve maximum energy output of 400 joules from the neodymium-glass rod with half the input energy necessary for similar laser systems. The AO 40 has a nominal threshold energy of 5000 joules and a nominal slope efficiency of 4%.

CIRCLE NO. 335

Junction circulator spans 1 to 2 GHz

Addington Laboratories, Inc., 1043 DeGiulio Ave., Santa Clar, Calif. Phone: (408) 248-5511.

A miniature junction circulator operating from 1 to 2 GHz can be used as an isolator simply by terminating one of its ports with a 50- Ω load. This miniature circulator/isolator has dimensions of 2.7 by 2.85 by 0.75 inches (exclusive of connectors). Specifications include 19-dB isolation, 0.5-dB insertion loss and 1.3:1 VSWR.

CIRCLE NO. 336



Chassis-Trak Slides ... where it really counts!

See us at
the NepCon
Booth 849

Hard, cold-rolled steel makes Chassis-Trak Slides extra strong and cadmium-plating gives them protection against corrosion. Poxytube 75 dry-film lubricant continues to give smooth slide operation even after years of use . . . no matter what climate, what conditions.

Chassis-Trak Slides are instantly removable and interchangeable for in-

spection or emergency replacement when it really counts. Three basic slide designs—tilt, non-tilt, and tilt-detent—support up to 1,000 lbs., and permit thorough flexibility of use and application.

These are just some of the reasons Chassis-Trak is specified for military applications throughout the world . . . where it really counts. Why don't you find out why!

A package for every Major Missile Project from . . .
525 South Webster Ave., Indianapolis, Indiana



THE TOMORROW MOSFETS SEE-FOR-YOURSELF SALE.

For months now we've been saying our Tomorrow MOSFETS are years ahead of their time.

This month you can see for yourself.

We've made up five sample MOSFET kits. Cut the regular price by well over half. And stocked them with distributors all over the country.

It's your chance to get a jump on the way that MOS design is going.

The Tomorrow Kits aren't smatterings of excess inventory. They're application oriented. Each one contains the appropriate MOSFETS, application notes, a hand book, specifications, and purchasing information.

You can buy one. Or three. Or all five.

All five will cost you a little over \$300. That's a savings of almost \$350 compared to regular stock.

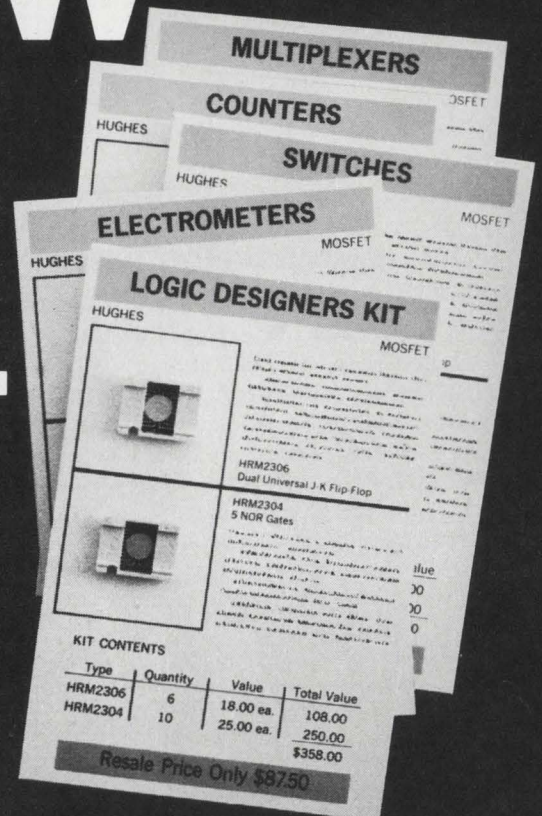

But once you get a taste of the future, we think you'll be back for more.

See for yourself. Check the opposite page for the distributor nearest you.

He's got tomorrow on sale today.

For any additional information, write Hughes MOSFETS, 500 Superior Ave., Newport Beach, California 92663.



Evaluation Samples

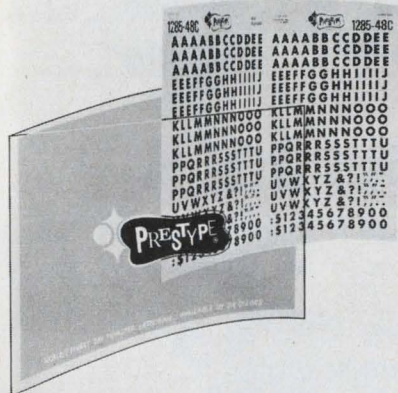

Dry-transfer lettering

Evaluation samples of dry-transfer lettering sheets are available without charge to designers. These sheets are now packaged in large, transparent plastic envelopes for convenient storage and improved long-term protection. Sheets are available with opaque and transparent letters in a selection of six colors. Prestype, Inc.

CIRCLE NO. 337

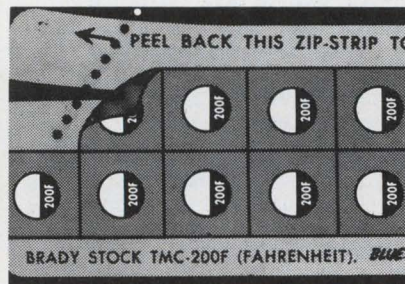

Temperature indicators

Able to irreversibly change color when a predetermined temperature has been reached, self-stacking temperature-monitoring labels provide an easy method to check electrical components and equipment. Priced from 5 to 12¢ each, twenty same-temperature Thermomarkers come mounted on a dispenser card. When their temperature threshold is exceeded, they turn black and show the word "over." Indication accuracy is $\pm 3^\circ$; temperature ranges include 100 to 500°F and 40 to 300°C. Free samples are available. W. H. Brady Co.

CIRCLE NO. 338

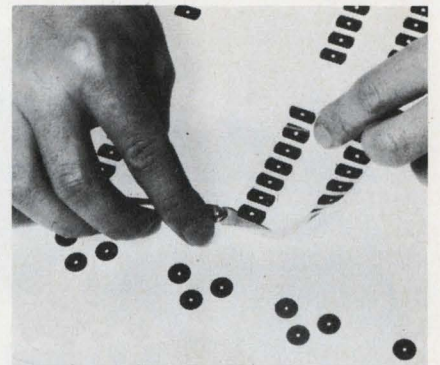

Dual in-line patterns

Complete multiple pad patterns for dual in-line package configurations eliminate the need for time-consuming repetitive drawing in printed-circuit artwork preparation. The new dual in-line symbols make it possible to lay down the entire artwork pattern in one operation. Patterns are manufactured to an accuracy within $\pm .002$ inch, for all common center-to-center and pad spacings. Patterns are available for 14- and 16-lead configurations in 1X, 2X, 4X and 5X scales. Packaged 100 and 250 to a roll, they are priced from \$7.55 to \$9.70, depending on size. Full technical data and free samples of these pressure-sensitive drafting symbols are available. Bishop Graphics, Inc.

CIRCLE NO. 339



Equipment nameplates

Free evaluation samples are included with descriptive literature on a line of nameplates and property identification tags. These tags are available with punched holes for mechanical fastening or with pressure-sensitive or solvent-activated adhesive backing. Identification tags suitable for marking equipment, tools, jigs, dies, and instruments of all types are featured in the line. Seton Name Plate Corp.

CIRCLE NO. 340

SEE-FOR-YOURSELF AT ONE OF THESE DISTRIBUTORS.

BIRMINGHAM, ALABAMA

M. G. Electronics and Equipment Co., Inc.
3112 Sixth Avenue South. 35233 • (205) 837-0350

HOLLYWOOD, CALIFORNIA

Hollywood Radio and Electronics, Inc.
5250 Hollywood Blvd. 90027 • (213) 466-3181

MIAMI, FLORIDA

Electro-Standard Laboratories, Inc.
3560 N.W. 34th Street. 33142 • (305) 633-6975

CHICAGO, ILLINOIS

Newark Electronics Corp.
500 N. Pulaski Road. 60624 • (312) 638-4411

ROCKVILLE, MARYLAND

Pioneer Washington Electronics
1037 Taft Street. 20850 • (301) 427-3300

BROCKTON, MASSACHUSETTS

Forsberg Electronics Distributors, Inc.
646 Summer Street. 02402 • (617) 522-6300

ALBUQUERQUE, NEW MEXICO

Kierulff Electronics Corp.
2524 Baylor Drive, S.E., 87119 • (505) 247-1055

FARMINGDALE, L.I., NEW YORK

Arrow Electronics, Inc.
900 Broadhollow Road (Rt. 110). 11735
(516) 694-6800

HICKSVILLE, L. I., NEW YORK

F-J-R Electronics, Inc.
49 Bethpage Road. 11802 • (516) 433-5530

NEW YORK, NEW YORK

Terminal Hudson Electronics, Inc.
236 W. 17th Street. 10011 • (212) 243-5200
Milgray Electronics, Inc.
160 Varick Street. 10013 • (212) 989-1600

CLEVELAND, OHIO

Pioneer Standard Electronics, Inc.
5403 Prospect Avenue. 44803 • (216) 432-0010

COLUMBUS, OHIO

Electronics Marketing Corp.
814 W. 3rd Avenue. 43212 • (614) 299-4161

DAYTON, OHIO

Argent Industries, Inc.
8514 North Main Street. 45415 • (513) 278-9407

PHILADELPHIA, PENNSYLVANIA

Radio Electric Service Company of Penna. (RESCO)
701 Arch Street. 19106 • (215) 925-6900

NASHVILLE, TENNESSEE

1914 West End Avenue. 37203 • (615) 255-8444

Design Aids

Panel-meter design kit

A boon to designers who specify panel meters with custom dials or insignia is offered in the form of a meter-modification portfolio. Nominally priced at \$5, the package comprises sheets of paper, on which meter window outlines have been printed, and transparent acetate sheets printed with dial markings. By superimposing these elements, the user can quickly prepare a mockup of the desired custom panel. The transparent sheets can also be used to fabricate prototypes. Sample acetate sheets and descriptive literature are available from the manufacturer without charge. Modutec, Inc.

CIRCLE NO. 341

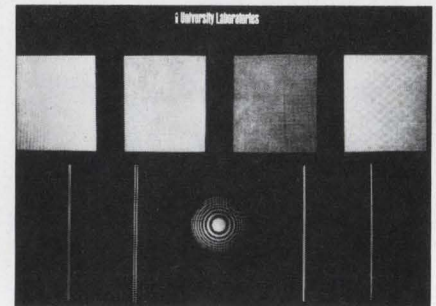

Laser demonstrator

Using coherent light from a helium-neon laser, at least seven experiments in diffraction can be performed with a transparency containing an assortment of diffraction-producing targets. Besides educational uses, the demonstrator is a must for showing He-Ne lasers to novices. With it, one can observe various light patterns produced by shining the laser beam through the hole patterns, double slits, single slits, zone plate, and sharp edge contained in the 2- x 2-in. transparency. An instruction leaflet suggests quantitative experiments to demonstrate the wave theory of light. Useful only to people having a He-Ne laser or planning to purchase one, the laser demonstrator is available free to qualified personnel. University Laboratories.

CIRCLE NO. 342



Meet Durant's New Electrics.

Models and sizes to match all electric counter applications

Durant's new YP Series electric counter is built around a unique drive mechanism that extends counter life to a new high. And it also gives you greater accuracy, lower cost and compact design.

Designed to meet the requirements of high-speed metering, copying or production equipment, the YP is available as 6- or 7-figure models. It operates at speeds to 25 cps or 1500 cpm.

The new ME Series counter was developed for use on office machines, metering devices, medical instrumentation and other highly sophisticated equipment. It's extremely compact, and operates at speeds up to 1000 cpm. Available in several DC voltages and 115 VAC. Maximum power is 3 watts. Fast, silent, highly simplified electromagnetic drive assures long life.

All Durant electrics have a strong one-piece case, with all components housed inside. The strength of this "package" helps Durant counters withstand all kinds of shocks, jars and vibrations without missing a count. To assure maximum life, the tight-fitting case provides protection against moisture and dirt; all moving parts are lifetime-lubricated.

Durant electric counters are shipped ready to operate, ready for mounting — no appendages necessary. Readability on all models is excellent. The counters described here are only part of the Durant electric counter line. Altogether, there are nine basic series and over 33 standard models available. For full information about them, write for Electric Counter Catalog. 622 North Cass Street, Milwaukee, Wisconsin 53201.

Compact 9434 Series — Small electric counters with built-in high-capacity rectifier. Count speed 1000 cpm. Operates on AC, DC available. 4 figures, base or panel mounting from front or rear of panel.

High-Speed YE Series — 2400 cpm electric counter, push button or electric reset. 6 figures, $\frac{3}{16}$ " characters. Base or panel mounting.

AC or DC 6-Y-1-RMF Series — 6 or 7 figure counter. Speeds up to 1000 cpm, with knob reset. Enclosed design. Built-in rectifier permits AC or DC operations. Base or panel mounting.



In Europe: Durant (Europa) N.V. Barneveld, Netherlands.

INFORMATION RETRIEVAL NUMBER 98

Bodine rotors and armatures are not the vibrating type. Dynamic balancing sees to that.



Vibration or noise in a Bodine motor is unthinkable. You wouldn't stand for it. And we know how to prevent it.

Precision balancing machinery handles this phase of our "quiet" program. The machines put the finger on unbalance in Bodine rotors and armatures—then indicate the exact means for restoring peaceful equilibrium. Armatures, in fact, go through the balancing act twice—before and after varnishing.

Our balancing tolerances run to the thousandths of an ounce-inch, so rotors

and armatures in Bodine motors revolve without annoying vibration or noise. Longer bearing life is an extra benefit.

Dynamic balancing is just one of several noise control procedures followed in all stages of manufacture of Bodine fractional horsepower motors. Doesn't your product deserve motors of such quality? Bulletin S describes over 275 stock types and sizes from 1/2000 to 1/6 hp. Write Bodine Electric Company, 2528 West Bradley Place, Chicago, Illinois 60618.

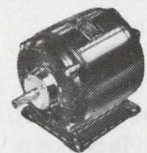

*Bodine motors wear out—
it just takes longer*

BODINE
fractional/horsepower
MOTORS



... the power behind the leading products

BODINE MAKES MOTOR CONTROLS, TOO—ASK FOR BULLETIN 1050

INFORMATION RETRIEVAL NUMBER 99

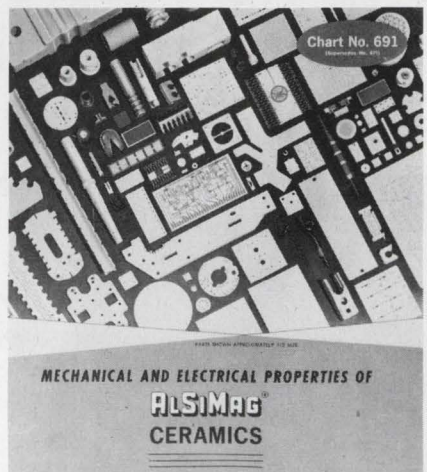

Ceramic property chart

A comprehensive data sheet on the properties of technical ceramics is offered as an aid to designers. Printed in four colors, the chart includes full data and specifications on steatite, forsterite, zircon, cordierite, lava, machinable magnesium silicate, crushable magnesia, alumina, beryllia, and leachable ceramics. American Lava Corp., sub. of 3M Co.

CIRCLE NO. 343

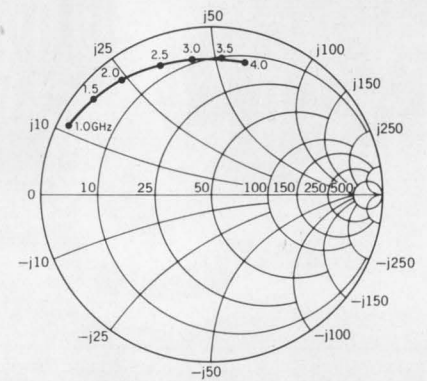

S-parameter charts

Permitting circuit optimization for amplifier or oscillator applications, S-parameter charts have an effective range of 100 MHz to 12.4 GHz, as compared to a Y-parameter range of dc to 500 MHz. Printed on 8-1/2 by 11-in. sheets, the charts are directly derived from the screen display on Hewlett-Packard's network analyzer equipment. They show four key impedance measurements for each of 15 microwave transistors. Two charts measure input and output performance. Fairchild Semiconductor.

CIRCLE NO. 344

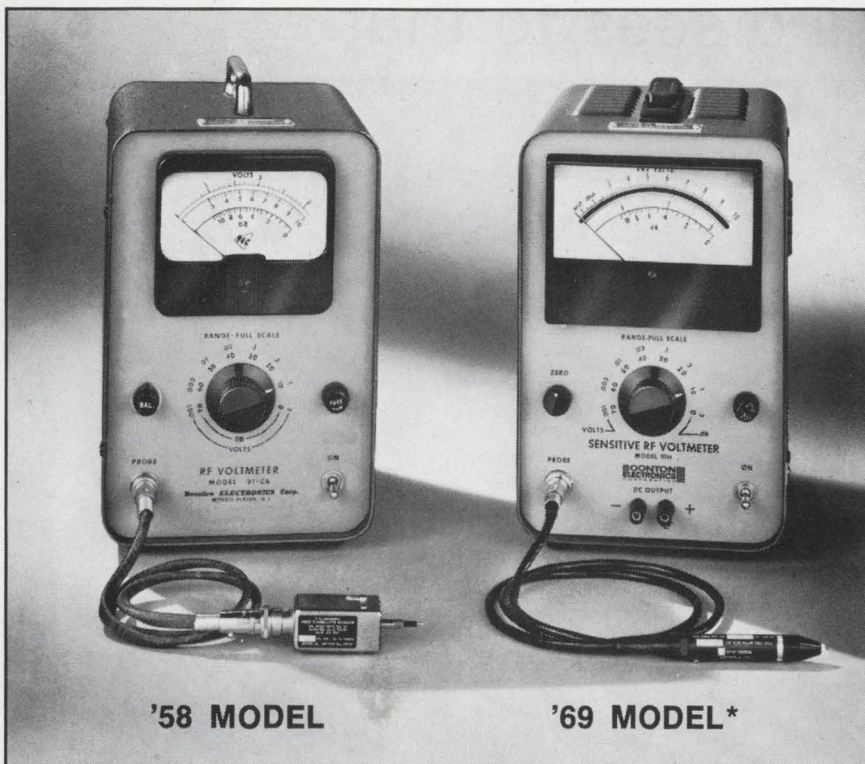

THE RF VOLTSWAGEN

11 years and 10,000 satisfied users later, our Model 91H RF Voltmeter looks pretty much the same. Actually, there are 94 modifications — only 4 meet the eye.

As with the well-known "bug," our styling changes are few. But, inside it's a different story. Here, the many changes have resulted in such major improvements as doubling the frequency range to 1200 MHz, almost halving the basic accuracy to 3%, lowering the minimum indication to 100 μ V, and adding dc output. These improvements and many more increase versatility and guarantee fast, accurate, and stable measurement year after year.

A demo will convince you that your best buy is the Boonton Model 91H RF Voltmeter—the voltmeter that's "styled like a Volkswagen but performs like a Cadillac."

*Price: \$650.

**BOONTON
ELECTRONICS**
CORPORATION

ROUTE 287
PARSIPPANY, N.J. 07054
Telephone: 201-887-5110
TWX: 710-986-8241

DISPLAY CIRCUIT MODULES

DYNAMIC FOCUS FUNCTION GENERATOR

FG100

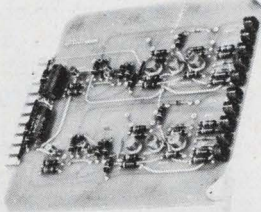

Converts X and Y deflection current samples into parabolic voltage wave forms to maintain beam focus anywhere on the CRT face.

LINEARITY CORRECTOR

LC101A

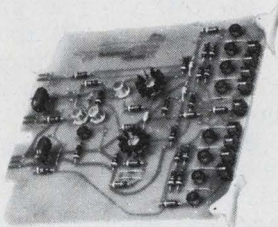

Gives on-axis linearity correction for geometric distortion occurring when a flat-faced CRT is used. Ideal for line-scan applications.

CENTERING COIL CURRENT REGULATOR

CR200

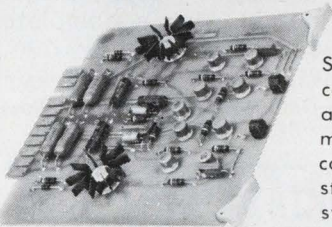

Supplies highly stable constant current to two axes of centering, alignment or static astigmatic correction coils in CRT, storage tube or vidicon systems.

VIDEO AMPLIFIER

VA105

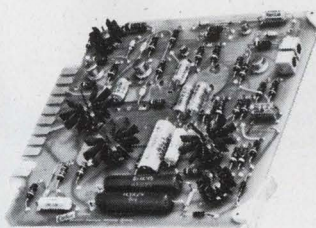

Linear, featuring high output capability, fast rise and fall time, excellent full power output and bandwidth. Unique damping control.

STATIC FOCUS CURRENT REGULATOR

SR1000

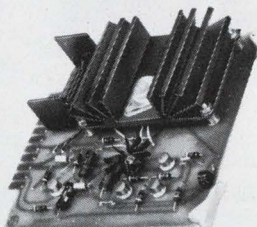

Provides a fully adjustable constant dc current supply to the static focus coil in magnetically focused systems. Low ripple, adjustable.

YOKES
Celco

Constantine
Engineering Laboratories Company

Mahwah, N. J.
201-327-1123

Upland, Cal.
714-982-0215

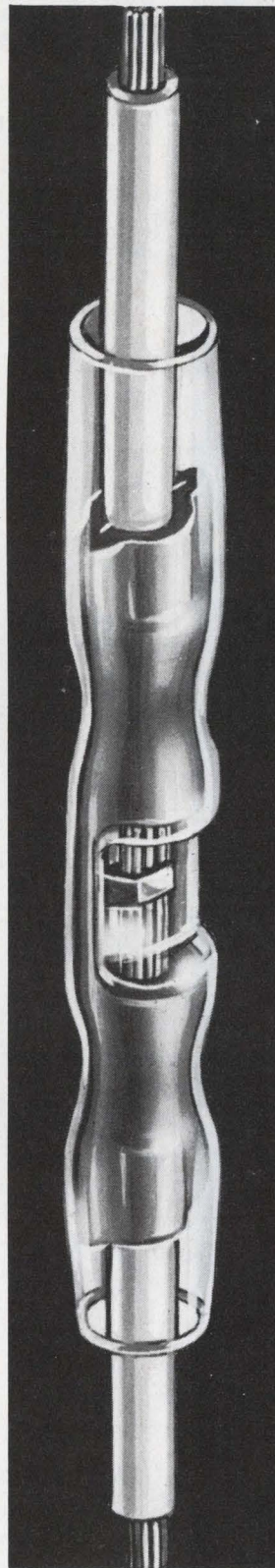

NICE SPLICE

it tells you
when to crimp

That's because the see-thru "window" at splice midpoint lets you inspect inserted conductor before crimping. Funneled barrel ends make conductor entry fast and snag-proof . . . reducing installation time. Center wire stop prevents over-insertion of wires. Color-coded transparent nylon sleeve — over one-piece seamless insert — eliminates dielectric flashover. Midpoint indent helps locate splice in crimping tool. (You'll want to see our match-mated tooling, too.) Our Window Butt Splice is *the* answer to structural and tensile stresses, temperature extremes in the #22-10 wire range. For more answers (and evaluation samples) write or call ETC, Inc., Cleveland, Ohio 44103. A subsidiary of International Telephone and Telegraph Corporation.

© 1969 ETC, Inc.



the twisters

The twist of the fingertips tells the user that he is handling quality.

A lot of effort has gone into making these aluminum knobs the best money can buy. ALCOKNOBS have been painstakingly machined and anodized to a high satin finish. A wide choice of stock knobs are now available to compliment your equipment design. All are available at a reasonable cost and competitive to plastics.

Send for the new ALCOKNOB catalog describing a wide variety of stock knobs and with particulars whereby ALCO can customize knobs to create your own individual image.



ALCO

ELECTRONIC PRODUCTS, INC.
Lawrence, Massachusetts 01843

Application Notes

Threaded inserts

A technical bulletin gives design engineers information pertinent to any threaded wire insert, material shear strengths and bolt selection. By looking at one of the 30 charts, it is possible to determine the length of an insert and strength of a screw required to safely support a given weight. If the designer knows two of four variables, he can obtain the other two from the charts. Heli-Coil Corp., Insert Products Div.

CIRCLE NO. 345

Directional relays

Relays for high-speed directional discrimination during faults on power systems are described in a 12-page brochure. The brochure gives complete application information, including a selector guide. Relay construction and operation are explained and illustrated, and characteristics are listed. Westinghouse Electric Corp., Relay Instrument Div.

CIRCLE NO. 346

Magnetic cores

Material processing and quality-control challenges that may be encountered by process and production engineers in many fields are dealt with in an article on the manufacturer of ferrite cores. The article covers the basic process of producing magnetic ferrite cores for computer core memories. Ampex Corp.

CIRCLE NO. 347

Technical journal

A new quarterly journal will deal with the latest advances in test instrumentation. The first issue features an article on a new approach to wideband interference-free microwave spectrum analysis. In addition, there is a section on spectrum analyzer applications. Free copies are available. The Singer Co., Instrumentation Div.

CIRCLE NO. 348

Uncommonly good sense

from our Tachometer Generators. They're temperature-compensated, miniaturized, and perfect for precision indicators and velocity servos requiring a highly linear speed/voltage relationship with minimum ripple. Linearity from 0 to 12,000 rpm is better than 1/10 of 1% of voltage output at 3600 rpm. The ripple value will not exceed 3% rms of the D-C value at any speed in excess of 100 rpm. The low-driving torque makes them excellent as damping or rate signals in all types of servos. Brushes and commutators are guaranteed for 100,000 hours of operation — more than ten years — at 3600 rpm. Various models are available with outputs as high as 45v/1000 rpm and can be supplied with an indicator as a complete Speed Indicating System.

SERVO-TEK PRODUCTS COMPANY
1086 Goffle Road, Hawthorne, New Jersey 07506.

SERVO-TEK

PRODUCTS COMPANY

For full technical details
write for Catalog 1163
with Test Report
and show
good sense.



INFORMATION RETRIEVAL NUMBER 105

ELECTRONIC DESIGN 12, June 7, 1969

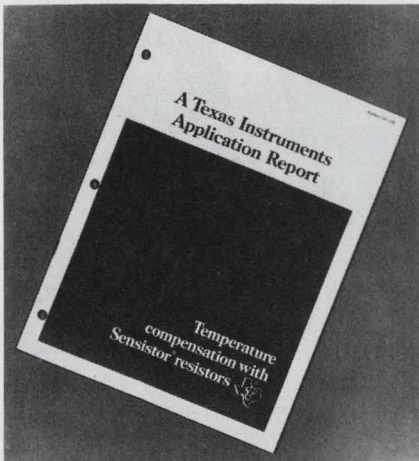

Temperature sensing

A comprehensive new application report shows how to use precision temperature-sensitive resistors. This 20-page booklet contains a section on compensating drift of transistor bias, due to temperature changes, through use of these resistors. A second section describes eleven sensing or control applications; a typical circuit is given for each application. A third section provides helpful circuit design information. Texas Instruments Inc.

CIRCLE NO. 349

Valve data

Complete engineering data on valves and flow control materials are given in a new 20-page bulletin. Detailed in the booklet are operating temperature ranges for seal and seat materials; material compatibility charts; metal specifications; seal materials and valve sizing data. Crane Co., Flomatics Div.

CIRCLE NO. 350

Plastic printed circuits

A four-page illustrated article reprint tells how to etch printed circuits from aluminum-clad plastic. The article presents solutions to problems encountered in processing aluminum-PPO laminate into microwave striplines. General Electric Co., Plastics Dept.

CIRCLE NO. 351

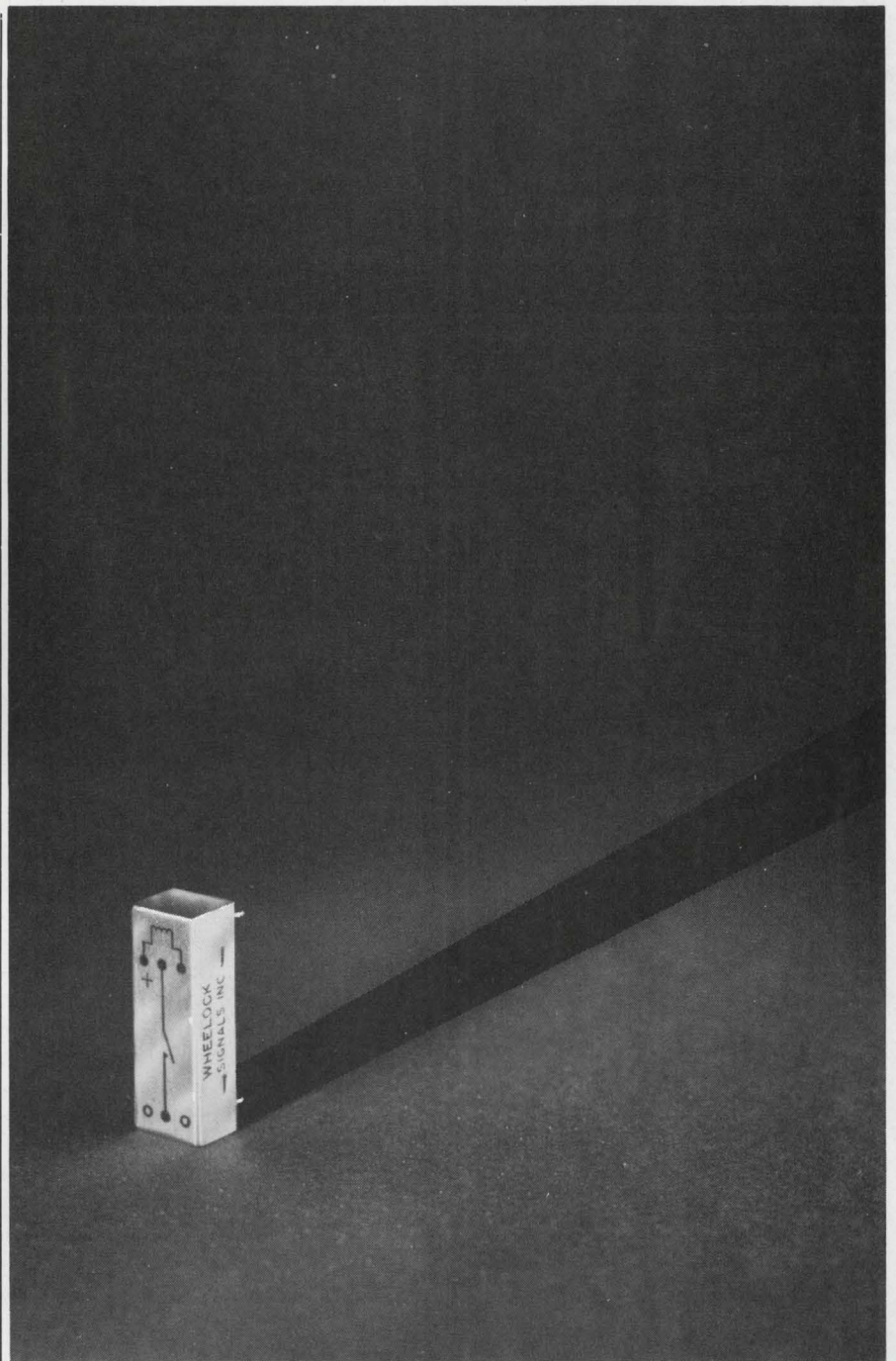

THE FIRST SIGNIFICANT STANDARD REED RELAY IN THE INDUSTRY—THE

502 BY
Wheelock

WHELOCK SIGNALS, INC.
273 BRANCHPORT AVENUE
LONG BRANCH, N.J. 07740
(201) 222-6880

- Standard grids:
(1.00" x .100") (1.00" x .150")
- Low cost . . . immediate delivery
- Coil voltages: 6, 12, 24, 48VDC
- Contacts: Forms A, B or True C

93 INFORMATION RETRIEVAL NUMBER 106

press... action

Press small buttons to control heavy currents with a compact ALCOSWITCH! Snap-action mechanisms allows quick make-and-break along with solid silver contacts for efficient switching capabilities.



NEWEST

Alco development—the illuminated push button Type MSPN is made to handle heavier currents. Over 50 varied buttons in colors and sizes to fit your specific applications. DPDT only. 6 amps @ 125 VAC.

NEW

"Mustang" features a miniature body with a standard 15/32" bushing and colored button. High impact case. Extra wide silver contacts. DPDT only. 6 amps @ 125 VAC.



WATERPROOF

"E Series" made to specifications exceeding industry standards. Miniature in size, and yet rugged. Available as momentary, or Push-ON or Push-OFF. In one, two and 4PDT models. 6 amps @ 125 VAC.



ORIGINAL

snap-action MSP push buttons are our smallest, lightweight models. SPDT and DPDT. Rated 5 amps @ 125 VAC. Lightweight models. SPDT and DPDT. Rated 5 amps @ 125 VAC.



ALCO

ELECTRONIC PRODUCTS, INC.

Lawrence, Massachusetts 01843

New Literature

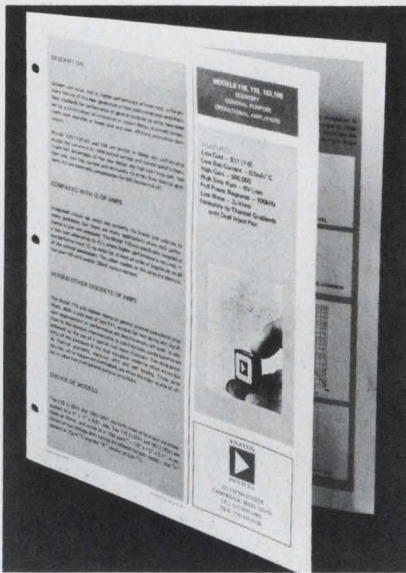

Low-cost op amps

A four-page data sheet describes four new economy-type operational amplifiers employing artificially increased collector-impedance circuitry. This new design provides gain, stability, impedance, bandwidth, response, and common-mode characteristics that would have cost at least twice the price just one year ago. The amplifiers use the same fundamental circuit principles for all-round advanced performance, but feature variations in their output circuitry for a range of power ratings. Analog Devices, Inc.

CIRCLE NO. 386

Manual switches

Revised for the first time, a new 56-page manual switch catalog reviews eleven categories of lighted and unlighted pushbuttons, indicators, matrix-mounted switches and toggle switches. The publication contains over 500 photographs, diagrams and cutaway drawings of the manual switches, in addition to information on electrical ratings, terminals and colors. Also discussed are hand- and tool-relamping techniques, special circuitry, hermetic sealing and locking configurations. Micro Switch, a div. of Honeywell Inc.

CIRCLE NO. 352

SCHAUER

1%

tolerance

1 WATT ZENERS ARE A REAL BUY!

ANY voltage from 2.0 to 16.0 at the industry's LOWEST PRICES!

Quantity	Price each
1-99	\$1.07
100-499	.97
500-999	.91
1000-4999	.86
5000 up	.82



THE HI-RELIABLE!

No fragile nail heads. Silicon junction aligned between two, parallel, offset tantalum heat sinks... great lead tension strength. All welded and brazed assembly. High pressure molded package. Gold plated nickel-clad copper leads. Write or phone for Form 68-4 for complete rating data and other tolerance prices.

Semiconductor Division

SCHAUER MANUFACTURING CORP.

4511 Alpine Avenue
Cincinnati, O. 45242
Ph. (513) 791-3030

INFORMATION RETRIEVAL NUMBER 108

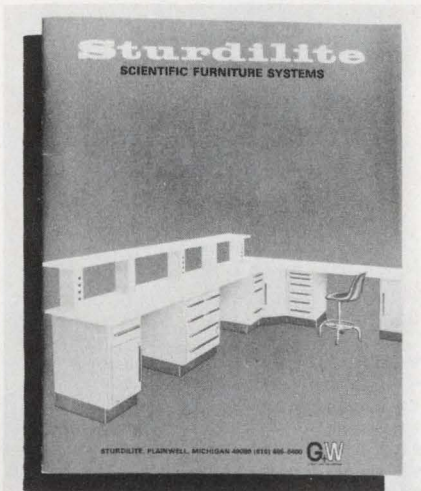

Scientific furniture

A 16-page catalog of scientific furniture systems illustrates and describes a complete line of technical and research-work stations. The system of design illustrated in the catalog involves a modular concept built around a standard base unit. Thus, any laboratory or work area can actually be customized to the specific needs of the user. Nearly 150 different pedestal base combinations can be immediately constructed from components. Sturdilite Scientific Furniture Systems.

CIRCLE NO. 353

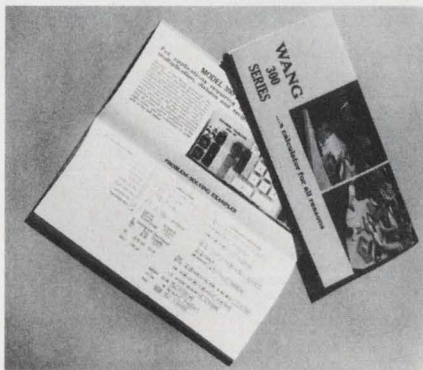

Compatible calculators

A complete line of calculators is presented in a compact 16-page booklet, describing the features and functions of each of the models. Typical application problems and keyboard solutions are detailed for individual calculator keyboards. Wang Laboratories, Inc.

CIRCLE NO. 354

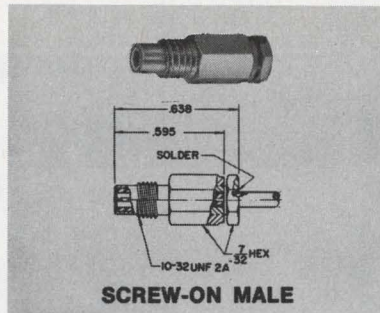

SCREW-ON MALE

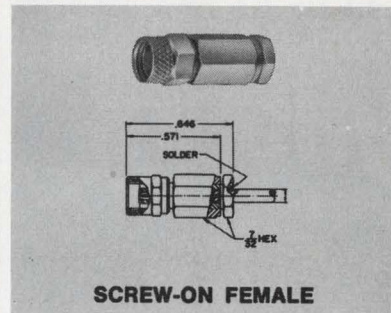

SCREW-ON FEMALE

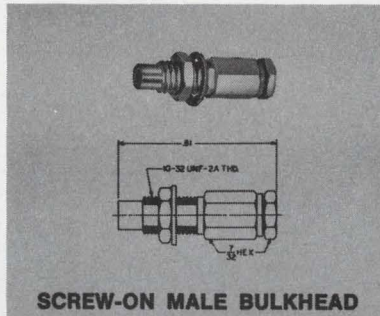

SCREW-ON MALE BULKHEAD

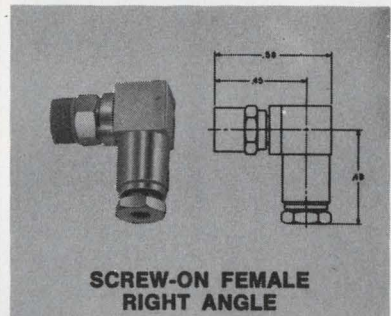

SCREW-ON FEMALE RIGHT ANGLE

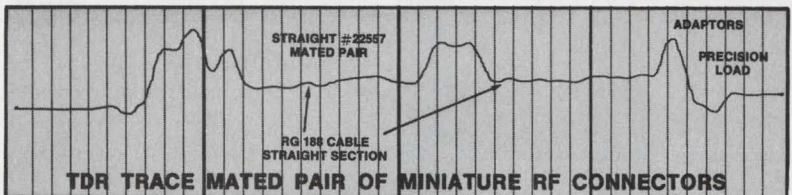
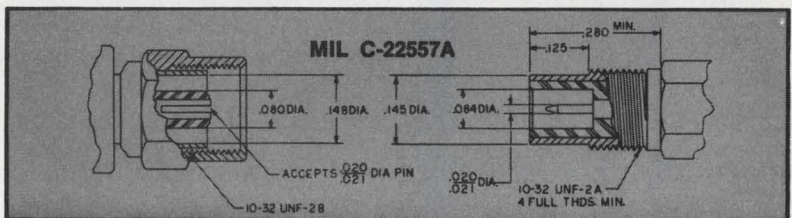

TDR TRACE MATED PAIR OF MINIATURE RF CONNECTORS

MINIATURE RF CONNECTORS

Emlock® compression type RF connectors achieve a new high in reliability and are more than a match for crimp-type in assembly time, thanks to our new T15 bench tool. Incorporating metal-to-metal contact, coaxial cable simply cannot be pulled out of an Emlock® connector. Disengagement will be caused by braid failure, never pull-out of the compression.

We have a full range of Emlock®

sizes and interfaces available from stock for both semi-rigid and braided cable. If you remain unconvinced about the capability of Emlock® compression fit design to meet your needs, we also offer a full series of crimp-types.

Why not ask for all the details? Write for: *Bulletin MMC Issue 1, Phelps Dodge Communications Company, 60 Dodge Avenue, North Haven, Connecticut 06473.*

PHELPS DODGE COMMUNICATIONS COMPANY



designer's keyboard

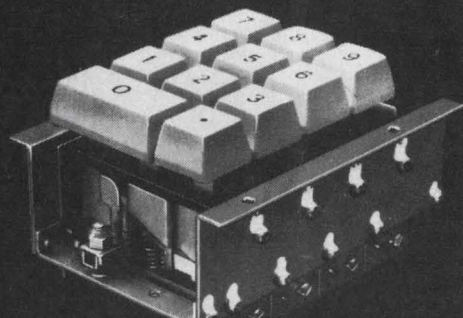

28.50 EACH

SB-033 — INTERLOCK
SB-034 — MOMENTARY

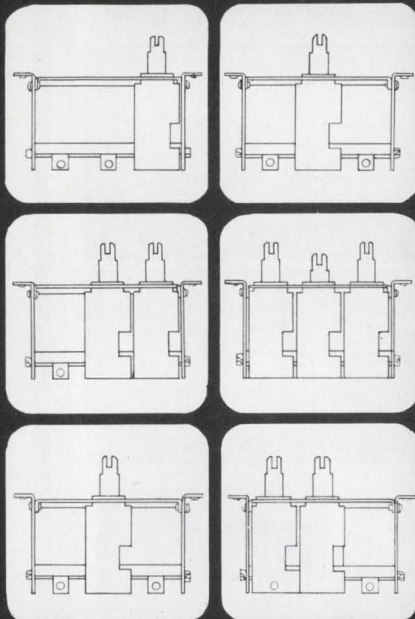

The ALCO modular idea is a simple concept for the design engineer to create his own custom push button layouts from "stock" switch modules and assemblies.

The basic modules allow use of one to three (or four) switches per section. A designer may stack any number of these switch sections in a group by themselves or in conjunction with the ALCO mating 12-segment keyboard assemblies.

Highly efficient, single pole "normally open" reed switches are used throughout, thus assuring reliability and extremely long life expectancy.

For design-service assistance call (Area 617) 686-3887.

ALCO
ELECTRONIC PRODUCTS, INC.
Lawrence, Massachusetts 01843

NEW LITERATURE

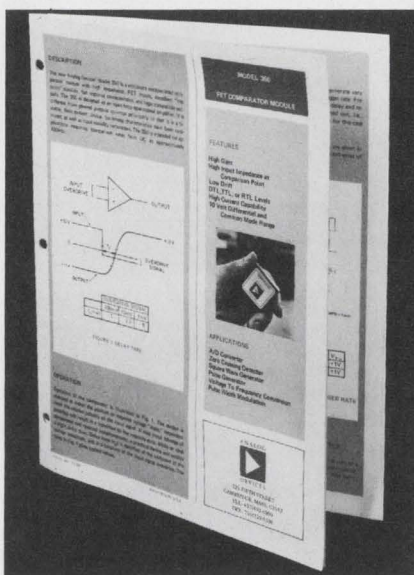

FET-input comparator

A six-page foldout application note and data sheet lists full specifications for the model 350 FET-input comparator; explains the importance of key parameters in the quasi-digital circuits that use comparators; then goes on to outline some of the unusual application possibilities) besides conventional comparators) that can be based on this new unit. Analog Devices, Inc.

CIRCLE NO. 355

Components catalog

A 17-page catalog describes an extensive line of microwave, rf, and i-f receiving systems and components. The catalog includes sections on integrated circuits, microwave receivers, converters, and mixer preamplifiers. In addition, it describes a line of stripline components. Varian, LEL Div.

CIRCLE NO. 356

Fluid controllers

Standard fluidic controllers, as well as a complete integral family of high-performance easily interconnectable fluidic devices are presented in a 10-page condensed catalog. This product line is said to operate reliably for extended periods in the most adverse industrial environments. Fluidionics, Div. of I-T-E Imperial Corp.

CIRCLE NO. 357

P/C Reed Relays

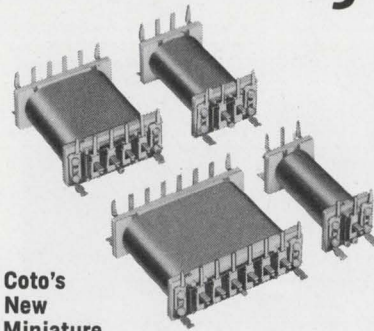

Coto's New Miniature Series 1000

- Especially designed for P/C board applications
- Pin spacing 1" x .150" centers
- Stock voltages 6, 12, 24, 32 and 48 volts
- Form A contacts, up to 6 poles, ratings 10 watts
- Form C contacts, up to 4 poles, ratings 3 watts
- Form A mercury-wetted, up to 6 poles, ratings 28 watts
- Electrostatic and/or magnetic shields

Special voltages and resistances available, with multiple windings for flip-flop, memory and crosspoint selection applications.



COTO-COIL COMPANY, INC.
54 Pavilion Avenue, Providence, R. I. 02905
Tel: (401) 941-3355

INFORMATION RETRIEVAL NUMBER 111

21.4 MHz quartz crystal monolithic filter. Miniature series.....

FOR SAVE SPACE TOYOCOM HAS THE ANSWER

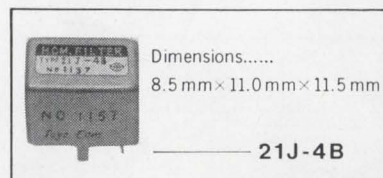

Dimensions.....
8.5 mm x 11.0 mm x 11.5 mm

21J-4B

■ 21J-4B

- Center Frequency.....21.4MHz
Bandwidth 6dB: ± 7.5KHz,
60dB: ± 15KHz,
80dB: ± 22KHz
Max. insertion loss.....4dB
Max. pass band variation.....2dB
Terminal Impedance1KΩ//1pF

TOYOCOM
TOYO COMMUNICATION
EQUIPMENT CO., LTD.
EXPORT DEPARTMENT:
TORANOMON BLDG.,
15, SHIBA-TOPANOMON,
MINATO-KU, TOKYO, JAPAN.
CABLE: EXPORTOYOCOM TOKYO

INFORMATION RETRIEVAL NUMBER 112
ELECTRONIC DESIGN 12, June 7, 1969

◀ INFORMATION RETRIEVAL NUMBER 110



Switch catalog

Emphasizing the availability of a complete switch package from a single source, a 16-page selector switch catalog includes the ratings and specifications of wafer assemblies and index assemblies. Complete electrical and mechanical specifications, as well as special construction features, are presented for all switch types. CTS Corp.

CIRCLE NO. 360

Surface coatings

A four-page folder describes a line of surface coatings. This is the only broad line of electrically characterized and calibrated coatings available for both electronic applications and general surface protection. Coating types described in the folder include epoxies, urethanes, and low electrical loss hydrocarbons, covering a wide range of applications. Emerson & Cuming, Inc.

CIRCLE NO. 358

Laminated metals

Offering specifications on laminated sheet, strip, wire and tubing, an eight-page brochure contains a useful chart that relates precious metals, their properties and typical applications; outlines the advantages and disadvantages for each metal; and lists base metals on which they are usually laminated. The variations possible in fabricating a laminate are illustrated in drawings of each mill product, while dimensional manufacturing tolerances are given in chart form. In addition, there is a section on electrical contact tape. Improved Seamless Wire Co.

CIRCLE NO. 359

Convert any X-Y scope into a curve tracer: \$595*

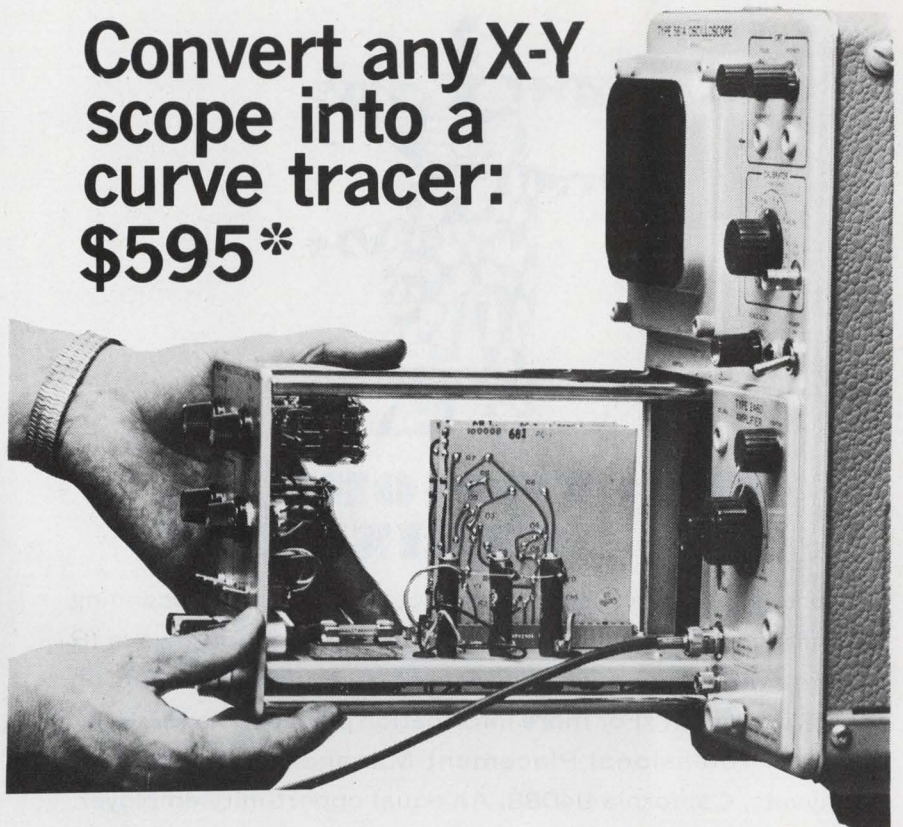

Now U-Tech's plug in and console units are all your oscilloscope needs to become a curve tracer. Save 1/2 to 1/3 the cost!

For the price of one curve tracer, you can now buy two to three of these U-Tech units that use the facilities of your present scope to display the dynamic characteristics of both NPN and PNP transistors, N Channel and P Channel junctions, FETs, MOS-FETs, bipolars, uni-junctions, diodes, tunnel diodes and SCRs.

Ask your distributor about these U-Tech curve tracer units or order direct from:

*Prices apply to purchase and shipments within U.S.A. fob Salt Lake City, Utah

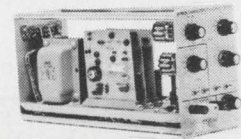

U-Tech plug-in Model 681: \$595.00*. For use with Tektronix 560 series Oscilloscopes.

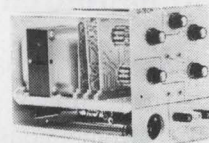

U-Tech plug-in Model 682: \$615.00*. For use with Tektronix 530, 540, 550, 580 series Oscilloscopes.

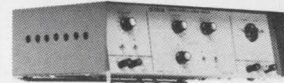

U-Tech Console Model 683: \$625.00*. For use with any X-Y Oscilloscope.

U-TECH

A Division of Industrial Physics and Electronics Company

4190 South State Street, Salt Lake City, Utah 84107 Tel. (801) 262-2663

Yes, send me curve tracer model.....

Enclosed is: Check P.O. Bill me Send literature

NAME _____ TITLE _____

COMPANY NAME _____

COMPANY ADDRESS _____ PHONE _____

CITY _____ STATE _____

INFORMATION RETRIEVAL NUMBER 113



ELECTRO-OPTICS ENGINEERS

Comprehensive knowledge of detectors, optics and scanning techniques. Design of near, intermediate and long-wave IR systems with experience in effects of launch environments on sensor systems. □ For more information please write Mr. H. W. Bissell, Professional Placement Manager, P.O. Box 504, Sunnyvale, California 94088. An equal opportunity employer.

LOCKHEED
MISSILES & SPACE COMPANY
A GROUP DIVISION OF LOCKHEED AIRCRAFT CORPORATION

INFORMATION RETRIEVAL NUMBER 901

SALES AND MARKETING MANAGER

The man we need will manage a sales force in the sale of sophisticated electronic equipment to industry and some military in U.S. and Canada, requiring 60% to 70% travel. Applicant should have at least a B.S. degree, plus a proven record of past performance, and be willing to relocate. Age 40 to 50.

This is an exceptional opportunity with an old line company and a real future. Remuneration: \$25,000 to start plus excellent fringe benefits. Send complete resume to **C. M. Spicer & Associates**, 2260 Francis Lane, Cincinnati, Ohio 45206.

Looking for a great vacation?

You don't have to look very far.

America with all its natural and man-made marvels is right in your own backyard.

You'll find everything from historical monuments, mile-high mountains, sand-duned deserts, bustling cities—and more. The natives, friendly.

America. It's a great place to visit, and aren't you glad you live here.



Space Contributed By
Hayden Publishing Company, Inc.

INFORMATION RETRIEVAL NUMBER 902

NEW LITERATURE

High-strength adhesive

A new 12-page bulletin describes a high strength, fast-setting material that bonds almost any combination of materials. This literature describes how Eastman 910 adhesive—a single-component, solvent-free cyanoacrylate system—joins almost any combination of materials. Metals, plastics, rubber, glass, ceramics, textiles and paper can be bonded. Tensile shear strengths over 5000 psi can be achieved on some substrates. Eastman Chemical Products, Inc. Chemicals Div.

CIRCLE NO. 361

Thermistor data

A series of eight data sheets give full specs on interchangeable curve-matched thermistors. A resistance-temperature conversion table is included to aid the designer in determining resistance-temperature for nonstandard thermistors. Fenwal Electronics.

CIRCLE NO. 362

Relays and controls

Condensed specifications, dimensions, and prices are given in a 24-page catalog for over 400 stock and standard relays and motor controls. Shown are 76 different basic types, including MIL-spec relays, dry and mercury-wetted reed relays, industrial plug-in and low-cost commercial-grade relays, 600-V power relays, timers, and general-purpose contactors and motor starters. Struthers-Dunn, Inc.

CIRCLE NO. 363

Temperature controllers

A four-page brochure illustrates and describes a new series of solid-state digital set-point temperature controllers. These units are designed for use in conjunction with SCR power controllers to provide a completely solid-state temperature control system for electric heating cartridges, furnaces, ovens, dies, molds, heat exchangers, etc. Loyola Industries, Inc.

CIRCLE NO. 364

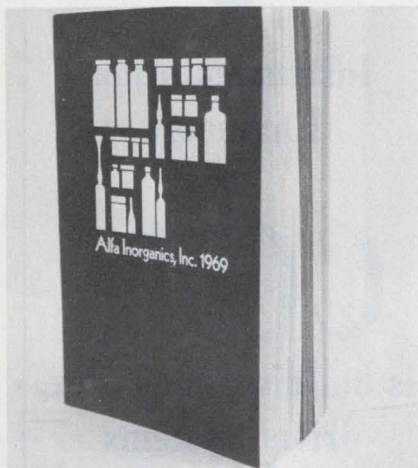

Materials catalog

A 1969 catalog lists 2500 inorganic chemicals, ultra-pure chemicals, organometallics and high-purity metals. The catalog is color-coded into five sections with an integrated alphabetical listing for ready reference. Included are high-purity salts, pure metals, doping agents, and over 200 exclusive items. Alfa Inorganics, Inc.

CIRCLE NO. 365

Data compression

Three bibliographies covering the published literature on data compression are combined in one publication. A total of 177 titles, comprising the bulk of the literature written on this subject since 1950, are listed. These bibliographies are of particular interest to persons involved in processing data telemetered to ground stations from space vehicles or from aircraft undergoing flight testing. Scientific Data Systems.

CIRCLE NO. 366

Electroplating

A fully illustrated color brochure on precision electroplating describes a line of electrodes, and how they are used to improve quality, efficiency, and scope. Also discussed is plating simple or complex parts to higher standards economically, thus permitting parts to be designed to preferred values of utility, appearance and cost. Engelhard Minerals & Chemicals Corp.

CIRCLE NO. 367

less than \$180 per function...

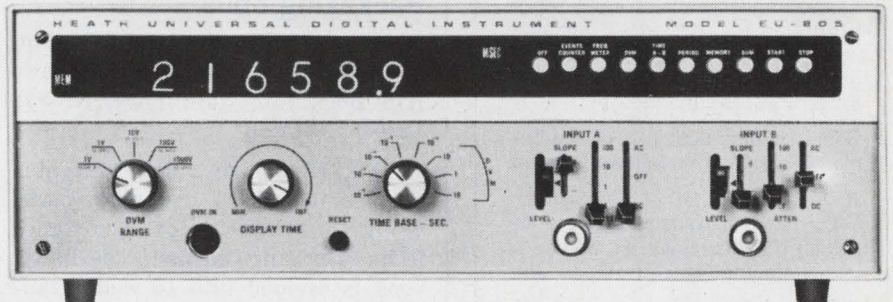

HEATH Universal Digital Instrument

Now you only need one instrument, the Heath EU-805A, to perform all these functions: Frequency, Period, Time Interval, Events count, Ratio, Integrating DVM, and Voltage Integrator. Combining in one package a DC-12.5 MHz Multi-Purpose Counter/Timer with a 0.05% accuracy Digital Voltmeter, the new Heath/Malmstadt-Enke UDI offers you unmatched versatility at less than \$180 per function! An original modular design based on TTL IC's plug-in cards protects the instrument from obsolescence.

The UDI features convenient fast cycling on slow time bases, continuous summing function, memory, 0.1 s to 30 s display time, 6 digit readout plus over-range.

The identical high-sensitivity (10 mV) input comparators provide 1 M Ω impedance, complete range of trigger controls (including Automatic Mode), oscilloscope monitoring of triggering point and four levels of input attenuation. Input pulse resolution is better than 50 ns. Time bases range from 1 μ s to 10 s and short term stability is better than 5 in 10^9 . Accuracy ± 1 count.

DVM section has Automatic Polarity, $5 \times 10^9 \Omega$ input impedance on separate 1 V range (10 M Ω on the others), four ranges from 1 V to 1000 V, 10 μ V resolution, 0.1 s to 10 s integrating time and V-F output available at rear panel.

The UDI is obviously the instrument you need and it is obviously priced right: \$1250. Less DVM order EU-805D at \$940. DVM conversion pack costs \$340.

Many cards from the UDI may be used in the Heath/Malmstadt-Enke Analog Digital Designer EU-801A:

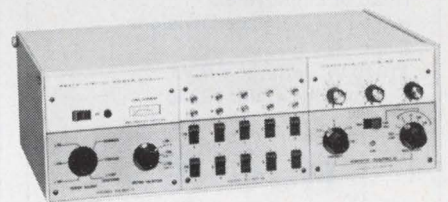

The ADD permits the design of various analog and digital circuits and instruments, by plugging-in logic cards into its power, binary and timing modules. Solderless connections are made with ordinary wire and components leads.

For full information send for the **FREE NEW Scientific Instrumentation Catalog**. An abridged Manual is available for **\$3.50**.

**HEATH COMPANY, Dept. 580-21
Benton Harbor, Michigan 49022**

In Canada, Daystrom Ltd.

- Please send Free New Scientific Instrumentation Catalog.
- Please send Manual EUA-800A, a special 250 pg. condensation of the manuals which accompany Heath Digital equipment ... \$3.50.

Name _____

Address _____

City _____ State _____ Zip _____

Prices & specifications subject to change without notice. EK-264



Opportunities for

CIRCUIT DESIGNERS

Expanding activity on long-range programs and advanced projects has created many stimulating growth-assignments for Circuit Designers at Hughes.

Some of our most urgent requirements exist in the following areas:

- Development of high-power airborne radar transmitters, the design of which involves the use of the most advanced components
- Design of low-noise radar receivers using parametric amplifiers and other advanced microwave components
- Design of digital radar signal processing subsystem circuits, including range and speed trackers, doppler filter banks and a variety of display circuits
- Design of high-efficiency power supplies for airborne and space electronic systems
- Development of telemetering and command circuits for space vehicles and communications satellites

Requirements: an accredited Engineering degree, a minimum of two years of directly related experience and U.S. citizenship.

For immediate consideration, please airmail your resume to:

MR. ROBERT A. MARTIN
Head of Employment
Hughes Aerospace Divisions
Dept. 37
11940 W. Jefferson Blvd.
Culver City, Calif. 90230

HUGHES

HUGHES AIRCRAFT COMPANY
AEROSPACE DIVISIONS

An equal opportunity employer—M & F

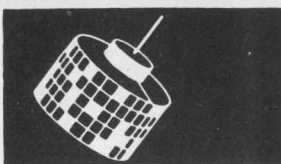
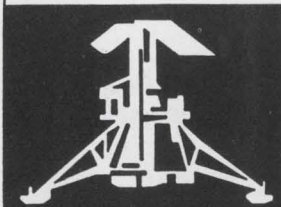

Book Reviews

Packaging opus

Handbook of Electronic Packaging, ed. Charles A. Harper, (McGraw-Hill Book Co., New York, N. Y.) 1200 pp. \$12.50.

This 1200-page volume elevates the technology of electronic packaging to a position of importance it has certainly earned. The handbook is divided into 15 well-organized chapters written by experts who represent the largest electronics companies in the industry.

Virtually all aspects of printed circuits, multilayer boards, flexible etched circuits, bonding techniques and basic materials are covered in the sections on materials and techniques. A second set of chapters covers mechanical, electrical and thermal design criteria and techniques for electronic packaging. Finally, a third group of chapters provides data and guidelines in the major application areas of aerospace, military and computer packaging.

CIRCLE NO. 368

Infrared-systems design

Infrared System Engineering, R. D. Hudson, Jr. (John Wiley & Sons, Inc., New York), 642 pp. \$19.75.

This applications-oriented treatment of infrared engineering opens with a historical discussion of the infrared portion of the electromagnetic spectrum. Following a systems approach, the subsequent chapters explore the separate elements of infrared technology, then explain the functional interaction of the individual elements when combined in a system.

The second part of the book focuses on the application of infrared technology to the solution of military, industrial, medical and scientific problems. Nearly 1400 references to the literature of the field are included.

CIRCLE NO. 369



Instrumentation
Engineers

c d c

is building computer
driven systems

WE NEED:

- ★ Computer language & hardware specialists for operations with IBM, Hewlett-Packard & PDP computers. Some training also offered.
- ★ Work areas include digital, linear, & circuit design responsibilities.
- ★ Applicants must be able to translate functional requirements to hardware and documentation.

WE OFFER:

Circuit design responsibility
Field service responsibility
Technical & Management growth

We are interested in:

Qualified professional people who will apply their capabilities to sustain our corporate growth. Excellent opportunity, working conditions, salary & benefits.

Apply or submit resume:

Mr. Pete Johnson
Industrial Relations
Manager

c d c 

**CONTINENTAL DEVICE
COMPONENTS**

A Teledyne Company
12515 S. Chadron Ave.
Hawthorne, California 90250
(213) 772-4551
M/F An Equal Opportunity Employer

Free Career Inquiry Service

Absolutely Confidential

Respond to the career opportunities advertised in this issue. Fill out and send us this handy resume. **Electronic Design** will do the rest – neatly typed copies of this form will be mailed to the companies of your choice, indicated by the circled Career Inquiry Numbers at the bottom of this page.

12

Name		Home Phone	
Home Address (Street)		City	State
		ZIP Code	
Age	U.S. Citizen	Security Clearance	
	<input type="checkbox"/> Yes <input type="checkbox"/> No		
Prime Experience		Secondary Experience	
Desired Salary		Availability Date	

Employment History – present and previous employers

Company			
City, State			
Dates	to	to	to
Title			
Specialty			

Education – indicate major if degree is not self-explanatory

Degree			
College			
City, State			
Dates	to	to	to

Additional Training – non-degree, industry, military, etc.

Professional Societies

Published Articles

Career Inquiry Numbers:

- | | | | | | | | | | |
|-----|-----|-----|-----|-----|-----|-----|-----|-----|---------|
| 900 | 901 | 902 | 903 | 904 | 905 | 906 | 907 | 908 | 909 |
| 910 | 911 | 912 | 913 | 914 | 915 | 916 | 917 | 918 | 919 925 |

ELECTRONIC DESIGN
 850 Third Avenue
 New York, New York 10022

ELECTRONIC DESIGN'S function is:

- To aid progress in the electronics manufacturing industry by promoting good design.
- To give the electronic design engineer concepts and ideas that make his job easier and more productive.
- To provide a central source of timely electronics information.
- To promote two-way communication between manufacturer and engineer.

Want a subscription? ELECTRONIC DESIGN is sent free to qualified engineers and engineering managers doing design work, supervising design or setting standards in the United States and Western Europe. For a free subscription, use the postfree application form inside the back cover. If none is included, write to us direct for an application form.

If you do not qualify, you may take out a paid subscription for \$25 a year in the U.S.A., \$35 a year elsewhere. Single copies are \$1.50 each.

If you change your address, send us an old mailing label and your new address; there is generally a prepaid postcard for this inside the back cover. You will have to requalify to continue receiving ELECTRONIC DESIGN free.

The accuracy policy of ELECTRONIC DESIGN is:

- To make reasonable efforts to ensure the accuracy of editorial matter.
- To publish prompt corrections whenever inaccuracies are brought to our attention. Corrections appear at the end of the Letters column.
- To refuse any advertisement deemed to be misleading or fraudulent.

Microfilm copies are available of complete volumes of ELECTRONIC DESIGN at \$19.00 per volume, beginning with Volume 9, 1961. Work is now in process to complete the microfilm edition of Volumes 1-8. Reprints of individual articles may be obtained for \$2.00 each, prepaid (\$.50 for each additional copy of the same article) no matter how long the article. For further details and to place orders, contact the Customer Services Department, University Microfilms, 300 North Zeeb Road, Ann Arbor, Michigan 48106; telephone (313) 761-4700.

Want to contact us? If you have any comments or wish to submit a manuscript or article outline, address your correspondence to:

Howard Bierman, Editor,
ELECTRONIC DESIGN,
850 Third Avenue,
New York, N.Y. 10022.

Design Data from

UNIQUE TO-5 SIZE RELAYS

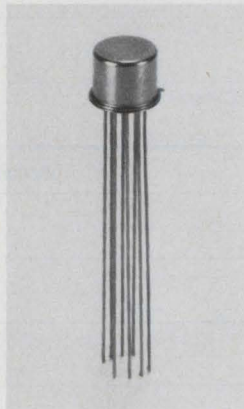

ACTUAL SIZE

An unusually efficient magnetic assembly gives Hi-G's new TO-5 size relays exceptionally good contact resistance. Meeting all applicable requirements of MIL-R-5757, these hermetically sealed DPDT relays are rated 1 amp at 32 Vdc. Bulletin No. 90, "Series MA and MS Microminiature Relays," is a 4 page data sheet detailing electrical and mechanical characteristics — as well as outlining Hi-G's strict environmental and quality control procedures maintained throughout manufacture. Send for your free copy by circling the number to the right.



Hi-G Incorporated
Spring Street and Route 75
Windsor Locks, Conn. 06096
(203) 623-2481

174

How To Write Technical Articles



A guide for the engineer-author, "How to Write Articles for Electronic Design" shows how easy it is to write for publication—once the engineer knows what to write and how to write it. The Author's Guide includes a complete run-down of the types of articles published by Electronic Design —plus detailed instructions on how to prepare technical articles and short special features. A MUST for every "would-be-writer" in the electronics industry. Send for your complimentary copy by circling the number to the right.

Electronic Design

850 Third Avenue
New York, N.Y. 10022

175

FUNDAMENTALS OF INTEGRATED CIRCUITS

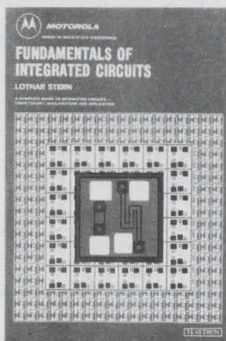

A practical guide to integrated circuits, their theory, manufacture, and applications. This new guide by Lothar Stern offers complete, highly readable coverage of the various techniques of circuit fabrication, and their effect on circuit design and performance. As to marketing considerations, it compares the characteristics of the numerous IC structures devised to date in terms of economics and logistics. A volume in the Motorola Series in Solid-State Electronics. 198 pages, 7 x 10, illustrated. \$8.95, clothbound. Send for 15-day examination copies.

Hayden Book Company, Inc.

116 West 14th Street
New York, N.Y. 10011

176

Manufacturers

Advertisements of booklets, brochures, catalogs and data sheets. To order use Reader-ServiceCard.
(Advertisement)

Terminal Block Selector



A new 24-page, completely illustrated catalog contains photos, descriptions, ratings, engineering drawings, and prices of the complete line of Curtis terminal blocks. Included are printed circuit, insulated feed-thru, quick disconnect, track type, and high current terminal blocks. Handy selection chart quickly locates the perfect block for your particular requirements. Send today for your free copy.

Curtis Development & Mfg. Co.
3236 North 33rd Street
Milwaukee, Wisconsin 53216

177

NEW 68-PAGE DRAFTING CATALOG — FREE

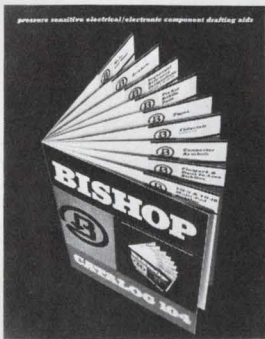

Bishop Catalog 104 — the most comprehensive manual type catalog of pressure-sensitive electrical/electronic component drafting aids ever assembled. Filled with thousands of printed wiring symbols and patterns to speed artwork preparation time and cut drafting costs. Featuring the latest information on printed wiring drafting techniques. Contains multi-pad component symbols, including flatpacs and dual in-lines. Also, general purpose wiring symbols, logics, schematics, reference designations, tapes, pads, shapes and many, many more. Send today for your free copy and samples.

Bishop Graphics, Inc.
7300 Radford Ave.
North Hollywood, California 91605
Phone: (213) 982-2000

178

FREE — CHIP CAPACITOR CATALOG



USCC's new 16-page illustrated catalog provides complete technical data for a broad line of sub-miniature Ceramolithic chip capacitors. Given are complete specifications, physical drawings and characteristic curves for both K1200 and NPO dielectrics. Featured are the smallest, most reliable chip capacitors on the market today. Also included are detailed procedures for tests conducted during manufacturing and high reliability testing. Handy chip size identification charts and complete part numbers facilitate ordering. Write today for your free copy.

USCC
2151 No. Lincoln Street
Burbank, California 91504
Phone: (213) 843-4222 TWX: 910-498-2222

179

Electronic Design

Advertising Sales Staff

New York 10022

Edward F. Clancy
Sales Service Manager
Robert W. Gascoigne
Thomas P. Barth
Samuel M. Deitch
Byron Adams
850 Third Avenue
(212) Plaza 1-5530
TWX: 867-7866

Philadelphia 19066

William C. Repetto
P. O. Box 206
Merion Station, Pa.
(215) MA-3-5888

Boston 01945

Richard Parker
P.O. Box 645
Clifton Station
Marblehead, Mass.
(617) 742-0252

Chicago 60611

Thomas P. Kavooras
Berry Conner, Jr.
200 East Ontario
(312) 337-0588

Cleveland

Thomas P. Kavooras
(Chicago)
(312) 337-0588
(call collect)

Los Angeles 90303

Stanley I. Ehrenclou
John V. Quillman
W. James Bischof
2930 Imperial Highway
Inglewood, Calif.
(213) 757-0183

San Francisco 94022

Arthur R. Shields, Jr.
175 San Antonio Rd., S 243
Los Altos, Calif.
(415) 941-3084

London W. 1

For United Kingdom & Holland
Brayton C. Nichols
44 Conduit Street
Tel: REGent 4714

Verviers, Belgium

For Continental Europe
Andre Jamar
1, Rue Mallar, 1
(087) 253.83 Telex 41563

Tokyo

Yoshio Takemura
IPS Group Ltd.
Box 36, Ohsaki Post Office
Phone (504) 1485
Cable Joshplans, Tokyo



Parker Power

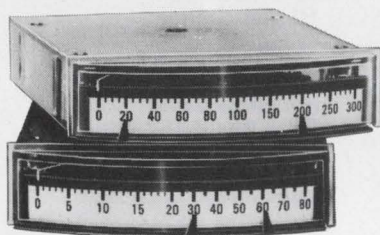

our tough, reliable
Control Meter!!

the ER-35

Complete control functions in minimum space, at minimum cost, retaining advantages of maximum readability and reliability. Design simplicity and standard options give you total flexibility in design and application.

the E-35

Matching indicator for use with ER-35 Control Meter when read-out only is required. Same appearance and panel cutout for uniform panel appearance.

Parker Instrument

A growth company dedicated entirely to manufacture and sale of Panel, Edgewise, and Control meters.



INSTRUMENT CORPORATION
200 Harvard Avenue • Stamford, Connecticut 06904
Telephone (203) 325-4361 • TWX 710-474-2277

Advertisers' Index

Advertiser	Page	Advertiser	Page
Alco Electronic Products, Inc.	180, 182, 184	Krohn-Hite Corporation	148
Alfred Electronics	60	Kurz-Kasch, Inc.	157
Allen-Bradley Co.	41, 43	Lansdale Transistor & Electronics, Inc.	142
Amphenol Controls Division, The Bunker-Ramo Corporation	59	Laser Diode Laboratories	161
Analog Devices, Inc.	16 A-B	Lear Siegler Inc., Cimron Division	45
Astrodata, Inc.	120, 121	Leasametric	169
Astrosystems, Inc.	165	Lockheed Electronics Company	57
Augat, Inc.	152	MicroSwitch, A Division of Honeywell	15
Automatic Coil Co.	166	Mohawk Data Sciences Corporation	56
B & B Motor & Control Corp.	156	Molex Products Company	55
Barden, A Division of Interdyne	143	Motorola Communications & Electronics, Inc.	61
Belden Corporation	50	Motorola Semiconductor Products, Inc.	17, 53
Bell Telephone Laboratories	123	National Beryllia Corporation	154
Bishop Graphics, Inc.	189	National Semiconductor Corporation	110, 111
Bodine Electric Company	175	Nytronics, Inc.	31
Boonton Electronics Corp.	176	Parker Instrument Corporation	190
Bourns, Inc.	145	Phelps Dodge Communications Company	181
Bulova Electronics Division of Bulova Watch Company	14	RCA Electronic Components and Devices	24, Cover IV
Burns & Towne, Inc.	162	Radiation, Incorporated	12
Burroughs Corporation	20	Raytheon Company, Semiconductor Operation	46
Caddock Electronics	191	Remac Components, Inc.	7
Cambridge Thermionic Corporation	170	Robinson Nugent, Incorporated	153
Centralab, the Electronics Division of Globe-Union, Inc.	150, 151	Rogan Brothers, Inc.	11
Ceramics Magnetics, Inc.	166	Schauer Manufacturing Corp.	180
Chassis-Trak Inc.	171	Servo-Tek Products Company	178
Clifton, Division of Litton Industries	38	Siemens America, Incorporated	10
Cohn Corp., Sigmund	158	Signetics Corporation	27
Constantine Engineering Labs. Co. (CELCO)	177	Siliconix Incorporated	151
Corning Glass Works, Electronic Products Division	36, 37	Simpson Electric Company	146
Coto Coil Company, Inc.	182	Singer Company, The, Gertsch Instrumentation	16
Curtis Development & Mfg. Co.	189	Sonotone Corporation, Battery Division	48
Cutler-Hammer	49	Spectrol Electronics Corporation	168
Dale Electronics, Inc.	Cover III	Sprague Electric Company	18
Datascan, Inc.	147	Stackpole Components Company	8, 9
Digital Equipment Corporation	51	Sylvania Electric Products, Inc.	138
Direct Access Computing Corporation	162	Systron-Donner Corporation	2
Discon Corporation	153	TRW Semiconductors, A Subsidiary of TRW, Inc.	140, 141
Dow Corning Corporation	104, 105	Tempil Division of Big Three Industrial Gas & Equipment Co.	152
Durant Digital Instruments, A Cutler-Hammer Company	174	Texas Instruments Incorporated, Components Group	98, 99
ETC, Inc.	177	Thermal American Fused Quartz Co., Inc.	168
Elco Corporation	35	Theta Instrument Corporation	23
Electrical Industries	164	Toyo Communication Equipment Co., Ltd.	182
Electro Materials, Division of Illinois Tool Works, Inc.	54	Trygon Power Supplies	158
Electronic Design	188	Tung Sol Division, Wagner Electric Corporation	6
Fairchild Semiconductor, A Division Fairfield Camera and Instrument Corporation	130, 131, 132, 133, 134, 135, 136, 137	Union Carbide Corporation	97
General Electric Company, Electronic Components	127	U. S. Capacitor Corporation	189
General Electric Company, Silicone Products Department	42	U.S. Components, Inc.	58
General Radio Company	1	U-Tech, A Division of Industrial Physics and Electronics Company	183
General Reed Company	166	Varian Electron Tube and Device Group	29
Hayden Book Company, Inc.	188	W & G Instruments, Inc.	44
Heath Company	185	Watkins-Johnson, CEI Division	163
Hewlett-Packard	Cover II, 33, 125, 142	Wentworth Labs, Inc.	153
Hi-G, Inc.	188	West-Cap Arizona, A Subsidiary of San Fernando Electric Manufacturing Co.	155
Honeywell, Precision Meter Division	62	Wheelock Signals, Inc.	179
Hughes Aircraft Company, Mosfet Devices	172, 173	White Industrial, S. S., A Division of Pennwalt Corporation	149
IRC, Division of TRW, Inc.	52	Whitney Metal Tool Company	156
Indiana General Corporation	4, 5	Wilson Technical Service, H. A.	157
Industrial Timer Corporation	170	Career Advertising:	
Inland Motor Corporation of Virginia	159	Continental Device Components, A Teledyne Company	186
Intradyme Systems, Inc.	13	Hughes Aircraft Company, Aerospace Divisions	186
Johanson Manufacturing Corp.	144	IBM Corporation	167
Johnson Company, E. F.	191	Lockheed Missiles & Space Company	184
Keithley Instruments, Inc.	160	Spicer & Associates, Inc.	184
Keystone Carbon Company	129		
Kinetic Technology, Incorporated	64		

New, miniature Teflon® trimmers

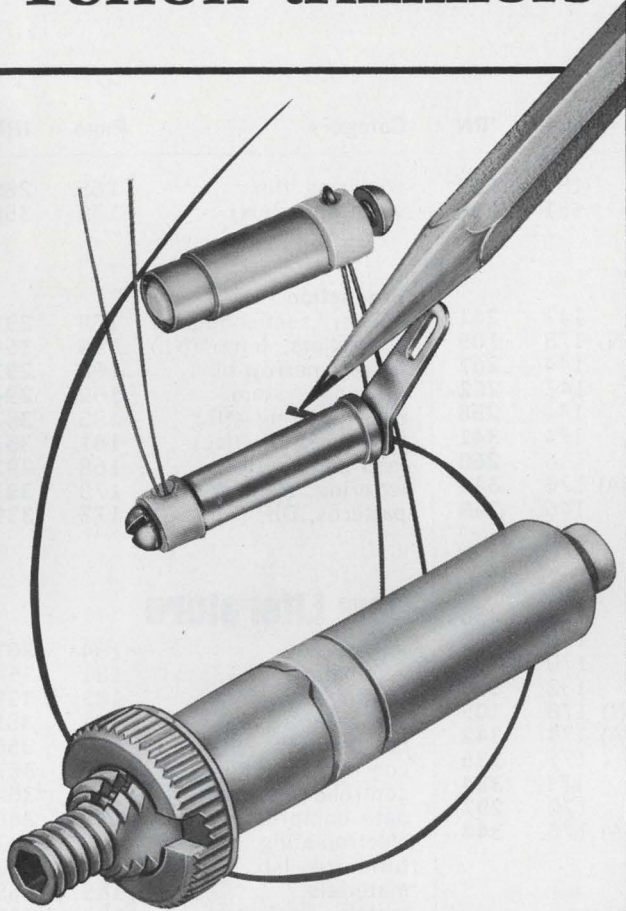

These new trimming capacitors are ideally suited for VHF and UHF applications requiring low minimum capacity and delta C. They provide high resolution and are electrically stable. Tuning is linear. High Q (2000 at 1 MHz typical). Insulation resistance 10⁶ megohms. Temperature range—55° to +150°C. Voltage breakdown 2000 VDC. Part numbers 273-1-1 and 273-1-2 nominal capacity .25 pf min., 1.5 pf max.; part 273-15-1 nominal .30 pf min., 2.9 pf max.

Metal parts are gold plated on PC and solder lug mounting types, silver plated on panel mount. Insulation is Teflon.® Rotor screw threaded 80 turns to the inch on PC and solder lug types, 40 turns per inch on panel mount version. Resistant to shock and vibration.

See your Johnson representative or write for complete information.

©Teflon is a registered trade name of DuPont Co.



E. F. JOHNSON COMPANY

3306 Tenth Ave. S.W., Waseca, Minnesota 56093

Providing nearly a half-century of communications leadership

MINIATURE MEGOHM RESISTORS

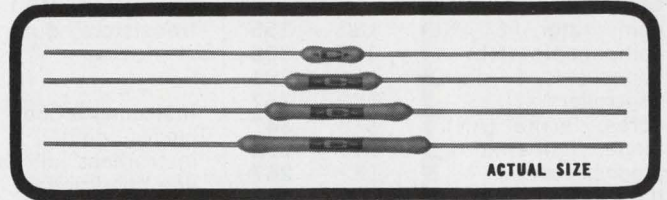

ACTUAL SIZE

T.C. Absolute: 80 PPM/°C*

T.C. Tracking: to 5 PPM/°C on special order.

Applications include high voltage dividers, high resistance networks, precision RC timing circuits, etc. We specialize in network sets with matched characteristics. Facilities available to perform Hi Rel screening.

Model No.	Wattage	Max. Voltage	Dielect Str'gth	Resistance		Dimensions		
				Min.	Max.	Length	Dia.	Lead Dia.
MG 650	.5	600	750	500 K	5 meg	.313 ±.020	.094 ±.015	.025 ±.002
MG 660	.6	1000	750	1 meg	10 meg	.500 ±.030	.094 ±.015	.025 ±.002
MG 680	.8	1500	750	1 meg	15 meg	.750 ±.030	.094 ±.015	.025 ±.002
MG 710	1.0	2000	750	1 meg	20 meg	1.000 ±.040	.094 ±.015	.025 ±.002
MG 721	2.0	2500	1000	1 meg	30 meg	1.000 ±.050	.240 ±.030	.040 ±.002
MG 750	3.0	3000	1000	3 meg	150 meg	2.125 ±.060	.315 ±.030	.040 ±.002
MG 780	5.0	4000	1000	4 meg	220 meg	3.125 ±.060	.315 ±.030	.040 ±.002

*Temperature Coefficient: 80 ppm/°C referenced to 25°C, ΔR taken at -15°C and +105°C. Maximum operating temperature: 225°C. Resistance Tolerance: ±1% (tolerances to .2% on special order). Insulation Resistance: 100 megohms, minimum. Overvoltage: 1.5 times working voltage for 5 seconds, R shift .8% max. Thermal Shock: MIL-STD-202, method 107, cond. C, R shift .5% max. Moisture Resistance: MIL-STD-202, method 106, R shift .8% max. Loadlife: 1000 hours at rated power, R shift .8% max. Encapsulation: Silicone Conformal. Leadwire: Gold Plated Dumet 1½" long ±¼".

MICRONOX™ Resistance Films

Micronox resistance films are produced exclusively by Caddock Electronics. They are composed of complex oxides fired in air at temperatures above 1400°F. The resulting films are relatively insensitive to high ambient temperatures and thermal shock. Films show negligible effect from moisture.

This totally new approach to precision resistors and networks opens new design possibilities because of the wide resistance range, precise temperature characteristics, and high temperature and power capability. Temperature coefficient can be accurately reproduced (within ±10 ppm/°C of curve if required). The typical curve shown below will vary slightly with resistivity of the film and configuration of the substrate.

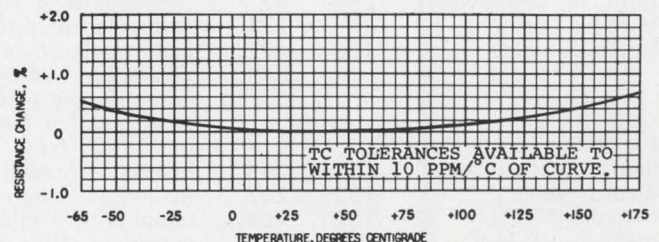

CADDOCK ELECTRONICS

3127 Chicago Avenue, Riverside, California 92507 • Telephone: (714) 683-5361

Information Retrieval Service

All products, design aids (DA), application notes (AN), new literature (NL), and reprints (R) in this issue are listed here with Page and Information Retrieval numbers. Reader requests will be promptly processed by computer and mailed to the manufacturer within three days.

Category	Page	IRN	Category	Page	IRN	Category	Page	IRN
Components			thermistors (NL)	184	362	soldering flux	165	289
comparator, FET (NL)	182	355	transistors, dual	151	266	valve data (AN)	179	350
components (NL)	182	356	Instrumentation			Production		
connectors, 14-pin DIP	166	291	clocks, digital	147	261	bonder, semiconductor	169	295
controllers (NL)	182	357	instrument journal (AN)	178	105	controllers, temp (NL)	184	364
cores, ferrite (AN)	178	347	line conditioner	144	257	cutter, narrow-tip	168	293
diode, light-emitting	148	263	measuring system	147	262	drawing system	169	294
diodes, zener	152	267	meter, digital panel	144	258	electroplating (NL)	185	367
ICs, digital TTL	152	268	meter design kit (DA)	174	341	furniture, lab (NL)	181	353
indicators, temp (ES)	173	338	phase meter	146	260	lead bender, IC	168	292
inserts, threaded (AN)	178	345	S-parameter charts (DA)	176	344	lettering, transfer (ES)	173	337
lamp, coaxial T-3/4	141	252	transmission test set	146	259	patterns, DIP (ES)	173	339
lamp, microminiature	143	255	Microwaves & Lasers			New Literature		
lamp, reflector	141	251	circulator, 1-to-2-GHz	171	336	adhesive	184	361
memory, 1024-bit	151	265	circulator, Xb-band	170	296	calculators	181	354
motor, stepping	142	253	coax switch, 18-GHz	170	298	coatings, surface	183	359
nameplates (ES)	173	340	components (NL)	182	356	comparator, FET	182	355
op amp, differential	162	283	instrument journal (AN)	178	105	components	182	356
op amp, low-cost	160	280	laser demonstrator (DA)	174	342	controllers, fluidic	182	357
op amp, wideband	162	282	laser system	171	335	controllers, temp	184	364
op amps, low-cost (NL)	180	351	microstrip adapter	171	334	data compression	185	366
potentiometer, plastic	143	256	receiver, 1-to-2-GHz	170	297	electroplating	185	367
printed circuits (AN)	179	351	S-parameter charts (DA)	176	344	furniture, lab	181	353
register, dynamic	148	264	Modules & Subassemblies			materials	185	365
relays (AN)	178	346	breadboard, DIP	164	287	metals, laminated	183	360
relays (NL)	184	363	breadboarding kit	165	288	op amps, low-cost	180	351
resistors, power	141	250	comparator, FET (NL)	182	355	relays	184	363
semiconductors,			controllers (NL)	182	357	switches	183	358
hardened	152	269	controllers, temp (NL)	184	364	switches, manual	180	352
switches (NL)	183	358	multiplier, 4-quadrant	163	285	thermistors	184	362
switches, manual (NL)	180	352	op amp, differential	162	283	Application Notes		
switches, rotary	142	254	op amp, low-cost	160	280	cores, ferrite	178	347
thermistors (AN)	179	349	op amp, wideband	162	282	inserts, threaded	178	345
thermistors (NL)	184	362	op amps, low-cost (NL)	180	351	instrument journal	178	105
transistors, dual	151	266	regulators, voltage	163	284	printed circuits	179	351
valve data (AN)	179	350	relays (AN)	178	346	relays	178	346
Data Processing			relays (NL)	184	363	thermistors	179	349
calculators (NL)	181	354	resistor, negative	160	281	valve data	179	350
computer, industrial	155	273	Packaging & Materials			Design Aids		
data compression (NL)	185	366	adhesive (NL)	184	361	ceramics chart	176	343
data instruments	156	274	breadboard, DIP	164	287	laser demonstrator	174	342
data terminal	154	270	breadboarding kit	165	288	meter design kit	174	341
disc pack	159	279	ceramics chart (DA)	176	343	S-parameter charts	175	344
memory, 1024-bit	151	265	coatings, surface (NL)	183	359	Evaluation Samples		
modem, high-speed	158	276	connectors, 14-pin DIP	166	291	indicators, temp	173	338
reader/terminal	159	278	cores, ferrite (AN)	178	347	lettering, transfer	173	337
register, dynamic	148	264	electroplating (NL)	185	367	nameplates	173	340
synchronizer, disc-drive	155	272	indicators, temp (ES)	173	338	patterns, DIP	173	339
terminal, CRT display	156	275	inserts, threaded (AN)	178	345			
terminal, printing	154	271	insulators, silicone	166	290			
terminal, video	158	277	liquid-crystal kits	164	286			
ICs & Semiconductors			materials (NL)	185	365			
diode, light-emitting	148	263	metals, laminated (NL)	183	360			
diodes, zener	152	267	nameplates (ES)	173	340			
ICs, digital TTL	152	268	patterns, DIP (ES)	173	339			
memory, 1024-bit	151	265	printed circuits (AN)	179	351			
register, dynamic	148	264						
semiconductors,								
hardened	152	269						
thermistors (AN)	179	349						

“”

“Funny,
you don't
look
resistive”



Dale reacts faster to your non-standard needs.

The resistive function you design doesn't have to have a standard shape and size...not when you deal with Dale. Look at these examples. The big one is a point for a vending machine can opener. Inside a Dale resistor provides heat for sterilization after each use. The small one is deceptively powerful—capable of 21 watts when heat sink mounted inside a computer to terminate line drive impulses. Of course, your problems will be different. But Dale has a head start toward solving them. Production blueprints on hundreds of special design situations including special packaging, termination, performance extremes, matching let us slash the lead time you'd expect for a non-standard part. Wirewound or film, single component or network, if you can't find it in your catalogs, call Dale first...402-564-3131.

Write for Dale's
**FUNCTIONAL GUIDE
TO NON-STANDARD
RESISTORS**

...listing by function
hundreds of readily
available design combina-
tions involving special
size, shape, performance
and other variables.

**FUNCTIONAL
GUIDE TO
NON-STANDARD
RESISTORS**

DALE



DALE ELECTRONICS, INC.

1352 28th Avenue,
Columbus, Nebr. 68601
In Canada, Dale Electronics, Ltd.



INFORMATION RETRIEVAL NUMBER 243

The Inside Story of Handling Current at High Speeds

Now, RCA introduces the multiple-emitter chip, a concept using RCA "overlay" techniques, in 2N5038 and 2N5039—multi-epitaxial silicon transistors for high-speed switching circuits. On the inside is the pellet with 12 discrete emitter sites, interconnected by a 12-pronged heat-conducting copper slug. The use of individual emitter sites provides the excellent 20-ampere current handling capabilities of these devices by increasing the emitter periphery. The copper slug assures good temperature and voltage distribution among the emitter sites across the pellet, and further contributes to the current handling, *while adding significantly to the forward second breakdown capability of the device.* These concepts (discrete emitters and copper slug) eliminate the non-uniform current injection normally associated with high current interdigitated transistor structures.

For the design engineer, 2N5038 and 2N5039 represent the right combination of mechanical structure and performance characteristics. They have low saturation voltage (1.0 volt max. at 12 A for 2N5038 and at 10 A for 2N5039) and fast saturated switching times (turn-on less than $0.5 \mu\text{s}$ and turn-off less than $2 \mu\text{s}$).

Available in production quantities, 2N5038 and 2N5039 are useful in a wide variety of applications including: dc-to-dc converters (at 25 KHz, 250 watts and 85% eff. may be achieved) and high frequency switching regulators (up to 50 KHz, 700 watts output, with 95% eff.). Both units make good linear amplifiers at frequencies up to 5 MHz.

Call your RCA representative today for more information or see your RCA Distributor. For technical data, write: RCA Electronic Components, Commercial Engineering, Section No. IG6-1, Harrison, N. J. 07029.

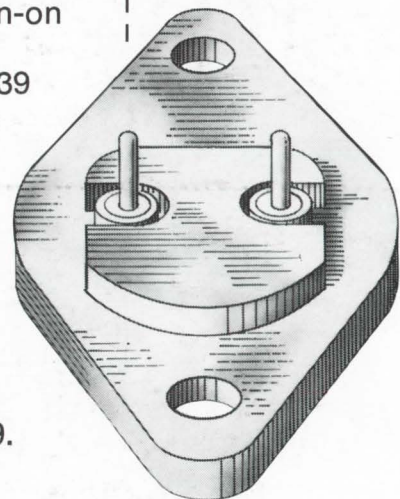
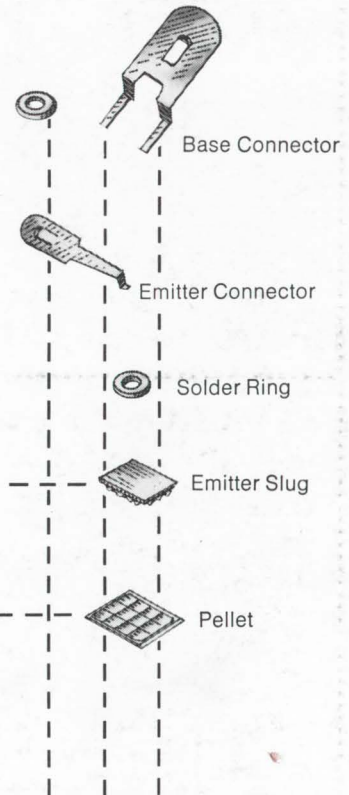

RCA