

Electronic Design 10

VOL. 18 NO.

FOR ENGINEERS AND ENGINEERING MANAGERS

MAY 10, 1970

The Paris Components Show — 20 countries, including the U.S. where East meets West. This Products on exhibition? From year's huge international trade exposition drew about 80,000 microwave tubes to memories visitors and 784 companies from to LSI devices. For the story on Europe's big show, see p. 25

RECEIVED
MAY 13 1970
GANNETT CO.

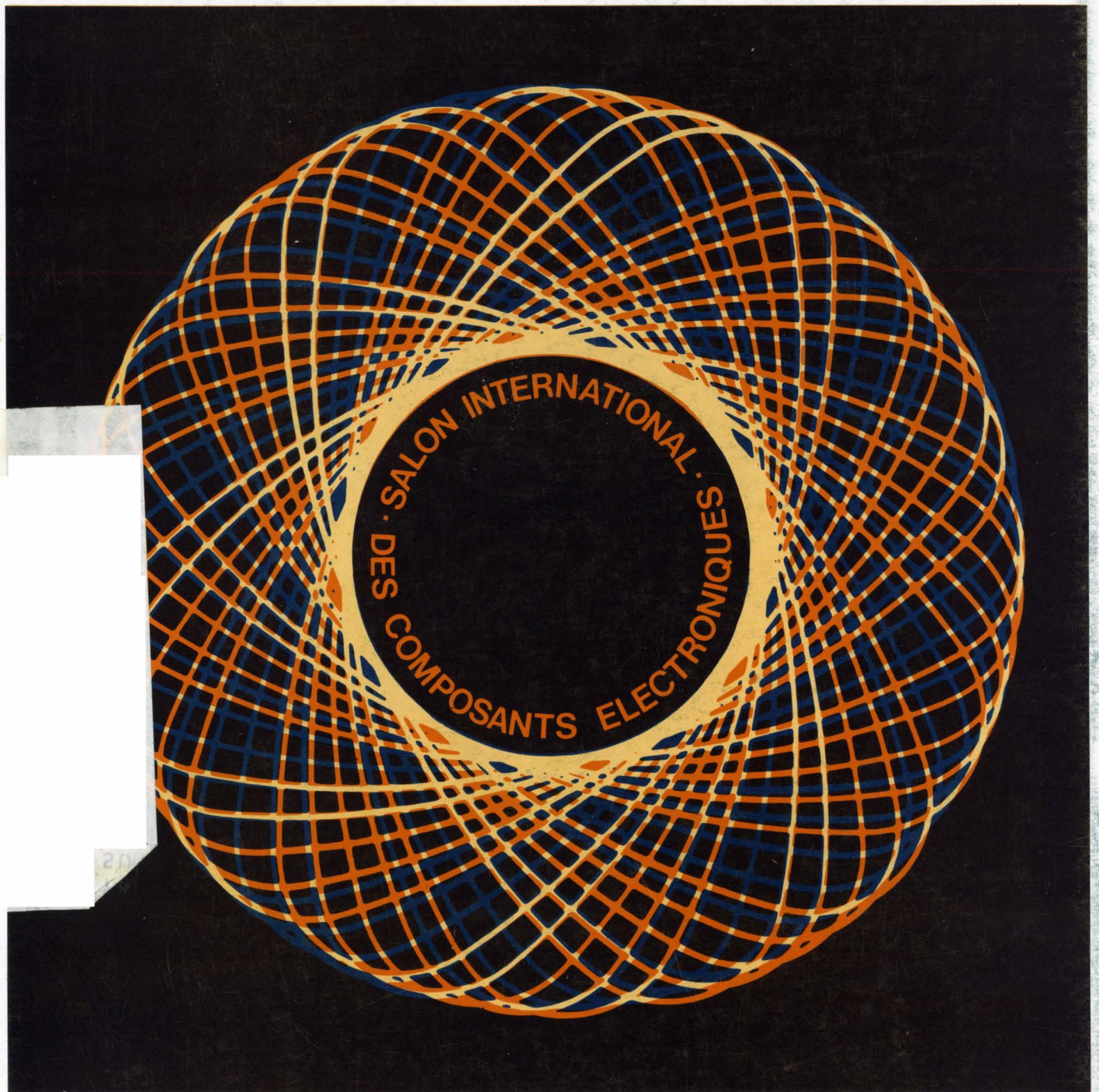

If price and performance are important— here's a 7 MHz value

This is a lab-quality, all-solid-state scope—at a price you'd ordinarily expect to pay for older vacuum-tube models.

Value—DC to 7 MHz bandwidth. This frequency range covers audio, video and most control circuit applications.

Value—5 mV to 20 V per division deflection factor. Here is sufficient capability to pick up most electronic or electro-mechanical system outputs without distortion or need for additional amplifiers.

Value—Rock solid triggering with capabilities ordinarily found only in more expensive lab type oscilloscopes . . . triggered or recurrent sweep, single-sweep, and automatic triggering.

Value—Low drift, long-term stability. Field effect transistors virtually eliminate drift from temperature changes, shock or vibration. Long-term stability means less frequent calibration.

Value—Easy to use. Logical arrangements of controls, beam finder, auto-triggering make operation easy. Interlocking controls on sweep time and magnifier prevent readout errors.

Value—Easy-to-see display. Internal graticule, 8 x 10 cm CRT for measurement accuracy. Bright, small spot-size trace increases visibility and resolution.

Value—Available in single channel cabinet or rack versions (1215A or 1215B), or in dual-channel cabinet or rack versions (1217A or 1217B). Electrical characteristics are identical. Rack version is only 5¼" high. Panel on the cabinet version is about the size of this page.

Value—Price, 1215A/B, \$950; 1217A/B, \$1175. Add up the features, then divide by price and you'll find this is the greatest performance/dollar value ever offered.

These 7 MHz oscilloscopes are new members of HP's growing family of low- and mid-frequency oscilloscopes. In addition to these new mid-range scopes you have 500 kHz scopes in 14 models with your choice of: Single or dual trace, 100 μ V/cm or 5 mV/cm deflection factors, conventional display or variable persistence and storage, all in cabinet or rack versions.

If you're looking for accurate mid-frequency measurements, ease of use, reliability—all at a low cost—here's a real 7 MHz value!

Call your local HP field engineer. Or, write to Hewlett-Packard, Palo Alto, California 94304. Europe: 1217 Meyrin-Geneva, Switzerland.

HEWLETT  PACKARD
OSCILLOSCOPE SYSTEMS

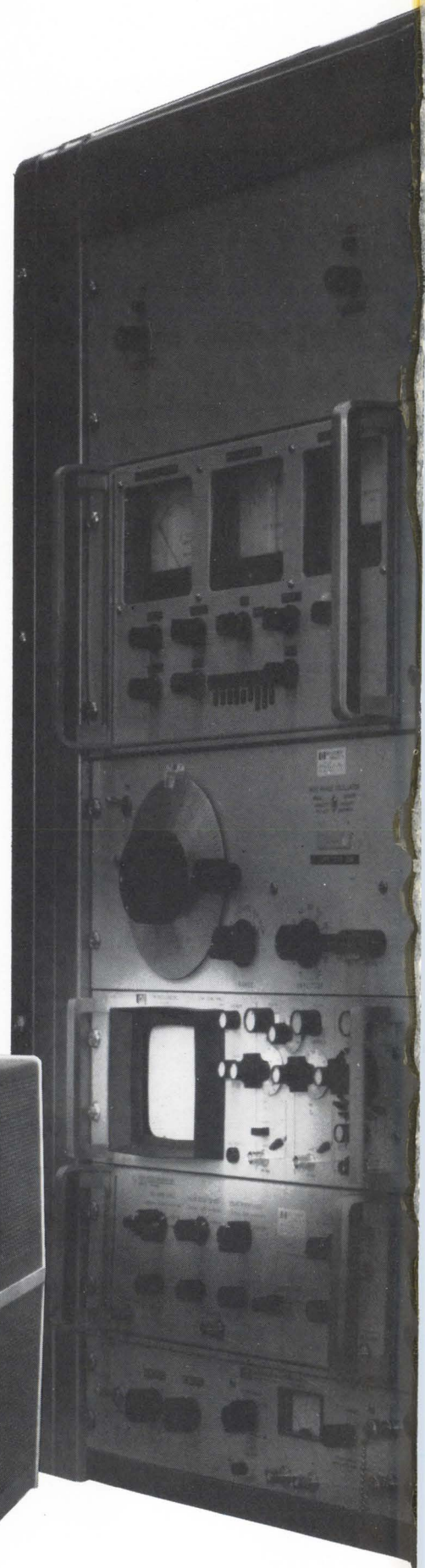
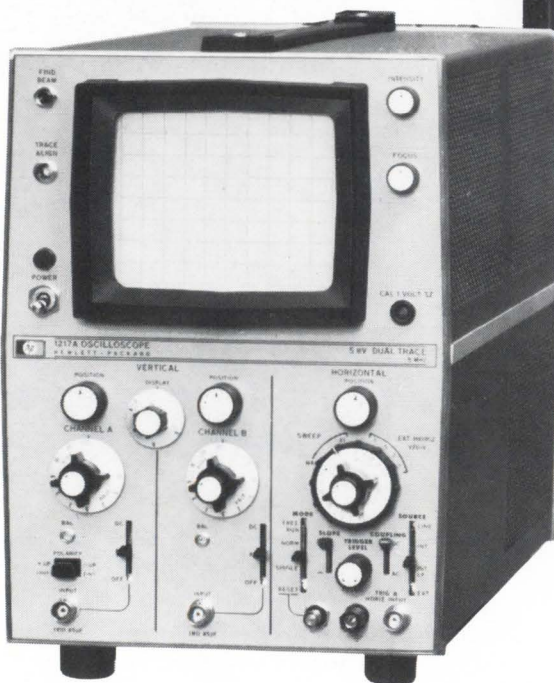

Suppose you wanted an Automatic RLC Bridge

that could measure up to 2 M Ω resistance, 2000 H inductance, and 0.2 F capacitance, plus equivalent series resistance and leakage current. A bridge with 5-digit resolution for reactance and resistive readouts, automatic decimal point and units of measurement; a 20-measurements-per-second capa-

bility; 120-Hz and 1-kHz test frequencies; 5-terminal connections to preserve a basic 0.1% accuracy; a built-in 0 to 3-V bias or external bias to 600 V; optional remote programmability and data output.

And prices that start at \$4,215. (in U.S.A.)

Where could you possibly find such a bridge?

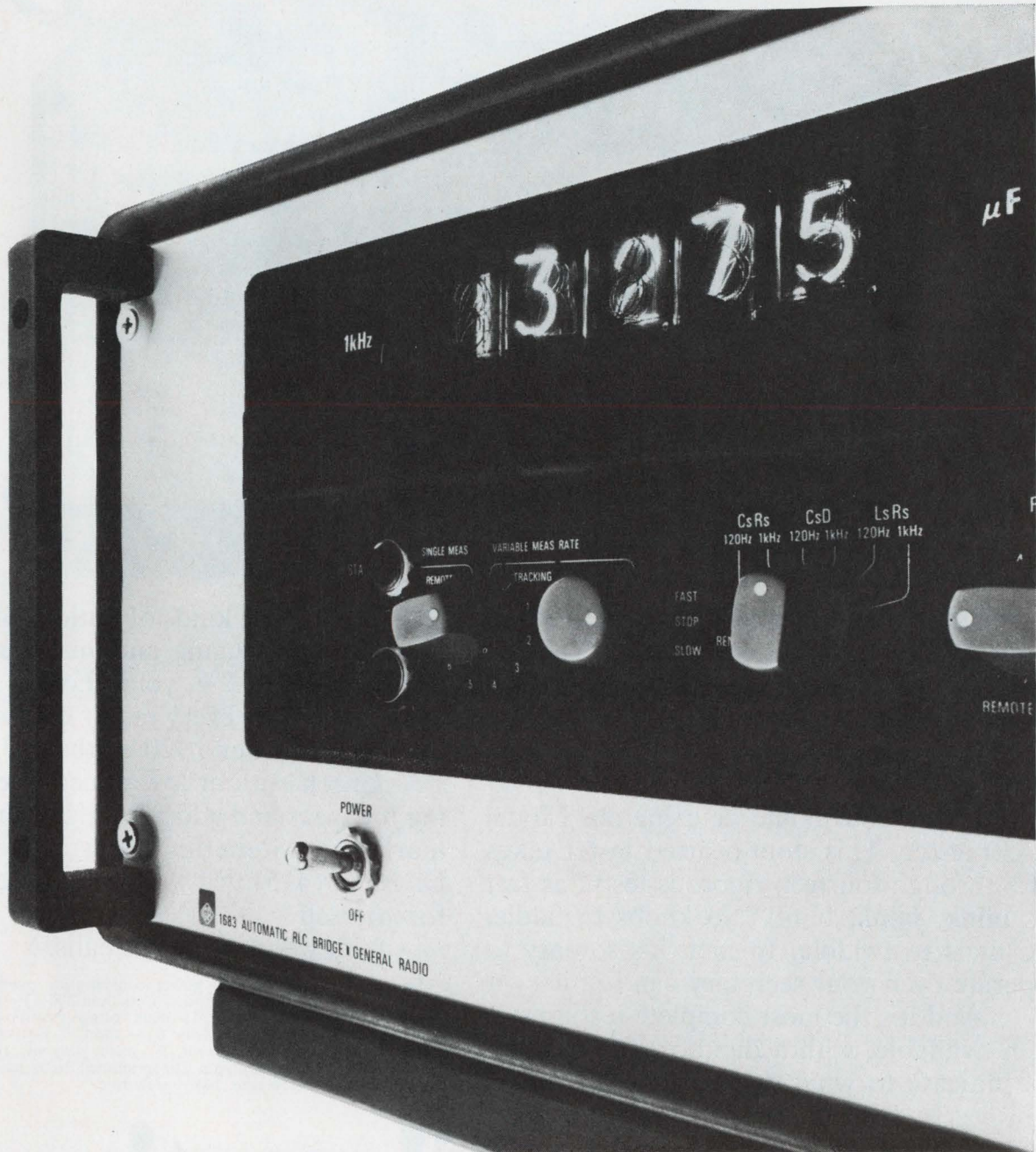

1683 Automatic RLC Bridge by **GENERAL RADIO**

West Concord, Mass. 01781 Tel: (617) 369-4400 Europe: Postfach 124, CH 8034 Zurich, Switzerland

INFORMATION RETRIEVAL NUMBER 2



Is your IC tester physically fit?



Does your tester test comparators and op amps?

Does your tester test with single card programming?

Is your tester simple to operate and fast?

If not, you should be using our Model 1420 tester. This stout-hearted tester takes ICs through fourteen rigorous tests* as fast as blink, blink, blink. No knobs to fiddle, no dials to twiddle. In fact, it's so easy to operate even your secretary can use it.

And it's the most complete testing system available, with a digital readout meter to indicate to what degree each IC passes

or fails. Plus, all kinds of options like classification, data logging and an accuracy rating from 1% to 5%, your choice.

That's why every major op amp manufacturer owns our 1420 or the 1410.

Check out our low priced line by writing for specs and addendum. Better yet, call marketing, Signetics Measurement Data Division, (415) 961-9384. And see the line for yourself.

Yes, we make house calls.

*The fearsome fourteen...1) power consumption overrange (greater than 200%), 2) power consumption (less than 200%), 3) offset voltage (source resistance zero ohms), 4) offset voltage (source resistance programmed), 5) + supply sensitivity, 6) - supply sensitivity, 7) common mode rejection, 8) bias current, 9) offset current, 10) gain (programmed full load), 11) gain (programmed light load), 12) noise, oscillation, 13) + slew rate, 14) - slew rate.

Signetics

MEASUREMENT/DATA

Signetics, Measurement/Data, 341 Moffett Blvd., Mountain View, Calif. 94040/A subsidiary of Corning Glass Works

INFORMATION RETRIEVAL NUMBER 3

NEWS

- 21 **News Scope**
- 25 **Big show with an eye for the tiny**
Paris components exhibition lures manufacturers from 20 countries, and they stress miniaturization.
- 30 **Pilots ask FAA for proximity warner—now**
A cheaper device is sought instead of expensive time-frequency system under slow development.
- 32 **Navy to computerize its message processing**
Device under test screens radio transmissions to ships and accepts only those that are 'relevant.'
- 34 **Laser or millimeter space communications?**
Both can do the job, 3 specialists conclude, but millimeter system can be put into operation first.
- 39 **Washington Report**

TECHNOLOGY

- 76 **Predict intermodulation distortion** from cross-modulation measurements. Third-order intermod and cross-mod have the same origin—and specs.
- 82 **Clock and control with TTL.** Standard logic components display time and generate command signals for as little as \$180.
- 92 **Use ECAP to design transistor models**—and refine approximate circuits to compute more accurate parameters.
- 98 **Synchro-to-digital converters:** Part 5 (conclusion) describes a mathematically exact encoder and discusses multispeed design.
- 106 **Get to know your local SBA agent.** If you qualify, he can help you obtain loans, management assistance, and government contracts.
- 112 **Ideas for Design**
- 121 **Product Source Directory:** Oscillators

PRODUCTS

- 129 **ICs & Semiconductors:** Schottky-clamped TTL ICs feature 3-ns delays.
- 136 **Modules & Subassemblies:** Chopperless op amp holds drift to 0.25 $\mu\text{V}/^\circ\text{C}$.
- 140 **Data Processing:** Terminal with photochromic-glass CRT makes hard copy.
- | | |
|-------------------------|------------------------------|
| 145 Instrumentation | 155 Packaging & Materials |
| 149 Components | 156 Tools & Engineering Aids |
| 151 Microwaves & Lasers | 176 Product Index |

Departments

- | | |
|---|------------------------|
| 75 Editorial: Don't take technology out of ecology | |
| 13 Designer's Calendar | 162 Annual Reports |
| 46 Sidelights | 164 Application Notes |
| 158 Evaluation Samples | 166 New Literature |
| 160 Design Aids | 174 Advertisers' Index |

Information Retrieval Service Card inside back cover

Cover: Designed by Art Director Clifford M. Gardiner.

ELECTRONIC DESIGN is published biweekly by Hayden Publishing Company, Inc., 850 Third Avenue, New York, N.Y. 10022. James S. Mulholland, Jr., President. Printed at Brown Printing Co., Inc., Waseca, Minn. Controlled circulation postage paid at Waseca, Minn., and New York, N.Y. Copyright © 1970, Hayden Publishing Company, Inc. 81,801 copies this issue.

what!



really!



yes, mag
tape
terminals



TELETYPE?

It's true.

After helping a jillion feet of paper tape wind and unwind its way through communications systems everywhere, Teletype announces the addition of magnetic tape data terminals.

There are some basic advantages in both mediums. But as you are well aware, the medium that's right for a system depends a lot on the application criteria.

The new magnetic tape data terminals have many operational features that make life less complicated for the operator.

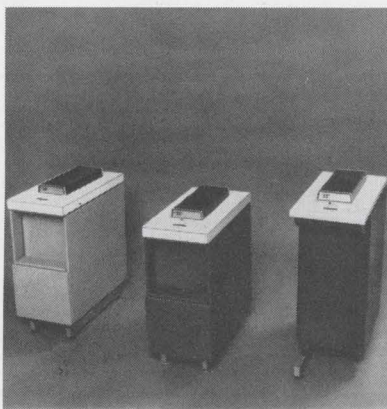

New, modular line of Teletype® 4210 magnetic tape data terminals.

For example, take a look at the tape cartridge, which was specifically designed for reliability required for data transmission.

Its vital statistics are: 3" x 3" x 1".

It contains 100 feet of 1/2" precision magnetic tape.

It will hold 150,000 characters of data, recorded at a density of 125 characters per inch. The equivalent of a 1000 foot roll of paper tape.

This means that your data is easier to store, easier to handle, easier to work with than ever before. And it's reusable.

DATA COMMUNICATIONS

equipment for on-line, real-time processing

The units have a "fast access" switch which will move tape forward or reverse at a speed of 33 inches per second. A digit counter provides a reference point to help locate various areas of the tape.

Four ASCII control code characters can be recorded in the data format to aid character search operations. When the terminal's "search" button is pressed, tape moves at the rate of 400 characters per second

Also magnetic tape adds high speed on-line capability to low speed data terminals.

You can zip data along the line at up to 2400 words per minute. For example: Take a standard speed Teletype keyboard send-receive set, and a typical typist. Add a new magnetic tape unit to this combination and the on-line time savings can pay for the magnetic tape terminal in short order.

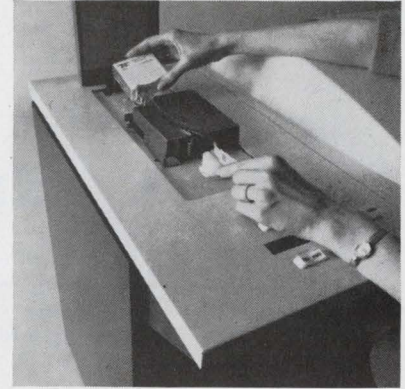

Straight-through threading makes tape loading and unloading exceptionally easy.

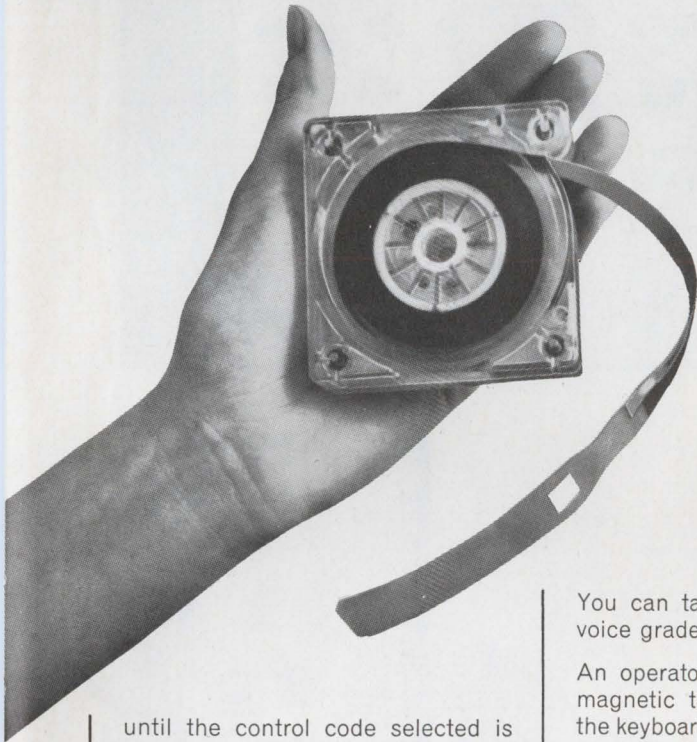

until the control code selected is detected. Then the terminal stops the tape automatically.

A "single step" switch is also provided which enables you to move the tape forward or backward one character at a time. In editing or correcting tape, you can send a single character using this feature.

You can take better advantage of voice grade line speed capabilities.

An operator can prepare data for magnetic tape transmission using the keyboard terminal in local mode. Then send it on-line via the magnetic tape terminal up to 2400 words per minute.

These new modular magnetic tape data terminals offered by Teletype are perfectly compatible with model 33, model 35, model 37 and Inktronic® keyboard send-receive equipment.

They can send or receive at high or low speed. Or can be used independently as stand-alone terminals on-line.

If you would like to know more about this new line of Teletype magnetic tape data terminals, please write Teletype Corporation, Dept. 89-15, 5555 Touhy Avenue, Skokie, Illinois 60076.



Teletype 4210 magnetic tape data terminal with 37 keyboard send-receive set.

machines that make data move



digital system instruments on your bench

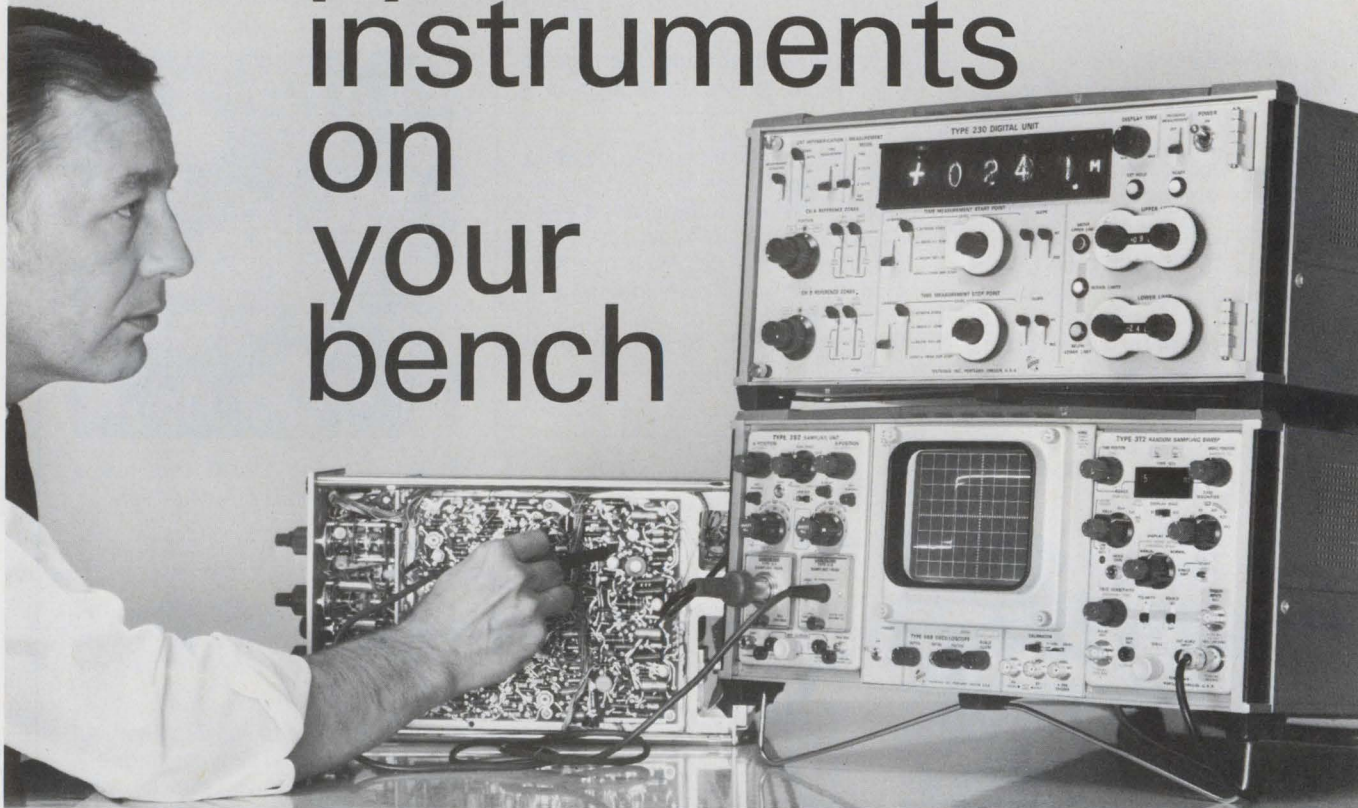

Digitize Analog Information

The Type 568/230 Digital Oscilloscope system provides digital readout of measurements from waveforms that are displayed in analog form on the CRT. The basic measurement characteristics are determined by the combination of the sampling sweep unit, the sampling vertical unit and the individual sampling heads used.

The Type 568/230 enables the engineer, technician or production worker to make dynamic switching time-measurements with greater speed, convenience and repeatability than is possible by making measurements directly from the cathode-ray oscilloscope display. Typical measurements include pulse amplitudes, risetime, delay time, storage time, pulse width and other related measurements.

The Type 568 Oscilloscope and the Type 230 Digital Unit are basic components in all Tektronix Digital Measurement Systems. Starting on your bench in development, progressing to a semi-automated system in pilot production and continuing in a fully-automated system in regular production, they provide the ability to correlate data on your product through all its testing phases.

Type 568 Oscilloscope without Plug-In Units	\$1025
Type 230 Digital Unit	\$3520
Instrument Combination Pictured Above	\$7330

U.S. Sales Prices FOB Beaverton, Oregon

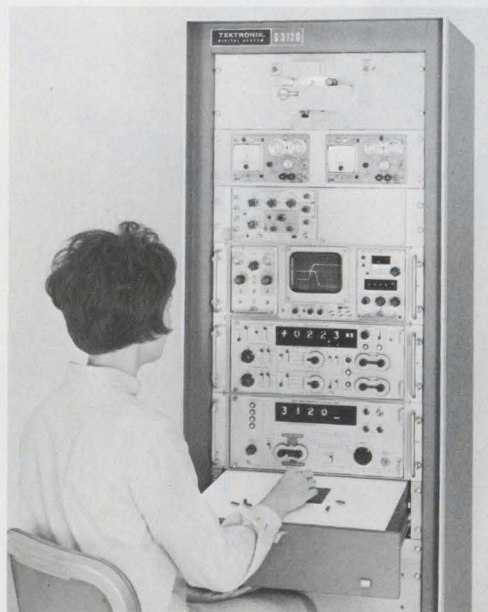

For complete information on digital and sampling instruments, please contact your local Field Engineer or refer to your Tektronix catalog.



Tektronix, Inc.
committed to progress in waveform measurement

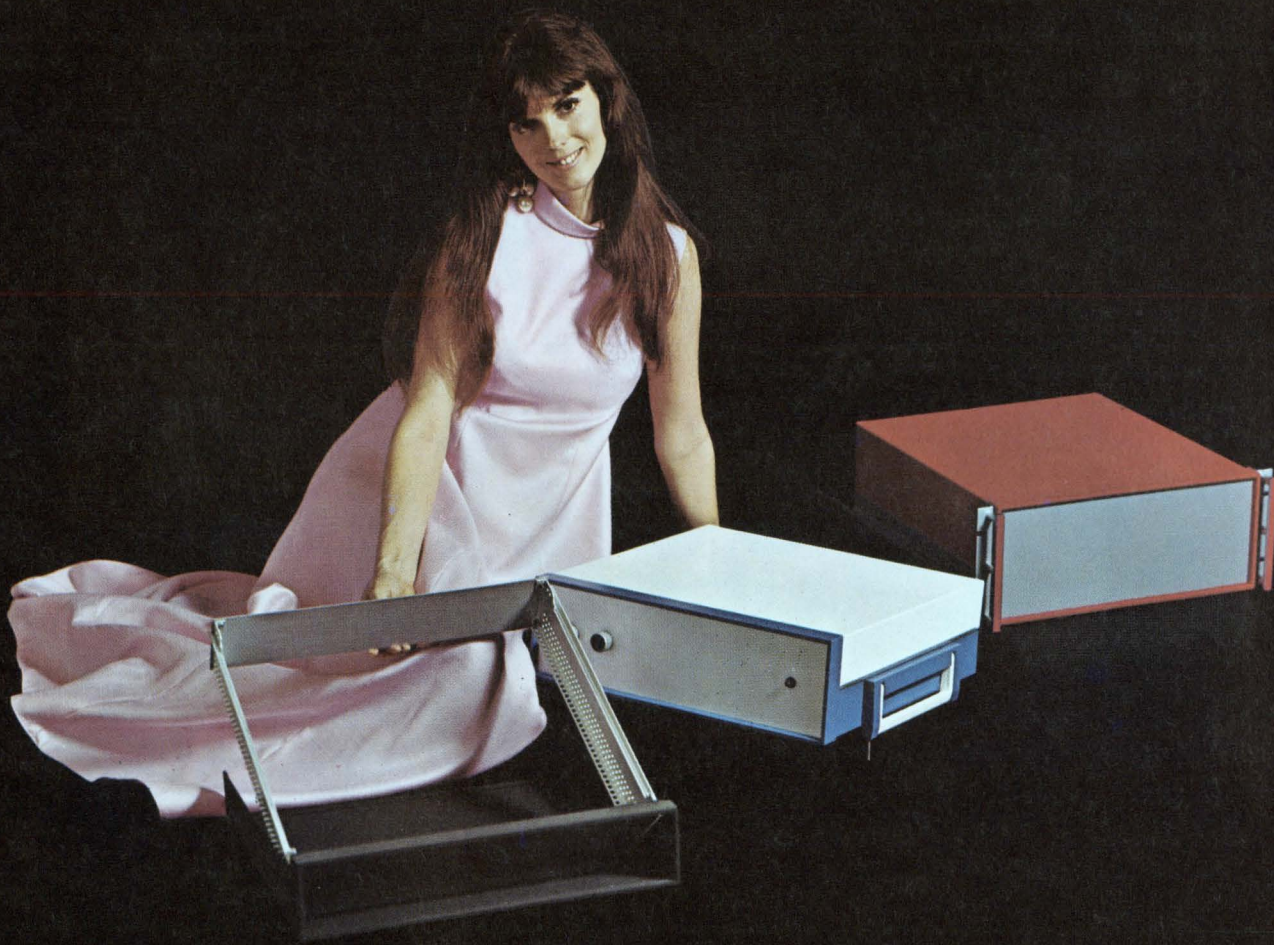

OPTIMA 17
an elegant combination of chassis and case. Rackable.

Optima enclosures, a division of Scientific-Atlanta, Inc. P.O. Box 13654, Atlanta, Georgia 30324. Telephone 404-939-6340

Who says you can't get beam lead?

Raytheon beam lead devices
available now in chip form,
in standard or custom packages,
or in hybrid assemblies.

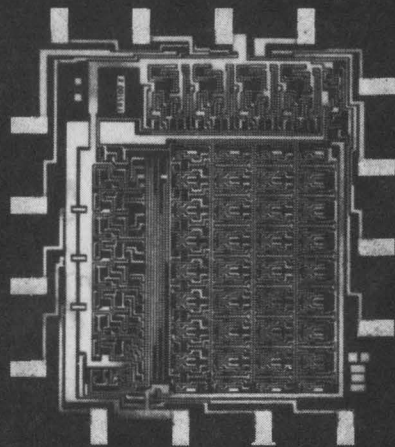

Help! We're up to our ears in beam lead semiconductor devices. All kinds. And more coming every day.

Hybrids, cans, dips or chips

Buy the chips. Take them in TO-18 cans or DIPs. Get them in custom packages. Or take advantage of our capability to design, assemble and completely test them in custom hybrid assemblies.

Any way you need them, we'll sell them. Now.

So don't just stand there. Send orders.

To the company that gets the ideas and delivers the goods.

Raytheon Semiconductor,
350 Ellis St.
Mountain View,
California
94040.
Phone (415)
968-9211.

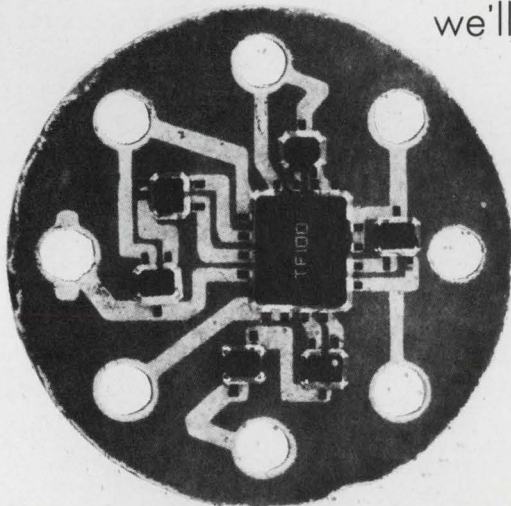

Raytheon custom beam lead hybrid assembly

Come and get them

Beam lead T¹L RAY I & II series

RG130, 1, 2, 3: Dual 4 input line driver	Now
RG200, 1, 2, 3: Expandable single 8 NAND gate	Now
RG220, 1, 2, 3: Quad 2 input NAND gate	Now
RG230, 1, 2, 3: Quad 2 input AOI expander	Now
RG240, 1, 2, 3: Dual 4 input NAND gate	Now
RG250, 1, 2, 3: Expandable quad 2 AOI gate	Now
RG310, 1, 2, 3: Exp. dual output, dual 2 input AOI gate	Now
RG320, 1, 2, 3: Triple 3 input NAND gate	Now
RG380, 1, 2, 3: Hex inverter	Now
RF100, 1, 2, 3: Dual J-K flip-flop (separate clocks)	Now
RF110, 1, 2, 3: Dual J-K flip-flop (common clock)	Now
RF200, 1, 2, 3: J-K flip-flop (AND inputs)	Now
RF210, 1, 2, 3: J-K flip-flop (OR inputs)	Now
RF9601/8601: Retriggerable monostable multivibrator	Now
RL10, 1, 2, 3: Fast full adder	Now
RL20, 1, 2, 3: Dependent carry fast adder	Now
RL30, 1, 2, 3: Independent carry fast adder	Now
RL40, 1, 2, 3: Carry decoder	Now
RL60, 1, 2, 3: Four bit storage register	Now
RL70, 1, 2, 3: Four bit storage register	Now

Beam lead T¹L RAY III series

RG3380, 2: Hex inverter	Now
RG3390, 2: Dual 4 input AND gate (split outputs)	Now
RG3410, 2: Quad 2 input NOR gate	Now
RF3200, 2: J-K flip-flop (AND inputs)	Now

Beam lead linear circuits

RM709: Operational amplifier	Now
RM741: Operational amplifier	Now

Beam lead transistors

BL1000: 2N930 equivalent. TO-18 cans 6/15. Chips	Now
BL1001: 2N2484 equivalent. TO-18 cans 6/15. Chips	Now
BL1002: 2N918 equivalent. TO-18 cans 6/15. Chips	Now
BL1003: 2N2221 equivalent. TO-18 cans 6/15. Chips	Now
BL1004: 2N2221A equivalent. TO-18 cans 6/15. Chips	Now
BL1005: 2N2222 equivalent. TO-18 cans 6/15. Chips	Now
BL1005QD: Quad DIP 2N2222	Now
BL1006: 2N2222A equivalent. TO-18 cans 6/15. Chips	Now
BL1007: 2N2906 equivalent. TO-18 cans 6/15. Chips	Now
BL1008: 2N2906A equivalent. TO-18 cans 6/15. Chips	Now
BL1009: 2N2907 equivalent. TO-18 cans 6/15. Chips	Now
BL1010: 2N2907A equivalent. TO-18 cans 6/15. Chips	Now
2N929: Available in chips only	Now
2N2369: Available in chips only	Now
2N2483: Available in chips only	Now
2N2604: Available in chips only	Now
2N2605: Available in chips only	Now
2N2894: Available in chips only	Now
2N2945: Available in chips only	Now

Beam lead diodes

IN914: Available in chips only	Now
IN3600: Available in chips only	Now

Beam lead memories

RR6100: 64 bit bipolar RAM (0° to 75°C)	6/15
RR5100: 64 bit bipolar RAM (-55° to 125°C)	6/15
RR6110: 256 bit bipolar RAM multi-chip array	6/15



Our plot to overthrow the electronics industry.

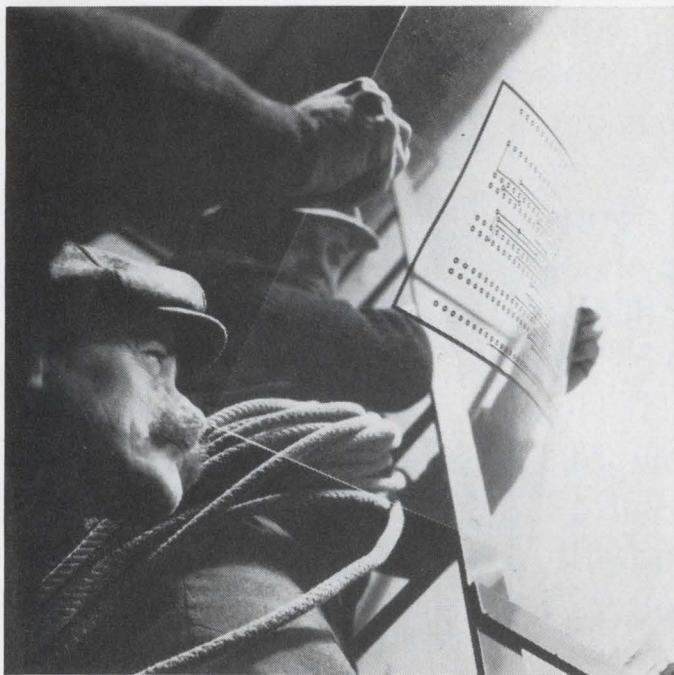

People are going to hate us.

Less than a year in the business, and already we're starting a revolution.

It's a revolution that revolves around our plot. A photoplot.

The idea is to produce a precision photoplotter system to generate all kinds of printed circuit and IC mask artwork.

The idea is to produce a cheap plot that is still the most accurate plot anywhere. It's shutterless to make it sharper and faster: accurate to 1 mil (or 1/2 mil, optionally). There's also a proprietary attachment allowing the use of Polaroid Land Film to produce test plots at

5 times the normal speed.

The idea is to produce a photoplotter that needs no darkroom for loading or plotting.

The idea is our Compucircuit 100. \$49,700, including a free IBM-compatible mag-tape system.

Instant revolution: take one home today and plug it in. Computervision, Northwest Industrial Park, South Avenue, Burlington, MA 01803, (617) 272-7240. See us at Booth 4932 Nepcon-East.

Computervision Corporation

Boy, have we got the vision.

The Tung-Sol[®] development that created a whole new set of digital display standards

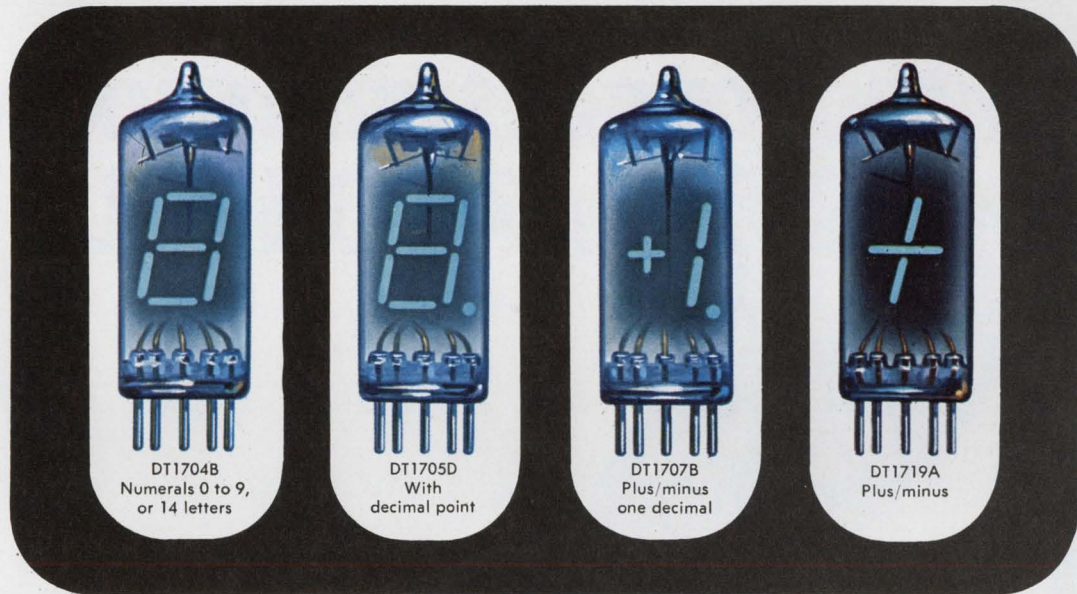

STANDARD CONFIGURATIONS

Low-voltage, low-power drain (25 V and 1.6 V) permits battery-operated applications. Standard miniature tube base. Inexpensive logic/driver requirements. Meets MIL specs. Space-age-type segmented character. Single plane display. Standard alphanumeric, or special symbols. Optimum visibility under ambient light conditions. Common filters provide unlimited color selection for identification, or to heighten contrast. Circuit-board mounting, with solderable-lead option. Write, or phone for detailed technical information and pricing.

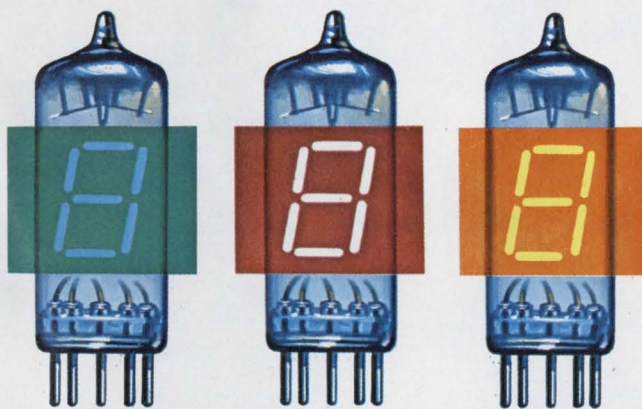

Standard filters provide color variation

DIGNAC S/G^{T.M.}

VACUUM FLUORESCENT DISPLAY

**TUNG-SOL DIVISION
WAGNER ELECTRIC CORPORATION**

630 W. Mt. Pleasant Avenue
Livingston, N.J. 07039
TWX: 710-994-4865
Phone: (201) 992-1100; (212) 732-5426

Trademark TUNG-SOL Reg. U.S. Pat. Off.
and Marcas Registradas

INFORMATION RETRIEVAL NUMBER 9

With eight other major sources of 7400N TTL already in the field, we'd be pretty silly to enter as a ninth source unless we had something very special to offer.

We do.

For a start, we guarantee* the hermeticity of every package to 1×10^{-7} cc/sec, 2% AQL. Try and find that spec on anybody else's data sheet.

We've also eliminated the only reason for ever considering plastic packages: price. Our Cerdip packages are priced directly competitive

with any plastic package.

You can't get far in the 7400N business unless you have immediate availability, and we've got it. Your local Sylvania distributor has our complete line in stock right now.

For a starter, we have selected the 14 most useful types as shown in the table. There are 13 more to come and we will be telling you about them in the near future.

Sylvania Electronic Components, Semiconductor Division, Woburn, Mass. 01801.

SYLVANIA CERDIP PACK		
FUNCTION	TYPE	100-999
Quad 2 NAND Gate	SG7400N	.85
Quad 2 NOR Gate	SG7402N	.97
Triple 3 NAND Gate	SG7410N	.85
Dual 4 NAND Gate	SG7420N	.85
Single 8 NAND Gate	SG7430N	.85
Dual 4 Buffer Gate	SG7440N	.97
Dual 2 x 2 AND-OR-Invert Gate with Expander Inputs	SG7450N	.85
Dual AND-OR-Inverter	SG7451N	.85
4 x 2 AND-OR-Invert Gate with Expander	SG7453N	.85
Single AND-OR-Inverter	SG7454N	.85
Dual 4-input Expander	SG7460N	.77
Master/Slave J-K Flip-Flop	SF7472N	1.31
Dual Master/Slave J-K Flip-Flop	SF7473N	2.15
Dual "D" Flip-Flop	SF7474N	1.88

Sylvania announces ninth-sourcing capability in 7400N TTL.



SYLVANIA
GENERAL TELEPHONE & ELECTRONICS

*These integrated circuits are guaranteed to substantially conform to Sylvania's applicable specifications and be delivered free of defects in materials and workmanship. If they are defective in such respects, at Sylvania's election, Sylvania will either repair, replace or grant a credit at invoice prices if defective integrated circuits are returned to the factory pre-paid within one year after shipment. THESE GUARANTEES ARE IN LIEU OF ALL OTHER GUARANTEES EXPRESSED OR IMPLIED. Sylvania shall not be liable for special or consequential damages of any nature.

Designer's Calendar

MAY 1970						
S	M	T	W	T	F	S
					1	2
3	4	5	6	7	8	9
10	11	12	13	14	15	16
17	18	19	20	21	22	23
24	25	26	27	28	29	30
31						

For further information on meetings, use Information Retrieval Card.

May 19-21

Power Sources Symposium (Atlantic City). Sponsors: U. S. Army Electronics Command, et al. Power Sources Division, U. S. Army Electronics Command, Fort Monmouth, N. J. 07703.

CIRCLE NO. 410

May 26-28

Society for Information Display Symposium (New York City). Sponsor: Society for Information Display. Bernard J. Lechner, RCA Laboratories, Princeton, N. J. 08540.

CIRCLE NO. 411

May 26-28

IEEE Sixth Region Conference, "West Into the 70's" (Seattle, Wash.) Sponsor: IEEE. P. R. Metz, Univ. of Washington, EE Dept., Seattle, Wash. 98105.

CIRCLE NO. 412

JUNE 1970						
S	M	T	W	T	F	S
	1	2	3	4	5	6
7	8	9	10	11	12	13
14	15	16	17	18	19	20
21	22	23	24	25	26	27
28	29	30				

June 8-10

International Conference on Communications (San Francisco). Sponsor: IEEE. A. M. Peterson, Stanford Research Institute, Menlo Park, Calif. 94025.

CIRCLE NO. 413

◀ INFORMATION RETRIEVAL NUMBER 10

New SOLID-STATE FET-INPUT MULTIMETER

from
SIMPSON
of course

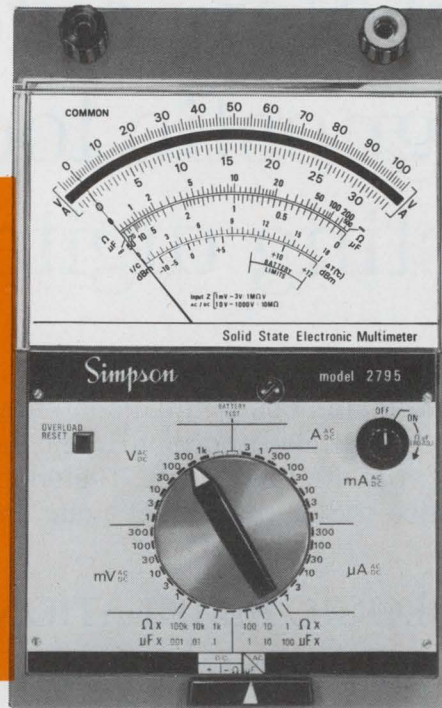

**Model
2795**
PORTABLE,
LABORATORY
ACCURACY,
SOLID-STATE
ELECTRONIC
MULTIMETER

- 68 Switch Selectable Functions:
 - 13 AC and DC Voltage Ranges (as low as 1 MV, full scale)
 - 14 AC and DC Current Ranges (as low as 1 μ A, full scale)
 - 6 low power (IC compatible) Resistance Ranges
 - 6 completely self-contained Capacitance Ranges
- Plus 12 Output Ranges
- Circuit Breaker Overload Protection
- High FET-Input Impedance
- $\pm 1\%$ Accuracy for AC and DC
- Negligible Voltage Drop
- Simple, Straight-Forward Operation
- Size: 8.07" High, 5.04" Wide, 3.94" Deep. Only 3.3 lbs.

2795 MULTIMETER supplied complete with batteries, test leads and operator's manual. Complete accessories available.

\$230⁰⁰

WRITE FOR BULLETIN L-1010 . . . OR CONTACT YOUR SIMPSON INSTRUMENTATION PRODUCTS DISTRIBUTOR FOR OFF-THE-SHELF DELIVERY

Simpson
INSTRUMENTS THAT STAY ACCURATE

SIMPSON ELECTRIC COMPANY

5200 W. Kinzie Street, Chicago, Illinois 60644

Phone (312) 379-1121

EXPORT DEPT.: 400 W. Madison St, Chicago, Ill 60606. Cable Simelco

IN CANADA: Bach-Simpson Ltd., London, Ontario

IN INDIA: Ruttonsha-Simpson Private Ltd., International House, Bombay-Agra Road, Vikhroli, Bombay



DIVISION

INFORMATION RETRIEVAL NUMBER 11

Now! New automated diagnostic tools for detecting digital faults.

A new service! Mellonics offers three fast, reliable and economical computer programs for detecting functional logic faults in sequential digital circuits. Tested, proven, and in use today they meet your design needs for:

LOGIC SIMULATION

to certify design correctness.

TEST SEQUENCE VALIDATION

to verify that all potential functional faults in a logic design will be detected by your test procedure.

AUTOMATIC TEST SEQUENCE GENERATION

to produce a test procedure assuring that all testable functional faults in a logic design will be detected.

And they're easy to use. A qualified engineer/analyst supervises processing, with full data security. Details promptly on request. Contact Test Systems Marketing.

MELLONICS SYSTEMS DEVELOPMENT DIVISION
LITTON INDUSTRIES
1001 WEST MAUDE AVE., SUNNYVALE, CALIFORNIA 94086 (408) 245-0795



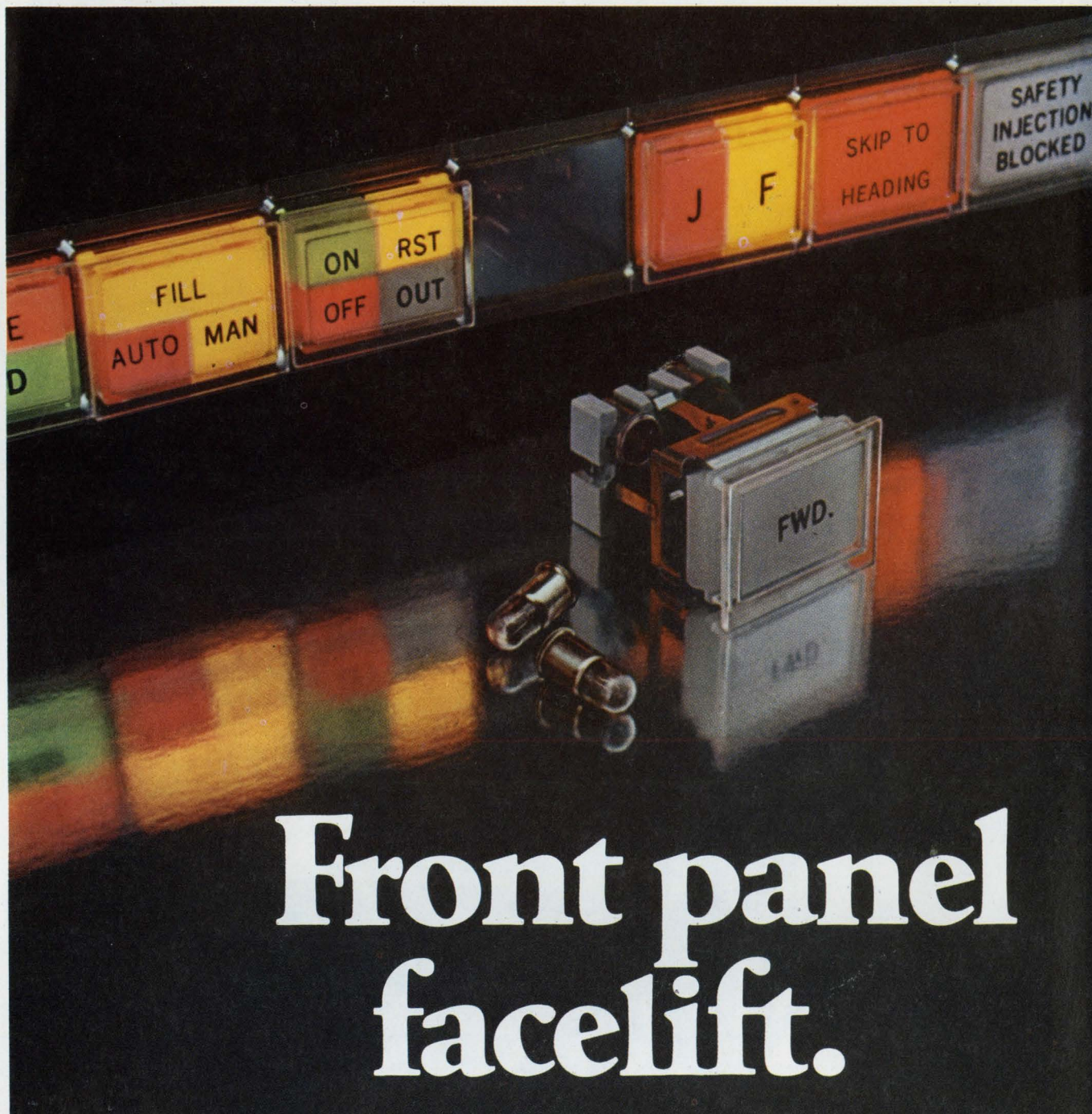

Front panel facelift.

When one of our 2W lighted pushbuttons needs a change of color filters, legends, or lamps—the change is simple. Because the switch stays mounted in the panel. Just one straight, gentle pull and the change is ready to be made.

The rugged design and proven switch performance are especially suited for military/aerospace applications. And our 2W

meets the requirements of MIL-S-22885.

The 2W is available with a wide variety of display screens, color filters and switch modules.

For more information call your MICRO SWITCH Branch Office or Authorized Distributor, or write for Product Sheet 2W.

MICRO SWITCH

FREEPORT, ILLINOIS 61032
A DIVISION OF HONEYWELL

HONEYWELL INTERNATIONAL: Sales and service offices in all principal cities of the world.

INFORMATION RETRIEVAL NUMBER 13

Even if your data goes from  to  you can see it all on one display.



Some of your data will barely twitch an indicator.

Some of it goes right off the scale.

No problem. The HP 7563A Voltmeter/Amplifier logarithmically compresses data with a dynamic range of 110 dB—110 dB!—and gives you a single output that includes both high and low amplitude data with constant resolution and accuracy. The 7563A accepts positive or negative signals from vibration tests, geophysical measurements, pulse height analyzers, computers and similar sources, compresses the amplitudes logarithmically and feeds the results directly to a recorder or oscilloscope. The front-panel meter gives an instant visual display in dB. And when it's not performing that job, the 7563A will double as a voltmeter (calibrated from 0.3 mV to 100 V) for

system or bench use. How's that for a voltmeter/amplifier with the modest price of \$695 and one of the widest dynamic ranges you can buy?

To add AC log conversion and voltmeter applications to DC, use the 7562A with its 80 dB dynamic range. It's the only converter on the market that can measure the true rms value of an AC voltage. Turn it loose on vibration studies, biochemical data, seismographic

studies, audio research or similar data with large asymmetrical wave forms and it will give you the most accurate log conversion you can get in AC. Or use it as an AC/DC voltmeter, calibrated directly in volts. Price is \$995.

For more information, call your local Hewlett-Packard field engineer or write Hewlett-Packard, Palo Alto, California 94304; Europe: 1217 Meyrin-Geneva, Switzerland.

HEWLETT  PACKARD

11907A

...like more capacitance in aluminum 'lytics?

Get SPRAGUE Type 36D POWERLYTIC® CAPACITORS



INFORMATION RETRIEVAL NUMBER 823

- Large cylindrical electrolytic capacitors for use in digital computer power supplies, industrial control equipment, energy storage applications, etc
- Low impedance construction
- Largest case (3" dia. x 8 5/8" high) provides 650,000 μ F at 3 volts!
- Can be operated at +85 C
- Tapped No. 10-32 terminals simplify filter bank assembly
- Available with or without outer plastic insulating sleeves
- Request Engineering Bulletin 3431C

45C-9153R2

Buy resistors with built-in dependability...

Vitreous-enamel BLUE JACKET® POWER WIREWOUND RESISTORS

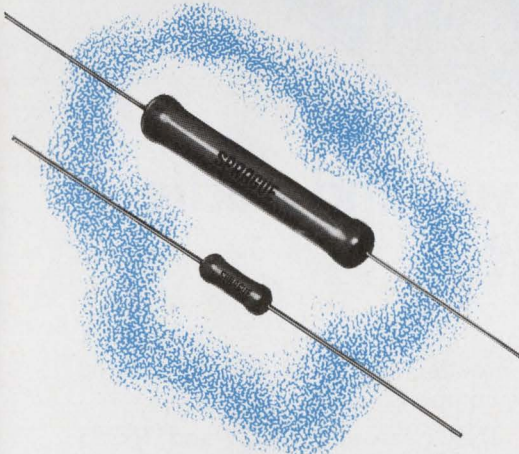

INFORMATION RETRIEVAL NUMBER 824

- All-welded end-cap construction eliminates moisture along leads, also anchors leads securely to resistor body
- Expansion coefficients of vitreous coating, ceramic core, and end caps are closely matched
- Standard wattage ratings include 1, 2, 2.5, 3, 5, 7, 10, and 11 watts
- Also available with radial tab terminals in ratings from 8 to 230 watts
- Request Engineering Bulletin 7410D

For Engineering Bulletins as noted above, write to:
Technical Literature Service, Sprague Electric Co., 347
Marshall Street, North Adams, Massachusetts 01247.

45R-9145R2



'Sprague' and '®' are registered trademarks of the Sprague Electric Co.

THE BROAD-LINE PRODUCER OF ELECTRONIC PARTS



Where in today's world can you find a little quiet and long-term stability?

Here. In an IR voltage reference zener.



Actual size

The world could use more things like it. Low-noise in character. Highly stable ($.01$ to $.0005\%/C^\circ$) over long term. Thoroughly tested and proved true-blue. Immediately available.

Silicon Controlled Rectifiers Power Logic-Triacs Silicon Power Rectifiers Selenium Rectifiers
 Zener Diodes Custom-engineered Sub-assemblies and Systems Light Sensitive Devices

INTERNATIONAL RECTIFIER 

Semiconductor Division, 233 Kansas Street, El Segundo, California 90245, Phone (213) 678-6281

MANUFACTURING FACILITIES: UNITED STATES, CANADA, GREAT BRITAIN, INDIA, ITALY, JAPAN, WITH SALES OFFICES AND DISTRIBUTION IN MAJOR CITIES THROUGHOUT THE WORLD

INFORMATION RETRIEVAL NUMBER 15

Highlighting

THE ISSUE

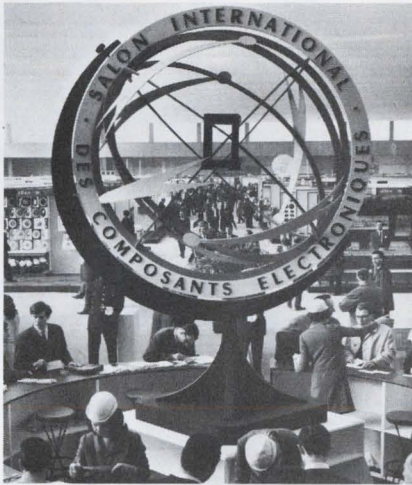

Every year they come from around the world—Americans, Germans, Italians, Japanese, Russians, Britons, Frenchmen and others—headed for the biggest electronic components show in the world: Salon International des Composants Electroniques in Paris.

The show lasted this year from April 3 to 8, and when it drew to a close, the management reported 80,000 visitors, 784 exhibiting companies and 20 nations represented.

Two broad trends emerged: miniaturization and mergers enabling European companies to compete with foreigners for growing commercial electronics orders.

PAGE 25

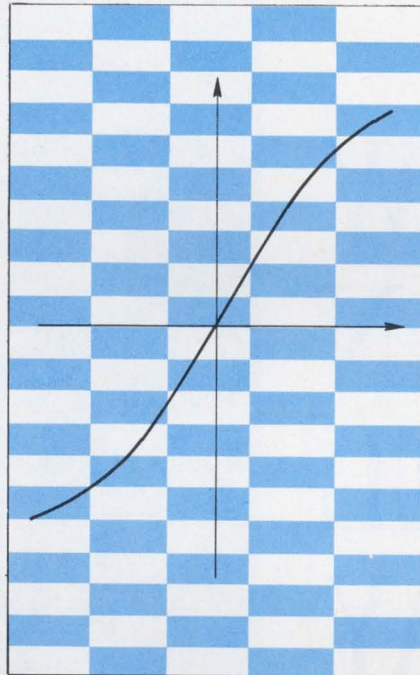

It's a basic fact, but not apparently widely known, that the third-order intermodulation distortion level and the cross-modulation performance of a given device cannot be specified independent of each other.

Both phenomena are caused by a third-order or higher nonlinearity in the transfer characteristic of the device. So specifying either one of them defines the nonlinearity and, hence, specifies the other. Converting from one type of description to the other can be done analytically or by means of a graph, and much time can be saved by measuring only one of them and calculating the other.

PAGE 76

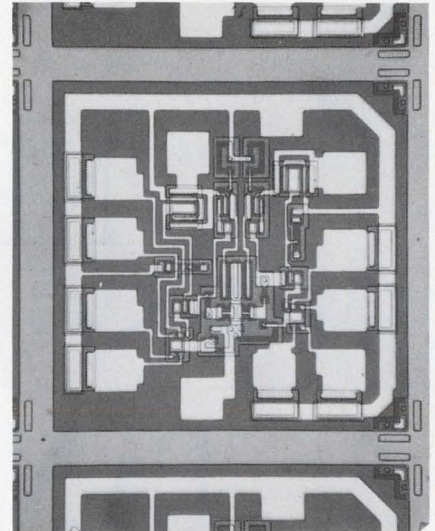

Providing extremely fast switching speeds at low power levels, a new family of Schottky-clamped TTL integrated circuits features typical propagation delays of 3 ns while holding power dissipation to only 20 mW per gate. Designated as series 54S/74S, the new logic circuits use Schottky diodes to clamp active transistors, thus preventing conventional saturation.

Initiating this high-speed TTL line are two NAND gates and a 100-MHz flip-flop.

PAGE 129

NEW SELF-SCAN™ PANEL DISPLAY

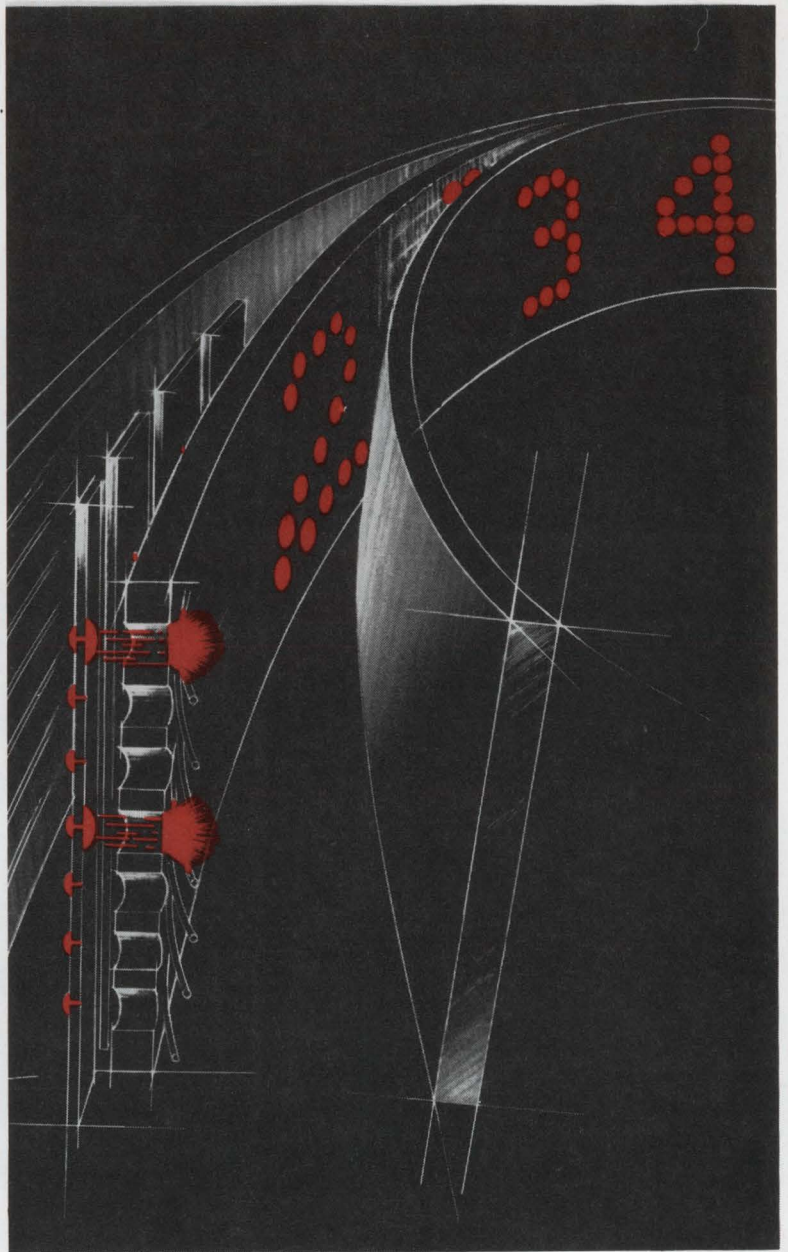

eliminates up to 90% of drive electronics

SELF-SCAN panel displays represent a Burroughs invention of panel design and circuitry that permits time sharing of the cathode electrode drivers in a flat panel display using gas discharge light emitters. Consequently a savings of up to 90% of the electronics required to drive the dot matrix display is realized.

For informational purposes the SELF-SCAN panel display can be thought of as a dot matrix panel with common cathode strips capable of glowing on both front and back sides. The glow on each side of the cathodes is independently controlled by a set of anodes located on the front and back of the panel. The rear portion of the display consists of 7 glow-priming anodes which work in conjunction with 111 vertical cathode strips (common to both sets of anodes). These cathodes are interconnected in three groups of 37 cathodes each and connected to a three phase

clock which sequentially brings each cathode to ground potential. As each cathode is grounded in sequence, the glow is transferred to the adjacent cathode. This transferred glow at the rear of the panel is not discernible from the front. (The illustration shows the first cathode grounded and glow at the 7 rear anode intersections.)

When it is desired to display a dot on the viewing surface, the front glow transfer anodes are utilized. (The glow transfer anodes and common cathodes make up the front matrix.) The appropriate transfer-anode is selected in synchronism with the cathode and the glow transfers forward to the panel front for viewing. (The illustration shows the top and center dots on the first cathode transferred for viewing.)

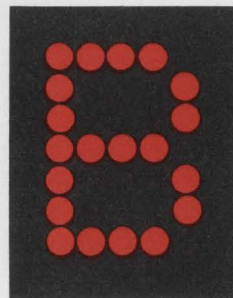

The whole display panel is refreshed and updated to produce a bright flicker-free display.

As a normal dot matrix panel requires a cathode driver for each cathode (80 high-voltage drivers required for a 16 digit display) and the SELF-SCAN panel display requires *only* 3 clock controlled cathode drivers regardless of the number of digits, the significance of this development is immediately apparent.

The SELF-SCAN panel display has unlimited applications, as alphanumeric and graphic messages can be presented with simplicity.

Write today for descriptive brochure, Burroughs Corporation, Box 1226, Plainfield, N. J. 07061.

(201) 757-3400.

Burroughs 

Congress generous with NASA, DOD funds -- so far

The House of Representatives has beaten back an attempt to point NASA away from manned space flight toward cheaper unmanned flights. In approving an authorization of \$3.6-billion for fiscal 1971, the House added \$268-million to the amount the President requested.

The authorization provides a total of \$1.087-billion for the Apollo program and the addition of one more flight—No. 20 in the series. NASA had asked for \$956.5-million. The House called for \$654.7-million in space-flight operations, including the Apollo Applications Program, and the development of a space shuttle and station—\$155-million more than NASA requested.

The attempt to slash the manned space budget was led by Rep. Joseph E. Karth (D-Minn.). Karth wanted \$240-million cut from the recommended appropriation, arguing that a shuttle was "the first step toward a Mars flight," and that such a mission had not been approved by Congress.

According to NASA, a shuttle would be used in a manned flight to Mars, but NASA has never asked for money for such a mission. The shuttle is needed for the manned orbiting laboratory, a project on which study contracts have been funded. The shuttle would be used to transport men and supplies to and from the laboratory.

Karth's amendment was defeated by a tie vote, 53 to 53.

While the House was taking the first step in the long funding process for NASA, the House Armed Services Committee approved an authorization bill for the Defense Dept. One big item was \$3.014-billion for new ships. The bill stated, however, that no money would be committed until the National Security Council makes its

ruling on the fate of CVAN-70, the third proposed nuclear carrier of the Nimitz class.

The committee also approved more than \$6-billion to buy aircraft—\$294.5-million for the Army, \$2.452-billion for the Navy and Marine Corps and \$3.314-billion for the Air Force.

For missile procurement, the Army got approval for \$1.086-billion, the Navy for \$946.6-million, the Marine Corps for \$27.6-million and the Air Force for \$1.505 billion.

U. S. Commerce Dept. sponsors show in Japan

Japan, a major competitor with the U. S. for electronic markets, is also a major consumer of electronic equipment. To help penetrate this expanding market, the U. S. Dept. of Commerce is sponsoring a trade show in Tokyo, Oct. 12-17. The show will feature advanced computers and peripheral equipment.

In 1969, the Dept. of Commerce says U. S. companies supplied more than \$91 million worth of computers and peripherals to Japan. This year, the figure is expected to exceed \$105 million, making Japan one of the largest markets in the world for these U. S. products (see 'Made in Japan,' ED 6, Mar. 15, 1970, pp. U162-U176).

Commerce reports that installed computer systems will increase from 5,600 in 1969 to 10,000 units by 1972. A large portion of these future needs will be supplied by Japanese industry, but, the Department says, imports of peripherals and software will be required to fill "acknowledged technical gaps in key categories."

More than half of Japan's large-

scale digital computers are now supplied by U. S. companies. The magnetic ink and optically sensed character imprinter market is totally supplied by imports. The demand for optical character readers continues, says the Dept. of Commerce, with imports accounting for 70 to 80% of needs.

The demand for software is expected to reach \$23-million by 1972, an estimated increase of 233% over 1969. Another big future market is CRT light sensing pen systems and electronic handwriting systems.

TI predicts worldwide boom in semiconductors

The worldwide market for semiconductor products will go from \$2.5-billion in 1970 to \$4-billion annually by 1980, Mark Shepherd, Jr., Texas Instrument's president, told last month's shareholders' meeting. In 1970, the U. S. market will grow 5% he said, to \$1.39-billion, with solid growth in the computer and industrial segments. The increases in Europe and Japan should exceed 20%.

The major feature in the semiconductor market growth is the integrated-circuit market, according to Shepherd. ELECTRONIC DESIGN was told by Charles Phipps, TI's manager of logic and memory functions that the worldwide demand for MOS IC's should top \$100-million this year. This is more than three times the \$35-million spent in 1969. And with production capability in the \$70-to-\$80-million range, it is unlikely that the full demand will be met in 1970 by industry.

The two factors most responsible for the increased demand, Phipps says, are 1) the many products now ready to start in volume production and 2) the increased complexity of products being produced. Manufacturing capability will be the principal factor in any company's penetration of the MOS market, whereas in the past, engineering was the key.

Within the discrete market, power, optoelectronics, and microwave segments are growing strongly says Shepherd.

Today's \$50-million optoelectronics market is expected to increase

by 15 to 20 times by 1980, according to Ed Youch, TI's Optoelectronics marketing manager. He said that significant breakthroughs in technology and processes have been bringing prices down while increasing performance.

Minicomputer to do skyscraper chores

Computers will be taking on a new role in the monitoring and control of building services. Honeywell's Delta 2000 series of automation systems can be used to control the entire environment of a large building or a series of smaller ones.

Air conditioning, heating, lighting, and elevator sequencing can be programmed for the regular work week or for holiday periods where building services are not so much in demand.

The Delta system, being built at Honeywell's headquarters in Minneapolis, Minn., is offered in three models: the 2000, which includes simple monitoring and alarm capabilities; the 2100 with rudimentary hard-wired programming; and the 2500, which incorporates Honeywell's model 316 computer and has full computer-control functions.

The key to the system is a single two-conductor coaxial cable connected to data concentrators on each floor of the building. Data rates can be as high as 50 kbits/s. External communication between buildings can be carried on a single standard voice-grade leased telephone line at 1200 bits/s.

The system can be time-shared to the computer to control several smaller buildings.

Microwaves may reduce sewage-treatment cost

By exploiting a phenomenon long regarded as an obstacle to communications—the atmospheric attenuation of millimeter waves—a radar engineer in Torrance, Calif., pro-

poses a way to reduce the cost of processing sewage and polluted water.

Edward J. Watt believes that his proposed approach can increase the efficiency of ozone-generating systems to a spectacular degree over existing electrical-discharge methods. And ozone, Watt points out, is "by far the most effective agent for the reduction of odors and tastes, and for the reduction of bacterial and coliform (intestinal) organisms found in polluted water and sewage."

Usually, Watt explains, ozone is produced by passing air through an electrical discharge or corona that, of course, covers a broad frequency range. Unfortunately, the natural molecular-resonance frequency of the oxygen molecule—and hence the only frequency that converts oxygen (O_2) to ozone (O_3)—is 60 GHz. All the other frequencies in the discharge go to waste.

With a microwave oscillator that generates energy at 60 GHz only, Watt claims, the efficiency of the conventional broadband discharge approach—10 kilowatt-hours per pound of ozone—theoretically can be upgraded one millionfold.

Automated heart care shown in N.J. hospital

Wireless monitoring of as many as 48 heart patients is a feature of the new convalescent wing of St. Barnabas Medical Center, Livingston, N.J. The installation is said to be the largest of its kind in the world.

The equipment, manufactured by Gulton Industries, Inc., consists of a sensor-transmitter worn by the patient and a receiver-monitor located at the nurse's station. The transmitter, no larger than a cigarette pack, permits a patient to be ambulatory and thus eases his convalescence. The receiving station, two banks of 24 receivers, has a display meter for each channel (patient) which includes high and low-limit alarms, a CRT display and a strip chart recorder.

If a danger condition is detected, alarm lights signal this fact to the nurse on duty, the CRT displays the cardiogram of the patient, and the strip chart recorder makes a hard copy record. Because the

patients are under continuous surveillance, doctors can examine their patients, awake or asleep, without disturbing them and thus avoid any emotional reactions.

NASA's job picture—a continuing decline

Illustrative of the changing set of national priorities that has cut civilian space jobs—including NASA employees and employees of NASA contractors—are the following figures supplied by the space agency:

The number of people working on U. S. space agency programs grew from 46,786 in 1960 to 409,900 in 1965, but is expected to drop to 143,900 by June, 1971. Here's how it has gone, year to year:

1960—	46,786
1961—	74,577
1962—	137,656
1963—	246,304
1964—	379,084
1965—	409,900
1966—	393,924
1967—	306,926
1968—	267,871
1969—	218,345
1970—	166,900 (est.)
1971—	143,900 (est.)

New computer firm pushes modular concept

Another entry in the growing, highly competitive real-time computer market is Modular Computer Systems, Inc. of Fort Lauderdale, Fla., now four months old.

The new company, according to co-founder Kenneth G. Harple, will manufacture a family of "fourth generation general-purpose computers employing LSI circuitry and featuring a novel design approach."

According to Harple, all computers will be assembled from four standard asynchronous modular blocks, which will include an 8-bit memory module, a control module with read-only memory, a register module and an input/output module. The modules will be designed with a byte format that will permit complete conversion of LSI as this technology develops. Powerful processor configurations can be built by adding modules.

TI's quiet revolution in Linear ICs

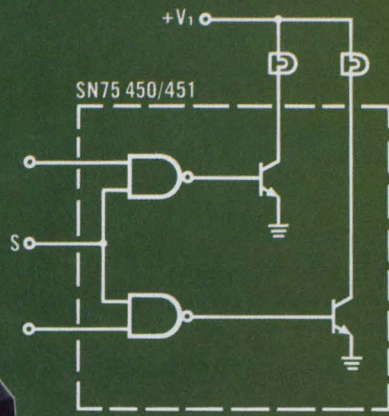
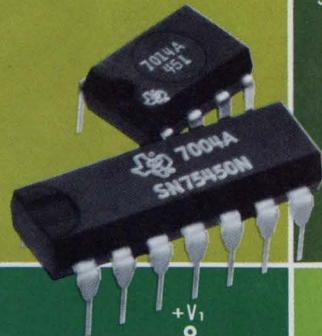

Dual Lamp Driver

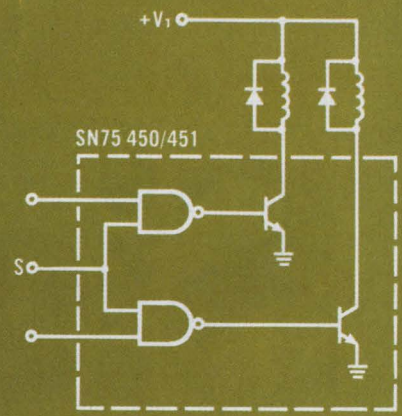

Dual Relay Driver

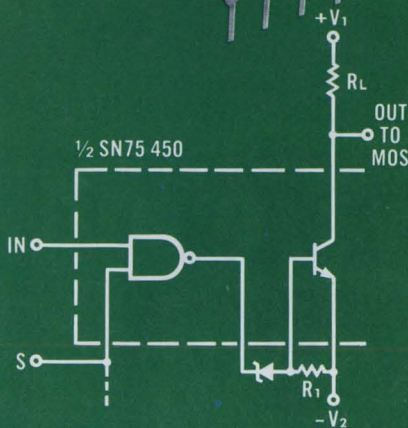

MOS Driver

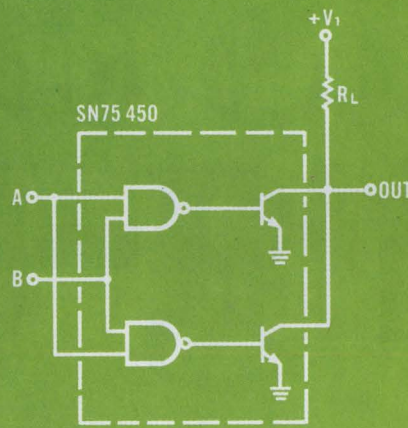

500 mA Sink Driver

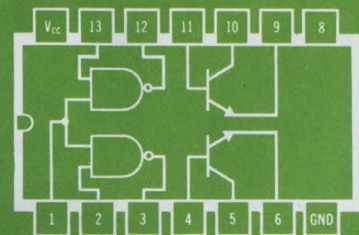

SN75450

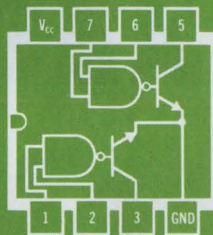

SN75451

As low as 97¢: TI's new "jack-of-all-trades" peripheral drivers.

TI's new SN75 450 dual peripheral driver is simply two TTL NAND gates and two transistors on a single chip. But because the transistors are not tied down, applications are virtually unlimited.

TI's new SN75 451 is identical except the transistors are tied down. In 8-pin plastic DIP, it's only 97¢ (100 pieces).

In addition to the applications above, use the SN75 450 as a gated comparator. Floating switch. Dual linear amplifier. Dual photo

switch. NAND-gate Schmitt. High Z_{in} low-speed Schmitt. Dual high-speed gate. SCR gate driver. Super TTL gate. Dual-channel single-ended line driver. Memory system current source. Film memory digit driver. Core memory driver. Phase detector. D-C to A-C converter. Tachometer. MOS memory/write driver. And you'll find dozens more.

Use the new 8-pin SN75 451 as a high-speed logic buffer and in most of your driver applications.

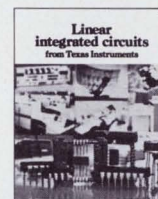

For more facts on the "jack-of-all-trades" SN75 450/451 and on all TI linear circuits, get our new Brochure CB-115. Just circle 225 on the Reader Service Card or write Texas Instruments Incorporated, P. O. Box 5012, M.S. 308, Dallas, Texas 75222. Or ask your nearest authorized TI Distributor.



TEXAS INSTRUMENTS INCORPORATED

Signetics has a hang-up.

Tear here. And help us get rid of it. ▶
P. S. If someone beats you to it, circle readership card.



Paris components exhibition lures manufacturers from 20 countries, and they stress miniaturization

John N. Kessler
News Editor

PARIS

Every year they come from around the world—Americans, Germans, Italians, Japanese, Russians, Britons, Frenchmen and others—drawn the way merchants of old were to the great bazaars of Damascus. They're headed for the biggest electronic components show in the world. Salon International des Composants Electroniques.

For six days, last April 3 to 8, they streamed into the Hall Monumental of the Parc des Expositions, and when the show finally drew to a close, the management released these statistics: visitors, 80,000; companies exhibiting, 784; nations represented, 20.

Amid the buzz, bustle and babble in the aisles, the give and take at technical sessions, two broad conclusions emerged:

- The major theme of technology at the salon exhibits was miniaturization.
- In the marketplace, mergers

are enabling European companies to compete with foreigners for growing commercial electronics orders.

The components at the show that visitors ogled the most were the smaller devices, both active and passive. Manufacturers reported that these new components could perform with more sensitivity over a broader bandwidth at higher speed and lower cost.

Advanced DVMs displayed

Schlumberger, claiming European leadership in digital instrumentation, introduced a new line of digital voltmeters, one of which it called "the most advanced in the world." The instrument, the company said, "reaches the present-day limit of technology in every basic parameter."

The new Schlumberger unit automatically calibrates itself. At preset time intervals, it disconnects itself from the voltage being measured and reconnects to an independent source. If the expected

value is not observed, the instrument recalibrates itself, so there is no residual error. The company says this eliminates the effects of time and temperature and provides a long-term accuracy "not significantly different from short-term accuracy." The operation can be unattended or carried out by unskilled users.

The Schlumberger DVM has a scale length of 250,000 and can measure dc voltages from 0.1 to 1200 V. Control can be manual, automatic, variable or remote, at speeds from 4 seconds per measurement up to 500 readings per second. This instrument, as well as other DVMs in the new line, are being marketed through the Solartron Electronic Group Ltd., Farnborough, Hampshire, England—a Schlumberger company.

Italian semiconductors on view

Ates Componenti Elettronici of Milan exhibited a full range of semiconductor devices for entertainment, industrial and profes-

NEWS

Paris Show (continued)

sional applications. Ates is affiliated with Siemens and has a technical assistance agreement with RCA. The company now has the largest laminar-flow facility in Europe turning out new lines of linear and digital ICs. Its present production is concentrated on i-f amplifiers and automatic, fine-tuning devices for TV, transistor arrays and audio amplifiers up to 5 W. This is to be followed by a range of digital devices.

This year, according to Ernesto Bartolozzi, Ates commercial manager, the company will produce circuits for fully transistorized monochrome and color television. The exhibit at the Salon des Composants included high-voltage (800 V, 4 A; 400 V, 4 A; 320 V, 10 A) and high-power (164 V, 10 A; 100 V, 15 A; 160 V, 15 A) transistors.

Ates is another company with an international marketing organization—in Britain, Austria, Denmark, Finland, France, Germany, Greece, Norway, Spain and South Africa.

Russians lead East Europe

Soviet, Hungarian and East German exhibits drew the usual interested stares from Westerners. The Russians demonstrated their technology was the most advanced. They displayed 40 types of ICs, some with 1340 MOS devices on a single chip. And they had DTL and RTL devices, FETs, linear ICs, hybrid LSIs, gallium arsenide light-emitting diodes and a splash of high-quality passive components.

The Russians seemed particu-

larly advanced in processing large ingots of silicon and germanium. They also had a range of cathode-ray tubes that were as small as one-inch across; they said they were for commercial TV.

Mullard House of London exhibited components for TV, radio, industrial process control, infrared detection and radar. The company's monochrome TV receiver uses variable-capacitance diodes (varactors) to do the tuning. No mechanical link is required between the tuning control and the module; tuning is effected by means of pushbuttons that apply dc potentials to varactors in the tuner rf stages and local oscillator.

Furthermore there is no high-frequency voltage on the lines between the tuner and the preset potentiometers that supply the control voltages. Therefore line length does not affect performance, and the designer can place the tuning module wherever he pleases in the set.

Because a solid-state television receiver can't use the same feedback techniques used in tube circuits to stabilize the line deflection current, it is necessary to stabilize the supply voltage instead. Mullard says that thyristor circuits that it has developed are "simpler and more reliable than similar transistor circuits."

Mullard's "supersquare" color-screen television picture—"the most advanced color tube in production"—was on view. It has, the company said, a "more rectangular and flatter faceplate than any color picture tube now available."

Mullard components for radio receivers included an integrated circuit for AM receivers that contained the mixer, oscillator, i-f

amplifier and audio preamplifier stages. This avoids much of the manual work involved in building the conventional receiver.

New Mullard industrial components on display included three "trigger blocks" for control systems. The new units are easily connected to form a variety of circuits with a wide range of control functions.

Microswitches operate car

The "car of the year 2000" was used by Honeywell S. A., France, to demonstrate its line of microswitches. These pushbutton devices maneuvered the car forward, backward, sideways, around and up and down at various speeds.

A number of Hall-effect devices were also exhibited by Honeywell. These could operate with DTL, TTL, RTL and MOS/LSI logic systems. They perform their switching operation by means of a magnetic field that ranges from 300 to 750 gauss. Applications for this type are primarily in command and control systems. It can perform a million switches a minute.

Other pushbutton switches from Honeywell were capable of lighting up in any of four colors—particularly useful in aircraft navigation systems.

Siemens exhibited three new types of semiconductor components: a new line of solar cells,



Schlumberger digital voltmeter measures dc voltages from 0.1 to 1200 V and can calibrate itself automatically. The scale length is 250,000.

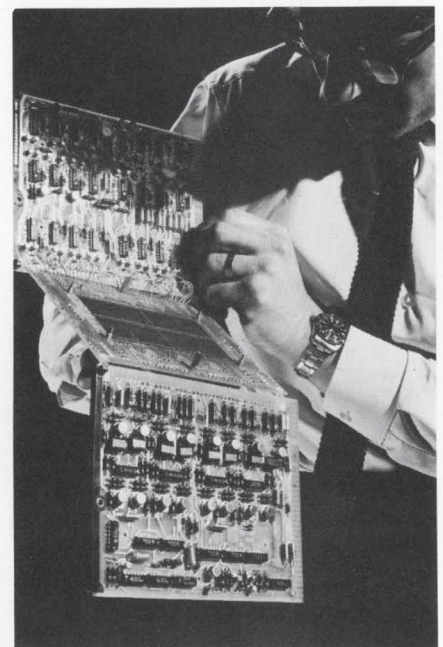

A random-access memory shown by the Plessey Components Group.

TRY TO MATCH THIS

for size and reliability

you can't!

For their size, Type BB resistors pack a tremendous power dissipating ability. Rated 1/8 watt at 70°C in a 0.0004375 cu. in. volume.

And miniaturization has not reduced reliability. Tests prove it. They satisfy the highest level—the S level—of the latest MIL-R-39008 Established Reliability Specifications in all resistance values.

The key is hot molding—the Allen-Bradley way. A-B developed and built the machines. Only A-B uses them. They're fully automatic. Built-in precision control. A high degree of uniformity. Predictable performance from resistor to resistor—year after year.

For immediate delivery at factory prices call your authorized A-B industrial electronics distributor. Or write Marketing Dept., Electronics Division, Allen-Bradley Co., 1201 South Second St., Milwaukee, Wis. 53204. Export Office: 1293 Broad St., Bloomfield, N.J., U.S.A. 07003. In Canada: Allen-Bradley Canada Limited.

© Allen-Bradley Company 1969



ALLEN-BRADLEY
QUALITY ELECTRONIC COMPONENTS

EC69-80



Exclusive

Only A-B Type BB
RCRO5 meets MIL-R-39008
ER (established reliability)
for 1/8-watt resistors
at the S level.
Shown actual size.

integrated solid-state circuits, and integrated operational amplifiers. The solar cells are of the n-p type and have boron-doped silicon as the base material. The junction can be located directly beneath the surface of the cells. This, says Siemens, makes the cells extremely sensitive to blue light.

Siemens' solid-state ICs are designed for AM/FM and i-f amplifiers in radio receivers. For AM operation (450 kHz), a control can be added to permit a voltage gain of 60 dB; without the control voltage, gain is 90 dB. In FM operation (10.7 MHz), the voltage gain is 86 dB at operating voltage of 9 V.

Op amps shown by Siemens, with stages that can be directly coupled, are for dc or ac amplifiers, servo amplifiers, active filters, ultra-linear rectifiers and many other applications.

Siemens' new core-memory stacks are—at their best—one-fifth the size of conventional designs, according to the company. In memories designed for high-speed computers, Siemens has eliminated one out of two matrix frames, and the units are said to be highly resistant to heat damage and vibration.

Fluidics there, too

Britain's Plessey Components Group showed not only examples of random-access memories but also

its new Logi-Pak fluidic system. It consists of miniaturized fluidic elements designed for industrial control systems.

There are nine basic elements, and most of these incorporate two or three gates each. A systematic method of port positioning is used throughout, to simplify mounting and connecting layouts.

Logi-Pak mounting provides a modular system for accommodating any number of elements, although for convenience, standard units that take from four to 48 elements are offered. Construction is simple, the elements mounting flat onto base units that incorporate the port nozzles.

A drop in exhibitors

The number of exhibitors at this year's Salon des Composants was down a bit from last year. Manufacturers said the reason lay in the growing importance of instrumentation in Europe, not in a diminishing market for components. There was a sharp drop in instrumentation displays in the Hall Monumental. These manufacturers are saving their powder for other, upcoming shows: Mesacura in Paris later this month, and the Electronica Show in Munich in November. But even allowing for this, visitors to the components extravaganza felt the industry looked vigorous and profitable.

Corporate cooperation, to a large extent, is responsible for this vigor. Lacking the financial backing of defense budgets, European

companies have joined together to meet U. S. competition and at the same time to assimilate U. S. technology by means of patent-licensing, cross-licensing and keen research efforts on their own. The two Continental electronic giants still remain Siemens and Philips, with plants spread throughout the world. Next come highly dynamic companies like Thomson-CSF in France, which also has factories scattered in many countries.

The future wave: mergers

Mergers are spurring European electronics growth. For example, Thomson-CSF, the biggest electronics manufacturer in France, not only has a large central research laboratory but also an electronic tube group, an underwater division, Sescosem (for semiconductors and microelectronics) and 10 or more sub-groups that represent a combination of what were once individual firms.

In Germany, AEG has merged with Telefunken. In Italy, SGS (Societa Generale Semiconduttori), headquartered in Milan, is under the control of Olivetti and has facilities in Germany, France, Britain, Singapore and Sweden. In England, Marconi-Elliott Microelectronics Ltd., Witham, Essex, is a member of GEC Semiconductors. In Spain, there is a somewhat different arrangement with Secartys (Servicio de Exportacion de Componentes y Aparatos de Radio, TV y Sondio), being set up as a free association of Spanish electronics companies to promote sales.

The Societe Precis, now one of the largest manufacturers of capacitors in France, was founded in 1958. By 1968, it had merged with Societes Bonohm, Variohm, Sorelem, and Same, and had opened a factory in Turin, Italy. Today its five factories churn out monthly nearly a million plastic-film and mica capacitors plus 200,000 tantalum and aluminum capacitors and a range of potentiometers, some of which were shown at the Salon des Composants.

In France, according to information released by the National Chamber of Commerce, the French electronics components industry will double by 1975. ■■



"Car of the year 2000," which Honeywell of France used to demonstrate its line of microswitches. Pushbutton-devices maneuver the vehicle.



**Behind this disguise
are 1001 ways to
build a more precise
timing circuit at
no extra cost**

The D13T1 Series

PUT

PROGRAMMABLE UNIJUNCTION TRANSISTOR

**Typical Unitrode reliability
in a hermetically-sealed
package suitable for
military use at only
90¢ each in lots of 100.**

■ Functionally equivalent to standard unijunction transistors with the advantage that external resistors can be used to program η , R_{BB} , I_p , and I_v , depending on the designer's needs.

■ Completely planar passivated, hermetically sealed TO18 type package.

■ Even long time-delay designs are more precise, because the PUT's low guaranteed I_p of 150 nA allows use of larger timing resistors and smaller capacitors.

■ For pulse and timing circuits, SCR trigger circuits, relaxation oscillators, and sensing circuits.

IN STOCK, READY TO DELIVER NOW • SEND FOR YOUR FREE SAMPLES AND CIRCUIT DESIGN GUIDE

For fast action call Pete Jenner collect . . . today!

From the
SSPI Product
Group



A product of the wide ranging semi-conductor technology of

UNITRODE

580 Pleasant St., Watertown, Massachusetts 02172 • (617) 926-0404



INFORMATION RETRIEVAL NUMBER 20

Navy to computerize its message processing

Device under test screens radio transmissions to ships and accepts only those that are 'relevant'

John F. Mason
Military-Aerospace Editor

The Navy is testing the prototype of an automatic message handling unit for destroyers and smaller ships that will solve a number of shipboard communications problems. And when funding loosens up, it should create a big market.

"I think there'll be one of these systems on almost every ship in the fleet," says D. W. Liddell, head of traffic management and system control at the Naval Electronics Laboratory Center in San Diego, where the system was developed.

Called GARD, for General Address Reading Device, the equipment screens incoming radio messages, allowing printout on standard teletype machines of only those with addresses that match a stored list. GARD is a stored-program computer with a memory capability of 99 addresses of 36 characters each. The system gets messages to addressees faster, by transmitting them to remote terminals equipped with high-speed printers. Now, they are printed and hand-carried.

GARD will achieve one of the Navy's major goals: It will reduce

the personnel required to process messages. "Supporting a serviceman for 20 years costs \$1-million," a cost-conscious Navy officer in Washington says.

"Screening messages automatically is a big step forward," Liddell says. "Now, small ships are inundated with messages that are of no interest to them. Probably only about 10% of the messages that come in are relevant."

Excess printing is expensive

Printing unwanted messages requires additional personnel to screen them; it creates a pile of unwanted classified messages that must be safeguarded or destroyed; it wastes supplies and wears out equipment; and it creates unnecessary noise. Noise is such a problem on ships that the Navy would like a quiet—or better yet, a silent—teletypewriter.

A GARD development model was tested for 12 months on the destroyer Joseph Strauss, and during this time it suffered only one failure: A microelectronic circuit went out. The mean time between failures was in excess of 5000 hours. Currently the GARD

service test model is undergoing operational evaluation aboard the destroyer Richmond Turner prior to procurement by the Naval Electronic Systems Command in Washington, D.C.

"The biggest problem" says the system's project manager, R. S. Rios, "is having to use the ship's power. If the voltage drops, GARD is bypassed automatically and all messages are printed."

There are several design features that Liddell feels are significant:

- Maintenance can be done without tools, except for a card puller. Everything can be repaired by hand. And all parts in the system are captive. "They are attached in some way so a sailor won't take a lid off, for example, and lay it down on the other side of the room," Liddell says.

- The machine opens up and slides out of its case, but it's not on ballbearings. "We don't want something that slides easily, which in heavy seas might come out and hit a sailor in the chest."

- Air filters are built on the front, where they won't be forgotten. They can be taken out and cleaned without tools and easily replaced.

- Flat cables are used instead of those that roll up. "The rollup kind causes trouble," Liddell says. "Ours lie flat, hooking into the chassis at the bottom. When you roll the chassis in, the cable just folds back on itself."

- Logic is partitioned between cards according to function. If a particular processor command can't be executed, the maintenance man knows that that function is associated with a particular card and can pull it out.

In designing the unit, Rios says, "we let one of our engineers who is accident-prone try it out.

"If anything can be broken, he'll break it, and if anything will hurt an operator, he'll get hurt. The system passed the test," Rios notes. ■■

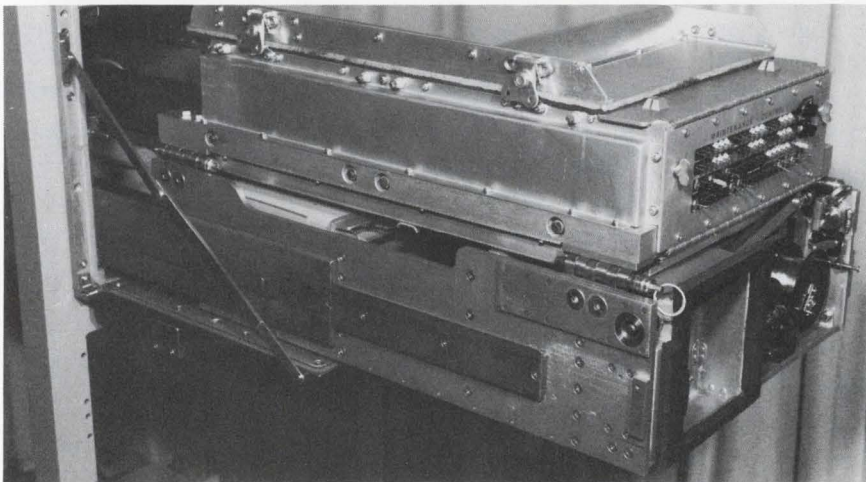

Compact design of the General Address Reading Device speeds installation and maintenance on Navy ships, where space is at a premium.

did you know?

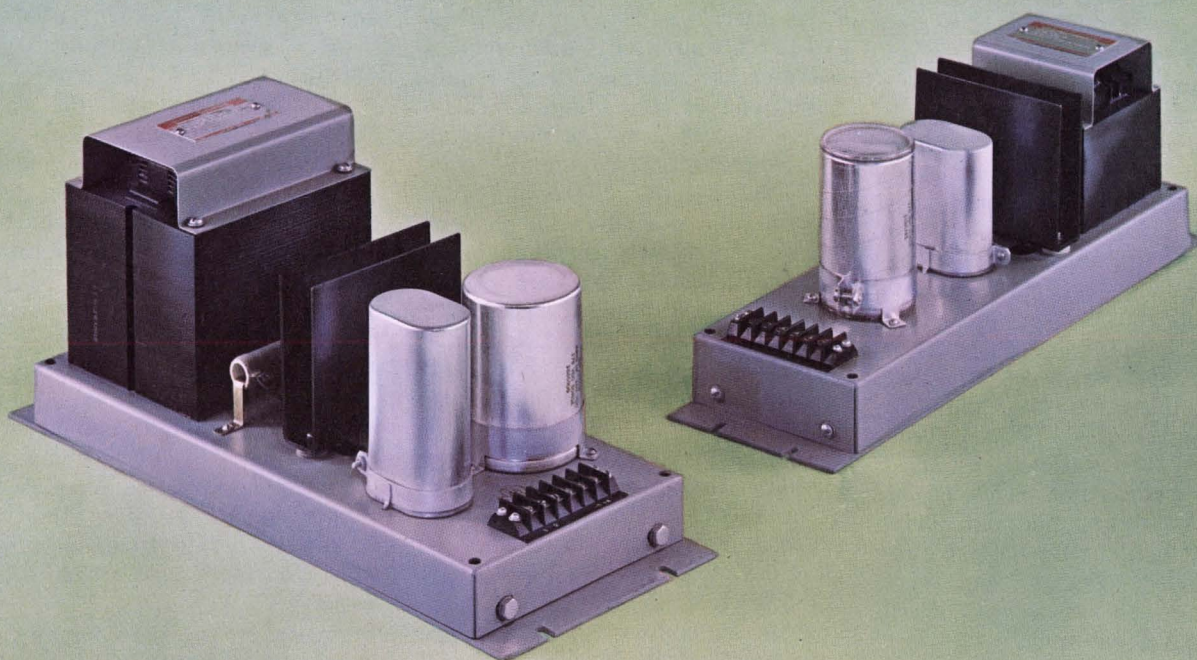

General Electric **REGULATED DC POWER SUPPLIES**

maintain DC load voltage precisely* . . .

precisely, precisely, precisely, precisely, precisely,
precisely, precisely . . .

Send in this coupon for free bulletin giving complete details on GE Regulated DC Power Supply features, ratings and application data; or see your GE sales representative today.

* Maintains $\pm 1\%$ output voltage for a variation in input voltage of $\pm 15\%$.

GENERAL  **ELECTRIC**

.....
• Section 413-36
• General Electric Company
• Schenectady, New York 12305

• Please send me free bulletin GEA-7353B on
• Regulated DC Power Supplies.

• NAME _____

• COMPANY _____

• TITLE _____

• ADDRESS _____

• CITY _____ STATE _____ ZIP _____

Pilots ask FAA for proximity warner—now

A cheaper device sought instead of expensive time-frequency system under slow development

John F. Mason
Military-Aerospace Editor

Tired of waiting for a panacea to prevent mid-air collisions, airline pilots and spokesmen for the general-aviation community have again urged the Federal Aviation Administration to initiate a high-priority project to develop a simple, inexpensive airborne proximity instrument that could alert a pilot to converging planes. Later, the device could serve as a building block for a more complicated system that would not only alert the pilot to an intruder but also evaluate the hazard and tell the pilot what maneuver to make and when to do it.

The plea for "action now" was made by spokesmen for the Air Line Pilots Association, the Aircraft Owners and Pilots Association and the National Business Aircraft Association. The occasion was FAA's second National Aviation System Planning Review Conference held at Gemma Conference Center in Washington, D. C., April 14-17. FAA organized the meeting. It wanted everyone in the aviation community to speak up, and many did.

Complaints are heard

The general aviation spokesman had several complaints about the collision-avoidance system that now seems most likely to be officially accepted by FAA. A time-frequency system that consists of ground and airborne units, it won't be ready before 1972; it is a cooperative system, which means that any aircraft not equipped for it will not be detected; the airborne unit will cost far more than the small plane pilot can pay; and there are doubts in some quarters that the system will work efficiently. McDonnell Douglas, however, one of companies that has been working on the system for the past 10

years, says it will.

The Air Transport Association, which represents the air lines, agrees and adds that the cost of "a simple minimum-performance time-frequency airborne unit can eventually be brought down to within reach of the general aviation flier."

Three proximity-warning instruments designed for general aviation—or any other aircraft—were described to the meeting by three industry representatives.

Loral Electric System of New York City described its cooperative infrared system that began flight tests more than a year ago. Equipped with an infrared sensor, the plane can detect other planes equipped with strobe lights as far out as 2.5 miles during the day and 5 miles at night.

Cygned Inc., of Salem, N.H., announced an airborne, non-cooperative, coded radar that uses high repetition rates, short pulses and low radiated power. It has a range of 5000 feet. Bearing information, within 45 degrees, and range are displayed on an illuminated panel when an intruder approaches. At the same time an audio alarm goes off. The system is completely solid state, weighs about 12 pounds and when produced in quantity will sell for about \$2000. The radar is called Aware.

Since 90% of all collisions happen in situations where one aircraft overtakes another from behind, the radar is designed to accommodate closing speeds of about 300 mph, providing the pilot with a 10-second warning (4500 feet) plus bearing information for making the right maneuvers. These minimum requirements were set forth by the Air Line Pilots Association.

Radiated peak power is 2.0 watts, and average power is 0.8-watt at 5.1 MHz, using a 400-ns pulse width and a 1-MHz repeti-

tion rate. A unique and proprietary antenna configuration rotates at 150 rpm with a radome to provide 360-degree bearing.

A system with extras

The sleeper at the conference was a development announced by Escoa Corp. of Phoenix that the company reports is able to detect and warn the pilots of other aircraft, clear-air turbulence and mountains.

The system senses the natural E-field (electric) of any given molecular structure, solid, gaseous or fluid; electromagnetic signals emitted by explosion or burning; and signals emitted by ionization caused by the collision of molecules.

For a proximity-warning instrument, the E-field sensor will reportedly be "passive and non-cooperative, weigh 10 pounds or less, cost about \$1000, display both azimuth and vertical displacement angle, operate in all weather, have a range of 3 to 10 miles, and require no more power than a VOR receiver."

According to the company's director of research, George Christofv, a successful test was made by airline captain Carl Smith, chairman of the Air Line Pilots Association's Collision Avoidance System Committee. Capt. Smith tested the equipment on Western Airlines flight 92, during descent over the Rock Mountains from 37,000 feet. The sensor picked up aircraft, Smith said, "anywhere from 2 miles to 10 miles away, 2000 to 4000 feet below us." Also, he said, he was able to "detect the anticipation of turbulence, and in about 15 seconds we'd hit the bump."

RCA's Secant system, among others, was not represented at the conference. The Air Transport Association, which is committed to the time-frequency system, says it can't comment on Secant because RCA has never let them in on how it works. ■■

**Sylvania ushers in
the Golden Age
of connectors.**

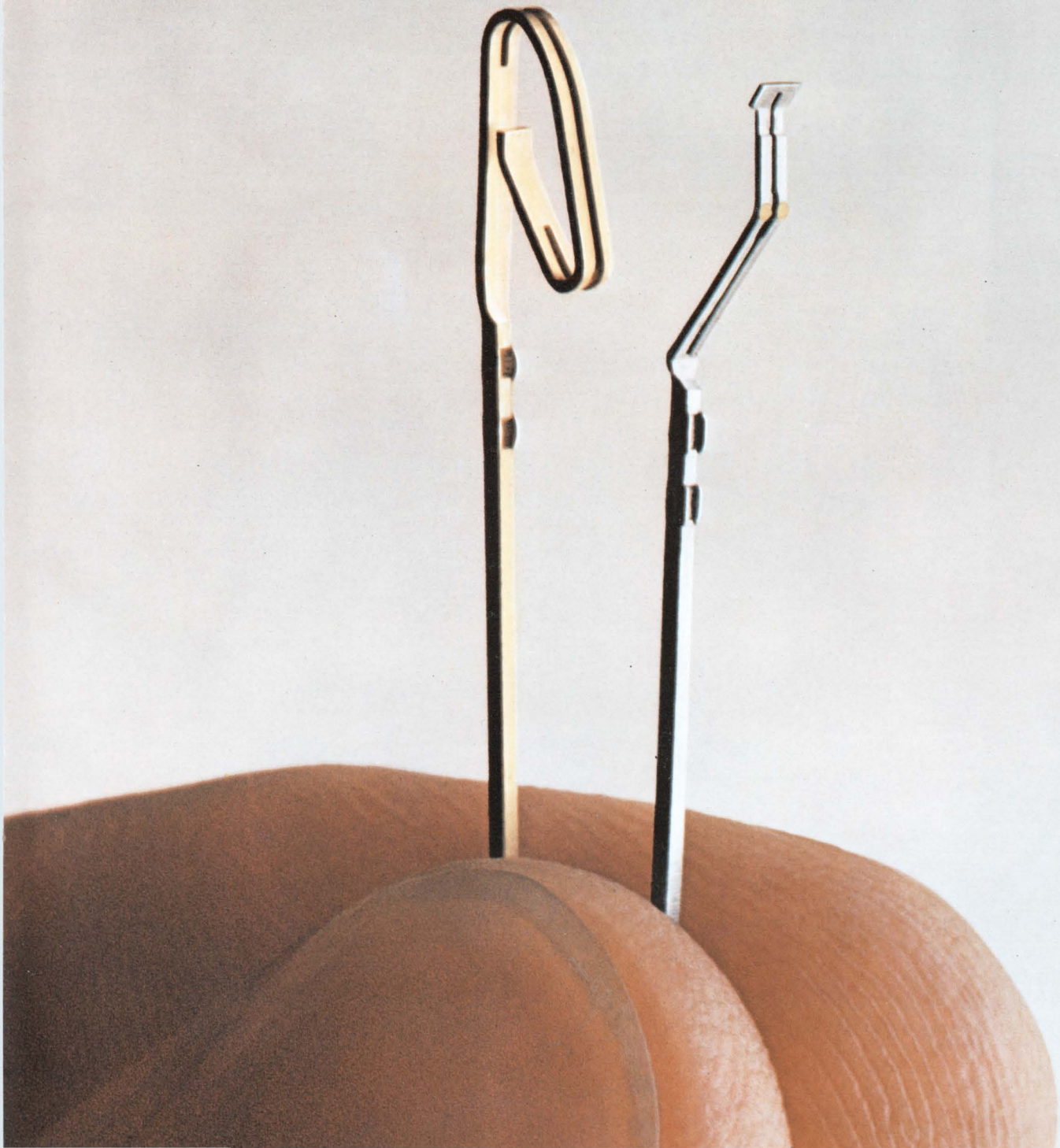

With two new off-the-shelf

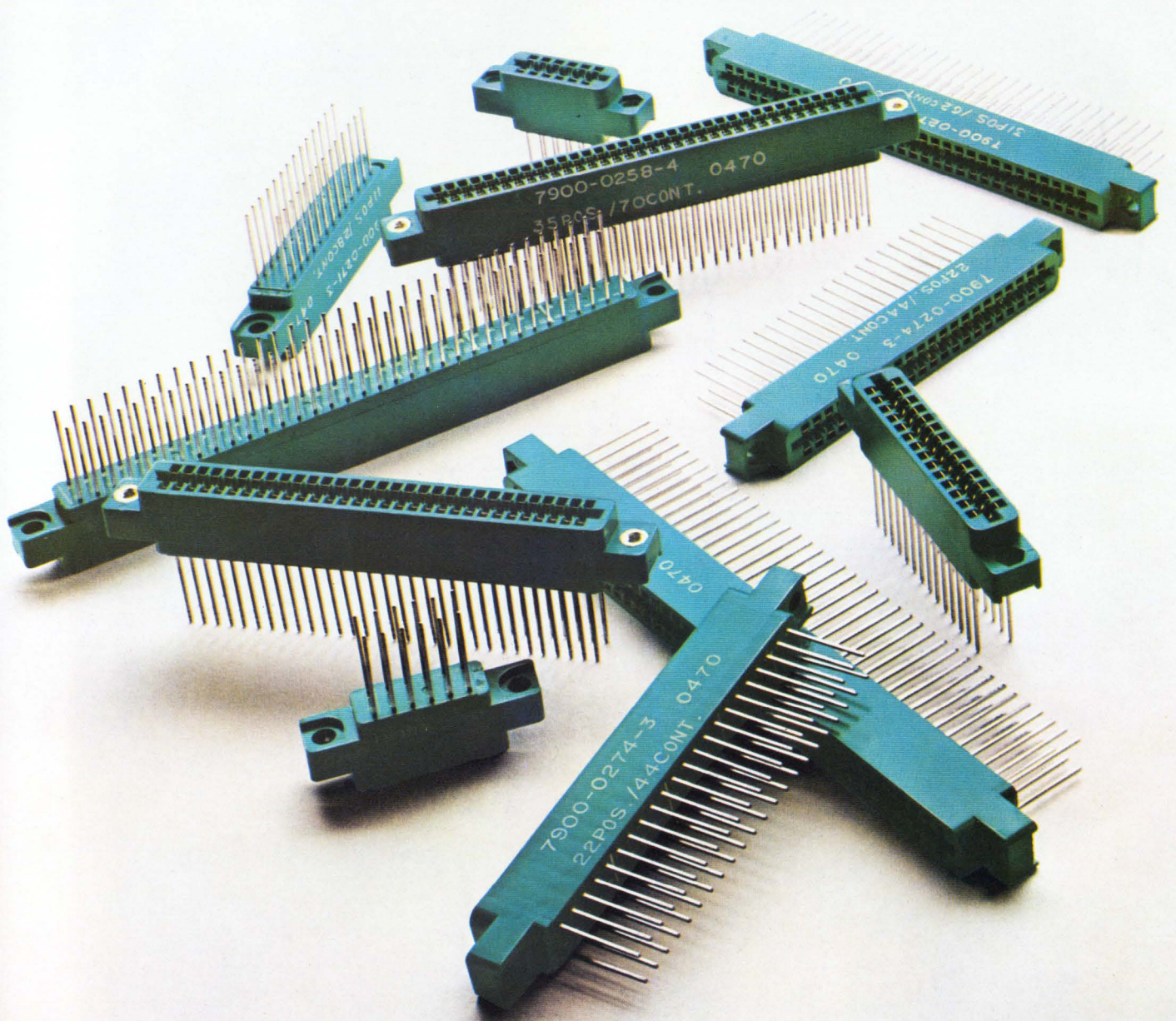

Now we can give you quick delivery even on connectors that used to be considered custom jobs.

Our first new line of PC-card edge connectors runs from 12 to 100 contacts with .125" contact spacing.

Our second gives you 36 to 100 contacts with .100" contact spacing.

For any connector in these lines, you can choose either gold-plated bellows contacts or gold-dot contacts which we've been making reliably for years.

No other manufacturer gives you this freedom of choice of contacts throughout a complete line in the same moldings.

With these connectors, we even manage to save

custom lines.

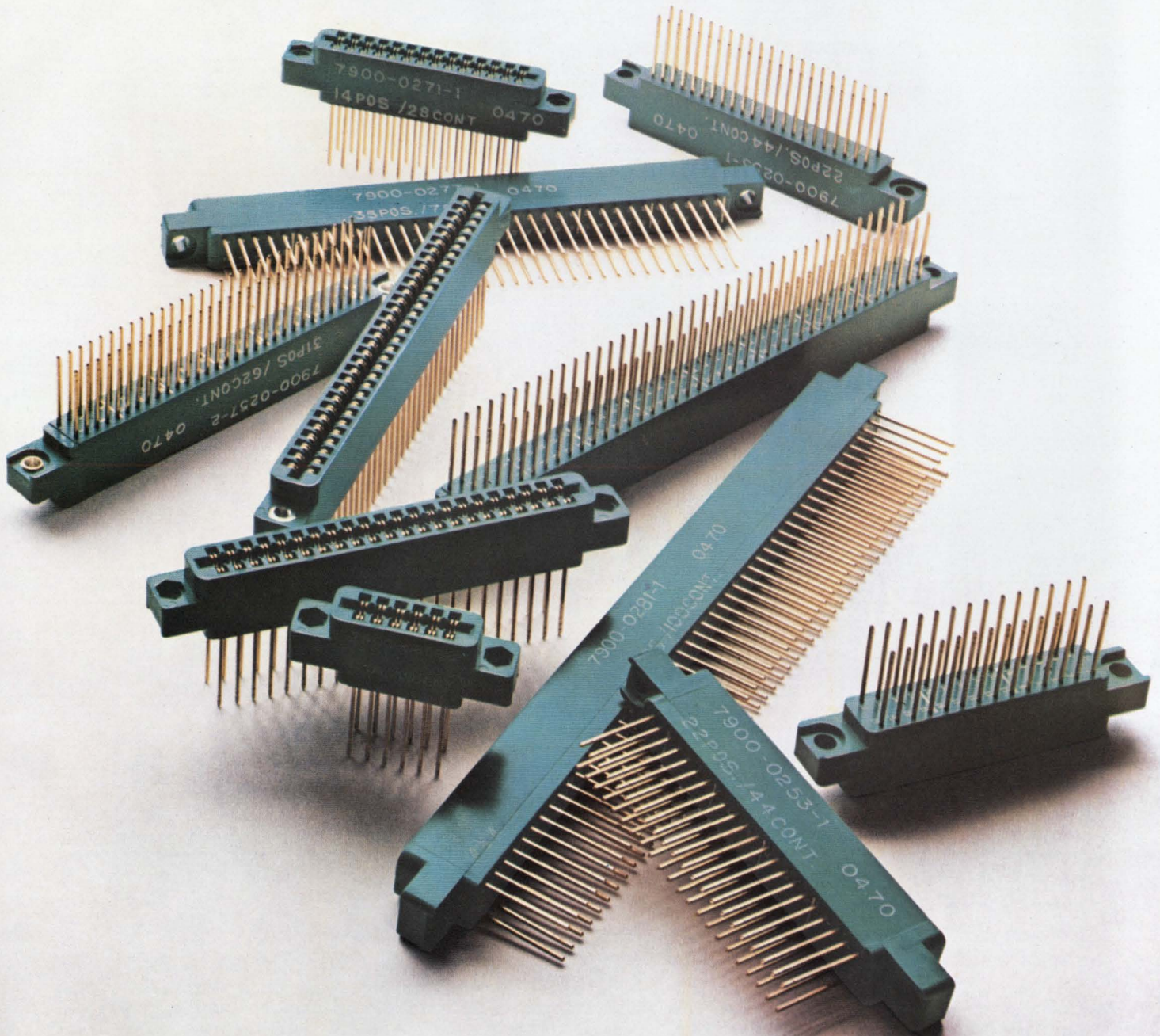

you money. Tooling costs are on the house. And if you choose gold-dot contacts, they'll cost you less.

Our new connectors—including the gold-dot types—are designed to meet Mil Spec C21097B. Which means they're designed to give you 500 or more trouble-free insertions. We're able to hold the locus point on contact tails within .010" radius

of true position, so you won't have any trouble with your programmed wiring machines.

The main thing is—we've speeded up the process of getting you good connectors.

And that's as good as gold.

Even the oddballs are conventional.

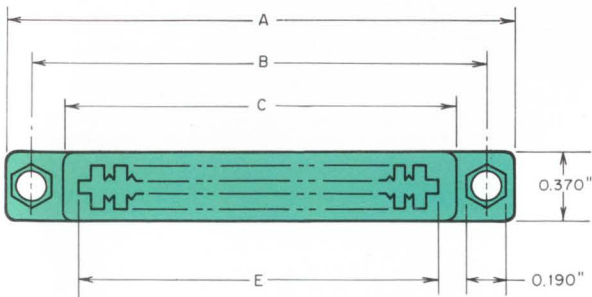

.125" Contact Centers
(Rated for 800 volts DC)

Number of pairs/contacts	Dimensions					
	A	B	C	D	E	F
6/12	1.555	1.295	1.035	.875	.875	.625
10/20	2.055	1.795	1.535	1.375	1.375	1.125
14/28	2.555	2.295	2.035	1.875	1.875	1.625
15/30	2.680	2.420	2.160	2.000	2.000	1.750
18/36	3.055	2.795	2.535	2.375	2.375	2.125
22/44	3.555	3.295	3.035	2.875	2.875	2.625
28/56	4.305	4.045	3.785	3.625	3.625	3.375
31/62	4.680	4.420	4.160	4.000	4.000	3.750
35/70	5.180	4.920	4.660	4.500	4.500	4.250
40/80	5.805	5.545	5.285	5.125	5.125	4.875
44/88	6.305	6.045	5.785	5.625	5.625	5.375
49/98	6.930	6.670	6.410	6.250	6.250	6.000
50/100	7.055	6.795	6.535	6.375	6.375	6.125

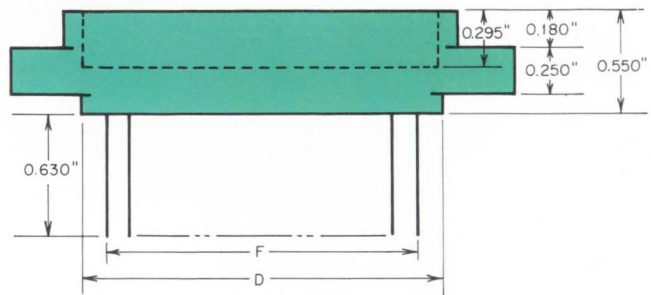

.100" Contact Centers
(Rated for 600 volts DC)

Number of pairs/contacts	Dimensions					
	A	B	C	D	E	F
18/36	2.635	2.375	2.060	1.950	1.900	1.700
20/40	2.835	2.575	2.260	2.150	2.100	1.900
22/44	3.035	2.775	2.460	2.350	2.300	2.100
25/50	3.335	3.075	2.760	2.650	2.600	2.400
28/56	3.635	3.375	3.060	2.950	2.900	2.700
30/60	3.835	3.575	3.260	3.150	3.100	2.900
31/62	3.935	3.675	3.360	3.250	3.200	3.000
35/70	4.335	4.075	3.760	3.650	3.600	3.400
36/72	4.435	4.175	3.860	3.750	3.700	3.500
40/80	4.835	4.575	4.260	4.150	4.100	3.900
43/86	5.135	4.875	4.560	4.450	4.400	4.200
44/88	5.235	4.975	4.660	4.550	4.500	4.300
49/98	5.735	5.475	5.160	5.050	5.000	4.800
50/100	5.835	5.575	5.260	5.150	5.100	4.900

Some technical details

Read between the lines for oddball connectors, such as 19/38 or 46/92. We supply these, too.

Connectors are designed for use with .062"-thick printed circuit cards. They are rated at 3 amps, voltage drop not to exceed 30 mV at rated current. Temperature range: -65 to +125°C.

Connector bodies of diallyl phthalate. Choice of bifurcated gold-plated bellows or gold-dot contacts. Choice of mounting holes: with or without bushing. Choice of plastic or metal polarizing keys.

For more information, write to: Sylvania Precision Materials, Parts Division, Warren, Pa. 16365.

SYLVANIA
GENERAL TELEPHONE & ELECTRONICS

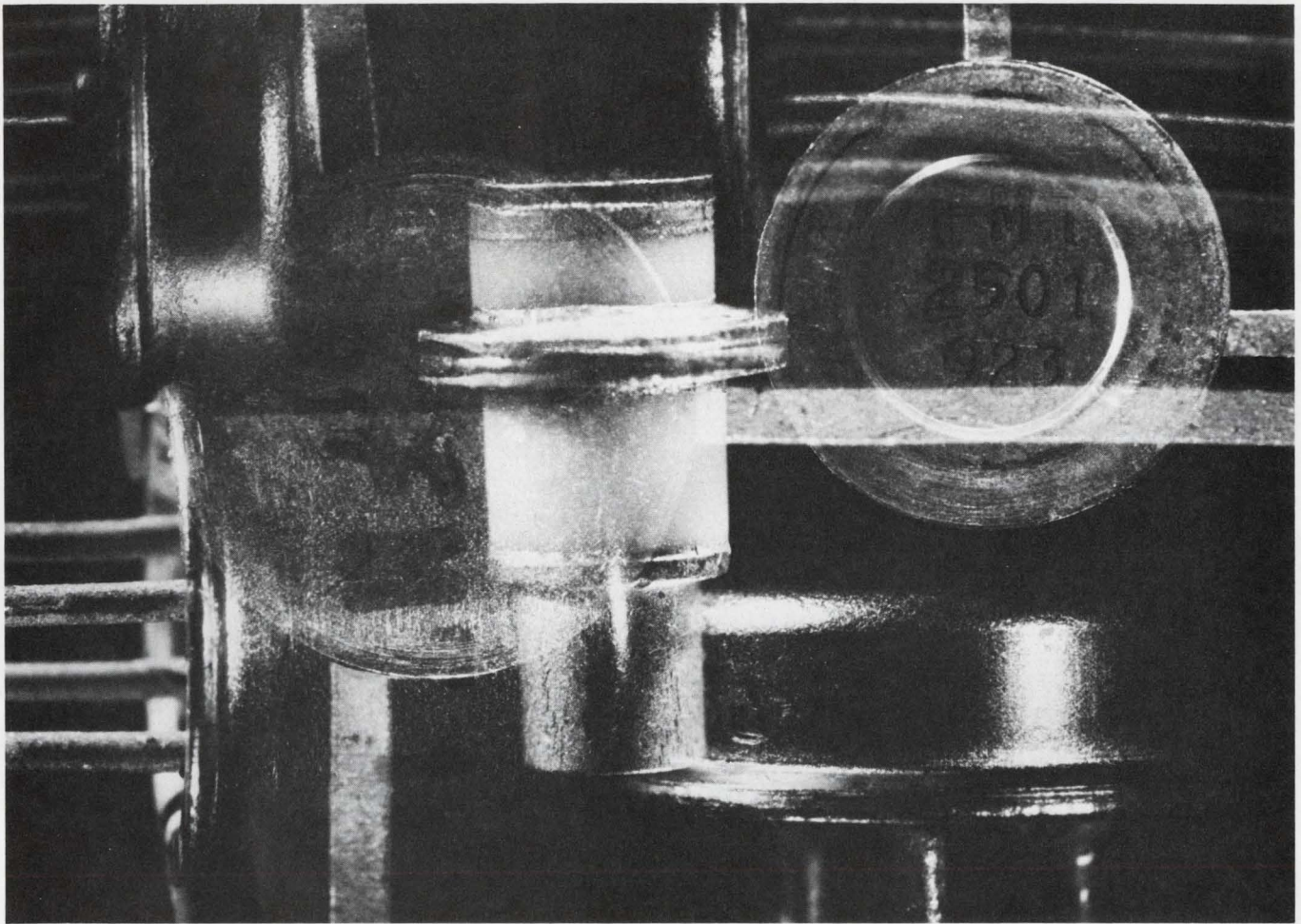

The MOD line... HF transistors

MOD stands for the Microwave and Optoelectronics Division of Fairchild. If you are designing high frequency circuits you will find MOD transistors give you a wide choice of design parameters. As amplifiers you can use them in radio and television circuits, active filters, TWT replacements, CATV applications, etc., etc. As oscillators you can apply them in sweepers, signal generators and other instruments that can benefit from solid state reliability.

Whatever your requirements your best source for a wide selection of specifications, high reliability and prompt delivery is Fairchild MOD. A variety of packages is available and even the basic chips can be supplied for your unique requirements.

You should know more about these high frequency devices. All you have to do is ask and we will send you a complete set of data sheets and price list.

Our application engineers will assist you in any way they can, it's part of our service. Your requirements come first at Fairchild Microwave and Optoelectronics Division (MOD).

You need to know about MOD transistors . . . If you don't have complete copies of the MOD transistor data sheets circle reader service number 1. Keep your eye on number 1 because in future months it will bring you important information about new products. Number 1 is . . . the MOD line . . . circle it today.

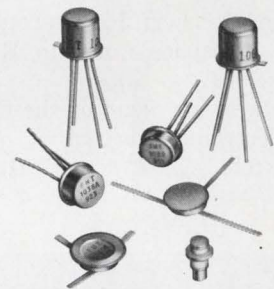

Gain Performance						
f (GHz)	Maximum Available Gain (dB)					
.5	MT1060	MT2116				
	MT1061	MT1038				
1.0		MT1060	MT1038			
		MT1061				
2.0			MT1070	MT1060	MT1038	
			MT2500	MT1062		
				MT1050		
3.0			MT1116	MT1070	MT1050	
					MT1062	
4.0				MT1116	MT1115	
5.0					MT1116	
					MT2500	

FAIRCHILD
 MICROWAVE AND OPTOELECTRONICS
 A DIVISION OF FAIRCHILD CAMERA AND INSTRUMENT CORPORATION
 2513 Charleston Rd., Mt. View, Ca. 94040

Laser or millimeter space communications?

Both can do the job, 3 specialists conclude, but millimeter system can be put into operation first

David N. Kaye
West Coast Editor

The first requirement for a flexible world-wide communications network is an efficient means of communicating large amounts of data from one communications satellite to another.

Two technologies are being considered as a means to this end: one is a millimeter-wave system, and the other is a laser link. They were compared recently in a paper given at the International Symposium on Submillimeter Waves at Polytechnic Institute of Brooklyn.

The paper concluded that both technologies could do the job. The millimeter-wave system would be the easiest to put into early use, the authors said, but the laser system would, in the long run, be better.

The authors were LaRue A. Hoffman, Dr. Thomas S. Hartwick, and Herbert J. Wintroub, all of the Aerospace Corp. in El Segundo, Calif.

Dr. Hartwick, head of the Quantum Electronics section of Aerospace, told ELECTRONIC DESIGN

that for deep-space communications, from space vehicle to space vehicle, laser systems are the only way to go.

An operable laser system, he said, could be ready in about five years. On the other hand, a three-satellite global system could be designed now and deployed in three to four years with millimeter-wave technology, according to Hoffman, associate director of the Electronics Research Laboratory at Aerospace. This system could relay information either from the ground or from another satellite, such as an earth resources satellite, to any point in the world.

Delays in laser systems

"The biggest problem," said Hartwick, "in a laser communication system is to get systems built and working in the field. It's not a big extrapolation to go from microwaves to millimeter waves with the tremendous history of communications behind you."

But if a laser satellite-to-satellite link were to be designed today, what form would it take?

Hartwick first divided lasers according to detection scheme. He pointed out that sources in the visible region—approximately 0.35 to 0.75 micron—can be detected with high quantum efficiency and long life, using direct or incoherent detectors. Sources in the infrared, however, are detected most efficiently by a coherent heterodyne system, using a laser local oscillator and a photoconductive or photovoltaic mixer.

An infrared, 10.6-micron, CO₂ system is currently being built (see ED 4, Feb. 15, 1970, p. 30).

Although the CO₂ laser project is currently in progress, Hartwick noted that it is not practical for high data rate systems. "There are specific objections to this type of system," he pointed out:

- Cooled (approximately 100°K) mixers are required.
- Doppler shifts prevent communication to low orbiting satellites.
- Local oscillator and signal wave-fronts must coincide at the detector.
- The requirement for two lasers in a transceiver is complex.
- Modulation rates and detector response times both limit the information rate to approximately 10 Mbits/sec."

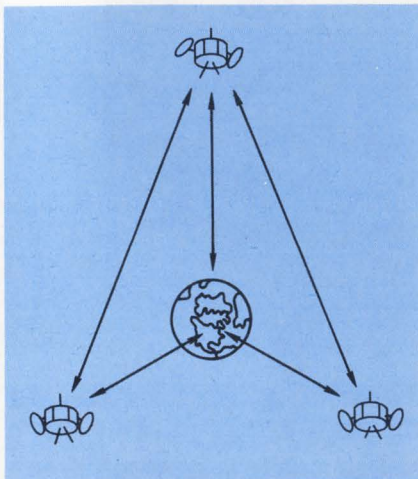

Three synchronous satellites would provide global coverage if spaced 120° apart.

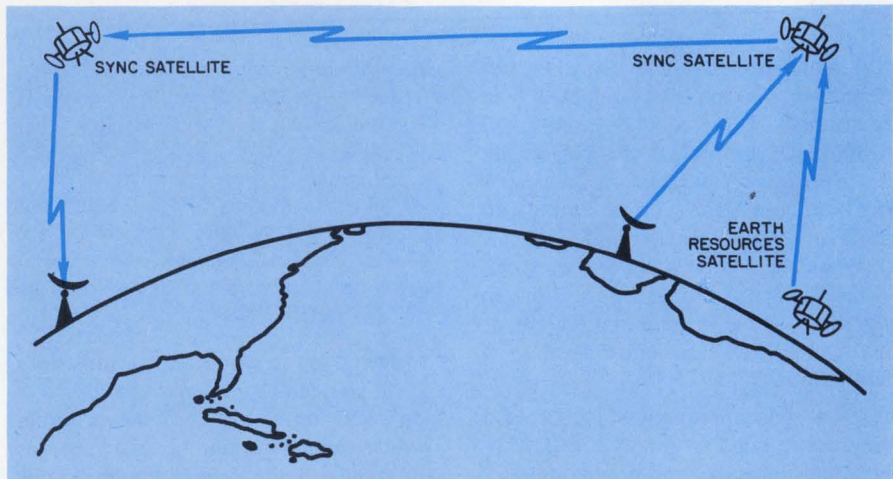

Information transmitted either from the ground or from another satellite could be relayed anywhere in the world by such a global communications system. The system could be deployed in four years with mm-wave technology.



CINCH PRECISION MINIATURE SOCKETS

INSURE EQUIPMENT DEPENDABILITY

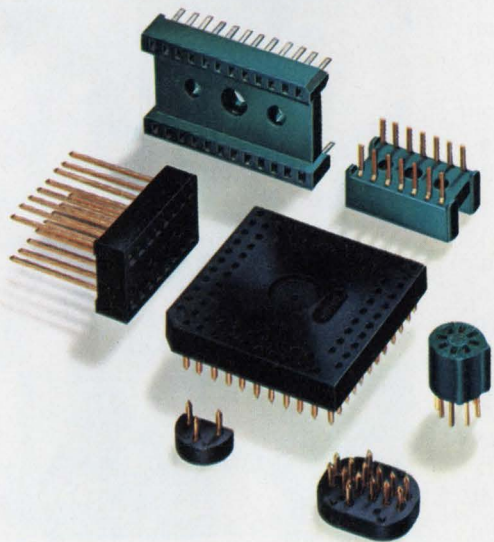

Equipment design frequently involves problems of field maintenance or circuit updating. Cinch component sockets provide inexpensive and effective solutions without compromising reliability.

DIP low-profile sockets for 14, 16 and 24 lead DIP's are typical of Cinch's specialized miniature sockets, available in three lead types for solder dip and wire wrap applications. Insulators are in GP black phenolic, dially phthalate or glass nylon. They are resistant to shock, vibration, humidity and corrosive atmospheres. Contacts are gold or tin plate for lower resistance and better solderability.

MSI or LSI low-profile sockets, utilizing Cinch's exclusive subminiature contact, can be custom-designed with up to 200 contacts per socket, for quantity production.

IC sockets for 6, 8 and 10 pin TO-5 cased devices, miniature NIXIE tube sockets and subminiature relay sockets are just a few of the other component sockets Cinch manufactures.

For information on these and other Cinch interconnection devices, write to Cinch Manufacturing Company, a division of TRW, Inc., 1501 Morse Avenue, Elk Grove Village, Illinois 60007.

C-7030

CINCH

(Communications, continued)

Therefore, Hartwick concluded that the visible spectrum should be utilized in order to use a direct detection scheme.

In the visible spectrum three types of lasers can be considered as sources. According to Hartwick: "The source must efficiently deliver a single mode diffraction limited beam with 0.1-1.0 watts of power, long lifetime, and a compact size. The GaAs diode laser is immediately ruled out because of poor lifetime, cryogenic cooling, and poor mode characteristics. Of the noble gas lasers, the He-Ne laser at 6328 Å is the best developed but suffers from a poor efficiency. The best choice, principally because of the high efficiency is the Nd:YAG laser."

Nd:YAG must be doubled in order to get into the visible spectrum. Doubling with nearly 100% efficiency has been demonstrated using BaNaNbO₃ crystals to yield an output at 0.53 micron.

At 0.53 micron, the best choice for a detector is a photomultiplier.

A 30% quantum efficiency can be achieved at 0.53 micron with a photomultiplier.

Best of the currently available modulators is the potassium dideuterated phosphate electro-optic type. Using 60-mw/MHz drive power, a bandwidth of 525 MHz has been demonstrated. Hartwick believes that "low drive power modulators operating throughout the visible into the near infrared region should be space qualified without difficulty up to 1 GHz of bandwidth."

Millimeters can be used now

According to Hoffman, "The specific advantage of millimeter waves is the extremely large data bandwidth that is theoretically feasible, while utilizing modest-size antennas to achieve both high radiation efficiency and protection from the detection and jamming threat by means of the narrow beamwidths obtainable."

If a millimeter system were designed today, Hoffman noted, "best judgment indicates the 70-GHz region of the spectrum as the high-

est frequency range providing a promising choice based on the present state of the technology."

As a source for the system, Hoffman told ELECTRONIC DESIGN that at present an impatt oscillator followed by a traveling-wave-tube amplifier to produce about 25 W at 70 GHz seems the best way to go. LSA is not far enough along yet to be considered for real systems. Impatt oscillators have been demonstrated at over 100-mW output with efficiencies of 2 to 4%.

Choice of an antenna is the old reliable Cassegrain. "Cassegrain is the most efficient millimeter antenna," Hoffman said. "Tolerances on the order of 0.007 inches for the surface of the dish are necessary at 70 GHz. Due to these tolerances and the state of the art in attitude control and steering technology an 8-foot dish is the largest that could be carried into space. This size is also compatible with existing launch vehicles."

Millimeter reception will be best handled by a superheterodyne system comprised of an uncooled parametric amplifier followed by a Schottky barrier diode mixer. ■■

Laser beam draws quick and clean patterns for ICs

A laser beam is being used to draw mask patterns for highly sophisticated integrated circuits in one-sixtieth the time the operation takes when done by conventional mechanical techniques.

Developed by Bell Laboratories, Murray Hill, N. J., the laser-equipped machine is called a Primary Pattern Generator. Bell Labs is using it to create circuit patterns in photolithographic masks, which in turn, are used by the Western Electric Co. to produce ICs for Bell System Equipment.

The machine consists of a moving table to hold an 8-by-10-inch photographic plate; an argon laser as the light source; modulators and lenses to control the laser beams; and a 10-sided mirror, rotating on air bearings, to reflect the laser beam and expose select portions of the photographic plate.

The laser beam is controlled with pin-point precision, Bell Labs engineers say, to traverse the photographic plate along 32,000 scan lines and with 26,000 positions per scan line.

The beam can be directed with an accuracy of less than one arc-second, the equivalent of a mile-long straight line, with a deviation of less than 5/16 inch.

To obtain such precision, the generator is operated in a special controlled environment chamber, where the temperature is maintained within 1/4°F, and each cubic foot of air contains fewer than 100 dust particles larger than 1 micron.

The machine is so fast that it takes only 12 minutes to complete a highly sophisticated circuit mask that formerly required more than 12 hours of machine time. ■■



Laser beam and 10-sided rotating mirror cut time to one-sixtieth for drawing mask patterns for ICs.

**AUTOMATIC TIMING DEVICE
FOR SYNCHRONIZING
QUICK STARTS (B)**

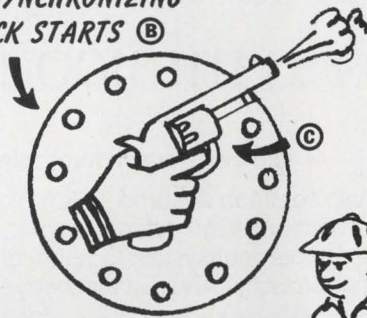

**TANTALUM CHIP
CARRYING TRAYS (A)**

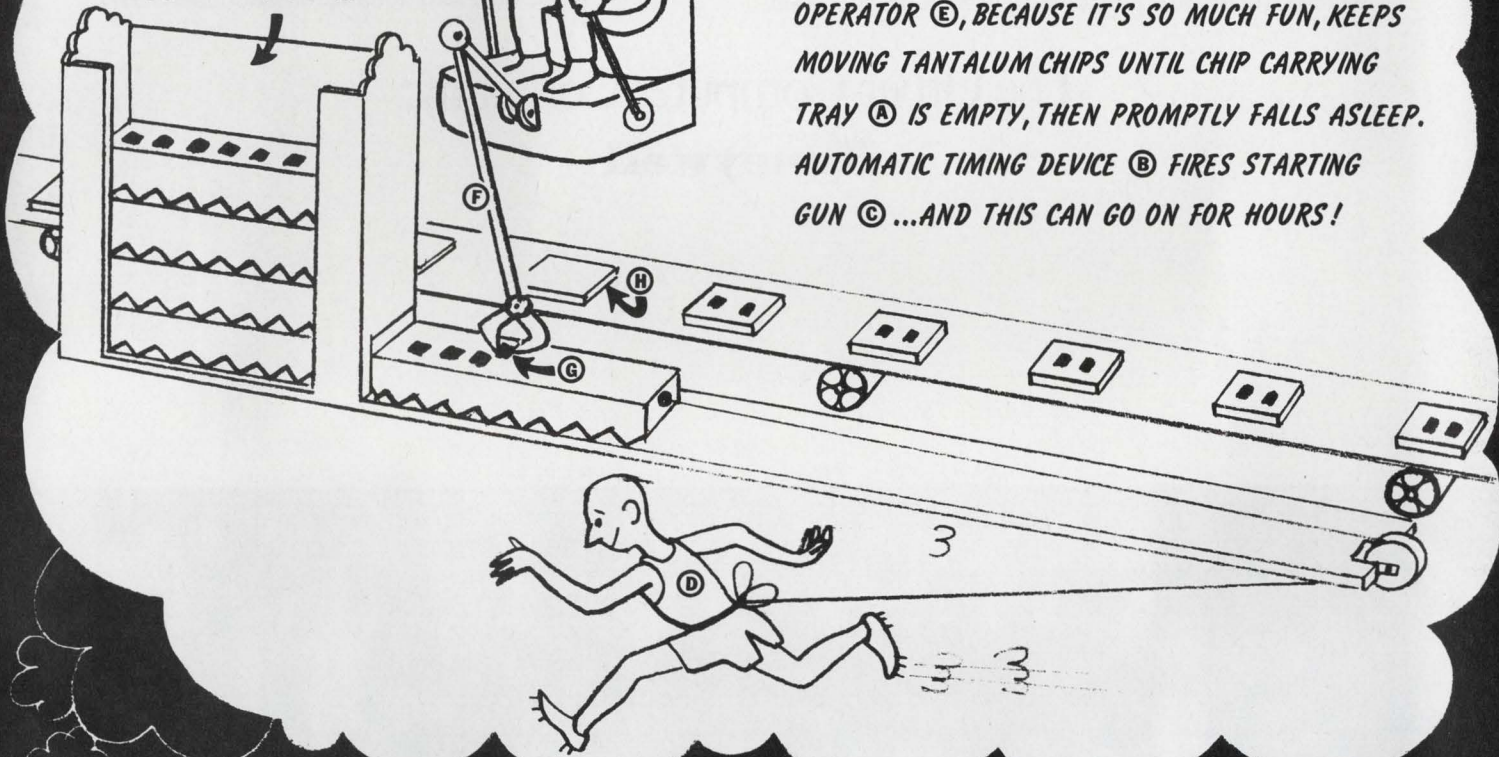

TANTALUM CHIP CARRYING TRAY (A) MOVES INTO POSITION WHEN AUTOMATIC TIMING DEVICE (B) FIRES STARTING GUN (C) AND RUNNER (D) TAKES OFF LIKE A RABBIT. CRANE OPERATOR (E) WAKES UP, MOVES DELICATE ARM (F), PICKS UP TANTALUM CHIP (G) AND DEPOSITS IT, IN PROPER POLARITY, UNTOUCHED BY HUMAN HANDS OR TWEEZERS, IN PRECISE POSITION ON SUBSTRATE (H). CRANE OPERATOR (E), BECAUSE IT'S SO MUCH FUN, KEEPS MOVING TANTALUM CHIPS UNTIL CHIP CARRYING TRAY (A) IS EMPTY, THEN PROMPTLY FALLS ASLEEP. AUTOMATIC TIMING DEVICE (B) FIRES STARTING GUN (C) ...AND THIS CAN GO ON FOR HOURS!

**T411 CHIPS (KEMET® SOLID TANTALUM CAPACITORS FROM UNION CARBIDE)
FOR HYBRID CIRCUIT APPLICATIONS
CAN MAKE YOUR CRAZIEST PRODUCTION DREAMS COME TRUE**

Eliminate hand assembly, improve reliability, save time, and substantially reduce assembly costs! KEMET T411 Series tantalum chip capacitors are specially designed for solder reflow assembly, and they are ideal for your mass market, low cost, consumer type hybrid circuit applications.

They're available in a UNION CARBIDE developed automated dispensing system that can be easily synchronized with your standard pick-and-place equipment. A manually operated automatic placing system is also

available, if you do not require a fully automated system. Standard capacitance values from 0.1 to 68 μ F (higher values on special order). Voltage range from 4 to 50 V DC. And a UNION CARBIDE developed copper coating process permits assembly temperatures as high as 300°C for a maximum of 3 minutes, continuous operating temperatures to 175°C when derated linearly.

Contact your local UNION CARBIDE representative for complete information...and make your craziest production dreams come true.

COMPONENTS DEPARTMENT

P. O. Box 5928, Greenville, S. C. 29606. Tel: (803) 963-7421 TWX: 810-287-2536

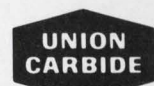

THE DISCOVERY COMPANY

Introducing the DATA-PAC family: Compatible from logic modules to minicomputers.

If you build digital systems, make life easy for yourself. Look into Honeywell's DATA-PAC family of digital products.

There are logic modules. Core memory systems. Controllers. Minicomputers. Analog interface modules. Hardware. Power Supplies. Accessories.

Every DATA-PAC product is compatible logically, electrically, and mechanically. Which lets you do something unique: pick precisely the items you need,

join them, attach the cables . . . and go.

You use common documentation. You don't have to select or design different power supplies and interfaces. You get your system together quickly, easily, economically. And just the way you planned it.

Our new DATA-PAC Family Brochure gives you all the facts. Write for it today. But whatever you do, consider the alternative: Honeywell, Computer Control Division, Framingham, Massachusetts 01701.

The Other Computer Company:
Honeywell



Washington Report

DON BYRNE, WASHINGTON BUREAU

ABM expectations soaring again in House

Hopes have been revived for expansion of the Safeguard antiballistic missile system—at least so far as approval by the House of Representatives is concerned. Rep. L. Mendel Rivers (D-S.C.), chairman of the House Armed Services Committee, has done another about face and is now supporting the \$300-million expansion of the program.

Originally Rivers was for the program. But he became unhappy with the Pentagon and the White House when, in his opinion, they didn't ask for enough money for naval ship construction. About a month ago, Rivers let it "leak" that he might withdraw his powerful support from the Administration-backed plan to expand Safeguard. He supposedly felt that it would not get through Congress anyway, and he said publicly that he was "much more concerned about the Navy" than he was about ABM.

In short order, an invitation to the White House was received, and Rivers journeyed down to 1600 Pennsylvania Avenue, where he and the President had what is termed "an exchange of ideas." The upshot: Rivers will back ABM expansion, and the White House will not object to the Armed Services Committee adding \$435-million to the Navy's request for new ships. The Navy will now have an authorization of \$3,013,900,000 for new ships.

Rivers also wanted, and got, the inclusion of \$152-million for design work on a new carrier, the third in the Nimitz class.

Meanwhile a joint Senate-House committee investigating the role of aircraft carriers has approved the funding of "long lead-time" construction items for the carrier without actually deciding the future of the big ships. That is now up to the National Security Council.

NASA fund slash due to Apollo failure unlikely

The near disaster of Apollo 13 will probably not have any serious effect on NASA's funding this year, sources in the space agency believe. They see the failure of the mission and recovery of the crew as providing about equal ammunition for both the pro and anti space-flight camps in Congress, and there are more pros than there are antis. NASA sources also point out that a probe of the accident will not be completed until long after the appropriations process is finished.

There is talk within the agency, however, that Apollos 18 and 19, scheduled for 1973 and 1974, may be scrubbed and the money and vehicles used for a "Skylab" space station instead of for lunar exploration. No firm decision, however, has yet been made.

FCC's proposed fee draws a loud no

The Federal Communications Commission is being inundated with literally hundreds of responses—all opposed—to its proposed rule to raise the fees for users of radiation-emitting equipment and to impose a new type of "acceptance" fee on manufacturers. The net intake would be about \$24.5-million—\$20 million more than the FCC takes in on its license-granting now.

Protests are coming in from the big communications common carriers, the National Association of Manufacturers and on down to individual ham radio operators.

The Air Transport Association and its subsidiary, ARINC, suggested taking the matter to court. The NAM saw a dangerous precedent in a "tax, not a fee, without Congressional action." The deluge will end May 16, when all comments are to be in. The FCC will then begin its deliberation leading to a decision.

Office proposed to educate Congress on technology

Congress is passing laws affecting modern technology, and modern technology is having a direct effect on Congress's laws. To help the men on the hill make the right decisions in the highly technical matters with which they must deal, an Office of Technology Assessment has been proposed to educate them as issues come up.

Proposed by Rep. Emilio O. Daddario (D-Conn), a key member of the House Science and Astronautics Committee and head of the subcommittee on Science, Research and Development, the office would not make actual assessments, it would operate no labs or test facilities, but it would rely on the National Science Foundation for referral to the right government agency, laboratory or company for help. Nor would the office's role be to recommend actions or positions; it would only provide Congress with information on which they could base conclusions. The bill (HR 17046) has been referred to the full Science and Astronautics Committee for action.

Capital capsules: The engineering development contract selection for the **B-1 advanced manned strategic aircraft has been pushed back** from the scheduled mid-May deadline. The selection board is now aiming for early June Federal Aviation Administration is seeking comments by June 15 on a proposed rule which **would ban flights by civil aircraft** over the U. S. at speeds that would cause a sonic boom to reach the ground **The joint study on civil aeronautical research and development** policy being made by NASA and the Dept. of Transportation is running a half year behind schedule and may not be completed until mid-1972. The purpose of the study is to identify benefits accruing to the public from specific levels of aeronautical R&D and to propose the levels necessary to achieve those benefits **Project Mallard**, the proposed tactical communications system to be used by the military forces of the U. S., Canada, Great Britain and Australia, will get the \$14-million requested for it this year, but it faces an uncertain future. The House Armed Services Committee is beginning to have strong doubts as to its merits vs its cost. It also questions the practicality of four countries having cooperative equipment The Dept. of Transportation's plan for a 150-to-200 mph **tracked air-cushion transportation system** between a city center and its airport has run into local financing snags. Also, the site announcement is not expected now before the end of May. Kansas City and Denver were under consideration, but Kansas City is reportedly out as DOT seeks new entries.

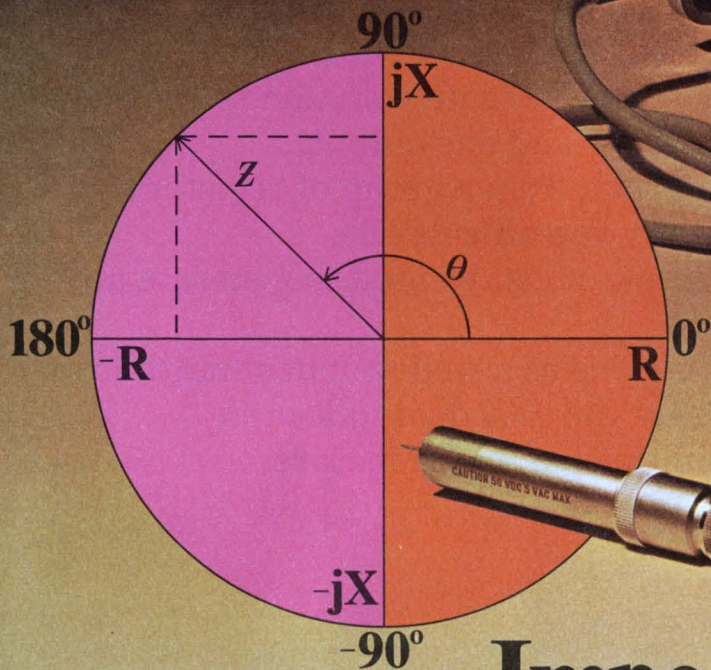

Impedance Measurement goes full circle

The HP 4815A RF Vector Impedance Meter will conveniently measure complex impedance over the entire impedance domain. You get instant, direct readout of impedance magnitude from 1 ohm to 100K ohms and phase angle from 0 to 360°, over a frequency range of 500 kHz to 108 MHz. Now you can easily measure impedances with negative real parts, often present in feedback amplifiers with small phase margin. To measure impedance at multiple frequencies, simply set the frequency, probe, and read. No nulling and balancing, as with conventional bridge measurements.

A convenient probe lets you measure directly in **active** circuits to determine driving point impedance under actual operating conditions, with minimum residual effects. For example, amplifier input or output impedance can be continuously monitored while bias, feedback, load, and frequency are varied. In-circuit measurements for determining loop gain and phase margin can also be made.

The 4815A is also ideal for evaluating **passive** devices, such as components and networks. Use it to characterize transformers, resonant circuits, transmission lines, filters, and crystals. You can measure at

actual operating frequencies and make network adjustments while impedance parameters are monitored. For example, antenna/transmission line matching networks can be quickly adjusted. Price: \$2650.

To learn more about how easy it is to use impedance for evaluating circuits and components, request Application Note 86 and a special impedance issue of the HP Journal. If you would like to discuss a particular application, call your local HP field engineer or write: **Hewlett-Packard, 100 Locust Ave., Berkeley Heights, N.J. 07922. In Europe: 1217 Meyrin-Geneva, Switzerland.**

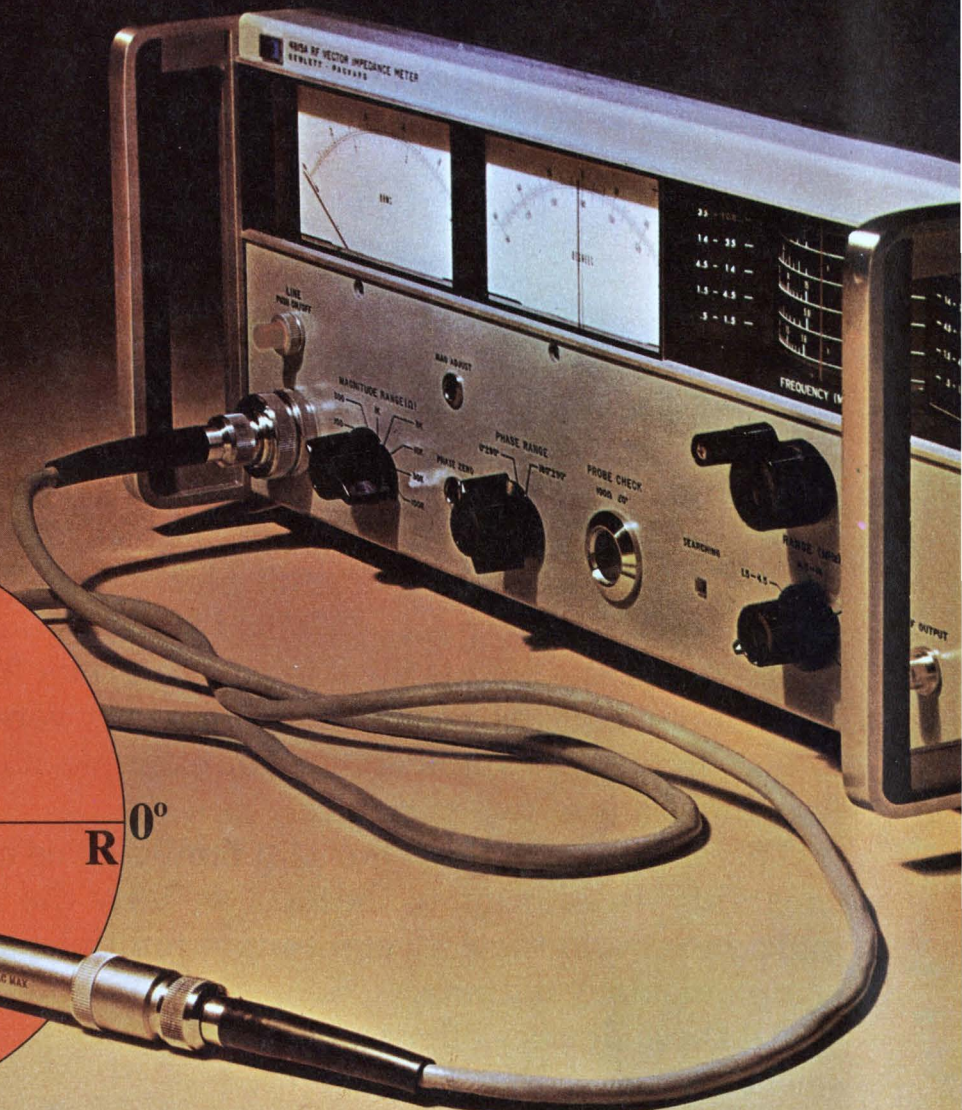

One of the nicest things about our new MSI Multiplexer

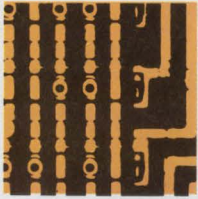

Even multiplexers can't escape the advantages of MSI family planning. (When we plan a family, we plan a *complete* family.) Here's proof: The 9322. Our third extremely versatile MSI multiplexer. A high-speed, quad two-input device that consists of four multiplexing circuits with common select and enable logic. Each circuit contains two inputs and one output.

Of course, the 9322 is ideal for moving data from a group of registers to a common output buss. But, being a very versatile device, it has many other applications. For example, it can be used to generate any four functions of two variables.

This latest addition to our MSI family gives us a well-rounded multiplexer capability. In addition to the 9322, we have the 9309 dual four-input multiplexer and the 9312 eight-input multiplexer which feature complementary outputs.

All three devices offer on-chip select logic decoding, fully buffered outputs, typical through delay of 9ns, and complete compatibility with Fairchild DT μ L, LPDT μ L, TT μ L and MSI families.

To order MSI Multiplexers, call your Fairchild Distributor and ask for:

PART NUMBER	PACKAGE	TEMPERATURE RANGE	PRICE		
			(1-24)	(25-99)	(100-999)
U6B930951X	DIP	-55°C to +125°C	\$15.80	\$12.70	\$10.60
U6B930959X	DIP	0°C to + 75°C	7.90	6.35	5.30
U4L930951X	Flat	-55°C to +125°C	17.40	14.00	11.70
U4L930959X	Flat	0°C to + 75°C	8.70	7.00	5.85
U6B931251X	DIP	-55°C to +125°C	15.80	12.70	10.60
U6B931259X	DIP	0°C to + 75°C	7.90	6.35	5.30
U4L931251X	Flat	-55°C to +125°C	17.40	14.00	11.70
U4L931259X	Flat	0°C to + 75°C	8.70	7.00	5.85
U6B932251X	DIP	-55°C to +125°C	15.80	12.70	10.60
U6B932259X	DIP	0°C to + 75°C	7.90	6.35	5.30
U4L932251X	Flat	-55°C to +125°C	17.40	14.00	11.70
U4L932259X	Flat	0°C to + 75°C	8.70	7.00	5.85

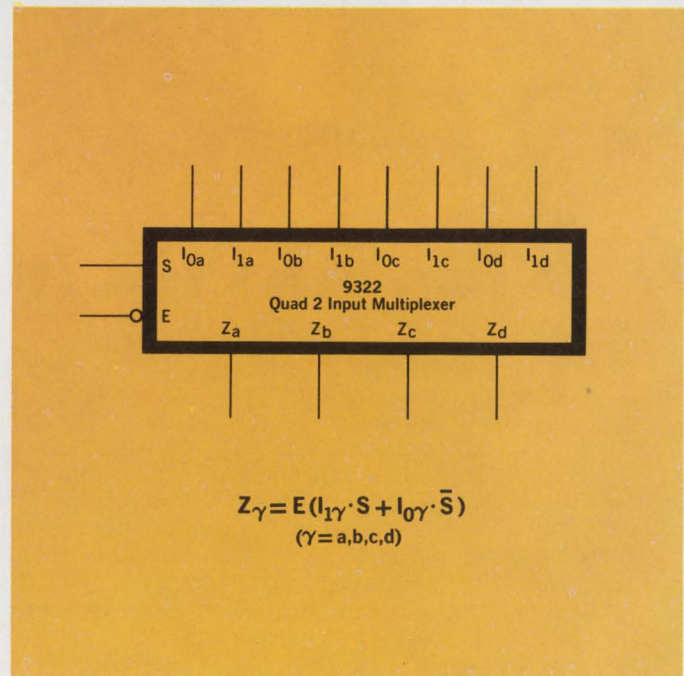

is the family it comes from.

We put together a family plan by taking systems apart. All kinds of digital systems. Thousands of them.

First we looked for functional categories. We found them. Time after time, in a clear and recurrent pattern, seven basic categories popped up: Registers. Decoders and demultiplexers. Counters. Multiplexers. Encoders. Operators. Latches.

Inside each of the seven categories, we sifted by application. We wanted to design the minimum number of devices that could do the maximum number of things. That's why, for example, Fairchild MSI registers can be used in storage, in shifting, in counting and in conversion applications. And you'll find this sort of versatility throughout our entire MSI line.

Finally, we studied ancillary logic requirements and packed, wherever possible, our MSI devices with input and output decoding, buffering and complementing functions. That's why Fairchild MSI reduces—in many cases eliminates—the need for additional logic packages.

The Fairchild MSI family plan. A new approach to MSI that's as old as the industrial revolution. It started with functional simplicity, extended through multi-use component parts, and concluded with a sharp reduction in add-ons. Simplicity. Versatility. Compatibility. Available now. In military or industrial temperature ranges. In hermetic DIPs and Flatpaks. From any Fairchild Distributor.

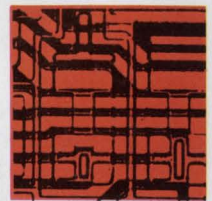

OPERATORS
9304—Dual Full Adder/Parity Generator

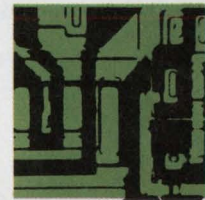

LATCHES
9308—Dual 4-Bit Latch
9314—Quad Latch

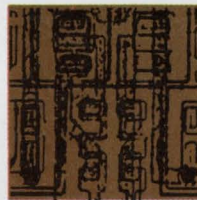

REGISTERS
9300—4-Bit Shift Register
9328—Dual 8-Bit Shift Register

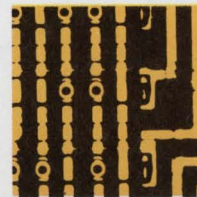

MULTIPLEXERS
9309—Dual 4 Input Digital Multiplexer
9312—8-Input Digital Multiplexer
9322—Quad 2-Input Digital Multiplexer

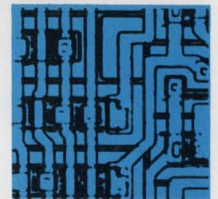

DECODERS AND DEMULTIPLEXERS
9301—One-Of-Ten Decoder
9315—One-Of-Ten Decoder/Driver
9307—Seven-Segment Decoder
9311—One-Of-16 Decoder
9317—Seven-Segment Decoder/Driver
9327—Seven-Segment Decoder/Driver



COUNTERS
9306—Decade Up/Down Counter
9310—Decade Counter
9316—Hexadecimal Counter



ENCODERS
9318—Priority 8-Input Encoder

FAIRCHILD
SEMICONDUCTOR

Strong, silent type

...and the price is right*!

Low, low price
— *less than \$5.00
in 1000 lots.

Delivers a full 100
CFM at free delivery.

Quiet operation.

Lightweight
— only 20 ounces

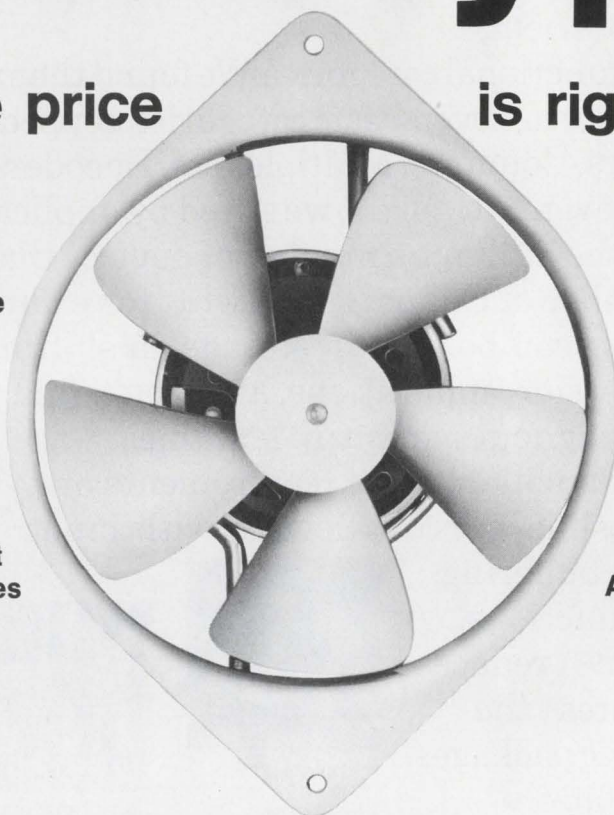

Five year operating
life at continuous duty.

Simple installation —
only two mounting
screws required.

Three optional mounting
arrangements available.

Available from stock.

Rotron's new Sergeant[®] fan



Get all the facts fast. Call 914-679-2401 or
write Rotron Incorporated, Woodstock, N. Y. 12498

INFORMATION RETRIEVAL NUMBER 27



Sonotone—the industry's broadest line of nickel-cadmium sealed cells—now has our name on it.

The new name for Sonotone sealed cell nickel-cadmium batteries is Marathon. The name is the only thing that has changed. The batteries are still made in the same way. In the same plant. By the same people. And they are still available through the same sales representatives and distributors.

Marathon has been growing and expanding for 47 years.

Now we have added the world's most versatile rechargeable to our diversified battery line.

Because you have relied on Sonotone for so many years, we want to be certain that you know the name—and only the name—is changed. So the next time you need Sonotones, ask for Marathon. Cold Spring, New York 10516.

marathon  battery company

INFORMATION RETRIEVAL NUMBER 28

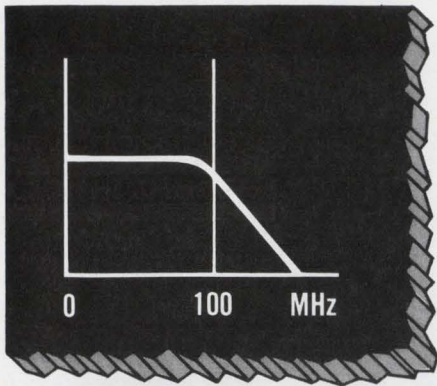

VIDEO SOURCE FOLLOWER

Problem: You want a zero offset source follower, operating from DC to 100 MHz.

Solution: One Siliconix 2N5912 and two matched resistors as shown.

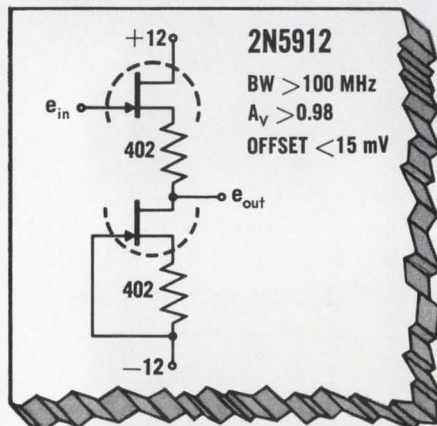

Half the device acts as a current generator for the source follower. Since the FETs are matched to less than 15 mV, $V_{GS1} = I_D R_1 = I_D R_2 = V_{GS2}$ and near zero offset is achieved.

We have more applications information on this and other FETs. Just write or call!

Siliconix
 incorporated

2201 Laurelwood Rd. • Santa Clara, Calif. 95054
 (408) 246-8000 Ext. 201 • TWX: 910-338-0227
 In Europe: Siliconix Limited, Saunders Way, Sketty, Swansea, Great Britain

Paris (and electronics fever) in the spring



Paris in the springtime: The bustling outdoor markets. The chestnut trees in bloom. Occasional showers. The sidewalk cafes. Love . . . And the Salon International des Composants Electroniques.

News Editor Jack Kessler was there mainly to cover the electronics show, the world's largest in the components field. But after a week in Paris, he kept moving—to Toulouse, London, Berlin, Munich, Eindhoven in the Netherlands and elsewhere on the Continent. The purpose of that two-week tour was to get an intimate look at what's reported to be exciting progress in Europe: industrial electronics. But that's a story for an early, upcoming issue. In the meantime, turn to page 25 and find out what happened at the electronic components exhibition, where the United States once again joined a field of 20 nations.

Editors on the move

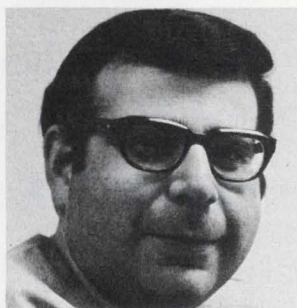

Steven A. Erenburg

Polytechnic Institute in Brooklyn, N. Y., has its eye on *ELECTRONIC DESIGN*. At its request, Managing Editor Raymond Speer was chairman of a technical panel session on IC chip interconnections. The session was part of a two-day professional seminar on "Semiconductor Packaging in the 70s," held in New York City in mid-April. Discussion periods were held each day.

Our new microelectronics editor, Steven A. Erenburg, is back from a nationwide get-acquainted trip on which he met manufacturers and users. Steve's experience has been mainly with automatic control and navigation systems in the aerospace and other industries. A BEE from Pratt Institute in Brooklyn, he will receive in June a master's degree in systems science from Polytechnic Institute.



Two best sellers with the same silly problem

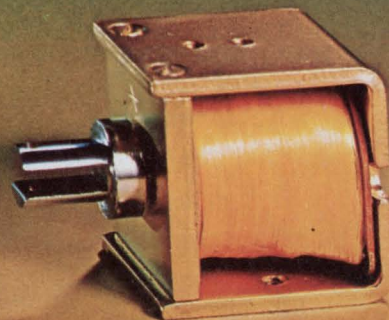

When your 1969 model looks the same as your 1968 model—getting across the engineering advances and improvements that are on the *inside* is a problem.

For instance, in 1966 we started using fully-annealed Armco steel for all Guardian Solenoid plungers . . . an "inside" improvement. Then, to compound the problem, we covered up this improvement with copper/nickel plating.

In 1968 we did it again. We took those

long-life plungers and started running them in a cavity lined with low-friction phenolic. This alone increases operating life by maybe half a million operations.

And there's more: The new acetate-yarn-sealed coil cover that's standard this year means better protection, complies with U/L construction at no extra cost.

Our "bug" changes. Inside. Where an engineering advance makes for a better solenoid. Write for Bulletin G2, TS.

NEW! TUBULAR SOLENOIDS

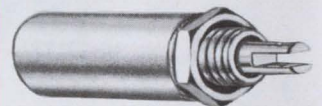

Eleven new Guardian Tubular Solenoids to fit every application. Practically install themselves. Just insert threaded bushing through installation hole and tighten furnished nut.



**GUARDIAN[®]
ELECTRIC**

MANUFACTURING COMPANY 1550 W. Carroll Ave., Chicago, Illinois 60607

Check 18

**Everyone talks
correed reliability,**

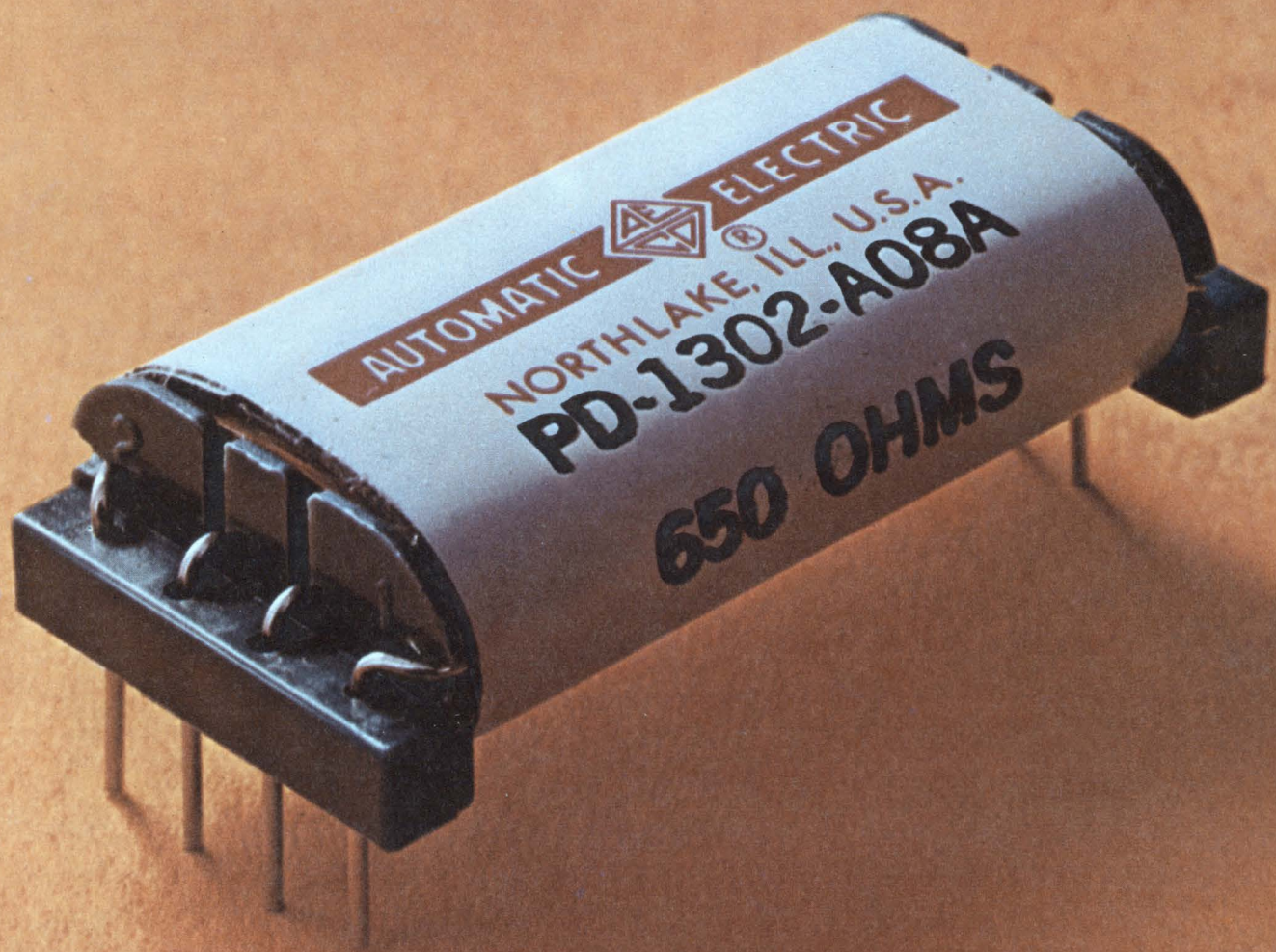

here's the way it looks.

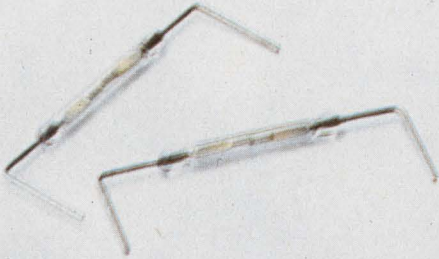

Switches under glass.

The heart of every AE correed is a reed switch consisting of two overlapping blades. For protection, we seal them inside a glass capsule. But only after we pull out all the dirty air and pump in a special, pure atmosphere. That way there's no chance of contact contamination or oxidation. Ever.

Notice our terminals are one piece. A special machine delicately forms them to precision tolerances. It's a lot of work, but one-piece terminals have distinct advantages over the two- and three-piece kind.

For one thing, there's no extra joint so you're always assured of a positive contact. Also, one piece terminals are more reliable when the correed is used to switch low-level analog signals. That's because thermal EMF is reduced to practically zero.

A different kind of bobbin.

Since we go through so much trouble with our correed capsules, we designed a special bobbin to protect them.

It's molded of glass-filled nylon. (You know how plastic chips and cracks.) Moisture and humidity have no effect on this stubborn material. No effect means no malfunctions for you to worry about. No current leakage, either.

Running the full length of the bobbin are a series of slots. They pamper the capsules and keep them from getting damaged or jarred.

And to help you remember which terminal is which, we mold the terminal numbers into the end of the bobbin. You can read them at a glance.

Little things mean a lot.

Reliability means that we pay attention to the little things. Like the tiny pressure rods we use in every miniature correed. They're placed at

each end of the bobbin, across the one-piece terminals. What they do is prevent stresses from being transmitted from the terminals to the reed blades. This keeps the contact gap right on the button. All the time.

The contacts are normally open. To provide them normally closed, we employ another little device—a tiny magnet. It's permanently tucked into a slot next to the reedcapsule. The magnetic action keeps the contacts normally closed.

Coiled by computer.

Once all the parts are secure in the bobbin, we cover them with protective insulation. Around this, we wind the coil. You can be sure the coil winding is correct. It was all figured out for us by computer.

Our next step is to protect the coil. We do that with more protective insulation.

A coat of iron.

On top of the insulation goes a layer of annealed iron. It acts as a magnetic shield and minimizes interaction between coils. Also, it improves the sensitivity of the entire unit. A coat of iron is standard on all AE correeds.

Finally comes super wrap.

To wrap it all up, we use some very special stuff. A layer of

mylar laminated material.

It's so tough we guarantee it to withstand all cleaning solvents known to man.

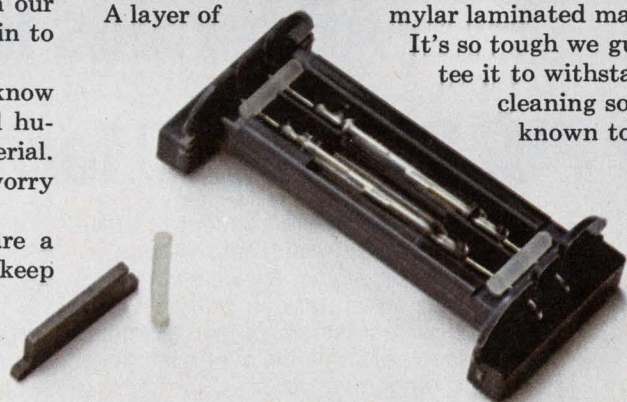

It's attention to detail that helps us keep our miniature relays miniature. Now we're just waiting to show you how perfectly it measures up to your specifications. Automatic Electric Company, Northlake, Illinois 60164.

AUTOMATIC ELECTRIC

SUBSIDIARY OF GENERAL TELEPHONE & ELECTRONICS

INFORMATION RETRIEVAL NUMBER 30



All toroids look alike.

Our PULSE-RATEDTM toroids really are alike.

We developed the concept of *pulse rated* toroids to eliminate tedious selection problems. Now we've developed new materials. Fully proven. Component tested. So you get guaranteed performance over a temperature range of 0° to 60° C.

Pulse-rated toroids not only simplify your selection process, they practically eliminate scrap. So you get 100% yield in your pulse transformer production.

Specifications provided for every *pulse-rated* toroid include pulse in-

ductance, volt-microsecond product, and temperature behavior under pulse conditions.

Parylene-coated *pulse-rated* toroids in sizes and specifications to suit your design requirements are now available for off-the-shelf delivery. Want some? We welcome the opportunity to send you samples. And hot-off-the-press spec sheets. And to consult with you about your design problems. Write Indiana General, Electronic Products, Keasbey, N. J. 08832.

indiana general 

a division of Electronic Memories & Magnetics Corporation

INFORMATION RETRIEVAL NUMBER 31

FREE ALL YOU NEED TO KNOW ABOUT SERIES 54/74 TTL CIRCUITS.

272 pages of data list specs, illustrate logic diagrams, give test conditions for

- 54/74 STANDARD CIRCUITS
- 54H/74H HIGH SPEED CIRCUITS
- 54/74 MSI COMPLEX ARRAYS

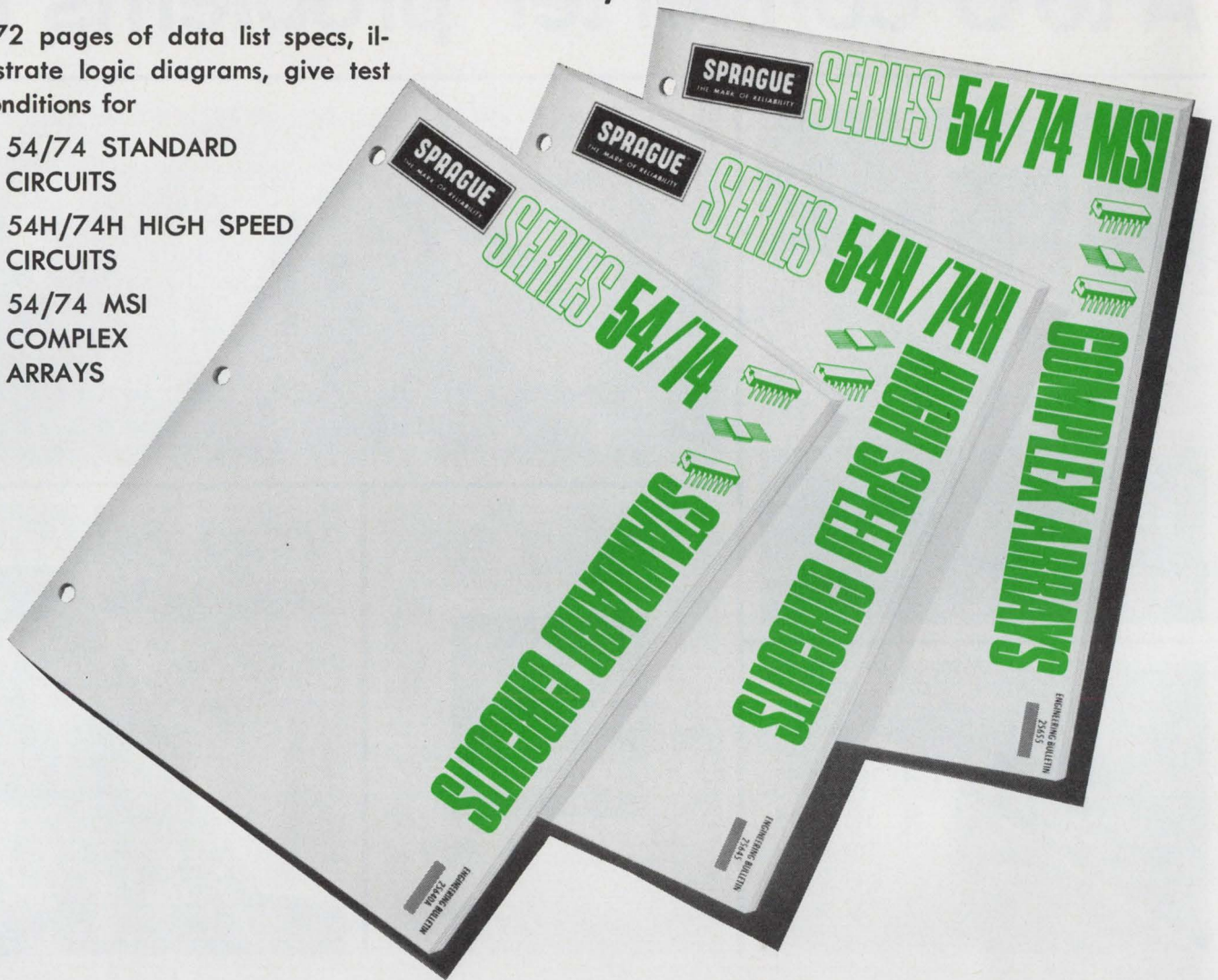

WANT THEM RIGHT AWAY? FILL OUT AND MAIL THE COUPON TODAY.

YES! Send me the 54/74 handbooks I've checked.

Standard Circuits—88 page handbook EB25640A.

High Speed Circuits—88 page handbook EB25645.

MSI Complex Arrays—96 page handbook EB25655.

Name _____

Title _____

Company _____

Address _____

City _____

State _____ Zip _____

MAIL TO:
TECHNICAL LITERATURE SERVICE
SPRAGUE ELECTRIC COMPANY
347 MARSHALL STREET
NORTH ADAMS, MASS. 01247

SPRAGUE
THE MARK OF RELIABILITY

Circle Reader Service Number 882
for 54/74 Standard Circuit Handbook

Circle Reader Service Number 883
for 54H/74H High Speed Circuit Handbook

Circle Reader Service Number 884
for MSI Complex Array Handbook.

A to D converter problems?

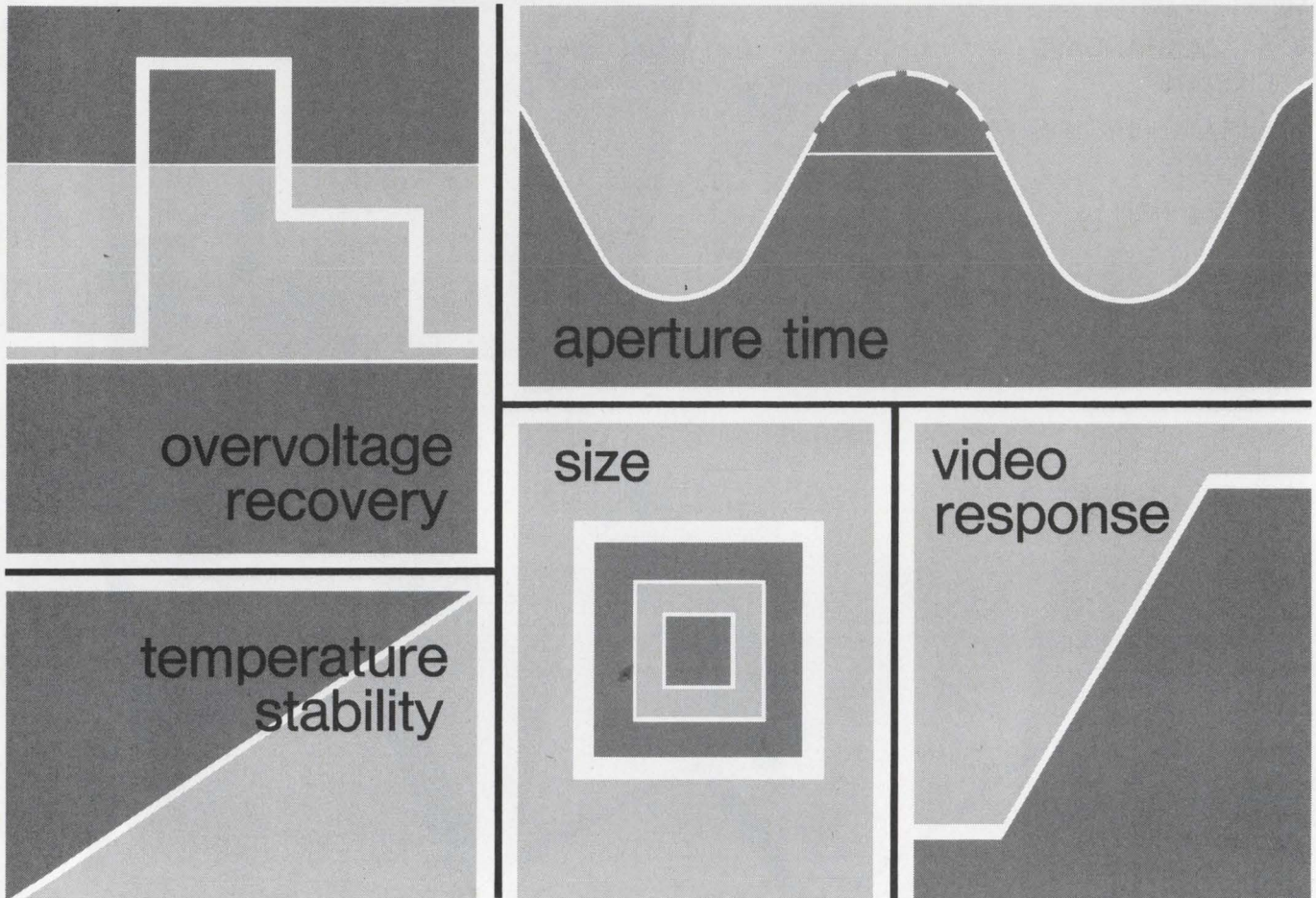

You may have tried to solve one or more of these problems. We have solved them for you. Satisfy your requirements with an extremely fast, accurate but stable and dependable Analog-to-Digital Converter. You can rely on them to consistently provide the conversion necessary for accurate and reliable system performance.

The American Astrionics 10 MHz Family of Analog-to-Digital Converters—6 bit, 7 bit and 8 bit versions—has the following characteristics:

Conversion Rate: 0 to 10 MHz
Aperture Time: <100 p sec

Overvoltage Recovery: 50 nsec typical without loss of output words.

Temperature Stability: Output stable over full 0–50° temp range to ± 2 LSB uncompensated; ± 1 LSB compensated

Video Response: up to 12 MHz

Size: Standard Units
2 $\frac{3}{8}$ x 14 x 11 without power supplies
3 $\frac{1}{2}$ x 19 x 22 with power supplies

Call or write today for detailed specifications.



american astrionics, inc. A Subsidiary of Technicolor, Inc., 3950 Fabian Way, Palo Alto, Calif. 94303, (415) 328-6800

Need a fast, accurate solution to an IC problem? E-H Research Laboratories, Inc. teams up with Iwatsu Electric Company, Ltd. to offer you the ideal test instrumentation.

E-H breaks through with the **E-H 129 pulser** which is capable of driving the fastest digital logic circuits. Until this compact, all solid-state instrument came along, no practical commercial pulse generator offered repetition frequency capability beyond 200 MHz. The E-H 129 offers 500 MHz, 2-volt pulses with less than 500 ps risetime and such extras as baseline offset, pulse-top/baseline inversion function, and synchronous gating.

And the ideal mate for this instrument is the **Iwatsu 5009B sampling scope** which allows you to observe and control the waveforms you generate. The Iwatsu 5009B with 18GHz bandwidth lets you evaluate fast circuits with high accuracy—in fact, direct measurements on 100 ps edges with less than 2% display error. Features include less than 20 ps risetime, sensitivity from 10mV/cm, dual-trace performance with seven operating modes, separate miniature sampling heads, big CRT and triggering to full bandwidth for extra convenience.

If these two instruments can't solve your problems, E-H can offer you E-H and Iwatsu instrumentation that can. Contact an E-H representative and get a fast solution. Today.

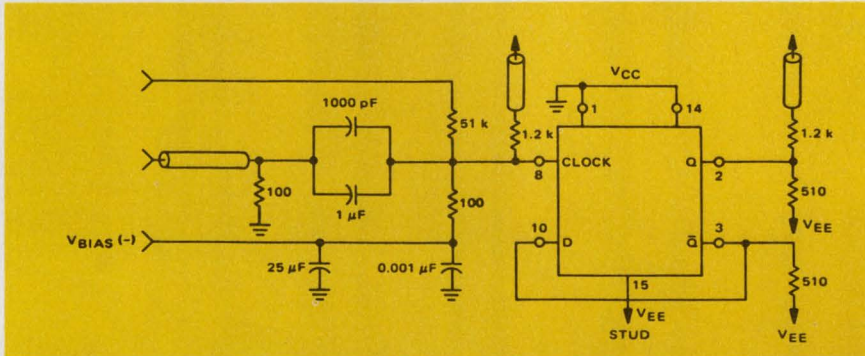

E-H
the
fast
solution

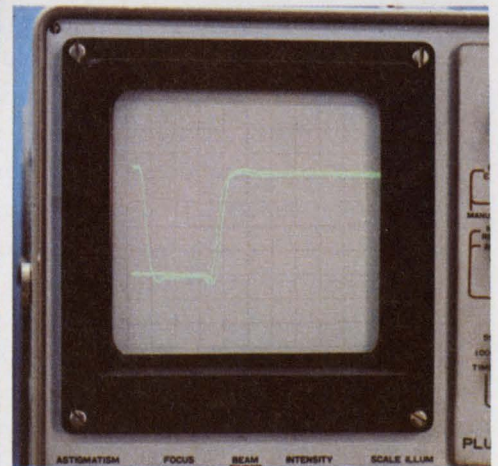
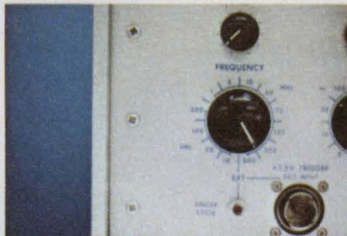
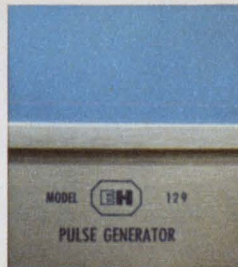

E-H RESEARCH LABORATORIES, INC.

515 Eleventh Street • Box 1289, Oakland, California 94604 • Phone: (415) 834-3030 • TWX 910-366-7258
 In Europe: E-H Research Laboratories (Ned) N.V., Box 1018, Eindhoven, The Netherlands, Telex 51116
 In Japan: Iwatsu Electric Company, Ltd., 7-41, 1-Chome Kugayama Suginami-Ku, Tokyo 167, Japan

INFORMATION RETRIEVAL NUMBER 33

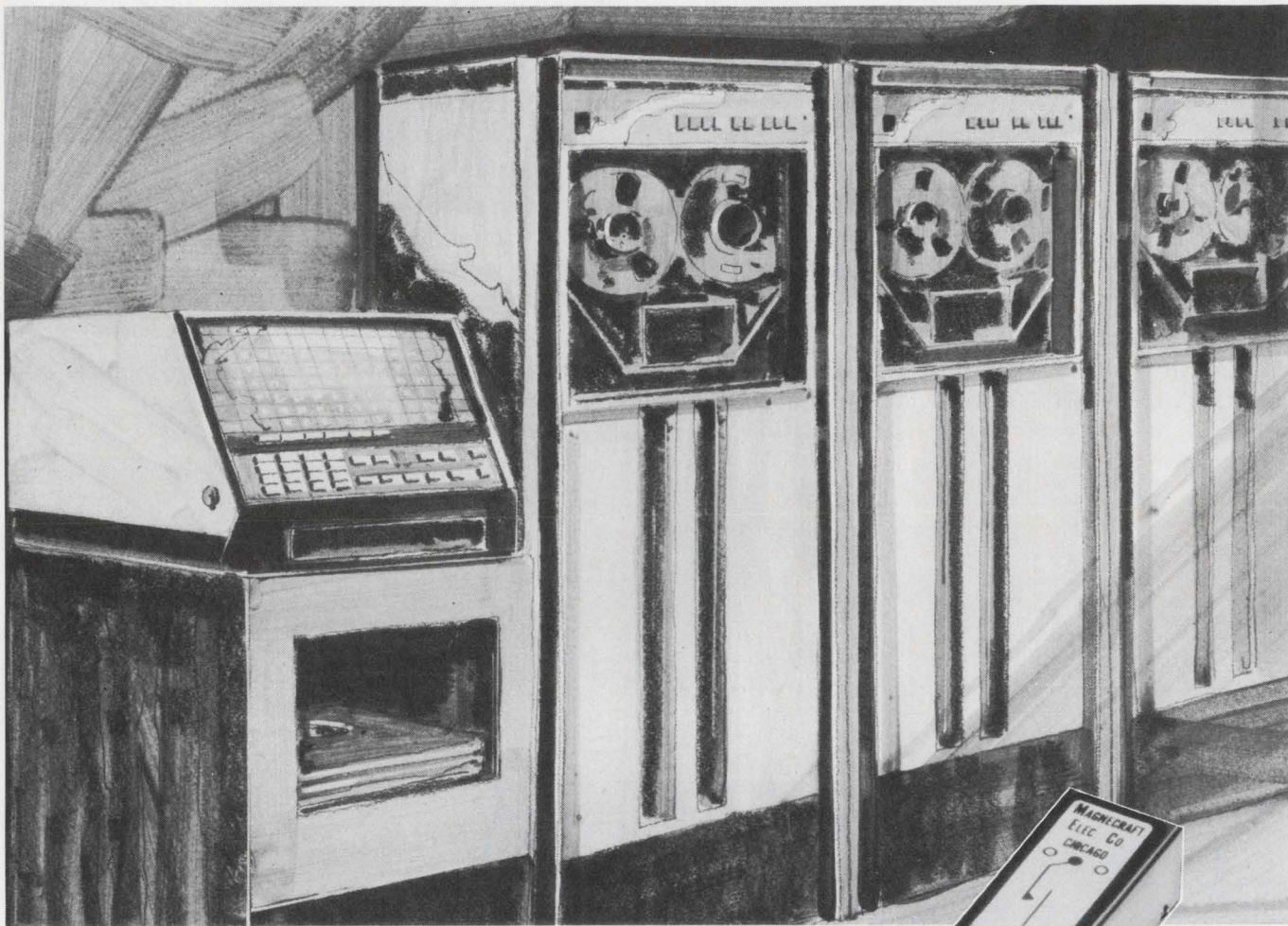

NEW! IC COMPATIBLE REED RELAYS

***Let Magnecraft relays work, while
your integrated circuits think...***

Our new IC compatible reed relays offer total isolation of the integrated circuit. These relays are capable of switching higher voltages, for example a neon lamp readout, while operating at the low input voltage of the IC, 2.5 volts or 5.0 volts.

Best of all, Magnecraft stocks the IC compatible reed relays for immediate delivery. They're priced right, too—as low as \$1.54 in 1000 quantities and even lower for larger quantities.

Contacts are rated 10 VA at 0.5 amp max. or 100 VDC max. resistive load with a configuration of SPST-NO (1 form A), and 3 VA at 0.25 amp or 28 VDC max. resistive load with a configuration of SPDT (1 form C). Two package designs for mounting are available: in-line axial leads; and low profile printed circuit type.

For all the facts on the new IC relays and Magnecraft's 512 other in-stock relays, send for our new Stock Catalog No. 271.

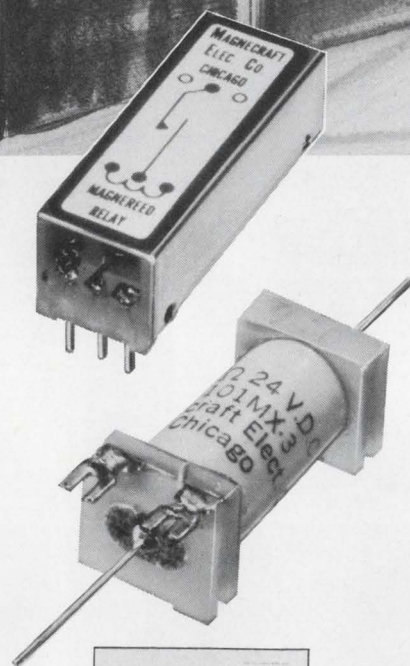

Manufacturing Stock Relays for Custom Applications

Magnecraft[®] ELECTRIC CO.

5575 NORTH LYNCH AVENUE • CHICAGO, ILLINOIS 60630 • 312 282-5500

INFORMATION RETRIEVAL NUMBER 34

ELECTRONIC DESIGN 10, May 10, 1970

CIRCUIT DESIGNERS

MATCH

YOUR CIRCUIT
PERFORMANCE
TO ANY DESIRED
FREQUENCY
CHARACTERISTIC

AUTOMATICALLY

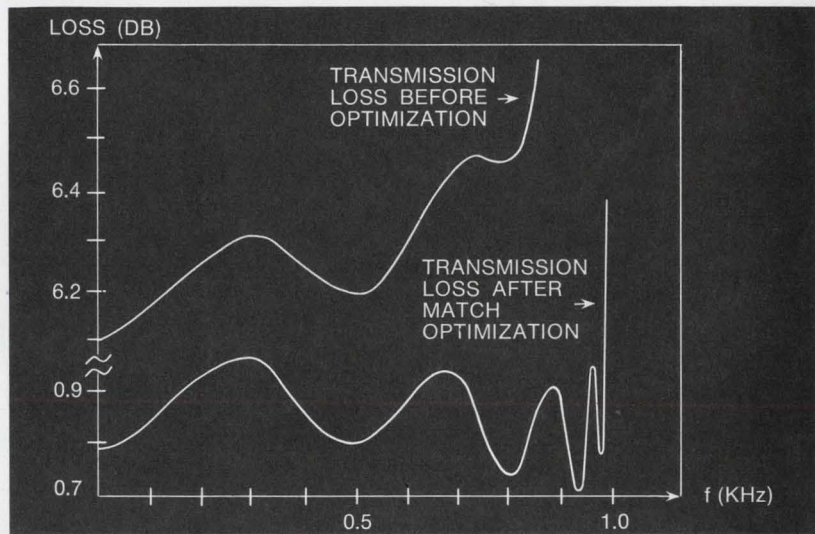

Now using APPLICON's unique **MATCH** program, engineers can automatically *optimize* circuit designs. Specify your desired frequency response, either magnitude or phase. Let **MATCH** take a ballpark design and vary the element values to fit its response to that desired. Broadband, equalize, synthesize or correct for parasitics.

MATCH does what designers need done

- Calculate Z, Y, G, H, ABCD and scattering parameters
- Calculate group delay
- Simulate component tracking
- Do frequency and impedance scaling

- Realistically model transformers, antennas, CATV cables, etc.
- Your choice of graphical output format
Linear or Log Frequency
Normal or Expanded Smith Charts
- Analyze and optimize any practical cascade circuit

MATCH is an interactive program that speaks your language. It's as near as your Teletype. Write now for a brochure describing how **MATCH** can help you make the most of your design time.

APPLICON 
INCORPORATED

83 Second Avenue
Burlington, Massachusetts 01803
(617) 272-7070

Design Assistance for Design Engineers

Going to IC's? Or Higher IF's?

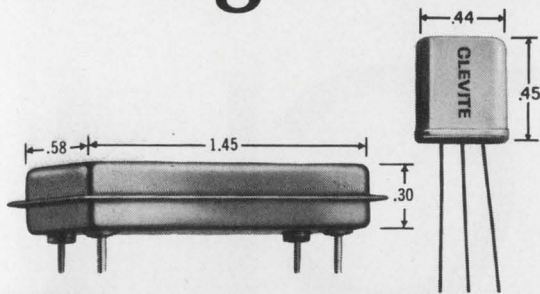

Go with Clevite's off-the-shelf coupled- mode quartz filters.

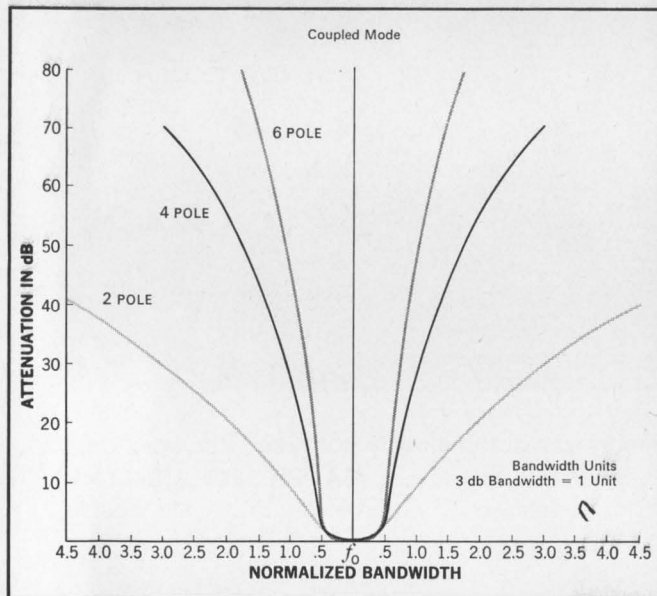

Now you can get *immediate delivery* on Clevite Uni-Wafer® coupled-mode Quartz Filters. Eleven models are available right off-the-shelf—two, four, and six pole; center frequencies of 10.7, 20.5, and 30 MHz; AM or FM bandwidths of 9, 14, and 30 kHz. And they're available in coldweld-sealed flatpacks or solder-sealed HC 18 cans.

Clevite's exclusive Uni-Wafer design uses trapped energy techniques to maximize resonant energy over arrays of resonators on a single quartz wafer. As a result, you get higher performance in a smaller package.

Clevite Uni-Wafer Filters are ideal for matching IC or conventional circuitry in VHF or UHF communications receivers, and radar, telemetry or aerospace systems. They're smaller and more reliable than discrete filters, have steeper skirt ratios, lower insertion losses, and better spurious mode rejection.

If you're going to IC's or higher IF's, Clevite Uni-Wafer coupled-mode Quartz Filters are the best way to go. For more information, including complete specifications, write Piezoelectric Division, Gould Inc., 232 Forbes Road, Bedford, Ohio 44146, or: Brush Clevite Company, Limited, Southampton, England.

GOULD CLEVITE

INFORMATION RETRIEVAL NUMBER 36

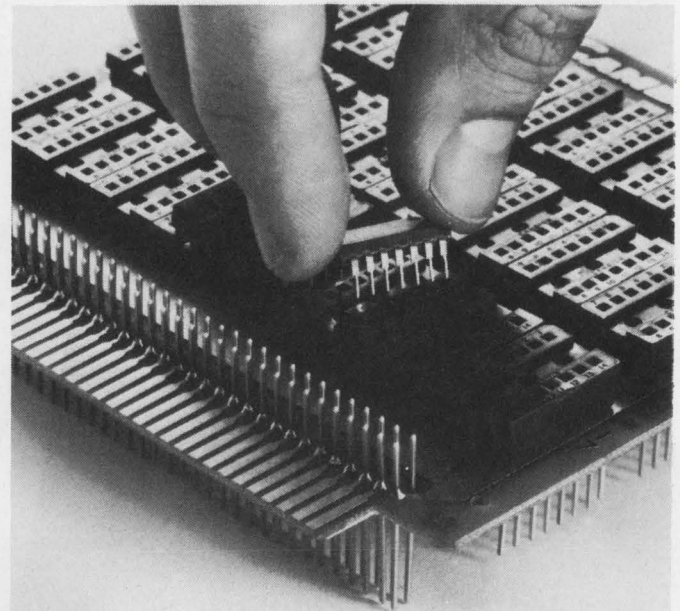

use our wire-wrap* cambi-cards to keep your ic's in line

Matter of fact, we'll help you package whole IC sub-systems. Start with our 4.5 x 4.5 inch or 4.5 x 9.25 inch Cambi-Card® printed circuit boards with 70-pin input/output edge connectors, containing Wire-Wrap sockets for 14, 16 or 24-pin dual in-line IC's. Then our precision fabricated card files with 13 or 26 positions. Next our 13 or 26 position power planes.

And if you need 'em, our card extenders, Wire-Wrap card connectors, blank Cambi-Cards for discretes, pluggable/patchable breadboards for 16, 32 or 64 DIPS, patch cord kits . . . even our super fast, economical wire-wrapping service.

For details, call us or write for Catalog 92, the latest word on IC accessories and wire-wrapping. Cambridge Thermionic Corporation, 445 Concord Avenue, Cambridge, Mass. 02138. Phone: (617) 491-5400. In Los Angeles, 8703 La Tijera Boulevard 90045. Phone: (213) 776-0472.

*Registered Mark of Gardner-Denver Co.

Standardize on

CAMBION®

The Guaranteed Electronic Components

INFORMATION RETRIEVAL NUMBER 37

ELECTRONIC DESIGN 10, May 10, 1970

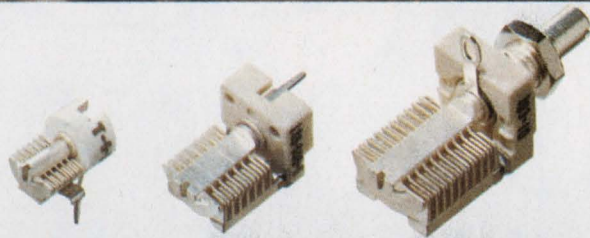
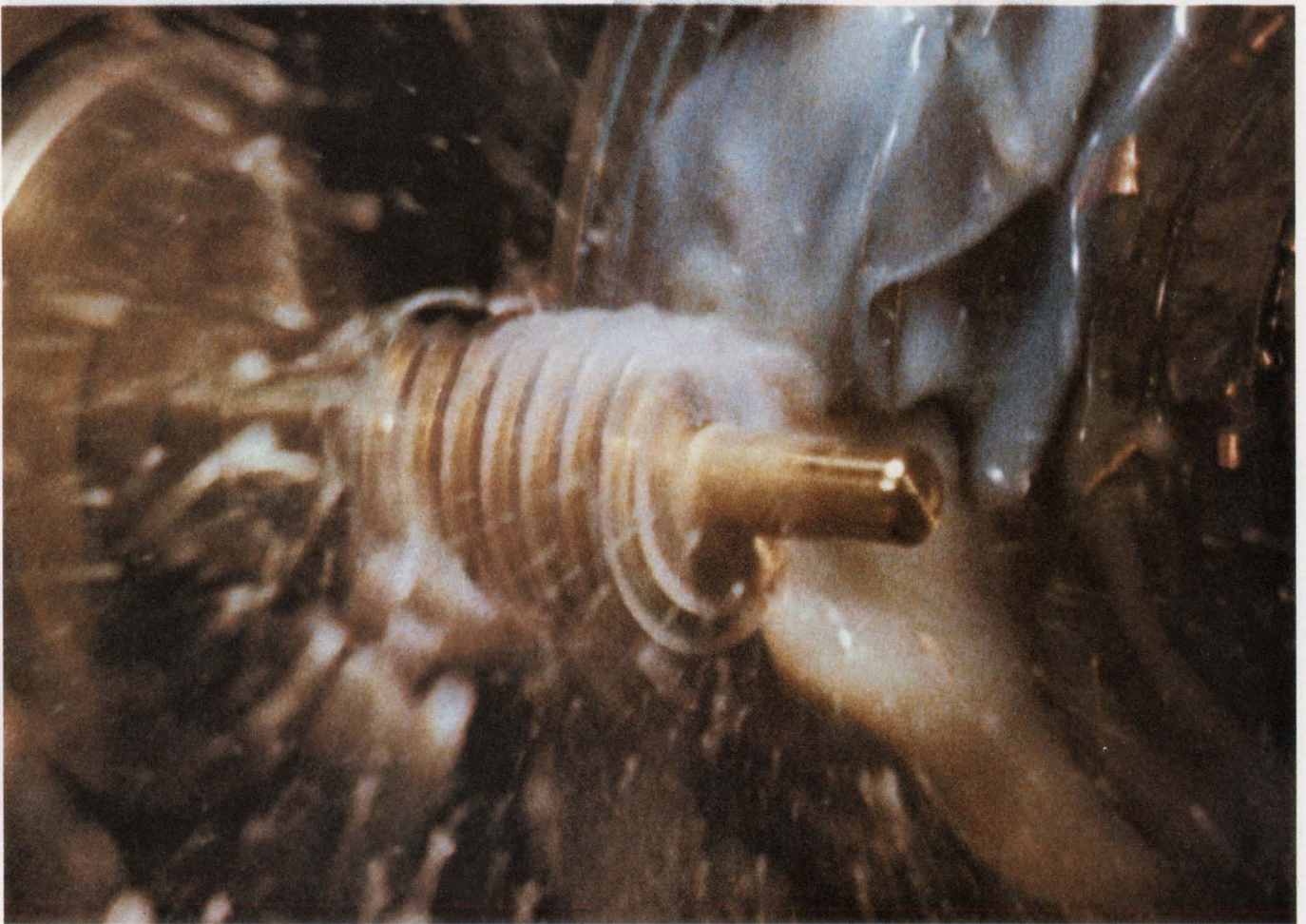

TYPE: T
 Mtg. Area: 0.1 sq. in.
 Q: > 2000 @ 150 MHz
 pF: 1.3-5.4 to 1.9-15.7
 TC: plus 30 ± 15 ppm/°C

TYPE: U
 Mtg. Area: 0.2 sq. in.
 Q: > 2000 @ 150 MHz
 pF: 1.2-4.2 to 2.4-24.5
 TC: plus 45 ± 15 ppm/°C

TYPE: V
 Mtg. Area: 0.3 sq. in.
 Q: > 2000 @ 150 MHz
 pF: 1.4-13 to 2.2-34
 TC: plus 50 ± 20 ppm/°C

It takes brass to machine capacitors like these.

Johnson precision machines each rotor and stator for these compact capacitors from a single, solid brass extrusion. The benefits are outstanding mechanical stability and electrical uniformity. As a result, you get consistently high performance from every Johnson capacitor. You can rely on them for exceptionally high Q, low temperature coefficients and uniform minimum and maximum values. All at a cost probably lower than what you are now paying.

Return the coupon today for more complete information on the famous Johnson line of machined plate air variable capacitors. Or, perhaps you have a unique need. Our en-

gineers will be glad to work with you. Call (507) 835-2050.

E. F. JOHNSON COMPANY / 3305 Tenth Ave. S.W. / Waseca, Minn. 56093

- Please send new 1970 Capacitor Catalog (702-01)
- Specific interest: _____

NAME _____ TITLE _____

FIRM _____

ADDRESS _____

CITY _____ STATE _____ ZIP _____



E. F. JOHNSON COMPANY

INFORMATION RETRIEVAL NUMBER 38

200 KHz to 220 MHz is standard on this FM/AM Signal Generator

... no extender required!

\$1,395

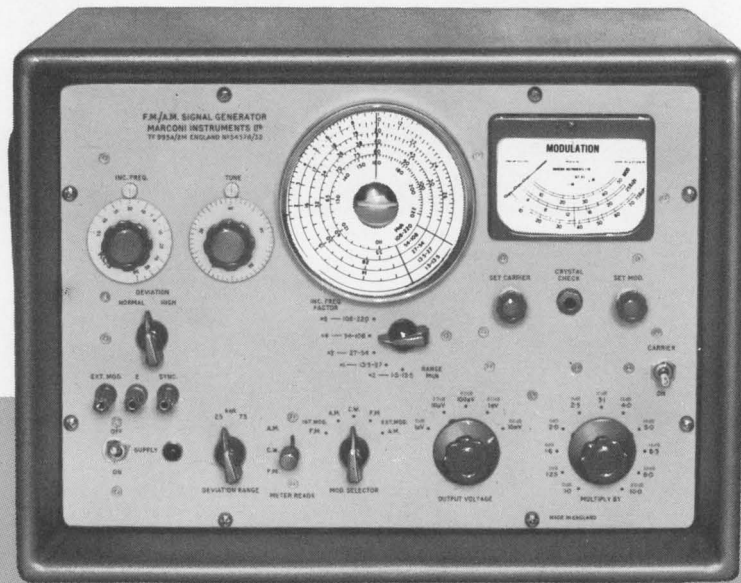

Model 995B/2

- FM to ± 75 KHz all ranges; up to ± 600 KHz on top band
- AM up to 50%
- Simultaneous FM and AM for AM rejection checks
- Crystal Calibrator
- Direct Reading Incremental Tuning
- Accepts Composite Stereo Signal

Available upon request
SIG. GEN. BOOK I

The Sig. Gen. Book I presents detailed discussions on signal generators and receiver measurements including: source impedance of feeder connected receivers, coupling to loop antennas, signal-to-noise ratio, automatic gain control, plotting response characteristics, measurement of adjacent channel suppression and spurious responses, etc.



MARCONI
INSTRUMENTS

Division of English Electric Corporation
111 CEDAR LANE • ENGLEWOOD • NEW JERSEY 07631
TELEPHONE: 201-567-0607

704

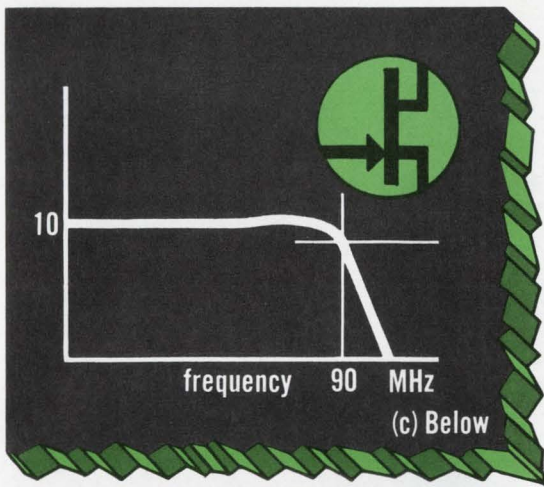

FETS FOR VIDEO AMPS from SILICONIX.

If you've a wide band application (approaching 100 MHz), need high Z_{in} ($10\text{ M}\Omega @ 1\text{ MHz}$) and want low C_{in} (down to 1 pF), think FETs. Here are three circuit ideas for starters:

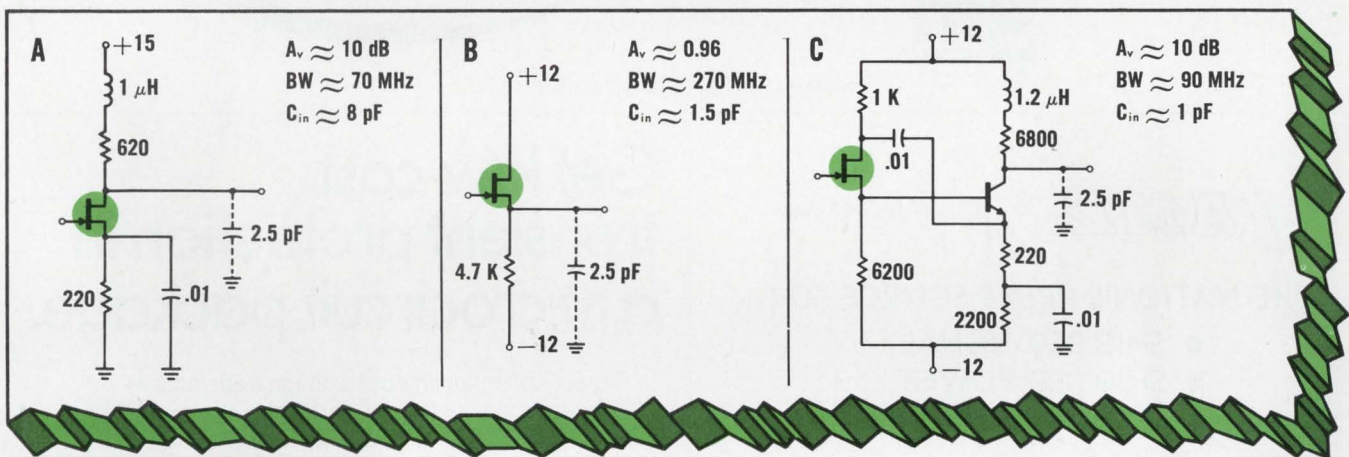

Siliconix assumes no responsibility for circuits shown, nor does it represent or warrant that they do not infringe any patents.

The Siliconix 2N5397 gives you the best g_{fs}/C_{in} . We do have FETs with even lower C_{in} . For details on these and other circuit approaches, write or call any of the numbers below.

New York: Sy Levine (516) 796-4680
New England: Al La Croix (617) 762-8114
Ft. Worth/Dallas: Charlie Williams (214) 231-8151
St. Louis: Jim Spicer (314) 291-3616
Minneapolis: Ed Koelgen (612) 920-4483
Southern California: Dave Ferran (213) 420-1307
Northern California: Chuck Brush (408) 246-8000



Siliconix incorporated

2201 Laurelwood Road • Santa Clara • California 95054
 Telephone (408) 246-8000 Extension 201 • TWX: 910-338-0227
 In Europe: Siliconix Limited, Saunders Way, Sketty, Swansea, Great Britain

BRAND POLYESTER
Scotchpar[®]
FILM

WE WANT OUR NAME
ON THE TIP
OF YOUR TONGUE!



INFORMATION RETRIEVAL NUMBER 40



★
JAMES[®] 

THE NATION'S PRIME SOURCE FOR—

- SHIELDED SIGNAL
- SHIELDED POWER
- SOLID STATE POWER

TRANSFORMERS

COMMERCIAL • INDUSTRIAL • MILITARY

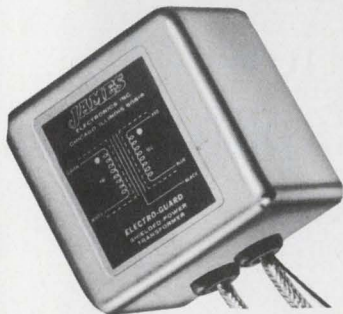

Shielding to 150 db
Power Ratings 1 watt to 1 kw
Flat Pack, Open Frame,
Sealed—A model for
every use



215 Standards In Stock

One may fit your needs or use the simplified "Transformateria" technique of ordering a special. Delivery in ten days to your specs. Send for your "Menu" today.

JAMES[®] ELECTRONICS, INC.

4050 N. ROCKWELL AVE., CHICAGO, ILL. 60618 • PHONE: 312 463-6500

INFORMATION RETRIEVAL NUMBER 41

Get low-cost
transient protection in
a microcircuit package.

Capable of deflecting overvoltage transients in 50 nano-seconds or less, the new TRANSTECTOR* Circuit Protector Hybrid Crowbar can operate in circuits carrying up to 10 Amps. Standard overvoltage trip points from 5 to 200 VDC.



Conveniently packaged in standard dual in-line integrated circuit and DO-27 diode cases — it permits you to save space on your printed circuit or multi-layer boards by 3 to 1 over the old method of using discrete components.

Find out about Transtector Systems from M&T Chemicals Inc., 1161 Monterey Pass Road, Monterey Park, Calif. 91754. Tel. (213) 264-0800.

*Trademark of M&T Chemicals Inc.

M&T Chemicals Inc. 
SUBSIDIARY OF AMERICAN CAN COMPANY

M&T can
make you look good.

INFORMATION RETRIEVAL NUMBER 42

ELECTRONIC DESIGN 10, May 10, 1970

microcircuit reliable, these new opto-hybrids

offer nominal light sensitivity thresholds of 7.0 ("A" version 1.5) mW/cm² • maximum channel matching ratios of 2.0 or 1.2 to 1 • minimum high output of 4.5 Vdc and maximum low output of 0.4 Vdc; inverted logic also available • speed of response 1 microsecond or less.

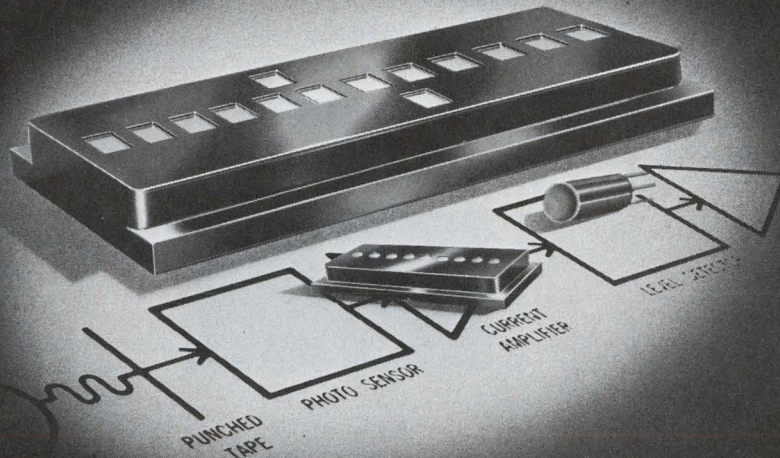

actual size

ready for market opto-hybrid™ readers

These standard Centralab Semiconductor products, complete subsystems with "built-in" light sensors, amplifier/digitizer, provide DTL/TTL-compatible output without the noise problems associated with low signal levels. About 1/10th the size of discrete component layouts and cost competitive with discrettes, these "opto's" are now available in 1, 9 and 12-channel configurations for position sensing and for reading punched cards and tape. Let us show you how to fit a Centralab Semiconductor opto-hybrid to your particular application. Write for all the facts about this newest Centralab Semiconductor family. □ Copies of our brochure "Hybrids . . . Practical answers to circuit improvement" are also available upon request. Write Centralab Semiconductor, Dept. H, 4501 N. Arden Dr., El Monte, Calif. 91734.



**CENTRALAB
SEMICONDUCTOR**

Division • GLOBE-UNION INC.
4501 NORTH ARDEN DRIVE
EL MONTE, CALIFORNIA 91734

zeners, temp.-compensated devices, tunnel diodes, rectifiers, scr's, semiconductor chips, hi-rel hybrids and photovoltaic products

ELIMINATE DOWN-TIME ON ROTARY & THUMBWHEEL SWITCHES

and also get accurate, precise control

UNLIMITED APPLICATIONS

CDI switches offer fast sure settings and quick read-out for computer, automated and control equipment, and for test and programming applications, etc.

QUICK SERVICEABILITY

Unique 5-second wafer replacement obsoletes other switches. Simply lift out old wafer, slip in new wafer. No unsoldering . . . no disassembling . . . no wire removing.

EXTREME VERSATILITY

Regardless of size or shape needed CDI is well prepared to meet your every switch requirement.

THUMBWHEEL SWITCHES

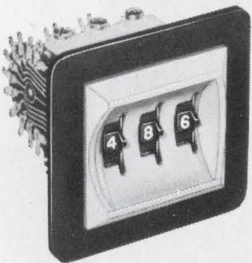

Digital and Binary. Meet MIL-S-22710. For critical reliability applications. Available with internal lighting MIL-L-25467A. Switch modules with panel and switching elements separately sealed for complete protection are available. Bezel types have no visible screws when rear mounted.

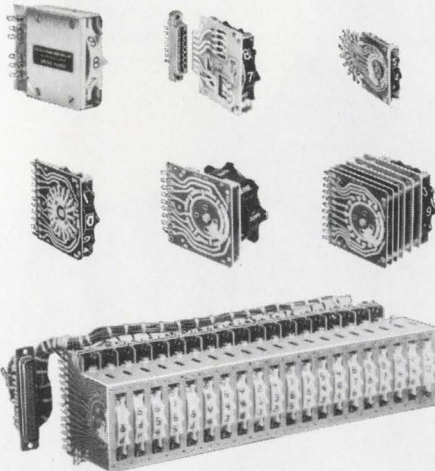
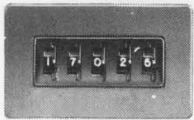

PUSHBUTTON SWITCHES

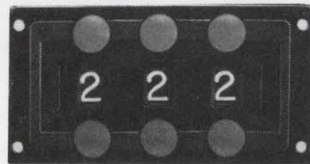

NEW MINI 10-POSITION ADD/SUBTRACT

Retrofits most miniature thumbwheel switch panel openings. 8 & 12 positions available. Simply push one button to add, the other to subtract. Each decade mounts on 1/2" centers. Over 1,000,000-operation service life.

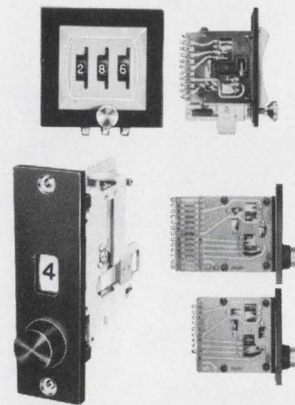

ROTARY SWITCHES

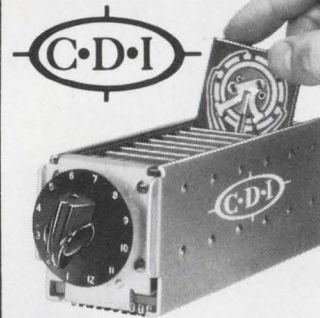

For critical reliability applications. Meet MIL-S-22710. Removable wafers permit quick changing of programs, configurations, circuits. CDI patented switches with dust covers available in sizes 2" x 2", 3" x 3" and 4" x 4" with lengths to accommodate up to 36 wafers. Operation may be manual, motor or solenoid.

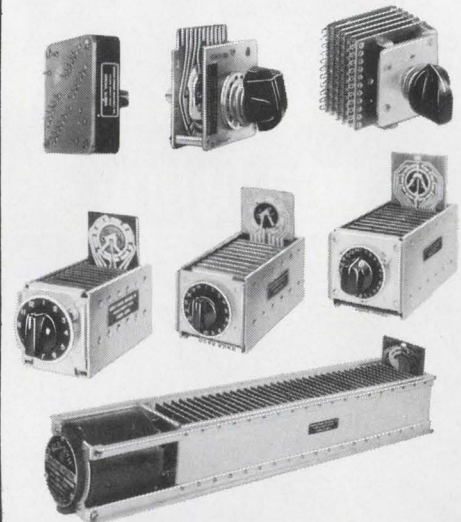

Mfd. under Tabel U. S. Patents 2,841,660, 2,971,066, 3,015,000, 2,956,131, 2,988,607



CHICAGO DYNAMIC INDUSTRIES, INC.

PRECISION PRODUCTS DIVISION 1725 Diversey Blvd., Chicago, Illinois 60614. Phone 312, 935-4600

ENCYCLOPEDIA ELECTRONICA

... BEING A COMPENDIUM OF MAGNETICS COMPONENTS
WITH A BUILT-IN EXTRA-STRENGTH PAIN RELIEVER

The *Aladdin Encyclopedia of Capabilities* is a genuinely new concept in magnetics component selection. It can reduce hours of tedious computations and reference-checking to minutes, and days (or weeks) of sample delays to virtual assurance of an on-the-button sample on the first try.

SUPERMARKET-IN-PRINT

It is a design engineer and distributor in one neat package. It gives you access to 20,000 designs (without endless lists of part numbers). It's a magnetics components "store-in-print" where you can shop around until you see something that might do the job for you, order it with a single phone call to your Aladdin representative, and get a sample on its way within 48 hours.

APPLICATIONS AND CONFIGURATIONS

A unique two-books-in-one format facilitates your selection of a component for your own *APPLICATION* (we've illustrated 13 circuits as examples, such as Sine Wave Demodulators, Pulse Gates, SCR Triggers, etc., told you the design parameters we need to give you an optimum design sample on the first try, given the test circuits and formulae for computing these parameters, and listed the available component configurations). Or you can begin with a *CONFIGURATION* (where we have shown 33 configurations with illustrated internal construction, dimensions, and all relevant parameter ranges for various functional applications).

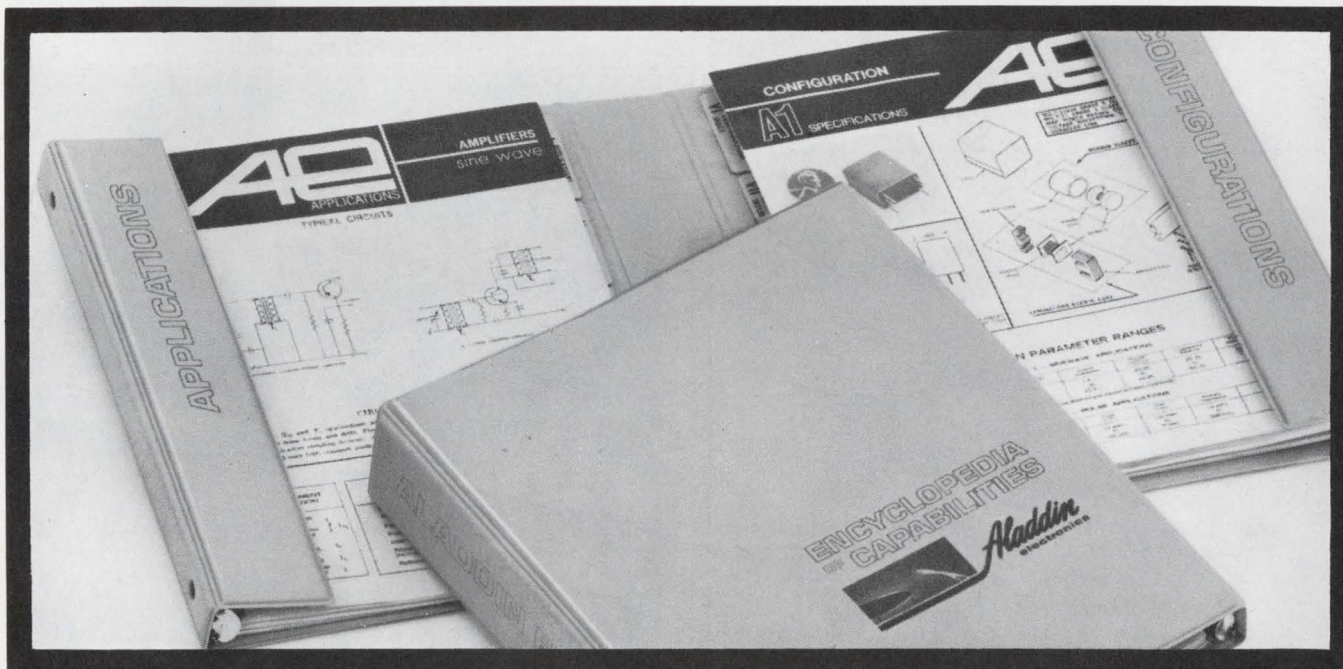

Applications Information
(Also Test Circuit Information)

Folds Into One Neat Book

Component Configurations
(No flipping back-and-forth)

The Aladdin Encyclopedia of Capabilities is Free to qualified design and purchasing personnel (write on your letterhead, giving us a few facts about yourself please), or may be purchased for \$3.95 by anybody who wants to see the greatest innovation in components selection in a dozen years or more.

Aladdin
ENCYCLOPEDIA OF CAPABILITIES

Aladdin Electronics • Nashville, Tennessee 37210

AE

INFORMATION RETRIEVAL NUMBER 45

*no lower price
for
mechanical
refrigeration
to -100° F*

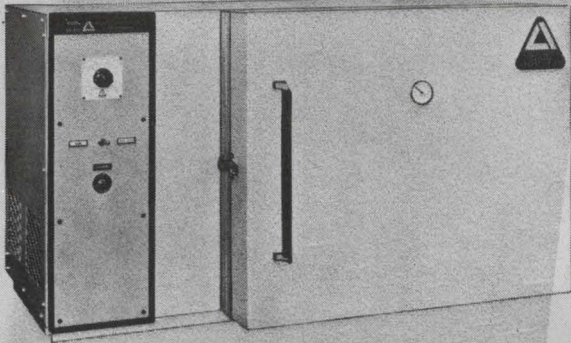

***Single compressor and
solid state controller
mean economy plus reliability***

Associated's Model SW-5101 Temperature Chamber offers a new concept in mechanical refrigeration that enables you to perform all military low-high temperature tests.

- full 1 cubic foot test area
- temperature range from -100 to +350°F.
- all solid state controller with $\pm 3/4$ °F stability
- delivery from stock
- adjustable high-temperature fail-safe with signal lamp
- indicating thermometer in door
- combination hinged and removable door
- bench-top design, can be modified for stacking
- stainless steel feed-through port, $3/4$ " diameter

Check the SW-5101 specifications against your testing requirements. You'll find they add up to outstanding performance at a down-to-earth price — without sacrifice of quality or reliability.

The new Associated catalog of environmental chambers is yours for the asking. Write for your free copy today.



**ASSOCIATED TESTING
LABORATORIES INC.**

200 Route 46, Wayne, N. J. 07470 • (201) 256-2800

West Coast Office:

1304 Seventh St., Santa Monica, Calif. 90401 • (213) 451-8521

INFORMATION RETRIEVAL NUMBER 46

L.E.D. INDICATORS

Solid State— Infinite Life!

Latest state-of-the-art made practical by TEC-LITE ... an easy-mounting line of subminiature indicators and switch-indicators, using the new L.E.D. (light emitting diodes).

The red-emitting L.E.D. light source gives infinite life and reliability, resistance to shock and vibration, avoids catastrophic failure. The lens is available in three colors (clear, amber or red) and designed to diffuse the light for greater angle viewing. Three models including one with switch, operate from a 5 VDC supply and rear mount in a $1/4$ " hole on $3/8$ " centers.

For full information on the SS Series — or our complete line of display/control products and systems — write: TEC, Incorporated, 6700 So. Washington Avenue, Eden Prairie, Minnesota 55343.



SSIL



SSBL



SSIM

Actual Size



INCORPORATED

INFORMATION RETRIEVAL NUMBER 47

Have you seen the light!

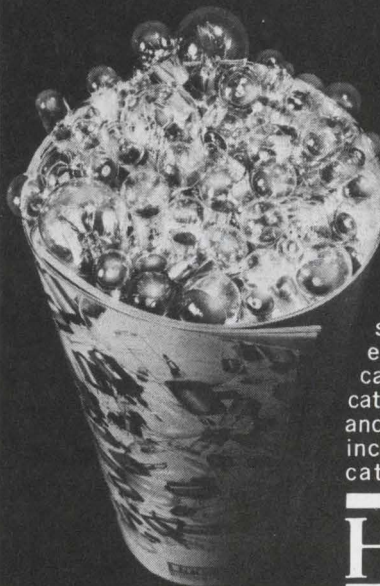

Hudson's informative, fully-illustrated 16 page catalog offers you much valuable data on miniature, sub-miniature and micro-miniature lamps, with separate sections covering automotive, indicator and panel applications. Cross references and ordering information included. Ask for your catalog today! Write:

LAMP COMPANY
Hudson

528 Elm Street, Kearny,
New Jersey 07032.

INFORMATION RETRIEVAL NUMBER 48

ELECTRONIC DESIGN 10, May 10, 1970

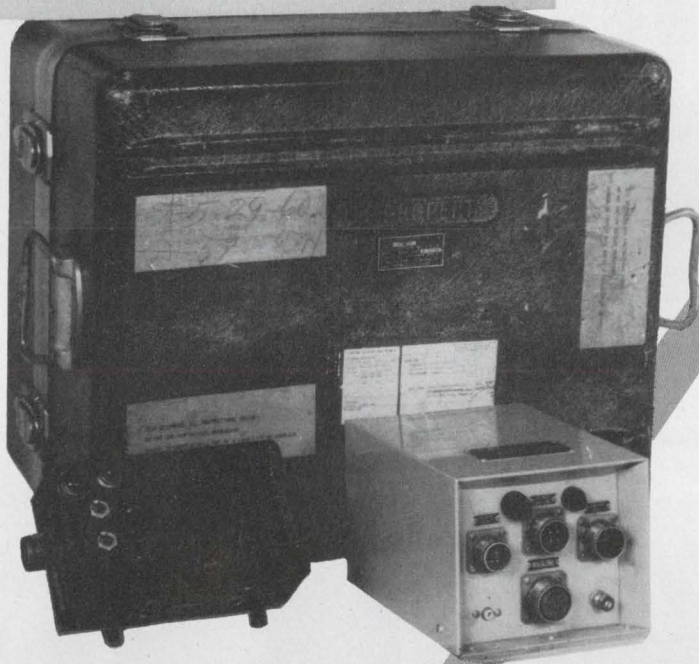
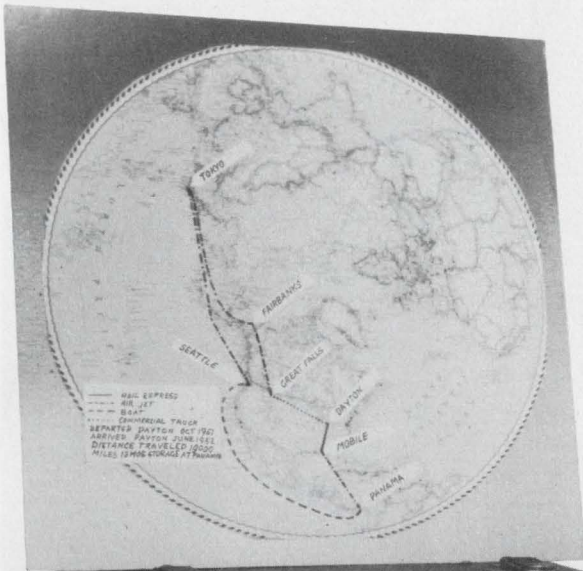

This fiberglass case, designed and manufactured by H. Koch & Sons to house the instruments shown in front of it, was shipped from Dayton, Ohio, in October, 1951, and arrived back in Dayton in June, 1952. During this eight months it travelled a total of 19,000 miles by rail, air, boat and truck including three months storage in Panama. (The route is shown on the map.) At the end of the odyssey, both the instruments and the case were in perfect condition.

STORAGE TRANSIT OPERATIONS

Koch fiberglass cases for delicate instrumentation have been designed to withstand high impact . . . to be watertight . . . to serve as an operating cabinet for the instruments . . . to register humidity, temperature and pressure inside the case. And they do all this in handsome, durable fiberglass that doesn't dent, scratch or lose its finish because fiberglass color permeates throughout. Write today for our "H" brochure or call Ray DuYore about your immediate requirements for cases protecting valuable, delicate instruments.

FIBERGLASS ↔ HARDWARE



FROM

H. KOCH & SONS DIV.

Global Systems

A Systems Division of GULF + WESTERN INDUSTRIES

Koch Road, Corte Madera, CA 94925 • Phone: 415/924-3510 TWX: 415/457-9131

INFORMATION RETRIEVAL NUMBER 49

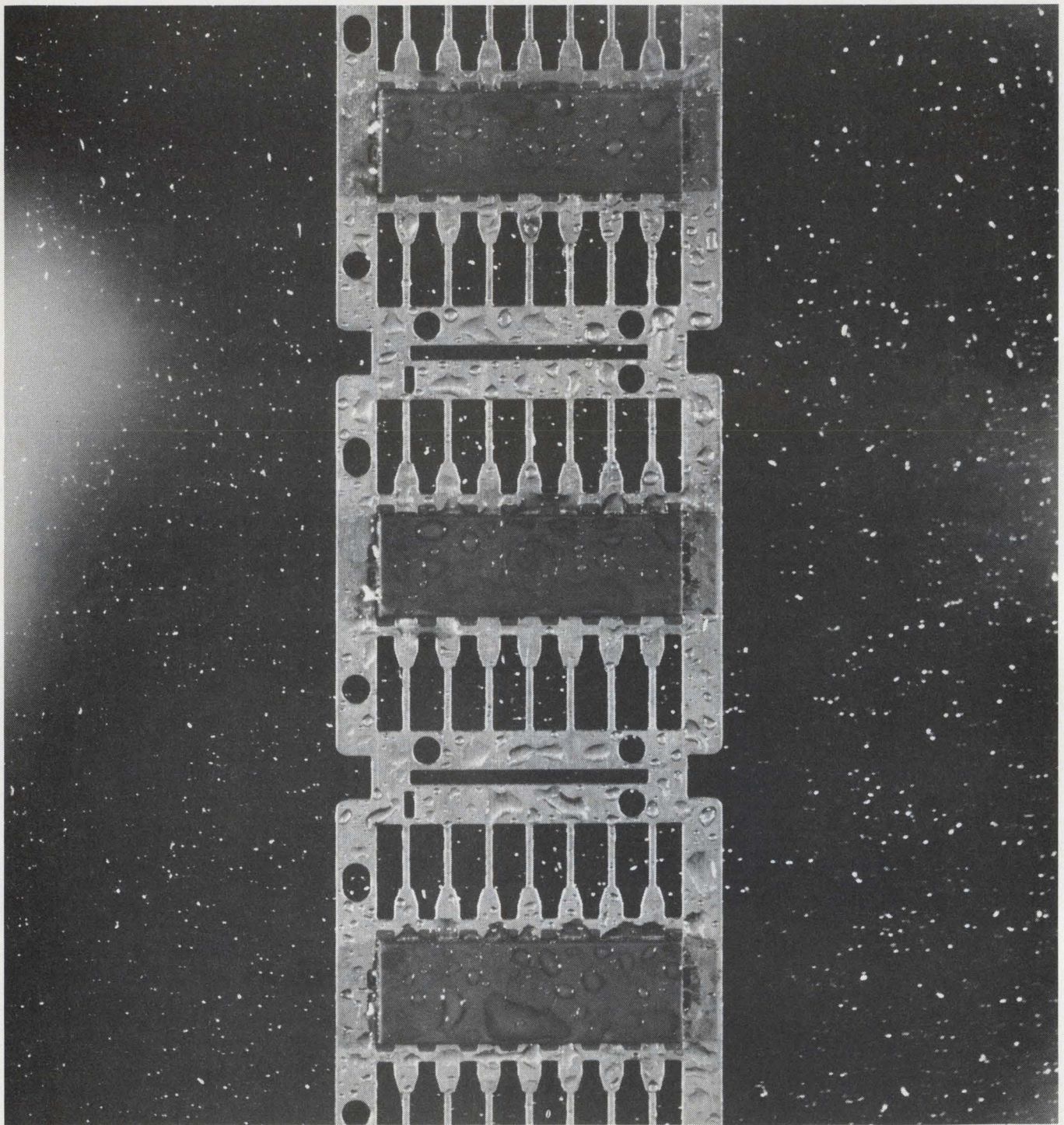

Keep your power dry

Dow Corning® silicone molding compounds and four organic plastics were tested under identical conditions—93% relative humidity at 70C for 5000 hours. The organic plastics absorbed nearly five times as much moisture as the silicones. Moral: silicones protect your power devices from galvanic corrosion. Other advantages of silicones include

superior resistance to thermal shock, cracking and burning. No derating is necessary, the initial cost is low, and you get faster production because of good mold release and minimum flash. Dow Corning silicone molding compounds are a genuine bargain that can improve your product and save you money. Our new booklet gives complete details on Dow Corning silicone

molding compounds. For your copy, write Dow Corning Corporation, Dept. A-9433, Midland, Michigan 48640.

Electrical / Electronic materials from

DOW CORNING

DOW CORNING

INFORMATION RETRIEVAL NUMBER 50

circuit problems?



ultra-high leakage resistance

Devices with leakage resistance in excess of 10^{12} ohms are available for circuits requiring this property. Such applications would include sample and hold for A to D conversion, and capacitor memory systems. See Signalite Application News for typical applications.



voltage regulators better than 1% accuracy

These subminiature voltage regulators are used in regulated power supplies, as reference sources, photomultiplier regulators, oscilloscopes, calibrators, etc. They are available in voltages from 82 to 143 V. They are used in multiples as regulators in KV ranges. See Signalite Application News for typical applications.



photo-cell applications

The A074 and A083 have been designed for use with Cadmium Sulfide or Cadmium Selenide photo-cells. Applications include photo choppers, modulators, demodulators, low noise switching devices, isolated overload protector circuits, etc. Speed of operation is limited only by the photo-cells. See Signalite Application News for typical applications.



neon timers

The bi-stable characteristics and high leakage resistance of Signalite's special glow lamps make them ideal as a component for timing circuits. The basic circuit resembles a relaxation oscillator network. See Signalite Application News for typical applications.

Signalite

glow lamps have solved problems in these areas:

- Voltage Regulation & References
- Photo-Cell Drivers
- SCR Triggering
- Timing
- Photo Choppers
- Oscillators
- Indicator Lights
- Counters
- Voltage Dividers
- Surge Protectors
- Logic Circuits
- Flip-Flops
- Memory
- Switching
- Digital Readouts

Signalite glow lamps combine long life, close tolerance and economy, and are manufactured with a broad range of characteristics to meet individual application requirements. For a creative approach to your design problem . . . contact Signalite's Application Engineering Department.

SIGNALITE APPLICATION NEWS —



is used to communicate new and proven techniques and applications of Signalite's neon lamps and gas discharge tubes. Signalite Application News provides a forum for an exchange of ideas to keep the design engineer aware of the versatility of neon lamps and their many applications. Copies are available from your Signalite representative or contact Signalite.

INFORMATION RETRIEVAL NUMBER 51

Signalite



A DIVISION OF
GENERAL INSTRUMENT

1933 HECK AVE., NEPTUNE, N.J. 07753
(201) 775-2490

INFORMATION RETRIEVAL NUMBER 52

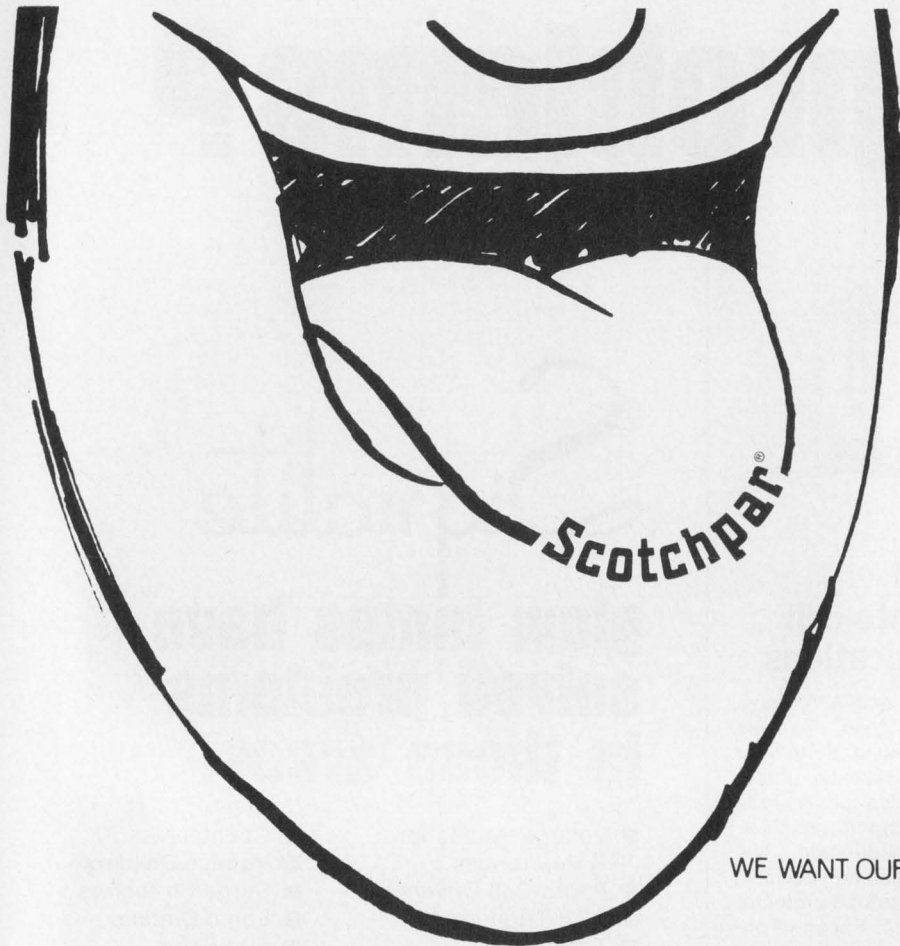

WE WANT OUR NAME ON THE TIP OF YOUR TONGUE!

Scotchpar 3M
BRAND POLYESTER FILM COMPANY

INFORMATION RETRIEVAL NUMBER 53

DEPENDABLE DURANT COUNT/CONTROL

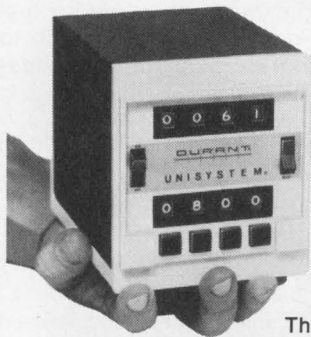

Lowest cost per million counts
of any comparable unit.

Speeds to 300 cps.*

In performance and design, Durant's Unisystem fills the need for fast, accurate count and control. There are two basic Unisystem series, available in optional splash- and dustproof versions.

The 49600 Series starts its count at zero and adds to a variable predetermined number. When it reaches this number, two form "C" predetermining contacts are actuated.

The 49800 Series starts its count at a variable predetermined number and subtracts. It actuates two form "C" predetermining contacts when the count reaches a fixed prewarn value, and two more when the count reaches zero.

All Unisystems give you a design that eliminates missed counts and retains preset and count values, even if power fails. Your choice of automatic or manual recycling. For full information, write for Unisystem Catalog, 622 N. Cass St., Milwaukee, Wis. 53201.

*With accessory divide-by circuit.



DURANT
DIGITAL INSTRUMENTS

A CUTLER-HAMMER COMPANY

In Europe: Durant (Europa) N.V. Barneveld, Netherlands

INFORMATION RETRIEVAL NUMBER 54

NPO CHIP CAPACITORS

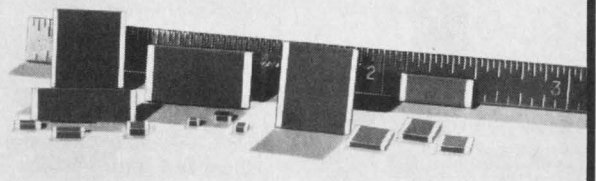

MDI offers 1000 pF

In a standard chip .100" x .050" x .050"

Search no more! They're here! These NPO ceramic multilayer chip capacitors offer the highest capacitance volumetric ratio, coupled with the lowest dissipation factor (less than 0.01% typ.) and highest insulation resistance (greater than one teraohm @ 25°C, and 50,000 megohms @ 125°C). Because they also meet applicable portions of MIL-C-11015 and MIL-C-39014 you can depend on these NPO chip capacitors where reliability and performance really count. Also available in kits... for further information call direct and ask for Jim Waldal.

Monolithic Dielectrics Inc.

P.O. Box 647 • Burbank, Calif. 91503 • (213) 848-4465

INFORMATION RETRIEVAL NUMBER 55

ELECTRONIC DESIGN 10, May 10, 1970

Our 5000 and 7500 permeability Ceramag[®] ferrite materials can pack a terrific amount of inductance into a small size.

And the higher the perm, the fewer turns required. Results. Lower distributed capacity. Material savings. Improved performance.

Ceramag[®] 24H offers the designer a true 5000 permeability. New, Ceramag[®] 24K is also a true 7500 permeability. Both materials hold their permeability over a wide range of sizes.

Ceramag[®] 24H and 24K are production materials, ready for immediate use in your design. Stock available in some sizes.

Precisely engineered, Stackpole ferrite materials are produced by exact processing, density checks, rigid kiln controls and accurate sintering. You get more out of Stackpole Ceramag[®] materials simply because we put more into them.

Study the characteristics of 24H

	$\frac{L}{N^2}$ (nh) TOROID SIZE: 0.230" O.D. 0.120" I.D. 0.060" L.	MAXIMUM PERMEABILITY	SATURATION FLUX DENSITY @ 1.5 OERSTED	RESIDUAL MAGNETISM	COERCIVE FORCE	CURIE POINT	TEMPERATURE COEFFICIENT OF μ_0	
							-25° to 25° C.	25° C. to 75° C.
CERAMAG [®] 24K	1485	9700	4100	700	0.05	175	+1.000	-0.450
CERAMAG [®] 24H	990	6900	3800	850	0.1	175	+0.700	-0.450
2500 PERM REFERENCE	495							

and 24K, then consider how you might use these ferrites.

For more information, samples and applications, contact:

Stackpole Carbon Company,
Electronic Components Division,
St. Marys, Pa. 15857. Ph: 814-834-1521. TWX: 510-693-4511.

Disaccommodation factor for both materials is 1.4×10^{-6} , typical.



STACKPOLE
Electronic Components Division

Producing high quality Ceramag[®] ferrite components for the home entertainment, industrial electronics and computer industries for over twenty-two years.



THE PRACTICAL REFERENCE SHELF

FUNDAMENTALS OF INTEGRATED CIRCUITS Lothar Stern

A practical guide to integrated circuits — their theory, manufacture and applications. This book offers complete discussion of the various techniques of integrated circuit fabrication and their strong influence on circuit design and performance. From a marketing viewpoint, it compares the relative qualities of the numerous IC's devised to date in terms of economics and logistics.

The book covers basic semiconductor principles, monolithic integrated circuits, thin-film circuits and their characteristics, hybrid and other integrated structures. There is also discussion of packaging, design and layout principles, and LSI. A volume in the *Motorola Series in Solid-State Electronics*. 208 pages, 7 x 10, illustrated, cloth cover.
#5695 \$8.95

LEVEL-HEADED LETTERS Dr. Dugan Laird and Joseph R. Hayes.

Will help the executive to write better letters, faster. In practical, down-to-earth style, this book shows how to find the real reasons for writing; provides a simple plan for organizing ideas logically and psychologically, and points out ways to get affirmative responses from readers. Shows how to avoid cliches, verbiage and how to inject an air of informality into letters. Key feature is the programmed learning section on painless grammar. 134 pages, 6 x 9.

Paper cover, #5032 \$3.50
Cloth cover, #5033 \$4.95

PROJECT ESTIMATING BY ENGINEERING METHODS Paul F. Gallagher.

A practical approach to attaining consistently accurate estimates by summarizing many general practices and introducing specific methods proven valuable in various kinds of work. Five methods of estimating are discussed, the fifth of which combines the two most important developments in the field: standard hours and the learning curve. To insure complete understanding, full coverage is given to construction and use of learning curves. Nearly 100 pages of learning curve tables appear in the appendix. 344 pages, 8½ x 11, illustrated, cloth cover.

#5018 \$15.00

PRACTICAL PA GUIDEBOOK: HOW TO INSTALL, OPERATE AND SERVICE PUBLIC ADDRESS SYSTEMS

Norman H. Crowhurst

A practical guide covering all aspects of the subject. The book shows how to select and install the appropriate equipment, covers routine operation and maintenance of the finished system. Special attention is given to solving the problems encountered in providing successful service. 136 pp., 6 x 9, illus., paper.

#0778 \$4.45

THEORY AND APPLICATIONS OF TOPOLOGICAL AND MATRIX METHODS Keats A. Pullen.

The dependence of electrical circuit theory on topology (theory of line graphs) is of growing importance because line graphs for networks represent their flow patterns. Application of topological methods has lagged behind the use of matrix methods only because of minor application problems. This volume resolves these problems in a logical and understandable way. 100 pages, 5½ x 8½, paper cover.

#0300 \$2.50

INDUSTRIAL STROBOSCOPY Gilbert Kivenson.

A comprehensive description of the history, development and use of stroboscopy in industry, commerce and research. Stroboscopy for analysis and measurement has spread to many specialized areas of science and engineering, such as high-speed cinematography, photometry, radiometry, torsional vibration and other areas. This book discusses the state of the art today and areas of further usage. 284 pages, 6 x 9, illustrated, cloth cover.

#5045 \$9.95

DESIGN OF LOW-NOISE TRANSISTOR INPUT CIRCUITS William A. Rheinfelder.

Design engineers and others interested in low-noise circuit design will find this book a real time saver. Gives a multitude of labor saving graphs and design curves for the practical circuit designer. Simple derivations of all important formulas help the reader obtain a deeper insight into the fundamentals of practical low-noise design. 128 pages, 6 x 9, illustrated, cloth cover.

#5014 \$6.50

WAVEFORM MEASUREMENTS Rufus P. Turner.

Complete how-to information on the various techniques of electrical waveform measurement—from troubleshooting to signal synthesis. Book details procedures for the isolation and measurement of a single harmonic from a multisignal mixture, measurement of total distortion, calculation of harmonic values from heights of the wave patterns, etc. 96 pages, 5¾ x 8¼, illustrated, paper cover.

#0775 \$2.95

UNDERSTANDING SILICON CONTROLLED RECTIFIERS

Saul Heller

A compact, illustrated guide to the capabilities and operation of the versatile SCR and the triggering circuits associated with these devices. Throughout the book, schematic diagrams illustrate the application of the various SCR's as static switches, phase-control switches, inverters, choppers, etc. Emphasis is placed on choosing the right SCR to do a given job. 134 pages, 5¾ x 8¼, illustrated, paper cover.

#0782 \$3.95

TRANSISTOR AND DIODE NETWORK PROBLEMS AND SOLUTIONS Harry E. Stockman.

This two-way reference demonstrates the practical application of theory and serves as sourcebook of step-by-step mathematical solutions to practical problems. With schematic situations covering the entire field of transistor and diode networks, the reader develops effective techniques by comparing his own solution methods with the author's. 352 pages, 6 x 9, illustrated.

#5694 \$9.95

TRANSISTOR AND DIODE LABORATORY COURSE Harry E. Stockman

Structured on engineering concepts and facts, this new course first provides a groundwork in transistor technology. Two-part theory viewpoints are applied continuously to give the work an engineering slant. The balance of the experiments deal with more intricate transistor networks, such as the theory and operation of multivibrators, and the concept of parametric action. 128 pages, 7¼ x 10, illus.

#5671 \$3.95

REVIEW ANY OF THESE BOOKS FOR 10 FULL DAYS — FREE!

HAYDEN BOOK COMPANY, INC. 116 W. 14 St., N. Y., N. Y. 10011



Please send me the books circled below, on a 10-day free examination. At the end of that time I will remit payment, plus postage, or return the books without obligation.

5695	0778	5014
5694	5032	0775
5671	5033	0782
5018	0300	5045

Payment enclosed (Hayden pays postage). Same return privilege.

Name _____

Firm _____

Address _____

City _____ State _____ Zip _____

On all overseas orders, payment in U.S. dollars must be enclosed. Publisher pays postage with same return privilege.

ED-270



FAIRCHILD

Where the sum is greater than the parts.

Semiconductors · Electron Tubes · Controls ·
Ordnance Devices · Systems · Optics ·
Reconnaissance Systems · Electrometrics · Graphics

When you put as many interrelated disciplines under one corporate roof as we have at Fairchild, and then give diverse talents the chance to make the most of them, new ideas and new products develop at an exponential rate.

Engineers at Fairchild share the uncommon ability to combine knowledge in one discipline with a wide-ranging interest in other technologies. To attract and keep these uncommon engineers, we've developed an uncommon organization. An organization that promotes ideas instead of pigeonholing them. An organization that tries to fit you, instead of redefining you to fit us.

We've structured Fairchild this way because we know our future is directly related to your potential. And our future looks great. We invite your resume. Write to Michael D. Hawkins,

Fairchild Camera and Instrument Corporation, 464 Ellis Street, Mountain View, California 94040.
An equal opportunity employer

New Oak Versatility



OAK ECONO-LINE PUSHBUTTON™.M.

JUST 25¢ A BUTTON*

*For most applications

We've got the button... throws from 1 PST to 8 PDT per button; sizes: .388" sq., .388" x .585" or .388" x .782"; legends engraved to your specifications; black or white buttons are standard, other colors on special order.

Push Rod Stroke... $\frac{3}{32}$ " plus $\frac{3}{4}$ " overtravel; push rod lengths optional at $\frac{1}{2}$ ", $\frac{5}{8}$ " standard length, $\frac{3}{4}$ ", $\frac{7}{8}$ " and 1".

Easy to wire... clips are Oak-pioneered double-wiping. For printed circuit boards or wire-soldering, PCB terminals are $\frac{3}{32}$ ", $\frac{1}{8}$ ", $\frac{3}{16}$ " standard length, $\frac{7}{32}$ " and $\frac{1}{4}$ " shoulder to tip. Choose terminals for wiring only or P.C. dual-purpose which have the wire hole in addition to the P.C. lug.

Compact Convenience... more buttons per area—24 on .394" centers, 16 on .591" centers, 12 on .788" centers. Any switching—momentary, push-push, interlock, or blockout or combinations. For full details, write today for Bulletin SP-346.

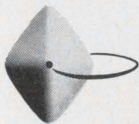

OAK MANUFACTURING CO.

A Division of OAK ELECTRO/NETICS CORP.
Crystal Lake, Illinois 60014
Phone: 815-459-5000 TWX: 910-634-3353
See us at NEW Show Booth #4218

INFORMATION RETRIEVAL NUMBER 58

SNOB KNOB



The first new styling innovation in fifteen years!

900 Series Snob Knobs come in four bright, handsome models. Spun aluminum cap. Spun aluminum inlay. Decorative metallic ring. And Black. From $\frac{1}{2}$ " to $1\frac{1}{4}$ " diameter.

Kurz-Kasch is known as **the** quality knob source by electronics manufacturers the world over. Send for your copy of our free full line catalog No. 112 or see it in Thom-Cat. And if you're just anxious to see the new Snob Knob, we'll send you a free sample.

 **Kurz-Kasch, Inc.**
Standard Parts Division • 1415 S. Broadway
Dayton, Ohio 45401 • Phone 223-8161

INFORMATION RETRIEVAL NUMBER 59

**Our Cam Timers are built to last
a lifetime...not to win beauty contests.**

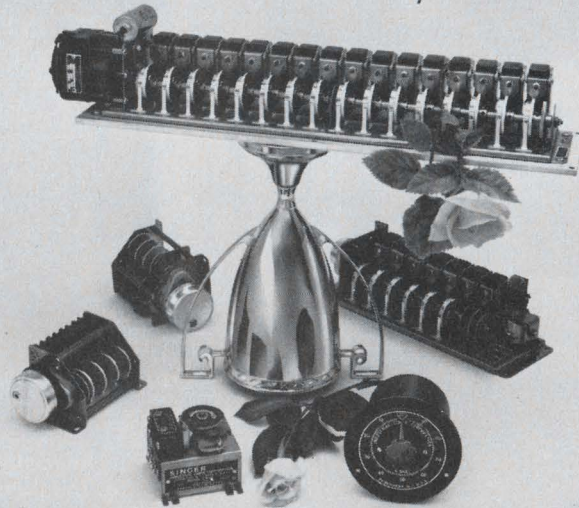

In fact, some of the cam timers we made in our first year in business are still in service.

Except for minor improvements, we build them very much the same... to perform reliably for a long, long time. That's the beauty

of our timers... they never let you down.

If you need cam timers with a great track record, talk to us. We're specialists, and have been since 1949. Write or call 201-887-2200 for faster service.

SINGER
INDUSTRIAL TIMER CORP.

Industrial Timer Corp., U.S. Highway 287, Parsippany, N.J. 07054 201/887-2200

INFORMATION RETRIEVAL NUMBER 60

ELECTRONIC DESIGN 10, May 10, 1970

The IBM Modem. Only the price will surprise you.

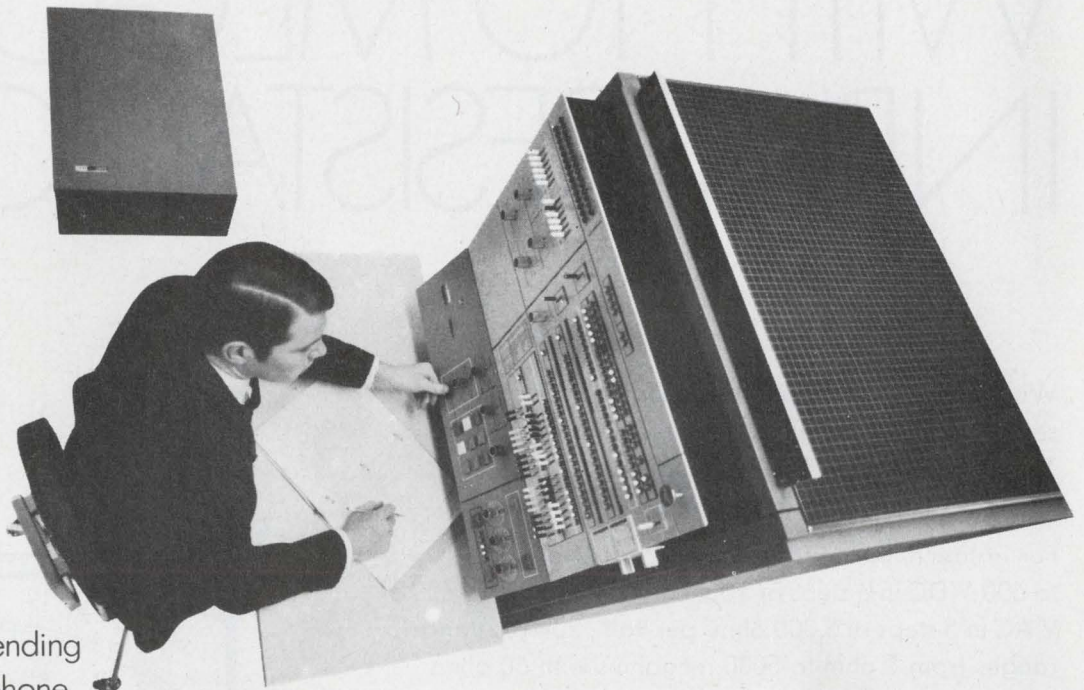

If you're sending data over telephone lines, our new modem can give you speed and reliability. And a new low cost.

The IBM 4872 Modem is a 4800 bps data set which operates over C2-conditioned telephone lines.

And which not only gives you built-in test equipment.

But also gives you manual equalization so you can easily adjust it to line characteristics.

The economy of multipoint capability.

And the same kind of dependable maintenance that's available with any of our IBM products.

And the purchase price will surprise

you. \$4460 for point-to-point. And \$4850 for multipoint.

And for another pleasant surprise call your nearest IBM representative about our fast delivery schedule.

Or mail the coupon below.

IBM Marketing Information, 18100 Frederick Pike, Gaithersburg, Maryland 20760

Please rush me more facts about the IBM 4872 modem.

Please have a marketing representative call on me.

Name _____
please print

Title _____

Company _____

Address _____

City _____ State _____ Zip _____

P201206

IBM®

NOW... A HAND-SIZE V-O-M WITH 10-MEGOHM INPUT RESISTANCE

With a 10-megohm input resistance and a high-sensitivity (0.3 V DC full scale) meter, this handy little Triplett Model 310-FET can handle practically any in-circuit electrical measurement you may need.

For instance, the voltage ranges cover from 0.005 to 600 V DC in 6 steps at 10 megohms and 0.1 to 600 V AC in 5 steps at 5,000 ohms per volt . . . 4 resistance ranges from 1 ohm to 5000 megohms with 50 ohms at the centerpoint of the low resistance scale . . . current in 2 ranges from 0.002 to 1.2 mA DC. With its optional clamp-on ammeter attachment, the Model 310-FET will read AC from 0.2 to 300 A in 6 steps. Accuracy on DC ranges is 3% . . . 4% on AC.

Never one to stand short when it comes to offering features and real value in its instruments, Triplett has even equipped the Model 310-FET with a rugged suspension-type meter to soak up the hard knocks and a polarity-reversing switch to simplify operation.

Value? It's priced at only **\$74** suggested USA user net, and it's available through your Triplett distributor. Ask him or your local Triplett sales representative for a demonstration. Triplett Corporation, Bluffton, Ohio 45817.

Shown actual size

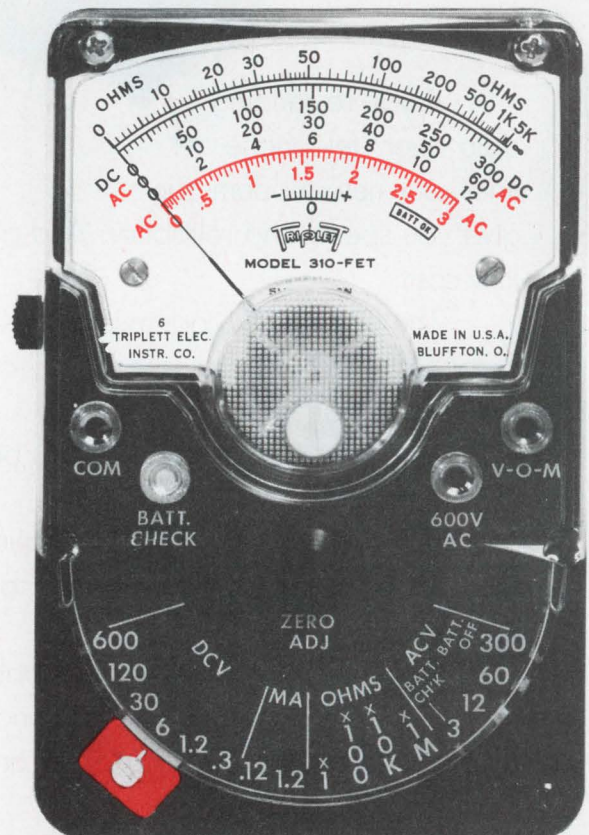

1. All Solid-State (F.E.T.) with 10 Megohm input resistance, battery operated.
2. High sensitivity (300 mV DC fs) for transistor bias measurements, resistance measurements to 5,000 Megohms.
3. Hand-size with single selector switch and provision for attaching AC clamp-on adapter.

TRIPLETT

*The World's most complete line of V-O-M's . . .
choose the one that's just right for you*

Publisher

Hugh R. Roome

Editors

New York Office
850 Third Ave.
New York, N.Y., 10022
(212) 751-5530

Editor: Frank Egan

Managing Editor: Ralph Dobriner
Managing Editor: Raymond D. Speer
Microelectronics, Steven A. Erenburg
Computers, Milton J. Lowenstein
Circuits, Don Mennie
Microwaves, Michael J. Riezenman
Management, Richard L. Turmail
News, John N. Kessler
Military-Aerospace, John F. Mason
New Products, Roger Allan
New Products, Lucinda Mattera
Directory Manager, Greg Guercio
Copy, Marion Allen

Field Offices

Massachusetts

Jim McDermott
P.O. Box 272
Easthampton, Mass. 01027
(413) 527-3632

San Francisco

Elizabeth de Atley
2051 Wellesley St. (Suite D)
Palo Alto, Calif. 94306
(415) 321-7348

Los Angeles

David Kaye
2930 Imperial Highway
Inglewood, Calif. 90303
(213) 757-0183

Editorial Production

Dollie S. Viebig
Richard D. Grissom

Art

Art Director, Clifford M. Gardiner
Assistant, William Kelly
Rita Jendrzewski
Lynn Thompson
JoJo Miskimmon

Production

Manager, Thomas V. Sedita
Helen De Polo
Kathleen McConkey
Leslie Stein

Circulation

Manager, Nancy L. Merritt

Information Retrieval

Genate Piccinetti

EDITORIAL



Don't take technology out of ecology

Of late, the hue and cry over pollution has reached gigantic proportions in some quarters. And, considering the stakes involved, it is a good thing that our society is finally waking up to the critical nature of the problem.

In some instances, though, it appears that concern has given way to mania—and that logical consideration has been replaced by precipitous action. Some recent examples of this include the public wreckage of brand-new cars, mass mailings of “no-return” bottles to a major soft-drink company, and a “trash-in” in Seattle, where refuse was returned to the companies responsible for the original product. Granted that such public demonstrations call attention to the problem, but they do little to promote practical solutions.

Condemn, if you will, the internal-combustion engine but not the automobile; rail against the dumping of garbage in off-shore waters or the burning of trash—but don't send burned-out light bulbs back to the manufacturer or apple cores back to the farmer. Such antics gain newspaper space but little else.

Of course, our environment could be cleansed to a remarkable degree if we all consented to revert to the agrarian society of our ancestors. But man has never tolerated a backward step in his social and economic evolution, and we doubt that he ever will.

The true solution seems obvious: namely, to bring technology to bear on pollution—the same technology that many accuse of causing the problem.

To be sure, modern technology is not going to clean our air and waterways by itself. Government regulations and funding, as well as public awareness and concern, will play major roles. But an equally important role should be played by engineers and scientists.

These are the people who can develop a practical electric car, clean power systems, and foolproof monitoring and detection equipment. And they can do so whether mobilized in the form of a national commitment, such as was done for the Manhattan Project and Project Apollo, or whether they operate within the framework of their own company or organization.

They and their talents must be committed to the fight against pollution; then an analytic rather than a headline-grabbing approach to the problem will be possible.

FRANK EGAN

Predict intermodulation distortion

from cross-modulation measurements. Since third-order intermod and cross-mod have the same origin, specifying one specifies both.

It's a basic fact, but not apparently widely known, that the third-order intermodulation distortion level and the cross-modulation performance of a given device cannot be specified independent of each other. If the fact were widely known, one wouldn't see so many procurement specifications with inconsistent cross-mod and intermod figures.

Both phenomena are caused by a third-order (or higher) nonlinearity in the transfer characteristic of the device. (In this article, higher-order nonlinearities will not be considered as they are usually not significant.) Specifying either one of them defines the nonlinearity and, hence, specifies the other. Converting from one type of description to the other can be done analytically or, more conveniently, by means of a graph. Similarly, in measuring these quantities, much time can be saved by measuring only one of them and calculating the other.

Cross-mod is measured by applying two carriers to the input of the device under test—one modulated and the other unmodulated. The amount of modulation transferred to the initially unmodulated carrier is a measure of the cross-modulation performance of the device.

Intermod is measured by applying two unmodulated carriers to the device input and measuring the output signal at a third (intermod) frequency. Let's see how the two measurements are related.

Examine the cross-mod

The transfer characteristic of a device can be expressed as the sequence of coefficients of the Maclaurin series relating the device's output to its input. The series will generally be of the form

$$E = A_0 + A_1V + A_2V^2 + A_3V^3 + \dots \quad (1)$$

where E is the output voltage, V is the input

voltage and A_0, A_1, A_2 , etc. are constants.

A perfectly linear device, of course, would have all of its coefficients except A_1 equal to zero and thus would introduce no distortion at all. If two sinusoidal signals were applied to such a perfectly linear device, the same two signals would appear at its output. They might be changed in amplitude and/or phase, but their frequencies would be unchanged. And no new frequencies would be generated.

In the nonlinear real world, however, the picture is a bit different. Let the composite input signal consist of two sinusoids, one of which is amplitude-modulated by a third sinusoid. The input voltage is thus given by

$$V = V_1 \sin \omega_1 t + V_2(t) \sin \omega_2 t \quad (2)$$

where

$$V_2(t) = V_2(1 + m \sin \omega_m t). \quad (3)$$

The modulation index, m , must satisfy the inequality $0 \leq m \leq 1$.

Substituting Eq. 2 into Eq. 1 gives us an expression for the output voltage. The first term in the expression containing new frequencies is the second-order term, A_2V^2 . It contains signals at twice the input frequencies and at the sum and difference frequencies, but none that affect the signals at ω_1 or ω_2 .

The third-order term, A_3V^3 , contains a signal at frequency ω_1 whose amplitude is partially controlled by $V_2(t)$. The complete expression for the output signal at ω_1 is

$$E_{\omega_1} = \{A_1V_1 + (3/4)A_3V_1^3 + (3/2)A_3V_1V_2^2 [1 + (m^2/2) + 2m \sin \omega_m t - (m^2/2) \cos 2\omega_m t]\} \sin \omega_1 t. \quad (4)$$

For small values of m , Eq. 4 reduces to

$$E_{\omega_1} = [A_1V_1 + (3/4)A_3V_1^3 + (3/2)A_3V_1V_2^2 + 3A_3V_1V_2^2m \sin \omega_m t] \sin \omega_1 t \quad (5)$$

and the effective modulation index, m' , is given by

$$m' = 3A_3V_2^2m/[A_1 + (3/4)A_3V_1^2 + (3/2)A_3V_2^2]. \quad (6)$$

By forming the ratio m/m' , we can relate the cross-modulation produced by a device to the input voltages, the coefficients of the transfer characteristic, and the original modulation index.

Harold B. Goldberg, Government Contracts Engineering Manager, Computone Systems, Inc., Liberty Corner, N.J.

The expression is.

$$m/m' = (A_1/3A_3V_2^2) + (V_1^2/4V_2^2) + 1/2. \quad (7)$$

Now look at the intermod

Algebraic manipulations similar to those used in the cross-modulation analysis will also yield expressions for the output signals at $\omega_2 \pm 2\omega_1$ and $\omega_1 \pm 2\omega_2$. These third-order intermodulation outputs are

$$E_{\omega_{im}} = (3/4)A_3V_1V_2^2(t) \sin(\omega_1 \pm 2\omega_2)t + (3/4)A_3V_1^2V_2(t) \sin(\omega_2 \pm 2\omega_1)t. \quad (8)$$

Since intermod measurements are usually made with unmodulated equal-amplitude signals, ($V_2(t) = V_2 = V_1$), the amplitude of each third-order intermod product is simply

$$E_{im} = (3/4)A_3V_1^3. \quad (9)$$

A standard way of specifying intermodulation distortion is to specify the third-order intercept point.¹ This point is defined as the output power level at which the third-order intermodulation power, at any one of the intermod frequencies, is equal to the first-order signal power at either of the input-signal frequencies. If the output impedance of the device is assumed to be the same at both the fundamental and the intermod frequencies, the output powers can be set equal to each other by simply setting the squares of the output voltages equal:

$$(A_1V_1)^2 = [(3/4)A_3V_1^3]^2. \quad (10)$$

Solving for V_{ip} , the intercept-point input voltage, Eq. 10, yields

$$V_{ip}^2 = 4A_1/3A_3. \quad (11)$$

It should be noted that Eq. 11 is valid only for relatively low signal levels—levels at which the distortion contributions of the higher-order terms in the series expansion of the output voltage contribute negligible amounts of power at the frequency of measurement.

By solving Eq. 11 for A_3 and then plugging the result into Eq. 9, an expression relating the output intermod voltage to the input voltage and the intercept-point voltage can be obtained:

$$E_{im} = A_1V_1^3/V_{ip}^2. \quad (12)$$

Eq. 12 can be transformed into a relationship between output powers by making the following substitutions: Intermodulation power, $P_{im} = E_{im}^2/R$; intercept-point power, $P_{ip} = (A_1V_{ip})^2/R$; and signal power $P_1 = (A_1V_1)^2/R$, where R represents both the input and output resistances (assumed equal) of the device. The resulting equation is:

$$P_{im} = P_1^3/P_{ip}^2. \quad (13)$$

(Note that Eq. 13, which was developed in terms of output power levels, can also be applied at the input by dividing all voltages by the linear gain, A_1 , of the device.)

Once the intercept point has been found, from

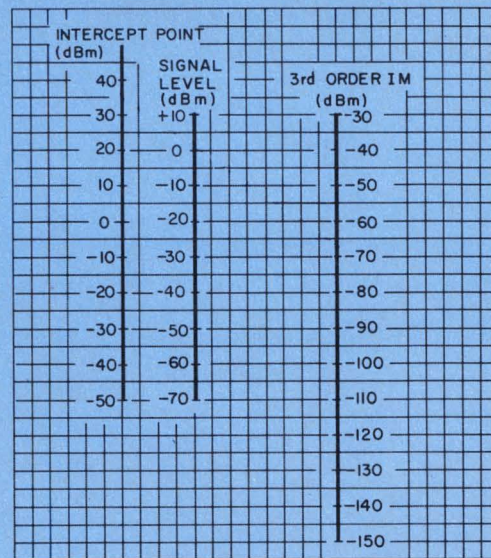

1. The third-order intermodulation produced by any two equal input signals is found by connecting a line between the intercept point and the signal level and reading the answer where this line intersects the third-order intermod line. The nomograph can be used with either input or output powers.

a single intermod measurement, Eq. 13 makes it possible to predict the intermod performance at any signal level. The nomograph of Fig. 1 can greatly simplify the job.

Relate cross-mod to the intercept point

With cross-mod and intermod both described and defined, our task now is to relate them to each other. This is easily done by solving Eq. 11 for A_3 and plugging the result into Eq. 7, yielding:

$$m/m' = V_{ip}^2/4V_2^2 + (1/4)V_1^2/V_2^2 + 1/2. \quad (14)$$

In most practical cross-modulation measurements, V_1 is much smaller than V_2 . Eq. 14 can thus be simplified to:

$$m/m' = V_{ip}^2/4V_2^2 + 1/2. \quad (15)$$

This equation gives the cross-modulation transferred from a large signal to a smaller one, in terms of the input level of the large signal and the intercept point for third-order intermodulation of the device. It should be noted that the cross-modulation is independent of the level of the smaller signal.

Since the ratio V_{ip}^2/V_2^2 is equivalent to the power ratio of the input intercept point and input signal (or, equivalently, the output intercept point and output signal), Eq. 15 can be modified to read

$$m/m' = P_{ip}/4P_2 + 1/2. \quad (16)$$

By solving Eq. 16 for P_{ip} , an expression is obtained that gives the intercept point for third-order intermodulation in terms of data gathered

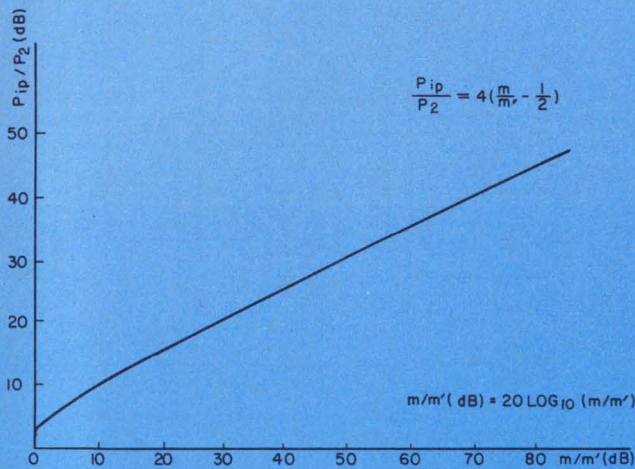

2. By relating the cross-modulation ratio m/m' , to the ratio of intercept point and signal power, P_{1p}/P_2 , this curve demonstrates the equivalence of cross-modulation and intermodulation measurements.

from a cross-modulation measurement:

$$P_{1p} = 4P_2 [(m/m') - 1/2]. \quad (17)$$

To speed intercept-point calculations, a graphical version of Eq. 17 (Fig. 2) may be used.

Method's accuracy is good

To experimentally verify the usefulness of this technique, the intercept point of a Computone SSMC-H antenna multicoupler was determined by a cross-modulation measurement and then compared with the same quantity as determined by a conventional intermodulation measurement. The SSMC-H is a broadband (2 to 30-MHz) coupler with a gain of 2 dB that can connect one antenna to 12 receivers. The 12 outputs are all isolated from each other by at least 50 dB.

To perform the cross-modulation measurement, a receiver tuned to 16 MHz was connected to one of the multicoupler's outputs. Then a 16-MHz carrier, modulated 50% by a 1-kHz tone, was applied to the input to establish a reference level in the receiver.

This large signal was then tuned out of the passband of the receiver, and a small (10-mV) unmodulated 16-MHz carrier was added to the multicoupler's input. (Sufficient attenuation was placed between the multicoupler output and the receiver to prevent the receiver from contributing any significant cross-modulation of its own).

The out-of-band large signal was then increased until a cross-modulation level 30 dB below the

reference level was detected by the receiver. The 30-dB ratio corresponds to an m/m' ratio of 31.5 (because $20 \log_{10} 31.5 = 30$ dB).

The input power level, P_2 , required to obtain the 30-dB cross-modulation ratio was +12.5 dBm. Thus, from Eq. 17 or Fig. 2, P_{1p} is found to be +33.5 dBm (because $4P_2 [31.5 - 0.5] = 6$ dB + 12.5 dBm + 15 dB = 33.5 dBm).

For comparison, the intercept point was also measured by applying two 250-mV unmodulated signals to the multicoupler's input. One signal was at 18 MHz and the other at 20 MHz. Thus, third-order intermodulation could be expected at 16 MHz (since $2 \times 18 - 20 = 16$).

A 16-MHz output that was equivalent to an input level of 100 μ V was measured. By applying Eq. 13 to these input voltages, and noting that the coupler's impedance is 50 ohms, a value of +35 dBm is easily calculated for P_{1p} . This is in pretty good agreement with the +33.5-dBm value calculated from the cross-modulation measurement. ■■

Reference:

1. McVay, Franz C., "Don't Guess the Spurious Level," *Electronic Design*, ED 3, Feb. 1, 1967, pp. 70-73.

Bibliography:

- Jeske, Harold O., "Rf Intermodulation Characteristics of Vhf Telemetry Preamplifiers and Receivers," *Telemetry Journal*, April/May, 1967.
- McKeon, E. F., "Cross-Modulation Effects in Single-Gate and Dual-Gate MOS Field-Effect Transistors," *RCA Application Note AN-3435*, RCA Electronic Components and Devices, Harrison, N.J.
- Reid, James R., "Spurious-Free Dynamic Range in Wideband High-Sensitivity Amplifiers," *Microwave Journal*, September, 1965.

Test your retention

Here are questions based on the main points of this article. Their purpose is to help you make sure you have not overlooked any important ideas. You'll find the answers in the article.

1. What is the common origin of both third-order intermodulation distortion and cross-modulation?
2. How is the intercept point used to describe intermodulation? Can it also describe cross-modulation?
3. Why was the placement of an attenuator in front of the receiver (in the cross-mod measurement described in the text) able to reduce the cross-mod produced by the receiver to a negligible level?
4. What important restriction must be placed on the amplifier's signal levels if the analysis described in this article is to be valid? Why?

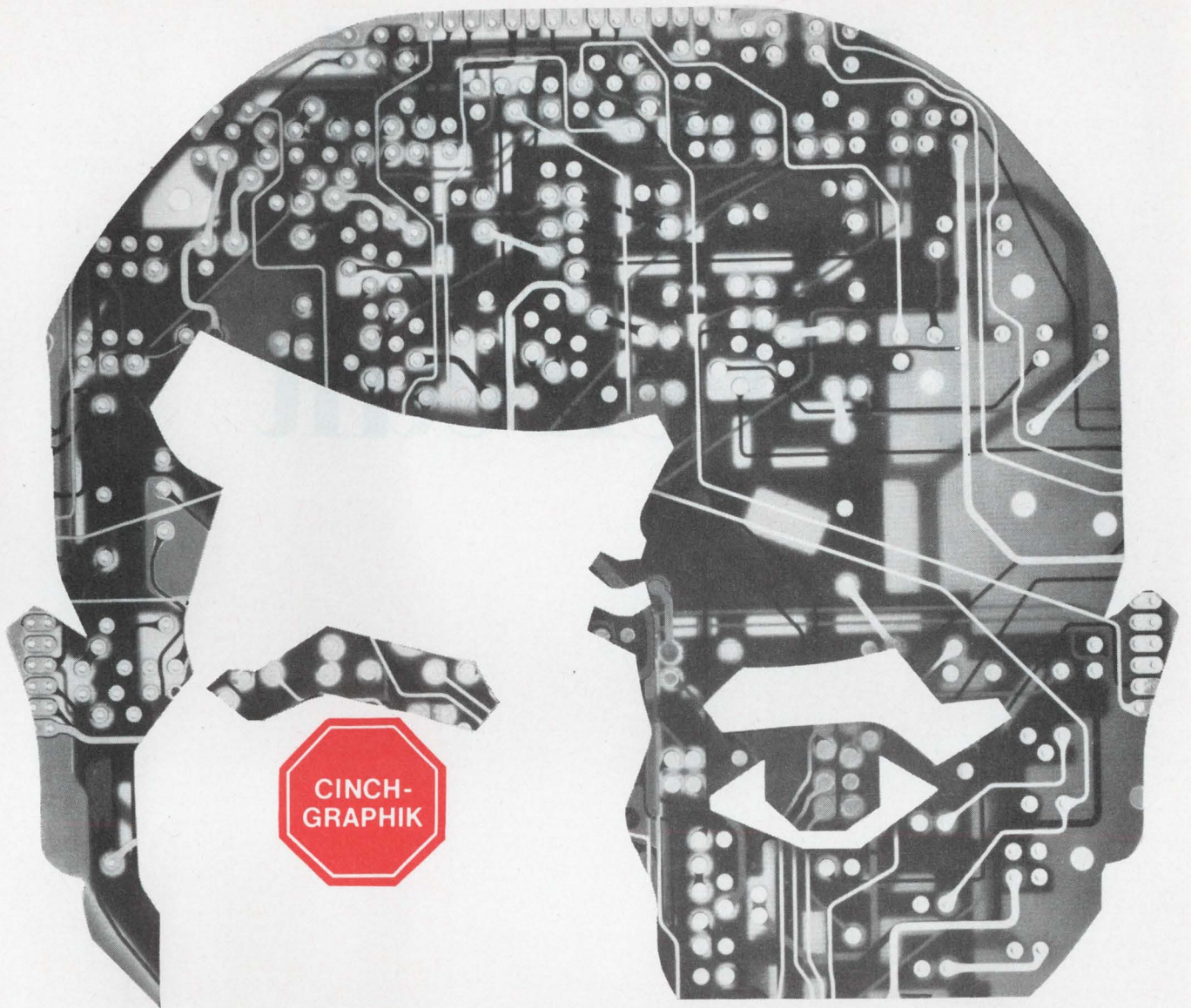

your multilayer man for volume production

Twenty million boards a year make Cinch-Graphik the world's largest independent producer of printed circuits. The industry's most advanced equipment, including an exclusive, 6-ton, 28 foot multilayer camera is housed in a 125,000 square foot plant that has capacity for additional volume production.

For information on how Cinch-Graphik can produce precision boards in volume, for you, contact your Cinch—Sales District Office or Cinch-Graphik, 200 South Turnbull Canyon Road, City of Industry, California 91744, Telephone, (213) 333-1201.

CINCH-GRAPHIK

National comes full circuit

with sense amps.

The LM354A/SN7524 completes the logic and interface package for designers of mini-computers. Proprietary MSI circuits and a full line of the most popular second source DTL and series 54/74 TTL; everything into and out of the memory. Logically from National.

The LM354A and LM354. Pin-for-pin replacements for the SN7524 and SN7525 monolithic dual sense amps. Independent channel strobing built to fit the specs of the most demanding mini-computer designer.

Our LM354A features plus or minus 4mV maximum threshold voltage tolerance. Parts to even tighter tolerances are available on special order. All circuits are 16-pin dual-in-line silicone.

LM354A/SN7524—\$6.25 @ 100 up.

LM354/SN7525—\$4.80 @ 100 up.

We've taken a strong position in supplying production quantities of advanced ICs for the mini-computer manufacturer. Everything you need. Take it from National. Delivery, performance and competitive pricing always. Write for specs. National Semiconductor, 2900 Semiconductor Drive, Santa Clara, California 95051. (408) 732-5000. Telex: 346-353. Cables: NATSEMICON

TTL, DTL & linear ICs for the mini-computer.

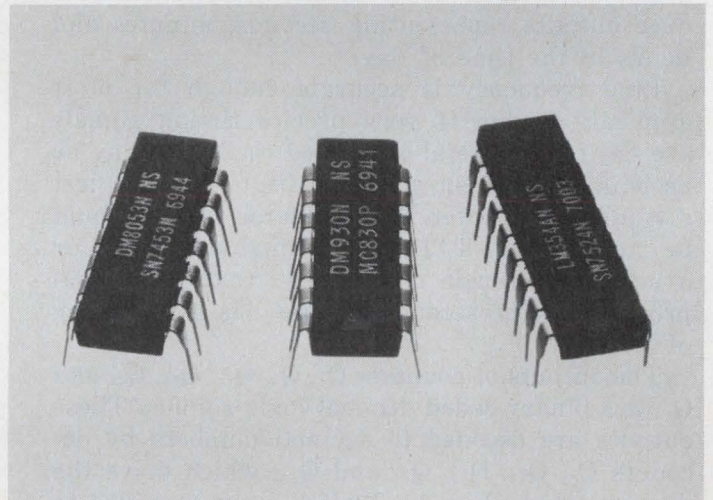

National/Linear

Clock and control with TTL.

Standard logic components display time and generate command signals for as little as \$180.

A digital clock can be much more than a time-piece. In addition to displaying time on a read-out, a simple TTL clock circuit can serve as the nucleus of a digital timing and control system—for consumer, industrial or scientific use.

The basic clock is formed by the counter chain, shown in the lower half of Fig. 1. The input time base in this case is 60-Hz line voltage, which is formed into a square wave by the Schmitt trigger and then divided down by the counters to produce outputs representing seconds, minutes and hours in the time of day.

Line frequency is accurate enough for most applications, but if very precise timing signals are desired a crystal-controlled oscillator may be used in the system as a substitute for the first divide-by-60 counter. The oscillator output should be run through TTL programmable dividers or a series of decade counters so that the signal provided to the seconds counter has a frequency of 1 Hz.

The outputs of counters Q_7 , Q_9 , Q_{11} , Q_{13} , Q_{16} and Q_{19} are binary-coded decimal logic signals. These outputs are decoded to decimal numbers by decoders Q_8 , Q_{10} , Q_{12} , Q_{14} and Q_{18} , which drive the display tubes (Fig. 1). Switches are provided to set the correct time on the display when the clock is first turned on.

The parts list for the basic 12-hour clock is given in Table 1. The voltages required by all components are provided by a single multiwinding transformer. The display tubes receive a supply of 250 V, and the other components receive a dc supply (V_{cc}) level of 5 V.

Shape the clock waveform

The raw 60-Hz line frequency cannot be used as the timing reference for the TTL logic circuits, because the rise and fall slopes are too gradual. TTL circuits are designed to operate at frequencies of roughly 20 MHz. This means that pulses used for timing reference must have very

fast rise and fall times, otherwise the TTL outputs tend to oscillate.

To avoid the rise-time problem the Schmitt trigger circuit (Fig. 1) is inserted between the 6.3-V transformer tap and the input of the first TTL logic stage (Q_5). This circuit converts the sine wave into a sharp square wave with a frequency of 60 Hz. The 0-V to 6.3-V wave is also clipped, to the standard TTL logic level of 4.5 V. (The logic reads a voltage below 0.8 V as a logic ZERO and a voltage above 2.0 V as a ONE.)

To generate the 1-Hz signal for the clocking logic the 60-Hz square wave is applied through a divide-by-60 network consisting of the first two counters, Q_5 and Q_6 . Q_5 has a maximum count or divide capability of 12, but it divides an input pulse train by six when connected as shown in Fig. 1. The output, at pin 8, therefore has a frequency of 10 Hz, which is divided down to 1 Hz by decade counter Q_6 .

When the 1-Hz timing signal is applied through switch SW_1 to the seconds decade counter Q_7 (in position 1), the counter's BCD output steps from 0 through 9. This type of counter is designed so that external feedback from the A output to the BD input (pin 12 to pin 1) causes it to divide any input frequency by 10. It resets itself, in this case, a frequency of $f/10$, or 0.1 Hz, and delivers a pulse train at $f/10$ to the next counter on output pin 11. The next decade counter, Q_9 , is connected to divide by six. It ticks off the tens-of-seconds digits at the $f/10$ frequency and transmits pulses at $f/60$ to the minutes counters.

The binary-coded decimal outputs of Q_7 are applied to the ABCD inputs of V_1 's decoder/driver Q_8 . This device converts the 0 through 9 BCD inputs into decimal outputs, as shown in the upper part of the DM8840 logic table (see box). Unlike most TTL ICs, the DM8840 is designed for high-voltage output—up to 70 V—so it can fire the display tube segments directly. The seconds tube thus displays numerals 0 through 9 at exactly the same rate as the input square wave, one per second.

In the divide-by-six connection of the tens-of-

(continued on page 86)

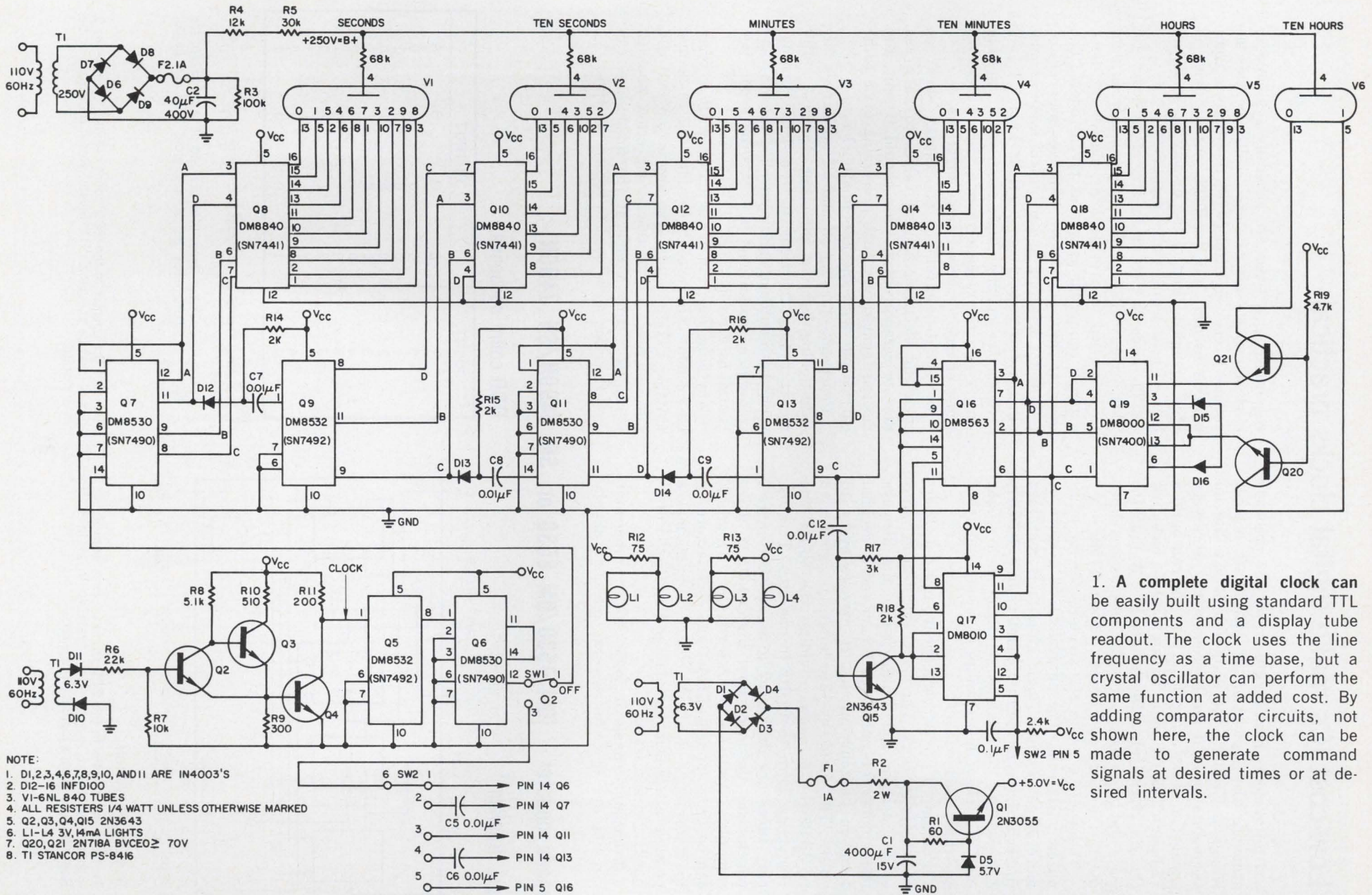

1. A complete digital clock can be easily built using standard TTL components and a display tube readout. The clock uses the line frequency as a time base, but a crystal oscillator can perform the same function at added cost. By adding comparator circuits, not shown here, the clock can be made to generate command signals at desired times or at desired intervals.

Low-cost ICs make digital clocks practical

Digital clocks have long been used to precisely sequence the separation of spacecraft booster stages and control the actuation of satellite instrumentation, but until recently they were very expensive. Now, using TTL ICs, you can build a 12-hour clock for approximately \$180, including the six Nixie tubes in the display. And if the logic and tubes used to display seconds are eliminated, the parts cost drops to about \$150.

The use of complex ICs accounts for the minimized parts cost. The equivalent of a score or more of conventional logic circuits is contained in each of the monolithic counters and decoder-drivers used in this design. Each is a single, plug-in package less than an inch long and about one-third inch wide.

Familiar TTL IC components are the heart of the digital clock. The monolithic decade counter (a) accepts and counts pulses and displays the number of pulses in binary-coded decimal form on its four outputs. It recycles every 10 pulses. The divide-by-12 counter (b), connected to divide by 6, allows dividing the 60-Hz line frequency down to 10 Hz in one step. The display tubes are driven by a decoder-driver (c), which has the necessary high voltage drive capability. And the up-down counter (d), which can be programmed to reset and cycle according to states applied at its control inputs, makes possible a less complex counter than would ordinarily be necessary.

Transistor-transistor logic (TTL) integrated circuits are best for several reasons: all the

required circuit types are generally available at electronic parts distributors; TTL operates at voltage levels compatible with the discrete components needed; and the TTL output drive is high enough to control the display or small relays without using buffer amplifiers.

TTL circuits have a fanout of at least 10. This drive capability allows the counter outputs to be tapped to provide logic signals to drive external equipment as well as the decoders. The designer has an almost limitless number of choices for handling and using the counter outputs. A few possible applications are:

Scientific—making data-acquisition system sample and record experimental data at specific times of day for preset time durations.

Industrial—controlling apparatus, such as operating electromechanical valves to vary gas flow to ceramic kilns. This should permit any desired temperature/time processing cycle to be carried out with the kiln unattended.

Consumer—turning on and off appliances, air conditioning, lighting, and other electrical equipment; timing functions in time-lapse photography with automatically controlled camera; and stop-watch applications in sports, or event-time recording control.

Anything that can be actuated with a relay or solenoid can be controlled by the clock and suitable TTL detectors. And any action that will make or break an electrical connection, such as a runner hitting a tape at the finish line, can stop the clock or be used to record the time.

decade counter (DM 7530/DM 8530 or SN 5490N/SN 7490N)

logic diagram

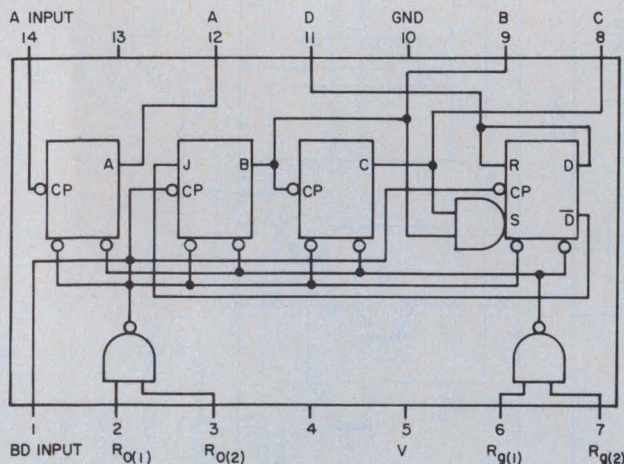

RESET OPERATION

To reset the counter to the BCD count of zero, both Reset 0 inputs must be at logical "1" levels while at least one Reset 9 input is at a logical "0" level.

BCD count sequence

COUNT	OUTPUT			
	D	C	B	A
0	0	0	0	0
1	0	0	0	1
2	0	0	1	0
3	0	0	1	1
4	0	1	0	0
5	0	1	0	1
6	0	1	1	0
7	0	1	1	1
8	1	0	0	0
9	1	0	0	1

Notes:

- Counting occurs on the negative-going edge of the input pulse.
- At least one of the Reset 0 inputs and at least one of the Reset 9 inputs must be at a logical "0" for proper counting.

To reset the counter to the BCD count of nine, both Reset 9 inputs must be at logical "1" levels. Reset 0 inputs may be in any state.

(a)

divide-by-twelve counter (DM 7532/DM 8532 or SN 5492N/SN 7492N)

logic diagram

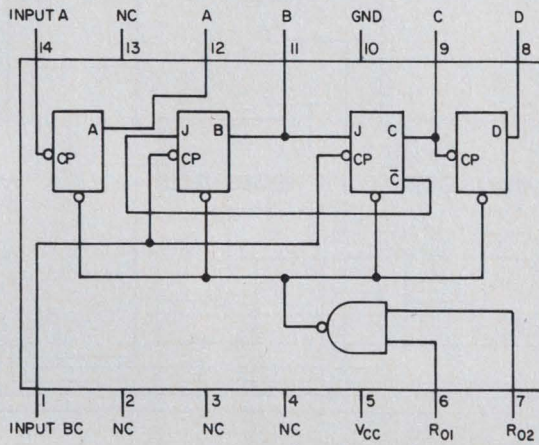

RESET OPERATION

To reset the counter to the count of zero, both Reset 0 inputs must be at logical "1" levels.

count sequence

COUNT	OUTPUT			
	D	C	B	A
0	0	0	0	0
1	0	0	0	1
2	0	0	1	0
3	0	0	1	1
4	0	1	0	0
5	0	1	0	1
6	1	0	0	0
7	1	0	0	1
8	1	0	1	0
9	1	0	1	1
10	1	1	0	0
11	1	1	0	1

Notes:

- Counting occurs on the negative-going edge of the input pulse.
- At least one of the Reset 0 inputs must be at a logical "0" for proper counting.
- For $\div 12$ counting, connect the A output to the BC input.

(b)

decimal decoder/nixie driver (DM 7840/DM 8840 or SN 5441A/SN 7441A)

pin configuration

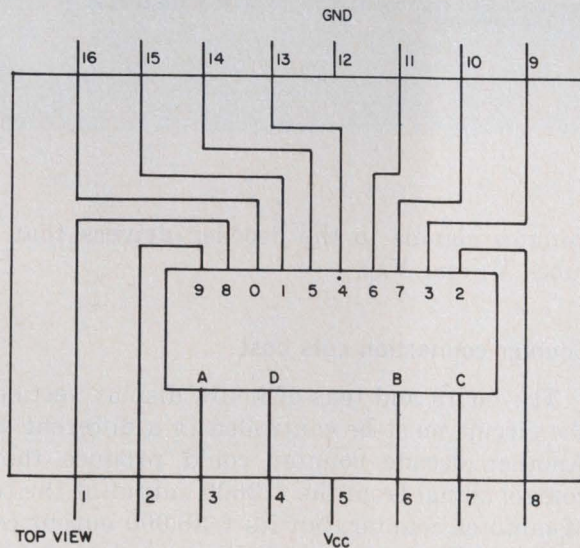

logic table

INPUT				LOW OUTPUT
D	C	B	A	
0	0	0	0	0
0	0	0	1	1
0	0	1	0	2
0	0	1	1	3
0	1	0	0	4
0	1	0	1	5
0	1	1	0	6
0	1	1	1	7
1	0	0	0	8
1	0	0	1	9
(OVER-RANGE)				
1	0	1	0	0
1	0	1	1	1
1	1	0	0	2
1	1	0	1	3
1	1	1	0	4
1	1	1	1	5

(c)

Box continued on next page

up/down binary counter (DM 7563/DM 8563)

logic and connection diagrams

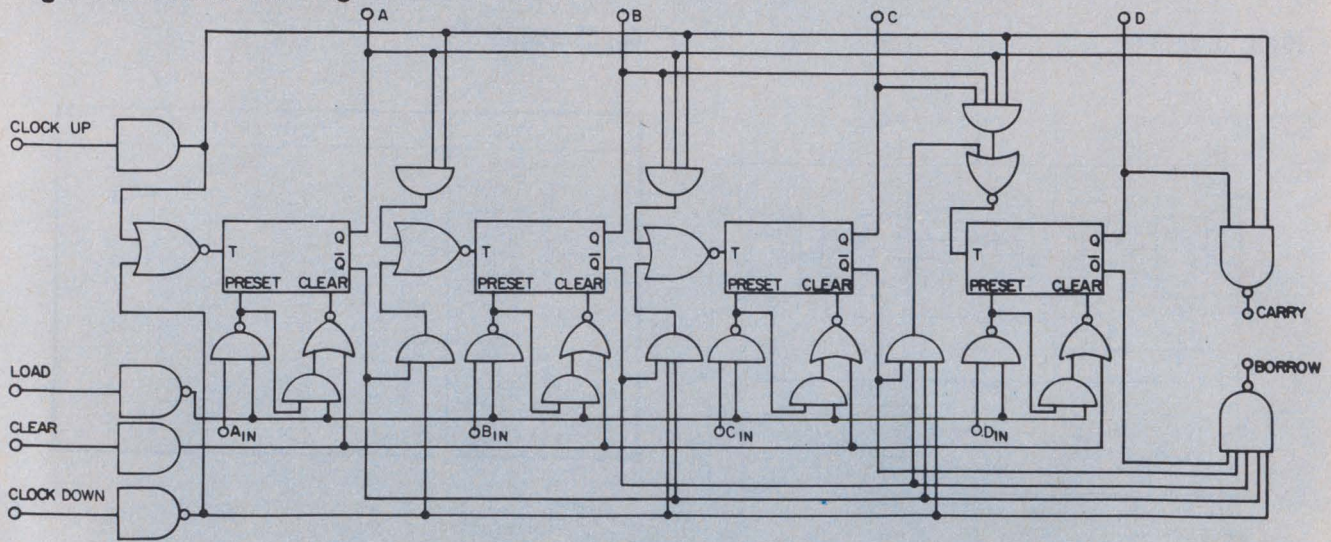

logic waveforms

(EXAMPLE SHOWN FOR (1) CLEARING, (2) ASYNCHRONOUSLY SETTING TO FOURTEEN COUNT, (3) COUNTING "UP" TO TWO, AND (4) COUNTING "DOWN" TO FOURTEEN.)

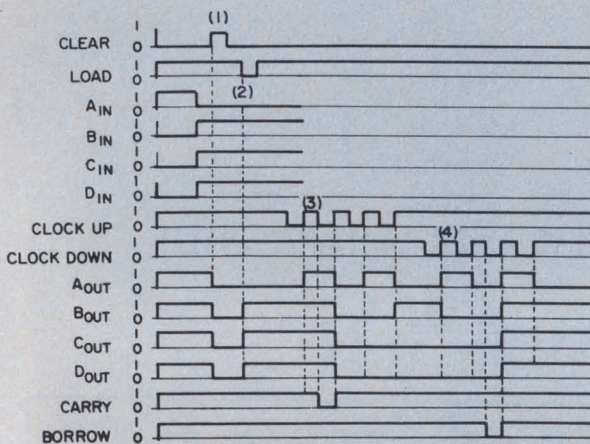

pin configuration

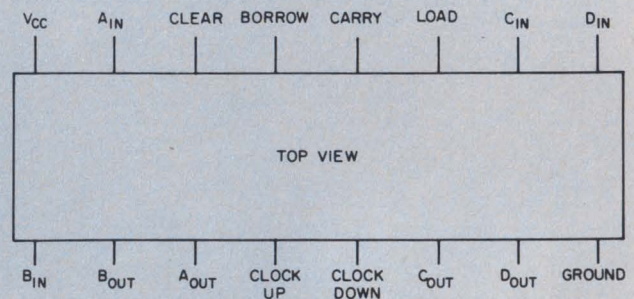

NOTES

1. LOAD AND CLEAR INPUTS SHOULD NEVER BE ENABLED TOGETHER.
2. A, B, C, AND D INPUTS ARE FREE TO CHANGE AFTER LOAD INPUT IS DISABLED.
3. WHEN COUNTING "UP", THE "DOWN" CLOCK MUST BE IN THE LOGICAL 1 STATE, AND CONVERSELY.



(continued from page 82)

seconds counter Q_9 , shown in Fig. 1, the counter steps from 0 through 5, but it does not provide a normal BCD output to decoder Q_{10} (see box). This situation is corrected by using the special interconnection scheme shown in Table 2. Note also that the D input of decoder Q_{10} must rise to logic ONE level (2.0 V or more) only when decimal outputs greater than 7 are to be produced. Since 5 is the largest number decoded by the counter, the Q_{10} decoder input is simply connected to ground.

The f/60 output of the tens-of-seconds counter is divided down in the same way by the next two counters, supplying the minutes and tens-of-

minutes signals to the decoder/drivers that fire tubes V_3 and V_4 .

Counter connection cuts cost

The hours and tens-of-hours display section of the circuit must be controlled in a different way. Another decade counter could produce the V_5 control signal from the f/3600 output of the tens-of-minutes counter, but its f/36,000 output could not drive V_6 in turn since V_6 must show 0 for 10 hours and then a 1 for three hours. Doing this with counters and decoders would be complex and costly.

TABLE 1. Digital clock parts list

Part	Function	Type number
Q1	transistor	2N3055
Q2, 3, 4, 15	transistors	2N3643
Q5, 9, 13	TTL counter ($\div 12$)	DM8532 (SN7492)
Q6, 7, 11	TTL decade counter	DM8530 (SN7490)
Q8, 10, 12, 14, 18	TTL BCD-to-decimal decoder/Nixie* driver	DM8840 (SN7441)
Q16	TTL triple 3-input NAND gate	DM8010 (SN7410)
Q17	TTL up/down counter	DM8560 (SN7419)
Q19	TTL quadruple 2-input NAND gate	DM8000 (SN7400)
Q20, 21	transistors	2N718A
D1-4, D6-11	diodes	1N4003
D5	diode	5.7 V zener
D12-16	diodes	1NFD100
V1-6	Nixie* tubes	NL840
T1	transformer	Stancor PS8416
L1-4	lamps	3V, 14 mA

*Nixie is a trademark of the Burroughs Corp. Equivalent display devices made by other manufacturers may be used.

TABLE 2. DM8532/DM8840/Nixie Connections

DM8532 Output	DM8840 Decoder/Driver Input	DM8840 Decoder/Driver Output	Number on Display
B	A	0	0
C	B	1	1
D	C	2	2
		4	3
		5	4
		6	5

Note: Package pin numbers are shown in wiring diagram.

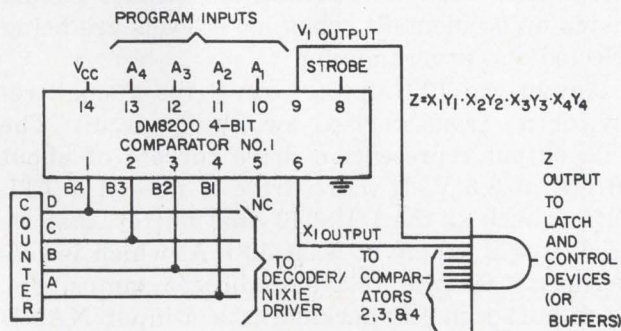

2. Control is achieved through comparators that compare programmed input states with the coded decimal time signals generated by the counters. Combinations of gates, comparators and up-down counters can yield control functions whose intricacy is limited only by the designer's ingenuity.

The hours-counting arrangement shown in Fig. 1 saves a decoder and requires only one counter, two low-cost TTL gate circuits and three transistors. The output of the tens-of-minutes counter is applied to one of the three 3-input NAND gates in Q₁₇. Its output, on pin 12, is reinverted by the second gate in the package and used to clock up the up-down counter, Q₁₆. This counter is programmable—it resets and cycles according to the states of the logic signals applied to its control inputs.

As connected, the counter will produce BCD outputs 0 through 13, enough to take the total hours count from 0 through 1 o'clock. Here's where the DM8840's overrange capability (Fig. 2) comes in handy. This IC was originally developed to permit automatic overranging on digital voltmeters and similar instruments. Outputs over 9 do not affect the accuracy of the hours display on V₅, because the DM8840 decodes the least significant bit in larger numbers. It fires the 0 segment of V₅ on the count of 10, and so forth.

In the BCD code, 13 is represented by logic ONEs on the ACD outputs and a ZERO on the B line. The ACD outputs are connected to the inputs of the third NAND gate on Q₁₇, and the gate's output, on pin 8, therefore loads a logic ZERO on pin 11 of the counter. This input causes the counter to parallel-load a ONE on an output because only an input of the DM8563 is tied to a logical ONE. All of the other parallel inputs are connected to ground.

Three 2-input NAND gates in the DM8000 (Q₁₉) also decode the counter output. They are connected so that the 0 segment of V₆ is held ON and the 1 segment held OFF when the counter output represents 0 through 9. During outputs 10 through 13, the 1 segment is ON and the 0 segment turned OFF. The change occurs at the end of the ninth hour, turning the display from 09-59-59 to 10-00-00.

Allowing the counter to go to 13 is cheating a bit, but it keeps the logic simple. Actually, the number 13 is never visible on the display. It fires for only a few nanoseconds every 12 hours.

The display should change to 01-00-00 immediately after 12-59-59, but it is allowed to go to 13-00-00 for the time it takes the counter's ACD outputs to go around the resetting circuit through the DM8010. As soon as the counter display inputs receive the ONE the display changes to 01-00-00 and the normal operation resumes.

Use high BV_{CEO} drive transistors

One cautionary word about the two transistors, Q₂₀ and Q₂₁, used to drive V₆. These must have a breakdown voltage BV_{CEO} of at least 70 V, since they have to hold display-tube segments OFF at

that level for long periods of time, and 2N718A or similar transistors are recommended.

If one or both of the transistors should short out, however, there will be no chain reaction through the logic circuitry. This is one of the virtues of connecting the emitters to the logic output stages. Another advantage is that the emitters are not continually biased, as in conventional display-tube drive circuits (biasing the emitters permits leakage currents to put an annoying glow on tube segments that are supposed to be OFF).

Fast-cycle to set the clock

Switches SW_1 and SW_2 allow the clock to be set to the correct time of day after it is turned on. Moving the switch from position SW_{1-1} to SW_{1-2} stops the clock. Moving SW_1 to position 3 and SW_2 to the various positions shown on the wiring diagram will cause the 1-Hz square wave to directly cycle the selected counters. All but the seconds counter can be rapidly advanced. The seconds display cannot catch up to real time, but it can be preset and stopped until real time catches up with it.

To synchronize the clock to a tone signal broadcast by radio, for example, the clock can be set to 12-00-00 and then stopped by placing the toggle switch at SW_{1-2} . When the tone is heard, the switch is flipped to SW_{1-1} to restart the clock.

The four-lamp inset diagram in Fig. 1 can be used to insert small punctuation lights between display sections. One possible arrangement is 00:00:00, with the dots continuously lit.

Control system demonstrates use

Since many different external control systems can be built around the clock, only one example will be given here. This subsystem is suitable for actuating an external device—say, a relay—at a specific time of day.

The 4-bit comparators shown in Fig. 3 are connected to the counter outputs, the number of comparators used depending upon the time resolution desired. For a 10-second resolution four comparators will be needed, and these would be connected to all counters except the seconds counter.

The input side of each comparator can be programmed to represent the desired counter output. That is, the logic level applied to each input pin matches the counter output to be detected. To detect the BCD 3 output of a DM8530 decade counter, for instance, the comparator pins corresponding to the counter's DCBA outputs would be set at ZERO-ZERO-ONE-ONE. These levels are established by connecting the comparator

pins to ground or to V_{CC} as the case may be. The connections can be made through 2-position switches for manual selection of the time detected. (Remember to use the connections in Table 2 when a comparator is connected to the DM8532 counter outputs.)

External logic can be used to control a rapid timing sequence. The first comparator output, for example, might be used to start a counter driven by the 1-Hz square wave, as well as to close a relay. Then the counter output at the end of a desired number of seconds or minutes might be used to open the relay. A similar subassembly, or one built around a TTL divider, could be used to open or close the relay every N seconds starting with the time programmed on the comparators.

The comparator produces a ONE pulse on both its X and Y outputs only when the logic levels on the comparator inputs match those produced by the counter (or other logic). At all other times, one or both of the comparator outputs are at the ZERO level. The match condition on one comparator can be detected with a 2-input AND gate, which will transmit a ONE control pulse to the relay circuit. If four comparators are used, an 8-input AND gate will detect a match on all four.

As a precaution against false triggering because of noise or other accidental perturbations, it is best to run the gate outputs through a latch, such as a J-K master-slave flip-flop. The DM8501 (or SN7473) dual J-K is a good device to use because it contains a special clock-line clamp to reduce ringing and prevent false clocking. It will hold the control signal at the correct logic level between state changes in the AND gate output, no matter how long the interval. Each DM8501 contains two independent flip-flops.

Normally, the comparator strobe pins should be at logic ZERO. But it's a good idea to provide a switch for changing the level of logic ONE during the reset operations. This will prevent a false all ONEs output of the comparators if the comparator inputs and counter outputs should match up accidentally when logic levels are being selected for programming.

Any of the TTL devices can drive a small relay, or a transistorized switching circuit. The TTL output represents a drive current of about 16 mA at 3.5 V. If more drive is needed a TTL buffer, such as the DM8040 dual buffer, may be used. It will supply at least 50 mA, which is sufficient to operate relays, indicator lamps, etc. Each buffer in the package is a 4-input NAND gate, providing a couple of extra inputs for additional control functions, if desired. Higher drive capability can be obtained with transistor circuits or hybrid IC buffers. A buffer such as the NH0006 will supply up to 400 mA at 28 V, which is enough to operate small motors. ■■

Full performance at a price you can afford



You don't have to be a Scotsman to know that you pay more for top performance. So if we told you this new 3-digit DPM was made to sell for less than \$115 in OEM quantities, you'd figure its performance at something less than that delivered by our higher priced models.

But you'd be wrong. And here's why.

First of all, our initial objective was to develop an instrument for OEM measurement needs of the scientific and medical community. Obviously, price was an important factor. But so was performance. The happy solution

was to eliminate a few of the more exotic functions that these users normally don't require. For example, 100% overrange and standard BCD output (an option available on Model 1261).

Secondly, instead of compromising performance, we've actually *improved* it! Model 1261 is a basic 0-99.9 millivolt DC meter with 50% overrange capability, 100 microvolt resolution, long-term stability, 50 megohm input impedance, high rejection characteristics, and Weston's patented dual slope* circuitry. It's packaged in the plug-in case that's common to all our

DPM's, giving you Weston front panel serviceability.

This latest addition to our DPM family brings .1% accuracy within range of practically everyone's budget. Make your own comparisons, spec for spec, with other digital compacts on the market. Write today for complete data and ranges available.

WESTON INSTRUMENTS DIVISION,
Weston Instruments, Inc., Newark, N.J.
07114, a Schlumberger company

WESTON®

*U.S. Pat. #3,051,939

Our new automatic test equipment tells you where your electronic system went wrong, and how to fix it. In plain English.

SCATE MK V READY
TYPE NAME AND SERIAL NUMBER OF UNIT UNDER TEST
NAME: AN/ARC SN#1948J

AN/ARC CONFIDENCE TEST
CONNECT INTERFACE CABLE W116 TO J3 OF SCATE
ADJUST AUDIO AND SIDETONE LEVEL CONTROLS FULLY CW.
TYPE "CONTINUE" WHEN READY

CONTINUEJ

LSB RECEIVE TEST
LSB AUDIO OUTPUT IS 1.27V FAILED TEST

USB RECEIVE TEST
USB AUDIO OUTPUT IS 6.5V PASSED TEST

REPLACE IF TRANSLATOR MODULE A6
TYPE "CONTINUE" WHEN READY TO RETEST.



Each new generation of electronic systems used to bring along its own maintenance and support problems. Because each new type of electronic equipment needed new testing procedures, new training and some new test equipment.

For the Army, the problem is even greater. Because its field maintenance and support equipment has to be mobile. And it has to be relatively simple to operate.

That's where our SCATE® MK V comes in.

General Dynamics' Electronics division went to work on this problem: creating a computer-controlled automatic test system light enough to be mobile, simple enough to be operated without complex training, adaptable enough to be used for all the Army electronic systems into the mid-1980's.

The answer is SCATE MK V, a unique electronic diagnostic tool.

SCATE MK V talks English.

SCATE MK V talks your language. The man who operates it, in the field, needs no advanced training. If he can read or write English, he can be trained to use this equipment in a matter of weeks, not months.

Once an operator is trained, he does not have to know how the unit under test works. SCATE MK V already does. Its computer is programmed for that.

Because the program is in English and on line, the programming costs and time are reduced by as much as 50% compared

to other automatic test equipment.

SCATE gets things down to size.

SCATE MK V is about one-third of the size of any similar existing equipment. It can be mounted in a portable shelter on the back of a truck. Or it can be delivered to the field by helicopter.

The reason for the smaller size of SCATE MK V is that its computer is used more extensively in the measurement function as

well as the control function. This eliminates the need for special and redundant test equipment.

One answer for nine commodity areas.

The Army has identified a requirement for computer-controlled automatic test equipment (CATE) in nine commodity areas: radio communications; wire and

carrier communications; army avionics; fire control equipment; engineering survey and map equipment; missile systems; combat surveillance; laser systems; and communications security.

SCATE MK V can be programmed to provide support in any of these materiel areas.

SCATE MK V is a good example of what we do best.

At General Dynamics we put technology to work solving problems from the bottom of the sea to outer space...and a good bit in between.

GENERAL DYNAMICS

Additional technical information is available on SCATE MK V on request. Write: General Dynamics, Dept. 850, 1 Rockefeller Plaza, New York, N.Y. 10020.

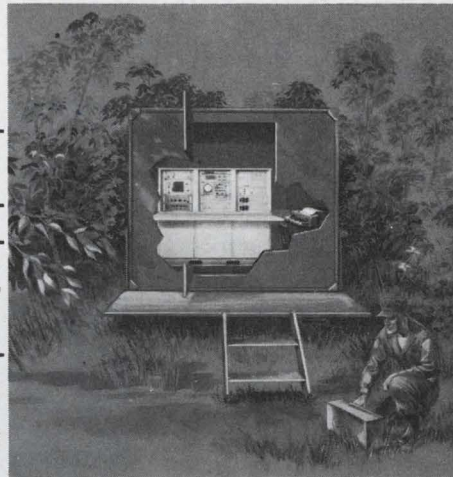

DO NOT
OPERATE
WITHOUT
PORTS

ON
EQUIPPED
10 Hz 1P+

Use ECAP to design transistor models.

Approximate circuits can be refined by means of the program to compute more accurate parameters.

Computer-aided design programs have become a great convenience in building circuits. Unfortunately, most of the easily available programs in this category have one serious limitation: inadequate capabilities for modeling semiconductor devices.

It is possible, however, to provide excellent results by using a computer subroutine in conjunction with the program. With this technique, ECAP, for example, can rival those programs known for their modeling of transistor nonlinearities.

ECAP has many advantages

The Electronic Circuit Analysis Program (ECAP) is one of the most suitable programs for the circuit designer for many reasons: it is widely available on many time-sharing services; it is easy to learn, and can readily handle circuit blocks, especially in transient analysis; and it has been around for a long time so is very well documented.¹

The method by which ECAP can be expanded to operate with transistor models is direct: You repeatedly feed the model into the ECAP program and use each computed result to refine the model for the next attempt. Thus, a man-machine iteration loop is obtained that closes out when the model is satisfactory (Fig. 1).

On a step-by-step basis, the procedure operates this way: Choose the device's operating points and obtain a set of model parameters; perform an ECAP analysis to get new operating points from which an improved set of model parameters can be derived; rerun the ECAP analysis; and repeat this process until the operating points are proper. Usually, two iterations suffice.

Choose the proper model

The modeling program uses the hybrid pi² configuration for dc and linear ac analysis, and a simplified Ebers-Moll model for transient or

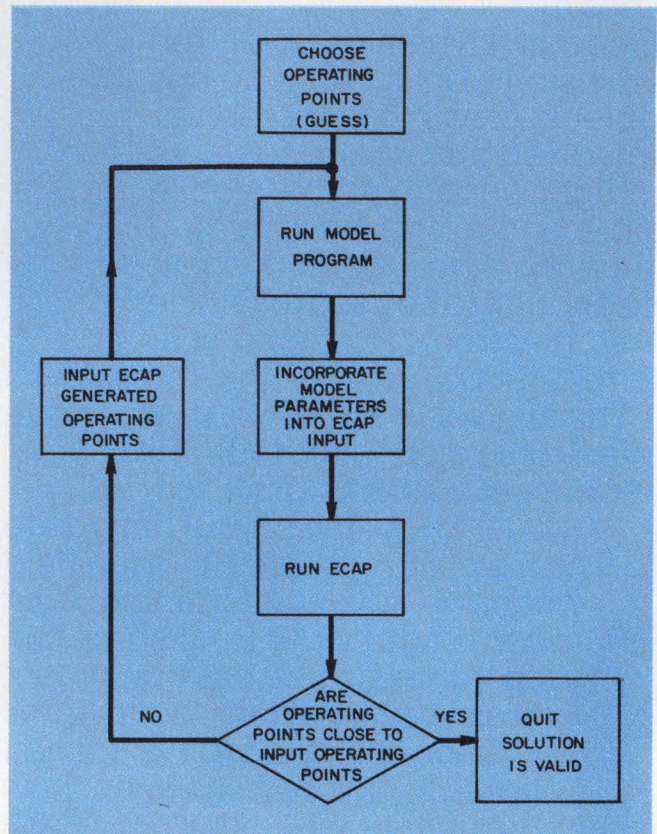

1. Flow chart of the man-machine iteration process closes the loop through the man. The machine runs the program; the man decides whether the resulting operating points are good enough.

switching, analysis (Fig. 2).

The dc model takes three branches, but if R_{bb} is ignored only two branches are needed. The ac model takes four or five branches, depending on the need for R_{bb} . The switching model takes eight branches, but many of them are unnecessary for most applications. R_{bb} and R_{sat} are often not required. The current generator $\alpha_1 T_c$ and the collector diode S_2 , V_{BC} and R_{CD} are not required if the transistor does not saturate. Thus, for many applications as few as four branches may be enough.

Once the appropriate model³ has been chosen, there must be adequate input data to support it. Most manufacturers supply excellent data that can be had for the asking.^{4,5,6,7} However, some-

Bruce Gladstone, Manager, Computer Systems, Gulton Industries, Inc., Hawthorne, Calif.

Table 1. Data Inputs for Model

Circuit element	Parameters	Input data	Precautions	Comment
Base—Emitter Diode	V_{be}, R_{ed}, R_{bb}	V_{be}, I_c (3 points) I_c/I_b	Use 2 points at low currents to minimize effect of R_{bb}	
Base—Collector Diode	V_{bc}, R_{cd}	V_{bc}, I_{cd} (2 points)	Data points should be 2-3 decades apart	Data is usually not supplied, measurement is required. This data is needed only for the saturation region of the transient model
β	$\alpha, \beta, h_{oe}, h_{ie}$	Nine values of β for 3 values each of V_{ce} & I_c	Cover range of interest check for consistent values	
Bulk Resistances, Inverted Alpha	$R_{sat}, R_{bb}, \alpha_I$	$V_{ce(sat)}$ at 2 values of $I_c, I_c/I_b$	Take lower set of data near minimum V_{sat} point. Accuracy of data is imperative.	Not needed for linear models
Transition Capacitance	C_{te}, C_{tc}	Two values each of transition capacitance at two values of reverse bias. η_e, η_c	Take data at extreme points	C_{te} needed only for back biased transient model
Emitter Diffusion Capacitance	C_{de}	Three values of f_t at 3 collector currents	Cover frequency range of interest	
Collector Diffusion Capacitance	C_{dc}	Value of storage time at I_c, I_{b1}, I_{b2}		Not needed for linear models

times the information is inconsistent, particularly if data from two different manufacturers is compared. One explanation for this condition is that different manufacturers use different processes, so that a device with the same type number can actually have two or more sets of parameters to describe it. To avoid this, you can stick to the data supplied by one reliable manufacturer or make the measurements yourself.

A listing of the pertinent parameters and their sources is given in Table 1, with precautions to ensure obtaining consistent results.

A few pieces of data are usually not available on a data sheet. The most important of these are the two grading constants, η_e and η_c . These are a function of the manufacturing process (see

Table 2).⁶

The grading constants are necessary to model the transition capacitances (junction capacitances under reverse bias conditions). Other parameters needed to help evaluate whether the

Table 2. (Grading Constants)

Transistor Process	η_e	η_c	α_I
Diffused-Base Epitaxial	0.33	0.1	0.1-0.4
Diffused-Base Mesa	0.33	0.33	0.2-0.8
Alloy	0.5	0.5	0.8-0.95

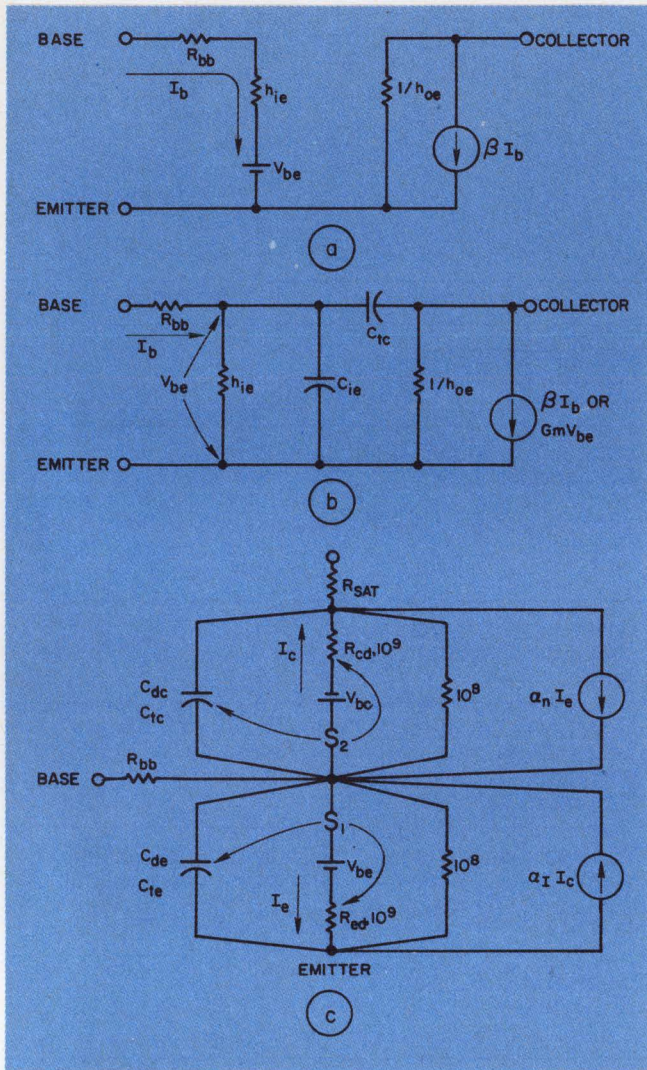

2. Three models are used for representing a transistor, depending on its operation. The dc model in (a) is simplest; the ac model is shown in (b); and the switching model (c) is the most complex. The symbol S is a switch with lines to the controlled elements.

model is reasonable, are the emitter and collector emission constants, $M(E)$ and $M(C)$. The emission constants at the emitter junction are usually 1.0 to 1.5 for low V_{be} transistors, and 1.5 to 2.0 for high V_{be} transistors. Generally they are nearly equal for the two junctions of a given transistor. This may also allow modeling of the collector diode without resorting to measurements.

Expected values for $\alpha I^{1.5}$ are also given in Table 2.

The 26 modeling constants required to define a transistor are listed in Table 3. These constants

Table 3. Model Constants

Model elements	Model constants	Definition of constant
$R_{ed}, h_{ie}, V_{be}, g_m$	k_1, k_2	$k_1 = I_{e1}/(e^{k_2 V_{be}} - 1)$ $k_2 = \ln((I_{e2} + 1)/k_1)/V_{be2}$
R_{ed}, V_{be}	k_3, k_4	$k_3 = I_{c1}/(e^{k_4 V_{be}} - 1)$ $k_4 = \ln((I_{c2} + 1)/k_3)/V_{be2}$
R_{bb}	R_{bb}	$R_{bb} = (V_{be3} - \ln(1 + I_{e3}/k_1)) / (6I_{e3} + 1)/V_{be3}$
β, h_{oe}	$[K] = \begin{bmatrix} k_{11}k_{12}k_{13} \\ k_{21}k_{22}k_{23} \\ k_{31}k_{32}k_{33} \end{bmatrix}$	$[I] = \begin{bmatrix} 1/I_1 & 1/I_1 \\ 1/I_2 & 1/I_2 \\ 1/I_3 & 1/I_3 \end{bmatrix};$ $[A] = \begin{bmatrix} A_{11} \\ A_{12} \\ A_{13} \end{bmatrix}$ $[D] = \begin{bmatrix} 1/(\beta_{11} + 1) \\ 1/(\beta_{12} + 1) \\ 1/(\beta_{13} + 1) \end{bmatrix};$ $[V] = \begin{bmatrix} 1 & V_1^{1/n} & V_1^{2/n} \\ 1 & V_2^{1/n} & V_2^{2/n} \\ 1 & V_3^{1/n} & V_3^{2/n} \end{bmatrix}$ $[I][A] = [D]V = V_1;$ $V = V_2$ $V = V_3$ $[V][k] = [A]A = A_{1j}, j = 1, 2, 3$ $A = A_{2j}, j = 1, 2, 3$ $A = A_{3j}, j = 1, 2, 3$
α_1	α_I	$\alpha_1 = \frac{(1 + I_c/I_b)}{(1 - I_c/\beta_{11})(e^{V_{sat}1/.0257} + I_c/I_b(1 - I_c/\beta_{11}I_b))}$ (β_{11} is beta at minimum measured V and I)
R_{sat}	R_{sat}	$R_{sat} = (V_{sat2} - V_{sat1})/I_{c3}$
C_{ic}	k_5, k_6, η_c	$k_5 = (k_6/C_{ob1})^{1/\eta_c} - V_{be1}$ $k_6 = C_{ob2}(k_5 + V_{be2})^{\eta_c}$
C_{te}	k_7, k_8, η_e	$k_7 = (k_8/C_{ib1})^{1/\eta_e} - V_{be1}$ $k_8 = C_{ib2}(k_7 + V_{be2})^{\eta_e}$
C_{dc}	t_s	$t_s = \tau_{stor}/\ln((I_{b1} + I_{b2})/(I_{b2} + I_{c}/\beta))$
C_{de}, C_{ie}	$[F] = \begin{bmatrix} F_1 \\ F_2 \\ F_3 \end{bmatrix}$	$[1/F_t] = \begin{bmatrix} 1/F_{t1} \\ 1/F_{t2} \\ 1/F_{t3} \end{bmatrix};$ $[I][F] = [1/F_t]$

are generated by the program from the input data. They are assumed to be invariant with operating points. This is not strictly true, but the results are still useful.

The modeling constants are then used to compute the model parameters (Table 4). Values are now known for all of the elements in the equivalent circuits of Fig. 2.

Inverter is example

A simple inverter circuit using a 2N2907

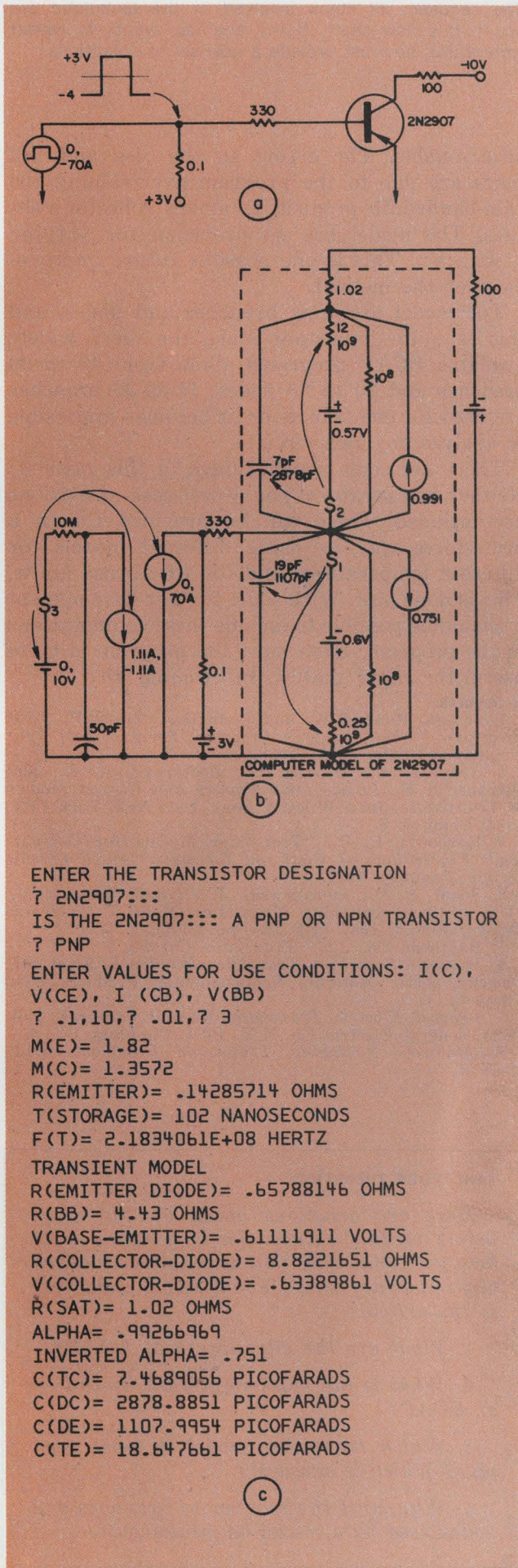

3. An example of the modeling technique uses a transistor operating in the switching mode. The actual circuit is shown in (a) and its equivalent circuit in (b). The two values on the controlled elements are for the switch open and closed. The unusual current values are chosen for convenience in ECAP. The model computed by ECAP is given in (c).

Table 4: Model Parameters

<p>DC model:</p> $\gamma = (k_{11} + k_{12}V_{ce}^{1/n} + k_{13}V_{ce}^{2/n}) + (k_{21} + k_{22}V_{ce}^{1/n} + k_{23}V_{ce}^{2/n}) I_c + (k_{31} + k_{32}V_{ce}^{1/n} + k_{33}V_{ce}^{2/n}) / I_c$ $\beta = (1 - \gamma) / \gamma \quad \text{note: } \gamma = 1 / (\beta + 1)$ $h_{ob} = I_c (-1 + \beta_2 / \beta) / .05V_{ce} \quad \left(\begin{array}{l} \beta \text{ is evaluated at use} \\ \text{voltage} \\ \beta_2 \text{ is evaluated at 1.05} \\ \text{use voltage} \end{array} \right)$ $h_{ie} = \beta / I_c k_2$ $V_{be} = \ln((1 + I_c / k_1) / k_2) - I_c h_{ie} / \beta$ $gm = I_c / k_2$ $R_{bb} = R_{bb}$
<p>In addition, for AC model:</p> $C_{tc} = k_5 / (k_6 + V_{ce})^{n_6}$ $C_{ie} = k_3 I_c / 2\pi f_t \text{ where } f_t = 1 / (F_1 + F_2 I_c + F_3 / I_c)$
<p>In addition, for switching model:</p> $\alpha_I = \alpha_I$ $\alpha = \beta / (1 + \beta)$ $V_{be} = \ln((1 + I_c / 100k_1) / k_2)$ $V_{bc} = \ln((1 + I_{cb} / 100k_3) / k_4)$ $R_{em \text{ diode}} = [\ln((1 + I_c / k_1) / k_2) - V_{be}] / I_c$ $R_{cb \text{ diode}} = [\ln((1 + I_{cb} / k_3) / k_4) - V_{bc}] / I_{cb}$ $R_{sat} = R_{sat}$ $C_{te} = k_7 / (k_8 + V_{be})^{n_8}$ $C_{dc} = \tau_8 / R_{cb \text{ diode}} (\beta + 1)$ $C_{de} = 1 / 2\pi f R_{em \text{ diode}}$

transistor was evaluated using this modeling technique in conjunction with ECAP. The actual circuit, the program-derived equivalent circuit and a printout of the results are shown in Fig. 3.

Results were obtained from the ECAP equivalent circuit that followed the flow chart of Fig. 4. I_{B1} was -9.86 mA. I_{B2} was -11 mA. I_c was -101 mA. Delay time, t_d , was 8.8 ns. Rise time, t_r , storage time, t_s , and fall time, t_f , were 16.9 , 68.8 and 12.8 ns respectively. The manufacturer's data gives 7 , 18 , 54 , and 15 ns for these quantities. The results, while not in total agreement, are not

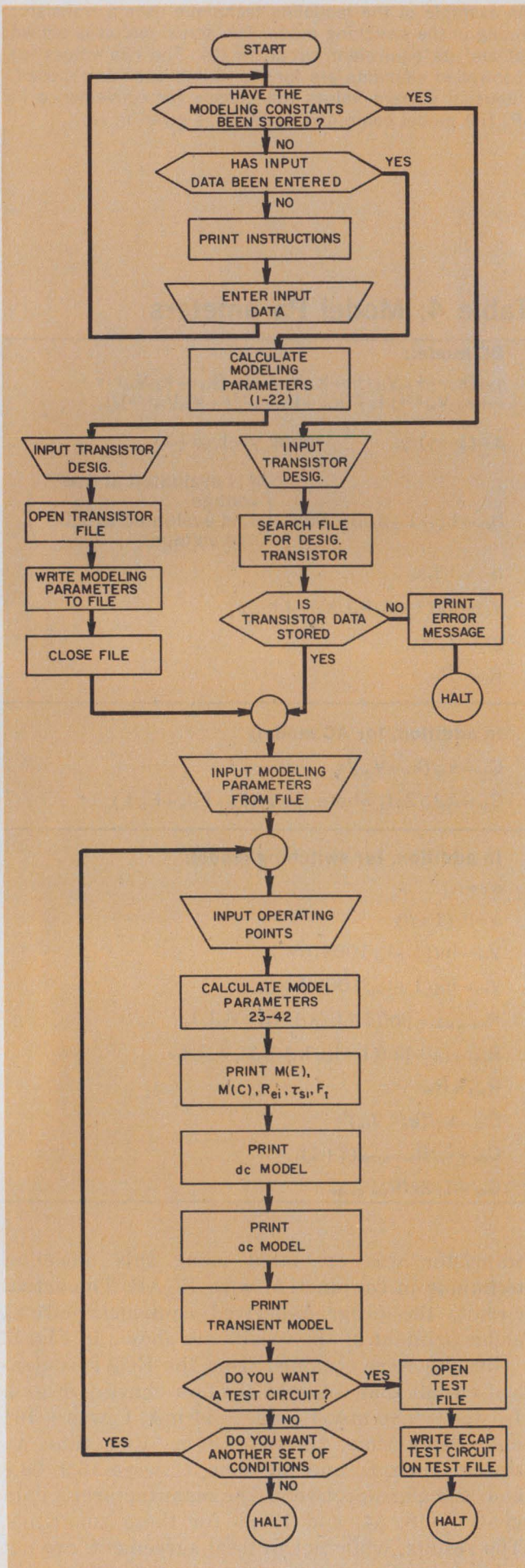

4. The sequence of steps involved in the technique are shown in this flow chart. If the engineer wants to repeat the procedure, he must provide a new set of conditions.

unreasonable. The errors in the rise and fall times are due to the program over-valuing the gain-bandwidth product, f_t , at low collector voltages. The model has no provision for varying f_t with V_{cc} . This is one possible future improvement of the method.

The model uses few branches and nodes, and this is quite important since the most widely available ECAP programs allow from 40 to 90 branches and 20 to 30 nodes. If 20-30 branches are used for one transistor, it becomes impossible to analyze any real circuits.

There are some shortcomings in this method: Neither temperature nor worst-case provisions are included. These can be provided for in a brute-force way by using different models for different temperatures and for worst-case limits. This is done now. With some further development it should be possible to include these computations in the program. Even now, the program is quite useful for rapid analysis of circuits. ■■

References:

1. Jensen, Randall W. and Lieberman, Mark D., *IBM Electronic Circuit Analysis Program*, Prentice-Hall, Inc., Englewood Cliffs, N. J., 1968.
2. Gray, R. E.; DeWitt, D.; Boothroyd, A. R.; and Gibbons, J. F., *Physical Electronics and Circuit Models of Transistors*, John Wiley & Sons, Inc., New York City, 1964, Chap. 7, 8.
3. Harbourt, C. O., "Transistor Models for Computing," *Proceedings of Conf. on Computer Aided Circuit Design*, January, 1967.
4. Sokal, N. O.; Sierakowski, J. J.; and Sirota, J. J., "Use a Good Switching Transistor Model," *Electronic Design*, June 7, 1967 (ED 12), pp. 54-59.
5. Raytheon Co., *1969 Transistor Catalog*.
6. *Motorola Switching Transistor Handbook*, First Ed., Phoenix, Ariz: Motorola Semiconductor Products Div., Chap. 5.
7. *General Electric Transistor Manual* (Seventh Edition) General Electric Co. N.Y. 1964, Chapters 1-3, 6.
8. *Motorola Switching Transistor Handbook*, *ibid.*, Chap. 4.

Test your retention

Here are questions based on the main points of this article. Their purpose is to help you make sure you have not overlooked any important ideas. You'll find the answers in the article.

1. What are the advantages of ECAP?
2. What is the most significant limitation of ECAP?
3. Which transistor model is most complex? Which is simplest?
4. Why must the number of branches and nodes used by a model be minimized?

A NEW FIELD-OF-ONE IN LIGHTED PUSHBUTTON SWITCHES.

Switchcraft's "PUSH-LITE" switch offers reliable leafspring switching in a neat little package.

This whole new field of compact (1" x 1 1/16" x 1 3/4") pushbutton switches reduces the size of your control panels, consoles—and cost, too! Our new field-of-one consists of 6 series—including non-illuminated and illuminated single and twin-lamp units in two housing colors (black or grey). Up to 4PDT switching in momentary and push-lock/push-release functions. Ratings range from dry circuit switching, up to 3 amps., A.C., non-inductive load.

A rugged molded housing encloses the highly reliable leafspring switching and protects against dust, dirt and mishandling.

Pick from flange or barrier mounting—individually or in matrix configurations. Series PL "PUSH-LITE" switches mount from front of panel with clamp brackets, simply and quickly. No mounting screws show!

Design with up to two lamps and either full or split display screens—vertically or horizontally. Full display provides up to 3 lines of 6 characters each. Virtually unlimited lighting versatility

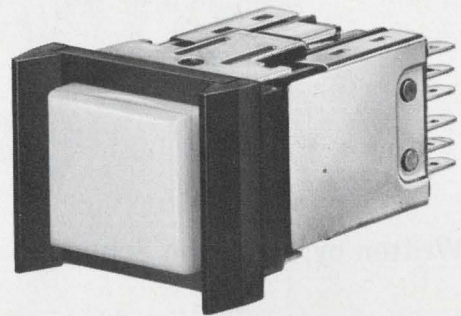

ACTUAL SIZE

provided by 7 different colors of pushbuttons, insert filters and silicone boots.

For additional information, contact a Switchcraft Representative or write for Catalog S-345. SWITCHCRAFT, INC. 5529 N. Elston Avenue Chicago, Illinois 60630



INFORMATION RETRIEVAL NUMBER 67

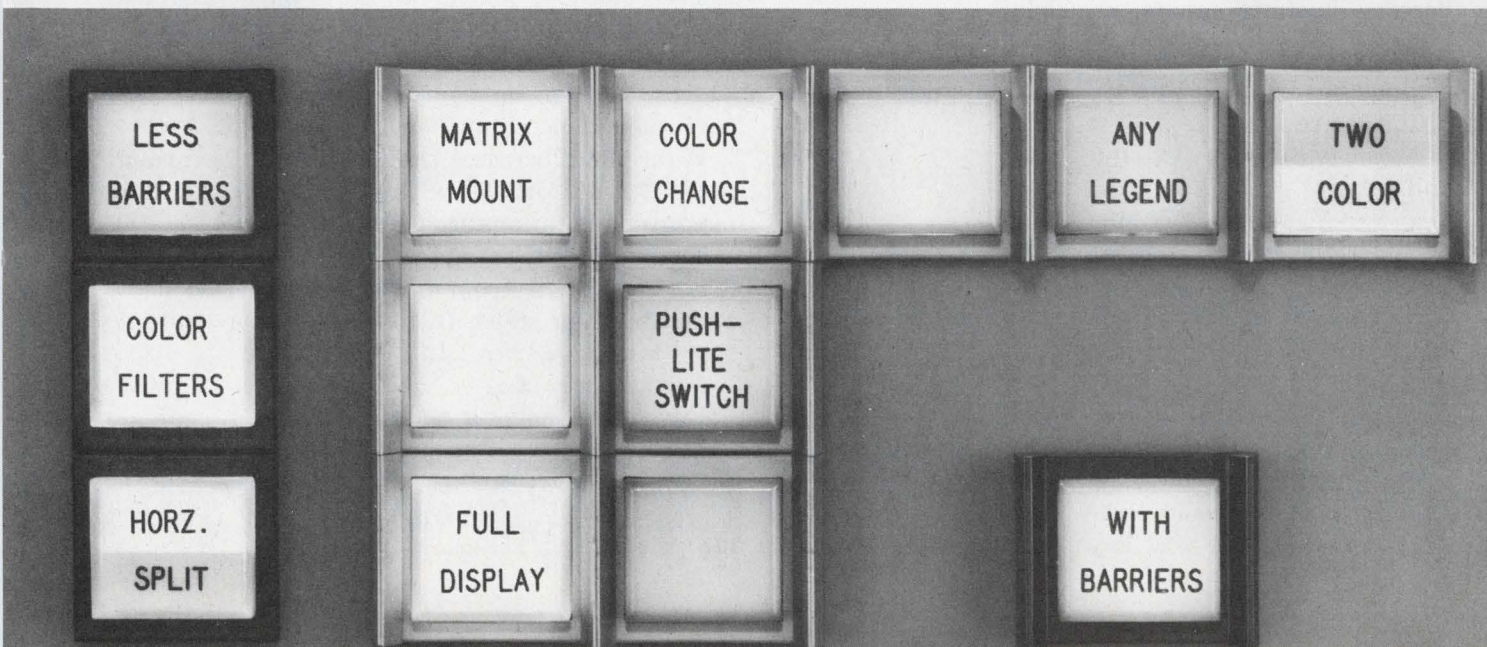

An Electronic Design practical guide for synchro-to-digital converters

Written by: Hermann Schmid, Senior Engineer, General Electric Co., Binghamton, N. Y.

Edited by: Don Mennie, Circuits Editor

Part 5: The Type VI and the multispeed converter.

Type VI converter is mathematically exact

This technique of encoding resolver output signals is based on the operation of the digital resolver.²⁸ It differs from previous designs in three ways:

- The technique is mathematically exact.
- The solution is generated by a sequence of fixed-magnitude rotations.
- The output signal is produced by summing all the fixed-magnitude rotation angles.

There are several possible implementations for this technique. One will be described.

Vectors illustrate general principle

The general expressions relating vector coordinates ($V_x, V_y; V_x', V_y'$) to the angle of rotation θ are

$$V_x' = V_x \cos\theta + V_y \sin\theta \quad (82)$$

and

$$V_y' = V_y \cos\theta - V_x \sin\theta \quad (83)$$

When the vector is rotated until Y' is zero,

$$\theta = \tan^{-1} V_y/V_x \quad (84)$$

The circuit in Fig. 37 employs a unique charge

transfer technique* and implements the general rotation equations

$$\sin(\theta \pm \alpha) = \sin\theta \cos\alpha \pm \cos\theta \sin\alpha \quad (85)$$

$$\text{and} \quad \cos(\theta \pm \alpha) = \cos\theta \cos\alpha \pm \sin\theta \sin\alpha \quad (86)$$

where α may have an arbitrary value. Implementing Eqs. 85 and 86 in general form would require complex circuitry.

If α is limited to a number of constant values ($90^\circ, 45^\circ, 22.5^\circ$, etc.), $\sin\alpha$ and $\cos\alpha$ are constants. Dividing both equations by $\cos\alpha$, gives

$$(1/\cos\alpha) \sin(\theta \pm \alpha) = \sin\theta \pm \tan\alpha \cos\theta \quad (87)$$

$$\text{and} \quad (1/\cos\alpha) \cos(\theta \pm \alpha) = \cos\theta \pm \tan\alpha \sin\theta \quad (88)$$

The equations above can be implemented with one addition and one scaling operation (multiplication by a constant). The constant multiplier ($1/\cos\alpha$) is of no concern, because succeeding operations depend only on the sign of V_y .

Figure 36 illustrates the rotation of R_i through angle θ_i , performed with a sequence of fixed magnitude rotations through angle $\pm\alpha_i$.

The subscript i denotes that the desired angle θ is determined from a series of iterations or approximating steps. In three steps for example, $\theta_3 = \pm\alpha_1 \pm\alpha_2 \pm\alpha_3$. In general form

$$\theta = \pm\alpha_1 \pm\alpha_2 \pm\alpha_3 \dots \pm\alpha_n \quad (89)$$

Figure 38 shows a timing generator peak de-

Adapted from ELECTRONIC ANALOG/DIGITAL CONVERSION by Hermann Schmid, Copyright © 1970 by Van Nostrand Reinhold Company, by permission of Van Nostrand Reinhold Company.

* Extracted from "Multiple Input Electronic Synchro/Resolver Encoder," *Internal Publication of Towson Laboratories* by permission from P. A. Hoffman, Towson Laboratories, Inc., Baltimore, Md.

tector, summing amplifier and two identical analog circuits that implement Eqs. 87 and 88. Each analog circuit performs resolver output signal sampling, the scaling operation and addition of sine and cosine terms.

Capacitive divider performs scaling

The scaling operation is performed with a capacitive divider. The charge initially on one capacitor (C_A , for example) is divided between capacitors C_A and C_B . The values of C_A and C_B are related to the charges across them, Q_A and Q_B , by

$$K = Q_B / (Q_A + Q_B) = C_B / (C_A + C_B) \quad (90)$$

Two types of switches are used in Fig. 37. Switches $S_9, S_{10}, S_{11}, S_{12} \dots$ may be operated by control signals and retained in the ON or OFF conditions as long as desired. Switches S_1 through S_8 close for short intervals only. Closure times of these switches are adjusted by a choice of circuit constants. Two operational amplifiers are provided in both the sine and cosine channels, one for summing and scaling, the other for polarity inversion.

To illustrate circuit performance, a sample operation will be followed for the first few binary digits. It will be assumed that the resolver shaft angle θ is at $+65^\circ$. Therefore, voltage V_{Y1} is positive and the comparator output is zero, indicating that the resolver shaft angle lies in the first or second quadrant. V_{X1} is positive, indicating that θ is in the first or fourth quadrant. Positive V_{Y1} and V_{X1} polarities establish the resolver shaft angle in the first quadrant. The polarity of V_Y and V_X supplies the most-significant and the second-most-significant bits of θ and sets up logic circuits for the next switching sequence.

This sequence begins with the closure of S_5, S_6, S_9, S_{10} . Switches S_5 and S_9 charge C_5 to $-V_Y$ while S_6 and S_{10} charge C_6 to V_X . Note that S_5 and S_6 close momentarily, whereas S_9 and S_{10} are closed for one word period. Thereafter, S_7 and S_8 are momentarily closed, transferring the charge on C_5 to C_4 and the charge on C_6 to C_3 . In both cases, the new charge adds algebraically to the charge already present. Voltages V_Y and V_X become

$$V_{Y1} = -V_{Y0} - (C_6/C_3)V_{X0} = -V_{Y0} - V_{X0} \quad (91)$$

and

$$V_{X1} = -V_{X0} + (C_5/C_4)V_{Y0} = -V_{X0} + V_{Y0} \quad (92)$$

during the first iteration.

Since the ratio between these capacitors is

$$\begin{aligned} C_6/C_3 &= C_5/C_4 = \tan \alpha_1 = 1 \\ \text{then } \alpha_1 &= 45^\circ \end{aligned} \quad (93)$$

To further illustrate the encoding process, the

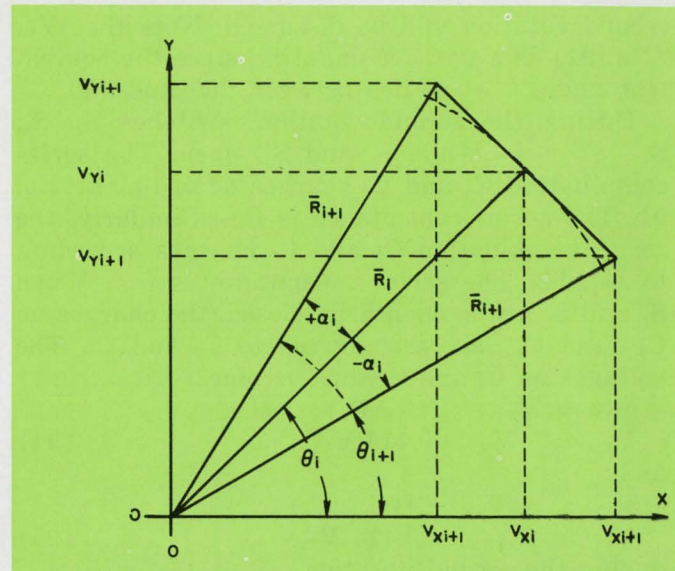

36. The vector \bar{R}_i is tuned through angle θ_i in a series of n fixed-magnitude rotations through $\pm \alpha_1$. The Type VI converter output is produced by summing all such rotation angles.

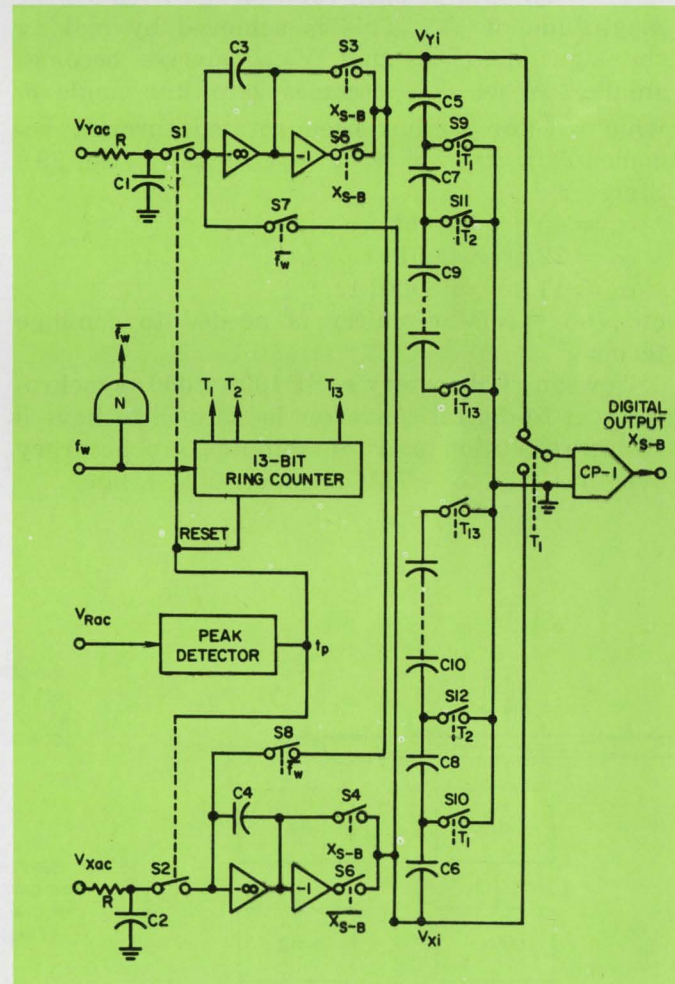

37. The Type VI converter features twin analog circuits for sampling resolver outputs, a 13-bit ring counter timing generator and a capacitive divider network for scaling. A charge-transfer switching sequence reduces the X_{Y1} magnitude to zero, thereby rotating \bar{R}_1 through θ_1 .

second rotation will be discussed. Note that V_{Y1} (Eq. 91) is a positive quantity, since the equivalent angle $\theta + \alpha_1$ lies between 90° and 180° .

During the second rotation, switches S_3, S_4, S_{11}, S_{12} close while S_9 and S_{10} open. The series combination C_5 and C_7 charges according to Eq. 91. The series capacitance is $C_{5,7}$. Similarly, the series combination C_6 and C_8 charges according to Eq. 92. The series capacitance is $C_{6,8}$. When S_7 and S_8 are momentarily closed, the charges on $C_{5,7}$ and $C_{6,8}$ are transferred to C_3 and C_4 . The voltages on C_3 and C_4 thus become

$$\begin{aligned} V_{Y2} &= V_{Y1} + (C_{6,8}/C_3) \\ V_{X1} &= -V_{Y1} + 0.414 V_{X1} \end{aligned} \quad (94)$$

and

$$\begin{aligned} V_{X2} &= -V_{X1} - (C_{6,8}/C_3) \\ V_{Y1} &= -V_{X1} - 0.414 V_{Y2} \end{aligned} \quad (95)$$

during the second iteration.

(Note: $C_{6,8}/C_3 = \tan \alpha_2 = \tan 22.5^\circ = 0.414$)

The operation in succeeding rotations can be generalized by

$$V_{Y_{i+1}} = V_{Yi} \pm V_{Xi} \tan \alpha_i \quad (96)$$

and

$$V_{X_{i+1}} = V_{Xi} \pm V_{Yi} \tan \alpha_i \quad (97)$$

The objective of each rotation is to reduce the magnitude of V_{Yi} . This is achieved by making the sign of α_i so that $V_{Y_{i+1}}$ always becomes smaller. When V_{Yi} becomes zero, the angle θ_i which vector \bar{R}_i has been rotated through becomes $\theta = \pm \alpha_1 \pm \alpha_2 \pm \alpha_3 \dots \pm \alpha_n$ (Eq. 89) Since

$$\begin{aligned} \alpha_1 &= 45^\circ = 001000\dots, \\ \alpha_2 &= 22.5^\circ = 000100\dots, \\ \alpha_3 &= 11.25^\circ = 000010\dots, \end{aligned}$$

etc., no special circuitry is needed to combine terms.

Towson Laboratory's SD1000/2000 synchro-resolver-to-digital converter is claimed to have a 13-bit resolution and ± 6 minutes arc accuracy over a -54° to $+71^\circ$ C temperature range.

Multispeed converters provide improved accuracy

The accuracy with which the output signals of a conventional single-speed synchro or resolver represent the angular position of the shaft is limited, by electrical and mechanical tolerances, to about one part in 8000 (approximately 3 minutes of arc). To overcome this limitation, multispeed systems have been introduced.

Two-speed operation explained

Most common is the two-speed system, consisting of coarse and fine circuits. The speed of the fine circuit is always n times higher than that of the coarse circuit. The number n is a multiple of the electromechanical transducer pole pair count; hence $n = 8, 16, 32$, etc.

Two-speed system operation is best understood by considering two single-turn (360°) potentiometers, P_1 and P_2 , (Fig. 38a) the outputs of which, V_1 and V_2 , are encoded with two digital voltmeters, DVM_1 and DVM_2 . The potentiometers and voltmeters are assumed to be free of errors, but resolution is only one part in n for either voltmeter. The second potentiometer (P_2) is driven at n times the speed of P_1 through a 1:n gear-train ratio. One complete revolution of P_2 corresponds to $360^\circ/n$ on the input shaft, or one unit increment on DVM_1 . By contrast, one unit increment on DVM_2 represents $360^\circ/n^2$. The input shaft angle θ can now (theoretically) be resolved to one part in n^2 .

For example, if $n = 10$, then DVM_1 and DVM_2 are single-decade voltmeters, P_2 operates at 10 times the speed of P_1 , and the resolution is 3.6° . Operation of the two-speed system is illustrated by curves (Fig. 38b) showing the numbers displayed by the two voltmeters plotted as a function of the input angle θ .

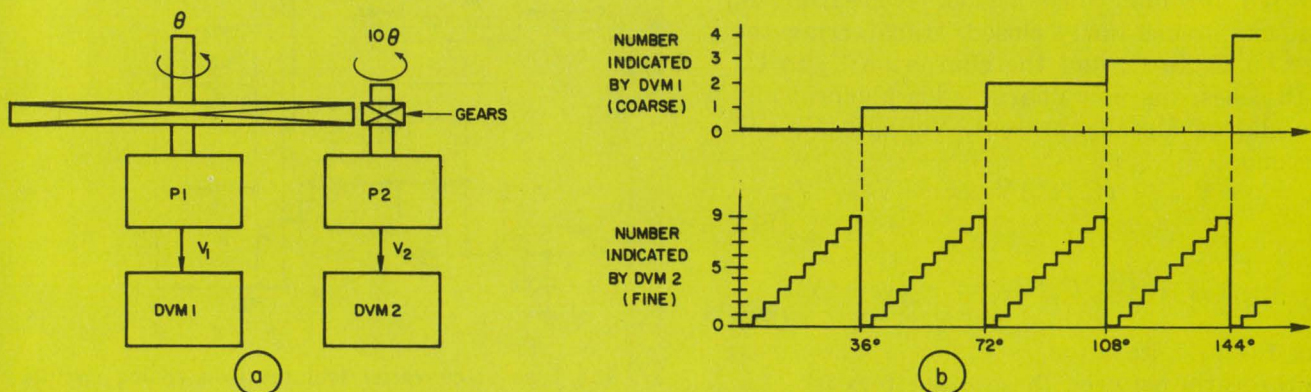

38. The two-speed converter system (a) uses gear-driven potentiometers and digital voltmeters to provide coarse

and fine outputs (b). Theoretical resolution for shaft angle θ is one part in n^2 . In this case $n=10$.

In practice, all systems of this type have drawbacks due to the dial and gear tolerances. These problems occur when the numbers indicated change in both meters. If, in our example, the number in DVM_1 changes first, then the indicated value can jump from 09 to 19 before it becomes 10. Should DVM_2 change first, the indicated number could change from 09 to 00 before it reaches 10.

This ambiguity problem can be overcome if the resolution on DVM_1 is made 20 while the $P_1 : P_2$ gear ratio is kept at 1:10. One revolution of P_2 would still be 36° , but there are now two numbers on DVM_1 for every revolution of P_1 .

Multispeed design has advantages†

Conventional two-pole single-speed synchro and resolver development has progressed to the point where their accuracy often surpasses that of practical gear trains. Although the once common two-speed synchro system has apparently lost its usefulness, new multiple synchro components effectively provide electrical gearing. Their use with conventional syncros in a two-speed system provides 10 seconds of arc accuracy.

Mechanically geared two-speed synchro systems were used for years to achieve greater accuracy than that available from individual syncros (Fig. 39). The one-speed portion drives the system close to its equilibrium position. Then the synchronizing network switches a servo amplifier from the one-speed control transformer (CT) to the high-speed CT. Final servo output shaft position and system position accuracy are determined by the high-speed circuit portion. Errors in one-speed components seldom affect system accuracy.

Mechanical gearing is error-limited

Because position accuracy in a two-speed system is not normally affected by errors in the one-speed loop, an error study can be confined to the n-speed portion. Signal flow and error accumulations through the n-speed loop are shown in Fig. 40. Two significant observations can be made: (1) n-speed control transmitter (CX) and n-speed CT electrical errors appearing at the output shaft, are reduced by the factor $1/n$; (2) gear errors are unaltered as seen at the output shaft.

Assuming that the system's high-speed portion uses a CX having 10 minutes of arc inherent error, a CT with 10 minutes of error and 36:1 gear trains each with 2-minute errors, then

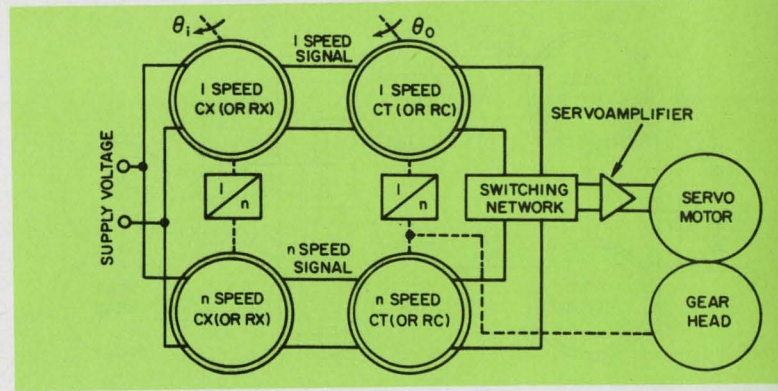

39. A servo-controlled mechanical n-speed system was long used to obtain greater accuracy than was available from one-speed units. The n-speed portion determines the final servo output shaft position, while the one-speed section seldom affects accuracy.

δ_{CX} = ANGULAR ERROR OF CX

δ_{CT} = ANGULAR ERROR OF CT

δ_{g1} AND δ_{g2} = ANGULAR ERRORS OF THE GEARS

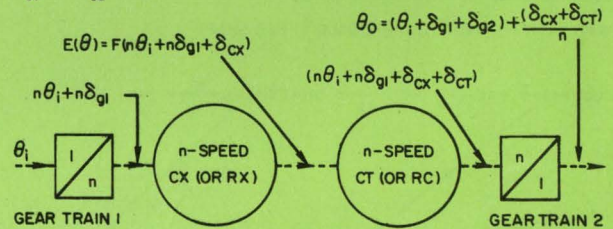

40. Error analysis for a mechanical n-speed loop indicates that control transmitter (CX) and control transformer (CT) errors appearing at the output shaft are reduced by $1/n$. Gear inaccuracies are unaltered.

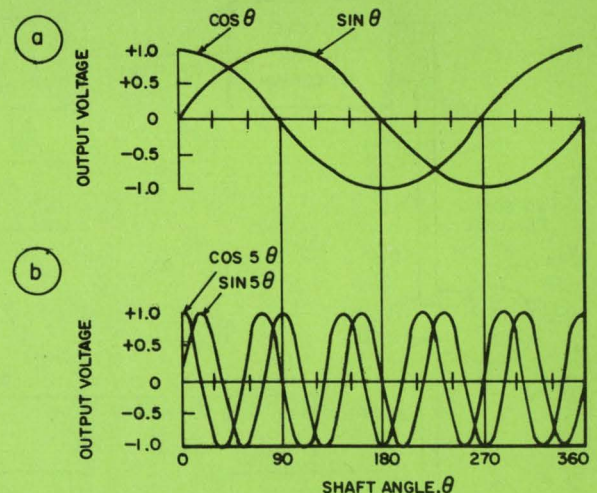

41. An n-speed system is termed "electronically geared" when its output voltage equals that obtained from a single-speed unit with the input shaft geared up by $1:n$. This example compares the outputs of a single-speed and five-speed resolver.

† Extracted from "Kearfott Technical Information for the Engineer, Number 1," by permission of General Precision System, Inc., Kearfott Products Division, Little Falls, N.J.

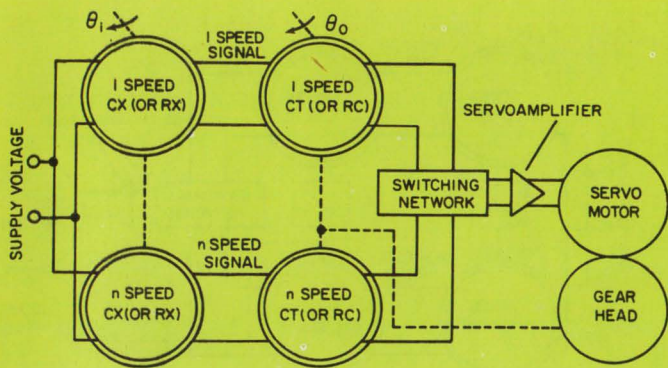

42. A servo-controlled electrical n-speed system provides electrical gearing that overcomes the tolerance limitations of mechanical gears.

δ_{CX} = ANGULAR ERROR* OF THE MULTIPLE CX
 δ_{CT} = ANGULAR ERROR* OF THE MULTIPLE CT
 * MEASURED WITH RESPECT TO THE SINGLE SPEED SHAFT

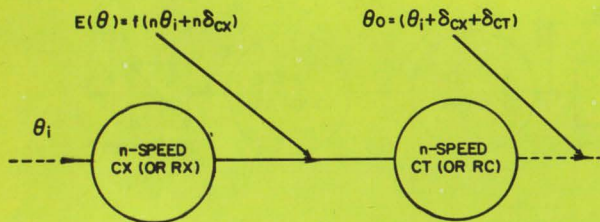

apparent CX or CT electrical error seen at the output shaft is 10/36 (≈ 0.3 minute each). Concurrently, gear error seen at this same shaft is 2 minutes per gear train. Thus gearing limits systems accuracy. Without improved gears, a two-speed system provides no advantage. CX and CT synchros having less than 2 minutes' error are readily available while 2-minute gears approach the best accuracy available at reasonable size and cost.

Electronic gearing cuts inaccuracy

Multipole synchros and resolvers are components whose output voltage is a sine (or cosine) function of n times input shaft angle. Unit n = speed equals the number of pole pairs. Such units are called electrically geared because their output voltages are the same as outputs from a single-speed unit with its input shaft geared up by the ratio of 1:n. For example, Fig. 41 shows the two output voltages of a single-speed resolver (a) compared with the two outputs of a

43. Error analysis for an electrical n-speed loop sums inaccuracies from the control transmitter (CX) and control transformer (CT). Although it affects system performance directly, this error is very low and therefore not a problem.

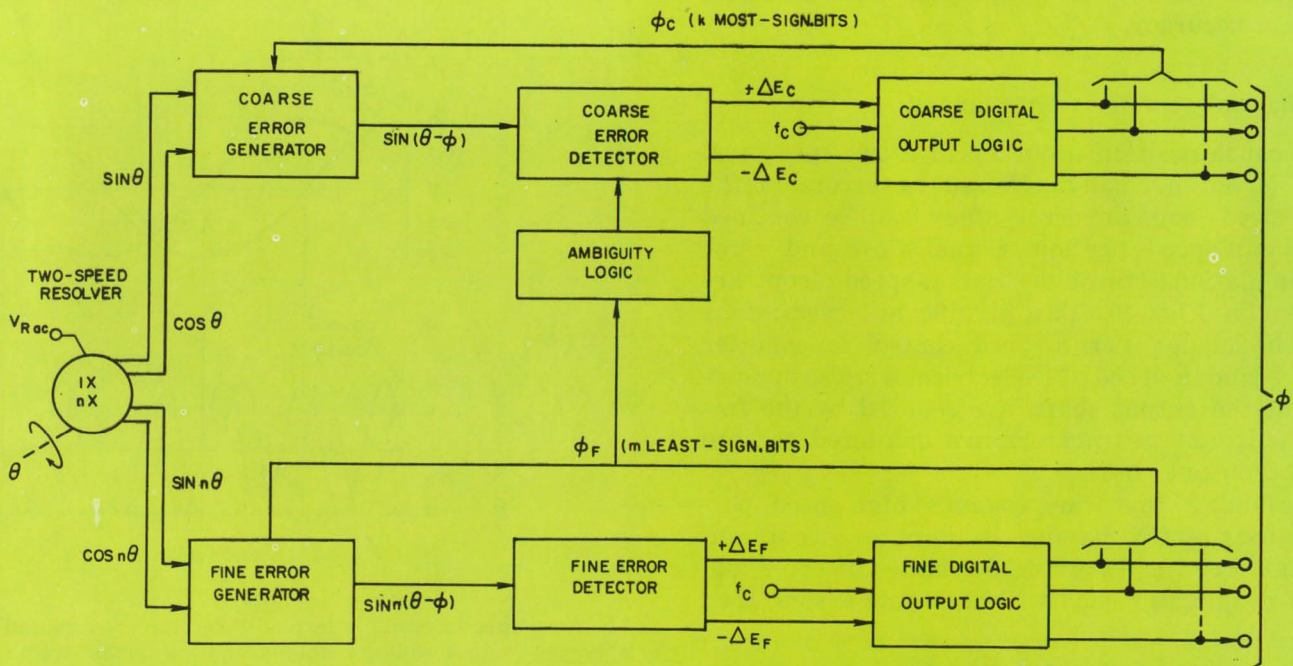

44. The typical two-speed resolver-to-digital converter is composed of coarse and fine digital logic. The fine

(high-speed) output can present speed problems if the converter is time-shared between many input signals.

five-speed multipole resolver (b).

Multipole synchros and resolvers in two-speed systems can eliminate the need for mechanical gearing. In such systems, gear inaccuracies are replaced by multipole component inaccuracies. Fig. 42 illustrates a two-speed synchro system in which the n-speed units are multipole synchros or resolvers and there is no mechanical gearing.

An electrically geared two-speed system's associated signal flow, and the error accumulations in the n-speed loop, are shown in Fig. 43. Inaccuracy introduced by this system is the error sum in the multipole CX and multipole CT. Note that synchro errors in this electrically geared system are not divided by speed.

If multipole synchros have a speed of 36 and a 10-minute error, the apparent electrical error per unit, as seen at the output shaft, is 10 minutes. The reason for no apparent component error division stems from error definition in multipole synchros. Normally, tolerances are given in shaft-position terms, relative to a complete input shaft revolution and therefore on a single-speed basis. Under this definition, error division caused by electrical gearing takes place inside the components themselves and therefore is already included in the manufacturer's specified synchro error. State error for multipole units is very low and is not a problem, even though it affects a system directly. Inaccuracies around 5 to 10 arc seconds are currently available, and since there is no gear error, 10 arc seconds' overall system accuracy is achieved.

Multipole synchros gain acceptance

Though the multipole synchro concept is not new, the potential is just beginning to be realized. Many new multipole components are now being developed because of their accuracy advantage. Other considerations such as driving torque, size and shape also figure in their selection. They can be designed in a pancake shape, ideally suited for gimbals mounting on inertial platforms. Multipole synchros and resolvers are currently being exploited in analog-to-digital converters. Digital accuracies to 2^{16} have been attained with multispeed resolver systems having a 14-arc-second analog accuracy as input to the digital circuits.

Two-speed unit has coarse/fine logic

The two-speed resolver-to-digital angle converter of Fig. 44 comprises a coarse and fine encoder, plus ambiguity logic circuitry that correlates the coarse and the fine data. Typical resolution values are 4 to 7 bits for the coarse channel and 8 to 12 bits for the fine channel.

Converter inputs to the dual-winding resolver

in Fig. 44 are the outputs of a two-speed resolver. They also have been derived from a pair of single-winding resolvers using mechanical or electrical coupling. Either way, the coarse channel inputs represent $\sin\theta$ and $\cos\theta$, whereas the fine channel inputs represent $\sin n\theta$ and $\cos n\theta$, because the mechanical or electrical gear ratio is 1:n.

Each channel converts its analog inputs into digital output signals. The coarse channel outputs (ϕ_C) represent the k most-significant bits, and the fine channel outputs (ϕ_F), represent the m least-significant bits of digital output signal ϕ . The most-significant bit of ϕ_F is allowed to overlap the least-significant bit of ϕ_C . This arrangement eliminates spurious output signals found at critical points of the resolver shaft angle θ .

The ambiguity logic shown (Fig. 44) provides control signals to the coarse error detector. The same task could be performed by using the ambiguity logic outputs to modify the coarse-channel digital output signal. In one example, the ambiguity logic compares the most-significant bit of ϕ_F with the least-significant bit of ϕ_C and subtracts a ONE from ϕ_C if the two bits are different.

One resolver-to-digital angle converter can be time-shared between the coarse and the fine channels, instead of using two separate encoders. Separate storage circuits must then be provided for the coarse and the fine values of the digital output signals.

Two-speed conversion systems impose speed problems. For example, if θ changes at 100 radians per second and $n=36$, the high-speed synchro or resolver output changes at 3600 radians per second. This requires the high-speed encoder to have a conversion rate of 3600 per second minimum, eliminating low-speed conversion techniques. If the converter is to be time-shared among a large number of input signals, the conversion rate becomes an important problem. ■■

References:

28. Volder, J. E., "The CORDIC Trigonometric Computing Technique," *IRE Transactions on Electronic Computers*, EC-8, Sept. 1959.

Correction

In Part 2 of this Practical Design Guide (ED 7 April 1, 1970), the term representing the n-3 significant bits of digital angle ϕ was defined as ϕ_F . The subscript F was mistakenly discontinued beginning with the subhead: "Resolver bridge produces error voltage." Text and drawings should show all resolver bridge designs with ϕ_F as the input.

1400V, 5.0A Transistors. Delivering now, in quantity.

The Kokomoans' new DTS 802 and 804 NPN triple diffused silicon high energy transistors are here. You can order them from your Delco Radio distributors now in sample or production quantities. They were specially designed for high voltage inductive switching from rectified 3 phase 220 line, and magnetic deflection circuits in large screen color TV receivers.

They've been application-tested from production lots by

prospective users with stringent reliability requirements. They do the job. And their energy handling capability is verified by Delco Pulse Energy Testing.

The high energy reliability of Delco silicon power transistors has earned them a reputation for survival in the toughest switching jobs. It's a built-in advantage, vitally important where circuits are subject to transients or fault conditions.

Now you can simplify the design of high energy circuits with reduced size, weight, and component cost. Convert HV tube circuits to solid state reliability without the complexity associated with high current, low voltage devices. And fewer components mean higher reliability.

For prices and delivery or additional data on Delco's new DTS 802 and 804 contact us or your nearest Delco Radio distributor.

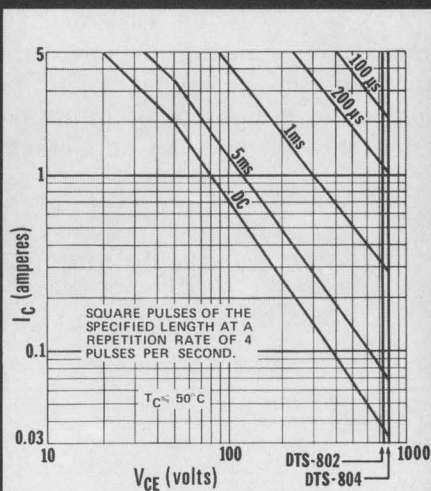

SAFE OPERATING CURVES

PARAMETER	DTS-802	DTS-804
Collector to emitter voltage (V_{CEX})	1200V max.	1400V max.
Collector to emitter voltage (V_{CEO})	1000V max.	1000V max.
Sustaining voltage ($V_{CEO\ sus}$)	750V min.	800V min.
Emitter to base voltage (V_{EBO})	5V max.	5V max.
Collector current (I_C) continuous	5A max.	5A max.
h_{FE} , $I_C = 3.5A$, $V_{CE} = 5V$	2.2 min.	2.2 min.
*P.E.T.; $I_C = 7A$, $V_{CE} = 200V$, $t_p = 300\ \mu\text{sec}$, duty cycle $<4\%$	420 mJ min.	420 mJ min.

*Pulse Energy Test

Available in solid copper JEDEC TO-3 package.

From these Delco Semiconductor distributors.

ALA., BIRMINGHAM • Forbes Distributing Co., Inc. (205)-251-4104
 ARIZ., PHOENIX • Sterling Electronics, Inc. (602)-258-4531
 • Hyer/Cramer Electronics, Inc. (602)-263-1112
 CAL., LOS ANGELES • Kierulff Electronics, Inc. (213)-685-5511
 • Radio Products Sales, Inc. (213)-748-1271
 CAL., PALO ALTO • Kierulff Electronics, Inc. (415)-968-6292
 CAL., SAN DIEGO • Milo of California, Inc. (714)-232-8951
 COLO., COLORADO SPRINGS • L. B. Walker Radio Co. (303)-636-1661
 COLO., DENVER • L. B. Walker Radio Co. (303)-935-2406
 • Hyer/Cramer Electronics Inc. (303)-758-2100
 FLA., MIAMI • Mountain Electronics, Subsidiary of Avnet, Inc., (305)-634-4556
 FLA., WEST PALM BEACH • Mountain Electronics, Subsidiary of Avnet, Inc., (305)-833-5701
 ILL., ROSEMONT • F-J-R/Midwest, Inc. (312)-678-8560
 ILL., SKOKIE • Merquip Electronics, Inc. (312)-282-5400
 IND., INDIANAPOLIS • Graham Electronics Supply, Inc. (317)-634-8486
 MD., BALTIMORE • Radio Electric Service Co. (301)-823-0070
 MASS., NEWTON • The Greene Shaw Co., Inc. (617)-969-8900
 MICH., KALAMAZOO • Electronic Supply Corp. (616)-381-4624
 MICH., ROMULUS (Detroit) • Harvey Radio Co. (313)-729-5500
 MINN., MINNEAPOLIS • Stark Electronics Supply Co. (612)-332-1325

MO., KANSAS CITY • Walters Radio Supply, Inc. (816)-531-7015
 MO., NO. KANSAS CITY • ECI Semiconductors, Inc. (816)-221-2400
 MO., ST. LOUIS • Electronic Components for Industry Co. (314)-647-5505
 N.J., CLIFTON • Eastern Radio Corporation (201)-471-6600
 N.M., ALBUQUERQUE • Hyer/Cramer Electronics Inc. (505)-265-5767
 • Sterling Electronics Inc. (505)-247-2486
 N.Y., BINGHAMTON • Federal Electronics, Inc. (607)-748-8211
 N.Y., NEW YORK • Harvey Radio Co., Inc. (212)-582-2590
 N.Y., WOODBURY, L.I. • Harvey Radio Company, Inc. (516)-921-8700
 OHIO, CINCINNATI • United Radio, Inc. (513)-761-4030
 OHIO, CLEVELAND • The W. M. Pattison Supply Co., Industrial Electronics Division (216)-441-3000
 OHIO, DAYTON • F-J-R/Ohio, Inc. (513)-278-9411
 OKLA., OKLAHOMA CITY • Radio, Inc. (405)-235-1551
 OKLA., TULSA • Radio, Inc. (918)-587-9123

PENN., PHILADELPHIA • Almo Electronics, Division of Sterling Electronics (215)-676-6000
 PENN., PITTSBURGH • RPC Electronics (412)-782-3770
 S.C., COLUMBIA • Dixie Radio Supply Co., Inc. (803)-253-5333
 TEXAS, DALLAS • Adleta Electronics Company (214)-742-8257
 TEXAS, FORT WORTH • Adleta Electronics Co. (817)-336-7446
 TEXAS, HOUSTON • Harrison Equipment Co., Inc. (713)-224-9131
 UTAH, SALT LAKE CITY • Hyer/Cramer Electronics Inc. (801)-487-3681
 VA., RICHMOND • Meridian Electronics, Inc., a Sterling Electronics Company (703)-353-6648
 WASH., SEATTLE • Kierulff Electronics, Inc. (206)-763-1550
 WASH., TACOMA • C & G Electronics Co. (206)-272-3181
 CANADA, ONT., SCARBOROUGH • Lake Engineering Co., Ltd. (416)-751-5980

Kokomoan's Regional Headquarters. Union, New Jersey* 07083, Box 1018 Chestnut Station, (201) 687-3770 ■ Santa Monica, Calif.* 90401, 726 Santa Monica Blvd., (213) 870-8807 ■ Chicago, Illinois* 60656, 5151 N. Harlem Avenue, (312) 775-5411 ■ Kokomo, Ind. 46901, 700 E. Firmin, (317) 459-2175 Home Office ■ *Office includes field lab and resident engineer for application assistance.



THE KOKOMOANS ARE IN POWER
DELCO RADIO
 DIVISION OF GENERAL MOTORS
 KOKOMO, INDIANA

Get to know your local SBA agent.

If you qualify, he can help you obtain loans, management assistance and government contracts.

Richard L. Turmail, Management Editor

In an industry that has a built-in capacity for rendering itself obsolete before its latest innovation can be comprehended, it's essential that electronics entrepreneurs and company managers learn of the government assistance that's available to them. Large numbers of companies have gone either public in search of funds or to a consultant in search of organization, when they might have gone to an independent government agency called the Small Business Administration.

How large is small business?

There's nothing small about the Small Business Administration or the segment of the business community it serves. Created by an act of Congress in 1953 to encourage, assist, and protect small business, and particularly to aid in getting government contracts, SBA is a big business operation with 4,000 salaried employees and over 3,000 voluntary counselors. They serve 73 field offices in the principal cities of every state, as well as Guam, Puerto Rico, and the Virgin Islands. They assist small companies that make up more than 95% of the business population, account for more than 40% of the business activity and provide employment for 35-million people.

Although, according to an SBA spokesman, the main thrust of agency activity recently has been toward helping low-income, disadvantaged businessmen belonging to minority groups, the agency has also assisted major companies when they're considered to be the smallest company in their industry in competition for a particular market.

Financial assistance varies in kind

The size standards of a small business vary widely from industry to industry, and from one type of assistance to another. Each standard is covered in the following descriptions of the four prime areas of assistance offered by SBA. They

are: financial; lease guarantee plan; management; and procurement.

SBA loans are available to small companies that want to construct, expand or convert facilities; purchase buildings, equipment and materials; or obtain working capital. They are available for such disparate reasons as natural disasters and displacement caused by urban renewal or other government construction.

By law, the agency will not make a loan if a business can obtain funds from a bank or other private sources. And for purposes of making loans, SBA defines a small business as follows:

- Wholesale—annual sales of not more than \$5-million.
- Retail or Service—annual sales or receipts of not more than \$1-million.
- Manufacturing—not more than 250 employees.

The agency will consider either participating in, or guaranteeing up to, 90% of a bank loan. If the bank cannot provide the funds, SBA will consider lending the entire amount as a direct government loan. Two-thirds of SBA's loans are now made in participation with banks.

Limits for SBA loan participation are:

1. Guarantee of up to 90% or \$350,000 of a bank loan, whichever is less, up to 10 years at 5-1/2% interest, and up to 15 years if the loan is for construction.
2. \$150,000 as the SBA share of a participation loan with a bank.
3. \$100,000 on a direct SBA loan.

SBA looks to past records and future prospects of a small businessman to decide whether he has the ability to repay a loan and any other debts out of company profits.

Three other loans made by SBA include:

- Pool Loans, whereby the agency lends money to corporations formed and capitalized by groups of small business companies for purchasing raw materials, equipment, inventory or supplies for the use of their individual businesses. Such loans may also be used to obtain the benefits of research and development or to establish facilities for these purposes;
- Economic Opportunity Loans, whereby the

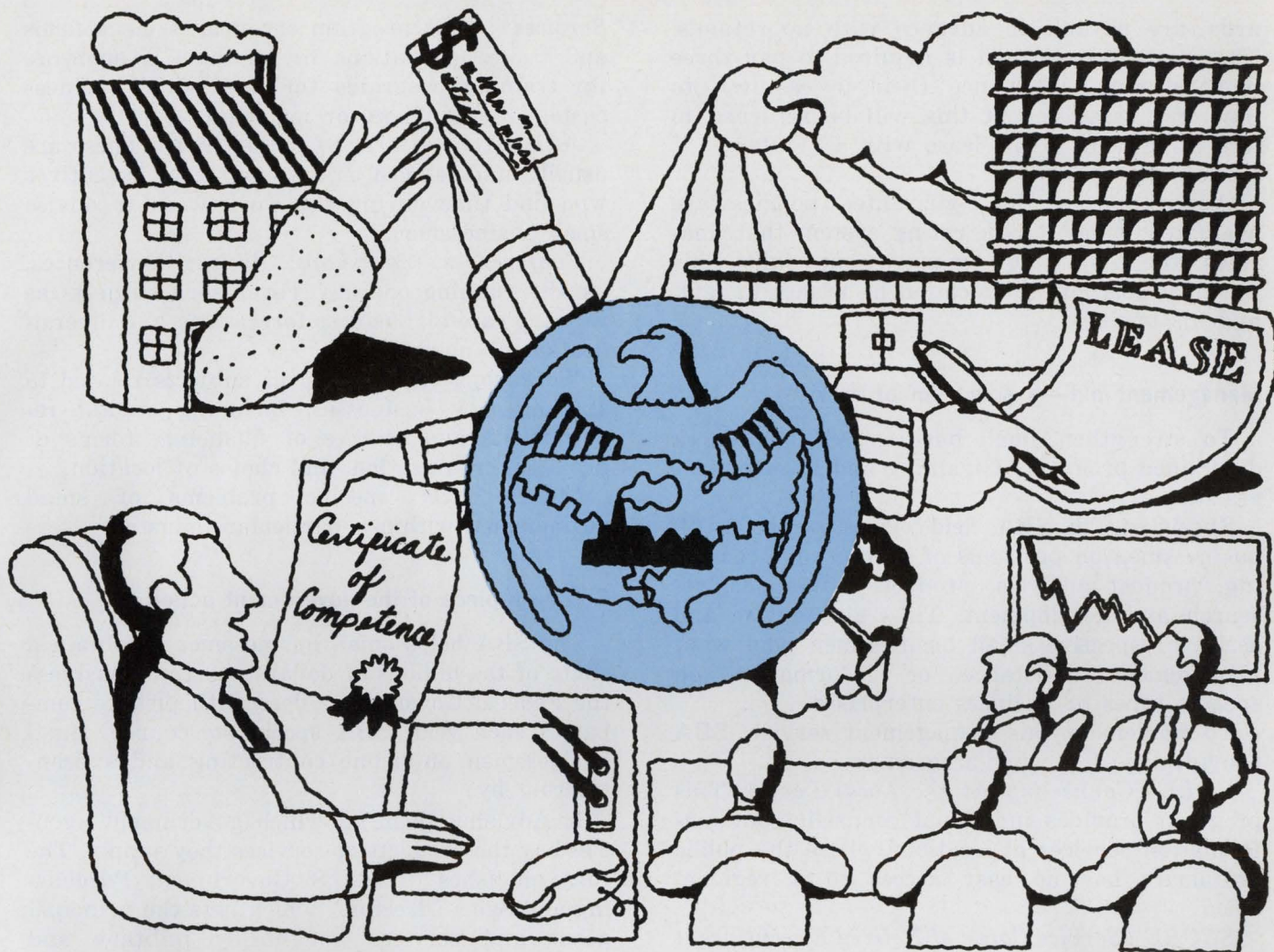

agency assists low-income or disadvantaged persons, who own businesses or want to go into business but are generally unable to obtain financing;

- Economic Development Loans, whereby the agency helps small firms to acquire or build facilities, expand or modernize through loans to state and local development companies formed to finance small businesses.

Another service offered by SBA in the area of financial assistance is Small Business Investment Companies (SBICs).

Such companies are privately owned and privately operated, and have been licensed by the Small Business Administration to provide equity capital and long-term loans to small firms that often have difficulty obtaining long-term capital to finance their growth.

Many SBICs are owned by relatively small groups of local investors. However, the stock of over 40 SBICs is publicly traded; more than 80 SBICs are partially or wholly owned by commercial banks; and some SBICs are subsidiaries of other corporations.

The size standards for a firm eligible for SBIC

financing are:

1. Assets do not exceed \$5-million.
2. Net worth does not exceed \$2.5-million.
3. Average net income after taxes for each of the preceding two years was not more than \$250,000.

SBA will often guarantee your rent

To help small businessmen obtain leases in choice business locations, such as new shopping centers or industrial parks, SBA will often back an insurance policy guaranteeing to the landlord that rent payments will be made. The guarantee extends for a minimum of five years up to a maximum of 20 years on a participating basis. Where private policies are not available, SBA will guarantee the leases directly for a period of 15 to 20 years.

For lease-guarantee purposes, SBA defines a small business as one that is independently owned and operated, is not dominant in its field, and meets employment or sales standards developed by the agency.

Premiums, based on insurance-industry stand-

ards, are payable in advance with no refunds. The small businessman is required to pay three months' rent in advance (held in escrow), to pay rent defaults, but this will be returned to him at the end of his lease with 4% interest if no defaults occur.

Applicants for lease-guarantee policies are evaluated under a risk rating system that analyzes the applicant's management skills, his financial position, the location he wishes to rent, and his business.

Management aid—a spectrum of services

To strengthen small business, SBA offers a diversified program of training and management assistance.

Specialists in SBA field offices advise small businessmen on problems of marketing, accounting, product analysis, production methods, research and development. They also advise and assist prospective small businessmen who want management assistance or information on specific types of business enterprises.

To implement this management service, SBA provides the following programs:

CALL (Counseling At the Local Level). This program provides individual counseling and information services at locations where the public ordinarily has no easy access to a regional office.

SCORE (Service Corps of Retired Executives): This corps is composed of more than 3000 retired business executives in more than 190 chapters throughout the nation. A SCORE volunteer will visit the small businessman in his operation, and through careful observation make a detailed analysis of the business and its problems.

A businessman doesn't need to be in trouble to get such aid. Perhaps he thinks that his business should be doing better or that the record-keeping system is a little out of date. Perhaps he's not even in business yet, but needs some expert advice to help him plan one soundly.

The SCORE service is free—except for direct expenses—to all businessmen who might otherwise not be able to hire experts to help them with their business difficulties.

Management Courses. Administrative management courses, co-sponsored by SBA, public and private educational institutions, and business associations are offered to help increase management skills. These are generally evening courses and are designed for owners and managers of small firms. They deal with planning, organizing, directing, co-ordinating, and controlling a business, as distinguished from day-to-day operating activities.

AIMS (Association and Industry Management

Services): This program encourages large firms and trade associations to serve as co-sponsors for training programs for their small-business customers, suppliers, or members.

ACE (Active Corps of Executives): These are usually middle-aged mid to top-level executives who find time during the work week to advise small businessmen.

Conferences, Workshops, Clinics: Conferences, usually running one day, cover such subjects as working capital, business forecasting and diversification of markets.

Workshops generally cover subjects related to starting new businesses, including capital requirements and sources of financing, forms of business, organization, and choice of location.

Clinics cover specific problems of small businessmen within a particular industry.

Getting a piece of the government action

The SBA helps small businessmen to obtain a share of the billions of dollars' worth of business the Federal Government does with private companies each year. SBA specialists counsel small businessmen on prime contracting and subcontracting by:

1. Advising them on which government agencies buy the products or services they supply. The SBA publishes "The U.S. Government Purchasing and Sales Director," which lists the principal goods and services bought by military and civilian agencies and the purchasing offices that buy them.
2. Guiding them to have their names placed on bidders' lists so they will be notified of opportunities to bid on purchases.
3. Helping them to obtain drawings and specifications for proposed purchases.
4. Providing information about scheduled meetings where government contracting agencies and prime contractors present their needs and requirements and discuss bidding opportunities.
5. Watching out for purchases on which few small firms have bid in the past.

Two additional assists

The major government purchasing agencies voluntarily set aside contracts or portions of contracts for small business. To increase this unilateral action, SBA has its own representatives stationed in major military and civilian procurement installations. They recommend additional "set-asides," provide small-business sources to contract officers, assist small concerns with contracting problems, and recommended relaxation of unduly restrictive specifications.

As an additional assist to the small company, which is the low bidder on a federal contract

SBA Field Offices

Agana, Guam
Albuquerque, N.M.
Anchorage, Alaska
Atlanta, Ga.
Augusta, Me.

Baltimore, Md.
Birmingham, Ala.
Boise, Idaho
Boston, Mass.
Buffalo, N.Y.

Casper, Wyo.
Charleston, W. Va.
Charlotte, N.C.
Chicago, Ill.
Cincinnati, Ohio
Clarksburg, W. Va.
Cleveland, Ohio
Columbia, S.C.
Columbus, Ohio
Concord, N.H.

Dallas, Tex.
Denver, Colo.
Des Moines, Iowa
Detroit, Mich.
Dover, Del.

Fairbanks, Alaska
Fargo, N.D.

Fresno, Calif.*

Harlingen, Tex.
Hartford, Conn.
Hato Rey, P.R.
Helena, Mont.
Honolulu, Hawaii
Houston, Tex.

Indianapolis, Ind.

Jackson, Miss.
Jacksonville, Fla.

Kansas City, Mo.
Knoxville, Tenn.

Las Vegas, Nev.
Little Rock, Ark.
Los Angeles, Calif.
Louisville, Ky.
Lubbock, Tex.

Madison, Wis.
Marquette, Mich.
Marshall, Tex.
Miami, Fla.
Milwaukee, Wis.
Minneapolis, Minn.
Montpelier, Vt.

Nashville, Tenn.

Newark, N.J.
New Orleans, La.
New York, N.Y.

Oklahoma City, Okla.
Omaha, Neb.

Philadelphia, Pa.
Phoenix, Ariz.
Pittsburgh, Pa.
Portland, Ore.
Providence, R.I.

Richmond, Va.

St. Louis, Mo.
Salt Lake City, Utah
San Antonio, Tex.
San Diego, Calif.
San Francisco, Calif.
Seattle, Wash.
Sioux Falls, S.D.
Spokane, Wash.
Syracuse, N.Y.

Tampa, Fla.*
Toledo, Ohio
Tucson, Ariz.*

Washington, D.C.
Wichita, Kan.

* Post-of-duty Office

and whose ability to perform the contract is questioned by the contracting officer, SBA specialists make an on-site study of the company's facilities, management, performance record, and financial status. If it concludes that the company can perform the contract, it issues a Certificate of Competence to this effect.

Assistance for electronics companies

The following are examples of electronics companies that asked for assistance at one SBA field office. They had the usual business problems: no capital; no work in the house; too small a staff.

One of the firms produced signal breakers, radio telephones and depth gauges for marine electronics. The company head requested SBA specialists to assist him in the management areas of setting up a procedure for marketing and for records and control. He also requested financial assistance for expansion and received it.

Another company hadn't been able to generate business in burglar alarms. The staff was small and limited the amount of business that could be handled. The firm got a contract and requested—and obtained—a small SBA loan so that a larger staff could be hired.

Another company is operated by a small busi-

nessman of a minority group. He worked for a large company before he gained enough confidence to start his own operation. SBA gave him a loan to finance equipment, facilities, and a payroll. He got a government contract, and then another to assemble and test megaphone and telephone sets. He requested an SBA loan for expansion. In eight months his company expanded its payroll from nine to 30 people. With SBA's assistance, this electronics entrepreneur was able to increase his contracts from \$60,000 to \$3-million in three years.

Congress has directed SBA to ensure free competition as the essence of the American economic system of private enterprise, and to strengthen the over-all economy of the nation. One enthusiastic advocate of the agency wrote *ELECTRONIC DESIGN* that the free classes, services and other programs, arranged through SBA by retired and salaried consultant personnel, "have saved many a small business from collapse." ■■

Bibliography:

- "Lease Guarantee," *Small Business Administration*, October, 1968.
- "SBA Business Loans," *Small Business Administration*, October, 1969.
- "SBIC Financing for Small Business," *Small Business Administration*, March, 1968.
- "Small Business Administration—What It Is, What It Does," *Small Business Administration*, March, 1968.
- "SCORE," *Small Business Administration*, 1968.

end your signal pollution problems

Beldfoil® ISO-Shielded™ Cable

It's the cable with virtually perfect shielding. It's a Belden exclusive. Beldfoil ISO-Shield is like a continuous metal tube enclosing each pair of conductors in a cable. It locks out crosstalk or interference . . . whether from outside sources or between shielded elements in the cable.

Beldfoil is a layer of aluminum foil bonded to a tough polyester film (for insulation and added strength.) To form an ISO-Shield, we apply it in any one of several unique ways to meet the requirements of different applications. (See Figures 1 and 2, for example). Each gives more physical shield coverage than braided wire or spiral wrapped (served) shields. And greater shield effectiveness . . . even after repeated flexing.

Beldfoil ISO-Shielded Cables are small, lightweight. They terminate easily. They're modest in price. Your Belden Distributor stocks a wide variety of standard Beldfoil shielded cables as listed in the "Belden Electronic Wire and Cable Catalog" (ask him for the latest edition). And, should you have specifications no standard product can meet, ask him to quote on a specially engineered design. Or, if you choose, contact: Belden Corporation, P. O. Box 5070-A, Chicago, Ill. 60680. Phone (312) 378-1000.

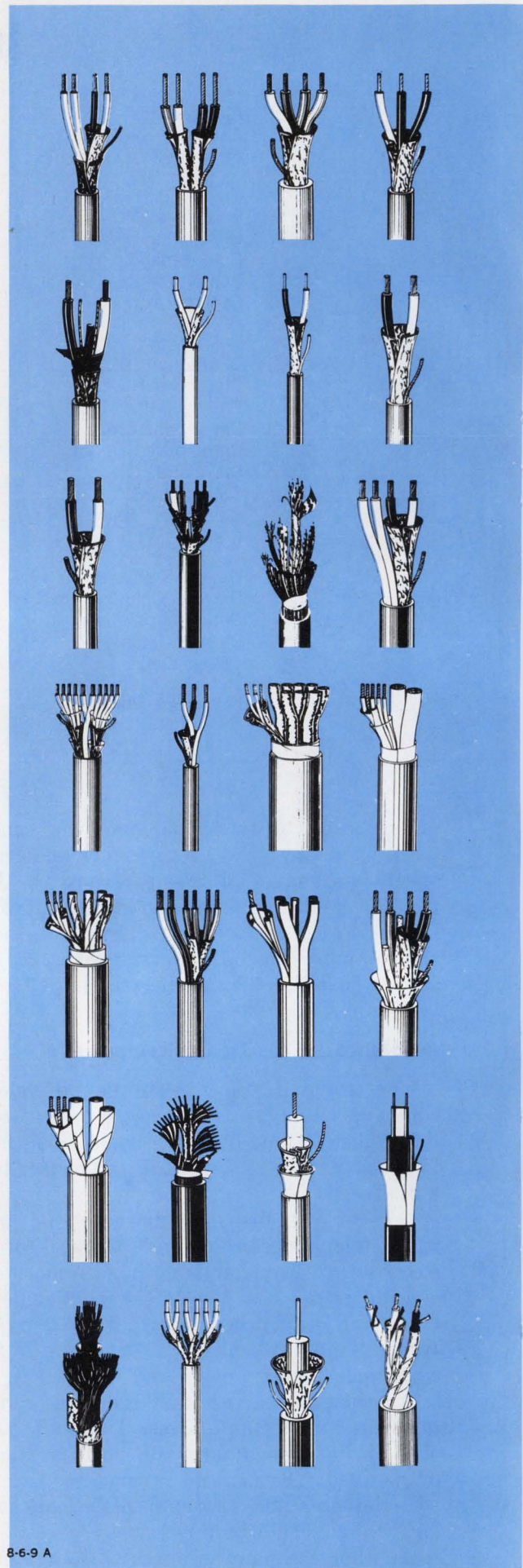

8-6-9 A



Metal (shield) foil, folded to assure metal-to-metal contact.

FIGURE 1

Polyester insulating layer folded to assure isolation between shields.

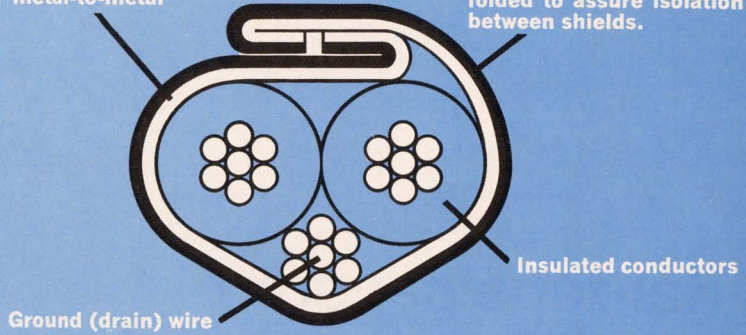

Beldfoil Multiple Pair Individually Shielded Cable

The Figure 1 cross-section shows Belden's exclusive Z-folded Beldfoil ISO-Shield. Note the metal-to-metal contact between the two edges of the aluminum foil. In essence, you have a continuous aluminum tube. And the polyester layer on the outside of the fold assures the isolation between shields so necessary for best performance in the field.

Technical Data

Nominal values for multiple pair individually shielded cables containing 3 to 27 pairs (including 8769 and 8773 through 8778 Series cables)
 Suggested working voltage: 300 volts rms max.
 Working voltage between adjacent shields: 50 volts rms max.
 Capacitance between conductors in a pair: 30 pf per ft. nom.
 Capacitance between one conductor and other conductor connected to shield: 55 pf per ft. nom.
 Capacitance between shields on adjacent pairs: 115 pf per ft. nom.
 Insulation resistance between shields on adjacent pairs: 100 megohms per 1000 ft. nom.

Metal (shield) foil, folded to assure metal-to-metal contact.

FIGURE 2

Polyester insulation layer folded to provide bonus insulation between conductors and shield.

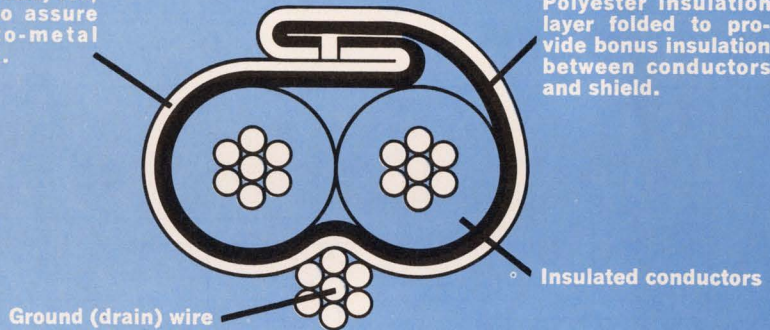

Beldfoil Shielded Single Pair Cable

The Figure 2 cross-section shows the exclusive Belden Z-fold with the polyester insulating layer inward. This makes use of the high dielectric strength of the polyester film as bonus insulation between the conductors and the shield. (The cable jacket provides the primary insulation of the shield from outside objects or adjacent cables.)

Technical Data

Nominal values for 8451 Shielded Pair Cable
 Suggested working voltage: 200 volts rms max.
 Capacitance between conductors: 34 pf per ft. nom.
 Capacitance between one conductor and other conductor connected to shield: 67 pf per ft. nom.



new ideas for moving electrical energy

Ideas For Design

Digital-tape sensor requires no adjustments

Reliable beginning-of-tape and end-of-tape detection is essential to the operation of all digital-tape memory systems. But many difficulties are involved.

The design shown operates, without adjustment, over wide ranges of the following variables:

- Illumination.
- Detector sensitivity.
- Wrinkled tape.
- Dull reflective tabs.
- Power-supply output.
- Temperature.

The key to the success of the design is that it monitors the differential output between the end-

of-tape and the beginning-of-tape sensors. When a significant change is detected between the two sensors, the appropriate output signal is given—either beginning-of-tape or end-of-tape.

The circuit operates in the following manner. Photo-diodes D_1 and D_5 , coupled with transistors Q_1 and Q_2 , form the two sensors. The output of these transistors results in a beginning-of-tape or end-of-tape signal at Q_3 and Q_4 , respectively. Transistor Q_5 acts as a constant-current source to supply Q_1 and Q_2 . This current source is achieved by maintaining a constant potential between the negative 15-V supply and the base of Q_5 via zener diode D_1 . The potential drop across D_1 is approximately 4 V with the current used. In

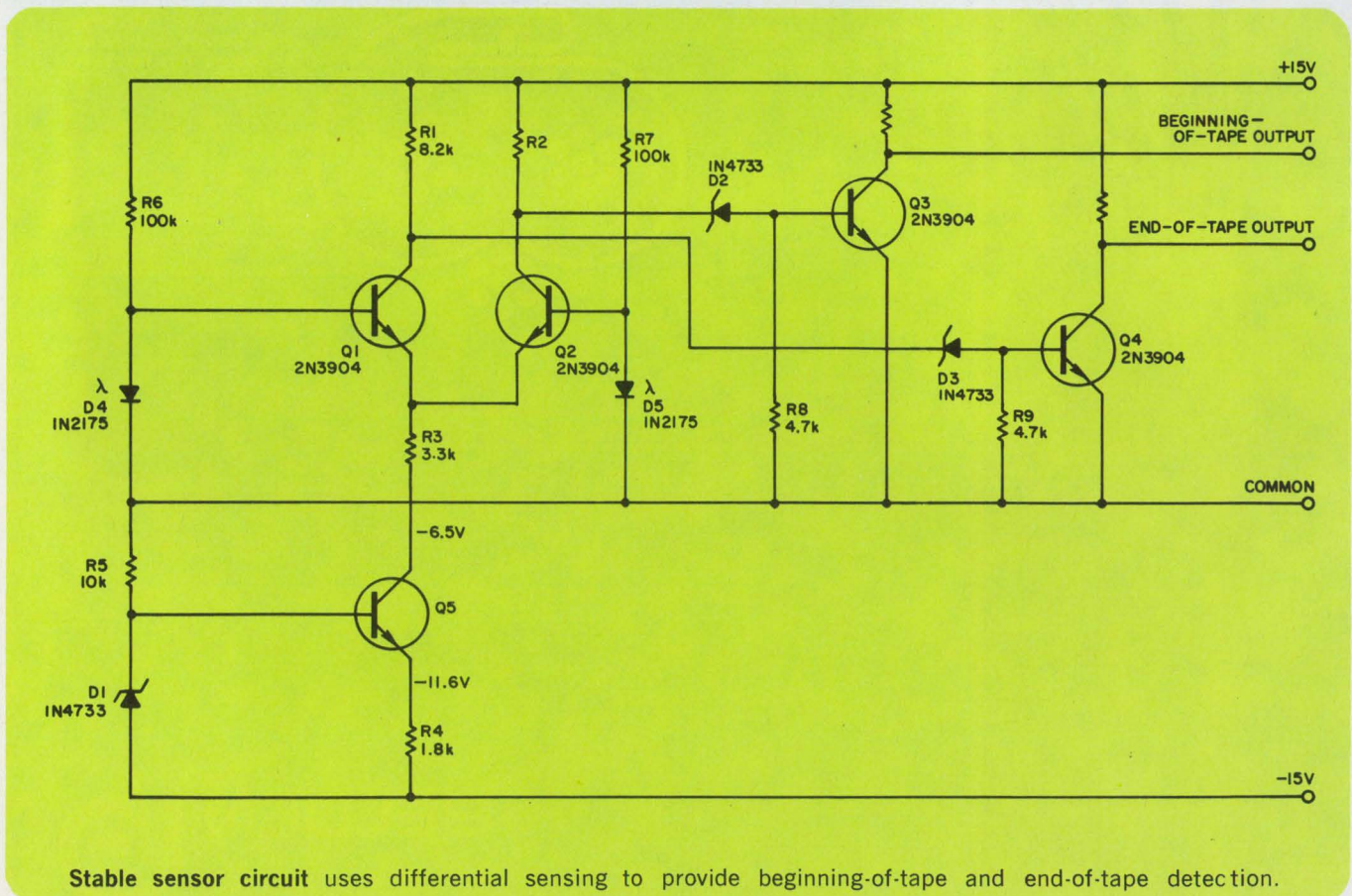

SUDDENLY ALL OTHER VOLTAGE REGULATORS ARE SECOND BEST.

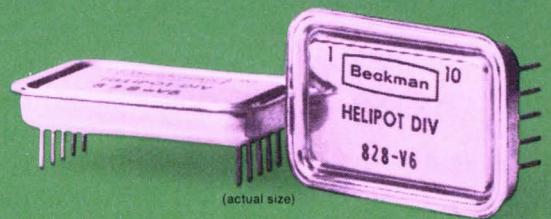

HERE'S WHY:

- $\pm 0.01\%$ line & load regulation
- $\pm 0.5\%$ preset output voltage
- Short-circuit proof
- MIL-STD-883 hermetic package
- \$40 (1-9 quantity)
- Model 828 (plus) and Model 838 (minus) from stock
- Many other outstanding features; contact your local Helipot representative.

Beckman

HELIPOT DIVISION

FULLERTON, CALIFORNIA • 92634

INTERNATIONAL SUBSIDIARIES: AMSTERDAM • CAPE TOWN • GENEVA • GLENROTHES,
SCOTLAND • LONDON • MEXICO CITY • MUNICH • PARIS • STOCKHOLM • TOKYO • VIENNA

this range D_1 has nearly a zero temperature coefficient, thus assuring setting consistency.

With no sensor output, the collector current of Q_5 is divided equally between Q_1 and Q_2 . Transistors Q_3 and Q_4 are on. Assuming that a beginning-of-tape tab is detected, the potential is decreased at the base of Q_1 by at least 50 mV. This decreases the collector current of Q_1 , which results in a higher Q_2 collector current. This Q_2 collector current cuts off Q_3 . As Q_3 goes off, its collector potential increases, providing the beginning-of-tape output.

In a similar fashion, the end-of-tape output is provided by Q_4 . Detection of an end-of-tape tab causes the Q_2 collector to decrease. Next, the Q_1 base potential increases, turning off Q_4 , which

gives end-of-tape output.

Selection of R_4 current determines the initial drive current available to Q_3 and Q_4 , thus defining the detection threshold. This initial setting will depend upon the detector sensitivities, their output level and the light level.

The circuit has high common-mode noise rejection capability, in excess of 1000:1. If a considerable noise is present on both detectors simultaneously, no output variation occurs. This feature is very desirable under low input signal level and noisy environment conditions.

Charles E. Wallace, Engineering Consultant, Palos Verdes Estates, Calif.

VOTE FOR 311

Voltage window detector provides logical output

When a varying voltage enters a window within the voltage's range of values, the circuit shown changes state from logical ONE to logical ZERO.

The input voltage, V_X , is compared with the voltage at the junction of R_1 and R_2 . If the absolute value of the difference between these two voltages exceeds approximately 2 V (that is, three pn junction drops), the network composed of D_1 , D_2 , D_3 and D_4 , gates current through R_3 , turning on Q_1 and Q_2 . During this condition, a logical ONE exists at the collector of Q_2 and may be used to activate load R_L (relay coil).

The circuit window is approximately 4 V wide and is level-centered by the R_1 , R_2 voltage divider. It is not possible to turn on the two gating diodes— D_1 and D_2 , if V_X is high or D_3 and D_4 if V_X is low—and the emitter-base junction Q_1 , once V_X is in this region. Consequently, while V_X is in the voltage window, Q_1 and Q_2 are turned off, producing a logical ZERO at the collector of Q_2 .

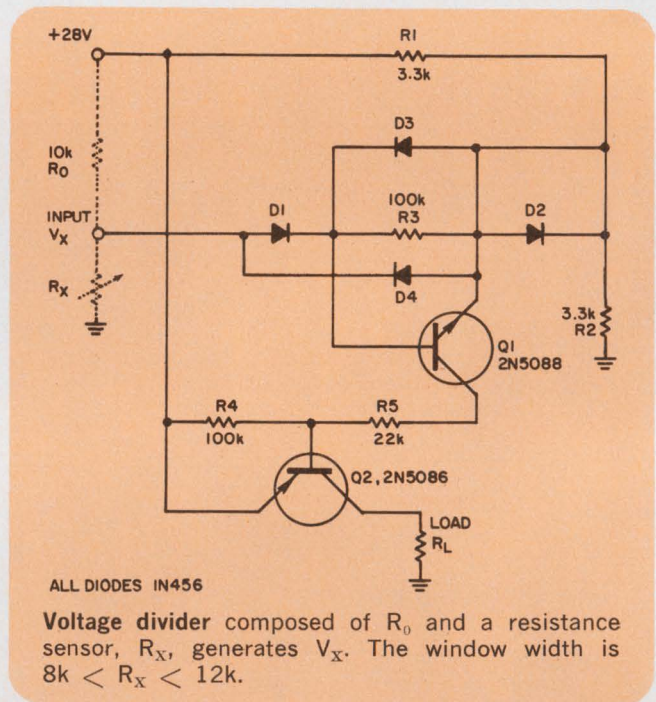

Tom McDonald, Electronics Systems Division, Babcock Electronics Corp., Costa Mesa, Calif.

VOTE FOR 312

Phase-locked loop utilizes current-controlled oscillator

Phase-locked oscillators are frequently used for regenerating and predicting signals for synchronous detection and for fm discrimination. A simple phase-locked loop using a current-controlled oscillator (CCO) is shown in the figure.

The CCO is operated at two frequencies, f_0 and f_1 , which correspond to the ZERO and ONE states of the flip-flop. This flip-flop is clocked at the end of each oscillator cycle. If the signal phase leads the oscillator phase, the D input be-

In our first act we introduced our precision miniature line of snap-action switches. Now comes a beautiful new addition—the sub subminiature line.

All we ask is a chance to prove our ability to give you real quality at a competitive price. With old-time service and on-time delivery a part of the deal. We invite comparisons.

For example. The unique design of our sub subminiature incorporates a floating contact blade and a low stressed C-spring which provides an overtravel tolerance minimum of .010 inch. Less than half as critical as competition.

And it has a minimum electrical life of 50,000 operations—at rated load.

As you can see, we're making a real play for your next switch order. Sub subminiature or miniature. Let your Cutler-Hammer Sales Engineer or Switch Distributor give you our product/service story. He could bring down the curtain on your old supplier.

CUTLER-HAMMER 
SPECIALTY PRODUCTS DIVISION, Milwaukee, Wis. 53201

INFORMATION RETRIEVAL NUMBER 71

Our SS10KT40 with gold contacts is one of the many stars in our sub subminiature line.
16 switches, all U.L. listed. 4 terminal variations (single turret, double turret, pin, and quick connect). 6 industry standard external actuators (leaf, reverse leaf, roller leaf, reverse roller leaf, lever, and roller lever). Gold contacts. Switches in stock for immediate delivery.

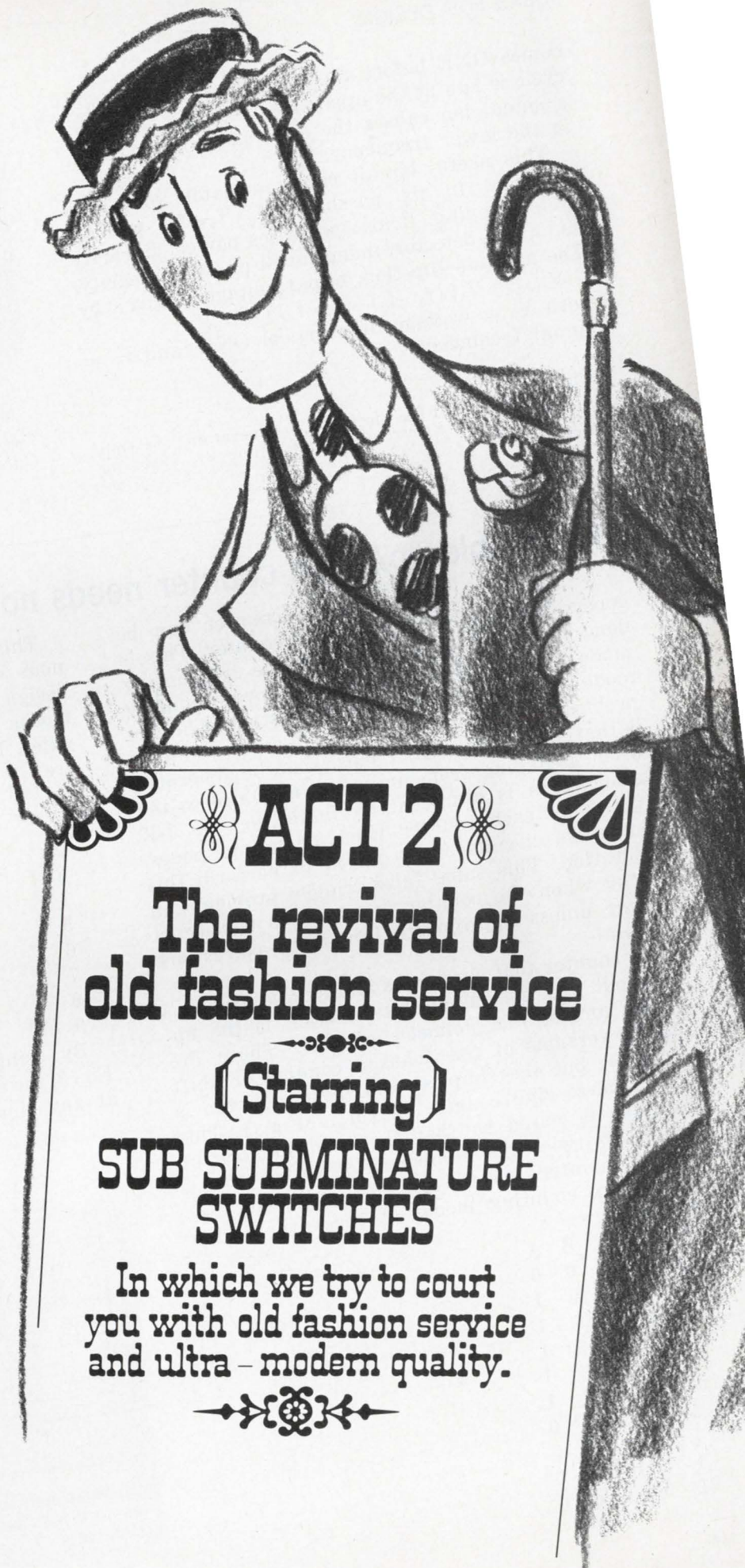
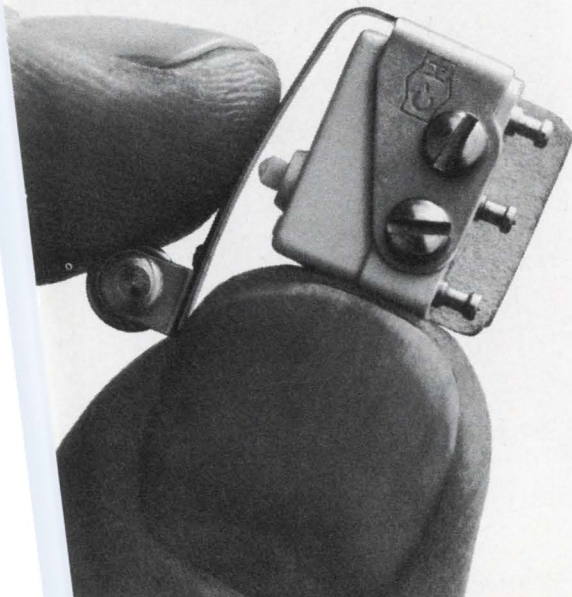

ACT 2

The revival of old fashion service

(Starring)

SUB SUBMINATURE SWITCHES

In which we try to court you with old fashion service and ultra - modern quality.

comes ONE before the clock does, and the next cycle is run at the upper frequency, f_1 . Similarly, a signal lag causes the subsequent cycle to run at the lower frequency, f_0 .

This useful circuit can immediately lock onto a signal in its passband, $f_0 \leq f_s \leq f_1$, without cycle skipping. It also possesses perfect linearity as an FM detector, independent of CCO linearity. The average flip-flop output voltage is given by

$$V_{ave} = V_1 [(f_s - f_0) / (f_1 - f_0)]$$

with V_1 = voltage of a logical ONE, and f_s = signal frequency.

Reference:

1. Osborn, C., "TTL Clock Pulse Generator Uses Only One Capacitor," *Electronic Design*, June 21, 1969, pp. 84-85.

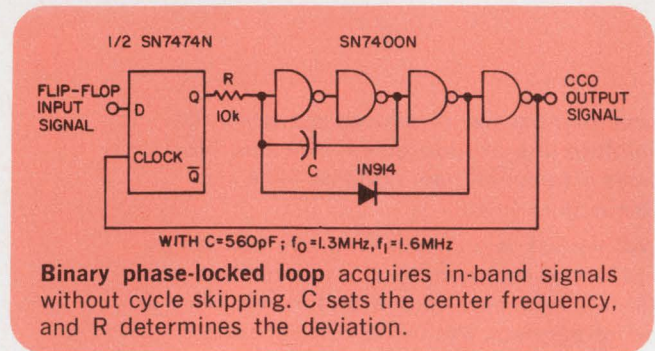

Binary phase-locked loop acquires in-band signals without cycle skipping. C sets the center frequency, and R determines the deviation.

Michael Lampton, Assistant Research Physicist, Space Sciences Laboratory, University of California, Berkeley, Calif.

VOTE FOR 313

Presetable up/down counter needs no inhibits or one-shots

A binary or BCD up-down counter can be constructed easily from a ripple counter. This is done by gating the Q output for the up counting mode and the \bar{Q} output for the down counting mode to the counter's clock input stage. The one problem with this method of up-down counters is that erroneous trigger pulses can be generated when switching from one counting mode to the other. This is corrected by inhibiting the J-K inputs on each counter when changing modes, but extra circuits are required to perform this operation. This same false trigger problem can occur when the counter is preset to a selected count unless appropriate inhibit measures are taken.

A counter that eliminates all of these problems without any special inhibit function is the up-down presetable Johnson counter. There are many versions of the Johnson counter or shift counter, but the simplest and most versatile is the reverse ring counter shown in Fig. 1. This counter is wired so that the total number of counts is twice the number of flip-flops. For a decade counter, five flip-flops are required.

The ten counting modes of the reverse ring counter are:

E	D	C	B	A
0	0	0	0	0
0	0	0	0	1
0	0	0	1	1
0	0	1	1	1
0	1	1	1	1
1	1	1	1	1
1	1	1	1	0
1	1	1	0	0
1	1	0	0	0
1	0	0	0	0

This counter is attractive because it is synchronous as opposed to the binary ripple counter design. Another feature is that all ten counting modes can be decoded by using only two-input gates. The Boolean expressions for the ten counts are:

0	\bar{A}	\bar{E}
1	A	\bar{B}
2	B	\bar{C}
3	C	\bar{D}
4	D	\bar{E}
5	A	E
6	\bar{A}	B
7	\bar{B}	C
8	\bar{C}	D
9	\bar{D}	E

By using the gating arrangement shown in Fig. 3, the up-down counting mode can be changed at any time without effecting the count being

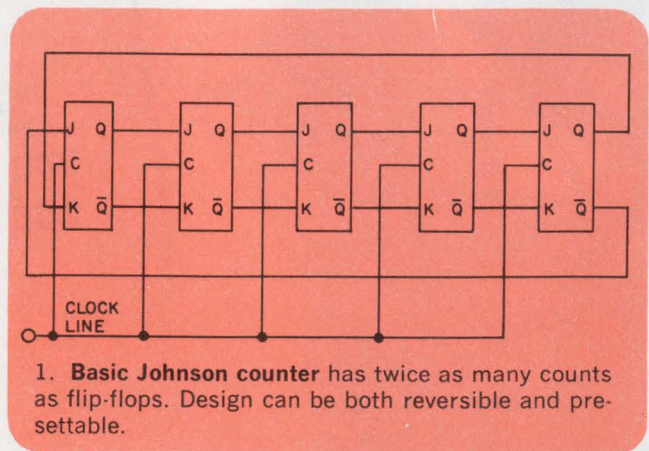

1. Basic Johnson counter has twice as many counts as flip-flops. Design can be both reversible and presetable.

New, high-speed A/D-D/A converters from Burr-Brown

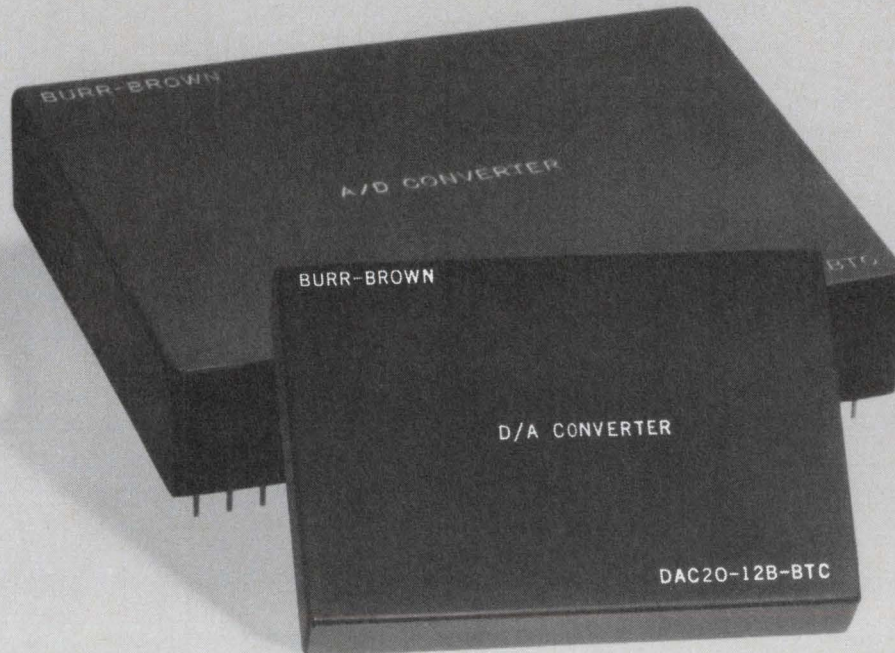

quick-change artists with a practical blend of performance and price

ANALOG-TO-DIGITAL UNITS

These self-contained, 3.4" x 4.4" x 0.8" modules utilize a successive-approximation technique to achieve high-speed conversion. 8, 10, and 12-bit units are available from stock with accuracies commensurate with resolution. Modules are designed for PC board mounting.

MAJOR FEATURES

HIGH SPEED: 30 μ sec for 10-bit conversion.
LOW DRIFT: 20 ppm/ $^{\circ}$ C for 10-bit converter.
ACCURATE: $\pm 1/2$ LSB relative accuracy for all models.
MANY OPTIONS: Operational input buffer amplifier. Four popular digital codes.
LOW COST (1-9 units):

8-bit	\$195.00
10-bit	\$225.00
12-bit	\$295.00

DIGITAL-TO-ANALOG UNITS

With built-in reference, weighted-resistor switching network, and fast settling output amplifier, these are self-contained converters requiring only external power and input signals. 8, 10, and 12-bit units are available in a 3" x 2.1" x 0.4" package . . . ideal for PC board mounting.

MAJOR FEATURES

HIGH SPEED: 1.5 μ sec for 10-bit conversion.
LOW DRIFT: 20 ppm/ $^{\circ}$ C for 10-bit converter.
ACCURATE: $\pm 1/2$ LSB relative accuracy for all models.
MANY OPTIONS: Optional input buffer register. Four popular input codes.
LOW COST: (1-9 units)

8-bit	\$ 95.00
10-bit	\$125.00
12-bit	\$155.00

FOR COMPLETE TECHNICAL INFORMATION contact Burr-Brown, your Burr-Brown Engineering Representative, or use this publication's reader service card.

BURR-BROWN
RESEARCH CORPORATION

International Airport Industrial Park • Tucson, Arizona 85706
TELEPHONE: 602-294-1431 • TWX: 910-952-1111 • CABLE: BBRCORP



Operational Amplifiers
Instrumentation Amplifiers
Active Filters
Multiplier / Dividers
A/D-D/A Converters

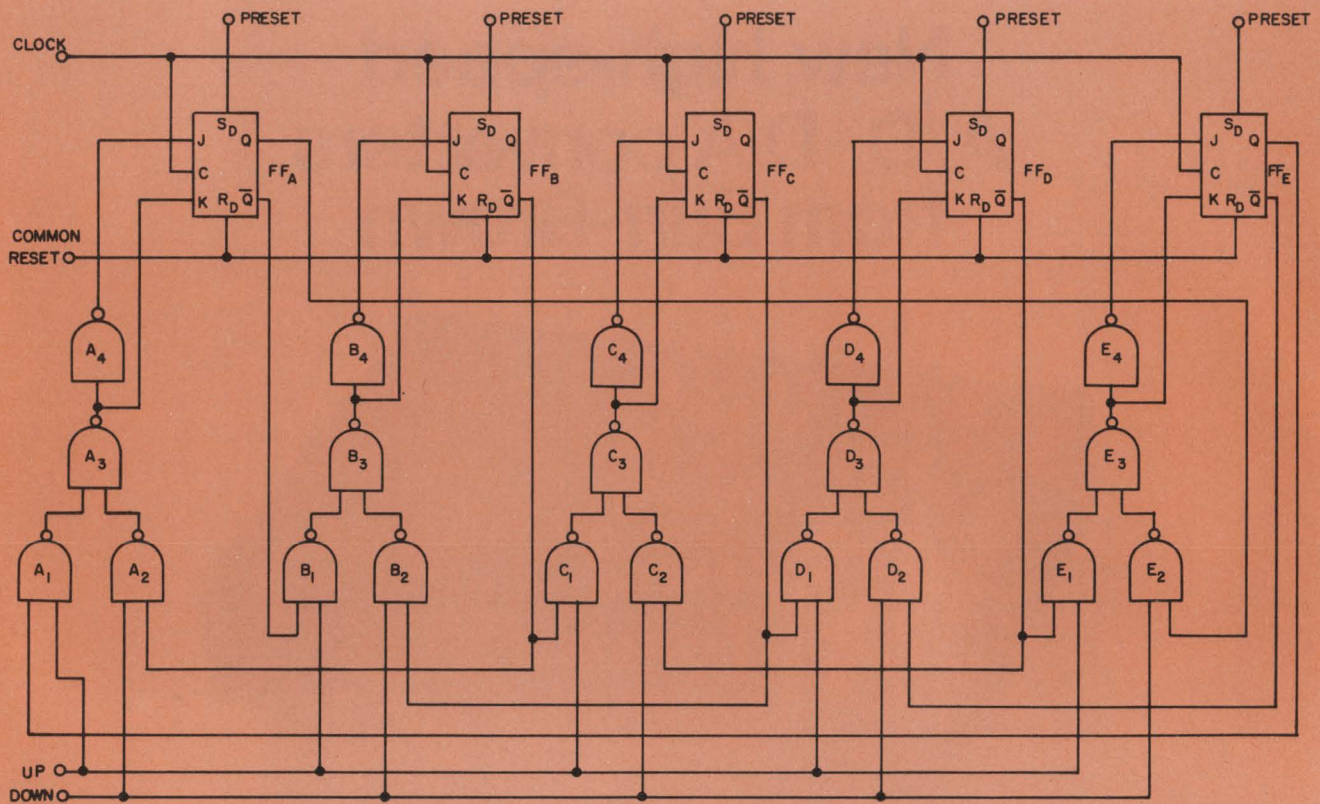

3. Gating system permits a count change at any time without affecting the existing count.

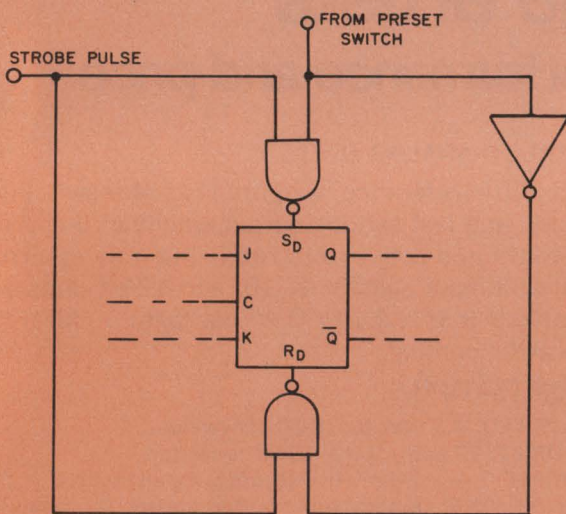

2. Typical stage of a reset method which eliminates the need for resetting prior to presetting.

held. Five sets of gates are used for the counter's updown steering networks, each gate set composed of a five-gate IC. The counter could also be built using gates in a wired-OR configuration. This approach uses only four IC's.

There are two methods used to preset the counter. The first method is to reset the counter with a common reset line and then preset it with a separate pulse routed to each flip-flop as shown in Fig. 3.

If desired, a separate line to each direct preset and reset input of each flip-flop can be used to eliminate the two-step presetting operation. This is shown for one stage in Fig. 2.

This counter can be preset with either of these two methods without any need for inhibit functions to suppress extra trigger pulses.

John T. Hannon, Jr., Design Engineer, Brown Engineering, Huntsville, Ala.

VOTE FOR 314

VOTE! Go through all Idea-for-Design entries, select the best, and circle the appropriate number on the Reader-Service-Card.

SEND US YOUR IDEAS FOR DESIGN. You may win a grand total of \$1050 (cash)! Here's how. Submit your IFD describing a new or important circuit or design

technique, the clever use of a new component or test equipment, packaging tips, cost-saving ideas to our Ideas-for-Design editor. You will receive \$20 for each accepted idea, \$30 more if it is voted best-of-issue by our readers. The best-of-issue winners become eligible for the Idea Of the Year award of \$1000.

Most engineers know ADC Products developed 82 different "Blue Chip" transformers for P.C. applications.

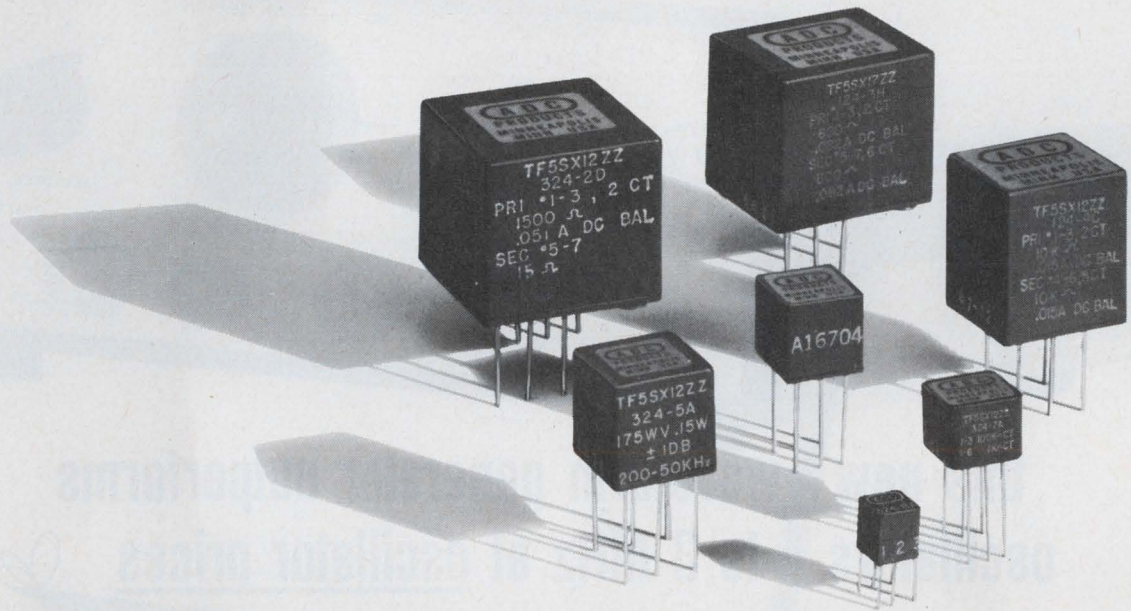

But do you know... ADC Products makes 19,897 different transformers, 3,512 different filters, 2,863 different jacks, plugs, jack panels and allied components, plus power supplies, solid state relays, pre-wired jack fields and complete communications sub-systems?

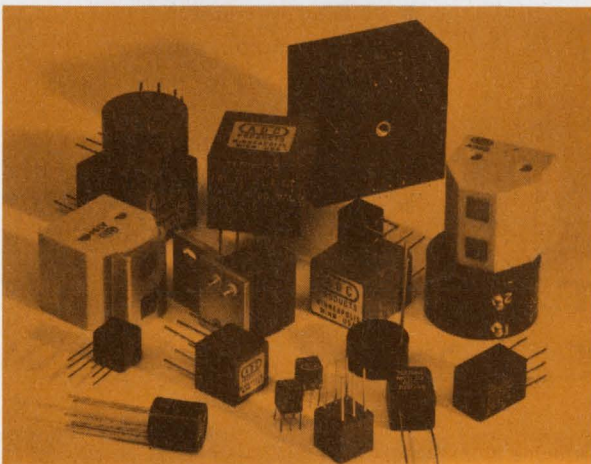

ADC not only makes hundreds of different standard products, but we also design thousands of custom devices—transformers, filters, prewired jack fields, jacks, to name but a few. We have the design staff to do it, the knowledge about your application . . . and we have a computer.

Nothing remarkable about a computer, except that we *need* it to keep track of over 26,300 custom designs already locked away. It provides us with a good starting point for optimizing your design.

This computer capability means faster service for you, higher confidence of performance in your application and just better all-around efficiency.

If you use custom iron-core components, or special components for communication applications, let ADC Products show you how computer-age technology and good old-fashioned quality can make your work easier. Write for complete information today.

ADC **ADC PRODUCTS**
A DIVISION OF MAGNETIC CONTROLS CO.

4900 West 78th Street, Minneapolis, Minnesota 55435
(612) 929-7881

INFORMATION RETRIEVAL NUMBER 73

next time you think oscillator... don't!



this new waveform generator outperforms
oscillators to 3 MHz at oscillator prices

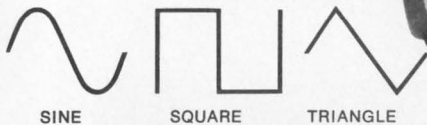

THREE WAVEFORMS

GREATER BANDWIDTH — Dynamic frequency from 0.1 Hz to 3 MHz.

EXTERNAL VCF — Control voltage can be either DC programming or AC frequency modulation. 1000:1 range.

OUTPUT POWER—All waveforms at least 20 V P-P into open circuit, 10 V P-P into 50-ohm load.

MINIATURE SIZE—Only 2 $\frac{7}{8}$ " high, 7 $\frac{3}{8}$ " wide, 8 $\frac{1}{2}$ " deep. Just 4 pounds.

Exact's new Model 123 VCF Waveform Generator not only outperforms oscillators in its range, but surpasses the performance of any waveform generator in the same league. And at a price you'd expect to pay for an oscillator!



EXACT
electronics, inc.

WHAT YOU GET FOR ONLY \$345 IN THE MODEL 123:

- Kelvin-Varley Divider frequency control for greater accuracy.
- Variable ± 5 V DC offset.
- db Step Attenuator.
- Floating output provision.
- Search mode for manually sweeping 1000:1.
- Combination tilt-stand and handle.
- Easy maintenance—single P.C. board with calibration procedure printed inside top cover.

 Tight budget? Check Exact's new Model 120. Only \$295.

Product Source Directory

Oscillators

This Product Source Directory covers Oscillators. It contains products frequently purchased by design engineers. For each table, the instruments are listed in ascending order of one major parameter. The column containing this parameter is color-coded white.

Unless otherwise noted in the tables, all oscillators have input requirements of 95-135 Vac, single phase. The following abbreviations apply

to all instruments listed:

ina—information not available

reg—request

n/a—not applicable

An index of models by manufacturer is included at the end of each table. Manufacturers are identified by abbreviation. The complete name of each manufacturer can be found in the Master Cross Index below.

Abbrev.	Company	Reader Service No.
AIL	Airborne Instruments Labs Microwave Inst. Div. Farmingdale, N.Y. 11735 (516) 595-3500	453
B&K	B&K Instruments 5111 W. 164th St. Cleveland, Ohio 44124 (216) 267-4800	454
B&W	Barker & Williamson Beaver Dam & Canal Rds. Bristol, Pa. 19007 (215) 788-5581	455
EICO	Electronic Instrument Co., Inc. 283 Malta St. Brooklyn, N.Y. 11207 (212) 949-1100	456
Exact	Exact Electronics P.O. Box 160 Hillsboro, Ore. 97123 (503) 648-6661	457
FEL	Frequency Engineering Lab. P.O. Box 527 Farmingdale, N.J. 07727 (201) 938-9221	458
GR	General Radio Co. 22 Baker Ave. W. Concord, Mass. 01781 (617) 369-4400	459
Heath	Heath Co. Benton Harbor, Mich. 49022 (616) 983-3961	460
H-P	Hewlett-Packard Co. 1501 Page Mill Rd. Palo Alto, Calif. 94302 (415) 326-7000	Contact local sales office
Inst Labs	Instrument Labs. Corp. 315 W. Walton Pl. Chicago, Ill. 60610 (312) 642-0123	461
Krohn-Hite	Krohn-Hite Corp. 580 Massachusetts Ave. Cambridge, Mass. (617) 491-3211	462
Kruse	Kruse Electronics 790 Hemmeter Lane Mountain View, Calif. 94040 (415) 967-2299	463

Abbrev.	Company	Reader Service No.
Leader	Leader Instruments Corp. 37-27 27 St. Long Island City, N.Y. 11101 (212) 729-7410	464
Marconi	Marconi Instruments 111 Cedar Lane Englewood, N.J. 07631 (201) 567-0607	465
Microdot	Microdot Inc. 220 Pasadena Ave. S. Pasadena, Calif. 91030 (213) SY 9-9171	466
Optimation	Optimation Inc. 9421 Telfair Ave. Sun Valley, Calif. 91352 (213) 768-0830	467
PRD	PRD Electronics Inc. 6801 Jericho Tpke. Syosset, N.Y. 11791 (516) 364-0400	468
Polarad	Polarad/Nelson Ross 5 Delaware Dr. Lake Success, N.Y. 11040 (516) 328-1100	469
Radiometer	Radiometer The London Co. 811 Sharon Dr. Westlake, Ohio 44145 (216) 871-8900	470
R&S	Rohde & Schwarz 111 Lexington Ave. Passaic, N.J. 07055 (201) 773-8010	471
Sage	Sage Labs. 3 Huron Dr. Natick, Mass. 01760 (617) 653-0844	472
TMC	Technical Material Corp. 700 Fenimore Rd. Mamaroneck, N.Y. 10543 (914) 698-4800	473
Wavetek	Wavetek 9045 Balboa Ave. San Diego, Calif. 92123 (714) 279-2200	474

	Manufacturer	Model	FREQUENCY				OUTPUT				Misc Features	Price \$
			Min. MHz	Max. MHz	Acc. %	Stability %	Power mW	Power W	Power Acc. %	Conn. or W/G Flange		
O S 1	B & K	1017A	2 Hz	0.002	1	ina	n/a	2	ina	conn		1460
	Optimization	RCD-11	0.1 Hz	0.01	1	0.01	50	n/a	ina	GR	4 phase	1490
	GR	1311	50 Hz	0.01	1	0.02	n/a	1	ina	GR938	h	295
	R & S	SRN	2 Hz	0.02	±2	0.01	n/a	30V	5	BNC		775
	B & K	1024A	20 Hz	0.02	1	ina	n/a	2.5	ina	conn		1795
	B & K	1022A	20 Hz	0.02	1	ina	n/a	2.5	ina	conn		1195
	Marconi	2000	20 Hz	0.02	±3	0.02	n/a	10 dBm	1 dB	bp		875
	Marconi	2005	20 Hz	0.02	±3	0.02	n/a	10 dBm	1 dB	bp	o	1295
	H-P	201C	20 Hz	0.02	±1	±2	n/a	3	±1 dB	bp		295
GR	1308-A	20 Hz	0.02	3	0.03	n/a	200VA	ina	GR938	g	1575	
O S 2	H-P	200AB	20 Hz	0.04	±2	t	n/a	1	12	bp	t	235
	GR	1304-B	20 Hz	0.04	1	7 Hz	ina	1	0.25 dB	GR938	cef	1275
	GR	1313-A	10 Hz	0.05	4	ina	n/a	n/a	2	GR938	de	350
	Krohn-Hite	4024	0.001 Hz	0.1	0.5	ina	125	n/a	1	BNC	bd	1200
	Krohn-Hite	4025	0.001 Hz	0.1	0.1	ina	125	n/a	1	BNC	bd	1950
	Optimization	RCD-2	0.01 Hz	0.1	0.1	0.01	50	5	0.01	GR		835
	Krohn-Hite	4001	0.1 Hz	0.1	0.1	ina	125	n/a	1	BNC	b	1450
	Krohn-Hite	4000	0.1 Hz	0.1	0.5	ina	125	n/a	1	BNC	b	850
	Krohn-Hite	4031R	0.1 Hz	0.1	0.1	ina	125	n/a	1	BNC	bl	2145
	Krohn-Hite	4030R	0.1 Hz	0.1	0.5	ina	125	n/a	1	BNC	bl	1495
O S 3	Optimization	RCD-10	0.1 Hz	0.1	0.1	0.01	n/a	1	ina	GR		695
	Optimization	RCD-4	0.1 Hz	0.1	1	0.01	50	5	0.01	GR		795
	Optimization	RCD-1	0.1 Hz	0.1	1	0.02	50	5	0.01	GR		595
	H-P	202C	1 Hz	0.1	±2	t	160	n/a	t		t	325
	B & W	210	10 Hz	0.1	±2	ina	ina	10V	0.2	ina		reg
	H-P	205AG	10 Hz	0.1	±2	y	n/a	5	±1 dB	bp	y	700
	GR	1309-A	10 Hz	0.1	2	0.01	10	n/a	2	GR938	de	375
	EICO	378	1 Hz	0.11	±5	ina	0	3V	ina	bp		90
	Leader	LAG-53	20 Hz	0.2	3	2 Hz	n/a	7V	0.5 dB		bd	49
	EICO	377	20 Hz	0.2	±3	ina	100	n/a	ina	bp	d	60
O S 4	Marconi	1101	20 Hz	0.2	1.5	0.15	n/a	20V	±1 dB	BNC		600
	Leader	LAG-54	20 Hz	0.2	3	2 Hz	n/a	3V	0.5 dB	ina	bd	85
	B & K	1013A	200 Hz	0.2	1	ina	n/a	2	ina	conn		1460
	R & S	SRM	30 Hz	0.3	±2	0.01	500	n/a	ina	BNC		560
	GR	1210-C	20 Hz	0.5	3	ina	0	45V	ina	GR938	cd	255
	H-P	208A	5 Hz	0.56	±3	ina	10	n/a	±3/skp	bp	n	565
	H-P	236A	50 Hz	0.56	±3	ina	10	n/a	ina	bp	r	600
	H-P	200CD	5 Hz	0.6	±2	t	160	n/a	t	bp	t	275
	Inst Labs	TR	6 Hz	0.6	2	1	40	n/a	ina	bp		255
	Krohn-Hite	4100	0.01 Hz	1	0.5	ina	500	n/a	1	BNC	b	550
O S 5	Optimization	RCD-3	0.1 Hz	1	1	0.01	50	5	0.01	GR		795
	Marconi	2103	10 Hz	1	3	ina	n/a	2.5V	±1 dB	bp	dn	135
	Optimization	RCD-9	10 Hz	1	0.1	0.01	n/a	1W	ina	GR		895
	GR	1312	10 Hz	1	1	0.005	160	n/a	2	BNC	di	495
	H-P	4204A	10 Hz	1	±0.2	±0.01	160	n/a	±2	bp	z	695
	H-P	241A	10 Hz	1	±1	±0.04	10	n/a	±2	bp	s	490
	R & S	SRB	10 Hz	1	±1	0.03	n/a	1.5	ina	BNC		880
	Radiometer	RCO11	10 Hz	1	1	0.1	ina	ina	ina	UHF	b	633
	H-P	204D	5 Hz	1.2	±3	ina	10	n/a	p	bp	p	325
	H-P	204-C	5 Hz	1.2	±3	ina	10	n/a	0.5-1	bp	q	250
O S 6	Wavetek	130	0.2 Hz	2	2	0.05	0.025	0.25	n/a	BNC		295
	GR	1310-B	2 Hz	2	3	0.03	160	n/a	2	GR938	d	295
	H-P	209A	4 Hz	2	±3	ina	40	n/a	ina	ina	dm	345
	EICO	379	20 Hz	2	3	ina	0	7.5V	ina	bp	d	95
	Exact	123	0.1 Hz	3	2	0.05	ina	ina	ina	ina	a	345
	Exact	120	0.1 Hz	3	2	0.05	ina	ina	ina	ina		295
	Wavetek	142	0.0001 Hz	10	1	0.05	562X10 ⁻³	0.562	1	BNC		595
	Marconi	1370A	10 Hz	10	2	1/10 ⁻³	n/a	30V	±1 dB	BNC	d	935
	H-P	652A	10 Hz	10	2-3	ina	200	n/a	w	BNC	w	725
	H-P	654A	10 Hz	10	2-4	ina	12.6	n/a	u	BNC	u	875
O S 7	H-P	651B	10 Hz	10	2-3	ina	200	n/a	x	BNC	x	590
	H-P	653A	10 Hz	10	2-4	ina	21	n/a	v	v	v	990
	Krohn-Hite	4200	10 Hz	10	2	ina	500	n/a	1	BNC	b	350
	Microdot	445/M183	2	10	1	±0.002	50	50	±0.2 dB	ina		reg
	TMC	VOX-7	1	30	100	0.0001	ina	1	ina	conn		6900
	GR	1211-C	0.5 Hz	50	2	0.4	n/a	1	ina	GR874	c	495
	Microdot	445/M184	10	50	1	±0.002	50	50	±0.2 dB	ina		reg
	Microdot	404A	10	50	1	±0.002	50	50	±0.2 dB	ina		reg
	Heath	IG-102	0.1 Hz	110	2	ina	100 mV	n/a	ina	ina		32
	Heath	IGW-19	0.1 Hz	110	2	ina	100 mV	n/a	ina	ina		30
O S 8	Kruse	2038A	8	112	±0.5 MHz	±0.025/°C	20	n/a	ina	OSM		1990
	Microdot	445/M185	50	200	1	±0.002	50	50	±0.2 dB	ina		reg
	Microdot	406A	50	200	1	±0.002	50	50	±0.2 dB	ina		reg
	GR	1215-C	50	250	1	0.2	ina	0.3	ina	GR874	c	325
	Kruse	2039A	45	255	±1 MHz	0.025/°C	20	n/a	n/a	OSM		1990

FROM THE

WAVE MAKERS:

A NEW SERIES OF SOLID STATE PROGRAMMABLE OSCILLATORS



Krohn-Hite's Series 4100 Rack-Mounted Solid State Programmable Oscillators are the new generation of medium-priced, precision general purpose oscillators. They combine the convenience of automatic programmed frequency and amplitude selection with the outstanding performance characteristics of the popular Model 4100 Push-Button Oscillator. Covering the frequency range of 0.1 Hz to 1 MHz, Series 4100 Programmable Oscillators boast a frequency calibration accuracy as low as 0.1%.

Available in four models, Series 4100 Oscillators are designed for either standard manual operation or automatic programmed frequency or amplitude selection by any one of several commonly available means, such as computer output, punched cards, punched tape or computer mag tape. Programming format is the standard 1-2-4-8 binary coded decimal system. A unique feature of the Series 4100 Programmable Oscillators is the capability to produce both sine and square wave outputs with 1/2 watt of power into 50 ohms with remote or local frequency control. Best of all, Series 4100 provides a degree of frequency stability, low distortion, and amplitude stability that can't be matched by competitive units.

The following chart provides a brief rundown of the important operating parameters of the new generation Series 4100 Solid State Programmable Oscillators. And don't forget the model 4100A non-programmable oscillator is still available at \$550. They're all products of the recognized leader in variable filters who's out to make waves in oscillators, too. For complete technical information on any of these new Krohn-Hite Oscillators, write THE WAVEMAKERS: Krohn-Hite Corporation, 580 Massachusetts Avenue, Cambridge, Massachusetts 02139 U.S.A.

Tel: (617) 491-3211 TWX: 710-320-6583

SERIES 4100 SOLID STATE PROGRAMMABLE OSCILLATORS

Frequency Range	Osc. Model	Freq. Acc. %	Max. Volts	Output Impedance	Dist.	Square Wave	Prog. Amplitude	Approx. Ship. Wt. lbs, kgs	Price
0.1 Hz to 1 MHz	4131R	0.1	10 RMS	50	0.02%	yes	no	30/15	\$1375
0.1 Hz to 1 MHz	4141R	0.1	10 RMS	50	0.02%	yes	yes	30/15	\$1585
1 Hz to 1 MHz	4130R	0.5	10 RMS	50	0.02%	yes	no	27/13	\$1075
1 Hz to 1 MHz	4140R	0.5	10 RMS	50	0.02%	yes	yes	27/13	\$1285

KH KROHN-HITE
CORPORATION

OSCILLATORS / FILTERS / AC POWER SUPPLIES / AMPLIFIERS

	Manufacturer	Model	FREQUENCY				OUTPUT				Misc Features	Price \$
			Min. MHz	Max. MHz	Acc. %	Stability %	Power mW	Power W	Power Acc. %	Conn. or W/G Flange		
O S 9	GR	1330-A	40 Hz	500	5	ina	500	n/a	ina	GR874	i	1150
	H-P	3200B	10	500	±2	±0.002	200	n/a	ina	BNC		525
	GR	1363	56	500	2	0.8	500	n/a	ina	GR874	c	495
	Microdot	445/M186	200	500	1	±0.002	50	50	±0.2 dB	ina		reg
	Microdot	408B	200	500	1	±0.002	50	50	±0.2 dB	ina		reg
	Kruse	2039A-1	90	510	±2 MHz	±0.03/°C	20	n/a	ina	OSM		2190
	GR	1362	220	920	1	0.2	400	n/a	ina	GR874	c	495
	Microdot	410B	500	1000	1	±0.002	50	50	±0.2 dB	ina		reg
	Microdot	445/M187	500	1000	1	±0.002	50	50	±0.2 dB	ina		reg
	Fel	SSH24VO	500	1000	ina	ina	200	0.35	ina	OSM		325
O S 10	Kruse	2041A	470	1030	±2.5 MHz	±0.05/°C	20	n/a	ina	OSM		1990
	GR	1361-A	450	1050	1	0.2	400	n/a	ina	GR874	c	445
	Microdot	445/M188	1000	1800	1	±0.002	50	25	±0.2 dB	ina		reg
	Microdot	411A	900	1800	1	±0.002	50	25	±0.2 dB	ina		reg
	GR	1218-BV	900	2000	1	0.1	ina	0.3	ina	GR874	c	995
	PRD	L712-B	950	2000	1	ina	10	n/a	ina	N		1440
	Sage	831-L-1	1000	2000	±0.1	1 ppm	80	0.15	ina	ina		6400
	Sage	851-L-1	1000	2000	±1	ina	n/a	0.1	ina	ina		2995
	Sage	841C-L-1	1000	2000	±0.1	1 ppm	80	0.15	ina	ina		9195
	Kruse	2042A	940	2060	±5 MHz	±0.05/°C	20	n/a	ina	OSM		1990
O S 11	Marconi	6055	850	2150	1	ina	60	n/a	ina	N		945
	Polarad	1205	950	2400	±0.5	0.0008	50	n/a	±2 dB	N		1590
	Polarad	1605	950	2400	±0.5	0.0008	1	n/a	±2 dB	N		2330
	Polarad	1105	950	2400	±0.5	0.0008	1	n/a	±2 dB	N		2090
	Kruse	2043A	1340	2460	±5 MHz	±0.05/°C	20	n/a	ina	OSM		2190
	Sage	851-S-51	2000	2500	±1	ina	n/a	0.1	ina	ina		2995
	Sage	814A-L-9	2000	2500	±0.1	0.05 ppm	n/a	0.1	ina	ina		5950
	Microdot	445/M189	2000	2500	1	±0.002	50	15	±0.2 dB	ina		reg
	Microdot	413	1800	2600	1	±0.002	50	10	±0.2 dB	ina		reg
	AIL	125	200	3000	1	0.05	n/a	50	n/a	N		4250
O S 12	Sage	814A-S-1	2500	3050	±0.1	0.05 ppm	n/a	0.075	ina	ina		4250
	Sage	851-S-52	2500	3600	±1	ina	n/a	0.1	ina	ina		2995
	Sage	814A-S-2	2950	3600	±0.01	0.05 ppm	n/a	0.08	ina	ina		4250
	PRD	S112-B	1900	4000	1	ina	10	n/a	ina	N		1440
	Sage	831-S-1	2000	4000	±0.1	1 ppm	40	0.2	ina	ina		6400
	Sage	841C-S-1	2000	4000	±0.1	1 ppm	40	0.2	ina	ina		9195
	Sage	841B-S-1	2000	4000	±0.1	0.2 ppm	40	0.2	ina	ina		7950
	GR	1360-B	1700	4100	1	0.15	200	n/a	ina	GR874		1750
	Kruse	2044A	1900	4100	±10 MHz	±0.05/°C	10	n/a	ina	OSM		2290
	Polarad	1206	1950	4200	±0.5	0.0008	50	n/a	±2 dB	N		1590
O S 13	Sage	814A-S-31	3700	4300	±0.01	0.05 ppm	n/a	1	ina	ina		8350
	Polarad	1606	1950	4600	±0.5	0.0008	5	n/a	±2 dB	N		2330
	Polarad	1106	1950	4600	±0.5	0.0008	15	n/a	±2 dB	N		2090
	Sage	851-C-51	5100	5900	±1	ina	n/a	0.1	ina	ina		2995
	Sage	814A-C-1A	5100	5900	±0.1	0.05 ppm	n/a	0.06	ina	ina		4250
	Sage	814A-C-10	5400	5900	±0.1	0.05 ppm	n/a	0.2	ina	ina		4500
	Sage	851-C-52	5925	6525	±1	ina	n/a	0.2	ina	ina		2995
	Sage	814A-C-31	5925	6525	±0.1	0.05 ppm	n/a	1	ina	ina		reg
	Sage	851-C-53	6575	7125	±1	ina	n/a	0.2	ina	ina		2995
	AIL	126	2000	8000	2	0.05	n/a	6	2	N		4950
O S 14	Sage	841B-C-1	4000	8000	±0.1	0.2 ppm	20	0.1	ina	ina		7950
	Sage	831-C-1	4000	8000	±0.1	1 ppm	20	0.1	ina	ina		6400
	Sage	841C-C-1	4000	8000	±0.1	1 ppm	20	0.1	ina	ina		9195
	Polarad	1607	3800	8200	±0.5	0.0008	5	n/a	±2 dB	N		2330
	Polarad	1107	3800	8200	±0.5	0.0008	5	n/a	±2 dB	N		2090
	Polarad	1207	3800	8200	±0.5	0.0008	25	n/a	±2 dB	N		1840
	Sage	854-X-55	7500	8500	±1	0.2 ppm	n/a	0.2	ina	ina		5995
	Sage	851-X-55	7500	8500	±1	ina	n/a	0.2	ina	ina		2995
	Sage	814A-X-5	7500	8500	±0.1	0.05 ppm	n/a	0.2	ina	ina		4700
	Sage	851-X-53	8500	10000	±1	ina	n/a	0.1	ina	ina		2995
O S 15	Sage	851-X-51	8500	10000	±1	ina	n/a	0.5	ina	ina		2995
	Sage	814A-X-21	8500	10000	±0.1	0.05 ppm	ina	0.5	ina	ina		4150
	Sage	814A-X-2	9000	10000	±0.1	0.05 ppm	n/a	0.08	ina	ina		4250
	Sage	814A-X-21S	9600	10200	±0.1	0.05 ppm	n/a	0.5	ina	ina		4300
	Sage	814A-X-12	9800	10300	±0.1	0.05 ppm	n/a	0.2	ina	ina		4450
	Polarad	1108	6950	11000	±0.5	0.0008	5	n/a	±2 dB	N		2090
	Polarad	1608	6950	11000	±0.5	0.0008	5	n/a	±2 dB	N		2330
	Polarad	1208	6950	11000	±0.5	0.0008	25	n/a	±2 dB	N		1840
	Sage	851-X-52	9800	11200	±1	ina	n/a	0.2	ina	ina		2995
	Sage	814A-X-3	9800	11200	±0.1	0.05 ppm	n/a	0.5	ina	ina		4750
O S 16	Sage	814A-X-3M	10600	11800	±0.1	0.05 ppm	n/a	0.1	ina	ina		4750
	Sage	841B-X-1	8000	12400	±0.1	0.2 ppm	50	0.35	ina	ina		7950
	Sage	831-X-1	8000	12400	±0.1	1 ppm	50	0.35	ina	ina		6400
	Sage	841C-X-1	8000	12400	±0.1	1 ppm	50	0.35	ina	ina		9195
	PRD	X712-A	8200	12400	1	ina	10	n/a	ina	UG-39/U		1475

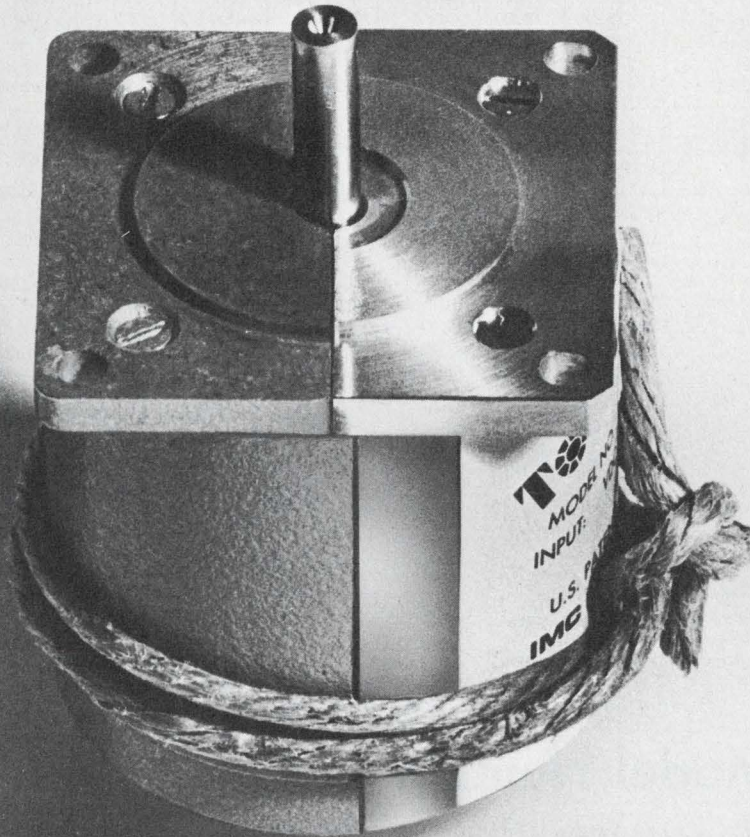

The Better Halves.

Or how to get the best of 2 single source suppliers.

Have the best of choices.
Try IMC's newly patented Tormax
200.

It's directly swappable with the
other one.

Steps in 1.8-degree increments at
rates up to 550 steps/sec.

Turns at 72 rpm from a 60-Hz input.

Backed by IMC's extensive stepper
design and manufacturing capability.

Available immediately in standard
models.

A little longer for dual shafts,
splines, keyways, different mounts,
and so forth.

IMC Magnetics Corp., Western Di-
vision, 6058 Walker Avenue, May-
wood, California 90270, Tel. (213)
583-4785, TWX 910-321-3089.

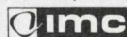

	Manufacturer	Model	FREQUENCY					OUTPUT				Misc Features	Price \$
			Min. MHz	Max. MHz	Acc. %	Stability %	Power mW	Power W	Power Acc. %	Conn. or W/G Flange			
OS 17	Marconi	6058	7000	12500	1	ina	10	n/a	ina	N		1395	
	Sage	851-K-51	12400	14500	±1	ina	n/a	0.1	ina	ina		2995	
	Sage	814A-K-21	12800	14500	±0.1	0.5	n/a	0.1	ina	ina		4150	
	Polarad	1809	10000	15500	±1	0.0008	1	n/a	±2 dB	WR75		3765	
	Polarad	1709	10000	15500	±1	0.0008	1	n/a	±2 dB	WR75		3525	
	Sage	814A-K-22	15000	17300	±0.1	0.05 ppm	n/a	0.2	ina	ina		5150	
	Sage	831-K-1	12400	18000	±0.1	1 ppm	40	0.2	ina	ina		6400	
	Sage	841B-K-1	12400	18000	±0.1	0.2 ppm	40	0.2	ina	ina		7950	
	Polarad	1810	15000	21000	±1	0.0008	1	n/a	±2 dB	WR51		3765	
	Polarad	1710	15000	21000	±1	0.0008	1	n/a	±2 dB	WR51		3525	
OS 18	Sage	814A-K-24	23000	25000	±0.1	0.05 ppm	n/a	0.1	ina	ina		6950	
	Sage	817A-K-35	34000	36000	±0.1	0.5 ppm	n/a	0.05	ina	ina		8200	

- a. Dc offset, dB step attenuator included.
- b. Solid state.
- c. Unit power supply required, check with factory.
- d. Also squarewave generator.
- e. Power output into 600Ω.
- f. Power accuracy to 20 kHz, 0.5 dB, 20-30 kHz, 1 dB, 30-40 kHz.
- g. Includes power amplifier.
- h. Transformer output.
- i. Decade oscillator.
- j. Accuracy, 400-1000 Hz, 3% to 150 kHz, 2% above 150 kHz.
- l. Programmable.
- m. Balanced output, 40 dB. Programmable sync. Distortion 0.1%, 200 Hz-200 kHz.
- n. Battery operated.
- o. Two tone test oscillator.
- p. Flatness 0.3-0.5 dB. Programmable sync. Distortion 0.1%, 30 Hz-100 kHz. Output attenuator 80 dB, accuracy ±0.3-0.5 dB, balanced output 40 dB.
- q. Programmable sync. Distortion 0.1%, 30 Hz-100 kHz.

- r. Output attenuator 40 dB. Balanced output 40 dB. Level accuracy, -31 to +10 dBm, ±0.2 dBm. Connector type WE241, 309, 310.
- s. Frequency selected by pushbutton, 4500 increments. Output -30 to +10 dBm.
- t. Stability included in accuracy spec at normal temperature. Voltage accuracy ±1 dB. Balanced output, 600Ω.
- u. Voltage accuracy, 0.15 dB or 1%/90 days. Output Z, 50, 75Ω unbalanced; 135, 150, 600Ω balanced.
- v. Voltage accuracy, reference ±2%, level ±0.1 dB/90 days. Output Z 75Ω unbalanced, 124Ω balanced. Connector type WE358A, WE408.
- w. Voltage accuracy, expanded scale adjustable to set-level 0.25-1.75%. Attenuation 90 dB, output Z 50Ω and 600Ω.
- x. Voltage accuracy 2-4%, no adjustment. Attenuation 90 dB, output Z 50 and 600Ω.
- y. Stability included in accuracy spec at normal temperature. Four output impedances floating and balanced.
- z. Digital frequency selection by rotary switch.

Index by Model Number

Name	Model	Code	Name	Model	Code	Name	Model	Code
AIL	125	OS11		1363	OS9	Kruse	2038A	OS8
Airborne Inst.	126	OS13				Kruse	2039A	OS8
B&K	1013A	OS4	Heath	IG-102	OS8	Electronics	2039A-1	OS9
B&K	1017A	OS1	Heath Co.	IGW-19	OS8		2041A	OS10
Instruments	1022A	OS1	H-P	200AB	OS2		2042A	OS10
	1024A	OS1	Hewlett-	200CD	OS4		2043A	OS11
B&W	210	OS3	Packard Co.	201C	OS1		2044A	OS12
Barker & Williamson				202C	OS3	Leader	LAG-53	OS3
EICO	377	OS3		204C	OS5	Leader	LAG-54	OS4
Electronic	378	OS3		204D	OS5	Instruments		
Instrument	379	OS6		205AG	OS3	Marconi	1101	OS4
Exact	120	OS6		208A	OS4	Marconi	1370A	OS6
Exact	123	OS6		209A	OS6	Instruments	2000	OS1
Electronics				236A	OS4		2005	OS1
FEL	SSH24VO	OS9		241A	OS5		2103	OS5
Freq. Eng.				651B	OS7		6055	OS11
GR	1210-C	OS4		652A	OS6		6058	OS17
General	1211-C	OS7		653A	OS7			
Radio	1215-C	OS8		654A	OS6	Microdot	404A	OS7
Co.	1218-BV	OS10		3200B	OS9	Microdot	406A	OS8
	1304-B	OS2	Inst Labs	4204A	OS5	Inc.	408B	OS9
	1308-A	OS1	Instrument	TR	OS4		410B	OS9
	1309-A	OS3	Labs. Corp.				411A	OS10
	1310-B	OS6	Krohn-Hite	4000	OS2		413	OS11
	1311	OS1	Krohn-Hite	4001	OS2		445/M183	OS7
	1312	OS5	Corp.	4024	OS2		445/M184	OS7
	1313-A	OS2		4025	OS2		445/M185	OS8
	1330-A	OS9		4030R	OS2		445/M186	OS9
	1360-B	OS12		4031R	OS2		445/M187	OS9
	1361-A	OS10		4100	OS4		445/M188	OS10
	1362	OS9		4200	OS7	Optimization	RCD-1	OS3

Name	Model	Code
Optimization	RCD-2	OS2
	RCD-3	OS5
	RCD-4	OS3
	RCD-9	OS5
	RCD-10	OS3
	RCD-11	OS1
PRD	S112-B	OS12
PRD	L712-B	OS10
Electronics	X712-A	OS16
Polarad	1105	OS11
Polarad/	1106	OS13
Nelson	1107	OS14
Ross	1108	OS15
	1205	OS11
	1206	OS12
	1207	OS14
	1208	OS15
	1605	OS11
	1606	OS13
	1607	OS14
	1608	OS15
	1709	OS17
	1710	OS17
	1809	OS17
	1810	OS17
R&S	SRB	OS5
Rohde &	SRM	OS4
Schwarz	SRN	OS1
Radiometer	RC011	OS5
Radiometer, London Co.		
Sage	814A-C-1A	OS13
Sage Labs	814A-C-10	OS13
	814A-C-31	OS13
	814A-K-21	OS17
	814A-K-22	OS17
	814A-K-24	OS18
	814A-L-9	OS11
	814A-S-1	OS12
	814A-S-2	OS12
	814A-S-31	OS13
	814A-X-2	OS15
	814A-X-3	OS15
	814A-X-3M	OS16
	814A-X-5	OS14
	814A-X-12	OS15
	814A-X-21	OS15
	814A-X-21S	OS15
	817A-K-35	OS18
	831-C-1	OS14
	831-K-1	OS17
	831-L-1	OS10
	831-S-1	OS12
	831-X-1	OS16
	841B-C-1	OS14
	841B-K-1	OS17
	841B-S-1	OS12
	841B-X-1	OS16
	841-C-1	OS14
	841C-L-1	OS10
	841C-S-1	OS12
	841C-X-1	OS16
	851-C-51	OS13
	851-C-52	OS13
	851-C-53	OS13
	851-K-51	OC17
	851-L-1	OS10
	851-S-51	OS11
	851-S-52	OS12
	851-X-51	OS15
	851-X-52	OS15
	851-X-53	OS14
	851-X-55	OS14
	854-X-55	OS14
TMC	VOX-7	OS7
Tech.		
Material		
Wavetek	130	OS6
	142	OS6

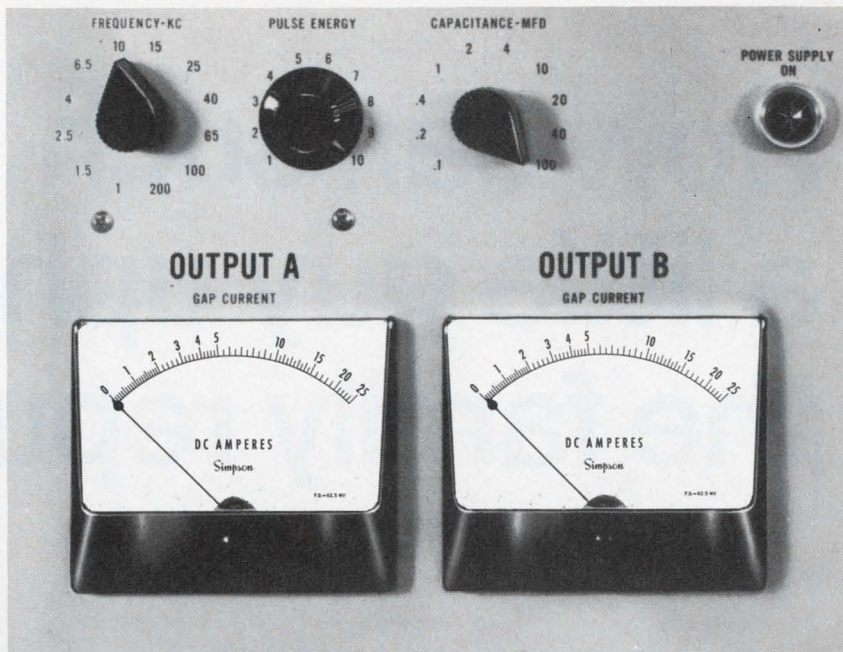

the sure way to let
customers know you
care about quality...

Simpson panel instruments on your equipment

Simpson's advanced self-shielding annular and core magnet construction provides optimum torque-to-mass ratio. Rugged Taut Band and Pivot & Jewel movements can withstand punishing shock and vibration. Your assurance of an instrument that will stay accurate. No wonder so many manufacturers with reputations to protect (or build!) specify Simpson.

Over 1,400 stock ranges, sizes, and types. Get "off the shelf" delivery from your local electronic distributor.

For special needs contact your local Simpson Representative. He's ready to help.

Simpson ELECTRIC COMPANY



5200 W. Kinzie Street, Chicago, Illinois 60644 • Phone (312) 379-1121

EXPORT DEPT.: 400 W. Madison Street, Chicago, Illinois 60606. Cable Simelco
IN CANADA: Bach-Simpson Ltd., London, Ontario • IN INDIA: Ruttonsha-Simpson Private
Ltd., International House, Bombay-Agra Road, Vikhroli, Bombay

INSTRUMENTS THAT STAY ACCURATE
INFORMATION RETRIEVAL NUMBER 77

How can such a little guy uphold the family reputation?

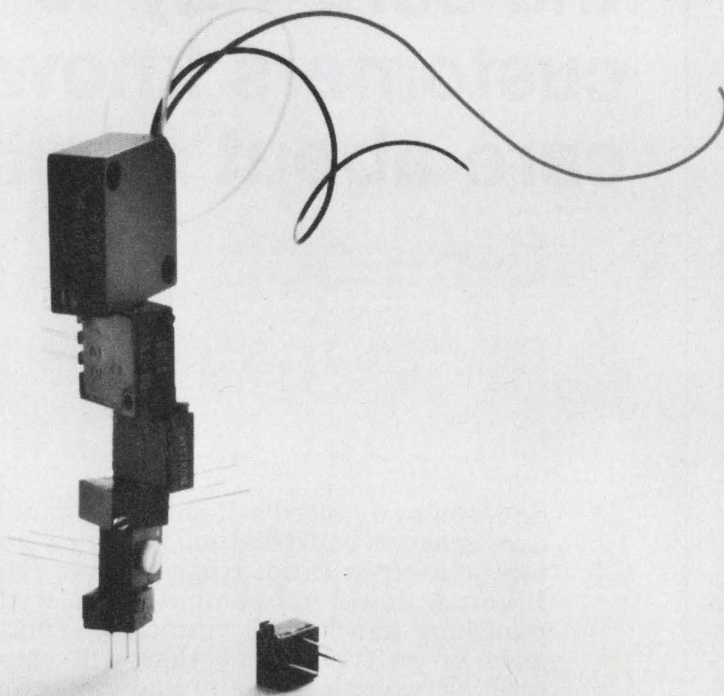

Our new 561/562 series are true Squaretrim® potentiometers down to the last quarter inch. As the smallest members of this distinguished family, they have to live up to a bigger reputation than other pots their size. They do. We made sure.

We gave them the same high quality element that makes our military pots so reliable . . . the same tight $\pm 5\%$ tolerance . . . the same wide 10 ohms to 20K standard resistance range and -55°C to $+150^{\circ}\text{C}$ temperature

range. We even designed them to meet all environmental requirements of MIL-R-27208, like their larger military brothers.

Models 561 and 562 $\frac{1}{4}$ " Squaretrims are available in three configurations, top or side adjustable, and they give you a generous 13:1 adjustment ratio. You wouldn't expect a general-purpose pot to have all these features and still be reasonably priced. But it's just another example of how our Squaretrim family supports its reputa-

tion as the biggest name in value for the smallest thing in pots.

They're in stock now at Weston Potentiometer distributors. Or ask us about special resistance values, data sheets, evaluation samples. The little guys.

WESTON COMPONENTS DIVISION,
Archbald, Pennsylvania 18403, Weston
Instruments, Inc. a Schlumberger company

WESTON®

New Products

Low-power Schottky-clamped TTL circuits boast propagation delays of just 3 ns

Texas Instruments Inc., Components Group, P.O. Box 5012, Dallas, Tex. Phone: (214) 238-2011. P&A: \$3.90 or \$10.51 for 1 to 24, \$2.65 or \$7.15 for 100 to 999; stock to 3 wks.

Providing extremely fast switching speeds at low power levels, a new family of Schottky-clamped TTL integrated circuits features typical propagation delays of 3 ns while holding power dissipation to only 20 mW per gate. Designated as series 54S/74S, the new logic circuits use Schottky diodes to clamp active transistors, thus preventing conventional saturation.

Initiating this high-speed TTL line are: the SN74S00 quadruple two-input positive NAND gate; the SN74S20 dual four-input positive NAND gate; and the SN74S112, a 100-MHz dual negative edge-triggered J-K flip-flop with preset and clear.

Additional circuits will be added to the family at the rate of about one per month for the balance of this year. These will include MSI functions, other NAND and AND gates, hex inverters, AND-OR inverters, and dual J-K and D flip-flops.

Because the effective storage

time of individual circuit transistors is zero, the 54S/74S Schottky-clamped devices can operate at high speeds and yet retain the low power consumption of saturated-logic lines. The clamped npn transistor is formed by placing an integrated Schottky-barrier diode in parallel with the base-collector junction. A metal electrode is then connected to the base and to the n region of the collector, where it forms a rectifying contact.

Since the Schottky diode has a lower forward voltage than the collector-base junction, it clamps the transistor by diverting excess base current and stops the transistor from saturating. This means there is practically no stored charge in either the diode or the transistor.

The result is a large reduction in storage time and an improvement in switching time. As a matter of fact, the performance of the new Schottky-clamped TTL IC family is comparable to that of unsaturated-logic families, but with the added advantage of low power dissipation, which is typical of popular saturated-logic families.

Able to interface directly with all standard TTL and DTL cir-

cuits, the new ICs can also use the same single 5-V power supply. In addition, their packaging and pin configurations are identical to those for conventional 54/74 TTL devices.

Series 54S/74S units have a low output impedance for high ac noise immunity. This also permits the circuits to drive highly capacitive loads with only small line reflections. Tight chip geometry and shallow diffusions also reduce capacitance to further enhance circuit performance and costs.

For many applications, series 54S/74S systems can be designed on conventional printed circuit boards with unterminated lines. This reduces a number of the costs normally associated with very high-speed digital systems.

Immediate applications include: computer central processor units and peripheral equipment, digital test and measuring equipment, and digital communication systems.

The three current 54S/74S devices are supplied in plastic dual-in-line packages. Future units will be available in ceramic dual-in-line packages and flatpacks, in both military and commercial versions.

CIRCLE NO. 250

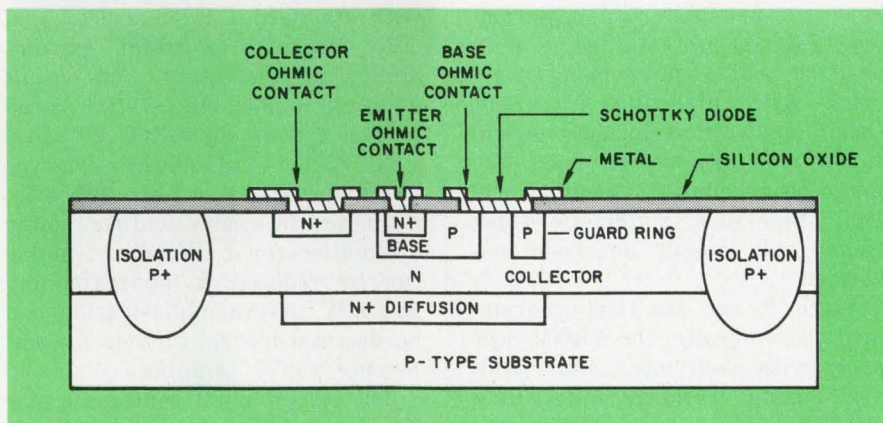

Schottky-clamped TTL ICs achieve delay times of 3 ns while keeping power levels to 20 mW per gate. Fast switching times are result of eliminating stored transistor charge with diode shunt across base-collector junction.

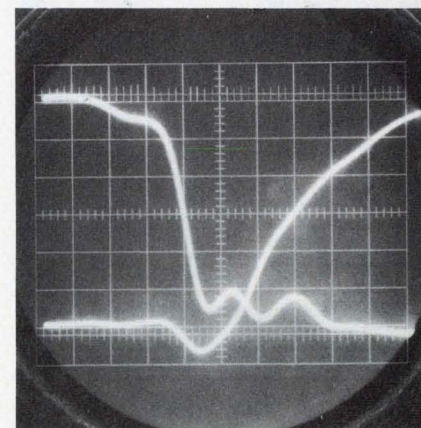

High-speed performance is verified by scope display that shows typical rise and fall times of 3 ns.

front panel ideas

*Prices shown are single lot. Inquire about quantities.



Keyboard Switch

A reliable reed switch is actuated by a permanent magnet. Stringent close tolerance maintained in operating pressure and operating points are standard. **RSM-41** with plain key cap. **2.70***

CIRCLE NO. 231

Replaceable Readout!

7-Segment incandescent numeric, 3-5V @ 40-60 ma. Wide angle, built-in filter. With socket. **MS-4000BR.**

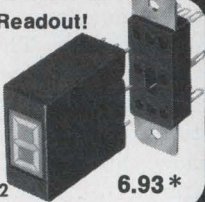

6.93*

CIRCLE NO. 232

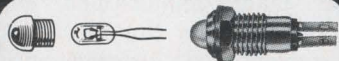

Replace-a-Lamp Pilot

Miniature lamp assembly utilizes unbased T-1 lamps replaceable from front. Equipped with #680 lamp rated 5V @ 60 ma. Screw lens colors optional. **BFK-5.**

1.29*

CIRCLE NO. 233

Miniature Slide Switch

World's best! Compact 1/2" case; new anti-tease design. SPDT (2-circuit). N.O., N.C., gold plated. 2A @ 120 VAC. **MSS-22**



1.75*

CIRCLE NO. 234

Miniature Proximity Switch Assemblies

Encased magnet actuates a reed switch to within .39" ctrs. Rated .15A, 50 VDC. N.O. **RS-11-NO.**



2.75*

CIRCLE NO. 235

Remote Control Relay

Plugs into 117 VAC outlet and provides "safe" low-voltage remote control. **FRE-103.**

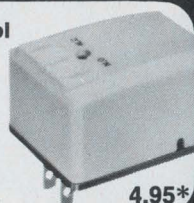

4.95*

CIRCLE NO. 236

Immediate Deliveries on Above Items!

ALCO®

ELECTRONIC PRODUCTS, INC.
Lawrence, Massachusetts 01843

ICs & SEMICONDUCTORS

Read-only 512-bit memory programs electronically

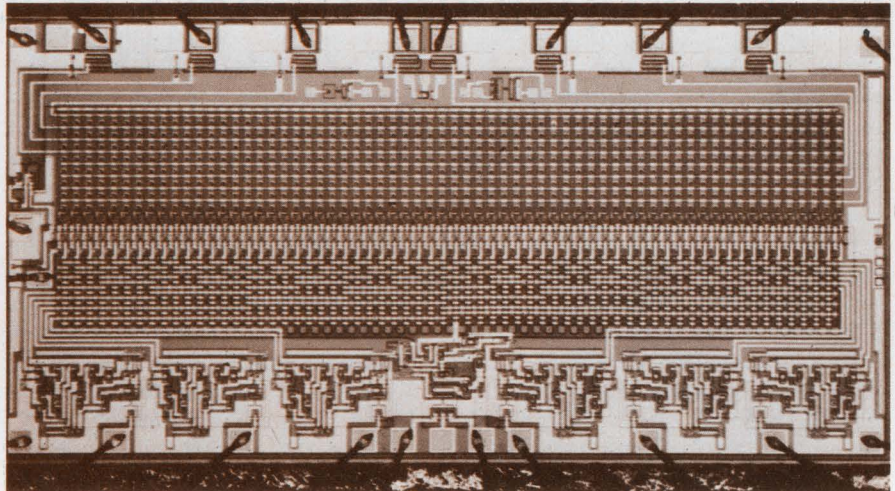

Radiation Inc., Microelectronics Div., sub. of Harris-Intertype Corp., P.O. Box 37, Melbourne, Fla. P&A: \$47 or \$61.50; stock.

Able to store up to 512 bits, a new monolithic bipolar read-only memory can be field-programmed by the user after it has been hermetically sealed. Because of this, there is no need for final pattern masking, which is always performed by the manufacturer, and memory costs can be reduced considerably. A military (-55 to +125°C) version sells for \$61.50 in quantities of 100 to 999, while a commercial version (0 to 75°C) is priced at \$47 for 100 to 999 units.

Primary applications for the new programmable read-only memory (PROM) are expected to be in systems that require many memories with differing programs. Other applications include conventional read-only-memory uses like micro-programming, combinational logic functions, arithmetic functions, table look-up and code conversion.

Since it can be field-programmed electronically, the PROM does away with such mechanical field-customizing methods as scribing and laser cutting. In addition, the user can stock a single type of read-only memory for any and all applications through both bread-

board and production phases of his design.

All bits of the memory matrix are set at logical 0. A logical 1 is patterned by simply programming the desired bit with a 30-mA current. Since, in any given word, each bit is in series with the base of one of the output buffers, a bit programmed as logical 1 is an open circuit and prohibits the flow of base current.

This causes a high or logical 1 voltage to appear at the output of the buffer. Conversely, bits that are programmed as logical 0 permit base current to flow, thus causing a low or logical 0 voltage at the buffer output.

The PROM, which is compatible with standard DTL and TTL circuits, features word-bit expandability, parallel input, and output and chip enable. Access time is 65 ns and fanout current is 20 mA.

At 25°C, total operating power for the memory is only 400 mW. By using the enable feature, power dissipation for a PROM not in use can be reduced to approximately 250 mW. Average dissipation can be decreased even further by employing power strobing.

The circuit itself contains a six-bit decode address and a 512-bit memory matrix organized as 64 eight-bit words.

CIRCLE NO. 251

Time interval measurements like you've never seen before.

Plug the HP 5379A Time Interval Unit into the HP 5360A Computing Counter and things happen faster than they could ever happen before.

This unique combination resolves time intervals to 100 picoseconds. With absolute accuracy of 1 nanosecond. And you can measure zero, positive and negative intervals, which makes it ideal for checking coincidence.

By adding the HP 5375A Keyboard, you can enter programs to produce instantaneous answers about phenomena that you could never previously measure with a counter. Things like peak-to-peak jitter; rms jitter; phase measurements; duty cycle; and radar ranging in feet,

inches, meters or any other units you want.

Thanks to the 5379A, dozens of jobs can be handled easily and accurately. These include calibration of radar, lasers, and laboratory instruments; testing semi-conductors and computers; cable fault location; delay line adjustment; ballistic and nuclear measurements.

It does all this while saving you the cost of a computer, because the computer's built in. And you're not buying a counter that only measures time interval. You're getting the most advanced frequency measuring system available today, ideal for measuring pulses, pulse trains or any time-based events.

The cost is \$750 for the plug-in and

\$6500 for the mainframe. Your local HP field engineer will be glad to arrange a demonstration. Give him a call. Or write for complete information to Hewlett-Packard, Palo Alto, California 94304; Europe: 1217 Meyrin-Geneva, Switzerland.

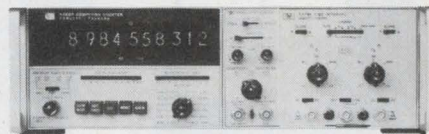

HEWLETT *hp* PACKARD

ELECTRONIC COUNTERS

02920



Quality product of Sigmund Cohn.

**SOLVE YOUR
POTENTIOMETER WIRE
PROBLEMS...
SIMPLE AS**

L
Temperature
T
C
Coefficient
of Resistance

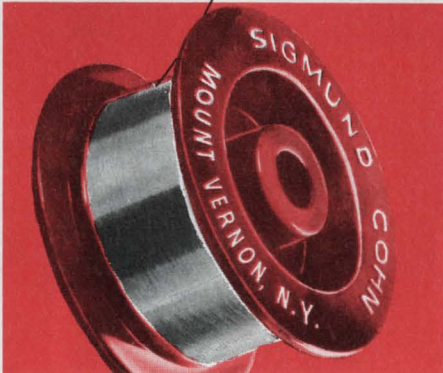

"L.T.C." Trademark/Patented

Developed exclusively by Sigmund Cohn research and produced, under rigid quality control, in our plant. Tests prove that L.T.C. Gold Alloy Potentiometer Wire has long life expectancy (million cycles +), extremely low noise level and high tensile strength. It is uniform, winds easily and is very corrosion-resistant. Write for Latest Engineering Data.

Resistivity	550 per cmf.
Temperature Coefficient of Resistance	20 ppm
Tensile Strength	200,000 psi (nom.)
Composition	65% GOLD; Nickel; Chromium

SIGMUND COHN CORP.,

121 So. Columbus Ave.
Mount Vernon, N.Y. 10553
(914) 664-5300



INFORMATION RETRIEVAL NUMBER 81

AM/FM demodulators use phase-locked loop

Signetics International Corp., Hamill Toms Public Relations S.A., 115, Rue Defacqz-1050 Brussels, Belgium. Price: \$18 or \$22.

Two new linear integrated circuits, which employ a phase-locked loop, can precisely duplicate the frequency of a signal and can demodulate FM and AM signals without tuned circuits. Models NE 560b and NE 561b operate over the frequency range of 1 Hz to 30 MHz. Their lock range is adjustable from ± 1 to $\pm 15\%$; input voltages can be 100 μ V to 1 V.

CIRCLE NO. 252

Multiplier chip sells for just \$18

Fairchild Semiconductor, 313 Fairchild Dr., Mountain View, Calif. Phone: (415) 962-3563. Price: \$18.

Able to perform multiplication, squaring and division functions, the μ A795C four-quadrant analog multiplier costs only \$18 in single-unit quantities and only \$12 in 100 to 999-unit lots. This monolithic circuit offers an input voltage range of ± 10 V, and operates a bandwidth of dc to 3 MHz with a typical error of less than 1% full scale.

CIRCLE NO. 253

MOS logic ICs ignore noise

Plessey Company Ltd. Components Group, Cheney Manor, Swindon, Wiltshire, England.

A new family of MOS logic circuits, series MP100, are said to offer a high degree of noise immunity. The devices are primarily intended for general industrial applications and as peripherals to, or breadboarding elements for, complex systems and subsystems. Each logic input has a protection device incorporated on the chip, making special handling precautions unnecessary.

CIRCLE NO. 254

Monolithic regulators dissipate up to 5 W

General Electric Co., Corporations Park, Scotia, N.Y. P&A: \$4 or \$4.50; 30 days.

Two new monolithic integrated circuit voltage regulators are capable of 5-W power dissipation over a wide range of input voltages and current levels. The PA264 has a maximum voltage rating of 25 V, while the PA265 is rated at 37 V maximum. Both units are housed in a plastic package with eight staggered leads and two heat-sink tabs. Output voltages can be as low as 3 V.

CIRCLE NO. 255

Trimmed amplifier slews at 1.4 V/ μ s

Sprague Electric Co., Marshall St., North Adams, Mass. Phone: (413) 664-4411.

A new high-speed operational amplifier contains a built-in trimming resistor to ensure a slew rate of 1.4 V/ μ s in voltage-follower configurations. Two versions are available: the ULS-2139D for operation from -55 to $+125^\circ\text{C}$ and the ULN-2139D for operation from 0 to 75°C . Offset current is 60 nA, and minimum large-power bandwidth is 20 V pk-pk at 20 kHz.

CIRCLE NO. 256

Monolithic circuit is full sound system

RCA/Electronic Components, 415 S. Fifth St., Harrison, N.J. Phone: (201) 485-3900.

Developed primarily for use as a television sound system, a new integrated circuit contains: a multi-stage i-f amplifier/limiter, FM differential peak detector, electronic attenuator, zener-diode-regulated power supply, and an audio amplifier/driver that can directly drive an npn transistor or a high-transconductance electron tube. Volume control for the CA3065 is implemented by varying the attenuator bias levels.

CIRCLE NO. 257

Low-cost 100- μ W op amp holds bias to 3 nA

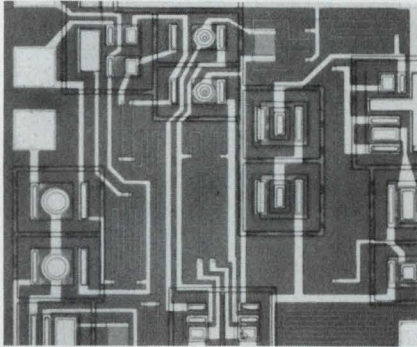

Qualidyne Corp., 3699 Tahoe Way, Santa Clara, Calif. Phone: (408) 738-0120. Price: \$15, \$12, \$9.60 per 100.

Featuring a high input impedance of greater than 10 M Ω and low input bias current of only 3 nA is the new model QC1735 low-cost micropower operational amplifier.

Key features of this new unit are a low quiescent power consumption of less than 100 μ W with the use of a \pm 3-V supply, a wide range of operations up to \pm 18 V, and an input bias current of 3 nA with a 1-nA offset.

These features were made possible through the use of two state-of-the-art processes.

One process is the use of high-gain low-noise transistors that operate with collector currents that are below 1 μ A.

The other process is the use of a proprietary thin film on a silicon resistor network. This allows the processing of many wafers at once and thereby reduces the cost per wafer.

The new amplifier exhibits a stable performance over a wide range of temperatures and has good common-mode and power supply rejection.

Three versions are available: one (QC1735) operates in the military temperature range of -55 to $+125^\circ\text{C}$; another (QC1735B) is an airborne version that operates from -20 to $+85^\circ\text{C}$; and a third (QC1735C) is a regular version operating from 0 to 70°C .

Prices for the military, airborne and regular versions are, respectively, \$15, \$12 and \$9.60 per 100.

CIRCLE NO. 258

The inside story on reed relay RELIABILITY

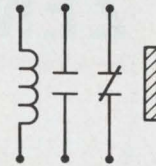

This is a diagram of our Life Qualified A + B (timed) Relay Package...

and this graph shows why it's superior to True Form C "Break-Before-Make" relays.

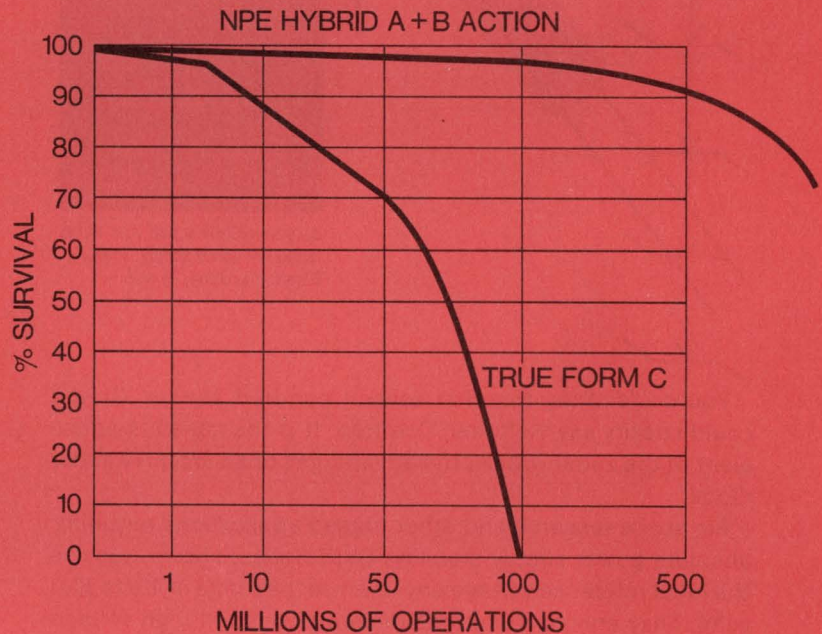

Data was compiled on our DATALOGER, an NPE designed and engineered switch-testing device. Because relay reliability starts with switch reliability, all NPE switches are 100% tested for "sticking" and voltage drop at a variety of load levels before being released for delivery.

Write for DATALOGER data on NPE's complete line of reliable reed relays.



NEW PRODUCT ENGINEERING, INC.
First and Webster Streets
Wabash, Indiana 46992

A Subsidiary of Wabash Magnetics, Inc.

NEED A
**10,000 VOLT
ZENER DIODE?**

PHOTO-MULTIPLIER POWER SUPPLY

GRD +12V HV ADJ.

A 10 9 8 7 6 5 4 3 2 1 C

Corotron 3000V actual size: Photo-multiplier power supply, showing Corotron location, $\frac{1}{3}$ size.

You could string together several hundred zeners. Or you could specify *one* Victoreen Corotron. It is the gaseous equivalent of the zener with all the advantages of an *ideal* HV zener diode.

For space research and other rugged applications requiring absolute power supply stability, GV3S Series, shown, provide the ideal reference voltage anywhere in the range of 400 to 3000 volts. They enable circuitry to maintain constant high voltage regardless of battery source voltage or load current variations. Cubage and weight (GV3S Corotron weighs only 4 gm.) are important considerations. So is temperature variation (Corotrons operate from 200°C down to -65°C). Ruggedized versions withstand shock to 2000 G, vibration 10 to 2000 cps.

If you're trying to simplify circuits . . . to cut cost, size and weight . . . to upgrade performance—you need Corotron high voltage regulators. Models are available now from 400 to 30,000 volts. A consultation with our Applications Engineering Dept. will speed up the countdown.

DMA 525



VICTOREEN INSTRUMENT DIV. of VLN
10101 WOODLAND AVENUE • CLEVELAND, OHIO 44104
 EUROPE: ARNDAL HOUSE, THE PRECINCT, EGHAM, SURREY, ENGLAND • TEL: EGHAM 4887

**Up/down counters
trim price tags**

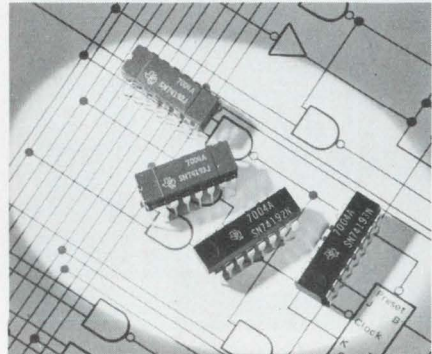

Texas Instruments, Inc., Components Group, P.O. Box 5012, Dallas, Tex. Phone: (214) 238-2011. P&A: \$7.70 to \$26.31; 3 wks.

Ranging in price from \$7.70 to \$26.31, two new TTL MSI synchronous up/down counters offer a complexity of 55 equivalent gates. Model SN54/74192 is a 4-bit binary counter, while model SN54/74193 is a binary-coded decimal (BCD) counter. Both units can be cascaded without the need for external circuitry. Power dissipation is 325 mW.

CIRCLE NO. 259

**Hybrid d/a converter
works 6 bits for \$75**

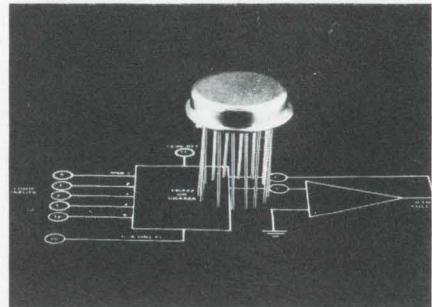

Crystalonics, a Teledyne Co., 147 Sherman St., Cambridge, Mass. Phone: (617) 491-1670. P&A: \$75; stock.

Costing only \$75, a new six-bit hybrid d/a converter is a complete circuit with a ladder network and switching system. The model CDAS2/A converter operates directly from logic, and features a typical 1- μ s settling time over the full military temperature range of -55 to +125°C. The unit's maximum error is 1% of full scale.

CIRCLE NO. 260

Fast number converter uses read-only memory

Motorola Semiconductor Products Inc., P.O. Box 20924, Phoenix, Ariz. Phone: (602) 273-6900. P&A: \$5.60; stock.

Employing a 128-bit read-only memory, a new binary-to-BCD/BCD-to-binary number converter allows the building of very-short-conversion-time systems—for example, 12 bits of binary data can be converted to BCD information in only 400 ns. Conversion of any-length binary or BCD words can be accomplished by interconnecting these type MC4001 packages.

CIRCLE NO. 261

Triple amplifier draws only 5.4 mW

Kinetic Technology Inc., 3393 De La Cruz Boulevard, Santa Clara, Calif. Price: \$6.

Containing three fully compensated operational amplifiers on a single chip, a new integrated circuit needs only 5.4 mW of power at ± 15 V from dc to 10 kHz. Model KA-10 triple amplifier has a maximum voltage gain of 86 dB at ± 15 V, a slew rate of 0.3 V/ μ s, and an input voltage range of ± 2 to ± 12 V. It is a general-purpose device that is housed in a 12-lead TO-101 package.

CIRCLE NO. 262

Monolithic amplifier holds offset to 0.5 nA

Intersil Inc., 10900 N. Tantau Ave., Cupertino, Calif. Phone: (408) 257-5450. P&A: \$9.60; stock.

Model ICB8008C monolithic operational amplifier features a typical input bias current of 3 nA and an input offset current of 0.5 nA. The device has total short-circuit protection, internal compensation, high common-mode voltage range and the advantages of no latch-up. Applications include integrators, voltage followers, and sample-and-hold circuits.

CIRCLE NO. 263

IC memory chip accesses in 40 ns

Computer Microtechnology Inc., 610 Pastoria, Sunnyvale, Calif. Phone: (408) 736-0300. P&A: \$74; 1 wk.

The CM 2100 64-bit random-access integrated-circuit memory has a typical read access time of 40 ns and a typical power dissipation of 360 mW. The unit's outputs offer both DTL and TTL compatibility and can drive ten unit loads. Input clamp diodes provide minimum line ringing, and operating temperature range is 0 to 75°C. The memory comes in a 16-lead DIP.

CIRCLE NO. 264

Sense amplifier has dual inputs

Qualidyne Corp., 3699 Tahoe Way, Santa Clara, Calif. Phone: (408) 738-0120. P&A: \$5.75; stock.

Intended for use between core memories and TTL circuits, the 1541-1441 interface sense amplifier is a dual-channel gated device with dual differential input amplifiers and a single gate output that is compatible with DTL and TTL levels. The unit's input threshold, which is normally 17 mV, can be adjusted from 10 to 25 mV. Typical input offset voltage is 1 mV and propagation delay is less than 20 ns from input to gate output.

CIRCLE NO. 265

Read-only memory stores 256 bits

Sylvania Electric Products Inc., Semiconductor Div., 1100 Main St., Buffalo, N.Y.

A new monolithic TTL-compatible 256-bit read-only memory is capable of storing up to 32 eight-bit words. Model SM320 achieves on-chip full-address decoding with a five-input address code that allows random selection of any of the 32 words stored. A chip-enable line allows individual package selection when the outputs are OR-wired.

CIRCLE NO. 266

INFORMATION RETRIEVAL NUMBER 84 ►

The big difference between chip capacitors and our 505 series

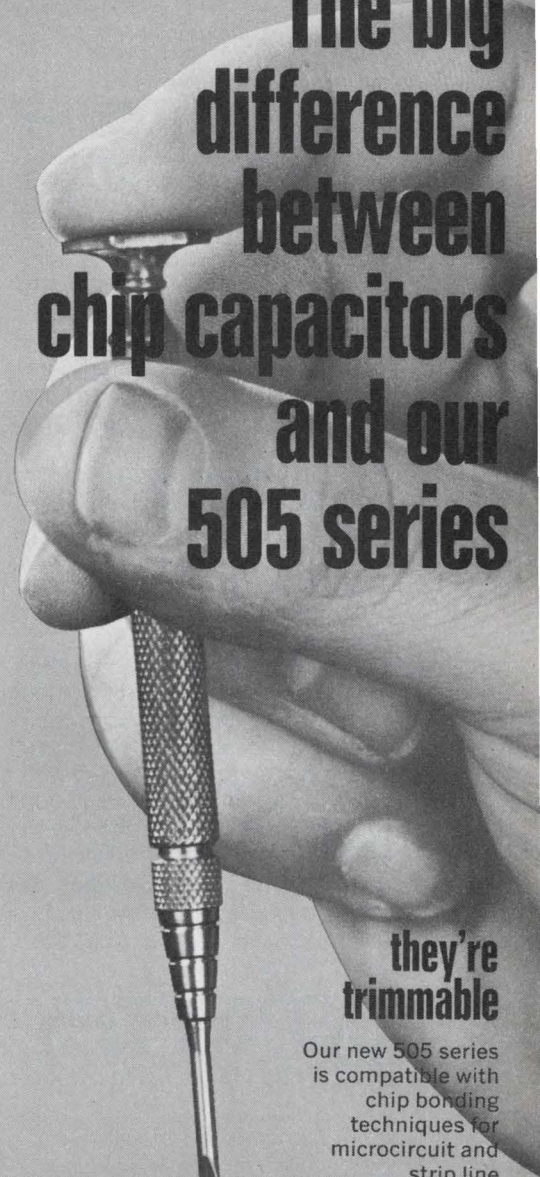

they're trimmable

Our new 505 series is compatible with chip bonding techniques for microcircuit and strip line applications... and they're trimmable in ranges from .1 to 100 pF!

But trimmability is only one of the plus advantages of this new series, they feature high Q (self-resonant into X band), ΔC 's of 1 to 15 pF, and low temperature coefficients (0 ± 20 PPM/ $^{\circ}$ C).

When your application calls for high Q chips, be sure to check the 505 series, they do everything a chip does — plus. Send today for full details.

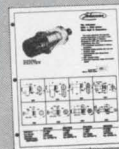

Johanson

MANUFACTURING CORPORATION

400 Rockaway Valley Road, Boonton, N.J. 07005
(201) 334-2676 TELEX: 13-6432

Uncommonly good sense

from our Tachometer Generators. They're temperature-compensated, miniaturized, and perfect for precision indicators and velocity servos requiring a highly linear speed/voltage relationship with minimum ripple. Linearity from 0 to 12,000 rpm is better than 1/10 of 1% of voltage output at 3600 rpm. The ripple value will not exceed 3% rms of the D-C value at any speed in excess of 100 rpm. The low-driving torque makes them excellent as damping or rate signals in all types of servos. Brushes and commutators are guaranteed for 100,000 hours of operation — more than ten years — at 3600 rpm. Various models are available with outputs as high as 45v/1000 rpm and can be supplied with an indicator as a complete Speed Indicating System.

SERVO-TEK PRODUCTS COMPANY
1086 Goffle Road, Hawthorne, New Jersey 07506.

SERVO-TEK
PRODUCTS COMPANY

For full technical details
write for Catalog 1163
with Test Report
and show
good sense.



MODULES & SUBASSEMBLIES

Trimmed chopperless op amp minimizes drift to $0.25 \mu\text{V}/^\circ\text{C}$

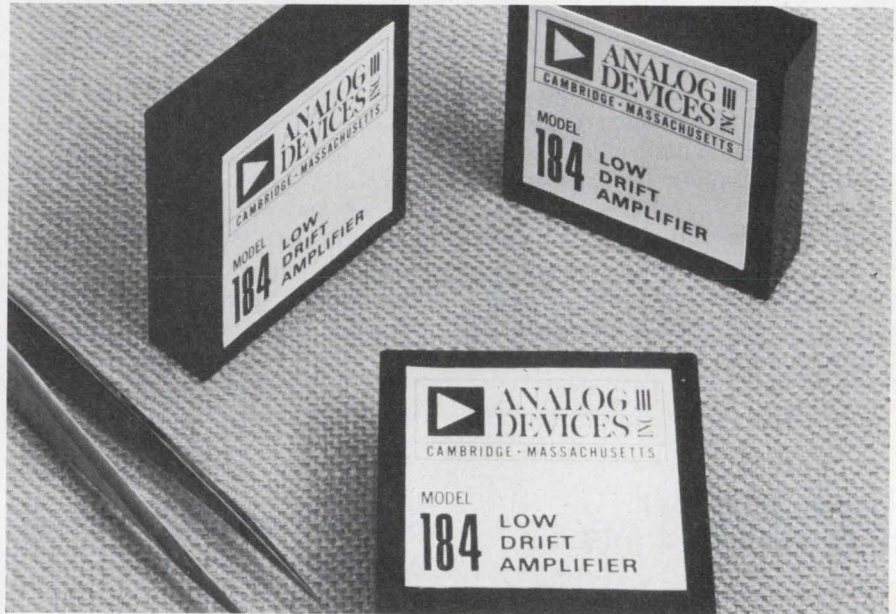

Analog Devices, Inc., 221 5th St., Cambridge, Mass. Phone: (617) 492-6000. P&A: \$45, \$60, \$75; stock.

A maximum voltage drift of only $0.25 \mu\text{V}/^\circ\text{C}$ and maximum initial offset voltage of $100 \mu\text{V}$ in a low-cost operational amplifier without chopper stabilization? Yes, it's true, with the new model 184L ultrastable amplifier.

It uses a newly developed dual monolithic transistor pair for the input stage to achieve ultra-stable performance features.

With a long-term drift of only $5 \mu\text{V}/\text{month}$, the unit features all the attributes of a chopper-stabilized amplifier without its limitations.

The low offset voltage of $100 \mu\text{V}$, which until now was only possible with a chopper-stabilized amplifier, means that the user need not perform any input voltage trimming.

Another important virtue of the model 184L is its low noise of $1 \mu\text{V}/^\circ\text{C}$ for the frequency range of 0.01 to 1 Hz. This is principally due to the absence of a chopper which causes intermodulation problems.

The unit can be used in differential non-inverting as well as

inverting circuit configurations. With chopper-stabilized amplifiers, only inverting modes could be used since one of the input terminals must be grounded.

Other important characteristics are a maximum bias current of 25 nA and a maximum bias-current drift of $0.25 \text{ nA}/^\circ\text{C}$. Offset current is 2 nA maximum and offset-current drift is $0.02 \text{ nA}/^\circ\text{C}$ maximum.

Dc gain is 300,000 and bandwidth is 500 kHz. Common-mode rejection is 100,000 and output rating is $\pm 10 \text{ V}$ at 5 mA.

Three amplifier versions are available: the models 184J, 184K and 184L with unit prices of \$45, \$60 and \$75, respectively.

The model 184J has an offset voltage of $250 \mu\text{V}$ and a voltage drift of $1.5 \mu\text{V}/^\circ\text{C}$. The model 184K has a voltage drift of $0.5 \mu\text{V}/^\circ\text{C}$. Otherwise, the performances of the three versions are identical.

All units measure 1.5-in. square by 0.4-in. high and are epoxy encapsulated.

Typical applications include use in null detectors for bridge measurements, strain gauges and thermistors.

CIRCLE NO. 267

Tiny SCR crowbars pass up to 10 A

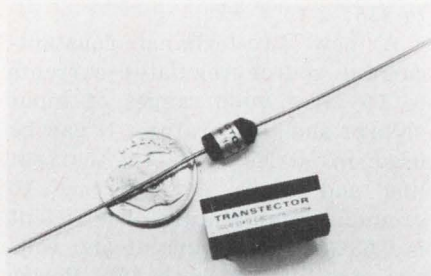

Transtector Systems, div. of M & T Chemicals Inc., sub. of American Can Co., 1161 Monterey Pass Rd., Monterey Park, Calif. Phone: (213) 264-0800. Availability: stock.

Housed in dual-in-line or DO-27 diode packages, a line of subminiature hybrid SCR crowbar circuits feature operating current levels as high as 10 A. They are capable of deflecting several million overvoltage transients. Standard overvoltage trip points range from 5 to 200 V dc.

CIRCLE NO. 268

High-speed op amp reaches 0.1% in 60 ns

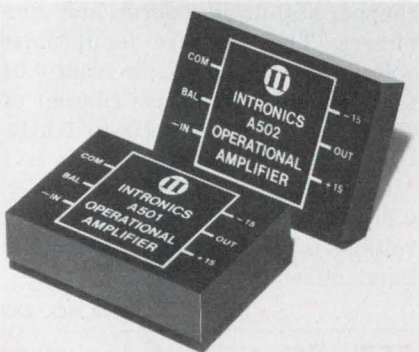

Intronics, 57 Chapel St., Newton, Mass. Phone: (617) 332-7350. P&A: \$125; stock.

Exhibiting extremely high-speed performance for high-frequency inverting applications, a new operational amplifier offers a slew rate of 100 V/ μ s, a 100-MHz gain-bandwidth product, and a settling time of 0.1% of 60 ns. Model A502 can drive loads as large as ± 50 mA at ± 10 V. It operates over a temperature range of -25 to $+85^\circ\text{C}$.

CIRCLE NO. 269

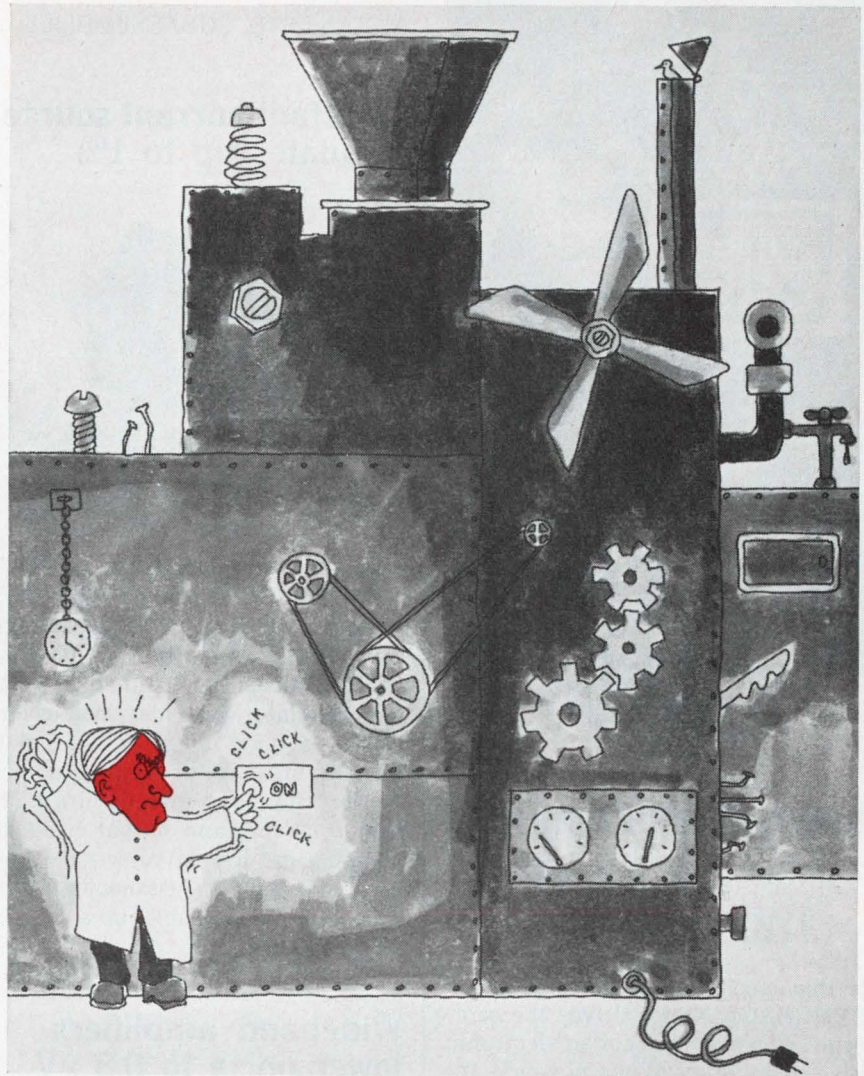

You invent it. We'll supply the custom rubber parts.

Big deal? Yes! If you're faced with a special design or performance problem, you can look to Stalwart for valuable assistance from prototype development to production volume. You see, Stalwart has nearly 50 years experience in compounding all types of elastomers. Three modern plants to serve you. And great quality control teams to make sure that your rubber parts meet the most exacting specifications. That's why our molded, extruded, calendered and specially-fabricated rubber parts are specified by leading manufacturers in virtually every phase of industry. Write today for your copy of the 18-page "Stalwart Rubber Selector."

SR

Stalwart Rubber Company

Bedford, Ohio 44146 Subsidiary of Blasius Industries, Inc.

INFORMATION RETRIEVAL NUMBER 86

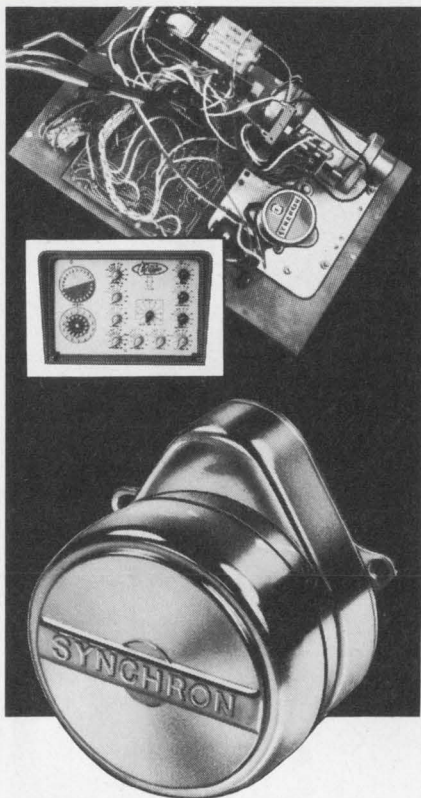

HOW SYNCHRON® MOTORS control this specialized TIME-DELAY RELAY

In this special design timer a Hansen SYNCHRON Motor drives the cam-type sequence timer for an electronic time-delay relay. When power is applied, SYNCHRON runs through the first three sequences; starts the time-delay relay, then stops. Relay performs a panel-adjustable delay period of 180-240 seconds, then returns power to the motor to complete the sequence. Special applications are easy to design, using SYNCHRON Motors. How about yours? Call or write Hansen, or your SYNCHRON representative, for brochure and all the facts.

SYNCHRON timing and control motors; 168 different speeds. Right, left or reversible rotations. 8, 20 or 30 oz.-in. torques; 220, 110 or 24 volts; 60, 50 or 25 cycles.

HANSEN

Manufacturing Co., Inc., Princeton, Ind. 47570

HANSEN REPRESENTATIVES: CAREY & ASSOCIATES, Houston and Dallas, Texas; R. S. HOPKINS CO., Sherman Oaks, Calif.; MELCHIOR ASSOCIATES, INC., San Carlos, Calif.; THE FROMM CO., Elmwood Park, Ill.; JOHN ORR ASSOCIATES, Grand Rapids, Mich.; H. C. JOHNSON AGENCY, INC., Rochester, N.Y.; WINSLOW ELECTRIC CO., Essex, Conn., Villanova, Pa., and New York, N.Y.

EXPORT DEPARTMENT: 2200 Shames Drive, Westbury, N.Y. 11590

INFORMATION RETRIEVAL NUMBER 87

MODULES & SUBASSEMBLIES

Constant-current source regulates up to 1%

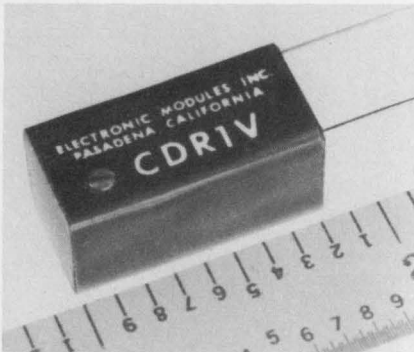

Quantum Devices Corp., 15 W. Main St., Bergenfield, N.J.

Featuring an output-voltage temperature stability of 0.01%/°C, the model VR401 hybrid voltage regulator provides load regulation of 0.5% at ± 15 V from 0 to 100 mA. Input voltage is 18 V dc. Standby current drain is held to 3 mA and output noise is 60 μ V rms. Ripple rejection is 60 dB and output impedance is 0.1 Ω . The unit is available in a 0.7x5x0.7-in. dual-in-line case.

CIRCLE NO. 271

Wideband amplifiers lower noise to 0.8 μ V

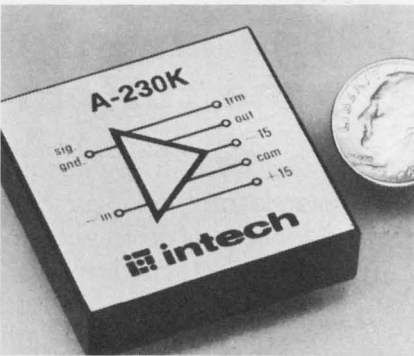

GPS Corp., 14 Burr St., Framingham, Mass. Phone: (617) 875-0607. Price: \$60.

Model 803 is a high-performance low-cost FET differential operational amplifier with a bias current of less than 15 pA and an input impedance of 10^{11} Ω . It exhibits exceptionally high stability and features an offset temperature coefficient of 10 μ V/°C, a slewing rate of 10 V/ μ s and a 20-mA output. The unit can drive high-capacitance loads without instability.

CIRCLE NO. 273

Electronic Modules, Inc., 2560 E. Foothill Blvd., Pasadena, Calif. Phone: (213) 795-4231. P&A: \$30 to \$45; 2 to 3 wks.

A new two-terminal constant-current source regulates currents to 1% over wide ranges of input voltage and temperature. It can be used in series with the current line and needs no reference to ground. Temperature coefficient is 0.03%/°C and current and voltage stability are both 1%. Power dissipation ranges from 1 to 3 W.

CIRCLE NO. 270

DIP hybrid voltage unit regulates load to 0.5%

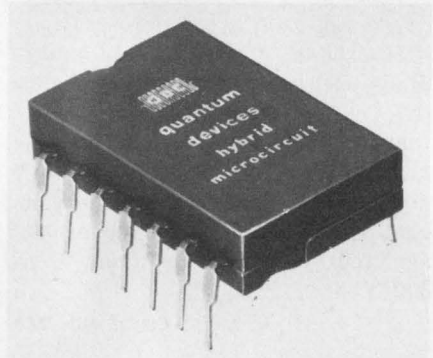

Intech Inc., 1229 Coleman Ave., Santa Clara, Calif. Phone: (408) 244-0500. Price: \$85 to \$125.

The series A-230 are low-noise chopper-stabilized operational amplifiers. They feature minimum input noise voltage of 0.8 μ V pk-pk from 0.01 to 1 Hz and input noise current of 35 pA pk-pk from 10 Hz to 1 kHz. Unity-gain frequency response is 1 MHz and supply rejection ratio is 0.1 μ V/V. Maximum input offset voltage is ± 15 μ V, and maximum input offset drift is 0.25 μ V/°C.

CIRCLE NO. 272

FET differential op amp gives 15-pA bias current

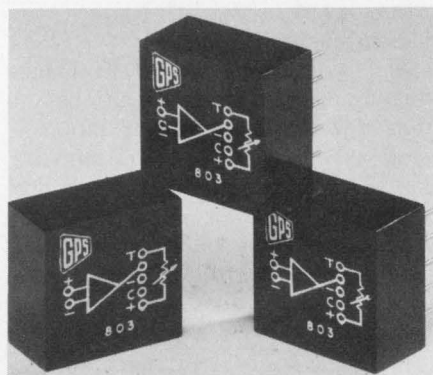

ELECTRONIC DESIGN 10, May 10, 1970

CTS TRIMS CERMET INDUSTRIAL TRIMMER PRICES TO

50¢

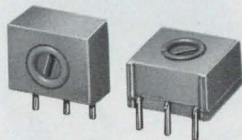

- 50¢ each in 50,000 quantity
- 65¢ each in 1,000 quantity
- \$1.14 each in 100 quantity

for ±20% Tolerance (Add 4¢ for 10% tolerance)

Series 360 single-turn cermet industrial trimmers provide...

- **Setability ±.03%**
- **Environmental performance requirements of characteristic C of MIL-R-22097D**
- ... plus!
 - 1.5% average equivalent noise resistance
 - 0.5% average contact resistance variation
 - Compact, single-turn design
- Top or side adjust
- ½ watt @70° C
- Tolerance to ±5%
- TC ±150 ppm/°C available at no extra cost over most of the resistance range.

Your CTS Distributor will have both styles in stock for fast, prototype delivery. Production quantities to you in 4 weeks.

See your distributor... call your CTS sales engineer... or write for complete data. We'll respond quickly. CTS of Berne, Inc., Berne, Indiana 46711. Phone: (219) 589-3111.

CTS CORPORATION
Elkhart, Indiana



Interactive terminal displays and copies

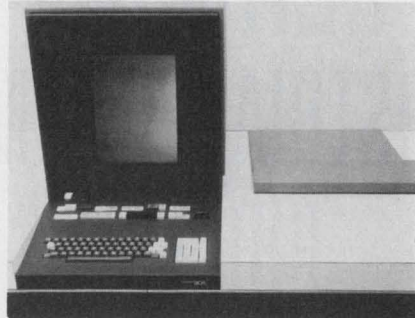

Corning Data Systems, Corning Glass Works, 3900 Electronics Dr., Raleigh, N.C. Price: \$19,650 or \$670/month.

Offering both graphic and alphanumeric display, a new time-sharing computer terminal features a built-in system for making electrostatic hard copy, and a system for superimposing slide data over computer-generated information. The heart of the 904 is a storage photochromic-glass CRT, which darkens when exposed to ultraviolet light and erases (regains transparency) when exposed to red light.

CIRCLE NO. 274

Computer terminal is portable system



Logitron, Inc., 197 Albany St., Cambridge, Mass. P&A: \$3000; 60 days.

Weighing approximately 25 pounds and packaged in a convenient case with a retractable CRT display, the Logiport/1 remote stand-alone computer terminal includes a complete standard alphanumeric keyboard and an integral acoustic coupler. It can be easily carried about and plugged into the ac line. The unit can transmit 10 or 30 characters per second.

CIRCLE NO. 275

Portable CRT terminal shows 1024 characters

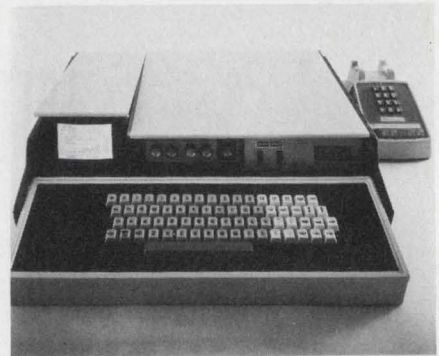

Applied Digital Data Systems, Inc., 89 Marcus Blvd., Hauppauge, N.Y. Phone: (516) 273-7799. P&A: \$3200 or \$3700; 90 days.

Featuring complete editing and formatting capabilities, a new portable CRT terminal can display up to 1024 alphanumeric characters. Operating the Envoy is simple. The user plugs it into an ordinary outlet, folds out the keyboard, pops up the screen, inserts a standard telephone into the built-in acoustic coupler and dials his computing center.

CIRCLE NO. 276

Desktop calculators program 1984 steps



Wang Laboratories, Inc., 836 North St., Tewksbury, Mass. Phone: (617) 851-7311. P&A: \$6700 or \$6800; 6 months.

The 720A and 720B are programmable desktop calculators that have a capacity of 1984 program steps or 248 data storage registers. Each machine can accommodate five levels or five nested subroutines. The units can remember up to five addresses when a subroutine within a subroutine occurs. Actual core memory storage is 16,384 bits.

CIRCLE NO. 277

VITREOSIL[®] PURE FUSED QUARTZ CLOTH

offers the design engineer a combination of extreme heat resistance, exceptionally low coefficient of thermal expansion and excellent dielectric properties for plastic reinforcement, screening and filtration of molten, non-ferrous metals, high temperature gases and liquids. Also available are Vitreosil Quartz mat and wool of extremely fine diameter fibers which provide excellent thermal insulation barriers (to 2000° F. indefinitely with no degradation).



THERMAL AMERICAN
FUSED QUARTZ CO.
RT. 202 & CHANGE BRIDGE RD.
MONTVILLE, NEW JERSEY
ZIP CODE 07045

74

Digital 16-bit computer has two memory types

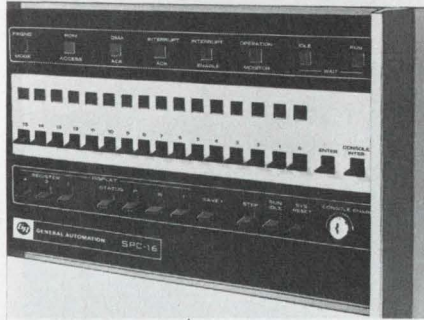

General Automation, Inc., 706 W. Katella Ave., Orange, Calif. Phone: (714) 633-1090. Price: from \$10,000.

Capable of either on-line or off-line operation, the SPC-16 16-bit computer provides up to 64 hardware priority interrupts, and incorporates completely interchangeable read-only and read/write memories, as well as 16 general-purpose registers. A set of base-relative/program-relative instructions allows full advantage to be taken of both memory types.

CIRCLE NO. 278

MSI minicomputer cycles in 750 ns



Varian Data Machines, a Varian subsidiary, 2722 Michelson Drive, Irvine, Calif. Phone: (714) 833-2400.

Incorporating state-of-the-art planar memories, MSI circuitry, and high-speed I/O transfers, the 620/f minicomputer boasts a cycle time of only 750 ns. Besides speed, this new computer also provides an extended set of instructions. Another feature is a priority memory access mode that permits asynchronous data transfers at rates to 1.3 MHz.

CIRCLE NO. 279

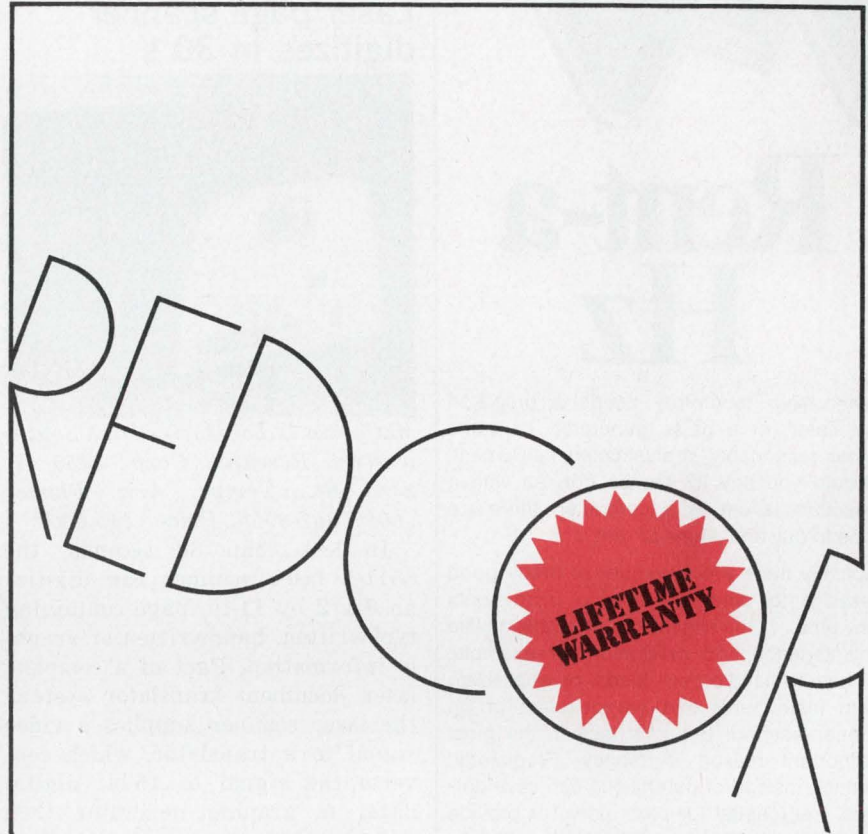

Our Red Badge of Courage

A new standard for the industry: Redcor Modules, Instruments, and IC Tester are warranted forever. Return them and we'll repair or replace them in 10 days.

R REDCOR CORPORATION
C Telephone: (213) 348-5892

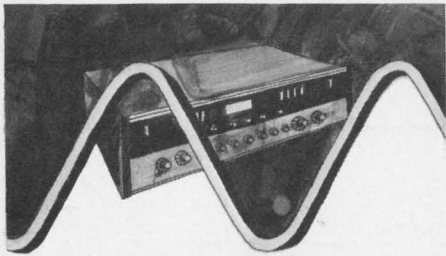

Rent-a Hz

When your laboratory needs a precision oscillator, or a pulse generator, or some other reasonably sophisticated instrument, should you buy it? Maybe not. As with a house or a car or a computer, there's a time to buy and a time to rent.

Actually there are a number of pretty good reasons for renting precision instruments any time . . . the elimination of problems like maintenance and calibration for example, or how to handle peak loads, or what to do with instruments that are obsolete or no longer needed. But let's face it, the most important reason is money. Frequently, renting instead of purchasing can save dollars, free capital for other uses, or provide financial advantages in other ways. So before you pay till it Hz, think RENTAL.

R.E.I. can give you the fastest service, the widest selection and the lowest rates of any rental firm in the country. One of our inventory centers is located near you, wherever you are, for instant delivery. Let us tell you more about the many advantages of renting vs. buying. Send today for your free copy of the new R.E.I. Instrument Rental Handbook.

Amplifiers	Filters	Power Supplies
Analyzers	Generators	Recorders
Attenuators	Meters	Sources
Bridges	Oscillators	Stroboscopes
Cameras	Oscilloscopes	Synthesizers
Counters	Plug-In Units	Test Chambers
Detectors	Generator/Synchronizer	

INSTANT INSTRUMENTS FROM THESE INVENTORY CENTERS:

Waltham, Mass. 02154
69 Hickory Drive
(617) 891-7610—Telex 923472

Anaheim, Calif. 92801
159 East Freedom Ave.
(714) 879-0561—Telex 655473

Gaithersburg, Md. 20760
16600 Oakmont Ave.
(301) 948-0620—Telex 898446

Rosemont, Ill. 60018
5607 Pearl St.
(312) 671-2464—Telex 726488

Ft. Lauderdale, Fla. 33308
4808 N.E. 10th Ave.
(305) 771-3500—Telex 51-4467

MORE INVENTORY CENTERS
COMING SOON



Rental Electronics inc.

A PEPSICO LEASING COMPANY

INFORMATION RETRIEVAL NUMBER 91

DATA PROCESSING

Laser page scanner digitizes in 30 s

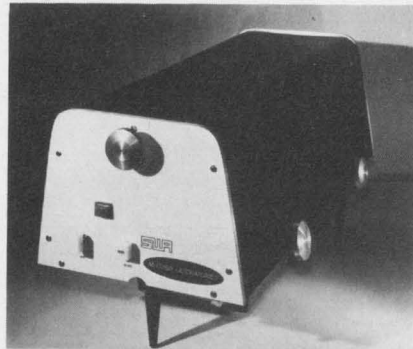

McCowan Laboratories Div., Southwestern Research Corp., 1155 W. 23rd St., Tempe, Ariz. Phone: (602) 967-8765. Price: \$15,000.

In less than 30 seconds, the 8511-1 laser scanner can digitize an 8-1/2 by 11-in. page containing typewritten, handwritten or graphic information. Part of a complete laser document translator system, the laser scanner supplies a video signal to a translator, which converts the signal to 16-bit digital data. A graphic generator then provides the necessary readout medium.

CIRCLE NO. 280

Audio response system is compatible with ICs

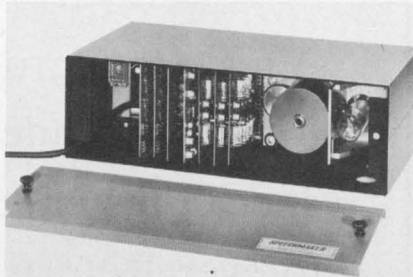

Cognitronics Corp., Speechmaker Div., 333 N. Bedford Rd., Mount Kisco, N.Y. Phone: (914) 666-2941.

Able to accept IC logic levels directly, Speechmaker 636 is a real-time audio response system that can interface with any commercial computer to give spoken answers in words, phrases or numbers to a request for information. It provides a direct and flexible means of machine-to-man speech communication. Vocabularies of up to 31 words can be stored in the unit.

CIRCLE NO. 281

Hard-copy peripherals print electrostatically

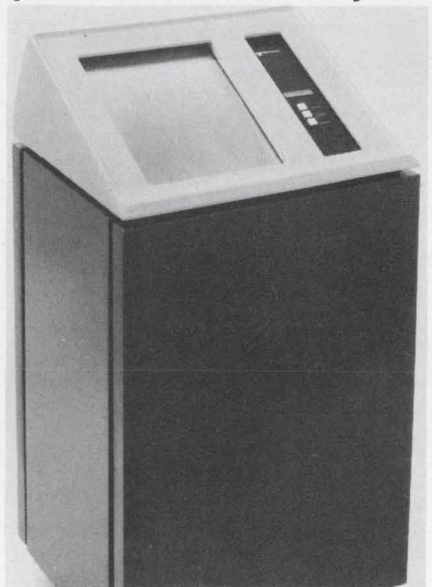

Versatec, Inc., 10100 Bubb Rd., Cupertino, Calif. Phone: (408) 257-9900. P&A: \$5500 to \$7900; June, 1970.

Six new hard-copy-output peripherals, the Matrix series, employ non-impact silent electrostatic printing. The Matrix 300 and Matrix 600 can put out 300 (400 characters per second) and 600 (800 characters per second) lines per minute, respectively. Matrix 100 and Matrix 200 are graphic output devices, Matrix 100A is a combination printer/plotter, and Matrix 200A is a combination of the 600 and 200 models.

CIRCLE NO. 282

Reel tape system packs 800 bits/in.

Wang Computer Products, Inc., 2000 Stoner Ave., Los Angeles, Calif. Phone: (213) 478-7727. P&A: \$3475; 30 days.

Emphasizing ease of use, the Mod 10 tape system can write or read IBM-compatible tapes at densities of 200, 556, or 800 bits per inch with phase-encoded 1600-bit-per-second operation optional. The unit incorporates automatic buffer arm retraction to reduce tape threading time to less than 10 seconds. It uses 0.5-in. tape on 10-1/2-in. or smaller reels.

CIRCLE NO. 283

Now you're down to no reasons not to buy **Fairchild trimming pots**

- QUALITY.** Better than MIL requirements
- PRICE.** Cost less
- DELIVERY.** Immediate

Fairchild trimming potentiometers meet — and in the most important ways exceed — MIL-R-22097C and 27208B requirements and they cost less to boot. And now these great wirewound and film trimmers are available *off-the-shelf*. That leaves no reasons not to call or wire Fairchild today for complete specs and prices.

Here are some of the many types available:

High resolution wirewounds. RT11 and RT12. Eighteen resistance ranges

from 10 ohms to 175K. Longer element for higher resolution, fewer parts, fewer connections, low noise, keeps performing in rigorous environmental conditions.

Infinite resolution Film pots®. RJ11 and RJ12. 18 resistance ranges in metal film from 10 ohms to 1 megohm. Low temperature coefficient you could get only in wirewounds before, circuit control 10 to 20 times better than wirewounds. Holds setting in extreme operating conditions. Low contact resistance

variation (noise in wire types). Low inductance lets you use Film pots in high frequency applications.

Commercial-industrial grade Film pots also available in 1/4" narrow rectangular, 3/4" rectangular, and 1/4" round. Also MIL grade 3/8" square RJ24C type.

See your Fairchild Controls representative or contact us at 5625 Kearny Villa Road, San Diego, California 92123. (714) 279-5600. Unless you like waiting. Or paying more.

FAIRCHILD
CONTROLS
A DIVISION OF FAIRCHILD CAMERA AND INSTRUMENT CORPORATION

SCHAUER

1%

tolerance

1 WATT ZENERS ARE A REAL BUY!

ANY voltage from 2.0 to 16.0 at the industry's **LOWEST PRICES!**

Quantity	Price each
1-99	\$1.07
100-499	.97
500-999	.91
1000-4999	.86
5000 up	.82



THE HI-RELIABLE!

No fragile nail heads. Silicon junction aligned between two, parallel, offset tantalum heat sinks . . . great lead tension strength. All welded and brazed assembly. High pressure molded package. Gold plated nickel-clad copper leads. Write or phone for Form 68-4 for complete rating data and other tolerance prices.

Semiconductor Division

**SCHAUER
MANUFACTURING
CORP.** 4511 Alpine Avenue
Cincinnati, O. 45242
Ph. (513) 791-3030

DATA PROCESSING

Microfilm station translates taped data

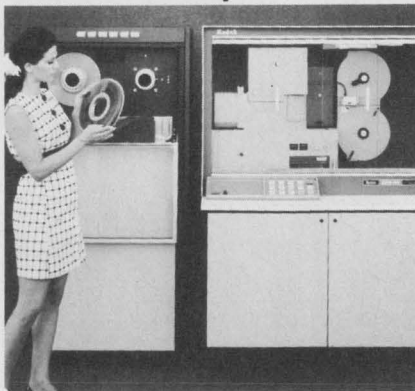

Eastman Kodak Co., Business Systems Markets Div., 343 State St., Rochester, N.Y. Phone: (716) 325-2000.

Converting taped information from computers into readily readable film images, KOM90 microfilmer processes up to 90,000 computer characters per second on to as many as 300 pages of man-readable information per minute. After decoding from tape, the microfilmer displays data on CRT. The displayed material is then photographed on 16-mm microfilm.

CIRCLE NO. 284

Multiplexer/coupler is interface terminal

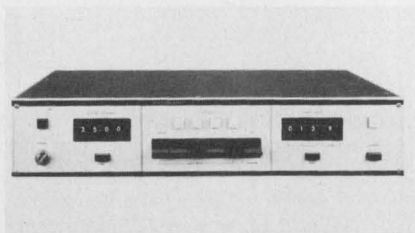

Eldorado Electrodata Corp., 601 Chalomar Rd., Concord, Calif. Phone: (415) 686-4200. Price: \$1350.

Designed for either on-line or off-line use, a new all-integrated-circuit multiplexer/coupler links digital instrumentation and computers, making it ideal for unattended data collection and reduction via a time-shared computer service. Model 5010 features a modular expandable configuration, selectable header control, word length and file length.

CIRCLE NO. 285

Data transfer systems go from key to cassette



International Computer Products, Inc., P.O. Box 34484, Dallas, Tex. Phone: (214) 239-5381.

Three new key-to-cassette data transfer systems include: the Key-Cette 1000, a duplex I/O system with tape-to-key and key-to-tape capability for read/write applications; the Key-Cette 1100, a data entry system for applications requiring write-only key-to-tape transfer; and the Key-Cette 1200 data logging system for read-only tape-to-key data transfer.

CIRCLE NO. 286

Digital plotter doubles surfaces

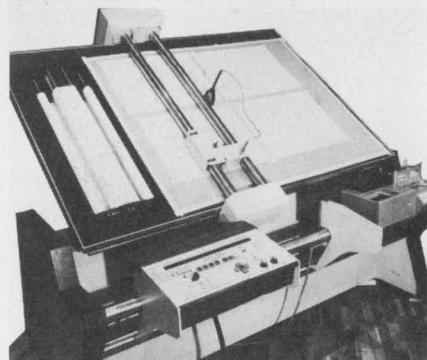

Auto-Trol Corp., 6621 W. 56th Ave., Arvada, Colo. Phone: (303) 421-5670. Price: \$35,000 to \$50,000.

Combining two plotting surfaces in the same machine—both flat bed and drum style—a new digital plotter can do straight-line drawing at any angle with a resolution of 0.0005 in. Model 6030 has a drawing speed of 10 inches per second. The sprocket on the drum is adjustable for varying paper widths from 11 to 36-in. wide.

CIRCLE NO. 287

Clip for DIP ICs shows logic with LEDs

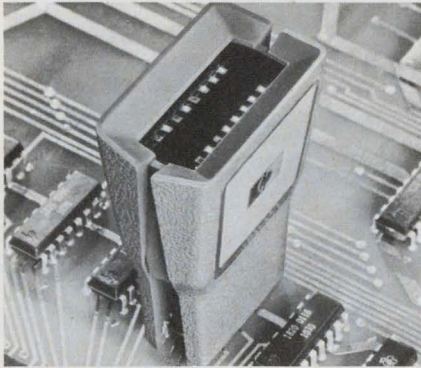

Hewlett-Packard, 1501 Page Mill Rd., Palo Alto, Calif. Phone: (415) 326-7000. P&A: \$95; stock.

Model 10528A logic clip is a troubleshooting device that clips onto DTL or TTL DIP ICs and displays the logic states of all 14 or 16 pins at the same time. The unit has 16 light-emitting diodes, each of which follows voltage-level changes of one pin; a lighted diode indicates a high logic state (5 V). The clip draws its power from the test circuit.

CIRCLE NO. 288

Auto-ranging counter displays with LEDs



Monsanto Electronic Instruments, 620 Passaic Ave., West Caldwell, N.J. Phone: (201) 228-3800. Price: \$1775.

Emphasizing solid-state reliability, the model 120A 150-MHz universal counter/timer uses MSI circuits for 60% of its components and light-emitting-diode numerics for its eight-digit display. All frequency and period measurements are automatically displayed with maximum resolution. The instrument can also operate in a pulse-burst mode.

CIRCLE NO. 289



the answer is yes!

Yes, you can get Digital Panel Meters on an **immediate delivery basis** from Datascan. Yes, immediate. We have 3½ digit in stock right now. The 4½ digit is on a two to four week cycle.

Yes, you can get the best specified DPM from Datascan . . . with features associated with more expensive DPM's.

Yes, you can get the 3½ digit for below \$150 in quantities of 100.

Yes, you can get the Bi-Polar 4½ digit for below \$300 in 100 quantities.

Yes, you can get A/D converters at prices starting at less than \$115 . . . and get them delivered two to four weeks.

Yes, we've tried to anticipate what you want . . . we're engineers too.



Write for complete information

Datascan

1111 Paulison Avenue, Clifton, N.J. 07013
Telephone 201-478-2800

**NEED
HIGH VOLTAGE
CAPACITORS
FAST?**

... Prompt Delivery -

NO!

... Immediate Delivery

YES!



GLASS
CONTAINERS



METAL CAN
CONTAINERS

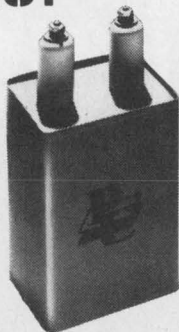

Our list of satisfied "blue chip" customers is growing and growing which necessitated a large expansion of our manufacturing and engineering facilities. Now, we can supply a complete range of voltages from 2,000 to 50,000 volt capacitors from our expanded "stock on hand". Don't take excuses, we'll supply you faster than at any time in our many years in the field—**BETTER PRODUCTION FROM US—BETTER DELIVERY FOR YOU!**

Write for complete list of Standard High Voltage Capacitors in stock—or, send specifications for custom quotations.



Plastic Capacitors, INC.

2620 N. Clybourn • Chicago 14, Ill.
DI 8-3735

INSTRUMENTATION

**VOM with 68 ranges
gauges capacitance**



Simpson Electric Co., div. of American Gage & Machine Co., 5200 W. Kinzie St., Chicago, Ill. Phone: (312) 379-1121. Price: \$230.

Powered by its self-contained battery supply, the 2795 solid-state FET-input multimeter offers 68 switch-selectable ranges: 13 ac and dc voltage ranges (as low as 1 mV full scale), 14 ac and dc current ranges (down to 1 μ A full scale), six resistance ranges (from 1 Ω to 100 k Ω), six capacitance ranges (from 1 nF to 100 μ F), two temperature ranges, and 12 output (dB) ranges.

CIRCLE NO. 290

**DIP IC tester
isolates malfunctions**

Innovation Development Co., P.O. Box 7, Azusa, Calif. Price: \$89.

Developed for remote testing of dual-in-line integrated circuits, the ICS-100 DIP tester allows the user to connect or isolate each IC pin in order to locate circuit malfunctions. The to-be-tested IC is removed from its in-circuit socket and plugged directly into the testing instrument. This provides for component isolation and also permits the monitoring of individual parameters.

CIRCLE NO. 291

**Battery-powered VOM
includes auto-polarity**

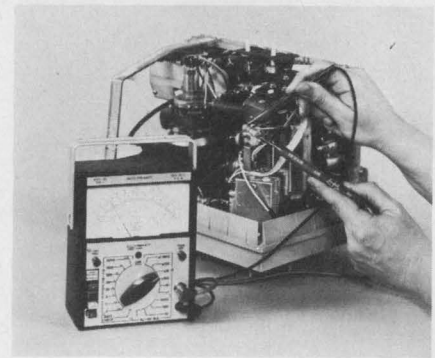

Triplet Corp., 286 Harmon Rd., Bluffton, Ohio. Phone: (419) 358-5015. P&A: \$100; stock.

A battery-operated solid-state volt-ohm-milliammeter, model 602, features an auto-polarity circuit, which is actuated by functional pushbutton switches and which eliminates the need for switching test leads. The new instrument has a full-scale sensitivity of 0.3 V for both ac and dc at a constant input impedance of 11 M Ω on dc and 10 M Ω on ac.

CIRCLE NO. 292

**Curve tracer plug-in
converts most scopes**

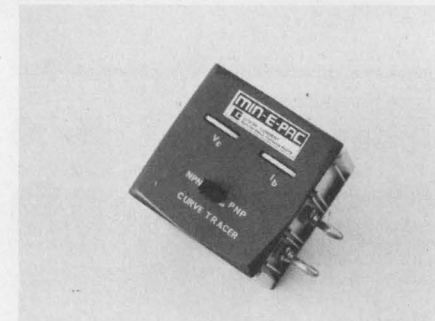

Eltron Co., 2501 Artesia Blvd., Redondo Beach, Calif. Phone: (213) 370-5749. Price: \$49.95.

The MOT-1 curve tracer plug-in module is a compact all-solid-state device that transforms most oscilloscopes to test instruments with the capability of displaying the voltage-current characteristics of a wide variety of solid-state devices. Thumbwheel controls allow collector or anode voltages to range from 1 to 12 V and base currents to be adjusted from 0 to 25 μ A.

CIRCLE NO. 293

Digital panel counters
can log up to 500 kHz



Starmark Electronics, 3710 Main St., Kansas City, Mo. Phone: (816) 931-7367. Price: from \$200.

General-purpose panel-mounted digital counters are now available with up to six digits of display and for operation at frequencies in excess of 500 kHz. Series 300 units will count contact closures or voltage signal inputs. All models have provisions for remote control, front-panel control, and BCD output for data acquisition or external monitoring.

CIRCLE NO. 294

Twin chart recorder
monitors 16 events

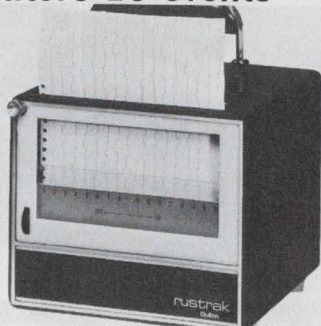

Rustrak Instrument Div., Gulston Industries, Inc., Municipal Airport, Manchester, N.H. Phone: (603) 623-3591.

Measuring only 5-5/8x6-5/8x6-1/2 in., a new twin strip-chart recorder monitors 16 events at one time. Model 392-16 gives time analysis and cost study data in a continuous rectangular trace, making an accurate time-correlated record of events and ON/OFF operations. It consists of two basic recorders sharing a single time base and chart.

CIRCLE NO. 295

JOSLYN'S SURE CURE FOR SWELLING CURRENT

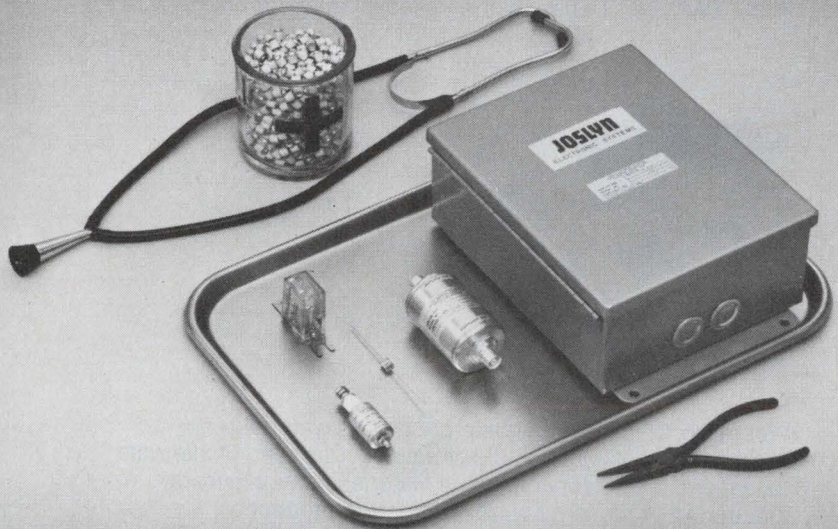

It comes as a single unit (a spark gap) or packaged with other exclusive properties. Either way, Joslyn's cure for swelling current (surge) is nanosecond quick, long lasting, and is sure to work. Again and again and again! True, your more devastating surges might possibly perhaps destroy a Joslyn protector. But your electronics will still go on working*. Over ten years of field use says so.

Don't experiment with other means when you can't afford a failure! For positive protection, Joslyn has the answer. Write or call today for facts on how to solve your protection problem for swelling current.

*when protector is properly selected and connected

When you can't afford a failure . . .



JOSLYN

ELECTRONIC SYSTEMS

Joslyn Electronic Systems □ Santa Barbara Research Park □
P.O. Box 817 □ Goleta, Calif. 93017 □ Tel. (805) 968-3551

1906

INFORMATION RETRIEVAL NUMBER 96

When our
*Chips come in
you will enjoy
smooth sailing
on the Sea of
Hybrid Circuitry.

*West-Cap

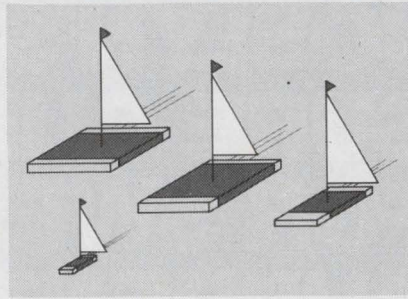

To help you smooth out your design problems you can choose from a large selection of values and sizes of **WEST-CAP** "SC" Series, highly reliable capacitor chips.

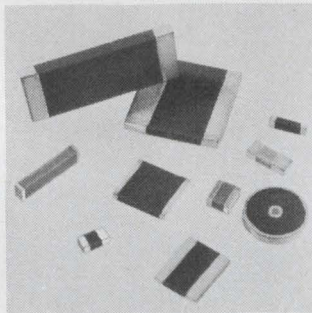

West-Cap Chips, the ceramic capacitors with built-in reliability, are of a monolithic structure, consisting of alternate layers of a proprietary dielectric material and noble metal electrodes. A closely-controlled firing in production kilns produces a rugged, fused "Monoceram" Chip. The end terminations are applied by recently developed automatic equipment, coating the chip ends uniformly and precisely. Prior to launching, "the schips" are given a final inspection mechanically and electrically by automatic equipment. Strict quality control is maintained throughout the entire process.

- West-Cap Monoceram Ceramic Chips are available in more than 50 sizes
- NPO, intermediate and Hi-K materials available
- Working Voltage: 25 to 100 VDC
- Tolerance: down to 0.5% or .25 Pf
- Temperature Range: -55°C to $+125^{\circ}\text{C}$
- Capacitance Range: .50 Pf to 5 Mfd
- Physical Size: Extra thin chips .010 to .020 available for I.C. applications

West-Cap Chips can be furnished with terminations compatible with all bonding techniques.

For Hybrid Circuit Designers—Just off the press, "Ceramic Chip Capacitor Handbook."

Send for your free copy today, by circling information retrieval number 151.

san fernando
electric manufacturing company
Specialists in capacitor design

West-Cap Division
1501 First Street
San Fernando, California

INFORMATION RETRIEVAL NUMBER 97

INSTRUMENTATION

PC-board exerciser simulates in-circuit test



Testex, Inc., 162 San Lazaro Ave., Sunnyvale, Calif. Phone: (408) 732-0461. P&A: \$945; 30 days.

A circuit board exerciser, the model number 420, enables the in-circuit testing of integrated circuits on a board as if the board were plugged into a system. The device generates a grey-code square wave to exercise the circuit board. The testing unit is available with 12, 16, 20 or 24 stages (outputs).

CIRCLE NO. 296

Digital panel meters are loaded with extras



Newport Laboratories, Inc., 630 E. Young St., Santa Ana, Calif. Phone: (714) 540-4914. P&A: \$300; 3 to 4 wks.

Series 2000 digital panel meters are 4-1/2-digit instruments offering 30 readings per second, $\pm 19,999$ counts full scale, automatic polarity, an accuracy of $\pm 0.01\%$ of reading, $\pm 0.01\%$ of full scale, and isolated BCD outputs. Besides determining ratios, the DPMS measure ac or dc voltages from $10\ \mu\text{V}$ to 200 V, and ac or dc currents from 1 nA to 200 mA.

CIRCLE NO. 297

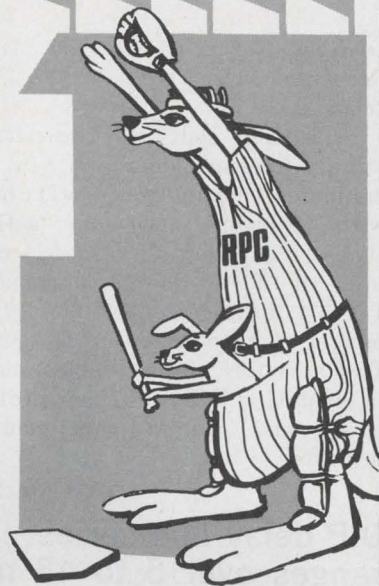

**catch RPC's
large line
of high voltage
high ohmic
carbon film resistors**

For example, 15 basic styles are available:

WATTS: .25 to 100w.

RESISTANCE: 10 to $10^{14}\Omega$

TOLERANCE: to $\pm 1\%$

STAND. SIZES: .563" L x .1" dia.
to 19.687" L x 2" dia.

A variety of terminal configurations are available such as: radial lugs or bands, axial wire leads and ferrule ends.

APPLICATIONS

Typical applications include those requiring high resistances, voltage capability from 250 to 125,000 v and high frequency or pulse circuits including power supplies, generators, X-ray equipment, electro-static air cleaners, paint sprayers, photo-copiers and high voltage-dropping monitors.

RPC's carbon film resistors will often exceed the requirements of metal oxide types, and with the lowest rejection rate in the industry.

SPECIALS

No order is too small . . . too large . . . or too unusual

Only RPC has a special interest in solving those "special" problems. Resistors up to 40" long have been manufactured on request.

Call RPC . . . and see how fast you SCORE against resistance problems.

RPC Resistance Products Co.

914 South 13th Street
Harrisburg, Pa. 17104 • (717) 236-5081

COMPONENTS

LED display modules show alphanumeric

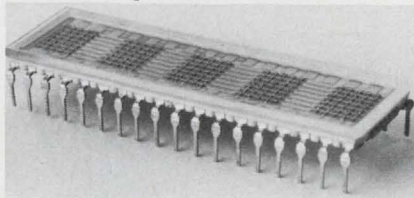

Hewlett-Packard, 1501 Page Mill Rd., Palo Alto, Calif. Phone: (415) 326-7000. P&A: \$30/character; 2 wks.

Consisting of light-emitting gallium-arsenide-phosphide light-emitting diodes mounted in a 5 by 7 matrix, the type 5082-7100, 01 and 02 alphanumeric displays come in a standard dual-in-line package as clusters of three, four and five characters. The modules are IC compatible and have 1/4-in.-high characters on 1/3-in. spacings. Display packages are end stackable so that spacing between characters within a package and between two packages is the same.

CIRCLE NO. 298

Rotary sp7t TO-5 switch adjusts by screwdriver

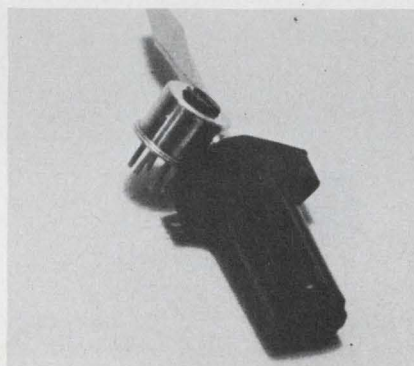

Chicago Switch, Inc., 2035 Wabansia Ave., Chicago, Ill. Phone: (312) 489-5500. P&A: \$5.55; 4 to 6 wks.

Featuring an sp7t rotary switch with an eighth OFF position at the case tab, the model 30-000-001 TO-5 PC board switch includes a top-of-the-case screwdriver adjustment. It is rated at 100 mA and 5 V dc and its initial contact resistance is 50 m Ω . Switch adjustment is in a clockwise direction with bidirectional versions to be made available later.

CIRCLE NO. 299

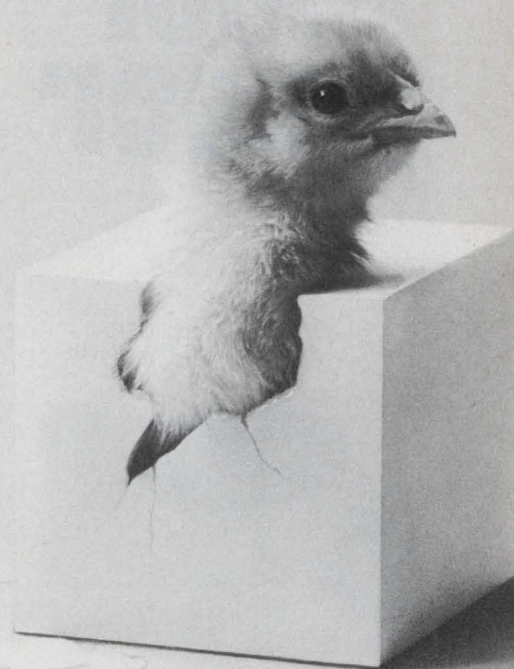

**One of the
unique qualities
of Electro Cube
is to produce
non-standard
packages readily**

electro cube
capacitors

We also make 4,000 or more standard capacitors with wound dielectrics. If case style is a problem, ask. We'll help. Electro Cube, Inc., 1710 South Del Mar Road, San Gabriel, California 91776. (213) 283-0511

ANNOUNCING:

Cool power

Model CP-5-5
Price: \$145.00



for IC logic

These new power modules from ERA provide *cool performance, total protection* for specialized use in IC, computer, telemetry, strain gauge and transistor applications.

The Transpac CP series is equipped with unique heat sinking for cool (71°C, free air) operation at high currents, protects itself and your equipment through built-in short circuit protection with instant recovery, adjustable current limiting and overvoltage protection.

A special burn-in test program at the factory assures reliability while compact silicon design saves space.

Send for catalog. Write today — before you design.

STANDARD MODELS

Output Voltage VDC	Current @				Model	Price
	50°C	60°C	71°C			
3.6	3.2	2.8	2.5	CP-3P6-2P5	\$125.00	
5	3.2	2.8	2.5	CP-5-2P5	\$125.00	
3.6	6.5	5.7	5.0	CP-3P6-5	\$145.00	
5	6.5	5.7	5.0	CP-5-5	\$145.00	
3.6	13.0	11.4	10.0	CP-3P6-10	\$185.00	
5	13.0	11.4	10.0	CP-5-10	\$185.00	
3.6	22.0	19.5	17.0	CP-3P6-17	\$230.00	
5	22.0	19.5	17.0	CP-5-17	\$230.00	
3.6	32.0	28.5	25.0	CP-3P6-25	\$310.00	
5	32.0	28.5	25.0	CP-5-25	\$310.00	



ERA TRANSPAC CORPORATION

A Subsidiary of
Electronic Research Associates, Inc.
67 Sand Park Road, Cedar Grove, N.J. 07009
(201) 239-3000

INFORMATION RETRIEVAL NUMBER 101

COMPONENTS

Illuminated pushbuttons enhance switching mode

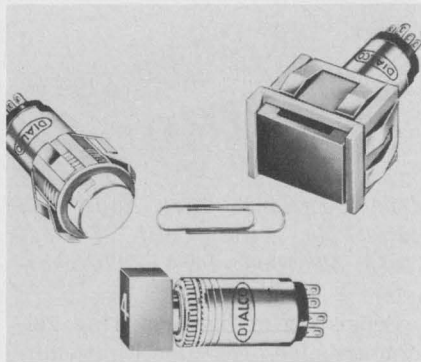

Dialight Corp., 60 Stewart Ave., Brooklyn, N.Y. Phone: (212) 497-7600.

Featuring spdt or two-circuit contact arrangements are new illuminated pushbutton switches with alternate and snap action styles. They include contact ratings of 5 A and accommodate T-1-3/4 incandescent bulbs with midget flanged bases up to 28 V. Two varieties are available: snap-in mounting types for low-profile panels and standard-panel-mounting types.

CIRCLE NO. 335

Pulse Engineering Inc., Box 12235, San Diego, Calif. Phone: (714) 755-9723. P&A: \$9.50; stock.

Eight new distributed-constant delay lines cover the time delay range of 5 to 45 ns with impedances of 100 and 390 Ω. Series 7200 units feature rise times of 2.2 to 12 ns. Other specifications include a peak pulse voltage of 100 V and maximum distortion of 15%. Maximum attenuation is 5% and temperature coefficient is 200 ppm/°C. All units are in 16-lead DIP cases.

CIRCLE NO. 336

DIP delay line series ranges over 5 to 45 ns

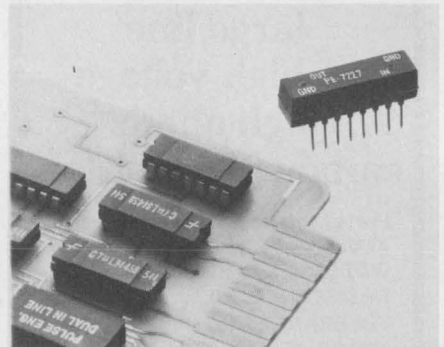

General Electric Co., Miniature Lamp Dept., Nela Park, Cleveland, Ohio. Phone: (216) 266-2258. Price: \$7.79.

A new gallium-arsenide solid-state lamp produces a 1-mW infrared output at 9400 Å peak when input current is 20 mA. Model SSL-315 is ideally suited for use with integrated circuits in such applications as paper-tape and card readers, and end-of-tape and start-of-tape sensing. The device is mounted in a coaxial package.

CIRCLE NO. 337

IR LED lamp puts out 1 mW

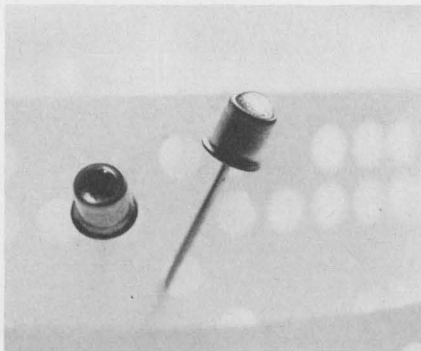

Gibbs Manufacturing & Research Corp., sub. of Hammond Corp., Janesville, Wis. Phone: (608) 756-1261. Price: \$10.

Called the model 1010 Coul-Cell, a new subminiature timing coulometer can handle time delays from a few seconds to about one hour. The device is actually an electrolytic cell that can be compared to a tiny plating tank. It has a capacity range from 1 to 100 μA-h, and a current range of 3 to 90 μA for accuracies to ±5%.

CIRCLE NO. 338

Small timing cell can delay for 1 h

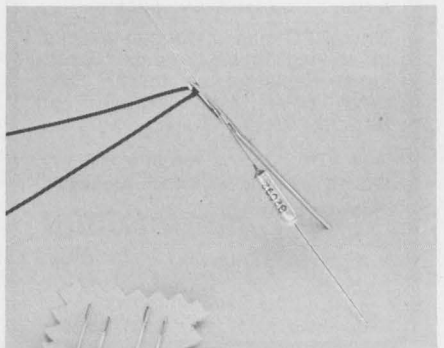

Coaxial transistor pushes 5 W at 2 GHz

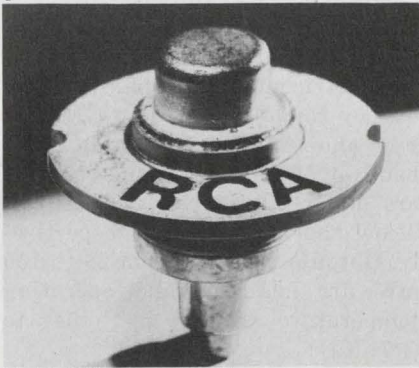

RCA/Electronic Components, 415 South Fifth St., Harrison, N.J. Phone: (201) 485-3900.

Intended to bring higher efficiency to uhf/microwave power amplifiers, a new silicon npn overlay transistor delivers a 5-W output with a minimum gain of 7 dB at 2 GHz and a 10-W output with 11-dB gain (typical) at 1.2 GHz. For coaxial, stripline, and lumped-constant circuit applications, the 2N5921 is housed in a ceramic-metal hermetic package with low parasitic capacitance.

CIRCLE NO. 339

S-band amplifier puts out 20 dBm

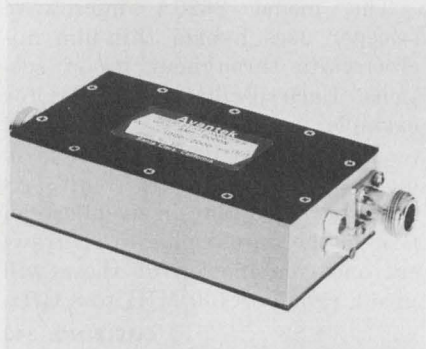

Avantek, Inc., 2981 Copper Rd., Santa Clara, Calif. Phone: (408) 739-6170. P&A: \$2000; 30 days.

Holding noise figure to 7 dB maximum, the AMP-2000N transistor amplifier supplies 20-dBm power output at the 1-dB gain compression point over the frequency range of 1 to 2 GHz. The unit has a minimum gain of 30 dB with a gain flatness of +1 dB. Its input VSWR is 2, while its output VSWR is 1.5. Required dc input power is only 15 V at 165 mA.

CIRCLE NO. 340



**TINY....
BUT—MVMs
CAN TAKE IT!**

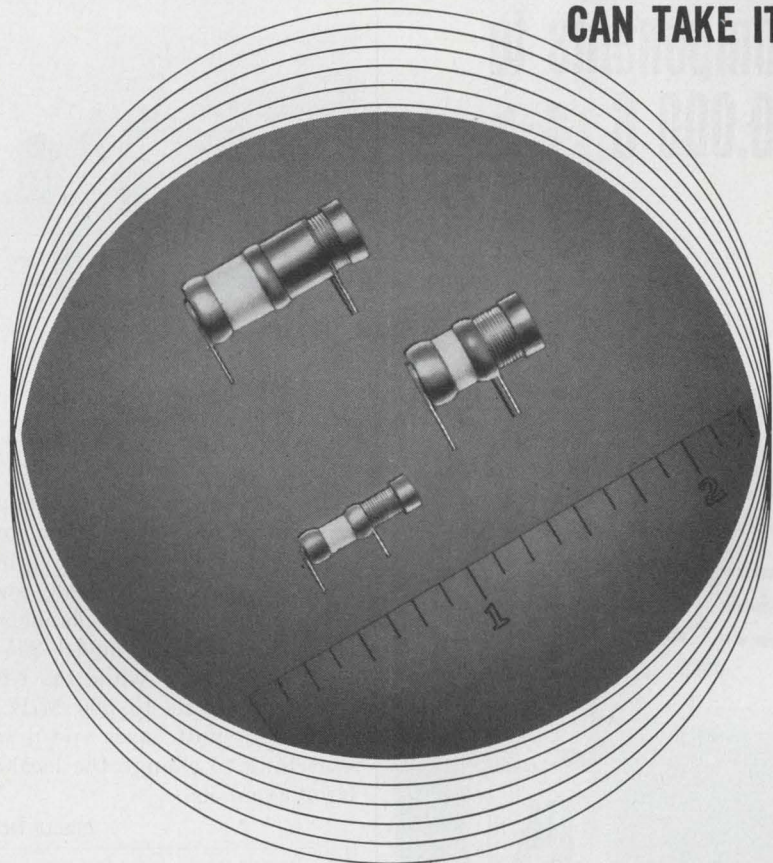

THESE NEW HIGH Q AIR VARIABLES ARE RUGGED

JFD has developed three sizes of unusually rugged air variable capacitors. All three feature a unique internal guiding mechanism with a positive stop. The result: concentricity is constant and these capacitors can withstand conditions of extreme shock and vibration.

Further, newly developed metal biasing elements provide smoother, more constant torque during and beyond life cycling.

Other unique features of the series are:

- Engineered to withstand heat — during soldering.
- Internal air meshing shells are silver plated to provide best surface conductivity and long life.

All MVM's are completely interchangeable with competitive models.

Write for MVM catalogs.

MVM-003 — Microminiature in size. Capacitance range is 0.35 pf to 3.5 pf. The Q factor measured at 3.5 pf and 100 MHz is 5,000. Available in 2 models.



MVM-010 — Adjustable from 0.8 pf to 10 pf. Q ranging from 3,000 to 100,000 measured at 10 pf and 100 MHz. Available in 4 models.



MVM-020 — Adjustable from 1 to 20 pf. Q ranging from 3,000 at minimum capacitance, to 1200 at maximum capacitance. Available in 4 models.

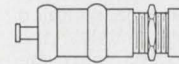

Illustrations actual size.



"TODAY'S COMPONENTS BUILT FOR TOMORROW'S CHALLENGES"

JFD ELECTRONICS CORP. / COMPONENTS DIVISION

15th Avenue at 62nd Street / Brooklyn, New York 11219 / Phone 212-331-1000

SUBSIDIARY OF RIKER-MAXSON CORPORATION

Shock Test Microelectronic Components to 30,000 G

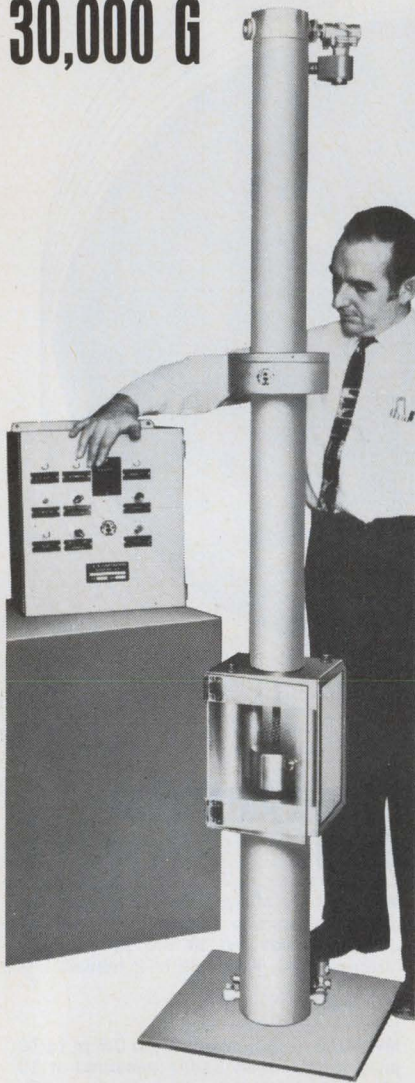

This new L.A.B. P4-30K shock machine tests integrated circuits and other solid state components on a pulse device supported by a pneumatically cushioned reaction mass.

A free piston provides the carriage for the test load and impinges on a pulse device supported by a pneumatically cushioned reaction mass.

Test specimens are preassembled into piston assemblies outside the machine. Several pistons may be used so that one group of specimens can be prepared or evaluated while another is undergoing shock tests.

Write or phone for full details.

L·A·B CORPORATION

A SUBSIDIARY OF MTI

P.O. Box H-14, Skaneateles, N.Y. 13152
Tel. (315) 685-5781

INFORMATION RETRIEVAL NUMBER 103

MICROWAVES & LASERS

Tunable Gunn oscillator covers 8 to 12.4 GHz

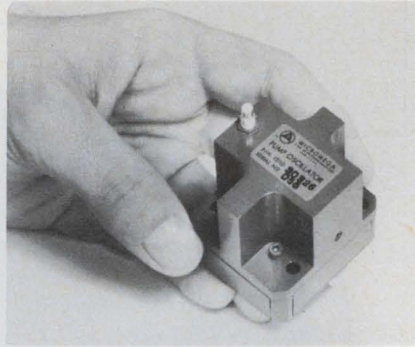

Acrodyne Industries, Inc., 666 Davisville Rd., Willow Grove, Pa. Phone: (215) 657-1800.

Performing low-noise frequency translation and up or down conversion, a new rf converter provides three or more electronically switchable crystal-controlled channels. The rf input range of model 205/3 is 20 to 1000 MHz, while the i-f output range is dc to 500 MHz. The converter unit uses p-i-n diode switching to change the local-oscillator channels.

CIRCLE NO. 342

Microwave sweeper uses thin-film hybrids



Microwave Power Devices Inc., 556 Peninsula Blvd., Hempstead, N.Y. Availability: 4 to 8 wks.

Transistorized modular amplifiers covering the instantaneous bandwidths of 1175 to 1424 MHz supply a cw power output of 10 W. These L-band units can be combined to provide an overall gain of 40 dB and power outputs as high as 35 W. They can operate indefinitely into load VSWRs of 2:1, any phase. The amplifier operates over the temperature range of -20°C to $+80^{\circ}\text{C}$.

CIRCLE NO. 344

Micromega 12575 Beatrice St., Los Angeles, Calif.

Mechanically tunable over 1 GHz, a new solid-state Gunn oscillator for pumping low-noise parametric amplifiers spans the frequency range of 8 to 12.4 GHz. Its FM and AM noise (in a 1-kHz band at 10 kHz from the carrier) are under 50 Hz rms and 120 dB below the carrier level respectively. Outputs ranging from 25 to 100 mW are available and operating temperature range is -54 to $+71^{\circ}\text{C}$.

CIRCLE NO. 341

Multi-channel converter switches electronically

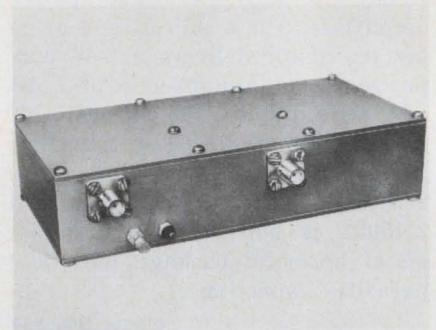

Hewlett-Packard, 1501 Page Mill Rd., Palo Alto, Calif. Phone: (415) 326-7000. Price: from \$1450.

The model 8620A microwave sweeper uses hybrid thin-film microcircuits throughout its rf sections. Each oscillator module, for example, contains a YIG-tuned oscillator microcircuit and a p-i-n diode modulator microcircuit. As many as three plug-in modules can nest in the unit's plug-in rf drawer; one combination of these will give a range of 100 MHz to 8 GHz.

CIRCLE NO. 343

L-band amplifiers deliver 10 W cw



Versatile generator sweeps 5 to 2350 MHz



Telexscan Corp., 2446 N. Shadeland Ave., Indianapolis, Ind. Phone: (317) 357-8781. P&A: \$2495; 8 wks.

Providing a full 10 mW of output power in both the cw and sweep modes, a new sweep-signal generator covers the frequency range from 5 to 2350 MHz in three overlapping bands. Model VS-90 has provisions for both single-frequency and harmonic-type frequency markers with crystal accuracies of 0.005%. It can also accept cw frequencies from external sources.

CIRCLE NO. 345

Miniature hybrids weigh but 0.5 oz

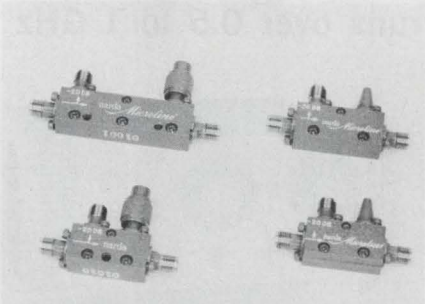

Narda Microwave Corp., Plainview, New York. Phone: (516) 433-9000. P&A: \$125 or \$135; stock.

Labeled Mini-Hybrids, series 4000C lightweight (0.5 oz) miniature hybrids are said to take up to 50% less space and weight than previously available units. They are ideal for systems use as power splitters, signal splitters, and mixers. Four models are available, covering the octave ranges of L, S, C and X bands. The units are equipped with stainless steel precision connectors.

CIRCLE NO. 346

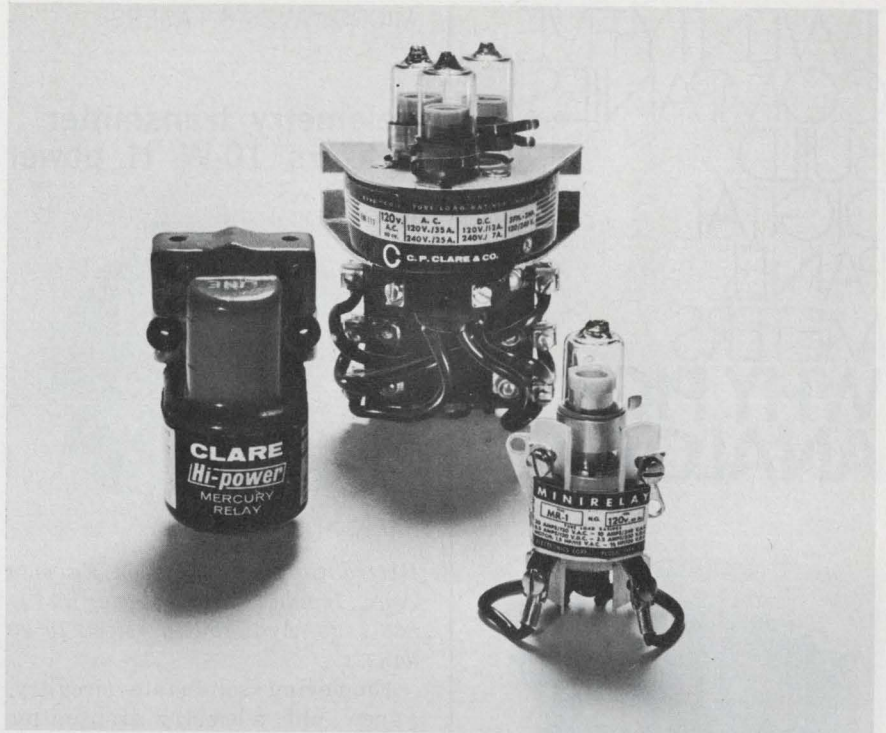

Take the plunge to the big new source for quality mercury plunger relays.

Think there's only one source for *quality* mercury displacement (plunger) relays? Think again.

Now Clare, the leader in mercury-wetted contact relays, can give you plunger relays that will handle 20-100 amps, up to 550 vac. What's more, only Clare gives you the extra long life, high reliability, and silent, service-free operation of Clare's exclusive Teflon* TF Roto-Plunger. Choose from a wide variety of models, including multi-pole units for switching both sides of ac line and three-pole units for three-phase operation. Your choice: economical glass-tube or high-power metal-tube devices. Also available: solid-state hybrid devices for time-delay, high-sensitivity, and temperature-control applications. No maintenance, no environmental problems, long life, immediate delivery, competitive pricing.

That's right: immediate delivery and competitive prices.

Don't get caught with that old single source. Take the plunge. Get all the facts. Mail the Reader Service card today!

*DuPont trademark



C. P. Clare & Co.,
Chicago 60645 and worldwide.
a General Instrument company

INFORMATION RETRIEVAL NUMBER 104

TWENTY-FIVE COMPANIES BUILD DIGITAL PANEL METERS. WHY PICK ANALOGIC?

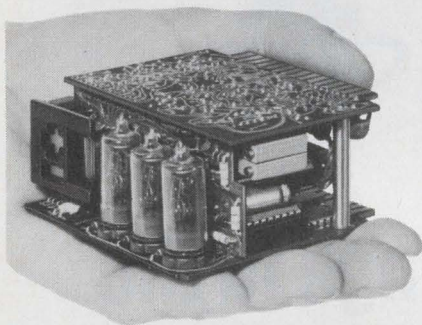

1. That's an average-sized hand in the illustration. Even when not removed from its attractive dustproof case, the Analogic AN2510 is half the size of competitive units, and requires only half the power . . . yet standard features are true differential input, 0.05% accuracy, BCD output, and -10°C to $+60^{\circ}\text{C}$ temperature range. No DPM at any price (or size) offers more features or better specs.

2. The fact that we also build the only true 0.01% units you can buy should indicate that we know how to design. We also know the applications problems. We'll work closely with you to meet performance and cost goals necessary for your competitive success.

3. Probably, one of our standard DPM's meets your requirements: The AN2510 with automatic polarity is only \$199.50.* The AN2517 true 0.01% modular $4\frac{1}{2}$ digit DPM is only \$426 (plus low cost power supply if needed)* AN2511 Expanded Range meters to 3000 counts at \$249.* Ultra high impedance AN2505 $2\frac{1}{2}$ digit units at \$109.50.* AN650 Digital Set Point Control for all the above at \$139.50*

ANALOGIC

Analogic Corporation, Audubon Road
Wakefield, Mass. 01880, Tel: (617) 246-0300

*These are one-piece prices: OEM discounts are substantial.

INFORMATION RETRIEVAL NUMBER 105

MICROWAVES & LASERS

Telemetry transmitter delivers 10-W rf power

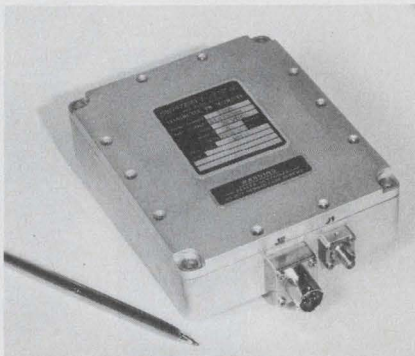

Bertea Corp., 18001 Von Karman Ave., Irvine, Calif. Phone: (714) 833-1424. Availability: stock to 90 days.

Employing solid-state circuitry, a new uhf telemetry transmitter supplies 5 to 10 W of rf power from a package measuring only $6 \times 5 \times 1\frac{1}{2}$ in. Model 1100 weighs but three pounds and features modular construction. Its rfi/emi characteristics comply with standards IRIG 106-69, MIL-STD-461 and MIL-STD-826A.

CIRCLE NO. 347

Adjustable equalizer smooths TWT outputs

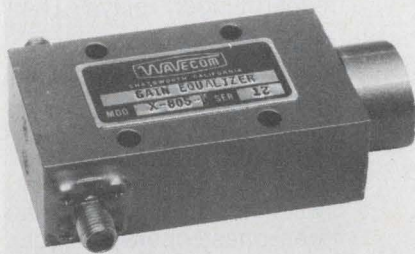

Wavecom, Inc., 9181 Gazette Ave., Chatsworth, Calif. Phone: (213) 882-3010.

Model X-805 user-adjustable gain equalizer is designed to flatten the output curve of broadband amplifiers operating in the frequency range of 7 to 11 GHz. Three continuously variable adjustments are available to the user so that practically any TWT response can be leveled. Midband attenuation can be varied from 4 to 8 dB; power capability is 10 W cw.

CIRCLE NO. 348

S-band circulator slims down size



Trak Microwave Corp., 4726 Eisenhower Blvd., Tampa, Fla. Phone: (813) 884-1411.

Spanning the frequency range from 2.6 to 3.2 GHz, an S-band ferrite circulator with 20-dB isolation measures only $1.25 \times 1.25 \times 0.5$ in. Model 1420-1300 has 100% shielding and an insertion loss of 0.4 dB maximum. VSWR for both input and output is less than 1.2. The completely self-contained device has a maximum phase deviation of ± 2 degrees.

CIRCLE NO. 349

Sweep signal generator runs over 0.5 to 1 GHz

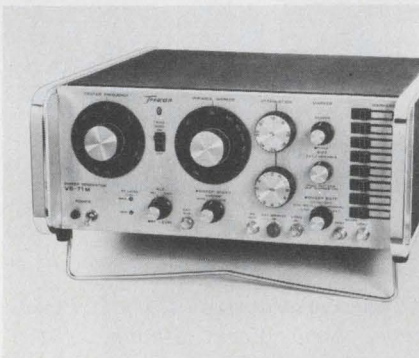

Texscan Corp., 2446 N. Shadeland Ave., Indianapolis, Ind. Phone: (317) 357-8781. P&A: \$1350, 6 wks.

Utilizing a voltage-swept oscillator, a new sweep generator ranges over 500 to 1000 MHz. Sweep control of the VS-71 is such that any center frequency from 500 to 1000 MHz or any sweep width from 0.2 to 500 MHz can be selected. Built-in automatic leveling keeps the output within ± 0.25 dB.

CIRCLE NO. 350

Mounting system snaps into place

Electraid, Inc., P.O. Box 53, Cambridge, Mass. Availability: 2 wks.

A solderless component mounting system employs boards called Hook-n-Push that easily snap into peg-board holes, allowing vertical mounting of all components including transformers. The boards, which are terminated with Flexi-Grip solderless connectors, are held firmly in place by a spring clip. The connectors can accept up to eight solid leads of various diameters.

CIRCLE NO. 351

Miniature coax has 19-mil OD

Berk-Tek, Inc., P.O. Box 60, Reading, Pa. Phone: (215) 376-8071.

Dubbed ultraminiature, a new line of 50-Ω coaxial cable features an outside diameter of 13 by 19 mils nominal. The center conductor is AWG #42 wire; the dielectric is a modified Teflon whose dielectric constant is below that of Teflon; the drain wire (for terminating) is AWG #36; the shield is aluminized Mylar; and the jacket is Vylex, a Mylar laminate. Applications include cryogenic environments.

CIRCLE NO. 352

Fiber-optic bundles come as flat ribbons

Edmund Scientific Co., 380 Eds-corp Bldg., Barrington, N.J. Phone: (609) 547-3488. Price: \$9 or \$81.

Resembling a paper-thin sandwich, new 1-in.-wide fiber-optic ribbons, which contain 330 glass fibers, can be cut, split, bent, bundled or stacked to transmit illuminated images through any zig-zag path. Besides the type 41,225 ribbons, type 60,795 9-by-12-in. sheets are also available. Both types can be shaped to form a polished point for spectrographic applications.

CIRCLE NO. 353

your toughest control problem is a soft-touch for ELECTRO's mini-family

Tell us the problem. We'll show you the most reliable low cost solution you can find-anywhere. Right now. From our complete line of solid state controls that are the standards of comparison for automating machinery, production lines, machine tools and industrial equipment of every conceivable kind. Call us. Our long years of show and tell experience can lower your operating costs, increase your operating efficiency. Here's proof positive.

MINI-PROX: High performance proximity control in both clapper relay or electronic output models for non-contact sensing and detecting of ferrous, and non-ferrous metal.

MINI-SPEED: Extremely accurate control for over-speed under-speed detection of shafts, gears, any moving ferrous or non-ferrous metal.

MINI-DELAY: The ultimate in reliability for any precision delayed-make, delayed-break timing requirement.

MINI-PROX SWITCH: A choice of AC or DC, solid state power switching for applications requiring limitless switching activations, or extremely high switching speeds.

MINI-TACH: First low cost plug-in frequency to DC converters providing precision conversion of any time varying electrical signal into a DC voltage or current.

WRITE FOR COMPLETE DETAILS:



ELECTRO[®]

ELECTRO PRODUCTS LABORATORIES, INC.

6125 WEST HOWARD STREET, CHICAGO, ILLINOIS 60648
312-647-8744/FAX: JMG/CABLE ELECTROLAB

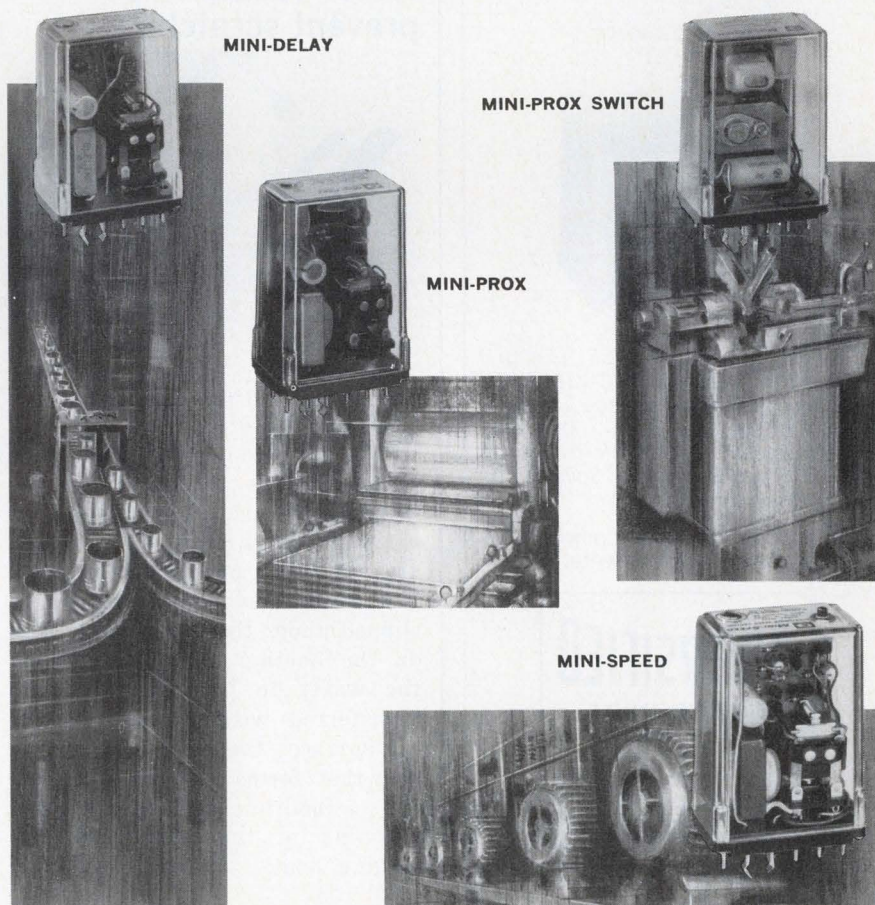

MINI-DELAY

MINI-PROX SWITCH

MINI-PROX

MINI-SPEED

DIVERSIFIED Power Supplies . . .

OUR CAPABILITY SUPPORTS YOUR LINE

From *Diversified Electronics* . . . low cost, custom-engineered OEM Power Supplies—based on imaginative new ideas in designing Power supplies for particular needs! Design-proven circuits are combined to achieve the power performance you require and the packaging flexibility needed. All this with off-the-shelf cost and delivery advantages plus custom-engineered OEM reliability.



TYPICAL
PRODUCT
DESIGNS

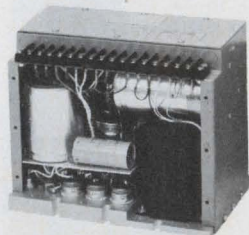

DIVERSIFIED EXPERIENCE . . . engineered supplies for: BWO-VTM-TWT • Photomultipliers • Storage and Display Cathode Ray Tubes • Discrete and Integrated Solid State Devices • Swept Power Supplies • Solid State Pulse Modulators.

For answers to all your power conversion needs—call or write:

DIVERSIFIED
ELECTRONICS
CO. INC.

718 EAST EVELYN AVENUE
SUNNYVALE, CALIFORNIA 94086
(408) 738-3911

TOOLS & ENGINEERING AIDS

Spring-loaded heat sink protects DIP devices

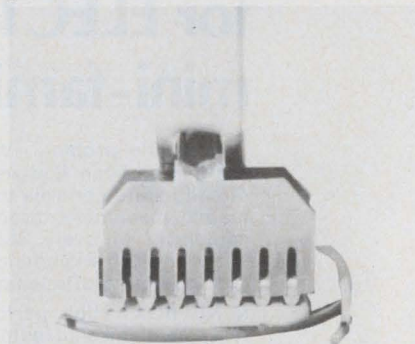

Techni-Tool Inc., 1216 Arch St., Philadelphia, Pa. Phone: (215) 568-4457.

Ensuring the thermal protection of dual-in-line packages during wave soldering, a new heat sink effectively wicks heat away from components without any danger to the machine transfer mechanism or the DIP itself. Model 4917 uses spring-loaded aluminum construction for easy installation and removal. It can accommodate either 14 or 16-pin dual-in-line packages.

CIRCLE NO. 354

Wafer vacuum tips prevent scratching

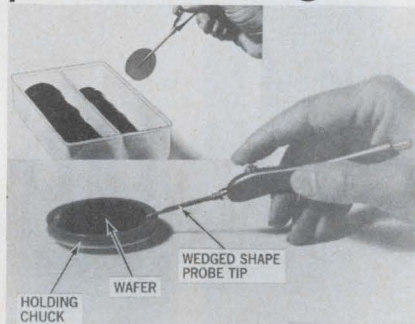

Air-Vac Engineering Co., Inc., 100 Gulf St., Milford, Conn.

Teflon-coated vacuum tips allow silicon wafers to be handled so gently that scratching or marring is virtually eliminated. Two tips are available: one is slender with a wedge-shaped point that can be slipped under the wafer while it is on the holding chuck, permitting the wafer to be picked off and transferred without touching the top surface; the second is a round disc that forms a tapered vacuum cup to facilitate removing and positioning of the wafer into the holding boat.

CIRCLE NO. 355

Desoldering tool cleans itself

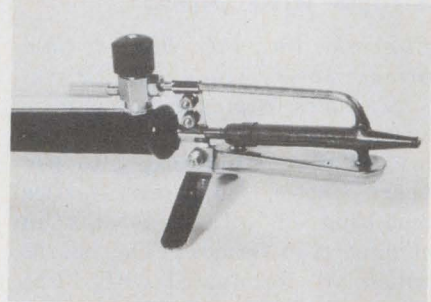

Hunter Associates, 182 Clairmont Terrace, Orange, N.J. Phone: (201) 672-0423. P&A: \$21.95; stock.

Working from compressed air, the model GSS desoldering tool, which is designed for use on miniature and microminiature circuit boards and subassemblies, continuously cleans itself by means of the high-pressure air flow. The unit has a stainless-steel solder catcher that is fitted with a hinged cover to prevent solder fragments from falling onto the circuit board or subassembly.

CIRCLE NO. 356

Thermal wire stripper uses centrifugal force



Republic Corp., Roto-Therm Div., 950 N. Sepulveda Blvd., El Segundo, Calif.

Able to strip most insulations including Teflon and Kapton, a new thermal wire stripper features a centrifugal-force insulation-severing technique that ends conductor damage. Model RT-1 uses a spinning gimbal-mounted thermal element that is applied to the wire by its own centrifugal force. Since the centrifugal force approaches zero as the element approaches the vertical position, application of the element is delicate yet positive.

CIRCLE NO. 357

Capacitor fixture butt-welds leads

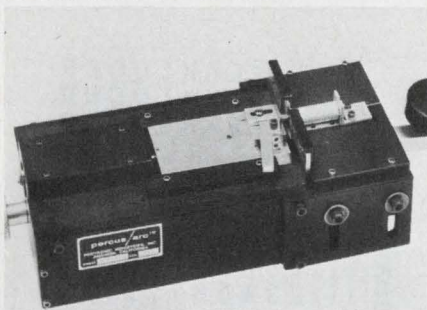

Protronic Industries, Inc., 2415 S. Manchester Ave., Anaheim, Calif. Phone: (714) 635-9310. P&A: \$895; 2 wks.

Utilizing the percussive arc welding method, a new welding fixture can butt-weld headed leads to aluminum foil-wound tubular capacitors. Tinned copper or nickel leads are metallurgically joined to the aluminum foil of the capacitor, creating a good electrical connection and a strong mechanical joint. Model ABW-310 handles capacitors with 3/8 to 2 in. dia and 3/4 to 2 in. long.

CIRCLE NO. 358

Component loader handles TO devices

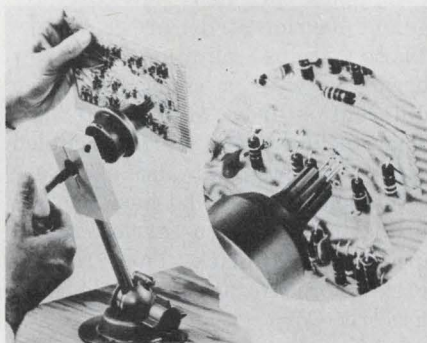

Solatron Enterprises, 421 E. Beach Ave., Inglewood, Calif. Phone: (213) 678-4981.

Available in several models, the model 79-3370 component loader allows quick and convenient handling of multiple-lead op amps and relays in TO-style packages. The unit will accommodate from 3 to 12 leads in any length on various pitch circles in round or square packages. As many as 12 units per minute can be loaded and their leads combed for quick insertion into insulators, printed circuit boards, carriers or sockets.

CIRCLE NO. 359

Are you suffering from Intermittent opens of the IC

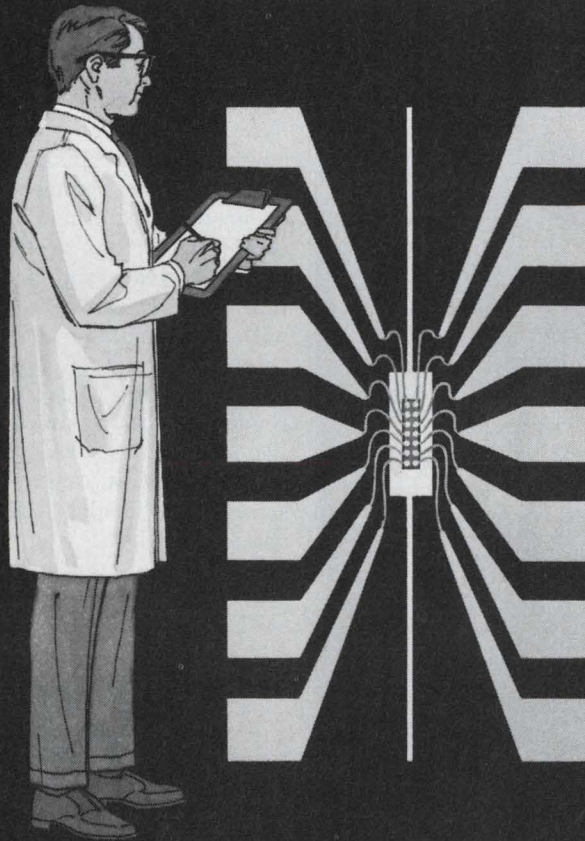

Cure it with Hysol MH15

New HYSOL MH15 semiconductor molding powders eliminate intermittent opens caused by bent or broken interconnecting lead wires in the molding process, by corrosion or thermal cycling of integrated circuitry at elevated temperatures. This molding powder is designed with a *better balance of properties* to meet more requirements than any other product we have seen. Its soft flow insures better moldability of dual in-line packages. HYSOL MH15 semiconductor molding powders increase yield and reduce costly material related IC failures. They're moisture resistant. Low flash, too!

For further information or technical assistance, call (716) 372-6310, or write HYSOL, Olean, New York 14760.

DEXTER HYSOL DIVISION
THE DEXTER CORPORATION

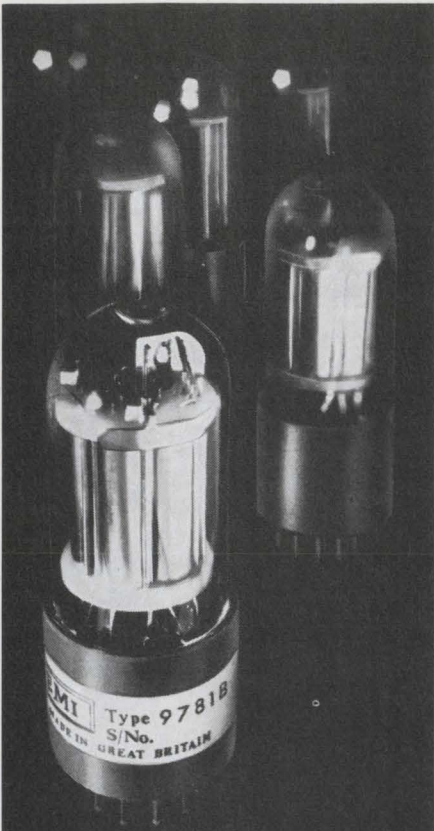

What's the difference?

Some typical squirrel cage photomultipliers. All similar in shape. But the one in the foreground, the new EMI Type 9781B, is different. Take a look at these typical performance figures:

- Photocathode sensitivity...55 μ A/L
- Overall gain at 1000V... 2×10^7
- Overall voltage at gain of 10^6 ...650V
- Dark current at gain of 10^6 ...1.2nA

The 9781B, a 9 stage tube with UV transmitting glass envelope, is designed for use with low level UV and visible radiation in spectrometer and similar applications. The B11A (B11-88) base means the 9781B will replace other tubes of this design to improve system performance.

For details of the complete EMI P.M. tube range contact:

GENCOM DIVISION
varian/EMI

80 EXPRESS STREET, PLAINVIEW, N. Y. 11803
TELEPHONE: (516) 433-5900

Evaluation Samples

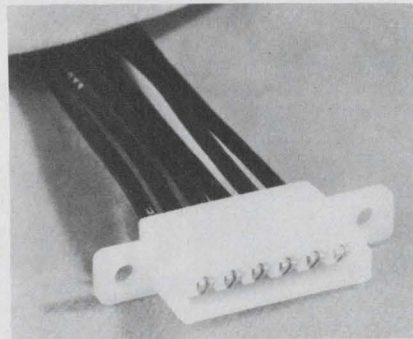

Six-circuit connector

A free sample is available of a new six-circuit straight-on printed circuit edge connector. This connector, like others in the Edge-Con series, has reliable crimp-type terminals supplied in chain-link form. It can be easily handled with automated crimping machines. Terminals snap-lock into nylon housings, but can be easily removed with a simple tool. Also included in the series are 9, 15, 21 and 22-circuit right-angle and straight-on models. Molex Products Co.

CIRCLE NO. 360

Temperature monitors

Free samples of self-adhesive temperature monitors are available. These monitors are transparent heat-resistant labels that turn black once the rated temperature on the label is reached. Because the color change is irreversible, a permanent temperature record of any device under test is available. Ratings are available from 100 to 500°F. Tempil Div. of Big Three Industrial Gas & Equipment Co.

CIRCLE NO. 361

Microwave substrates

Rf sputtered chrome-gold substrates for microwave integrated circuits are available as free evaluation samples. The latest in deposition technology, they offer the ultimate in film adhesion and quality. Electrotec, Inc.

CIRCLE NO. 362

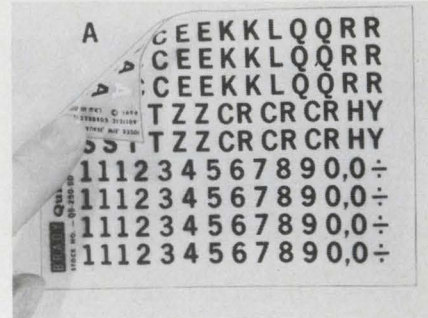

Dry transfer lettering

A sheet of Quikset, a new dry transfer PC lettering that offers extra convenience in handling and inventory because of its compact design is available as an evaluation sample. Each sheet contains several complete sets of either numbers, alphabets or sequential designations. Two sizes are available: 1/4-in. high lettering for 4:1 layouts and 1/8-in. high lettering for 2:1 layouts. W. H. Brady Co.

CIRCLE NO. 363

Barrier strips

Samples of new low-cost resilient barrier strips are available. These strips eliminate barrier breakage with a choice of three different sturdy strip materials. They include factory pre-assembled captive screws that also eliminate screw shake-outs. Flat-base or self-insulating feed-thru carrier configurations and black, blue, red or gray colors are available. Magnum Electric Corp.

CIRCLE NO. 364

Electronic lubricant

Electrolube is a new highly effective cleaning agent for lubricating contacts in electronic circuits. This lubricant combines the desired properties of conventional contact lubricants with a unique property that decreases contact resistance. It is available in aerosol spray cans, tubes, pen and bottle dispensers or bulk packages. Free samples are available. Trans Atlantic Electronics Inc.

CIRCLE NO. 365

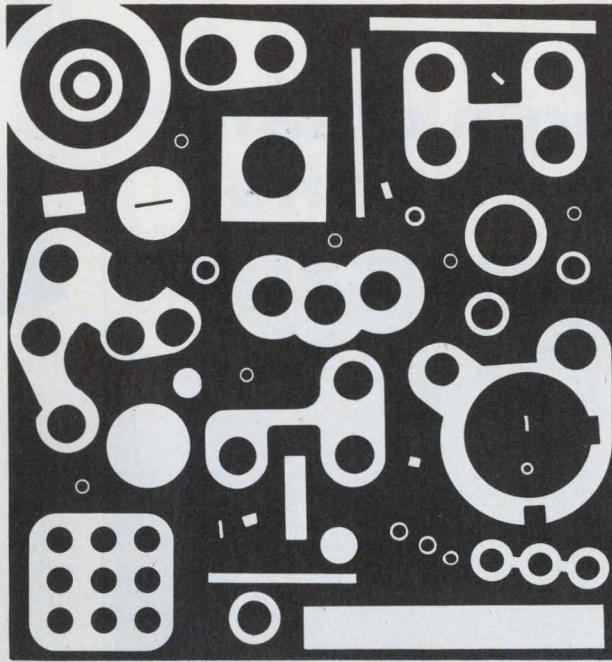

Tin-novation

Solder preforms . . . a new way to use tin solder

Automation and miniaturization have made it necessary to change the physical structure and dimensions of many components and products. Solder is no exception.

Solder preforms are available from most of the large solder manufacturers—in either flux cored or solid forms—in an almost limitless variety of shapes, sizes, designs, and configurations: washers, discs, rectangles, ovals, pellets, rings, coils, stampings, wire, sleeves, tubes, spheres, etc.

Just the right amount of flux and solder of a predetermined tin alloy is placed exactly where it is required. Waste is eliminated, production increased, joints uniform, and rejects reduced. Many soldering operations can be made part of an automatic operation, eliminating the need for skilled soldering help. Solder preforms are especially adaptable for soldering inaccessible points—and where previous bonds should not be disturbed. Further operating cost reductions are realized with mass production heating techniques.

Solder is the second largest user of tin in the world, tinplate being first. About 20%

of the world's consumption of tin goes into solder. Tin's unusually advantageous combination of properties makes it an ideal metal for use in solder alloys. Tin has a low melting temperature, malleability, corrosion resistance, and an attractive lustrous appearance.

Think Tin

Just as tin works so well in solder and solder preforms, it may also hold the answer to one of your current or future metal problems—as an additive, an alloy, or coating. Straits Tin from Malaysia, the sterling of tin . . . world standard for uniformity.

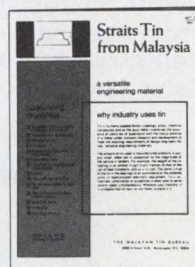

Send for new engineering bulletin on Straits Tin.

Contains thorough descriptions of major applications and useful technical data on general, thermal, electrical, and mechanical properties. Send for your free copy today.

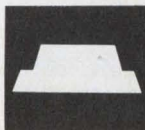

THE MALAYAN TIN BUREAU

Dept. S19-E, 2000 K St., N.W., Washington, D.C. 20006

INFORMATION RETRIEVAL NUMBER 111

Everything's clearer with the flat one!

Letters! Digits! Symbols! Equations! All varieties of data are displayed as undistorted images on Zenith Flat-Face Metal CRTs. Ideal for light pen operations, alphanumeric and analog presentations — they're even available with a rear port for optical chart projection. When you need CRTs, face up to the flat one. Write for details.

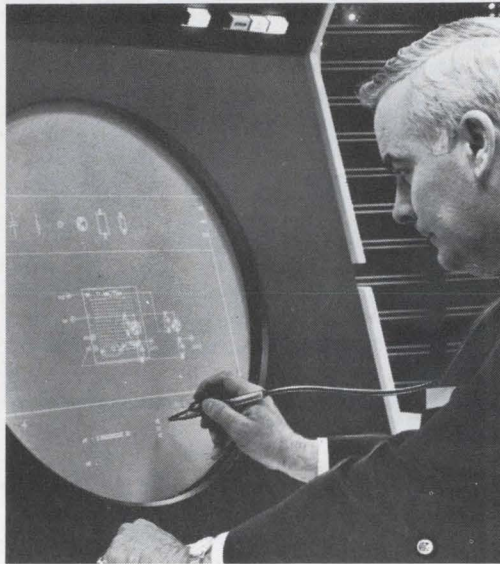

ZENITH RADIO CORPORATION
THE RAULAND DIVISION
5616 W. JARVIS AVE. • CHICAGO, ILL. 60648 • 312-647-8000
INFORMATION RETRIEVAL NUMBER 112



Soldering irons for every use

Specify Wallbrand for top value — choose from such "firsts" as the IDL (Instant Heat), DH (Duo Heat) and XLS (9 interchangeable elements), plus numerous other pencils, irons and guns for many metal joining jobs. All Wall products are made in U.S.A.



and accessories



HOLDERS



TIPS and DISPENSERS



DESOLDERER

SEND FOR CATALOG I-669A

WALL MANUFACTURING CO.
Dept. ED-50 Box 3349 Kinston, N. C. 28501

INFORMATION RETRIEVAL NUMBER 113



RF and POWER SWITCHES

A complete line of rotary, high voltage and high current ceramic-type switches for RF and low frequency applications.

Write for catalog, containing information on the mechanical and electrical properties of our standard line of switches.

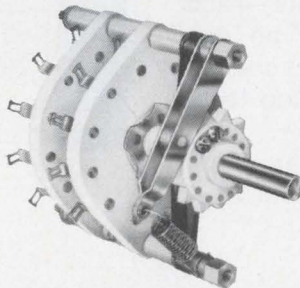

RADIO SWITCH CORPORATION
P.O. Box 79 Marlboro, N.J. 07746
Tel. (201) 462-6100

INFORMATION RETRIEVAL NUMBER 114

Design Aids

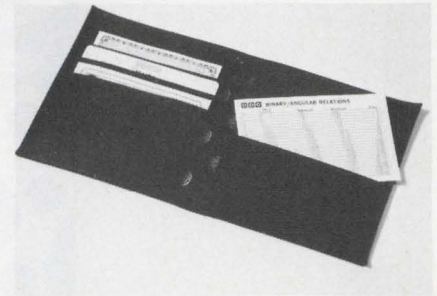

Binary/angular card

Binary and angular relationships are shown on a new laminated wallet-sized card that is useful to the engineer working with the conversion of data, such as synchro-to-digital applications. In chart form, it shows equivalent angular values in degrees and minutes per bit, and the least significant bit in percent of full scale. DDC, a Div. of Solid State Scientific Devices Corp.

CIRCLE NO. 366

Paste-on logic symbols

Various geometric symbols such as circles, squares, triangles and rectangles that can be pasted on PC boards for use as logic symbols are available. These symbols could be used to indicate operational amplifiers, gates, mixers, and summing junctions. They were designed to be used with the Wrap-X system of PC boards. Datascan Inc.

CIRCLE NO. 367

Zener surge guide

Especially useful when designing for surge applications is a zener surge selection guide which lists zener types from 1 to 10 W with specific voltage and surge ratings for each individual type. This handy reference guide includes a graph showing reverse surge power for pulse durations from 100 ns to 10 ms for each family. It also includes each zener package's outline drawing. Uni-trode Corp.

CIRCLE NO. 368

ELECTRICAL
COMPAC
E2B



Life Tests:

Electrical impulse E2B counters, running at 600 counts per minute under laboratory conditions, have achieved the following—

50,000,000 counts—DC units;
15,000,000 counts—AC units;
Testing still in progress.

Accuracy: Complete reliability under variable test conditions.

Figures: 6-digits, black on white.

Voltages: 115 V. AC; 230 V. AC; 24 V. AC; and 24 V. DC. (4 watts)

Drive: New patented reciprocating Delrin verge.

Mounting: Base or panel mount.

Face Size: 1.72" W x 1.19" H x 2.34" D. (Net wt. 5 oz.)

Recognition: Meets U.L. and C.S.A. standards.

Delivery: Most voltages available from stock.

Price: \$1.85 in OEM quantities.

Covered by Patent No. 3470361

Write for literature. Application help available.



ENM COMPANY

5306 W. Lawrence Ave., Chicago, Ill. 60630
PHONE: (312) 282-8787 TELEX: 02-5468
Representatives in principal cities

INFORMATION RETRIEVAL NUMBER 115



MAIL COUPON FOR GIANT FREE CATALOG!

EDMUND SCIENTIFIC CO.
300 Edscorp Building, Barrington, N. J. 08007
Please send Free Giant Catalog "DA"

NAME _____
COMPANY _____
ADDRESS _____
CITY _____ STATE _____ ZIP _____

FREE CATALOG!
148 PAGES • MORE THAN 4000
UNUSUAL BARGAINS
SCIENCE • OPTICS • SPACE

1000's OF HARD-TO-FIND BUYS FOR INDUSTRY.
Speed your work! Improve quality! Cut development and production costs! Completely new edition loaded with on-the-job helps, quality control aids, unique items available nowhere else. 148 easy-to-read pages packed with new products, charts, diagrams, illustrations. A treasure house of optical and scientific equipment available direct from stock for industry, research labs, design engineers, experimenters, hobbyists.

AMERICA'S GREATEST ONE-SOURCE MARKET PLACE
Hard-to-get surplus bargains. Ingenious scientific tools. Thousands of components: Lenses, prisms, wedges, mirrors, mounts, accessories of all descriptions. Hundreds of instruments: lasers, comparators, magnifiers, microscopes, projectors, telescopes, binoculars, photo attachments, black light equipment and the largest selection of unique lighting items in the country.

ORDER DIRECT WITH ABSOLUTE CONFIDENCE
Edmund ships more than 5,000 orders monthly to the country's largest industrials. Every item completely guaranteed. You must be satisfied with any purchase or return it in 10 days for your money back. Shop the catalog of America's largest Science-Optics-Space Mart. Send for your free copy today. Absolutely no obligation. No salesman will call. Request FREE catalog "DA".

EDMUND SCIENTIFIC CO., 300 Edscorp Bldg.
Barrington, New Jersey 08007

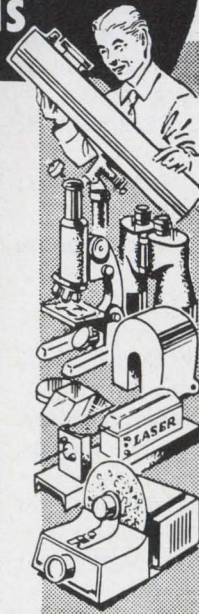

INFORMATION RETRIEVAL NUMBER 116

ELECTRONIC DESIGN 10, May 10, 1970

CEI has it.

Magnetrons

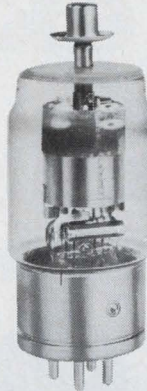

CEI has it.

Hydrogen Thyatrons

CEI has it.

Receiving Tubes



CEI has it.

Tetrodes

Calvert products:

- | | |
|-----------------------|---------------------------|
| Special Purpose Tubes | Diode Semiconductors |
| Receiving Tubes | Transistor Semiconductors |
| Thyatron | SCR's |
| Magnetron | Microwave Transistors |
| Klystron | Gunn Diodes |
| Transmitting Tubes | GaAs Schottky Diodes |

Write.



Calvert Electronics International, Inc.
220 E. 23rd St., New York, N.Y. 10010

ED-5

- Please send me your catalog.
 Please send information on (product) _____

Name _____ Title _____
Company _____ Tel. _____
Address _____
City _____ State _____ Zip _____

Western Div.: 871 E. Hamilton Ave. Campbell, Calif. 95008

INFORMATION RETRIEVAL NUMBER 117

Annual Reports

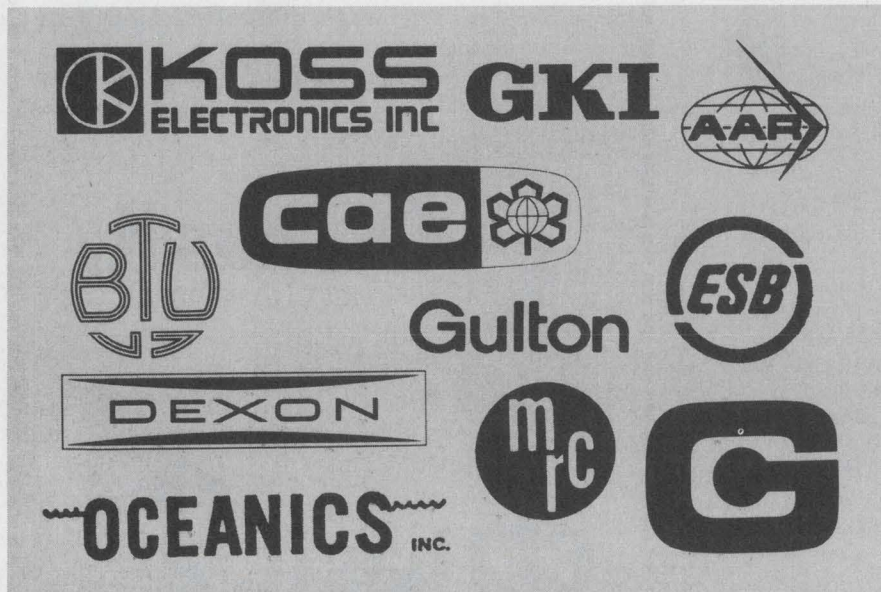

Allen Aircraft Radio, Inc., 2050 Touhy Ave., Elk Grove, Ill.

Aircraft instrumentation, manufacturing, overhaul and certification, aviation services.

1969: Net sales, \$9,956,274; net income, \$354,210.

1968: Net sales, \$5,722,861; net income, \$64,880.

CIRCLE NO. 369

BTU Engineering Corp., 179 Bear Hill Rd., Waltham, Mass.

Furnaces for flatpack lidding and soldering and for high-temperature hydrogen sintering.

1969: Net sales, \$3,433,118; net income, \$215,196.

1968: Net sales, \$2,745,940; net income, \$153,281.

CIRCLE NO. 370

CAE Industries Ltd., P.O. Box 6166, Montreal, Quebec, Canada.

Airlines, flight simulators, data processing, pulp, paper, textiles, sheet metal fabrication.

1969: revenue, \$39,244,350; earnings, \$1,008,453.

1968: revenue, \$42,820,898; earnings, \$1,153,367.

CIRCLE NO. 371

Dexon, Inc., 3440 Belt Line Blvd., Minneapolis, Minn.

Ultra-clean process equipment for the microelectronic, biological and hydraulic industries.

1969: sales, \$1,468,108; net earnings, \$1,564.

1968: sales, \$1,212,437; net earnings, \$154,645.

CIRCLE NO. 372

ESB Inc., 2 Penn Center Plaza, Philadelphia, Pa.

Batteries, lighting devices, minerals, chemicals, plastics, power and communications systems.

1968: net sales, \$232,833,988; net income, \$7,020,705.

1967: net sales, \$227,077,002; net income, \$9,386,166.

CIRCLE NO. 373

Genisco Technology Corp., 18435 Susana Rd., Compton, Calif.

Control systems, tape recorders, filters, panel lamps, PC boards, accelerometers, transducers.

1969: net sales, \$11,786,509; net income (loss), (\$1,085,654).

1968: net sales, \$13,295,377; net income, \$349,973.

CIRCLE NO. 374

General Kinetics Inc., Isaac Newton Square, Reston, Va.

Tape equipment, metal enclosures, instruments for analysis.

1969: sales, \$3,447,856; net income (loss), (\$374,948).

1968: net sales, \$4,262,680; net income, \$470,321.

CIRCLE NO. 375

Gulton Industries, Inc., Gulton St., Metuchen, N.J.

Aircraft systems, components, power and medical systems.

1969: net sales, \$92,201,813; net earnings, \$2,950,036.

1968: net sales, \$92,487,576; net earnings, \$4,794,289.

CIRCLE NO. 376

Koss Electronics Inc., 2227 N. 31st St., Milwaukee, Wis.

Electrostatic stereo-fidelity headphones and home entertainment products.

1969: net sales, \$2,902,932; net income, \$251,569.

1968: net sales, \$1,846,556; net income, \$115,619.

CIRCLE NO. 377

Materials Research Corp., Orangeburg, N.Y.

Sputtering systems and targets, metal purification and fabrication, ceramic substrates.

1969: net sales, \$4,174,951; net income, \$302,259.

1968: net sales, \$2,692,317; net income, \$145,978.

CIRCLE NO. 378

Oceanics, Inc., Technical Industrial Park, Plainview, N.Y.

Ship propulsion systems and computerized routing, computers and computer services.

1969: total income, \$526,203.52; net income, \$27,945.24.

1968: total income, \$426,812.06; net income, \$28,705.67.

CIRCLE NO. 379

Making speed/cost trade-offs in conversion equipment? With Raytheon Computer, you can have it both ways.

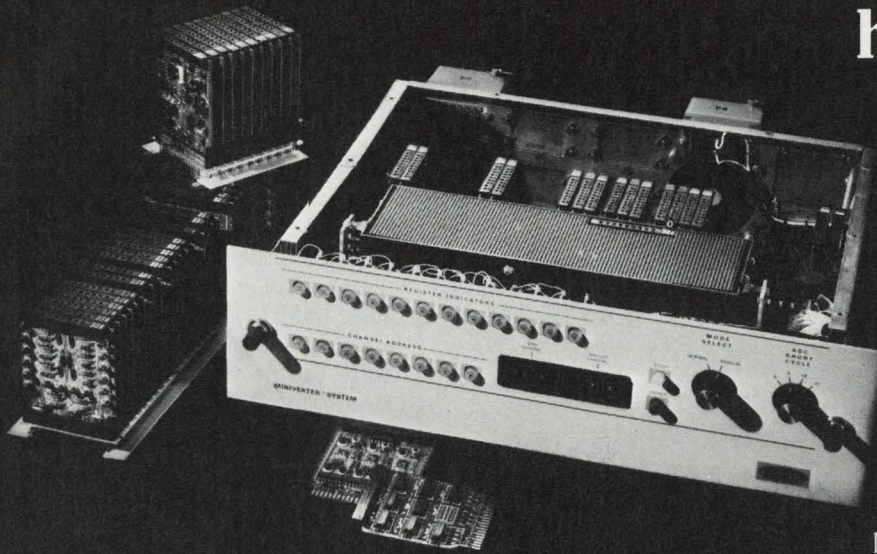

Analog/digital interfaces and conversion can end up costing you more than any other portion of your system.

So we've come up with a system of our own. Instant conversion in a range of prices and performance levels. All with the best price/performance ratio in the industry.

For analog-to-digital conversion, \$1,220 buys you our 10-bit A-to-D converter and a 50kHz word rate. \$1,790 buys our 12-bit high-speed 100kHz Miniverter™. \$4,095 gets our 100kHz, 15-bit Multiverter® III. Each of these analog-to-digital converters has 8 multiplexed channels (expandable to 128) and a short-cycle control for even higher through-puts with shorter words.

And every converter is fully-wired, fully-tested and fully documented with wiring

lists, test results and technical manuals. You get a complete instrument, not just a collection of cards.

The same story holds for our other conversion and interface equipment. DAC's. Multiplexers. Sample-and-holds.

Or even complete computerized systems. We have a family of 16-bit computers that let you make your trade-offs working with a choice of CPU's that range in cycle times from 900ns to 1.75 μ s and in price from under \$10,000 to \$19,000. And we'll get you on-line faster than anyone else because we have over 400 debugged proven programs available off-the-shelf.

Like we said, we'll give you the best price/performance ratio in the industry. If that's what your systems need, call or write today. Ask for Data File CB-180.

Raytheon Computer, 2700
S. Fairview St., Santa Ana,
Calif. 92704. Phone 714/
546-7160.



RAYTHEON

The only thing Raytheon Computer does is your job. Better.

Application Notes

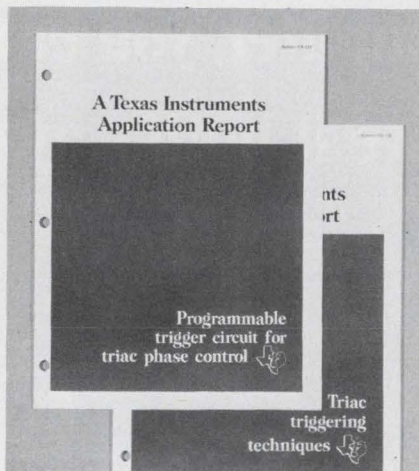

Triacs

Two new application reports cover triac phase-control and triac triggering techniques. Bulletin CA-137, "Programmable Trigger Circuit for Triac Phase Control," explains how a trigger circuit combined with a suitable triac can regulate ac power by phase control in response to voltage inputs to an operational amplifier. Bulletin CA-138, "Triac Triggering Techniques," describes how to accomplish the triac triggering function and illustrates different methods for controlling ac power with triacs. This 20-page bulletin reviews triac characteristics and principles and then discusses triac construction and electrical parameters. Texas Instruments, Inc.

CIRCLE NO. 380

Electromagnets

The laboratory electromagnet and its applications are discussed in a new 37-page booklet. Through simple qualitative discussions, the booklet acquaints the reader with the basic features of the laboratory electromagnet, its principle applications, and the terms which describe its performance. References are furnished throughout for readers who wish to study an application in depth. Varian Analytical Instrument Div.

CIRCLE NO. 381

Materials publication

A new publication titled the SAMPE Quarterly (Science of Advanced Materials and Progress Engineering) published by the Society of Aerospace Materials and Process Engineering is now available. It includes thorough articles on materials, disciplines, current advanced materials technology and the latest developments in materials research, written by experts in the field. Society of Aerospace Materials and Process Engineering.

CIRCLE NO. 382

Fast-recovery diodes

Circuit applications of fast-recovery power diodes are discussed in a 24-page report. It discusses the measurement of reverse waveforms and recovered charge. Also included are circuit applications for high-frequency power rectification, free-wheeling diodes and inverters and dc choppers. Schematic representations and characteristic curves are also given. International Rectifier, Semiconductor Div.

CIRCLE NO. 383

Filter simulation

A technical abstract giving analog techniques for filter simulation is available. It provides various simulation techniques for low-pass and high-pass filters. These techniques are based on the filter transfer function. Frequency scaling is discussed for converting cutoff frequencies from the normalized one radian per second to the desired cutoff frequencies. The abstract is illustrated with circuit configurations and contains many useful equations. Electronic Associates, Inc.

CIRCLE NO. 384

Neon-lamp applications

The application of neon glow lamps to a test system and to diagnose computers is discussed in two feature articles of a recent issue of Signalite Application News, volume 7, number 3. It explains how a relatively inexpensive testing system was designed to check the circuits on a multilayer board. Also in this issue an article discusses the diagnosis of a computer employing neon glow lamps. The lamps are used to indicate malfunctions, and the amount and state of the data stored. Signalite Inc.

CIRCLE NO. 385

Thermocouple response

A 20-page brochure contains the basic theory of millisecond-response thermocouples. It includes a mathematical analysis of the basic theory of thermocouple response, accuracy and the relationship of heat transfer to thermocouple junctions. It concludes that ultra-miniature thermocouples, having the smallest exposed junction available, offer faster temperature measurements than other thermocouple junctions having identical materials of larger size. It notes that small size has the advantage of offering a minimum disturbance to the temperature and flow fields of the environment in which they are used. Also included is information regarding the effect of the time constant on thermocouple response to discontinuous and linear temperature variations and the effect of thermocouple time constant on frequency response. Radiation error versus thermocouple wire diameter, thermocouple time constant versus wire diameter, and the effect of gas velocity on thermocouple time constant are also shown. High Temperature Instruments Corp.

CIRCLE NO. 386

Now There's A Better, More Effective Way To Teach (And Learn) Computer Logic... Costs Less Too

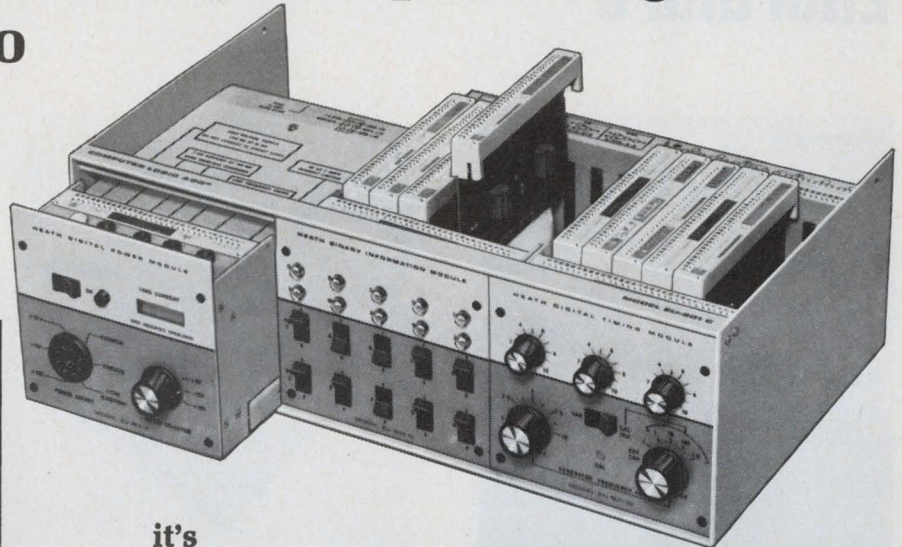
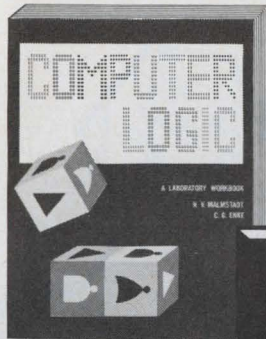

the
NEW Heath
801C
Computer Logic
Teaching System...
\$365* Complete

- it's Complete**—Includes the Computer Logic (ADD™); a Workbook and a Text "Digital Electronics For Scientists".
- Versatile**—Circuit Cards can be plugged in and arranged in any order; Chassis Modules are removable and rack-mountable.
- Expandable**—Other Digital, Analog and Analog-Digital functions can be studied by substituting appropriate plug-in circuits cards.
- Sophisticated**—Modern, state-of-the-art TTL IC's are used throughout the system; complete complex function circuit cards are also available to ensure up-to-date capability.
- Inexpensive**—Complete 801C System, including the Computer Logic ADD, workbook and text is only \$365.00* ... 20% less than any other logic system.

The New Heath 801C Computer Logic Teaching System is a radical departure from ordinary computer logic systems. Designed by professional educators (Drs. Malmstadt and Enke) with the problems of teaching this complex subject in mind, it will do a thorough, effective job. Here's why...

It's Complete. The new 801C System includes the EU-801C Computer Logic Analog-Digital Designer (ADD™), a pioneering new text by Drs. Malmstadt & Enke "Digital Electronics For Scientists" and a detailed, comprehensive workbook containing 50 experiments. The EU-801C ADD is a complete computer logic training device, including Power, Binary Information and Timing Modules and 18 NAND Gates, 4 And-Or-Invert Gates and 8 J-K Flip-Flops on plug-in circuit cards. The Workbook "Computer Logic", by Drs. Malmstadt & Enke, includes 50 experiments written to be performed on the 801C ADD and keyed to the text. The 500 page "Digital Electronics For Scientists" is an up-to-date text for the study of modern digital logic. Although only the non-electronic portions of the text are used with the 801C ADD, the complete text is an invaluable study and reference source for modern digital techniques.

It's Versatile... far more so than any other logic training device available. Each plug-in circuit card contains a discrete function such as a gate or flip-flop, and the cards can be arranged in any order. All cards are labeled with standard logic symbols. Cards are simply patched together with ordinary hook-up wire without soldering to form complete logic

sub-systems or systems. The three Chassis Modules can be removed from the cabinet, interchanged, even rack mounted. **It's Expandable.** The 801C is the only logic teaching system available that can be expanded to other uses... quickly, efficiently and inexpensively. Heath now offers over 20 plug-in circuit cards and more are being introduced regularly. Combinations of these low-cost cards can be used to provide teaching and design capability for computer interfacing, digital instruments and analog-digital measurement and control systems... merely by plugging in the appropriate cards. No other system at any price has this vast flexibility.

It's Sophisticated. TTL Integrated Circuit Logic—as used in modern computers—is used throughout the 801C to provide reliable operation, high speed and noise immunity and compatibility with today's computers. And because new circuit cards are continually being introduced, the 801C will never be obsolete.

It's Inexpensive. The complete 801 Computer Logic Teaching System, is only \$365*... at least 20% lower in cost than other systems. And the unique low cost plug-in logic circuit cards used in the system give your course the flexibility it must have to stay abreast of the latest technological developments... something other systems are unable to give you except at large cost.

Write For The New Free Heath Scientific Instrumentation Catalog and investigate this unique system now.
EU-801C, complete Computer Logic System\$365.00*

FREE Heath Scientific Instrumentation Catalog

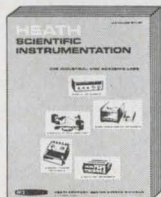

Describes these and other precision instruments for laboratory, engineering, education and R & D applications. Send for your FREE copy now... just write on your school or company letterhead.

HEATH COMPANY, Dept. 580-21
 Benton Harbor, Michigan 49022



Please send FREE Heath Scientific Instrumentation Catalog

Name _____

Address _____

City _____ State _____ Zip _____

Prices and specifications subject to change without notice.

*Mail Order Prices; F.O.B. Factory

EK-283

New Literature

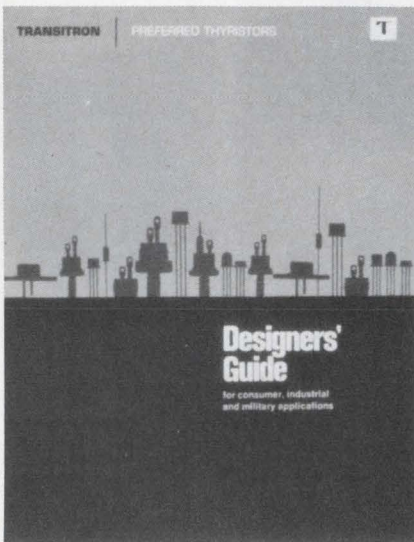

Thyristors

A new 20-page designer's guide to industry-preferred thyristors is available. It covers triacs, SCRs, gate-turn-off and photosensitive devices and chips. Included are thyristor symbology and definitions, applications suggestions and packaging considerations. Products covered are used in computers, opto-electronic circuits, displays, power conversion, ac power control and microwave systems. Transistron Electronic Corp.

CIRCLE NO. 387

Active filters

Salient features of a previously unexploited transistor mechanism which has been found to yield a stable high-Q inductance are outlined in a new paper on active filters for uhf and microwave applications. It shows how a transistor can be substituted for an inductor in conventional filter designs. Described are such characteristics as stability, frequency range, temperature effects, noise figure, and dynamic range. Several applications are discussed including active bandpass and band-stop filters, and active frequency multiplexing or contiguous channelizing filters. Wavecom, Inc.

CIRCLE NO. 388

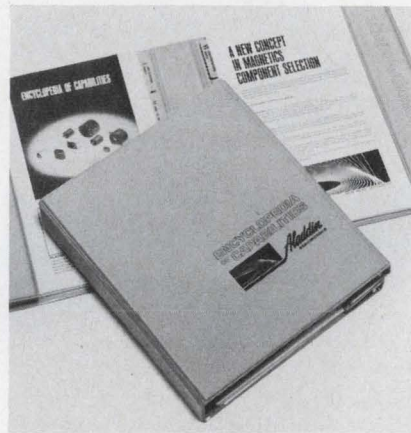

Magnetics encyclopedia

The "Encyclopedia of Capabilities" is a comprehensive publication which provides direct access to magnetic-component design capabilities, including more than 15,000 designs without listing a single part number. It is contained in a double-ring binder, which separates the book into an applications section and a configurations section. The reader can open to any applications page and configurations page simultaneously. The applications section allows the reader to specify pertinent parameters while the configurations section contains line drawings showing actual internal construction as well as external dimensions and mounting. Aladdin Electronics

CIRCLE NO. 389

Infrared spectroscopy

Applications and techniques useful to infrared spectroscopists are included in a new 40-page authoritative handbook. Performance characteristics, spectra, prices and ordering information are given on a complete line of IR spectrophotometer cells, crystals and accessories. Hundreds of items illustrated show advanced designs in micro-sampling accessories including a new precision microcell, specular reflectance units, a new pyrolyzer and liquid and gas cells. Barnes Engineering Co.

CIRCLE NO. 390

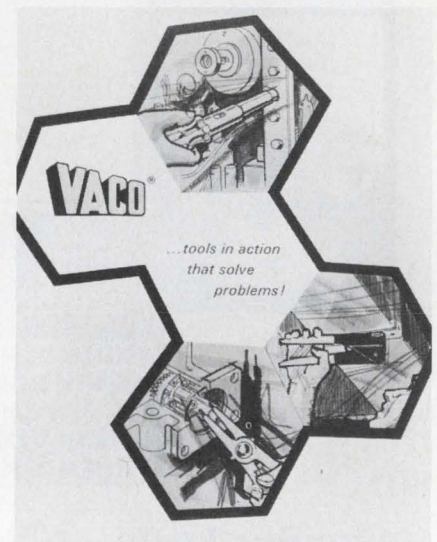

Tools

Catalog SD-170 is a 36-page book that contains hand tools of nearly every variety. These tools include screwdrivers, nutdrivers, pliers, wrenches, fasteners, riveters, wire strippers and ratchet sets. Also included are special tools such as clutch-head drivers, hex-key wrenches, offset drivers and screw launchers. Included in the catalog are complete descriptions, dimensions and handy tool accessories. Vaco Products Co.

CIRCLE NO. 391

Time-share program

A seven-page application abstract explains how a remote time-sharing terminal and a computer program allows circuit designers to quickly and efficiently determine where to place components and how to route conductors on IC boards. Called PWR, the program is one of several that can be used for electrical-engineering applications. Described are the program's input and output. A simple problem illustrates its over-all capability. Execution times for several jobs that were performed by the program in analyzing various circuits are tabulated. Remote Computing Corp.

CIRCLE NO. 392



PASS ME THE AVO!

SIL VOUS PLAIT • POR FAVOR

Worldwide, "Pass the AVO" means someone wants the most accurate, most reliable multimeter... anywhere. Twenty four ranges for AC and DC current, voltage and resistance. Full meter protection includes fuse, velocity actuated mechanical cutout and diode protection for meter movement.



This internationally famous AVO Model 8 has for over 50 years set the highest standard in multimeters. Over a million in use today!

Calibration, parts and service by factory trained personnel are available at our Plainview, N.Y. facility and in most countries throughout the world.

GENCOM DIVISION

varian/EMI

80 EXPRESS STREET, PLAINVIEW, N. Y. 11803
TELEPHONE: (516) 433-5900

INFORMATION RETRIEVAL NUMBER 120

PEC

PEC in 1967 was the first to recognize the need for compact inexpensive IBM compatible magnet tape units to serve the rapidly expanding market for small computers, data terminals and digital systems.

SALES ENGINEER

(Based out of San Francisco)

An exceptional opportunity to join PEC in opening new accounts and maintaining contact with prospective and existing digital tape unit customers based out of San Francisco. Successful candidates should possess a BSEE, ME, Math or Physics plus 4 years directly applicable experience.

Salary Open

To arrange local interviews, mail you resume including salary history to:

Director of Industrial Relations PERIPHERAL EQUIPMENT CORP.

9600 Irondale Ave.
Chatsworth, Calif. 91311

an equal opportunity employer

INFORMATION RETRIEVAL NUMBER 904

ELECTRONIC DESIGN 10, May 10, 1970

radar simulators

Vega Radar Simulators are flight line test sets which are used to interrogate and measure the parameters of a radar transponder or beacon for purposes of final checkout on the launch pad or flight line. It is particularly useful when tracking radars are located at great distances from the launching site.

The Vega Radar Simulator incorporates a transmitter and receiver calibrated and controllable from the front panel in tuned frequency, output power, code spacing and sensitivity, with which the parameters of a remote transponder can be monitored and measured. In addition, it also contains a built-in Oscilloscope, which is used for viewing transmitted and received pulses. The entire unit operates on either external 117 VAC, 12 VDC or internal battery.

Vega C, S and X-Band Radar Simulators will check these transponder parameters while under test:
Receiver Frequency • Receiver Sensitivity • Transmitter Frequency • Transmitter Power Output • Code Spacing • Pulse Parameters (Pulse width, rise time, fall time, etc.)

Units with telescoping legs are also available. Picture how a Vega Radar Simulator would fit into your launch operation, particularly for final checkouts. Contact:

VEGA PRECISION LABORATORIES, INC.

239 Maple Avenue W.,
Vienna, Virginia 22180
Phone: (703) 938-6300

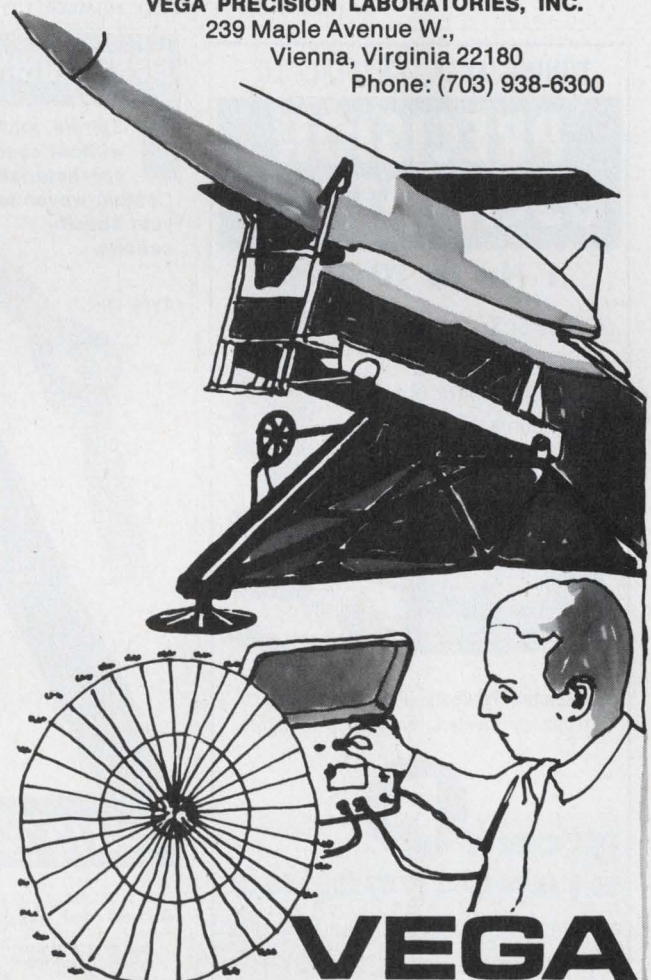

INFORMATION RETRIEVAL NUMBER 121

UNBELIEVABLE ADHESIVE



It's a fact: EASTMAN 910® Adhesive can form remarkably strong, long-lasting bonds between just about any materials you can think of — and do it with surprising speed, without the need for any mixing, heat, solvents, catalysts or more than contact pressure.

Hard to believe? Find out for yourself what this unique adhesive can do, and how it can help you cut assembly costs. Get your copy of the EASTMAN 910 Adhesive information kit by writing to Chemicals Division, EASTMAN CHEMICAL PRODUCTS, INC., Kingsport, Tennessee.

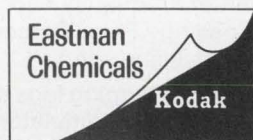

INFORMATION RETRIEVAL NUMBER 122

TUNING FORK, CRYSTAL, LC

PRECISION OSCILLATORS

.1 Hz to 10 MHz

- Sine or Square Wave
- Standard or Custom
- Commercial or MIL Spec
- IC Compatible
- Chassis or PCB mount
- Fast Delivery



Related Products: Power Inverters,
Frequency Dividers, Frequency Inverters

FORK
STANDARDS, INC.

217 Main St., West Chicago, Ill. 60185
Telephone Area Code 312 — 231-3511

INFORMATION RETRIEVAL NUMBER 123

ZIPPERTUBING® FAB-RI-CABLE

*Spirals, folds, knots, rolls
without change in
characteristics!*

*Custom woven to
your specifications.*

TYPE FRC

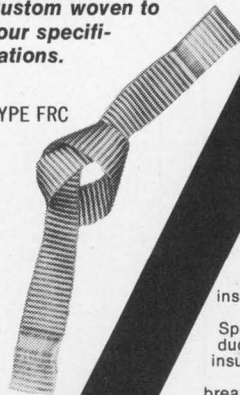

FRC, a flat tightly woven yet flexible ribbon cable does the job of heavy, bulky cables, yet fits in tight spaces or along edges. Breakouts do not disturb insulation of adjacent conductors.

Specify 4 to 100 conductors with any type insulation in any combination of colors, breakouts or conductor sizes. Available woven in synthetic fibers such as Kapton, Teflon, Nylon, Nomex, as well as cotton or linen.

for full information
on specialized,
high-performance
jacketing, contact

THE ZIPPERTUBING®

13000 S. BROADWAY, LOS ANGELES, CALIF. 90061
Los Angeles Phone: (213) 321-3901

BALTIMORE • BOSTON • CHICAGO • CLEVELAND
DALLAS • NEW YORK • ORLANDO • PHOENIX
SAN FRANCISCO • WEST GERMANY



INFORMATION RETRIEVAL NUMBER 124

NEW LITERATURE

ICs and semiconductors

A condensed 16-page catalog describes several lines of integrated circuits and discrete semiconductors. Integrated circuits include TTL, linear and DTL lines. Discrete components include epoxy and glass rectifiers, germanium, silicon and thyristor diodes and silicon transistors. Also included are MOS arrays, military and high-reliability semiconductors, semiconductor chips and wafers, modules and special products. ITT Semiconductor Div.

CIRCLE NO. 393

Terminals

An entire line of solderless electrical terminals is contained in a new 20-page catalog. It includes complete descriptions, electrical and mechanical specifications, and dimensional data for nearly 300 items. Products described include straight and flag-type terminals, splices and quick disconnects. The terminals described can be crimped either individually or with semi-automatic machinery at various production rates. AMP Incorporated.

CIRCLE NO. 394

Graphic recording

The "Flying Spot" component recorders for pattern, plot or picture forms are described in a 16-page catalog. Featured applications include frequency spectrum analysis. Recordings of low radio-frequency emanations from lighting and other electromagnetic phenomena of interest in communications studies are clearly illustrated. Also included are recordings of ionospheric back scatter made during long-range communications studies by radar in real time. Alden Electronic & Impulse Recording Equipment Co., Inc.

CIRCLE NO. 395

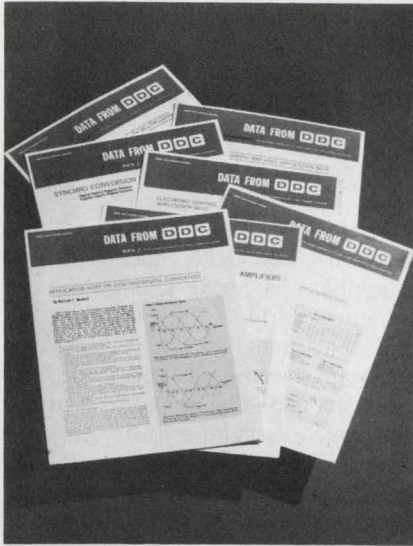

Design notes sets

Many fields of interest to design engineers are covered by several sets of application notes. They cover topics such as applications of wideband amplifiers, digital-to-analog converters and analog-to-digital converters. Also covered are sample-and-hold circuits, multiplexers and synchro converters. Recipients of these application notes will have the opportunity to receive future notes as they are produced. DDC, a div. of Solid State Scientific Devices Corp.

CIRCLE NO. 396

Hewlett-Packard Journal

The March 1970 issue of the Hewlett-Packard Journal is now available. It includes three articles. One article deals with a computing counter and a keyboard combination that form a programmable measurement and computing system. A second article deals with factors to be considered in protecting hospital patients from dangerous electrical hazards. A third article discusses a processing system formed of a desktop calculator and a multichannel analyzer system for data processing. Hewlett-Packard.

CIRCLE NO. 397



Terminal blocks

Complete information and specifications on a modular terminal-block and terminal-strip line are shown in a 32-page catalog. The line provides a wide range of precision engineered melamine terminal blocks which snap individually into or out of one of two standard assembly rails. All units are shrouded by the insulating body for safety and feature captive screws to prevent loss during shipping or installation. Electrovert, Inc.

CIRCLE NO. 398

Test accessories

Electronic test accessories covering 56 pages are contained in a new catalog. Featured are 420 items such as molded test accessories and patch cords, cable assemblies, test and connecting leads, socket adapters, black boxes and other items. Complete engineering information on each item is provided, including photographs, dimensioned drawings, schematics, specifications, features and operating ranges. All items are designed to meet rigid industrial and military specifications. Pomona Electronics.

CIRCLE NO. 399

brite glo[®] ALCOLITE

Alco's new Brite Glo[®] miniature lamp series is achieved through painstaking workmanship that assures the best pilot assembly on the market.

The new T-1 3/8 MNE neon series has an exclusive ring electrode construction that glows on the entire surface with direct current. Available as individual lamps or as miniature panel assemblies.

All our miniature incandescent pilot assemblies contain the most popular and long-life MIL-grade T-1 5 volt lamps. Choice of domed or cylindrical assemblies, in a variety of colors.

Our standard neon series are all equipped with NE2 lamps and are available in many lens styles and colors, with or without built-in series resistors.

For design-service assistance and price quotations, call (Area 617) 686-3887.

SEND FOR COMPLETE
ALCOLITE
CATALOG



ALCO

ELECTRONIC PRODUCTS, INC.

Lawrence, Massachusetts 01843

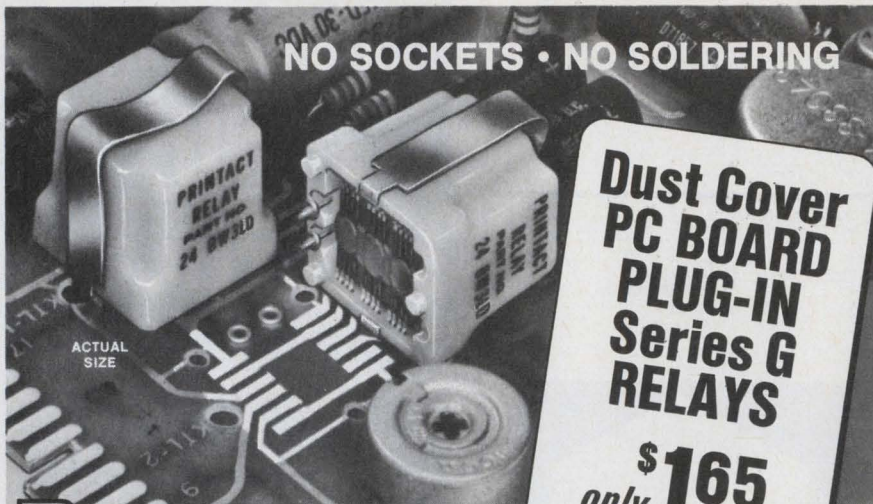

Printact®

Plugs into your PC board... mates with plated conductors

The design concept of the series G non-latching and series LD dual coil magnetic latching relays is to simply mate the encapsulated motor assembly and its associated swinger blade assembly with etched and plated conductors on your PC board which become the fixed contact section.

Encapsulated coil, bifurcated gold or palladium contacts, low thermal EMF, plug-in without sockets or soldering, low bounce and chatter, series-break switching eliminates pig-

tails, permanent magnet avoids return spring and mechanical linkage—all of which assures continuous performance for many millions of cycles.

Available with 6, 12 or 24 VDC coils (0.5 watt G series, 1.0 watt LD series) in 2, 3 and 4 pole configuration. Series break swingers permit each pair of fixed contacts to be etched with common (Form C) or isolated (Form A plus Form B) switching between make and break circuits.

For data write or call 212-EX 2-4800.

Printact Relay Division, Executone, Inc., Box 1430, Long Island City, N.Y. 11101
INFORMATION RETRIEVAL NUMBER 126

Micro-Miniature Reed Relays

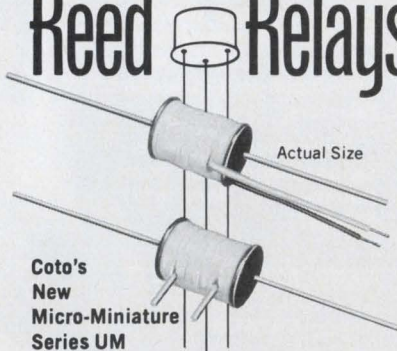

- Extremely small size: .400" x .300"OD
- Occupies less than 0.03 cu. in.
- Ultra-high speed 100 Microseconds operate time excluding bounce
- Stock voltages 3, 6, 12 and 24 volts
- Available with either leads or pins with 0.2" spacing

Special voltages, resistances, electrostatic and/or magnetic shields available. Write for new Data Sheet MR-9.1



COTO-COIL COMPANY, INC.
59 Pavilion Avenue, Providence, R. I. 02905
Tel: (401) 941-3355

INFORMATION RETRIEVAL NUMBER 127

LARGEST AND MOST DIVERSIFIED STOCK OF RELAYS IN THE WORLD!

We also stock MICROSWITCHES®

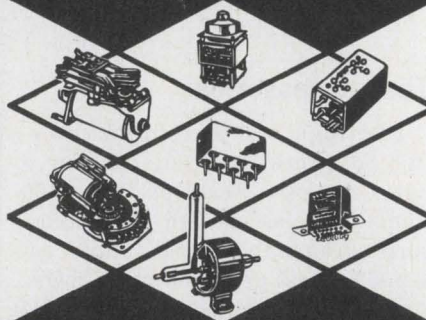

Faster Delivery / Lower Prices
All Types / Most Makes
SEND FOR CATALOG ED

Universal RELAY CORP.

42 White St., New York, N.Y. 10013
(212) 925-6900 • TWX 710-581-4461

INFORMATION RETRIEVAL NUMBER 128

NEW LITERATURE

Silicones

A wide variety of General Electric silicone greases and compounds are described in a 12-page technical data book. Contained within the data book are sections detailing silicone greases for lubrication and silicone compounds for insulation and general-purpose applications. The book also features an application guide and a product summary guide. The latter outlines the typical physical and electrical properties of the full line of products. Silicone grease properties such as compatibility, resistance to temperature variations, stability, oxidation resistance and chemical content are discussed. General Electric Co.

CIRCLE NO. 400

Vhf and uhf filters

A line of standard low-pass filters for incorporation in vhf and uhf transmitters and receivers are described in a new catalog. They operate in the frequency regions of 110 to 150 MHz and 225 to 400 MHz and feature power capabilities up to 75 W. Filters described include connector options of N, BNC, TNC, HN, and subminiature types. The catalog includes typical operating characteristics and case outline drawings. Microwave Filter Co., Inc.

CIRCLE NO. 401

Instrument cases

Standard fiberglass cases designed for hand-held portable field instruments and equipment are the subject of a 12-page catalog. Specifications and general information are included for an extensive line of cases that are available from stock. Also described and illustrated are cases manufactured to military specifications, custom case interiors, special hardware, cases with sandwich-construction features, and plastic and custom models. Skydyne, Inc.

CIRCLE NO. 402

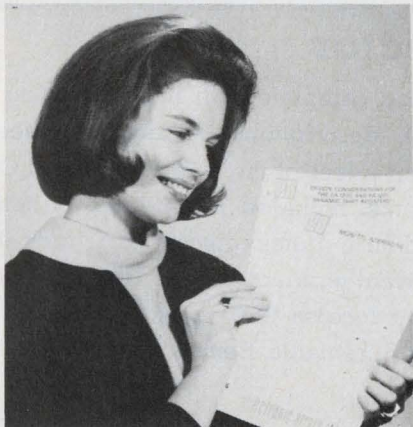

MOS shift registers

An eleven-page paper generated to aid the user in the selection, testing and proper electrical implementation of dynamic MOS shift registers is available. It covers general design considerations and includes sections concerning clock options, power dissipation considerations, interfacing factors, a shift register circuit and application examples. Electronic Arrays, Inc.

CIRCLE NO. 403

Minicomputer report

The entire special 1970 Spring Joint Computer Conference section of the April 26 issue of *ELECTRONIC DESIGN*, which includes the directory on minicomputers, is now available. The section also includes a special 10-page report on minicomputers, plus the conference's complete product highlights and features. Hayden Publishing Co., Inc.

CIRCLE NO. 404

Tools

Catalog 171 is a new publication that contains a listing of hand tools, tool kits, and tool assortments. It includes such tools as screwdrivers, nutdrivers, scratch awls and four-in-one tools. In addition, 44 new items are included. Prices, a list of sales representatives and important conversion tables that are applicable to the hand-tool industry are provided. Upson Tools, Inc.

CIRCLE NO. 405

Ethyl silicates

The scope of information on ethyl silicates has been increased with a new 11-page bulletin. Several applications are described in an expanded applications section. In many instances the U. S. patent number is listed so that the reader can follow through in obtaining information. An expanded formulations table outlines the formulations to use in preparing solutions for hydrolysis. It is supplemented by a complete description of both the solvent and the nonsolvent methods for achieving this hydrolysis. Union Carbide Corp.

CIRCLE NO. 406

Metal powder directory

The latest edition of a directory of domestic and foreign sources of metal powders is available. The directory, which was released by the Metal Powder Producers Association lists more than 50 ferrous and nonferrous metal powders. These are indexed alphabetically according to the types of powders supplied by each of 52 companies. Complete addresses of all the firms, who are members of the Metal Powder Producers Association, are also given. Metal Powder Producers Association.

CIRCLE NO. 407

Aluminum capacitors

New performance data on aluminum capacitors is available in an engineering bulletin that describes a tubular non-aqueous electrolyte capacitor series for operation over an extended-temperature range. Within their temperature range of -55 to $+85^{\circ}\text{C}$, these capacitors show performance characteristics which equal those of the more costly tantalum foil units. Included in the bulletin is a list of standard ratings in capacitance values from $13,000 \mu\text{F}$ at 5 V dc to $290 \mu\text{F}$ at 200 V dc . Complete performance characteristics are also given. Sprague Electric Co.

CIRCLE NO. 408

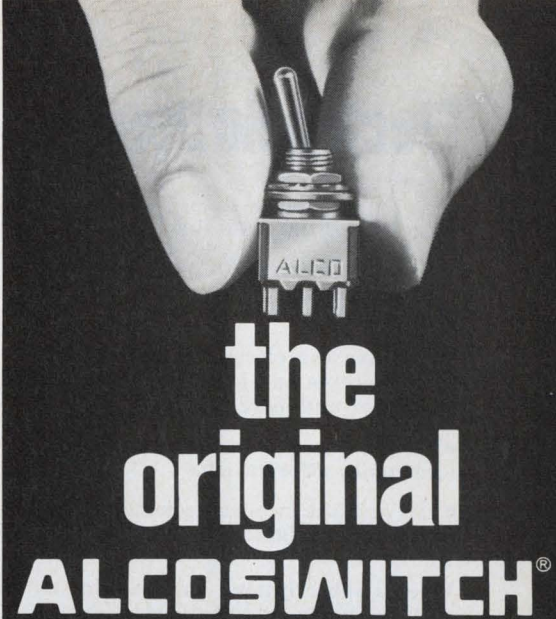

The original miniature ALCOSWITCH® has been the engineer's 1st choice for contemporary front panel designs.

When most every one was working with conventional switches of the 1930's, ALCOSWITCH® introduced the concept of mass-produced switches compatible with the new technology of miniaturization.

Ultra-miniature in size, the original ALCOSWITCH® combines high current capacity and exceedingly long life into a $\frac{1}{2}$ " size case. Contacts are solid silver and the phenolic body has high voltage barriers between terminals and contacts.

Since its introduction the original ALCOSWITCH® has withstood the test of time, where today it is the "most-asked-for" miniature switch.

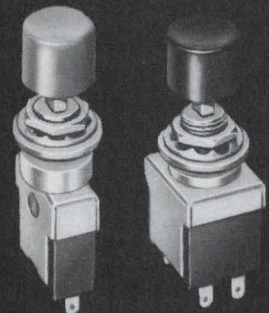

This broad line of miniature switches includes toggles, push buttons and rotaries, all available in one, two, three and four pole in a single case construction.

Read all about it in this 20-page catalog!



ALCO®

ELECTRONIC PRODUCTS, INC.

Lawrence, Massachusetts 01843

Electronic Design

ELECTRONIC DESIGN's function is:

- To aid progress in the electronics manufacturing industry by promoting good design.
- To give the electronic design engineer concepts and ideas that make his job easier and more productive.
- To provide a central source of timely electronics information.
- To promote two-way communication between manufacturer and engineer.

Want a subscription? ELECTRONIC DESIGN is sent free to qualified engineers and engineering managers doing design work, supervising design or setting standards in the United States and Western Europe. For a free subscription, use the postfree application form inside the back cover. If none is included, write to us direct for an application form.

If you do not qualify, you may take out a paid subscription for \$25 a year in the U.S.A., \$35 a year elsewhere. Single copies are \$1.50 each.

If you change your address, send us an old mailing label and your new address; there is generally a prepaid postcard for this inside the back cover. You will have to requalify to continue receiving ELECTRONIC DESIGN free.

The accuracy policy of ELECTRONIC DESIGN is:

- To make reasonable efforts to ensure the accuracy of editorial matter.
- To publish prompt corrections whenever inaccuracies are brought to our attention. Corrections appear at the end of the Letters column.
- To refuse any advertisement deemed to be misleading or fraudulent.

Microfilm copies are available of complete volumes of ELECTRONIC DESIGN at \$19.00 per volume, beginning with Volume 9, 1961. Work is now in process to complete the microfilm edition of Volumes 1-8. Reprints of individual articles may be obtained for \$2.00 each, prepaid (\$.50 for each additional copy of the same article) no matter how long the article. For further details and to place orders, contact the Customer Services Department, University Microfilms, 300 North Zeeb Road, Ann Arbor, Michigan 48106; telephone (313) 761-4700.

Want to contact us? If you have any comments or wish to submit a manuscript or article outline, address your correspondence to:

ELECTRONIC DESIGN,
850 Third Avenue,
New York, N.Y. 10022.

Design Data from

Terminal Block Selector

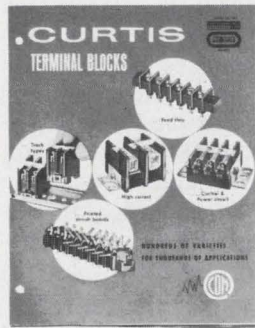

A new 24-page, completely illustrated catalog contains photos, descriptions, ratings, engineering drawings, and prices of the complete line of Curtis terminal blocks. Included are printed circuit, insulated feed-thru, quick disconnect, track type, and high current terminal blocks. Handy selection chart quickly locates the perfect block for your particular requirements. Send today for your free copy.

Curtis Development & Mfg. Co.

3236 North 33rd Street
Milwaukee, Wisconsin 53216

See us at booth 321 - Design Engineering Show

171

Calibrated Frequency-Domain Measurements

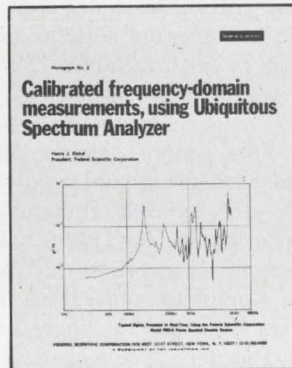

A theoretical discussion of the methods of performing calibrated frequency-domain measurements using narrow-band and wide-band signals are detailed. Methods of calibrating real-time spectrum analyzers, such as with the Ubiquitous® Spectrum Analyzer, are discussed using pure sine waves and broadband noise to obtain power spectral density plots. The calibration method described provides accurate, quantitative measurement of noise, vibration, and underwater acoustic signals which have been processed by a power spectral density system using the well-known Ubiquitous® Spectrum Analyzer. Send for free Technical Monograph #2.

Federal Scientific Corporation

a subsidiary of Elgin National Industries, Inc.
615 West 131st Street, New York, N.Y. 10027

172

FUNDAMENTALS OF INTEGRATED CIRCUITS

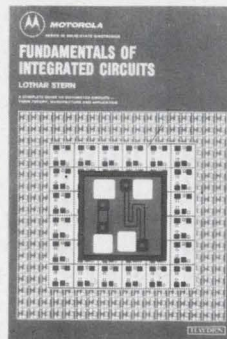

A practical guide to integrated circuits, their theory, manufacture, and applications. This new guide by Lothar Stern offers complete, highly readable coverage of the various techniques of circuit fabrication, and their effect on circuit design and performance. As to marketing considerations, it compares the characteristics of the numerous IC structures devised to date in terms of economics and logistics. A volume in the Motorola Series in Solid-State Electronics. 198 pages, 7 x 10, illustrated. \$8.95, clothbound. Circle the reader-service number below for 15-day examination copies.

Hayden Book Company, Inc.

116 West 14th Street
New York, N.Y. 10011

173

Manufacturers

Advertisements of booklets, brochures, catalogs and data sheets. To order use Reader-ServiceCard.
(Advertisement)

1970 Electronic Components Drafting Aids Catalog

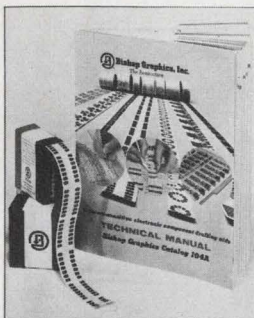

Free Catalog! Free Samples! Exciting innovations in pressure-sensitive electronic component drafting aids and methods are detailed in the new 1970 edition of the combined Bishop Technical Manual and Catalog 104A.

68 illustrated pages of over 15,000 multi-pad configurations, symbols, tapes, sequential reference designations plus hundreds of time-and-money-saving hints in making artwork for PC boards. Includes instructions for using the industry's only red and blue tape system for making two-sided boards in perfect registration. Send now for free Catalog 104A and free samples.

Bishop Graphics, Inc.

7300 Radford Avenue
North Hollywood, California 91605
(213) 982-2000 Telex: 674672

174

Minimizing Capacitance Changes

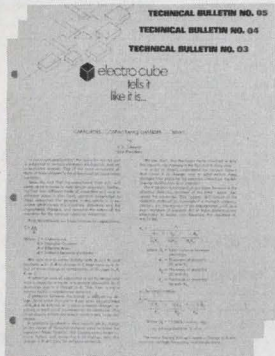

Causes of capacitance value changes in wound dielectric capacitors are treated in an Electro Cube technical bulletin to aid designers in selecting and using capacitors. Graphs and formulas are used to illustrate the straight-forward discussion and to compare performance of various dielectrics with changes in operating and environmental conditions. Also available are bulletins treating the sometimes confusing considerations of capacitor dissipation factor and insulation resistance, as part of a continuing series of two and four page technical discussions by Fred L. Johnson.

Electro Cube, Inc.

1710 South Del Mar Avenue
San Gabriel, California 91776

175

ELECTRONIC KITS CATALOG



Build all-professional Eico Kits and **save 50%**. The more you know about electronics, the more you appreciate Eico for 25 years uncompromising engineering at lowest cost.

- SOUND N' COLOR® high fidelity color light-works: color organs, strobes, translators.
- SERIES-5® solid state test instruments guaranteed for 5 years.
- CORTINA® solid state stereo receivers, amplifiers, tuners.
- EICOCRAFT® solid state jiffy project electronic kits.

Send for FREE 32-page catalog.

EICO Electronic Instrument Co., Inc.

283 Malta Street, Brooklyn, N. Y. 11207

176

Electronic Design

Advertising Sales Staff

Keith Aldrich
Sales Manager

New York 10022

Robert W. Gascoigne
Thomas P. Barth
Samuel M. Deitch
850 Third Avenue
(212) Plaza 1-5530
TWX: 867-7866

Philadelphia 19066

William C. Repetto
P. O. Box 206
Merion Station, Pa.
(215) MA-3-5888

Boston 01945

Joseph F. Palmer
14 Peter Hobart Drive
Hingham, Mass.
(617) 742-0252

Chicago 60611

Thomas P. Kavooras
Berry Conner, Jr.
200 East Ontario
(312) 337-0588

Cleveland

Thomas P. Kavooras
(Chicago)
(312) 337-0588
(call collect)

Los Angeles 90303

Stanley I. Ehrenclou
W. James Bischof
2930 Imperial Highway
Inglewood, Calif.
(213) 757-0183

San Francisco 94022

Arthur R. Shields, Jr.
95 Main St.
Los Altos, Calif.
(415) 941-3084

London W. 1

For United Kingdom and Holland
Brayton C. Nichols
44 Conduit Street
Tel: REGent 4714

Verviers, Belgium

For Continental Europe
Andre Jamar
1, Rue Mallar, 1
(087) 253.83 Telex 41563

Tokyo

Haruki Hirayama
Electronic Media Service
Rm. 601, Daini Miyouchi Bldg.
6-8-14, Roppongi,
Minato-ku
Phone: 402-4556
Cable: Electronicmedia, Tokyo



AMERICAN BUSINESS PRESS, INC.

the best way
to start
designing
a system is to
**SEND FOR
THE LATEST
CATALOG of
PREMIER
STANDARD
METAL
ENCLOSURES**

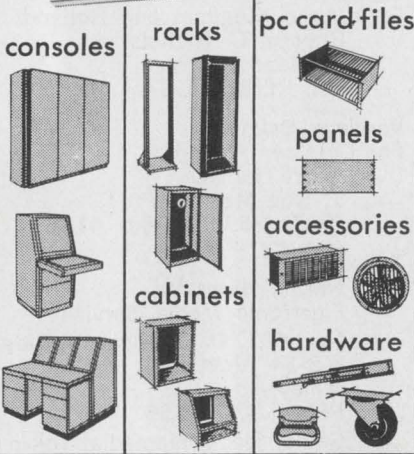
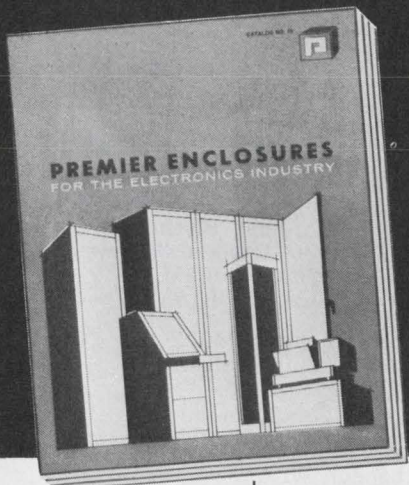

**PREMIER
METAL PRODUCTS CO.**

A Division of Sunshine Mining Company
Pioneers in Metal Housings
for the Electronics Industry Since 1946
337 Manida Street, Bronx, N.Y. 10474
(212) 991-6600



Advertisers' Index

Advertiser	Page	Advertiser	Page
ADC Products, A Division of Magnetic Controls Co.	119	Koch & Sons, H.	65
Aladdin Electronics	63	Krohn-Hite Corporation	123
Alco Electronic Products, Inc.	130, 169, 171	Kurz-Kasch, Inc.	72
Allco	64D	L.A.B. Corporation	152
Allen-Bradley Co.	27	3M Company, Scotchpar	60, 68
American Astronics, Inc.	52	M & T Chemicals, Inc.	60
Analogic Company	154	Magnecraft Electric Company	54
Applicon Incorporated	55	Malayan Tin Bureau, The	159
Associated Testing Laboratories, Inc.	64	Marathon Battery Company	45
Automatic Electric Company	48, 49	Marconi Instruments Division of English Electric Corporation	58
Beckman Instruments, Inc., Helipot Division	113	Mellonics Systems Development Division, Litton Industries	14
Belden Corporation	110, 111	MicroSwitch, A Division of Honeywell	15
Bishop Graphics, Inc.	173	Monolithic Dielectrics, Inc.	68
Burr-Brown Research Corporation	117	National Semiconductor Corporation	80, 81
Burroughs Corporation	20	New Product Engineering Inc.	133
CTS Corporation	141	Oak Manufacturing Co.	72
Calvert Electronics, Inc.	161	Philips Electronic Components and Materials Division	64F, 64G
Cambridge Thermionic Corporation	56	Plastic Capacitors, Inc.	146
Centralab Semiconductor Division, Globe Union, Inc.	61	Premier Metal Products Co.	174
Chicago Dynamics Industries, Inc.	62	RCA Electronic Components and Devices	Cover IV
Cinch-Graphik	79	Radio Switch Corporation	160
Cinch Manufacturing Company	35	Raytheon Computer	163
Clare & Co., C. P.	153	Raytheon/Semiconductor	8, 9
Cohn Corp., Sigmund	132	Redcor Corporation	141
Computervision Corporation	10	Rental Electronics, Inc.	142
Coto Coil Company, Inc.	170	Resistance Products Company	149
Curtis Development & Mfg. Co.	172	Rohde & Schwarz	64B
Cutler-Hammer	115	Rotron, Incorporated	44
Dale Electronics, Inc.	Cover III	San Fernando Electric Manufacturing Company	148
Datascan, Inc.	145	Schauer Manufacturing Company	144
Delco Radio, Division of General Motors	104, 105	Scientific Atlanta, Inc.	7
Diversified Electronics, Inc.	156	Schlumberger	64A, 64C, 64E
Dow Corning Corporation	66	Servo-Tek Product Company	136
Durant Digital Instruments, A Cutler-Hammer Company	68	Signalite, Incorporated	67
E-H Research Laboratories, Inc.	53	Signetics Corporation	24, 24A-Y
EICO Electronic Instr. Co., Inc.	173	Signetics Corporation, Measurement/Data	2
ENM Company	161	Siliconix, Incorporated	46, 59
ERA Transpac Corporation	150	Simpson Electric Company	13, 127
Eastman Chemical Products, Inc.	168	Sprague Electric Company	18, 51
Edmund Scientific Company	161	Stackpole Carbon Company	69
Electro Cube	149, 173	Stalwart Rubber Company	137
Electro Products Laboratories, Inc.	155	Switchcraft, Inc.	97
Exact Electronics, Inc.	120	Sylvania Components, Semiconductor Division	12
Executone, Inc.	170	Sylvania Precision Materials, Parts Division	32 A-B-C-D
Fairchild Controls, A Division of Fairchild Camera and Instrument Corporation	143	TEC Incorporated	64
Fairchild Microwaves and Optoelectronics	33	Tektronix, Inc.	6
Fairchild Semiconductor, A Division of Fairchild Camera and Instrument Corporation	42, 43	Teletype Corporation	4, 5
Federal Scientific Corp.	172	Texas Instruments Incorporated, Components Group	23
Fork Standards, Inc.	168	Thermal American Fused Quartz Co., Inc.	140
Gencom Division, Varian/EMI	158, 167	Triplet Corporation	74
General Dynamics	90, 91	Tung Sol Division, Wagner Electric Corporation	11
General Electric Company	31	Union Carbide, Components Department	37
General Radio Company	1	Unitrode Corporation	29
Gould Inc., Piezoelectric Division	56	Universal Relay Corp.	170
Guardian Electric Manufacturing Company	47	Vega Precision Laboratories, Inc.	167
Hansen Manufacturing Co., Inc.	138	Victoreen Instrument Division	134
Hayden Book Company, Inc.	64H, 70, 172, 175	Wall Manufacturing Co.	160
Heath Company	165	Weston Instruments, Inc., Newark Division	89
Hewlett-Packard	Cover II, 16, 41, 131	Weston Instruments, Inc., Archbald Division	128
Honeywell, Computer Control Division	38	Zenith Radio Company	160
Hudson Lamp Company	64	Zippertubing Corp., The	168
Hysol Division of Dexter Corporation	157		
IBM Marketing Information	73		
IMC Magnetics Corp.	125		
Indiana General, A Division of Electronic Memories & Magnetics Corporation	50		
Industrial Timer Corporation	72		
International Rectifier, Semiconductor Division	17		
JFD Electronics Corp./Components Division	151		
James Electronics, Inc.	60		
Johanson Manufacturing Corp.	135		
Johnson Company, E. F.	57		
Joslyn Electronic Systems	147		

Career Advertising:

Fairchild Camera and Instrument Corporation	71
Peripheral Equipment Corp.	167

MICROELECTRONIC DESIGN

Edited by Howard Bierman

A complete and concise survey of the entire field of microelectronics providing practical and professional ideas from the pages of *Electronic Design*. Almost 90 important studies cover all aspects of this rapidly expanding technology—basic integrated circuit components, thick and thin film, reliability, black-boxing, etc. Valuable data charts on more than 500 devices, a list of manufacturers, and a full bibliography insure the book's usefulness. 320 pages, 8½ x 11 illustrated, clothbound.

#5762 \$11.50

ELECTRONIC DESIGN TECHNIQUES

Edward E. Grazda

This vital reference presents fresh ideas and proven techniques selected from articles that appeared in *Electronic Design*. Grouped in sections, they cover the use and design of amplifiers, resistor networks, filters, control devices, power supplies, microwave systems, oscillators, and pulse and switching circuits. Tables, nomographs, performance charts, and guidelines for techniques in many areas make this an extremely valuable tool for the engineer. 312 pages, 8½ x 11, illustrated, clothbound.

#5648 \$13.95

DESIGN OF TRANSISTORIZED CIRCUITS FOR DIGITAL COMPUTERS

Abraham I. Pressman

Offering a firm knowledge of both principles and practice, this authoritative book employs "worst case" design calculations as an essential aspect of this type of design. It covers the major schemes currently employed in designing computer logic, including Pyramiding Factors, Turn On, Turn Off, and Storage Time calculations. Circuit analysis and all aspects of output waveforms are calculated treating the transistor as a current switch. 328 pages, 6 x 9, illustrated, clothbound.

#0215 \$13.95

ENGINEERS' RELAY HANDBOOK

Revised Second Edition

National Association of Relay Manufacturers

More than ever "a relay handbook to rely on,"* the Revised Second Edition of this practical working reference provides a complete, authoritative roundup of essential information on the operating principles, properties, performance characteristics, application requirements, specifications, and testing of relays.

New sections detail reed and mercury wetted relays, and solid state devices. Particularly valuable features are the complete discussion of magnet wires, and the unique description of hybrid combinations of relays and solid state devices. This time- and money-saving handbook includes numerous diagrams, charts, and tables, and a complete, up-to-date bibliography. *From a review of the First Edition, *Control and Measurement*. 355 pages, 7¾ x 10¾, illustrated, clothbound.

#5867 \$13.95

MATRIX ALGEBRA FOR ELECTRONIC ENGINEERS

Paul Hlawiczka

A basic course for the practicing engineer or student, for whom matrix algebra is often an indispensable tool for solving problems in physics and electronics. Gives a general orientation and shows the solution of simple problems. Part I covers the essentials of matrix methods and their applications. Part II treats more complex methods, applying them to differential equations of linear networks. 224 pages, 5¾ x 8¾, illustrated, clothbound.

#5629 \$8.75

MICROWAVE SYSTEMS PLANNING

Kenneth L. Dumas and Leo G. Sands

Designed for managers and engineers, this book defines and explains in a semi-technical manner the important criteria involved in the planning, engineering, and installation of microwave communications equipment. Covers point-to-point FM systems beginning with frequency, wave theory and propagation, and following through to hardware theory and the practical aspects of establishing a microwave path with a high probability of good performance. 152 pages, 6 x 9, illustrated, clothbound.

#5696 \$8.00

NONDESTRUCTIVE HIGH POTENTIAL TESTING

Harold N. Miller

This single-volume sourcebook covers the essentials of nondestructive electrical testing from general principles to specific how-to instructions. It stresses important techniques for determining the ability of solid, gas and liquid insulation to withstand predetermined amounts of over-voltage without failure. Guides to proper selection of test sets and mechanical features are also included. 160 pages, 5½ x 8½, illustrated, clothbound.

#5028 \$8.95

SIMPLIFIED MODERN FILTER DESIGN

Phillip R. Geffe

Bringing together the various modern, or network-synthesis methods in filter design, this book enables the engineer to achieve practical design more easily. Extensive tables of numerical data preclude much of the difficulties in design. Covers lowpass, high-pass, simplified and refined designs, band-stop, attenuation, equalizers, linear-phase and delay equalizers, measurement techniques, etc. 182 pages, 5½ x 8½, illustrated, clothbound.

#0317 \$9.95

Time- and Money-Saving Guidebooks!

**Review
any of them
for
10 full days
—FREE!**



HAYDEN BOOK COMPANY, INC.
116 W. 14 St., New York, N.Y. 10011

ED-470

Please send me the books circled below on 10-day free examination. At the end of that time, I will remit payment, plus postage, or return the books without obligation.

5867	5648	5629	5762
5676	5028	0215	5537
5512	0317	5696	

Payment enclosed (Hayden pays postage). Same return privilege.

Name _____

Firm _____

Address _____

City _____

State _____ Zip _____

On all overseas orders, payment in U.S. dollars must be enclosed. Publisher pays postage with same return privilege.

400 IDEAS FOR DESIGN

Selected from *Electronic Design*

Here are over 400 tested engineering ideas selected from the popular "Ideas for Design" column of *Electronic Design*. These ideas proved their value as parts of larger designs and aids in measuring the parameters or testing the effectiveness of designs. Arranged in convenient categories for handy reference, they provide practical tips on improving equipment performance, developing versatile designs, saving on materials and time, etc. 232 pages, 8¾ x 11¼, illustrated, clothbound.

#5537 \$10.95

SYNTHESIS OF RC NETWORKS

Hun H. Sun

Dealing with the fundamentals of both active and passive networks, this convenient reference for faculty and research personnel includes new and original contributions by the author. For example, it covers the algorithm for ladder development and the criteria for determining the negative real roots of a polynomial. These class-tested materials are backed up by problems and suggested readings. 150 pages, 6 x 9, illustrated, clothbound.

#5676 \$7.50

ELECTRICAL INTERFERENCE

Rocco Ficchi

Provides the designer, field engineer, program manager and technician with a broad view of interference in modern electronics systems. The book shows the entire field as a unified discipline and makes it possible to solve problems encountered in small radio receivers on up to large missile systems. Includes material on how interference control is introduced in design and the best practices to contain interference. 256 pages, 6 x 9, illustrated, clothbound.

#5512 \$9.95

Product Index

Information Retrieval Service. New Products, Evaluation Samples (ES), Design Aids (DA), Application Notes (AN), and New Literature (NL) in this issue are listed here with page and Information Retrieval numbers. Reader requests will be promptly processed by computer and mailed to the manufacturer within three days.

Category	Page	IRN
Components		
capacitors (NL)	171	408
delay lines, DIP	150	336
displays, LED	148	298
electromagnets (AN)	164	381
filter simulation (AN)	164	384
filters (NL)	170	401
filters, active (NL)	166	388
IC catalog (NL)	168	393
lamp, solid-state	150	337
lamps (AN)	164	385
magnetics (NL)	166	389
switch, rotary TO-5	149	299
switches, pushbutton	150	335
thermocouples (AN)	164	386
thyristors (NL)	166	387
timing cell	150	338
triacs (AN)	164	380
zener guide (DA)	160	368
Data Processing		
audio response system	142	281
calculators	140	277
computer, 16-bit	141	278
computer terminal	140	274
data transfer system	144	286
graphic recording (NL)	168	395
microfilmer	144	284
minicomputer	141	279
minicomputers (NL)	171	404
multiplexer/coupler	144	285
plotter, digital	144	287
printers, electrostatic	142	282
scanner, laser	142	280
tape system	142	283
terminal, portable	140	275
terminal, portable	140	276
time sharing (NL)	166	392
ICs & Semiconductors		
amplifier, sense	135	265
amplifier, triple	135	262
converter, d/a	134	260
converter, number	135	261
couters, up/down	134	259
demodulators, IC	132	252
diodes (AN)	164	383
IC catalog (NL)	168	393
ICs, MOS logic	132	254
ICs, TTL	129	250
memory, 64-bit	135	264
memory, read-only	130	251
memory, read-only	135	266
multiplier, analog	132	253
op amp	135	263
op amp, high-speed	132	256
op amp, micropower	133	258
regulators, voltage	132	255
shift registers (NL)	171	403
sound system, TV	132	257
thyristors (NL)	166	387
triacs (AN)	164	380
zener guide (DA)	160	368
Instrumentation		
clip, logic	145	288

Category	Page	IRN
counter/timer	145	289
counters, digital	147	294
curve tracer plug-in	146	293
DIP tester	146	291
DPMs, 4-1/2-digit	148	297
instrument journal (NL)	169	397
multimeter	146	290
PC-board exerciser	148	296
recorder, chart	147	295
spectroscopy, IR (NL)	166	390
test accessories (NL)	169	399
VOM, portable	146	292
Microwaves & Lasers		
amplifier, S-band	151	340
amplifiers, L-band	152	344
circulator, S-band	154	349
converter, rf	152	342
equalizer, gain	154	348
generator, sweep	153	345
generator, sweep	154	350
hybrids, compact	153	346
oscillator, Gunn	152	341
substrates (ES)	158	362
sweeper	152	343
transistor, coaxial	151	339
transmitter, telemetry	154	347
Modules & Subassemblies		
amplifier notes (NL)	169	396
circuit protectors	137	268
filter simulation (AN)	164	384
filters (NL)	170	401
op amp, fast	137	269
op amp, FET	138	273
op amps	137	272
operational amplifiers	136	267
regulator, current	138	270
regulator, voltage	138	271
Packaging & Materials		
barrier strips (ES)	158	364
cases, instrument (NL)	170	402
coax, miniature	155	352
connector (ES)	158	360
lubricant (ES)	158	365
materials (AN)	164	381
monitors, temp (ES)	158	361
mounting system	155	351
powders, metal (NL)	171	407
ribbons, fiber-optic	155	353
silicates, ethyl (NL)	171	406
silicones (NL)	170	400
terminal blocks (NL)	169	398
terminals (NL)	168	394
Tools & Engineering Aids		
binary card (DA)	160	366
desoldering tool	156	356
heat sink, DIP	156	354
lettering (ES)	158	363
loader, component	157	359
logic symbols (DA)	160	367
tips, vacuum	156	355

Category	Page	IRN
tools (NL)	166	391
tools (NL)	171	405
welding fixture	157	358
wire stripper	156	357

New Literature

amplifier notes	169	396
capacitors	171	408
cases, instrument	170	402
filters	170	401
filters, active	166	388
graphic recording	168	395
IC catalog	168	393
instrument journal	169	397
magnetics	166	389
minicomputer report	171	404
powders, metal	171	407
shift registers	171	403
silicates, ethyl	171	406
silicones	170	400
spectroscopy, IR	166	390
terminal blocks	169	398
terminals	168	394
test accessories	169	399
thyristors	166	387
time sharing	166	392
tools	166	391
tools	171	405

Application Notes

diodes, fast-recovery	164	383
electromagnets	164	381
filter simulation	164	384
lamps	164	385
materials	164	382
thermocouples	164	386
triacs	164	380

Design Aids

binary card	160	366
logic symbols	160	367
zener guide	160	368

Evaluation Samples

barrier strips	158	364
connector	158	360
lettering	158	363
lubricant, electronic	158	365
monitors, temperature	158	361
substrates, microwave	158	362

Power hungry?



Dale makes an industrial wirewound for every appetite...

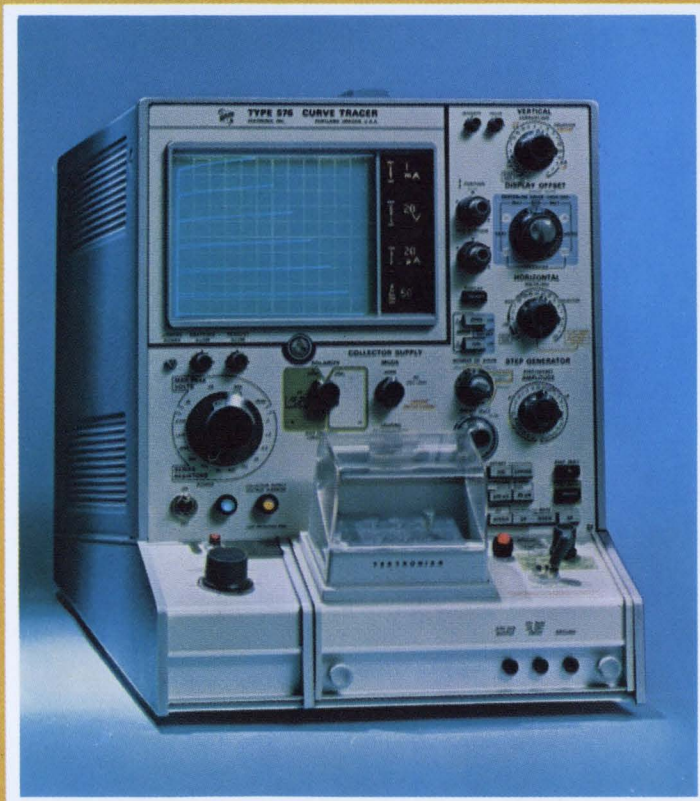

Tektronix, for example...

Dale offers you a wider choice in meeting industrial power resistor requirements: Silicone-coated HL types where maintenance of tolerance and low TC are important. Vitreous-enamel coated VL types where rugged environments are encountered. Tektronix uses the space-saving flat HL style in the collector supply of its versatile Type 576 Semiconductor Curve Tracer. For precision instruments like this, tolerances down to 1% are available, plus taps, sliders, lugs, leads—even special sizes to 1,000 watts. You name it—we're waiting.

PHONE 402-564-3131 for information or write for Catalog A



DALE ELECTRONICS, INC.

1300 28th Ave., Columbus, Nebraska 68601
In Canada: Dale Electronics Canada, Ltd.

A subsidiary of The Lionel Corporation



INTRODUCING NEW RCA SUPERSWITCH:

LIGHT SENSOR AND POWER AMPLIFIER ON ONE IC CHIP!

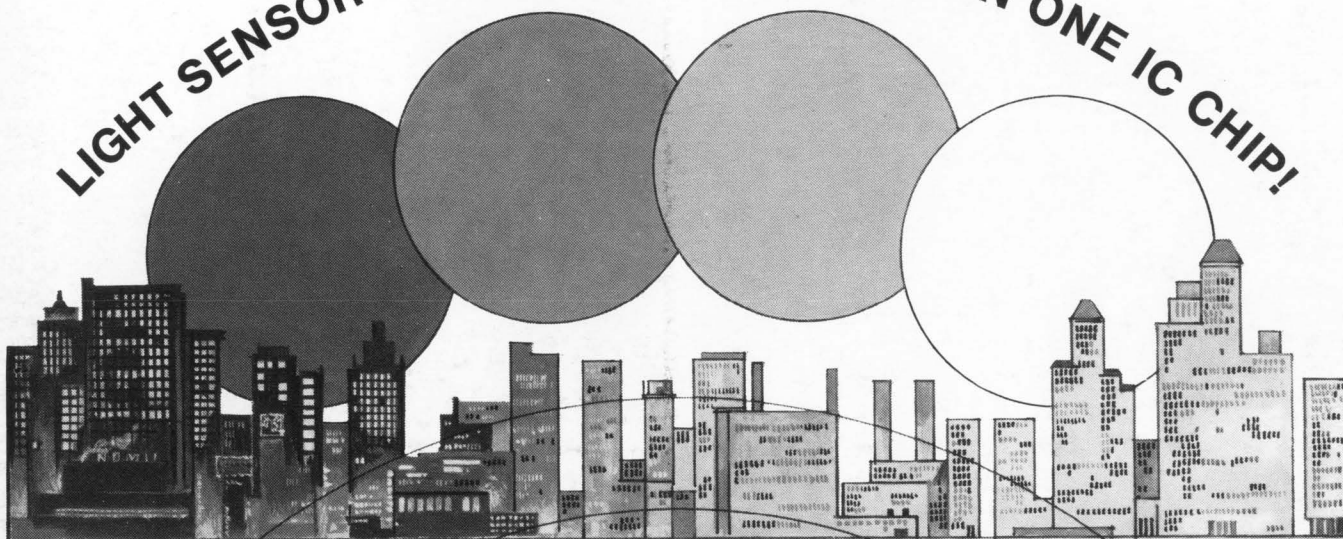

THE NEW CA3062

\$2.95 (1000-UNIT LEVEL)

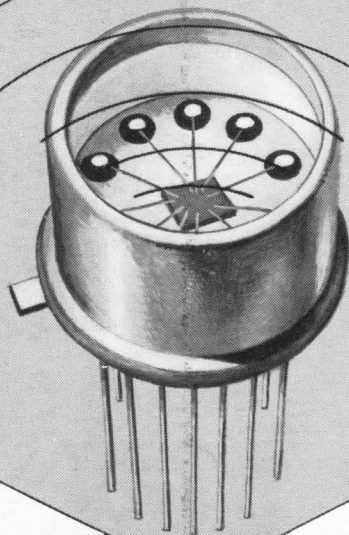

Choose any medium-speed application that uses a light sensor. You'll find the circuitry easier to design when you use the RCA-CA3062—because there's less to design. The CA3062 consists of two parallel-connected photosensitive Darlington pairs which drive a differential power amplifier to provide a normally-off and a normally-on output in response to a light input. Turn-on time is typically 38 μ s. Turn-off time is 43 μ s. Available in a compact, window-ended TO-5 style package, the CA3062 has 100 mA output current capability, and can be operated at supply voltages in the

range of 5 to 15 volts dc. It is compatible with RCA's 40736R infrared emitter. Use it for counter and position sensors, optical tachometers, limit detectors, level scanners, paper web sensors, wheel balancers, and similar devices.

For further details, see your local RCA Representative or your RCA Distributor. For technical bulletin, File No. 421, write: RCA Electronic Components, Commercial Engineering, Section E52-1/CA26, Harrison, N. J. 07029. In Europe: RCA International Marketing S.A., 2-4 rue du Lièvre, 1227 Geneva, Switzerland.

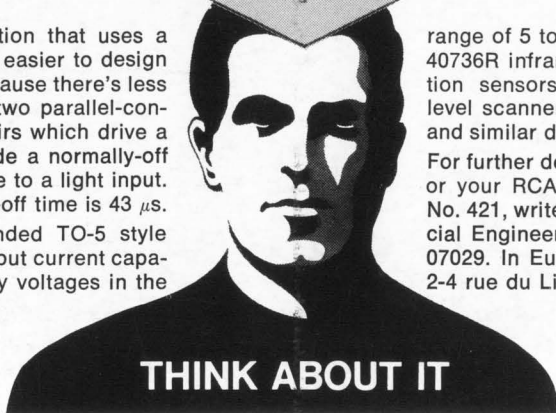

THINK ABOUT IT

RCA Integrated Circuits