

Electronic Design 6

VOL. 22 NO.

FOR ENGINEERS AND ENGINEERING MANAGERS

MARCH 15, 1974

CMOS has become a favorite in designs calling for low power and high noise immunity. But which standard line do you use? The 4000 series is the most

popular, but others feature higher speeds, denser circuits or TTL pinouts. What are the tradeoffs and how well can you trust the specs? See Focus on page 86.

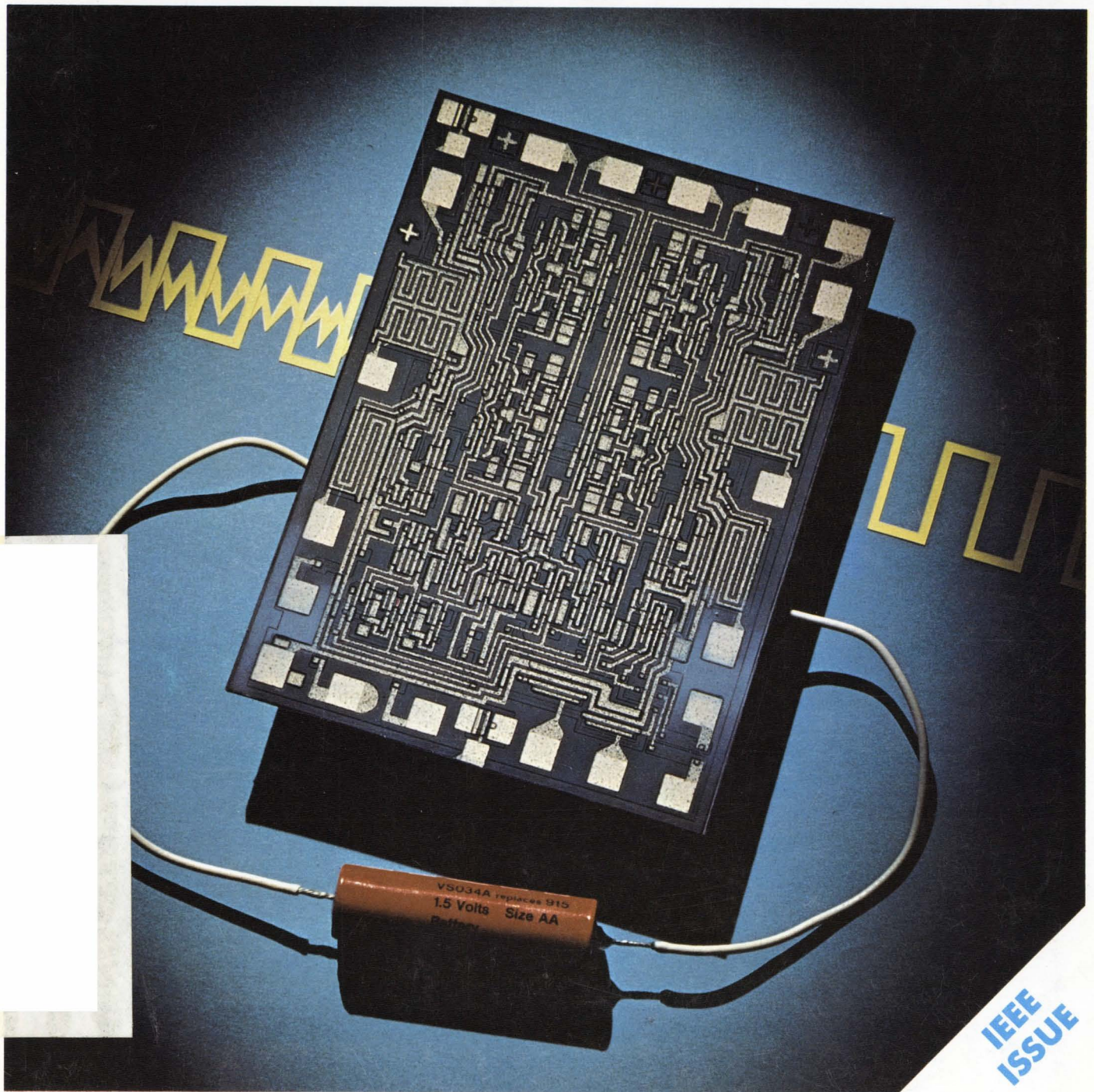

Think AVX NiGuard™



- eliminates silver scavenging
- prevents base metal bleed-thru
- eliminates silver migration
- allows either soldering or bonding

AVX's development of a new, exclusive technique for applying silver, nickel and gold terminations on ceramic chip capacitors is another example of AVX technical leadership.

AVX ceramic chip capacitors with NiGuard can speed your assembly and improve dramatically your production yields.

Nobody makes more . . . or better multilayer capacitors than AVX. This combined with AVX technical leadership means you can depend on AVX to deliver consistent quality chip after chip after chip. Available in a wide range of sizes. Meets all standards including EIA, and high reliability MIL C-55681A specifications. Whether you need chips in ½ pf to 50 mfd ranges or higher, AVX can supply them. Need applications assistance, it's yours for the asking.

For complete information, request a copy of the AVX Short Form Catalog. Write AVX Ceramics, P.O. Box 867, Myrtle Beach, S.C. 29577. Telephone: (803) 448-3191. TWX: (810) 661-2252. Or D.I.A.L. EEM toll-free (800) 645-9200 (In N.Y. State, call (516) 294-0990).



THE CERAMIC CAPACITOR MANUFACTURER

THE FIRST OF THE BIG COUNT TIMERS

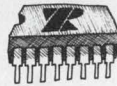
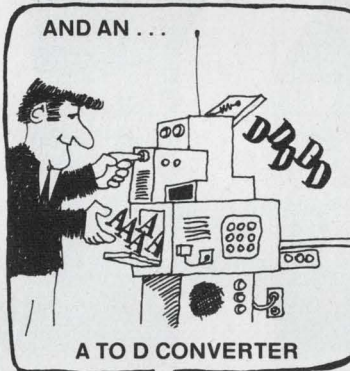
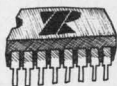
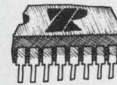
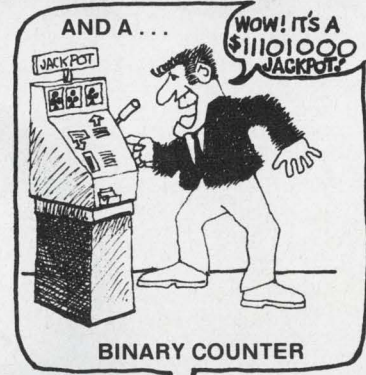
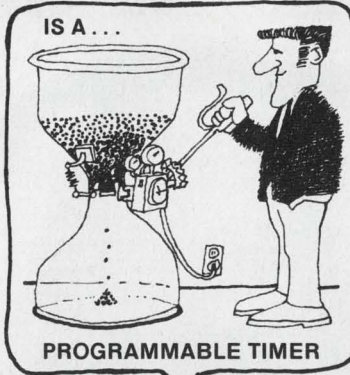
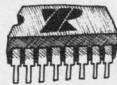
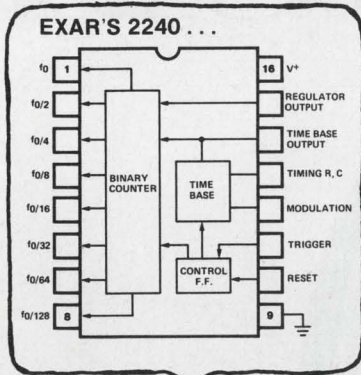

- AND AN ...
- ULTRA-LONG DELAY GENERATOR
 - DIGITAL SAMPLE AND HOLD
 - FREQUENCY SYNTHESIZER
 - PULSE COUNTER
 - BINARY PATTERN GENERATOR
 - PRECISION OSCILLATOR
- ... ALL IN ONE.

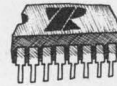

Exar's new XR-2240 counter/programmable timer solves so many tough problems that designers will unanimously agree that it's really the universal timer.

With its unique combination of analog and digital timing methods, you can now replace inadequate and complex assemblages of monolithic and electromechanical timers with the much simpler XR-2240. As a bonus, you get greater flexibility, precision operation, and a reduction in components and costs for most applications.

Because of built-in programmability, you can also use the XR-2240 for frequency synthesis, electronic music synthesis, digital sample and hold, A to D conversion, binary counting and pattern generation, and more.

With a single XR-2240 you can now generate pre-

cision time delays programmable from 1RC to 255RC, a range of microseconds to 5 days. By cascading only two XR-2240 timers, you can extend the maximum delay by a factor of 2^N , where $N = 16$ bits, resulting in a total delay of 3 years!

The XR-2240 operates over a 4V to 15V supply range with an accuracy of 0.5% and a 50 ppm/°C temperature stability. It's available in either a 16-pin ceramic or plastic dual-in-line package for military or commercial applications. Prices start at \$3.00 in 100 piece quantities.

For the more conventional timing applications, look to our other timers: the XR-220/230 timing circuit and the XR-2556 dual timers. Call or write Exar, the timer leader, for complete information.

EXAR SPEAKS YOUR LANGUAGE



EXAR INTEGRATED SYSTEMS

750 Palomar Sunnyvale, California 94086 (408) 732-7970 TWX 910-339-9233

INFORMATION RETRIEVAL NUMBER 2

SURPRISE!



A quality LED for just 9¢*.

Now you can get HP quality in an LED lamp for only 9¢*
That's your price when you order one million. If you only need
one thousand, the price is a low 17¢*. And HP is ready to
deliver that kind of volume to meet your schedule.

This T-1 size lamp features a new low profile lens for
high density application in calculators, cameras, computers, appliances
and automobiles. The 5082-4487 and 5082-4488 both
have a clear lens and a 0.8 mcd at 20 mA typical light output.
Get the full story from your nearby HP distributor
or, write Hewlett-Packard directly.

HEWLETT  PACKARD

Sales, service and support in 172 centers in 65 countries.
Palo Alto, California 94304. Offices in principal cities throughout the U.S.

Electronic Design 6

VOL. 22 NO.

FOR ENGINEERS AND ENGINEERING MANAGERS

MARCH 15, 1974

NEWS

- 25 **News Scope**
28 **Integrated injection logic** shaping up as strong bipolar challenge to MOS.
30 **New CCD image structure** makes processing easier and lifts yields.
32 **Advances on three fronts** herald next generation of linear circuits.
34 **Microprocessors turn to NMOS** for speed, CMOS for low power.
36 **Sophisticated large-scale IC chips** are turning up in consumer items.
43 **Washington Report**
-

50 **IEEE Intercon '74—A special section devoted to this year's big show**

TECHNOLOGY

- 86 **FOCUS on CMOS:** A special report on the tradeoffs between competing CMOS logic families, and a look at some of the latest design trends.
98 **Review the basics of MOS logic.** The characteristics of simple logic functions, shift registers and memories apply to newer, more complex MOS ICs.
108 **Match impedances in microwave amplifiers** for successful solid-state designs. Here's how to analyze input/output factors and to create a practical design.
116 **Build high-gain, wide-range, log amps** that combine good high-frequency capability with excellent full-range logarithmic accuracy.
122 **Design a nonaveraging tachometer** that outputs a voltage proportional to rate. Low power drain and battery operation make it useful in the field.
128 **Watch that op-amp noise!** Feedback resistors and source resistances generate signals that can mask the device's true performance.
132 **Want to cut costs to the bone?** Try the learning curve. Besides helping you predict manufacturing expenses at a fixed rate, it's also a sharp management tool.
142 **Annual Index**
156 **Ideas for Design:** Four-digit BCD programmability featured in variable modulus 60-MHz counter . . . Seven-segment display modified to reduce readout confusion . . . Clocked circuit debounces multiple single-throw contacts synchronously . . . Circuit built with quad op amp measures temperature digitally.
162 **International Technology**
-

PRODUCTS

- 164 **Modules & Subassemblies:** 14-bit a/d converter keeps price/performance low.
172 **ICs & Semiconductors:** 2000-A diode offers high reverse voltage at low cost.
184 Instrumentation
196 Data Processing
212 Components
226 Power Sources
236 Packaging & Materials
244 Microwaves & Lasers
-

Departments

- 83 **Editorial:** It's going to get tougher
7 Across the Desk
256 Evaluation Samples
256 Vendors Report
258 New Literature
262 Bulletin Board
268 Advertisers' Index
270 Product Index
272 Information Retrieval Card

Cover: Photo courtesy of RCA Solid State. COS/MOS chip used by Northern Electric Co. Ltd. in telephone systems.

ELECTRONIC DESIGN is published biweekly by Hayden Publishing Company, Inc., 50 Essex St., Rochelle Park, N. J. 07662. James S. Mulholland Jr., President. Printed at Brown Printing Co., Inc., Waseca, Minn. Controlled circulation postage paid at Waseca, Minn., and New York, N. Y., postage pending Rochelle Park, N. J. Copyright © 1974, Hayden Publishing Company, Inc. 84,392 copies this issue.

'rithmetic was never

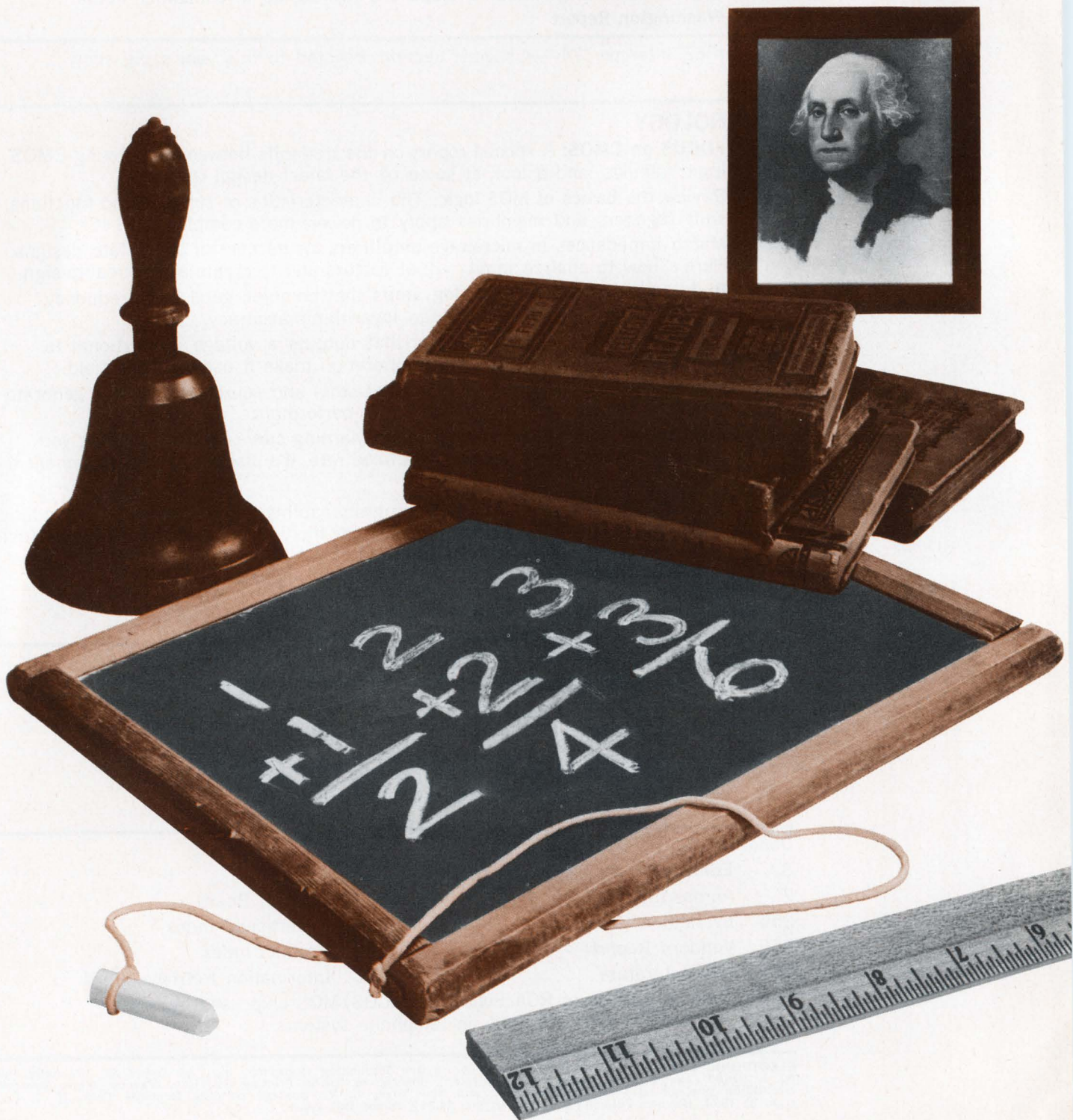

like this...

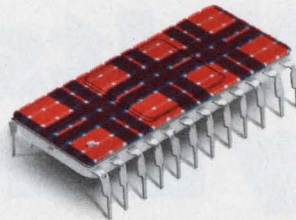

Now CMOS Rings The Bell For Arithmetic Systems

The lessons of today focus attention on Motorola's McMOS* MC14500 series. And we learn there's another new device designed to improve data handling in environmental controls, process controllers . . . or anywhere CMOS is used for arithmetic logic systems.

MC14580. The CMOS Four-Word by Four-Bit Multiport Register.

Let's briefly study a four-bit CMOS arithmetic processor where the MC14580, with its output latch capability, serves as a scratchpad memory to eliminate the need for storage registers on the inputs of the MC14581 ALU. It has one write and two read ports with independent addressing. All addressing, input (write) data, and output (read) data are stored on the positive transition of the clock, leaving storage registers required only for the input/output section of the processor.

Application of the MC14508 Dual 4-Bit Latch for storing input data further reduces the complexity of the processor by removing the data selector requirement on the ALU's B input. Data selection now is achieved by using the three-state capability of the MC14508 and MC14580. Expansion to larger m-by-n register files is also simplified by the three-state outputs of the Multiport Register.

Suppose we did have a larger design; a 16-bit processor with four MC14581s. As the CMOS version of the popular TTL Four-Bit ALU, the

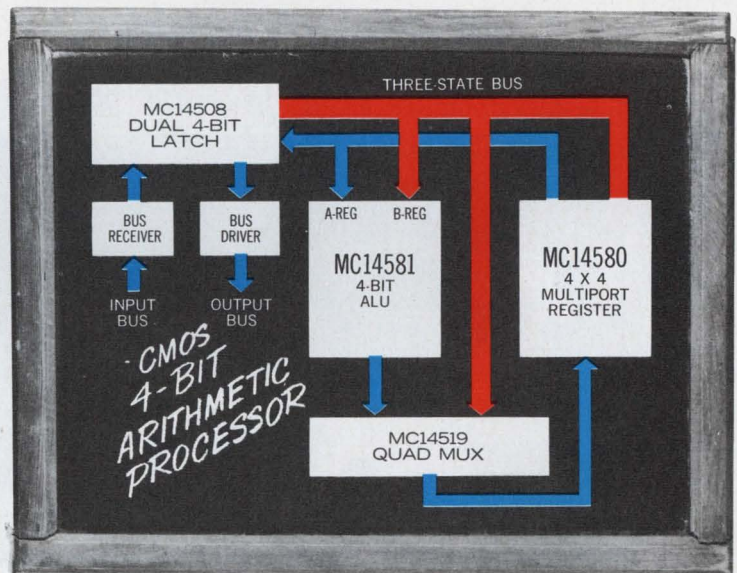

MC14581 performs 16 logical and 16 arithmetic operations. In the larger system, speed is maintained by adding the MC14582 Look-Ahead Carry Block for significant reduction of ripple-through delay.

A curriculum for further study of McMOS arithmetic devices should include the MC14527 BCD Rate Multiplier, the MC14554 Two-by-Two Flow Through Multiplier, and the MC14585 Magnitude Comparator. Optional courses cover the MC14008 Four-Bit Full Adder, MC14032 Triple Full Adder (positive), and MC14038 Triple Full Adder (negative).

Source materials for technical information on the McMOS MC14500 series arithmetic devices are available via the reader service card, or on request from Motorola Semiconductor Products Inc., P. O. Box 20912, Phoenix, Arizona 85036. Consult your Motorola salesman or franchised Motorola distributor for information on price and delivery.



MOTOROLA McMOS

— MOS for contemporary systems

*McMOS is a trademark of Motorola Inc.

Volts My Line?

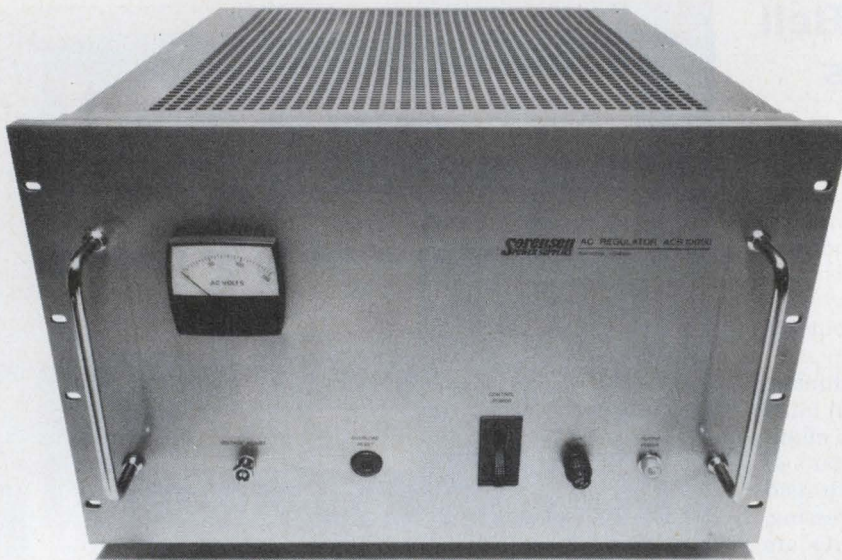

Holding that line-voltage. AC voltage regulation is efficient with the Sorensen ACR Series all solid-state regulators. Problems and damage caused by erratic line voltage are eliminated . . . performance is maximized with ACR features that include MTBF > 25,000 hours . . . remote sensing and remote programming capabilities . . . electronic current limiting . . . adjustable output voltage . . . power outputs to 15kVA—depending on model. Eight models in series. Three-phase systems available. For complete data, contact the Marketing Manager at Sorensen Company, a Unit of Raytheon Company, Manchester, N.H. (603) 668-4500.

Representative Specifications—ACR

- Input Voltage: 95 to 130 Vac
- Total Regulation: 0.4% to 0.6%
- Efficiency: to 95%
- Price Range: \$380 to \$1775

Sorensen
POWER SUPPLIES

Vice President, Publisher

Peter Coley

Editors

Editorial Offices

50 Essex St.

Rochelle Park, N.J. 07662

(201) 843-0550

TWX: 710-990 5071

Cable: Haydenpubs Rochellepark

Editor-in-Chief George Rostky

Managing Editors:

Ralph Dobriner

Michael Elphick

Associate Editors:

Dave Bursky

Jules H. Gilder

Morris Grossman

Seymour T. Levine

John F. Mason

Stanley Runyon

Edward A. Torrero

Richard L. Turmail

Contributing Editors:

Peter N. Budzilovich

Editorial Field Offices

East

Jim McDermott, Eastern Editor

P.O. Box 272

Easthampton, Mass. 01027

(413) 527-3632

West

David N. Kaye, Senior Western Editor

2930 West Imperial Highway

Inglewood, Calif. 90303

(213) 757-0183

Northe K. Osbrink, Western Editor

112 Coloma St.

Santa Cruz, Calif. 95060

(408) 426-3211

Washington

Heather M. David, Bureau Chief

2506 Eye St., N.W.

Washington, D.C. 20037

(202) 338-3470

Editorial Production

Marjorie A. Duffy

Art

Art Director, William Kelly

Richard Luce

Anthony J. Fischetto

Production

Manager, Dollie S. Viebig

Helen De Polo

Anne Molfetas

Christopher G. Hill

Circulation

Manager, Nancy L. Merritt

Information Retrieval

Peggy Long

Promotion

Manager, Jeffrey A. Weiner

Karen Kerrigan

across the desk

Promises, promises— Watch those specs

Gorgeous George R. may, in time, tame the immodest advertiser who, paying two grand a page, promises too much in his attempt to capture our attention. Meanwhile, behind the intrepid chief editor's broad back, evil over-specifiers are at work in the very vitals of his own jurisdiction.

I refer specifically to "Linearize Your V/F Converter" (ED No. 23, Nov. 8, 1973, p. 112) in which the promise of "five decades with .0005% linearity" appears. On p. 113 data are shown to prove 1.5% deviation in 4.5 decades, and on p. 114 the article ends with four undetailed hints on making it better.

Tsk! Tsk! Better turn both cheeks toward the overzealous editor who, evidently bored to distraction by honest, humble, new-product releases, blew his cover by boldly printing the unfulfilled promise of a Nordic neophyte. For other disillusioned readers, a real 0.005% five-decade VFC is sold by D.M.C. (6 Lowell Ave., Winchester, Mass.) for \$69, including guarantee.

Joel Cohen

BBF Group, Inc.
42 Fourth Ave.
Waltham, Mass. 02154

Correction

The article "CCDs Are Breaking New Ground as Analog Signal Processors" in the Dec. 7, 1973, issue, p. 28, erroneously attributed a system design for a charge-transfer-device implementation of the discrete Fourier transform to Texas Instruments. The system was designed at the Naval Undersea Center by H. J. Whitehouse,

J. M. Speiser and R. W. Means. This design was first presented at the All Applications Digital Computer Conference in Orlando, Fla., in January, 1973.

A hardware implementation of the system design was presented at the CCD Applications Conference at the Naval Electronics Laboratory Center in San Diego on Sept. 19, 1973, in a joint paper by R. W. Means and H. J. Whitehouse of the Naval Undersea Center and D. D. Buss of Texas Instruments. The bucket-brigade devices used to demonstrate this system were built by Texas Instruments under contract to Rome Air Development Center.

R. H. Campbell
Commander, USN
Chief Staff Officer

Naval Undersea Research and
Development Center
San Diego, Calif. 92132

From the WOM to the DEAD File

We've followed with great interest the development of Signetics' revolutionary WOM, and we were especially intrigued by the discussion of the WOM housing and its impressive physical construction (see "WOM Details Aired," ED No. 18, Sept. 1, 1973, p. 7). Our R&D has been involved in a similar project, and after intensive study and experimentation, we have devised an alternative to the WOM that completely eliminates discarded data-storage problems.

The enclosed photograph shows the prototype of our device, the Discarded Excess Accumulated Data (DEAD) File, whose operation is based on the familiar Gar-

(continued on page 16)

low cost ceramic trimmer capacitors

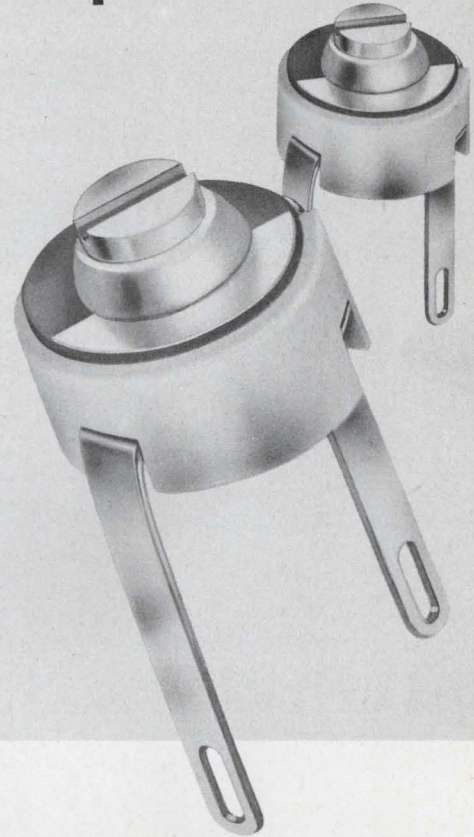

These ceramic trimmer capacitors are designed for broadband application, from audio to 500 MHz and afford an ideal *low cost* means of "trimming" circuitry such as crystal oscillators, CATV amplifiers and all varieties of communication and test equipment.

FEATURES

- Capacitance values from 1 - 3 to 5 - 25 pf
- Low profile - .208 above board height
- Low cost - 75¢ in 1000 quantities
- Delivery from stock

Johanson

MANUFACTURING CORPORATION

BOONTON, NEW JERSEY 07005
201 / 334-2676
TWX 710-987-8367

Electronic Design welcomes the opinions of its readers on the issues raised in the magazine's editorial columns. Address letters to Managing Editor, Electronic Design, 50 Essex St. Rochelle Park, N.J. 07662. Try to keep letters under 200 words. Letters must be signed. Names will be withheld on request.

Across the desk

This chip
is the world's first
SOS processor.



It makes all the
stuff on the next page
possible.

Silicon-on-sapphire isn't new. The aerospace industry and the military have recognized its high-speed, high-density and high-reliability characteristics for years.

But no one was ever able to use it in a computer processor.

Until now.

Now General Automation designers have built the world's first commercial processor using SOS technology.

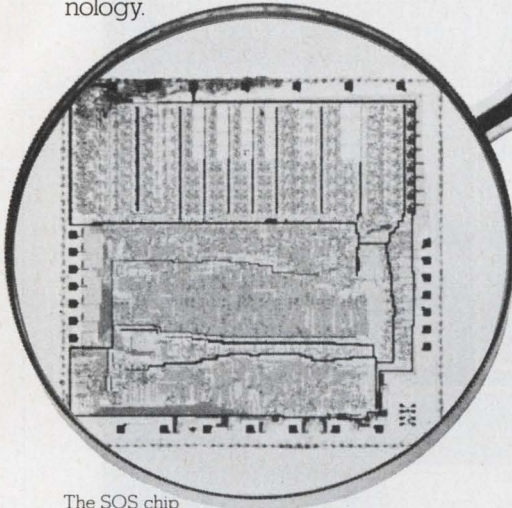

The SOS chip magnified 16 times.

They've placed 2000 gates or the equivalent of 4000 to 5000 transistors on a single semiconductor chip.

An 800 times size reduction from its predecessor product, the SPC-12.

The world's first microcomputer.

That tiny SOS chip has made it possible to bring you the LSI-12/16. A complete digital automation microcomputer with from 1K to 32K bytes of semiconductor memory.

We call it the world's first microcomputer because it's the only

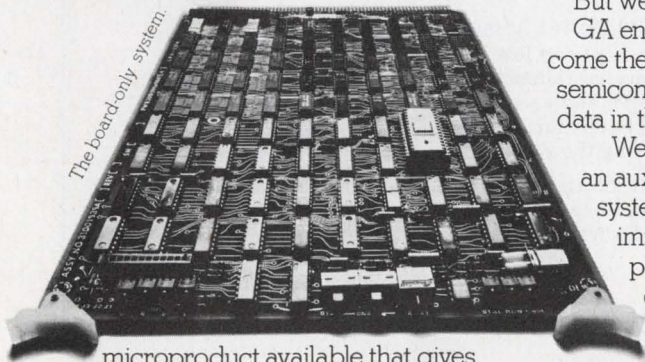

The board-only system.

microproduct available that gives you the performance, the systems features, the reliability and the applications support you would normally expect from a minicomputer.

More work, less money.

In the past this kind of size reduction

always meant you had to make major concessions in performance.

With SOS you make none.

The LSI-12/16 has an instruction execution cycle time of 2.64 microseconds.

It's faster than any microprocessor on the market.

It's more powerful. And lower in cost. In board-only configuration with 1K memory, it costs only \$495 in minimum OEM quantities of 1000 per year. In short, we offer all the performance of a minicomputer at microprocessor prices.

Breakthroughs across the board.

The LSI-12/16 is the first microproduct to successfully put all of the following on a single board: A processor, power fail/auto

unique built-in ROM patch that lets the user retrofit new instructions to any ROM.

Custom tailoring.

There's one more advantage the LSI-12/16 has that no other microproduct can offer. It's the systems backup and application expertise that General Automation gives you. Helping solve customer problems has always been our long suit. It still is.

We can customize I/O boards and match the LSI-12/16 exactly to your requirement.

Our microcomputer is available in one of two different configurations:

As a board-only system, packaged with memory, control console and processor on a single 7-3/4 by 10 inch printed circuit board.

Or the same board packaged in an enclosure with power supply, battery backup for semiconductor memory and card slots for additional I/O boards.

For more information, write

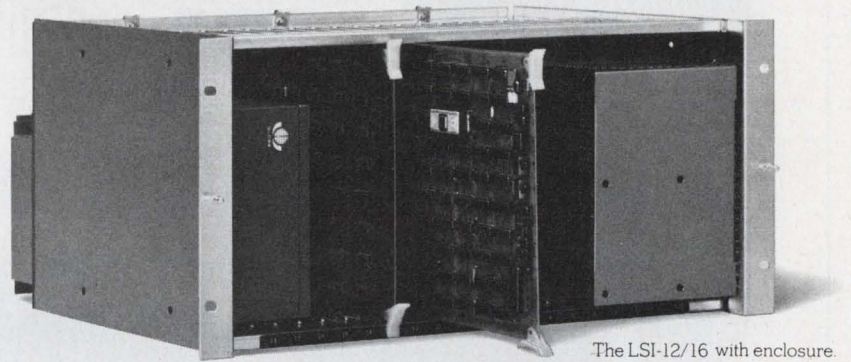

The LSI-12/16 with enclosure.

restart, remote cold start, 16 bit parallel I/O interface and up to 2K bytes of semiconductor memory.

But we didn't stop there.

GA engineering has also overcome the problems associated with semiconductor memory. Like loss of data in the event of power failure.

We handled that by developing an auxiliary battery backup system that will activate immediately upon loss of power and will retain the contents of memory for up to 15 hours.

In case you're interested in more memory, we've designed a piggyback board that will give you an additional 2K of RAM or 8K of ROM.

And if there's ever an error in ROM programming, it can be corrected. The LSI-12/16 has a

General Automation, 1055 South East Street, Anaheim, California 92805. Or call us at (714) 778-4800.

Our European headquarters is at Centre Silic, Cidex L242, 94533 Rungis, Paris, France. Call 686-7431.

GENERAL AUTOMATION

A new generation of computer processors is beginning. All because of this.

See the LSI-12/16 in the Computerworld Caravan

INFORMATION RETRIEVAL NUMBER 7

Spectrum analysis made easy

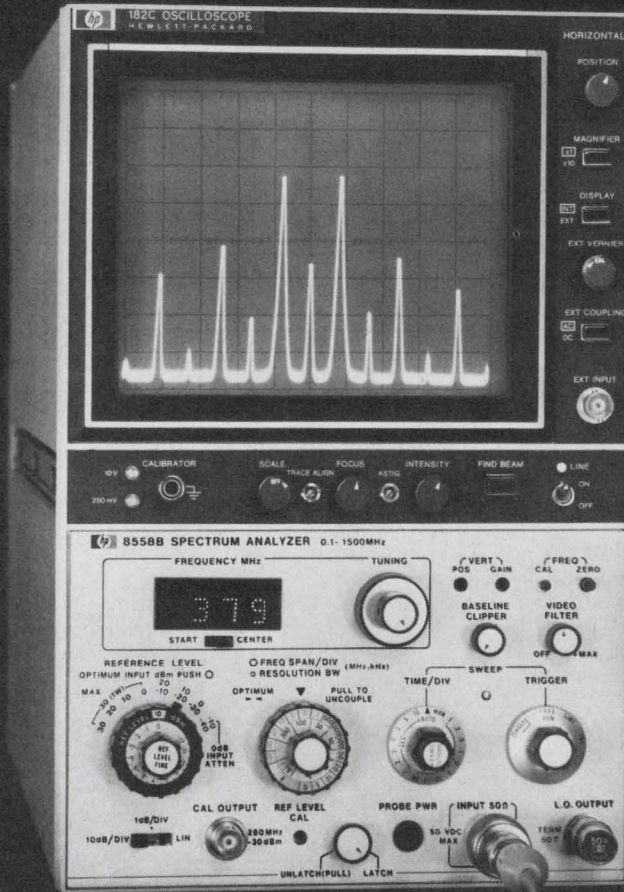

A new 1500 MHz plug-in for HP 180 series Scopes

Three Controls Do It. The 8558B Spectrum Analyzer makes most measurements with three simple settings: tuning frequency, frequency span and amplitude reference level. Resolution bandwidth and sweep time are automatically optimized, and LED's digitally display frequency. Panel markings guide you to the settings that minimize the possibility of errors from signal overloads.

Lab Grade Performance. Compare the 8558B's frequency and amplitude accuracy against any other analyzer and you'll quickly see how good it is. Frequency response over the full 0.1-1500 MHz range is ± 1 dB, and its frequency accuracy is ± 5 MHz. Distortion-free dynamic range exceeds 70 dB. Signal levels from +30 dBm to -117 dBm can be measured. Resolution bandwidths from 1 KHz to a wide 3 MHz are provided.

Domestic USA prices only.

Just \$3450. The 8558B Spectrum Analyzer plug-in is priced low enough to make it practical for every workbench; no need to "timeshare" the expensive analyzer. And since it's part of the HP 180 Scope family, the mainframe can do double-duty using the wide array of other 180 plug-ins.

For full information on this tremendous value in spectrum analysis, call your nearest HP field office. Or write.

HEWLETT  PACKARD

Sales and service from 172 offices in 65 countries.
1501 Page Mill Road, Palo Alto, California 94304



Are you into red, yellow & green?

We hope so. Because we are definitely into Gallium Arsenide Phosphide, Gallium Phosphide and Gallium Arsenide. And, as we all know by now, these are the materials that LED colors are made of.

If your game is LED's, be it discreet, display or array, Monsanto has the material for you.

We've been making III-V Intermetallics since 1956, and with that background and experience we know materials.

Our production facilities are among the most efficient and technically advanced in the world and we are ready to meet your every need.

To get the full story on Monsanto's colorful line of intermetallics, please write or call:

Monsanto Commercial Products Co. Electronic Materials
P.O. Box 8, St. Peters, Missouri 63376 (314) 272-6281
A unit of Monsanto Company

Monsanto

INFORMATION RETRIEVAL NUMBER 9

TTL, MOS, LEDs interface them all with

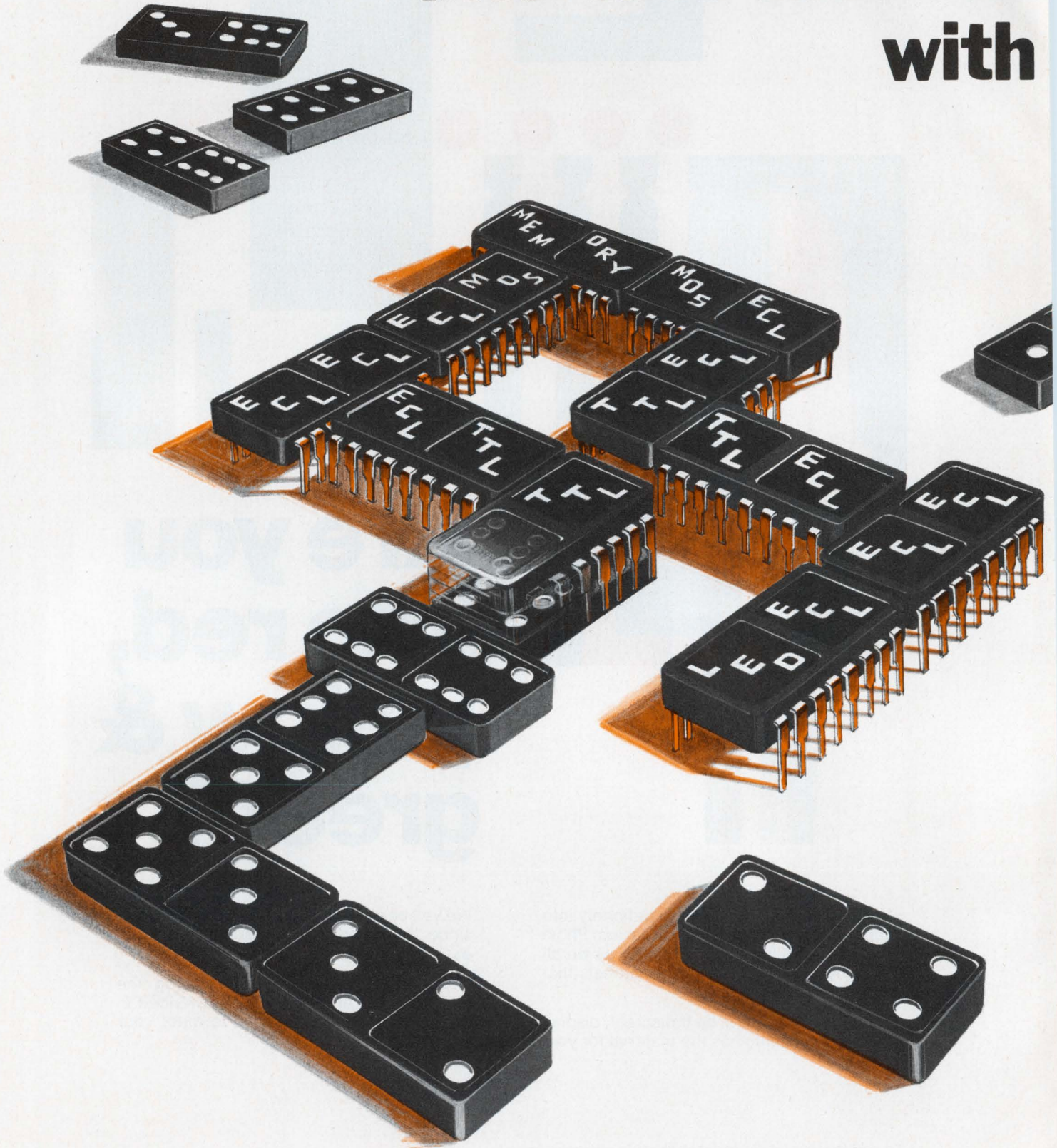

MECL and MECL 10,000
are trademarks of Motorola Inc.

MECL 10,000

Designing a system today is like a game of dominoes. To realize an optimized system may require the use of several logic families. The challenge is to translate and match different logic levels, maintain a minimum part count, and still operate at maximum speed.

MECL 10,000 offers a comprehensive selection of interfacing devices to meet the various input and output problems encountered. MECL translators, drivers, receivers, and comparators open up new methods for efficient coupling of non-compatible signals.

Interfacing Made Easy!

We have a new design file covering system interfacing. It's loaded with interfacing techniques, line driving/receiving tips, bus line interfacing, operating from common power supplies, and latest methods of driving LED displays. For your copy, write to Motorola Semiconductor Products Inc., P.O. Box 20912, Phoenix, AZ 85036 and ask for MECL Design File No. 6.

**Face Up To
System Interfacing
with MECL 10,000!**

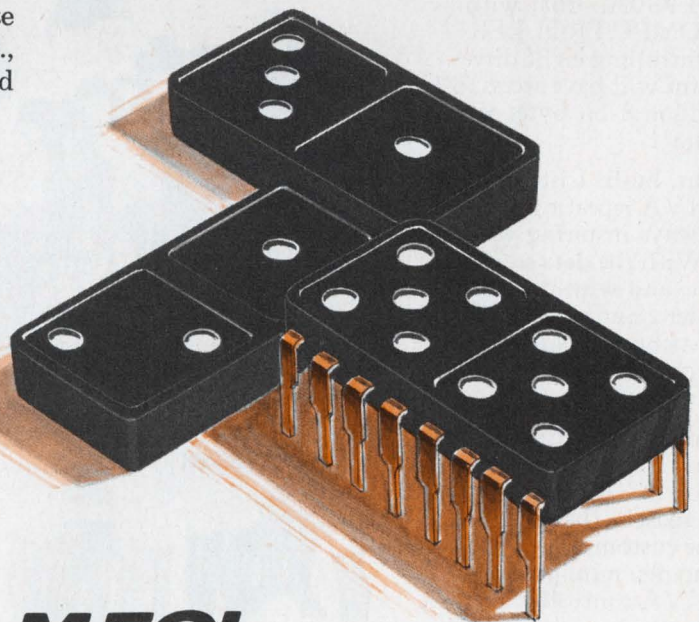

MOTOROLA MECL
... new logic capabilities for the 70's!

INFORMATION RETRIEVAL NUMBER 10

DIVA'S COMPUTROLLER, PDP 11, AND 3330 TYPE DISC DRIVE UNITE. AN INCREDIBLE MARRIAGE.

An Episode in the True Chronicle of the DIVAS, Proudest Peripheral Family in the Computeworld.

The computeworld stares in awe at the incredible wedding scene which has unfolded before them. The bride is minicomputer PDP 11, offspring of the illustrious maxi-computer clan, begat of Abacus. The bridegroom is DIVA COMPUTROLLER, scion of this proud, most respected peripheral family. Officiating at the ceremony is Duke DIVA Disc Drive, direct descendant of IBM compatible 3330 type disc drives.

Realizing the great impact this interfacing will have on the computeworld, our happy guests monitor the wedding with joyous solemnity.

"Mated," Interdata 70 whirrs, "PDP 11 will have access to 100 million bytes of data on a single spindle or 200 million bytes on a dual spindle disc drive unit within an average access time of 32 msec."

"And with COMPUTROLLER providing a buffering sector, data will be transferable at the rate of 645,000 bytes/sec," marvels Nova II.

"And keep in mind," interrupts a breathless TI 980A, "that with COMPUTROLLER controlling eight drives, mini will have access to 1.6 billion 8-bit bytes of data!!"

But, hush! Listen to Duke DIVA repeating those always-inspiring words: "With the data stored in me, and with provided interconnecting cables and distribution panel, I now pronounce you linked in holy matrimony."

Resounding cheers befitting the occasion arise from the crowd. "A toast! A toast! A toast!" they roar. As is the custom, the proud parents, mini processor and DIVA controller, propose the toast to the dazzling couple: "To the most splendid and significant union in all our memories."

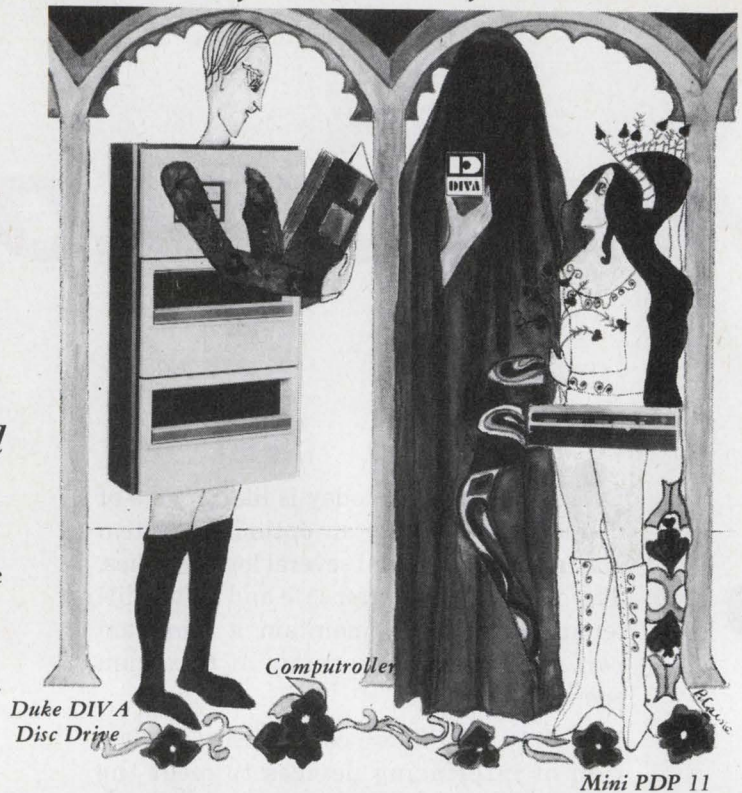

"Vive, DIVA! Vive, DIVA! Vive, DIVA!" Everyone unwinds.

But even as we listen to the clink of ceremonial glasses and the exuberant laughter, we sense an underlying sadness. Those unchosen minis — do they count for nothing now? Will they not be able to enter the world of high speed data storage/access and low cost/bit performance? And why — throughout this entire festivity — has COMPUTROLLER remained hidden under his purple robe? Is there more to

COMPUTROLLER than meets the eye? Be sure to join us for the next episode in the True Chronicle of the DIVAS when we will hear the horrendous accusation: "Bigamy! BIGAMIST!"

In the meantime, learn COMPUTROLLER'S inside story. Find out about the free implementation and training courses, the software packages, and warranties that go with each disc system. All you PDP 11 users call George Roessler at 201-544-9000 for cost and delivery information. Or write: DIVA, Inc. 607 Industrial Way West Eatontown, N.J. 07724 TWX 710-722-6645.

REGIONAL SALES OFFICES:

CT: 203-526-3222
CA: 415-349-3482
Wash. DC: 703-370-5211.

GSA CONTRACT NO.
GSS-OOC-00159.

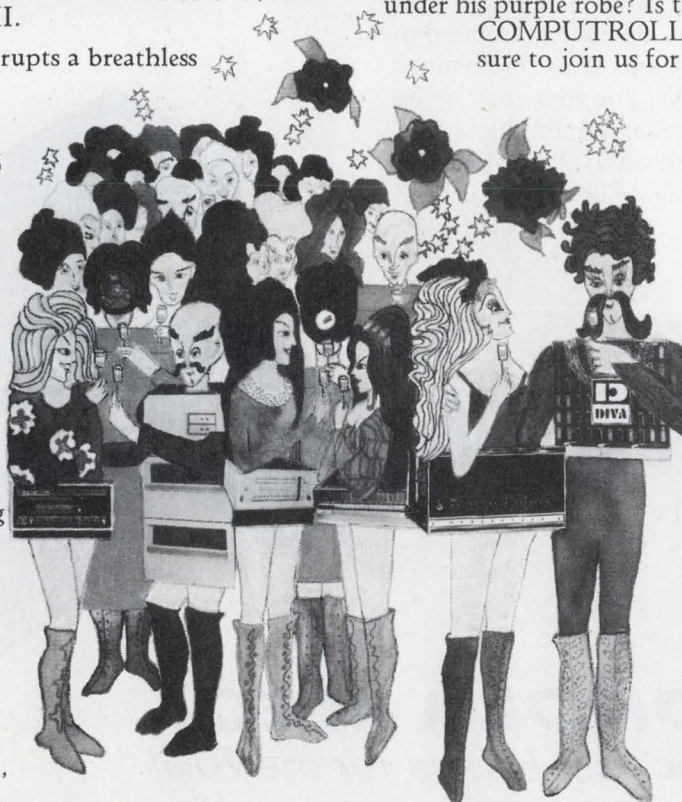

NOW AVAILABLE IN THE U.S.A.— FUTABA FLUORESCENT READOUTS KEYBOARDS

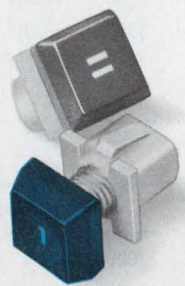

With over 35 years of electronics experience, FUTABA is well known for high quality, reliable fluorescent readouts and compact, attractive keyboards. Widely used by most major electronic calculator manufacturers in Japan and other countries, these items are now available for the first time in the U.S.A. in quantity. FUTABA guarantees prompt delivery!



• For additional information, please contact:
FUTABA INDUSTRIES U.S.A.
630 West Carob Street, Compton, California 90220, U.S.A.
Phone: (213) 537-9610 Telex: 69-1227

FLUORESCENT READOUTS

※ CT, CR Series for Hand Calculators
..... Available in 6, 8 and 9 digits with or without symbol.

FEATURES:

- Compact.
- Bright blue/green.
- Easy to read.
- Low voltage, low power.
- Direct LSI drive.

※ MT, MR Series for Desk-top Calculators
..... Available in 8, 10, 12, 14, and 16 digits.

FEATURES:

- Plug-in type flat package.
- Easy to read blue/green readouts (0.3" high).
- Low voltage, low power.

KEYBOARDS

M-2B: Individual mechanical switch, plug-in mounting.
M-3: Same as M-2B, but smaller.

FX, SD Series: Thin keyboards for hand calculators.

Standard keyboard switches and key tops available from FUTABA stock for instant keyboard layout on your mounting plate.

OTHER FUTABA PRODUCTS:

- Press die sets.
- Mold bases for plastics.
- Material feeders for press work.
- Automatic stopping devices for automatic machinery.
- Radio control for hobby aircraft, race cars, etc.

"FUTABA—THE BRIGHT PRODUCER"

FUTABA ELECTRONIC INDUSTRIES LIMITED
Super Bldg., 1-11-5, Sotokanda, Chiyoda-ku, Tokyo, Japan. Phone: 255-5881
Telex: J26532

Cut package count . . . Simplify board layout . . .
Reduce equipment size . . . with

DIP MULTI-COMP[®] RESISTOR-CAPACITOR NETWORKS

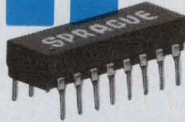

(Metanet[®] Film Resistors, Monolithic[®] Ceramic Capacitors)

STANDARDIZED DESIGNS* FOR
BETTER AVAILABILITY, BETTER PRICES

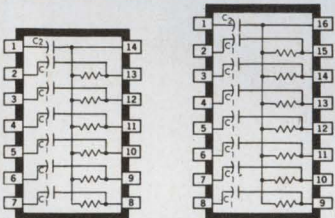

R (Ω)			C ₁
100	470	2000	100pF
150	500	2200	330pF
200	680	3300	0.01μF
220	1000	4700	C ₂
330	1500	6800	

BYPASSED PULL-UP AND R-C COUPLING NETWORKS

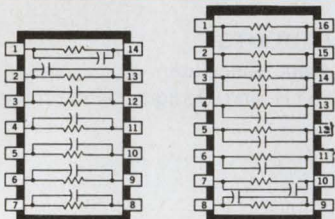

R (Ω)			C
100	470	2000	1000pF
150	500	2200	
200	680	3300	3300pF
220	1000	4700	0.01μF
330	1500	6800	

SPEED-UP NETWORKS

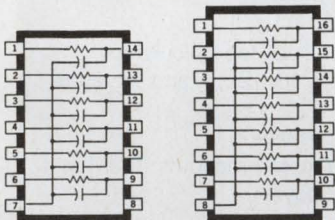

R (Ω)			C (pF)
100	470	2000	100
150	500	2200	
200	680	3300	330
220	1000	4700	
330	1500	6800	

ACTIVE TERMINATOR NETWORKS

* OTHER PACKAGES, CIRCUIT CONFIGURATIONS, AND RATINGS AVAILABLE ON SPECIAL ORDER

Sprague puts more passive component families into dual in-line packages than any other manufacturer:

- TANTALUM CAPACITORS
- CERAMIC CAPACITORS
- TANTALUM-CERAMIC NETWORKS
- RESISTOR-CAPACITOR NETWORKS
- PULSE TRANSFORMERS
- TOROIDAL INDUCTORS
- HYBRID CIRCUITS
- TAPPED DELAY LINES
- SPECIAL COMPONENT COMBINATIONS
- THICK-FILM RESISTOR NETWORKS
- THIN-FILM RESISTOR NETWORKS
- ION-IMPLANTED RESISTOR NETWORKS

For more information on Sprague DIP components, write or call Ed Geissler, Manager, Specialty Components Marketing, Sprague Electric Co., 347 Marshall St., North Adams, Mass. 01247. Tel. 413/664-4411.

THE BROAD-LINE PRODUCER OF ELECTRONIC PARTS



INFORMATION RETRIEVAL NUMBER 13

ACROSS THE DESK

(continued from page 7)

bage-In/Garbage-Out Theory. Instead of maintaining an infinite storage capacity, as in the WOM, the DEAD device involves a highly sophisticated electrochemical system that liquidates the input data altogether. By utilizing the P. Grey Code and an innovative,



fast, bit-ingestion mechanism in its Bit Compressor and Disposal (BCD) unit, the DEAD File compacts the incoming discarded data to a concentration of 10²² bits per square centimeter. The compacted data is then pulverized and flushed through the central drain into the city sewer system. An additional advantage of the DEAD File is that its design ensures 1000% efficiency, since data continue to be flushed through the system even when there is no input.

We worked closely with local sanitation engineers while this project was in the developmental stages, and we have their full assurance that effluent from the unit will have no deleterious effects on the ecology of the bacteria cultures in the treatment plant.

The DEAD File is already in extensive use—notably by government agencies, whose need for such a device is especially great. However, it should be noted that prudent utilization of the DEAD File is essential. If this method were adopted wherever useless electronic data were encountered, we would all soon be up to our knee-socks in sand!

Grant C. Riddle
Manager, Applications Engineering
Monsanto Commercial Products Co.
10131 Bubb Rd.
Cupertino, Calif. 95014

Connector or IC panel— we can give you exactly what you need.

Single-, double- or multilayer.
Mother/daughter board
connectors, IC receptacle
packaging, feedthrough posts,
low-profile DIP headers,
or cable-to-board connectors.
Prewired or ready to wire by
automatic techniques.



Panels with high reliability, competitive cost and ease of repairability.

We built our reputation for quality and low applied cost in the connector field. And carried it over into back panels—the very heart of modern electronic systems. To give you the kinds of connectors, manufacturing techniques and equipment which ensure reliability, performance and repairability—at a competitive cost.

High reliability.

We eliminate plated through-hole distortion and possible damage caused by force fit insertion. This is done by selectively pre-depositing bands of solder on posts and receptacles before inserting and reflow-soldering them into panels. This process also greatly increases the reliability and performance of our panels by eliminating wicking, bridging, peaks, icicles and board delamination.

Fillets are more uniform and complete, with full solder top to bottom. And posts are left clean and solder-free for automatic wiring. AMP has also developed connector housings which snap on over the contacts *after* contacts are flow soldered, so there's better use of printed circuit real estate. For information on our panels circle Reader Service Number 150.

Ease of repair.

When snap-on connector housings are used, individual contacts can be exposed for quick, easy removal and replacement, without the need to desolder *all* contacts.

Competitive cost.

There are several important ways in which we keep the cost of our panels competitive. First, by inserting contact posts with high-speed, automated machines. Second, by soldering *all* contacts simultaneously instead of individually. And third, by conducting rigorous electrical and mechanical quality checks on *every single panel* we make, eliminating the cost and burden of incoming inspection for our customers. Additional economies can be achieved by using snap-on housings which do not require time-consuming individual contact loading.



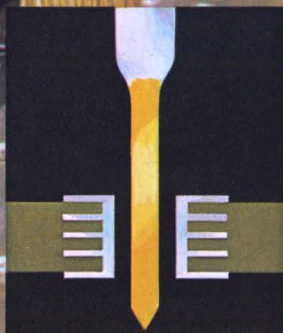

Presoldered contact is inserted into plated panel through-hole.

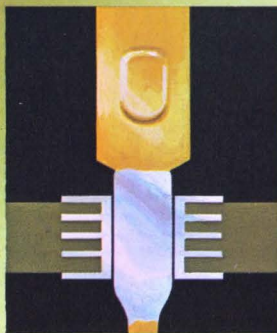

Solder band is pulled into through-hole with just enough force to retain it during reflow.



Contact is flow soldered in place, producing uniform fillet with full solder, top to bottom, and clean, solder-free posts.

We can design with you or for you.

If you customarily design your own panels, we can assist in optimizing your circuit patterns. Or, we can take your parameters and complete the entire panel-making operation, sparing you considerable investment. Using computer-driven plotters, we "pack" the greatest number of circuit paths into the smallest possible board space, consistent with other design parameters.

We'll set you up to wire or do your wiring for you.

Give us your parameters. We'll give you assembled connector or IC panels, pre-wired or ready for your automatic wiring. If you choose the TERMI-POINT clip system, you'll get highly-reliable, spring-action terminations that are easier to test, maintain and service.

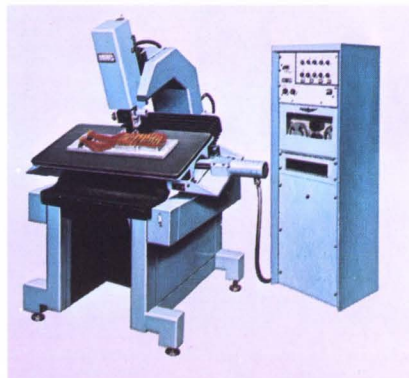

Panel construction is AMP-engineered and manufactured.

One main reason we can control the quality and cost of our panels so well is the fact that we design, engineer and manufacture literally everything that goes into them.

DIP headers are ideal for low-cost, high-density packaging.

Our low-profile DIP headers provide some of the industry's lowest-cost, highest-density packaging for 14- and 16-lead IC's. Standard headers accept a full range of lead sizes—round, rectangular or both, and are compatible with high-speed, automated wiring methods. Low-profile headers (.150-inch high) accept rectangular leads up to .015 x .030-inch.

Low-profile miniature spring socket offers maximum retention and conductivity.

Designed specifically for electronic and wiring applications that require low profile miniature sockets, this product has an inner spring member and a body with either a .022 x .036-inch or .025" post configuration. The inner spring member maintains consistent pressure against the lead, providing excellent retention and conductivity. A "barbed" design allows the socket to be self-retained in the panel and, at the same time, prevents socket "pullout."

IC receptacles have unique anti-overstress design.

The unique, built-in anti-overstress stop on our IC receptacles assures tight, constant contact. The receptacle will accommodate any known IC configuration or package with round or flat leads up to .022-inch diameter or .022 x .040-inch dimensions. Removable gold-over-nickel-plated contact springs provide excellent performance.

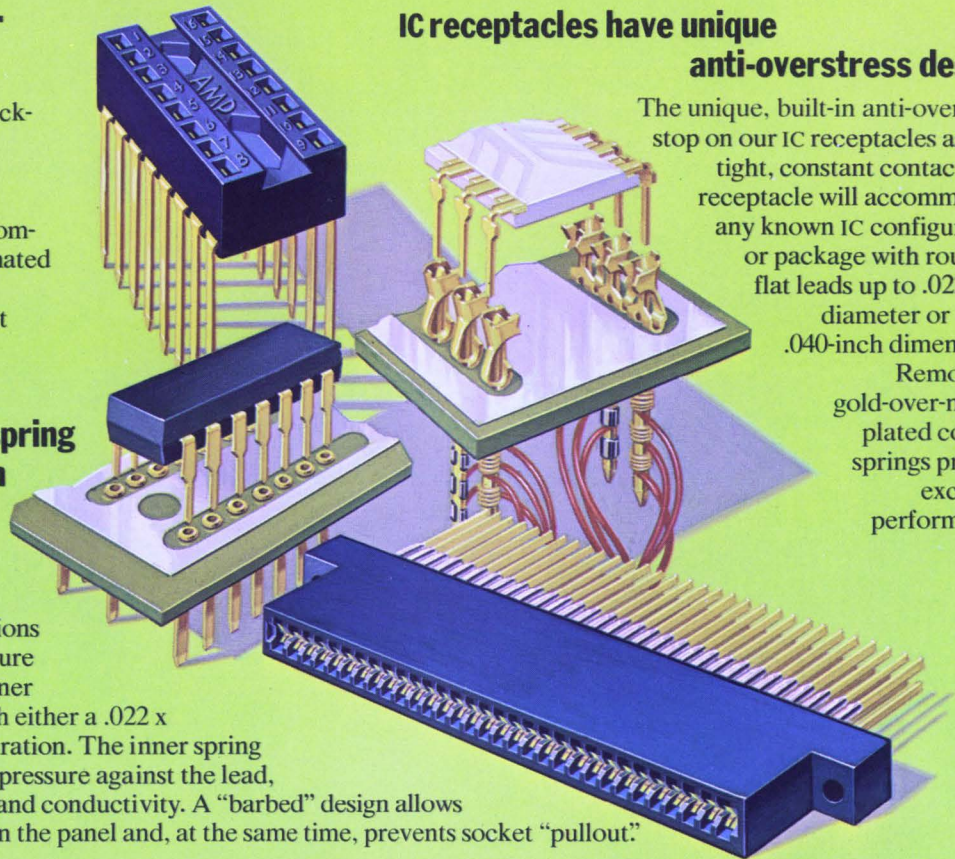

Posted card connectors offer great versatility in panel design.

Our TERMI-TWIST Connectors are available in a variety of configurations, depending on your requirements for post size, number of positions and center-line spacing. Board area contacts are bifurcated for redundancy. Connectors can all be wired by high-speed, automatic techniques.

Engineering backup...worldwide.

At AMP, nearly 900 application, service and sales engineers are prepared to assist you with every phase of panel-making, connectors and programming systems. At your domestic manufacturing plant, or wherever you use AMP products and machines throughout the world. You'll find AMP manufacturing and service facilities in most major international markets. In the United States, district offices are located in California, Georgia, Illinois, Massachusetts, Michigan, Minnesota, New Jersey, Ohio, Pennsylvania, Texas, and the District of Columbia.

Write for Panel Packaging Folder

Find out how we're able to give you exactly the panel you need. Write on your company letterhead for our Panel Packaging Folder. It contains full documentation of our various processes, with suggestions of how they can work best for you. AMP Incorporated, Harrisburg, Pa. 17105.

AMP, TERMI-POINT, TERMI-TWIST are trademarks of AMP Incorporated.

AMP

INCORPORATED

For \$395 how many functions should a Function Generator generate?

Fifteen. That's the number of waveforms you can get with Krohn-Hite's Model 5100A. How? A unique Symmetry Control that allows pulse rep rate to be set independently of pulse width and also provides independently adjustable triangle slopes. You can skew any of the basic sine, square, triangle and ramp waveforms by as much as 99% to produce 10 additional functions. Frequency range of 0.002 Hz to 3 MHz can be manually tuned or externally controlled for VC of 1000:1. When you compare the 5100A with the rest, there's quite a generation gap. For fast action, call The Wavemakers at (617) 491-3211, TWX 710-320-6583 Krohn-Hite Corporation, 580 Mass. Ave., Cambridge, Mass. 02139.



KH KROHN-HITE CORPORATION

SALES OFFICES: ALA., Huntsville (205) 534-9771; ARIZ., Scottsdale (602) 947-7841; CAL., Santa Clara (408) 243-2891, Inglewood (213) 674-6850; COLO., Denver (303) 934-5505; CONN., Glastonbury (203) 633-0777; FLA., Orlando (305) 894-4401; HAWAII, Honolulu (808) 941-1574; ILL., Des Plaines (312) 298-3600; IND., Indianapolis (317) 244-2456; MASS., Lexington (617) 861-8620; MICH., Detroit (313) 526-8800; MINN., Minneapolis (612) 884-4336; MO., St. Louis (314) 423-1234; N.C., Burlington (919) 227-3639; N.J., Haddonfield (609) 795-1700; N.M., Albuquerque (505) 299-7658; N.Y., E. Syracuse (315) 437-6666, Rochester (716) 328-2230, Vestal (607) 785-9947, Elmont (516) 488-2100; OHIO, Cleveland (216) 261-5440, Dayton (513) 426-5551; PA., Pittsburgh (412) 371-9449; TEX., Houston (713) 621-0040, Richardson (214) 231-2573; VA., Alexandria (703) 354-1222; WASH., Seattle (206) 624-9020; CANADA, Montreal, Quebec (514) 636-0525, Toronto, Ontario (416) 444-9111, Stittsville, Ontario (613) 836-4411, Vancouver, British Columbia (604) 688-2619.

INFORMATION RETRIEVAL NUMBER 14



We'll alter a standard, or create an original.

It's your brainchild: That new or redesigned instrument or system. Now to find the cabinet, rack or enclosure to house it.

No problem. Deal with Bud!

Our special fabrication service is as comprehensive as our standard product line.

A practical and, in many cases, the most economical method of providing a special housing is to alter a standard Bud product to fit your application. That's one approach.

Another is to design an original housing; submitting a quote on a normal production run, then producing a finished quality product. On time!

For short runs or pilot models, there's the Bud Imlok system which enables you... or Bud... to design, alter, refine, then build a housing that fits your product and budget to a T.

For further information and quotes on special housings, contact your Bud Representative. For his name, address and phone number, call (800)645-9200, toll free. You can also contact Bud Radio directly.

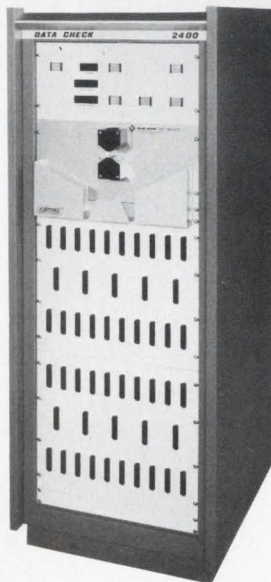

The Bud Series 2000 cabinet rack was altered to house this automatic continuity test system. Standard rack panels were modified to provide required access for testing.

Test stand for determining flow rate of various substances was fabricated from standard Imlok extrusions and connectors. Sheet aluminum panels completed the structure.

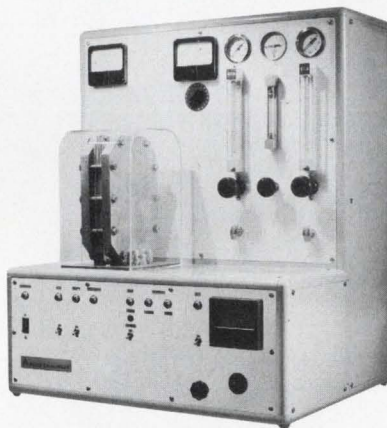

By altering a standard Tilt-A-View cabinet, Bud developed this enclosure for equipment which controls the action of an electrode which disintegrates a predetermined shape or aperture in metal.



Bud handled all silk screening, fabricating and finishing operations.

Bud adapted a standard Contour Utility cabinet to house this pulse generator. Front panel was punched to permit installation of switches and controls. Silk screened legends were part of the Bud special fabrication package.



This special enclosure, based on the Bud Compucab design, houses an audiometer unit for a system used for the selection and fitting of hearing aids.

Cabinet is an adaptation of the Bud Series 60 cabinet rack and houses a "Viscometer" unit

used for measuring viscosity, scorch and cure rate of elastomers. Front panel, including silk screening, built to customer's specifications.



BUD

"The Housing Authority"

BUD RADIO, INC.
4605 E. 355th St. Willoughby, Ohio 44094
216/946-3200 TWX 810-427-2604

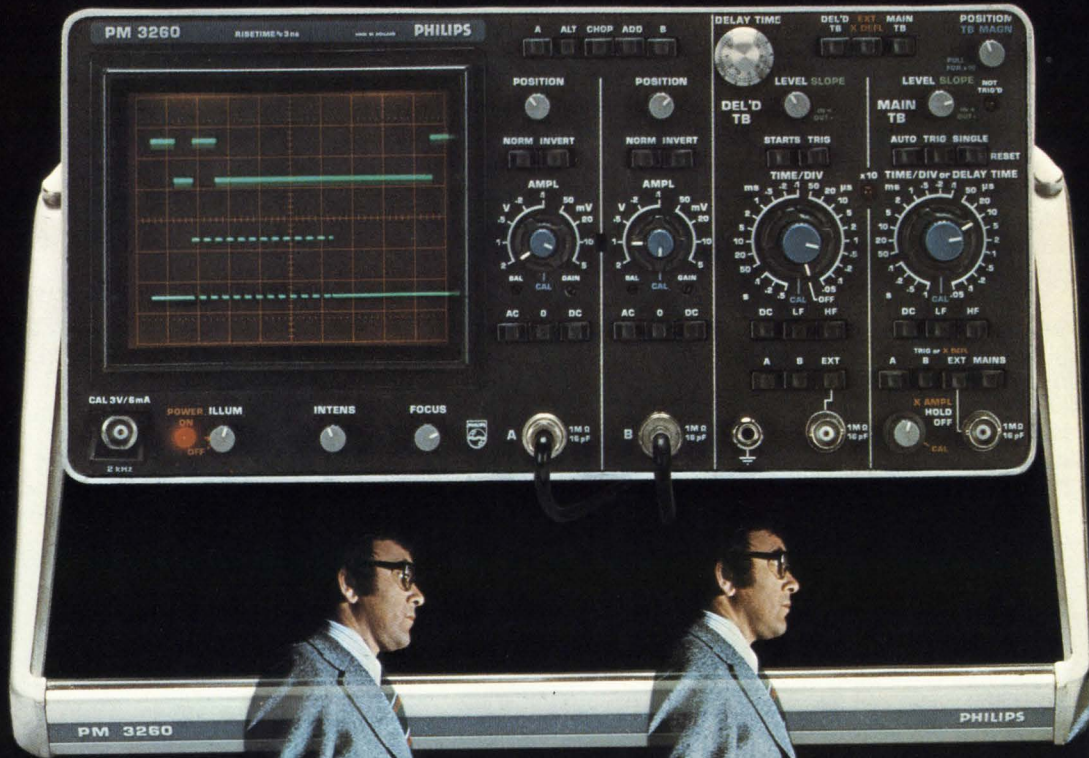

NOW THERE'S A CHOICE WITH THREE BIG DIFFERENCES

120 MHz, 20 lb and a logical layout

This oscilloscope does the job.

The job being servicing, testing and developing communications and computing systems.

For this you need a bandwidth of at least 100 MHz, therefore Philips supply 120 MHz in order to keep ahead of component developments like Schottky TTL.

A sensitivity of 5 mV is more than adequate, while a weight of only 20 lb comes as a pleasant surprise, (parking being what it is, every pound counts on a service call).

And a logical front panel layout is equally important since it lets you take measurement easier, quicker and with less possibility of error. (One example of our logic is the separation of main

and delayed time base controls in order to avoid any ambiguity).

Even more

As well as these obvious benefits, the new PM 3260 has even more significant features like : the clean display, even at the highest writing speeds;

the wide use of thin film circuits that help the space and weight reduction and that increase overall reliability;

the specially-developed power supply that accepts any line voltage / frequency and DC and that dissipates only 45 W, thereby eliminating the need for a fan (and associated filters) and finally, the modular

construction that gives fast access to all boards, controls and components.

First in a family

The new PM 3260 is also the first in a new series of oscilloscopes that will soon include higher and lower bandwidth instruments - all with the same important benefits of high performance, light weight and excellent ergonomic design.

To find out more about the first in the family write to :

Test and Measuring Instruments Inc., 224 Duffy Avenue, Hicksville, L.I., N.Y. 11802

ieee intercon⁷⁴



PHILIPS

From ele to blood analy



Smart system designers use Intel Microcomputers for almost everything.

Right now, Intel Microcomputers are being used to replace hardwired control logic, cut component and assembly costs, raise reliability and make systems easier to maintain. With control programs stored in read-only memories, Intel Microcomputers are replacing hundreds, in some instances even a thousand TTL packages.

Intel Microcomputers are making systems smarter, opening new markets and preventing product obsolescence. Our customers are adapting the Microcomputer to new applications and markets by programming ROMs instead of hardwiring logic. Products get to market faster since software takes months, perhaps man-years less time to develop than hardwired logic.

General purpose Microcomputers, invented two years ago by Intel, have already outmoded hardwired logic and expensive custom MOS/LSI in hundreds of applications:

computer terminals, traffic light controllers, medical instruments, business machines, mass-transit equipment, reservation systems, cash registers, inventory computers for fast-food restaurants, process controllers, electronic test instruments

and even pinball and slot machines.

You'll soon be seeing a new Toledo digital computing scale at the corner food store. Accurate to the penny, it converts weights to prices and operates a



ctronic games zers.

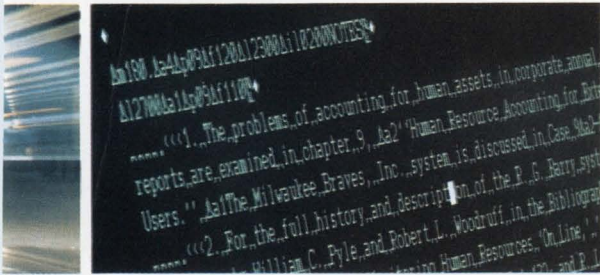

display, label printer, or both with an Intel Microcomputer. With equal ease, a similar Microcomputer handles graphics composition and editing in Automix Keyboard's Ultra Comp intelligent terminal for typesetting.

blood analyzer, an Intel Microcomputer translates the raw data from a sensing instrument into medically meaningful numbers and prints out separate quantitative readings of several different proteins.

The Microcomputer reduced the electronics cost of the system about 30%. Another Microcomputer automated instrument is Coherent Radiation's Dioptron™

While a patient reads an eye chart, the central processor analyzes the eyes' focus and prints out the results. Even kids too young to read the chart are tested rapidly and accurately.

Finally, take a look at the new video games, pinball machines and slot machines. A microcomputer makes them more fun and imaginative. In these machines, the Intel Microcomputer acts just dumb enough to let people win once in a while.

We started the Microcomputer revolution and we continue to lead the industry in the development, production, applications support and delivery.

To find out how you can enhance your product's capability, take advantage of our know-how, software library and programming aids, subscribe now to Microcomputer News. Just for asking, we'll also send you our new Microcomputer catalog.

Intel Corporation, 3065 Bowers Avenue, Santa Clara, California 95051 (408) 246-7501.

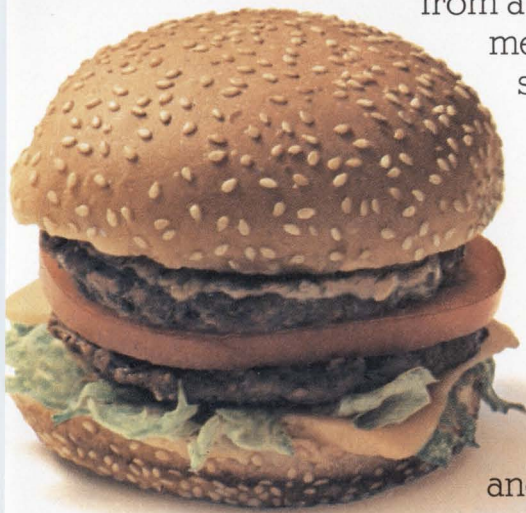
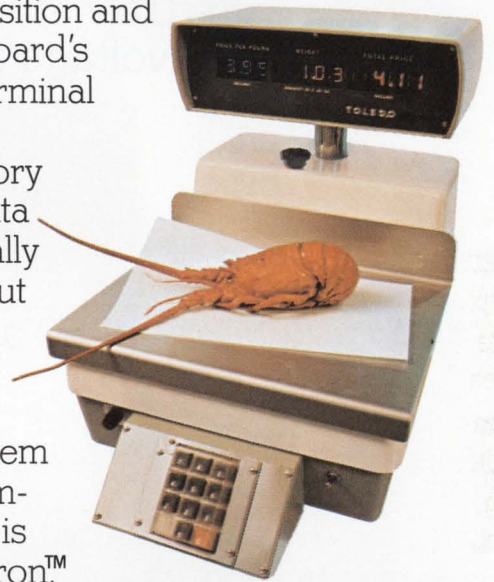

intel® Microcomputers. First from the beginning.

A startling announcement:

TRW's new
Schottky Power
Rectifier

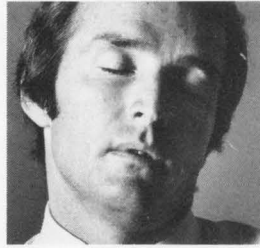

gives a
0.5V forward
voltage drop

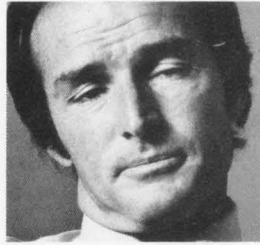

at 50 amps

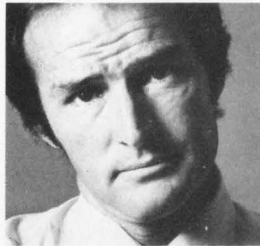

at a T_j of...125°C!



If that doesn't startle all power supply designers, nothing will.

Here's the first, and only, Schottky power rectifier that doesn't fsst-out at 100°C—let alone, higher! In fact, TRW's new device actually operates at a T_j of 125°C with a 0.5V_f at 50 amps.

Maybe you have heard discouraging talk about similar devices made by other companies. Or tried one, yourself. If so, you may have experienced "mysterious failures." Certainly you had

failure when T_j reached 100°C. And it was no mystery: the thing melted!

But this is different. This is made by TRW. After 5 years R&D to be sure it would work. And it does! At 100° At 125° With 35V reverse operating voltage.

Ask the nearest distributor for TRW's new Schottky power rectifier. Part number SD 51. Or contact John Powers, TRW Semiconductors, an Electronic Components Division of TRW, Inc., 14520 Aviation Boulevard, Lawndale, California 90260.

TRW® SEMICONDUCTORS

These products are available through the following authorized distributors:

Almo Electronics
Bell Industries
Cramer Electronics Inc.
De Mambro Electronics

Eastern Radio Corp.
Electronics Marketing Corp.
Elmar Electronics Inc.
Hall-Mark Electronics Corp.

Harvey-Michigan Inc.
Liberty Electronics
Powell Electronics
Pytronics

Semiconductor Concepts Inc.
Summit Distributor
R. V. Weatherford Co.
Westates Electronics Corp.

600 IC contacts possible with elastomeric system

IC technology of the future points towards tiny, complicated devices like wristwatch calculators and Dick Tracy TV cameras. One problem has been: How do you make high-density connections to the tens or perhaps hundreds of contacts needed for such devices?

One answer may be an elastomeric connector system made by Chomerics, Inc., in Woburn, Mass. According to Edgar Cornish, product marketing manager, the system can connect up to 600 contacts/sq. in.

The connector is a thin sheet of proprietary conductive, rubbery material—nominally 0.015 in. thick. An unusual property of the sheet is that it is selectively conductive. For example, under the pressure of contact areas formed by screened or plated contact pads, that rise a thousand or two thousands of an inch above IC or PC-board substrates, the depression in the elastomer produces a maximum contact resistance of about 0.5 Ω , Cornish says. To make contact, the IC is forced against a substrate or PC board with only about a half ounce of pressure.

However Chomerics' material has been designed so resistance in the nonpressurized areas between adjoining contact pads—as close as 20/1000ths of an inch apart—is a billion ohms. This high value of resistance makes the connector suitable for use with MOS circuitry, Cornish notes.

Developed specifically for leadless ICs, electronic-watch circuitry, liquid-crystal displays and flat packs, the system makes its connections to the circuits when an area is die-cut out of the proprietary Solid-State Connector sheet. The die-cut area conforms to the regions where connections are to be made between an IC and its substrates or terminal assembly.

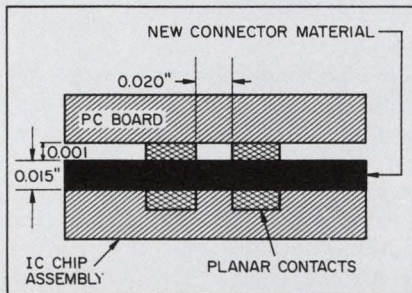

Squeezing the PC board and the IC chip assembly together produces low-resistance contacts.

The IC and substrate, for example, are simply clamped together, with the elastomer between them. Connections are formed between opposite contact pads. Because the contact material is an elastomer, it is self-aligning. The material also provides an airtight seal to conform to the opposing surfaces, and is secured in place with a small metal clamp.

The Chomerics' connector is low-cost; a typical connection costs about 20 cents in volume quantities, Cornish says. Since the connection can be readily disassembled, difficulties are eliminated in unsoldering and soldering fine wires to repair or replace such parts as liquid-crystal displays in watches.

Central maintenance: Wave of the future?

When something goes wrong with any of the 13,000 or so communications terminals that Western Union leases to companies, laboratories and Government offices across the country, the problem—no matter how trivial—ends up in the lap of a computer center in Mahwah, N.J.

The center, operated by Western Union's Data Services Co. and

called Termicare, conducts remote tests to diagnose the problem. If necessary, it dispatches a serviceman to the terminal with spare parts once the fault has been isolated.

Western Union sees centralized maintenance operations like this as the wave of the future, and it plans to expand horizontally for new business.

When a report of trouble comes in from the field, an analyst in Mahwah calls up from the computer all the data he has on the ailing terminal—its specifications and history. Armed with this knowledge, he checks out the likely causes of the difficulty, then asks the operator of the terminal to send in a sample of the malfunctioning communication. Test instrumentation can be hooked up to the line, or the communication can be switched to a laboratory where more complicated tests can be made.

Western Union looks for improvements in this centralized maintenance operation. The next step will be to "educate" the computer to diagnose and repair the problems by itself. Ultimately, says Z.V. Zakarian, president of Western Union Data Services, the terminals will be intelligent, "built with multiprocessors that solve problems right at the site."

Japanese radar setup deploys car air bags

A Japanese radar system that can deploy automobile air bags automatically in an impending crash was described at the Solid-State Circuit Conference in Philadelphia.

According to Teruo Kondoh, manager of the radar section of Mitsubishi Electric Corp., Amagasaki, Japan, the experimental system operates at 10.5 GHz and uses a 10-ns pulsed-doppler radar with a range of about five feet.

Two horn antennas—one for transmission, the other for reception—define a tight radar-coverage pattern directly in front of, and somewhat narrower than, the vehicle.

A reflected signal that returns within 10 ns—equivalent to a distance of about five feet—is detected and stretched. The resulting pulses, which are amplitude-modu-

lated at the doppler frequency, are then sampled and held, and the output pulses are frequency-counted. The level of the count determines whether the relative speed of approach is dangerous. Above a preset speed, say 20 mph, the air bag is triggered.

The auto radar system uses a GaAs Schottky-barrier diode to generate the very short pulses with fast rise and fall times. A Gunn diode is the active element in the system's continuous-wave oscillator.

The experimental system now costs between \$3000 and \$4000, but this can be reduced to \$300 or less in production quantities, Kondoh says.

Laser communications spurred by modulation

An electro-optic modulator that promises to increase channel capacity of laser-communication systems while decreasing power requirements has been developed by RCA.

According to Brown Williams, head of quantum-electronics research at the David Sarnoff Research Center, Princeton, N.J., the modulator is the first that is truly compatible with integrated circuits. The device requires low voltages—between 3 and 8 V—and consumes only 0.1 mW/MHz of power. Power consumption is given in frequency terms, Williams notes, because it is consumed only in the ac mode and it increases with frequency. If the device were used in a dc mode, it would consume no power because of its capacitive nature.

The modulator is capable of spatial switching—changing the direction of a laser beam—and can operate over wavelengths from the visible to the near infrared. Broad bandwidth means that the device can be used with both gas and injection lasers.

Since signals can be modulated from a few hertz to several gigahertz, as many as 25,000 phone calls may be feasible over a single laser beam.

Many effective laser modulators have been developed, but they have been either difficult to fabricate, bulky, slow or heavy power users. Other modulators have employed

costly, high-quality, bulky single crystals that required several hundred watts of power. The RCA unit needs only a few watts to perform comparably.

The electro-optic modulator is made primarily from lithium tantalate. However, a thin film of lithium niobate tantalate acts as a waveguide for the laser light. The device is topped by minute, interleaved metal fingers that control the functioning of the waveguide through the application of voltages.

While both lithium niobate and tantalate have long been known for their strong linear, electro-optic properties, RCA's development of a diffusion technique that produced the thin film on the lithium-tantalate substrate made possible the new modulator. The thin-film technique gives the device a very high width-to-length ratio, which lowers the voltage requirements.

Williams points out that the modulator is still in the research stage and that several problems must be solved before it can become part of a practical optical-fiber communications system. One problem is the development of a fiber that can handle the high-modulation frequencies. Such fiber, he predicts, should be perfected by the end of the year.

IBM saving energy— with computer, naturally

IBM has cut consumption of fuel and electricity in one of its large manufacturing facilities by monitoring the weather with an instrument station, keeping tabs on heat-producing machinery inside with a sensor network and feeding data from both sources into an IBM System/7 computer.

On line for over a year at the company's semiconductor manufacturing division in East Fishkill, N.Y., the system has cut fuel-oil consumption 6% and demand for electricity to cool the 2.3-million-square-foot plant 10%.

The outside weather station records temperature and wind velocity in the winter so the computer can predict the necessary heating load. In summer, temperature and relative humidity are recorded to predict the maximum

cooling load.

Inside the plant, the system's sensors monitor 200 variables. It compares the variables with high and low limits and sounds an alarm if they shift out of limit. The system also calculates boiler and cooling efficiency minute by minute.

Real-time data are presented visually on the performance, maintenance requirements, loads and capacities of five boilers and 10 cooling units. The system also generates diagnostic data and operator guidance messages on a continuous basis, and it produces various troubleshooting reports on demand.

Data are logged and analyzed at the console of an IBM 1130 computer linked to the System/7.

The system has worked so well at East Fishkill that IBM is installing it at several of its other plants.

Tunable lasers aid study of atoms and molecules

Tunable lasers have now been pushed to frequencies sufficiently high for scientists to study, with high precision, the electronic, magnetic, vibrational and rotational properties of atoms and molecules.

Researchers have been particularly interested in the ways in which these particles interact to gain and lose energy. With a new laser developed at IBM's Watson Research Center, Yorktown Heights, N.Y., scientists can study the particles more carefully.

The new light source is powered by two lower-frequency dye lasers, and it covers a wavelength range from 1500 to 2000 Å. The two lasers are of different frequency and provide the input energy to a vapor of strontium metal.

The output power of the new laser is several hundred milliwatts.

An IR ignition system

TRW has signed an agreement with Lumenition Ltd. of London to manufacture and market Lumenition's optoelectronic ignition system. The system operates on the basis of an interrupted infrared light beam, eliminating the need for breaker points.

We shaped up DC

SOLID STATE RELAY WITH CONTROLLED RISE AND FALL TIME

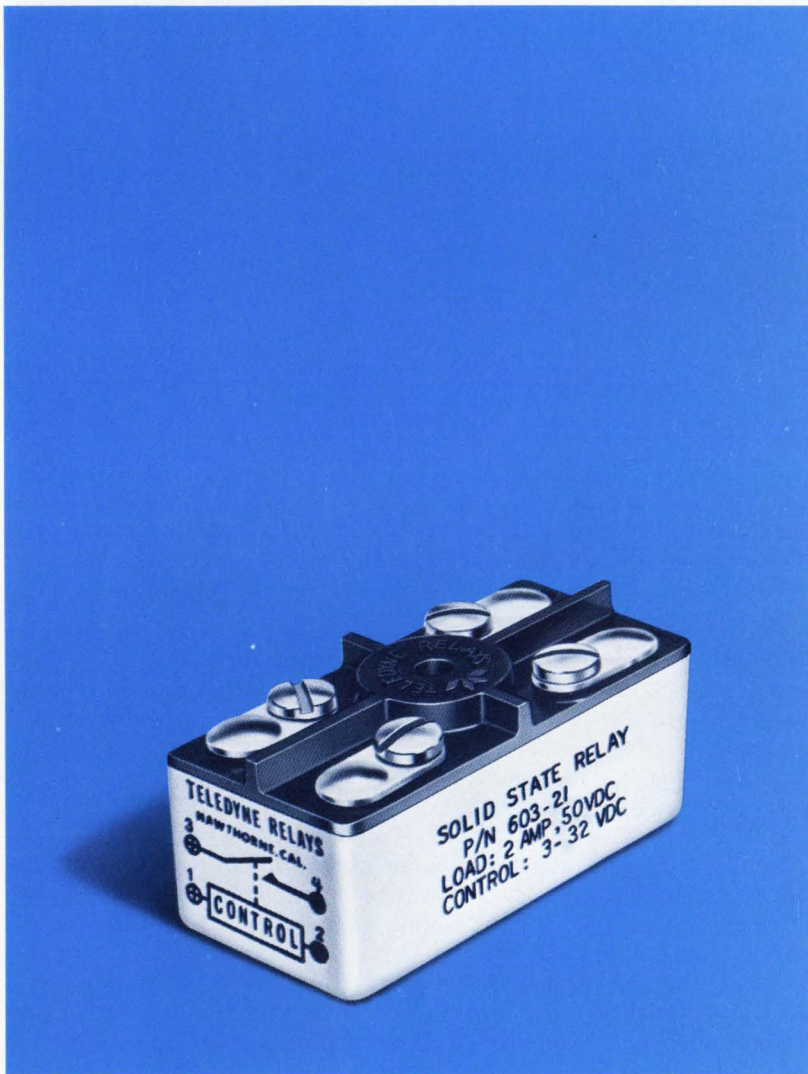

Take a good solid state DC relay — Teledyne's 603, for example — add some shaping circuitry so its response waveshape is carefully altered (rise time, turn-off slope, etc.), and something good happens for designers. In-rush currents for capacitive and lamp loads are limited, and so are turn-off transients for inductive loads. Also, controlled rise and fall time minimize EMI and switching transients.

An excellent choice for applications like process control systems, and machine tool controls, the 603 is optically isolated, with sensitive control input (directly compatible with TTL). It's available for loads up to 5 amps, 50 VDC.

The 603 also features Teledyne's exclusive "adaptive" packaging . . . screw or quick-disconnect terminals for chassis mounting, pins for PC boards.

If your application is less critical about in-rush currents and transients, you can order the 603 without controlled rise and fall time; it's identical, with a fast clean conventional waveshape. If you want to switch even higher level loads, shape up and call Teledyne.

 **TELEDYNE RELAYS**

3155 West El Segundo Boulevard Hawthorne, California 90250
Telephone (213) 973-4545

INFORMATION RETRIEVAL NUMBER 20

AT THE SOLID-STATE CIRCUITS CONFERENCE

Integrated injection logic shaping up as strong bipolar challenge to MOS

The much talked about IC logic race between MOS and bipolar technologies has heated up again because of a form of bipolar logic known as integrated injection logic (I²L).

According to engineers interviewed at the 1974 IEEE International Solid-State Circuits Conference in Philadelphia, the high packing density and low power-delay product will make I²L a serious competitor to MOS technology.

When it was introduced at the conference two years ago, experts were not sure whether the technique would become just another curiosity or herald a new era of bipolars for low-cost, low-power logic. Presentations at last month's conference by researchers from three companies have erased much of this doubt.

In a paper on "Integrated Injection Logic—A New Approach to LSI," Nico C. De Troye, head of the digital circuit design group at Philips Research Laboratories, Eindhoven, the Netherlands, noted in Session 1 that I²L is not a new technology but rather a new digital circuit technique, and as such can be manufactured on any standard linear production line.

The bipolar approach uses vertical npn transistors with multiple collectors and lateral pnp transistor current sources as loads. The supply current is fed into the switching transistor by carrier injection.

According to de Troye, I²L has a speed-power product that is far superior to that of any other tech-

The following editors contributed to this report: Jules H. Gilder, Morris Grossman, Jim McDermott and Ed Torrero.

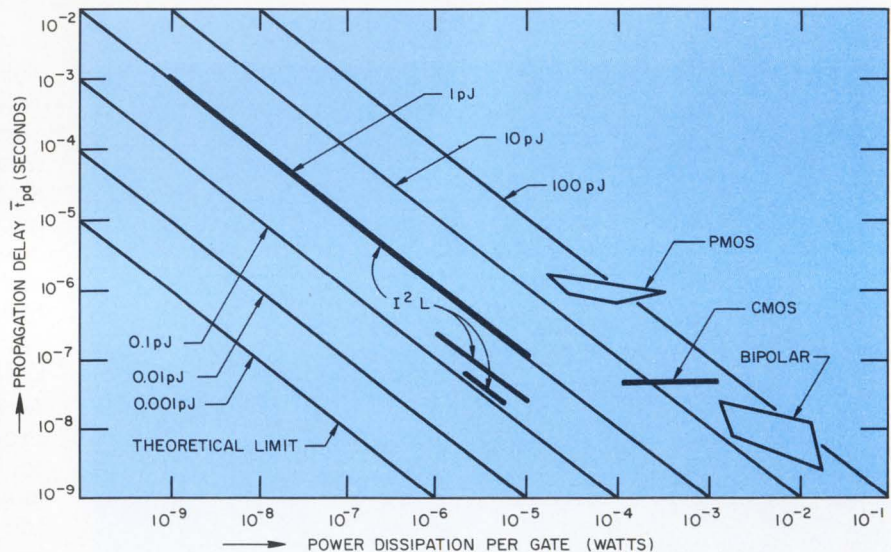

Power-delay curves for different types of logic gates are compared with I²L. The three curves for I²L are for different geometries.

nology (see graph). Products as low as 0.13 pJ have been obtained with a cell geometry in which current is injected into the switching npn transistor from three sides instead of one. This is done, however, at the expense of density.

It is not always necessary to sacrifice density for speed, de Troye notes. Both can be increased if the linear dimensions of the basic gate are held down and the diffusion depths kept constant. In the case of a cell with current injection from only one side, the speed power product is 1 pJ. By a decrease in the dimensions of the contact holes from 10 μm to 5 and cuts in other corresponding dimensions, the power-delay product was decreased to 0.25 pJ. At the same time the density was increased by a factor of 4 to 400 gates/mm².

Although only five masking steps are required to produce injection logic devices, de Troye points out

that if seven masks are used, other technologies—such as ECL, TTL and analog—can be combined with I²L on the same monolithic chip.

It's denser than MOS

To support his claim that injection logic is denser than MOS, de Troye did a layout comparison of the area required for 101 gates (part of a control logic of a calculator). Standard cells, with layouts of constant height and a length depending on the logic function, were designed with I²L and different MOS Si-gate circuits. Local oxide isolation was applied, and two layers of interconnections were permitted. The same layout rules were applied to all cells. The results of this comparison show that I²L is significantly smaller than any of the MOS technologies (see table).

In another paper at the same

FAST RECOVERY POWER RECTIFIERS

Reverse Recovery(T_{rr}) 200ns and 2 μ s

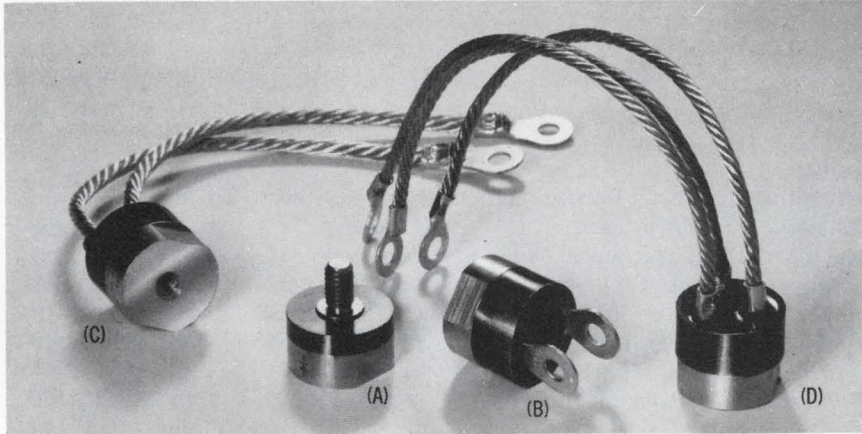

CUPAC 150

... the power house

CuPac 150 is specifically designed for high frequency-high power applications. CuPac 150 is capable of supplying up to 150 amperes with proper heat sinking. Available as half wave rectifier, doublers, center taps and three phase half wave bridge circuits.

Internally, CuPac 150 utilizes Semtech's Metoxilite rectifiers mounted on an (OFHC) oxygen-free hard copper insert base. Inherent rugged design and reliability enables the CuPac 150 to be used in stringent commercial, industrial, military and space applications.

Body Dimensions: 1.12" D x .70" H (+ stud)

FAST RECOVERY — (T_{rr}) 200ns. (Fig. A)
Peak Inverse Voltage: 50, 100, 200 & 400V.
 V_F (max.) (@ 100A): 1.40V, T_j @ 25°C; 1.35V, T_j @ 100°C.

Reverse Current (max.) @ PIV:
25 μ A @ 25°C; 1 MA @ 100°C.

MEDIUM RECOVERY (T_{rr}) 2 μ s.
PIV: 50, 100, 200, 400, & 600V.
 V_F (max.) (@ 100A): 1.22V, T_j @ 25°C; 1.17V, T_j @ 100°C.

Reverse Current (max.) @ PIV:
25 μ A @ 25°C; 1mA @ 100°C.

CUPAC 150, LO- V_F

Peak Inverse Voltage: 30 & 50V.
Reverse Recovery: 85ns (typ.) & 100ns (max.)

• 1/2 WAVE RECTIFIER

	@ 25°C	@ 100°C	@ 150°C
V_F (typ.) @ 20A	.86V	.77V	.72V
V_F (typ.) @ 60A	.95V	.88V	.85V
V_F (typ.) @ 100A	1.02V	.97V	.93V

• DOUBLERS & CENTER TAPS Figs. (B) & (C)

Body Dimensions: 1.12" D x .9" H (+ leads).

FAST RECOVERY (T_{rr}) 200ns
PIV: 50, 100, 200 & 400V.
 V_F (max.) (@ 50A): 1.40V @ 25°C; 1.35V @ 100°C.
Reverse Current, per leg (max.):
13 μ A @ 25°C; 500 μ A @ 100°C.

MEDIUM RECOVERY (T_{rr}) 2 μ s.
PIV: 50, 100, 200, 400 & 600V.
 V_F (max.) (@ 50A): 1.22V @ 25°C; 1.17V @ 100°C.
Reverse Current, per leg (max.):
13 μ A @ 100°C; 500 μ A @ 100°C.

• 3 PHASE 1/2 WAVE BRIDGE Fig. (D)

Body Dimensions: 1.12" D x .9" H (+ leads).

FAST RECOVERY (T_{rr}) 200ns
PIV, per leg: 50, 100, 200 & 400V.
 V_F (max.) @ 33A: 1.40V, T_j @ 25°C; 1.35V, T_j @ 100°C.

Reverse Current, Per Leg @ PIV:
10 μ A @ 25°C; 350 μ A @ 100°C.

MEDIUM RECOVERY (T_{rr}) 2 μ s.
PIV, Per Leg: 50, 100, 200, 400 & 600V.
 V_F (max.) @ 33A: 1.22V, T_j @ 25°C; 1.17V, T_j @ 100°C.

Reverse Current, Per Leg @ PIV:
10 μ A @ 25°C; 350 μ A @ 100°C.

• DOUBLERS & CENTER TAPS

	@ 25°C	@ 100°C	@ 150°C
V_F (typ.) @ 10A	.86V	.77V	.72V
V_F (typ.) @ 30A	.95V	.88V	.85V
V_F (typ.) @ 50A	1.02V	.97V	.93V

• 3 PHASE 1/2 WAVE BRIDGE

	@ 25°C	@ 100°C	@ 150°C
V_F (typ.) @ 5A	.86V	.77V	.72V
V_F (typ.) @ 15A	.95V	.88V	.85V
V_F (typ.) @ 25A	1.02V	.97V	.93V

NEW "STUD"

... Super stud rectifier



Semtech Corporation introduces the DO-5 Stud, a new series of high current silicon stud rectifiers for high frequency applications. Capable of supplying up to 50 amperes with proper heat sinking, the DO-5 Stud has been specifically designed for industrial, military and space applications.

Metoxilite rectifiers are used internally, the base is a DO-5 configuration and terminals offer easy soldering properties.

Body Dimensions: .69" D x .45" H.

FAST RECOVERY (T_{rr}) 150ns
IR (@ PIV), Per Leg: 13 μ A @ 25°C; 500 μ A @ 100°C.
 V_F (max.) @ 50A: 1.40V @ 25°C; 1.35V @ 100°C.

MEDIUM RECOVERY (T_{rr}) 2 μ s.
PIV: 100, 200, 300, 400, & 600V.
IR (@ PIV), Per Leg: 13 μ A @ 25°C; 500 μ A @ 100°C.
 V_F (max.) @ 50A: 1.22V @ 25°C; 1.17V @ 100°C.

LO- V_F "STUD"



... Low forward voltage drop.

LO- V_F stud rectifier is specifically designed for high frequency, high power applications.

VERY FAST RECOVERY (T_{rr}) 100 ns.
Peak Inverse Voltage: 30V.

	@ 25°C	@ 100°C	@ 150°C
V_F (typ.) @ 10A	.86V	.77V	.72V
V_F (typ.) @ 30A	.95V	.88V	.85V
V_F (typ.) @ 50A	1.02V	.97V	.93V

"We're number 1 because we try harder"

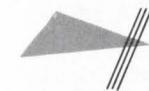

SEMTECH CORPORATION

652 Mitchell Road, Newbury Park, California 91320
(805) 498-2111, (213) 628-5392 / TWX: 910-336-1264

CHICAGO: (312) 352-3227
DALLAS: (214) 253-7644
FLORIDA: (305) 644-5404
NEW JERSEY: (201) 654-4884
SAN FRANCISCO: (415) 328-8025
EUROPEAN SALES: (Switzerland) (042) 323-242

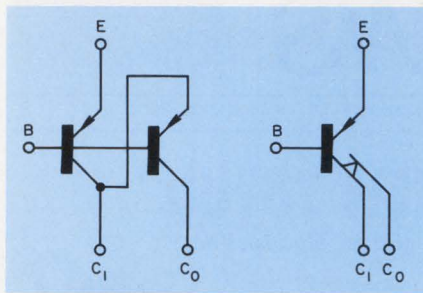

The CHL inverter has an extra collector between the emitter and output. Proposed symbol is at right.

Area comparison of I²L and MOS technologies

Type of circuit	Area in mm ²	Ratio
I ² L	0.75	1
CMOS	1.11	1.48
Static-enhancement PMOS (AND/OR)	1.30	1.73
Static-enhancement PMOS with depletion load (AND/OR)	1.17	1.56
Dynamic-enhancement PMOS (AND/OR)	1.08	1.44
Dynamic-enhancement PMOS (NAND)	1.41	1.88

session, Reginald A. Allen, an engineer from the Northrop Research and Technology Center, Hawthorne, Calif., described an oxide isolated form of integrated injection logic.

Oxide isolated devices were compared with n⁺ isolated devices and devices with no isolation. The comparisons, Allen noted, show that the power-delay product can be reduced significantly by use of oxide isolation. For nonisolated devices the power-delay product was 0.27 pJ, while for n⁺ isolated devices, it was 0.22 pJ. For oxide isolated devices, the power-delay product turned out to be 0.17 pJ.

Another novel bipolar logic concept was also unveiled at the conference. Called current-hogging logic (CHL), it is similar to I²L in that it uses multicollector

transistors. Its main advantage, however, is that it has high noise immunity.

According to Heinz Lehning of the Institut für Theoretische Elektrotechnik der TH Aachen in West Germany, the basic CHL element (inverter) has an additional collector between the emitter and the output collector, C₀ (see figure). This additional collector, C₁, is known as a control collector.

In describing the operation of a CHL inverter, Lehning noted that under floating conditions C₁ saturates and thus acts like an emitter, injecting holes that are collected at C₀. This makes the structure E-B-C₀ act like a normal npn transistor.

However, if C₁ has a negative bias on it with respect to the emit-

ter, it hogs the carriers that are collected at C₀, and only the junction leakage current remains at the output collector. To implement the NOR function, two control collectors are connected in series between the emitter and output collector. The NAND function results when one control collector is split into two halves.

High density—up to 200 NAND and NOR gates/mm²—can be achieved, because all logic elements can be placed within one common isolation region, Lehning pointed out.

The high noise immunity of CHL results from the use of saturated elements, Lehning said. In addition the Miller capacitances of the output npn transistors result in relatively long rise times. ■■

New CCD image structure makes processing easier and lifts yields

A new charge-coupled device structure that relaxes the demands on photolithography and eliminates many of the problems associated with earlier CCDs was described at a Solid-State Circuits Conference session on "Charge-Coupled Devices and Image Sensing."

Other advances described at the same session include a high-sensitivity charge-injection-device TV camera and a half-million-element bucket-brigade optical scanner, the largest ever constructed.

In a paper on "Charge-Coupled Image Sensing Devices Using Three Levels of Polysilicon," Carlo H. Sequin, a member of the technical staff at Bell Laboratories,

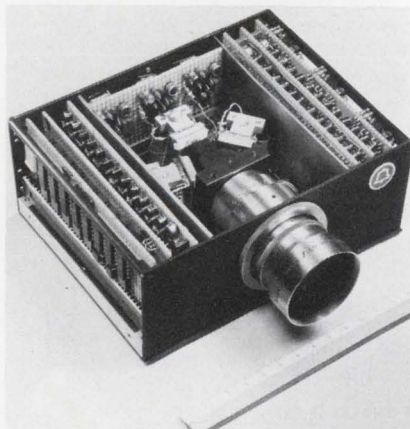

A prototype color TV camera that uses three 220-by-128-element, charge-coupled-device arrays has been built by Bell Laboratories.

Murray Hill, N.J., noted that because the single-level metal structures of CCDs have exposed transfer gaps, they are unstable and sensitive to the ambient. But by forming each set of transfer electrodes of a three-phase CCD in separate levels of polycrystalline silicon he went on, the designer can eliminate these problems and avoid the need for tight tolerances in mask-making and photolithography.

In describing the fabrication of this new structure, Sequin noted that, first, a level of polysilicon is deposited on an oxidized silicon wafer, which is doped with phosphorous and steam oxidized. Using



SCHOTTKY PROMs

1,024 fusible links, like this one, let TI's new PROMs shorten your design time.

TI's new 1024-bit Schottky* PROMs give you the capability to complete your custom designs or new designs **faster**—when your customers want them.

Whether you're implementing random logic, code converters, micro-programmers, or software emulators—virtually anything you can express in binary symbols can be programmed into these PROMs. Immediately and permanently. At your facility or at a TI authorized Distributor Programming Center near you.

Programmability is enhanced by the incorporation of additional fusing circuitry that is tested during manufacture. And, reliability

TI Schottky PROM Features

- Popular 256-word-by-4-bit organization
- Choice of output circuits
3-state SN74S287
open collector SN74S387
- High Performance
15 nanosecond typical enable delay
40 nanosecond typical address delay
- Factory tested programmability

is assured through TI's experience in Schottky technology and an in-house PROM QA test qualification program.

The SN74S287 and the SN74S387 are second generation electri-

cally programmable read-only memories in the industry standard 74187 ROM pin configuration.

With 100 to 999-quantity pricing of \$19.20 for industrial plastic DIPs, PROMs are becoming an economical option for more and more designs.

Order any of these Schottky PROMs from your local authorized TI distributor.

For a copy of a new 28-page brochure *Designing with TI TTL PROMs and ROMs*, Bulletin CB-162, write: Texas Instruments Incorporated, P.O. Box 5012, M/S 308, Dallas, Texas 75222



TEXAS INSTRUMENTS
INCORPORATED

this oxide as an etch mask for the polysilicon, the designer defines the first set of electrodes. Part of the remaining mask oxide and exposed gate oxide are then removed to obtain equal gate oxide thicknesses under all electrode levels. A new gate oxide is then thermally grown, and the electrodes are partly oxidized. These steps are repeated, Sequin said, to form the second and third levels of polysilicon.

A variety of CCDs have been built with this new structure, Sequin reported, including a 220-by-128 image sensor. Three of these arrays have been combined with a color-splitting prism to form a color TV camera.

Charge-injection camera built

Another TV camera, a black and white unit, was described by Gerald J. Michon of the General Electric Research and Development Laboratory, Schenectady, N.Y. Unlike the Bell camera, this one uses

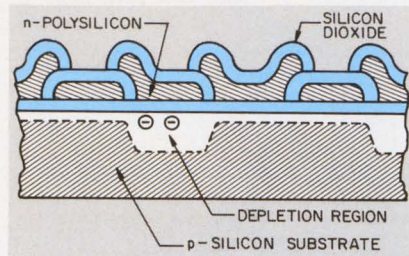

New three-level CCD structure eases photolithography tolerances and helps increase device yields.

a charge-injection-device imaging array instead of a CCD.

The charge-injection principle, offers several important advantages over CCDs, according to Michon. Since no special structures are needed for transporting the signal charge, almost the entire chip can be photosensitive, thus significantly increasing sensitivity.

Another advantage, he continued, is the chip's high tolerance to defects. If a pair of capacitors—one array element—should fail, the result is only one small dark spot on

the TV screen. With CCD imagers, the charge is passed on from capacitor to capacitor, and thus the failure of a single element can mean darkening of an entire line in the picture.

524,288-element array made

What is perhaps the largest image sensor developed to date was described by Norbert G. Vogl Jr., a researcher from IBM's Systems Product Div., Essex Junction, Vt. The sensor, a 524,288-element bucket-brigade array is fabricated on a single chip 1.05 by 1.6 inches.

The array is organized into 1024 shift registers, each 512 bits long and was fabricated with standard n-channel MOSFETs.

Because the chip is so large, Vogl noted, it has not yet been possible to fabricate one that is free of defects. The best results to date have been chips that have 13 of 16 subsections that are operational. ■■

Advances on three fronts herald next generation of linear circuits

IC manufacturers have opened a three-way drive to develop the next generation of linear circuits. One approach is to build relatively simple general-purpose circuits that can be produced easily in volume and by alternate sources. Another way is to build highly specialized, complete linear systems on a chip with conventional techniques. Still another approach—the most revolutionary—seeks to develop new standards of circuit design and signal level to simplify the fabrication of analog LSI circuits.

The relative merits of each approach were discussed at the Solid-State Circuits Conference in a panel session on "Function Shaping and Generation—the New Linear Game." The session was devoted to new linear ICs other than op amps.

Robert Dobkin of National Semiconductor, Santa Clara, Calif., contended that new ICs should follow the pattern set by op amps, if they are to achieve wide acceptance. Op amps, he noted, became popular be-

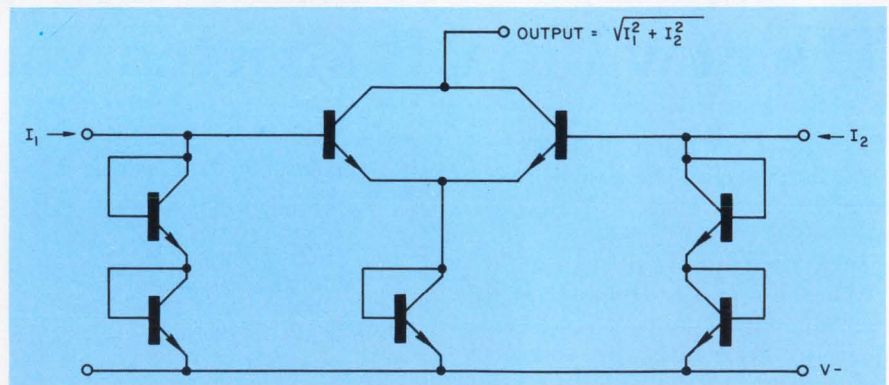

Use of a current-mode interface rather than a voltage mode simplifies the design of complex analog circuits, such as this one that performs a vector-sum function.

cause the versatility of the circuits allowed designers to use them in a wide variety of applications. Moreover the use of standard process techniques and the op-amp's small chip size permitted many manufacturers to produce them in large quantities.

Dobkin pointed to similar ingredients for acceptance in a temperature sense and control circuit that

he described in a paper, "Monolithic Temperature Transducer."

Another panel member, Alan Grebene of Exar Integrated Systems, Sunnyvale, Calif., saw the trend in linear ICs leading to standard techniques to build ever more complex circuitry for special applications. For example, he said, phase-locked-loop ICs offer a whole subsystem on a chip. And complete

Introducing the new standard of quality in cermet film fixed resistors.



Now Allen-Bradley quality is available in cermet film fixed resistors. We coupled 40 years of know-how in reliable fixed resistor mass production with 15 years of experience in metal film resistive elements.

The result will change your thinking about film resistor suppliers.

Features? Capless design that does away with problems associated with end cap construction. And an alumina core with superior thermal characteristics and physical strength to resist fractures. Solderable/weldable leads. Even dual markings that are easy to read.

Now available in preferred number values from 10 ohms to 1 meg; 1% tolerance; $\frac{1}{4}$ watt at 70°C, $\frac{1}{8}$ watt at 125°C; Size 0.250 L. by 0.090 D. Approved to MIL-R-10509 for style RN55, characteristic D. With tape reel packaging if you prefer.

For complete technical information on the Type CC cermet film fixed resistor, write Allen-Bradley Electronics Division, 1201 South Second St., Milwaukee, Wisconsin 53204.

There's more to resistors than resistance.

Actual Size



EC68



ALLEN-BRADLEY
Milwaukee, Wisconsin 53204

linear systems—such as four-channel stereo decoder ICs and waveform generator ICs—are also available.

In addition Grebene believes IC manufacturers should emphasize ease of use in their designs of complex circuits. A general-purpose phase-locked loop, he said, can be hooked up in, say, 10 different ways to produce 10 different functions.

"The result is an engineer's delight but a marketing man's nightmare," concluded Grebene, who prefers to see an optimized circuit in a simple 8-pin package with perhaps two external components to make it work.

Barrie Gilbert of Analog Devices, Norwood, Mass., offered perhaps the most far-reaching suggestion, were it to be adopted by the industry. He advocated a new set of interface standards for linear and nonlinear analog processors. The new standards would be based on ± 1 -V full-scale (FS) levels and ± 3 -V supply levels. Furthermore the new interface would employ a current mode. These changes, according to Gilbert, could reduce present difficulties in obtaining high-accuracy analog LSI circuits.

Present standards of ± 15 -V supply levels and ± 10 -V FS levels arose in part because of the proliferation in designs of op amps, which use these voltages. And accuracy would be impaired by the use of, say, a ± 1 -V FS signal. However, Gilbert said, the precision of the input stages of recent linear

circuits—which largely determine accuracy—has increased at least an order of magnitude over that of the early circuits.

Furthermore, Gilbert noted, the use of virtual-ground inputs and an external series resistor permit even kilovolts to be handled. With thin-film resistors on the chip, he said, "it's practical to accept inputs up to ± 50 V at the package pin, even with supplies of ± 3 V." And use of totem-pole output configurations allow the handling of standard ± 15 -V signals, even though the collector breakdown voltages are less.

Hence, Gilbert concluded, compatibility with standard interfaces can be retained, and thin-epi processes can replace the thick epi processes now required for the larger voltage levels.

"The use of thin-epi processes would result in dramatic chip-area reduction of a factor of 2 to 4, with attendant yield improvements," Gilbert said.

Other advantages of a switch to the lower voltage standard include a sharp reduction in power dissipation—perhaps by a factor of 5. Also, Gilbert said, at least a fifty-fold increase in full-power bandwidth can be realized in wideband IC amplifiers for the same power dissipation, and without the traditional division into large and small-signal operation. Gilbert envisions a 35-MHz, full-power bandwidth for the new generation of products.

Gilbert noted that low-voltage

operation would pave the way for use of high-density techniques, such as the Isoplanar process. Moreover the 1.2025-V bandgap of silicon could provide the basis for a very convenient voltage reference point.

On the switch from a voltage to a current-mode interface, Gilbert noted that the new interface would eliminate the need for on-chip op amps used simply to convert voltage to current. The op amps can cause dc and dynamic errors and also introduce noise. Also, the op amps typically consume more chip area than the current-oriented core that performs the function.

Other advantages of a current-mode interface, Gilbert said, include a wider dynamic range. At present, he noted, an offset voltage of 1 mV and a full-scale input of 10 V set a dynamic range of only 100:1 for 1% accuracy. But with current mode, the dynamic range can be greatly extended.

He also sees the elimination of offset adjustments, since the voltage at the current-driver inputs is of no consequence and circuits can be designed to have no current offsets.

"The function of addition," Gilbert said, "consists of a short-circuit—two inputs are just tied together. And one-quadrant multiplication and division can be performed to at least 0.005% linearity with a simple eight-transistor cell."

More complex functions can be performed with a small number of devices, stated Gilbert. ■■

Microprocessors turn to NMOS for speed, CMOS for low power

Two new 8-bit MOS/LSI microprocessors described at the Solid-State Circuits Conference set the pace in performance and capability for so-called "computers on a chip." One is an n-channel MOS single-chip processor that offers increased speed and improved instruction-set repertoire. The other is a complementary MOS two-chip

set that provides reduced power dissipation and emphasizes input/output capability.

Masatoshi Shima of Intel, Santa Clara, Calif., reported on the NMOS circuit, called the 8080, in a paper entitled "An N-Channel, 8-Bit Single Chip Microprocessor." The CMOS chip set, called COSMAC, was described by Robert

Winder of RCA, Somerville, N.J., in "COSMAC—A COS/MOS Microprocessor." Both units are scheduled for commercial sampling this year.

The Intel 8080 is an advanced design based on the company's highly successful 8008, an 8-bit processor that uses p-channel MOS techniques. Compared with

Due to a major industry breakthrough it is now possible to automate garbage.



First of all, it's a major breakthrough for OEM computer automation: \$990 buys you a full-blown computer in quantities of 200—our NAKED MINI®/LSI.

And as far as garbage is concerned, our mini is also a breakthrough for ecology. It can take over a city dump and automate the entire recycling process. Hooked up to sensors, our mini sorts out reusable metals, plastics, and paper. Activates vibrating screens that separate the disposables from the recyclables. Puts carts on the right tracks to different loading and dumping stations. Keeps track of the compacted loads that are returned to manufacturers. To people who pay good money for salvaged materials.

As a result, the whole smelly mess becomes a highly profitable business. And through garbage automation, our mini keeps city dumps from taking over the city.

This is just one of many down-to-earth

operations that can be run by our NAKED MINI/LSI—using only a small portion of its total capabilities. Because it's equipped with a full-scale LSI processor and 168 instructions, a 4K x 16 memory, plus a

fully implemented input/output for low-cost interfacing.

All this affordable computer power can go far to stimulate creative OEM thinking. In areas where computer control was thought of as too expensive. In all types of businesses and OEM systems. And no matter how smelly or dirty the tasks may be, now you can really clean up through computer automation.

Write or call: Computer Automation, Inc., 18651 Von Karman, Irvine, California 92664. Tel. (714) 833-8830. TWX 910-595-1767.

THE NAKED MINI® COMPANY
Computer Automation, Inc.

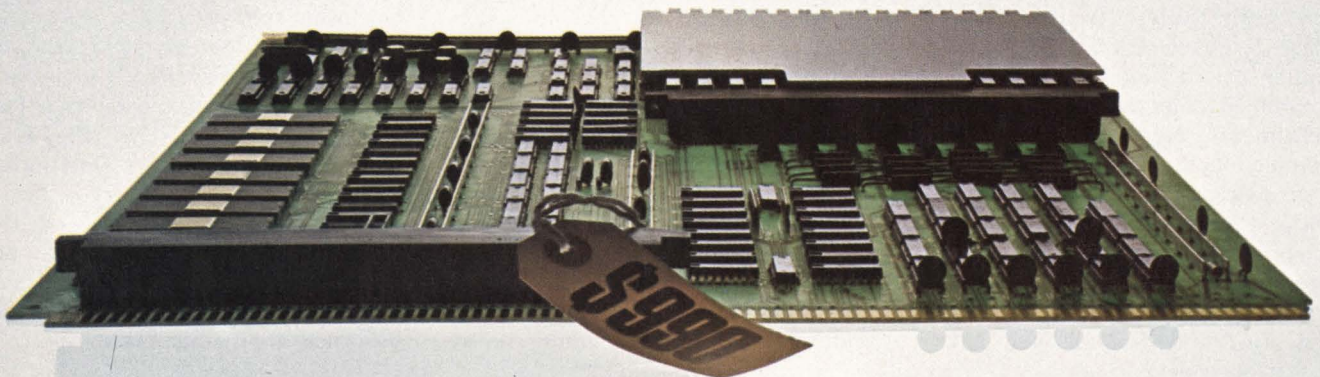

*NAKED MINI is a registered trademark of Computer Automation, Inc.

the PMOS circuit, the 8080 combines 30 more instructions and a 6:1 faster execution time. According to Shima, that combination and the 8080 architecture provide a 10:1 speed improvement in sample problems investigated.

Several architectural differences between the 8008 and 8080 account for the improved processing. For example, the PMOS 8008 uses an 8-bit adder twice to increment 14-bit addresses, since addresses are sent in two parts through the output buffers. In the NMOS 8080, a 15-bit incrementer/decrementer updates and transfers addresses in parallel. The difference saves two memory and arithmetic operations in each instruction cycle, Shima reported.

Other improvements in the NMOS 8080 over the PMOS 8008 include capabilities for decimal arithmetic for BCD numbers, 16-bit operations, interrupt-control instructions and push-down stack operators.

The RCA COSMAC microprocessor chip set is built around a 16×16 -bit scratch-pad register. References to memory are made through one of the 16 registers.

Compare PMOS and NMOS processors

	8008	8080
Technology & threshold voltage	P 1.5–2.5	N .8–1.4
Supply voltages	+5, -9 Volts	+12, +5, 0, -5 Volts
Number of pins on package	18	40
Number of interface chips	20	6
Number of instructions	48	48+30=78
Instruction execution speed	12 μ s–22 μ s	2 μ s–9 μ s
Internal memory type, Number of bits	Dynamic, 168 Bits	Static, 104 Bits
Chip size (mils)	124 \times 173	164 \times 191
RAM size/speed typical systems	256/1 μ s	1024/500 ns
ROM size/speed typical systems	2048/1 μ s	4096/600 ns

The processor can address up to 65-k bytes of memory, and it uses an 8-bit bidirectional data bus.

Each chip dissipates only 100 μ W. The chip set presents a 40-pin interface and can drive a TTL load. The processor cycle, consisting of eight clock pulses, ranges from 3 to 10 μ s. With the faster speed and a 1- μ s RAM, a 6- μ s fetch-and-execute time can be obtained for any instruction. Re-

sponse to interrupts, which are allowed only after complete instruction cycles, ranges from 3 to 9 μ s.

COSMAC uses a simple two-step fetch-and-execute sequence and places heavy emphasis on the I/O interface. A total of 23 lines, including the bidirectional data bus, control the I/O. And 16 separate I/O commands are available for control. ■■

Sophisticated large-scale IC chips are turning up in consumer items

Large-scale integrated circuits are appearing in consumer applications, like camera electronics and small-boat sonar. And these new low-cost chips are incorporating sophisticated features, such as protection against high-level circuit noise, current limiting of power stages and thermal sensing of the chip with automatic over-temperature shutdown.

The advances were described at the Solid-State Circuits Conference in a session on "ICs for Consumer Applications."

John W. Chu, senior product development engineer, Fairchild Semiconductor, Mountain View, Calif., described "An IC for Automatic Sequencing of Flash-Bulb Firing in Cameras." Designed to fire sequentially five flash bulbs of the Polaroid SX-70 Land Camera, the Fairchild IC has five power

cells, one for each bulb (see figure). When the shutter control is depressed, a logic high is placed on the chip's input amplifier. This turns on a voltage-reference circuit and applies power to the power cell for the first bulb, L_1 .

An energizing sensor transistor and a comparator circuit—one for each stage—signal whether the bulb is good. A good bulb has a dc resistance between 0.9 and 1.5 Ω , Chu pointed out.

The power cell sends a 300- μ s, 700-mA current pulse through the bulb to initiate firing. A lock-up latch is set at the same time, preventing the following power cell from firing.

This sequence is required, Chu noted, to make sure that only one bulb fires each time the shutter is operated, and also to prevent accidental firing of other bulbs

through interference from high transient currents developed when a bulb fires.

When the bulb ignites, Chu explained, short-circuits occur within the envelope during the electrochemical reaction that produces the light. These short-circuits produce noise currents with transients on the order of nanoseconds. Without protective features, this high-level, high-frequency noise could trigger the other power stages.

To protect the chip's circuits and to extend battery life, the power-cell current is limited by two factors designed into the IC. First, the base drive of the Darlington transistor power-cell stage is limited by circuit elements. Second, the power-stage transistors are designed so their beta gain falls off rapidly with currents beyond the designed operating level.



Put a little Teradyne in your lab.

You've probably heard of the big Teradynes—our highly sophisticated production-line test systems that have become the standards of industry.

Now hear about a little Teradyne—the J127 Accutest Circuit Analyzer, a bench-top digital IC tester that lets you lab-test ICs like never before. Quickly. Conveniently. And all for just \$3500.

The J127 has four constant-voltage supplies, a constant-current supply, four dual-limit comparators, a 24-pin crosspoint matrix, a pulse generator, and a 3½-digit panel meter.

It analyzes. It measures. It performs functional and parametric tests. It handles combinatorial and sequential logic. It's short-circuit-proof and it has programmable voltage and current limiting.

Set a switch to connect any lead of a 14-, 16-, or 24-pin device to any voltage supply, comparator, or the pulse generator. Turn a dial to set a bias or pulse level or a comparator limit. Push a button to connect the meter to a voltage or current supply, to a comparator, or to the matrix where it can then be switched to any pin on the device under test.

You can use the J127 for vendor analysis, reject analysis, pre-production inspection, and, especially, for engineering evaluation.

It has all this going for it and Teradyne behind it. Now that's a lot for \$3500—but it isn't all.

For the rest, write Teradyne, Inc., 183 Essex Street, Boston, Massachusetts 02111. In Europe: Teradyne Europe S.A., 11 bis, rue Roquépine, 75 Paris 8^e, France.

TERADYNE

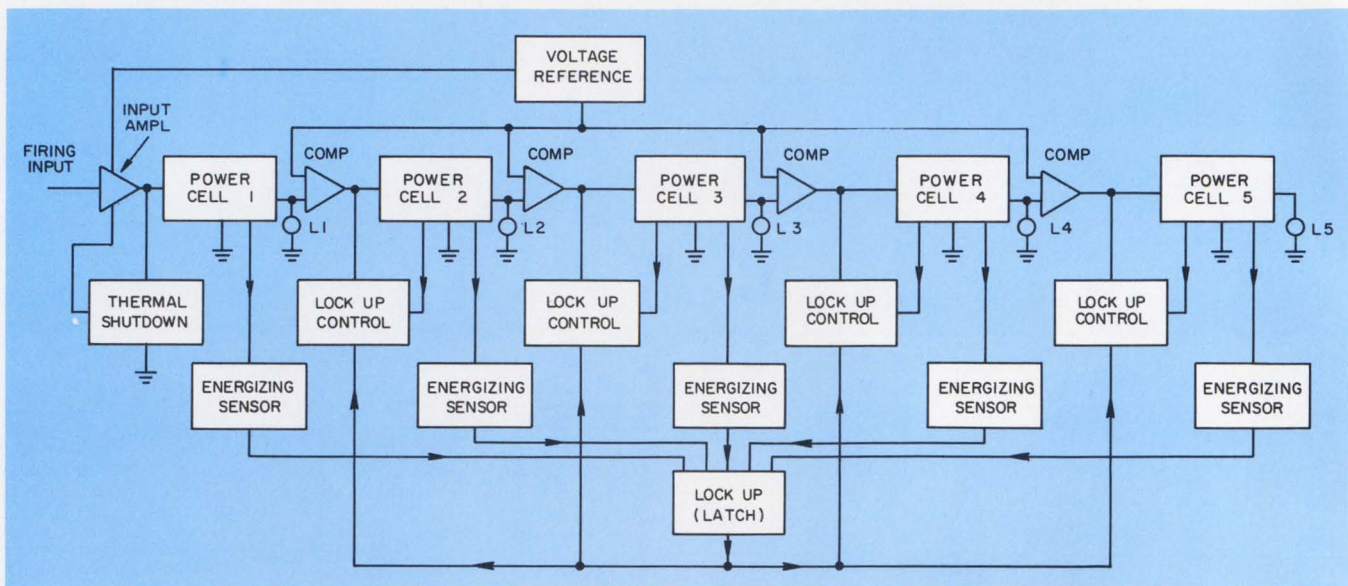

The flash-firing IC, above, is used in the SX-70 camera along with motor-control and exposure control modules.

When each bulb is fired the lockup control removes power from following cells, preventing misfiring.

As an added protective feature, the die temperature is sensed by an on-chip circuit that inhibits IC operation upon excessive temperature rise.

IC sonar better than discrete

In a paper at the same session, William M. Howard, designer at National Semiconductor, Santa Clara, Calif., told of a new 18-pin DIP that contains the transmit-receive circuits of a portable fish-locator and depth-finder sonar. The LSI circuit solves a major problem encountered with the discrete version of the sonar electronics: the multistage tuning circuits of the receiver and transducer drift out of alignment.

As Howard explained it in his paper, "A Single-Chip Monolithic Sonar System," the equipment is comprised of the LSI receiver-transmitter electronics, a trans-

ducer and a rotating neon-lamp display that indicates the bottom depth.

Loss in performance due to tuning drift—a loss encountered with the discrete version—is eliminated in the National IC, Howard reported, by use of a single RC resonator network that is time-shared with the receiver and transmitter. The drift of the RC network is normally less than 1%, Howard said.

This single resonant circuit eliminates alignment problems, Howard noted, for two reasons: First, the transmit frequency cannot drift outside of the broad receiver bandwidth. And, second, the frequency to which the network is tuned is used to drive the transducer.

The frequency drift of the transmit-oscillator configuration is only 0.5%, Howard pointed out—more than adequate to keep it within

the receiver bandwidth of 12%. The amplitude of the sine wave across the LC circuit is compensated for temperature variations by use of a stable current source to supply the circuit.

The timing and conduction angle of the class-C output amplifier that drives the transducer are controlled by a special one-shot multivibrator (see figure at right). The one-shot timing capacitor, made of a buried n⁺ layer and a p-isolation junction, does not occupy any surface area of the chip, and it has a relatively large breakdown voltage of 17 V.

The 12-V battery supply is stepped up, by action of the autotransformer driving the transducer, to about 220 V peak-to-peak.

No special heat-sinking is required with this IC, Howard pointed out, because of a short transmit period and low average power. ■■

Microwave bipolars take spotlight as GaAs and InP wait in the wings

"Instead of better and better state-of-the-art microwave transistors, let's do a better job on present devices for which we have a market."

The comment, made by N. George Bechtol of Fairchild Semiconductor, Palo Alto, Calif., summarizes

the consensus of an informal discussion session on microwave transistors at the Solid-State Circuits Conference. Bechtol cited the following as areas where improvement could give more mileage with present bipolars:

- Better control of active-ele-

ment dimensions.

- Better contact techniques.
- Improved basic materials.
- Reduced thermal resistance.

The largest bipolar transistors made today provide about 1 W of continuous output at 4 GHz. R. Dean of the RCA Sarnoff Research

vactec phototransistors

VACTEC, INC.

2423 Northline Industrial Blvd.

Maryland Heights, Mo. 63043

Phone (314) 872-8300

Vactec npn epitaxial large chip, high sensitivity phototransistor. An enlarged section of the wafer forms the colorful background.

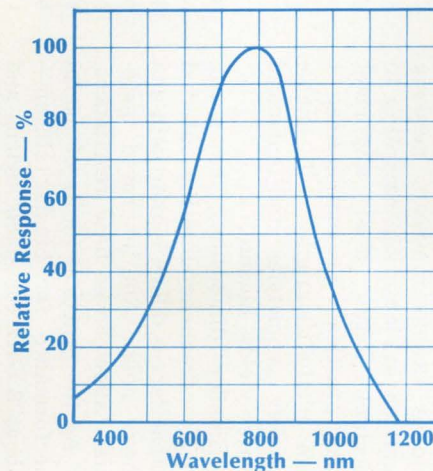
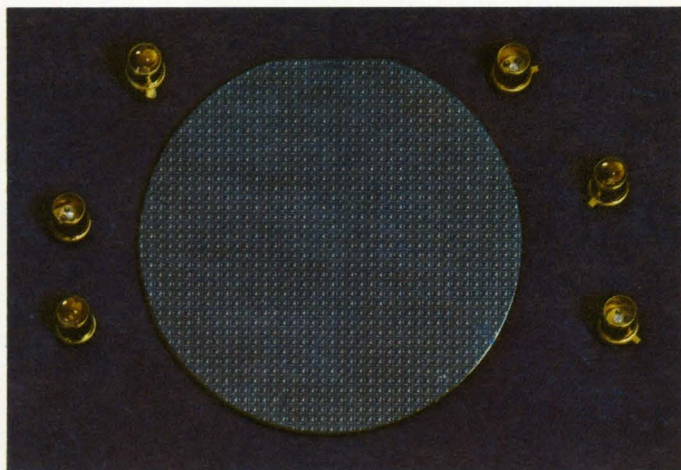

Standard Vactec phototransistors provide very high sensitivity and good blue response. Liberal design flexibility is also offered with trade-off for some characteristics, including: light current; response time; spectral sensitivity; and breakdown voltage. Selection of packages are TO-18, co-axial, pill, non-hermetic TO-18 size and special arrays on 50-mil or 25-mil centers.

Custom design is practical for quantities as low as 10M per year. Masking charges are nominal. Our automatic test capability includes 100% sort (with light applied) for I_{CEO} , breakdown voltage and dark current. Vactec can also second-source practically anyone's phototransistors. Write for Bulletin VTTA-1 today.

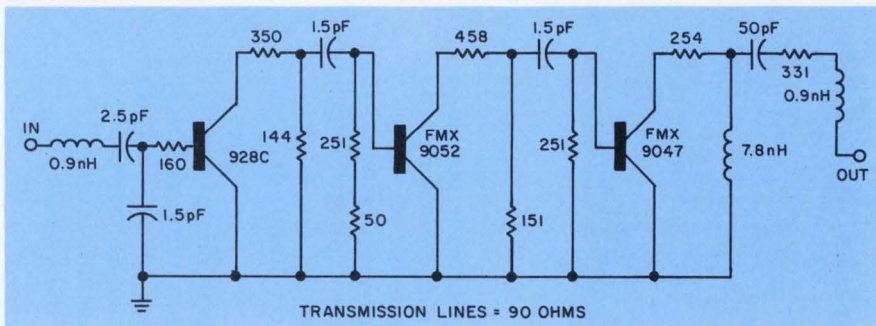

Microwave bipolar transistors can provide considerable gain over reasonably wide bandwidths, as in this integrated S-band amplifier. The three-stage amplifier provides about 24 dB at 3.1 to 3.5 GHz, with a noise figure of 3 dB.

Center, Princeton, N. J., another of five panelists at the session, said that 5 GHz at 5 W would be achieved for silicon units by the end of this year. These values are still far from theoretical limits seen by D. Jacobsen of RCA Solid-State Div., Somerville, N.J.: 157 W per picofarad of output capacitance at 10 GHz.

Advances in silicon bipolars will follow improvements in such techniques as electron-beam masking and ion implantation, according to Bechtol. Better mask alignment and practical, production-line, 1 μm photolithography will enable smaller geometries and enhanced wafer yields, he said.

Smaller dimensions, he noted, reduce frequency-limiting internal capacitances, allow higher gain and lower noise. And improved materials allow lower base resistances.

As the practical limits of useful performance for bipolar silicon—about 8 GHz for small signals and 5 to 6 GHz for high-power applications—are reached, new materials such as gallium arsenide (GaAs) and indium phosphide (InP) are emerging as successors, Bechtol noted. Gallium arsenide transistors now perform to 16 GHz for small-signal use and 10 GHz for high power. Power FETs have been made in the laboratory that generate 1 W at 6 GHz. InP has higher electron mobilities than GaAs, and it promises to extend the limits of small-signal FETs to perhaps over 25 GHz, Bechtol said. However, he added, high reverse leakage is a serious problem with both these materials.

“Promising as the newer GaAs and InP materials are, present transistor manufacturing technologies leave room for plenty of improvement and they have consider-

able distances to go,” Jacobsen told the session. Dean agreed with both Jacobsen and Bechtol. “Develop for the markets that exist,” he advised. “Instead of merely pushing the devices to higher power at higher frequencies.”

A persistent spec problem might then be alleviated by concentrating on improvement instead of innovation, he went on. “Noise figures listed as typical,” he pointed out, “unfortunately continue to represent only a small proportion of a given batch of transistors.”

Lower thermal resistance

A major area for improvement in power transistors is in reducing the thermal resistance of the active structure to its sink, Jacobsen pointed out. A practical technique, he said, is to make the silicon pellet thinner by about a fifth. Laboratory studies show that this reduces the thermal resistance by as much as one-half.

As the microwave transistor is made smaller to improve frequency and noise figures, the power-handling ability of an individual transistor is reduced. An obvious step is to parallel these small units for higher-power capabilities. Such microwave integrated circuits are in development. The development of integrated output and input impedance matching networks can contribute immensely to the production of broadband power stages, especially above 1 GHz, the panel agreed. However, there are many problems. Silicon microstrip lines must function as both active devices and transmission lines. Usually the active device has requirements that make for a poor transmission line, and vice versa.

For systems to use the centi-

meter-wave bands, whether radar for automobiles or carriers for communications, practical circuits—such as oscillators, amplifiers, frequency converters, modulators—are needed. Oscillators must be stabilized and made tunable and wide-band amplifiers with low-noise capabilities and new active components must be developed.

George D. Vendelin of Fairchild Camera and Instrument Corp., Palo Alto, Calif., described a three-stage, 3.1-to-3.5-GHz amplifier that delivers 24 dB with a noise figure of 3 dB (see figure). Microwave bipolar transistors are used. The design of the first stage was based on a compromise between power-gain match and noise figure, and the second stage uses a 1- μm emitter in the transistor, biased at 5 mA, with its input optimized for a power-gain match. The third-stage transistor is built with larger geometry than the first two. With a 15-mA bias, it has an output capability of 8 dBm.

An X-band Gunn oscillator, with its frequency stabilized to better than two parts in 10^4 over a -54 to 71 C temperature range, was described by Nicholas P. Morenc, head of the Receiver Dept., Radar Microwave Laboratory, Hughes Aircraft, Culver City, Calif. The unit features a temperature-compensated microwave discriminator to provide the error signal for a high-gain AFC loop.

Another Gunn oscillator, described by Gunkichi Satoh of Kokusai Denshin Henwa Co., Tokyo, uses a temperature-stabilized dielectric resonator to control the oscillator's frequency. The resonators are made of properly proportioned mixtures of TiO_2 , BaO, ZnO and other ingredients. They provide unloaded Qs in the range of 1700 to 5200.

The high Q and temperature stability of the resonator, when properly coupled to the Gunn diode with 50- Ω microstripline arrangements, control the oscillator's stability to 1×10^{-4} to $4 \times 10^{-4}/^\circ\text{C}$. ■■

A complete ISSCC 74 digest of the technical papers is available at \$15 (IEEE members) \$25 (nonmembers) from H. G. Sparks, Moore School of Electrical Engineering, University of Pennsylvania, Philadelphia, 19104.

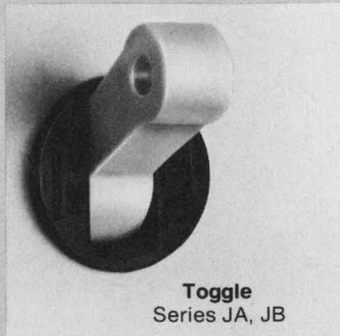

Toggle
Series JA, JB

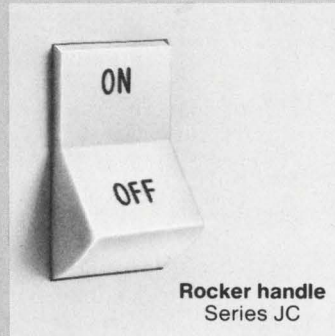

Rocker handle
Series JC



Environmentally sealed
Series JE



Pushbutton
Series JD

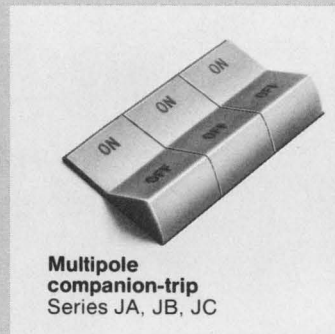

**Multipole
companion-trip**
Series JA, JB, JC



Snap-In installation
Series JB

UP FRONT.

That's where Heinemann Type J breakers look best on your equipment.

If a circuit breaker looks this good, why not put it on your equipment's front panel, where it can double as a power switch? It's an ingeniously simple way to cut component and assembly costs.

To meet the widest possible range of application requirements, Type J breakers are offered in any integral or fractional current rating from 0.020 to 30 amp at 240V 60Hz or 400Hz, or 65V DC. With a choice of four time delays and seven special-function internal circuits. With quick-on or screw terminals. And in one, two, three, or

four poles.

What about delivery? Well, we now have a Quick-Draw procurement program, under which the most frequently specified Series JA breakers are stocked for shipment within a few days of your order, sometimes overnight.

One final point. Though Heinemann Type J breakers are modestly priced, please don't confuse them with breakers of other types. All Heinemann breakers operate on a totally different, hydraulic-magnetic principle that

permits close-tolerance protection with complete freedom from nuisance tripping and other ambient temperature effects. To this day, they're the only circuit breakers good enough to be covered by a five-year warranty.

We'd like you to have our 16-page Bulletin J-3333, which will tell you almost everything you need to know about these breakers. Get it from your nearby Heinemann representative or Heinemann Electric Company, Trenton, NJ 08602. Phone (609) 882-4800.



We keep you out of trouble.

INFORMATION RETRIEVAL NUMBER 27

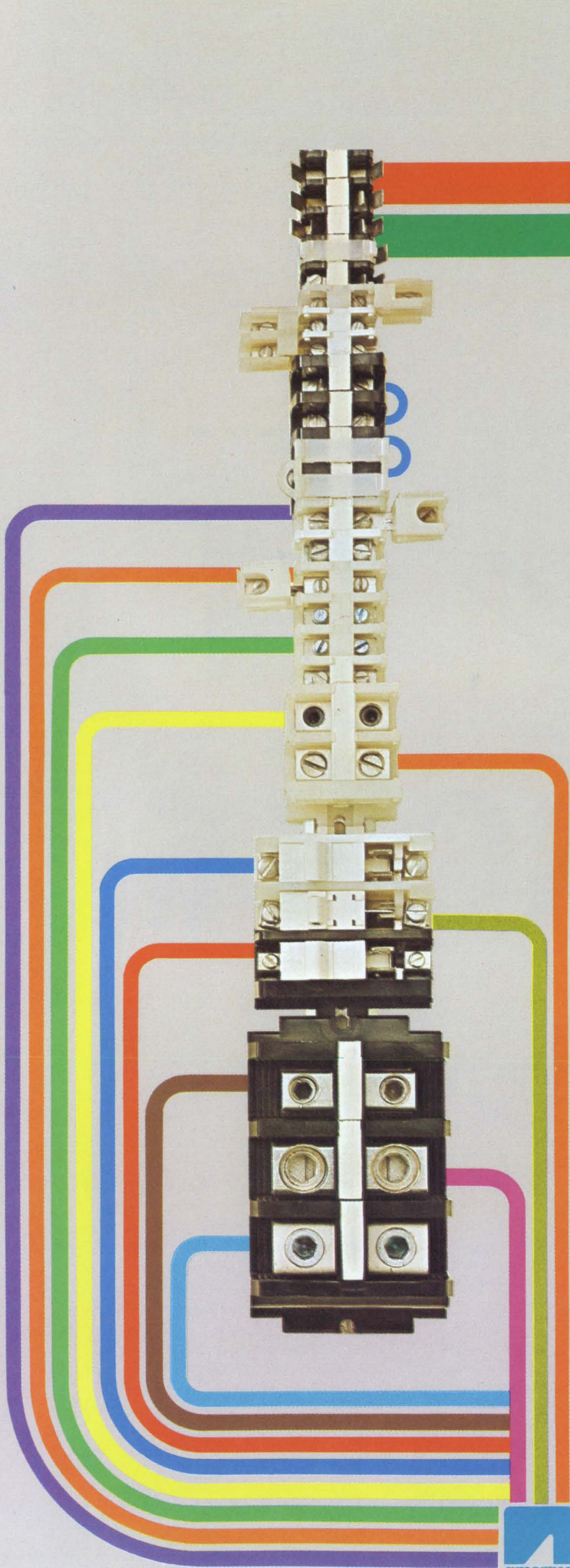

Put it all together with Buchanan[®] Terminal Blocks!

10 ways we can help you solve your design problems:

- 1. Eliminate lugging!**
Just insert wire and tighten the screw.
UL and CSA listed.
- 2. Save space!**
Terminate up to 48 circuits per foot; wires from #30 thru 600 mcm.
- 3. Work at high temperatures!**
Up to 302 F with Buchanan phenolic blocks; also resist moisture, solvents, shock, radiation.
- 4. Choose your mounting method!**
Flat base blocks for direct mounting; dovetail bases if you want a channel; combination bases for either way.
- 5. Assemble quickly!**
Snap off sections from pre-assembled lengths of 6 to 25 . . . or order the exact number you want!
- 6. For aluminum wire, too!**
Al-Cu contacts are UL listed for aluminum or copper wire, #18 thru #4/0.
- 7. Identify circuits quickly!**
Four marking methods: Directly on block; on painted area; removable vinyl strip; or pressure-sensitive tape.
- 8. Meet non-tracking requirements!**
Nylon or polypropylene blocks meet automotive non-tracking requirements—yet provide close spacing for tight layouts.
- 9. Get dead-front safety!**
See-thru covers snap over contacts—permit viewing with protection.
- 10. Bridge other components!**
Steel and pre-punched aluminum channels are available for dovetail or combination base blocks.

Want to cut design time? Our literature can really help you. Ask for a catalog and "What You Should Know About Terminal Blocks." Phone (201) 964-4400 or write us at Dept. ED-3.



**CONTROL PRODUCTS
DIVISION**

Amerace Corporation
Control Products Division
2330 Vauxhall Road
Union, New Jersey 07083

washington report



Heather M. David
Washington Bureau

NASA studies solar propulsion

NASA's Marshall Space-flight Center is studying methods of using solar energy to supply the main propulsion power for the upper stage of interplanetary and geosynchronous earth-orbital spacecraft. The space agency is focusing on the design of a propulsion stage that would use two solar-array wings, each 90 feet long and 13-1/2 feet wide, to generate 25 kW of power, which would operate ionized mercury thrusters to propel the spacecraft. It would also power spacecraft payloads during the period the propulsion stage is still attached. The solar propulsion stage is envisioned as working with the Space Shuttle and Space Tug, and NASA planners are considering a 1979 launch, with a slow flyby of the Comet Encke as its first mission. With continuous low-thrust capability and long life in orbit, solar propulsion should be more efficient and cheaper than chemical, NASA officials predict.

Air Force seeking surveillance sensors

Companies in the intrusion-sensor field are being asked to submit data or hardware to the Air Force Electronic Systems Div., Hanscom Field, Mass., to help the Air Force improve the security of its installations, equipment and personnel. The Air Force plans to award study contracts for concepts with long-term potential and to award development contracts for near-term systems already in the hardware stage. The Air Force wants sensors that would surround permanent installations as well as those for temporarily deployed equipment such as aircraft and missiles.

B-1 electrical system to be tested further

The Air Force will do further testing on the unusual double-voltage system that Rockwell International has designed for the B-1 bomber—a 230/400 V, three-phase ac system—to make sure it will perform as predicted at B-1 flight altitudes. The voltage system was singled out by a technical committee headed by Dr. Raymond Bisplinghoff, deputy director of The National Science Foundation, as one of the aircraft's systems that needs more testing. In response to recommendations by Bisplinghoff, the Air Force is asking Congress for money to build two more R&D models, for a total of five B-1s, so that all design bugs can be worked out and the systems thoroughly tested. The Bisplinghoff report gave a vote of confidence to the avionics subsystem for offensive missions, saying that schedule and costs were reasonably close to those projected. It did, however, recommend postponing the installation of the defensive avionics system on the fourth aircraft, to relax the schedule and to

assure that the defensive system reflects the latest intelligence on Soviet weapons and electronic countermeasures. The cost of each production aircraft, Air Force Chief of Staff George Brown told Congress, is now pegged at \$56-million.

New Telecom chief faces tough decision

Thomas C. Reed, new director of the Defense Dept.'s Telecommunications and Command and Control Systems, has been handed a hot potato. He must make recommendations to the Secretary of Defense on a plan for a global data switching network that would merge all the specialized defense data networks, the Autodin digital network and the Autovon voice sets. Suggested by Gen. Gordon Gould, director of the Defense Communications Agency, the plan would be based on technology developed by the Advanced Research Projects Agency. There is opposition in some military quarters, including the Joint Chiefs of Staff, who want to start immediately on a dedicated network to link the World Wide Military Command and Control System computer complexes. Reed, a former appointments secretary to Gov. Ronald Reagan of California, may have a disadvantage in arguing with the military, in that his job, the top telecommunications post in the Pentagon, has been downgraded from Assistant Secretary of Defense status to that of staff assistant to the Secretary of Defense.

New role for laser guidance

Lasers have been used with outstanding success in guiding air-to-ground missiles to their targets, usually slow-moving vehicles or fixed ground installations. The Naval Ordnance Laboratory thinks they could also track air vehicles and guide surface-to-air missiles to intercept the vehicles. The laboratory is trying to get industry to participate in a preliminary systems analysis of a laser-guided anti-aircraft missile defense system for ships. There is only one catch. The studies will be "unfunded," the Navy says.

Capital Capsules: NASA's Flight Research Center in Edwards, Calif., will award two or more contracts for the conceptual design of a fighter aircraft that is expected to use digital flight-control techniques for greater maneuverability and weight savings. . . . The Navy will develop for the Marine Corps an air-traffic-control system with a computerized, digital display to show the output of area and approach radar systems. It will be used to control landing aircraft within a radius of 60 miles in tactical situations. . . . The Defense Dept. has given grudging assent to the sale of U.S. technology to the Soviet Union for an air-traffic-control system proposed by IBM and Raytheon. The IBM system would involve turning over a software package developed for the Federal Aviation Administration. . . . The House of Representatives has passed a \$50-million bill that would provide for demonstrations of solar heating and cooling systems for homes and commercial buildings. NASA and the Dept. of Housing and Urban Development would carry out the projects until a formal energy R&D organization is set up. . . . Formation of such an Energy Research and Development Administration has been backed by the Institute of Electrical and Electronics Engineers and the National Society of Professional Engineers. They point out that "governmental proposals for increased funding . . . are encouraging, but cannot be implemented unless effectively and efficiently managed."

T0-5 Double-Balanced Mixers from DC...to...2 GHz



These new mixers offer the best performance
and highest quality available
in a 4-pin TO-5 package.

Individual units are hermetically sealed and specifications are guaranteed over a temperature range of -54°C to $+100^{\circ}\text{C}$ and after environmental stressing per MIL-STD-202D.

For additional data, call our Field Sales Office/Representative in your area or W-J/Relcom Applications Engineering at (415) 493-4141, ext. 637. Better yet, requisition your own evaluation unit from our stock.

Typical Performance at 25°C with +7 dBm LO

	Model M6V	Model M6R	Model M6G
Inputs (L):	.4 to 500 MHz	10 to 1200 MHz	.6 to 2 GHz
(R):	.4 to 500 MHz	10 to 1000 MHz	.6 to 2 GHz
Output (I):	DC to 500 MHz	DC to 1 GHz	DC to .3 GHz
Noise Figure:	5.5 dB	6 dB	6.5 dB
Isolation:	50 dB	40 dB	25 dB



WATKINS-JOHNSON

Watkins-Johnson—U.S.A.: 3333 Hillview Ave., Palo Alto, CA 94304 • (415) 493-4141 • TWX: 910-373-1253 • Telex: 34-8415 • Cable: WJPLA • 700 Quince Orchard Rd., Gaithersburg, MD 20760 • (301) 948-7550 • TWX: 710-828-0346 • Telex: 89-8402 • Cable: WJCEI • **United Kingdom:** Shirley Ave., Windsor, Berkshire SL4 5JU, England • Tel: Windsor 69241 • Cable: WJUKW-WINDSOR • Telex: 847578 • **West Germany:** 8033 Planegg, Muenchenerstr. 17 • Tel: (0811) 859-9441 • Cable: WJDBM-Muenchen • Telex: (841) 529401 • **Italy:** Piazza G. Marconi, 25 00144 Roma-EUR • Tel: 59 45 54 • Cable: WJROM-ROMA • Telex: (843) 60117

INFORMATION RETRIEVAL NUMBER 29

These ideas for cooling board-mounted semis could improve your circuit's performance

Thermal management is a highly versatile and valuable circuit design tool that can be used to increase semiconductor power, increase circuit density (or reduce the number of semiconductors), improve switching

and temperature-related rise and fall characteristics, increase small signal gain and DC beta, match operating characteristics of two or more devices, improve reliability and cut costs. Here are some ways circuit de-

signers have used IERC heat sinks/dissipators to beat printed circuit board-mounted semiconductor heat problems in order to improve their circuits, ideas that may be of help to you.

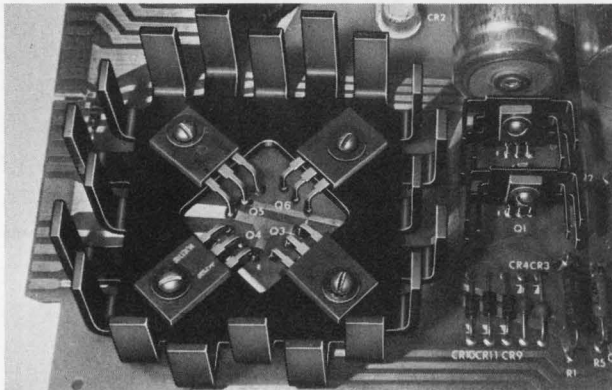

Four times the power from four power plastics took just one IERC dissipator. Bare transistors were capable of only 2 watts with 102°C substrate rise above ambient so designer used modified HP3 dissipator and got 8 watts from each at the same temperature rise. Or you could improve transistor life — roughly 7 times — by operating the devices at 2 watts and letting the same dissipator keep the substrate temperature rise to 32°.

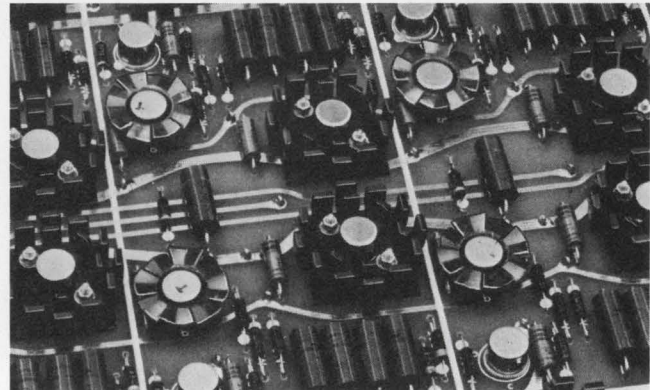

Temperature matching at varying power levels is easy with the wide variety of IERC dissipators. On this board problem was to keep TO-5s at approximately equal case temperatures although some were operated at 2.2 watts and others at 1 watt. Press-on Fan Tops costing pennies kept 1 watters at 55°C case rise above ambient while LP dissipators held 2.2-watt devices at nearly identical case temperatures. IERC Insulube® coating permits mounting LPs directly on printed circuit lines.

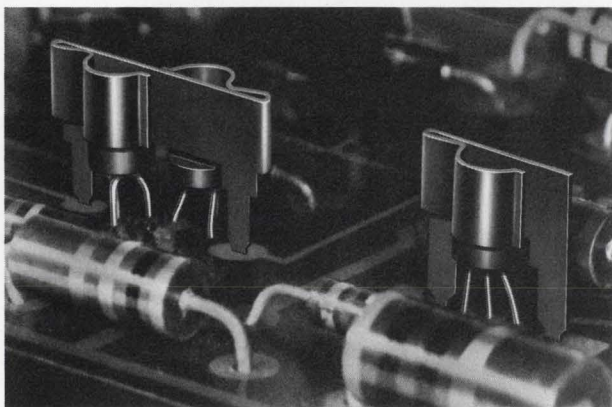

Dissipators protect circuit — Designer of this TV circuit made sure dissipators would stay when D-case devices needed replacing. He designed dissipators as a part of the circuit, making it impossible to fire the circuit without them. In addition to this circuit protection the dual "Universals" gave him some other benefits: excellent retention in shock/vibration environments, good heat sinking during solder operations, and they cost just pennies.

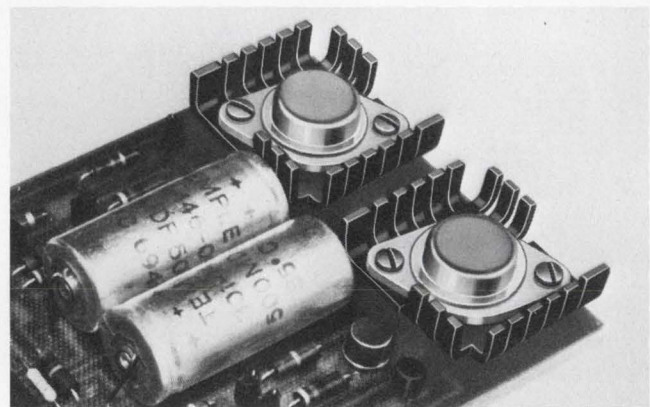

Lower cost per unit was result of replacing four TO-3s used in this 10-watt power supply with two TO-3s in UP3 dissipators. Dissipators allow two TO-3s to operate at 5 watts each with same 65°C case rise above ambient as four devices operated at 2.5 watts each. Low profile dissipators plus TO-3s were assembled in less space allotted to four transistors. New design saved money, improved reliability and eliminated troublesome charring of G-10 board.



For more information

on heat sinks and dissipators for milliwatts to kilowatts, send for the IERC Short Form Catalog today. It covers the most complete line of thermal problem solving devices available anywhere.



Heat Sinks/Dissipators

INTERNATIONAL ELECTRONIC RESEARCH CORPORATION / A SUBSIDIARY OF DYNAMICS CORPORATION OF AMERICA / 135 WEST MAGNOLIA AVENUE, BURBANK, CALIFORNIA 91502

INFORMATION RETRIEVAL NUMBER 170

INFORMATON RETRIEVAL NUMBER 30 ►

PROVISIONS
FOR LEGEND
STAMPING

NON-SLIP
ROCKER WITH
RIBBED ENDS

CAN TAKE THE
PLACE OF MORE
EXPENSIVE RELAYS AND
ROTARY SWITCHES

EXCLUSIVELY DESIGNED
SWITCHING ELEMENT

INHERENT
SNAP-ACTION

NO
MOUNTING
HARDWARE
REQUIRED

COMES IN
3 SERIES -
8 DIFFERENT
COLORS

More switching
COMBINATIONS
than any other
ROCKER SWITCH ON
THE MARKET
TODAY

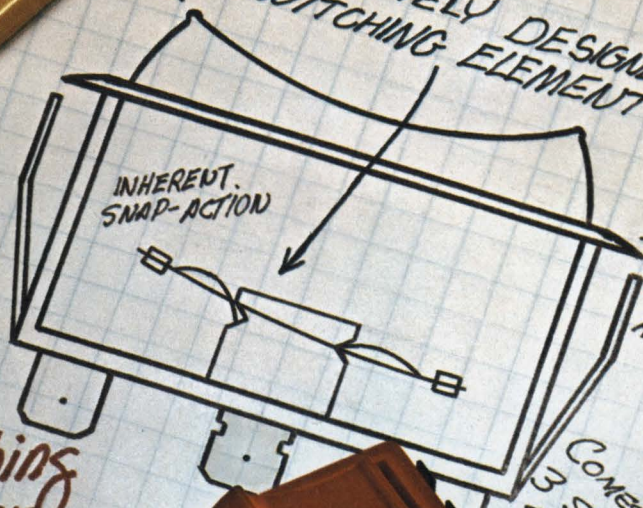

NEW SNAP-ACTION ROCKER SWITCHES

At Littelfuse, we've made a switch for the better. But you'll probably consider it a switch for the best.

Especially after you've examined the many features our new snap-action rocker switches have to offer.

To find out more about our three new series of snap-action rocker switches, write for Product Bulletin #1002 . . . or contact your nearest Littelfuse representative.

LITTELFUSE

SUBSIDIARY OF TRACOR

800 E. Northwest Highway
(312) 824-1188
Des Plaines, Illinois 60016



Datacraft® SLASH 4 Virtual Memory Computer System.

Delivers power, economy, flexibility and versatility. All you'll ever want. Or need. For concurrent multi-batch processing. Critical real-time. Remote job entry. Time sharing.

Whatever your application, the SLASH 4 VM's 750 nanosecond cycle time, automatic program relocation, re-entrant processors, and effective memory utilization deliver higher throughput for you. Big single programs...up to 256K...are handled with ease in a multi-task oriented architecture that virtually eliminates costly software penalties.

That's Efficiency.

That's Money Saved.

You'll be amazed at what you get. And how much you can do. Contact us for all the facts. Datacraft®, 1200 Gateway Drive, Fort Lauderdale, Florida 33309, Telephone (305) 974-1700. For international inquiries write: Techmation N.V. Gebouw 105/106, Schiphol-Oost, Holland.

Datacraft®

SUBSIDIARY OF HARRIS-INTERTYPE CORPORATION.

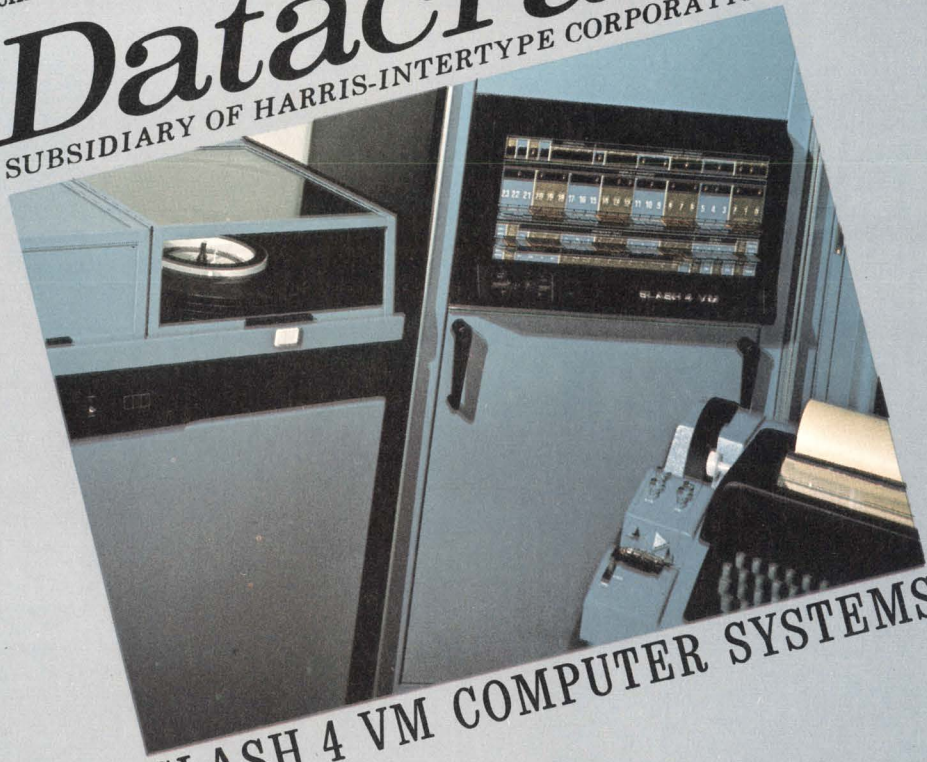

SLASH 4 VM COMPUTER SYSTEMS

This new Guardian Relay Catalog...

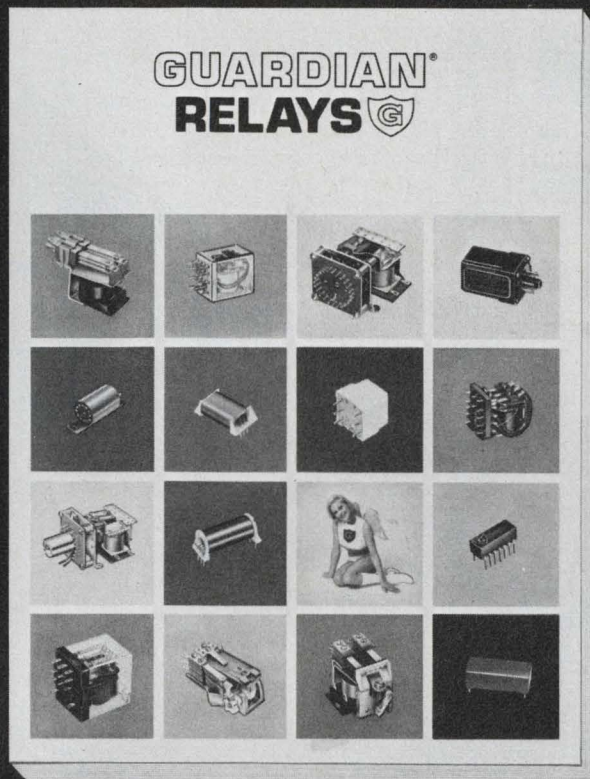

...is no small thing.

It's

THE BIG BOOK

of relay facts, specs and ordering info.

(And it's yours free for the asking.)

CIRCLE 240 ON THE READER SERVICE CARD
for your very own personal copy. Free from your Guardian Angel.



GUARDIAN[®]

GUARDIAN ELECTRIC MANUFACTURING CO. 1572 West Carroll Ave., Chicago, Illinois 60607



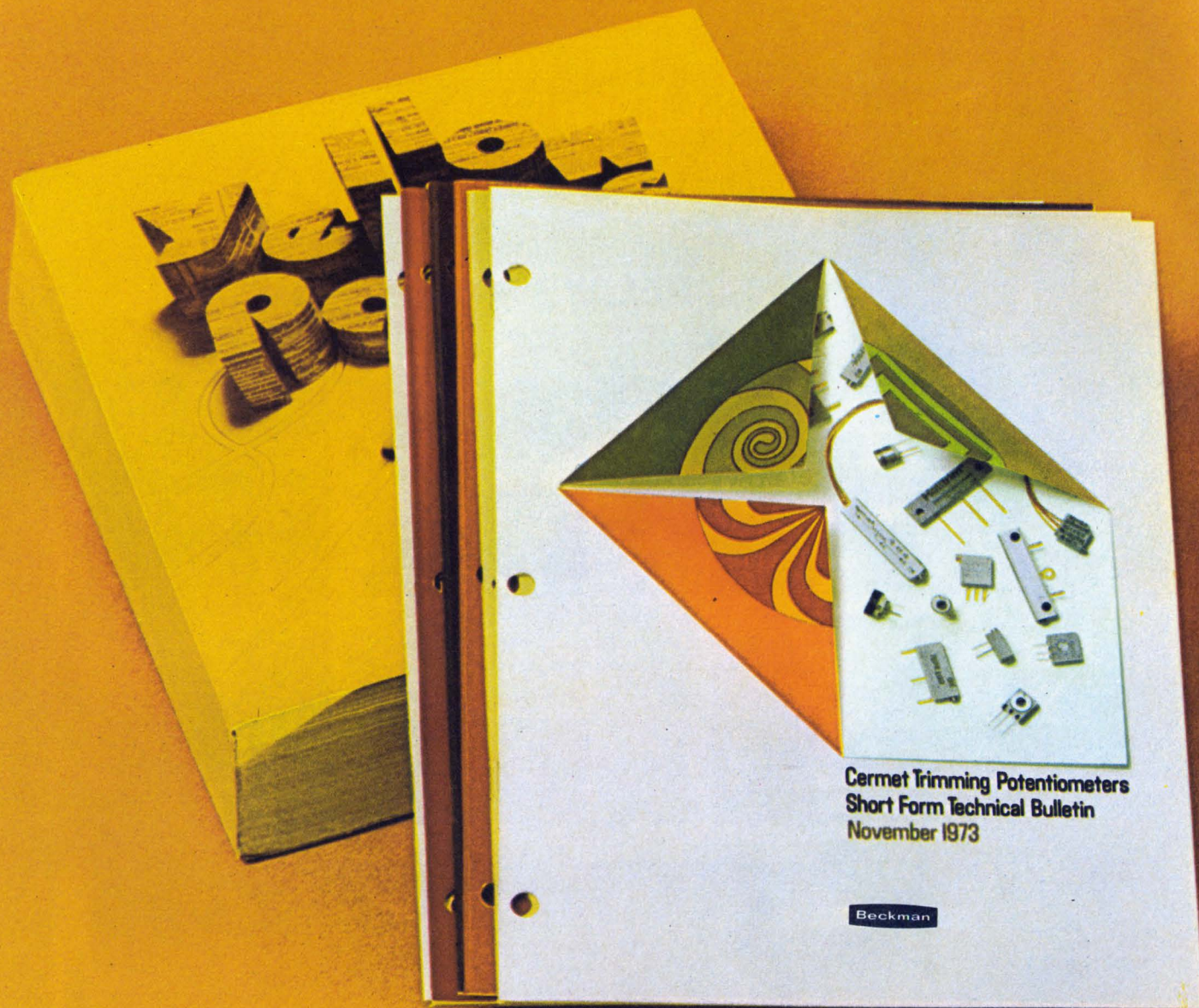

For the great mass of products and services, the yellow directory is your quick guide to local sources. Likewise, for precision potentiometers and trimmers – especially high-performance cermet types – the Beckman catalogs are your books. Broad standard lines, stocked for you by a nationwide network of dependable local distributors.

In precision pots, you'll find wirewound, cermet, single-turn and multiturn types ranging from 3 up to 40 turns. And, in size, the line goes from 40-turn master pot variety to units as small as 7/8" diameter.

Our cermet trimmers come in low-cost single-turn, multiturn, or DIP types. They typify our long experience and proven

control in materials technology. We develop, improve, and manufacture the materials in these highly stable trimmers. And they assure you wide resistance range, good high temperature/power characteristics, and complete moisture resistance. These are the trimmers for now and the future – their design advantages over wirewound types are many.

Look into our dials, too. The RB vernier-readout, for instance, with 100 graduations per turn. And the 2620, the perfect answer where position setting is a must but the budget permits less than highest precision.

For the complete reading on these Beckman components, ask your nearest distributor for applicable catalogs. They may become your favorite source books.

Find it fast in these standard reference books.

Beckman Electronic Component Distributors

EASTERN REGION

Arrow/Angus
P. O. Box 126
Moorestown, N. J.
(609) 235-1900
(215) 928-1800

Arrow Electronics, Inc.
5207 East Dr.
Baltimore, Md.
(202) 737-1700
(301) 247-5200

Arrow Electronics, Inc.
900 Route 110
Farmingdale, N. Y.
(516) 694-6800

Arrow Electronics, Inc.
295 Treadwell St.
Hamden, Conn.
(203) 248-3801

Arrow Electronics, Inc.
No. 15 A Street
Burlington, Mass.
(617) 273-0100

Arrow Electronics, Inc.
285 Midland Ave.
Saddle Brook, N. J.
(201) 797-5800

Harvey R & D Electronics
44 Hartwell Ave.
Lexington, Mass.
(617) 861-9200

Kierulff Electronics, Inc.
5 Industrial Dr.
Rutherford, N. J.
(201) 935-2120

Lynch-Gentry Associates, Inc.
1932 Drew Street
Clearwater, Fla.
(813) 443-2697

Lynch-Gentry Associates, Inc.
3470 Bowman Dr.
Winter Park, Fla.
(305) 671-7649

**Marshall Industries
G. S. Marshall Products Group**
88 Needham St.
Newton Highlands, Mass.
(617) 965-5115

M & C Sales
500 Plasamour Drive, N. E.
Atlanta, Ga.
(404) 875-2525

M & C Sales
1106 Burke St.
Winston-Salem, N. C.
(919) 723-1001

M & C Sales
904 Bob Wallace Ave.
Huntsville, Ala.
(205) 539-8476

Ossmann Component Sales Corp.
395 Cleveland Dr.
Buffalo, N. Y.
(716) 832-4271

Ossmann Component Sales Corp.
411 Washington Ave.
Kingston, N. Y.
(914) 338-5505

Ossmann Component Sales Corp.
280 Metro Park
Rochester, N. Y.
(716) 442-3290

Ossmann Component Sales Corp.
132 Pickard Building
Syracuse, N. Y.
(315) 454-4477

Ossmann Component Sales Corp.
1911 Vestal Parkway East
Vestal, N. Y.
(607) 785-9949

CENTRAL REGION

Magnuson Electronics
2420 Oakton St.
P. O. Box 130
Mount Prospect, Ill.
(312) 956-0700

Magnuson Electronics
1246 West 7th St.
St. Paul, Minn.
(612) 227-8495

Norvell Electronics
10210 Monroe Dr.
Dallas, Tex.
(214) 350-6771

Norvell Electronics
6440 Hillcroft Ave.
Houston, Tex.
(713) 774-2568

Norvell Electronics
3340 S. Memorial Dr.
Tulsa, Okla.
(918) 663-1247

Sheridan Sales Co.
Box 37826
Cincinnati, Ohio
(513) 761-5432

Sheridan Sales Co.
Box 4457
Cleveland, Ohio
(216) 524-8120

Sheridan Sales Co.
Box 423
Dayton, Ohio
(513) 277-8911

Sheridan Sales Co.
33708 Grand River Ave.
Farmington, Mich.
(313) 477-3800

Sheridan Sales Co.
P. O. Box 677
Florissant, Mo.
(314) 837-5200

Sheridan Sales Co.
Suite 5009
1717 Penn Ave.
Wilkinsburg, Penn.
(412) 244-1640

WESTERN REGION

Almac/Strom Electronics
8888 S.W. Canyon Rd.
Portland, Ore.
(503) 292-3534

Almac/Strom Electronics
5811 Sixth Ave. South
Seattle, Wash.
(206) 763-2300

Barnhill Five, Inc.
1410-D Wyoming N. E.
Albuquerque, N. M.
(505) 299-7658

Barnhill Five, Inc.
1170 S. Sheridan Blvd.
Denver, Colo.
(303) 934-5505

Barnhill Five, Inc.
7329 E. Stetson Dr.
Scottsdale, Ariz.
(602) 947-7841

**Marshall Industries
G. S. Marshall Products Group**
9674 Telstar Ave.
El Monte, Ca.
(213) 686-0141

**Marshall Industries
G. S. Marshall Products Group**
8057 Raytheon Rd.
San Diego, Ca.
(714) 278-6350

**Marshall Industries
G. S. Marshall Products Group**
788 Palomar Ave.
Sunnyvale, Ca.
(408) 732-1100

Wyle Distribution Group:

Elmar Electronics
6777 East 50th Avenue
Commerce City, Colo.
(303) 287-9611

Elmar Electronics
2288 Charleston Road
Mt. View, Ca.
(415) 961-3611

Liberty Electronics
124 Maryland Street
El Segundo, Ca.
(213) 322-8100

Liberty Electronics
3130 North 27th Avenue
Phoenix, Ariz.
(602) 257-1272

Liberty Electronics
8248 Mercury Court
San Diego, Ca.
(714) 565-9171

Liberty Electronics
5305 Second Avenue South
Seattle, Wash.
(206) 763-8200

Beckman

HELIPOT DIVISION

INFORMATION RETRIEVAL NUMBER 33

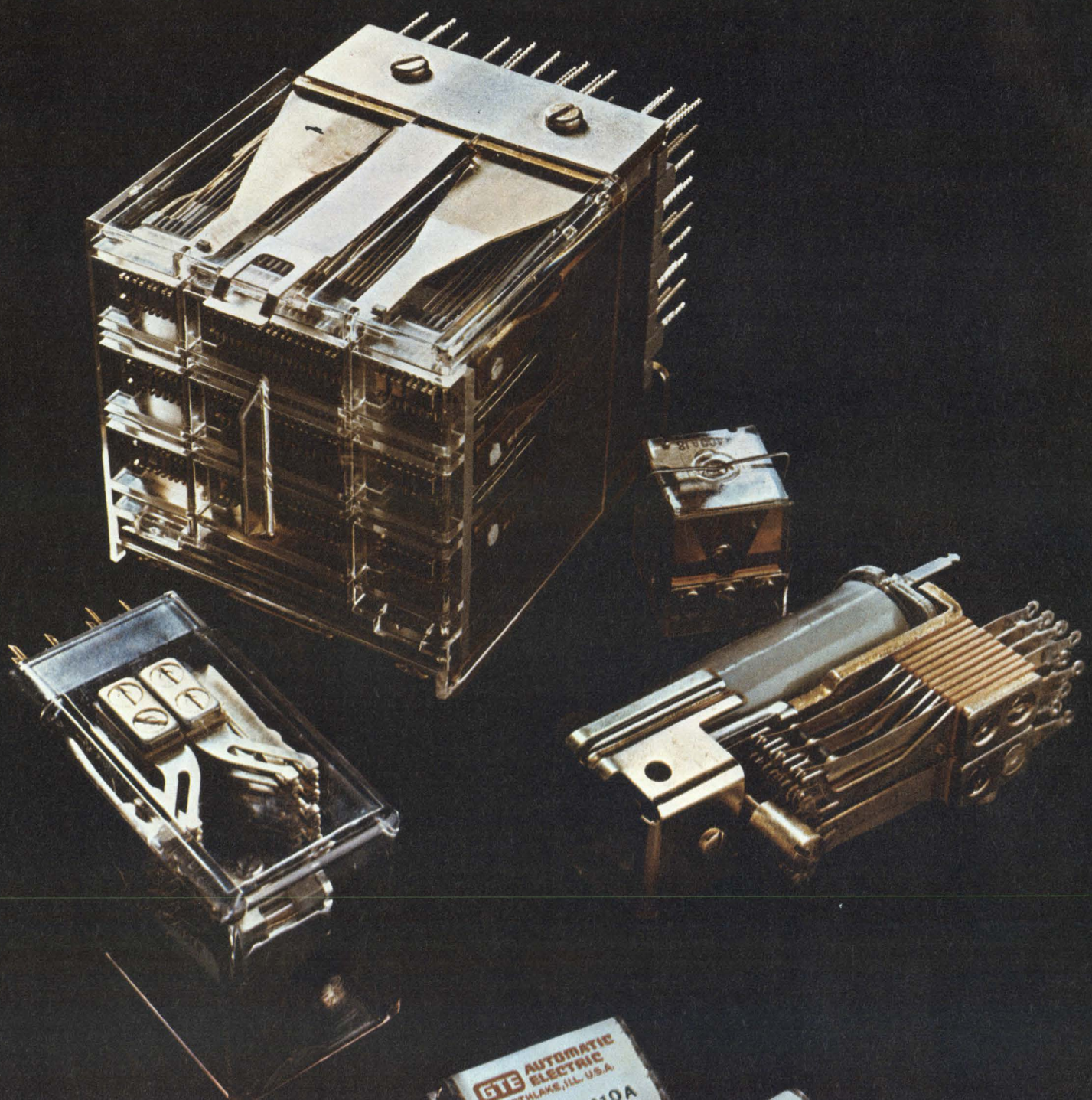

GTE AUTOMATIC
ELECTRIC
NORTHLAKE, ILL. U.S.A.
PD1311 A10A
1930 OHMS

GTE AUTOMATIC
ELECTRIC
NORTHLAKE, ILL. U.S.A.
PD1308 A11A
2600 OHMS

Announcing the rediscovery of the relay.

In an age when most people think solid state is the only way to go, some designers have rediscovered the good old electro-mechanical relay. They found relays still can't be beat when it comes to certain jobs. And when they're dealing with tight fisted cost control committees. Maybe you can save some effort and expense by rediscovering the relay whenever you need these things:

1. Simple logic:

Relays let you combine both power switching and logic functions economically. Memory can usually be retained, even after a power loss. And you don't need special power supplies or noise suppression techniques.

2. Easy troubleshooting:

Most relay failures (and they do occur occasionally) can be identified visually. You can see what's wrong. And fix it easily.

3. Heat resistance:

A relay shrugs off a short dose of overheating. Give a solid state device the same treatment while it's functioning near capacity and it's ruined forever. The amount of heat a solid state device can take is usually dependent on the heat sink used. It can take up all the room you expected to save with solid state in the first place. And finding the right heat sink design can become very involved.

4. Electrical isolation:

Relays have a natural isolation between input

circuits, between output circuits, and between output and input control circuits. You can't get that with junction type semiconductors.

5. High insulation resistance:

Open relay contacts have an insignificant amount of leakage (10^{10} ohms or more). Semiconductors can't match this. And, their leakage rates vary greatly with temperature changes.

6. Wide operating power range:

Relays work with operating power anywhere from milliwatts to watts. And they usually don't require regulated power. Semiconductors do.

7. Transient voltage immunity:

Transient voltage doesn't bother a relay. But high voltage, short duration transients can be sure death to semiconductors.

8. Forgiveness:

Relays give you a little margin of safety should you want to change your mind. Maybe you find you need more contacts, or uncover a timing problem, or discover a need for absolute input-output isolation. You can change your circuit design a lot easier with relays.

If your project or product needs any of these things, just ask our salesman to help you rediscover relays. GTE Automatic Electric, Industrial Sales Division, Northlake, Illinois 60164.

GTE AUTOMATIC ELECTRIC

INFORMATION RETRIEVAL NUMBER 34

GENERAL ELECTRIC ROTRON
PAMOTOR BODINE
ROBBINS & MEYERS AMPHENOL
IMC INDIANA GENERAL

Need another prime^{*} source?...

** If we've missed any, we apologize*

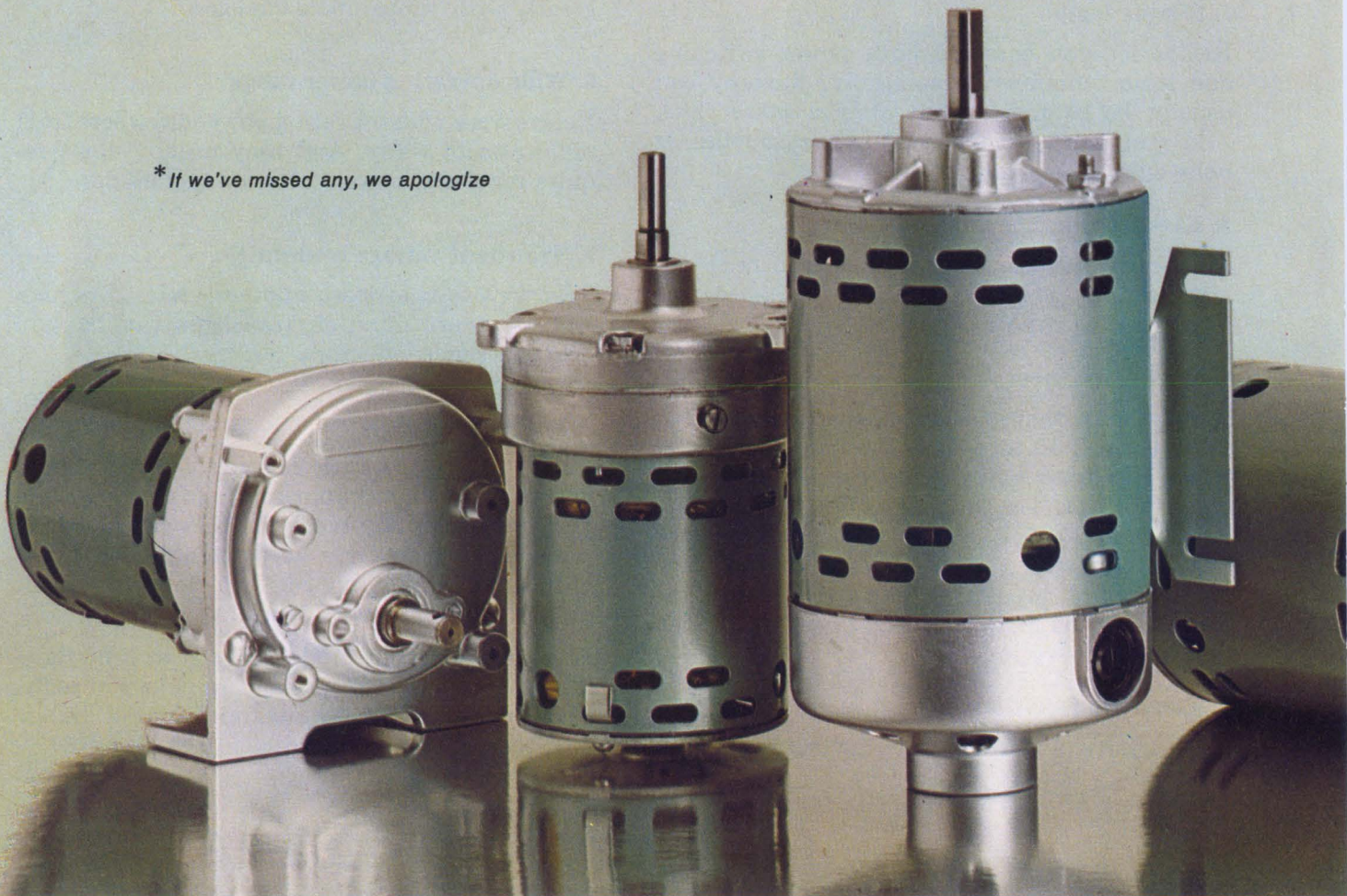

For fast help on INDUCTION MOTORS
call Bill Samaras (815) 889-4105

For assistance on UNIVERSAL/DC MOTORS
call Art Grau (815) 889-4107

Circle Card No. 196 for data on FHP MOTORS/GEARMOTORS

**If you need UNIVERSAL/DC...
INDUCTION... SHADED POLE
FHP motors, gearmotors, fans
or blowers—Call Howard now.**

When price, quality and delivery are *prime* considerations—look into what Howard can offer you. Today, because of greatly expanded facilities, you (just as many other major firms) can depend on Howard as a *prime* source for more of your FHP motor, fan and blower needs. Geared to work closely with O.E.M. customers, Howard can meet your particular design requirements.

Prototypes and production models can be developed to your specifications.

And delivery is much earlier than you'd expect! With the broadest line of FHP motors, gearmotors, fans and blowers in the industry—Howard is large enough to insure dependable service, small enough to respond to your individual needs. Our customer service representatives and phone numbers are listed below.

*For another reliable prime source
call Howard now!*

Call

HOWARD

HOWARD INDUSTRIES / Division of MSL Industries, Inc.
One North Dixie Highway, Milford, Illinois 60953

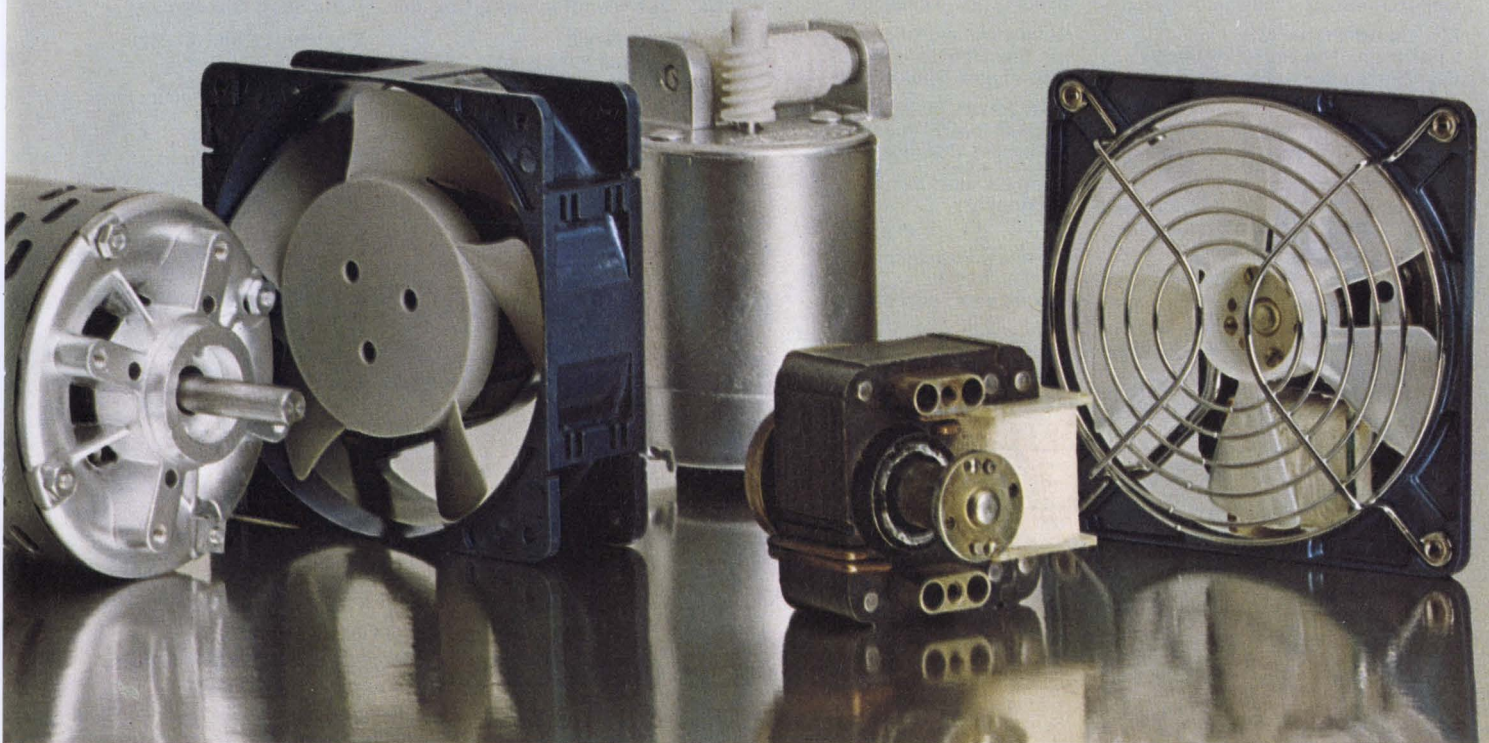

If you need SHADED POLE MOTORS—FANS, BLOWERS
call Larry Taylor (815) 889-4106

Circle Card No. 197 for data on FANS/BLOWERS

Electronic Design, The Financial Times (London)
 Electronics Weekly (London) and BOAC
 announce the sponsoring of

"TOMORROW IN WORLD ELECTRONICS"

a major international conference to coincide
 with the International Instruments, Elec-
 tronics and Automation Exhibition (IEA).

GROSVENOR HOUSE, LONDON – MAY 14-15, 1974

This conference, to be addressed by a panel of the electronics commu-
 nity's most distinguished members, will consider current and future
 technological developments in the world, and assess the challenges they
 pose for management, marketing and financial functions in the interna-
 tional electronics industry.

Day One - May 14

Chairman: Dr. C. Lester Hogan
 President, Fairchild Camera and
 Instrument Corporation

Mr. Earl Wantland
 President, Tektronix, Inc.

Mr. Edward Fennessy, CBE
 Managing Director
 Post Office Telecommunications

Mr. Sebastian de Ferranti
 Chairman and Managing Director
 Ferranti Ltd.

Speaker to be announced

Dr. Ieuan Maddock, CB, OBE
 Chief Scientist
 Department of Trade and Industry

Mr. David Price, MP
 Chairman, The Parliamentary
 Committee for Technology

Speaker to be announced from
 Commission of the
 European Communities

Mr. Gordon Haley
 Manager, Systems Technology
 ICL Computer Development Div.

Speaker to be announced

**Prospects for
 Semiconductors**

**Prospects for
 Electronic Instruments**

**Prospects for
 Telecommunications**

**Electronics
 in the 1980's**

**The International
 Military Market for
 the Electronics Industry**

**The Commercial
 Exploitation of
 Electronics Research**

**Government Policies
 for Electronics
 (Luncheon Speaker)**

**The Growth Potential
 of Electronics in the
 European Community**

**Future Computer
 Technology**

**International Military
 Market for the
 Electronics Industry**

Day Two - May 15

Chairman: M. R. J. Clayton, CBE
 Technical Director
 The General Electric Company Ltd.

Dr. J. Fred Bucy, Jr.
 Executive Vice President
 Texas Instruments Inc.

Mr. J. C. Akerman
 Managing Director
 Mullard Limited

Dr. Robert Heikes
 Managing Director
 Motorola Europe, Switzerland

Speaker to be announced

Mr. John Fluke, Sr.
 Chairman
 John Fluke Manufacturing Co., Inc.

Dr. Edward David
 Executive Vice President
 Gould, Inc.
 Former Science Adviser to the
 President of the United States

Dr. William Hittinger
 Executive Vice President
 RCA Corporation

Monsieur Edouard Guigonis
 Directeur Delegee and Directeur
 Commercial General, Thomson CSF

**Vertical Integration:
 Components to Systems**

**Performance and
 Prospects in the World's
 Electronics Industries**

**The Role of an
 American Multi
 National in Europe**

**Japanese Electronics
 in World Markets**

**New Challenges to the
 Instrument Industry
 (Luncheon Speaker)**

Electronics and Energy

**The Future of World
 Consumer Electronics**

**International
 Cooperation
 in Electronics**

To register for the conference use the coupon below. We will be pleased to assist
 you in securing trans-atlantic flight reservations and London hotel accommodations.
 Registration fee for "Tomorrow in World Electronics" is \$200.

REGISTRATION FORM

"TOMORROW IN WORLD ELECTRONICS"

A major international conference sponsored by Electronic Design, The Financial Times, Electronics Weekly and BOAC.
 Please register the following individual:

Name _____ Title _____

Additional registrations:

Name _____ Title _____

Name _____ Title _____

Company _____ Division _____

Address _____ Telephone _____

City _____ State _____ Zip _____

Registration fee: \$200 per person.

Payment enclosed. Please bill me. I would like assistance in flight hotel reservations.

Mail this registration form to:

Ms. Gay Donnelland
 Electronic Design/Financial
 Times Conference
 Financial Times
 Publications, Ltd.
 Suite 1006
 516 Fifth Avenue
 New York, N.Y. 10036

again



semiconductor data handbook

second edition

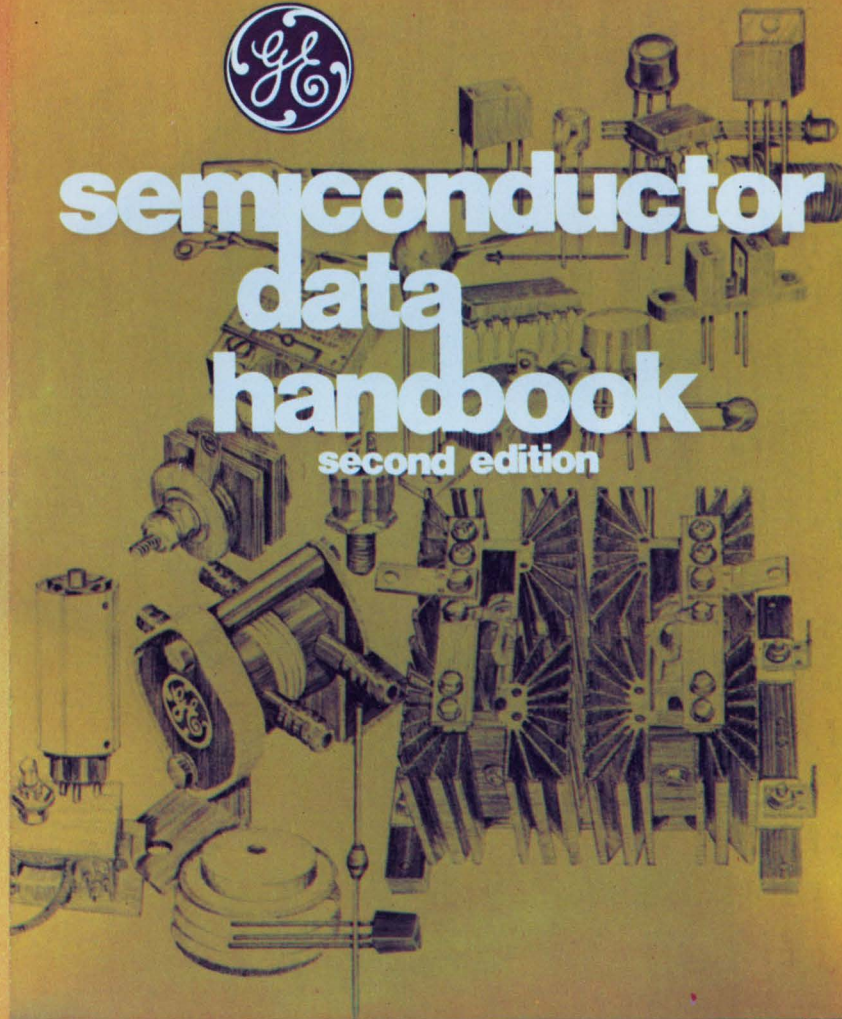

New 1484 page 2nd edition Semiconductor Data Handbook from General Electric...leading supplier of transistors unijunctions, diodes, rectifiers, varistors, SCRs and triacs.

To get your copy, contact any authorized GE distributor, GE Electronic Components Sales Office, or send \$4.95 plus tax to GE Semiconductor, Electronics Park, 7-49, Syracuse, N.Y. 13201.

IEEE INTERCON 74

A bigger Big Show...



and a practical one

It's that time of year again, IEEE show time—that potpourri of product hoopla and hullabaloo with a side attraction of hard technical facts—and after a disappointing show in 1973, IEEE officials are optimistic. Intercon 74 is bigger and better, they say—an annual refrain, but with some firm figures to back it up this time.

Last year's show—one of the smallest in years—drew only about 23,000 visitors to 365 booths of 207 companies. This year the number of companies booked has climbed to about 250, booth space has risen to 400, and attendance is expected to reach 30,000.

And the Russians are coming. For the first time, the Soviet Union is taking space in the IEEE show: six booths, or 600 square feet—on the main floor, yet—and with products for export.

The exhibition will be held March 26-29 in the New York Coliseum. The major technical and business sessions will run from March 26 to 28—a new, shrunken three-day format—in the Statler Hilton. The reason for the one-day cut, according to Jack Raper, program chairman, is that Friday is an almost mandatory “get-away day” for out-of-town visitors. The more compact schedule is expected to increase participation.

The technical program will consist of 41 half-day sessions, with a total of about 160 papers. This compares with 58 sessions and 250 papers at Intercon 73. One IEEE spokesman says the smaller program will offer more practical papers for the practicing engineer: “There'll be less of the blue-

sky and a lot more of the useful stuff.”

The sessions are concentrated in five major areas: Solid-State Electronics, Computers and Information, Instruments and Instrumentation, Communications, and Marketing and Finance. In addition there will be special meetings and programs organized by IEEE professional groups. These are scheduled at the Statler Hilton on Monday of convention week and are open to all Intercon registrants.

The technical papers cover some of the latest technological developments and explore trends. Session 2, for example, looks at the current status and future of charge-transfer-device image sensors, while Session 18 reports on advances in packages for ICs and packaging methods for assemblies that incorporate those chips.

In the computer area, the action is in microprocessors. Session 17 explores devices now available commercially, as well as three radically different newer architectures. One paper in this session describes a bit-serial microprocessor that establishes a “first” by placing both the memory and the processor on a single chip with the serial approach.

An important area in instrumentation is covered in Session 13, which deals with automatic test equipment. Papers here discuss the growing trend of ATE in applications outside the electronics industry—in the automotive industry, for example.

In communications, papers run the gamut from CATV to optical fibers to satellites and even parapsychology.

Design trends in major engineering areas

Computers	52
Consumer	54
Communications	56
Microelectronics	57
Instrumentation	61

Outstanding new products on display at the New York Coliseum exhibit areas

Data Processing	65
Instrumentation	68
Packaging & Materials	78
Microwaves & Lasers	81

Microprocessors enter boom era —from 4-bit machines and up

Microprocessors are following the same explosive growth pattern of minicomputers. Almost weekly, a new one is announced. But what is really available and what are the guidelines for choosing them? And what is the newest microprocessor architectures?

To answer these questions R. O. Winder, manager of LSI systems design at the RCA Solid State Technology Center, Somerville, N.J., organized Session 17, "Microprocessor Architecture."

"Key points to look for in choosing a microprocessor or microcomputer include demonstrated experience and availability of parts," says J. L. Ogdin, president of Software Technique, Reston, Va., and author of a Session 17 paper on "Micro Computer: Promises and Experiences."

Other things to consider he says, are: How easy is it to interface with the outside world? How easy is it to write programs? How much support is offered, in both hardware and software, to make it easy to build complete systems?

The world of microprocessors can be divided into 4-bit machines and larger, Ogdin points out. The 4-bit machines tend to be harder to program but less expensive. And they tend to be designed by MOS engineers rather than computer architects, Ogdin notes.

The larger-than-4-bit machines tend to be more expensive, Ogdin points out, because the real-estate utilization on the chip is not so efficient. But the larger machines are more efficient for systems.

As to the support provided by microprocessor manufacturers, Ogdin says, some supply a CPU chip and leave the rest up to you. Others supply essentially whole systems in a few chips. And there is a spectrum of devices in between, Ogdin advises.

He points out that three of the newer microprocessors with unique architecture include bit-serial, 4-bit and 8-bit machines, each with different approaches to microprocessing.

A bit-serial microprocessor—the Mini-D—establishes a first in placing both the memory and the processor on one chip, and by using a serial

approach, it reverses the trend to parallel processing. The Mini-D is described by Ulbe Faber and John P. McAllister of Burroughs, Downingtown, Pa., in a paper entitled "A Bit-Serial Microprocessor."

"To place both the memory and processor on one chip required that we go to serial processing," McAllister notes.

"Years ago we used to be digit-serial in nature, but serial processing went by the wayside towards parallel processing, either by digit byte or with varying word sizes up to 64 bits.

"Now we're returning to bit-serial format, which we say has advantages other than digit serial. For example, while everybody else uses either 4 or 8-bit parallel processing, we went to bit serial for economy in interfacing and for flexibility in interfacing.

"The concept is that serial processing gives you economy in the interface, because you're not multiplexing four lines every time you want to come into the processor. For example, suppose you've got to route 10 4-bit words into four lines. With bit-serial organization, we only have to do one-fourth the multiplexing that we'd have to do with the 4-bit parallel structure."

Another prime advantage McAllister points to is that the bit-serial processor works more conveniently than a parallel processor with variable length registers, which may be required in the microprocessor interface.

If the input to the microprocessor is of variable length—like 4 bits, 8 bits or perhaps 64 bits long—it's difficult to handle 4 bits at a time in parallel, McAllister says, because of the extensive amount of multiplexing required. If the register that's holding the information is a shift register, the data can be simply shifted into the processor in bit-serial form. As a result, he concludes, there is basically no multiplexing for length, which can provide substantial economy in interfacing.

The bit-serial processor and a 256-word ROM (12 bits per word) microprogram memory are included in one 16-pin DIP package. If you want to handle more complex tasks than the memory

can take—meaning more than 256 instructions—multiples of these low-cost processors can be netted together to do complex tasks.

“I believe that this net-working of microprocessors is the way that these systems will be developed for a wide variety of future applications,” McAllister concludes.

Parallel structure boosts speed

Whereas a prime limitation of the Burroughs Mini-D is its necessarily slow speed, Juan A. Monico, manager of systems development for Microsystems International, Ottawa, Canada, tells in Session 17 of a developmental microprocessor that is fully parallel and has a 2- μ s cycle time—the fastest of any microprocessor on the market.

In his paper, “Microprocessors—A Case History of an Integrated Approach,” Monico points out that one significant thing about the Microsystems microprocessor—the MP-1—is that it doesn’t require special peripheral circuits. It is a 4-bit machine with a 19-bit parallel bus: 4 bits of data, 12 bits of address and 3 for control lines.

Comparing the Microsystem’s 2- μ s cycle speed with about 12.5 μ s for the Intel microprocessor, Monico says that the MP-1’s greater speed was achieved principally by the parallel organization. The structure eliminates the multiplexing time required for machines like the Intel, which has a fully multiplexed bus. But Monico also makes a point of noting that some of the speed is also attributable to good circuit design.

The MP-1 microprocessor can be plugged directly into standard TTL parts, because it doesn’t require special peripheral circuits, as some of the other microprocessors do. The basic philosophy of design was to “keep it simple,” Monico explains, instead of trying to make it look like a sophisticated minicomputer. As a result, he points

out, it requires an absolute minimum of parts to put together a small system.

“We have systems in-house which require only seven chips total,” Monico notes, “including the CPU chip, memory chips and peripheral chips.”

Other, comparable microprocessors, he says, require about 30 parts before they can be used.

An 8-bit parallel CMOS microprocessor that has simple instructions, provides efficient use of the memory, has a simple input-output structure and can operate from 5 to 12 V with a dissipation of 100 μ W is being developed by RCA. Called COSMAC, the microprocessor is described in Session 17 by Norman P. Swales and J. A. Weisbecker, members of the technical staff, RCA, Palm Beach Gardens, Fla.

COSMAC is a COSMOS LSI system on two chips. It’s a matrix-oriented accumulator basic-processing unit, with what RCA says is a superior input-output scheme.

As Swales describes COSMAC, it has a 16-by-16 scratch pad, and each register in the pad may be used for data or address storage or as a program counter.

“It’s not a classical instruction set,” Swales says, “but is somewhat simpler than other machines on the market.”

Additional information is needed

The 8-bit instruction that is used requires some added information to provide a reasonable instruction set, the author points out. So a set of registers within the processor are set up by instructions and are used to address the internal scratch pad. Executed instructions reference a single register, and resulting data bits then reference the scratch pad. The pad’s output, in turn, goes to memory, where it pulls out operand or address information.

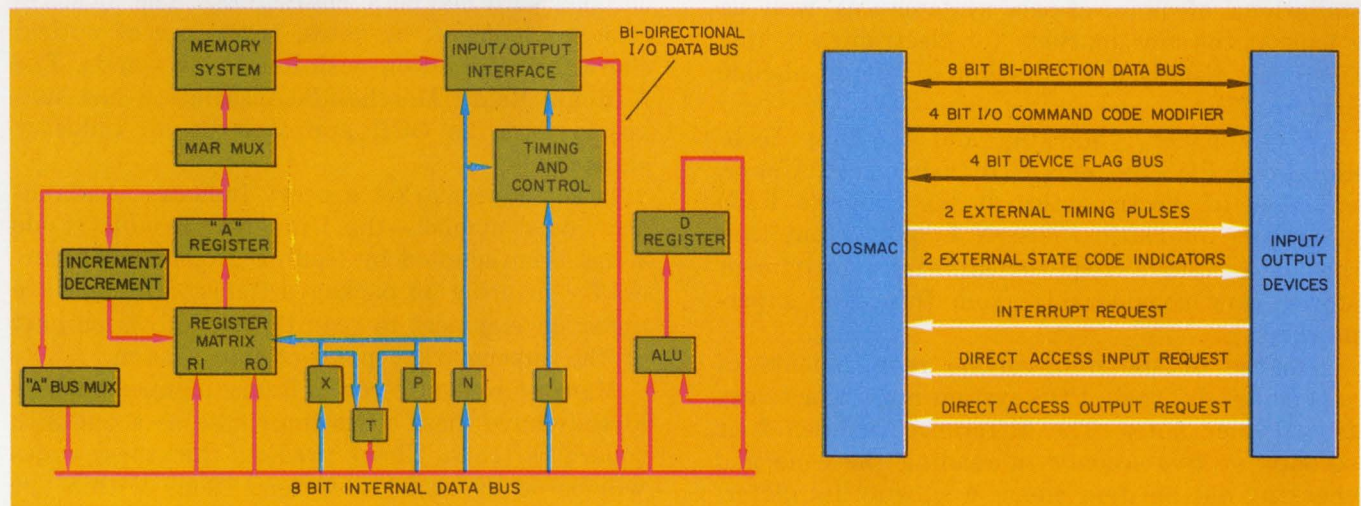

An eight-bit, parallel, register-oriented architecture (left) was chosen for RCA’s COSMAC microprocessor. The

Input-Output interface (right) was designed to minimize memory requirements and complexity. **Session 17.**

"The biggest advantage of this organization," Swales says, "is that it gives us a very efficient memory usage. The other big advantage I see in this machine is the I/O structure. We tried not to multiplex a lot of information on the data bus, to start with. The instructions are 8 bits long, broken into 4-bit instruction code or op-code field, and a 4-bit modifier."

The instruction field or the operational code determines the generic instruction type, Swales points out. "And then," he continues, "we use the least-significant 4 bits to either select one of the matrix registers or to further define the generic instruction being executed."

This single generic input-output instruction,

which is taken to the I/O interface, can be broken down into 16 I/O instructions.

The organization, Swales notes, can be used for device selection or to replace sequencing logic within controllers.

"I feel that this microprocessor is going to fit in anywhere where you're controlling a mechanical device or where you've got a human interaction," Swales says. "Unless you have an overly complex system, there is no reason not to use a microprocessor in lieu of something like a mini-computer, if you require the intelligence.

"Also, the microprocessor can be used in place of discrete logic as a very low-cost way to realize a system that is easily changeable." ■■

Consumer

Point-of-sale systems still need standardized data-code readers

A new generation of consumer electronics—point-of-sale systems for retail stores and supermarkets—is emerging or in development, but not without problems. Not standardized are the systems for reading sales and inventory data on retail department-store tags or labels in grocery supermarkets.

A review of such reading systems—some under development and others turning up in pilot installations of point-of-sale systems—as well as a look at the new markets for electronics in this field are discussed in Session 8, "Point-of-Sale Systems."

In one paper "Marking and Reading Techniques for POS Systems" Dr. Edward A. Ulmer, manager of electro-optics at the Singer's R&D laboratory in Little Falls, N.J., points out that the data-capture requirements for department stores vary considerably from those for supermarkets.

Because of the high-volume requirements of supermarkets, their POS system must work very fast, Ulmer notes. The difference between four seconds or two seconds in reading the code and checking out an item makes a substantial difference in high-volume daily productivity.

On the other hand, the pace is more leisurely

in department stores. If a customer takes 25 minutes to select a suit, and a salesman uses an optical wand to read the tag, the 10 or 20 seconds required are inconsequential, Ulmer says. What is important, he notes, is that the information be read off for inventory control.

For the department stores, Ulmer says, "there are optically encoded tags that can be read with optical hand wands, or the retail tags can be encoded with magnetic characters." The most recent development, he notes, is the use of optical character recognition with hand-held wands. The National Retail Merchant's Association has suggested that the OCR approach be an industry standard.

In the supermarket grocery industry, a standard, coded symbol—the Universal Product Code—has been adopted by leading food manufacturers for printing on packaged items. Scanners are under development to read these symbols as part of the supermarket point-of-sale system.

Many of Kellogg's cereal items in supermarkets already have these codes imprinted as a one-inch square bar code. Ulmer predicts that these codes will be on 80 or 90% of food items within the next couple of years.

The cost of data-capture equipment varies



Point-of-sale systems are beginning to replace electro-mechanical cash registers in retail stores and super-

markets. This terminal is made by Singer Co.'s Business Machines Div. in San Leandro, Calif. **Panel Session 8.**

widely. Small hand-held light pens for reading department-store tags are low-cost items compared with the supermarket's readers, with fixed, hands-off scanners.

The latter system has a scanning window, and packages are carried swiftly by this window on a conveyer belt. The code is designed so a package need not be oriented carefully to be read.

The over-all supermarket system, Ulmer notes, is comprised of a POS terminal at the checkout counter plus a couple of minicomputers in the back room. Two minicomputers are needed because all the pricing information is there; if one computer fails, the other is needed as a backup. There is also a price file on discs, plus the scanner and the logic unit that decodes the labels.

For supermarket pricing, a unique code number will be assigned to each brand item, and this number will be the same throughout the country. The scanner, on reading that number, will send the information to the minicomputer. The computer will send the price back to the POS terminal, where it will be entered as part of the total billing.

Ulmer predicts that many microprocessors will be used with these systems, because the terminal itself requires intelligence.

He notes that there is not as much agreement on standards among department stores as there is among supermarkets. Recently, he points out, the manufacturers of department-store items proposed an optical-character reading system, so customers could read the tags as well as the machine does. No decision on this has been reached yet, but Ulmer believes optical character reading will become the universal choice.

While some supermarket POS systems have been installed for pilot tests, there is no immediate rush to install them on a wide scale, for two reasons. First, the system costs about \$100,000 for each store. And it is not yet economically viable to install the system until at least 75% of the items going across the checkout counter have the standard coded symbols on them.

Ulmer sees wide use of POS systems for supermarkets by late '75 or early '76, by which time, he says, 80 or 90% of the items will be coded.

Needed: electronic cash registers

Thomas F. Horan, senior industrial economist at Stanford Research Institute, author of a Session 8 paper on "A Structured Approach to the POS Market," distinguishes between two kinds

of point-of-sale equipment.

"On the high end," he says, "you have the sophisticated, multithousand-dollar data-capture machines. These are the kind that are capable of producing, say, a punched tape or other machine-readable media, such as an optical printed font. At the end of the day the register roll can be pulled out and sent down to the EDP center to be read.

"On the low end you have a stand-alone electro-mechanical cash register selling for perhaps \$1000."

Between these two categories, Horan says, the market is split about 50-50.

He sees a major opportunity for electronics manufacturers to replace the present electro-mechanical cash register with an all-electronic version. Taking sales figures for 1972, Horan notes that about 110,000 electromechanical cash registers are sold annually. He predicts that this demand will grow at about 5% a year and that the potential for electronic replacements could be several times the basic rate.

Another potential development, Horan says, is an electronic-cash-register/terminal combination. With this, the retailer, instead of needing his own independent EDP computer, could process the sales data through an EDP service bureau.

New thinking in order

In Session 22, Larry T. Sullivan, vice president and general manager of Modular Instrumentation Div., Analog Devices, Westwood, Mass., sees great opportunity for new electronics markets—if the electronics industry begins to reorient its thinking and is willing to learn about "the other

guy's business."

Organizer and chairman of Session 22, "Developing New End-Use Markets for Electronics," Sullivan says that "the electronic business has, for a long time, consisted of a lot of electronic companies selling to each other. They understood each other's products pretty well and talked the same language."

Now, says Sullivan, electronics engineers, engineering managers and marketing people will have to examine the specialized needs of such potential customers as the textile industry and translate those needs into electronic solutions. Session 22, "Developing New End-Use Markets for Electronics," takes a hard, realistic look at the problem, with speakers representing the viewpoints of buyers in the point-of-sale market, the municipal-government market and the textile industry.

"A lot of electronic firms think that because a market exists all that is necessary is to develop a product and put out a data sheet with specs on it," says Sullivan. "But people who want to go after these end-use markets have to understand the customer's business, and particularly his viewpoint."

This new type of customer, Sullivan points out, "couldn't care less" about technical characteristics, like common-mode rejection.

"What he wants to know is: What does this thing do? How well does it do it? How well does it do it compared with other ways? How much does it cost? And is it going to be reliable?"

"If the equipment breaks down he doesn't want to listen to technical reasons why it did. All he knows is that the old electromechanical device worked for 40 years." ■■

Communications

CATV, fiber optics and telepathy: The promise and the problems

What do CATV, optical fibers, satellites and parapsychology have in common? All are used in communication systems that will be discussed at this year's IEEE show.

In Session 4 "The Changing Face of CATV," Jacob Shekel, chairman and organizer, describes

new technology and systems. He stresses that CATV should not be thought of as a simple system for the distribution of off-the-air signals; new services, such as interactive two-way communication and electronic mail, are possible.

In a paper on "Television Receivers for CATV

Timetable to the technical sessions at Intercon '74

Tuesday, March 26		Wednesday, March 27		Thursday, March 28	
9.30 a.m. - 12:30 p.m.	2 p.m. - 5 p.m.	9:30 a.m. - 12:30 p.m.	2 p.m. - 5 p.m.	9:30 a.m. - 12:30 p.m.	2 p.m. - 5 p.m.
<p>Session 1 Electronic Calculators: Market, Design, Applications</p> <p>Session 2 Imaging With Charge-Transfer Devices</p> <p>Session 3 The Foreign Thrust to Capture U.S. Markets</p> <p>Session 4 The Changing Face of CATV</p> <p>Session 5 The Semiconductor Crunch: When Will Deliveries Catch Up With Demand? What Will Happen to Prices?</p> <p>Session 6 Radio Amateur Space Communication</p> <p>Session 7 Testability—The Key to Automation in Circuit Testing</p>	<p>Session 8 Point-Of Sale Systems (Panel)</p> <p>Session 9 CCDs in Analog Signal Processing</p> <p>Session 10 How Will Computing Costs Come Down?</p> <p>Session 11 New International Markets</p> <p>Session 12 Optical Communications</p> <p>Session 13 Automatic Test Equipment—Lessons Learned and Deterrents to Wider Application</p> <p>Session 14 Investment Plans for Engineers and Employers</p> <p>Feature Session 8 p.m. New Advances in Parapsychology</p>	<p>Session 15 Technology Assessment and the Engineer</p> <p>Session 16 Data-Base Systems—A Technical Perspective for Engineers</p> <p>Session 17 Microprocessor Architectures</p> <p>Session 18 Packaging Concepts for Solid State</p> <p>Session 19 Switching Systems Control by Minicomputer</p> <p>Session 20 User Software for Automatic Test Equipment (Panel)</p> <p>Session 21 New Technology in Telephones</p>	<p>Session 22 Developing the New End-Use Markets for Electronics</p> <p>Session 23 Recent Advances and Trends in Computer Storage</p> <p>Session 24 Microprocessor Applications</p> <p>Session 25 Electronic Displays in Action</p> <p>Session 26 Control and Instrumentation Systems: For the Operator, for a Change (Panel)</p> <p>Session 27 The Uncommon Carrier—Problems and Plans (Panel)</p>	<p>Session 28 Using Memory Today</p> <p>Session 29 Alternatives to Random Logic</p> <p>Session 30 Solid-State Systems for Consumer and Industrial Products</p> <p>Session 31 The Changing Marketing Interface—Who Wins, Who Loses?</p> <p>Session 32 Growth Potential in New Microwave Semiconductors</p> <p>Session 33 Required and Available Instrumentation Systems</p> <p>Session 34 Earth and Ocean Physics Application Program</p> <p>Session 35 High-Density Semiconductor Memories</p>	<p>Session 36 Solid-State Systems for Automotive Electronics</p> <p>Session 37 Venture Capital: Frontier of Finance</p> <p>Session 38 Data Networks</p> <p>Session 39 New Instruments, New Concepts, New Technology</p> <p>Session 40 Go/No-Go Testing—A Thing of the Past?</p>

Systems," Edward D. Chalmers, of Zenith Radio in Chicago, notes that consumers may soon be required to buy special television sets if they want to be connected to a CATV system. Two types of receivers are suggested by Chalmers. The first is a telecast receiver that is also cable-compatible, while the second is a special cable-only receiver.

"Logically, first priority should be given to working out the details of a broadcast TV receiver which is cable compatible," he notes.

TV manufacturers are leaning toward a plan for such a set, Chalmers goes on. It would incorporate all of the present telecast channels and up to 16 new cable channels. This plan, he says, permits a maximum of 28 general-purpose cable channels per cable, but places no unnecessary restraints on special cable services or special channels that may also be carried on the CATV system.

In another paper, Hubert J. Schlafly, of TelePrompTer in New York, tells how the cable TV companies will soon be able to use less cable and still do the same job—by use of satellites. He reports on recent satellite-receiver tests conducted in the U.S. A portable satellite earth station was set up at 25 to 30 sites in the country to receive signals from the Canadian satellites Anik I and Anik II.

The tests were surprisingly successful, Schlafly notes. Although the satellites were designed to beam signals to Canada, usable signals were received as far south as San Diego and Mobile, Ala. Two major objectives of the tests were to determine the extent of terrestrial interference and to measure the quality and strength of the received signal. Other goals, Schlafly continues, were to train personnel in the use of satellite receiving equipment and to convince the public and industry, by demonstration, that the era of domestic satellites was here.

In explaining why the CATV industry is looking to satellites rather than land links, Schlafly notes that satellites are considerably less expensive. Although the final figures are not yet in, he estimates that a satellite link will result in savings of 50% or more. And there are also technical advantages, he says.

Since there is only one repeater—the satellite—the problems of noise from cascaded repeaters and signal degradation are minimized, Schlafly points out. In addition there is no need to worry about terrain, weather, rights-of-way, roads or power. A satellite CATV system, he says, will have one or two satellite receivers right in the community that it is going to serve and will easily interface with present cable systems.

Other work with communications satellites is described by Perry I. Klein and Jan A. King, of the Radio Amateur Satellite Corp. (AMSAT) in

Washington, D.C. In a session on "Radio Amateur Space Communication," they detail the results obtained with the AMSAT-Oscar 6 communications satellite.

Oscar 6, they note, is unlike any other communications satellite, in that it was built by radio amateurs on a shoestring budget. It is, they say, the only satellite of its kind designed for free-access international communications on a noncommercial basis. Oscar 6 is part of a long-range program designed to provide wide-band orbiting repeaters for amateur radio that will ensure reliable daily communications over an entire hemisphere.

In another paper, Allen Katz of Trenton State College describes a stress parabolic reflector that provides high gain in the uhf and lower-microwave spectrum. The stress parabolic reflector, he says, overcomes some problems encountered

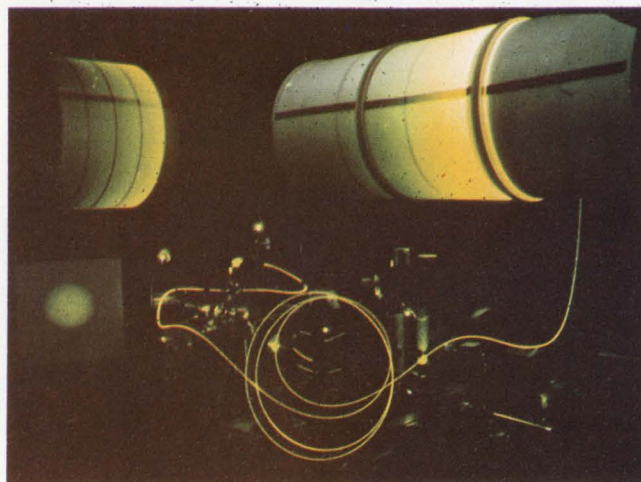

Optical fibers by Corning Glass Works, N.Y., may be used in optical communications systems. They can carry wide band signals at very low loss. **Session 12.**

with the conventional parabolic reflector. It is less expensive, lighter and partly eliminates wind loading of the antenna, he reports. In addition minimum skill and measurement in construction is required, and a gain in excess of 20 dB can be produced.

Communicating with optical fibers

Because of rapid progress in optical-fiber transmission in the last few years, practical applications are now being considered. In Session 12, B. S. Helliwell, of Plessey Telecommunications Research in England, describes CATV and subscriber networks that use optical fibers.

According to Helliwell, optical fibers have several advantages for carrying wideband signals to a subscriber. These include small physical size and low losses—and thus the elimination of intermediate amplifiers. In addition, with a multi-

mode fiber, several transmission parameters can be varied to alter the performance and meet system requirements.

To achieve the low cost that CATV applications require, Helliwell says, it may be necessary to compromise and use a noise figure somewhat higher than would ordinarily be desirable. Early systems will use a multimode fiber, he predicts, to retain choice of light source and to avoid manufacturing and joining problems.

Helliwell notes that there still are some problems to overcome. Manufacturers must be able to make optical fibers in long lengths to specified optical and mechanical tolerances. Once the fibers are formed, they must be made into cables and installed with a minimum of breakage. Another problem is splicing. Reliable joining methods with less than 0.5-dB loss must be developed for field use.

Parapsychology and communication

In a special session on "New Advances in Parapsychology," E. Douglas Dean, of the Newark College of Engineering, presents what some engineers might consider a far-out paper on "Channel Capacity for Telepathy Channels." Dean asserts that mental stimulus, and the

physiological responses resulting from it, can be used to provide long-distance telepathic communication.

The "transmitter" is a person who concentrates on names from a list, Dean says. Some names are familiar to another person who acts as the "receiver," and constriction in his blood vessels results when the recognizable names are transmitted. The blood-vessel volume is monitored by a plethysmograph.

Since only the presence or absence of a stimulus can be detected, Morse Code is used to send messages. To transmit a dot, the person "transmitting" reads a name that stimulates the "receiver." For dashes, an unfamiliar random name is read. At the receiving end, a large deflection of the plethysmograph is decoded as a dot, while a small one represents a dash. Information is sent in fixed time slots. This process is slow and results in a data rate of about 1 bit every five minutes, with a reliability of two out of three, Dean asserts. The process may be speeded, he contends, if a direct connection is made to the sympathetic nervous system.

Dean reports that distance is not a serious problem and that experiments have shown that a "receiver" in the U.S. was able to pick up telepathic messages transmitted from Italy. ■■

Microelectronics

A new imaging technology grabs hold: Charge-transfer devices

Charge-transfer-device image sensors are emerging from development laboratories and appearing in industrial and military applications. The current status of the new imaging technology and a look at its future unfold in Session 2, "Imaging with Charge-Transfer Devices."

"Unique Capabilities of the CID Imager" by John Hooker and G. J. Michon of General Electric, Syracuse, N.Y., discusses the development of REMBIS (Remotely Monitored Battlefield Information System) for the Army. The CID imagers in this system consist of arrays of 100-by-100 points, with a dynamic range of up to 1000 to 1.

One of the most interesting aspects of the paper is the highlighting of the differences between the charge-injection-device (CID) and the more widely known charge-coupled-device (CCD) image sensor. According to Hooker: "The image signal is developed and stored in a CID array in much the same way as in a CCD array. The main difference is in the way the signal is retrieved. In a CID array the image points are accessed in an x-y fashion, rather than sequentially as in the CCD."

The importance of this difference is that it permits a CID array to be scanned at any speed, or individual points to be accessed randomly. Another area of difference, according to the

paper, is that a CID is flexible in layout and the image points can be spaced relatively far apart, if necessary. With the CCD, close spacing of the array electrodes is required for high transfer efficiency.

Other advantages of the CID array are that single-point defects cause the loss of only one image point, and the array does not have to have storage registers on the chip—giving it fewer elements in a given size array.

In a paper on "Noise Considerations in Solid-State Imagers," Marvin H. White and Donald R. Lampe of Westinghouse Electric, Baltimore, compare some of the characteristics of CID, phototransistor and photodiode image arrays. The inherent noise level of the ideal CCD array is lower than the photodiode array and is filterable, the authors note. The noise of a diode array is created by the reset switching transistors required for operation—and it is white noise that cannot be filtered.

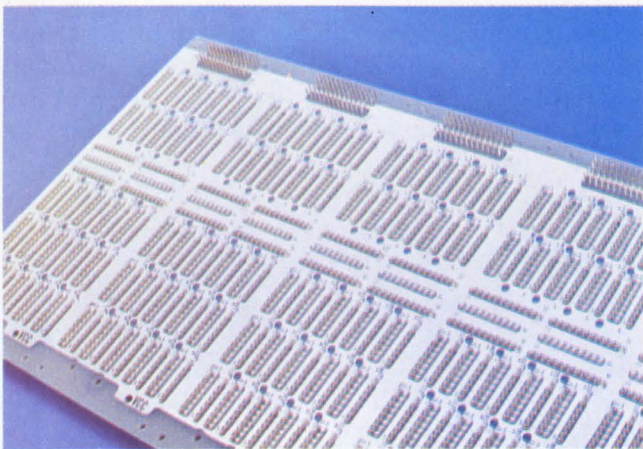

Specially designed packaging panel made by Augat, Inc., Attleboro, Mass., can accommodate high-speed ECL integrated circuits. **Session 18/2.**

"In a practical application," White says, "the noise level is controlled by the signal-processing system. For minimizing the noise level in any image system, the design of the processing circuits is critical."

The paper gives hints on how to minimize processor noise to bring the noise level of diode arrays and CCDs to about the same level.

In comparing imagers, White explains: "The important advantage of the photodiode image array is that it has an excellent spectral uniformity over the 400-to-800-nm range, so when color response is vital, it becomes the sensor of choice. The CCD array is composed of several layers of polycrystalline silicon and oxides, which cause light interference—the spectral response waves like a flag. Phototransistors are difficult to make uniform across an array."

Session 9, "CCDs In Analog Signal Processing," explores the use of charge-coupled devices in nonimaging applications.

Packaging chips and systems

The packaging of IC chips and integration of the packages into systems, while maintaining maximum performance, is discussed in Session 18, "Packaging Concepts for Solid State."

In a paper on "Low-Temperature Ceramic DIP Sealing," William C. Wakely and C. H. Wang of Diacon, Inc., San Diego, review methods for keeping the chip temperature down during sealing, including the "hot cap" seal, improved package designs and the new glasses that can be used at lower temperature.

According to Wakely: "The ceramic DIP is one of the best IC packages, due to economy, ruggedness, hermeticity and ease of installation. The major drawback is in the high temperature usually needed to produce the final package seal. Many circuits can be damaged or at least have their characteristics changed during the sealing process."

A specially designed integrated-circuit packaging panel, for building circuits with wrapped-wire interconnect, is described in "Packaging High-Speed ECL ICs," by Leonard Doucet, Augat, Inc., Attleboro, Mass. He indicates that the introduction of the Motorola ECL 10,000 logic family increased the speed of logic comparable to that of the interconnection delays of conventional packaging systems. Doucet reports:

"We have designed a multilevel interconnect wrapped-wire system which maintains a relatively constant 100-to-120- Ω transmission line environment with undershoot limited to about 12%."

The use of an ECL-designed wrapped-wire technique is intended to make the production of high-speed logic boards economical and versatile while maintaining the performance inherent in ECL.

Techniques to improve custom logic

Session 29, "Alternatives to Random Logic," looks at several methods for designing custom logic, while bypassing the complex design techniques required for random logic. Random logic normally requires a highly irregular and complex layout.

"Array Logic and LSI," by Harold Fleischer, IBM, Poughkeepsie, N.Y., discusses the reasons for choosing certain formats in designing LSI logic arrays. According to Fleischer: "The design process for a given group of variables with array logic is to generate the desired output functions with a minimum number of pro-

grammed bits. The logic designer is provided with a fixed format structure which has been designed and tested on the basis of electrical characteristics and which has a high degree of regularity."

The paper points out that two-level logic, such as that used in array logic, is easier to design than multilevel random logic, and may lead to fewer compromises in design. Array logic, while not always competitive in speed with the finest-tuned random logic, has a number of advantages—and not the least is easier design.

Semiconductors for microwaves

Session 32, "Growth Potentials In New Microwave Semiconductors," views a variety of microwave devices with substantial commercial and military appeal, including GaAs FETs, millimeter diodes, monolithic amplifiers and D-MOS.

A design example of a monolithic linear amplifier is given by Einar Traa of Tektronix, Beaverton, Ore., in a paper, "Monolithic Wideband Oscilloscope Amplifier." The amplifier covers dc to 3.3 GHz with a power gain of 29.8 dB.

"Perhaps the most interesting feature of the design," Traa says, "is that it is so straightforward. The circuit gives good performance without resorting to expensive microwave packaging. It is built in a TO-8 can."

The current status of double-diffused MOS transistors for high-frequency linear amplification and high-speed switching is outlined in "D-MOS for Microwave Linear and Nanosecond Switching Applications," by Dr. Hans Sigg, D. Pitzer and T. Cauge of Signetics, Sunnyvale, Calif. According to Dr. Sigg: "The major advantage of D-MOS is that we can make well-controlled channels of about 1- μ length which remain independent of drain voltages across a wide range."

The D-MOS products discussed in the paper are discrete transistors used for linear uhf applications and high-speed analog and digital switches. The paper also explains some of the problems with D-MOS, the major one being a low Gm caused by the scattering-limited velocity of the electrons. Also, capacitances limit present units to about 1.5 GHz, although by use of a narrower metal width—such as the Texas Instruments 4- μ metal—the operating frequency of later units may be increased.

D-MOS appears to have a bright future for both linear and switching circuits, but development is taking a long time. Dr. Sigg says: "We have been working on D-MOS since 1968, with the first products introduced about a year ago. This is a device which will undergo a relatively long development cycle, but looks like it will be well worth it." ■■

Instrumentation

Test-equipment users suggest software-hardware improvements

Automatic test equipment—the lessons learned and deterrents to wider application—is analyzed in Session 13. The speakers are users who have gathered to tell designers of their experiences with automatic test equipment (ATE) and to recommend improvements, according to the session organizer and chairman, Oliver T. Carver, RCA, Burlington, Mass.

One reason for the session, Carver says, is growing interest in the use of ATE in nonelectronic applications—"the automotive industry, for example."

Applications would expand even more, Carver

says, if it weren't for the high cost of generating individual diagnostic software. One project that designers are working on is how to simplify software validation. In hardware, a more flexible interface between the automated test system and the things it is testing is also being sought.

Some newer systems have been built to enable the control computer to handle more of the measurement analysis; this, of course, calls for less hardware. "And the less hardware you have, the less you have to rebuild or modify to meet new requirements," Carver notes. "In the hardware-software tradeoff, the software is favored."

Requests for advances in technology come from the airlines, where ATE has been a way of life for a long time. "We have the experience and knowledge that qualifies us to make these requests," says James P. Valdez, who authored a paper, "Airline ATE Applications and Technology Requirements," with Robert G. Huene-mann, both managers in maintenance operations for United Air Lines at the San Francisco International Airport.

Many software and hardware problems have been encountered by the airlines and solved since they began using ATE equipment in 1967, the authors say, "but new technology is still needed.

"We are looking for several things," they point out, "but new languages are not among them. We need improvements to existing ones to increase throughput and to reduce programming efforts."

United Air Lines operates three ATE systems. One, referred to as the analog station, is primarily concerned with testing 747 jetliner autopilot avionics, although programming is under way to add autopilot units for the 727 and 737 jets.

The second ATE system is an rf station. Radio altimeters and VOR navigation units are being tested. Vhf communication units are next in line.

The third station, and the largest, is for DC-10 avionics, which require 20,000 programming stations, compared with the 12,000 needed for the 747. This system handles 14 different units that have analog and digital electronics. It also has pressure capability for simulating airspeed and altitude.

United wants a fourth system to help repair circuit boards. At present the boards are sent to the vendor for warranty repair, but warranties are running out, the airline says.

"Basically," the authors say, "an ATE system for electronic circuit boards must be able to locate faulty components with minimum costs. . . . After a lot of work, we have settled on a design which can handle our needs, not like we desire but at the lowest cost that present techniques can offer."

United hopes to have the fourth system installed soon. And since most of the avionics is still analog, the new system will have both analog and digital capability.

Units for car maintenance

Automotive automatic test equipment is described in a paper by two engineers from RCA in Burlington, Mass.—Newton A. Teixeira and P. Bokros. The automobile industry uses ATE for both preventive and corrective maintenance, Teixeira explains.

For preventive maintenance, the instrumentation, including logic storage, must be completely



Automatic test equipment (ATE) station at the San Francisco International Airport checks out a digital air data computer in a United Air Lines DC-10. Session 13.

on board the automobile. For corrective maintenance at fixed diagnostic and repair sites, some instrumentation—harness and diagnostic connectors—should be on board, but readout and decision equipment can be at the site.

Several approaches to corrective maintenance have been tried, Teixeira notes. For military tanks and automobiles, two approaches are under development by RCA. One is a fully programmed computer-operated unit and the other a simplified unit for the mechanic.

An obstacle to more ATE use, Teixeira points out, is the problem of finding engine-pressure-measurement transducers that are low-cost, highly reliable and made in production quantities.

In the panel discussion, the role of the computer as a part of the car engine is described as one that will grow very quickly once a computer is finally designed into a production-line vehicle.

"The first installation will probably come as a result of legislation—for emission control or for safety," Teixeira says. "But from then on, the computer will take on all kinds of jobs the car must perform."

Digiscope: A new approach

New instruments, new concepts and new technology are discussed in Session 39. One of the new instruments is Digiscope, a test instrument designed expressly for the check-out and maintenance of digital electronic equipment. Developed by E-H Research Laboratories, Inc., Oakland, Calif., and described in a paper by J. Carver Hill and Burnell G. West, Digiscope is both a new instrument and a new concept. While conventional waveform oscilloscopes can display one or two simultaneous traces of voltage vs time, Digiscope can display up to 16 simultaneous traces of logic level vs time. It can display either digital or analog information, and it can handle on the same scope such data as rise time and aberrations.

Unlike a waveform scope, Digiscope has sep-

arate data acquisition and data-display processes. The digital process is compatible with standard video techniques. Consequently the display can be bright enough and large enough to display the data for 16 channels together with all the settings of the instrument and its plug-ins.

During the acquisition process in Digiscope, the input to each channel is continually being converted to a binary sequence and shifted into a data-acquisition register at some selected clock rate suitable to the measurement being made. In response to a control signal (analogous to a trigger or delayed trigger in a waveform scope), the acquisition process is suspended and the accumulated data are transferred to a second shift register, the display register. Once the transfer is complete, data acquisition may resume, while the transferred data recirculates in the display register at a rate suitable for displaying the data.

Since new data will not replace the data recirculating in the display register until another trigger is received, Digiscope automatically functions as a memory unit for single-shot events.

There is a disadvantage to the system, the authors point out: the loss of critical information present in the waveform of the logic signal. For example, simply making a periodic comparison of the amplitude of the logic signal against some threshold voltage midway between logic ZERO and ONE cannot detect the four most important waveform anomalies. And since these waveform anomalies are frequently the cause, or directly related to the cause, of malfunctions in digital systems, they must be detected and displayed.

But there is a solution. Digiscope, equipped with type 1300 general-purpose plug-ins, uses an analog-to-binary conversion technique that preserves the essential part of the amplitude, rise time, ringing and glitch information present in a logic signal waveform.

A new fast-storage oscilloscope is described by R. Eugene Andrews, program manager for Tektronix, Beaverton, Ore. The new instrument, designated type 7633, is an improved version of the company's type 7623, introduced in 1972. The main advantage of the new oscilloscope is its faster writing speed—900 cm per microsecond. The older one is capable of 90 cm per microsecond with an optional speed of 200.

The greatly improved speed was achieved in two ways, Andrews reports. "We incorporated a different mode of storage—a variable persistence mode of transfer storage as opposed to the older system's bistable mode," he says. "This alone tripled the writing speed. Secondly, the scan flow was designed to be selected independently of other operations; this reduces the scan to half size and at the same time improves writing speed three to four times." ■■

Exclusive Technical session order form

Please send me the following IEEE technical session preprints at \$3 a session (average: four papers a session), plus \$1 mailing charge for the complete order. I understand this order will be mailed to my address within two weeks after receipt. Offer good until June 1, 1974.

(Note: Papers are bound by sessions; no individual papers available.)

Session No.	Quantity	Session No.	Quantity
1		21	
2		22	
3		23	
4		24	
6		25	
7		28	
8		29	
9		30	
10		31	
11		32	
12		33	
13		34	
14		35	
15		36	
16		37	
17		38	
18		39	
19		40	

Total Sessions × \$3 = \$ _____

Plus \$1 Mailing Charge = \$ _____

Total Cost = \$ _____

Make check payable to IEEE/Intercon and mail with this form to:

**IEEE/Intercon
3600 Wilshire Blvd.
Los Angeles, Calif. 90010**

DATE _____

NAME _____

FIRM _____

STREET ADDRESS _____

CITY, STATE, ZIP CODE _____

For built-in reliability, design with "Scotchflex" Flat Cable/Connector Systems.

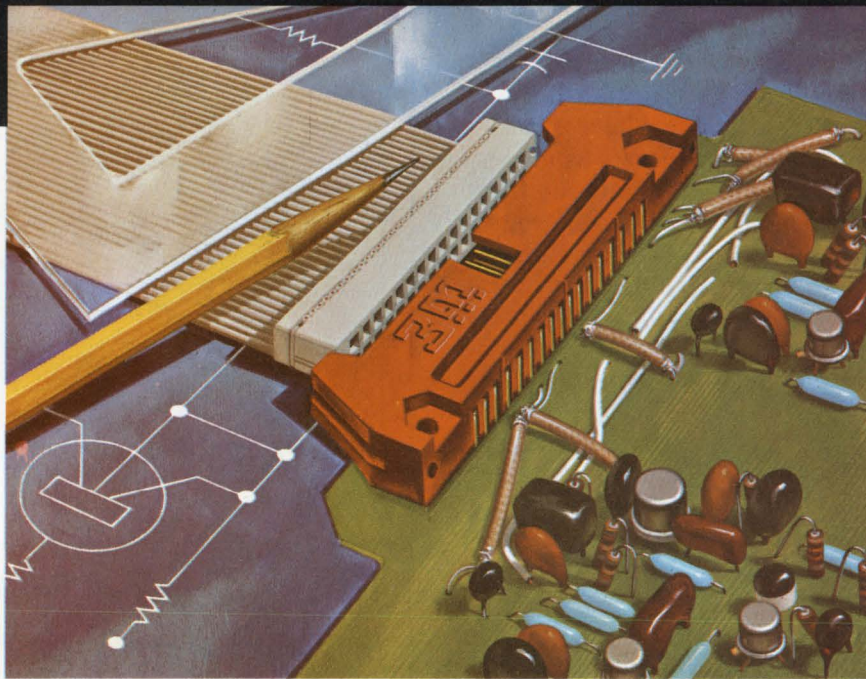

"SCOTCHFLEX" IS A REGISTERED TRADEMARK OF 3M CO.

"Scotchflex" Flat Cable and Connectors can offer you trouble-free packaging for your next generation equipment.

There's built-in reliability for your circuit inter-connects. Our flat, flexible PVC Cable has up to 50 precisely spaced conductors. The gold plated U-contacts are set into a plastic body to provide positive alignment. They strip through the insulation, capture the conductor, and provide a gas-tight pressure connection.

Assembly cost reductions are built-in, too. "Scotchflex" Connectors make up to 50 simultaneous connections without stripping or soldering. No special training or

costly assembly equipment is needed.

Off-the-shelf stock offers you flat cable in a choice of lengths and number of conductors from 14 to 50. Connector models interface with standard DIP sockets, wrap posts on .100 x .100 in. grid, or printed circuit boards. Headers are available to provide a de-pluggable inter-connection between cable jumpers and printed circuit boards (as shown). Custom assemblies are also available on request.

For full information on the "Scotchflex" systems approach to circuitry, write to Dept. EAH-1, 3M Center, St. Paul, Minn. 55101.

3M
COMPANY

THE NATIONAL ANTHEM

A Review of

New Products and Literature

from National Semiconductor

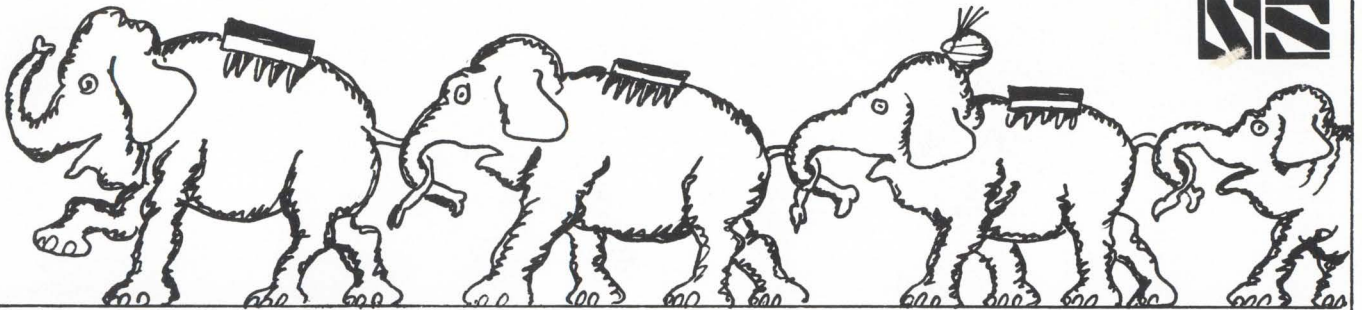

REVEALED: BROADEST LINE OF MOS MEMORY PRODUCTS

Do you know who has one of the broadest lines of MOS memory products in today's marketplace? You're right — if you said National Semiconductor Corporation. Take your pick of ROMs (14 types, including programmable versions), which lead to character generators (18 standard types) and code converters (31 standard types), RAMs (four), shift registers (27 dynamic, 13 static), and peripherals such as clock drivers, interface drivers, memory drivers, sense amplifiers and so on.

And if you'd like a variety of packages, National can provide you with large and small molded DIPs, ceramic DIPs, flat-packs, and metal cans.

Commercial and military temperature-range parts are available, and you can specify MIL-883 processing if you so desire.

You can, in fact, build a complete memory system with NSC products, and everything is normally available from stock.

The newest addition to National's list of MOS memory products is the MM5262, a fast, fully-decoded, 2048-bit RAM for read/write applications; it's described in detail elsewhere in this issue.

And to be added very soon is the MM2102, a static, 1024-bit, N-channel RAM that operates from a single supply voltage. Look for it right here in the Anthem. **Circle AA on Bingo Card**

New ROMs big on bits, low on power

The 54L/74L family is designed for applications that require very-low power dissipation. Typically, the use of the family results in a system with a factor-of-ten power savings over a similar system built with conventional 54/74 TTL. And although power in the 54L/74L family is radically reduced, speed is not proportionately sacrificed.

The latest additions to National's low-power TTL family are also the only 1024-bit, low-power ROMs on the market. Designated the DM54L187/DM74L187 and DM76L97/DM86L97, the new ROMs are organized as 256 4-bit words, with word selection through eight Select inputs. The memories are built with full tenth-power technology: 85mW for the open-collector-outputs DM74L187 (85ns typ.

access time); and 75mW for the Tri-State® — outputs DM86L97 (70ns typ. access time). They are pin-compatible with the SN54187/SN74187.

Both ROMs are custom programmed, and have overriding mask-programmable Memory Enable inputs. These ME inputs are programmable in one of three options that will cause all four outputs either to read the normal memory contents or to go to the logic-1 state (for the DM74L187) or to the high-impedance state (for the DM86L97).

The memories are available in commercial and military temperature-range versions, in 16-lead molded and ceramic DIPs, and flat-packs.

Circle AB on Bingo Card

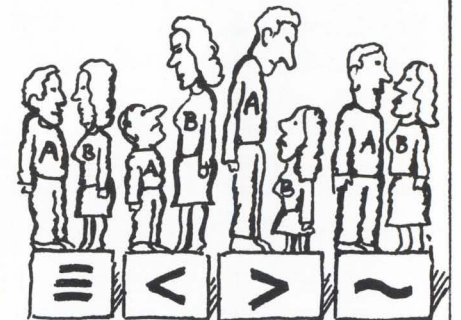

4-bit magnitude comparator has A-almost-B output

The DM76L24/DM86L24 is a low-power (60mW typ.) Tri-State® 4-bit magnitude comparator compatible with most TTL/DTL families. It is expandable without gates to compare longer-than-4-bit words.

The new comparator offers $A > B$, $A < B$, and $A \equiv B$ outputs, and one other that is unique to this device: $A \sim B$ (A almost, but not equal to, B). The $A \sim B$ output is high only when word A is within one binary count of word B.

The DM76L24/DM86L24 is implemented with National's new DM76L97/DM86L97 1024-bit low-power ROM.

Circle AC on Bingo Card

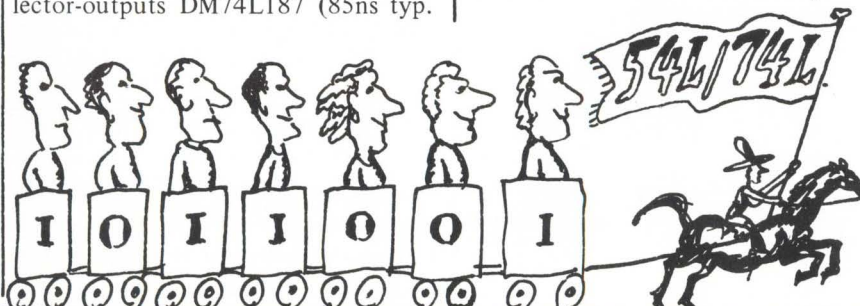

Fast, fully-decoded, 2048-bit RAM for read/write applications.

The MM5262 is designed for efficient operation in modern, bus-organized systems as a high-speed mainframe memory or for mass memory storage.

Most bused systems present the address information to the data bus only during the early portion of the machine cycle, and then transfer data during the remainder of the cycle. The MM5262, unlike many other RAMs, doesn't need a memory address register to hold the address stable on its inputs during the complete cycle: the address is clocked into the MM5262's on-chip address register by phase 1. The address and chip-select signals need be applied only during phase 1 and the phase-1-to-phase-2 gap.

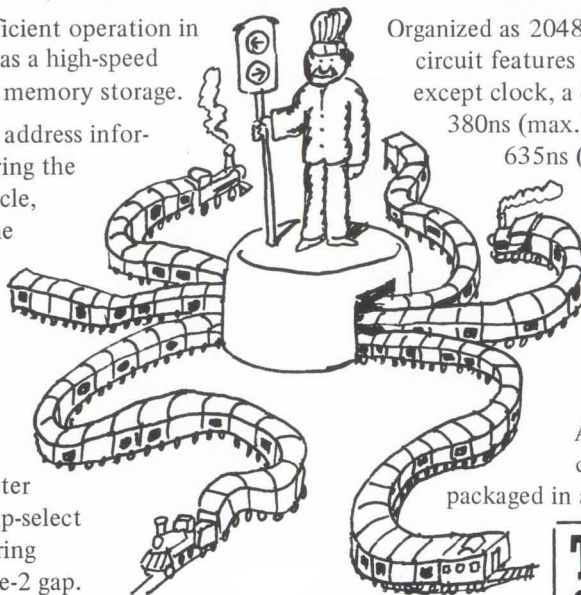

Organized as 2048-bits by one word, the new silicon-gate circuit features bipolar compatibility on all input lines except clock, a current-pulse output, an access time of 380ns (max.) and cycle times of 475ns (read/read), 635ns (read/write, or write). A chip-select pin provides for easy memory expansion.

Other specs include a 2ms refresh cycle, operation from -15V, +5V, and +8.5V supplies, 400mW (max.) operating power, and 2.5mW (max.) standby power. The RAM is second-sourced by AMS and Signetics.

Available in both military and commercial temperature ranges, the MM5262 is packaged in a 22-pin DIP. **Circle AD on Bingo Card**

TRUE TRI-STATE COMES TO CMOS!

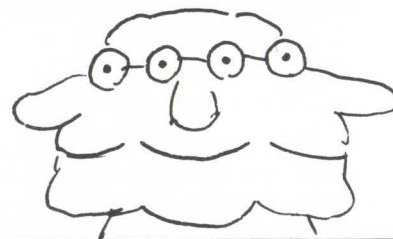

True Tri-State[®] circuits are the newest additions to National's broad line of 74C products. The MM80C95 and MM80C97 are hex buffers that convert CMOS or TTL outputs to Tri-State outputs with no logic inversion. And with these circuits, the designer—for the first time—can design his system with a common bus.

Until now, if bussing was desired in a CMOS system, the designer had to use a bilateral switch. This switch, the CD4016A, was not designed for Tri-State bussing; it has high ON impedance, and therefore a low drive capability. The new buffers have Tri-State outputs for bus driving, and can drive single TTL loads directly.

The MM80C95/97 feature a high, guaranteed noise margin of one volt (two and-a-half times that of TTL), high noise immunity (typically 45% of V_{DD}), and a wide 3 to 15V supply-voltage range. As bus drivers, the new buffers have a typical propagation delay of 40ns into a 150pF load. The MM80C95 has common Tri-State controls for all of its six buffers, while the MM80C97 has two controls—one for two buffers, and another for the other four. **Circle AF on Bingo Card**

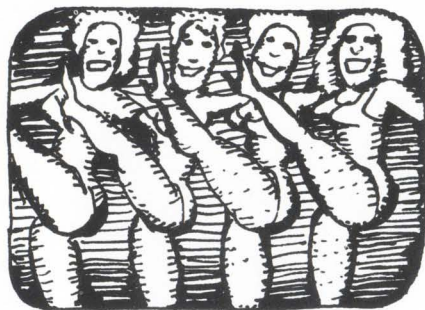

TV camera sync generator features gen-lock input

A new MOS/LSI chip supplies all basic synchronizing functions for either color or monochrome 525-line/60Hz, interlaced camera and video recorder applications.

The MM5320 supplies these standard output functions: Horizontal Drive Out; Vertical Drive Out; Composite Blanking Out; Composite Sync Out; and Color Burst Gate. Additionally, the new generator provides Field Index and Color Burst Sync outputs. Identical push-pull output buffers, clocked internally, minimize phasing differences among the various outputs.

Inputs include Horizontal and Vertical Resets, Reset Control, Clock, and Divider Control.

By connecting the Divider Control to V_{SS} or V_G, the MM5320's user can select a 2.04545MHz input ($14.318180\text{MHz} \div 7$) or a 1.260MHz input ($15.750\text{kHz} \times 80$) reference frequency.

The Horizontal and Vertical Reset inputs allow an externally-generated control pulse to reset directly the appropriate divider (or dividers). Or, the user may connect together the Horizontal and Vertical Reset pins, and drive them with a common reset signal, thus simultaneously resetting the dividers.

The Field Index occurs for two clock periods, at a rate of 30Hz, at the leading edge of Vertical Blanking in the odd field, or field one, and thus identifies that field. A Field Index output pulse occurs once each odd field; it can be used to reset—or "gen-lock"—similar sync generator chips by being fed to their Vertical and Horizontal Reset inputs.

The Color Burst Sync output occurs at half the horizontal rate, with the same timing as the Color Burst Gate output, and may be used to sync the color burst; Color Burst Sync is present during the vertical interval.

The MM5320 operates on +5V and -12V power supplies, and comes in a 16-lead dual-in-line package. Military and commercial temperature ranges are available. **Circle AE on Bingo Card**





ULTRA-HIGH-SPEED Schottky dual/J-K clocks to 125 MHz

The DM74S112 is a new member of National Semiconductor's rapidly-growing Schottky product line. And it is the first of four series-74S flip-flops to be released for production.

The series 74S is an ultra-high-speed version of National's 54/74 family. As such, the gates, inverters, buffers, and flip-flops in the series are usable in combination with series-54/74 circuits whenever a user needs a minimum propagation time. The family includes multiplexers, and will soon also include shift registers.

General features of series-74S circuits include gate delays of only several nanoseconds, higher source and sink currents than standard TTL, fanouts of 10 series-74S loads or 12 series-54/74 loads, and relatively-low power dissipation.

The introduction of the first flip-flop rounds out the small-scale-integration portion of the series (the other three flip-flops will be available shortly, and all gates have been available since May). The MSI portion of the line is well on its way to production status, with the DM74S153 multiplexer available since early June, and other multiplexers and shift registers coming along. And there are some new standard memory products and custom consumer products in the works for this line, as well.

The DM74S112/113/114 dual/J-K flip-flops all feature the 125MHz (typ.) maximum clock rate, and have propagation delay times of 2ns (min.) to 7ns (max.).

Both the DM74S112 and DM74S113 are in 14-lead DIPs, but the dual sections of the 112 have common clock and clear connections, while the clock connections to the dual sections of the 113 are separate. The DM74S114 is a 16-lead package with sections separately clocked and cleared.

The DM74S74 is a 14-lead, dual-D flip-flop with sections separately clocked and cleared; it clocks to 110MHz.

Circle AK on Bingo Card

HOW TO TRANSMIT THERMOCOUPLE, STRAIN GAGE AND PRESSURE GAGE SIGNALS WITHOUT A LOT OF SWEAT, HOURS, DOLLARS, INCHES AND OUNCES.

Introducing National's new 2-Wire Transmitter. It converts the voltage from a sensor to current, and sends it through a receiver, utilizing the same simple twisted pair as the supply voltage.



No sweat. You buy it off the shelf, instead of having to juryrig your own transmitters.

So naturally you save a lot of size, weight, effort, time, and since time is money — money.

Goodbye noise. But the 2-Wire Transmitter eliminates more than juryrigging hassles. It also eliminates line drops and voltage noise.

Line drops and voltage noise can only happen when your signal is being transmitted in the voltage mode. But we transmit in current mode...which is impervious to either resistance in the wire or voltage noise spiking. So you get fewer bugaboos all the way around.

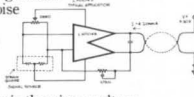

Available in 8 lead TO-3 and 12 lead TO-8 package.

For the full story call our nearest office or write National Semiconductor Corporation, 2900 Semiconductor Drive, Santa Clara, California 95051.

National

National Semiconductor Corp., 2900 Semiconductor Drive, Santa Clara, Calif. 95051, Telephone: (415) 351-5000, Telex: 542000, Fax: (415) 351-5001, (415) 351-5002, (415) 351-5003, (415) 351-5004, (415) 351-5005, (415) 351-5006, (415) 351-5007, (415) 351-5008, (415) 351-5009, (415) 351-5010, (415) 351-5011, (415) 351-5012, (415) 351-5013, (415) 351-5014, (415) 351-5015, (415) 351-5016, (415) 351-5017, (415) 351-5018, (415) 351-5019, (415) 351-5020, (415) 351-5021, (415) 351-5022, (415) 351-5023, (415) 351-5024, (415) 351-5025, (415) 351-5026, (415) 351-5027, (415) 351-5028, (415) 351-5029, (415) 351-5030, (415) 351-5031, (415) 351-5032, (415) 351-5033, (415) 351-5034, (415) 351-5035, (415) 351-5036, (415) 351-5037, (415) 351-5038, (415) 351-5039, (415) 351-5040, (415) 351-5041, (415) 351-5042, (415) 351-5043, (415) 351-5044, (415) 351-5045, (415) 351-5046, (415) 351-5047, (415) 351-5048, (415) 351-5049, (415) 351-5050, (415) 351-5051, (415) 351-5052, (415) 351-5053, (415) 351-5054, (415) 351-5055, (415) 351-5056, (415) 351-5057, (415) 351-5058, (415) 351-5059, (415) 351-5060, (415) 351-5061, (415) 351-5062, (415) 351-5063, (415) 351-5064, (415) 351-5065, (415) 351-5066, (415) 351-5067, (415) 351-5068, (415) 351-5069, (415) 351-5070, (415) 351-5071, (415) 351-5072, (415) 351-5073, (415) 351-5074, (415) 351-5075, (415) 351-5076, (415) 351-5077, (415) 351-5078, (415) 351-5079, (415) 351-5080, (415) 351-5081, (415) 351-5082, (415) 351-5083, (415) 351-5084, (415) 351-5085, (415) 351-5086, (415) 351-5087, (415) 351-5088, (415) 351-5089, (415) 351-5090, (415) 351-5091, (415) 351-5092, (415) 351-5093, (415) 351-5094, (415) 351-5095, (415) 351-5096, (415) 351-5097, (415) 351-5098, (415) 351-5099, (415) 351-5100, (415) 351-5101, (415) 351-5102, (415) 351-5103, (415) 351-5104, (415) 351-5105, (415) 351-5106, (415) 351-5107, (415) 351-5108, (415) 351-5109, (415) 351-5110, (415) 351-5111, (415) 351-5112, (415) 351-5113, (415) 351-5114, (415) 351-5115, (415) 351-5116, (415) 351-5117, (415) 351-5118, (415) 351-5119, (415) 351-5120, (415) 351-5121, (415) 351-5122, (415) 351-5123, (415) 351-5124, (415) 351-5125, (415) 351-5126, (415) 351-5127, (415) 351-5128, (415) 351-5129, (415) 351-5130, (415) 351-5131, (415) 351-5132, (415) 351-5133, (415) 351-5134, (415) 351-5135, (415) 351-5136, (415) 351-5137, (415) 351-5138, (415) 351-5139, (415) 351-5140, (415) 351-5141, (415) 351-5142, (415) 351-5143, (415) 351-5144, (415) 351-5145, (415) 351-5146, (415) 351-5147, (415) 351-5148, (415) 351-5149, (415) 351-5150, (415) 351-5151, (415) 351-5152, (415) 351-5153, (415) 351-5154, (415) 351-5155, (415) 351-5156, (415) 351-5157, (415) 351-5158, (415) 351-5159, (415) 351-5160, (415) 351-5161, (415) 351-5162, (415) 351-5163, (415) 351-5164, (415) 351-5165, (415) 351-5166, (415) 351-5167, (415) 351-5168, (415) 351-5169, (415) 351-5170, (415) 351-5171, (415) 351-5172, (415) 351-5173, (415) 351-5174, (415) 351-5175, (415) 351-5176, (415) 351-5177, (415) 351-5178, (415) 351-5179, (415) 351-5180, (415) 351-5181, (415) 351-5182, (415) 351-5183, (415) 351-5184, (415) 351-5185, (415) 351-5186, (415) 351-5187, (415) 351-5188, (415) 351-5189, (415) 351-5190, (415) 351-5191, (415) 351-5192, (415) 351-5193, (415) 351-5194, (415) 351-5195, (415) 351-5196, (415) 351-5197, (415) 351-5198, (415) 351-5199, (415) 351-5200, (415) 351-5201, (415) 351-5202, (415) 351-5203, (415) 351-5204, (415) 351-5205, (415) 351-5206, (415) 351-5207, (415) 351-5208, (415) 351-5209, (415) 351-5210, (415) 351-5211, (415) 351-5212, (415) 351-5213, (415) 351-5214, (415) 351-5215, (415) 351-5216, (415) 351-5217, (415) 351-5218, (415) 351-5219, (415) 351-5220, (415) 351-5221, (415) 351-5222, (415) 351-5223, (415) 351-5224, (415) 351-5225, (415) 351-5226, (415) 351-5227, (415) 351-5228, (415) 351-5229, (415) 351-5230, (415) 351-5231, (415) 351-5232, (415) 351-5233, (415) 351-5234, (415) 351-5235, (415) 351-5236, (415) 351-5237, (415) 351-5238, (415) 351-5239, (415) 351-5240, (415) 351-5241, (415) 351-5242, (415) 351-5243, (415) 351-5244, (415) 351-5245, (415) 351-5246, (415) 351-5247, (415) 351-5248, (415) 351-5249, (415) 351-5250, (415) 351-5251, (415) 351-5252, (415) 351-5253, (415) 351-5254, (415) 351-5255, (415) 351-5256, (415) 351-5257, (415) 351-5258, (415) 351-5259, (415) 351-5260, (415) 351-5261, (415) 351-5262, (415) 351-5263, (415) 351-5264, (415) 351-5265, (415) 351-5266, (415) 351-5267, (415) 351-5268, (415) 351-5269, (415) 351-5270, (415) 351-5271, (415) 351-5272, (415) 351-5273, (415) 351-5274, (415) 351-5275, (415) 351-5276, (415) 351-5277, (415) 351-5278, (415) 351-5279, (415) 351-5280, (415) 351-5281, (415) 351-5282, (415) 351-5283, (415) 351-5284, (415) 351-5285, (415) 351-5286, (415) 351-5287, (415) 351-5288, (415) 351-5289, (415) 351-5290, (415) 351-5291, (415) 351-5292, (415) 351-5293, (415) 351-5294, (415) 351-5295, (415) 351-5296, (415) 351-5297, (415) 351-5298, (415) 351-5299, (415) 351-5300, (415) 351-5301, (415) 351-5302, (415) 351-5303, (415) 351-5304, (415) 351-5305, (415) 351-5306, (415) 351-5307, (415) 351-5308, (415) 351-5309, (415) 351-5310, (415) 351-5311, (415) 351-5312, (415) 351-5313, (415) 351-5314, (415) 351-5315, (415) 351-5316, (415) 351-5317, (415) 351-5318, (415) 351-5319, (415) 351-5320, (415) 351-5321, (415) 351-5322, (415) 351-5323, (415) 351-5324, (415) 351-5325, (415) 351-5326, (415) 351-5327, (415) 351-5328, (415) 351-5329, (415) 351-5330, (415) 351-5331, (415) 351-5332, (415) 351-5333, (415) 351-5334, (415) 351-5335, (415) 351-5336, (415) 351-5337, (415) 351-5338, (415) 351-5339, (415) 351-5340, (415) 351-5341, (415) 351-5342, (415) 351-5343, (415) 351-5344, (415) 351-5345, (415) 351-5346, (415) 351-5347, (415) 351-5348, (415) 351-5349, (415) 351-5350, (415) 351-5351, (415) 351-5352, (415) 351-5353, (415) 351-5354, (415) 351-5355, (415) 351-5356, (415) 351-5357, (415) 351-5358, (415) 351-5359, (415) 351-5360, (415) 351-5361, (415) 351-5362, (415) 351-5363, (415) 351-5364, (415) 351-5365, (415) 351-5366, (415) 351-5367, (415) 351-5368, (415) 351-5369, (415) 351-5370, (415) 351-5371, (415) 351-5372, (415) 351-5373, (415) 351-5374, (415) 351-5375, (415) 351-5376, (415) 351-5377, (415) 351-5378, (415) 351-5379, (415) 351-5380, (415) 351-5381, (415) 351-5382, (415) 351-5383, (415) 351-5384, (415) 351-5385, (415) 351-5386, (415) 351-5387, (415) 351-5388, (415) 351-5389, (415) 351-5390, (415) 351-5391, (415) 351-5392, (415) 351-5393, (415) 351-5394, (415) 351-5395, (415) 351-5396, (415) 351-5397, (415) 351-5398, (415) 351-5399, (415) 351-5400, (415) 351-5401, (415) 351-5402, (415) 351-5403, (415) 351-5404, (415) 351-5405, (415) 351-5406, (415) 351-5407, (415) 351-5408, (415) 351-5409, (415) 351-5410, (415) 351-5411, (415) 351-5412, (415) 351-5413, (415) 351-5414, (415) 351-5415, (415) 351-5416, (415) 351-5417, (415) 351-5418, (415) 351-5419, (415) 351-5420, (415) 351-5421, (415) 351-5422, (415) 351-5423, (415) 351-5424, (415) 351-5425, (415) 351-5426, (415) 351-5427, (415) 351-5428, (415) 351-5429, (415) 351-5430, (415) 351-5431, (415) 351-5432, (415) 351-5433, (415) 351-5434, (415) 351-5435, (415) 351-5436, (415) 351-5437, (415) 351-5438, (415) 351-5439, (415) 351-5440, (415) 351-5441, (415) 351-5442, (415) 351-5443, (415) 351-5444, (415) 351-5445, (415) 351-5446, (415) 351-5447, (415) 351-5448, (415) 351-5449, (415) 351-5450, (415) 351-5451, (415) 351-5452, (415) 351-5453, (415) 351-5454, (415) 351-5455, (415) 351-5456, (415) 351-5457, (415) 351-5458, (415) 351-5459, (415) 351-5460, (415) 351-5461, (415) 351-5462, (415) 351-5463, (415) 351-5464, (415) 351-5465, (415) 351-5466, (415) 351-5467, (415) 351-5468, (415) 351-5469, (415) 351-5470, (415) 351-5471, (415) 351-5472, (415) 351-5473, (415) 351-5474, (415) 351-5475, (415) 351-5476, (415) 351-5477, (415) 351-5478, (415) 351-5479, (415) 351-5480, (415) 351-5481, (415) 351-5482, (415) 351-5483, (415) 351-5484, (415) 351-5485, (415) 351-5486, (415) 351-5487, (415) 351-5488, (415) 351-5489, (415) 351-5490, (415) 351-5491, (415) 351-5492, (415) 351-5493, (415) 351-5494, (415) 351-5495, (415) 351-5496, (415) 351-5497, (415) 351-5498, (415) 351-5499, (415) 351-5500, (415) 351-5501, (415) 351-5502, (415) 351-5503, (415) 351-5504, (415) 351-5505, (415) 351-5506, (415) 351-5507, (415) 351-5508, (415) 351-5509, (415) 351-5510, (415) 351-5511, (415) 351-5512, (415) 351-5513, (415) 351-5514, (415) 351-5515, (415) 351-5516, (415) 351-5517, (415) 351-5518, (415) 351-5519, (415) 351-5520, (415) 351-5521, (415) 351-5522, (415) 351-5523, (415) 351-5524, (415) 351-5525, (415) 351-5526, (415) 351-5527, (415) 351-5528, (415) 351-5529, (415) 351-5530, (415) 351-5531, (415) 351-5532, (415) 351-5533, (415) 351-5534, (415) 351-5535, (415) 351-5536, (415) 351-5537, (415) 351-5538, (415) 351-5539, (415) 351-5540, (415) 351-5541, (415) 351-5542, (415) 351-5543, (415) 351-5544, (415) 351-5545, (415) 351-5546, (415) 351-5547, (415) 351-5548, (415) 351-5549, (415) 351-5550, (415) 351-5551, (415) 351-5552, (415) 351-5553, (415) 351-5554, (415) 351-5555, (415) 351-5556, (415) 351-5557, (415) 351-5558, (415) 351-5559, (415) 351-5560, (415) 351-5561, (415) 351-5562, (415) 351-5563, (415) 351-5564, (415) 351-5565, (415) 351-5566, (415) 351-5567, (415) 351-5568, (415) 351-5569, (415) 351-5570, (415) 351-5571, (415) 351-5572, (415) 351-5573, (415) 351-5574, (415) 351-5575, (415) 351-5576, (415) 351-5577, (415) 351-5578, (415) 351-5579, (415) 351-5580, (415) 351-5581, (415) 351-5582, (415) 351-5583, (415) 351-5584, (415) 351-5585, (415) 351-5586, (415) 351-5587, (415) 351-5588, (415) 351-5589, (415) 351-5590, (415) 351-5591, (415) 351-5592, (415) 351-5593, (415) 351-5594, (415) 351-5595, (415) 351-5596, (415) 351-5597, (415) 351-5598, (415) 351-5599, (415) 351-5600, (415) 351-5601, (415) 351-5602, (415) 351-5603, (415) 351-5604, (415) 351-5605, (415) 351-5606, (415) 351-5607, (415) 351-5608, (415) 351-5609, (415) 351-5610, (415) 351-5611, (415) 351-5612, (415) 351-5613, (415) 351-5614, (415) 351-5615, (415) 351-5616, (415) 351-5617, (415) 351-5618, (415) 351-5619, (415) 351-5620, (415) 351-5621, (415) 351-5622, (415) 351-5623, (415) 351-5624, (415) 351-5625, (415) 351-5626, (415) 351-5627, (415) 351-5628, (415) 351-5629, (415) 351-5630, (415) 351-5631, (415) 351-5632, (415) 351-5633, (415) 351-5634, (415) 351-5635, (415) 351-5636, (415) 351-5637, (415) 351-5638, (415) 351-5639, (415) 351-5640, (415) 351-5641, (415) 351-5642, (415) 351-5643, (415) 351-5644, (415) 351-5645, (415) 351-5646, (415) 351-5647, (415) 351-5648, (415) 351-5649, (415) 351-5650, (415) 351-5651, (415) 351-5652, (415) 351-5653, (415) 351-5654, (415) 351-5655, (415) 351-5656, (415) 351-5657, (415) 351-5658, (415) 351-5659, (415) 351-5660, (415) 351-5661, (415) 351-5662, (415) 351-5663, (415) 351-5664, (415) 351-5665, (415) 351-5666, (415) 351-5667, (415) 351-5668, (415) 351-5669, (415) 351-5670, (415) 351-5671, (415) 351-5672, (415) 351-5673, (415) 351-5674, (415) 351-5675, (415) 351-5676, (415) 351-5677, (415) 351-5678, (415) 351-5679, (415) 351-5680, (415) 351-5681, (415) 351-5682, (415) 351-5683, (415) 351-5684, (415) 351-5685, (415) 351-5686, (415) 351-5687, (415) 351-5688, (415) 351-5689, (415) 351-5690, (415) 351-5691, (415) 351-5692, (415) 351-5693, (415) 351-5694, (415) 351-5695, (415) 351-5696, (415) 351-5697, (415) 351-5698, (415) 351-5699, (415) 351-5700, (415) 351-5701, (415) 351-5702, (415) 351-5703, (415) 351-5704, (415) 351-5705, (415) 351-5706, (415) 351-5707, (415) 351-5708



Monolithic timer is a package of precision versatility

A precision timer that maintains constant timing periods from microseconds to hours is now available from National Semiconductor Corp. The LM122 is a monolithic IC with a host of features — some externally obvious, and some not — that give it great versatility.

For example, the LM122 has an internal voltage regulator. Besides freeing you from regulated supplies (the timer operates from unregulated supplies of 4.5V to 40V), and besides being brought out for use as a handy reference voltage for other-than-timing uses, the regulator helps make the timer immune to supply ripple and noise during the timing interval. Changes on the trigger input are also kept from influencing the timing interval, once it's initiated. This is a result of the timer's input structure, which reacts only to the rising edge of the initial trigger signal.

The internal regulator has yet another use. It acts as the reference for an internal divider that sets the timing period to one (external) RC. This means that if you could drive the divider from an external voltage source, you could alter the basic timing period. The LM122 lets you do exactly that, and the pin is labeled VADJ — it lets you adjust the threshold voltage at which the timer times out, with timing ratios of 50:1 easily reached.

And speaking of the 1-RC timing period: the LM122's comparator draws such a minute input current that you can set the timing period with a larger R and a smaller C than you're used to using. This means longer intervals



with a given-size capacitor, and less need for precision capacitors in setting longer intervals.

For timing periods less than 1ms long, there's a Boost terminal that lets you increase the comparator's operating current. Boost is recommended for intervals shorter than 1ms; its use lets the timer operate with excellent repeatability for intervals between 3 μ s and several hours in length.

The LM122's output is a floating, current-limited transistor. It can drive either ground-referred or supply referred loads of up to 40V and 50mA. Because of the floating output, the timer is ideally suited for use where an open collector or emitter is needed: interfacing; lamp or relay driving; signal conditioning; and so forth. And there's a Logic Reverse input that lets you program the output transistor to be either on or off during the timing period.

Besides being useful in a wide variety of timing applications, the LM122 lends itself to some rather offbeat applications — for a timer, that is — such as in interfacing higher-voltage supplies to 5V logic, or acting as a 5V, 1A switching regulator, or being used as a voltage comparator.

The LM122 is the military temperature-range version of the timer; industrial-range (LM222) and commercial-range (LM322) versions are also available. Packaging variations include a 14-lead molded DIP (LM322N), a 10-lead flat-pack (LM122F), and a 10-pin metal can (LM122H/222H/322H). And by the way: if you don't need the VADJ and Boost controls, check out National's LM2905/LM3905. It has all the advanced features of the LM122, less the two just mentioned, and it comes in an 8-lead, molded, mini DIP package. **Circle AM on Bingo Card**

2048-bit MOS dynamic shift registers: high-frequency operation, low dissipation

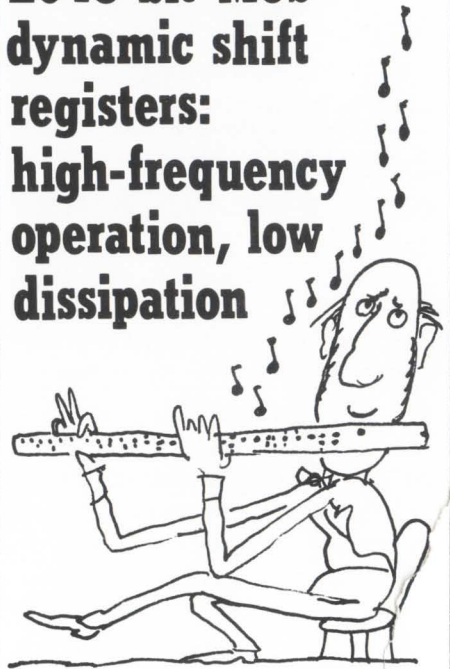

National Semiconductor adds three new circuits to its line of silicon-gate, P-channel products with the introduction of a 2048-bit and two dual 1024-bit shift registers. The new circuits will find wide application in, for example, buffer memories, as "silicon store" replacements for drum and disc memories, and in crt displays.

The MM5025, MM5026, and MM5027 all feature 6MHz operation (guaranteed), low power dissipation (120 μ W/bit at a 1MHz rate and 0°C, also guaranteed), and full bipolar compatibility (operation from -12V and +5V supplies). Clock capacitance is 190pF max., and the clock rate is half the data rate (this means that one data bit is entered for each phase-1 and phase-2 clock pulse).

The MM5025 (dual 1024-bits) and MM5027 (2048-bits) have on-chip logic to load and recirculate data, while the MM5026 (dual 1024-bits) has an individual logic-select line to load one of the two inputs on each of the 1024-bit registers.

The shift registers are available in both military (-55°C to +125°C) and commercial (0°C to +70°C) temperature-range versions, and in 8, 10, and 16-lead molded DIPs, 16-lead glass/metal DIPs, and a 14-lead flat-pack.

Circle AN on Bingo Card

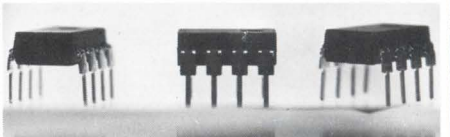



New guide details over 200 JFETs!

Here's a new, working guide to JFET selection that puts everything into focus for you. This hang-up-for-reference, six-page foldout lists all the more popular JFETs, which comprise about 40% of National's extensive line, and indicates both stock and preferred types.

It's a practical guide designed for rapid device selection. With it, you can quickly identify your needs in both standard and modified devices; and it will even help you standardize on parts.

A unique—and very useful—feature of the guide is the way in which the JFETs are broken out and grouped into major application areas. The guide begins, for example, with "General Purpose N-Channel Amplifiers," then comes a P-channel grouping, and so on. The major identified areas include ultra-low input current amplifiers, low-frequency/low-noise amplifiers, rf/vhf amps, vhf/uhf amps/mixers/oscillators, switches (P and N-channel); plus a number of applications groupings for duals (general purpose, low-frequency/low-noise, wide-band/low-noise, low-leakage/high CMRR/wide band, and replacement types).

Within each application area grouping, the units described are listed in a logical sequence based on a major spec of JFETs for that particular use (e.g., I_{DSS} for general purpose amps, $r_{ds(on)}$ for switching types, and so forth. In addition to the defining parameter, the guide charts all the major parameters for every device listed, and shows test conditions, min./max. limits, etc., etc. Also listed for every device is National's process number, so that you can determine relevant family types. Soon-to-be-available MIL JAN and TX JAN types are also indicated. And a separate section completely details all dimensioning of the various JFET packages available. **Circle AO on Bingo Card**

PROCESS-94 JFETs-- a combination of superior features



National Semiconductor's Process 94 describes a dual-JFET geometry and family that features extremely-high CMRR, super-low leakage, and wide-band performance.

The NDF9401-9410 series is what we're talking about. Minimum CMRRs are 100, 110, or 120dB, depending on the device; this means essentially zero error due to large common-mode input swings. Super-low leakage? Check out a spec of only 5pA max. I_G at $V_{DG} = 35V$; this easily beats other types, which may have nanoamp leakage at lower voltages. And with a C_{iss} of only 5pF max., this series has a figure of merit two to three-times higher than its competition.

Now, when you note that \bar{e}_n is in the same range as the best available low-noise FETs on the market today, and discover that this family has a glassivated monolithic construction—which means that you can operate them at high currents for wideband performance with no match deterioration—then you'll realize that the NDF9401 through NDF9410 are hard to beat.

Circle AP on Bingo Card

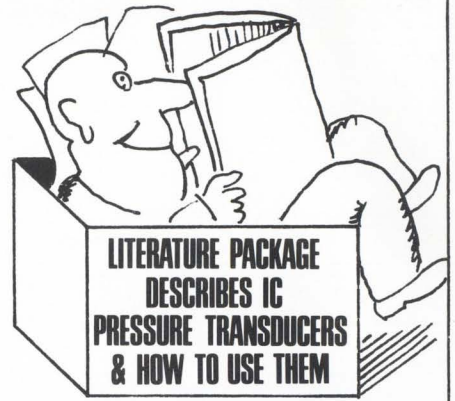

National Semiconductor has put together a literature package that describes its line of pressure transducers and tells you a great deal about their use.

Included are data sheet sets for the entire family—the LX1601A, G, and D through LX1704G; LX1610A, G, and D through LX1730A and G; and the LX2600G and D series (brand-new additions to the family). These data sheet sets give you complete electrical and mechanical specifications.

There are six application notes included with the package, and they describe the use of the transducers as, among other things, load cells and accelerometers. One note describes the use of the transducer, with additional electronics, to give a transponder a built-in altitude-reporting capability. And there are others: general transducer design information; installation ideas; transducers in fluid-flow applications; and so forth.

Eight transducer briefs also come with the package. These are one to two-page information sheets that spell out miscellaneous specific data pertaining to the transducers, such as operating-characteristic adjustments, certain options, sensor diaphragm life testing, and so on. **Circle AQ on Bingo Card**



Complete card and mail to:
NATIONAL SEMICONDUCTOR
 2900 Semiconductor Drive, Santa Clara, Ca. 95051
 Att: Marketing Services
 For FREE technical data,
 circle the numbers that correspond to the
 Bingo numbers at the bottom of the articles.

Please print clearly. This will be used as a mailing list.

NAME _____ TITLE _____

COMPANY _____

ADDRESS _____

CITY _____ STATE _____ ZIP _____



AA	AJ
AB	AK
AC	AL
AD	AM
AE	AN
AF	AO
AG	AP
AH	AQ
AI	

BINGO!

SECOND SOURCING FROM NS

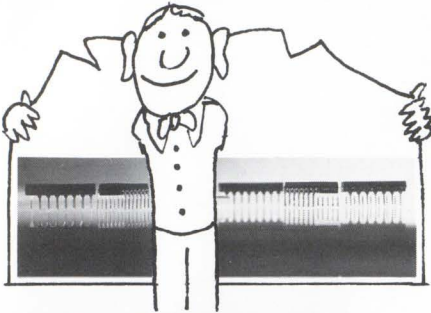

ADDITIONS TO THE 54/74 LINE:

National Semiconductor has added a number of second-source products to its already broad line of series-54/74 TTL. The newly-added products, all in the MSI area, are listed below:

- DM5414/DM7414 – Hex Schmitt trigger
- DM5485/DM7485 – 4-bit magnitude comparator
- DM54132/DM74132 – Quad Schmitt trigger
- DM54190/DM74190 – Up/down decade counter
- DM54191/DM74191 – Up/down binary counter
- DM54194/DM74194 – 4-bit left/right shift register
- DM54195/DM74195 – 4-bit shift register

All parts are immediately available.
Circle AG on Bingo Card



9300-series circuits list filling



All of the most popular 9300-series MSI circuits are now available from National Semiconductor. You can have these devices in both commercial (0°C to +70°C) and military (-55°C to +125°C) temperature-range versions, and in molded and ceramic DIPs, or in flat-packs.

National's line now consists of the following circuits:

- DM9300, 4-bit shift register;
- DM9301, BCD-to-decimal decoder;
- DM9309, dual 4-input multiplexer;
- DM9312, 8-input multiplexer;
- DM9322, quad 2-input multiplexer;
- DM9334, 8-bit addressable latch;
- DM9601, monostable multivibrator;
- DM9602, dual monostable multivibrator.

All of these circuits are immediately available.

The DM9334 8-bit addressable latch is a high-speed circuit for general purpose storage. It's multifunctional, and can store single line data in eight separate, addressable latches, or can act as a 1-of-8 decoder and demultiplexer. The DM9334 is easily expandable, and is TTL compatible.

Circle AH on Bingo Card

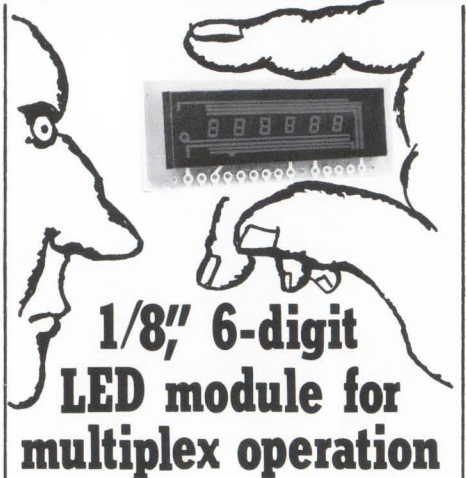
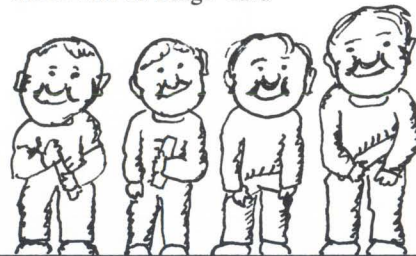

1/8" 6-digit LED module for multiplex operation

National's NSN66A, a six-digit common-cathode LED module, is now in production. A companion to the NSN98 described in the August Anthem, the new display is also designed for multiplex operation, and will find wide application in hand-held and desk-top calculators, data terminals, and digital equipment in general. Simple interface circuits let you use the display with DTL, TTL, or MOS drive circuits.

The package of the NSN66A, which has a red faceplate for excellent visual contrast and wide-angle readability, is designed for easy system incorporation. And because of its thin profile, the NSN66A allows a significant size reduction for high-density equipment.

Circle AI on Bingo Card

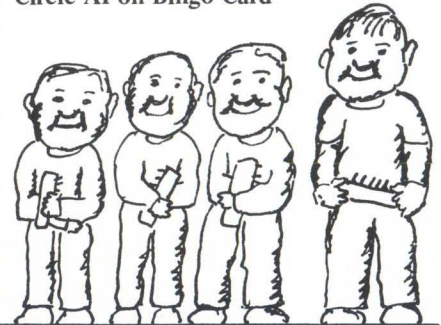

MOS static shift-register family grows and grows and g

The static shift-register line at National Semiconductor Corporation isn't static: it is growing, and now runs from 16 to 1024 bits. And these p-channel, silicon-gate products are available in a wide variety of configurations to satisfy a wide range of requirements. They're all TTL-compatible, too, including the clock, which needs only a single-phase input.

Bring yourself up-to-date: the MM5055 (quad 128-bits), MM5056 (dual 256-bits), and MM5057 (single 512-bits) have a newly-revised, complete data

sheet, which shows, for example, the temperature performance of both the military and the commercial parts. The MM5055/56/57 are now available in volume, a reflection of the increased acceptance of these parts.

Operation of the MM5055/56/57 is guaranteed to 2.2MHz (0°C to +70°C) and 1.6MHz (-55°C to +125°C). The circuits feature on-chip clock generation and internal recirculate.

The newest member of the static shift-register family is the MM5058. This 1024-bit part has all the general features

of the family (on-chip clock driver, -12V and +5V operation, full bipolar compatibility, and so forth), plus some niceties of its own. For example, the MM5058 has a "stream select" input that lets on-chip logic choose between two inputs, thus easing external recirculate operation. This register has a guaranteed high-frequency operation to 1.5MHz; and it dissipates 250µW/bit (typ.). The MM5058 comes in an 8-pin mini-DIP, and is equivalent to the Signetics 2533.

Circle AJ on Bingo Card

Programmable calculators fill middle spot for users



Computer Design Corp., 12401 W. Olympic Blvd., Los Angeles, Calif. 90064. (213) 478-9761. 325: under \$2000, 326: \$1195; 60 day.

The Compucorp 326 and 325 programmable calculators are low-cost units with capabilities that fall between sophisticated desk-top programmable calculators and the hand-held HP-65 from Hewlett-Packard.

The 325 and 326 are extremely easy to use. A straight algebraic keyboard entry allows equations to be keyed-in exactly as written, including four levels of nested parentheses.

The two units have similar capabilities, but the 325 is larger and includes a built-in alphanumeric printer. Both calculators come with an external digital cassette recorder as a standard feature. With the cassette, the 326 can handle over 120,000 program steps, and the 325 over 150,000. The 326, while not pocket-sized, can be held; it is 5.5 x 9 x 2 in. The 325 is 11.5 x 14 x 4.25 in.

The programming capability includes symbolic addressing, conditional and unconditional branching, jumping and full subroutine capability to six levels of nesting. In addition the calculators can modify their own programs.

The more than 100 pre-programmed functions include 48 metric conversions, basic arithme-

tic functions, exponentiation, logs, antilogs, different angle formats, conversion of degrees-minutes-seconds to decimal degrees and back, trigonometric functions, rectangular-polar conversion and statistical functions, such as mean and standard deviation.

In addition the calculators have a group of data-manipulation and register-arithmetic keys. Register arithmetic can be performed by use of the four basic functions and also a^x . Up to 12 storage registers are available for data manipulation.

The cassette recorder can work with the calculator, transferring data back and forth as an operating system. At any one time the Model 326 holds 160 program steps and the 325 holds 416.

Both calculators have 13-digit accuracy. Twelve-digit, gas-discharge displays offer commas. Both fixed and floating-point notation are available. If fixed is selected, the decimal-point setting is adjustable from zero to nine places. A dynamic range of 10^{-99} to 10^{99} can be displayed.

Self-testing is also a feature on both calculators. Four key strokes call for a diagnostic test of the entire calculator.

Booth No. 2123-2125

For Compucorp Circle No. 252

For Hewlett-Packard

Circle No. 253

Desk-top calculator does scientific routines



Litton Monroe, 550 Central Ave., Orange, N.J. 07051. (201) 673-6600. \$595; stock.

A desk-top calculator that combines algebraic and special function keys, the Model 1920, provides 18 hardwired engineering and scientific functions. The calculator also has 10 independent storage registers with full register arithmetic and features nested parenthesis to three levels. The scientific routines include rectangular-polar conversion, trigonometric calculations, logarithms, exponentiation and square roots. An unique planar display outputs a 10-digit mantissa for floating point display together with a signed 2-digit exponent. The entry register accommodates a 13-digit mantissa with sign and a signed 2-digit exponent.

Booth No. 2503, 2505, 2507

Circle No. 259

Calculators learn from magnetic cards

Victor Comptometer Corp., 3900 N. Rockwell St., Chicago, Ill. 60618. (312) 539-8200. From \$1000.

Magnetic library cards keep the books straight for users of the series 4000 programmable printing calculators. The four machines range in price from \$1000 to \$2000 and handle up to 1000 steps at a time—with the Model 4800. The number of data registers can range from four to over 100. Computer-like decision making capabilities permit symbolic jumps, loops and subroutines. A high-speed matrix printer prints up to five lines or 110 characters each second with 14-digit capacity. In order of increasing capability, the four models are: 4500 (no card reader), 4600, 4700 and 4800. Victor also provides an extensive library of scientific and business programs to support these machines.

Booth No. 2726-28 Circle No. 260

Give
your
sweep
and
signal
generators
a

boost

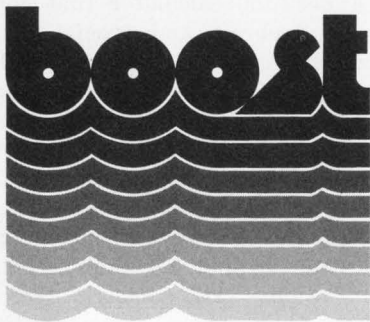

Our boost is a 2-500 MHz RF Power Amplifier, known as the Model 500L. This completely solid-state laboratory instrument will boost the output of any signal source by 27 dB and provide more than 11 volts P-P into 50 ohms. A combination of hybrid integrated circuits and microstrip construction, our state-of-the-art amplifier will operate into any load impedance (from an open to a short circuit) without oscillation or damage.

The boost. Priced at \$345, it's one of the great bargains of our time. Give yourself a boost by writing to Electronic Navigation Industries, Inc., 3000 Winton Road South, Rochester, New York 14623. For an even faster boost, call 716-473-6900, TELEX 97-8283.

ENI

ENI . . . The world's leader
in solid-state power amplifiers.

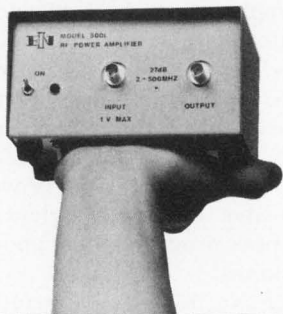

INFORMATION RETRIEVAL NUMBER 37

Calculator-instrument system offers flexible programming



Tektronix, Inc., P.O. Box 500, Beaverton, Ore. 97005. (503) 644-0161. P&A: See text.

Take a powerful desk-top calculator and add a mainframe that accepts a combination of plug-in digital counters and a digital multimeter. The result is a flexible calculator-based instrumentation system that can be programmed for a wide variety of applications.

The Tektronix 31/53 instrument system, based on the Model 31 calculator, is relatively inexpensive and extremely versatile. The calculator is cabled to a mainframe power source that contains an interface module.

The mainframe accepts a pair of TM500 instruments, but mainframes can be daisy-chained for up to 10 inputs.

Standard software comes with the 31/53 system for data acquisition and analysis, but most specific applications will require additional programming. The calculator is fairly easy to program, and user-defined overlays allow a custom-

ized system to be set up by the user.

Choice of input modules includes counters for up to 550 MHz, a universal counter that can be used to generate a timebase for other measurements, and a digital multimeter. The multimeter measures ac or dc voltage and current, resistance or temperature. The calculator also has a pair of TTL-level outputs that can be used to start a measurement cycle or to initialize a measurement circuit.

Accessories and options include the 4010 graphic terminal or the 4661 digital plotter for graphic output.

Previously most computer-based instrumentation systems were dedicated to a specific function: process control, machine monitoring or frequency measuring. These systems cost over \$10,000.

The basic 31/53 system costs \$3995. But you can get the 21/53 system, which uses the less powerful Model 21 calculator, for \$2895. Both are available from stock.

Booth No. 2326-39 Circle No. 250

There's no such thing as an "Augat-like" socket.



**Unretouched contact entries magnified 50X.*

Either it is...

or it isn't

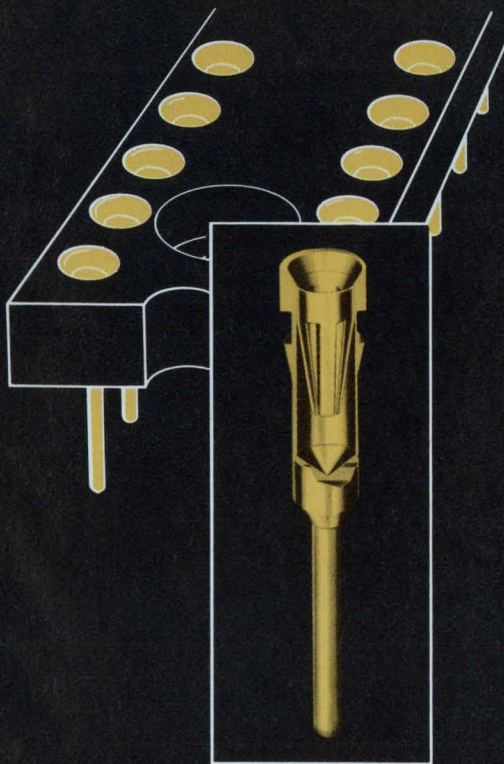

Lots of our competitors call their stamped contacts "Augat-like". But frankly they're not. Because no stamped contact can compare to the Augat machined assembly.

Look for yourself. Note how both the sleeve and contact of the 500 Series socket are precision-machined. Not stamped. Not formed. And how the contact is completely and uniformly covered with gold. Guaranteed .000030" minimum.

Augat's contact offers firm retention and excellent reliability for a wide range of lead sizes. Also, the wide-angle tapered entry makes IC insertion easier, faster and virtually error-free.

The extremely low profile 500 Series socket is available in sizes from 8 through 40 contacts, and features Augat's unique closed end sleeve that completely eliminates solder wicking problems.

So you see, there is no such thing as an "Augat-like" socket. The closer you look, the more you see why.

AUGAT® Augat Inc.
33 Perry Avenue
Attleboro, Mass. 02703
(617) 222-2202

Europe - Augat International, Inc., Boulevard A. Reyers, 103, 1040 Brussels, Belgium, Tel. (02) 36-93-99.

Japan - Kyokuto Boeki Kaisha Ltd., New Otemachi Bldg., 2-1, 2-Chome Otemachi, Chiyoda-Ku, Tokyo 100-91, Japan, Tel. (03) 244-3788.

1
 AMERICAN MADE
 Tolerance
SCHAUER
 1-Watt
ZENERS

**Immediate Shipment
 Low Prices**

ANY voltage from 2.0 to 16.0

Quantity	Price each
1-99	\$1.07
100-499	.97
500-999	.91
1000-4999	.86
5000 up	.82

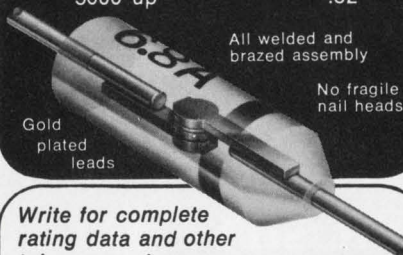

All welded and
 brazed assembly

No fragile
 nail heads

Gold
 plated
 leads

Write for complete
 rating data and other
 tolerance prices.

**Buy the kit-
 Save
 a lot**



Kit contains a 51-piece assortment of SCHAUER 1% tolerance 1-watt zeners covering the voltage range of 2.7 to 16.0. Three diodes of each voltage packaged in reusable poly bags. Stored in a handy file box. Contact your distributor or order direct.

A \$54.57 value for
ONLY \$24⁵⁰

Semiconductor Division

SCHAUER
 Manufacturing Corp.

4511 Alpine Ave. Cincinnati, Ohio 45242
 Telephone: 513/791-3030

INSTRUMENTATION

**Function generator offers
 ASCII programmability**

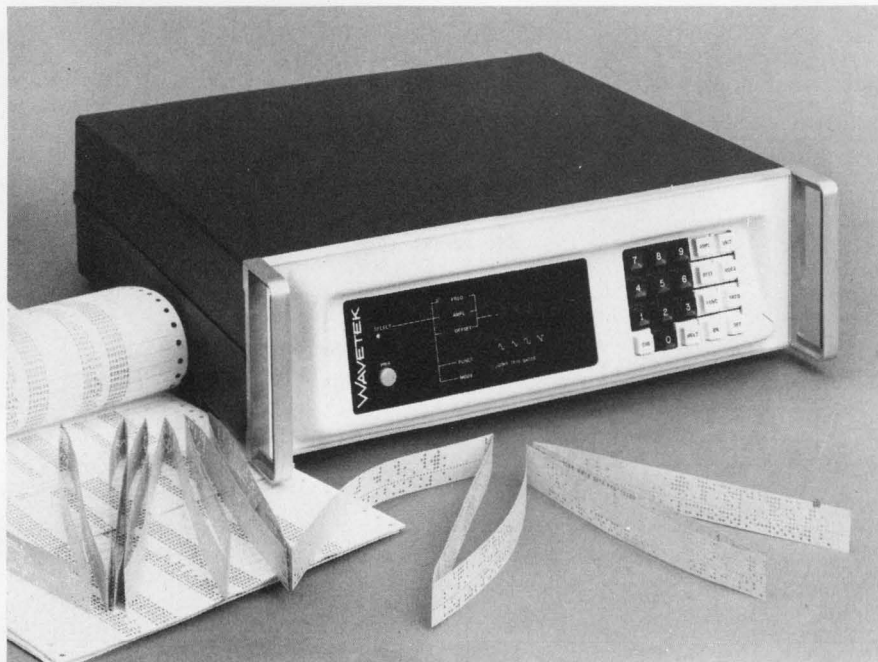

Wavetek, 9045 Balboa Ave., San Diego, Calif. 92123. (714) 279-2200. See text; 45 day.

Full ASCII programmability is available for the first time in a function generator. Produced by Wavetek and called the Model 159, the generator outputs sine, triangle and square waves in six basic ranges up to 3 MHz.

The generator does not have any dials or range switches. Frequency, amplitude, waveform, mode and dc offset are all determined by a keyboard entry. The result of each entry is shown on a LED display. Either keyboard or remote ASCII programming can be used.

When used in an automatic test system, the controller can lock out the keyboard so the unit is under total computer control. In addition the output can be disabled until the program is loaded, thus eliminating unwanted output transients during the program transition. The digital display can verify the data sent from the central processing unit.

The ASCII interface consists of 10 lines, as opposed to the 40 to

50 usually needed for BCD programming. Of the 10 lines, seven transmit an ASCII character, one strobes, one is the program common and one is the keyboard lock-out. The program input data lines can be driven directly from the I/O bus of most computers. With an optional TTY (RS 232) interface, a keyboard or CRT terminal can program the Model 159 function generator.

A ramp output is also available in five ranges up to 1 MHz. The output level is 10 V pk-to-pk into 50 Ω or 20 V pk-to-pk into an open circuit. An additional TTL sync pulse output is available, and all waveforms can be inverted. Resolution of range and frequency settings is three digits.

Continuous, triggered and gated modes of operation are provided. The frequency of the generator can also be controlled externally by an analog voltage. This provides dc programming for FSK or wideband ac modulation.

Stability of the generator over a 10-minute period is $\pm 0.05\%$,
(continued on p. 70)

Buying a function generator isn't a big deal.



Using one every day is!

Because there's not much difference in function generator prices, there is often a tendency to specify the "name" brand. But **handle-ability** can be an essential factor. When a basic signal-source goes into your lab, consider first the **day-to-day efficiency** of the instrument and **its effect on the real cost of ownership**.

For example, with sweep width a critical factor in testing network frequency response or developing a response plot, INTERSTATE's F34 allows you to precisely dial the controlled starting and end points. This, coupled with a Sweep Limit Indicator that won't let you dial an invalid output, puts it miles ahead of Wavetek's 134 for accuracy and ease-of-use.

This, and many other human engineering and price/performance differences that exist between the two function generators reflect INTERSTATE's continuing concern for the user, and are factually catalogued in our **FREE** specifier guide. Check the number below to receive it, or for more direct information, call John Norburg, (714) 772-2811.

**INTERSTATE
ELECTRONICS
CORPORATION**
Subsidiary of **A-T-O** Inc.



"THE \$495 COMPARISON:
INTERSTATE F34, WAVETEK 134 FUNCTION GENERATORS."

U.S. HEADQUARTERS: Dept. 7000, Box 3117, Anaheim, CA. 92803. **OVERSEAS SALES OFFICES:** AUSTRALIA, Parameters Pty., Ltd.; FINLAND, Havulinno Oy; FRANCE, Tekelec Airtronic, S.A.; ITALY, Tekelec Airtronic; ISRAEL, Radat International Company Ltd.; JAPAN, Asahi & Co., Ltd.; NETHERLANDS, Tekelec Airtronic, N.V.; NEW ZEALAND, David J. Reid, Ltd.; REPUBLIC OF CHINA, Bons International Co., Ltd.; SPAIN, Telco, S.L.; SWEDEN, M. Stenhardt AB.; SWITZERLAND, Traco Trading Co., Ltd.; UNITED KINGDOM, Euro Electronic Instruments, Ltd.; WEST GERMANY, Tekelec Airtronic GMBH; CANADA, Radionics Limited. **TWX U.S.A. 910-591-1197** **TELEX U.S.A. 655443 & 655419**

INFORMATION RETRIEVAL NUMBER 40

Be selective turn to **SERVO-TEK**

for superior quality products produced by efficient, modern manufacturing techniques. These products — Bi-Mode Servos, Control Meter Relay Systems, Adjustable-Speed Drives, Permanent-Magnet Servomotors, Speed Indicating Systems and Tachometer Generators — are products of proven design versatility and reliability. Turn to us for advice on your design problems and information on standard unit modifications too! Be selective.

FREE CATALOG of rotating components available.

SERVO-TEK[®]
PRODUCTS COMPANY

1086 Goffle Road
Hawthorne, NJ 07506
201-427-3100

Servo-Tek of California, Inc.
8155 Van Nuys Blvd.
Van Nuys, CA 91402
213-786-0690



INSTRUMENTATION

(continued from p. 68)

and over 24 hours it is $\pm 0.25\%$.

The generator may be used in either a bench-top or rack-mount configuration. It measures 17.25 × 5.25 × 17 in. and weighs 15 lb.

The 159 sells for \$1495. The Model 158, for remote use only, has no keyboard and costs \$1245. Optical isolation of the program lines is available for both models as an option at \$150. A TTY interface costs \$150. Special interfaces for the HP 2100 and the PDP-11 computers cost \$250 each. Booth No. 2231-2233

Circle No. 251

12-bit a/d plug-in samples at 2 MHz



Nicolet Instrument, 5225 Verona Rd., Madison, Wis. 53711. (608) 271-3333. \$2700; 120 days.

Model 93 is an a/d converter plug-in for the 1090 Digital Oscilloscope. The unit offers 12-bit resolution (one part in 4096) at a 2-MHz sampling rate. Each of the two inputs has its own digitizer, thereby maintaining bandwidth when two inputs are used. The 1090 offers mid-signal triggering, numerical display of any selected data point values, display expansion up to 64X on both axes, and the ability to store and simultaneously display up to four waveforms.

Booth No. 2616 Circle No. 261

A truly beautiful instrument cabinet

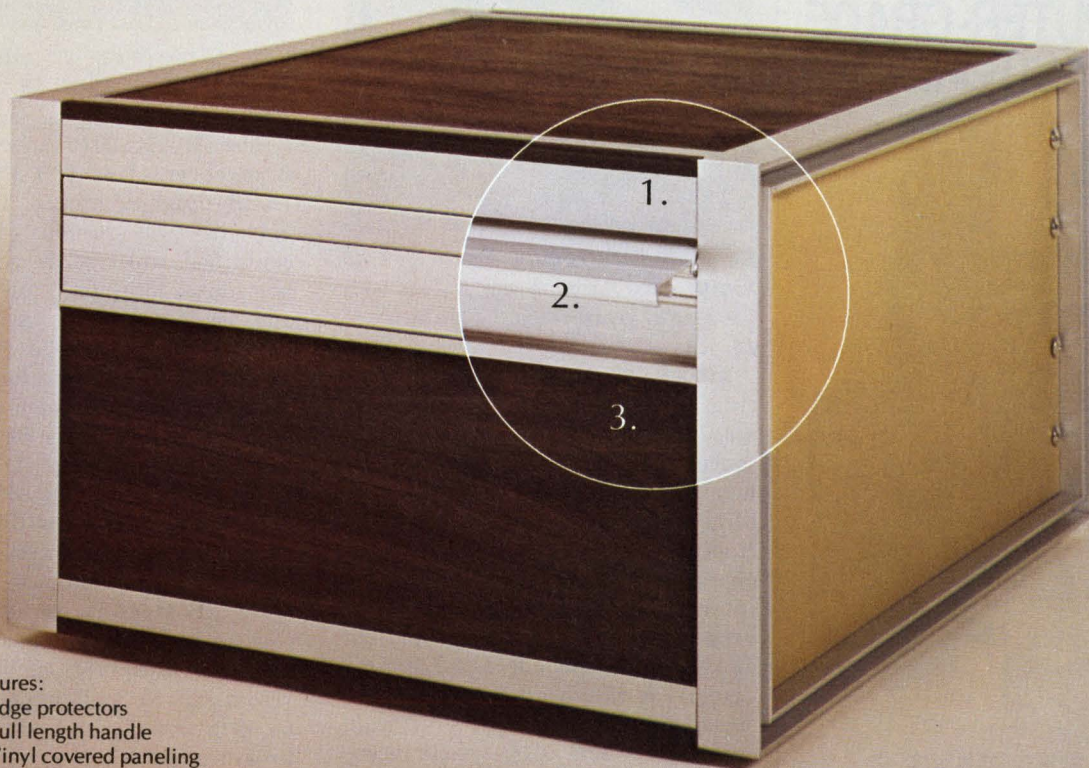

Features:

1. Edge protectors
2. Full length handle
3. Vinyl covered paneling
4. Any pie angle required
5. Panel mounting—horizontal, vertical, or in combination.
6. Economy in size modification—any direction
7. Heavy duty construction

Poly-Dimensional (P/D) Instrument Cabinet (Patents pending)

Cabinet appearance does create a strong impression on customers regarding the quality of the equipment mounted within it. That's why we've stressed design in our new P/D cabinet and backed it up with engineering features, flexibility and quality, making it a truly beautiful cabinet.

Its versatility is fantastic! In addition to the standard sizes, its structural design economically satisfies virtually any desired height, width or depth. Our pie section design allows angular

arrangements of any specified degree from 0° on. Its hinged handle is always the full depth of the cabinet for perfectly balanced lifting. And we haven't forgotten the "little" details either, like the edge protectors and vinyl covered paneling. Color selections are available for both paneling and anodized aluminum trim. Our distributors offer immediate delivery on conventional orders, while special sizes and colors require additional time. Contact us for your free catalog 400.



4.



5.



6.



7.



GENERAL ELECTRIC'S ELECTRIC'S 92F ADVANCED CAPABILITY COMPUTER-GRADE CAPACITOR...



Now! A highly reliable long life capacitor designed for applications requiring large amounts of ripple current at operating temperatures of 85 C and above. Ideal for power supplies, particularly the new switching mode types, energy storage and discharge, input filters for SCR power supplies . . . anywhere large amounts of ripple current are needed. Features include:

- 3,000 hour life rating at 85 C
- Ratings to maximum volt-microfarads per case size
- Capable of operating up to 125 C
- Standard screw-type terminal inserts
- Standard units available in 21 case sizes — over two hundred ratings

For more information on these, or any of General Electric's wide range of capacitors, call your nearest GE sales office today, or write Section 430-53, Schenectady, N. Y. 12345.

MAKE SOMETHING OUT OF IT!

GENERAL ELECTRIC

INFORMATION RETRIEVAL NUMBER 43

INSTRUMENTATION

Automatic bridge reads capacitance at 1 MHz



Boonton Electronics, Route 287 at Smith Rd., Parsippany, N.J. 07054. (201) 887-5110. \$4900 (tentative); 16 wk.

Model 76A uses internal computing to provide fully automatic and programmable 1-MHz capacitance and conductance measurements. Also available with a touch-of-a-button is the display of the change of capacitance or percent change of capacitance versus an internally stored reference, series or parallel resistance, dissipation, and Q. Specs include a 4-1/2-digit display, a range of 0 to 2000 pF, serial or parallel, ·2-pF full-scale sensitivity and 0.1% basic accuracy.

Booth No. 2619 Circle No. 262

AM/FM mod meter goes up to 1200 MHz



Marconi Instruments, 111 Cedar Lane, Englewood, N.J. 07631. (201) 567-0607. \$2650; stock.

Model 2300B measures FM deviation up to 500 kHz at carrier frequencies up to 1200 MHz, and AM depth up to 95% at carrier frequencies up to 400 MHz. Its wide range of deviation frequency, modulation bandwidth and carrier frequency make it particularly suitable for use with equipment for fixed and mobile communications, telemetry and multichannel links.

Booth Nos. 2711-7 Circle No. 263

Spectrum analyzer spans 1 to 300 MHz

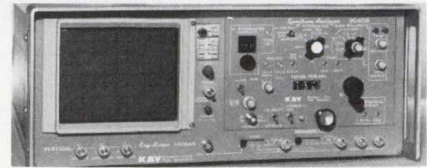

Kay Elemetrics, 12 Maple Ave., Pine Brook, N.J. 07058. (201) 227-2000.

The Model 9040 spectrum analyzer covers 1 to 300 MHz with a 72-dB dynamic range. It is available in two versions—as a self-contained unit, with vertical and horizontal outputs, for use with any oscilloscope—or as a plug-in module for the 9000 series Kay-Scopes. The unit provides continuously variable frequency spans in eight steps, over its 30 MHz/div. to 10 kHz/div. range. Display flatness is held to ± 1 dB over-all. Display modes are switchable from 10 dB/div. to 2 dB/div. The rf input level attenuator is calibrated in 10 dB steps up to 70 dB, while the i-f level control has 50 dB of variable attenuation. Frequency resolution is switchable (1 MHz, 60 kHz and 1 kHz). The analyzer provides spurious and intermod levels of greater than 65 dB down.

Booth Nos. 2312, 14, 16

Circle No. 264

2-to-30-MHz receiver shows ± 1 Hz stability



Raytheon Electromagnetic Systems Div., P.O. Box 1542, Goleta, Calif. 93017. (805) 967-5511. \$4475; 30 days.

This general-purpose communication receiver, Model 1230, is continuously tunable from 2 to 30 MHz. The instrument has digital afc referenced to a proportionally-controlled master oscillator, for a stability of ± 1 Hz at any frequency. Direct digital readout to the nearest hertz and tracked pre-selection are standard features. The unit provides FSK/SSB detection and has phase locked detectors on AM and FM.

Booth No. 2226 Circle No. 265

P&B... get the message?



Thousands of communications equipment designers do. They specify P&B relays in their products because reliability in communications is a must, and P&B relays have a reputation for long life.

Specifying P&B is easy. After all, P&B makes more different types of relays than anyone else. Electromechanical... reed... solid state/hybrid... solid state... time delay. As well as relays created specifically for a particular application. And even relay-oriented sub-assemblies custom produced to your requirements.

And, when relays do need to be replaced, identical-to-original relays can be obtained from the

broadest network of relay distributors in the country. Ours.

Our message is clear.

Whenever you need relays or design assistance concerning relays and assemblies employing relays, contact your P&B representative. He can also give you our free

226-page catalog. Or, write Potter & Brumfield Division of AMF Incorporated, Princeton, Indiana 47670. Telephone 812 385 5251.



Solving switching problems is what we're all about.



If the timing diagram says your logic should look like this...

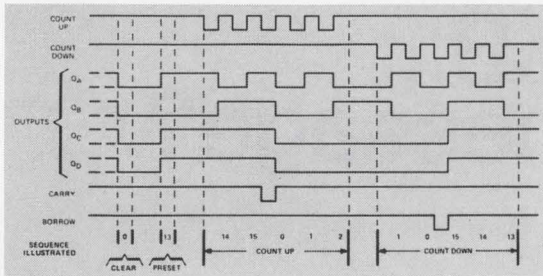

...now you can see if it does.

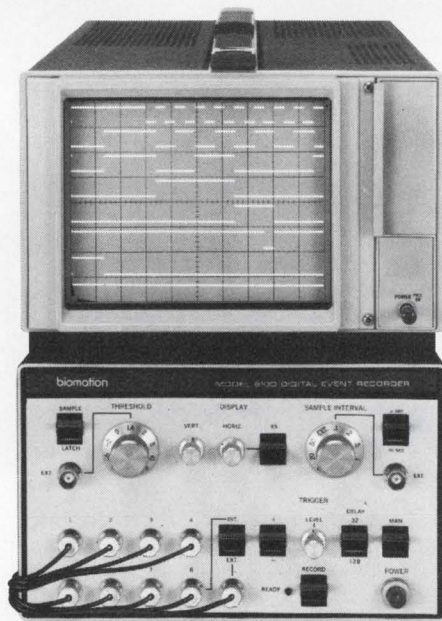

Introducing the Glitch Fixer: Biomation's new 810-D Digital Logic Recorder makes any scope a data stream display.

Analyzing a complex logic circuit—especially asynchronous logic—used to be a tough assignment. No longer. Not if you put Biomation's new Glitch Fixer—the 810-D Digital Logic Recorder—between your troubled circuit and any oscilloscope. It lets you record up to eight digital signals simultaneously. Presents them in the same format you're used to seeing on data sheets. And lets you expand the 250-bit data line (x5) to get a closer look at what you've got.

Best of all, it features an input latch that grabs hold of any random logic pulse—the glitch you're looking for—as narrow as 30 nanoseconds.

Here are some other features to mull

over: records 8 logic channels using 1 M Ω inputs selectable logic thresholds, including TTL and EIA levels synchronous clock input to 10 MHz or internal clocking selection from 20Hz to 10MHz storage of selected data ahead of trigger digital output for computer analysis or mass storage.

The Glitch Fixer is a new basic piece of diagnostic instrumentation designed for (and at the request of) logic circuit designers and troubleshooters. If you work with logic circuits, our 810-D Digital Logic Recorder will do the job. For \$1950 (without display). Get the product literature and see for yourself. Write, wire, or phone Biomation at 10411 Bubb Road, Cupertino, CA 95014, (408) 255-9500, TWX 910 338 0226.

biomation

"See us at IEEE Intercon Booth 2223-5"

INFORMATION RETRIEVAL NUMBER 45

INSTRUMENTATION

Variable persistence added to scope line

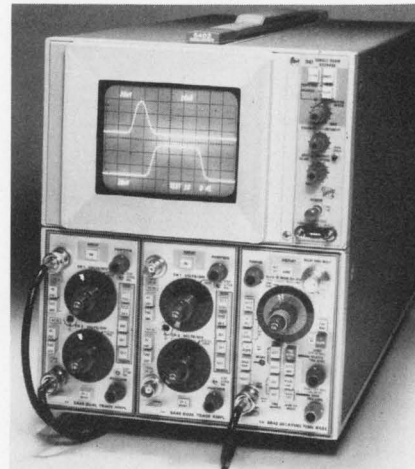

Tektronix, P.O. Box 500, Beaverton, Ore. 97005. (503) 644-0161. \$2275; 2 to 3 wk.

The 5403/D41 is a new 60-MHz variable-persistence storage unit for the company's 5000 series of plug-in oscilloscopes. For maximum writing speed, the unit provides an integrating or half-tone mode of operation, with writing speeds ranging from 0.1 div/ μ s and 5 minutes viewing time, up to 5 div/ μ s with 15 s viewing time. The trace can be stored for 5 minutes to an hour at a reduced brightness level. Erase time is 0.5 s.

Booth Nos. 2326-2339

Circle No. 266

50-MHz pulser delivers 20 V



Chronetics, 500 Nuber Ave., Mount Vernon, N.Y. 10551. (914) 699-4400. \$1450; 3 to 4 wk.

Model PG-14B 50-MHz Pulse Generator provides 0 to 20 V into 50 Ω , sufficient to drive MOS, CCD, CMOS, TTL and ECL logic. Specs include rise time as fast as 2 ns at 5 V, and baseline offset capability to 5 V. The unit allows control of input level, polarity, frequency pulse, duration pulse, delay from trigger to output pulse, double pulse, variable rise and fall time, variable amplitude, output polarity and output impedance.

Booth No. 2528

Circle No. 267

ACDC ANNOUNCES THE GRAND OPENING OF OUR NEW HIGH EFFICIENCY POWER SUPPLY.

We've opened it up to give you an inside look at things like the modular construction that adds to reliability and simplifies circuit check out...the low voltage drop, high speed rectifiers that combine the best elements of reliability, speed and low forward voltage drop...the low impedance output capacitors that reduce high frequency ripple to about 5mV peak-to-peak...and the sealed input EMI filter that minimizes conducted RFI.

These 20KHz inaudible switchers operate from 115/230VAC, 47-63Hz or from 150VDC with 70% efficiency and 0.1% regulation. (100VAC also available).

Overvoltage and overload protection is standard and EMI is minimized by shielding and filtering. (We even offer an optional built-in filter for compliance with Mil-Std 461, CE03). You get low inrush on turn on for soft start and can parallel up to six switchers in master-slave configuration.

There are 10 models in this new series. Five 300 watt models range from 5V at 60A to 24V at 14A. Five 500 watt models range from 5V at 100A to 24V at 23A. They're all in our new brochure. Just circle the reader service number and we'll get a copy to you right away. However, if you would like a copy of our 64-page catalog containing technical data on our complete line, fill out the coupon company letter-



Name

Company Name

Address

City

State

Zip Code

acdc electronics inc

Oceanside Industrial Center Oceanside, CA 92054 (714) 757-1880



**our products
are more fully
developed...**

Standard Condenser capacitors are indeed fully developed to produce the optimum in performance and durability. Standard is in one business only, the design and manufacture of the world's finest capacitors. We have designed and delivered thousands of specialized capacitors for industry. In fact, what you think of as "special" may be among the many designs already available from stock at Standard. However, if you require capacitors of unusual shape, size, value and material, our engineering department will help you design and produce them to your exact specifications at stock prices. For immediate action, send us a sketch and complete details.

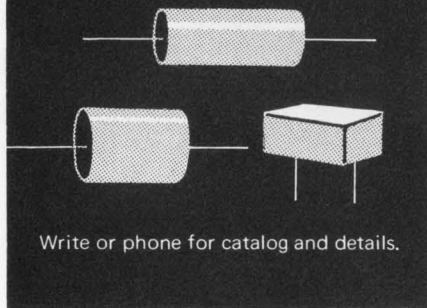

Write or phone for catalog and details.

Standard

CONDENSER CORPORATION

Dept. ED-3 1065 West Addison Street
Chicago, Illinois 60613 • (312) 327-5440

INFORMATION RETRIEVAL NUMBER 47

INSTRUMENTATION

**3-1/2-digit DMM
resolves 1 μ V**



Keithley Instruments, 28775 Aurora Rd., Cleveland, Ohio 44139. (216) 248-0400. \$995; 45 days.

Model 164 3-1/2-digit Digital Multimeter measures resistance over 13 decade ranges with an over-all sensitivity of 10 $\mu\Omega$ to 2000 M Ω using a dc constant-current method. The 28 ranges of the unit include a voltage span of 1 μ V to 1000 V dc, and over-all dc current sensitivity of 0.1 nA to 2 A. Other features include an analog output for recorder monitoring, 1000-V overload protection, 500-V floating capability, 80-dB normal-mode and 120-dB common-mode ac rejection, and 100% over-ranging on all ranges except the 1000-V range.

Booth Nos. 2309-2311

Circle No. 268

**Digital impedance meter
offers 0.25% accuracy**

Electro Scientific Industries, 13900 N.W. Science Park Dr., Portland, Ore. 97229. (503) 646-4141. \$990; stock to 60 days.

Model 251 Digital Impedance Meter makes rapid four-terminal measurements of L, R, C, and G with an accuracy of 0.25% plus 1 digit. Display is 3-1/2 digits. Lead resistance, leakage impedance, stray field effects and temperature and humidity problems are said to be eliminated through redundant circuitry. An external guard signal is available at the front panel. Only function and range need be set (one knob for both). Indicator lamps tell the operator at a glance which function is being used.

Booth No. 2108-2110

Circle No. 269

**Digital IC tester
costs just \$3500**

Teradyne, 183 Essex St., Boston, Mass. 02111. (617) 482-2700. \$3500; 4 wk.

J127 Accutest Circuit Analyzer evaluates digital ICs, as well as some linear devices and discrete components. It performs functional and parametric tests on combinatorial and sequential logic and has voltage and current ranges for testing TTL, DTL, MOS, CMOS and HTL devices. Major circuitry includes four constant-voltage supplies, a constant-current supply, a pulse generator, four dual-limit comparators, a 3-1/2-digit panel meter and a 24 \times 11 cross-point matrix.

Booth No. 2208

Circle No. 270

**Three plug-ins join
scope family**

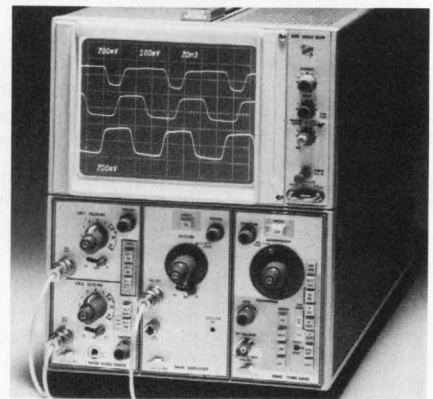

Tektronix, P.O. Box 500, Beaverton, Ore. 97005. (503) 644-0161. 5A38: \$350; 5A45: \$250; 5B40: \$275; 2 to 3 wk.

Two new amplifier plug-ins (5A38 and 5A45) and a new time-base plug-in (5B40) have been added to the company's 5400 Series Oscilloscopes. The 5A38 is a dual-trace amplifier with 35-MHz bandwidth and sensitivity from 10 mV/div to 10 V/div. Deflection-factor accuracy is 3%. The 5A45 Amplifier is a single-trace, 60-MHz unit with sensitivity settings ranging from 5 mV/div to 10 V/div. The 5B40 Time Base provides both sweep and an external amplifier. Sweep rate ranges from 5 sec/div to 10 ns/div and sweep accuracy is 3%. CRT READOUT capability is provided in all three plug-ins.

Booth Nos. 2326-2339

Circle No. 271



TOGGLE TERRITORY.

It's anywhere you are in the whole land.

It's anywhere you have to put your hands on exactly the right toggle switch to complete your design.

Especially if you need extraordinary design flexibility, distinctive appearance and proved performance in your toggle switches.

Cutler-Hammer not only provides the broadest line of toggle switches available, but offers you the greatest selection of ratings, terminations,

hardware, toggle shapes, materials and colors.

AC-rated. AC/DC. Low energy. Dry-circuit capability, or up to 25 amps. One, two and four poles. Select Cutler-Hammer Designer Line, miniature, slow-make/slow-break or hesitation switches from the complete Cutler-Hammer line. We have thousands of varieties ready for delivery. And if the toggle you need isn't among those thousands, we'll work with you to build exactly what you want.

You needn't look very far to get the finest quality in toggle switches. Wherever you are in the U.S.A., get the toggle you want. Because we cover Toggle Territory best. With

more distributors than anyone else. Call your Cutler-Hammer Sales Office or Stocking Distributor. Or write for full-line catalog LD-110A.

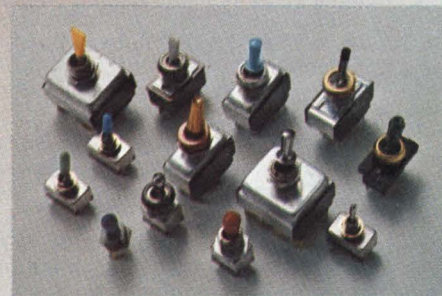

Switch
to No.1

More than just switches;
prompt availability,
field help, innovation,
quality assurance, too.

INFORMATION RETRIEVAL NUMBER 48



CUTLER-HAMMER
SPECIALTY PRODUCTS DIVISION, Milwaukee, Wis. 53201

PRINTED CIRCUIT RELAYS Without Socket or Soldering

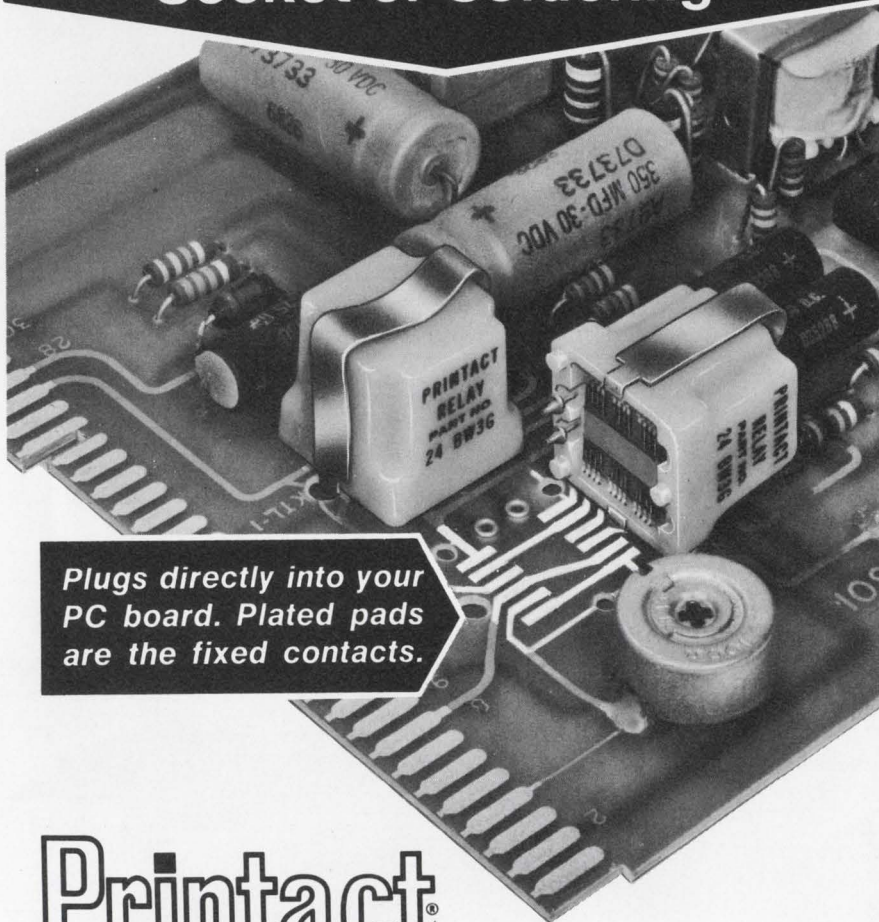

Plugs directly into your PC board. Plated pads are the fixed contacts.

Printact® MAGNETIC LATCHING AND NON-LATCHING RELAYS

Fully utilizing printed circuit technology Printact provides custom features. This compact low cost general purpose relay can be used in RF, Thermocouple and other specialized circuitry. The pivoting contact armature, hinged to a permanent magnet, is the only moving part. Elimination of pigtailed, return springs, and mechanical inter-connections assures long life and reliability for millions of cycles.

Relays with 6, 12, or 24 Vdc 500 mw coils have 2, 3, or 4 double break contact blades. Each blade can switch a form C or A and B in separate circuits, up to 2 amps. These small lightweight highly reliable Printact relays can save you space, time, money and manhours.

General purpose PC Boards for point-to-point wiring or solder-in mounting for multi-pole switching, cost less than plug-in sockets.

For a sample and catalog NOW write direct or call (212) EX 2-4800 for specs, design aids, and cost data on relays and PC boards.

Executone

/PRINTACT RELAY DIV., Box-1430ED, L.I. City, N. Y. 11101

INFORMATION RETRIEVAL NUMBER 49

Inherent Custom Features:

- **Low Thermal EMF**
Less than 2 micro-volts
- **Cross Talk Isolation**
70-50 db. over 50-500 Mhz
- **Characteristic Impedance**
75 ohms PC board pads
- **Low Contact Bounce**
Less than 0.5 ms
- **Bifurcated Blades**
Contact resistance stability
- **Encapsulated Coil**
Corrosion protection
- **Switching Versatility**
Blade functions as 2 poles
- **Plug-In Replacement**
Without solder or socket

PACKAGING & MATERIALS

Desolder system easy on PC-board material

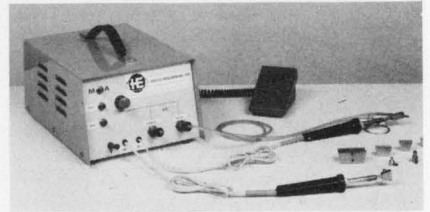

Hollis Engineering, Inc., Box 1189, Charron Ave., Nashua, N.H. 03060. (603) 889-1121. \$550; 4 wks.

Desoldering-deplugging tools that are slotted to focus heat on the soldered connections protect the board against blistering and measing. And these same slots absorb, by capillary action, excess solder that might form bridges. Hollis claims that the cavities never plug up and never require maintenance. Temperature is kept constant in both the desoldering and deplugging iron. Temperatures are carefully regulated just above the solder melting point to protect the laminate. For versatility, there's a choice of vacuum or blown air to deglaze holes. And a timer controls duration of air flow to keep excessive hot air off the sensitive walls of plated-through-holes. The desolderer comes complete with built-in air pump, desoldering iron with six standard tips, deplugging iron with three tips and a foot-pedal control for vacuum or blown air. Tips for TO-5, TO-18 and most DIPs are available from stock.

Booth No. 1527-29 Circle No. 272

Zig-zag pattern handles three voltage busses

Vector Electronic Co., Inc., 12460 Gladstone Ave., Sylmar, Calif. 91342. (213) 365-9661. \$12.95 (1-19); stock.

The heart of the 4066 board is two separate zig-zag patterns for V_{BB} and V_{EE} that are interleaved on the wiring side between up to 34 DIP positions. V_{CC} is a continuous ground plane on the component side. The over-all result is a consistent impedance from each plane to ground, and convenient pin connections to any of the three voltage planes, as may be required in ECL-10,000-series logic.

Booth No. 1221 Circle No. 273

When the questions are about enclosures, Optima has beautiful answers.

Whether packaging small, digital multimeters or a huge, communications center, you need enclosures with structural integrity, access, and versatility. Doing their job and doing it well.

How do you get them? Consider the alternatives... job shop?...in-house construction?... a manufacturer? To decide, it is important to ask the right questions and get the right answers.



Sales Appeal

The first ten seconds of display for an electronics unit focus simply on its style, color and finish. They won't break a sale—the equipment inside does that. But they can sure help make one.

- Is an industrial designer with packaging skills involved?
- Can you get the superior vinyl finishes so much in demand today? Or woodgrains? Or special textures?
- Is a total range of designer colors on hand?

Versatility

An important sales tool is the ability to adapt to the changing needs of a client.



The Optima Line

Our line of enclosures for electronics is the product of finding good answers to tough questions. Whether your question is component access, cooling, special applications or new product development and even safe shipping—we're ready!

Ready with Small Cases in 24 sizes from 133.6 to 1445.4 cubic inches; Instrument Cases and Racks in 124 sizes for 19- and 24-inch panels; Desk Consoles which are adaptable systems of instrument housing, counter and storage space; and the unique combination of chassis and case—Optima 17.

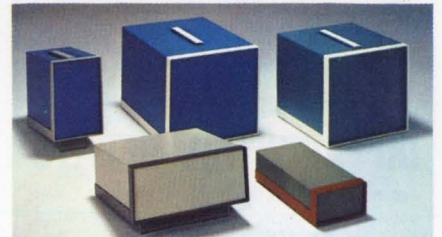

Computer scheduled manufacturing assures you of top quality control. We finish each unit inside and out with rugged vinyl and assemble them for final inspection—including most options and accessories—right at the plant.

Optima is the best answer. No question about that.

Write Optima Enclosures, 2166 Mountain Industrial Blvd., Tucker, Ga. 30084 or call (404) 939-6340.

OPTIMA

- Does a source offer hundreds of configurations to choose from? If, for instance, your client is thinking vertical rack, but wants the operator seated, can you offer a console-desk?
- Does a client need a ventilating grille? a blower? stabilizers? Wouldn't drawer slides help his operations? What about writing surfaces, storage areas, drawers, casters? Are they in production, on line and ready to go?

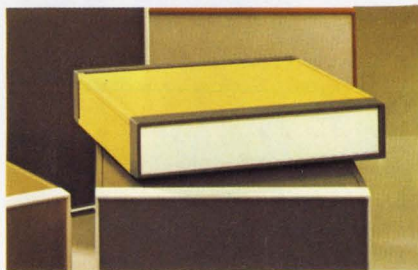

Customer Service

Are your own needs being served?

- Can you get personal service from engineers, designers, and production people?
- Can you get special applications assistance?
- Does your source have a knowledgeable customer-service representative?

AMPERITE

Thermostatic RELAYS - LONG DELAY -



240 & 300 Seconds

New! For applications requiring long delays. Hermetically sealed — not affected by altitude, moisture, or climate changes... **SPST only** — normally open or normally closed... Compensated for ambient temperature changes from -55° to $+80^{\circ}\text{C}$... **Rugged, explosion-proof, long-lived**... Standard radio octal base only.

Price, under \$6.00 ea.

Write for Bulletin No. LD-73.

DELAYS: 2 to 180 SECONDS*

Same rugged construction, hermetic sealing and stability as the long Delay Relays described above... For standard radio octal and 9-pin miniatures.

Price, standard or min., under \$4.00 ea.

*Miniatures delays: 2 to 120 seconds.

PROBLEM? Send for Bulletin No. TR-81.

All Amperite Delay Relays are recognized under component program of Underwriters' Laboratories, Inc. for all voltages up to and including 115V.

DIFFERENTIAL RELAYS

For automatic overload, over-voltage or under-voltage protection... Made only to specifications for 70V, 80V, 90V and 100V.

Price, under \$6.00 ea.

AMPERITE BALLAST REGULATORS

Automatically keeps current and voltage at a definite value. For AC or DC... Hermetically sealed, rugged, vibration-resistant, compact, most inexpensive.

Price, under \$3.00 ea.

Write for 4-p. Bulletin No. AB-51.

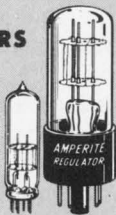

AMPERITE

600 PALISADE AVE., UNION CITY, N.J. 07087

Telephone: 201 UNION 4-9503

In Canada: Atlas Electronics, Ltd.,
50 Wingold Ave., Toronto 19

PACKAGING & MATERIALS

Heat sinks available in 24 sizes

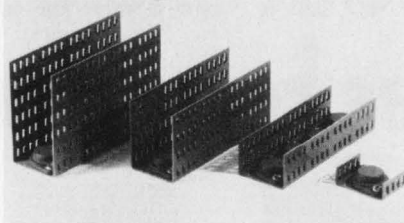

Aham, 968 W. Foothill Blvd., P.O. Box 909, Azusa, Calif. 91702. (213) 334-5135.

AHAM 300 series heat sinks come in 24 sizes. They can be ordered in multiples of 1.1 to 4.4-in. in length by multiples of 0.5 to 3-in. high. Their fin design takes advantage of the slightest air movement to increase heat transfer. At high velocities (500 ft³/min) the thermal resistance may drop by a factor of four over the values listed for natural convection. The 300 series of heat sinks is available with TO-3 or TO-66 hole patterns and with black-anodize, chemical-film or unfinished surfaces.

Booth No. 1516-18 Circle No. 274

Breadboarding socket uses ordinary wire

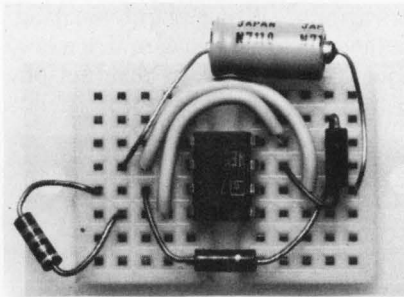

E&L Instruments Inc., 61 First St., Derby, Conn. 06418. (203) 735-8774.

The SK-20 solderless breadboarding socket handles all types of ICs, up to 16-pin, and all interconnections are made with ordinary 22-gauge solid wire. The components and wires simply plug into the socket with no soldering. All components are instantly reusable. The SK-20 uses nickel/silver terminals which maintain their contact characteristics beyond 10-million insertions.

Booth No. 1318-20 Circle No. 275

Test chambers occupy small floor space

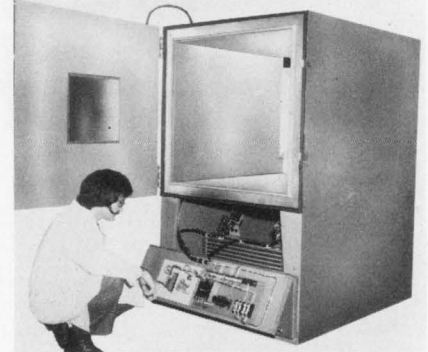

Tenney Engineering, Inc., 1090 Springfield Rd., Union, N.J. 07083. (201) 686-7870.

Available in five basic models, a new 30-ft³ line of environmental test chambers occupies only 45-in. wide and 63-in. deep floor space. All standard instruments and controls are on the front panel. These Tenney Thirties cover the dry bulb range from -100 to 350 F, and humidity models operate with controlled relative humidity between 20% and 98%. Temperature-control tolerances are as close as $\pm 1/2$ F and the units operate with low temperature gradients in the chamber.

Booth No. 2017 Circle No. 276

Captive screw assembly fits small panels

Southco, Inc., Industrial Highway, Lester, Pa. 19113. (215) 521-0800.

The new Southco No. 09 quick-opening captive-screw fastener fits small access panels. It has basically the same design as the larger Southco No. 12 and No. 17 fasteners. The 09 uses a square-threaded screw assembly that engages with a hardened-steel receptacle. The screw assembly is held captive with a special retainer in an oversized hole in the outer panel, and it floats to minimize alignment problems. The mating receptacle can be clipped, riveted or welded to the frame. The fastener is available in a variety of grip lengths to fit a wide combination of frame and panel thicknesses. Screw heads come in slotted, knurled or wing shapes.

Booth No. 1609-11 Circle No. 277

The first modular instrumentation calculator.

Just \$5905 as shown.

It's our 31/53 Calculator Instrumentation System

A powerful, yet inexpensive calculator combined with our TM 500 power supply and system software. You add the instrumentation modules you need. It's all there and it's portable. Now that's versatility!

With our 31 Calculator, you can read input from our DMM's and counters. You can log data selectively, calculate results and output data or trigger signals.

Programming? Little more than natural math. Go ahead, write your own. Also, our standard software gives you data logging (on the optional printer) and data capture on the 31 at operator selected intervals.

For numerical monitoring or

analysis, there's our 21/53 for \$2895 less plug-ins. And in case you wondered, our TM 500 plug-ins are less expensive, too.

Energy monitoring.

Quality control testing. Laboratory and production instrumentation.

The applications go on, and so does our system's potential. Just add the main-

frames and modules you need. We have a graphic calculator system, too. Let our sales engineer fill you in. Pick up your phone and call our nearest center. Or write

Tektronix, P.O. Box 500,
Beaverton, Oregon 97005

Our programmable calculators. Natural. Powerful. Significantly less expensive.



Programmable Op Amps for Solutions

HA-2720 Single Programmable Operational Amplifier

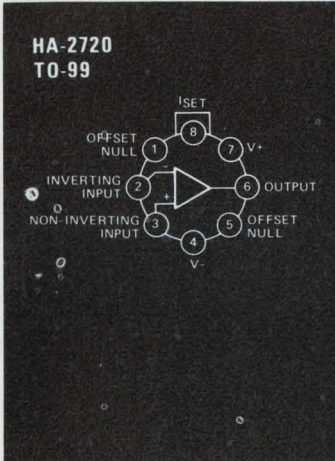

Slew Rate vs. Supply Current

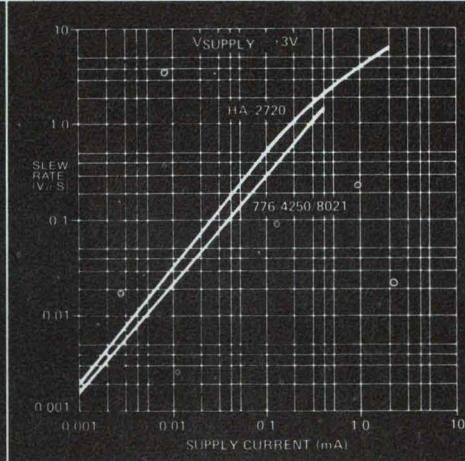

Output Current vs. Supply Current

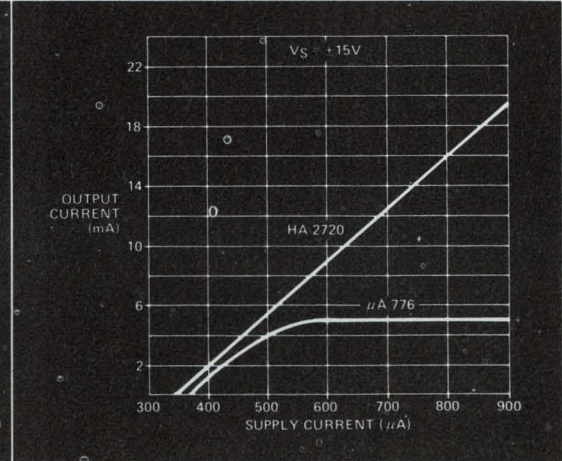

HA-2730 Dual Programmable Operational Amplifier

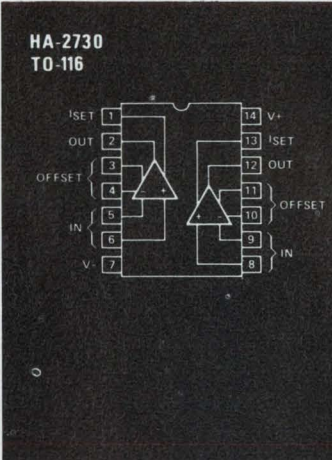

Gain Bandwidth Product vs. Supply Current

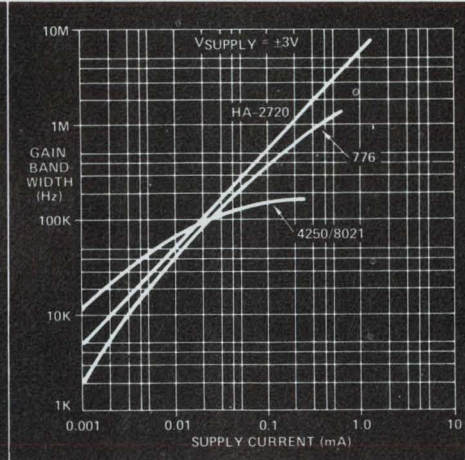

Input Noise Current vs. Supply Current

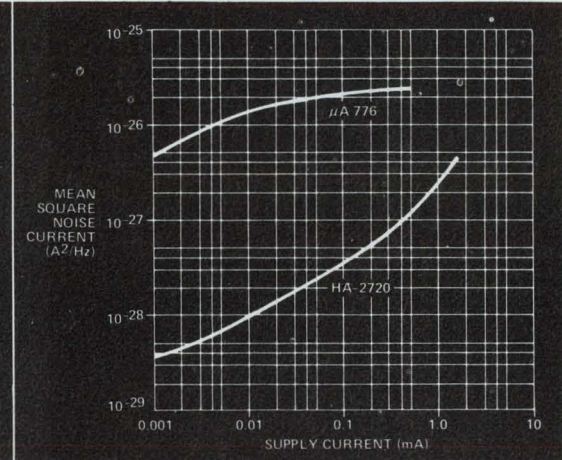

Above comparative data curves were experimentally derived or extrapolated from published data sheets where available.

Harris



HARRIS SEMICONDUCTOR
A DIVISION OF HARRIS-INTERTYPE CORPORATION

P.O. Box 883, Melbourne, Florida 32901
(305) 727-5430

WHERE TO BUY THEM: ARIZONA: Phoenix—Liberty, Weatherford, Scottsdale—HAR (602) 946-3556 CALIFORNIA: Anaheim—Weatherford, El Segundo—Liberty, Glendale—Weatherford, Long Beach—HAR (213) 426-7687; Mountain View—Elmar, Palo Alto—Weatherford, HAR (415) 964-6443; Pomona—Weatherford; San Diego—Liberty COLORADO: Denver—Elmar, Weatherford WASHINGTON, D.C.: HAR (202) 337-3170
FLORIDA: Hollywood—Schweber, Hamilton, Melbourne—HAR (305) 727-5430 GEORGIA: Atlanta—Schweber ILLINOIS: Chicago—Schweber Schaumburg—HAR (312) 894-8824; Schiller Park—Hamilton INDIANA: Indianapolis—Pioneer KANSAS: Lenexa—Hamilton MARYLAND: Baltimore—Hamilton, Rockville—Schweber MASSACHUSETTS: Lexington—R&D, Waltham—Schweber, Wellesley—HAR (617) 237-5430 MICHIGAN: Livonia—Hamilton, Troy—Schweber MINNESOTA: Edina—Hamilton, Minneapolis—Schweber, HAR (612) 432-6111 MISSOURI: Hazelwood—Hamilton NEW JERSEY: Cedar Grove—Hamilton, Mt. Laurel—Hamilton, Somerset—Schweber NEW MEXICO: Albuquerque—Weatherford NEW YORK: Melville—HAR (516) 249-4500; East Syracuse—Hamilton, Syracuse—HAR (315) 463-3373; Rochester—Schweber, Westbury—Schweber
NORTH CAROLINA: Raleigh—Schweber, OHIO: Beachwood—Schweber, Cleveland—Pioneer, Dayton—Pioneer, HAR (513) 226-0636 PENNSYLVANIA: Wayne—HAR (215) 687-6680 TEXAS: Dallas—Hamilton, Weatherford, HAR (214) 231-9031; Houston—Weatherford WASHINGTON: Seattle—Liberty, Weatherford.

LEGEND FOR HARRIS SALES OFFICES & DISTRIBUTORS: Harris Semiconductor (HAR); Elmar Electronics (Elmar); Hamilton Avnet Electronics (Hamilton); Harvey/R&D Electronics (R&D); Liberty Electronics (Liberty); Pioneer Standard Electronics (Pioneer); Schweber Electronics (Schweber); R.V. Weatherford Co. (Weatherford).

INFORMATION RETRIEVAL NUMBER 542



“CANNON® ZERO FORCE DL CONNECTORS GAVE OUR COSTS A CUT, and me a boost.”

**“Management wiggled
out at first.”**



“No wonder. I had just told them that Cannon’s rectangular DL rack and panel connector offered a 10,000 cycle life, instead of the 500 or less we’d had to live with. The order of magnitude difference was hard for them to believe.

“So I made it short and simple. The reason for the low wear, I said, is that the contacts don’t touch during mating. A quarter turn of the actuator knob cams the contacts and locks the connector together with no jack-

screws, and no problems.

“As usual someone brought up cost, but I cut him down by telling him that Cannon zero force DL’s cost less than other rectangular connectors.

**“Automatic termination
equipment that really
does a job.”**



“Then I showed them Cannon’s automatic strip-and-crimp machine. We just cut the wires to length — it strips the end and crimps on a contact. Takes jacketed cable too, which had been a headache for us.

“They bought the idea.

And Cannon zero force connectors. Then Cannon delivered, on time, on target price with the performance we needed. Our costs went down, and my future went up. So can yours. Just send for ‘Secrets of Connector Success’ — and save yourself some wear and tear.”

ITT Cannon Electric, International Telephone and Telegraph Corporation, 666 East Dyer Road, Santa Ana, CA 92702. (714) 557-4700.

“Give yourself a boost.”

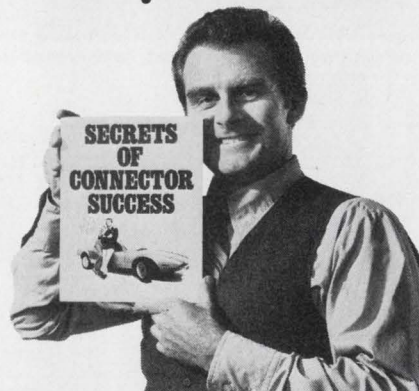

CANNON ITT

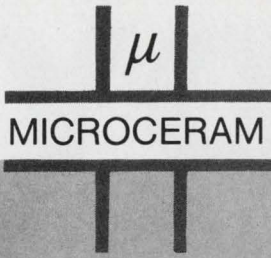

New from **JFD**

Porcelain Ceramic Multilayer Capacitors



for tough-to-crack microwave requirements

FEATURES

- High Q
- Excellent Microwave Performance
- High Temperature Stability
- High Power Capability
- Low Noise Figure
- High Voltage Stability
- Perfect Retrace Characteristic
- Impervious to Environmental Conditions
- No Drift
- Rugged to Thermal or Mechanical Shock and Vibration

OUTSTANDING ENVIRONMENTAL CHARACTERISTICS

- Hermetically sealed – impervious to moisture, solvents and other conditions.
- Temperature range of -55°C to + 125°C
- No measurable change in electrical characteristics at conclusion of two hour boiling salt water test.
- Meet Mil-C-11272B requirements with respect to: Shock, Vibration, Moisture Resistance, Solderability, Barometric Pressure, Temperature Cycling, Solder Immersion, and Salt Spray.

Got a tough microwave application?

Crack it with **our** nutcracker – the all new Microceram Porcelain Ceramic Multilayer Capacitor.

JFD Microcerams meet today's critical needs for precision ceramic capacitors that have extremely high Q's; solid stability with temperature, voltage or frequency; no aging or piezoelectric effects; excellent high power and low noise characteristics – plus imperviousness to environmental ambients.

Their very small size suits them perfectly for use in your miniature and hybrid microwave circuits. Microceram Capacitors are available in chip (0.110" x 0.100" x 0.100" maximum thickness); pellet (0.130" x 0.110" x 0.100" maximum thickness), and in a variety of leaded configurations.

Next time use **our** nutcracker – the Microceram. Write today for form 2153 to:

JFD Electronics Components Corporation
15th Avenue & 62nd Street
Brooklyn, New York 11219
212-331-1000



GET READY



In a few months *Electronic Design's Master Directory* — the GOLD BOOK — will be rolling off the presses and moving on to desks, lab benches, reference shelves, and information centers throughout the U.S. and Europe. It's the directory that will change your thinking about directories . . . the most massive compendium of product information ever compiled . . . a one-step reference source for the data you need to specify, select and buy.

Recognizing potential paper shortages, rising printing, postage and mailing costs, many manufacturers have taken action to be sure their catalog material will reach you no matter what happens. They're choosing the GOLD BOOK to be their personal industry representative.

CONTENTS INCLUDE:

- PRODUCT DIRECTORY (Lists the manufacturers of each product.)
- DIRECTORY OF MANUFACTURERS AND SALES OFFICES (Includes company profiles.)
- DIRECTORY OF DISTRIBUTORS
- DIRECTORY OF TRADE NAMES
- CATALOG DATA AND TECHNICAL INFORMATION SECTION (A massive compendium organized by product category.)

TO REACH FOR THE GOLD BOOK

Electronic Design's 1974 Master Directory

PRODUCT CATEGORIES

- | | | |
|---|---|---|
| 0100 Amplifiers | 1700 Engineering Aids (Copying Equipment, Drafting Equipment & Supplies) | 3100 Meters, Panel (Analog & Digital) |
| 0200 Audio Equipment | 1800 Environmental Testers & Chambers | 3200 Microwave, Radar Components/Accessories |
| 0300 Books | 1900 Fans, Blowers, Cooling Devices & Cooling Equipment | 3250 Microwave, Radar Systems & Subsystems |
| 0400 Cabinets, Chassis, Containers, Racks, etc. | 2000 Filters, Electrical | 3300 Motors, Rotating Components |
| 0500 Calculators | 2100 Function Modules | 3400 Multiple Products |
| 0600 Capacitors (Fixed & Variable) | 2200 Hardware and Panel Components (Non-Current Carrying) | 3500 Optoelectronic and Laser Components, Equipment & Systems (except Discrete LEDs and Displays) |
| 0700 Circuit Breakers, Fuses and Other Protective Devices | 2300 Inductors & Transformers (Fixed and Variable) | 3600 Panel Lamps, Discrete LEDs & Lampholders |
| 0800 Communications Equipment | 2400 Instruments, Measuring and Testing (except Panel Meters) | 3700 Power Supplies, Batteries |
| 0900 Computer Peripherals (including I/O Equipment, except Storage Equipment) | 2450 Instruments, Recording | 3800 Production Machinery & Automation Equipment |
| 0950 Computer Peripherals, Storage (including Disc, Drum and Tape Equipment) | 2470 Instruments, Signal Source | 3900 Relays & Solenoids |
| 1000 Computers and Data Handlers (except Peripherals) | 2500 Integrated Circuits (Monolithic), MSI, LSI | 4000 Resistors, Fixed |
| 1100 Connectors, Sockets, Terminals & Terminal Boards | 2560 Integrated Circuits, Hybrid | 4050 Resistors, Variable |
| 1200 Controls, Control Components & Control Systems | 2600 Keyboards & Keyswitches | 4100 Semiconductors, Discrete (except LEDs) |
| 3450 Corporate Profiles | 2700 Manufacturing, Subcontracting, Fabrication Services | 4200 Services (Engineering, Software, Timesharing, etc.) |
| 1300 Crystals, Oscillators, Timing Devices | 2800 Magnetic Components & Materials (except Memory) | 4300 Switches |
| 1400 Delay Lines | 2900 Materials, Chemicals and Printed Circuits, Fabricated & Non-Fabricated (except Magnetic) | 4400 Thermal Devices |
| 1500 Displays & Readouts (Alpha, Numeric & Graphic) | 3000 Memory Components, Equipment & Systems (except ICs and Peripherals like Discs, Drums, Tape Drives) | 4500 Tools, Soldering Supplies |
| 1600 Distributors | | 4600 Transducers |
| | | 4700 Tubes |
| | | 4800 Wire & Cable |

now 50 amps from the leader in 20kHz switching power supplies

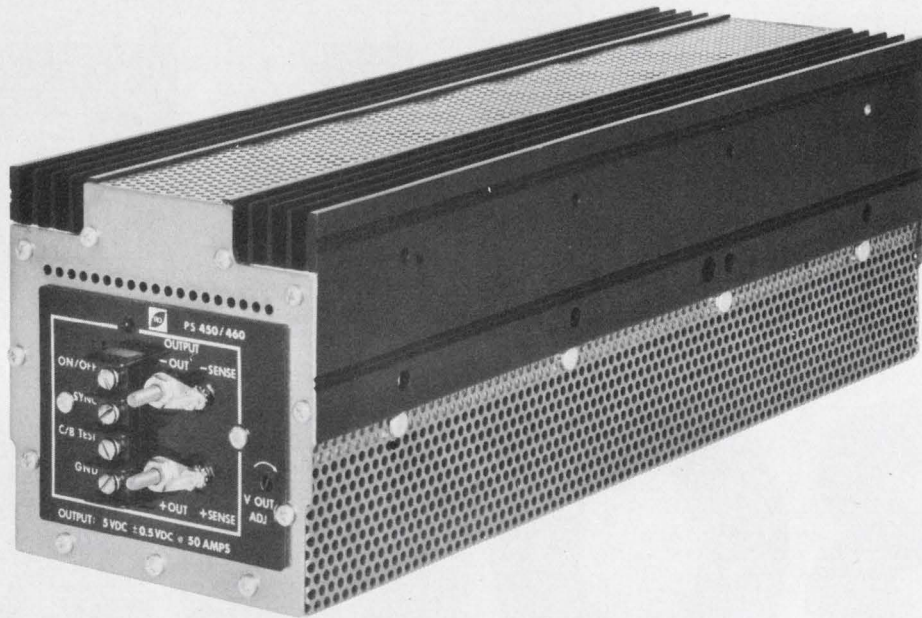

RO introduces its newest high efficiency 20 kHz switching power converters; series 400. It comes in 5V at 50 amps or other single or dual voltages up to 300 watts. Efficiencies are 65% at the 5V level and reach 80% at higher voltages. Inputs can be AC or DC. 48 VDC input is standard for the telecommunications industry. Units are parallelable without limit by simply strapping the outputs together.

This series is the latest in a line of 20 kHz converters that RO has produced over 6 years of from 5 to 300 watts. Over 20,000 units delivered in this period make us the leader in "switchers."

Write for complete catalog and specifications.



Right-angle adapters meet MIL specs

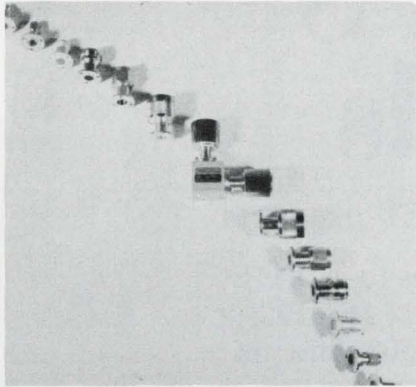

Alford Manufacturing, 120 Cross St., Winchester, Mass. 01890. (617) 729-8050.

The Type 4819 right-angle inter-series adapters operate over the frequency range of dc to 18 GHz, connector types permitting. They feature rugged construction, low SWR and several thousand different connector combinations. Connector types such as N, BNC, TNC, SMA, C and SC provide conformity to MIL-C-39012, while connectors such as EWN, EWSC and EWTNC provide conformity to MIL-T-81490.

Booth No. 2536 Circle No. 278

Delay line provides 1.5 to 5.5 μ s delays

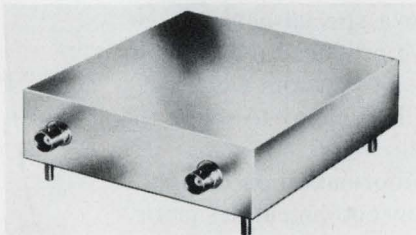

Allen Avionics, 224 E. 2nd St., Mineola, N.Y. 11501. (516) 248-8080. 2 to 3 wk.

High time-delays modules are available with delays from 1.5 to 5.5 μ s with rise time ratios of 40/1 and 50/1. Line impedance is 100 Ω . The operating range is from -55 to +105 C. The temperature coefficient over this range is 100 ppm/ $^{\circ}$ C. Units are packaged in metal cans and supplied with two BNC connectors and four mounting studs. Size is from 3 x 4.5 x 1.5 in. to 5 x 6.5 x 1.5 in.

Booth No. 1321 Circle No. 279



We can deliver the world's smallest 180° air variable capacitors. On time.

And since we're nice people, we don't even charge much for them. So if you have an application that calls for a sub-miniature capacitor that you can "tweak" to a specific frequency, these Johnson trimmers are ideal.

You can choose from either PC or stripline mount, either vertical or horizontal tuning. These Type "T" capacitors are about one-third the size of the familiar type "U" capacitors, so you can save space, cut costs and insure improved performance in the most compact electronic equipment.

Rotors and stators are precision-machined from solid brass extrusions, resulting in exceptional stability and uniformity. High Q—typically 2000 at 150 MHz. Temperature coefficient is a low plus 30 \pm 15 ppm/ $^{\circ}$ C. High torque (1½ to 8 oz./inches) holds rotor securely under vibration. They're designed to meet or exceed EIA-RS 204 and MIL Standard 202C Methods 204A and 201A.

In short, these capacitors may be just what you've been looking for. It'll only cost you a stamp to get more information. And if you give us your phone number, we'll call you and send free samples after we have clarified your application.

E. F. JOHNSON COMPANY
3005 Tenth Ave. S.W. / Waseca, MN. 56093

- Please send me technical information on the type T.
 - Also, include information on your entire line of variable capacitors.
 - I want test samples. Please call me at _____
- NAME _____
TITLE _____
FIRM _____



ADDRESS _____
CITY _____ STATE _____ ZIP _____

E. F. JOHNSON COMPANY

FET CHIPS For Hybrids

from the industry leader in high-quality FET products

When your hybrid design calls for FET chips to a JEDEC specification, your first choice should be Siliconix JEDEC-equivalent dice. You can select from more than 500 different JEDEC-type FET chips, all manufactured with the same meticulous attention to product quality which has made Siliconix a byword in the industry.

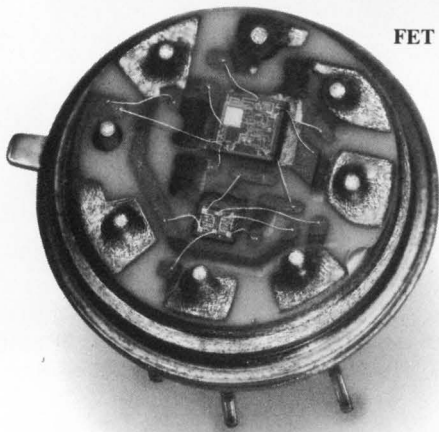

FET Input Op Amp

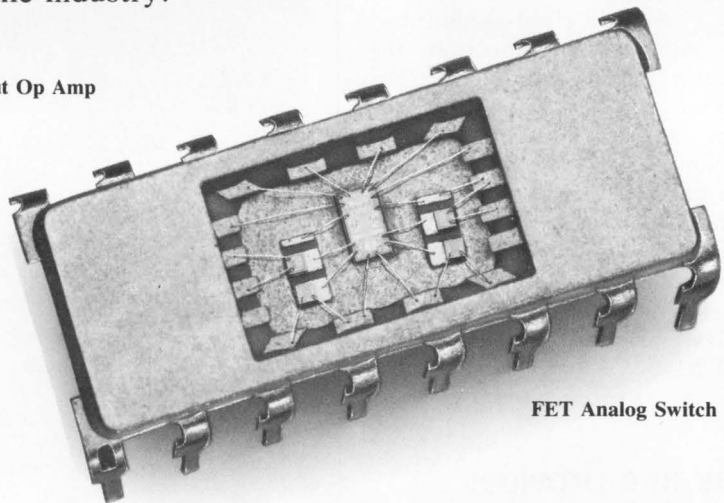

FET Analog Switch

All standard Siliconix FET chips are equivalent to their JEDEC or house-numbered parents on *all testable parameters*. We have hundreds of JEDEC and house-numbered parts in our product line. To specify a JEDEC-equivalent chip simply add the suffix "CHP," as in 2N4416 (JEDEC registration) = 2N4416CHP (chip form). When

your design calls for a special device, remember that we've produced over 4000 different FETs sorted to custom electrical specifications—We'll be happy to select to your individual requirements.

For additional information on chips recommended for new equipment design or replacement service, plus a list of tested parameters and test conditions

write for data

FET Applications Engineering (408) 246-8000, Ext. 120



Siliconix incorporated

2201 Laurelwood Road, Santa Clara, California 95054

INFORMATION RETRIEVAL NUMBER 53

It's going to get tougher

For many months now, things have been easy. Most companies in our industry could sell anything they could make. The problem was making things fast enough. Users weren't fussy. And the world market welcomed American goods because dollars were cheap.

That situation is changing. The dollar's value is going up again, relative to the major currencies. To buy U.S. products, the Japanese will need more yen, the British more pounds and the French more francs. The electronic goods of the United States are becoming less competitive. So it's going to be tougher for Americans to compete abroad. And that's just the beginning. The energy shortage, whether natural or manufactured to serve special interests, is real. As long as it lasts, it will reach into every phase of our industry. We won't be able to take for granted the electricity we need to power our furnaces, turn our drill presses and heat our soldering equipment.

Products we've always taken for granted are going to be tougher to get. It won't be easy to pick up the aluminum and steel we may need for our chassis. We'll have to wait for the plastics we need to encapsulate our circuits, insulate our wire and support the etched foil in our printed circuits. There will be shortages, bad shortages of every component and every piece of equipment that depends on the use of electricity, plastics and metal raw materials. That leaves out just about nothing. The challenges, then, are probably the most severe that engineers have ever faced. Reduced to a ridiculous extreme, we've got to design products that give a lot of performance so people will want them, that don't use any components so we'll be able to make them. And we've got to design them for low cost, so people will be able to buy them.

Of course, that's extreme. Energy and the parts derived from energy are in short supply; they haven't disappeared. So our real challenge will be to plan—and plan very far ahead. We'll have to learn how to cope with immediate shortages and how to cope with shortages that pop up later when we don't expect them. We'll have to learn how to make substitutions. We'll have to learn how to compromise—how to accept a less than optimum design that uses parts we can get. We'll have to forget our beautiful design that can't be produced because the parts aren't available.

If we are to survive this period in history, we'll have to learn these new disciplines. When the shortages go away—as they will—we'll be better engineers for what we've learned in coping with them.

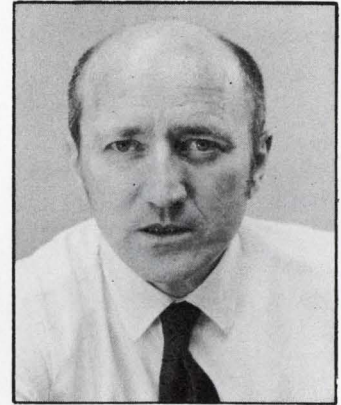

George Rostky

GEORGE ROSTKY
Editor-in-Chief



Bern Golbeck's nifty idea gave a crisp new feel to rotary switches.

A few years back, Oak's Director of Engineering, Bern Golbeck, had a hunch. Use two ball bearings instead of one, and let them index a simple starwheel. This would give crisp detenting while greatly reducing the wear on any single moving part.

It worked. The two ball bearings, controlled by flat springs, travel independently over notches in the starwheel. Detenting is smooth, even and sure.

Positioning is precise. And it gives a crisp, uniform feel that you're sure to recognize.

We call this fancy detent system Unidex,[®] and it's just one of many improvements Oak engineers like Bern have pioneered. Since Unidex, we've added molded rotors and molded sections to our rotaries—innovations that are now benchmarks of the industry. And today we're busy incorporating PC board mountings into almost all our switch designs for the quickest and simplest installation possible.

We think you and the people who use your products will notice the difference great ideas like Unidex make. Just try, for example, the storage select switch on an IBM System/370 Model 145 operator's console. Or the sweep selector on a new Hewlett-Packard 1220A oscilloscope. You'll feel it.

While you're at it, write Dave Clifton at Oak. He'll send you free literature detailing the broadest line of quality rotaries in the industry. And he'll pass along some of Bern's helpful ideas on how to choose the right rotary switch for your job.

DAK Industries Inc.

SWITCH DIVISION / CRYSTAL LAKE, ILLINOIS 60014
TELEPHONE: 815 • 459 • 5000 ■ TWX: 910 • 634 • 3353 ■ TELEX: 72 • 2447

“Nice going Bern”

FOCUS on CMOS

Designers of low-power logic systems really don't think twice about which technology to use. Complementary MOS (CMOS) offers the best combination of features. It has very low power dissipation, very high noise immunity and good switching speeds. Moreover standard CMOS ICs are available from a growing number of manufacturers.

But choosing the right CMOS circuits is another matter. Competing circuits all offer the basic advantages of CMOS. However some offer increased speeds, others provide improved capability, and still others offer pinouts compatible with TTL. In addition the problem of selection may be compounded by incomplete or misleading specifications.

4000 series—first in CMOS

By far the most popular CMOS family is the 4000 series, introduced by RCA in 1968. It contains a very wide selection of circuits and has more alternate sources than any other logic family, bipolar or MOS. But compared with other lines, the 4000 series has a disadvantage: non-uniform specifications. For example, system speed and output drive can vary by at least a factor of three from circuit to circuit.

However the 4000 series has been around long enough for most designers to know how to use the circuits. Also, extensive education in the circuits' use continues through applications material and seminars.

The leading alternative to the 4000 series is the 54C/74C family introduced by National Semiconductor. Both the 4000 and 54C/74C circuits use standard metal-gate fabrication techniques and silicon substrates. Consequently they have comparable performance characteristics.

Edward A. Torrero
Associate Editor



Motorola offers a wide selection of circuits and components for time-keeping applications. In analog watches, CMOS circuits obtain a stable time base with a crystal and provide the drive for the hands on the face.

But unlike the 4000 units, 54C/74C ICs—promoted as the CMOS logic counterpart of 7400-TTL circuits—exhibit the same key interface characteristics of equivalent TTL units. Pinouts are the same, too. Hence designers familiar with popular TTL circuits can transfer that experience to a 54C/74C design.

Critics of the 54C/74C family say that the line does not offer the more complex circuits that CMOS designers are beginning to seek. Much of the 54C/74C series consists of small-scale ICs. However the acceptance of the series, as measured by the number of alternate sources, seems to be on the upswing.

Several manufacturers are introducing proprietary 4000-type ICs to answer the call for more complex CMOS circuits. For example, Motorola in its 14500 series is offering a growing number of MSI functions.

■ *Harris DI/CMOS HD-4000 series* uses dielectric-isolation techniques to obtain a 2:1 improvement in speed over 4000 counterparts.

■ *Inselek's SOS/CMOS series* exploits silicon-on-sapphire technology to achieve speeds up to 20 MHz.

Still other alternatives involve silicon-gate and ion-implant processes to achieve benefits like improved speeds, lowered thresholds and increased circuit densities. Products using these processes are available. However, much of this activity is associated with custom LSI circuits.

Specs may mislead

Ideally one should be able to select CMOS ICs on the basis of published data. But unfortunately, specs don't always provide the information you need, and sometimes they can be misleading.

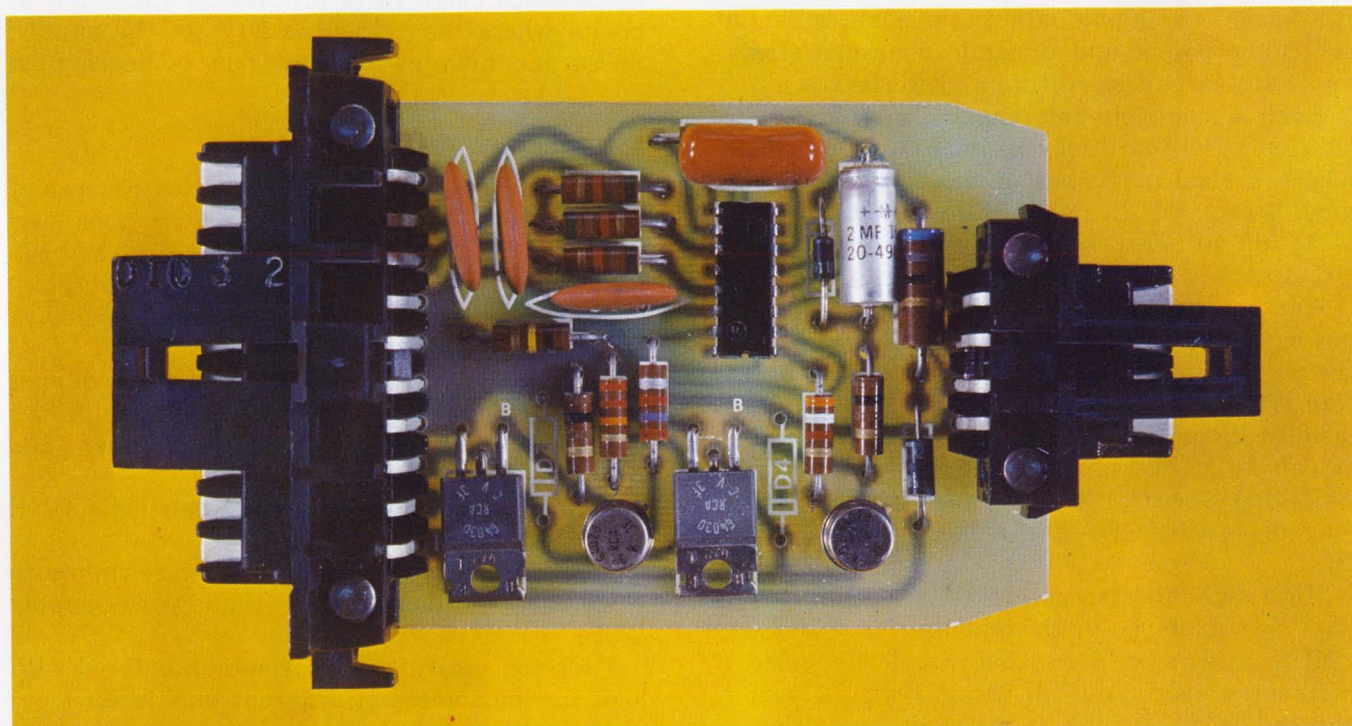

RCA's circuits are used in automotive applications, as in this interlocking module for a Fisher Body seat belt.

These applications exploit the ability of CMOS to tolerate a wide range of supply voltages.

While 54C/74C ICs are designed for TTL sockets, other alternatives to the leading series stay with the 4000-series pinouts. These circuits are sole-source lines offered by Fairchild, Harris and Inselek, and they permit upgrading of existing 4000-circuit designs. Improved performance results from the manufacturers' use of either isolation techniques with silicon substrates or silicon-on-sapphire fabrication methods.

Here are the lines and their major advantages:

■ *Fairchild F34000 series* features Isoplanar-C fabrication to produce denser circuits with higher drive capabilities than equivalent 4000 ICs.

For example, virtually all CMOS spec sheets claim TTL compatibility. But don't expect many CMOS circuits to drive TTL loads—most don't. The term refers primarily to the fact that both CMOS and TTL can operate from a common 5-V power supply. But a high sink current for CMOS is often barely sufficient to drive a standard TTL load.

Of course, high-current CMOS buffers are available to drive TTL loads. But in some circuits—the 4009 hex buffer, for example—the output device on the chip can produce currents high enough to cause power dissipations beyond the

absolute rating. You have to limit the current to safe levels.

Sometimes even TTL voltage compatibility may not be a precise description for circuits promoted as TTL-compatible. In some cases a careful check of the data sheets reveals that logic interface levels are not those needed for compatibility.

Other circuits do not offer direct TTL compatibility but do promise low-power operation. However, to obtain compatibility, the designer must connect an external resistor from the IC input terminals to the supply. The power required by the resistors can easily exceed that of the circuit, so that the total power drain becomes much larger than expected.

Some CMOS circuits claim complete TTL equivalence, and back it up with a formidable listing of comparative specs. But circuit "equivalence" does not mean interchangeability of parts. Differences between the CMOS and TTL ICs—such as input/output impedances, input switching points and dynamic characteristics—make any circuit substitution very risky.

Even a complete interchange, circuit by circuit, on a PC board may be impossible, especially where a sizable number of discrete components have been used. In general, the safest approach is to do at least some redesign for the new circuits.

Another gap may arise between the negligible power dissipation listed for most CMOS ICs and the much higher power actually needed for operation. The first power spec you see on data sheets usually gives the quiescent, or standby, rating. It can be in the nanowatt range. But for high switching speeds, the low-power CMOS circuit may dissipate more than a medium-power TTL IC.

High switching speeds force other limitations too. For example, high fanouts for CMOS-to-CMOS interfaces are often listed alongside a high-speed spec. You can obtain both the fanout and the speed, but not at the same time. The increased capacitive loading associated with a high fanout reduces circuit speed.

CMOS can give high ac noise immunity even when switching speeds are high or power dissipation is low. Standard CMOS circuits usually list noise immunity as 30 to 45% of the supply level.

But CMOS circuits don't reject noise transients that are below the rated maximum; they simply dampen them. And all CMOS circuits generate spikes of their own during switching. These spikes become significant as the switching speed increases, creating a need for bypass capacitors.

Propagation delays, too, can be confusing. In some standard circuits, the switching point can range from 30 to 70% of supply levels. But

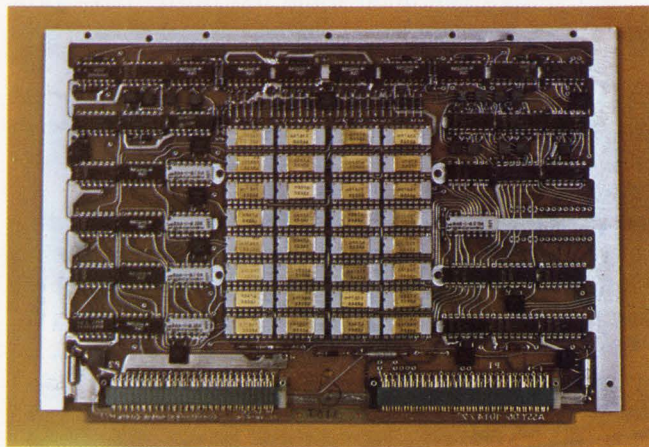

AMI's 512-bit static RAM—the largest in CMOS—is used in Rolm's memory board for the Rugged Nova minicomputer. The AMI memory features an access of 200 ns and an operational dissipation of 5 μ W/bit.

propagation-delay specs are usually measured at points where the voltage is 50% of the supply. So the maximum listed delays may be misleading.

Specs don't always appear

Some useful specs are often omitted because of oversight, limited test procedures or poor performance. For example, one or more of the following may not appear on a CMOS data sheet:

- Propagation delay and rise times for heavy capacitive loads.
- Dynamic characteristics for supply voltages between 10 and 15 V.
- Guaranteed parametric limits at other than 5 and 10 V.
- Ac noise margins at other than logic ONE and ZERO levels.
- Ac noise margins from worst-case inputs to worst-case outputs, rather than power-supply levels.
- Dc noise margins for circuits interfaced with logic having somewhat different bias levels.

Also, the omission of exact test conditions or test circuits can present difficulties in obtaining even essential specs, such as source current. On data sheets for CMOS switches, you may not find the logic input conditions for the specified drain-source ON resistance and specified drain OFF current. Also, the applied input voltages are not always indicated for input-current limits.

And don't assume that leakage currents specified for an open switch are necessarily the same with the switch closed. The apparent current leakage with the switch closed can be much larger than expected, causing a noticeable current loss between input and output terminals. The solution is to check the closed-switch specs before you count on getting out the current that you put in.

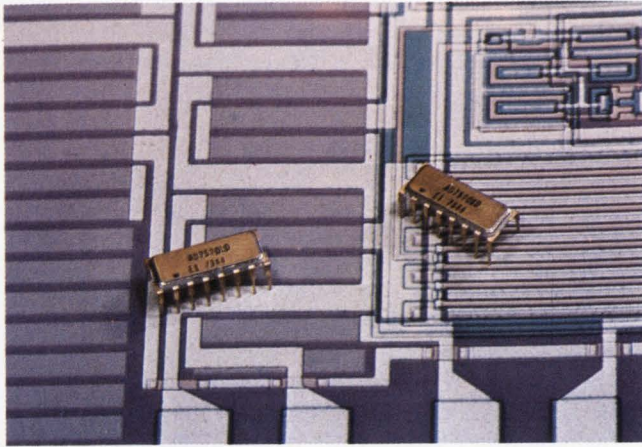

Analog Devices offers the only CMOS 10-bit DAC. The circuit consists of thin-film R-2R ladder networks, feedback resistor and 10 CMOS switches. Monotonicity is guaranteed over the full MIL-temperature range.

Manufacturers promote CMOS as being “very forgiving.” The high tolerance of the circuitry for a variety of ills makes it easy to use. But CMOS can be unforgiving, too. Here are some typical examples:

- Most CMOS ICs have input clamp diodes connected to the positive and negative supply terminals. The diodes protect the gate from shorting. But input levels that exceed either the positive or negative supply can cause either damaging dissipation in the diodes or faulty IC operation because of substrate current flow.

- CMOS logic ICs operate effectively with input levels up to the voltage supply levels. And supply levels are typically a maximum of ± 15 V for standard circuits. However, maximum ratings can be exceeded by a 15-V supply that fails to regulate properly or to suppress line transients.

- Some switches require current-limiting supplies. For these circuits, the voltage developed across the switch can also cause parasitic SCR-action under certain conditions. A limit on the current drain protects the circuit from damage. The requirements must be checked carefully to see if the additional protective circuitry is needed.

- A switch is not necessarily off or open in CMOS circuits simply because the power supply happens to be off. Expect any one of a number of existing diode paths to cause some current flow when the input terminals are activated.

- CMOS devices usually have some input protection circuitry. Nevertheless, the ICs should be protected against electrostatic damage during handling and connection operations.

Still, the advantages of CMOS easily outweigh the difficulties. Equipment can be made smaller because low-power CMOS permits the elimination or minimization of bulky cooling systems.

Low power dissipation also means that the operating period for portable equipment and products, dependent on the limited power of batteries, is extended. Flexible power-supply requirements permit the use of unregulated supplies and open new areas of application where supply voltages may vary substantially. And the high noise immunity of CMOS allows extensive use in noisy environments.

For these reasons and more, the present CMOS worldwide market—estimated at about \$50-million a year—is expected to grow tenfold in about five years. Manufacturers are responding to this boom in ways that are often unique.

COS/MOS leads the field

By any standard, the recognized leader in CMOS is RCA. More CMOS circuits from RCA are used than from any other manufacturer. The company pioneered CMOS in its COS/MOS CD-4000 series, which has grown to include over 70 ICs and now has about ten alternate sources.

Since the COS/MOS series was the first on the scene, most of the circuits represent firsts of their kind. This is true not only for small-scale integrated circuits, like gates and flip-flops, but also for more complex MSI circuits.

A recent first, for example, is the CD4059 divide-by-N counter. It can be programmed to divide an input frequency by any number, N, from 3 to 15,999. The counter contains four BCD decades of counting on the chip, has presettable down counters and features fully static operation. The IC typically consumes $30 \mu\text{W}$ at a supply level of 10 V and has TTL-drive capability.

For linear applications, the COS/MOS series includes the CD4046 micropower phase-locked loop. The IC has a voltage-controlled oscillator with a typical linearity of 1%, and the entire circuit consumes only $70 \mu\text{W}$ typical at a VCO frequency of 10 kHz and supply of 5 V. At 10-V the CD4046 has a frequency drift of $0.06\%/^{\circ}\text{C}$ typical and can operate up to 1.2 MHz.

The largest shift register in the series is the CD4062A 200-stage dynamic register. The IC allows either single-phase or two-phase clocking. The single-phase option permits operation to 1 MHz with noncritical rise and fall times. Two-phase clock signals allow operation to 5 MHz. The minimum operating speed is 1 kHz.

In addition to complex circuits such as these, RCA also expects to modify earlier circuits, where needed, to boost output drive capabilities. Because the COS/MOS series evolved, at times, on a circuit-by-circuit basis, several ICs have output capabilities that differ widely from others in the series.

Still other developments from RCA include circuits with operating levels down to 1.5 V.

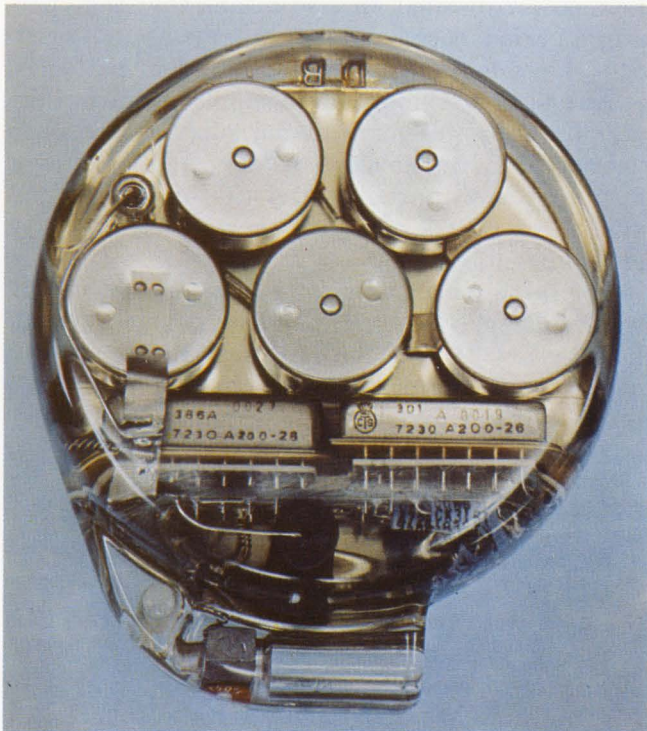

Meter readers use RCA circuits in several ways. In one, a CMOS memory stores the reading until needed. Manual reading, used in conventional billing, is eliminated.

These ICs are intended for portable applications where battery space is limited. Pocket pagers and heart pacers are examples.

For higher speeds—in the 20-to-30-MHz range—RCA plans to introduce SOS/CMOS ICs by the end of the year. The company sees the new products as higher speed complements, rather than competitors, of existing COS/MOS products.

Also by year's end, RCA expects to be sampling the first CMOS microprocessor. Dubbed COSMAC, the new LSI circuit is an 8-bit, two-chip set that emphasizes input/output capabilities and low-power dissipation. Each chip dissipates only about 100 μ W. RCA plans to follow with an 8-chip SOS version and a single-chip COSMAC.

McMOS operates at 18 V

Most standard CMOS circuits operate from supplies ranging from 3 to 15 V. The Motorola CMOS line—called McMOS—includes ICs that can operate from 3 V up to 16 or 18 V. The 18-V level is the highest guaranteed power-supply rating for standard CMOS.

The McMOS line also features uniformly specified circuits. Minimum output drive capability of one low-power TTL load, or 1.4 mA typical, applies to all devices, while propagation delays are typically 50 ns for all gates. In addition a noise immunity of 45% of typical supply voltage and an input capacitance of 5 pF typical are spec'd across the board.

The entire Motorola line consists of about 80 products, many of which are 4000-type ICs (14000 series). A proprietary line, called the 14500 series, contains a number of complex circuits that are being alternate-sourced by Fairchild, Harris, RCA, TI and others.

The 14500 series contains the largest CMOS ROM, a 1024-bit memory called the 14524. It features a typical quiescent power dissipation of 11 nW, operates from either a positive or negative supply and contains output latches for use as a storage register.

The longest CMOS divider is offered as the 14521 24-stage frequency chain. The divider has a frequency of operation of 9 MHz typical at a supply voltage of 10 V. The outputs of the last seven stages, 18 through 24, are accessible to obtain various counts.

Other notable circuits in the 14500 series include a 4-bit arithmetic logic unit (14581), 5-decade counter (14534) and dual 64-bit shift register (14517).

Most circuits in the McMOS line use standard metal-gate fabrication. However, Motorola has recently introduced some circuits fabricated with silicon-gate techniques. These are the 14502 hex buffer and 14529 analog multiplexer. The use of silicon gate permits higher speeds, typically 20 to 25 MHz. Typical speeds for corresponding metal-gate circuits are about 10 MHz.

Motorola plans to expand its McMOS line further with a series of CMOS/LSI. Called the 14400 series, the circuits will be dedicated-function units intended for applications in communications, instrumentation and telephony.

54C/74C features TTL pinouts

The 54C/74C logic line, introduced by National Semiconductor, consists of CMOS ICs that are pin and functional equivalents of like-numbered standard-TTL (7400 series) circuits. The equivalence is a major advantage: In some cases a CMOS version of a TTL logic system can be obtained by completely replacing the TTL circuits with corresponding 54C/74C versions.

Besides pinout and function capabilities, both types of circuits use the same control logic levels and have the same clock-edge characteristics. The CMOS system dissipates far less power but operates at slower speeds. With the 5-V supplies used by TTL circuits, the CMOS ICs operate at 2-to-3-MHz rates, compared with about 20 MHz for TTL.

For CMOS-to-TTL interfaces, the 54C/74C series has a guaranteed fanout of two low-power TTL loads. Each circuit in the series sinks at least 360 μ A at 0.4 V. It can also source the same amount, and it has symmetry, or the same positive-going and negative-going slew rates. This

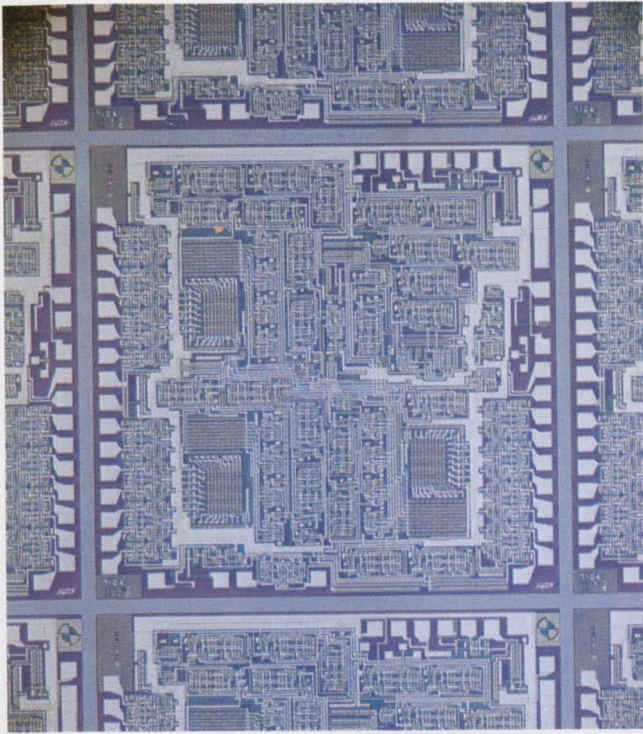

Micro Power Systems uses its high-density process in this chip. The IC contains the circuitry for the Danameter, a multimeter with a liquid-crystal display.

symmetry gives predictable delay times and prevents the propagation of partial pulses down a CMOS logic string.

Six circuits are equipped with Tri-state outputs. These circuits can drive standard-TTL loads. The Tri-state feature also simplifies databus operations. A third, high-impedance state permits common-output terminals to be tied together directly. Without Tri-state extra circuitry, usually NAND gates, would be needed.

Like other CMOS logic lines, the 54C/74C series has a noise-immunity rating of 45% of the power-supply voltage. National Semiconductor refers to this ac spec as noise susceptibility and goes on to spec a dc noise margin. The dc margin comes into play when a circuit operates at a slightly different dc bias than that of the driving circuit.

The 54C/74C line has a guaranteed dc noise margin of 1 V, compared with 0.4 V for TTL. The CMOS spec says that the output of a circuit can be within $0.1 \times V_{cc}$ of the right level, even if the input is $0.1 \times V_{cc}$, plus 1 V, away from the supply.

Propagation delays for 54C/74C circuits are guaranteed for capacitive loads of 50 pF, compared with 15 pF for many CMOS circuits. Also, 54C/74C ICs have double-diode input protection against circuit damage caused by either positive or negative transients.

At present, National Semiconductor offers about 50 products in its 54C/74C line. A number of these, representing the most popular circuits

of the line, are alternate-sourced by Harris and Teledyne Semiconductor. National plans to expand the line with long shift registers and large RAMs and ROMs.

Isoplanar CMOS makes debut

The most recent CMOS logic line—Fairchild Semiconductor's 34000 series—uses the company's Isoplanar-C process to achieve output drive currents of 400 μ A at 0.4 V—sufficient to drive low-power TTL and low-power Schottky-TTL loads. The low-level output drive rating meets or exceeds that of competing gate and flip-flop circuits specified for either the commercial or military temperature ranges. Typical static dissipation is 10 nW per gate.

The Isoplanar-C process combines local oxidation-isolation techniques with silicon-gate technology to obtain both a savings in chip area and an increase in speed over equivalent metal-gate circuits. Circuit designs contain increased output buffering that provides the high drive capability. In addition the buffering reduces usual variations of propagation delay with output load capacitance.

The improved buffering also improves voltage-transfer characteristics, which, as a result, more closely resemble ideal curves. Noise immunity should improve as well, although no spec is given for this parameter on preliminary data sheets.

High circuit gains—more than 10,000—also permit greater pulse shaping. For input transitions of 100 ns or less, both the buffered and conventional circuits exhibit similar outputs. But for input transitions of 1 μ s, the conventional gate suffers increased transition times. The output transition time of the buffered gate doesn't change. This helps eliminate progressive deterioration of pulse characteristics in a system.

The initial offering of 34000-series circuits consists of about 10 ICs. Most of the circuits are basic gates and flip-flops and include the 34028 decoder. This IC allows a 4-bit BCD input code to select one of 10 outputs.

Fairchild plans to offer the 34000 series in several package styles. These will include premium MIL-temperature ceramic, as well as commercial-temperature ceramic and epoxy.

DI/CMOS uses dielectric isolation

For the highest speeds from CMOS on silicon, Harris Semiconductor offers the DI/CMOS HD-4000 series. These circuits provide twice the speed of equivalent, standard 4000 circuits and give an order-of-magnitude reduction in standby power dissipation.

The improvement results from the use of di-

electric-isolation techniques in the fabrication process. Dielectric isolation achieves performance improvements with silicon as the substrate. The company thus avoids less widely used silicon-on-sapphire techniques, which also offer similar performance advantages.

A NAND gate in the Harris series has propagation delays of 20 and 10 ns, for a load capacitance of 15 pF, and supplies of 5 and 10 V, respectively. The corresponding delays of equivalent 4000 units are 35 and 25 ns. For a 50-pF load and the same two supply voltages, the Harris gate maintains a better than 2:1 improvement in speed. Flip-flop toggle rates with 5 and 10-V supplies are 6 and 15 MHz in the Harris series. Equivalent 4000 circuits list 4 and 10 MHz, respectively.

Furthermore a Harris NAND gate has a static dissipation of only 0.5 nW as opposed to 5 nW for 4000-series circuits. And supply voltages can range from 3 to 18 V, as opposed to the more common 3-to-15-V range.

Like other logic lines containing standard 4000-type functions, the DI/CMOS series features pinout compatibility with 4000-series circuits. These circuits can replace or interface with standard CMOS ICs and provide identical input/output levels. The Harris series covers most of the more popular 4000 small-scale functions.

Harris also offers a line of CMOS analog switches and multiplexers, and the company plans to offer CMOS digital interface circuits. The new circuits, called the HD-4800 series, are three-state interface ICs intended for use in common-bus applications.

SOS/CMOS yields higher speeds

For speeds higher than those provided by standard metal-gate circuits, Inselek offers CMOS ICs fabricated from silicon-on-sapphire. The SOS/CMOS circuits permit designs calling for clock frequencies that extend to 20 MHz. The higher-speed series consists of about 30 circuits ranging in complexity from small-scale to medium-scale integration.

The higher speeds of SOS/CMOS, however, depend on the supply voltage. Compared with an equivalent 4000-series circuit, the SOS/CMOS IC provides only a 20 to 30% speed increase at 5 V. But at 10 V, the speed can be increased by a factor of 2 to 3.

Along with the higher speeds comes increased dissipation. For example, a typical SOS/CMOS gate dissipates about 10 mW when operated at 10 V and 5 MHz into a 25-pF load. At 10 MHz, the circuit dissipation increases to 22 mW.

The input protective circuitry of SOS/CMOS ICs draws higher leakage currents than metal-gate circuits—about 2 nA for SOS/CMOS vs

2 pA for standard circuits. However, SOS/CMOS circuits, unlike metal-gate circuits, don't use isolation diodes between source and drain and the substrate. The absence of the diodes eliminates a possible source of SCR-type parasitic action.

Recent additions to the SOS/CMOS line include a 256-bit static RAM. Called the INS4200S, it has an access time of 150 ns and quiescent power dissipation of 40 μ W. It consumes 26 mW in the operational mode. The RAM has bipolar-pinout compatibility. It permits a simultaneous read-while-write operation and a successive-read operation similar to that of bipolar RAMs.

Most CMOS manufacturers have developed static RAMs, rather than dynamic types, to maintain low power dissipation. Also, with SOS/CMOS the interstage capacitance is too low for dynamic operation. Larger capacitors could be used, but at the expense of circuit density.

Other ICs increase versatility

The availability of many proprietary circuits increases the scope and variety of functions for users of CMOS. Generally these circuits offer functions or capabilities not found in standard lines. Solid State Scientific, for example, has a seven-segment LED-display decoder-driver—SCL 4426A/4433A—that combines CMOS logic and bipolar drivers on the same chip.

CMOS has no trouble driving liquid-crystal displays directly because LCDs don't need high drive currents. But with LEDs, a seven-transistor bipolar array is often used with CMOS decoders to obtain the higher drive currents needed.

Solid State Scientific eliminates the need for a separate array chip by putting the bipolar circuitry on the CMOS chip. The CMOS-bipolar driver has a minimum drive current of 20 mA with a 10-V supply. At 25 C, typical drive current with the same supply reaches 60 mA. The driver is pin-compatible with CMOS 4000-series ICs having the same function.

The 4426A/4433A decoder uses a decade counter. For BCD-to-seven-segment conversions, another CMOS bipolar IC—the 4511 latch/decoder/driver—can be used to drive LED displays. Solid State Scientific alternate-sources the 4511 in addition to other circuits in Motorola's 14500 proprietary series.

Solid State Scientific's CMOS line also features double-buffered outputs on gate functions. Compared with equivalent, standard 4000-type circuits, the increased buffering yields lower output impedances, faster transition times and transfer characteristics that more closely approach the ideal case.

From Solitron comes a CMOS voltage-uplevel quad translator—the CM 4104A—representing a function not available elsewhere in CMOS. With

the 4104A, CMOS circuits can be interfaced with TTL but need not be limited in speed by the 5-V levels required by TTL ICs. The CM 4104A can also be used in systems where high-frequency CMOS oscillators, supplied by low voltages to conserve power, must drive higher voltage devices.

The translator lists a characteristic dissipation of 100 μ W, and specs output impedance at 700 Ω . Each of the four level translators has true and complement outputs. And the four translators can be enabled to provide a high-impedance output for three-state operation.

For instrumentation applications, the proprietary Solitron line includes the CM4102 3-1/2-digit counter/multiplexer with BCD data storage and drivers. The chip contains three decade counters, an overrange flip-flop, a set of latches and a multiplexer that provides TTL-compatible out-

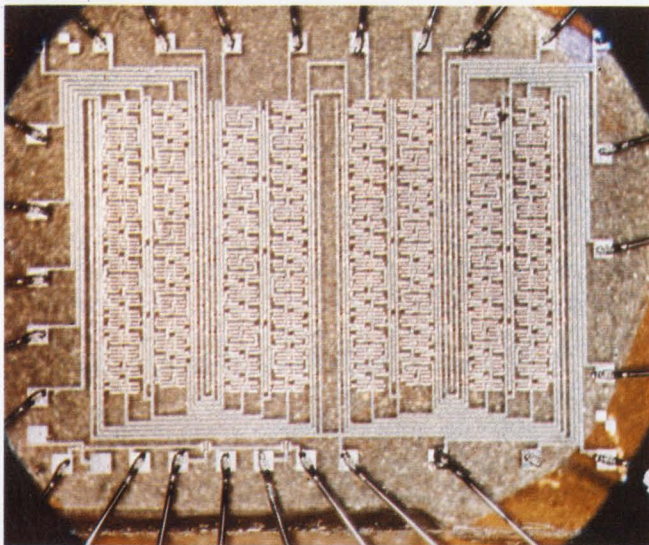

A test array from RCA uses SOS techniques for increased speed. The circuit contains a dual eight-stage digital parallel correlator that operates to 45 MHz.

puts for display decoders. The chip can be used to simplify low-power DVM, DPM and digital counter designs. Dynamic power dissipation is typically 14 mW when the chip interfaces to TTL and the clock and multiplexer inputs are switched at 10 kHz.

CMOS for switches and multiplexers

Several manufacturers specialize in CMOS analog switches and multiplexers. Though most are now branching out into other product areas, the switch product line remains a strong suit.

Siliconix, for example, offers an extensive line of CMOS analog switches and multiplexers. All circuits handle ± 15 -V input signals, provide a direct interface with TTL logic circuits, and offer break-before-make switching action.

A recent addition to the Siliconix line is the DG506 16-channel, random-access multiplexer. The circuit comes in a 16-pin DIP and features ON resistances below 500 Ω over the full temperature and input-signal ranges. In the ON condition, each switch conducts current in either direction, and in the OFF condition each switch blocks voltages up to 30 V pk-pk.

The ON-OFF state driver of each switch is controlled by a 4-bit binary input word and an enable-inhibit input. The controls select one of 16 channels and permit the output line to be common to several other units. The typical standby power spec is 36 mW.

In the next few months Siliconix plans to expand its CMOS line beyond switches and multiplexers, with three designs. They consist of a CMOS-JFET crosspoint switching matrix for applications in telephony; LSI circuits to be used with LED displays and display drivers for four-digit, crystal-controlled timing units, and 18-MHz shift registers in both programmable and fixed lengths up to 256 bits.

CMOS switches vs reed relays

At Intersil, the IH 5040 series of CMOS analog switches is offered as a replacement for reed relays. Reed units, however, have much lower ON resistance and far greater signal-handling capability—up to several hundred volts. Also, they are easier to apply: A current through a coil opens or closes isolated contacts. But switching speeds in reed relays are limited to hundreds of microseconds, and contact bouncing can lead to troublesome transient problems. The CMOS switches offer speeds of less than a microsecond while avoiding contact-bounce problems. Moreover the integrated switches can be obtained with more switches per package than are available with reed relays, and they can interface directly with TTL circuits without need for back-emf diode protection.

Intersil emphasizes the equivalence between analog switches and relays. Each switch in the series uses contact forms that are common to relays. The IH 5040, for example, is a single-pole, single-throw—or Form-A—device, while the IH 5047 performs the four-pole, single-throw function.

Each analog circuit switches up to ± 14 V with ± 15 -V supplies, provides overvoltage protection for input signals up to ± 25 V and draws less than 100 μ A (1 μ A typical) from ± 15 -V supplies. Switching action is break-before-make, and ON resistances are less than 75 Ω .

The switch circuits use a "floating body" structure to avoid possible latch-up problems and to obtain the 25-V overvoltage rating. Compared with conventional designs, the structure differs

in its use of a diode between the body of n-channel devices and the positive supply.

Conventional structures tie the body to the negative supply, forming a reverse-biased diode between the drain and source and the body. If supplies are off and negative signals are applied, the diode can become forward-biased, causing excessive current flow. Or it may form part of a parasitic SCR that gives rise to a latch-up condition. The floating-body structure blocks the excessive current path and prevents the SCR from turning on.

Other CMOS products available from Intersil include a 256-bit static RAM and a timer/stop-watch/clock circuit. The RAM, TM 6523, uses silicon-gate technology and features TTL pinouts and compatibility. It accesses in less than 500 ns and dissipates less than 1 μ W/bit.

The ICM 7045 timer circuit contains the basic circuitry for a digital timer, stopwatch and 24-hour clock. The circuit combines metal-gate and ion-implantation techniques to obtain a supply range of 2.5 to 4.5 V and an operational dissipation of 0.9 mW at 3.6 V. It works from an external 3-MHz crystal and drives LED displays.

Switches form basis for 10-bit DAC

Another manufacturer of CMOS switches and multiplexers—Analog Devices—offers the only CMOS integrated d/a converter. Consisting of a thin-film R-2R ladder network, feedback resistor and 10 CMOS switches, the AD7520 DAC combines 10-bit accuracy, resolution and linearity with a maximum dissipation of only 30 mW.

The unit has an accuracy of 0.05% of full-scale range (FSR). Moreover, its linearity tempco of 1 ppm of FSR/ $^{\circ}$ C and gain tempco of 5 ppm of FSR/ $^{\circ}$ C guarantees monotonicity over the entire MIL-temperature range. The DAC can operate from a single supply, ranging from 5 to 15 V. With two external op amps, it performs four-quadrant multiplication.

Compared with bipolar units, the AD7520 sets the pace for several key specs. Many of the improvements are obtained as a direct result of the characteristics of CMOS and special processing techniques. Bipolar DAC designs require special attention to finite betas and base-emitter voltages of the switching transistors. Finite betas can lead to tracking errors, while base-emitter voltages require matching circuitry.

In the CMOS DAC, negligible input current is needed for the switches, so finite betas don't lead to errors. Also, there's no CMOS equivalent to the base-emitter voltage of bipolar devices. Rather an ON CMOS switch essentially becomes a small resistor whose value depends on switch geometry.

The AD7520 also uses a high-density process

that permits a chip size of 74×96 mils, or about a third less than would otherwise be required. In the process, two layers of metal interconnect provide the increased density.

Silicon-gate for memories and watches

The largest CMOS RAM—the 512-bit S2222—comes from American Microsystems. And though the static memory is twice as large as competing 256-bit RAMs on silicon, the S2222 has a faster access time of typically 200 ns and lower power drain—4 nW/bit for standby and 5 μ W/bit in operation at 25 C.

The RAM uses a single 10-V supply and has a single read/write control line. Minimum read/write cycle times are 420 ns. The IC also features full decoding on the chip and a chip-enable input for memory expansion.

In another important CMOS development, American Microsystems has a single-chip circuit, the S1400, for 3-1/2-digit, liquid-crystal-display watches. Containing display drivers and decoders on the chip, the S1400 can replace currently available two-chip systems. Silicon-gate, ion-implanted fabrication results in the increased circuit density and operation from a 1.5-V cell.

The watch circuit provides a 1024-Hz up-converter output and a 32-Hz display output from an external 32-kHz crystal. The chip's display drivers operate from a voltage up to 12 V that is generated from an external coil or transformer up-converter.

Like other manufacturers, American Microsystems uses silicon-gate techniques to achieve 0.6-V thresholds for both p and n-channel devices. The low threshold levels permit operation from a single 1.5-V battery. A higher threshold can be obtained by use of a slightly different type of silicon.

Conventional aluminum-gate CMOS generally yields thresholds of about 2 V for p and n-channel devices. Engineers at American Microsystems feel that lower values cannot be obtained with metal-gate without the use of uncomfortably thin gate oxides or more complex nitride-gate structures.

Another advantage of silicon-gate lies in the self-aligning feature of the gate formation. The feature provides reduced drain-to-gate feedback capacitance (Miller effect). It also allows shallower junctions and more tightly packed layouts. Metal-gate structures require selective oxidation techniques to recover some of these advantages.

The latest ICs for watches—Intel's two-chip set for LCD displays—also uses silicon-gate techniques to achieve low power consumption. The two ion-implanted circuits have a total average consumption of less than 15 μ W when used with a 32-kHz crystal. Maximum operating current is

only 500 nA at 15 V.

The chip set consists of the 5801 oscillator-divider circuit and a decoder-driver circuit available in two versions: the 5201, featuring hours minutes and seconds on command; and the 5202, displaying hours and minutes. The chips operate from a single 1.35-V battery.

Custom vendors offer special functions

All CMOS manufacturers have some custom capability to develop and build circuits for specific needs. Some manufacturers operate primarily in this area.

Hughes, for example, offers ion-implant techniques to build high-density CMOS circuits. Usually a customer gives the company a working breadboard design containing 30 to 40 4000-SSI circuits. Hughes then replaces the circuits with an LSI chip.

The company has a proprietary ion-implantation process that is said to yield about 25 to 30% more density than competing processes. The company favors ion-implant techniques because they give lower thresholds and thus lower dissipations. Also, the techniques avoid the need for such density-limiting devices as channel stoppers in the IC design. Hughes—along with Intersil, RCA, Solid State Scientific and others—supplies many of the ICs for watches.

A specialty of the house at Micro Power Systems, another custom manufacturer, is a high-density process—HD/CMOS—that uses two layers of metal interconnect. The process reportedly achieves all the performance advantages of conventional metal-gate CMOS—which uses a single layer of interconnect—at higher circuit densities that are more typical of p-channel MOS.

The first layer of HD/CMOS is similar to the layer in silicon-gate processes. But compared with the silicon-gate material, the HD/CMOS material has a resistivity that is orders of magnitudes lower. This permits a low first-layer profile—an essential feature of a two-metal system.

As with silicon-gate, problems of oxide formation and step coverage—sometimes associated with metal-gate—are avoided by HD/CMOS. In addition the high-density process is said to increase density by about 30 to 40% over conventional metal gate. The final process steps include silicon-nitride and glass passivations.

What's next in CMOS?

The pace of activity in CMOS suggests marked expansion of all product lines. By the end of the year, standard functions should number over 100. The newer ICs include more MSI circuits and some LSI. Moreover many manufacturers report plans for expanded facilities and produc-

tion that will cut the excessively long lead times now required for deliveries.

Meanwhile the 4000 series continues to gain in popularity. Recent entries into CMOS production—such as General Instrument, OKI Electronics and Siltek—are primarily alternate sources for the 4000 series, although other, proprietary products are included. OKI is a U.S. affiliate of a company by the same name based in Japan, while Siltek operates in Canada.

However, some observers see a possible shake-out in MSI functions. They contend the 4000 series is firmly established for small-scale integrated circuits. But the MSI circuits that will ultimately become the standard, they say, will be a combination of the most popular ICs among proprietary lines—such as Motorola's 14500, National's 54C/74C and, of course, RCA's COS/MOS. ■■

Need more information?

The products and services discussed in this report don't represent manufacturers' full lines and capabilities. Readers may consult with the following for additional details:

Analog Devices, P.O. Box 280, Route 1 Industrial Park, Norwood, Mass. 02062. (617) 329-4700. (Richard Ferrero). **Circle No. 425**

American Microsystems, Inc., 3800 Homestead Rd., Santa Clara, Calif. 95051. (408) 246-0330. **Circle No. 426**

Cal-Tex Semiconductor, 3090 Alfred St., Santa Clara, Calif. 95050. (408) 247-7660. (C. Michael Christoff). **Circle No. 427**

*Collins Radio, 19700 Jamboree Blvd., Newport Beach, Calif. 92663. (714) 833-4600. (Dr. Floyd English). **Circle No. 428**

Fairchild Semiconductor, 464 Ellis St., Mountain View, Calif. 94040. (415) 962-5011. **Circle No. 429**

General Instrument, P.O. Box 600, 600 W. John St., Hicksville, N.Y. 11802. (516) 733-3000. **Circle No. 430**

Harris Semiconductor, P.O. Box 883, Melbourne, Fla. 32901. (305) 727-5400. **Circle No. 431**

*Hughes, Microelectronics Products Division, 500 Superior Ave., Newport Beach, Calif. 92663. (714) 548-0671. (Dennis Olson). **Circle No. 432**

Inselek, Inc., 743 Alexander Rd., Princeton, N.J. 08540. (609) 452-2222. (Robert Burlingame). **Circle No. 433**

Intel, 3065 Bowers Ave., Santa Clara, Calif. 95051. (408) 246-7501. (Mike Markulla). **Circle No. 434**

Intersil, 10900 N. Tantau Ave., Cupertino, Calif. 95014. (408) 257-5450. (John T. Corser). **Circle No. 435**

*Micro Power Systems, 3100 Alfred St., Santa Clara, Calif. 95050. (408) 247-5350. (R. Koury). **Circle No. 436**

Motorola Semiconductor Products, P.O. Box 20912, Phoenix, Ariz. 85036. (602) 244-3810. (Ronald P. Komatz). **Circle No. 437**

National Semiconductor Corp., 2900 Semiconductor Dr., Santa Clara, Calif. 95051. (408) 732-5000. **INQUIRE DIRECT**

OKI Electronics of America, Inc., 4031 N.E. 12th Terrace, P.O. Box 24260, Fort Lauderdale, Fla. 33307. (305) 563-6234. (J. T. Webb). **Circle No. 438**

RCA Solid State Div., Route 202, Somerville, N.J. 08876. (201) 722-3200. Ext. 2565. **Circle No. 439**

Ragen Semiconductor, 53 S. Jefferson Rd., Whippany, N.J. 07981. (201) 887-4141. (Andrew A. Melnychuk). **Circle No. 440**

Rockwell Microelectronics Division, P.O. Box 3669, Anaheim, Calif. 92803. (714) 632-2321. (Jack Hefley). **Circle No. 441**

Siltek International Ltd., Airport Industrial Park, Bromont, Quebec. (514) 372-0201. (Ralph A. Bennett). **Circle No. 442**

Siliconix Inc., 2201 Laurelwood Rd., Santa Clara, Calif. 95054. (408) 246-8000. (Dave Hage). **Circle No. 443**

Solid State Scientific, Montgomeryville Industrial Center, Montgomeryville, Pa. 18936. (215) 855-8400. (Walt Kalin). **Circle No. 444**

Solitron Devices, 8808 Balboa Ave., San Diego, Calif. 92123. (714) 278-8780. (Jim Everett). **Circle No. 445**

Texas Instruments, P.O. Box 5012, Mail Station 914, Dallas, Tex. 75222. (214) 238-4625. (Wayne Hawse). **Circle No. 446**

*Primarily engaged in custom CMOS.

We've found an ideal ROMmate for your microprocessor.

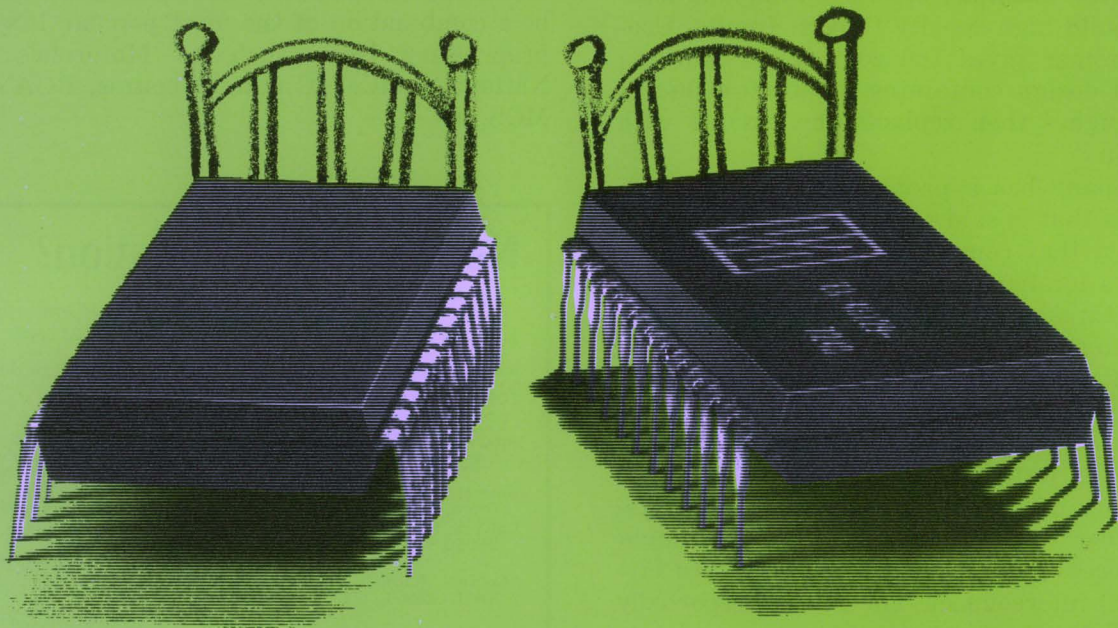

Big ROM contributes 16K bits program storage at lowest cost ever

Every little 8-bit microprocessor needs a companion ROM willing to share cramped quarters and supply low-cost program storage. And there's no more perfect companion than EA's 4800 MOS ROM. It has a compatible 2048 x 8 organization and a 100-piece price of \$28. It will eagerly move in, custom-programmed, to join your microprocessor in 6 to 8 weeks.

Your microprocessor will find our big ROM is extraordinarily undemanding to

live with. It doesn't need a clock because it's static. It gets along without address decoding circuits because it's decoded internally. It doesn't require input pull-up resistors because they're already on the chip. It demands only two supply voltages, +5v and -12v. And it will welcome more ROMmates with outstretched OR-wired outputs.

Our ROM's maximum access time is 1.2 μ sec — fast enough to satisfy your microprocessor. Power dissipa-

tion is a low .032 mW/bit. It's clothed in a 24-pin silicone-molded DIP. And it will also take on a 4096 x 4 organization to mate with any 4-bit microprocessors you happen to have around.

Contact us right now for data showing how easily the EA4800 interfaces with popular microprocessors. Electronic Arrays, Inc., 550 Middlefield Road, Mountain View, Calif. 94043. Phone (415) 964-4321.

Cramer Electronics is our distributor nationwide.

electronic arrays 

new, pocket-size Tri-Phasic^{T.M.} multimeter



MODEL 245, ACTUAL SIZE

Try It

\$295.00
COMPLETE

You can't match Data Precision's Model 245 for price/performance, size, reliability and usability.

PERFORMANCE: .005% RESOLUTION, .05% BASIC ACCURACY FOR 6 MONTHS, MEASURES ACV, DCV, DC AND AC CURRENT, AND RESISTANCE WITH 100% OVERRANGING.

DC Volts, 1 volt to 1000 volts full scale, 100 μ V resolution.
AC Volts, 1 volt to 500 volts RMS full scale, 100 μ V resolution, 30HZ-50kHz.

DC Current, 1 ma to 1A f.s., 1 μ A resolution.

AC Current, 1 ma to 1A f.s., 1 μ A resolution, 30HZ-50kHz.

Resistance, 1 K Ω -10M Ω full scale, 100 milliohms resolution. Calibration guaranteed 6 months minimum.

PRICE: \$295 COMPLETE

Includes rechargeable battery module, line cord/recharger, fused input probes, carrying case and strap, complete software and test documentation, full Data Precision calibration Instruction Manual and separate Operator's Manual, and one year warranty.

RELIABILITY:

Proven LSI P-MOS and C-MOS Components plus our improved autozeroing Tri-Phasic^{T.M.} conversion, Isopolar^{T.M.} reference, Ratiohm^{T.M.} resistance provide reliability normally found in instruments costing 3 to 4 times as much.

USABILITY: IDEAL FOR LAB, PRODUCTION OR FIELD USE. Truly portable, pocket size 1 $\frac{3}{4}$ " x 3 $\frac{1}{2}$ " x 5 $\frac{1}{2}$ " packaged in a rugged impact resistant case, rechargeable 6 hour battery for in-spec operation and line recharge.

To get your hands on this remarkable instrument, phone your local sales representative.

AL (205) 536-1941	MD (301) 552-2200	OH (N) (216) 243-7430
AZ (602) 948-8410	MI (313) 482-1229	OH (S) (513) 298-3033
CA (N) (408) 733-9000	MN (612) 781-1611	OR (503) 238-0001
CA (S) (714) 540-7160	MO (W) (816) 737-0066	TX (N) (214) 234-4137
CO (303) 449-5294	MO (E) (314) 731-2331	TX (S) (713) 461-4487
CT (203) 525-7647	NC (919) 275-3725	UT (801) 268-3181
HI (808) 262-6286	NJ (215) 925-8711	WA (206) 763-2210
IL (312) 593-0282	NM (505) 265-6471	
IN (317) 293-9827	NY (N) (315) 446-0220	CAN (W) (416) 661-1404
MA (617) 273-0198	NY (S) (516) 482-3500	CAN (E) (514) 731-9328

Data Precision Corporation
Audubon Road Wakefield, MA 01880
(617) 246-1600

 **DATA PRECISION**
...years ahead

Review the basics of MOS logic.

The characteristics of simple logic functions, shift registers and memories apply to newer, more complex MOS ICs.

Integrated circuits are becoming more and more sophisticated. Incorporating thousands of transistors, each chip can economically implement increasingly complex functions. Applications are proliferating as designers learn to trade off the higher speed and drive capability of bipolar approaches for the higher densities and lower power that MOS technology offers. More than ever the designer must understand these tradeoffs.

A good first step is to explore the basic characteristics of MOS technology. What are its advantages? What are its inherent limitations? How can it be used to construct simple logic functions which are, in turn, combined to make complex logic functions. If you plan to use MOS logic circuits in some of the newer, complex applications, it's time for a review.

Let's begin with simple logic functions and see how they can be used to build the more complex memory functions.

Fig. 1 shows how p-channel MOS transistors are used to achieve the NOT logic function. The upper transistor in each inverter functions solely as a load resistor and uses the transistor's transconductance to get a large-value resistor in the relatively small area required by the device. Otherwise resistors composed of relatively low resistivity materials would be needed on the chip. And these tend to take up considerable space. High resistances are often needed to minimize the power consumed in complex functions. A high load resistance can be achieved using MOS transistors because the gate voltage governs the channel resistivity.

The difference between the two circuits of Fig. 1 lies in the mode of operation of the load devices. In Fig. 1a, $|V_{GS}| \leq |V_{DS} + V_T|$. Hence the load resistor is saturated, and it behaves like a current source. The voltage across a load capacitance attached to the output of the inverter has the following slope:

$$\frac{dv}{dt} = i_{SAT}/C_{LOAD}, \quad (1)$$

Joe Kroeger, Manager of MOS Systems Applications, Bruce Threewitt, Manager of MOS Device Applications, Signetics, 811 E. Arques Ave., Sunnyvale, Calif. 94086.

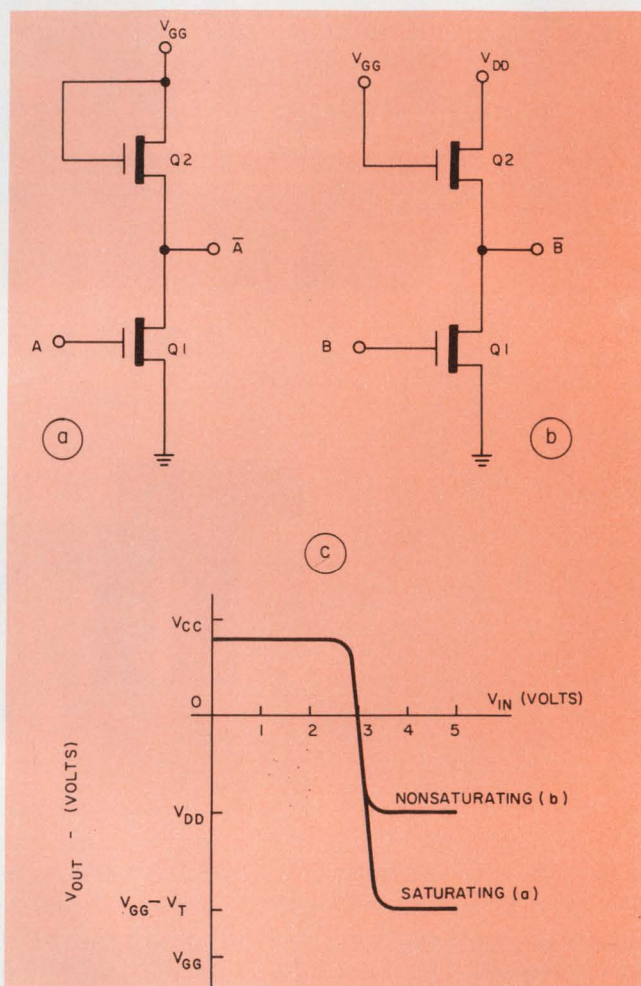

1. An MOS inverter performs the NOT function. The design can use either a saturating (a) or nonsaturating (b) mode. The major difference between the two lies in their output transfer characteristics (c).

where i_{SAT} is the saturation current of the load resistor for a particular gate-to-source voltage. Note that the gate-to-source voltage of the load resistor decreases as the output voltage swings toward V_{GG} . Thus the load resistance increases with time.

The load resistor for the inverter in Fig. 1b is nonsaturated, and it behaves like a resistor. The value of this resistor increases as the inverter output voltage swings toward V_{DD} . This ON resistance varies less with changing source-

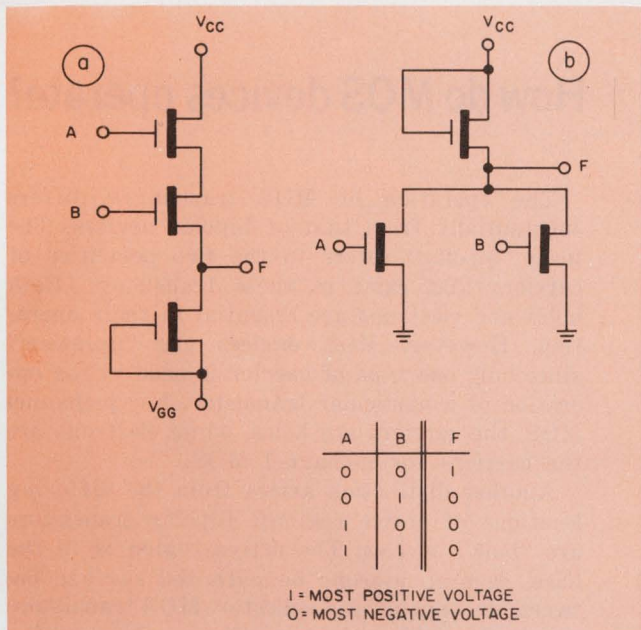

2. A NOR gate can be formed with a p-channel (a) or n-channel (b) MOS device. These require a series and parallel connection, respectively, because of the devices' threshold-voltage polarity.

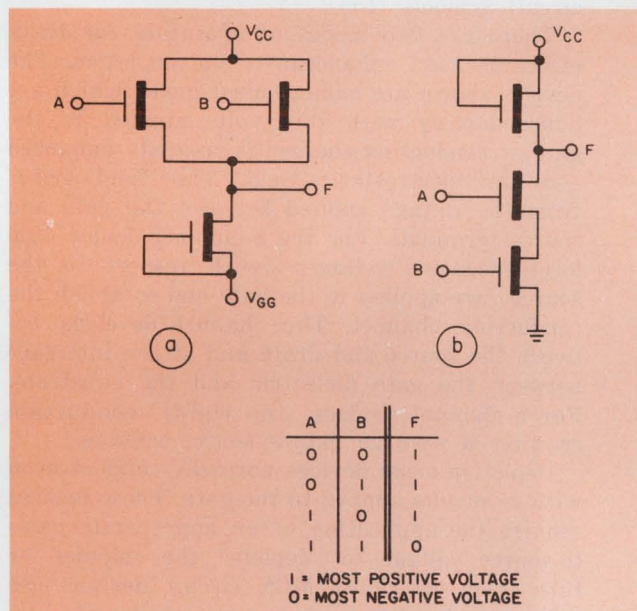

3. The NAND function can be formed with parallel-connected p-channel devices (a) or series-connected n-channel transistors (b).

terminal voltage than does the saturated inverter.

Trade off speed and dissipation

As a result, the time delay through the non-saturating inverter is shorter than that through a saturating inverter of similar size. However, the saturating design uses less power compared with the nonsaturating design. The latter requires up to three supply voltages.

For both designs, transfer curves of V_{OUT} vs V_{IN} are shown in Fig. 1c. The ratio of ON resistance of Q_1 and Q_2 determines the output level when the input is at zero. The relationship is given by the following equation:

$$V_{OUT(HI)} = V_{GG} + (V_{CC} - V_{GG}) \left(\frac{R_{ON(Q_2)}}{R_{ON(Q_1)} + R_{ON(Q_2)}} \right). \quad (2)$$

The same ON resistance ratio affects the non-saturating inverter-output HIGH level. In that case, however, substitute V_{DD} for V_{GG} in Eq. 2.

The MOS circuitry for the Boolean NOR function appears in Fig. 2. The polarity of the threshold voltage determines whether a series or a parallel structure is used. For p-channel MOS, the positive-logic NOR gate uses a cascode, or series, structure.

The MOS circuitry used to perform the NAND function is shown in Fig. 3. Again, the device's threshold-voltage polarity determines whether a parallel structure or a series structure performs the function. The parallel structure used in p-channel MOS positive logic circuits also performs the NOR function in negative logic (Fig. 3a).

The NOR and NAND logic functions can be accomplished with dynamic circuit structures (Fig. 4). The dynamic approach involves a pre-charging of load capacitor C_L during the clock (ϕ) pulse duration. Then C_L is either left charged or is discharged, depending on the input states, after the clock turns off and isolates C_L from the power supply. Either circuit in Fig. 4 dissipates less power than corresponding static logic gates. Address decoders for random-access memories often use this technique.

Memory—another essential logic function

A simple way to obtain a memory function is to use the bistable multivibrator or flip-flop. Fig. 5 shows the MOS version of a basic R-S flip-flop. The circuit uses p-channel MOS devices and consists of two cross-coupled inverters.

Transistors Q_1 and Q_4 provide access to the memory cell. The ON resistance ratio of Q_1 and either Q_2 or Q_3 , depending on the cell state, determine the logic ONE, or most positive-voltage, level. The logic ZERO level is $-V + |V_T|$.

The circuit is often used in static MOS read/write random-access memories. A static memory holds data as long as power is applied. Hence data refresh can be avoided. The n-channel circuit is the same as the p-channel, except that the power-supply polarity is positive rather than negative.

To build a memory matrix, the device designer arranges memory cells in an array so that an addressed cell connects to a pair of "sense" lines. If a read cycle is required, information stored

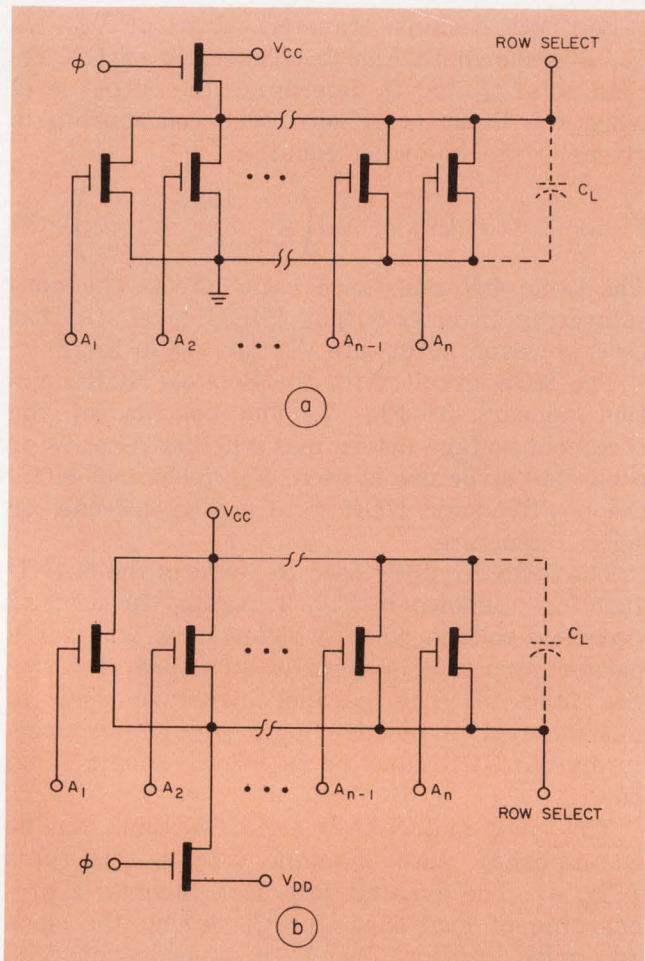

4. Dynamic circuit structures dissipate less power than static configurations. Shown here are a dynamic NOR gate using n-channel devices (a) and a dynamic NAND gate using p-channel transistors (b).

in the selected cell appears on the DATA and $\overline{\text{DATA}}$ lines. Output circuitry then senses the information. If a write cycle is required, the DATA and $\overline{\text{DATA}}$ lines are forced to the appropriate states, and the selected cell is set accordingly. This cell design requires six devices and 4-1/2 interconnections.

The high input impedance of MOS inverters permits the use of dynamic memory-cell designs. In a dynamic cell a parasitic capacitance stores charge that is periodically refreshed. The refresh compensates for the small leakage current at the storage nodes. By comparison, a static cell continuously refreshes the charge through load resistors.

Fig. 6 shows the evolution of dynamic MOS RAM cells to higher densities. Cell sizes are distinguished by two factors: One is the number of transistors used to form the memory function; the other is the number of interconnect lines needed to connect the cells to the rest of the circuitry.

The dynamic cell in Fig. 6a is identical to the static cell previously described, except that the

How do MOS devices operate?

The operation of MOS transistors differs substantially from that of bipolar devices. The term "bipolar" refers to the two polarities of carriers that exist in these transistors. Both holes and electrons are essential to their operation. However, MOS devices are "unipolar," since only one type of carrier is used in the operation of a particular transistor. For p-channel MOS, the carriers are holes, while electrons are the carriers for n-channel MOS.

Another distinction arises from the differing locations of active regions. Bipolar transistors are "bulk" devices. The active region is in the base, several microns beneath the surface between the emitter and collector. MOS transistors are surface-effect devices. Their active region consists of a channel that is induced (for enhancement-mode operation) at the silicon-silicon-dioxide interface.

The basic silicon-gate MOS transistor appears in cross-section along with conventional circuit symbols (top).

There are two modes of operation for field-effect devices: enhancement and depletion. The devices shown are enhancement-mode, which are nonconducting with zero volts applied to the gate. A conducting channel is created—enhanced—by an electrostatic field. The field arises from the voltage applied between the gate and source terminals. For the p-channel device (top left), negative voltages (with respect to the source) are applied to the gate and establish the conducting channel. The channel develops between the source and drain and at the interface between the gate dielectric and the substrate. For n-channel devices (top right), conduction requires a positive gate-to-source voltage.

Depletion-mode devices normally conduct even with zero volts applied to the gate. These devices require the application of an appropriate gate-to-source voltage to "deplete" the channel, or turn them off. Most MOS circuit designs use enhancement-mode devices.

MOS transistors are field-effect devices because the gate is electrically isolated from any other part of the transistor. As a result, the dc input impedance (using the gate as the input) is extremely high—on the order of $10^{14} \Omega$. This high dc impedance characteristic primarily determines the nature of the MOS input interface.

The characteristic V-I behavior of MOS enhancement-mode transistors appears at the lower left. When the device operates in the region labeled nonsaturated, its V-I characteristic is approximately resistive. The term "nonsaturat-

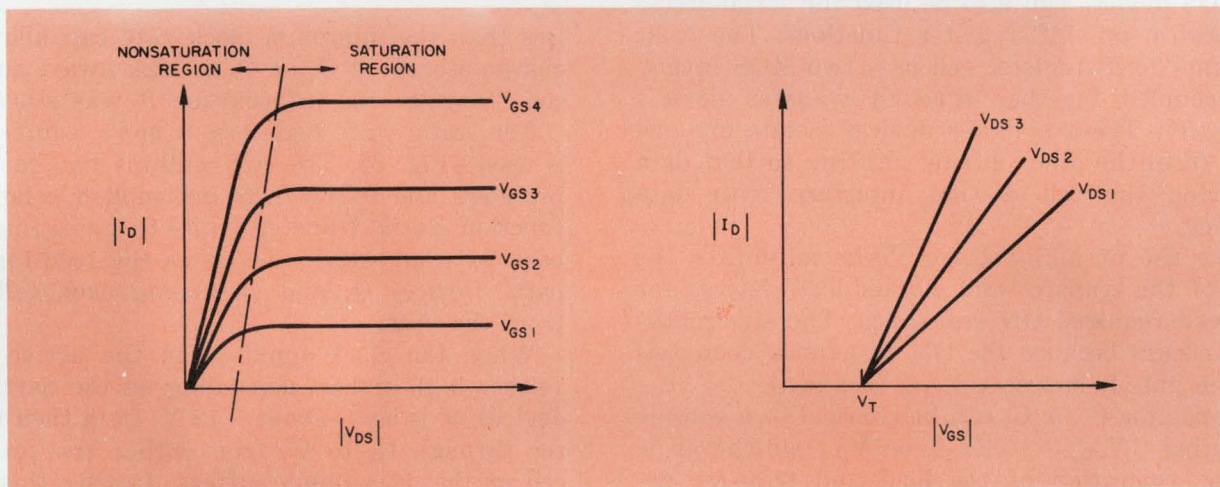
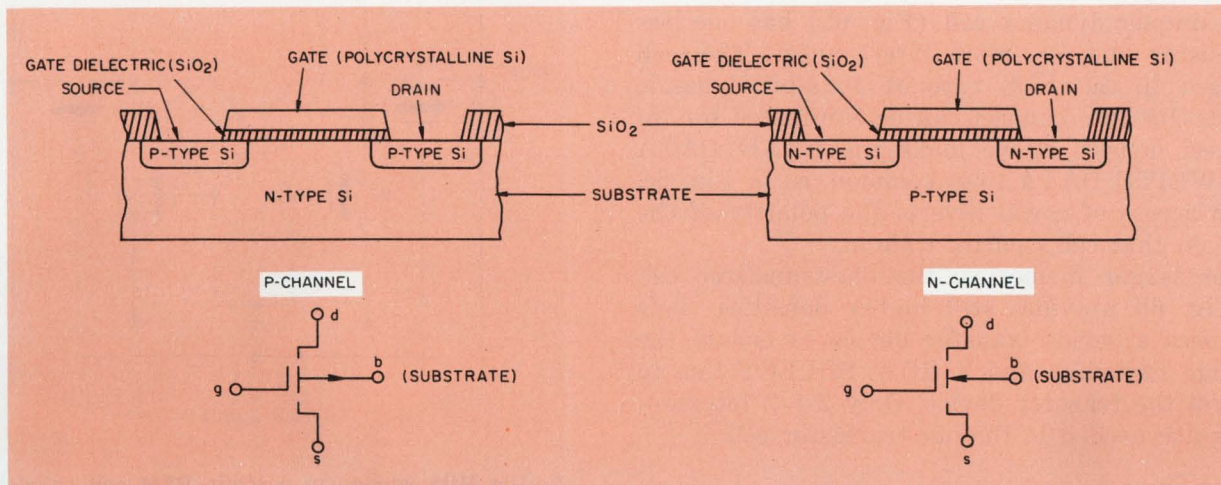

ed" means that the device is not conducting as much drain current as possible for a given gate-to-source voltage.

The device behaves like a current source or sink when operated in the saturated region of the curves. In this area the drain current is no longer a function of the drain-to-source voltage. Note that the larger the gate-to-source voltage, the larger the saturation current becomes.

The input-transfer curves (lower right) show the drain current as a function of gate-to-source voltage. The device is off ($I_D = 0$) until $V_{GS} \geq V_T$. Low-threshold MOS processes, such as silicon gate, allow MOS logic to be compatible with bipolar families. These families include standard TTL and other common bipolar logic lines

with switching thresholds of about 1.5 V.

For p-channel silicon gate devices, V_T is nominally 2 V, while n-channel silicon-gate devices have a V_T of 1 V. The threshold voltage has a typical variation with junction temperature of about $-2 \text{ mV}/^\circ\text{C}$ from -50 to 125 C . Clearly, the threshold voltage is not very sensitive to temperature variations.

The slope of the input transfer curves is the transconductance, g_m . This parameter can be used as the gain figure or transfer function for the MOS transistor. It governs the output current of a device for a given input voltage.

Transconductance decreases with rising junction temperature. Current gain (β or h_{FE}) in bipolar devices increases with rising temperature.

dc load devices have been removed. As a result, the cell has two less transistors and one less interconnect and is correspondingly smaller. The substrate connection counts as a half interconnect. This dynamic cell maintains the differential data-sense feature offered by the static cell.

A simpler dynamic cell (Fig. 6b) has one less transistor and one more interconnect. This cell is used in the 1103 type of 1024-bit dynamic RAM. One interconnect can be eliminated for increased density if we make the READ DATA and WRITE DATA lines common, as in Fig. 6c. Each access of a cell inverts the polarity of the data on that cell's entire column.

For larger memories, the one-transistor cell of Fig. 6d provides still higher densities. This cell uses a series transfer device to isolate the storage capacitor and a ROW SELECT line to control the transfer device. Only 2-1/2 interconnects are needed in the one-transistor cell.

Shift registers use MOS, too

MOS devices can also be used for serial-access memories, or shift-register functions. The basic dynamic shift-register cell uses two MOS inverters coupled together through transfer devices (Fig. 7). These transfer devices isolate one cell half from the other during shifting so that data entering the cell do not interfere with data leaving.

The use of high-voltage clocks minimizes the size of the transfer and clocked-load devices for a given required ON resistance. The size reduction occurs because the ON resistance decreases as the gate-to-source voltage increases.

Capacitor C_1 or C_2 can be charged to a voltage of either $(V_{\text{CLOCK}} - 2V_T)$ or V_{DD} , whichever is lower. Operation of the load and transfer devices in the nonsaturated mode means that $|V_{\text{CLOCK}}| > |V_{\text{DD}} + 2V_T|$. As a result, the voltage on C_1 or C_2 can be maximized without dissipation of excessive power.

When ϕ_{IN} is low, data stored on capacitor C_1 transfer to C_2 through Q_3 . During the time ϕ_{OUT} is low, data transfer to the output structure through Q_6 . Hence data shift from one cell to the next with each pair of input-output clock pulses.

Since load devices Q_2 and Q_5 are turned on and off by the clocks, dc current flows between V_{DD} and the substrate only when a clock is low. Consequently the power consumed varies with the duty cycle of the clocks.

The use of dynamic logic for serial memories necessitates refreshing to prevent loss of data, just as in dynamic random-access memories. Here shifting accomplishes the refresh, and a minimum clock-frequency constraint must be observed on the use of the device. Operation at

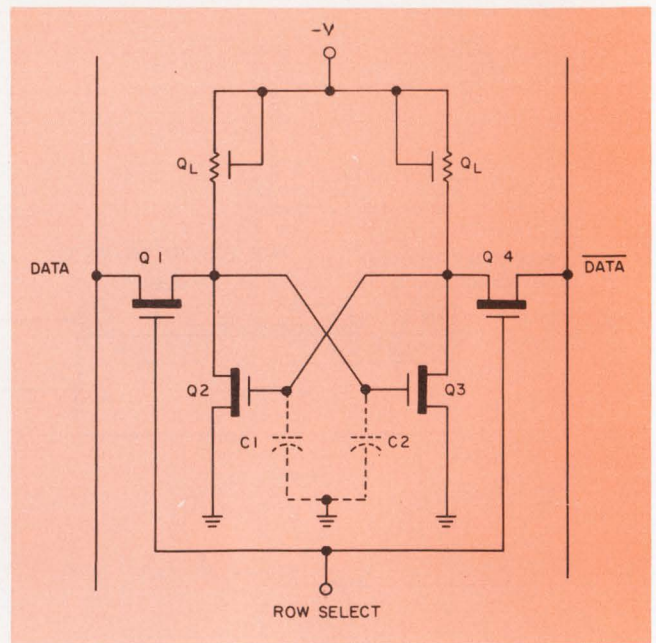

5. The MOS version of a static RAM cell consists of a simple R-S flip-flop. The RAM cell uses six devices and requires 4-1/2 interconnects.

less than the minimum clock rate can allow the charge stored on C_1 or C_2 to leak away, and the cell "forgets" the information it was storing.

For static shift registers, a more complex cell is used (Fig. 8). The cell contains two cascaded inverters and feedback to accomplish a latching function. Serial transfer device Q_5 gates the feedback path and device Q_3 gates the feed-forward path. Devices Q_1 and Q_3 isolate each cell half from the other.

When the clock input is in the active state (either high or low, depending on the particular device) ϕ_1 is low—about -12 V. Data then transfer through Q_1 to C_1 from either the previous cell or the data input buffers. During this time ϕ_2 and ϕ_3 are high—about $+5$ V—and C_2 is isolated from the input of the cell.

When the clock input returns to the inactive state, ϕ_1 goes high, ϕ_2 goes low and ϕ_3 begins to fall. C_1 is now isolated from the cell input, and the data transfer to C_2 .

At this point the cell has completed a full clock cycle and data have shifted from the cell input to the cell output. So far the cell operates in much the same way as a dynamic shift register cell. The static cell differs in the operation of the load devices, Q_L . These are not clocked, as in the dynamic cell, but are always conducting.

The static feedback path is enabled only at relatively low frequencies, since an interval of about $5 \mu\text{s}$ occurs before ϕ_3 goes low. Were ϕ_3 to go low as quickly as ϕ_2 , the cell would not have time to "flip" and would be bypassed through Q_5 .

Note that Q_3 is on only during the inactive clock state. As a result, the device cannot retain

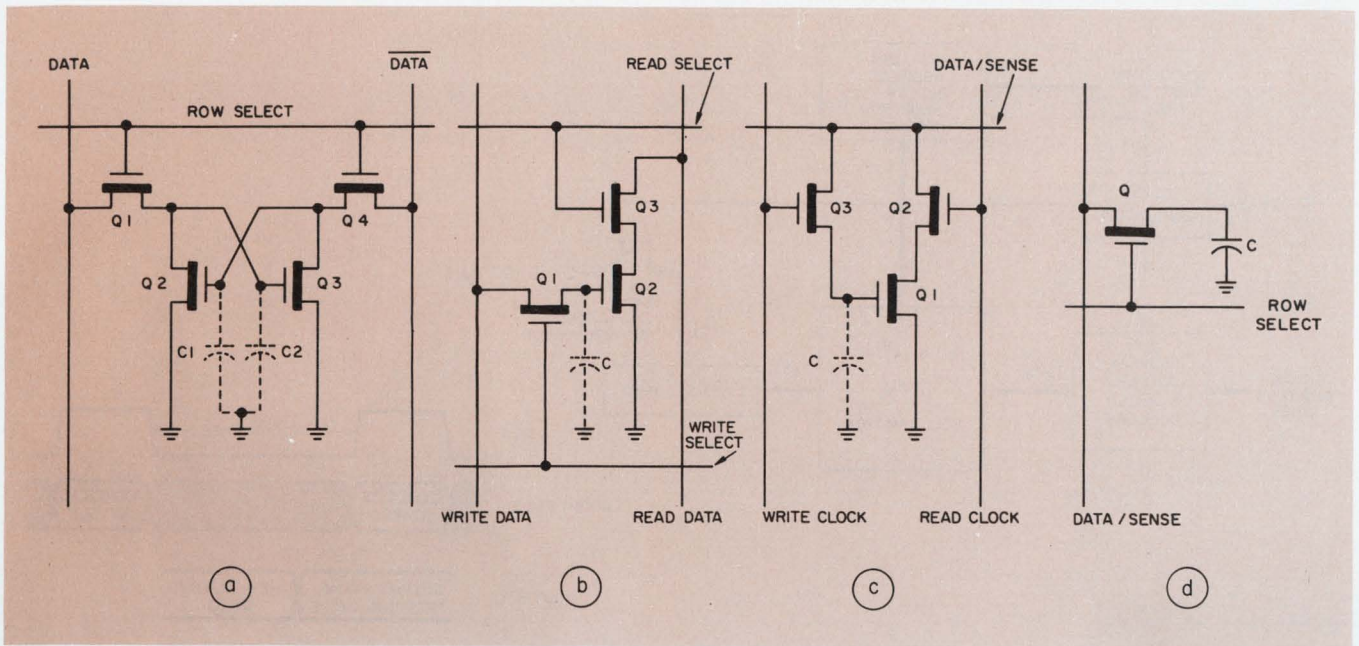

6. Dynamic RAM cells differ in the number of transistors and the corresponding number of interconnects. Cells can have as many as four, and as few as one,

transistor per cell (a through d, respectively). The four and three-transistor cells (a, b and c) use 3-1/2 and 4-1/2 interconnects.

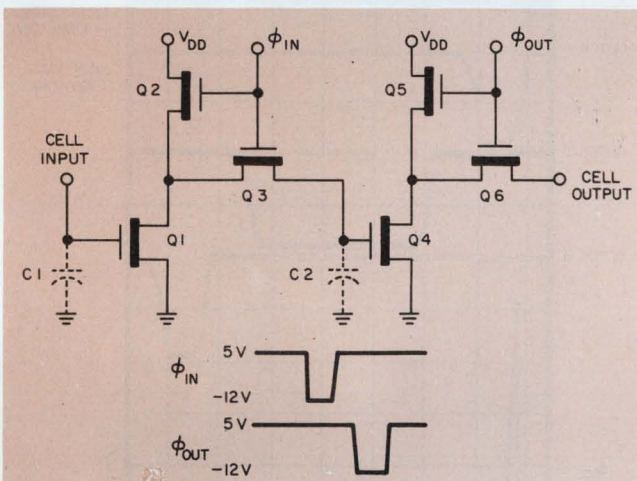

7. A dynamic shift-register cell. It uses high-voltage clocks to minimize the size of both transfer devices and load devices.

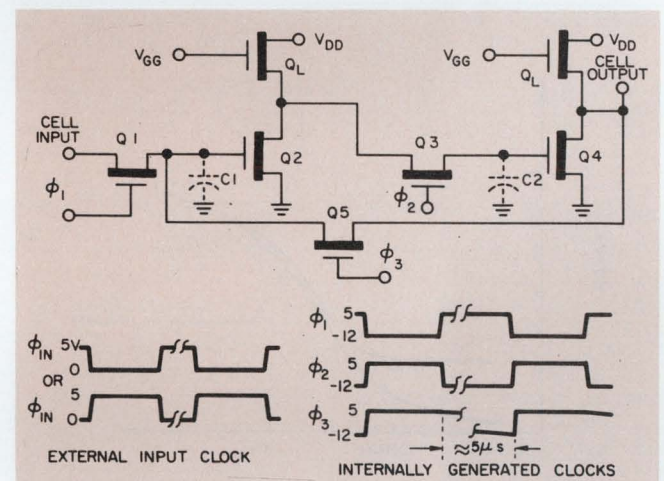

8. Static shift registers require more complex cell structures than dynamic shift registers. The purpose of the additional circuitry is to provide level shift and multi-phase high-voltage clock signals.

data in the static state if the input clock signal stops in the active state. This constraint causes an upper limit to be placed on clock pulse width. Conversely, when ϕ_3 does latch up the cell, data are retained without refresh as long as power is applied.

MOS for ROMs

A typical MOS mask-programmed ROM cell appears in Fig. 9. To store a positive logic ONE in a particular cell, a hole is cut in the source-drain diffusion mask for transistor Q_1 at the location of the cell. Conversely, for a logic ZERO, no hole is cut.

Then to gain access to a given cell, the appro-

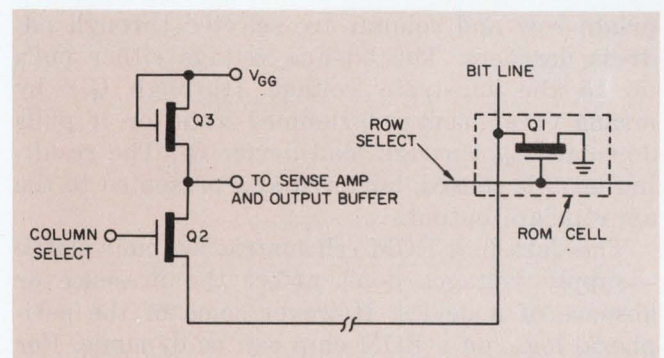

9. A ROM is formed by mask programming a device where a ONE is required and omitting a device where a ZERO is called for. Row and column select lines are used to provide access to a cell.

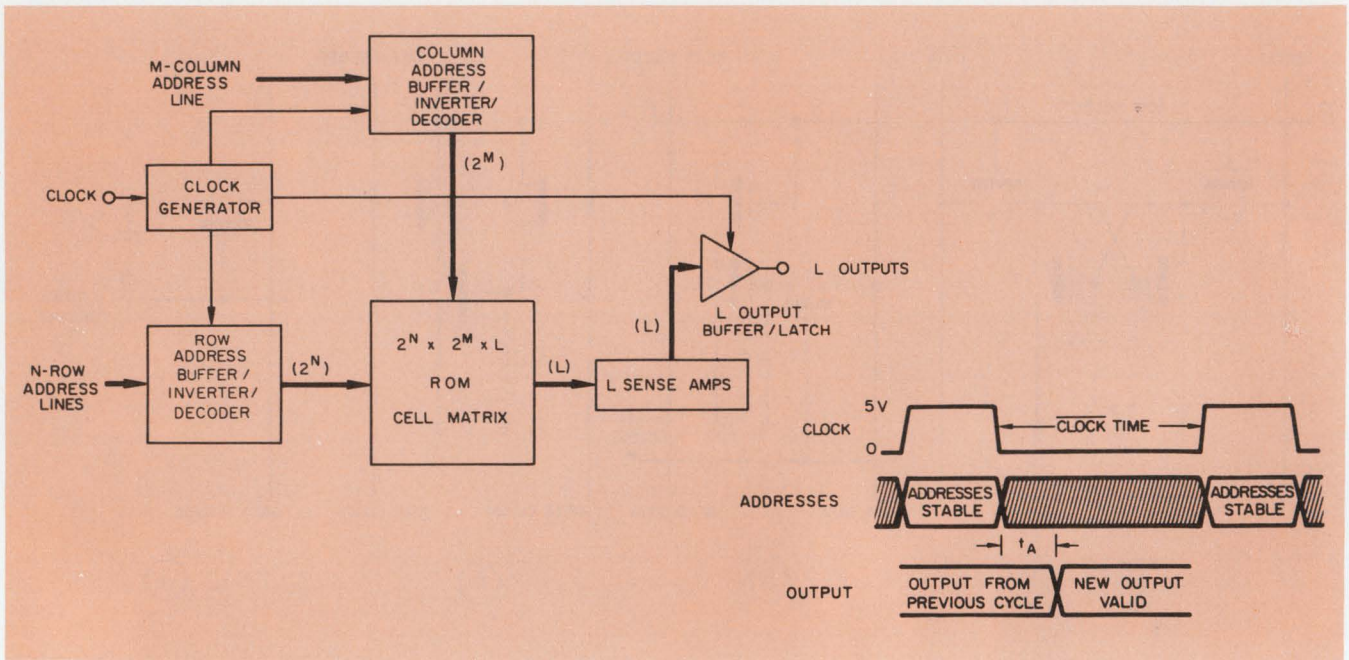

10. ROMs sometimes use dynamic address decoders to reduce power dissipation.

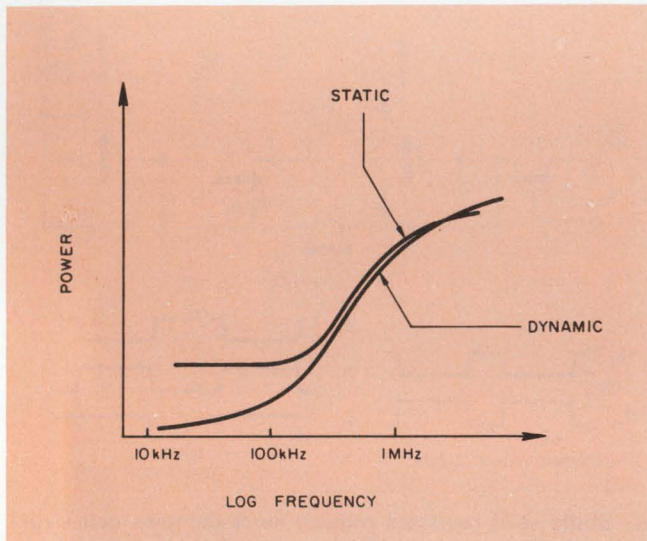

11. Static and dynamic shift-register curves of power vs frequency show similarity above 100 kHz.

appropriate row and column are selected through address decoders. The bit-line voltage either pulls up to the substrate voltage (through Q_1) by means of a mask-programmed gate, or it pulls down to V_{GG} through load device Q_3 . The resulting level is sensed, buffered and presented to the appropriate output.

The data in a ROM cell matrix are nonvolatile—supply voltages don't affect the presence or absence of a device. However some of the peripheral logic on a ROM chip can be dynamic. For example, some large ROMs use dynamic address decoders to save power. These ROMs require a logic signal that is used as a clock. The IC is called a dynamic ROM, even though the stored

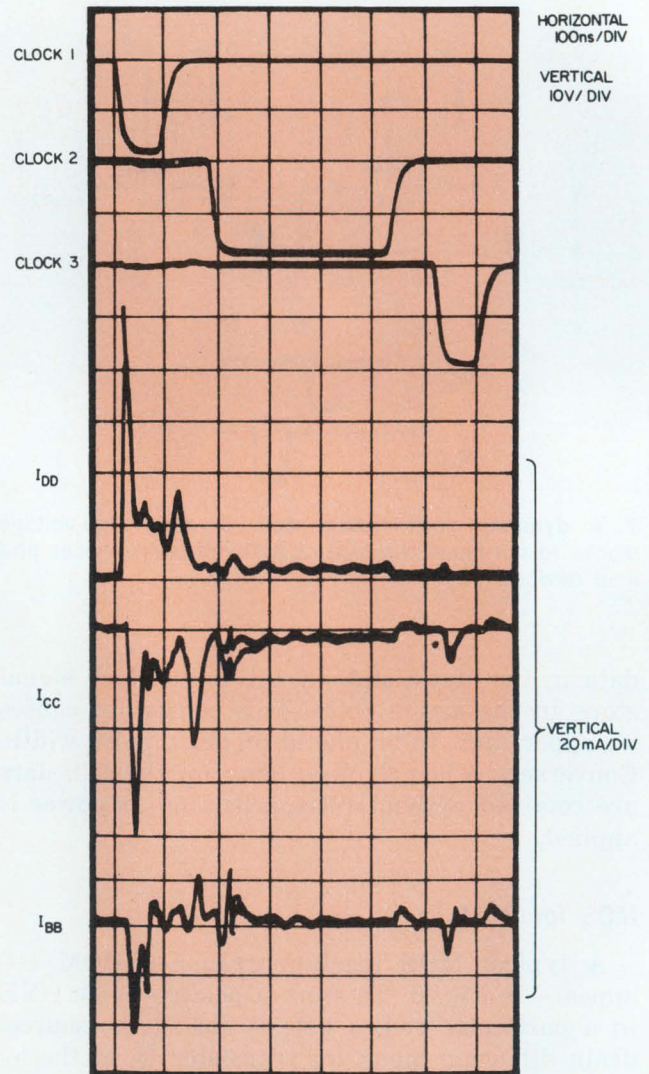

12. Typical current waveforms for a 2048 x 1-bit MOS RAM exhibit noise spikes. The noise occurs because large currents are drawn in short time intervals.

data are not dynamic.

The levels on the address lines are clocked into the decoders, and data are clocked into output latches (Fig. 10). During $\overline{\text{CLOCK}}$ time, the decoder lines (ROW and COLUMN SELECT) are precharged to a negative level. When $\overline{\text{CLOCK}}$ goes high, the address lines are decoded, and data are presented to the output latches. On the trailing edge of $\overline{\text{CLOCK}}$, the data are strobed into the output latches and are valid to the output after interval t_A has elapsed.

The output remains stable as long as the chip is enabled or until the next clock cycle. The block diagram in Fig. 10 also applies to static ROMs, with the exception of the clock generator circuitry. The static ROM outputs are valid one access time after all the address lines become stable and in each data cycle.

Static vs dynamic power

A comparison of average power vs frequency characteristics for static and dynamic shift registers appears in Fig. 11. Note that above about 100 kHz the two curves have similar shapes. The similarity occurs because both cell types operate in much the same way at frequencies above which the slower feedback path can function.

The steepest slope occurs between 100 kHz and 1 MHz. In this range, capacitor charging current is the predominant power component. The inflection point on both curves arises from the decrease in g_m that occurs as junction temperatures rise with increased power dissipation. The resulting higher on-chip resistances tend to reduce the slope of the power vs frequency curves for both static and dynamic shift registers. Below this range the primary power factor for static shift registers is the dc power drawn by the memory cells. For dynamic shift registers, leakage current represents the dominant factor.

Although the circuits may be configured differently, the same basic mechanisms affect other static and dynamic memory circuits. Generally, dynamic memories draw large currents during short intervals at some point in their cycle. The resulting current spikes create system noise problems.

Some typical current waveforms are shown in Fig. 12 for a 2048×1 -bit MOS RAM. Note the large I_{DD} current drawn at the leading edge of Clock 1. This current spike corresponds to the precharging of address decoder lines, which represent a large capacitive load. The load is switched onto the V_{DD} line by the leading edge of Clock 1. Static logic circuits, on the other hand, do not require large transient currents. They dissipate a more constant power, although they tend to consume more average power per function at low speeds. ■■

You say you want a

low-profile snap-in-mounting push button switch or matching indicator that is interchangeable with most 4-lamp displays... available in a full range of cap colors... with a choice of bezels with or without barriers in black, gray, dark gray or white.

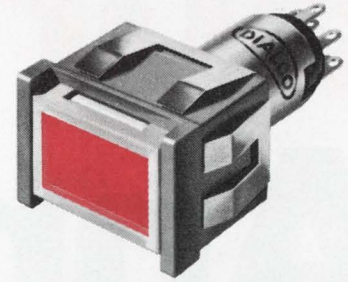

and a

legend presentation that's positive (like this one) or negative (like the one below) or just plain (like the one above)... one that's white when "off" and red, green, yellow (amber), blue or light yellow when "on"... or colored both "on" and "off."

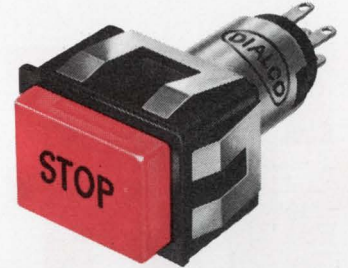

and a

highly reliable switch proven in thousands of installations... available in momentary or alternate action... N.O., N.C. or two circuit (one N.O., one N.C.)... that accommodates a T-1 3/4 bulb with midget flanged base, incandescent, in a range of voltages from 6-28V.

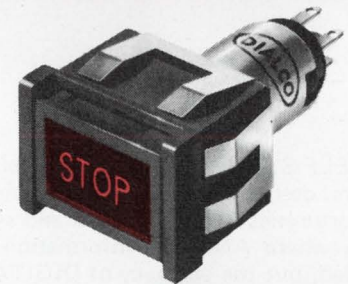

*etc.
etc.
etc.*

Now, for the first time Dialight gives you custom panel designing with a standard line of push-button switches and matching indicators

Dialight offers a broader range of switch and indicator possibilities than you'll find anywhere in a standard single-lamp line. Sizes: $\frac{3}{4}$ " x 1", $\frac{5}{8}$ " and $\frac{3}{4}$ " square and round. Send today for our new full-color catalog.

DIALIGHT

A North American Philips Company
Dialight Corporation, 60 Stewart Ave., Brooklyn, N.Y. 11237
INFORMATION RETRIEVAL NUMBER 57

Burroughs

Announces...

SELF-SCAN[®] Bar

SELF-SCAN BAR GRAPH display offers design engineers exciting new opportunities for instruments and systems where ANALOG information is needed, but the accuracy of DIGITAL information is desired.

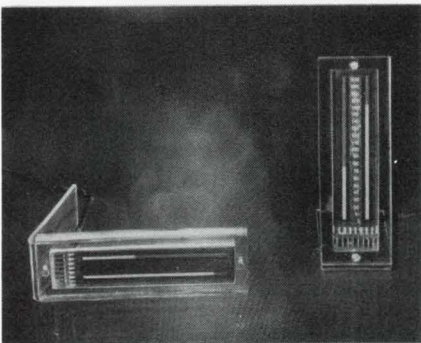

Data is presented as highly visible, illuminated bars that can be used horizontally or vertically. SELF-SCAN BAR GRAPH displays can be read instantaneously anywhere in the data range. The resolution is more precise than any mechanical equivalent available (a 200-element bar has 0.5% resolution).

SELF-SCAN BAR GRAPH panels combine the thick-film technology of Burroughs' PANAPLEX[™] displays and the internal scanning techniques of the Burroughs SELF-SCAN alphanumeric display. There are no moving parts; the problems of life, shock, vibration, and calibration have been virtually eliminated.

Compact, attractive and adaptable to the display of most any parameter which can be displayed in analog or digital form, the SELF-SCAN BAR GRAPH display is an ideal solution for the measurement and display of speed, torque, pressure, temperature, stress, force, or acceleration . . . wherever you need to monitor and control parameters . . . wherever your engineering ingenuity leads you.

These panels are extremely thin (only 0.25", excluding tubulation). That means you gain extra rear panel space.

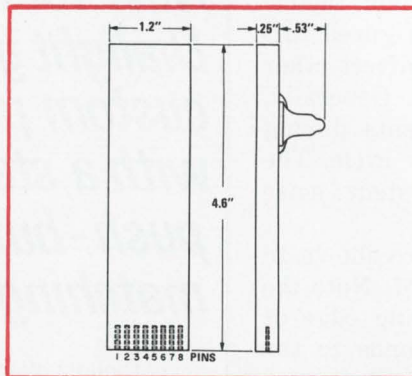

OUTLINE DRAWING OF PANEL

Only 8 connections to the display enable you to accurately control two independently variable 200-element displays. Control is achieved by scanning the 200 cathode elements sequentially using Burroughs' internal scanning technique, with the bar lengths controlled by the time the anode is on. This

simple technique permits you to use linear, non-linear, binary, or digital inputs to control the output of the comparators as shown on the block diagram.

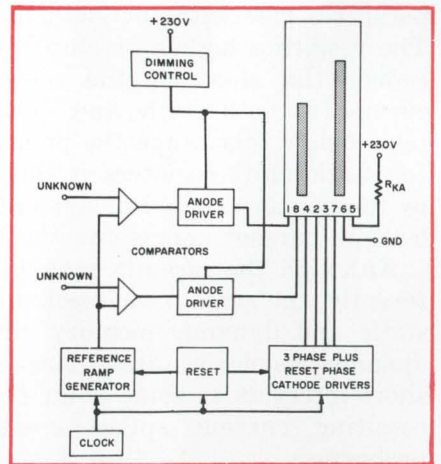

TYPICAL DRIVE CIRCUIT

These panels are available now for engineering evaluation, and production quantities will be available soon.

The best part is the price.
Dual 200-element display panels (0.5% resolution) are \$29.00 each in 1000 quantities.

*For complete information write:
Burroughs Corporation,
Electronic Components Division,
P.O. Box 1226, Plainfield, N.J. 07061,
or call (201) 757-3400 in New Jersey,
or (714) 835-7335 in California.*

Graph

**an
analog
display
with
digital
precision**



Burroughs

INFORMATION RETRIEVAL NUMBER 58



Match impedances in microwave amplifiers

and you're on the way to successful solid-state designs. Here's how to analyze input/output factors and to create a practical design.

The key to successful solid-state microwave power-amplifier design is impedance matching.

In any high-frequency power-amplifier design, improper impedance matching will degrade stability and reduce circuit efficiency. At microwave frequencies, this consideration is even more critical, since the transistor's bond-wire inductance and base-to-collector capacitance become significant elements in input/output impedance network design.

In selecting a suitable transistor, therefore, keep in mind that the input and output impedances are critical along with power output, gain and efficiency.

Unless the selected transistor is used at frequencies that are much lower than the maximum operating frequency, the input impedance is largely inductive with a small real part. The large inductance is due to bond wires that connect the transistor chip to the input lead of the package and to the common-element bond wires. The small real part of the input impedance is due to the large geometries required to generate high power at high frequencies; the base bulk resistance may be the predominant part of the real input impedance.

Use microstrip stubs at input network

The first and most important step in designing the input matching network for the selected device is to provide a shunt capacitance that will resonate the inductive component of the input impedance. This step forms the low-pass matching section of the network and should provide the smallest possible transformed impedance. To minimize the inductive component, the input and common-element lead lengths must be kept short.

The resonating capacitance is generally best provided by a microstrip stub. In some cases the stub producing the required capacitance is so large that a practical circuit size cannot be realized. It is best then to distribute as much of

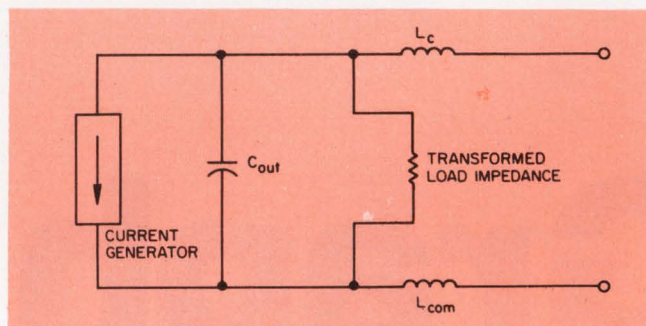

1. In this output equivalent circuit, capacitance C_{OUT} is almost equal to the selected transistor's collector-to-base capacitance C_{ob} .

this capacitance as is physically practical and to provide the balance with high-quality chip capacitors.

The first section of the impedance matching network is extremely important because it can degrade the stability of the amplifier if it is not well designed. Depending on the design frequency of the amplifier and the transistor selected, the resonated real impedance can range from less than $50\ \Omega$ to much higher. When it is below $50\ \Omega$, an additional low-pass matching section can be conveniently added to achieve the required $50\text{-}\Omega$ impedance at the input.

The higher-impedance case presents a special problem if microstrip techniques are used to build the matching network. The problem occurs because the resonated impedance may be as high as $300\ \Omega$. Reducing this to $50\ \Omega$ by use of a low-pass network configuration requires a series-transmission line that will behave as an inductor. The rule of thumb is that the characteristic impedance of the transmission line must be at least twice the higher impedance before such behavior results. Examination of the accompanying table shows that characteristic impedance lines of greater than $100\ \Omega$ are very narrow. Narrow transmission lines (less than 0.01-inch wide) should be avoided wherever possible, because repeatability of width dimensions is poor. Also, the loss in a narrow line may become excessive. A better solution is to use a quarter-wave transmission-line transformer with a characteristic impedance

Roger DeBloois, Senior Applications Engineer, TRW Semiconductors, Lawndale, Calif. 90260.

equal to the square root of the 50- Ω impedance product: $Z_o = \sqrt{50 Z_R}$.

Make output bandwidth wider than input

The output impedance of a microwave power transistor is usually defined as the conjugate of the load impedance required to achieve the device performance. A typical output equivalent circuit is shown in Fig. 1. The capacitance C_{out} is nearly equal to the collector-base capacitance C_{ob} specified for the selected transistor. L_c is the inductance of the bond wires used to bridge from the collector metallization area to the package output lead, and L_{com} represents the inductive effects of the common element bond wires.

For correct operation of the transistor, the ultimate load impedance must be transformed to a real impedance across the current generator. This real impedance is determined by

$$R_L = \frac{[V_{cc} - V_{ce}(\text{sat})]^2}{2P_{out}}$$

The load impedance presented to the package terminals will contain the real impedance at the current generator, transformed to a lower value by the low-pass L section formed by C_{out} and the parasitic inductances L_c and L_{com} . Usually the reactive part of the load impedance is made inductive to tune out the residual capacitance of the device.

The output matching network should be designed so it has greater bandwidth than the input matching network. Providing a good collector match, both above and below the design frequency, ensures that the input power will be reflected before the collector VSWR rises to values that endanger the transistor. In this way the transistor is protected from off-frequency operation. The amount of additional bandwidth required for protection of the transistor depends on the ruggedness of the transistor used. The manufacturer's specifications for VSWR tolerance and input Q can be a guide for determining the bandwidth requirements of the input matching network.

One technique for obtaining the required bandwidth is to resonate a portion of the capacitive

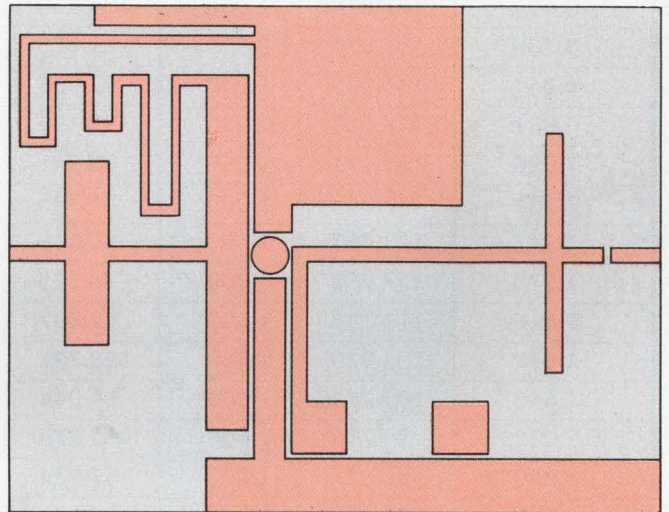

2. With this typical microwave amplifier breadboard layout, the entire board can be soldered to a metal plate to provide a path for thermal cooling.

reactance of the transistor output impedance with a shunt inductor. The shunt inductor can also be used to feed the collector supply voltage to the transistor. Additional transformation may be obtained from a low-pass matching section. By adjusting the amount of shunt inductance and rematching with the low-pass section, the designer can create a truly broadband output match.

Don't overlook base and collector paths

In addition to matching the device impedances, direct-current paths must be provided to the base and collector of the transistor. The collector path is provided by the shorted stub in the impedance-matching network. The base path requires the addition of a choke from the base to ground. The choke can be a lumped element or a distributed shorted stub of sufficient impedance to be negligible in the circuit. A quarter-wavelength stub is ideal. The narrowest practical line should be selected. In addition a dc blocking capacitor is required in the collector circuit. Also needed is a bypass capacitor to provide the proper ac shorting point for the inductive stub in the col-

Microstrip Z_0 and velocity factor vs width-to-height (W/H) ratio.

(Prepared by Don Schulz, Applications Engineer, TRW)

W/H	Air K = 1.0		Teflon K = 2.55		Epoxy K = 4.25		Alumina K = 9.6	
	Z_0	V_P	Z_0	V_P	Z_0	V_P	Z_0	V_P
0.630	168.425	1.000	110.683	0.657	87.986	0.522	60.977	0.362
0.695	161.878	1.000	106.258	0.656	84.414	0.521	58.441	0.361
0.766	155.370	1.000	101.865	0.656	80.870	0.521	55.927	0.360
0.844	148.909	1.000	97.509	0.655	77.360	0.520	53.440	0.359
0.931	142.506	1.000	93.199	0.654	73.888	0.518	50.985	0.358
1.026	136.171	1.000	88.941	0.653	70.463	0.517	48.566	0.357
1.131	129.916	1.000	84.745	0.652	67.090	0.516	46.187	0.356
1.247	123.753	1.000	80.616	0.651	63.775	0.515	43.853	0.354
1.375	117.692	1.000	76.565	0.651	60.524	0.514	41.568	0.353
1.516	111.746	1.000	72.597	0.650	57.345	0.513	39.337	0.352
1.672	105.926	1.000	68.721	0.649	54.243	0.512	37.164	0.351
1.843	100.242	1.000	64.944	0.648	51.223	0.511	35.053	0.350
2.032	94.706	1.000	61.273	0.647	48.291	0.510	33.007	0.349
2.240	89.327	1.000	57.714	0.646	45.451	0.509	31.030	0.347
2.470	84.115	1.000	54.271	0.645	42.709	0.508	29.123	0.346
2.723	79.076	1.000	50.951	0.644	40.066	0.507	27.289	0.345
3.002	74.218	1.000	47.757	0.643	37.527	0.506	25.531	0.344
3.310	69.546	1.000	44.692	0.643	35.094	0.505	23.849	0.343
3.649	65.065	1.000	41.759	0.642	32.768	0.504	22.244	0.342
4.023	60.779	1.000	38.959	0.641	30.550	0.503	20.716	0.341
4.435	56.689	1.000	36.292	0.640	28.440	0.502	19.266	0.340
4.890	52.796	1.000	33.760	0.639	26.439	0.501	17.892	0.339
5.391	49.100	1.000	31.360	0.639	24.544	0.500	16.594	0.338
5.944	45.600	1.000	29.091	0.638	22.755	0.499	15.370	0.337
6.553	42.291	1.000	26.952	0.637	21.069	0.498	14.218	0.336
7.224	39.173	1.000	24.938	0.637	19.485	0.497	13.138	0.335
7.965	36.233	1.000	23.047	0.636	17.998	0.497	12.125	0.335
8.781	33.484	1.000	21.275	0.635	16.606	0.496	11.179	0.334
9.681	30.904	1.000	19.618	0.635	15.305	0.495	10.295	0.333
10.674	28.491	1.000	18.071	0.634	14.091	0.495	9.472	0.332
11.768	26.240	1.000	16.629	0.634	12.961	0.494	8.707	0.332
12.974	24.143	1.000	15.288	0.633	11.911	0.493	7.996	0.331
14.304	22.192	1.000	14.043	0.633	10.937	0.493	7.338	0.331
15.770	20.381	1.000	12.888	0.632	10.033	0.492	6.728	0.330
17.387	18.702	1.000	11.818	0.632	9.198	0.492	6.164	0.330
19.169	17.148	1.000	10.830	0.632	8.425	0.491	5.644	0.329
21.133	15.172	1.000	9.917	0.631	7.713	0.491	5.164	0.329
23.300	14.385	1.000	9.074	0.631	7.056	0.490	4.722	0.328
25.688	13.162	1.000	8.299	0.630	6.451	0.490	4.315	0.328

Table continued

W/H	Air K = 1.0		Teflon K = 2.55		Epoxy K = 4.25		Alumina K = 9.6	
	Z _o	V _p	Z _o	V _p	Z _o	V _p	Z _o	V _p
28.321	12.036	1.000	7.585	0.630	5.894	0.490	3.942	0.327
31.224	10.999	1.000	6.929	0.630	5.383	0.489	3.598	0.327
34.424	10.047	1.000	6.326	0.630	4.914	0.489	3.284	0.327
37.953	9.172	1.000	5.773	0.629	4.483	0.489	2.995	0.327
41.843	8.370	1.000	5.266	0.629	4.089	0.489	2.731	0.326
46.132	7.634	1.000	4.801	0.629	3.727	0.488	2.489	0.326
50.860	6.960	1.000	4.376	0.629	3.397	0.488	2.267	0.326
56.073	6.343	1.000	3.987	0.629	3.094	0.488	2.065	0.326
61.821	5.779	1.000	3.632	0.628	2.818	0.488	1.880	0.325
68.157	5.264	1.000	3.307	0.628	2.566	0.487	1.711	0.325
75.144	4.792	1.000	3.010	0.628	2.335	0.487	1.557	0.325
82.846	4.362	1.000	2.739	0.628	2.125	0.487	1.417	0.325
91.337	3.969	1.000	2.492	0.628	1.933	0.487	1.289	0.325
100.700	3.611	1.000	2.267	0.628	1.758	0.487	1.172	0.324

lector-matching network.

Selection of a blocking capacitor is relatively straightforward. The capacitor should be chosen to provide low loss at the operating frequency while maintaining the capacitance at a value that inhibits low-frequency oscillation. The latter is caused by the series capacitor's tendency to display rising reactance with decreasing frequency.

Blocking capacitors must be large enough to preserve coupling characteristics down to a frequency where the shunt-feed chokes can effectively short the respective port to ground. Coupling capacitors should not be excessively large, or they may produce as much as 1-dB loss in gain with a corresponding decrease in efficiency in the case of collector coupling capacitors. The Q of the coupling capacitor determines the acceptable range of capacitance values and is generally inversely related to capacitance.

Bypass capacitors are selected by analysis of the same considerations as those for blocking capacitors. A large bypass capacitor (tantalum or electrolytic), placed from the dc feedpoint to ground, prevents tendencies toward low-frequency oscillation in the circuit. Also, it may be necessary to add smaller bypass capacitors to preserve stability over a wide range of frequencies.

Adjust for bandwidth and physical dimensions

The circuit design may be adjusted quickly for bandwidth requirements through use of a computer optimization program such as Magic, of-

fered by University Computing of Dallas, Tex. When that step is finished, electrical dimensions must be converted to physical dimensions.

At this point in the design sequence, the dielectric material must be chosen. Three commonly used materials are Teflon fiberglass, epoxy fiberglass and alumina. Above 500 MHz, epoxy fiberglass exhibits too many losses to be a good choice. Teflon fiberglass can be used up to several gigahertz; it has reasonable dielectric losses and is easy to process. Alumina, a ceramic, offers a high dielectric constant, good dimensional consistency and small circuit geometry.

When plastic materials are used, it's a good practice to measure the material thickness and dielectric constant, because variations are common. In a recent test the dielectric constant of a sheet of epoxy fiberglass material was measured at 4.55 at 1 MHz and 4.25 at 500 MHz. If the manufacturer's value of 5.5 had been used for the design of matching networks, considerable error would have resulted.

The physical dimensions of the matching circuitry may be calculated from the data in the table. The line lengths are scaled by the velocity factor, which is equal to $Z_o/Z_{o(\text{air})}$ in air for a constant width-to-height ratio, W/H.

The final design of a typical breadboard microwave amplifier is shown in Fig. 2. The ground areas on the top of the board are connected to the microstrip ground plane by 2-mil-thick foil wrapped around the edges of the board and the areas directly under the emitter leads of the transistor. The foil is secured to the top and bot-

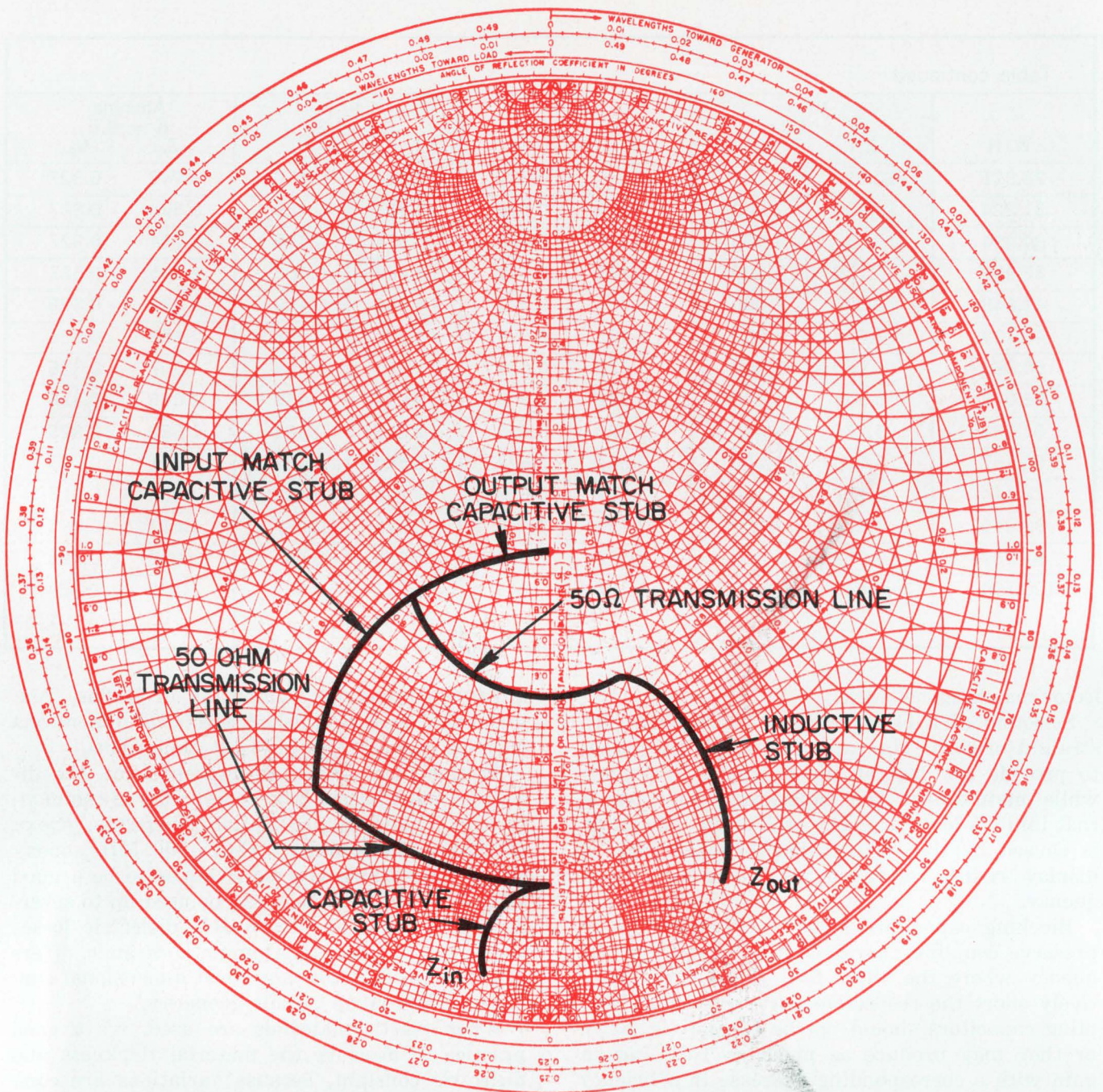

3. The immittance chart, with values specified for the design example, indicates the necessary inductive and

capacitive stubs. Impedance transformations are achieved by 50- Ω series-transmission lines.

tom surfaces with solder. Plating may be used for production units. The entire board can be soldered to a metal plate to allow connector mounting and to provide a thermal path for the heat generated by the transistor.

The initial tune-up of the amplifier matching circuits can be expedited by use of a network analyzer and a precision load on the input or output connector. The circuit can be adjusted to match the nominal impedances supplied by the transistor manufacturer. Distributed stubs are purposely made longer than necessary and are adjusted to the correct length by trimming of the

foil on the capacitive stubs. The inductive stub in the output network is adjusted by positioning of the bypass capacitor along the stub and the adjacent ground plane.

This procedure results in a load line that is fairly close to optimum. A transistor can now be inserted in the circuit and the collector matching network readjusted for maximum collector efficiency. Stub tuners are used to match the amplifier input impedance, so that only one variable at a time need be considered. Initially it may be necessary to operate the transistor at reduced collector voltage and power output to avoid

excessive stress. When maximum efficiency is obtained, the stub tuner is removed and the input network adjusted for minimum input VSWR.

Now let's design an impedance-matching circuit

Let's consider a practical example of a procedure for the design of impedance-matching circuitry. The sample circuit uses a TRW 2N5596 at 700 MHz as the active device.

Specifications for the completed amplifier are:

$$\begin{aligned} Z_{in} &= 50 \Omega, \\ Z_{out} &= 50 \Omega, \\ P_{out} &= 20 \text{ W}, \\ G_p &= 7 \text{ dB}, \\ \eta &= 55\% \text{ minimum.} \end{aligned}$$

Specifications for the TRW 2N5596 are:

$$\begin{aligned} P_{out} &= 20 \text{ W at 1 GHz}, \\ \eta &= 55\% \text{ minimum at 1 GHz}, \\ G_p &= 5 \text{ dB minimum at 1 GHz}, \\ Z_{in} &= 2.5 + j4.0 \text{ at 700 MHz}, \\ Z_{out} &= 6.0 - j12.5 \text{ at 700 MHz}. \end{aligned}$$

In practice, the gain of a common-emitter amplifier decreases at a rate of 4 to 5 dB per octave. The 2N5596 at 700 MHz produces about 7 dB of gain. Therefore approximately 4 W of drive will be required to produce 20 W of output power. The collector efficiency can be expected to increase at the lower frequency, but it is difficult to estimate because it is a complex phenomenon. Manufacturers' curves of typical behavior are useful. Output power will not increase significantly with the decreased frequency.

The efficiency-frequency relationship depends on device f_T and ballasting. Heavily ballasted transistors tend to give increased efficiency as frequency is decreased. However, they level out at a lower efficiency than a nonballasted part because of I^2R losses in ballast resistors. The average increase in efficiency as a result of decreasing frequency is about 20% per octave. Values from 10 to 40% per octave have been measured.

The initial phase of the design is best accomplished on an immittance chart. The chart with appropriate values indicated for the sample design is shown in Fig. 3. The input match is achieved when the input impedance is resonated with a capacitive susceptance of 0.18 mhos. This susceptance is realized by use of a pair of capacitive microstrip stubs. Each stub must exhibit a reactance of $2 \times 1/0.18$ mhos, or 11.1 Ω . The length of the stub may be calculated by

$$\tan \theta = \frac{Z_o}{X_c}.$$

For ease of adjustment, the length of the stubs should be less than 60 degrees. Because ca-

pacitive reactance is a tangential function, the reactive variations per unit length become increasingly severe past 60 degrees. It is better to decrease Z_o rather than to use longer stubs to achieve higher capacitance. Therefore $Z_o \leq 1.732 X_c \leq 19.24 \Omega$. Because it is easier to shorten a microstrip stub than to lengthen it, the Z_o of 15 Ω , for example, provides sufficient adjustment range to accommodate device variations.

The next step is to transform the resonated impedance to 50 Ω . This is accomplished by a series-transmission line with a characteristic impedance of 50 Ω . From Fig. 3, we see that the length of this line can be directly determined to be 0.062 wavelengths, or 22.3 degrees, long. A capacitive susceptance of 0.040 mhos completes the transformation. Again, a pair of capacitive stubs will provide the susceptance. For ease of converting the design to microstrip dimensions, it is convenient to choose a Z_o for the second stub that is equal to that selected for the first. Therefore:

$$\begin{aligned} \tan \theta &= \frac{Z_o}{X_c} = \frac{15}{50} = 0.3, \\ \text{or } \theta &= 16.7 \text{ degrees.} \end{aligned}$$

In this case the length chosen is 20 degrees to allow for some adjustment.

The output match is achieved by partial resonating of the device's output impedance with an inductive susceptance. While the amount of susceptance chosen is arbitrary at this point, the output network bandwidth is affected by the value. From Fig. 3, we can determine that 0.05 mhos is required for the first matching element. This susceptance is achieved by use of a shorted microstrip stub. The length of the stub may be calculated from the equation

$$\tan \theta = \frac{X_L}{Z_o}.$$

If Z_o of the stub is arbitrarily chosen to be 50 Ω ,

$$\begin{aligned} \tan \theta &= \frac{20}{50} = 0.4, \\ \theta &= 21.8 \text{ degrees.} \end{aligned}$$

Again, the stub is made somewhat longer because it can be adjusted by sliding the chip capacitor (ac short) up or down the line length. The remaining transformation is achieved by a 50- Ω series-transmission line of 0.15 wavelengths (54 degrees long) and a capacitive susceptance of 0.014 mhos. Selecting a pair of 50-ohm microstrip lines to provide the susceptance requires a stub length of

$$X_c = 2 \times \frac{1}{0.014} = 143 \Omega.$$

$$\tan \theta = \frac{Z_o}{X_c} = \frac{50}{143} = 0.350 = 19.3 \text{ degrees.}$$

A stub length of 25 degrees will provide an adequate allowance for adjustment of the circuit. ■■

Do you face
a make or buy
decision on
power supplies?

BUY LAMBDA'S LZ SERIES MOUNTABLE POWER SUPPLY.

LZS-34
5V, 1400mA
\$95

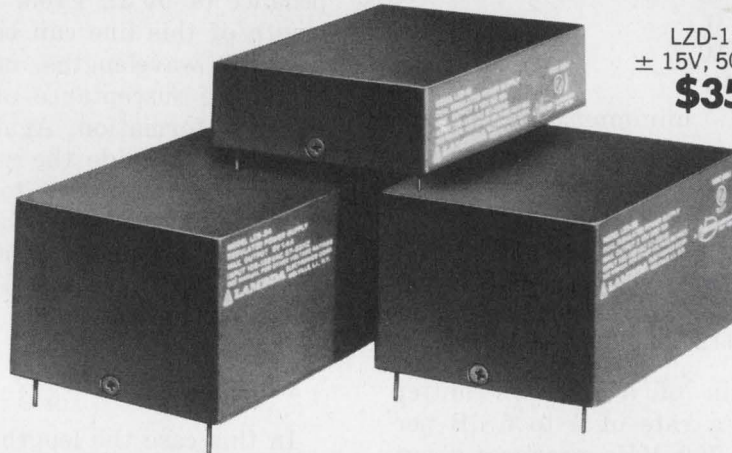

LZD-12
± 15V, 50 mA
\$35

LZD-35
± 15V, 300 mA
\$95

LZ-10 SERIES SINGLE OUTPUT

2½" x 3½" x 7⁄8"

MODEL	VOLTAGE ⁽¹⁾ VDC	CURRENT mA	PRICE ⁽²⁾
LZS-10	3	317	\$35
LZS-10	4	384	35
LZS-10	5	450	35
LZS-11	10	225	35
LZS-11	12	195	35
LZS-11	15	150	35

LZ-10 SERIES DUAL TRACKING OUTPUT

2½" x 3½" x 7⁄8"

MODEL	VOLTAGE ⁽¹⁾ VDC	CURRENT mA	PRICE ⁽²⁾
LZD-12	±15V	50	\$35

LZ-20 SERIES SINGLE OUTPUT

2½" x 3½" x 1¼"

MODEL	VOLTAGE ⁽¹⁾ VDC	CURRENT mA	PRICE ⁽²⁾
LZS-20	10	247	\$55
LZS-20	12	268	55
LZS-20	15	300	55
*LZD-22	24	73	40
*LZD-23	24	129	55
*LZD-22	28	84	40
*LZD-23	28	143	55

*Single output ratings for dual output models connected in series

LZ-20 SERIES DUAL TRACKING OUTPUT

2½" x 3½" x 1¼"

MODEL	VOLTAGE ⁽¹⁾ VDC	CURRENT mA	PRICE ⁽²⁾
LZD-21	± 3	217	\$55
LZD-21	± 4	258	55
LZD-21	± 5	300	55
LZD-22	±10	61	40
LZD-23	±10	114	55
LZD-22	±12	73	40
LZD-23	±12	129	55
LZD-22	±15	90	40
LZD-23	±15	150	55

LZ-30 SERIES SINGLE OUTPUT

2½" x 3½" x 1¾"

MODEL	VOLTAGE ⁽¹⁾ VDC	CURRENT mA	PRICE ⁽²⁾
LZS-30	3	633	\$65
LZS-30	4	767	65
LZS-30	5	900	65
LZS-33	10	293	65
LZS-33	12	336	65
LZS-33	15	400	65
LZS-34	3	950	95
LZS-34	4	1180	95
LZS-34	5	1400	95
*LZD-32	24	186	65
*LZD-32	28	208	65
*LZD-35	24	240	95
*LZD-35	28	280	95

*Single output ratings for dual output models connected in series

...PRINTED-CIRCUIT BOARD

LZ-30 SERIES DUAL TRACKING OUTPUT

MODEL	2½" x 3½" x 1⅞"		PRICE ⁽²⁾
	VOLTAGE ⁽¹⁾ VDC	CURRENT mA	
LZD-31	± 3	333	\$65
LZD-31	± 4	417	65
LZD-31	± 5	500	65
LZD-32	±10	163	65
LZD-32	±12	186	65
LZD-32	±15	220	65
LZD-35	±10	200	95
LZD-35	±12	240	95
LZD-35	±15	300	95

LZ-30 SERIES TRIPLE OUTPUT

MODEL	2½" x 3½" x 1⅞"		PRICE ⁽²⁾
	VOLTAGE ⁽¹⁾ VDC	CURRENT mA	
LZT-36	5	500	\$70
	±15	50	

NOTES: (1) LZ models are adjustable between the following limits: LZS-10 2.5 to 6V LZS-11 8 to 15V LZS-20 8 to 15V LZS-30 2.5 to 6V LZS-33 8 to 15V LZS-34 2.5 to 6V LZD-12 ± 14.5 to ± 15.5V LZD-21 ± 2.5 to ± 6V LZD-22 ± 8 to ± 15V LZD-23 ± 8 to ± 15V LZD-31 ± 2.5 to ± 6V LZD-32 ± 8 to ± 15V LZD-35 ± 8 to ± 15V LZT-36 2.5V-6V for + 5V output only, ± 14.5 to ± 15.5 for ± 15V output only. Contact factory for current ratings at voltage settings not indicated in the tables. (2) All prices and specifications are subject to change without notice.

SPECIFICATIONS FOR LZ SERIES

Regulation

0.15%—line or load; models LZS-10, LZS-30, LZS-34, LZD-21 and LZD-31 have load regulation of 0.15% + 5mV; model LZD-12 has line or load regulation of 0.25%; LZT-36 line regulation 0.15% (±5V) 0.25% (±15V); load regulation 0.15% + 10mV (+5V), 0.25% (±15V).

Ripple and noise

1.5mV RMS, 5mV, pk-pk

Temperature coefficient

0.03%/°C

Overshoot

no overshoot on turn-on, turn-off, or power failure

Tracking accuracy

2% absolute voltage difference for dual output models only and only for the ±15V output in LZT-36; 0.2% change for all conditions of line, load and temperature

Ambient operating temperature range

continuous duty from 0°C to + 50°C

Wide AC input voltage range

105 to 132 Vac, 57-63 Hz

Storage temperature range

-25°C to +85°C

Overload protection

fixed automatic electronic current limiting circuit

Input & output connections

printed circuit solder pins on lower surface of unit. For model LZT-36 the ± 15V outputs are independent from the 5V output.

Controls

screwdriver voltage adjustment over entire voltage range.

Mounting

tapped holes on lower surface

Physical data

Size

see tables

Weight

LZ-10 series 10 oz. net 18 oz. ship.

LZ-20 series 17 oz. net 25 oz. ship.

LZ-30 series 24 oz. net 32 oz. ship.

60-day guarantee

60-day guarantee includes labor as well as parts

LZ SERIES NOW AVAILABLE IN NEW TRIPLE OUTPUT MODEL

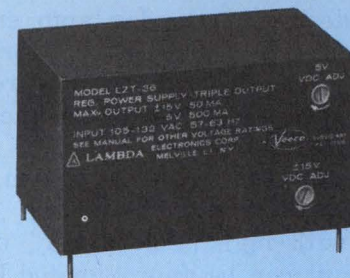

MODEL	VOLTAGE ⁽¹⁾ VDC	CURRENT mA	PRICE ⁽²⁾
LZT-36	5V	500	\$70
	±15V	50	

**1 DAY DELIVERY
60 DAY GUARANTEE**



**LAMBDA
ELECTRONICS CORP.**

A Veeco Company

MELVILLE, NEW YORK 11746 515 Broad Hollow Road Tel. 516-694-4200 ARLINGTON HEIGHTS, ILL. 60005 2420 East Oakton St., Unit Q Tel. 312-593-2550 NORTH HOLLYWOOD, CALIF. 91605 7316 Varna Ave. Tel. 213-875-2744 MONTREAL, QUEBEC 100C Hymus Blvd., Pointe Claire, Quebec 730 Tel. 514-697-6520 HIGH WYCOMBE, BUCKS, ENG. Abbey Barn Road, Wycombe Marsh Tel. High Wycombe 36386/7/8 ORSAY, FRANCE 91 Gometz le Chatel.

INFORMATION RETRIEVAL NUMBER 59

Build high-gain, wide-range log amps

that combine good high-frequency capability with excellent full-range logarithmic accuracy.

Here's a different approach to logarithmic amplifier design. If you add a feedback loop around an rf detector, you can achieve good log accuracy, high gain, wide dynamic range and high-frequency capability simultaneously.

A two-stage circuit that uses this method produces a gain range of over 20 dB, has a maximum sensitivity of 3 mV at 21.4 MHz and has a log accuracy of better than ± 0.3 dB. To increase the gain range even further, more stages can be added easily. For example, a five-stage circuit produces a gain range of 75 dB.

Such amplifiers can be used in communications receivers, spectrum analyzers and field-strength meters. Their high gain and selectivity often make them less expensive than the conventional successive-limiting type. Also they avoid some of the problems of linear amplifiers and logarithmic detectors (see box).

Understanding the design approach

The design of the log amp employs the log characteristics of a semiconductor diode. The use of feedback, however, greatly reduces the dynamic-range requirements of the amplifier and detector.

To understand this approach, consider the common-emitter amplifier (Fig. 1a). For transistors with high betas and f_t , the gain, G , of this circuit can be approximated by

$$G = R_1/R_2 \quad (1)$$

Next, consider a simple common-emitter amplifier that operates at a frequency of 21.4 MHz (Fig. 1b). If the rf resistance of the p-i-n diode is much smaller than both R_b and R_c , the emitter impedance of the circuit is essentially that of the p-i-n diode. Since several commercially available p-i-n diodes have current-controlled rf resistances of a few ohms to several hundred ohms, this condition can be easily met.

At resonance, the collector impedance is simply R_a , so the equivalent circuit is like the one in Fig. 1a. This means that the gain at resonance is

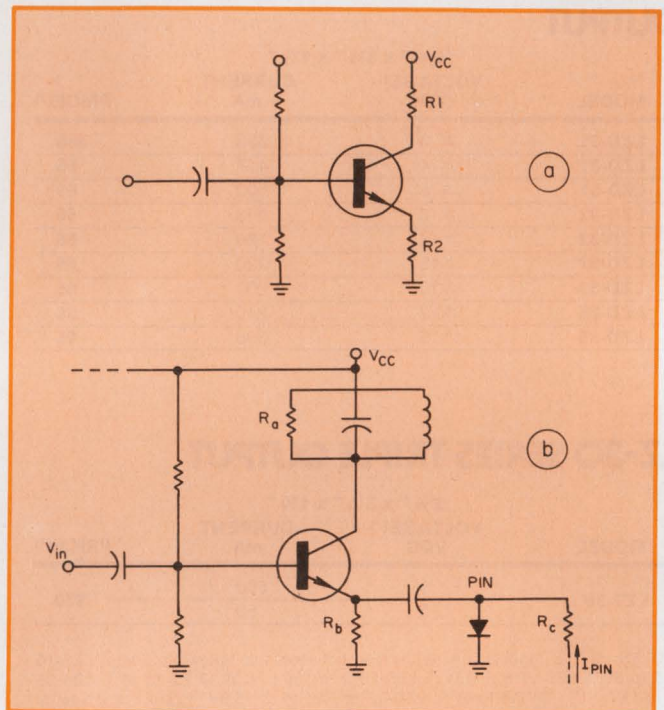

1. The operation of a log amp is very much like that of a simple common-emitter amplifier (a), since at resonance, the collector impedance of an rf amplifier (b) is simply R_a . Its gain is then a function of the p-i-n diode resistance.

given by

$$G = R_a/R_{p-i-n} \quad (2)$$

where R_{p-i-n} denotes the rf resistance of the p-i-n diode.

Many p-i-n diodes have linear current vs rf resistance characteristics over several orders of magnitude. Thus we can express R_{p-i-n} by a simple linear relationship:

$$R_{p-i-n} = KI_{p-i-n} \quad (3)$$

where I_{p-i-n} is the diode current and K is a constant.

If we substitute this into Eq. 2, we get

$$G = R_a/(KI_{p-i-n}) \quad (4)$$

as the gain for a simple common-emitter amplifier at resonance.

To use feedback for gain control, the circuit of Fig. 2 is employed. The rf amp in this circuit is actually the common-emitter amplifier of Fig.

Two basic ways to design log amps

There are two common ways to design log amps. The first is by linear approximation. In many cases the designer cascades a number, N , of limiting amplifiers or stages, with each stage having a specific limiting threshold (Fig. a). As the input signal increases, the gain of the N stages changes as each stage limits and ceases to contribute to the system gain. Consequently the plot of output vs input is a series of straight-line segments—where the number of segments is one more than the number of stages. The slope of each segment corresponds to the amplifier gain for that range of input voltages.

The advantages of this log amp include: high gain, reasonable insensitivity to temperature and operation at high frequencies.

The most obvious disadvantage is that it produces only approximate results. Between the break points, the output-vs-input curve is strictly linear. If you want to expand the output display, the de-

parture from a true log can introduce considerable error.

The second method (Fig. b) is based on the inherent logarithmic relationship between voltage and current in various semiconductors, such as a common diode. Here a linear amplifier with a wide dynamic range drives a linear detector. The output of the detector is converted into a logarithm by the diode.

This method has one significant advantage over the first approach: The output of the circuit is a true logarithm of the input rather than an approximation. Fairly good log accuracy can be achieved throughout the entire dynamic range of the circuit.

But this method also has some serious disadvantages: The linear amplifier may often need an enormous dynamic range; the linear detector must also be linear over the same large range; and the semiconductor "logarithm converter" is temperature sensitive.

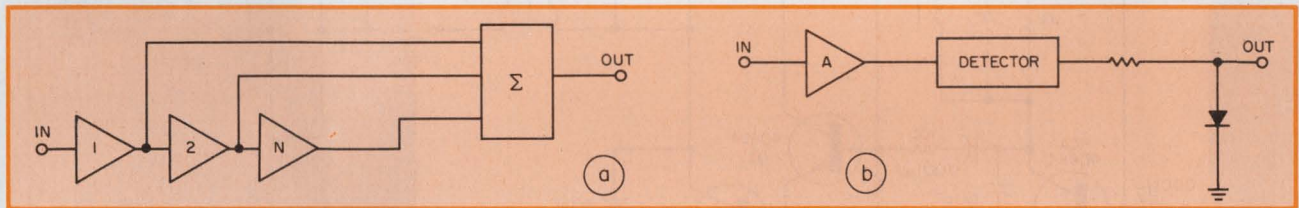

1b. The input voltage for the circuit of Fig. 2 is given by

$$V_{in} = V_{ref} / (GD) = (V_{ref} KI_{p-i-n}) / (R_a D), \quad (5)$$

where G (gain) was replaced by its expression of Eq. 4, and where D is the diode-detector coefficient. Since the detector operates at a constant level, D is a constant.

Since in Eq. 5 all terms except I_{p-i-n} are constants, this equation can be written as

$$V_{in} = BI_{p-i-n}, \quad (6)$$

where $B = (V_{ref}K) / (R_a D)$. (7)

If we take the log of Eq. 6, we get the following:

$$\log V_{in} = \log I_{p-i-n} + \log B = \log I_{p-i-n} + B', \quad (8)$$

where the term B' simply means that the log of a constant (B) is also a constant.

Now, like any other semiconductor diode, the p-i-n has a logarithmic relationship between for-

ward voltage, V_{p-i-n} , and forward current, I_{p-i-n} . Therefore

$$\log I_{p-i-n} = AV_{p-i-n} + \beta, \quad (9)$$

so Eq. 8 can be rewritten as

$$\log V_{in} = AV_{p-i-n} + \beta + B'. \quad (10)$$

Thus we can see that the circuit of Fig. 2, with the feedback arrangement, has the log of the input signal as a linear function of the voltage across the p-i-n diode. Input signals with wide dynamic ranges can be accommodated easily by this configuration.

A practical two-stage log amp

Fig. 3a depicts a two-stage amplifier, built for test purposes. It has more than 20-dB range, a maximum sensitivity of 3 mV at 21.4 MHz and log accuracy of ± 0.3 dB. The only significant

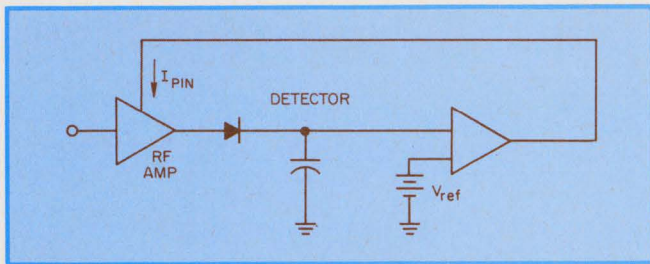

2. The dynamic range of a log amp is boosted when a feedback loop is closed around the detector. The rf amp is essentially the common-emitter amplifier detailed in Fig. 1b.

departure from the simplified schematic of Fig. 2b is the addition of an emitter-follower between the first and second stages. This reduces the loading effects of succeeding stages.

The value of V_{ref} in this circuit is set by R_a , R_b and R_c at 15 mV. Note that the agc op amp has no feedback around itself and works at a supply voltage of 30 V and ground. Other supply

schemes could be used, but then it would be necessary to ensure sufficient current flow through the p-i-n diodes for the required dynamic range.

To achieve temperature stability, we obtain the log output voltage by taking the voltage difference between the p-i-n diodes in the agc loop and a fixed reference diode. There are two basic temperature-sensitive parameters: One is the variation of diode voltage vs temperature; the other is the variation of the diode rf resistance.

The first effect is compensated quite easily by the use of the fixed-current reference diode. The second effect (which can vary the scale factor of the log output) can be compensated by a thermistor in the feedback loop of the output op amp (A_2). The value of the thermistor depends on the type of p-i-n diodes used.

One, two, four and five-stage amplifiers have been built and tested successfully. The five-stage amplifier produces a gain range of more than 75 dB. The performance of the two-stage log amp is demonstrated in the plot of Fig. 3b. ■■

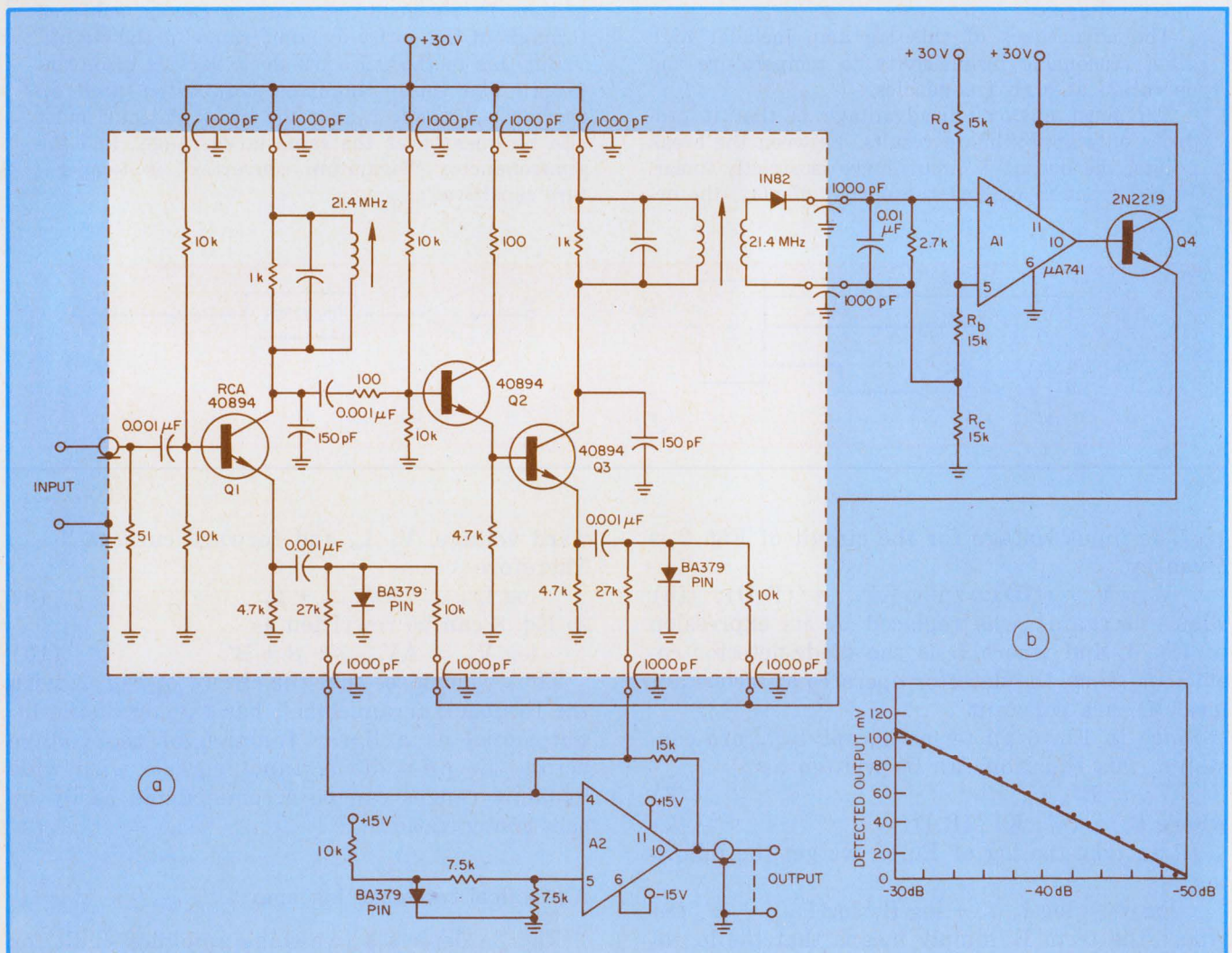

3. A two-stage log amp (a) has a 20-dB gain range and a sensitivity of 3 mV. The log accuracy is ± 0.3 dB over the complete range (b). A p-i-n diode in the reference

circuit of the output stage is used for temperature stability. Further temperature stabilization is achieved by a thermistor in the feedback loop of the output stage.

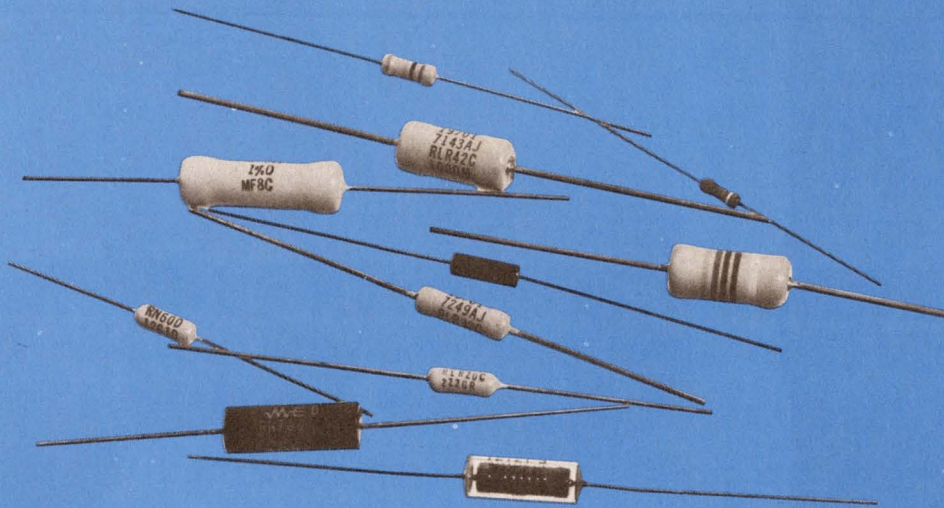

TAKE RESISTORS!

(Take ours!)

For ultra-stable 0.1% metal films through "comp" priced carbon films, you'll find just the resistor you need from the single source for passive components ... MEPCO/ELECTRA.

Take our *metal films*. We cut across market lines with our low cost conformally coated 1% and 2% devices for consumer equipment; our high performance 0.1% industrial and commercial product; our conformally coated, molded or hermetically sealed standard military and professional parts (EDP, Communications, Instrumentation); our "top-of-the-line" ER resistors to MIL-R-39017 and 55182.

Or take our *carbon films*. We call them the "comp killers" because our price/performance ratio can't be matched. You get all the precision of film resistors, priced to knock the "comp" out

every time. Our resistance range is 2Ω through $20\text{ M}\Omega$, tolerances to 1% in all the most wanted wattage styles.

Our *thick film Cermets* are unique in the industry, offering the best resistance per unit of volume in its class. These high ohm devices are available from $100\text{K}\Omega$ to $50\text{ Meg}\Omega$ with tolerances of 1%, 2% and 5%.

For hybrid and microwave applications, we offer our miniature, leadless *rod resistors* in thick or thin film, sized to meet the tightest hybrid module application.

Doesn't it make sense to talk to the company with the most to offer in product, experience and expertise? Talk to the Man From Mepco/Electra about all your resistor needs. Call or write Mepco/Electra Inc., Morristown, New Jersey 07960. (201) 539-2000.

Talk to the
man from
**MEPCO/
ELECTRA**



Sold through
North American Philips
Electronic Component
Corporation



Plant Locations:
Morristown, New Jersey; San Diego, California; Mineral Wells, Texas; Canandaigua, New York; Oakland, California.

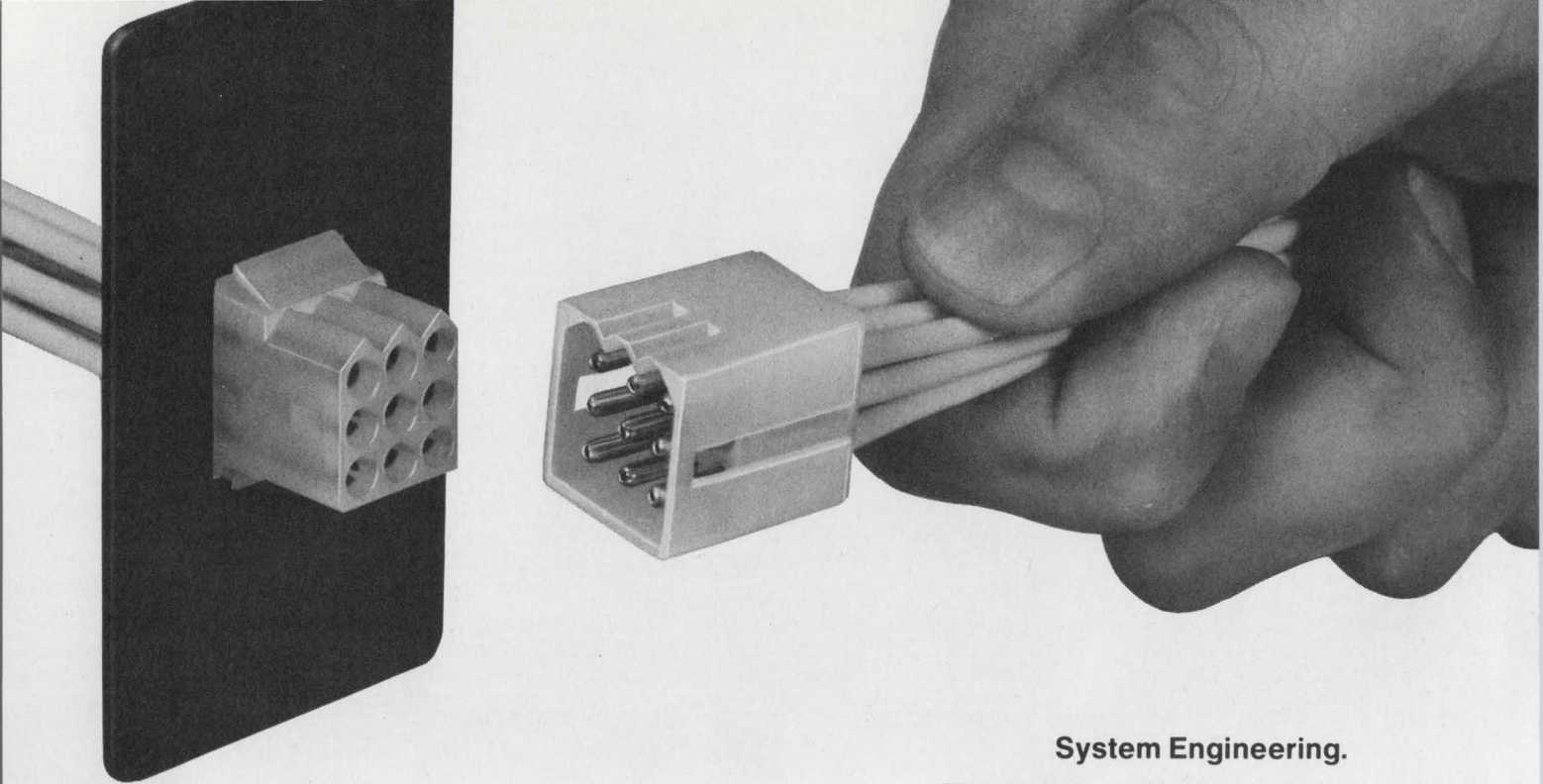

**You can't
beat
"the system."**

**Burndy Hylok[®]
pin and socket connectors
and installation tools offer
highest reliability
at lowest installed cost.**

System Engineering.

That's what makes the Burndy Hylok[®] pin and socket connector system perform at the lowest installed cost. Our contacts are specifically designed to be terminated in our rugged, automatic tooling and installed reliably and easily in our connector housings. It's a system that's designed to work together to give you trouble-free and faster assembled connectors. The result is lower installed cost because assembly is faster and easier at every step.

The Housings.

They're available in either panel mountable or free hanging styles and are made of tough flexible nylon. The housings have positive polarizing keys to eliminate

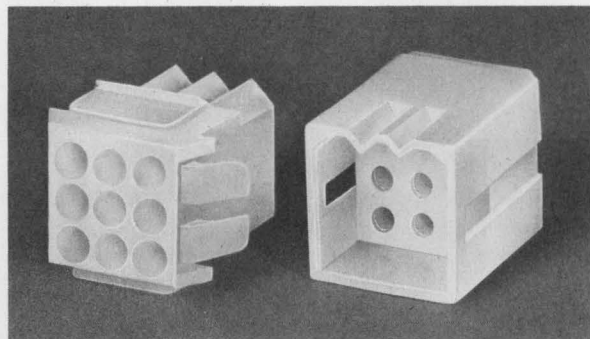

mis-mating. Low profile mounting ears make Hylok[®] fast and easy to install, and resilient take-up springs hold the housing securely over a wide range of panel thicknesses. Hylok[®] housings are available in 2,3,4,6,9,12 and 15 positions to cover virtually every application.

The Contacts.

Burndy Hylok[®] contacts feature a three point stabilizer and three positive

BURNDY

International Sales and Manufacturing: Brussels, Barcelona, Paris, Rotterdam, Stockholm, Stuttgart, Turin, Zurich, St. Helens (Eng.), Toronto, Sydney, Tokyo, Mexico, Sao Paulo

COMMECTS



forward stops. The result is an accurate, precise contact "float," so mating is always fast, easy and smooth. Never a contact out of alignment. Our contacts

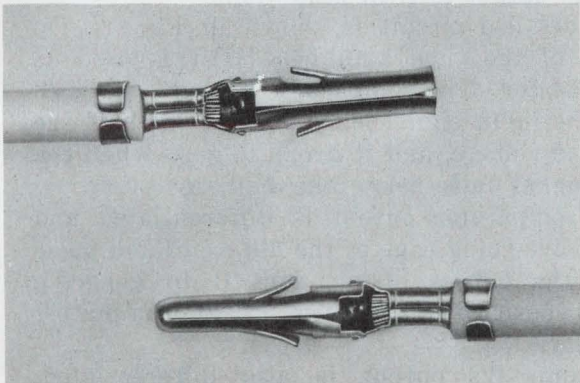

cover the full range of wire sizes. Number 24 to 16 AWG and .040" to .130" insulation diameter. They also feature serrated wire barrels to break up surface oxides and a stepped insulation barrel to keep the conductors in perfect alignment with the contacts.

The Tooling.

There's a complete line of Burndy installation tooling to match every production requirement. The Burndy UTM Universal Terminating Machine is a rugged 5-ton bench press that delivers the quietest, most consistently reliable crimps in the business. For larger runs, choose the Burndy automatic wire processing machines ADET or ASET that cut the leads to length, mark them, strip them to length and terminate one or both ends. All at speeds up to 4,000 leads per hour! Burndy installation tooling is as versatile as it is fast. Both pin and socket contacts are terminated in the same mechanisms to reduce change-over time and all

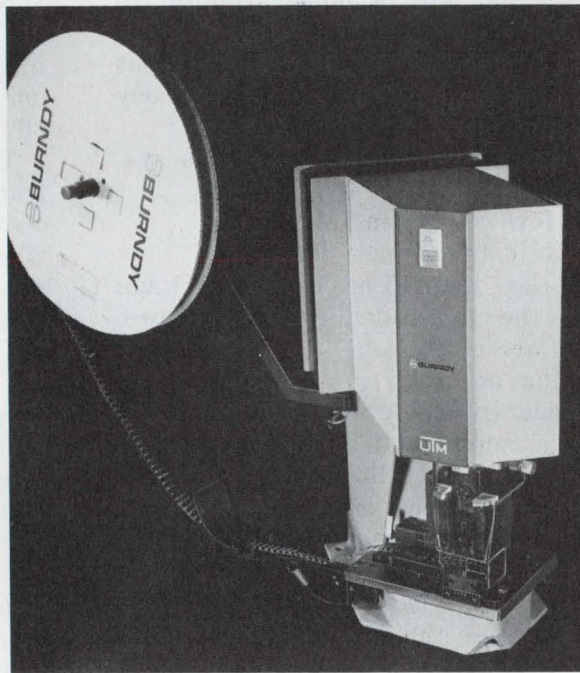

machines feature easy-to-set dial adjustments for wire size and insulation size.

Compatibility.

Burndy Hylok® pin and socket connectors are intermateable and interchangeable with other standard pin and socket connectors.

It all adds up to the finest system of pin and socket connectors ever made. A system that can't be beat for dependability and total value. For more information on Burndy Hylok® pin and socket connectors, write Burndy Corporation, Norwalk, Connecticut 06856. And see why you can't beat our system.



BURNDY

Offices in principal cities throughout the United States.

INFORMATION RETRIEVAL NUMBER 61

Design a nonaveraging tachometer

that outputs a voltage that is proportional to rate. Low power drain and battery operation makes it useful in the field.

To monitor periodic events—such as motor speed, heartbeat or waveform frequency—it's fairly common to start off with a pulse train whose pulse-to-pulse time intervals are inversely proportional to the rate of the event. But then a problem arises: How do you convert the pulse-to-pulse intervals—which are hyperbolically related to the rate—to a linear readout of the rate?

Here's a way that uses a binary counter to switch a series of binary-related resistors into or out of a voltage divider network. The output of the network is a voltage level that is linearly proportional to rate.

Among the advantages offered by such a system are these:

- Relatively few components are used.
- Minimum adjustments are needed.
- Low-drain (less than 15 mA), single-voltage operation makes the circuit ideal for portable use.
- Rate limits are easily set.
- Programming accuracy can be adjusted.
- A low-impedance analog output is provided.

Furthermore a commercial DVM can be used to display relatively slow rates—such as those from slowly turning motors or heart rate. And for higher rates, the analog output can be recorded in digital form and then reviewed by playback at slow speeds. Note that the maximum rate is limited only by the frequency characteristics of the selected ICs.

Pulses converted to binary number

The circuit operates as follows (Fig. 1): The input signal is first shaped and then used to strobe a latch and, at the same time, to trigger a one-shot. During the one-shot time interval, the clock is disabled and the binary counter is reset. At the end of the one-shot period, the clock is enabled and the binary counter then proceeds to count up the clock pulses.

At the next signal, the latch is strobed. This transfers the binary-counter state to the output

of the latch, which in turn closes those switches in sequence S_1 to S_n that designate the binary number stored in the latch.

Thus the divider output voltage represents the rate information carried between successive pulses. This voltage is first buffered by a voltage follower, then read out digitally on a DVM and simultaneously copied on a strip-chart recorder.

Note that if a signal interval extends beyond the minimum rate limit of the system or is missing, Q_s will be turned on by the clock. With Q_s on, the clock is disabled and transistor Q_v turns off. The output is then zero volts.

The detailed circuit is shown in Fig. 2. Op amp A of the quad amplifier (IC_1) is used as a comparator. The comparator output goes high when the input signal level reaches one-half the reference voltage, and it drops to zero when the input signal falls below the halfway point.

The comparator output is differentiated and the positive-going edge of the differentiated pulse causes the output of op amp B to generate another positive-going pulse of approximately 25- μ s duration.

Op amp B's output is also differentiated. The positive-going pulse of the differentiator has no effect on op amp C, since the negative terminal is clamped to the reference voltage. However, the negative-going pulse causes the negative input terminal to go approximately 0.5 V below ground. Since the positive input terminal of op amp C is tied to ground, C's output is also a positive-going pulse of about 25- μ s duration.

The positive-going pulse of op amp C triggers the one-shot, which is comprised of gates A and B of the quad two-input NOR gate, IC_2 . The two NOR gates, so used, make a simple, stable one-shot. However, if the one-shot is retriggered too soon after the end of a previous timing period, the subsequent one-shot period will be shorter than the previous one.

The reason for the shortened period is illustrated in Fig. 3. At the positive-going trigger, capacitor C charges negatively towards ground and then begins to discharge through R. As soon as the transfer voltage of NOR gate B is reached, capacitor C becomes positively charged above V_{cc} by the amount of the voltage drop of the

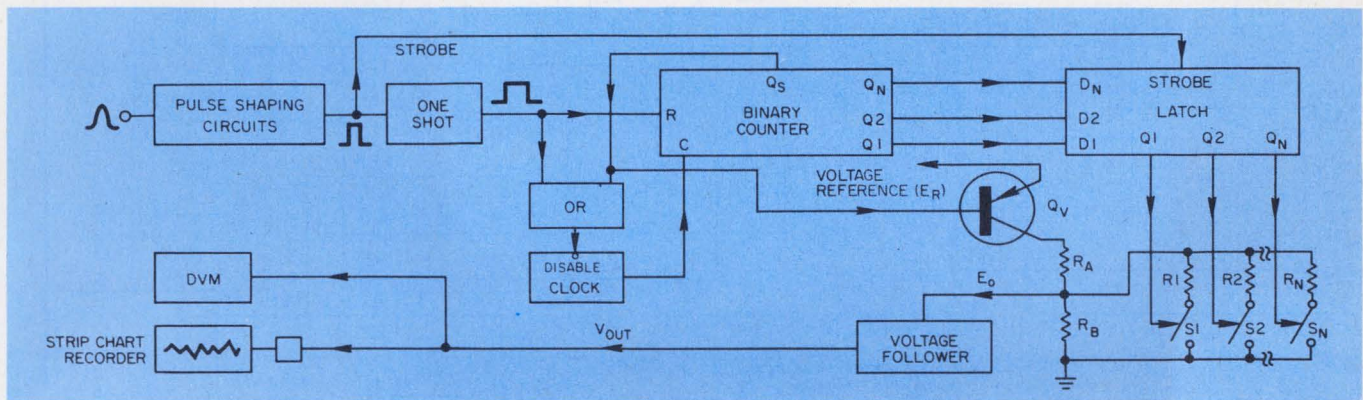

1. **Basic rate-meter scheme** uses a counter to register the number of clock pulses that occur during the input pulse-to-pulse time intervals. The stored binary clock

number then determines which voltage-divider resistors to switch in or out to provide an output voltage that is linearly proportional to input rate.

internal protection diode of NOR gate B.

If the one-shot is retriggered before that voltage has discharged to V_{cc} , capacitor C will charge to a less negative value than the previous instance. The time to reach the transfer voltage of NOR gate B will therefore be decreased.

Modified one-shot improves reliability

A method to improve the repeatability of the one-shot period is shown in Fig. 3c. At the end of the period, the output of NOR gate A becomes high and turns on FET Q, which presents a low-resistance discharge path for capacitor C. After the one-shot period, the astable multivibrator—composed of NOR gates C and D—is enabled and the binary counter IC₁ begins to count up.

Between -55 and $+125$ C there is very little change in the transfer characteristics of the quad two-input NOR gates. Consequently the one-shot and oscillator require no thermal compensation, provided that the timing resistors and capacitors track with temperature.

If the pulse intervals extend beyond the maximum allowable rate, the latch will indicate a false rate (maximum). The dual flip-flop (IC₃) prevents this. When the binary counter counts to Q_n , the oscillator is disabled and FF₁ is reset. $\overline{Q_1}$ is now high and cuts off the pnp Darlington, the output of which goes to 0 V. FF₂ is also re-

set, which makes Q_2 low.

At the next pulse FF₁ is prevented from being set, since forward-biased diode D₁ sinks the set pulse. When the one-shot is triggered, FF₂ sets and reverse biases D₁. At the next pulse FF₁ is set, $\overline{Q_1}$ is now low and the pnp Darlington turns on. E_o now gives the new rate.

To calculate clock rate and divider-resistor values, first determine the difference in the time intervals between the minimum and maximum expected rate limits. Next divide the time difference by $2^N - 1$, where N is the desired number of binary stages. The result represents the increase in time for each clock. The first time increase, Δt , is added to the time representing the maximum rate, and a new rate is calculated: $\text{rate} = 1/(t_{\text{max}} + \Delta t)$.

A voltage-divider network is now established so that the output voltage represents the maximum rate. The rate after the first clock is determined numerically, and a resistor value is now calculated, which, when placed in parallel with the bottom resistor of the divider, results in a new, lower voltage. This voltage represents the rate after the first clock.

This resistor value—calculated after the first clock—is placed in parallel by the least significant bit (LSB) of the binary counter. Resistor values for each succeeding stage are determined when each previous resistor is divided by two.

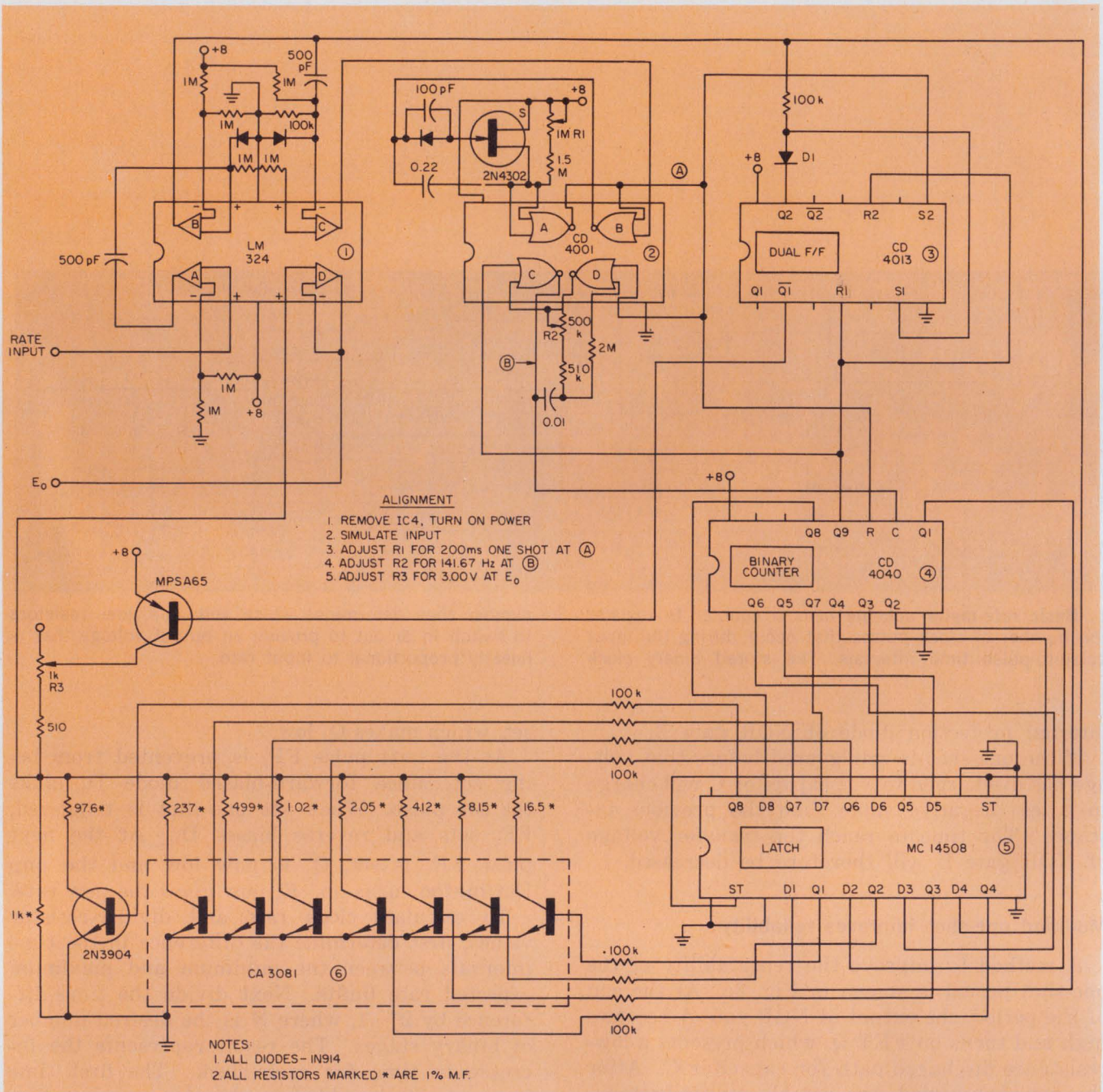

2. Schematic of rate meter used as a cardiometer. Only six ICs are needed, plus some discrete elements.

As a detailed example, let's design a cardiometer with the following characteristics:

1. Rate limits of 30 to 300 beats per minute (bpm).
2. Voltage limits of 3.00 V to represent 300 bpm and 0.30 V to represent 30 bpm.
3. Binary counter of eight stages.
4. Reference E_R of +8.0 V.

The one-shot time equals the maximum rate. Thus 300 bpm = 5 Hz = 200 ms. The difference in time between the maximum and minimum rate is 2000 - 200 = 1800 ms. Since there are eight

binary stages, divide the time difference by 2⁸ - 1. Thus 1800/255 = 7.059 ms represents the increment of change in time per bit (Δt) and also the clock period. Clock frequency is therefore 141.67 Hz.

In the voltage-divider network in Fig. 1, let R_B equal 1 kΩ. Since E_R = + 8.0 V and E_o for the maximum rate = 3.00 V,

$$R_A = \frac{R_B(E_R - E_o)}{E_o} = 1.67 \text{ k}\Omega.$$

After the first clock the pulse time interval in-

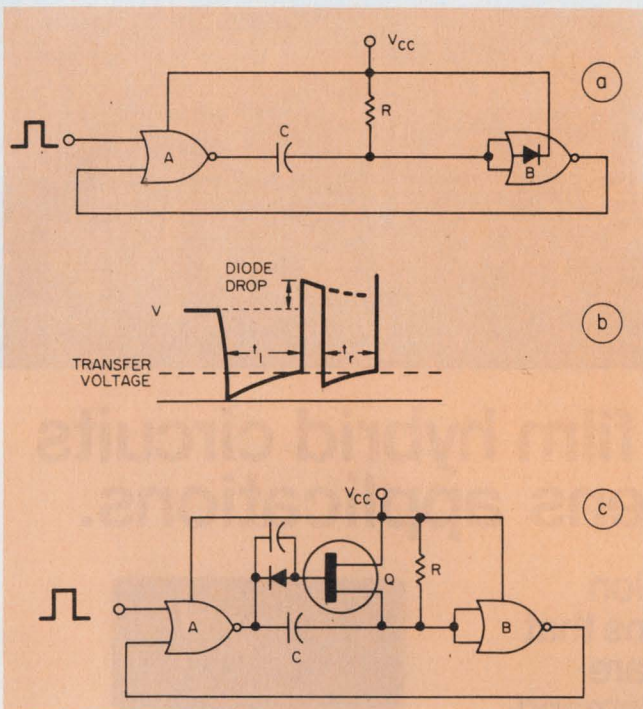

3. Repeatability of the one-shot period can suffer if the one shot is retriggered too soon (a). Shortened period occurs because C hasn't fully discharged when the next pulse comes in (b). This is prevented by addition of a FET to provide a low-resistance discharge path for C (c).

creases to $200 + 7.059$ ms. This represents $1/0.207059 \times 60$ or 289.77 bpm. Since an output of 3.00 V represents 300 bpm, E_o should equal 2.8977 V after the first clock.

A resistor value is now calculated that, when placed in parallel with R_B , results in $E_o = 2.8977$ V:

$$\begin{aligned} \text{Parallel resistor } R_P \\ = \frac{E_o R_A R_B}{R_B (E_R - E_o) - R_A E_o} = 17.38 \text{ k}\Omega. \end{aligned}$$

Thus 17.380Ω is the LSB of the divider network. The values of the next seven resistors are calculated by dividing each previous resistor by two.

Note that the values of the parallel resistors in the detailed divider circuit of Fig. 2 are less than those calculated. This is because the equivalent collector-emitter resistances of the transistor switches appear in series with the parallel resistors. To compensate for switch loss, the output for each bit can be calculated:

$$E_o = E_R \frac{R_P R_B}{R_A R_B + R_P (R_A + R_B)}$$

The circuit has about a 4% error at the higher rates, and this decreases to about 1.5% near the 100-bpm rate. This occurs because the time increase per clock is proportionately greater at the higher rates. However, for each additional bit, the error is halved. ■■



Licon takes the "butterflies" out of the rush hour.

By putting its double-break, double reliable Butterfly® switches to work in mass transit systems.

Licon® switches are at work 24 hours a day, in automatic door devices, on thousands of mass transit vehicles throughout the world. Rugged, dependable, and able to withstand countless trouble free operations under most severe conditions.

The same rugged dependability is yours in every basic Licon switch. What are your load requirements? What kind of actuator or mounting will best suit your needs?

Look to Licon: Your Licon representative or distributor has a switch solution for you.

iTW LICON

Division Illinois Tool Works Inc.
6615 W. Irving Park Road
Chicago, Illinois 60634
Phone (312) 282-4040
TWX 910-221-0275



LICON

puts ideas to work
in electronics

The Innovative Electronic Group of ITW...
LICON ■ ELECTRO MATERIALS ■ PAKTRON

Centralab perspectives

FOR USERS OF ELECTRONIC COMPONENTS

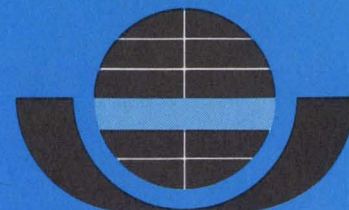

CENTRALAB

Electronics Division
GLOBE-UNION INC.

5757 NORTH GREEN BAY AVENUE
MILWAUKEE, WISCONSIN 53201

A new concept in thick film hybrid circuits lowers cost and broadens applications.

New resistor paints, automated production and laser trimming aren't the only reasons that the NEW PEC™ circuits from Centralab are the high quality performers engineers demand.

It's not surprising that the announcement of a breakthrough in thick film hybrid technology should come from Centralab. The product of a totally new concept in automated production, NEW PEC employs specially developed resistor paints that give these thick film circuits improved tolerance, better TCR, reduced noise and greater stability during load life. They offer unmatched reliability, through laser trimming and computerized pretest and final testing. Automation means increased production capacity for high volume orders and faster delivery. Complete processing time — from substrate to finished circuit — has been reduced from several days to a matter of hours. Yet, with all these improvements, NEW PEC is price competitive with discrete components.

Ever since 1945, when Centralab pioneered thick film microcircuitry, they have continued to make major contributions to the technology and have been a leading supplier of thick film hybrid circuits. With the announcement of the NEW PEC system, they can now meet the increasing demands of present high-volume users and have extended the use of thick

film hybrids to a whole new range of applications.

The automated production equipment recently developed by Centralab engineers brings a new degree of sophistication to the art of thick film hybrid microcircuitry. Advanced features like these can help you apply NEW PEC thick film hybrids:

- TCR reduced from $-1700 \text{ ppm}/^{\circ}\text{C}$ to $-375 \text{ ppm}/^{\circ}\text{C}$.
- Resistor tolerance improved from $\pm 10\%$ to $\pm 5\%$.
- Noise reduced from 15 db to 9 db.
- Resistor stability improved 35%.
- Alumina and steatite substrates for greater strength and better heat sinking for mounting active devices.
- Automatic screen printing insures precise metallization and resistor patterns.
- Mechanized component and lead attachment improves reliability 86%.
- Computer controlled laser pretest and adjustment. No problems of over-adjustment, abraded metallizing or contamination from sand abrasion.
- All circuits tested before and after encapsulation.

Centralab's NEW PEC opens new vistas for the user of thick film hybrids. For full details on how they can meet the needs of your application write Centralab for Catalog 1547.

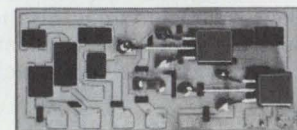
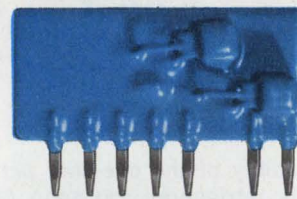

Centralab's NEW PEC is low-cost, high-quality thick film circuitry for a wide range of applications. Automotive electronics, copiers, point-of-sale terminals, peripheral computer equipment, instrumentation and process control are just a few.



Screen printing is the first step in the NEW PEC automated process. Substrates are automatically fed through the printer where precise metallization patterns are deposited before firing.

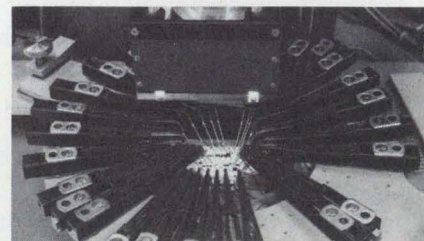

Computer controlled laser equipment provides pretest to insure proper screening and curing and precise adjustment of resistors. Resistor trimming is shown in this view of the laser head.

Centralab perspective:

Rotary switches.

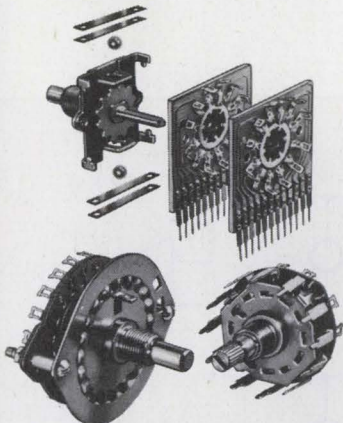

Designed with human factors in mind.

Select a Centralab miniature or sub-miniature rotary switch and you meet human engineering requirements three ways:

1. **EASY TO SET** — operation is with a natural wrist motion for quick and precise changes from one setting to another.
2. **CONTROLLED TORQUE** — light, medium or heavy feel to suit operator's touch. Dual ball side thrust index and adjustable springs provide variable torque.
3. **PANEL GRAPHICS** — space-saving mounting, best appearance. Choice of degree throw from 15° minimum to 120° maximum.

Open-frame rotary switches give you more switching for your dollar. That's a human factor too.

Contact Centralab for Bulletin EP2197.



INFORMATION RETRIEVAL NUMBER 572

Centralab perspective:

WHEN THE CHIPS ARE DOWN WE DELIVER!



CAPACITORS
THAT IS

We said it and we meant it. We're USCC/Centralab and we said we were preparing to meet the capacitor delivery crisis by substantial commitment to automated production machinery and facilities expansion.

We did it, and we've got the chips to prove it — ELEVEN MILLION in stock, most in the following popular sizes:

- BC - .080±.010x.050±.010
- BF - .100±.010x.050±.010
- BI - .150±.010x.050±.010
- DJ - .180±.010x.080±.010
- FH - .125±.010x.095±.010

We'll also deliver non stock and custom chips in not more than 8 to 12 weeks A.R.O.

Whether it's an immediate or future requirement, contact our applications engineering department now at (213) 843-4222.

USCC/Centralab
2151 N. Lincoln Street
Burbank, California 91504



INFORMATION RETRIEVAL NUMBER 573

Centralab perspective:

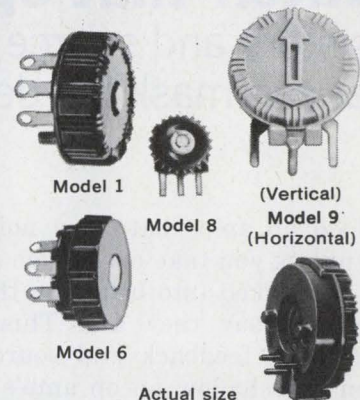

Actual size

Miniature pots at a mini-price.

Centralab gives you more to choose from in miniature potentiometers. Take the 1/5 watt, 45/64" dia. Model 9 for example. Typical pricing, in production quantities of 1000, is 34¢. That's economy because you also get:

- **Rotational life in excess of 25,000 cycles.**
- **Choice of mountings** — perpendicular or parallel plug-in.
- **Resistance Range** — 100 ohms to 10 megohms.
- **Adjustability** — Knob edge or screwdriver slot.
- **Tolerance** — ± 20%

For quantities under 250 contact your local Centralab Distributor.

Three other miniature potentiometers in the Centralab line of standard controls are:

- **Model 1** — 5/8" dia. 1/5 watt (Available with switch)
- **Model 6** — 1/2" dia. 1/10 watt (Available with switch)
- **Model 8** — 9/32" dia. 1/10 watt

Get complete specifications on all four. Write Centralab for Bulletin No. EP2184.



INFORMATION RETRIEVAL NUMBER 574

Watch that op-amp noise!

Feedback resistors and source resistances generate signals that can mask the device's true performance.

Good op amps have low noise characteristics, but unless you take care when you test them, you can be tricked into believing they're noisier than the specs say they are. This is because noise sources in feedback and source resistances can often overshadow an op amp's low noise.

Many of today's op amps have very low input bias currents that produce only small dc errors even with large feedback and source resistances. Usually the low bias currents are accompanied by correspondingly small input noise currents which improve signal sensitivity.

To ensure accurate testing, the extra noise sources must be isolated and accounted for.

Op amps that exhibit very low input noise currents are the FET input, chopper-stabilized and some bipolar transistor types. Except for flicker noise and that produced by chopper switching, the input noise currents can be approximated by the shot noise current of the untrimmed input bias currents, I_b . This is expressed by

$$i_{ni} = (2qI_b \Delta f)^{1/2},$$

where q is the electron charge and Δf is the bandwidth considered.

From this expression, an op amp that has a 1-nA input bias current would have a 1.8-pA rms input noise current for a measurement bandwidth of dc to 10 kHz. A FET input op amp, with an input bias current of 1 pA and measured over the same bandwidth would have an input noise current of only 0.056 pA.

How noise affects performance

To see how these small noise currents affect noise performance, consider the ideal op amp and its noise sources (Fig. 1). The noise currents flow in the source resistances and create a noise voltage that combines with the uncorrelated e_{ni} to produce a total amplifier noise¹:

$$e_{nit} = \sqrt{e_{ni}^2 + 2i_{ni}^2 R_G^2}.$$

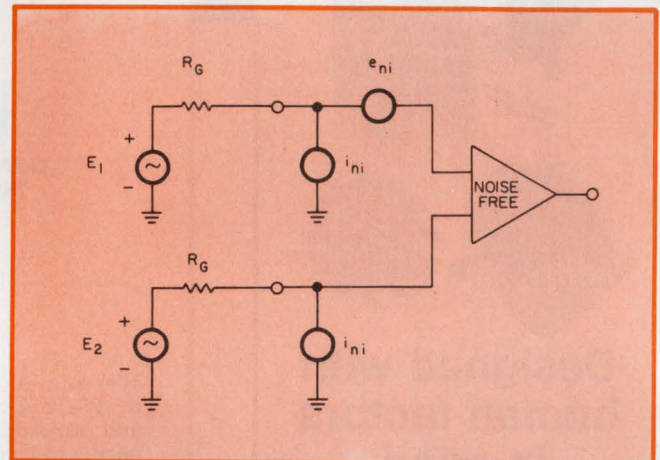

1. The combined effects of all noise sources in an operational amplifier can be represented by equivalent input noise generators.

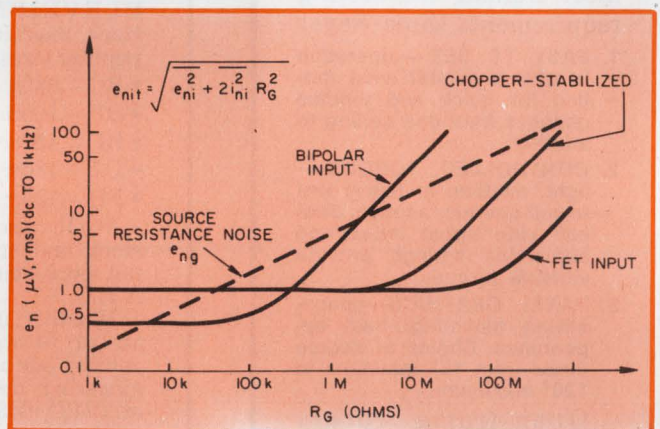

2. For all practical source resistances above 5 k Ω , you can select an op amp that introduces less noise than that generated by the source resistance of the input signal source.

One or both of the source resistances, R_G , seen by the op amp will be set by the choice of feedback resistance. Usually the two source resistances are matched to reduce dc errors created by input bias currents.

In addition to noise created by input noise currents, the source resistances produce a thermal noise voltage expressed by

$$e_{ng} = \sqrt{4KT \Delta f R_G}.$$

Jerald Graeme, Manager, Monolithic Engineering, Burr-Brown, International Airport Industrial Park, Tucson, Ariz. 85706

K is Boltzman's constant, and T is temperature in °K. In many cases noise introduced by the op amp is less than the thermal noise of the signal source. The curves in Fig. 2 are representative of higher-quality, general-purpose op amps. Note from the figure that an op amp can be chosen that will contribute less noise to the signal than the signal source does for source resistances

At the optimum turns ratio, the signal-to-noise ratio is maximized and will be

$$\left(\frac{S}{N}\right)_{\max} = \frac{e_i}{\sqrt{2 e_{ni} i_{ni} R_G + e_{ng}^2}}$$

For low noise current i_{ni} , the signal-to-noise ratio depends primarily upon the noise of the source e_{ng} .

Can op amp noise be predicted?

To predict the noise performance of an op amp, its input noise voltage and currents must be measured. However, since low input noise current is overshadowed by other noise sources, it becomes very difficult to measure. Unless the effects of interfering noise sources and other measurement limitations are considered in choosing measurement conditions, noise current measurements can be in error by orders of magnitude.

Even with such precautions, measurement constraints make some input noise current measurements impossible. Typically, op-amp input noise current is measured by monitoring the noise voltage it produces on a resistor (Fig. 4). However, added to the desired noise voltage is the input noise voltage of the amplifier and the thermal noise of the resistor. These three uncorrelated noise sources combine to develop an output noise voltage of

$$e_{no} = \sqrt{e_{ni}^2 + i_{ni}^2 R^2 + 4KTR \Delta f}$$

For this output signal to represent i_{ni} , the resistance must be made large, so that the noise current term is dominant. This can require resistances in the hundreds of megohms to overcome the thermal noise background of the resistance itself. With the curves of Fig. 2, you can see the resistance levels required to make the amplifier noise greater than the resistor noise. However, at such resistance levels any stray or parasitic capacitance can greatly limit measurement bandwidth. Only 1 pF across a 500-MΩ resistor limits measurement bandwidth to 250 Hz. It is essentially impossible to measure the lowest noise currents with bandwidths that cover the normal op-amp operating frequencies. However, if actual source resistances reach these high levels, where a low noise current has significant effect, then these source resistances will also be shunted by stray capacitances, which again limit the effect of noise current. ■■

References

1. Tobey, G., Graeme, J., Huelsman, L., *Operational Amplifiers; Design and Applications*, McGraw-Hill, New York, 1971.
2. Graeme, J., "Don't Minimize Noise Figure," *Electronic Design*, Jan. 21, 1971.

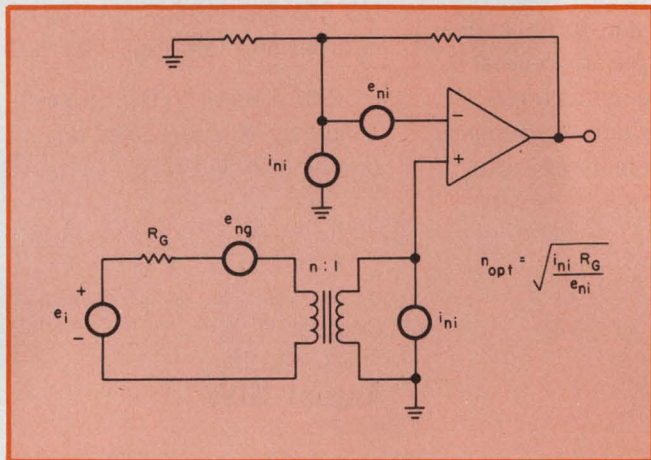

3. For low source-resistance ac applications, a transformer can boost the signal along with the source resistance, thus improving the signal-to-noise ratio.

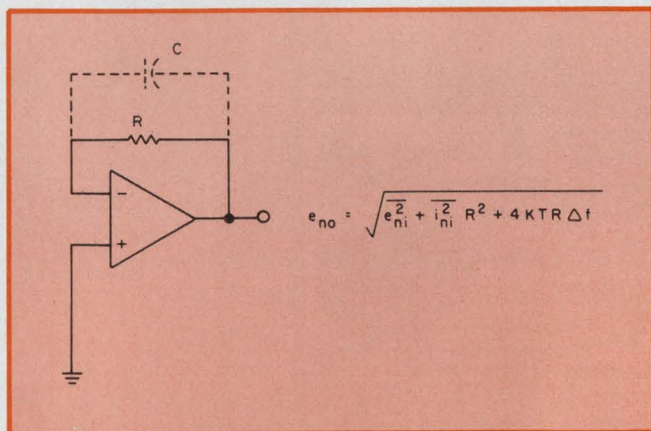

4. Measurement of low input-noise currents is complicated by the high background noise of the resistor, the amplifier input noise voltage and stray capacitance across the large resistor.

from 5 kΩ to hundreds of megohms. Over much of this range the amplifier noise is negligible because of very low input noise currents.

Where source and feedback resistances are held below this range, transformer coupling can be used in ac applications to transform the source resistance to higher levels (Fig. 3). The transformer also increases the signal voltage, resulting in an improved signal-to-noise ratio.

Counters: Another new way to think of Tektronix

You get more quality, functions, and counting-time capability per dollar with the Tektronix DC 505 Universal Counter. This compact, dual channel counter performs virtually any counting-timing function up to 225 MHz.

Various functions include conventional frequency operation on channel A, ratio of channel A frequency to channel B frequency, period of signal B, time interval from channel A start to channel B stop, width of signal in channel B, number of events in channel A during channel B gate, and totalize. The DC 505 also features inde-

pendent selectable averaging factors and clock rates to 10 ns. By use of maximum averaging on width or interval measurements of repetitive waveforms, resolution to better than 100 picoseconds is possible. With all these features, the DC 505 is priced at only \$1195.

Other Tektronix counters in our expanding line include:

DC 501 Seven digit, 110 MHz counter and totalizer \$ 550

DC 502 Similar to DC 501 with divide by 10 pre-scaler for counting to 550 MHz \$ 895

- **Frequency range: 225 MHz (both channels)**
- **Time interval: single-shot resolution to 10 ns**
- **Time interval averaging: resolution to 100 ps**
- **Repetitive pulse width measurements to 2.5 ns**

Counter
Price, \$1,195
Actual Size

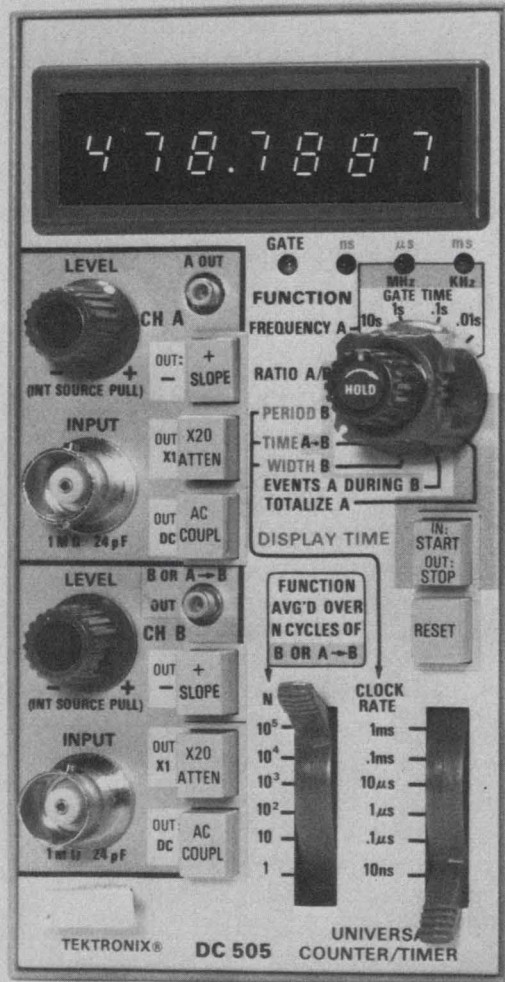

Simulated Display

DC 503 Seven digit, 100 MHz universal counter with dual channels\$ 695

DC 505 Seven digit, universal counter, 225 MHz on both channels\$1195

Tektronix offers many other test and measurement instruments in the TM 500 Series in addition to counters. These include: multimeters, power supplies, signal sources, signal processors, and CRT monitors. Presently, 24 general purpose modular test instruments are available with many more to come.

These instruments are interchangeable.

able. They plug into one compartment (\$115) or three compartment (\$150) power units. Instruments in the three compartment unit can be interconnected via a common interface board. This results in increased measurement capabilities and can actually produce synergistic effects. The TM 500 Series is based on the latest technology and proven principles developed in oscilloscopes. In addition, the TM 500 Series gives you more performance per dollar than competing instruments.

Send for a free brochure and spec sheets on counters, and our other

TM 500 test and measurement instruments. They're all new ways to think of Tektronix.

Write: Tektronix, Inc.
P.O. Box 500
Beaverton, Oregon 97005

In Europe write:
Tektronix Ltd.
P.O. Box 36
St. Peter Port, Guernsey, C.I., U.K.



INFORMATION RETRIEVAL NUMBER 64
FOR DEMONSTRATION, CIRCLE 245

Digital Multimeter
Price, \$395

Pulse Generator
Price, \$995

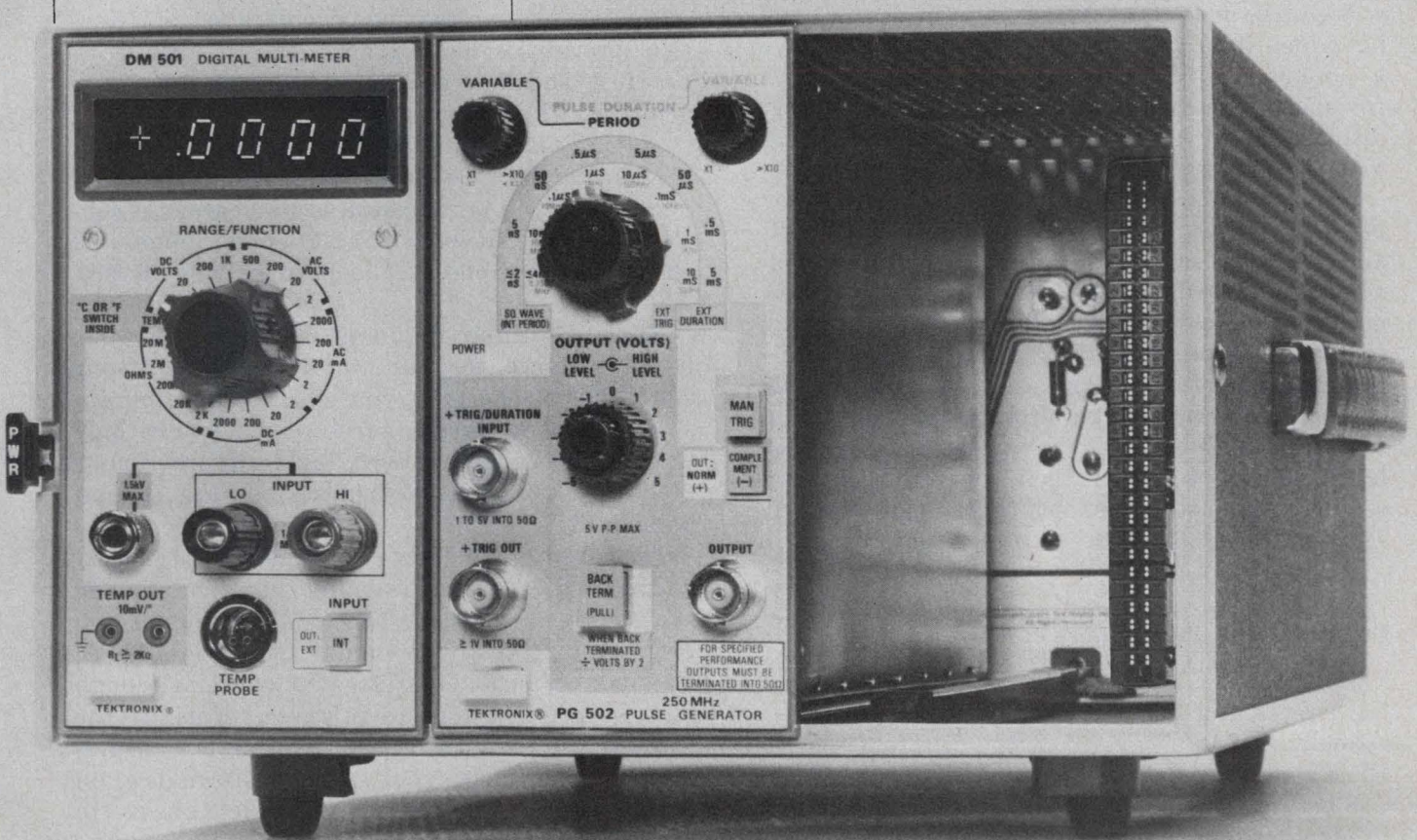

Want to cut costs to the bone? Try the learning curve. Besides helping you predict manufacturing expenses at a fixed rate, it's also a sharp management tool.

In 1936, T. P. Wright, of Curtis-Wright Corp., published the finding that as you double the quantity produced of a given item, the cost of making that item will decrease at a fixed rate. Wright had discovered a manufacturing phenomenon called the *learning curve*. It applies to every manufacturer who produces more than one of anything, including electronics producers who turn out semiconductors, diodes, and connectors like jelly beans.

Stated baldly, the finding seems rather obvious. The subtlety is that the quantity produced must be *doubled* before the rate of decrease is fixed and can be measured. When it is measured, you have identified your learning curve and you have a potent tool for predictive purposes and thus for many areas of management, including cost estimating, contract negotiations, production planning, cost control and purchasing negotiations.

The learning curve, under many names, has become a vital management tool in the aircraft airframe and engine industries, where it is considered standard operating procedure. It is underused in the electronics industry, and in many electronics companies it is not used at all. The practical use of the learning curve, however, has been achieved by enough electronics manufacturers in enough different management areas to leave no doubt that it is a proven tool. Any company not using it should learn more about it and how to apply it to its own situation.

Other uses for the learning curve

Before describing the various types of learning curves and how they're developed, let's first see how they can be used in the electronics field. Here are some practical applications:

Small lot costing: Many electronics companies produce custom items in small quantities. Since the learning curve effects are greatest in absolute terms in the early stages of the production

program, when costs are at their highest, costing errors can be the most serious on small lots, particularly on high-cost products. Use of the learning curve allows a more objective evaluation of the cost of the few pieces involved in such small lots.

Cost control: One of the most prevalent management fallacies is to establish a standard cost goal to be reached at a specified quantity of production. When production reaches that level and the costs are at standard, everyone beams happily and assumes that the goal has been reached. Then as more units are produced—and if costs stay standard—a feeling of continued satisfaction prevails. This assumes that learning or progress should cease once standard costs are achieved. This is nonsense.

If you reduce your high initial unit costs down to the standard level by the time you've produced, say, 200 units, there is no reason to conclude that the downward cost trend cannot and should not continue as you produce beyond that 200th unit.

Thus the thing to do is to lay down your learning curve for the item then track your actual performance. If you start to level off instead of following the curve down, you're only treading water and not moving to improve your cost and profit performance to the extent possible.

Purchasing negotiations: Some of the most dramatic uses of the learning curve have been achieved in this area. When a vendor quotes you prices for successively higher quantities, he is, in effect, declaring his learning curve, although he may not be thinking in these terms. If the learning curve he is really quoting is substantially higher than your own performance on similar work, you have an excellent basis to begin objective cost negotiation. It is amazing to see how some purchasing groups use this technique to such excellent effect, while others have no inkling of its use or potential.

Manpower planning: The great majority of electronics companies have difficulty hiring and keeping trained personnel. They are expensive

Lawrence M. Matthews, Certified Management Consultant, 958 N. Fifth St., Philadelphia, Pa. 19123.

How design changes affect the learning curve

Any factor that interrupts the sequential and unchanged production of successively larger quantities of an item tends to affect the learning curve for that item. Obviously one such factor is design changes.

Learning-curve analysis is used to estimate the cost effects of such design changes. When a change is introduced, the work content affected by that change reverts to the beginning of the learning process, while the unaffected work content continues along its uninterrupted learning path. Then,

146 hours. If a major design change is introduced just prior to the eighth unit that affects 50% of the total work content, 73 hours would have to revert back to the start of the learning path, and it would take 100 hours instead of 73. Thus the eighth unit's approximate total cost would be 173 hours instead of 146. Then, as subsequent units are produced, the effect of learning on the changed one-half of the job gradually brings the total unit cost back onto the original learning path. The area under that blip is the cost of the change that

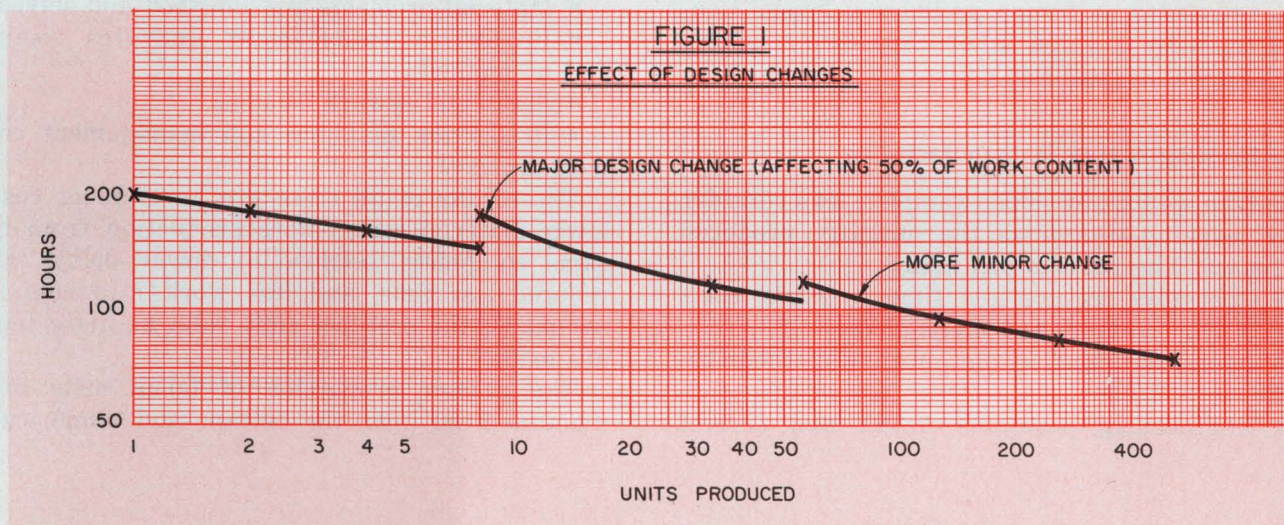

as learning occurs on the changed portion of the total work content, the cost per unit of that changed portion declines. The more major the change, the greater the work content affected and the higher the additional costs incurred.

Graphically the effect of a design change on the learning curve is a "blip," also called a "scallop" or "hiccup" (see Fig. 1.).

For example, assume an electronic assembly, following a 90% learning curve, the first unit of which cost 200 hours to produce. By the time the eighth unit was made, the cost per unit should be

was made in the design.

Of importance is the fact that the later in a production program the design change is introduced, the more costly its effects. This is true because the work content affected has further back to go as it reverts to the start of the learning curve involved.

It is important to note that the same blip effect and its consequent higher costs occur when there is a time lag of a substantial nature between successive production runs, or when there is a major turnover in production personnel.

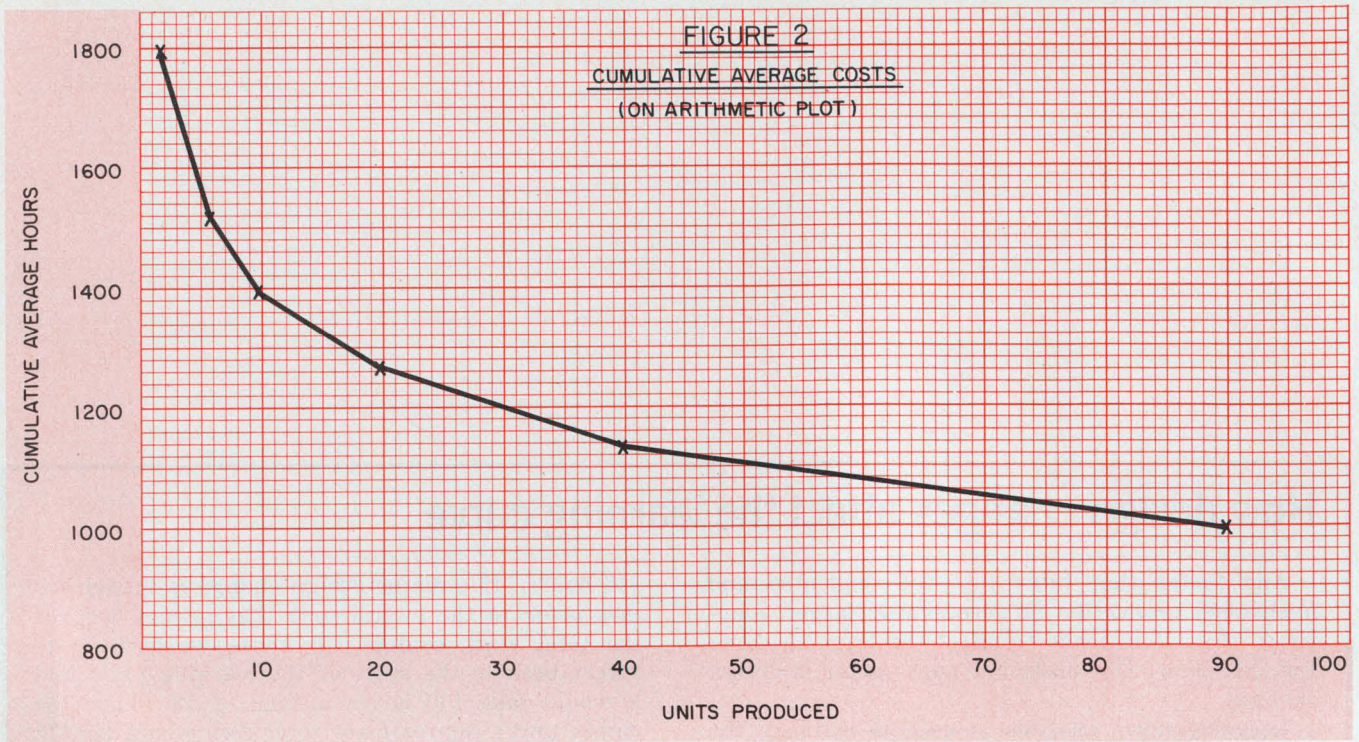

to find and costly to train; therefore they should be used efficiently. The learning curve offers an objective basis for predicting how many people will be needed at future production levels. Conversely, with a given labor capacity, it allows development of realistic delivery schedules.

Why learning occurs in manufacturing

Before we look at some examples, let's consider why learning occurs as the quantity produced increases. The reasons are many:

- Operators require less time to study their job as they do more and more pieces.
- Operators' physical motions and methods become more efficient.
- Engineering personnel detect and correct

the design "bugs."

- Engineering changes decrease in degree and number.
- Material problems are analyzed and solved.
- Production management improves tooling and/or methods.
- Scrap and rework declines.
- Production planning and management controls improve.

The results of all these are lower labor costs, lower material costs, more production from the same equipment because of fewer delays and reduced lost time, and less work-in-process. In summary, the cost per unit falls as more units are made.

The greater proportion of labor costs in a manufactured item, the better—and numerically

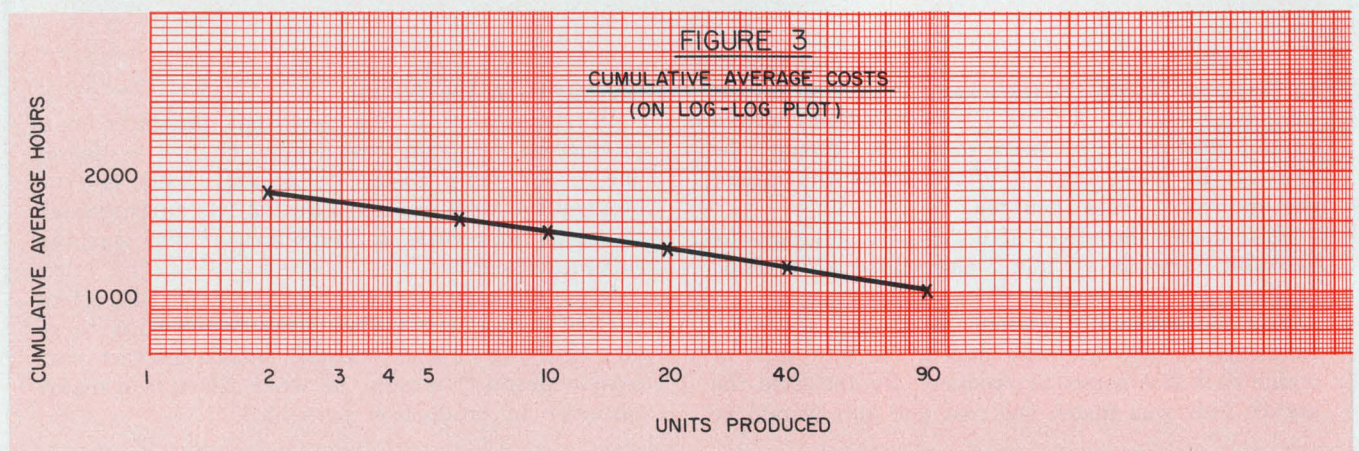

lower—should be the learning curve. However, it cannot be concluded that the greatest effects on costs result from labor improvement. Learning or progress in cost improvements are the result of both improvements in labor ability and management performance.

For example, suppose you are producing a major and complex electronic assembly. You record the labor expended for each unit as follows:

Pieces	Hours per Piece
1	100
2	90
4	81

This indicates that every time you doubled the quantity produced, the assembly cost dropped 10%. You are developing and following a 90% unit-cost learning curve on this assembly. Having identified this, you have a means to predict what your 200th or 2000th unit will cost you.

One mental block that inevitably confronts a newcomer to the learning curve is the question, "What will we do—eventually reach zero?" You don't, of course. Remember that the absolute cost decline grows decreasingly less for doubled quantities, and that when you deal with doubled quantities, it doesn't take many doublings to reach really huge numbers.

Does it all sound too theoretical? If so, consider the following four cases:

1. One of the plants of a major communications company produced 15 different models of an electronic subassembly. It followed a 73.6% learning curve down from the 10,000th piece to the 500,000th piece.

2. One company recorded its testing time over three continuous contracts for a given power supply. The time taken was 0.60 cumulative average hours for the first 1200 units. By the time it had produced 6000 units, the cumulative average time per unit was down to 0.44 hours, and by the 18,000th unit, it was down to 0.38 hours. It was following approximately an 88% cumulative average learning curve.

3. An electronics company producing a relatively complex subassembly for a major office-equipment company tracked its assembly labor costs through the 43,000th unit. It followed a 93.8% cumulative average learning curve.

4. A company producing a \$9000 electronic assembly for missile use followed an 85% learning curve. However, when the design was changed radically and the newly designed unit selling for \$18,000 went into production, the company developed a 90% learning curve.

Cumulative average curve: Some straight talk

The learning curve that was first identified by Wright was the cumulative average curve.

In this type of curve it is the cumulative average costs of successive doubled quantities produced that bear a declining and fixed relationship to each other.

The cost records for a major electronic assembly revealed the following example:

Lot	Pieces in Lot	Hours to Produce Lot
1	2	3,600
2	4	5,520
3	4	4,880
4	10	11,400
5	20	20,200
6	50	44,400

Cumulative Hours	Cumulative Pieces	Cumulative Average
3,600	2	1,800
9,120	6	1,520
14,000	10	1,400
25,400	20	1,270
45,600	40	1,140
90,000	90	1,000

Fig. 2 is the plot on arithmetic graph paper of the cumulative average hours at successive cumulative quantities produced.

Fig. 3 is the same data on log-log paper. Because we are dealing with a constant rate of change for successive doubled quantities produced, the data fall along a straight line. Straight lines are much easier to develop and work with. They can be much more readily extended for predictive purposes. For all these reasons, log-log paper is universally used in learning-curve work and analysis.

In this example a 90% learning curve is indicated because the cumulative average cost at successive doubled quantities is 90% of the cumulative average cost at the prior, undoubled quantity. Thus the cumulative average cost at two pieces is 1800 hours. At four pieces the line indicates a cumulative average of 1620 hours, or 90%.

The unit-cost learning curve

With the unit-cost learning curve, it is the plot of the unit costs of successively higher individual unit numbers produced that will fall along a straight line on log-log paper. Example:

Unit Number	Hours to Produce
1	1,200
5	715
9	592
15	502
40	366
60	321
100	272

Fig. 4 is a plot of this data on log-log paper. This plot of unit cost data falls along a straight line and would be considered a unit-cost learn-

FIGURE 4
UNIT COSTS
(ON LOG-LOG PLOT)

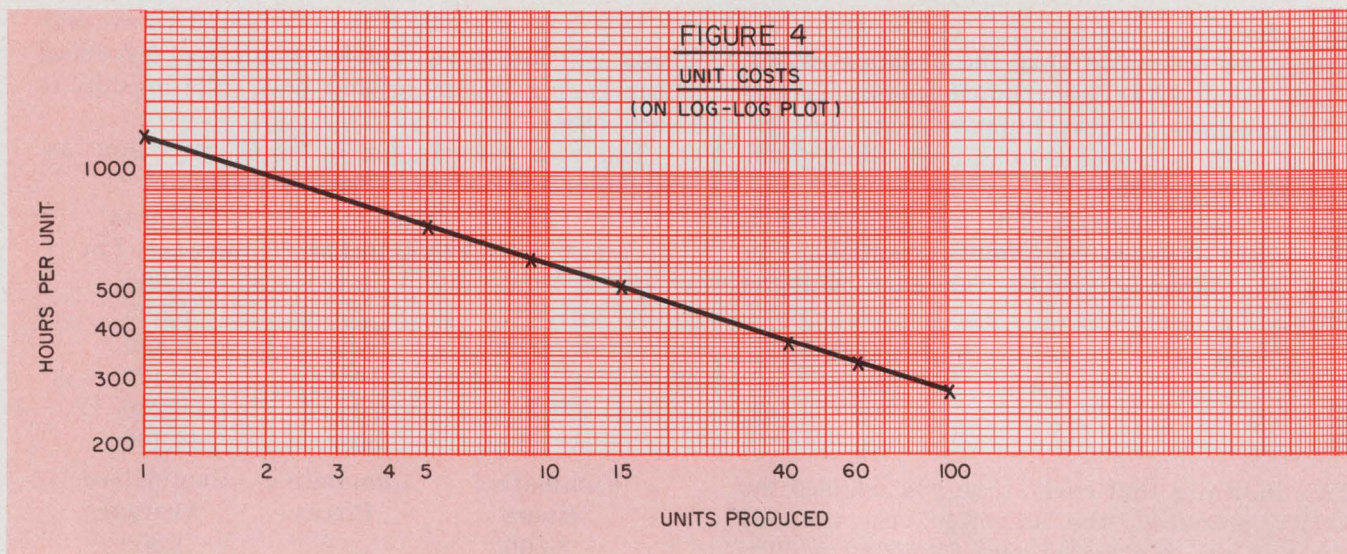

ing curve. Reading of the plot at Unit No. 2 indicates a cost of 960 hours and an 80% learning curve, calculated by dividing 960 by 1200, the cost for Unit No. 1.

The basic learning-curve formula is

$$y = ax^n,$$

where y = cost or value at unit x

a = cost or value at the first unit

x = any given unit

n = slope of the learning curve (always a negative exponent when there is cost improvement at successively higher quantities).

In logarithmic terms the formula is:

$$\log y = \log a + n \log x.$$

Because the learning-curve line on log-log paper is straight, the slope for any given learning curve is a constant. This constant value is commonly called "n," or "slope constant." Typical n values for various curves are:

Learning curve	"n" Constant
95%	-.074006
90%	-.152003
85%	-.234465
80%	-.321928
75%	-.415037

Cost data are most commonly available in terms of production lots or batches. Such data can be adapted to unit-cost learning-curve analysis by relating the average cost of a lot to a specific unit number within that lot. For example, one widely used rule of thumb is the so-called "lot midpoint" approach, under which:

- On the first lot: If less than 10 units use the lot midpoint. If 10 or more units use the unit at one-third of the lot.

- On all subsequent lots: Use the lot midpoint.

By this, or more precise calculations, it is possible, with cost information for successive production lots, to develop the learning pattern for

a given manufactured item in terms of unit costs.

Relationship between the two types of curves

If the plot of your cumulative average costs most nearly approximates a straight line on log-log paper, you are developing a cumulative average learning curve. If the plot of your unit costs most nearly approximates a straight line on log-log paper, you are developing a unit-cost learning curve.

In the first case (cumulative average learning curve) the plot of unit costs will curve out and below the straight-line trend of the cumulative average curve and, somewhere below 100 pieces, will parallel it downward (Fig. 5). In the second case (unit-cost learning curve), the plot of the cumulative average costs will curve out and above the straight-line trend of the unit-cost learning curve and, somewhere below 100 pieces, will parallel the unit-cost curve downward (Fig. 6).

This parallelism between the two types of curves allows us to convert from cumulative average to unit cost, or vice versa. Typical conversion factors are:

Learning Curve	Factor of Relative-Value Unit Cost to Cumulative Average Cost
95%	0.926
90%	0.848
85%	0.766
80%	0.678
75%	0.585

In these examples the data fell very nicely along a straight line. In real-life applications the data usually plot scattered about a downward trend. In such cases the line of "mathematical best fit" can be calculated by the least-squares method. The formulas used are: $\log a =$

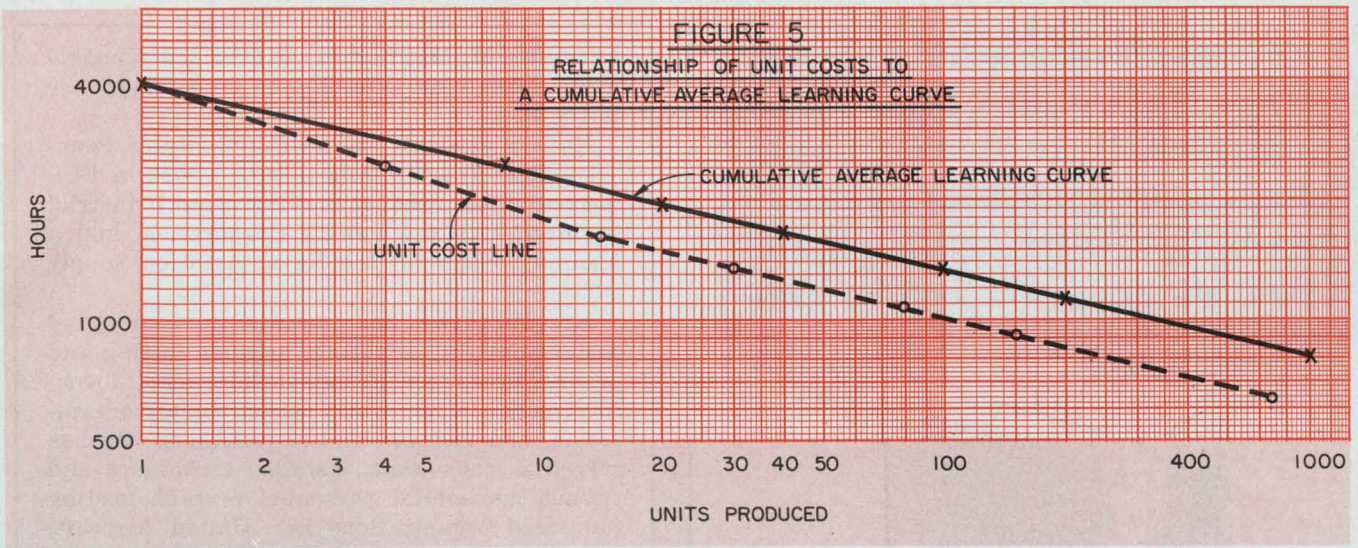

$$n = \frac{\frac{\sum (\log x)^2 \sum \log y - \sum \log x \sum (\log x \log y)}{N (\log x)^2 - (\sum \log x)^2}}{\frac{N \sum (\log x \log y) - \sum \log x \sum \log y}{N \sum (\log x)^2 - (\sum \log x)^2}}$$

These formulas establish, from the data available, the cost or value of the first unit, and the slope of the learning curve indicated by that data. Having these two values, the cost of any unit number can be calculated.

Visualize plotting your own cost experience on a given item, then eyeballing a line through the

plotted points and then extending the line to predict the cost at future higher quantities. Obviously the very thickness of your pencil line can affect your prediction. For that reason, learning-curve tables are used. These tables provide factors that, when multiplied by the first-piece cost, result in the cost of any later piece. With these tables, once you know your learning-curve slope and the first-piece cost, calculated from your data, you can calculate the predicted cost of any piece up to 999. Beyond that quantity the formu-

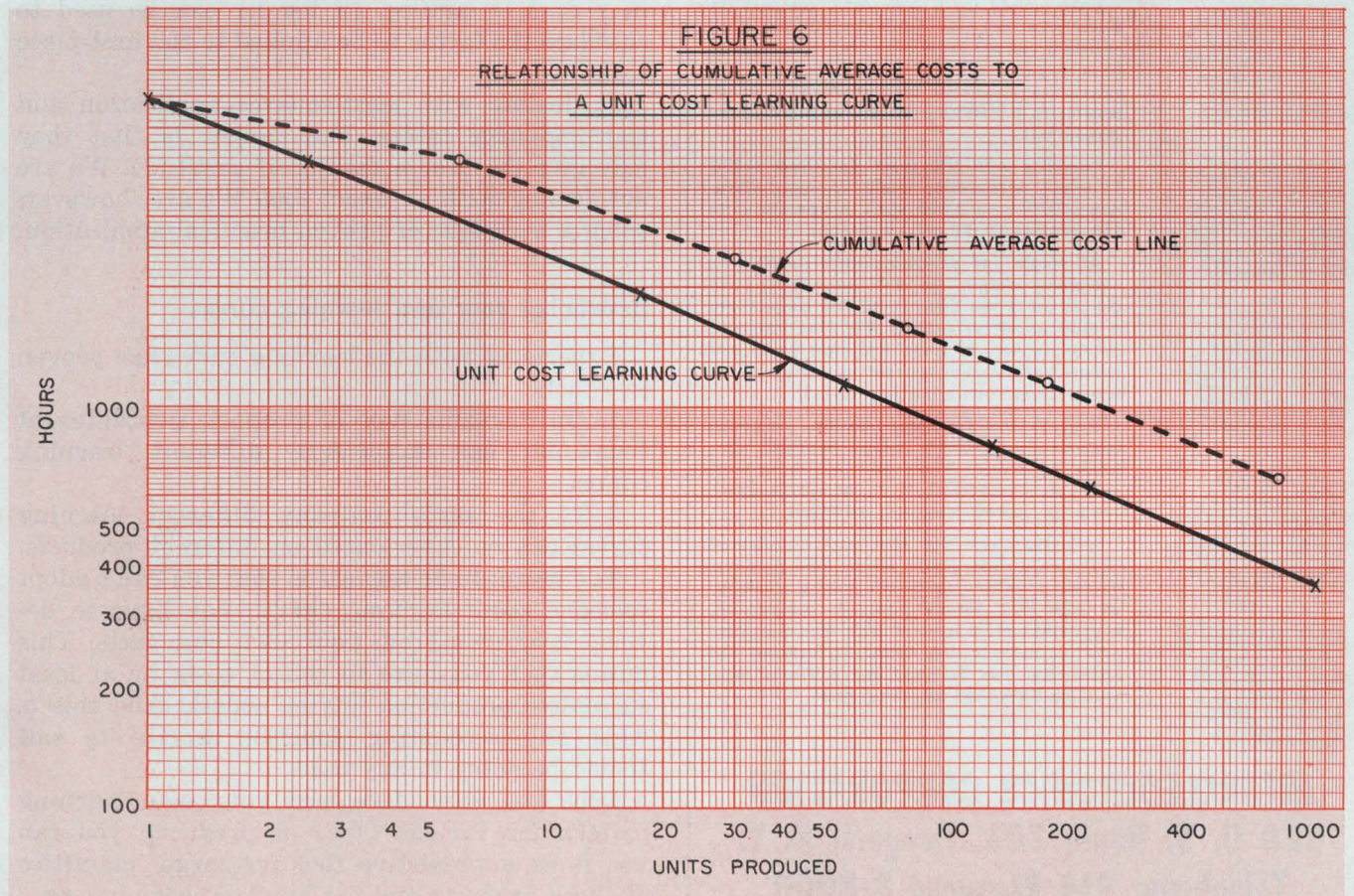

**PROVEN RELIABILITY—
SOLID-STATE POWER INVERTERS,
over 260,000 logged operational hours—
voltage-regulated, frequency-controlled,
for missile, telemeter, ground support,
135°C all-silicon units available now—**

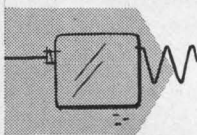
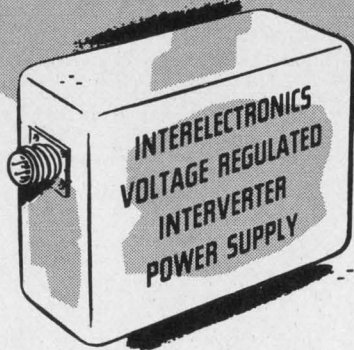

Interelectronics all-silicon thyatron-like gating elements and cubic-grain toroidal magnetic components convert DC to any desired number of AC or DC outputs from 1 to 10,000 watts.

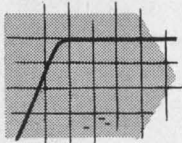

Ultra-reliable in operation (over 260,000 logged hours), no moving parts, unharmed by shorting output or reversing input polarity. High conversion efficiency (to 92%, including voltage regulation by Interelectronics patented reflex high-efficiency magnetic amplifier circuitry.)

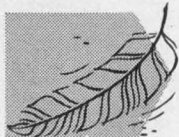

Light weight (to 6 watts/oz.), compact (to 8 watts/cu. in.), low ripple (to 0.01 mv. p-p), excellent voltage regulation (to 0.1%), precise frequency control (to 0.2% with Interelectronics extreme environment magnetostrictive standards or to 0.0001% with fork or piezoelectric standards.)

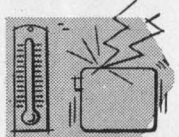

Complies with MIL specs. for shock (100G 11 msec.), acceleration (100G 15 min.), vibration (100G 5 to 5,000 cps.), temperature (to 150 degrees C), RF noise (I-26600).

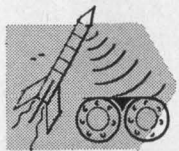

AC single and polyphase units supply sine waveform output (to 2% harmonics), will deliver up to ten times rated line current into a short circuit or actuate MIL type magnetic circuit breakers or fuses, will start gyros and motors with starting current surges up to ten times normal operating line current.



Now in use in major missiles, powering telemeter transmitters, radar beacons, electronic equipment. Single and polyphase units now power airborne and marine missile gyros, synchros, servos, magnetic amplifiers.

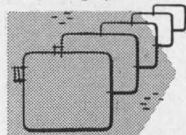

Interelectronics—first and most experienced in the solid-state power supply field produces its own all-silicon solid-state gating elements, all high flux density magnetic components, high temperature ultra-reliable film capacitors and components, has complete facilities and know how—has designed and delivered more working KVA than any other firm!

**INTERELECTRONICS CORPORATION
550 U. S. Route 303, Congers, N. Y.
Telephone: 914 ELmwood 8-8000**

INFORMATION RETRIEVAL NUMBER 65

Lawrence M. Matthews is a Certified Management Consultant with 26 years of experience in the field.

He is a graduate of the University of Pennsylvania's Wharton School with a B.S. in Economics. After graduation, he was an industrial engineer with the Bendix Corporation, and a planning officer for the Naval Aviation Supply Office.

Mr. Matthews has successfully completed assignments in budgeting, product costing and pricing, production planning and control, inventory management, work measurement, organization, and mergers and acquisitions. He has served as consultant, installed techniques and trained managerial personnel in such leading industrial organizations as: United Aircraft, Coca-Cola, General Dynamics, North American Rockwell, Singer, Pittsburgh Plate Glass, Cessna Aircraft, Sprague Electric, and many smaller companies.

He is the author of many articles and papers in professional journals and business magazines and has conducted numerous seminars not only in the U.S. but in Canada, Great Britain, Germany, Switzerland, and South America. He is a senior member of the American Institute of Industrial Engineers, the Planning Executive's Institute and the National Association of Accountants.

la $y = 1 \div \text{antilog}(n \log x)$ can be used to calculate the factor to be applied to the first-piece cost.

In dealing with least-squares application and learning-curve tables, one danger is that they may give the user a feeling of certitude. We are not dealing with an exact tool. We are, however, using a technique of proven practical application.

Developing your own learning curves

Experience with the learning curve has proven two facts:

1. On the same type of product, two different companies can experience different learning curves.

2. In the same company different learning curves can be experienced on different products.

The lesson to be applied is that you can't adopt someone else's learning curve. You have to develop your own from your own cost facts. This means that you have to collect costs by at least successive production lots or orders. And this is what any accounting function worth its salt should be doing in any case.

Once you have developed your own learning pattern for various types of products, you can use it as a predictive tool for large quantities of those products and for similar products. ■■

CONVERT 8 BITS IN 6 MICROSECONDS FOR \$25.....

it's easy!

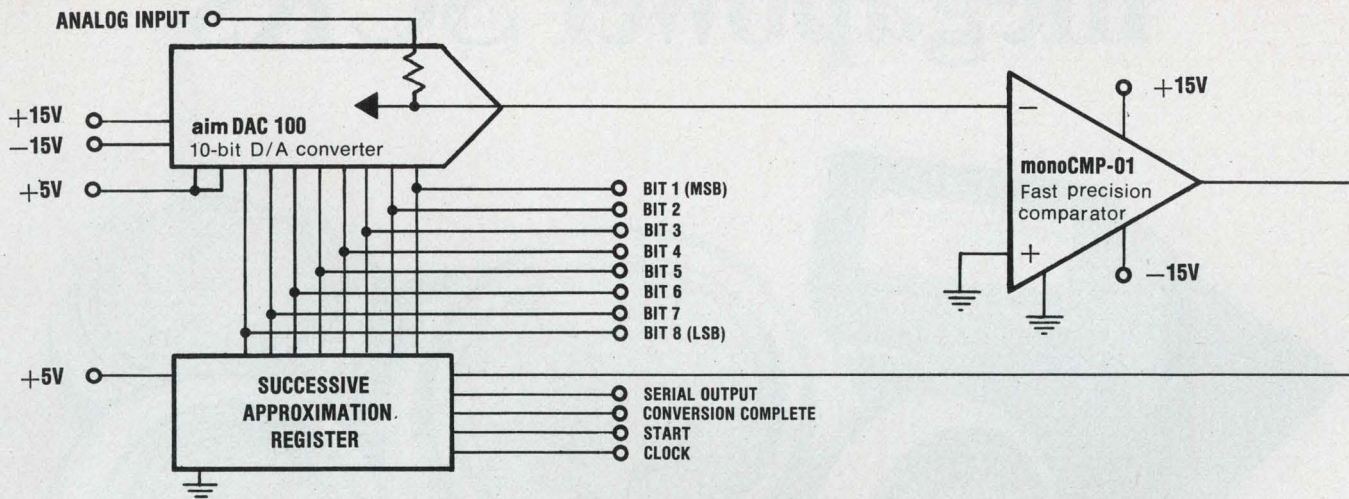

THREE IC'S BUILD A FAST A/D CONVERTER - FOR UNDER \$25!

It's easy with high performance analog components from Precision Monolithics—start with PMI's aimDAC100 Low Cost D/A Converter—with its internal precision reference voltage, 10-bit resolution, choice of linearities and high speed current output, it's ideal for all D/A and A/D applications. Next, add the PMI monoCMP-01 Precision Comparator with its fast 90ns response, low Vos, drift and superior stability—complete your converter with a

successive approximation logic chip and that's it! Sound easy? You bet—and 10-bit versions can be built for under \$40! Circuit construction and performance are fully detailed in our new Application Note: pre-drilled demonstration circuit cards are available free by contacting your local PMI rep or stocking distributor—call him today and find out how easy A/D conversion can be!

SPECIFICATIONS		PRICES
aimDAC 100 DDT1*	0.30% Linearity Max-0/70°C	\$ 9.95 @ 100 pcs.
aimDAC 100 CCT1*	0.20% Linearity Max-0/70°C	\$12.00 @ 100 pcs.
aimDAC 100 BCT1*	0.10% Linearity Max-0/70°C	\$17.00 @ 100 pcs.
aimDAC 100 ACT1*	0.05% Linearity Max-0/70°C	\$26.00 @ 100 pcs.
*Specify T1 for 0 to 10 Volt usage; T2 for 0 to 5 Volt usage.		
monoCMP-01CJ	Vos 2.8 mV Max	\$3.25 @ 100 pcs.
monoCMP-01EJ	Vos 0.8 mV Max	\$7.50 @ 100 pcs.

PRECISION MONOLITHICS REPRESENTATIVES

Alabama (205) 539-4411	Maryland (301) 944-8262	North Carolina (919) 725-5384
Arizona (602) 992-9884	Massachusetts (617) 890-0011	Ohio, North (216) 461-8333
California, North (415) 948-6533	Michigan (313) 557-1934	Ohio, South (513) 293-3145
California, Los Angeles (213) 340-1745	Minnesota (612) 646-7217	Pennsylvania, East (215) 644-3477
California, South (714) 830-3939	Missouri, St. Louis (314) 731-5799	Texas (214) 363-8591
Colorado (303) 771-4920	Missouri, Kansas City (816) 761-6543	Virginia (703) 548-7818
Connecticut (203) 634-0179	New Jersey, North (516) 567-5900	Washington (206) 624-9020
Florida, Ft. Lauderdale (305) 776-4800	New Jersey, South (609) 966-4070	Wisconsin (414) 933-2733
Florida, Orlando (305) 425-5505	New Mexico (505) 265-5655	Canada, Toronto (516) 864-2666
Illinois, North (312) 774-3535	New York, New York City (516) 567-5900	Canada, Vancouver (714) 979-4894
Indiana (513) 252-9981	New York, Upstate (716) 464-8636	

AUTHORIZED DISTRIBUTORS

NEW YORK METROPOLITAN AREA Harvey Radio, Woodbury, N.Y.: (516) 921-8700 • NEW ENGLAND AREA Gerber Electronics, Dedham, Mass.: (617) 329-2400 • UPSTATE NEW YORK Harvey Federal Electronics, Binghamton, N.Y.: (607) 748-8211 • NORTHEAST Newark Electronics, Woburn, Mass.: (617) 935-8350 • BALTIMORE-WASHINGTON Whitney Distributors, Baltimore, Md.: (301) 944-8080 • PHILADELPHIA Hallmark Electronics, Huntingdon Valley, Pa.: (215) 355-7300 • MICHIGAN RS Electronics, Detroit, Mich.: (313) 491-1000 • SOUTHEAST Kirkman Electronics, Winston-Salem, N.C.: (919) 724-0541 • EAST CENTRAL Pioneer/Cleveland, Cleveland, Ohio: (216) 587-3600 • Pioneer/Dayton, Dayton, Ohio: (513) 236-9900 • CENTRAL Hallmark Electronics, Elk Grove Village, Ill.: (312) 437-8800 • Minneapolis, Minn.: (612) 925-2944 • St. Louis, Mo.: (314) 521-3800 • TEXAS-OKLAHOMA Sterling Electronics, Houston, Texas: (713) 623-6600 • Dallas, Texas: (214) 357-9131 • SOUTHWEST Sterling Electronics, Albuquerque, N.M.: (505) 345-6601 • Phoenix, Ariz.: (602) 258-4531 • WEST Westates Electronics Corp., Chatsworth, Calif.: (213) 341-4411 • Sterling Electronics, San Carlos, Calif.: (415) 592-2353 • Intermark Electronics, Sunnyvale, Calif.: (408) 738-1111 • Denver, Colo.: (303) 936-8284 • Salt Lake City, Utah: (801) 359-0531 • San Diego, Calif.: (714) 279-5200 • Santa Ana, Calif.: (714) 540-1322 • Almac-Stroum, Seattle, Wash.: (206) 763-2300 • Portland, Ore.: (503) 292-3534.



1500 SPACE PARK DRIVE, SANTA CLARA, CALIFORNIA 95050
TEL. (408) 246-9225 • TWX 910-338-0528 • CABLE MONO

Open a Savings Account with our new megapower SCRs



When you invest in IR's new Megapower SCR Family Savings Plan you start earning dividends three important ways.

First, you can eliminate over 70% of the devices and parts normally needed (see the 3-phase converter "savings account" below for full details). That gives you a lower total system cost, plus more reliability.

Second, having fewer parts cuts assembly time sharply, increases reliability and makes your field servicing that much easier, too.

Third, Megapower SCRs give you more production power with only a minimum change in your equipment size.

If you want to parallel Megapower SCRs, there's a special bonus. Our epitaxial process

yields SCRs of virtually identical switching characteristics, so you eliminate expensive current balancing equipment. It also produces the high voltage SCRs you need. Specifically: 700A(av), 500 to 2100V; 850A(av), 500 to 2000V; 1000A(av), 500 to 1500V, and 1600A(av), 500 to 1200V.

IR'S 4800 Amp, 3-PHASE CONVERTER SAVINGS ACCOUNT

Parts Per Assembly	4800A Assy. Using 3-550A SCRs Per Leg	4800A Assy. Using 1-1600A SCR Per Leg	Parts Saved Per Assy.
1. SCRs	18	6	12
2. Heat Sinks	21	9	12
3. Clamps	18	6	12
4. Fuses	18	6	12
5. Balancing Reactors	18	0	18
6. Trigger Pulse Pwr. Amplifiers	6	0	6
7. Isolated Gate Drive Windings	18	6	12
Totals	117	33	84

There is also an extra dividend in overall productivity because Megapower SCRs will keep your equipment on line longer. Their surge capability is so high, they can ride through massive overloads without resorting to protective fuses.

Open a savings account today. Call your IR branch office, or bank headquarters (213) 678-6281; Telex: 67-4666. International Rectifier, 233 Kansas Street, El Segundo, CA.

International Rectifier

International Rectifier, 233 Kansas Street, El Segundo, CA 90245. . . *the innovative power people*



INFORMATION RETRIEVAL NUMBER 67

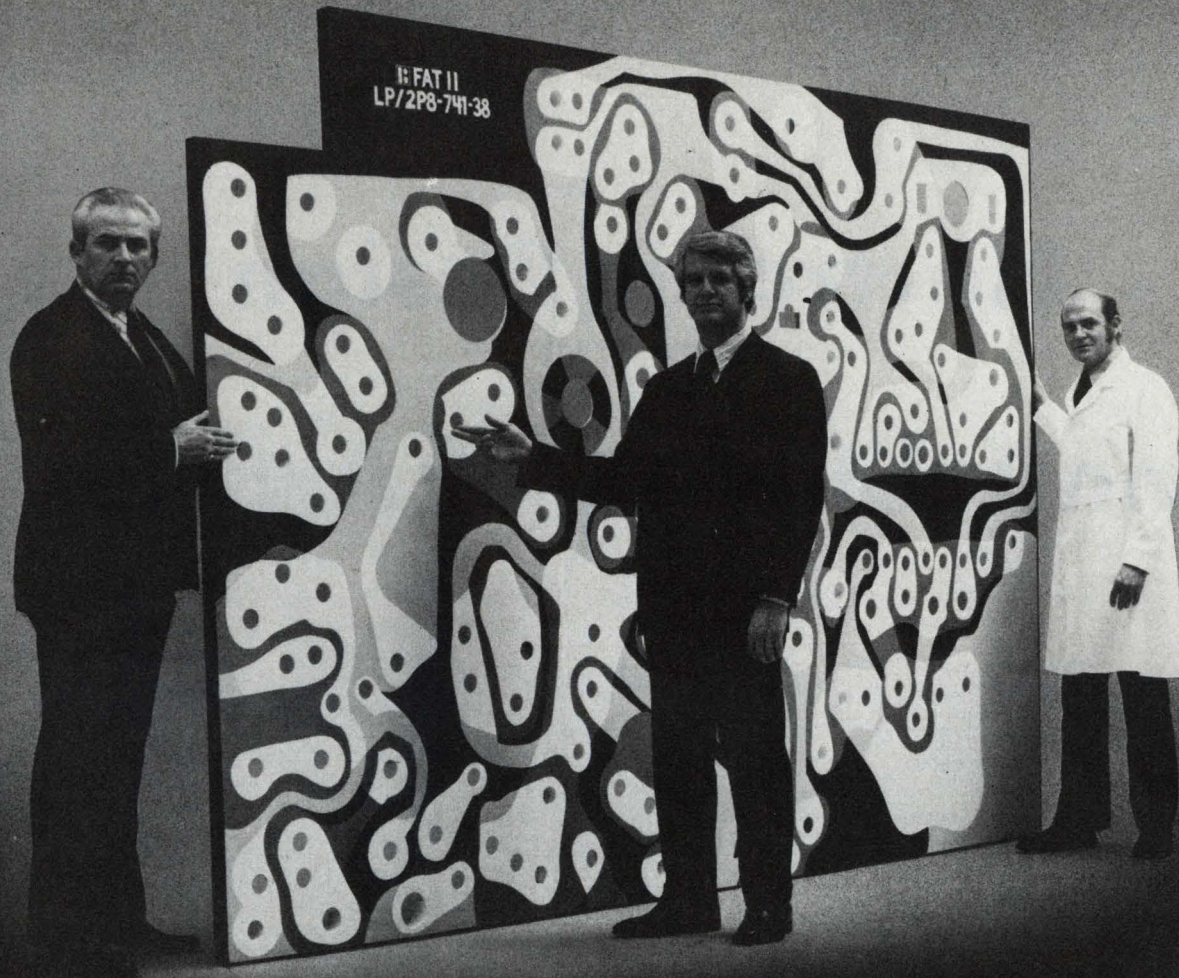

When ACD brings a new board out of the lab—it's ready.

FAT's Ready.

FAT™—Fully Additive Technology—is the volume user's ticket to cost efficiency. And it's ready now to be mass produced.

Why do we make a big thing out of being ready? Our reputation. Even though our FAT board is less expensive than conventional boards—we want you to know it's a precision piece of circuitry. And even though the holes are pierced instead of drilled, you'll find them ACD reliable. We've been

perfecting the undrilled hole for years—we're pros at the pierced through process. With FAT you'll find no slivering or undercut characteristics that can cause bad circuitry.

So if you're a volume house looking for economical per-board cost, don't need conventional, multilayer or exotic boards, or require military documentation, you should call us. We're ready to quote production orders on our FAT boards right now.



ADVANCED CIRCUITRY

4811 West Kearney Street, Springfield, MO 65803 • (417) 862 0751

Electronic Design 1973 Annual Index of Articles

Circuits & Circuit Theory

A/d converter offers fastest throughput for 10-bit resolution, but it'll cost you... PF, ED 10, p. 113.

Acoustic-wave filters improve radar... ART, ED 14, p. 56

Additional codes extend full-scale range of DAC... IFD, ED 18, p. 144.

Ambiguous contact closures eliminated in sequential timers... IFD, ED 6, p. 138

Analog sorting network ranks inputs by amplitude and allows selection... IFD, ED 2, p. 72

Analyzing the dynamic accuracy... ART, ED 19, p. 80

BCD decimal-point location... ART, ED 16, p. 80

BCD division... ART, ED 15, p. 86

BCD logarithms and exponentials... ART, ED 18, p. 118

BCD: Logic of many uses... ART, ED 13, p. 90

BCD multiplication... ART, ED 14, p. 62

BCD square root... ART, ED 17, p. 66

BCD trig and hyperbolic functions... ART, ED 19, p. 68

Banish inductors from resonant circuits... ART, ED 17, p. 72

Boost a/d rates with staggered operation... ART, ED 4, p. 54

Build stable, compact narrowband circuits... ART, ED 3, p. 60

CMOS a/d is lean on power, yet it delivers 12 bits... PF, ED 25, p. 190

Cascade differential pairs... ART, ED 6, p. 120

'Celerate' the digital stepping motor... ART, ED 1, p. 84

Check coil windings for correct turns... ART, ED 20, p. 84

Circuit applies power at precise phase angle... IFD, ED 11, p. 168

Control 10 A with a hybrid diode-and-SCR unit in a TO-3... PF, ED 10, p. 130

Department key

ART	Technical Article
IFD	Idea for Design
NEWS	News
PF	Product Feature
SR	Special Report

Countdown technique simplifies BCD-to-binary conversion circuitry... IFD, ED 8, p. 130

Cut reference junctions loose... ART, ED 11, p. 156

D/a converter design modification permits operation over a specified output range... IFD, ED 5, p. 80

Dc motor generates own tach signal... NEWS, ED 24, p. 28

Design versatile d/a converters... ART, ED 2, p. 66

Designers' touch needed to exploit acoustic surface waves to the hilt... NEWS, ED 16, p. 35

Determine noise of dc/dc converters... ART, ED 20, p. 100

Digitally programmable oscillator selects frequency in integer units from one to 15... IFD, ED 25, p. 140

Diode bridge and current source provide current limiting for bipolar supplies... IFD, ED 25, p. 144

Don't forget d/a converter tempco!... ART, ED 9, p. 130

Double clocking cuts off-the-shelf registers to custom sizes... IFD, ED 11, p. 166

Down, down go the prices for op-amp power supply... PF, ED 17, p. 112

Dual-output dc-to-dc supplies have 1 mV max output noise... PF, ED 25, p. 157

Ease multiplexing and a/d conversion... ART, ED 8, p. 84

Electronic controller resolution improved with an equilibrium sus-

taining mode... IFD, ED 13, p. 130

Expand counter capability... ART, ED 26, p. 68

Fast clock helps convert 2-phase encoder signals to positional data... IFD, ED 20, p. 112

FOCUS on A/D and D/A converters... SR, ED 1, p. 56

FOCUS on Analog-function modules... SR, ED 21, p. 64

FOCUS on Power supplies... SR, ED 25, p. 58

Foolproof way to sequencer design... ART, ED 10, p. 76

Get perfect linearity in CRTs... ART, ED 1, p. 76

Get true-rms ac equivalents regardless of waveshape... PF, ED 24, p. 240

Get up to 40 mA at ± 10 V from multiplying DACs... PF, ED 15, p. 116

Go active for sonar or radar filters... ART, ED 9, p. 126

Ground lead provides inhibit function for TTL inverters... IFD, ED 9, p. 144

Improve single-slope a/d accuracy... ART, ED 2, p. 58

Isolation amplifier provides 160-dB isolation and gain, too... PF, ED 21, p. 132

Join two unipolar d/a converters and get bipolar operation... IFD, ED 3, p. 74

Kilovolt supply circuit fashioned from cheap, low-voltage parts... NEWS, ED 6, p. 36

Latest 12-bit DAC shrinks size and price to new lows... PF, ED 11, p. 186

Lift afc discriminator performance... ART, ED 7, p. 48

Line-voltage control technique improves resolution, lowers parts cost... IFD, ED 23, p. 138

Log-ratio module handles either voltages or currents... PF, ED 11, p. 194

Low-temperature-coefficient current source becomes ultra-compliant

with two resistors...IFD, ED 12, p. 108

Minimize the effects of time delay...ART, ED 15, p. 78

Minor changes convert an astable multivibrator into a sweep generator...IFD, ED 3, p. 72

Modified current-limiter circuit ensures turn-on of power supply with constant-current loads...IFD, ED 23, p. 128

Monolithic s/d converter boasts high reliability...PF, ED 12, p. 114

Multifunction log module achieves 0.25% accuracy...PF, ED 21, p. 131

Multiple-output NAND networks...ART, ED 23, p. 98

Multiplexer technique solves X-out-of-Y bit pattern-recognition...IFD, ED 2, p. 70

Negative feedback gives ultra-flat filters without altering the selectivity...IFD, ED 10, p. 106

Nonlinear low-pass filter exhibits zero phase shift...PF, ED 2, p. 78

Optical Schmitt reduces photodetector uncertainties...IFD, ED 20, p. 114

Phase-locking increases range of wide-range phase controller...IFD, ED 16, p. 96

Positive voltage changed into negative, and no transformer is required...IFD, ED 11, p. 164

Program gives FET model from specs...ART, ED 12, p. 92

Protect solid-state power rectifiers...ART, ED 6, p. 106

Resistive network converts limit detector to movable window operation...IFD, ED 6, p. 144

Self-correcting ring counter requires no external gates...IFD, ED 9, p. 138

Simple dc current controller adapts easily to any supply voltage and load current...IFD, ED 14, p. 80

Simplify sequencers with an improved counter...ART, ED 18, p. 124

Solve LC network transfer functions...ART, ED 21, p. 96

Stretch counter size...ART, ED 25, p. 104

Thermal converter raises the accuracy of rms converter over wide input range...PF, ED 9, p. 166

Toroid and photo-SCR prevent ground loops in high-isolation biological pulser...IFD, ED 13, p. 128

Trade your Karnaugh maps...ART, ED 21, p. 88

Two resistors remove limiting effects of input voltages on current-mode amplifiers...IFD, ED 23, p. 136

Use a 723 as a switching regulator and get half an amp from a plastic TO-5 transistor...IFD, ED 12, p. 106

V-F and F-V modules convert signals over 100-kHz range...PF, ED 11, p. 190

Subject Listing

Circuits & Circuit Theory	General Industry
Communications, Microwaves & Lasers	Industrial Electronics
Components	Management
Computers & Data Processing	Materials & Packaging
Consumer Electronics	Medical Electronics
Displays	Military & Aerospace
Electro-Optics	Semiconductors
	Test & Measuring

Variable-speed, synchronous-motor control operates from 12-V battery or 120-V ac line...IFD, ED 20, p. 110

Versatile circuit detects change in voltage or frequency...IFD, ED 24, p. 192

When d/a converter glitches rear...ART, ED 22, p. 100

Write a Fortran wire-listing program...ART, ED 11, p. 140

8-bit d/a converter module settles to 0.4% within 15 ns...PF, ED 2, p. 77

14-bit conversion with sign in 1 μ s given by a/d unit...PF, ED 5, p. 88

Communications, Microwaves and Lasers

Advances in MIC design reported at conference...NEWS, ED 22, p. 27

Approaching Intelsat traffic jam raises problem in satellite design...NEWS, ED 21, p. 40

Automate your Smith Chart plots...ART, ED 18, p. 130

Bidirectional coupler comes in 14-pin DIP at low cost...PF, ED 13, p. 142

CO₂ laser heat gives better glass fibers...NEWS, ED 20, p. 20

Calculate large-signal behavior...ART, ED 23, p. 90

Challenge of linking satellites to more and more ground terminals...SR, ED 6, p. 70

Comsat planning 2 new satellites...NEWS, ED 7, p. 20

Extra line feeds speed telescope's data input...NEWS, ED 1, p. 28

FM-cw radar detects atmospheric pressure...NEWS, ED 15, p. 24

Ferrite toroids in hybrid ICs improve power efficiency and reduce heating...IFD, ED 11, p. 170

IBM trying new way to build X-ray laser...NEWS, ED 25, p. 26

'Interference-proof' portable radio is easy on the draw: only 50 mW...NEWS, ED 21, p. 42

It's a tree...a pole...a man; No!

A short-range hf antenna...NEWS, ED 26, p. 52

Lab advances giving GaAs FET edge over bipolar for microwaves...NEWS, ED 6, p. 29

'Ladar' concept proved in experimental system...NEWS, ED 19, p. 39

Laser control system operates vehicles in hazardous areas...NEWS, ED 23, p. 32

Laser point-of-sale system speeds checkout...NEWS, ED 23, p. 36

Laser-scanner system produces color pictures on black-white film...NEWS, ED 12, p. 22

Laser system tracks where radar can't...NEWS, ED 12, p. 34

Low-cost, low-power laser: It's here, there, everywhere...NEWS, ED 2, p. 24

Low-loss method of laser transmission discovered...NEWS, ED 19, p. 23

Low-noise paramp reaches 65 GHz...NEWS, ED 14, p. 30

Major advance in OICs hastens the day of optic communications...NEWS, ED 14, p. 26

Microwave transistor employs Gunn effect...NEWS, ED 4, p. 26

Monitor determines caller's phone number...NEWS, ED 20, p. 20

New material promises stripline advantages...NEWS, ED 4, p. 25

Processor for radar made more versatile...NEWS, ED 7, p. 19

Quartz Q-switch modulates high power laser...NEWS, ED 10, p. 42

RCA achieves mass holography in iron-doped lithium niobate...NEWS, ED 25, p. 32

Remote radar system raises harbor safety...NEWS, ED 20, p. 33

Researchers see laser fusion as safe, cheap power of future...NEWS, ED 22, p. 38

Search for X-ray laser is expanding...NEWS, ED 16, p. 20

Single laser rod yields 4 beams for high-speed holographic work...NEWS, ED 7, p. 26

Thermal profiler operates from ultraviolet to far IR...PF, ED 10, p. 140

ANNUAL INDEX

- Transistors and solid-state sources spur new commercial applications...SR, ED 18, p. 72
- Tunable laser widens its reach in IR region...NEWS, ED 10, p. 26
- U.S. continues search for laser fusion system...NEWS, ED 4, p. 25
- U.S. developing a super-efficient laser...NEWS, ED 13, p. 58
- Ultra-broadband amplifiers deliver gain of 26 dB...PF, ED 9, p. 154
- Varactor-tuned oscillators cut size, weight to new lows...PF, ED 19, p. 104
- Waveguide coupler developed for OICs...NEWS, ED 15, p. 24
- Wide-angle laser receiver has low noise and high sensitivity...NEWS, ED 21, p. 36
- 2 developments spur laser communications...NEWS, ED 13, p. 25
- 4.5-to-5.3-GHz source features 'frequency-agile' phase locking...PF, ED 6, p. 98
- 6-beam laser setup detects intruders...NEWS, ED 17, p. 20
- \$30 double-balanced mixer lists 1-GHz range in miniature package...PF, ED 6, p. 164
- 400 W average power reported with new inorganic liquid laser...NEWS, ED 18, p. 25

Components

- Better transducer sought for automobiles...NEWS, ED 12, p. 20
- CV transformer holds output to 0.5% over wide load, line, frequency changes...PF, ED 6, p. 147
- FOCUS on Fixed passive components...SR, ED 12, p. 56
- FOCUS on Piezoelectric crystals and devices...SR, ED 17, p. 44
- FOCUS on Small motors...SR, ED 20, p. 52
- Green LED production spurred by a new process at Ferranti...NEWS, ED 12, p. 36
- Magnetic semi urged to widen automation...NEWS, ED 12, p. 19
- Monsanto cuts price of non-red LEDs...NEWS, ED 21, p. 28
- Nickel-cadmium battery takes fast, fast charge...NEWS, ED 11, p. 30
- Offbeat connector protects circuits from lightning...NEWS, ED 4, p. 37
- Piezoelectric relay runs on only 1 W of power...NEWS, ED 20, p. 19
- Pressure sensor defies 10-g vibration...NEWS, ED 3, p. 36
- Protect against transients with clamping/crowbars...PF, ED 18, p. 96

- Solid-state relays are finding gradual acceptance—at last...NEWS, ED 19, p. 26
- Ten-year chemical battery could power future heart pacemakers...NEWS, ED 23, p. 66
- Time-delay relay repeats cycles to 0.1% or better...PF, ED 11, p. 192
- With something old, a bit of new, photosensors are taking off...NEWS, ED 26, p. 34

Computers & Data Processing

- Breadboard active filters at a computer...ART, ED 13, p. 104
- CAD methods for ICs are called inadequate...NEWS, ED 26, p. 32
- CMOS data logger records with 900 mW, idles on 10 μ W...PF, ED 6, p. 90
- CRT terminal gives sophistication at low cost...NEWS, ED 8, p. 142
- Canada claims a digital-data 'first'...NEWS, ED 7, p. 31
- Changes in architecture are giving users more computer at less cost...SR, ED 11, p. 58
- Clear the hurdles of microprocessors...ART, ED 20, p. 76
- Consider in-house time-sharing...ART, ED 11, p. 144
- Core and wire memories facing a challenge...NEWS, ED 9, p. 32
- Data networks putting the vast power of computers at fingertips of everyman...SR, ED 11, p. 108
- Desk-top computer cuts price by nearly 50%...NEWS, ED 22, p. 27
- Desk-top computer uses PL/I language...NEWS, ED 3, p. 19
- Digitize the X-Y coordinates of video signals into 8 bits...PF, ED 25, p. 153
- Editing problems with your mini?...ART, ED 11, p. 152
- European data traffic headed for huge rise...NEWS, ED 14, p. 20
- Flat-stacked tape said to combine reel and continuous-loop benefits...NEWS, ED 9, p. 46
- Get accurate Fast Fourier Transforms...ART, ED 10, p. 84
- HP introduces advanced version of its model 35...NEWS, ED 3, p. 20
- How to build a microcomputer...ART, ED 19, p. 60
- How to increase computer size...ART, ED 11, p. 148
- IBM puts entire disc system in one removable cartridge...NEWS, ED 8, p. 57
- IBM reported building 'electronic notebook'...NEWS, ED 3, p. 19
- Interactive design takes another step forward...NEWS, ED 8, p. 26
- Interdata, trying harder, offers 2 new mini systems...NEWS, ED 21, p. 27

- It's a 40-billion bit ROM, it's a TV programmer—it's Disco-Vision!...NEWS, ED 3, p. 35
- LED-and-photodiode blend yields first reprogrammable logic array...NEWS, ED 15, p. 36
- Line printer for minicomputer offers high speed at low cost...PF, ED 7, p. 92
- Medium-scale computer announced by Univac...NEWS, ED 23, p. 28
- Memories turn to new materials, but core hangs on as the old reliable...SR, ED 11, p. 70
- Microprocessor or Random Logic?...ART, ED 18, p. 106
- Microprocessors finding growing role between calculator chip and minis...SR, ED 11, p. 80
- Microprogramming: More 'in' than ever...ART, ED 17, p. 58
- Minicalculator to become 'major market'...NEWS, ED 2, p. 22
- Minicomputer interface card speeds data at 1 M word/sec...PF, ED 24, p. 223
- Modular family lets you build your own digital sequences...PF, ED 21, p. 140
- Multiplexer converts BCD to serial ASCII characters...IFD, ED 16, p. 94
- New minicomputers: Faster, sophisticated and a choice of MOS or bipolar memories...NEWS, ED 1, p. 32
- New monitor system for word processor...NEWS, ED 10, p. 26
- New small calculator and new chip available...NEWS, ED 13, p. 26
- New tricks in hardware are making it easier to improve the software...SR, ED 11, p. 100
- Next: A programmable HP pocket calculator...NEWS, ED 25, p. 25
- Offensive against IBM shapes up in Europe...NEWS, ED 6, p. 25
- Optical isolation of data bus simplifies logic design and eliminates noise...IFD, ED 25, p. 138
- Opto-isolators replace relays for the injection of time-mark signals...IFD, ED 26, p. 110
- Printers with CRTs speed data handling...NEWS, ED 11, p. 30
- Program uses convolution technique to compute linear network output...IFD, ED 15, p. 102
- Proliferous peripherals: They come fast, slow, versatile and with 'brains'...SR, ED 11, p. 88
- Push for hardware and software power...SR, ED 11, p. 56
- Rockwell slide rule to make its debut...NEWS, ED 18, p. 25
- Rugged disc-memory system accesses data in only 5 ms...PF, ED 11, p. 177
- Serial-data modules simplify automation of process measurement and control...PF, ED 7, p. 94
- Simple algorithm computes square roots on a four-function calculator...IFD, ED 15, p. 104

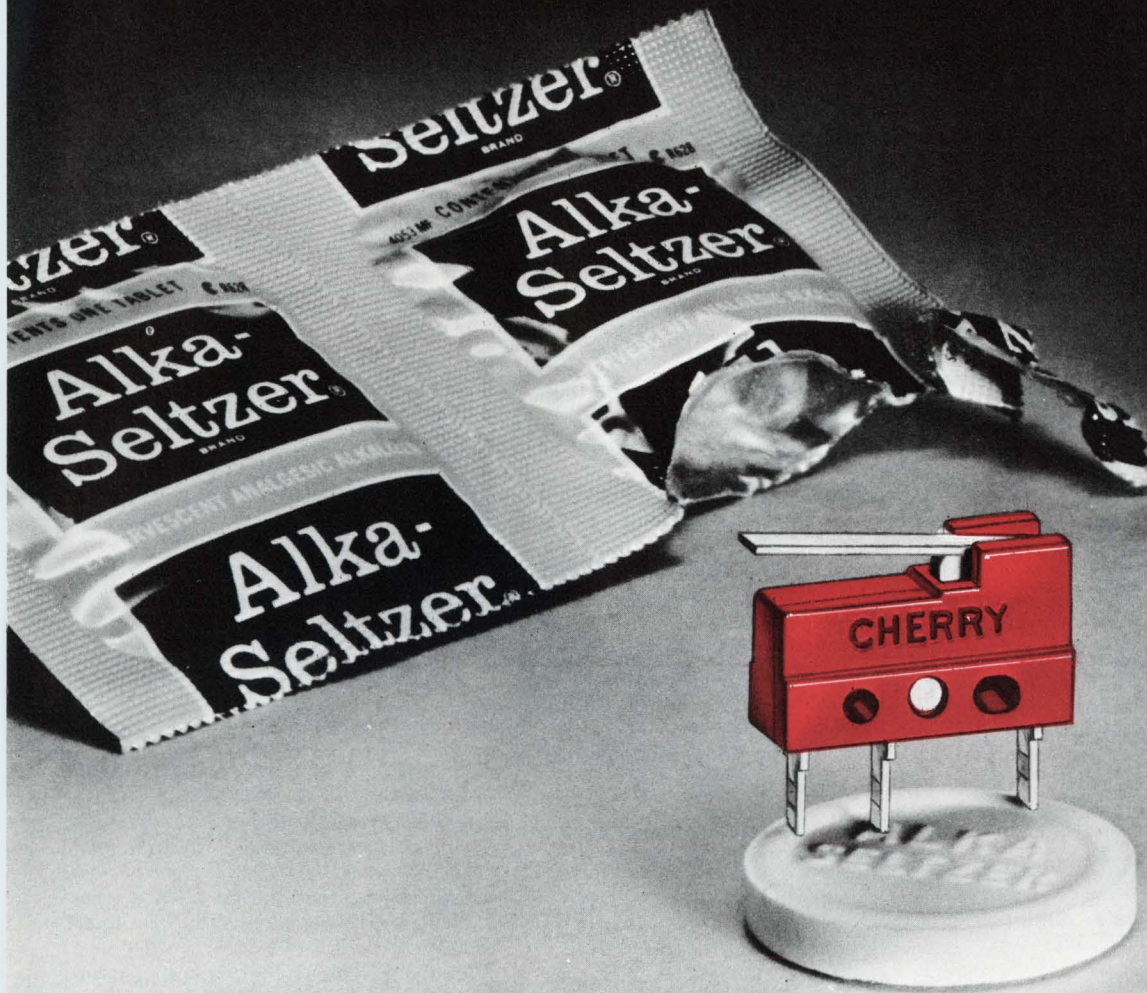

TRY 'EM...YOU'LL LIKE 'EM

Instant relief for design congestion: Cherry Subminiature snap-action switches.

When your design is afflicted with circuit congestion brought on by acute lack of space, here's the prescribed cure: Cherry 5 and 10 amp subminiature switches! Compact, easy-to-take size . . . refreshingly dependable coil spring action . . . plus long overtravel to combat assembly line headaches. You get Speedy snap-action relief in the dosage you prescribe: Either individual switches or space-saving multiple switch modules. Consultation available if design distress persists . . . Cherry diagnoses proven in over 160 million cases.

Try 'em: Send for free sample switch.
You'll like it.



E61-00A
Standard Force Basic 10 amp.
Circle Reader Service No. 242

E63-00A
"Goldie" Low Energy 0.1 amp.
Circle Reader Service No. 241

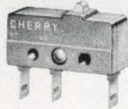

E62-50K
Roller Actuator 10 amp.
Circle Reader Service No. 243

CHERRY



TWX 910-235-1572 . . . or PHONE (312) 689-7600 . . . or WRITE:

CHERRY ELECTRICAL PRODUCTS CORP.
3609 Sunset Avenue, Waukegan, Illinois 60085



Cherry affiliates worldwide • Hirose Cherry Precision Co., Ltd., Tokyo • G. W. Engineering Pty. Ltd., Sydney
Cherry Electrical Products (U.K.) Ltd., St. Albans, Herts • Cherry Mikroschalter GmbH, Bayreuth, Germany

ANNUAL INDEX

- Simplify minicomputer maintenance...ART, ED 16, p. 86
- Speed your serial printer...ART ED 3, p. 54
- 'Super disc' can store over six billion bytes...NEWS, ED 22, p. 28
- Synthesizer produces speech with 100-bit/s input data...PF, ED 11, p. 175
- Tape and disc share package and electronics...PF, ED 14, p. 83
- That lowly calculator is turning into a vest-pocket computer...NEWS, ED 13, p. 28
- Thermal printer upstages mechanical units for long, unattended operation...PF, ED 25, p. 151
- Used computers offer big savings to buyers...NEWS, ED 4, p. 26
- Using processors to solve today's and tomorrow's problems...SR, ED 6, p. 72
- World's biggest computer show aims at drawing designers and end users...SR, ED 11, p. 118
- 2 desk-top calculators announced by Tektronix...NEWS, ED 16, p. 19
- 16-bit computer smaller than a hand...NEWS, ED 9, p. 31
- 16-bit minicomputer costs under \$1000...PF, ED 10, p. 118

Consumer Electronics

- Acoustic-wave filters studied for TV use...NEWS, ED 23, p. 28
- BART system problems under close scrutiny...NEWS, ED 1, p. 28
- Beam switching cuts landing-system costs...NEWS, ED 21, p. 28
- Charge-transfer camera designed for home TV...NEWS, ED 22, p. 27
- Coding symbol to spur grocery electronics...NEWS, ED 9, p. 31
- Color television swinging to in-line tubes as complex ICs widen consumer market...NEWS, ED 1, p. 34
- Consumer electronics adding sophistication...NEWS, ED 13, p. 25
- Electronic watches: A big step forward...NEWS, ED 3, p. 19
- Electronics for cars said to pose bigger challenge than space work...NEWS, ED 7, p. 28
- Electronics for watches: Packages get smaller...NEWS, ED 17, p. 19
- Flammability ratings are revised by UL...NEWS, ED 21, p. 28
- How to change bulky, discrete circuits into their micro-chip equivalents...SR, ED 6, p. 72
- Hydrogen fuel cells for cars passes tests...NEWS, ED 20, p. 19
- Missile sync generator offers variable scan for TV systems...NEWS, ED 10, p. 30

- New fears plaguing μ W-oven industry...NEWS, ED 7, p. 20
- New portability for phones coming...NEWS, ED 9, p. 32
- New stamps mark electronics milestones...NEWS, ED 9, p. 44
- PMOS memories turn up in phones...NEWS, ED 11, p. 30
- Point-of-sale market rings up dramatic growth...NEWS, ED 19, p. 36
- Quadrasonic systems getting better pickups...NEWS, ED 14, p. 20
- Radio control built into car seat-belt...NEWS, ED 17, p. 19
- Signetics penetrating automotive market...NEWS, ED 4, p. 26
- TV cameras employing charge-coupled devices being readied for market...NEWS, ED 17, p. 26
- TV industry views discs as "break-through of '70s"...NEWS, ED 11, p. 29
- Tiny CCD TV camera offered commercially...NEWS, ED 18, p. 26
- Tiny TV antenna has beam rotator...NEWS, ED 15, p. 23
- U.S. acts to implement consumer safety rules...NEWS, ED 8, p. 26
- U.S. prepares full-scale attack on consumer products hazards...NEWS, ED 9, p. 42
- U.S. regulation opens a new field: electronics for antiskid braking...NEWS, ED 14, p. 28
- Van Allen rebuts report of microwave oven peril...NEWS, ED 9, p. 32
- Which semis for cars? Panel to debate issues...NEWS, ED 1, p. 27
- 2-way CATV system to be tested in homes...NEWS, ED 4, p. 26
- 8 Quadraphonic systems being evaluated by EIA...NEWS, ED 16, p. 19
- \$100 electronic slide rule could make it this year...NEWS, ED 8, p. 25

Displays

- Black-white display terminals adapted for color by controller...IFD, ED 22, p. 112
- Ceramic image-storing device can project data by reflection...NEWS, ED 12, p. 40
- Custom LX displays for small-quantity needs...PF, ED 3, p. 79
- Display makers debate pros and cons of 4 leading types...NEWS, ED 19, p. 34
- Display method draws curves, not vectors, and with less data...NEWS, ED 22, p. 32
- Feedback circuit improves electron-gun aim by limiting acceleration-voltage changes...IFD, ED 23, p. 134
- LED array helps build a bargraph display...IFD, ED 21, p. 118
- Liquid-crystal cell used for sonic viewing...NEWS, ED 26, p. 32

- Liquid-crystal panel overcomes video-rate operating 'barrier'...NEWS, ED 12, p. 40
- Liquid crystals used in holographic memory...NEWS, ED 5, p. 24
- New TV setup allows programmed learning...NEWS, ED 15, p. 24
- 6000-line resolution planned in TV camera...NEWS, ED 8, p. 26

Electro-Optics

- Fiber-optic modules pave way for data and control systems...NEWS, ED 22, p. 43
- New ways to exploit an old material emerge...SR, ED 18, p. 76
- Optically controlled PMOS logic bypasses pin-limitation problem...NEWS, ED 4, p. 33
- Promise and the big hitch in fast, fast optical computing...SR, ED 6, p. 77

General Industry

- Check before you freeze that design!...ART, ED 1, p. 90
- Devices meeting will scan advances in 3 major areas...NEWS, ED 24, p. 27
- Exporting of technology stirs a protest by labor...NEWS, ED 7, p. 19
- FAA investigates vlf for civilian navigation...NEWS, ED 10, p. 25
- Fivefold growth forecast for specialized carriers...NEWS, ED 20, p. 20
- IEEE moves closer to an expanded role...NEWS, ED 4, p. 26
- Intercon '74: The accent will be on marketing...NEWS, ED 19, p. 24
- Japan's electronics: Industry in transition...SR, ED 26, p. 42
- Nuclear power electronics: Industry with a long future...NEWS, ED 15, p. 26
- One-day courses due at the IEEE show...NEWS, ED 5, p. 24
- Paris show attracts 121 U.S. semi makers...NEWS, ED 10, p. 25
- Rising \$26.9-billion market seen for electronics in '73...NEWS, ED 5, p. 23
- Seminar to consider electronic thievery...NEWS, ED 14, p. 19
- Three ways outlined to ease energy crisis...NEWS, ED 20, p. 20
- U.S. spur to oil exploration a boost to electronics, too...NEWS, ED 10, p. 25
- Wescon '73: Year of the comeback?...SR, ED 18, p. 62

Industrial Electronics

- Air-pollution detection creating wide interest...NEWS, ED 8, p. 25
- As industrial control systems grow, problems arise in controller choice...SR, ED 18, p. 68

Another first.

10-bit monolithic CMOS DAC.

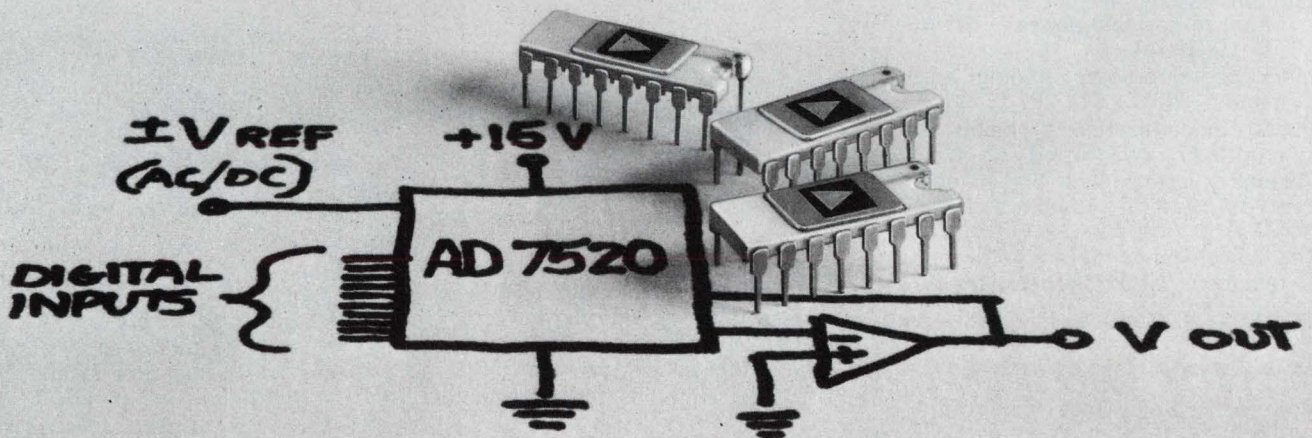

True 10-bit accuracy.

0.05% max. nonlinearity over $\pm V_{REF}$ range.
2 ppm/°C max. nonlinearity temperature coefficient.
10 ppm/°C max. gain temperature coefficient.

Low power consumption.

20mW power dissipation.

Versatile — like two DACs in one.

A straight (unipolar) converter.
2 quadrant multiplier.

4 quadrant multiplier.
AC/DC reference.
CMOS and TTL/DTL compatible.

The 16-pin ceramic DIP AD7520 comes in 3 versions.

100 piece prices are:
\$17 for 10-bit resolution and 8-bit accuracy.
\$25 for 10-bit resolution and 9-bit accuracy.
\$33 for 10-bit resolution and 10-bit accuracy.

INFORMATION RETRIEVAL NUMBER 69

To order, give us a call.

East Coast: 617-329-4700
Mid West: 312-297-8712
West Coast: 213-595-1783
CMOS DAC is just another innovative use of advanced technology to keep you — and us — a step ahead of everyone else.

From Analog Devices, Inc.,
Norwood, Mass. 02062

 **ANALOG
DEVICES**

ANNUAL INDEX

- Bypassing the phase capacitor helps brake reversible ac motors electrically... IFD, ED 11, p. 170
- Designers compete for that snug electronic bug in a rug... NEWS, ED 20, p. 22
- FAA completes Phase 1 of automation program... NEWS, ED 6, p. 26
- Fighting the skyjacking menace: Anyone have a bomb detector... NEWS, ED 8, p. 36
- First hybrid relay line offered for factory use... NEWS, ED 12, p. 20
- IEEE meeting will focus on electronic security... NEWS, ED 19, p. 23
- Industrial electronics becoming 'a way of life'; manufacturers see a year of growth ahead... NEWS, ED 2, p. 35
- Lithium battery: It just might revolutionize portable power... NEWS, ED 10, p. 44
- Mars photo process finding earth uses... NEWS, ED 23, p. 34
- Postal modernization problems are reported... NEWS, ED 22, p. 28
- Telemetry is making it big in industry as the costs tumble... NEWS, ED 4, p. 28
- Ulf beacon pinpoints site of trapped miners... NEWS, ED 11, p. 29

Management

- Andrew F. Kay: Once an inventor, it's hard to stop creating... SR, ED 24, p. 84
- 'Born' managers don't exist!... ART, ED 18, p. 138
- Consider the part-time engineer... ART, ED 12, p. 100
- Control projects by hours, not dollars... ART, ED 10, p. 102
- Creativity—every engineer has some... ART, ED 4, p. 76
- Designing what the customer wants... ART, ED 6, p. 132
- Don't spoon-feed your engineers!... ART, ED 21, p. 108
- DuMont legacy lives on, reflected in the modern CRT... SR, ED 24, p. 126
- Engineering jobs: What, why and where?... ART, ED 1, p. 68
- 'Fashion' the company's growth... ART, ED 13, p. 120
- Four ways to motivate engineers... ART, ED 9, p. 134
- Gene Amdahl competition plan: Make the machine big, but keep it simple... SR, ED 11, p. 66
- Getting the best inside information... ART, ED 19, p. 86
- Giving engineers the 'business'... ART, ED 23, p. 122
- Good managers are made... ART, ED 17, p. 76

- Is Monte Carlo worth the gamble?... ART, ED 3, p. 66
- Managers promote engineering 'digestion'... ART, ED 26, p. 102
- Portrait of a minicomputer mastermind: Gordon Bell, engineer in a big hurry... SR, ED 11, p. 96
- Putting an engineer in the wrong... ART, ED 11, p. 160
- Raises: How often and how much?... ART, ED 8, p. 110
- Stop stumbling over internal reports!... ART, ED 25, p. 130
- They'd rather switch than take flight... ART, ED 16, p. 90
- Time-managed meetings are a must!... ART, ED 22, p. 104
- Try getting it all together... ART, ED 7, p. 58
- What ails electronics management?... ART, ED 15, p. 58
- You'll turn out good products for less... ART, ED 20, p. 104

Materials and Packaging

- Connector and semi makers weigh alternatives of high-priced gold... NEWS, ED 22, p. 34
- Don't overload those connectors... ART, ED 20, p. 90
- Dust filters can block cooling air... ART, ED 23, p. 108
- Ferrite-bead specs permit precise attenuation matching... PF, ED 19, p. 114
- FOCUS on Connectors for PCs and substrates... SR, ED 5, p. 50
- FOCUS on High temperature materials... SR, ED 22, p. 54
- FOCUS on Materials... SR, ED 8, p. 74
- Heat pipes carry heat from component to sink... PF, ED 13, p. 150
- LSI circuit connector used with thick films... NEWS, ED 10, p. 26
- Lithium battery uses inorganic electrolyte... NEWS, ED 19, p. 24
- New material simplifies making of ceramic parts... NEWS, ED 5, p. 24
- New material spurs superconductor hopes... NEWS, ED 21, p. 27
- Plastic semi packages may rival hermetics... NEWS, ED 12, p. 20
- Superconducting magnet yields 165,000 oersteds... NEWS, ED 25, p. 25
- Tape-automated bonding pushed as replacement for chip-and-wire... NEWS, ED 13, p. 52
- Thick-film networks starting to take off... NEWS, ED 9, p. 31
- Thin, copper-clad laminate replaces ceramics in hybrids... PF, ED 24, p. 217
- Universal plug-in PC board eases component mixing... PF, ED 21, p. 146
- Voice-coil-driven laser trimmer offers accuracy to $\pm 0.005\%$ and $m\Omega$ - $M\Omega$ range... PF, ED 8, p. 148

- Wrap-around cabinets meet tight production tolerances... PF, ED 14, p. 87

Medical Electronics

- Consumerism and the makers of medical electronics collide... NEWS, ED 5, p. 26
- Design may be a success, but product may die unless you're qualified... SR, ED 18, p. 66
- Insulin 'pacemaker' for diabetics sought... NEWS, ED 25, p. 25
- Multiple medical pack a NASA spin-off... NEWS, ED 24, p. 28
- Top medical care for rural areas planned via electronics network... NEWS, ED 5, p. 34
- Ultrasonic probe sought to show heart damage... NEWS, ED 21, p. 28

Military & Aerospace

- ACES: New electrical system for space... NEWS, ED 16, p. 40
- AF automates watch on celestial events... NEWS, ED 1, p. 27
- AF data link to use time-shared system... NEWS, ED 23, p. 27
- AF presses design of 'flying computer'... NEWS, ED 24, p. 28
- AF tests radio waves in 'whispering gallery'... NEWS, ED 15, p. 23
- Abdominal flying tested for Navy... NEWS, ED 6, p. 26
- Air Force continues push toward laser communication satellite net... NEWS, ED 17, p. 28
- Air Force to develop low-accuracy guidance... NEWS, ED 17, p. 19
- Aneroid altimeter gives way finally to a computerized electronics one... NEWS, ED 10, p. 46
- Bubble memory planned for recording in space... NEWS, ED 21, p. 27
- CMOS makes possible digital navigation system... NEWS, ED 20, p. 19
- Design in the 1980s: How NASA sees its equipment shaping up... NEWS, ED 16, p. 42
- Electronic flying passes initial Air Force test... NEWS, ED 5, p. 23
- Iran seeking to buy U.S. 'smart' bombs... NEWS, ED 6, p. 25
- It's a leaner Fort Monmouth today—but a better R&D operation... SR, ED 18, p. 38
- 'Largest' TV tube developed by AF... NEWS, ED 14, p. 20
- Laser airspeed meter being tested by NASA... NEWS, ED 1, p. 28
- Laser gets hotter in military application... NEWS, ED 18, p. 26
- Mideast War is forcing changes in American military electronics... NEWS, ED 25, p. 42
- NASA aims to hold the line with a \$3.4-billion budget... NEWS, ED 2, p. 21

BARGAINS GALORE on LEDs from DIALIGHT

FEATURES:

High luminous intensity

Low cost

Low power consumption

IC compatible

Vibration/shock resistant

Solid state reliability

Life measured in years

Wide viewing angle



Dialight's high brightness 521-9200 LED is an intense large area light source that has this typical luminous intensity:

$$@ I_F = 20 \text{ mA} \quad I_0 = 2.0 \text{ mcd.}$$

APPLICATIONS:

Panel lighting • Circuit-status indicators • Back lighting of annunciators • Alpha-numeric displays • Automobile dashboards • Appliances • Desk-top calculators • Housewares



9¢

Quality LEDs are 9¢ each when purchased in million piece quantities



21¢

LEDs from 100 to 999 are only 21¢ each.

17¢



If you need LEDs from 1000 to 9999, Dialight has them for 17¢ each.

28¢



Even if you only need LEDs from 1 to 99, Dialight has them for 28¢ each.



16¢

Quantities from 10,000 are a low 16¢ each and Dialight can fill your order today

FREE!

With this coupon you can get a free LED sample. Send this coupon to your nearest Dialight distributor or give him a call.

All prices are domestic and subject to change without notice.

DIALIGHT

Dialight Corporation, A North American Phillips Company
60 Stewart Avenue, Brooklyn, N.Y. 11237 (212) 497-7600

AVAILABLE NOW FROM THESE STOCKING DISTRIBUTORS

ARIZONA
Moltronics of Arizona, Inc.
602-272-7951

CALIFORNIA
Western Electromotive
213-870-7621
Bell Electronics Corp.
415-323-9431
Fisher/Brownell
408-244-6182
Richey Electronics, Inc.
213-875-2862
Westates Electronics Corp.
213-341-4411

COLORADO
Meter Master Instrument Corp.
303-722-5766

FLORIDA
Hammond Electronics, Inc.
305-241-6601

ILLINOIS
Newark Electronics
312-638-4411

INDIANA
Graham Electronic Supply, Inc.
317-634-8202
Radio Distributing Co.
219-287-2911

MARYLAND
Pioneer Washington Elect. Co.
301-424-3300
Radio Electric Service Co.
301-823-0070

MASSACHUSETTS
Cramer Electronics, Inc.
617-969-7700
DeMambro Supply Co., Inc.
617-787-1200
Gerber Electronics, Inc.
617-329-2400
Sager Electrical Supply Co.
617-542-2281

MICHIGAN
RS Electronics
313-491-1000

MINNESOTA
Gopher Electronics Co.
612-645-0241

MISSOURI
Lcomp-St. Louis, Inc.
314-647-5505

NEBRASKA
Scott Electronic Supply
402-434-8308

NEW JERSEY
Federated Electronics
201-376-8900
Resco Electronics
609-662-4000
State Electronics
201-887-2550

NEW YORK METROPOLITAN AREA
Arrow Electronics, Inc.
516-694-6800
Harrison Radio Corp.
516-293-7990
Harvey Radio Co., Inc.
516-921-8700
Melville Radio Corp.
914-592-7100
Peerless Radio Corp.
516-593-2121

NEW YORK STATE
Summit Distributors, Inc.
716-884-3450

NORTH CAROLINA
Hammond Electronics of Carolina, Inc.
919-275-6391

OHIO
Hughes-Peters, Inc.
614-294-5351
Pioneer-Cleveland Div.
Pioneer-Standard Electronics
216-587-3600
Stotts-Friedman Co.
513-224-1111
Sun Radio Co., Inc.
216-434-2171

OKLAHOMA
Radio, Inc.
918-587-9124

PENNSYLVANIA
Almo Electronics Corp.
215-676-6000
George D. Barbey Co.
215-376-7451
Cameradio Co.
412-288-2600

TEXAS
Harrison Equipment Co., Inc.
713-224-9131

UTAH
Standard Supply Co.
801-355-2971

WASHINGTON
Almac/Stroum Electronics
206-763-2300

WISCONSIN
Parts Mart Corp.
414-276-4160

CANADA
Saynor Electronics Ltd.
416-445-2347
L. A. Varah Ltd.
604-736-9252
Wackid Radio TV Labs, Ltd.
613-726-1821

FREE!

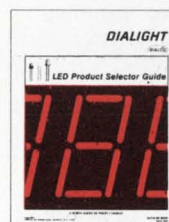

Ask for free LED Product Selector Guide. 60 pages of LEDs: discretes, indicators, displays, fault indicators, opto-isolators, etc.

Navy miniaturizes radio mike and earphone... NEWS, ED 10, p. 42
 Navy to try fiber optics instead of wiring... NEWS, ED 14, p. 19
 New avionics may help counter jet noise... NEWS, ED 7, p. 19
 New MIL spec-cost; Designers must meet it... NEWS, ED 8, p. 52
 New spacecraft system to cut fuel use in half... NEWS, ED 16, p. 20
 Ready for man's longest stay in space... NEWS, ED 8, p. 28
 'See all' Navy radar tracks multiple targets... NEWS, ED 8, p. 25
 Sensitive IR bolometer developed for military... NEWS, ED 16, p. 20
 Skylab crew ready if gyros malfunction... NEWS, ED 17, p. 19
 U.S. speeding weapons R&D to match Soviet advances... NEWS, ED 26, p. 31
 U.S. still favors solar cells despite Skylab difficulties... NEWS, ED 12, p. 19
 U.S. weighs Israeli request for latest ECM equipment... NEWS, ED 23, p. 27
 'Underground' radar resolves to one inch... NEWS, ED 22, p. 28
 'Who is it?' machine sought by Air Force... NEWS, ED 6, p. 26
 4-billion hike in defense spending due, with little if any of it trickling into R&D... NEWS, ED 2, p. 32
 \$13-billion spending by Pentagon forecast... NEWS, ED 14, p. 19

Semiconductors

Active diodes crowding Gunns in noise, power and efficiency... NEWS, ED 7, p. 22
 Acoustic-wave structure blends digital MOS and hybrid features... NEWS, ED 18, p. 32
 Adjustable logic-delay circuit covers 40- μ s to 375 ms with one control... IFD, ED 25, p. 146
 Adjustable sine wave audio oscillator employs improved agc for wide frequency range... IFD, ED 4, p. 82
 Advances in resistor fabrication yield monolithic 10-bit DACs... SR, ED 6, p. 34
 Amorphous metallic films promise easy-to-make bubble memories... NEWS, ED 5, p. 32
 Analog methods may yield denser computer memories... NEWS, ED 6, p. 25
 Analog multiplication or amplitude modulation are provided by a single MOSFET... IFD, ED 1, p. 98
 Analog switches replace reed relays... ART, ED 13, p. 98

BCD decade counter exceeds 600 MHz, uses only 420 mW... PF, ED 4, p. 91
 Bell Labs' new thin-film hybrid may be most complex ever built... NEWS, ED 15, p. 34
 Bi-directional interval timer includes snap-action trip points... IFD, ED 25, p. 142
 Binary adder technique recognizes m out of n bits... IFD, ED 16, p. 98
 Biphasic data transmission system uses IC one-shot as converter and doubler... IFD, ED 8, p. 128
 Blend ECL and TTL ICs... ART, ED 6, p. 112
 'Blue sky' amorphous memory ready for down-to-earth uses... NEWS, ED 16, p. 22
 Boost CMR in differential... ART, ED 20, p. 94
 Boost counting speed to 11 MHz... ART, ED 7, p. 42
 Bubble memory developed in lab, and it appears to be a success... NEWS, ED 9, p. 40
 Bubble memory-logic chip? IBM heads toward that goal... NEWS, ED 12, p. 38
 Bubble-memory material promises faster readout... NEWS, ED 23, p. 27
 Bucket-brigade MOS ICs delay analog signals... PF, ED 8, p. 135
 Build a wideband phase-locked loop... ART, ED 18, p. 112
 Build power amplifiers with IC drivers... ART, ED 21, p. 80
 Build stable frequency synthesizers... ART, ED 12, p. 76
 Build the n-flop, a multiple pulse-input, level-output device that uses simple gates... IFD, ED 17, p. 84
 CCDs are breaking new ground as analog signal processors... NEWS, ED 25, p. 28
 CMOS and bipolar on chip drive LED numeric display... PF, ED 8, p. 138
 CMOS logic elements interface easily... ART, ED 5, p. 66
 Chopper-stabilized amp shrunk by new process... NEWS, ED 12, p. 19
 Chopper-stabilized op amp goes monolithic... NEWS, ED 18, p. 25
 Chopper-stabilized op-amp IC reduces drift to 0.2 μ V/ $^{\circ}$ C... PF, ED 19, p. 100
 Chopper stabilized op amp now fits in a 14-pin DIP... PF, ED 13, p. 136
 Chroma demodulator chip makes low-distortion AM detector... IFD, ED 24, p. 196
 Circuit based on four-bit addition finds average value of BCD numbers... IFD, ED 23, p. 130
 Cut component count... ART, ED 19, p. 76
 Diffused junction gives rms-to-dc conversion... NEWS, ED 8, p. 25

Digital watch advances disclosed by Intersil... NEWS, ED 18, p. 25
 Divide by n with the 7490... ART, ED 8, p. 106
 ECL-gate propagation delay cut to 0.91 ns or less... PF, ED 25, p. 182
 EFL, a new logic family for LSI, promises to ease designer's job... NEWS, ED 6, p. 30
 Eight-bit a/d converter is smallest available in size, price and power... PF, ED 24, p. 244
 Fast BCD/binary conversions... ART, ED 22, p. 84
 Fastest IC op-amp settling time, 1 μ s to 0.01 μ s, given by 10-MHz unit... PF, ED 6, p. 94
 Fivefold boost in diode speed... NEWS, ED 10, p. 41
 Flexible power switch/amp IC delivers 10 W of peak power... PF, ED 1, p. 105
 Floating voltage regulator helps build high-compliance current source... IFD, ED 10, p. 108
 FOCUS on IC voltage regulators... SR, ED 14, p. 46
 FOCUS on Power semiconductors... SR, ED 23, p. 80
 FOCUS on RF transistors... SR, ED 3, p. 46
 Four-bit microprocessor cycles instructions in 5 μ s... PF, ED 5, p. 94
 Generate low-distortion sine waves... ART, ED 14, p. 70
 Get square-wave tone bursts with a single timer IC... IFD, ED 18, p. 148
 Get wider dynamic range in a log amp... ART, ED 4, p. 60
 Get \pm 0.02% full-scale VCO accuracy... ART, ED 6, p. 126
 'Glitchless' hybrid-IC DAC has 500-mA drive capability... PF, ED 16, p. 118
 High-frequency clock helps extract vertical sync signal... IFD, ED 15, p. 104
 High-speed shift registers use TTL RAMs and counters to do all the shifting... IFD, ED 18, p. 146
 IC op amp slew rate soars to 320 V/ μ s... PF, ED 22, p. 128
 Improve avalanche-photodiode designs... ART, ED 15, p. 68
 Improve fast-logic designs... ART, ED 10, p. 90
 Improve op-amp audio circuits... ART, ED 20, p. 68
 Increase bandwidth of cascaded synchronous counters to 35 MHz... IFD, ED 1, p. 100
 Increase phototransistor bandwidth... ART, ED 8, p. 102
 Ion-implanted diodes switch 1 to 30 A in 25 ns or less... PF, ED 12, p. 127
 It's a year for bubble memories; Prototypes will appear shortly... NEWS, ED 3, p. 22

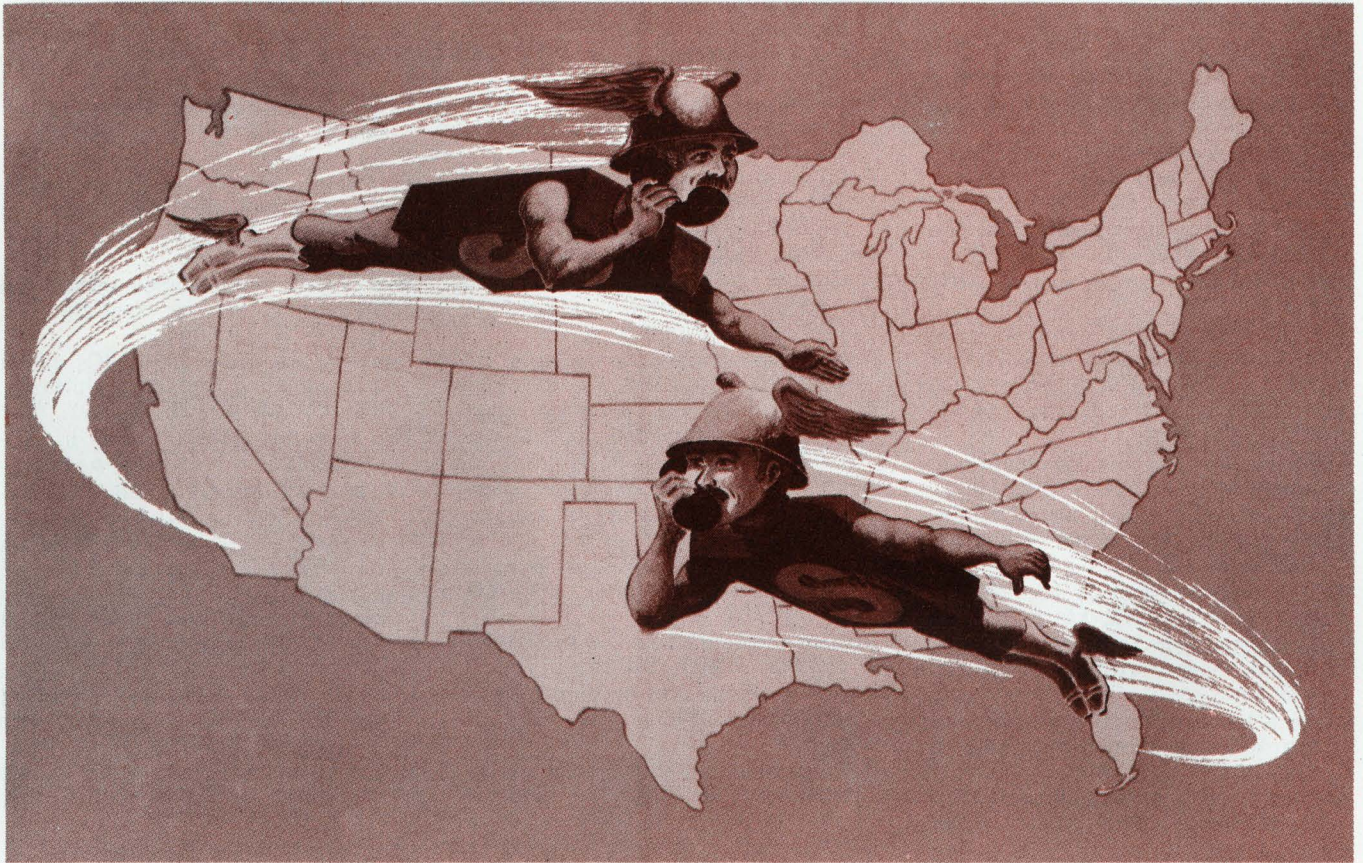

FROM COAST TO COAST

we've got your number

We've got the greatest numbers game in the country.

California: 800-854-2799. Florida: 800-327-3243.

Dial either one of these toll-free exchanges anytime for information on 60,000 semi-conductor part numbers. CMOS. FET's. PMOS. Power Transistors. All Hybrids. Diodes. Rectifiers. Virtually any Semi-conductor, Custom or Standard. We'll provide on-the-spot price information along with in-depth technical assistance.

Just call us first for any of your semi-conductor requirements.
After all, we've got your number. And now you've got ours!

CALL TOLL-FREE

800-854-2799

8808 Balboa Avenue
San Diego, California 92100

CALL TOLL-FREE

800-327-3243

1177 Blue Heron Blvd.
Riviera Beach, Florida 33404

Soliton
DEVICES, INC.

PLANTS IN: CALIFORNIA • FLORIDA • NEW YORK • ENGLAND • HONG KONG • MEXICO

INFORMATION RETRIEVAL NUMBER 71

ANNUAL INDEX

- Japanese IC metallization method hailed as reliability 'breakthrough'... NEWS, ED 13, p. 54
- Largest programmable ROM stores 4096 bits and has 70-ns max access time... PF, ED 19, p. 99
- Latest quad op amp needs only one supply... NEWS, ED 3, p. 20
- Lift IC op-amp performance... ART, ED 4, p. 66
- Line receiver rejects common-mode spikes but employs only 2 flip-flops... IFD, ED 4, p. 86
- Linearize your v/f converter... ART, ED 23, p. 112
- Low-cost IC contains complete log amplifier... PF, ED 17, p. 102
- MNOS memory upstaging MOS and fixed heads in some areas... NEWS, ED 18, p. 28
- MOS memories seen at 16,000 bits per chip... NEWS, ED 3, p. 19
- MOS/LSI modem replaces expensive bipolar type... NEWS, ED 19, p. 43
- Make a true-rms-to-dc converter, using only one IC multiplier and an op amp... IFD, ED 21, p. 116
- Materials seminar due in semiconductor field... NEWS, ED 18, p. 25
- Matrix approach cuts component count for decoding digital words... IFD, ED 14, p. 76
- Microprocessors, building blocks for logic design, maintain hot pace... SR, ED 18, p. 70
- Motorola offers prizes for innovative design... NEWS, ED 16, p. 20
- NMOS and CMOS are surging forward in drive to dominate semiconductor scene... NEWS, ED 1, p. 31
- Need an inverter? Use a spare J-K flip-flop... IFD, ED 13, p. 132
- New IBM semis aim for terahertz range... NEWS, ED 24, p. 27
- New TI courses to cover 3 fields... NEWS, ED 17, p. 20
- New processing and design tricks skyrocket the performance of LSI... SR, ED 6, p. 68
- Nondifferential phase inverter offers balanced-output Z with 2 transistors... IFD, ED 19, p. 94
- Nonselective frequency tripler uses transistor saturation characteristics... IFD, ED 17, p. 86
- One-shot timing circuit blocks EMI pulses that cause counting errors... IFD, ED 22, p. 110
- Op-amp summer modifies VCO chip for clean sine wave operation... IFD, ED 9, p. 140
- Optical devices get JEDEC numbers... NEWS, ED 7, p. 20
- PLAs replace ROMs for logic designs... ART, ED 22, p. 66
- Phase-lock indicator operates with either periodic or PCM inputs... IFD, ED 6, p. 140
- Phase-locked loop helps generate waveforms with variable duty cycle or phase shift... IFD, ED 19, p. 90
- Programmed logic array puts 16-bit mini in economy class... NEWS, ED 10, p. 28
- Programmed logic array replaces 131 k bits of ROM... PF, ED 12, p. 124
- Projectile fuze first to use MNOS circuits... NEWS, ED 16, p. 19
- Protect op amps from overloads... ART, ED 10, p. 96
- Protect series-pass transistors... ART, ED 25, p. 82
- Quad-linear ICs racing up the pike, paced by automotive applications... NEWS, ED 21, p. 32
- Quad op-amp comparators allow continuous monitoring of two inputs... IFD, ED 7, p. 82
- Quad op amp IC operates from a single power supply... PF, ED 20, p. 120
- Reduce system noise with CMOS circuits... ART, ED 25, p. 112
- Resistive bridge and op amp form a multiplying DAC... IFD, ED 19, p. 92
- Retriggerable one-shot prevents false triggering of PLL tone detector... IFD, ED 1, p. 102
- SCR turn-off problem eliminated in rapid-fire stroboscope trigger... IFD, ED 22, p. 116
- SOS central processor makes debut in a mini... NEWS, ED 26, p. 31
- Schmitt trigger provides switch drive and regulation for power supply... IFD, ED 15, p. 106
- Series SCR lamp flasher operates with a wide range of loads... IFD, ED 5, p. 84
- Shift option improves handling of binary counter data... IFD, ED 7, p. 84
- Shortcomings noted in solid-state surger... NEWS, ED 13, p. 26
- Shorter, more compact show salutes transistor... SR, ED 6, p. 66
- Silicon rectifier unit can operate at 500 F... NEWS, ED 19, p. 23
- Simplify amplifier selection... ART, ED 16, p. 72
- Single diode extends duty-cycle range of astable circuit built with timer IC... IFD, ED 5, p. 80
- Single supply runs op-amp circuit... ART, ED 25, p. 124
- Single-transistor cell reaching for first place in MOS memories... NEWS, ED 6, p. 28
- Soviet acting to get IC process capability... NEWS, ED 4, p. 25
- Stereo IC with all functions on chip, simplifies quadraphonic decoding... PF, ED 2, p. 82
- Successive-approximation a/d converters fit 40-pin DIPs and offer many options... PF, ED 22, p. 121
- System designers feel impact of semiconductor memories... NEWS, ED 19, p. 32
- Temporal-priority circuit latches after receipt of first input signal... IFD, ED 23, p. 132
- Tiny modular op amp slews and settles in a hurry... PF, ED 18, p. 94
- Transistor and two resistors reduce noise and widen bandwidth of 101/748 op amps... IFD, ED 14, p. 78
- Two offbeat technologies invade the burgeoning field of memories... NEWS, ED 14, p. 22
- Two very-low power CMOS ICs detect tone-signaling frequency shifts... IFD, ED 13, p. 126
- Two-wire line-drivers come in TO-packages... PF, ED 24, p. 221
- UV process speeds photoresist removal... NEWS, ED 1, p. 27
- Unconventional uses for IC timers... ART, ED 12, p. 84
- Unijunction oscillator helps increase range of monolithic timer without use of big capacitors... IFD, ED 22, p. 114
- Unusual filter concept promises high-Q, low-frequency IC device... NEWS, ED 17, p. 22
- Use a quad amplifier IC to handle transducer bridge signals... IFD, ED 3, p. 74
- Use current-mode IC amplifiers... ART, ED 2, p. 48
- Use thyristor switches for proportional... ART, ED 23, p. 118
- Users demand and get higher reliability ICs... NEWS, ED 2, p. 22
- Variable-modulus ICs simplify PLLs for 200 MHz... PF, ED 8, p. 136
- Voltage-to-frequency converter constructed with few components is accurate to 0.2%... IFD, ED 13, p. 124
- Volume compressor with 50-dB range built around single op amp... IFD, ED 10, p. 110
- Which voltage regulator is best?... ART, ED 25, p. 92
- Wideband nonsaturating multivibrator features nanosecond rise and fall times... IFD, ED 26, p. 112
- Year of MNOS is coming, with 4-k bit RAMs and more... NEWS, ED 9, p. 34
- 2-component RC network initializes CMOS registers... IFD, ED 21, p. 118
- 3 years after birth, CCDs head for first commercial applications... NEWS, ED 1, p. 36
- 4-bit BCD adder and arithmetic unit perform faster with less power... PF, ED 6, p. 156
- 8-k CCD memory chips due to replace discs... NEWS, ED 15, p. 23
- 14-pin ceramic DIP holds matched op-amp pair... PF, ED 13, p. 135
- 30-MHz power transistors yield more watts per dollar... PF, ED 20, p. 122
- 100-V/ μ s slew rate available in a

Only AEL delivers ASCII compatible 32 character self-contained LED displays

Features:

- Exclusive error correction feature.
Permits on-line editing of text.
- Accepts data input at 20,000 character/second rate.
- Self-contained display drive & display data storage.
- Requires only ASCII input code, +5V, -12V, clock & load control.
- Refresh not required.
- Alpha numeric segmented LED display with separate decimal points.
- Total unit size: 6½" x 1" x 1".
- Display modes: BURST (32 characters at once)
Typewriter display
Walking display



For further
information
write, Dept. 526



American **E**lectronic
Laboratories, Inc.

P.O. Box 552, Lansdale, PA 19446
215-822-2929 • TWX: 510-661-4976
Cable: AMERLAB

- high-voltage FET op amp...PF, ED 9, p. 149
- Test & Measuring**
- Analog divider simplifies ac ratio meter and yields ± 0.2 -dB measurement accuracy...IFD, ED 2, p. 72
- Analogs aren't dead, but they're facing a digital onslaught...SR, ED 24, p. 108
- Be on guard when using DVMs...ART, ED 12, p. 70
- Bench instruments or systems, they come with high IQs...SR, ED 24, p. 132
- Calculate receiver sensitivity...ART, ED 25, p. 118
- Catch a transient pulse—store it, display it and digitize it...PF, ED 17, p. 92
- Compute the noise figure...ART, ED 4, p. 72
- DPM automatically switches range: It's an industry first...PF, ED 18, p. 84
- DPMs vs analog meters...ART, ED 24, p. 158
- DVMs aren't what they used to be...ART, ED 24, p. 166
- DVMs can do more than measure...ART, ED 21, p. 102
- Data storage improves with new magnetic and paper tape units...SR, ED 24, p. 140
- Detector gives computer warning of ac power-line failure in 150 μ s...IFD, ED 26, p. 108
- Digital and analog printout given simultaneously by single device...NEWS, ED 13, p. 56
- Digital logic give rise to three devices for easing design work...SR, ED 24, p. 66
- Digital readout sig gen stretches peak FM deviation...PF, ED 6, p. 80
- Don't be strangled...ART, ED 26, p. 86
- Don't clobber your circuit...ART, ED 24, p. 178
- Don't eyeball noise...ART, ED 24, p. 184
- Don't get burned!...ART, ED 5, p. 72
- Dual comparator and R-C filter estimate probability density functions...IFD, ED 4, p. 84
- Easy way to match impedances...ART, ED 5, p. 76
- Electron microscope method promises 10-Å resolution...NEWS, ED 21, p. 39
- Energy meter improves aircraft performance...NEWS, ED 23, p. 65
- Equipment is getting faster and smaller and much more digital...SR, ED 24, p. 90
- FOCUS on Digital multimeters...SR, ED 16, p. 58
- FOCUS on Pulse and word generators...SR, ED 11, p. 128
- FOCUS on Signal generators and synthesizers...SR, ED 10, p. 62
- For versatility and wide choice, try the bargain counters...SR, ED 24, p. 118
- Give it a whack!...ART, ED 7, p. 54
- H-P will market automobile analyzer...NEWS, ED 17, p. 20
- High-speed counter-timer carries a low price tag...PF, ED 10, p. 114
- Hung up on synthesizer specs?...ART, ED 15, p. 96
- ICs give automatic selection of range for frequency counters...IFD, ED 17, p. 82
- Improve optical measurement accuracy...ART, ED 26, p. 92
- Instrument interfacing can be done—but it takes a bit of doing...SR, ED 24, p. 74
- Integrate-and-hold circuit gives electro-chemical measurements...IFD, ED 1, p. 96
- Integrate with a DMM?...ART, ED 22, p. 92
- Integrate with a function generator...ART, ED 26, p. 96
- Intruder alarm is based on electrostatic charge detection...IFD, ED 9, p. 142
- Is it convenient to use? Gains are being made outside and inside...SR, ED 24, p. 56
- LEDs check transient response of sensors...NEWS, ED 23, p. 63
- Lightweight 15-MHz scope sells for just \$500...PF, ED 24, p. 230
- Logic analyzer displays up or downstream data bits...PF, ED 7, p. 89
- Measure GHz power and freq with only one instrument...PF, ED 24, p. 224
- Measure vhf-FM receiver sensitivity...ART, ED 26, p. 78
- Measure random-pulse frequencies...ART, ED 13, p. 114
- Measuring system uses white noise to indicate temperature from 10 to 2500 °K...IFD, ED 24, p. 190
- Modular function generators output waveshapes to 1 MHz...PF, ED 17, p. 108
- Multi-testers have many benefits, but there are disadvantages, too...SR, ED 18, p. 64
- New IR source offered for air pollution testing...NEWS, ED 26, p. 32
- New generators are sharp setters, and they keep quiet...SR, ED 24, p. 98
- Optical isolators provide diverse functions in signal-detector circuit...IFD, ED 12, p. 104
- Plug-ons extend versatility of DMM measuring system...PF, ED 2, p. 86
- Portable DMM responds to rms instead of average...PF, ED 18, p. 86
- Precision, precision: Federal bureau sets the pace for industry...SR, ED 24, p. 146
- Precision resistance-ratio detector gives 0.5% accuracy for less than \$3...IFD, ED 22, p. 114
- Programmable current generator has linear response and ignores power variations...IFD, ED 21, p. 120
- Quiet breakthroughs for the designer's indispensable tools...SR, ED 24, p. 38
- Reference axis without optics? Rf coil's magnetic field provides it...NEWS, ED 15, p. 38
- Reject common-mode noise...ART, ED 9, p. 120
- Select digital testers systematically...ART, ED 24, p. 172
- Shedding light on LED luminance...ART, ED 8, p. 92
- Simplify small-lamp selection...ART, ED 22, p. 74
- Single-digit readout offers range of 95 dB with 0.002% resolution...IFD, ED 6, p. 142
- Single-slope conversion makes cool, tough DPM...PF, ED 5, p. 90
- Skinny 3-1/2 digit DPM offers fat performance, low cost...PF, ED 4, p. 100
- Standard predicted for instrument interface...NEWS, ED 2, p. 21
- Swing to the digital raises problems; 'Smart' hardware growing popular...SR, ED 6, p. 72
- Thin-film effect points to new photodetectors...NEWS, ED 18, p. 25
- Those dazzling advances depend on industry-wide teamwork...SR, ED 24, p. 40
- Tiny CMOS counters rival electro-mechanical imports...PF, ED 6, p. 82
- Two amplitude measurements determine unknown phase angle...IFD, ED 7, p. 86
- Unmanned observatory would detect A-blasts...NEWS, ED 25, p. 26
- Wideband circuit fits curves with straight-line segments...IFD, ED 6, p. 136
- With LSI, you'll get more instrument punch in a much smaller package at a lower price...NEWS, ED 1, p. 30
- 3-1/2 digit autoranging multimeter fits in the palm of a hand...PF, ED 18, p. 82
- 4-1/2 digit DMM resolves 1 μ V on signals to 20 mV...PF, ED 5, p. 87
- 500 MHz synthesizer switches in under 100 μ s...PF, ED 24, p. 229

What You Should Know About...

Miniature High Voltage Resistors

new Mini-Mox resistors offer 100 ppm TCR plus low noise characteristics

If you are responsible for design of high-voltage, highly-stable miniaturized electronic networks and equipment, the new Mini-MOX resistor can be a life saver. Mini-MOX resistors have all the ingredients you need to cook-up new designs for ultra-critical applications. For instance, Mini-MOX resistors are a fraction the size of conventional types; they meet or exceed MIL-R-10509-F for environmental parameters . . . 100 ppm or less; stability better than $\pm 2\%$ for 2,000 hours at full load; low-voltage coefficient less than 5 ppm/volt, measured between 100 volts and

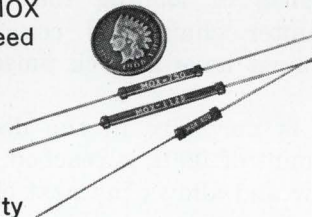

full-rated voltage; in addition, typical quantech noise at 20 megohms is less than 0.5 microvolt/volt.

All these characteristics combine to provide extremely-rugged and highly-stable resistor configurations that are virtually immune to environmental extremes. Available off-the-shelf in a wide range of resistance values, Mini-MOX resistors are ideally-suited for high-voltage applications where long-term stability and power-to-size ratios are critical.

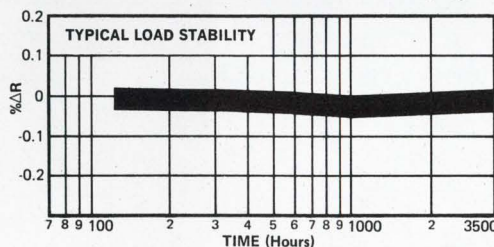
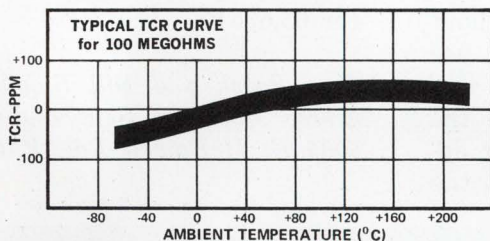

Model	Resistance	Rating @70°C	*Max. Oper. Volts	Length Inches	Diameter Inches
MOX-400	1-2500 megs	.25W	1000V	.420	.130
MOX-750	1-5000 megs	.50W	2000V	.790	.130
MOX-1125	1-10,000 megs	1.00W	5000V	1.175	.130

Write for complete Technical Data Sheet on Mini-MOX Resistors: Victoreen Instrument Div. of VLN Corp., 10101 Woodland Avenue, Cleveland, Ohio 44104. Telephone: 216/795-8200



Expertise in high voltage

The 70-range circuit reader. 630-NA.

This versatile, general purpose V-O-M ideal for communications/computer circuits, Triplet Model 630-NA, is priced at just \$108.

The electronics equipment designer likes the 630-NA's 1½% DC accuracy, ease of operation, sensitivity, and reliability. So do the men who maintain communications equipment, computers, and satellite electronics. Still, it's no delicate flower. These strengths plus rugged dependability have put the 630-NA to work wherever a general purpose tester is needed: construction, electrical machinery, fabricated metal products, transportation systems, consumer electronic products, utilities, and radio, TV and appliance service.

You'll also like these features:

1. 70-range V-O-M with single range switch and DC polarity-reversing switch.
2. Accuracy 1½% DC and 3% AC; mirrored scale.
3. Diode overload-protected suspension movement with temperature compensation.

The 630-NA measures DC volts from 120 mV to 6,000 volts (10,000 or 20,000 ohms/volt). There are AC voltage ranges from 1.5 to 6,000 volts (5,000 or 10,000 ohms/volt). Six resistance ranges to 100 M Ω are provided.

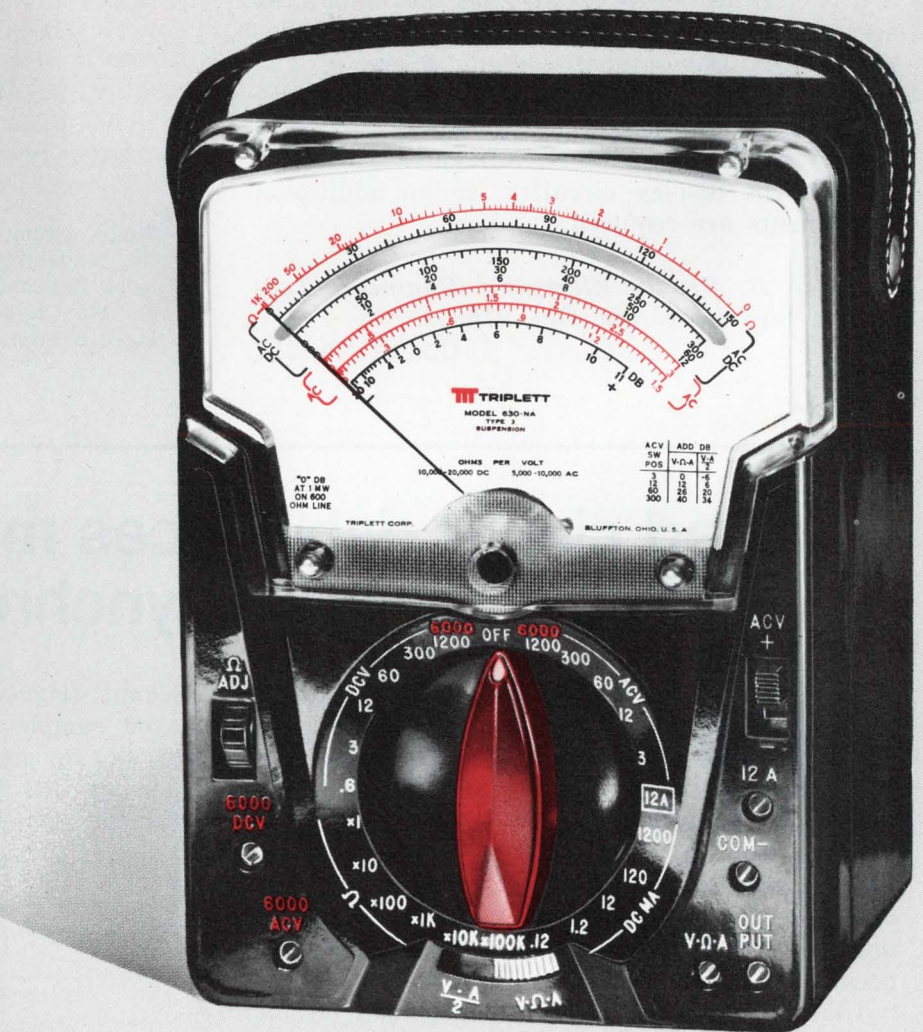

Need higher ohms per volt, greater sensitivity? Then you'll want Triplet's 630-NS at just \$128. Up to 200,000 ohms per volt DC and 20,000 ohms per volt AC; down to 150 mV at 60 microamperes.

For more information or a free demonstration, call your Triplet distributor or sales representative.

For the name of the representative nearest you, dial toll free (800) 645-9200. New York State, call collect (516) 294-0990. Triplet Corporation, Bluffton, Ohio 45817.

TRIPLET
ALL YOU'LL EVER NEED IN V-O-M's.

Triplet. The easy readers.

Seven-segment display modified to reduce readout confusion

By adding an extra horizontal segment to the 6 and 9 generated by the 7447 decoder/driver, you can enhance the readability of these digits. The circuit scheme is simple, and it readily eliminates confusion in distinguishing between a b and a 6.

The two NAND gates add horizontal bars to the top of the 6 and the bottom of the 9. The BCD inputs labeled B and C are high only when a 6 or 7 is to be displayed. And the uppermost segment is now on for both digits. The BCD input labeled D is high for digits 8 and 9. The open-collector arrangement of the 7447 allows illumination of the lower segment.

Very often the spare NAND gates are available in the display circuitry, so no additional components are required.

Roger B. Frank, *Electronic Engineer, Tektronix, Inc., Beaverton, Ore. 97005.*

CIRCLE NO. 312

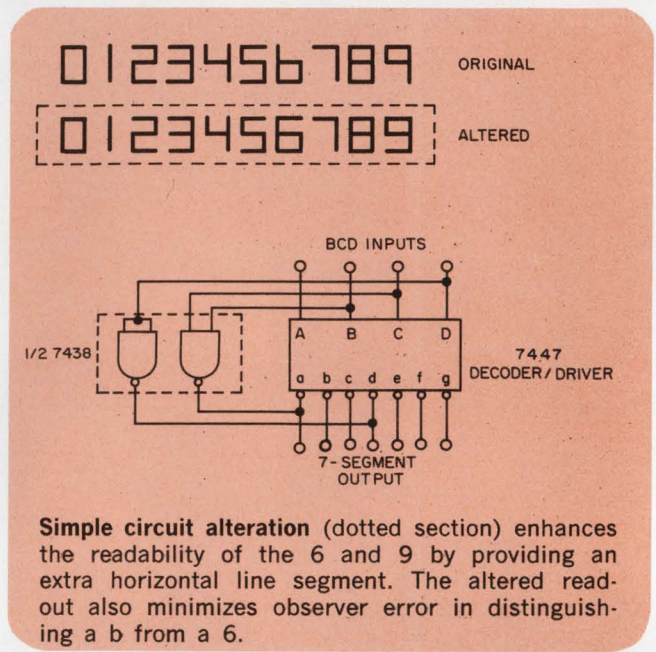

Clocked circuit debounces multiple single-throw contacts synchronously

A digital circuit debounces multiple single-throw contacts and synchronizes the outputs to a master clock. The circuit uses comparatively little hardware for each contact and requires minimal design effort.

Since there's no logical difference between bounce and throw with a form A switch, time discrimination based on two parameters—maximum bounce and minimum stable times—is necessary.

Under control of the IC timer, the circuit samples the switch or switches' state once every T seconds. The D flip-flops provide outputs that are synchronized to the clock. A single clock can handle many switches. Period T is set to lie between the maximum bounce and minimum stable times.

In the worst case the sample occurs during a bounce. The corresponding flip-flop will either retain the previous state or change to the new state. In either event the next sample leaves the flip-flop in the new state, so only one transition occurs.

Previous techniques—such as integrator and

Schmitt-trigger, latch-and-timed lockout or delayed sample—often require analog and delay circuits for each switch. By contrast the clocked-memory approach needs only one resistor and one memory element for each switch.

Peter A. Miller, *Senior Engineer, Computer Systems Dept., Martin Marietta Corp., P.O. Box 5837, Orlando, Fla. 32805.*

CIRCLE NO. 313

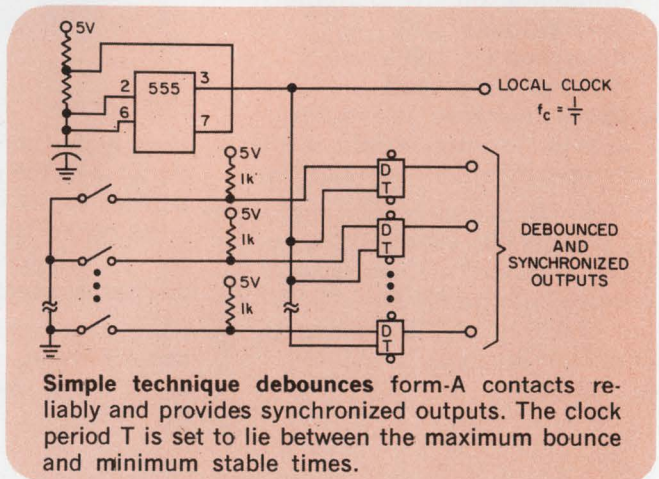

LOW POWER RAMS

64 BIT TTL

At Monolithic Memories we're expanding our line of low power RAMs to solve your **3101A** and **31L01** problems.

Chances are you've already seen our L5530/L6530 low power, bipolar 256-bit RAMs. Now we're introducing four new devices into our growing family. The L5560 (Open Collector) and L5561 (Three State) 64-bit RAMs operate over the full mil temp and voltage range with a maximum access time of 100ns (at 35mA max I_{cc}).

The commercial parts, L6560 (Open Collector) and L6561 (Three State) 64-bit RAMs, have an access time of 80ns max (at 35mA max I_{cc}). All four are low power. All four are bipolar. And all four are **available**. In stock. Now.

Maybe you've been using 3101A's and want to save up to 350mW of power per package. Or

maybe you need 3101A's in a three state version. Or maybe you've been buying 3101A's on a waiver or looking high and low for 31L01's. Now you'll find that our L6560/61 and L5560/61 are pin-for-pin compatible with the 3101A and interchangeable with the 31L01.

	-55°C to +125°C	0°C to 75°C
Open Collector	L5560	L6560
Three State	L5561	L6561
Price (100-999)	\$18.00	\$8.00

Please call our nearest sales office, rep or distributor. Or call, write or wire Dale Williams, Monolithic Memories, 1165 East Arques Avenue, Sunnyvale, CA 94086, (408) 739-3535, TWX 910-339-9229.

Monolithic Memories, Inc.

EASTERN AREA SALES OFFICE: (617) 653-3158 • NEW ENGLAND REGION: (617) 475-8883 • NEW YORK REGION: (607) 748-3211 • CENTRAL AREA SALES OFFICE: (317) 844-3241 • MINNEAPOLIS REGION: (612) 922-9122 • WESTERN AREA SALES OFFICE: (714) 556-1216
Representing your best buy in memories: ALABAMA, Huntsville (205) 539-1771; ARIZONA, Phoenix (602) 264-7971; CALIFORNIA, San Diego (714) 743-3015; Palo Alto (415) 369-4671; COLORADO, Denver (303) 423-1020; CONNECTICUT, North Haven (203) 239-9762; FLORIDA, Orlando (305) 423-7615; ILLINOIS, Chicago (312) 593-0200; INDIANA, Ft. Wayne (219) 744-4331; IOWA, Cedar Rapids (319) 393-8703; KANSAS, Kansas City (913) 236-4646; KENTUCKY, Louisville (502) 893-7303; MARYLAND, Baltimore (301) 825-3330; MASSACHUSETTS, Boston (617) 444-2484; MICHIGAN, Detroit (313) 358-2020; Grand Rapids (616) 451-8901; MINNESOTA, Minneapolis (612) 929-6721; MISSOURI, St. Louis (314) 432-2830; NEW JERSEY, Teaneck (201) 692-0200; NEW YORK, N.Y.C./L.I. (201) 692-0200; NORTH CAROLINA, Raleigh (919) 834-6591; OHIO, Cincinnati (513) 521-2290; Dayton (513) 298-9546; Cleveland (216) 228-7525; PENNSYLVANIA, Willow Grove (215) 674-3850; Pittsburgh (412) 242-0100; TEXAS, Dallas (214) 239-9148; Houston (713) 721-1054; WASHINGTON, Seattle (206) 455-2778; WISCONSIN, Waukesha (414) 786-6330.

INFORMATION RETRIEVAL NUMBER 75

Circuit built with quad op amp measures temperature digitally

A circuit made from a quad IC op amp, a single transistor and a thermistor network provides digitized temperature readings. The resistance of the thermistor network—which varies linearly with temperature—controls a VCO whose output frequency is calibrated to the temperature.

Each function shown in the block diagram (a) is performed by one section of the LM 3900 op amp IC (b). Two user adjustments match the slope of the thermistor's resistance-temperature curve to the frequency-voltage slope of the VCO. A third adjustment centers the dynamic range of the VCO.

To calibrate the circuit, adjust trimmer R_3 so that f_{out} equals 635 Hz when $V_o = 7.50$ V. This provides range-centering of the VCO.

A temperature range of 14 to 113 F is chosen for use with the 44203-thermistor network. Substitute known resistance values for T with a decade-resistance box. Adjust slope and offset as follows:

1. Set R_T to 10,000 Ω and adjust offset trimmer R_2 for $f_{out} = 635$ Hz.
2. Set R_T to 13,430 Ω and adjust trimmer R_1 for $f_{out} = 143$ Hz.

Repeat Steps 1 and 2 until the adjustments converge to within 0.5 F. The output frequency now equals 10 times the temperature in $^{\circ}$ F.

Once adjusted, the circuit provides temperature accuracies to within one degree over the range of measurements.

Richard P. Rufer, Electronic Engineer, University of California, Lawrence Livermore Laboratory, Livermore, Calif. 94550. CIRCLE NO. 314

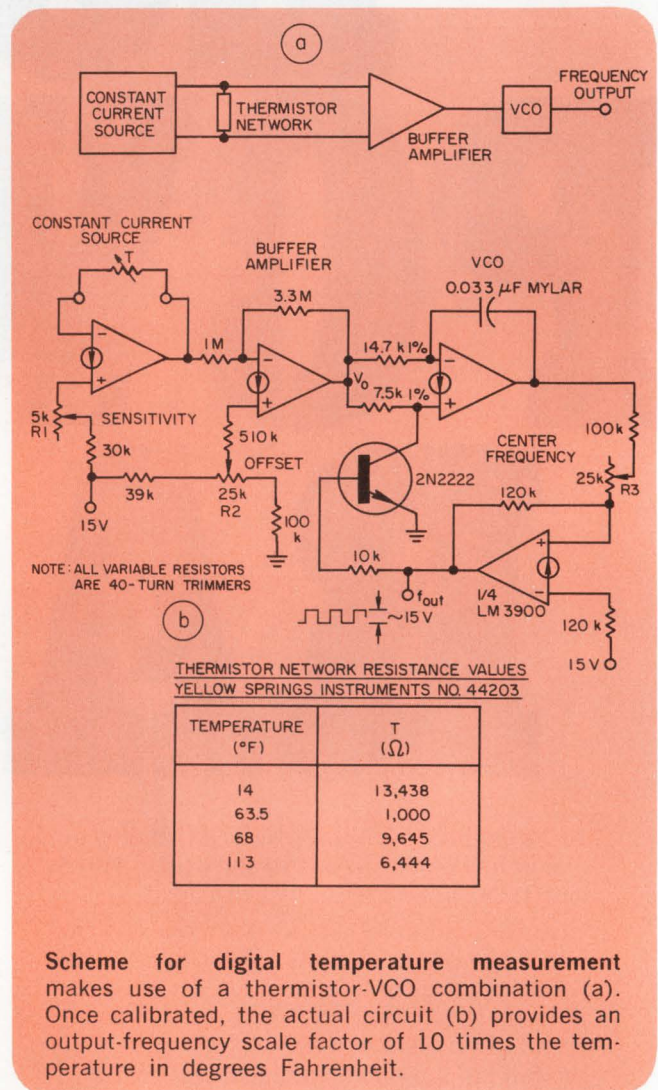

Scheme for digital temperature measurement makes use of a thermistor-VCO combination (a). Once calibrated, the actual circuit (b) provides an output-frequency scale factor of 10 times the temperature in degrees Fahrenheit.

IFD Winner of November 8, 1973

Michael J. Salvati, Staff Engineer, Sony Corp. of America, 47-47 Van Dam St., Long Island City, N.Y. 11101. His idea "Line-voltage control technique improves resolution, lowers parts cost" has been voted the Most Valuable of Issue Award.

Vote for the Best Idea in this issue by circling the number for your selection on the Information Retrieval Card at the back of this issue.

SEND US YOUR IDEAS FOR DESIGN. You may win a grand total of \$1050 (cash)! Here's how. Submit your IFD describing a new or important circuit or design technique, the clever use of a new component or test equipment, packaging tips, cost-saving ideas to our Ideas for Design editor. Ideas can only be considered for publication if they are submitted exclusively to ELECTRONIC DESIGN. You will receive \$20 for each published idea, \$30 more if it is voted best of issue by our readers. The best-of-issue winners become eligible for the Idea of the Year award of \$1000.

The "Above-Average" Sub-System by Celco



CELCO makes Precision CRT Displays for your "above-average" CRT requirements.

Need a CRT spot-size as small as 0.00065"? This standard CELCO 5" CRT display is being used for Satellite Photography. They needed the best they could get. You can get performance like that too with CELCO's DS5-065 Precision CRT Display.

A CELCO DS5-08 with 0.1% linearity, and spot size of 0.0008" is being used by another CELCO customer for Nuclear Photography Film Recording. Special features include programmable Raster Generators, and triple-layer and articulated shielding for ambient fields from earth's field and from dc to RF fields.

Fingerprint Scanning is the job of CELCO's DS5-10 Optical Character Recognition System for one of our customers. They needed that wide 2.5 MHz deflection bandwidth for high-speed scanning of vast amounts of data. And the DS5-10 has a settling time of

10 microseconds to 0.1% large signal, and 350 nanoseconds to 0.02% small signal settling time. Spot-size is 0.001".

One CELCO customer is using our 5" Color Display System for color separation and color photo scanning. One display does all that!

If your *needs* are "above-average" but your budget is *below-average*, CELCO also makes a 5" Precision CRT Display System especially for you that's ideal for your Low-Cost Film-Scan applications. Or if your display needs are larger, CELCO makes standard precision 7" and 9" CRT displays.

Our DS5-075 provides NASA with a 0.00075" spot-size for their Viking Orbiter and Viking Lander satellite photography. They needed 0.01% repeatability too. And they got it. From CELCO.

Two different customers with "above-average" display needs are using CELCO CRT Display Systems for Astronomy Research. One is an observa-

tory; they're keeping their eye on the Sun. The other is recording their Stellar Observations with a CELCO CRT Display System.

High-speed map making is the task of another CELCO customer using a CELCO precision display for topographical projects.

CELCO displays are helping a leading Oil Company in their oil explorations. While another CELCO display is being used in Eye Research.

Maps and satellites, eyeballs and oilwells. All "above-average" display requirements. If your needs are ABOVE-AVERAGE, you need a CELCO "above-average" Precision CRT Display System.

(Don't you think so too?)

Call CELCO for your "above-average" CRT Display System.

UPLAND CA 714-982-0215
MAHWAH NJ 201-327-1123

(average is so . . . ho-hum to us.)

CONSTANTINE ENGINEERING LABORATORIES COMPANY

1150 E. Eighth Street, Upland, CA 91786

70 Constantine Drive, Mahwah, NJ 07430

INFORMATION RETRIEVAL NUMBER 76

Ceramic substrates show stability and low losses

Temperature-stable zirconate ceramics have been produced that can be used for such applications as microwave integrated-circuit substrates.

Developed at the Hirst Research Centre of General Electric Co. Ltd. in England, the materials combine a permittivity of 30 to 40, a controllable temperature coefficient and low microwave losses. Materials with high permittivity usually have either a negative temperature coefficient or high losses.

The ceramics are based on solid solutions that blend zirconate having a positive temperature coefficient of permittivity with zirconates and titanates having a negative temperature coefficient. The composition is adjusted to give the required low-temperature coefficient and low losses. The use of solid solutions rather than mixtures ensures that the materials are homogeneous.

Composition and processing techniques have been developed to give a fine-grain ceramic that machines to a smooth-surface finish, permitting the deposition of microcircuit conductors and gaps as narrow as 50 μm .

The materials are particularly suitable for microwave IC substrates for frequencies below 5 GHz, where the dimensions of distributed circuits on alumina become excessively large. Other applications include dielectric disc resonators—especially for miniature multistage filters—and dielectric loading of ferrite phase shifters, to reduce the amount of ferrite and therefore the switching power required.

The zirconate ceramics are available as plates, blocks, bars, rods, discs and tubes. Maximum sizes are 4 × 2 × 1 in. for rectangular shapes and 0.8 in. diam. × 4 in. for cylindrical ones.

CIRCLE NO. 317

Modulation meter tunes and adjusts itself

Completely automatic tuning and amplitude leveling are provided in a modulation meter developed by Racal Instruments in England.

The instrument, Model 9009, uses a sampling principle combined with search-and-lock techniques to make fully automatic measurements of AM and FM signals with carrier frequencies within specified limits.

As soon as the instrument has tuned itself to the appropriate frequency and has made the necessary amplitude adjustment, a lock lamp lights and the AM modula-

tion depth or FM frequency deviation is indicated on a meter. The typical time for the operation is about one second.

If the amplitude or frequency of the input signal is outside the specified limits, the lock lamp flashes on and off until corrective action has been taken.

Automatic measurements can be made on signals that have carrier frequencies between 30 MHz and 1 GHz. Below 30 MHz, automatic measurements can also be made within the bands 10 to 13.7 MHz and 20.5 to 27.9 MHz. By use of

an external oscillator, measurements can be made manually at all carrier frequencies between 6 MHz and 1 GHz.

The Model 9009 can be operated from ac lines or from internal nickel-cadmium cells if an optional battery pack is fitted. The basic price of the instrument on the British market is £305 (\$732).

CIRCLE NO. 318

Airborne terminal has an optical link

An airborne computing terminal with an optical link, developed under a British Ministry of Defense contract by Marconi-Elliott Avionic Systems in Rochester, England, translates electrical impulses into coded light signals. The optical signals carry instructions and information between computer elements. Light is transmitted by low-attenuation fiber-optics cables. External electrical interference is completely eliminated. Quick-release optical connectors have been evolved. The optical cables can be as long as 75 m between components.

Tool removes DIPs easily from PC boards

A special tool for the easy removal of DIPs from printed-circuit boards has been developed by Siemens AG in West Germany.

The tool consists of a pair of jaws which are pressed around the component to be removed, and a plier handle for control. The top part consists of a spring-loaded suction pump and a heating head, and the lower part is a mechanism that grasps and removes the component from the board when it is free.

After the tool is placed in position, heat is applied for five seconds. The pump sucks the liquid solder into a chamber and leaves the pins free. The heater runs from a 10-to-12-V supply and draws about 45 W.

A power pack is available for use with ac-line voltages. All 14 and 16-pin dual-in-line packages, as per DIN 41866, can be removed. There is also a version for 24-pin packages.

CIRCLE NO. 319

Reliability is buying 100 DPM's and having less than five fail in your plant — or in the field, installed in your instrument.

You're probably *not* getting reliability now and it's costing you \$5, \$10, up to \$25 *extra* for every DPM you buy — not only for the ones that fail, but the ones that don't too!

Consider the paperwork costs, the shipping costs, the downtime costs, and the cost of useless inventory; and you'll see we're right. Then add on customer frustration,

wasted time, mistakes on vital readings — and the cost will *really* mount up.

LFE has a complete line of the most reliable DPM's available today. Not according to "calculated MTBF" numbers, but actual experience. The initial cost is probably a little higher than less reliable units, but you pay less — and worry less — in the long run.

LFE Digital Panel Meters, Digital Control Meters, and Digital Temperature Indicators are available in models ranging from 2½

digits to 4¾ digits. For complete specifications and for applications assistance on LFE's Digital Panel Meters, Digital Temperature Indicators, and Digital Control Meters, call or write LFE Corporation, 1601 Trapelo Road, Waltham, Massachusetts 02154, telephone (617) 890-2000.



Process Control Division

INFORMATION RETRIEVAL NUMBER 77

a new concept in
digital panel meters...
RELIABILITY



THICK FILM RESISTORS COME IN MANY SHAPES!

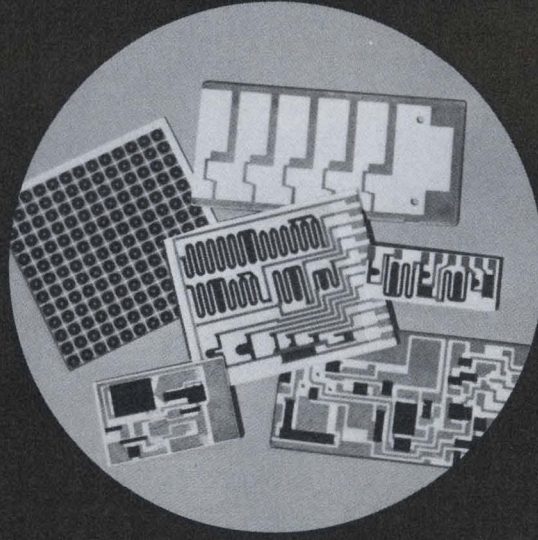
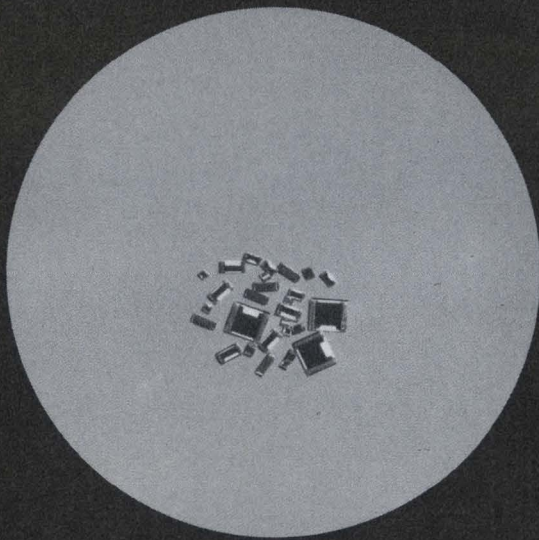
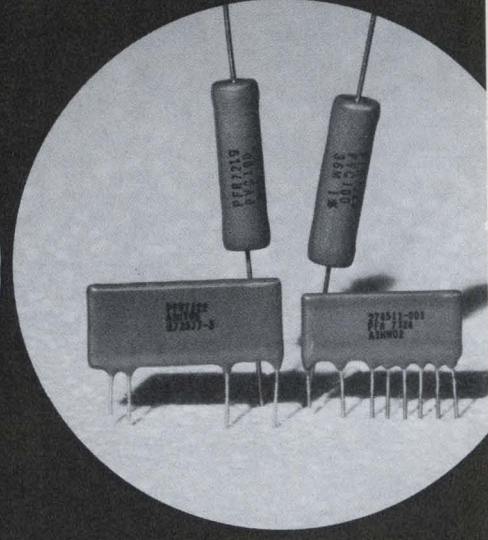
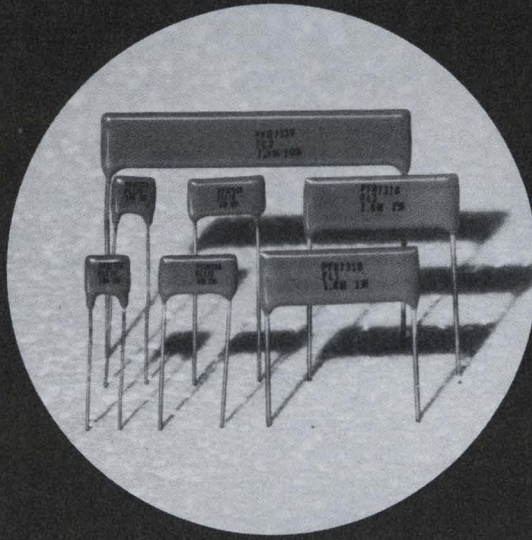
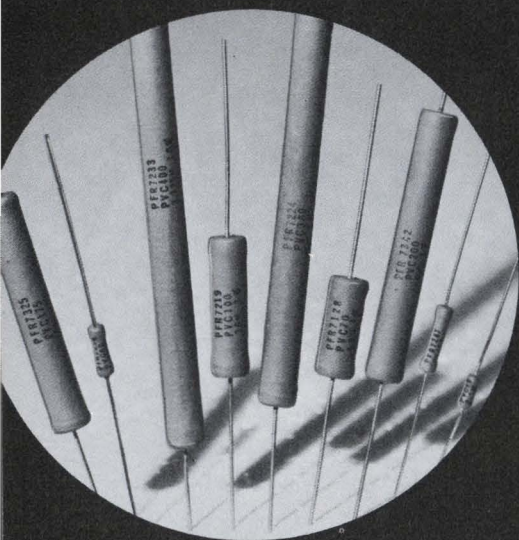

When You Specify Pyrofilm ...

PVC—High Voltage, up to 17.5 KV, up to 1000M, as low as 100 PPM/°C.

FLATSO—4 Sizes up to 10 KV, 100M. 1/2, 1/4, 1 & 2W. Tolerances: 1, 2, 5 & 10.

NETWORKS—Matched in Temp. Coefficient, Ratio and/or Tolerance.

CHIPS—6 sizes with values ranging from 10 ohms to 5 meg. ohms.

CUSTOM NETWORKS—Sure, the Pyrofilm Thick Film Resistor Line is broad...but there are times when you have a unique set of requirements. That, too, is the time to talk to the Pyrofilm people.

Setting New Standards in Reliability

PYROFILM

60 S. Jefferson Road • Whippany, N. J. 07981 • (201) 887-8100

new products

14-bit a/d converter keeps price/performance ratio low

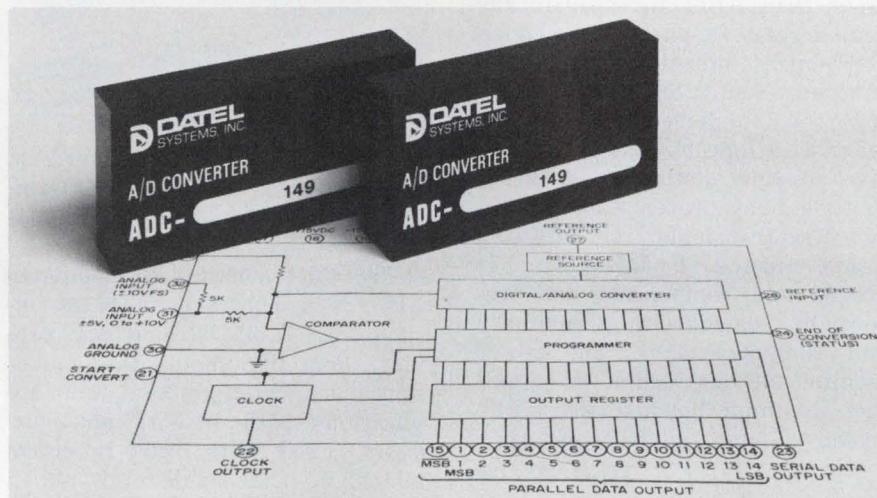

Datel Systems, 1020 Turnpike St., Canton, Mass. 02021. (617) 828-8000. \$249; stock.

High-accuracy, 14-bit a/d converter prices have hit new lows. The \$249 ADC-149 converter from Datel Systems has an accuracy adjustable to $\pm 0.005\%$ of full scale, $\pm 1/2$ LSB.

The unit accepts bipolar inputs of -5 to $+5$ V, -10 to $+10$ V or a unipolar input of $+10$ V, and it delivers its 14-bit binary output in a maximum time of only $50 \mu\text{s}$. Temperature drift, though higher than for some competing units, is a respectable $15 \text{ ppm}/^\circ\text{C}$ over the operating temperature range of 0 to 70 C.

The ADC-149 can resolve to one part in 16,383. This means that the unit can detect less than a 1-mV change within a 10-V full-scale input. Successive approximation techniques are used to obtain the unit's 20-kHz throughput rate and to ensure that the linearity is kept to within $\pm 1/2$ LSB over the entire input range.

Digital coding of the output is pin-selectable. There is a choice of straight binary, offset binary or 2s-complement binary, all with conventional TTL logic levels on

the outputs and controls. Serial and clock outputs are provided for data transmission over a limited number of lines.

Power consumption of the $2 \times 4 \times 0.8$ -in., epoxy-encapsulated, module is $+5$ V at 150 mA and ± 15 V at 55 mA max. The pins are spaced for DIP compatibility. The user can also connect an external high-input impedance amplifier directly to the summing junction of the a/d.

Competing units from manufacturers like Analogic (Models MP-2814 and MP2914) cost at least \$150 more. Phoenix Data also offers several units (Models 1314, 1414, 1514, 1614), but they sell for at least \$100 more. Both of these companies' units have conversion times from $10 \mu\text{s}$ to $100 \mu\text{s}$ and tempcos from $5 \text{ ppm}/^\circ\text{C}$ to $12 \text{ ppm}/^\circ\text{C}$.

Application areas for the Datel ADC-149 a/d converter include geophysical, seismological and oceanographic measurement, optical chromatography and biomedical instrumentation.

Datel

CIRCLE NO. 254

Analogic

CIRCLE NO. 255

Phoenix Data

CIRCLE NO. 256

Low power DACs use only 60 mW when on

Hybrid Systems, 87 Second Ave., Burlington, Mass. 01803. (617) 272-1522. From \$84; stock.

The DAC-375 series of d/a converters operates from supplies that can range from ± 12 to ± 18 V. The converters consume only 60 mW. Linearity error is $\pm 1/2$ LSB with a tempo of $7 \text{ ppm}/^\circ\text{C}$. The accuracy tempo is $30 \text{ ppm}/^\circ\text{C}$ between 0 and 70 C. The WT option extends the temperature range from -25 to $+85$ C. Worst-case settling time is $75 \mu\text{s}$. While all units provide 12 bit resolution, versions with 8, 10, 11 and 12-bit linearity as well as three-decade BCD are available. The DACs are housed in $2 \times 2 \times 0.4$ in. packages with DIP compatible pinouts.

Booth No. 2230 Circle No. 280

RC oscillator stable to $\pm 0.1\%$

Conner-Winfield Corp., West Chicago, Ill. 60185. (312) 231-5270. \$85; 3 wk.

Model L79AH RC synchronizing oscillator has a $\pm 10\%$ frequency adjust and a frequency tolerance of $\pm 0.1\%$ from $+20$ to $+40$ C. Its pulse output will drive two TTL loads and has an amplitude stability $\pm 5\%$. The flat PC mountable package measures $1.6 \times 1.2 \times 0.4$ in., with four 0.03 in. diameter gold-plated solder pins.

CIRCLE NO. 281

Synchro-to-dc converter is accurate to 0.028%

Astrosystems, 6 Nevada Dr., Lake Success, N.Y. 11040. (516) 328-1660.

The M3000 synchro-to-dc converter and conditioner pairs will accept synchro, resolver or Selsyn input signals. They can convert them to a linear dc output proportional to angle, with an accuracy of 0.028%. Each converter unit provides a choice of outputs: either 0 to 10 V dc for 0 to 360° or -5 to $+5$ V dc for -180 to $+180^\circ$. The modules will accept frequencies of 400 or 50/60 Hz and line-to-line voltages of 11.8, 57.5 and 90 V and feature infinite resolution and accuracy of 0.1 degree.

CIRCLE NO. 282

Active filters offer programmability

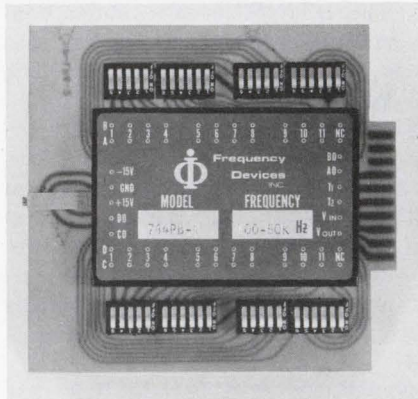

Frequency Devices, Inc., 25 Locust St., Haverhill, Mass. 01830. (617) 372-6930.

The 744 series of active filters are BCD programmable four-pole low-pass filters. Their cutoff frequencies (f_c) are variable in 500 equal increments over a 500:1 range and they are offered with either a Butterworth or Bessel response characteristic. Four basic models cover the frequency range 0.1 Hz to 50 kHz with maximum cutoff frequencies of 50 Hz, 500 Hz, 5 kHz and 50 kHz. Each model's tuning increment is equal to the minimum f_c of the module, e.g. 0.1 Hz for models B-1 and L-1 and 100 Hz for models B-4 and L-4. The dc offset is externally trimmable to zero and dc gain is held to ± 0.02 dB. Frequency drift is nominally 0.2%/°C. Each 744 model has a dynamic range of 100 dB. There are a number of optional accessories offered with the 744 series.

CIRCLE NO. 283

Power monitor protects ac operated equipment

Logitek Inc., 42 Central Dr., Farmingdale, N.Y. 11735. (516) 694-3080.

The Logitek WMA Power Monitor allows normal operation of system loads when the power line characteristics are within predetermined limits. In the event that either voltage (any phase), or frequency is not within specified limits, or the phase sequence is other than ABC, the hermetically sealed relay de-energizes to operate alarm indicators or system shutdown contactors. Voltage sensing is accomplished with the use of an rms detector and is insensitive to line distortion. A built-in time delay prevents short duration line transients from affecting performance. Printed circuit boards and components are conformally coated with a humidity and fungus sealant. The power monitor is contained in a rugged cast aluminum housing with a corrosion resistant surface coating.

CIRCLE NO. 284

TCXOs span fractions of a Hz to 30 MHz

Connor-Winfield, West Chicago, Ill. 60185. (312) 231-5270. From \$138; 3 to 7 wk.

Series 20DH TTL compatible temperature compensated crystal oscillators are available at any fixed frequency from fractions of a hertz to 30 MHz. They have a frequency tolerance of $\pm 0.001\%$ from -25 to $+65$ C, a supply voltage of 5 V dc $\pm 1\%$, a fanout of 10 TTL loads and measure only $1.75 \times 1.75 \times 0.5$ in.

CIRCLE NO. 285

Photoelectric control uses modulated light



Photoswitch Div., Electronics Corp. of America, 1 Memorial Dr., Cambridge, Mass. 02142. (617) 864-8000.

The 42RL series 3000 modulated LD reflex control eliminates incandescent lamp burnout and provides long life. Modulation makes it usable in high ambient light applications both indoors and outdoors. Used with retro-reflective materials, the single unit 42RL operates at distances up to 25 ft. and is easy to wire and install. Alignment is fast and simple by means of a visible LED mounted in the housing. Plug-in modules for control function (on-off, one-way and two-way time delay) simplify preparation. The standard output relay is a plug-in heavy duty DPDT industrial type, rated at 5 A, 120 V ac and 2.5 A, 230 V ac (noninductive). A hold down clip on the relay prevents possible loosening in high vibration industrial environments. Heavy duty terminals accept up to two #12 AWG wires.

CIRCLE NO. 286



ANALOG
STAY IN CONTROL WITH INTECH'S INDUSTRIAL CONTROL IC'S THE 3030 AC DETECTOR, DIFFERENTIAL OR SINGLE ENDED TO 1MHZ, 30-40 QUAD MONITOR ALARM DRIVES EXTERNAL SPEAKER DIRECTLY. 3030 TEMPERATURE ALARM SETS OFF BELLS AND WHISTLES, EXCELLENT REPEATABILITY. THE 3020 TRI-STAGE ALERT/ALARM AND 3010 TONE ALARM DRIVE LEDs OR LAMPS. ALL 14-PIN DIP TTL COMPATIBLE. STOCK DELIVERY. LOW PRICES. WRITE US!

intech INCORPORATED
(408) 244-0500
1220 COLEMAN, SANTA CLARA CA 95050

OUR 5V POWER MINI'S STACK UP LIKE THIS



OUTPUT VOLTAGE	OUTPUT CURRENT AMPS.	REGULATION LOAD $\pm\%$	REGULATION LINE $\pm\%$	RIPPLE MV RMS	PRICE	MODEL	SIZE INCHES
5	.250	.05	.05	0.5	\$39.00	5E25	2.3 x 1.8 x 1.00
5	.500	.1	.05	1	49.00	5E50A	3.5 x 2.5 x 1.00
5	1.0	.2	.05	1	69.00	5E100	3.5 x 2.5 x 1.25
5	1.5	.3	.1	1	98.00	5E150	3.5 x 2.5 x 1.25
5	2.0	.15	.05	1	110.00	5E200	3.5 x 2.5 x 2.00
5	2.5	.15	.05	1	125.00	5E250	3.5 x 2.5 x 2.00

... and the model you choose will be shipped 3 days after Acopian receives your order. With a 105-125 VAC input, use it at full rated load to 71° C. Short circuits won't damage it. These mini-modules can be mounted on a printed circuit

board in a space of only a few square inches. Generous quantity discounts are available. Or, if you're working with other voltages, choose from hundreds of other models. Single outputs from 1 to 75 volts.

Duals for op-amps with output currents from 25 to 500 ma. Even triple outputs. Complete details on these plus a comprehensive line of other power supplies and systems are included in the Acopian 73-74 catalog. Request a copy.



Corp., Easton, Pa. 18042. Telephone: (215) 258-5441.

INFORMATION RETRIEVAL NUMBER 80

NEW
FROM
AIRPAX

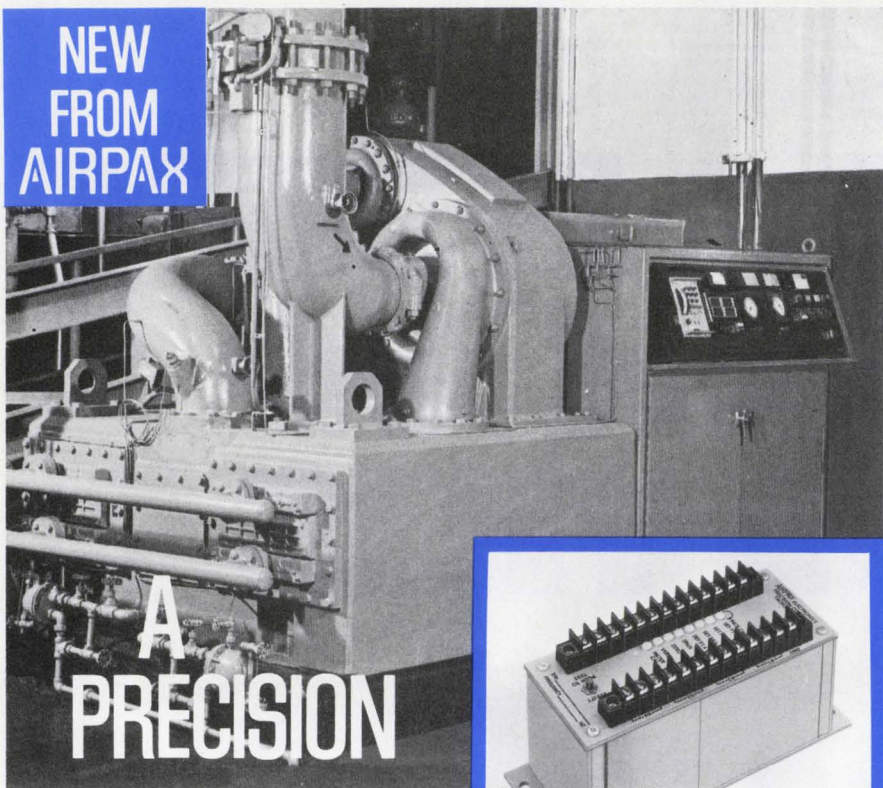

A
PRECISION

CONTROL TACHOMETER THE SERIES 300

Compact, solid state, flexible and all new... designed to meet industrial control requirements... can monitor shaft RPM... provide start-up, over/underspeed protection, turbine overspeed alarm and control; sequential switching; conveyor protection and machine control. The 300 Tachometer will accept signals from any type sensor. It will operate from signals produced by magnetic or zero-velocity type pickups mounted in proximity to a rotating gear as well as many other signal sources. Set points are adjustable from 0-100% of full scale range. Other set point options available for special application requirements. Analog control outputs, verify features, selectable relay logic and other standardized options are available.

Write for bulletin 8511.

AIRPAX Controls Division P.O. Box 8488
Fort Lauderdale, Florida 33310 Phone: 305/587-1100

AIRPAX™

INFORMATION RETRIEVAL NUMBER 81

MODULES & SUBASSEMBLIES

Charge amp handles piezoelectric sensors

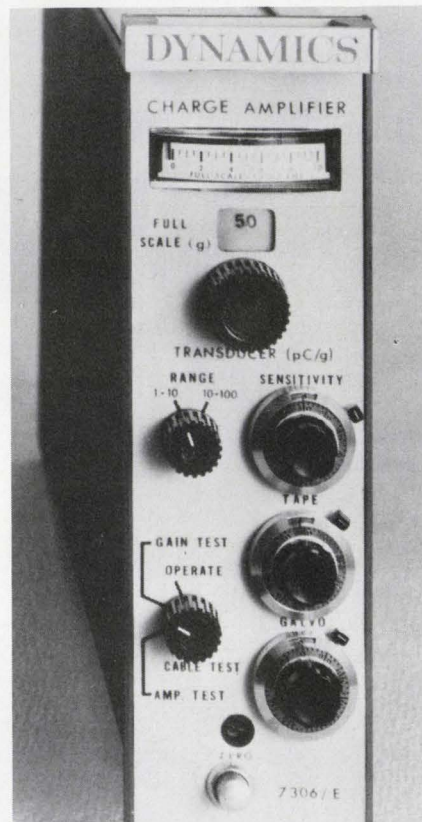

Dynamics, 12117 E. Slauson Ave.,
Santa Fe Springs, Calif. 90670.
(213) 945-2493. From \$480; stock
to 60 day.

The Model 7306 charge amplifier can operate with all types of piezoelectric transducers. Included in the unit is an integral power supply. The amplifier has a charge gain of 0.05 mV/pC to 5000 mV/pC with a direct reading charge gain meter. It can also use the company's Model 7819 remote charge converter. Model 7306 has a power line isolation of 1000 M Ω shunted by less than 0.1 pF. The transducer sensitivity control provides adjustment from 1 to 10 pC/g or 10 to 100 pC/g. The range switch is calibrated in mV/g, thus allowing direct calculation of gain from the front panel. Several options are available: Three gain configurations, front panel meter, galvo and servo outputs, output level controls, three-pole filter, calibration options, and an input/output isolation option that allows the unit to operate with grounded transducers without creating a ground loop. The unit measures 7 × 2.125 × 18 in.

CIRLCE NO. 287

ENDING THE CONVERTER PARADOX

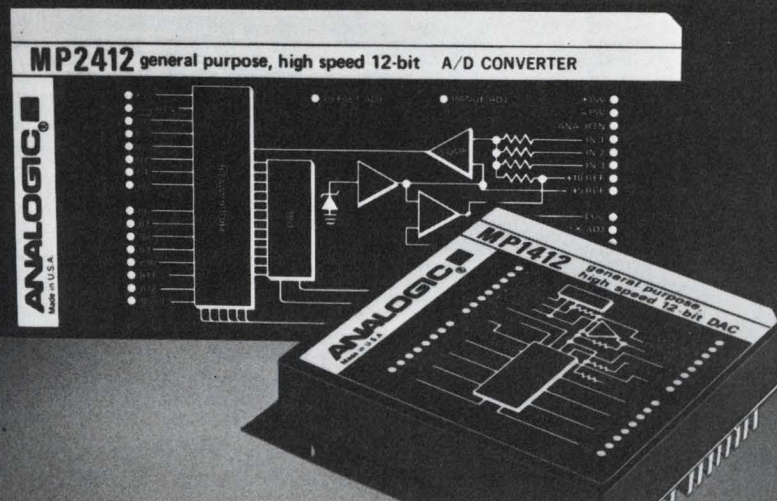

**You always had
to pay high
prices for high
performance.
Now, Analogic
gives you
complete 12 bit
performance
at 10 bit prices.
(available
off the shelf)**

Yes, immediate delivery in OEM quantities. At the lowest current prices for 12-bit computer-grade A/D and D/A converter modules.

How did we cut the cost of these high-speed converters without cutting corners or compromising on specification integrity? By using everything our staff has learned about circuit and package optimization in 200 man-years of converter engineering. By using modern, field-proven MSI technology to minimize the number of components even by comparison to "so-called" monolithic converters. And by using circuit and thermomechanical configurations that preserve generous safety margins under worst-case conditions . . . and cut production costs, too.

Tightly disciplined design pays off. You see it in every specification.

In high accuracy, linearity and monotonicity, maintained at computer-compatible data throughput rates. In unusually high time/temperature/power supply stabilities, maintained over wider-than-usual ranges. And, true computer-grade reliability, fully supported by worst-case design validation, by premium-grade components, and by exhaustive, computer-programmed testing that begins at the component level.

Call or write for the comprehensive data sheets on these remarkable converters—or order one (or a thousand) for quick delivery, Analogic, Audubon Rd., Wakefield, Mass. 01880; phone (617) 246-0300.

Northeast, 617-235-2330, 203-966-2580, 315-466-0220, 201-652-7055, 212-947-0379

Mid Atlantic, 215-272-1444, 215-687-3535, 703-790-5666, 301-252-8494

Midwest, 314-895-4100, 913-362-0919, 216-267-0445, 513-434-7500, 313-892-2500, 412-892-2953, 312-283-0713, 414-476-1500, 317-844-0114

South, 713-785-0581, 214-620-1551, 305-894-4401, 919-227-3639, 205-534-9771, 305-773-3411, 813-867-7820

West, 303-744-3301, 505-523-0601, 602-946-4215, 505-292-1212, 714-540-7160, 415-398-2211, 206-762-7664, 503-643-5754.

Canada, 613-836-4411, 604-688-2619, 416-499-5544, 514-636-0525, 902-434-3402

SPECIFICATIONS

MP1412 12-BIT DAC	MP2412 A/D CONVERTER
\$39	\$75
in 100 quantities	in 100 quantities
Settling time 4 µsec	Throughput to 50 kHz
Linearity 0.012%	Linearity 0.012%
Reliability 200,000 hours MTBF	Reliability 100,000 hours MTBF
Stability 15 PPM/°C.	Stability 20/PPM/°C.

ANALOGIC 
... The Digitizers



“CANNON’S BURGUN-D CONNECTORS BROUGHT LOWER COSTS TO OUR COMPANY, and a bonus to me.”

**“But we had a little
difference of opinion
at the start.”**



“They thought that the Burgun-D universality meant over-engineering. I reassured them by pointing out all Cannon did was take its aerospace expertise and put it into a low-cost crimp contact connector that works with stranded or solid wire, flex circuits, pc boards or what have you.

“They were still doubtful about the low cost, so I explained it in two ways. First, we could save a bundle by standardizing on one Burgun-D connector and bulk buying it, yet still

be able to tailor it to our exact application. Secondly, we could bulk buy our contacts and use Cannon’s automatic strip and crimp machine.

“They thought ours was plenty good enough. It was, until now, I said.

**“It makes our
termination equipment
obsolete.”**

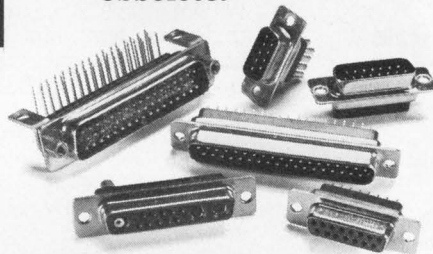

“The Cannon machine even strips and crimps twisted pairs, jacketed cable and hard-coated wire, and handles up to four gage sizes at one setting. One operator can terminate 10,000 contacts per shift.

“They got the message. Cannon got the job. We got the performance and delivery we wanted, at a price

we could afford. And I got a little something extra in the old pay check.

“Now I could have laid the world-wide availability of Burgun-D on them, and a lot more, but they could read it for themselves. So can you, in Cannon’s ‘Secrets of Connector Success.’ Send for it today and count your blessings.”

ITT Cannon Electric, International Telephone and Telegraph Corporation, 666 East Dyer Road, Santa Ana, CA 92702. (714) 557-4700.

“Help yourself.”



CANNON ITT

CANNON DISTRIBUTORS ARE INNOVATIVE, TOO. CALL THEM.

ALABAMA
Hall-Mark Electronics
Corp.
Huntsville
205/539-0691

ARIZONA
Liberty Electronics/
Arizona
Phoenix
602/264-4438

CALIFORNIA
Kieruff Electronics, Inc.
Los Angeles
213/685-5511
Kieruff Electronics, Inc.
Palo Alto
415/968-6292
Liberty Electronics
El Segundo
213/322-8100
Richey Electronics, Inc.
Sun Valley
213/875-2862
Time Electronics
West, Inc.

Inglewood
213/673-5900
Western Radio/
Liberty
San Diego
714/235-6571

COLORADO
Cramer Electronics, Inc.
Denver
303/758-2100

CONNECTICUT
A.S.I./Connector
Corporation of
America
New Haven
203/624-0127

FLORIDA
Hall-Mark Electronics
Corp.
Orlando
305/855-4020

GEORGIA
Electro Air Corp.
Atlanta
404/351-3545

ILLINOIS
Cramer Electronics, Inc.
Mt. Prospect
312/593-0230
Radio Distributing
Company, Inc.
Chicago
312/237-1105

INDIANA
Radio Distributing
Company, Inc.
South Bend
219/287-2911

KANSAS
Hall-Mark Electronics
Corp.
Lenexa
913/888-4747

MARYLAND
Schweber Electronics
Rockville
301/881-2970

MASSACHUSETTS
Cramer Electronics, Inc.
Newton
617/969-7700

Schweber Electronics
Waltham
617/891-8484
Time Electronics/
New England
Woburn
617/935-8080

MINNESOTA
Cramer/Bonn
Minneapolis
612/941-2770
Hall-Mark Electronics
Corp.
Minneapolis
612/925-2944

MISSOURI
Hall-Mark Electronics
Corp.
St. Louis
314/521-3800

NEW JERSEY
A.S.I./Resco
Electronics
Pennsauken
609/662-4000

NEW MEXICO
Cramer Electronics, Inc.
Albuquerque
505/265-5767

NEW YORK
A.S.I./Progress
Electronics Co., Inc.
Plainview, L.I.
516/433-1700
Schweber Electronics
Westbury, L.I.
516/334-7474
Summit Distributors, Inc.
Buffalo
716/834-3450
Time Electronic Sales
Hauptaugue, L.I.
516/273-0100

OHIO
Radio Distributing
Company, Inc.
Cleveland
216/461-9090

OKLAHOMA
Hall-Mark Electronics
Corp.
Tulsa
918/835-8458

PENNSYLVANIA
Aercon, Inc.
Clifton Heights
215/622-2500
Philadelphia
Electronics, Inc.
Philadelphia
215/568-7444

TEXAS
Hall-Mark Electronics
Corp.
Dallas
214/231-5101
Hall-Mark Electronics
Corp.
Houston
715/781-6100

Harrison Equipment
Co., Inc.
Houston
713/224-9131
Kieruff—Dallas
Garland
214/271-2471

UTAH
Cramer Electronics, Inc.
Salt Lake City
801/487-3681

WASHINGTON
Kieruff Electronics, Inc.
Seattle
206/763-1550

WISCONSIN
Cramer Electronics, Inc.
Milwaukee
414/462-8300

MODULES & SUBASSEMBLIES

Signal conditioner has three output ranges

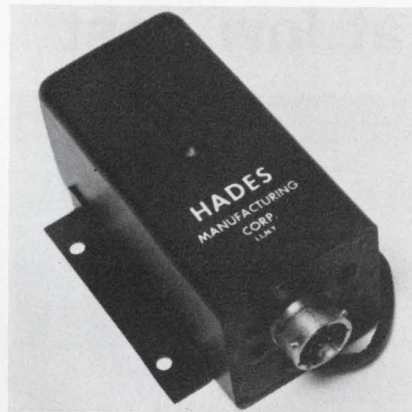

Hades Manufacturing Corp., 151A Verdi St., Farmingdale, N.Y. 11735. (516) 249-4244. 6 to 12 wk.

The NCA150 signal conditioning amplifier is a ruggedized unit with fully isolated input, output and power. It provides high accuracy over an ambient temperature range of -60 to $+212$ F. The unit accepts low level inputs from thermocouples, strain gauges, etc., and has outputs of 0 to 1, 0 to 5 or 0 to 10 V dc. The internal solid state thermocouple reference junction provides accuracies to 0.25 C. The NCA150 is designed to operate in military, aerospace and extreme industrial environments. Input voltage is 28 V dc and the unit is short-circuit protected.

CIRCLE NO. 288

Telephone tone decoder handles 16 tone pairs

Advanced Terminal Systems, P.O. Box 90121, Los Angeles, Calif. 90009. (213) 644-5321.

The TTD-1000 series of tone decoder modules is designed to perform decoding of all 16 dual-tone multifrequency pairs of the standard telephone tone system. The decoders will operate over a 35 dB input voltage range with minimum tone-on and tone-off times of 40 ms. They can provide any desired output code including BCD, ASCII and 2 of 8. These decoders draw only 600 mW from a single +5 V dc supply. They are packaged on a 4.5×6.25 PC card and mount on 0.75 in. centers using standard 22-pin card edge connectors.

CIRCLE NO. 289

Triple-mode amplifier offers wide flexibility

Dynamics, 12117 E. Slauson Ave., Santa Fe Springs, Calif. 90670. (213) 945-2493. From \$665, stock to 30 day.

A triple-mode amplifier, Model 7350, combines a differential amplifier, isolated charge amplifier and an ac voltage amplifier in one compact package. The dc mode of operation features a gain of 1 to 3300, gain accuracy of 0.1% and $\pm 2 \mu\text{V}$ RTI zero stability. The charge mode precedes the basic differential amplifier with a charge to voltage converter. Transducer sensitivities of 1 to 100 pC/g are accommodated by direct reading controls. Total gain range of 0.1 to 3300 V/pC is provided. The Model 7350 delivers ± 10 V at ± 100 mA with output level controls. Several options are available and include dual outputs, dual outputs with frequency limiting filters, \pm full scale RTO offset and fixed variable current limiting. The amplifier is housed in a $1.75 \times 7 \times 18$ in extruded aluminum package. Ten Model 7350's mount in a 19 in. wide EIA rack.

CIRCLE NO. 290

16-bit DAC has 1/2 LSB linearity (0.00075%)



Hybrid Systems, 87 Second Ave., Northwest Park, Burlington, Mass. 01803. (617) 272-1522. \$495; stock.

The Model 355 16-bit d/a converter has a linearity of 1/2 LSB (0.00075%). Integral linearity is 15 ppm while the differential linearity of 1/2 LSB (7-1/2 ppm). The converter settles to 0.01% in 3 μs (current output) and has a slew rate of 0.3 V/ μs . Linearity varies with temperature at a rate of 3 ppm/ $^{\circ}\text{C}$; voltage offset also varies at the same rate. The unit's long term stability (less the internal reference voltage) is only 10 ppm/yr. Power requirements for the $2 \times 4 \times 0.4$ in. converter are +15 V at 25 mA and -15 V at 10 mA.

CIRCLE NO. 291

CANNON **ITT**

2000-A diode offers high reverse voltage at low cost



International Rectifier, 233 Kansas St., El Segundo, Calif. 90245. (213) 678-6281. \$175 (1 to 9); 6 wk.

Costs of high-current power rectifiers are plunging to new lows.

At only \$175 in unit quantity, International Rectifier's type 2001-PD160 can withstand a peak reverse repetitive voltage of 1600 V and handle a 2000-A average cur-

rent. The diode can also withstand a maximum surge current of 30,000 A.

The power silicon rectifier has a maximum peak forward voltage of 1.52 V. Maximum reverse average current for the diode is 50 mA.

A hockey-puck configuration gives the unit high thermal efficiency and permits a wide range of uses. The compact 2001PD160 has a diameter of 2.85 in., and it is 1.09 in. high. It weighs about 15 oz.

Other diodes in the 2001PD series range from the PD60 with a peak-repetitive reverse voltage of 600-V to the PD 140 with 1400 V. All units have storage and operating temperature ranges of -40 to 200 C.

The closest competing unit is from Westinghouse—R9201220. It has a peak reverse voltage of 1200 V and a maximum surge rating of 22,000 A. The Westinghouse unit sells for \$300 in quantities of 1 to 9, almost double IR's price at the same quantity level.

International Rectifier

Westinghouse

CIRCLE NO. 257

CIRCLE NO. 258

Some use Deltrols' 170 relays only in case of emergency ...

some use them all of the time.

Deltrol Controls' Series 170 high current relays are used in applications ranging from switchover functions in emergency lighting systems to industrial controls. These ruggedly built compact units measure only 1-1/4"H x 1-5/8"W x 1-7/8"D yet handle loads up to 30 amps/1 HP at 120 VAC; 1-1/2 HP at 240 VAC. Units also have a tungsten load rating of 30 amps/12 VDC. Relays feature gold flashed 1/4" dia. contacts in form 1C (SPDT) or form 1X (SPDT-NO-DM) configurations. These inexpensive units are offered in a wide range of AC or DC coil voltages and feature nylon encapsulated coils for superior heat dissipation and dependable performance under adverse conditions. Terminals are 1/4" quick-connects. Series 170 relays are listed under the Components Program of Underwriters Laboratories, Inc., file No. E37066.

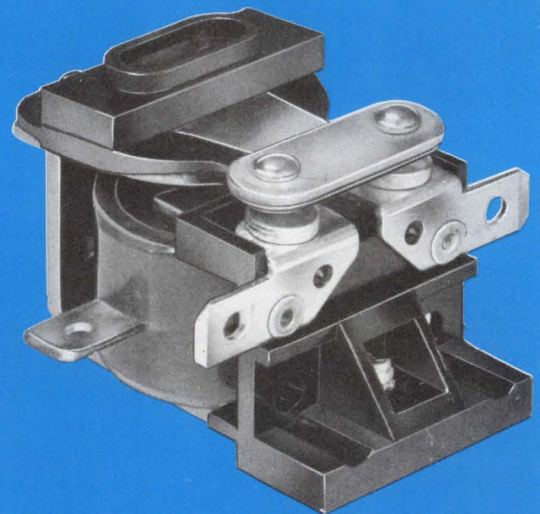

DELTRON
controls

Division Of Deltrol Corp.

2745 South 19th Street, Milwaukee, Wisconsin
53215, Phone (414) 671-6800, Telex 2-6871

1705

OEM'S \$



MODEL 5110
U.S. Pat. No. 3,735,269

FREQUENCY SYNTHESIZER

- **Low Cost** AS LITTLE AS \$1,880 IN OEM QUANTITIES
- **DC to 2 MHz**
- **Full Programmability** BINARY OR BCD
- **No Switching Transients**
- **Direct Digital Techniques**
NO MIXING OR PHASE LOCKING
- **High Spectral Purity** —70db SPURIOUS
—55db HARMONIC
- **High Stability** $\pm 2 \times 10^{-8}/^{\circ}\text{C}$ STANDARD
 $\pm 2 \times 10^{-10}/^{\circ}\text{C}$ OPTIONAL
(OR YOUR OWN EXTERNAL REFERENCE STANDARD)

SOME APPLICATIONS

- Automated Test Systems
- High Speed Signal Processing
- Computer controlled frequency generation, sweeping & hopping (FSK)

For immediate information on how Rockland can meet your specific application and delivery requirements — call our local rep or Dave Kohn directly at:

ROCKLAND

ROCKLAND SYSTEMS CORPORATION 230 W. Nyack Rd., W. Nyack, N.Y. 10994 • (914) 623-6666

INFORMATION RETRIEVAL NUMBER 85

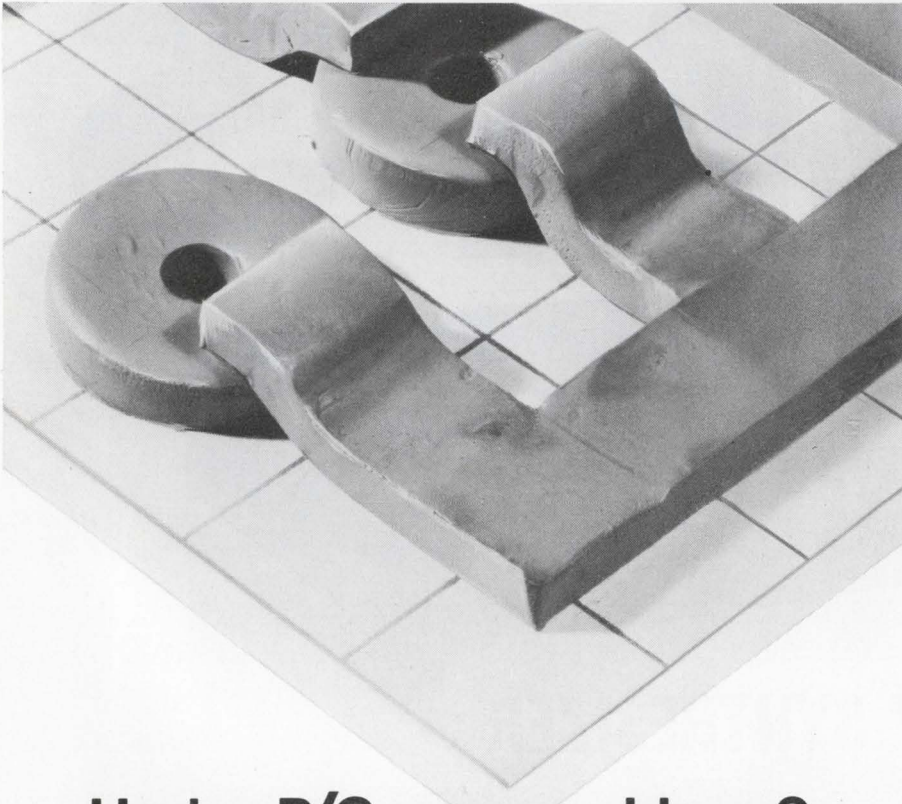

Having P/C repro problems? Maybe your artwork is too fat.

What you see here is a clay model representing art made with die-cut symbols. To your eye your artwork doesn't look like that. But the lens of the repro camera picks up the buildup of those die-cut symbols and tape.

Mecanorma symbols, on the other hand, are printed on an ultra-thin transparent carrier film just 20 microns thick! The tape lies flat. There is no buildup, hence there is no distortion, no parallax.

You can apply Mecanorma symbols with pinpoint accuracy, too. Unlike die-cut symbols, Mecanorma comes in handy transparent strips which give you rapid and precise positioning. No sticky situations, either. The symbols and the carrier sheet can actually come in contact with your work surface without the symbol sticking before you want it to.

And if you change your mind, you can quickly correct it with tape or rubber cement pick-up (it's 40% or 50% quicker than other methods). Mecanorma symbols come in a flat box so they're easy to store (they have a 7-year shelf life). And if you think variety is the spice of life, we have over 800 different symbols to keep you happy.

To prove Mecanorma symbols are all we say, we'll send you some samples and one of our catalogues. Free. Just write Keuffel & Esser Co., 20 Whippany Road, Morristown, N.J. 07960.



KEUFFEL & ESSER CO.



Power Darlington spec'd at 10 A

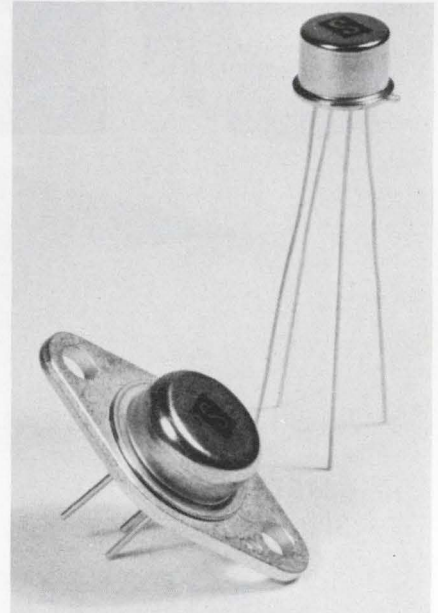

Solitron Devices, 1177 Blue Heron Blvd., Riviera Beach, Fla. 33404. (305) 848-4311. TO-66 version: \$5; TO-5 version: \$3 (1-99); stock.

A series of npn or pnp silicon power Darlington transistors is rated for 10-A operation. The npn versions are called the SDM 3100-3300 Series, and the pnp versions are designated as the 3400 Series. The devices come in either 3-lead TO-66 or 4-lead TO-5 cases. Device features include V_{CE0} of 40 V to 80 V, a 5-A h_{FE} of 1000 minimum and multiple gain selections at 2.5 or 5 A. The devices have an f_t of 70 MHz typical, and turn-on and turn-off times are 0.6 and 2.5 μ s, respectively.

Booth No. S-7

Circle No. 292

COS/MOS gate has three-state outputs

RCA Solid State, Route 202, Somerville, N.J. 08876. (201) 722-3200. Plastic package: 81¢ (1000).

The COS/MOS CD4048A expandable multifunction three-state gate features medium-power TTL drive capability. Three binary control inputs select one-of-eight output functions of eight input variables. The eight output functions are OR, NOR, AND, NAND, OR/AND, OR/NAND, AND/OR and AND/NOR.

CIRCLE NO. 293

MATRI-Dot Printers

Print In English and Another Language You'll Appreciate...

Price! \$516 in quantity

(low unit price . . . only \$645)

You'll trade off nothing but speed to save substantially. So if a through-put of 24 characters per second is o.k. (and that's not bad!) you'll get in exchange all of the features you *won't* find in drum printers.

- Print a 64 character ASCII Set . . . letters, numbers, symbols
- Change the plug-in ROM, change the language . . . consider your export market
- Print on standard adding machine tape and ribbon, or pressure sensitive paper
- Print duplicate copies
- Lower power consumption. No motors that have to accelerate to speed or run continuously. Matri-Dot printers are always in standby awaiting your command to commence printing immediately
- Interface flexibility . . . Matri-Dot printers interface to any system—by character, by line, serial, or parallel
- Cost — from \$516. You get a Matri-Dot full alpha-numeric and symbolic impact printer for the price you would expect to pay for numerics alone

Other Available Matri-Dot Printers . . .

- A 40 character per line model similar to the Matri-Dot 24 character/line version
- A Data-Print model with tape descending downward from front panel

**Matri-Dot Printers . . .
As flexible as electronics
itself.**

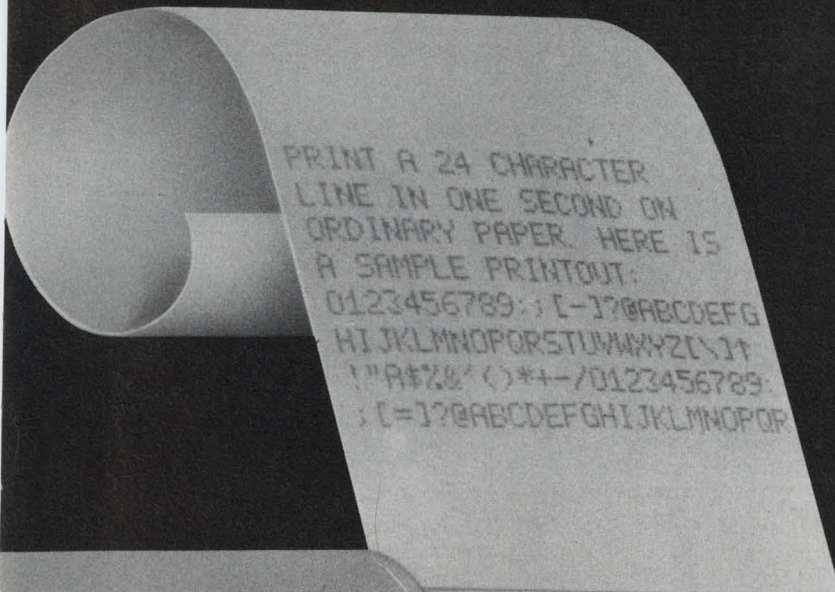
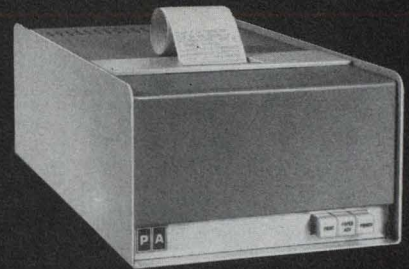

**PRACTICAL
AUTOMATION, INC.**

Trap Falls Road, Shelton, Conn. 06484
Tel: (203) 929-1495

Transceiver handles party-line data

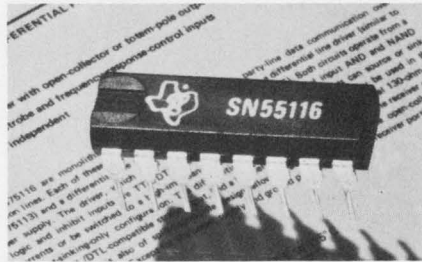

Texas Instruments, P.O. Box 5012, M/S 308, Dallas, Tex. 75222. (214) 238-3741. SN75116J: \$3.12.

A differential transceiver can be used for party-line data communication over differential transmission lines. Called the SN55/75116, the new transceiver combines a differential line driver and receiver in one package. Both circuits operate from a single 5-V supply. The logic and inhibit inputs of the three-state driver are TTL/DTL compatible, and the differential outputs can source or sink 40-mA currents or be switched to a high-impedance inhibit state.

CIRCLE NO. 294

S-TTL counters toggle at 100 MHz

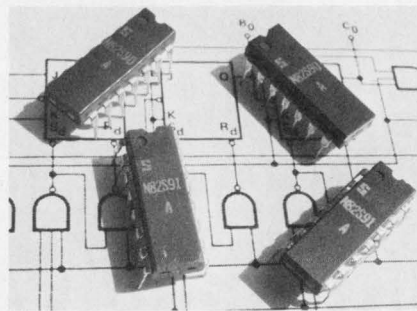

Signetics, 811 E. Arques Ave., Sunnyvale, Calif. 94086. (408) 739-7700. \$3.15 (100).

Two presetable high-speed Schottky-TTL counters, the 82S90 decade and the 82S91 binary counters, can replace lower speed ICs performing equivalent functions. The 82S91 can be connected as a divide-by-two, four, eight or 16 counter. The ICs operate with a typical clock frequency of 100 MHz and have a typical strobe/reset hold time of 10 ns. Minimum output current is 20 mA at 0.5 V, for a ZERO output, and 1 mA at 2.7 V for a ONE output.

INQUIRE DIRECT

Transistors rated at 70, 100 A

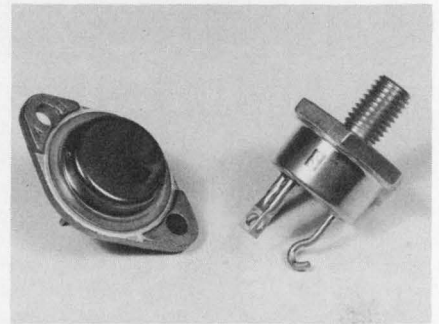

Solitron Devices, 1177 Blue Heron Blvd., Riviera Beach, Fla. 33404. (305) 848-4311. \$35 (100); 3 wk.

Two series of industrial npn silicon power transistors have peak-current capabilities of 70 and 100 A. Each is available in two packages: standard TO-3—the SDT 96301-2-3 for 100 A and the SDT 96304-5-6 for 70 A—and the TO-63—the SDT 96401-2-3 for 100 A and the SDT 96404-5-6 for 70 A. The devices feature a $V_{CE(sat)}$ at 70 A of 1.5 V typical, h_{FE} at 70 A of 20 typical and BV_{CEO} from 60 to 300 V.

Booth No. S-7

Circle No. 295

CDI CREATES THE BETTER LINEAR SWITCH

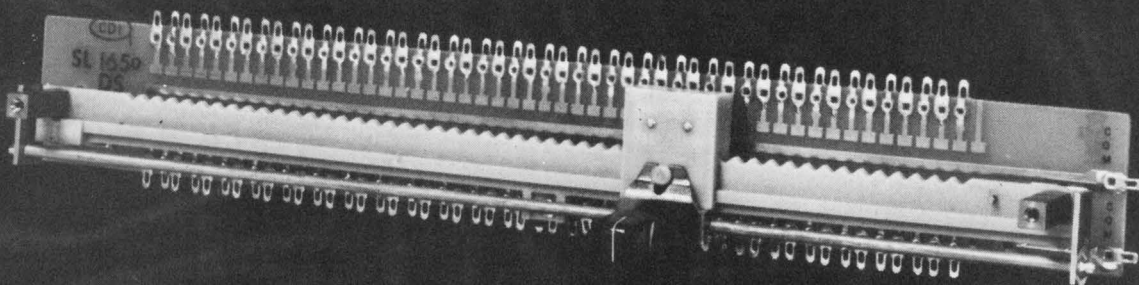

CHOOSE ANY NUMBER OF POSITIONS UP TO 100 (UNIQUE)

Series SL Linear Slide Switch (Patented)

APPLICATIONS: CONTROL FUNCTIONS REQUIRING RAPID POSITION SELECTING

- CATV channel selecting
- High & Low limit switches
- Process equipment controls
- Computers & peripherals
- NC applications
- Many others

OTHER REMARKABLE FEATURES:

Mounts EITHER left/right OR up/down (versatile) • Single or multiple position selectors • Solder lugs or dip solder termination for p.c. use • 1 or 2 Poles, or coded outputs available.

ELECTRICAL CHARACTERISTICS:

200 megohms min. insulation • 1000 volts min. dielectric strength • 2 amps @ 115 VAC current carrying capability • 125 ma @ 115 VAC current breaking capability.



CHICAGO DYNAMIC INDUSTRIES, INC.

PRECISION PRODUCTS DIVISION

1725 Diversey Blvd., Chicago, Illinois 60614, Phone (312) 935-4600 TELEX 25-4689

This is a
4023
C/MOS logic
IC...

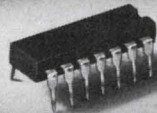

Actual Size

This is a
4023
C/MOS logic
IC...



Actual Size

Now— for hybrid circuits...
Amperex introduces
microminiature  versions
of 14 of the most popular C/MOS logic IC's
of the 4000 series.

Until now, hybrid circuit manufacturers have had only two ways to use C/MOS logic: the conventional packages that traded away space for C/MOS performance... or individual C/MOS chips trading away production-economy and yield to get C/MOS performance.

Now there's a third choice—C/MOS IC's in microminiature LID packages—and now you have C/MOS performance in small space *with* production-economy and high circuit yields.

With Amperex LID C/MOS IC's, you get a 20 times reduction in volume that allows you to take full advantage of the inherent high-density possibilities of C/MOS circuitry... and you get fully pre-tested packaged devices that mount directly, economically and reliably onto the substrate by ordinary reflow solder techniques. Your costly semiconductor-bonding operations are eliminated along with the need for expensive equipment and the skilled labor to handle it.

We can deliver LID versions of 14 of the most popular of the 4000 series C/MOS IC's off-the-shelf, in production quantities. They are available, with either 14 or 16 terminals, as indicated at right. Delivery schedules on others of the 4000 series can be obtained via telephone.

For technical data and details of how you can design C/MOS circuitry into your hybrid IC's with LID densities and LID economy... or for information on the full line of Amperex LIDS for hybrids... write: Amperex Electronic Corporation, Solid State and Active Devices Division, Slatersville, Rhode Island 02876. Tel: 401-762-9000.

TYPE	FUNCTION	TERMINALS
LFG4000	Dual 3-Input NOR Gate Plus Inverter	MA-14
LFG4001	Quad 2-Input NOR Gate	MA-14
LFB4009	Hex Buffer/Converter (Inverting)	MA-16
LFB4010	Hex Buffer/Converter (Non-inverting)	MA-16
LFG4011	Quad 2-Input NAND Gate	MA-14
LFF4013	Dual "D" Type Flip-Flop	MA-14
LFR4015	Dual 4-Stage Static Shift Register	MA-16X
LFS4016	Quad Bilateral Switch	MA-14
LFC4017	Decade Counter/Divider	MA-16X
LFC4020	14-Stage Ripple-Carry Binary Counter	MA-16X
LFR4021	8-Stage Static Shift Register	MA-16X
LFG4023	Triple 3-Input NAND Gate	MA-14
LFF4027	Dual J-K Master-Slave Flip-Flop	MA-16
LFG4030	Quad Exclusive-OR Gate	MA-14



Actual Size

Amperex

TOMORROW'S THINKING IN TODAY'S PRODUCTS

Sold through
North American Philips Electronic Component Corporation

INFORMATION RETRIEVAL NUMBER 89

SMART GAUDY

YES	NO
<input checked="" type="checkbox"/>	<input type="checkbox"/>
<input type="checkbox"/>	<input checked="" type="checkbox"/>

DRESS YOUR SYSTEMS IN TRIMLINE ENCLOSURES . . .
TO GET THAT ADMIRING ATTENTION YOU WANT!

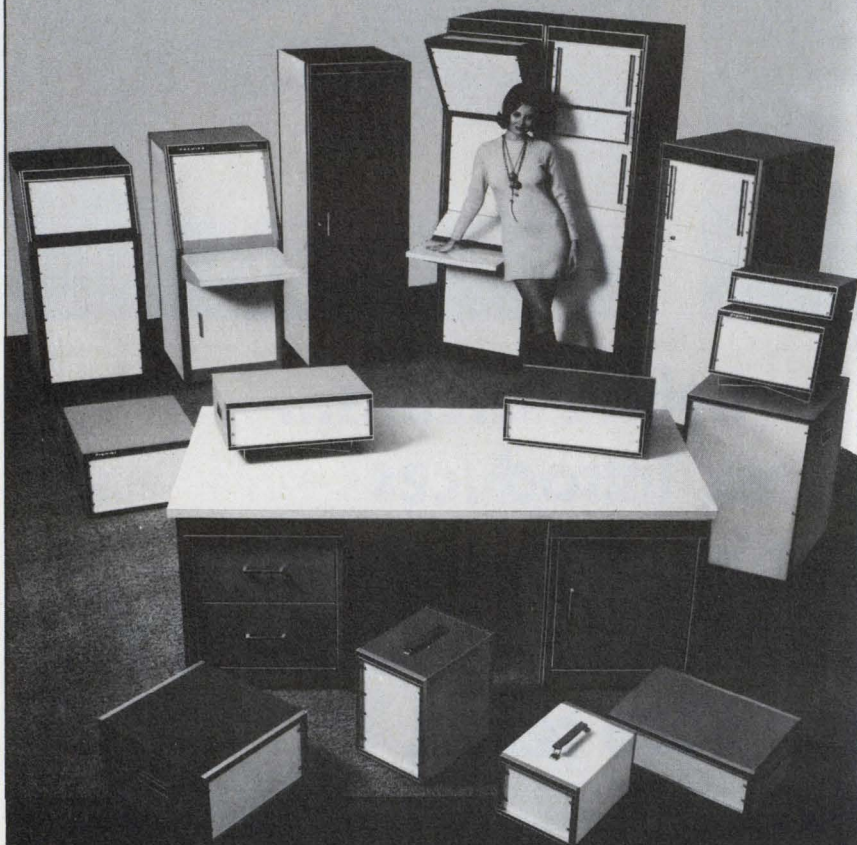

INSTRUMENT CASES—TIC SERIES

TVA Series Vertical Assembly— Construction Details (1 Frame, 2 End Panels, Rear Door)

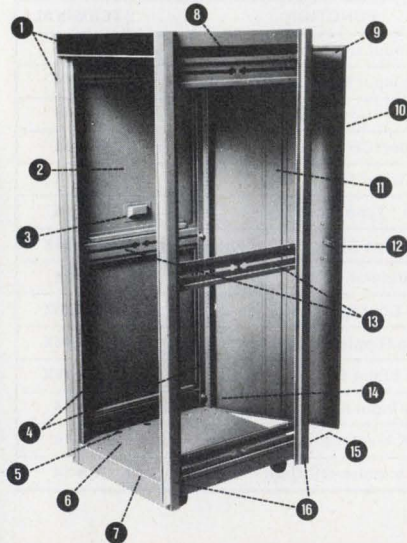

1. Trim: extruded anodized aluminum with textured vinyl inlays
2. Outside removable flush end panels (16 ga.)
3. Recessed hand grip for panel removal
4. 2 pr. panel mounting angles, fully adjustable front to rear with tapped 10-32 holes on EIA & WE Standards spacing (12 ga.)
5. 1" dia. holes for cable entry beneath base
6. Recessed caster mounting holes
7. 1 piece formed steel base provides for heavy equipment mounting area and concealed caster mounting (14 ga.)
8. 1 piece solid top for extra rigidity and squareness (14 ga.)
9. Foam gasketing (3 sides)
10. Magnetic closure gasket
11. Door stiffener channel
12. Keyed latch and brushed aluminum pull handle
13. Horizontal cross-brace and panel mounting angle supports
14. Quick release, spring loaded door hinges (top and bottom)
15. 1 1/8" dia. knock-outs for rear cable entry underneath rear door
16. Formed steel uprights (14 ga.) provide 1/2" recess to panel mounting angles

All features shown are standard in the Trimline TVA Series
Welded, formed steel construction

Complete catalog and prices on request



PREMIER METAL PRODUCTS COMPANY
337 Manida St., Bronx, N.Y. 10474/(212) 991-6600

ICs & SEMICONDUCTORS

Multifunction clock IC costs only \$6.25

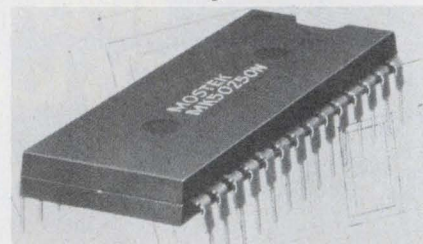

Mostek Corp., 1215 W. Crosby Rd., Carrollton, Tex. 75006. (214) 242-0444. P: See below; stock (samples).

A multifunction MOS/LSI clock circuit, called the MK 50250N, provides four or six-digit multiplexed display drive, AM/PM indication and 24-hour alarm setting with "snooze" function. It sells for \$6.25 in 100-piece quantities. Operation is from standard 50 Hz (24-hour operation) or 60 Hz (12-hour operation) input. The circuit is compatible with gas discharge or LED displays and comes in a 28-pin plastic package.

CIRCLE NO. 296

3-lead regulators output 15 V, 1 A

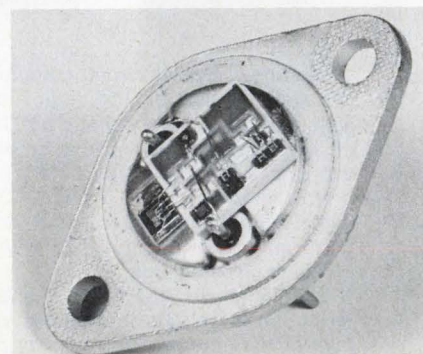

Solitron Devices, 1177 Blue Heron Blvd., Riviera Beach, Fla. 33404. (305) 848-4311. \$20 (1-99); 4-6 wk.

Hybrid IC three-terminal regulators provide ± 15 -V regulation at 1.0 A. Called the CJSE015P (+15 V) and CJSE015N (-15 V), the devices spec room-temperature line and load regulation at $\pm 1\%$, and they limit line, load and temperature variations to $\pm 3\%$ from -55 to 125 C. The regulators feature foldback current limiting and are rated for 50-V maximum input voltage and 70-W maximum power dissipation.

Booth No. S-7

Circle No. 297

inverter-rated™

cool power!

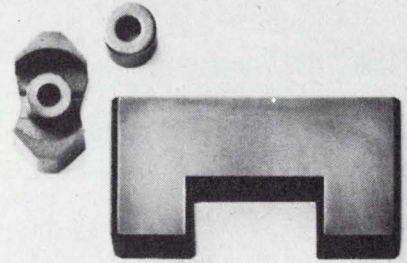

Ferramic® components guarantee circuit performance

Typical power dissipation vs temperature curves under high drive conditions

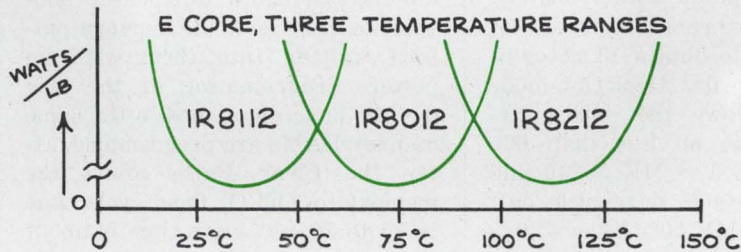

Three temperature ranges

Inverter-Rated components are now available in three temperature ranges. You can select components matched to your temperature requirements and get the highest efficiency possible in your inverter designs.

By specially processing our components for low loss at the temperature you require, we can offer you better performance under all circuit conditions. And significantly improved characteristics in high temperature applications.

Ferrite components for inverters

Our *Inverter-Rated* ferrites are designed specifically for your inverter applications. You get highest efficiency

in the full range of shapes—E Cores, U Cores, Toroids, Pot Cores and Cross Cores. And each of these *Inverter-Rated* components is tested under inverter conditions to assure performance in your circuit. So your inverter design is based on specified and guaranteed electrical characteristics—not just routine magnetic parameters.

New design data

Our new design guide gives you the facts you need to apply the latest ferrite technology to your inverter circuits. We speak your language with complete component specifications, temperature characteristics, application information. We spell out the circuit characteristics of our components and give you guaranteed circuit parameters.

To learn more about our *Inverter-Rated* components

and how they can improve your inverter designs, just check the reader service cards. Or call (201) 826-5100 and talk to the men who developed this ferrite technology. Either way, if you're talking inverters, talk to the ferrite component experts.

That's us.

Indiana General
Electronic Products
Keasbey, N.J. 08832

National distribution through Permag locations in Atlanta, Boston, Chicago, Dallas, Detroit-Toledo, Los Angeles, New York, and San Francisco.

indiana general

a division of Electronic Memories & Magnetics Corp.
INFORMATION RETRIEVAL NUMBER 91

Tone generator IC gives 13 musical notes

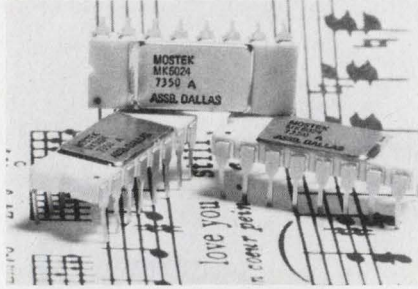

Mostek Corp., 1215 W. Crosby Rd., Carrollton, Tex. 75006. (214) 242-0444. \$10 (100).

A top-octave tone generator, called the MK 50240 series, provides full octave plus one note on the equal tempered scale. Each IC divides an external frequency of 2.00024 MHz to obtain 13 notes of the musical scale. Depletion-mode technology allows the entire circuit to operate on less than 600 mW of power. The MK 50240 and 50242 have a 50% duty-cycle output, while the MK 50241 has a 30% duty-cycle output.

CIRCLE NO. 298

MNOS ROMs make commercial debut

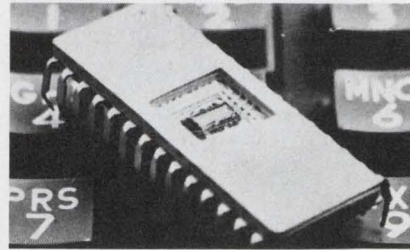

Nitron Corp., 10420 Bubb Rd., Cupertino, Calif. 95014. (408) 255-7550.

The first commercially available family of MNOS electrically alterable read only memories—the NC-7000 series—consists of 64 and 1024-bit configurations. The new circuits operate with powers as low as 3 μ W/bit. Completely non-volatile, they hold the memory pattern written into them with no power. Programming of the new devices is accomplished in the same manner RAMs are programmed, after the Clear Pulse resets the memory to ZERO. Read cycle time is 10 to 20 μ s, write time is about 1 ms.

CIRCLE NO. 299

Fast transistors handle 20 A

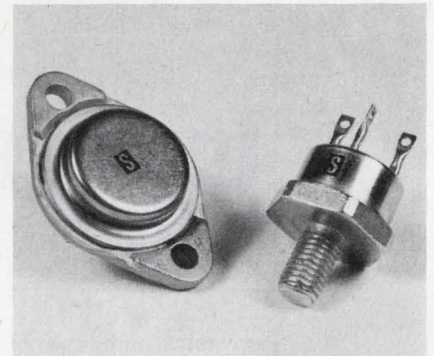

Solitron Devices, 1177 Blue Heron Blvd., Riviera Beach, Fla. 33404. (305) 848-4311. TO-3 units: \$10; TO-61 units: \$30; 3-4 wk.

A series of fast-switching npn silicon power transistors has a peak current capability of 20 A. Typical switching specs are 0.2 μ s for t_{on} and t_r , and 1.2 μ s for t_s . Other features include a $V_{CEO(sus)}$ of 200 V minimum, peak collector current of 20 A and power rating of 125 W. The series comes in either TO-61 isolated or standard TO-3 packages.

Booth No. S-7

Circle No. 300

THINK SINGER

OEM Printer Mechanisms for your Reservations Terminal



Singer's Model 30 OEM Printer Mechanism has the performance characteristics and high reliability you need to assure your Reservation Terminal's success in the marketplace. Your customers will like the 30 char/sec print speed, low noise level, high quality impact printing and the flexibility of the paper handling system. And, the mechanism's design simplicity and high reliability make servicing extremely simple—we have eliminated all conventional clutches, brakes, stepper or servo motors and complex mechanical mechanisms. Plus, our low price will make your terminals both more competitive and more profitable.

We offer the Model 30 in both 80 and 132 column configurations with a broad range of options, including forms-feed, tab, vernier platen, and an integrated paper-tape punch and reader.

Send for our new catalog and/or request a demonstration; call, write or circle the reader service number.

Singer-International Teleprinter Corp., 286 Eldridge Road, Fairfield, New Jersey 07006, (201) 785-4450, TWX 710-988-3658.

SINGER

INTERNATIONAL TELEPRINTER CORP.

Cooling, lifting, holding, pulling, damping, drying...

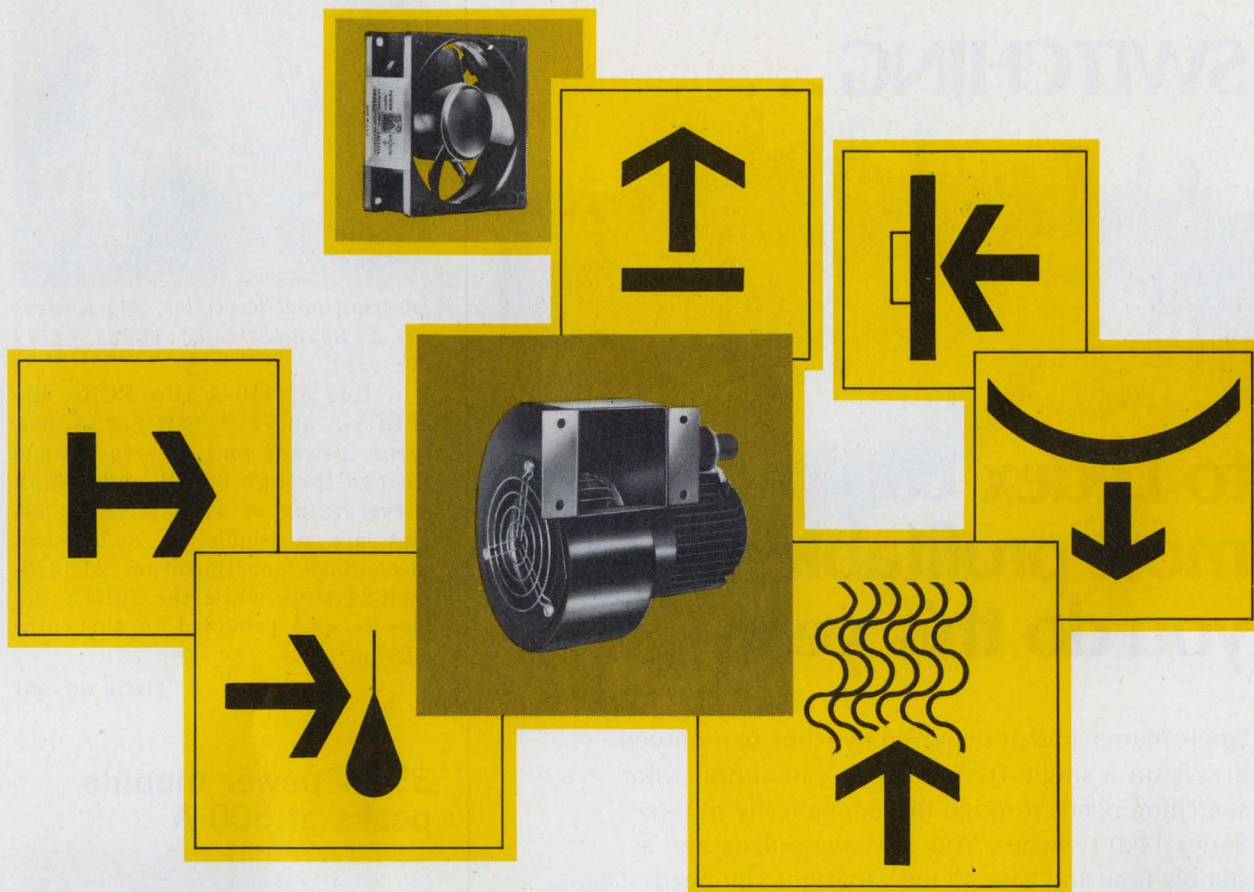

Rotron has a way...with air

Air, in the hands of the world's most advanced manufacturer of precision air moving devices, has a potential for doing things that designers and manufacturers are beginning to appreciate.

Forced convection cooling of electronic equipment—providing for more densely packaged components with equal or even greater system reliability—is just one of the jobs air, by Rotron, performs so well.

In buffer columns and tape hold downs and a dozen other non-cooling applications within the electronics industry alone, air moving devices from Rotron simplify system design, increase both efficiency and reliability.

Rotron's extensive line of air movers require an absolute minimum of space (as little as 1 cu. inch). They're quiet. (As low as NC 20). They consume surprisingly little power (a low of 5 watts). And they are exceptionally reliable. (Ten years and more of continuous duty without maintenance.)

Learn more about the Rotron line of fans and blowers, with pressures to 165" wg., flows to 2600 cfm. Contact your local Rotron representative or distributor or write us directly.

Why settle for less when the best costs no more.



ROTRON INC.

Woodstock, N. Y. 12498 □ 914 • 679-2401 □ TWX 510-247-9033
Pacific Div., Burbank, Cal. 91506, 213•849-7871 • Rotron B.V., Breda, Netherlands, Tel: 79311, Telex: 844-54074

See us at the Design Engineering Show-Booth #346

INFORMATION RETRIEVAL NUMBER 93

SWITCHING...

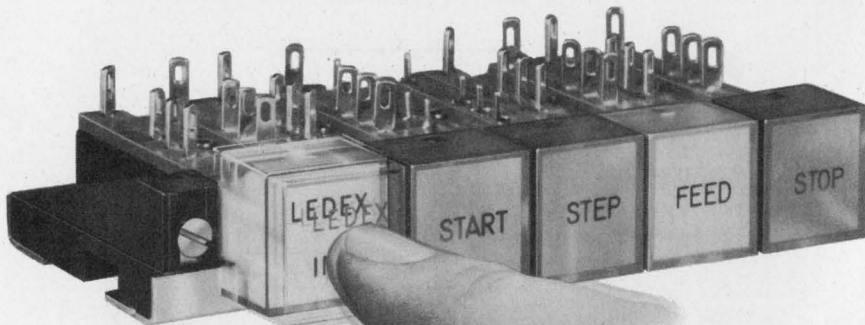

to Ledex® could be the most profitable thing you do this year.

Single illuminated push button switches, or mounted arrays on a single frame, Ledex can supply your switching needs through the dramatically different Series 1400 switches. You can save dollars and assembly time and have all the variations you need... Momentary... Push/Push... Reciprocal Release... Master Release... Interlock... you name it.

It all starts with a basic momentary push button switch and is built to your specifications. Specify 2 to 20 on a single frame, silver or gold plated contacts, 6, 12, or 24 volts illumination, rectangular or square caps, transparent or opaque colors, and on and on. Ledex is also known for dependable, long-life rotary switches, stepping switches, and solenoids.

To help you specify Ledex Series 1400 illuminated push button switches and to make your time more profitable, we have available a unique switch design chart. It serves as your engineering drawing and ties down every detail to ensure that purchasing specifies exactly the switching you have designed. Send for it now.

Toll free number for name of your nearest representative: 800-645-9200



LEDEX INC.
123 Webster St.
Dayton, Ohio 45401
(513) 224-9891



110-A SCRs come in popular package styles

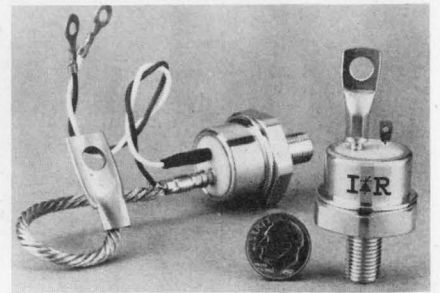

International Rectifier, 233 Kansas St., El Segundo, Calif. 90245. (213) 678-6281.

A line of 110-A rms SCRs, the 70RCS-A and 71RCS-A Series, features forward and reverse voltage ratings through 800 V and a high surge rating of 1200 A. Both series are available in a low-cost mechanical configuration of 3/8-inch-24 stud, while the 70RCS Series is also provided in the cathode-lug style.

CIRCLE NO. 301

350-V power module peaks at 500 A



Solitron Devices, 1177 Blue Heron Blvd., Riviera Beach, Fla. 33404. (305) 848-4311.

A power module, for use as a pulse-width modulated switch in motor speedsetting applications, can accept a maximum input voltage of 350 V and boasts a peak current of 500 A. The module has a collector-base voltage of 375 V, a collector-emitter voltage of 350 V and an emitter-base voltage of 10 V. The 500-A peak collector can be obtained with a maximum pulse width of 300 μ s and a maximum duty cycle of 2%. Continuous collector current is 400 A.

Booth No. S-7, Circle No. 302

Frame them any old way

Or any new way.

Then sit back and watch your Ise display electronics get your ideas across. Beautifully.

In an eye-easy fluorescent green glow.

At the same time, they're low on voltage and current drain.

High on stability.

Pick the readouts that offer more of everything, including variety, for a whole host of digital display ideas.

They're a difference you can see.

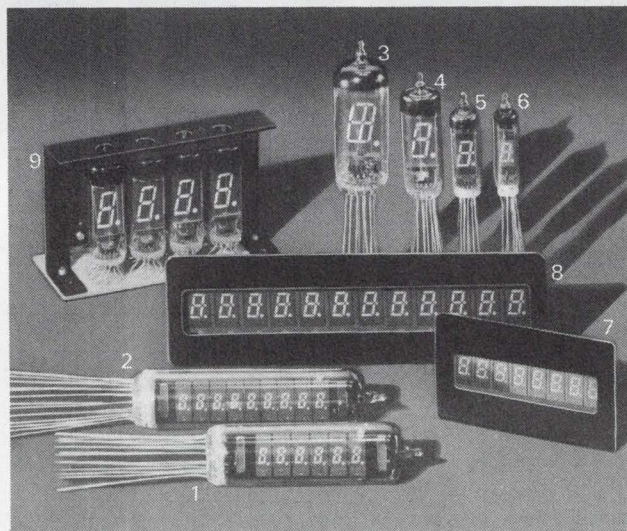

1. DP60A
2. DP90A
3. DG19E
4. DG12H
5. DG10F1
6. DG 8F
7. DP 89A
8. DP127F
9. DMCL12H (NEW)

Display module w/counter & latch

- Fluorescent green glow.
- 12-pin connector.
- Three performance perfect models.
- Custom ROM programming with other than BCD and seven-segment output.

International Div.

ISE INTERNATIONAL CORP.

No.2-7-7, Higashi-Shinbashi, Minato-ku, Tokyo, Japan

Tel: 433-6616~9 Telex: J26546

Cables: "ISEWORLDREP" TOKYO



The Brighter Side of Electronics

ISE ELECTRONICS CORP.

P.O. Box 46 Ise-city, Mie Pref., Japan

Representative: Los Angeles, Paris, Munich, Amsterdam, Stockholm, Vienna, Milan, Bombay, Hong Kong, Taipei.

INFORMATION RETRIEVAL NUMBER 95

Compact sweeper ranges to 500 MHz



Kay Elemetrics, 12 Maple Ave., Pine Brook, N.J. 07058. (201) 227-2000. \$1150 (without markers); 6 to 8 wk.

Marka Sweep 9060 is a compact unit which features 0.5-to-500-MHz frequency range, 100-to-600-MHz sweep width and 0.25-dB flatness. The unit's sweep rep rate is variable from 1 sweep per 10 to 100 sweeps per s, while its sweep duration time (scan rate) can be set over a range of 2 to 5 ms.

Booth Nos. 2312-2316

Circle No. 303

Frequency counter runs on batteries for field

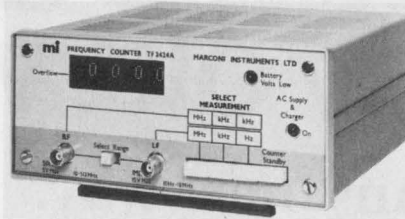

Marconi Instruments, 111 Cedar Lane, Englewood, N.J. 07631. (201) 567-0607. \$1295.

Model 2424A mobile frequency counter provides continuous frequency coverage from 10 Hz to 512 MHz and a 10-mV input sensitivity. Frequency is displayed by a four-digit LED readout, with an effective eight-digit count achieved by means of front-panel switches. Thus, the unit provides 10 Hz resolution with a reading time of only 3.2 s. The counter internal standard has a very short warm-up time of only 4 min. to reach a stability of 2×10^{-7} . The counter's built-in battery permits many field testing applications.

Booth No. 2711-2717

Circle No. 304

Miniature recorder offers 3 channels

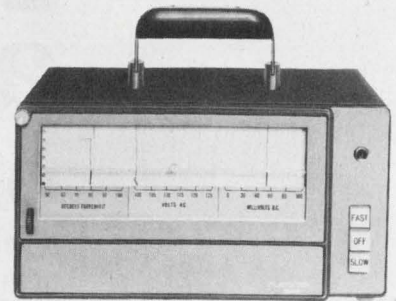

Recorder Systems Div., Gulton Industries, Gulton Industrial Park, East Greenwich, R.I. 02818. (401) 884-6800. \$975; 4-6 wk.

The Rustrak 4300 is a three-channel miniature recorder that accepts over 100 plug-in preamps and records ac and dc volts, amps, temperature and various industrial and process control functions. Accuracy is $\pm 1\%$ of full scale, sensitivity is 100 mV full scale, and response is 2 s full scale deflection. The recorder writes on pressure-sensitive, rectilinear chart paper—requiring neither ink nor cartridges. Size is 5-5/8 x 11 in.

CIRCLE NO. 305

8 GREAT INVERTERS

from 125 VA to 1.5 KVA

■ LOWEST COST ■ HIGHEST RELIABILITY ■ FASTEST DELIVERY

Frequency Range: 60Hz Adjustable $\pm 5\%$
 Distortion: Less than 6%
 Regulation, Line and Load $\pm 1\%$
 Frequency Regulation $\pm 0.15\%$ for line and load
 Operating Temperature: -20° to $+55^\circ\text{C}$

If any of these 8 units won't satisfy your requirements, we've got 250 more — standard inverters from 30 VA to 3000 VA or choose a custom unit to meet your special requirements. Get our complete catalog and price lists; call, write or circle the reader service number.

Output VA	Input DC Volts	Input DC Amps	Approx. Wt. Lbs.	Size HxWxD	Model No.	Price
125	11-16	17.4	19	5x6x10	1260-12	\$315
125	22-32	8.0	19	5x6x10	1260-24	315
250	11-16	35	37	7x9x13	2560-12	475
250	22-32	16	37	7x9x13	2560-24	445
500	11-16	70	60	7x11x14	5060-12	690
500	22-32	32	60	7x11x14	5060-24	635
1000	22-32	64	100	9x14x16	1K60-24	1070
1500	22-32	96	145	9x17x17	1.5K60-24	1450

NOVA ELECTRIC MANUFACTURING CO.
 263 Hillside Avenue
 Nutley, New Jersey 07110
 (201) NOVA-1-3434

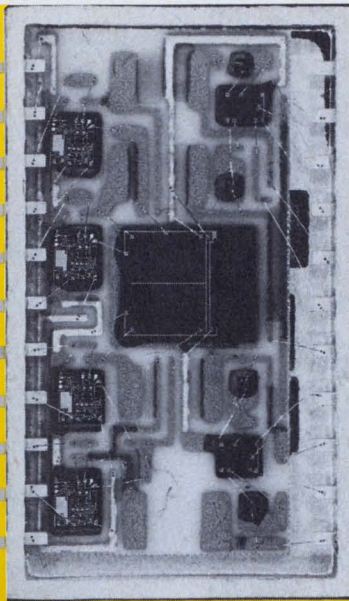

We're in the chips . . .

Hybrid Systems now offers a broad line of thin-film products, including single resistors and multiple resistor arrays, as well as an expanded capability in the design and manufacture of custom hybrid microcircuits . . . a result of our acquisition of Sprague's Worcester hybrid microelectronics operation.

We're in the chips . . . with thin-film resistors

Precision nickel-chromium or tantalum nitride thin-film resistor chips. Resistance values from 10Ω to $510K\Omega$ in standard 30 mil sq. designs; values up to $8\text{Meg}\Omega$ in larger chip sizes. Features include low noise, uniform tracking, and excellent temperature characteristics. Individual resistors with 1%, 5%, or 10% tolerances. Laser trimmed to $\pm 0.01\%$.

We're in the chips . . . with thin-film resistor networks

High-performance nickel-chromium and tantalum nitride designs in chips, wafer, or hermetic packages. Ladder, scaling, and adapter networks. Accuracies to 14 bits. Laser trimmed to exact tolerances. NiCr types feature high temperature stability. TCR from 0 to $+50\text{ppm}/^\circ\text{C}$, tracking to better than $1\text{ppm}/^\circ\text{C}$, and noise $< 0.1\mu\text{V}/\text{V}$ decade of frequency.

We're in the chips . . . with custom hybrid microcircuits

High-reliability custom hybrid assemblies using chip and wire technology as well as thin and thick-film processes to meet your specific needs. Typical circuits include transceivers, demodulators, oscillators, drivers, and comparators.

All of our thin-film components and custom hybrid circuits are manufactured and tested to MIL-STD-883, MIL-E-5400N, and other stringent standards.

For more information, contact us.

Visit us at Booth #2230, IEEE Intercon '74



HYBRID SYSTEMS CORPORATION

87 Second Avenue, Burlington, Massachusetts 01803 • Tel: 617-272-1522 • TWX: 710-332-7584

INFORMATION RETRIEVAL NUMBER 97

"Sure. Florida's great. But working for ECI will make you a better engineer."

JOE BRUMBAUGH,
Manager,
Airborne
Transceivers

"We're small enough so you can get to know the technical people. We have good group leaders, experienced in advanced technology, who bring their people along. A guy who wants to learn anything at all can do it. Our leadership encourages this. We're involved in advancing the state of the art, and the company has committed its own money to this."

Career opportunities for electronic engineers:

We have openings at all levels for electronic engineers experienced in the design and development of communications systems, RF, digital, and modem equipment. You'll be working with major UHF command and control systems, satellite relay and telemetry systems and a variety of other challenging long-term projects including advanced mail handling systems.

If your specialty doesn't match exactly:

If you're a creative Electronic Design or R & D engineer, really know the fundamentals of electronics, and are highly flexible, we'd like to hear from you. It may well be that you're the man for us.

ECI is on Florida's West Coast in sunny, cosmopolitan St. Petersburg. If you're interested in a career opportunity on long-term programs in a stimulating environment, write in confidence today to William C. Peterson, Personnel Manager, Electronic Communications, Inc., Box 12248, St. Petersburg, Fla. 33733.

ELECTRONIC COMMUNICATIONS, INC.

A subsidiary of NCR
An equal opportunity employer.

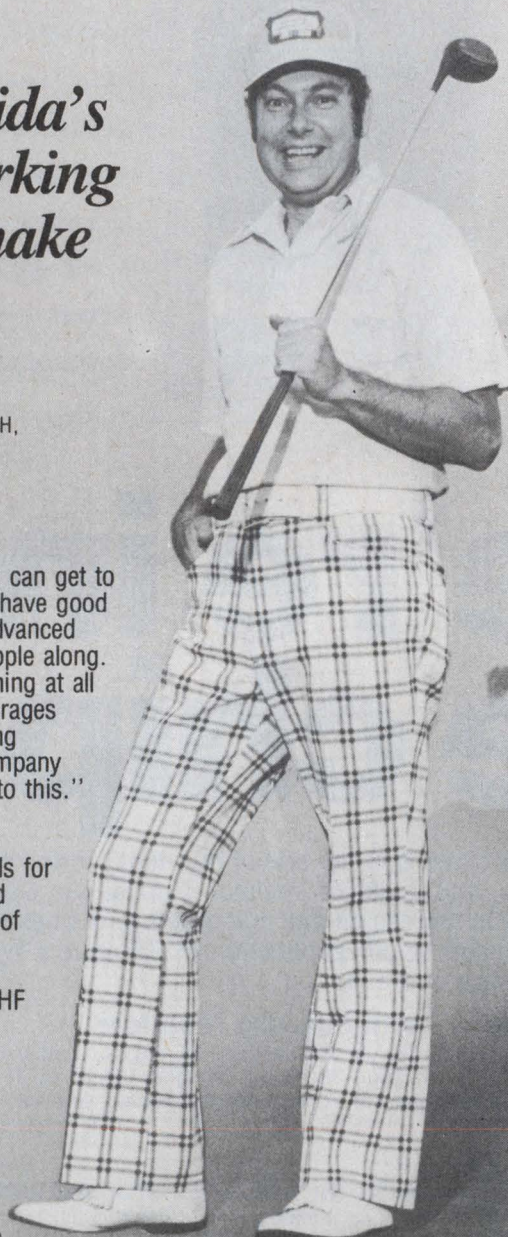

INSTRUMENTATION

Single-pulse analyzer programs with ASCII

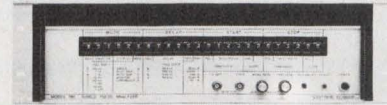

Systron-Donner, Datapulse Div.,
10150 W. Jefferson Blvd., Culver
City, Calif. 90230. (213) 871-0410.
\$14,500; 120 days.

Model 780 Single Pulse Analyzer is a programmable instrument for making digital measurements (time and voltage) on single pulse events or on a particular pulse within a train. Time measurement capabilities include transition time, pulse width, delay between start and stop pulses and delay between programmed thresholds, with resolution to 0.1 ns. Voltage measurements may be made at a programmed point in time with a 1-ns access window.

CIRCLE NO. 306

Slow sweep display memory is flicker free

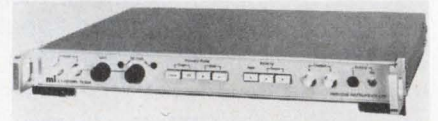

Marconi Instruments, 111 Cedar
Lane, Englewood, N.J. 07631. (201)
567-0607. \$1295; 90 day.

The Model TK2214 digital X-Y memory enables any oscilloscope to present a continuous, flicker-free picture of slow moving repetitive or singly occurring signals, X and Y information from the measuring system is fed into the 2214 where it is digitized and stored in the memory. The output from the memory is then continuously scanned and converted back into analog form together with a coincident X-ramp, which can then be displayed with infinite persistence on a simple display unit. A dual memory mode allows retention and display of half the memory, while displaying the real time characteristics using the other half.

Booth No. 2711-2717

Circle No. 307

Designed for noise and vibration analysis: The only combined 500-line Real-Time Spectrum Analyzer-Averager.

You asked for fastest speed to minimize test time and to generate flicker-free displays.

The new UA-500 operates in real-time to 10 KHz and analyzes up to 100 KHz. It produces 20 displays/sec.

You asked for the best possible resolution so that small peaks can be detected close to large ones . . . no chance to miss important detail.

The new UA-500 gives you 500 of the sharpest analysis filters with our proven 24 dB/octave slope.

You asked to measure digitally with a quickly set marker to prevent errors in reading the spectra and averages.

The new UA-500 gives you a digital reader which calculates the absolute frequency setting of a vertical cursor consisting of a line and a dot. (Digital amplitude display optional.)

You asked to hold past data for comparison of averages before and after changes in the test conditions.

The new UA-500 gives you three memories . . . two in the averager and one in the spectrum analyzer. Spectrum data obtained from any two can be compared on one CRT. Total storage is 2500 digital words.

You asked to see what's being analyzed to verify the quality of the data.

The new UA-500 gives you instantaneous spectra which can be viewed on the same CRT as average . . . input time function can also be displayed on CRT.

You asked for a small portable unit to use in the laboratory or in the field.

The new UA-500 gives you the first combined 500-line Analyzer-Averager . . . one 8 $\frac{3}{4}$ " unit.

Plus other standard features:

Transient capture, exponential and peak averaging, lin-log scales both vertical and horizontal, complete plotter set-up and recording, and computer compatibility with remote sensing or control (optional).

The new UA-500 is the ultimate analysis system . . . the most powerful performance for the lab plus compact size to take into the field. The features you've been asking for are now all in the standard unit at a reasonable price. You can also rent now and buy later.

To save time, write us for our free booklet "11 questions you should ask when buying a real-time spectrum analyzer," or call us for a demonstration at your facility.

We are ready to assist you with your analysis problems. Contact George Lang, Manager Application Engineering.

Federal Scientific Corp. 615 West 131st Street, N.Y., N.Y. 10027

federal scientific

(212) 286-4400 TWX: 710 581 4059

An affiliate of Nicolet Instrument

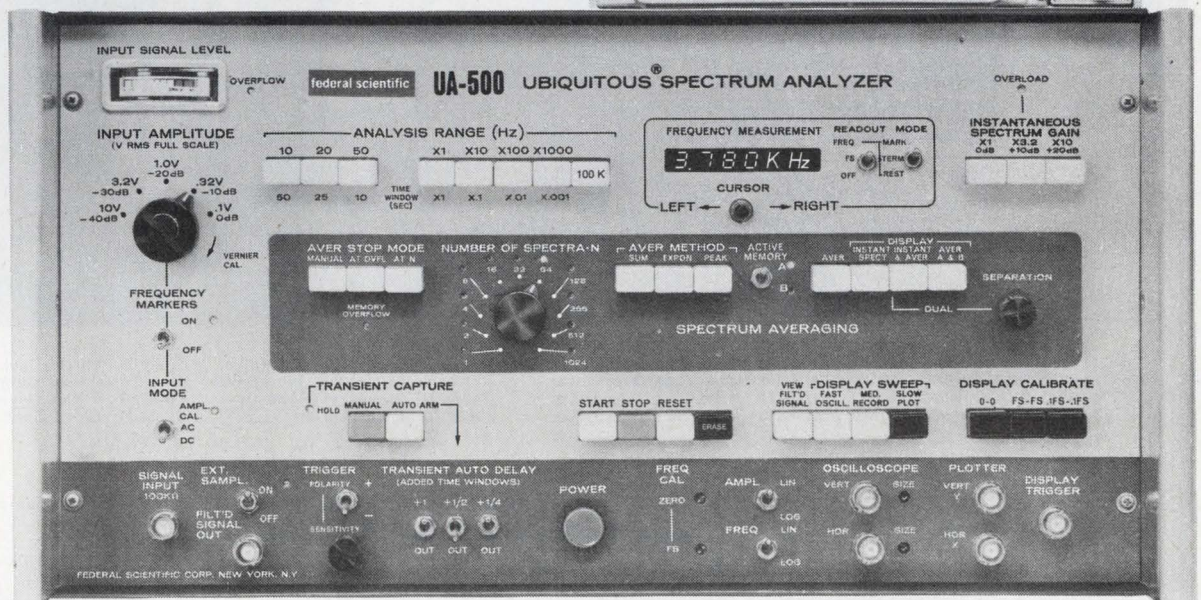
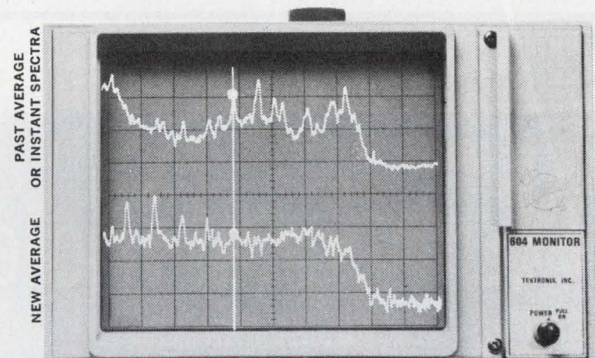

20-MHz pulse generator delivers three outputs

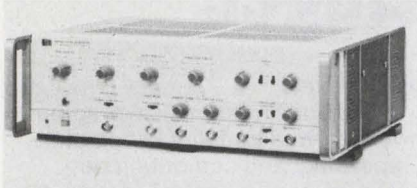

Hewlett-Packard, 1501 Page Mill Rd., Palo Alto, Calif. 94304. (415) 493-1501. \$1165; 9 wk.

Model 8005B 20-MHz pulse generator has simultaneous ± 10 V outputs, ample for HTL, as well as DTL and RTL ICs. The unit also has a separate TTL-compatible output. Compared with its predecessor, the Model 8005A, the new unit is said to cost about the same, but offers twice the pulse rate, twice the output, and three simultaneous outputs. Output source impedance is selectable at 50 Ω or current-source.

CIRCLE NO. 308

Capacitance meter measures at 1 MHz

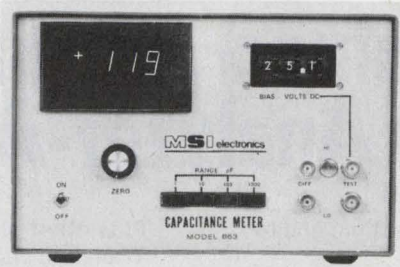

MSI Electronics, 34-32 57th St., Woodside, N.Y. 11377. (212) 672-6500. \$1645; 6 wk.

Model 863 Capacitance Meter has a built-in digital programmable power supply for varactor, p-i-n and other semiconductor junction capacitance measurements under voltage bias. By selecting one of four pushbutton switches, measurements can be made from under 1 pF to 1999 pF at digitally set bias voltages up to 99.9 V. A dc analog voltage proportional to measured capacitance is available on the rear panel. Also available are jacks for applying external bias voltages up to 200 V.

CIRCLE NO. 309

3-1/2-digit DVM handles 10 MHz

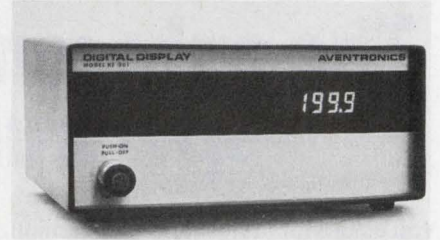

Aventronics, 14545 Keswick St., Van Nuys, Calif. 91405. (213) 994-8161. \$279; 6-8 wks.

Model KE 301 3-1/2-digit DVM indicates 1 to 200 mV and 1 to 200 mA ac or dc. Ac accuracy is 5%, the dc is 0.1%. The instrument features a field-effect liquid-crystal display. An ac-coupled, differential, 1-M Ω input is suitable for digital display of read-back signal amplitude from magnetic recording heads, video monitoring and general ac voltage and current measurements. Frequency range is 10 Hz to 10 MHz. Optionally available are parallel BCD output, external read command and higher voltage ranges.

CIRCLE NO. 310

IC Kyodo Electronic Laboratories Inc.

Numerical Indication Tube Driver

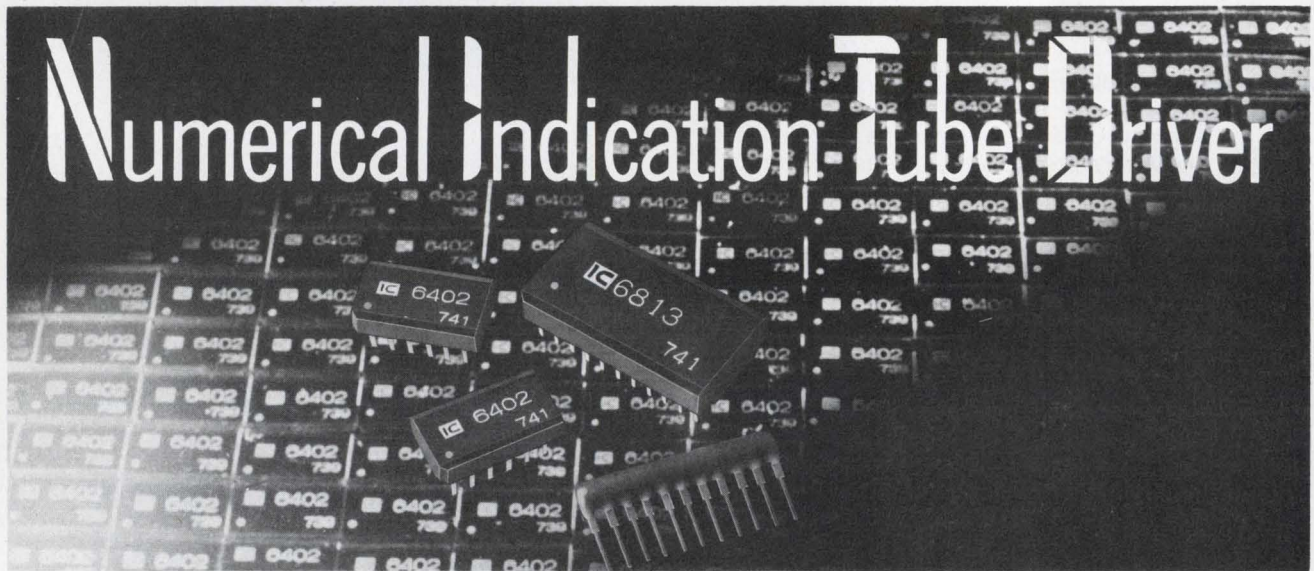

- | | | | |
|-----------------------------------|-----------------------------------|---------------------------------|------------------------------------|
| KB-6400 LED Segment Driver | KH-6288 Nixie Tube Segment Driver | KH-6814 Nixie Tube Digit Driver | KH-6298 Printer Driver |
| KB-6401 LED Digit Driver | KH-6800 Nixie Tube Digit Driver | KM-6608 Fluorescent Tube Driver | KH-6275 Printer Driver |
| KB-6402 LED Digit Driver | KH-6811 Nixie Tube Digit Driver | KM-6609 Fluorescent Tube Driver | KH-6269 Printer Driver |
| KH-6286 Nixie Tube Segment Driver | KH-6813 Nixie Tube Digit Driver | KH-6270 Printer Driver | KB-5404 Clock Generator Dual Phase |

Trademark of Burroughs corporation.

IC KYODO
ELECTRONIC
LABORATORIES INC.

11-18, 2 Chome, Sonan, Sagami-hara-shi,
Kanagawa-ken, Japan
TEL: 0427-42-6731-6
CABLE ADDRESS: KELIC MACHIDA
TELEX: 2872-239 KELIC

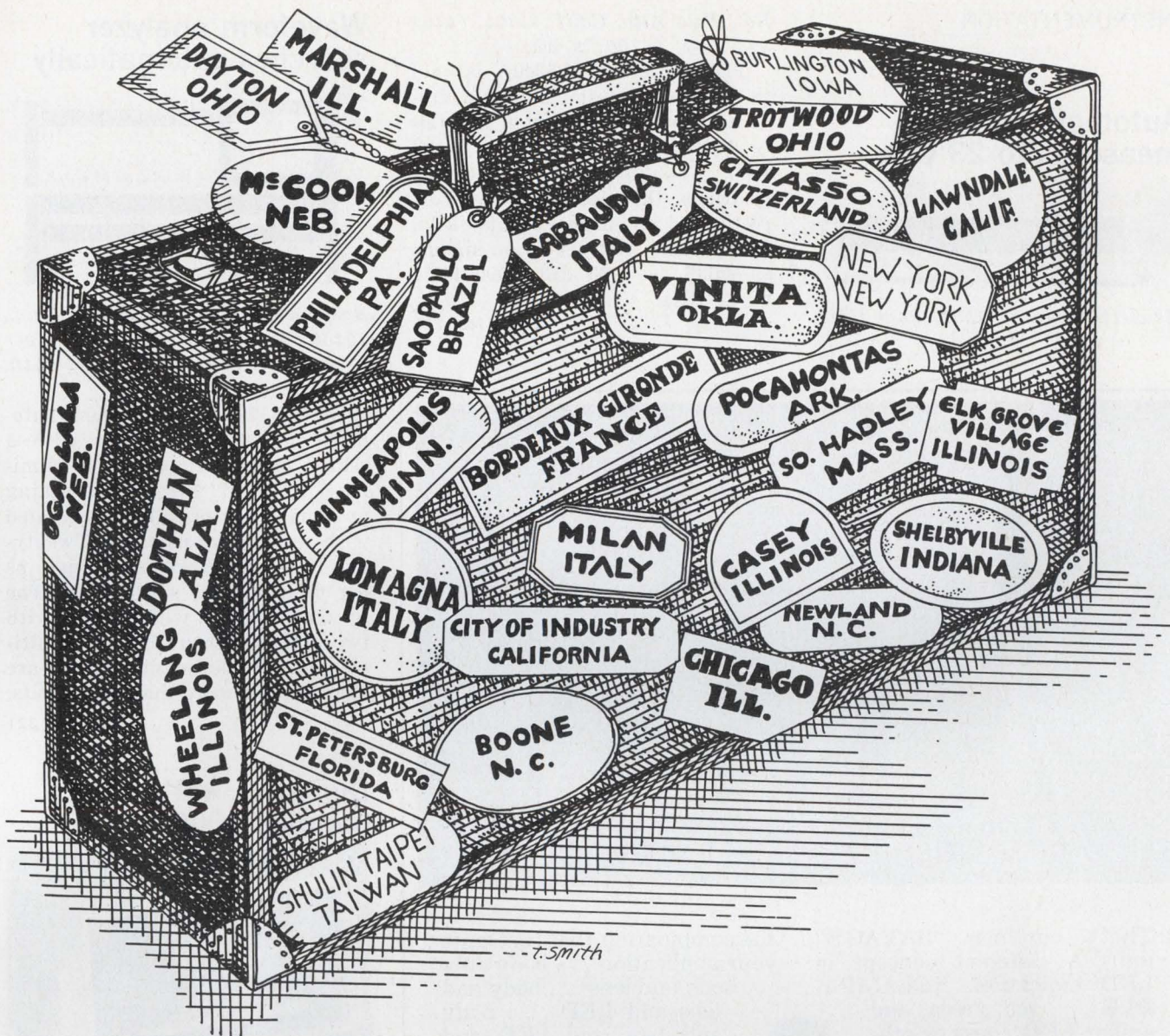

Our plant tour is well worth taking — but pack for a long trip

You'll need a lot of time. Because we cover a lot of territory. TRW Electronic Components has 32 plants in 30 cities in six countries.

And the territory keeps growing.

As one of the few companies capable of producing both high-technology components and high-volume components, we make over 300 different products. For all the major OEMs in all major industries using electronics. With a steadily increasing demand.

And we are often called upon to apply our high-volume manufacturing know-how to state-of-the-art

technology. Which means we can be a source for whatever you need in electronic components. High-technology, high-volume—or both! Maybe we already make what you need. Certainly we can make it. Even if it means building or buying another new plant.

So, while you would surely find our plant tour fascinating, it would be pretty exhausting. By the time you saw the plants we have, we'd probably have new ones for you to see. No telling when it would end.

Because we *are* TRW.

TRW ELECTRONIC COMPONENTS

10880 Wilshire Boulevard, Los Angeles, CA 90024

Connectors • Resistors • Semiconductors • Capacitors • Motors • PC Boards • Potentiometers • Transformers • Coils and Inductors • Wire and Cable

Automatic counter measures to 23 GHz

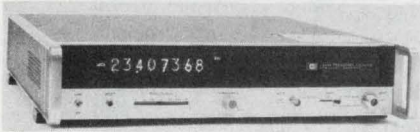

Hewlett-Packard, 1501 Page Mill

Rd., Palo Alto, Calif. 94304. (415) 493-1501. \$6100; 9 wk.

The 23-GHz H10-5340A is said to be the fastest automatic frequency-counter. Operation is totally automatic from 10 Hz to 23 GHz. The unit displays 8 digits, positions the decimal point correctly and annunciates units (kHz, MHz, GHz). It triggers on signals as small as -35 dBm, 500 MHz to 12 GHz.

CIRCLE NO. 320

Waveform analyzer searches automatically

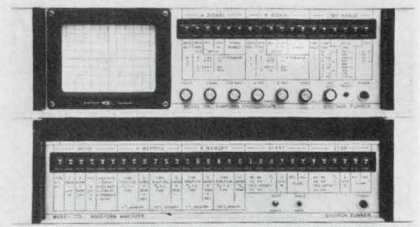

Systron-Donner, Datapulse Div., 10150 W. Jefferson Blvd., Culver City, Calif. 90230. (213) 871-0410. \$14,500; 120 days.

System 770/774 is a new automatic waveform analyzer with a search mode that is said to eliminate most of the signal-seeking problems historically associated with waveform analyzers. Twenty-five time ranges extend from 1 ns per division to 5 s full scale. The System 770/774 will operate with two probes without external multiplexers. Probe multiplexers are available for more than two inputs.

CIRCLE NO. 321

Digital rf wattmeter handles 1000 W



Bird Electronic Corp., 30303 Aurora Rd., Cleveland (Solon), Ohio 44139. (216) 248-1200. \$950; mid-1974.

Model 4371 THRULINE Directional High-Power Wattmeter is said to be the first digital insertion instrument for measuring forward or reflected cw power in coaxial transmission lines. The unit measures power flow under any load condition from 25 to 520 MHz and from 1 to 1000 W in six ranges. Insertion VSWR in 50-Ω systems is 1.1 and accuracy is ±5% OFS. Model 4371 is also said to be the first such unit that the user can calibrate in the field to known rf power standards, eliminating weeks of transit for periodic certifications.

Booth No. 2509 Circle No. 322

3,693 Indicator Lights in 1 LED Package

That's our new "SAVAGE" unit. A different concept in LED indication. RELAMPABLE . . . red, green, and amber LED (ours or others) . . . 2 to 28 volts . . . with or without resistors . . . snap-on flat and domed



Flat



Domed



the combination that best suits your application . . . body only . . . body and lens . . . body and lens and LED . . . body and lens and LED and resistor.

We said inexpensive. 89¢ in 2K quantities WITH red LED, 40¢ without LED. Attack your application with the "SAVAGE" approach. You can't beat our combination. TEST US. Call us, or contact your nearest Sloan Company distributor or representative.

lenses producing 180° visibility. The "SAVAGE" unit offers you an inexpensive nylon-bodied unit that provides push-in panel mounting in a 1/4" hole on 3/8" centers or PC mounting either vertical or horizontal.

Order your "SAVAGE" unit in

1974-1975
eem
Vol. TWO



THE SLOAN CO.

7704 San Fernando Road
Sun Valley, California

Phone: (213) 875-1123 / TWX 910-498-2250

FREE! FAST FACT-FINDER!



New KEMET® Capacitors Condensed Catalog.

We've packed a lot of information on Solid Tantalum, Monolithic Ceramic and Precision Thin-Film Capacitors into the new 1974 KEMET Capacitors Condensed Catalog.

And we've included a handy tabbed index that lets you find the right capacitor fast.

Just flip to the section covering the general category you need, and you'll find condensed tables and neat performance curves to guide your selection.

Save time with the all-new, totally revised KEMET Capacitors Condensed Catalog. Rush coupon for your free copy!

If coupon is missing, just send your request to KEMET Catalog, Union Carbide Components Dept., Box 5928, Greenville, SC 29606.

KEMET is a registered trademark of Union Carbide Corporation

UNION CARBIDE COMPONENTS DEPARTMENT

PO Box 5928, Greenville, SC 29606

I need KEMET® Capacitors data in a hurry.
Please rush me your new Condensed Catalog.

Name _____

Title _____

Company _____

Address _____

City _____ State _____ Zip _____

INFORMATION RETRIEVAL NUMBER 104

New line of 10-in. recorders offered

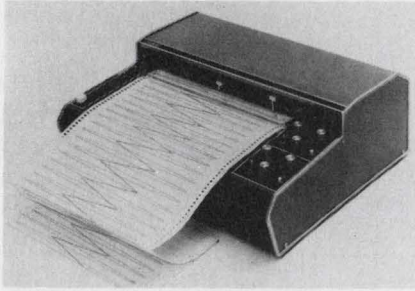

MFE Corp., Keewaydin Dr., Salem, N.H. 03079. (603) 893-1921. Start at \$395.

2100 series of 10-in. strip chart recorders feature: Z fold or roll-chart feed without machine adjustments; single or dual crossover pens; flat bed or 19 x 5-1/4-in. RETMA vertical rack; disposable fiber tip pens in five colors; 1-mV through 10-V spans; electronic off-scale protection; 50 to 400 Hz, 115/230-V switchable power.

CIRCLE NO. 323

Logic checker displays DTL/TTL states

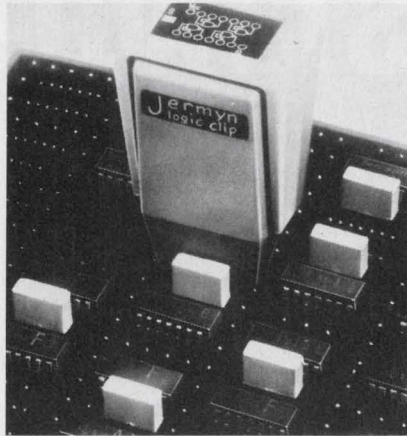

Jermyn, 712 Montgomery St., San Francisco, Calif. 94111. (415) 362-7431. \$85.

The A23-2086 Logic Checker tests the states of DIP ICs, including DTL and TTL, up to 16 pins. Just clip the unit on the DIP and V_{cc} and ground are located automatically. A set of transparent masks, with logic diagrams of 24 ICs, is supplied to fit over the display screen.

CIRCLE NO. 324

Pulse generator delivers 31 kW



Cober Electronics, 7 Gleason Ave., Stamford, Conn. 06902. (203) 327-0003. \$4750; 30 days.

Designated the Model 606, this high-power pulse generator can provide 31 kW of power with pulse widths from 0.05 to 3000 μ s. In addition, the unit provides a 1-MHz rep rate and bursts with pulse-to-pulse spacing as close as 1 μ s. Both negative and positive polarities are available and pulse amplitude can be varied continuously up to a maximum of 2500 V at 12.5 A. Rise time is 20 ns and fall is 30 ns.

CIRCLE NO. 325

The first

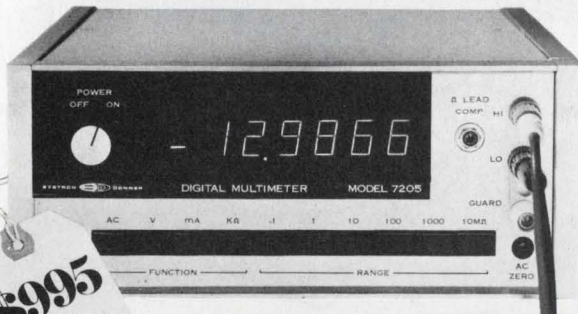

\$995
fully loaded

at this price!

$\pm 1 \mu$ V resolution

5 full functions

26 ranges

Lead-compensated ohms

For immediate information on Systron-Donner's new Model 7205 5 1/2-digit Multimeter, call us collect on our **Quick Reaction** line: (415) 682-6471. Or you may contact your Scientific Devices office or S-D Concord Instruments Division, 10 Systron Drive, Concord, CA 94518. **Europe:** Systron-Donner GmbH, Munich, W. Germany; Systron-Donner Ltd., Leamington Spa, U.K.; Systron-Donner S.A., Paris (Le Port Marly) France. **Australia:** Systron-Donner Pty. Ltd. Melbourne.



INFORMATION RETRIEVAL NUMBER 105

ac, dc, volts, amps, ohms

25 ranges

\$595 complete

5-day delivery

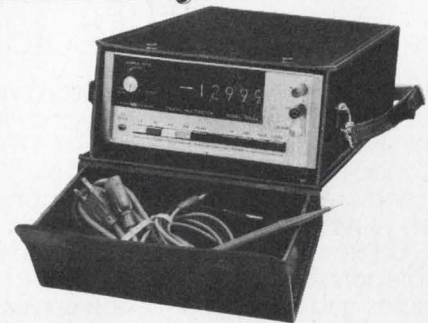

- New expanded AC response to 100 KHz
- New carrying case option
- New color-coded pushbuttons
- Optional battery pack with recharger (\$95) mounts internally
- 0.01% dc accuracy
- 1,000 megohm input impedance on 3 lowest ranges
- lab, field, or systems use.

For Model 7004A literature, contact your Scientific Devices office or Systron-Donner at 10 Systron Drive, Concord, CA 94518. Phone (415) 682-6161. **Europe:** Munich, W-Germany; Leamington Spa, U.K.; Systron-Donner S.A. Paris (Port Marly) France. In **Australia:** Systron-Donner Pty. Ltd. Melbourne.



INFORMATION RETRIEVAL NUMBER 106

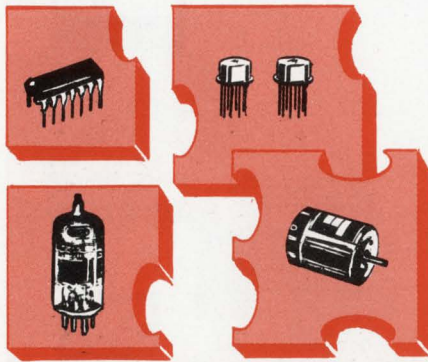

TROUBLE?

finding components
to solve your
design puzzle ...
ADLAKE
has them!



ADLAKE MERCURY WETTED RELAYS

Single side stable or bistable; multiple poles; sensitive form C, D, or K, or neutral form D; millions of trouble-free operations; low, stable contact resistance; plug-in or PC mountings.

ADLAKE MERCURY DISPLACEMENT TIME DELAY RELAYS



Time delays from 0 to 20 minutes; N.O. or N.C. slow "make" and N.O. slow "break" switching. AC and DC operated units, -37 to 200°F operating temperature range. 0.5-15 ampere ratings, non-inductive at 115 volts, 60Hz. Screw terminal or pigtail leads. U.L. listed types.

ADLAKE LOAD RELAYS

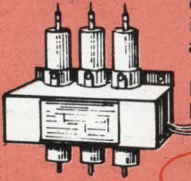

Light, medium, and heavy load switching; up to 3 poles. Screw or pigtail leads. Ratings from 35 to 100 amp, non-inductive at 115 volts 60 Hz. U.L. listed types. All popular coil voltages.

ADLAKE DRY REED RELAYS



1, 2, 3, and 4-pole styles, hermetically sealed precious metal contacts, extended life, magnetic shielding, high operating speeds. Miniature, intermediate and standard sizes.

ADLAKE HYBRID TIMERS



Highly reliable operation handles 35 amp loads. 12, 24, 32, 48 and 115 VAC or VDC inputs. Fast recycle time, fixed or adjustable timing from 100 msec. to 2+ minutes. Wide selection of N.O., N.C., On, Off, Delay, or Instant Close or Open switching.

ADLAKE TRANSFER TIMERS, LATCHES



Transfer timers switch DC input to output with precise delay times. Close tolerance accuracy, wide operating temperature range, quick recycle, 1 amp rating. Pulse latch switches 2 amp (100% duty cycle) "off" and "on." Choice of packages.

Adlake components are ideal interface timing and switching control components for the most modern and complete systems. Fast, stable, and reliable operation are prime features. Dry circuit to heavy current loads, input/output isolation, excellent environmental features, choice of packaging, terminations.

Let ADLAKE
supply the
missing piece!

USE READER SERVICE NUMBER FOR COMPLETE INFORMATION

THE ADAMS & WESTLAKE COMPANY



ELKHART, INDIANA 46514
219 · 264 1141
TELEX 25 8458
CABLE ADLAKE

INSTRUMENTATION

3-1/2-digit DMM senses 10 $\mu\Omega$

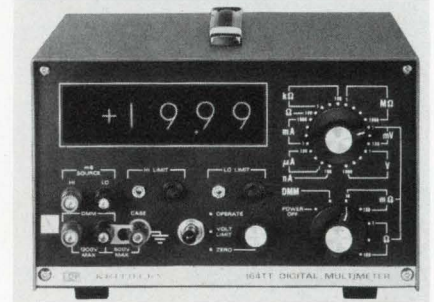

Keithley Instruments, 28775 Aurora Rd., Cleveland, Ohio 44139. (216) 248-0400. \$995.

The 3-1/2-digit Model 164 Digital Multimeter has 28 ranges, including a resistance sensitivity of 10 $\mu\Omega$ to 2000 M Ω , a voltage span of 1 μ V to 1000 V dc, and over-all dc current response of 0.1 nA to 2 A. Other features include an analog output, 1000-V overload protection, 500-V floating capability, 80-dB normal-mode and 120-dB common-mode ac rejection, and 100% overranging on all ranges except the 1000-V.

CIRCLE NO. 326

Power monitors read from 1 μ W to 100 mW

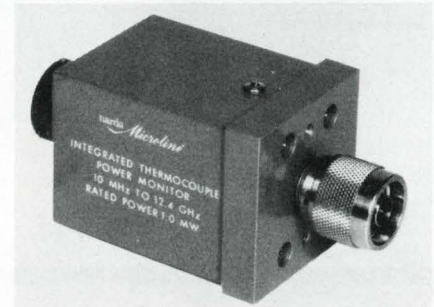

Narda Microwave, Plainview, N.Y. 11803. (516) 433-9000. From \$225.

The 460 series of broadband 20 and 30 dB integrated thermocouple power monitors cover the frequency range of 10 MHz to 12.4 GHz. They provide power measurements from 1 μ W to 100 mW. These monitors utilize a thermocouple sensing element and operational amplifier to provide a high level dc output. With slight changes in external wiring these monitors can perform as either constant voltage or constant current sources.

Booth No. 2426, 2428, 2430

Circle No. 327

INTRODUCING THE TWO-FACED SWITCH

EECO introduces the Stripswitch™—a versatile, low cost printed circuit switch that's available in strips of one to eleven stations, for ease of handling and installation.

Because it's two-faced, you can mount

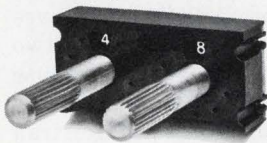

it either horizontally or vertically.

And you can wave-solder it directly to the printed circuit board.

Saves you money

Stripswitch is inexpensive to begin with—less than \$1 per station in quantity.

And, because you can wave-solder it directly to the printed circuit board, the need for rivetting, eyeletting, mounting hardware, switch-to-board wiring or expensive special plating is normally eliminated.

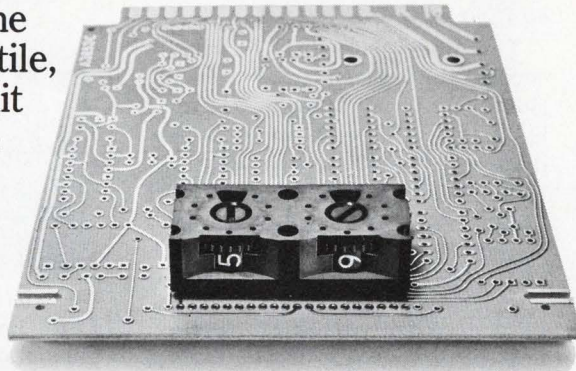

Actuates three ways

You can actuate Stripswitch by means of

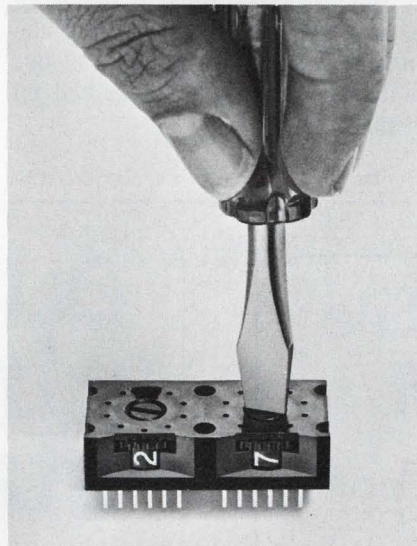

knurled wheels. Or, if you mount it behind a panel, you can actuate Stripswitch by means of a screwdriver or shaft

extension and knobs.

Guaranteed rugged

The Stripswitch is a simple, rugged design available in a variety of

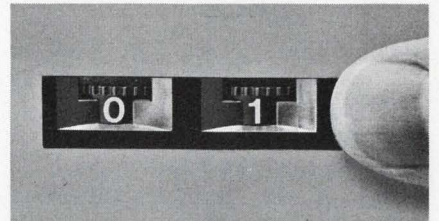

codes and switching functions, backed by an exclusive two-year warranty. And it's constructed from materials that can withstand caustic cleaning solutions.

That's the straightforward story of our two-faced switch.

For more information write to Electronic Engineering Company of California, 1441 East Chestnut Ave., Santa Ana, California 92701. Or phone (714) 835-6000.

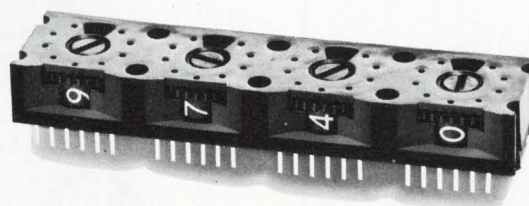

Stripswitch by EECO

Distributed by Schweber, Hall • Mark and G.S. Marshall

INFORMATION RETRIEVAL NUMBER T09

Controller fits most printers to PDP-11 minis

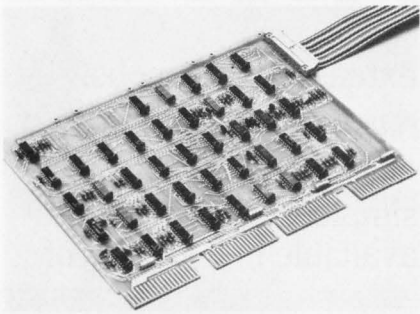

MDB Systems, Inc., 981 N. Main St., Orange, Calif. 92667. (714) 639-7238. From \$450; stock.

According to the manufacturer, the controller interfaces most makes of line printer to PDP-11 minicomputers. The single unit handles buffered and unbuffered types. The controller is fully software compatible with Digital Equipment's LP-11 and LS-11 line-printer products. No changes are necessary for operation or programming. The price includes the cables.

CIRCLE NO. 328

Hardcopy recorder works with graphics terminals

Alden Electronic & Impulse Recording Equipment Co., Alden Research Center, Westboro, Mass. 01581. (617) 366-8851. See text; 60 days.

The Model 600 Push-to-Print recorder—interfaced to a conversational terminal—provides graphic hardcopy at a rate of 1800 scan lines/min. The pictures cost less than 2¢/frame and require no toners, developers or other processing. The self-contained recorder makes an ideal companion to terminals that use bistable storage tubes. TV or CRT-type terminals require an additional scan-converter to interface with the Model 600. The facsimile-type recorder advances the paper at a rate of 18 in/min which is the equivalent of 90 data lines/min. A standard 200-ft roll of Alfax type A recording paper will provide up to 400 images. Unit price is \$2500; multiple orders will be quoted on request.

Booth No. 2418

Circle No. 329

Microcode add-on ups Fortran execution rate

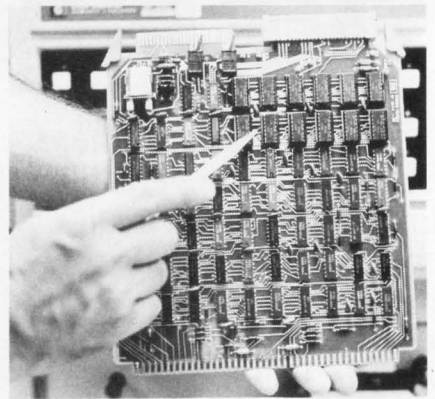

Hewlett-Packard, 1501 Page Mill Rd., Palo Alto, Calif. 94304. (415) 493-1501. \$1250; stock.

A Fortran processor package designated the 12907A improves execution time by factors of two to 28. The plug-in package for use with the HP-2100 minis implements 12 most-often used Fortran subroutines in microcode. A subroutine call to the program library places the call in appropriate microcode. This frees approximately 700 words of main memory.

CIRCLE NO. 330

Buy the Ballantine 3/24 DMM

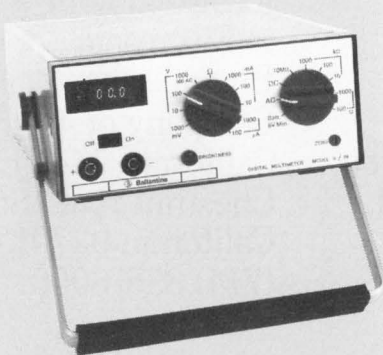

24 Ranges — 3 Full Digits

- AC Volts, AC Current, Ohms, DC Volts, DC Current
- Fully Overload Protected
- 300 Hour Dependable Battery Life
- Pocket Size — Weighs Under 2 Pounds
- 0.2% DC Accuracy — AC to 20 kHz

Available from Stock
Factory/Distributor

\$195

complete



Ballantine Laboratories, Inc.

P.O. Box 97, Boonton, New Jersey 07005
201-335-0900, TWX 710-987-8380

INFORMATION RETRIEVAL NUMBER 110

automatic transfer standards

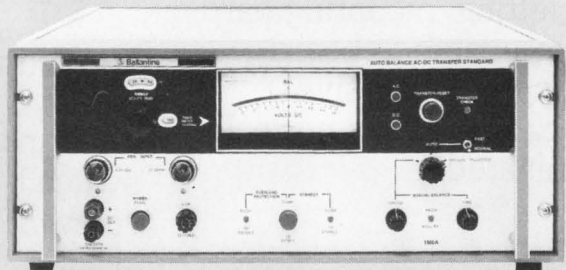

The 1600A Auto-Balance AC/DC Transfer Standard. Precise repeatable measurements every 30 seconds. Traceable to NBS. Takes tedium and guesswork out of 100 ppm transfer measurements in Lab, QA and production.

0.25 V to 1 kV rms, dc to > 100MHz: **\$3950**



Ballantine Laboratories, Inc.

P.O. Box 97, Boonton, New Jersey 07005
201-335-0900, TWX 710-987-8380

INFORMATION RETRIEVAL NUMBER 111

ELECTRONIC DESIGN 6, March 15, 1974

If you've been looking for a miniature crystal-controlled clock oscillator in a 14 pin DIP package to fit standard PC board sockets, stop looking and start ordering. Get details on model K1091A from Motorola Component Products Dept. 2553 No. Edgington Franklin Park, Ill. 60131



MOTOROLA

INFORMATION RETRIEVAL NUMBER 112

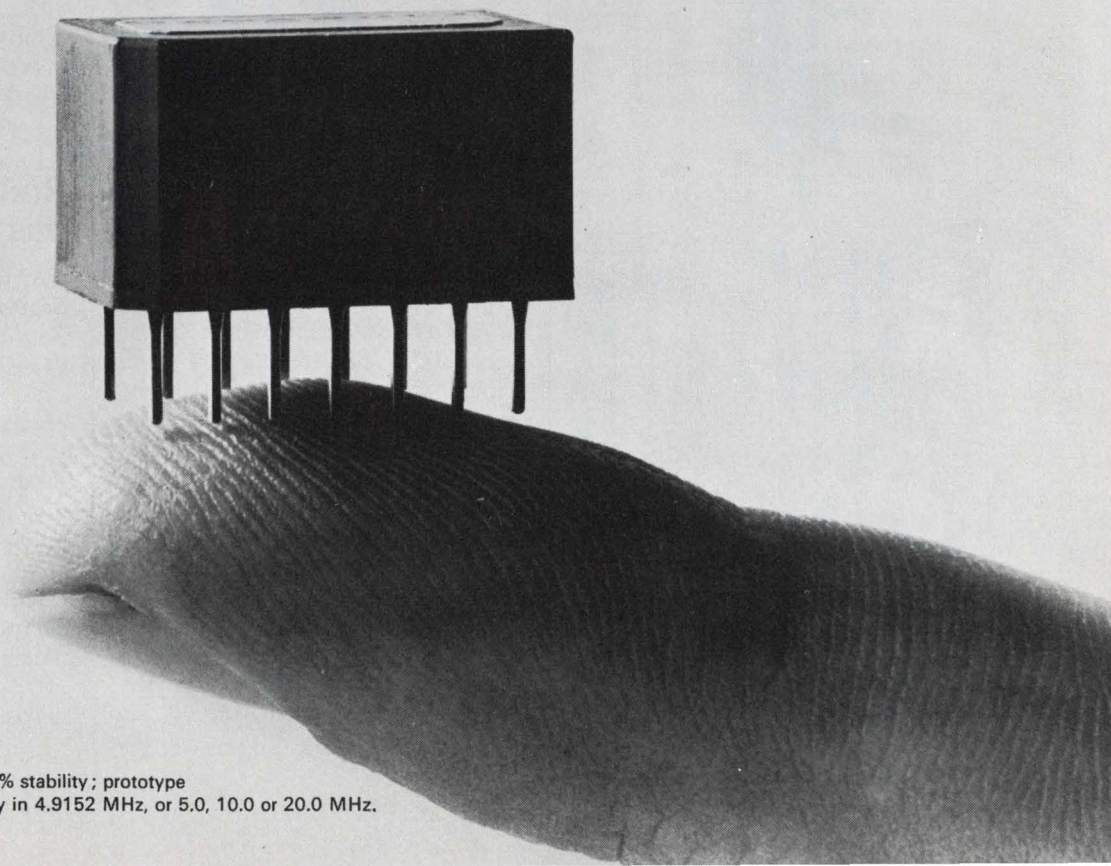

Specifications: 4 to 20 MHz range; 0.01% stability; prototype quantities available for immediate delivery in 4.9152 MHz, or 5.0, 10.0 or 20.0 MHz.

The game of PCB insertion/extraction is a common one with headaches like stubborn connectors and damaging stresses and strains.

Card insertions and extractions are made safer and easier with simple, lever action CARD-O-PULLS™ that are designed for 1/16" and 3/32" thick PCBs and for most card support systems. No special tools are needed.

Nylon CARD-O-PULLS are available from stock in 8 styles, including locking versions to prevent accidental releases, and can be color coded and/or permanently marked for identification on a custom basis.

Details, pricing and specific samples on request.

BIVAR, Inc. 1500 South Lyon Street, Santa Ana, California 92705. Phone (714) 547-5832

push,
Pull &
LOCK

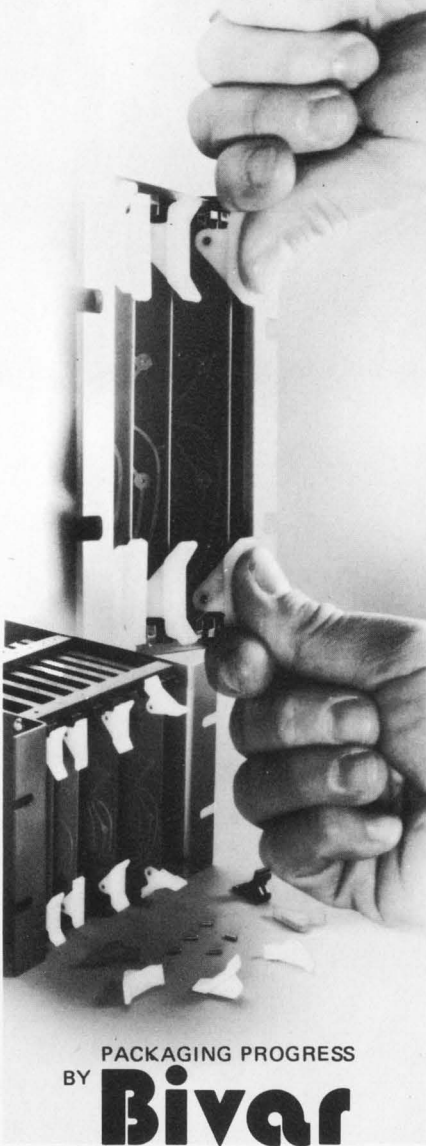

PACKAGING PROGRESS
BY
Bivar

INFORMATION RETRIEVAL NUMBER 113

DATA PROCESSING

Speedy array processor is also programmable

Culler Harrison, Inc., 150 A Aero Camino, Goleta, Calif. 93017. (805) 968-1813.

The AP-120 is a microprogrammable array and arithmetic processor. Sixteen bits are used for fixed-point and 32 bits for floating-point computations. Easily interfaced to a host computer, the unit executes all operations at an 8-MHz rate. In the arithmetic mode, the AP-120 can add or subtract in 375 ns and multiply in 625 ns. As an array processor, the unit performs FFT computations at real sampling rates of 250 kHz. Pre-programmed algorithms are furnished in ROMs or special algorithms can be added to the system.

CIRCLE NO. 331

Printer/plotters come in 8.5 and 11-in. widths

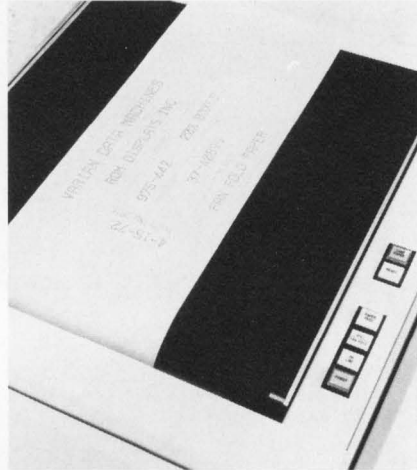

Varian Data Machines, 2722 Michelson Dr., Irvine, Calif. 92664. (714) 833-2400. See text; stock.

Two additions to the Statos 31 printer/plotter line provides 8.5-in. and 11-in. output widths. These electrostatic printer/plotters complement the company's 14-7/8-in. unit. The 8.5-in. unit offers an 80-column, 64 character dot matrix (5 × 7) output for printing at speeds to 1000 line/min. For plotting the paper speed is 2.75-in/s. The 11-in. model has a 120-character, 132-column output dot matrix (7 × 11) output with speeds to 1000 line/min. The plotting speed is 2.2 in/s. Prices for the systems range from \$7000 to \$8000.

CIRCLE NO. 332

Magnetic cards extend calculator applications

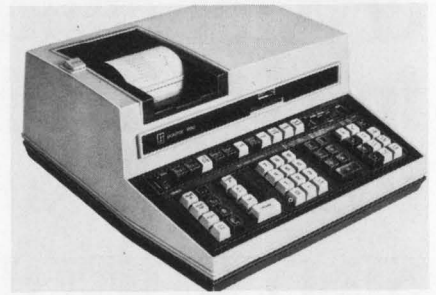

Litton Monroe, 550 Central Ave., Orange, N.J. 07051. (201) 673-6600.

Both Models 1860 and 1880 programmable calculators have a built-in card reader/writer that can input or record programs or data on magnetic cards. The units have an I/O capability that permits direct connection to a variety of peripheral equipment and data acquisition devices. The Model 1860 is designed for statistical applications and offers single-stroke generation of statistical functions such as three-variable linear regression. The 1880, designed for scientific use, has single-stroke keys for trigonometric and hyperbolic functions. Both machines provide computer-like power that includes subroutines and branch points. The desk-top computers have 74 data storage registers which are expandable to 522, provide printout capability and have a minimum of 512 program steps—expandable to 3072 in 512-step increments. And Monroe offers a wide variety of prerecorded applications programs.

Booth No. 2503, 2505, 2507

Circle No. 333

Budget-priced calculator has 9-digit capacity

NS Electronics, Div. of National Semiconductor, 2921 Copper Rd., Santa Clara, Calif. 95051. (408) 245-8956. \$39.95.

A 9-digit LED display plus chain calculation are features of the NS900 calculator. Like its predecessor the NS600 (6-digit display), the NS900 has an automatic shut-off feature that increases battery life. Both units do calculations with fixed two-place decimal. The semiconductor complement consists of a National MOS calculator chip, a bipolar driver chip and the LED display.

CIRCLE NO. 334



If you're into control applications, We'll give you one-million good reasons to spend 19¢.

Here they are. MA47110s, MA47111s and MA47120s. Hermetically sealed glass packaged PIN diodes from Microwave Associates. 19¢ apiece in quantities of 1,000,000.

These rugged, application-oriented diodes are designed for use as switches and current controlled attenuators in constant impedance AGC circuits, such as those found in CATV and other communications systems. But the MA47111 gives you even lower intermodulation products than the MA47110.

The MA47120 is what you're looking for if you work with modulating circuits and matrix switching at frequencies as low as 1 MHz.

And all three of them give you uniformity and

repeatable performance. Even under extreme environmental conditions.

That means they're ideally suited for control applications. Like RF switching, limiting, duplexing, phase shifting, variable attenuation, modulation and pulse forming.

If you have a prototype to test, we'll be glad to send you some free samples. Because we're sure you'll be more than satisfied with what you can get for 19¢.

Microwave Associates, Inc., Northwest Industrial Park, Burlington, Mass. 01803, 617-272-3000; Dunstable Woodside Estate, Dunstable, Beds., United Kingdom, Tel: Dunstable 601441.



**MICROWAVE
ASSOCIATES**



It's logical

Panasonic's new R-relay makes a lot of sense. It's the smallest reed-type relay you can buy with a latching function (memory). And it's available in a form C (SPDT) contact closure.

When we set out to build our logical relay, we decided not to refine old ideas. Instead we invented (and patented) a relay of revolutionary design and construction with features no other relay has. We used an easily manufactured plastic bobbin instead of the expensive glass capsule used in every other reed relay. We included a barium ferrite permanent magnet to provide latching (logic) function. And we molded it together in one piece of hermetically sealed heat-resistant epoxy resin that occupies less than one-sixth of a cubic inch. Our relay

has a mechanical life of over a billion operations performed as rapidly as 500 Hz. It operates with an extraordinarily wide range of currents—from a few microamps up to a full amp. It's even available in a two-coil bi-stable configuration.

Do you need to mount a relay on a circuit board with a high parts density? Do you need a relay that needs no maintenance over an extra long life? One with higher sensitivity in low power semiconductor circuits? Or one that can withstand currents up to a full amp? Perhaps you need a relay with negligible contact bounce, rapid response, and high operational frequency. If you do, send for more information about Panasonic's unique R-relay. It's the logical thing to do.

**Matsushita Electric Corp. of America
Industrial Division**
200 Park Avenue, N.Y., N.Y. 10017
Telephone: (212) 973-8210

Attn: Tom Gottlick
 Please send R-relay literature.
 Please have an engineer call.

Name _____ Title _____
 Company _____
 Address _____
 City _____ State _____ Zip _____

Panasonic

our technology is all around you

INFORMATION RETRIEVAL NUMBER 115

Try it first. Send for a free sample.

Tempilabel^o

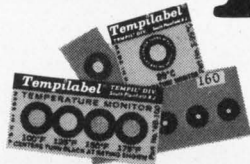

Temperature Indicating Labels

The center spot on a Tempilabel^o turns black when the surface to which it is affixed reaches the specified temperature (from 100° to 600°F).

Tempilabels^o are available with single spots, or with multiple spots for monitoring safe operating temperatures. They provide permanent temperature records, and are thus useful in designing components and selecting materials.

If you are not now using Tempilabels^o, fill in the coupon. We'll be glad to send you a sample that you can try in your own plant or laboratory.

Tempilabel^o

Division, Big Three Industries, Inc.
Hamilton Blvd., South Plainfield, N.J. 07080
Phone: 201 • 757-8300 • Telex: 138662

Send sample of Tempilabel^o.
For use at _____ ° temperature.

Name _____
 Title _____
 Company _____
 Street _____ City _____
 State _____ Zip _____

Can you spot your limitations?

INFORMATION RETRIEVAL NUMBER 116

DATA PROCESSING

Voice band modems operate at 2400 baud

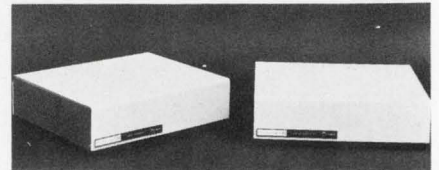

Sperry Rand Corp., 322 N. 2200 W., Salt Lake City, Utah 84116. (801) 328-8066. See text.

Both the U-201 and U-202 are voice band modems. The U-201, priced at \$1720, provides synchronous transmission at 2400 baud over unconditioned lines. The U-202 operates at speeds up to 1200 baud on unconditioned lines and is priced at \$1200. Both modems offer loop test, auto answer and full or half-duplex operation.

CIRCLE NO. 335

Dot-matrix printer has comb mechanism

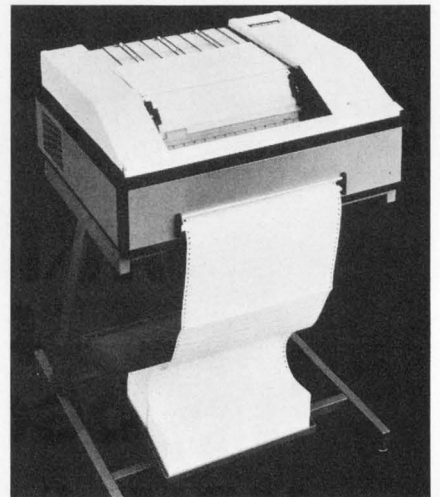

Hewlett Packard, 1501 Page Mill Rd., Palo Alto, Calif. 94304. (415) 493-1501. \$7950.

The HP 12987A dot-matrix printer operates at 200 line/min and prints 132-column lines. A movable 132-tine comb indexes to five positions for each of seven vertical paper steps to provide 5 × 7 dot-matrix characters. The 64-character set is standard. A 128-character set is optional (\$500), and reduces the print speed to 165 lines/min. The printers interface with the HP 2100 series mini-computers. The sales price includes the printer, stand, interface card and cable, software and documentation.

CIRCLE NO. 336

New 1/4" square cermet... a spec-tacular, low-cost trimmer from TRW/IRC Potentiometers



Background units shown actual size.

With specs you'd only expect in a military-approved trimmer, yet at a price that's definitely low-cost industrial—that's the spec-tacular new line of 1/4" square cermet now in stock at distributors of TRW/IRC Potentiometers.

The space-saving 180 series of single-turn trimmers features a sealed polyester case that meets the stringent leak test of MIL-R-22097. The exclusive Metal Glaze® element and low-noise brush wiper also conform to the rotational and load life requirements of the same specification.

Three solder-plated pin configurations for PC board mounting offer a choice of top or side adjustment. All are available in 13 standard resistance values from 100 ohms to 1 Megohm at $\pm 10\%$ tolerance. Temperature operating range is -55°C. to $+155^{\circ}\text{C.}$, with a power rating of 0.5 watt at 70°C.

For prompt delivery, call toll-free (800) 645-9201 for the name of the distributor in your area. Complete data on the full product range is available from your distributor or TRW/IRC Potentiometers, 2801—72nd St., N., St. Petersburg, FL 33733. Ph. (813) 347-2181.

TRW IRC POTENTIOMETERS

INFORMATION RETRIEVAL NUMBER 117

PUT
OUR CMOS
STAR IN
YOUR SHOW

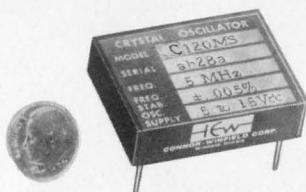

CONNOR-WINFIELD'S CMOS Oscillator

Frequency:

Available at any fixed frequency, .001 Hz to 10 MHz.

Frequency Tolerance:

(accuracy + stability)

16 different combinations of tolerance and temperature range ranging from $\pm 0.001\%$, $+20^\circ\text{C}$ to $+40^\circ\text{C}$, to $\pm 0.05\%$, -55°C to $+125^\circ\text{C}$.

Supply Voltage:

Any supply voltage from 4 Vdc to 15 Vdc, with supply current from .2 ma to 13 ma, depending on supply voltage.

Output Waveform:

Square wave.
Rise time 50 ns nominal.

Output Amplitude:

from 2.6 Vpp to 12 Vpp into a 2 K Ω load, or
from 3.6 Vpp to 18 Vpp into a 10 K Ω load, depending on supply voltage.

Termination:

.03" diameter gold plated pins.

Dimensions:

1.6" L x 1.2" W x 0.4" H.

Delivery:

Stock to 4 weeks.

CONNOR-WINFIELD CORP.



West Chicago,
Illinois 60185
Phone: (312) 231-5270

INFORMATION RETRIEVAL NUMBER 118

202

DATA PROCESSING

Pass key initiates 28-bit code from reader

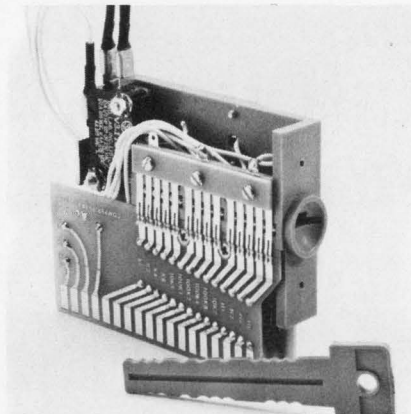

Facit-Addo, Inc., 501 Winsor Dr., Secaucus, N.J. 07094. (201) 866-5111. \$59.50; stock.

The KR-107 key reader assembly prevents improper entry through pre-coding of the activating key. The plastic key, when inserted into the reader assembly, initiates operation. The reader provides up to 28 information bits arranged in BCD code. The KR-107 can be mounted either vertically or horizontally, and requires only two connectors—one 15-pin and one 18-pin.

CIRCLE NO. 337

Card reader mimics paper tape inputs

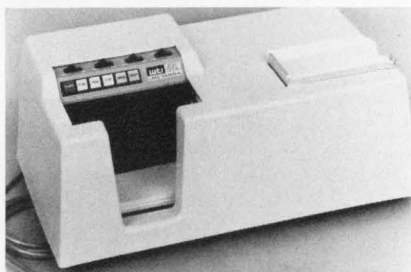

Western Telematic, Inc., 3001 Red Hill, Building 5-107, Costa Mesa, Calif. 92626. (714) 979-0363. \$3550-\$4175; 6 wk.

Use of the CT series punched card terminals converts printer-style terminals to remote job entry stations. The card terminals are interposed between the dataset and user terminal. The CPU then reads the cards in a similar manner to punched tapes. The card terminal converts Hollerith code to ASCII or "2741-Selectric" codes at rates up to 30 char/s. The units permit unattended reading of up to 500 cards.

CIRCLE NO. 338

Calculator versatility enhanced with plotter



Tektronix, Inc., P.O. Box 500, Beaverton, Ore. 97005. (503) 644-0161. \$2550; April.

The Model 4661 incremental X-Y plotter attaches to members of the Tektronix 21 or 31 calculator family. The unit completes a full size plot (10.24 in. x 15.36 in.) in less than a second. Plotter accuracy is specified as ± 0.0025 -in. and $\pm 0.4\%$ of vector length. The plotter attains 15 to 22 in/s velocity in 100 ms. Precomputation of X and Y speeds eliminates overshoots or wavy lines. Additional features include buffered data input and front-panel selection of full or half-scale plots. The package price also includes software, five pens, a supply of paper and the necessary interconnecting cables.

CIRCLE NO. 339

Computers feature MOS or core to 256-k words

Varian Data Machines, 2722 Michelson Dr., Irvine, Calif. 92664. (714) 833-2400.

The V-72 and V-74 10-bit computers have core/MOS memory expansion capability to 256-k words and feature a microprogrammable CPU. The V-72, smallest of the series, is designed for dedicated applications. The 660 ns core memory is expandable from 8-k to 32-k words. Standard features include a bootstrap loader, multiply/divide and memory protect. Optional features include memory expansion and map to 256-k words and writable control store. MOS memory is not available for the V-72. The V-74, largest of the series, accommodates 330 ns MOS and 660 ns core memory in any combination from 32-k to 256-k words. Standard features include dual-port memory access (for processor sharing), priority memory access and writable control store. The V-74 uses firmware to enhance throughput for Fortran programming.

CIRCLE NO. 340

Front panel components should look good.

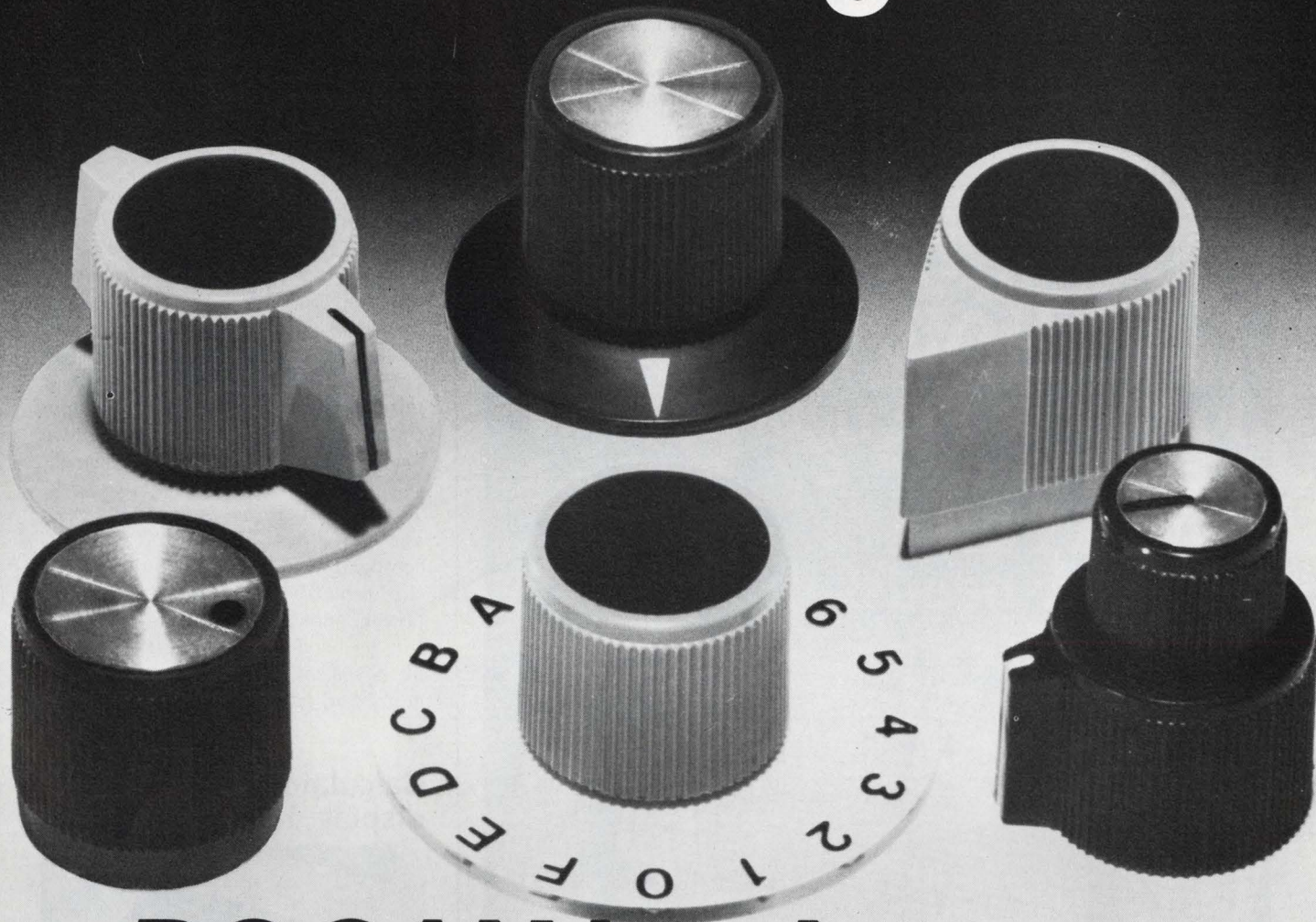

ROGAN knobs and dials do.

Today's market is aesthetics-conscious. An attractive front panel adds to the acceptance of your product. Front panel components, including control knobs and dials, must contribute to the overall design. Some knobs and dials simply look better than others. We think that the Rogan line illustrates superior styling details, while offering the largest selection of functional shapes and sizes available. Obtain a copy of our catalog by contacting Rogan... the control knob and custom dial company.

ROGAN
CORPORATION

3455 Woodhead Drive, Northbrook, Illinois 60062
Phone: (312) 498-2300 · TWX: 910-686-0008

Minicomputer ignores environmental stress

Sanders Associates, Inc., Computer Systems Dept., 95 Canal St., Nashua, N.H. 03060. (603) 885-2817. See text.

High-speed processing in severe environments are what distinguish the MIP-16 minicomputer. The

CPU features a 5-MHz instruction rate plus microprogram control. The complete computer for severe environments requires as little as 70 in³, operates over a base-plate temperature range of -55 to 105 C, and withstands 10 g vibration levels. The CPU alone is packaged on two 5 x 7-in. cards. With 8-k core an industrial version costs \$15,000; the severe-environment version costs \$30,000.

CIRCLE NO. 341

Cassette recorder can also replace paper tapes



Memodyne Corp., 369 Elliot St., Newton Upper Falls, Mass. 02164. (617) 527-6600. \$898; 2-4 wk.

The Model 333 cassette recorder accepts parallel 7 or 8-bit asynchronous data. The data are stored in a two-track format and read out—in 8-bit parallel form—at a minimum rate of 50 char/s. Functional features include automatic load, forward/backward search, fast rewind and input data check. The 333 operates on any dc voltage from 5 to 12 V and is TTL compatible. CMOS logis used throughout the unit minimizes power consumption. The recorder can be used for customary storage purposes or as a direct replacement for paper tape.

CIRCLE NO. 342

Calculators print or display 14 digit results



Monroe, 550 Central Ave., Orange, N.J. 07051. (201) 673-6600. 1305: \$395; 410: \$245.

A printing calculator with 14-digit capacity, the model 1305, features three working registers, automatic round-off and punctuation for the integer portion of the answer. The unit prints answers at 2.5 lines/s and automatically double-spaces for subtotals and totals. A companion unit, the 410, provides a silent planar display. The 410 displays 14-digits but calculates with 24. Both machines provide the standard four functions, and floating or fixed-point computations.

CIRCLE NO. 343

Here's HOW to choose the right ROTARY SWITCH for your needs!

FREE!
11" x 17" WALL CHART

ELECTRO SWITCH CORP.
Weymouth, Massachusetts 02188
Telephone: 617/335/5200 TWX: 710/388/0377

With this handy new guide, you can cross-check over 50 basic specifications against each of our 15 switch "families". In just a few minutes, you can narrow your applications down to a few possibilities...save hours of catalog search and research! Covers our Rotary Switch lines from 10A-240V to 200A-600V. Send for your free copy today.



ELECTRO SWITCH CORP.

Weymouth, Massachusetts 02188

Telephone: 617/335/5200 TWX: 710/388/0377

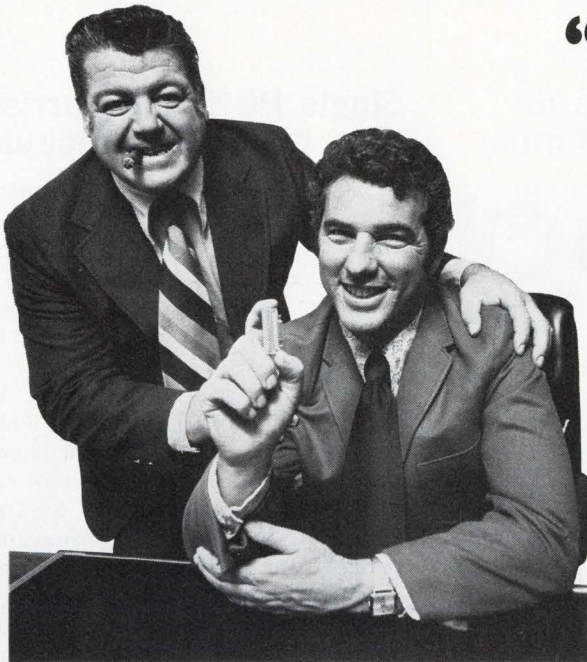

“CANNON[®] MICROMINIATURE CONNECTOR CAPABILITIES GOT US OUT OF OUR BOX, and me into a corner office.”

**“We’ll hard wire it, said they.
‘You’re out of your mind,’
said I.”**

“Our design engineers had really boxed us in. They had stuffed so many goodies into our computer memory that there was no space left for a connector—or so they thought. Until I brought up Cannon’s custom miniature connector assemblies. They balked.

**“So we’ll make our own
microminiatures, said they.
‘Brain surgery self-taught,’
said I.”**

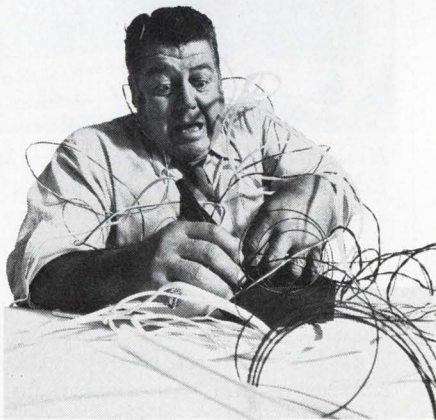

“I laid our tough reliability requirement on them. And

reminded them how tough it was to connect those superfine wires in a small area—much less trying to repair them. I finished them off by saying that no solder joint is as reliable as Cannon twist-pin* contacts.

**“Cannon connected—and we
all got what we wanted.”**

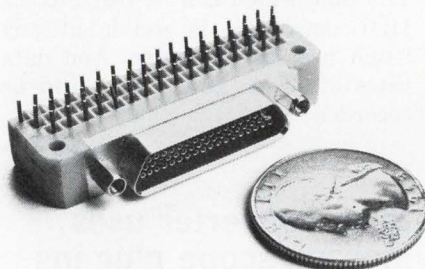

“It’s not our bag, I told them. We’ll have to buy the wire, set up the line, train the labor, set up quality control—it’ll end up costing us a bundle. Better we let Cannon do it all. They can deliver up to 1600 twist-pin contacts per square inch on 25 mil centers. As for reliability—well, if Cannon can put a microminiature connector on the moon, they ought to be able to put one in our box. “Cannon came through in

just four weeks on our prototype order. Our company got the performance—and price—it wanted, and I got a rather posh corner office. Worked out extraordinarily well all around.

“Find out how I did it by sending today for this unflappable guide to everything you need to know... about everything.”

ITT Cannon Electric, International Telephone and Telegraph Corporation, 666 East Dyer Road, Santa Ana, CA 92702. Or call (714) 557-4700.

**“Get the secrets of my
success—free.”**

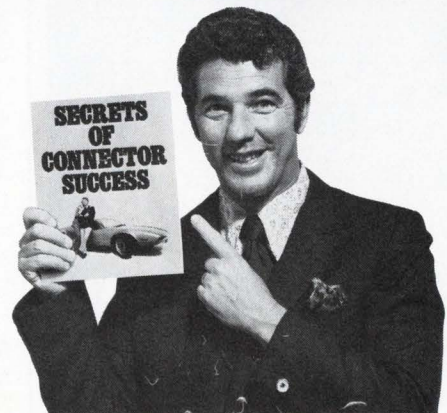

*Licensed by New Twist

CANNON ITT



specialist or general practitioner?

Specialist, of course... in the art of reducing or eliminating unwanted, troublesome signals from electronic circuits. Rtron specializes in the design and manufacture of RFI/EMI filters to cure virtually every electronic interference problem. UL Recognized data processing filters, MIL-F-15733 types and filters for every industrial application are readily available... from stock to custom designed, tubular, rectangular or bathtub types, in single or multi-circuit units.

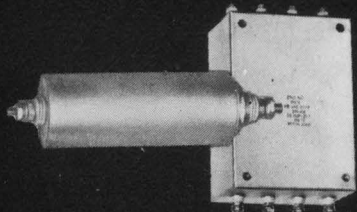

If you like our specialist, you'll like our treatment... phone or write...

Rtron

Dept. ED-3

P.O. Box 743 Skokie, Illinois 60076
Phone 312 • 679-7180

INFORMATION RETRIEVAL NUMBER 122

DATA PROCESSING

System logs data in IBM-compatible format

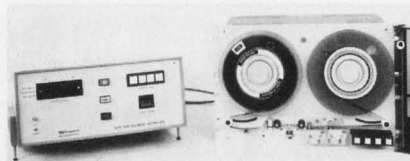

Whittaker Corp., Space Sciences Div., 335 Bear Hill Rd., Waltham, Mass. 02154. (617) 890-5100.

The interface and controller combines data to be recorded with status information such as experiment code, real-time clock, and counters, and places them in a preformatted fashion on computer tape. The system controls the writing of the tape recorder; the desired status information is specified by the user. The input sample can be written on tape synchronously at predetermined increments of time or asynchronously. The operator can run and stop the recorder at will and can abort selected portions of data if problems occur. An inter-record gap is placed on tape after a predetermined number of sample points. The tape which can be 7 or 9-track IBM-compatible is usable at any batch processing center. And data rates of up to 10-k char/s can be recorded.

CIRCLE NO. 344

Scan converter uses storage scope plug-ins

Video, Inc., 888 S.W. Canyon Rd., Portland, Ore. 97225. (503) 292-4104. \$2700; 30 to 60 days.

Video display monitors function as storage oscilloscopes when used with the Model 100 scan converter. A silicon-target storage tube holds time or X-Y plots of analog input signals. The unit uses Tektronix' 5100 series amplifiers and time base modules to process the input signals. The modules plug into the mainframe of the converter. Overall X and Y response is dc to 1 MHz. Intensity modulation signals can be entered to write gray-scale images. Options include a "smoothing" feature that intensifies rapidly changing signal segments and an electronic graticle.

CIRCLE NO. 345

Single PC board carries data acquisition module

Prime Computer, Inc., 17 Strathmore Rd., Natick, Mass. 01760. (617) 655-6999. See text; 60 days.

An analog-input subsystem on a single printed circuit board handles all analog to digital conversion applications for PRIME's family of three small and medium scale computers. The Model 6000 has 12-bit accuracy, random channel select, and a throughput of 50 kHz (same channel rate is 100 kHz). A dual channel programmable DMA capability permits data transfer directly to computer memory while random multiplexer addresses are supplied direct from memory. This feature provides for programming ease and increased efficiency. Four programming ranges— ± 10 V, ± 5 V, ± 2.5 V and ± 1.25 V FS—improve accuracy and resolution, as does the standard sample-and-hold features with its 20 nanosecond aperture. Cost of the subsystem with 16 differential channels implemented is \$3000. Up to 64 differential channels, in 16-channel increments, are available on the same board.

CIRCLE NO. 346

Two CRT terminals added to peripheral line

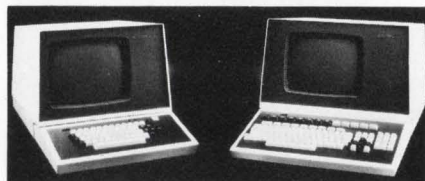

Hewlett-Packard, 1501 Page Mill Rd., Palo Alto, Calif. 94304. (415) 493-1501. 2615A: \$2750; 2616A: \$4500.

The more powerful of two terminals, the HP 2615A, offers page-mode operation with off-line editing. The unit stores up to 2048 characters and can display up to twenty-five 80-character lines on a 12-in. CRT. The terminal provides switch selectable asynchronous transmission rates from 110 to 960 baud. The HP2615A is an improved TTY-compatible terminal that offers a 35% reduction in service costs over previous HP terminals.

CIRCLE NO. 347

DO-IT-YOURSELF grabber



NEW

- Simplified Assembly
- Versatile
- Comfortable Finger Grip Action
- Completely Field Serviceable
- Molded of Tough Lexan*

Model 3925
Mini Test Clip
Shown Actual Size

This test clip with gold plated hook is excellent for rapid testing of components and Wire Wrap† pins. Clip is completely insulated to point of connection. Build any combination of test leads with wire up to .090 dia. Easy and comfortable to operate. Molded of rugged Lexan to resist melting when soldering. Write for literature and prices.



MODEL 3925

hooks onto components or slips over square Wire-Wrap pins

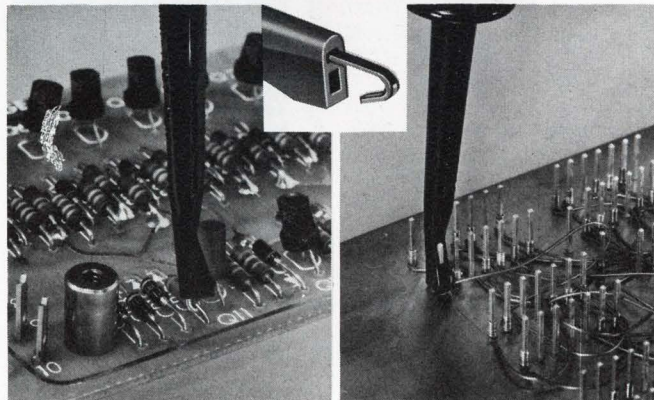

*Lexan is a General Electric trade-mark. †Registered trade-mark of Gardner-Denver Co.



POMONA ELECTRONICS

A Subsidiary of ITT

1500 East Ninth St., Pomona, Calif. 91766
Telephone (714) 623-3463

INFORMATION RETRIEVAL NUMBER 123

ELECTRONIC DESIGN 6, March 15, 1974

FUJI

EAROM PERFECTION WITH NOVEL FERRITE CORE

New memory system operated as a **NDRO** operating mode has been developed. This **non-volatile** core memory is operated as an **Electronically Alterable Read Only Memory** with low power consumption and high speed over a wide temperature range. The **EAROM WRITER EW2001** is available to rewrite information of this system. This unit rewrites the stored information in 8 track paper tape. Since the stored information is retained indefinitely, it has a wide range of applications, such as micro program, sequential control, customer program, character generation, and code conversion for computer and I/O machine of peripheral devices.

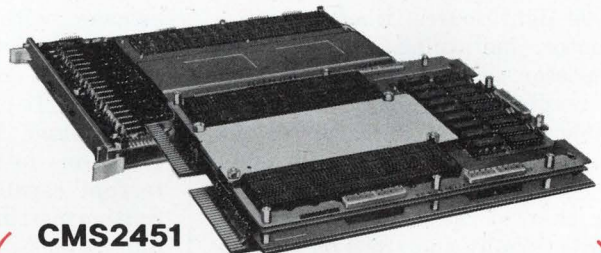

CMS2451
(4K words-18 bits)

CMS2251
(2K words-9 bits)

STANDARD MODELS

A complete system card operated by TTL input/output in the 2.5D mode or bipolar sensing mode is available. Fast access times up to 100ns are possible. Power dissipation is a low 4.5 watts for 2K bytes and a low 7 watts for 8K bytes. Operation over a wide temperature range from 0°C to +50°C without temperature compensation is possible. The price of this EAROM is comparable to that of RAM. Quick delivery of not only standards models, but also of EAROM manufactured to the customer's design is possible.

Model	Capacity	Access time	Dimensions
CMS2251A	2048W	150 ns max.	9.3" x 7.5" x 0.9"
CMS2251B	×9 bits	300 ns max.	
CMS2451A	4096W	150 ns max.	10" x 15" x 0.9"
CMS2451B	×18 bits	300 ns max.	

FUJI ELECTROCHEMICAL CO., LTD.

Head Office: Hamagomu Bldg., 5-36-11, Shinbashi, Minato-ku, Tokyo, Japan
TEL: 434-1271

Overseas Office: New York, TEL: (212) 532-5630
Los Angeles, TEL: (213) 620-1640
Düsseldorf, TEL: (211) 89031

INFORMATION RETRIEVAL NUMBER 124

Photoelectric reader stops on character

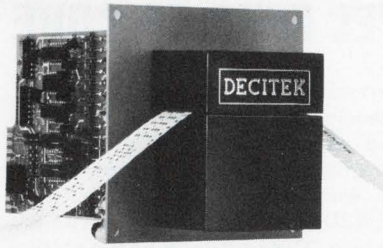

Decitek, 15 Sagamore Rd., Worcester, Mass. 01605. (617) 757-4577.

A photoelectric punched tape reader, named SAM, handles all standard 6, 7, or 8-level tapes. A single light source, fiber-optic distributor, and a nine-element photo-transistor sensing system perform the reading. A stepping motor and dual-sprocket drive transport the tape through the read head asynchronously at rates from zero to 100 char/s. The reader operates bidirectionally and stops on character.

CIRCLE NO. 348

Low cost processor has 1.3 μ s cycle time

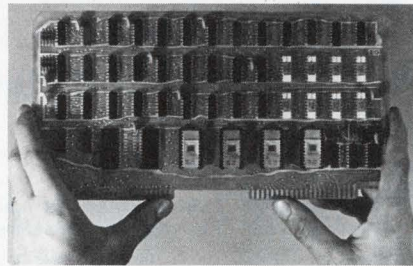

I/O Devices, Inc., 100 Route 46, Mountain Lakes, N.J. 07046. (201) 335-2935. See text; stock.

The IOP-8 processor is designed for use as a low-cost control computer. Features of the eight-bit computer include a 1.3 μ s cycle time, 256 words of random access memory with expansion to 4096 words, 55 instructions and addresses for 16 external devices. The entire TTL processor is contained on a single 11.5 \times 6.5-in board. Additions to the IOP-8 include interrupt capability, DMA and sub-routine nesting. Price of a single unit is \$395; \$295 for OEM quantity orders.

CIRCLE NO. 349

Line printer offers wide choice of character sets



Centronics, Hudson, N.H. 03051. (603) 883-0111. \$2600.

The Model 500 is a 5 \times 7 dot matrix printer that operates at 100 char/s; column width is 132 characters. Capable of producing an original and four carbon copies, the 500 can operate with the paper supply located to the rear or below the printer. The character set can be increased to 128 characters. Many foreign as well as special characters sets are available.

CIRCLE NO. 350

THERMOSET PLASTICS

INJECTION • COMPRESSION

ENCAPSULATION
CUPS AND COVERS
MANUFACTURED
OF FLAME RESIS-
TANT MATERIAL.



TOYS



ELECTRONICS



OEM

CAPABILITIES &
TECHNICAL DATA
AVAILABLE

AHAM

968 W. FOOTHILL BLVD.
AZUSA, CALIF. 91702
(213) 334-5135

free HEAT SINK HANDBOOK

LIMITED FIRST EDITION

The very first HEAT SINK HANDBOOK ever published is now available to you. 152 pages of up-to-date information. Written and compiled by MR. JACK SPOOR, physicist, specializing in thermal engineering. GET YOUR COPY NOW!

SEND \$1.00 to cover handling and postage, with your name and address to: Azusa Advertising, P.O. Box 243, Azusa, Calif. 91702



NAME _____
ADDRESS _____
CITY _____ STATE _____ ZIP _____

AHAM

968 W. FOOTHILL BLVD.
AZUSA, CALIF. 91702
(213) 334-5135

REI has one question for people who buy electronic test equipment.

Why?

When you need it fast . . . rent it. Purchasing equipment usually involves long delivery lead times. When you rent your electronic equipment from REI it's a safe bet that you can get what you need within 36 hours of the time you call in your order, sometimes sooner. This fast service is possible because we maintain 9 Instant Inventory Centers throughout the U.S. and Canada, stocking millions of dollars worth of equipment.

When you need it for only a short time . . . rent it. Need equipment for a short-term project? Rent it from REI. When you don't need it any more, return it to us. It's the easy, low-cost way to use the equipment you need for just the time that you need it.

When you care about what it costs . . . rent it. Renting from REI can be less expensive than purchasing. There's no capital investment to adversely affect your company's cash flow. This means you'll get more mileage from your equipment budget. And, since you can treat your monthly payments as an expense in most situations, you'll also achieve tax advantages from renting.

All REI rental equipment is guaranteed to meet manufacturers' specifications and is operationally checked out prior to shipment. Routine maintenance is provided free of charge. Certification and calibration are available upon request. Our flexible arrangements include rental, rental-purchase and leasing packages to give you the use of equipment from one week to three years or more.

Get your free copy of our 1974 catalog that lists virtually every item in our rental inventory. Use reader service card, or write Rental Electronics, Inc., 99 Hartwell Ave., Lexington, MA 02173. For immediate information, call your local REI Instant Inventory Center listed below. Once you rent from REI, you may never buy electronic test equipment again.

Rental Electronics, Inc.

A **PEPSICO** LEASING COMPANY

Lexington, MA (617) 861-0667 • Gaithersburg, MD (301) 948-0620 • Oakland, NJ (201) 337-3757 • Ft. Lauderdale, FL (305) 771-3500
Des Plaines, IL (312) 827-6670 • Dallas, TX (214) 661-8082 • Mountain View, CA (415) 968-8845 • Anaheim, CA (714) 879-0561
Rexdale, Ontario (PLC Leasing Ltd.) (416) 677-7513



Think about renting. It's the smart way to go.

Visit us at the IEEE Show, Booth No. 2631.

INFORMATION RETRIEVAL NUMBER 127

Terminate connection problems with Curtis terminal blocks

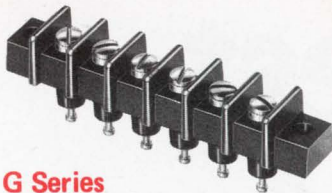

G Series

Our popular 7/16" center barrier-type blocks are ideal for jobs demanding a variety of terminations at low cost. Tab, screw, clamp, PC pin, solder or taper pin terminals are available. Surface-connect and full feed-thru insulation models are also offered. Available in one thru 26 terminals. G Series feature precision-machined brass inserts, molded in place, for a full mechanical thread system. Rated 20 amps/300 volts.

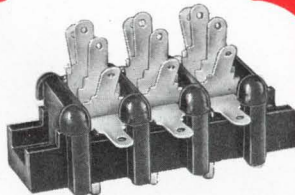

E Series

Designed primarily for electronic control and low power circuit application, these 3/8" center inexpensive barrier-type blocks are available in one thru 22 terminals. Your choice of screw, clamp, two, four or six tab quick-connect, PC pin or solder terminals. Surface-connect and feed-thru models are offered. Rated up to 15 amps/300 volts.

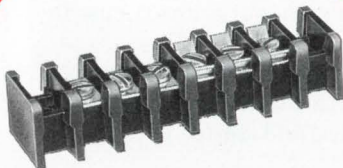

SE Series

Several terminal variations coupled with miniature size make these 1/4" center blocks ideal for use in tight spaces where versatility must not be sacrificed. These barrier-type blocks are available in screw, clamp, two, four or six tab terminals. Surface-connect and full feed-thru insulation models are also offered. Available in one thru 26 terminals. Rated 5 amps/300 volts.

Send for free engineering catalog No. 1273.



CURTIS INDUSTRIES, INC.
formerly Curtis Development & Mfg. Co.

8000 West Tower Avenue, Milwaukee, Wisconsin 53223. Call (414) 354-1500 for the name of a representative or distributor near you. In Canada: A.C. Simmonds & Sons, Ltd., Willowdale, Ontario.

1680

DATA PROCESSING

TV reticle generator helps position parts

ITP, Inc., 9186 Independence Ave., Chatsworth, Calif. 91311. (213) 341-0722.

An "electronic reticle," the Model 156, is ideally suited for the alignment of computer read/write heads. Other uses include the bore-sighting and marking of critical mask areas. The unit generates dashed reference lines on a TV monitor that are positioned to a master reference and then locked in place. The master reference need not be matched to the reticle. The Model 156 is compatible with all 525-line, 1.4 volt composite video TV cameras.

CIRCLE NO. 351

Single card interfaces mini with Selectric

Information Laboratories Inc., Box 15451, Charlotte, N.C. 28210. (704) 523-6373. See text.

A plug-in interface makes an IBM Selectric console an I/O device for any Nova computer. The unit provides 15 char/s I/O speed, red ribbon shift and use of the upper/lower case character set. The interface card comes with its own power supply and occupies a single slot of any Nova CPU chassis. The complete package (card, power supply, all cables and diagnostic program) costs \$1375 in single unit quantity.

CIRCLE NO. 352

Incremental plotter can use fanfold paper

Artronix Instrumentation, 1314 Hanley Industrial Court, St. Louis, Mo. 63144. (314) 968-4740. \$3000 (quan.); stock.

A 22-in. incremental plotter is plug-to-plug compatible with similar 300 step/s plotters. The plotter uses bidirectional stepping motors for both paper and pen axis. Each step gives 0.01-in. (0.25 mm optional) movement in either direction. Up to 367 ft. of fanfold paper can be used. The plotter comes with integral stand and paper storage. All drive and control circuits are contained on a single PC board which simplifies servicing.

CIRCLE NO. 353

Floppy disc drive features two spindles

Shugart Associates, 335 Soquel Way, Sunnyvale, Calif. 94086. (408) 738-2524. \$1275.

The SA902, a dual diskette drive, is designed to be IBM-compatible. The unit provides a total storage capacity of 6.2 Mbits and a transfer rate of 250-k bits/s. Average access time for each spindle is 250 ms. The SA902 provides independent access to either Diskette, with individual read/write heads and incremental positioning motors. The SA902 measures 11 × 9.25 × 14-in. and can be used in a standard rack mount or incorporated into a system.

CIRCLE NO. 354

Tape system for maxis now available for minis



Diva, 607 Industrial Way West, Eatontown, N.J. 07724. (201) 928-0190.

A tape-drive system, the DMT 1000, consists of a controller, distribution panel, interconnecting cables, and up to four magnetic tape drives. Eight speeds are optional. Recording speeds are from 75 to 200 in/s in a 7-track or 9-track format at densities of 200, 556, 800, or 1600 byte/in., with resulting transfer rates to 320-k byte/s. Any industry-compatible 0.5-in. tape reels may be used—from mini reels to 10.5-inch reels, as well as IBM wrap-around tape cartridges. Tape encoding is NRZI or phase encoded. The system features automatic load and unload, air bearing turn points, vacuum column guidance, photo-electric sensing, fixed-position head, single capstan drive, off-line self-testing, and IBM compatibility. Minicomputer software is usable with the system and saves the cost and complications of having software provided separately.

CIRCLE NO. 355

AFTER YOU USE OUR PPS, THERE'S ONLY ONE THING WE'LL KNOW ABOUT YOUR MACHINE DESIGN:

IT JUST GOT BETTER.

Even if you're already using MOS/LSI circuits, our new PPS (Parallel Processing System) offers you a whole new set of potential advantages: Improvement of the design characteristics of machines such as professional and programmable calculators, business machine terminals, system controllers, etc. Reduction of their development time. And their circuit costs.

And PPS offers these potential advantages while enabling you to keep system design responsibility solely in your own hands.

Here's how it works.

The PPS is based on a powerful one-chip CPU controlled by ROM microprogramming and possessing its own discrete I/O capabilities. The other building blocks are compatible ROM/RAM, ROM, RAM and I/O

circuits plus a crystal-controlled clock generator circuit. The entire system—except for one ROM circuit—is pre-designed to work in a variety of machines, performing the arithmetic and logic functions of a four-bit parallel microprocessor.

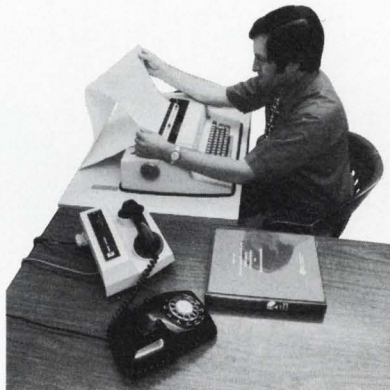

The one ROM circuit that is *not* completely pre-designed is the one that's uniquely designed for your machine. By you. Through microprogramming. Our only involvement,

besides providing the PPS circuits, is to provide you with plenty of design aids: A time-tested program for microprogramming through Tymshare or G.E. . . . special equipment for microprogram assembly and ROM emulation . . . evaluation board for prototype testing . . . programmer's reference manual, and all required documentation.

Drop us a line on your company letterhead and we'll send you additional information so you can make your own microprocessor comparison. Address your request to: Microelectronic Device Division, Rockwell International, Marketing Services, P.O. Box 3669, Anaheim, California 92803, U.S.A.

Write us today for an appointment for a PPS demonstration at IEEE in New York.



Microelectronic Device Division
Rockwell International

...where science gets down to business

INFORMATION RETRIEVAL NUMBER 129

Who should know more about using semiconductor fuses than a semiconductor company?

No one. That's why IR wrote the book on it.

For 25 years we've specialized in semiconductors. We know how to get the most out of them. We know what they need in the way of protection.

Now we're introducing what we think is the finest semiconductor fuses available — AMPKIP fuses, rated at 130 to 700-Volts, with all-welded construction and a ceramic body. And we wrote the book on how to apply them.

This 100-page handbook lets you do



a better job of selection, because we tell you more about fuse behavior than anyone else. Our fuses are rated by semiconductor experts. We give you curves and graphs on every single rating. We tell you exactly what happens under "worst case" conditions.

This book can spell the end of trial and error fuse selection. To get your copy, call your local IR sales office or distributor, or write on company letterhead to International Rectifier, 233 Kansas Street, El Segundo, California 90245.

... the innovative power people

INTERNATIONAL RECTIFIER



INFORMATION RETRIEVAL NUMBER 130

COMPONENTS

Dropout and pickup volts adjust on volt sensor



Zenith Controls, Inc., 830 W. 40th St., Chicago, Ill. 60609. (312) 247-6400. \$55 (unit qty).

Zenith Series AR voltage sensors are single-phase, voltage-supervisory relays that are easily adjusted for both their dropout and pickup points. A broad setting range enables their use as under or overvoltage sensors. Other important features include: an indicating light for contact closure; supply voltages of 120, 208/240 or 277 V, single phase; supply frequency range of 50 to 400 Hz; pickup points adjustable between 50 and 125%; dropout point adjustable from 2% to 30% below the pickup point; a repeat accuracy of $\pm 0.5\%$ of voltage range and the unit's SPDT contact ratings are 10 A, 240 V or 5 A, 480 V ac.

CIRCLE NO. 356

Low-pass LC filters have linear phase

Allen Avionics, 224 E. 2nd St., Mineola, N.Y. 11501. (516) 248-2475.

Linear phase low-pass LC filters are available with Bessel, Gaussian, and transitional transfer functions. They cover a frequency range from 400 Hz to 50 MHz with impedances from 50 Ω to 20 k Ω . The units are epoxy encapsulated or sealed in metal cans. Prototypes can often be delivered in less than three days.

Booth No. 1321 Circle No. 357

18 sizes...

10-14-20-24-26-30-36-40-44-50-54-56-60-66-70-90-100-120

We have expanded our series WTB right angle PC Connectors to include sizes up to 120 contacts and a choice of solder cup, dip pin, or Wire-Wrap™ terminals. Crimp terminals available on all sizes up to 90. This very versatile subminiature connector features. 100" spacing, 2 rows offset for .050"

For details, call 214/233-2000 or write our Dallas plant at 4321 AirBorn Drive, Addison, Texas 75001

AirBorn, Inc.

INFORMATION RETRIEVAL NUMBER 131

INFORMATION RETRIEVAL NUMBER 902 ►

YOUR EDUCATION REPRESENTS
AN IMPORTANT
PERSONAL INVESTMENT--

**WHAT HAVE YOU
DONE WITH IT
SO FAR?**



"Got a job" isn't quite the full answer, is it? You're *you*. And there's more to life than just "a job" — or should be.

What could you expect if you joined us? A quality of life that means the difference between "a job" and a way of living.

We design and manufacture complete electronic systems of various kinds for business, industry and government. It is our practice to hire very able people and then put them to work doing what they most like to do.

Because we are a large company, we offer a total career growth-potential that is as big as we are. And because we work in relatively small product-oriented divisions, your abilities and contributions are highly visible from the time you join us, with prompt recognition of superior performance.

Whether you work for us in California, New York,

Ohio, Florida, Kansas or Delaware, you'll find yourself looking forward to coming to work in the morning. And your technology won't become obsolescent in 5 or 10 years, because, to remain a leader, we must continue to work on the far edge of the current state of the art.

Professional involvement . . . continuing development as an engineer . . . an environment of individual responsibility that encourages new ideas and rewards initiative. These are *good* dividends on the personal investment you've already made on your education!

If you're not realizing them now, write:

**NCR Worldwide Headquarters, Dept. ED-3
Corporate Executive &
Professional Placement
Dayton, Ohio 45479**

NCR

An Equal Opportunity Employer M/F



When you Build a Better Control...

... leading design engineers know it. World-wide manufacturers of precision computer/data/communication equipment, as well as commercial appliances, are specifying Elmwood snap-acting thermostats. A choice of wide or narrow differentials reduce cost. UL, CSA and European listings are available for world-trade applications. All are factory preset, tamperproof and 100% temperature and mechanically tested, for high limit or control functions at -65° to $+550^{\circ}$ F exposure. Phone, TWX or write for prototypes, specs and prices. Elmwood Sensors, Inc., 1675 Elmwood Avenue, Cranston, R. I. 02907, U.S.A. Phone (401) 781-6500. TWX 710-381-6413.

ELMWOOD SENSORS

INFORMATION RETRIEVAL NUMBER 132

COMPONENTS

Complete crystal filter housed in single package

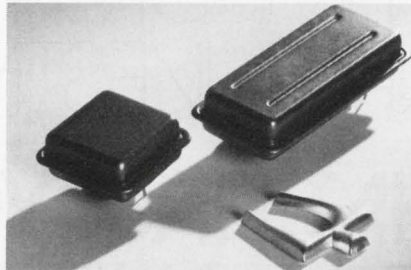

Bulova Watch Co., Inc., 61-20 Woodside Ave., Woodside, N.Y. 11377. (212) 335-6000 ext. 744.

Bulova's crystal filters are true single component packages that differ from the current practice in such filters. The complete filter is fabricated and housed in a single hermetic can. The usual crystal filter is built from a collection of crystals in individual cans and additional components are housed in separate often larger cans. Bulova's units are designed for PC board mounting. Present models include 2, 3 and 4-pole response versions. They cover the frequency range from 350 to 525 kHz with bandwidths from 0.005 to 0.02%. Ripple is 0 to 1 dB, and the typical impedance for a 455-kHz, 3-pole filter with a 90-Hz bandwidth is 6.2 k Ω .

CIRCLE NO. 358

Molded battery holder comes in AA size

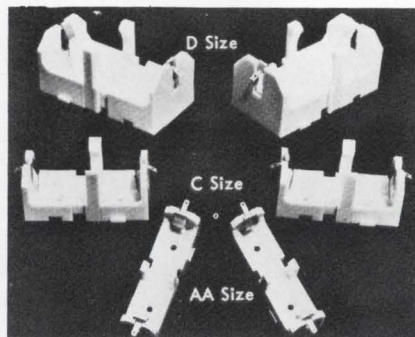

Cambridge Thermionic Corp., 445 Concord Ave., Cambridge, Mass. 02138. (617) 491-5400.

Cambridge Thermionic's line of molded battery holders for C and D-size cells now includes a new AA holder. Important features of the new battery holder are: lightweight glass-filled nylon, tinned phosphor-bronze contacts and an integral shock and vibration retainer.

CIRCLE NO. 359

Slow-blow thermal unit plugs into PC boards

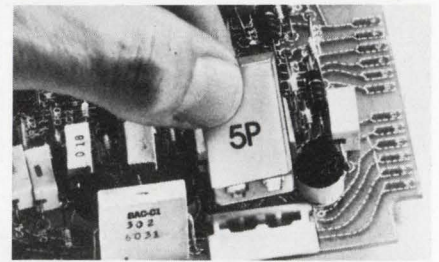

Micro Devices Corp., 1881 Southtown Blvd., Dayton, Ohio 45439. (513) 294-0581. \$0.20 to \$0.30 (OEM qty); 6 to 8 wk.

A standard Microtemp thermal cutoff when combined with a resistive heating element becomes the 5P MultiProtector series thermal cutoff. The unit is mounted inside a thermoplastic polyester enclosure that plugs into a convenient snap-in base. Once the 5P has been activated to cut off power, it can easily be removed and replaced after the trouble source or fault is corrected. The cutoff is unaffected by aging and it is accurate to ± 3 F. The unit comes in 23 temperature ranges, and though it tolerates transients and short current surges, it responds nimbly to a definite overload.

CIRCLE NO. 360

Tension unit uses no external power



Lear Siegler Inc., 17600 Broadway, Maple Heights, Ohio 44137. (216) 662-1000.

The drag torque of this tension unit can be manually set at any point between 0.1 and 8.0 oz-in. The full range is obtained in 45 degrees of rotation of the adjusting disc. No external power is required. An integral permanent magnet is used. Output torque is consistently smooth. The output shaft is ball-bearing mounted for long life.

Booth No. 375

Circle No. 361

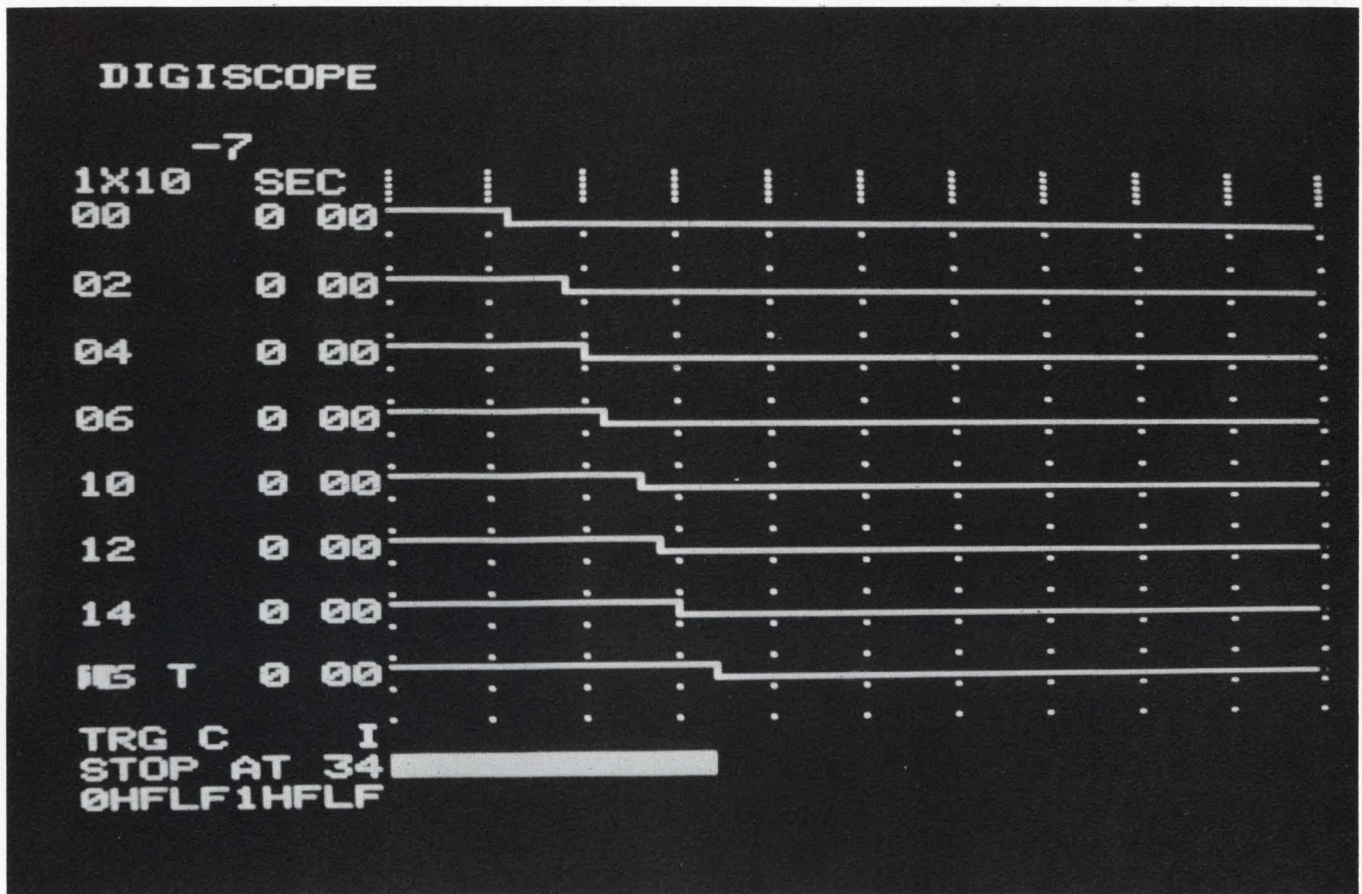

DIGISCOPE:

Eight channels of simultaneous digital logic at 50 MHz

"1973 will be remembered as the year of the Logic Scope . . . It is remarkable that since their introduction last spring, logic scopes have already evolved to their second generation. The first of these second generation instruments is the AMC 1320 Digiscope."

—Michael Riezenman, ELECTRONICS Magazine, 12/20/73

"In the world of analog test and measurement, there's no doubt that the oscilloscope reigns supreme. But if you're working with digital signals — as more and more people are — you're probably more interested in looking at the simultaneous time relationships of multiple signals. And that's where the AMC 1320 Digiscope comes in."

—Stan Runyon, ELECTRONIC DESIGN Magazine, 1/18/74

"The Digiscope is a test instrument designed expressly for the debugging and maintenance of digital electronic equipment . . . (it) permits the ready implementation of many features long desired in testing digital systems: Features like *Simultaneous display of many channels in true time relation *Negative trigger delay *Triggering on a logical combination of the inputs *Multi-channel recording of fast, one-shot events."

—Bill Furlow, EDN Magazine, 1/5/74

"A radically new logic state analyzer from E-H Research gives you the equivalent of an 8 or 16 gun, 50 MHz, real time scope

display of logic timing. It lets you 'see' such analog parameters as glitches, ringing, rise and fall times, and voltage levels."

—Jerome Lyman, ELECTRONIC PRODUCTS Magazine, 1/19/74

The editors have had their opportunity to preview the Digiscope, and now it's time you discovered all the ways in which this new digital test instrument can help you save time and error in designing, producing, and trouble-shooting digital circuits and equipment. Our new brochure is ready for mailing to all engineers with an application for a compact instrument that offers, among other features:

- 50 MHz bit rate
- Double-threshold comparison
- Up to 100 bits of look-back before trigger
- High impedance active probes (10 megohm, 8 pf)
- Simple operation and clear, plain-English screen display of test parameters for photographic recording.

Write today for full particulars.

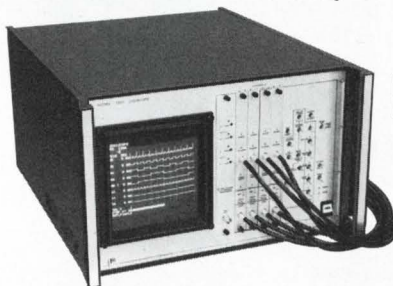

**E-H Research
Laboratories, Inc.**

515-11th Street, Box 1289
Oakland, California 94604
(415) 834-3030

European subsidiary:
P.O. Box 1018, Eindhoven, The Netherlands, (040) 433704

INFORMATION RETRIEVAL NUMBER 133

IN CALCULATOR CHIPS...

CZL-550...
a super-powerful, four function,
eight digit calculator chip with direct
segment LED drive, supplied with the
digit driver, at a super-low price.

For complete information call (516) 733-3354 or write:
General Instrument Corporation, Microelectronics,
600 West John Street, Hicksville, N.Y. 11802

GPS GOT IT!



INFORMATION RETRIEVAL NUMBER 134

*The HS-200S... a wire memory offering
speed, capacity, cost and reliability
of ample proportions.*

This is our latest wire memory. It gives you access time of 180 ns and cycle time of 250 ns. Memory elements, of course, consist of our own special development, magnetic wires. Non-destructive read-out is featured. HS-200S means maximum reliability at minimum cost. In fact, you get a 65 kilo-byte assembly with an MTBF figure of 10,000 hours. HS-200S is a component precisely matched to computers of the new age.

Wire Memory System HS-200S Specifications

- 1. Memory elements** Non-destructive read-out
- 2. Storage capacity** 8 kwords/80 bits, 16 kwords/40 bits, 32 kwords/20 bits
- 3. Access time** 180 nanoseconds
- 4. Cycle time** Write-in Read-out 250 nanoseconds
- 5. Interface levels** TTL logic ...
H +2.4—+5V L -0.5—+0.5V
- 6. Dimensions** 500×300×112mm (Basic unit capacity is 65 Kbytes. Expansion to one megabyte is possible.)
- 7. Required power** +30V, +15V, +5V, -15V

Please contact our sales department if you have special requirements.



TOKO, INC.

Head Office: 1-17, 2-chome, Higashi-Yukigaya, Ohta-ku, Tokyo, Japan
New York: **Toko New York Inc.**
350 Fifth Avenue, New York, N.Y. 10001 U.S.A. Tel: 565-3767
Los Angeles: **Toko, Inc. Los Angeles Liaison Office**
3440 Wilshire Blvd., Tishman Building, Suite 1106 Los Angeles, Calif.
90010, U.S.A. Tel: 380-0417
Düsseldorf: **Toko, Inc. Europe Liaison Office**
4 Düsseldorf, Kölner Straße 246, Düsseldorf, W. Germany Tel: 78-7064

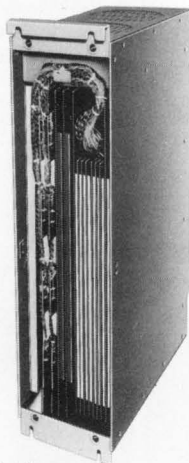

INFORMATION RETRIEVAL NUMBER 135

COMPONENTS

**Servomotor speeds to
17,000 rpm at no load**

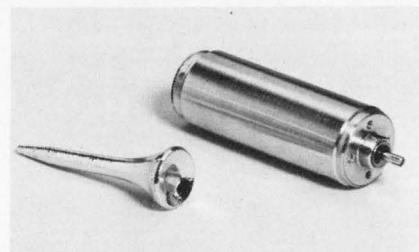

*Portescap U.S., 730 Fifth Ave.,
New York, N.Y. 10019. (212) Ci 5-
7716.*

A newly designed miniature servomotor of the Escap 16C series has a mechanical time constant of 16 ms and no-load speeds to 17,000 rpm. The motor employs the same continuously skew-wound, ironless rotor that is featured in other Escap servomotors. Moment of inertia of the rotor is 0.4 g-cm² and acceleration at start is 28×10^3 rad/s². Gearheads with ratios of 9.1 to 7200 are available and windings for 1.5, 3, 5, or 6-V-dc operation are standards.

CIRCLE NO. 362

**Single lever resets
bank of toggle switches**

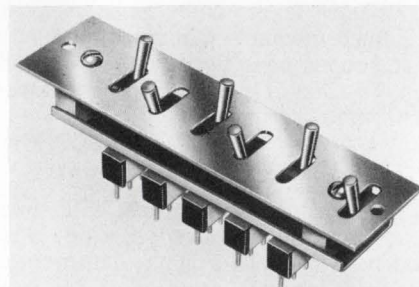

*Alco Electronic Products, Inc.,
1551 Osgood St., North Andover,
Mass. 01845. (617) 685-4371.*

A reset lever, which can be mounted to the left or right of an array of up to 15 switches, can simultaneously throw all switches back to their original positions. The one or two-pole, double-throw toggle switches in the array have a current carrying capacity of 6 A. Life expectancy is over 200,000 operations at rated current. This module is available only on a custom basis. Price is determined by the length of the module—preferably in multiples of five—and the types and quantities of switches.

CIRCLE NO. 363

SEASTROM OFFERS ITS ALL NEW COMPREHENSIVE CATALOG #40B. This 250 page catalog features the company's full range of products in a colorful book specially indexed for ready reference.

Including such items as . . .

- Flat Round Washers—Metallic
- Flat Round Washers—Non-Metallic
- Spring Washers
- Shoulder Washers
- Tab & Notch Washers
- Washers—Miscellaneous Configurations
- Expansion Plugs
- Military Standards
- Clamps & Brackets
- Spring Clips
- Solder Lugs
- Solid State Insulators
- Bus Bars, Terminal Blocks & Insulating Strips
- Miscellaneous Electrical/Electronic Hardware/Tags
- Sheet Metal Nuts & Strips
- Engineering Tables, Materials & Finish Specifications
- Numerical & Alphabetical Index of Parts

No need to design it . . . you will undoubtedly find it in Seastrom's Catalog all stocked for immediate delivery . . . write to



SEASTROM

MANUFACTURING CO., INC.

701 SONORA AVE., DEPT. D-3
 GLENDALE, CALIF. 91201
 (213) 245-9121 • TWX 910-497-2271



INFORMATION RETRIEVAL NUMBER 136

THE 25 YEAR METERS...

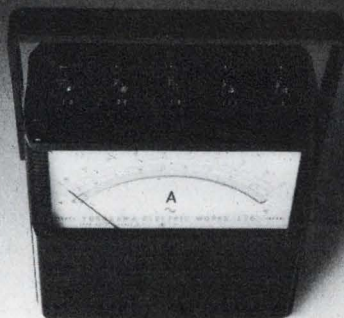

10/20/50/100 A AC: \$99.00

YEW's Precision Portables!

95% of all YEW precision portables that are returned for calibration certification are within original specifications, even after 25 years of use. We have even had instruments dating back 50 years within original specifications. *That is long term reliability* and that is why YEW is the world's largest manufacturer of precision portables.

Add taut band 0.5% accuracy, high quality and low cost, fast service, a vast selection of models and 25 years from now, you'll be glad that you tried a YEW portable. Prices start at \$95.

1% Portables also available. Prices start at \$37.



Yewtec Corporation
 1995 Palmer Ave., Larchmont, N. Y. 10538
 Telephone: 914 834-3550

60 Years of Measuring and Recording Instrumentation

INFORMATION RETRIEVAL NUMBER 137

ELECTRONIC DESIGN 6, March 15, 1974

The long-billed heat sucker would like you to meet her family.

Our good friend, the Heat Sucker (better known as a Hughes heat pipe), is now the proud mother of an entire flock: round and flat bills, flexible round bills and the cold mounted plate bill. Each variant feels right at home in electronic, chemical and mechanical equipment; industrial processing; and medical applications. Anywhere you might need thermal control.

Heat Suckers come in various sizes: 3/16" to 1" diameter, 6" and 12" lengths. They have thermal transport capabilities of 10 to 2,000 watts covering temperature ranges from: -90°C to +200°C.

Since the birds have mass migrated to our shelves, you can order right off the shelf for as little as \$37.00 (less in quantity).

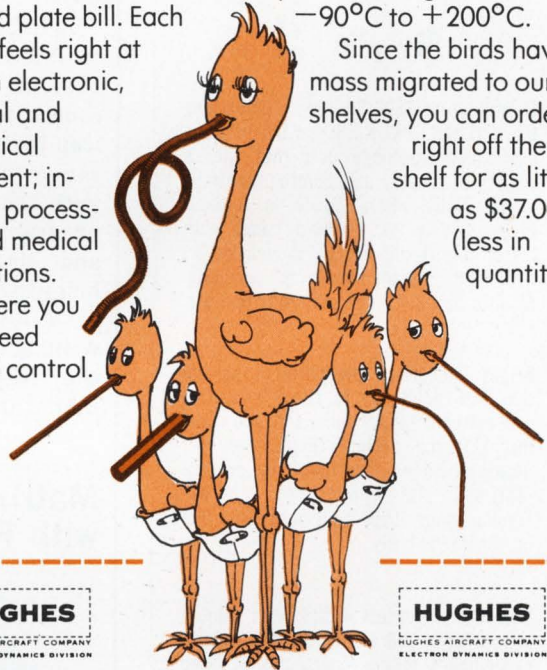

HUGHES

HUGHES AIRCRAFT COMPANY
 ELECTRON DYNAMICS DIVISION

HUGHES

HUGHES AIRCRAFT COMPANY
 ELECTRON DYNAMICS DIVISION

Celebrate along with us. Send the coupon and get a cigar and literature. Hughes Electron Dynamics Division, Advertising Dept., 3100 W. Lomita Blvd., Torrance, California 90509. Or call (213) 534-2121, Ext. 451.



1350H Series — stainless steel and methanol.



1370H Series — copper and water.



1333H — stainless steel and ammonia.



Custom Designs — flexible, flat, and base plates.

Name _____

Company _____

Address _____

City _____ State _____

Zip _____ Telephone _____

ED-3

INFORMATION RETRIEVAL NUMBER 138

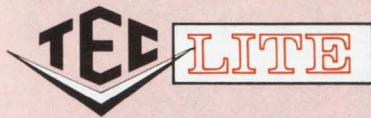

THE SMALLEST LED SWITCH/INDICATOR ON THE MARKET

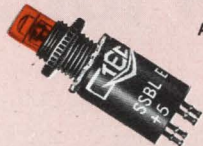

ACTUAL SIZE

NOW AVAILABLE IN RED, GREEN, YELLOW AND REDUCED 15%!

Low As **\$3.50** Each in 100 Qtys.

Subminiature SSBL Series combines long life LED and SPST-NO-DB switch in a low cost, highly reliable unit that fills a variety of display and control functions — especially where space is limited. Projects only $\frac{5}{16}$ " behind panel with turret lug terminals (as shown) or 1" with .025" square Wire-Wrap terminals. Mounts in $\frac{1}{4}$ " hole on $\frac{3}{8}$ " centers.

Bright indication, low power consumption and resistance to shock, vibration and extreme temperature changes make this LED the perfect replacement for incandescent or neon lamps in low current, solid state applications. Lens has Fresnel rings that distribute light for maximum visibility.

Momentary contact pushbutton switch has rating of 100 mA @ 115 VAC and life exceeding 1 million operations at rated current. The SSBL operates from a 5 VDC supply; however, can accommodate up to 28 VDC by adding an external series resistor.

MATCHING LED INDICATOR CUT 22%!

Low As **\$2.10** Each in 100 Qtys.



The SSIL Series has all the outstanding features of the SSBL, but is an indicator only. Built-in resistor adapts unit for 5 to 28 VDC operation.

TEC also has a matching switch only — the SBS — plus subminiature indicators and switch/indicators with neon and incandescent lamps.

NOTE: Green and yellow LED's are available only with 5V rating.



COMPONENTS

LED provides constant output as volts vary

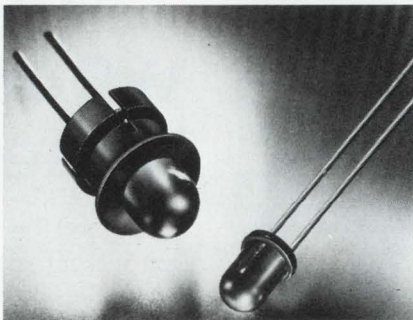

Litronix, Inc., 19000 Homestead Rd., Cupertino, Calif. 95014. (408) 257-7910. RLC-200: \$.50 (1000 up).

Red-Lit C200/210 LEDs when combined with current regulating ICs in single packages produce constant-brightness outputs. A typical brightness of 1.2 mcd over a range of 4.5 to 12.5 V is obtained with the RLC-200. The RLC-210 is programmed at half the current and therefore provides half the brightness. The RLC-200 comes in a T-1-3/4 panel-mount package with a snap-in mounting clip and the RLC-210 is packaged in a miniature T-1 size.

CIRCLE NO. 364

Matrix boards mount with PC terminals

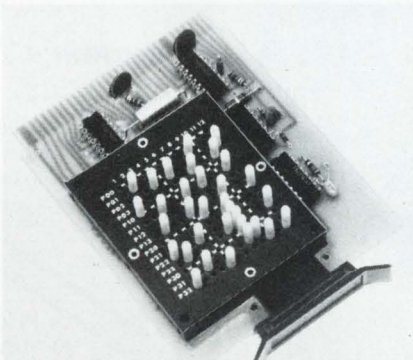

Info-Lite Corp., 46-10 104th St., Corona, N.Y. 11368. (212) 476-1287. Boards: \$0.07 to \$0.30 per crosspoint; stock to 2 wk.

Logic-Mate program boards are used for programmable diode matrices and input-output switching with cordless patch-boards. Both diode and shorting-plug models have PC pin terminals and a 0.75-in. height. The program boards handle digital signals to 10 MHz unshielded.

CIRCLE NO. 365

Alphanumeric readout readable in sunlight

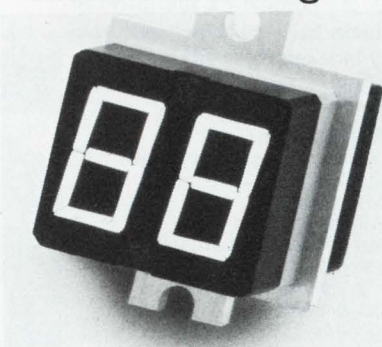

Aerospace Optics Inc., 7112 Burns St., Fort Worth, Tex. 76118. (817) 284-2293.

The 93 Series single-plane alphanumeric display features high brightness and a black background for easy viewing in direct sunlight. And at low brightness, for night viewing, the light output is uniform. Character height is 0.4 in. and standard modules of one-to-six digits are available. The displays use T-3/4, bipin, incandescent lamps, which are compatible with DTL and TTL circuits.

CIRCLE NO. 366

Polyester capacitors wound noninductively

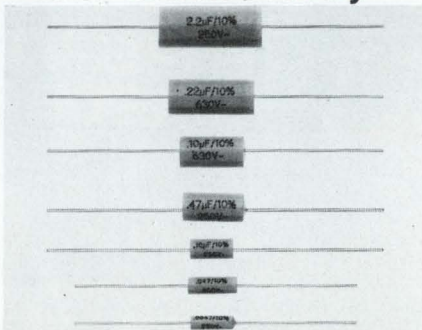

International Components Corp., Asbury & Broune, Asbury Park, N.J. 07712. (201) 922-1800. \$0.09 (OEM qty); stock to 90 day.

The foils are noninductively wound and the ends of the tubular YM series of metalized polyester-film capacitors are sealed with epoxy resin. Leads are welded to the foil. The units are self-healing for long life and they are available in standard ratings of 250, 400 and 600 V dc. Capacitances range from 0.0047 to 4.7 μ F with tolerances of 5, 10 and 20%. Operating temperature is -40 to 85 C with no derating. The change in capacitance over a -40-to-100-C range is 2% from the value at 25 C.

CIRCLE NO. 367

Inselek can now provide total custom LSI design and fabrication, at a price competitive with bulk CMOS, and do it in less time than our competition.

The Classical Design Story —

A typical approach to custom LSI circuits employs either MOS or bipolar technologies. MOS offers low cost and low power, but lacks a high switching speed. Bipolar has the speed, but it's expensive to make and power dissipation is high. This leaves you with a formidable design decision. Will it be MOS or bipolar? Either way it's a compromise.

The No Compromise Way —

Inselek now offers you a custom SOS/CMOS approach where you never have to compromise. Using our proven technology you'll receive all the inherent benefits of both MOS and bipolar, and obtain comparable development costs as well. Here's what we'll do for you. Inselek will either design and fabricate a custom SOS/CMOS IC for you, or produce integrated circuits from your own design (in either ceramic or plastic packages), or, if you prefer, we'll provide you with only the wafers. Any way you choose you come out a winner.

Getting Started —

Before you commit to any process, get all the facts first. Compare costs, reliability and technologies. For details on the Inselek "No Compromise Way" circle the reader service number or write:

Inselek, Inc., 743 Alexander Road, Princeton, N.J. 08540. Telephone: (609) 452-2222.

You'll find we may not be very modest, but we're easy to do business with.

Inselek customizes the SOS/CMOS IC.



SALES OFFICES IN
CONCORD, MASS. (617) 369-5298 AND
LOS ANGELES, CALIF. (213) 889-2788

DISTRIBUTORS:
WEST COAST — WESTATES (213) 341-4411 NEW ENGLAND — GREEN SHAW (617) 969-8900 MID-ATLANTIC — WILSHIRE ELECTRONICS (609) 786-8990

INFORMATION RETRIEVAL NUMBER 140

When PRD makes vector voltmeters, it makes the one that's programmable.



Our P2020 programmable Vector Voltmeter provides a wealth of information about signals and devices in the 1.5 MHz to 2.4 GHz frequency range. It measures insertion loss, gain, phase shift, group delay, scattering parameters—any measurements relying on accurate determinations of amplitude and phase.

It has 50-ohm coaxial inputs (no probes); and its control functions can be programmed through a single rear-panel connector by standard TTL logic levels. Phase locking is automatic over the entire frequency range—minimizing programming efforts and simplifying operation in the manual mode. Planning to automate your RF and microwave testing? Learn more about the cost-effective P2020 Vector Voltmeter. Write:



PRD Electronics, Inc.
A subsidiary of Harris-Intertype Corporation
1200 Prospect Avenue
Westbury, N.Y. 11590 Tel: (516) 334-7810

INFORMATION RETRIEVAL NUMBER 141

Bridge Rectifiers



IBR
SILICON
CONTROLLED
AVALANCHE
INTEGRATED
BRIDGE
RECTIFIERS



Stud Mount



TO-3 outline
mounting flange



Press-fit

- 10A and 25A (I_O) single phase full-wave bridges
- 15A & 36A (I_O), 3 ϕ full-wave bridges
- 100V, 200V, 400V, 600V (V_{RRM})
- 250V, 450V, 650V minimum avalanche voltages (V_{BR}) permit lower (V_{RRM}) safety factors in design considerations
- Fast recovery series, 200 nsec. (t_{rr})
- Low junction-to-case thermal resistance ($R_{\theta JC}$) 1°C/W or less allows operation at full rated load to 100°C, T_C

\$2.50 ea.

(10A, 200V, TO-3 mounting
1000 qty.).



Design us in; we'll stay there

VARO SEMICONDUCTOR, INC.

P.O. BOX 676, 1000 N. SHILOH, GARLAND, TEX. 75040, 214/272-4551, TWX 910-860-5178

Distributed by:

ALLIED ELECTRONICS, Chicago, Ill. 312/421-2400. **THE ALTAIR CO.**, Houston, Tex. 713/462-3029, Richardson, Tex. 214/231-5166. **BELL INDUSTRIES**, Menlo Park, Cal. 415/323-9431; Sokie, Ill. 312/282-5400; Bellevue, Wash. 206/747-1515. **BLUFF CITY DIST. CO.**, Memphis, Tenn. 901/725-9500. **BRIDGEFIELD SUPPLY**, Chesterland, Ohio 216/729-9451. **CRAMER ELECTRONICS**, Nationwide; Newton, Mass. 617/969-7700; **ELECTRONIC PARTS CO.**, Denver, Colo. 303/744-1992. **MILGRAY ELECTRONICS**, Freeport, N. Y. 516/546-6000; Hyattsville, Md., 301/864-1111; Cherry Hill, N. J., 609/424-1300. **WESTATES ELECTRONICS**, Chatsworth, Calif. 213/341-4411.

In Canada:

ELECTRO SONIC, Toronto, Ont. 416/924-9301. **R.A.E. IND. ELECTRONICS**, Vancouver, B. C. 604/687-2621. **PRELCO ELECTRONICS, LTD.**, Montreal, Quebec 514/389-8051. **WESTERN RADIO SUPPLY**, Hamilton, Ont. 416/528-0151.

INFORMATION RETRIEVAL NUMBER 142

COMPONENTS

Single thumbwheel switches many sections

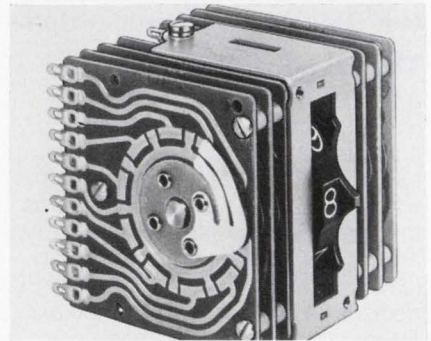

Chicago Dynamic Industries Inc., Precision Products Div., 1725 W. Diversey Blvd., Chicago, Ill. 60614. (312) 935-4600. 8-pole: \$25.18 (100 up); 2-3 wks.

Switch many rotary PC contact sections at one time—2 to over 15 poles—with a single thumbwheel. The number of circuits selected in the TTG series of rotary switches is limited only by the amount of torque that is practical. The standard CDI, one-pole switch needs 10 to 12 oz-in. of torque, and an eight-pole switch, 34 to 36 oz-in. Typical life is over 100,000 cycles. Electrical ratings include: 115 V ac, 3-A current-carrying and 125-mA current-breaking capacity; 0.050- Ω max contact resistance, 200-M Ω min insulation resistance; and 1000-V dielectric strength.

CIRCLE NO. 368

Point-source Xenon arcs radiate UV and IR

ILC Technology, 164 Commercial St., Sunnyvale, Calif. 94086. (408) 738-2944.

A family of short-arc, point-source Xenon lamps employs special additives to concentrate light intensity into various narrow UV and IR wavelength bands. The highly efficient conversion of power (250 W) to light in the desired portion of the spectrum makes these lamps well suited for underwater illumination (blue or green light), hologram illumination, exposure of photosensitive films and testing and processing of bulk material surfaces. The lamps have a quick-start capability and can be mounted in any position. They operate in the 25-to-50-V range and can be powered by an ILC PS150/300 power supply.

CIRCLE NO. 369

ELECTRONIC DESIGN 6, March 15, 1974

Versatile, low cost plug and socket connectors for electronic systems

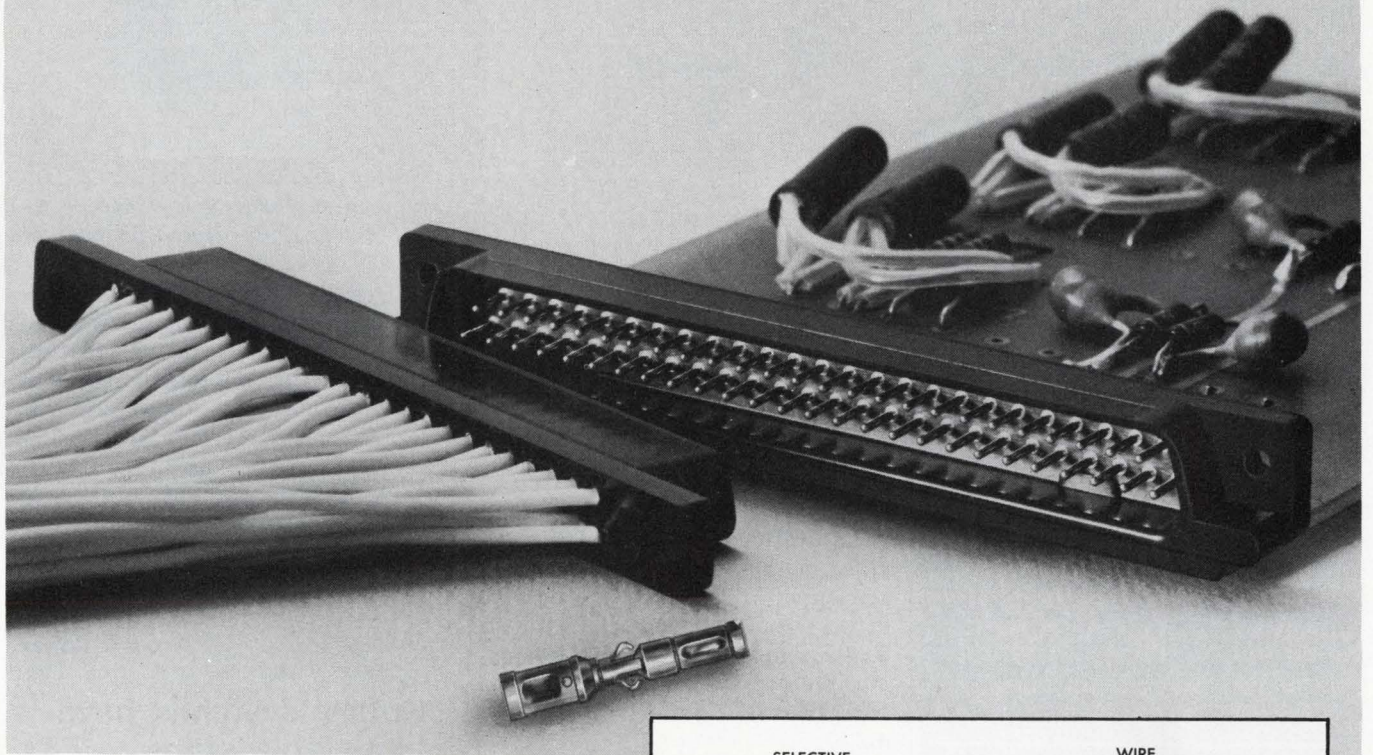

CONTINENTAL SERIES J CONNECTORS provide high density in small areas of computers, control applications, instrumentation and printed circuitry.

FEATURES:

- .100 Contact Centers
- High Strength, Single Piece Molded Shells
- Removable Socket Contacts
- Right Angle or Straight Thru Wiring
- Molding Configuration Polarized
- Integrally Molded Plug Contacts

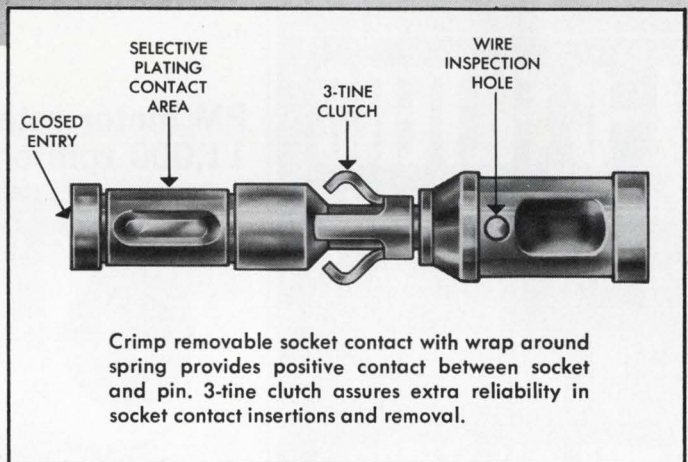

For a free brochure on Series J Connectors, write or phone sales department, Continental Connector Corporation, 34-63 56th Street, Woodside, N.Y. 11377, (212) 899-4422.

For the Sales Representative Nearest You, See Our Listings in EEM and VSMF Directories.

CONTINENTAL CONNECTORS

CONTINENTAL CONNECTOR CORPORATION ■ WOODSIDE, NEW YORK 11377

INFORMATION RETRIEVAL NUMBER 143

DELAY LINES

NEW



"HI-RATIO" SPIRADEL®

Provides highest ratio of time delay to rise time in Spiradel family. Maintains same excellent electrical specs. for which Spiradel is famous.

NEW

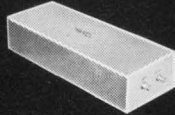

ADDITIONS TO OUR EXTENSIVE

'HF', 'HR' & 'VHR' SERIES

Offers highest ratio of time delay to rise time ever built in a Lumped Constant Line.

NEW



ADDITIONS TO OUR

"MINI" & "MIDI" SPIRADEL

Affords even greater selection of these high quality, dual-in-line Delay Lines.

L-C FILTERS

FAST PROTOTYPES!

FILTERS OFTEN SHIPPED IN AS LITTLE AS 2 OR 3 DAYS!

NEW

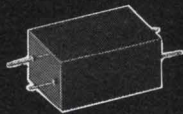

LINEAR PHASE BANDPASS LINEAR PHASE LOWPASS

PLUS extensive listings of typical Lowpass, Highpass, Bandpass & Dip Filters we build.

WRITE FOR NEW CATALOGS

SEE OUR PAGES IN EEM
VISIT US AT INTERCON 74
BOOTH 1321

 **Allen Avionics, Inc.**

224 E. 2nd St., MINEOLA, N.Y. 11501
PHONE: 516-248-8080

INFORMATION RETRIEVAL NUMBER 144

COMPONENTS

Piezo transducer needs no signal conditioning

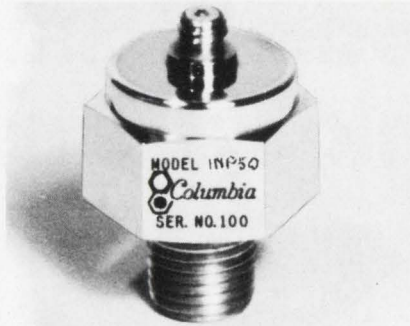

Columbia Research Labs, Inc., MacDade Blvd. & Bullens Lane, Woodlyn, Pa. 19094. (212) 532-9464. \$35.00 (unit qty); stock to 4 wk.

The Columbia Series INP-50 Piezoelectric Sensors are made with a newly discovered piezoelectric crystal composition. These units are self-amplifying and require no auxiliary signal-conditioning electronics for dynamic pressure measurements. Numerous configurations are available. Coupling methods include most standard pipe-thread sizes, flared-tube fittings and finished surfaces for gaskets and seals. The in-line construction allows simple installation in pressure systems to 50,000 lb/in².

CIRCLE NO. 370

PM motor rotates at 11,000 rpm on 6 V

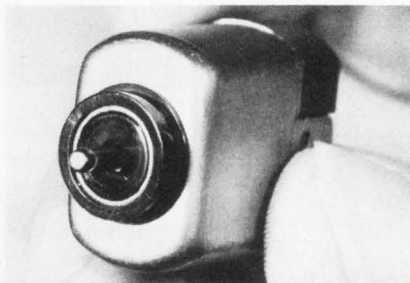

North American Philips Controls Corp., Cheshire Industrial Park, Cheshire, Conn. 06410. (203) 272-0301.

Used in the new Polaroid SX-70 camera, the 6-V A17101, three-pole, permanent-magnet dc motor has an output speed of 11,000 rpm $\pm 10\%$ at a 0.32 oz-in. load. Current input is 350 mA at no load and 1.2 A at 0.32 oz-in. Starting torque is 0.72 oz-in. The motor measures 1.15 \times 0.60 \times 0.89 in.

CIRCLE NO. 371

Print 155-mil numbers with thermal head

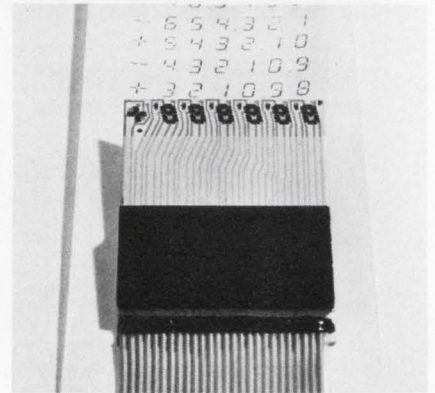

Gulton Industries, Inc., 212 Durham, Metuchen, N.J. 08840. (201) 548-2800. Four digit-PS4151: \$56 (1-9); 6 wks.

The PS-015 series of numeric, seven-segment, thermal printheads for nonimpact printing features highly legible 155-mil slanted characters that are especially configured for data logging. Characters are interconnected with isolation diodes for multiplexed operation. Standard units have from four to seven digits and they are expandable to any number of digits.

CIRCLE NO. 372

Rotary switches have adjustable stops

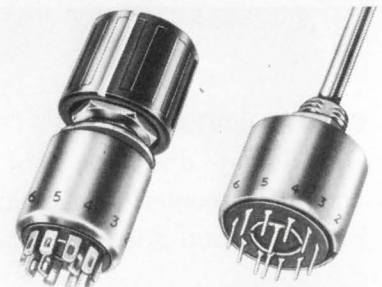

Alco Electronic Products, Inc., 1551 Osgood St., North Andover, Mass. 01845. (617) 685-4371. \$3.13 (500 up); stock.

New MRB series miniature rotary switches with preset adjustable position stops come in 1, 2, or 3-pole versions with 36 degree detents and adjustable stops from 2-to-10 positions. Also 30 degree detent models are available in 1, 2 or 4-poles, adjustable from 2-to-12 positions. In addition, single-pole types are designed for continuous rotation. Shafts come in 0.750 and 0.325-in. lengths with screwdriver slots.

CIRCLE NO. 373

METAL CARD MOUNTS

For Vertical or Horizontal Mounting to Chassis



CAT. NO.
VM 7700

In Stock
Immediate
Shipment

Mount smaller isolated
p.c. boards with plastic
Versamount Cat.No. 7500

Mount large p.c. boards with the metal Versamount™ which takes rivet-on metal UNITRACK™ card guides or snap-in plastic UNITRACK card guides. Provides sturdy support as well as shielding, grounding and heat dissipation.

UNITRACK™

UNITRACK Division, Calabro Plastics, Inc.
8738 West Chester Pike, Upper Darby, Pa. 19082
Telephone (215) 789-3820

INFORMATION RETRIEVAL NUMBER 145

STANDARDIZED PLUG-IN HOUSINGS

FROM STOCK



For packaging Relays, Filter Networks, logic circuits, and other assemblies requiring dust, dirt or tamper-proof protection.

Housings: A variety of sizes and colors available in Polystyrene, Butyrate, Nylon and Aluminum.

Headers: Available in 7, 8, 9, 11 and 20 pin configurations.

NEW FREE CATALOG ON REQUEST

Manufacturers of Standardized Hardware for Electronics



KEYSTONE

ELECTRONICS CORP.

49 Bleecker Street • New York, N.Y. 10012

INFORMATION RETRIEVAL NUMBER 146

ELECTRONIC DESIGN 6, March 15, 1974

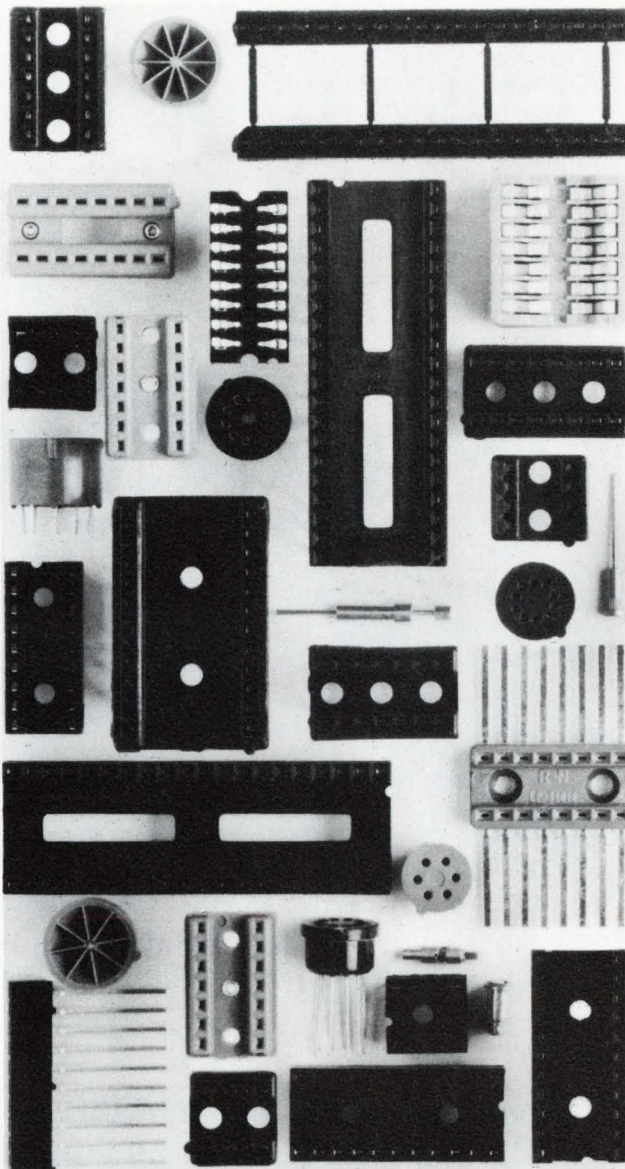

SOCKETS

The most complete
competitive line in the industry.

Literally hundreds of socket products - over 800 standard items. Sockets for 8-pin mini-Dips to 64-pin LSIs. Can styles. Transistor sockets. Pin sockets. Surface mount, solder and wirewrap styles. Adaptors. Plugs. Jumpers. Even complete interconnect systems. You name it, we make it. To meet RNs exacting standards. At a price that's right.

And delivered when and where you need them. Off the shelf. From our plant or one of 20-plus stocking distributors.

If you need to know about plug-ins, see...The Socket People.



ROBINSON NUGENT INC.
800 EAST EIGHTH STREET
NEW ALBANY, INDIANA 47150
(812) 945-0211 TWX 810-540-4082

INFORMATION RETRIEVAL NUMBER 147

custom options at compact prices

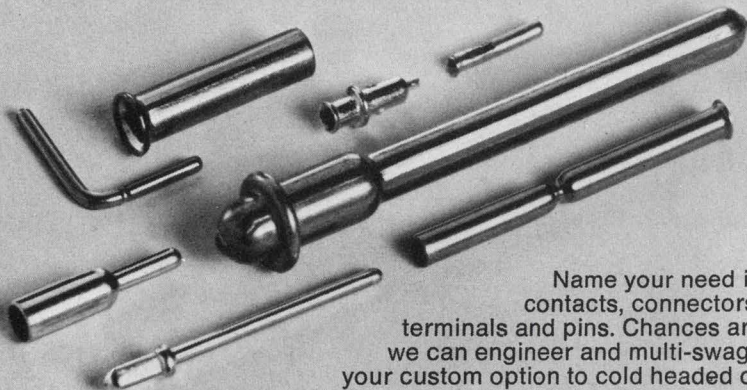

Name your need in contacts, connectors, terminals and pins. Chances are we can engineer and multi-swage your custom option to cold headed or machine screw quality. And slash your costs 40% or more. Delivery is when you want it, too. Get all the details in our new catalog. Write or call.



bead electronics

A Division of Bead Chain Manufacturing Co.
58 Mountain Grove St., Bridgeport, Conn. 06605
Phone: (203) 334-4124

INFORMATION RETRIEVAL NUMBER 148

System 9400
changes as quickly as your needs do.

DATA LOGGER

A new breed of data logger that easily configures to your needs now—quickly reconfigures as your requirements change. Can be stand-alone logger or part of a powerful NOVA computer based system with software drivers in BASIC, FORTRAN and ASSEMBLY languages.



Outputs to integral printer, TTY, mag tape, modem, punch tape. Don't get locked into another logger before you've seen the System 9400 in action. Contact Monitor Labs Incorporated, 4202 Sorrento Valley Boulevard, San Diego, CA 92121. Tel: (714) 453-6260. TWX: 910-337-1278.



INFORMATION RETRIEVAL NUMBER 149

COMPONENTS

Solid-state timer counts to 9.999 seconds

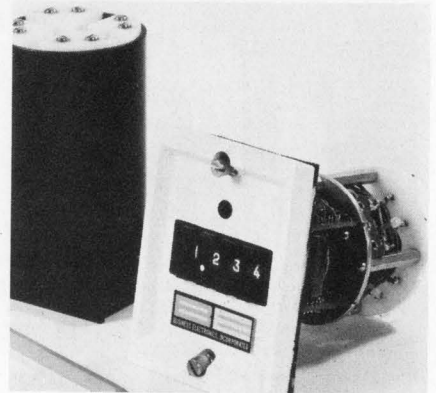

Business Electronics, Inc., 112 3rd Ave. N., Minneapolis, Minn. 55401. (612) 332-1492.

The PL-1047 solid-state timer features a four-digit to 9.999 second range with bidirectional reset switches on the panel face. Time is measured by digital counting. The timer operates on 120 V ac, 50 or 60 Hz, with its own internal power supply. The output is via a solid-state relay that can handle a 0.5-A load. Output may be either normally open or normally closed. Timer repeatability is 0.02%. A panel LED indicates when the unit is in the timing mode. Timing may be initiated by an impulse or a maintained start signal.

CIRCLE NO. 374

Binary-coded switch slides into positions

Chicago Dynamic Industries, Inc., 1725 Diversey Blvd., Chicago, Ill. 60614. (312) 943-4600. 4-6 wks.

Series SLB binary-coded slide switch with eight to 64 positions operates in either a vertical or horizontal position and its behind-the-panel dimensions are less than most rotary or thumbwheel switches. Solderlug or PC dip-solder terminations are available. Switch life exceeds 1,000,000 detents. The switch is constructed on a glass-laminate PC board and the contacts are plated with precious metals. Electrical specifications include: 200 M Ω min, insulation resistance; 1000 V min, dielectric strength; 2-A, 115-V ac current-carrying capability; and 125-mA, 115-V ac current breaking capability.

CIRCLE NO. 375

Only **CIMRON** gives you a choice in 4½ digits for \$695⁰⁰

We've built every desirable feature that's available today into these top-of-the-line 4½ digit multimeters . . . and, no one else gives you the choice between two instruments with this dollar-for-dollar trade off. Whether you need a full-multimeter with complete automatic operation and print output capability or a manual instrument with auto zero and a 20 MHz counter built in at no extra cost . . . Cimron has it. Both models are AC/DC powered so order the one that does your job.

DMC 45 **Digital Multimeter Counter**

From the originator of the DMC™ here is our third generation of two instruments in one package. In addition to 5 ranges of AC and DC voltage (with 10 microvolt sensitivity), AC and DC current, and 6 resistance ranges (10 milliohms to 40 megohms), the DMC™.45 gives you 6 ranges of frequency counting (10 Hz to 20 MHz). That's a grand total of 6 functions with 32 ranges. Cimron's exclusive Deca State Logic

delivers high speed and high noise rejection. You'll like the auto zero convenience, and the 300% over-range gives 5 digit performance up to 40,000 counts. Keep it in the field for 2 days normal operation without a battery recharge.

Model DMM 40 **Digital Multimeter**

This systems compatible 4½ digit instrument, with 100% overrange, features full autoranging of all functions and that gives you error free operation in production testing . . . a big cost savings bonus. Our two speed clock system measures at the rate of 4 readings per second with no degradation of accuracy. You get AC, DC, ohms and current built into one small 8 pound package . . . nothing extra to buy unless you need isolated data outputs and that costs only \$150. You'll like the bright planar easy-to-read display, and the MSI/LSI circuits that add to the reliability.

Write or call today for complete details.

300% OVERRANGE — BUILT IN COUNTER



CALIFORNIA INSTRUMENTS
a division of
AIKEN INDUSTRIES, INC.

5150 Convo St. • San Diego, Ca. 92111 • (714) 279-8620

INFORMATION RETRIEVAL NUMBER 179

AUTORANGE — BATTERY OPERATION

DESIGN ENGINEERS:

Custom's Capacitors have what you need

Do you deal with specifications like these in your work:

- capacitance over 40 pf up
- frequencies in MHz
- voltage over 1000 VDC

Then reconstituted mica capacitors are what you need.

Do you work with energy density of .05-.25 joules/in.³, at high voltage?

Reconstituted mica capacitors will best fill your requirements.

Looking for high voltage in small packages?

You need reconstituted mica capacitors!

Another of the many advantages of reconstituted mica capacitors is excellent performance under environmental extremes.

Custom can meet your needs better, because each process in our capacitor production begins and ends with quality control to avoid failure in the field. Let us show you how we can fill your requirements.

See our page in *Electronic Buyer's Guide and EEM* and write for FREE product sheets today.

P.S. Oil exploration personnel: Custom can help you with your logging tool problems.



CUSTOM ELECTRONICS, Inc.
4 Browne St., Oneonta, N.Y. 13820
PH: (607) 432-3880 TWX: 510-241-8292

POWER SOURCES

UPS delivers 10 kVA from single phase lines

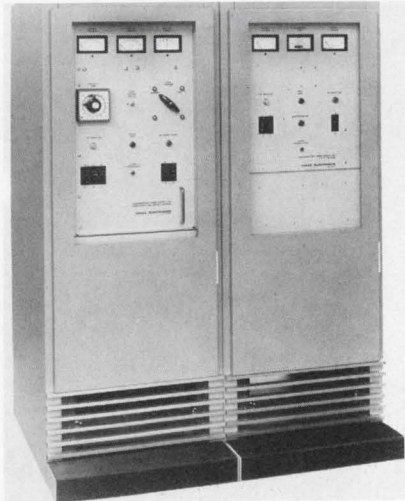

Topaz Electronics, 3855 Ruffin Rd., San Diego, Calif. 92123. (714) 279-0111. From \$11,300.

The 10 kVA "MINI-UPS" uninterruptible power system operates from power lines of 95 to 130 V ac and attenuates power-line noise spikes. The MINI-UPS comes complete with battery charger, inverter and choice of either relay or solid-state transfer switch. Integral meters show battery voltage and output voltage. The operating mode is indicated by panel lights. A wide choice of full load back-up time is available through battery selection.

CIRCLE NO. 376

Small modular supplies deliver up to 2.5 A

Acopian, Easton, Pa. 18042. (215) 258-5441. \$130 (dual output); \$125 (single output); 3 day.

The E Series of miniaturized power modules has been expanded to include models with output current ratings up to 2.5 A. Previous models only handle 1.5 A max. The new models provide outputs ranging from 1.5 to 28 V. Dual models for driving op amps, offer either ± 12 or ± 15 V outputs and are rated at 500 mA. Most models have line regulation of $\pm 0.05\%$, load regulation of $\pm 0.1\%$, and ripple of 1 mV rms. Standard input is 105 to 125 V ac, 47 to 420 Hz. These units are designed for mounting directly on PC boards and they are housed in cases measuring $3.5 \times 2.5 \times 2$ in.

CIRCLE NO. 377

High voltage supply switches levels fast

AMP, Captron Div., Elizabethtown, Pa. 17022. (717) 367-1105.

A high voltage switching power supply is capable of switching between any two of the 6, 8, 10, or 12 kV output levels within 50 μ s into a load of 500 μ A and 500 pF. The supply operates from a 20 V dc input and includes positive short-circuit and overload protection. At any of the four output levels, ripple is less than 0.5% and dynamic regulation is within 0.5%. The hermetically sealed steel case measures $9 \times 5.5 \times 6.5$ in. and the unit weighs just under 20 lb.

CIRCLE NO. 378

Marx generator can deliver 4 MV

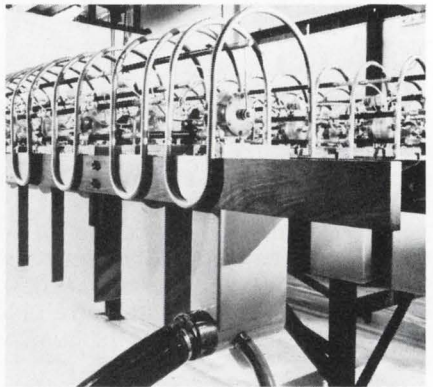

Maxwell Labs, Inc., 9244 Balboa Ave., San Diego, Calif. 92123. (714) 279-5100.

High voltage Marx generators provide pulsed power sources for fusion research, plasma physics and high power laser studies. The basic circuit consists of charging a group of capacitors in parallel and discharging them in series through overvoltage, two-electrode spark gaps. Electrical characteristics are: Erected voltage of about 4 MV and stored energy of 200 kJ with a stage voltage of 75 kV. The Marx generator is housed in a tank containing 55,000 gallons of insulating oil. It is arranged in a horizontal zigzag pattern of five rows and all components are readily accessible for ease of maintenance. To ensure low jitter the system utilizes switch triggers which resistively couple alternate Marx stages. Solid resistors are used instead of copper sulphate, which also minimizes maintenance.

CIRCLE NO. 379

Quick relief for design headaches.



Avantek's family of TO-8 packaged thin film amplifiers and oscillators are just the cure you've been waiting for to relieve those equipment design headaches.

Their basic ingredients include Avantek thin film technology and semiconductors. Amplifiers feature low noise figure and high dynamic range from 5 to 2300 MHz. Oscillators are voltage tunable in eight overlapping bands from 600 to 6600 MHz and

deliver power at +10 dBm to +13 dBm. Units can be specified from -54°C to $+100^{\circ}\text{C}$.

When you're in a squeeze with cramped circuit layouts and budgets, these low cost miniature components will leave you breathing a little easier.

Call or write Avantek and we'll prescribe the UTO or VTO for you — 3175 Bowers Avenue, Santa Clara, CA 95051 (408) 249-0700.

Avantek... years ahead today.

COMPLETE PACKAGING CAPABILITY

only
from
Vero

CASES
CONNECTORS
CARD FRAMES
MODULE RACKS
VEROBOARD
CARD HANDLES
FRONT PANELS
PANEL HANDLES

ALL
DELIVERED
FROM
STOCK



VERORACK 3

The ULTIMATE PC CARD FRAME

• Exceptional Strength • Precision Aluminum Extrusion Guide Rails • Concealed Guide Mounting • Identification Strip Standard in Front—Optional in Rear • Noryl Guide Temp. Range —60 +125 C • Selection of Guide Lengths • 4" & 4½" Wide Guide Blocks With .5" Cards Spacing for Fastest Assembly Guides Slide Into Extrusions • Individual Variable Spaced Guides from .4" Available • Combine Guide Lengths for Extra Length Cards With Special Center Extrusion • Unique Extruded Connector Rails Allow Connector Mounting at any Point and Identification of Connector Position.

VERO

Vero Electronics Inc.

171 Bridge Road, Hauppauge, N.Y. 11787
Tel.: 516-234-0400 • TWX510-227-8890

INFORMATION RETRIEVAL NUMBER 152

PICTURE, PATTERN, OR PLOT

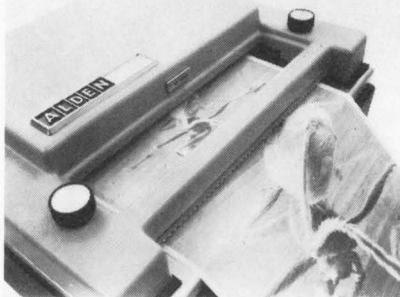

Now you can afford to add instant graphic hard copy output to your data terminals, storage tubes, computer outputs, SSTV, scanning sensors.

- Get low cost hard copy by instant graphic recording on ALFAX Type A electrosensitive paper where electricity is the ink.
- Interface ALDEN "Flying Spot" Component Recorders by simple synchronizing with your sweep circuit or scanning sensors and record directly from your target or cathode signal current.

Send for free brochure:
"ALDEN Components to Picture,
Pattern or Plot"

ALDEN
ELECTRONIC & IMPULSE RECORDING EQUIPMENT CO., INC.

Westboro, Mass. 01581 Tel: (617) 366-8851 TELEX: 94-8404

INFORMATION RETRIEVAL NUMBER 153



Bi

TIMING

**YOU'RE YEARS
AHEAD WITH . .**

**SOLID
STATE
TIMING**



... We know you are—with over 30 "Custom . . . Standard" models to suit your exact requirements. Our digital timing instruments assure absolute accuracy for elapsed time measurements of processes, reaction time, cycle time, relay testing, viscosity, etc. . . .

**PANEL OR BENCH MODELS
EASY TO USE**

Bi

**FREE Applications Manual
DURGIN-BROWNE INC.**
80 Allen Road
So. Burlington, Vermont 05401
(802) 863-6873

INFORMATION RETRIEVAL NUMBER 154

POWER SOURCES

NiCad battery-pack has protective plastic case

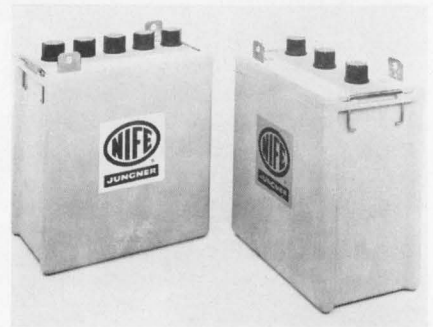

NIFE Inc., 21 Dixon Ave., Copiague, N.Y. 11726. (516) 842-5240.

Ruggedized pocket-plate nickel cadmium storage batteries are available in three different cell types: LFD long-rate batteries from 70 to 230 ampere-hour capacities; HFD high-rate in 80 ampere-hour capacity; and MFD intermediate-rate in 100 ampere-hour capacity. They are housed in heavy wall expanded plastic containers. These containers are inert to all oils and lubricants. Dead-top design with no exposed connector prevents short-circuits.

CIRCLE NO. 380

High voltage supplies offer many options

Spellman High Voltage Electronics, 1930 Adee Ave., Bronx, N.Y. 10469. (212) 671-0300. From \$55; stock to 4 wk.

The RM series of regulated power supply modules is available in various categories up to 30 kV and 10 W. The modules can be ordered fully adjustable from 0 to maximum rated output voltage (RM) or adjustable over a narrow range (FRM). Both types operate from a 28 V dc input and incorporate remote resistance programming. All models are available with either positive or negative output polarity with respect to ground. The units feature line regulation of $\pm 0.01\%$ for $\pm 10\%$ line change; load regulation of 1%/W output rating; and ripple of 0.1% rms/W output rating. All models in the RM and FRM line are overload, short-circuit, arc and reverse voltage protected. Normal operating temperature range for the power supplies is 0 to 60 C.

CIRCLE NO. 381

Now there's something better than simultaneous reading and writing tubes. Complete systems.

We began with our dual gun storage tube TME 1496, and we built it into a system; our new TH7500 storage scan converter. It lets you store and continuously visualize slowly varying analogical information on a TV display. And in addition, it gives you a choice of two trace widths for writing or erasing, a very long storage capacity, and global or selective fast erasing. Our TH7500 can be used for all applications applying slowly varying signals with a frequency range from 0 to 3.5 KHz.

And while we were developing the TH7500, we

also built a sequential reading and writing system—the TTV3900. It's designed around our TME 1238 (or 1239) single gun storage tube, and functions as a high quality storage, scan converter or freeze frame device.

Both of the systems (and the tubes used in them) are marketed in the U.S. by DuMont Electron Tubes and Devices, Clifton, New Jersey, in other countries by Thomson-CSF Electron Tubes. For complete information and specifications, please circle the reader's service card or contact us directly.

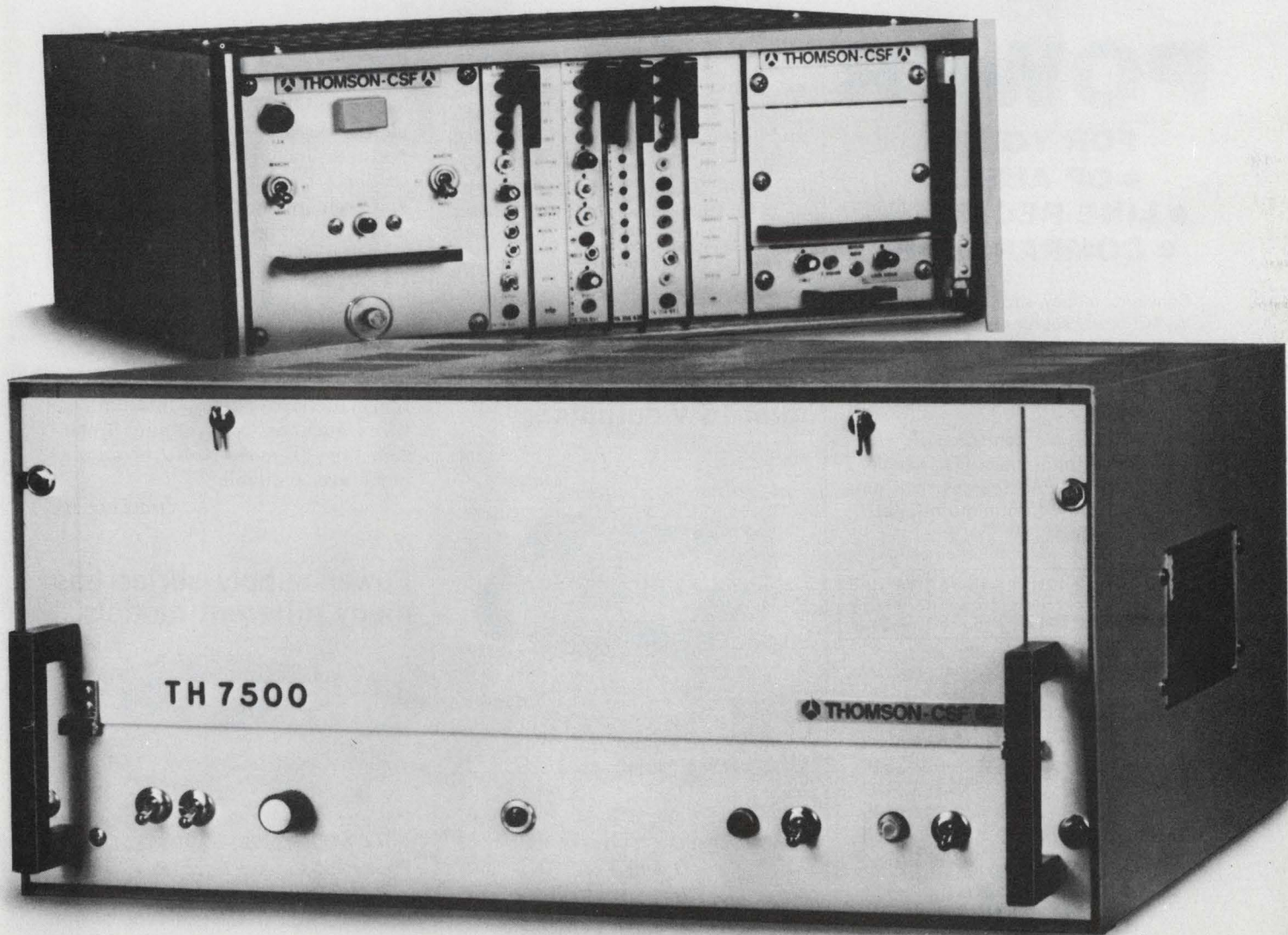

THOMSON-CSF

MARKETED IN NORTH AMERICA BY DUMONT ELECTRON TUBES & DEVICES, CLIFTON, N.J. / TEL (201) 773-2000

France - THOMSON-CSF Groupement Tubes Electroniques/8, rue Chasseloup-Laubat/75737 PARIS CEDEX 15/Tel. 566 70.04

Germany - THOMSON-CSF Elektronenröhren GmbH/Am Leonhardsbrunn 10/6 FRANKFURT/MAIN/Tel. 70 20.99

Italy - THOMSON-CSF Tubi Elettronici SRL/Viale degli Ammiragli 71/ROMA/Tel. 638 14.58

Japan - THOMSON-CSF Japan K.K./Kyosho Building/1-9-3 Hirakawa-cho/Chiyoda-ku/TOKYO/TEL. (03) 264.6341

Sweden - THOMSON-CSF Elektronrör AB/Box 27080/S 10251 STOCKHOLM 27/Tel. (08) 22 58.15

SEE US AT
THE I.E.E.E.
BOOTHS 2303-05
2402-04

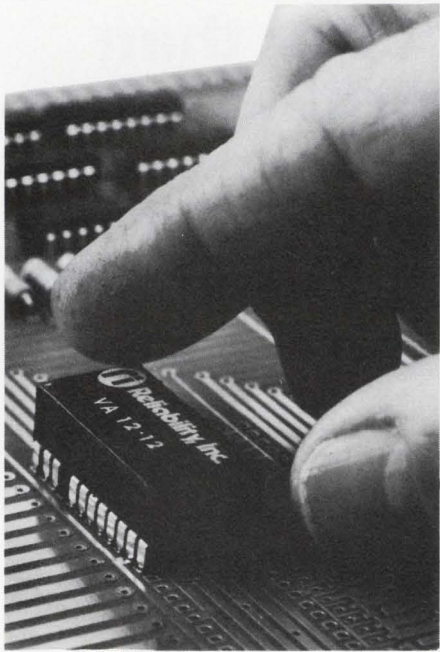

POWER

- FOR YOUR
- OP AMPS
- LINE RECEIVERS
- COMPARATORS

Convenient, money saving, practical — V-PAC* power sources give you needed voltages for linear ICs from standard +5v source. Operate as many as 25 linear devices from a single V-PAC power source!

Standard DIP pin configuration, and less than a third cubic inch volume, lets you use V-PAC sources right on the PC card, with minimum length interconnections.

TYPE:	VA 12-12	VA 15-15	VA 12-6
VOLTAGES:	+12 -12	+15 -15	+12 -6

Write or call for full specifications.

WEST:	EAST:
213-843-5200	513-761-5432
214-231-6181	201-992-2505
505-265-6794	803-288-4450
312-654-8645	416-743-9130
415-593-2189	617-272-7655
206-747-9424	305-941-5544



Reliability, Inc.

5325 Glenmont, Houston, Texas
77036 • 713-666-3261

Europe and the Far East: TISCO (TI Supply Co.)

TWX: 910-881-1739 *TM, Reliability, Inc.

INFORMATION RETRIEVAL NUMBER 156

POWER SOURCES

Regulated mini-supplies deliver up to 1000 mW

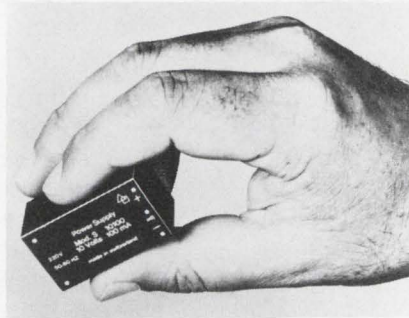

EPP Corp., 10180 W. Jefferson Blvd., Culver City, Calif. 90230. (213) 838-1912. \$31.40 (10-up); stock.

The SD Series of miniature ac-to-dc power supplies can deliver dc outputs of from 3 to 24 V at currents of 15 to 140 mA for a 1-W maximum output power. Output voltage is preset to within $\pm 5\%$ and can be externally trimmed with a single resistor. Load regulation is 0.35% with a ripple of 2 mV rms max. The operating temperature range is -10 to $+60$ C. The supply is housed in a $1.7 \times 1 \times 0.85$ in. case.

CIRCLE NO. 382

Dc-to-dc converter gives dual 15 V outputs

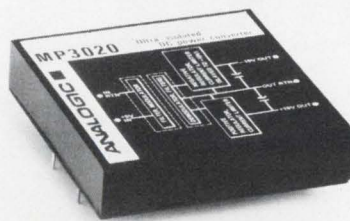

Analogic, Audubon Rd., Wakefield, Mass. 01880. (617) 246-0300. \$85; stock.

The MP3020, a 5 to ± 15 V dc-to-dc converter, offers isolation of 80 pF, $10^{12} \Omega$ and 1 kV. It is 65% efficient, can supply up to 150 mA from each of the two output circuits, and regulates output voltage to within 0.1% during a full-load change. The 2-in. square converter is 3/8-in. high and can be plugged or soldered into a PC card for 0.5 in. card cage spacing.

CIRCLE NO. 383

High current dc supplies deliver up to 15 A

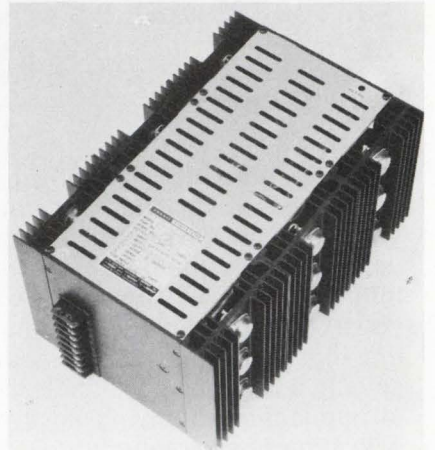

Abbott-Transistor, 5200 W. Jefferson Blvd., Los Angeles, Calif. 90016. (213) 936-8185. From \$219; stock.

The RN15 series of dc supplies provides 15 A at preset voltages between 4.5 and 17 V. Line and load regulation are 0.1% and ripple is less than 0.02%. Standard features include short-circuit protection, input transient protection and remote error sensing. Anodized aluminum case construction permits sustained full-load operation at an ambient temperature of 71 C without the need for heat sinking or forced air cooling. A temperature coefficient of 0.03%/°C guarantees stability in a fluctuating thermal environment. Optional features such as overvoltage protection and remote voltage adjustment are available.

CIRCLE NO. 384

Power supply series has many different models

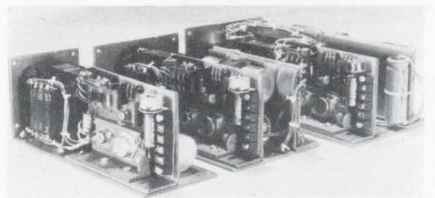

Voltex, 115 Marine St., Farmingdale, N.Y. 11735. (516) 249-2336. From \$59; stock to 4 wk.

The 86-300 series of single, dual and triple output OEM-type power modules deliver voltages which range from 3.6 V to 28 V at from 300 mA to 4 A. Overvoltage crowbar, foldback current limiting, and remote sensing are standard features of these supplies.

CIRCLE NO. 385

Overload protected power supplies with more filtering, line and load regulation per dollar

B&K Model 1601 • \$170.00

0-50 VDC @ 0-2 Amperes
Typical regulation:
Line-0.02%, load-0.07%
Ripple: 5mV p-to-p



B&K Model 1602 • \$180.00

0-400 VDC @ 0-200 mA
Typical regulation: 0.1%
Ripple: 10mV p-to-p
0-100 VDC @ 0-2mA, regulated 1%
for line & load, series
current limited.
6.3/12.6VAC @ 3.5A

Well filtered and regulated output voltages are continuously variable over full range with a single control. Foolproof fully automatic overload shuts down when current on 2 A or 200 mA supply exceeds the adjustable preset level. Pushbutton restores operation. Stack these supplies to provide a wide range of well regulated, and filtered currents in minimum bench space and at reasonable cost. See your distributor or write Dynascan Corporation.

FOR POWER SUPPLY AND CIRCUIT PROTECTION

You can set the overload trip point to the exact value you want without disconnecting or shorting output terminals, so you're apt to always use the safety feature . . . and wrong polarity reconections can't occur. Just push the current limit button and adjust current to the desired overload value.

With the off-on switch combined with the voltage control, voltage above the desired value can't be accidentally applied to the circuit, yet a standby switch allows no-voltage circuit adjustments without changing the voltage setting.

B&K PRODUCTS OF
DYNASCAN
1801 W. Belle Plaine Ave.
Chicago, IL 60613 • (312) 327-7270

INFORMATION RETRIEVAL NUMBER 157

Three-phase regulator handles up to 24 kVA

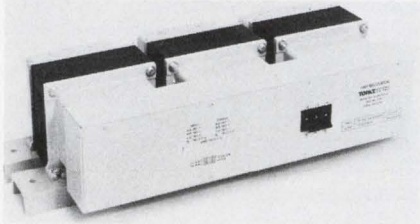

Topaz Electronics, 3855 Ruffin Rd., San Diego, Calif. 92123. (714) 279-0111. From \$1160.

The LRB series of three-phase ac line regulators is available in power ratings from 6 to 24 kVA. Voltage outputs of 115 V ac to 240 V ac can be selected. The units operate with line frequency variations from 47 to 63 Hz. The regulators have a 98% minimum efficiency. Their response time is less than 1 cycle. The output adds less than 1% total harmonic distortion. Audible noise is typically 2 dB.

CIRCLE NO. 386

Magnetic amp regulator has 85% efficiency

Arnold Magnetics, 11520 W. Jefferson Blvd., Culver City, Calif. 90230. (213) 870-7014.

A 25-kHz magnetic amplifier regulator is part of a "Design-As-You-Order" system that offers over 1200 possible configurations of ac-to-dc and dc-to-dc power converters. Model ARM delivers 6 W per cubic inch and has a 100,000 hour MTBF, 0.1% regulation and an over-all efficiency approaching 85%. It is also provided with fold-back current limiting and over-voltage protection. The regulator module is available with adjustable regulated 150 W outputs of 4.2 to 6, 11.2 to 16, 15 to 22, 21 to 30 or 70 to 100 V dc. Compatible input modules range from 11 to 120 V dc, and 115 V ac, 50 to 500 Hz. Systems are available with up to six isolated outputs and are provided in pretested, encapsulated miniature packages.

CIRCLE NO. 387

Triple output supplies deliver up to 12 A

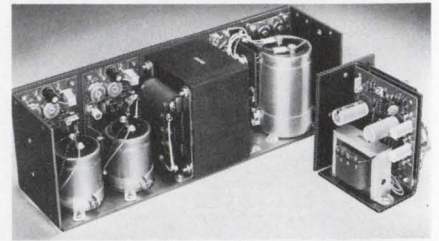

Standard Power, 1400 S. Village Way, Santa Ana, Calif. 92705. (714) 558-8512. From \$75; stock.

Current ratings of all eight models in the triple-output series dc supplies range from a low of 0.25 A up to 12 A. For example, Model SPS 30T-5-12/15 provides 5 V dc at 2 A and ± 12 to 15 V dc at 0.25 A. Model SPS 250T-5-12/15 delivers 5 V dc at 12 A and ± 12 to 15 V dc at 3.5 A. All units operate on 115/230 V ac inputs, 47 to 440 Hz. Regulation is $\pm 0.1\%$ and ripple is typically 0.1%. Other models in the series have ratings between the two units mentioned.

CIRCLE NO. 388

DESIGN CHALLENGE

#1 How to minimize flutter and wow in the motor-to-capstan drive of a precision tape recorder.

DATA GIVEN:

0.800" Drive Pulley, 1800 rpm.
2.550" Capstan, 2.7" C. D. Torque,
approx. 2 oz in. Single Ply Drive
Belt, 0.025-0.030" thick; 0.250"
widthmax. Takeup Pulley available
for non-elastic belt.

SOLUTION:

A custom-engineered, elastic
Tilton Endless Belt that meets all
requirements and eliminates need
for takeup mechanism. For solution
details, request Tilton Case
History #1.

CHALLENGE:

... an ASB
applications engineer
to solve your light to
medium conveying and
power transmission problems.

**ARTHUR S. BROWN
MFG. CO.**

Tilton, N. H. 03276 Phone (603) 286-4376

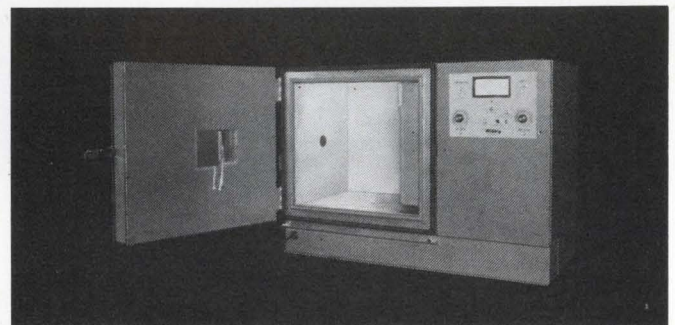

BENCHMASTER... 5 CUBIC FEET OF BENCH-TOP TEST SPACE!

Economical, portable, and compact, this all-new front-opening temperature and humidity test chamber is only 4 feet wide!

It's extremely versatile, too. Benchmaster offers medium or extreme temperature ranges—with or without humidity.

Benchmaster is available in 4 performance variations:

Model BTH: 0°F to 200°F with humidity

Model BTRS: -30°F to 350°F with humidity

Model BTR: -100°F to 350°F with humidity

Model BTC: -100°F to 350°F without humidity

Write for complete information.



Tenny
ENGINEERING, INC.

1090 Springfield Rd., Union, N.J. 07083 • (201) 686-7870 • (212) 962-0332

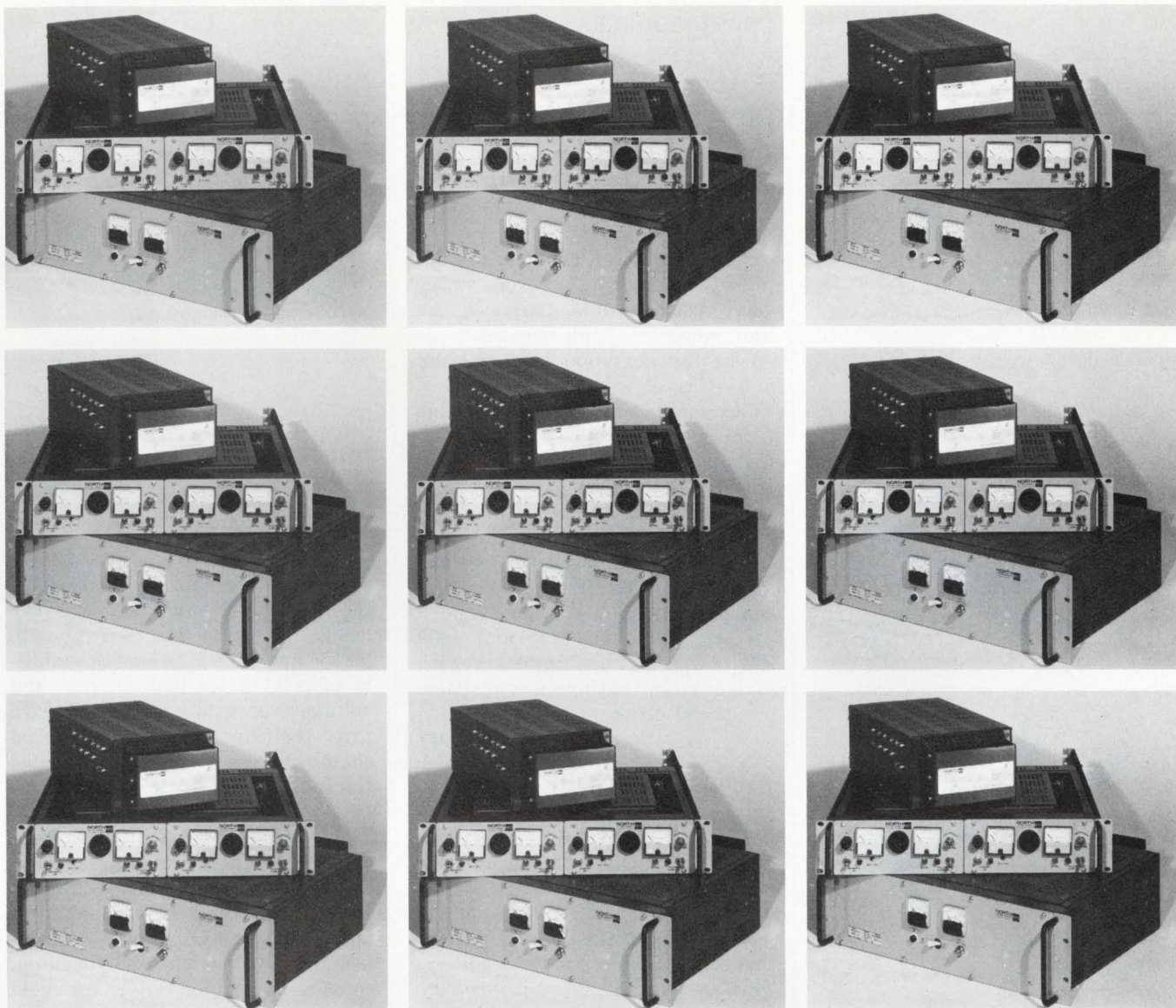

Whether you buy one's, two's or multitudes North delivers power reliability!

The performance of your business machine products should never depend on anything less than reliable power supplies. It just doesn't make sense to risk the valuable reputation of a major piece of equipment over a minor component—especially, when the cost difference is so little.

Many O.E.M.'s are beginning to agree with this point of view, and if you're one of them, we'd like to quote your next power supply order. Whether you need one unit—or one hundred, North Electric has both the product selection and the production capacity to deliver more "reliability" for your power supply dollar.

And, to back it up, we offer the industry's finest technical specialists and more than 40 years experience as the leader in custom power supplies.

SP-15

Send for a product catalog today, or for service information call your North Standard Product Manager at 419/468-8874.

MODEL	10000
VDC	AMPS
0-7.5	2.10
0-16	1.25
0-25	0.85
0-33	0.68

DUAL OUTPUT SUPPLIES	
MODEL	N03052
VDC	AMPS
±15-12	400MA
MODEL	N60052
VDC	AMPS
±15-12	1.0A

Listed here are the more popular models—many other voltages are available.

MODEL	11000	12000	13000	14000	15000	16000	17000	18000
VDC	AMPERES							
5.0	3.9	5.3	11.3	13.0	20.0	32.5	49.0	82.0
12.0	2.8	4.2	8.0	10.5	15.0	23.0	36.0	58.0
15.0	2.4	3.7	7.5	9.5	14.0	20.5	27.0	47.0
18.0	2.1	3.3	6.0	8.0	13.0	18.0	26.0	40.0
24.0	1.5	2.8	4.2	7.0	11.0	15.0	21.0	33.0
28.0	1.4	2.4	4.0	6.3	9.0	14.0	20.0	29.0
36.0	1.2	2.2	3.1	5.6	8.0	11.0	14.0	23.0
48.0	.95	1.8	2.6	4.2	6.0	8.0	10.0	18.0

NORTH 
ELECTRIC COMPANY

North Electric Company / Galion, Ohio 44833 / A United Telecom Co.

INFORMATION RETRIEVAL NUMBER 160



HI-TEMP SOCKETS

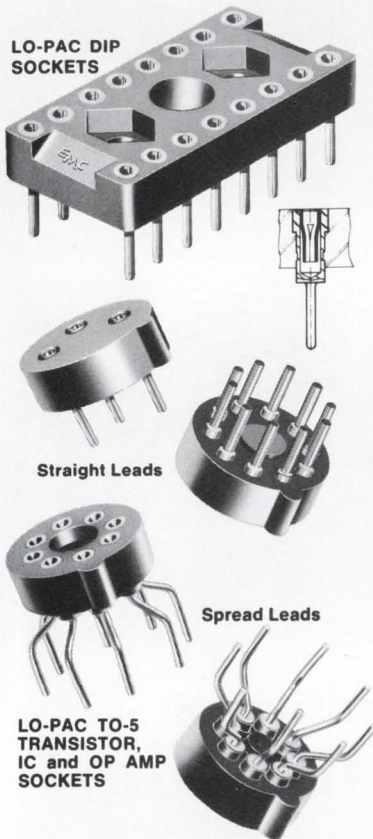

- Hi-Temp thermoset glass-filled phenolic insulation will not soften during soldering or burn in.
- Closed end terminal prevents solder flow into contact area.
- Low Profile for max. packaging density.
- Easy lead-in, no lead hang-up.
- Rigid, molded-in terminal will not bend during installation into p.c. board.
- DIP Sockets 8 to 36 leads
TO Sockets 3 to 12 leads.

Write, TWX or Phone for
Computer Products Catalog

ELECTRONIC MOLDING CORP.
96 Mill Street
Woonsocket, R. I. 02895
Phone (401) 769-3800
TWX 710-387-1350

POWER SOURCES

Power inverter delivers high frequency ac power

Induction Process Equipment, 32251 N. Avis Dr., Madison Heights, Mich. 48071. (313) 585-9393.

The Statipower IV inverters are induction heating power units. They convert low frequency ac line power to high frequency ac power for induction heat treating and forge heating applications. Floor space requirements range from only 12 to 48 sq. ft. depending upon the kW rating of the inverter. Statipower IV inverters are recommended for applications requiring power ratings greater than 150 kW at 3 kHz or 200 kW at 1 kHz. The inverter line includes units that provide 1 and 3 kHz at 400, 800, 1200 and 1600 kW power ratings. Inverters with higher power ratings are available on special order.

CIRCLE NO. 389

Ac line regulator keeps losses low

Power-Matic Inc., 8057 Raytheon Rd., San Diego, Calif. 92111. (714) 292-4422. From \$350.

The MPS-5000 series of ac line regulators achieves 99% efficiency. This is due to the multiprimary switching circuit (Pat. pend.) This switching technique generates no noise or distortion, is not affected by load power factor, and operates over the frequency range from 45 to 70 Hz. It permits high speed, 1/2-cycle step-response without generating any unbalance in the regulated output. The total regulation response time is 1-1/2 cycles for worst-case line voltage steps from max. high line to min low line input, 60% of such a step is regulated within 1/2 cycle. Standard, single phase regulators are offered in the power range from 500 VA to 15 VA. All models are available for 110 and 220 V power lines. The output voltage is adjustable over a 20% span, and all units have remote sensing. Six choices of regulation ranges are offered so that a great variety of power sources, line conditions or special systems requirements can be satisfied with standard products.

CIRCLE NO. 390

X-ray power source provides 50 kV at 1 mA

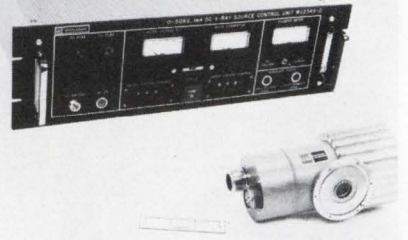

Watkins-Johnson Co., 3333 Hillview Ave., Palo Alto, Calif. 94304. (415) 493-4141.

The WJ-2370-2 X-ray power source consists of a WJ-2345-2 source control unit which operates the WJ-2307-2 side-window X-ray head. The source is rated for 0 to 50 kV and 0 to 1 mA, with stability of $\pm 0.1\%$ for both current and voltage over a 24-hour period. Two three-position binary-coded digital thumbwheel switches are provided for independent adjustment of target voltage and target current. The indirectly heated thermionic emission cathode requires no settling time, and permits rapid changes in target current or voltage. The X-ray head may be specified with tungsten, molybdenum, copper, chromium, silver or gold targets.

CIRCLE NO. 391

Variable dc power supply covers 0 to 30 V

Grumil Instrumentation, 4626 Idlewilde Lane, S.E., Albuquerque, N.M. 87108. (505) 265-2320. \$189; stock.

The GM202S power supply has a variable metered dc output from 0 to 30 V at 0 to 1.5 A. Load regulation is ± 3 mV max (NL to FL) and line regulation is 0.01% + 1 mV for inputs of 105 to 125 V ac. Ripple and noise is under 250 μ V rms or 1 mV pk-pk. The transient response for a NL to FL change is 20 μ s to ± 10 mV of set output. Meter accuracy is 3% of reading. The supply operates over a 0 to 60 C temperature range with convection cooling and is 3.65 \times 10.50 \times 6.44 in. (9.3 \times 26.9 \times 16.5 cm).

CIRCLE NO. 392

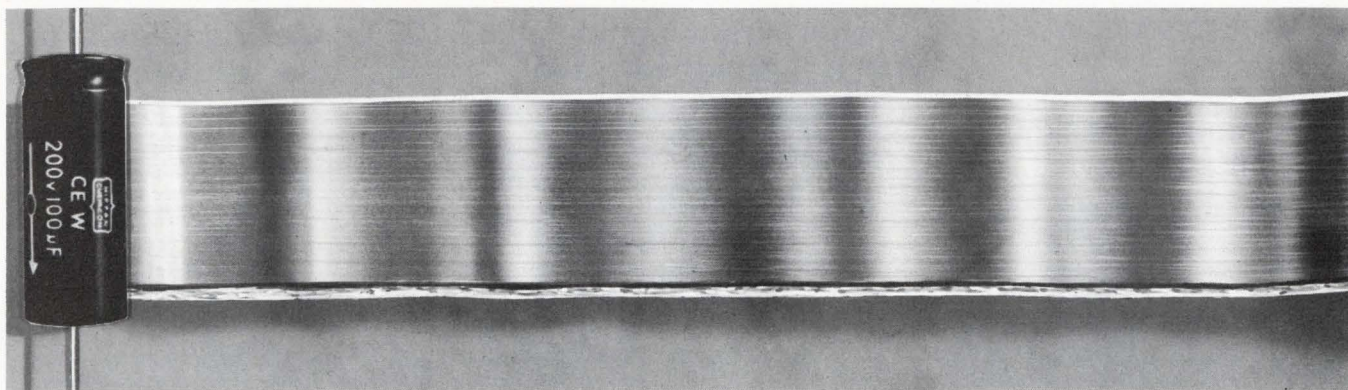

The world's largest manufacturer of miniature aluminum electrolytics wants to show you their etchings.

In the production process of electrolytic capacitors, the etching and forming of the foil is one of the most critical processes. The design of the foil directly affects performance and life.

This is why United Chemicon designs, etches and forms all its own foil and achieves complete quality control of every one of the over 60 million miniatures we sell each month. We know that we must use exactly the right type of foil to meet our customers' specific performance characteristics. That's why we welcome special, tough applications.

Now that you know more about our etchings, you should also know that our special machinery division designs, develops and builds all our machinery. Every capacitor is automatically aged and 100% tested.

This control guarantees an unparalleled degree of product uniformity, predictability and reliability of supply.

Shouldn't you know us?

Write, call 315/474-2954
or wire for full information
and latest technical bulletins.

6.3 to 500 WV, op temps from -40° to +85° C.
We solicit inquiries to your specs, as broader temperature ranges and performance characteristics are available.



United Chemicon.

World's largest manufacturer of miniature aluminum electrolytics. You should know us.

©1974 United Chemicon, Inc. 731 James Street Syracuse, New York 13203 315/474-2954 TELEX 937439

INFORMATION RETRIEVAL NUMBER 162

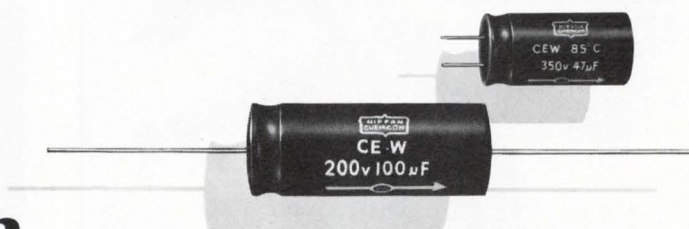

Cable clamps backed with self-adhesive

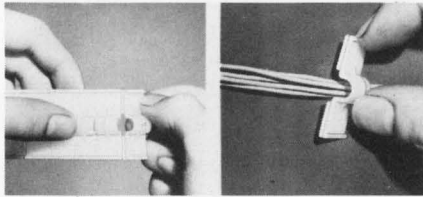

Weckesser Co., Inc., 4444 W. Irving Park Rd., Chicago, Ill. 60641. (312) 282-8626.

Plastic press clips are simply pressed into place for clamping and holding wires, cables, pipes, etc. They are backed with a two-sided, closed-cell, foam adhesive that provides permanent bonding even to irregular surfaces. Four sizes, packaged in strips, handle bundles from 1/8 to 1/2-in. diameter. They are molded from nylon. A half press clip is also available with one pad for use in limited space or for working close to corners.

Booth No. 1520 Circle No. 393

Panel wire-wrapping pins lock IC leads in place

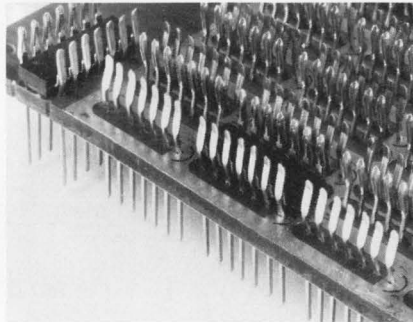

IFE Div. of Plastic Mold & Engineering Co., 25 Trippis Lane, East Providence, R.I. 02914. (401) 438-3315. \$15 to \$225.

A new Series 800 high-density wire-wrapping packaging panel with Lifeloc contacts offers low cost, reliability and ease of IC insertion, according to IFE. The contact is stamped from phosphor bronze. It features a groove on the interior surface that accepts and locks the IC lead in place. The panels are available in increments of 30 to a maximum of 180 positions.

CHECK NO. 394

Dispenser handles small quantities of compounds

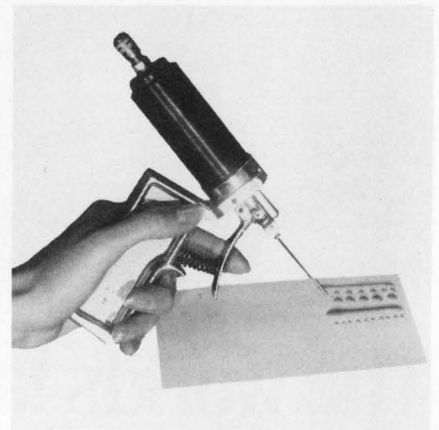

Kenics, One Southside Rd., Danvers, Mass. 01923. (617) 774-8600.

The Model 102 Epoxer is designed for dispensing epoxy, adhesives, potting compounds and other materials in small quantities. Once filled and pressurized, it is completely self-contained until the material in a polyethylene cartridge is completely dispensed. The Epoxer dispenses materials with a positive, no drip, cut-off control.

CIRCLE NO. 395

Call Kathy collect at (201) 542-1902 to get all the facts (prices, delivery, samples) on our 2 through 25 amp bridges, and especially our 40 amp full wave rectifier. The Power Physics 40PPR series can significantly reduce your assembly costs. They replace two discrete devices, are electrically isolated and easily handle high cyclic loading rates.

If you're really serious, call Kathy now; or, circle the reader service number to obtain a data sheet.

Power Physics -
Specialists in Power
Semiconductor
Technology
Industrial Way West,
Eatontown,
N.J. 07724

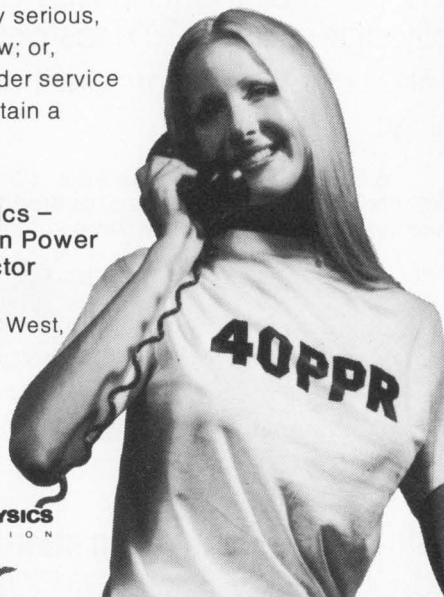

INFORMATION RETRIEVAL NUMBER 163

200 W power supply with full-rated performance to 71°C

\$99 (Dual \$119)



Stock Delivery

SPECIFICATIONS

Size: 5 x 5.5 x 10.75
Weight: 15 lbs
Input: 105-125V, 47-420Hz
Remote Sensing: Standard
Regulation: Line 0.01%
Load 0.10%
Ripple: Less than 250 Microvolts
Recovery: 25 Microseconds

Temperature: -20° to +71°C
Operating: -65° to +81°C
Storage: -0.01% / °C Max
Coefficient:
Current Limiting:
Fixed-foldback type
Overvoltage (OV): Optional
SCR Crowbar

SINGLE			DUAL (Two independent outputs)		
MODEL	VOLTS	AMPS	MODEL	VOLTS	AMPS
200-5	4.5 to 5.5	15.0	200-0505	4.5 to 5.5	7.0
200-12	11.5 to 12.5	10.0	200-1212	11.5 to 12.5	5.0
200-15	14.5 to 15.5	9.0	200-1515	14.5 to 15.5	4.5
200-24	23.5 to 24.5	7.5	200-2424	23.5 to 24.5	3.5
200-28	27.5 to 28.5	7.0	200-2828	27.5 to 28.5	3.5
200-48	47.5 to 48.5	4.0	(Any voltage 3 to 30 available)		
(Any voltage 3 to 50 available)			For OV models add -0 to model No.		

QUANTITY	SINGLE	WITH OV	DUAL	WITH OV
1-9	\$99	\$114	\$119	\$129
10-24	\$94	\$107	\$113	\$122

FREE POWER SUPPLY CATALOG

"Quality Power Supplies Since 1965"

Electrostatics, inc.

7718 CLAIREMONT MESA BLVD. • SAN DIEGO, CA 92111 • (714) 279-1414

INFORMATION RETRIEVAL NUMBER 99

ELECTRONIC DESIGN 6, March 15, 1974

You can't tell by looking at them!

ALL THESE RESISTORS LOOK ALIKE!

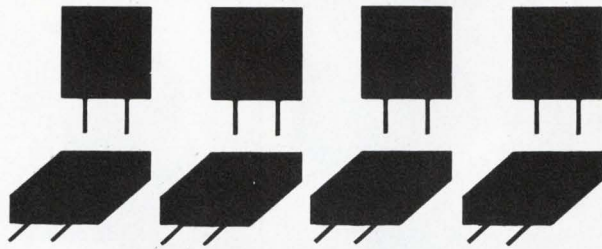

The only way to find out which one of the 'look alike's is a Vishay is to test their performance . . .

**ONLY THE VISHAY
BULK METAL™ RESISTOR
WILL GIVE YOU
ALL THESE SPECS.**

Don't be fooled by appearances or claims . . .

ONLY VISHAY RESISTORS
GIVE VISHAY PERFORMANCE . . .

**LOOK ALIKES
DON'T!**

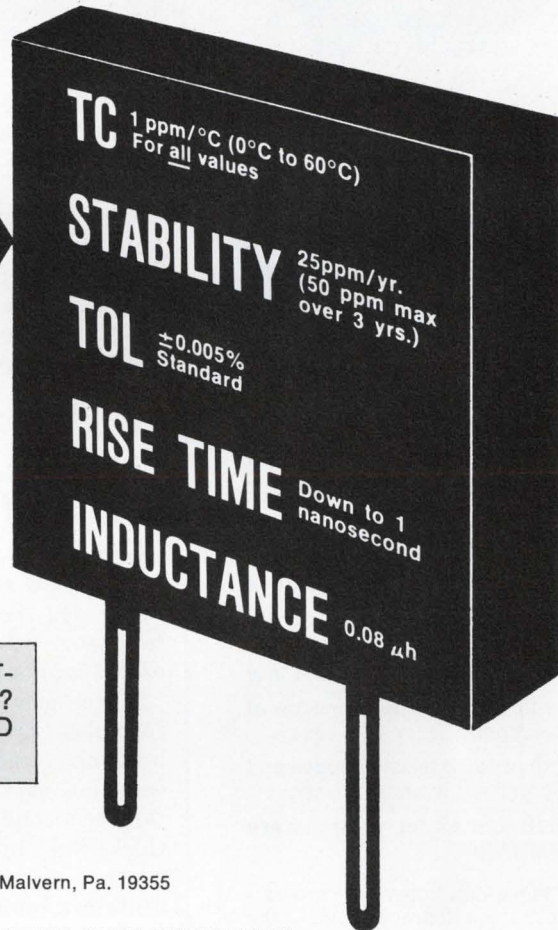

WANT A FREE SAMPLE FOR TESTING AGAINST LOOK ALIKES? WRITE ON YOUR LETTERHEAD TO:



VISHAY RESISTOR PRODUCTS

a division of Vishay Intertechnology, Inc. • 63 Lincoln Highway • Malvern, Pa. 19355

FILL IN—TEAR OFF AND MAIL FOR MORE INFORMATION

Gentlemen:

Tell me more about how to make sure I get what I order. Please send the following information:

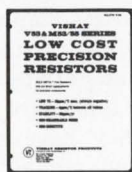
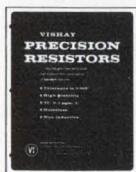

Ultra-precise Resistors

Precision Resistors

Technical article on Bulk Metal™ Film resistors

Please have salesman call.

NAME _____

TITLE _____ DEPT. _____

COMPANY _____

ADDRESS _____ STREET _____

CITY _____ STATE _____

ZIP _____

PHONE NO. _____



**PLUG-IN
COMPATIBLE
with savings
up to 40%**

Function Modules NEW Models 171 and 170 are Pin and Function Compatible to (Analog Devices QM and Burr-Brown 40/50).

- Model 171 with same performance ($\pm 5\text{ppm}/^\circ\text{C}$) is 20% less
- Model 170 with performance of ($\pm 10\text{ppm}/^\circ\text{C}$) for 40% less
- Both have no missing codes and still convert in under $25\mu\text{sec}$
- 8, 10 and 12 bit versions are available.

And these new converters are versatile. . . . An improved form of the successive-approximation technique of conversion is used to convert unipolar input voltages (0 to +5V, +10V, +20V) or bipolar input voltage ($\pm 2.5\text{V}$, $\pm 5\text{V}$, $\pm 10\text{V}$) to corresponding digital output codes of straight binary, offset binary, or 2's complement. This highly reliable family of pin-compatible converters from Function Modules takes the worry out of single sourcing.

They're in stock now!

Call or write today
FUNCTION MODULES, INC.
711 W. Seventeenth St.
Costa Mesa, CA 92626
Phone: (714) 645-6001

INFORMATION RETRIEVAL NUMBER 165

PACKAGING & MATERIALS

Work holder supports prototype PC boards

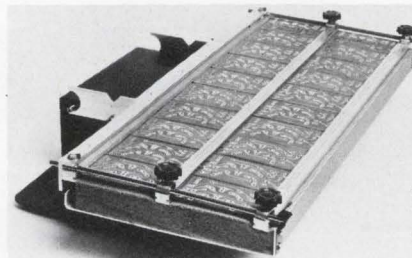

Micro Electronic Systems Inc., 8 Kevin Dr., Danbury, Conn. 06810. (203) 746-2525.

The prototype work holder, Model PWH, comes standard with 4, 6, 8 or 10-in. clamps. The holder is 16-in. wide. An optional channel clamp divider, Model CCD, permits the holder to accommodate twice as many, but smaller PC boards. A foam pad that backs the board is silicone treated to resist the heat of soldering irons.

CIRCLE NO. 396

Gold-paste formulas produce fine lines

Thick Film Systems Inc., 324 Palm Ave., Santa Barbara, Calif. 93101. (805) 963-7007. Conductrox: \$130 to \$140; Vitr-Au-Less: \$143 (25 oz); 10 days.

Three new thick-film, gold-paste formulas routinely produce 3-mil lines and spaces with conventional emulsion backed, 325-mesh screens for semiconductor packages and thick-film hybrid circuits. Conductrox formulas 3007 and 3009 contain a high-adhesion glass binder. Vitr-Au-Less 4007, without any glass, fires to 99% gold. All three formulas contain a low evaporation-rate screening vehicle to make them suitable for long manufacturing runs, where paste is exposed on the screen for many hours. The organic screening vehicle, trademarked Partilok, is a principle contributor to the fine-line printing capabilities. The Conductrox formulas can be fired at 730 to 1000 C on alumina substrates and 550 to 600 C on glass substrates and their resistivity is 2.8 to 4.0 M Ω /square. Vitr-Au-Less 4007 is fired at 950 to 1030 C and produces a resistivity of 1.3 to 1.7 M Ω /square.

CIRCLE NO. 397

Polyurethane foam is electrically conductive

Richards, Parents and Murray, Inc., 206 S. 14th Ave., Mount Vernon, N.Y. 10550. (914) Mo4-3464.

The conductivity of RPM #735 electrically conductive, flexible, polyurethane foam can be custom controlled within a range of 1000 to 5000 Ω . Flexibility diminishes as conductivity increases. The foam maintains stable conductivity in service temperatures from -40 to 180 F. Under compression, resistances have been measured as low as 25 Ω . The foam is available in 1/8 and 1/4-in. thicknesses and die-cut to almost any specification.

CIRCLE NO. 398

NEMA enclosures made from stainless steel

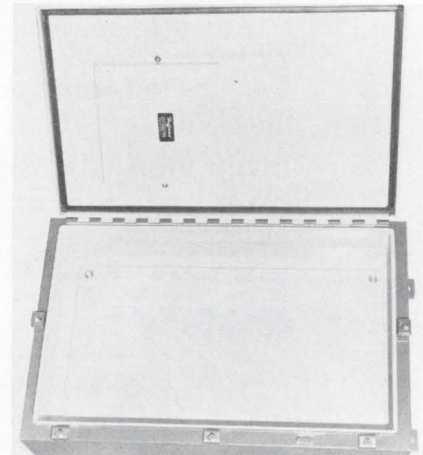

Hoffman Engineering Co., 3865 Tyler St., Anoka, Minn. 55303. (612) 421-2240.

Stainless-steel, NEMA, Type-4X enclosures are now available for use in wet areas where serious corrosion problems exist. They are made from 14-gauge, type-304 stainless steel. All seams are continuously welded and there are no holes or knockouts. The neoprene door gasket is attached with an oil-resistant adhesive and reinforced with stainless-steel retaining strips. Stainless-steel door clamps are easy to operate and they have no loose parts. A hasp and staple are provided for padlocking. Collar studs are furnished for mounting optional interior panels. Print pockets and panels are finished in white enamel. Nineteen stock sizes are available from 16 x 12 x 6 to 60 x 36 x 12 in.

CIRCLE NO. 399

Some of the best things about our new Digivac[®] 1000 are what you can't see.

When you look at our vacuum fluorescent readout, you won't see the low voltage requirements making it directly compatible with available MOS IC logic packages.

You won't see the exclusive mica substrate which supplies mechanical strength and helps emphasize lighted segments through a desirable halo effect.

You won't see the low cost, lower than competing readouts with fewer customer advantages.

Of course, there are things about our Tung-Sol[®] Digivac 1000 you can see.

Like the Digivac 1000's brightness. 50% more brightness and greater uniformity than ever before.

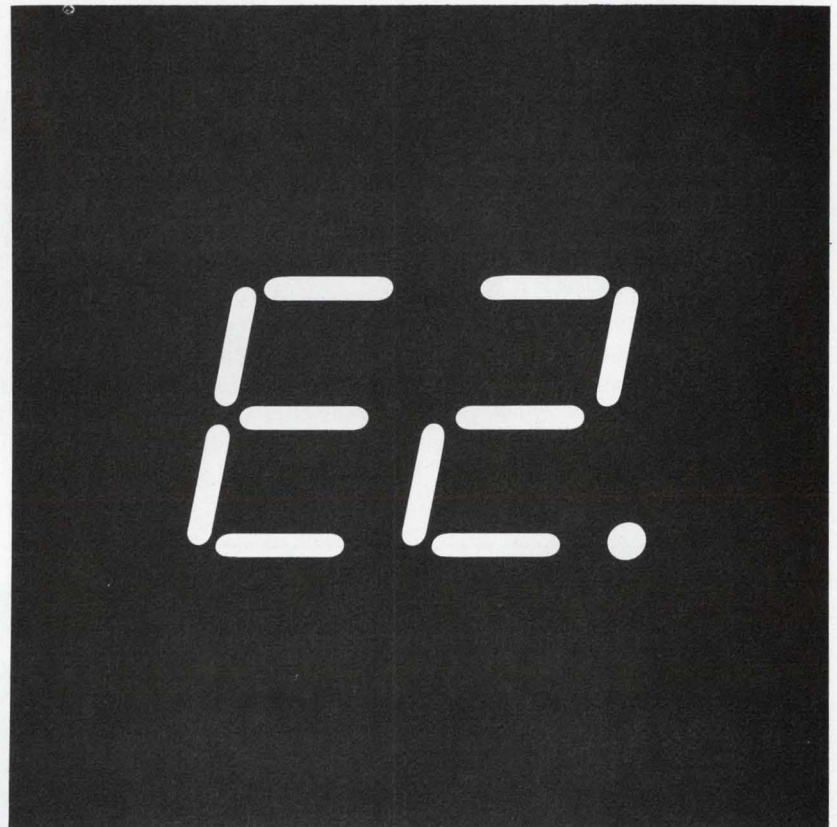

You can see the flexible language with alpha, numerical and symbolic figures.

You can see the wide range of colors, including white, available with common types of filters.

And because of the unique construction, you can see the accurate viewing assured from virtually any angle.

With the Digivac 1000 readout, whether you see it or you don't... it's still nice to know it's all there.

For additional information on the Digivac 1000, write to: Wagner Electric Corporation, 1 Summer Avenue, Newark, New Jersey 07104.

Wagner makes other quality products in volume for the electronics industry, including bridges, power supplies and subsystems, silicon rectifiers, resistors, miniature lamps and status indicators. And Wagner offers contract manufacturing.

WAGNER[®]

We've got a lot more riding for you.

®Trademarks Wagner, Tung-Sol and Digivac, Reg. U.S. Pat. Off. and Marcos Registradas

INFORMATION RETRIEVAL NUMBER 166

DIP socket accepts eight-pin devices

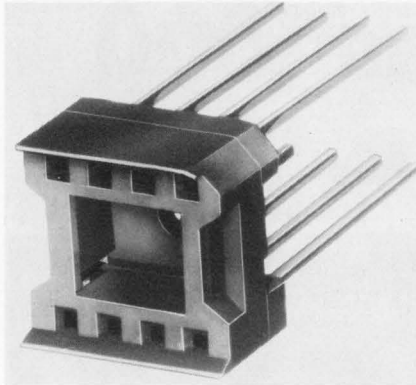

Aries Electronics Inc., P.O. Box 231, Frenchtown, N.J. 08825. (201) 996-4096. \$0.18 to \$0.95; stock.

A new eight-pin socket for DIP features bifurcated pins that accept both round or flat leads. It is available in either solder-tail or wire-wrappable versions. Its molded body is 30% glass-filled polyester. Contacts are phosphor-bronze with tin or gold plating.

CIRCLE NO. 400

Aluminum case to make coupler or hybrid box

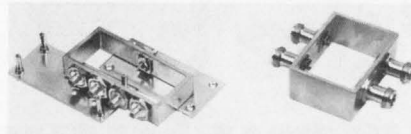

Modpak, 31A Green St., Waltham, Mass. 02154. (617) 891-7048. 704: \$13.75 to \$14.50; 705: \$12 to \$16.50 (1-500).

Each Modpak package consists of a nickel-plated aluminum case, a choice of four connector types (BNC, TNC, N or SMA), top and bottom covers (with Rivnuts), all hardware and self-adhesive blank labels. The 704 series has a 2 x 3-in. rectangular cross-section and 4-1/2-in.³ capacity for use as a four-connector coupler or hybrid box, or a two-connector, feed-through amplifier box. The 705 series has a 1-1/2 x 3-1/4-in. cross-section and 2.8 to 4.2 in.³ capacity. This series features a four-port configuration for housing a four-way power divider. Also two-way power-divider and amplifier configurations are available.

CIRCLE NO. 401

Heat dissipator raises power capability

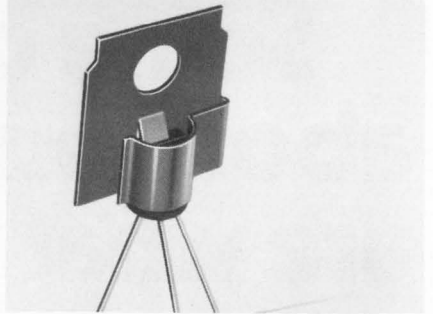

International Electronic Research Corp., 135 W. Magnolia Blvd., Burbank, Calif. 91502. (213) 849-2481. \$0.05 to \$0.10 (5000 up).

A new free-standing heat dissipator, RUR671-2B, for D-case plastic transistors incorporates a metal stop to prevent the dissipator from slipping down the transistor case. In natural convection, the dissipator increases transistor power capability by as much as 65%, and under forced convection as much as 300%. You can install the dissipator before soldering to the transistor to reduce failures from solder heat.

CIRCLE NO. 402

How welded contacts cut material costs up to 80%

- Improve physicals, performance and reliability
- Maintain original specified resistance

With welded contacts, only the exact amount of contact metal needed is applied to the base material. This eliminates indiscriminate use of precious metals compared with plating. You also save metal compared with riveted contacts. Welded contacts never increase in resistance as do riveted contacts. Heat conductivity and full strength of the base material are retained because there is no perforation. Let us quote on your contact sub-assemblies with welded contacts. Send for our FREE 20-page catalog.

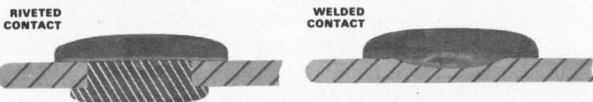

Riveted contact loses strength, Welded contact saves metal increases resistance loss

braun

company inc.

4200 31st Street North St. Petersburg, Florida 33714
813/526-9104

INFORMATION RETRIEVAL NUMBER 167

Murata's Posistors® can.....



...heat, switch, start motors, control temperature, limit current, sense, aid automotive anti-pollution devices, control and on and on. They're small but powerful positive temperature coefficient devices that can handle hefty loads with a degree of reliability that mechanical switching contacts find impossible to imitate. Let us give you a few ideas as to how Posistors can fit into your scheme of things . . . just circle the reader service number below.

muRata MURATA CORPORATION OF AMERICA
2 Westchester Plaza, Elmsford, New York 10523
Telex: MURATA EMFD 137332 / Phone: 914/592-9180
A Subsidiary of Murata Mfg. Co., Ltd., Japan

INFORMATION RETRIEVAL NUMBER 168

ELECTRONIC DESIGN 6, March 15, 1974

W-J THIN-FILM 5-500 MHz CASCADABLE AMPLIFIERS

give you the best gain stability, repeatability and power supply selection of all available TO-8 amplifiers.

Watkins-Johnson A5 and A7 integrated amplifiers are unconditionally stable for any source and load condition. Up to four stages may be cascaded to achieve typically 58 dB gain and ± 0.5 dB flatness. In addition, there is no loss of maximum output power.

Excellent stability is provided by the use of thin film tantalum nitride resistors with low temperature coefficients deposited on sapphire substrates and a stable dc biasing circuit.

The amplifiers are supplied in hermetic 4-pin TO-8 packages. Each unit is a complete amplifier with power supply decoupling provided internally. Apply either 8 to 20 Vdc (A5) or 20 to 24 Vdc (A7) and obtain unequalled performance.

Typically:

- Gain 14.5 dB
- Gain Flatness $< \pm 0.3$ dB
- Noise Figure 4 dB (A5), 5 dB (A7)
- VSWR < 1.2 input, < 1.5 output
- Output Power +9 dBm (A5), +14 dBm (A7)
- Intercept Point +22 dBm (A5), +26 dBm (A7)
- Phase Linearity $\pm 1.0^\circ$, 10–500 MHz

Small quantity orders will be shipped from stock. Call either our Field Sales Office in your area or W-J Applications Engineering at (415) 493-4141 ext. 637. Ask about units with test fixtures available for a three-week evaluation.

Prices: A5 \$99 ea., quantity 1–9
A7 \$109 ea., quantity 1–9

WJ-A5 TYPICAL PERFORMANCE

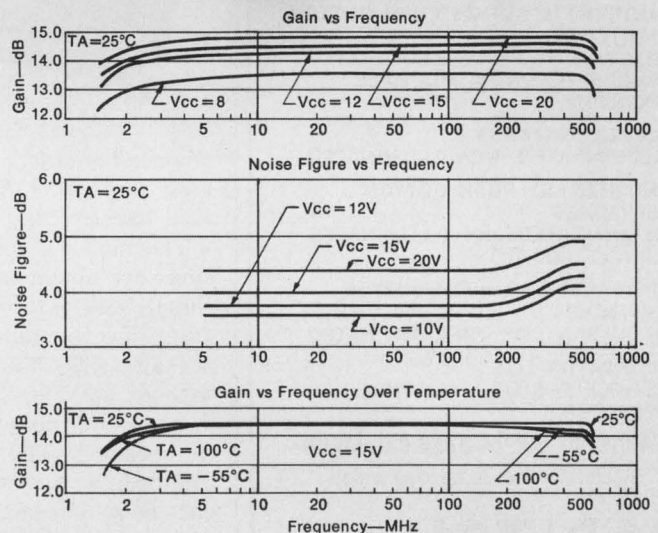

**I'm an L.E.D.
illuminated
Capitol Switch**

**..QUALITY and
DEPENDABILITY . . .
that's where I shine!**

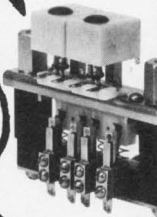

**We're just part of
the gang**

**Top quality, dependable
circuit selector
push-button and
lever switches - - -**

**many custom combinations
and assemblies**

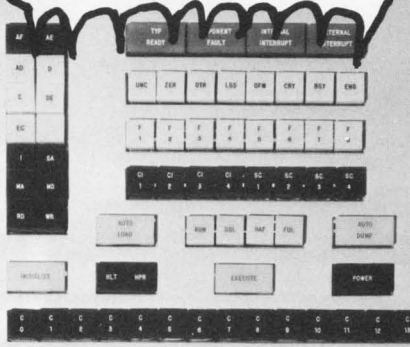

**ALTERNATE ACTION PUSH BUTTON
SWITCHES**
ILLUMINATED, NON-ILLUMINATED
SINGLE POSITION, MULTIPLE
POSITION

LEVER SWITCHES
ILLUMINATED, NON-ILLUMINATED

**MOMENTARY PUSH BUTTON
SWITCHES**
ILLUMINATED, NON-ILLUMINATED
SINGLE POSITION

**INTERLOCKING PUSH BUTTON
SWITCHES**
ILLUMINATED, NON-ILLUMINATED

INDICATOR LITES
SINGLE POSITION, MULTIPLE
POSITION

Write for our 24 page catalogue
Representatives in principal cities.

CAPITOL SWITCHES

THE CAPITOL MACHINE & SWITCH CO.
87 NEWTOWN RD. DANBURY, CONN. 06810

PACKAGING & MATERIALS

**Female disconnects
now fit small tabs**



*Panduit Corp., 17301 Ridgeland
Ave., Tinley Park, Ill. 60477. (312)
532-1800.*

New female Pan-Term disconnects are now available with vinyl insulation, or noninsulated, for both 0.187 and 0.110-in. tabs and for wire gauges of 22-18 and 16-14. The existing disconnects fit 0.250-in. tabs. Convenience packages contain 100 tabs. Bulk packages of 1000 are also available.

CIRCLE NO. 403

**Heat sink has universal
hole pattern for two**

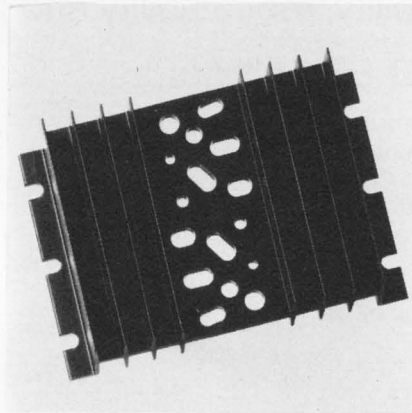

*Thermalloy Inc., 2021 W. Valley
View Lane, P.O. Box 34829, Dallas,
Tex. 75234. (214) 243-4321.*

Thermalloy's 6500 series heat sinks are now available with a universal hole pattern that accommodates seven popular semiconductor packages: TO-3 and TO-66 with or without sockets, TO-36, 10/32 and 1/4-in. stud mounted and two plastic packages. The 6500-B-6 will accommodate two of any of these packages. Thermal performance is identical with units using custom hole patterns. Black-anodized finish is the most popular, but the unit is also available unfinished (6500-U-6) or with a gold-chrome finish (6500-C-6).

CIRCLE NO. 404

**Apply cooling as
easily as you can heat**



*FTS Systems Inc., P.O. Box 158,
Stone Ridge, N.Y. 12484. (914)
687-7664.*

A new cascade, mechanical refrigeration system can provide temperatures of -100°C , well below dry ice, for less than two cents per hour. The compressors occupy a 16-W \times 16-D \times 11-H-in. cabinet with the cooling coil at the end of a 5-ft. flexible line. This cold, remote, immersion probe can be used for below ambient temperatures as easily as cartridge heaters can be used for high temperature control.

CIRCLE NO. 405

**Fine-grained alumina
readily machined**

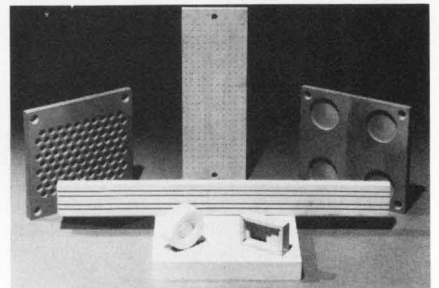

*Cotronics Corp., 37 W. 39th St.,
New York, N.Y. 10018. (212) 531-
9376. See text; stock.*

Cotronics 902 machinable ceramic is fabricated from high-purity aluminum silicate with a melting point of 3200F. It has an extremely fine grain structure that enables the machining of highly detailed, close-tolerance components with conventional shop equipment. The ceramic is inert to furnace atmospheres and it offers excellent corrosion and thermal-shock resistance. The material is available in plates from 2 \times 2 to 4 \times 20 in. with 1/8 to 1-in. thicknesses and in rods from 1/4 to 2-in. diameters. Special sizes are available on request. A trial kit is available for \$20.00.

CIRCLE NO. 406



WIDE BAND SIGNAL PROCESSING COMPONENTS

FROM VARI-L CO., INC.



VOLTAGE TUNED FILTER

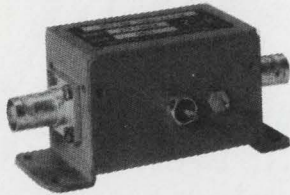

- Full octave tuning
- Constant bandwidth
- Low VSWR
- Low intermod. distortion
- No hysteresis
- No tuning power consumed
- High power handling
- Qualified for MIL use
- Butterworth performance

Full details in EEM Vol. 2, P. 584

DOUBLY BALANCED MIXERS



- Wide bandwidth
- High isolation
- Low insertion loss
- Low noise figure
- Flat conversion efficiency
- Low intermod. products
- Military qualification
- Many configurations

Full details in EEM Vol. 2, PP's 623-626

LINEARIZED VOLTAGE TUNED FILTERS

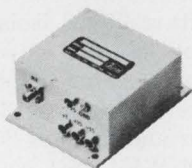

- Better than 1% voltage/frequency linearity
- Constant loss and bandwidth
- 2 pole Butterworth design
- Low temp. drift
- Full octave tuning
- 1 MHz to 2 GHz types

For details write for Bul. 111

WIDE BAND FREQUENCY DOUBLER



- Models available for inputs from .5 MHz to 6.25 GHz
- High power handling
- Output level over band: ± 1.5 dB maximum
- Fundamental suppression 30 dB minimum
- Completely shielded

For details see EEM Vol. 2, P. 627

HYBRID POWER DIVIDERS

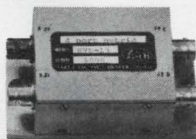

- Wide range of types and power handling abilities
- Styles to fit various circuit layouts
- Ruggedized
- May be used in tandem for 2nd signal combining or dividing

For details see EEM Vol. 2, P. 622

WIDE BAND TRANSFORMERS

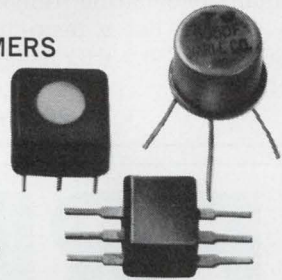

- 65 models to choose from with 11 circuit configurations
- Power handling up to 50 watts
- Military qualified
- Doubles as a high quality pulse transformer
- Many thousands in use

For details see EEM Vol. 3, P. 1308

ELECTRICALLY VARIABLE INDUCTORS

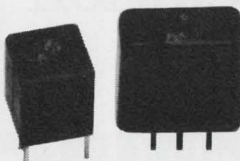

- Wide range — up to 15:1 (Tuned frequency)
- Types for frequencies from audio to 250 MHz
- Solid state — no moving parts
- Military qualified
- Tuned circuit isolated from control source

For details see EEM Vol. 3, P. 1310

WIDE BAND R.F. CHOKES

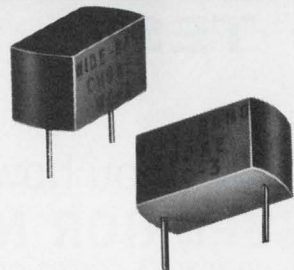

- No sharp resonances 1 MHz to 1 GHz
- Fully encapsulated
- Inexpensive
- Four types
- Less than .1 ohm DC resistance
- Will handle up to 2 amps. average current

For details see EEM Vol. 2, P. 628

SOLID STATE R.F. SWITCHES

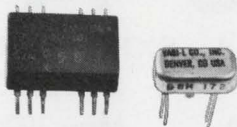

- Switching speed 2 nanoseconds or less
- +10 dBm signal handling
- Completely shielded
- Coax. and pin types

For details see EEM Vol. 2, P. 628

PHASE DETECTORS



- High level — up to +17 dBm each port
- .5 to 500 MHz inputs
- 10 mv./degree sensitivity with +10 dBm inputs
- Miniature pin package

For details see EEM Vol. 2, P. 628

VARI-L Company, Inc.

3883 Monaco Parkway
Phone: (303) 321-1511

Denver, Colorado 80207
Twx: 910-931-0590

(Formerly located in Stamford, Connecticut)

SEND FOR COMPLETE CATALOG OF WIDEBAND SIGNAL PROCESSING COMPONENTS

FOR CURRENT SOURCE DATA D.I.A.L. EEM TOLL-FREE 800-645-9200 (IN N.Y. STATE CALL COLLECT (516) 294-0990)

Dividers handle up to 2.5 MW

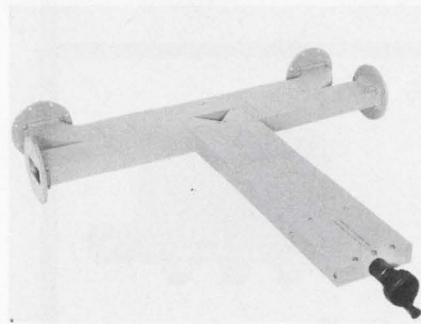

Waveline Inc., P.O. Box 718, West Caldwell, N.J. 07006. (201) 226-9100.

Peak-power handling capability for a series of variable dividers ranges from about 60 kW in WR-62 waveguide to 2.5 MW in WR-284. Power ratings can be achieved without pressurizing waveguides. The dividers cover a frequency range of 2.9 to 3.1 GHz, have a minimum attenuation range of 0 to 28 dB and list a maximum insertion loss of 0.3 dB. Isolation is 20 dB.

CIRCLE NO. 407

P-i-n diodes have low insertion losses



Alpha Industries, 20 Sylvan Rd., Woburn, Mass. 01801. (617) 935-5150. \$116 to \$175 (1-9); stock to 6 wk.

A line of p-i-n diode transfer switch modules called the MO1852 series have insertion losses between 0.8 and 2.3 dB, depending on frequency. The switches measure 0.5-inch in diameter by 0.15-inch thick, meet MIL-E-5400 environmental requirements and cover the frequency range of 0.1 to 18 GHz. Switching speed is 800 ns maximum and isolation is 35 to 50 dB minimum. The switches can accept a maximum input power of 1 W.

CIRCLE NO. 408

Isolators cover 12 and 14-GHz bands

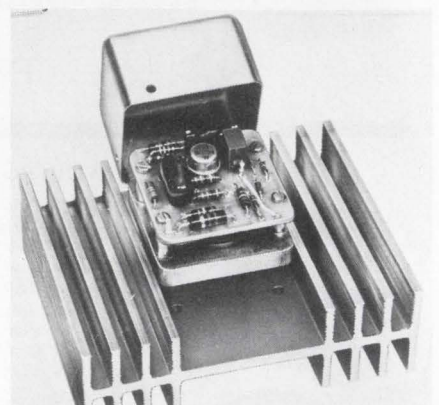

Com Dev, Ltd., 6 Ronald Dr., Montreal 263, Quebec, Canada.

Three new models in this line of isolators for satellite communications feature 26 dB isolation, 0.1 dB insertion loss and an input return loss of -30 dB. Model WIH 75-12 covers 11.9 to 12.2 GHz, weighs 9 oz and handles 250 W cw max. Model WIM 75-1 covers 11.7 to 12.2 GHz, weighs 6 oz and is rated at 20 W cw max. Model WIL 75-14 is a 2 W device covering 13.9 to 14.4 GHz and weighs 5 oz. All models accept WR-75 waveguide.

CIRCLE NO. 409

FREE TEST



shows you how to save costs
SUPERIOR NO. 30 FLUX
prevents corrosion when soldering
Ideal for printed circuit boards

Why take chances that corrosion from soldering will cause rejects and unnecessary expense? Use the same flux that hundreds of our customers all over the world are using—Superior No. 30 NON-CORROSIVE SOFT SOLDER LIQUID FLUX. We'll sample it to you at no cost to prove that it will end corrosion problems! It's positively non-corrosive. No zinc, ammonium chloride, resin or gum. Non-hygroscopic, non-conductive... no fumes or disagreeable odors. Residue is water soluble. Makes soldering easier and faster!

Send coupon below or check reader service card for free sample now. After you've tested it, you'll be mighty glad you did.

SO SUPERIOR THAT IT IS PATENTED

Meets U.S. Army Sat. Com. Agency Spec. SM-A-571678

send for
FREE
sample
TODAY!

SUPERIOR FLUX COMPANY • Est. 1932
653 Alpha Drive, Cleveland, Ohio 44143 Dept. ED

- Send free sample, No. 30 FLUX
 Send prices and details

FIRM _____

ATTN. OF _____

ADDRESS _____

CITY _____

STATE _____

ZIP _____

INFORMATION RETRIEVAL NUMBER 203



international coil winding association

(Devoted Entirely To The Coil Winding Industry)

PRESENTS

COIL WINDING CHICAGO '74

CONVENTION and EXHIBITION
Sheraton O'Hare Hotel, 21, 22, 23,
Rosemont, Illinois, U.S.A. May, 1974.

FOR FURTHER DETAILS CONTACT:-

INTERNATIONAL COIL WINDING ASSOCIATION
EUROPEAN & HEAD OFFICE N. AMERICAN OFFICE

Cleveland House
344A Holdenhurst Road
Bournemouth BH8 8BE
Hampshire
England
TEL: Bournemouth 38738
TELEX: 417123

Suite 106
3158 Des Plaines Ave
Des Plaines
Illinois 60018
U.S.A.
TEL: (312)827-4060

INFORMATION RETRIEVAL NUMBER 204

ELECTRONIC DESIGN 6, March 15, 1974

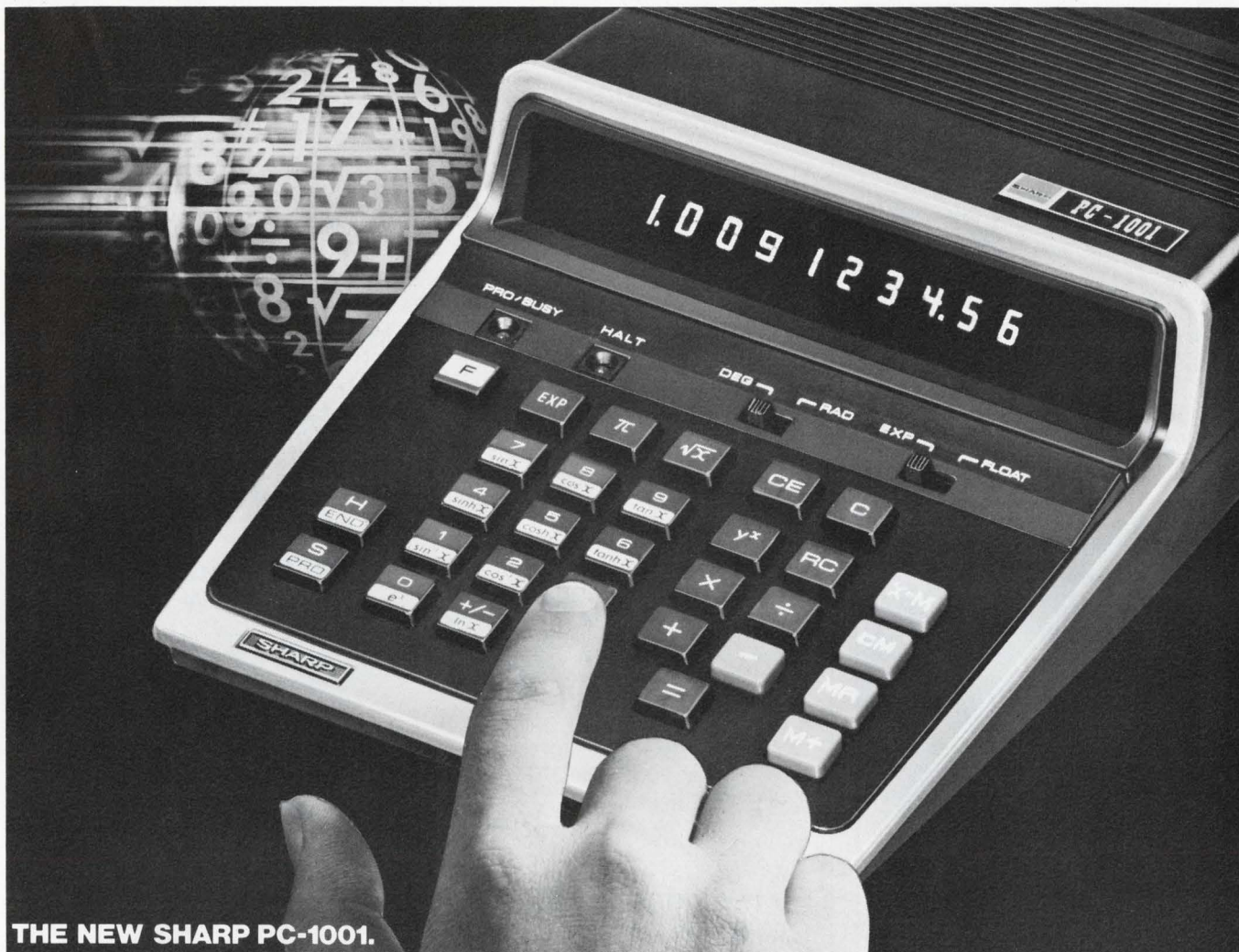

THE NEW SHARP PC-1001.

For fast, accurate answers to complex everyday scientific and engineering problems—count on Sharp's new PC-1001. Because not only is the PC-1001 ideal as a desktop, scratch pad, scientific, programmable calculator...it also features a 10-digit display that automatically operates in scientific notation. Results of the functions can be computed in degrees or radians at the touch of a switch.

With the PC-1001, difficult programming of functions is already incorporated. So you compute instantly with just a one-touch key operation. A total of "15" different scientific functions are hardwired in, including trigonometrical, inverse trigonometrical, hyperbolic, exponential, and logarithmic. In addition, 64 steps of programming or 8 registers are available for formula and equation evaluation. And you can use both decimal point positioning systems. Both the floating decimal point and the exponential system—with exponential display capacity from 10^{-99} to 10^{100-1} and 0. The PC-1001 also features a new simplified keyboard operation.

THE SCIENTIFIC PROGRAMMABLE BIG ENOUGH FOR YOUR DESKTOP AND SMART ENOUGH

TO OPERATE IN SCIENTIFIC NOTATION.

FROM



THE COMPANY THAT CREATED THE INDUSTRY™

And here's one for the road...it's the new SHARP mini scientific calculator.

Tuck this 12-3 oz. Battery Portable in your pocket and take it with you on field trips, construction sites...wherever—and for whatever you need a quick scientific answer. With 8 digits and a memory,

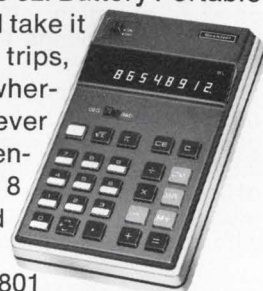

the small PC-1801 incorporates the scientific functions of the PC-1001 except hyperbolic, Y to X keys, and that it is not programmable. Phone toll-free (800) 447-4700 for nearest Sharp Dealer. In Illinois (800) 322-4400.

Or just mail the coupon today.

Sharp Electronics Corporation, Dept. ED-3
10 Keystone Place, Paramus, N. J. 07652
Gentlemen: Please send me full information on Sharp's PC-1001 and PC-1801.

Name _____ Company _____
Address _____
City _____ State _____ Zip _____

at prices from \$50
Hipotronics offers you
delivery from stock
on over 800 standard
models of

hv dc power supplies

... with output voltages
from 1 to 1000 KV and
current outputs from
2 ma to 50 amperes.



model 860-6.5
60 KV, 6.5 ma.

ALSO:

■ **Custom design units:** for wide range of applications — electrostatics, accelerators, lasers, monocylic charging, high power radars, high voltage testing, and more.

■ **HV power packs:** wide range of compact, miniaturized power packs, with output voltages from 2.5 to 100 KV and current ratings of 2 to 10 ma. Also, standard 5-ma and 2-ma HV power packs with simplified controls.

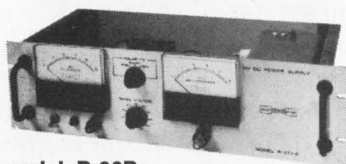

model R-30B

Send for our 24-page catalog, "High Voltage DC Power Supplies and Components," or call our Sales Department and ask for the Power Supplies Manager.

HIPOTRONICS
HIPOTRONICS, INC.
Brewster, N. Y. 10509 / (914) 279-8091
TWX: 710-574-2420

MICROWAVES & LASERS

Uhf amps come with internal matching

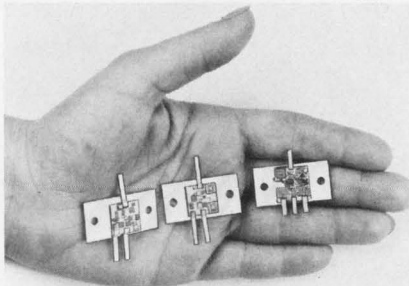

Ampere Electronic, 230 Duffy Ave., Hicksville, N.Y. 11802. (516) 931-6200. \$22 to \$28 (sample qty.); stock.

A line of uhf amplifier modules contains internal matching networks for broadband applications. Three units, called BGY22, BGY23 and BGY24, furnish output powers of 2.5, 7 and 17 W, respectively, over the 380-to-512-MHz frequency range. With a supply voltage of 12.5 V, the BGY22 requires 50-mW drive power while the BGY23 and BGY24 require 2.5 W.

CIRCLE NO. 410

P-i-n diodes simplify CATV circuits

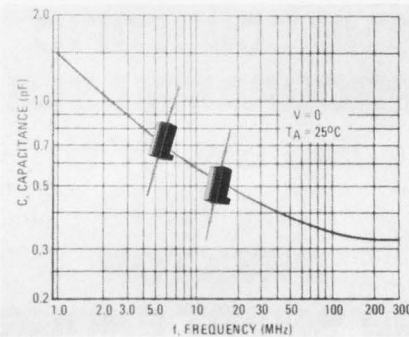

Motorola, P.O. Box 20924, Phoenix, Ariz. 85036. (602) 244-3466. MPN-3411: \$1.85; MPN3412: \$1.55 (100-999); stock.

To facilitate its use in T and Pi attenuator circuits for CATV, the MPN3411/12 silicon diode comes in a low-inductance Mini-L plastic package for easy handling and mounting and is wire bonded for reliable performance. The MPN-3411 is a 1-pF device, and the MPN3412 is a 2-pF diode. The units have a respective forward resistance of 10 and 15 Ω , at 10 mA and 100 MHz. Both units are specified for linear resistance vs current down to 5 MHz.

CIRCLE NO. 411

Photodiode has 10 nA/lux sensitivity

Siemens Corp., 186 Wood Ave. S., Iselin, N.J. 08830. (201) 494-1000.

The BPX 63 photodiode has a photosensitivity of 10 nA/lux. At an illuminance of 10^{-2} lux (10^{-3} behind the matching filter), the component supplies an output voltage exceeding 0.5 mV. This voltage is achieved without excessive interference from thermally generated charge carriers on the useful current. The new photodiode has a low saturation current. The diode current does not reach 1 pA until the diode voltage exceeds 0.5 mV.

CIRCLE NO. 412

Uhf transistor outputs 45 W

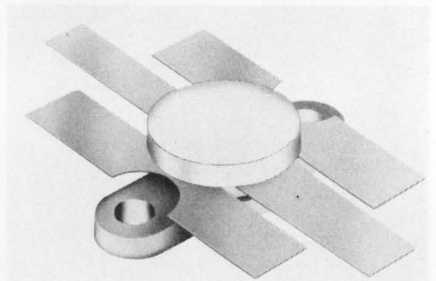

RCA Solid State, Route 202, Somerville, N.J. 08876. (201) 722-3200. \$40; 30 days.

A 45-W transistor for mobile uhf applications uses internal MOS capacitors in a T-matching network for each base cell to provide the input resistance and input Q for broadband operation. Called the 40971, the device can withstand an infinite load VSWR at rated input power and supply voltage of 15.5 V. The 40971 comes in the RCA HF-40 package.

CIRCLE NO. 413

Circulators, isolators feature low loss

Ferranti Electric, E. Bethpage Rd., Plainview, N.Y. 11803. (516) 293-8383.

A series of low-loss coaxial circulators and isolators can be used in communication systems operating in the 2-to-4-GHz frequency range. Typical insertion losses for the units are 0.12 dB, or about that usually associated with bulkier waveguide components.

Booth Nos. 1326, 1328

Circle No. 414

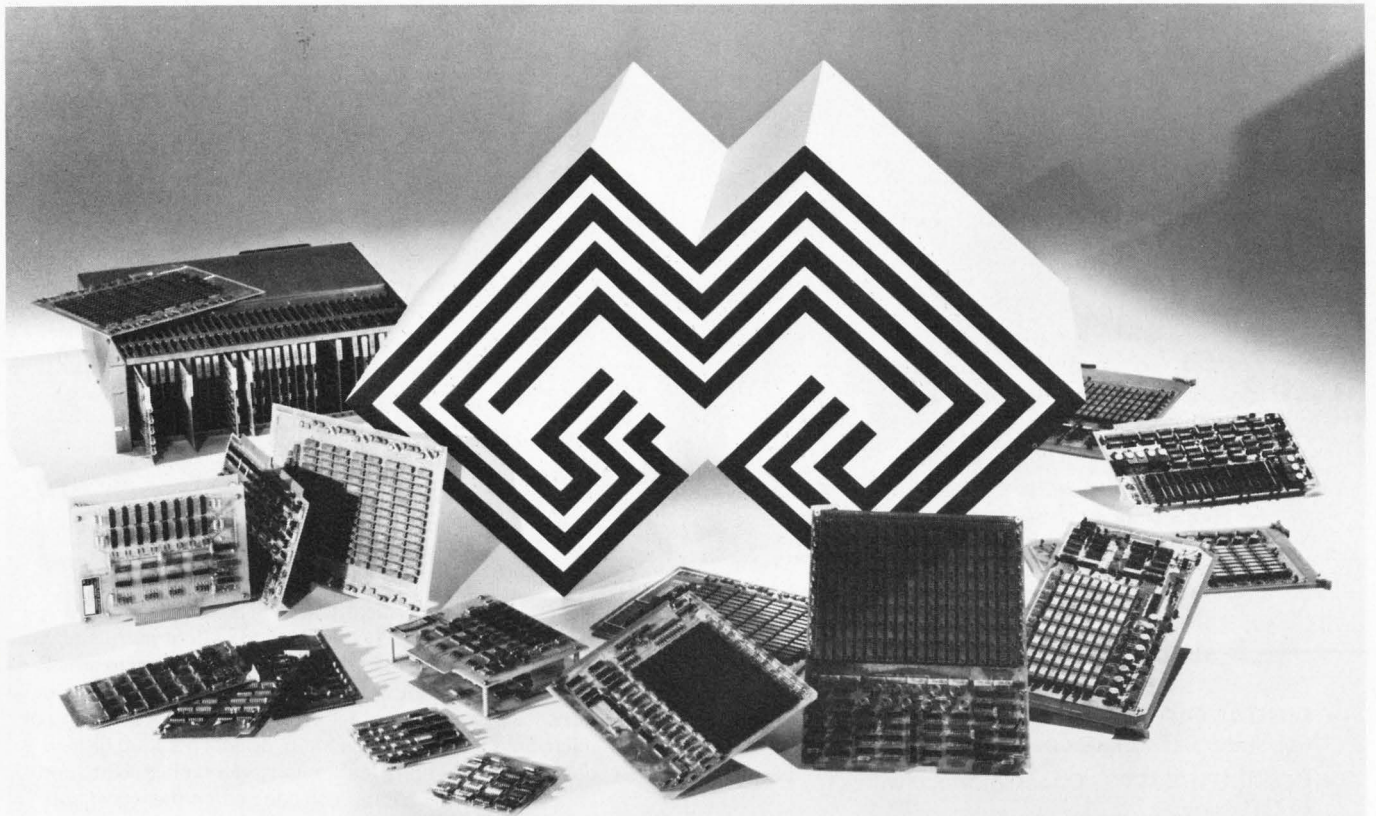

We Have Your Semiconductor Memory System On The Shelf... Or We'll Deliver A Special Within 45 Days.

You can have the latest in memory technology without investing time and money in a development program. We've already made the investment to bring you proven random-access semiconductor memory systems with low power consumption, small size and up-to-date design. And we give you fast delivery at competitive prices. You avoid the problems of design and component selection, debugging and redesign, slow component delivery and expensive testing.

Our MONOSTORE semiconductor systems provide memory capacities from 256 bits for buffer memories to 3.9 megabits for mass memory systems. Eight standard systems give you a wide choice of bipolar or P and N-channel MOS memories. For example, our Planar systems are single-board units with capacities up to 4K x 20. MONOSTORE/PLANAR boards include timing, control, address register, input data register, refresh circuitry (when required) and the memory array...you supply only DC voltages and signals for address, data and cycle initiate.

For larger systems, our MONOSTORE/MODULAR Systems are packaged rack-mounted units with capacities up to 65K x 60. These systems can be sup-

plied with DC power supplies, Livestore non-volatility battery packs and cooling fans if required.

These are just our standard products. We do custom designs and modifications too. And because of our memory-system experience and IC stock, we can deliver your prototypes in 30 to 45 days...production units in 60 days. In addition to all that you'll find us competitive with core systems. Planar prices, in OEM quantities, run about 0.76c/bit and Modular Systems run 1.1 to 1.2c/bit depending on the system.

Since Monolithic Systems Corporation gives you the advantages of the latest technology, fast delivery and low price, you'll want to think twice about specifying core or designing your own semiconductor memory systems. Write to us or give us a call. We'll be happy to send additional information and discuss your memory system needs with you.

Plan to visit our exhibit at the National Computer Conference, May 6-10, McCormick Pl., Chicago, Illinois, booth 127-129. We'll be there with hardware and operating systems.

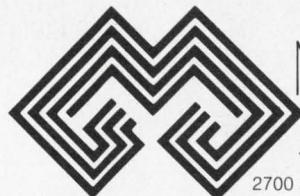

Monolithic
Systems corp.

2700 S. Shoshone, Englewood, Colorado. Phone 303/761-2275.

DI-MAG[®]

... SUPER
SENSORS

THE SENSIBLE CHOICE...

- **DIGITAL OUTPUT** — Constant amplitude pulses independent of surface speed or air gap.
- **COMPATIBILITY** — Direct interface with TTL, DTL or HTL logic.
- **NOISE IMMUNITY** — High signal-to-noise ratio not achievable in analog sensors.

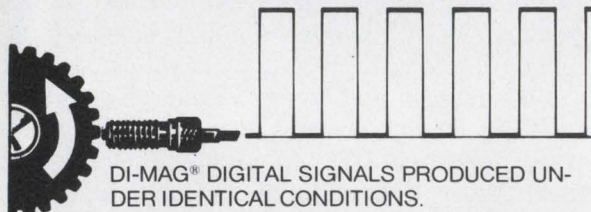
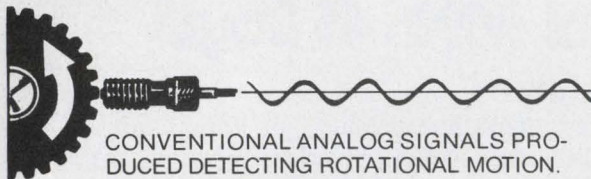

DI-MAGS[®] work particularly well in these computer peripheral functions and applications:

- FEED RATE CONTROL
- PRINT HAMMER SYNCHRONIZATION
- DISK POSITION INDICATION
- DISK AND TAPE DRIVE RPM MEASUREMENT
- INDEXING CONTROL
- CONTROL SIGNAL FOR CLOSED-LOOP SERVO SYSTEMS.

THAT'S WHY I'M CALLED THE SUPER SENSOR!

Send for your free copy of our Di-Mag[®] "AIR GAP V/S SENSITIVITY" selector.



ELECTRO CORPORATION

1845 57TH STREET, SARASOTA, FLORIDA 33580
AREA CODE (813) 355-8411 • TELEX 5-2683

INFORMATION RETRIEVAL NUMBER 208

General Scanning is a reconnaissance Wizard

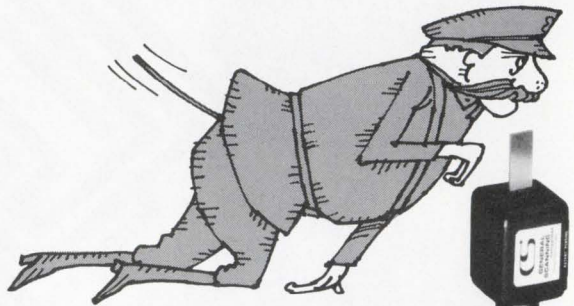

General Scanning optical scanners are precision instruments specifically designed to deflect mirrors of varying sizes at the fastest possible rates. They're small, rugged and efficient. Whether they're used for facsimile transmission, photographic typesetting, laser trimming of microcircuits, infrared scanning, optical tracking or flaw detection, these units feature long life, high stability and large angular excursions. You can search the world and not find a better optical scanner than the General. For detailed information, get in touch with him today.

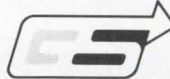

GENERAL SCANNING INC.

150 Coolidge Avenue/Watertown, MA 02172
(617) 924-1010

INFORMATION RETRIEVAL NUMBER 209

sapphire substrates

.000000" surface finish variation in Meller's high quality, in-stock substrates make them ideal for SOS, hybrid microcircuitry, delay lines, etc.

The substrates feature high and uniform resistivity and have a scratch-free surface finished (up to 70X magnification), obtained using a special polishing method. Both x-ray and random orientation are available.

For more information, contact ADOLF MELLER CO., P.O. Box 6001, Providence, R.I. 02904. Tel: 401-331-3717.

MELLER **QUALITY**

Founded in 1921

INFORMATION RETRIEVAL NUMBER 210

ELECTRONIC DESIGN 6, March 15, 1974

**Slotted lines
have low SWR**

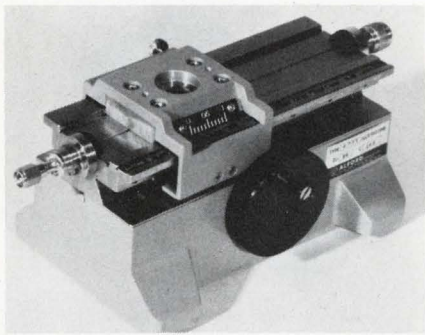

Alford Manufacturing, 120 Cross St., Winchester, Mass. 01890. (617) 729-8050. \$1940; 45 days or less.

The Type 5240 series of slotted lines provides a high accuracy for SWR or impedance measurements of 2-to-26.5-GHz instruments equipped with SMA connectors. The residual SWR of the SMA slotted lines is tentatively rated at 1.05 at frequencies up to 18.0 GHz, and 1.065 up to 26.5 GHz. Other features include a contacting probe carriage driven by a stationary drive knob and replaceable connectors that conform to MIL-C-39012.

Booth No. 2536 Circle No. 415

**BWO delivers 6 dBm
from 33 to 50 GHz**



Watkins-Johnson, 3333 Hillview Ave., Palo Alto, Calif. 94304. (415) 493-4141.

The WJ-2055 magnetically shielded helical BWO delivers +6 dBm minimum power output from 33 to 50 GHz. The tuning voltage is less than 2000 V and the beam current is 6 mA maximum. The WJ-2055 comes in a 4 x 4 x 8-inch rectangular package weighing 6.5 pounds.

CIRCLE NO. 416

*We chose to call
our new Real-Time
Spectrum Analyzer
Omniscient^{*}
and we'll continue to!*

With a name like that you have to measure up, and the EMR Model 1510 does. It goes anywhere, does any job ... It's a Fourier Analyzer, a Spectrum Averager and a Display in one convenient, portable package. And most important, it performs its tasks digitally ... no interactive controls to fumble with ... no complicated computer interface problems.

But to be Omniscient there must be more ... and there is!

- Switch it on, it's ready to operate without calibration
- Analyze a signal repeatedly and get repeatable answers ... over and over again
- 60 dB dynamic range at the input and no gimmickry
- Foolproof LED display of signal amplitude, frequency and averaging time
- Control setting status appears on graticule of CRT for permanent photographic record
- Availability of many options ... Peak Hold, 3-D Display, Computer Interface, Low Frequency Sync, Any Window, etc.

**Possessed of universal or complete knowledge —*

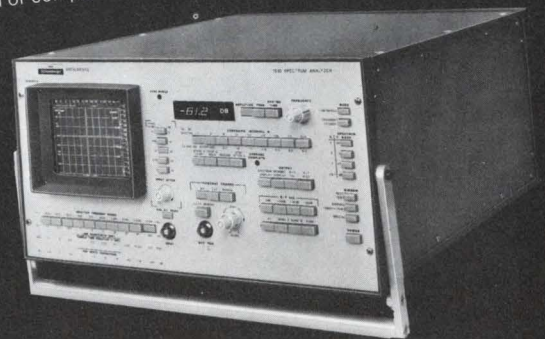

Well...What else could we call it?

Write today for a comprehensive technical brochure or call for a demonstration.

EMR EMR
Schlumberger

EMR Telemetry
Weston Instruments, Inc.
Box 3041, Sarasota, Florida 33578
813-958-0811

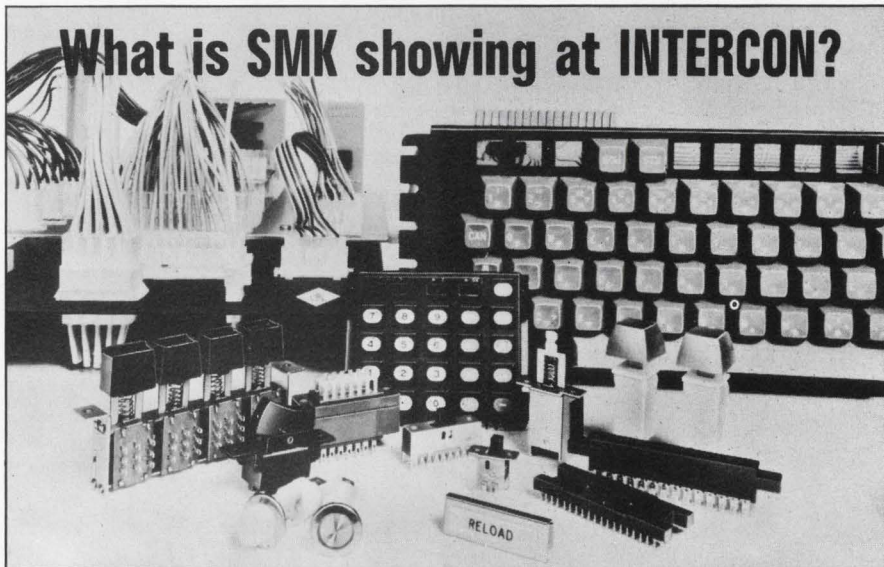

What is SMK showing at INTERCON?

Outstanding SMK electronic parts services solutions!
 We have so much to offer we can't find words here to tell you. But, for complete details, visit our display at INTERCON. Lots of reference materials will be available and our experts of electronics will answer all questions.

INTERCON BOOTH NO.1317

SMK ELECTRONICS CORP. OF AMERICA

743. W. Gardena Blvd., Gardena, Calif. 90247, U.S.A.
 Phone: (213) 770-8915
 Telex: 691144

SHOWA MUSEN KOGYO CO., LTD.

No. 5-5, 6-chome, Togoshi, Shinagawa-ku, Tokyo 142, Japan.
 Phone: 785-1111
 Telex: 2466301 SMK TOK J
 Cable: "SHOWAMUSEN" TOKYO

*SMK MAIN PRODUCTS:

Switches, Connectors, Terminals, Sockets, Plugs, Jacks, Back Panel Boards, Fuse Holders, Keyboard, Switches, Others.

INFORMATION RETRIEVAL NUMBER 212

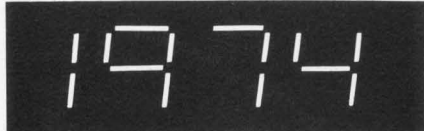

IT'S THE YEAR FOR...

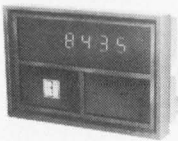

THE DESIGNERS' CHOICE

Our Slim DPC-200 Counter/Display; a high performance component for all TTL/DTL serial totalizing to 18 MHz.

- 2 to 5 1/2 decades
- +5 VDC Power input
- BCD output
- Pre-wired, ready to install
- Versatile, low cost

FREE Applications Manual
DURGIN-BROWNE INC.
 80 Allen Road
 So. Burlington, Vermont 05401
 (802) 863-6873

INFORMATION RETRIEVAL NUMBER 213

Compact High-Level Stability!

TEMPERATURE COMPENSATED X-TAL OSCILLATORS

Now, a highly stable crystal oscillator which does not have a temperature controlled oven. Applications are manifold, including mobile radio equipment, tv satellite equipment, and general communication equipment.

FEATURES: ● Compact, with high stability ● Low power consumption ● Short start-up time ● Low aging characteristics.

House of Crystal...Kinseki

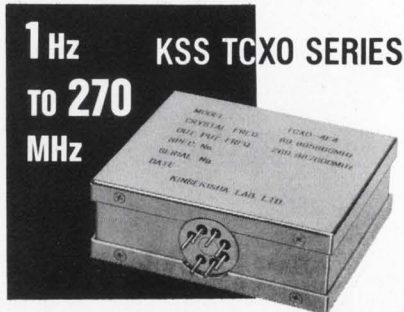

STANDARD TECHNICAL DATA

Item	Type	TCXO-3E	TCXO-4F	TCXO-5A
Frequency range		55MHz~110MHz	55MHz~270MHz	1Hz~500kHz
Dimensions L x W x H (mm)		65 x 40 x 24	65 x 55 x 24	55 x 60 x 35
Weight (g)		120	140	160

For catalogue please write to:
Kinsekisha Laboratory Ltd.
 2-23-17, MIYASAKA, SETAGAYA-KU, TOKYO, JAPAN

INFORMATION RETRIEVAL NUMBER 214

MICROWAVES & LASERS

EW amplifiers feature 7-dB noise figure

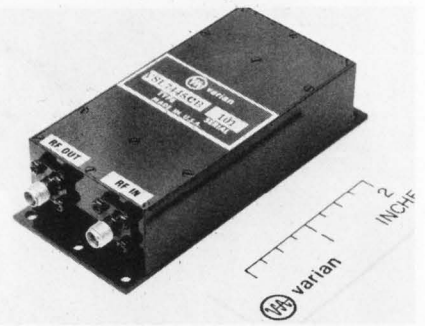

Varian, Solid State West Div., 611 Hansen Way, Palo Alto, Calif. 94303. (415) 493-4000.

Two medium power, solid-state amplifiers are extended-band low-noise units primarily for electronic warfare applications and test equipment. The VSL-7445C is a 1.0-to-2.6-GHz amplifier providing over 200 mW output, while the VSS-7455A unit has a frequency range of 2 to 4 GHz with a power output in excess of 100 mW. Typical noise figures are 7.5 and 6.5 dB, respectively. Both units weigh 10 oz and meet the general requirements of MIL-E-5400 and MIL-E-16400.

CIRCLE NO. 417

Detector modules come in compact packages

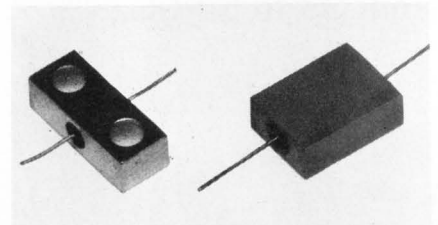

Microwave Associates, South Ave., Burlington, Mass. 01803. (617) 272-3000. \$40 (1-9); 3 wk.

Two stripline/microstrip detector modules are available in compact packages. Called the MA-7707H and MA-7707J, the detectors have a dynamic range of 70 dB with -52 dBm TSS at 18 GHz. Square law characteristics are maintained for input power levels below -20 dBm. Response is linear above 0 dBm. Operating frequencies range from 0.1 to 18 GHz. The packages measure as small as 0.16 x 0.125 x 0.410 inches (H package).

CIRCLE NO. 418

IC POWER SUPPLY 5 volts at 1 amp

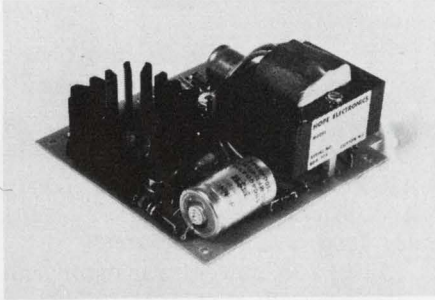

DELIVERY FROM STOCK

1-9 QUANTITY **\$3300**

- Input 117 V $\pm 10\%$ — 60 to 400 CPS
- Output Adjustable $\pm 10\%$ at 1 amp
- Line Regulation 0.1%
- Load Regulation 0.5%
- Ripple and Noise <1 MV peak to peak
- Short Circuit Proof
- Over Voltage Protection

HOPE ELECTRONICS

Box 773, Clifton, New Jersey 07013
Phone (201) 777-3522

Contact us for Your Custom Requirements

Oscillators • Amplifiers • Modulators
Attenuators • Sweep Generators • Filters
INFORMATION RETRIEVAL NUMBER 215

TOYO HCM FILTER T-2 SERIES

TOYOCOM was the first in the world to produce a marketable monolithic crystal filter. The brand name was designated TOYO HCM FILTER.

Utilizing accumulated experience, Toyo-com developed the tandem monolithic filter for 21.4MHz IF applications. The designation is T-2 Series HCM Filter.



TOYO COMMUNICATION EQUIPMENT CO., LTD.
EXPORT DEPARTMENT: TOYO BUILDING, No.6-12-20,
JINGUJUA-MAE, SHIBUYA-KU, TOKYO, JAPAN
CABLE: EXPORTTOYOCOM-TOKYO TEL: (03) 406-3355
TELEX: 02423001 TOYOCOM TOK

Dimensions: 14 x 25 x 10 (m/m)



SMALLEST!

INFORMATION RETRIEVAL NUMBER 216
ELECTRONIC DESIGN 6, March 15, 1974

Multi-octave mixer overlaps rf and LO

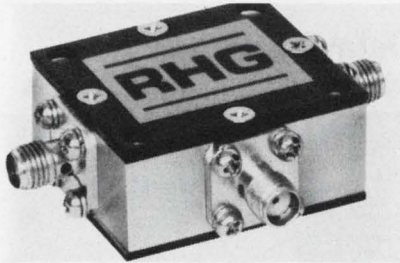

RHG Electronics Laboratory, 161 E. Industry Ct., Deer Park, N.Y. 11729. (516) 242-1100. \$560; 45 days.

The DMH2-14 "quad-line" double-balanced mixer features an 8-GHz i-f capability over an rf and LO range of 2 to 14 GHz. The mixer has a noise figure of 7 dB at midband, and maintains a minimum isolation from LO to rf and i-f of 16 dB. Intercept points are typically +20 dBm and 1-dB compression points are +6 dBm (with a +10-dBm LO). Typical VSWRs are 3:1 (LO) and 2.5:1 (rf).

CIRCLE NO. 419

Tuning diodes use ion implantation

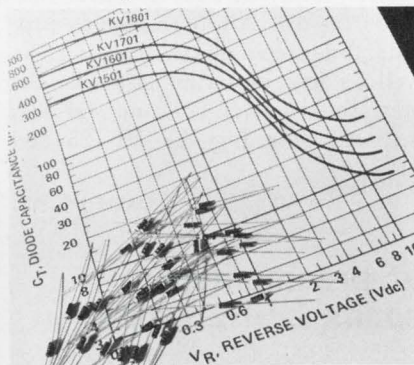

KSW Electronics, South Bedford St., Burlington, Mass. 01803. (617) 273-1730. \$3.30 to \$9.10 (100-999); 60 days.

A line of ion-implanted hf diodes, which can replace conventional MV1401-MV1405 series of AM tuning diodes, spans a frequency range of audio up to 30 MHz. The series offers frequency ratios as high as 4:1 and capacitances from 125 to 350 pF at 2 V. The KV1501-1801 series is intended for hf tuning and offers Q values that are more than twice those available from the older MV-1401 through MV1405 series. The KV1502-1802 is intended for medium-frequency tuning applications.

CIRCLE NO. 420

POWER SPLITTERS- COMBINERS

Great Value at

\$7⁹⁵
500 piece quantities.

\$9.95 in 6-piece quantities.

0.1-400MHz
0.5dB insertion loss
40dB isolation
EMI shielded case

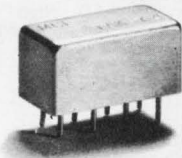

A breakthrough in technology and high production volume enables Mini-Circuits Laboratory to offer these new products at an unprecedented low price.

In today's tough competitive market can you afford not to use these remarkably low priced and high performance units?

Ruggedness and durability are built in the PSC2-1. Packaged within an EMI shielded metal enclosure and hermetically sealed header. This new unit uses a broadband hybrid junction and uniquely designed matched transmission line transformers.

We invite you to convince yourself. Place your order now and check our delivery, product performance and reliability.

Mini-Circuits Laboratory

2913 Quentin Rd., Brooklyn, N.Y. 11229
(212) 252-5252, Int'l Telex 620156
A Division Scientific Components Corp.

FRANCE: S.C.I.E., *31, rue George-Sand, Palaiseau 91, France. GERMANY, AUSTRIA, SWITZERLAND: Industrial Electronics GMBH, *Klüberstrasse 14, 6000 Frankfurt/Main, Germany *UNITS IN STOCK

INFORMATION RETRIEVAL NUMBER 217

CIRCUIT-STIK introduces

GP BOARDS

GENERAL PURPOSE
CIRCUIT BOARDS
Plug-in & Chassis Mounting
and ELECTRONIC
PACKAGING MATERIALS

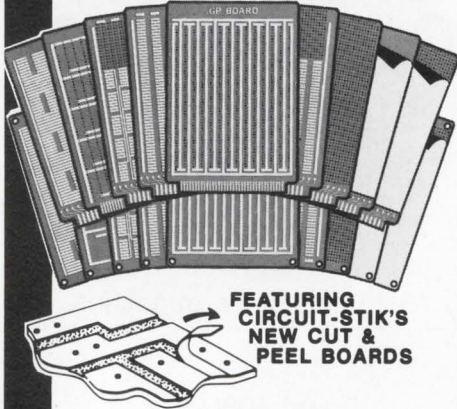

FEATURING
CIRCUIT-STIK'S
NEW CUT &
PEEL BOARDS

GP CIRCUIT BOARDS

HIGH QUALITY

- FR-4 Blue Epoxy Glass
- Computer "DRILLED", High Accuracy Holes (not punched)
- Mil-Spec Plating
- Precision Routed Edges

VERSATILITY

- Mix All Types of DIP Sockets (8 to 40 Leads)
- Low, Medium and High Profile Interconnections
- Hybrid Designs for Mixing Discretes and Sockets
- Designed for Edge Connector "Plug-In" or Chassis Mounting
- RFI Shielding

HIGHEST DENSITY

- Up to 50 DIP's on one 4½" x 6½" Plug-In Card
- Plus Space for 50 Decoupling Capacitors

COMPLETENESS of STANDARD DESIGNS

- Choose from 74 Off-the-Shelf Boards
- 4 Sizes of Boards available

APPEARANCE

- Beautiful Gold, Blue and Bright Tin

FULL LINE of ACCESSORIES (HIGH QUANTITY PRICING AVAILABLE)

- Sockets - Low and Standard Profile, P.C. and Wire Wrap
- Molded Nylon and Highest Quality Gold Contacts
- Adapterplugs
- Connectors
- Card Pull Handles

EPOXY GLASS BOARD MATERIALS

- 76 Standard off-the-Shelf Boards
- Including Unclad, Copper Clad, Cut & Peel Copper Clad, Pre-etched "X-Y" Pattern and Plated thru Hole Copper Clad
- .100" Grid Hole Pattern or Undrilled

SEND FOR YOUR FREE CATALOG



P.O. BOX 3396
Torrance, California 90510
Phone (213) 530-5530

MICROWAVES & LASERS

Octave-BW hybrids standardize connectors

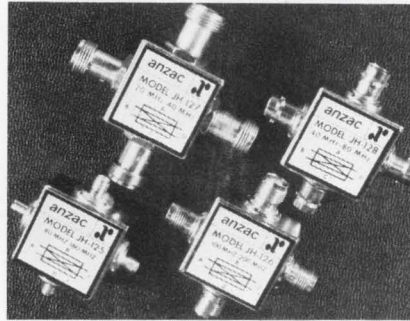

Anzac Electronics, 39 Green St., Waltham, Mass. 02154. (617) 899-1900. \$90 ea.

Four octave-bandwidth quadrature hybrids are available in 1-11/32-inch square by 3/4-inch high packages with types BNC, TNC, SMA or N connectors. The models consist of the following: JH-127 (20-40 MHz), JH-128 (40-80 MHz), JH-125 (80-160 MHz), and JH-126 (100-200 MHz). Isolation for the JH-127 and JH-128 is greater than 25 dB; for the JH-125 and JH-126, isolation exceeds 20 dB. All four models provide 3-degrees phase tracking, as well as low insertion loss: 0.5 dB max for the JH-127 and JH-128, 0.75 dB max for the JH-125 and JH-126.

CIRCLE NO. 421

I-f preamplifier spans 2-GHz range

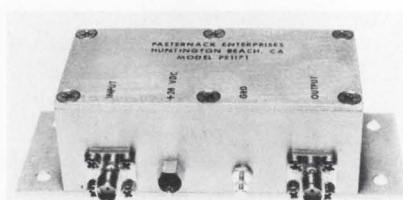

Pasternack Enterprises, 9562 Dumbreck Dr., Huntington Beach, Calif. 92646. (714) 962-8887. \$90; stock to 2 wk.

The PE1171 series of low noise i-f preamplifiers is available with center frequencies from 10 to 2000 MHz. Gain is 30 dB minimum and noise figures range from 1.5 to 4 dB. The PE1171 measures 3 x 1.5 x 1 inches, weighs 4 oz and operates over the -55-to-85-C temperature range.

CIRCLE NO. 422

175-MHz transistor delivers 50 W

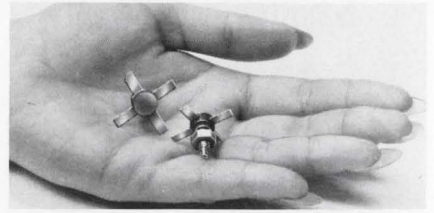

Amperex Electronic, 230 Duffy Ave., Hicksville, N.Y. 11802. (516) 931-6200. \$26 to \$40; stock.

A 12.5-V power transistor can output 50 W at 175 MHz with a gain of 5.5 dB. Called the BLW 60, the new device is an epitaxial npn planar transistor and comes in the SOT-56 stripline package. The BLW 60 may be used in SSB operation from 1.6 to 30 MHz with output powers of 40 W and intermodulation-distortion characteristics of better than -30 dB.

CIRCLE NO. 423

Ku-band antenna offers high aspect ratio

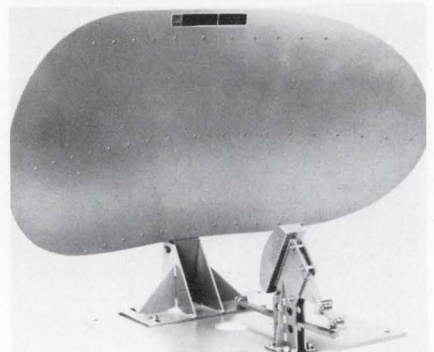

Watkins-Johnson, 3333 Hillview Ave., Palo Alto, Calif. 94304. (415) 493-4141.

The WJ-8572-4 compact reflector antenna system offers a high aspect ratio between elevation and azimuth bandwidths across its operating frequency range of 12.4 to 18 GHz. The WJ-8572-4 provides gains of 32 dB at 12.4 GHz and 34 dB at 18 GHz and, respectively, azimuth beamwidths of 1.5° and 1.0°, and elevation beamwidths of 10° and 7°. The offset-fed dish configuration allows sidelobes to be held below -20 dB (azimuth plane) and -15 dB (elevation plane). Input VSWR is less than 1.6 to 1 over the entire frequency range. The system may be used for receiving and transmitting up to 350 W average power and can withstand a wind load of 120 mph.

CIRCLE NO. 424



SEMI-CONDUCTIVE SILICONE

• Highly to moderately, electrically conductive compounds to provide tailor-made electrical and mechanical properties • Volume resistivity from 10 to 100,000 ohm-cm • Molded parts • Extruded shapes • Standard sheets • EMI shielding • Switching • Motion sensing • Static discharge • Grounding • Inter-Connecting • Contacting • Write for data #850.



Technical Wire Products, Inc.

Eastern Division • 129 Dermody St., Cranford, NJ 07016 (201) 272-5500
Western Division • 427 Olive St., Santa Barbara, CA 93101 (805) 963-1867

INFORMATION RETRIEVAL NUMBER 219

Shorter Slim Slider
Great for new control styling

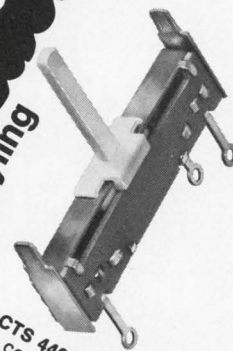

NEW CTS 440 Series 1 1/4" linear motion composition slide controls offer the slim profile mounting economy, performance... and control styling... asked for in new Compact space-saver housing... full 1 1/4" travel... 1/4-watt power rating... resistances from 200 ohms thru 5 megohms... choice of mountings.

Only 19¢ each in production quantities. Complete data available from CTS of Elkhart Division, 1142 West Beardsley Ave., Elkhart, Indiana 46514. Phone: (219) 523-0210.

CTS CORPORATION

Elkhart, Indiana



INFORMATION RETRIEVAL NUMBER 221

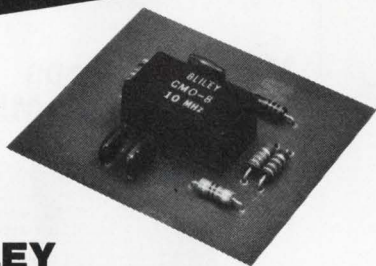

BLILEY CLOCK OSCILLATORS

OFFER:

- DIP or PC board adaptability
- Frequency Range: up to 30 MHz
- Stability: (Std.) ± 50 ppm 0° - 50° C or (Optional) ± 25 ppm 0° - 70° C
- Output/Supply:
DTL/TTL logic with +5 Vdc.
CMOS logic with +5 to +15 Vdc.
(Optional) Triple output @ 1, 2 & 4 MHz
- Size: .820 x .480 x .370 max.

Complete Crystal Oscillator Data Sheets Available On Request

Bliley if you buy quality

BLILEY ELECTRIC COMPANY
2545 West Grandview Boulevard
Erie, Pennsylvania 16512

INFORMATION RETRIEVAL NUMBER 220

ELECTRONIC DESIGN 6, March 15, 1974

FOR THE UTMOST IN RELIABILITY

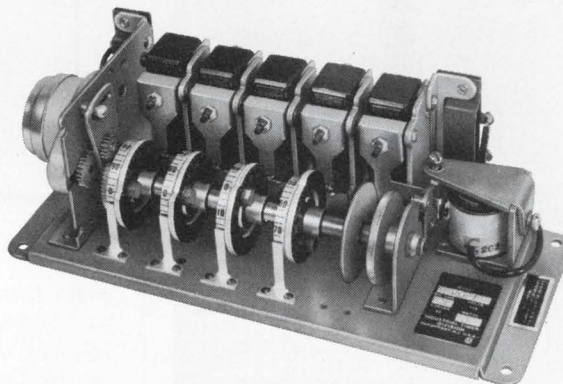

RECYCLING TIMERS Series RC

This multi-cam timer is one of a family of very versatile recycling timers that are available in single or recycling types with up to 20 control circuits. Control cams are independently adjustable from 2% to 98% of the total time cycles enabling the timer to be used as a programming device. And with supplied interchangeable gear and rack assemblies you can select from 700 time cycles ranging from 2/3 second up to 72 hours. All our timers are made to give you service far beyond what you'd reason-

ably expect. Our line consists of 17 basic types, each available in various mountings, voltages, cycles, circuits and load ratings... and with whatever special wrinkles you may need. Bulletin #206 tells all about our line of reliable Recycling Timers. Write for it or a catalogue of our entire line. If you have an immediate timer requirement, send us your specifications. Or for fastest service, call (201) 887-2200.



INDUSTRIAL TIMER

A UNIT OF ESTERLINE CORPORATION

INFORMATION RETRIEVAL NUMBER 222

253

THE NEXT GENERATION OF Broadband Power Amplifiers Starts with The **isfi** M403

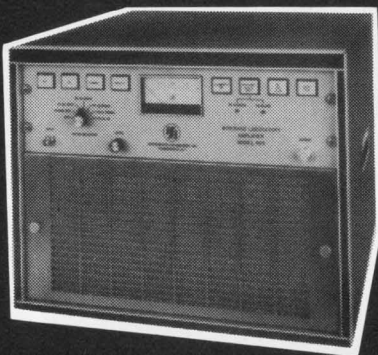

.01-250MHz
100W min.
50db gain

SMALLER
LIGHTER
QUIETER

DESIGNED FOR RELIABILITY
AND
EASE OF MAINTENANCE

Solid State protection and control circuitry with complete remote control capability. *Write or Call.*



**instruments
for industry,
inc.**

151 Toledo Street,
Farmingdale, N.Y. 11735
(516) 694-1414

MICROWAVES & LASERS

K-band circulator has 16-dB isolation

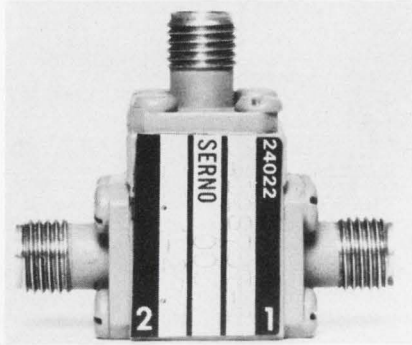

Teledyne Microwave, 1290 Terra Bella Ave., Mountain View, Calif. 94043. (415) 968-2211.

The C-18S33T circulator covers the 18-to-26-GHz frequency range and gives an isolation of 16 dB. Insertion loss is 1.0 dB and VSWR is 1.5:1. The circulator measures 0.68 × 0.51 × 0.53 inch. Standard connectors are SMA female.

CIRCLE NO. 447

Ruby/glass lasers list 100-mW outputs

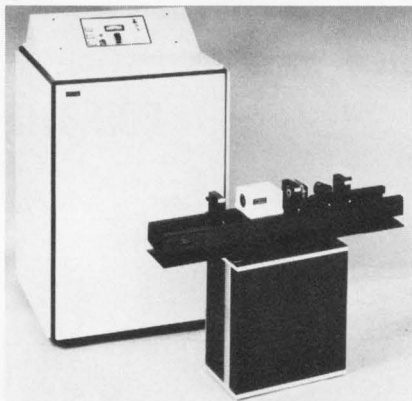

Apollo Lasers, 6357 Arizona Circle, Los Angeles, Calif. 90045. (213) 776-3343. P. See below.

Output powers in the 100-mW range can be obtained with a series of pulsed ruby or Nd:glass laser oscillators. Units in the series are priced under \$10,000. Called the Model-5 pulsed-laser systems, the new units use the same optical train found in the company's more expensive Model 22, including reinforced U-channel optical rail and torsional mirror mounts. In addition, the systems incorporate circuitry for lamp double-ignition, automatic recharge and overvoltage protection.

CIRCLE NO. 448

1-GHz transistors use gold metallization



TRW Semiconductors, 14520 Aviation Blvd., Lawndale, Calif. 90260. (213) 679-4561. \$79.50 (100); stock.

A version of a standard line of 1-GHz transistors features gold metallization and reduced package parasitics that improve reliability, gain and power output. Models in the series are rated for 1, 3, 5, 10 and 20 W. Minimum gain at 1 GHz is 5 dB for the 1 and 20-W devices and 6 dB for the 3, 5 and 10-W devices. The devices are rated for frequencies down to 400 MHz.

CIRCLE NO. 449

Miniature amps span 5 to 400 MHz



Spectrum Microwave, 328 Maple Ave., Horsham, Pa. 19044. (215) 672-9190. Stock to 3 wk.

The A-M Series of miniature amplifiers cover the 5-to-400-MHz frequency range. Nominal gain is 12 dB and variations are ±1 dB. The amps have a maximum noise figure of 5 dB and they are available with either 50 or 75-Ω input/output impedances. Units measure 1-inch round by 3/4-inch high.

CIRCLE NO. 450

This new 10-watt amplifier is tough -- even in a mismatch!



The Model 10LA is one broadband amplifier you don't have to treat with kid gloves. It will stand up under any mismatched load and provide you with 10 watts of swept power from 1-110 MHz. A directional wattmeter enables you to determine actual power delivered to the load. You can perform antenna and component testing, equipment calibration, NMR research -- any number of tests -- with complete confidence. It takes more than a mismatch to knock out our 10LA. Find out for yourself, write: Amplifier Research, 160 School House Road, Souderton, Pa. 18964. Phone: 215-723-8181



INFORMATION RETRIEVAL NUMBER 224

Thin-Profile Open-Face Trimmer (low as 23° each)*

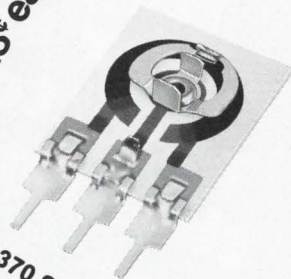

NEW CTS 370 Series cermet thick film trimmer. Open face, single turn with optional serrated adjustment knob. Great power, stability and reliability in compact design. Multiple mounting styles. Wide resistance range: 50 ohms through 1 megohm. Power rating: ¼ watt @ 85°C. Proven CTS cermet resistance element. Economically priced. Contact CTS of Berne, Inc., 406 Parr Road, Berne, Indiana 46711. Phone: (219) 589-3111.
*In volume production quantities

CTS CORPORATION

Elkhart, Indiana



INFORMATION RETRIEVAL NUMBER 225

Millions already in use

NEW KIT LETS YOU TRY IT

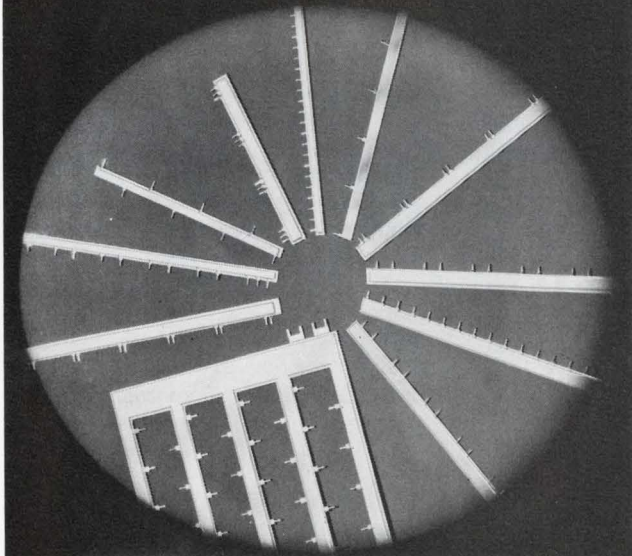

Evaluation kits @ \$25 in stock.
Standard parts on 2 weeks delivery, or less!
Custom parts 4 to 6 weeks delivery!

MINI-BUS The low-cost, noise attenuating, high packaging density, power distribution system for PC boards. Ask for data.



Rogers Corporation / Chandler, Arizona 85224
West: (602) 963-4584 East: (203) 774-9605

INFORMATION RETRIEVAL NUMBER 226

ELECTRONIC DESIGN 6, March 15, 1974

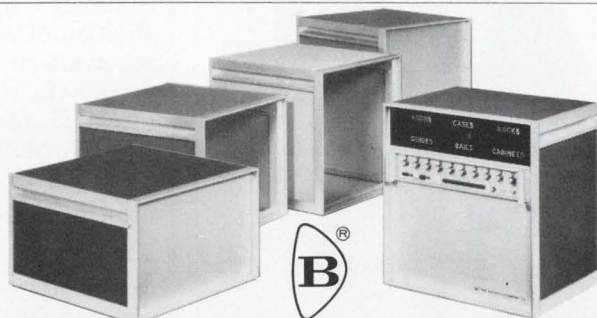

BUCKEYE CABINETS

Buckeye's classic cabinetry line of aluminum enclosures is colorful, strong and budget priced. Universal 19" front panels, with heights from 12.25" to 28". You can also depend on Buckeye for other instrument-packaging needs: Designer Cases of all types and sizes — Patented card guide modules — PCB racks — Retractable, locking tilt-stands — and the recognized high quality matching instrument knob line.

the **BUCKEYE stamping co.** Write today for free colorful literature!
555 Marion Rd., Columbus, Ohio 43207

"QUALITY PRODUCTS SINCE 1902"



GUIDES • CASES • KNOBS • RACKS

"SEE US AT NEPCO S/W BOOTH 318"
INFORMATION RETRIEVAL NUMBER 227

255

Have you
ever seen
a button
that fits
your
finger?

We now offer the new
**LIGHTED PUSH-
BUTTON SWITCH**
SERIES LPS-100

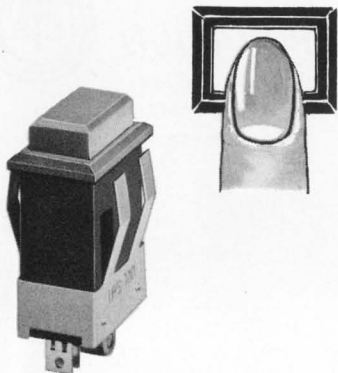

(Actual size)

FEATURES:

- Small space—only .750" x .550" mounting space and 1.100" behind panel.
- Snap-lock mounting.
- Matrix mounting is available.
- Momentary or alternate actions.
DPST, SPST, N.O., N.C.
- Light touch button—operation force 8 oz.
- Clean Color Button—Transparent cap with white diffusion filter.
—Permit insertion of film with any LOGO or picture.
- Front lamp replacement.

• Ask informations to:

WAMCO Technical Sales, Inc.

705 W. 16th Street, Costa Mesa, California
92627 TEL:(714)642-5100 TELEX:678459

**OSHINO ELECTRIC LAMP
WORKS, LTD.**
TOKYO, JAPAN

evaluation samples

Striping tape

A sample roll of a paint striping tape enables users to make sharp and decorative pin stripes easily. The tape, Scotch No. 263, provides a double stripe of 1/16-in. and 3/32-in. widths, separated by a 1/8-in. space. By removing either one or more of the three pull-out pieces, five different single stripes of from 1/16 in. to 9/32 in. can be made, plus the one double stripe. 3M.

CIRCLE NO. 451

Metric ruler

A red-and-white 7-in. pocket ruler made of flexible plastic features a metric scale. Equipto.

CIRCLE NO. 452

Female disconnects

Pre-insulated female disconnects eliminate costly time-consuming addition of separate insulation. Also available are female disconnects with vinyl insulation or non-insulated for 0.187 and 0.110-in. tabs. Panduit.

CIRCLE NO. 453

No-bounce switches

The LC2 switch is a rugged welded hermetically sealed switching capsule capable of being hammered into a wooden board without damage. Its self-healing mercury contacts survive shock levels in excess of 1400 g. Reliability exceeds 1.07-billion operations until mean first failure. Fifth Dimension.

CIRCLE NO. 454

Epoxy adhesives

A 51-piece assortment of 17 different high-performance epoxy adhesive systems comes in one kit. The fully cured adhesives are resistant to moisture, weathering, fuels and lubricants, mild acids and alkalis, and other organic and inorganic compounds. The kits are available at \$25 each. Tra-Con, Resin Systems Div., 55 North St., Medford, Mass. 02155.

INQUIRE DIRECT

vendors report

Annual and interim reports can provide much more than financial-position information. They often include the first public disclosure of new products, new techniques and new directions of our vendors and customers. Further, they often contain superb analyses of segments of industry that a company serves.

Selected companies with recent reports are listed here with their main electronic products or services. For a copy, circle the indicated number.

LVO Corp. Cable TV and microwave common carrier.

CIRCLE NO. 455

Data General. Computers, software, hardware, memories, paper tape readers, cores and disc heads.

CIRCLE NO. 456

Fluke. Digital electronic counters, test clips, multimeters and automatic production test equipment.

CIRCLE NO. 457

Threshold Technology. Speaker identification systems.

CIRCLE NO. 458

Tocom. Central data systems, traffic control systems and CATV amplifiers.

CIRCLE NO. 459

The Aerospace Corp. Aerospace, satellite systems, launch vehicles, space transportation, missile systems, urban and civil systems.

CIRCLE NO. 460

Bowmar. Semiconductors, consumer electronics, precision mechanical components, servomechanisms, potentiometers and telecommunications test equipment.

CIRCLE NO. 461

General Automation. Minicomputers, computers, computer numerical control, production machine control and process control systems, and disc monitoring systems.

CIRCLE NO. 462

Gulf & Western. Traffic control systems and process control components and systems.

CIRCLE NO. 463

Remote viewing at a price competitive models can't even approach.

This new, low-cost FS-100 Fiberscope with a 24" flexible length can reveal hidden flaws, peer into recesses, and trace vibrations to their source. Built with AO quality throughout, this battery-powered unit features a high resolution fiber bundle with a wide angle fixed focus objective lens and an adjustable eyepiece. For further information on the entire Fiberscope line, write or call American Optical Corporation, Fiber Optics Division, Southbridge, Massachusetts 01550. Tel. (617) 765-9711 Extension 2240.



Only \$295
Model FS-100
Fiberscope

AO
American
Optical

INFORMATION RETRIEVAL NUMBER 229

Cermet Reliable Variable Resistor
(versatility+long life)

CTS 550 Series 3/4" dia. variable cermet resistor. MIL-spec reliability plus wide resistance range: 50 ohms through 5 megohms (linear taper). 2 watt power @ 70°C. MIL approved to style RVC5, MIL-R-23285. Features low noise, high overload capacity and excellent hf characteristics. Available with dual or concentric pots with lug, U/L approved power switch. Get CTS cermet quality at low prices. Write: CTS of Berne, Inc., 406 Parr Road, Berne, Indiana 46711. Phone: (219) 589-3111.

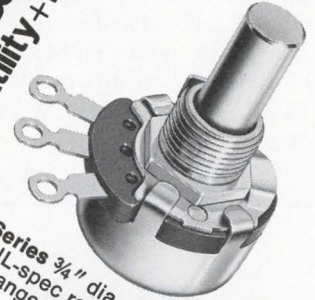

CTS CORPORATION
Elkhart, Indiana



INFORMATION RETRIEVAL NUMBER 230

NEW Acrylic Case PANEL METERS from HOYT

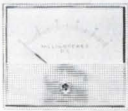

- 3 // MODEL 2430 DC / 2431 AC**
- Acrylic front Noryl back
 - Choice of shielded DC 2% Accu-ring or standard movements DC & AC Types
 - Interchanges with standard 2", 3 stud mounting meters



- 6 // MODEL 2260 DC / 2261 AC**
- Projected front Acrylic case
 - Mounts on panel or through rectangular hole from behind panel
 - Choice of Hoyt Hi-Torque movements

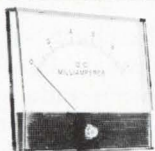

- 6 // MODEL 2360 DC / 2361 AC**
- Acrylic case stylized front
 - Resistant to chemicals and hydrocarbons
 - Choice of case colors

HOYT
QUALITY INSTRUMENTS
SINCE 1904

HOYT ELECTRICAL INSTRUMENT WORKS, INC.
BURTON-ROGERS COMPANY, Sales Division
556 Trapelo Road, Belmont, Mass. 02179
(617) 489-1520

INFORMATION RETRIEVAL NUMBER 231

ELECTRONIC DESIGN 6, March 15, 1974

SPDT DPDT 3PDT 4PDT

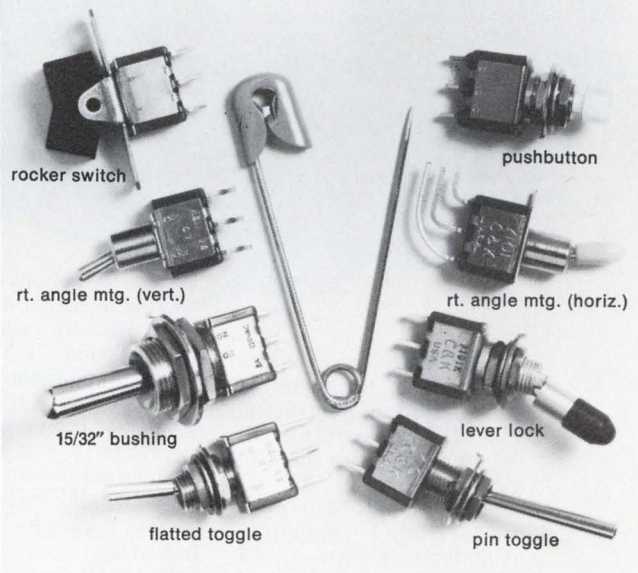

8 beautiful babies.

There they are - in a proud family portrait. And like all C&K subminiature switches, they're competitively-priced and Made-in-America. Ask for our new catalog.

C&K COMPONENTS, INC.

103 Morse Street, Watertown, Massachusetts 02172
Tel: (617) 926-0800

Engineering samples on request.

"SEE US AT IEEE"

INFORMATION RETRIEVAL NUMBER 232

257

new literature

Epoxies

A four-page brochure details Epo-Tek "H" series epoxies for microelectronics applications. Included are specifications for five gold-filled and eight silver-filled electrically conductive epoxies. Epoxy Technology, Watertown, Mass.

CIRCLE NO. 464

Linear/digital circuits

A short-form catalog describes linear and digital microcircuits. The catalog provides key specifications for more than 400 amplifiers, voltage regulators, timers, drivers, comparators, receivers and standard circuits. Raytheon Semiconductor, Mountain View, Calif.

CIRCLE NO. 465

Test
your logic
before you
test your logic
circuit. **Logical.**

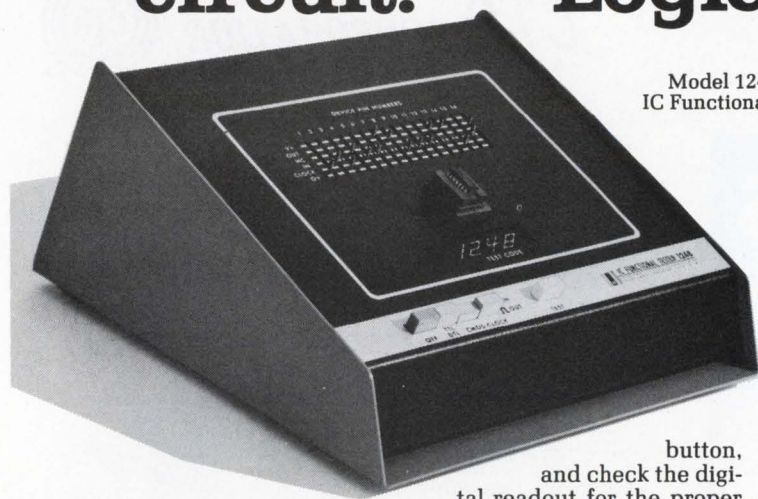

Model 1248
IC Functional Tester

Doesn't it make great good sense to eliminate your malfunctioning digital ICs—TTL, DTL and CMOS—before you wire them in a circuit?

The Model 1248 does precisely that, evaluating each device in from 1 to 5 seconds, for only \$495. And every time you eliminate a disabled IC with your Model 1248, you save yourself from 30 to 60 minutes of expensive logic circuit troubleshooting trying to find the little bugger.

Simply insert the IC in the tester socket, push the

button, and check the digital readout for the proper test code. No comparison with a "good" IC is necessary, and changeover from one device type to another takes less than a minute.

Write for our free full-color brochure on this entirely logical logic tester.

Electro Scientific
Industries
13900 N.W. Science Park
Drive
Portland, Oregon 97229
Phone: (503) 646-4141



Openings: Application Engineers, Product Manager.

Data-acquisition system

A 12-page brochure illustrates the Brush 6000 digital data-acquisition system. Performance specifications, features, operating characteristics, and, by block diagram, a typical system configuration are shown. A full line of peripherals is illustrated. Gould, Cleveland, Ohio.

CIRCLE NO. 466

Magnetic garnet films

Applications of epitaxially grown magnetic garnet films to bubble domain devices, e.g., memories, shift registers, counters, etc., are described in a bulletin. Allied Chemical, Synthetic Crystal Products, Morristown, N.J.

CIRCLE NO. 467

Trimming pots

Cermet and wirewound trimming potentiometers for industrial, general-purpose and military applications are described in a catalog. Mechanical, electrical and environmental characteristics are included. Weston Components, Archbald, Pa.

CIRCLE NO. 468

Miniature slide switches

Mechanical and electrical specifications for miniature linear slide switches for use in low-power applications are given in a catalog. Standard Grigsby, Aurora, Ill.

CIRCLE NO. 469

Panel meters

A 108-page master catalog contains data on the company's panel meters, meter relays, controllers, recorders, digital instruments and test equipment. In loose-leaf form, the catalog is bound in a durable hard cover, three-ring binder for long-lasting service and easy data change. Simpson Electric, Elgin, Ill.

CIRCLE NO. 470

Autoranging DPM

A four-page brochure contains electrical and mechanical information plus application data on an auto-ranging digital-panel meter. It measures readings from 20 V down to 100 μ V without external scaling. Datel Systems, Canton, Mass.

CIRCLE NO. 471

Microwave components

A 112-page catalog contains specifications, features and application information on more than 4000 coaxial and waveguide microwave components and subsystems. Systron-Donner, Van Nuys, Calif.

CIRCLE NO. 472

Pressure transducers

Three illustrated bulletins contain data on high-temperature pressure transducers. Diagrams show direct-mounting or mounting with standard and special adaptors. Kristal Instrument, Grand Island, N.Y.

CIRCLE NO. 473

Integer processors

A technical brief and 31-page programming manual describes the FXP-01 integer processor. The manual describes the internal two-card hardware for single, double and extended (64-bit) operation with Nova and DCC D-116 mini-computers. Floating Point Systems, Portland, Ore.

CIRCLE NO. 474

Oscillographic time codes

The 10 most common types of serial time codes used for recording real or elapsed time on a recording channel or event marker channel of recording oscillographs are shown in a two-page bulletin. Chrono-Log, Broomall, Pa.

CIRCLE NO. 475

Rf power amplifiers

All solid-state rf power amplifiers and power multicouplers, transformers and preamplifiers are featured in a short-form catalog. Included are applications and specifications of amplifiers covering a frequency range of 9 kHz to over 560 MHz and power levels from 300 mW to more than 1000 W. Electronic Navigation Industries, Rochester, N.Y.

CIRCLE NO. 476

Connectors

DEC-8 and DEC-11 series compatible 36-pin printed-circuit connectors are described in a two-page bulletin. Specifications, application, price and delivery information are given. California Data Processors, Santa Ana, Calif.

CIRCLE NO. 477

Linear and interface ICs

A 688-page hardback data book, "The Linear and Interface Circuits Data Book for Design Engineers," provides data on the company's 75/55 series of linear ICs. Indices and selection guides are provided. The handbook is priced at \$3.95 per copy. Texas Instruments, P.O. Box 3640, M/S 84, Dallas, Tex. 75221.

INQUIRE DIRECT

Tape data protectors

A two-color, four-page problem solving technical catalog on tape data protectors details causes of tape degradation and how to avoid such costly hazards. Test procedures, equipment and considerations are described and the results tabulated for quick comprehension. Ad-Vance Magnetics, Rochester, Ind.

CIRCLE NO. 478

PLUG UGLY.™

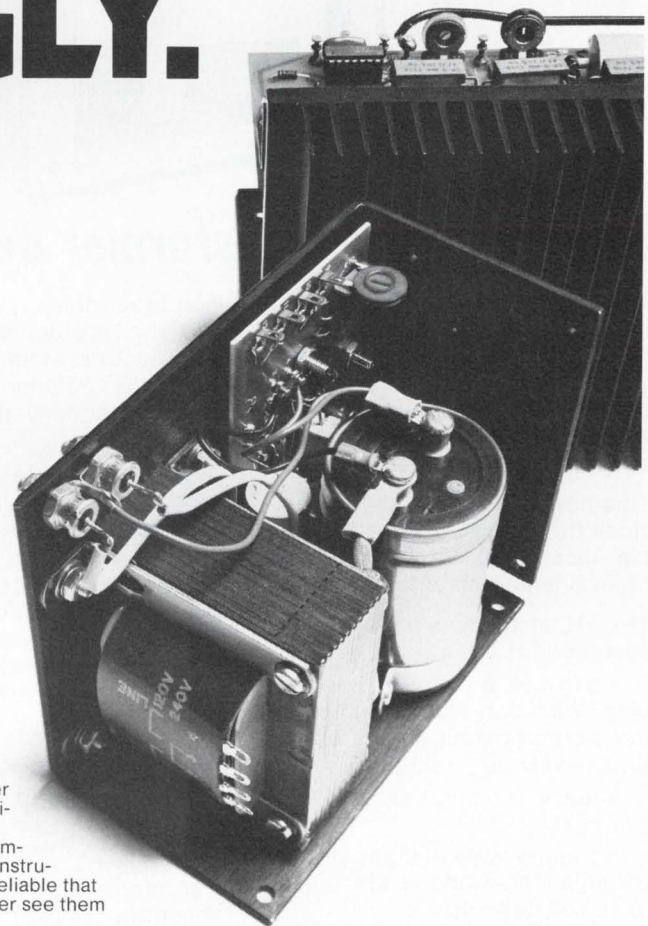

\$44 (1-9)
5V, 6A

They're not much to look at.

Because instead of fancy front panels, we designed our standard open-frame dc power supplies to cover 90% of your OEM applications. And once you plug them into your computers, peripherals or instrumentation, they're so reliable that chances are you'll never see them again.

They're designed and built conservatively, so you get full rated power all the way up to +55°C. Regulation, ripple and noise are specified by the book. And with no expensive options, you can now get your dc power for as little as 68¢/W (1-9 qty).

If you've looked at the competition, we know that has to be a sight for sore eyes.

For more info, use the bingo card or call 714/979-4440. Or call your local Cramer or Newark distributor and get Ugly today.

OPEN-FRAME OLV SERIES: 4-28 Vdc, 15-250 W

STANDARD FEATURES: Choice of 16 voltages, adjustable ±5%. Currents to 50A, no derating to +55°C. ±0.1% IC regulation. ±0.1% ripple and noise. Remote sensing/programming. Spike suppression. Foldback current limiting. 120/240 Vac, 50/60 Hz inputs.

OPTIONS: OVP crowbar. PRICES: \$24.95 to \$179 (1-9)

Elexon Power Systems

© Copyright 1974 Elpac, Inc. ELPAC

INFORMATION RETRIEVAL NUMBER 234

Ceramic modules

Miniature ceramic thermoelectric modules are described in a six-page folder. Thermal and electrical ratings of the three basic models in various sizes under varying load conditions are given. Specifications for all units are included. Materials Electronic Products, Trenton, N.J.

CIRCLE NO. 479

Industrial control modules

Noise-immune solid-state industrial control modules are outlined in a brochure. The fold-out brochure uses an easy-to-understand approach plus photos and diagrams to describe what modules are in the family, how they integrate into a control system and why they were designed for the industrial environment. Digital Equipment, Maynard, Mass.

CIRCLE NO. 480

Switches

Pushbutton, toggle, switchlights, basic, and limit and PCB switches for industrial and process control, computer, automotive, medical electronics, aircraft and military applications are described in a four-page brochure. Control Switch, Folcroft, Pa.

CIRCLE NO. 481

Subminiature rectifiers

Subminiature high-voltage silicon rectifiers are described in a two-page bulletin. Electrical ratings, performance curves and specifications are included. Edal Industries, East Haven, Conn.

CIRCLE NO. 482

Plotters and readers

Digital incremental plotters, magnetic tape readers and an off-line digital plotting system are described in a four-page short-form catalog. Houston Instrument, Belaire, Tex.

CIRCLE NO. 483

Data-Flo newsletter

Data-Flo, a user-oriented newsletter, is designed to keep people engaged in data processing and communications up-to-date with the latest developments. It is an eight-page publication, distributed 10 times yearly. Mohawk Data Sciences, Utica, N.Y.

CIRCLE NO. 484

ISA conference papers

The Instrument Society of America (ISA) offers a brochure, "1973 ISA International Conference Publications." It lists 104 papers on the state of the art and advances in instrumentation, including measurement and automatic control. Instrument Society of America, Pittsburgh, Pa.

CIRCLE NO. 485

Terminal blocks

Specifications for quick-connect terminal blocks are given in a bulletin. The bulletin covers 0.250, 0.187 and 0.110-inch terminal sizes in a variety of configurations and terminations. Also included are specials, through-type and terminal blocks in kit form. Underwriters Safety Device Co., Chicago, Ill.

CIRCLE NO. 486

a NEW approach to ferroresonant transformer design

The Magnetic Metals FR series of laminations was developed to take into consideration the *total* transformer construction . . . optimizing performance, while minimizing space requirements and manufacturing cost.

This new series of EI shapes provides the utmost in versatility and the most effective utilization of grain-oriented materials.

The FR laminations are designed to:

- provide a smooth overlapping transition from high to low transformer output ratings without excessively large stacks
- lower winding time and copper costs
- reduce mean-length of turn through long windows which minimize coil build-up
- allow ferroresonant transformers of different ratings to have a family resemblance because of the similarity of lamination proportions . . . thus eliminating the problems of changing form-factors, winding proportions, and other relationships encountered with conventional laminations.

The *exclusive* Magnetic Metals 33B grade of grain-oriented silicon steel provides relatively low losses and high permeability, especially in the saturated region. These improved properties enhance performance and provide greater freedom of design.

For more information on Ferroresonant Transformer Laminations, materials and shunts for FR series . . . contact your local Magnetic Metals Representative or write for our new catalog to:

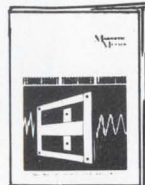

**MAGNETIC
METALS**

Hayes Avenue at 22nd Street, Camden, N. J. 08101 • (609) 964-7842

IC replacement guide

An up-to-date issue of the Linear IC Direct-Replacement Guide includes the solid-state devices of 13 industry manufacturers. The guide reflects the change in the company's linear IC type designations. To simplify the recognition and identification of second-source types in the linear IC line, the type numbers have been changed to include the exact source manufacturer's type number. RCA Solid State Div., Somerville, N.J.

CIRCLE NO. 487

Casting resins

Crystal-clear casting resins are described in a folder. Material classes include epoxies, silicones, urethanes, polyesters and hydrocarbons. Emerson & Cuming, Canton, Mass.

CIRCLE NO. 488

Communication equipment

A 640-page handbook contains 24 application reports that have been written to aid the communications design engineer in his efforts to bring the power amplifier stage of his communications equipment from the drawing board to the production floor in the shortest period of time. The reports cover subjects ranging from single side-band drivers and amplifiers to vhf and uhf FM power amplifier stages. The price of the book is \$15, and it includes all updated and new reports that are published at no additional charge for a full 2-year period from date of purchase. Amperex, 230 Duffy Ave., Hicksville, N.Y. 11802.

INQUIRE DIRECT

Gas, vapor tolerances

A 68-page report contains infrared spectra of maximum OSHA tolerance levels for 62 of the most common hazardous gas and vapor compounds. Arranged alphabetically by compound name, the report details the maximum allowable OSHA limit plus two related reference spectra for each compound. The manual also describes sampling system, procedure and applications of the spectra. The report is priced at \$5 per copy. Beckman Instruments, Scientific Instruments Div., 2500 Harbor Blvd., Fullerton, Calif.

INQUIRE DIRECT

Software

A 12-page Versaplot software brochure discusses the universal Fortran package and the various systems integrated packages designed to facilitate plotting with Matrix plotters. Numerous charts, tables and plot samples are included to clarify the functioning of the software and to illustrate the Versaplot subroutines. Versatec, Cupertino, Calif.

CIRCLE NO. 489

Monitor timer

Details on the monitor timer Model 43 solid-state time-delay relay are given in a two-page illustrated bulletin. The bulletin gives diagrams of the timing operation and circuit, along with operating characteristics and specifications. Ordering information and module dimensions are also included. Struthers-Dunn, Pitman, N.J.

CIRCLE NO. 490

MEAN AND UGLY.™



\$79 (1-9)
3 outputs

Our OEM dc supplies have always been stark, but now they're twice as ugly (also 3x).

Because instead of working up a new color scheme, we've combined two and three of them on a single chassis to make them an even better buy for your computers, peripherals and instruments.

We've taken out redundancies, but they still offer the widest range of voltages you can get in a modular dc supply. Still deliver all the power we promise across the full temperature range (even with 50 Hz inputs). And still include all the features you need as standards, not expensive options.

So that now if you check us out against the competition, they're liable to tell you that we're not just ugly.

We're downright mean.

For more info, use the bingo card or call 714/979-4440. Or call your local Cramer or Newark distributor and get Ugly today.

MULTIPLE OUTPUT DLV/TLV SERIES: 1st output: 5 V at 3-15 A, OVP standard. 2nd and/or 3rd outputs: each 4-28 V, 6-15 W, OVP optional. All outputs isolated, may be used as positive or negative supplies.

STANDARD FEATURES: Choice of 16 voltages, adjustable $\pm 5\%$. Currents to 15 A, no derating to $+55^\circ\text{C}$. $\pm 0.1\%$ regulation, $\pm 0.1\%$ ripple and noise. Remote sensing/programming. Spike suppression. Foldback current limiting. 120/240 Vac, 50/60 Hz inputs.

OPTIONS: Enclosure. PRICES: \$29 to \$151 (1-9)

Elexon Power Systems

© Copyright 1974 Elpac, Inc. ELPAC

INFORMATION RETRIEVAL NUMBER 236

bulletin board

Metrix Instrument has announced that its models 5173 and 5097 weatherproof vibration switches have received a general-purpose listing by Underwriters Laboratory.

CIRCLE NO. 491

Four independent voltage comparators in one 14-pin dual-inline package are provided by the SG139/239/339 quad comparators available from Silicon General, 2712 McGaw Ave., Irvine, Calif. Input offset voltage is ± 2 mV. Input bias current is typically 25 nA. Supply voltage range is 2 to 36 V (or ± 1 to ± 18 V). Supply current drain is 0.8 mA, and differential input voltage range is 36 V.

INQUIRE DIRECT

Availability of production quantities from stock of the TBA231 dual preamp, which is a pin-for-pin equivalent to the μ A739, has been announced by SGS-ATES.

CIRCLE NO. 492

The SM 200 Mk III counter/timer has had its bandwidth increased to 100 MHz at 30 MV, according to SE Labs (EMI).

CIRCLE NO. 493

A low-cost line of 3/8-in. sq. wire-wound trimmers has been introduced by TRW/IRC Potentiometers. Designated as Type 70, they are rated at 0.75 W at 70 C and have an operating temperature range of -65 to $+150$ C. Twelve standard resistance values, from 50 Ω to 20 k Ω $\pm 10\%$ tolerance, are available.

CIRCLE NO. 494

Omega Engineering has introduced ultra-high temperature thermocouple probes with tungsten-rhenium and platinum elements. The probes are available in more than 20 different calibrations and combinations of sheaths, insulations and diameters.

CIRCLE NO. 495

A line of over 30 high reliability modular dc power supplies that are directly interchangeable with the Lambda LM series and other standard types has been announced by Tele-Dynamics/Wanlass.

CIRCLE NO. 496

Microsemiconductor has developed a custom assembly capability for packaging diode arrays in small-to-medium (1000 to 5000) quantities. Prototype delivery is two to four weeks ARO. In most cases, there are no tooling charges.

CIRCLE NO. 497

LED displays—MAN50 (green), MAN70 (red) and MAN80 (yellow)—have been introduced by the electronic special products group of Monsanto Commercial Products Co. The family offers common anode, common cathode, right-hand and left decimal and plus-or-minus one overflow digits. All are 0.3-in. high digits and have identical mechanical configurations.

CIRCLE NO. 498

Connect the dots for \$1095.

It's not enough to have high speed vector graphics from your mini dynamically displayed on your x-y scope. Now Megatek has the lowest cost full graphic interface available. Supplied with ready-to-use software (BASIC) to generate a wide variety of real-time flicker-free (50Hz refresh memory built-in) plots and alphanumeric. Complete CPU compatibility (now available for NOVA series) — no hardware modification.

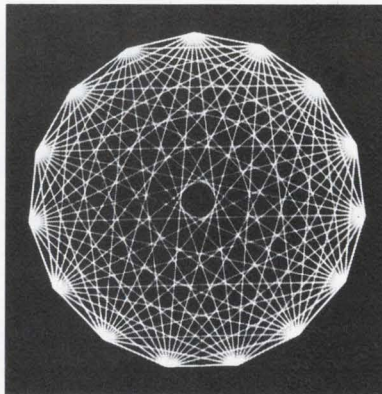

So don't pay a cent unless you're convinced it's the unbeatable value we say it is. See for yourself. Call us for convincing details on NOVA, PDP-11 and NAKED MINI/ALPHA 16, (714) 224-2721 or write Megatek, 1055 Shafter Street, San Diego, CA. 92106.

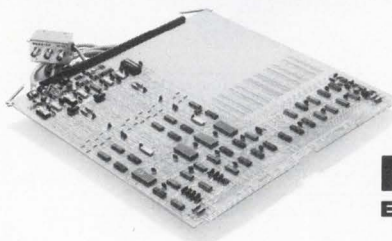

MEGATEK
BUDGET PERIPHERALS

Keeping peripheral prices in line.

INFORMATION RETRIEVAL NUMBER 237

AVX Ceramics has developed a **multilayer termination of silver-nickel-gold** which virtually eliminates stress and cracking of parts caused by the difference in expansion coefficients of palladium-silver and ceramic chip capacitors.

CIRCLE NO. 499

Data Test Corp. and Tymshare have reached an agreement that allows test equipment users to dial a local phone number almost anywhere and have a paper tape prepared for **programming computerized and automatic test systems**.

CIRCLE NO. 500

Teledyne Semiconductor has announced the **D555 dual timer IC** for direct replacement of two 555-type timers. The D555 has been developed to reduce complexity and save circuit hardware in applications requiring two or more 555s.

CIRCLE NO. 501

Precision thin-film precircuits—resistor-conductor networks fabricated on thin-film coated substrates—are available through **Resistor Products Div. of Analog Devices**.

CIRCLE NO. 502

Chicago Switch has announced the addition of a **subminiature (0.5 × 0.3 × 0.57 in.) dpdt slide switch** with insert molded terminal pins specifically designed to inhibit solder and flux contamination.

CIRCLE NO. 503

Fairchild Camera and Instrument Corp. has introduced 17 **solid-state lamps**, including the company's first green lamps. The 17 lamps include six green GaP devices, three red GaP lamps and eight red GaAsP units.

CIRCLE NO. 504

Price reductions

Federal Scientific has reduced the price of the **UA-14A 400-line ubiquitous spectrum analyzer** to \$4800 from \$8900. The 500-line UA-15A has been reduced to \$5500 from \$9200. The companion averagers, respectively models 1014 and 1015, are now \$2000 each, down \$1000 each.

CIRCLE NO. 505

Inselek has announced a 15 to 20% across-the-board price reduction on its **silicon-on-sapphire wafers**.

CIRCLE NO. 506

A 10% price reduction for **Scotchflex DIP connectors** has been announced by 3M.

CIRCLE NO. 507

Price reductions ranging up to 25% on **MIC mixers and mixer-preamps** and **IC i-f amplifiers** have been announced by RHG

Electronics Laboratory.

CIRCLE NO. 508

Price reductions up to 40% for the **PDP-8 line of minicomputers** have been announced by Digital Equipment Corp.

CIRCLE NO. 509

National Semiconductor has reduced the price on its NS Electronics Model 600 **six-digit pocket calculator** to \$29.95 from \$39.95. 2900 Semiconductor Dr., Santa Clara, Calif. 95050.

INQUIRE DIRECT

GET UGLY™

at Cramer... at Newark.

Newton, Mass. 617/969-7700
 North Haven, Conn. 203/239-5641
 Endwell, N.Y. 607/754-6661
 Rochester, N.Y. 716/275-0300
 East Syracuse, N.Y. 315/437-6671
 Hauppauge, L.I., N.Y. 516/231-5600
 Moonachie, N.J. 201/935-5600
 Cherry Hill, N.J. 609/424-5993
 Gaithersburg, Md. 301/948-0110
 Hanover, Md. 301/796-5790
 Cleveland, Ohio 216/248-8400
 Cincinnati, Ohio 513/771-6441
 Livonia, Mich. 313/425-7000
 Winston-Salem, N.C. 919/725-8711
 Atlanta, Ga. 404/448-9050
 Orlando, Fla. 305/894-1511
 Hollywood, Fla. 305/923-8181
 Huntsville, Ala. 205/539-5722
 Mt. Prospect, Ill. 312/593-8230
 Milwaukee, Wis. 414/764-1700
 Edina, Minn. 612/835-7811
 Dallas, Texas 214/350-1355
 Denver, Colo. 303/758-2100
 Salt Lake City, Utah 801/487-4131
 Albuquerque, N.M. 505/265-5767
 Phoenix, Ariz. 602/263-1112
 Seattle, Wash. 206/762-5755
 Sunnyvale, Calif. 408/739-3011
 Irvine, Calif. 714/979-3000
 San Diego, Calif. 714/565-1881
 De San German, P.R. 809/892-1130
 Roma, Italy 51-393-87
 Downsview, Ont., Canada 416/661-9222

Woburn, Mass. 617/935-8350
 Westport, Conn. 203/226-6921
 Rochester, N.Y. 716/473-6600
 Canandaigua, N.Y. 315/394-0941
 Red Hook, N.Y. 914/758-8229
 Plainview, N.Y. 516/822-5000
 Kenilworth, N.J. 201/272-8410
 Beltsville, Md. 301/937-5085
 Cincinnati, Ohio 513/874-5115
 Cleveland, Ohio 216/641-2800
 Ft. Lauderdale, Fla. 305/587-2372
 Oak Park, Mich. 313/548-0250
 Wyoming, Mich. 616/241-6681
 South Bend, Ind. 219/272-2992
 Carmel, Ind. 317/846-2673
 Chicago, Ill. 312/638-4411
 Des Plaines, Ill. 312/298-1420
 Milwaukee, Wis. 414/781-2450
 Minneapolis, Minn. 612/331-6350
 St. Louis, Mo. 314/843-2080
 Dallas, Texas 214/271-2511
 Houston, Texas 713/782-4800
 Denver, Colo. 303/757-3351
 Salt Lake City, Utah 801/486-1048
 Inglewood, Calif. 213/678-0441

We make the OEM dc supplies that only an engineer could love. No fancy front panels, but loaded with everything you need for 90% of your applications off-the-shelf:

16 voltages from 4-28V, adjustable ±5%.
 Currents to 50A, with no derating to +55°C. ±0.1% IC regulation. 120/240 Vac. 50/60 Hz inputs. And even remote sensing/programming.

All standard for as little as 68¢/W. And all yours from Cramer or Newark. (For more info, use the bingo card or call 714/979-4440.)

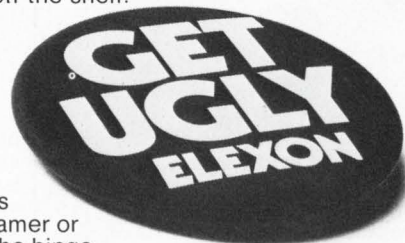

Elexon Power Systems

©Copyright 1974 Elpac, Inc. ELPAC

INFORMATION RETRIEVAL NUMBER 238

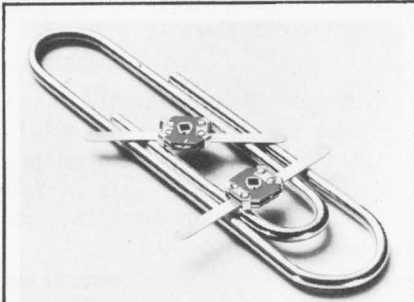

Thin-Trim variable capacitors provide a reliable means of adjusting capacitance without abrasive trimming or interchange of fixed capacitors. Series 9401 has high Q's and a range of capacitance values from 0.2-0.6 pf to 3.0-12.0 pf and 250 WVDC working voltage. Johanson Manufacturing Corporation, Boonton, New Jersey (201) 334-2676.

INFORMATION RETRIEVAL NUMBER 181



PED-A-VAC Desoldering System—Places all power desoldering/soldering elements in one location. Foot-controlled vacuum generator uses standard shop air. Adjustable tip temperature control. Mechanical switching won't damage circuit components. PACE, INC. 9329 Fraser St., Silver Spg., Md. 20910

INFORMATION RETRIEVAL NUMBER 182

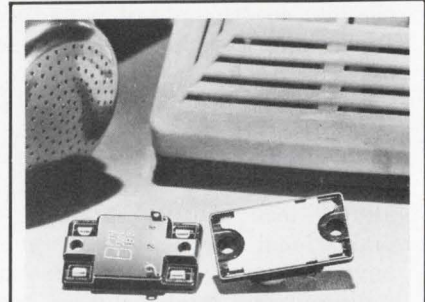

New Posistors provide both heat and temperature control in one compact semi-conductor package. Eliminates hot wires - bimetallic thermostats. For small appliances, ovens, controls. Offers very smooth and precise temperature control with capacities to 100 watts. Murata, 2 Westchester Pl., Elmsford, N.Y. 10523. 914-592-9180.

INFORMATION RETRIEVAL NUMBER 183

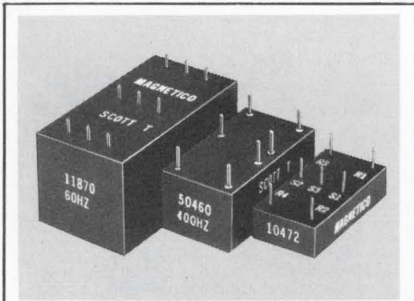

Scott T Transformer. 11870: 60HZ, 90v, L-L In. 1.1x2.1x1.1. 50460: 400HZ, 90v, L-L In. 7/8x1-5/8 x11/16. 50642: 400HZ, 11.8v, L-L In. 7/8x1-5/8x11/16. 10472: 400HZ, 11.8v, L-L In. 3/4x1-1/2x3/8. All with 6v RMS sine & cosine output. MAGNETICO, INC., E. Northport, N.Y. 11731. 516-261-4502.

INFORMATION RETRIEVAL NUMBER 186

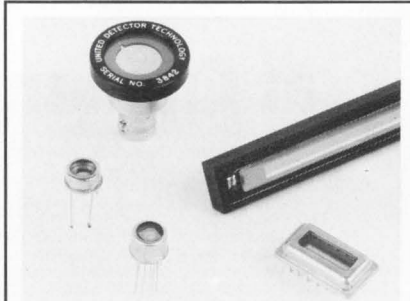

UDT offers a complete line of silicon photodiodes. Schottky for large area and enhanced UV responsivity, planar diffused for low noise and extended responsivity, photops (detector/amplifier combinations), special arrays and detectors to customer specifications. United Detector Technology, 1732 21st St., Santa Monica Ca 90404. (213) 829-3357.

INFORMATION RETRIEVAL NUMBER 187

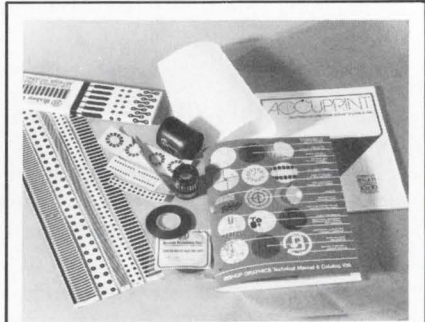

Free 84-page Printed Circuit Drafting Aids Technical Manual & Catalog contains hundreds of time & money-saving tips, plus details on over 15,000 component symbols & tapes, film, vellum, grids. Bishop Graphics, Inc., 7300 Radford Ave., North Hollywood, CA 91605, (213) 982-2000.

INFORMATION RETRIEVAL NUMBER 188

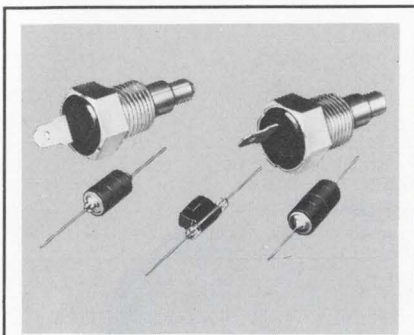

Thermal reed switches feature reliability and precision, long-term stability, immediate response, chatter-free operation, corrosion-explosion resistant, various operating temperatures and lends itself to multiple applications. Pye TMC Canada, 15 Sheffield Street, Toronto, Ontario. (416) 249-7044.

INFORMATION RETRIEVAL NUMBER 191

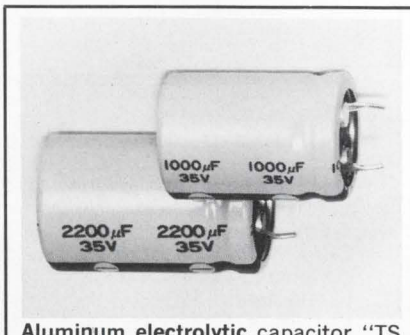

Aluminum electrolytic capacitor "TS series" for pc board mounting is available in short delivery. Snap-in shaped self mounting terminal and solid top vent construction. Capacitance range: 470~4700µF, Voltage range: 16~100Vdc, Operating temperature: -40~+85°C, Life: 1,000 hours at 85°C, Matsushita Electric Corp., Pan Am Bldg., N. Y.

INFORMATION RETRIEVAL NUMBER 192



Timing programmer—Activates 8 external relays in a pre-programmed sequence or relative to the starting time. Timing selectable in 0.25, 0.5, or 1 second increments to over 1000 seconds. Applications include rockets, missiles and aircraft.—BAYSHORE SYSTEMS—Springfield, Va.

INFORMATION RETRIEVAL NUMBER 193

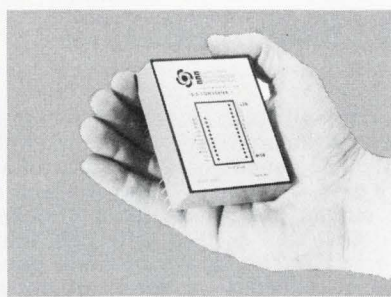

"Synchro to digital converters - 10, 12, or 14 bit output, errorless tracking up to 4 r.p.s., accuracy ± 4 min. of arc $\pm .9$ LSB, resolution - 1.3 minutes, 60 or 400 Hz input, Module 2.6 x 3.1 x .82" H, Price From \$350 in qty.
Computer Conversions Corp., East Northport, N.Y. 11731 (516) 261-3300."

INFORMATION RETRIEVAL NUMBER 184

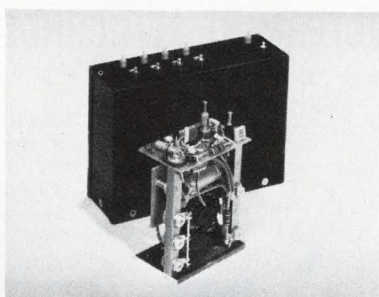

Modular DC-DC power converters. Designed to meet military/aerospace specs . . . priced for industrial applications. 12, 28, 48, 115 VDC inputs. 1-6 isolated, regulated (1% & 0.1%) outputs. 1-500 watts. Efficiencies to 85%. 1200 design-as-you-order configurations using standard modules. Arnold Magnetics, Culver City, Ca. (213) 870-7014.

INFORMATION RETRIEVAL NUMBER 185

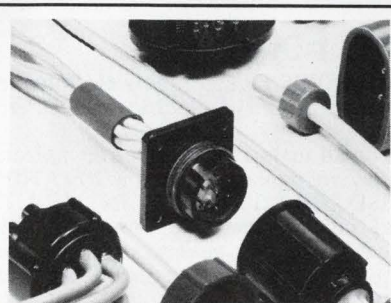

Capitron LGH high voltage lead assemblies and receptacles. Miniature and lightweight. Yet highly reliable. Peak performance is assured whenever high voltage is required and a hostile environment is a factor. Safe, too, because there are no exposed high-voltage parts. AMP Incorporated, Capitron Division, Elizabethtown, Pa. 17022. (717) 367-1105.

INFORMATION RETRIEVAL NUMBER 189



'Miniscan' miniature uniselector features scanning and collecting information from remote points, translating signals from one code to another, distribution of signals at pre-set intervals, radio program switching, decade counting and many other applications. Pye TMC Canada, 15 Sheffield Street, Toronto, Ontario. (416) 249-7044.

INFORMATION RETRIEVAL NUMBER 190

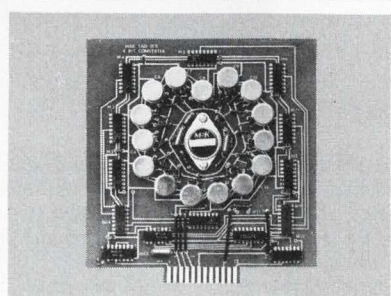

The MSK T.A.D.C. Series of A/D Converters have been designed to meet full temperature ranges of 0°C to 70°C and -55°C to +125°C with temperature drift of less than 1 bit over temperature range. T.A.D.C.—8 bits 10 MHz; 9 bits 2 MHz; 5 bits 20 MHz; 4 bits 20 MHz. Size: 6" x 6". M. S. Kennedy Corp., Pickard Dr., Syr., N.Y. 13211. (315) 455-7077.

INFORMATION RETRIEVAL NUMBER 194

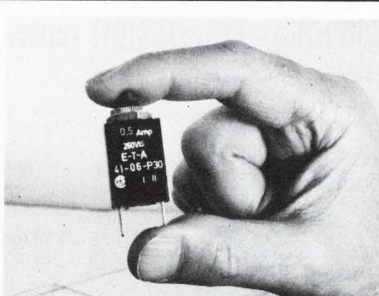

Overcurrent Protector, manual reset eliminates fuse replacement. Convenient panel mounting. 15 fractional ratings from 0.1 to 3 amp. Other models up to 400 amp. Trip-free and fool-proof, UL and CSA approved. High quality, low cost—\$1.12 ea. in 1000 lots. E-T-A Products Co. of America, 6284 N. Cicero Ave., Chicago, Ill. 60646. Tel. (312) 545-1553.

INFORMATION RETRIEVAL NUMBER 195

Advertisers wishing to reserve Quick Ad units should note the following mechanical requirements: Specs—Supply glossy photo of product and approximately 40 words which will set no more than 10 lines of 34 characters each. AFTER SUBMISSION NO COPY CHANGES CAN BE ACCEPTED. Quick Ads cost only \$300 per insertion, less for frequency advertisers.

RATES:

1x
\$300

7x
\$280

13x
\$255

19x
\$250

26x
\$245

39x
\$240

52x
\$235

104x
\$230

ELECTRONIC DESIGN's function is:

- To aid progress in the electronics manufacturing industry by promoting good design.
- To give the electronic design engineer concepts and ideas that make his job easier and more productive.
- To provide a central source of timely electronics information.
- To promote communication among members of the electronics engineering community.

Want a subscription? ELECTRONIC DESIGN is sent free to qualified engineers and engineering managers doing design work, supervising design or setting standards in the United States and Western Europe. For a free subscription, use the application form bound in the magazine. If none is included, write to us direct for an application form.

If you do not qualify, you may take out a paid subscription for \$30 a year in the U.S.A., \$40 a year elsewhere. Single copies are \$1.50 each.

If you change your address, send us an old mailing label and your new address; there is generally a postcard for this bound in the magazine. You will have to requalify to continue receiving ELECTRONIC DESIGN free.

The accuracy policy of ELECTRONIC DESIGN is:

- To make diligent efforts to ensure the accuracy of editorial matter.
- To publish prompt corrections whenever inaccuracies are brought to our attention. Corrections appear in "Across the Desk."
- To encourage our readers as responsible members of our business community to report to us misleading or fraudulent advertising.
- To refuse any advertisement deemed to be misleading or fraudulent.

Microfilm copies are available of complete volumes of ELECTRONIC DESIGN at \$19.00 per volume, beginning with Volume 9, 1961. Work is now in process to complete the microfilm edition of Volumes 1-8. Reprints of individual articles may be obtained for \$2.00 each, prepaid (\$.50 for each additional copy of the same article) no matter how long the article. For further details and to place orders, contact the Customer Services Department, University Microfilms, 300 North Zeeb Road, Ann Arbor, Michigan 48106 telephone (313) 761-4700.

Want to contact us? If you have any comments or wish to submit a manuscript or article outline, address your correspondence to:

Editor
ELECTRONIC DESIGN
50 Essex Street
Rochelle Park, N.J. 07662

DETERMINE SEMICONDUCTOR CHARACTERISTICS

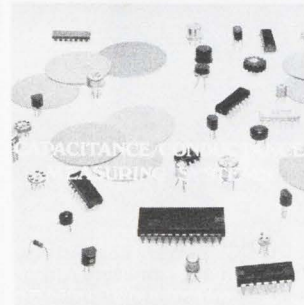

Important information about a semiconductor device or material can be determined by measuring the capacitance and conductance characteristics as a function of voltage and frequency. Measurement of flat band voltage, mobile ion concentration, doping profiles, carrier lifetime and surface state concentrations using lock-in amplifier (i.e. phase sensitive detection) techniques are described in a series of application notes. Equipment available for R&D as well as Production/QC applications.

PRINCETON APPLIED RESEARCH CORPORATION

P.O. Box 2565
Princeton, New Jersey 08540 (609) 452-2111

CIRCLE NO. 171

Why Test Semi-Conductors For Noise?



The **QUAN-TECH NOISE FILE** contains technical reports on the nature and origin of electrical noise in semi-conductors.

The effects of noise in terms of impaired performance have been widely recognized, and the **RELATIONSHIP BETWEEN NOISE AND COMPONENT RELIABILITY** generally accepted in the electronic industry. Thus the analysis of electrical noise generated by components is not only vital to the development and production of low-noise circuits, but also is becoming of major importance in achieving maximum reliability of instrumentation.

Instruments are available for testing noise of transistors, and thin film circuits. Applications include Incoming Inspection, Laboratory Studies, and High-Speed Production Testing.

CIRCLE NO. 172

Quan-Tech
Div. of Scientific/Atlantic, Inc.
43 South Jefferson Road
Whippany, N. J., 07981

400 IDEAS FOR DESIGN Volume 2

Edited by Frank Egan

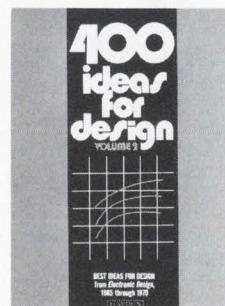

A unique sourcebook of practical design techniques and approaches using the latest components, representing the best contributions to *Electronic Design's* "Ideas for Design" column. All selected for their practical value in solving the design engineer's most common, everyday problems. They have proved useful as parts of larger designs or as aids in measuring the parameters and testing the effectiveness of existing designs. 288 pp., 7 1/8 x 9 3/4, illus., cloth, \$11.95. **Circle the reader-service number to order a 15-day examination copy.**

CIRCLE NO. 173



HAYDEN BOOK COMPANY, INC., 50 Essex St., Rochelle Park, N.J. 07662

Manufacturers

Advertisements of booklets, brochures, catalogs and data sheets. To order use Reader-Service Card (Advertisement)

Free Comparison Report on FFTs

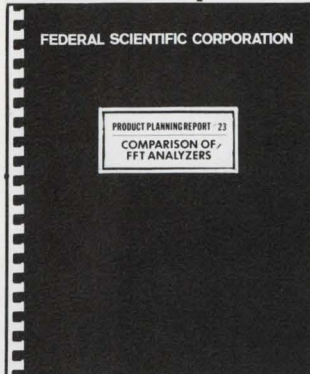

Recently Federal Scientific conducted a detailed side-by-side analysis of current Fast Fourier Transform systems—specification by specification—with the aim of designing a better unit, its own Omniferous™ FFT Analyzer.

This Product Planning Report #23, originally prepared as an internal document, includes comparisons of speed, dynamic range, usable resolution, ease-of-use, price.

Please call or write Joseph Flink, VP Data Processing.

CIRCLE NO. 174

Federal Scientific Corp.

An affil. of Nicolet Instrument

615 West 131st Street, New York, N.Y. 10027. (212) 286-4400.

MAGNETIC SHIELD COSTS REDUCED



Existing tooling for nearly every type magnetic shield reduces your costs. Or, our Magnetic Shielding Specialists will design and fabricate an AD-MU shield to your performance requirements. Our shielding is used off-planet in spacecraft & satellites, and world-wide in precision industrial, laboratory, military & consumer applications. Ad-Vance, the Old Firm with the New Name, is the industry's largest, oldest and most experienced independent firm exclusively manufacturing magnetic shielding. Our Engineering Department can help you.

CIRCLE NO. 175

AD-VANCE MAGNETICS, INC.

The Magnetic Shielding Specialists

225 E. Seventh St., Rochester, Ind. 46975. (219) 223-3158.

Low-Noise High-Gain Pre amplification

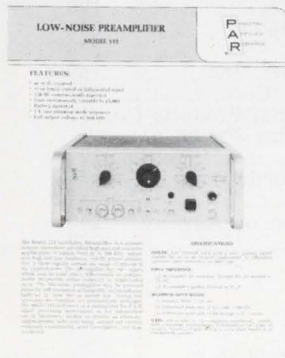

Complete specifications of a variable-bandwidth high-gain preamplifier are contained in the Model 113 data sheet, T-224. Included are typical noise figure contours illustrating the amplifier's exceptionally low noise, which is as low as .05 dB at mid frequencies with a 1 megohm source. Other illustrations include typical plots of the equivalent input noise and common mode rejection, which exceeds 100 dB at 60 Hz at all gain settings. The data contained in the specification sheet will be of interest to all engineers and researchers looking for a preamplifier with calibrated gain and rolloffs from dc to 300 kHz.

CIRCLE NO. 176

Princeton Applied Research Corporation

Box 2565, Princeton, New Jersey 08540 - (609) 452-2111

Electronic Design

Advertising Sales Staff

Tom W. Carr
Vice President &
Sales Manager

Rochelle Park, N.J. 07662

Robert W. Gascoigne
Daniel J. Rowland

(Recruitment, Quick Ads, Classified)

50 Essex Street
(201) 843-0550
TWX: 710-990-5071

Philadelphia

Thomas P. Barth
50 Essex Street
Rochelle Park, N.J. 07662
(201) 843-0550

Boston 02178

Gene Pritchard
P.O. Box 379
Belmont, Mass. 02178
(617) 489-2340

Chicago 60611

Thomas P. Kavooras
Berry Conner, Jr.
200 East Ontario
(312) 337-0588

Cleveland

Thomas P. Kavooras
(Chicago)
(312) 337-0588
(call collect)

Los Angeles 90303

Stanley I. Ehrenclou
Burt Underwood
2930 Imperial Highway
Inglewood, Calif.
(213) 757-0183

San Francisco 94022

Jerry D. Latta
P.O. Box 1248
Los Altos, Calif.
(415) 965-2636

London

For United Kingdom and Europe

John Ashcraft
John Ashcraft & Co.
12, Bear St.
Leicester Square
London WC2H 7AS England
Phone: 01-930-0525

W. J. M. Sanders
John Ashcraft & Co.
Herengracht 365
Amsterdam C., Holland
Phone: 020-24-09-08

Tokyo

Haruki Hirayama
Electronic Media Service
5th Floor, Lila Bldg.
4-9-8 Roppong
Minato-ku
Phone: 402-4556
Cable: Electronicmedia, Tokyo



advertiser's index

Advertiser	Page	Advertiser	Page	Advertiser	Page
ACDC Electronics, Inc.	75	Datacraft	48	Inselek, Inc.	219
AMP, Incorporated	16A,B,C,D, 265	Data Precision Corporation	97	Instruments for Industry, Inc.	254
AVX Ceramics Corporation	Cover II	Deltrol Controls	172	Intech, Incorporated	166
Acopian Corp.	167	Dialight Corporation	105, 149	Intel Corporation	22, 23
Ad-Vance Magnetics, Inc.	267	Diva, Inc.	14	Interelectronics Corporation	138
Adams & Westlake Company, Inc., The	194	Durgin & Browne, Inc.	228, 250	International Coil Winding Association	244
Aham Electronics	208	Dynascan Corporation	231	International Electronic Research Corporation	46
AirBorn, Inc.	212	ECCO	195	International Rectifier	140, 212
Airpax Electronics, Control Division	168	EH Research Laboratories	215	Interstate Electronics Corporation	69
Alden Electronic & Impulse Recording Equipment Co., Inc.	228	EMR Telemetry, Weston Instruments, Inc.	249	Ise International Corporation	183
Allen Avionics, Inc.	222	E-T-A Products Co. of America	265	JFD Electronic Components Corp.	80E
Allen Bradley Co.	33	Electro Corporation	248	Johanson Manufacturing Corp.	7, 264
Amco Engineering Co.	71	Electro Scientific Industries	258	Johnson Company, E.F.	81
Amerace Corporation	42	Electro Switch Corp.	204	Kennedy Corporation, M.S.	265
American Electronic Laboratories, Inc.	153	Electronic Arrays, Inc.	96	Keuffel & Esser	174
American Optical Corporation	257	Electronic Design	48H	Keystone Electronics Corp.	223
Amperex Electronics Corporation	177	Electronic Communications, Inc.	186	Kinsekisha Laboratory Ltd.	250
Amperite Co., Inc.	80	Electronic Molding Corporation	234	Krohn-Hite Corporation	17
Amplifier Research Corporation	255	Electronic Navigation Industries	66	Kyodo Electronic Laboratories, Inc.	188
Analog Devices, Inc.	147	Electrostatics, Inc.	236	LFE Corporation	163
Analogic Corporation	169	Elexon Power Systems	259, 261, 263	Lambda Electronics Corp.	114, 115
Arnold Magnetics Corp.	265	Elmwot Sensors, Inc.	214	Ledex, Inc.	182
Augat, Inc.	67	Excutone, Inc., Printact Relay Division	78	Licon, Division of Illinois Tool Works, Inc.	125
Avantek, Inc.	227	Federal Scientific Corporation	187, 267	Littlefuse, Subsidiary of Tracor	47
Ballantine Laboratories, Inc.	196	Fuji Electrochemical Co., Ltd.	207	Litton Industries	141
Bayshore Systems	264	Function Modules, Inc.	238	3M Company	64
Bead Electronics	224	Futaba Industries	15	Magnecraft Electric Company	Cover III
Beckman Instruments, Inc. Helipot Division	48B, 48C	GTE Automatic Electric	48D, 48E	Magnetic Metals	260
Biomation	74	General Automation, Inc.	8, 9	Magneto, Inc.	264
Bishop Graphics, Inc.	264	General Electric Company	49, 72	Matsushita Electric Corp.	264
Bivar, Inc.	198	General Instrument Corporation	216	Megatek	262
Billey Electric Co.	253	General Scanning, Inc.	248	Mellor Co., Adolf	248
Braun Co.	240	Gold Book, The	80B, 80C	Mepco/Electra, Inc.	119
Brown Mfg. Co., Arthur S.	232	Guardian Electric Manufacturing Company	48A	Microwave Associates	199
Buckeye Stamping Company, Inc.	255	Harris Semiconductor, A Division of Harris Intertype Corporation	80B, 80C	Mini-Circuits Laboratory	251
Bud Radio, Inc.	18, 19	Hayden Book Company, Inc.	266	Monitor Labs Inc.	224
Burdny Corporation	120, 121	Heinemann Electric Company	41	Monolithic Memories, Inc.	159
Burroughs Corporation	106, 107	Hewlett-Packard	2, 10	Monolithic Systems Corp.	247
C & K Components, Inc.	257	Hipotronics, Inc.	246	Monsanto Commercial Products Co.	11
CELCO (Constantine Engineering Laboratories, Inc.)	161	Hope Electronics	251	Motorola Components Products Dept.	197
CTS Corporation	253, 255, 257	Howard Industries, A Division of MSL Industries, Inc.	48F, 48G	Motorola Semiconductor Products, Inc.	4, 5, 12, 13
California Instruments Company	225	Hoyt Electrical Instruments Works, Inc.	257	MuRata Corporation of America	240
Capitol Machine & Switch Co., Inc., The	242	Hughes Aircraft Company, Electron Dynamics Division	217	Murata	264
Centralab, The Electronics Division of Globe-Union, Inc.	126, 127	Hybrid Systems Corp.	185	NCR Corporate Executive & Professional Placement	213
Cherry Electrical Products Corp.	145	ITT Cannon, A Division of International Telephone and Telegraph Corporation	80D, 170, 171, 205	National Semiconductor Corporation	64 A1 thru A-6
Chicago Dynamics Industries, Inc.	176	Indiana General, Electronic Products	179	North Electric Company	233
Circuit Stik, Inc.	252	Industrial Timer, A Unit of Esterline Corporation	253	Nova Electric Manufacturing Co.	184
Computer Automation, Inc.	35				
Computer Conversions	265				
Conner-Winfield Corp.	202				
Constantine Engineering Laboratories, Inc. (CELCO)	161				
Continental Connector Corporation	221				
Curtis Industries, Inc.	210				
Custom Electronics, Inc.	226				
Cutler-Hammer, Specialty Products Division	77				

Advertiser	Page
Oak Industries, Inc.	84, 85
Optima Enclosures	79
Oshino Electric Lamp Works, Ltd.	256
PRD Electronics, Inc.	220
Pace, Inc.	264
Panasonic Matsushita Electric Corp. of America	200
*Philips Electronic Components & Materials	48-A
Pomona Electronics Co., Inc.	207
Potter & Brumfield, Division of AMF, Incorporated	73
Power Physics Corporation	236
Practical Automation Inc.	175
Precision Monolithics Incorporation	139
Premier Metal Products Company	178
Princeton Applied Research Corp.	266, 269
Pye TMC Canada	264, 265
Pyrofilm Corporation	164

Quan-Tech, Division of Scientific Atlanta, Inc.	266
--	-----

RCA Solid State	Cover IV
R O Associates	80H
Rtron Corporation	206
Reliability, Inc.	230
Rental Electronics, Inc.	209
Robinson Nugent, Incorporated	223
Rockland Systems Corporation	173
Rockwell International	211
Rogan	203
Rogers Corporation	255
Rotron, Inc.	181

SMK Electronics Corporation of America	250
Schauer Manufacturing Corp.	68
Seastrom Manufacturing Co., Inc.	217
Semtech Corporation	29
Servo-Tek Products Company	70
Sharp Electronics Corporation	245
Singer-International Teleprinter Corp.	180
Siliconix, Incorporated	82
Simpson Electric Company	193
Sloan Co., The	190
Solitron Devices, Inc.	151
Sorensen Company, A Unit of Raytheon Company	6
Sprague Electric Company	16
Standard Condenser Corporation	76
Superior Flux Company	244
Systron-Donner	192

Advertiser	Page
TEC, Incorporated	218
TRW Electronic Components	189
TRW/IRC Potentiometers, An Electronic Component Division of TRW, Inc.	201
TRW Semiconductors, an Electronic Components Division of TRW, Inc.	24
Technical Wire Products, Inc.	253
Tektronix, Inc.	130, 131, 80A
Teledyne Relays, A Teledyne Company	27
Tempil Division, Big Three Industries, Inc.	200
Tenney Engineering, Inc.	232
Teradyne, Inc.	37
Test & Measuring Instruments, Inc.	20, 21
Texas Instruments, Incorporated	31
Thermalloy Company	271
Thomson CSF	229
Toko, Inc.	216
Toyo Communication Equipment Co., Ltd.	251
Triplett Corporation	157

U. S. Components, Inc.	269
Union Carbide, Components Dept.	191
United Chemi-Con	235
United Detector Technology, Inc.	264
Unitrack Division, Calabro Plastics, Inc.	223

Vactec, Inc.	39
Vari-L, Inc.	243
Varo Semiconductor, Inc.	220
Vero Electronics, Inc.	228
Victoreen Instruments, Div. of VLN Corp.	155
Vishay Resistor Products, a division of Vishay Inter-technology, Inc.	237

Wagner Electric Company	239
Watkins-Johnson	45, 241

Yewtec Corporation	217
--------------------------	-----

Zeltex, Inc.	272
-------------------	-----

* Advertisers in non-U.S. edition.

USC UPCC/REPC CONNECTORS

Draw-Pull and Screwlocking. Built to MIL-C-55302 & Commercial Specifications. Printed Circuit & Related Applications. REPC Connectors are Removable, Re-Entrancy, Crimp Contact Types

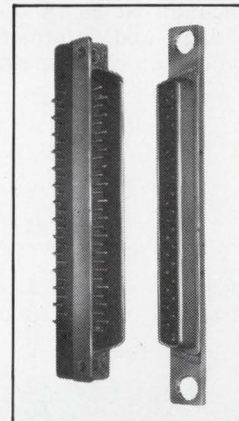

1 of over 20,000 Connector Types Manufactured. Send today for UPCC-REPC-A Series 32-page Catalog

U.S. COMPONENTS, INC.

Leader in advanced engineering design
1320 Zerega Avenue
Bronx, N.Y. 10462
(212) 824-1600 TWX: 710-593-2141
Cable: COMPONENTS, NYK

INFORMATION RETRIEVAL NUMBER 239

recruitment and classified Ads

IMMEDIATE DELIVERY

Minis & Peripherals
**DEC - HIS - NOVA
SEL - HP - MOHAWK**
CPU, Card, Printer, Tape, Disk
NEW • MOHAWK 4320
PRINTERS

**PDP11 PERIPHERALS
CPU, MEMORY**

PDP 8 CPU \$1500

\$750 Minis

**TELETYPE 35 & 37
DEC & HONEYWELL Modules
617/261-1100**

Send for Free Report "Maintenance of Computers"

AMERICAN USED COMPUTER CORP.
P.O. Box 68, Kenmore Sta.
Boston, MA 02215
"Members Computer Dealers Association"

CIRCLE NO. 249

product index

Information Retrieval Service. New Products, Evaluation Samples (ES), Design Aids (DA), Application Notes (AN), and New Literature (NL) in this issue are listed here with page and Information Retrieval numbers. Reader requests will be promptly processed by computer and mailed to the manufacturer within three days.

Category	Page	IRN	Category	Page	IRN	Category	Page	IRN
Components			Data Processing			SCRs		
battery holder	214	359	calculator	198	334	semiconductors	201	117
board, matrix	218	365	calculator, desk	65	259	transceiver	151	71
capacitors	11	246	calculator-instrument system	66	250	transistors, silicon-power	176	294
capacitors	7	6	calculator, printing	240	343	transistors	180	300
capacitors	72	43	calculator, programmable	245	205		176	295
capacitors	76	47	calculators, programmable	65	252	Instrumentation		
capacitors	226	150	computer, 16-bit	35	24	analyzer, logic	192	324
circuit breaker	214	360	converter, scan	206	345	analyzer, spectrum	187	100
components	179	91	data logger	206	344	analyzer, waveform	190	321
components, rotating	70	41	data logger	224	149	chamber, test	232	159
core, ferrite	207	124	generator, reticle	210	351	converter, a/d	70	261
display, alphanumeric	218	366	interface, computer	206	346	counter, frequency	184	304
fiberscope	257	229	interface, graphic	262	239	counters	131	64
filter, crystal	214	358	interface, microcode	196	330	DMM	76	268
filters	243	202	memory, floppy disc	210	354	DMM	194	326
filters, low pass	212	357	memory systems	48	31	DMM	196	110
fuses, semiconductor	212	130	memory, tape	210	355	DPMs	163	77
LED, constant output	218	364	minicomputer	204	341	DVM	188	310
LEDs	11	9	minicomputer	208	349	enclosures	19	15
LEDs	218	139	minicomputer	202	340	generator, pulse	74	267
light source, arc	220	369	modem, data	200	335	generator, sweep	184	303
motor, PM, dc	222	371	parallel processing systems	211	129	generators, function	17	14
posistors	236	163	plotter, digital	202	339	memory, scope	186	307
printhead, thermal	222	372	plotter, digital	210	353	meter, AM/FM	72	263
readouts	15	12	printer, line	200	336	meter, capacitance	72	262
readouts	239	166	printer mechanisms, OEM	180	92	meter, capacitance	188	309
rectifiers, bridge	220	142	printer/plotter unit	198	332	meter, impedance	76	269
relay	200	115	printers	175	87	meters	193	107
relays	III	247	processor, array	198	331	meters	217	137
relays	48A	32	reader, card	202	338	meters, panel	257	231
relays	48D	34	reader, key	202	337	monitor, μ W power	194	327
relays	194	108	reader, photoelectric	208	348	multimeters	192	105
relays, high current	172	84	recorder, cassette	204	342	plug-ins	76	271
relays, magnetic	78	49	recorder, graphic	196	329	receiver	72	265
relays, thermostatic	80	51	scanners, optical	248	209	recorder	184	305
resistor-capacitor networks	16	13	wire memory	216	135	recorder, digital logic	192	323
resistor, cermet	257	230	ICs & Semiconductors			recorder, rental equipment	74	45
resistors	119	60	chips, calculator	224	148	scopes	209	127
resistors	237	164	clock, multifunction	178	296	scopes	74	266
sensor, voltage	212	356	Darlington, power	174	292	tester, IC	76	270
sensors	248	208	detector, ac	166	79	transfer standard	196	111
servomotor	216	362	diodes, zener	68	39	voltmeters	220	141
solid-state timing	228	154	gate, three-state	174	293	wattmeter	190	322
switches	125	62	generator, tone	180	298	Microwaves & Lasers		
switches	145	68	ICs, linear	IV	248	adapters	81	278
switches	182	94	LSI, custom	219	140	amplifiers, EW	250	417
switches	250	212	McMOS	5	4	amplifiers, miniature	254	450
switches	257	232	module, power	182	302	amplifiers, uhf	246	410
switches, linear	176	88	ROMs, MNOS	180	299	antenna, Ku-band	252	424
switches, pushbutton	105	57	rectifier, power	172	257	BWO, helical	249	416
switches, rotary	204	120	regulators, B-lead	178	297	circulator, K-band	254	447
switches, toggle	77	48	SCRs	141	67	circulators, oscillators	246	414
timer, solid-state	224	374				diodes, p-i-n	244	408
timers	253	222				diodes, p-i-n	246	411
torque-drag unit	214	361				diodes, tuning	251	420
transducer, pressure	222	370						
trimmer, trick-film	255	225						

dividers	244	407	paper, electrosensitive	228	153
hybrids, octave-bw	252	421	plastics	208	125
isolator	244	409	plugboard, DIP	78	273
lasers, ruby/glass	254	448	screws, captive	80	277
line, delay	80	279	silicone	253	219
lines, slotted	249	415	slide control	253	221
mixer, multi-octave	251	419	socket, breadboard	80	275
modules, detector	250	418	sockets	67	38
photodiode	246	412	sockets	223	147
preamplifier, i-f	252	422	solder flux	244	203
splitters, power	251	217	stripswitch	195	109
transistor, rf power	252	423	substrates, sapphire	248	210
transistor, uhf	246	413			
transistors, 1-GHz	254	449			
Modules & Subassemblies			Power Sources		
amplifier, charge	168	287	battery-pack, NiCad	228	380
amplifier, rf power	66	37	converter, dc-to-dc	230	383
amplifiers	241	169	drivers, tube	188	101
amplifiers, power	254	223	generator, marx	226	379
conditioner, signal	171	288	inverter, static	234	389
control, photoelectric	166	286	inverters	184	96
converter, a/d	165	254	inverters, power	138	65
converter, d/a	165	280	regulator, line	234	390
converters	238	165	regulator, magnetic	232	387
converters, d/a	171	291	regulators	6	5
converters, synchro	165	282	source, ac power	226	376
DAC, CMOS	147	69	sources, power	230	156
decoders, tone	171	289	supplies, dc power	246	206
filter, active	166	283	supplies, high-current	230	384
filters, LC	222	144	supplies, high-V	228	381
monitor, power	166	284	supplies, modular	226	377
oscillator, clock	197	112	supplies, power	115	59
oscillator, RC	165	281	supplies, power	167	80
oscillator, TCXO	166	285	supplies, power	233	160
oscillators, clock	253	220	supplies, power	236	99
oscillators, Xtal	250	214	supplies, power	261	236
			supply, dc power	263	238
			supply, mini dc	231	157
			supply, power	230	382
			supply, power	251	215
			supply, power	259	234
			supply, variable	234	392
			X-ray, power	234	391
Packaging & Materials			new literature		
air movers	181	93	amplifiers, rf power	259	476
belt, endless	232	158	blocks, terminal	260	486
blocks, terminal	42	28	circuits, linear/digital	258	465
blocks, terminal	210	128	connectors	259	477
boards, g-p	252	218	DPM, auto-ranging	258	471
box, aluminum	240	401	data-acquisition system	258	466
cabinets	71	42	Data-Flo newsletter	260	484
cabinets	255	227	epoxies	258	464
cable/connector systems	64	36	films, magnetic garnet	258	467
card frame, PC	228	152	handbook, heat sink	208	126
card mounts	223	145	IC replacement guide	261	487
ceramic, alumina	242	406	ISA conference papers	260	485
chambers, test	80	276	meters, panel	258	470
clamps, cable	236	393	microwave components	259	472
clip, test	207	123	modules, ceramic	260	479
connectors	170	83	modules, indus. control	260	480
connectors	205	121	plotters and readers	260	483
connectors	221	143	potentiometers,		
connectors, PC	212	131	trimming	258	468
control slides	253	221	processors, integer	259	474
cooling, refrigerator	242	405	protectors, tape data	259	478
desolderer	78	272	rectifiers, subminiature	260	482
disconnects, female	242	403	resins, casting	261	488
dispenser, compound	236	395	software	261	489
enclosures	79	50	switches	260	481
enclosures	178	90	switches, miniature slide	258	469
enclosures, NEMA	238	399	time codes, oscil.	259	475
foam, conductive	238	398	timer, monitor	261	490
gold paste	238	397	transducers, pressure	259	473
heat pipes	217	138			
heat sink	240	402	evaluation samples		
heat sinks	46	170	disconnects, female	256	453
heat sinks	80	274	ruler, metric	256	452
heat sinks	242	404	switch, no-bounce	256	454
housings	223	146	tape, striping	256	451
knobs and dials	203	119			
labels, temp indicating	200	116			
laminations	260	235			
minibus	255	226			
PC-board work holder	238	396			
panels, wrap-wiring	236	394			

FREE CATALOG



WRITE TODAY FOR YOUR COPY

NEW GUIDES PULLERS AND EJECTORS for PC Boards

FREE Samples of new designs from Thermalloy:

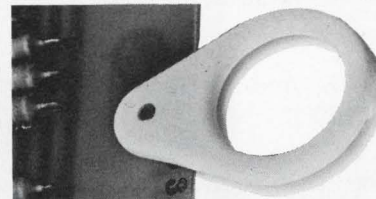

new easy-to-use ring puller, unique combination ejector-puller. Catalog also includes standard ejectors, pullers, and guides. Guides are black nylon. Pullers and ejectors are white nylon with color coding available.

Thermalloy Inc.

P.O. BOX 34829
2021 VALLEY VIEW LANE/DALLAS, TEXAS 75234
TELEPHONE (214) 243-4321/TWX 910-860-5542

INFORMATION RETRIEVAL NUMBER 244

The colossal problem solver!

Zeltex high performance DAC's.

If you are finding it hard to solve D/A converter problems, here's how our ZD 300 series can help you five ways:



1. 14 bits for high resolution.



2. A multiplying DAC for servo and display applications.



3. A fast-settling DAC - 1 μ sec. to 0.005%.



4. A highly linear DAC \pm 0.005% FS.



5. And the price is right (from \$75, 100's).

The ZD 300 series DACs are a result of ZELTEX's unique product design and manufacturing technologies, the same technologies which have produced a comprehensive line of D/A and A/D converter problem solvers. Phone (415) 686-6660 to find out fast how you can put ZELTEX Micro Giants to work, solving your systems design problems. ZELTEX, INC. 940 Detroit, Concord, California 94518 (415) 686-6660 TWX 910-481-9477

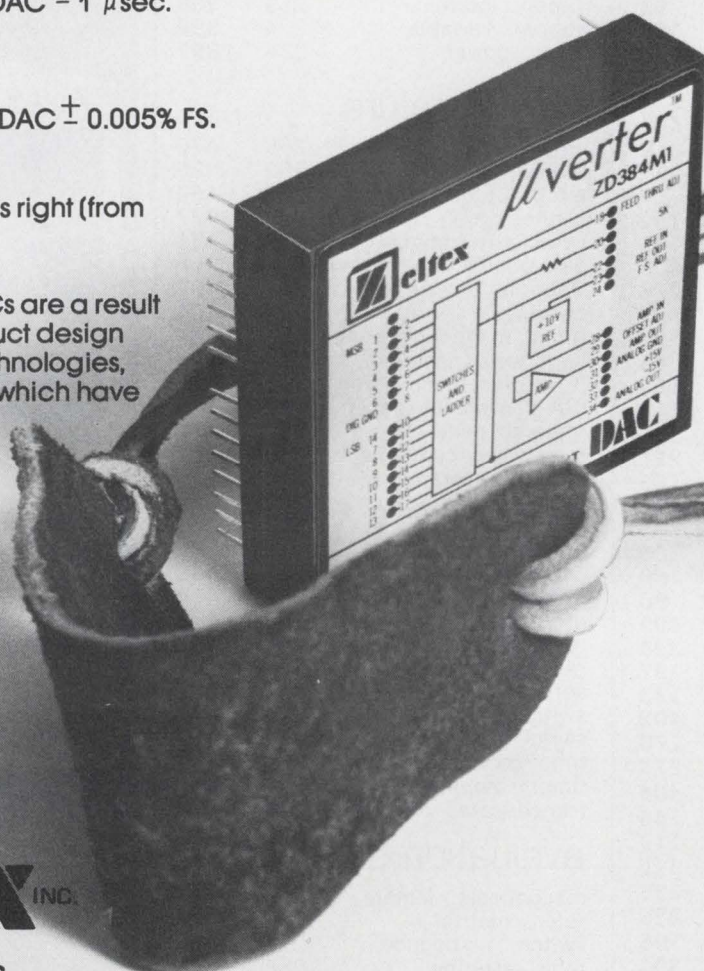

Zeltex INC.

The Micro Giants.

INFORMATION RETRIEVAL NUMBER 200

The Most Versatile Miniature Industrial Relay

THE MINI



Magnecraft's MINI Class 67 is designed for applications requiring 2 to 8 form C contact where reliability, space, weight, and low cost are of prime importance. It is ideal for use in business machines, medical and communications equipment, vending machines, and all applications requiring long life and trouble free performance.

Solder and printed circuit terminals, plug-in mountings, AC versions, time delays and sensitive versions are in stock. U.L. listed relays and sockets are also available.

Contacts are rated 3 and 5 amps at 28VDC or 115/120 VAC resistive load. Unbreakable dust covers protect all the relays. Single and bifurcated, extra wide cross bar contact blades for greater current capacity and cooler operation is an exclusive design feature.

Prices for 1 to 24 pieces on a Class 67, 3 amp, DPDT is \$3.30. Quantity prices are available. Over 190 Class 67 variations are in stock for immediate delivery.



Free!
STOCK CATALOG

To help specify your relay needs ask for Magnecraft's new 1974 Stock Catalog with the most diversified line of over 1060 relays. A MINI catalog with specific data, drawings, and photos on all the Class 67's will accompany the Stock Catalog.

Find Magnecraft Relays in EEM sec. 4500.

Magnecraft ELECTRIC COMPANY

5575 NORTH LYNCH AVENUE • CHICAGO, ILLINOIS 60630 • 312 • 282-5500 • TWX 910 221 5221

INFORMATION RETRIEVAL NUMBER 247

Our High-Rel Team is set to tackle your linear IC RFQ's.



Anytime you need High-Rel Linear IC's for military aerospace or industrial applications, come to RCA. Your RFQ's will receive first class "team" attention.

RCA has come on strong to meet your needs for High-Rel Linear IC's. With a team dedicated exclusively to High-Rel IC's and a MIL-M-38510 approved facility, we are keeping pace with the industry's increasing demand for high-reliability linears.

Our team can bring you a variety of High-Rel circuits, such as Operational Amplifiers, Differential Amplifiers, Transistor Arrays, RF Amplifiers, and Voltage Regulators, all processed to MIL-STD-883. Here are just some of the more popular amplifier circuits offered.

Industry Designation	RCA Number	100-999 Price
Class B* Type 741	CA741T/3	\$4.50
Class B* Type 747	CA747T/3	5.50
Class B* Type 748	CA748T/3	4.50
Class B* Type 1558	CA1558T/3	5.50

*Parts processed to MIL-STD-883 Method 5004 Class B

Send for our free 20-page brochure which tells the complete story of RCA's COS/MOS and linear high-reliability IC's.

Also available . . . RCA's new, 1974, 576-page Solid State "High-Reliability Devices" DATABOOK (SSD-207B). This handy reference provides complete Technical Data Sheets and other useful information on the broad range of RCA High-Rel integrated circuits and transistors.

Send for your copy today. Only \$2.00.

RCA Solid State
Section 57C-15 Box 3200
Somerville, New Jersey 08876

- Please rush my order for _____ copies of the 1974 "High-Reliability Devices" DATABOOK (SSD-207B). My cost, \$2.00 each.
- Please send a free copy of RCA's High-Rel IC Brochure (RIC-200).

Name/Title _____

Company _____

Address _____

City/State/Zip _____

I enclose payment by: Check Money Order
Offer good only in U.S. and Canada. Direct other inquiries to RCA Sales Offices or Distributors.

RCA Solid State
products that make products pay off