

Crack the secret of relay specs when you select miniature types. Since data sheets don't always reveal interdependence among specs, it's hard to find the right

combination. New developments add to the confusion. Should you use an electromechanical relay or a reed or solid-state unit? For help, turn to p. 56.

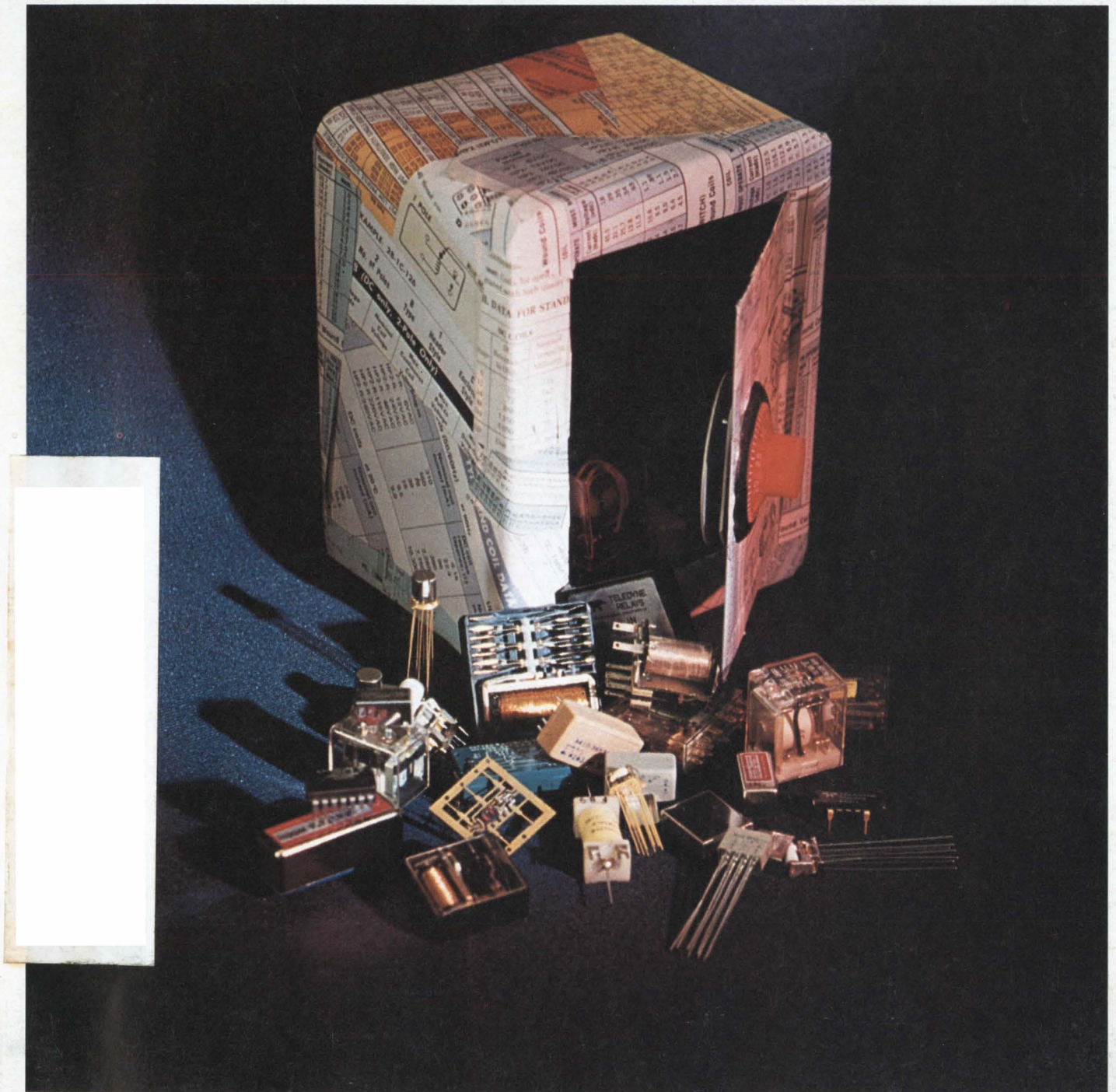

There's a new dip store in town.



Dale ships standard resistor networks in less than a week.

Dale builds *and stocks* standard resistor networks compatible with your system. Automatic insertion. Hand insertion. All are quality-built with the same materials we use to make the industry's first thick film network qualified to MIL-R-83401.

Circuit Uses Include:

Pull-Up

- Power Gate
- Open Collector
- Parallel
- "Wired OR"
- MOS Memory
- TTL Unused Gate
- Power Driver

Pull-Down

- ECL Output
- TTL Input
- MOS Memory

Other Applications:

- Impedance Balancing
- Current Limiting
- Line Termination
- Pulse Squaring
- TTL to ECL Translator

Check this cross reference chart

DALE	BECKMAN	CTS
LDP14-02-XXXG	899-1-RXXX	760-1-R
LDP14-01-XXXG	899-3-RXXX	760-3-R
LDP16-02-XXXG	898-1-RXXX	761-1-R
LDP16-01-XXXG	898-3-RXXX	761-3-R

Phone 402-371-0080 for complete price & delivery details.



DALE ELECTRONICS, INC.
 Box 74, Norfolk, Nebr. 68701
 In Canada: Dale Electronics Canada Ltd.
 In Europe: Dale Electronics GmbH,
 8 Munchen 60, Falkweg 51, West Germany
 A subsidiary of The Lionel Corporation

INFORMATION RETRIEVAL NUMBER 252

Our complete product line can be found in *Electronic Design's GOLD BOOK.*

SURPRISE!

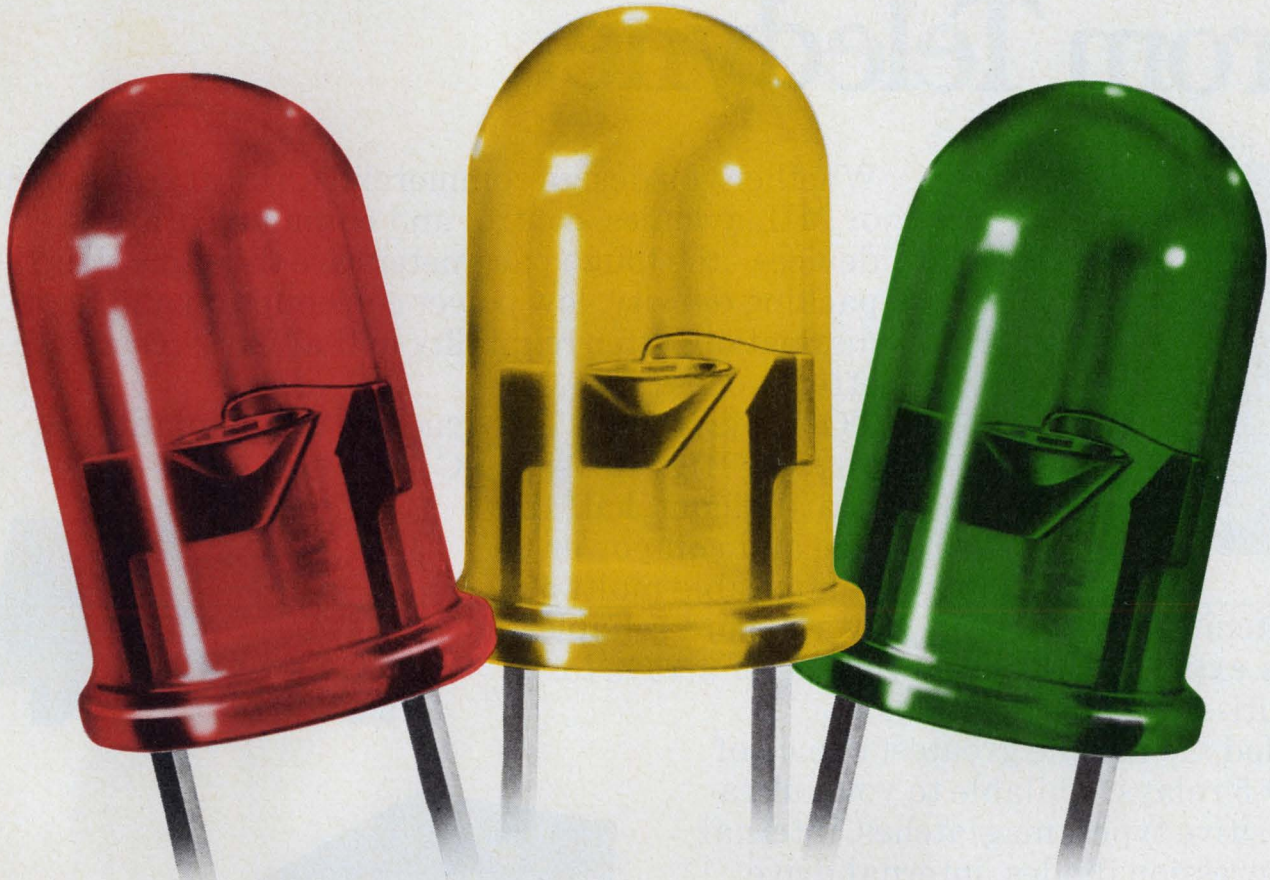

The first 24 mcd LED lamp!

And that's 24 mcd at only 10 mA for our brightest red lamp. At 20 mA you can get over 48 mcd of light output.

	RED	YELLOW	GREEN
NARROW BEAM 5082 -	4658	4558	4958
	4657	4557	4957
WIDE BEAM 5082 -	4655	4555	4955
	4650	4550	4950

HP's new high efficiency material makes these new bright LED's possible. With our brightest yellow you get 16 mcd at 10 mA. Our brightest green offers 16 mcd at 20 mA.

Three colors, two beam angles, and two luminous intensity categories are available in the popular T 1-3/4 package. Twelve new LED's, one just right for your application.

All are available for immediate delivery, just \$0.89* each or \$1.15* each at the 100 piece level, depending on brightness category.

Contact Hall-Mark, Schweber, Wilshire or the Wyle Distribution Group (Liberty/Elmar) for immediate delivery. Or, write us for more details. They offer you new ways to apply solid-state technology in your products.



Sales and service from 172 offices in 65 countries.
1501 Page Mill Road, Palo Alto, California 94304

01502 *Domestic USA Prices Only.

INFORMATION RETRIEVAL NUMBER 2

ELECTRONIC DESIGN 11, May 24, 1975

Total cost effectiveness. TO-5 relays from Teledyne.

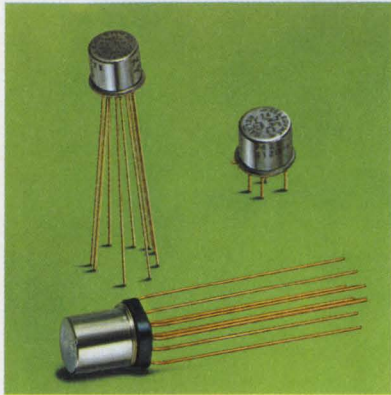

Whether you design commercial aircraft equipment, or MIL avionics, control and communications devices—the tough parameters are the same. High packing density, low power consumption and heat dissipation, utter reliability and always—cost effectiveness.

TO-5 relays from Teledyne are the unqualified answer. High density, PC board pinout, **half** the size and coil power of comparable multi-pole

switching devices. And they are **more reliable** and **less expensive** than semiconductor arrays for multi-switching functions.

Teledyne has the greatest choice of TO-5 relays available to you—ultra-sensitive types, maglatches, internal suppression diodes, internal drive transistors and many contact arrangements. All—welded and hermetically sealed; all fully qualified to MIL-R 39016 B, level “L” and “M” reliability. Specify them for your most exacting designs. Teledyne TO-5 relays—the totally cost effective switching solution. There’s an economical Commercial/Industrial line, too—and they’re in stock near you. Call your nearest Teledyne Relays office for location of your local representative or distributor.

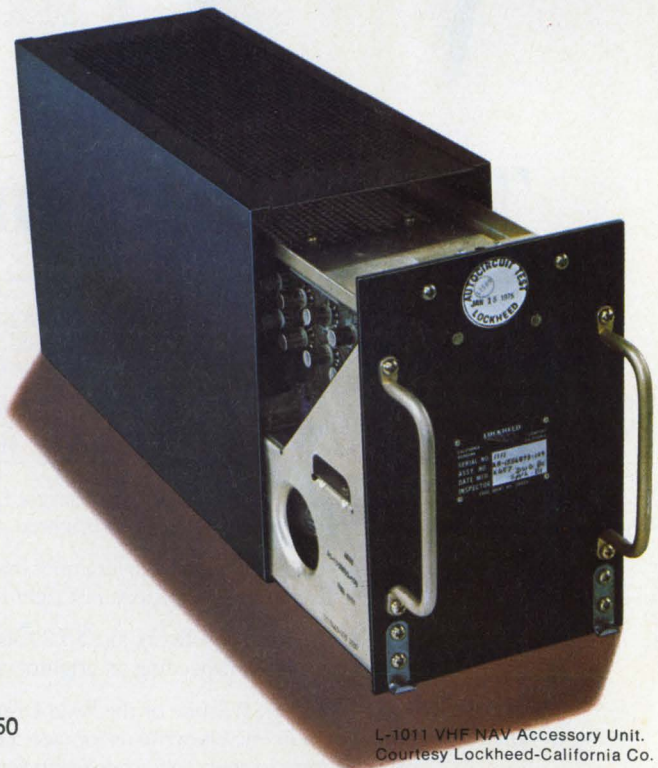
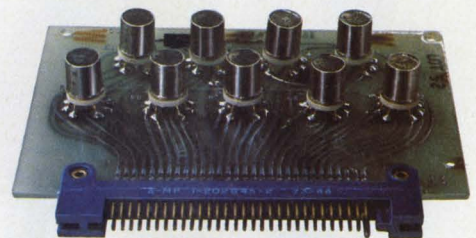

TELEDYNE RELAYS

3155 West El Segundo Boulevard, Hawthorne, California 90250
Telephone (213) 973-4545

Burgstrasse 6-8, 62 Wiesbaden, West Germany
Telephone: 06121-302031/2 Telex: 04-186851 (Trel-D)

Heathrow House, Bath Road, Cranford, Hounslow, Middlesex, U.K.
Telephone: 01-8972501 Telex: 935008

L-1011 VHF NAV Accessory Unit.
Courtesy Lockheed-California Co.

NEWS

- 23 **News Scope**
- 30 **The Federal Aviation Administration is pushing new electronic aids** to prevent airliners flying into the ground.
- 38 **Thin silicon film on metal substrate** promises low-cost solar power.
- 40 **Digital flight-control systems** are beginning to take wing in emerging military aircraft.
- 49 **Washington Report**

TECHNOLOGY

- 56 **FOCUS on miniature relays:** A maze of specifications is used to describe relays. This report explains the specs and gives guidelines for selection.
- 68 **Get to know digital shaft encoders.** These electromechanical transducers can change mechanical motion into computer-compatible outputs for easy control.
- 76 **Consider hollow-rotor motors** when you design start/stop and servo systems. Low rotor inertia and inductance promote accurate step or servo performance.
- 82 **Build dc/dc converters that work.** With a careful choice of bias and drive, plus design against known failure modes, you can ensure a reliable power source.
- 88 **John Fluke of Fluke Mfg.** speaks on training engineering managers.
- 94 **Ideas for Design:** Agc provides 0.1% amplitude stability for Wein-bridge oscillator . . . Improved voltage-to-frequency converter has automatic polarity inversion . . . CMOS audio amplifier features ± 15 -dB bass/treble control range.
- 100 **International Technology**

PRODUCTS

- 103 **Integrated Circuits:** Quiet JFET op amps keep inputs matched.
- 104 **Integrated Circuits:** Standard PROM family starts with 2-k and 1-k units.
- 107 **Power Sources:** Triple-output dc supply ignores ac power failures.
- 110 **Modules & Subassemblies:** Miniature time-delay relays are available in fixed, variable and flasher models.
- 112 **Instrumentation:** Logic recorder freezes 10 Mbit/s serial data.
- 116 Data Processing
- 118 Components
- 122 Microwaves & Lasers
- 124 Packaging & Materials
- 125 Discrete Semiconductors

DEPARTMENTS

- 53 **Editorial:** Growing up
- 7 Across the Desk
- 126 Design Aids
- 127 New Literature
- 129 Bulletin Board
- 136 Advertiser's Index
- 138 Product Index
- 140 Information Retrieval Card

Cover: Photo by Art Director, Bill Kelly, samples courtesy of Arrow-M, C.P. Clare, Guardian, Magnecraft, Potter & Brumfield, Shigoto, Struthers-Dunn, Teledyne Relays, WABCO.

The first available 256x4 CMOS RAM

Intel's new 5101 1K silicon gate CMOS static RAM is the first easy to use nano-power RAM. It combines high density and ultralow power with a fast, fully static, 256 x 4 modular organization that eliminates clocks, interface circuits and special power supplies while minimizing package count. Now available from stock at Intel distributors, the 5101 is the ideal RAM for upgrading non-volatile, battery backup and portable equipment memory system designs.

Even at elevated temperatures, the 5101 keeps battery drain extremely low.

At 70°C, maximum standby current is 15 nA per bit, limiting standby power to 75 nW per bit.

Worst case access time (and minimum cycle time) is only 650 ns over the 0°C to 70°C temperature range.

Intel distributors also stock the M5101 for military temperature range applications. At 125°C, maximum standby current is 200 nA/bit, maximum standby power 1000 nW/bit. Worst case access time for the M5101 is 800 ns over the -55°C to 125°C temperature range.

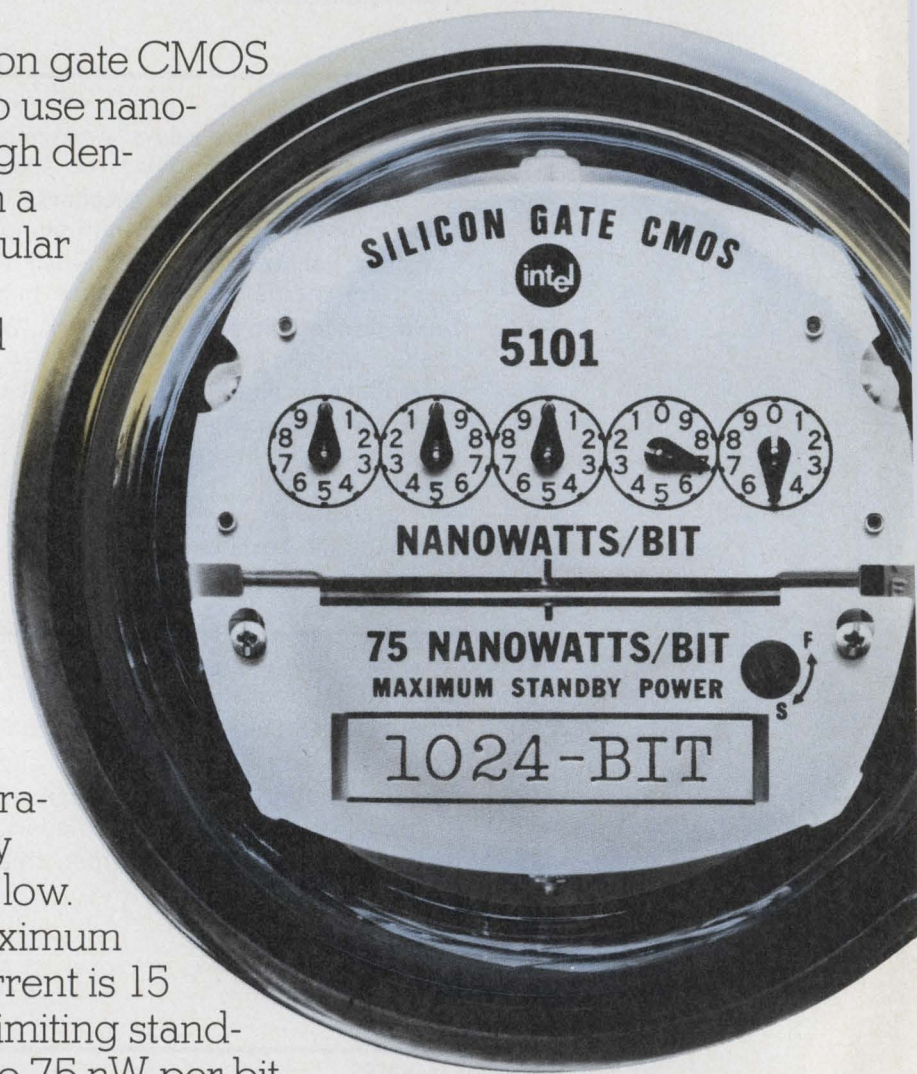

Available nanopower M. Intel's 5101.

**AVAILABLE AT
YOUR INTEL
DISTRIBUTOR**

INTEL'S 1K CMOS STATIC RAM FAMILY

PART NO.	WORST-CASE SPEED*	SIZE	PINS	STANDBY POWER/BIT	AVAIL.
5101	650 ns	256x4	22	75 nW	Now
5101L**	650 ns	256x4	22	75 nW	Now
5101-3	650 ns	256x4	22	1 μ W	Now
5101L-3**	650 ns	256x4	22	1 μ W	Now
M5101-4	800 ns	256x4	22	1 μ W	Now
M5101L-4**	800 ns	256x4	22	1 μ W	Now
M5101-5	800 ns	256x4	22	5 μ W	Now
M5101L-5**	800 ns	256x4	22	5 μ W	Now

*Worst case access times and minimum cycle times are guaranteed over full operating temperature range (-55°C to +125°C for M5101-4, M5101L-4, M5101-5, M5101L-5; 0°C to +70°C for all other types).
**Guaranteed data retention at power supply voltage as low as 2V.

The easy to use 5101 is fully static, chip enable clocking is not required during address transitions. It also interfaces directly with TTL or CMOS and operates with a single +5V supply.

The 256 x 4 configuration is optimum for any memory system organization and is an ideal building block for memory expansion. You get two chip enable inputs, four data inputs, four three-state outputs with output disable control, and read/write control. The output disable pin controls bus states,

making bidirectional logic unnecessary in common I/O buses.

The 5101, with its high density and ease of use, is the ideal nanopower RAM for portable instruments and microprocessors, advanced calculators, data collection devices, process controllers, POS, OCR, medical, avionics, ground support — for any equipment demanding long battery life, or non-volatility with battery

back-up. The 5101 silicon gate CMOS RAM is in full production and in distributor stock, along with our other easy to use n-channel static RAMs.

For immediate delivery contact Almac/Stroum, Component Specialties, Inc., Cramer, Hamilton/Avnet, Industrial Components, Inc., Sheridan, and L.A. Varah Ltd.

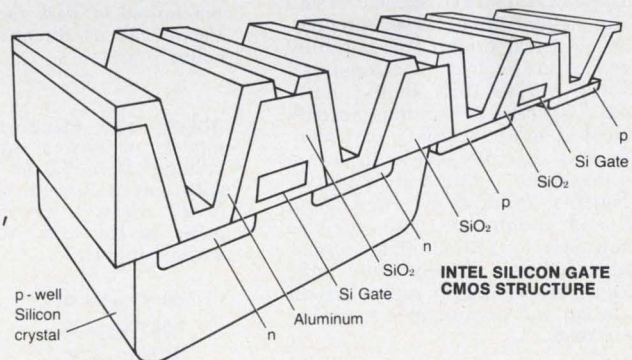

intel® delivers.

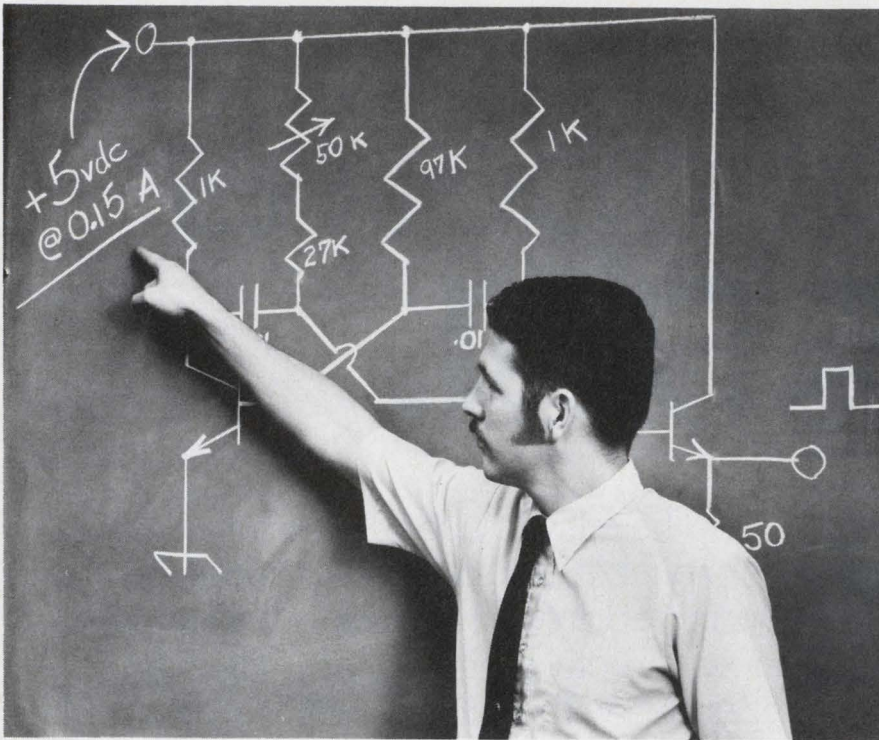

How to Design Your Power Supply for \$72

You get the **complete schematic diagram, and parts list** with operating and installation instructions when you spend \$72 for an Abbott Model "RN" power supply. Two years in development, this model represents the latest state of the art in power module design. It features close regulation (0.1%), low ripple (0.02%), automatic short circuit and complimentary overvoltage protection and continuous operation in a 160°F ambient.

Abbott Engineers followed specific design criteria in engineering these modules. First, the electrical design was carefully engineered to insure that all components operate well within their limits, under "worst case" operating conditions. Second, the thermal design, including case construction, was carefully made to insure that the maximum temperature limits of all components are never exceeded. Then the size and weight of these modules were controlled to a minimum, without sacrificing reliability. Finally these units were thoroughly tested to make certain that all design and performance specifications were met.

So, you can build your own power supply using our schematic diagram if you want to—but we think we can build it more

Please see pages 307-317 Volume 1 of your 1974-75 EEM (ELECTRONIC ENGINEERS MASTER Catalog) or pages 853-860 Volume 3 of your 1974-75 GOLD BOOK for complete information on Abbott Modules.

Send for our new 60 page FREE catalog.

reliably and for less cost, simply because we have been doing it for ten years. Put our power supply in your system first and try it. Examine its performance. We think you will be pleasantly surprised at the quality, adherence to specifications, and the reliability you find in the Abbott Model "RN".

Any output voltage from 5 to 100 volts DC with current from 0.15 to 20 amperes is available. **Many of the popular voltages are carried in stock for immediate delivery.** Please call us for attractive O.E.M. discount prices.

Abbott also manufactures 3,000 other models of power supplies with output voltages from 5.0 to 740 volts DC and with output currents from 2 milliamperes to 20 amperes. They are all listed **with prices** in the new Abbott catalog with various inputs:

60 A to DC
 400 A to DC
 28 VDC to DC
 28 VDC to 400 A
 12-38 VDC to 60 A

Sr. Vice President, Publisher

Peter Coley

Editors

Editorial Offices
 50 Essex St.
 Rochelle Park, NJ 07662
 (201) 843-0550
 TWX: 710-990 5071
 Cable: Haydenpubs Rochellepark

Editor-in-Chief George Rostky

Managing Editors:

Ralph Dobriner
 Michael Elphick

Associate Editors:

Dave Bursky
 Jules H. Gilder
 Morris Grossman
 Seymour T. Levine
 John F. Mason
 Stanley Runyon
 Edward A. Torrero

Contributing Editors:

Peter N. Budzilovich
 Alberto Socolovsky
 Nathan Sussman

Editorial Field Offices

East

Jim McDermott, Eastern Editor
 P.O. Box 272
 Easthampton, MA 01027
 (413) 527-3632

West

David N. Kaye, Senior Western Editor
 8939 S. Sepulveda Blvd.,
 Suite 510
 Los Angeles, CA 90045
 (213) 641-6544
 TWX: 1-910-328-7240

Editorial Production

Marjorie A. Duffy

Art

Art Director, William Kelly
 Richard Luce
 Anthony J. Fischetto

Production

Manager, Dollie S. Viebig
 Helen De Polo
 Anne Molfetas
 Maxine Correal

Circulation

Manager, Evan Phoutrides

Information Retrieval

Peggy Long

Promotion

Manager, Walter G. Salm
 Karen Kerrigan (Reprints)

Creative Layout Services

Manager, Albert B. Stempel

abbott transistor

LABORATORIES, INCORPORATED
 general offices eastern office

5200 W. Jefferson Blvd./Los Angeles 90016
 (213) 936-8185 Telex: 69-1398

1224 Anderson Ave./Fort Lee, N.J. 07024
 (201) 224-6900 Telex: 13-5332

INFORMATION RETRIEVAL NUMBER 5

Across the Desk

Job objectives urged, not job standards

I am an advisory engineer with the Westinghouse Hanford Co. and wish to comment on "Job Ratings Hinge on Mutual Commitment," ED No. 2, Jan. 18, 1975, p. 68. My comments are my personal opinion, based upon 20 years' experience in engineering and management positions; they should not be confused with any company position.

The management system in the article not only fails to "make those creative people comfortable," but it also lacks effectiveness in communicating the company goals to the employe and in obtaining feedback from him. Why? Because by using "key responsibilities and work objectives"—which are based upon "adopted job descriptions"—as a measure of performance, the author is actually setting standards of performance rather than objectives.

Standards, as opposed to objectives, are often too rigid to accommodate fast-changing economic conditions and technological advances. It is important to acclimate the work force to change and to create an atmosphere in which change is not only welcomed but created by the work force.

More emphasis should be placed on coaching the employe rather than on monitoring his or her progress. Remuneration, especially fair pay, is not a simple problem, and there is more to it than can be solved by a year-end evaluation program. On the other hand, employe motivation is not based

solely on salary increase either.

Dr. Hans C. F. Ripfel

4034 King Drive
West Richland, WA 99352

Caution is advised in use of coil graph

In the Idea for Design Inductance Calculations Simplified for Small Air-Wound Coils" (ED No. 21, Oct. 11, 1974, p. 124), Martin Mann uses a graphical method to solve Wheeler's equation for inductors in the 1-to-100-nH range. It has been my experience that this formula is not accurate and provides about 20 to 50% error for inductors in this range. It therefore should be used with caution.

Bruce K. Murdock
Head, Control Circuit
Design Group

General Motors Corp.
Delco Electronics Div.
6767 Hollister Ave.
Goleta, CA 93017

Martin Mann is incorrect in the way he interprets his nomograph. In his example, he arrives at a 10-turn coil having, when tightly wound, a length of 10 mm. According to his nomograph, the inductance of this coil is 370 nH, nearly twice as high as required (200 nH). Even stretching of the coil to 20 mm will not bring down the inductance to the required value.

One could iterate by reducing the number of turns, until one eventually arrived at the correct value of six turns. It is, however, faster and more accurate to solve

(continued on page 16)

Electronic Design welcomes the opinions of its readers on the issues raised in the magazine's editorial columns. Address letters to Managing Editor, Electronic Design, 50 Essex St. Rochelle Park, N.J. 07662. Try to keep letters under 200 words. Letters must be signed. Names will be withheld on request.

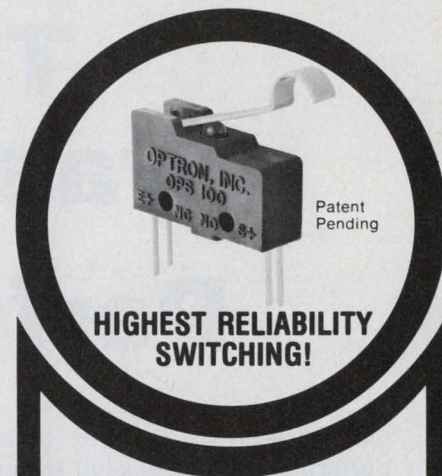

HIGHEST RELIABILITY SWITCHING!

OPTICALLY COUPLED LIMIT SWITCHES

OPTRON OPS-100 SWITCH LIFE FIVE TIMES THAT OF CONVENTIONAL SWITCH

OPTRON's new subminiature high-reliability optically coupled limit switch features switch life exceeding 25,000,000 cycles, five times that of conventional switches.

The new OPS-100 limit switch combines the non-contact switching feature of popular optically coupled interrupter modules with the mechanical characteristics of conventional smaller limit switches. It consists of an infrared LED optically coupled to a phototransistor to provide solid state reliability in a conventional mechanical switch package.

The switch lever arm of the OPS-100 actuates an optical shutter mechanism to interrupt the light beam changing the state of the switch. The shutter is unique in that the switch can be converted at any time by the user from "normally open" to "normally closed" or vice versa. In addition, the OPS-100 eliminates contact bounce and RFI while offering an input-to-output isolation voltage exceeding 5 kV.

The optically coupled limit switch has a guaranteed minimum current output of 0.4 mA and is specified for interfacing directly with low power TTL or CMOS circuits. Selected units are available for interfacing with standard TTL circuits.

New OPS-100 limit switches are available from stock.

Detailed technical data on the OPS-100 limit switch and other OPTRON optoelectronic products . . . chips, discrete components, isolators, assemblies, and PC board arrays . . . is available from your nearest OPTRON sales representative or the factory direct.



OPTRON, INC.

1201 Tappan Circle
Carrollton, Texas 75006, U.S.A.
214/242-6571 • TELEX-73-0701
TWX-910-860-5958

TRW's MAR™ ultra stable resistors. Performance plus.

Our ultra-precision MAR resistors match the performance of precision wirewound, *plus* they give the inherent advantages of TRW metal film.

Like smaller size, better frequency response, higher resistance values and lower cost.

And MAR's are not "selected" from a lower grade process. The entire facility was *designed* to yield *only* high accuracy devices.

And it *DOES*:



MAR axial lead family

Tolerances to $\pm 0.01\%$. TC's ± 5 to 25 ppm/ $^{\circ}\text{C}$. Where speed and precision count, the MAR does it all. In a dimensionally clean, axial lead molded package.

With the non-measurable noise, low voltage coefficient, load stability, resistance/size ratio and *reliability* of our metal film process.

Plus MAR matched sets and packaged networks have tolerance and TC matching to $\pm 0.005\%$ and 1 ppm/ $^{\circ}\text{C}$.

Specifications

IRC Type	Resistance Range* (Ohms)	Temperature Coefficients -20°C to +85°C (\pm ppm/ $^{\circ}\text{C}$)	Tolerances ($\pm\%$)	Power Rating** @ 85°C (Watts)	Voltage Ratings (Volts)
MAR3	20 - 100K	T10 = 15	1.00, 0.50, 0.25,	$\frac{1}{20}$	200
MAR5	20 - 250K	T13 = 10	0.10, 0.05, 0.02,	$\frac{1}{10}$	250
MAR6	20 - 500K	T16 = 5	0.01	$\frac{1}{8}$	300
MAR7	20 - 1 Meg			$\frac{1}{4}$	500

*Wider ranges available, contact factory.

**Higher power ratings available. Contact factory.

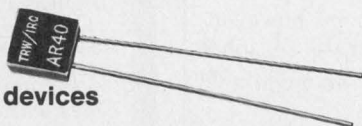

AR40 radial lead devices

This plug in configuration offers absolute accuracy and documented reliability. TC's to ± 2 ppm/ $^{\circ}\text{C}$, tolerances to $\pm 0.01\%$ are standard.

Plus, AR40 uses only .03 in.² PCB area including lead attachment, and has the same mechanically rugged terminations used on all MAR resistors.

Specifications

TCR Class.	Standard Temp. Coeff. ($^{\circ}\text{C}$)	Resistance Range* (Ohms)	Standard Tolerance ($\pm\%$)	Wattage 85°C
T-18	2 ppm 0 to 60°C 5 ppm -55 to 125°C	20 to 100K	.01, .02, .05, .10,	.3 watts
T-16	5ppm 0 to 60°C 10 ppm -55 to 125°C		.25, .50, 1.00	

*Wider ranges available, contact factory.

AR90 high range resistors

Designed for applications where you need values up to 10 Meg Ohms—such as precision voltage dividers, input attenuators.

Plus, despite its high resistance range, the AR90 has standard TC's to ± 5 ppm/ $^{\circ}\text{C}$ and tolerances to $\pm 0.05\%$. And it is a *real* space saver.

Specifications

IRC Type	Resistance Range* (ohms)	Temperature Coefficients -20°C to +85°C (\pm PPM/ $^{\circ}\text{C}$)	Tolerances	Power Rating	Voltage Rating
AR90	1M - 10M	T10 = 5 T13 = 10 T16 = 15	1.0, 0.5, 0.25, 0.1, 0.05	.5W	1000

*Wider ranges available. Contact factory.

Need prototypes fast?

TRW has on stream another *big plus*—a short order production line (in addition to our regular facility) designed to give you quick delivery on bread board quantities. Delivery to satisfy your needs, typically 2-3 weeks.

For more information on ultra-precision resistors, contact TRW/IRC Burlington. TRW/IRC Resistors, an Electronic Components Division of TRW, Inc., 2850 Mt. Pleasant St., Burlington, Iowa 52601. (319) 754-8491.

TRW[®] IRC RESISTORS

INFORMATION RETRIEVAL NUMBER 7

Let's get the facts straight on IC packaging panels.

The IC packaging panel, or "Augat board," has become so widely accepted, you'd think Augat would be happy.

But frankly, we're concerned.

People have gotten so used to IC panels that they may have lost sight of the reason for buying panels in the first place: flexibility in design, production and service. With the result that they may not be getting all the benefits panels can provide.

We'd like to correct this situation by reviewing exactly what's at stake in your choice of a panel supplier.

GETTING THE RIGHT PANEL.

People often select a panel from a limited catalog without realizing the wide selection of stock panels available.

When in fact, they can get exactly what they need right off the shelves of Augat distributors all over the world.

With the largest product line anywhere, we're sure to have a standard board that fits virtually all your development and production needs—including ECL and Schottky.

For really special requirements, though, you should probably consider a custom-designed panel. If you're dealing with an experienced engineering staff like Augat's, it's surprisingly easy. And it won't cost you any premium—it might even save you money.

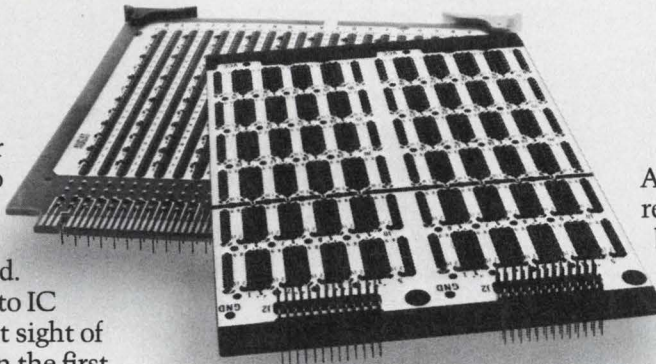

Whatever your requirements, you shouldn't settle for an approximation. Because you don't have to.

HOW GOOD IS GOOD ENOUGH?

The payoff for getting the right panel is faultless performance. No surprises in product development, production, or field service.

It's the reason for Augat's no-compromise approach to quality control. And it's why Augat uses the best precision-machining technology in the world, rather than conventional stamping methods, to produce the contact assemblies that are the heart of Augat panels.

The result speaks for itself. The elimination of these common contact pitfalls:

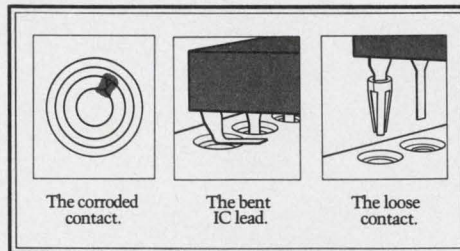

The corroded contact.

The bent IC lead.

The loose contact.

When others succeed in duplicating Augat's machining technology, the result will be better panels for everybody. But until then, there's only one place in the world to get this degree of fail-safe protection: Augat.

DELIVERY YOU CAN COUNT ON.

In 1974 Augat completed a multi-million-dollar program to automate production and bring the manufacture of IC panels under 100% in-house control.

Result: The fastest turnaround the industry's ever seen.

Most standard panels are on the shelf. But if the one you want isn't, you can still get it in no more than 2 weeks. And our custom panels are being turned out in volume to meet the most stringent delivery standards in the industry.

So next time you're selecting IC panels, consider all the facts. For full information, send for our new brochure. Or phone George P. Howland, Engineering Manager, at (617) 222-2202. Augat, Inc., 33 Perry Avenue, Attleboro, Massachusetts 02703.

YOU ONLY GET IT ALL FROM AUGAT.

AUGAT[®]

Europe—Augat N.V., Boulevard A. Reyers, 103, 1040 Brussels, Belgium, Tel. (02) 7369399.
Japan—Kyokuto Boeki Kaisha Ltd., New Otemachi Bldg., 2-1, 2-Chome Otemachi, Chiyoda-Ku, Tokyo 100-91, Japan, Tel. (03) 244-3788.
Canada—A.C. Simmonds & Sons Ltd., 285 Yorkland Blvd., Willowdale, Ont. M2J1S8, Tel. (416) 491-1010.

"Smart"



.but friendly!

INTRODUCING THE 6010A SYNTHESIZED SIGNAL GENERATOR

The first signal generator to incorporate a microprocessor.

The Fluke 6010A is a remarkable new instrument—a smart but friendly (easy to use) general purpose signal generator. It's a versatile 7 digit, 10 Hz to 11 MHz instrument with performance comparable to instruments costing twice our \$2,495.*

The key to the 6010A is . . . automation.

The Fluke 6010A features free-form entry of frequency in Hz, kHz, or MHz. Stores and recalls up to ten preset frequencies, modulation and attenuator settings by pushing a single button . . . a unique capability.

This feature is particularly important in any kind of repetitive testing, where tediously punching in a 7-digit number exposes the operator to error. It also radically shortens the time required by the testing sequence.

The microprocessor plays a part in several other operations, including *automatic range selection* and *automatic justification* (the unit automatically justifies the entry on the bright, 7-digit LED readout to give the greatest possible resolution).

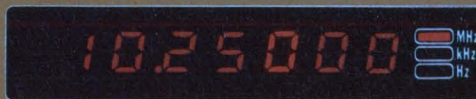

A sophisticated bench oscillator that's easy to use.

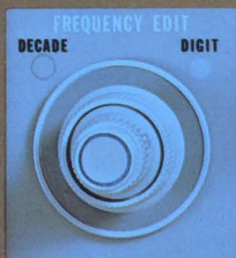

For all its sophistication, the 6010A works easier than any other instrument of its kind.

Continuous tuning is possible with Frequency Edit which consists of a large dual-concentric rotary knob.

The bright digit denotes the tuned decade. The bright digit can be decremented or incremented with complete wraparound and carryover.

Spacewise, the unit measures only 5½" x 8½" x 19", so it takes up minimum space on the work bench.

Interfaces directly with ASCII systems.

The 6010A fits easily into an auto-testing system, because expensive interfacing is not needed. The unit "handshakes" directly with most ASCII (IEC) systems; the microprocessor handles the interfacing problems.

Here's price/performance without peer. And, it is backed by Fluke's second-to-none reputation for engineering, reliability and service.

For data out today, dial our toll-free hotline: 800-426-0361.

John Fluke Mfg. Co., Inc.
P.O. Box 43210
Mountlake Terrace, WA 98043



For a demo circle #161. For literature only circle #162.
For information on the rest of the Fluke line, see EEM or the Gold Book.

*U.S.A. price .

Motorola's M6800 family

Creates the new age for microcomputer systems design

The M6800 family is the first LSI family designed as a coherent modular building block approach to the implementation of microcomputer systems. From the deceptively powerful MC6800 Microprocessor to the byte-organized family memories, to the capability expanding peripheral and communications interface adapters, the M6800 family plays together as the total product solution for microcomputer designs.

Shared qualities place M6800 family in leadership position.

Family devices are all state-of-the-art high performance N-channel Silicon Gate units requiring only a single common +5 V power supply. All peripheral bus devices are directly bus and TTL compatible. Among the many notable family features are •Basic 1 MHz operation •Direct Memory Access capability •64 kilobytes of directly accessible memory in any combination of ROM, RAM, or peripheral registers •Bi-directional data bus and wide address bus •Simple yet powerful instruction set with enhanced addressing modes. Beyond all else, the family is distinguished by a set of intelligent programmable logic interface adapters for I/O communications requirements.

Meet the family members



MC6800 Microprocessor. The executive control and processing block of Motorola's total product for microcomputer systems is the 8-bit MC6800 Microprocessor. The MC6800 is fast establishing a reputation for performance and throughput based on varied factors, including •Simple universal bus structure, powerful programming modes, and interrupt handling features •16-bit address bus for direct address of up to 65,536 memory locations •8-bit bi-directional parallel processing on a three-state data bus. These features only scratch the surface. MC6800 is a super 8-bit MPU.



A revolution is anticipated in word processing.

MC6820 Peripheral Interface Adapter. The totally unique PIA is a universal interface between peripheral equipment and the MPU bus. It's a flexible method, virtually without external logic, of connecting the MPU to status line or byte-oriented peripherals. The PIA features •8-bit bi-directional data bus for MPU communications •Two 8-bit bi-directional peripheral interface buses •Handshake control logic for input and output peripheral operation. The functional configuration of the PIA may be changed by the MPU during system operation.

There's more, but just remember this. The MC6820 provides total programmable logic for complete I/O task management.



Memories designed for microprocessors

Another system advantage of the M6800 family is the set of byte-organized memories designed to maximize efficiency in many systems. Just as useful in some situations is the fact that non-family memories also fit in, usually without sacrifice. Here are the family memories.

MCM6810 Static RAM. This 128 x 8 memory is designed for bus-organized systems. It needs no clocks or refreshing. Memory expansion is achieved with six chip select inputs. Two versions are available. The MCM6810L-1 is faster, with an access speed of 575 ns (max). Access time of the MCM6810L is 1 μ s.

MCM6830 ROM. The MCM6830 also is byte-organized for application in bus-organized systems. It's a mask programmable 1024 x 8-bit ROM with a maximum access time of 575 ns. Expansion is achieved with four programmable chip select inputs.



Communications power

One distinctive advantage of the M6800 family in the new wave of serial data communications systems is the inclusion of the necessary interface devices and MODEMs in the basic family.

MC6850 Asynchronous Communications Interface Adapter. The ACIA provides the data formatting and control to interface serial asynchronous data communications information to bus-organized systems.

The ACIA includes control lines for direct MODEM interface and features •8-bit and 9-bit transmission •Odd, even, or no parity •One or two stop bits •Optional divide by 1, 16, and 64 clock modes.

Functional configuration of the ACIA is programmed via the data bus during system initialization, using a control register programmed by the MPU. When all is said, the ACIA provides complete I/O task management for serial communications.

MC6860 MODEM. This 600 bps MODEM provides the necessary modulation, demodulation, and supervisory controls to implement a serial data communications link over a voice grade telephone channel.

The MC6860 offers compatible functions for 100 series data sets and 1001 A/B data couplers. Of course the MODEM interfaces directly with the ACIA in microprocessor-based data comm systems.



M6800 family second source

Motorola has solved the alternate source problem of many engineering and purchasing managers by signing an agreement with AMI for a true second source, where we share similar processes and the same masks.

M6800

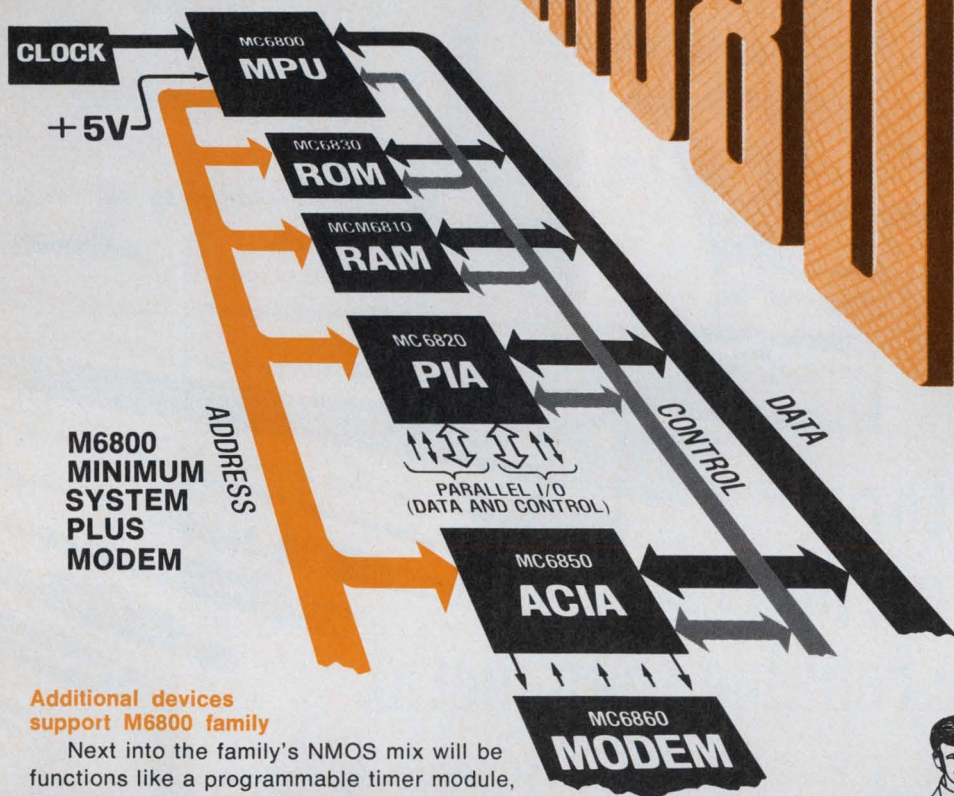

**M6800
MINIMUM
SYSTEM
PLUS
MODEM**

Additional devices support M6800 family

Next into the family's NMOS mix will be functions like a programmable timer module, 256 x 4 and 1K x 1 static memories, and a synchronous serial data adapter. While the family includes memories, others are often desirable. Additional appropriate Motorola memories are the MCM6831 8K ROM, the MCM6832 16K ROM, and the MCM6815 dynamic 4K RAM.

Motorola's Linear products group has designed a new family of interface functions around the memories and MPU family, and our CMOS people have come up with supplemental functions including a bit rate generator available now, and a new RAM and Tone Encoder on the way.

M6800 Software and Hardware Motorola's M6800 support software is a cohesive, interactive system for program development and checkout available on both G. E. and United Computing Service timesharing. A Fortran IV source deck cross assembler for 16 and 32-bit machines is available for customer host computers.

Hardware system development tools are the MEC6800 Evaluation Module, a complete minimum microcomputer system on a single board with RS232 interface, and the EXOR-ciser*, a system prototyping minicomputer complete with power supply and functional board options.

Other diverse support activities include a three-day technical design seminar in Phoenix and major U.S. cities throughout '75.

Retailers and their customers are taking advantage of MPU-based intelligent terminals.



Consumers are beginning to see typical bookkeeping and control functions handled by micro-computer systems.

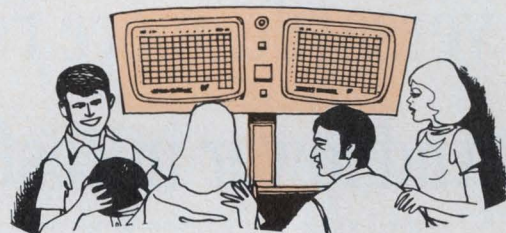

What it's all about: Simplify design, reduce costs!

All this distills to the simple idea that the M6800 family system architecture is designed to achieve •Minimization of components •Minimization of support packages •Interface simplicity •Minimization and simplicity of power requirements •System throughput.

There's a Motorola salesman ready to help you keep up with the leaders . . . and ahead of the rest. Get more detailed information by writing to Motorola Semiconductor Products Inc., P.O. Box 20912, Phoenix, AZ 85036. Discover why the M6800 family creates a new age as the standard against which all others must be measured: Why M6800 is now the benchmark family for microcomputer systems.



MOTOROLA M6800
Benchmark family for microcomputer systems.

*Trademark of Motorola Inc.



AMP Circular Plastic Connectors. Stronger, lighter, more versatile, more reliable than metal.

And lower in cost.

No matter where you go, you won't find a more versatile line of circular plastic connectors. From mating plugs to panel-mount or free-hanging receptacles. From square flange to feed-thru pressure bulkhead receptacles. They're available with many types of contacts and arrangements as well as 35A power contacts. And in popular shell sizes.

Why plastic connectors are better than metal ones.

Besides offering greater versatility, AMP gives you

high-strength, glass-filled nylon connectors that are as reliable as metal ones—but cost much less. In some ways, they're even more rugged. Because AMP circular plastic connectors are resilient. Yet, up to lighter. And nonconducting.

AMP automatic machines. For high-speed termination.

The contacts—you pay only for the ones you use—are supplied in continuous strip form. So termination is possible at volume production rates. And at the lowest possible cost to you.

AMP is at the core of reliable circular plastic connectors.

We can handle virtually all your requirements. No matter what industry you're in. And no matter where in the world you're doing business. To prove it, call (717) 564-0100 for information that deals with your specific needs. Or write AMP Incorporated, Harrisburg, Pa. 17105.

AMP is a trademark of AMP Incorporated.

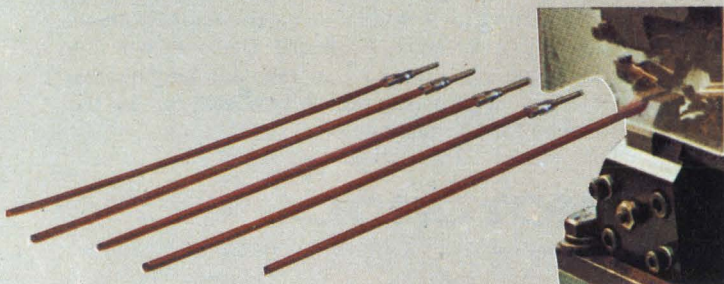



AMP
INCORPORATED

INFORMATION RETRIEVAL NUMBER 10

From **RCL**,
The World's
Largest
Manufacturer
Of
Precision/Power
Wire-Wound
Resistors

FREE
ENGINEERING
HANDBOOK,
1975
EDITION

- △ Military style cross-reference chart
- △ Heat distribution curves
- △ Special T.C.'s
- △ Typical circuitry
- △ Resistance temperature characteristics
- △ Networks - (DIPs)
- △ Established reliability resistors
- △ Low cost commercial styles
- △ Computer and fast rise time applications
- △ Vitreous enamel resistors
- ...and much more

Call our hotline for prompt
service and delivery.
(603) 627-3831

AMF
RCL Electronics

General Sales Office:
700 So. 21st Street
Irvington, N. J. 07111

ACROSS THE DESK

(continued from page 7)

the metricated equation,

$$L(nH) = \frac{n^2 d^2}{\ell + 0.45d} \quad (\ell, d \text{ in mm}),$$

for n , with the assumption of a tightly wound coil ($\ell = n \cdot t \cdot t =$ wire thickness):

$$n = \frac{A}{B} + \sqrt{\left(\frac{A}{2B}\right)^2 + 0.45A}, \text{ with}$$

$a = L/d$ and $B = d/t$.

This equation could also be presented in the form of a normalized nomograph.

Dr. A. Engelter

Fairmount
Talma Road
Muzenberg
South Africa 7945

"Inductance Calculation Simplified for Small Air-Wound Coils" is known by every schoolboy interested in electronics. It is included in the "Radio Amateurs Handbook" published by the American Radio Relay League. Furthermore, who needs a graph in this day of low-cost calculators?

Robert A. Sullivan

Engineering Services
P.O. Box 6226
Shirlington Station
Arlington, VA 22206

The author replies:

Wheeler's formula, which is usually accurate to 5%, was used because it can be presented easily as a graph. The more complicated sheet-inductance formula of Esnault Pelterie can be used for accuracy to 0.1%.

Dr. Engelter is correct to say that a 10-mm-long coil would be 370 nH. However, the 200-nH coil in the example was 20-mm long.

Martin Mann

45 Old School Lane
Milton
Cambridge, CB4 4BS
England

Correction

The illustrations for my article "Improve Analog Data Transmission With Two-Wire Transmitters" (ED No. 1, Jan. 4, 1975, pp. 94-101) have the signal common symbols erroneously converted to

ground symbols.

As described in the article, actual connection of the signal common to the ground return of the load resistor, R_L , will result in circulation of significant error currents. Only R_L can be connected to ground in Figs. 2, 3 and 5. All other points shown as ground in these figures should be common but not grounded. This common is the common return of the derived floating power supplies used to bias the transmitter circuits.

In Fig. 6 that common can be grounded, as shown, but this precludes the ground-isolation capability of that circuit.

Jerald Graeme

Manager, Monolithic Engineering
Burr-Brown Research Corp.
International Airport Industrial
Park
Tucson, AZ 85706

Misplaced Caption Dept.



"Thanks for the great lunch, but I really must get back to the lab."

Sorry. That's Edouard Manet's "Lunch on the Grass," which hangs at the Louvre in Paris.

Who got there fustest with digital RDF?

In "Radiophones and Precision Gear Make a Splash at Boat Show" (ED No. 5, March 1, 1975, p. 24) Heathkit says its MR-1010 is "the world's first" digital radio direction finder. This is erroneous. Vast Inc. demonstrated a true digital RDF in June of 1974. The display on the Vast Way Finder 8 shows the bearing from the receiving antenna to a selected vhf transmit-

(continued on page 21)

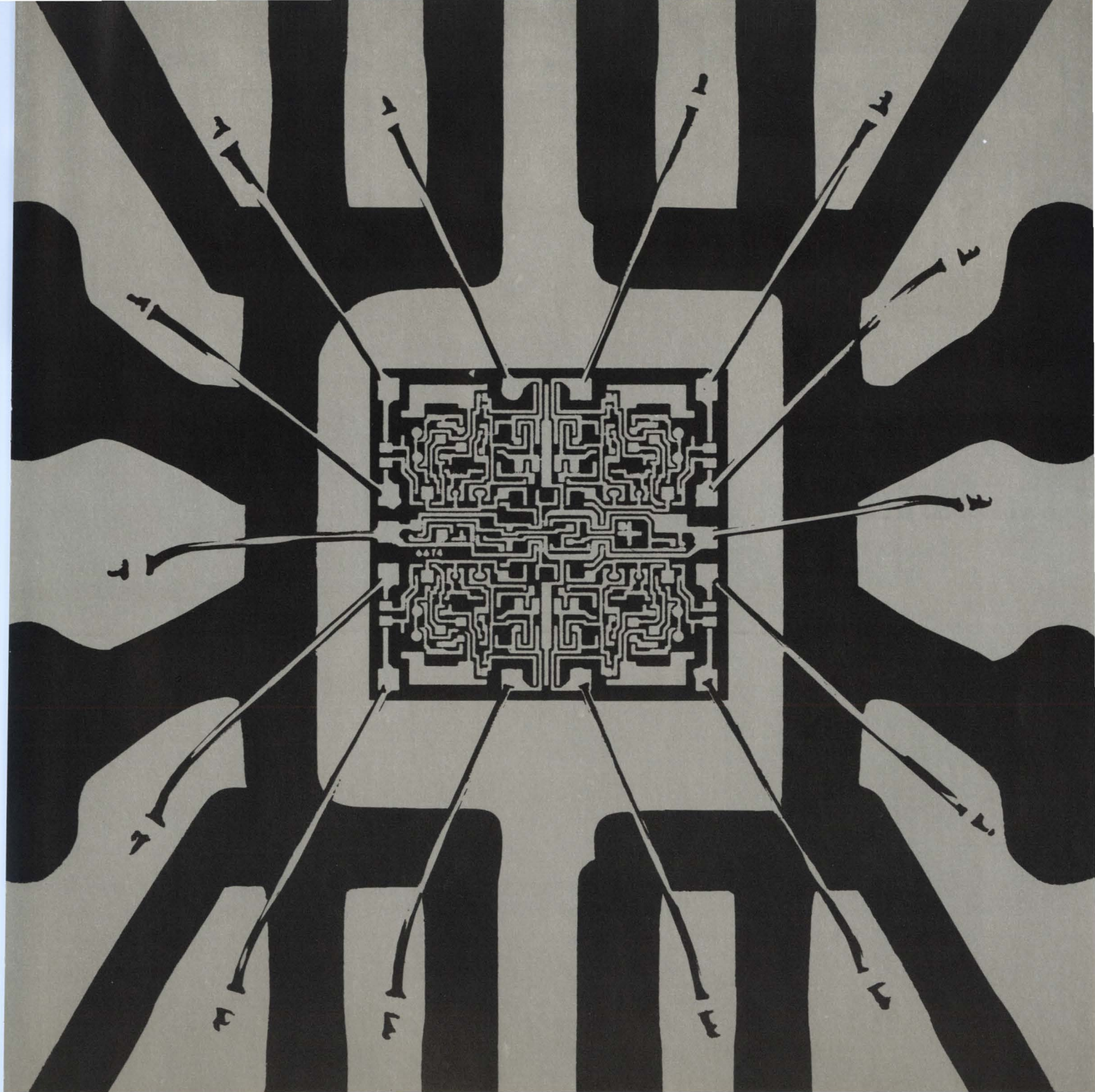

Aluminum is out.
Gold is in.
To bring you a
hermetic/plastic LDC.

RCA announces Hermeticity at

Gold metalization plus Chip Hermeticity In Plastic (CHIP) means corrosion-free, extended life.

Up to now, standard plastic LICs may have caused you some worries. Maybe a gnawing concern about field

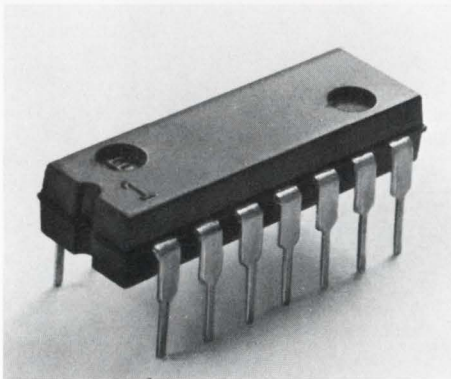

failures, actual or potential. But you didn't want to pay the price of ceramic or frit seal. Or, maybe you've been using expensive hermetic packages, but they've been getting damaged during insertion into equipment.

Now, the solution. RCA "Gold CHIP" linear ICs. For the assurance that comes from hermeticity, *plus* the economy and ruggedness of plastic.

Gold CHIP LICs have non-corroding gold metalization and leads. No aluminum with its potential problems.

The chip itself is hermetic. And protected in our advanced plastic package that has proven outstanding reliability. The result of all this is a truly cost-effective hermetic linear IC. Priced at standard plastic LIC prices. How do we do it?

We make the junctions hermetic with a protective layer of silicon nitride.

We complete the chip hermeticity with gold runs and interconnects. Under the gold is a layer of platinum which acts as a barrier to the titanium layer, used to obtain maximum adherence.

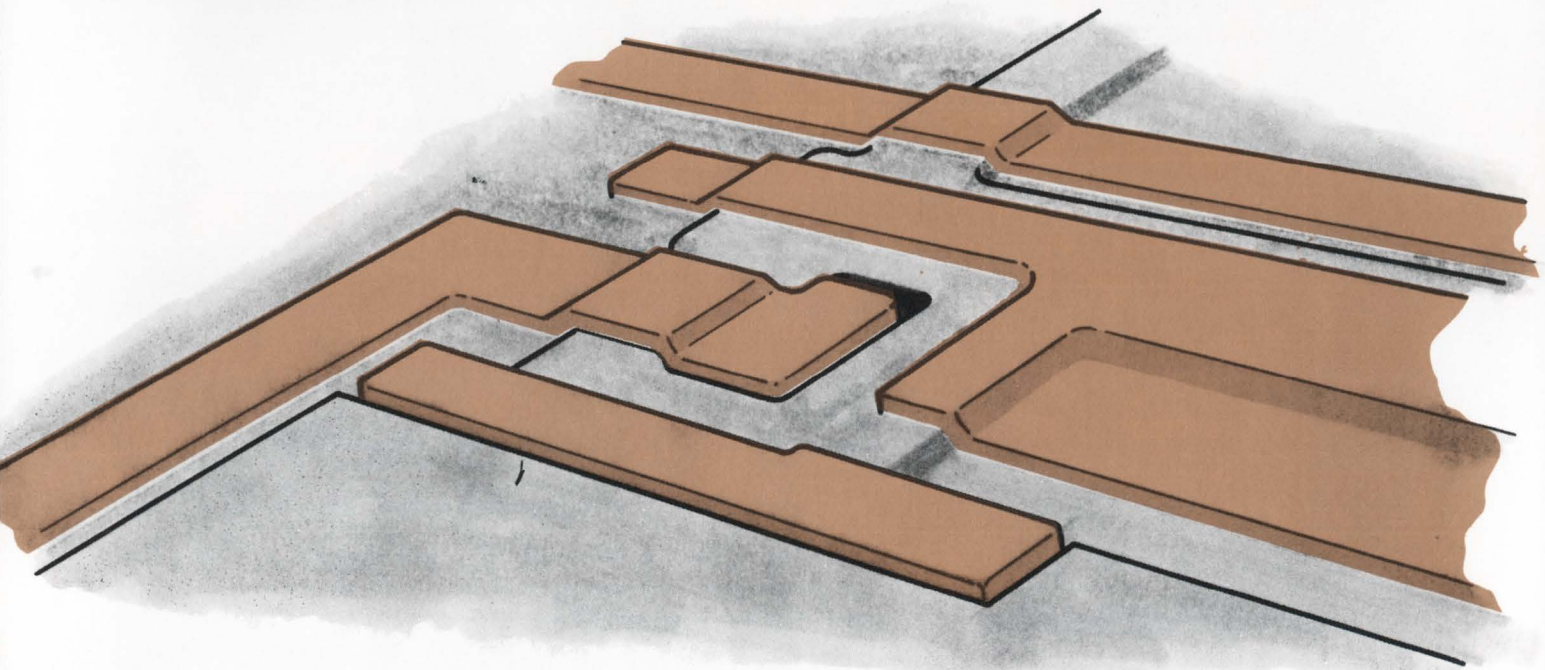

Gold runs and interconnects eliminate corrosion failure mechanisms.

"Gold CHIP" LICs. plastic prices.

Gold-to-gold-to-gold, from chip to external world.

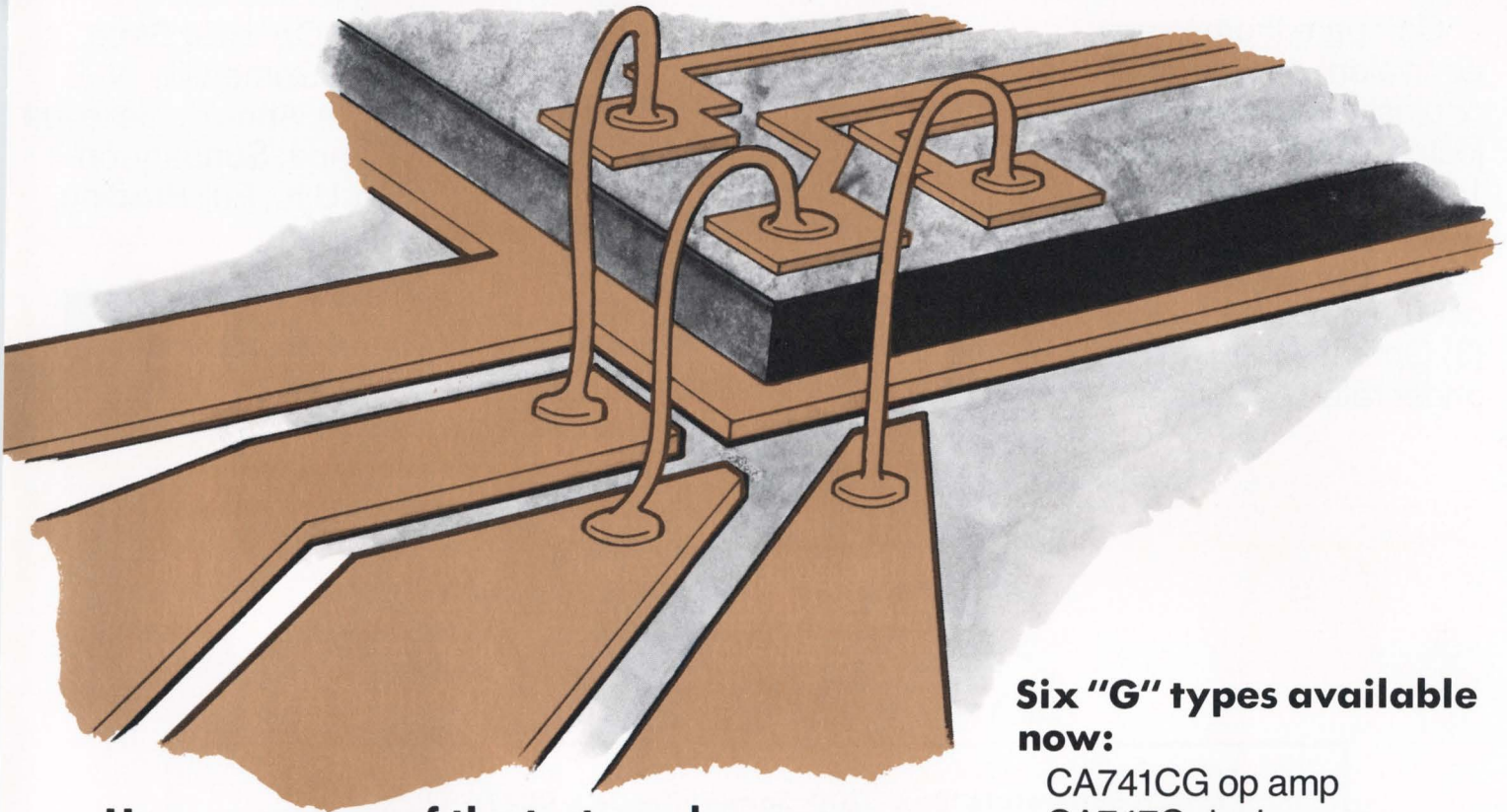

Here are some of the tests we have run:

Test	Conditions	Sample Size	Duration	Unit-hours	Failures
Temperature/ Humidity/Bias	85°C,	200	5000	1,000,000	0
	85% R.H.	35	3000	105,000	0
	15V reverse	60	2000	120,000	0
	bias	19	1000	19,000	0

We have also had zero failures on the following tests: Operating Life; Thermal Fatigue; Pressure Cooker;

Thermal Shock; Temperature Cycle. All of the data is available to you.

Six "G" types available now:

CA741CG op amp
CA747G dual op amp
CA324G quad op amp
CA339G quad voltage comparator

CA3724G high voltage transistor array
CA3725G high voltage transistor array

These types are available off the shelf from RCA Solid State distributors. They're also available processed in accordance with MIL-M-38510, Class B (RCA in-house program "/3").

FOR A FREE SAMPLE, MAIL COUPON →

Our challenge: evaluate Gold CHIP LICs yourself.

Compare them to any equivalent ceramic, frit-seal or plastic packages subjected to (1) Pressure cooker: 15 psi above atmosphere; (2) Temperature-humidity: 85°C, 85% RH, devices under rated bias conditions; (3) Operating life: operated under rated conditions.

Now you have no reason to take chances with non-hermetic plastic LICs. To find out more, contact your local RCA Solid State distributor. Or RCA.

Write: RCA Solid State, Box 3200, Somerville, N.J. 08876; Ste. Anne de Bellevue 810, Canada; Sunbury-on-Thames, U.K.; Fuji Building, Tokyo, Japan.

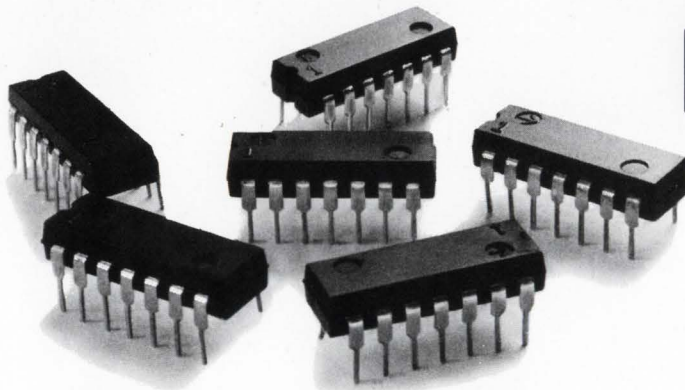

RCA

FOR A FREE SAMPLE, MAIL THIS COUPON.

Offer expires August 15, 1975

Mail to RCA Solid State, Box 3200, Somerville, N.J. 08876

Please send me, free, one Gold CHIP linear IC (check one, below):

_____ CA741CG op amp; _____ CA747G dual op amp; _____ CA324G quad op amp;
_____ CA339G quad voltage comparator; _____ CA3724G high voltage transistor array;
_____ CA3725G high voltage transistor array.

Estimated annual requirements _____

My firm buys ICs: Through distributor Direct from RCA

Distributor name _____

Address _____

My name _____

Title _____

Company _____

Address _____

City, State, Zip _____

ED5-24

RCA. Full house in Linear ICs.

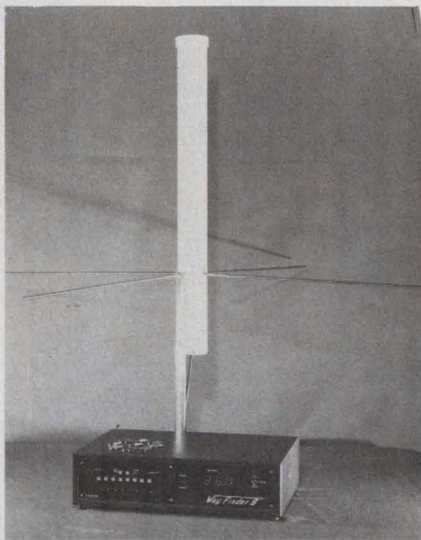

ter. This RDF can be used either on a vessel or at a shore station and can be purchased through selected distributors or directly from Vast.

F. M. Morris
Marketing

Vast Inc.
Friendship St.
Waldoboro, ME 04572

Getting deeper into the soup

Re your postal alphabet soup ("About That Postal Alphabet Soup," ED No. 1, Jan. 4, 1975, p. 17), we here at EI have used these abbreviations for states for quite a while. Here are some additions to your list:

- | | |
|------|----------------------------|
| BC | British Columbia |
| MEX | Mexico |
| NFLD | Newfoundland |
| NWT | North West Territories |
| NS | Nova Scotia |
| ONT | Ontario |
| PEI | Prince Edward Island |
| QUE | Quebec |
| MIQ | St. Pierre-Miquelon Island |
| SASK | Saskatchewan |
| YUK | Yukon |

F. M. Woody Liljedahl
Chairman of the Board

Electronic Ideas Inc.
211 Cedar St.
Denton, TX 76201

Only Sprague bantam 4-pin DIP capacitors can give you these advantages...



guaranteed max. high frequency impedance



low inductance and low ESR...
4-terminal connection mode option



preferred capacitance values to optimize performance when tantalum and ceramic capacitors are paralleled



automatic insertion capability



your choice of layer-built ceramic or solid-electrolyte tantalum

Type 935C MONOLYTHIC CERAMIC CAPACITORS

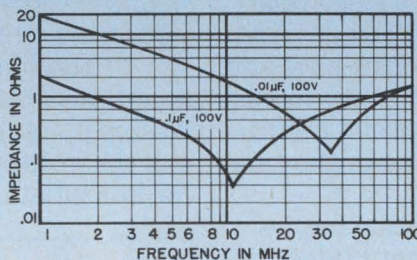

Proven multi-layer construction. C0G(NP0) and X7R temperature characteristics. Preferred ratings are .01, .047, and .1 μF @ 100 WVDC. Operating temperature range, -55°C to $+85^{\circ}\text{C}$.

INFORMATION RETRIEVAL NUMBER 121

Type 935D TANTALEX SOLID-TANTALUM CAPACITORS

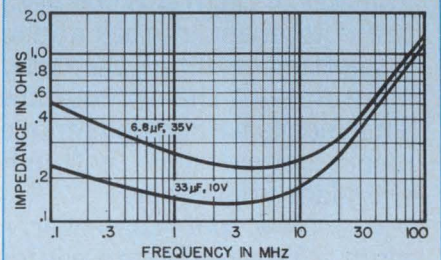

Dual in-line plastic package for mechanical protection and increased reliability. Preferred ratings are 6.8 μF @ 35V, 15 μF @ 20V, 22 μF @ 15V, and 33 μF @ 10V. Operating temperature range, -55°C to $+85^{\circ}\text{C}$.

INFORMATION RETRIEVAL NUMBER 122

For complete technical data on Type 935C or 935D Capacitors, write for Engineering Bulletins 6242.3 or 3542.3, respectively, to: Technical Literature Service, Sprague Electric Company, 347 Marshall St., North Adams, Mass. 01247.

THE BROAD-LINE PRODUCER OF ELECTRONIC PARTS

SPRAGUE

THE MARK OF RELIABILITY

Here's why REI can rent you what you want when you want it.



Our inventory. It's the biggest in the industry, with over 8,000 items of electronic test equipment in stock and ready to go. And it's getting better all the time, because we add more state-of-the-art equipment every month. This means we can deliver one special instrument... or a dozen... within hours of the time you place your order.

Now, more than ever, renting makes sense... to stretch your equipment budget, to fill temporary needs, and to avoid the long delivery lead times associated with purchasing. And renting from REI makes even more sense... because we're better equipped to fill your needs than any other rental company.

REI is backed by the tremendous resources of the PepsiCo organization, which gives us the financial strength to keep on hand whatever test equipment you may need. And renting from us helps *your* financial strength,

too. Since you pay only for the time you have your instruments, you'll never have to spend your money on idle equipment.

Send for our catalog today for a description of our rental, rental/purchase and leasing plans, and for our low rental prices. Or call the instant inventory center nearest you for immediate assistance.

Rental Electronics, Inc.,
99 Hartwell Avenue, Lexington, Mass. 02173.
Please send me your free instrument rental catalog:

Name _____ Title _____

Company _____

Address _____

City _____ State _____ Zip _____

Tel. Number _____

Rental Electronics, Inc.

A PEPSICO LEASING COMPANY

Burlington, MA (617) 273-2770 • Gaithersburg, MD (301) 948-0620 • Oakland, NJ (201) 337-3757 • Ft. Lauderdale, FL (305) 771-3500
Des Plaines, IL (312) 827-6670 • Dallas, TX (214) 661-8082 • Mountain View, CA (415) 968-8845 • Anaheim, CA (714) 879-0561
Rexdale, Ontario (PLC Leasing Ltd.) (416) 677-7513

INFORMATION RETRIEVAL NUMBER 13

MAY 24, 1975

TV industry disputes U.S. on power-saving proposals

The Federal Government's call for a reduction of 50% in the power used by television sets may hamper the design of advanced TV sets, according to television industry representatives who attended a recent meeting at the National Bureau of Standards, Gaithersburg, MD.

The bureau is the agency that will monitor what is envisioned as a voluntary-power-reduction program embracing some 115 TV and appliance manufacturers. The new conservation levels would be achieved by 1980.

An "energy factor" for TV sets, proposed by NBS representatives at the meeting also has drawn industry criticism. This factor would, if accepted, define the power as directly proportional to the screen size.

While indicating support for the principle of energy conservation, the industry representatives contend the Government's proposals as not practical.

"At the Gaithersburg meeting," says Thomas Collins, director of consumer affairs for RCA. Consumer Electronics, Indianapolis, "NBS came out with an average goal of 50%, and if the TV manufacturers chose to break it down separately, it was 48% reduction for color and 55% for black and white. My own feeling is that these goals are unrealistic. The two basic areas where real improvements can be made in energy conservation are in the shift towards solid state and in the elimination of the instant-on feature."

Another suggestion that Collins offers is that "the program ought to take into consideration technological improvements which could better set performance—and any added energy consumed for this purpose shouldn't necessarily count against the design."

TV representatives say that a major effect of the energy requirements would be to inhibit the use of the new 110° picture tubes, since they require more power than the 90°.

Richard Sanderson, director of product safety for Sylvania Entertainment Products, Batavia, NY, says:

"I don't believe the screen area belongs in these proposals at all. Considering the shift to solid state between 1972 and 1974, the reduction in power achieved will not satisfy the energy factor.

"For example it is not a linear function, when you get into color TV, there are a lot of circuits that have nothing to do with screen size."

Sanderson suggests that a more meaningful standard should be the "average energy per cent."

Because of the shift away from instant-on sets and the trend to solid-state, Sanderson says that his research has shown that the average wattage dissipated in 1975 TV sets is approaching the 50% goal.

Bernard McGuire, chief of the NBS appliance labeling section and supervisor of the energy-saving program, points out that television receivers are just one element in the Voluntary Appliance Efficiency Program. The TV-conservation objective is the highest of all the appliances, however—50% as compared with 22% for room air-conditioners, 42% for refrigerators, 40% for gas ranges and 20% for electric ranges.

The over-all savings in the program, McGuire says, should reduce the energy used by new home appliances by 20% by 1980. He is careful to note, however, that all of the figures are tentative.

The Government's objective is to have general agreement or at least support of the program by 85% of the appliance industry by July 15.

Better radar antennas tested by the FAA

Two radar-beacon antennas are undergoing evaluation by the Federal Aviation Administration to overcome problems that become particularly acute in the new computer-controlled air traffic control systems. The problems cause false targets to appear on controllers' screens when there are no planes and make known aircraft disappear from the screen in certain sectors.

Designed as potential replacements for present beacon antennas, the new units—a planar array and a multifeed horn reflector—have been installed at the National Aviation Facilities Experimental Center, Atlantic City. Both antennas incorporate large vertical apertures that give vertical radiation patterns with a sharp cutoff at the horizon as well as reduced vertical lobes.

Albert Lolli, program leader at Atlantic City, points out that side-lobe suppression is incorporated in both units by use of a separate sidelobe suppression antenna.

The planar array, designed by Westinghouse, Baltimore, is well suited for integrating the suppression antenna within the phase array itself, says Lolli. The planar array is 26 ft long, 8 ft high and weighs 3200 pounds.

In the multifeed antenna, developed by Texas Instruments, Dallas, the suppression antenna must be mounted on top of the main unit, which is 30 ft long, 10 ft high and weighs 6000 pounds. However, Lolli points out the multifeed antenna is much more adaptable to beam steering, so that in cases where it is necessary to lift the beam over an airport building each time the antenna scans, the TI design can be more easily controlled by computer.

Niobium tin offered in flexible cable

Niobium tin, a superconducting metal, has been fabricated in cable form, so flexible that it can be bent around one's finger without damage to it or effect on its performance.

The developers of the cable, which consists of hundreds of fine

wires, are the General Electric Research Development Center in Schenectady, NY, and the Intermagnetic General Corp. in Guilderland, NY.

Heretofore rigid niobium tin was the best metal superconductor available, but it had handicaps. Designers working with motors, generators and other devices that require high magnetic fields had to compensate for the metal's brittleness and the fact that it couldn't be bent.

Intermagetics will market the niobium-tin cable either separately or as part of superconducting net systems. It will be available in diameters ranging from 0.4 to 2 mm and capable of carrying currents from 90 to 1500 amperes, respectively, in fields of 50,000 gauss.

Niobium tin is a far superior superconductor than niobium titanium, the only other major superconductor now on the market, says Carl H. Rosner, president of Intermagetics. Niobium tin permits operation at higher temperature (10 to 12 K), higher magnetic fields (above 100,000 gauss), and higher current densities, he notes.

Until now, Intermagetics has marketed niobium-tin superconductors only in a tape configuration.

"Although tape geometry is suitable for many applications, it is not as magnetically stable as the new cable conductor, and tape-wound magnets must be energized slowly to avoid transition to a non-conducting state," Rosner points out. "The new cable also remains superconductive in the presence of rapidly changing magnetic fields."

In one configuration to be marketed, six of the wires are wound around a stainless-steel wire for increased strength. The cable is then plated with tin and heated in a furnace, causing the tin to diffuse through the copper and interact with the niobium filaments, thereby forming the desired niobium-tin alloy.

Dielectric field probe replaces metal

What is described as the first accurate dielectric field probe has been developed to measure the intensity of a field at microwave frequencies. The probe is made of fiber

optics and liquid crystals, and it replaces present metal probes.

The developer, Dr. Om P. Gandhi, professor of electrical engineering at the University of Utah, Salt Lake City, reports: "A small quantity of cholesteric liquid-crystal material is held in a 1.5-mm cylinder at the end of a fiber-optic bundle. The cylinder is coated with graphite so as to present about 50- Ω impedance to the microwave field. When microwave energy is present, the graphite absorbs energy and heats up."

As the graphite heats, the wavelength of the light reflected by the liquid crystals changes. The wavelength goes from infrared through the red as the temperature rises, and it continues on through the spectrum towards the ultraviolet.

A red LED shines through some of the fibers in the fiber-optic bundle down to the liquid crystals. As the crystals take on the red color of the LED, the red light reflected increases linearly until it peaks at the LED wavelength. The reflected light travels back up the fiber-optic bundle to the phototransistor detector. The output is then displayed on a digital voltmeter.

"For the first five seconds after the probe senses microwave energy," Gandhi notes, "the slope of the voltage change vs time is proportional to the microwave field strength. To make repetitive measurements, the microwave field must be switched every 10 to 15 seconds. The system cannot be allowed to reach a steady state."

If the probe remains in the field too long, the liquid crystals continue to heat, and the reflected wavelength passes through the red. Therefore the voltage starts to decrease.

Simpler circuitry due for flat-panel displays

Two developments that simplify and reduce the external circuitry that drives flat-panel displays were described at the Society for Information Display's 1975 International Symposium in Washington, DC.

One experimental approach uses thin-film transistors to provide nonvolatile storage, while the other uses a shifting plasma technique.

According to T. Peter Brody, manager of the Westinghouse Research Laboratories Thin Film Devices Dept. in Pittsburgh, an electroluminescent display with non-volatile thin-film transistors has been fabricated. It reduces the devices required for a memory cell from 3 to 1, minimizes the bandwidth required to transmit displayed data and decreases power requirements by 20 to 25%.

The key to the new development is the thin-film memory transistor, Brody points out, and not the use of an electroluminescent panel. He notes that the memory technology could just as easily be used with other display technologies, such as liquid crystals.

Until now, Brody says, display memory cells generally required at least two transistors and a storage capacitor. However, by use of a thin-film cadmium-selenide (CdSe), field-effect transistor with an electrically alterable threshold voltage, these three components can be reduced to one, thereby increasing the possible array density.

Operation of the memory cell is similar to that of MNOS devices, where charge is retained in gate insulator tapes. Display information stored in the CdSe memory cells can be held for several hours before a picture starts to degrade in quality.

As far as bandwidth is concerned, Brody says that the memory reduces the bandwidth needed to transmit a picture by a factor of at least 100. The reason for this is that it is only necessary to transmit those parts of the picture that change.

Closer to commercial availability is a serial-input plasma charge-transfer display from National Electronics, Geneva, IL. According to William Coleman, engineering manager of the company's Readouts Div., transfer of plasma charge in a gas channel along a four-phase transfer electrode network holds down the number of address lines for a 128-character display to 17.

In the new display, Coleman notes, the voltages on the input electrode, four transfer electrodes and the erase electrode are synchronously controlled. Thus plasma discharges may be entered, shifted and held in place anywhere along the gas channel.

Mini-Circuits' answer to holding down your costs of Double Balanced Mixers

Specify our model SRA-1...

1971 — \$7.95*

SRA-1 (in 500 quantities)



1972 — \$7.95*

SRA-1 (in 500 quantities)



1973 — \$7.95*

SRA-1 (in 500 quantities)



Mini-Circuits Laboratory, now the world's largest supplier of double-balanced mixers, guarantees to maintain its famed low-price structure throughout 1975 and 1976. \$7.95 (model SRA-1, 500 quantity). You, the design engineer, have made this offer possible. Your large volume orders, from over 500 companies throughout the world, have enabled us to purchase our components and packages at lowest possible costs with guaranteed delivery schedules from our vendors. And we think it's appropriate to pass these savings to you. Need fast delivery? One week or better is routine; for your emergency needs, 24-hour turnaround is possible.

Our history of quality and performance is unmatched. All our units are unconditionally guaranteed for 1 year. Every Mini-Circuits employee, from the president to the final test operator, is committed to excellence in performance and quality for every unit produced. For reliability, performance and quality more and more systems engineers are specifying Mini-Circuits mixers as the industry standard.

1974 — \$7.95*

SRA-1 (in 500 quantities)

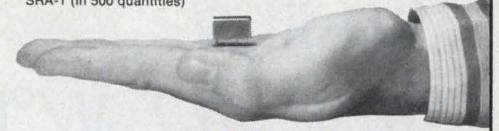

1975 — \$7.95*

SRA-1 (in 500 quantities)

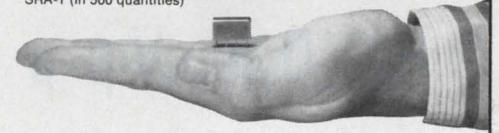

STILL ONLY \$7.95* IN 1976

SRA-1 (in 500 quantities)

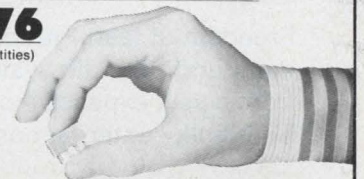

*\$9.95 (1-49)

SRA Series

Frequency Range (MHz)	Conversion Loss (dB) Total Range	Isolation (dB)						Price (Quantity)
		Lower band edge to one decade higher		Mid range		Upper band edge to one octave lower		
		LO-RF	LO-IF	LO-RF	LO-IF	LO-RF	LO-IF	
SRA-1 LO-0.5-500 RF-0.5-500 IF-DC-500	6.5 typ. 8.5 max.	50 typ. 35 min.	45 typ. 30 min.	45 typ. 30 min.	40 typ. 25 min.	35 typ. 25 min.	30 typ. 20 min.	\$9.95 (1-49)
SRA1-1 LO-0.1-500 RF-0.1-500 IF-DC-500	6.5 typ. 8.5 max.	50 typ. 45 min.	45 typ. 30 min.	45 typ. 30 min.	40 typ. 25 min.	35 typ. 25 min.	30 typ. 20 min.	\$11.95 (6-49)
SRA-1W LO-1-750 RF-1-750 IF-DC-750	6.5 typ. 8.5 max.	50 typ. 45 min.	45 typ. 30 min.	45 typ. 30 min.	40 typ. 25 min.	35 typ. 25 min.	30 typ. 20 min.	\$14.95 (6-49)
SRA-2 LO-1-1000 RF-1-1000 IF-0.5-500	6.5 typ. 8.5 max.	45 typ. 30 min.	45 typ. 30 min.	35 typ. 20 min.	35 typ. 20 min.	30 typ. 20 min.	30 typ. 20 min.	\$24.95 (1-24)

Common specifications for all models

Signal, 1 dB compression level - 1 dBm

Impedance all ports 50 ohms

Phase detection - DC offset - 1 mV typical

DC polarity - negative

Frequency Range (MHz)	Conversion Loss (dB) Total Range	Isolation (dB)						Price (Quantity)
		Lower band edge to one decade higher		Mid range		Upper band edge to one octave lower		
		LO-RF	LO-IF	LO-RF	LO-IF	LO-RF	LO-IF	
SRA-4 LO-5-1250 RF-5-1250 IF-0.5-500	6.5 typ. 8.5 max.	50 typ. 40 min.	50 typ. 40 min.	40 typ. 20 min.	40 typ. 20 min.	30 typ. 20 min.	30 typ. 20 min.	\$26.95 (1-24)
SRA-3 LO-0.025-200 RF-0.025-200 IF-DC-200	6.5 typ. 8.5 max.	60 typ. 50 min.	45 typ. 35 min.	45 typ. 35 min.	40 typ. 30 min.	35 typ. 25 min.	30 typ. 20 min.	\$12.95 (6-49)
SRA-6 LO-0.003-100 RF-0.003-100 IF-DC-100	6.5 typ. 8.5 max.	60 typ. 50 min.	60 typ. 45 min.	45 typ. 30 min.	40 typ. 25 min.	35 typ. 25 min.	30 typ. 20 min.	\$19.95 (5-24)
SRA-8 LO-0.005-10 RF-0.005-10 IF-DC-10	6.5 typ. 8.5 max.	60 typ. 50 min.	60 typ. 50 min.	50 typ. 40 min.	50 typ. 40 min.	45 typ. 35 min.	45 typ. 35 min.	\$24.95 (5-24)

World's largest supplier of double balanced mixers

Mini-Circuits Laboratory
A Division Scientific Components Corp

Foreign Sales Representatives: **AUSTRALIA** General Electronic Services, 99 Alexander Street, New South Wales, Australia 2065; **ENGLAND** Dale Electronics, Dale House, Wharf Road, Frimley Green, Camberley Surrey; **FRANCE** S. C. I. E. - D. I. M. E. S., 31 Rue George - Sand, 91120 Palaiseau, France; **GERMANY, AUSTRIA, SWITZERLAND** Industrial Electronics GMBH, Klüberstrasse 14, 6000 Frankfurt/Main, Germany; **ISRAEL** Vectronics, Ltd., 69 Gordon Street, Tel-Aviv, Israel; **JAPAN** Densho Kaisha, Ltd., Eguchi Building, 8-1 1 Chome Hamamatsucho Minato-ku, Tokyo; **EASTERN CANADA** B. D. Hummel, 2224 Maynard Avenue, Utica, NY 13502 (315) 736-7821; **NETHERLANDS** Coimex, Veldweg 11, Hattem, Holland

OUR NEW ADDRESS IS: 837-843 Utica Avenue, Brooklyn, NY 11203 (212) 342-2500 Int'l Telex 620156

US Distributors: **NORTHERN CALIFORNIA** Cain-White & Co., Foothill Office Center, 105 Fremont Avenue, Los Altos, CA 94022 (415) 948-6533; **SOUTHERN CALIFORNIA, ARIZONA** Crown Electronics, 11440 Collins Street, No. Hollywood, CA 91601 (213) 877-3550

For complete U.S. Rep listing and product line see MicroWaves' Product Data Directory

CHOPPER AMP PERFORMANCE AT BIPOLAR PRICES... *it's easy!*

$$V_{OS} - 10 \mu V$$

$$TC V_{OS} - 0.2 \mu V/^{\circ}C$$

$$V_{OS}/Time - 0.2 \mu V/Month$$

$$e_n - 0.35 \mu V p-p$$



NO EXTERNAL COMPONENTS - NO CHOPPER PROBLEMS!

Freedom at last! Freedom from zeroing potentiometers and periodic system recalibrations. Freedom from noisy, expensive chopper amplifiers. Freedom from bulky external components.

New monoOP-07 Ultra-Low Offset Voltage Op Amps combine ultra-low noise, ultra-stable performance

with applications ease and flexibility—at unbelievably low prices. Upgrade system performance, reduce design time, improve MTBF while saving money. The monoOP-07 is a direct replacement for 725, 108A/308A, 741 and most other op amps—they're off-the-shelf at your Precision Monolithics distributor now!

GUARANTEED MIN/MAX SPECIFICATIONS

	monoOP-07AJ	monoOP-07J	monoOP-07EJ	monoOP-07CJ	
Temp. Range	-55/+125	-55/+125	0/+70	0/+70	°C
V_{OS} @ 25°C	25	75	75	150	μV
V_{OS} @ Full Temp.	60	200	130	250	μV
TCV_{OS}	0.6	1.3	1.3	1.8	$\mu V/^{\circ}C$
Long Term Drift	1.0	1.0	1.5	2.0	$\mu V/Month$
Noise Voltage (.1 to 10 Hz)	0.6	0.6	0.6	0.65	$\mu Vp-p$
CMRR ($V_{IN} = \pm 13V$)	110	110	106	100	dB
Price @ 100 Pcs. (TO-99)	\$60.00	\$25.00	\$15.00	\$9.95	•

AUTHORIZED DISTRIBUTORS:

NEW YORK METROPOLITAN AREA Harvey Radio, Westbury, N.Y.: (516) 921-8700 • NEW ENGLAND AREA Gerber Electronics, Dedham, Mass.: (617) 329-2400 • UPSTATE NEW YORK Harvey Federal Electronics, Binghamton, N.Y.: (607) 748-8211 • NORTHEAST Newark Electronics, Woburn, Mass.: (617) 935-8350 • BALTIMORE-WASHINGTON Whitney Distributors, Baltimore, Md.: (301) 944-8080 • PENNSYLVANIA Hallmark Electronics, Huntingdon Valley, Pa.: (215) 355-7300 • Pioneer/Pittsburgh: (412) 391-4846 • MICHIGAN RS Electronics, Detroit, Mich.: (313) 491-1000 • SOUTHEAST Kirkman Electronics, Winston-Salem, N.C.: (919) 724-0541 • EAST CENTRAL Pioneer/Cleveland, Cleveland, Ohio: (216) 587-3600 • Pioneer/Indianapolis, Indianapolis, Indiana: (317) 849-7300 • Pioneer/Dayton, Dayton, Ohio: (513) 236-9900 • CENTRAL Hallmark Electronics, Elk Grove Village, Ill.: (312) 437-8800 • Minneapolis, Minn.: (612) 884-9056 • St. Louis, Mo.: (314) 291-5350 • TEXAS-OKLAHOMA Sterling Electronics, Houston, Texas: (713) 627-9800 • Dallas, Texas: (214) 357-9131 • SOUTHWEST Sterling Electronics, Albuquerque, N.M.: (505) 345-6601 • Phoenix, Ariz.: (602) 258-4531 • WEST Westates Electronics Corp., Chatsworth, Calif.: (213) 341-4411 • Sunnyvale, Calif.: (408) 733-8383 • Intermark Electronics, Sunnyvale, Calif.: (408) 738-1111 • Denver, Colo.: (303) 936-8284 • San Diego, Calif.: (714) 279-5200 • Santa Ana, Calif.: (714) 540-1322 • Almac-Stroum, Seattle, Wash.: (206) 763-2300 • Portland, Ore.: (503) 292-3534 • WEST CANADA Bowtek Electronics, Vancouver, B.C.: (604) 736-1141 • EAST CANADA Westburne-Haldane Electronics, Toronto, Ont.: (416) 789-4181 • Cesco Electronics, Montreal, Que.: (514) 735-5511 • INTERNATIONAL: Europe: Bourns AG, Baarerstrasse 8, Zug, Switzerland • India: Electronic Enterprises, 46 Karani Bldg., New Charni Road, Bombay 4 • Japan: Toyo Trading Co., Ltd., P.O. Box 5014, International, Tokyo • Australia: CEMA (Distributors) Pty. Ltd., 21 Chandos St., Crows Nest, N.S.W. 2065.



1500 SPACE PARK DRIVE, SANTA CLARA, CALIF. 95050
TEL. (408) 246-9222 • TWX 910-338-0528 • CABLE MONO

47A-9

Repeatability in
thin film networks
is a matter of
experience.

If you're really
serious about cost,
be serious about quality.

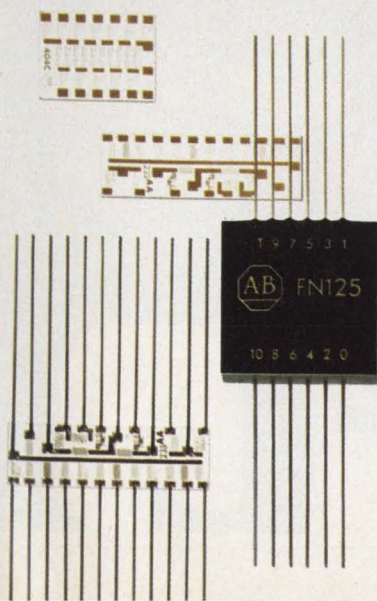

Our chrome-cobalt technology, for example, has been proven in dozens of applications ranging from D/A and A/D conversion, voltage division in digital multimeters and telemetry equipment, to communications paging devices.

In seventeen years of film resistor production, we've solved many problems that others are yet to encounter. This hard earned experience allows us to respond quickly to your custom needs. We regularly duplicate prototype performance in virtually any quantity. You get excellent delivery along with greater assurance of part-to-part consistency and quality.

Profit from the practiced teamwork of our application, quality control and production engineers. Standard items are available through your appointed Allen-Bradley Electronic Distributor. Write for Publication 5801, Allen-Bradley Electronics Div., 1201 South 2nd St., Milwaukee, WI 53204.

Performance specifications

TCR: 10 to 25 ppm/°C
Absolute tolerance: as low as .01%
Interconnections: metal film (no soldered or welded joints)
Stability: 50 ppm/year
Packaging: chip, conformal coated, encapsulated.



ALLEN-BRADLEY

Milwaukee, Wisconsin 53204

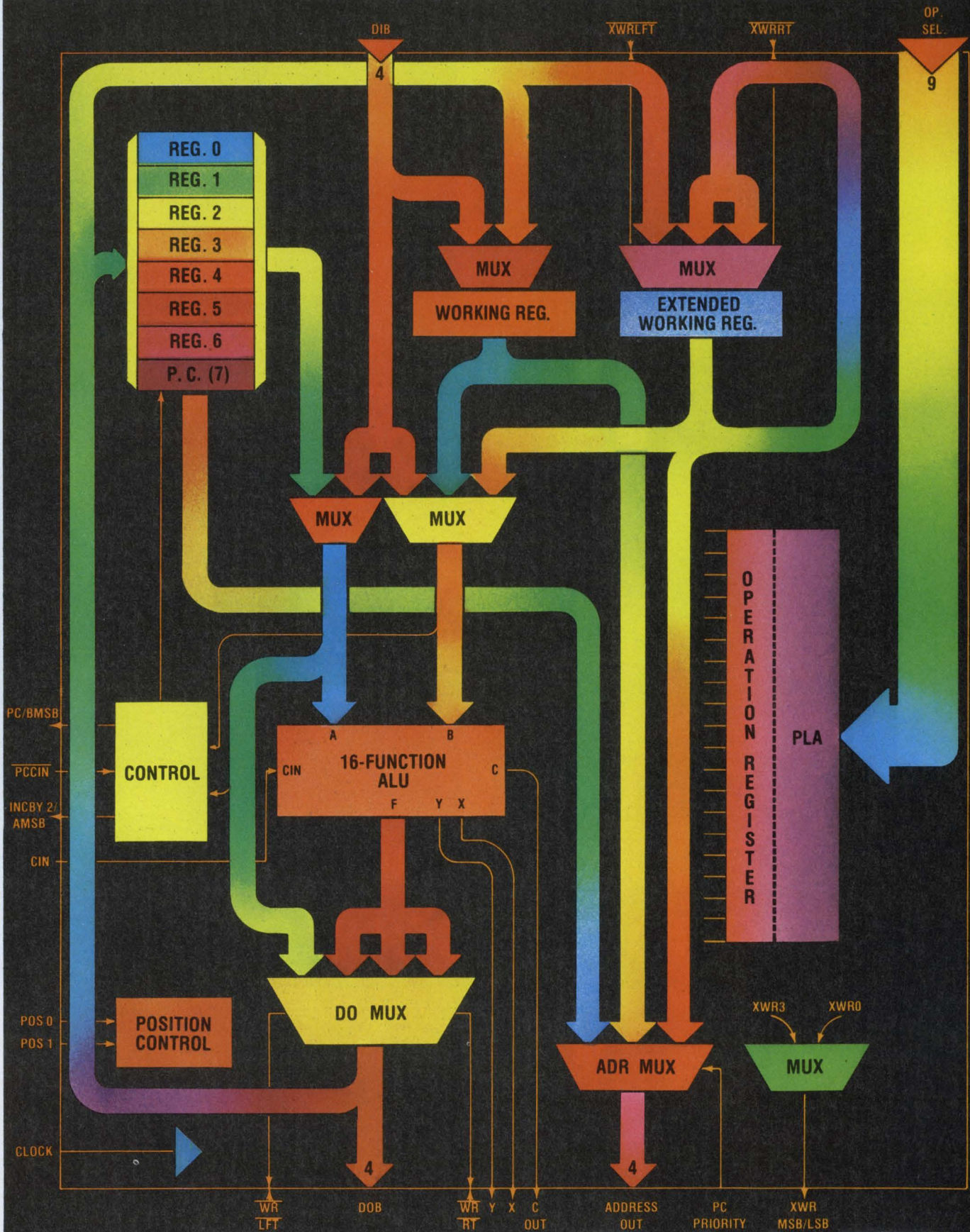

Combine the unique properties of integrated injection logic with microprogrammable bit-slice architecture. The result. A very powerful microprocessor element and the beginning of a revolutionary new technology. Texas Instruments has pioneered both.



SBP0400

4-bit slice microprogrammable microprocessor element. Integrated Injection Logic ...from Texas Instruments.

The SBP0400 is a digital processor building block and the first of the standard Integrated Injection Logic (I²L) ICs from TI.

The 0400 combines the unique properties of I²L technology with an expandable 4-bit slice architecture to offer an unmatched level of performance and design flexibility.

It's microprogrammable. You build instructions by externally sequencing the 0400's factory-programmed micro-operations. Emulate existing designs, at either the micro or macro level, with software compatibility. Or create highly efficient new designs with tailored instructions.

With over 1,600 gates, monolithically integrated into a 40-pin package, the 0400 offers the basis for efficient, low cost design solutions to a host of applications in both industrial (0° to 70°C) and military (-55° to 125°C) environments.

The SBP0400 is also directly expandable to any word size which is a multiple of 4-bits.

Some examples: One SBP0400 can make a basic 4-bit intelligent controller. Two, in parallel, makes an 8-bit dedicated processor. Three makes a 12-bit controller. And, with four - the CPU of a general purpose 16-bit "mini".

SBP0400 is characterized by the ability to perform any one of its 512 preprogrammed operations within a single clock cycle.

Basic Architecture

- Microprogrammable, bit-slice design expandable in 4-bit multiples.
- Parallel access to all control, data and address functions.
- 16-function ALU with full-carry look ahead capability.
- 8-word general register file including independent program counter with incrementor.
- Dual 4-bit working registers with full shifting capability.
- On-chip factory programmable logic array (PLA) contains a repertoire of 512 micro-operations.

Functional Power

- Static edge-triggered operation with full TTL compatibility.
- ALU operand modifications/combination via 8 arithmetic or 8 Boolean functions.
- Bidirectional logic/arithmetic shift/circulate of single/double signed, single/double precision binary words.
- Single clock ALU-shift combinations simplify implementation of iterative multiply and non-restore divide algorithms.
- Internal operation register and independent program counter provide pipelining capability.

Performance: The SBP0400 operates at a constant X power product over a 10⁵ performance range. Virtually any single DC power source, voltage or current, can be used.

Speed is a direct function of supply current. As the graph shows: For typical microcycle times of one

microsecond, just over 100 miliamps of total supply current is required. Any point along the constant speed X power plot can be chosen: Down to one microamp of total supply current for corresponding microcycles of 100 miliseconds.

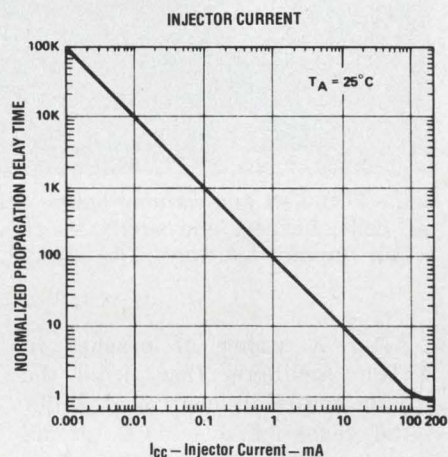

Design with the 0400 and the choice is yours: Word size. Instruction set. Power and speed. Use your imagination. The SBP0400 is just the beginning.

Engineering evaluation devices are available now. Designated X0400N, they are \$90.00 each (1-24). Order directly from your nearest TI Sales Office. A product manual accompanies purchase. For a "Mini-Spec" write Texas Instruments Incorporated, P.O. Box 5012 M/S 308, Dallas, Texas 75222.



TEXAS INSTRUMENTS
INCORPORATED

FAA pushing new electronic aids to prevent flight into the ground



Some 200 alert and warning lights and 20 or more warning bells, buzzers and sirens, as shown in this view of a Pan American Airways 747 cockpit, add a burden to

the tasks of a jet-liner pilot. Failure of the man-machine interface in the cockpit is a constant concern of the pilots, the airlines industry and the FAA.

After a string of crashes in which airliners flew into the ground while in controlled flight—the cause of over 50% of all airline crashes in the last 20 years—the Federal Aviation Administration is countering heavy criticism by pointing to electronic aids that are on the way.

Among the programs being sponsored or mandated by the FAA to prevent accidents in the approach and landing phases of flight, are these:

- A ground-proximity warning system to alert pilots that they are about to fly into the ground. This has been mandated for installation on all jetliners by Dec. 1.

- An altitude-warning system to

alert traffic controllers when a plane is below safe altitude. This is to be fully implemented by August of 1976.

- A precision approach and landing monitor, now under development at MIT's Lincoln Laboratories, Cambridge, MA.

- An independent landing monitor to give the pilot, on a cockpit TV-like display, a detailed radar picture of the terrain and runway ahead of him. This is under development by Newmax, Hauppauge, NY.

When asked why, as critics have charged, the FAA takes so long to put new equipment like this into use, David Israel, deputy associate administrator for engineering and development, says: "The FAA is a very conservative operation, unlike the military. We push technology and explore things, but slowly and with caution. We don't

build things and discard them, like the Dept. of Defense, which will try almost anything. The FAA has safety-first in mind at all times."

The FAA has been under particular fire for its delay in ordering the use of ground-proximity warning systems in the cockpit. The National Transportation Safety Board and the Airline Pilots Association have for several years recommended the installation of such a warning device.

Until Dec. 10, 1974—10 days after a Trans World Airlines jet struck a 1764-ft mountain 23 miles northeast of Dulles International Airport, killing 92 people in the worst U.S. air disaster of the year—the FAA had maintained that no proximity warning system was needed.

Alexander P. Butterfield, then Administrator of the FAA, outlined the agency's position to Con-

Jim McDermott
Eastern Editor

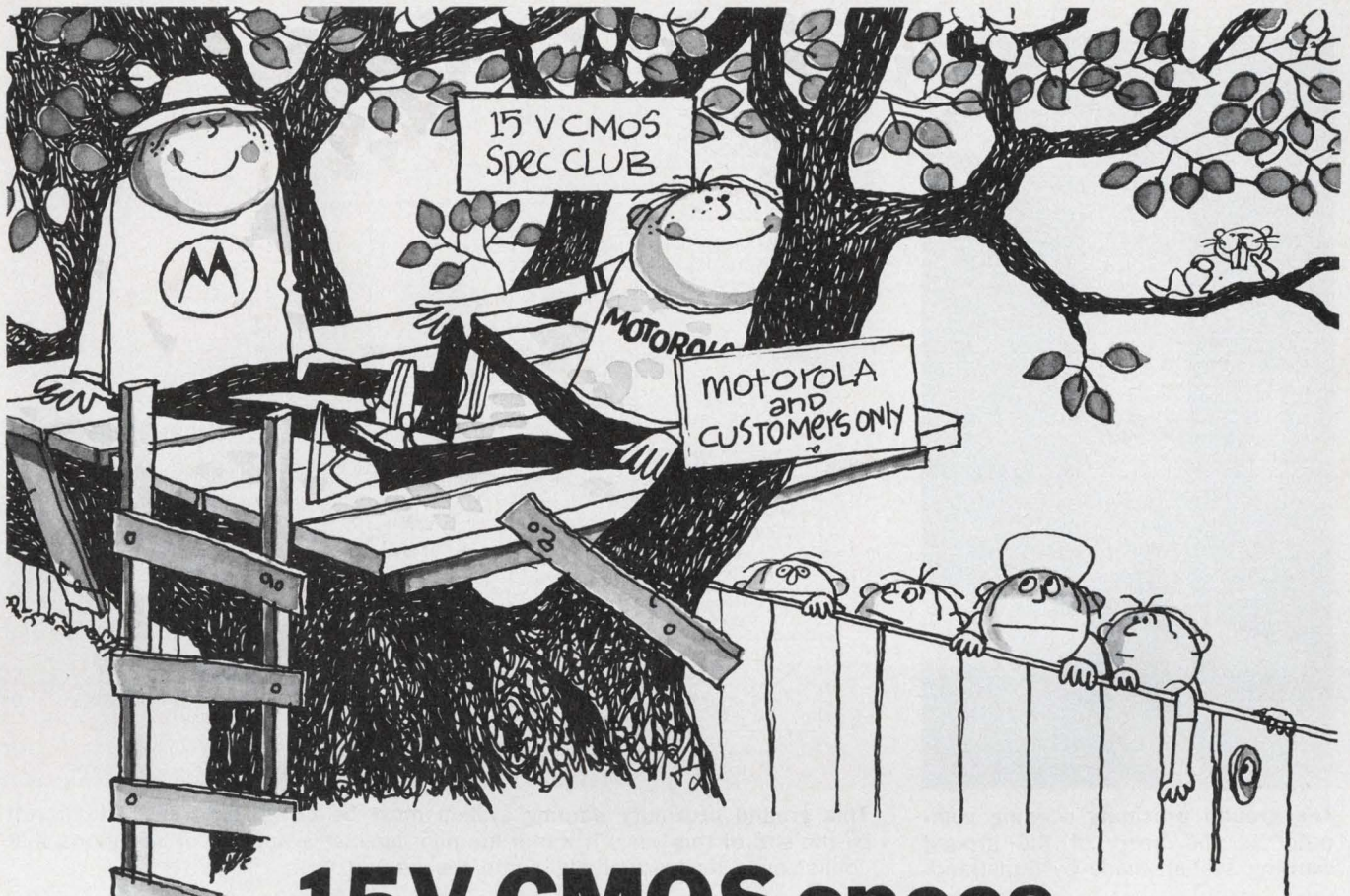

15V CMOS specs are not for everyone

Just about everybody says their CMOS operates up to 15 V, or above. They don't say *how* their CMOS operates at that level. Only Motorola's McMOS* is actually described with min and max specifications at 15 V, plus 5 V and 10 V, too.

These are specs you can design to for maximum speed and maximum noise immunity. And, the meaning of these 15 V specs extends beyond 15 V applications. McMOS can be used with full confidence at or anywhere in between maximum voltage ratings, because the designer knows exactly what to expect. Confidence like this is justified. We publish 15 V specs because that's the way we test McMOS.

No, 15 V CMOS specs are not for everyone, but they do benefit you. Only Motorola supplies them.

**Better noise immunity specs, too!
Look for our footnote.**

Recent McMOS data sheets and

Sample 15 V Specifications

(From device data for the MC14022 Octal Counter/Divider) Switching Characteristics	Symbol	V _{DD} Vdc	Min		Typ All Types	Max		Unit
			AL Device	CL/CP Device		AL Device	CL/CP Device	
Output Rise Time (C _L = 15 pF)	t _r	5.0	—	—	70	175	200	ns
t _r = (3.0 ns/pF) C _L + 25 ns		10	—	—	35	75	110	
t _r = (1.5 ns/pF) C _L + 12 ns		15	—	—	25	55	80	
Maximum Clock Frequency	PRF	5.0	2.5	2.0	5.0	—	—	MHz
		10	7.0	5.0	12	—	—	
		15	9.0	6.7	16	—	—	

the new McMOS Data Book have an important footnote to noise immunity specs. The message applies equally to all McMOS devices, and it says "Noise immunity specified for worst case conditions". Worst case conditions are, in this case, all inputs switching randomly and regardless of input conditions. The devices will have to work under those conditions in systems, so that's the way we test them.

Add superior specs to leadership in MSI, broadest functional coverage, leading-edge pricing (down with

the TTL it replaces so nicely), and formidable reliability. No wonder McMOS is the standard for new CMOS designs.

A batch of diverse useful information on McMOS has been collected into one 40-page brochure called the "McMOS Idea Book". Address your request to McMOS Idea Book, Motorola Semiconductor Products Inc., P.O. Box 20912, Phoenix, AZ 85036, or circle the reader service number.

*Trademark of Motorola Inc.



MOTOROLA McMOS
— complementary MOS for contemporary systems

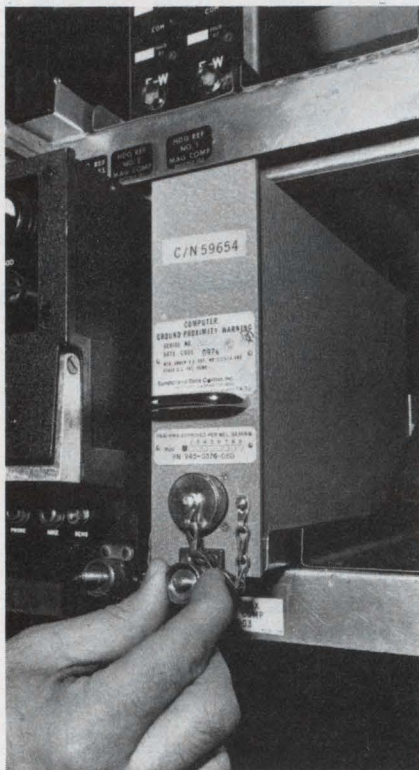

The ground proximity warning computer is the heart of the ground warning system made by Sundstrand.

gress this way: "Present instrumentation and procedures in the cockpit provide for safe and adequate terrain clearance, as long as proper flight-crew discipline is maintained and appropriate flight operation procedures are followed."

But last Dec. 10 the FAA issued a rule making it mandatory for airliners to have ground-proximity warning systems on board by Dec. 1, 1975. The system, the FAA ruled, "must operate at any height less than 2500 feet above the ground.

"It must provide both visual and aural warnings that are distinct from any other warning device," the FAA mandate went on, "and these warnings must be automatic and must operate continuously until the hazardous condition no longer exists.

"Further, these warnings must be based on the rate of descent of the aircraft, including any negative rate of climb after takeoff, in relation to the height of the aircraft above the terrain directly beneath the aircraft."

The FAA's ground-warning requirement, which was speeded up by six months, is based on a system developed around a ground-

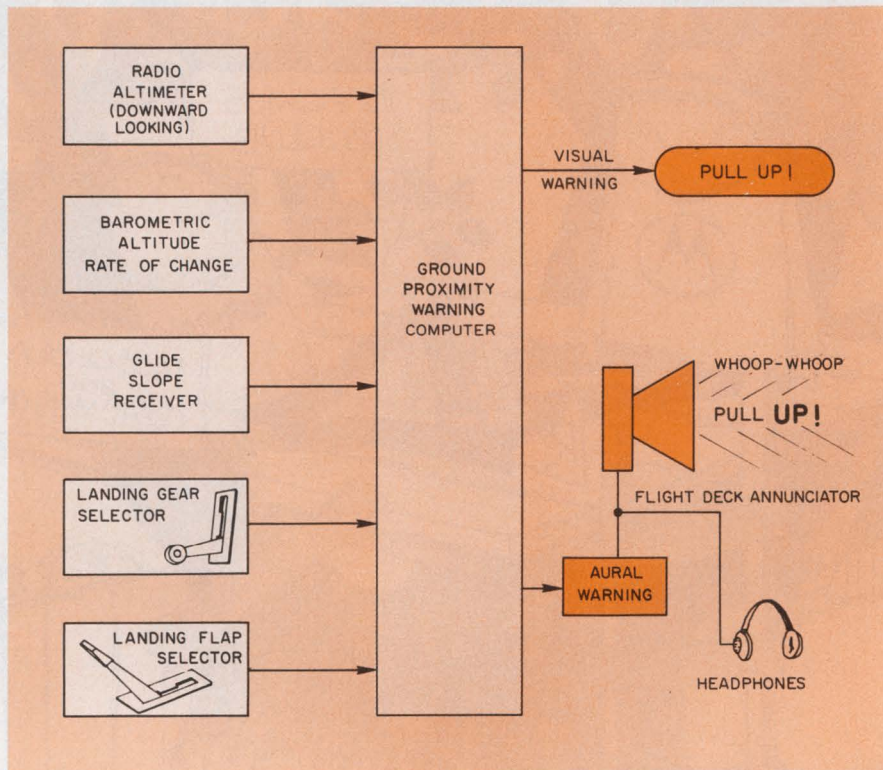

This ground proximity warning system must be on all jet transport aircraft by the end of this year. It warns the pilot against a number of situations that could cause inadvertent flight into the ground.

proximity-warning computer that Sundstrand Data Control, Redmond, WA, has been working on since early 1966. Sundstrand began producing a first-generation system for European carriers in 1970, and as of last December, it was the sole U.S. supplier of such systems.

Since then Bendix Avionics, Collins, McDonnell Douglas, Litton and Edo have developed their own versions of the system. Bendix, because of previous in-house work on such a system, is already supplying its GPW-83 system.

Ground warning device inputs

The ground-proximity-warning computers now under development or being supplied have the following inputs:

- The absolute height of the aircraft above ground, from a downward-looking radio altimeter.

- The rate of change in the altitude, from a barometric altimeter, that tells how fast the plane may be descending or sinking.

- The output of a glide-slope receiver, from which the degree of descent below the glide slope may be derived. This input is not yet

an FAA requirement. However, the Airline Pilots Association and the air carriers demand that such an input be included in the system.

- The closures of landing-gear and flap-position switches, to provide a computer generated warning to the pilot when the plane is less than 500 feet above the terrain and not preparing to land.

Heretofore the FAA had been reluctant to mandate a ground proximity warning system because there already were altitude-alert warnings and lights for both the radio altimeter and barometric altimeter in the cockpit.

According to National Transportation Safety Board investigators, a variety of circumstances can disrupt crew procedures and cause a plane to fly into the ground.

A prime outside influence is poor visibility—two out of three controlled-flight-into-ground accidents occur at night and the rest in clouds or fog. Another external contributing factor has been the interface between the pilot and the air traffic control system.

Other adverse influences in the cockpit include navigation error, misreading of instruments, visual

ANOTHER DIMENSION

has been added to the world famous family of

Simpson® 260 VOMS

the SERIES 6XL



FOR THE SPECIAL NEEDS OF THE SOLID STATE ELECTRONICS INDUSTRY

- Extra shock and drop-resistant construction, high impact, custom-molded panel and case
- Extra large viewing area with four-color (Red, Green, Blue and Black) scales, keyed to matching range panel
- 33 ranges with extra voltage, current, resistance and low-power ohms functions
- Plus — all the features of the time-honored, ever popular 260-6

260-6XL, Complete with batteries, test leads and manual **\$90.00**
 260-6XLM, with mirror scale **\$93.00**

260-6XLP WITH CIRCUIT OVERLOAD-PROTECTION

Reset pushbutton releases when overload exists. Will not reset until overload condition is eliminated.

260-6XLP, complete with batteries, test leads and manual **\$125.00**
 260-6XLPM, with mirror scale **\$128.00**



RANGES:

DC Volts	0-0.25; 0-1; 0-2.5; 0-10; 0-25; 0-100; 0-250; 0-500; 0-1000
AC Volts	0-2.5; 0-10; 0-25; 0-100; 0-250; 0-500; 0-1000;
DC Microamperes	0-50 (250 MV Drop)
DC Milliamperes	0-0.5; 0-5; 0-50; 0-500
DC Amperes	0-5 (250 MV Drop)
AC Amperes	6 ranges from 0-5 to 0-250 with optional Model 150 Amp-Clamp adapter.
DB Scale (1 MW 600 Ω Reference)	-20 to +10; -9 to +21; -1 to +29; +11 to +41; +19 to +49
Resistance (Standard Power)	Rx1 (6 Ω center scale), Rx100 (600Ω center scale), Rx1K (6000 Ω center scale), Rx10K (60,000 Ω center scale)
Resistance (Low Power)	Rx1 (20 Ω center scale) Rx10 (200 Ω center scale) Max. open circuit voltage only 100mV! Max. measuring power only 0.125 mW!
Size	5¼ x 7 x 3⅞" (133 x 178 x 79 mm)
Weight	2.5 lbs. (1.14 kg)

ACCESSORIES

Model 150 Amp-Clamp, Catalog No. 00532 complete with a No. 00533 test lead	\$29.50
30 kV DC Probe, Catalog No. 00509	\$22.00
Grip-Tip Extension Probe, Catalog No. 00118	\$ 4.75
Rigid Case, Catalog No. 00805	\$20.50
Sheath Case, Catalog No. 01818	\$16.75
5 kV DC Probe, Catalog No. 00506	\$ 5.25
5 kV AC Probe, Catalog No. 00505	\$ 5.25

Available Now at Leading Electronics and Electrical Equipment Distributors • Write for Complete Specifications



SIMPSON ELECTRIC COMPANY

853 Dundee Avenue, Elgin, Illinois 60120 • (312) 697-2260
 CABLE: SIMELCO • Telex: 72-2416
 IN CANADA: Bach-Simpson, Ltd., London, Ontario
 IN ENGLAND: Bach-Simpson (U.K.) Ltd., Wadebridge, Cornwall
 IN INDIA: Ruttonsha-Simpson Private, Ltd., Vikhroli, Bombay

INFORMATION RETRIEVAL NUMBER 19



misconceptions, vertigo, distraction and inattention.

A major problem when new electronic aids are added, however, is overloading of the man-machine interface.

Joseph Schwind, a senior staff engineer for the Airline Pilots Association, points out that whenever another alarm is added to the some 20 aural alarms and 200 warning lights already in the cockpit, the pilot has a tendency to tune out.

Many of these alarms sound much alike, and some go off routinely during a normal flight—such as the altitude-alert buzzer, which signals that a pilot has reached an assigned altitude. It sounds like the radio altimeter alarm.

The significance of the problem of getting the pilot's attention during times of distraction, confusion or overconcentration on a task is illustrated by a classic tale among pilots of aircraft with retractable landing gear. To begin with, gear-up warning horns have been on aircraft for the past 40 years. With these systems, when the throttle is pulled back to land, if the gear is still up, a horn sounds.

One day, after a pilot crashed and slid along the runway with his landing gear up, he was called to the control tower to explain to the FAA chief what happened.

"I kept calling you and telling you your gear was up," the tower controller said. "Why didn't you answer?"

"Sorry," the pilot replied, "I couldn't hear you because the horn was blowing."

Pilot can't turn it off

While the FAA and pilots and industry members interviewed by ELECTRONIC DESIGN agree that the proximity-warning system will not prevent 100% of the accidents, it should stop a substantial number because two facets of the design are a step forward in the man-machine problem.

First, the aural alarm is distinctive. It is a siren that goes "Whoop! Whoop!" and a man's voice shouts: "Pull up! Pull up!"

Another important facet of the system is this: Unlike the other alarm systems, this one cannot be readily turned off by the pilot.

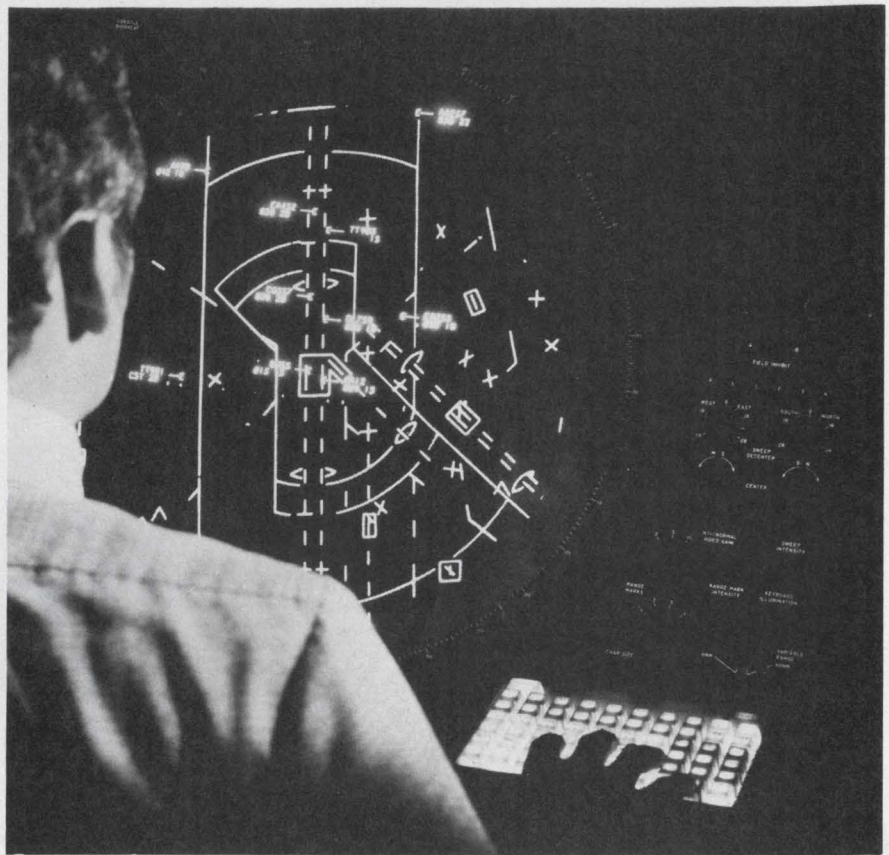

Target returns from air traffic control radars tracking aircraft are combined with computer-generated tracks and alphanumeric information in the ARTS III system. These data aid the controller in keeping air traffic separated.

The alarm must be silenced by pulling the aircraft up into a safe flight mode. Interestingly enough, if the flights are properly made through all phases, the alarm will never sound.

There are holes in the warning system, however. There are no provisions in the first generation of this equipment for a forward-looking radar input. Consequently it is not designed to warn if the aircraft is about to run into a high cliff, even though flying at a safe altitude.

Also, the system does not provide any warning during a normal landing descent. Consequently the aircraft can crash short of a runway or into flat terrain where there is no runway. And there is no warning against a normal landing descent into a body of water, such as occurred when a jet making an approach to Chicago landed, in the late 60s, in Lake Michigan.

The FAA is attacking the problem of making approaches and landings safer from other angles. One is the use of jet transport altitude readouts that appear on the

controller's display of the Automated Radar Terminal System (ARTS III).

In this system, computer-generated alphanumeric tags are assigned to aircraft being tracked (see photo).

The first line of the alphanumeric tag or data block contains the aircraft identification. For example, Trans World Airlines' Flight 70 might appear as TW70. The altitude of the aircraft, which is derived from an altitude-encoded transponder reply from the plane, is shown in the first three characters of the second lower line in the data block. For example, 7400 feet would be displayed as 074. A blank character space follows the altitude and the aircraft ground speed appears in the last three character spaces in the second line. For example, a ground speed of 250 knots would appear as 25, rounded off to the nearest 10 knots.

The altitude readout on the ARTS III scope was designed to assist the controller in identifying situations in which the pilot is below a safe altitude. However, de-

New from Potter & Brumfield



The lowest profile 3 amp relay we've ever offered!

The P&B T10 Series relay is lower than many other circuit board components. Only 0.375" high, it's ideal for high-density applications. Permits pc boards to be mounted on 0.5" centers!

T10 relays provide 0.1 to 3 ampere switching @ 30VDC. Coil ratings are 6, 12, 24, and 48VDC. Permissive make, gold-flashed silver contacts are noted for low contact bounce, long operating life. Bifurcated contacts for low level switching are available on special order.

Designed for low cost general purpose applications, the T10 is ideal for use in tele-communications, copy and reproduction machines, computer and peripheral equipment.

For additional information, contact the Potter & Brumfield sales representative or authorized distributor nearest you, or write Potter & Brumfield Division AMF Incorporated, Princeton, Indiana 47671. Telephone 812 385 5251.

AMF
Potter & Brumfield



Solving switching problems is what we're all about.

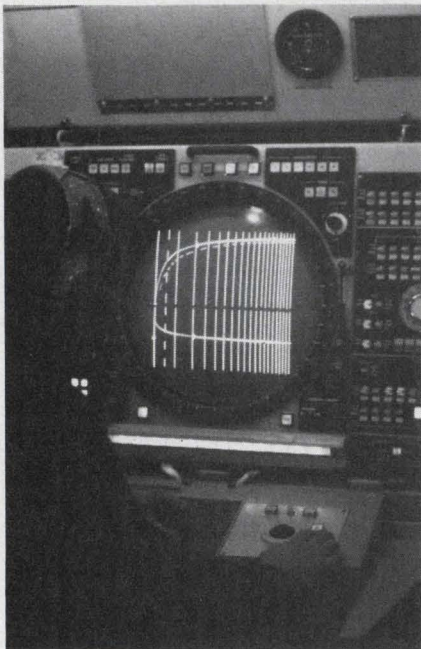

A computer-generated glide path and localizer path appear on this Raytheon TPN-25 radar scope.

spite this feature, the problem of man/machine interaction has not prevented crashes.

To overcome this flaw in the system, the FAA is adding an altitude-alerting feature, says FAA's Israel, the alert will warn controllers that a plane under surveillance is below a safe altitude.

This new safety feature has been under development for two years, Israel points out, and it will eventually give protection at 64 airports that have the ARTS III equipment.

With the altitude-alerting feature, the topography within the radar coverage is segmented into squares—or bins—and a minimum safe altitude is assigned to each square.

When the plane's encoded altitude return—a barometric encoder on the aircraft modifies its transponder return in response to a query from the traffic control radar—is lower than the designated value for its present or predicted square, the warning symbols will appear on the scope face to tag the target. In addition an aural alarm will sound, alerting the controller to the problem.

In making the approach and landing phases of flight safer during poor visibility or at night, there are two ways to go. One is to give the pilot substantially more information than he now has, such

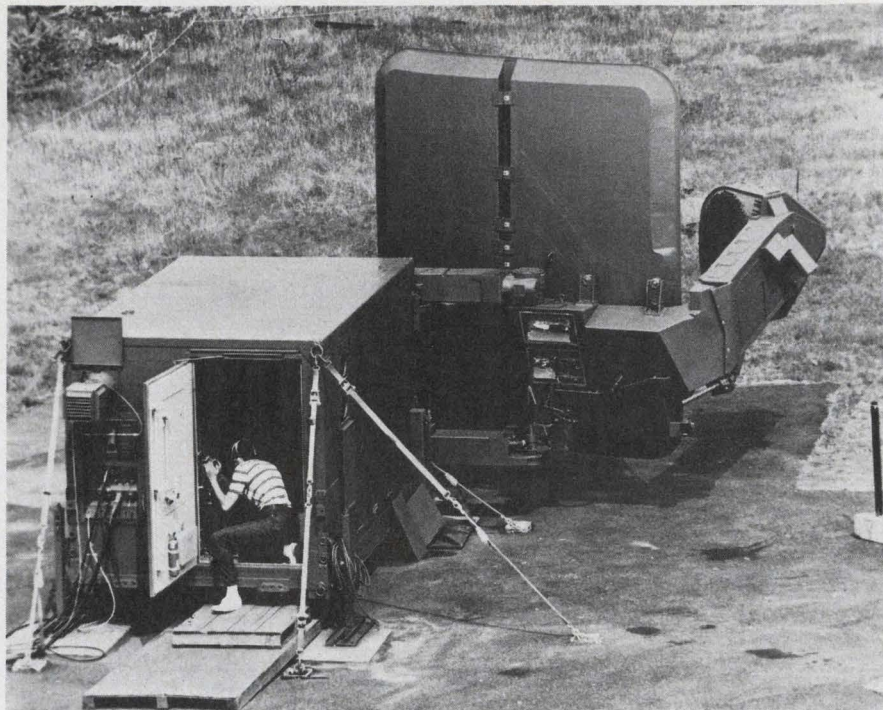

Continuous surveillance of approaching and landing aircraft out to 20 miles is provided to the ground controller by this Raytheon TPN-25 radar. The system handles more than one runway by rotating the radar antenna.

as in the form of a TV picture of the terrain and runway ahead of him. The other is to closely monitor, from the ground, the pilot's approach and descent down the glide path of the landing system, and warn him against unsafe deviations of the aircraft.

On-board phased array used

Under development as part of the FAA's all-weather landing system is the Independent Landing Monitor, which uses an on-board radar in the Ka band. Developed for the FAA under contract to the Air Force, the system uses a scanned phased array that searches ahead of the aircraft.

The radar returns are processed and converted into a TV-like display of the scene as the pilot would see it under conditions of good visibility.

Refinements of the system give the pilot the altitude with respect to the view ahead and also display obstructions in the radar field.

To monitor the aircraft from the ground, the design of a Precision Approach and Landing Monitor has been undertaken by Lincoln Laboratories, also under contract to the Air Force.

The system is comprised of a vertical antenna array that sends

out a signal to interrogate the transponder of approaching aircraft. The array then picks up the reply and processes it with a mini-computer to provide precise location of the aircraft in space.

The system also generates the distance from touchdown.

The output of the system can be fed to a control tower to directly indicate on-the-beam, high, low, left or right. And it can be tailored to indicate a dangerous situation, such as an excessive sink rate of an incoming aircraft. The controller can thus advise the pilot.

The Professional Air Traffic Controllers Association agrees that safety can be improved with a ground-monitoring system—one that will allow them to follow the plane from 15 or 20 miles out, down the glide slope to touchdown. And they point to equipment already designed and in production for the Air Force—the TPN-25.

Developed for the Air Force by the Raytheon Equipment Div., Wayland, MA, the TPN-25 is a new precision microwave radar-monitored landing system that can provide a computer-generated ILS. The antenna can be rotated to give coverage to more than one runway. The system has demonstrated outstanding performance in rain as heavy as five inches an hour. ■■



Before you buy indicator lights, check these facts:

- LITTELITES** include Cartridge Lamps and Lampholders, Subminiature and Miniature Lampholders, and Snap-Mount Plastic Lites. We offer a wider selection among these four product groups than any other single manufacturer.
- LITTELITES** are made with all new tools and molds. This plus total in-house production capabilities make Littelites the finest quality lights on the market today.
- LITTELITES** are all U.L. Recognized or Listed and Certified by C.S.A.
- LITTELITES** Snap-Mount Plastic Lites feature unique flex arms to ensure positive retention and protection against shock and vibration. Absolutely no additional mounting hardware required.
- LITTELITES** are available off-the-shelf from a nationwide network of Littelites distributors. For large volume requirements, you can depend on a fast turn-around on orders.
- Our **LITTELITES** team of R & D and sales engineers is ready to assist you at any time with standard or special applications.

Then check the source... Littelfuse

Send for your Littelites Product Guide today!

LITTELFUSE

Subsidiary of Tracor

800 E. Northwest Highway • (312) 824-1188 • Des Plaines, Illinois 60016

INFORMATION RETRIEVAL NUMBER 21

Thin Si film on metal substrate promises low-cost solar power

A new fabrication technique accidentally discovered by engineers at the Three H Corp., Wana-massa, NJ, could lead to inexpensive silicon photocells for generating solar power.

According to Robert Wright, the company's vice president of research and development, the new technique makes it possible to fabricate a square meter of photocells from about 5 grams of silicon, instead of the several hundred grams now required.

During purity tests of silane gas, which the company manufactures, epitaxial silicon films consisting of single crystals were observed on a metallic substrate. Wright believes that these single-crystal films can be deposited on metal substrates, so Schottky-barrier devices can be constructed. If satisfactory barriers can be made, it would be possible to build at low cost a solar-cell structure with high efficiency and durability.

More development needed

While the Three H Corp., which has a subsidiary in Israel, is nowhere near commercialization of this type of solar cell, Wright notes, the company is hoping to get funding from the Israeli Government to continue its investigations. What has been proved so far, he observes, is that it is possible to produce a Schottky barrier by chemical vapor-deposition of silicon on a metal. The growth of a single crystal layer that develops a rectifying junction with metal substrate is enough to convince Wright that everything else is possible. The doping and other details have yet to be developed.

The cell, Wright reports, consists of a hetero-epitaxial layer of silicon only a few microns thick

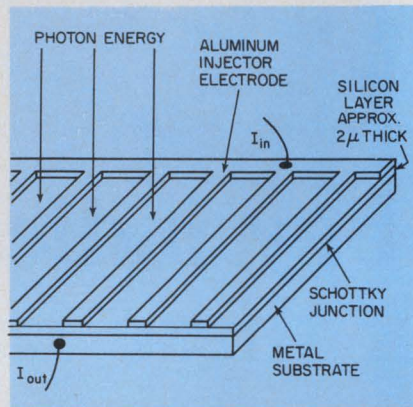

A metal substrate can be used to support thin-film solar cells, minimizing the amount of silicon needed.

and deposited onto a metal substrate. The substrate material is proprietary; he says it is metal with a coefficient of expansion that matches that of silicon.

The deposition process consists of heating the metal to close to 1000 C and causing a mixture of hydrogen and silane gases to flow past it. At this temperature, Wright says, the deposition rate approaches 1 μ per minute.

With use of a continuous-deposition process, a ribbon of metal substrate can be heated and run through a deposition chamber a meter long. Such a setup, Wright believes, would make it possible to produce solar-cell strips at the rate of one meter per minute.

After the silicon deposition, an ohmic contact grid of aluminum is evaporated onto the silicon. Over this is deposited a protective layer of silicon dioxide, topped by a phosphate glass.

"I am not trying to reinvent the silicon solar cell," Wright says. "I am just interested in coming up with a way of using only a few grams of silicon per square meter."

Current technology, he notes, requires that solar cells be fabricated on silicon strips 10 to 20 thousandths of an inch thick, so the silicon is strong enough to avoid breaking. However, if a metal substrate is used to provide support for a very thin silicon layer, the amount of high-purity silicon needed could be reduced a hundredfold. This is where the metal substrate comes in.

Use of a metal substrate has other advantages, too. The cost of processing can be reduced, because a continuous deposition process can be used. And if the current levels are not too high, the metal substrates of an array of cells can be connected, eliminating the need for an additional current bus. If large currents are a must, Wright says, one need only use a separate bus to collect the current.

1 MW per acre possible

The amount of electrical power that can be produced by solar cells is significant. It is possible to get 1 MW per acre, Wright says. That works out to about 1 kW per square meter of cell area.

A square-meter array can be composed of 40 strip cells, each providing 0.5 V, the Three H vice president continues. Connected in series, these cells would yield 20 V at 50 A. This amount of current, however, requires a separate current-collection bus. Therefore, Wright concludes, it is cheaper to cut the solar-cell strips into shorter lengths, connect the cells in series and produce higher voltages at lower currents.

The potential power available, Wright notes, is not unique to his solar cell, but is the same for all silicon units that have an efficiency of about 10%. ■■

5 reasons why the Keithley model 168 should be your number 1 digital multimeter

- 1.** Autoranging. All you do is connect the signal to the two-terminal input and push the function you want. The 168 takes it from there to save you time.
- 2.** 5 Functions. Dc voltage from $100\mu\text{V}$ to 1000V , ac voltage from $100\mu\text{V}$ to 500V , ac and dc currents from $0.1\mu\text{A}$ to 1A and resistance from $100\text{m}\Omega$ to $20\text{M}\Omega$.
- 3.** Hi-Lo Ohms. Select ranges with 1-volt drop for turning on semiconductors or 100 millivolts for keeping them off.
- 4.** Full 1-Year Guarantee. It's a Keithley, no less. And that means all specs including accuracy are guaranteed for a full year. Maintenance is easy too.
- 5.** Low Price. Only \$315 puts the Model 168 in your hands. A complete line of accessories gives the 168 even more versatility.

The Model 168 Autoranging DMM will make your job easier . . . and that should make it your number 1 choice. Send for full details or phone (216) 248-0400 for a right-away demo.

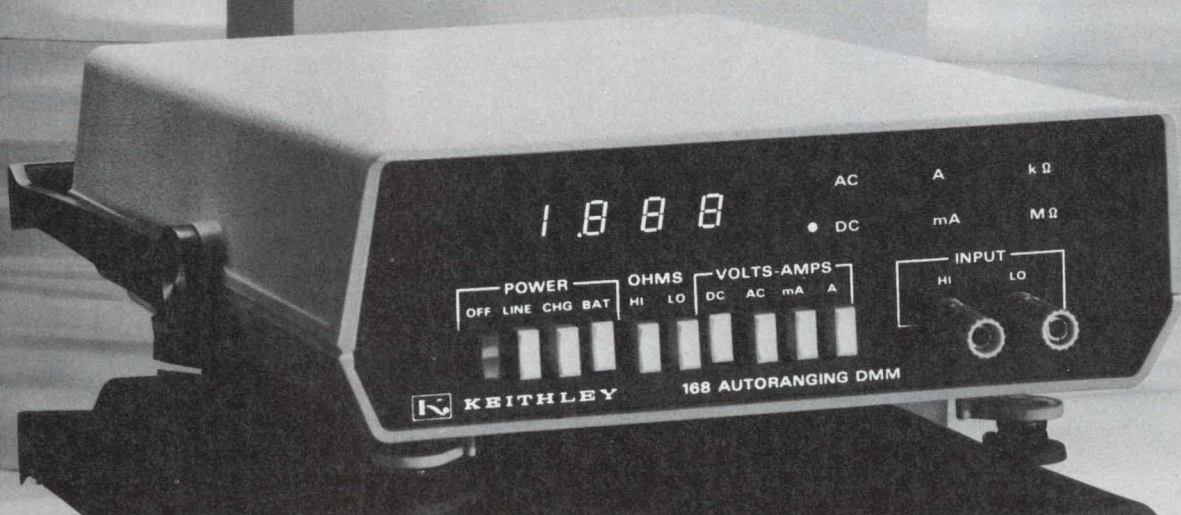

**KEITHLEY
INSTRUMENTS**
U. S. A.: 28775 AURORA ROAD, CLEVELAND, OHIO 44139
EUROPE: 14, AVENUE VILLARDIN, 1009 PULLY, SUISSE

INFORMATION RETRIEVAL NUMBER 22

Digital controls are taking wing in emerging military aircraft

Digital technology is quietly revolutionizing military avionics.

An A-7D equipped with a digital flight-control system recently made its first flight at Edwards Air Force Base in California. New

John F. Mason
Associate Editor

aircraft, such as the Navy's F-14 Tomcat, are equipped with multiple computers. And the F-4, an old fighter-plane design but still in production, is being digitized a piece at a time. ITT and Lear Siegler are competing to supply new F-4Es with a digitized navigation system, designated the

AM/ARN-101.

Why is digital technology pushing analog out? Digital technology makes an aircraft simpler and lighter, requires less power and, finally, is cheaper.

With digital control, called fly-by-wire, the aerodynamic control surfaces of an aircraft are actuated by electronic signals rather than cables. This is a distinct advantage, since cables are heavy and bulky and tend to stretch, giving rise to control problems.

Bulk is also eliminated elsewhere in an aircraft's electronic systems. "The need to design a dedicated piece of hardware for a dedicated function is rapidly becoming a thing of the past," says Ralph Asher, development manager for the Navy's Integrated Tactical Air Control System, being developed by ITT's Avionics Div. in Nutley, NJ.

"The answer," Asher explains, "is reprogrammable hardware, shared hardware. Eventually, when you need to introduce a new capability to an aircraft, such as a different pulse bandwidth, you won't put in a new black box. You just write a new program."

It's the logical way to go, Asher says. The speeds of digital measuring devices and the bandwidths of radio and identification frequencies far exceed the information content of the individual signals that the hardware must process.

"Using digital techniques, a single piece of hardware can handle any number of functions," Asher notes.

Nor is this blue-sky talk. "The technology is beginning to emerge now and should be fully operational in military aircraft in from seven to 10 years," Asher predicts. "Commercial aviation will go digital later. Manufacturers of com-

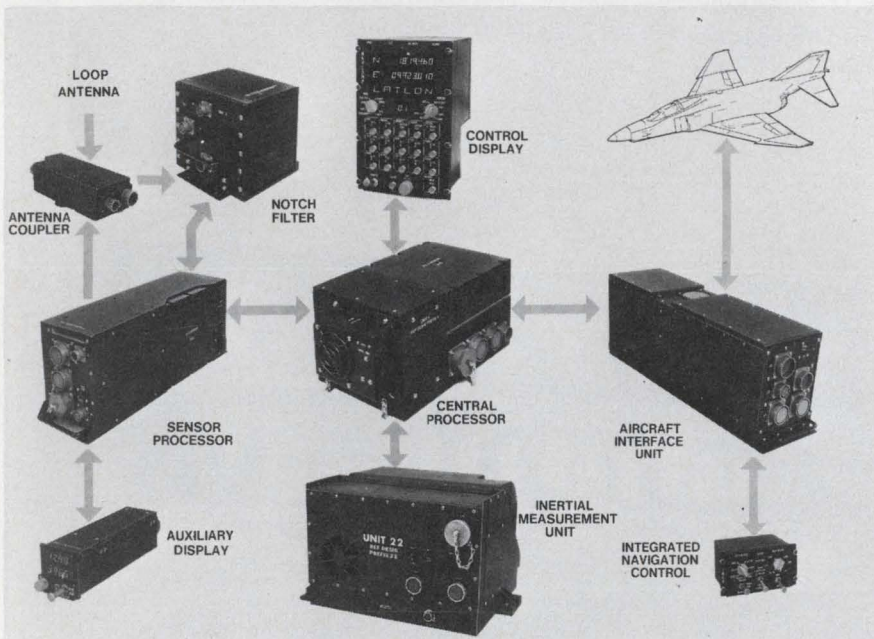

The F-4 fighter aircraft, originally an analog system, is being digitized piecemeal. New F-4Es will get a new navigation-weapons delivery system, the AN/ARN-101, which is currently undergoing competitive fly-offs. The competing systems are by Lear Siegler and ITT Avionics.

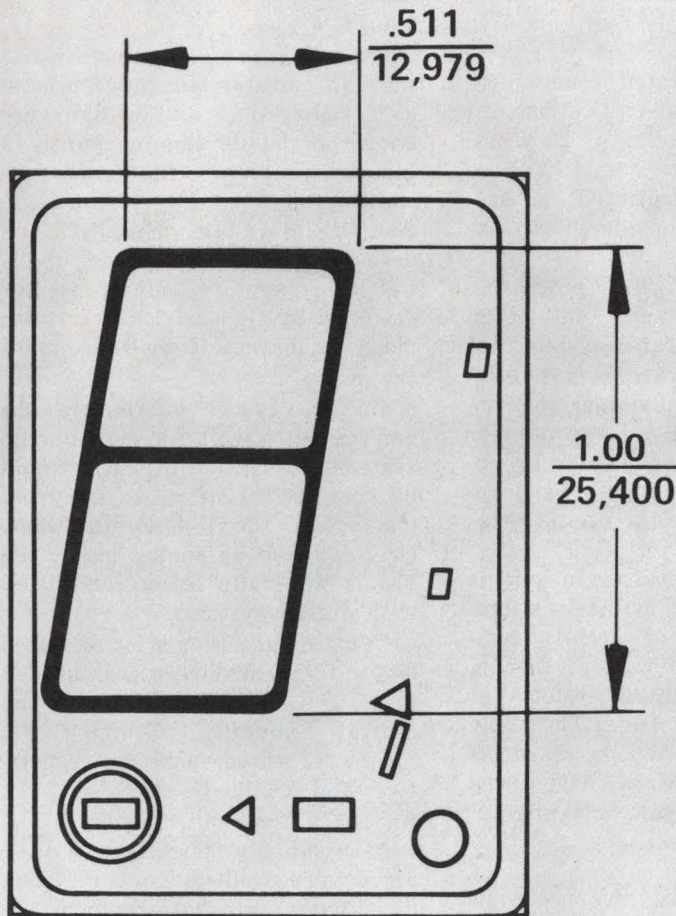

A bright, new display from Beckman



Here's the answer to your big display projects — a one-inch, seven-segment display from Beckman. Named the SP-101, it's ideal for any application requiring readability at extended distances or where styling dictates a large digit size.

- Easily read at distances up to 60 feet with 150° viewing angle...even in direct sunlight.
- Digit to digit spacing is flexible.

Minimum centerline spacing is 1.120".

- Brightness is rated between 100 and 500 footlamberts depending upon current.

- Beckman displays have crisp, clear, unbroken numerals that are easy to read; with a neon orange color (filterable to red) that's pleasing to the eye.
- Quality is assured through extensive in-process testing including 100% burn-in.
- Beckman will extend its minimum one-year warranty to match your product's warranty.
- Price is \$5.75 in 1000 unit quantity.

For additional information contact your Beckman sales office, or write, Beckman Instruments Inc., Information Displays Operations, P. O. Box 3579, Scottsdale, Arizona 85257.

Beckman[®]
INFORMATION DISPLAYS OPERATIONS

There's more eye appeal in Beckman Displays!

Thin-Trim[®] capacitors



 Tucked in the corner of this Pulsar Watch is a miniature capacitor which is used to trim the crystal. This Thin-Trim capacitor is one of our 9410 series, has an adjustment range of 7 to 45 pf., and is .200" x .200" x .050" thick. The Thin-Trim concept provides a variable device to replace fixed tuning techniques and cut-and-try methods of adjustment. Thin-Trim capacitors are available in a variety of lead configurations making them very easy to mount.

 A smaller version of the 9410 is the 9402 series with a maximum capacitance value of 25 pf. These are perfect for applications in sub-miniature circuits such as ladies electronic wrist watches and phased array MIC's.

Johanson Manufacturing Corporation,
Rockaway Valley Road., Boonton, N.J.
07005. Phone (201) 334-2676, TWX 710-
987-8367.

MANUFACTURING CORPORATION

mercial planes should begin to show interest in four or five years."

A fully integrated communications-navigation-identification system has been sought for 20 years, Asher says. But a multipurpose system with dedicated subsystems has been considered too expensive.

"Now that digital processing is powerful enough, and cheap enough, an integrated system that shares its hardware is possible," the development manager goes on. "We can replace a large number of black boxes with a few broadband antennas and broadband receivers and share the digital processing."

The digital processor in avionic systems eventually will be a microprocessor instead of a central computer, predicts Gerald P. Zemlin, director of advanced systems at ITT's Avionics Div. The only problem right now, he says, is that microprocessors have been geared to the commercial market and don't meet military specifications.

"And," he adds, "we need microprocessors in military aircraft. For one thing, we could use more intelligent displays in the cockpit."

There are interactive computer terminals in the AN/ARN-101 that ITT has developed for the F-4E, but they are tied in to the central computer. "It would be better to have this feature in the display itself," Zemlin says.

A military microprocessor

Rockwell International's Autonetics Group, Anaheim, CA, has announced a militarized microprocessor, the μ P-16, to be ready for delivery in the fall. The parallel processor and associated memory chips use p-channel MOS technology. The μ P-16 provides a data word length of 16 bits, including sign, and 8-bit and 16-bit instruction wordlengths. A ROM has a capacity of 8192 8-bit words, and RAM can store 512 16-bit words. The memory cycle time is 2.5 μ s. The processor can address 65,536 8-bit instruction words or 4096 16-bit data words. The 72-instruction repertoire features half and full words and a 5- μ s execution time for most instruc-

tions. The multiplication time is 100 μ s.

Other companies are also working on militarized microprocessors. Motorola and TRW are known to be developing jointly a bipolar processor that will use emitter-follower-logic technology. And Solid State Scientific is developing a militarized 8-bit CMOS-on-sapphire microprocessor designed by General Electric, with plans to market it by the end of the year.

Militarized microprocessors don't have to wait for new avionic systems to be built. They would be very useful in retrofitting old planes like the F-4, Zemlin says. Originally an all-analog plane, the F-4 is gradually being retrofitted with digital systems.

"This means that a lot of a-to-d and d-to-a converters are needed to tie the subsystems in with the central computer," Zemlin says. "Many of these tasks are repetitive and could be handled very well by a read-only memory."

A read-only memory would serve very well to convert loran coordinates into geographical coordinates, Zemlin suggests.

The read-only memory has its drawbacks, of course. When the user wants to modify his avionics package himself, he can't do it.

Zemlin says that more work should go into read-write, or random-access, memories.

"Semiconductor memories are volatile and, like it or not, aircraft are subject to power glitches," he notes. "As a result, we are still using magnetic core memories, plated wires and magnetic thin films."

The MNOS memory offers the first breakthrough in a monolithic solid-state, electrically alterable, nondestructive, read-out memory, Zemlin says, "but it's not available yet for military systems."

The Navy's F-14 Tomcat fighter is a good example of the trend away from a central control computer toward distributed computers. The Tomcat system requires six computers, each designed for a different task. The arrangement permits both flexibility and software economies, says A. V. Barnes of Teledyne Systems, Northridge, CA, which built two of the plane's computers.

But there are drawbacks to having so many different computers, Barnes points out. The system user is faced with different software and hardware designs, which lead to duplicate efforts and high logistics costs. Special interfaces are required, each with unique conversions.

Alternatives to multicomputers

Several alternatives have been offered to reduce these drawbacks. One suggestion: Use a common high-level language with a special translator to accommodate each special processor. Another: Use a common data bus for all units.

But "each of these suggestions attacks the symptom rather than the fault," Barnes observes. To remove the actual drawbacks of a distributed computer system, he says, a common universal digital computer element should be distributed among various functions.

With this element, economies can be realized: in hardware, by use of invariant processors and memories; in software, by use of common support software and documentation; and in logistics, by use of smaller spares inventory, fewer special test equipment and the simplest change control.

The Army is also looking at digital systems for its future aircraft. According to J. S. Dasaro, engineer in the Army Avionics Laboratory, Fort Monmouth, NJ, the aircraft will probably use a centralized multiplexed communications control system rather than the present arrangement, which consists of up to four communications radios plus interphone control boxes scattered throughout the cockpit control panel area.

Since only switching and control functions are included in the operation of such a multiplexed communications control subsystem, a Class 1 type computer/processor can be used. This enables easy-to-change software routines to replace complex and costly hard-wired logic functions. And by partitioning stored program memory and interfacing circuitry onto separate circuit cards or modules for each equipment unit, each aircraft's communications capability can be tailored to specific missions. ■■

DESIGN-IN ULTRA LOW ON RESISTANCE

WITH OUR COMPLEMENTS

4-OHM PNP and NPN Switching Transistors.

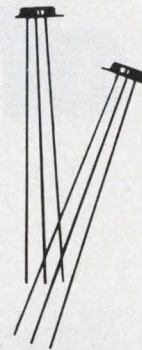

Samples on Request:
Call your Crystalonics Rep.



ULTRA LOW r_{ec} (sat)
SILICON EPITAXIAL JUNCTION
PNP/NPN SWITCHING TRANSISTORS

2N3677
2N5066

- Complementary Types 2N3677(PNP) 2N5066(NPN)
- r_{ec} (sat) 4 Ohms Typical
- LOW C_{eb}
- LOW LEAKAGE
- HIGH BV_{EBO}

ELECTRICAL DATA ABSOLUTE MAXIMUM RATINGS

PARAMETER	SYMBOL	2N3677/2N5066	UNITS
Collector to Emitter Voltage	BV_{CES}	20	Volts
Emitter to Collector Voltage	BV_{ECS}	20	Volts
Collector to Base Voltage	BV_{CBO}	30	Volts
Emitter to Base Voltage	BV_{EBO}	30	Volts
Collector Current	I_C	100	mA
Power Dissipation	P_C	400	mW
Derating Factor	D_F	2.3	mW/°C
Junction Temperature (operating and storage)	T_J	-65°C to +200°C	
Lead Temperature (1/16" ± 1/32" from case)	T_L	240°C for 10 sec.	

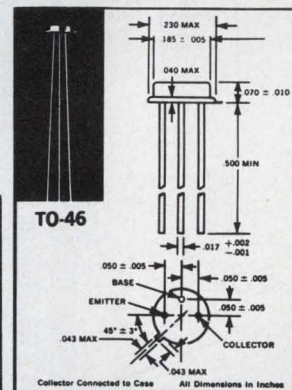

ELECTRICAL CHARACTERISTICS: $T_J = 25^\circ\text{C}$ (UNLESS OTHERWISE STATED)

PARAMETER	SYMBOL	CONDITION	2N3677/2N5066			UNITS
			Min.	Typ.	Max.	
Collector To Base Leakage	I_{CBO}	$V_{CB} = V_{CB} \text{MAX.}$	—	0.5	1.0	nA
Emitter to Base Leakage	I_{EBO}	$V_{EB} = V_{EB} \text{MAX.}$	—	0.5	1.0	nA
Collector To Base Leakage	I_{CBO}	$V_{CB} = V_{CB} \text{MAX.}$ (TEMP = 100°C)	—	30	100	nA
Emitter To Base Leakage	I_{EBO}	$V_{EB} = V_{EB} \text{MAX.}$ (TEMP = 100°C)	—	30	100	nA
Offset Voltage	V_O	$I_B = 1 \text{mA}$ $I_E = 0$	—	0.7	1.0	mV
DC Common Collector Forward Current Transfer Ratio	h_{FC}	$V_{EC} = 6 \text{V}$ $I_E = 1 \text{mA}$	4	8	—	—
High Frequency Current Gain	h_{FE}	$V_{CE} = 6 \text{V}, I_C = 1 \text{mA}$ $f = 1 \text{MC}$	5	10	—	—
Inverted Dynamic Saturation Resistance	$r_{ec}(\text{sat})$	$I_C = 0.1 \text{mA}$ $I_E = 1.0 \text{mA}$ $f = 1 \text{KHz}$	—	4	8	Ohms
Collector To Base Capacitance	C_{ob}	$V_{CB} = 6 \text{V}, I_C = 1 \text{mA}, f = 159 \text{KHz}$	—	6	10	pf
Emitter To Base Capacitance	C_{eb}	$V_{EB} = 6 \text{V}, I_E = 0, f = 159 \text{KHz}$	—	5	6	pf



TELEDYNE
CRYSTALONICS

147 Sherman Street, Cambridge, Mass. 02140
Tel: (617) 491-1670 • TWX: 710-320-1196

- | | | | | |
|----------------|----------------|----------------|----------------|----------------|
| (201) 935-5454 | (213) 822-8977 | (305) 941-5544 | (416) 661-2494 | (612) 488-0201 |
| (206) 747-9424 | (215) 667-0990 | (312) 358-8900 | (513) 299-4144 | (617) 731-0858 |
| (213) 431-1101 | (219) 489-4447 | (315) 458-4775 | (514) 341-5207 | (716) 342-1413 |
| (213) 821-7958 | (301) 340-2130 | (415) 592-8333 | (516) 593-2628 | (803) 268-1125 |
| | (305) 831-8688 | | (602) 959-6060 | |

Now! A better answer of connecting PCB's

Here's how to change your
from this...

to this...with

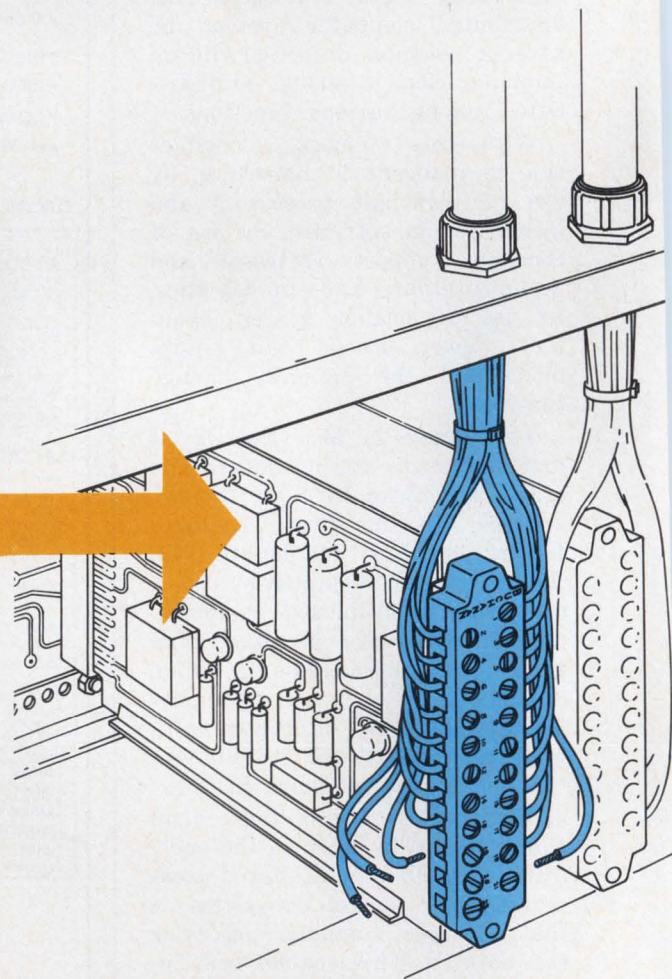
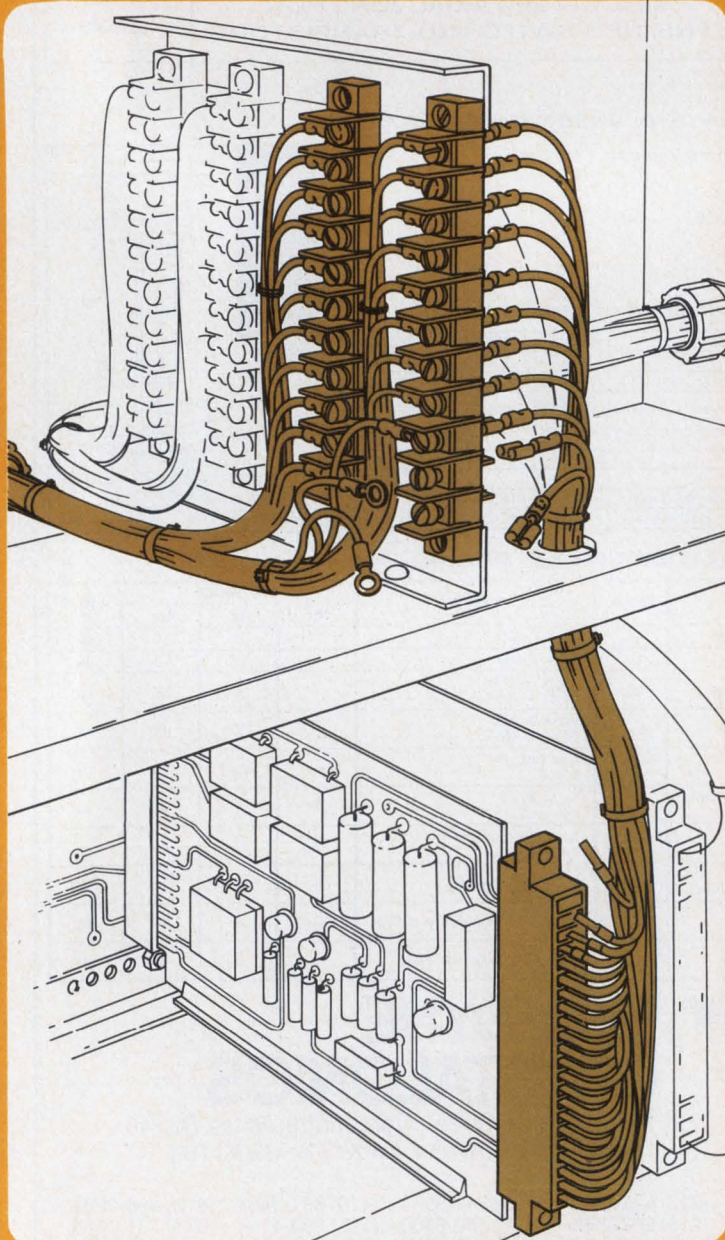

Just one Buchanan
Printed Circuit Board Connector replaces
the two barrier strips, the edge card
connector, the double wiring, and the 110
costly terminations shown at left.
Result: LTIC (Lower Total Installed Cost)!

to the problem to the outside world! system wiring

Buchanan[®] PC Board Connectors

- Accepts unterminated wires from 12 through 30 AWG
- Saves up to 5 connection points per circuit
- Eliminates barrier strips & terminal blocks
- Available for inside or through-the-panel wiring
- Saves time, money and cabinet space

If you're building control panels or other electrical/electronic equipment that uses printed circuit boards, here's a new PCB connector that's sure to give you LTIC (Lower Total Installed Cost)!

The new Buchanan connector eliminates hybrid interfaces between electronic circuitry and electrical connections. It replaces terminal blocks and barrier strips and the costly wiring between them and internal electronics. Actually saves you up to 5 separate connection points per circuit!

The unique screw terminals accommodate unterminated solid or stranded wires, #30 through #12 AWG. Models are available with .156" or .200" (.508 cm) centerlines; for up to 43 10-Amp circuits; and for inside panel or through-the-panel mounting. Many carry UL component recognition for field wiring.

For complete engineering and ordering information, use the Reader Service Card. Or, call one of our Factory Regional Offices shown below. They'll also be happy to talk to you about special configurations.

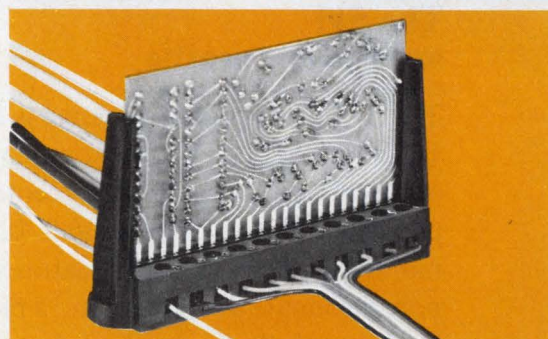
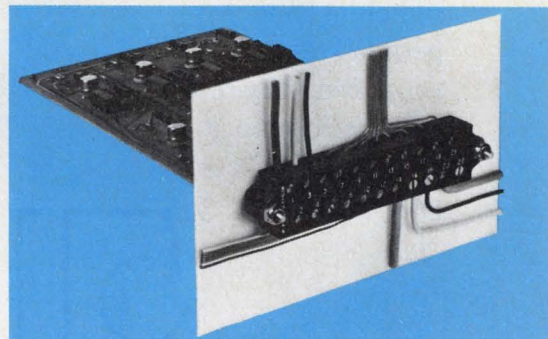
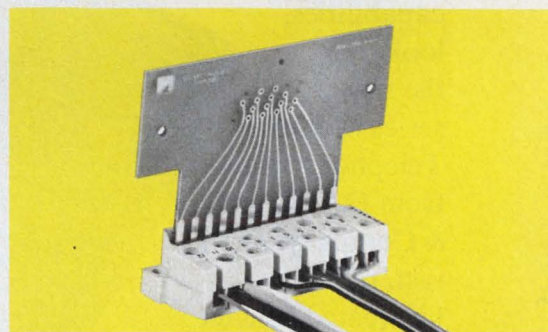

Models available for surface or through-the-panel mounting, with or without card guides and keys.



**CONTROL PRODUCTS
DIVISION**

Amerace Corporation
Control Products Division
Union, New Jersey

New LOW PROFILE TELEPHONE RELAY from CLARE

If you have pcb designs calling for low level to 2 ampere switching capabilities, look over the new 511 series Modern Telephone relays from C. P. Clare & Company. With fast, reliable bifurcated contact switching, and permissive-make actuation, they're a high performance relay in a low profile package.

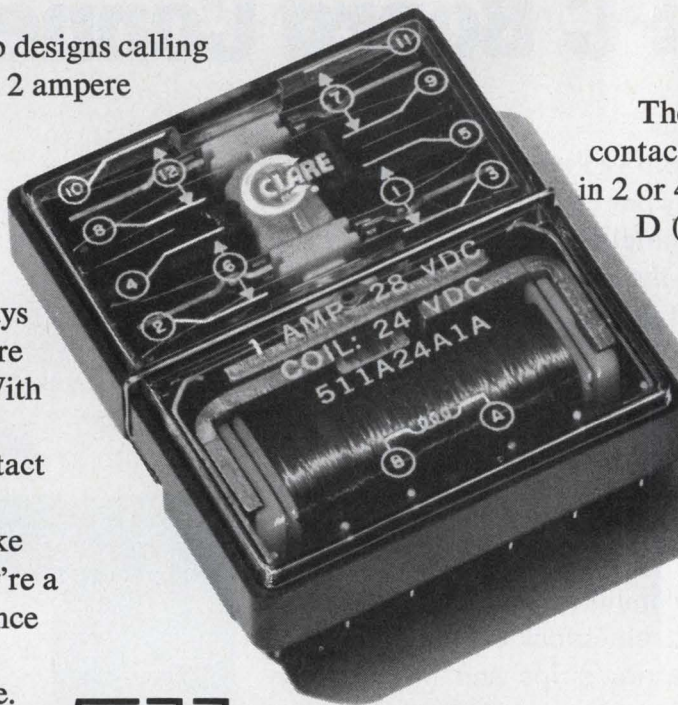

511

The 511 keeps a low profile

The 511's low profile package is only 0.35" (8.9mm) high . . . allowing pcb mounting on standard 0.5" (12.7mm) centers. On the pcb itself, there's convenient 0.100" grid mounting. The enclosure features an amber polycarbonate dust cover and a molded base housing of thermosetting electrical grade diallylphthalate. And with molded-in terminal pins, this sturdy low profile package reliably protects the inside of the relay during wave soldering and partial immersion cleaning operations.

The 511 fits right in

The standard 511 bifurcated contact arrangement is provided in 2 or 4 Form C packages. Form D (make-before-break), and C/D combinations, are optional. And the 511 contact rating boasts a long life of up to 50 million operations depending on current and voltage (Current: low level to 2A . . . Coil: 6, 12, 24 and 48 Vdc).

Want to know more?

The 511 series offers an off-impedance insulation resistance of 50,000 megohms minimum at 500 Vdc. Operating and storage temperatures range from -45°C to $+65^{\circ}\text{C}$. They're in stock, ready for shipment. So contact your nearest Clare sales office or distributor for specification data. Or for more extensive application information, contact G. A. Larsen, C. P. Clare & Company, 3101 W. Pratt Avenue, Chicago, Illinois 60645. Or phone: (312) 262-7700.

QUALITY, SERVICE, RELIABILITY

C. P. CLARE & COMPANY a subsidiary of
GENERAL INSTRUMENT CORPORATION





At last! Systems capability in a low cost DMM.

Buy it now... or add it later.

What's so great about systems capability? Well, did you ever want to put your 5½ digit bench meter into a system? Don't bet you won't want to tomorrow. Systron/Donner's Model 7215 digital multimeter lets you buy a programming option now or add it later...a simple plug-in board does the trick. Model 7215 is an autoranging DMM featuring:

- complete system programming (optional)
- ACCU-OHM lead compensation
- large in-line/in-plane display
- 16 ranges of DC volts, AC volts, and ohms are standard
- guarded input.

Here's how to get details on the industry's first low cost DMM with systems capability: In the United States, give your local Scientific Devices office a call or contact us in Concord. Abroad, contact Systron-Donner GmbH, Munich; Systron-Donner Ltd., Leamington Spa, U.K.; Systron-Donner S.A., Paris (Le Port Marly); Systron-Donner Pty. Ltd., Melbourne.

1 Systron Drive / Concord, CA 94518 / Phone (415) 676-5000

SYSTRON  **DONNER**

INFORMATION RETRIEVAL NUMBER 28

what's a **BIPOLAR** power supply?

The world is full of power supplies that can do this:

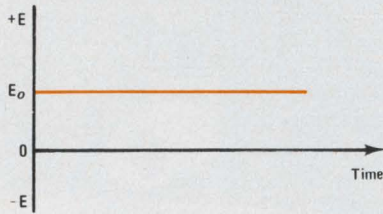

Even programmable ones that can do this:

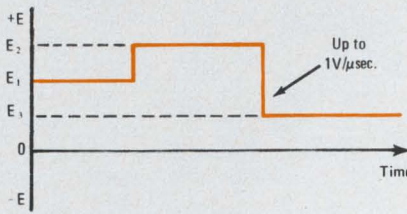

Or this:

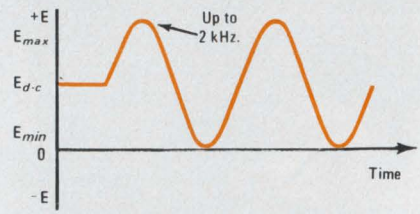

Only a **BIPOLAR OPERATIONAL POWER** supply (we call 'em BOP) will let you do things like this:

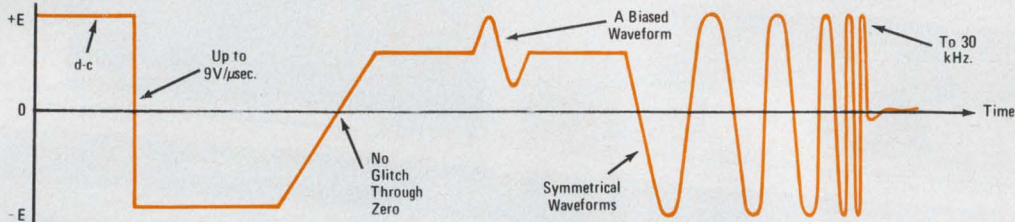

We make a bunch of different BOP's:

- +15V to -15V @ 20 amperes
- +36V to -36V @ 1.5 amperes
- +36V to -36V @ 5.0 amperes
- +72V to -72V @ 1.5 amperes
- +72V to -72V @ 5.0 amperes

The $\pm 36V$ BOP's are illustrated in metered and modular styles.
The $\pm 15V$ and both $\pm 72V$ models are double width and rack-mount without adapters.

The "OPERATIONAL" part of the BOP means that you use 'em like giant OP-Amps:

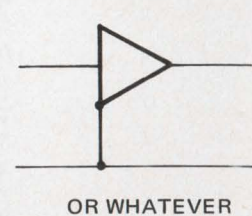
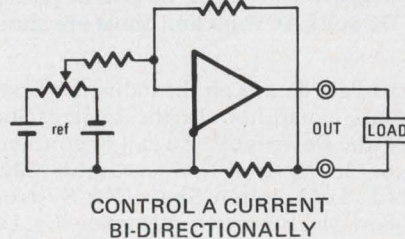
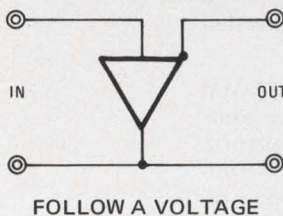
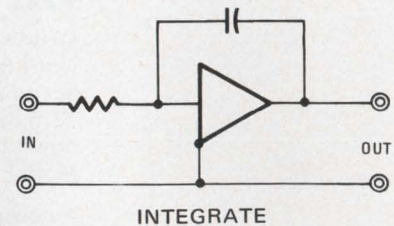
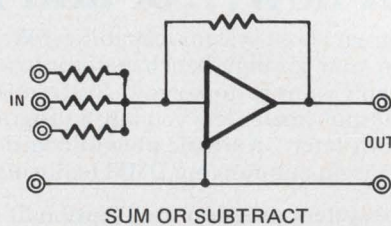
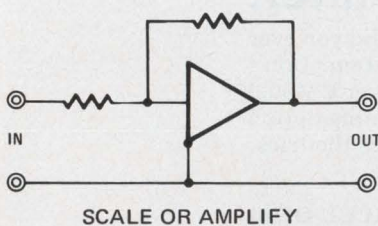

If you think you can use one of our BOP's, call us for complete specifications, or write Dept. EC-05



Washington Report

Military tells Congress of austere plans

In an effort to stave off crippling budget cuts, Defense Dept. officials are revealing to Congress some planning data that in other years would have been classified.

Leonard Sullivan Jr., Assistant Secretary of Defense for Program Analysis and Evaluation, recently appeared before the House Armed Services Committee and explained how the department is developing an austere five-year plan. The department isn't talking about replacing equipment until its useful life has been exhausted, Sullivan advised. This means 20 years for helicopters, 25 years for tactical aircraft and nuclear submarines, 30 years for patrol aircraft, bombers and first-line ships, 35 years for transport and tanker aircraft, and 40 years for support ships.

Sullivan says that a "real growth" (growth over inflation) of 2% per year is needed to stay even on military modernization and readiness and that if there is no increase in real growth, the Defense Dept. must begin to base its planning on recognized weaknesses. The force the department wants as a minimum is 16 active and eight reserve Army divisions, 26 active and 10 reserve tactical Air Force fighter wings, a 500-to-600-ship Navy plus the present Marine Corps, and upgraded mobility and strategic forces.

China opens its door to EIA

After several years of negotiations with the Red Chinese, the Electronic Industries Association has been invited to send a delegation of communications equipment manufacturers to Peking. A 10-man delegation, announced EIA President V. J. Adduci, plans to arrive in the People's Republic of China on July 27 for discussions on areas of marketing opportunity and mutual interest.

A dormant threat: Materials shortages

While materials shortages have become less noticeable in recent months, experts don't think the problem has gone away permanently, despite apparent White House inaction.

One senator who objects to the lack of concern is Sen. Gaylord Nelson (D.-WI), who has introduced a bill to set up a National Resources and Materials Information Act. It would establish a permanent information-gathering system to give planners the data for decisions as more and more nations scramble for resources.

Last year Congress passed legislation creating a National Commission on Supplies and Shortages to study the problem and make recommenda-

tions by last March 1. When that date rolled around, it had to be extended to June 30 because the White House had taken no action.

The President was to name four Administration officials and five private citizens nine months ago to join with four congressmen on a 13-member commission. Thus far he hasn't announced his nominees, and there still is no evident sense of urgency in the White House. But with indications that the economy will start revving up by this fall, the problem may once again become acute.

Ban on calculators aboard airliners remains

Although the rule has never been strictly enforced, it has always been verboten to use portable electronic calculators on airliners in flight. Now the Federal Aviation Administration, which has been thinking since December, 1972, of making their use legal, has backed away from a decision again. This despite the fact that even the pilots themselves want to use the devices.

The FAA, which has been under sharp criticism because of recent airliner crashes, says the calculators may cause "possible" electromagnetic interference with on-board navigation equipment. Documented incidents, it contends, have shown some types of calculators have interfered with automatic direction finding and omni-range gear.

The agency admits the test results are inconclusive and vary with types of aircraft. But since it is unable to reach a conclusion on present calculators or to predict the effects of a flood of cheap devices that are expected to be marketed in the future, the ban remains.

Capital Capsules: The National Aeronautics and Space Administration is **looking at the insect world in a search for new ways to increase the efficiency of solar radiation converters.** Insects can communicate by the transmission and reception of infrared and other electromagnetic radiation. The University of Florida has a \$20,000 contract to explore the concept, called Electromagnetic Wave Energy Conversion. A possible civilian spin-off is an electronic means of insect control. . . . The Pacific region of the nation **continues to get a healthy share of the Defense Dept.'s spending on electronic and communications equipment,** says the Air Force Systems Command. It puts the total at 34%. And California is still the leader in drawing Research, Development, Test and Evaluation dollars—\$1.89 billion, or more than the next four states combined. . . . On the quest for a 100-million-bit solid-state data recorder, NASA says that Rockwell International **has developed a 102,400-bit single-chip memory element, which it believes is the largest integrated memory element ever fabricated.** . . . A possible companion to the Air Force's "heads up" display is a new helmet visor system. The heads-up system displays flight data on the windscreens of A-7 and F-15 aircraft. **The same data would now be displayed with holographic techniques on the visor of the pilot. An obvious advantage is that the data would be visible at all times—heads up, down or around.** . . . Sen. Barry Goldwater, a strong backer of the AWACS, airborne warning and control system, advises his fellow senators that in a meeting of the NATO Conference of National Armament Directors, **AWACS was designated an urgent first-priority.** The NATO directors intend to support a contract-definition phase for the program. Last month the Air Force took the test-bed Boeing E-3A aircraft to Europe for extensive demonstration flights.

If you can't bring your troubleshooting into your lab, roll Tektronix TM 500 to the problem.

- digital multimeters
- counters
- generators
- amplifiers
- power supplies
- oscilloscopes
- a blank plug-in for your own circuitry
- and more

The TEKTRONIX Rollabout Configuration of TM 500 modular instruments helps you conveniently take your test and measurement "laboratory" right to the problem . . . whether it's routine maintenance, calibration, repairs, QC or production testing, or whatever. TEKTRONIX TM 500 modular instruments are designed to fulfill your needs in such widely divergent areas as: computer circuitry and data handling equipment, numerically controlled machines, laboratory instrumentation, communications equipment, and medical instrumentation.

The modular Rollabout Configuration provides up to six operating test and measurement instruments, which you can tailor from a growing line of 29, plus the TEKTRONIX portable or plug-in oscilloscope of your choice . . . all on a SCOPE-MOBILE[®] cart. TM 500 modular instruments can work together through a common interface circuit board within their mainframe enclosures, and they can also function totally independently. Some are general purpose, such as DMMs, some are highly specialized, such as those for oscilloscope calibration. They comprise a test and measurement system that is difficult to duplicate with "monolithic" instruments.

The TM 500 Product Line is a growing, compatible family of 29 plug-in modular instruments, accessories, and one,

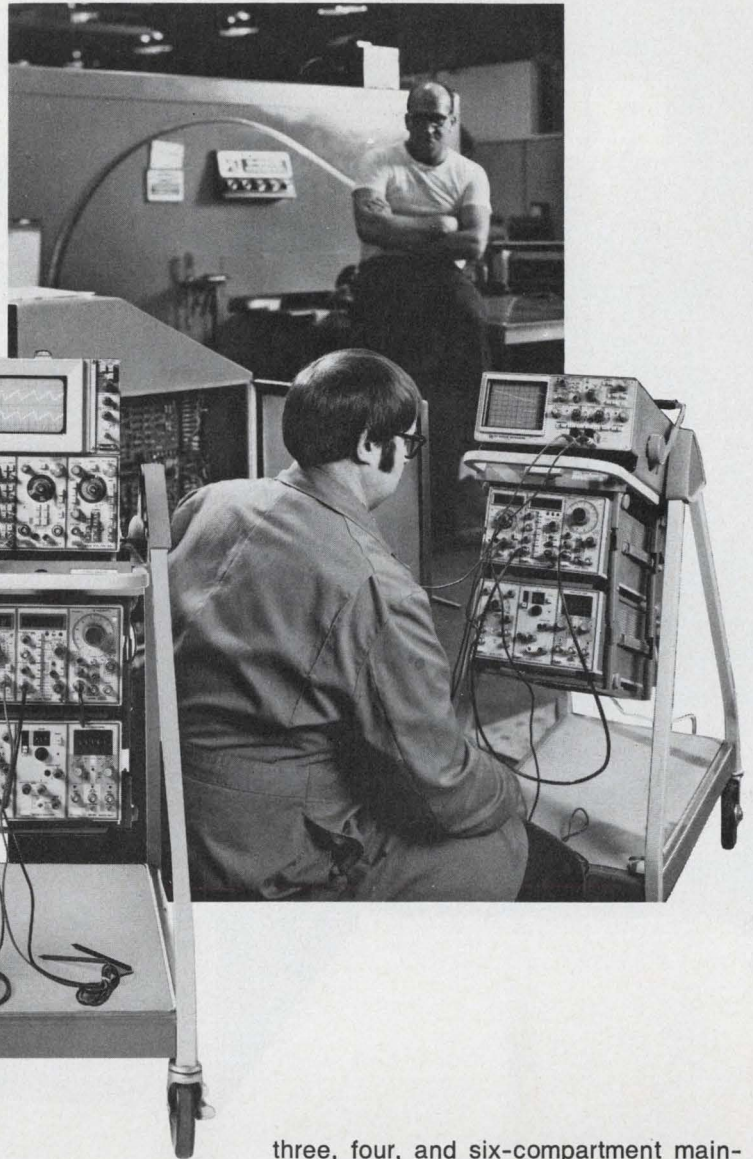

three, four, and six-compartment mainframes providing the common power supply. The modular Rollabout Configuration can accommodate two TM 503, 3-compartment mainframes. Select the plug-ins from 11 signal sources, 5 counters, 2 digital multimeters, 5 power supplies, 3 signal processors, 1 oscilloscope, and an X-Y monitor. There's also a blank plug-in kit to make it more convenient for you to assemble the specialized circuits you require. A TM 500 modular Rollabout Configuration lets you take the instrumentation you need where you need it.

Find out what TM 500 instrumentation can do for you. Send for the TM 500 Booklet A-3072 with full specifications and suggested selections of instruments for typical applications. Or contact your local Tektronix Field Engineer for a demonstration of how TM 500 instruments can solve your needs. Write to Tektronix, Inc., P.O. Box 500, Beaverton, Oregon 97077. In Europe write Tektronix Limited, P.O. Box 36, St. Peter Port, Guernsey, Channel Islands.



TEKTRONIX[®]
committed to
technical excellence



The perfect RF/DC millivoltmeter



Now for Only \$950 Measure Any RF/DC Voltage

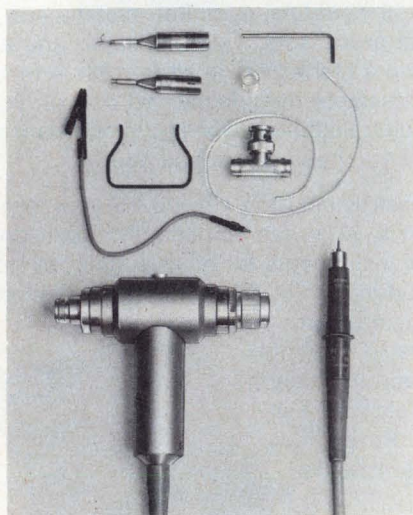

A complete line of accessories for both AC & DC voltages and current measurements are available.



FEATURES:

- The Rohde & Schwarz Model URV measures DC and RF from 1 kHz to 1.6 GHz
- Wide Measuring Range — 50 μ V to 1050V (30 kV-DC)
- True RMS and Peak value measurements
- Floating input eliminates ground loops, hum, pick-up ... and it provides added safety
- Measure superimposed AC/DC voltages
- Linear DC recorder output
- Low VSWR — 1.02
- Measure 4 terminal networks rapidly and easily with switched dual probe inputs

Call or write for more information or a demonstration.



World Leader in Test Inst. & Communications for Over 40 Years

ROHDE & SCHWARZ

14 Gloria Lane, Fairfield, N.J. 07006 ■ (201) 575-0750 ■ Telex 133310

INFORMATION RETRIEVAL NUMBER 31

Growing up

When you look at the history of our industry you get the feeling the old sage was right when he said, "We grow old too fast and smart too slow." We seem to make the same mistakes over and over again. As an example, when inventory levels are reaching a peak, we seem to be furiously building plant capacity. And when inventory levels bottom out, we keep cutting back.

But every once in a while we see something encouraging—something that suggests we may be growing up, not just growing old. Maybe I'm attaching too much significance to it. But at the IEEE Intercon Show I was intrigued to find, manning one booth, representatives of Advanced Micro Devices, Fairchild Semiconductor, Intersil, Motorola, RCA and Signetics. They were all pitching microprocessors or support circuits at the booth of Schweber Electronics, one of industry's leading distributors.

Since microprocessors are the most dramatic development of recent years, it's not surprising that the Schweber booth drew swarms of engineers, especially since Schweber provided an arena (that may not be the best word) for rather fierce competitors to talk about their wares. One passer-by swore to me that he heard the Motorola man recommend an RCA circuit for one fellow's application—or it may have been the other way around. And I'm told the competitors spelled each other out during lunch and coffee-breaks.

That kind of "let's help the customer even if we lose a sale" attitude is not exactly widespread in our industry. Maybe it should be. Maybe Schweber's innovative approach to helping people at a trade show has opened the door to greater customer service.

Or maybe the situation was made possible by a unique set of circumstances. The microprocessor is still in its infancy. Nobody really knows yet how it's going to take off. When the product matures and most vendors offer directly competitive units, the competition may turn keen again, and vendors may return to the "normal" mode of slitting each other's throats. I hope not. I hope we can learn that, in the long run, we don't boost our business by knifing our competitors but, rather, by offering greatest value to our customers.



A handwritten signature in dark ink that reads "George Rostky". The signature is fluid and cursive, written in a professional style.

GEORGE ROSTKY
Editor-in-Chief

A tough semiconductor in the hands of a wise

We put a lot of time and money into the development and production of reliable Delco Electronics semiconductor devices for a wide range of industrial, military and automotive applications.

So, understandably, we don't fool around when it comes to selecting our Delco semiconductor distributors.

We handpick

them for their excellence in customer service.

We insist that they give us—and you—their best distribution services.

Delco Electronics semiconductor distributors are strategically located across the country in locations that make fast service practical.

The people you'll find listed on the facing page are front-line members of our sales force. They handle our entire line of Delco Electronics semiconductor devices. They know how to get immediate assistance and advice from our factory personnel.

Next time you need a reliable power semiconductor, get it from a reliable semiconductor distributor.

Your Delco Electronics distributor.

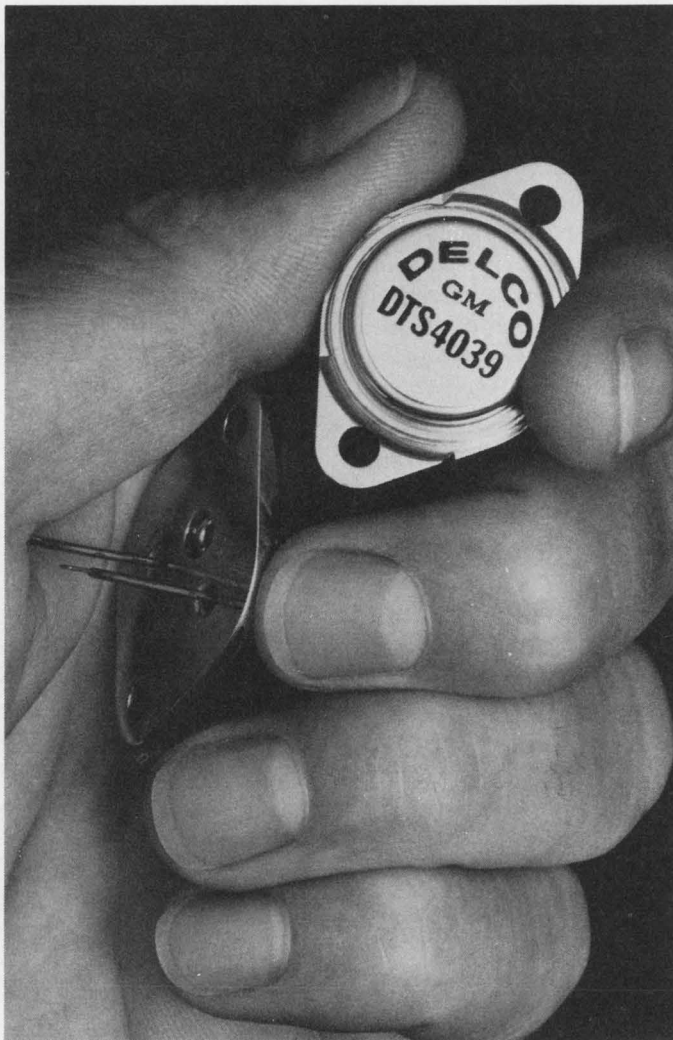

ctor has no business hy-washy distributor.

ALABAMA, Birmingham
Forbes Distributing Co., Inc.
(205) 251-4104

ALABAMA, Huntsville
Powell Electronics
(205) 539-2731

ARIZONA, Phoenix
Sterling Electronics, Inc.
(602) 258-4531

CALIFORNIA, Goleta
R.P.S. Electronics, Inc.
(805) 964-6823

CALIFORNIA, Los Angeles
Kierulff Electronics, Inc.
(213) 685-5511

CALIFORNIA, Los Angeles
R.P.S. Electronics, Inc.
(213) 748-1271

CALIFORNIA, Palo Alto
Kierulff Electronics, Inc.
(415) 968-6292

CALIFORNIA, San Diego
Kierulff Electronics, Inc.
(714) 278-2112

CALIFORNIA, San Diego
R.P.S. Electronics, Inc.
(714) 292-5611

CALIFORNIA, Sunnyvale
Bell Industries
(408) 734-8570

COLORADO, Denver
Kierulff Electronics, Inc.
(303) 371-6500

CONNECTICUT, Norwalk
Harvey Electronics
(203) 853-1515

FLORIDA, Miami Springs
Powell Electronics/Florida
(305) 592-3260

ILLINOIS, Rosemont
Kierulff Electronics, Inc.
(312) 678-8560

ILLINOIS, Skokie
Bell Industries
Electronics Distributors Div.
(312) 282-5400

INDIANA, Indianapolis
Graham Electronics Supply, Inc.
(317) 634-8202

MARYLAND, Baltimore
Radio Electric Service Co.
(301) 823-0070

MASSACHUSETTS, Billerica
Kierulff Electronics, Inc.
(617) 935-5134
(617) 667-8331

MASSACHUSETTS, Newton
The Greene-Shaw Co., Inc.
(617) 969-8900

MICHIGAN, Livonia
Pioneer/Michigan
(313) 525-1800

MINNESOTA, Minneapolis
Stark Electronics Supply Co.
(612) 332-1325

MISSOURI, Kansas City
Walters Radio Supply, Inc.
(816) 531-7015

MISSOURI, St. Louis
LCOMP-St. Louis
(314) 647-5505

NEW JERSEY, Cinnaminson
Wilshire Electronics/Philadelphia
(609) 786-8990 (215) 627-1920

NEW JERSEY, Clifton
Wilshire Electronics/New Jersey
(201) 365-2600 (212) 244-8930

NEW MEXICO, Albuquerque
Sterling Electronics
(505) 345-6601

NEW YORK, Binghamton
Harvey Electronics
(607) 748-8211

NEW YORK, Buffalo
Summit Distributors, Inc.
(716) 884-3450

NEW YORK, Farmingdale
Wilshire Electronics/Long Island
(516) 293-5775

NEW YORK, Woodbury
Harvey Electronics
(516) 921-8700 (212) 895-9260

OHIO, Cincinnati
United Radio, Inc.
(513) 761-4030



OHIO, Cleveland
Pattison Supply Co.
Industrial Electronics Division
(216) 441-3000

OHIO, Dayton
Pioneer/Dayton
(513) 236-9900

PENNSYLVANIA, Philadelphia
Almo Electronics
(215) 698-4000

PENNSYLVANIA, Pittsburgh
Cameradio Electronics
(412) 288-2600

SOUTH CAROLINA, Columbia
Dixie Radio Supply Co., Inc.
(803) 253-5333

TEXAS, Dallas
Sterling Electronics
(214) 357-9131

TEXAS, Houston
Harrison Equipment Co., Inc.
(713) 224-9131

WASHINGTON, Seattle
Kierulff Electronics, Inc.
(206) 763-1550

IN CANADA: ONTARIO, Scarborough
Lake Engineering Co., Ltd.
(416) 751-5980

ALL OVERSEAS INQUIRIES:
General Motors Overseas
Operations
Power and Industrial Products
Dept.,
767 Fifth Avenue, New York, N.Y.
10022
PHONE: (212) 486-3723

Delco Electronics Regional Sales Offices
Union, New Jersey 07083
Box 1018 Chestnut Station
(201) 687-3770

Van Nuys, California 91404
Box 2968
(213) 988-7550

General Sales Office
700 E. Firmin, Kokomo, Ind. 46901
(317) 459-2175

Delco Electronics.
The Power Specialists.

Focus on Miniature relays

It's easy to get the impression that manufacturers of miniature relays all worked on a modern Tower of Babel.

Specifications for similar relay functions may bear the same name but different vendors often define the terms differently.

And the manufacturers offer such a wide variety of types and sizes that just picking the right relay family can be a tough job. For many applications you can choose from miniature electromechanical, reed and solid-state relays that all claim to perform the same function.

When specifying a relay, you can get caught in four major traps.

1. Overspecifying the relay ratings.
2. Underspecifying the relay ratings.
3. Overlooking complex interrelationships between parameters.
4. Assuming that specs from one manufacturer will be equivalent to those of another.

As a start, let's look at what can happen when you are too conservative during relay selection.

Don't overrate ratings

Manufacturers find it difficult to shrink the size of relays while providing the capability to switch large currents. The material used by the manufacturer for the relay contacts determines the load the relay can handle. Other factors that affect load capability include the shape of the contacts and the pressure used to close the contacts. Table 1 shows the choice manufacturers have of just the more common contact materials.¹

When you must switch signals in the millivolt or microampere range, manufacturers recommend that you use a relay with gold contacts. But as load current increases above about 0.5 A, manufacturers change the contact material to

one that wears better.²

Each of the materials in Table 1 has different properties. The differences can cause trouble if you vastly overspecify the contacts for a particular load. For instance, if you want to switch a 0.5-A load and you decide to buy a relay rated for 5 A, the relay's contact material would probably cause erratic behavior.

Gold-plated contacts on "general purpose" miniature relays are constant sources of trouble. Even though the relay might be rated for operation from "dry circuit" through 2 A, you can't



Miniature hermetically sealed relays manufactured by Westinghouse Air Brake Co. run the gamut from tiny TO-5 packages to full crystal cans and larger.

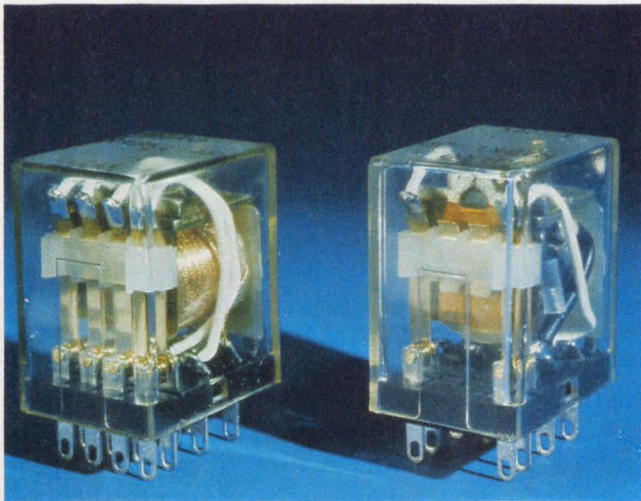

Miniature multipole relays designed by Struthers-Dunn are designed for plug-in applications. These relays are available in a wide variety of contact styles.

use it for both loads. If a single-pole relay operates at dry-circuit voltages, the gold plating on the contacts resists most wear and tear. However, if you use the relay to switch 2 A, the gold plating soon vaporizes and lays bare the base contact material. The base material can cause erratic behavior if used for low-level switching.

Many multipole miniature relays have symmetrical and unkeyed pin configurations. This increases the chances of accidentally overloading contacts intended to switch low currents. If one set of contacts is used for high-level signals and



Low-profile relays made by Siemens are designed for mounting on printed-circuit boards and have a height above the board of only 0.5 in.

the other for low-level, and if you reverse the relay in the socket you will have ruined both sets of contacts for low-level operation.

Thus a manufacturer's contact rating doesn't really tell you much, unless it's qualified with plenty of other data. If a data sheet says the contact can handle 2 A, does it mean that 2 A can flow through the contacts or that the contacts can make or break 2 A?

It's much easier for the contacts to carry 2 A than to make or break 2 A. Make sure you nail down what the manufacturer means.

Not only must you know whether the relay can switch the load, but how many times can it do it? Relay operating life can be hundreds of thousands of operations for high power switching relays, millions of operations for general-purpose relays and hundreds of millions for mercury-wetted and solid-state relays.

Find out if the rated life is specified for the unit under load conditions or under no-load conditions. The difference between the two can be like night and day.

Also, have the manufacturer define what he means by one operation. Is it one make, or one break, or one make and one break? The definition varies from vendor to vendor and sometimes from relay family to relay family from the same vendor.

Contact failure: Definitions vary

When contacts fail you can usually trace the problem to one of these reasons:

- Increased operating temperature.
- Formation of contaminants on contacts.
- Worn or pitted contacts.

Whatever the reason, many of the failures can be traced to a change in the contact resistance. But, depending which vendor you talk to, "failure" can occur when the contact resistance increases to anything from 4 to 100 times the specified initial value.

And the manufacturer can also increase the apparent lifetime by more loosely specifying the initial resistance. Even different relays made by the same manufacturer can have different definitions of failure. So beware.

The operating temperature of a relay also affects contact resistance. As the temperature rises so does the basic resistance of the contact material. Thus, data that the manufacturer gives you for operation at 25 C doesn't tell you how the relay operates at 85 C. Take any data with a grain of salt until you've added in any derating factors and combined all the conditions.

Load current can also cause a rise in temperature and thus contact failure. Check the power or volt-ampere (VA) contact rating. Most contact materials can handle only a limited



These miniature TO-5 and square header relays from Teledyne Relays can handle currents up to about 1 A and provide up to two form C sets of contacts.

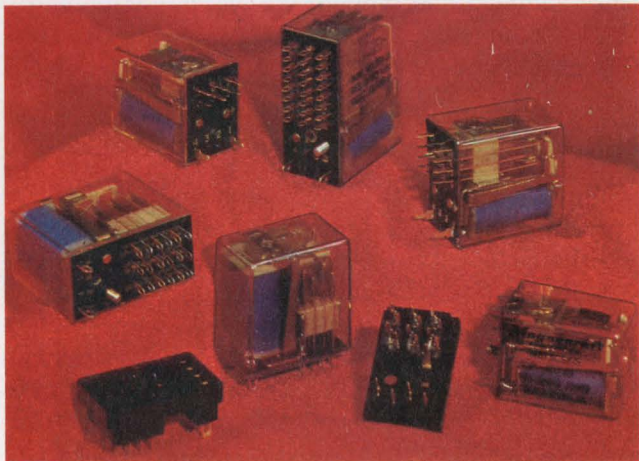

Plug-in relays designed by Magnecraft are available in versions that have up to eight poles and that can handle high or low level loads.

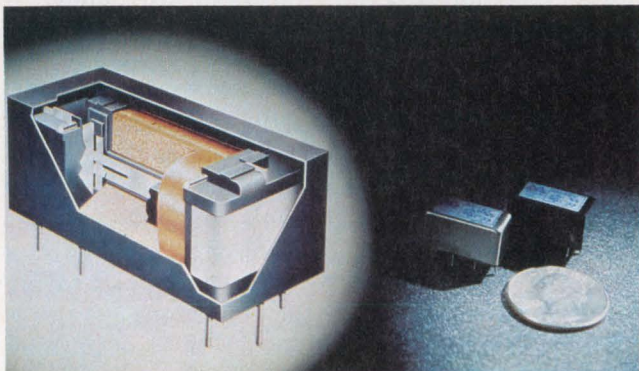

The miniature reed R-relay has a form C set of contacts and is available from Arrow-M in two versions—hermetically sealed in plastic or magnetically shielded.

amount of power before they start to soften and deform. Self-heating, a result of I^2R losses in the contacts, can cause failure. Make sure that, along with the power or VA rating, you get a maximum limit on the load voltage or current.

Look closely at the loads

What type of load will the relay contacts be seeing? Here are the possibilities:

- Resistive loads—the easiest to handle. All you have to know is the current and voltage of the load, and you can select the relay you need.
- Capacitive loads—which call for circuit protection. Are the contacts going to connect a large capacitance to a voltage source? Or are they going to discharge the capacitance through them? In either case the instantaneous current at contact closure is very large and can weld the contacts closed, unless you place current-limiting resistors in series with the load.
- Inductive loads—which cause problems since their building or collapsing magnetic fields create large instantaneous voltages. These large voltages can cause arcs that are powerful enough to weld the contacts or to vaporize and distort the contact material. When relays switch inductive loads, make sure you add arc suppression diodes, or that the manufacturer does.
- Incandescent-lamp loads—which create the problem of high in-rush currents. These currents are caused by low filament resistance at start-up and must be limited by some form of series resistance. As the lamp filament warms up, its resistance increases and the load current drops back to its nominal value. So when you select a relay for lamp driving, make sure you get an in-rush current rating from the vendor.
- Ac vs dc loads. For dc loads, arc-suppression circuits are recommended. With ac power loads, any arc created by the opening of slow-moving contacts is quenched when the voltage passes through zero. For switching power, especially with dc or inductive loads manufacturers recommend that arc-resistant contact materials be used to minimize wear.

Which contact form?

Once you know the load the relay will handle, make sure you know the contact form you need (Table 2). There are many different types to choose from; the ones shown are just a few. And you also have a choice of the number of poles (sets of contacts).

The choice of contact is especially critical for reed relays which are often used for situations that require low contact resistance and long life. Should you use butting, wiping or cascaded contacts (Fig. 1)? Or, do you need the long life of

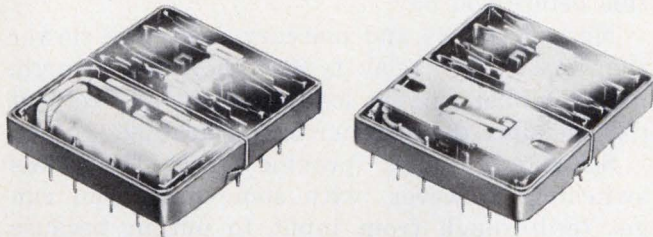

Low-profile relays that use permissive-make contacts are designed for tightly spaced printed-circuit boards. These relays are from C. P. Clare.

mercury-wetted reed contacts? And, for electro-mechanical relays should you use single contacts, or bifurcated dual contacts for extra reliability?

Butting contacts are the most resistant to mechanical wear and are fairly immune to galling (permanent mechanical distortion caused by mechanical stress of the contact surface). But the lack of a sliding motion lets film build up on the surface, and the transfer of metal from contact to contact increases contact roughness.

Contacts that wipe have a self-cleaning effect. But this makes them more susceptible to wear.

Cascaded contacts avoid the problems of high in-rush currents (Fig. 1c). They usually use two materials to minimize wear—tungsten for the contacts that close first and a softer, lower resistance material for the second set of contacts.

The time it takes for contacts to operate (pull-in) or release (drop-out) can be divided into a waiting and a transit time. The waiting time is the period needed for the magnetic flux to build up (or drop) to the value needed to operate or release the relay armature. The transit time is the period from the start of movement until contact closure (or separation).

Both the operate and release times depend on the coil conductance, the weight of the armature, the "springiness" of the counterbalance, the temperature, and the characteristics of any suppression circuit used to protect the coil drive circuit or the relay contacts.

If speed is important, spell out your requirements carefully. When a vendor says the relay has a pull-in time of 2.5 ms, check to see if the time includes or excludes the bounce period of normally open contacts. It may or may not.

Contact bounce, of course, depends on how hard the contacts are pulled together, and on the resiliency of the spring materials. When a relay operates or releases, the contacts don't close and stay that way—they rebound and separate and then reclose several times.

And when the contacts close for the last time they are still in motion. Thus their resistance is still changing, due to varying contact pressure. Mercury-wetted contacts, used in many reed relays, and solid-state relays avoid the problems of

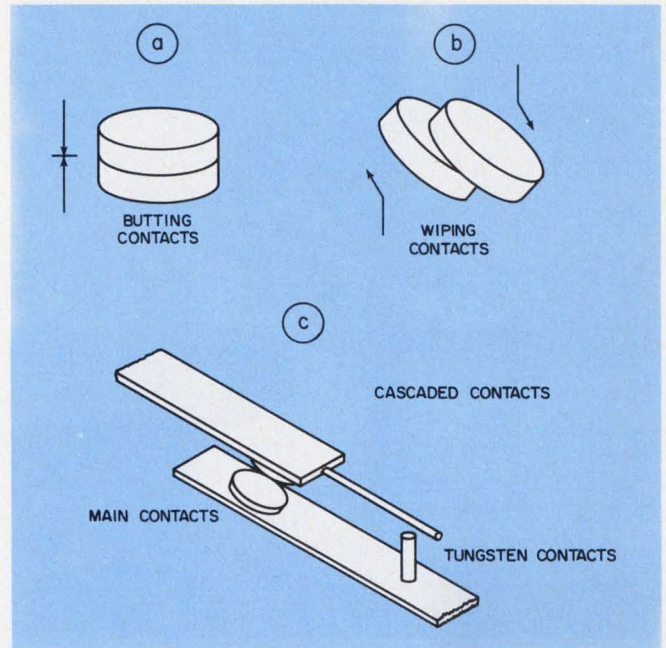

1. When you select a reed relay, check the type of contacts. You can get butting contacts (a), wiping contacts (b) or cascaded contacts (c).

Table 1. Contact material properties

	INCREASING RESISTANCE TO ELECTRICAL WEAR (INCREASING LOAD CAPABILITY)	
INCREASING CONTACT RESISTANCE	RHODIUM	PLATINUM-SILVER-GOLD
	GOLD	PLATINUM
		IRIDIUM-PLATINUM
		RUTHENIUM-PLATINUM
		IRIDIUM-RUTHENIUM-PLATINUM
		IRIDIUM-OSMIUM-PLATINUM
	PALLADIUM	SILVER-PALLADIUM
	GOLD-SILVER	COPPER-PALLADIUM
	PALLADIUM-SILVER	
	SILVER	
	CADMIUM-SILVER	
	COPPER-SILVER	
	SILVER-NICKEL	
	SILVER-MOLYBDENUM	
	SILVER-TUNGSTEN	
COPPER	COPPER-TUNGSTEN	
	TUNGSTEN	

bounce and dynamic resistance, but they introduce other headaches.

Hold down the bounce

As you can see, bounce is not just a mechanically dependent factor. The more power you apply, the longer the bounce; and the stronger the spring, the longer the bounce. If you want fast contact closure the manufacturer can reduce the spring tension or make the air gap smaller. But in either case the relay's susceptibility to shock and vibration will increase.

Some mercury relays and mercury-wetted reed relays must be mounted in certain orientations because of the gravitational sensitivity of the mercury reservoir in the switching capsule. Some of the newer styles have eliminated this problem. Check with the manufacturer about

(continued on p. 60)

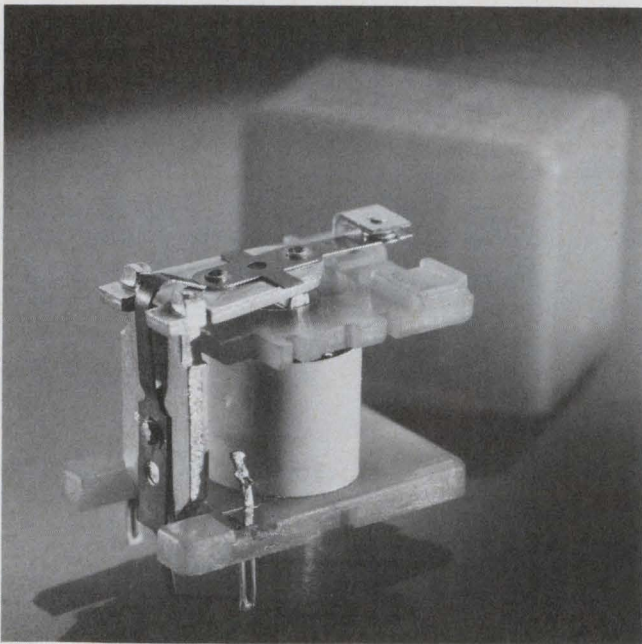

Plastic-covered relays that are made for direct insertion into printed-circuit boards, like this Model 27, are available from North American Phillips.

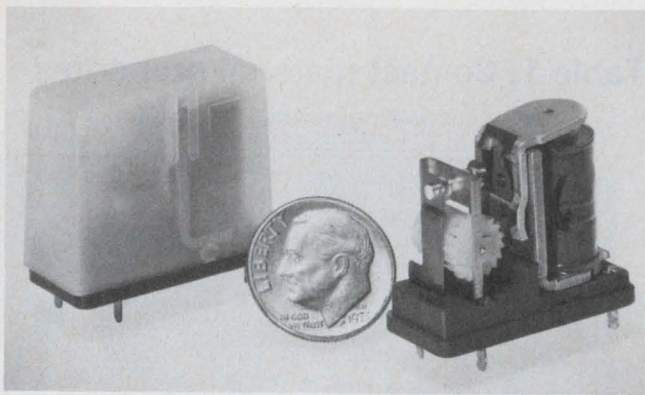

Miniature bistable relays are controlled by short pulses of current instead of a continuous holding current. The unit here is made by Babcock.

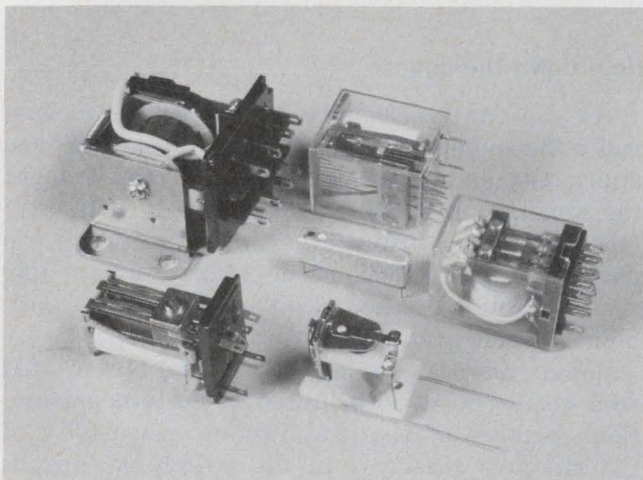

Electromechanical and reed relays are only part of the selection available in a line of relays manufactured by Shigoto Industries.

this before you buy.

Mercury relays and mercury reeds are slower than most other relay types. They can, though, handle higher current loads without any contact damage since the mercury is self-healing.

Solid-state relays provide fast, bounceless switching. However, with some units you can get feedthrough from input to output because of leakage through the semiconductor material. And you may get a large voltage drop and current limiting in the "contacts" of the relay.

Noise and transient voltages on the input lines can also cause false triggering of solid-state relays. Mechanical relays, with their large coils, tend to dampen these transients and are rarely affected by them.

Not only must you worry about the load and input lines for solid-state relays but also about how many functions it must replace. Most solid-state relays contain only one switching function, while electromechanical relays can easily handle six poles simultaneously at little extra cost. And, once a solid-state device fails, it can short out and leave the load connected; most mechanical relays, though, fail safely.

Be careful with drive power

How much power do you need to drive a relay? Check the drive circuit and relay specs carefully. The power the relay needs depends upon the weight of the armature and the type of coil used. A relay may be small enough to squeeze into a corner of the circuit board, but if it requires a lot of drive current, the extra circuitry needed for driving can counter any space savings you may have.

The power the relay draws depends upon the coil resistance. Since most data sheets give only a nominal coil resistance, the coil current load your driving circuit sees can vary by as much as 20%. Make sure the drive circuit can handle any increase.

Coil current is often linked to the sensitivity of the relay. Usually the higher the coil resistance (or the lower the current it draws) the more electrically sensitive the relay. Thus a sensitive relay might operate at 1.5 V and 1 mA, a general-purpose relay at 6 V and 250 mA and a power-switching relay at 12 V and 700 mA.

Closing relay contacts requires more than just applying a voltage. First, don't overspecify the pull-in rating. If you want a relay that will operate at 15 V, don't order one designed for 12 V supplies. The unit will function—but for how long? You'll dissipate excessive power in the coil, and thus more heat. The heat, in turn, can cause changes in the coil resistance, break down the coil insulation and release gas contaminants that can cause contact failure.

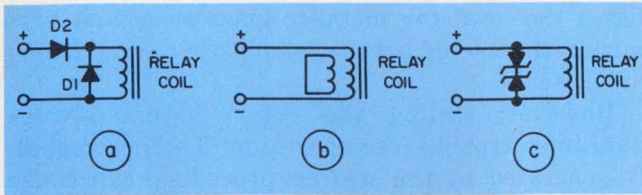

2. Three common ways to protect the drive circuit are the use of two diodes to polarize the coil (a), a bifilar winding (b) or back-to-back zener diodes (c).

Table 2. Common contact forms

FORM	DESCRIPTION	USASI SYMBOL	FORM	DESCRIPTION	USASI SYMBOL
A	MAKE OR SPSTNO		H	BREAK, BREAK, MAKE, OR SPDT (B-B-M)	
B	BREAK OR SPSTNC		I	MAKE, BREAK, MAKE, OR SPDT (M-B-M)	
C	BREAK, MAKE OR SPDT (B-M), OR TRANSFER		J	MAKE, MAKE, BREAK, OR SPDT (M-M-B)	
D	MAKE, BREAK OR MAKE-BEFORE-BREAK, OR SPDT (M-B), OR 'CONTINUITY TRANSFER'		K	SINGLE POLE, DOUBLE THROW CENTER OFF, OR SPDTNO	
E	BREAK, MAKE, BREAK OR BREAK-MAKE-BEFORE-BREAK, OR SPDT (B-M-B)		L	BREAK, MAKE, MAKE OR SPDT (B-M-M)	
F	MAKE, MAKE SPST (M-M)		M	SINGLE POLE, DOUBLE THROW, CLOSED NEUTRAL SPDTNC (THIS IS PECULIAR TO MIL-SPECS)	
G	BREAK, BREAK OR SPST (B-B)		U	DOUBLE MAKE, CONTACT ON ARM SPSTNO DM	

For reed relays that use magnetic biasing, overdriving can permanently reverse the magnetic field of the internal magnet and render the relay useless.

Controlling the voltage at which the relay drops out requires some circuit tricks—especially if transient protection circuitry is used in the drive or load circuits. The collapsing magnetic field of the relay coil generates spikes that can reach 1000 V.

There are several ways to counter these spikes, as shown in the circuits of Fig. 2. However, the dropout time can increase as much as tenfold over the time of the unsuppressed relay. Thus the separation of the contacts would be slowed and the contacts made more susceptible to arcing.

Of the methods in Fig. 2, the back-to-back zener diodes offer the best nonpolarized way to eliminate transients (Fig. 2c). But all these circuits increase the relay dropout delay, since they lengthen the time constant of the energy decay.

Almost all relays drop out at much lower voltage than that at which they pick up. More energy is needed to move the armature than to just hold it in place. Thus, a relay that operates at 5 V

may not drop out until the coil voltage drops to 1 V or so. This could cause many headaches in some logic systems where logic ZERO is higher than the release voltage.

Manufacturers don't usually specify the release voltage. They might give a typical number or none at all. Check this very carefully.

And when you energize multipole relays, watch out for the independence of poles, especially if the poles are not mechanically linked. Independence is when one set of contacts closes before others, even though all sets are energized at the same time. In many applications this independence isn't important, but don't be the one case in 100 to burn out a circuit because of inconsistent switching times.

Relay insulation: What's really needed?

Now that you know the coil voltages and the type of load that the relay will be seeing, what about the other voltages in the circuit? Can the relay insulation withstand any large potential differences that might appear? Be wary of ground potential differences; they might be several hundred volts in some circuits, and can wipe out the relay and load.

Some inexpensive relays have a grounded armature. Make sure you check the data sheet for this gremlin. You can unknowingly short out the entire power supply or an ac power line and destroy the relay and associated circuits.

How far apart are the relay contacts? If the relay case is grounded, is there any chance of flashover between the contacts and case? Or arcing between contacts? Some manufacturers tell you how well isolated their relays are against potential differences between contacts or between contacts and case. Look for these numbers.

But not all voltages must be high to cause trouble. Will the relay be handling audio frequencies and higher? If it will be, how much crosstalk does the relay have between adjacent sets of contacts? You need high-impedance, low-capacitance, insulation between contacts.

All forms of insulation act as tiny capacitors and pass some of the signal. The insulation also appears as a high resistance and thus permits a small amount of leakage current. Check the manufacturer's data sheet for these values and add any derating factors from temperature, voltage or humidity.

Whatever the insulator, it should not emit vapors that could cause insulating films to form on the relay contacts. This is especially important for dry circuit loads, since a minimum voltage must be present to break down the insulating film before current can flow. This "softening voltage" depends upon the contact material and is 60 mV for gold and 600 mV for tungsten.

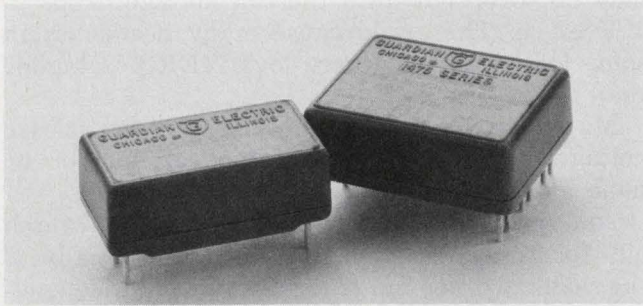

Compact relays, like these units made by Guardian, can handle loads up to 5 A at 12 V and provide two sets of form C contacts to do the switching.

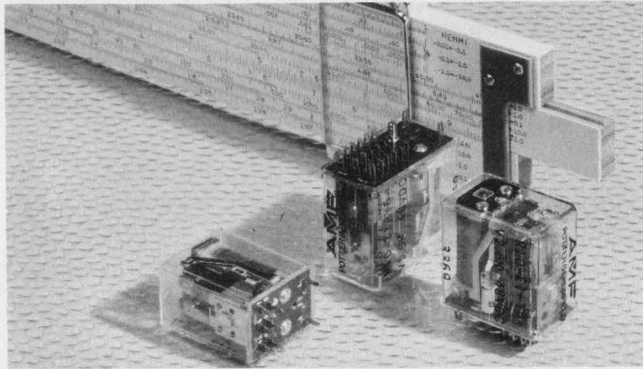

These miniature Potter and Brumfield plug-in relays come with a choice of connection methods. You can get them with socket terminals or solder tails.

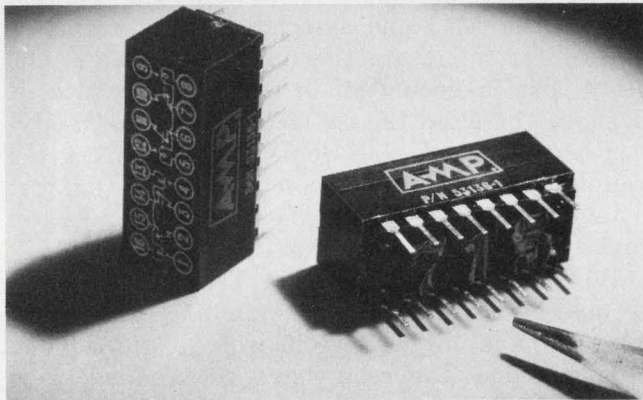

One of the smallest electromechanical relays available is this Model 43451 developed by AMP. The DIP-housed unit contains two independent DPDT relays.

The heat from the assembly process can also cause outgassing from materials in the relay—the insulators, the coil insulation and seals. The heat can even affect hermetically sealed relays and damage them permanently.

Hermetic relays: Not always a cure-all

Hermetically sealed relays offer the best guarantee of freedom from contaminants but their cost is more than double that of the covered unsealed relay. Developments in sealing techniques and materials have, in some cases, elimi-

nated the need for metal-to-glass seals and permitted the use of lower-cost plastic-to-metal hermetic seals.

However, sealing the relay doesn't always guarantee trouble-free operation. The heat usually generated by the sealing procedure can cause outgassing from materials in the relay and the formation of insulating films on the contacts. Or it may slowly erode the coil insulation.

Severe industrial and military environments usually require sealed relays to ensure reliable switching. However, check your application carefully to see if you really need hermeticity or just a dust cover. Some of the newer inexpensive plastics are almost as impervious to adverse conditions as the old metal-cased units.

Reed relays use a hermetically sealed glass switching capsule that is encased in a coil. Further encasement in a dual in-line package, for easy insertion into circuit boards, can cause cracking of the glass capsule or twisting of the contact blades within the capsule. In either case the hermetic seal will be lost, and contaminants from the plastic encapsulant may seep in.

Solid-state relays have few hermeticity problems. There are no arcs and no major contaminants to stop the circuit from switching. The only substance to be wary of is oil. It can seep through most types of plastic encapsulation, even though the material is airtight. Safety standards, especially in the petrochemical field, are extremely high. Not only must the relay be spark-proof but also fail-safe.

Covers protect relays from most types of dust, but they don't do much else. You can get burned pretty badly if you use nonhermetic relays on a flow-solder production line; the fumes caused by the heat and solder can contaminate the relay contacts and erode insulation in the coil winding.

Another mounting method permits etching of the relay terminals directly onto the printed-circuit board. All you do afterwards is clip the sealed relay to the etched landings once the board is assembled and soldered. In this way no contaminants can enter from the assembly process.

Relays have no actual classification as to size. One manufacturer's miniature is another's sub-miniature, and someone else's general-purpose unit can be the same size as a rival's 1/6th crystal-can unit.

The crystal-can relay, named after the case that housed quartz crystals during the 1940s once was the smallest available. The most common size was the 0.4 × 0.8 × 0.97 in. case. Today you can get relays that are no bigger than a transistor TO-5 metal case; however, you will have to sacrifice current-handling capability.

Wherever you place the relay, make sure you have all the space you need between circuit boards. Some of the newer low-profile relays are

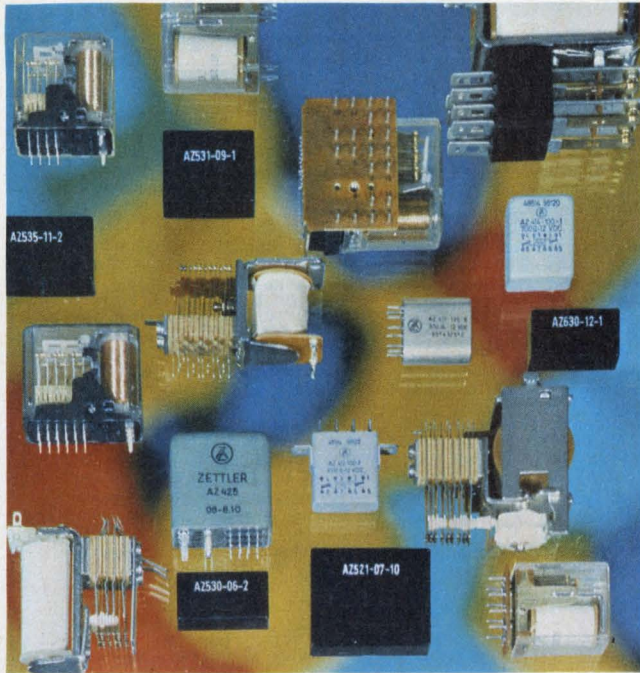

The extensive line of relays available from American Zettler includes crystal can, cradle, open frame and units with dust covers.

made for tightly spaced circuit boards, where the center-to-center distances are 0.5 in. This means the relay should not be higher than 0.375 in. to allow for tolerance mismatches.

Most of the other relays, including many of the DIP outlines, may be made for PC boards but they are not usable for low-profile applications. In fact, some reeds and electromechanical relays have adopted the 14 or 16-pin DIP for pin spacing and length and width, but have increased the height off the circuit board to well over 0.4 in. Check the relay outline carefully for tolerances.

With all that's been said, there is still tremendous confusion between manufacturers when you compare different relays. There are several places you can turn to and get an unbiased opinion.

The largest data bank is the federal government with its array of MIL specs that define everything under the sun, and more. The most commonly used spec, MIL-R-5757 is presently under revision and will be known as MIL-R-39016. Several other important government publications include MIL-R-28776, 19523, 19648, 83726, and 6106. Also, the government publishes handbooks for calculating reliability data and test methods—check into them for test guidelines.

The National Association of Relay Manufacturers (NARM) holds yearly conferences to discuss possible standardization and developments in the relay field. The yearly conferences are held at Oklahoma State University, while the NARM headquarters is located in Scottsdale, AZ.

You can also seek out help from Underwriters Laboratories, based in Chicago, IL. They have several publications that provide "standards" and

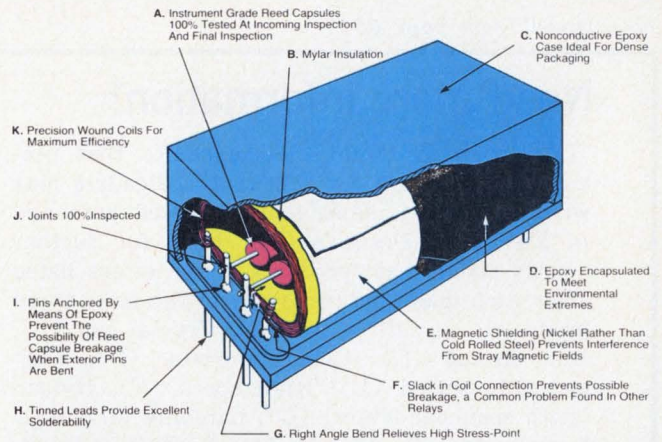

The internal construction of a multireed relay made by Electronic Instrument & Specialty Corp. shows all the factors that must be considered when a relay is chosen.

test procedures for some relay types. The Canadian Standards Association (CSA) located at 178 Rexdale Blvd., Rexdale, Ontario, M9W1R3, Canada, also has a set of guidelines and standards. The Verband Deutscher Elektronika (VDE) located at Auslieferungsstelle, Merianstrasse 29, 605 Offenbach, a.M., West Germany, also contributes expertise.

One of the newest standards groups, the International Commission on Rules for Approval of Electrical Equipment (CEN), is located at 310 Utrechtseweg, Arnhem, the Netherlands. This organization has also helped define some requirements and procedures. Aside from the yearly proceedings and sets of specifications there are several texts that can help clear some of the confusion.^{1,2,3}

One other source of reference material for relay selection is the Miniature and Subminiature Relay D.A.T.A. book published by Derivation and Tabulation Associates in Orange, NJ. This book lists several thousand relays and cross-indexes them by type numbers and characteristics.

What will the future bring?

Improvements in miniature relays are still to be found. Most manufacturers believe that higher switching capabilities are just around the corner. The present limit of about 10 A in a 1 cubic inch package will soon increase to about 15 A.

With the energy crunch affecting everyone, relay manufacturers are designing lower coil power relays, and looking into solid state switching—including the use of the popular optocoupler as a low power relay. Other companies are using the magnetic latching relay and the mechanical latching relay as a means of saving power. ■■

References

1. Gaylord, M. L., "Modern Relay Techniques," Transatlantic Arts, Inc., Levittown, NY, 1969.
2. National Association of Relay Manufacturers, "Engineers Relay Handbook," Hayden Book Co., Rochelle Park, NJ, 1969.
3. Oliver, F. J., "Practical Relay Circuits," Hayden Book Co., Rochelle Park, NJ, 1971.

(continued on p. 64)

Need more information?

We wish to thank the companies that provided information for this report. Readers may wish to contact manufacturers listed here and in Electronic Design's Gold Book for further details about their products. Code letters listed after each manufacturer refer to the relay types produced: Circuit board (A), Crystal can (B), Dry circuit (C), General-purpose (D), Hermetically sealed (E), High speed (F), Hybrid (with semiconductors) (G), Latching (H), Mercury wetted (I), Plug-in (J), Reed (K), Sensitive (L), Solid state (M), Transistor and DIP case (N).

- Adams & Westlake Co., 1000 N. Michigan St., Elkhart, IN 46514. (219) 264-1141. (Mr. Lint) G, H, I, K, L, M
Circle No. 401
- Allied Control Co., 100 Relay Rd., Plantsville, CT 06479. (203) 628-9654. (R. Delaney) A, D
Circle No. 402
- American Zettler Inc., 16881 Hale Ave., Irvine, CA 92705. (714) 540-4190. (G. Rueb) All but A, B, K, M, N
Circle No. 403
- AMP Inc., 449 Eisenhower Blvd., Harrisburg, PA 17105. (717) 564-0100. (L. Blewitt) A, C, D, J, N
Circle No. 404
- Amperite Co., Inc., 600 Palisade Ave., Union City, NJ 07087. (201) 864-9503. (E. Yaschak) Thermal delay, J
Circle No. 472
- Arrow-M, Subsidiary of Matsushita, 250 Sheffield St., Mountaintside, NJ 07092. (201) 232-4260. (J. Deith) All but B, G, M
Circle No. 405
- Artisan Electronics, Eastmans Rd., Parsippany, NJ 07054. (201) 887-7100. (A. Seman) A, D, J
Circle No. 406
- Aztec Electronics, 1240 Blue Gum St., Anaheim, CA 92806. (714) 630-6750. (W. Chidester) A, C, K
Circle No. 407
- Babcock Electronics, Div. of Eserline Electronics, 3501 N. Harbor Blvd., Costa Mesa, CA 92626. (714) 540-1234. (A. Martin) All but G, L
Circle No. 424
- Branson Corp., Vanderhoff Ave., P.O. Box W, Denville, NJ 07834. (201) 625-0600. (J. Witzler) B, D, E
Circle No. 408
- Cardinal Control Co., Inc., 40 Kensington Rd., Kensington, CT 06037. (203) 828-6379. (L. Beatman) All but B, K, N
Circle No. 409
- CP Clare & Co., 3101 W. Pratt Blvd., Chicago, IL 60645. (312) 262-7700. (G. Neeno) All
Circle No. 410
- Computer Components, 88-06 Van Wyck Expressway, Jamaica, NY 11419. (212) 291-3500. (H. Weinberg) B, F, H, I, J, K, L
Circle No. 411
- Cornell Dubilier Electric, 150 Ave. L, Newark, NJ 07101. (201) 589-7500. (B. Butler) A, D, L
Circle No. 412
- Cosar Corp., 3121 Benton St., Garland, TX 75042. (214) 276-9487. (D. Dukes) A, I, J, K, N
Circle No. 413
- Coto Coil Co. Inc., 75 Pavilion Ave., Providence, RI 02905. (401) 467-4777. (R. Bellem) A, C, H, I, J, K, L
Circle No. 414
- Davis Electric Co., PO Box 38, Cape Girardeau, MO 63701. (314) 335-5547. (B. Davis) D, E, H, J
Circle No. 415
- Deltrol Controls Corp., 2745 S. 19 St., Milwaukee, WI 53219. (414) 671-6800. (G. Shepherd) D
Circle No. 416
- Deutsches Relays Inc., 65 Daly Rd., E. Northport, NY 11731. (516) 864-6000. (A. Siegel) All but F, I, K, M
Circle No. 417
- Douglas Randall Div. Walter Kidde, 6 Pawcatuck Ave., Pawcatuck, CT 02891. (203) 599-1750. (E. Goehring) F, I, J, K, L, N
Circle No. 418
- Elec-Trol Inc., 26477 N. Golden Valley Rd., Saugus, CA 91350. (805) 252-8330. (K. Doriot) K, M, N
Circle No. 419
- Electronic Specialty Div., Datron Sys Inc., 18900 NE Sandy Blvd., Portland, OR 97220. (503) 665-0121. (R. Lisdero) B, C, D, E, H, J, K, L, N
Circle No. 420
- Electronic Application, 2213 Edwards St., El Monte, CA 91733. (213) 442-3212. (G. Stockton) J, K, L, M, N
Circle No. 421
- Electronic Instrument & Specialty Corp., 42C Pleasant St., Stoneham, MA 02180. (617) 438-5300. (W. Crawford) I, K, L, M, N
Circle No. 422
- Essex International Inc., Hqtrs., 131 Godfrey St., Logansport, IN 46947. (219) 753-7521. (F. Grant) A, C, D, L
Circle No. 423
- Executone, Printact Div., Box 1430, Long Island City, NY 11101. (212) 392-4800. (J. Richards) A, C, D, F, H, K, L
Circle No. 425
- Fifth Dimension Inc., P.O. Box 483, Princeton, NJ 08540. (609) 924-5990. (W. Kinney) A, C, H, I
Circle No. 426
- Fujitsu Ltd, 2-chome 6-1, Chiyoda-ku, Tokyo, Japan 100 03 21 63211 (H. Seimiya)
Circle No. 427
- General Electric, Data Com Products, GE Dr., Waynesboro, VA 22980. (703) 942-8161. (C. Rockwell) A, B, D, E, J
Circle No. 428
- Gordos Corp., 250 Glenwood Ave., Bloomfield, NJ 07003. (201) 743-6800. (M. Hauser) I, K, L, N
Circle No. 429
- Grayhill Inc., 565 Hillgrove Ave., La Grange, IL 60525. (312) 354-1040. (F. Vetrovec) G, J, M, N
Circle No. 430
- GTE Sylvania, Automatic Elec., 400 N. Wolf Rd., Northlake,

- IL 60164. (312) 562-7100. (J. Ashby) A, C, D, E, F, H, I, J, K
Circle No. 431
- Guardian Electric, 1550 W. Carroll Ave., Chicago, IL 60607. (312) 243-1100. (E. Lorge) All but B, I, N
Circle No. 432
- Gunther-America, 9 Manee Rd., Holmdel, NJ 07733. (201) 264-2488. (A. Ghio) K, N
Circle No. 433
- Hamlin Inc., Lake & Grove Sts., Lake Mills, WI 53551. (414) 648-2361. (W. Bruenger) G, M
Circle No. 434
- Heinemann Electric Co., Brunswick Pike-Rte 1, Trenton, NJ 08602. (609) 882-4800. (E. Lisnay) All but C, H, I, K, N
Circle No. 435
- Hi-G Inc., 580 Spring St., Windsor Locks, CT 06096. (203) 623-2481. (J. Parsons) All but D, F, I, K, M
Circle No. 436
- Ingraham Div., McGraw Edison Co., 210 Redstone Hill Rd., Bristol, CT 06010. (203) 582-6321. (B. Hinman) A, D, J
Circle No. 437
- Instrument Resistor Co. Inc., 503 Adamston Rd., Brick Town, NJ 08723. (201) 477-5454. (M. Baum) K
Circle No. 438
- ITT Components Group, 1551 Osgood St., N. Andover, MA 01845. (617) 688-1881. (L. Holt) A, D, J
Circle No. 439
- Jaidinger Manufacturing Co., 1919 W. Hubbard St., Chicago, IL 60622. (312) 421-1090. (F. Smith) A, C, D, E, F, H, J, L
Circle No. 440
- Le Prototype Mechanique, 23 Rue Pasteur 23, L'Etang La Ville (S. & O.). France. 963-31-64. (M. Cloiseau) C, E, F, H, L
Circle No. 441
- Leach Corp., Relay Div., 5915 Avalon, Los Angeles, CA 90003. (213) 232-8221. (D. Cope) A, B, E, G, H, J
Circle No. 442
- Littelfuse Inc., 800 E. Northwest Hwy., Des Plaines, IL 60016. (312) 824-1188. (J. Borzoni) D, H
Circle No. 443
- Mack Electric Devices, 200 Glenside Ave., Wyncote, PA 19095. (215) 884-8123. (N. McKinney) A, D, J
Circle No. 444
- Madison Labs, P.O. Box 608, Madison, CT 06443. (203) 245-4280. (D. MacDonald) H, N
Circle No. 445
- Magnecraft Electric Co., 5575 N. Lynch, Chicago, IL 60630. (312) 282-5500. (A. Maag) All but B, F, M
Circle No. 446
- Master Elecs Controls, 1553 17 St., Santa Monica, CA 90404. (213) 393-3177. (I. Nizam) A, D, J, M
Circle No. 447
- Midtex Inc., 1650 Tower Blvd., North Mankato, MN 56001. (507) 387-6521. (C. May) A, B, C, D, E, I, J, K, M
Circle No. 448
- North American Philips Controls Corp., Frederick Div., Huskey Park, Frederick, MD 21701. (301) 663-5141. (B. Reeder) All
Circle No. 449
- N. V. Phillips Gloeilampenfabrieken, Elcoma Div., Eindhoven, the Netherlands. (040) 7 22091. (M. Hull) G, K
Circle No. 450
- OKI Elecs of America Inc., P.O. Box 24260, Fort Lauderdale, FL 33307. (305) 563-6234. (J. Webb) A, H, K, N
Circle No. 451
- Potter & Brumfield, Div. AMF Inc., 1200 E. Broadway, Princeton, IN 47670. (812) 385-5251. (P. Craney) All
Circle No. 452
- Regent Controls Inc., Harvard Ave., Stamford, CT 06902. (203) 348-7734. (W. Carroll) C, D, E, M
Circle No. 453
- Relay Service Co., 1310 N. Pulaski Rd., Chicago, IL 60651. (312) 252-2700. (C. Badger) D, H, J, L
Circle No. 454
- Ross Engineering Corp., 559 Westchester Dr., Campbell, CA 95008. (408) 377-4621. (H. Ross) High voltage.
Circle No. 455
- FA Scherma Mfg., 424 Broome St., New York, NY 10013. (212) 925-2077. (M. Scherma) A, D, E, J, L
Circle No. 456
- Schrack Electrical Sales, 1140 Broadway, New York, NY 10001. (212) 683-0790. (H. Siegel) C, D, H, J, L, N
Circle No. 457
- Shigoto Ind. Ltd., 350 5th Ave., New York, NY 10001. (212) 695-0200. (M. Rubin) A, B, C, D, H, J
Circle No. 458
- Siemens Corp., 186 Wood Ave., S. Iselin, NJ 08830 (201) 494-1000. (G. Zappe) A, D, J
Circle No. 459
- Sigma Instruments Inc., 170 Pearl St., Braintree, MA 02185. (617) 843-5000. (W. Davis) All but I
Circle No. 460
- Square D Co., Dept. SG, 4041 N. Richards, Milwaukee, WI 53212. (414) 332-2000. (L. Pike) A, D
Circle No. 461
- Sterer Engineering & Mfg. Co., 4690 Colorado Blvd., Los Angeles, CA 90039. (213) 245-7161. (F. Galneder) J, M, N
Circle No. 462
- Struthers-Dunn Inc., Lambs Rd., Pitman, NJ 08071. (609) 589-7500. (C. Jones) All
Circle No. 463
- Teledyne Crystalonics, 147 Sherman, Cambridge, MA 02140. (617) 491-1670. (T. Paradise) M
Circle No. 464
- Teledyne Relays, 3155 W. El Segundo Blvd., Hawthorne, CA 90250. (213) 973-4545. (D. Stalker) All but B, K
Circle No. 465
- Thermosen Inc., 375 Fairfield Ave., Stamford, CT 06904. (203) 324-6125. (N. Magida) C, E, I, J, K, N
Circle No. 466
- Time Mark Corp., 855A N. Sheridan Rd., Tulsa, OK 74115. (918) 939-5811. (J. Moon) G
Circle No. 467
- Triridge Corp., Box 12420, Pitts Airport, Pittsburgh, PA 15231. (412) 899-2288. (M. Minich) C, E, H, I, J, K
Circle No. 468
- Wabash Relay & Electronics, First & Webster St., Wabash, IN 46992. (219) 563-2191. (J. Cook) I, K, M, N
Circle No. 469
- WABCO Aerospace, Swissvale P.O., Pittsburgh, PA 15218. (412) 242-5000. (J. Connolly) A, B, C, D, E, J, L, N
Circle No. 470
- Wheelock Signals, 273 Branchport Ave., Long Branch, NJ 07740. (201) 222-6880. (J. Kimsey) D, K
Circle No. 471

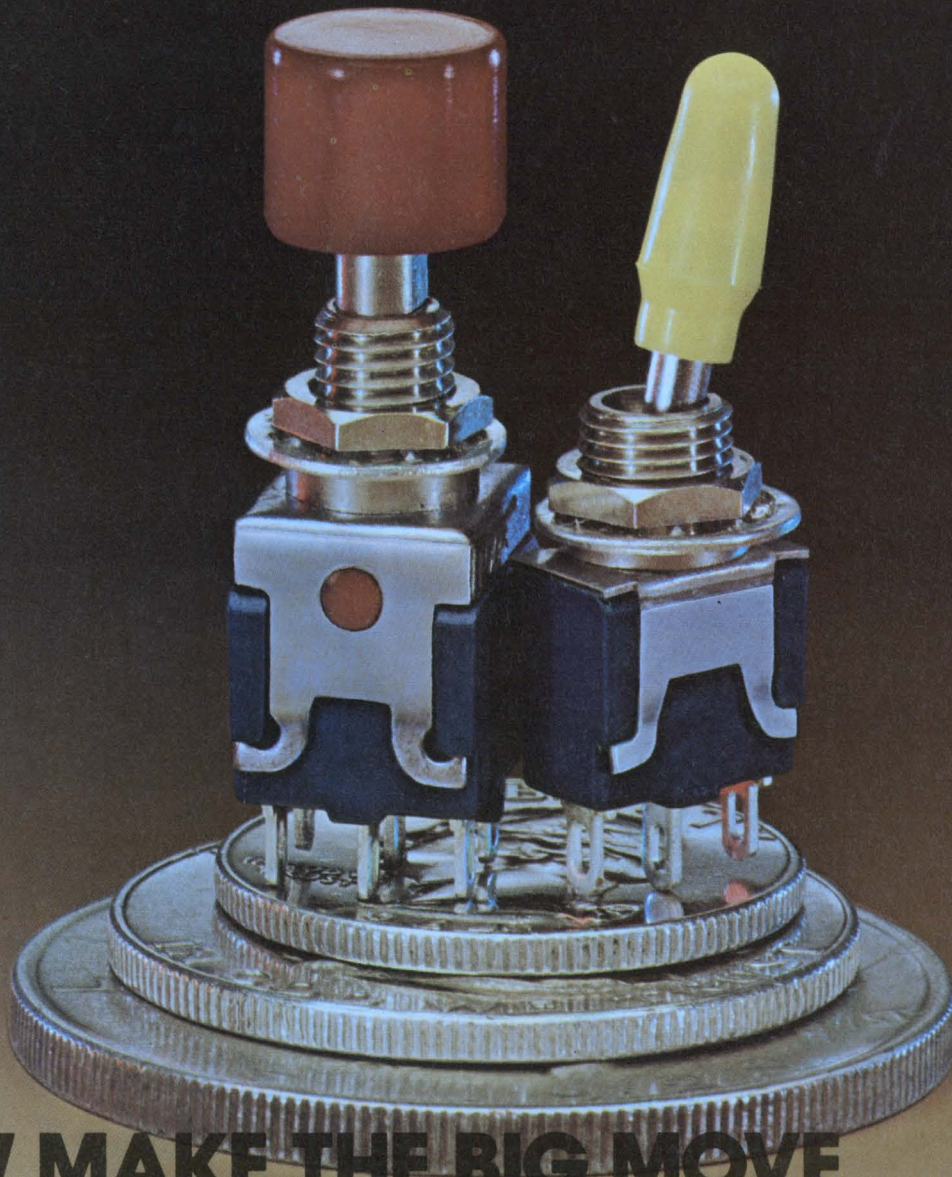

NOW MAKE THE BIG MOVE TO MINIATURIZATION WITH CUTLER-HAMMER.

As you miniaturize your products, rely on these space-saving new Cutler-Hammer ultra-miniature switches. They deliver additional quality, together with a full choice of style, color, and shape.

You get full current-carrying capacity at 115 V.A-c in toggles or pushbuttons. One or two poles in 5 different circuits.

Superior construction details include: a 1/4-inch bushing for con-

venient one-hole mounting, silver-alloy contacts with initial contact resistance of only 0.010 ohm maximum, a polyester base partially jacketed in steel for extra switch-mechanism protection, and either solder-lug or PC terminals.

Cutler-Hammer's remarkable application flexibility continues externally with a wide range of decorator caps, buttons, and bezels in many colors.

And all circuits are in stock for fast delivery.

To learn more about how this highly adaptable new line can add function and style to your products, check with your nearest Cutler-Hammer Sales Office, or Authorized Stocking Distributor.

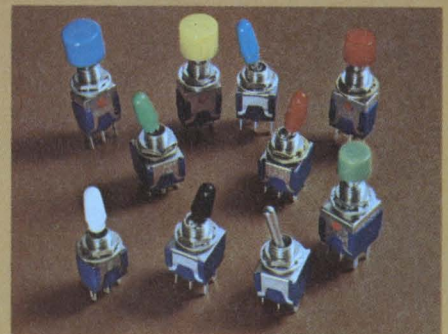

Cutler-Hammer ultra-miniature switches are available in a variety of designs and colors. In both toggles and pushbuttons.

Switch
to No.1

More than just switches; prompt availability, field help, innovation, quality assurance, too.

INFORMATION RETRIEVAL NUMBER 33



CUTLER-HAMMER
SPECIALTY PRODUCTS DIVISION, Milwaukee, Wis. 53201

When we introduce we don't just introduce

We introduce everything you might need to go with it.

A total support package that helps you get our new microprocessor on the job, working, with the least possible time, effort and money.

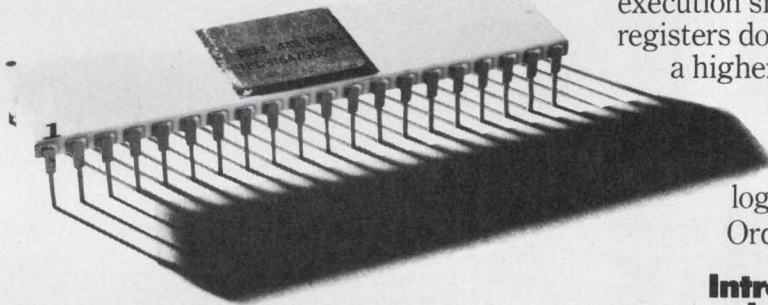

Introducing PACE.

The first 16-bit microprocessor on one chip.

PACE brings you 16-bit performance at an 8-bit price...and 8-bit simplicity.

By including on its single chip the functions that you typically had to add on yourself later, we can save you time and money.

PACE contains not just the bare bones CPU functions but a full-fledged processor with control logic, status register, four accumulators, a ten word stack and a six-level, vectored priority interrupt system.

16 bits has a lot to offer over 8 bits.

Higher efficiency, for one thing. You need a lot less memory, and in a microprocessor system memory is typically two or three times the cost of the CPU, so you're not talking about peanuts.

Lower programming costs, for another. A 16-bitter's more powerful instruction set lets you do in one instruction fetch what an 8-bit machine would take 3 instruction fetches to perform.

And higher system throughput. On the execution side, 16-bit data paths and registers do so much more in one go, there's a higher net performance.

Getting 16 bits down onto a single chip is a pretty good example of National's technology leadership in microprocessing. Order your evaluation sample.

Introducing everything that goes with PACE.

To go with PACE we've developed optimized support and memory products that allow you to cut your development

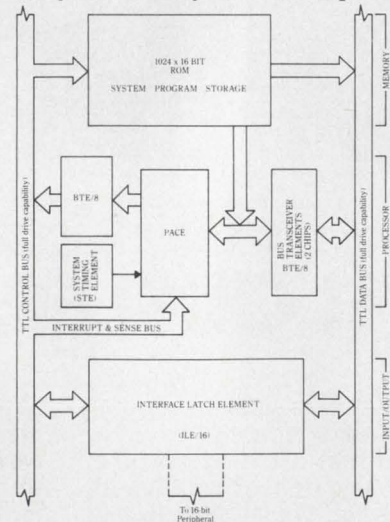

PACE Microprocessor Systems

a new microprocessor a new microprocessor.

costs and implement a complete PACE system inexpensively in seven packages.

Seven.

That's a complete, usable 16-bit system, with clocks, buffers, interrupts, handshake I/O control, sense inputs, control outputs, on-chip stack, and 16K bits of program storage.

Stack that up against 30 or so packages you need for some other microprocessors and you begin to get the picture of PACE's remarkable simplicity and economy.

But we know development effort comes before production hardware. That's why PACE is fully supported with development aids: a prototyping system, executing resident software including Edit, DEBUG, Conversational Assembler, and the best Relocating Macro-assembler in the industry. Coming soon, a Disk Operating System (D.O.S.) and our SM/PL resident high level language. This makes PACE the only fully supported one-chip microprocessor in the industry.

To complete our total customer support, we also provide application cards, training at our new Training Centers, field applications assistance, factory service, complete documentation, complete everything.

We can even provide all the other electronic parts you need in your microprocessor-based system. The displays, opto-isolators, transducers, A/D & D/A

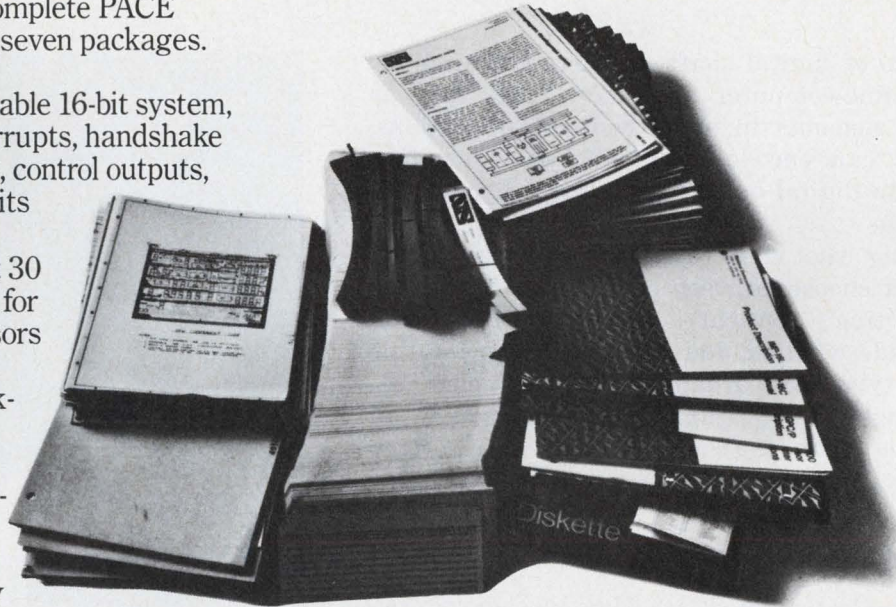

converters, analog & digital IC's, transistors, etc.

That's what we mean by our headline above, and our slogan below.

And that's what we can give you that nobody else can.

And that's our story.

Please send me a copy of your Microprocessor Brochures and complete details about PACE.

Name _____

Company _____

Address _____

City _____ State _____ Zip _____

Mail to: National Semiconductor, 2900 Semiconductor Drive, Santa Clara, California 95051.

ED524

National

There's more to microprocessing
than microprocessors.

Get to know digital shaft encoders.

These electromechanical transducers can change mechanical motion into computer-compatible digital outputs for easy control.

The use of digital shaft encoders can simplify the machine-computer interface. They act as feedback elements in many control applications, and they can encode mechanical-shaft position inputs into digital outputs for direct display and processing.

Selecting the right encoder isn't easy. You must first choose between contacting (brush) or noncontacting (optical) encoders. Then you must decide whether you need an incremental or absolute type. And finally, you must select between single or multiturn devices. To add to all this—make sure the output codes and voltage levels are compatible with the external circuits.

Examine the encoder types

The simplest form of position transducer, the potentiometer, delivers an output voltage that is proportional to the input voltage and the position of the wiper arm on the resistance element. The wiper arm is usually linked, via gears or direct connection, to the shaft whose position you're trying to monitor. Any movement of the shaft changes the wiper position and thus the voltage.

Although this form of position transducer is extremely simple, you need an extensive array of electronic circuitry to make the output computer compatible.

You can improve upon the potentiometric method by using a contacting or noncontacting encoder, which costs considerably more than the potentiometer—typically \$500 to \$3000. Contacting encoders use a disc that is made from a precious metal alloy and etched with a digital code pattern. After etching, the disc gets back-filled with an insulating epoxy.

The disc now has conducting and insulating areas that form an absolute code (Fig. 1b). The codes can range from true binary to binary-coded decimal (BCD), Gray and BCD-excess-3.

Wiping brushes made of the same alloy material ride on top of the disc, reading the conduc-

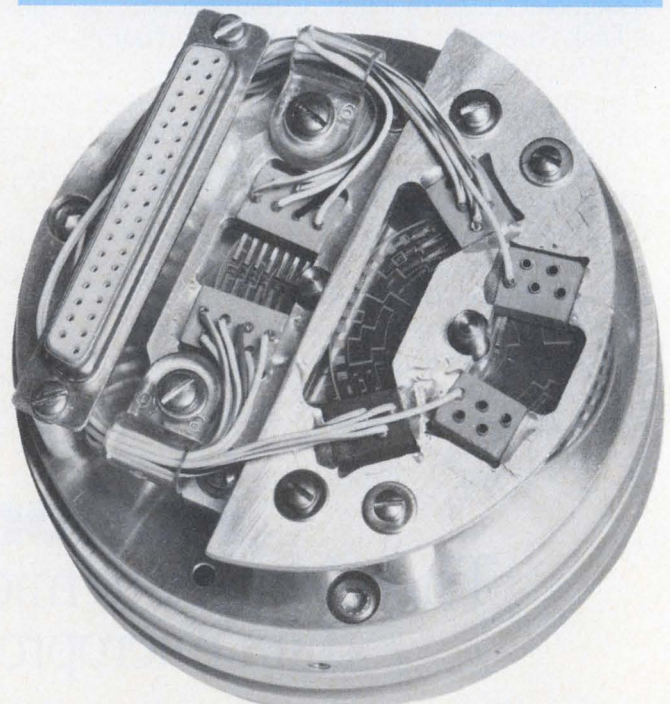
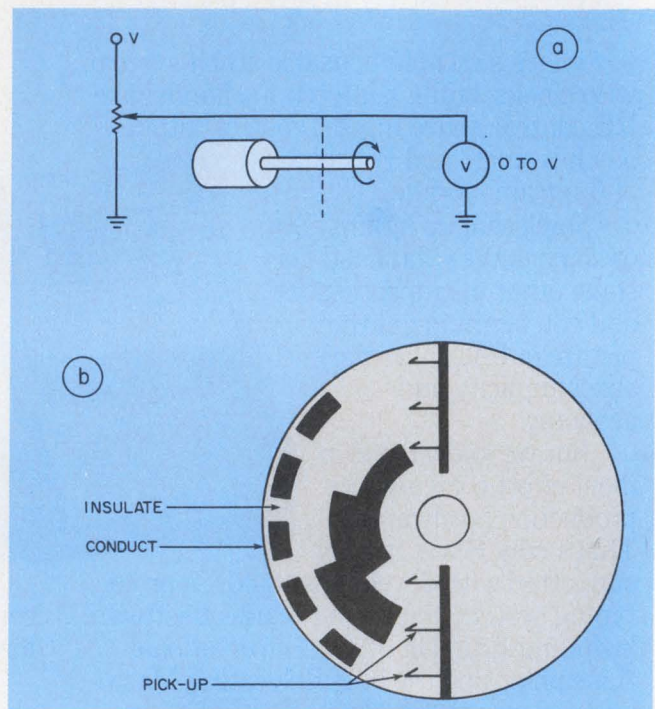

1. The simple potentiometric encoder (a) requires a lot of external electronics, while the contacting encoder (b) provides computer-comparable signals.

Thomas Villano, Vice President, Theta Instruments, Fairfield, NJ 07006.

tive and nonconductive areas like digital words. Each position of the encoder disc thus has a different output code, much like a multiposition switch.

Contacting encoders are immune to power outages, since the output code is determined by shaft position and not by logic states. Similarly, high electrical noise has no effect on the output.

A particular code may consist of many numbers and result in a very dense contact pattern. Thus mechanical problems make it impossible to

mental shaft encoder, which might cost about \$100 to \$250. These devices use discs that have equal transparent and opaque areas. The disc has a light source on one side and a light-sensitive receiver on the other (Fig. 3).

The encoder delivers pulse trains when the shaft is in motion. The pulses have no information by themselves; they must feed into a counting circuit that can accumulate the number of pulses. When the disc is stationary, the receiver output is either high or low, and no code pattern

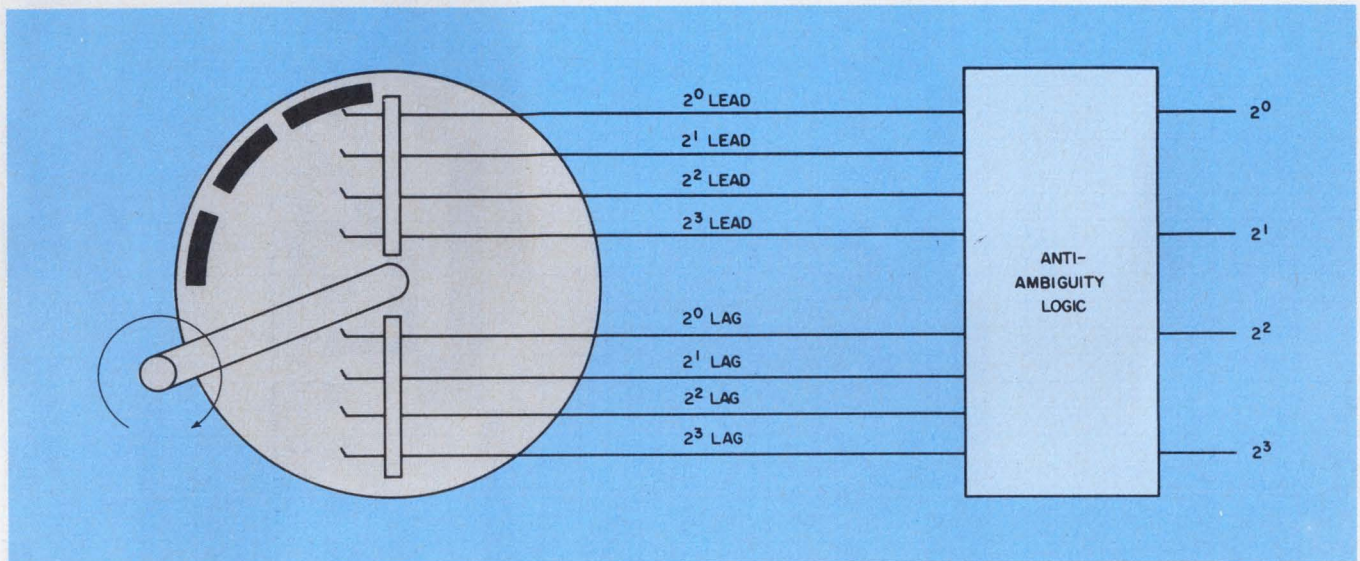

2. Signals from two sets of brushes in the contacting encoder are fed into anti-ambiguity logic circuits.

align all the brushes so the code can be read correctly. To counter the problem, encoders usually have an additional set of brushes to read the same pattern, but mechanically displaced from the first set. The brush sets are usually called lag and lead brushes. Both sets of output signals are then fed into an anti-ambiguity logic circuit that will resolve the code (Fig. 2).

Of the different digital codes (Table 1), the Gray code is the only one that doesn't need any anti-ambiguity logic, since only one bit changes at a time as the disc moves. For true binary or BCD codes, you can have as many as four changes occurring simultaneously for a 4-bit code.

But applications for the Gray code are limited, and the code isn't compatible with most computers and display devices. Conversion to BCD or binary is usually needed. And since no logic buffering is needed by the brushes, the encoding disc for the Gray code usually switches the load and has a limited life.

Incremental encoders save wear and logic

To avoid the relatively high replacement cost of contacting encoder discs you can use an incre-

mental shaft encoder, which might cost about \$100 to \$250. These devices use discs that have equal transparent and opaque areas. The disc has a light source on one side and a light-sensitive receiver on the other (Fig. 3).

The encoder delivers pulse trains when the shaft is in motion. The pulses have no information by themselves; they must feed into a counting circuit that can accumulate the number of pulses. When the disc is stationary, the receiver output is either high or low, and no code pattern

results. The accrued value in the counter represents the amount of disc rotation.

One big disadvantage of this approach: Power failures or large transients can destroy the accumulated information.

There are several advantages to the optical method:

- Low cost.
 - Zero reset capability.
 - Ability to measure speed (when used with a time-base counter).
- Incremental encoders are available either as unidirectional or bidirectional devices. The sensing direction can be determined if two light-sensitive receivers and sources are used to provide a dual square-wave output signal with the waveforms displaced by 90°. With logic circuitry, you can determine which set of pulses came first and thus indicate clockwise or counterclockwise rotation of the shaft.

You can also use the same outputs and multiply the number of square waves by two or four. The output in this case would be a pulse of predetermined width that would be generated only when the encoder shaft was turned in the desired direction. For instance, when the shaft turns in

Table 1. Etch patterns for contacting encoders

Decimal Number	Binary										Binary Coded Decimal (BCD)								Gray																		
	Code					Pattern					Code				Pattern				Code			Pattern															
	2nd Decade		1st Decade		2nd Decade		1st Decade		2nd Decade		1st Decade		2nd Decade		1st Decade		Code		Pattern																		
	32	16	8	4	2	1	32	16	8	4	2	1	8	4	2	1	8	4	2	1	8	4	2	1	8	4	2	1	31	15	7	3	1	31	15	7	3
0	0	0	0	0	0	0						0	0	0	0	0	0	0	0						0	0	0	0	0								
1	0	0	0	0	0	1						0	0	0	0	0	0	0	1						0	0	0	0	1								
2	0	0	0	0	1	0						0	0	0	0	0	0	1	0						0	0	0	1	1								
3	0	0	0	0	1	1						0	0	0	0	0	0	1	1						0	0	0	1	0								
4	0	0	0	1	0	0						0	0	0	0	0	1	0	0						0	0	1	1	0								
5	0	0	0	1	0	1						0	0	0	0	0	1	0	1						0	0	1	1	1								
6	0	0	0	1	1	0						0	0	0	0	0	1	1	0						0	0	1	0	1								
7	0	0	0	1	1	1						0	0	0	0	0	1	1	1						0	0	1	0	0								
8	0	0	1	0	0	0						0	0	0	0	1	0	0	0						0	1	1	0	0								
9	0	0	1	0	0	1						0	0	0	0	1	0	0	1						0	1	1	0	1								
10	0	0	1	0	1	0						0	0	0	1	0	0	0	0						0	1	1	1	1								
11	0	0	1	0	1	1						0	0	0	1	0	0	0	1						0	1	1	1	0								
12	0	0	1	1	0	0						0	0	0	1	0	0	1	0						0	1	0	1	0								
13	0	0	1	1	0	1						0	0	0	1	0	0	1	1						0	1	0	1	1								
14	0	0	1	1	1	0						0	0	0	1	0	1	0	0						0	1	0	0	1								
15	0	0	1	1	1	1						0	0	0	1	0	1	0	1						0	1	0	0	0								
16	0	1	0	0	0	0						0	0	0	1	0	1	1	0						1	1	0	0	0								
17	0	1	0	0	0	1						0	0	0	1	0	1	1	1						1	1	0	0	1								
18	0	1	0	0	1	0						0	0	0	1	1	0	0	0						1	1	0	1	1								
19	0	1	0	0	1	1						0	0	0	1	1	0	0	1						1	1	0	1	0								
20	0	1	0	1	0	0						0	0	1	0	0	0	0	0						1	1	1	1	0								
21	0	1	0	1	0	1						0	0	1	0	0	0	0	1						1	1	1	1	1								
22	0	1	0	1	1	0						0	0	1	0	0	0	1	0						1	1	1	0	1								
23	0	1	0	1	1	1						0	0	1	0	0	0	1	1						1	1	1	0	0								
24	0	1	1	0	0	0						0	0	1	0	0	1	0	0						1	0	1	0	0								
25	0	1	1	0	0	1						0	0	1	0	0	1	0	1						1	0	1	0	1								

the CW direction, a pulse train is generated on the CW line output of the encoder, and nothing is generated on the CCW line. When the direction reverses, the outputs also reverse.

Absolute optical encoders give accuracy

An advanced version of the contacting absolute encoder minimizes wear by using optical encoding instead of brushes. The encoded patterns are etched through the disc so light can pass from one side to the other. For this type of encoder, you must again use the anti-ambiguity logic to avoid having more than one bit change at a time.

With the absolute optical encoder, you get several advantages:

- It needs less torque to turn the shaft than most other encoder types.
- It can operate about 10 times faster than most other mechanical encoders.
- Its expected lifetime is much longer, since there are no brushes to wear out and no loss of contact due to contaminants.
- It has memory. Power outages don't affect the output when power is restored.

When an encoder rotates through a full turn, the code marked on the disc starts to repeat it-

self. However, if you want to measure angular rotation from 0 through 360° with BCD coding, you can follow the code pattern outlined in Table 2. To get 1° resolution, you must use three decades of coding—and, of course, one more decade for each higher degree of resolution.

Size and cost limitations restrict the number of bits that can be placed on a code disc. You can, though, extend the range by mechanically gearing another disc to the first (Fig. 5). As the first disc completes its rotation, all the digits—from, say, 1 to 99—are read. When the disc passes through zero, the slower disc registers its first digit, and the output appears as 100.

As shaft rotation continues, the higher-speed disc repeats its full cycle and keeps incrementing the slower disc. This process continues until the full range of 9999 is reached. Since there are no mechanical stops, the encoder resets to 0000 after it reaches its full count.

Select the right encoder

Now let's look at how you can best apply the encoders.

Automated machine control presents many difficult instrumentation problems. Here's one example: Accurately determine the location of a

cutting tool that is positioned by a lead screw and driven by an external motor.

Here's the background data you will probably have to work with:

- Total travel of the lead screw—30 in.
- Required display accuracy— ± 0.001 in.
- Maximum operating speed—1000 rpm.
- Pitch of lead screw—5.
- Extremely high electrical noise environment.

When you look through the different encoder types, consider the following factors:

1. Operating temperature range.
2. Shock and vibration effects.
3. Special packaging requirements (water and oil-mist protection).
4. Vacuum operation.
5. Available electrical power.
6. Cabling needed between the encoder and readout or computer.

As a start in the selection process, you can rule out all but absolute encoders, since the equipment is in a high noise environment. Next, decide whether you want the long life, but high cost, of the optical encoder or the lower cost and shorter life of the brush encoder. Since the machine operates at 1000 rpm, for best long-term reliability, noncontacting optical absolute encoders would be best for the job.

Now what code should you select? Your display or computer system will determine the code. By far the most popular is BCD.

The selected encoder must provide an exact output that corresponds to the movement of the cutting tool. Use of a five-pitch lead screw requires that for one revolution of the lead screw, the encoder output corresponds to 0.2 in. However, since the spec requires 0.001 in. accuracy, the encoder must generate an output of 0.200 in. for one revolution of the encoder disc.

Thus the encoder must provide 200 counts per revolution to relate the position of the cutting tool. The range the encoder needs to read a position of 30 in. would actually have to be 30.000 in.

Now let's look at the output voltage levels. TTL-compatible outputs are probably the easiest to work with; so for a logic ONE, the signal should be at least 2.5 V and 5 V max. For a logic ZERO, the signal should be 0.5 V max.

If the encoder is to be used as a computer input, make sure you have all the timing worked out. To ensure correct data entry, you can use the least-significant digit of the encoder output as a data-ready signal.

Use encoders as control elements

By mechanically coupling the encoder to the element you are trying to position, you can use the encoder as a feedback element. To couple the two shafts, you have a choice of bellows, rack-

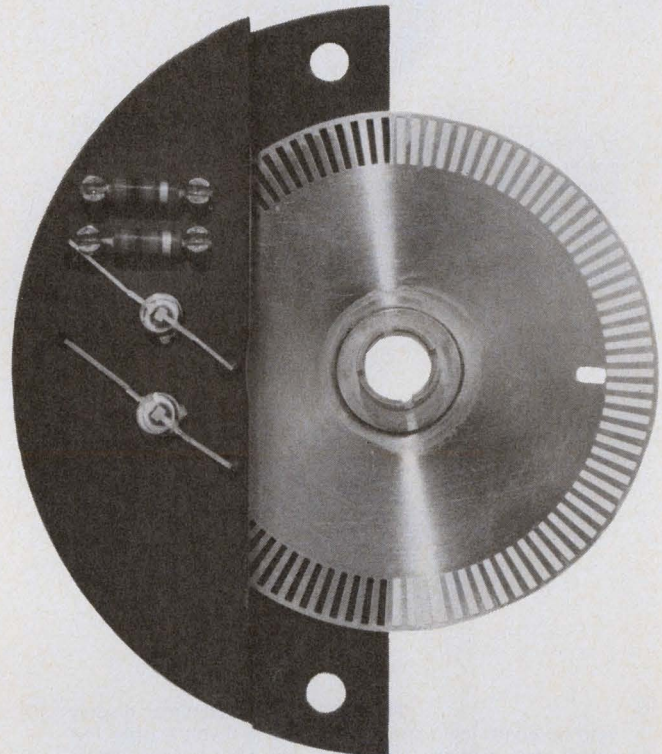
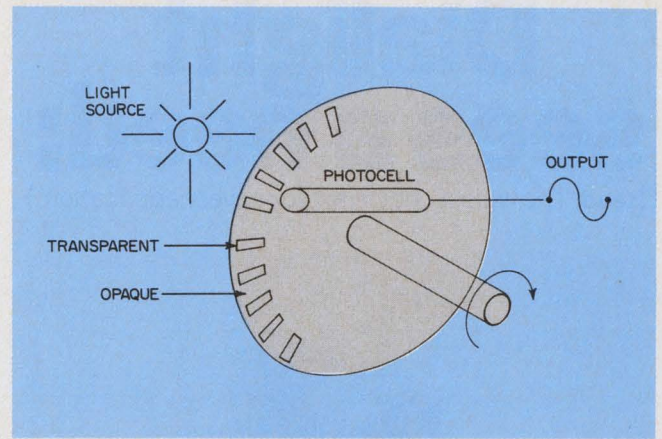

3. Incremental optical encoders use simple disc patterns to generate pulse outputs when the encoder shaft is in motion.

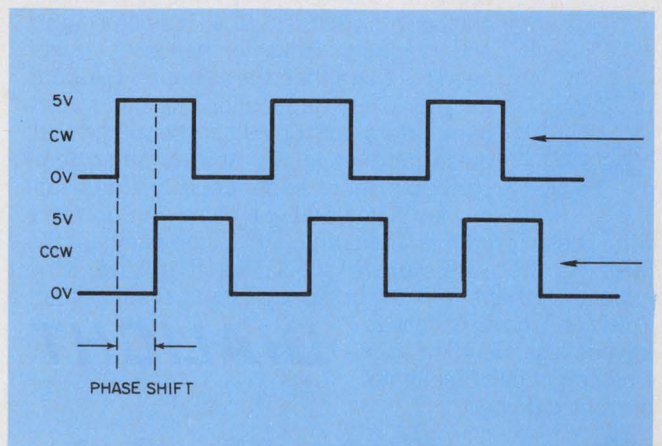

4. Pulse train outputs from optical encoders can tell you in which direction the shaft is turning if the pulses are phase-shifted by 90°.

Dialight sees a need:

(Need: The widest choice for your every application.)

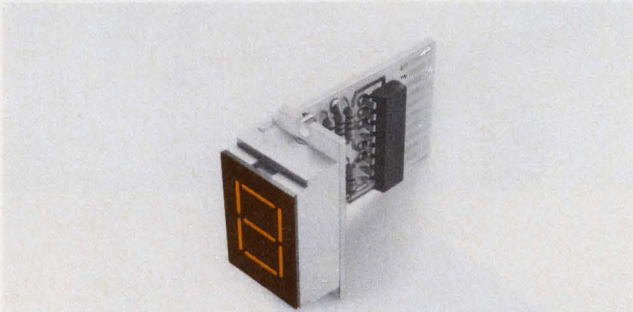

730 SERIES Your choice . . . a red or green LED readout with large 0.625" characters . . . low power, operates with standard IC power supply levels. Comes in plus-minus module. Display uses standard or high brightness LEDs for maximum light output arranged in a seven-segment format. Available with or without on-board decoder/driver. Unique lens design generates bright, highly legible characters.

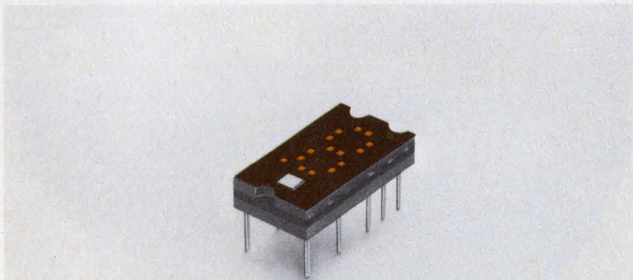

745-0007 LED hexadecimal display with on-board logic operates from 5 to 6 volt supply, low power consumption. Integral TTL MSI chip provides latch, decoder and drive functions. 0.270" character display has wide angle visibility and mounts into standard 14-pin DIP socket.

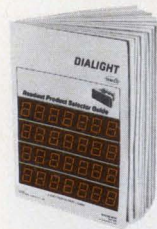

Dialight, the company with the widest choice in switches, LEDs, indicator lights and readouts, looks for needs . . . your needs . . . and then they develop solutions for your every application. No other company offers you one-stop shopping in all these product areas. And no other company has more experience in the visual display field. Dialight helps you do more with these products than any other company in the business, because we are specialists that have done more with them. Talk to the specialists at Dialight first. You won't have to talk to anyone else. Send for your free new copy of Dialight's current catalog.

DIALIGHT

Dialight, A North American Philips Company
203 Harrison Place, Brooklyn, N. Y. 11237
(212) 497-7600

See Dialight.

INFORMATION RETRIEVAL NUMBER 35

Table 2. Etch pattern for angular-displacement encoder

Shaft Rotation (Degrees)	Decimal Count	BCD Output											
		Most Significant Decade			Second Least Significant Decade			Least Significant Decade					
		2 ³	2 ²	2 ¹	2 ⁰	2 ³	2 ²	2 ¹	2 ⁰	2 ³	2 ²	2 ¹	2 ⁰
000	0												
001	1												
002	2												
003	3												
004	4												
005	5												
006	6												
007	7												
008	8												
009	9												
010	10												
011	11												
012	12												
013	13												
014	14												
015	15												
↓	↓												
095	95												
096	96												
097	97												
098	98												
099	99												
100	100												
↓	↓												
355	355												
356	356												
357	357												
358	358												
359	359												

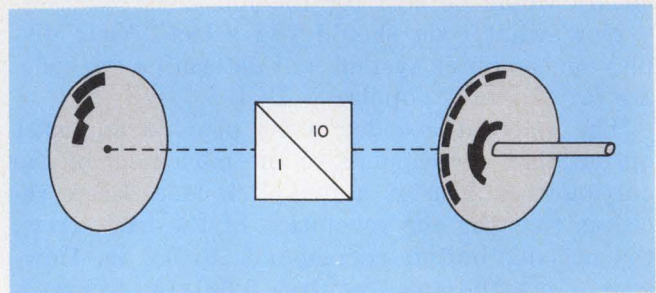

5. By using gear ratios to reduce the speed of shaft rotation, you can scale down the encoders and get a wide operating range.

and-pinion elements, lead screws and gears.

Since the element is being driven by some sort of motor, you can probably use the existing drive and couple to it. By taking the information the encoder delivers and comparing it with a digital command signal, you can determine where the element will travel and how fast. Let's look at a control example.

A machine must automatically cut sheets of fabric of predetermined sizes as the material passes through a set of 10-in.-dia rollers. Since the roller circumference can be found to be 31.4 in., an incremental encoder that provides 314 counts per disc revolution would give all the information you need.

The encoder output is then fed to a preset counter. When the counter reaches the preset value, it produces a signal, which in turn controls the material-cutting blade. ■■

Amperex has what it takes to be Number One in RF Power Semiconductors...

The Line • The Book • The Boards

The line has been expanded with the addition of all the popular 2N types to the standard in-house types that have been available all along; there are new supplements to the book, available at no charge of course, to every recipient of the original edition... and our applications assistance has kept pace by the addition of many more prototype sample boards

Yes, we are still going all out to support our state-of-the-art line with a state-of-the-art program of applications engineering assistance.

Today, there's an Amperex RF power transistor for virtually every fixed or mobile transmitter application from 1.6 MHz to 2300 MHz, from 1/4 watt to 150 watts, in 25 different packages and operating at any standard voltage from 6V to 50V.

As new RF transistors are added to our product line, we publish supplements that keep the application manual right up to date. But the engineering assistance doesn't end with the manual—it only starts there. You won't even have to build the prototypes to get these circuits into production! We will supply sample boards, built for you, here in the Amperex applications laboratory. Use them to test, to evaluate, to demonstrate your system. Typical of the sample boards now being made available to Amperex customers is a 100 watt, 1.6 to 18 MHz, 12.5 volt Marine Radio Amplifier (illustrated below).

For more information... on the line, the book, the boards, contact
Marty Burden, Group Product Manager, Amperex Electronic Corporation,
Hicksville Division,
Hicksville, N.Y. 11802.
Tel. 516-931-6200.

Amperex®

TOMORROW'S THINKING IN TODAY'S PRODUCTS

Sold through
North American Philips Electronic Component Corporation

Marine Radio Amplifier
100 W output, 1.6 to 18 MHz,
12.5 V operation

... now —
all these popular
2N types as well
as our standard
in-house types:

2N4040	2N5862
2N4041	2N5913
2N4127	2N5914
2N4128	2N5915
2N4428	2N5916
2N4429	2N5917
2N4430	2N5918
2N4431	2N5919
2N4933	2N5922
2N5016	2N5923
2N5070	2N5924
2N5071	2N5925
2N5090	2N5941
2N5102	2N5942
2N5108	2N5992
2N5177	2N5993
2N5178	2N5994
2N5589	2N5995
2N5590	2N5996
2N5591	2N6080
2N5635	2N6081
2N5636	2N6082
2N5637	2N6083
2N5641	2N6084
2N5642	2N6094
2N5643	2N6095
2N5644	2N6096
2N5645	2N6097
2N5646	2N6104
2N5687	2N6105
2N5688	2N6136
2N5689	2N6166
2N5690	2N6197
2N5691	2N6198
2N5697	2N6199
2N5698	2N6200
2N5699	2N6201
2N5700	2N6202
2N5701	2N6203
2N5702	2N6204
2N5703	2N6205
2N5704	2N6206
2N5705	2N6207
2N5706	2N6208
2N5707	2N6255
2N5708	2N6256
2N5709	2N6265
2N5711	2N6266
2N5712	2N6267
2N5713	2N6268
2N5714	2N6269
2N5773	2N6361
2N5774	2N6362
2N5775	2N6363
2N5776	2N6364
2N5846	2N6369
2N5847	2N6368
2N5848	2N6366
2N5849	

... our standard
in-house types:

BFS22A	BLX95
BFS23A	BLY87A
BGY22	BLY88A
BGY23	BLY89A
BGY24	BLY90
BLX13	BLY91A
BLX14	BLY92A
BLX15	BLY93A
BLX65	BLY94
BLX66	2N3375
BLX67	2N3553
BLX68	2N3632
BLX69	2N3924
BLX92	2N3926
BLX93	2N3927
BLX94	

Digivue® - a better way to look at it.

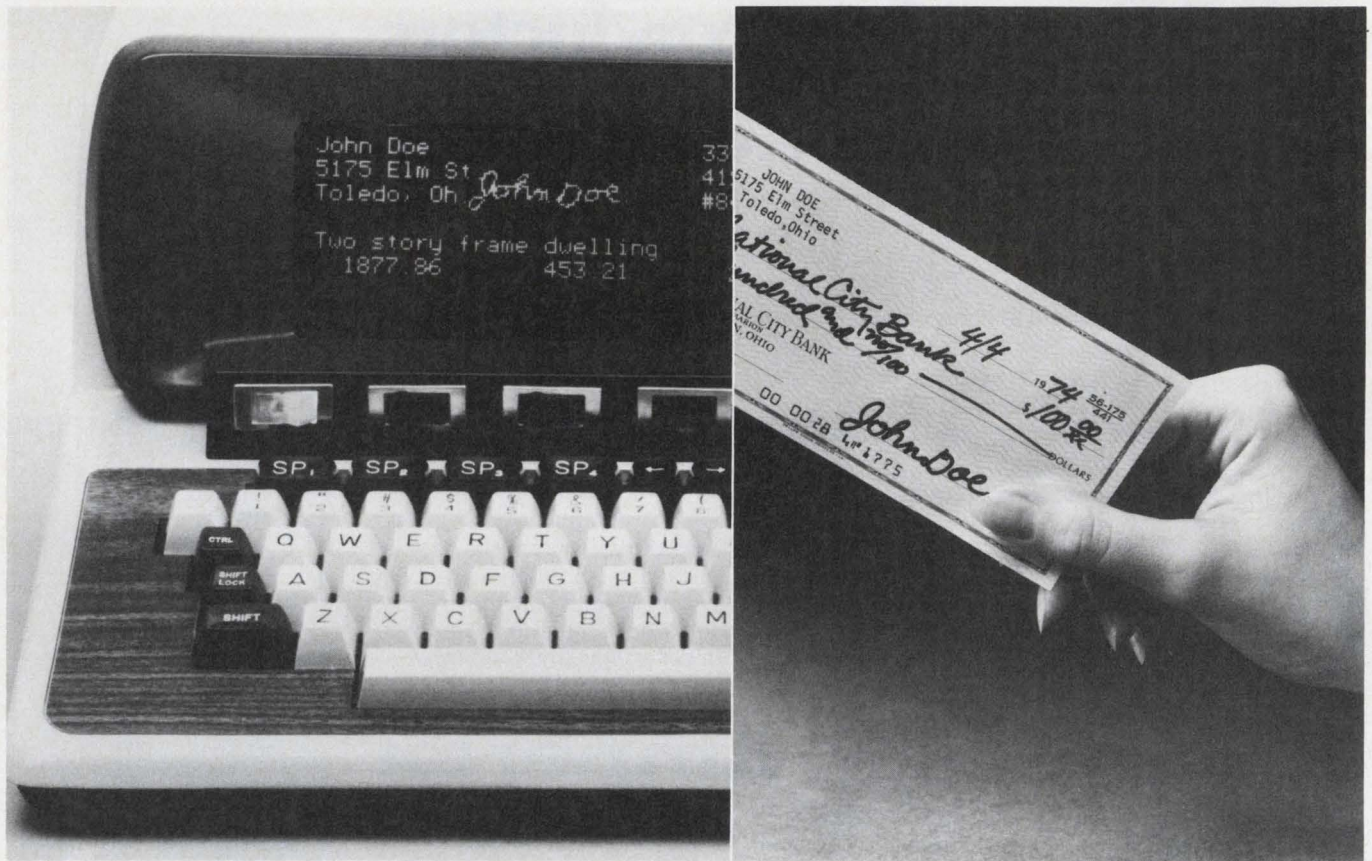

Digivue 80-33 in demonstration unit, showing high-contrast display for use in signature verification.

Because computer time is valuable to your customers, Digivue display/memory units offer an unforgettable advantage.

The advantage is inherent memory and it's an inherent part of every Digivue unit. This makes Digivue units especially useful for graphic presentations like signature verification since refresh is not required.

And Digivue units offer a high-contrast, flicker free display for precise readings with less chance of eye fatigue for people who spend long periods referring to data displays and computer terminals.

There's a lot more to Digivue, too. Our 512-60 models have hard copy and rear projection capabilities. And Digivue panels are flat and thin, allowing precise display and broad equipment design parameters.

As you may have guessed, Digivue display/memory units currently cost more than CRT's. But then, they offer a lot more. For a booklet that explains Digivue more fully, call (419) 242-6543, Ext. 66-415. Or write Electro/Optical Display Business Operations, Owens-Illinois, Inc., P.O. Box 1035, Toledo, Ohio 43666.

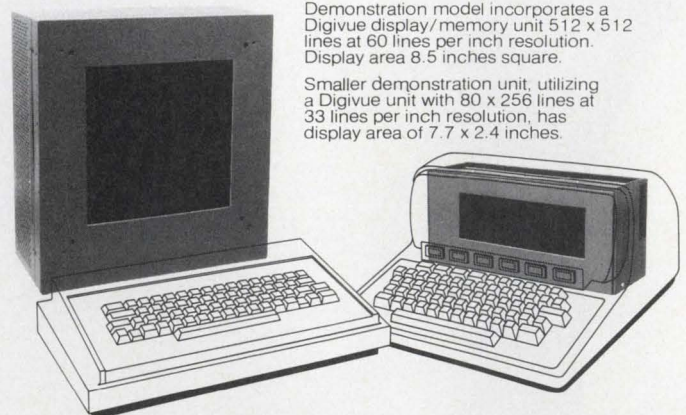

Demonstration model incorporates a Digivue display/memory unit 512 x 512 lines at 60 lines per inch resolution. Display area 8.5 inches square.

Smaller demonstration unit, utilizing a Digivue unit with 80 x 256 lines at 33 lines per inch resolution, has display area of 7.7 x 2.4 inches.

OI
OWENS-ILLINOIS

Toledo, Ohio

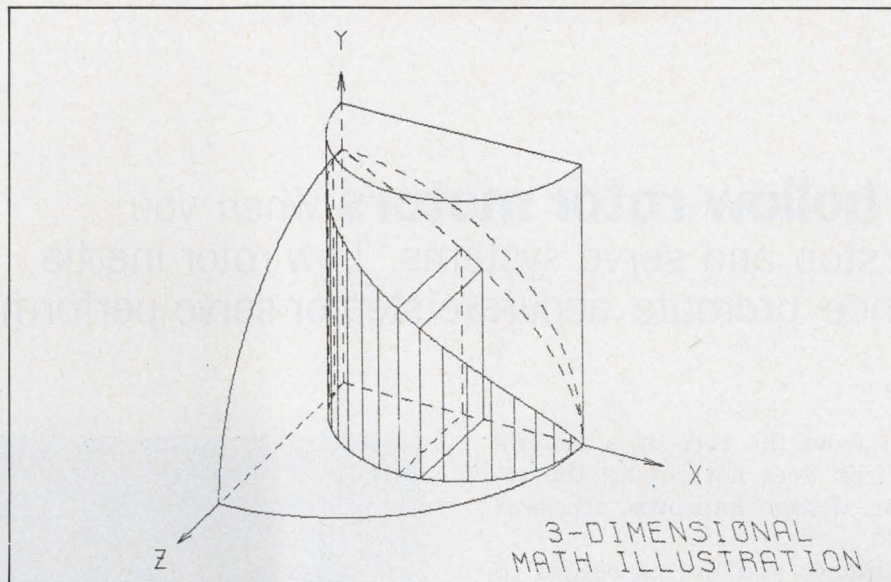

After your 360/370 massages the information, a Gould Plotmaster^{T.M.} can draw you a picture within 3 seconds.

If alphanumeric information is what you want, a Gould Plotmaster can print it for you. At speeds up to 3000 lines per minute. But there are times when alphanumeric listings are just too much. Too much paper to handle, too tough to read, too difficult to digest.

And it's at times like these that a Gould Plotmaster can draw you a picture. A line chart, a bar chart, a pie chart, a graph. A picture that tells your story at a glance.

Employing high-speed electrostatic printer/plotters, Gould Plotmaster Systems give you power and versatility for both on-line and off-line operation. And they're designed to run on any IBM System/360 or 370 operating under DOS or OS, real or virtual.

Easy-to-use software packages help our Plotmaster Systems do the whole job. There's our DISPLAYTM package that provides even non-programmers with the capability of easily generating line, bar and pie

charts. And there's our PLOT package which, due to the speed and flexibility of our printer/plotters, lets you do background grids, variable line weights, automatic stripping, text annotation, and allows you to erase previously programmed line segments.

In addition to business graphics, a Gould Plotmaster can add engineering/scientific graphics and computer-aided-design capabilities to your operation. These optional software packages include DADS (Data Acquisition Display), PAL (Precision Artwork Language) and FAST-DRAW.TM As for the hardware itself, our Plotmaster Systems can provide on-line/off-line operation, paper widths up to 22 inches, resolution up to 200 dots per inch, output speeds up to 7 inches per second. And, of course, a printing capability, as well.

Get all the facts on Plotmaster Systems from Gould Inc., Instrument Systems Division, 3631 Perkins Avenue, Cleveland, Ohio 44114 U.S.A. or Kouterveldstraat 13, B 1920 Diegem, Belgium.

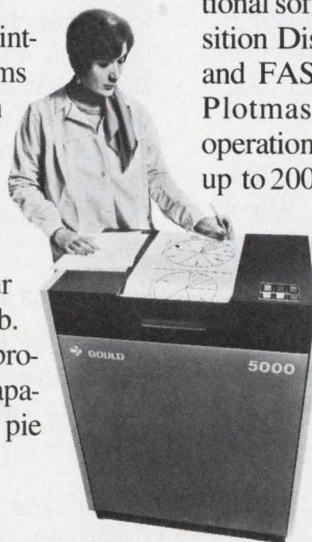

 **GOULD**

INFORMATION RETRIEVAL NUMBER 38

Consider hollow-rotor motors when you design start/stop and servo systems. Low rotor inertia and inductance promote accurate step or servo performance.

Remove the iron from the core of a motor's rotor, so that the iron does not rotate; the resulting hollow-rotor design improves acceleration at least tenfold.

No longer are clutches and brakes needed to disconnect or connect the load to a continuously running motor—as is necessary when the rotor has too high an inertia. With low-inertia rotors, the motor, by itself, can quickly accelerate or decelerate loads, such as in tape transports, printers and other servo applications.

In hollow-rotor designs, the armature-coil wire is wound to form a cylindrical shell, which is then reinforced with glass yarn, coated with an epoxy resin and cured (Fig. 1). The hollow, or basket, rotor now rotates about the iron, not with it.

Rotors of conventional electric motors are constructed with copper windings set into slots of an iron core. The rotor is heavy, and it has high rotary inertia, which impedes quick starts and stops.

However, hollow-rotor designs are still limited to motors with less than about 0.5 hp. Therefore, for higher power start-stop drives that require a motor with greater power output, clutches and brakes must still be used.

Though the hollow-rotor motor is not the answer to all problems, with hollow rotors the weight and inertia are dramatically reduced—a 1.3-ms mechanical time constant is typical—and acceleration soars. For example, a hollow-rotor dc motor can accelerate at 1000×10^3 rad/s²; a similar conventional iron-core unit speeds up only 40×10^3 rad/s².

These are initial acceleration values at the instant voltage is applied to the motor. When the rotor is not turning, armature current is a maximum. As soon as the rotor starts to rotate, the motor generates back emf, which opposes the applied terminal voltage. The armature current drops, and torque and acceleration are lowered.

The generator action of dc servo-motors is

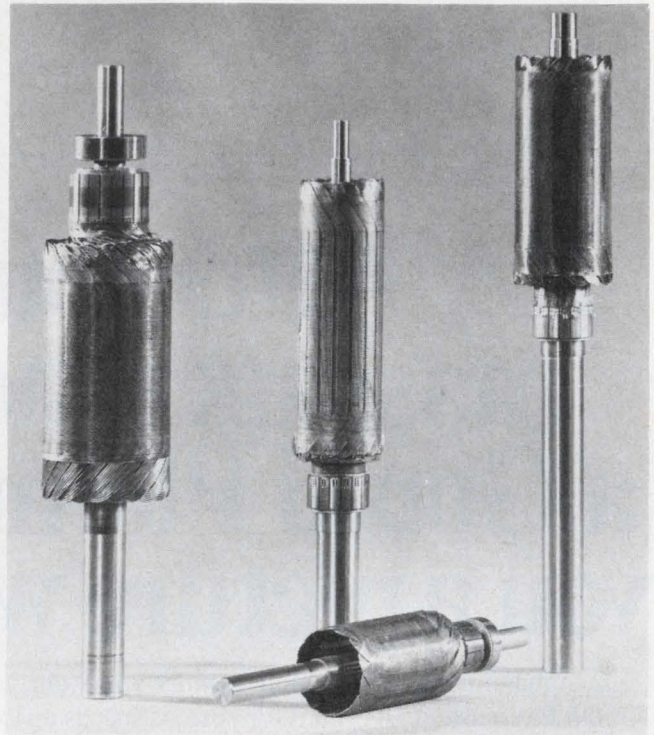

1. Hollow-rotor armatures have low inertia and inductance. They thus make motors easy to start and stop quickly, and follow rapid servo signals.

characterized by a generator coefficient, k_E , which specifies the amount of back volts generated per rpm and depends on the motor's magnetic field strength and the length and number of turns in the armature winding. To overcome the drop in torque as back emf builds up, the motor may be driven from a constant-current source, or the applied terminal voltage may be increased at the same rate as the back emf.

Low inertia and high acceleration

Angular acceleration, α , or the rate of change of angular velocity, ω , is approximately proportional to rotor current, I :

$$\frac{d\omega}{dt} = \alpha \cong \frac{T}{J} = \frac{k_T I}{J}, \quad (1)$$

where k_T is the motor's torque/current coefficient (oz-in/A) and T is torque in oz-in.

The k_T constant for a given motor frame, k_E , also depends upon the number and length of conductors in the rotor and the strength of the magnetic field that is cutting them. For a fixed field, as in PM motors, torque is directly proportional to rotor current. Since hollow-rotor motors have very low inertia, even when compared with disc motors (radial rotor conductors molded in an epoxy disc) of equal torque, the hollow-rotor types can accelerate at a much higher rate.

Where a conventional, laminated-steel-core motor might have a rotor inertia of 10×10^{-3} oz-in.-s² and a disc-type 5×10^{-3} oz-in.-s², the hollow-rotor type of about the same power and torque rating might have inertia of only 0.4×10^{-3} oz-in.-s².

Inertia of a rotating device varies as the fourth power of radial dimension. Therefore a small-diameter cylindrical shell inherently has a much lower inertia than a large-diameter disc rotor. To determine rotor inertia, all rotating parts must be included in the calculation.

A motor's equivalent circuit

A hollow-rotor motor's equivalent circuit is accurate for first-order calculations (Fig. 2). The terminal voltage, V_T , is related to the back emf induced in the rotor, V_E , by the equation

$$V_T = IR_T + V_E + L di/dt.$$

However, since inductance is small, it can be neglected for a hollow-rotor motor, and the equation reduces to

$$V_T = IR_T + V_E, \quad (2)$$

and the back emf induced in the motor is

$$V_E = \omega k_E, \quad (3)$$

where ω is the angular velocity of the rotor in radians/second— $\omega = 2\pi n/60$, $n =$ revolutions/minute—and k_E is the motor's back emf constant.

Since

$$T = k_T I,$$

then

$$V_T = \frac{T R_T}{k_T} + \omega k_E.$$

Also, because the power input to the motor is

$$P_T = V_T I = T\omega + I^2 R_T,$$

which is the sum of the mechanical power pro-

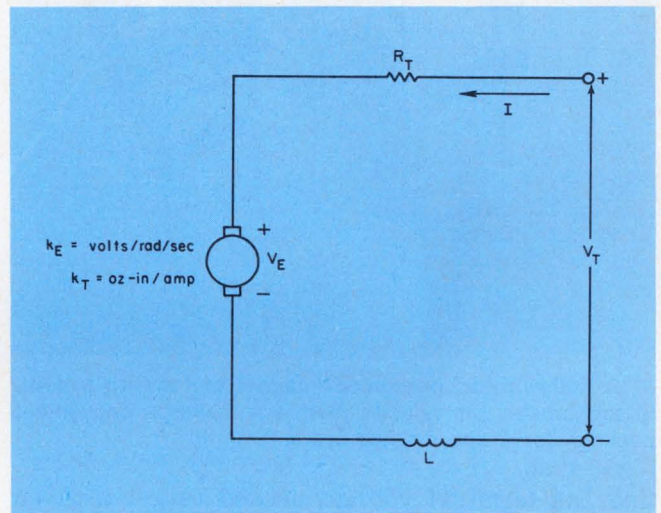

2. A motor's equivalent circuit provides a model of sufficient accuracy for first-order calculations.

duced by the rotor and the power it dissipates, and

$$P_T = V_E I + I^2 R_T,$$

obtained by multiplication of Eq. 2 by I , then

$$T\omega = V_E I.$$

Finally,

$$\frac{V_E}{\omega} = \frac{T}{I} = k_E = k_T = k \text{ (constant)}, \quad (4)$$

$$V_T = k\omega + IR_T, \quad (5)$$

and

$$V_T = k\omega + \frac{TR_T}{k}. \quad (6)$$

The starting, or stall, current is

$$I_s = \frac{V_T}{R_T}.$$

And if the no-load current is I_0 , then the torque loss because of friction can be calculated as

$$T_F = kI_0.$$

Further, since

$$V_T = k\omega_0 + I_0 R_T,$$

where ω_0 is the no-load speed, then

$$k = \frac{V_T - I_0 R_T}{\omega_0} \quad (7)$$

in terms of no-load speed and current. Starting torque is

$$T_s = I_s k - T_F = (I_s - I_0) k, \quad (8)$$

the torque available for a given load T_L is

$$T_L = (I_s - I_0) k - k^2 \omega / R_T, \quad (9)$$

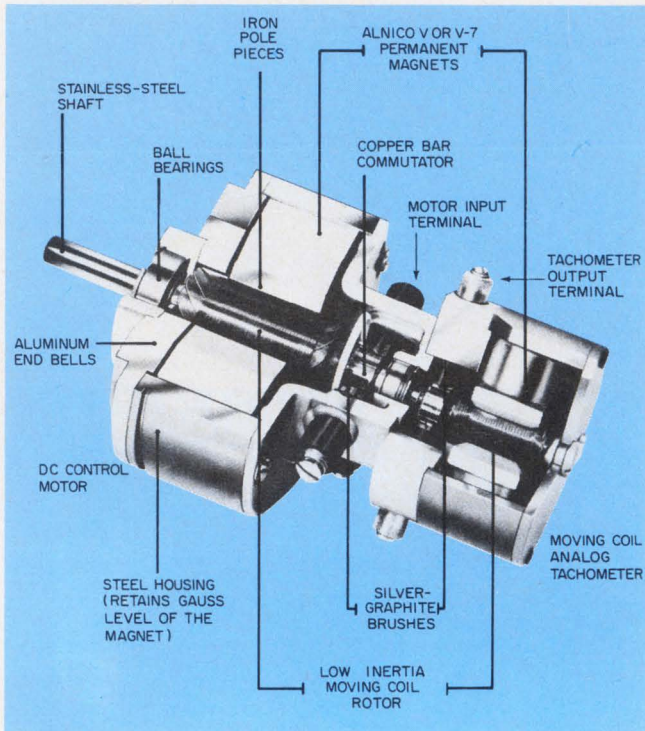

3. A hollow-rotor, permanent-magnet motor with a built-in tachometer for velocity feedback makes a convenient package for a speed-servo system.

and the terminal voltage needed to get a given speed is

$$V_T = (T_L/k + I_0) R_T + k\omega. \quad (10)$$

Low inductance speeds motor response

An additional advantage of the hollow rotor is low inductance. The coils of a shell rotor have few turns, do not intimately encompass iron and therefore have low inductance. Low inductance allows rotor current to build up and decay rapidly, and the motor's torque can follow variations in applied voltage closely. A conventional rotor can easily have 100 times the inductance of a hollow rotor. Consequently, after a change in applied voltage, V_T , a torque change can take 100 to 1000 times longer to reach with regular motors than with hollow-rotor types.

Inductance limits the rate at which the current can build up in the coil:

$$I = \frac{V_T}{R_T} (1 - e^{-t/T_E}),$$

where the electrical time constant, T_E , of a dc servo motor is the ratio of armature inductance, L_A in henries to terminal resistance, R_T in ohms.

$$T_E = \frac{L_A}{R_T}$$

The low rotor inertia and inductance dc servo motors allow well-designed units to go from dead stop to 3840 rpm in as little as 0.7 ms and to attain full speeds of 12,000 rpm quickly (Fig. 3).

In addition to providing benefits for step oper-

ation, low inertia and inductance also allow a servo motor to follow sinusoidal signals closely. In general, as the frequency of an applied sinusoidal signal increases, a motor's amplitude response decreases. But the rate of decrease is less rapid when the motor's rotor inertia and inductance are low. The range of frequencies that the motor can follow is called its "bandwidth." And the ratio of response amplitude to amplitude of input signal is called the frequency response.

Not only is amplitude response adversely affected by high inertia and inductance, but also the phase of the motor's movement increasingly lags as the frequency of the applied voltage increases. This lag, together with armature and shaft flexing under the stress of rapidly reversing torques, can produce a resonance condition that results in a delayed feedback signal to the amplifier of the servo control system. The entire system can become completely unstable, because of this delay.

Terminal resistance is a simplification

Though the terminal resistance, R_T , of a servo motor is usually given as a single constant value, its true nature is not that simple. The specified value is only an average of the dynamic resistance of the total rotor circuit, which includes the resistance of the copper wire of the armature, the resistance of the brushes, the resistance between the brushes and terminals and the contact resistance between brushes and the commutator.

The brush-to-commutator resistance is a complex function of brush pressure, commutator surface speed and commutator surface conditions. A further complication results from variations as the brushes short-circuit rotor coils during commutation. In addition motor terminal resistance usually is specified at 25 C. Thus for greater computational accuracy, the resistance should be corrected for temperature by the formula

$$R_T = R_{25} (1 + \gamma \Delta T),$$

where $\gamma = 0.004/^\circ\text{C}$ for copper.

Voltage and current ratings

In general, a rated voltage is used for servo motors, for specification only. In applications, the applied voltage may vary from zero to as much as two or three times the rated value, depending upon the mode of operation and torque requirements. However, if motors are operated below a maximum of 42.5 V dc, the system meets Underwriters' Laboratory requirements for unprotected systems.

Rated current in servo motors is the maximum continuous current that the motor can handle and yet not exceed its rated temperature without

Meet the first scope with a microprocessor.



It counts, calculates, and improves accuracy too.

Now, HP has combined a high-performance scope, a microprocessor, and an LED display to put an end to graticule counting, mental calculations, and the conventional 5% scope error. The 1722A gives you a giant leap in measurement accuracy and convenience. It's a working lab partner that speeds measurements of time intervals, frequency, instantaneous or dc voltage levels, and relative amplitude. It allows you to make all these measurements more accurately...with less chance of human error.

The microprocessor takes over several tasks you used to perform. It keeps track of

ing of your measurements...in seconds, hertz, volts, or percent. Working with the 1722A is like having an assistant that takes care of the mental gymnastics.

There's another reason for easier, more accurate measurements—HP's unique Dual Delayed Sweep. It gives you two adjustable intensified markers for displaying the start and stop points of a time interval. The microprocessor then gives you an automatic read-out of the time interval between the markers. This speeds digital timing measurements and simplifies the adjustment of circuits to meet a timing spec.

The combination of a proven 275 MHz dual-channel scope, microprocessor, LED display, and Dual Delayed Sweep gives you faster, more complete waveform characterization than you'll get from conventional scopes costing twice as much.

And instead of the conventional 3 to 5 percent reading errors typically associated with voltage and time

measurements, the 1722A puts you in the 0.5 to 1 percent range.

The 1722A begins a new era of measurement technology by giving you faster answers, more accurate answers, even answers you couldn't get before. And at a price of just \$4,500.*

Let your local HP field engineer introduce you to the new scope generation. Call him today. Or, write for our informative 8-page brochure.

*Domestic USA price only.



dial settings, automatically computes time intervals and voltage levels, converts time measurements to frequency, and calculates percent. It even signals if you make an erroneous setting. In addition, the microprocessor drives a 3½-digit LED display to give you a direct digital read-

HEWLETT  PACKARD

Sales and service from 172 offices in 65 countries.
1501 Page Mill Road, Palo Alto, California 94304

Build dc/dc converters that work.

With a careful choice of bias and drive, plus design against known failure modes, you can ensure a reliable power source.

Along with the high efficiencies of dc/dc converters come a number of failure modes and other problems that careful design can eliminate. Spikes, excessive power dissipation, EMI—just a few of the offenders—can be locked out by proper selection of the circuit configuration, judicious bias and drive arrangements and other steps. The net result: a small, reliable converter with 80% efficiency, or more.

In the basic, self-oscillating, saturating-transformer design (Fig. 1), the dc input is chopped to generate complementary square waves. These are then transformed and rectified to deliver the final dc-output level.

In Fig. 1, the square waves are produced at the collectors of Q_1 and Q_2 , which conduct alternately: When Q_1 saturates, Q_2 is cut off, and vice versa. Both transistors are driven by feedback windings on transformer T_1 . Since the voltage across the on transistor is small—about 0.2 V—the drop across its winding (half the primary) nearly equals the supply voltage E_{in} .

The primary voltage remains constant for a half-cycle, during which the magnetizing flux in the core steadily increases. When the core becomes saturated, the device tries to maintain the flux rate of change. But magnetizing current rises rapidly to a peak, the flux rate of change can no longer be maintained, and the rate decays to zero. The voltages across the windings vanish, thereby removing base drive from the on transistor.

As the transistor turns off, the magnetizing current drops toward zero and the total flux falls. The negative flux change reverses the winding polarity and completes the turn off of the transistor. The second transistor now turns on and, because of regeneration, quickly saturates.

Transformer saturation in the reverse direction then cuts off the second transistor and turns the first back on to complete the cycle. In this process, the switching frequency is determined

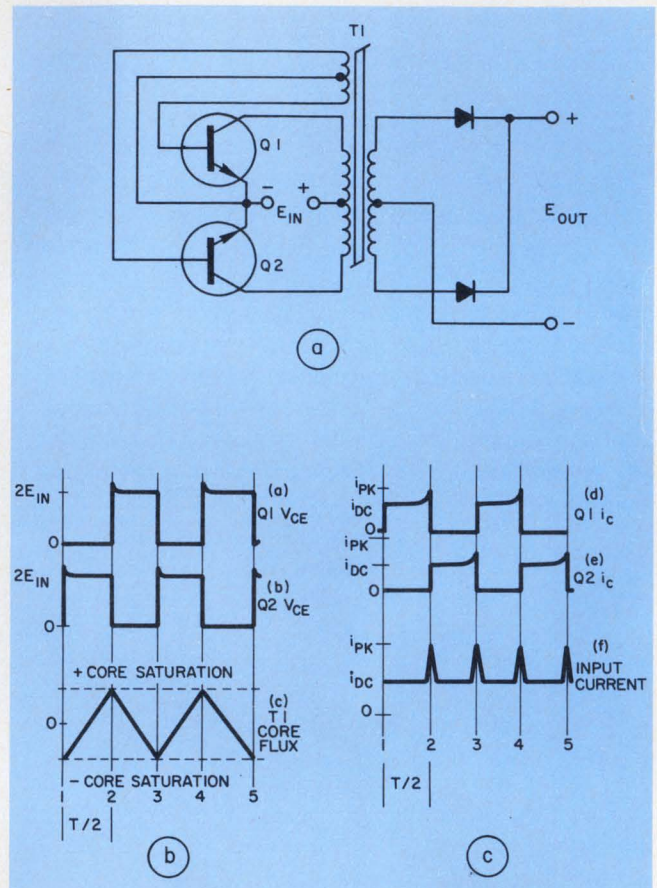

1. The basic, two-transistor dc/dc converter (a) generates a square wave (b) that is transformed and rectified to produce the final output. Current waveforms are shown in "c."

by the time interval required for the transformer to saturate in each direction.

Watch out for spikes

Note, in Fig. 1c, the current spikes in each half-cycle at the end of each transistor's conduction period. The current peaks are caused by core saturation, so are relatively independent of the load. Peak collector current, I_{pk} , is given by:

$$I_{pk} = \beta I_b,$$

where β is the transistor-current gain and I_b is

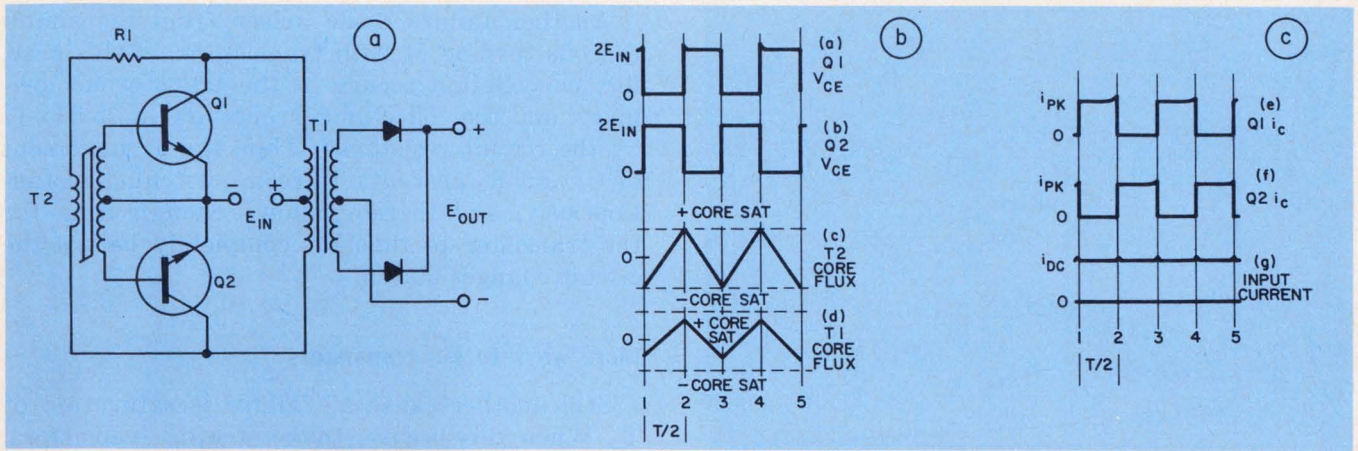

2. To reduce power losses and minimize problems caused by current spikes, a separate transformer is

used for the output and base-drive functions (a). The two-transformer design reduces spiking (b and c).

the base current. The peak collector current, stemming from the saturation of the transformer, rises sharply just before transistor cut off. Unfortunately, these collector spikes are reflected to the power input.

Although short, the spikes occur while the collector voltage is rising, and result in an instantaneous peak power dissipation many times that at steady-state. Besides a reduction in converter efficiency, the transistor junctions may overheat, degrading reliability.

It can be seen that if the transistors are not fairly well matched, the spiking and power dissipation can become excessive and the output waveforms asymmetrical. While asymmetry may affect system operation, too high a dissipation will destroy the transistors. Moreover, the spikes create EMI, which is sure to affect the power lines.

Fortunately, interference can be minimized and power losses cut by the use of a two-transformer design (Fig. 2). In the figure, transformer T_1 does not saturate. This just about eliminates collector spiking. The transistors are driven—and the oscillation frequency determined—by an additional, small, saturable transformer T_2 . Thus transformer design is less critical and T_1 and the remaining circuit can be designed to be more efficient.

A more pragmatic approach

In a more practical circuit (Fig. 3), the transistors are biased by a regenerative circuit, consisting of saturating transformer T_1 , limiting resistors R_6 and R_3 , and components D_1 and C_7 (do not consider L_1 or winding 3 of T_1 at this time).

When Q_1 is on in Fig. 3, the voltage at the collector of Q_2 is high and provides base drive for Q_1 through T_1 , which simultaneously back-biases Q_2 . During this time, C_7 charges to the

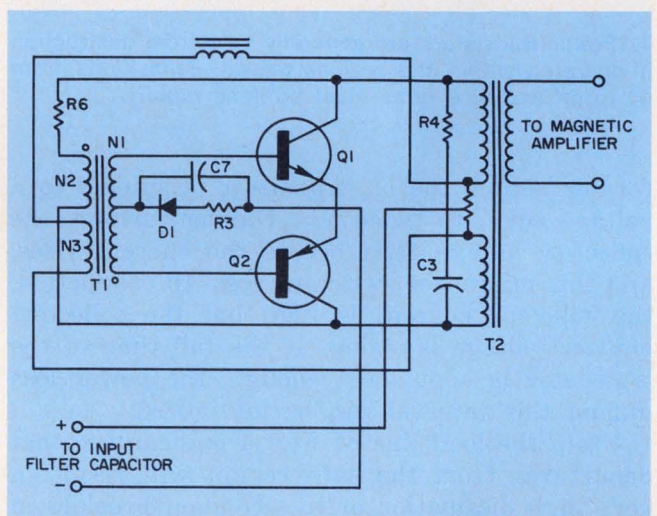

3. A more pragmatic approach to converter design adds limiting networks and other components to safeguard against various failure modes.

voltage drop across D_1 and R_3 . At some time after the beginning of the cycle, T_1 saturates and its primary and secondary voltages go to zero. The voltage on C_7 is then such that Q_1 turns off. Regenerative action of the closed loop consisting of T_1 , T_2 , Q_1 and Q_2 , then causes the circuit to switch states, turning Q_2 on.

The frequency of operation is selected by an adjustment of the drive-circuit parameters. Operating frequency is a compromise: As the frequency increases, magnetic-material sizes go down but semiconductor switching losses go up. At high operating frequencies, the wiring inductance becomes crucial and wiring techniques must change from those used in 60-Hz power supplies. For these reasons, switching supplies are usually operated above 16 to 17 kHz to eliminate audible noise, and below 25 kHz to keep switching losses at acceptable levels.

The operating load line of a converter transistor is shown in Fig. 4. Because of the trans-

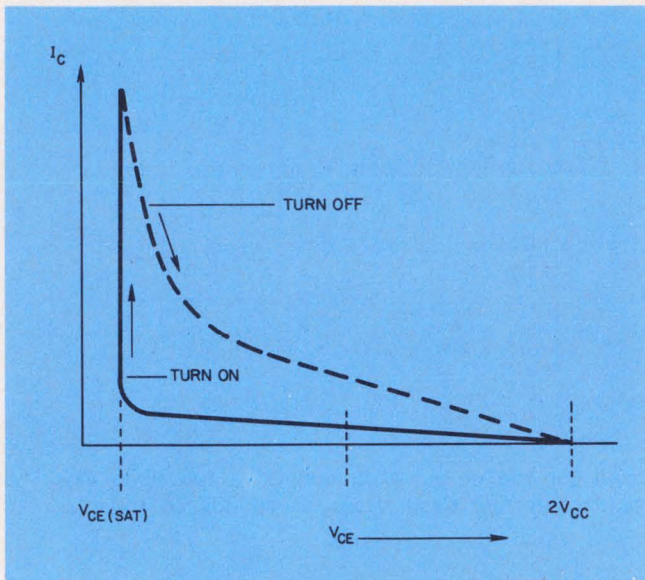

4. Power transistors are generally safe from destruction if operated within the regions shown. Transitions from on to off and vice versa must be done rapidly.

former action, the off transistor is subject to a voltage equal to twice V_{cc} . During turn-on, the collector voltage falls before the current rises, and this minimizes switching loss. In conduction, the collector current is high but the collector-emitter voltage is rising. If the fall time of the transistor is kept short enough, the power loss during this interval can be minimized.

From the load line of Fig. 4 one can see that departures from the safe region will result in very high dissipation or in secondary-breakdown failures. Each transistor must be kept in saturation during its conduction time. For example, a transistor operating from a 200-V source, with a collector current of 5 A, will have a conduction loss of about 5 W ($5 \text{ A} \times 2 \text{ V} \times 1/2$) when saturated. If, however, the transistor comes out of saturation, the instantaneous power could go to 1000 W ($5 \text{ A} \times 200 \text{ V}$)—a value that would surely destroy the device.

Another failure mode arises from the simultaneous turn-on of both transistors. In this case, flux cancellation occurs in the transformer primary, and the collector currents are limited only by the circuit resistance. Thus the arrangement of C_3 and R_4 prevents T_2 from switching instantaneously, and thereby allows enough time for the transistor to turn off completely before the circuit changes status.

More ways to kill transistors

Still another cause of failure is saturation of T_2 . When this occurs, the switching transistors' currents again are limited only by circuit resistance. Normally, T_2 is designed to withstand the operating ac-flux levels. But any imbalance in the switching transistors leads to dc bias of T_2 's core. Though the core may be designed to withstand a certain level of dc flux, if this level is exceeded the transformer will saturate. One source of dc imbalance is storage-time mismatch.

When T_1 saturates, C_7 back biases both transistors. A reverse base current then flows in the conducting transistor. During this time, there is no change in the collector current. This phenomenon, known as storage time, results from an excess of charge in the base region. It is not until this charge is swept out of the base that the transistor current begins to fall.

Storage time varies from transistor to transistor and even within the same device family. When two transistors with unequal storage time are combined, an asymmetrical square wave—which has a dc component—results.

Dc biasing of the core can also result from mismatch of other parameters—like $V_{be}(\text{sat})$ or $V_{ce}(\text{sat})$. One design approach is to select matched transistors. However, there is little assurance that transistors will remain matched. Thus, the long-term reliability of such a system would be suspect.

A better approach takes advantage of a closed-

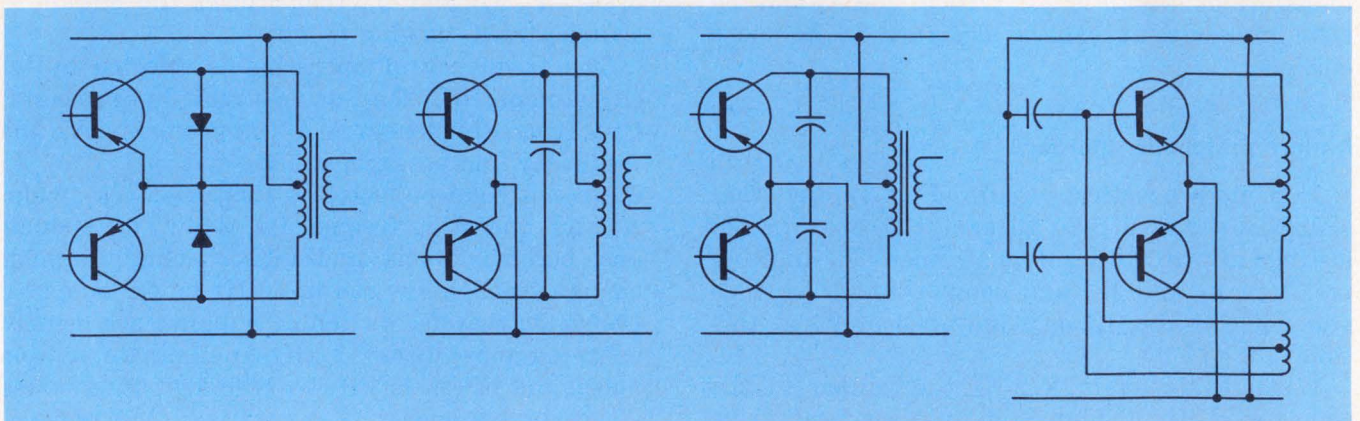

5. Transient spike-suppression networks can be added at various points in the converter. Either diodes or ca-

pacitors can be used to do the job. The transistors are protected and some EMI is eliminated.

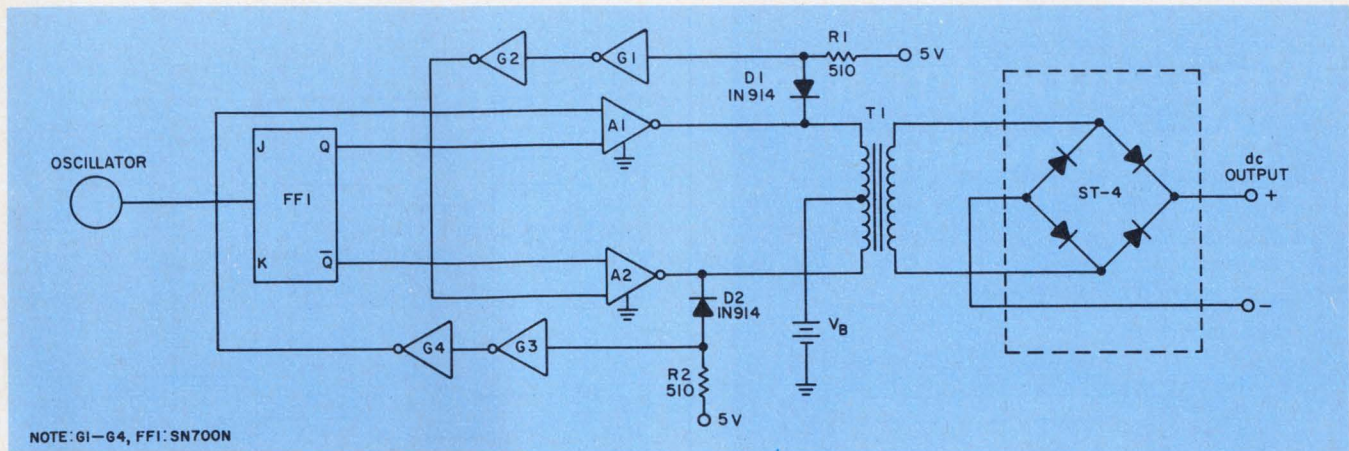

6. Overlap of transistor on states is to be avoided to prevent power loss. One way to do this is to use gates to

sense turn-off delays, and to prevent one transistor from turning on until the other is completely off.

loop balancing circuit— L_1 and winding 3 of T_1 in Fig. 3. If there is any net dc across R_s , the driver core will be biased in a direction to correct the imbalance. Consequently, transistors with very divergent parameters can be safely selected.

To ensure sufficient base-drive current under worst-case conditions, the transistors are overdriven. This also improves efficiency, since $V_{ce}(sat)$ losses are kept low when a transistor is on. But one tradeoff is unavoidable: spikes.

One transistor may be driven on before the other turns off, resulting in a spike that lasts throughout the storage time, which is directly proportional to the amount of overdrive. Power losses caused by spikes increase with frequency and make it difficult to achieve high efficiency.

Pick and choose

Careful selection of core material and good transformer design will alleviate spiking. Spike rise time depends on the shape of the knee of the core material's hysteresis loop. If the squareness ratio B_r/B_m is low, incomplete saturation and undesirable flux changes will increase the spike duration. On the other hand, spike fall time depends on transistor switching speed and circuit reactances.

Ideally, the core's flux density will be high and its losses low. These characteristics are especially desirable in portable equipment to keep transformer size down and efficiency high. Of course, cost, allowable temperature rise, frequency and desired power output also temper the selection of materials.

Loosely coupled asymmetrical transformer windings can cause output spiking, too. It is good practice therefore to spiral half the collector winding over the full periphery of the core, and to bifilar wind the remaining turns between the first spiral's turns. Feedback windings should

be applied in the same way. If the center-tapped collector windings must have many layers, try winding both the collector and feedback windings simultaneously.

At the least, do the feedback winding in one 360-degree sweep and place it next to the collector winding. If possible, use a large core area to minimize the number of secondary-winding turns. This will reduce output ringing (damped oscillations) caused by stray capacitance. Use progressive or sector windings if a large number of turns cannot be avoided.

EMI: a constant headache

Networks intended to suppress power-line transients can also do the same with collector spikes. To do this, several appropriate network locations are shown in Fig. 5. The networks protect the transistors from catastrophic failure caused by load, line and supply turn-on transients, and also suppress some of the generated interference. However, they cannot do the total EMI-filtering job.

When the power-switching transistors are on, overlap of the on states decreases efficiency as switching frequency increases. The overlap results from turn-off delay that occurs when the transistor's base drive is removed. If the delay—which can be on the order of $10 \mu s$ —is sensed, overlap can be minimized: Just prevent one transistor from turning on until the other is off (Fig. 6).

The dc/dc converter in Fig. 6 consists of an oscillator clocking a flip-flop. The flip-flop, through amplifiers A_1 and A_2 , switches the primary of T_1 about its dc-biased center tap. The winding configuration of T_1 and the rectifier network determine the dc-voltage output (T_1 is non-saturating).

In Fig. 6, when the delay is sensed, A_1 is gated with the output of A_2 , and vice versa. Diodes

Why settle for less than Preston?

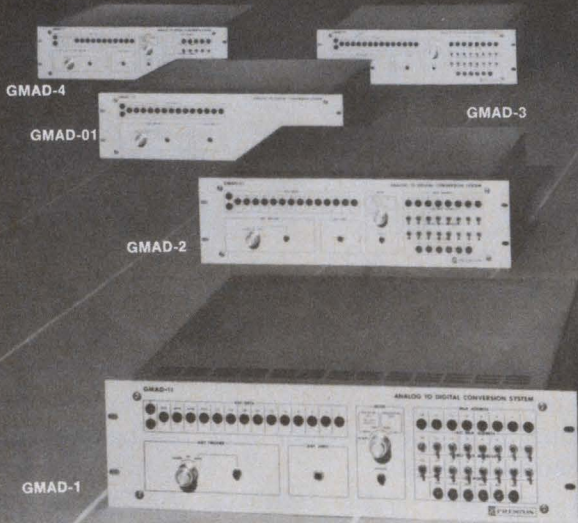

Preston's A-D Conversion Systems Combine Higher Speed, Lower Cost, and All the System Flexibility You Need!

Five models of Preston's GMAD Series cover the entire range of resolution and speed. Everything from 8 bits in 20 microseconds to 15 bits in 1.5 microseconds, including the world's fastest ADC - the GMAD-01 — with 9 bits in 100 nanoseconds!

And you can choose the sub-system components that match your special system requirements —

SAMPLE-AND-HOLD AMPLIFIERS — for both simultaneous sequential signal acquisition, and 1 nanosecond aperture errors!

DC COUPLED AMPLIFIERS — for broadband signal conditioning and 0.01% specs on accuracy, linearity and stability.

MULTIPLEXERS — High Level, Low Level, and Amplifier-per-Channel designs can be intermixed with 0.01% crosstalk!

LOGIC CONTROL CIRCUITS — for front panel first- and last-channel selection of short-cycle "quick-looks" that can increase system speed and efficiency!

DELIVERED COMPLETE — with integral power supplies and all the input and output control signals you need!



This time, be sure you get the world's best ADCs into your system — the ADCs from Preston — the only company that has the know-how and the experience to deliver all these advantages!

Write to us at 805 East Cerritos Avenue, Anaheim, Calif. 92805, — or call us at (714) 776-6400. We'll put all our years of experience on the line!

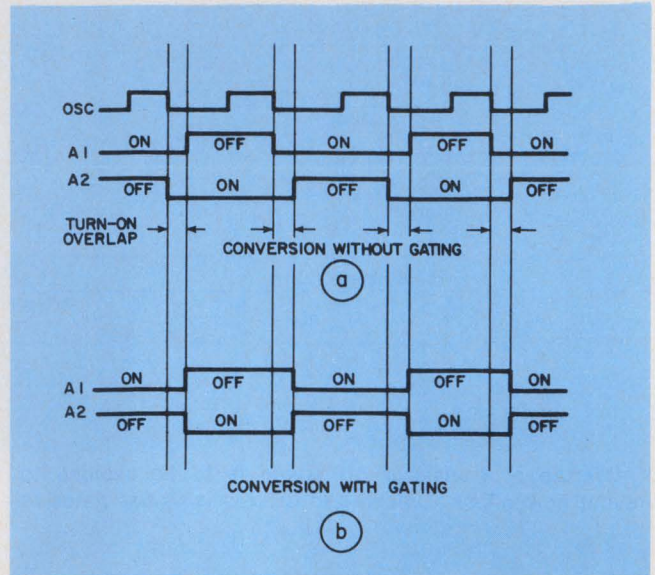

7. Conversion efficiency with gating (a) and without gating (b). Gating prevents an increase in overlap with increasing switching frequency.

D_1 and D_2 prevent the high primary swing from damaging the 5-V-powered logic gates. Resistors R_1 and R_2 alternately bias the inputs of gates G_1 and G_3 high, while D_1 and D_2 are alternately back-biased.

To see how the overlap works, assume FF_1 is reset and all power-transistor delays of A_1 and A_2 have passed. Since V_B is greater than 5 V and A_1 is biased off by FF_1 , then D_1 is also off, and A_2 is on. In effect, FF_1 supplies a logic ONE to A_1 and ZERO to A_2 . With a ZERO at its input, A_2 starts to turn off (turn-off delay). But D_2 remains forward-biased and G_4 prevents A_1 from turning on until A_2 actually turns off.

After the A_2 turn-off delay (logic ZERO output of A_2 removed), D_2 is back-biased and A_1 turns on through the action of R_2 , G_3 and G_4 . The sequence repeats each time FF_1 toggles—once per cycle. Fig. 7 shows the effects of gating on overlap and efficiency.

It is important to note that though the circuits described use transistors as the switching medium in a push-pull configuration, transistors connected as a bridge provide several advantages. The output-transformer primary is used 100% of the time, compared with 50% for the push-pull circuit. Also, the output transistors see half as much voltage stress.

Thus the unregulated output voltage can be double that of comparable push-pull circuits, but with the same current and voltage stresses at the transistors. In effect, this doubles the output power capability.

Transistor bridge configurations can provide more than 1000-W out in high-voltage supplies. If still higher levels are needed, SCRs can be used instead of transistors. ■■

These power semiconductor cooling ideas could get you out of a hot spot.

No. 12 of a Series

Semiconductor control of power means lots of heat generation in the semiconductor device. If the inherent power handling and switching capabilities of the device are to be taken advantage of, you've got to get rid

of that heat. But in power applications, the capabilities of discrete dissipators relying on natural convection or unchanneled air movement are soon outstripped. Here are some innovative ways power circuit de-

signers have used IERC liquid-cooled heat sinks, IERC heat dissipators in channeled air environments, and IERC heat dissipators in IERC forced air packages to get themselves out of big-power hot spots.

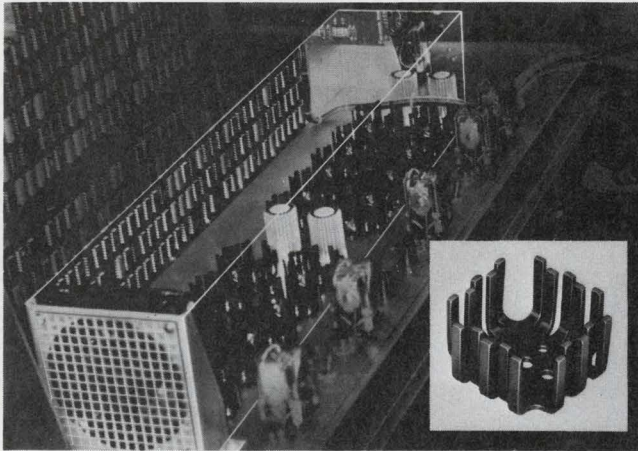

X-Y plotter designer put all his hot TO-3 power transistors in one basket to cope with heat problem. Utilizing existing chassis, he mounted devices in UP dissipators, wrapped a shroud around the assembly, and installed a blower. The UP's staggered fingers create turbulence in air stream for maximum efficiency of both the dissipator and air flow, and allowed the designer to meet his design goal of 80°C case rise maximum. He also had room within the shroud to cool his hot resistors.

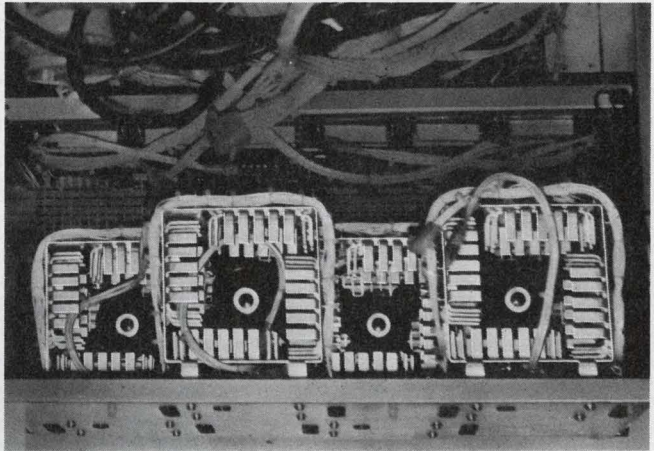

Dissipate 1280 watts in 530 cubic inches was the word given to designer of this power supply so he turned to our FAHP4 forced air packages. It took 4 units to do the job at a cost of \$26 (\$6.50 each/1000 pc qty.) plus \$40 for the fans. Average case rise of the 16 transistors was only 75°C.

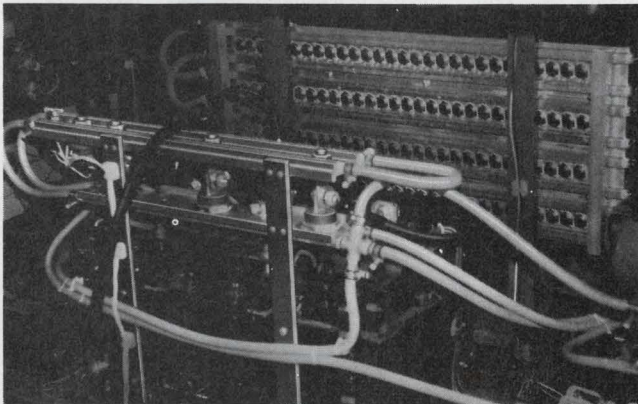

6000 watts of heat produced by 125 TO-3 case transistors in an industrial welding machine power supply was raw-power problem solved by IERC E4 liquid cooled sinks. Designer brazed together four standard E4's cut to 36 inches in length and tier stacked two other E4's to cool high power SCR's. Total area of heat sinks used only a fraction of the space required for a blower-cooled system of similar capacity.

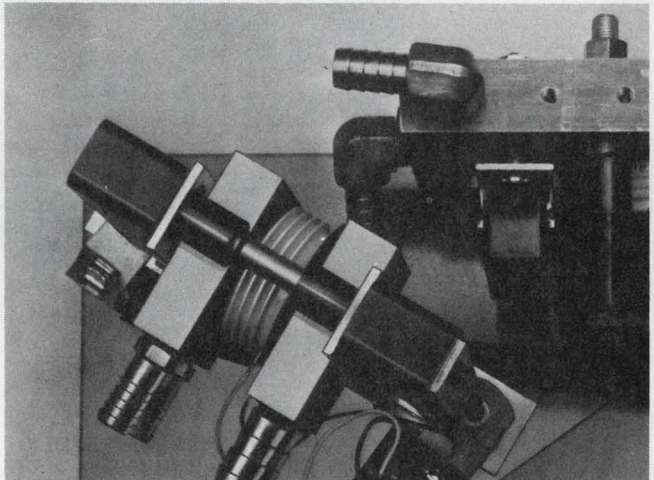

Fork-lift truck speed control used SCR's in hocky puck packages to handle thousands of watts in drive power. Big heat problem was solved with IERC liquid-cooled, double-side heat exchangers specially designed to let these big pressure-mount semiconductors dissipate on the order of 1000 watts each with just a 20°C case rise above ambient. Where did the designer get the coolant? He routed vehicle hydraulic fluid through the heat exchangers.



For more information

on heat sinks and dissipators for milliwatts to kilowatts, send for the IERC Short Form Catalog today. It covers the most complete line of thermal problem solving devices available anywhere.



Heat Sinks/Dissipators

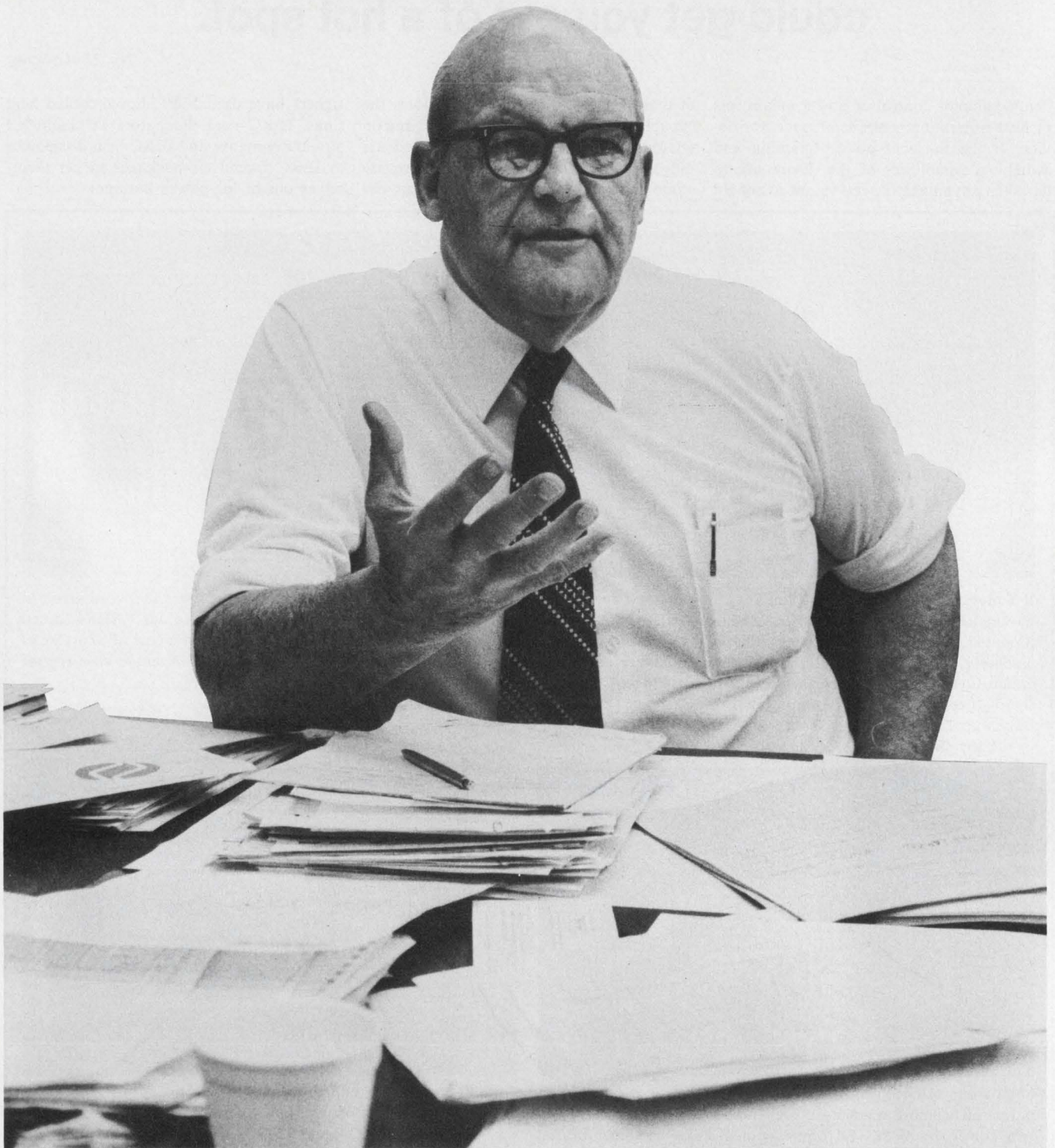

We're doing a lot about teaching engineers to engineer, but we're not teaching them how to manage. And that's a man-size problem.

Back when I went to school, which was before the beginning of time, it seems now, it took four years to get a bachelor's degree, another year to get a master's and a couple of more years beyond that to get a PhD. That's exactly the time it takes to get equivalent degrees now.

Meanwhile, engineering has tended to become

more and more a group effort. We keep thinking there was a time when an individual engineer invented something on his own hook. We think of the fellow who goes into a dark closet without food and water and comes out with a burning light bulb in his hand and shouts "Eureka." But if you believe history, this kind of scenario didn't take place even in Edison's time. It was a team effort then, too. And it's gotten more so.

Yet we haven't addressed ourselves to the problem of teaching engineers how to manage other

John Fluke of Fluke Mfg.

Speaks on

Training Engineering Managers

engineers. They're not even given an instruction book; they merely fall into the job. We stand them by the swimming pool, shove them in, and tell them they're Olympic swimmers.

The fact that the engineer's training is basically limited to engineering is a problem for him, too. Consider this analogy. Suppose I get a 25-horsepower motor with beautiful Class-H insulation. It will take a helluva beating. If I have an eighth-inch shaft on it, the power will be there but I'll never get it out. Similarly, the engineer has the potential; he has the power. But if he doesn't have some other skills, he's limiting himself because he doesn't have a full kit of tools.

This is a particular problem with engineers because they're trained to deal rigorously with numbers and that's a process that fails miserably when you try to apply it to a complexity like a human being.

We start with the problem that we have engineers working together in a group and we don't have anybody equipped by education to guide them. Let's say we assemble a group that's comprised of the 20 hottest guys we can get hold of. Each one is an acknowledged specialist in his field. Right away we know we need a manager for this group, a strong manager. Without one, each guy is going to be marching off in his own direction, and we would develop—not one product—but 20.

**Now, how do we select this manager?
We really don't have a good way. So
we use a popular method—accident.**

How do we find our manager? We throw a dart at a guy and say, "OK, you're it." We really don't know how to select managers and we don't exercise ourselves about the problem. We work by trial and error. In our group of 20, there will

probably be several subgroups of three or four. Each small group tends to develop a leader—a fellow who seems to organize things and provide direction. So we select one of these leaders. But that's a gamble because the person who can provide informal leadership in a group of three might fall on his face if he's supposed to direct 20 of his former peers.

So it's a bit like climbing a tree. You keep climbing until the next limbs start getting a little springy and then you don't go any higher. Similarly, you may stick a guy in to manage a group of, say, three or four engineers. If that works well, you may move him up to lead a group of 10 or 15. If he just barely manages that, you don't move him any higher. If he does well, you keep him climbing.

But this is a helluva way to train people. In general, our industry does not do a good job in cultivating managers. Some of our companies pay a lot of attention to the problem, but these are exceptions.

Now there's another approach. We can use Master's in Business Administration types. I'm talking, of course, about the MBA types with engineering backgrounds. This approach has been tried with varying degrees of success.

The MBA type has probably learned something about organizing people to get things done and he probably has learned a bit about accounting. But he may not be as rigorous in the engineering aspects.

Let's take a closer look at the problem and what we can do about it. Let's say I'm VP Engineering of the Joe Doaks Company and I have a bunch of engineers working for me. How do I select the men who can run the next important

project? How do I select the men who can lead their former peers? How do I cultivate such people? How do I train people to take managerial responsibilities?

Business schools all over the country constantly wrestle with the question of how to measure management potential. In view of this, how can we succeed?

I suppose it's like trying to find out if you have an oil well on your property. You first go out and study the geology and the structure and so forth, and try to determine if the conditions are conducive to oil being there. You look for a manager in somewhat the same way. You look for certain qualities—perception, intuition, maybe some suspicion, ability to communicate, to meet dates, to innovate. That's where it starts.

So you start by looking for the right kind of guy. Let's face it, there are two kinds of engineers in the world. One type wants to know more and more about less and less. That's the specialist. You probably want to keep him in engineering.

The other guy is the one who wants to know a little bit about things across the board and, perhaps, less and less about any specific thing. He's the generalist—the fellow who knows less and less about more and more so that, at the extreme, he knows nothing about everything. He's the man who's likely to be your better manager.

You have to develop such people, of course. You can't relegate this job to textbooks. You can't teach a fellow to become an Olympic swimmer without getting his bathing suit wet. You've got to throw him in the water at some point. You've got to develop managers by job exposure that develops the process.

One thing you do is to prepare a statement of objectives. But you can't rely too much on the initial approach. It's a little bit like PERT (Programmed Evaluation and Review Technique) charts. When they first came out, a lot of people thought they would take care of themselves and just work automatically. Of course, they didn't. So, in many places, PERT got a bad name and became a dirty word.

We have the same kind of problem in developing managers. You can't depend on any techniques to work by themselves. You've got to talk to each of your management "trainees" on a regular basis and find out how things are going.

You can amplify on these things, of course. And you can pursue other things, like knowing where a fellow wants to go, where his interests lie, and whether or not they can be developed. You can check for general skills and for a man's flat spots, too. Every supervisor has some flat

Who is John Fluke?

It takes almost six type-filled pages to describe the background and contributions of John M. Fluke, the man who gave his name to the differential voltmeter. In addition to his technical achievements, he has made contributions in civic, military, cultural, educational, business and government affairs.

His earthy, self-deprecating manner makes it hard to believe it. But Fluke has served on the American Security Council and on the President's Blue Ribbon Defense Panel. He has worked and is working for the Department of Defense, the Secretary of the Army and Junior Achievement. He's currently serving as Chairman of the Electronic Test Equipment Committee for the Deputy Secretary of Defense. And that's just part of it.

He was a member of a five-man Trade Mission to England and Scotland and a member of the Governor's Advisory Committee. He was Chairman of the Seattle Area Industrial Council and Vice-President, then President, of the

spots—except, maybe, you and me.

Better yet, you can sponsor courses or seminars within the company. This way you can help many aspiring engineering managers at one time. You could, for example, have different departments within the company present courses. It would be particularly useful, say, if you could get somebody from the accounting department to give a lecture on the basics of accounting.

This is very important because any engineer coming into a profit-making organization (or an organization trying to make a profit) must sooner or later learn how that company accounts for the money it spends.

It's not that I believe accountants should run engineering companies. Not at all. But accounting is one of the dimensions that helps a company know where it is in the fiscal scene. I think it's extremely important for the engineering profession to understand this and to understand at least the rudiments of accounting. And yet I know of no engineering school that teaches it. There's no requirement in any engineering school, other than as an elective, to teach the young engineer how to keep track of money.

So maybe you can make up for this deficiency of the schools by having the accounting department give lectures to your engineers. You could profitably follow such lectures with presentations by some of the people in manufacturing. It's odd that, in this country, we rose to the height of manufacturing preeminence without essentially

Seattle Chamber of Commerce. He's a member of the executive committee of the Seattle Historical Society and a member of Seattle's Major League Sports Committee.

He was a member of the Large Gifts Committee of Seattle Pacific College. And with the Seattle Symphony, he served as Chairman of the Endowment Fund, Vice-President, member of the Executive Committee and member of the Board of Trustees. And of course, he was a member of the Board of Directors of WEMA (Western Electronic Manufacturers' Association), Chairman of its Northwest Council, and Vice-President and Director.

He's Chairman of the Visiting Committee of the College of Engineering of the University of Washington, where he took his BSEE in 1935 and was elected President of his chapter of Tau Beta Pi (the honorary engineering fraternity) before moving to MIT for his master's degree.

And the list goes on. But Fluke doesn't talk about these things.

His engineering career started in 1936 with the General Electric Company in Bridgeport,

CT. It was interrupted by his service in the Navy, where he worked for a young Lt. Commander, Hyman G. Rickover, who ultimately became Admiral.

After his Navy days he worked as an engineering consultant in Stamford, CT, where he developed an automatic bowling-pin spotter for American Machine and Foundry. "I had a ball working on that," he puns.

The turning point in his career came in 1948 when, in the basement of his home in Springdale, CT, he launched John Fluke Engineering Co., with one employee. Four years later he moved the business to Seattle, "God's country," subsequently changed the name to John Fluke Mfg. Co., Inc., and became the company's president, a position he retained until 1972 when John Zevenbergen was made President and Fluke was named Chairman of the Board and Chief Executive Officer.

In addition to outside activities Fluke puts in some 25 hours a day with his own company. And what does he do with his spare time? "Oh," he says, "I putter around a bit."

ever providing college training in the process of factory management.

We tend to develop our manufacturing managers the same way we develop our engineering managers—by accident.

A fellow on the production line may rise up through the ranks. Or, more often, some engineer gets tired of bending the integral sign and decides he'd like to get out into the shop and deal with people. Such engineers are usually the more extroverted types who aren't quite as extroverted as those who wind up in sales.

Our need for sharp engineering types to run manufacturing departments is growing more critical all the time. The reason is that the requirement for technical expertise in the manufacturing process is growing at a tremendous pace.

There is a vastly increasing rate of injection of high technology into the factory because of the increasing complexity of the product and of the capital equipment required to test it. We have large-scale integrated circuitry, for example. Right now that work is being done by the semiconductor crowd. But I think the equipment manufacturers will have to suck more of that work into their own plants, just as, in the past, they pulled in their own printed-circuit work. Then you need complex capital equipment like

automatic testers. When you run a factory built around that kind of stuff you need highly qualified technical managers. Our industry is becoming more complex, not less, so we're going to need technical managers with excellent technical training and excellent management training.

After you give courses or lectures on accounting and on manufacturing, you could follow with presentations on general management. Maybe you can get some prof from a school of management to come in and talk to your engineers a few times.

These are some of the things you can do in the short run to develop the managers you're going to need tomorrow. What about the managers you'll need the day after tomorrow? For that you'll probably have to reach into the schools.

You'll have to urge them to build more engineering management into their engineering curricula. Most of your engineers are connected, in one way or another, with schools. They graduated from one. They may be active in affairs of the old alma mater. And they may contribute money or serve on an engineering committee or two related to their schools. So they have some influence and they should exercise this influence to get the schools to prepare youngsters better for what they'll face several years hence.

Will this solve our engineering-management problems? Probably not. But we've got no place to go but up. And anything we do—unless we're really stupid—will surely help. ■■

System designers by NMOS

MC3459 Quad NMOS Memory Address Driver
Specifically designed to supply highly capacitive address line requirements. Especially useful in larger systems where paralleling of numerous memories requires a powerful driver.

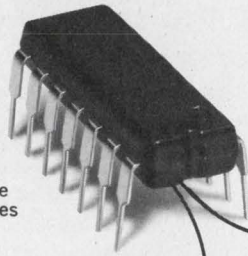

MC3461 Dual NMOS Memory Sense Amplifier
A complete functional block to overcome problems of level shifting, input termination resistors, odd power supply requirements, and long propagation delays. Typical response prop delays; Amplifier (5.0 ns), Enable (2.5 ns), Latch (1.0 ns).

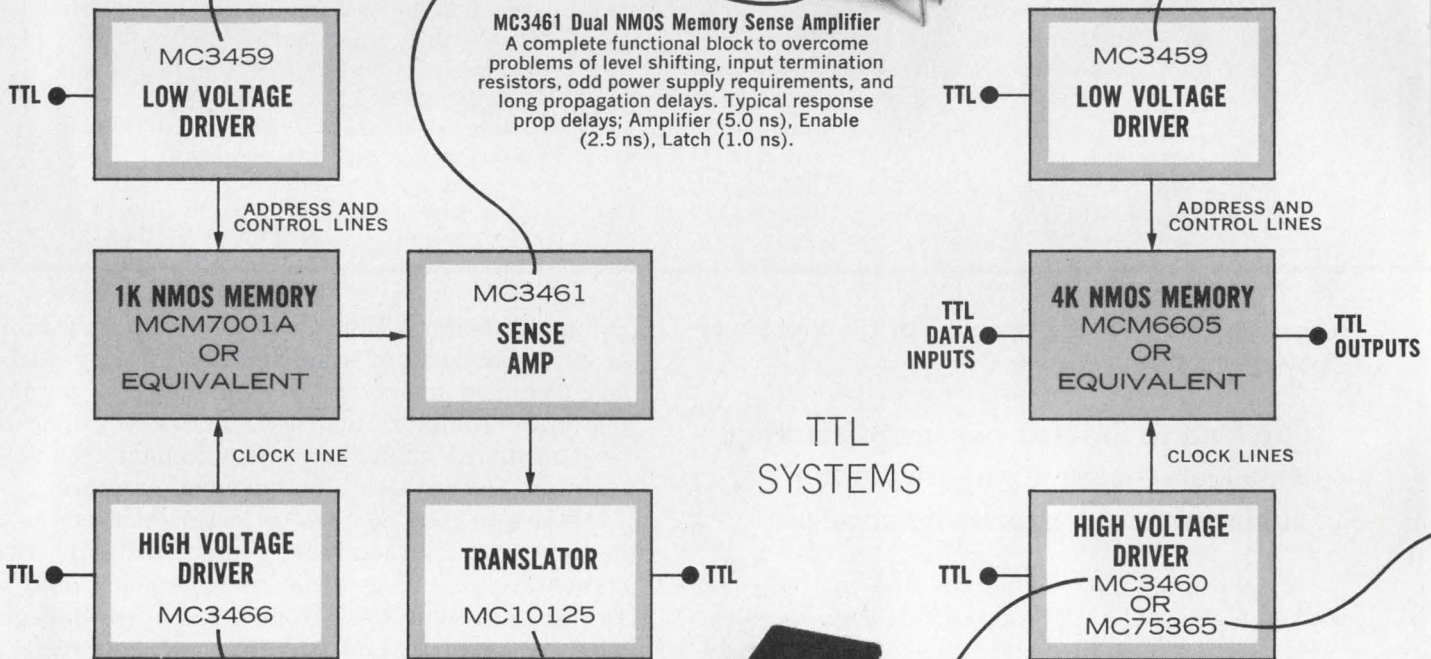
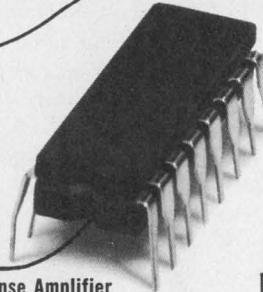

MC3466 Quad NMOS Memory Clock Driver
Meets the higher clock line voltage needs of "7001" type memory systems. With proper inputs, all four drivers may be deactivated for standby operation; or single driver may be activated for READ/WRITE operation.

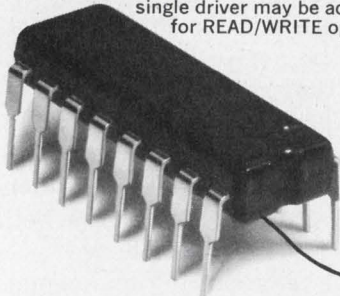

MC10125 Quad MECL-to-MTTL Translator
A versatile device for interfacing the sense amplifier MECL outputs to saturated logic sections of digital systems. Typical prop delay is 4.5 ns.

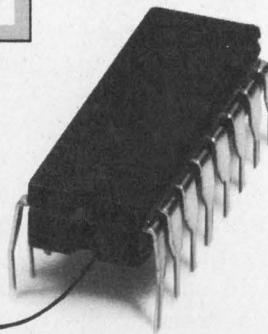

MC3460 Quad NMOS Memory Clock Driver
Similar to the MC3466 but is specified for 4K memory applications. Prop delay times with a 480 pF load and operating in the READ/WRITE mode are less than 25 ns. All four drivers may be activated for REFRESH operation.

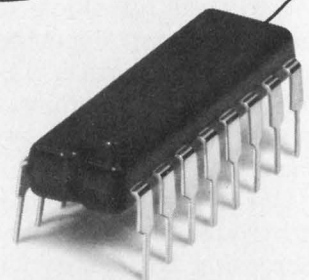

do not live memories alone...

MC10177 Triple MECL-to-MOS Translator (N-Channel)

Designed for NMOS memory systems as a Read/Write, Data/Address driver. May be used for other applications requiring the capability to drive high-capacitive loads.

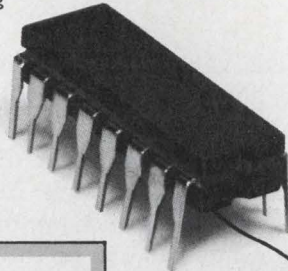

Your selection of NMOS memories for that new system is only the first step in providing a high-performance, cost-effective memory system. To fully utilize NMOS technology capabilities you have to consider interfacing trade-offs that affect overall system performance.

Motorola's new interface functions draw upon linear and MECL 10,000 processing technologies to create a new generation of interface devices that reduce system trade-offs to a minimum. These new functions offer higher speed, greater drive capabilities, and increased package functionality. Take a look at a few typical application areas.

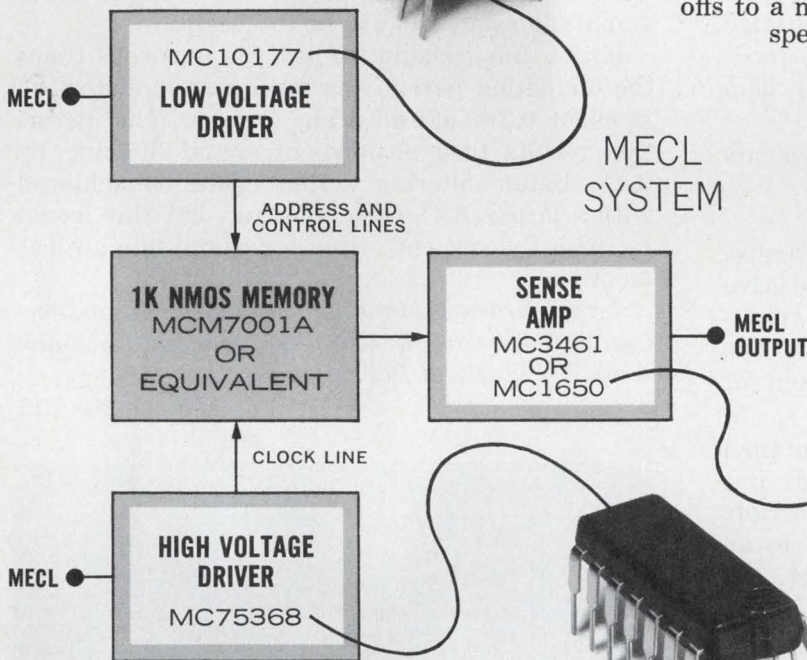

MC1650 Dual A/D Comparator
Used to maximize speed in MECL systems, typical prop delay 3.5 ns. Requires a low overdrive, low switching current, and has a latch for data storage. Complementary outputs permit maximum utility.

MC75368 Dual NMOS Driver
Accepts standard MECL 10,000 and IBM grounded-reference ECL input signals and creates high-current and high-voltage output levels suitable for driving MOS circuits. May also be used as MECL-to-MTTL translators.

MC75365 Quad MOS Clock Driver
Ideal for driving highly capacitive Address, Control and Timing inputs on a variety of MOS RAMs such as the "1103" and "6605" types. Usable over a wide latitude of supply voltages.

Interfacing is on the Move!

Your NMOS memory can't go it alone. Advanced memories dictate new interfacing specifications. Future functions have already been defined to keep pace with NMOS RAM expansion and innovations such as microprocessor chips and high-speed minicomputers.

Applications and device specifications for the functions displayed here are available on request from Motorola Semiconductor Products Inc., P.O. Box 20912, Phoenix, AZ 85036 or any authorized Motorola distributor and OEM sales office. Evaluate your interfacing requirements now... we'll help you face up to your problems!



MOTOROLA LINEAR
Interface—The End Is Nowhere In Sight

Agc provides 0.1% amplitude stability for Wien-bridge oscillator

An amplitude-stabilized, low-distortion Wien-bridge oscillator with a 100:1 output-amplitude range and 0.1% amplitude stability can be kept simple with FET control of the circuit's gain. Three factors that determine this gain are: (1) Positive feedback supplied through the Wien-bridge C_2 , R_9 , C_3 and R_{10} ; (2) Negative feedback of R_7 and R_8 , and (3) Negative feedback of the automatic gain control (agc) loop supplied through JFET Q_2 .

The positive-feedback Wien-bridge elements determine the oscillator's frequency:

$$f = 1/2\pi\sqrt{R_9 C_2 R_{10} C_3}$$

The component values of the bridge in the figure, where $R_9 = R_{10}$ and $C_2 = C_3$, provide a positive feedback factor of one-third. Then if the amplifier gain is at least three, oscillations result. The amplifier gain is determined by the amount of negative feedback to its inverting input.

The initial gain must be somewhat higher than three, to make sure that oscillations start. But the higher the gain, the greater is the distortion. Agc feedback, however, controls the gain to an optimum distortion-free level. Without agc, the signal amplitude would be limited only by saturation of the amplifier, and distortion would be high.

Agc is achieved with JFET Q_2 operating as a voltage-controlled resistor. The resistance of Q_2 can be varied from about 500 Ω to 100 M Ω . The gate-control voltage of Q_2 is derived from the oscillator output via differential stage Q_{1a} and Q_{1b} . The differential circuit compares an attenuated oscillator signal with reference voltage E_R .

When the oscillator output amplitude varies, output from the differential circuit to C_1 adjusts the resistance of Q_2 to keep the net gain around the positive feedback loop near unity. Since the shunting action of Q_2 reduces negative feedback and raises the amplifier gain, the gain without Q_2 is designed to be lower than that required for self-oscillation.

Control potentiometer R_1 varies the oscillator output amplitude over the full range of the op amp. The amplitude can also be voltage-controlled for external modulation by replacement of E_R with an external control voltage.

Amplitude variations after initial warmup are limited to about ± 10 mV by the agc. Temperature changes cause about 1 mV/ $^{\circ}$ C in additional variation, mainly because of differential drift of the comparator transistors. In a laboratory environment, the amplitude stability over a 100:1 amplitude range is 0.1% of full scale.

If the time constant of $R_5 C_1$ is about 10 times the oscillation period, the total output distortion is about 0.2% of full scale. Some of the distortion results from insufficient signal filtering by $R_5 C_1$. Better filtering action could be achieved with a larger $R_5 C_1$ time constant, but this would increase the response time for amplitude adjustment.

Jerald Graeme, Manager, Monolithic Engineering, Burr-Brown Research Corp., International Airport Industrial Park, Tucson, AZ 85706.

CIRCLE NO. 311

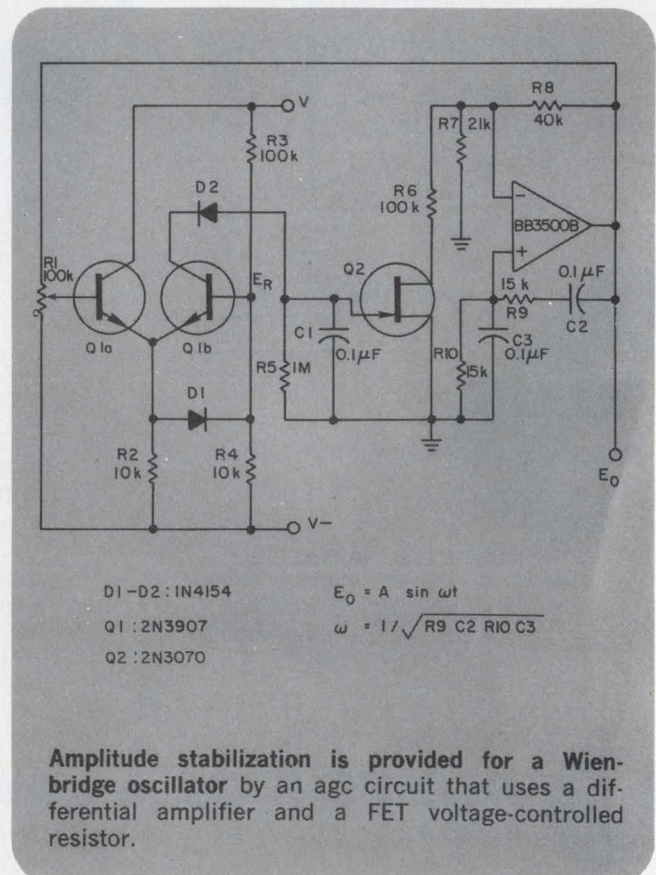

It's new. It's drop-proof. It's burnout-proof. It's super-safe. The Triplet Model 60. Only \$90.

New unconventional concept in V-O-M design gives you an extra chance after accidental misuse ... not a repair bill or downtime.

The 28-range, general-purpose Triplet Model 60 was specifically developed to withstand over 90% of the costly in-field and at-workbench misuses of V-O-M's in electronics/electrical testing and circuit trouble shooting environments.

Forget about a cracked case when it falls off that workbench or a burned out meter movement because of wrong range or test function setting with this new Triplet Model 60. It's also built with safety-for-you, the user in mind.

The new Triplet Model 60 is made for many uses and many users like electrical/electronic circuit designers, vocational training schools, production line testing and quality control, research labs, industrial maintenance, tv, radio and stereo service shops, appliance and automotive maintenance work, hazardous and remote area installations, hobbyists and experimenters.

You also get more extras when you buy the new Triplet Model 60. A special "Confidence-Test" circuit is built into the new test instrument for periodic reassurance checks of its meter. The rugged 4 1/2" suspension type meter is complete and separately cased for easy, fast replacement in field. Includes a polarity-reversing switch plus a single range selector switch for the eight DCV ranges from 0.3 to 1000, six ACV from 3 to 1000, four DCmA from 0.1 to 1000 and five resistance ranges from 1k to 10Meg. Also has direct reading scale for optional clamp-on ammeter.

The new Triplet Model 60 is yours for only \$90. See it at your local Triplet distributor or Mod Center. For more information, or for a free demonstration see him or your nearest Triplet sales representative. Triplet Corporation, Bluffton, Ohio 45817.

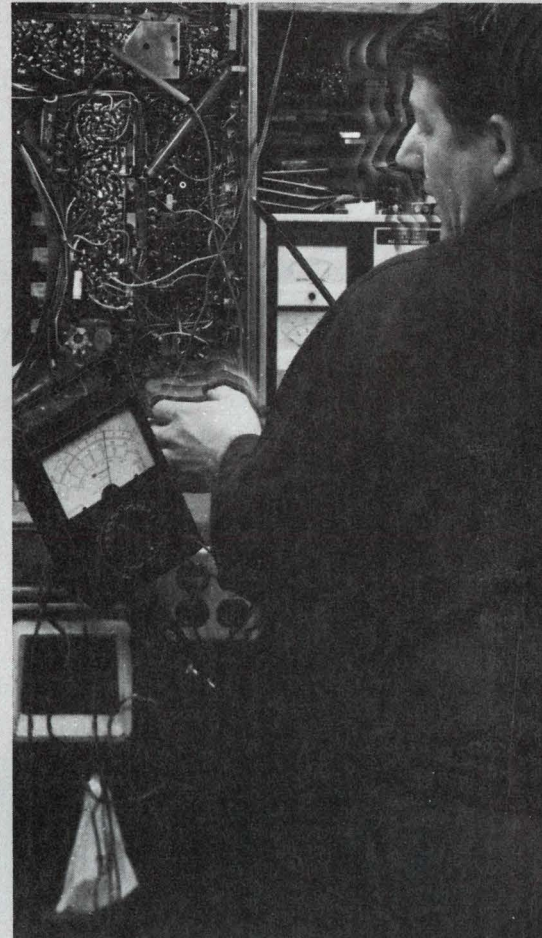

1. DROP-PROOF. Virtually indestructible for an accidental drop up to a five foot height with deviation from stated accuracy not exceeding $\pm 4\%$.

2. BURNOUT-PROOF. Protected by diodes and unusual three fuse arrangement including 1/8 Amp, 1 Amp and 2 Amp/1,000 V fuses. Maximum protection level provided by the 2 Amp/1,000 V (20 kW) fuse.

3. SUPER-SAFE. Designed to meet most rigid safety standards to prevent explosive arcs in high energy circuits, up to the 2 Amp/1,000 V (20 kW) fuse capacity; completely insulated unit with newly designed safety leads.

TRIPLET
BLUFFTON, OHIO 45817

Super Safe
Triplet. The easy readers.

Great American Logic. From Jefferson, Franklin, Madison, and HiNIL.



Give your industrial control system a great constitution with HiNIL, the high noise immunity logic from Teledyne. It works reliably in adversity—like the great political logic our Founding Fathers used in the Constitutional system.

HiNIL doesn't operate illogically when it sees electrical noise and high voltage transients. With a 3.5 volt guaranteed noise margin (versus 1.0 V for CMOS and 400 mV for TTL), it runs without shielding.

HiNIL also runs true when the power supply doesn't. It doesn't need expensive regulated supplies, filters and spot regulators because HiNIL's power supply tolerance is a comfortable ± 1 V.

And HiNIL is slow—that's right, slow not fast. Its 100 nanosecond propagation delay is fast enough for most control systems. But it won't be switched falsely by noise spikes when a fork lift rolls by (can you say the same for the hair-trigger logic you've been using?).

Like the Constitution, HiNIL is adaptable. It interfaces easily with TTL, DTL, RTL, MOS and CMOS directly, through open-collector outputs or through interface circuits. And it comes in about 40 types: from diode-expandable gates to quad schmitt triggers, shift registers, display decoder/drivers and a dozen other complex MSI functions. All conveniently packaged in ceramic or molded silicone DIPs.

Finally, HiNIL is cheap. It's priced right in there with TTL so you can save a small fortune on supply regulation, noise suppression and other "extras" you'll no longer need.

So if you want to read about great logic, trade in your history books for Teledyne's free literature on HiNIL. Better yet, experience HiNIL in your own designs. Get it from Teledyne, reps or distributors. Write or call now.

 **TELEDYNE**
SEMICONDUCTOR

1300 Terra Bella Avenue Mountain View, California 94043

(415) 968-9241 TWX: 910-379-6494 Telex: 34-8416

INFORMATION RETRIEVAL NUMBER 46

CMOS audio amplifier features ± 15 -dB bass/treble control range

A CMOS linear amplifier provides tone-control over a range of ± 15 -dB for both bass and treble ends of the audio spectrum. The boost and cut-off frequencies are 100 Hz and 10 kHz, respectively. All control potentiometers are standard linear-taper units. Since the input current to the CA3600 is essentially zero, there is no dc current through the controls, and they will not become noisy.

The output is biased at one-half the supply voltage via the resistive path R_1 and R_2 in the

feedback network. This allows the circuit to function properly over a wide range of power-supply voltages from 5 to 15 V. The maximum volume gain is set by the ratio R_2/R_1 . With the values shown, the gain is about 12 dB. The circuit will handle inputs up to about 200-mV rms without overloading.

Leonard Kaplan, Member of Technical Staff, RCA Solid State Div., Route 202, Somerville, NJ 08876.
CIRCLE NO. 313

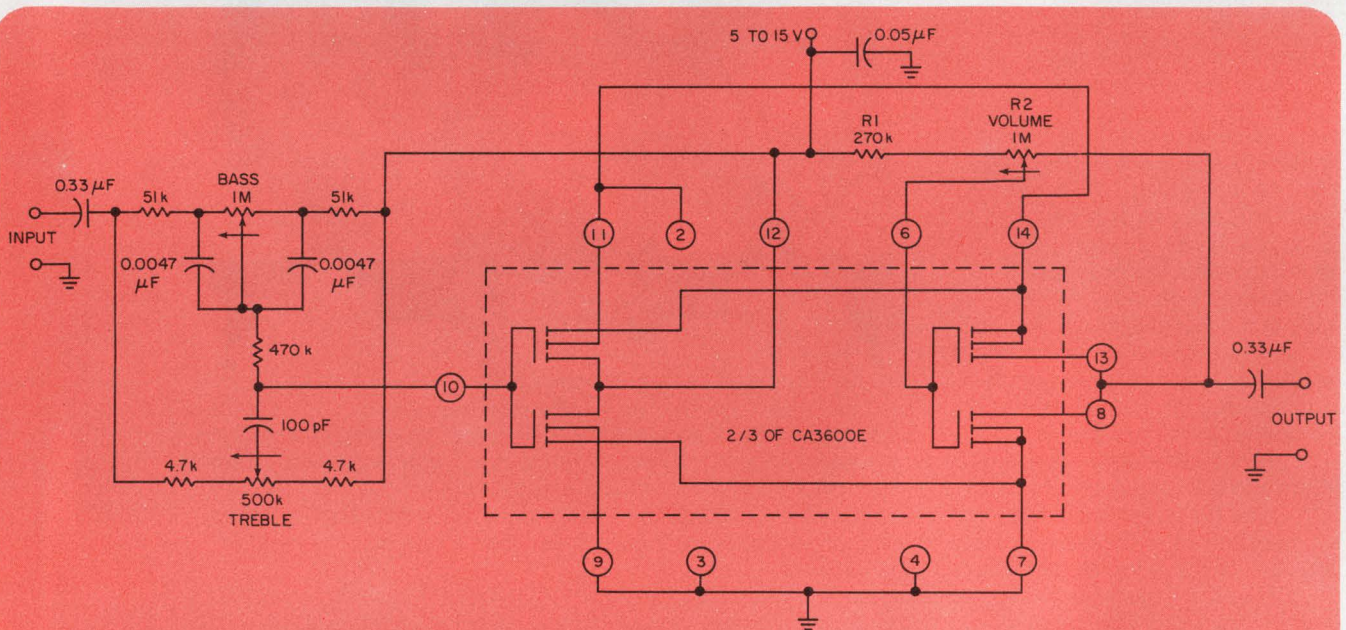

CMOS linear amplifier with feedback and bass/treble tone controls provides a maximum of 12-dB gain.

IFD Winner of January 18, 1975

A. Paul Brokaw, Director of Advanced Product Development, Analog Devices, Semiconductor Div., Route 1, Industrial Park, P.O. Box 280, Norwood, MA 02062. His idea, "Precision Voltage Reference Easily Converts to a Current Limiter" has been voted the Most Valuable of Issue Award.

Vote for the Best Idea in this issue by circling the number for your selection on the Information Retrieval Card at the back of this issue.

SEND US YOUR IDEAS FOR DESIGN. You may win a grand total of \$1050 (cash)! Here's how. Submit your IFD describing a new or important circuit or design technique, the clever use of a new component or test equipment, packaging tips, cost-saving ideas to our Ideas for Design editor. Ideas can only be considered for publication if they are submitted exclusively to ELECTRONIC DESIGN. You will receive \$20 for each published idea, \$30 more if it is voted best of issue by our readers. The best-of-issue winners become eligible for the Idea of the Year award of \$1000.

What Would You Call an Easy-to-Use, Low Cost, Portable, Flexible, Time-Saving, Four Channel Test Instrument?

Most people would call it unbelievable.

We call it the Bell & Howell® Datagraph Model 5-144, probably the most convenient test instrument you'll ever use.

With a frequency response of up to 10,000 Hz, the Model 5-144 records both analog and digital data with equal ease.

Four channels are available for viewing simultaneous events, such as timing sequences or multiple, inter-related functions.

The Model 5-144 contains all electronics needed to record information. There's no need to make special cables or calculate complicated damping networks. Just plug in your scope probes and record your data.

And after you've captured that data, the Model 5-144 provides a hard-copy for further examination.

In fact, think of it as a scope with a screen 200 feet wide.

Other user features include trace polarity reversal, ac or dc coupling, and three selectable timing reference line spacings.

Two choices of gridlines and ten recording speeds are also available.

Total weight for all of this capability is only 34 pounds.

For more information or a demonstration, circle the appropriate reader service number below or write the CEC Division of Bell & Howell.

The Datagraph Model 5-144 will make a believer out of you.

CEC DIVISION

360 Sierra Madre Villa, Pasadena, California 91109



(In Canada: 125 Norfinch Drive, Downsview, Ontario M3M 3B5)

CEC is a registered trademark of Bell & Howell.

© Bell & Howell 1975

INFORMATION RETRIEVAL NUMBER 45



LED display allows mutes to communicate

A light-emitting display system that permits people who are unable to talk to communicate with others has been developed at the Dept. of Electronics, University of Southampton in England.

The display is a 7×35 LED matrix on which five alphanumeric characters can be displayed simultaneously by the selective illumination of the LEDs. The display is clipped on the wearer's coat lapel or breast pocket. The characters slowly move off the display to the left, so that new characters appear continuously to convey a complete message.

The input is a miniature push-button keyboard similar to that of a typewriter. The user carries the electronics in a shoulder bag or pocket.

The keyboard pushbuttons are electronically scanned to give a serial 6-bit binary output corresponding to each key as it is de-

pressed (See figure). In the control unit, the encoded characters are fed into a block of six, 6-bit shift registers, because to move the characters across the small screen, it is necessary to store one more character than the number displayed. A diode matrix in the display panel is wired as an x-y addressable array, and a read-only memory converts the 6-bit codes into character patterns on the seven LEDs of the display.

The movement of the displayed characters to the left is achieved—one column of the matrix at a time—by a simple timing circuit that can be adjusted to suit the user's "typing" speed.

An advantage of the display design is that "listeners" can read it and also watch the user's face for indication of emphasis or emotion. Researchers estimate that it could be produced in quantity for around \$500.

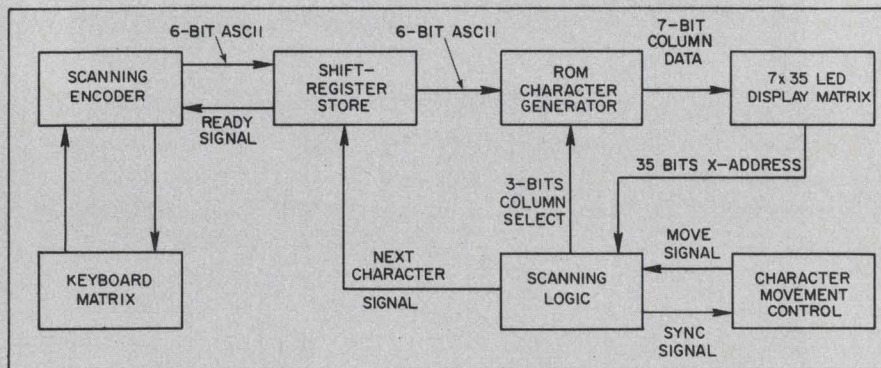

150-sec sweep is given by saw-tooth generator

A saw-tooth voltage generator that provides a sweep time of more than 150 sec has been de-

signed at North East London Polytechnic, England. The generator uses the direct-current attenuation property of bipolar transistors to achieve the extended sweep durations.

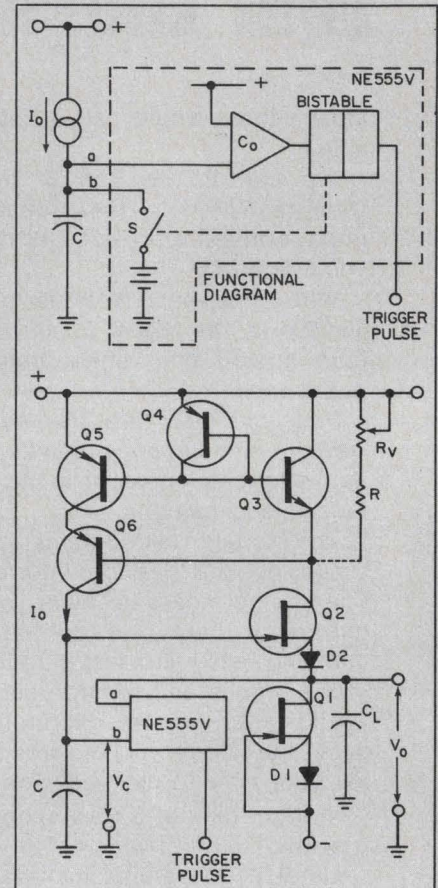

The Polytechnic circuit, which is externally triggered, provides a sweep of fixed amplitude. An NE555V IC is used as a time base.

In operation (Fig. 1), the bistable switch, on triggering, opens S and allows C to charge linearly over the time-base period. The differential-voltage comparator, C_0 , resets the bistable at a preset voltage and closes S for rapid discharge of the capacitor.

For operation with low charging current, which is required for long sweeps, Q_1 and Q_2 are used with their bias diodes (Fig. 2) as a source-follower having unity gain. The source-follower buffers the timing-capacitor C from external variations in capacitance. Charging current I_0 is derived via the current transforming network of Q_3 - Q_6 .

Circuit protection —with resistors

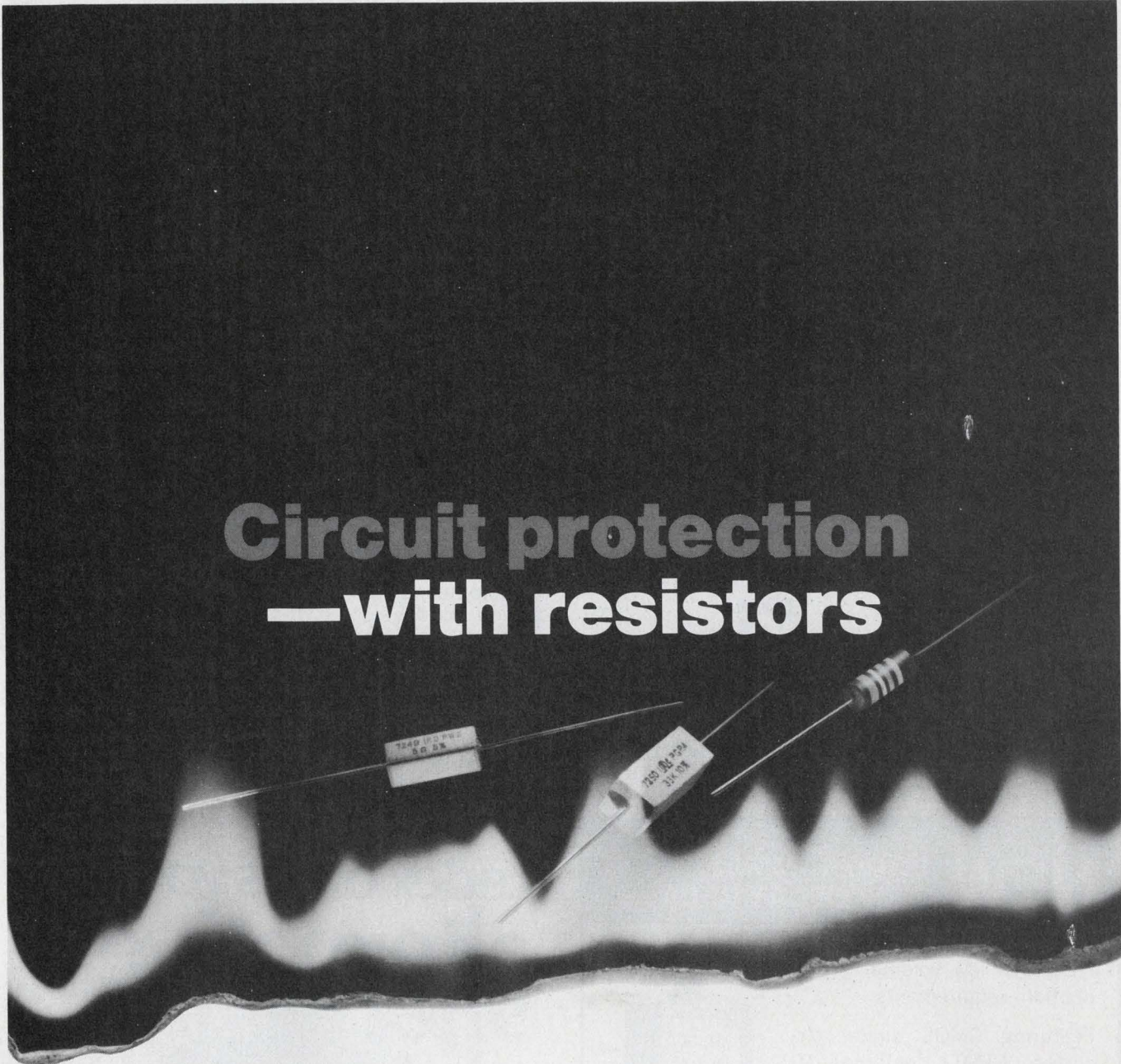

Where your circuits require resistors with built-in fault protection, TRW may have a solution. Specifically:

IRC Type PW. Wirewound power resistor, 2-50 watts. Inorganically constructed. Use as a standard power resistor. Or use as a *fusible* resistor. Highly effective where you need a versatile, low-cost power resistor, or specific fusing characteristics.

IRC Type BWF. Economical 2-watt wirewound resistor in the familiar 1-watt size molded jacket. For years an industry standard for high-volume, automated assembly application. Available with fusible flameproof feature for hazard applications up to 1000 X overload or 1000 V. *New BW-20F 1-watt rating, 1/2-watt size, now available.*

IRC Type PGR. Ceramic-insulated, semi-precision film resistor, 1-3 watts. Famous Metal Glaze™ construction—rugged and stable. A low-cost, universally applicable

flameproof resistor in ranges up to 100K ohms—far beyond wirewound resistor capability.

Complete resistor choice. Remember, TRW/IRC offers a total resistor capability—wirewound, carbon comp., metal film, functions.

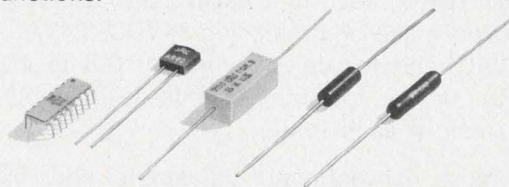

For technical data, flameproof specifications or specific application needs, contact your local TRW sales representative. Or write TRW/IRC Resistors, an Electronic Components Division of TRW, Inc., Greenway Rd., Boone, N.C. 28607. (704) 264-8861.

TRW[®] IRC RESISTORS

INFORMATION RETRIEVAL NUMBER 47

SWITCHES MOTOR LOADS.

This incredible super compact HG relay series switches 1.5 KW, 3 phase, 220 VAC motor loads. It also switches 20 A, 250 VAC resistive. Under these loads, its mechanical life is $>10^7$ and its electrical life at top load rating is $>2 \times 10^5$. Here are a few of the features that make all this possible: a unique magnetic system that multiplies pull-in forces, arc-resistant contacts, arc barriers, arc-debris wells, and welded internal construction.

HG relays come in 2pdt, 3pdt, and 4pdt contact arrangements with 6 through 240 VAC or 6 through 110 VDC coils. You can select plug-in, solder, or quick connect terminals, and any necessary mounting. All HG relays are UL and CSA recognized.

DPDT size: 1.417" L x 1.339" W x 2.205" H

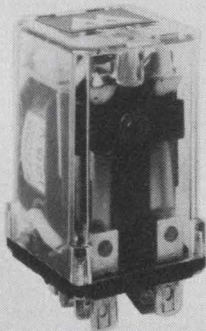

Send for complete specifications. Or if you want really fast action, call Arrow-M or your nearest Arrow-M representative.

Relays for advanced technology.



Arrow-M Corp. 250 Sheffield St.
Mountainside, N.J. 07092 U.S.A.
Telephone: 201-232-4260

INFORMATION RETRIEVAL NUMBER 48

**SPEED PRODUCTION...
SAVE SPACE AND WEIGHT...
REDUCE ASSEMBLY COSTS...**

WITH BUCKBEE-MEARS FLEXIBLE CIRCUITRY

BMC flexible circuitry offers significant advantages over conventional hand wiring of discrete circuits. It can simplify assembly, reduce costs, and greatly improve wiring accuracy and reliability.

Buckbee-Mears' Circuits Division also can provide as much—or as little—engineering assistance as you require . . . from preliminary drawings through testing to finished products. This team of flexible circuit specialists can help define your requirements, then work with you in developing the circuitry to fit your exact application. For information, write or call Ed Dugan.

BUCKBEE-MEARS COMPANY
FLEXIBLE CIRCUITRY DIVISION **bmc**
245 EAST SIXTH STREET
ST. PAUL, MINNESOTA 55101 612/228-6253

INFORMATION RETRIEVAL NUMBER 50

NEW PROGRAMMABLE TIME DELAY RELAYS

For R&D, low volume & production requirements.

Featuring CMOS digital circuitry; DPDT contacts—10 amps resistive; no "false" operation on delay on make function; competitive pricing; low inventory requirements.



Model TDP-1: Each unit easily field selected for delay on make or break; for 24VDC, 24VAC, or 120VAC; and for delay ranges of 0.3 to 10, 3 to 80, or 10 to 300 seconds—adjustable to min/max of each range.

Low cost conventional, adjustable and fixed, single mode timers also available.



for further information contact
Hi-G, Inc./Windsor Locks, CT 06096
Area Code (203) 623-2481
see complete Hi-G line in EEM

INFORMATION RETRIEVAL NUMBER 49

Ledex offers you an alternative



in economically priced solenoids

New, low priced, D-frame solenoids are now available from Ledex. Get all the advantages of dealing with a reputable source and cost efficiency too. Send for this complete catalog of specifications, sizes, and details on how you can keep your products competitive.



LEDEX

LEDEX INC.
123 Webster St.
Dayton, Ohio 45401
(513) 224-9891

INFORMATION RETRIEVAL NUMBER 51

ELECTRONIC DESIGN 11, May 24, 1975

Quiet JFET op amps keep inputs matched within 2.5 mV

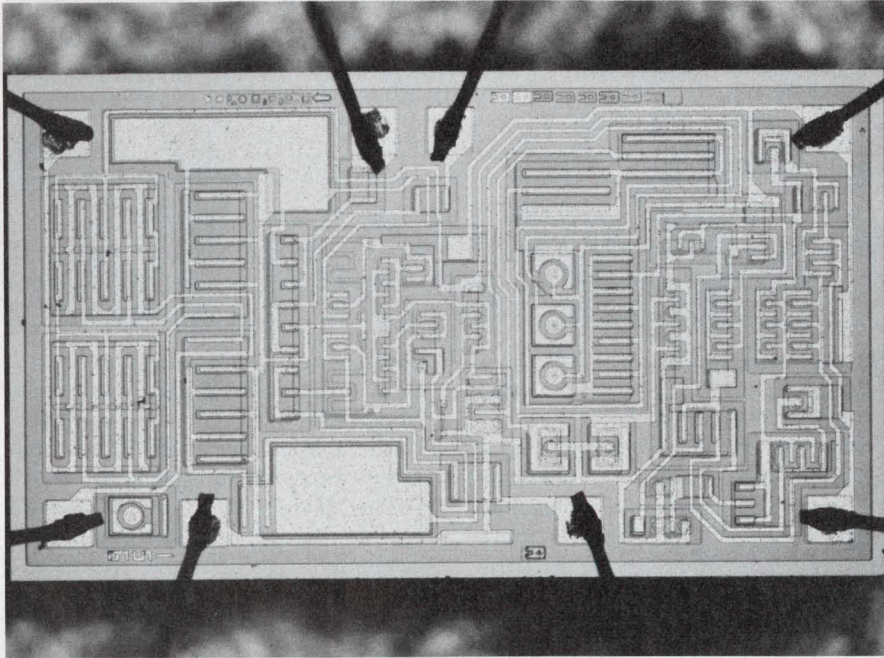

National Semiconductor, 2900 Semiconductor Dr., Santa Clara, CA 95050. (408) 732-5000. P&A: See text.

In a quest for better noise performance, National Semiconductor has developed the LF series of monolithic JFET-input op amps. These units have typical input noise voltages of only $20 \text{ nV}/\sqrt{\text{Hz}}$ at 1000 Hz, and input noise currents of $0.01 \text{ pA}/\sqrt{\text{Hz}}$.

The input FETs are matched to within 2 mV when measured at 25 C, and to within 2.5 mV over the full operating temperature range. As temperature varies, so does the offset voltage—at a rate of $5 \text{ } \mu\text{V}/^\circ\text{C}$. When the offset voltage is nulled out, the change in offset tempco is only $1 \text{ } \mu\text{V}/^\circ\text{C}/\text{mV}$. This contrasts with most op amps, where drift tempcos worsen to 5 to $20 \text{ } \mu\text{V}/^\circ\text{C}/\text{mV}$ when offsets are nulled out.

Input resistance is a high $10^{12} \text{ } \Omega$, while the input offset current is a low 10 pA max for the 100A

and 300A series, 20 pA max for the 100 and 200 series and 50 pA max for the 300 series. All op amps have a 3-pF input capacitance.

There are 15 op amps in the LF series. The LF155, 155A, 255, 355 and 355A are designed for low supply-current operation. The LF156, 156A, 256, 356 and 356A are for wideband applications. The LF157, 157A, 257, 357 and 357A are for wideband partially compensated operation at a minimum voltage gain of 5.

The LF100 and 200 series can operate from supply voltages of from ± 5 to $\pm 22 \text{ V}$, while the LF300 is spec'd at $\pm 18\text{-V}$ max. All devices have power dissipation capability of 500 mW. The op amps can deliver about $\pm 25 \text{ mA}$ to capacitive loads of up to $0.01 \text{ } \mu\text{F}$ without becoming unstable.

Differential input voltages for the LF100, 200 and 300A series can reach a maximum of $\pm 40 \text{ V}$,

while the 300 series can handle only $\pm 30 \text{ V}$. All devices have a minimum common-mode rejection ratio of 80 dB, and some reach 85 dB. Similarly the power-supply rejection ratio is 80 dB min., climbing to 85 dB in some cases.

All of these National low-noise amplifiers are characterized with a source resistance of $200 \text{ } \Omega$ and at two frequencies. The op amps fall into two groups—the “high” noise units and the low noise. At 100 Hz the first group, which consists of the LF155, 155A, 255, 355 and 355A have typical noise voltages of $25 \text{ nV}/\sqrt{\text{Hz}}$. The other group, which includes all other models, has only $15 \text{ nV}/\sqrt{\text{Hz}}$, typical. At 1000 Hz, the “high” noise group has $20 \text{ nV}/\sqrt{\text{Hz}}$ of noise and the other group has $12 \text{ nV}/\sqrt{\text{Hz}}$, typical.

Op amps in the LF100 series are specified over the -55 to $+125 \text{ }^\circ\text{C}$ MIL temp range. Units in the 200 series have a -25 to $+85 \text{ }^\circ\text{C}$ range, while the 300 series is spec'd over the 0 to $70 \text{ }^\circ\text{C}$ range.

Prices for the LF op amps start at \$2.50 for the LF356 in lots of 100. Delivery is from stock.

CIRCLE NO. 305

256-bit ECL RAM compensates voltage

Texas Instruments Inc., P.O. Box 5012, MS 308, Dallas, TX 75222. (214) 893-5166. \$22.50; 8 wks.

A 256-bit ECL RAM, the SN-10144, features voltage compensation and a power dissipation of 500 mW. Organized $256 \times 1\text{-bit}$, the memory has a typical address access delay of 15 ns, and typical write pulse width of 12 ns. The RAM operates over the 0-to- $85\text{-}^\circ\text{C}$ temperature range, and it comes in a 16-pin ceramic DIP.

CIRCLE NO. 306

Get it from the quality DMM specialists

(Systron-Donner)

More functions/ranges • field proven
• large displays • rugged metal
cases • high acceptance • low
prices • short delivery

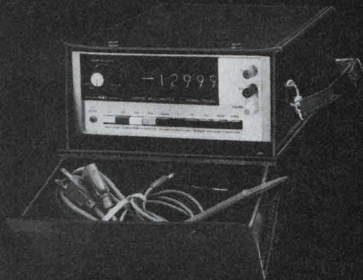

Model 7004A. All-function unit measures dc/ac volts, dc/ac current and resistance with excellent overload protection. AC response to 100 KHz. $\pm 0.01\%$ DC accuracy. Optional internal battery pack and carrying case. Basic price \$675.



Model 7205. 26 ranges. Resolves ± 1 microvolt DC, 1 milliohm resistance, ± 1 nanoamp current. Measures dc/ac volts, dc/ac current and resistance with excellent overload protection. $\pm 0.005\%$ accuracy. Display digits over $\frac{1}{2}$ " tall. Lead-compensated ohms. Optional isolated BCD output. Basic price \$1150.

For immediate details, call our Quick Reaction line (415) 676-5000 collect, or contact Systron-Donner at 1 Systron Drive, Concord, CA 94518.

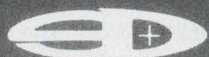

SYSTRON-DONNER

INFORMATION RETRIEVAL NUMBER 52

INTEGRATED CIRCUITS

Standard PROM family starts with 2-k and 1-k units

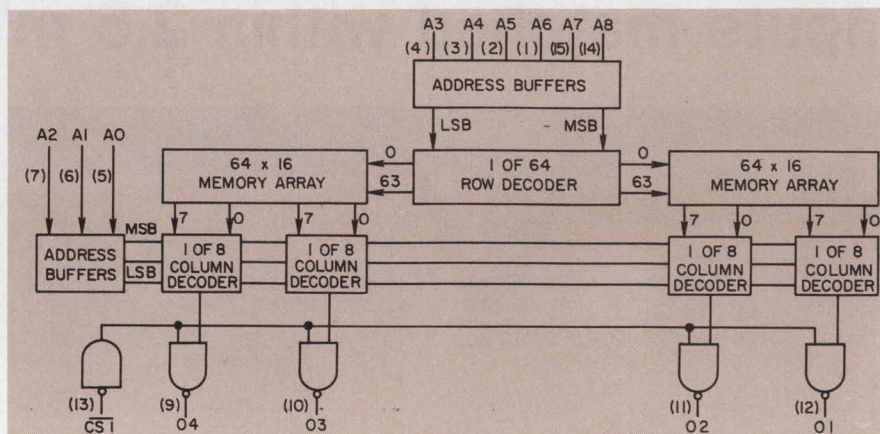

Harris Semiconductor, P.O. Box 883, Melbourne, FL 32901. (305) 727-5407. P&A: See text.

Aiming to overcome a major problem that users of field-programmable, read-only memories face—lack of standardization—Harris Semiconductor has introduced the Generic PROM family with 2048-bit and 1024-bit units.

Eventually, the company says, the family will encompass the remaining industry-standard bit capacities: 256 and 4096 bits. All the Schottky-bipolar PROMs will use fusible nichrome-links, and they will have the same programming requirements and standard dc parameters. Pinouts will follow the patterns of popular PROMs.

Moreover access times will be guaranteed over operating-temperature and voltage-supply ranges. And additional circuitry on the chips allows factory testing of ac, dc and programming parameters.

The first available member of the family—the 512×4 -bit HM-7620/1—guarantees an access time of less than 70 ns over the voltage range of 5 V $\pm 5\%$ and temperature range of 0 to 70 C. MIL-temperature versions guarantee access at 85 ns. Both commercial and MIL circuits list a programming time of less than 2 s.

Like other members of the family, the 2-k bit PROM contains two extra rows and two extra col-

umns of test fuses placed at worst-case locations. These additional fuses are used by the manufacturer to perform tests of key parameters prior to shipment.

The HM-7620/1 has TTL-compatible inputs and outputs. Input currents are 400 μ A for logic ZERO and 40 μ A for logic ONE. Outputs can sink 15 mA and source 2 mA.

An open-collector configuration is offered in the HM-7620, while the HM-7621 provides three-state outputs. For commercial temperature ranges, either version costs \$20.45 in quantities of 100. For MIL temperatures, the corresponding price is \$51.25. Packaged in 16-pin DIPs, the 2-k bit PROMs are available from stock.

Following close on the heels of the 2-k bit PROM is the 1-k memory: the open-collector HM-7610 and the three-state HM-7611. Also available from stock, the 256×4 -bit PROM guarantees access at 50 ns and lists a typical programming time of 1 s. The price for commercial-temperature-range products in quantities of 100 is \$12.80; for MIL temperatures, it's \$26.86.

For other members of the family, Harris plans a second-quarter introduction.

The over-all chip size of the 2048-bit HM-7620 is 107×188 ,

(continued on next page)

or 20,116 square mils. Each of the chip's four outputs has an associated array of 64×8 fuses. Also, each output has a 1-of-8 decode on the columns, while a 1-of-64 row-decode scheme is common to all four arrays. The 64-row decoders are deployed down the middle of the chip, while the column decodes are along the end, near the output buffers.

CIRCLE NO. 303

IC demodulates FM signals

Exar Integrated Systems, 750 Palomar Ave., Sunnyvale, CA 94086. (408) 732-7970. \$2.40 (100); stock.

The XR-1800 stereo demodulator IC can directly replace the μ A758, MC1311 or LM1800. The IC comes in a 16-pin DIP, and it uses a phase-locked loop to demodulate composite FM inputs. It is adjusted with a single potentiometer and requires no inductor. The PLL's signal-capture range of $\pm 3.5\%$ makes tuning noncritical. Other features include operating temperature range of -45 to $+85$ C, supply range of 10 to 18 V and a choice of audio output levels up to 1.5 V rms.

CIRCLE NO. 307

1-k NMOS RAM has 128×8 -bit scheme

Motorola Semiconductor Products, Inc., P.O. Box 20924, Phoenix, AZ 85036. (602) 244-3466. \$30.50 to \$37.50 (1-24).

The MCM6810, a 128×8 -bit static RAM, is offered as one of the building blocks in the company's microcomputer chip set. Operating statically, the n-channel MOS, silicon-gate memory need not be clocked or refreshed. Data flow in this byte-organized memory is bidirectional; the data buffers are three-state operable. Six chip-select inputs provide a means of increasing the size of a memory subsystem without the need for additional address decoding. The MCM6810 is fully TTL-compatible and requires only a single 5-V supply. Two versions of the memory are available: the MCM6810L has a maximum access time of 1.0 μ s; the MCM6810L-1 version has a maximum access of 600 ns.

CIRCLE NO. 308

**Capture Signals like a Transient Recorder
Store and Playback Data like a Tape Recorder
with Better Accuracy, Computer Compatibility,
and Portability.**

That's the Beauty of an ERDAC!



COLLECT Several Waveforms Simultaneously
EXAMINE Analog Signals In Real Time
FREEZE and Study the Important Events
MEASURE Time and Amplitude Values Quickly
REMEMBER the Captured Signals for Detailed Analysis
STORE Traces on Computer Quality Tape Cartridges
PLAYBACK Exactly the Record Segment Selected for Review
ANALYZE the Data With Precisely the Time Resolution Desired

Unattended Signal Capture Applications

ELECTRICAL POWER TRANSMISSION & DISTRIBUTION

• Circuit Breakers • Lightning Strikes • Switching Transients

ACCELEROMETER DATA COLLECTION

• Ballistics • Hydraulic Transients • Earthquakes • Impact Tests

Now you can really capture and process data effectively!

Rent an ERDAC!

**GE Quick-rental^{*}
instruments**

*Trademark General Electric

Call RAY MORIN collect at GE's HOTLINE (518) 372-9900 for a FREE 52 page catalog of the rental instruments available for immediate delivery from the General Electric Company.

Buy an ERDAC!

MACRODYNE INC

Call DAN ANTOS at MACRODYNE's HOTLINE (518) 372-5619 for further technical information.

You get a lot in a little package with General Electric Reed Switches

GE Reed Switches feature rugged design, fast operation, long life. For complete information, use the reader service card, or write GE, 316 E. 9th St., Owensboro, Ky. 42301



Hi-voltage 2" (DR680) closed-contact resistance less than 0.1Ω, open-contact IR greater than $10^{12}\Omega$, and dielectric strength to 15 KVDC; contacts rated 50 watts, up to 10 KVDC, up to 2A.

Standard 2" (DR600), a rugged and dependable switching device; contact ratings of 15, 50, and 100 watts; up to 250 VDC, up to 3A.

Miniature (DR400) low, stable contact resistance and dielectric strength to 750 VDC; contacts rated 10 watts, up to 250 VDC, up to 0.5A.

Intermediate (DR500), gold-silver alloy contacts (10 watts) for applications requiring low, stable dynamic contact resistance; rhodium contacts (15 watts) for heavier loads; dielectric strength to 1000 VDC.

Sub-miniature (DR300) low-level keyboard loads; power-loads up to 10 watts for relay, auto, other applications requiring minimum package size.

GENERAL  ELECTRIC

364-01

INFORMATION RETRIEVAL NUMBER 54

Increase your Profit with Automatic Insertion

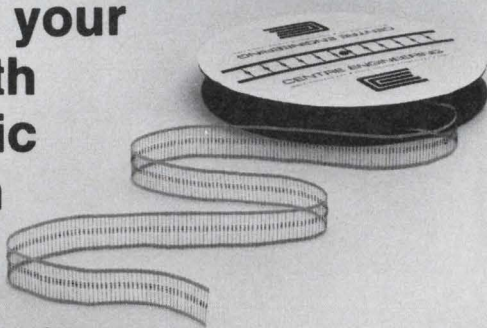

glass sealed multi-layer capacitors

Glass sealed multi-layer capacitors in strip form are available from Centre Engineering. These capacitors are rugged, reliable, and ideal for automatic insertion.

Available in three case sizes; .170" L X .100" D, .250" L X .100" D, .400" L X .150" D with temperature

ranges from -55°C to +125°C. Capacity range of 5pf to 1mfd in three voltages and four formulations; 50, 100 and 200 volts.

Increase your profit with glass sealed multi-layer capacitors from Centre Engineering. Write today for complete information.

 **CENTRE ENGINEERING**
2820 E. COLLEGE AVE., STATE COLLEGE, PA 16801
814-237-0321 ■ TWX 510-691-2634

INFORMATION RETRIEVAL NUMBER 55

INTEGRATED CIRCUITS

CCD memory makes debut

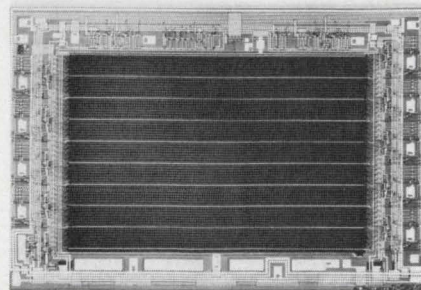

Fairchild, 464 Ellis St., Mountain View, CA 94042. (415) 962-3816. \$90; sample quantities.

The first CCD memory has been announced by Fairchild. Called the CCD450, the new memory is a 9216-bit serial storage element that is organized as 1024 words by 9 bits. Power dissipation in read and write modes is 250 mW maximum, and only 30 mW in a standby recirculate mode. Average random byte access time is 200 μs. The circuit uses simple two-phase clocking, and it comes in a standard 18-pin ceramic DIP. Data rate is 50 kHz to 3 MHz.

CIRCLE NO. 309

Instrumentation amp evolves to new level

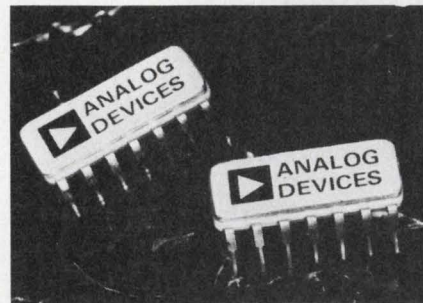

Analog Devices, Route 1 Industrial Park, P.O. Box 280, Norwood, MA 02062. (617) 329-4700. P: See text; stock.

Called a second-generation instrumentation amplifier, the AD521 combines 110-dB CMRR with 1.5 μV/°C input-offset drift and 1.2 μV rms noise. Unit costs start at \$8.50 in hundred quantities. The IC has differential inputs and its input-to-output gain can be programmed from 0.1 to 1000. The AD521 guarantees the CMRR spec at the worst-case gain of 1000 with a 1-kΩ source imbalance from dc to 100 kHz.

CIRCLE NO. 310

Triple-output dc supply ignores ac power failures

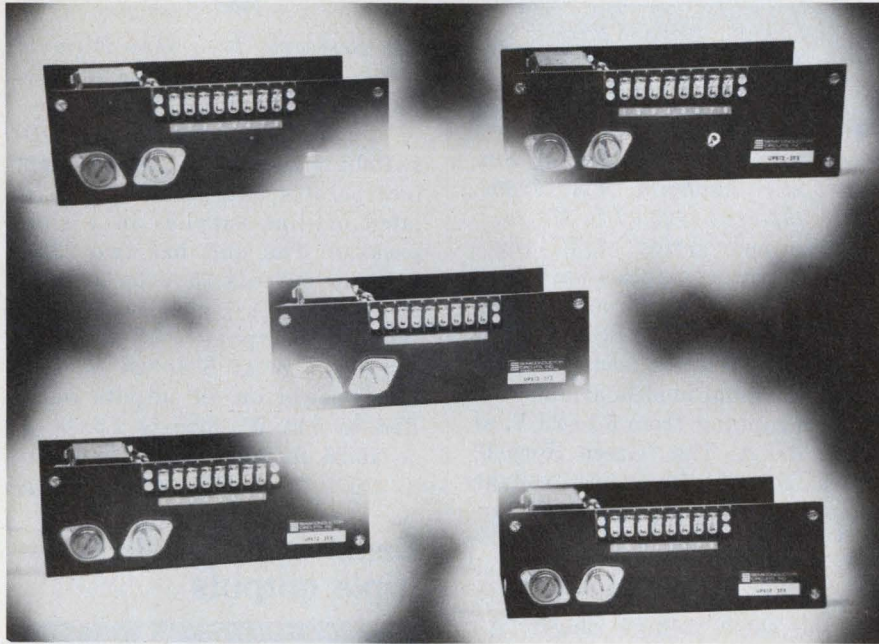

Semiconductor Circuits, 306 River St., Haverhill, MA 01830. (617) 373-9104. See text.

What appears to be the first uninterruptible, triple-output ac-to-dc supply has made its appearance in Semiconductor Circuits' UPS12 series. Not only does the series deliver ± 15 V for analog circuitry and +5 V for digital, but a 13.5-V output is provided to charge an external backup battery.

The 13.5 V also serves as the input to the 5-V and ± 15 -V sections of the supply. With a 12-V battery floating across the 13.5-V terminals, the outputs are maintained in the face of brownouts or total loss of the primary ac input power. All models in the series accept an ac input voltage ranging from 105 to 125 V at 50 to 440 Hz. These are the "normal" line conditions.

If a blackout does occur, the battery will carry the supply for one-half hour even at loads of, say, 2 A at 5 V and ± 100 mA at ± 15 V.

The float-charge voltage of 13.5 V was selected to safely handle

any 12-V battery that can sustain a continuous level of 2.5 V per cell.

Housed in a $6 \times 9 \times 3$ -in. aluminum case, the UPS12 comprises nine regulated models of various current ratings. The model with the highest output current provides ± 300 mA at ± 15 V, and 3 A at 5 V. Up to 1 A at 13.5 V is provided by this model, but other units in the series deliver higher charging currents. All units operate from -25 to 71 C with no derating, and all outputs are short-circuit protected.

Regulation of the 13.5-V battery supply is 0.1% for both line and load. Ripple of this output is 2 mV rms. The ± 15 -V output is regulated to $\pm 0.5\%$, line and load, with only 1 mV rms ripple, and the 5 V is regulated to 0.2% for line and 0.5% for load at 7 mV rms ripple.

Prices range from \$186.95 to \$253.95, depending on the relative current ratings of the three voltage levels. OEM discounts are offered. Availability is two to four weeks.

CIRCLE NO. 304

Advertisement

ELECTRONIC PACKAGING

500 lb. capacity cabinet won't tilt, won't sway



Bud Radio, Inc., 4605 E. 355 St., Willoughby, O. 44094, (216) 946-3200. Immediate delivery.

The Stylist from Bud. Duo-rimmed anodized aluminum extrusions frame front panel. Full-width flanges add strength at corners, no tilt or sway. Bustle-type door clears knobs, dials, switches, etc. Doors for front, rear; left or right opening. Louvered rear panel for peak ventilation. Stackable. 16-gauge cold rolled steel. No internal framework. Six sizes. For further information phone —

1-800-321-1764, TOLL FREE

IN OHIO, 1-800-362-2265, TOLL FREE

Cabinet racks: upright, inclined, big, deep

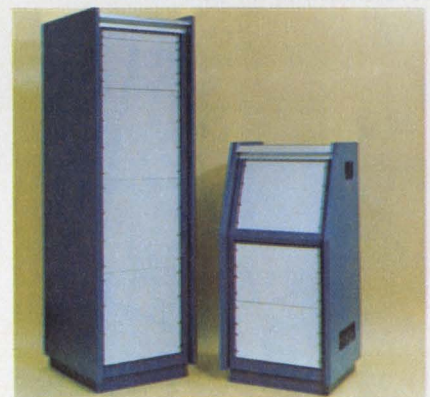

Bud Radio, Inc., 4605 E. 355 St., Willoughby, O. 44094, (216) 946-3200. Shipped ready for use.

Series 2000 cabinet racks from Bud. Standard uprights, 16 sizes. Clear inside depths, 20 $\frac{1}{2}$ ", 24". Eight extra-deep units have 29 $\frac{1}{4}$ " clear inside depth. Outside heights, 30 $\frac{1}{4}$ " to 88". Mounting rails adjusted horizontally. Six inclined units. Clear inside depths, 20 $\frac{1}{2}$ ", 29 $\frac{1}{4}$ ". Front panel, 20° off vertical. Compare value, shipping economies. For further information phone—

1-800-321-1764, TOLL FREE

IN OHIO, 1-800-362-2265, TOLL FREE

ELECTRONIC PACKAGING

Low-cost enclosures for a variety of uses

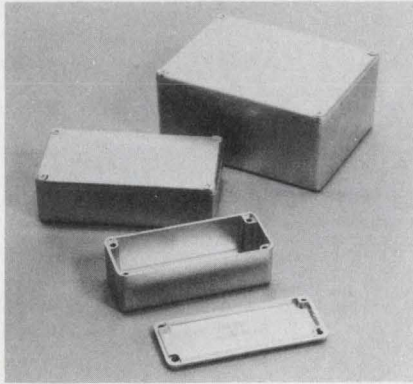

Bud Radio, Inc., 4605 E. 355 St., Willoughby, O. 44094, (216) 946-3200. Cast aluminum construction.

Econoboxes by Bud. Five sizes for instrument and meter cases, filter networks, junction boxes, and more! Effective for concealed or other interior use where safety enclosures are necessary. Lightweight. Easy to machine. LM-380 aluminum alloy, plus close-fitting flanged lids offer excellent screening properties. Immediate delivery. For further information phone—

1-800-321-1764, TOLL FREE

IN OHIO, 1-800-362-2265, TOLL FREE

Standard enclosures with custom features

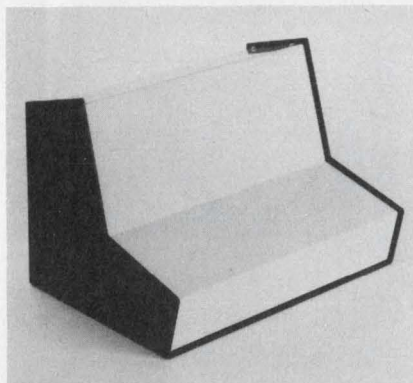

Bud Radio, Inc., 4605 E. 355 St., Willoughby, O. 44094, (216) 946-3200. Your Bud Distributor has it.

Compucab by Bud. Dual-slope, off-the-shelf enclosures with custom-designed configurations. Use for a range of instruments. Maximum visibility — no fasteners on panel area. All aluminum. Cover and back in smooth white enamel. Base and sides, black textured enamel. Knockouts in rear panel. Rubber feet furnished. Two styles. Shipping economies. For further information phone —

1-800-321-1764, TOLL FREE

IN OHIO, 1-800-362-2265, TOLL FREE

POWER SOURCES

The Green Hornet meets the Red Baron...curses!

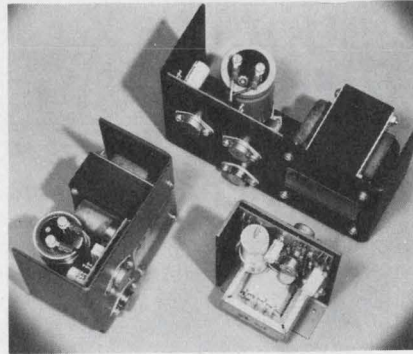

Advanced Power, Inc., 1621 S. Sinclair St., Anaheim, CA 92806. (714) 997-0034. \$26.95 to \$72.25.

Three new series of IC regulated dc power supplies have been dubbed the "Red Baron," "Green Hornet," and "Black Beauty." The "Red Baron" series leads the pack with individual models available in outputs ranging from 5 to 28 V, at 0.8 to 3.0 A. The "Green Hornet" series covers the same voltage ranges, but at slightly higher current ratings from 2 to 6 A. The "Black Beauty" series is available in current ratings from 4 to 10 A for the same voltage ranges. All units accept universal inputs of 115/230 V ac, 50/60 Hz.

CIRCLE NO. 320

Switcher supplies protect memories

Pioneer Magnetics, 1745 Berkeley St., Santa Monica, CA 90404. (213) 829-3305. About \$500 (qty.) 750-W unit; 60 days.

A complete line of single and multiple-output computer switching power supplies, available in all the popular semiconductor and core memory voltages, has power ranges from 300 to 2000 W. Up to four outputs in a single supply are standard. Internal forced air cooling is provided to give full rated output at 50 C and 80% full rating at 71-C ambient. Ruggedness of the electrical design is shown through brownout protection for line drops of 30% or more while the units maintain full regulation. In addition, full output is maintained during input power loss long enough for the computer to perform an orderly shutdown of the volatile memory.

CIRCLE NO. 321

16-lb switcher delivers two 250-W outputs

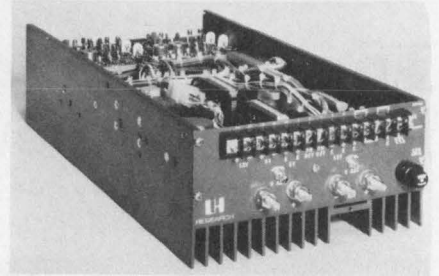

LH Research, Inc., 4444 Riverside Dr., Suite 201, Burbank, CA 91505. (213) 843-8465. \$759 (500).

"Double" dual Model LH600DD switching-regulated power supply incorporates two separate and isolated off-line supplies in a single package. The unit has two 250-W primary outputs (5 V to 50 A and 12 V at 22 A), plus two isolated secondary outputs—8 A at 5 to 18 V, and 1 A at 5 to 24 V. Combined power on all outputs is limited to 500 W. Size is 7.5 × 3.9 × 16.25 in. and weight is 16 lb.

CIRCLE NO. 322

Bench supply delivers triple outputs



Hewlett-Packard, 1501 Page Mill Rd., Palo Alto, CA 94304. (415) 493-1501. \$325; 2 wks.

Model 6236A is a three-in-one bench dc supply that delivers an output of 0 to 6 V at up to 2.5 A and plus and minus outputs from 0 to 20 V, each at 0.5 A. The unit is designed for ICs and general lab use. The 0 to +20 V and 0 to -20 V outputs track one another within 1%; they can also be used to obtain a single 0-to-40-V, 0.5-A output. Regulation is 0.1% + 2 mV, with ripple and noise of 0.35 mV rms/1.5 mV pk-pk. The supply can be powered from a nominal 100 V, 120 V, 220 V or 240 V, 47 to 63 Hz ac input. Both the 6 and ±20-V outputs are protected from overloads by fixed current-limiting circuits.

CIRCLE NO. 323

Modules offer remote sensing & programming

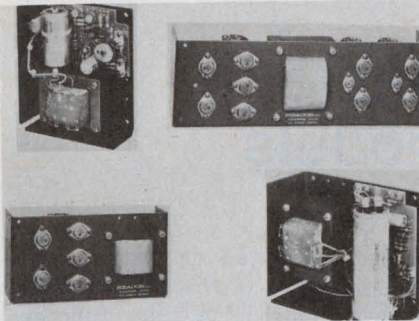

Reacor, Inc., 718 Lingo Dr., Richardson, TX 75080. (214) 231-7218. \$32 to \$87.

Four new power-supply modules, the RM Series, cover the range of 2 to 28 V at up to 12 A. These modules offer remote sensing and programming, TTL-compatible logic inhibit, automatic series and parallel operation, adjustable current limiting and full output to 50 C (derated to 71 C), and a full five-year warranty. The models range from 5 V at 3 A (case B) to 5 V at 12 A (case D) and feature screw-terminal outputs, 115/230 V, 47-440/Hz input variation, optional screen covers, shielded transformers and factory adjusted overvoltage protection.

CIRCLE NO. 324

Modular supply joins instrument line

Tektronix, Inc., P.O. Box 500, Beaverton, OR 97005. (503) 644-0161. \$225; stock to 6 wks.

PS 503A triple power supply features plus and minus 0 to 20 V dc constant-voltage, current-limited floating operation with a common terminal; plus an auxiliary +5 V at 1-A supply. The unit provides a floating 0-to-±20 V dc at 1 A when used in the high-current compartment of the company's new four hole TM 504 power mainframe. In the standard compartments of the TM 501, TM 503 or TM 504 power mainframes, the PS 503A supplies a floating 0 to ±20 V dc at 400 mA. Drift stability is 0.1% ±5 mV, or less, in 8 h at constant line load, and temperature. Ripple and noise is held to within 0.5 mV or less peak-to-peak, with a 400-mA load in standard current compartments.

CIRCLE NO. 325

only this digital delay module gives you . . .

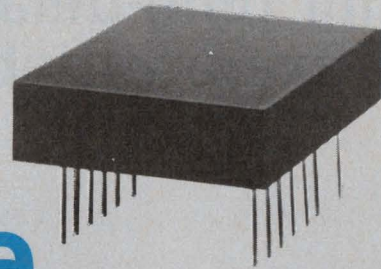

- FROM 25 to 1000 ns DELAY
- 10 TAPS FOR BEST RESOLUTION
- TTL-DTL COMPATIBILITY
- LOW PROFILE .250" OFF BOARD

Pulse has added a new dimension to its long favored standard 5 tap digital delay modules (1" L. x .4" W.). Our new 20100 series is only .250 inches high. Eight models are available from stock with precision digital timing from 25 to 1000 nanoseconds total delay. Also available are six 10 tap models (1" L. x .8" W.) with total delays from 100 to 1000 nanoseconds. All modules are TTL and DTL compatible. Built-in interface gives you direct plug-in devices without the need for additional components.

5 tap price is \$26.00 (1-9)

10 tap price is \$49.50 (1-9)

8 FIVE TAP MODELS TO CHOOSE FROM

CATALOG NUMBER	TOTAL DELAY (ns ±5%) or ±2 ns which ever is greater	NO. OF TAPS	DELAY (ns) PER TAP	RISE TIME (ns MAX.)	LOGIC 1 V OUT	LOGIC 0 V OUT
20100	25	5	5	2	2.4 V Min.	0.4 V Max.
20101	50	5	10	2	2.4 V Min.	0.4 V Max.
20102	100	5	20	2	2.4 V Min.	0.4 V Max.
20103	150	5	30	2	2.4 V Min.	0.4 V Max.
20104	200	5	40	2	2.4 V Min.	0.4 V Max.
20105	250	5	50	2	2.4 V Min.	0.4 V Max.
20106	500	5	100	2	2.4 V Min.	0.4 V Max.
20107	1000	5	200	2	2.4 V Min.	0.4 V Max.

6 TEN TAP MODELS TO CHOOSE FROM

CATALOG NUMBER	TOTAL DELAY (ns ±5%) or ±2 ns which ever is greater	NO. OF TAPS	DELAY (ns) PER TAP	RISE TIME (ns MAX.)	LOGIC 1 V OUT	LOGIC 0 V OUT
20151	100	10	10	2	2.4 V Min.	0.4 V Max.
20152	150	10	15	2	2.4 V Min.	0.4 V Max.
20153	200	10	20	2	2.4 V Min.	0.4 V Max.
20154	250	10	25	2	2.4 V Min.	0.4 V Max.
20155	500	10	50	2	2.4 V Min.	0.4 V Max.
20156	1000	10	100	2	2.4 V Min.	0.4 V Max.

CALL (714) 279-5900

PULSE ENGINEERING, INC.

P.O. Box 12235
San Diego, California 92112

PULSE ENGINEERING — IRELAND

Dunmore Road, Tuam
County Galway

Republic of Ireland
Phone: 093-24107
WORLDWIDE SALES

**Pulse
Engineering
Inc.**

A Varian Subsidiary

Mini time-delay relays are available in fixed, variable and flasher models

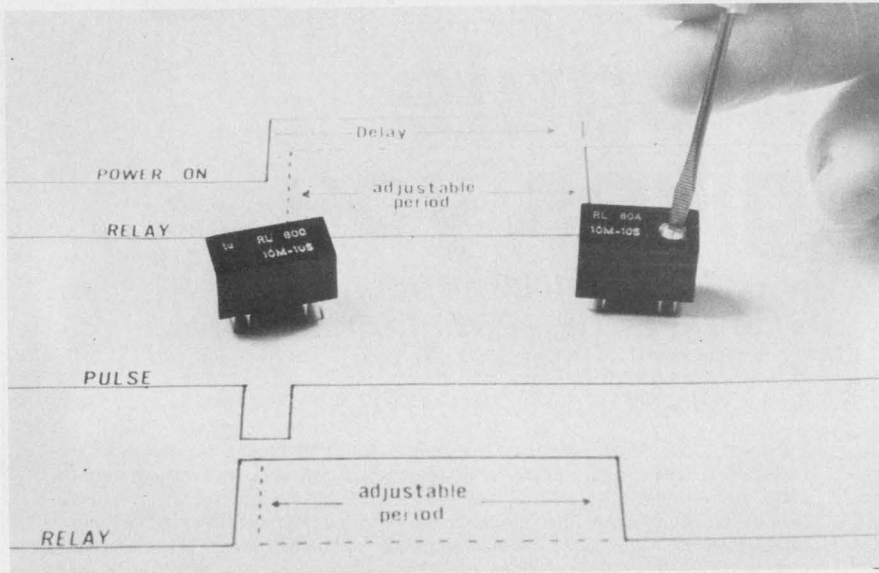

Timers Unlimited, 25572 Avenue Stanford, Valencia, CA 91355. (805) 257-3662. P&A: See text.

Adjustable time-delay relays no longer have to be large and expensive to do their job. The 800 series of miniature time-delay relays made by Timers Unlimited provide adjustable delays from 20 ms to 5 minutes.

The mini units are housed in DIP-like packages that measure $0.8 \times 0.4 \times 0.35$ in., and cost \$12.50 for fixed-delay versions and \$18.75 for variable models, both in 1000-piece quantities.

Three versions of the 800 series are available. The RL 800 relays

provide delays-on-operate, the RL 810 units a timed-on period and the RC 850 a flasher function. All three are available with fixed or adjustable time periods.

The fixed timers come with delays of 20 ms, 500 ms, 1 s, 30 s, 1 minute and 5 minutes. The adjustable units are readily available in several ranges: The lower-range units have delays that span 20 ms to 9 s, 10 to 20 s and 50 to 60 s. The higher range unit spans 4.6 to 5 minutes.

The adjustable units use a single-turn potentiometer that can trim the delay to $\pm 5\%$ accuracy. But, with minor modifications,

these units can be adjusted to within $\pm 1\%$ if the potentiometer is used only as a trim function. For example, a 5-s delay relay can be trimmed between 4 and 6 s.

Interval repeatability is $\pm 2\%$ under normal operating conditions, and the delay-time accuracy on fixed-delay units is $\pm 10\%$. All RL series relays are available with contacts for 5, 6, 12 and 24 V dc at 0.5 A, in forms A, B or C. Typical life at full rated load is 5×10^6 operations, and this increases to 100×10^6 if only small signals are handled by the relay contacts. The RC 850 flasher relays are available with preset times of 1 s. You can, though, get custom preset times or order units with variable on and off times.

Package heights for the time-delay relays range from 0.35 to 0.425 in., which permit these units to be used on printed-circuit boards spaced only 0.5 in. apart. The packages require only about 1/8th the space taken up by most competing time-delay relays.

The RL units require about 90 mW for operation and could thus be driven directly by logic outputs. Delivery is from stock to 30 days and custom delay times are available at a 10% price premium. Single evaluation samples of stock units are available at 1000 piece prices.

CIRCLE NO. 302

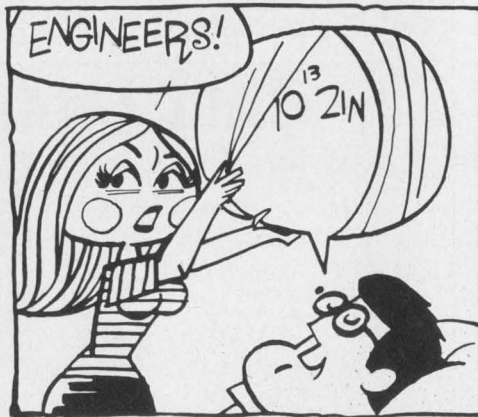

ANALOG:
IF YOUR TRANSDUCERS ARE LOADED DOWN BY LOW Z INPUT AMPLIFIERS, STOP DREAMING AND TRY AN A-126 OR A-127 J-FET INPUT AMPLIFIER. ZIN IS GREATER THAN $10^{13} Z$ INPUT BIAS CURRENT GUARANTEED 100 fA (0.1 pA MAX.) AS LOW AS $5 \mu\text{V}/^\circ\text{C}$ DRIFT IN A SMALL, LOW COST, PLUG-IN PACKAGE.

intech INCORPORATED
(408) 244-0500
1220 COLEMAN, SANTA CLARA CA 95050

Microprocessor clocks need no other interface

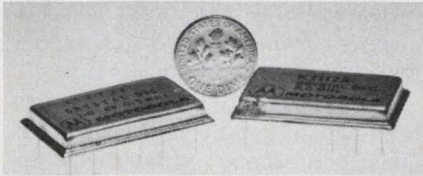

Motorola Component Products Dept., 2553 N. Edgington, Franklin Park, IL 60131. (312) 451-1000. \$68.13 (1 to 4); stock to 8 wk.

Model K1117A crystal oscillator is designed specifically to drive the Intel 8080 CPU at about 2 MHz and the MC6871A is designed to drive the Motorola 6800 MPU at about 1 MHz. No other interface circuitry is required. Each plug-in, packaged module occupies 1.34×0.84 in. of board space, uses only 0.2 in. of height, yet contains the crystal, the oscillator circuit, NMOS and TTL drivers, wave-shaping and interface circuitry, and provides the critical, non-overlapping two-phase waveforms required by the specific microprocessor.

CIRCLE NO. 326

D/s converters provide up to 3-VA power output

Computer Conversions, 6 Dunton Ct., East Northport, NY 11751. (516) 261-3300. Under \$450 (prod. qty.); 4 to 6 wk.

The DSC series of miniature 14-bit digital-to-synchro converter modules can drive torque receiver synchros. The modules provide up to a 3-VA power output and ± 6 min accuracy when driving this heavy load (size 11 TR). The $2.6 \times 3.1 \times 1$ in. units accept a 14-bit natural binary angle and convert it into a three-wire synchro or four-wire resolver signal. The output is short-circuit protected and only ± 15 -V and $+5$ -V dc power supplies are required. Standard output voltages are 90 or 11.8 V rms line-to-line, 60 or 400 Hz. Digital inputs are TTL/DTL compatible and the synchro output and reference are fully transformer isolated. Part No. DSC40-L-3 requires a 26-V reference, ± 15 V at 200 mA, -15 V at 150 mA and $+5$ V at 50 mA. Operating temperature ranges are 0 to 70 C or -55 to $+85$ C.

CIRCLE NO. 327

Your line needs our line.

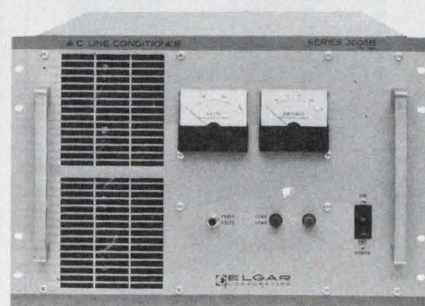
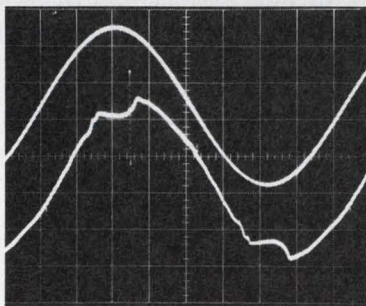

If your line is feeding a computer, the electronics are probably getting an unbalanced diet. The lower curve is an actual scope display of AC line power. The upper curve shows how an Elgar Line Conditioner smoothed out the transients and distortion. And it did it quickly—about 5,000 times as quickly as a line regulator. Elgar Line Conditioners have an impulse settling time of less than 20 μ sec. They provide $\pm 0.025\%$ load regulation and reduce 500 V 10 μ sec. transients by 1000:1. Instruments are available in 1, 3 and 5 KVA versions. For more information, contact Elgar Corporation, 8225 Mercury Court, San Diego, California 92111. Phone (714) 565-1155.

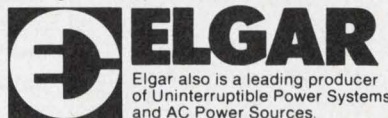

Check your total cost... then check ours

Stacoswitch's competitive purchase price plus ease of installation and quick, simple servicing from front of panel add up to **LOW TOTAL COST**. You save three ways.

And Staco's matrix mounted Series 1M and 1MR Lighted Push-button Switches help conserve precious panel space for added savings in design and production.

Choice of circuitry, switch action, and display style to meet your

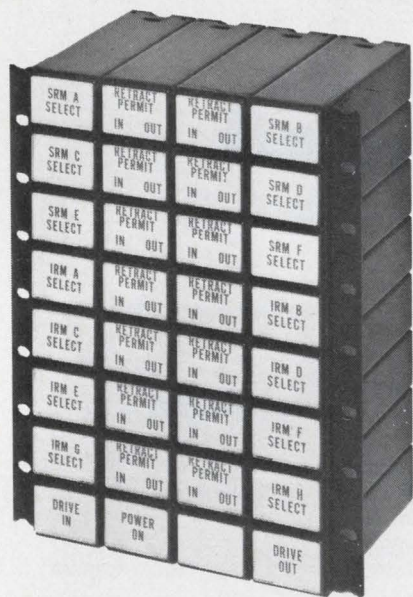

particular needs. Write today for General Catalog showing complete switch line. When you think switch... think **STACOSWITCH** and save!



1139 BAKER STREET, COSTA MESA, CALIF. 92626
(714) 549-3041 TWX: 910/595 1507

Other STACO Company products: Fixed Ratio Transformers, STACO, INCORPORATED, Richmond, Indiana; Variable Transformers, STACO, INCORPORATED, Dayton, Ohio.

INFORMATION RETRIEVAL NUMBER 59

INSTRUMENTATION

Logic recorder freezes 10 Mbit/s serial data

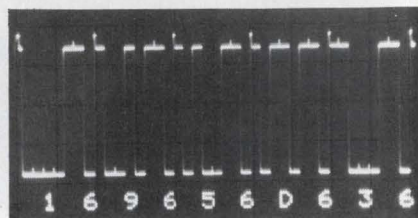
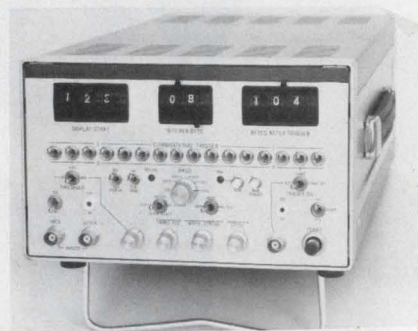

Biomation, 10411 Bubb Rd., Cupertino, CA 95014. (408) 255-9500. \$2250; 90 days.

Debugging serial data is a problem that Biomation's 110-D logic recorder sets out to solve. With the unit, you can monitor, take snapshots—that is, store in memory—and display, on an external X-Y CRT or scope, synchronous or asynchronous data at speeds up to 10 Mbit/s. Thus you can watch for trouble on, say, an EIA RS232 interface.

The 110-D's memory can store up to 4096 bits segmented in byte sizes from 1 to 99 bits. A displayed cursor at the end of each byte defines the boundaries, while a second display, below the stream pattern, provides an alphanumeric, hexadecimal translation of each byte.

Even slow data rates can be displayed with no flicker, since the unit's RAM first records the information, then spits it out at a fast rate. Various modes of the 110-D let you use an external source or the input data as the trigger. For example, in the "start bit" mode, the first bit triggers the instrument after an initial arming.

Another mode—called the "combinational trigger"—watches for a pattern set up on 16 ONE, ZERO or "don't care" toggles. When the pattern shows up at the input, the 110-D triggers.

CIRCLE NO. 301

Fast a/d converter works at 1-ns aperture

Phoenix Data, Inc., 3384 W. Osborn Rd., Phoenix, AZ 85021. (602) 278-8528. \$4285; 60-90 days.

Model ADC 1105-60 a/d converter is capable of 60 million conversions per second with 0.1-ns aperture time. Resolution is 5-bit binary or 2's complement. The converter's strobed, parallel-conversion technique provides sample-and-hold. All converters are fully-assembled, tested and calibrated "system-ready" modules. The only external requirement is a power-supply input.

CIRCLE NO. 328

Synthesizer formed around microprocessor



John Fluke, P.O. Box 7428, Seattle, WA 98133. (206) 774-2211. \$2495.

Model 6010A synthesized signal generator is the first to use a built-in microprocessor. Featured is a keyboard control that allows free-form entry of frequency in Hz, kHz or MHz. Programmed frequencies are read on a 7-digit LED display. The entire output of the instrument is programmable. Up to 10 preset frequency-modulation and amplitude levels can be stored and recalled using the keyboard. Thanks to the microprocessor, the 6010A provides the user with automatic range selection. And whenever an entry is made, the unit automatically justifies the number on the readout to give the greatest possible resolution. The instrument covers the range from 10 Hz to 11 MHz. Although the 6010A has three ranges of added attenuation—20, 40 and 60 dB—the instrument always starts out automatically with the maximum value. The unit measures only 5.25 x 17 x 8.5 in. so it takes up minimum space on the work bench.

CIRCLE NO. 329

Compare The Data.

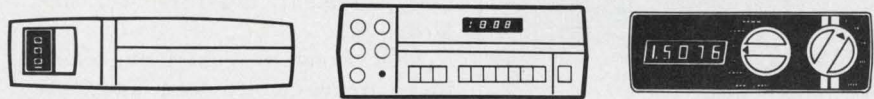

		HP970A	Fluke 8000A	Data Precision 245
Number of Digits		3½	3½	4½
Functions	DCV, ACV, Ohms	Yes	Yes	Yes
	DCmA, ACmA	With ext. shunts (\$47)	Yes	Yes
Resolution		.09%	.05%	.005%
Normal Maximum Display		1099	1999	19999
Overrange		10%	100%	100%
Ranging		Auto only	Manual only	Manual only
Basic DC Accuracy		±(.7% rdg. ±.2% range)	±0.1% reading ±1 LSD	±.05% reading ±1 LSD
Display Size		.125"	.250"	.33"
AC Freq. Response		45Hz-3.5KHz	45Hz-20KHz	30Hz-50KHz
Recharge While Using		No	Yes	Yes
Price (with batteries)		\$310	\$349	\$295

From manufacturers' published specifications.

Here's a comparison of the three leading portable digital multimeters.

The top three.

Data Precision, Fluke and Hewlett-Packard.

But the word "leading" in this case can be very misleading.

Because only one of the three — Data Precision's Model 245 — is a 4½ digit instrument. All of the others are 3½.

Check the facts and figures.

Compare the price, accuracy, resolution and features.

We think the Model 245 speaks for itself.

**Data Precision Corporation,
Audubon Road,
Wakefield, MA 01880
(617) 246-1600**



DATA PRECISION®
...years ahead

INSTRUMENTATION

Vhf sweeper sells for \$495



Wavetek Indiana, 66 N. 1st Ave., Beech Grove, IN 46107. (317) 783-3221. \$495; 30 days.

This sweep generator, designated Model 1050, sells for less than \$500 (said to be approximately one-half the cost of most comparable units on the market). The instrument covers a frequency range of 1 to 400 MHz and has a maximum rf output of +10 dBm. Sweep linearity is 2%. Flatness of ± 0.25 dB is accomplished with p-i-n diode leveling and both harmonic and nonharmonic spurious signals are 30-dB below the output.

CIRCLE NO. 330

Build your own function generator



Heath Co., Benton Harbor, MI 49022. (616) 983-3961. IG-1271 (kit), \$99.95; SG-1271 (assembled), \$140.

This function generator comes in kit or assembled form and generates sine, square or triangle waveforms from 0.1 Hz to 1 MHz. A short-circuit-proof output amplifier supplies a 10-V pk-pk signal into a 50- Ω load. A calibrated step attenuator adjusts from 0 to 50 dB (10 V pk-pk to 30 mV pk-pk) in 10-dB steps. Variable attenuation gives up to 20-dB additional attenuation. Attenuator accuracy is ± 1 dB, frequency accuracy $\pm 3\%$ and triangle waveform nonlinearity is 5% max. with waveform symmetry within 10%. Square wave rise and fall times are 100-ns max.

CIRCLE NO. 331

Economical scope offers built-in delay line

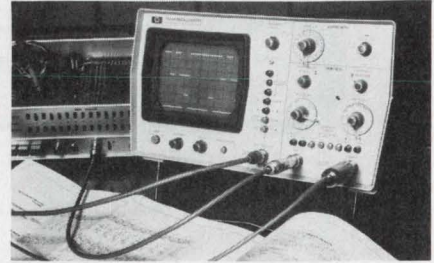

Hewlett-Packard, 1501 Page Mill Rd., Palo Alto, CA 94304. (415) 493-1501. \$895; Early June.

Model 1222A 15-MHz dual-channel scope has a built-in delay line to make visible the leading edge of traces. The unit gives the user the option of viewing Channel A with Channel B either added or subtracted ($A \pm B$ modes). Identical dual channels provide calibrated X-Y displays. Specs include 3% vertical accuracy, calibrated 8 x 10-cm display, internal graticule to eliminate parallax, dc coupling, triggered sweep and pushbutton beam finder. Deflection factor is adjustable from 2 mV/cm to 10 V/cm.

CIRCLE NO. 332

We've made a few Switches (in our catalog).

Actually, as one of the world's leading manufacturers of electrical switching devices, we've made millions of switches: miniature, subminiature, and microminiature — with pushbutton, toggle, rocker, and paddle handles. But the switches we're referring to, here, are the switches in format and design of our catalog. We've simplified it. Made it easier to mix and match switch components and options. Easier to order. Easier to read. Get your 24-page C&K catalog now!

C&K COMPONENTS, INC.

103 Morse St., Watertown, MA 02172, (617) 926-0800
TWX: 710 327 0460 TELEX: 92 2546

SEASTROM OFFERS ITS ALL NEW COMPREHENSIVE CATALOG #40B. This 250 page catalog features the company's full range of products in a colorful book specially indexed for ready reference.

Including such items as . . .

- Flat Round Washers—Metallic
- Flat Round Washers—Non-Metallic
- Spring Washers
- Shoulder Washers
- Tab & Notch Washers
- Washers—Miscellaneous Configurations
- Expansion Plugs
- Military Standards
- Clamps & Brackets
- Spring Clips
- Solder Lugs
- Solid State Insulators
- Bus Bars, Terminal Blocks & Insulating Strips
- Miscellaneous Electrical/Electronic Hardware/Tags
- Sheet Metal Nuts & Strips
- Engineering Tables, Materials & Finish Specifications
- Numerical & Alphabetical Index of Parts

No need to design it . . . you will undoubtedly find it in Seastrom's Catalog all stocked for immediate delivery . . . write to



SEASTROM

MANUFACTURING CO., INC.

701 SONORA AVE., DEPT. E-5
GLENDALE, CALIF. 91201
(213) 245-9121 • TWX 910-497-2271

FREE

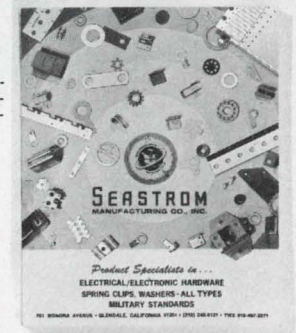

'Naked' scope offered for OEM applications

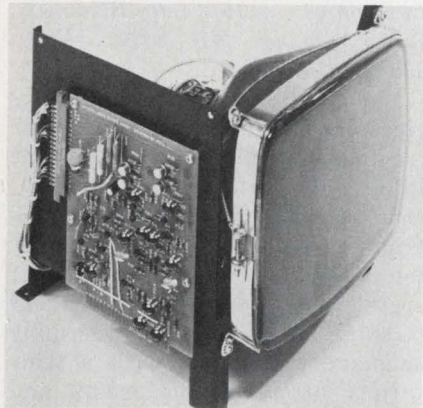

Telonic Altair, 21282 Laguna Canyon Rd., Box 277, Laguna Beach, CA 92652. (714) 494-9401. \$350.

Model 4060 X-Y display oscilloscope (11-in. CRT) is supplied as a basic, uncased chassis for use in OEM systems. The unit offers X, Y, and Z-axis inputs, with PC plug-in connections for direct interface with the user's equipment. Bandwidth is 15 kHz vertically and 4 kHz horizontally. Sensitivity is 5 V for 5.2 in. of vertical deflection and 7.56 in. of horizontal deflection. Deflection linearity is rated within 5% in both directions.

CIRCLE NO. 333

5-V-powered DPM offers flexible mounting



Data Technology, 2700 S. Fairview Rd., Santa Ana, CA 92704. (714) 546-7100. \$129; 4-6 wks.

Model 5312 3-1/2-digit, 5-V-powered DPM is accurate to 0.05% and is compatible with panel cut-outs from 3.19 to 3.63 in. x 1.77 to 1.79 in. (including the 9.2 x 4.5 cm DIN standard), and has a power drain of only 2.25 W. Bipolar, 2000-count (on 0.43-in. LED) full-scale input ranges of ± 22 mV, ± 2 V, ± 20 V or ± 200 V are standard.

CIRCLE NO. 334

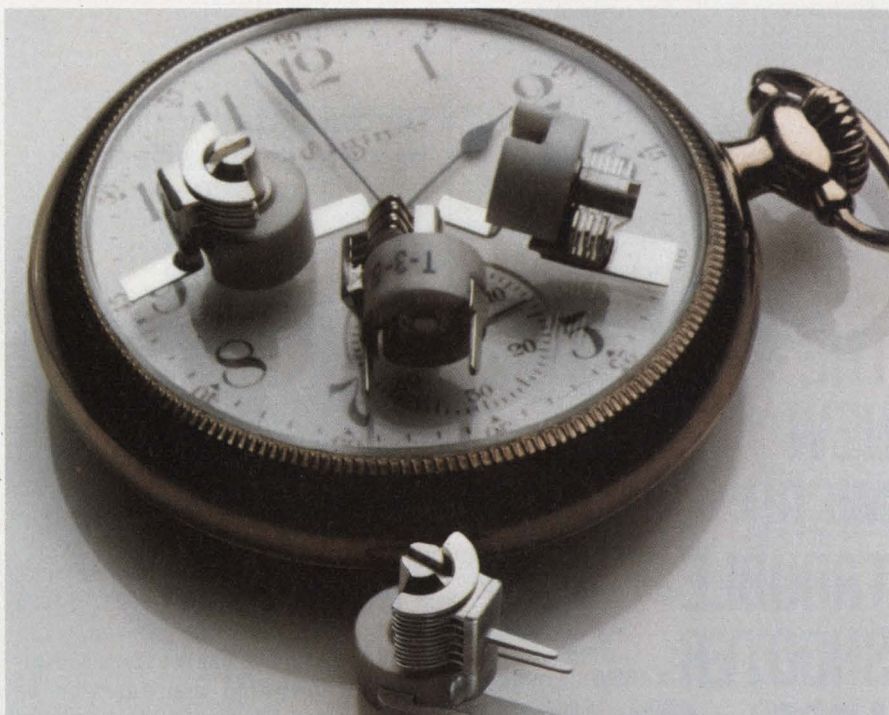

We can deliver the world's smallest 180° air variable capacitors. On time.

And since we're nice people, we don't even charge much for them. So if you have an application that calls for a sub-miniature capacitor that you can "tweak" to a specific frequency, these Johnson trimmers are ideal.

You can choose from either PC or stripline mount, either vertical or horizontal tuning. These Type "T" capacitors are about one-third the size of the familiar type "U" capacitors, so you can save space, cut costs and insure improved performance in the most compact electronic equipment.

Rotors and stators are precision-machined from solid brass extrusions, resulting in exceptional stability and uniformity. High Q—typically 2000 at 150 MHz. Temperature coefficient is a low plus 30 ± 15 ppm/°C. High torque (1½ to 8 oz./inches) holds rotor securely under vibration. They're designed to meet or exceed EIA-RS 204 and MIL Standard 202C Methods 204A and 201A.

In short, these capacitors may be just what you've been looking for. It'll only cost you a stamp to get more information. And if you give us your phone number, we'll call you and send free samples after we have clarified your application.

E. F. JOHNSON COMPANY
3305 Tenth Ave. S.W. / Waseca, MN. 56093

- Please send me technical information on the type T.
 Also, include information on your entire line of variable capacitors.

I want test samples. Please call me at _____

NAME _____

TITLE _____

FIRM _____

ADDRESS _____

CITY _____ STATE _____ ZIP _____



E. F. JOHNSON COMPANY



THE NEW MICRO TROUBLE SHOOTER ADDS A LITTLE LENGTH TO OUR LINE

HOOKS ILLUSTRATED ACTUAL SIZE



(1.75" - 4.45 cm) long and VERY little weight (less than 1 gram). Ideal for difficult IC testing. Connect DIRECT to IC... Reduce resistance build-up. Same high quality construction as our models X-100W, (2.25" - 5.7 cm) and XL-1, (5" - 12.7 cm): Durable heat and chemical resistant nylon body, Gold-plated Beryllium copper contact, Stainless steel spring. Single contact point makes fast, safe, short-free connections... assures accurate readings.

Available in 10 RETMA Colors: Red, Black, Blue, Green, Orange, Yellow, White, Violet, Brown or Gray.

ALL MODELS FEATURE EXCLUSIVE FIELD SERVICING

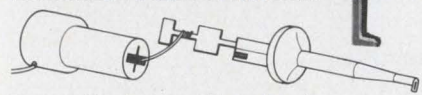

Damaged lead wire easily replaced.

Send for complete catalog & price list.

EZ-HOOK

114 EAST SAINT JOSEPH STREET
ARCADIA, CALIFORNIA 91006
(213) 446-6175 / TWX 910 582 1614

DATA PROCESSING

Digital data terminal has internal buffers



MFE Corp., Keewaydin Dr., Salem, NH 03079. (603) 893-1921. \$1495 (unit qty.); 4 to 5 months.

The Model 5000 buffered digital-data terminal can function as a batch data terminal, program loader or data logger. The terminals feature high density storage of 145,000 char/cassette; RS-232 compatible I/Os with switch selectable speeds of 110, 300, 1200 or 2400 baud; half or full-duplex operation; full remote control of X-on, X-off, send, receive, edit, initialize, and high speed bidirectional search at 6000 char/sec and an average rewind speed of 120 ips. The units have a microprocessor buffer for maximum data transfer rates and use a type 250B digital tape cassette transport with bi-phase formatting.

CIRCLE NO. 335

Large-scale instruments coupled to calculators

Fluidyne Instrumentation, 1631 San Pablo Ave., Oakland, CA 94612. (415) 444-2376. \$500/channel.

Universal digital interfaces with 8, 10 and 16-channels allow connection of laboratory instruments that range from digital voltmeters to emission spectrographs with programmable calculators. Programmable outputs including digital-to-analog conversion capability can also be provided by the system. Accessories such as counters, interval timers, digital panel meters, and similar devices help increase versatility. Average cost, including the plug-in function card, is \$500 per channel.

CIRCLE NO. 336

Micro's cross-assembler runs on interactive mini

Innovonics, 14119 Castle Blvd. 402, Silver Spring, MD 20904. (301) 890-8813. \$1500.

Innovonics' cross-assembler provides absolute-load paper tapes for the following microprocessors: the Intel 8008, Intel 8080 and DEC MPS series. The assembler program runs on a disc-based mini, the PDP-11, under the RSX-11 operating system. The assembler accepts microprocessor assembly language statements with a wide variety of addressing modes and expressions, and it provides editing capability, 20 types of error reporting plus extensive output listings of debugged μP commands. The use of RSX-11 makes the entire operation user-interactive. Three types of output are produced to accommodate the Data I/O, Intel MCS-8, Prolog and MPS PROM programming systems. The program is available on mag tape, cassette, disc or DEC tape.

CIRCLE NO. 337

Cartridge transceiver is user programmable



Three Phoenix Company, 10632 N. 21 Ave., Phoenix, AZ 85029. (602) 944-2222. \$2695.

A programmable tape cartridge transceiver that uses the 3M DC300A tape cartridge is available. The user must be able to program the Intel 8008 microcomputer and 1702A PROMs, which are used in the Model PTT 8000 alternatively. Three Phoenix Co. or most Intel distributors can provide the service to program the PROMs. The PTT 8000 comes with a standard RS-232 interface and also has hard-wired full-duplex modes, switchable transmission speeds of 110 to 2400 baud, local or on-line operation, and a switch to provide operation with even, odd, or no parity.

CIRCLE NO. 338

150-GRID RELAY TO-5



IN A NUTSHELL WE THINK OUR 150-GRID RELAY IS A BETTER CHOICE

We make both. But when you add these features to the variety of mounting configurations, the 150-grid relay, in a nutshell, is a better choice.

	150-Grid (3SBC)	TO-5	Difference
Pin Spacing:	.150" grid on pin centers	Non-standard .062" spacing	150-grid meets MIL-STD-275 — mounting easier — no lead spreader needed.
Size:	.320" max. height .610" max. length .310" max. width .0605 cubic inches	.375" max height (w/transi-pad) .405" max. length .370" max. width .0562 cubic inches (w/transi-pad)	150 grid offers a 16% linear space improvement and reduced height for closer PCB spacing
Dielectric Strength:	750 VRMS	500 VRMS	150 grid offers a 50% increase in capability to withstand transient voltages
Contact Switching:	2 amps	1 amp	100% greater capacity and overload protection
Contact Resistance:	50 milliohms	100 milliohms	150 grid will operate cooler at high currents and offer lower circuit resistance at low levels
Hybrid Options:	Internal Single and Dual Diodes Internal Transistor Drivers	Internal Single and Dual Diodes Internal Transistor Drivers	150 grid switches higher current (2 amps) from equal signal current

For a more detailed comparison contact your GE electronic component sales representative or write General Electric Co. Relays, 792-51, Waynesboro, Virginia 22980

GENERAL ELECTRIC

INFORMATION RETRIEVAL NUMBER 141

If you're looking for a 4-1/2 digit multimeter with 0.05% DC accuracy, 1-year stability, unmatched noise rejection, 1,000 megohm input impedance, 40 Hz to 100 kHz AC bandwidth, six DC current ranges with 1 nA resolution, plus optional isolated BCD output, you're looking at it.



\$399
4-1/2 digit Model 4200

You're looking a

These new multimeters have a lot more of what you're looking for—call us for a demonstration that will prove it.

If you're looking for a 3-1/2 digit multimeter with .1% DC accuracy, 1-year stability, unmatched noise rejection, 1,000 megohm input impedance, 40 Hz to 100 kHz AC bandwidth, six DC current ranges with 10 nA resolution, plus optional isolated BCD output, you're looking at it.

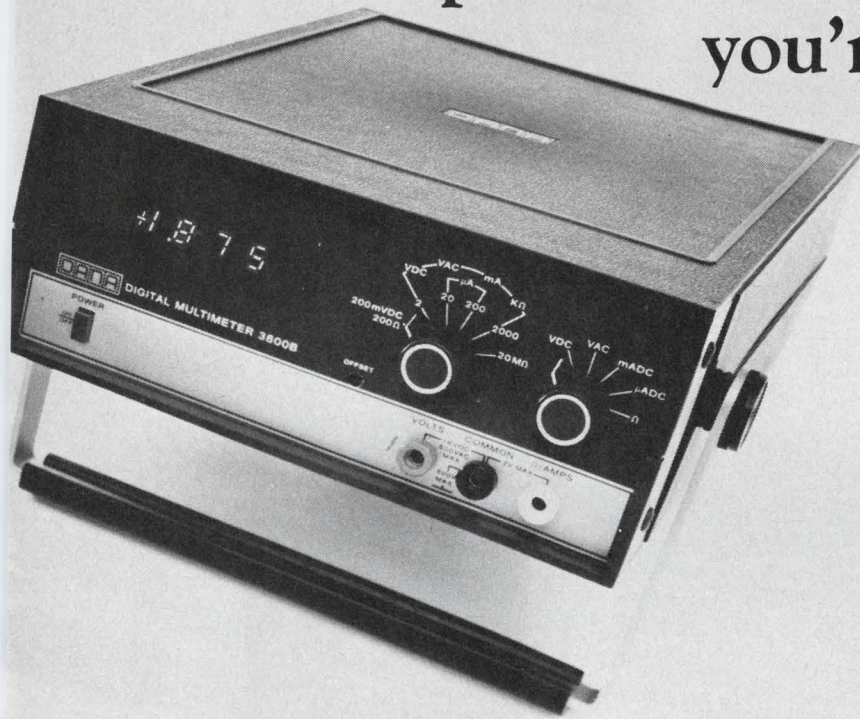

DANA[®]
Others measure by us.

\$299
3-1/2 digit Model 3800B

t the Ultimeters.

Or write us at 2401 Campus Drive, Irvine, CA 92664. Phone (714) 833-1234, Teletype 910-595-1136, Telex 67-8341.

Plessey's contribution to the Nova

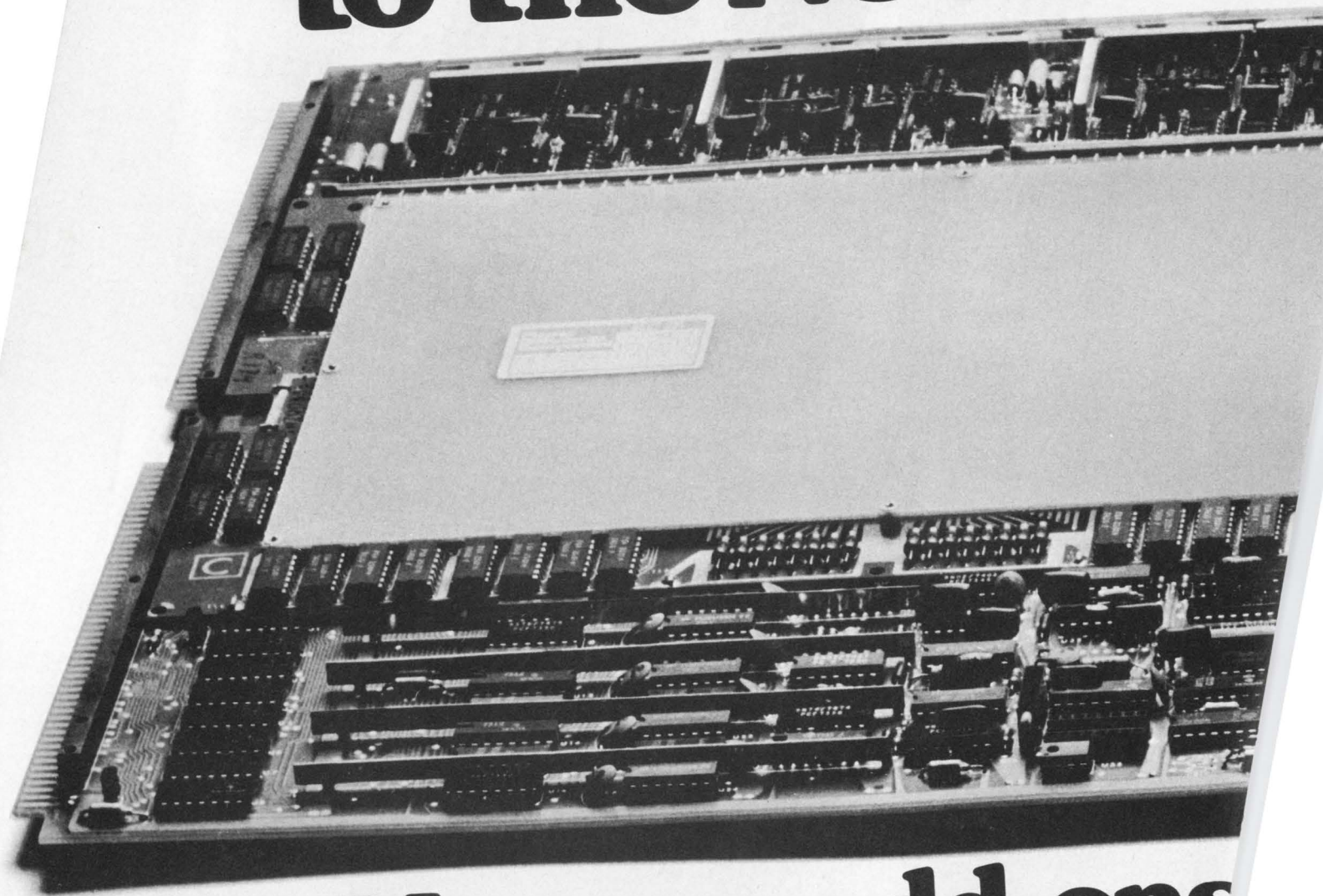

Memory add-ons

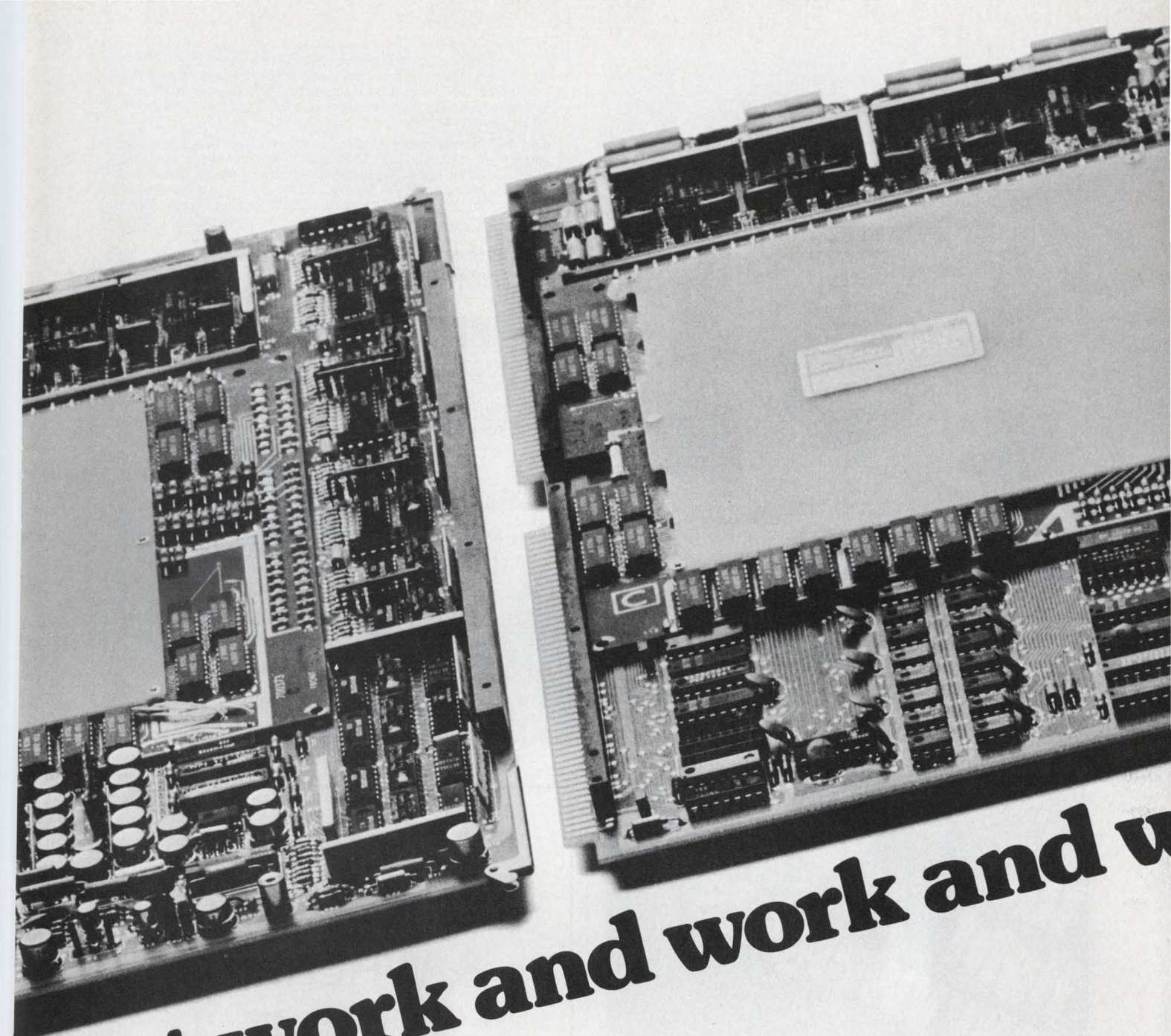

that work and work and work

If you've got a NOVA mini, Plessey Memories can save you more than money.

Our 16k PM-216 core memory module saves time on your NOVA 2/4 or 2/10, with a cycle time of just 800 nS.

Our PM-816 saves a slot in your NOVA 800, 820 and 840 cpu, with 16k words on a single plug-in card. It is also plug-compatible with the NOVA 830. And with the 800 nS Plessey PM-816 an expanded NOVA 840 costs less than a slower NOVA 830 with DGC memory.

There's just no reason to pay more for less.

So use the bingo card and get all the details on our NOVA (and DEC) add-ons—compatible memories, memory management and support equipment. They're all competitively-priced and available off-the-shelf.

Or if your problems won't wait, phone for a demo and get Plessey Memories working for you today.

Plessey
 **Memories** (714) 540-9945
The mini expanders

U.S.A., Santa Ana (714) 540-9945. Canada, Ottawa (416) 661-3711. United Kingdom, Towcester (0327) 50312. Switzerland, Geneva (022) 33-97-30. France, Paris (01) 727-43-49. Germany, Munich (089) 351-6021. Netherlands, Noordwijk (01719) 4847. Belgium, Brussels (02) 3745971. Italy, Milan (02) 349-1741. Sweden, Stockholm (08) 23-55-35. Spain, Madrid (01) 241-3230.

INFORMATION RETRIEVAL NUMBER 146

ENCODERS

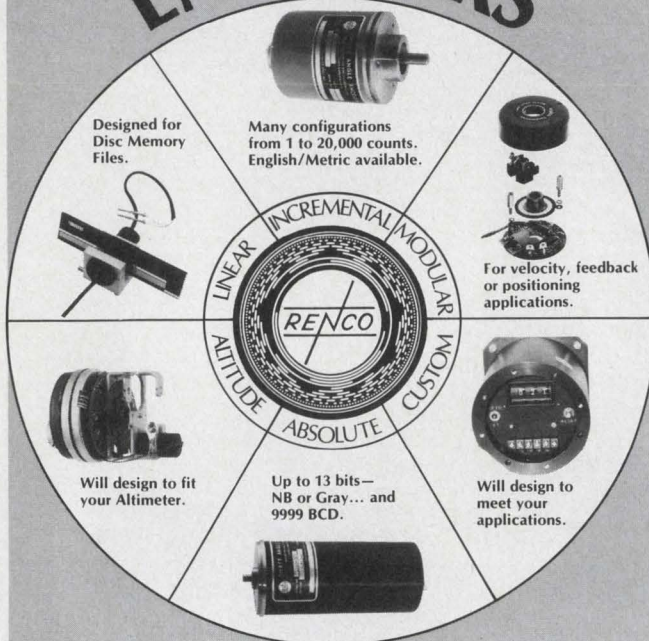

RENCO CORPORATION

Santa Barbara Research Park
26 Coromar Drive • P.O. Box 246
Goleta, California 93017
Phone (805) 968-1525 TWX 910-334-1180

INFORMATION RETRIEVAL NUMBER 147

With new, cost-savings design, these Sandwich Panel, Series 600/800 lighted push-button switches can be inserted directly onto PCB's during assembly; boards washed clean without damage to switch; and, simultaneously plugged-in to rear openings of display panels as boards are positioned into place.

Early, high-density mounting saves costly wiring and extra handling. Piloting Flange automatically guides switch into prepared panel, mating with a narrow profile for ideal button display. Switches provide up to 92 switch combinations; 3/4" square or 3/4" x 7/8" rectangular style; 2PST to 6PDT dual or quad-lites; sturdy PCB pin terminals. Labor savings multiply as more switches are used. Complete technical data on request.

electro-mech's
PCB n' PANEL

automatic
insertion
switch.

the
labor saver.



electro-mech
components, inc.

1826 N. FLORADALE
SOUTH EL MONTE,
CALIFORNIA 91733

(213) 442-7180

INFORMATION RETRIEVAL NUMBER 149

INFORMATION RETRIEVAL NUMBER 148

WHO MAKES WHAT & WHERE TO FIND IT

Volume 1 of **Electronic Design's GOLD BOOK** tells all. And, when you look up an item in its **PRODUCT DIRECTORY** you'll find each manufacturer listed **COMPLETE WITH STREET ADDRESS, CITY, STATE, ZIP AND PHONE**. Save time. There's no need to refer elsewhere to find missing information.

IT'S ALL THERE
in
**Electronic Design
GOLD BOOK**

ELECTRONIC DESIGN 11, May 24, 1975

How to drive a microprocessor.

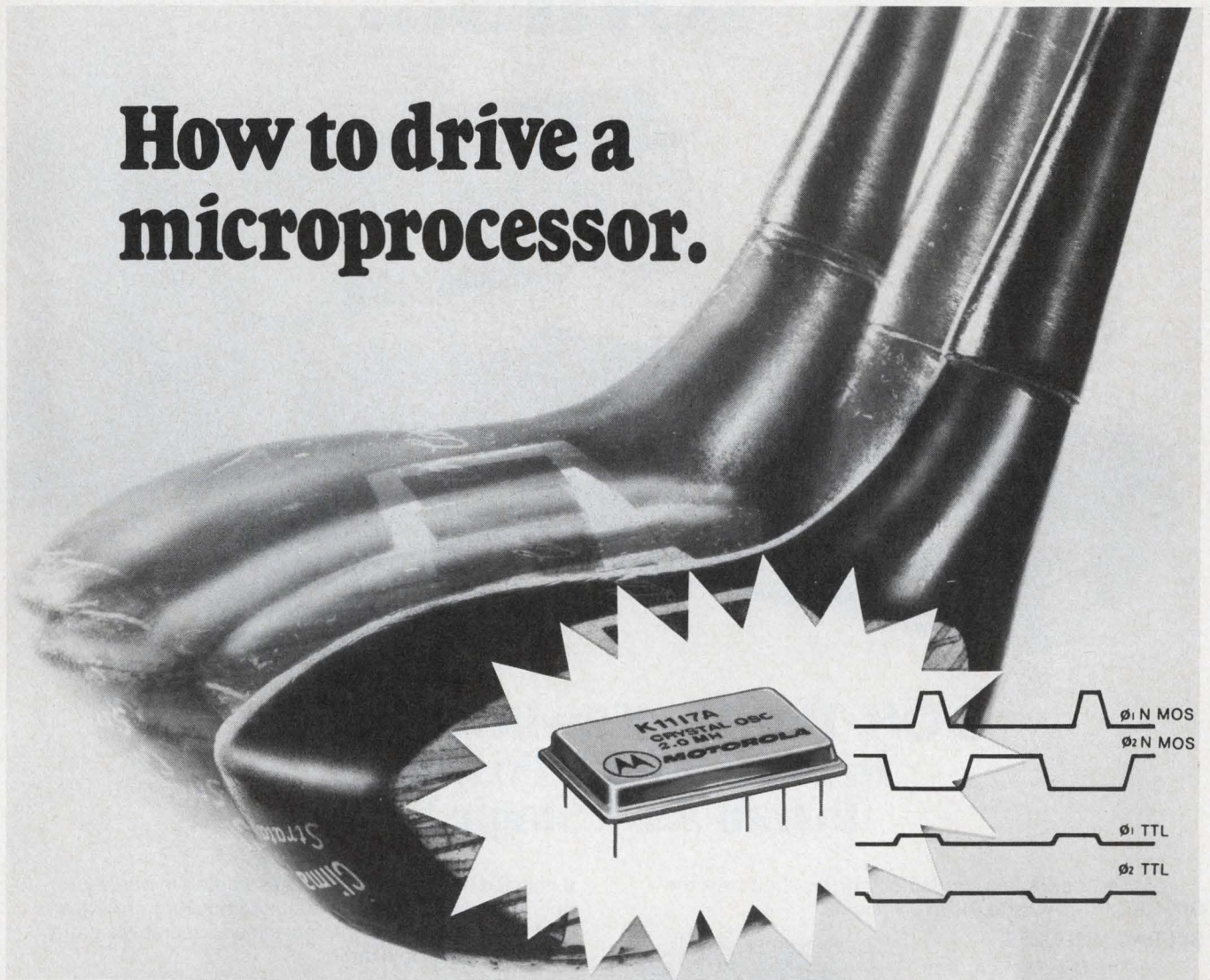

For the Intel 8080 CPU, use our K1117A.

For the Motorola MC6800 MPU, use our MC6871A.

Each is designed to provide the critical 2-phase nonoverlapping waveforms required by the specific microprocessor. Crystal, oscillator, TTL and NMOS drivers and necessary waveshaping circuitry are packaged by hybrid thick-film IC technology into one dual-in-line module that cuts your component count and board space.

Cut out this coupon. Cut down your design time.

Now you can divert valuable engineering time from oscillator/driver design to equipment or software design.

Send this coupon for information and prices to Motorola Inc., Component Products Department, 2553 North Edgington, Franklin Park, Illinois 60131. Or call (312) 451-1000 for immediate attention.

Name _____

Title _____

Company _____

Address _____

City/State/Zip _____

Send more information on _____ K1112A

_____ MC6871A _____ Both



MOTOROLA INC.
COMPONENT PRODUCTS DEPT.

Yours...

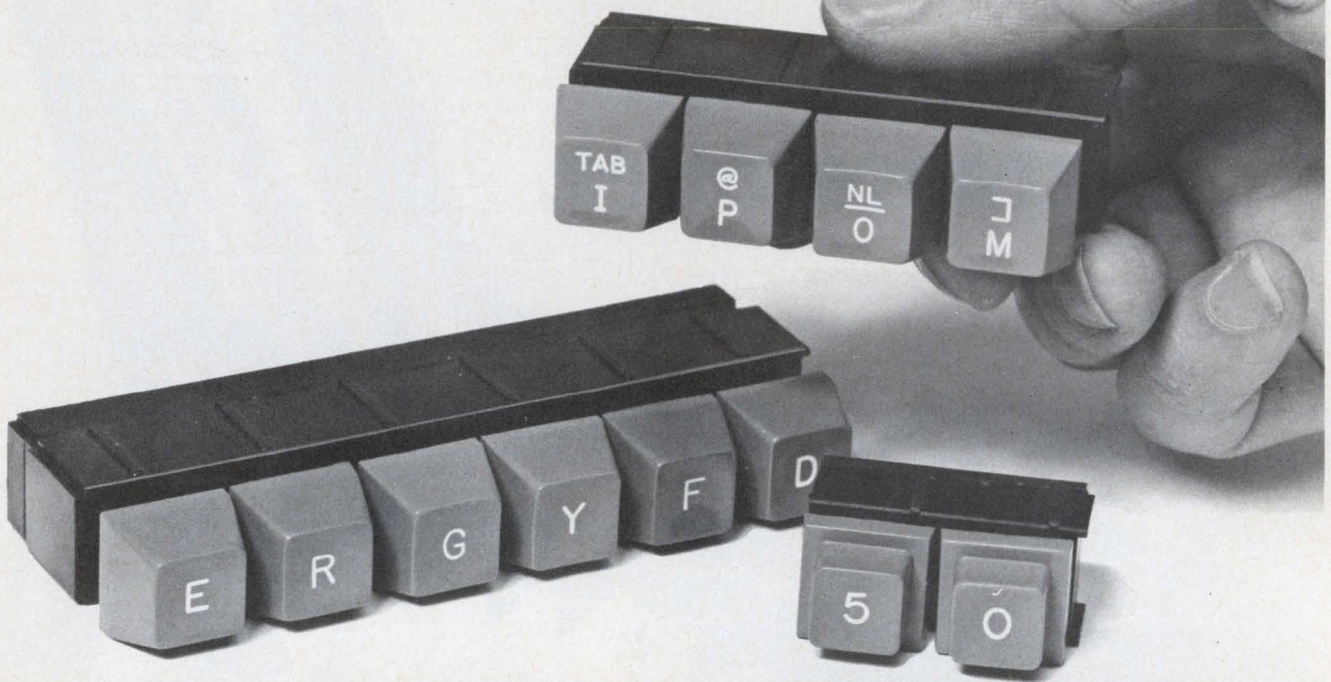

3 Off-The-Shelf Switch Modules, In 1 To 6 Switch Positions, Install As A Single Unit

The 3 switches available "off-the-shelf" are the SIX-PAC, BI-PAC and BI-PAC Phase 2.

SIX-PAC MODULES

The Six-Pac features a dry Reed switching element which is magnetically operated and hermetically sealed. High reliability and life in excess of 20 million cycles are assured.

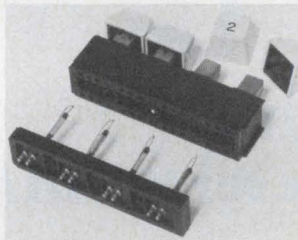

BI-PAC MODULES

The contact mechanism in this switch consists of form A gold plated dual concentric springwire contacts which offer redundant, self-wiping action. Electrical life is over 10 million cycles at 10 VDC, 0.050 A mx. and 1 ohm max. Bounce is 5 m sec.

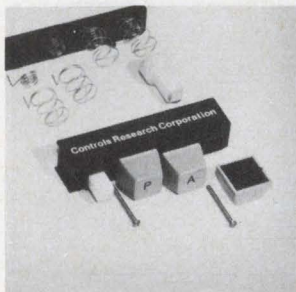

BI-PAC PHASE 2

This is a low profile version of the BI-PAC with which it shares electrical and mechanical operating characteristics. This switch features a 5 million cycle life at a greatly reduced cost over the standard BI-PAC.

MODULES CONTAIN 1-6 POSITIONS

You can assemble these modules much faster than conventional switches since multiple switches in

a unitized housing can all be assembled in one easy operation. In addition, the unitized housing provides perfect switch alignment. Increased assembly rigidity and fewer parts to handle.

Features common to all 3 switches are • mounting on 3/4" centers • truncated or touch tone style keytops • light natural feeling 2.5 ounce touch • 0.150 stroke • temperatures from 0°C to 65°C operating and -35°C to 65°C storage. Cases are glass filled nylon, with self-lubricating Celcon® plungers, stainless steel hardware and 2 shot molded ABS high strength plastic keytops.

	SIX-PAC	BI-PAC	PHASE 2 BI-PAC
1. Life	20 Million	10 Million	5 million
2. Contact Type	Form A	Form A	Form A
3. Contact	Dry Reed	Bifurcated-Gold	Bifurcated-Gold
4. Resistance	1 Ohm Max	1 Ohm Max	1 Ohm Max
5. Bounce	1 Msec Max	5 m Sec Max	5 m Sec Max
6. Profile*	1.81 inches	1.59 inches	1.25 inches
7. Module Size	1-6 Switch	1-6 Switch	1-4 Switch

*With truncated keytop, touch tone keytop is .1 inch less

Quantities under 250 are ordered and shipped factory direct. Contact the factory for YOURS.



Controls Research Corporation

2100 South Fairview Avenue
Santa Ana, California 92704
Phone: (714) 549-2990

Terminal processes data and handles I/O

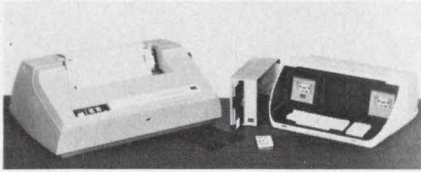

Microtech Data Systems, 1141 E. Janis St., Carson, CA 90746. (213) 659-1715. 8/640: \$4800; 8/640II: \$5700; 90 days.

Models 8/640 and 8/640II are microcomputer-based terminal systems with processing capability. The 8/640 is a self-contained unit, with CRT monitor, standard typewriter keyboard with a 10 key numeric pad, twin digital cassettes (contained in the 8/640), and has a memory capacity from 8k to 16k bytes. The 8/640II is also a self-contained unit, with memory capacity from 8k to 65k bytes in any combination of ROM, PROM or RAM. The 8/640II will support twin digital cassettes (contained in 8/640II) and floppy discs, fixed head discs, character and line printers, 3M cartridge and 7/9 track magnetic tape units. The 8/640II supports a full range of data communications, including both asynchronous and synchronous, with a variety of line protocols.

CIRCLE NO. 339

Cartridge tape drive built for rugged use

Data Electronics, 370 N. Halstead St., Pasadena, CA 91107. (213) 351-8991. From \$566 (100 qty).

Three tape drives designed for rugged MIL or commercial use are designated CMTD-3000 S1, CMTD-3000 R1 and CMTD-3000 R2. The "S1" and "R1" are identical mechanically. The main difference being that the R1 is built with mil-spec grade components to MIL-E-16400F criteria. The "R2" is built as a complete plug-in unit. Panel front, rack handles, mode indicators, test and I/O connectors are all included. The R2 drive is used in several government programs. The new drives are all ANSI/ECMA compatible and use the 3M DC300A cartridge with 1600 BPI phase encoding. Storage is 23.04×10^6 bits with a transfer rate of 192 kbit/s.

CIRCLE NO. 340

DC/DC Converters



\$ 64.95 each
(Qty. 100)

We Have The
LOWEST NOISE
DC/DC Converter

at least 6 times lower
than the competition

GENERAL SPECIFICATIONS

INPUT VOLTAGE:	4.5 - 5.5 Vdc
OUTPUT VOLTAGE:	± 15 Vdc
OUTPUT CURRENT:	± 100 mA
REGULATION:	Line & Load - 0.02%
EFFICIENCY:	60%
SIZE:	2" x 2" x 0.4"

Other models are available upon request.

For more information, PLEASE CONSULT FACTORY.

For immediate requirements, call (617) 373-9104

SEND FOR OUR NEW 1975 CATALOG



SEMICONDUCTOR CIRCUITS, INC.

306 RIVER STREET • HAVERHILL, MASSACHUSETTS 01830
TEL. (617) 373-9104 • TWX. 710-347-0269

INFORMATION RETRIEVAL NUMBER 65

Complete RF Network Analysis

- 0.4 to 500 MHz in three overlapping bands; log, linear, CW, and $f_0 + \Delta f$ modes.
- 115-dB Dynamic Range - 80 dB direct display.
- 0.005-dB Resolution - 0.05 dB flatness per 10 MHz; 0.4 dB full-band flatness.
- Absolute Level in dBm - direct swept display 0 to -80 dBm.
- Phase and Group-Delay Measurements - direct-reading swept displays.
- 50 and 75 Ω - interchangeable measuring circuits with complete selection of coaxial components for each impedance level.
- Measure filters, amplifiers, antennae, cables, delay networks, equalizers, components, transistors, etc.
- Display Simultaneously magnitude and phase, magnitude and absolute level, magnitude and group delay, transmission and reflection.
- Synthesizer-Based Systems from 0.2 to 500 MHz - for precision narrow-band measurements on devices such as crystal or surface-wave filters, consider the GR 2261 Synthesizer Network Analyzer.



GR's 1710 RF Network Analyzer is the instrument that provides the complete RF network analysis described above. Call or write for complete information, application assistance, or for a demonstration.

For High-Frequency Measurements



General Radio

300 BAKER AVENUE, CONCORD, MASSACHUSETTS 01742
GR COMPANIES • Grason-Stadler • Time/Data

NEW YORK (N.Y.) 212 964-2722, (N.J.) 201 791-8990
BOSTON 617 646-0550 • DAYTON 513 294-1500
CHICAGO 312 992-0800 • WASHINGTON, D. C. 301 948-7071
ATLANTA 404 394-5380 • DALLAS 214 234-3357
LOS ANGELES 714 540-9830 • SAN FRANCISCO 415 948-8233
TORONTO 416 252-3395 • ZURICH (01) 55 24 20

INFORMATION RETRIEVAL NUMBER 66

COMPONENTS

Double-bladed relays require only 100 mW

Printact Relay Div., Executone, 29-10 Thomson Ave., Long Island City, NY 11101. (212) 392-4800. From \$4.54; 4 to 6 wk.

A BW2-GS series of sensitive, double-bladed relays requires only 100 mW for activation. The relays are available with a variety of coil resistances up to a maximum of 4.8 kΩ. Contact ratings are from low level up to 1 A maximum at 24 V dc. The series break swinger blade configuration permits layout of the printed circuit board for either isolated or common switching between closed and open contacts. Each of the blades can function as both a form A and form B, isolated from each other, or as a form C with a common connection between the normally open and normally closed contacts. The relays measure 0.9 × 0.95 × 1.032 in.

CIRCLE NO. 341

Reed relay's bobbinless coil offers advantages

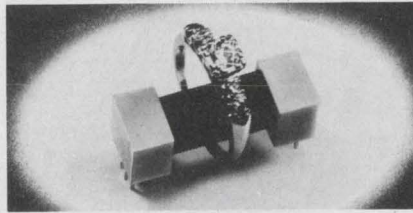

Electronic Applications Co., 2213 Edwards Ave., South El Monte, CA 91733. (213) 442-3212. \$0.62; 1A, 6V 100 Ω, SPST (50,000 up).

Unlike conventional reed relays, the "Little Gem" Series uses a bobbinless construction; the coil is wound directly on the reed. Because the magnetic field is close to the reed blades, the contact gap can be larger. Thus, the relay has a higher breakdown voltage with the same ampere-turns. Also, tension is two to three times greater. With a normal gap spacing, the relay is more sensitive—up to 14,500-Ω coil resistance for a 12-V relay.

CIRCLE NO. 342

Low-profile relay handles difficult loads

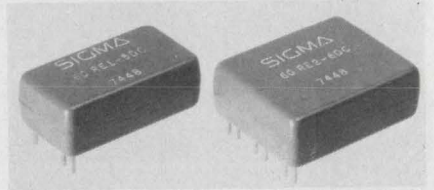

Sigma Instruments Inc., 170 Pearl St., Braintree, MA 02185. (617) 843-5000. \$1.50 (OEM qty); stock.

A new low-profile (0.415-in. high) 2-A relay, Series 60, is specially designed for direct soldering to 0.6-in. spaced PC boards. No bigger than a reed relay, the relay can switch capacitive, tungsten lamp and inductive loads that would weld the contacts of a reed relay. And it can be operated from TTL-driver circuits. Both SPDT and DPDT models are available, with either standard or sensitive coils in six sizes from 5 to 110 V dc. Operate time is 3 ms and release time is 2 ms.

CIRCLE NO. 343

No matter what you're looking for in RF signal generators—we think you'll find it here.

Convenient monitor meter — multi-function and auto-ranging meter for calibrated output level or modulation.

Versatile modulation — AM or FM, internal or external, metered, calibrated. Low distortion amplitude modulation tests most state-of-the-art AM receivers. High accuracy frequency modulation is ideal for narrow-band FM receivers. Simultaneous AM and FM possible. External pulse.

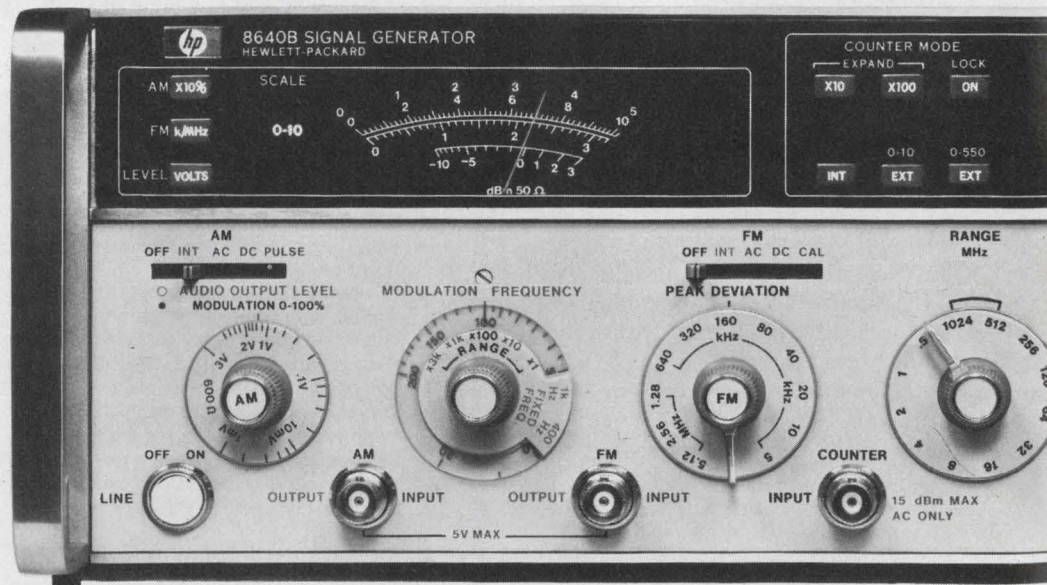

8640B with variable modulation, reverse power protection, and extended frequency options.

Variable modulation oscillator option — 20 Hz to 600 KHz; use for internal AM or FM; also available at front panel.

Built-in counter — measures external signals to 550 MHz.

Spectral purity — high Q, cavity-tuned solid-state oscillator yields excellent low noise performance needed for new stringent receiver testing. SSB noise 130 dB/Hz down at 20 KHz offset.

04503

Solid-state DIP relay handles up to 50 V

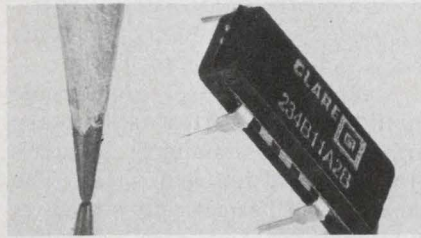

C. P. Clare & Co., 3101 W. Pratt Ave., Chicago, IL 60645. (312) 262-7700. Under \$10 (unit qty); stock.

Series 234 ac/dc solid-state relays are designed for applications to 50 V at 80-mA peak output. The relays feature 0.2- μ s response time and life in excess of 10-billion operations. Inputs are DTL/TTL compatible in the range of 3.8 to 10 V dc. Dielectric-withstanding voltage is 1500 V ac and insulation resistance is $10^9 \Omega$. The units are DIPs made of a full-molded epoxy case 0.165-high \times 0.75-long \times 0.250-in. wide.

CIRCLE NO. 344

Solid-state relay rated at 480 V and 12 A



International Rectifier Corp., 1521 Grand Ave., El Segundo, CA 90245. (213) 322-4987. \$39 (100 up); 1 to 2 wks.

A solid-state relay, D4812, rated for operation at 480 V and 12 A increases the current rating of Crydom's 18-model line of SSRs. European countries typically operate with 380-V-ac power, well within the ratings of the new units. The SSRs can handle 5.7 kW of ac, and they feature photoisolation and zero-voltage switching for reduced rfi and direct compatibility with transistor signal levels. Other SSRs in the line are rated for 120 and 240-V operation with a wide range of power ratings.

CIRCLE NO. 345

Liquid crystal displays operate from 3 or 6 V

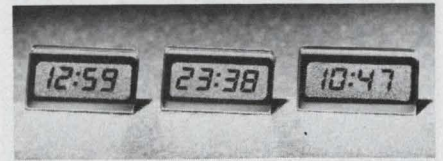

Beckman Instruments, 2500 Harbor Blvd., Fullerton, CA 92634. (714) 871-4848. From \$12.50 (100-up); stock.

Series 701 and 703 field-effect liquid crystal displays are designed for 12-hour (3-1/2 digit) displays. Series 702 provides a 24-hour readout. All displays have CMOS-compatible drive characteristics and are available in either 3 or 6-V standard models. Power consumption for the displays is typically 1 μ W. Over-all dimensions for series 701 and 702 are 0.95 \times 0.54 \times 0.1 in., and both have 26 terminal pads. The series 703 measures 1 \times 0.545 \times 0.1 in., has a slightly larger viewing area and has 24 terminal pads.

CIRCLE NO. 346

Wide frequency range — wide application range — from AM & FM broadcast through HF, VHF, mobile FM, and avionics receiver test, 450 KHz to 550 MHz. (optional extension to 1100 MHz)

High resolution tuning and display — easy to tune and phase lock carrier to desired setting on 6-digit LED readout; resolution of 100 Hz at 500 MHz.

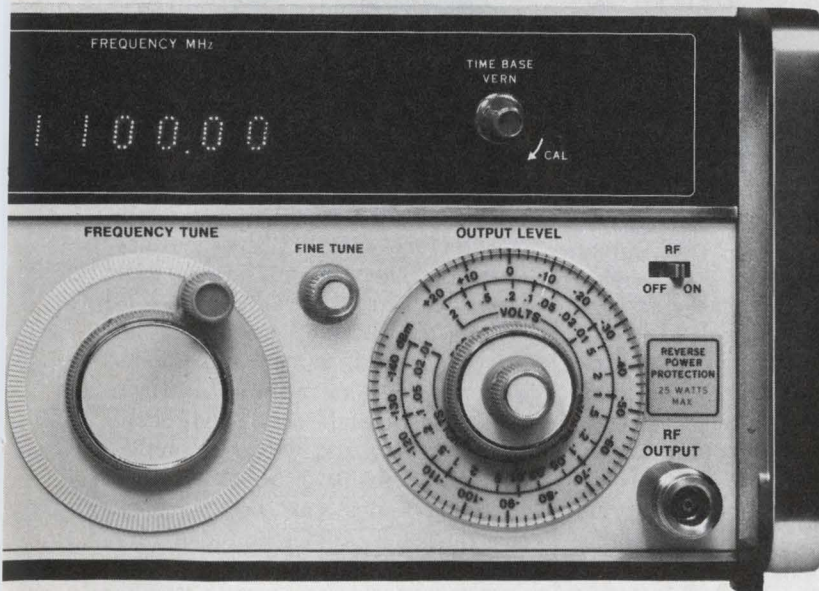

Wide dynamic range for complete testing — high level (+19 dBm) for spurious response tests, down to -145 dBm for tests at <0.03 μ V on shielded receivers. Reverse power option protects against damage from accidental transceiver triggering to 25W.

Phase-lock frequency stability — long term stability locked to crystal time base is $<5 \times 10^{-8}$ /Hr. Spectral purity and FM capability are preserved during phase-lock.

These are just a few of the reasons why the 8640 does today's job so well, and gives you built-in assurance that you won't run out of capability as tomorrow's demands come along. Price \$5900 (w/o options); \$6650 (1100 MHz). Also available with avionics option specially adapted for testing ILS (marker, glide slope, localizer), VHF communication and VOR receivers.

For more information on the 8640B and all of its options, call or write your nearest HP sales office.

Domestic US prices.

HEWLETT  PACKARD

Sales and service from 172 offices in 65 countries.
1501 Page Mill Road, Palo Alto, California 94304

Grayhill solid-state relay advances

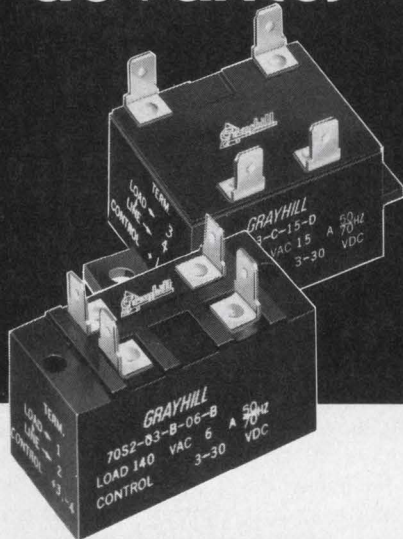

**optically isolated,
zero-crossing
switching with
superior new features**

- **Superior transient protection:**
dv/dt > 4000V/microsecond to 600V (240VAC relay)
- **Wide operating range...**
a single relay covers from 100 to 240 VAC
- **High thermal transfer**
potting allows for cooler operation
- **Anodized heat dissipator**
for maximum corrosion resistance

Here's tomorrow's relay... today! And the performance features of the relays are matched by those of the manufacturer: prompt engineering assistance, flexible production capability, quick delivery (many standard units from stock). Consult EEM or write for complete technical data.



561 Hillgrove Avenue • LaGrange, Illinois 60525
(312) 354-1040

INFORMATION RETRIEVAL NUMBER 68

COMPONENTS

Solenoids feature quick-disconnect lugs

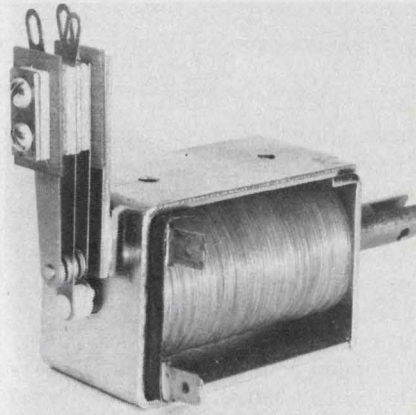

Magnetic Corp., 96 Granby St., Bloomfield, CT 06002. (203) 243-8941.

A new line of box-frame solenoids with quick-disconnect terminations is interchangeable with many types of other manufacturers. Available coil ratings are 6, 12, 24 and 120 V dc in three duty-cycle classes—100%, a combination 25/50% and 10%—with or without an attached SPDT switch. Pull types with slotted and cross-drilled plungers are standard. Options include push type, spring returns, solder lugs and long-lead wire terminations. Special voltages and duty cycles also are available.

CIRCLE NO. 347

Gas-discharge displays have 1 in. height

Beckman Instruments, P.O. Box 3579, Scottsdale, AZ 85257. (602) 947-8371. \$5.75 (1000-up); stock to 15 day.

The Model SP-101 seven-segment, planar gas discharge display has a character height of 1 in. Displays are orange but are filterable to red and the brightness varies from 100 to 500 foot-lamberts depending upon current. Units are single-digit modules incorporating colon, comma and decimal point. They add on horizontally, up to any length. A keep-alive cathode provides an internal ion source that reduces reionization time to less than 30 μ s and allows zero suppression. Power requirement of the SP-101 is 160 V dc at 700 μ A per segment.

CIRCLE NO. 348

Rotary relays resist shock and vibration

Westinghouse Air Brake Co., Pittsburgh, PA 15218. (412) 242-5000. \$19 (1000 up); 8 to 10 wks.

A family of aerospace/electronic miniature relays features rotary armatures for immunity to acceleration, vibration and shock. The new Type M hermetically sealed relays come in two case styles: a standard 3.75-oz case for general-purpose dc models and a long 5-oz case for ac or sensitive dc types. Both are available in four and six-pole, double-throw versions. The relays are designed to meet MIL-R-5757. Operating life is 100,000 operations at rated load, and the four contact ratings range from 2 A, 28 V dc or 0.3 A, 115 V dc to 0.1 A, 28 V dc or 1 A, 115 V rms. Class A temperature rating is 55 to 85 C; type B is -65 to 125 C. The relays can withstand vibration of 0.1-in. double amplitude and shock of 100 G for six ms, half-sine.

CIRCLE NO. 349

Rotary switch handles dry circuits

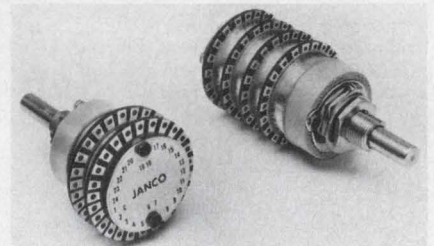

Janco Corp., 3111 Winona Ave., Burbank, CA 91504. (213) 845-7473.

Janco 3100 Series rotary switches interface with low-level and dry circuits. The series is ideal for use with TTL, ECL and CMOS devices. Available detent angles are 15, 18, 20, 23, 36 and 45 degrees. Output codes include straight decimal, octal and hexadecimal, with and without complements and parity bits. Most other standard codes can be provided. Special detent angles and arbitrary codes are available on request. The switch is designed to meet the environmental requirements of MIL-S-22710. All switching parts are hard-gold plated and treated for dry-circuit service. Standard units can be ganged up to 9 decks.

CIRCLE NO. 350

the Great Seal

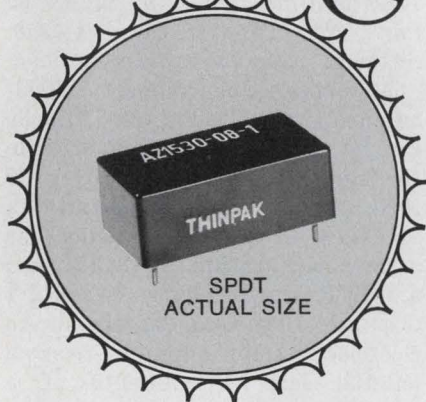

The greatest seal in the industry is American Zettler's THINPAK™ **Miniature Sealed Relay**. As low as \$2.70 (1 to 49 units)!

If you need a relay you can wave solder, and spray or vapor clean, you need American Zettler.

Design and construction are quality all the way: relay cover ultrasonically welded to the base... rigid relay body with heat sealed contacts for physical stability... husky one-piece core for efficient magnetic circuit... true-wiping contacts assure millions of trouble-free cycles... contact currents up to 5 amps.

Available in one- or two-pole versions, and magnetic latching models.

Contact us today for free samples and full technical details.



IT'S A BETTER RELAY

AMERICAN ZETTLER, INC.

16881 Hale Avenue, Irvine, Ca. 92705
Phone 540-4190, Telex 67-8472.

For immediate action call collect

INFORMATION RETRIEVAL NUMBER 69
ELECTRONIC DESIGN 11, May 24, 1975

New relay claims 10⁶ life, high mag force

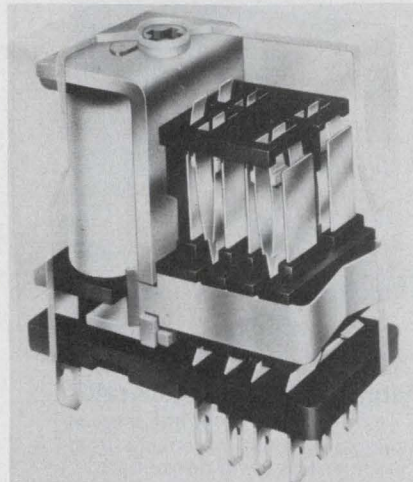

Arrow-M Corp., 250 Sheffield St., Mountainside, NJ 07092. (201) 232-4260. \$4.02: 2 form C (1000 up); stock.

KE relays are over 100 times more reliable than comparable relays, according to Arrow-M, because its magnetic system creates magnetic forces far in excess of those normally created at the gap. These forces assure a positive contact-make and high contact pressure. At 1 A, 100 V ac, electrical life is 10⁶ operations minimum. Initial contact resistance, typically 25 mΩ is relatively stable over the relay's life. Operate/release times are about 15/5 ms, bounce 3 ms for single-contact versions and 1 ms for bifurcated-contact versions.

CIRCLE NO. 351

Vibrator kit eliminates meter friction error

Sensonics, Inc., 25 Louis St., Hicksville, NY 11801. (516) 938-7520.

LTD-331 is an electrically operated vibrator kit for the elimination of frictional error in instruments. Applications also include study of the movement and suspension of granular materials and air bubbles. The kit includes an On-Off switch, a 6-ft line cord with plug, rod clamps, a V clamp and a strap for mounting the unit on cylindrical surfaces from 1/8 to 4 in. dia. Lugs and double-sided tape are also provided for easy mounting on flat surfaces. The device can maintain a uniform flow of solid or liquid materials along a gravity-fed track.

CIRCLE NO. 352

LOW X_L @ UHF

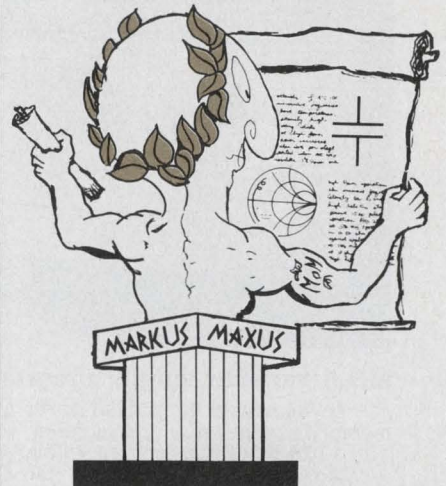

NOW HEAR THIS ...

Connect to your microstrip circuitry with ATC low inductance MS (microstrip) silver leaded capacitors

Take advantage of the stable, low R_s, ATC line of capacitors in an "easy on production" configuration.

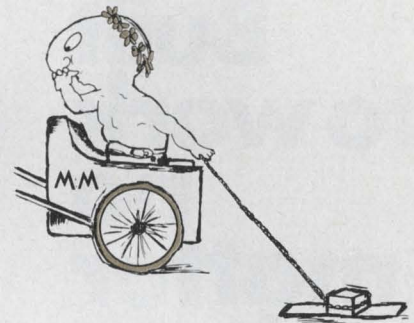

...AND GET THIS FREE

MINI MARKUS or your postman will deliver your free sample of an ATC 100-B-300-J-MS [that's 30 pf]. Just circle the number below.

For samples of other lead styles and capacity values, call Ralph Wood (516) 271-9600.

american technical ceramics

ONE NORDEN LANE,
HUNTINGTON STATION, NEW YORK 11746
516/271-9600 • TWX 510-226-6993

INFORMATION RETRIEVAL NUMBER 70

New...Words and Bits to 50 MHz

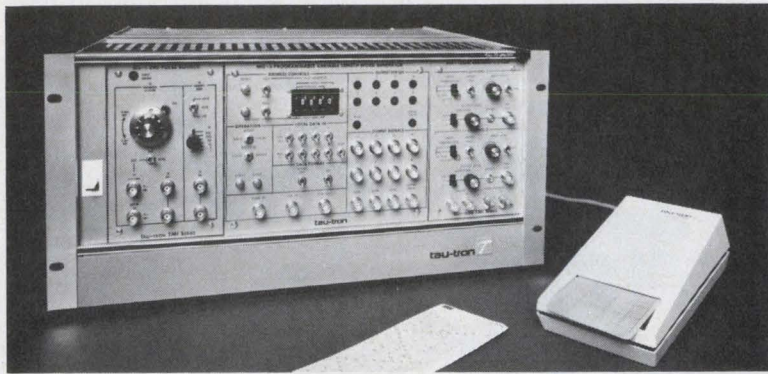

MG-3 variable length, programmable data/word generator

If you need 8 bit parallel words up to 128 words (256 with the optional memory expansion) . . . or a serial word selectable in bit increments from 1 to 1,024 bits (2,048 option) — then our modular MG-3 will do your job.

An auxiliary ninth channel can be used as parity or variable position sync . . . it also has NRZ/RZ control, single cycle mode and remote control.

Load the generator's high speed memory using front panel controls or with the optical card reader shown. You program and change the cards with a pencil.

Apply the MG-3 to testing IC's, digital circuits, and communications components or systems.

Call or write for data sheets and demo.

tau-tron
inc



11 Esquire Road, North Billerica, Mass. 01862 Tel: (617) 667-3874

INFORMATION RETRIEVAL NUMBER 71

MICROWAVES & LASERS

Dipole features 20:1 tuning bandwidth

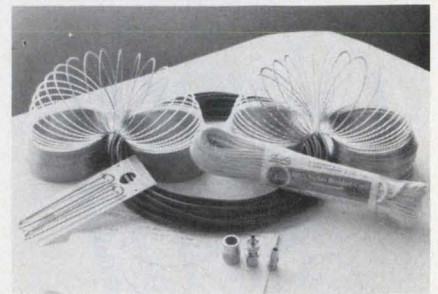

Teletron Corp., P.O. Box 84, Kings Park, NY 11754. (516) 724-4250. Antenna plus accessories: \$39.95.

A portable and compact helical antenna, called the Slinky Dipole, can be tuned to any frequency in the range of 3 MHz to over 60 MHz, for a tunable bandwidth in excess of 20:1. The antenna has a cw-power rating of 1 kW and a VSWR of typically less than 2:1 over any 10% frequency band. An electrically small antenna—over-all lengths can be one-tenth of a wavelength—the new unit permits band switching by a change in the number of expanded turns in each of the dipole's arms. When access is not possible, additional coil pairs—tuned to separate bands—can be fed from a common feed. Unlike vertical antennas, the helical dipole doesn't require elaborate ground-plane systems.

CIRCLE NO. 353

X-band filters come in small packages



Cirqtel Inc., 10504 Wheatley St., Kensington, MD 20795. (301) 946-1800.

Filters for the 7-to-10-GHz range are offered in small housings that measure 1/4-in. square with over-all lengths as short as 1-1/4-in. The company says the new filters have "the widest bandwidth and lowest insertion loss available in a miniature package." However, specifications for bandwidth and loss are not immediately available.

CIRCLE NO. 354

**Built
to work
no
matter
how
you
use it.**



The Crown 800 1/4" mag tape transport is rugged¹, computerized², professional³ and adaptable⁴. It's designed, built and one-by-one tested by people who are good at their jobs. It will work exactly the way you expect. No glitches.

Good design and careful fabrication are the reasons why the 800 transport works in many different systems. Audio record/playback systems. Data recording. Program origination.

If your latest project includes 1/4" mag tape capabilities, ask Crown to explain the 800 transport.



CROWN INTERNATIONAL

1718 W. MISHAWAKA ROAD ELKHART, INDIANA 46514 219-294-5571

1. 3/8" thick aluminum front plate. Anodized or plated metal parts. Only 10 moving parts. All sub-assemblies are plug-in.

2. Logic circuit automatically sequences transport, regardless of command sequence, to prevent tape spill or breakage. Remotable.

3. Three motor drive. DC braking. Automatic end-of-tape braking. 19" rack mount. Wow and flutter 0.09% @ 7 1/2 ips guaranteed maximum.

4. Heads independently mounted — can be easily changed. 4ch, 2ch or mono. Build your own electronics or order from Crown. Crown will customize. Variable speed drive available.

INFORMATION RETRIEVAL NUMBER 72

Isolators turn to field displacement

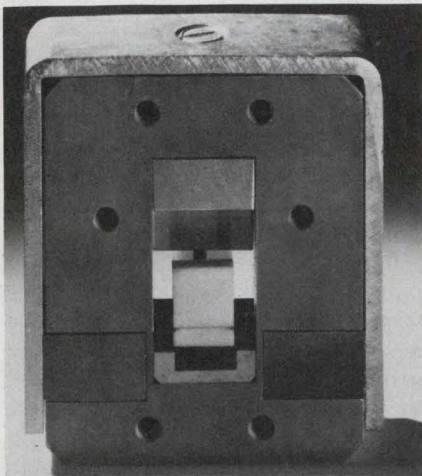

N. V. Philips Gloeilampenfabrieken, Elcoma Div., P.O. Box 523, Eindhoven, the Netherlands.

Compact waveguide isolators are offered for uncoupling oscillators from their loads. The isolators employ a field-displacement technique, rather than the common circulator design. The isolators have a bandwidth of 4% of the carrier frequency, VSWR under 1.2, isolation in excess of 20 dB and insertion loss under 0.3 dB. Throughgoing and reverse power is 1 W at 70 C, the upper end of the units' temperature range that extends down to 0 C.

CIRCLE NO. 355

0.5-to-1.5-GHz amp has 5.5-dB NF



Aerotech Industries, 825 Stewart Dr., Sunnyvale, CA 94086. (408) 732-0880.

Model AMT5002 transistor amplifier covers the 500-to-1500-MHz range with a maximum noise figure of 5.5 dB. The amplifier has a minimum gain of 20 dB, and gain variations are limited to ± 1 dB. Other specifications include a 1-dB compression power of +5 dBm, typical intercept point of +15 dBm and maximum VSWR of 2.0:1.

CIRCLE NO. 356

Automatic coupler eases antenna hookups

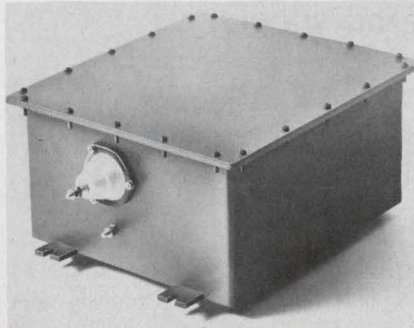

Harris Corp., 1680 University Ave., Rochester, NY 14610. (716) 244-5830.

The RF-281, an automatic hf antenna coupler for military applications, eliminates manual tuning and simplifies transmitter operation. It can be used with 100-W transmitters, and the coupler requires only an rf coax and a minimum of four control lines. The unit has a frequency range of 1.5 to 30 MHz and a 50- Ω maximum VSWR of 1.5:1.

CIRCLE NO. 357

2-to-14-GHz DB mixer flattens i-f response

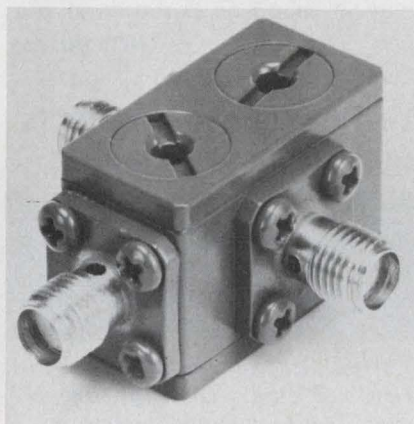

Watkins-Johnson Co., 3333 Hillview Ave., Palo Alto, CA 94304. (415) 493-4141. \$490 (1-4).

The WJ-M19 double-balanced mixer features a frequency range of 2 to 14 GHz on the L and R ports, and 5 MHz to 4 GHz on the I port. A two-tone, input intercept point of +20 dBm is typical with +13 dBm LO drive. The mixer offers an i-f response that is typically within ± 0.5 dB over the full i-f band. Conversion loss is typically 6.5 dB for the full 2-to-14-GHz band. The WJ-M19 measures 1.0 \times 0.5 \times 0.7 in. and comes with SMA connectors.

CIRCLE NO. 358



AMPERITE

THERMOSTATIC DELAY RELAYS

For **LOW COST,**
LONG LIFE,
Maximum Stability

Delays: 2 to 180 Sec.*

Hermetically sealed — not affected by altitude, moisture, or climate changes... **SPST only** — normally open or normally closed... Compensated for ambient temperature changes from -55° to +80°C... **Rugged, explosion-proof, long-lived**... Standard radio octal and 9-pin miniatures.

Price, standard or min., under \$4.00 ea.
*Miniatures delays: 2 to 120 seconds.
PROBLEM? Send for Bulletin No. TR-81.

New! LONG DELAYS

240 & 300 Sec.

Same rugged construction, hermetic sealing and stability as the shorter Delay Relays described above... For delays beyond 300 seconds, these Relays may be used in series.

Price, under \$6.00 ea.
Write for Bulletin No. LD-73.



DIFFERENTIAL RELAYS

For automatic overload, over-voltage or under-voltage protection... Made only to specifications for 70V, 80V, 90V and 100V.

Price, under \$6.00 ea.

AMPERITE BALLAST REGULATORS

Automatically keeps current and voltage at a definite value. For AC or DC... **Hermetically sealed, rugged, vibration-resistant, compact, most inexpensive.**

Price, under \$3.00 ea.
Write for 4-p. Bulletin No. AB-51.



AMPERITE

600 PALISADE AVE., UNION CITY, N.J. 07087
Telephone: 201 UNion 4-9503
In Canada: Atlas Electronics, Ltd.,
50 Wingold Ave., Toronto 19

OUR COMPLETE PRODUCT LINE CAN BE FOUND IN ELECTRONIC DESIGN'S GOLD BOOK.
INFORMATION RETRIEVAL NUMBER 73

the only printed circuit Relay

that plugs into your PC board without SOCKETS or SOLDERING

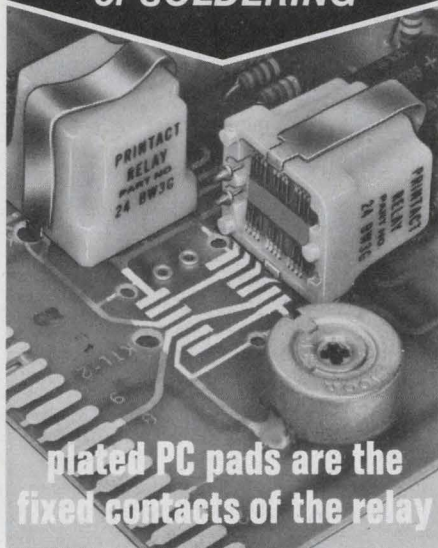

plated PC pads are the fixed contacts of the relay

Printact[®] MAGNETIC LATCHING AND NON-LATCHING RELAYS

The only relay designed to make full use of printed circuit technology. Unlike others adapted with terminal pins or sockets for solder mounting, Printact plugs directly into your module. Precious metal plated PC pads mate with shorting bar contacts on the pivoting armature, which is the single moving part. Held by a permanent magnet, it eliminates return springs, pigtailed, electrical and mechanical connections—assuring reliability for millions of cycles.

Inherent Custom Features include: Low Thermal EMF, Low Contact Bounce, Impedance Matching, 45-60 db Isolation, Bifurcated Contacts, and Encapsulated Coil—all at low cost!

Send for Test Sample and PC Board Preparation Aids to simplify design and production of your module.

For action write or call 212—EX 2-4800.

Executone

PRINTACT RELAY DIVISION
P.O. Box 1430 ED
LONG ISLAND CITY, N.Y. 11101

PACKAGING AND MATERIALS

Aluminum knobs have groovy look

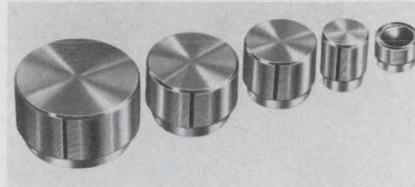

Alco Electronic Products Inc., 1551 Osgood St., North Andover, MA 01845. (617) 685-4371. \$0.72 (500 up); stock.

An attractive family of aluminum knobs described as the Groovy Series is offered in a choice of natural or black-anodized finish. These knobs are distinctive in appearance because of the intentional grooves on top and sides. Grooves are precision machined in 0.020-in. increments. They are available in four diameters: 1/2, 3/4, 15/16 and 1-1/4 in. with 1/4-in. shaft holes. The 1/2-in. knob is also available with a 1/8-in. shaft hole. Natural aluminum knobs have black vertical indicator lines and black knobs have white lines. Cup-pointed hex screws provide a good grip on round or D-flatted shafts.

CIRCLE NO. 359

Air-flow sensor protects against loss of cooling



Warren G-V Communications, 101 Okner Pkwy., Livingston, NJ 07039. (201) 992-6200. Stock.

An air-flow sensor switch (Type LS) monitors the flow of cooling air within electronic systems and opens a set of contacts if the air velocity falls below an acceptable level. Air enters and leaves the sensor through perforations in its shell that cool the electrically heated internal mechanism. A built-in time lag avoids operation of the sensor during brief air-flow reductions. Standard units are available with 24 or 115-V heaters that draw 5 W. Contact rating is 0.2 A at 115 V ac or 1 A at 24 V dc. An air velocity level of 500 ft/min is standard.

CIRCLE NO. 360

Connectors grounded before contacts mate

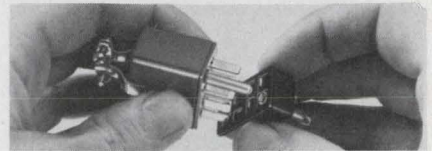

Vernitron Electrical Components, P.O. Box 10, Laconia, NH 03246. (603) 524-5101.

Two new series of pregrounding plug and socket connectors are specially designed for safety. The new connectors have an extra-long grounding contact that is designed to engage before any other active contacts are mated. The grounding contact is designed to carry up to 30 A of current at rated voltages. The 3300 series, at 10 A per contact, is available with three to 33 contacts. The 5400 series, at 15 A per contact, is produced with five to 16 contacts. In the 5400 series, the grounding tail is mounted on an elevated creep-path barrier. The connectors are UL recognized and CSA approved.

CIRCLE NO. 361

Flexible plastic conduit snaps together easily

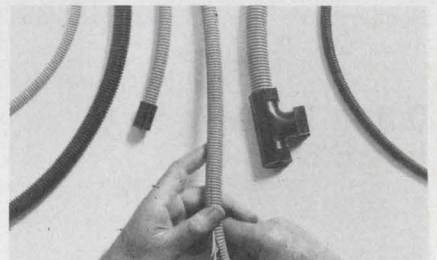

Zippertubing Co., 1300 S. Broadway, Los Angeles, CA 90061. (213) 321-3901. Stock.

Z-Flex, a new flexible plastic conduit system for fast, simple harness fabrication, consists of a crush-resistant plastic conduit that is formed in continuous convolutions. When used with special Z-Flex fittings, the entire system snaps together with only finger pressure, and can be just as easily reopened and reused. The Z-Flex conduit comes either as a solid tube or split longitudinally. The tubing is available in six different ID sizes and in standard packages of 100-ft lengths. Fittings include: outlets, T's, end fittings and various clips and hangers for fast installation.

CIRCLE NO. 362

DISCRETE SEMICONDUCTORS

Diode arrays designed for core memories

Ampex Corp., P.O. Box 33, Marina del Rey, CA 90291. (213) 821-8933. From under \$1; stock.

A 10-pin diode array is specifically designed for core memory applications. The array comes in several circuit configurations and is also available in a standard 14-pin package. The 10-pin array is available in either a ceramic or plastic package with a maximum body length of 0.57 in. and a width of 0.3 in., including lead bend.

CIRCLE NO. 363

Switching transistors handle 3-A loads

General Semiconductor Ind., 2001 W. Tenth Pl., Tempe, AZ 85281. (602) 968-3101. 100-up prices: \$7 (3506); \$8.10 (3507); stock.

Two npn fast switching transistors, the 2N3506 and 2N3507, have a maximum collector current of 3 A. The transistors can dissipate 5 W in a standard, TO-5 package. Both devices have been designed for industrial and military high-speed switching and core driver applications. They have a turn-on times of less than 45 ns and turn-off times of less than 90 ns. The collector base capacitance is less than 40 pF.

CIRCLE NO. 364

Voltage reference diodes have 1 ppm/°C tempcos

Codi Semiconductor, Pollitt Dr., Fair Lawn, NJ 07410. (201) 797-3900. \$25 (100-up).

Precision reference diodes in the PRD105 through PRD160 series have a guaranteed stability over a one year period with a temperature coefficient of 1 ppm/°C from 25 to 45 C. Each unit is measured for a maximum voltage change of 2.5 mV dc between 0, 25 and 75 C. However, for the temperature range of 25 to 45 C, the maximum voltage change with temperature is less than 6 μ V/°C. Units can be purchased with a 5 ppm/year stability and a reference voltage of 6.2 V \pm 5% at 7.5 mA with an impedance of 15 Ω maximum.

CIRCLE NO. 365

Thyristors in TO-64 cases handle up to 20 A

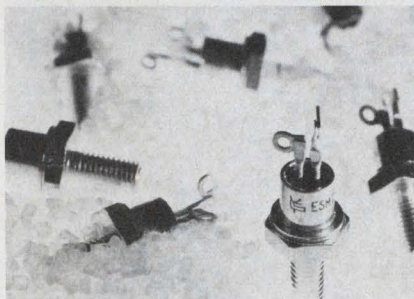

Sescosem, 101 boulevard Murat, 75781 Paris Cedex 16, France.

The ESM 248 series of thyristors handles blocking voltages from 50 to 600 V. Forward current of up to 20 A rms can be handled by the unit's TO-64 packages. The thyristors have a current rate of change, dI/dt, of 100 A/ μ s and a critical voltage switching speed, dV/dt, of 200 V/ μ s.

CIRCLE NO. 366

No need to look further for a reliable R-F power source. MCL has one.



And here's what we built into it:

- solid state circuitry
- short and open circuit protection
- frequency stability \pm 0.1 db
- external pulse or AM modulation
- internal square wave modulation
- low tube cost/operating hour
- qualified to MIL-STD-461 and 810

It has six different plug-in heads

Model	Freq. (MHz)	Pwr. (MIN)
6047	10-50	65
6048	50-200	65
6049	200-500	65
6050	500-1000	65
6051	1000-2000	40
6052	2000-2500	25

You have now ended your search for a stable, reliable 65 watt oscillator. Just call or write for detailed engineering data. Or ask for a demonstration

MCL, INC.,
10 North Beach Avenue,
LaGrange, Illinois, 60525.
(312) 354-4350



Now on GSA contract GSOOS-27086 See us in EEM—Vol. 1 pp. 284-291

Our attenuators can be

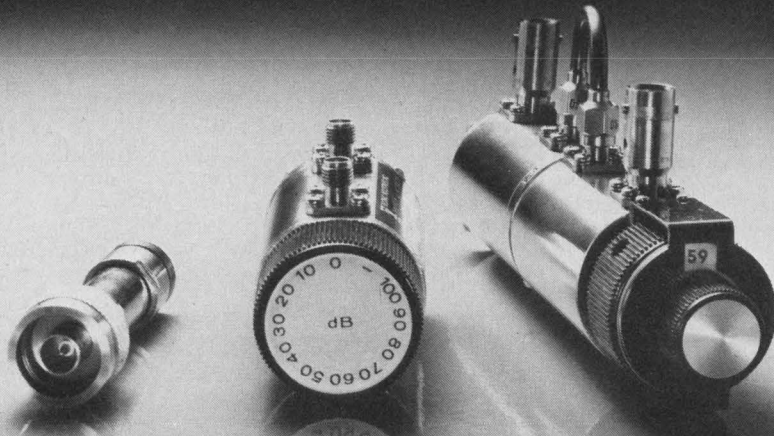

Fixed Rotated Ganged

If your design calls for any type of attenuator in the DC to 4 GHz range, talk to Telonic first. We have 'em for handling .1 dB all the way to 140 dB. The solid-state, thick film resistors we use give longer service life, higher accuracies and power capabilities of 3 watts or better. Prices start at \$28.00, even lower in quantities. Our attenuator catalog is yours on request. Write or call.

TelonicAltair  2825 Laguna Canyon Rd. • Box 277
Laguna Beach, California 92652
Tel: 714 494-9401 • TWX: 910 596-1320 • Cable: TELENG
Telonic—the name for attenuators

INFORMATION RETRIEVAL NUMBER 76

High-Accuracy

Phase Meters

0.5 Hz to 2 MHz

Digital or meter readouts

As low as \$1050



930 E. Meadow Dr. Palo Alto, Ca. 94303
(415) 321-7428

INFORMATION RETRIEVAL NUMBER 77



WHEN THE BLOCK READS "DIGITAL DISPLAY" ...don't get involved!

Let us fill the block for you.

When your lead time is short, our off-the-shelf PDC series display modules can save you time and money on moderate volume or prototype applications. We have modules in a wide range of digit sizes. They include LED, incandescent, and seven-segment numeric as well as dot-matrix alphanumeric. They're pre-wired for BCD logic and are ready to mount to your panel with just two screws. Ask for our catalog.

In fact, contact us whatever the requirements of that digital display block may be; we also design and produce custom systems. We are digital display specialists and thrive on involvement.

Precision Dynamics Corporation
3031 Thornton Ave. • Burbank, CA. 91504
(213) 845-7606

INFORMATION RETRIEVAL NUMBER 78

Design Aids

Resistor networks

Special size and packaging variations of thin-film resistor networks and matched resistor sets are illustrated in a guide. Dale Electronics.

CIRCLE NO. 367

Displays and connectors

A six-page foldout covers segment designations, pin locations and physical dimensions of Models SP-100, SP-300, CS-100 and CS-300 gas discharge displays and connectors. Beckman Instruments, Information Displays Operations.

CIRCLE NO. 368

Heat exchangers

A semiconductor heat exchanger cross-reference lists over 300 part numbers and their IR replacements. International Rectifier, Semiconductor Div.

CIRCLE NO. 369

Thermosetting laminates

Mechanical, electrical, physical and thermal properties of thermosetting laminated materials are given in a chart. Commercial Plastics & Supply Corp.

CIRCLE NO. 370

Trimmers

A trimmer potentiometer cross-reference guide lists the equivalent devices of six major manufacturers. The guide measures 11 × 17 in. and is folded and punched for insertion into a ring binder. TRW/IRC Potentiometers.

CIRCLE NO. 371

Transducer selector

A handy, short-form, quick-reference guide lists the major characteristics of the company's LX-1400, LX1600, LX1700, LX3700 and LX3800 series pressure transducers and barometers and the LX5600 and LX5700 temperature transducers. National Semiconductor, 2900 Semiconductor Dr., Santa Clara, CA 95051

INQUIRE DIRECT

New Literature



D/a, a/d converters

Specifications on more than 60 a/d and d/a converters are detailed in a six-page catalog. Tele-dyne Philbrick, Dedham, MA

CIRCLE NO. 372

Alarm/security cable

Electronic wire and cable for alarm/security applications are featured in a 12-page catalog. The catalog contains an index to cable configurations based upon wire size and number of conductors. Belden, Geneva, IL

CIRCLE NO. 373

Surplus electronic equip

One can find a geiger counter, a reading pacer, clocks and calculators in kit or ready-to-go form, workshop items, the latest in high-technology computers—even hi-fi components—in a catalog. B & F Enterprises, Hathorne, MA

CIRCLE NO. 374

Control systems

Proven control systems concerned with air pollution, water treatment systems (influent), water pollution (effluent), and the instrumentation used to make up these industrial environmental control systems are described in a 36-page catalog. The Foxboro Co., Foxboro, MA

CIRCLE NO. 375

Timing relays

Major factors in selecting pneumatic and solid-state timing relays are included in a 12-page brochure. Allen-Bradley, Milwaukee, WI

CIRCLE NO. 376

Signal conditioners

Oscillators and signal conditioning products are featured in a 32-page catalog. Solid State Electronics, Sepulveda, CA

CIRCLE NO. 377

SAW technology

The fundamentals and inherent advantages of surface acoustic wave (SAW) technology to the systems design engineer is explained in a 16-page brochure. Plessey Semiconductors, Santa Ana, CA

CIRCLE NO. 378

Relays

A complete listing and prices for about 200 different relays, switches and other components are given in a catalog. GTE Automatic Electric, Government Industrial Sales Div., Northlake, IL

CIRCLE NO. 379

Resistor networks

Precision resistor networks are highlighted in a 16-page design data catalog. Vishay Resistive Systems Group, Malvern, PA

CIRCLE NO. 380

Dc power supplies

Key features, dimensional data and specifications of dc power supplies are given in a 20-page catalog. Also covered are transformers, thermostats, heat sinks, OVP modules and rack adapters. Powertec, Chatsworth, CA

CIRCLE NO. 381

Strip-chart recorders

A 32-page catalog describes Rustrak miniature strip-chart recorders, including standard and special recorders and recorder/controller configurations. Gulton Industries, Measurement & Control System Div., East Greenwich, RI

CIRCLE NO. 382

ECCOAMP

ELECTRICALLY CONDUCTIVE ADHESIVES & COATINGS



New four page folder describes materials from 0.0001 to 100 ohm-cm. Adhesive pastes to replace hot solder, thin liquids, silver lacquer in aerosol spray, lossy coatings, etc.

INFORMATION RETRIEVAL NUMBER 80

TRANSFER MOLDING COMPOUNDS FOR ELECTRICAL ENCAPSULATION



This new Eccomold® Folder contains comparative physical, and electrical properties, mold design considerations and processing techniques for powders and liquids. Properties and application data are presented in tabular form.

INFORMATION RETRIEVAL NUMBER 81

NEW -- FREE -- DATA PLASTIC/CERAMIC FOAMS



ECCOFOAM® is the broadest line of plastic and ceramic foams for electronics. Foam-in-place; sheet stock; pourable syntactic; artificial dielectrics all described and properties tabulated in new booklet. Send for copy.

INFORMATION RETRIEVAL NUMBER 82

Emerson & Cuming, Inc.



CANTON, MASS.
GARDENA, CALIF.
NORTHBROOK, ILL.
Sales Offices
in Principal Cities

EMERSON & CUMING EUROPE N.V., Devel, Belgium

BIG POWER SUPPLIES



IN LITTLE PACKAGES

**AC-DC and DC-DC
miniaturized power converters
that deliver 3.9 watts
per cubic inch.**

- AC inputs: 115VAC, 50-500Hz
- DC inputs: 12, 28, 48 & 115VDC.
- 1 to 6 isolated and regulated DC outputs from 4.2 to 300VDC.
- Line and load regulation to 0.1%.
- Up to 120 watts per output.
- Efficiencies to 85%
- Design-As-You-Order construction from standard sub-modules . . . over 1200 possible configurations.
- Completed converters provided in tested and encapsulated, conduction cooled packages in just days.

See for yourself how we've packed the power and performance in . . . request our actual size "little black box" punch out kit and catalog today!

Call us collect . . . ask for Jim Dunn.



ARNOLD MAGNETICS CORPORATION

11520 W. Jefferson Blvd.
Culver City, Ca. 90230 • (213) 870-7014

NEW LITERATURE



Instruments

Detailed within six pages are condensed descriptions and specifications on FM/AM signal generators, FM deviation meters, mobile radio test gear, digital communications-PCM test gear, programmable attenuators and many other items. Marconi Instruments, Northvale, NJ

CIRCLE NO. 383

Tantalum capacitors

Subminiature dipped solid tantalum capacitors offering a capacitance range from 0.1 to 10 μ F are described in a 4-page illustrated data sheet. Performance and mechanical characteristics are listed. Corning Glass Works, Corning, NY

CIRCLE NO. 384

Mercury relays

Photos, line drawings, specifications and features of mercury displacement steel tube relays are given in a six-page brochure. Magnecraft Electric, Chicago, IL

CIRCLE NO. 385

Thermoplastic resins

Thermoplastic resins are presented in a 28-page brochure. The brochure covers thermal, mechanical and electrical properties, dimensional stability, environmental resistance, melt flow data, injection molding details, mold design, machining, decorating, bonding and assembly. GE Plastics Dept., Selkirk, NY

CIRCLE NO. 386

Magnetic alloy

Alloy 48, a vacuum-melted, 48% nickel-iron soft magnetic alloy, is described in a bulletin. Magnetics, Specialty Metals Div., Butler, PA

CIRCLE NO. 387

Industrial instrumentation

Process-control instrumentation is highlighted in a 20-page brochure. Honeywell Process Control Div., Fort Washington, PA

CIRCLE NO. 388

Capacitors

Application information on a variety of film and metallized capacitors are contained in a 50-page catalog. The catalog is illustrated with curves, tables and photographs. Wilhelm Westermann, D-68 Mannheim 1, West Germany

CIRCLE NO. 389

Visible filters

Specifications for over 2000 in-stock visible filters are listed in a 100-page catalog. The part number is listed first, followed by the quantity, center wavelength of the filter half-power bandwidth, substrate, transmission and size. Barnes Engineering, Spectrum Systems, Waltham, MA

CIRCLE NO. 390

Bucket-brigade devices

Dual 512-stage bucket brigade devices for audio signal delays are described in a data sheet. Matsushita Industrial Div., New York, NY

CIRCLE NO. 391

Minicomputers

A 92-page booklet describes the configurations, software and peripherals of the 3000CX mini DataCenters. Hewlett-Packard, Palo Alto, CA

CIRCLE NO. 392

Digital devices

Over 5500 digital devices for which Teradyne has program cards available to use with the J133C analogical circuit test instrument are listed in a 60-page catalog. Teradyne, Boston, MA

CIRCLE NO. 393

Schottky Barrier Rectifiers

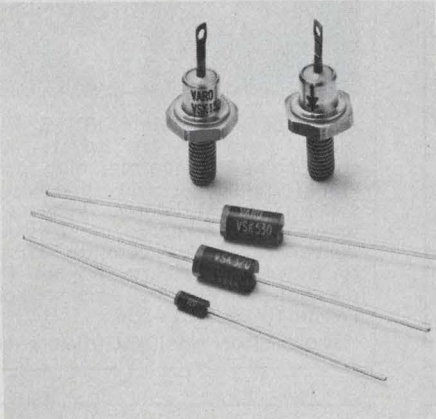

- Four series: 1A, 3A, 5A and 15A (Io) with 20V and 30V (V_{RRM}).
- Extremely fast recovery (t_r), very low forward voltages (VF), high reliability and low cost.
- VSK 120 & 130-1A series in DO-41 packages. 450 & 550 mV (VF). 40A peak $\frac{1}{2}$ cycle surge (I_{FSM}). 10 mA (IR) at 100°C.
- VSK 320 & 330-3A series. Epoxy package, axial leads. 475 & 500 mV (VF). 150A surge. 30 mA (IR) at 100°C.
- VSK 520 & 530-5A series. Epoxy package, axial leads. 380 mV (VF). 250A surge. 75 mA (IR) at 100°C.
- VSK 1520 & 1530-15A series in DO-4 metal stud cases. 550mV (VF). 300A surge. 75 mA (IR) at 100°C.
- All series have junction operating temperature range of -65°C to +125°C.
- Typical pricing, 1000 qntys, from \$1.38 ea. (VSK 120) to \$3.67 ea. (VSK 1530).

Call Charlie Merz 214/272-4551
for complete information



VARO

VARO SEMICONDUCTOR, INC.

P.O. BOX 676, 1000 NORTH SHILOH,
GARLAND, TEXAS 75040
(214) 272-4551 TWX 910-860-5178

INFORMATION RETRIEVAL NUMBER 84
ELECTRONIC DESIGN 11, May 24, 1975

Bulletin Board

General Semiconductor Industries has qualified its 2N4150 npn transistors to MIL-S-19500/395 (USAF).

CIRCLE NO. 394

For a low one-time fee, owners of Redactron's Series A word processing typewriters can convert their machines to more advanced Series B systems. Conversion to Series B involves the change of an electronic package in the word processing typewriter.

CIRCLE NO. 395

Spectronics has expanded its line of optically coupled isolators offered in six-pin dual in-line packages. Pin-for-pin interchangeability with standard industrial six-pin isolators is a key feature of the new series.

CIRCLE NO. 396

INSYTE, an English language-based information storage and retrieval system, has been upgraded on Remote Computing Corp.'s time-sharing system to include the concept of multiple system management.

CIRCLE NO. 397

Corning Glass Works has announced price increases ranging from 5% in large quantities to an average of 57% in quantities of one to 49 for its glass capacitors. These capacitors are designed to meet or exceed military established reliability (ER) specifications.

CIRCLE NO. 398

Mosfet * Micro * Labs has developed a PLANOX high-voltage, charge-coupled-device (CCD) wafer fabrication process and is offering custom CCD fabrication.

CIRCLE NO. 399

National Semiconductor, 2900 Semiconductor Dr., Santa Clara, CA 95051 has announced an across-the-board price reduction of its CMOS ICs. The price reduction ranges up to 51% for the Series MM7CXXN and the Series-4000-equivalent MM56XXAN (CD-40XXBE).

INQUIRE DIRECT

AMERICAN **1** MADE

Tolerance
SCHAUER
1-Watt
ZENERS

Immediate Shipment Low Prices

ANY voltage from 2.0 to 16.0

Quantity	Price each
1-99	\$1.07
100-499	.97
500-999	.91
1000-4999	.86
5000 up	.82

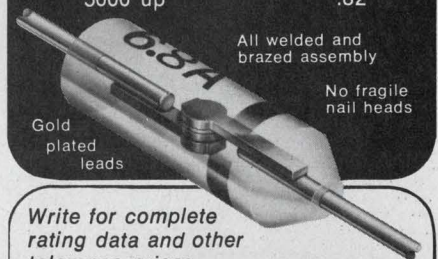

Gold plated leads

All welded and brazed assembly

No fragile nail heads

Write for complete rating data and other tolerance prices.

Buy the kit- Save a lot

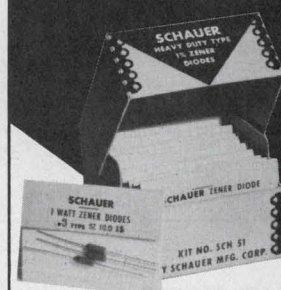

Kit contains a 51-piece assortment of SCHAUER 1% tolerance 1-watt zeners covering the voltage range of 2.7 to 16.0. Three diodes of each voltage packaged in reusable poly bags. Stored in a handy file box. Contact your distributor or order direct.

A \$54.57 value for
ONLY **\$24⁵⁰**

Semiconductor Division
SCHAUER
Manufacturing Corp.

4511 Alpine Ave. Cincinnati, Ohio 45242
Telephone: 513/791-3030

INFORMATION RETRIEVAL NUMBER 85

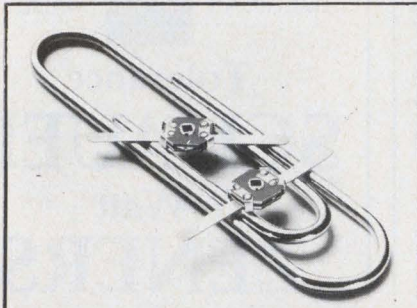

Thin-Trim variable capacitors provide a reliable means of adjusting capacitance without abrasive trimming or interchange of fixed capacitors. Series 9401 has high Q's and a range of capacitance values from 0.2-0.6 pf to 3.0-12.0 pf and 250 WVDC working voltage. Johanson Manufacturing Corporation, Boonton, New Jersey (201) 334-2676.

INFORMATION RETRIEVAL NUMBER 601

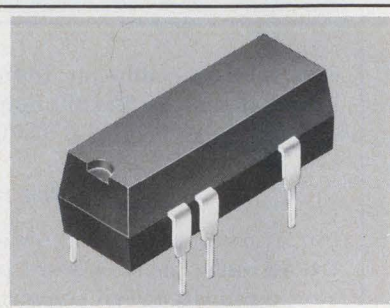

DUAL IN LINE MERCURY WETTED RELAY. New reed relay 847 series withstands voltage transients, switches microamps and large currents. Constant contact resistance; fast on-off with no bounce. Use common drivers, DIP socket. 5, 12, 24 VDC coil voltages Gordos Corp., 250 Glenwood Ave., Bloomfield, N.J. 07003. (201) 743-6800.

INFORMATION RETRIEVAL NUMBER 604

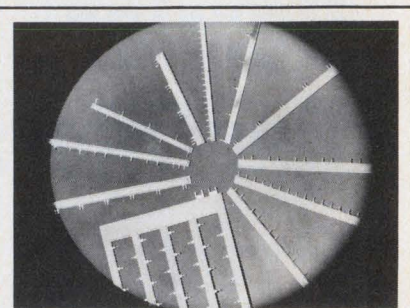

Mini/Bus® Evaluation Kit, \$25, in stock. Lets you try Rogers' low-cost, noise attenuating, high packaging density power distribution system for PC boards. Millions in use. Standard parts on 2 weeks delivery, or less! Customer parts 4 to 6 weeks delivery. Rogers Corporation, Chandler, Ariz. 85224. Phone (602) 963-4584

INFORMATION RETRIEVAL NUMBER 607

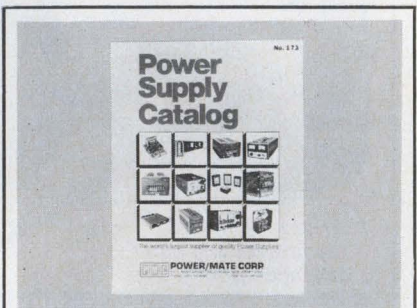

Free catalog of 34,500 power supplies from the worlds largest manufacturer of quality Power Supplies. New '74 catalog covers over 34,500 D.C. Power Supplies for every application. All units are UL approved, and meet most military and commercial specs for industrial and computer uses. Power Mate Corp. (201) 343-6294.

INFORMATION RETRIEVAL NUMBER 602

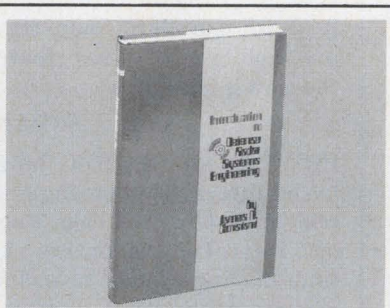

Introduction To Defense Radar Systems Engineering. Excellent introduction and practical reference to radar systems design and applications. #9194, 260 pp., \$22.95. Circle the Info Retrieval No. to order 15-day exam copy. When billed, remit or return book with no obligation. Hayden Book Co. 50 Essex St. Rochelle Park, N.J. 07662

INFORMATION RETRIEVAL NUMBER 605

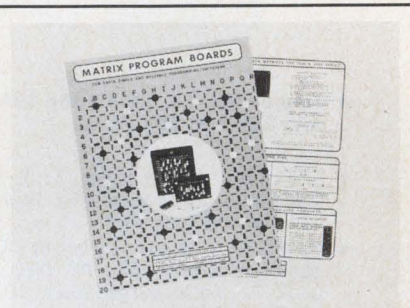

NEW MATRIX BOARD BROCHURE details design advantages, application information with electrical schematics of typical programming/switching circuits, electrical and mechanical specifications, complete check list for specifying, specs on breadboard kits. Send for free copy INFO-LITE CORP, 46-10 - 104 St, Corona, NY 11368 (212) 476-1287

INFORMATION RETRIEVAL NUMBER 608

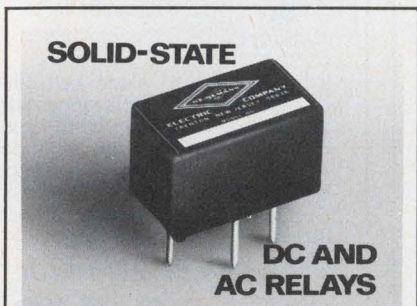

SOLID-STATE
DC AND AC RELAYS

For computer peripherals and other high-speed, high-reliability switching jobs, with either DC or AC loads up to 6 amp, these transformer-coupled Heinemann relays offer highest sensitivity and control-to-output pulse-shape conformity for TTL and other low-level control signals. Heinemann Electric Company Trenton, NJ 08602.

INFORMATION RETRIEVAL NUMBER 603



Electronic Design 24

A collector's item . . . 20th anniversary issue of Electronic Design (11/23/72) salutes 25th anniversary of the transistor, features milestones in design over past quarter century. Rare nostalgic view of industry. Fascinating reading. \$2 per copy pre-paid. Checks, money orders: Electronic Design, Promotion Mgr., 50 Essex St., Rochelle Park, N.J. 07662.

INFORMATION RETRIEVAL NUMBER 606



Precision rotary switches for instrumentation and control applications. Many combinations of various electrical and mechanical features offer a wide range of switching functions in three basic sizes. Catalog 201. Shalco, Inc., P.O. Box 1089, Smithfield, NC 27577.

INFORMATION RETRIEVAL NUMBER 609

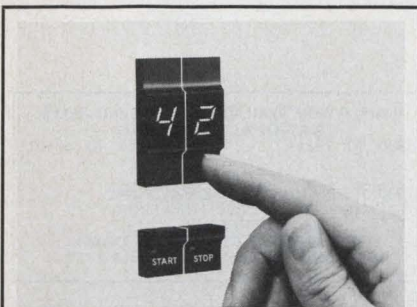

Solid-State Digital Advance Switch—The thumbwheel switch you activate with only a TOUCH! No rotating of cumbersome ratchet wheels. Simply touch the "touch plate" and the switch advances, step-by-step, until you remove your finger. Stepping rate 0.3 seconds/digit. Master Specialties, 1640 Monrovia, Costa Mesa, Calif. 92627.

INFORMATION RETRIEVAL NUMBER 610

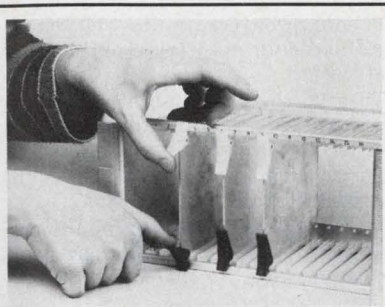

FREE SAMPLES of rugged, low-cost Electro-Flex P.C. Card Ejectors with improved lever action and greater strength. Longer handle provides sure grip for quick, damage-free extraction. UL-approved nylon in white and red; stainless roll pins included. Nylon card guides also available. Electro-Space Fabricators, Tipton, Pa. 19562. (215) 682-7181.

INFORMATION RETRIEVAL NUMBER 613

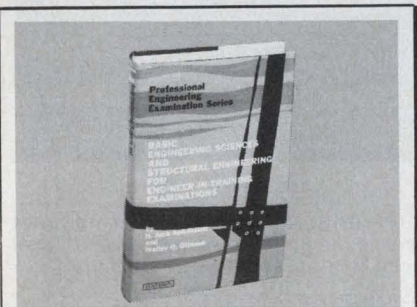

Basic Engineering Sciences & Structural Engineering for E-I-T Exams. Sampling for test problems makes the best preparation yet for exams. #5712-1, 424 pp., \$17.20. Circle the Info Retrieval No. to order 15-day exam copy. When billed, remit or return book with no obligation. Hayden Book Co., 50 Essex St., Rochelle Pk., N.J. 07662

INFORMATION RETRIEVAL NUMBER 611

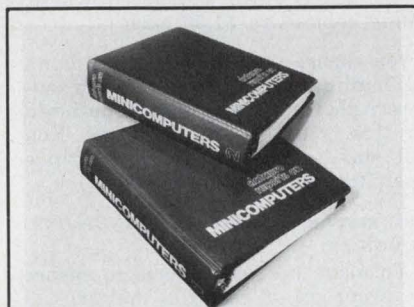

Datapro Reports on Minicomputers, a two-volume information service, provides prices, specifications, evaluations, and users' experiences with 100's of mini and microcomputer systems and their peripherals. Information about a \$10 trial subscription is available from Datapro Research Corp. 1805 Underwood Blvd. Delran, NJ 08075, 609-764-0100.

INFORMATION RETRIEVAL NUMBER 614



Drives piezoelectric transducers. Negative output pulse variable from 50 to 350 volts into 50 ohms, 15 nsec. risetime, output pulse monitor, adjustable damping. Low noise receiver amplifier has selectable 0, 20, and 40 db gain, 15 MHz bandwidth, switchable high-pass filter. MetroTek, Inc., Box 101, Richland, WA 99352, (509) 946-4778.

INFORMATION RETRIEVAL NUMBER 612

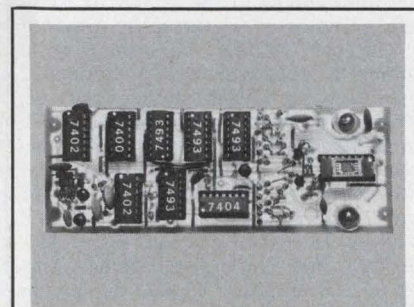

Low Cost Image Sensing Module contains a 1024 element (32-by-32) image sensor and all support circuitry on a single pc board. Digital video output may be displayed directly on an oscilloscope. Complete module (SE1024W) is \$150. Kit (SE1024K) is \$90. Cromemco, 26655 Laurel, Los Altos, CA 94022.

INFORMATION RETRIEVAL NUMBER 615

Advertisers wishing to reserve Quick Ad units should note the following mechanical requirements: Specs—Supply glossy photo of product and approximately 40 words which will set no more than 10 lines of 34 characters each. AFTER SUBMISSION NO COPY CHANGES CAN BE ACCEPTED. Quick Ads cost only \$325 per insertion, less for frequency advertisers.

RATES:

1x
\$325

7x
\$300

13x
\$275

19x
\$270

26x
\$265

39x
\$260

52x
\$255

104x
\$250

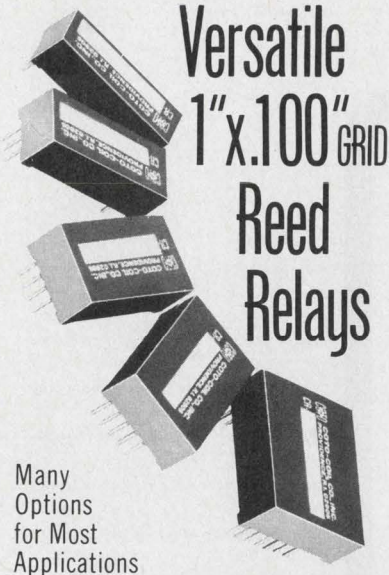

Versatile 1"x.100" GRID Reed Relays

Many
Options
for Most
Applications

New CR-2000 Series utilizes the popular 1" x .100" grid pattern, with 1 to 6 poles and a variety of options and contact forms for almost any application. Reliable low-level switches may be conditioned by special run-in and dynamic testing. Models can be epoxy-encapsulated or simply encased for added economy. Ask for Bulletin MR 11.1 for full details.



**COTO-COIL
COMPANY, INC.**
59 Pavilion Ave.
Providence, R. I. 02905
Tel: (401) 467-4777

INFORMATION RETRIEVAL NUMBER 105

Circuit Savers



Here's positive low cost protection for your IC's, transistors, power supplies and pc cards.

The LVC-1A crowbar switches to a short circuit whenever the voltage across it exceeds a specified level.

Any trip voltage level between 4.7V and 200V \pm 10% can be selected. The unit will handle a peak current of 50 Amps (8ms) and 3A continuously, MIL Temperature range. Call Mike Coyle for applications assistance.

Full line of protection modules for every hi-lo voltage/current requirement. Write or call for Catalog 749.

279 Skidmore Road
Deer Park, New York 11729
Telephone: 516 - 586-5125



See Gold Book vol 2 p. 1277.

INFORMATION RETRIEVAL NUMBER 106

Electronic Design

ELECTRONIC DESIGN's function is:

- To aid progress in the electronics manufacturing industry by promoting good design.
- To give the electronic design engineer concepts and ideas that make his job easier and more productive.
- To provide a central source of timely electronics information.
- To promote communication among members of the electronics engineering community.

Want a subscription? ELECTRONIC DESIGN is sent free to qualified engineers and engineering managers doing design work, supervising design or setting standards in the United States and Western Europe. For a free subscription, use the application form bound in the magazine. If none is included, write to us direct for an application form.

If you do not qualify, you may take out a paid subscription for \$30 a year in the U.S.A., \$40 a year elsewhere. Single copies are \$1.50 each.

If you change your address, send us an old mailing label and your new address; there is generally a postcard for this bound in the magazine. You will have to requalify to continue receiving ELECTRONIC DESIGN free.

The accuracy policy of ELECTRONIC DESIGN is:

- To make diligent efforts to ensure the accuracy of editorial matter.
- To publish prompt corrections whenever inaccuracies are brought to our attention. Corrections appear in "Across the Desk."
- To encourage our readers as responsible members of our business community to report to us misleading or fraudulent advertising.
- To refuse any advertisement deemed to be misleading or fraudulent.

Microfilm copies are available of complete volumes of ELECTRONIC DESIGN at \$19 per volume, beginning with Volume 1, 1952 through Volume 20. Reprints of individual articles may be obtained for \$3.00 each, prepaid (\$.50 for each additional copy of the same article) no matter how long the article. For further details and to place orders, contact the Customer Services Department, University Microfilms, 300 North Zeeb Road, Ann Arbor, Michigan 48106 telephone (313) 761-4700.

Want to contact us? If you have any comments or wish to submit a manuscript or article outline, address your correspondence to:

Editor
ELECTRONIC DESIGN
50 Essex Street
Rochelle Park, N.J. 07662

classified ads

UNUSED WIRE AVAILABLE ON ORIGINAL REELS
NATIONAL CABLE CO.
3800' NX 1524J 700' NX 5245J

CAROL
2500' 16-3 STO 600V E-27520 VINYL
750' 16-3 600V RUBBER COVERING
IF INTERESTED CALL
GREYHOUND COMPUTER CORP.
EL PASO, TEXAS • 915-544-2700

WYOMING & UTAH

Ranch land. Wild horses, antelope, deer, elk. 10 acres \$30 down, \$30 month. FREE maps, photos, information. Owner—Dr. Michael K. Gauthier, 9418 Florence Ave, Downey, CA. 90240

CIRCLE NO. 281

HERMETIC SEALING

Connectors • Headers • Relay Bases
Terminals • Custom Seals • Testing
Glass/Ceramic To Metal • Since 1959

DETORONICS CORPORATION

10660 E. Roush • S. El Monte, CA 91733
(213) 579-7130 • TWX 910-587-3436

CIRCLE NO. 282

SUBSCRIBER SERVICE For prompt service include the addressed label when writing about your subscription.

CHANGE OF ADDRESS

NEW ADDRESS	name	company	division/department	company address	city
	title				state
					zip

If you're moving, please let us know six weeks before changing your address. If you have a question, place your magazine address label here and clip this form to your letter.

MAIL TO: ELECTRONIC DESIGN Circulation Dept. Hayden Publishing Co., Inc., 50 Essex Street, Rochelle Park, NJ 07662

A GOLD MINE OF INFORMATION & DATA

- **520** CATALOG PAGES ON ICs & SEMICONDUCTORS
- **300** CATALOG PAGES ON INSTRUMENTS
- **290** CATALOG PAGES ON POWER SUPPLIES
- **210** CATALOG PAGES ON WIRE & CONNECTOR PRODUCTS
- **150** CATALOG PAGES ON SWITCHES
- **2800** CATALOG PAGES ALL TOLD IN 52 PRODUCT CATEGORIES

Electronic Design's GOLD BOOK puts the entire electronics industry at your fingertips. Use it for product search, selection, specification and purchase. It's the most thorough industry master catalog & directory ever compiled.

When you need Information . . .

Electronic Design's

GOLD BOOK IS THE PLACE TO LOOK

Electronic Design

Advertising Sales Staff

Tom W. Carr, Sales Director
Rochelle Park, NJ 07662
Robert W. Gascoigne
Daniel J. Rowland
(Recruitment, Quick Ads, Classified)
50 Essex Street
(201) 843-0550
TWX: 710-9990-5071

Philadelphia

Thomas P. Barth
50 Essex Street
Rochelle Park, NJ 07662
(201) 843-0550

Boston 02178

Gene Pritchard
P.O. Box 379
Belmont, MA 02178
(617) 489-2340

Chicago 60611

Thomas P. Kavooras
Berry Conner, Jr.
200 East Ontario
(312) 337-0588

Cleveland

Thomas P. Kavooras
(Chicago)
(312) 337-0588

Los Angeles 90045

Stanley I. Ehrenclou
Burt Underwood
8939 S. Sepulveda Boulevard
Suite 510
Los Angeles, CA
(213) 641-6544

San Francisco 94022

Robert A. Lukas
Box 126
3398 El Camino Real
Highway 82
Palo Alto, CA 94306
(415) 965-2636

London, Amsterdam, Tokyo, Seoul

John Ashcraft
12, Bear St.
Leicester Square
London WC2H 7AS England
Phone: 01-930-0525

W. J. M. Sanders
John Ashcraft & Co.
Herengracht 365
Amsterdam C., Holland
Phone: 020-24-09-08

Haruki Hirayama
Electronic Media Service
5th Floor, Lila Bldg.,
4-9-8 Roppongi
Minato-ku, Tokyo, Japan
Phone: 402-4556
Cable: Electronicmedia, Tokyo
Mr. O-kyu Park, President
Dongbo Int'l Corp.—
World Marketing
C.P.O. Box 4010
Seoul, Korea
Tel. 76-3910/3911
Cable: DONGBO SEOUL
Telex: EBKOREA K27286

ABP

BPA

THEY SAID "IT SHOULDN'T BE DONE!"

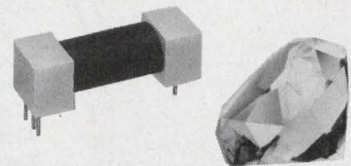

PRESENTING THE "LITTLE GEM" REED RELAY

Internally, our new "Little Gem" reed relays are unique. Experts said "you shouldn't make them this way". We did anyway. And added a few unusual twists.

The result is a reed relay that costs you a lot less than comparable types and beats them in performance too! For instance, the leads on open frame relays have a fragile construction, often resulting in broken reeds. The encapsulated ends of the "Little Gem" on the other hand eliminate the problems associated with lead twisting and bending during insertion. Performance-wise, the "Little Gem" is sensational. CONTACT RESISTANCE is typically 100 mΩ. OPERATING TIME is typically 200 μsec compared to 350 to 500 for comparable relays. BOUNCE TIMES are typically less than 1/4 msec, compared to an average of 1/2 msec for comparable types. And you get an honest -55° to 85°C OPERATING TEMPERATURE. What's more "Little Gem" relays are much less susceptible to damage from solvents.

Order them in 1-6 Form A standard and 1-4 Form C standard versions with 1-24 V coil operation and .1" to .15" spacing.

How much? The example below tells the story.



6 Volt-100Ω samples to letterhead requests.
THE "LITTLE GEM"
PROVES IT CAN BE DONE!
The secret is patent pending.



ELECTRONIC APPLICATIONS CO.
2213 Edwards Avenue
So. El Monte, CA 91733 • (213) 442-3212

INFORMATION RETRIEVAL NUMBER 107

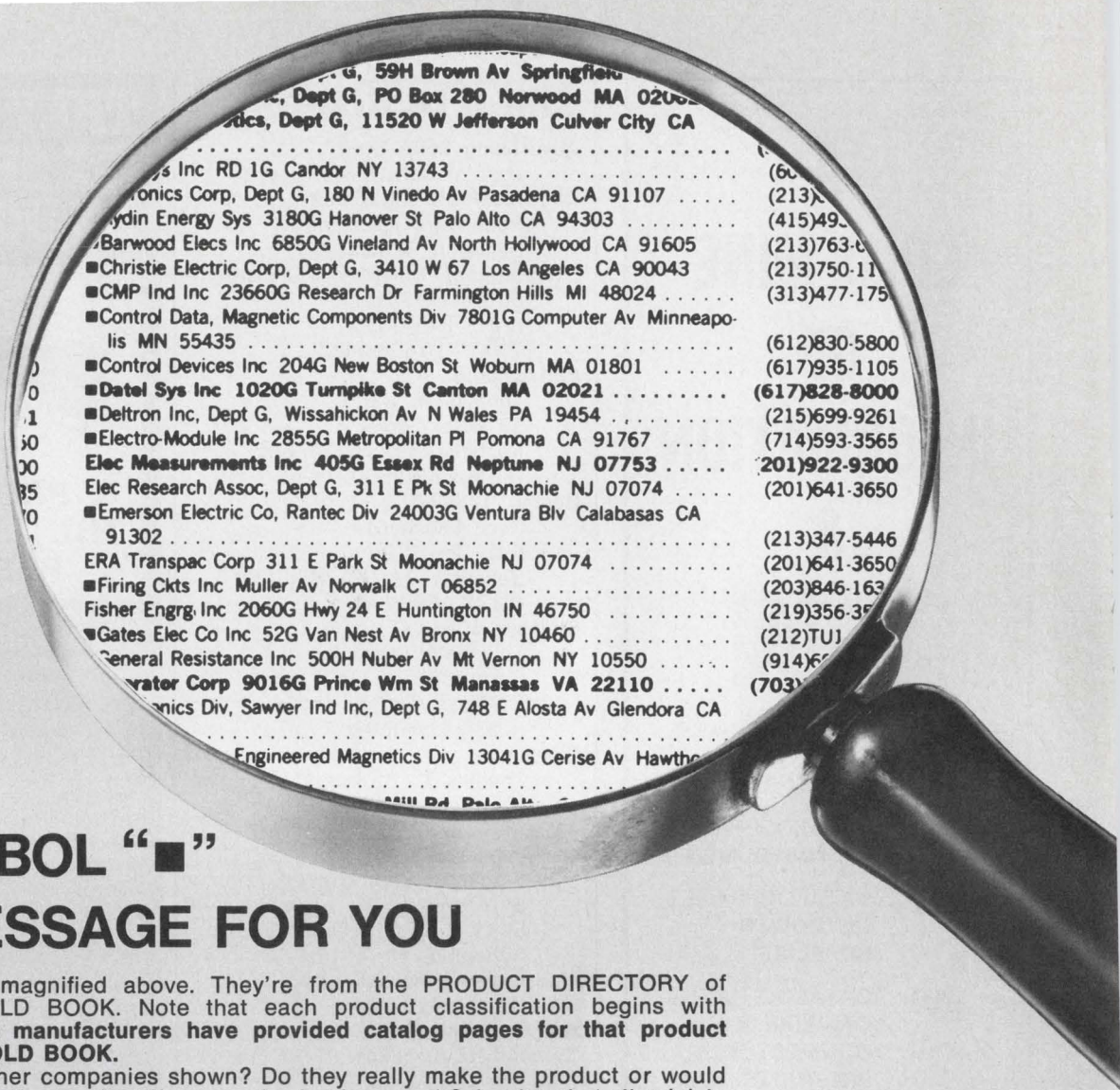

THIS SYMBOL "■" HAS A MESSAGE FOR YOU

Look at the listings magnified above. They're from the **PRODUCT DIRECTORY** of *Electronic Design's* **GOLD BOOK**. Note that each product classification begins with boldface listings. **These manufacturers have provided catalog pages for that product in vols. 2 or 3 of the GOLD BOOK.**

But what about the other companies shown? Do they really make the product or would they merely *like* to make the product if your order is big enough? A printer's bullet (■) in front of its name means that the company has submitted printed literature on that product to the editors of the **GOLD BOOK**. It's reasonable to assume that these suppliers actually make the product, for its not likely that a supplier would prepare literature for a product he can't ship. The bullet ■ gives you a measure of verification.

Manufacturers listed in boldface in the second sub-group have provided catalog pages, but not for the specific product heading the list.

In a constantly moving industry, these measures of verification are of course subject to change. Yet they can be helpful guides as you seek out potential suppliers.

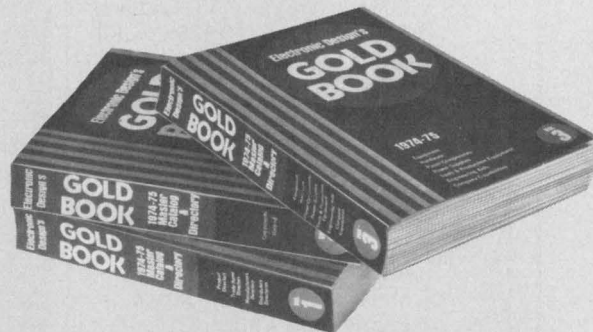

Electronic Design's
GOLD BOOK
**BIGGEST AND BEST ELECTRONICS MASTER CATALOG
 & DIRECTORY IN THE WORLD**

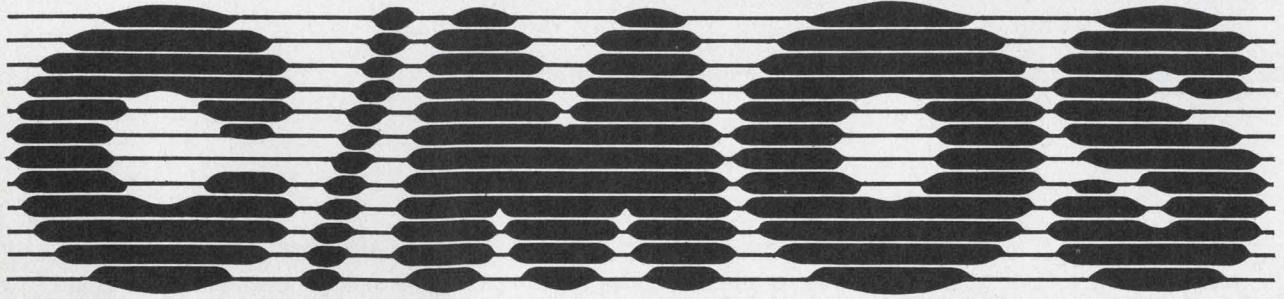

HIGH NOISE IMMUNITY

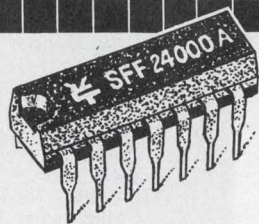
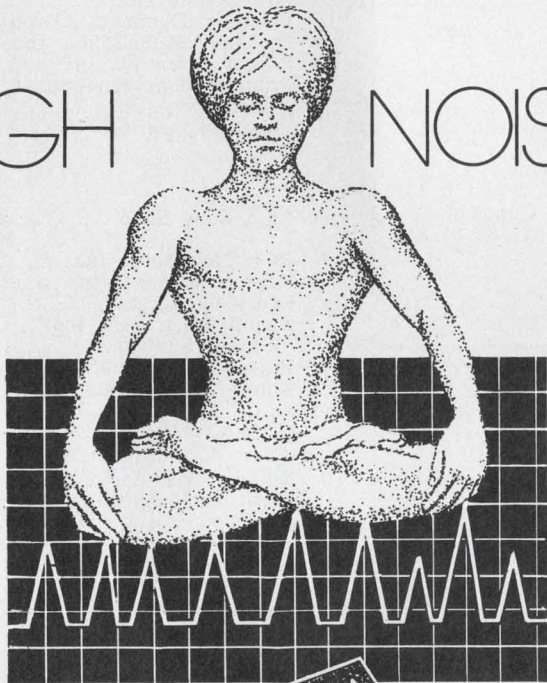

SFF 2400 A SERIES

- An ion implantation for better control of performance.
- The best possible selection in the field of industrial electronics (numerical control, process control, industrial automation) for noise immunity.
- The best possible choice for portable equipment owing to its wide supply voltage range and low power consumption.

Full specifications of this series are given in our 1974/1975 MOS and C/MOS catalog.

Perez Publicidad. 102A



THOMSON-CSF

SEMICONDUCTOR DIVISION
50, rue Jean-Pierre-Timbaud / B.P. 120 / 92403 Courbevoie
Téléphone 788 50 01 Télec Sescom 61560 F

SALES REPRESENTATIVES IN EUROPE

BELGIQUE - Bruxelles - Thomson S.A. Tel. 648.64.85 Twx : 23.113 - **BRD** - München - Thomson - CSF GmbH Tel. (089) 76.75.1 Twx : 5.22.916 - **DANMARK** - København - Scansupply Tel. Aegir 5090 Twx : 19037 - **ESPAÑA** - San Juan Despi (Barcelona) - Componentes Electronicos S.A. Tel. 319.46.50 Twx : 53.077 - **FINLAND** - Helsinki - OY Sufra AB Tel. 49.01.37 Tlg : Pierrejoly Helsinki - **GREAT BRITAIN** - London - Thomson CSF UK Ltd Tel. (01) 579.55.11 Twx : 25.659 - **ITALIA** - Milano - Sescosem Italiana Tel. 68.84.141 Twx : 31.042 & **ROMA** Tel. 31.27.22/35.30.05 Twx : 61.173 Telonde - **NEDERLAND** - La Haye - Compagnie Générale d'Electricité Tel. 60.88.10 Twx : 31.045 - **NORGE** - Oslo - J.M. Feiring A/S Tel. 02.68.63.60 Twx : 16.435 - **ÖSTERREICH** - Wien - Transalpina Tel. (0222) 56.15.71 Twx : Ausland 12.717 - **PORTUGAL** - Lisboa 2 - Sd. Com. Rualdo Tlg : Rualdo Lisboa Tel. PP.C 33 725 - **SUISSE** - Berne - Modulator S.A. Tel. 232.142/43 Twx : 32.431 - **SVERIGE** - Solna - Elektroholm AB Tel. 08/82.02.80 Twx : 19.389

INFORMATION RETRIEVAL NUMBER 109

Good things come in small packages.



MS Series Reed Relays
Prices reduced 20%!

IMMEDIATELY.

For delivery within 48 hours, call (617)-438-5300

- Popular .100" x 1.00" grid
- Micro-sized reed relays for high-density circuit packaging
- High insulation resistance, 10¹² typical
- Epoxy encapsulated
- Available in 5, 6, 12 and 24 volts
- Perfect for high-speed switching in computer, telemetry, instrument applications

Electronic Instrument & Specialty Corp.

42 Pleasant Street
Stoneham, Mass. 02180 (617)-438-5300

• See us in EEM, Vol. 2

INFORMATION RETRIEVAL NUMBER 86

one probe tests C-MOS HTL TTL/DTL



Kurz-Kasch has it. The PLP-550 Logic Probe. Simple selection of internally programmed logic thresholds allows multiple logic family testing in one probe. Plus the added feature of pulse catching or "memory". The popular Kurz-Kasch 3 lamp, (red, white & blue) readout displays logic "0", "1" and "P". The PLP-550 also provides easy interpolation of duty cycles through the direct relationship of the displays and their relative intensities. Get full information now from:



Kurz-Kasch, Inc.

ELECTRONICS DIVISION
2876 Culver Avenue
Dayton, Ohio 45429
Tel: (513) 296-0330

INFORMATION RETRIEVAL NUMBER 88

Sb+Cs, BIALKALI, MULTIALKALI, Ag+O+Cs, Cs+Te, Ga, GaAs(Cs), RNOX Sb+Cs, BIALKALI, MULTI...

QUALITY DETECTORS FOR INSTRUMENTATION

A complete line of side on, end on, photomultipliers and phototubes including the new GaAs and RNOX.



FREE CATALOG call or write

HAMAMATSU CORP.

120 Wood Avenue
Middlesex, New Jersey 08846
201 - 469-8640

INFORMATION RETRIEVAL NUMBER 87

ELECTRONIC DESIGN 11, May 24, 1975

NEW FROM AUGAT.

Our 28-pin, high-density cable plug assembly and socket offer twice the I/O density of conventional assemblies. Features include Augat's exclusive two-piece machined contact assembly, plus compatibility with other Augat boards, P.C. boards, or chassis mounts.

Available now from your Augat distributor.

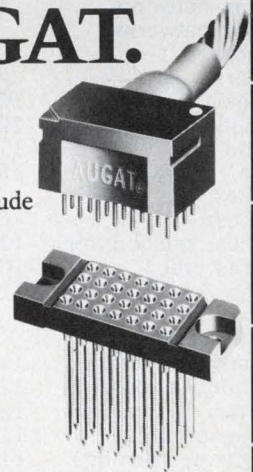

AUGAT®

Augat, Inc., 33 Perry Avenue, Attleboro, Massachusetts 02703

Name _____
Title _____
Company _____
Address _____
City _____ State _____ Zip _____

INFORMATION RETRIEVAL NUMBER 89

Product Index

Information Retrieval Service. New Products, Evaluation Samples (ES), Design Aids (DA), Application Notes (AN), and New Literature (NL) in this issue are listed here with page and Information Retrieval numbers. Reader requests will be promptly processed by computer and mailed to the manufacturer within three days.

Category	Page	IRN	Category	Page	IRN	Category	Page	IRN
Components			Instrumentation			connectors	124	361
capacitors	121	70	a/d conversion systems	86	246	elec. hardware catalog	114	62
capacitors, DIP	21	12	a/d converter	112	328	flexible circuitry	102	50
capacitors, multilayer	106	55	DMM	47	28	heat sinks & dissipators	87	41
capacitors, variable	115	63	DMM	104	52	hooks	116	64
crowbar, dc	132	106	DPM	115	334	IC packaging panels	9	8
display, LC	119	346	function generator	114	331	knobs, aluminum	124	359
display, gas-discharge	120	348	logic probes	137	88	knobs, knurled	140	101
displays	41	23	logic recorder	112	301	knobs, phenolic	140	102
indicator lights	72	35	millivoltmeter, rf/dc	52	31	PC board connectors	45	26
lamps	140	104	modular instruments	51	30	sensor, air-flow	124	360
motor	140	100	multimeter	39	22			
reed relay	133	107	multimeters	113	60	Power Sources		
relay	1	2	oscilloscope	29	17	converter, dc-dc	117	65
relay	121	351	phase meters	126	77	lab supply	108	323
relay, reed	118	342	plotter	75	38	line conditioner	111	58
relay, solid-state	119	344	power source, rf	125	75	OEM supplies	108	320
relay, solid-state	119	345	programmable generator	122	71	open-frame supply	109	324
relay, 3-A	35	20	rf network analysis	117	66	power supplies	128	83
relays	118	341	rf signal generators	119	67	power supply	6	5
relays	118	343	rental equipment	22	13	power supply	48	29
relays	120	349	scope	114	332	power supply	109	325
relays, delay	123	73	scope	115	333	switcher supplies	108	322
relays, gp	140	103	signal generator	11	162	switching supply	108	321
relays, reed	137	86	sweeper	114	330	UPS supply	107	304
relays, reed	132	105	synthesizer	112	329			
relays, solid-state	120	68	test instruments	97	45	new literature		
relays, TO-5	2	3	VOM	95	44	alarm/security cable	127	373
relays, time-delay	102	49	VOMs	33	19	bucket-brigade device	128	391
relays, 30-A	139	91				capacitors	128	389
resistor networks	16	11	Integrated Circuits			control system	127	375
resistor networks	11	252	amp, instrumentation	106	310	d/a, a/d converters	127	372
resistors	8	7	CMOS RAM	5	4	dc power supplies	127	381
resistors	27	16	demodulator	105	307	digital devices	128	393
solenoids	102	51	MECL	13	9	industrial		
solenoids	120	347	memories	93	43	instrumentation	128	388
switch	114	61	memory, CCD	106	309	instruments	128	383
switch, rotary	120	350	NMOS RAM	81	39	magnetic alloy	128	387
switches	7	6	op amp, JFET	103	305	mercury relays	128	385
switches	65	33	op amps	26	15	minicomputers	128	392
switches, pushbutton	112	59	programmable ROMs	104	303	relays	127	379
switches, reed	106	54	RAM	105	308	resistor networks	127	380
vibrator kit	121	352	RAM, 256-bit ECL	103	306	SAW technology	127	378
						signal conditioners	127	377
Data Processing			Microwaves & Lasers			strip-chart recorders	127	382
coupler, instrument	116	336	amplifier	123	356	surplus electronic equip.	127	374
digital display block	126	78	coupler, antenna	123	357	tantalum capacitors	128	384
mag tape transport	122	72	dipole antenna	122	353	thermoplastic resins	128	386
storage, cartridge	116	338	filters	122	354	timing relays	127	376
tape drive, cartridge	117	340	isolators	123	355	visible filters	128	390
terminal, data	116	335	mixer	123	358			
terminal, intelligent	117	339				Modules & Subassemblies		
x-assembler, μ P	116	337	clocks, crystal	111	326	converters, d/s	111	327
			converters, d/s	111	327	input amplifier	110	57
Discrete Semiconductors			relay, time delay	110	302			
arrays, diode	125	363				Packaging & Materials		
detectors	137	87	adhesives and coatings	127	80	adhesives and coatings	126	368
diodes, reference	125	365	cable	139	90	heat exchangers	126	369
rectifiers	129	84	cable plug assembly	137	89	resistor networks	126	367
semiconductors	55	32	conduit, flexible plastic	124	362	thermosetting laminates	126	370
thyristors, high-current	125	366	connectors	15	10	trimmers	126	371
transistor, npn	43	25						
transistors, switching	125	364						
zeners	129	85						

SOUTH BAY CABLE SOLVES TOUGH CABLE PROBLEMS!



For computer applications,
business machines . . . or
a custom design to fit your
particular requirement.
Write for catalog or send
details of your needs.

Manufacturers of cable for electronic
use both military and commercial.

SOUTH BAY  **CABLE CORP.**

Idyllwild, California 92349 • Tel. (714) 659-2183

INFORMATION RETRIEVAL NUMBER 90

NEW Miniature 30 Ampere Relays

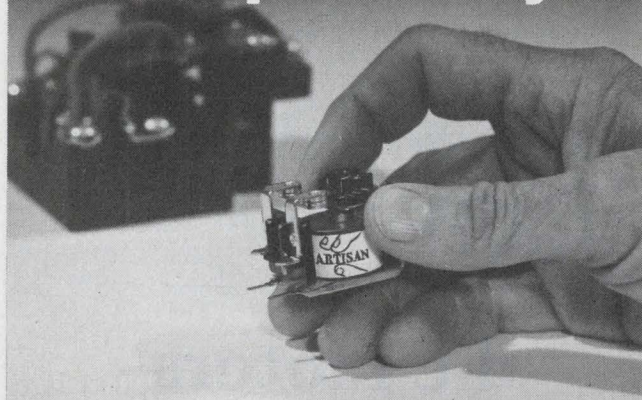

The ARTISAN Series of miniaturized, high current relays are U.L. recognized. A new 30 Ampere relay is contrasted above with a much larger, typical 25 Ampere unit. They are available with either normally open or normally closed contacts, and with either PC or solder mountings. The relays operate quietly and are inexpensive. We are relay experts with 25 years experience.

ARTISAN **ELECTRONICS CORPORATION**
25 YEARS OF CRAFTSMANSHIP
5 EASTMANS RD., PARSIPPANY, N.J.
07054 • TELEPHONE: (201) 887-7100

INFORMATION RETRIEVAL NUMBER 91

Do you train or retrain employees? Consider these famous courses...

BASIC ELECTRICITY

By Van Valkenburgh, Nooger & Neville, Inc.

This simplified illustrated course is the civilian version of the Basic Electricity course used for years by the U.S. Navy and requires no previous background in electricity and little mathematics. The step-by-step approach covers basic concepts from electromagnetism to AC and DC circuits and motors. Frequently only one new concept is introduced on each page and it is amplified by at least one illustration per page. Each topical section concludes with helpful review pages. In five volumes, 624 pages.

- Paperbound set, #0033-2, \$18.40
- Combined Cloth Edition, #0039-1, \$16.70



HAYDEN BOOK COMPANY, INC., 50 Essex St., Rochelle Park, N.J. 07662

Please send me the book(s) checked above on 15-day free examination. At the end of that time, I will remit payment, plus postage, or return the book(s) with no further obligation. **Save Money!** Payment enclosed. Publisher will pay all shipping and handling charges—same 15-day guarantee.

BASIC ELECTRONICS

By Van Valkenburgh, Nooger & Neville, Inc.

Any trainee with a basic knowledge of electricity (equivalent to *Basic Electricity* study) can master the fundamentals of electronics with this progressive course. *Basic Electronics* explains all vital concepts in a logical, step-by-step sequence — from power supply elements and circuits through amplifiers, transmitters, receivers and transistors. In six volumes, 680 pages.

- Paperbound, #0048-0, \$22.15
- Combined Cloth Edition, #0049-9, \$19.50

Tests (and answers) for both courses are available for group and self-study applications.

Prices subject to change without notice.

Name _____
Firm _____
Address _____
City/State/Zip _____

hico-maxon

HICO-maxon

MINIATURE PRECISION DC MOTORS

extra long life... extra efficient
...for servo and open-loop drive



d-c motors

Precision made Swiss motors sized 12 to 32mm, featuring low inertia, servo design, ironless rotors, PM, and long life. Up to 90% efficient with highest torque to size ratio available and flatter speed-torque curves. Reliable, low voltage starts and smooth running with up to 13 bar commutators and 3 or 4 element brushes. Operating temperature range from -20° to +65°C. Geared and tach-motor assemblies also available. Write/call today for applications and free tech data.

HICO Horizons International,

716 Willow Rd., Menlo Park, CA 94025
(415) 328-1111

INFORMATION RETRIEVAL NUMBER 100

One of today's
lowest cost
SPDT GP
relays!



Actual Size

...and probably the most compact!

Think of it...these low cost Series 27 miniature GP relays provide low level to 3 amp switching in a 0.526" cube. And they're priced at only \$1.05 each in 1,000-piece lots for 3, 6 and 12 vdc units—slightly more for 24 vdc relays.

Designed for high density PC board mounting on .69" centers, our Series 27 relay weighs only 0.5 oz. and has a 450 mw pick-up sensitivity. (Also available at 180 mw.) Contact rating is 3 amp res @ 28 vdc, 120 vac and contact resistance is 0.10 ohm max.

Small size...small price...big performance. Consider it for appliance controls, industrial process and machine controls. It's ideal for large volume applications because each and every unit is subject to computerized inspection and individualized contact adjustment.

Write for information today!

NORTH AMERICAN PHILIPS CONTROLS CORP.

Frederick, Md. 21701 · (301) 663-5141

INFORMATION RETRIEVAL NUMBER 103

ALCOKN®

Don't just take our beautiful KNURLED KNOBS for granted! They're different because they are completely machined, including the knurl and then carefully anodized. This takes a little more time and effort, but we think it's worth it.

You'll agree too, when you see these knobs.



KN SERIES

Call us today at
(617) 685-4371
for samples
& prices.

ALCO ELECTRONIC PRODUCTS, INC.
1551 Osgood St., No. Andover, Mass. 01845

INFORMATION RETRIEVAL NUMBER 101

ALCOKN®

A new family of PHENOLIC KNOBS with a refreshing appearance and economical priced. Molded of black phenolic resin. All models made to cover mounting hardware.

Featuring aluminum spin plates, brass inserts with screws and white indicators. Available in 1/2" or 1" diameters.



PKF SERIES

Call (617) 685-4371 for detailed information and free knob catalog.

ALCO ELECTRONIC PRODUCTS, INC.
1551 Osgood St., No. Andover, Mass. 01845

INFORMATION RETRIEVAL NUMBER 102

LOOKING FOR A DISTRIBUTOR NEAR YOU?

Electronic Design's GOLD BOOK lists 5,700 distributors with access both **alphabetic**, by distributor name, and **geographic** by location.

When you need
information . . .

**Electronic Design's
GOLD BOOK
IS THE PLACE
TO LOOK**

Fujitsu's Highly Versatile Reed Relays Combine Sub-miniature Size with High Sensitivity, Superior Performance, Long-life and Outstanding Reliability

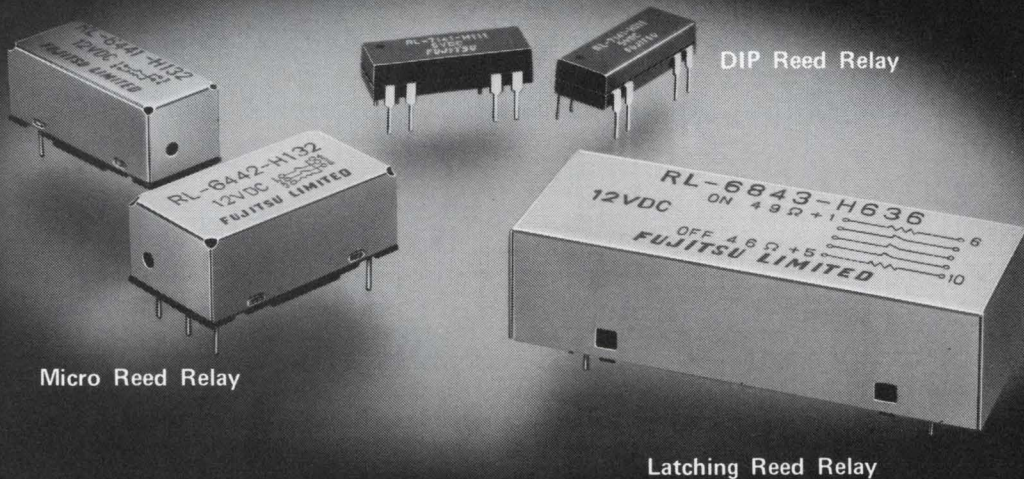

Micro Reed Relay

DIP Reed Relay

Latching Reed Relay

RL-7100 series DIP reed relays can be mounted on the standard 14-pin dual-in-line package and driven directly from TTL and DTL ICs. Current requirements are lower than for any other relay in this class. These relays, whose contacts are one Form A, come in coil voltages of 5, 6 and 12V DC and have 4 VA contact ratings. All Fujitsu DIP reed relays are available with or without an internal clamping diode across the coil.

RL-6400 series micro reed relays feature extremely high sensitivity and low cost. With a low profile (1.0 x .4 x .4 in.), they are suitable for mounting on printed circuit boards. These relays, whose contacts are one and two Form A, come in coil voltages of 5, 6 and 12V DC. Contacts are rated for low-level loads of up to 10W DC. Contact life expectancy is specified at more than 10^7 operations at 0.5A-12V DC power to the resistive load.

RL-6800 series latching reed relays which feature a memory function and a drive pulse width of 1ms, employ a self-latching reed switch as the switching element. The blades of these relays remain magnetically latched even after the applied magnetic field is removed, and never release until the opposite mode is applied. These relays, whose contacts are one, two and three Form A, are available in coil voltages of 6, 12, 24 and 48V DC. The contacts are rated for up to 5 VA. Ideal for use in control systems, display devices, measuring instruments and communications equipment.

DESIGNATIONS

Type (Order No.)	Contact Arrangement	Rated Coil Voltage (DC)	Must Operate Voltage (DC) at 20°C	Coil Resistance (Ohm ± 10%) at 20°C	Coil Power Dissipation
------------------	---------------------	-------------------------	-----------------------------------	-------------------------------------	------------------------

DIP Reed Relays

RL-7141-H111	1 make	5V	3.8V	550Ω	45 mw
RL-7141-H121	1 make	6V	4.5V	550Ω	65 mw
RL-7141-H131	1 make	12V	9.0V	850Ω	170 mw

Micro Reed Relays

RL-6441-H112	1 make	5V	3.0V	500Ω	50 mw
RL-6441-H122	1 make	6V	4.0V	500Ω	70 mw
RL-6441-H132	1 make	12V	7.7V	900Ω	160 mw
RL-6442-H112	2 make	5V	3.5V	210Ω	120 mw
RL-6442-H122	2 make	6V	4.1V	210Ω	170 mw
RL-6442-H132	2 make	12V	8.3V	720Ω	200 mw

Latching Reed Relays

Type (Order No.)	Contact Arrangement	Rated Coil Voltage (DC)	Must Operate Voltage (DC) at 20°C	Must Release Voltage (DC) at 20°C		Coil Resistance (Ohm ± 10%) at 20°C	
				Operate	Reset	Operate	Reset
RL-6841-H626 RL-6841-H636 RL-6841-H646 RL-6841-H656	1 make	6V	4.0V	4.0V	40Ω	47Ω	
		12V	7.8V	8.3V	130Ω	150Ω	
		24V	15.7V	15.9V	580Ω	660Ω	
		48V	30.8V	31.2V	2,050Ω	2,400Ω	
RL-6842-H626 RL-6842-H636 RL-6842-H646 RL-6842-H656	2 make	6V	3.9V	4.0V	23Ω	22Ω	
		12V	7.9V	8.1V	92Ω	90Ω	
		24V	15.6V	16.5V	345Ω	330Ω	
		48V	31.8V	30.8V	1,270Ω	1,230Ω	
RL-6843-H626 RL-6843-H636 RL-6843-H646 RL-6843-H656	3 make	6V	3.9V	4.0V	12.5Ω	12Ω	
		12V	7.9V	7.9V	49Ω	46Ω	
		24V	16.2V	16.2V	190Ω	180Ω	
		48V	33.5V	33.0V	670Ω	660Ω	

FUJITSU LIMITED
Communications and Electronics
Marunouchi, Tokyo, Japan

For further information please contact:

Components Division: Syuwa Onarimon Bldg., 1-1, Shinbashi 6-chome, Minato-ku, Tokyo 105, Japan
(Head Office) Phone: Tokyo (03) 437-2111 Cable: FUJITSULIMITED TOKYO Telex: 2422808 FT SIN J
New York Office: 680 Fifth Avenue, New York, N.Y. 10019, U.S.A. Phone: (212) 265-5360
Fujitsu California, Inc.: 1135 East Janis Street, Carson, California 90746, U.S.A. Phone: (213) 636-0858, (213) 537-8930

MAIN PRODUCTS □ Telephone Exchange Equipment □ Carrier Transmission Equipment □ Radio Communication Equipment □ Space Electronics Systems □ Electronic Computers & Peripheral Equipment (FACOM) □ Telegraph & Data Communication Equipment □ Remote Control & Telemetry Equipment □ Electronic Components

What's new in solid state ...

First feedback on our CA3130 op amp: "Great." "Super." "Terrific."

Engineers who expressed an interest in the RCA CA3130 received data and a free sample. Plus a reply card that asked for reactions to its characteristics.

The response? Enthusiastic! About 3/4 of the first returns carry words like Great. Super. Very good. Terrific. Better than the industry standard. Some respondents used such terms to describe all of the CA3130's major characteristics. The second largest group used words like Good, Nice, Useful or Okay. A small group—less than 10%—didn't find it ideal for their application.

This wide acceptance of the CA3130 isn't really a surprise. We combined MOS/FET, bipolar

and COS/MOS to give you a good measure of the most wanted characteristics. Typical: Input resistance of 1.5 TΩ (1.5 x 10¹²Ω). 110 dB signal voltage gain.



22 mA output current. 10 V/μsec slew rate. Wide voltage swing on single supply. Now, those who have tried the CA3130 confirm its usefulness.

If you're interested, mail the coupon and we'll send you a free CA3130 and data. For more information, contact your local RCA Solid State distributor. Or RCA.

Write: RCA Solid State, Box 3200, Somerville, New Jersey 08876; Ste. Anne de Bellevue 810, Canada; Sunbury-on-Thames, U.K.; Fuji Bldg., Tokyo, Japan.

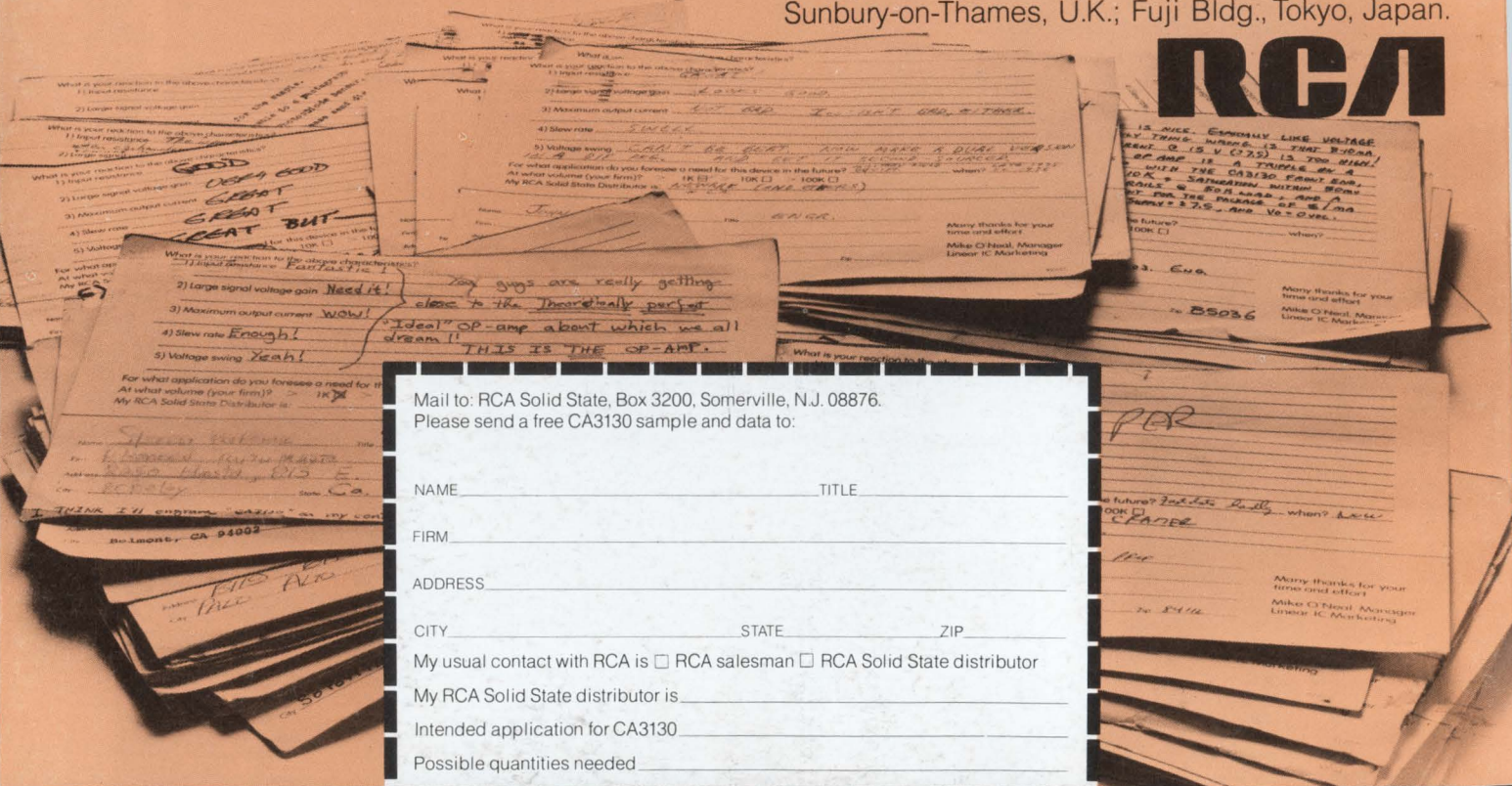

Mail to: RCA Solid State, Box 3200, Somerville, N.J. 08876.
Please send a free CA3130 sample and data to:

NAME _____ TITLE _____

FIRM _____

ADDRESS _____

CITY _____ STATE _____ ZIP _____

My usual contact with RCA is RCA salesman RCA Solid State distributor

My RCA Solid State distributor is _____

Intended application for CA3130 _____

Possible quantities needed _____

RCA. Full house in Linear ICs.