

# Electronic Design. 21

FOR ENGINEERS AND ENGINEERING MANAGERS

VOL. 23 NO.

OCT. 11, 1975

**A MOSFET challenges bipolar** devices for power switching and linear applications. The FET can switch 2 A in 5 ns, and it has 600-MHz unity-gain BW.

Unlike bipolar devices, the FET does not suffer from secondary breakdown or thermal runaway. It also has extremely low carrier storage time. More on page 103.





# Powerhouse.

Dale makes more power wirewounds... E-Rel, precision, industrial, commercial... has more QPL's... more ways to meet your special housing and performance requirements... and just plain works harder to make sure you're satisfied.

*Here are four ways to prove it:*

- For Complete Cross Reference Guide, Circle 351
- For Comprehensive Wirewound Resistor Wall Chart, Circle 352
- For Guide to Non-Standard Wirewound Resistors, Circle 353
- Call 402-564-3131 for immediate information.

DALE ELECTRONICS, INC., 1300 28th Avenue, Columbus, Nebr. 68601

In Canada: Dale Electronics Canada Ltd.

In Europe: Dale Electronics GmbH, 8 Munchen 60, Falkweg 51, West Germany

A subsidiary of The Lionel Corporation



*Our complete product line can be found in Electronic Design's GOLD BOOK.*

# Another technical knockout

## *the first bulletproof UHF device*

The way to shoot holes in any land-mobile RF transistor is to give it 100% worst-case conditions, like high line at 16 V with 50% overdrive into a 20:1 VSWR.

Zap.

Zip.

Not so with the MRF644/646.

These off-the-shelf 25 and 40 W, 470 MHz units are rugged-in the **full** sense of the word!

For the first time in the industry, you get devices correctly tested under real-use conditions **exactly** like the above... conditions usually fatal to less armored types.

It's all fully verified by IR scan in our QC rifle range.

The units furnish Controlled Q\* technology, with computer designed, internal matching networks maximizing bandwidth and ensuring easier circuit design.

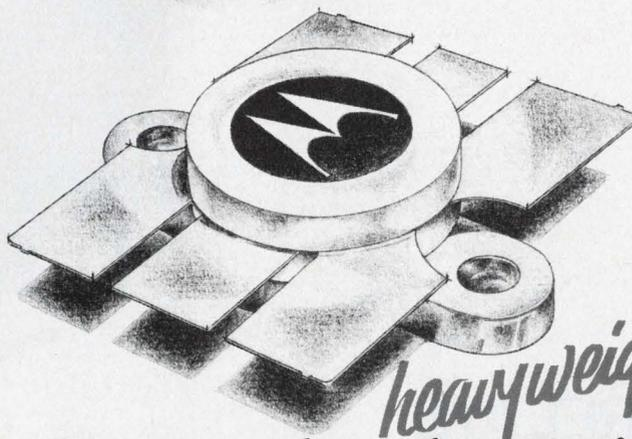
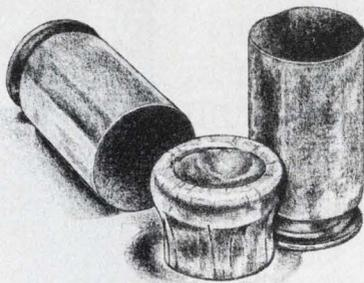

*heavyweight*

## from Motorola, the RF producer.

More specs for these state-of-the-RF-arts include 5.2 dB gain for the 25 W MRF644 and 4.9 dB for the 40 Watt MRF646.

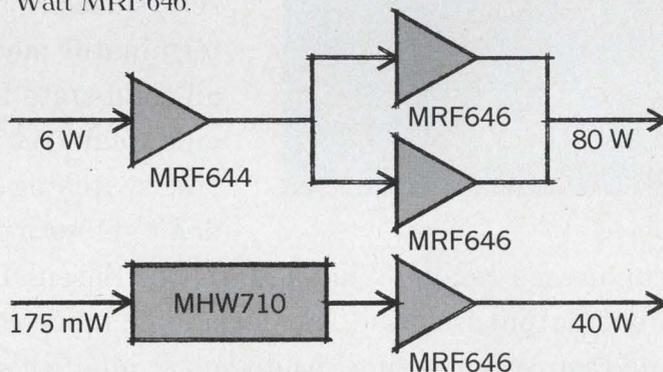

If you want more detailed reports on the MRF644/646, we'll shoot off our mouth on the data sheets. Send for them. Be first with the first...

\*Trademark of Motorola Inc.

# Did you get the message about our solid state SerenDIP relays?

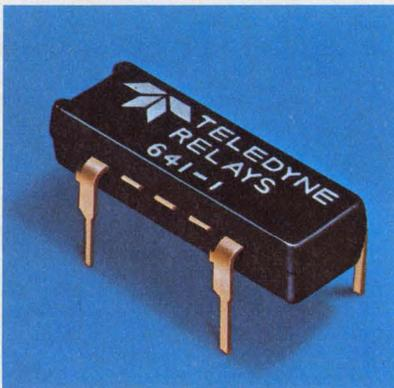

International telex communication switching systems often are expected to run on a 24-hour, seven-day shift. Continuous duty like that calls for dependable, long-life component reliability — the kind RCA requires from Teledyne SerenDIP® relays used in their trunk terminator modules. These all-solid-state DIP relays provide wear-free and bounce-free switching — features you don't get with electro-mechanical or reed relays.

What's more, our SerenDIP's offer high input/output isolation, low level logic input compatibility, and fast response time. And you get all of this in a low cost, low-profile TO-116 DIP package ready-made to replace any standard DIP reed relay. You also get your choice of output: bi-polar, AC (triac), or DC. There's lots more to a SerenDIP relay that you ought to know about. For detailed specs or applications help, contact the Teledyne Relays people nearest you. You're sure to get the message about our all-solid-state DIP relays.

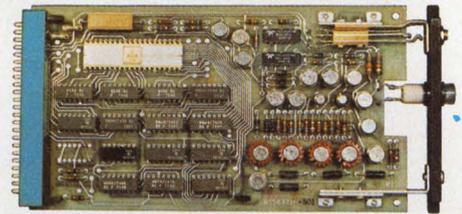

RCA Trunk Terminator Module



RCA CCT-3 Series  
Telex Switching System  
(Courtesy of RCA/Camden, N.J.)

 **TELEDYNE RELAYS**

3155 West El Segundo Boulevard, Hawthorne, California 90250  
Telephone (213) 973-4545

---

## NEWS

- 23 **News Scope**
- 28 **Secure and private communications** devices abound but they're far from foolproof.
- 37 **Microprocessors are helping police departments** lower the cost of fighting crime.
- 40 **Cryogenic magnetometer** detects field of single atom.
- 47 **Washington Report**

---

## TECHNOLOGY

- 58 **FOCUS on FETs:** Field-effect transistors often outperform bipolar devices, but they usually cost more. While FET data sheets tend to be confusing, the astute engineer can avoid specification pitfalls and save money.
- 70 **Consider electromechanical counters** for those tough jobs. But they must be interfaced to match the levels, impedances and speeds of solid-state circuits.
- 76 **Squeeze more data onto mag tape** by use of delay-modulation encoding and decoding. Packing densities of up to 40,000 bits/in./track can be obtained.
- 82 **Build high-speed sync-pattern detectors** for digital communications. Of two methods, a ROM is more versatile and can be reprogrammed more easily than ECL.
- 88 **Which multiplier?** Analog signals can be multiplied by circuits ranging from inexpensive ICs to complex oscilloscopes. But watch out. Results can vary widely.
- 94 **Ideas for Design:**
  - Op-amp scale expander allows high-resolution with ordinary voltmeter.
  - Linear VCO made from a 555 timer.
  - Crystal oscillator provides low noise.
- 100 **International Technology**

---

## PRODUCTS

- 103 **Discrete Semiconductors:** MOSFET power soars to 60 W with currents to 2 A.
- 108 **Discrete Semiconductors:** Low-power diodes at low prices come in a top-grade package.
- 110 **Instrumentation:** Broadband power amplifier delivers 700 mW at 1 GHz.
- 126 **Integrated Circuits:** Fully monolithic 12-bit a/d contains all active elements.
- 133 **Power Sources:** Dc/dc converter shrugs off 6:1 input voltage changes.
- 116 Modules & Subassemblies
- 121 Microwaves & Lasers
- 129 Data Processing
- 136 Packaging & Materials
- 139 Components

---

## DEPARTMENTS

- 55 **Editorial:** The shortcut
- 7 Across the Desk
- 143 Evaluation Samples
- 143 Application Notes
- 144 New Literature
- 148 Bulletin Board
- 152 Advertisers' Index
- 154 Product Index
- 154 Information Retrieval Card

**Cover:** Cover designed by Anthony J. Fischetto, photo by Melgar Photographers, courtesy of Siliconix, Inc., Santa Clara, CA.

---

ELECTRONIC DESIGN is published biweekly by Hayden Publishing Company, Inc., 50 Essex St. Rochelle Park, NJ 07662. James S. Mulholland Jr., President. Printed at Brown Printing Co., Waseca, MN. Controlled circulation postage paid at Waseca, MN and New York, NY, postage pending Rochelle Park, NJ. Copyright © 1975, Hayden Publishing Company, Inc. All rights reserved. POSTMASTER: Please send form 3579 to ELECTRONIC DESIGN, P.O. Box 13803, Philadelphia, PA 19101.

# Intel is the way to

You can go into production of higher density memory systems confidently now that Intel's new 2104 16-pin, 4096-bit dynamic RAM is in stock at Intel distributors, and readily available in OEM quantities.

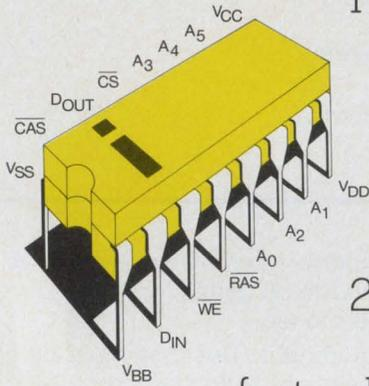

We are mass producing the 2104 on the same fabrication lines and with the same silicon gate n-channel MOS process as the industry standard 2107B 22-pin 4K RAM.

Intel's 16-pin RAM assures you fast, reliable parts as well as delivery in

volume. The Intel 2104 is based on the proven single-transistor cell design of the Intel 2107B, the highest performance 22-pin 4K MOS RAM. Like the 2107B, the 2104 chip is much smaller than other 4K RAM chips produced today.

The fastest available 16-pin 4K RAMs are also in the 2104 series. Our 2104-2 guarantees an access time of only 250 nanoseconds and a cycle time of 375 nanoseconds over the full

0 to 70°C operating temperature range.

To keep system costs low, the 2104 operates on standard -5, +5 and +12V power supplies, and TTL I/O levels. All inputs including clock

INTEL'S STANDARD 4K RAM FAMILY				
Part Number	Pins	Max. Access Time (ns), 0-70°C	Min. Cycle Time (ns), 0-70°C	
			Read or write	Read modify write
D2104-2	16	250	375	515
D2104-4	16	300	425	595
D2104	16	350	500	700
2107B	22	200	400	520
2107B-2	22	220	470	680
2107B-4	22	270	470	590
2107B-6	22	350	800	960

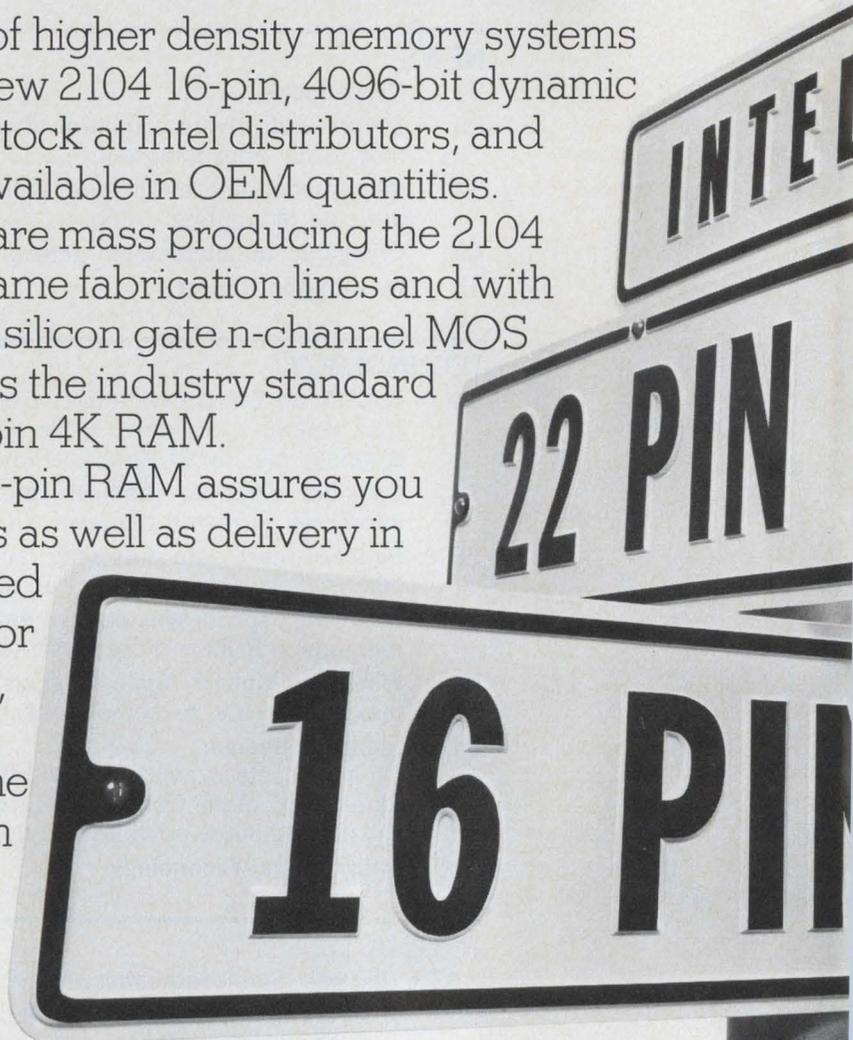

# go for 4K RAMs.

inputs are fully TTL compatible.

Overall system advantages of the 2104 are detailed in a new application brief, "Which Way for 4K... 16, 18, or 22 Pin?" It explains why the 16-pin 2104 is best for very compact systems such as minicomputers, microcomputers, terminals, business equipment, scientific calculators and anywhere high density is needed.

Moreover, we show how the 16-pin standard is compatible with the next generation of even higher density memories. The application brief also tells why the 2107B's simple, straightforward 22-pin design has become an industry standard for computer main memories and many other applications.

Now the industry has two standard configurations — 16 pins with multiplexed addresses and 22 pins with parallel addresses. Whichever way you go, you'll find Intel ready to support both in volume production. For delivery of the 2104 or 2107B contact our franchised distributors: Almac/Stroum, Component Specialties, Cramer, Elmar, Hamilton/Avnet, Industrial Components, Liberty, Pioneer, Sheridan or L.A. Varah.

For your copy of "Which Way for 4K..." or data sheets on any of our 4K RAMs write: Intel Corporation, 3065 Bowers Avenue, Santa Clara, California 95051.

**intel<sup>®</sup> delivers.**



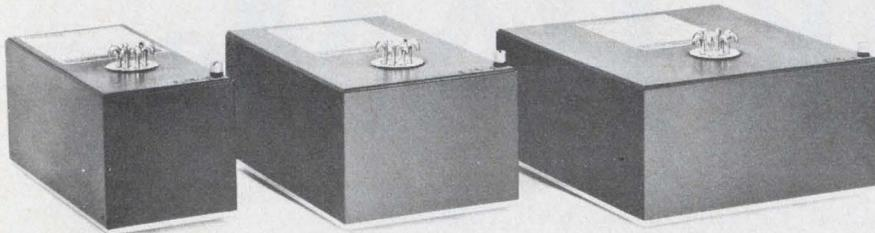

25 WATTS

50 WATTS

100 WATTS

## Save 5 Ways with Abbott's New 77% Efficient Power Supplies!

Abbott has a Hi-Efficiency series of power modules that can save 5 ways in your system. The Model "VN" series converts 47-440 Hz AC lines to regulated DC power and uses a new approach in switching technology that provides a highly reliable line or sixty-three high efficiency power modules.

### The Model "VN" series saves in the following 5 ways:

- 1 SAVES POWER** – High frequency pulse width modulation and C/MOS digital IC control circuitry allow efficiencies of up to 77% in the Model "VN" series. This high efficiency realizes almost twice the output power per input watt than dissipative regulators.
- 2 SAVES SIZE** – Off line techniques and IC technology combine for packages of 70% less volume compared to dissipative regulators.
- 3 SAVES WEIGHT** – High efficiency means less power dissipated and less heat generated, thereby reducing or eliminating the need for bulky heat-sinking and forced air cooling. This translates into less total weight and smaller system size.
- 4 SAVES TIME** – You can quickly get the power supply you need because we have an extensive line of models to choose from. Outputs of 25, 50 and 100 watts are available at any voltage between 4.7 and 50.0 VDC. With popular voltages in stock, chances are the unit you need is available immediately.
- 5 SAVES MONEY** – At only \$299 for 25w, \$339 for 50w, and \$359 for 110w in small quantities, the "VN's" are among the lowest priced Hi-efficiency units on the market.

Abbott also manufactures 3,500 other models of power supplies with output voltages from 2.7 to 740 VDC and output currents from 4 milliamps to 20 amps. They are all listed, with prices, in the new Abbott Catalog. Included are:

60  $\text{A}$  to DC  
 400  $\text{A}$  to DC  
 28 VDC to DC  
 28 VDC to 400  $\text{A}$   
 12-38 VDC to 60  $\text{A}$

Please see pages 1037-1056 Volume 1 of your 1975-76 EEM (ELECTRONIC ENGINEERS MASTER Catalog) or pages 612-620 Volume 2 of your 1975-76 GOLD BOOK for complete information on Abbott Modules.

Send for our new 60 page FREE catalog.

**abbott transistor**

**LABORATORIES, INCORPORATED**  
 general offices eastern office

5200 W. Jefferson Blvd./Los Angeles 90016  
 (213) 936-8185 Telex: 69-1398

1224 Anderson Ave./Fort Lee, N.J. 07024  
 (201) 224-6900 Telex: 13-5332

INFORMATION RETRIEVAL NUMBER 5

**Sr. Vice President, Publisher**  
 Peter Coley

### Editors

Editorial Offices  
 50 Essex St.  
 Rochelle Park, NJ 07662  
 (201) 843-0550  
 TWX: 710-990 5071  
 Cable: Haydenpubs Rochellepark

**Editor-in-Chief** George Rostky

### Managing Editors:

Ralph Dobriner  
 Michael Elphick

### Associate Editors:

Dave Bursky  
 Jules H. Gilder  
 Morris Grossman  
 John F. Mason  
 Stanley Runyon  
 Edward A. Torrero

### Contributing Editors:

Peter N. Budzilovich  
 Alberto Socolovsky  
 Nathan Sussman

### Editorial Field Offices

#### East

Jim McDermott, Eastern Editor  
 P.O. Box 272  
 Easthampton, MA 01027  
 (413) 527-3632

#### West

David N. Kaye, Senior Western Editor  
 8939 S. Sepulveda Blvd.,  
 Suite 510  
 Los Angeles, CA 90045  
 (213) 641-6544  
 TWX: 1-910-328-7240

### Editorial Production

Marjorie A. Duffy

### Art

**Art Director**, William Kelly  
 Richard Luce  
 Anthony J. Fischetto

### Production

**Manager**, Dollie S. Viebig  
 Helen De Polo  
 Anne Molfetas

### Circulation

**Manager**, Evan Phoutrides

### Information Retrieval

Peggy Long

### Promotion, Creative Layouts

**Manager**, Albert B. Stempel  
 Maxine Correal  
 Nancy Gordon (Reprints)

# Across the Desk

## Alternatives listed for divider idea

I'm sure that Ed Woodward's Idea for Design, "Divide a Digital Signal by Any Digit from 1 to 9, (ED No. 1, Jan 4, 1975, p. 120) works exactly as he describes it. And there are truly a multitude of applications for this programmable divider. Unfortunately it takes three TTL packages to implement this scheme, one of them a 24-pin giant!

There are a number of alternatives to this plan, each requiring only a single 16-pin package. If you must stick to TTL, there's Motorola's old standby, the MC-4018, recently renumbered to MC-74418. There's also a BCD version, the MC4016, now called the MC-74416. Or, more in keeping with

the times, there's the MC14526 (binary) and MC14522 (BCD) CMOS series. In addition all of these devices are cascadable for divide-by-N applications.

Otherwise it wasn't a bad idea.

*Harold J. Turner Jr.*

*Senior Technical Editor*

McGraw-Hill Continuing Education Co.

3939 Wisconsin Ave.  
Washington, DC 20016

Here's an improvement on the Idea for Design "Divide a Digital Signal . . ." by Ed Woodward in the Jan. 4, 1975 issue.

The frequency divider can be fabricated with just two ICs.

The input signal toggles an SN-7490 decade counter, which provides a BCD input to an SN7485,

(continued on page 8)

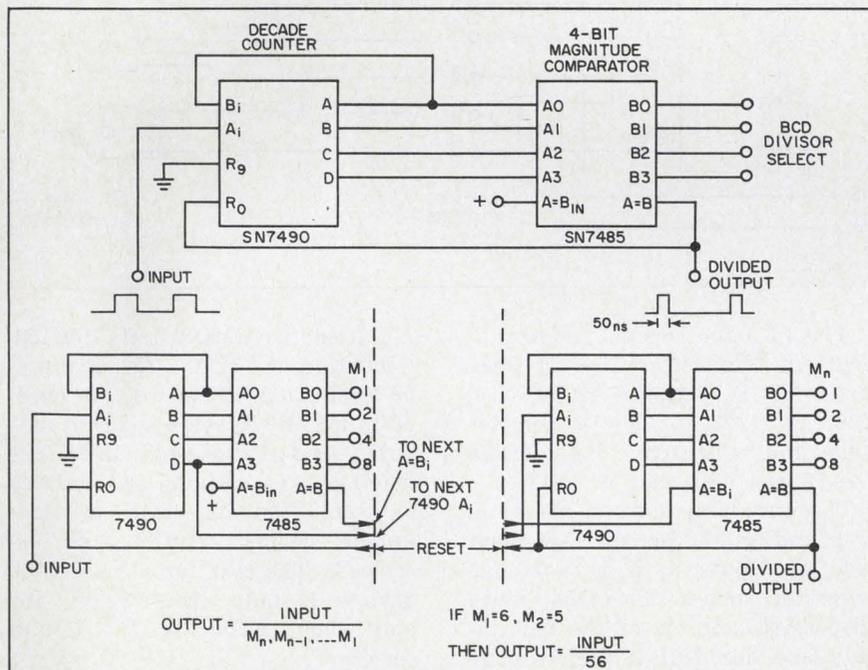

Electronic Design welcomes the opinions of its readers on the issues raised in the magazine's editorial columns. Address letters to Managing Editor, Electronic Design, 50 Essex St. Rochelle Park, N.J. 07662. Try to keep letters under 200 words. Letters must be signed. Names will be withheld on request.



## LOW COST INFRARED SOURCE/SENSOR PAIR

VERSATILE OPTRON DEVICES  
ALSO MATCH EQUIVALENT  
INDUSTRY TYPES!

Now, you can match the high efficiency emission of OPTRON's OP 160 infrared source with the high sensitivity OP 500 sensor or mix either low cost device to pair with equivalent industry types!

The OP 160 LED features a typical output of 1.5 mW at 20 mA in a concentrated beam at a high efficiency emission wavelength of 940 nanometers. The OP 500 N-P-N planar phototransistor has a high spectral sensitivity designed to match that of the OP 160. Typical output of the OP 500 is 10 mA at 20 mW/cm<sup>2</sup> tungsten lamp irradiance.

When operated as a pair, the OP 160/OP 500 provide a typical output of 1.0 mA with an input of 20 mA at a lens-to-lens spacing of 0.25 inch. The identical input at a spacing of 1.0 inch generates an output of 0.5 mA.

Specified individually, the devices are mechanically and optoelectronically matched to replace equivalent industry types as follows:

<b>OPTRON</b>	<b>REPLACES</b>
<b>OP 160</b>	<b>TIL32</b>
<b>OP 500</b>	<b>TIL78</b>

Both the OP 160 LED and OP 500 phototransistor are available from stock in a clear plastic mini-axial package. They are ideally suited for mounting in high density arrays for such applications as shaft encoders, position sensing, key boards, and limit switch replacement.

Detailed technical data on the OP 160 source/OP 500 sensor and other OPTRON optoelectronic products . . . chips, discrete components, isolators, assemblies, and PC board arrays . . . is available from your nearest OPTRON sales representative or the factory direct.



**OPTRON, INC.**

1201 Tappan Circle  
Carrollton, Texas 75006, U.S.A.  
214/242-6571 • TELEX-73-0701  
TWX-910-860-5958

## ACROSS THE DESK

(continued from page 7)

a 4-bit comparator.

Divisors from 1 to 9 can be selected at the  $B_0$  to  $B_3$  inputs to the SN7485. The  $A = B$  output feeds back to reset the counter at the end of each count cycle.

Cascade this divider with others, and you can get many divisors.

The output pulse is approximately 50 ns wide. This width represents the propagation delay of the circuit.

John M. Franke  
Senior Design Engineer

Old Dominion University  
Dept. of Physics  
P.O. Box 6173  
Norfolk, VA 23508

## Misplaced captions



"Linda and I have been working on the project for quite a while and we got to be good friends."

Sorry. That's Jan van Eyck's "The Marriage of Giovanni Arnolfini and Giovanna Cenami," which hangs in The National Gallery in London.

## Metric system found wanting

A small item in the July 19 issue ("U.S. Metric Conversion Is Called 'Disjointed,'" ED No. 15, p. 21) discusses metric conversion

and the fact that it is most disjointed. Perhaps this is best.

The sad fact is that the best of the metric systems, the Systeme Internationale, is itself not abreast of present technology. It gives no cognizance to the fact that radiant energy in the visible band is the same as radiant energy in other bands—using the candela to measure the former and the watt to measure all other. It relates energy and mass through Newton's Law rather than Einstein's. It has two units for mass—the kilogram and the mole.

And worst of all, in this age of computers—which renders manda-

tory the adoption of the hexadecimal numbering system—the Systeme Internationale would load us for another go-round with the outmoded decimal-numbering system.

Let's hope our conversion to the metric system continues to be sabotaged by the people heading the program, either through design or ignorance. If they muddle it enough, we stand a good chance of emerging eventually with a system that is fully abreast of modern technology.

George E. Row

Rowco Engineering Co.  
4719 Squire Dr.  
Indianapolis, IN 46241

## Another way to convert seven-segment code

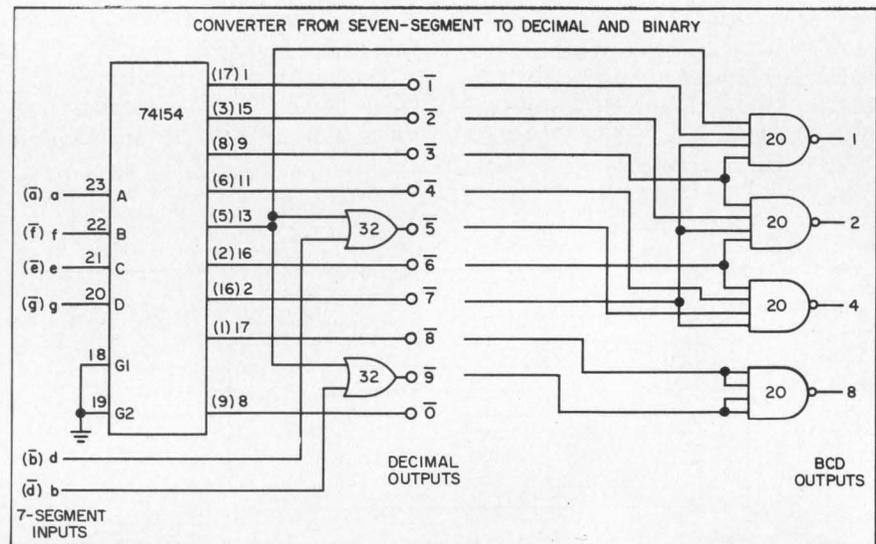

The Idea for Design "Convert 7-Segment Numerical Code to Decimal or BCD Outputs" (ED No. 4, Feb. 15, 1975, p. 96) is cumbersome and expensive. My solution uses fewer and cheaper devices.

The circuit employs segments a, e, f and g of the seven-segment code as inputs to a 4 to 16-line convertor, such as the 74154. Since all possible outputs of the four inputs are decoded, it makes little difference which inputs are used for the four segments; a unique output will appear for all seven-segment input codes except for 5 and 9. For these, OR gates resolve the ambiguity. If needed, two dual, four-input NAND gates produce the BCD outputs.

I used the CMOS units 74C154, CD4001 and 74C20. No inverters or level-matching devices are needed to match the seven-segment outputs. And it makes no difference whether these outputs are inverted or not; the 154 still provides unique decimal outputs, as described. The cost for normal 7400 devices is only about \$2.25, and only about \$4.50 for the CMOS series.

Note that the seven-segment code should be as produced by a 7447—no segment d on the 9, etc.

W. J. Richards

Adviser on Telecommunications  
North Atlantic Treaty Organization  
1110 - Bruxelles

(continued on page 19)



# MEASUREMENT COMPUTATION

innovations from Hewlett-Packard

# NEWS

OCTOBER, 1975

## in this issue

New MLA for 2700-channel radio systems

Low distortion and conversion loss with new mixer

Logic analyzer mates with your scope

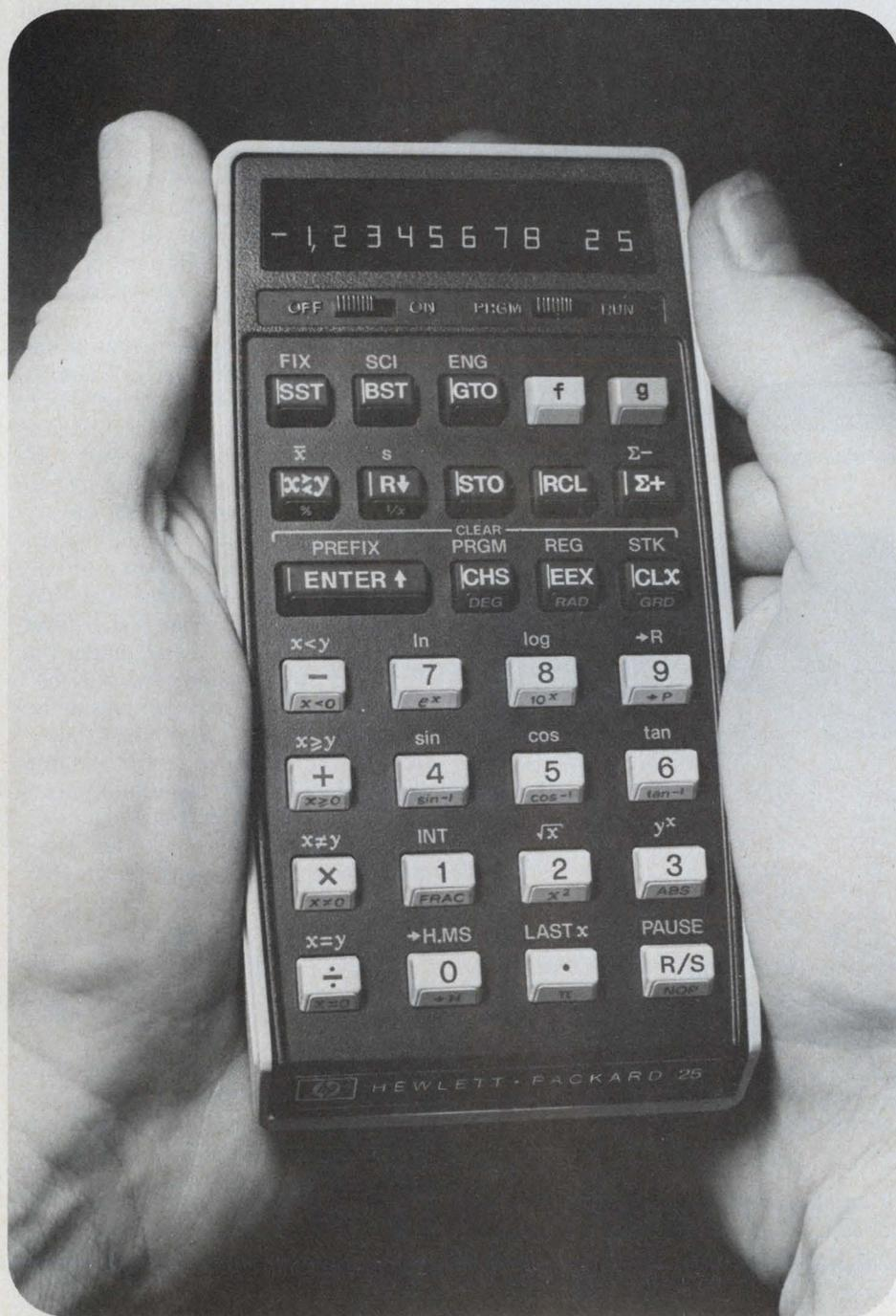

## The newest programmable

In the HP-25, power is combined with a price that allows any professional to keep his own personal model right at his fingertips.

The HP-25 is the newest member of the Hewlett-Packard hand-held calculator family. It incorporates all of the scientific features that engineers have told us were most important in their work. This includes programmability.

The HP-25 is a powerful calculator with the quality you have come to know from HP. With 72 pre-programmed functions and operations, 8 addressable memories, register arithmetic, you will have a tool that makes previously difficult tasks easy to complete.

With its programming capability, you just switch to PRGM, key in up to 49 steps in the same sequence you would use to solve the problem manu-

*(continued on third page)*

## "Hardware plus software" for swept measurements

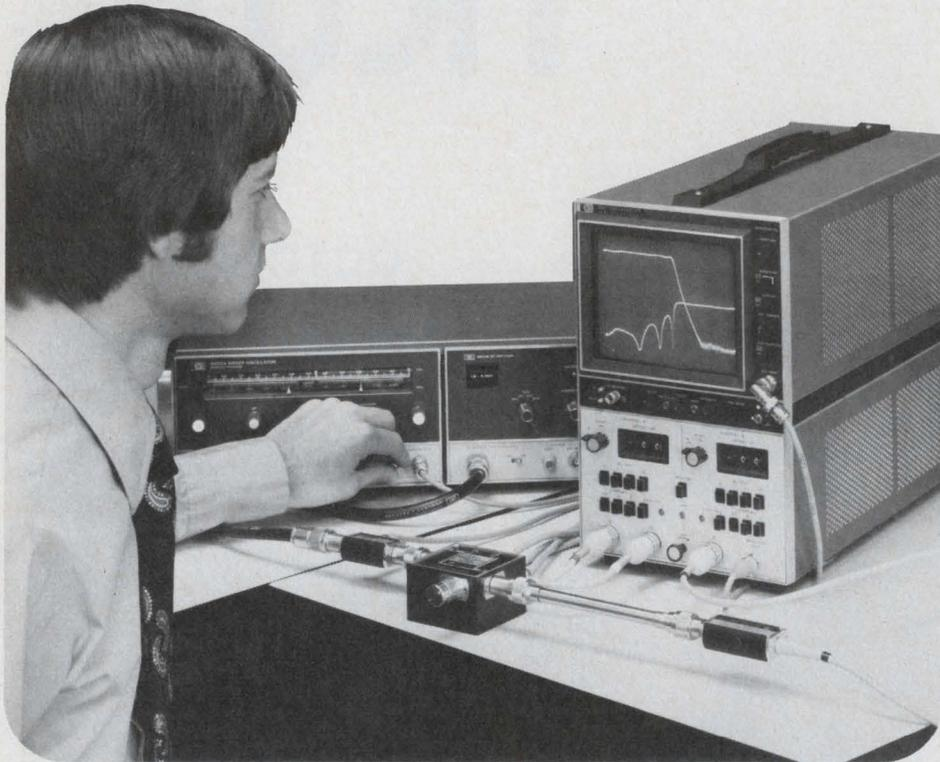

"Hardware"—New reflectometer bridge for HP 8755 test set brings convenience and precision to broadband measurements.

An ideal team for wideband swept measurements of transmission and reflection characteristics is the HP 8755 frequency response test set and HP 8620A sweeper with its new multi-octave RF plug-ins. Compact size, flat frequency response and wide 60 dB dynamic range are major features of this two-channel measurement system. And now the system's usefulness is further enhanced by the addition of the new HP 11666A Reflectometer Bridge. This diminutive directional device, with built-in detectors for the 8755, covers 40 MHz to 18 GHz with high directivity (>26 dB at 18 GHz).

To help assure that you will be making the most accurate, most thorough measurements possible, you'll want a copy of our new application note (AN 183), "High Frequency Swept Measurements." This 46-page booklet is a comprehensive presentation of swept impedance and transmission measurements in both coaxial and waveguide systems. Measurement procedures and accuracy considerations are discussed in detail.

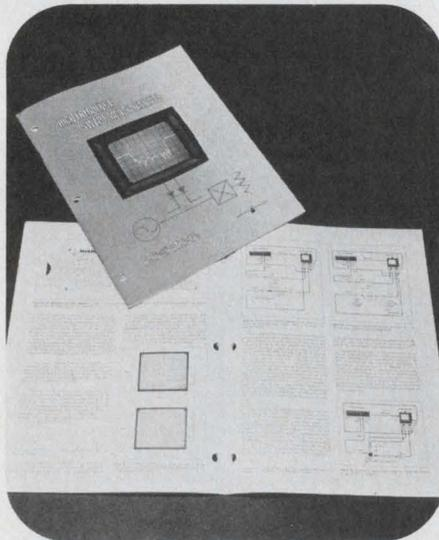

"Software"—Virtually everything you need to know about swept-frequency measurements is in our new Application Note.

*For a data sheet on frequency response test sets, check L on the HP Reply Card.*

*For your copy of Application Note 183, check P on the HP Reply Card.*

## HP ATLAS— a comprehensive approach to a world-wide test language

Hewlett-Packard offers HP ATLAS, a common test language for designers, test engineers, and test technicians designed to reduce the overall cost of test program generation, documentation, and maintenance while providing ease of understanding and use.

The English-like test language structure allows test procedures written in ATLAS to be read and analyzed by computers making it possible to develop computer programs that can translate ATLAS test procedures into instructions that control automatic test equipment (ATE).

HP ATLAS is an implementation of standard 416-10 ARINC ATLAS and is designed to work with HP 9500 Automatic Test Systems. It is the first implementation of a comprehensive subset of the 416-10 standard; not just a highly adapted pseudo-ATLAS. HP ATLAS is a higher-level language than the ATS BASIC previously used in HP 9500 ATE in much the same way that FORTRAN and COBOL are higher-level languages than assembly language. The HP ATLAS programmer need only be concerned with the requirements of the unit-under-test (UUT), with test statements that are independent of the test system. Therefore the test requirements of the UUT define the test procedure, and the test procedure is the test program. A test procedure written in HP ATLAS does not have to be rewritten or recoded for use on the test system. Thus an HP ATLAS Test Program is transportable, and can be employed by many users who may have different test system configurations.

HP ATLAS and HP 9500 Series Automatic Test systems have been combined to provide an integrated solution to the electronic test program problems of industry.

*For more details call your local HP representative or check M on the HP reply Card.*

## The newest programmable

(continued from page one)

ally. Switch to RUN, key in your variables. Press RUN/STOP and you can run your program over and over again. You save time, achieve a high level of accuracy, and solve problems for which you previously may have had to wait for time on a computer.

The HP-25 can be programmed to make decisions because it can do conditional branching, using eight relational tests.

Here are other extras: engineering notation, RPN logic, an integer/fraction truncation key, absolute value key.

The HP-25 puts programming power into your hands. The application manual supplied helps you to realize the full potential of your new scientific calculator. 54 programs are included from the varied areas of algebra, number theory, trig, analytical geometry, numerical methods, statistics, finance, surveying, navigation and even games.

For science and engineering students, the HP-25 can be the key that opens up the world of higher mathematics and computer programming.

Don't just take our word for it. Try one for yourself.

*If you want more detailed capability information sent to you, check A on the HP Reply Card. We will send you a brochure that takes you through the HP-25 a step at a time.*

## Improve lab recording with HP's most sensitive recorder

A special combination of acceleration and sensitivity, the 7047A x-y recorder is the fastest, most sensitive recorder that HP has ever built. Sensitivity ranges from 50  $\mu\text{V}/\text{in.}$  to 10 V/in. (20  $\mu\text{V}/\text{cm}$  to 5 V/cm). Acceleration on the y axis is greater than 3000 in/sec.<sup>2</sup>. Slewing speed is 30 in/sec. (76 cm/sec).

To meet the demands of the most exacting lab work, the 7047A recorder has a switchable input filter, fully-guarded input, 130 dB common mode rejection, 11 scales of calibrated offset,

## Very low phase noise oscillator at affordable price

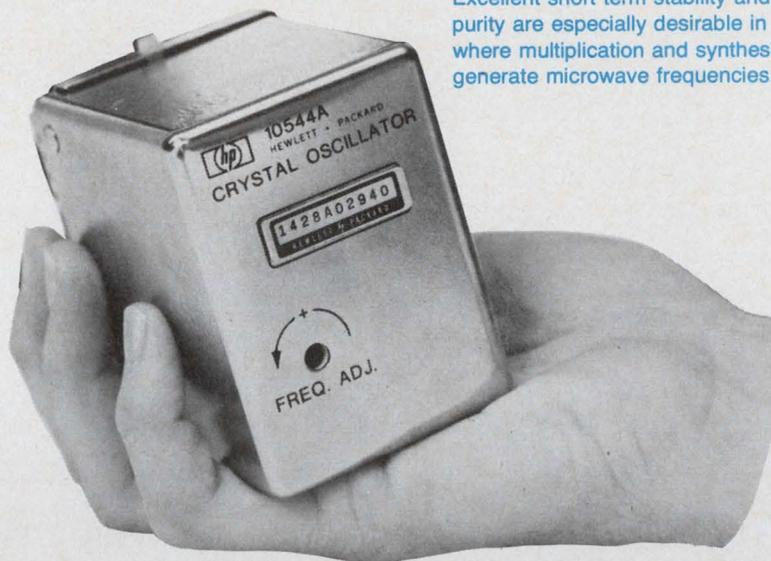

Aging Rate:  $5 \times 10^{-10}$ /day

Phase Noise: -140dB/Hz at 100 Hz  
-145 dB/Hz at 1000 Hz

Short Term Stability:  
 $1 \times 10^{-11}$  at 1 sec avg.

Fast Warm Up:  
Within  $5 \times 10^{-9}$  in 20 min.

Consider these specifications and you will discover that the HP 10544A is a superior oscillator in its class. In addition, the rugged 10544A also offers low operating power (3W at 25°C after 15 min.), wide operating temperature range (-55°C to +71°C), and small size (72mm x 52mm x 62mm).

Excellent short term stability and high spectral purity are especially desirable in applications where multiplication and synthesis are used to generate microwave frequencies.

If you have an application in communication or navigation systems, frequency synthesizers, time-code generators, counters, spectrum analyzers, or any other application that requires a very stable 10 MHz\* output frequency, we believe that the 10544A has much more to offer for its price.

\*Other frequencies available from 4.5 to 12 MHz on special order.

For more information, check K on the HP Reply Card.

an internal time base, and TTL remote control. And the 7047A is easier to use than any other x-y recorder available: its internal guard circuit enables you to use the 7047A with virtually any input connection configuration. In most applications, there's no need for external guard connections.

For details and specifications, check J on the HP Reply Card.

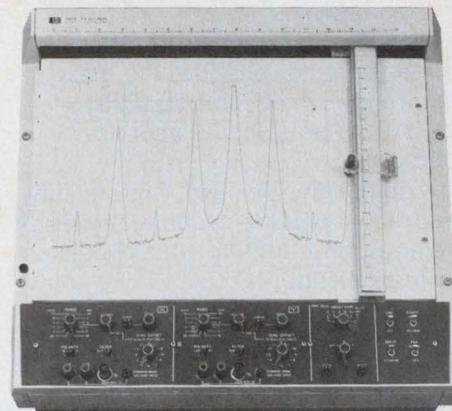

The 7047A: the best x-y recorder HP has ever developed.

## Pulse generator delivers tailored pulses for your testing problems

## NEW applications literature for RF and microwave work

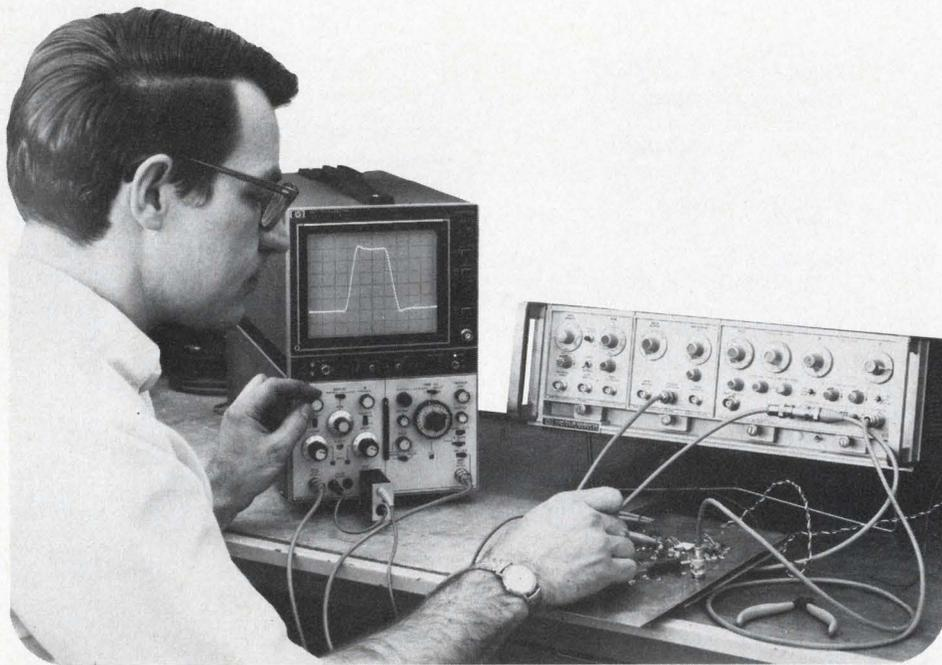

The all solid-state 1900 series pulse generator provides the maximum in flexibility and versatility both in pulse and digital applications.

Completely specified, high-quality test pulses provide accurate, dependable response tests of your circuits or instruments.

With HP's 1900 series pulse generators, you can deliver pulses with power as high as 50V (1A into 50 $\Omega$ ). Or, you can select lower-power units with selectable rep rates up to 125 MHz. Plug-in building blocks let

you custom design your pulse testing system.

For the "what" and "how" kind of technical data you need to tailor a pulse testing system for your applications, get our free 38 page data sheet. You'll then have complete data on output pulse shapers, generators (rate, delay, multiphase, word), and PRBS and bit-error detectors. As part of this data sheet, you'll also receive a planning guide to simplify your selection and to save you time and money.

For your free copy, check D on the HP Reply Card.

Three new application notes are available for work in specialized areas of RF and Microwave.

### AN 164-3 New Techniques for Analyzing Phase Lock Loops

All engineers designing phase-lock loops should be interested in this significant new measurement technique. By using the phase-modulated 8660C synthesized signal generator, complete phase/amplitude characterization and transient performance of phase lock loops and phase detectors is easily accomplished. Detailed procedures and test set-ups are described.

Check Q on the HP Reply Card.

### AN 164-4 Digital Phase Modulation (PSK) and Wideband FM

With newly-available phase modulation capability, the HP 8660C synthesized signal generator offers unique modulation formats that are not immediately apparent. Simulation of digital phase modulations such as phase-shift-keyed (PSK), bi-phase (BPSK), and quadra-phase (QPSK) can be simulated with procedures described in this note.

Frequency band coverage of the 8660C (1 to 2600 MHz) matches the emerging applications of digital phase formats. High rate FM simulations are also described.

Check R on the HP Reply Card.

### AN 196 Automatic Power Measurement Using the HP 436A Power Meter

Five practical measurements are described for a microwave mini-system using the 436A programmable power meter under calculator control. One useful example is calibration of coaxial attenuator pads with typical accuracy of  $\pm 0.2$  dB at 20 dB and 18 GHz. Another is a procedure for transferring calibration factor of coaxial thermocouple power sensors, usually a tedious, expensive process for calibration labs.

Such attenuation measurements and calibration transfers can be made with good accuracy because of the low SWR inherent in the 8480 series power sensors used. Accuracy considerations and annotated listings of software are given.

Check S on the HP Reply Card.

## Introducing NEW 140 MHz IF microwave link analyzer for 2700-channel systems

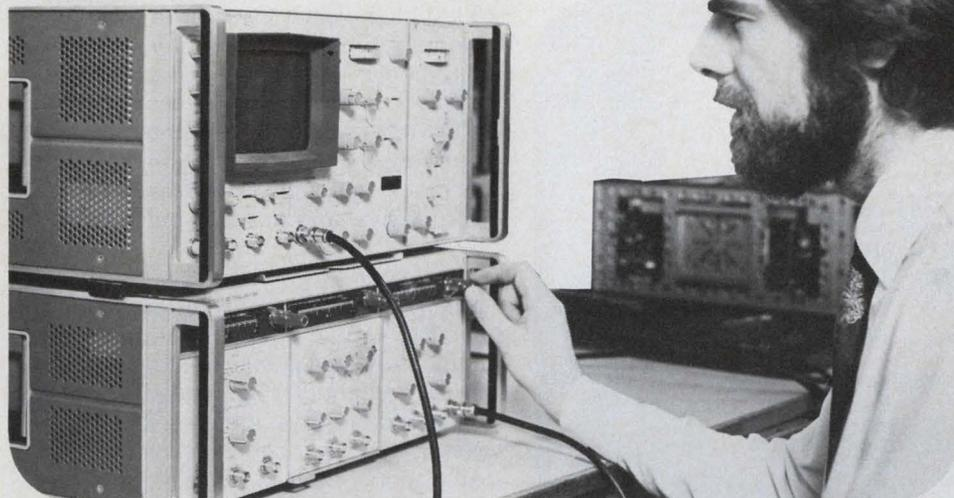

Perform swept measurements of group delay, linearity, differential gain and differential phase on broadband microwave radio systems with the new 3790A/3792A 140MHz IF MLA.

Growth in telecommunications has led to the development of microwave radio systems which use the RF spectrum more effectively by increasing the number of channels per radio carrier from 1800 to 2700. Implementation of the new 2700-channel systems requires the use of an IF carrier frequency of 140MHz, compared with the 70MHz of 1800-channel systems. With higher channel capacities, the use of high-frequency test-tone measuring techniques becomes increasingly more important, as does the need for improved back-to-back performance from the test equipment.

The 3790A/3792A Microwave Link Analyzer (MLA) is a combined baseband (BB) and intermediate frequency (IF) analyzer designed for operation on the new 2700-channel radio systems. The MLA (3790A IF/BB transmitter + 3791A plug-in, and 3792A IF/BB receiver + 3793A plug-in) allows the various forms of distortion occurring in these systems to be identified, measured and localized to BB and IF devices.

The 3790A/3792A performs swept measurements of IF amplitude, group delay, linearity, return loss, differential phase and differential gain on systems operating with an IF in the band 115 to 165 MHz.

A versatile measuring instrument, the new MLA has applications in the

development, production, installation and maintenance of broadband microwave radio systems.

- Comprehensive IF coverage, 115 to 165 MHz.
- Comprehensive BB coverage, 83.333kHz to 12.39 MHz; eight selected baseband test tones up to 12.39MHz; plus an external test tone up to 15MHz.
- Internal demodulation up to 5.6MHz.
- IF frequency markers of 2 or 5MHz 'comb' and/or sliding marker (with frequency indication on 4-digit LED display).
- Inbuilt CRT, with dual-trace display.
- Complete microwave link analysis at BB and IF (with add-on RF capability).

As higher modulating frequencies, number of channels and performance requirements are increased, the need for more accurate and easy to use instrumentation also increases. The HP 3790MLA provides the necessary performance to insure accurate measurement of important distortions and high performance radio systems.

For technical information, check F on the HP Reply Card.

Just published—Guide to HP Spectrum Analyzers

Now available is our new 12-page brochure describing Hewlett-Packard's wide-range spectrum analyzer product line. The illustrated booklet presents summaries of each analyzer's features and characteristics, making it easy to find the instrument and accessory items that best match your requirements.

With spectrum analyzers covering from 5 Hz to 40 GHz, you can be sure there's an HP analyzer with the range and precision to fill your frequency domain measurement needs.

Send for your free copy today. Check O on the HP Reply Card.

The Answer to your Frequency Domain Measurement Needs

Quantitative Spectrum Analyzers 5 Hz to 40 GHz

HEWLETT-PACKARD

## New portable digital multimeter delivers lab-grade quality and performance at an economical price



New 4½ digit five-function DMM is accurate, sensitive and easy to use.

The new HP 3465A Digital Multimeter features performance and accuracy that qualify it for lab use. Its 10 mV dc range provides 1  $\mu$ V sensitivity. Its ease of operation, light weight, and battery power make it attractive for such cost sensitive applications as production test, service maintenance and education. With its dc/ac/ohms and current measurement capability, it is well suited for CATV, communications and appliance troubleshooting.

Take a look at the front panel. It has all the functions and ranges you'd expect, and more. You get ohms, ac/dc volts, and ac/dc current. The display is a large LED for easy viewing, and extra resolution is obtained with a full scale readout of 19999. Accuracy is  $\pm 0.02\%$  of reading  $\pm 0.01\%$  of range on dc, meeting the needs for most field or bench applications. The 10 mV dc range and 100 mV ac range provides performance typically found only on

more expensive 5½ digit multimeters. The instrument can be powered by any one of four optional power sources: D-cell batteries, the hand-held calculator charger, Ni-cad batteries, ac line.

HP's 3465 uses IC and thin-film technology to combine high sensitivity and accuracy offering wide capability, measurement convenience and user confidence within a reasonable cost.

The standard 3465A is fully equipped with an internal power supply, a battery recharging circuit, and Ni-cad batteries. If you wish to power the HP 3465A from its furnished dry cell batteries, order Option 002. (Option 002 will operate from ac lines when using one of HP's 82002A chargers supplied with most HP pocket calculators). For ac operation only, order Option 001.

To receive new data sheet on this multimeter, check E on the HP Reply Card.

## New Universal Counter measures time intervals precisely

A choice of 100 ns or 10 ns single-shot resolution fits the new HP Model 5328A Universal Counter to a broad range of precision time interval measurements. With averaging to 10 ps resolution for repetitive events, this 100 MHz counter is well suited to measure key logic circuit parameters such as clock rates, pulse widths, propagation delays, and pulse-to-pulse time intervals.

An extensive user feedback system speeds measurement setup and helps avoid potential errors. Tri-state trigger lights show at a glance the trigger status of each channel. High speed markers, for scope displays, indicate where triggering actually occurs on a waveform. An optional built-in DVM reads trigger level settings with digital accuracy.

For more demanding applications, the optional high performance universal module offers several added features. Single-shot resolution of 10 ns meets requirements for ballistic time-of-flight and nuclear event measurements. Switch selectable 50 ohm input impedance solves termination problems common with standard 1 megohm inputs used in high speed pulse circuits. A "delay" feature allows the stop channel to ignore events until the delay expires. For example, delay makes possible measurements from the first to the fourth bit in a bit stream.

For more information check G on the HP Reply Card.



This 100 MHz counter is well suited to measure key logic parameters such as clock rate, pulse widths, propagation delays, and pulse-to-pulse time intervals.

## New miniature printed circuit balanced mixer for TV, stereo, mobile radio

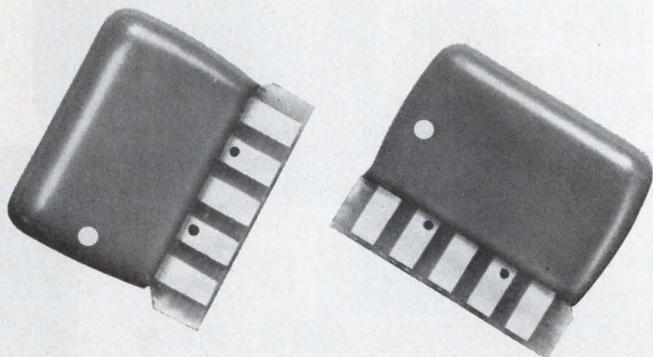

The HP 5082-9200 printed circuit balanced mixer covers the range from dc to 1200 MHz (RF/IF) and 100 to 1200 MHz (LO).

For users requiring large quantities in manufacture of television tuners, CATV converters, FM stereo, mobile radio and instrumentation, this new single-balanced mixer has lower distortion and lower conversion loss than currently available types in its price range. Its 2nd order distortion intercept is +38 dBm; its 3rd order intercept is +23 dBm. Conversion loss is 6.5 dB and isolation (LO to RF/IF) is 45 dB at 200 MHz; 25 dB at 900 MHz.

The mixer contains a monolithic Schottky diode pair and a printed circuit transformer. This construction, with epoxy encapsulation, results in a rugged,

low-cost package with product uniformity.

The 5082-9200 package is designed for easy printed-circuit board insertion and soldering. It measures 14.6 mm (0.579 in.) wide, 12.7 mm (0.5 in.) high and 3.05 mm (0.12 in.) thick.

*For more information and suggested applications, check I on the HP Reply Card.*

## New subminiature, solid state red lamps can be spaced 2.54 mm center-to-center

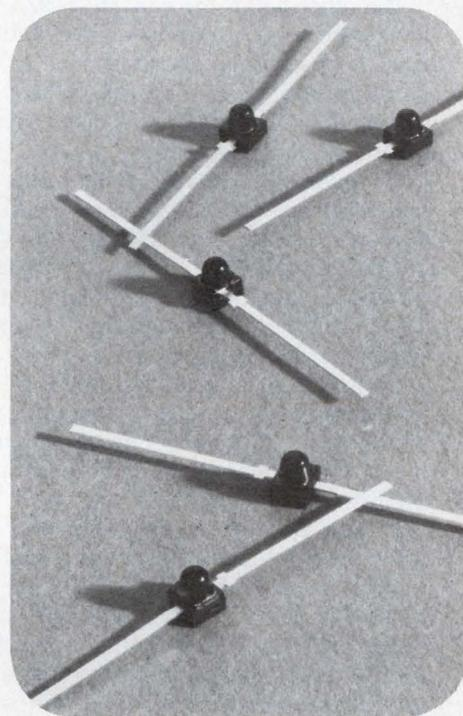

Long life and solid state reliability in new low package profile lamp.

## HP diodes are now in stock at your local distributor

Now you can order Hewlett-Packard high-performance Schottky and PIN diodes from distributor stock near you. Here are some of the popular devices available.

### SCHOTTKY DIODES

- 5082-2800 70 V breakdown, picosecond switching Schottky diode. (1N5711)
- 5082-2810/2811 15 V and 20 V low capacitance Schottky diodes. (1N5712/13)
- 5082-2835 Low turn-on voltage, picosecond switching Schottky diode.

- 5082-2900 High sensitivity, low noise detector Schottky diode.
- ### PIN DIODES
- 5082-3080/3081 HF/VHF/UHF low distortion current controlled resistor and general purpose switching diodes. (1N5767)
  - 5082-3168/3188 Low series resistance, general purpose VHF/UHF switching PIN diodes.

*If you wish to have someone contact you regarding HP Schottky or PIN diodes, check N on the HP Reply Card.*

The 5082-4100/4101 are Gallium Arsenide Phosphide Red Solid State Lamps packaged in a radial lead subminiature outline of molded epoxy. The red diffused lens provides high on-off contrast and wide-angle viewing.

Arrays are available upon special request. The arrays are comprised of a group of 5082-4101 solid state lamps arranged in a molded linear configuration with separately accessible radial leads for each device. The center-to-center spacing is 2.54 mm (0.100 in.).

*For detailed specifications, check H on the HP Reply Card.*

# The scope on your bench is half of our digital analysis system

The other half is the new HP 1607A logic state analyzer. Simply make four BNC connections, and you have a combination logic analyzer and oscilloscope—a complete analysis system for the digital designer.

**Data domain or time domain.** In the data domain, the system shows you a display of logic states in operational circuits so you can pinpoint a program problem. Then in the time domain, the 1607A triggers your scope at the point where the problem occurs so you can analyze the electrical characteristics of the waveform using the conventional scope input. Now you can really pin down those hardware/software compatibility problems.

**Parallel words to 16 bits.** The 1607A triggers on any preset word up to 16 bits wide...and at clock speeds to 20 MHz. In the data domain, it displays—on your scope's CRT—15 sequential words before, after, or surrounding the trigger word. You see the bits as 0's or 1's for easy analysis of your circuits or programs—while they're operating full speed.

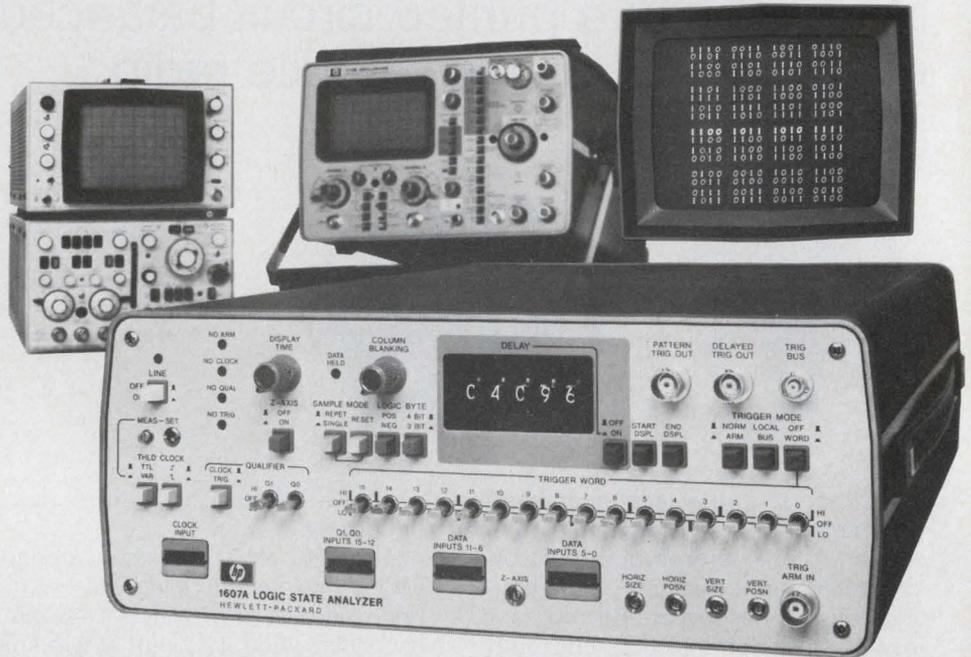

The 1607A and your scope provide you with the tools for program analysis of microprocessor based systems, for microprogram analysis in minicomputers, faster design or easier troubleshooting.

**Qualifier inputs help locate data.** If you're looking for specific data on a busy bus, the 1607A's qualifier inputs let you selectively extract data of interest...then observe either logic states or electrical parameters.

**Drives a scope or display.** The 1607A drives nearly all modern scopes. You can even combine the logic state an-

alyzer with a large-screen CRT display for easy viewing at a distance, such as a classroom situation.

*For complete details on how it can take you and your scope into the data domain, check C on the HP Reply Card.*

HEWLETT  PACKARD

East-4 Choke Cherry Road, Rockville, MD 20850

Ph. (301) 948-6370.

South-P.O. Box 28234, Atlanta, GA 30328,

Ph. (404) 434-4000.

Midwest-5500 Howard Street, Skokie, IL 60076,

Ph. (312) 677-0400.

West-3939 Lankershim Blvd, North Hollywood, CA 91604, Ph. (213) 877-1282.

Europe-P.O. Box 349, CH-1217 Meyrin 1, Geneva, Switzerland, Ph. (022) 41 54 00.

Canada-6877 Goreway Drive, Mississauga, Ontario, L4V 1L9, Ph. (416) 678-9430.

Japan-Yokogawa-Hewlett-Packard Ltd., Ohashi Bldg., 59-1 Yoyogi, 1-chome, Shibuya-ku, Tokyo 151, Ph. 03-370-2281/92.

*(continued from page 8)*

### Good news, bad news

First, the bad: The price of the Hewlett-Packard Model 1712A oscilloscope, as published in the New Product item "Scope Resolves Time Intervals to 100 ps" (ED No. 16, Aug. 2, 1975, p. 114) should have been \$3100, not \$310. Sorry for the typographical error.

Now the good news: HP has since dropped the price of the 1712A to \$2950.

### Price counts, too, in squaring circuits

A. Paul Brokaw suggests in a letter entitled "Squaring Circuit Idea Missed a Good Bet" (ED No. 14, July 5, 1975, p. 7) that I should have used the Analog Devices AD532 internally trimmed multiplier instead of the externally trimmed MC1495L in my Idea for Design ("Squaring Circuit Generates Second Harmonic for Controlled-Distortion Test Signal," ED No. 8, April 12, 1975, p. 78).

Of course, it is advantageous to avoid adjustments wherever possible. However, what Mr. Brokaw failed to mention was that the small-quantity price of the AD532 is \$26 vs approximately \$7 for the MC1495L. A cost-convenience tradeoff must be made. If an adjustment-free approach is desired, the AD532 has truly impressive parameters and can be used to implement the test circuit.

*Arthur B. Williams*

*Manager Analog Development  
Coherent Communications Systems Corp.  
85D Hoffman Lane South  
Central Islip, NY 11722*

### Wrong telephone number

We accidentally used the TWX number for the Hybrid Systems product announcement in ED No. 17, August 16, 1975, p. 104. The correct telephone number is (617) 272-1522.

# TIPS TO IMPROVE YOUR DRIVING

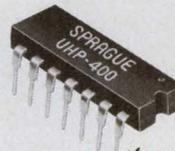

(power and relay driving, that is)

## 1. Control 100-watt loads with a single IC.

Sprague's Power Driver Series UHP-500 will switch 4 outputs of 250 mA each @ 100 volts.

## 2. Use the power driver line that gives you a choice of three breakdown voltages.

Sprague's new 70-volt series is now available, along with 100-volt and 40-volt devices, to more closely match your specific needs.

## 3. Don't settle for dual drivers when you can get quads.

Sprague's power and relay drivers give you twice the capability for practically no additional cost. The line includes AND, OR, NAND, and NOR devices that incorporate suppression diodes, monolithic logic gates, and high-current switching transistors.

## 4. Select drivers of proven reliability.

Sprague power and relay drivers have been around a lot longer than competitive devices. Years of design and manufacturing know-how insure dependable driving of lamps, relays, solenoids, and other interface devices.

*If you've got the application, we've got the drive! Write or call Chuck Scott, Semiconductor Division, Sprague Electric Co., 115 Northeast Cutoff, Worcester, Mass. 01606. Tel. 617/853-5000.*

*For Engineering Bulletin 29300B, write to Technical Literature Service, Sprague Electric Co., 347 Marshall St., North Adams, Mass. 01247.*

*For the name of your nearest Sprague Semiconductor Distributor, write or call Roger Lemere, Sprague Products Company, North Adams, Mass. 01247. Tel. 413/664-4481.*

THE BROAD-LINE PRODUCER OF ELECTRONIC PARTS

**SPRAGUE**  
THE MARK OF RELIABILITY

455-4144

# INTRODUCE SURVIVE

To help you survive in the fast-paced, sometimes costly, world of microprocessors, MOSTEK introduces the F8 Evaluation Kit for only \$297.

Three F8 circuits (MK 3850 CPU, MK 3851 ROM — with DDT-1™ —, MK 3853 Static Memory Interface), 1K x 8 of static RAM, a crystal, 2 CMOS buffers and our 6.75" x 5.5" PC Board.

You add a few discrete components and a TTL 7406. Now you've got a complete F8 microcomputer with 24 lines of I/O for your use.

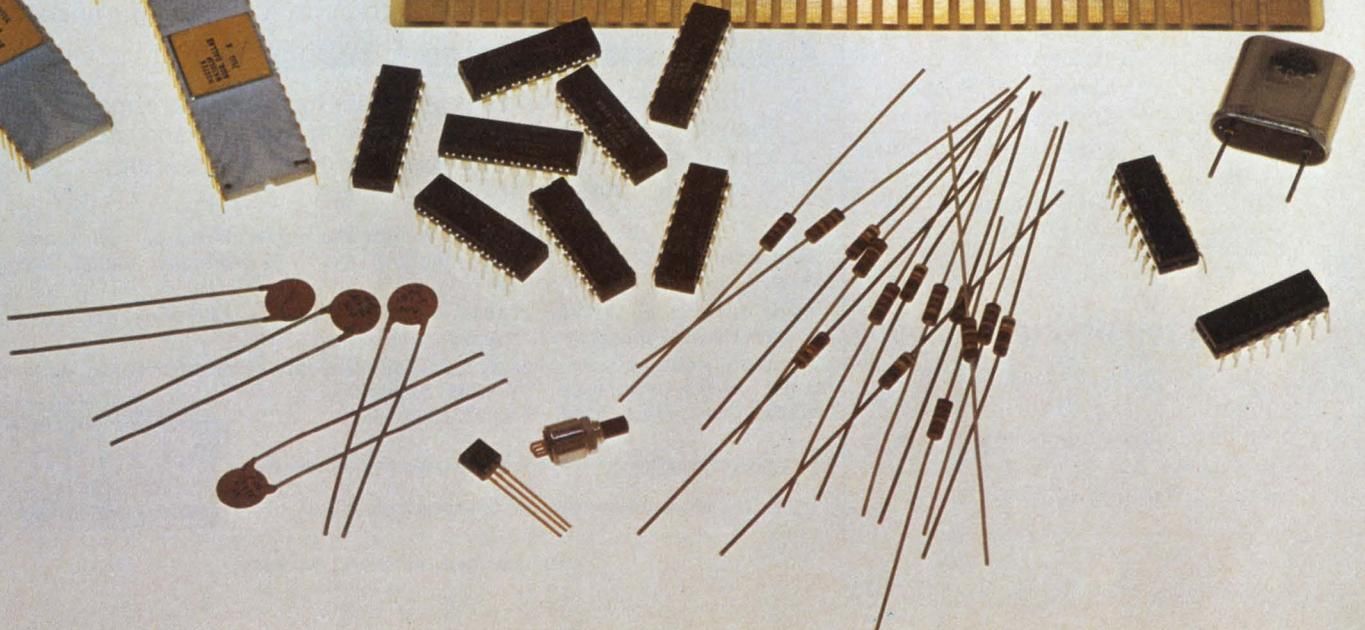
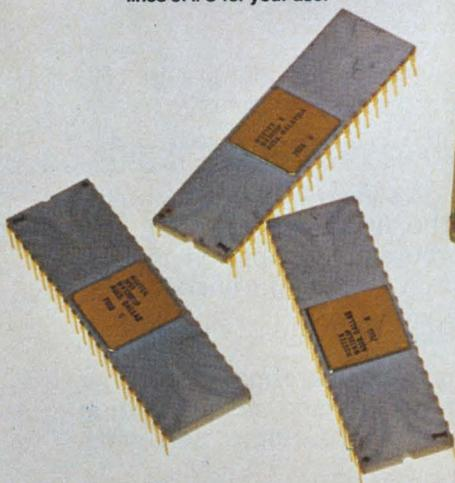
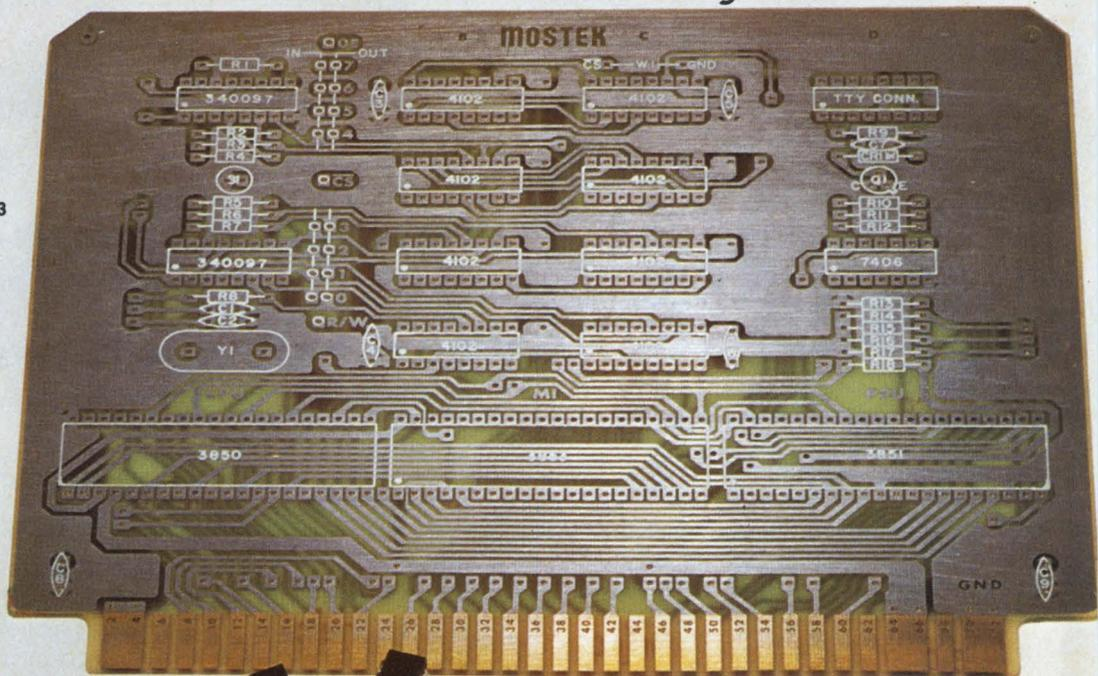

# CING THE VAL KIT.

What is the world of microprocessors coming to?

Everytime you turn around there's another one. And here you go. More research. Another breadboard. More time. More expense.

The F8 goes a long way towards solving the problem. It is the first 2 chip, 8-bit, self-contained microprocessor system. And it's, by far, the simplest to build and the least expensive.

There's no need for additional packages for I/O logic and latches, clock generation, address logic, RAM storage or power-on reset. It's all there on the F8 CPU and the F8 ROM.

But let's face it, it is another microprocessor to evaluate. Normally, this would mean another system to build up. More time. More expense.

Not any more. With our F8 Survival Kit, we've made it easy. All it takes is a soldering iron, 30 minutes of assembly, your teletype or CRT terminal and you can be writing and executing F8 programs.

Our documentation support includes a detailed application note with step-by-step assembly instructions and sample programs to get you started.



And to aid in program development, the DDT-1™ ROM software will permit program loading, storing, modification, debugging (with "traps") and even hexadecimal arithmetic — all from the teletype.

Stop by one of our distributors and pick up an F8 Survival Kit. Only \$297.

We're out to make it easy for you to survive in the world of microprocessors.

## DISTRIBUTORS

### ARIZONA

Phoenix:  
Cramer Electronics  
602/267-7312  
Kierulff Electronics  
602/273-7331

### CALIFORNIA

Irvine:  
Cramer Electronics  
213/771-8300  
Los Angeles:  
Kierulff Electronics  
714/636-1030  
Palo Alto:  
Kierulff Electronics  
415/968-6292  
San Diego:  
Cramer Electronics  
714/565-1881  
Kierulff Electronics  
714/278-2112  
Sunnyvale:  
Cramer Electronics  
408/739-3011

### COLORADO

Denver:  
Cramer Electronics  
303/758-2100  
Kierulff Electronics  
303/371-6500

### CONNECTICUT

Hamden:  
Arrow Electronics  
203/248-3807  
North Haven:  
Cramer Electronics  
203/239-5641

### FLORIDA

Clearwater:  
Southland, Inc.  
813/443-4514  
Hollywood:  
Cramer Electronics  
305/923-8181  
Orlando:  
Cramer Electronics  
305/894-1511

### GEORGIA

Atlanta:  
Cramer Electronics  
404/448-9050

### ILLINOIS

Elmhurst:  
Semiconductor Specialists  
312/279-1000  
Mt. Prospect:  
Cramer Electronics  
312/593-8230  
Skokie:  
Bell Industries  
312/965-7500

### INDIANA

Indianapolis:  
Pioneer Standard  
317/849-7300  
Semiconductor Specialists  
317/243-8271

### MARYLAND

Baltimore:  
Arrow Electronics  
202/737-1700  
Gaithersburg:  
Cramer Electronics  
301/948-0110  
Hanover:  
Cramer Electronics  
301/796-5790

### MASSACHUSETTS

Billerica:  
Kierulff Electronics  
617/667-8331  
Newton:  
Cramer Electronics  
617/969-7700

### MICHIGAN

Farmington:  
Semiconductor Specialist  
313/478-2700

Livonia:  
Pioneer Standard  
313/525-1800

### MINNESOTA

Edina:  
Cramer Electronics  
612/835-7811  
Minneapolis:  
Semiconductor Specialists  
612/854-8841  
Stark Electronics  
612/333-3361

### MISSOURI

Hazelwood:  
Semiconductor Specialists  
314/731-2400  
Kansas City:  
Semiconductor Specialists  
816/452-3900  
St. Louis:  
Olive Industrial Electronics  
314/863-7800

### NEW JERSEY

Cherry Hill:  
Cramer Electronics  
609/424-5993  
Moonachie:  
Cramer Electronics  
201/935-5600

### NEW MEXICO

Albuquerque:  
Cramer Electronics  
505/265-5767  
Moorestown:  
Arrow Electronics  
609/235-1900  
Saddlebrook:  
Arrow Electronics  
201/797-5800

### NEW YORK

East Syracuse:  
Cramer Electronics  
315/437-6671  
Farmingdale:  
Arrow Electronics  
516/694-6800  
Hauppauge, L.I.:  
Cramer Electronics  
516/231-5600  
Rochester:  
Cramer Electronics  
716/275-0300

### NORTH CAROLINA

Winston-Salem:  
Cramer Electronics  
919/275-8711

### OHIO

Cleveland:  
Cramer Electronics  
216/248-8400  
Dayton:  
Pioneer Standard  
513/236-9900  
Semiconductor Specialists  
513/278-9455

### PENNSYLVANIA

Pittsburgh:  
Semiconductor Specialists  
412/781-8120

### TEXAS

Dallas:  
Cramer Electronics  
214/661-9300

### UTAH

Salt Lake City:  
Alta Electronics  
801/486-7227  
Cramer Electronics  
801/487-4131

### WASHINGTON

Seattle:  
Cramer Electronics  
206/762-5755  
Kierulff Electronics  
206/763-1550

### WISCONSIN

Milwaukee:  
Semiconductor Specialists  
414/257-1300

### CANADA

Downsview, Ontario:  
Cramer Electronics  
416/661-9222

### Montreal:

Prelco Electronics  
514/389-8051

### PUERTO RICO

San German:  
Cento Commercial  
809/892-1130

# MOSTEK

1215 W. Crosby Rd.  
Carrollton, Texas 75006  
In Europe, contact:  
MOSTEK GmbH, TALSTR. 172  
7024 Bernhausen, West Germany  
Telephone: 798038

**You can buy  
this Spectrum Analyzer  
and take a big chunk  
out of your budget.**

**You can rent  
this Spectrum Analyzer  
and get more  
equipment out of  
your budget.**



Even the best equipment budget can only go so far. And at the price you pay for electronic test equipment nowadays, that's not very far at all.

Unless you rent your equipment from REI.

When you rent from us, there's no large cash outlay. You pay only for the time you have your instruments, and you return them when you're through. So you never have to spend your money on idle equipment.

Getting more for your money is just one reason for renting from REI. Immediate delivery is another. We have over \$10 million in inventory in fully stocked centers around the country. And, when you have short-term needs, you can rent equipment for just as long as you need it, and make it pay for itself.

REI stocks over 8,000 fully checked-out test instruments, and they're ready whenever you are. For the full story on renting, as well as our low prices, send in the coupon for prompt delivery of our free illustrated catalog... or call us now for your immediate requirements.

Rental Electronics, Inc.  
99 Hartwell Avenue, Lexington, Mass. 02173  
Please send me your free instrument rental catalog:

Name \_\_\_\_\_ Title \_\_\_\_\_

Company \_\_\_\_\_

Address \_\_\_\_\_

City \_\_\_\_\_ State \_\_\_\_\_ Zip \_\_\_\_\_

Tel. Number \_\_\_\_\_

**Rental Electronics, Inc.** 

A PEPSICO LEASING COMPANY

Burlington, MA (617) 273-2770 • Gaithersburg, MD (301) 948-0620 • Oakland, NJ (201) 337-3757 • Ft. Lauderdale, FL (305) 771-3500  
• Des Plaines, IL (312) 827-6670 • Dallas, TX (214) 661-8082 • Mountain View, CA (415) 968-8845 • Anaheim, CA (714) 879-0561  
• Rexdale, Ontario (PLC Leasing Ltd.) (416) 677-7513

INFORMATION RETRIEVAL NUMBER 9

OCTOBER 11, 1975

## 13 radio navigation systems urged instead of present 77

There are far too many radio navigation systems in use today, according to a report prepared for the President's Office of Telecommunications Policy by Computer Sciences Corp.

If the 77 systems now operating were reduced to 13, the study says, \$3.5-billion would be saved over the next 20 years.

In addition to the monetary savings, says the office's acting director, John Eger, a tremendous amount of radio spectrum would be saved. Navigation equipment now uses 16 per cent of the radio spectrum, compared with 1 per cent by the nation's broadcast industry.

Two of the key issues are whether the future Federal systems should be satellite or ground-based, and whether separate military and civilian systems should be maintained.

The Office of Telecommunications Policy has requested and interagency steering group to develop an integrated plan based on models developed in the study for both approaches—space and ground.

The satellite plan would consist of 13 systems and cost an estimated \$7.73-billion to install and maintain over a 20-year period. The ground-based plan would consist of 14 systems at a cost of \$7.95-billion.

Under the satellite plan, long and medium-range navigation would be provided by a 24-satellite network with a ground-based system for backup, and a system for coastal approach and channel navigation by ships.

The ground-based plan would utilize a system such as Omega or Loran for long-range and medium-range navigation, a less elaborate 24-satellite network for aerial mapping and a backup radio system for long-range navigation.

Common to both would be a Discrete Address Beacon System, an

en-route air traffic control system, an MLS (microwave landing system), ship-board radar, radar altimeter, transponder for ships, a proximity system for vehicle tracking, a radio-positioning system for surveys, and ICNI (integrated communications, navigation, identification) for friendly unit position-determination.

Both plans call for a maritime radio beacon-direction finder and ADF for visual homing in conjunction with ILS.

Officials in the Office of Telecommunications Policy carefully refrain at this time from spelling out which systems would be dropped in either plan.

### 'Classified ads' put into computer system

For the designer or company searching for an obscure component, for the engineer seeking technical advice on a little known area of design or for the engineer looking for venture capital to start his own company, a new worldwide computerized "classified ad" system is being set up by Control Data of Minneapolis.

All you do is dial a toll-free number to CDC's computer and describe your needs via special keywords. The computer indicates the companies that can fill your needs. Then you can request detailed descriptions about those companies and subsequently get as many names and addresses as you want for \$50 apiece.

The computer is part of a system CDC calls Technotec, designed to make the sharing of technical information easier.

Engineers or companies with a product or service to sell can place an "ad" in this system for only 10¢ per character per year. In ad-

dition to the ad, an advertiser would submit a list of keywords that describe the product or service.

According to Gerard M. Beau-gonin, president of CDC's Technotec and Worldtech operations, a user who wishes to access any of the ideas, processes, patents or expertise recorded in the system has to pay \$80 for each hour he is connected to the computer. Most searches, he points out, should only take a few minutes.

Access to the Technotec system can be obtained with a computer terminal through CDC's Cybernet time-sharing network, or with a teletype machine through the Telex or TWX networks.

### Network processor has unusual structure

A family of data-communication network processors recently introduced by Codex Corp., Newton, MA, is said to provide a completely new approach to data network architecture.

Arthur Carr, Codex president, notes that the 6000 Series processors permit sophisticated data networks to be built without customized programming and at considerably reduced cost.

Carr points to such features as these:

- Transparency. The replacement of existing communications hardware with Codex network processors requires no software changes, modification of protocols or hardware engineering by the user.

- Network management. From a central site, the user or host computer can monitor conditions throughout the network, initiate diagnostic routines and reconfigure network characteristics.

- Efficiency. Line costs are reduced by use of statistical multiplexing, data compression and a "highly efficient protocol" that is said to give greater throughput efficiency.

These and other features, Carr notes, are made possible by an expandable multiple-microprocessor architecture. Each Codex processor unit contains from one to eight functionally identical bipolar LSI microprocessors, depending upon

the wide variety of speeds and applications encountered in data networks.

Two initial products in the Codex 6000 INP (Intelligent Network Processor) Series are Models 6030 and 6040. The 6030 can accommodate up to 124 terminal ports with an aggregate throughput rate of 19.2 Kbps. The more powerful 6040 INP can be expanded to handle up to 252 ports, and system throughput can be raised to 56 Kbps.

A typical system composed of 28 ports would cost about \$12,500, or it could be leased at \$420 a month.

## New MOS cell offers nonvolatile memory

A new kind of MOS memory cell—a zinc sulfide discovered during a search for a blue LED—promises to provide a solid-state memory array with useful cell storage times of up to 30 hours after power has been removed from the device.

In addition, because the cell can be erased by infrared or visible light, it is potentially useful in an image-screen array for an electronic camera, according to Prof. G. W. Pratt Jr., at the Center for Materials Science and Engineering, Massachusetts Institute of Technology, Cambridge, MA., who supervised the LED investigation conducted by Dr. L. G. Walker.

Writing time for the new cell is 1  $\mu$ s at 10 V, according to Pratt. Reading is nondestructive.

"We were looking at zinc-sulfide/gallium-phosphide combination for a new LED," says Pratt, "and to make the device, we had to use a silicon dioxide mask. So we produced a structure that had three layers: one of zinc sulfide, one of silicon dioxide, one of a metal. For the experimental devices, the metal was gold."

In Walker's investigation, a forward bias was put across the zinc sulfide and the gold contact, Pratt explains, with the sulfide negative and gold positive. Walker found that the capacitance of the device increased in a quasi-permanent way.

When the bias voltage was removed, the capacitance of the cell remained at the higher level. This capacitance change, which is in the

order of a few pF, can be sampled to provide the digital information, Pratt points out.

The capacitance change is due to the storage of a charge at or near the semiconductor/insulator interface—that is, when the cell is biased in a forward direction, electrons are driven into the zinc-silicon dioxide interface.

This stored charge does not leak off for extended periods, Pratt notes; 60% of the charge is retained for about three hours and 25% for about 28 hours.

Pratt sees a ROM using the zinc-sulfide MOS structure as having two configurations. In one, the non-destructive readout might be accomplished by sensing cell capacitance—with an empty cell as a reference—by use of a negative pulse through a series resistance, such as a biased MOSFET. The difference in capacitance could be sensed with the transistor.

In the second configuration the storage elements would be fabricated as thin-film transistors. In this case, the transconductance of each element would change drastically upon the storage of a charge, Pratt points out.

For an imaging array, Pratt sees the readout from the individual elements produced by use of a silicon charge-coupled device in parallel with a line of zinc-sulfide MOS capacitors.

## Strong growth seen for optoelectronics

The optoelectronics market is expected to quadruple between 1974 and 1982, according to a study by Frost & Sullivan market research organization in New York City. The annual total will move from \$200-million to \$1.1-billion, the study says.

The devices are expected to have a strong place in telephone technology, particularly as it begins to move toward fiber-optic systems.

The greatest growth, the study shows will be in liquid-crystal displays (from \$3.2-million in 1974 to \$230-million by 1982). Eventually, however, another type of reflective display, electrochromatics, may come out of the laboratory to replace liquid crystals, Frost & Sullivan says.

Charge-coupled devices are seen racing past the competition in self-scanned photodiode displays by 1977 and occupying a strong place in optical memories as well as in imaging devices.

Laser use will shoot up, the study says, mainly because of the increased use of point-of-sale terminals in supermarkets and in video playback units for the home. The market for POS scanners alone will hit \$36-million by 1982, the researchers conclude, and POS displays, \$35-million.

Other findings include the following:

- LEDs will double in sales by 1978 and gas-discharge displays will reach their peak in 1978 and then decline, giving way to displays that are less fragile and operate more efficiently.

- Electronic watch displays will triple in sales by the end of this year and peak out by 1977, even though the digital electronic watch market will continue to expand.

## Holographic memory checks credit fast

The time-consuming job of checking for fraudulent or stolen credit cards at the cash register may soon be reduced to one requiring only a few seconds.

A new device introduced by Optical Data Systems, Mountain View, CA, combines an Intel 4004 microprocessor with a laser to produce a holographic read-only memory. The device is called Holoscan 300, and data in the memory are stored on cassettes of 35-mm film, according to John Lauer, technical director. The film contains 40 data channels, each of which is 30 feet long. It can store 20 Mbits of data in 56-bit holograms.

In describing the system, Lauer notes that digital data are converted into optical information. The interference pattern produced by the optical data are then recorded on ordinary photographic film, which is then processed. The system can be accessed by special keyboards or by Touch Tone telephones.

When a credit card number is entered, the film is scanned at a rate of 40 inches per second. If the number is not found in the memory, the credit card is good.

# The largest selection of "OFF-THE-SHELF" POWER SPLITTERS/COMBINERS Available!

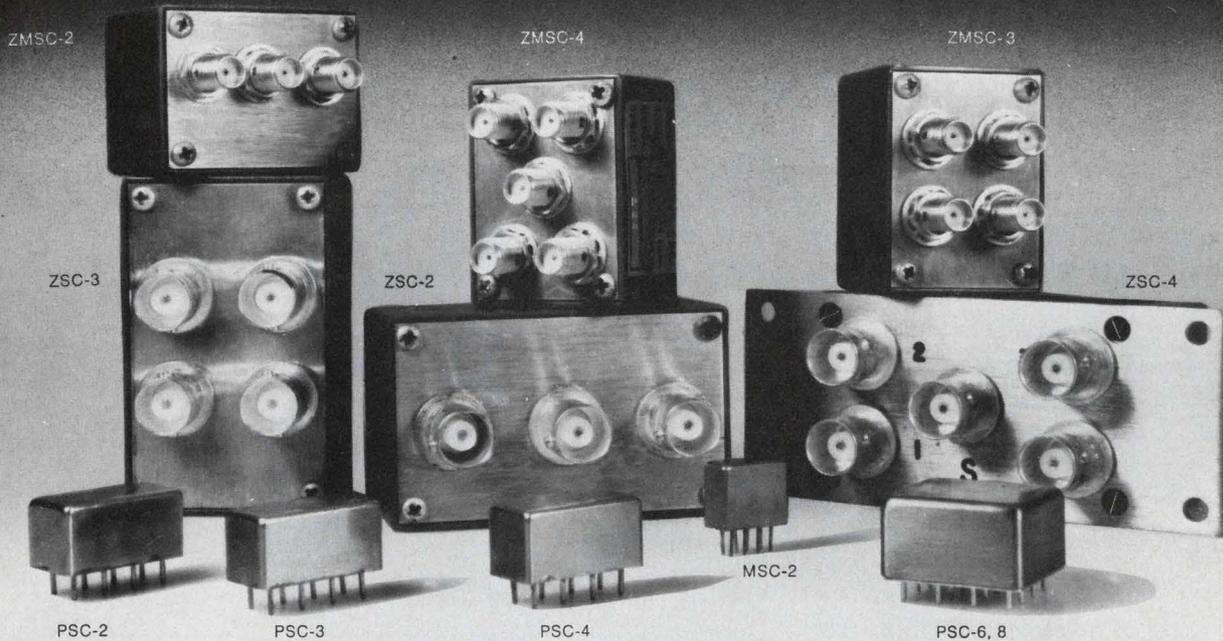

## TWO-WAY, THREE-WAY, FOUR-WAY, SIX-WAY AND EIGHT-WAY POWER SPLITTER/COMBINERS

Model No.	Freq. range (MHz)	Isolation between outputs (dB) typical	Insertion loss (dB) (typical)	Unbalance		Price (Quantity)	Model No.	Freq. range (MHz)	Isolation between outputs (dB) typical	Insertion loss (dB) (typical)	Unbalance		Price (Quantity)
				$\phi$ (deg)	Amp. (dB)						$\phi$ (deg)	Amp. (dB)	
<b>Two-way 0°</b>						<b>Three-way 0°</b>							
PSC 2-1	0.1-400	25	0.4 above 3dB split	1	0.1	\$ 9.95 (6-49)	PSC 3-1	1-200	30	0.4 above 4.8 split	2	0.1	\$19.95 (6-49)
ZSC 2-1						\$24.95 (4-24)	ZSC 3-1						\$34.95 (4-24)
ZMSC 2-1						\$34.95 (4-24)	ZMSC 3-1						\$44.95 (4-24)
PSC 2-2	0.002-60	40	0.3 above 3dB split	1	0.1	\$19.95 (6-49)	PSC 3-2	0.01-30	40	0.25 above 4.8 split	2	0.1	\$29.95 (6-49)
ZSC 2-2						\$34.95 (4-24)	ZSC 3-2						\$44.95 (4-24)
ZMSC 2-2						\$44.95 (4-24)	ZMSC 3-2						\$54.95 (4-24)
PSC 2-1W	1-650	25	0.5 above 3dB split	3	0.20	\$14.95 (6-49)	<b>Four-way 0°</b>						
ZSC 2-1W						\$29.95 (6-49)	PSC 4-1	0.1-200	30	0.5 above 6dB split	2	0.1	\$26.95 (6-49)
ZMSC 2-1W						\$39.95 (6-49)	ZSC 4-1						\$41.95 (4-24)
PSC 2-1-75*	0.25-300	25	0.4 above 3dB split	1	0.05	\$ 9.95 (6-49)	ZMSC 4-1						\$51.95 (4-24)
MSC 2-1						0.1-450	30	0.4 above 3dB split	1	0.1	ZSC 4-2	\$29.95 (6-49)	
PSCJ 2-1**											1-200	33	0.6 above 3dB split
	ZSCJ 2-1	\$34.95 (5-49)	PSC 4-3	0.25-250	30								
PSCQ 2-90	55-90	30	average of coupled outputs less 3dB 0.3			3	1.0	\$19.95 (5-49)	ZSC 4-3	\$38.95 (4-24)			
				ZMSC 4-3	\$48.95 (4-24)								
<b>Two-way 180°</b>						<b>Six-way 0°</b>							
PSC 6-1	1-175	30	0.75 above 7.8dB split	4	0.2	\$59.95 (1-5)	<b>Eight-way 0°</b>						
PSC 8-1	0.5-175	30	0.8 above 9dB split	3	0.2	\$59.95 (1-5)							

**COMMON SPECIFICATIONS FOR ALL MODELS:** Impedance all ports, 50 ohms. \*Except 75 suffix denotes 75 ohms VSWR:1.1-1.2 typical Nominal phase difference between output ports, 0° \*\*Except J suffix denotes 180° Q denotes 90° Delivery from stock; One week max.

For complete product specifications and U.S. Rep. listing see MicroWaves' "Product Data Directory," Electronic Designs' "Gold Book" or Electronic Engineers Master "EEM"

**Mini-Circuits Laboratory**  
A Division Scientific Components Corp

837-843 Utica Avenue, Brooklyn, NY 11203  
(212) 342-2500 Int'l Telex 620156 Domestic Telex 125460

**Foreign Sales Representatives:**  AUSTRALIA General Electronic Services, 99 Alexander Street, New South Wales, Australia 2065;  ENGLAND Dale Electronics, Dale House, Wharf Road, Frimley Green, Camberley Surrey;  FRANCE S. C. I. E. - D. I. M. E. S., 31 Rue George - Sand, 91120 Palaiseau, France;  GERMANY, AUSTRIA, SWITZERLAND Industrial Electronics GMBH, Klüberstrasse 14, 6000 Frankfurt/Main, Germany;  ISRAEL Vectronics, Ltd., 69 Gordon Street, Tel-Aviv, Israel;  JAPAN Denso Kaisha, Ltd., Eguchi Building, 8-1 1 Chome Hamamatsucho Minato-ku, Tokyo;  EASTERN CANADA B. D. Hummel, 2224 Maynard Avenue, Utica, NY 13502 (315) 736-7821;  NETHERLANDS, BELGIUM, LUXEMBOURG: Coimex, Veldweg II, Hattem, Holland.

**US Distributors:**  NORTHERN CALIFORNIA Cain-White & Co., Foothill Office Center, 105 Fremont Avenue, Los Altos, CA 94022 (415) 948-6533;  SOUTHERN CALIFORNIA, ARIZONA Crown Electronics, 11440 Collins Street, No. Hollywood, CA 91601 (213) 877-3550

INFORMATION RETRIEVAL NUMBER 10



T921



T912



T935



T922



T932

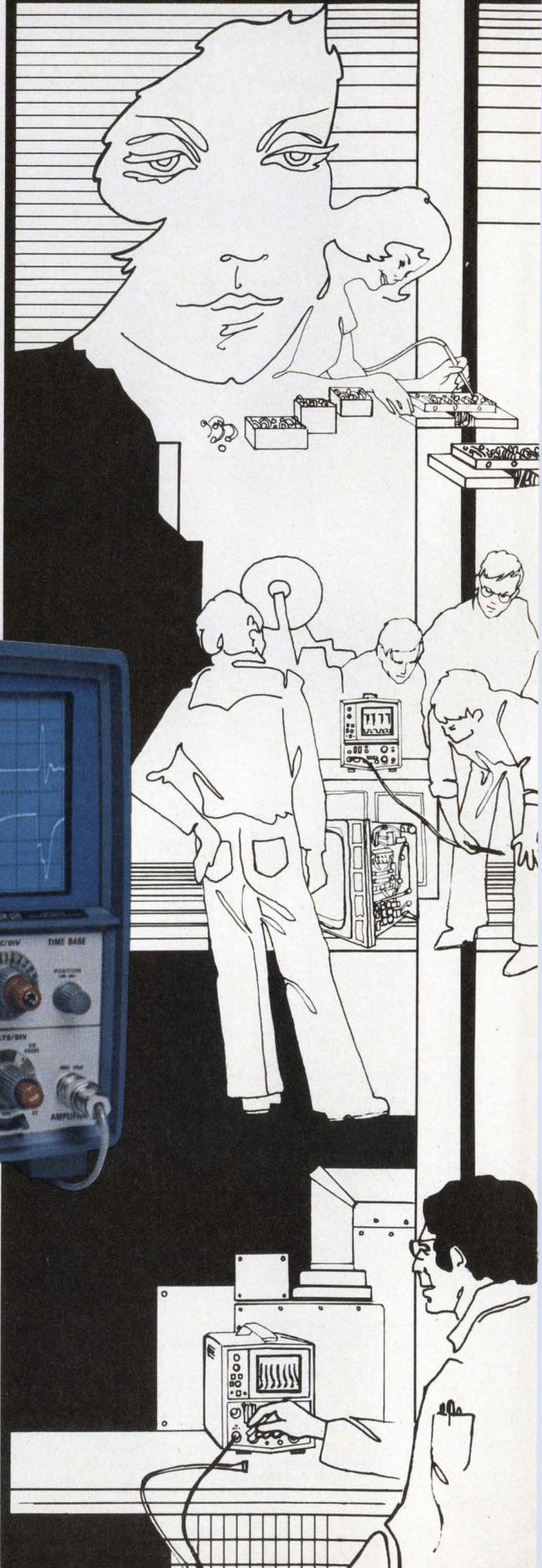

# ANNOUNCING the TEKTRONIX T900 Oscilloscopes

from \$695  
probes included and more...

Here's important news for engineers, technicians and educators who want the quality, reliability and support associated with TEKTRONIX Oscilloscopes—all at a modest price. T900\* Oscilloscopes are an entirely new line designed for cost savings without sacrifice of basic performance.

#### This new line includes:

T921—Dc to 15 Mhz; single-trace, mono time-base ..... \$ 695\*\*  
 T922—Dc to 15 MHz; dual-trace, mono time-base ..... \$ 850\*\*  
 T932—Dc to 35 MHz; dual-trace, mono time-base ..... \$1050\*\*  
 T935—Dc to 35 MHz; dual-trace, dual time-base with delayed sweep ..... \$1250\*\*  
 T912—(Storage model) Dc to 10 MHz, dual-trace, mono time-base \$1195\*\*  
 (NOTE: prices include probes.)

#### Easy to View

All T900 models offer large (8 x 10 cm) display areas. The four non-storage models use a 12 kV post-accelerator crt. (Compare this with the relatively low-voltage crt's used in typical low-priced instruments). This crt provides the added brightness required at low rep rates or fast sweep speeds, and helps in making quick, accurate measurements. For capturing single shot events our T912 storage model offers a stored writing speed up to 250 cm/ms. Also, an internal graticule eliminates parallax errors on all T900 models.

#### Easy to Handle

Measuring only 7" x 10" x 19", the T900 Oscilloscopes take little space on the production line or work bench. Light weight (15-18 lbs), small size, protective front cover and impact-resistant plastic case let you carry or ship a T900 with little effort or special handling.

#### Easy to Use

Carefully selected controls and color coded control panels contribute to quick, simple operation of all T900 Oscilloscopes. For instance, simply flip the trigger mode switch to AUTO and press the beam-finder push button. If you have a signal at the input it's now on-screen. Switching between alternate and chopped sweep modes and tv line or frame trigger modes takes place automatically, insuring optimum display presentation. A delay line in the vertical system allows you to see the leading edge of fast rise-time signals (a feature often lacking in modestly-priced oscilloscopes). This feature adds to the accuracy and speed of analog and digital timing measurements. Accessories are designed with ease-of-use in mind, and include 10X probes as standard equipment. Optional accessories include a scope stand, camera, protective front-panel cover, rain/dust jacket and more...

#### Easy to Believe

With a T900 Oscilloscope you can depend on the accuracy of your measurements (within 3% or better). Detent position on variable vertical amplitude and

horizontal time-base controls give you positive identification of the calibrated positions. Amplitude and response accuracy of many low-priced oscilloscopes falls off significantly as the signal is positioned to top and bottom of display. In T900 Oscilloscopes these effects are minimized. Also, bandwidth is maintained at all deflection factors.

#### Tektronix Support

T900 Oscilloscopes are warranted against defective materials and workmanship for one year. Thirty-seven national service centers and 50 U.S. Tektronix field offices are strategically located to provide customer support. Your local Tektronix field engineer is trained to help you in the selection, operation, application and maintenance of all T900 oscilloscopes—no extra charge, just extra value. (Users who wish to perform their own maintenance will appreciate the T900 modular design, few calibration adjustments, simple construction and clearly written, well documented service manuals).

For a copy of the new T900 Brochure (includes complete specifications).

write to Tektronix, Inc.,

P.O. Box 500, Beaverton, Oregon 97077. For immediate information call your local Tektronix field engineer or Tektronix, Inc. (503) 644-0161 extension T900.

\* Available presently in U.S.A. only.  
 \*\* U.S.A. price FOB Beaverton, Oregon.



**SPECIAL HANDLING:** Please rush me the new T900 brochure, A3178.

I would like a demonstration of the following oscilloscopes:  T912  T921  T922  T932  T935

My need is:  immediate  6 months  1 year

I would like information for the following application:

\_\_\_\_\_

Telephone No. \_\_\_\_\_

Name \_\_\_\_\_ Title \_\_\_\_\_

Delivery/Mail Station \_\_\_\_\_

Company/Organization \_\_\_\_\_

Address \_\_\_\_\_

City \_\_\_\_\_ State \_\_\_\_\_ Zip \_\_\_\_\_



**TEKTRONIX®**

committed to  
technical excellence

## Stop that bugging of your phone! Here's how to do it simply...maybe

**D**o you sometimes hear a faint clicking sound on your telephone and think that it's a tap? Do you imagine that someone is purposely listening in on your conversation?

You may be right.

A tremendous number of people are interested in tuning in on other people's private communications. If conversation takes place over a radio link, eavesdropping can be made difficult. If any ordinary telephone is used, it's a lot easier. In fact, it is even possible to use the sophisticated design of the telephone network to listen in remotely on someone's conversation without his knowing it; a special telephone network called the verification system makes this possible. This is the system that is used by operators to check if a line is busy or just off the hook. It also allows an operator to break in on a conversation and let the parties talking know that there is an emergency call waiting.

While the verification network was designed with good intentions, it is by no means tamper-proof. In fact, almost anyone who dials the correct number and says the right words can tap

into anyone's telephone line, using telephone company circuits.

### Tapping via 'the system'

To start with, the would-be tapper direct-dials the verification operator and indicates that he is a repairman working on a particular switching board and he needs a no-test trunk for the central office to which the phone to be tapped is connected. Depending on the air of authenticity of the would-be tapper or the gullibility of the verification operator, the trunk will be given. Once the trunk connection is made, all the tapper has to do is whip out a blue box—a multifrequency tone encoder—and punch in a few numbers. He is then immediately connected to the line of the phone to be tapped. Of if anyone in the central office wanted to tap a line, all he would do is get on the verification network and punch out the desired number.

A spokesman for American Telephone and

**Jules H. Gilder**  
Associate Editor



Mobile data terminals are being used to prevent eavesdropping on police communications. The digital signals from mobile terminals, like this one from Motorola, cannot be understood by anyone listening to the transmitted signal.

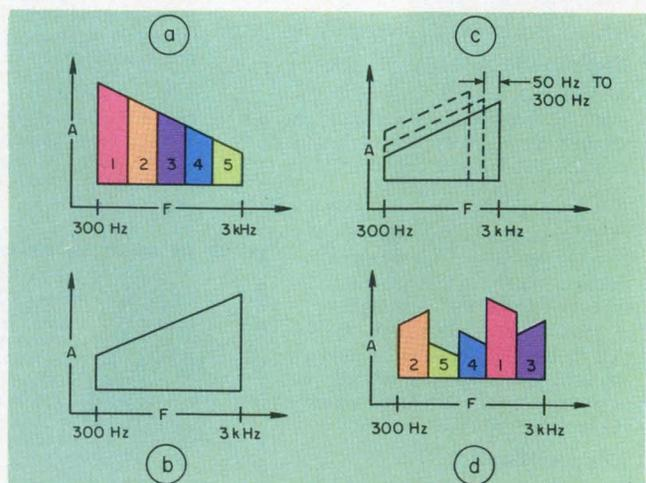

Normal speech can be modified in several ways to provide secure communications (a). It can be inverted (b) so that high speech frequencies produce low output frequencies. With regular changes in the oscillator frequency, it is possible to produce a frequency-hopping inverter that increases security (c). More secure than inversion, is band-splitting (d), where the audio channel is divided into four or five separate frequency bands that are transposed and/or inverted.

Telegraph notes that verification operators are trained to look out for such attempts to abuse the network. The chances of a person succeeding with such a ruse, he contends, are very small. Telephone personnel with access to the network are thoroughly screened to eliminate people who might misuse the system, the spokesman adds.

Security and privacy are possible but they come at a price. Simple scrambler devices are easy to come by and they're inexpensive, but they're also easy to defeat. More sophisticated devices are available and safer but they're expensive.

Probably the simplest eavesdropping countermeasure to be had is a diode detector that is usually hooked up to a sensitive meter. Relatively inexpensive, these devices can be used to locate hidden transmitters, but often the frequency range is limited. If such a device is used in close proximity to commercial radio transmitters, cross-modulation products can form, resulting in false readings.

A more sophisticated device to locate surreptitious transmitters is a spectrum analyzer. The display will show signals from all stations above a certain signal strength and within the tuning range of the analyzer. While commercial analyzers can be used, they also have some disadvantages.

The sensitivity of commonly available analyzers is lower than that of narrow-tuned receivers. Another big problem is that it is not uncommon to find false signals being generated within the equipment itself, giving rise to ghosts, which can't be tracked down.

To check out telephones, at least two companies have come out with telephone line analyzers. They are Dektor Inc. of Springfield, VA, and Communication Control Corp. of New York City.

The Dektor device, known as a Digital Telephone Analyzer (DTA), will find all bugs connected to the telephone lines and also all taps connected to the line that cause a change in voltage or current.

Clint Perry, director of countermeasures services for Dektor, is quick to point out, however, that not all taps cause a change in voltage or current. One that doesn't is the inductive tap; since it makes no physical connection to the line, it cannot be detected by the analyzer. Perry estimates that 75% of all taps used will change the voltage or current of the telephone line enough for them to be detected.

The DTA can perform both on-line and off-line tests. The on-line tests consist of voltage and current measurement that indicate whether a device connected to the phone line is stealing power from it. If the test proves positive, it's probably a bug or a tap.

Another test performed with the DTA on a

connected telephone is a tone sweep. This automatically injects a sweeping audio tone into the telephone to activate any devices, such as infinity transmitters, that may be on the line or inside the telephone instrument.

The final on-line DTA test calls for connection of an amplifier across the wires going to the phone. This will uncover any use of the telephone to listen in on room conversations.

Off-line capabilities of the DTA include measurement of the resistance and capacitance line leading from a telephone. Perry at Dektor notes that variations in the capacitance of phones are remarkably small. He points out, for example, that the biggest variance between lines in the same telephone is 70 pF. Between telephones, the variation in capacitance is only about 60 pF.

Thus by measurement of the capacitance of the lines leading from the telephone, it is possible to detect hidden bugs. The DTA can detect a



Bugs and taps can be detected and eliminated with telephone analyzers, such as the TA-17 from Communication Control Corp. It can check for tone and voltage activated devices, as well as hook-switch bypasses.



Special speech scramblers, called linear predictive encoders, are used by the military to provide secure communication between two points. These devices were built by ITT for use by the Navy.

capacitance difference of as little as 200 pF and a resistance across the line as high as 5 M $\Omega$ . Perry is not worried about devices that have a capacitance of less than 200 pF or an input impedance of greater than 5 M $\Omega$ , because such units would not be able to pass an audio signal.

The TA-17 analyzer from Communication Control is similar to the DTA, except that it cannot measure resistance and capacitance. It has a high-voltage pulse test that checks for use of voltage-controlled devices that short out the normally open telephone hook switch. But this test only applies 1000 V to the phone, compared with the 6000 V supplied by the DTA. When this switch is shorted conversations in the room can be picked up by the telephone and transmitted.

Another device offered by Communications

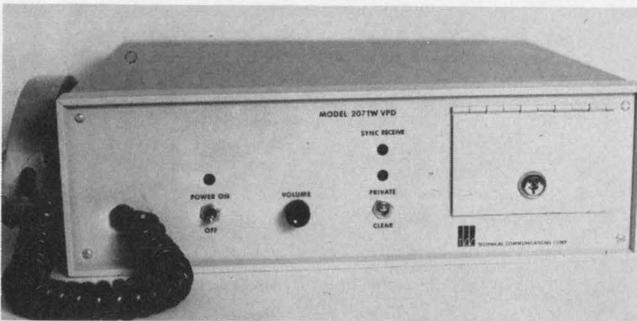

Rolling code combinations of band-splitting and frequency-hopping can be used to provide a very high level of security. Technical Communication's 207 TW voice-privacy device has a million codes, and any 122,880 can be chosen at a single time.

Control is described as a "tap-proof" telephone. This is an ordinary telephone that contains a built-in system to defeat wiretaps. According to the company literature, the Wiretap Trap concealed in the phone "automatically cancels out illegal wiretap." Experts from telephone companies and the antipugging industry contend there is no such thing as a tap-proof phone.

Perry of Dektor says he will bet Communication Control \$1000 that its "tap-proof" phone won't detect a bug that he places on it. Ben Jamiel, Communication Control's security consultant, concedes that certain low-power devices can be connected to the phone and not be detected, but he notes that such devices produce a relatively weak signal and thus are not very useful.

Another feature of the "tap-proof" phone is that anyone who picks up an extension to listen in trips a circuit that automatically disconnects the phone and puts the party on the other end on hold. When the extension receiver is replaced on the hook, the "tap-proof" phone is reconnected to the line.

This can be a handy feature—so much so that

the Bell System has made a telephone with a similar capability. Bell calls it automatic exclusion. It automatically disconnects all extensions when the phone is lifted off the hook.

Another device that is being offered to consumers who desire privacy is the Eavesdropper Stopper, a device that supposedly "eliminates the possibility of taps or unauthorized listeners-in on your phone." The device is manufactured by Telco Products Corp. of Glen Cove, NY. According to Joe Getz, a company spokesman, the Eavesdropper Stopper senses changes in the voltage level of the phone line. The level will drop, says Getz, if an extension phone is picked up and if listening devices are connected to the line.

While the unit will indeed indicate if someone has picked up an extension while you are talking, it is not very effective against taps connected to the phone. To be sure, some taps can be detected. But even casual electronics experimenters, with nothing more than a handful of simple parts, can build a tap that cannot be detected by this device. Getz himself indicates that listening devices with an impedance of more than 5 k $\Omega$  might not be detected.

Since the unit does not detect high-impedance listening devices, users may be lulled into a false sense of security. Good privacy equipment is expensive.

### Scramblers help a little

Most experts believe that some sort of coding, or scrambling of the conversation, is necessary to ensure privacy on the phone. They note, however, that it is very difficult to scramble speech enough to make it nonintelligible. The ear can tolerate or even ignore surprising amounts of noise, nonlinearity, frequency distortion, misplaced components, gaps, superpositions and other forms of interference. Very often intelligence can be obtained from a privacy system by imperfect decoding.

Scramblers can be used for both radio and telephone communications, and the techniques range from the simple to the complex. The simplest scrambling technique is frequency inversion. The low frequencies in the voice signal are converted to high ones, and the high ones to low ones. This can be done easily if the voice signal is fed into a diode modulator and a coding carrier is applied. The output signal of this arrangement is the upper and lower sidebands of the modulated signal.

Now, if a filter is used to cut off all frequencies above the carrier frequency, only the lower sideband will remain. A characteristic of the lower sideband is that its frequency is the difference between the carrier and the applied audio. Thus, as the audio input frequency in-

## Transient Voltage Suppressors! Zeners - Voltage Regulators!



**LOWEST  
DYNAMIC  
IMPEDANCE**

**Maximum Power  
in a Mini Package!**

Semtech technology once again sets the standard for semiconductors! Now, a new generation of Voltage Regulators and Transient Suppressors for protection of delicate logic circuits and sophisticated power supplies, providing protection against voltage transients in airborne equipment as well as suppression of relay coil and contact noise.

The smallest package in the industry and with power ratings up to 1500 watts is available now thanks to a breakthrough in junction technology, combined with the proven metoxilite (metal-oxide) coating and superior non-cavity monolithic high temperature bonded construction!

### LOW DYNAMIC IMPEDANCE VOLTAGE REGULATORS "ZENERS"

These new devices offer significantly lower dynamic impedance. Lower impedance means improvement in regulation ripple reduction and transient protection.

#### 1 watt

1N5559A,B thru 1N5589A,B.  
Nominal Voltage: 6.8 to 120 V ( $\pm 5\%$ )  
Low Reverse Leakage  
Dimensions (max.): Body .070"D x .165"L  
Leads .031"D x 1.25"L

#### 5 watt

1N4954 thru 1N4984  
Nominal Voltage: 6.8 to 120 V ( $\pm 5\%$ )  
Low Reverse Leakage  
Dimensions (max.): Body .140"D x .165"L  
Lead .038"D x 1.10"L

#### 3 & 5 watt

SX6.8 thru 120  
Nominal Voltage: 6.8 to 120 V ( $\pm 5\%$ )  
Low Reverse Leakage  
Dimensions (max.): Body .140"D x .165"L  
Lead .040"D x 1.10"L

#### 10 watt

SY6.8 thru 120  
Nominal Voltage: 6.8 to 120 V ( $\pm 5\%$ )  
Low Reverse Leakage  
Dimensions (max.): Body .165"D x .165"L  
Lead .040"D x 1.10"L

### BI-POLARITY TRANSIENT SUPPRESSORS

At last, a single chip device providing symmetrical transient voltage protection. Voltage matching to 5% in either direction. Protection for A.C. and D.C. circuits.

#### 500 watt Peak Pulse Power

L 10A, 20A, 30A, 39A, 51A, 60A, 82A, 100A and 110A.  
Nominal Voltage: 10 to 110 V  
Dynamic Impedance (max.): 1.5 to 70 Ohms  
Dimensions (max.): Body .140"D x .165"L  
Lead .031"D x 1.25"L

#### 1500 watt Peak Pulse Power

TS 10A, 20A, 30A, 39A, 57A, 60A, 82A, 100A and 110A.  
Nominal Voltage: 10 to 110 V  
Dynamic Impedance (max.): 0.7 to 35 Ohms  
Dimensions (max.): Body .165"D x .165"L  
Lead .040"D x 1.10"L

1975 NATIONAL SBA SUBCONTRACTOR OF THE YEAR



652 Mitchell Road, Newbury Park, California 91320  
(805) 498-2111, (213) 628-5392 / TWX: 910-336-1264  
CHICAGO: (312) 352-3227  
DALLAS: (214) 387-3551  
FLORIDA: (305) 644-5404  
MARYLAND: (301) 424-6663  
NEW JERSEY: (201) 654-4884  
SAN FRANCISCO: (415) 494-0113  
EUROPEAN SALES HDQ: Bourns AG Zug,  
Switzerland (042) 232-242

Contact factory for complete specifications.

INFORMATION RETRIEVAL NUMBER 12

creases, the output of the inversion scrambler decreases.

While this type of scrambler does produce what at first appears to be an unintelligible signal, a person, after listening to it for a while, frequently can learn to understand inverted speech. In addition, it is relatively easy for anyone to build an inverter.

While speech inverters protect from casual listeners on telephone circuits, they cannot be used at all on single sideband radio systems, be-



**"Tap-proof" telephone** from Communication Control really isn't. While it does detect most bugs and wiretaps, there are still some that it doesn't catch. The phone indicates that a conversation is not secure by sounding a buzzer or disconnecting from the circuit.

cause SSB receivers contain an inversion circuit and an adjustable reference oscillator. The oscillator can be tuned until speech is intelligible.

A second form of voice scrambling divides the 300-to-3000-Hz voice band into several subbands. Signals within these subbands can then be interchanged, inverted or both. This approach is called band-splitting. Unscrambling requires that the subbands be reinverted and interchanged (see diagram).

Many different code settings are possible with band-splitters. For example, there are 3840 ways to shuffle and invert five subbands. However, not all of these codes are useful. American Telephone and Telegraph used a five-band band-splitting system for radio telephone service in 1937. And of the 3840 possible codes, only 11 were considered suitable for privacy.

The privacy offered by inverters and band-splitters can be increased if extraneous tones

and noise are added to mask the speech. But they must be added in such a way that they can be filtered out at the unscrambler. Removal of these tones is always less than perfect, and the listener is aware of their presence.

In addition to changes in the frequency domain, scrambling of information can be done in the time domain. The time-domain equivalent of a speech inverter would generate speech backward. In practice, this is not done, because such a scrambler would need to save a whole sentence before playing it back in reverse. This would ordinarily introduce unreasonably long time delays.

A more practical approach is to divide the voice signal into small time segments of 60 ms or less and to delay these for varying brief intervals before reproducing them. This varying delay mixes the order of the voice segments and can make the scrambled output unintelligible.

#### Digital systems more secure

There has been an increasing trend toward digital communications for increased security. Digital techniques make it very difficult for the casual listener to interpret what is being sent, because all he hears is a series of pulses, which the ear cannot decode.

Most military communications that require security use a digital transmission system. Data encryption algorithms, which can be performed by computers, can easily code the information to be transmitted.

One such technique, developed to protect computer data but just as applicable to digital communications, would take 100 years to decipher if the key was not known. The algorithm was developed by IBM and is being considered as a standard for adoption by the National Bureau of Standards. The algorithm works on 64 bits of data at a time and requires a 64-bit key. With semiconductor manufacturers considering incorporation of the algorithm onto a single LSI chip, it may become the most attractive means yet of ensuring privacy.

#### Optical techniques explored

Several other sophisticated techniques for secure communications are being developed. One is optical communication. By use of lasers and optical fibers, it is possible to get very secure data-transmission paths. It is very difficult to couple into a fiber-optic link and to tap the signal. This cannot be done without at least temporarily destroying the communications link. ■■

# If you've got the microprocessor, we've got the socket board.

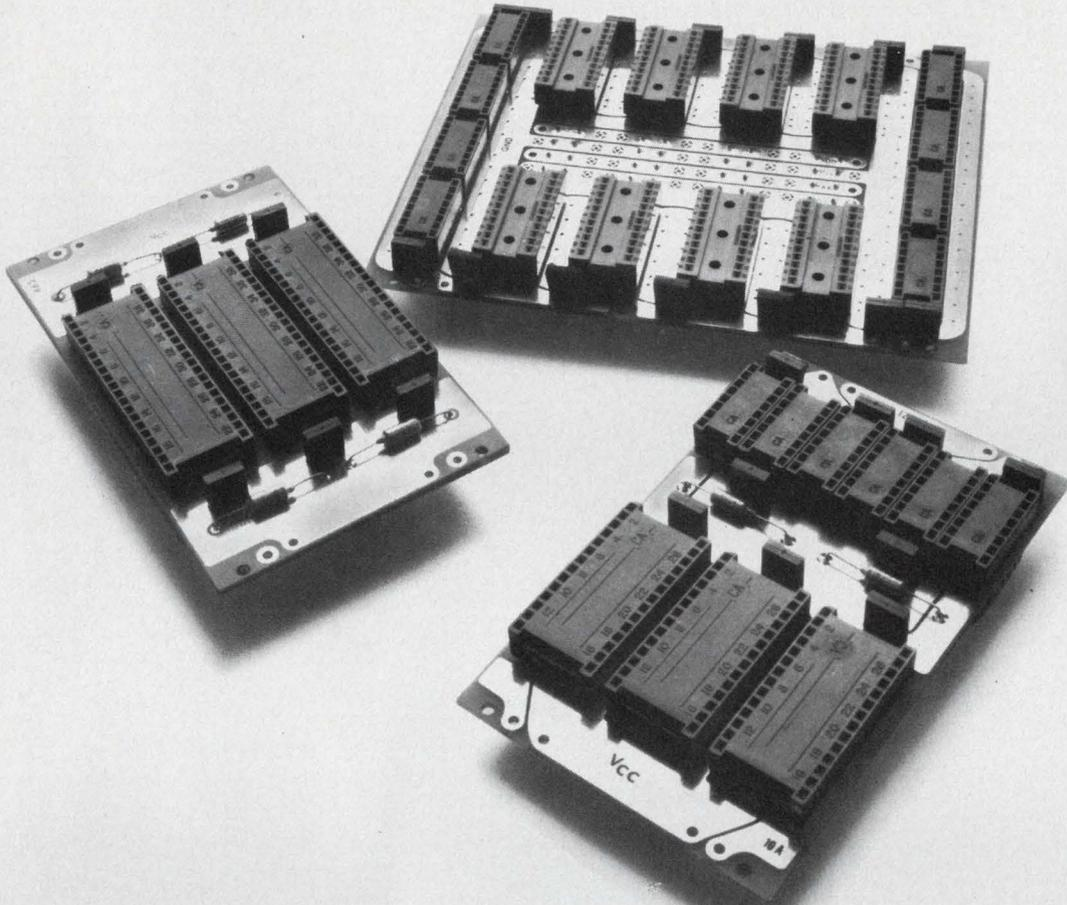

Look no further, we've got the board for your microprocessor. And your PROM. And your RAM. Off the shelf. At standard prices.

These new socket boards are the latest designs in our 2D family of socket boards:

**H-2954** Eight 22-pin sockets and eight 16-pin sockets, \$75.

**H-2955** Three 28-pin sockets and six 16-pin sockets, \$42.

**H-2961** Three 40-pin sockets, \$36.

These socket boards come to you sized and spaced for instant LSI mounting. Like our entire 2D family of socket boards, they include built-in

filtering for low noise. On the reverse side the only wire-wrap pins you have to cope with are those of the sockets themselves. Power connections to these sockets are made with our unique soldered wire loops.

We can also give you complete support hardware, including frames, drawers, I/O connectors, and tools. Not to mention our automated wiring service.

We're ready for you right now. And so is our nationwide distributor, G. S. Marshall. So call either of us today. Or tear out this page and keep it as a reminder until you are ready.

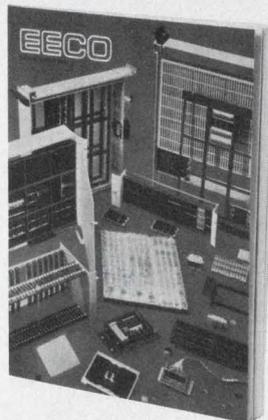

## EECO

FOR PACKAGING

1441 East Chestnut Avenue, Santa Ana, California 92701  
Phone 714/835-6000

INFORMATION RETRIEVAL NUMBER 13

# You're not alone anymore...

## Meet Omron.

Omron's exceptionally broad lines of control components didn't create themselves—*people* made them. And people continue to be the most important ingredient in Omron's success as a world-wide leader in control components.

In our expanding American operations, Omron has brought together

some of the world's finest professionals in engineering, manufacturing, and marketing. They come from some of this country's best-known companies, as well as from our international staff.

The professionals shown have a total of 259 years of experience—the kind of experience necessary to fill your needs, both at home and abroad.

Omron is committed to both quality products and service. Ask us for design and applications help. You'll get an answer to your phone inquiries for key performance data within 48 hours. And with Omron's production capabilities and inventories, you'll get *what you need, when you need it.*

The people at Omron will prove that you're not alone anymore.



**Omron  
Representative  
Organization**

**EASTERN REGION**

**Andres Component  
Sales, Inc.**  
(716) 244-2445  
Upstate New York

**The Candor Co., Inc.**  
(803) 448-8361

No. Carolina, So. Carolina,  
Tennessee, Mississippi,  
Georgia, Alabama, Florida

**Gerber Sales Co., Inc.**

(617) 890-8040  
Maine, Vermont,  
New Hampshire,  
Massachusetts,  
Connecticut,  
Rhode Island

**S-J Associates, Inc.**  
(212) 291-3232  
Metro New York,  
Northern New Jersey

**Trinkle Sales, Inc.**  
(215) 922-2080  
Southern New Jersey,  
Delaware, Maryland,  
Virginia, West Virginia,  
Pennsylvania, D.C.

**CENTRAL REGION**

**Bear Marketing-Neal  
Bear Corp.**  
(216) 659-3131  
Ohio

**Mark Kruvand Co., Inc.**  
(214) 691-4592  
Arkansas, Louisiana,  
Oklahoma, Texas

**R. C. Nordstrom & Co.**  
(313) 559-7373  
Michigan

**Quantum Sales, Inc.**  
(612) 831-8583  
North Dakota, South  
Dakota, Minnesota,  
Western Wisconsin

**The John G. Twist Co.**  
(312) 593-0200  
Eastern Wisconsin,  
Illinois, Iowa, Kansas,  
Missouri, Eastern  
Nebraska

**James Woolgar Co.**  
(317) 546-6888  
Indiana, Kentucky

**WESTERN REGION**

**N. R. Schultz Company**  
(206) 454-0300  
Washington, Oregon,  
Northern Idaho, Western  
Montana, Alaska

**Straube Associates, Inc.**  
(415) 321-9050  
Northern California,  
Nevada, Colorado, Utah,  
New Mexico, Wyoming,  
Eastern Montana,  
Southern Idaho, El Paso  
County, Texas,  
Western Nebraska

**Q. T. Wiles & Associates**  
(213) 478-0183  
Southern California,  
Arizona, Hawaii

For more information on  
branch offices, call  
representative's office  
or contact Omron Sales  
and Service office.



Omron Corporation of America  
Corporate Headquarters  
Sears Tower, Chicago, Illinois

Sales and Service  
1051 State Parkway  
Schaumburg, Illinois 60172  
Phone: (312) 885-9500

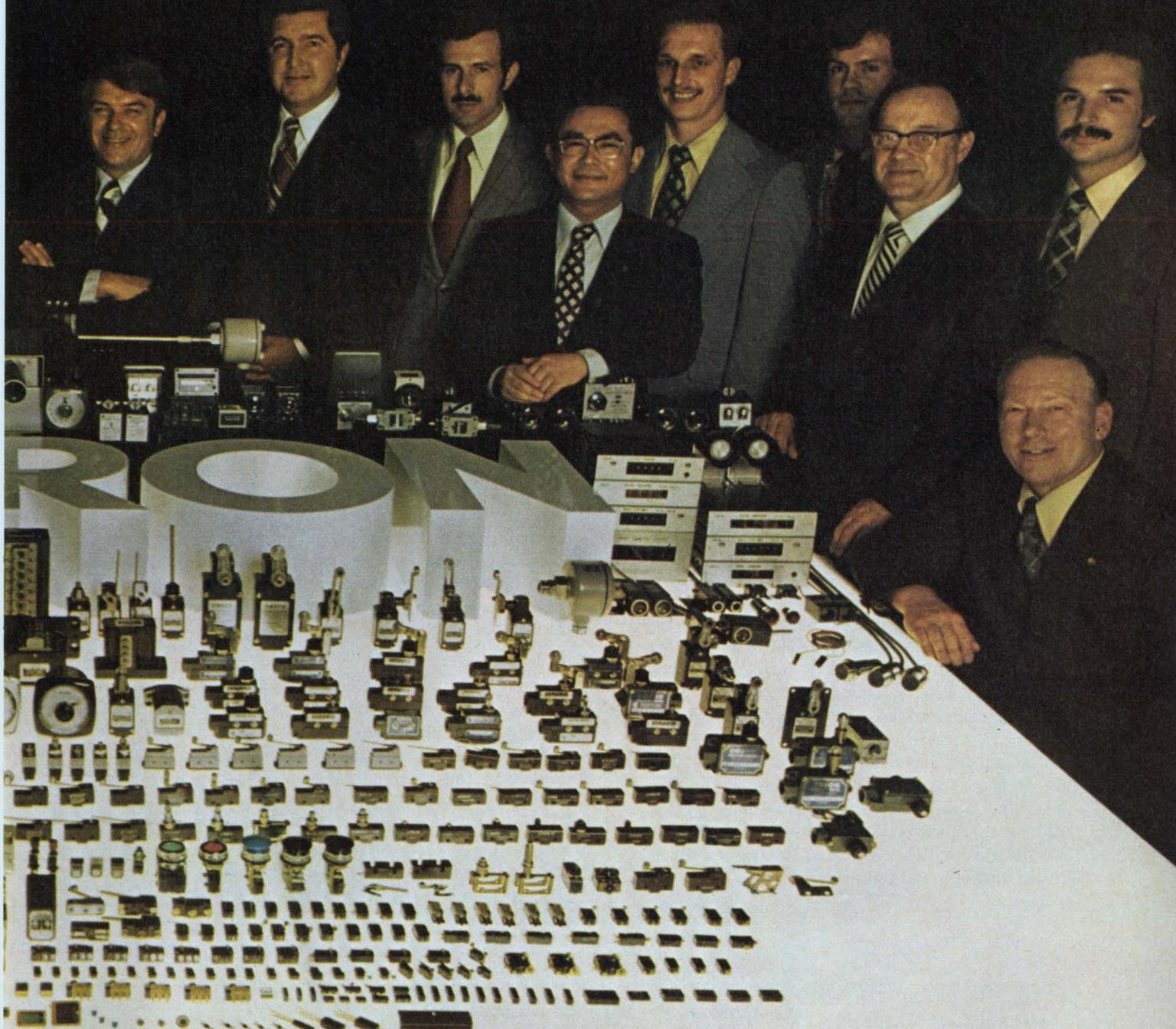

# To measure lower distortion than ever before

## -- just push a button

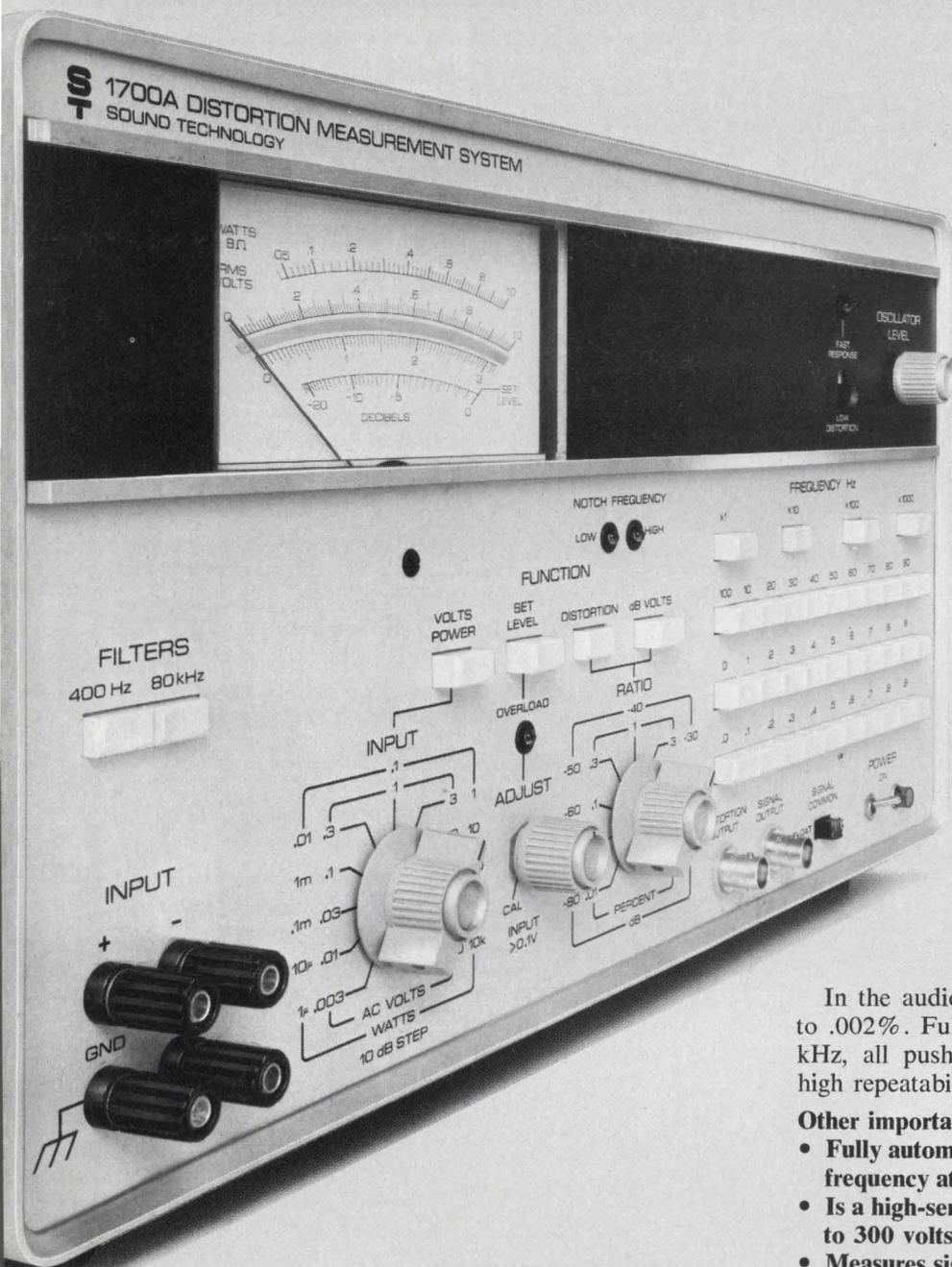

### MEASURE DOWN TO .002%

Here is an important new system for measuring distortion.

This new Sound Tech 1700A is both an ultra-low-distortion signal source and a total harmonic distortion analyzer.

It's an instrument that's fast and easy to use. You can make a measurement in 5 seconds — because both source and measuring circuits are tuned by the same pushbuttons. Even non-technical production personnel can measure with it. And that can save a lot of test dollars in the plant and lab.

### AUTOMATIC NULLING

In the audio range you can typically measure down to .002%. Full frequency range is from 10 Hz to 110 kHz, all pushbutton-controlled for fast selection and high repeatability.

### Other important features:

- Fully automatic nulling — just push a button for frequency at which you want the measurement.
- Is a high-sensitivity AC voltmeter — 30 microvolts to 300 volts.
- Measures signal ratios up to 100 dB.
- Has differential input.
- Reads power in 8-ohm loads.

### ECONOMICAL

The 1700A truly saves on initial outlay, too. It's only \$1625 (other models only \$1340). That's less than the cost of much lower performance oscillators and distortion analyzers.

### MAKE PROFIT HAPPEN — CALL NOW

So don't get caught short. Make profit happen. Call Larry Maguire or Bob Andersen and get full performance data on this important new development.

**ST**

### SOUND TECHNOLOGY

1400 DELL AVENUE  
CAMPBELL, CALIFORNIA 95008  
(408) 378-6540

DEVELOPERS OF THE INDUSTRY-STANDARD 1000A STEREO ALIGNMENT GENERATOR AND 1400A ULTRA-LOW-DISTORTION OSCILLATOR

INFORMATION RETRIEVAL NUMBER 15

# Microprocessors helping police cut the cost of communicating

Microprocessors are helping to lower the cost of fighting crime.

One of the most effective tools of modern law-enforcement agencies is the large-scale communications system that provides access to Federal, state, county and city data bases. Action Communications of Dallas, TX, has incorporated microprocessors in a new message-switching system designed for the New York City Police Dept.

These microprocessors do communication-line preprocessing and controlling in a system run by a Nova 1200 minicomputer from Data General, Southboro, MA. According to Michael Fannin, system designer at Action, the function performed by the microprocessors is usually performed by one or more minicomputers in other systems. The minis generally cost three to four times more than the microprocessors to do the same job.

In the New York City system, up to four IMP-16 microprocessors from National Semiconductor, Santa Clara, CA, and a 32 k × 16-bit semiconductor memory are used to handle synchronous and asynchronous data from up to 16 communication lines. The memory uses 2102-type chips from National Semiconductor.

The microprocessors also perform a cyclic redundancy check on the data. If more than 16 communication lines are needed, additional microprocessor modules can be added.

The full system operates by transmitting inquiries from each user terminal in the most convenient form to the IMP-16. A data check is performed, and the data are converted to the form required

by the data base.

The request is transmitted under control of the Nova 1200 to the appropriate data base. The reply from the data base is reconverted by the IMP-16 and transmitted back to the inquiring terminal.

## Variety of data channels

Communication can take place over a variety of data channels. The user normally originates an inquiry through a CRT or hard-copy terminal via a direct line. However, microwave links, WATS telephone or direct-dial lines may be used. Microwave and direct lines are the fastest (to 9600 baud) but also the most expensive. WATS and direct dial are slower (up to 2400 baud) but lower in cost.

Direct lines usually are synchronous, hard-wire modems, while the others use an asynchronous scheme with hard-wired or acoustic couplers.

Each processor is capable of handling up to 19.2 k baud rates. A single processor can handle two 9600-baud lines, four 4800-baud or one 9600-baud and two 4800-baud lines. There are many other combinations, if 2400-baud lines are used.

With CRT terminals, the system produces a format mask for certain messages. The operator keys information into the displayed form, which identifies what information is required. If teleprinter terminals are used instead of CRTs, the operator must key in both the for-

*(continued on page 38)*

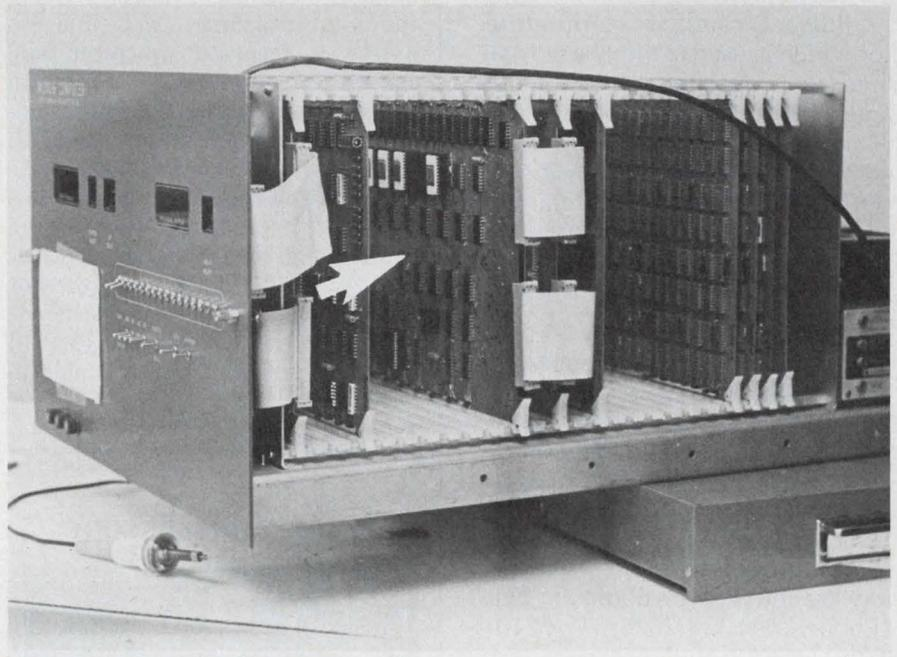

The heart of the message system is the microcomputer module (arrow). The module is a pair of coupled printed-circuit boards containing four IMP-16 microprocessors and a 32 k × 16-bit semiconductor memory, both from National Semiconductor. A single chassis can hold up to four microcomputer modules. Each processor can handle up to 19.2 k baud rates.

David N. Kaye  
Senior Western Editor

# Thin-Trim<sup>®</sup> capacitors



Tucked in the corner of this Pulsar Watch is a miniature capacitor which is used to trim the crystal. This Thin-Trim capacitor is one of our 9410 series, has an adjustment range of 7 to 45 pf., and is .200" x .200" x .050" thick. The Thin-Trim concept provides a variable device to replace fixed tuning techniques and cut-and-try methods of adjustment. Thin-Trim capacitors are available in a variety of lead configurations making them very easy to mount.

A smaller version of the 9410 is the 9402 series with a maximum capacitance value of 25 pf. These are perfect for applications in sub-miniature circuits such as ladies electronic wrist watches and phased array MIC's.

Johanson Manufacturing Corporation, Rockaway Valley Road., Boonton, N.J. 07005. Phone (201) 334-2676, TWX 710-987-8367.

*Johanson*

(continued from page 37)

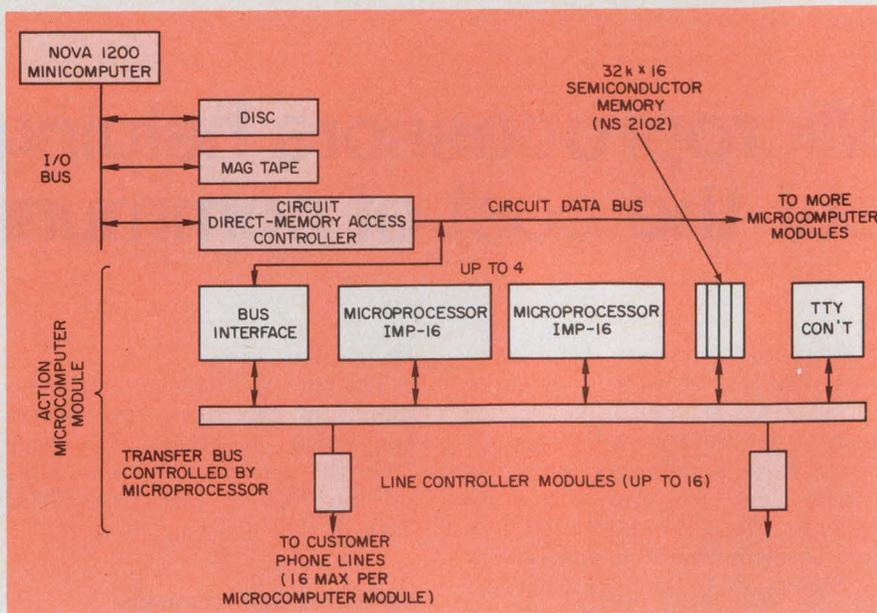

**Message switching system** of the New York City Police Dept. is controlled by a Data General 1200 minicomputer, with communication interfaces under the control of a group of National Semiconductor IMP-16 microprocessors. Each microprocessor can handle communication rates of up to 19.2 k baud.

mat and the information.

The New York system required an analysis of the various microprocessor capabilities.

"Our preliminary design investigation included 4-bit devices, one of the best 8-bit microprocessors and the IMP-16, which at the time was the only available 16-bit device," Fannin relates. "Using the 4-bit machine, each line requires a separate processor and special OR-gate logic to perform the cyclic redundancy code calculations. Maximum baud rate with the 4-bit processor is 2400.

"Although the 8-bit machine has a faster cycle time, our design exercises proved that the greater capability of the 16-bit processor actually made it faster in terms of real operation. With the IMP-16 interrupt structure, we are able to

develop a small, real-time operating system to handle multiple lines. Software for the IMP-16—the program counter, relative addressing, addressing through index registers—conserves memory and provides faster operation than smaller units with faster cycle times."

The IMP-16 also has exclusive OR instructions, which give software capability to calculate the cyclic redundancy code (CRC) numbers without special hardware, Fannin notes, adding:

"The 8-bit processor would have required a greater memory allocation to perform software calculations of the CRC number. On a cost-per-line basis, the 16-bit processor is approximately 75 to 80% less expensive than the 4-bit machine and 60 to 70% less than an 8-bit device." ■■

## A sound microscope



**First commercial acoustic microscope** uses ultrasonic sound waves (1 MHz) to reveal characteristics of living tissues which cannot be seen through optical or electron microscopes. Available from Sonoscan Inc., IL, the "sonomicroscope" is being used at the Indianapolis Center for Advanced Research.

# FET selection made simple.

**1. We give you a single source for all your FETs, dual FETs and dual bipolar transistors.**

Intersil has been solidly in the discrete semiconductor business since 1967. We currently produce over a thousand types of FETs and duals, almost four hundred 2N- and 3N- devices, more than two hundred proprietary types and a wide second-source selection. We offer all devices in a variety of packages, or in chip or wafer form. If we don't have the standard device you need, we'll gladly make a special selection to fit your requirement.

Our entire line is covered in great detail by our brand new 112 page Discrete Semiconductor Guide. It's far more than just a catalog. Here's why.

**2. We help you select the correct device.**

This new Guide groups products by typical application with a comparison table of key parameters for each device.

It illustrates applications with detailed schematics.

It contains a full section devoted to chips and wafers, outlining purchase and package options, recommended assembly procedure and test limitations.

And it gives complete specifications for every device, including chip geometry, package dimensions and all electrical characteristics.

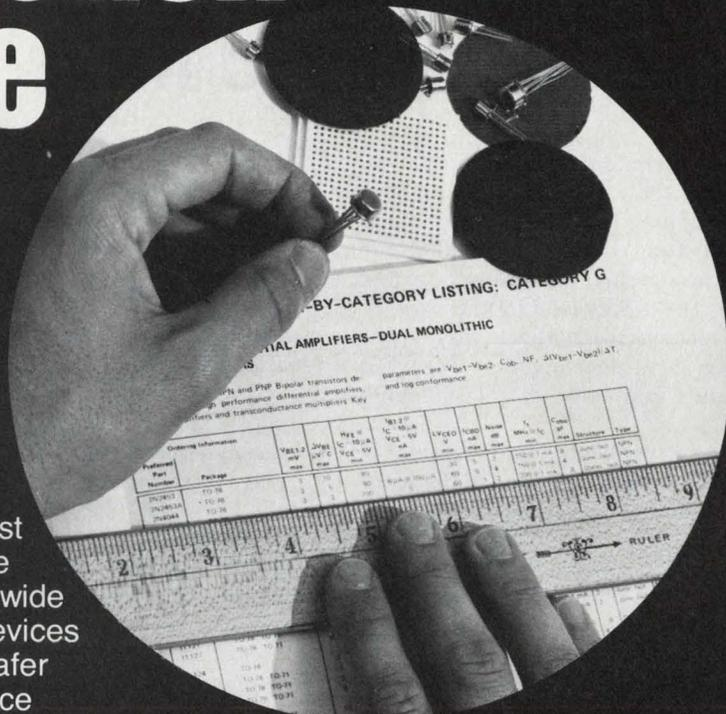

**3. We simplify the buying process.**

In addition, our new Guide contains a comprehensive cross-reference, indexing each Intersil device to industry standard part numbers, plus a complete listing of parts in alphanumeric order. Ordering information is given for parts in packaged, wafer or chip form.

**4. We'll send you our new Discrete Semiconductor Guide, free.**

For your copy, simply circle information retrieval number 132.



**Intersil stocking distributors**

Arrow Electronics (Conn., Dayton, Minn.,  
Md./D.C., N.J., N.Y., Wisc.)  
Century Electronics (N.M.)  
Elmar/Liberty Electronics  
Kierulff Electronics (Mass.)

R.A.E. Ind. Elect. Ltd. (Van. B.C.)  
Schweber Electronics  
Semiconductor Specialists  
Southland (Fla.)  
Weatherford

**Intersil area sales offices**

Boston (617)273-2055  
Chicago (312)371-1440  
Dallas (214)387-0539  
Los Angeles (213)532-3544  
Miami (305)971-6160

Minneapolis (612)925-1844  
New York (201)567-5585  
San Francisco Bay Area (408)984-2170  
Upstate New York/Canada (315)463-3368  
**Representatives in all major cities.**

# Cryogenic flux meter detects atomic field

A magnetometer has been developed that measures flux as weak as the magnetic field of a single metal atom in a protein molecule. The cryogenic instrument, which uses the superconducting Josephson effect to achieve this sensitivity, was developed at the California Institute of Technology, Pasadena.

Major problems that had to be overcome lay in the supersensitivity of the instrument itself and also in the fabrication of reliable superconducting elements, according to Cal Tech researchers Dr. James Mercereau and Dr. Harry Notarys.

Mercereau points out that while these superconducting magnetometers can achieve ultra-high sensitivity, one problem in making useful low-field measurements lies in isolating a sample to be measured from external magnetic "noise."

For example, the earth's magnetic

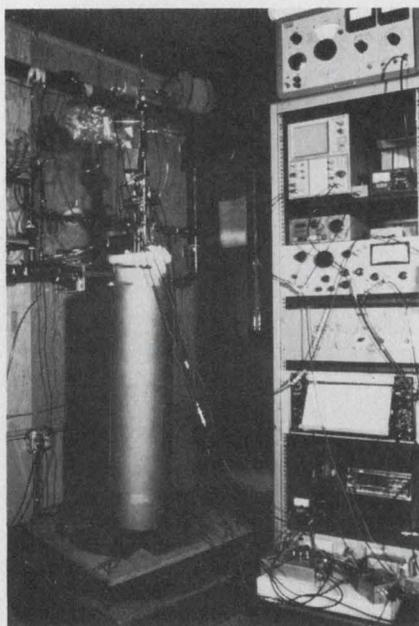

Superconducting magnetometer uses Josephson effect for ultrasensitive measurements.

field is some 10-billion times as strong as the weakest signal that the Josephson magnetometer can detect and can easily mask measurements. Also, cars moving in the vicinity of the instrument add to system noise. Even the perturbation of the moon's magnetic field due to the rotation of the sun is an undesirable influence on the ultrasensitive measurements.

So, Mercereau points out, a shielded room plus concentric Mu-metal shielding together with a special internal superconducting chamber inside which the actual measurements were made is used.

Another key element in the development was the fabrication of reliable and stable Josephson devices that could be reproducible, Mercereau says.

"The active junction of the superconducting elements is perhaps only a few square microns in size," he points out. "We had to build this into a loop and make the whole loop superconducting."

"The impedance of the loop is measured to obtain a measure of the magnetic field."

These superconducting elements are maintained in the device, at a temperature of  $-269\text{ C}$ , the temperature of liquid helium.

The magnetometer elements were fabricated in a program funded by the Office of Naval Research to develop a family of practical Josephson devices, says researcher Notarys.

"To achieve sensors with reproducible characteristics, semiconductor fabrication techniques are used to make the sensitive elements," Notarys points out.

For stability and reliability of the element, semiconductor films of hard, refractory superconducting metals like combinations of niobium and tantalum with tungsten and hafnium are deposited in layers and thinned in critical areas for sensitivity, he notes. ■■

## ALL IN THE FAMILY

All the important elements of waveform measurements that you need - - - accuracy, flexibility, ease of use to minimize human error and low cost. are in the Philips family of compacts.

Just as circuits and systems get smaller and faster, so too do our oscilloscopes.

The 50 MHz model, PM3240, for example, weighs in at a mere 18 1/2 lbs. And because it's used as much outside the laboratory as in, we've given it a logical front panel layout where every control falls naturally to hand. The PM3240 has also been designed to operate from almost any supply, including DC; to have a bright 8 x 10 cm display and good circuit access for short service down-times on the oscilloscope itself.

### MOVING UP TO 120 MHz

For higher bandwidth application, the 120 MHz model, PM3260 is available. This 19.8 pounds light instrument therefore keeps you well ahead of Schottky TTL speeds and at the same time goes on triggering to over 200 MHz to meet the great majority of ECL applications.

Like the 50 MHz model, the PM3260 includes layout features such as clear separation of the main and delayed timebases, as well as operation from DC plus 100 - 240V supply having frequencies from 46 - 440 Hz.

### MULTIPLYING AT 100 MHz

The PM3265 extends all the previous benefits to a bandwidth of 150 MHz and also adds a unique built-in 100 MHz analog multiplying facility. Only with this instrument can you therefore make transient power and dynamic phase measurements on high-speed components and circuitry. Moreover, this facility like the rest of the instrument, is extremely easy to use. You simply push the 'A x B' button to obtain the product which can also be displayed together with the B input signal.

Find out more by contacting Philips or utilize our toll free HOT LINE number 800 645-3043. New York State residents call (516) 921-8880 collect.

Philips Test & Measuring Instruments, Inc.  
400 Crossways Park Drive  
Woodbury, New York 11797



# PHILIPS

INFORMATION RETRIEVAL NUMBER 18

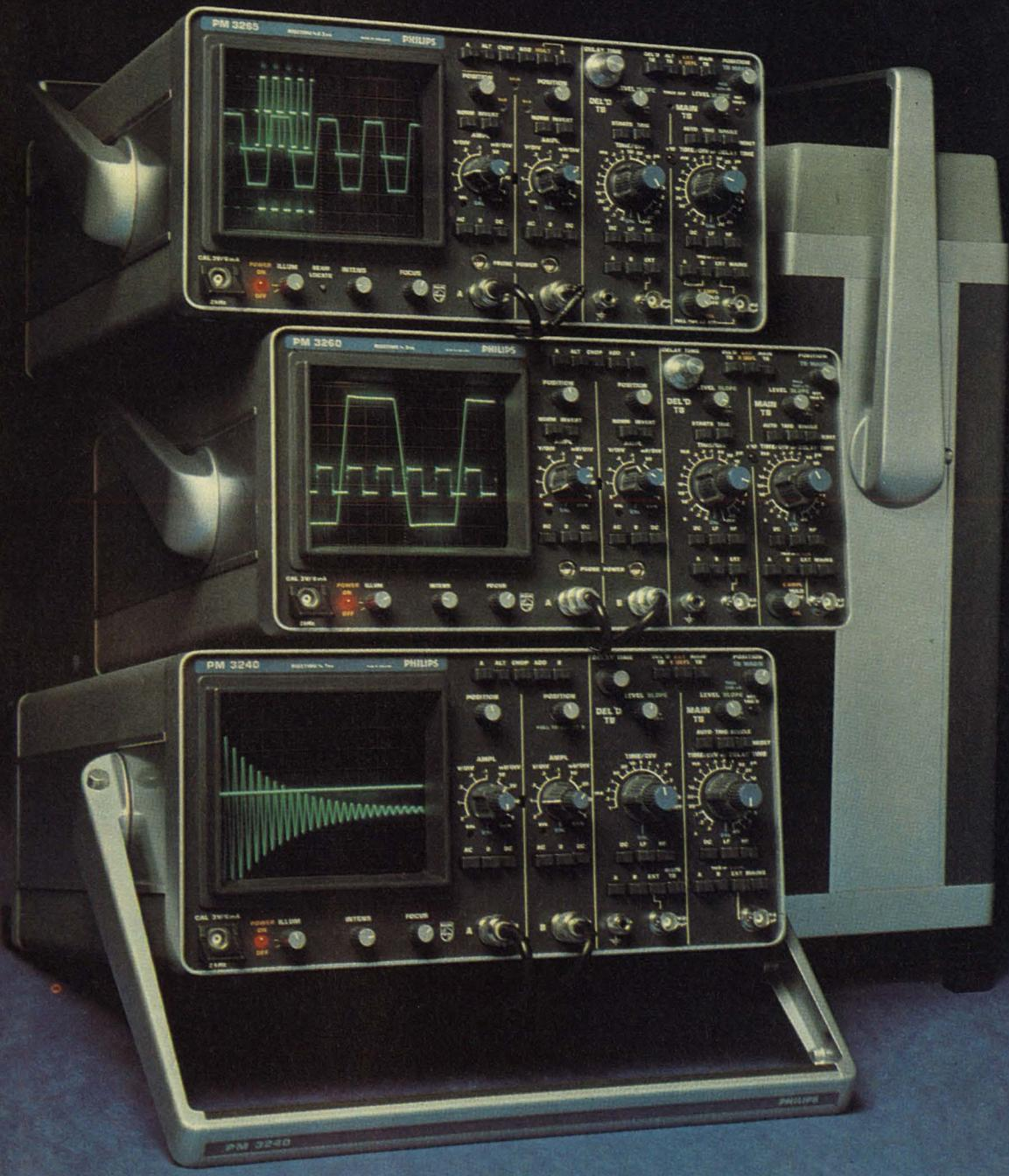

**ALL IN THE FAMILY**

**PHILIPS**

**Modular versatility.  
Zero entry force.  
And low cost.**

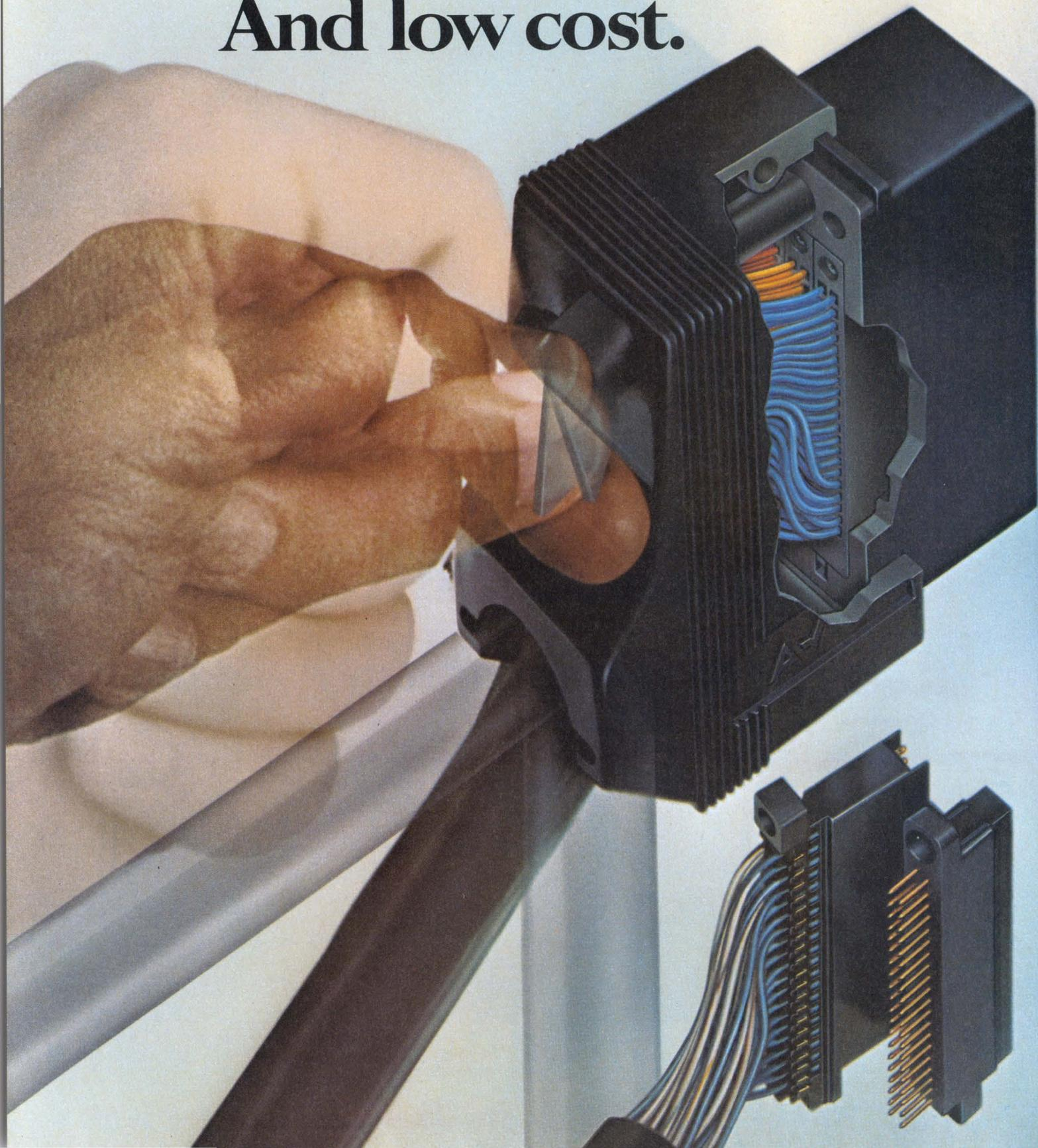

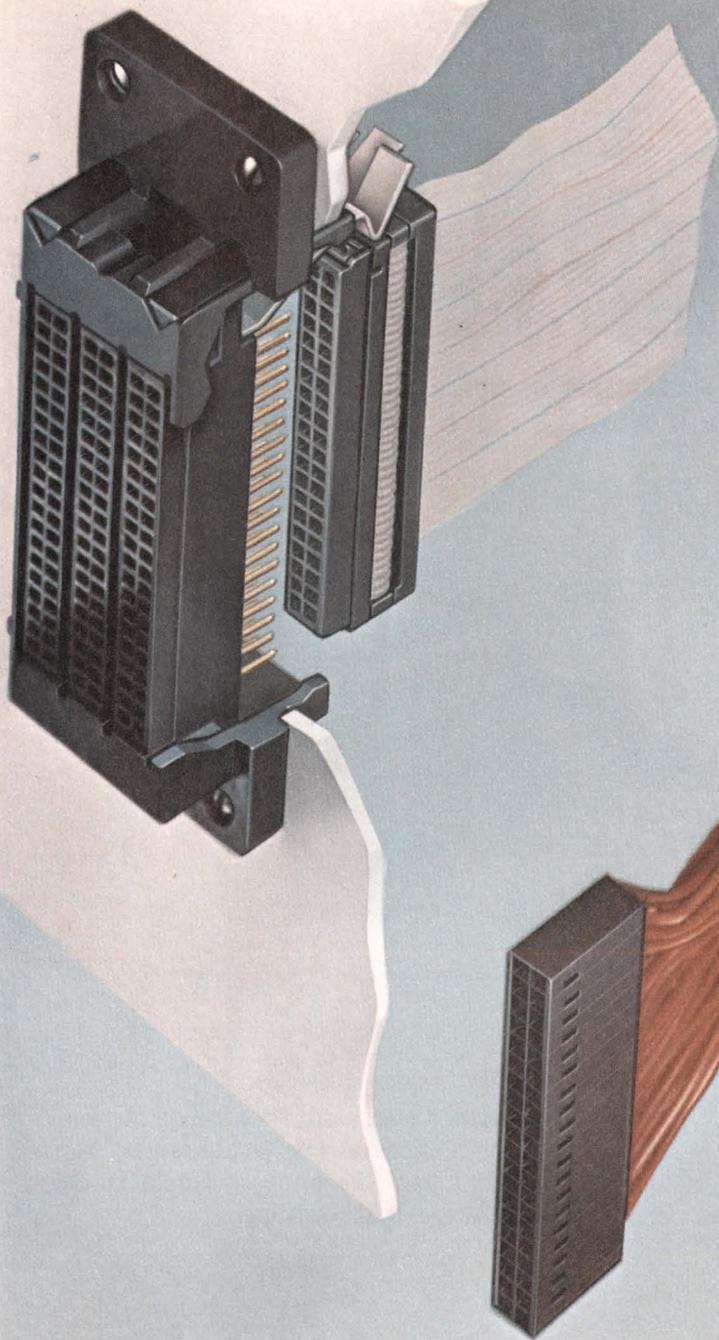

Versatile AMP CR uses connector modules for ribbon cable, discrete wires, flat flexible cable. Connections include wrap types, and the recently introduced mass termination technique—displation.

## New AMP CR Series I/O terminator

Just turn the cam 90° clockwise, and 120 or 156 contacts come together instantly. Connections are self-made with wipe and back-wipe actions.

With zero entry force. When the CR is closed there are over 150 grams of force on each contact. Yet there is virtually no contact wear for well over 5,000 cycles.

The new AMP CR Series connectors are designed for cable-to-cable, cable-to-board, and cable-to-panel applications. The Versatile CR is built of modules of your choice to accept connectors for ribbon cable, discrete wires and flat flexible cable. Additional economy is realized in the all-plastic construction which includes cable clamps and jack-screws, requiring no retaining hardware.

For easy, fast, zero-entry-force mating of large numbers of contacts, the new AMP CR Series is unequalled. For more information call (717) 564-0100, circle the Reader Service Number, or write AMP Incorporated, Harrisburg, PA 17105.

AMP is a trademark of AMP Incorporated.

# AMP

INCORPORATED

INFORMATION RETRIEVAL NUMBER 20

# Introducing

## ...the world's lowest cost computer system

# JOLT™

**JOLT™ is the new, fully-tested microcomputer with the exclusive on-board DEMON™ debug monitor. You can build it, plug it in and talk to it in three hours or less . . . for a price of just \$249!**

**The basic JOLT™ card includes an 8-bit MOS Technology Model 6502 CPU, which requires no clock, can directly address 65k of memory, has two index registers, 58 instructions with 11 addressing modes, two interrupts and includes both single step and address halt capability. And that's only a part of it.**

JOLT's™ CPU card is available IMMEDIATELY\* in either kit form or assembled (\$249 for the kit in single quantity and \$348 assembled). Either way, the JOLT™ CPU is completely tested prior to delivery. It comes complete with a terminal interface (TTY or EIA) and a unique software DEbugger/MONitor called DEMON™, for which full documentation is provided. It is very easy to program, and any JOLT™ delivery includes an easy-to-follow assembly instruction manual, showing you exactly how to put everything together . . . correctly. Complete assembly should take you no more than three hours if you choose the CPU in kit form. Besides the JOLT™ CPU — the 6502 from MOS Technology — the basic JOLT™ card has a fully static memory accommodating 512 bytes of the user RAM. The JOLT™ CPU memory also has 64 bytes of interrupt vector RAM. ROM Program memory on the basic card consists of 1k bytes of monitor/debugger with an automatic Power-On bootstrap program — so you can start talking to JOLT™ and it to you as soon as you plug it in to your terminal. On-board Input/Output devices on the JOLT™ CPU card include TTY 20 milliamp current loop and an EIA interface, both full duplex. The card has high speed reader interface lines and 16 fully programmable user I/O lines with full TTL drive.

**Nobody, but nobody, except MAI can offer you an on-board debugger/monitor like DEMON™. It's fully documented, too.**

The exclusive DEMON™ Debug Monitor really makes JOLT™ one of the most outstanding computer systems offered at any time, at any price. Even without DEMON™ and its superior software features, JOLT™ is the lowest cost computer system in existence. And DEMON™ is a bonus you'll have to use to believe. First, it self-adapts

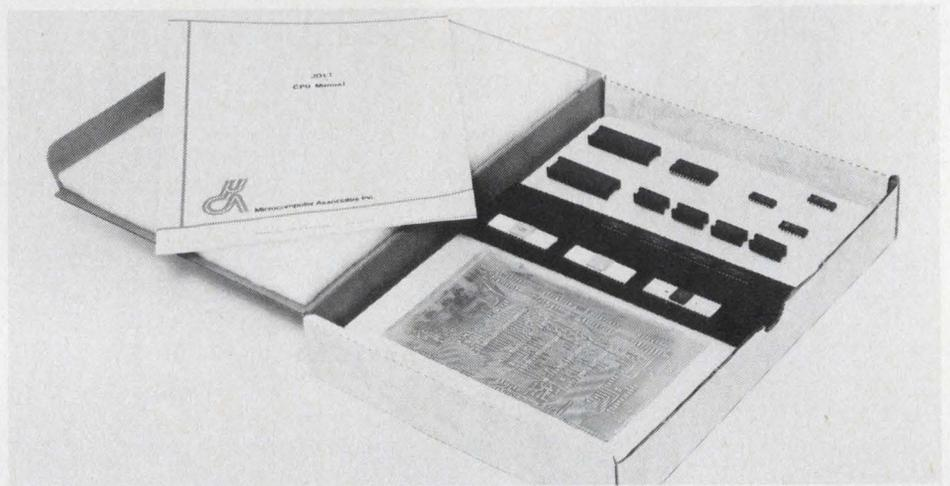

*All kits are delivered with a complete instruction manual and packaged for easy visual identification of parts to aid you in assembly.*

to any terminal speed from 10-30 CPS. With it, you can display and alter your CPU register and memory locations, plus you can read, write and punch Hex formatted data . . . with Write/Punch BNPF format data for PROM programmers. It has unlimited breakpoint capability along with separate non-maskable interrupt entry and identification. External device interrupts can be directed to any location you choose, or they can be defaulted to DEMON™ recognition. DEMON™ also gives you (1) a completely protected ROM resident debug/monitor; (2) the capability to begin execution at any location in memory; (3) the capability to bypass DEMON™ entirely to permit full control by you over your system; (4) a high-speed 8-bit parallel input option; and (5) it includes user callable DEMON™ I/O subroutines. MOST IMPORTANT, DEMON™ IS INCLUDED AS STANDARD WITH ANY JOLT™ CPU KIT OR ASSEMBLED BOARD!

**Obviously, the JOLT™ basic card is a computer in and of itself. But you can add significantly to its capacity and versatility by adding 4k RAM JOLT™ memories — in one card or a whole bunch. A RAM card kit is only \$265 (\$320 assembled). Now.**

The JOLT™ memory card is a fully static 4,096-bit Random Access Memory (RAM) with 1 microsecond access time and on-board decoding. It is also available now.\*

And the quantity of one price is what you might expect to pay in quantities of 100 . . . very inexpensive!

**There's also a JOLT™ I/O card for you, our Peripheral Interface Adapter. You can't beat the price — single kit 96 bucks — or the function.**

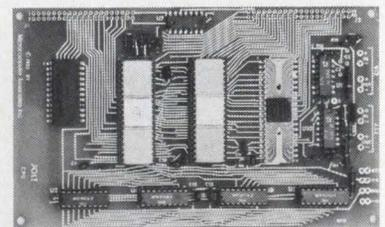

*Pictured above is the assembled JOLT™ CPU card with DEMON™. Just plug it in and you're ready to go.*

The JOLT™ PIA (Peripheral Interface Adapter) I/O card includes two PIA LSI chips, 32 input/output lines, two interrupt lines, on-board decoding and standard TTL drive. It is also fully programmable and available IMMEDIATELY\* in either kit or assembled form . . . at a very attractive single unit price (\$140 assembled).

**Considering the function and capacity of the JOLT™ Power Supply Card, you probably think the quantity of one price — \$145 — is a misprint. It isn't.**

The JOLT™ family also includes a power supply card, which operates at any of

three voltages — +5, +12 and -10. The power supply supports the basic JOLT™ CPU card, plus 4,096 bytes of RAM and I/O. The only two words for the price are "dirt cheap." It is available for delivery immediately with a single unit kit price of \$145 (\$190 assembled).

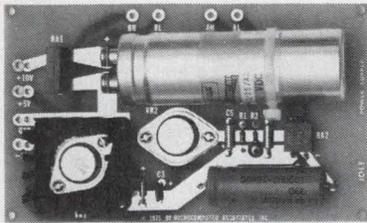

The assembled power supply card shown above powers the JOLT™ CPU, I/O, and RAM Memory cards.

You can also choose a blank JOLT™ universal card. Or several.

The JOLT™ Universal card is completely nude. It's a blank you can use any way you wish, for control panels, T.V. interfaces, keyboards, LED's, or any other interface logic, because the card's holes are drilled to accept 14, 16, 24, or 40 pin sockets and has the same form factor as the other JOLT™ cards. The single unit price is just \$25.

**If you think you need extra cables, wires and the like, choose a Super Value JOLT™ Accessory Bag. A \$55 Value for just \$40.**

The JOLT™ Accessory Bag includes 25 separate parts, enough hardware to connect one JOLT™ card to another. Order an Accessory Bag for each additional JOLT™ card. The Bag contains such necessary items as flat cable, connectors, cord spacers, hardware, wire, etc.

**THE JOLT PLAIN ENGLISH WARRANTY**

All components in the JOLT™ family are new and fully tested prior to shipment. Kit components are fully warranted during the first 60 days of ownership. Assembled parts are fully warranted during the first 6 months of ownership. If your properly assembled kit does not work, just ship your order back to Microcomputer Associates Inc. and we'll repair, replace, or refund your money.

**20% BONUS**

NOW! Special ONE TIME BONUS DISCOUNT. Order one CPU before **November 10, 1975** and deduct 20% off of all additional cards and accessories. (Note: Discount does not apply to CPU cards, assembled or unassembled.)

**We told you JOLT™ was the world's lowest priced computer system. These prices prove it.**

<b>JOLT KITS</b> (ALL PAYMENTS MUST BE IN U.S. DOLLARS)					
	<b>QUANTITY PRICING</b>				
	1-4	5-19	20-49	50-99	100 up
JOLT™ CPU	\$249	\$235	\$230	\$225	\$215
JOLT™ RAM	265	255	250	245	235
JOLT™ I/O	96	90	88	82	75
JOLT™ POWER SUPPLY	145	135	130	128	115
JOLT™ UNIVERSAL CARD	25	20	18	16	14
JOLT™ ACCESSORY BAG	40	36	34	32	30

**ALL JOLT™ KITS ARE DELIVERED COMPLETE WITH A DETAILED AND ILLUSTRATED ASSEMBLY MANUAL**

\* Order will be shipped within 15 days.

<b>JOLT™ ASSEMBLED PRICES</b> (ALL PAYMENTS MUST BE IN U.S. DOLLARS)					
	<b>QUANTITY PRICING</b>				
	1-4	5-19	20-49	50-99	100 up
JOLT™ CPU	\$348	\$325	\$320	\$315	\$305
JOLT™ RAM	320	305	300	295	280
JOLT™ I/O	140	125	120	115	105
JOLT™ POWER SUPPLY	190	175	170	165	150

**THE NEW JOLT™ FROM MAI IS AVAILABLE ONLY ON A DIRECT BASIS. USE THIS COUPON TODAY TO ORDER FROM**



**Microcomputer Associates Inc.**  
111 Main St., Department D  
Los Altos, Calif. 94022  
Phone (415) 941-1977

©1975 Pehaco Corporation

**This coupon will bring you a JOLT™! Complete and return it.**

Here is my check, money order or credit card payment for the following JOLT™ products. If a U.S. or Canadian order, please add \$4.86 for shipping, handling and insurance. (Orders to all other countries are priced F.O.B. Los Altos and will be shipped **FREIGHT COLLECT.**)

Send me immediately:

QUANTITY	PRODUCT	PRICE
_____	JOLT™ CPU KIT	\$ _____
_____	JOLT™ RAM MEMORY KIT	_____
_____	JOLT™ I/O KIT	_____
_____	JOLT™ POWER SUPPLY KIT	_____
_____	JOLT™ UNIVERSAL CARD	_____
_____	JOLT™ ACCESSORY BAG	_____
_____	JOLT™ CPU ASSEMBLED	_____
_____	JOLT™ RAM MEMORY ASSEMBLED	_____
_____	JOLT™ I/O ASSEMBLED	_____
_____	JOLT™ POWER SUPPLY ASSEMBLED	_____
TOTAL		\$ _____
+U.S./CANADA SHIPPING/HANDLING/INSURANCE		4.86
NOTE: CALIFORNIA RESIDENTS, +6% SALES TAX		
<b>TOTAL REMITTANCE (U.S. DOLLARS ONLY)</b>		\$ _____

MAIL Pehaco Corporation, JOLT™ Sales Agents  
YOUR **Microcomputer Associates Inc. Dept. D**  
ORDER 111 Main St., Los Altos, Ca 94022  
TO: All orders subject to the prior approval of the manufacturer.



**20% BONUS**

NOW! Special ONE TIME BONUS DISCOUNT. Order one CPU before **November 10, 1975** and deduct 20% off of all additional cards and accessories. (Note: Discount does not apply to CPU cards, assembled or unassembled.)

**20% BONUS**

PLEASE CHARGE THE TOTAL TO MY CREDIT CARD:

BANKAMERICARD # \_\_\_\_\_

MASTER CHARGE # \_\_\_\_\_ (include 4-digit #)

My credit card expires on \_\_\_\_\_

SIGNATURE \_\_\_\_\_  
(All credit card orders must be signed!)

**I UNDERSTAND THAT ALL U.S. ORDERS WILL BE SHIPPED VIA U.P.S. AND ALL INTERNATIONAL ORDERS WILL BE SHIPPED BY AIR. SEND MY ORDER TO:**

NAME \_\_\_\_\_

ADDRESS \_\_\_\_\_

ORGANIZATION \_\_\_\_\_

CITY \_\_\_\_\_ STATE \_\_\_\_\_ ZIP \_\_\_\_\_

PHONE \_\_\_\_\_  
(Include Area Code)

**\*Make your check payable to: Microcomputer Associates Inc.**  
International Orders: Payment should be cabled to Account #00417-06355 Bank of America, 215 So. Murphy Avenue, Sunnyvale, California, USA, 94086

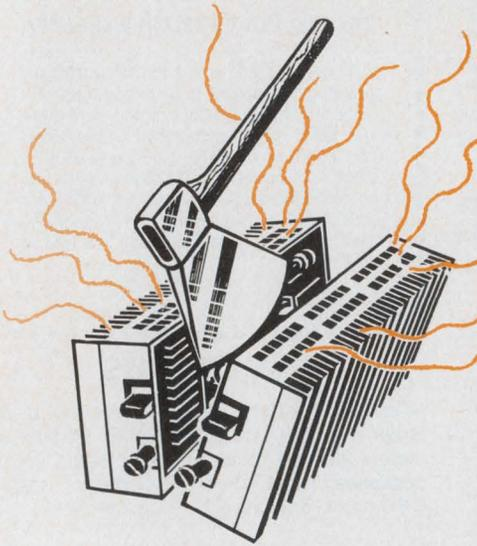

# don't settle for half a power supply at +60°C

or perhaps give up two thirds of  
the rating you bought as its  
temperature edges towards +70°C

We build power supplies with sufficient built-in heat exhaust capacity, that they require no external sinking whatever. They'll maintain their full rating right up to +71°C and, thanks to *internal* radiators, run their exterior *cool*. This conforms with IEC recommendations that discourage—for safety reasons—external fins that run hot to the touch.

The Kepco Group CPS Linear Power Supply Modules range from 100 watts to 1000 watts offering 0–6V and 0–15V fully adjustable, programmable outputs with rectangular (not fold-back) adjustable current limiting. A fast-acting overvoltage crowbar is built-in, linked to a double-pole on-off circuit breaker. The Kepco CPS is a precision stabilizer. A 100% load change produces less than 0.005% effect in the stabilized d-c voltage. Noise is suppressed well under 0.2 mV rms (2 mV p-p measured to 10 MHz) and recovery from a step-load or impulse load is complete in less than 50 microseconds.



100W Module

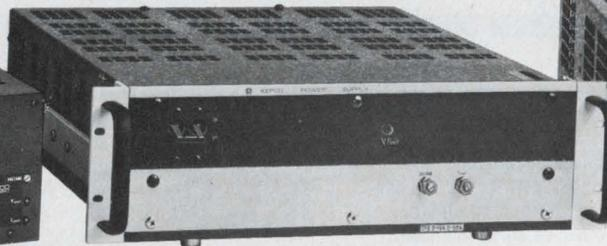

1000W Module  
Model CPS 15–50, unmetred Power Module  
shown with "ears" for 19" rack mounting.  
The ears are detachable for chassis mounting.

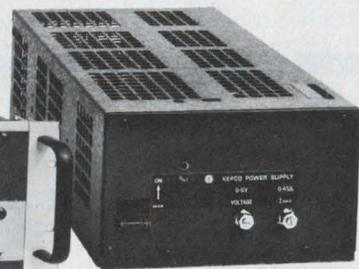

250–500W Module

**KEPCO** **CPS** is  
a no-compromise  
computer power supply!



Write Dept. CL-05 for your copy of  
the new Kepco Power Supply Hand-  
book and Catalog.

**KEPCO**®

KEPCO, INC. • 131-38 SANFORD AVENUE • FLUSHING, N.Y. 11352 U.S.A.  
(212) 461-7000 • TWX #710-582-2631 • Cable: KEPCOPOWER NEWYORK

INFORMATION RETRIEVAL NUMBER 22

# Washington Report

## **Squabble over contract renegotiation looms**

There is growing alarm in industry circles that, as a result of hearings on Capitol Hill on the contract renegotiation process, even tougher legislation may be introduced before this Congressional session ends to increase the power of the Renegotiation Board. This is the controversial board that initially was created to review defense contracts to see if excess profits were being made, and if they were, to force the contractors to reimburse the Government. Later the board's jurisdiction was extended to cover Atomic Energy Commission and National Aeronautics and Space Administration contracts.

Now there is talk of extending the board's authority over all Government agencies, with the new Energy Research and Development Administration as an obvious target. The Electronic Industries Association is in the forefront of a fight to prevent that revision of the act. It also opposes other revisions that would do the following:

- Discontinue the present practice of allowing the averaging of profits on a corporate basis.
- Impose interest rates on excessive profits from the fiscal year in which the profits were realized rather than when they were determined.
- Move the appeals process from the Court of Claims to the Tax Courts, which would shift the burden of proof from the Federal Government to the contractor.

## **Air Force to develop new space booster**

By 1984 the Air Force hopes to depend on NASA's space tug to take its secret satellites from low-earth orbit, where the space shuttle has delivered them, on up to synchronous orbits of 22,000 miles, where they will remain to carry out their work. Between 1980, when the space shuttle begins operation, and 1984, when the tug is ready, the Air Force will have to move its satellites from low-earth orbit to synchronous orbit on its own.

The solution: The Air Force will develop an interim upper stage in-orbit booster. Potential contractors include Lockheed, Boeing, General Dynamics, McDonnell Douglas and Martin Marietta—all of whom submitted studies on June 30.

## **Senate to consider new procurement rules**

A long-awaited Ford Administration proposal to update and consolidate Federal procurement rules has been introduced in the Senate by Sen. Charles Percy (R.-IL). The now extinct Commission on Government Procurement made a number of recommendations, many of which could be adopted without legislation, but certain reforms require Congressional

action. The Office of Management and Budget prepared the needed bill.

Should the legislation become law, it would consolidate the two basic procurement statutes—the Armed Services Procurement Act and Title III of the Federal Property and Administrative Procurement Act—and modernize existing systems of awarding contracts. It would authorize all agencies to enter into multiyear (of not more than five-year duration) contracts with annual appropriations; eliminate advance notification of certain subcontracts; provide for competitive procurement of professional and architect-engineer services and eliminate the 6% limitation on their fees, and extend the truth-in-negotiations requirements for costs or pricing data to all agencies.

The new bill would prohibit the cost-plus-a-percentage-of-cost system of contracting; limit the fee of cost-plus-a-fixed-fee contract for experimental, development or research to 15% of the estimated cost of a contract, exclusive of fee, and set a fee limit of 10% on other contracts of this type.

## Federal R&D budget outrunning inflation

The \$21.7-billion for R&D in the 1976 Federal budget not only is a record high, but the \$2.7-billion increase from 1975 to 1976 is also the largest for any year in the past seven, reports the National Science Foundation. The foundation sees this as a positive indicator of a real rise in R&D activities. Spending for defense, space, energy and education is slated for increases that run well ahead of inflation.

Defense is the clear winner in the dollar sweepstakes, increasing \$1.86-billion. Energy and space will each get \$343-million more this year, and education research will go up \$160-million. The defense spending will add money in just about every category, especially in aircraft and missiles. R&D spending for manned-space flight programs, after a decline for years, now appears to have stabilized. Communications spending, however, continues to decline as the National Aeronautics and Space Administration communications satellite program is phased out in the expectation that industry will take over in this area.

**Capital Capsules:** After years of struggle, the House of Representatives has finally passed a bill that would get the nation on **an orderly road toward conversion to the metric system**. Passage by the Senate is expected sometime this fall, providing other legislation doesn't slow the calendar. The House bill calls for a 21-member board to guide a voluntary program, with no time limit on the conversion. . . . A production award is scheduled by the Air Force in July, 1976, for **purchase of airborne OMEGA navigation equipment**. Three companies are now in contention: Tracor, Dynell Electronics, and Bendix—a collection of 25 papers, presented on **surface analysis for silicon devices** at a workshop held last spring by the National Bureau of Standards and the Defense Advanced Research Projects Agency, is being readied for publication by the NBS. . . . The Army's Air Mobility Research and Development Laboratory at Fort Eustis, VA, says it intends to solicit competitively in fiscal 1976 for a program to develop a cost-effective, **on-board interface between the helicopter electrical system and the nickel-cadmium battery**. The objective is to eliminate any safety hazards with the use of NiCd batteries, reduce maintenance cost and extend battery life.

# SOUND OFF

with SONALERT® signals!



LOUD, LITTLE, ALL-ELECTRONIC.

There's a complete family of big-voice Sonalert® audible signals. A choice of 28 compact space-saving models . . . three distinctive frequencies . . . "beeping" or "warbler" tone.

No matter what your preference, each model has a penetrating, yet nonirritating voice. One that gets through even when background noise is high.

The sound is produced by a piezoelectric transducer using solid-state electronics. So you get maximum efficiency, low current requirements, high reliability. There are no moving parts, no arcing, no RF noise, no mechanical wear. With the low-power feature, Sonalert signals can be turned on or off with a transistor, SCR, or an integrated circuit and are ideally suited for battery operated equipment.

Sonalert signals are a snap to install. And they're economically priced, especially for high-volume applications—such as automotive, appliance, computer, process control, entertainment or communications equipment.

We have a new bulletin that gives the Sonalert specifics. For your copy, just ask your Mallory capacitor salesman or your local Mallory distributor.

**MALLORY**

**MALLORY CAPACITOR COMPANY**

a division of P. R. MALLORY & CO. INC.  
Box 372, Indianapolis, Indiana 46206; Telephone: 317-636-5353

Electrical and Electronic Components • Timing Devices and Motors • Metallurgical Products • Batteries  
SONALERT® is a registered trademark of P. R. Mallory & Co. Inc.

INFORMATION RETRIEVAL NUMBER 23

# Pick a Plug-in Scope For

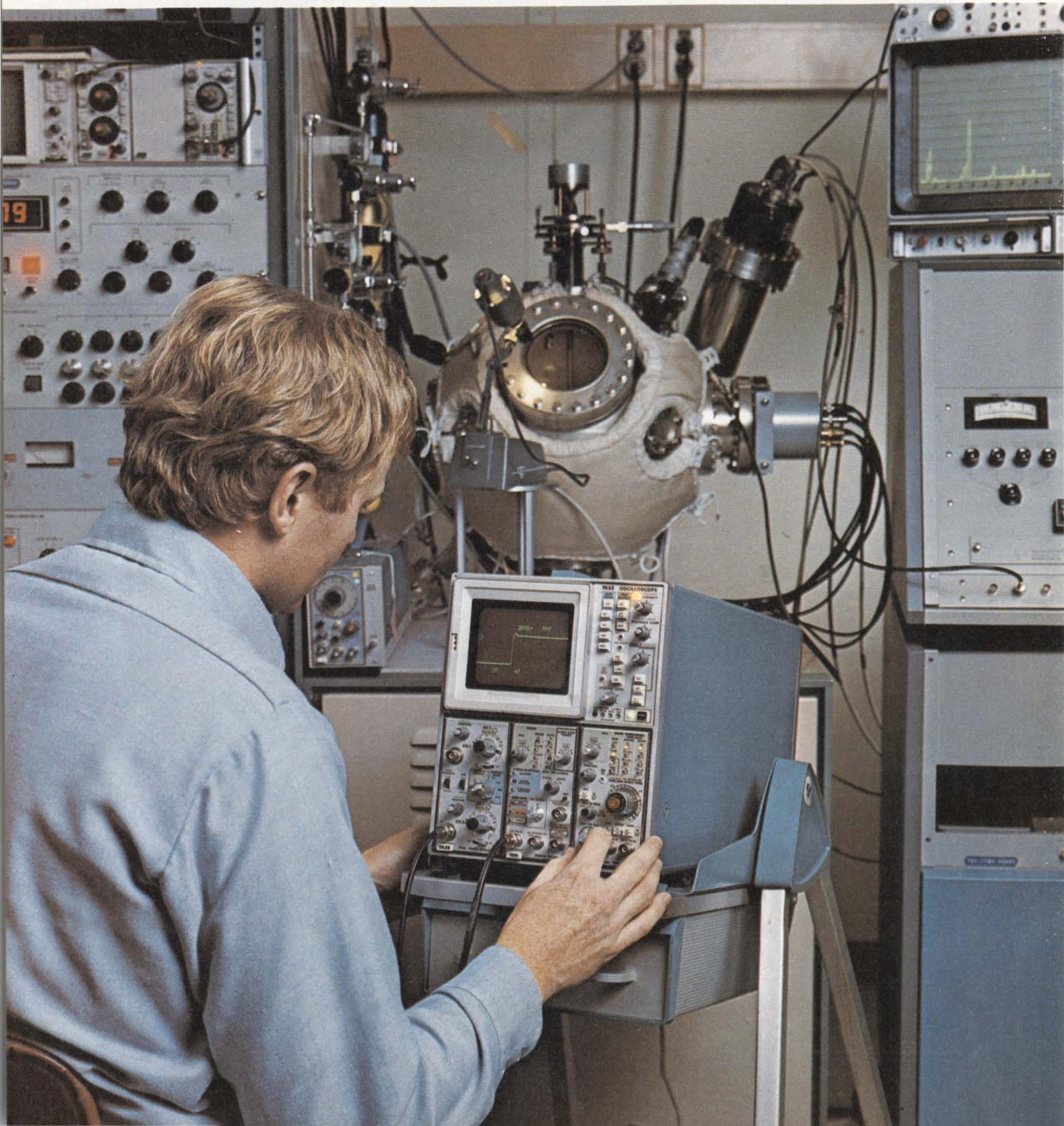

# Superior Performance

TEKTRONIX plug-in oscilloscopes define the state of the art today. With the 7000 Series, you can make the most complex measurements technology permits. The 7000 Series features:

The 7904, with the widest bandwidth available in any real-time oscilloscope. (Dc to 500 MHz with signal amplification, 1 GHz with your signal applied directly to the crt.)

The 7633, with three storage modes at the fastest usable writing speeds in one instrument. (1000 cm/ $\mu$ s captures a 100-MHz sine wave or a 3.5-ns rise time.)

The 7D11, 7D12, 7D13, 7D14, and 7D15, with interactive analog-digital measurements. (Digital ease and accuracy for voltage and timing measurements between selected points on complex waveforms.)

The 7844, with dual beam at 400 MHz. (Two electronically independent electron beam and deflection systems within one crt.)

The 7A22, with maximum differential capability. (10  $\mu$ V/div input sensitivity; 100,000:1 common-mode rejection ratio.)

The 7L13 spectrum analyzer. (0 to 18 GHz frequency domain displays with 30-Hz resolution bandwidth.)

The 7J20 rapid-scan spectrometer. (400 nm scanned in 4 ns.) (Available in U.S. only.)

The 7S11 sampling unit. (Displays repetitive signals up to 14-GHz equivalent bandwidth.)

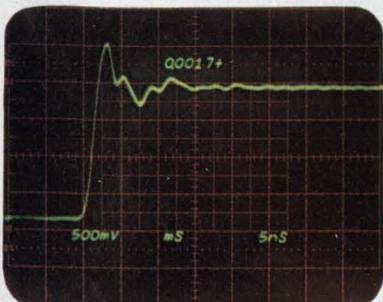

In the application shown, an engineer evaluates the circuit he's designing with a 7633 multimode storage, 100-MHz bandwidth mainframe, a 7A26 dual-trace amplifier, a 7D11 digital delay unit, and a 7B53A dual time base. In the FAST transfer variable persistence storage mode, he can capture and display the 3.5-ns rise time of a single-shot event for detailed analysis.

At the push of a button, he has the option of normal (nonstored) operation or a choice between variable persistence and bistable storage, each with or without FAST mesh transfer. The fastest writing speed is obtained by selecting a reduced crt scan.

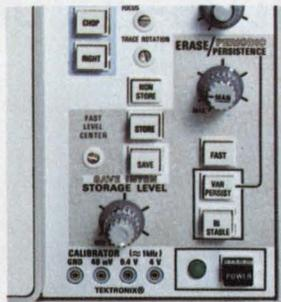

With the 7D11 digital delay unit, he can delay the start of a sweep for a given number of events such as clock counts or data pulses. By tying his sweep start to the data domain he's examining, he eliminates the display jitter often associated with time delays.



He can also make digitally accurate timing measurements — between points on the same trace or on dif-

ferent traces—by using the 7D11 in a digital delay-by-time mode.

This configuration is only one of countless combinations of superior performance mainframes and plug-ins from Tektronix' 7000-Series.

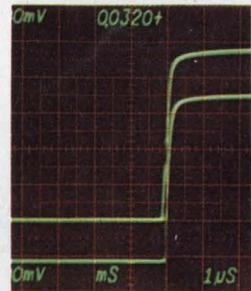

High frequency, storage, sampling, dual beam, differential, analog-digital synergism, rapid scanning spectroscopy—whatever the state of your art, turn to a plug-in oscilloscope from Tektronix to measure it.

For a catalog of 7000-Series plug-in instruments, write Tektronix, Inc., P.O. Box 500, Beaverton, Oregon 97077. In Europe, write Tektronix Limited, P.O. Box 36, St. Peter Port, Guernsey, Channel Islands.

## The 7000 Series more than an oscilloscope

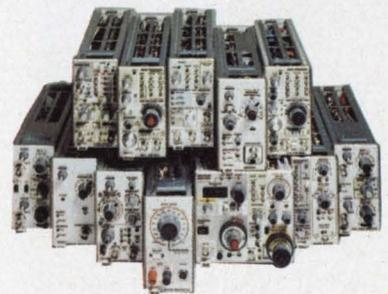

**TEKTRONIX®**  
committed to  
technical excellence

# We made them first. To last.

Available now from Singer: Size 8 and 11 Bu/weps synchros designed to meet the latest requirements of MIL-S-20708C specifications.



Kearfott, the first to design Bu/weps size 5, 8 and 11 synchros, has over the years constantly made them better. These units are used in fire control systems, radar, navigation, missile functions and other applications requiring a high level of precision, endurance and reliability.

These Kearfott synchros operate over the entire temperature range of  $-55^{\circ}\text{C}$  to  $+125^{\circ}\text{C}$ . They are DOD qualified and listed in the QPL.

(They can also meet reasonable cost requirements in computers, electronics and other types of business equipment.)

INFORMATION RETRIEVAL NUMBER 25

You can get these synchros in the following Bu/weps types:

Size 8	Size 11
26V 08CX4c	26V 11CX4c
26V 08CDX4c	11CX4e
26V 08CT4c	26V 11TX4c
	26V 11CDX4c
	11CDX4b
	26V 11CT4d
	11CT4E

We'll be happy to send you drawings and technical details on request. Also for Kearfott Size 5 Bu/weps CX, CDX and CT units, and Size 11 and 15 resolvers. Units with the same characteristics but different Bu/weps shaft variations are also available. Write for information to the Singer Company, Kearfott Division, 1150 McBride Avenue, Little Falls, N.J. 07424.

**SINGER**  
AEROSPACE & MARINE SYSTEMS

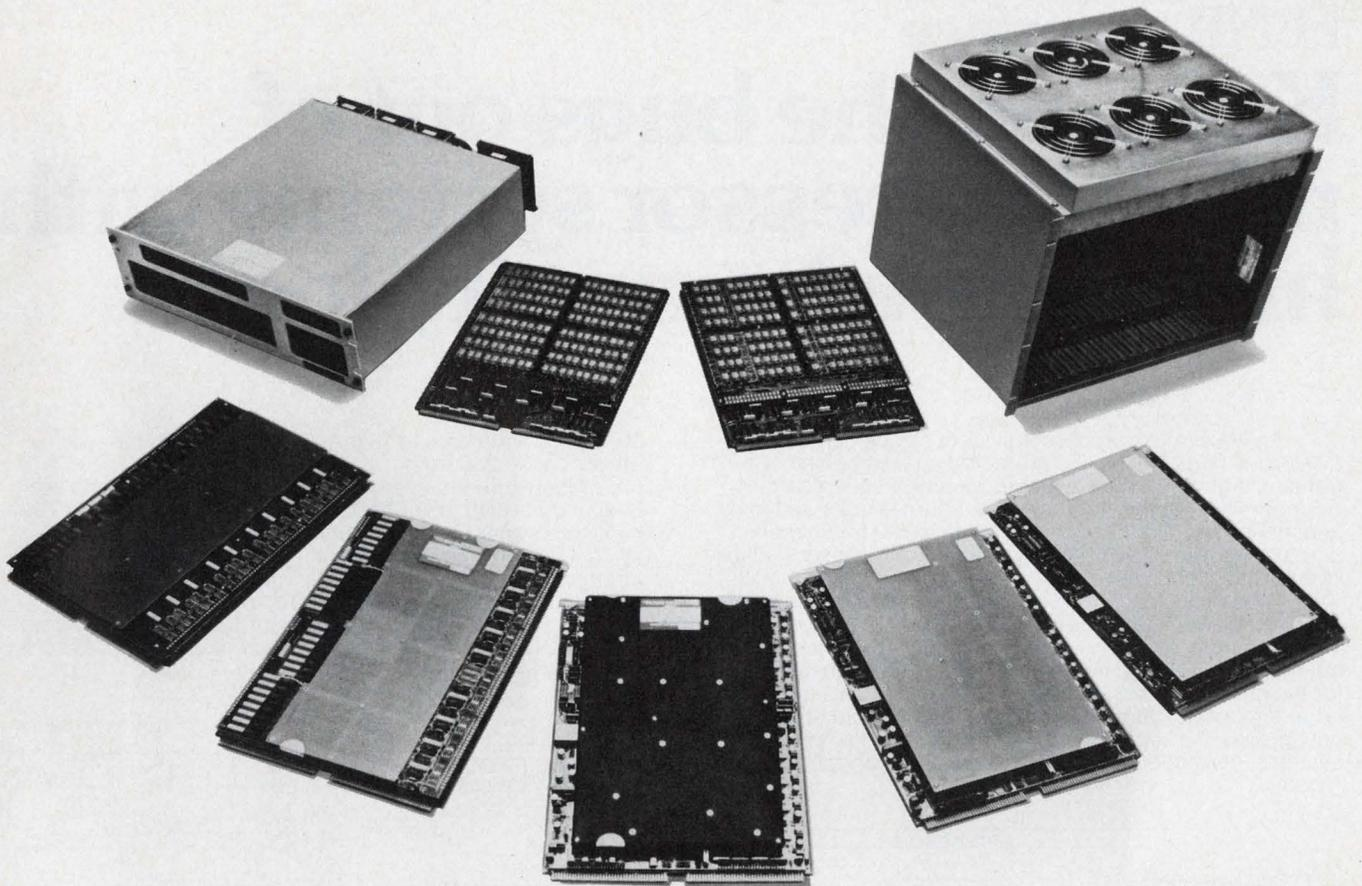

# Only EMM Offers Core & NMOS Memories You Can Mix & Match

That's the MICROMEMORY 3000 family. Probably the most versatile family of memory systems available today. Or tomorrow.

Start, for example, with the basic, reliable MICROMEMORY 3000 8K x 18 core memory card — which can be depopulated down to 4K if you want. There's a standard chassis with power supply to hold four of these plus interface card, self test card, other accessories. Or you can substitute the 16K MICROMEMORY 3000DD card. Or the 32K MICROMEMORY 3000QD card. Make it NMOS with our MICRORAM 3000N 16K x 20 card memory. Or the MICRORAM 3400N 32K memory using our new SEMI 4402 4K static RAM.

The beauty of it is, you can mix or match any of these in the same 5¼" chassis, and go from 4K core to 32K NMOS cards without any basic change in the support electronics. (There's even a vertical chassis which holds up to 16 cards totalling a megabyte if you need that much.)

Call your nearest EMM sales office to find out how you can build the precise memory system you need today. And tomorrow.

**EMM ELECTRONIC  
MEMORIES  
COMMERCIAL MEMORY PRODUCTS**

A Division of Electronic Memories & Magnetics Corp.  
12621 Chadron Ave., Hawthorne, Calif. 90250

EMM OFFICES: WESTERN REGION, Regional Office, San Francisco (408) 247-9711, Los Angeles Area (213) 644-9881, Orange County Area (714) 639-5811, Phoenix Area (602) 968-2492, EASTERN REGION, Regional Office, Boston (617) 861-9650, Chicago Area (312) 297-7090, New York Area (516) 423-5800, Ohio Area (216) 867-5435, INTERNATIONAL OFFICES, European Headquarters, Belgium (031) 76.69.75, United Kingdom (01) 751-1213, West Germany (089) 714.30.40.

REPRESENTATIVES: Gentry Associates; Orlando (305) 894-4401, Huntsville (205) 534-9771, Burlington, N.C. (919) 227-3639. The Thorson Co., Washington/Oregon (206) 455-9180. In Canada: Megatronix, Ltd.; Toronto (416) 742-8015, Montreal (514) 488-0404, Ottawa (613) 729-4004, Vancouver (604) 526-3312. In Japan, Nissho Electronics (03) 544-8396.

INFORMATION RETRIEVAL NUMBER 26

# HiNIL Interface

# Keeping the bugs out of microprocessor systems with high noise immunity logic.

An MOS microprocessor system can be troubled by disastrous bugs unless it is protected against noise transients generated by switches, electromechanical peripherals and other nearby noise sources, such as lamps and machinery. But filters and shielding, the traditional cures, are often difficult to add to a microprocessor because of size and cost constraints.

These problems can be avoided by substituting HiNIL interface devices for conventional I/O logic. HiNIL—Teledyne's bipolar High Noise Immunity Logic—has a guaranteed DC noise immunity about 10 times that of TTL, for example (3.5 vs. 0.4V). Also, HiNIL blocks AC transients large enough to cause TTL malfunctions. Two additional advantages are superior output drive and, in low power systems, protection of CMOS memory and random logic inputs.

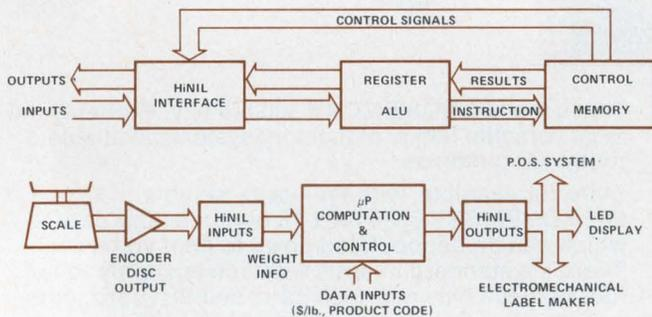

Figure 1. Use of HiNIL interfaces in POS systems with electronic scale. Top diagram shows basic microprocessor configuration.

One manufacturer of microprocessor-controlled electronic scales decided to use the configuration in Figure 1 because he was concerned about the consequences of incorrect weights and prices. The probability of errors resulting from noise transients was high because the scale would be used in a supermarket POS system, where the environment includes refrigerators, fluorescent lamps, meat grinders and electromechanical label makers.

In the system, the microprocessor receives weight codes from an encoder disc in the scale and operates a cash register interface, LED display, and relays of a receipt printer or label maker. The system designers put HiNIL interface logic on the microprocessor board to handle the I/O functions, suppress noise transients picked up along the transmission lines, and drive the peripheral devices. HiNIL output interfaces can drive long lines, relays, displays and lamps without additional components since they sink up to

65 mA and source up to 12 mA. (The new 390 buffer series will sink up to 250 mA.)

Manufacturers of systems requiring random logic are finding that HiNIL and CMOS are an ideal combination. They maximize system noise immunity and assure an excellent system function/power product. HiNIL and 54C/74C CMOS interface directly at  $V_{CC}$  voltages from 10 to 16 volts, the power supply range of HiNIL. Moreover, HiNIL protects CMOS inputs from destruction by static electricity and from harmful DC input levels that can exist before CMOS circuits are powered up.

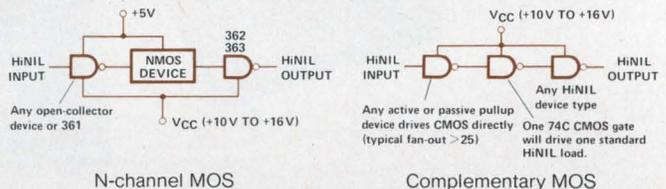

Figure 2. Typical HiNIL/MOS and HiNIL/CMOS interfaces

The rules for using HiNIL with MOS or with CMOS operating at lower voltages are simple. The pullup resistor of an open collector HiNIL device is connected to the desired high logic level voltage (see Figure 2). To use HiNIL with other bipolar logic, just plug in a Teledyne dual or quad interface circuit (see table). HiNIL is also compatible with most analog devices.

## Examples of HiNIL Interface Devices

301 Dual 5-Input Power Gate	65mA relay or lamp driver
302 Quad Power NAND Gate (OC)	
323 Quad NAND Gate (OC)	
332 Hex Inverter (OC)	
334 Strobed Hex Inverter (OC)	Drive longer lines than TTL with 10X noise immunity ( $I_{OH}=12mA$ )
350 8-Bit Multiplexer	
351 Dual 4-Bit Multiplexer	
361 Dual Input Interface	
362 Dual Output Interface	361 directly connects HiNIL to DTL/RTL/TTL 362 and 363 connect DTL/RTL/TTL to HiNIL
363 Quad Output Interface	
367 Quad Schmitt Trigger	
368 Quad Schmitt Trigger (OC)	Suppress 100V/1 $\mu$ s spikes, protect CMOS, decode switches, etc.
380 BCD to Decade Decoder	
381 BCD to Decade Decoder (OC)	
382 BCD to Decade Decoder	Provide decode/drive for lamps, LEDs, gas discharge displays, etc.
383 BCD to 7-Segment Decoder	
390 Interface Buffer Series	

If you need a simple, inexpensive solution to a difficult noise problem, write or call Teledyne Semiconductor for a copy of application notes and specifications on Teledyne's High Noise Immunity Logic family.

# TELEDYNE SEMICONDUCTOR

1300 Terra Bella Avenue, Mountain View, California 94043 Tel: (415) 968-9241 TWX: 910-379-6494 Telex: 34-8416

ENGLAND: Heathrow House, Cranford, Hounslow, Middlesex, Tel: (44) 01-897-2503 Telex: 851-935008

FRANCE: 90, Avenue Des Champs Elysees, 75008 Paris, Tel: 2563069 Telex: 842-29642

WEST GERMANY: Albert Gebhardtstrasse 32, 7897 Tiengen, Tel: 7741-5066 Telex: 841-792-1462

JAPAN: Nihon Seimei-Akasaka Bldg. (3F), 1-19, Akasaka 8-chome, Minato-ku, Tokyo 107, Tel: 03-405-5738 TWX: 781-2424241

Additional offices in West Germany, Hong Kong and the United States. Representatives and distributors worldwide.

## The shortcut

Wearing what seemed like a 400 pound pack on my back, and carrying just about everything human fiendishness could devise, I was charged with leading a squad of infantrymen from Point A to Point B in the woods of Alabama.

But it wasn't that simple. The instructions were to leave Point A at midnight and move 550 yards at a compass setting of 290 degrees to Point C, then 470 yards along a 60-degree compass setting to Point D, and on through Points F, G and H to Point B.

Well, to a fellow who had even the scantiest background in vectors, this looked like a lead-pipe cinch for beating the system, which, of course, was the object of every infantryman. So I led my squad a few yards away from our staging area and took a few minutes to calculate the shortest route from A to B. It was beautiful. I saw right away that we would arrive hours early. Then, after posting a "volunteer" to stay on the lookout for insomniac captains and majors who might be pacing the area, the rest of us could get a half-night's sleep. Ah, what luxury.

So we started on our newly plotted course from A to B and, after about 75 yards, we were waist deep in a miserable ice-water stream. With the vision of hours of sleep ahead of us, we shivered our way across the stream only to find ourselves mashing through a swamp. With the swamp behind us, we scraped our way through the world's thorniest forest. Finally, we found ourselves crossing, of all things, a machine-gun training course. Several dozen men on our right were firing live ammunition and tracers at impossible-to-see targets on our left. Needless to say, we crossed this obstacle very much on our bellies.

Well, we did get some sleep at the end of our jaunt, though not as much as we'd hoped. But none of us felt the shortcut was worth it. We concluded that it's not smart to take a shortcut unless you know a great deal about the terrain you'll be crossing.

I suspect that's a good guide for most of our business and engineering decisions. Too many of us look for shortcuts to riches without knowing what lies along the way. Too many of us, overly eager to rush a product to the marketplace to beat a competitor or to meet the deadline of a trade show, take dangerous shortcuts in product design. Many of us might do lots better if we avoided shortcuts that weren't accompanied by a really fine map of the territory.



A handwritten signature in dark ink, which reads "George Rostky". The signature is fluid and cursive, with a long horizontal stroke extending from the end of the name.

GEORGE ROSTKY  
Editor-in-Chief

# DELCO'S NEW FAS HIGH-GAIN TRANSIS

## MAJOR PARAMETER LIMITS

TYPE	$h_{FE}$ @ 10A	$V_{CBO}$	$V_{CEO}$ (sus)	$V_{CE}$ (sat) @ 7A	tf (typical) @ 5A)
DTS 515	3.5	300V	250V	5.0V	0.25 $\mu$ sec
DTS 516	4	400V	250V	1.9V	0.25 $\mu$ sec
DTS 517	5	500V	250V	1.6V	0.25 $\mu$ sec
DTS 518	5	600V	275V	1.4V	0.25 $\mu$ sec
DTS 519	5	700V	300V	1.4V	0.25 $\mu$ sec
2N6573	5	500V	250V	1.6V	0.25 $\mu$ sec
2N6574	5	600V	275V	1.4V	0.25 $\mu$ sec
2N6575	5	700V	300V	1.4V	0.25 $\mu$ sec

NPN triple diffused silicon transistors. Packaged in solid copper cases conforming to JEDEC TO-3 (TO-204MA) outline dimensions.

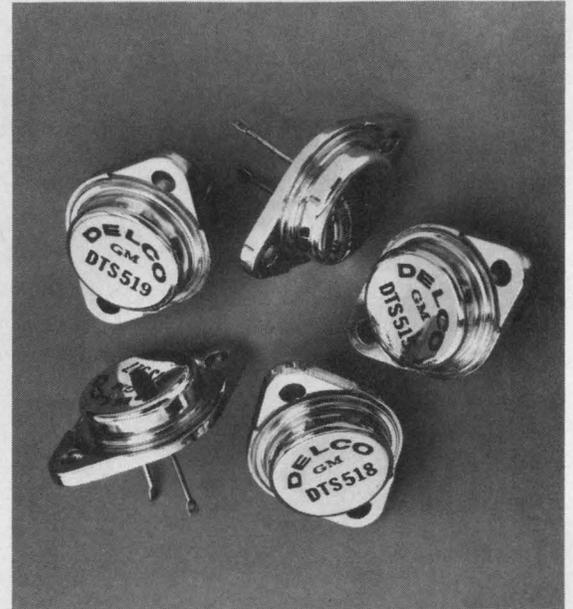

Our newest high-energy silicon power transistors have increased capabilities over our earlier types in current ratings, gain and switching speeds. These improvements were achieved without sacrificing the useful peak power handling capacity that is characteristic of Delco's transistors.

Fall time of these transistors is typically 0.25 microseconds. Their biggest advantage, however, is their high current gain as shown on the accompanying beta curves.

A new characterization feature offered with the DTS-515 series is a graph of capabilities for reverse bias clamped inductive switching. Parameter variables, dealt with in the graph, are voltage, collector current, temperature, and forward and reverse base current. As can be seen in the

" $V_{BE}(\text{reverse}) \geq 5V$ " notation, emitter diode avalanche is recommended under certain conditions.

And, of course, these high-energy silicon power transistors come in Delco's solid copper TO-3 packages to ensure low thermal resistance.

The accompanying curves, charts and circuits tell part of the story. Prices, applications literature and electrical data from your nearest Delco sales office or Delco distributor can supply another part.

But the most important part of the story is how well these new transistors function in your applications.

You can order them today; they're in stock at your Delco distributor's.

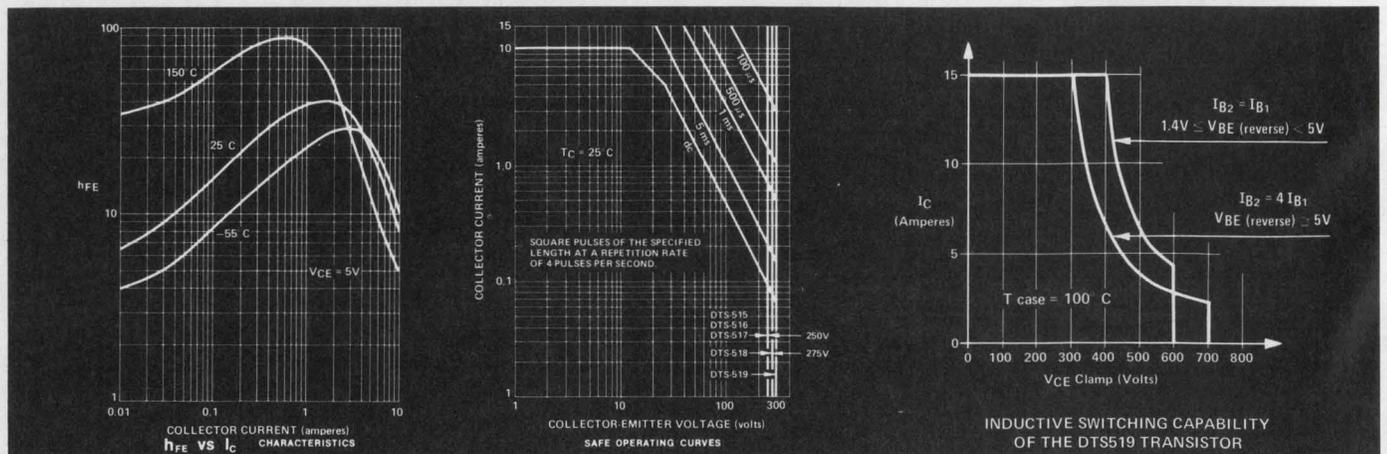

# TER SWITCHING, TORS NOW IN STOCK.

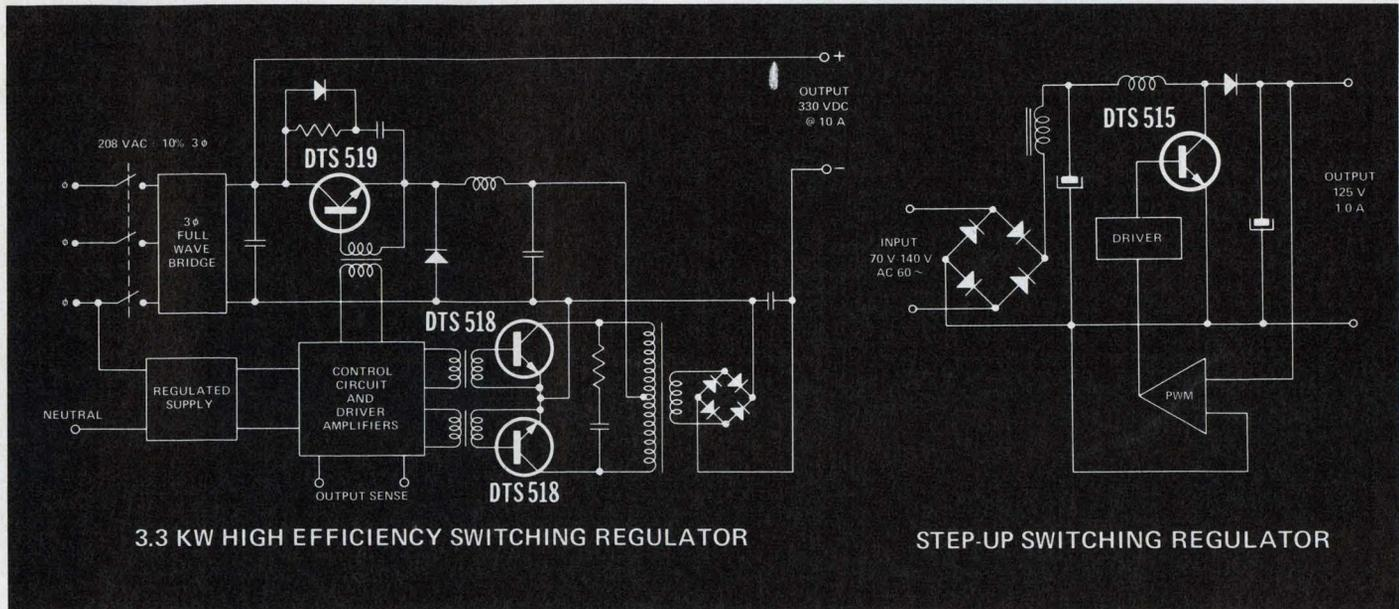

**NOW AVAILABLE FROM THESE DISTRIBUTORS IN PRODUCTION QUANTITIES.**

**ALABAMA, Birmingham**  
Forbes Distributing Co., Inc.  
(205) 251-4104

**ALABAMA, Huntsville**  
Powell Electronics  
(205) 539-2731

**ARIZONA, Phoenix**  
Sterling Electronics, Inc.  
(602) 258-4531

**CALIFORNIA, Gardena**  
Bell Industries  
Electronics Distributors Div.  
(213) 321-5802

**CALIFORNIA, Goleta**  
R.P.S. Electronics, Inc.  
(805) 964-6823

**CALIFORNIA, Los Angeles**  
Kierulff Electronics, Inc.  
(213) 685-5511

**CALIFORNIA, Los Angeles**  
R.P.S. Electronics, Inc.  
(213) 748-1271

**CALIFORNIA, Palo Alto**  
Kierulff Electronics, Inc.  
(415) 968-6292

**CALIFORNIA, San Diego**  
Kierulff Electronics, Inc.  
(714) 278-2112

**CALIFORNIA, San Diego**  
R.P.S. Electronics, Inc.  
(714) 292-5611

**CALIFORNIA, Sunnyvale**  
Bell Industries  
(408) 734-8570

**COLORADO, Denver**  
Kierulff Electronics, Inc.  
(303) 371-6500

**CONNECTICUT, Norwalk**  
Harvey Electronics  
(203) 853-1515

**FLORIDA, Clearwater**  
Diplomat/Southland  
(813) 443-4514

**FLORIDA, Miami Springs**  
Powell Electronics/Florida  
(305) 592-3260

**ILLINOIS, Elk Grove Village**  
Kierulff Electronics, Inc.  
(312) 640-0200

**ILLINOIS, Skokie**  
Bell Industries  
Electronics Distributors Div.  
(312) 282-5400

**INDIANA, Indianapolis**  
Graham Electronics Supply, Inc.  
(317) 634-8202

**MARYLAND, Baltimore**  
Radio Electric Service Co.  
(301) 823-0070

**MASSACHUSETTS, Billerica**  
Kierulff Electronics, Inc.  
(617) 935-5134  
(617) 667-8331

**MASSACHUSETTS, Newton**  
The Greene-Shaw Co., Inc.  
(617) 969-8900

**MICHIGAN, Livonia**  
Pioneer/Michigan  
(313) 525-1800

**MINNESOTA, Minneapolis**  
Stark Electronics Supply Co.  
(612) 332-1325

**MISSOURI, Kansas City**  
Walters Radio Supply, Inc.  
(816) 531-7015

**MISSOURI, St. Louis**  
LCOMP-St. Louis  
(314) 647-5505

**NEW JERSEY, Cinnaminson**  
Wilshire Electronics/Philadelphia  
(609) 786-8990 (215) 627-1920

**NEW JERSEY, Clifton**  
Wilshire Electronics/New Jersey  
(201) 365-2600 (212) 244-8930

**NEW MEXICO, Albuquerque**  
Sterling Electronics  
(505) 345-6601

**NEW YORK, Binghamton**  
Harvey Electronics  
(607) 748-8211

**NEW YORK, Buffalo**  
Summit Distributors, Inc.  
(716) 884-3450

**NEW YORK, Farmingdale**  
Wilshire Electronics/Long Island  
(516) 293-5775

**NEW YORK, Woodbury**  
Harvey Electronics  
(516) 921-8700 (212) 895-9260

**OHIO, Cincinnati**  
United Radio, Inc.  
(513) 761-4030

**OHIO, Cleveland**  
Pattison Supply Co.  
Industrial Electronics Division  
(216) 441-3000

**OHIO, Dayton**  
Pioneer/Dayton  
(513) 236-9900

**PENNSYLVANIA, Philadelphia**  
Almo Electronics  
(215) 698-4000

**PENNSYLVANIA, Pittsburgh**  
Cameradio Electronics  
(412) 288-2600

**SOUTH CAROLINA, Columbia**  
Dixie Radio Supply Co., Inc.  
(803) 253-5333

**TEXAS, Dallas**  
Sterling Electronics  
(214) 357-9131

**TEXAS, Houston**  
Harrison Equipment Co., Inc.  
(713) 224-9131

**TEXAS, Houston**  
Sterling Electronics  
(713) 627-9800

**WASHINGTON, Seattle**  
Kierulff Electronics, Inc.  
(206) 763-1550

**IN CANADA: ONTARIO, Scarborough**  
Lake Engineering Co., Ltd.  
(416) 751-5980

**ALL OVERSEAS INQUIRIES:**  
General Motors Overseas  
Operations  
Power and Industrial Products  
Dept.  
767 Fifth Avenue, New York, N.Y.  
10022  
PHONE: (212) 486-3723

**Delco Electronics Regional Sales Offices**  
Union, New Jersey 07083  
Box 1018 Chestnut Station  
(201) 687-3770

Van Nuys, California 91404  
Box 2968  
(213) 988-7550

**General Sales Office**  
700 E. Firmin, Kokomo, Ind. 46901  
(317) 459-2175

## Delco Electronics



Division of General Motors

INFORMATION RETRIEVAL NUMBER 28

# FOCUS

## on Field effect transistors

Probably the biggest mistake an engineer can make in specifying FETs is to choose a FET when perhaps a familiar bipolar transistor can do the job better and cheaper.

You won't find transistor vendors very helpful when you're trying to make the basic choice between a bipolar and a FET. Some companies make only FETs, so naturally they will favor that alternative. And large companies, that make both types, often have different product managers for FETs and bipolars. These men may bombard you with literature that presents seemingly conflicting performance claims. Of course, the specs for FETs and bipolars aren't directly comparable—so, at this stage, data sheets aren't very helpful.

Even something as basic as the pinout can cause confusion when you're making preliminary tests. For a FET in a TO-5 or TO-18 can, you would expect to find the gate terminal in the position where the base lead would be on a conventional transistor. But often it's not. It's in the position usually occupied by the collector.

Design engineers can save themselves a lot of time and trouble, therefore, if they understand the basic strengths and weaknesses of FETs and bipolars. Sometimes it will quickly become clear that one type of device is completely unsuited to your circuit. And if you want to do a nose-to-nose comparison, it's useful to know which performance characteristics are likely to prove most critical—these, of course, are the specs to look at first. Usually it won't be necessary to wade through a complete worst-case design analysis—considering both FETs and bipolars for your application. If after a first-cut comparison both types seem to offer comparable performance, then

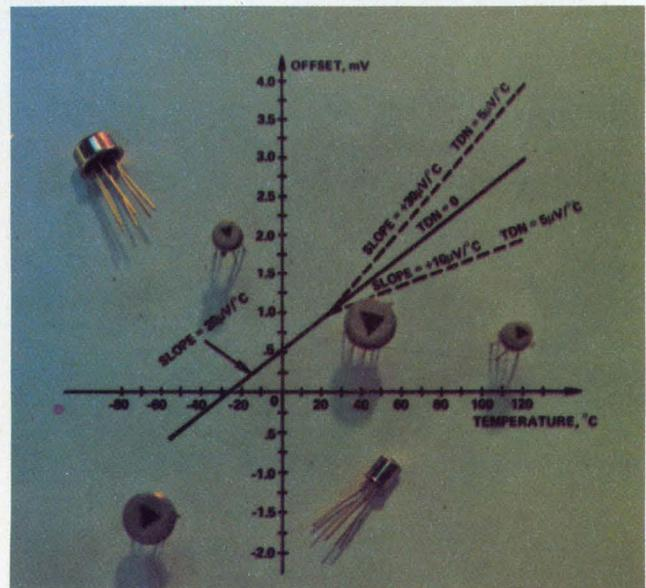

Monolithic dual n-channel FETs from Analog Devices are backed up by guaranteed specifications for temperature drift nonlinearity. An AD3956 with a maximum drift of  $50 \mu\text{V}/^\circ\text{C}$ , and a suitable TDN spec, can be externally trimmed to yield a drift of only  $5 \mu\text{V}/^\circ\text{C}$ .

you'll probably select the bipolar device because of its lower cost.

In amplifiers, FETs are primarily used when high input impedances are needed (over  $10^{13}$  ohms is possible) and in applications where input leakage current must be minimized (less than  $500 \text{ pA}$  is easily attained). Essentially, bipolar transistors are current amplifiers whereas FETs are true transconductance (voltage in, current out) amplifiers. Bipolar transistors have superior offset-voltage drift while FETs win for leakage-current drift with temperature variations. However FETs can be easily biased to the

“zero-tempco” point, whereas this is much more difficult—and expensive—with bipolar transistors.

FETs are often claimed to offer superior noise characteristics in audio amplifiers. But beware. The noise figure of an amplifier depends on the source impedance, and the FET comes out ahead only when the impedance is high—greater than a few kilohms. For low generator impedances, bipolars will usually win the contest.

If you’re designing low-power amplifiers for battery operated equipment, FETs will win hands down. They can operate at less than a volt with quiescent currents as low as 10 microamps.

At the other end of the power spectrum, however, the picture is less clear. Right now, you’re pretty much stuck with bipolar transistors for power amplifiers. Though power FETs promise important theoretical advantages, available versions in the U.S. market are limited to around

they don’t have an offset voltage. Also they can be operated symmetrically—with the control voltage near ground potential—though this may require a second power supply.

Some types of FETs, especially metal-oxide-semiconductor (MOS) versions, suffer from high ON resistance compared with bipolar devices. But new structures for power devices may lead to improvements in this area. Another problem with MOSFETs is that unprotected versions are easily damaged by voltage transients at the gate. Also extra circuitry may be required to prevent unwanted latching of some types of FET switches.

### FETs are catching up at rf

In rf circuits, bipolar transistors have historically provided better gain-bandwidth products than have FETs. This was because it was easier

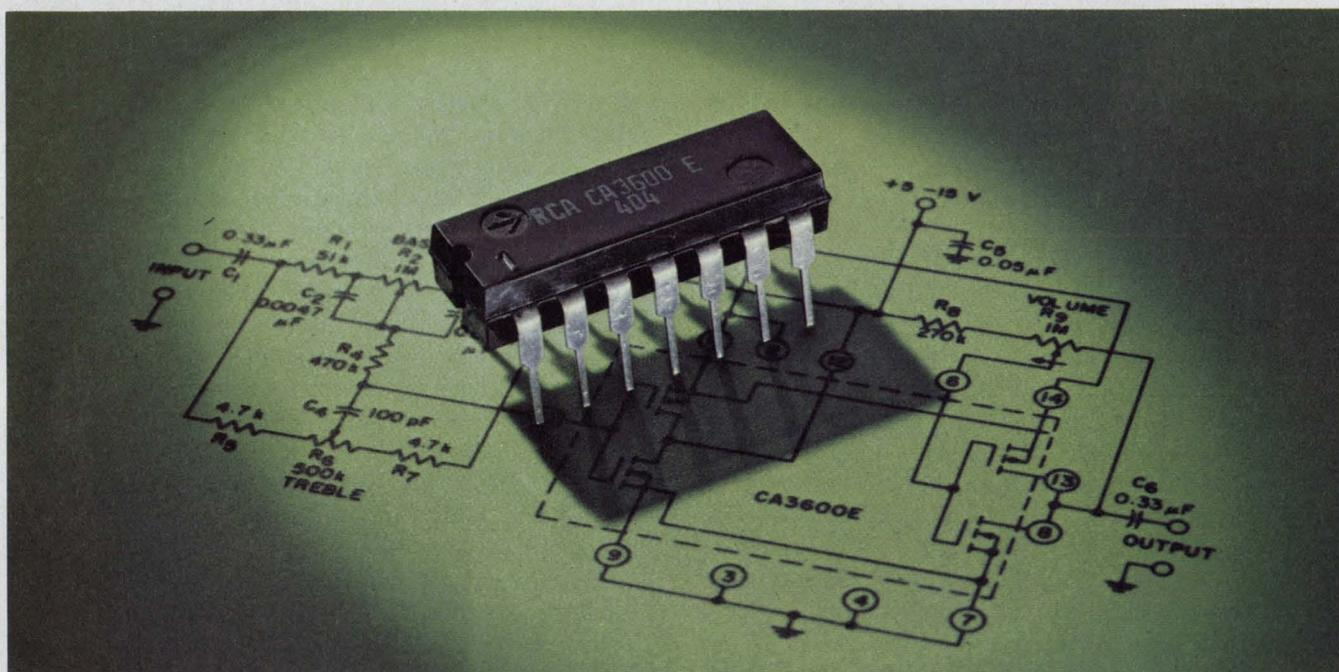

The CA3600E CMOS transistor array from RCA is a versatile circuit building block. For example, the integrated

array provides all the active devices needed for the tone-control section of an audio system.

10 watts. There is hope for the future, however, because Japanese researchers have achieved FET powers of several kilowatts. Among the advantages claimed for FET power devices are freedom from second voltage breakdown and thermal runaway, and reduced distortion in amplifiers.

In switching circuits the major advantage of FETs is that they are turned on and off by voltages rather than currents. And the voltages can be quite low, making the FET switches compatible with digital ICs. Because FETs are majority-carrier devices, they are essentially resistive when they’re conducting. This means

to control the bipolar transistor’s base width by diffusion than to control the FET’s channel length by photomasking. Several recent developments, however, have allowed FETs to compete with bipolars in the rf spectrum. The two most significant developments are probably double-diffused MOS (DMOS) and gallium-arsenide FETs (GaAs FETs). In DMOS devices the channel length is controlled by diffusion, thus allowing fine control. GaAs devices have much higher carrier mobility than the more commonplace silicon FETs—and this leads directly to better high-frequency performance. And, of course, there

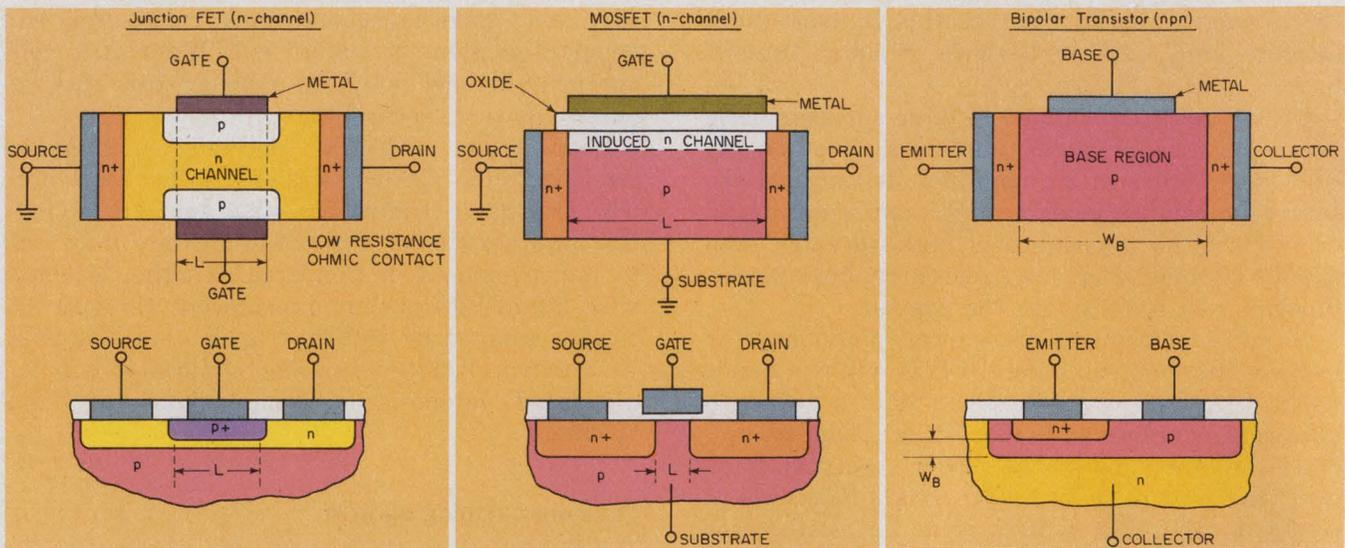

**Theoretical basic structures** (top) and modern planar versions (bottom) of JFETs, MOSFETs and bipolar transistors. Note that for the FETs the current flow is lateral from source to drain, while for the bipolar device it is vertical from emitter to collector. In general, a vertical

dimension such as  $W_B$  can be controlled more accurately and made narrower than a lateral dimension such as  $L$ . This explains why, historically, bipolars have had better frequency response than FETs—though recent technological advances have narrowed the gap.

have been advances in photolithography which have given FETs a competitive edge.

So today we find GaAs FETs operating at satellite-communication frequencies in the 6-GHz and 12-GHz range. And DMOS devices are widely used for the front ends of FM tuners and TV receivers, and, more recently, for mobile-communications transceivers. In these rf applications, the primary advantage of FETs is improved cross-modulation and intermodulation distortion. This results from the FET's parabolic (square-law) transfer characteristic. This characteristic also yields superior performance in mixer circuits. Furthermore, tetrode MOSFETs have a second gate electrode which allows simple AGC operation—without the elaborate external circuitry that would be needed with bipolar transistors.

The question of noise in rf circuits is a tricky one, and you'll almost certainly find yourself confronted by conflicting claims. The problem is that an amplifier's noise figure depends on the circuit impedances, the gain and the operating frequency. Also the total noise has several contributing factors.

FETs clearly have the edge in noise generated by distortion products, but for other noise components the picture is less clear. As we've already seen in the discussion of low-frequency amplifiers, FETs offer superior noise performance when the circuit impedances are high. But, unfortunately, impedances in rf circuits tend to be quite low. And in the area of operating frequency, FETs are on the horns of another dilemma. The noise of FETs tends to increase as frequency decreases. Yet it is only recently that FETs have been able

to provide worthwhile gain at the higher frequencies. Thus at frequencies where FETs could provide gain they also tended to be noisy.

As a result of all these tradeoffs, it's generally agreed that there's some crossover frequency above which FETs offer superior noise performance to bipolars. But the exact frequency is continually changing and is a matter of dispute. However it's believed by some FET researchers that GaAs FETs may be superior even at frequencies as low as 4 GHz. (For more information about the state-of-the-art in rf semiconductor devices, see "RF and Microwave Semis Rising in Power and Declining in Noise," ED 18, September 1, 1975, pp. 34-36.)

Before leaving our comparison of FETs and bipolars we should briefly note one performance area where FETs clearly have the edge. Because FETs are majority-carrier devices (like resistors), they are relatively immune to the effects of gamma radiation. Thus, if your equipment must be radiation hardened, you will probably choose FETs over bipolars, even though their performance may be inferior in other areas—such as noise.

### Should you use MOSFETs or JFETs?

After you've decided to use a FET, your problems haven't ended; they've barely begun. Next you'll have to decide whether to use a MOSFET (also called IGFET for "insulated-gate" FET) or a junction FET (JFET). Then you'll have to decide whether you want p-channel, n-channel or, perhaps, complementary MOS (CMOS). And then there's the question of enhancement-mode

versus depletion-mode devices. Finally you'll have to dig into the specs to choose a specific device.

Let's first look at the advantages and disadvantages of MOSFET and JFET devices.

As we've already seen, most FETs for rf applications are either MOS (which allows incorporation of a second gate) or high-performance offshoots of MOS such as DMOS and the metallized-semiconductor FET (MESFET). The second gate in dual-gate devices not only allows AGC but simplifies the design of mixer circuits and reduces feedback capacitance in amplifiers—thus improving stability.

At low frequencies (below about 10 MHz), the MOSFET loses ground to the JFET in several areas. The JFET usually has lower noise—though this is debatable. Actually the JFET has a lower noise voltage, whereas the MOSFET has lower noise current (assuming equal transconductance); therefore in most amplifier situations the JFET is quieter. Other advantages claimed for JFETs include higher breakdown voltages and better stability. In switching circuits, the JFET offers lower ON resistance than the MOSFET. And the JFET doesn't need gate protection.

On the other hand, the MOSFET has some advantages which may make it the best choice even for low-frequency amplifiers and switching circuits. If you need an extremely high input impedance that is not temperature-dependent, then a MOSFET may be the best choice. If you need leakage currents less than about 0.1 pA, you should consider MOSFETs—especially if temperature drift could cause problems. Also you can get both enhancement-mode (normally-OFF) and depletion-mode (normally-ON) MOSFETs, whereas JFETs are strictly depletion-mode—there's no such thing as an enhancement-mode JFET.

It should be remembered, however, that the MOSFET may require a substrate-bias circuit. Also it may need gate protection. And if you buy a MOSFET that has built-in gate protection, it probably won't have the same input characteristics as its nonprotected counterpart. This can be a real trap. If you're going to need gate protection, consider it in the initial design—don't try to tack it on after you've selected a FET and designed the rest of the circuit.

In switching circuits, MOSFETs are often more convenient to use—that is if you don't need the low ON resistance of JFETs. The drive circuitry is simplified with MOSFETs because they can be normally ON or OFF, and because they don't draw input current—regardless of the drive-voltage polarity. Also MOSFETs are available as high density arrays—if you're using a lot of analog switches this can slash the package count and, probably, the cost for your system. (For more on analog switches, see "FOCUS on IC Analog Switches and Multiplexers," ED 18,

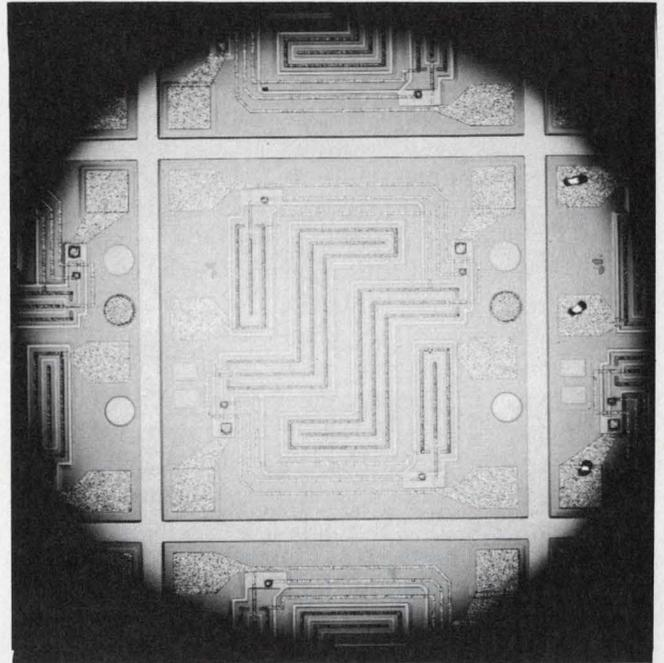

The IC-like geometry of Teledyne Semiconductor's dual n-channel JFETs contributes to their performance in differential preamps. Devices selected from this basic 38-mil square chip include Teledyne's SU2365 through SU2369 types, which exhibit characteristics matched to within 2%.

September 1, 1975, pp. 64-72.)

Both JFETs and MOSFETs are available in either n-channel or p-channel versions—though new devices are almost exclusively n-channel. In general, n-channel FETs offer much better performance. This is because negative charges (electrons) carry the current in n-channel devices, whereas positive "holes" carry the current in p-channel devices. And, of course, electrons travel much faster than holes.

In MOS there is a third choice called CMOS. This type of circuit has both n-channel and p-channel devices on the same chip. The primary advantage of CMOS is its extremely low quiescent power dissipation. CMOS is available either in the form of dedicated circuits or as arrays of nondedicated devices. Strictly speaking, all CMOS circuits are ICs; therefore they don't fall within the boundaries of this report—which is restricted to discrete FETs. (For more information on CMOS, see "FOCUS on CMOS," ED 6, March 15, 1974, pp. 86-95.)

### Specsmanship flourishes in FET data

Even after you've decided which type of FET you need and which characteristics are important for you, your battle is only half won. The next problem is to thresh through bundles of FET data sheets in an attempt to separate the wheat from the chaff. And this can be a tough task.

Unfortunately, specsmanship runs rampant in

FET data. It's quite common for data sheets to highlight a list of specs that are measured under different conditions. Almost none of them will be under conditions that will occur in your circuit, and some may even be under conditions that exceed the maximum ratings for the device.

Worse yet, highlighted specs are almost always "typical," and, of course, you can't do a worst case design without knowing maximum and minimum values. And frequently, the "typical" specs aren't even typical of what you will get. The production process may have changed since the device was originally characterized. Or the vendor may have selected so many premium devices from the production run that the distribution of the remainder is heavily skewed.

One reason why specsmanship has flourished is that FET terminology has never been standardized. As FETs evolved, manufacturers borrowed some terminology from vacuum tubes, some from bipolar transistors, and some they just invented. Inevitably manufacturers of JFETs and MOSFETs drifted in different directions because their devices didn't directly compete with each other.

The result is an Alice-in-Wonderland world in which things mean whatever the FET vendor says they mean. Thus the common-source forward transconductance appears as  $Y_{fs}$ ,  $g_{fs}$  or  $g_m$ . Another important characteristic, the gate-source cutoff voltage, appears as either  $V_{GS(off)}$  or as  $V_p$  (for pinch-off voltage).

Then there are specs that sound the same but which are really different. One example of this is "shutoff" voltage instead of "cutoff" voltage. Another example is gate operating current,  $I_G$ , and gate leakage current,  $I_{GSS}$ . In this case,  $I_G$  is the input leakage current you'll get in linear and differential amplifiers, whereas  $I_{GSS}$  is the leakage of a back-biased FET in a nonoperating mode. But  $I_{GSS}$  isn't the only component of leakage in an analog switch. There's also something called drain OFF current,  $I_{D(off)}$ . It gets confusing, doesn't it?

Even something as basic as the FET symbol hasn't been fully standardized. At present, there are two sets of symbols for JFETs—both of which have IEEE/ANSI approval. And, as we saw earlier, there is no standard pinout for FETs in TO-5 and TO-18 cans.

### Different specs for different folks

It's generally agreed throughout the industry that 2N-type specs, registered with the Electronic Industries Association, are almost useless—especially for rf FETs. But nobody's really to blame for the woeful inadequacy of the 2N data sheets. What happened was more like a comedy of errors.

In the early days of FETs, manufacturers real-

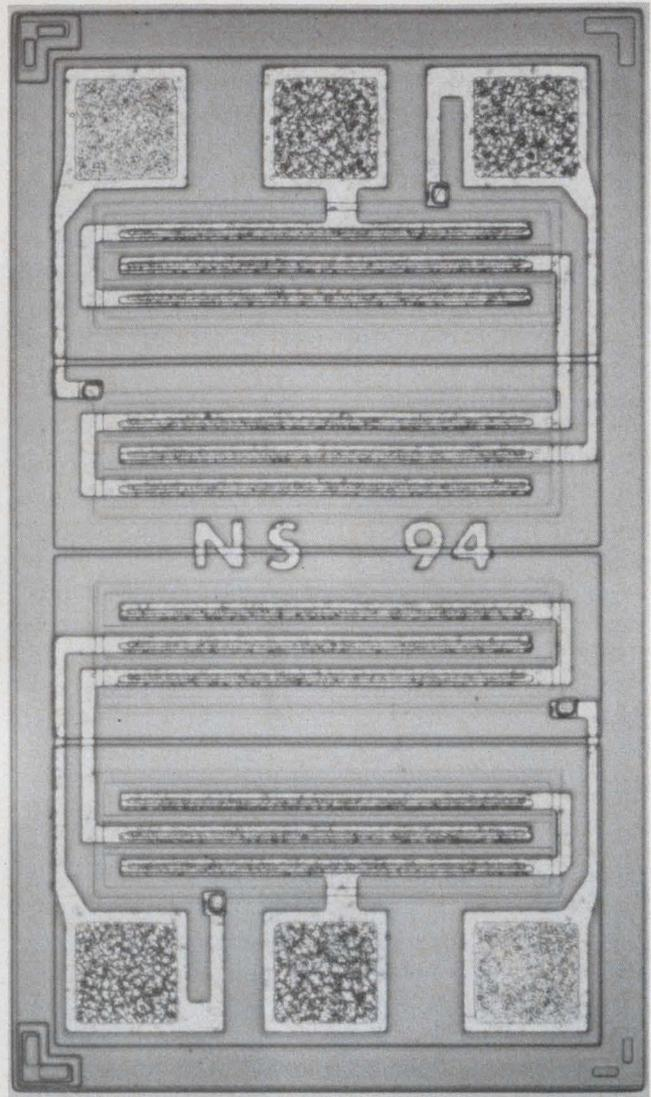

Cascode dual n-channel JFETs from National Semiconductor are said to maintain a high input impedance—even with large drain-gate voltages. Another advantage of the cascode structure is improved common-mode rejection ratio in differential-amplifier applications.

ized that different engineers would be using them for vastly different jobs. So rather than attempt to provide all the specs an engineer could conceivably need, the vendor tried to meet him halfway. If the manufacturer figured that the major application for his FET would be in switches, he tried to list just those specs that would be most useful to switch designers.

Unfortunately, after 2N registration, the specs were cast in concrete and couldn't be modified. If the manufacturer then discovered that there was a large demand for amplifier characteristics, he was forced to reregister the device, under a different 2N number, as an amplifier. The result was a proliferation of 2N numbers. Sensing that this could cause confusion and might prove bad for business, manufacturers then swung to the other extreme. As they developed new processes that offered improved FET performance, they

either introduced the new device with their own, non-2N, part number, or they tried to characterize it within the constraints of an existing, preferably popular, 2N number.

The result today is that devices that share the same 2N number may be vastly different. If the performance of one manufacturer's FET is strong in one area—say, leakage or breakdown voltage—you can't assume that all the other specs will be equally good. And the areas of strength may differ from manufacturer to manufacturer. This problem becomes especially acute if the spec isn't guaranteed. What you measure for one manufacturer's FET may not be valid for a second source.

Perhaps the biggest problem, however, is not the specs that are listed but the ones that are omitted. For example, 2N data sheets for rf devices rarely list S parameters. As another example, the 2N4393 was originally specified as a switch but it also offers superior performance as an amplifier. For an amplifier, you would like to know the value of  $I_G$ , but the 2N data sheet doesn't include this. And you may want to know, say, the noise of a device that isn't a low noise device, but which may, nevertheless, be good enough for your circuit. Unfortunately, if the news isn't good, vendors often omit it. Other specs that are widely omitted are cross-modulation characteristics, and the input, output and reverse capacitance of MOSFETs. Also most manufacturers are mute on the subject of what happens when you vary the substrate bias of MOSFETs.

Even if you're designing, say, an amplifier, and the FET is characterized as an amplifier, your problems aren't over. The specs may not be listed for the conditions that will occur in your circuit. For example, the forward transconductance,  $g_{fs}$ , is commonly measured with a gate-source voltage,  $V_{GS}$ , of zero—though this isn't likely to be the situation in your circuit.

Noise is another characteristic that's often specified under nonstandard conditions. As we saw earlier, the low-frequency noise figure depends heavily on the gate impedance. Therefore a low noise figure is no guarantee of low noise voltage. For example, the 2N3684 has a mandatory maximum noise figure of 0.5 dB. This corresponds to a noise voltage,  $e_n$ , of  $150 \text{ nV}/\sqrt{\text{Hz}}$  with an  $R_s$  of 10 M $\Omega$ . But if  $R_s$  were only 10 k $\Omega$ ,  $e_n$  would have to drop to  $4.5 \text{ nV}/\sqrt{\text{Hz}}$  to maintain a 0.5 dB noise figure.

Parasitic capacitances are yet another set of specs that depend heavily on the measurement conditions. These capacitances tend to be voltage-dependent. Many manufacturers have registered the specs for completely unrealistic bias conditions that are way beyond the cutoff point for the FET. They justify this specsmanship by pointing

out that the information is useful if you're designing a switch. But this is poor consolation to the man who's trying to design an amplifier.

A complete solution to the problem of the interdependence of characteristics would be for vendors to provide complete sets of curves—and to guarantee them. But in the real world this just isn't feasible. Fortunately, vendors are starting to provide typical curves, but they can't (and you can't) afford to do the extensive testing that would be needed to guarantee them. Nevertheless, the curves can be useful, and it pays to study them. At the very least, they give you a feel for the trend of the interactions—what goes down when something else goes up. And a more careful study can help you understand the tradeoffs that result from a particular manufacturer's fabrication process. This can help when you're selecting a second-source supplier. You will want to choose one that uses a similar process to your original supplier. Otherwise the specs wouldn't interact in the same way—though they may conform to the same 2N spec.

#### Shrewd specifying cuts costs

Though a manufacturer may have hundreds of different FETs in his catalog, these all use just a few basic processes and geometries. And if you know the range of capabilities for each basic chip in the manufacturer's repertoire, this comes in very handy when you want to specify a custom device without paying too much for it. If you know the general characteristics of a basic chip, you can pretty accurately approximate the value of those characteristics that don't appear on the data sheet.

You can avoid paying too much for FETs if you don't call for very difficult combinations of specs. Thus don't ask for a very low  $I_{DSS}$  and a very low  $r_{DS(on)}$ . The two tend to be mutually exclusive. And such parameters as  $I_{DSS}$ ,  $r_{DS(on)}$ ,  $g_{fs}$  and  $g_{os}$  are all related to pinchoff voltage, in addition to being interrelated. Thus if you put too tight a spec on  $V_{GS(off)}$ , you may make it very difficult for the manufacturer to meet your other specs—and the cost will soar.

In general, it doesn't pay to overspecify. Testing takes time. And, regardless of whether you do it or the manufacturer does it, you will have to pay for it. Tests that can be done quickly and automatically won't break the bank. But the difficult ones like capacitance, noise and temperature drift are best avoided wherever possible. Also stay clear of tests that require special equipment. For example, standard equipment for measuring S parameters can't handle four-terminal devices, like dual-gate MOSFETs, unless you add a custom test fixture.

There are, however, some special situations

where you can actually save money by specifying a characteristic that doesn't appear on most 2N data sheets. One example of this sort of spec is temperature drift nonlinearity (TDN). If you're using a dual FET in a differential amplifier, you can null out the temperature drift by adjusting the operating currents in the devices. But, usually, this only works over a narrow temperature range because of nonlinearities in the temperature coefficient. For a well designed dual FET, it's easier for a manufacturer to provide a low value of tempco nonlinearity than to select devices with low absolute tempco. Thus you can often save money by specifying a device with low TDN rather than a device with low tempco. For example, a 2N3954A with a drift of  $5 \mu\text{V}/^\circ\text{C}$  costs \$4.25 (in 100 pieces). Yet a 2N3957 with a drift spec of  $75 \mu\text{V}/^\circ\text{C}$ , but with a TDN of  $5 \mu\text{V}/^\circ\text{C}$ , can be made to do the same job—and it costs only \$1.80 at the same quantity level.

And here's another tip. If you're really concerned about saving money, be sure to check the volume discounts before you design a FET into your circuit. FET pricing can be very sneaky. Some manufacturers are so eager to get their parts designed into new equipment that they've slashed sample-quantity prices to the point where volume discounts almost don't exist anymore.

### Get to know the manufacturers

Perhaps the best way to choose a FET supplier is first to narrow down the field to a few vendors who seem most likely to have what you need. Then you can work closely with the applications engineers of these companies to see who can best meet your exact requirements.

Surprisingly, the FET marketplace isn't as crowded as it may appear to be. Most manufacturers concentrate their efforts in a narrow range of applications, so you can narrow down the field quite rapidly.

Some companies, like RCA, Motorola and Signetics, make only MOS devices. Others, like National Semiconductor, Intersil, Teledyne Semiconductor and Analog Devices, specialize in JFETs. Note, however, that the latter group all have MOS capability and all make CMOS ICs—they've merely chosen to concentrate their discrete-component marketing efforts on JFETs.

Of course, there are some broad-line manufacturers like Texas Instruments and Siliconix who make various types of FETs. But even these companies tend to specialize—with TI strongest in MOS and Siliconix strongest in JFETs.

Then there are manufacturers whose major strength in the FET area is microwave GaAs devices. Companies in this category include Nippon Electric, Plessey Semiconductor and Fairchild. Also there are companies that are strong in GaAs

FET research but which do not sell the devices they make—companies like Hewlett-Packard, RCA, Varian, Avantek, and, of course, Bell Labs. These companies use microwave FETs in their own equipment and, therefore, want to keep abreast of new developments. But, with the exception of Bell Labs, any of them could decide to enter the GaAs FET marketplace.

### A look at some significant products

Now let's take a quick look at some of the most important product lines of leading vendors. It should be realized, however, that we will barely be able to scratch the surface of what's available.

RCA was one of the pioneers of MOS and the first company to introduce a CMOS transistor array—the CA3600E. Currently the company's product line is concentrated exclusively in these MOS areas. In 1966, RCA introduced the first dual-gate MOSFET, the 3N140, and this design spawned a vast product line including devices with and without gate protection. An innovative applications team at RCA continues to find exciting new uses for mature products. For example, the CA3600E CMOS array can be used as a power booster for the company's successful CA3130 CMOS op amp.

Texas Instruments is probably the leading vendor of dual-gate MOSFETs for VHF and UHF TV tuners and high-performance FM tuners. The 3N201 series is said to be the most designed-in MOSFET in the industry. Though TI application engineers say that dual-gate MOSFETs show great promise in VHF/UHF communications receivers, this market remains relatively untapped.

Another strong contender in the MOSFET market is Signetics. The company pioneered DMOS in the U.S., and now uses this process exclusively throughout its discrete FET product line. The products are concentrated in two major categories: switching and rf. DMOS devices feature very low parasitic capacitances. Typical capacitance of 2.4 pF (input), 0.3 pF (feedback) and 0.1 pF (feedthrough), combined with typical ON resistance of  $30 \Omega$ , lead to very "clean" switching. In the rf area, the company has devices with typical noise figures of 3.5 dB at 1 GHz and 5 dB at 1.8 GHz. The corresponding power gains are 10 dB and 6 dB. Another device, the SD308, is said to offer the best performance for a MOSFET device at UHF frequencies. The company also has a line of FETs characterized as mixers.

Motorola is also aggressive in the MOSFET market and is starting to push in the DMOS sector. The company's most outstanding FET product is probably the MFE823/824 low-leakage MOSFET for smoke detector applications. This provides the high impedance needed to interface

with an ionization chamber and is claimed to be the most stable MOSFET on the market. Motorola's future product line will include power MOSFETs. These are expected to be faster than bipolar devices, will have low  $C_{iss}$  and will avoid the secondary voltage-breakdown problems associated with bipolar power transistors.

The broadest JFET product line in the industry is offered by Siliconix. Perhaps the most exciting product in the company's catalog, however, is a MOS device—the brand-new power FET, marketed under the trade name MOSPOWER. (See separate story in this issue.) Apart from power devices, the company's major strengths are

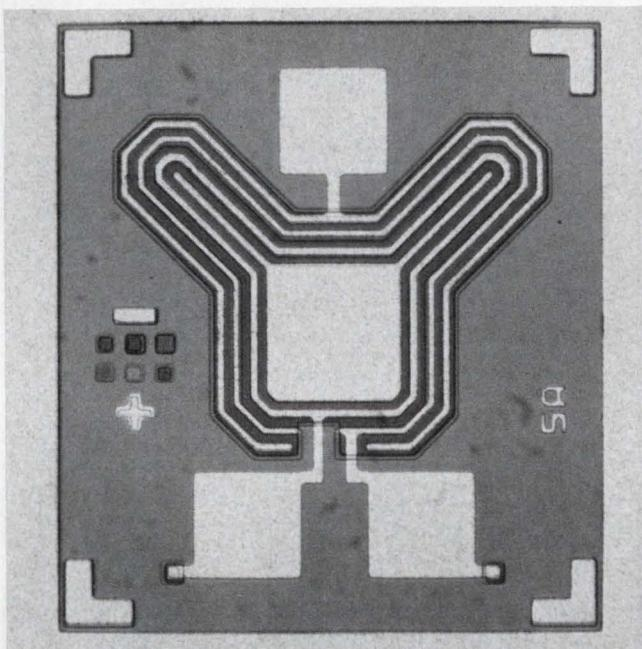

Intended for use up to 1 GHz, the Signetics SD308 features a typical noise figure of 4 dB and a gain of 20 dB at 860 MHz. The dual-gate DMOS device provides AGC capability in a uhf TV tuner.

in monolithic duals, analog switches, low-noise audio FETs, VHF/UHF amplifiers, plastic encapsulated JFETs and current sources—which are actually FETs connected as diodes. One of the company's duals, the U401 series, offers a guaranteed 0.1 pA (25 C) input gate current and is also said to have a higher forward transconductance and lower noise voltage than any other femtoampere-leakage dual. The Siliconix line of FET analog switches offers ON resistances as low as 1.5  $\Omega$ .

Another company to check out if you're looking for a broad line of JFETs is the French manufacturer, Thomson-CSF. This company offers a complete range of switching FETs from the 2N3966 with an ON resistance of 200  $\Omega$  to the 2N5432 with a low  $r_{DS}$  of 5  $\Omega$ . And the company has several high-reliability devices qualified for space applications.

Analog Devices is another JFET specialist, offering both monolithic duals and analog switches. Among the duals, the two most important products are probably the AD830 series and the AD840 series. The AD830 has a maximum leakage current of only 0.1 pA, while the AD840 has a spectacular noise voltage of only 10 nV/ $\sqrt{\text{Hz}}$ . Many of Analog's monolithic duals list guaranteed values for temperature-drift nonlinearity.

National Semiconductor's line of JFETs offers a wide selection of low-noise and general-purpose amplifiers, low-leakage buffer amplifiers, low-resistance switches, high-performance rf amplifiers and monolithic duals. An important innovation from National is proprietary cascode structure for monolithic duals. This design maintains its high input impedance even with large supply voltages. Also it boasts a typical common-mode-rejection ratio of 120 dB.

Intersil also is using a cascode structure for some new dual FETs current under development. More unusual, however, is a device called a varafet—which has just been announced. This device, type IT400, monolithically incorporates a varactor diode in the gate circuit of an otherwise-conventional 2N4391-style switching FET. The diode prevents forward-biasing of the source-gate or drain-gate junction when the device is used as a switch. Other upcoming products—source-follower amplifiers and zero-in/zero-out amplifiers—could more strictly be classified as ICs rather than as discrete FETs. More mature products in the Intersil line include a wide range of monolithic duals and analog switches. The dominant technologies are JFETs and CMOS.

Yet another company specializing in JFETs is Teledyne Semiconductor. Like Analog Devices and Intersil, the company's strongest area is monolithic dual FETs. Typically the company is able to match these pairs to better than two percent. Also devices can be selected from the company's TD5902 chips with  $I_G$  of under 150 fA, at good yield. Another strong area for Teledyne is high voltage FETs, where 11 different devices are available with breakdown voltages up to 300 V. The company also has amplifiers with maximum noise voltages of 10 nV/ $\sqrt{\text{Hz}}$  and switches with ON resistances of 2.5  $\Omega$ . Historically, a lucrative market for Teledyne has been the telecommunications industry where the company has had a lot of success with its FETRON replacements for vacuum-tube amplifiers.

Finally there are the manufacturers of GaAs FETs for microwave applications. In this area, the Japanese Nippon Electric Company is the recognized leader. However, companies like Plessey and Fairchild are starting to challenge this leadership. Perhaps the most impressive device from NEC is the NE388—a half-micron gate-width device with a noise figure of 4 dB at 14

## FOR THE UTMOST IN RELIABILITY

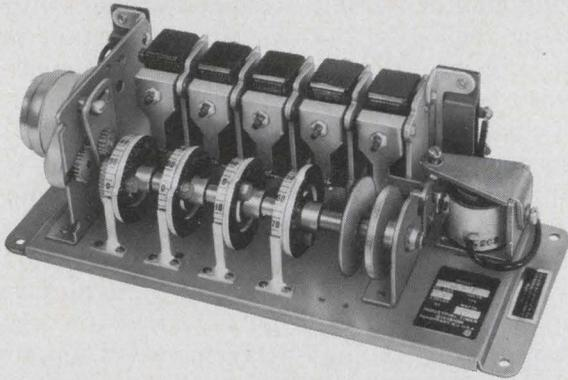

### RECYCLING TIMERS Series RC

This multi-cam timer is one of a family of very versatile recycling timers that are available in single or recycling types with up to 20 control circuits. Control cams are independently adjustable from 2% to 98% of the total time cycles enabling the timer to be used as a programming device. And with supplied interchangeable gear and rack assemblies you can select from 700 time cycles ranging from 2/3 second up to 72 hours. All our timers are made to give you service far beyond what you'd reason-

ably expect. Our line consists of 17 basic types, each available in various mountings, voltages, cycles, circuits and load ratings . . . and with whatever special wrinkles you may need. Bulletin #206 tells all about our line of reliable Recycling Timers. Write for it or a catalogue of our entire line. If you have an immediate timer requirement, send us your specifications. Or for fastest service, call (201) 887-2200.



INFORMATION RETRIEVAL NUMBER 29

**Facts.**  
**The GOULD 2400**  
**delivers more of them with**  
**less fuss, bother and cost**  
**than any other oscillograph**  
**you can buy.**

And it does it on a wide 100mm channel and at a remarkable 30Hz. Available in 2, 3 and 4 channel models with all the Gould exclusives, of course.

For the full Gould 2400 story, write Gould Inc., Instrument Systems Division, 3631 Perkins Avenue, Cleveland, Ohio 44114. Or Gould Allco S.A., 57 rue St. Sauveur, 91160 Ballainvilliers, France.

**PHONE FREE (800) 648-4990 FOR BROCHURE.**



**GOULD**

INFORMATION RETRIEVAL NUMBER 30

GHz. Another NEC FET, the NE244, has a noise figure of 3 dB at 8 GHz. Plessey is currently manufacturing 1- $\mu$  devices similar to NEC's NE244, and has 1/2- $\mu$  devices in the lab. ■■

## Need more information?

We wish to thank the many companies that provided information for this report. The companies and products cited in the report have, of necessity, received only brief coverage. And other companies not mentioned may offer similar products. Readers may wish to consult the manufacturers listed below and in ELECTRONIC DESIGN's GOLD BOOK for further information.

- American Microsystems Inc., 3800 Homestead Rd., Santa Clara, CA 95051. (408) 246-0330. (J. S. Richardson). **Circle No. 401**
- Amperex Electronic Corp., 230 Duffy Ave., Hicksville, NY 11802 (Philips in the Netherlands). (516) 931-6200. (M. Smoller). **Circle No. 402**
- Analog Devices Inc., P.O. Box 280, Norwood, MA 02062. (617) 329-4700. (Steve Collins). **Circle No. 403**
- Avantek Inc., 3175 Bowers Ave., Santa Clara, CA 95051. (408) 249-0700. (W. F. Epperly). **Circle No. 404**
- Barry Electronics Corp., 512 Broadway, New York, NY 10012. (212) 925-7000. **Circle No. 405**
- California Eastern Labs Inc., 1 Edward Court, Burlingame, CA 94010. (Nippon Electric Co. in Japan). (415) 342-7744. (C. A. Peterson). **Circle No. 406**
- Calvert Electronics, 220 E. 23rd St., New York, NY 10010. (AEI Semiconductors Ltd. in England). (212) 679-1340. **Circle No. 407**
- EEP Corp., 6060 Manchester Ave., Los Angeles, CA 90025. (213) 641-9020. (E. Backer). **Circle No. 409**
- Fairchild Semiconductor, 464 Ellis St., Mountain View, CA 94042. (415) 962-5011. (Merlin Vellaquette). **Circle No. 410**
- Ferranti Electric Inc., E. Bethpage Rd., Plainview, NY 11803. (516) 293-8383. (I. S. Gewant). **Circle No. 411**
- General Instrument Corp., 600 W. John St., Hicksville, NY 11802. (516) 733-3333. (G. Cacavio). **Circle No. 412**
- Intersil Inc., 10900 Tantau Ave., Cupertino, CA 95014. (408) 996-5000. (Art Johnson). **Circle No. 414**
- KMC Semiconductor Corp., 2A Parker Rd., Long Valley, NJ 07853. (201) 876-3811. (C. Blaine). **Circle No. 415**
- Matsushita Electric Corp. of America, One Panasonic Way, Secaucus, NJ 07094. (Matsushita in Japan). (201) 348-7000. (Robert Zolkowski). **Circle No. 416**
- Motorola Semiconductor Products, P.O. Box 20912, Phoenix, AZ 85036. (602) 244-6900. (Jim Wick). **Circle No. 417**
- National Semiconductor Corp., 2900 Semiconductor Dr., Santa Clara, CA 95051. (408) 732-5000. (Mike Turner). **Circle No. 418**
- Nippon Electric Co. Ltd., Takanawa, Tokyo, Japan. (See also California Eastern Labs). **Circle No. 437**
- NJ Semiconductor Products, 20 Commerce St., Springfield, NJ 07081. (201) 376-2922. **Circle No. 419**
- Philips Industries, ELCOMA Div., Building BF, Eindhoven, the Netherlands. (See also Amperex). **Circle No. 420**
- Plessey Semiconductor, 1674 McGaw Ave., Santa Ana, CA 92705. (714) 540-9979. (Dennis Chant). **Circle No. 421**
- RCA Solid State Div., Box 3200, Somerville, NJ 08876. (201) 722-3200. (Merle Hoover). **Circle No. 422**
- Signetics Corp., 811 E. Arques Ave., Sunnyvale, CA 94086. (408) 739-7700. (Tom Cauge). **Circle No. 423**
- Siliconix Inc., 2201 Laurelwood Rd., Santa Clara, CA 95054. (408) 246-8000. (Ed Oxner). **Circle No. 424**
- Solid State Inc., 46 Farrand St., Bloomfield, NJ 07003. (201) 429-8700. **Circle No. 425**
- Solitron Devices Inc., 8808 Balboa Ave., San Diego, CA 92123. (714) 278-8780. **Circle No. 426**
- State Laboratories Inc., 215 Park Ave., New York, NY 10003. (212) 677-8400. **Circle No. 427**
- Teledyne Crystalonics, 147 Sherman St., Cambridge, MA 02140. (617) 491-1670. **Circle No. 430**
- Teledyne Semiconductor, 1300 Terra Bella Ave., Mountain View, CA 94043. (415) 968-9241. (Phyllis Stroock). **Circle No. 431**
- Texas Instruments Inc., P.O. Box 5012, Mail Station 84, Dallas, TX 75222. (214) 238-2011. (Paul Davis). **Circle No. 432**
- Thomson-CSF, SESCOSEM Div., 50 rue J. P. Timbaud, BP 120/92403, Courbevoi, France. **Circle No. 433**
- Thor Electronics Corp., 741 Livingston St., Elizabeth, NJ 07207. (201) 354-2420. **Circle No. 434**
- UPI Semiconductor Div., United-Page Inc., 481 Getty Ave., Paterson, NJ 07503. (201) 279-7500. (M. Renselear). **Circle No. 435**
- Workman Electronic Products Inc., P.O. Box 3828, Sarasota, FL 33578. (813) 371-4242. **Circle No. 436**

Really, comparison with others isn't worth your time. Not when you've got Plessey's quality and constantly-expanding selection: a comprehensive, low-cost range of commercial IF and RF amplifiers with full AGC and bandwidths to 140 MHz. VOGAD, audio and AGC amplifiers. Plus double balance modulators and mixers with carrier peaks as low as -60 db.

These products are available now. The SL 1600 series low-cost plastic mini dual in-line family and the SL600 series a full MIL spec family in the TO5 package.

In fact, using only these Plessey IC's you can build the heart of a single sideband transceiver on a single printed circuit board.

But for those of you from Missouri, and other doubters, we'll go you a step further.

Write on your letterhead, and we'll quickly send you a copy of Plessey's Application Manual for Radio Communications—96 pages of hard data for non-believers.

Read and know why the choice is Plessey.



## **PLESSEY SEMICONDUCTORS**

1674 McGaw Avenue Santa Ana, California 92705,  
Tel: (714) 540-9979, TWX: 910-595-1930; Cheney Manor,  
Swindon Wiltshire, England, Tel: (0793) 6251, Telex: 449637;  
West Germany, Tel: 811 351 6021, Telex: 521 5322; France,  
Tel: 727-4349, Telex: 62789; Italy, Tel: 3491741, Telex: 33245;  
Sweden, Tel: (08) 23 55 40, Telex: 10558.

INFORMATION RETRIEVAL NUMBER 31

**Compare Plessey  
to anyone  
in radio  
communication  
IC's. We'll come  
out on top  
every time.**

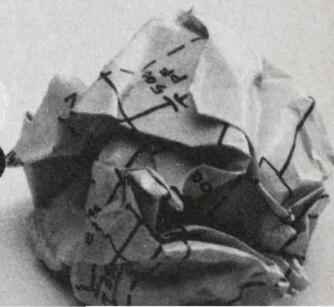

# Q.

## Is there a recorder just for spectrum analyzers?

# A.

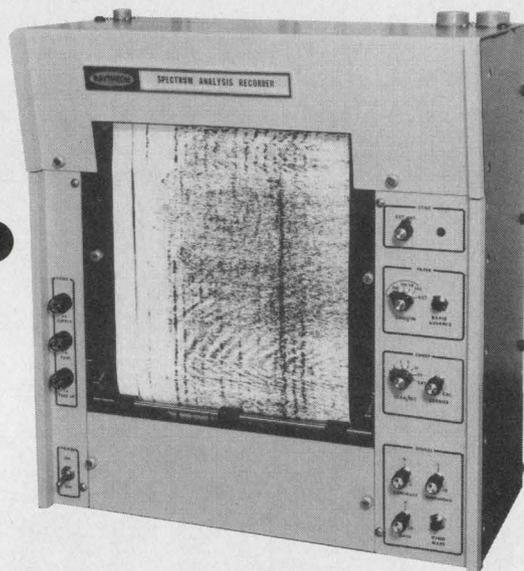

The new 19" rack-mounting SPECTRUM ANALYSIS RECORDER from Raytheon. It's the first dry paper line scanning recorder specifically developed for direct plug-in operation with commercially available spectrum analyzers.

Any new or existing spectrum analyzer equipped with the SAR-097 will have a lot more going for it. Like infinitely variable 100:1 speed range - 5 sec/scan to 50 millisc/scan . . . stylus position encoder . . . automatic recorder synchronization . . . computer/analyzer compatibility . . . high resolution and dynamic range . . . all-electronic drive. And more.

If you design and build - or buy and use - spectrum analyzers, you don't have to settle for multi-purpose recorders any more. The SAR-097 is here. For full details write the Marketing Manager, Raytheon Company, Ocean Systems Center, Portsmouth, R.I. 02871. (401) 847-8000.

**RAYTHEON**

# The way our distributors stock Wood Mini-Mag Circuit Breakers, they're practically on their way to you right now.

Say you need a supply of circuit breakers, the kind that trips instantaneously on short circuit. And you need them installed now.

Call your authorized Wood Electric Circuit Breaker distributor. He's nearby to give you quick delivery. And chances are he has what you need, right in stock: Mini-Mag compact magnetic-hydraulic circuit breakers. Ratings from 0.5 to 30 amperes.

Voltages from DC to 400 Hz. Trip times from .009 to 10 seconds at 200% of rated load.

In single, double and 3-pole units.

He also has a complete line of other magnetic-hydraulic models, plus thermal types.

For technical literature, call the Wood Electric Circuit Breaker distributor or our sales representative nearest you, or write Potter & Brumfield Division AMF Incorporated, Princeton, Indiana 47671. Telephone 812-385-5251.

**AMF**  
Potter & Brumfield

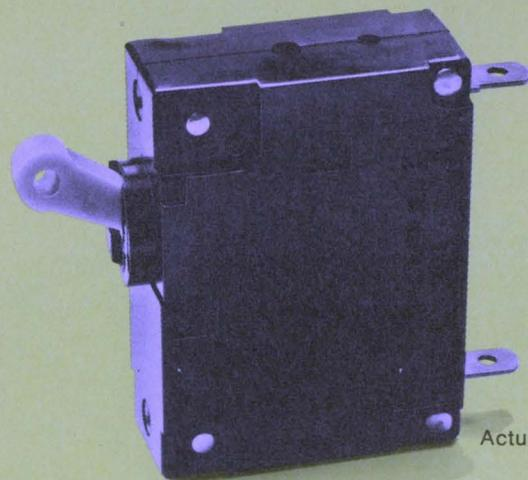

Actual Size

## Consider electromechanical counters

for those tough jobs. But they must be interfaced to match the levels, impedances and speeds of solid-state circuits.

Electromechanical (EM) counters can be used where all-electronic units often fail—in industrial controls that are subject to severe line transients and noise, and where the radiated and conducted EMI generally are high. Applications where all of these problems are apt to be at a peak—the control of spot-welding, assembly and grading lines, solenoid actuators and NC machine tools—demand electromechanical counters.

But the interfacing of slow-acting EM devices with modern high-speed data-processing systems may present problems. A series of circuits—from impedance buffers to a data link for a remote count transfer over a single line—provide a selection to satisfy many needs (Figs. 2 to 7).

### EM counters have advantages

At low speeds—to about 60 counts per second—EM counters that use well-designed actuator mechanisms (Fig. 1) have many advantages over electronic units. These include:

- The EM counter is nonvolatile. Power failure

Armand Bassi Jr., Manager Industrial Products, Sodeco, Landis and Gyr, 4 Westchester Plaza, Elmsford, NY 10523

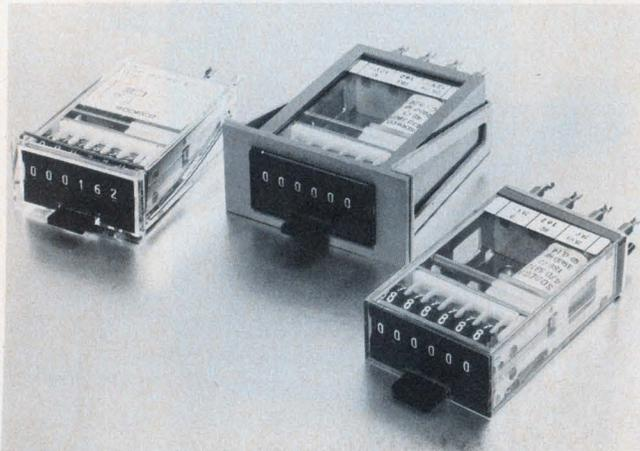

1. Modern electromechanical counters use well-designed step actuators to increase life, reduce impulse-power requirements and provide counting rates to 60 counts per second.

or shut-off doesn't destroy the data. Data are retained indefinitely without power.

- Some EM counters can print. They do it very inexpensively, and the count is retained after printing.

- EM counters can withstand hostile environments. High temperature and even nuclear fields, in addition to strong EMI and conducted-noise pickup, are readily tolerated.

- EM counters are versatile. At low cost, they can include such features as printout, bidirectional counting, predetermined (preset) counting, remote reset and programmable function/mode/

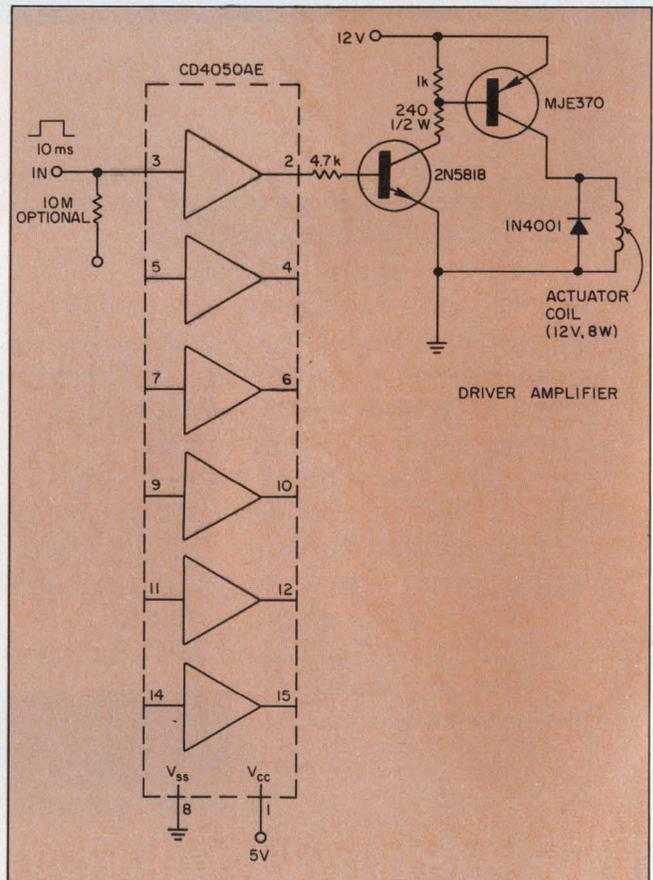

2. A high-impedance drive circuit for electromechanical counters can deliver 12 V at 8 W. The component cost is less than \$2. The unused buffer sections can be used for other circuit functions.

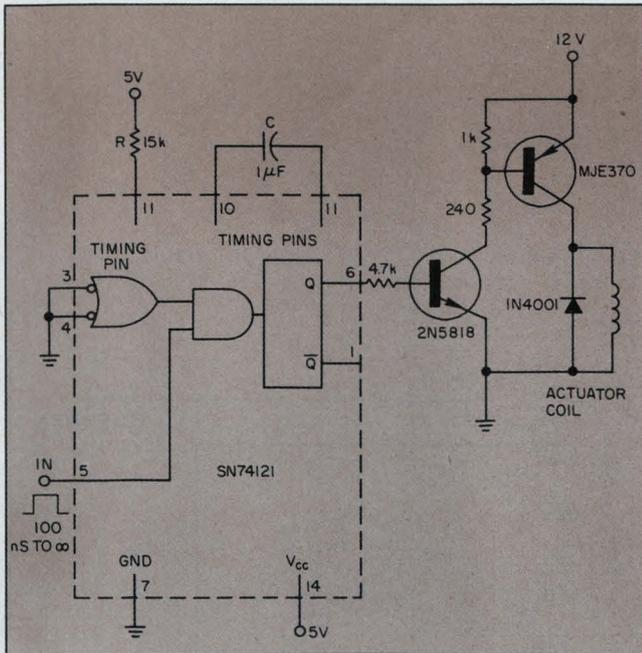

3. A pulse-stretcher and pulse-width standardizer circuit uses a one-shot to drive a power amplifier, as in Fig. 2. The one-shot accepts pulses as narrow as 100 ns at TTL levels, and it stretches and shapes them to standard 10-ms-wide pulses. Longer input pulses produce the same standard output pulse. The component cost is less than \$2.

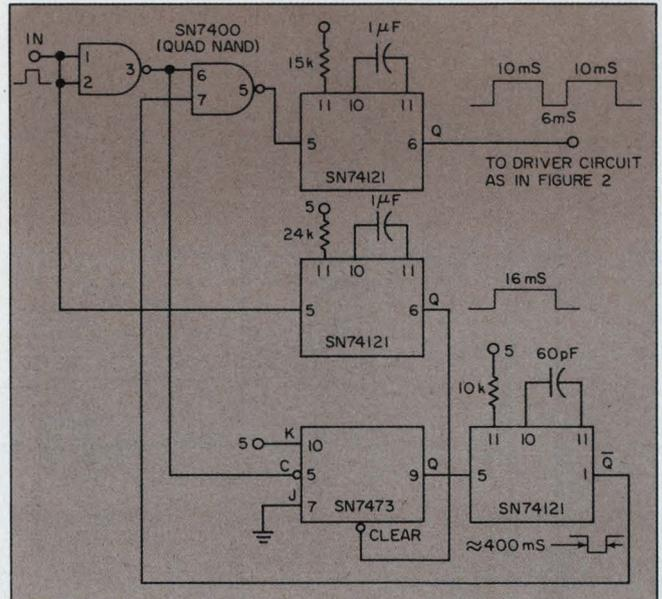

4. An anti-coincidence circuit accepts input pulses that are spaced as closely as 100 ns. The circuit delays the second pulse until the first has been stretched and standardized, as in Fig. 3. The first pulse is then counted. The second input pulse, if it occurs within 16 ms after the end of the first, initiates a second 10-ms output pulse that starts 6 ms after the first ends. Thus both pulses can be counted by a standard EM counter. The total component cost is about \$1.50.

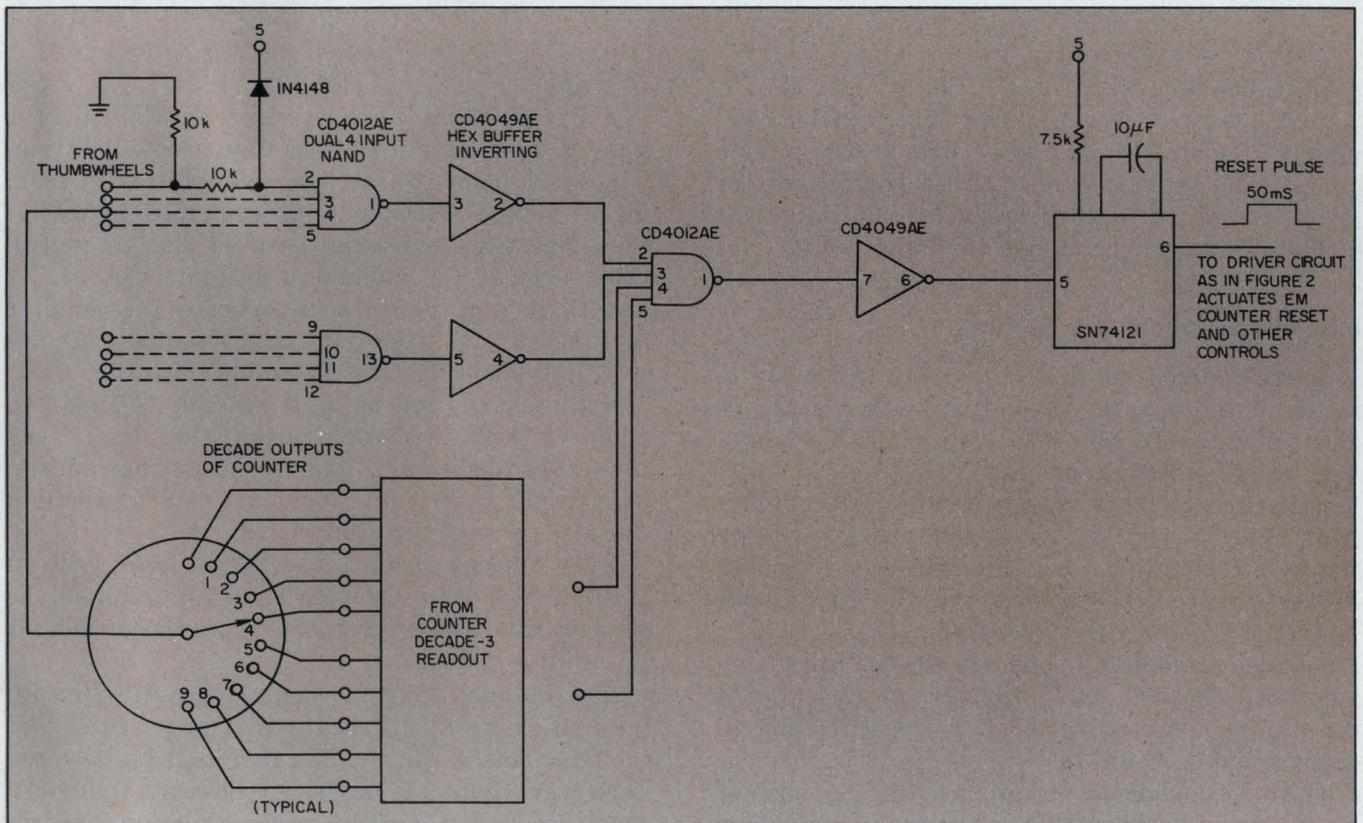

5. A preset/reset circuit creates an output only when the count corresponds to settings on thumbwheel switches or other input source. The output pulse can then be used to control the counted process and to reset all counter decades to zero. Note that the EM

counter must be resettable with a single pulse, and also should provide an electrical readout of the position of each digit. An eight-decade version of this circuit has a component cost, excluding the thumbwheel switches, of about \$4.

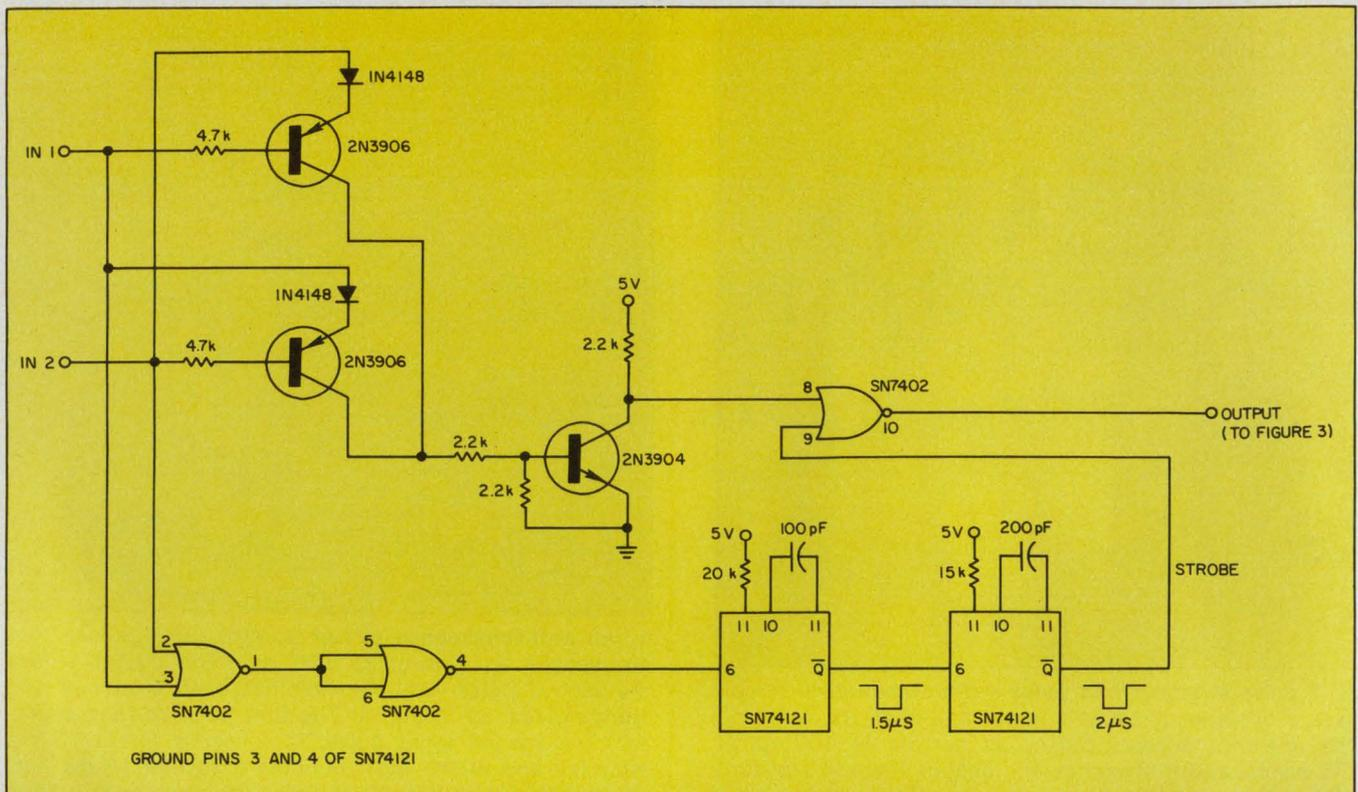

6. A difference detector produces a count output only when almost simultaneous pulses differ in amplitude by about 1 V or more. The circuit has a 1.5- $\mu$ s delay to allow acceptance of small time differences between the two input pulses. A 2- $\mu$ s strobing pulse generates an

output when the difference in amplitude is detected. This output pulse is then directed to a circuit, as in Fig. 3, to obtain a standardized pulse to drive an EM counter. The component cost for only the difference detector circuit is less than \$2.50.

cycle controls.

- The newer EM counters are reliable and rugged. Several designs are rated at 200-million operations. At least one design is guaranteed for an MTBF of 10 to 25 years when calculated for 10,000 counts per hour and a 40-hour week.

#### Interface variations are limitless

There's almost no limit to what you can do to make an EM counter compatible with a system's electronics. Here is a relatively short list for a wide range of requirements:

- **Impedance buffers** to operate EM counters from high-impedance, low-current, low-energy sources. Careful design and effective shielding of the electronics can preserve the high noise immunity inherent in the counter (Fig. 2).

- **Pulse-stretcher** to operate the counter from very-fast, short-duration pulses. A typical EM counter requires a pulse of at least 10 ms to count reliably (Fig. 3).

- **Anti-coincidence circuit** to prevent loss of pulses that occur too close together to be resolved by an EM counter. The circuit stores any pulse that arrives close to a preceeding one. The pulse is then gated into the EM counter, when the counter can reliably accept it. But first the pulse

is stretched to 10 ms (Fig. 4).

- **Preset/Reset logic** to reset an EM counter back to zero after it reaches any selected setting. The reset point can be selected arbitrarily from either switch settings or programmed logic signals. The reset pulse can be used also to control other logic in the interfaced system (Fig. 5).

- **Difference detector** to operate the counter only when two approximately simultaneous inputs differ significantly in amplitude (Fig. 6).

- **Bit-serial, digit-by-digit readout** to link two counters with a single transmission line. Very often, the remote unit has a printout mechanism. The circuit needs only about 2.5 s to transmit a count of as much as 99,999,999.

Even the most complex of these circuits draws very little average power; thus they can all be temporarily battery-supported in the event of power-line failure.

And also each one can be accommodated easily on a single small PC card. Often the card can be mounted inside the counter case and be powered from the counter's dc power supply, though a good decoupling circuit would then be needed. The circuits are rugged and not sensitive to long-term drift, temperature or power-supply level. No trim adjustments are required. And the circuit costs are low. ■■

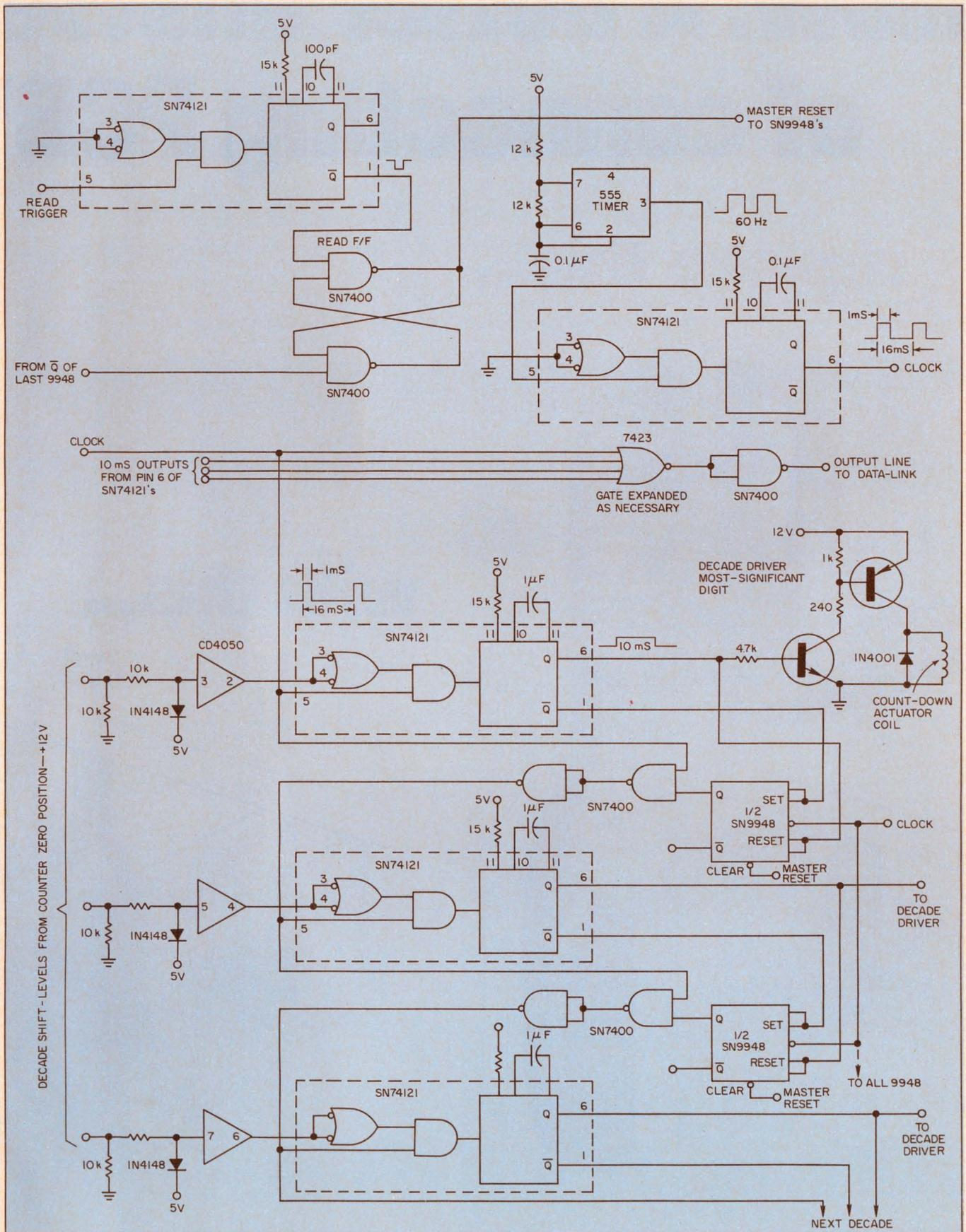

7. For transmission over a data link to a remote counter, countdown logic used with up-down EM counters converts a parallel, multidigit reading into a serial pulse train. When a read-trigger signal is detected, a local counter's decades are successively driven back to zero by independent driver coils. One output pulse is gen-

erated for each step. Starting with the most-significant digit, each counter decade successively reaches zero. The +12-V signals, which are used to shift the count-down to the next lower decade, also feed the logic circuit to stop the stepping when a decade reaches zero. A six-decade counter component cost is \$15.

# Now! A better answer of connecting PCB's

replace this...

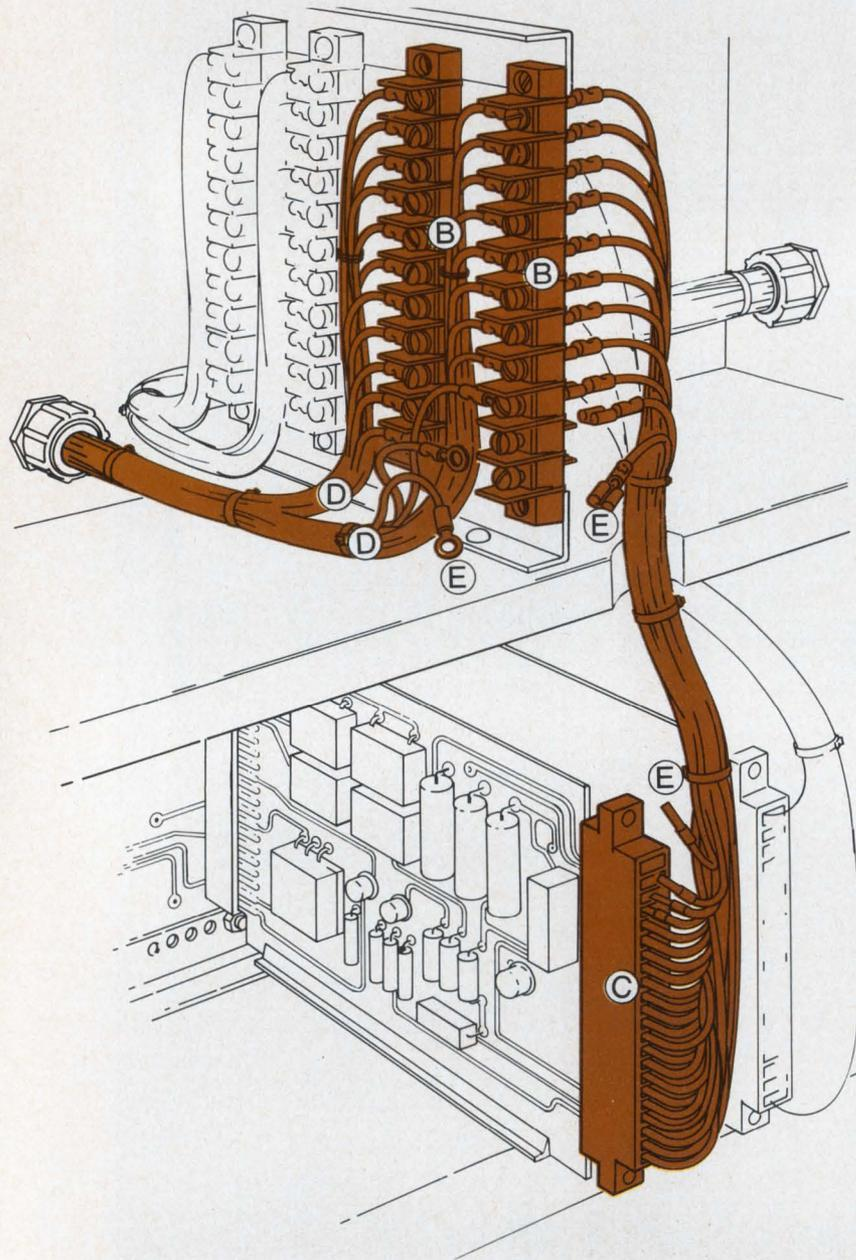

with this...

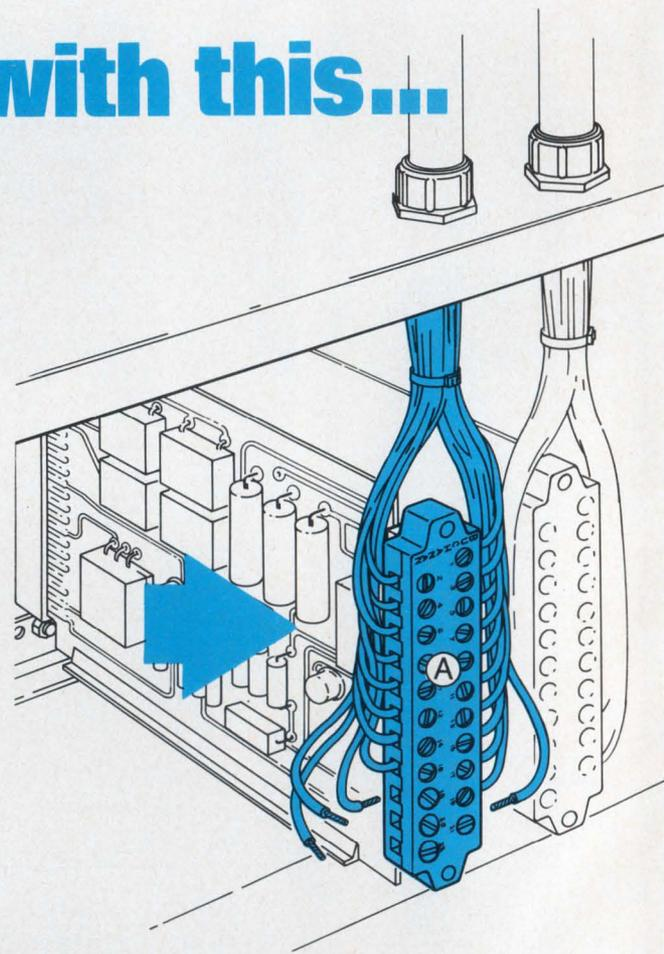

Just one Buchanan Printed Circuit Board Connector (A) replaces the two barrier strips (B), the edge card connector (C), the double wiring (D), and the 110 costly terminations (E) shown at left. Result: LTIC (Lower Total Installed Cost)!

# to the problem to the outside world!

## with **Buchanan**<sup>®</sup> PCB Connectors

- Accept unterminated wires from 12 through 30 AWG
- Save up to 5 connection points per circuit
- Eliminate barrier strips & terminal blocks
- Available for inside or through-the-panel wiring
- Save time, money and cabinet space

If you're building control panels or other electrical/electronic equipment that uses printed circuit boards, here's a new PCB connector that's sure to give you LTIC (Lower Total Installed Cost)!

The new Buchanan connector eliminates hybrid interfaces between electronic circuitry and electrical connections. It replaces terminal blocks and barrier strips and the costly wiring between them and internal electronics. Actually saves you up to 5 separate connection points per circuit!

The unique screw terminals accommodate unterminated solid or stranded wires, #30 through #12 AWG. Models are available with .156" or .200" (.508 cm) centerlines; for up to 43 10-Amp circuits; and for inside panel or through-the-panel mounting. Many carry UL component recognition for field wiring.

For complete engineering and ordering information, use the Reader Service Card. Or, call one of our Factory Regional Offices shown below. They'll also be happy to talk to you about special configurations.

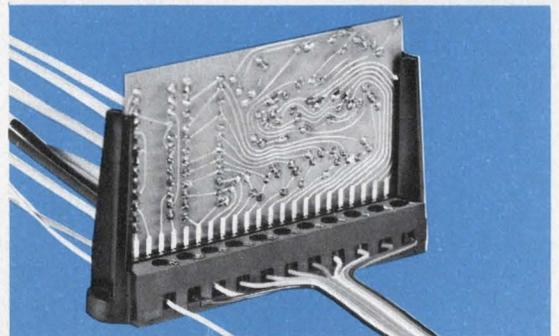
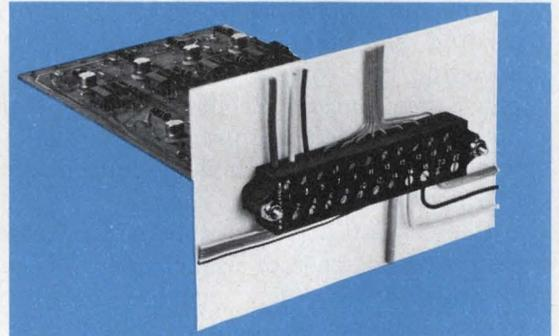
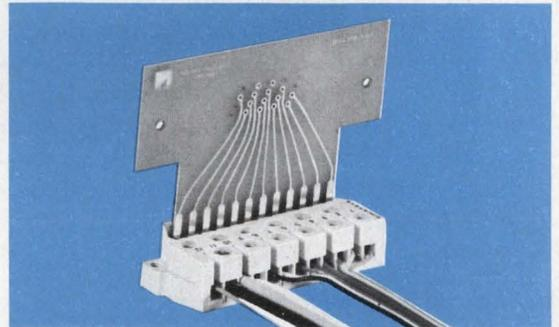

*Models available for surface or through-the-panel mounting, with or without card guides and keys.*



**CONTROL PRODUCTS  
DIVISION**

Amerace Corporation  
Control Products Division  
Union, New Jersey

# Squeeze more data onto mag tape by use of delay-modulation encoding and decoding. Packing densities of up to 40,000 bits/in./track can be obtained.

To pack data tighter on magnetic tape, use delay modulation. The delay-modulation code, sometimes known as the Ampex-Miller code, combines both bandwidth conservation and self-clocking. This permits packing densities for data-acquisition to reach 40,000 bits/in./track, with a reliability approaching one error in  $10^6$  bits.

Of course, the analog data must be encoded into digital form before recording. To encode wideband analog signals, for instance, some form of pulse-code modulation (PCM) is used. PCM techniques permit good signal-to-noise ratios of typically 70 dB while minimizing errors caused by flutter, time-base instability, crosstalk, frequency-range limitations, limited dynamic range or nonlinearities.<sup>1</sup>

## Pack data by encoding

Optimum encoding of digital data prior to recording can avoid zero-signal-level drifts. The encoding can consist of amplitude, frequency or phase modulation. Proper selection depends primarily on system factors, such as available bandwidth and ease of implementation of encoding and decoding circuits.

Codes that are useful for data recording include the bi-phase or Manchester. These are self-clocking codes—they provide a transition for every clock period—and they eliminate the need for dc response. However, they require a wider bandwidth than nonreturn-to-zero (NRZ) codes. Packing densities are merely about 12,000 bits/in./track, for an error reliability of 1 in  $10^6$ , and better.

The delay-modulation code is basically a phase-shift code and can be defined as follows: A ONE is represented by a transition in the middle of a bit cell. A ZERO has no transition, unless it is followed by another ZERO, in which case there is a transition at the end of the first ZERO's bit cell. This format is arbitrary, and the definitions

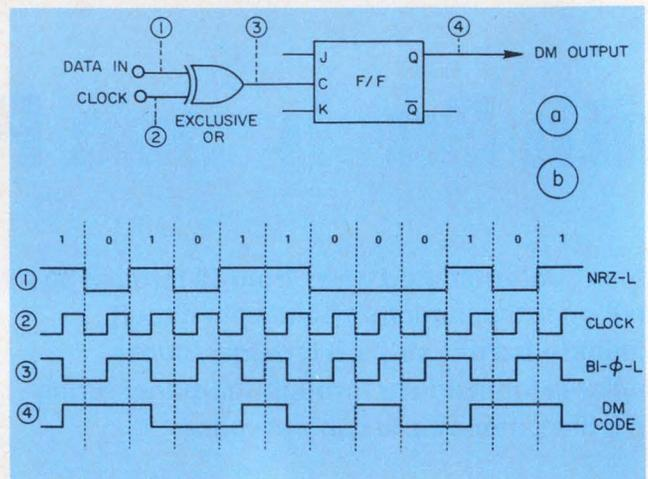

1. Just one EXCLUSIVE-OR gate and a JK flip-flop are needed to convert NRZ data into delay-modulated form (a). The differences between NRZ, bi-phase and a delay-modulated data stream are clearly visible (b).

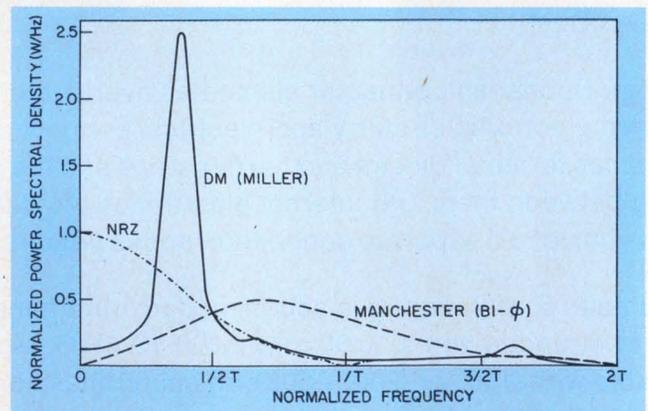

2. Plots of the power spectral density distributions of NRZ, bi-phase and delay-modulation codes show widely different spreads of power.

of a data ONE and ZERO can be interchanged.

A simple circuit, consisting of an EXCLUSIVE-OR gate and a JK flip-flop can convert conventional NRZ data to delay-modulated form (Fig. 1a). The EXCLUSIVE-OR gate first converts NRZ data into bi-phase and then the JK flip-flop converts the bi-phase into a delay-modulation code. Comparative waveforms, broken into bit cells, show the differences in the codes as they flow through the circuit (Fig. 1b).

Walter E. Bentley, Engineer, and Spyros G. Varsos, Engineer Principal, Lockheed Electronics Co., 16811 El Camino Real, Houston, TX 77058.

The corresponding spectral contents of a random bit sequence are shown in Fig. 2.<sup>2</sup> As shown by the graph, the power spectral density for Manchester codes is centered on 3/4 the recorded bit rate, while that of the delay-modulation code is concentrated at 3/8 the bit rate. Thus the packing density can be increased to about double that of the Manchester. And since there is no appreciable signal energy at the lower end of the spectrum, there is no limit to the length of any bit pattern.<sup>3</sup>

### Decoding is harder than encoding

To decode the delay-modulated signal accurately, use the circuits in Fig. 3. The input section consists of conventional circuits that condition, shape and bit-rate synchronize the signal. The blocks to the left of the dotted line form the synchronizer. A conventional NRZ bit-synchronizer design, specified at twice the bit-rate frequency, may be used.

The digital circuits in the decoder determine how the conditioning circuit will shape the input signal (Fig. 4). The shaped waveform passes through a transition-detector circuit, which then generates pulses of predetermined width that represent the transition points of the waveform.

The transitions in the waveform contain the basic clock information of the original digital signal source. The synchronizer circuit extracts the clock from the incoming signal at twice the

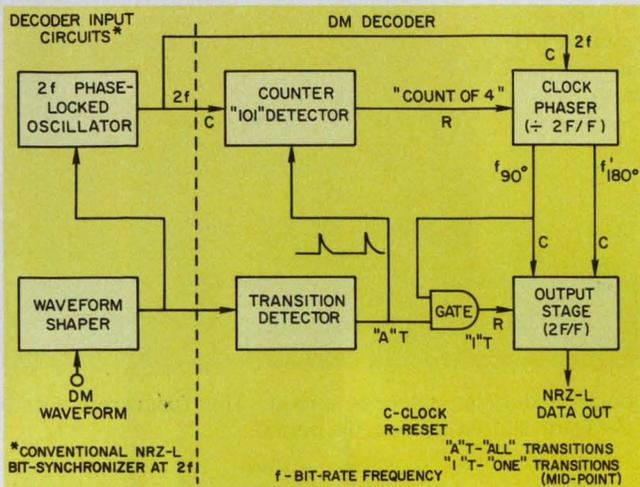

3. The delay-modulation decoder in this block diagram shapes the input signal, counts pulse widths, checks phasing and detects mid-point transitions before delivering the NRZ data.

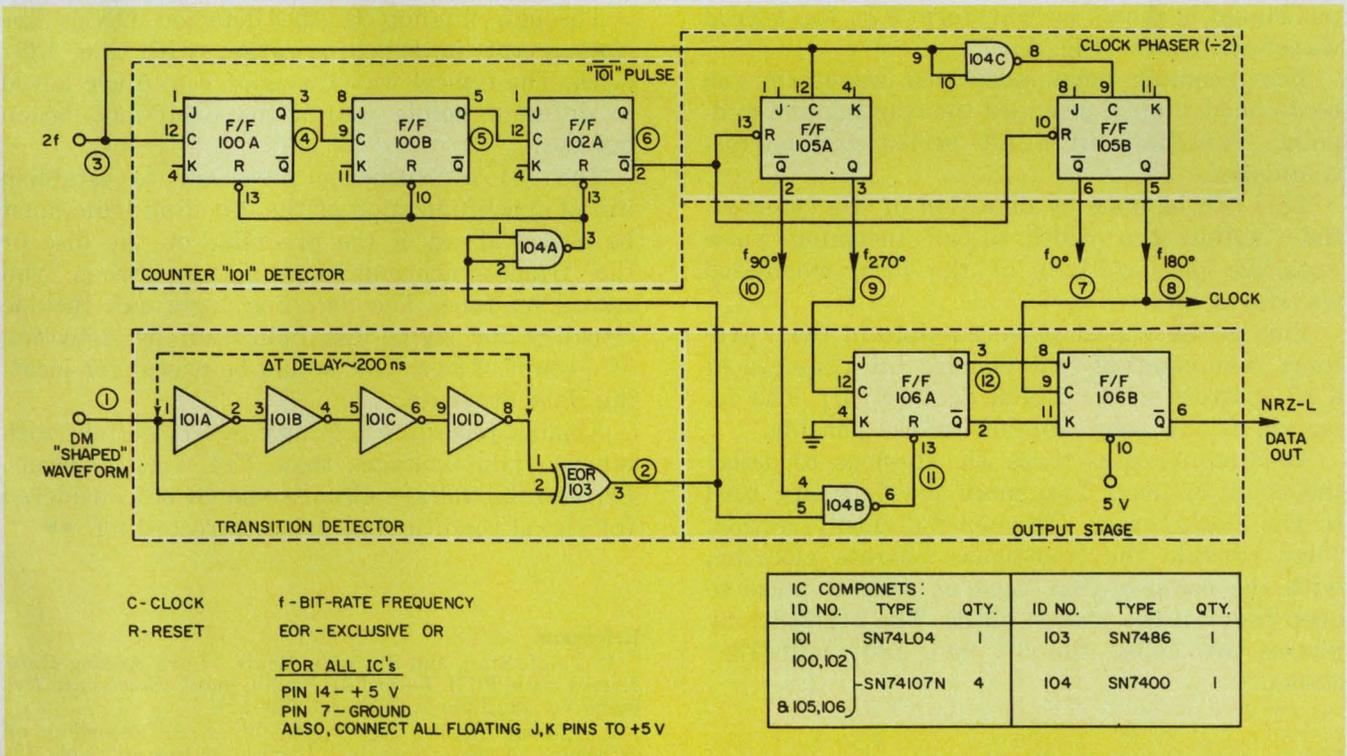

4. The shaped waveform is manipulated in the delay-modulation decoder by use of JK flip-flops and several gates. A count-of-four detector provides the phasing

control to reconstruct the signal. The logic family you use is determined by the speed requirements of the application you have.

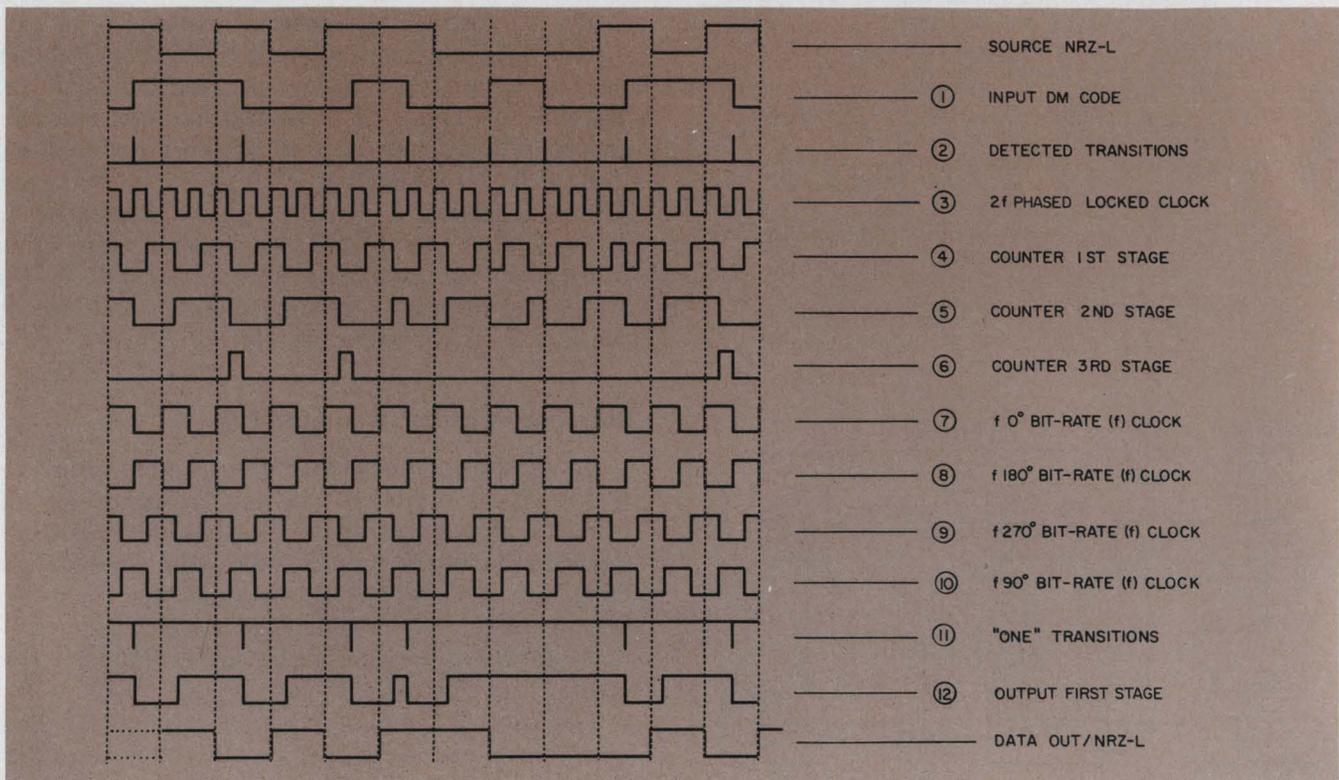

5. The progression of a signal from input to output is shown by waveforms from each of the stages in the

delay-modulation decoder circuit. The recovered output data are shifted by one bit period.

bit-rate frequency ( $2f$ ). Thus the phase-locked oscillator stays synchronized to the initial clock. The output of the oscillator is a  $2f$  pulse train in phase with the start-point and mid-point transitions of the incoming signal. The oscillator output signal is shown as waveform 3 in the typical waveform chart (Fig. 5).

The incoming delay-modulated waveform can be decoded simply, provided the starting and mid-point transitions of a bit period can be distinguished.

This can be done by detection of the count-of-four within the width of an incoming pulse (positive or negative) of the delay-modulated waveform.

This is the widest pulse possible in the waveform. The count-of-four denotes the presence of a 101 pattern in the digital data (NRZ). The detection of this count establishes the phasing.

The counter uses three JK flip-flops to detect the count-of-four. Two more flip-flops are used in the clock-phaser (frequency-divider) section. They provide the four-phase bit-rate clocking, with the count-of-four used as a reset pulse to keep them in the proper phase. The derived four phases are called the  $0^\circ$ ,  $90^\circ$ ,  $180^\circ$  and  $270^\circ$  clocks.

#### Clocks reconstruct the signal

All clocks except the  $0^\circ$  clock are used in the final output stages of the detector (Fig. 4). The

transitions occurring at the mid-point of a bit period pass through the gate that is controlled by the  $90^\circ$  clock. The transition pulses passing through the gate represent logic ONES, and they are used to reset flip-flop A.

Through flip-flop B, the detected ONES are clocked out in synchronization with the  $180^\circ$  clock. The typical waveforms of Fig. 5 are keyed to different points within the delay-modulation decoder.

The 101 bit sequence necessary to establish initial synchronization of the decoding logic must be placed ahead of the preamble on the disc or the frame-synchronization pattern when you record on tape. The decoding logic can include circuitry for signal-loss indication by detection of a count of five. This would be useful for locating data dropouts.

Analog recording circuits work better with bipolar input voltages than TTL voltage levels. Differential voltage circuits should be considered for signal conditioning prior to recording. ■■

#### References

1. Yalof, Stan, and Shrinkle, Louis, "Curb Analog Data Errors with PCM Recording Techniques," *Electronic Design*, No. 12, June 7, 1974, pp. 124-127.
2. Spitzer, Charles F., "Digital Magnetic Recording of Wideband Analog Signals," *Computer Design*, Vol. 12, No. 10, October, 1973, pp. 83-90.
3. Telemetry Standards, Inter-Range Instrumentation Group, Document No. 106-71, White Sands Missile Range, NM.

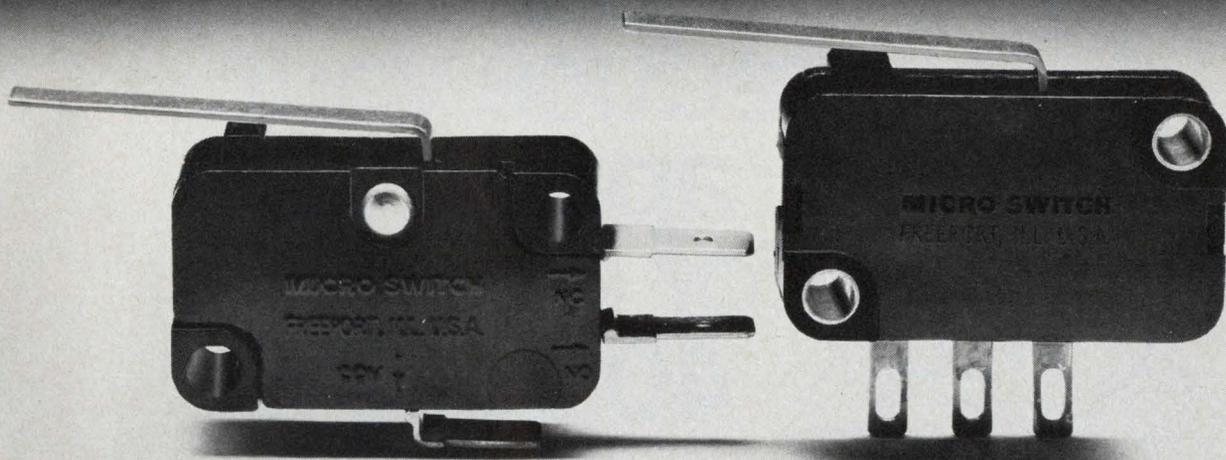

## One of these is a new solid state switch. It's important that you can't tell which one.

The switch on the left is the V3. A mechanically-actuated snap-action switch the size of a postage stamp. It was an industry first when MICRO SWITCH introduced it in 1943. And it's gone on to become the industry standard, with hundreds of millions in use worldwide.

The switch on the right looks like the V3. Mounts like the V3. It's even actuated like the V3. And that's exactly where the similarities end. Because it's all solid state inside.

Designed around a Hall-effect integrated circuit perfected by MICRO SWITCH, the XL has been made to provide every benefit of true solid state design without the necessity of getting out of mechanical control.

Because the XL is all solid state, there are no contacts to bounce or become contaminated. And the Hall-effect integrated circuit has been performance tested through over 12 billion operations without a single failure. Unlike

standard mechanical switch designs, the XL can also interface directly with other solid state components. Its 20MA output eliminates the need for amplifiers, in most applications. And you can order it with either current sinking or current sourcing outputs.

It needs very little force for actuation—down to 10 grams. Even less with a lever. And the choice of actuator styles is the same as for the V3: over 500 different actuators in all. Including simple pin plunger, straight lever, simulated roller or roller lever.

Power supply requirements are also flexible. 5 VDC or 6 to 16 VDC with built-in regulator, over a temperature range of  $-40^{\circ}\text{C}$  to  $+100^{\circ}\text{C}$ .

So the XL obviously offers some unique advantages. It's just one of a wide range of MICRO SWITCH solid state designs that do. Including a complete range of magnetically operated solid state position sensors, like the ones pictured here.

If you'd like more information on the XL, or any of the other MICRO SWITCH solid state switches, call your nearest MICRO SWITCH Branch Office or Authorized Distributor. Or write for literature.

We'll tell you the advantages of solid state design in your particular application.

And about a switch that looks very familiar. But works like nothing you've ever seen.



**MICRO SWITCH**  
FREEPORT, ILLINOIS 61032  
A DIVISION OF HONEYWELL

MICRO SWITCH products are available worldwide through Honeywell International.

CIRCLE 231 FOR DATA  
CIRCLE 232 FOR SALESMAN CALL



# How to reduce your appetite for gold by 40 to 60%

Instead of barrel plating electronic contacts with gold or other precious metals, SELECT-O-PLATE them. SELECT-O-PLATE deposits the precise amount and kind of precious metal plating only where it's needed. On just the tips of plug-in contacts, or the center of lead frames, or on continuous coils-stripe or spot. Or on specific wear areas on pre-formed or stamped parts. Deposit thicknesses can range as low as .000005".

SELECT-O-PLATE sharply reduces precious metal waste and fabrication costs while maintaining—or even improving—product reliability. Quality control throughout the process is as strict as it's possible to make it. And our staff of plating technologists will work with you to achieve the ideal match of function and economy.

We'd like to tell you the whole story about SELECT-O-PLATE and how it can put you on a profitable precious metals "diet." Just call us or drop us a line.

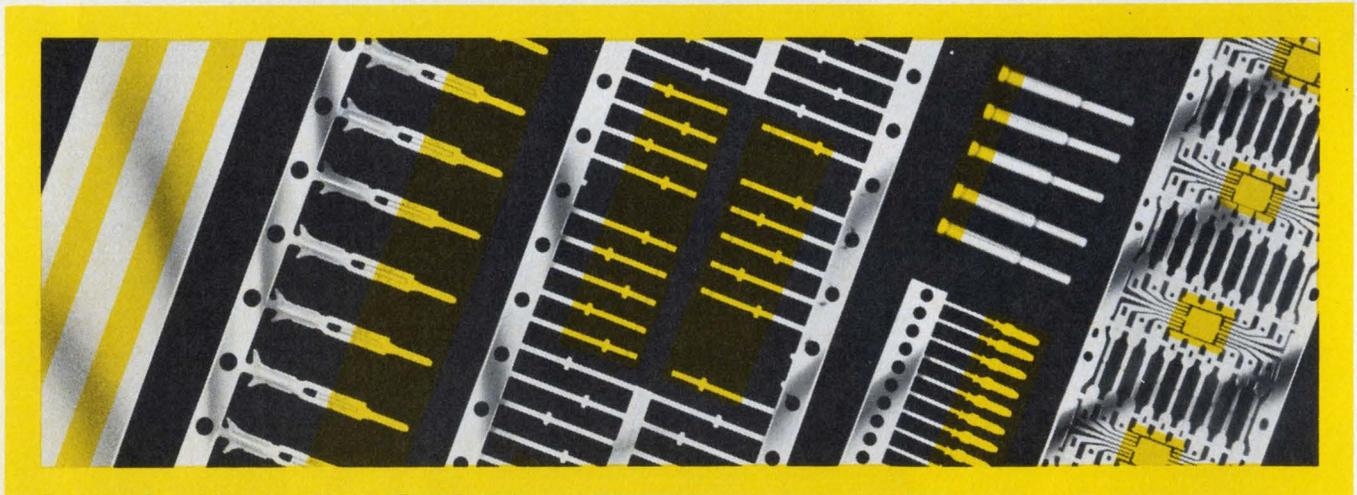

Our new Capability and Facility Brochure is just off the press. Write for your copy today. No cost or obligation.

## SELECT-O-PLATE

... Makes a little bit of gold go a long, long way.

### PRECISION PLATING COMPANY, INC.



Precious metal plating since 1904  
4123 West Peterson Avenue  
Chicago, Illinois 60646  
Tel: 312/583-3333

INFORMATION RETRIEVAL NUMBER 36

# Burroughs SELF-SCAN<sup>®</sup> panel

## NEW DIMENSIONS in electronic displays

Now, there's a whole new dimension in electronic readouts: Burroughs' new SELF-SCAN II display panels . . . the most advanced, most versatile display ever. There's nothing else like it in the world. SELF-SCAN II panels, with bright, large multi-digit alphanumeric characters, permit an entirely new display concept.

SELF-SCAN II panels can open up new applications for electronic displays. As single panels, they are ideal for point-of-sale displays, computer applications, moving message centers, and others; as modular building blocks, for attention-getting displays in airport terminals; for surface communication systems; for store window displays. Whatever the application, their high brightness and extra-wide viewing angle make them more cost effective, more visible and readable than other readouts.

**VERSATILE** The modular design of the 20-character SELF-SCAN II panel means it can be butted horizontally, and stacked vertically to appear as one large display. You can assemble displays of almost unlimited size in various combinations without sacrificing performance.

**READABLE** The large, 0.7-inch high characters can be read easily at 50 feet in high ambient light. The viewing angle is extra wide: 165°. The gas

plasma technology means that all characters are uniformly bright and sharp: no matching or alignment problems.

**UNIQUE** Combining the best of Burroughs' famous display products, SELF-SCAN and PANAPLEX<sup>®</sup> displays, the planar construction with screened electrodes of SELF-SCAN II means nothing moves . . . nothing wears. Only 18 external connections are required for 20 alphanumeric characters!

### LOW COST

The price will amaze you—LESS THAN \$5 PER DRIVEN ALPHA-NUMERIC CHARACTER! Price includes display, drive electronics and modified 64-character ASCII subset character generator, in 1000-piece quantity.

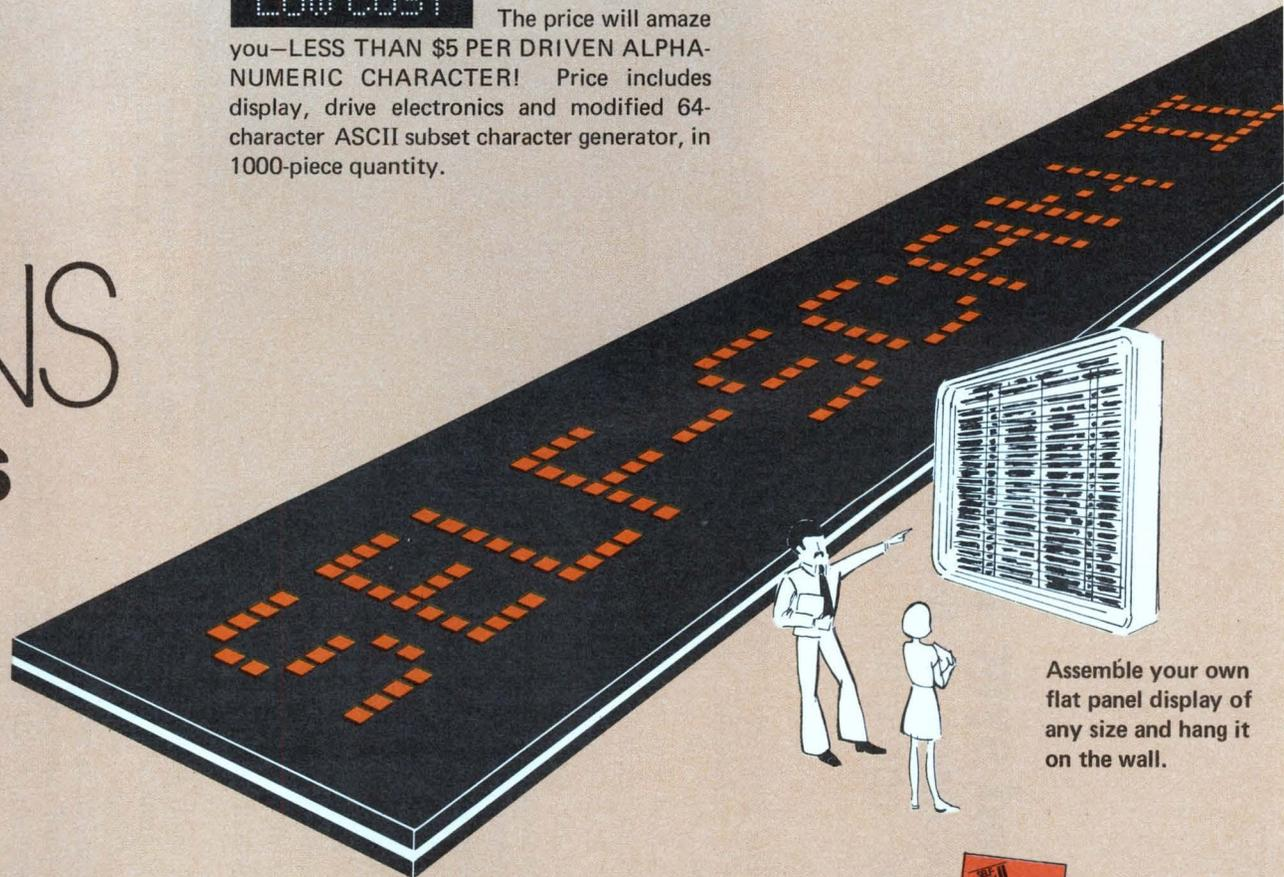

Assemble your own flat panel display of any size and hang it on the wall.



Write for:  
"Self Scan II:  
Important product information  
from Burroughs"

Burroughs' new SELF-SCAN panels are designed to interface with microprocessors. And they are available . . . NOW!!

To find out how you can build the information display you want with SELF-SCAN II panel displays, write or call Burroughs Corporation, Electronic Components Division, P. O. Box 1226, Plainfield, New Jersey 07061; or call our special sales/applications assistance number, (201) 757-3400, or (714) 835-7335 in California.

**Burroughs**   
INFORMATION RETRIEVAL NUMBER 37

# Build high-speed sync-pattern detectors

for digital communications. Of two methods, a ROM is more versatile and can be reprogrammed more easily than ECL.

When digital communications rely on TDMA (time-division multiple-access) techniques, they commonly require the identification of an  $n$ -bit pattern for synchronization.<sup>1,2</sup> And that calls for high-speed sync-pattern detectors—units capable of detecting at more than 50 Mbit/sec.

There are two basic approaches you can take: One—a fast, hard-wired approach—is based on all-ECL logic; the other makes use of read-only memories (ROMs) and programmable read-only memories (PROMs).

While both methods have been found quite satisfactory from the standpoints of performance and cost, the ROM approach has an obvious advantage: It can be reprogrammed easily, and so is more versatile. Either method is applicable to any digital-communications system requiring correlation detection.

In a typical TDMA system, each station transmits a data burst at a specific time. At the start of the time frame an  $n$ -bit pattern, selected by a computer-assisted study for maximum auto-correlation and minimum cross-correlation, is transmitted by a reference station. Each station must then detect the  $n$ -bit sync pattern to find the start of the time frame and thus the information intended for that station.

Error rates are generally considered to be of the order of  $10^{-4}$  at normal operating power levels. Thus the circuit must recognize an  $n$ -bit pattern allowing for  $t$  errors. Since experience indicates that in a practical TDMA system  $n = 20$ , a large part of the synchronization problem consists of recognizing  $20 - t$  bits out of 20 bits at high logic speeds.

## Consider all-ECL logic

One practical, all-ECL circuit to accomplish this has been used in a 50 Mbit/sec TDMA system (Fig. 1). Here the serial data are clocked

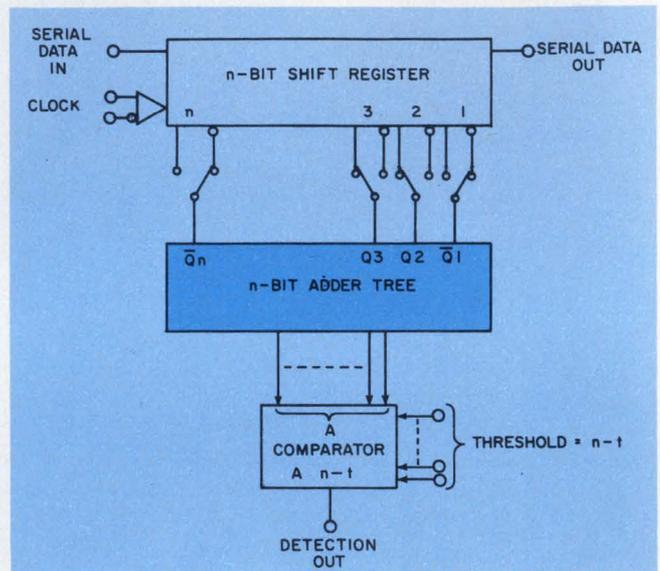

1. The adder-tree sync-pattern detector is built with ECL logic and operates in systems at up to 50 Mbit/sec. The correct pattern registers all ONES.

through a shift register. The true or false outputs of each of the flip-flops in the shift register are selected to match the desired sync pattern, so that all ONES are presented when the desired pattern enters the register.

For example, suppose that  $n = 8$  and the desired pattern is 11010010. If bit 1 on the right is assumed to be the oldest bit, the choice of outputs is  $\overline{Q1}$ ,  $\overline{Q2}$ ,  $\overline{Q3}$ ,  $\overline{Q4}$ ,  $\overline{Q5}$ ,  $\overline{Q6}$ ,  $\overline{Q7}$ ,  $\overline{Q8}$ . These outputs presented to an  $n$ -bit adder tree that converts the number of simultaneous ONES presented on  $n$  lines into a binary number. Thus the adder tree weights the number of matches to the desired pattern.

The output of the adder tree is then digitally compared with the desired threshold,  $n - t$ . If  $t = 2$  for  $n = 8$  in this example, the circuit detects  $A > (n - t)$  when the comparator input  $(n - t)$  is set at binary 5 (or 0101), and zero ( $A=1000$ ), one (0111) or two errors (0110) occur in the received sync pattern of 11010010.

To accommodate any number of bits,  $n$ , the detector has been built modularly with cards—two each of three different types—measuring 3 by 4

Brady H. Warner Jr., Design Engineer, Comsat Laboratories, Communications Satellite Corp., P.O. Box 115, Clarksburg, MD 20734.

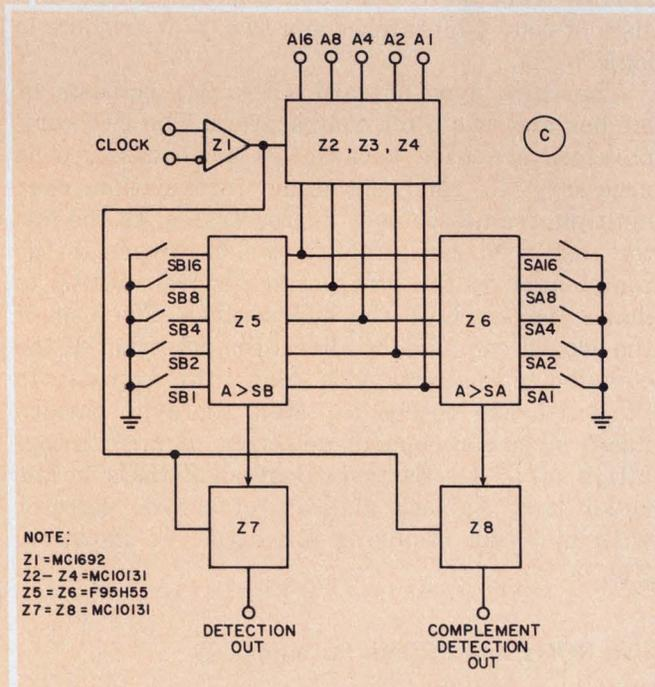
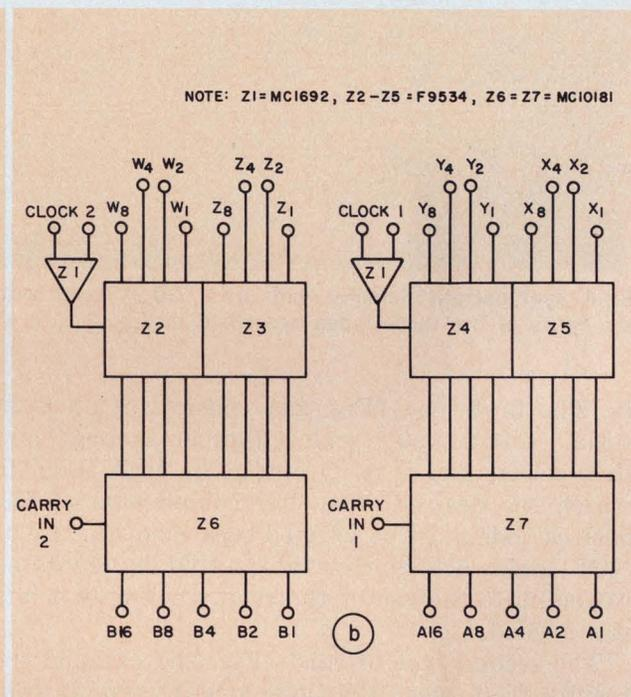
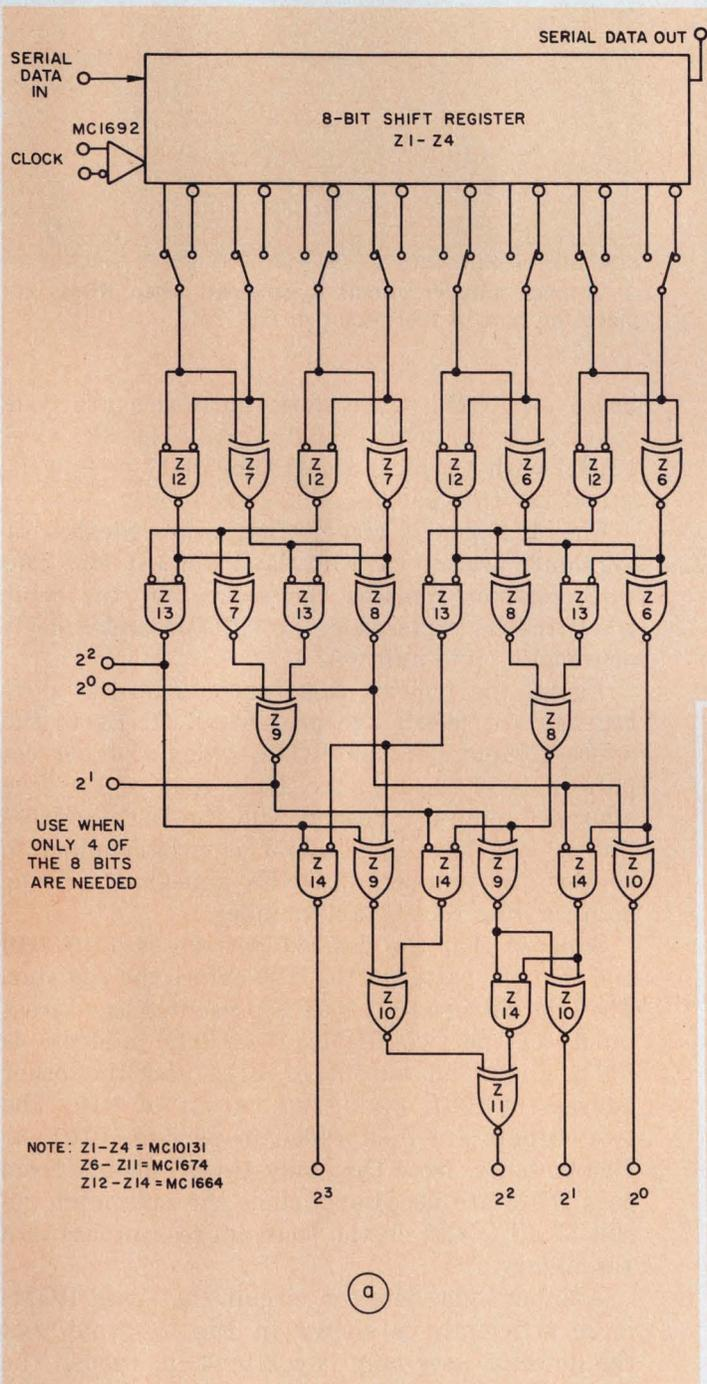

2. Only three types of boards are needed to build the adder-tree sync-pattern detector. Type 1 (a) contains an 8-bit shift register and the adder tree. Type 2 (b) contains four 4-bit latches and two 4-bit arithmetic

units. Type 3 (c) contains latches and two 5-bit comparators. With these six 3 x 4-in. modules, a sync-pattern detector for any n can be built. Two comparators are used to accommodate multiple-frame information.

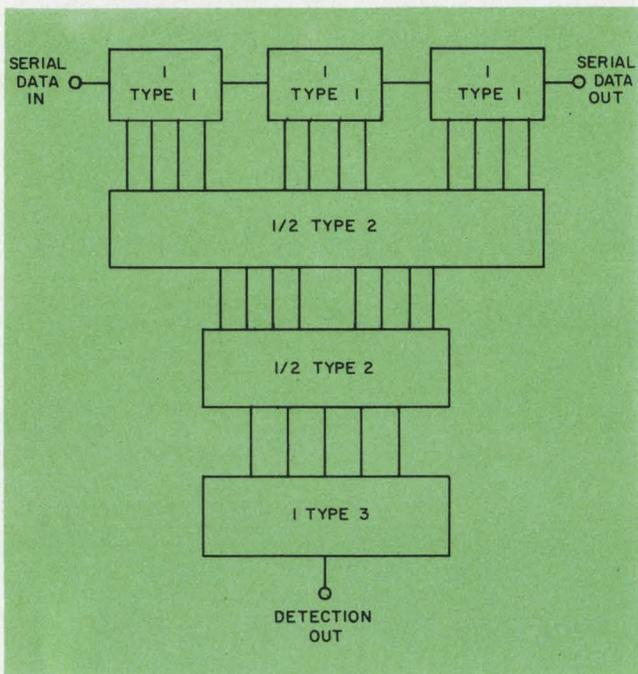

3. A sync-pattern detector with  $n = 20$  is built with six cards of the three types described in Fig. 2.

in. The first type (Fig. 2a) consists of an 8-bit serial shift register with a jumper arrangement that selects the  $Q$  or  $\bar{Q}$  output of each stage to match the desired code. The complement of the desired code must be selected because of the use of NOR logic. An intermediate output is generated to facilitate the use of the card when only 4 bits are needed.

The second type of card (Fig. 2b) can add the results from more than one type-1 card. It consists of four 4-bit latches and two 4-bit arithmetic logic units.

The third type of card (Fig. 2c) consists of latches and two 5-bit comparators. The two comparators are used because, in some cases, it is necessary to send signaling information over multiple frames or over a superframe. In the latter case, you can simplify the hardware if the complement to the sync pattern is transmitted to mark the start of the superframe. The use of the second comparator allows the detection of the complement pattern with very little increase in the hardware needed to detect the sync pattern itself, since complement detection requires recognition of all ONES instead of all ZEROS in the adder tree. A block diagram of a sync detector with  $n = 20$ , requiring six cards, is shown in Fig. 3.

#### Use ROMs and PROMs for simplicity

As we have seen, a code converter that converts the number of simultaneous matches on  $n$  lines to a binary number is an important part of the circuit. This suggests the use of a circuit

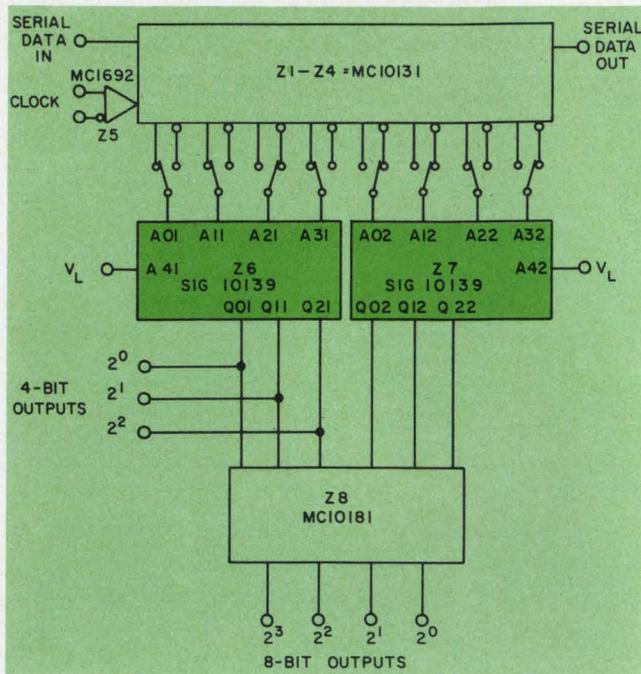

4. A much simpler circuit is obtained when ROMs replace the part of the circuit in Fig. 2a.

based on ROMs, since these memories are code converters. A commercially available  $32 \times 8$  PROM with a typical access time of 17 ns is well-suited for this purpose.

Fig. 4 depicts a circuit that is a redesign of the configuration of Fig. 2a, using ROMs. The shift register remains the same, but the 8-bit adder tree is replaced by two ROMs and a 4-bit arithmetic logic unit (ALU).

Again, the true or false outputs of the shift register are selected to present all ONES to the address inputs of the ROMs when the correct pattern is in the register. Only four of the five address inputs are needed, and the fifth address line is tied low. Each ROM is programmed to convert the number of ONES appearing on the address lines to a binary number.

Suppose that the desired pattern is 11010010 and that the pattern 01010100 enters the register. Then the pattern 01111001 is presented to address inputs of the two ROMs. One ROM address is 0111, giving an output of 011; and the other address is 1001, giving an output of 010. The two outputs are then added to produce 0101, or five matches. Note that only three outputs from each ROM are necessary, since the maximum result of all ONES on the four address inputs is 4 (or binary 100).

Another sync detector circuit that uses ROMs more efficiently is shown in Fig. 5. Note that the detector uses only two 3-by-4 in. cards. The shift register consists of four MC10176 hex flip-flops. Because the MC10176 has only the true outputs available, it cannot be used in the adder approach unless extra gating is provided.

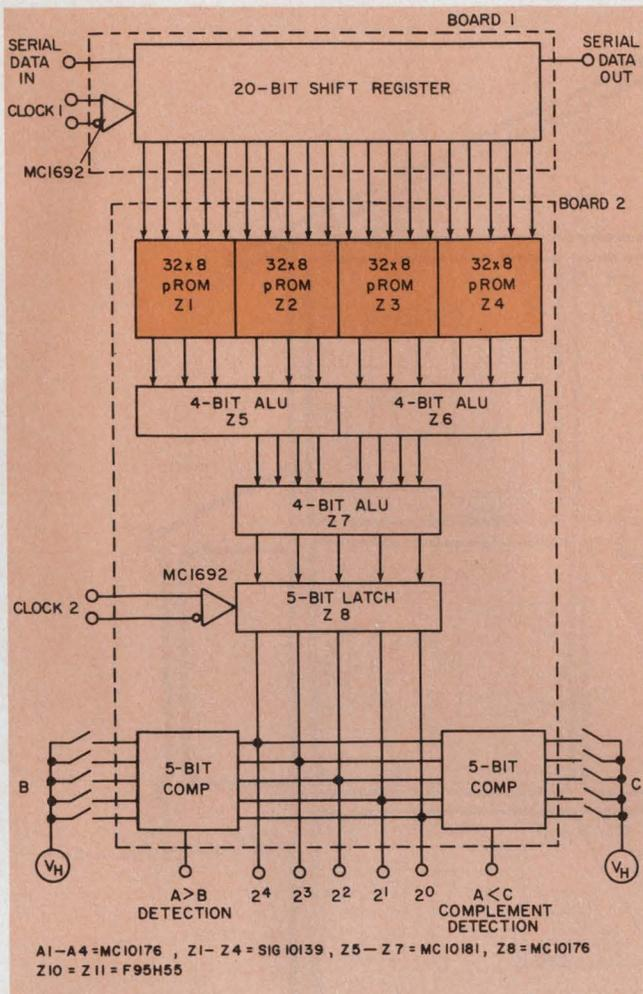

5. Only two boards, instead of six, are used to build a sync-pattern detector with  $n = 20$  (compare with the configuration of Fig. 3).

The ROMs, however, can be programmed to yield a binary number that represents the number of matches to a desired code. For instance, you can readily program the ROM to match the number 00010.

Note that if all ZEROS are presented to the ROM address lines, the output is 100, representing four matches between 00000 and 00010. Note that each ROM must be programmed differently in this case. If PROMs are used, this is not a serious drawback, since they must be user-programmed in any case. Also note that the ROM design of Fig. 5 lends itself more to increasing  $n$  in blocks of 10 rather than eight, as in the adder design of Fig. 3.

When the circuit of Fig. 5 was built and tested, it operated well to 95 MHz with a 35-ns delay between the register and the latch clocks. The delay between the data from the register and the output detection is about 45 ns, because of the access time of the ROMs and the delay of the adders, latch and comparator. This speed limitation is a function of the quality of matching of the delay through the ROMs and adders as well as

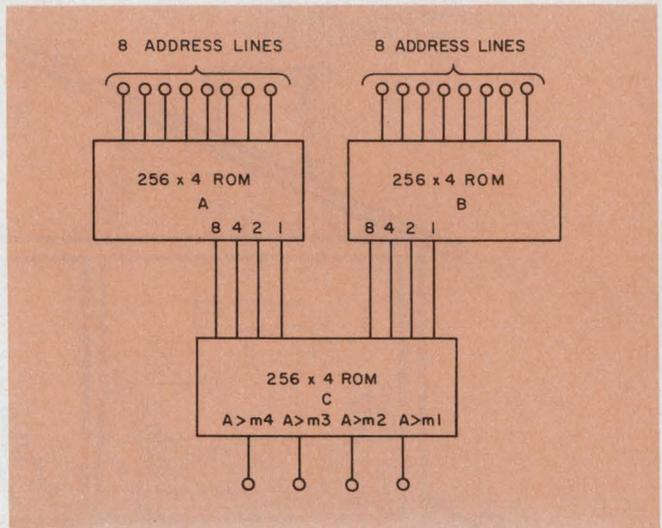

6. Very simple threshold detectors can be built with  $256 \times 4$  ROMs. The threshold detector above can be used for  $8 < n \leq 16$ .

of the rise and fall times of the various internal signals.

While the ROM approach is economical for  $n = 20$ , it may not be for certain other values of  $n$ . But for all values of  $n$ , the ROM design offers simplicity.

The ROM approach can also be used to design high-speed threshold decoders for error-correcting codes. If TTL speeds are adequate, there are several  $256 \times 4$  ROMs and PROMs that can be used. The number of address lines limits the simplicity of the circuit in this case. For instance, a threshold decoder of  $m$  out of  $n$  bits can be built simply with a single  $256 \times 4$  ROM, provided that  $n$  does not exceed 8. The ROM is programmed to produce a ONE output on one of the four possible output lines, if the input contains  $m$  or more ONES on the  $n$  lines.

A threshold detector for  $8 < n \leq 16$  can be built with just three ROMs (Fig. 6). The first two ROMs are programmed to convert the number of ONES to a binary number. Thus with eight inputs the maximum number that can be represented is eight (or 1000 in binary). The third ROM is programmed to produce a ONE output, if the sum of the two outputs of the first two ROMs (A and B) exceeds a preset threshold.

Suppose that  $m = 8$ . Then for each combination of addresses A and B, for which  $(A + B) \geq 8$ , the output of C is programmed to be a ONE. Note that up to four separate outputs, programmed for different thresholds, are possible with a  $256 \times 4$  ROM. ■■

#### References

- Schrempp, W., and Sekimoto, T., "Unique Word Detection in Digital Burst Communications," *IEEE Transactions on Communications Technology*, August, 1968.
- Wu, W. W., "Coding Unique Words in Communication Satellites," *National Telemetry Conference Record*, 1971, pp. 270-276.

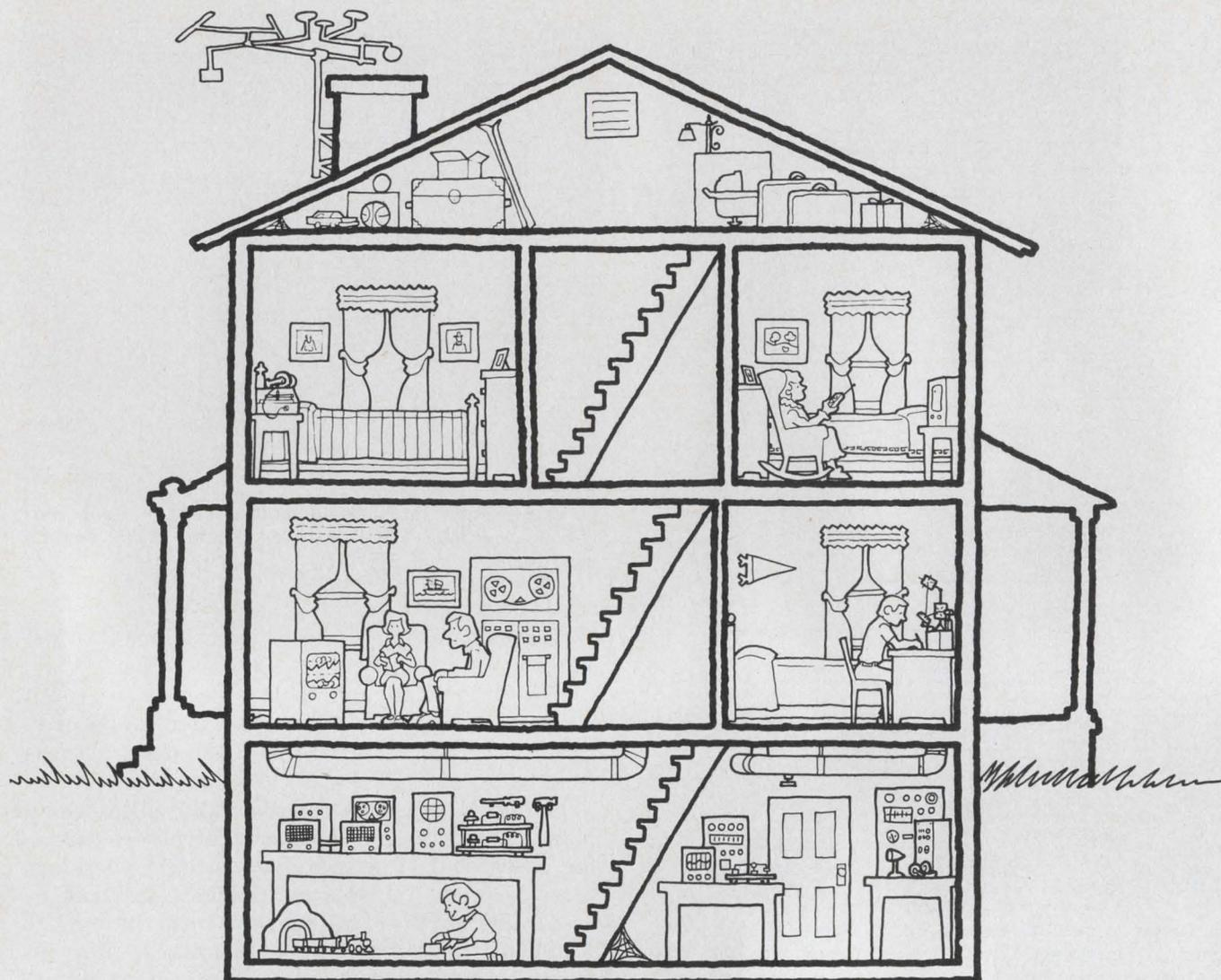

## Engineers gotta have fun, too!

Here are 10 hobby and project books that let the engineer use his special talents for improving his home or just having fun.

1. **HOW TO SELECT AND INSTALL ANTENNAS**, #0786-8, \$4.90. All aspects of antenna selection and installation. Instructions for putting up UHF, VHF, FM antennas or complete master TV systems.

2. **20 SOLID-STATE HOME AND HOBBY PROJECTS**, #0134-7, \$4.55. Two-station intercom, electronic siren, power regulator, metal detector, water-operated alarm, etc. Complete instructions, parts lists, diagrams.

3. **25 SOLID-STATE PROJECTS**, #5881-0, \$4.90. Auto burglar alarm, programmable auto-speed-minder, indoor-outdoor electrothermometer, telephone call timer, electronic dice, TV remote-sound system, etc., etc.

4. **50 IC PROJECTS YOU CAN BUILD**, #0723-x, \$4.55. Hi-fi headphone amp, auto tachometer, intercom, TV commercial killer, etc. Each project can be put together in one night with these simple instructions.

5. **BUILDING THE AMATEUR RADIO STATION**, #0709-4, \$4.30. Complete construction of amateur radio station. Schematic and wiring diagrams and chassis layouts for Novice and General Class stations.

6. **COLOR TELEVISION: Principles and Servicing**, #5929-9, \$5.70. Receiver troubleshooting and servicing techniques. Charts listing trouble symptoms, causes, and remedies. Instructions for using the latest test instruments.

7. **HOW TO BUILD A LOW-COST LASER**, #5934-5, \$4.55. How to build a laser at home, from readily available parts, for approximately \$100! Includes a collection of laser experiments.

8. **BENCH-TESTED COMMUNICATIONS PROJECTS**, #0788-4, \$3.75. Telephone broadcaster, party line listening, canned light music, rollaway ham

shack, VHF extender, 6-meter solid-state transmitter, etc.

9. **HOW TO BUILD A WORKING DIGITAL COMPUTER**, #0748-5, \$5.45. Step-by-step instructions for building an inexpensive digital computer simulator. Includes parts lists, theory of operation, and fundamental programming techniques for solving simple problems.

10. **110 THYRISTOR PROJECTS USING SCR'S AND TRIACS**, #5096-8, \$4.30. Burglar, fire and water level alarms, power control devices for electric tools, and other useful projects built and fully evaluated by the author.



**Hayden Book Company, Inc., 50 Essex St., Rochelle Park, N.J. 07662**

Please send the books I have circled on 15-day free examination. At the end of that time, I will remit payment, plus postage, or return the book(s) with no further obligation. (SAVE MONEY! Payment enclosed. Publisher pays all shipping and handling charges. Same 15-day return guarantee.)

Name \_\_\_\_\_

Address \_\_\_\_\_

City \_\_\_\_\_ State \_\_\_\_\_ Zip \_\_\_\_\_

Prices subject to change without notice.

75-42

# 5 reasons why the Keithley model 168 should be your number 1 digital multimeter

- 1.** Autoranging. All you do is connect the signal to the two-terminal input and push the function you want. The 168 takes it from there to save you time.
- 2.** 5 Functions. Dc voltage from  $100\mu\text{V}$  to  $1000\text{V}$ , ac voltage from  $100\mu\text{V}$  to  $500\text{V}$ , ac and dc currents from  $0.1\mu\text{A}$  to  $1\text{A}$  and resistance from  $100\text{m}\Omega$  to  $20\text{M}\Omega$ .
- 3.** Hi-Lo Ohms. Select ranges with 1-volt drop for turning on semiconductors or 100 millivolts for keeping them off.
- 4.** Full 1-Year Guarantee. It's a Keithley, no less. And that means all specs including accuracy are guaranteed for a full year. Maintenance is easy too.
- 5.** Low Price. Only \$315 puts the Model 168 in your hands. A complete line of accessories gives the 168 even more versatility.

The Model 168 Autoranging DMM will make your job easier . . . and that should make it your number 1 choice. Send for full details or phone (216) 248-0400 for a right-away demo.

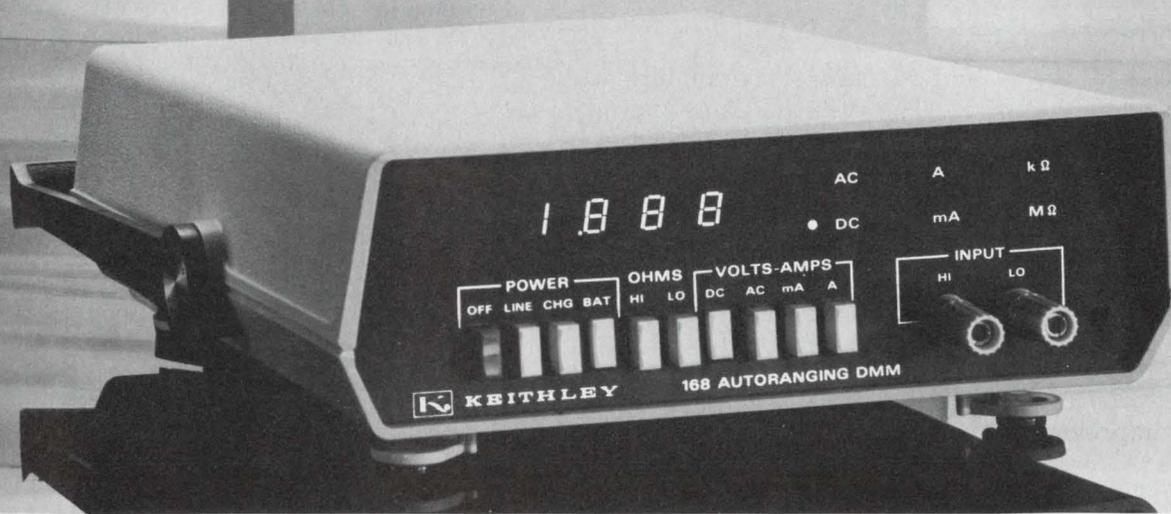

**KEITHLEY  
INSTRUMENTS**  
U.S.A.: 28775 AURORA ROAD, CLEVELAND, OHIO 44139  
EUROPE: 14, AVENUE VILLARDIN, 1009 PULLY, SUISSE

INFORMATION RETRIEVAL NUMBER 39

# Which multiplier?

Analog signals can be multiplied by circuits ranging from inexpensive ICs to complex oscilloscopes. But watch out. Results can vary widely.

All multipliers are not alike. Which to select depends on what you need in the way of accuracy, stability and frequency response.

Electromechanical or purely mechanical devices, the earliest multipliers, offer limited bandwidths—up to 40 or 50 Hz—with accuracies of about 10%. Magnetic amplifiers, those that rely on the Hall effect, tend to be expensive and have limited frequency response—200 or 300 Hz—with accuracies of about 10%.

Modern magnetic multipliers use magnetodiodes or transistors to get bandwidth up to about 1 kHz and accuracy to 1%. Mag amps have two great advantages: high stability and completely isolated inputs.

Most modern multipliers are solid-state and range from simple potted modules to complex multiplying oscilloscopes. One basic multiplying circuit is the one-quadrant, log-diode summer, which works by converting the input signals into forms that are subsequently added to provide the product (Fig. 1). More complex, but ultimately more useful, is the four-quadrant multiplier.

The quarter-square, or piecewise linear approximation, technique (Fig. 2) is based on the well-known relationship

$$\frac{(X + Y)^2 - (X - Y)^2}{4} = XY.$$

In the figure, the X and Y signals are applied to operational amplifiers. The resulting sum and difference signals are then squared and added to obtain the product. Bandwidth is wide—up to 2 MHz—temperature stability is good, and accuracy is between 0.25% and 1%. But the disadvantages are poor linearity at low signals and undesirable output ripple. The latter can be traced to discontinuities in the squaring device and is particularly bad at low signal levels.

The linearity of the quarter-square system can be improved, but at increased complexity and cost. Two other methods have much better linearity but narrower bandwidths: triangular-

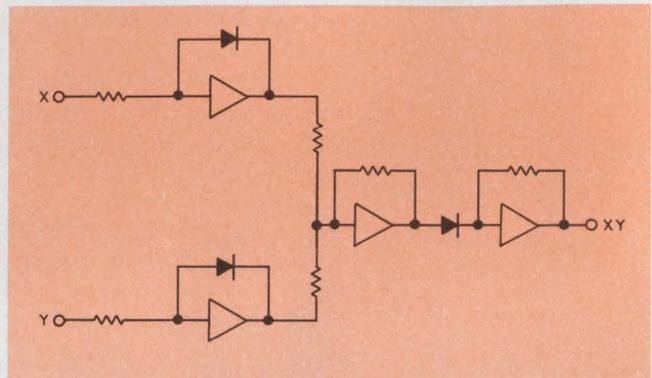

1. **Multiplication by addition** marks the log-diode summer, a basic multiplying circuit that is limited to one-quadrant operation.

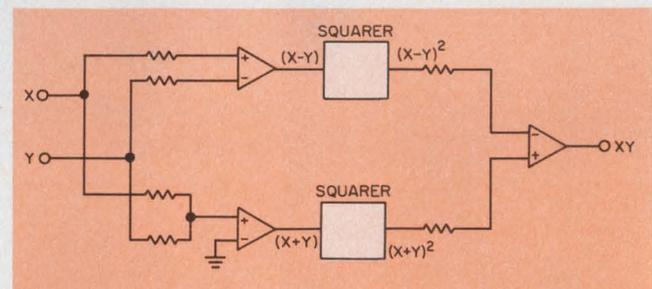

2. In the **quarter-square multiplier**, a piecewise approximation is used to obtain four-quadrant performance. Bandwidth is wide but linearity is poor.

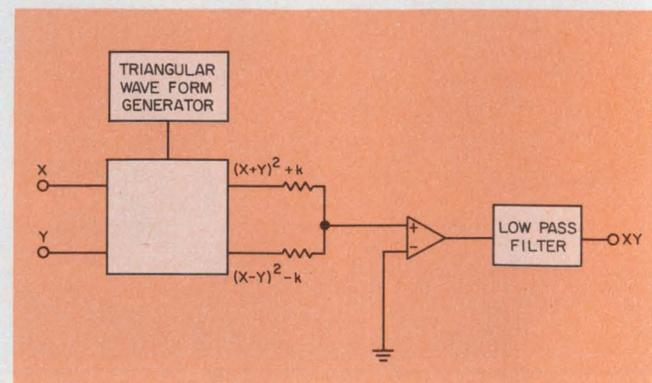

3. **Improved linearity at narrower bandwidths** is offered by the triangular-averaging technique, in which the inputs are combined with a triangle waveform.

David J. Wilson, Philips Test & Measuring Instruments Inc., 400 Crossways Park Dr., Woodbury, NY 11797.

## Multiplier comparison

Technique	Bandwidth	Accuracy	Comments
Electromechanical	20/30 Hz	10%	
Magnetic amplifiers	200/300 Hz	10%	Highly stable, isolation between inputs.
Quarter square	2 MHz	1%-0.25%	Poor linearity, error ripple significant for low signals.
Triangular averaging	10 kHz	0.1%	Temperature stability problems.
Time division	1 kHz	0.01%	Narrow bandwidth.
Transconductance	5 MHz	2%	Temperature stability problems.
Multiplying (transconductance) oscilloscope	100 MHz	2%	Improved version of basic circuit, more stable.

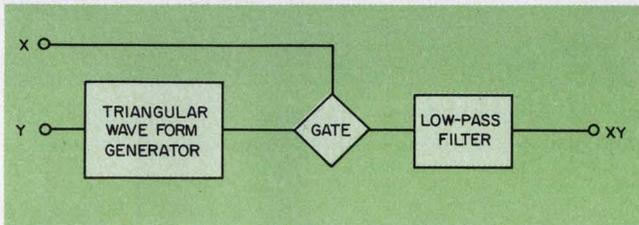

4. Like the triangular averager, the time division, or pulse-height/width, multiplier is a carrier-based system. Output is a pulse train that is filtered to provide the average product.

averaging and the time-division, or pulse-modulation, technique.

### Tradeoffs: linearity and bandwidth

The triangular-averaging system combines the X and Y inputs with a triangular wave and rectifies the result (Fig. 3). Two signals are obtained, one proportional to the squared difference of the two inputs and one proportional to the squared sum. Summation of these two signals results in the desired product. Though linearity is much improved, a low-pass filter, required at the output, limits the bandwidth to 10 kHz. And this system is also relatively expensive.

In the time-division, or pulse-height/width, technique, a square wave is generated with an average value that depends on the input signals (Fig. 4). As shown, the output of a triangular waveform generator is added to one input, and the resulting signal is then applied to an electronic switch that is controlled by the other input signal. The resulting pulse train is ampli-

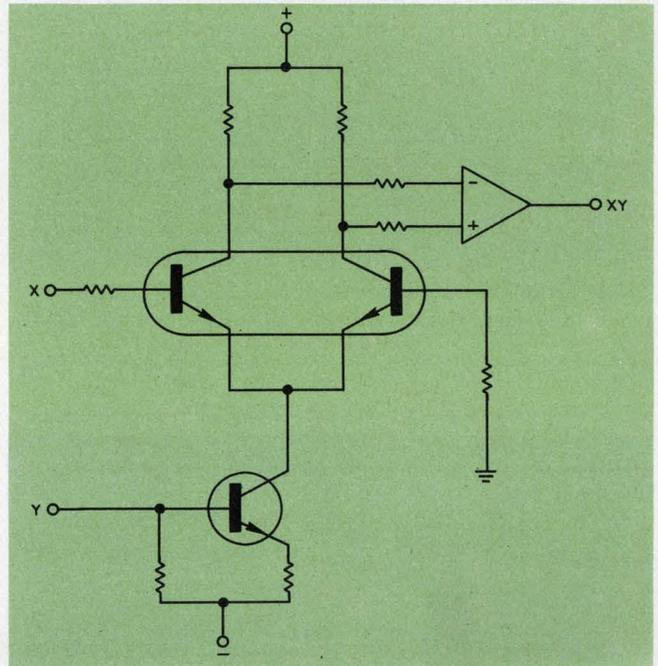

5. Widest bandwidth, at the cost of stability, is given by the variable transconductance multiplier. In this circuit, one input controls the transconductance of the amplifier. The output is proportional to the product of the transconductance and the second input.

tude-controlled by one input and its duty cycle is controlled by the other.

Since time division, like triangular averaging, is a carrier-based system, a low-pass filter is needed to smooth the train and provide the average value of the product.

Time division offers excellent temperature stability, high accuracy and very good linearity. The tradeoffs: narrow bandwidth—about 1 kHz—and relatively high cost. Also, the output shows appreciable ripple unless it is properly filtered.

For wide bandwidths, look into multipliers that use the variable transconductance principle. Here the current through a matched pair of transistors is made proportional to one of the input signals. If the transistors are perfectly matched, the differential collector current—and therefore the differential collector voltage—is proportional to the product of X and Y (Fig. 5).

High-speed operation, good linearity—not as good as time-division but better than the quarter-square at low signal levels—and wide bandwidth (to 10 MHz) are features of this system. Temperature stability is a problem, however, accurate matching of transistors helps to minimize the drift. Cost of the variable transconductance type is generally less than that of pulse-width/height or quarter-square multipliers.

The table summarizes the advantages and disadvantages of the various types of multipliers. In practice, the choice normally lies between the more accurate time-division system—with lim-

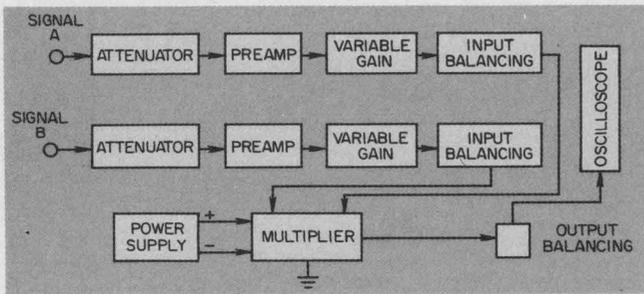

6. A complete multiplier requires signal conditioning, power supplies, output processing and a readout device.

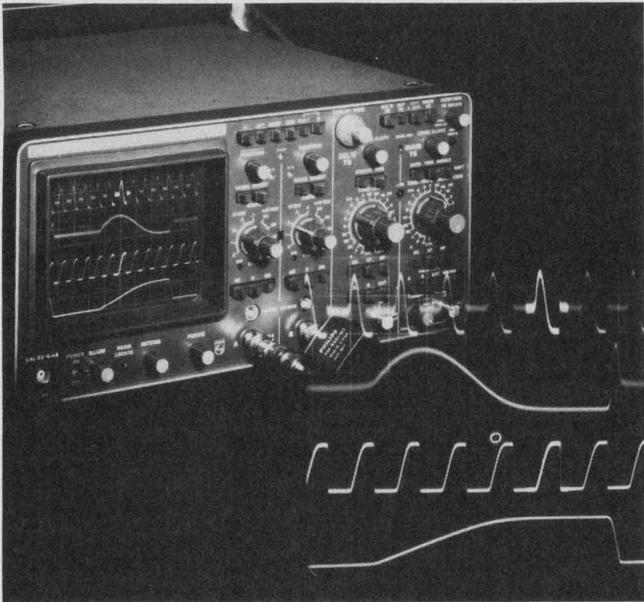

7. With the multiplying scope, the instantaneous power in a circuit is readily available. The top waveform shows the power dissipation in the collector of a transistor, while the waveform immediately below is the expansion of the intensified portion of the power waveform. The third display down is the transistor collector-emitter voltage. At bottom is an expansion of the intensified  $V_{CE}$  pulse.

ited bandwidth—or the wide-bandwidth, low-stability transconductance method.

### A multiplier alone isn't enough

But selection of a multiplier is not the end of the matter. There is still the problem of putting together a complete operating system. And this is the part that has made the multiplier a rather esoteric measuring tool.

Fig. 6 shows the block diagram of a typical measuring set-up and gives some idea of the complexity of a complete system. Input signal conditioning is required to get the two inputs to the same level; this calls for either amplifiers or attenuators. Fairly stable power supplies are needed for accurate output. And some form of output conditioning is essential to match the

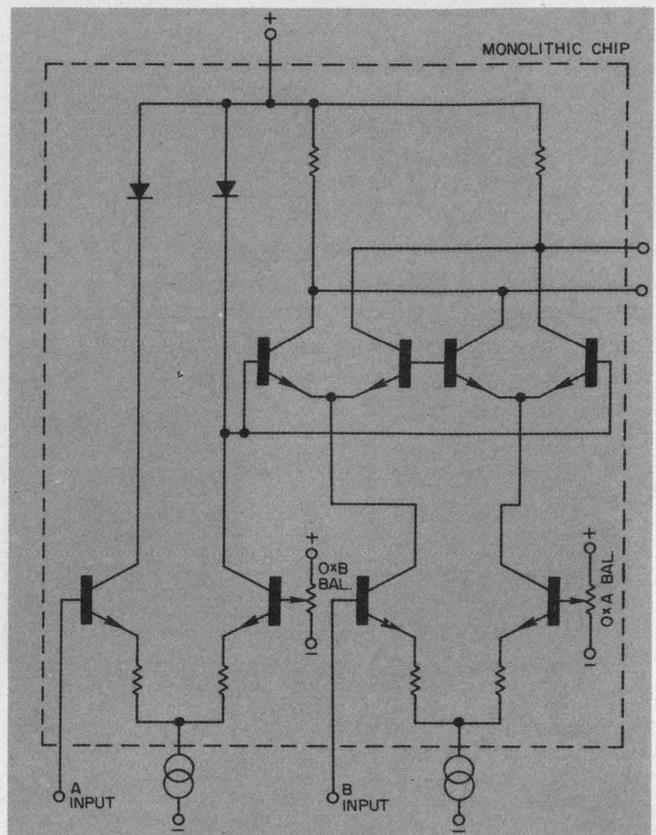

8. The scope's internal multiplier: a single, monolithic chip using the variable transconductance principle.

multiplier to the instrument that will make the readings.

Since the readout is often an oscilloscope, which already contains circuitry for signal conditioning plus stable power supplies, it seems logical to combine the multiplier and scope. And indeed such a unit is available (Fig. 7).

Today's multiplying scope uses a much improved version of the variable-transconductance device. The heart of the multiplier in the Philips scope is a single monolithic chip containing a double differential amplifier with cross-coupled collectors (Fig. 8). The output of the amplifier is proportional to the product of the amplifier's transconductance and the instantaneous amplitude of X. The circuit is designed so the transconductance is directly proportional to the instantaneous amplitude of Y. Thus the output voltage is directly proportional to the product of inputs X and Y. The scale factor of the multiplier is unity.

Since monolithic ICs with  $f_t$ s of 2 GHz are used in the scope, and since interconnections are kept very short, a multiplier bandwidth of 100 MHz is possible. And specified accuracy is within 2%.

Typical of the problems that can be tackled with a multiplier scope is that of power-supply design. For instance, it's often necessary to de-

termine the collector dissipation of the output transistors. Voltage and current may be high, but the power curve can be such that the current is high when the voltage is low, and vice versa. The power peaks only when there is a changeover, and it is this peak that has to be determined.

With traditional methods, the voltage and current curves are plotted, and then point-by-point measurements are made. The results are then sent for computer analysis; several days and a large bill later, the answer comes back. With the scope, voltage and current are applied directly, and the power curve is immediately displayed on the screen. Note that, with a fast multiplier, all details are shown, including needle-shaped transients that occur during rise and fall times.

The strength of the multiplying scope is that it gives a direct analog power reading. Thus, unlike scopes that use digital processing to multiply, the analog multiplier scope can handle single-shot events.

Surprisingly, multipliers can determine phase relationships. Suppose the signal at one input to a multiplier is  $A \cos \omega t$  and the other signal is  $B \cos (\omega t + \phi)$ .

Now remember:

$$\cos \alpha \cos \beta = 1/2 [\cos (\alpha + \beta) + \cos (\alpha - \beta)].$$

Then the product of the two signals can be written as

$$1/2AB \cos (\omega t + \phi - \omega t) + 1/2AB \cos (\omega t + \phi + \omega t),$$

which becomes:

$$1/2AB \cos \phi + 1/2AB \cos (2\omega t + \phi).$$

Therefore the product waveform contains a dc component,  $1/2 AB \cos \phi$ , and an ac component,  $1/2AB \cos (2\omega t + \phi)$ . The dc component gives a direct indication of the phase difference, and this can be displayed on a simple dc voltmeter or on the multiplying scope.

This new way to read phase angle has two advantages. It is not very sensitive to distortion of the input waveforms—as are expensive phase-difference measurement bridges—and the bandwidth of the measurement is as high as that of the multiplier.

One neat trick with phase: A problem with multichannel data recorders is that the heads have to be adjusted in exact phase alignment. Usually you do this by displaying two head signals at a time and mechanically shifting the heads until the signals are in phase.

But this method relies on vision and is therefore prone to human error. With multiplication, apply the two signals to the multiplier inputs after one signal has passed through a 90-degree phase shift. Then adjust the two heads until they are in phase. At this point the power factor,  $\cos \phi$ , becomes zero, the output of the scope gives the power factor directly, and the result can be read on a digital voltmeter. ■■

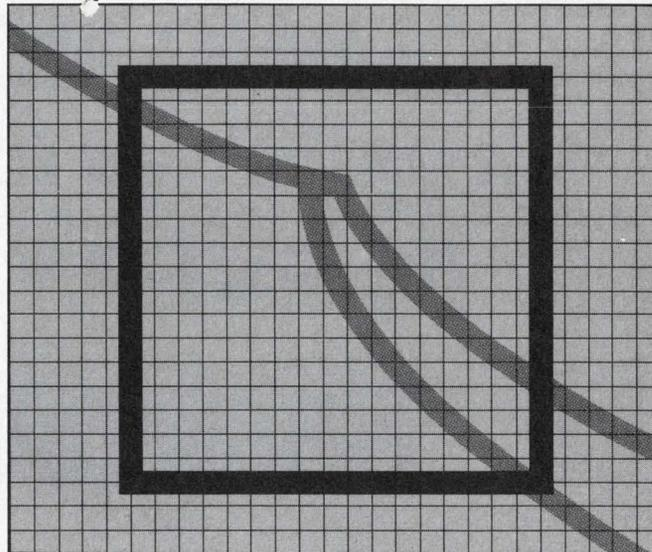

## New From Micro Devices A Unique Slow-Blow Current Limiter.

It's the new MICROTEMP® 5P Series MultiProtector. A versatile, yet extremely accurate slow-blow current limiter that lets you design-in protection for a specific current requirement within a precise time and current window.

triggering the exclusive pellet-type opening mechanism.

When properly applied, 5P will not nuisance trip reducing costly and annoying "in warranty" service calls.

No other commercially available slow-blow fuse even comes close to matching the 5P's ability to handle high current surges without being derated.

### Here's more:

- current values—500 milliamps to 10 amps.
- ambient temperature range—25 to 100° C.
- can be designed to withstand surges up to 100 amps for 30 milliseconds
- operates within 130% of rated current
- designed and manufactured to comply with U.L. Standard 492.7. Our tests show these standards are being met. Units are now being tested by U.L. for Yellow Card listing.

5P's unique opening mechanism design guarantees life time rating stability and excellent surge absorption. Conventional slow-blow fuses operate through a metallic, current carrying element making them extremely susceptible to surging and derating. Thanks to MICROTEMP's patented non-current carrying, temperature sensitive opening mechanism, it reacts only when current put through the heater element generates temperatures capable of



For more information, check the reader service card, or call or write:



**MICRO DEVICES CORP.**

1881 Southtown Blvd., Dayton, Ohio 45439  
Ph: (513) 294-0581 Telex: 28-8087

---

# COMING NOVEMBER 22

## A MAJOR NEW EDITORIAL SECTION

# IN EVERY ISSUE OF

# Electronic Design

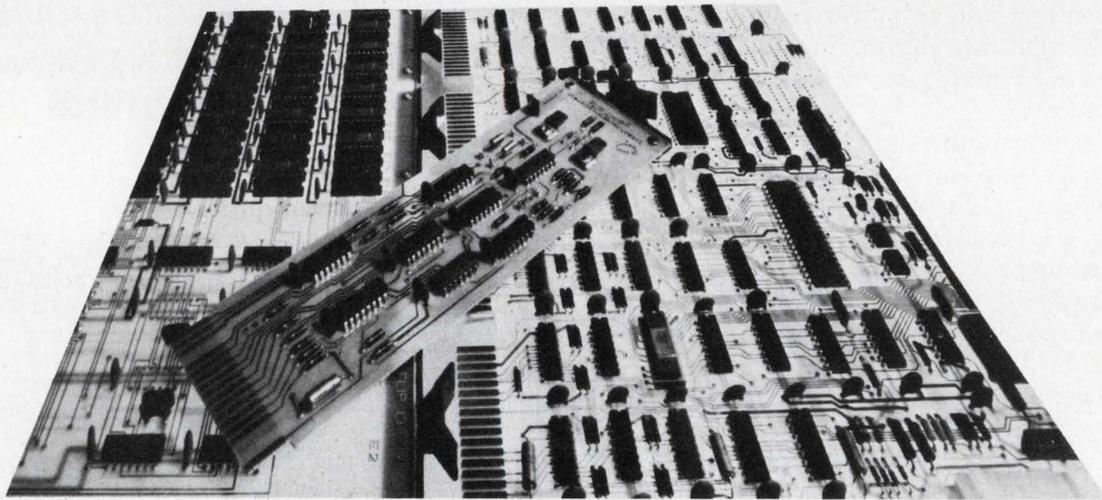

# "MICROPROCESSOR DESIGN"

**Microprocessors are hot**...and they're going to get even hotter. That's why we've been giving microprocessors extensive coverage ever since their first commercial availability three years ago.

**Now we're going to do even more.** A major new section of the magazine, MICROPROCESSOR DESIGN, will begin November 22 and will continue in every subsequent issue.

**The new section** will cover all important developments that relate to designing with microprocessors. In addition to several major reports devoted exclusively to microprocessors in 1976, tech articles, news, new product data, new lit, new books, announcements of meetings and seminars and interviews with industry experts will be consolidated in this section.

**Microprocessors don't stand alone.** Our approach will be to help our readers not only to specify the microprocessor, but also to deal with everything that will surround the microprocessor and everything that will help him to design with a microprocessor.

So if microprocessors figure in your future...watch for MICROPROCESSOR DESIGN...another service to the reader from *Electronic Design*.

---

# Power conversion is our business ...smooth, clean, reliable power.



## Ultra-Isolation Transformers

Unique box shielding techniques achieve 1,000,000 to 1 common-mode noise attenuation. Equipment is protected from noisy power lines and clean power lines from noise-generating equipment. Effective capacitance between windings is less than 0.0005 picofarads.

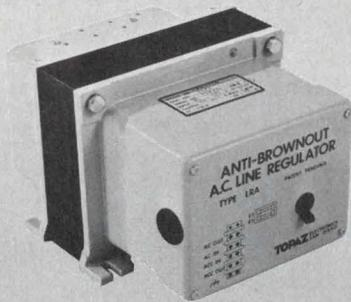

## AC Line Regulators

Provides AC line regulation in sizes and weights unusually small in relation to power rating. Topaz AC line regulators are typically 1/5th the size of other units of equal kVA rating. Regulator efficiency guaranteed greater than 98% with less than 1% total harmonic distortion added to the output. Both single phase and three phase units are available. Rated 500 VA and larger, all units feature less than one cycle response and low audible noise.

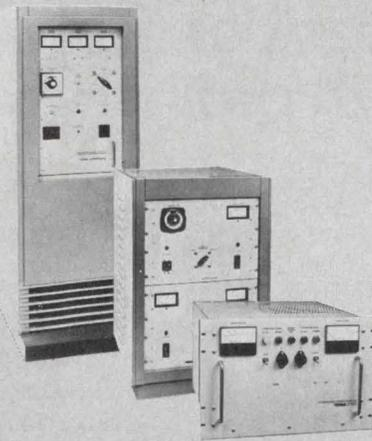

## Uninterruptible Power Systems

Topaz systems provide instant, dependable back-up power when power failure or brownout conditions occur. Excellent for minicomputers, programmable calculators, process controls and other applications where power loss or momentary power interruption results in serious economic loss. Units are rated 300 VA and larger, with battery power furnished to meet your needs.

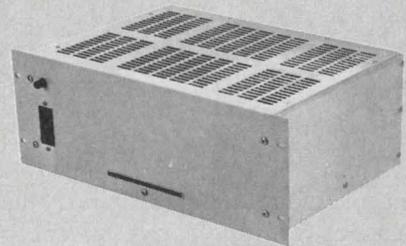

## Inverters

Topaz inverters are the finest DC to AC inverters available. Thousands of units have demonstrated their reliability in DC mobile systems, telecommunications, and other applications requiring clean, dependable conversion of DC to AC power.

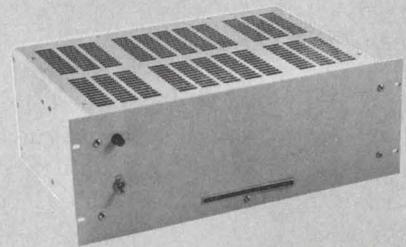

## Frequency Changers

Used extensively overseas, Topaz frequency changers are also excellent for domestic applications. Mobile video systems, airborne test, and R & D laboratories are typical examples.

Both frequency changers and inverters are rated 200 VA and larger. Output regulation is  $\pm 3\%$  with frequency stability of  $\pm 0.05\%$ . Total harmonic distortion is less than 5% at full load.

**Uninterruptible  
power systems,  
frequency changers,  
DC to AC inverters,  
Ultra-Isolation  
Transformers,  
AC line regulators and more.**

Send for our catalog.

Topaz is also a major supplier of **custom** power conversion equipment.

# TOPAZ

**ELECTRONICS** 3855 Ruffin Road, San Diego, California 92123 • Phone: (714) 279-0831. TWX (910) 335-1526

## Op-amp scale expander allows high-resolution with ordinary voltmeter

The problem of measuring small percentage changes of a voltage can be solved at low cost with an expanded-scale meter circuit (Fig. 1). The circuit can be used with any good multirange voltmeter, and it costs less than \$10 to build.

Expansion adjustment  $R_1$  is a 10-turn potentiometer that provides an output voltage,  $V_{ex}$ , from 0.00 to 10.00 V. Voltage  $V_{ex}$  is then applied to the inverting input of op-amp  $A_1$ . The gain of  $A_1$  is  $-1$ . Since  $R_i \gg R_1$ , the gain does not vary significantly as  $R_1$  is adjusted. The voltage to be measured,  $V_{in}$ , is applied via a selective attenuator to the noninverting input of  $A_1$ , which provides a gain of

$$\left[1 + \frac{R_f}{R_i}\right] = 2.$$

Since the attenuator is designed to divide  $V_{in}$  by a factor of  $2M$ , an over-all noninverting gain of  $1/M$  is produced (see table). Thus the output of  $A_1$  is

$$\left[\frac{V_{in}}{M} - V_{ex}\right].$$

With the component values shown,  $V_{ex}$  can offset an input as high as 200 V.

Since  $V_{ex}$  is subtracted from the attenuated input, the output of  $A_1$  is negative whenever  $V_{in}/M$  is less than  $V_{ex}$ . To keep the voltmeter from pegging at zero and possibly becoming damaged,  $A_2$  is connected as a precision rectifier to pass only positive inputs at a gain of unity.

A voltmeter connected to the output of  $A_2$ , therefore, has a scale expanded by the amount  $MV_{ex}$ , which must be added to the voltmeter reading.

For example, to measure small variations in the output of a 40-V regulated supply, set the attenuator to position 10. With  $V_{ex}$  set to 3.95 V,  $MV_{ex} = 39.5$ . When the voltmeter is set for a 1-V range, its scale is expanded, so that it measures 39.5 V when it shows zero on its scale and 40.5 V when the reading is at full scale, or 1 V. However, be careful. Since the meter doesn't peg, below 39.5 V the voltmeter still reads zero.

With this expansion setting, it is possible to read variations as small as 10 mV. By contrast, use of the voltmeter in the conventional way

would, on its 50-V range, show changes to about 500 mV at best.

The accuracy of the expander is limited mainly by resistor tolerances. Higher input impedance can be obtained with higher attenuator resistor values; however, an op amp with lower bias current would be needed to replace the inexpensive 747.

*Robert L. Taylor, Research Director, I & F Electronics, 317 Rosebank Ave., Nashville, TN 37206.*

CIRCLE No. 311

### Ranges and input impedances

ATTENUATOR M	INPUT RANGE VOLTS	EXPANSION RANGE VOLTS	INPUT IMPEDANCE OHMS
1	0-10	0-10	200 k
2	0-20	0-20	400 k
5	0-50	0-50	1 MEG
10	0-100	0-100	2 MEG
20	0-200	0-200	4 MEG

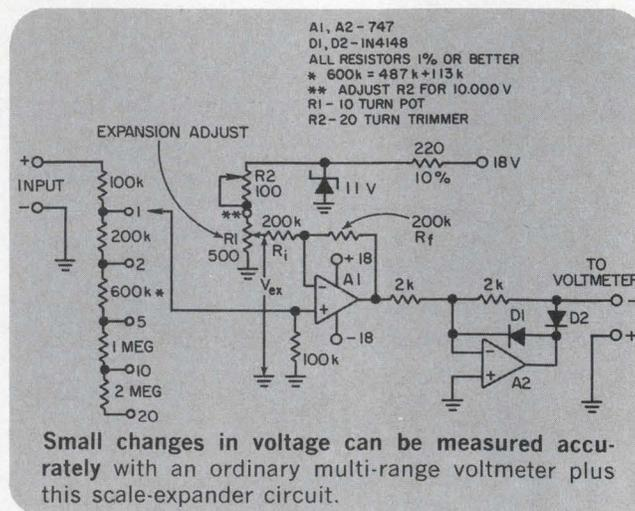

# It's new. It's drop-proof. It's burnout-proof. It's super-safe. The Triplet Model 60. Only \$90.

**New unconventional concept in V-O-M design gives you an extra chance after accidental misuse ... not a repair bill or downtime.**

The 28-range, general-purpose Triplet Model 60 was specifically developed to withstand over 90% of the costly in-field and at-workbench misuses of V-O-M's in electronics/electrical testing and circuit trouble shooting environments.

Forget about a cracked case when it falls off that workbench or a burned out meter movement because of wrong range or test function setting with this new Triplet Model 60. It's also built with safety-for-you, the user in mind.

The new Triplet Model 60 is made for many uses and many users like electrical/electronic circuit designers, vocational training schools, production line testing and quality control, research labs, industrial maintenance, tv, radio and stereo service shops, appliance and automotive maintenance work, hazardous and remote area installations, hobbyists and experimenters.

You also get more extras when you buy the new Triplet Model 60. A special "Confidence-Test" circuit is built into the new test instrument for periodic reassurance checks of its meter. The rugged 4 1/2" suspension type meter is complete and separately cased for easy, fast replacement in field. Includes a polarity-reversing switch plus a single range selector switch for the eight DCV ranges from 0.3 to 1000, six ACV from 3 to 1000, four DCmA from 0.1 to 1000 and five resistance ranges from 1k to 10Meg. Also has direct reading scale for optional clamp-on ammeter.

The new Triplet Model 60 is yours for only \$90. See it at your local Triplet distributor or Mod Center. For more information, or for a free demonstration see him or your nearest Triplet sales representative. Triplet Corporation, Bluffton, Ohio 45817.

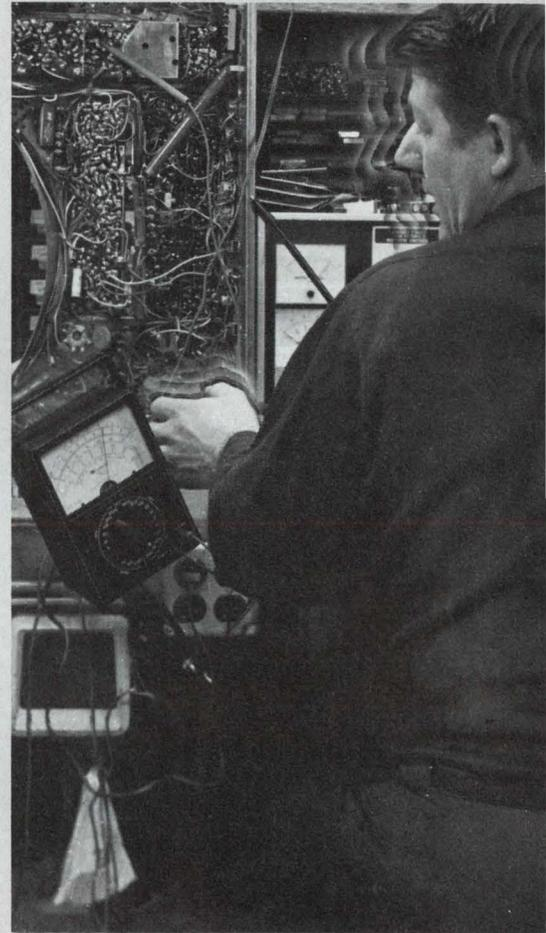

**1. DROP-PROOF.** Virtually indestructible for an accidental drop up to a five foot height with deviation from stated accuracy not exceeding  $\pm 4\%$ .

**2. BURNOUT-PROOF.** Protected by diodes and unusual three fuse arrangement including 1/8 Amp, 1 Amp and 2 Amp/1,000 V fuses. Maximum protection level provided by the 2 Amp/1,000 V (20 kW) fuse.

**3. SUPER-SAFE.** Designed to most rigid safety standards to prevent explosive arcs in high energy circuits, up to the 2 Amp/1,000 V (20 kW) fuse capacity; completely insulated unit with newly designed safety leads.

**TRIPLETT**  
BLUFFTON, OHIO 45817

*Super Safe*  
**Triplet. The easy readers.**

# Linear VCO made from a 555 timer

The versatile 555 timer has many desirable characteristics and even a voltage-modulation capability.<sup>1</sup> But the factory-recommended circuit (Fig. 1) for a voltage-controlled oscillator provides poor frequency-vs-voltage linearity (see curve A of Fig. 3). Control linearity can be markedly improved by replacement of  $R_a$  in Fig. 1 with a voltage-variable current source (Fig. 2).

Matched monolithic transistors, CA3096AE, designated  $Q_1$  and  $Q_2$ , are connected as a current mirror.<sup>2</sup> With this connection, the frequency output is approximately equal to  $0.2(I/C)$ , where  $I$  is the mirror current in amperes and  $C$  is capacitance in farads. Curves B and C show the modulation response of the modified circuit for two values of  $R_1$ . With  $R_1 = 39\text{ k}\Omega$ , the linearity is  $\pm 0.5\%$  from 2 to 7 V and  $\pm 1\%$  from 1 to 9 V. For  $R_1 = 22\text{ k}\Omega$ , the linearity is  $\pm 15\%$  from 1 to 8 V.

But  $V_{cc}$  must now be regulated to preserve a control accuracy that's consistent with the linearity. And the ratio of the maximum to minimum frequency drops from 20:1 for the basic circuit to about 15:1 in the modified circuit.

## References

1. NE/SE 55 Timer data sheet, Signetics, 1972.
2. Solid State Data Book SSD-202B, RCA, Appendix 1, ICAN 6668, 1974.

Ralph Tenny, Engineer, Texas Instruments, Inc., P.O. Box 5936, Dallas, TX 75222. CIRCLE NO. 312

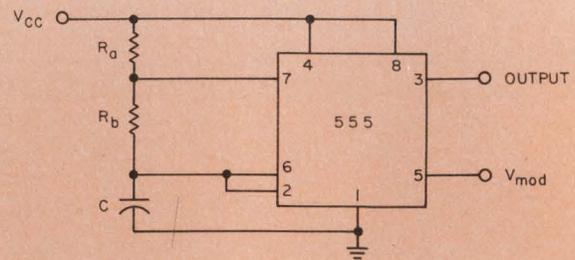

1. Basic VCO circuit for a 555 timer provides poor linearity (Fig. 3, curve A).

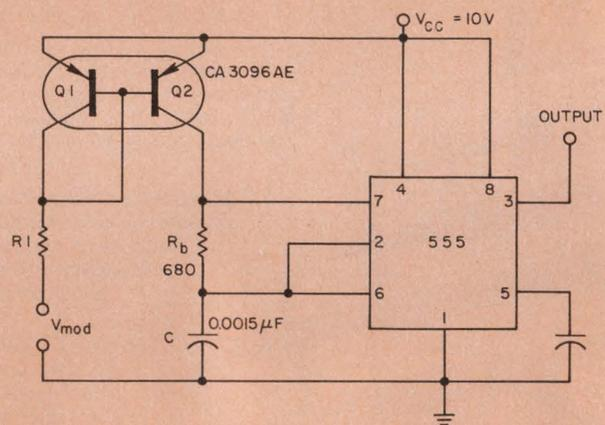

2. Current mirror made from  $Q_1$  and  $Q_2$ , replaces resistor  $R_a$  in the basic circuit to improve the circuit's linearity.

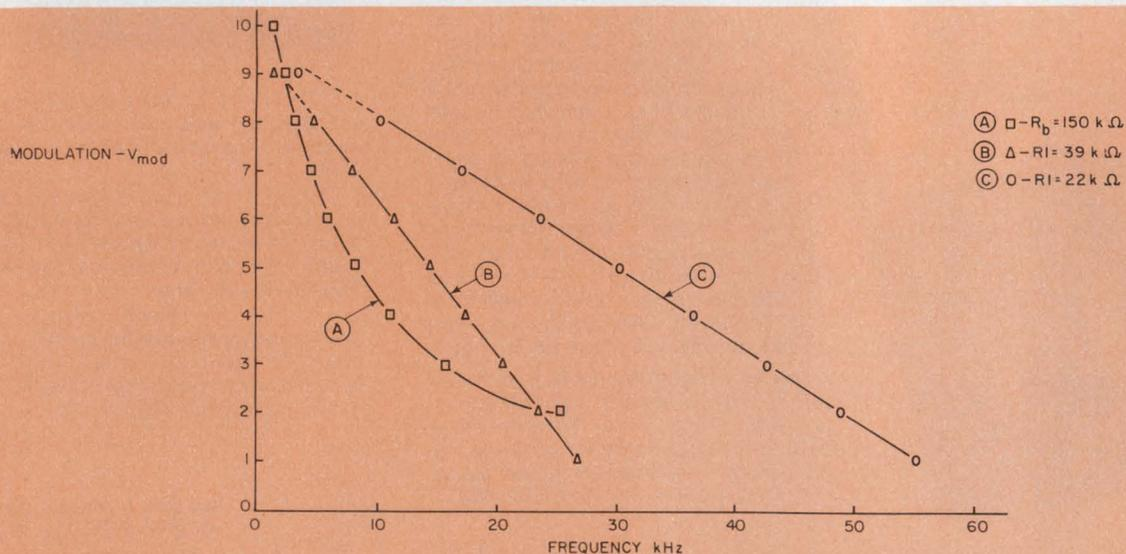

3. Linearity is markedly improved (curves B and C) over the basic circuit (curve A) by use of a

voltage-variable current source. When  $R_1$  is  $22\text{ k}\Omega$ , the linearity is  $\pm 1.5\%$  (curve C).

# A BREAKTHROUGH...

the world's first low-cost  
3½ digit multimeter with dB.

HITCH YOUR BUDGET TO THE STAR... a low cost, portable multimeter with dB. Boasting 31 ranges, DC and AC volts and current, resistance and dB, the model 2180 is truly a breakthrough at only ..... **\$395.**

or you can select the model 2120 with 26 ranges, AC and DC volts and current plus resistance at only ... **\$295.**

or choose the model 2110 with 15 ranges, ACV, DCV and resistance for just ... **\$199.50**

Whichever you choose, you're getting DigiTec quality, accuracy and reliability. Every DigiTec 3½ digit multimeter has an integral, automatic battery recharger and is completely portable with optional batteries.



Send for our new brochure that colorfully demonstrates how to match your budget to our instruments.

**DigiTec**

UNITED SYSTEMS CORPORATION

918 Woodley Road • Dayton, Ohio 45403 • Ph: (513) 254-6251 • TWX: (810) 459-1728

These instruments available under GSA Contract GS-OOS-27741

# CHOPPER PERFORMANCE at Bipolar Prices!

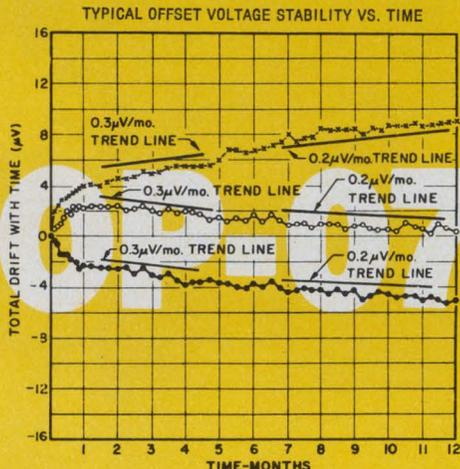

## ULTRA-LOW OFFSET VOLTAGE OP AMPS

- No Choppers or Chopper Noise
- Ultra-Low  $V_{OS}$  .....  $10\mu\text{V}$
- Ultra Stable vs Time .....  $0.2\mu\text{V}/\text{Month}$
- Reliable Single Chip Monolithic Construction
- True Differential Input .....  $\text{CMRR } 126\text{dB}$
- No External Components Required
- Fits 725, 108A/308A, 741 Sockets

Model Number	OP-07A	OP-07	OP-07E	OP-07C
Temperature Range	-55 to +125°C	-55 to +125°C	0 to +70°C	0 to +70°C
$V_{OS}$ Maximum	25 $\mu\text{V}$	75 $\mu\text{V}$	75 $\mu\text{V}$	150 $\mu\text{V}$
$\text{TCV}_{OS}$ Maximum	0.6 $\mu\text{V}/^\circ\text{C}$	1.3 $\mu\text{V}/^\circ\text{C}$	1.3 $\mu\text{V}/^\circ\text{C}$	1.8 $\mu\text{V}/^\circ\text{C}$
$I_B$ Maximum	2.0 nA	3.0 nA	4.0 nA	7.0 nA
$\text{TCI}_B$ Maximum	25 pA/ $^\circ\text{C}$	50 pA/ $^\circ\text{C}$	35 pA/ $^\circ\text{C}$	50 pA/ $^\circ\text{C}$
Input Noise Voltage 0.1Hz to 10Hz Max.	0.60 $\mu\text{V}$ p-p	0.60 $\mu\text{V}$ p-p	0.60 $\mu\text{V}$ p-p	0.65 $\mu\text{V}$ p-p
Input Noise Current 0.1Hz to 10Hz Max.	30 pA p-p	30 pA p-p	30 pA p-p	35 pA p-p

**PMI**™  
**PRECISION MONOLITHICS**  
INCORPORATED

1500 SPACE PARK DRIVE, SANTA CLARA, CALIFORNIA 95050  
TEL. (408)246-9222 • TWX 910-338-0528 • CABLE MONO  
INFORMATION RETRIEVAL NUMBER 45

## Crystal oscillator provides low noise

In frequency synthesizers where the high-order harmonics of a crystal-controlled frequency are used in the generation of the output signals, the sideband and noise of the oscillator is particularly crucial to good circuit performance.

The oscillator circuit in Fig. 1, with only minor variations from a conventional design, delivers an output of high spectral purity without any substantial sacrifice of the usual stability of a crystal oscillator.

Conventional crystal oscillators, despite the high Q of the crystal, are still very noisy, and produce many spurious signals mainly because of the large-signal characteristics of the transistor in the circuit. But in the improved design, the crystal, in addition to determining the oscillator's frequency, is used also as a low-pass filter for the unwanted harmonics and as a bandpass filter for the sideband noise.

The circuit arrangement provides two significant advantages. First, the noise bandwidth is limited to less than 100 Hz. And, second, all higher harmonics are substantially suppressed—60-dB down for the third harmonic of the 4-MHz fundamental oscillator frequency.

Fig. 2 shows the circuit's performance, as measured on an EZF/EZFO sweep-frequency analyzer. The full scale of the screen's vertical is 90 dB; the horizontal line indicates the 70-dB level. The horizontal deflection sweeps at 10 kHz/div. The 100th harmonic (400 MHz) on the screen, when measured through a 1-kHz filter, shows only 0.5  $\mu\text{V}$  of noise.

*Ulrich L. Rohde, President, Rohde & Schwarz Sales Co., Inc., 14 Gloria Lane, Fairfield, NJ 07006.*

CIRCLE No. 313

### IFD Winner of June 7, 1975

**Ernie Thibodeaux**, Senior Applications Engineer, Harris Semiconductor, P.O. Box 883, Melbourne, FL 32901. His idea "Wide-Range Voltage-to-Frequency Converter Uses Only One Dual Op-Amp IC" has been voted the Most Valuable of Issue Award.

Vote for the best Idea in this issue by circling the number for your selection on the Information Retrieval Card at the back of this issue.

# FASTEST, MOST FLEXIBLE Monolithic DAC!

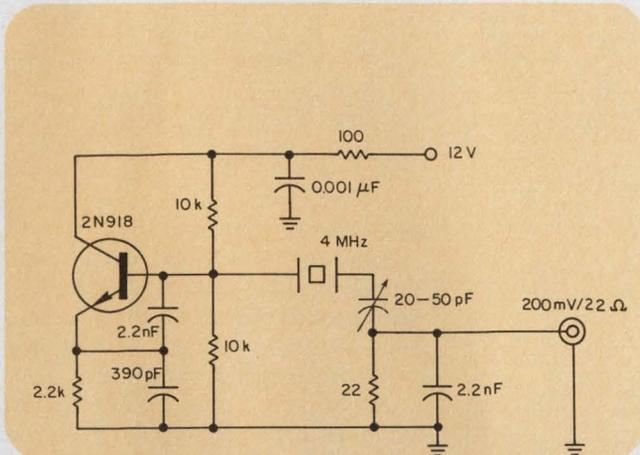

1. Quartz crystal acts as low-pass filter in this oscillator to band-limit the noise output and suppress harmonics.

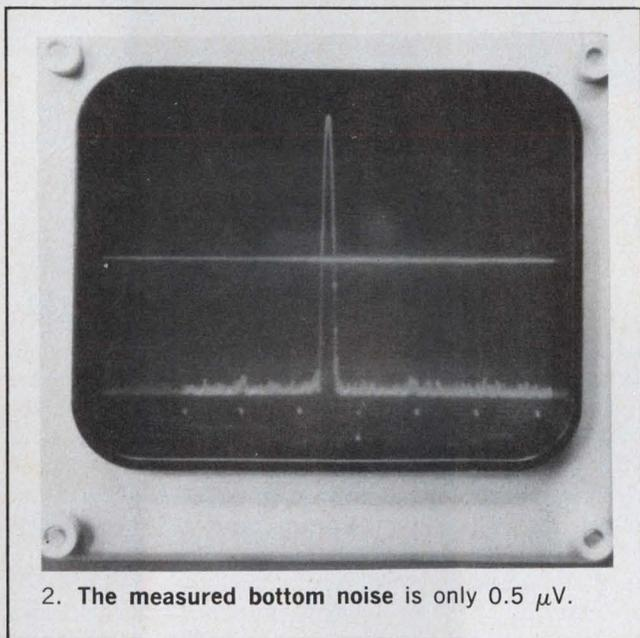

2. The measured bottom noise is only 0.5 μV.

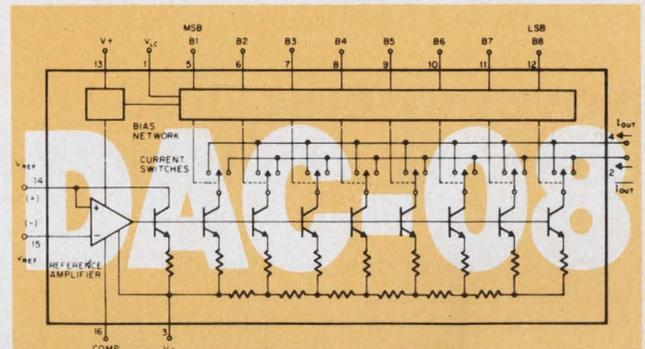

## 8 BIT HIGH SPEED MULTIPLYING DACS

- 85 nsec Settling Time . . . . . Low Cost
- Full Scale Current Prematched to  $\pm 1$  LSB
- Direct Interface to TTL, CMOS, ECL, HTL, PMOS
- $\pm 4.5$  to  $\pm 18$ V Supplies . . . . . 33mW @  $\pm 5$ V
- High Output/Voltage Compliance . . . . . - 10 to +18V
- True and Complemented Outputs
- Wide Range Multiplying Capability

Model Number	DAC-08AZ	DAC-08Z	DAC-08EZ	DAC-08CZ
Temperature Range	-55 to +125°C	-55 to +125°C	0 to +70°C	0 to +70°C
Monotonicity Over Temperature	8 Bits	8 Bits	8 Bits	8 Bits
Max. Non Linearity Over Temperature	$\pm 0.1\%$ FS	$\pm 0.19\%$ FS	$\pm 0.19\%$ FS	$\pm 0.39\%$ FS
Settling Time	85 nsec	100 nsec	100 nsec	100 nsec
Package Type	16 pin hermetic DIP	16 pin hermetic DIP	16 pin hermetic DIP	16 pin hermetic DIP

**SEND US YOUR IDEAS FOR DESIGN.** You may win a grand total of \$1050 (cash)! Here's how. Submit your IFD describing a new or important circuit or design technique, the clever use of a new component or test equipment, packaging tips, cost-saving ideas to our Ideas for Design editor. Ideas can only be considered for publication if they are submitted exclusively to ELECTRONIC DESIGN. You will receive \$20 for each published idea, \$30 more if it is voted best of issue by our readers. The best-of-issue winners become eligible for the Idea of the Year award of \$1000.

shown nor represent freedom from patent infringement.



**PRECISION MONOLITHICS INCORPORATED**  
1500 SPACE PARK DRIVE, SANTA CLARA, CALIFORNIA 95050  
TEL. (408)246-9222 • TWX 910-338-0528 • CABLE MONO

INFORMATION RETRIEVAL NUMBER 46

## Novel circuit aids coupling and isolation

An unusual approach to coupling and isolation in a deceptively simple resistive network has been developed at the European Space Research and Technology Center at Noordwyk in Holland. In this network (Fig. A) if  $R_6/R_3 = R_2/R_5$  in the bridge,  $R_4$  is isolated from  $R_1$  because changes in  $V_1$  cannot affect the current in  $R_4$ , which will be always zero.

If  $R_1$ ,  $R_2$  and  $R_3$  are replaced by external ports for connection to  $50 \Omega$  loads or generators, and  $R_4$  is  $50 \Omega$  for isolation of ports 2 and 3, then  $R_6/R_4 = R_1/R_5$ . In this case the general equations are:  $R_1 = R_2 = R_3 = R_4 = 50 \Omega$ ; and  $R_5 R_6 = (50)^2$ . As a result ports 1, 2, 3 and 4 are all matched, and the impedance seen at port 1 is:  $(R_6 + R_3)/(R_2 + R_5) = 50 \Omega$ .

To accommodate a grounded load, mode b (Fig. B) is grounded and a balun is used. The low value of  $R_3$  ( $\leq 50 \Omega$ ) ensures that the several-hundred-ohm loss resistance of the balun's ferrite, which appears across  $R_5$ , will have little effect on the network. The coupling

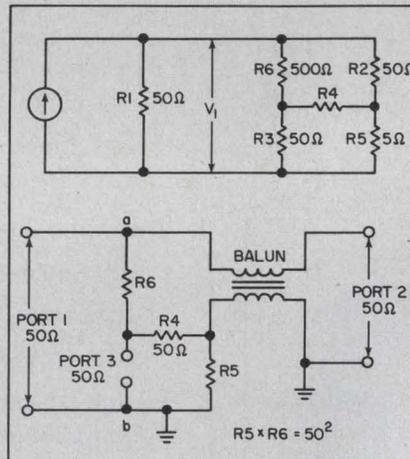

between ports 2 and 3 is defined as  $V_2/V_3 = C$ . The loss is taken to be  $V_1/V_2 = L$ , where  $V_4$  is zero.

For the resistive coupler  $V_1 = V_2 + V_3$ . Therefore  $V_1/V_2 = 1 + V_3/V_2$  and consequently,  $L' = 1 + 1/C'$ .

For a lossless coupler  $L' = 1 + 1/C'$  where  $L'$  and  $C'$  are power ratios for ports 1 and 2 and 3 and 2, respectively. In this case,  $R_5 = 50/C$  and  $R_6 = 50 C$ .

mode of propagation.

The line was constructed from aluminum alloy (AGS T<sub>1</sub>), but researchers report that the attenuation could be reduced if the line were fabricated from copper.

Although the mechanical strength depends on the thickness and width of the rings and the rod, the line's losses are essentially unaffected by these dimensions. In use, the line is supported above the ground on plastic pipes, which are set in the plane of the rod so the electromagnetic field of the dipolar mode is only slightly perturbed.

The designers see applications of this line in long-distance telecommunication and railway traffic control.

## Narrow-spectrum laser has tunable wavelength

A laser that has a narrow spectrum and a tunable wavelength has been developed by the Commissariat à l'Énergie Atomique in Paris. The laser uses a mode-selecting system that is said to avoid the disadvantages of the Fabry-Perot standard.

An active medium, such as ruby or neodymium-doped glass, suitably excited, is confined in a resonator comprising two mirrors. Between the medium and one of the mirrors is a selective transmission assembly. This is made up of an optical plate having parallel surfaces cut in a birefringent substance parallel to the optical axis.

The two surfaces are covered with reflecting layers. A polarizer is used that has an angle of polarization of 45 degrees with respect to the neutral lines of the birefringent plates. A second plate of the laser is constructed of an electro-optical substance in which the birefringence is varied by an adjustable voltage.

## Open-ring waveguide holds down losses

The cost of low-loss corrugated waveguide has been reduced at the University of Limoges in France by removal of the outer shielding. The resulting open-ring line propagates the  $EH_{11}$  hybrid dipolar mode at a loss of less than 5 dB per kilometer below 1.8 GHz. The spacing of the rings determines the polarization of the hybrid

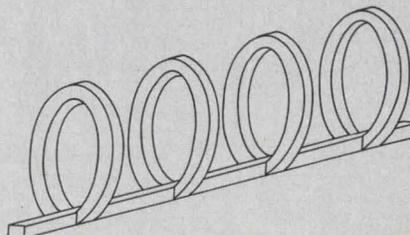

Noise at the front-end of an otherwise tight low frequency design is terribly frustrating. And we don't blame you for sounding off if you want to specify for lower noise and can't come up with an FET to suit your purpose.

Crystalonics new 2N6550 is a silicon, N-Channel, junction FET designed for low frequency amplifier applications, with an ultra low noise figure of  $2nV/\sqrt{Hz}$  at 1 KHz. You won't find one quieter! This device is designed to produce the cleanest signal possible at the front-end, for pure follow-through and ultimate signal clarity, so critical to military field communications. It's as silent as current technology allows, and with Crystalonics' 2N6550, you'll note a marked improvement in your prototype.

Crystalonics has been in the business of helping to solve designers' problems for over a decade. While other companies have abandoned military applications and opted for the production of commercial standards, we've stuck by our trade: high quality, innovative production with the designer in mind. Direct communication between the designer and our applications engineers is our mark.

**We're at your elbow to ease your design.**

Send for our new condensed catalog of Junction FETs, Fotofets, and Low Level Bipolars, including the 2N6550 at \$15, 1-99; \$10, 100-999. Samples on request. Or for immediate design assistance, give us a call. Ask for Jack Senoski, Art Pauk or Richard Antalik, of our applications engineering squad.

Crystalonics. We listen.

Give us  
a little of your noise

 **TELEDYNE**  
**CRYSTALONICS**

147 Sherman Street, Cambridge, Mass. 02140  
Tel: (617) 491-1670 • TWX: 710-320-1196

# It's 4K! It's fast! It's static! It's a whole RAM system!

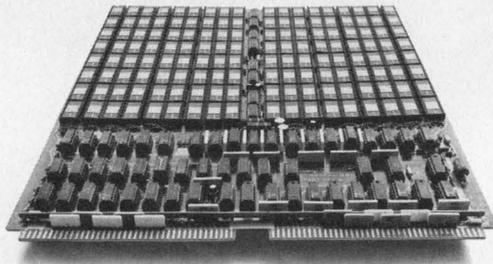

It's all of those and more, much more. It's our new Micromem 3400N — a 32K x 16 or 18 bit memory system using our own SEMI 4402, 4K STATIC RAM components . . . the only production 4K STATIC RAM's available today. The 4402 is fast, with a worst case access time of 200 nsec. And . . . it's second-sourced, of course!

The Micromem 3400N is form, fit, and functionally compatible with all core and NMOS members of the Micromem family, and is completely contained on a single printed circuit card. Optional features include chassis and power supply. The Micromem 3400N is immediately available with a worst case access time of 275 nsec.

Call your nearest EMM sales office and discover how "The Memory Company" can give you system building block flexibility, 4K to 32K, core or NMOS.

**EMM SEMI**

A division of Electronic Memories & Magnetics Corporation • 3883 North 28th Avenue, Phoenix, Arizona 85017  
(602) 263-0202

EMM OFFICES: WESTERN REGION, Regional Office, San Francisco, (408) 247-9711, Los Angeles Area, (213) 644-9881, Orange County Area (714) 639-5811, Minneapolis Area, (612) 941-2404, Phoenix Area (602) 968-2492, Dallas Area (214) 231-7207, EASTERN REGION, Regional Office, Boston, (617) 861-9650, Chicago Area, (312) 297-7090, Washington, D.C. Area (703) 941-2100, New York Area 516) 423-5800, Cleveland Area (216) 842-8920 INTERNATIONAL OFFICES, European Headquarters, Belgium(031) 76.69.75, United Kingdom (01) 751-1213, West Germany (089)714.30.40.

REPRESENTATIVES: Gentry Associates; Orlando (305) 894-4401, Huntsville (205) 534-9771, Burlington, N.C. (919) 227-3639. In Canada: Megatronix, Ltd., Toronto (416) 742-8015, Montreal (514) 488-0404, Ottawa (613) 729-4004, Vancouver (604) 526-3312. In Japan, Nissho Electronics (03) 542-2351.

INFORMATION RETRIEVAL NUMBER 48

# MOSFET power soars to 60 W with currents up to 2 A

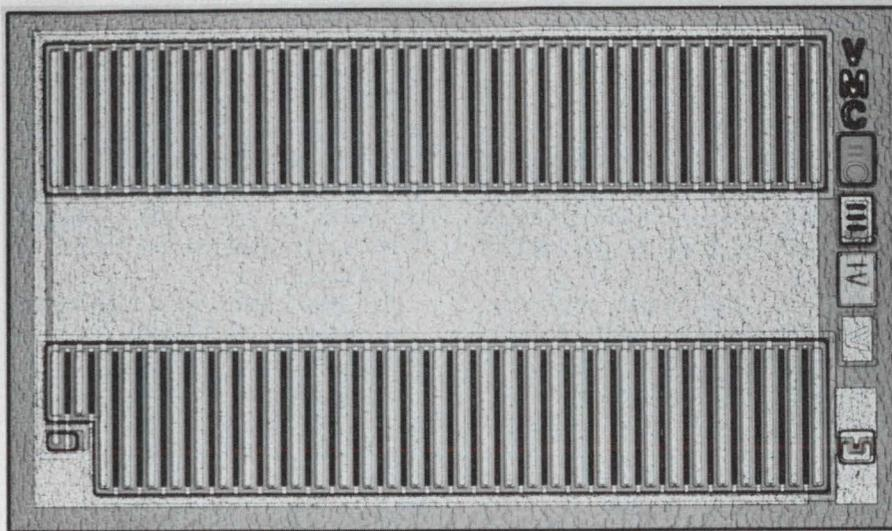

Siliconix, 2201 Laurelwood Rd., Santa Clara, CA 95054. (408) 246-8000. \$5.50 (100); factory stock.

No longer are MOSFETs just small-signal devices. With the introduction of Siliconix' Mospower devices, MOSFETs will be able to compete with bipolar devices for power switching and linear applications.

The first unit in the Mospower series—the VMP-1—has a power rating of 60 W, and it specs maximum allowable current as 2 A. These values are much higher than those available from existing MOSFETs.

The n-channel FET employs a vertical structure, known as VMOS, to achieve the high ratings. A similar technique has been used by Sony in Japan to build junction FETs with somewhat higher power and current specs. However, these JFETs, which aren't generally available in the U.S., have slower switching speeds. And the depletion-mode JFETs don't offer the CMOS-logic compatibility pro-

vided by the enhancement-mode MOSFETs.

Compared with bipolar transistors, the Mospower device offers all the advantages of a FET. Though bipolar units can provide far higher powers, FETs don't suffer from secondary breakdown or thermal runaway (FETs have a negative temperature coefficient). Also FETs have no minority-carrier storage time, so switching speeds can be much higher. The VMP-1 can switch 2 A in only 5 ns.

Moreover the Mospower chip is substantially smaller than an equivalent bipolar chip. The VMP-1 measures just  $38 \times 63$  mils. A bipolar device having similar power and current capabilities measures  $140 \times 140$  mils.

A voltage-controlled device, the FET boasts low gate leakage currents. Even when high currents are switched, leakage doesn't exceed a few nanoamperes. The VMP-1 guarantees a continuous operating current of 1 A. Currents can be increased, of course, by the parallel

connection of several devices.

Gate threshold levels are specified as 0.8 to 1.8 V. Thus signals can be switched with 5-V CMOS levels. Maximum gate voltage is 10 V, and the device has a source-to-drain breakdown voltage of 60 V. Also, the FET has a minimum transconductance of 200 mmhos.

The VMP-1 comes in a TO-3 package. Its 60-W maximum dissipation decreases with increasing temperature at the rate of 1 W for every 3.5 C.

Initial prices are \$5.50 in quantities of 100. The VMP-1 is available from factory stock.

Siliconix plans to follow the VMP-1 with a version intended for linear rf applications. The new version will be housed in a package similar to the TO-117. Preliminary data indicate the device will achieve unity-gain bandwidth of 600 MHz. Further, Siliconix reports that the planned device will deliver nearly 20 W at 200 MHz with 11-dB gain. And it will be able to tolerate infinite VSWRs and permit broadband matching.

In other Mospower versions, Siliconix expects to obtain even more impressive specs. All models will use the company's proprietary VMOS technique, so-called because current travels vertically (see illustrations).

A VMOS device consists of four diffused layers. By contrast, conventional MOS devices are three-region lateral structures that employ looser-tolerance photolithographic techniques. The VMOS structure is directly responsible for the device's high current density, high source-to-drain breakdown voltage and low gate-to-drain feedback capacitance.

The high current results, in part, from the short channel spacing—

# If you want to hurt the 240L RF Power Amplifier



**...you've got to do more  
than short circuit its output.**

As a matter of fact, this *brand new* instrument will deliver more than 40 watts of Class A linear power and up to 150 watts of CW and pulse power to any load impedance (from an open to a short circuit). Immune to load damage and unconditionally stable the 240L covers the frequency range of 20 KHz to 10 MHz with a flat 50 db gain. Completely *solid state* the 240L will faithfully reproduce input waveforms from any signal or function generator in its range.

If you need a transducer drive source for ultrasonics, RFI/EMI, biological research, electro or acousto optics the 240L was designed for you.

Solid state reliability is here at \$1595.00.

For further information or a demonstration contact ENI, 3000 Winton Road South, Rochester, New York 14623 (716) 473-6900 or TELEX 97-8283



## ENI

**The world's leader  
in solid-state power amplifiers.**

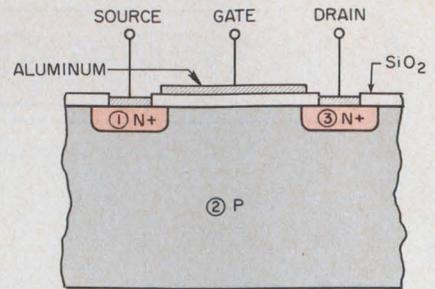
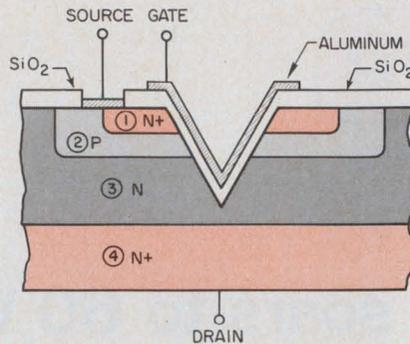

An n-channel MOSFET employing the VMOS structure (left) consists of four layers whose critical dimensions are controlled by diffusions in a conventional structure (right) photolithographic techniques control three lateral regions. The fourth region in the VMOS device increases breakdown voltage and decreases feedback capacitance.

about  $1.5 \mu$  versus  $5 \mu$  in conventional MOS devices. Another contributing factor is the availability of two current paths rather than one. Still another factor is the location of the drain on the back of the chip.

An additional n-type region increases breakdown while decreasing capacitance. The region's relatively low impurity concentration allows the channel-drain depletion region to spread into the drain thereby reducing the peak electric field and thus breakdown.

Gate-to-drain capacitance is reduced by the buffering effect of the depletion region and by the minimal overlap of the gate on the drain region. The VMP-1 has an input capacitance ( $C_{iss}$ ) of 35 pF and a reverse capacitance ( $C_{rss}$ ) of 8 pF.

Another important benefit of VMOS is the linear relationship of drain current to gate voltage over

a wide range of drain current. This is in marked contrast with conventional MOS devices, which exhibit square-law characteristics. In VMOS, the short channel length is mainly responsible for the linear relationship.

The fabrication of a VMOS device involves techniques used in both MOS and bipolar processing. The first step diffuses channel and source regions in a manner like that of a bipolar device's base and emitter.

Next the V-shaped groove is etched through the channel and source regions. This step employs an anisotropic, or preferential, etching material to ensure precise dimensions, determined only by the oxide-window width and the crystal structure of the silicon. In the last step, silicon dioxide is grown over the V-groove gate region and metallization is applied.

CIRCLE NO. 304

## 1-k CMOS RAM costs \$10.20

Intel Corp., 3065 Bowers Ave., Santa Clara, CA 95050. (408) 246-7501.

A  $256 \times 4$ -bit CMOS RAM, the P5101-8, costs only \$10.20 in 100-999 quantities and less than 1¢ per bit in production quantities. The static memory operates from a single 5-V supply, features a maximum standby current of 50 nA per bit and has a worst-case access of 850 ns. Standby power dissipation is 250  $\mu$ W or less per package. The unit is a low-cost version of Intel's Model 5101 RAM.

CIRCLE NO. 500

## 24-hr watch circuits come on single chips

Intersil, Inc., 10900 N. Tantau Ave., Cupertino, CA 95014. (408) 257-5450. \$10.80 to \$16.70 (100-999).

Each of two single-chip CMOS circuits for LED wristwatches provides all the functions needed to provide 24-hour readouts. The ICM7203 offers an alphanumeric capability, providing hours, minutes, day, date and seconds. The ICM7204 is a numeric only version of the 7203. It interfaces with existing seven-segment LED displays.

CIRCLE NO. 501

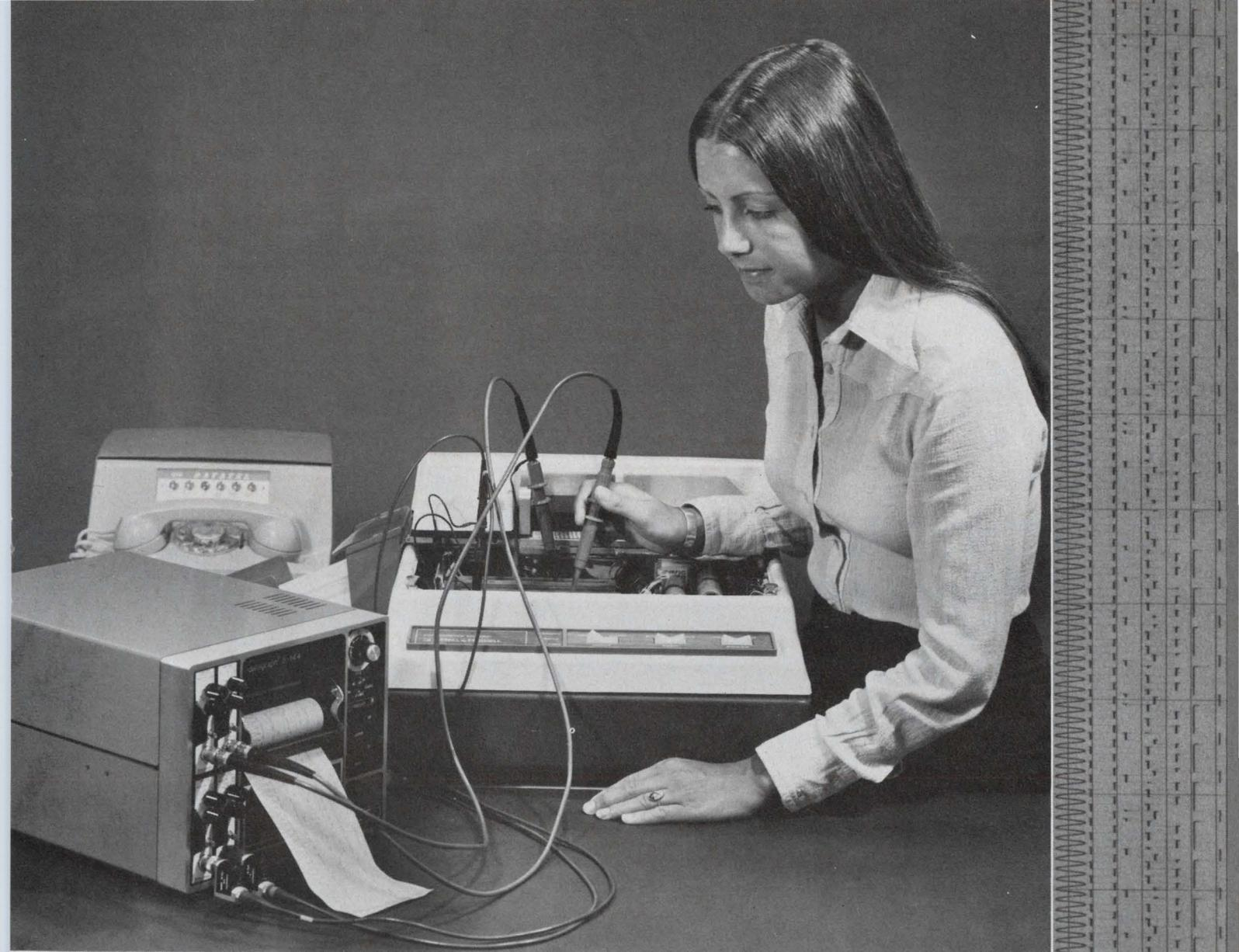

# Have a Closer Look

Bell & Howell's Datagraph® Model 5-144 recording oscillograph. Probably the most convenient test instrument you'll ever use.

In addition to the on-off switch, only five controls are needed to operate the Datagraph® 5-144.

Human engineered for efficiency, the 5-144 is as easy-to-use as an oscilloscope, and provides a permanent record up to 200 feet long for later study.

The Model 5-144 contains all of its own necessary electronics. Plug-in amplifiers eliminate the need for special cables or calculating complicated damping networks. Just plug in your scope probes and record your data.

Its four channels permit simultaneous examination of several data signals, and

with a frequency response greater than 10,000 Hz, the 5-144 is capable of recording both analog and digital data with equal ease. Complete systems from \$2570.00.

Bell & Howell's Datagraph® Model 5-144 recording oscillograph — backed by more than 35 years of experience in the development of quality, precision instrumentation.

## CEC DIVISION

360 Sierra Madre Villa, Pasadena, Calif. 91109 (213) 796-9381



## BELL & HOWELL

(In Canada: 125 Norfinch Drive, Downsview, Ontario M3M 3B5)

CEC is a registered trademark of Bell & Howell. © Bell & Howell 1975

# JOIN OUR BME™ CAPACITOR SAVINGS PLAN

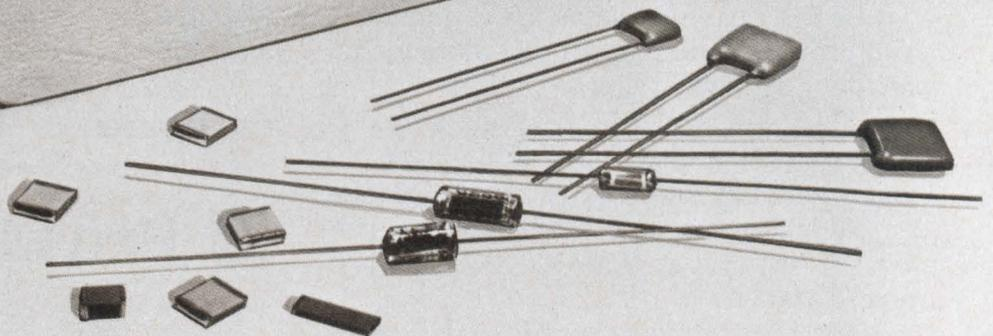

**SAVE 30% TO 50%  
ON THE COST OF MONOLITHIC  
CERAMIC CAPACITORS**

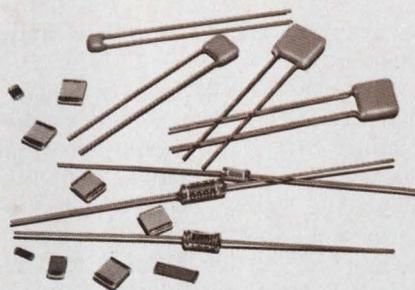

This major cost saving is the result of our new BME™ capacitor technology. We've eliminated precious metals entirely from the electrodes and terminations of our BME™ capacitors. No precious metals means lower cost. So now we offer you our complete line of monolithic ceramic capacitors — BME Chips™, BME Radials™ and BME Axials™ — at a genuine savings of 30% to 50%.

This significant reduction is not based on a momentary drop in precious metal prices. This is a long-term solution due to the replacement of precious metals by non-noble metals which are not subject to the same dramatic cost spirals.

**SAVE WITH RELIABILITY**

Our BME™ capacitors have not sacrificed the inherent electrical and mechanical Ceramolitic® quality. Their reliability can be demonstrated by the extensive test procedures to which they have been subjected. Write to our Applications Engineering Department for complete test reports.

**SAVE WITH DESIGN  
FLEXIBILITY**

Now you can seriously consider monolithics to replace micas and tantalums. Our BME™ capacitors feature non-polarity, a wide range of

**TYPICAL SELLING PRICES PER UNIT FOR  
USCC'S BME-KAPS™ ON  
QUANTITIES OF 5000 OR MORE**

BME™ "J" DIELECTRIC (COG)	BME-Chip™	BME-Axial™	BME-Radial™
1 thru 100 pF, 5%, 50WVDC	5.1¢	6.8¢	7.5¢
1000 pF, 5%, 50WVDC	12¢	16¢	16¢
BME™ "S" DIELECTRIC (X7R)	BME-Chip™	BME-Axial™	BME-Radial™
.01 µF, 20%, 50WVDC	3.5¢	5.8¢	5.8¢
.1 µF, 20%, 25WVDC	9¢	16¢	14¢
1.0 µF, 20%, 25WVDC	52¢	—	73¢
BME™ "R" DIELECTRIC (Z5U)	BME-Chip™	BME-Axial™	BME-Radial™
.1 µF, +80 —20%, 25WVDC	5.7¢	8.8¢	8.8¢
.47 µF, +80 —20%, 25WVDC	13¢	16.5¢	16.5¢
1.0 µF, +80 —20%, 25WVDC	19¢	27¢	25¢
2.2 µF, +80 —20%, 25WVDC	35¢	—	49¢

capacitance value, low leakage, high volumetric efficiency, availability in chip, radial and axial packages at prices competitive with mica below 1000pF and tantalum up to 2.2µF.

**SAVE ON DELIVERY TIME**

Elimination of precious metal material costs have permitted us to stockpile chips. We now have five to ten million units in over 40 popular values ready for two-week delivery in chip style or four-week delivery in leaded configurations.

**JOIN THE USCC/CENTRALAB  
BME™ CAPACITOR  
SAVINGS PLAN**

Get all the details today. Write on your company letterhead for your

concise Savings Plan Price list — your pass book to the lowest monolithic ceramic capacitor prices available. Compare it with anyone else's price list and see.

Remember, USCC/Centralab — Quality, Volume, Savings.



**USCC/Centralab**

Electronics Division ■ Globe-Union Inc.

4561 Colorado Boulevard ■ Los Angeles, Ca. 90039  
(213) 240-4880



# Low-power diodes at low prices come in a top-grade package

General Instrument, 600 W. John St., Hicksville, NY 11802. (516) 733-3000. P&A: See text.

Glass reliability at plastic prices is here for low-power rectifiers with the introduction of the Superectifier series by General Instrument. The diodes are available in standard DO-41, 15 and 27 epoxy cases, but they are actually first hermetically sealed in glass and then given a plastic outer case.

Initial device offerings include units in the 1N4000 series. Current ratings from 0.5 to 3 A, with surge ratings from 30 to 150 A, are available. Reverse voltage ratings of from 50 to 1600 V peak permit a wide range of applications. Standard diodes are available with recovery times of 2 to 5  $\mu$ s. Also, fast recovery units with times of

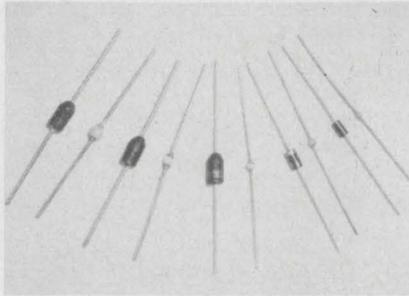

150 to 500 ns are also offered.

The new case design for the Superectifiers lets them pass the tough European 10-10-10 test. This requires the units to undergo 10 s at 285 C with 10 kg of tension on the leads at a distance of 10 mm from the diode body. Brazed connections between the chip, molybdenum contacts and copper leads

assure mechanical strength at high temperatures.

Since the new package has internal glass-passivation and hermetic sealing, the outer epoxy coating doesn't have to protect the chip. Thus the epoxy doesn't have to form a hermetic seal. The materials used in the package are all matched for thermal expansion coefficients, so that during extreme changes in temperature, stresses do not damage the package.

Prices for the diodes start at about 5 cents each in 100,000-piece lots. Availability is from distributor stock for small quantities and four weeks for large orders. Units with rms current ratings of 4 and 5 A will be available in the near future.

CIRCLE NO. 307

## Portable Digital Multimeter at an Analog Price

MODEL 280  
\$99<sup>95</sup>



Enjoy the benefits of auto-polarity digital read-out plus full overload protection and high-low power ohms for accurate tests in solid-state circuits.

**Accuracy better than analog VOM's!**

### 22 RANGES

Reads in decades: AC and DC volts and mA, 1-1000; ohms, 100-10 meg. Resolution: 1mV, 1mA, 0.1 ohm.

Accuracy: DC typically  $\pm 1\%$  F.S.; AC and ohms typically  $\pm 2\%$  F.S. except  $\pm 2.5\%$  on highest range. Uses "C" cells. Optional AC adapter/charger.

**In stock at your local distributor**

**BK PRECISION**

PRODUCTS OF DYNASCAN  
1801 W. Belle Plaine Avenue Chicago, IL 60613

## Reliable dual-trace scope useful to 30MHz.



MODEL  
1472  
\$599

We nominally rate the 1472 at 15MHz ( $-3$ dB), but it easily syncs and displays a 30MHz signal with sure triggering. It automatically selects chopped or alternate trace display to avoid flickering at any sweep speed... so even with 11 sensitivity ranges from 10mV to 20V/cm and 19 sweep ranges from 0.5 $\mu$ SEC to 0.5SEC/cm, it's easier to use than most scopes. The 1472 has 24nSEC risetime and can be used in X-Y mode with matched phase-shift and sensitivity inputs.

**In stock at your distributor.**

**BK PRECISION**

PRODUCTS OF DYNASCAN  
1801 W. Belle Plaine Avenue Chicago, IL 60613

## DISCRETE SEMICONDUCTORS

### Snap-in indicators come in red, green & yellow

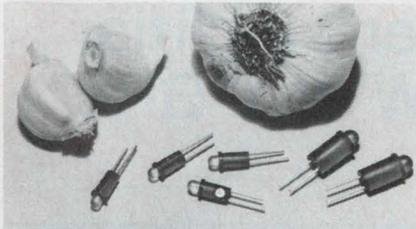

Dialight, 203 Harrison Pl., Brooklyn, NY 11237. (212) 497-7600. 1000-up prices \$0.33 (red), \$0.65 (green & yellow); stock.

The 558 and 559 series of high brightness LED indicators snap into a panel and require no additional hardware. The 558 series indicators mount in a 5/32-in. clearance hole; the 559 indicators mount in a 0.25-in. clearance hole. Both are available with red, green or yellow LEDs, with and without integral current limiting resistors. The compact design of the indicators allows high density packaging. For example, the 558 series mounts on 0.2 in. centers; the 559 series on 0.3 in. Terminal polarity is clearly identified.

CIRCLE NO. 308

### High current SCRs handle 825 A at 3 kHz



General Electric, W. Genesee St., Auburn, NY 13021. (315) 253-7321. \$103 (100-up); stock.

Two high frequency inverter type SCRs, the C447 and C448, have involute, interdigitated gates for optimum frequency capability. Ratings include 825 A (rms) switching at 3 kHz, and blocking voltages up to 1200 V. The turn-off time of the C448 is 25  $\mu$ s with voltage reapplied at 400 V/ $\mu$ s. The C447 is similarly characterized, but offers a relaxed turn-off time of 40  $\mu$ s.

CIRCLE NO. 309

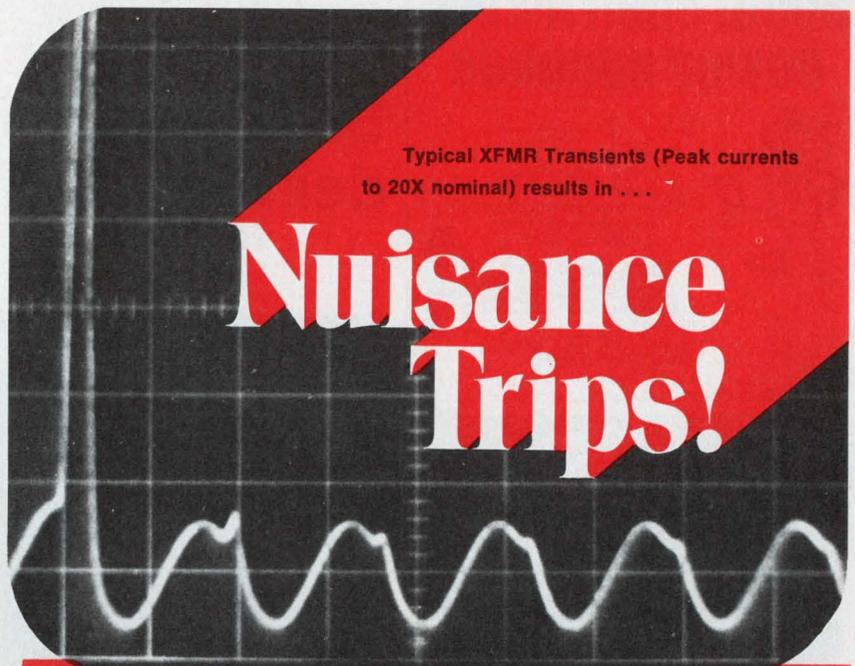

## Eliminate them with Airpax Electromagnetic Circuit Protectors

with patented Inertial Delay

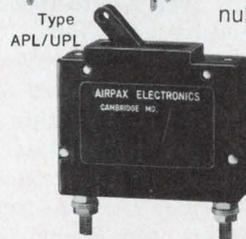

Many circuit protector applications involve a transformer turn-on, an incandescent lamp load, or a capacitor charge from a dc source. Each of these applications have one common factor: a steep wave front transient of very high current amplitude and short duration. This takes the form of a spike, or a single pulse, and is the cause of most nuisance tripping associated with circuit protectors.

Airpax circuit protectors, with patented inertial delay, assure positive protection without nuisance tripping by providing tolerance of short duration inrush currents without decreasing steady state protection. This does not affect standard delay curves and trip points.

Just another example of Airpax "application-oriented" engineering.

Get the full story on Airpax electromagnetic circuit protectors. Write for Short Form Catalog 2013.



Type 209 (E-Frame)

# AIRPAX

Airpax Electronics  
CAMBRIDGE DIVISION  
Cambridge, Maryland 21613  
Phone (301) 228-4600

Other Airpax Divisions:

CONTROLS DIVISION, Ft. Lauderdale, Florida 33313, Instruments for Industry  
AMERICAN DATA, Huntsville, Alabama 35805, TV Products

# Some open talk about open frame power supplies



Forward and reverse voltage protection.  
Barrier block interface.  
Infinite resolution adjustments.  
Full interchangeability.  
115/230 vac, 47-440 hz.

Socketed IC regulation system.  
Filters meet mfrs. ripple ratings.  
Glass epoxy PC boards.  
Loss of sense protection.  
Designed for U.L. Recognized Component Index.



Socketed power semiconductors.  
Iridated aluminum chassis.  
Computer grade electrolytics.  
Special circuits to protect IC's.



We're so open about our Q Series Open Frame Power Supplies because we want you to know everything about them. Like our one year warranty. And stock delivery. About our thermal design, the best around, making our heat sensitive parts run cooler and operate longer. And we're the **only** maker of Open Frame Power Supplies where **all** components operate well within mfrs. specs.

That's why Deltron "Open Frames" save you money three ways: When you buy them. By avoiding costly downtime. And by lasting longer.

Choose from these models:

Size A Model No.	Size B Model No.	Size C Model No.	Size D Model No.	Size F Model No.
volts — amps	volts — amps	volts — amps	volts — amps	volts — amps
0 5 — 3.0	0 5 — 6.0	0 5 — 9.0	0 5 — 12.0	0 5 — 18.0
0 6 — 3.0	0 6 — 6.0	0 6 — 9.0	0 6 — 12.0	0 6 — 18.0
0 12 — 1.7	0 12 — 3.4	0 12 — 5.7	0 12 — 7.0	0 12 — 10.8
0 15 — 1.5	0 15 — 3.0	0 15 — 4.8	0 15 — 6.3	0 15 — 9.5
0 18 — 1.3	0 18 — 2.6	0 18 — 4.0	0 18 — 5.2	0 18 — 7.8
0 20 — 1.3	0 20 — 2.6	0 20 — 4.0	0 20 — 5.2	0 20 — 7.8
0 24 — 1.2	0 24 — 2.4	0 24 — 3.3	0 24 — 4.8	0 24 — 7.2
0 28 — 1.0	0 28 — 2.0	0 28 — 3.1	0 28 — 4.2	0 28 — 6.0
Dimensions: 4 7/8 x 4 x 1 3/8	Dimensions: 5 7/8 x 4 7/8 x 2 1/2	Dimensions: 7 x 4 7/8 x 2 3/4	Dimensions: 9 x 4 7/8 x 2 3/4	Dimensions: 14 x 4 7/8 x 2 3/4
Price: 1 — \$32.00 100 — \$26.00 250 — \$24.00	Price: 1 — \$54.00 100 — \$44.00 250 — \$41.00	Price: 1 — \$67.00 100 — \$54.00 250 — \$51.00	Price: 1 — \$87.00 100 — \$70.00 250 — \$66.00	Price: 1 — \$113.00 100 — \$91.00 250 — \$85.00

For some more open talk about Deltron Q Series and a copy of our Comparative Engineering Reports, write or call collect to Deltron, Inc., Wissahickon Avenue, North Wales, Pa. 19454, Telephone: 215-699-9261, TWX 510-661-8061.



INFORMATION RETRIEVAL NUMBER 55

## INSTRUMENTATION

# Broadband power amplifier delivers 700 mW at 1 GHz

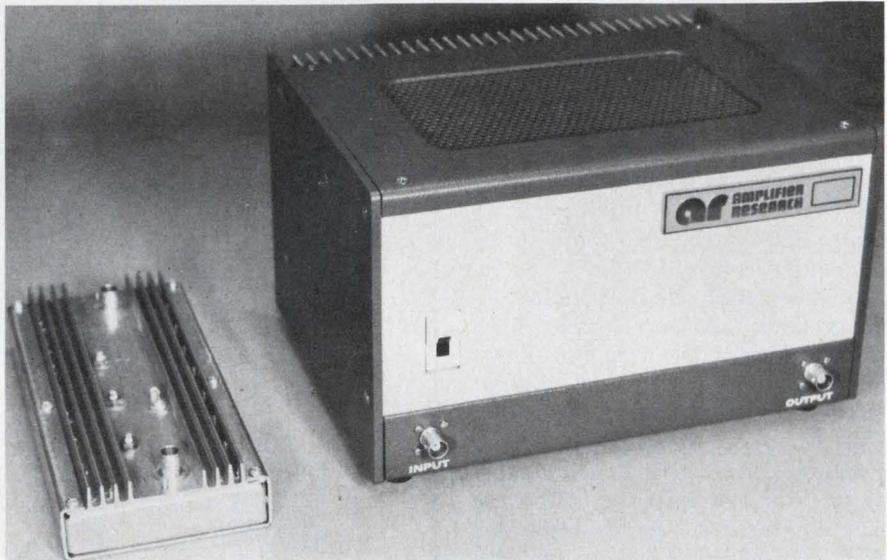

Amplifier Research, 160 School House Rd., Souderton, PA 18964. (215) 723-8181. P&A: See text.

If you need an ultra-wideband amplifier that can deliver useful power at frequencies to 1 GHz, Amplifier Research has the answer. Its Model W1000, a Class A rf power amplifier, provides up to 350 mW of linear power at less than 1 dB of gain compression, or up to 700 mW of usable continuous power, both over a 1-to-1000-MHz instantaneous bandwidth.

The wideband amplifier has a fixed power gain of 26 dB, minimum, and is flat to within  $\pm 1.5$  dB, maximum. Any laboratory signal generator, sweep generator or synthesizer can drive the amplifier to full output. Any harmonics in the output are at least 20 dB below the fundamental frequency when the amplifier operates in the linear mode.

The third-order intercept point for intermodulation distortion is typically +39 dBm. The noise figure of the output is typically 8 dB.

Both input and output terminals are matched for 50- $\Omega$  load impedances. The maximum input

VSWR is less than 2:1 and the maximum output VSWR is under 2.5:1. Any load can be connected to the output or input without causing the amplifier to oscillate or any internal damage—regardless of the phase and magnitude of both the source and load impedances. The W1000 can also withstand up to 20 times its normal input drive without damage, according to the company.

There are two versions of the W1000: an OEM model and a lab model. The OEM unit is the complete amplifier without a case and without power supplies. The lab unit comes complete with 115/230-V-ac power supply and a bench-top case.

The OEM version requires a power supply that can provide -30 V dc at a maximum current of 0.5 A. The amplifier is housed in an 8.5 x 4 x 1.5-in. convection-cooled heat sink, and it weighs 1.5 lb. The lab model measures 10.3 x 6 x 8 in. and weighs 11 lb.

Other power amplifiers are available from many companies, but none has the bandwidth of the

(continued on page 112)

# MANY HAVE FOUND PEACE OF MIND IN THIS WONDERFUL BOOK.

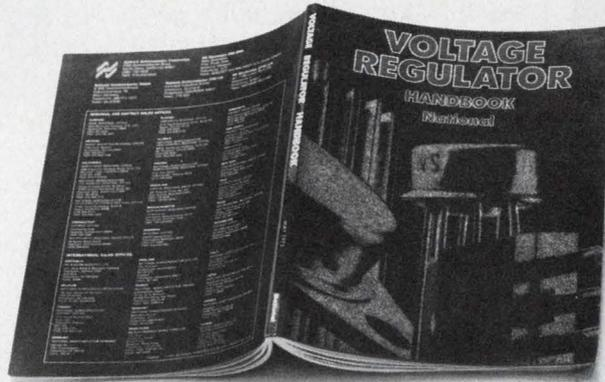

Our new Voltage Regulator Handbook. It's no mere catalog. It's a Something Else. True, it does cover a whole range of products from 100 mA to 3 amps. With eight different packages, positive and negative voltages, plus dual-tracking regulators. A thousand interesting and useful products, including our LM 320 series three-terminal negative regulators.

But, it also simplifies the design of the whole power supply. It tells how to select the optimum three-terminal regulator. It even covers power supply items we don't make: such as heat sink selection and design, power transformer and filter specs, and unique applications for the basic three-terminal and dual-tracking regulators. All to make power supply design that much easier and handier.

The Handbook is \$3, and worth every penny of it.

We're also planning a series of local seminars on regulators. During October and November, in 22 major cities. Contact your nearest National sales office, listed below — or us — for details.

Because if our book can't solve your problems, there's only one alternative. Group Therapy.

Gentlemen:  
I'll take the Handbook. Here's my \$3 check, payable to  
National Semiconductor. (Calif. residents add 6% sales tax).  
Name \_\_\_\_\_ Title \_\_\_\_\_  
Company \_\_\_\_\_  
Address \_\_\_\_\_  
City \_\_\_\_\_ State \_\_\_\_\_ Zip \_\_\_\_\_  
Mail to: National Semiconductor Corporation, Dept. 081510  
2900 Semiconductor Drive, Santa Clara, Calif. 95051

## National Voltage Regulators

National Semiconductor Corp., Scottsdale, Ariz. (602) 945-8473, Mountain View, Calif. (415) 961-4740, Sherman Oaks, Calif. (213) 783-8272, Tustin, Calif. (714) 832-8113, Miami, Fla. (305) 446-8309, Chicago, Ill. (312) 693-2660, Indianapolis, Ind. (317) 255-5822, Lenexa, Kan. (816) 358-8102, Glen Burnie, Md. (301) 760-5220, Burlington, Mass. (617) 273-1350, Farmington, Mich. (313) 477-0400, Minneapolis, Minn. (612) 888-4666, Englewood Cliffs, N.J. (201) 871-4410, Syracuse, N.Y. (315) 455-5858, Dayton, Ohio (513) 434-0097, Dallas, Tex. (214) 233-6801.

# 2N3954 2N3955 Solitron FETS rated No. 1\*

FOR AUDIO  
APPLICATIONS

OVER 140 OTHER  
TYPES IN STOCK  
FOR IMMEDIATE  
DELIVERY.

Low Noise, Low Leakage,  
Low  $R_{ON}$ , UHF/VHF, Duals,  
Epoxy, Switching, General  
Purpose, Current Limiting Di-  
odes, N-Channel, P-Channel.  
High REL devices available  
tested to all of the most strin-  
gent specifications.

SEND FOR FREE  
SHORT FORM CATALOG

And \*Copy of  
Article  
describing  
test



# Solitron

8808 Balboa Avenue  
San Diego, Calif. 92123  
Phone: (714) 278-8780

## INSTRUMENTATION

(continued from page 110)

W1000, according to Dan Roth, vice president of Amplifier Research. Most of the other amplifiers are limited to an instantaneous bandwidth of about 500 MHz, he says.

The W1000 OEM version costs \$600 and the lab model \$950. Both are available from stock to 30 days. Substantial discounts are available on orders of 10 or more units. Soon to be available from Amplifier Research will be a 1-W output version of the W1000.

CIRCLE NO. 301

## Miniature printer teams up with DPMs

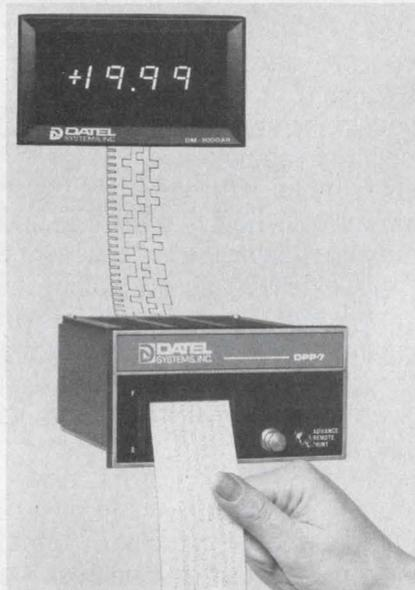

Datal Systems, Inc., 1020 Turnpike St., Canton, MA 02021. (617) 828-8000. \$475; 4-6 wks.

Model DPP-7 digital panel printer is a miniature unit that prints up to seven columns of BCD input data. The unit, which measures only 5.25-in. (13.7 cm) wide by 2.82-in. (7.15 cm) high weighs 2.3 lb and uses an electronic thermal printhead that operates at three lines per second. An outstanding feature is mechanical simplicity: only two parts—a linear solenoid and rotary clutch—are used to advance the paper. The DPP-7 accepts six, full-parallel, four-line BCD (8-4-2-1) digital inputs and sign with TTL or DTL logic level.

CIRCLE NO. 320

## 10-MHz scope operates in X-Y mode



Heath Co., Benton Harbor, MI 49022. (616) 983-3961. \$299.95 (kit); \$420 (assembled).

The 4530 10-MHz, single-trace scope features TV coupling, dc-to-10-MHz bandwidth and a wide-band, calibrated X-channel input. The unit is one of the few single-trace scopes with two input channels. The Y-input has a maximum sensitivity of 10 mV with an 11-position attenuator to set deflection from 10 mV/cm to 20 V/cm. For true X-Y operation, a calibrated X-input is provided with maximum sensitivity of 20 mV. A calibrated three-position attenuator can be switched through three ac or dc ranges from 20 mV/cm to 2 V/cm. Time base can be switched from 200 ms/cm to 200 ns/cm. Any sweep speed can be magnified five times.

CIRCLE NO. 321

## Unit replaces ice bath for thermocouples

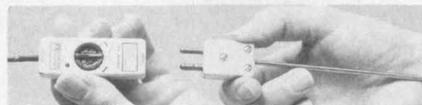

Omega Engineering Inc., Box 4047, Stamford, CT 06907. (203) 359-1660. \$49.

Omega-MCJ thermocouple ice-point reference is built into a color-coded thermocouple connector and provides the physical and electrical equivalent of an ice bath reference at 0 or 32 F. The unit comes with compensated adaptor pins to convert it from a female to a male connector and is available in all nine important thermocouple calibrations: T, K, J, E, R, S and the three tungsten/rhenium calibrations. Omega MCJ operates over 2000 h on a replaceable button-type mercury energizer. The unit, including battery, weighs less than 2 oz. It is 2-15/16 × 1 × 1/2-in. thick.

CIRCLE NO. 322

## DPM uses pinouts of competitive units



Analog Devices, Rte. 1 Industrial Park, Norwood, MA 02062. (617) 329-4700. \$140; stock.

A 3-1/2-digit, ac-line-powered DPM, the AD2009, is designed for general-purpose applications such as data logging and digital-feedback control systems. The unit measures bipolar input voltages over full-scale ranges of either  $\pm 1.999$  V or  $\pm 199.9$  mV, with an accuracy of  $\pm 0.1\%$  readings  $\pm 1$  digit. Features are 0.55-in. Beckman displays, industry-standard panel cutout ( $3.924 \times 1.682$  in.), and use of the same pinout as several other DPMs.

CIRCLE NO. 323

## Bar-graph design kits offered for prototypes

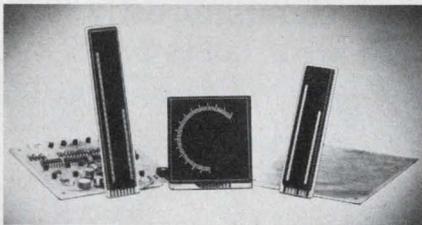

Burroughs, P.O. Box 1226, Plainfield, NJ 07061. (201) 757-5000. \$79.95 to \$109.95.

Four design kits enable engineers to construct a prototype with any of the company's standard SELF-SCAN bar graphs. Currently available: 200-element linear, 100-element linear, and 120-element circular bar-graph kits, as well as a power-supply kit. These kits include a PC board and all discrete and IC components needed to permit rapid assembly and connection to any system. They are designed for systems having any analog input signal level from 1 up to 30 V max.

CIRCLE NO. 324

# 1024 Element Analog Delay 75 DB S/N

RETICON's SAD-1024 Serial Analog Delay is the most recent in our line of analog signal processing devices. It is designed for variable or fixed delay of analog signals including various audio applications (e.g., reverberation, echo and chorus effects in electronic organs and musical instruments, speech compression, voice scrambling, etc.) It is packaged in a 16 lead DIP and is priced at less than 1¢/bit in OEM quantities.

Other units offer up to 12 MHz sampling frequency, independent read-in/read-out, and can be used to perform analog storage, digital filtering, convolution, correlation, real time Fourier transforms and many other functions.

There are over 70 salesmen and 16 distributors to serve you worldwide.

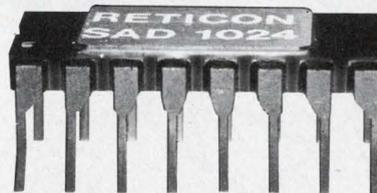

**RETICON®**  
910 Benicia Avenue  
Sunnyvale, Ca. 94086  
(408) 738-4266  
TWX: 910-339-9343

# announcing the new 9 volt rechargeable

an exciting new  
design and marketing  
opportunity

The VARTA Ni-Cad TR 7/8.  
Looks like a 9 volt primary.  
Takes no more space than a 9 volt primary—  
but it can be recharged!  
Over 500 times...

Perfect for calculators, transistor radios,  
dictation equipment, etc.

For specifications and technical assistance  
call or write today.

**VARTA**  
Batteries Inc.   
85 Executive Boulevard  
Cross Westchester Executive Park  
Elmsford, N.Y. 10523  
(914) 592 - 2500

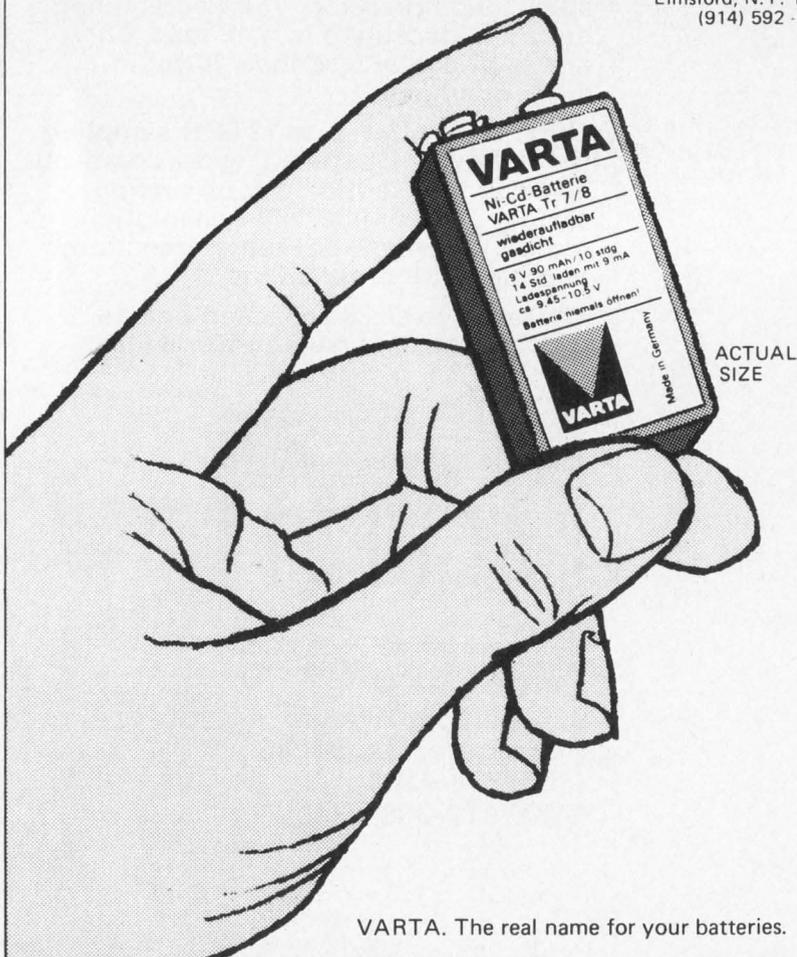

VARTA. The real name for your batteries.

INFORMATION RETRIEVAL NUMBER 60

## INSTRUMENTATION

### Adapter converts scopes to dual-trace operation



RCA Corp., 30 Rockefeller Plaza,  
New York, NY 10020. (212) 598-  
5900. \$108; stock.

Dual-Tracer Adapter, WM541A,  
can be attached to any manufac-  
turer's triggered or recurrent-  
sweep scope to update it to a dual-  
trace operation. The unit provides  
two displays on a single-trace scope  
or adds additional traces to dual-  
trace scopes. Display modes include  
channel A only, channel B only, or  
both A and B channels simultane-  
ously ("chopped" or "alternate").  
Switching rate is continuously  
variable over a range designed to  
minimize flicker and beat interfe-  
rence.

CIRCLE NO. 325

### Unit counts directly to 520 MHz, costs \$795



Hewlett-Packard, 1501 Page Mill  
Rd., Palo Alto, CA 94304. (415)  
493-1501. \$795; 30 days.

Model 5383A frequency counter  
counts directly to 520 MHz and  
displays nine digits. Resolution is  
1 Hz for a 1-s gate time at 520  
MHz. The price of \$795 is said to  
be the lowest of any 520-MHz di-  
rect-counting instrument available  
to date. Inputs of two impedances,  
1 M $\Omega$  and 50  $\Omega$ , are selected from  
the front panel. The 50- $\Omega$  input is  
fused. Accuracy over the frequency  
range of 10 Hz to 520 MHz is  $\pm 1$   
count  $\pm$  timebase error.

CIRCLE NO. 326

# SIEMENS

## Low profile relays Space savings in a proven design.

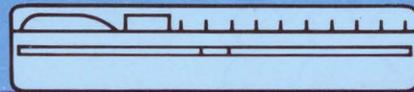
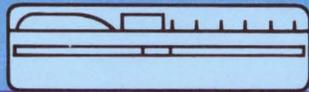
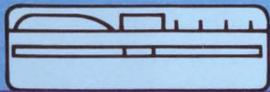

Siemens low profile relays permit nearly double the PC board mounting density compared to standard height relays. And only the Siemens design covers the full range—1, 2, 4 and 6 PDT contacts, with a uniform height of only 0.4 inches. Space savings that add up to greater dollar savings through better cabinet utilization.

Bifurcated contacts (standard) of fail-safe design assure maximum reliability over a long electrical life. Millions in use over the past four years confirm this proven design. Typical applications include communications systems, data processing and automatic control systems.

Delivery is assured as Siemens-designed low profile relays are available from more than one source.

Siemens low profile relays. Space savings in a proven design. Write for detailed literature.

**Siemens Corporation**  
**Special Components Division**

186 Wood Avenue South, Iselin, New Jersey 08830 (201) 494-1000

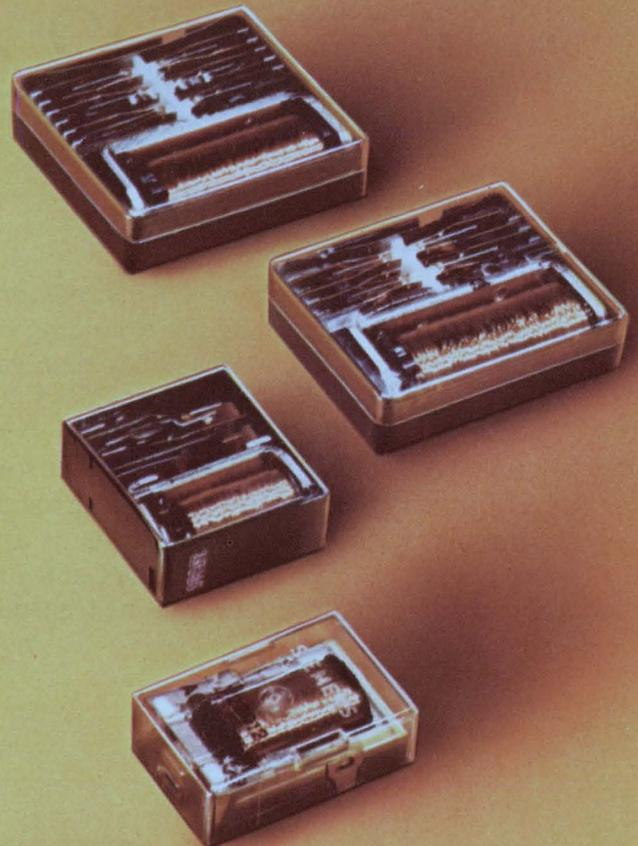

# Two New DIP SOLID STATE RELAYS from CLARE

If you have pcb designs that need fast, long-life switching for DC loads to 250 Volts—or AC/DC loads to 50 Volts—check these new solid-state relays from C. P. Clare & Company.

They're DTL/TTL compatible, packaged in full-molded epoxy cases with a standard DIP footprint, and sized to fit 0.5" pcb centers. Rugged...reliable...versatile.

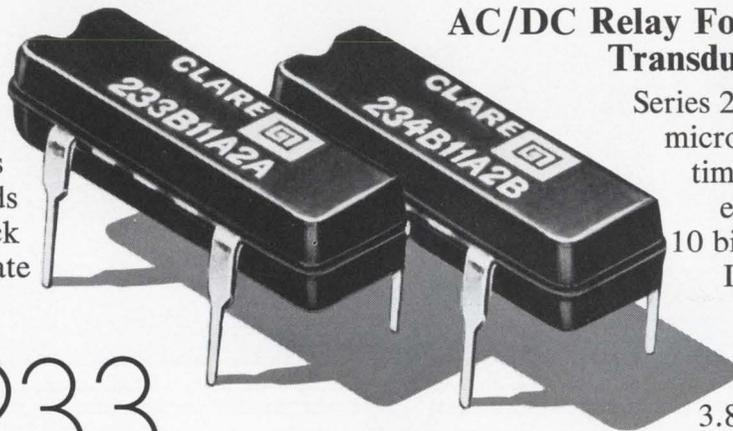

## 233

## 234

### Two Choices For DC Load Switching

Series 233 relays feature a 1-microsecond response time plus a long life extending beyond 10 billion operations. They give you a choice of 60 Vdc/400 mA or 250 Vdc/100 mA peak outputs, both controlled by 3.8 to 10 Vdc input. They're ideal for solenoid, motor and lamp drivers in process controls, automatic test equipment and peripherals... or data couplers and line drivers in digital communications transmission networks.

### AC/DC Relay For Analog And Transducer Switching

Series 234 features a 1-microsecond response time plus a long life extending beyond 10 billion operations. It offers 50 V/80 mA peak output with input ranging from 3.8 Vdc to 10 Vdc.

A natural choice for analog and transducer switching, choppers, A-to-D converters, multiplexers, scanners and other sensing/input circuits for automatic process control and test equipment... or for line drivers between computers and their peripherals.

### Want To Know More?

All Series 233 and 234 models are SPST (N.O.) devices, rated for dielectric withstanding voltage of 1500 Vac and insulation resistance of  $10^9$  ohms. Operating and storage temperatures range from  $-20^{\circ}$  C to  $+100^{\circ}$  C. All models are in stock for immediate shipment. For specification data, contact your nearest Clare sales office or distributor. For more comprehensive application information, contact Rick Prieto, C. P. Clare & Company, 3101 W. Pratt Avenue, Chicago, Illinois 60645. Or Phone (312) 262-7700.

QUALITY, SERVICE, RELIABILITY

**C. P. CLARE & COMPANY** a subsidiary of  
**GENERAL INSTRUMENT CORPORATION**



RIGHT ON TARGET AGAIN



A perfect match when things get hot



# 1st monolithic complementary darlington pair

TDA 1420/1410  
Equivalent circuit

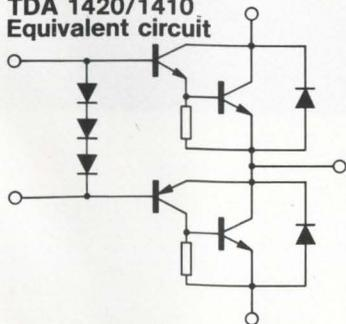

The TDA 1420 integrates a quasi-complementary (NPN/PNP) darlington pair and biasing diodes for perfect electrothermal matching. Applications for this versatile power IC include DC or stepping motor drivers, op amp power boosters, audio output stages, etc.

All this in Pentawatt<sup>®</sup>, the rugged 5-pin plastic pack.

For lower voltages try the TDA 1410.

INFORMATION RETRIEVAL NUMBER 134

Key parameters	TDA 1420	TDA 1410
$V_{CE0}$	44 V	36 V
$V_{CES}$	60 V	50 V
$I_C$	3 A	3 A
$P_{tot} @ T_c \leq 60^\circ C$	30 W	30 W

SGS-ATES Semiconductor Corporation - Newtonville, Mass. 02160 - 435 Newtonville Avenue - Tel: 617-9691610 - Telex: 922428. Stocking Distributors: Edmar Electronics Co., Des Plaines, ILL., (312) 298-8580 - Energy Electronic Products, Los Angeles, CA, (213) 670-7880 - Esco Inc., Dayton, OHIO, (513) 226-1133 - KA Electronic Sales, Dallas TX, (214) 634-7870 - Radar Electric Co., Seattle, WA, (206) 282-2511 - Re-Coil Electronics Inc., Santa Clara, CA, (408) 984-0400 - Rosyl Electronics, Bayshore, NY, (516) 586-1800 - Wilshire Electronics, Burlington, MASS. (617) 272-8200 - Prelco Electronics Ltd., Montreal 357, Quebec, (514) 389-8051.

# Hot-molded resistors provide low temperature coefficient and unmatched reliability.

The Resistance Temperature Coefficient of Allen-Bradley hot-molded fixed resistors is typically less than 200 PPM over the entire resistor range shown in the normal equipment operating temperature of +15°C to +75°C. Excellent RTC ratings have always been an Allen-Bradley benefit. And consistency of Allen-Bradley resistors means repeatable results and tight performance patterns. Allen-Bradley resistors offer the **lowest cost—on the board**—where it counts!

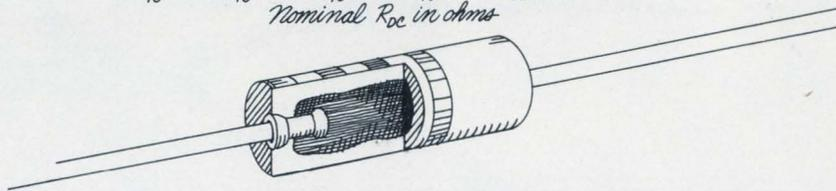
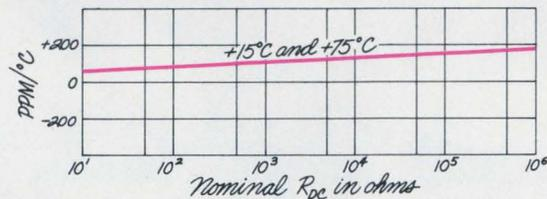

## Reliability

is unsurpassed. Over 700 million unit test hours without a single failure.

## No coatings

Insulation and resistance element integrally molded into one solid structure.

## Pulse handling

characteristics offer outstanding protection against surges and transients.

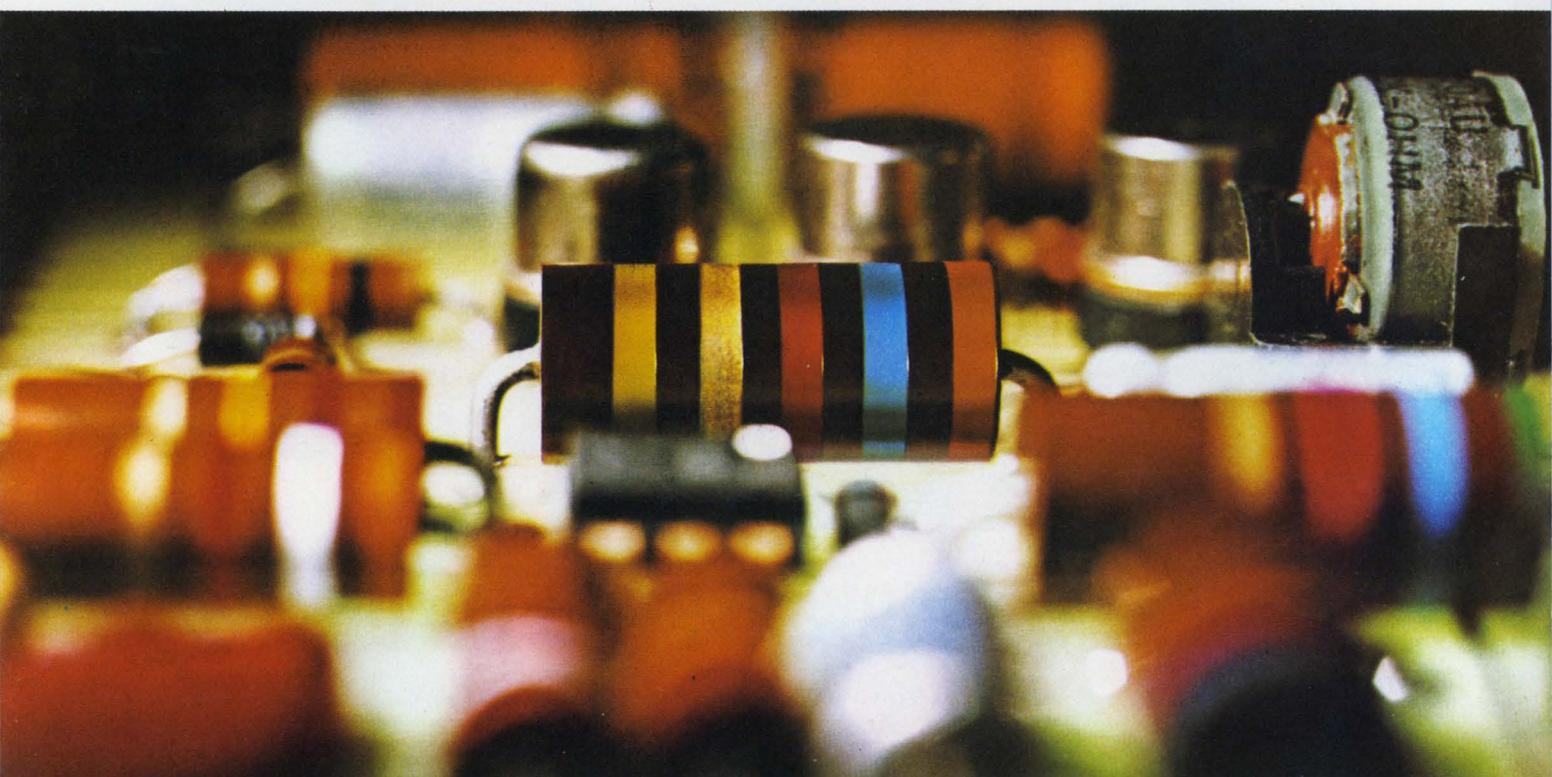

## Quality in the best tradition.



**ALLEN-BRADLEY**

Electronics Division  
Milwaukee, Wisconsin 53204

INFORMATION RETRIEVAL NUMBER 135

EC113

## Unit measures thermal resistance of semis



Sage Enterprises, P.O. Box 7189, Menlo Park, CA 94025. (415) 321-0110. \$4250; 90-120 days.

The THETA 100 thermal resistance tester is said to be the first commercially available instrument specifically designed to measure thermal resistance to a high degree of accuracy on a production basis. The instrument features internal heating current selection to 2.0 A, variable K Factor selection from zero to 0.999 C/mV, and four-wire Kelvin contact configuration. A 3-1/2-digit display provides 0 to 199.9 C/W readings. Worst case accuracy is  $\pm 5\%$  of reading  $\pm 0.3$  C/W.

CIRCLE NO. 327

## Edgewise panel meters handle high vibrations

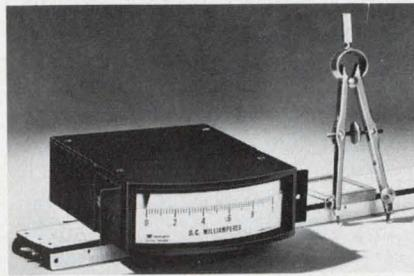

Triplet Corp., Bluffton, OH 45817. (419) 358-5015. \$39.70 to \$46.10.

A new series of 3-1/2-in. edgewise panel instruments with glass-reinforced thermoplastic fronts and sealed-glass meter windows is made for high vibration and rough environments. Model 320-EG Series features gasket-sealed cover plates, steel mounting brackets, stainless-steel connection screws, high-temperature thermoplastic fronts and rugged thermosetting plastic backs. Scale length is 2.58 in., depth is 4.250 in., and width, including steel mounting brackets, is 4.188 in. Height is 1.312 in. Standard accuracy is  $\pm 2\%$ .

CIRCLE NO. 328

## Transient recorder claims infinite memory

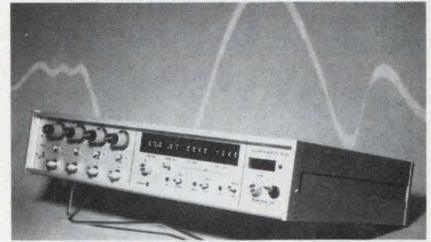

Quantalog, Inc., 42 Enterprise Dr., Ann Arbor, MI 48106. (313) 769-4936. Begin at \$5000; stock to 60 days.

The QuantaLatch Series 4000 four-channel transient recorder can record data prior to the event of interest (post event triggering), permitting the capture and analysis of data from one-time and random events. Input channels will accept analog signals from 50 mV to 50 V, and are extendable to 500 V using an ordinary scope probe. The series features a 4096-point memory that will store data at up to one million points per second, and is expandable virtually without limit in 4 k increments.

CIRCLE NO. 329

## NEW LOW COST REED RELAY ROCK HARD EPOXY COATED

\$1.85 to 49¢

Depending on coil voltage, contact level and volume.

### Blue Boy Reed Relays offer:

- Protection from handling, solvents, tough environments
- 1 pole normally open contacts up to 10 watts
- General purpose or logic level contacts
- Coil voltages 5 through 48 VDC; .35" H x 1" L

Available from distributors.

26477 Golden Valley Road • Saugus, California 91350  
(805) 252-8330 • (213) 788-7292 • TWX 910-336-1556

## ELEC-TROL, INC.



INFORMATION RETRIEVAL NUMBER 61

ELECTRONIC DESIGN 21, October 11, 1975

MEMORY SERIES NO. 11

## WHAT ARE 16 INPUT VARIABLES WORTH IN OUR FPLA'S?

Four times the address-scan capability of competitive Field Programmable Logic Arrays. As a bonus you get chip enable. Simplifies expansion of our 48 product terms and 16 input variables. Permits tristate application in bus organization. Provides logic inhibit, conditional decoding. Got it? Get it now.

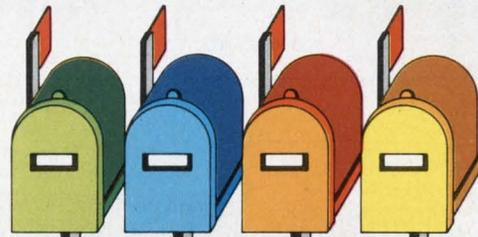

For specs & data on our unique chip-enable FPLAs #82S100 (Tristate) & #82S101 (Open Collector), attach coupon to letterhead.

Name \_\_\_\_\_

Tel \_\_\_\_\_

Ext \_\_\_\_\_

Send pricing for sample parts.

THINK

# Signetics

811 E. ARQUES, SUNNYVALE, CALIF 94086

INFORMATION RETRIEVAL NUMBER 62

115

## MODULES & SUBASSEMBLIES

### Hybrid power amps deliver up to 60 W

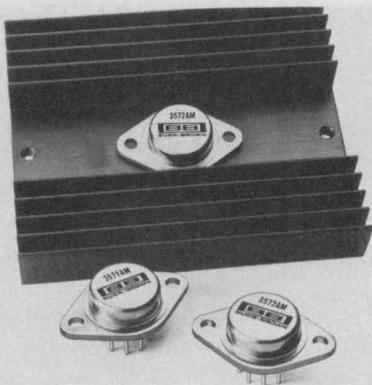

Burr-Brown, International Airport Industrial Park, Tucson, AZ 85734. (602) 294-1431. 1 to 24 pieces: \$60 (3571), \$65 (3572); stock.

The 3571 and 3572 hybrid power amplifiers combine the versatility of FET operational amplifiers with the power capabilities of servo amplifiers. Both models have monolithic FET input stages for low bias current (100 pA max) and high input impedance ( $10^{11} \Omega$ ). Laser trimming reduces offset voltage drift to  $40 \mu\text{V}/^\circ\text{C}$  max. The output stage of the amplifiers consists of a complementary Darlington pair in a class AB configuration which delivers up to 60 W. External current limiting in the output stage permits both the positive and negative current limits to be preset. The amplifiers in the 3571 and 3572 are electrically isolated from the metal case. The 3571 can dissipate 33 W, max and deliver  $\pm 30 \text{ V}$  at  $\pm 1 \text{ A}$ , while the 3572 dissipates 50 W, max and delivers  $\pm 30 \text{ V}$  at  $\pm 2 \text{ A}$ .

CIRCLE NO. 330

### Opto proximity sensor has range of 4 ft

Scientific Technology, 1201 San Antonio Rd., Mountain View, CA 94043. (715) 965-0910. \$155; 4 to 6 wk.

Noncontact detection of objects at distances up to 4 ft (1.2 m) is possible with the L3030-series Omniprox sensor. It "sees" any material, even liquids and transparent surfaces. Operation is not affected by environmental contaminants such as dust or fog, or thin film depositions of oil, water or dust. The STI L3030 sensors are available for operation from any power source from 12 V dc to 240 V ac. Optional outputs include TTL or HTL logic, mechanical or solid state relays and analog response. Control option modules such as time delays, one shots, latches and predetermined count, can be plugged into the control card.

CIRCLE NO. 331

### Phase control units provide orthogonal gates

Evans Associates, P.O. Box 5055, Berkeley, CA 94705. (415) 848-6839. \$155; 2 to 4 wk.

The Model 4114 phase control unit generates two orthogonal  $180^\circ$  gates for the 0.1-Hz-to-100-kHz range. The gates appear at the fundamental frequency of the periodic input waveform, and can be phase-delayed over a  $0$ -to- $360^\circ$  range with on-board and external program control. Frequency tracking is automatic and acquisition time is less than four periods.

CIRCLE NO. 332

### Power line monitor detects phase trouble

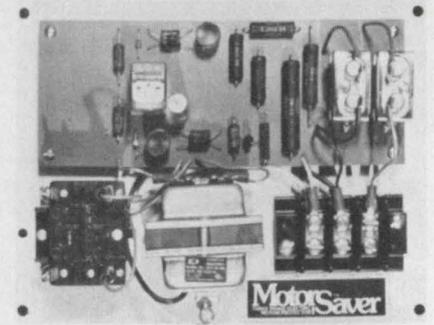

Sym Com, Dept. ED, 528 Kansas City St., Rapid City, SD 57701. (605) 348-5580. From \$189.50; stock.

The MotorSaver is a three-phase electric motor protector that provides protection against electric motor loss due to phase failure, single phasing and phase reversal. It also protects the motor against damage or decreased life due to phase imbalance, angle deviation, overvoltage or undervoltage (brownouts). The unit continuously monitors power line conditions and can be programmed to detect any pre-determined percentage change in phase balance, angle deviation, over or undervoltage differential between phases; it can also be programmed to shut down a motor and/or issue a warning of "nonstandard" conditions; and permit automatic system re-start when the power system problem is cured. The MotorSaver has built-in transient and surge protection and is built to meet UL and NEMA standards. It is available in several different models which perform related protective functions, and custom models.

CIRCLE NO. 333

**ANALOG**

I'M DOING MY INCOME TAX WITH THIS NEW WIZARD CALCULATOR.

ARE YOU SURE YOU KNOW HOW TO USE IT?

SIMPLE. THERE YOU GO. I OWE UNCLE SAM  $\sqrt{Tr}$ ?

**ANALOG-Y**

SAVE ON ANALOG COMPUTATIONS WITH FMI MATH MODULES. OUR NEW RMS-TO-DC CONVERTER IS FASTER AND MORE ACCURATE THAN THERMAL RMS METERS. IT COMPUTES TRUE RMS LEVELS BY AVERAGING SQUARING AND SQUARE-ROOTING. OUR DIVIDERS ACHIEVE 0.1% ACCURACY AND WIDE BANDWIDTH OVER A 100:1 DIVISOR RANGE. OUR 90 VOLT 4-QUADRANT MULTIPLIERS ALSO DIVIDE, SQUARE, SQUARE-ROOT, ETC. AT ACCURACIES TO 0.1%. AND FOR SCALING OUR LOG AMPLIFIERS REMAIN PRECISE OVER AN 8-DECADE RANGE.

**intech/FMI**  
282 BROOKAW RD. SANTA CLARA, CA 95050 (408) 244-0500

## Instrumentation amp has max drift of $0.5 \mu\text{V}/^\circ\text{C}$

Analog Devices, Rte. 1 Industrial Park, P.O. Box 280, Norwood, MA 02062. (617) 329-4700. For 1 to 9 pieces: \$39 (J); \$49 (K); \$59 (L); stock.

The Model 610 general-purpose instrumentation amplifier has a  $\pm 0.02\%$  maximum nonlinearity. The low nonlinearity combines with a  $0.5\text{-}\mu\text{V}/^\circ\text{C}$  maximum drift, a  $2\text{-}\mu\text{V}$  pk-pk maximum input noise, and an 86-dB minimum CMRR to give high performance. The amplifier has an almost constant bandwidth over a gain range of 1 to 10,000 V/V. A 6-kHz full power response independent of gain, and gain tempcos of  $\pm 15$  ppm/ $^\circ\text{C}$  and  $\pm 0.01\%$ /month assure the long term stability. The amplifier requires only 90 mW and operates over a  $\pm 12$  to  $\pm 18$  V dc supply range. The 610 is packaged in a  $2 \times 2 \times 0.4$  in. ( $50.8 \times 50.8 \times 10.4$  mm) module and is specified over 0 to  $70^\circ\text{C}$ . Three versions with different drift and noise are available: the Model 610J with  $\pm 3\text{-}\mu\text{V}/^\circ\text{C}$  maximum drift and  $2.5\text{-}\mu\text{V}$  pk-pk maximum noise, the 610K with  $\pm 1\text{-}\mu\text{V}/^\circ\text{C}$  drift and  $2\text{-}\mu\text{V}$  pk-pk noise and the 610L with  $0.5\text{-}\mu\text{V}/^\circ\text{C}$  drift and  $2\text{-}\mu\text{V}$  pk-pk noise.

CIRCLE NO. 334

## Fast a/d converters have resolution to 13-bits

Computer Labs, 1109 S. Chapman St., Greensboro, NC 27403. (919) 292-6427. From \$8200; 12 to 14 wk.

The 9000 Series "Bare Bones" a/d converters are available in 11, 12 and 13-bit resolution models for both 5 and 10-MHz word rates. Internal track-and-hold circuits have an aperture time of 10 ps to assure accuracy on fast-changing analog inputs. The converters require  $\pm 15$ , +5 and  $-5.2$  V dc for operation. All units can handle input signals over a  $\pm 2.048\text{-V}$  range. Their offset voltages are adjustable to within 0.2 mV of zero and have a tempo of 20 ppm/ $^\circ\text{C}$ . Options include a choice of input impedance, 50, 75 or 93  $\Omega$ . The converters are housed in cases that measure  $12 \times 7.48 \times 9$  in.

CIRCLE NO. 335

# CUSTOM HYBRID MICROCIRCUITS

For Military/Aerospace Applications

# CIRCUIT TECHNOLOGY INCORPORATED

160 Smith Street, Farmingdale, N.Y. 11735  
Phone (516) 293-8686 • (213) 374-7446

INFORMATION RETRIEVAL NUMBER 64



## The Attache Kit

For the engineer who makes house calls

We want you to take the SPC-88 along on your next field service call. Our rugged llama-grain case is outfitted with the finest precision-made tools to help you do the job quickly, easily and professionally.

SPC also custom builds other electronics tool kits from a complete line of top quality, name-brand hand tools. We can provide you with individual tools or a complete kit. Just tell us what you need — we can deliver!

Make your rounds with the SPC-88 or one of our other custom kits.

**Who knows? You may get invited to stay for dinner!**

Send for free brochure and product information.

**SPECIALIZED PRODUCTS COMPANY**

2324 SHORECREST DRIVE  
DALLAS, TEXAS 75235 / 214-358-4663



INFORMATION RETRIEVAL NUMBER 65

# Still designing without 16-pin 4K RAMS?

You may be kicking yourself tomorrow.

Let's not beat around the bush. Fairchild has put a lot of money into developing its ion-implanted Isoplanar 16-pin 4K RAM. Why? Because we'd be nuts to ignore 16-pin. It's a better design, hands down, than either 18 or 22-pin RAMS. It's the design of the future. Here's why.

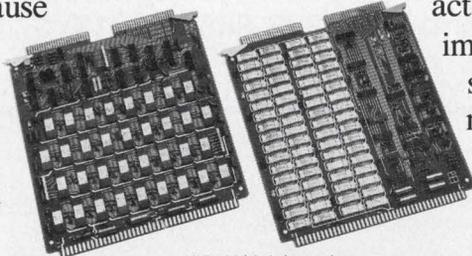

16-pin 4K RAM (right) requires significantly less board space than 22-pin design (left)

## Easier, less costly

The 16-pin 4K RAM uses only six address lines. That means you only need *half the number* of address drivers that you do with 18 or 22-pin designs! Result? Fewer parts, less cost.

Support functions are included on-chip. (TTL-to-

MOS conversion, address, chip-select and output latches.) Results?

Your system noise characteristics are improved. Your system is more reliable. And your system design and component costs are lower.

Fairchild's 16-pin 4096 is designed with low-voltage, low-capacitance clocks—rather than 12-volt clocks—throughout the system. Results? System noise reduced to a minimum. And again, a simpler and less costly system.

## Lower power requirements

Our 16-pin 4K is a power-miser compared to 18 or 22-pin RAMS. (See diagram.) It also requires smaller voltage swings, producing smaller transient spikes.

## Higher board density

With the Fairchild 16-pin 4096, you get the most RAM bits per unit area of PC board.

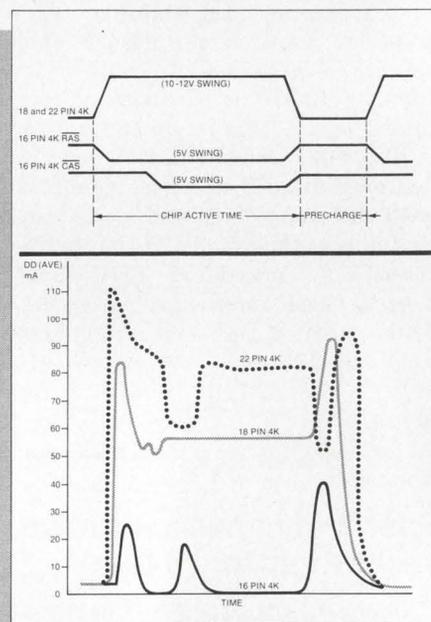

16-pin 4K RAM consumes far less average power and generates much lower noise spikes than 18- or 22-pin design.

Significantly more than any other design on the market. (See photo.) And you get *exactly the same* speeds as 18 or 22-pin designs.

## True alternate sourcing

The 16-pin package is the only 4K RAM with true, identical-spec alternate sources.

## Easier future expansion

When 16K RAMS are developed, they will be made

Part Number	Random Access Time (ns)	Cycle Time (ns)	Average I <sub>DD</sub> (mA)
4096-2	200	300	35
4096-3	250	365	30
4096-4	300	425	27
4096-5	350	500	25

## MODULES & SUBASSEMBLIES

### Self-powered reference eliminates ice baths

*Hades Manufacturing, 151A Verdi St., Farmingdale, NY 11735. (516) 249-4244. \$76 (1 to 9); stock to 4 wk.*

The NC340 series of self-powered thermocouple reference junction compensators converts any millivolt recorder or readout so that it may be used accurately as a thermocouple temperature instrument. The unit eliminates the need for ice baths and ovens when used in conjunction with thermocouples. The circuit is energized from a self-contained, replaceable battery when the power switch is turned on. The NC340 output terminals are standard banana plugs which allow direct insertion into readout or recording instruments, such as chart recorders, oscilloscopes, meters, etc. Standard reference temperature setting is 0 C with other references available for use with all types of thermocouple materials. Compensation accuracies are typically  $\pm 0.25$  C at 25-C ambient to  $\pm 0.75$  C from 0 to +50-C ambient. Output impedance is less than 250  $\Omega$  on the standard models. The compensator measures  $1.875 \times 2.625 \times 1.25$  in.

CIRCLE NO. 336

### CRT correction modules handle 20 to 70° tubes

*Intronics, 57 Chapel St., Newton, MA 02158. (617) 332-7350. From \$130 (1 to 9); 4 wk.*

The C201/202 CRT correction modules accurately correct pin-cushion distortion in flat face CRT displays. The units smoothly synthesize approximations to the correction equations for CRT angles between 20 and 70°. Both modules have slew rates of 20 V/ $\mu$ s, settling times of 1  $\mu$ s (to 1%) and typical accuracies of 0.5% for tubes with 60° deflection angle. The C201 is a current output device with an output impedance of  $10^7 \Omega$  while the C202 is a voltage output unit with a 0.1- $\Omega$  output impedance. The modules are housed in  $2 \times 2 \times 0.4$  in. epoxy packages with gold-plated circuit pins.

CIRCLE NO. 337

### 8-bit a/d converter has 15-MHz throughput

*Function Modules, 711 W. Seventeenth St., Costa Mesa, CA 92626. (714) 645-6001. \$6125 (1 to 4); 6 to 8 wk.*

The AN-DI 802 RAD-C 8-bit a/d converter has a throughput rate of 15 MHz. The system is a completely self-contained unit with built-in, wideband differential input amplifier, fast sample/hold network and 8-bit encoder. It accepts a  $\pm 1$ -V differential input signal and provides a binary coded output. The sample/hold unit also has less than a 100-ps aperture uncertainty for precision sampling of signals. The parallel output data are double buffered and remain true for a complete conversion cycle except during the 5-ns update period.

CIRCLE NO. 338

### Complete reference housed in 14-pin DIP

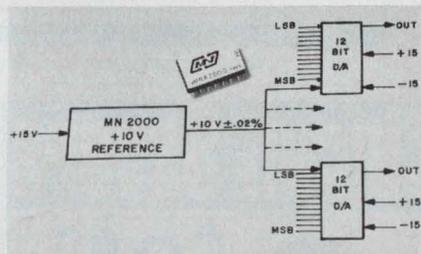

*Micro Networks, 324 Clark St., Worcester, MA 01606. (617) 852-5400. From \$50 (1 to 24); 2 to 4 wk.*

A family of 10 V precision reference sources is available in 14-pin hermetic DIPs. Four models are offered: the MN2000 and MN2001 are +10 V reference units and the MN2002 and MN2003 are -10 V references. All references are laser trimmed for initial accuracy of better than 0.02% at 25 C. The MN2000 and MN2002 guarantee accuracy of 0.05% over the operating range of 0 to 70 C. For full MIL range applications, the MN2000H and 2002H guarantee 0.05% accuracy over the range of -55 to +125 C. Models MN2001 and MN2003 guarantee accuracy of 0.1%. All models have an op-amp output, short circuit protection and require just a single power supply. Each unit can supply 5 mA to a load.

CIRCLE NO. 339

in 16-pin packages with identical pin-out to the 4K. Very little board re-design will be required.

### Available now

Prototype quantities of our 4096 16-pin 4K RAM are available now from your local Fairchild distributor, along with complete product information. For production requirements, contact your Fairchild Sales Office or Representative.

Take a good, hard look at the system you're designing now. And take a good hard look at our 16-pin 4K RAM. You may be kicking yourself if you don't.

Semiconductor Components Group, Fairchild Camera & Instrument Corp., 464 Ellis St. Mountain View, CA 94040  
Telephone (415) 962-3941  
TWX: 910-379-6435

# FAIRCHILD

## No.1 for logic and memory.

# Parallel Entry Printer

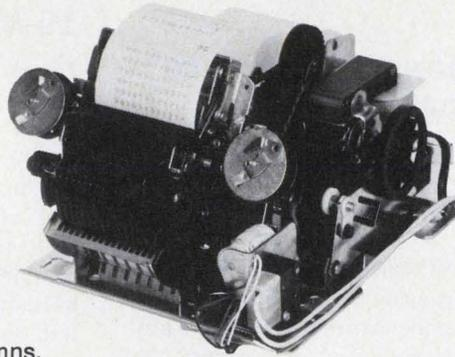

Prints 3 lines per second, 11 character locations per column with a capacity up to 16 columns. Print mechanism is small (5¼" x 10" x 8").

**Options available:** Serial or parallel BDC interface  
Power supply                      Attractive case

With the addition of calculator logic, it becomes our "Intelligent Printer".

Write for catalog of Addmaster computer peripherals.

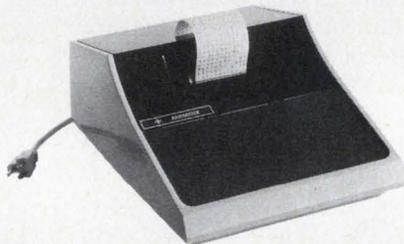

416 Junipero Serra Drive • San Gabriel, California 91776

INFORMATION RETRIEVAL NUMBER 67

## MODULES & SUBASSEMBLIES

### Serial data decoder handles bi-phase data

Digital Technology Group, 31218 Pacific Highway, South, Federal Way, WA 98002. (206) 839-2950. From \$175; 30 to 60 day.

The UBISYN serial decoder is designed for variable-speed, asynchronous operation with bi-phase coded data. The decoder accepts data at random rates from printed bar-code, magnetic strips (as on bank cards) or transmitted data. The unit can decode even while the bit rate is being varied by over 100,000%. UBISYN allows bi-phase bar codes or magnetic cards to be scanned at irregular rates using such items as hand-held wands. The UBISYN is compatible with any bi-phase code system application: standard alphanumeric character codes (i.e., ASCII, EBCDIC, BCD); nonstandard character codes; fixed or variable-length words and random binary data streams. Two models are available: one with a six octave and the other with a 10 octave self-rate-adaptive operating range that is adjustable on the frequency scale up to 50 k BPS.

CIRCLE NO. 340

### Void and jam detector uses one sense head

Allen-Bradley, 1201 Second St., Milwaukee, WI 53203. (414) 765-0280. From \$420.

The Series 870 void and jam detector has only one sensing head but can sense the motion of conductive, magnetic and metallic objects. Formerly, most proximity switches required two sensing heads with AND/OR logic input functions. By combining the functions and using two isolated outputs, the cost to the customer is cut by almost 25%. The device provides two N.O. isolated outputs designated as void and jam. Each output has a sensitivity adjustment and LEDs provide visual indication of status. The void output has on and off time delays and the jam output has on time delay adjustment. The timing range for both outputs is 0.1 to 5 s.

CIRCLE NO. 341

# Circuit Savers



Here's positive low cost protection for your IC's, transistors, power supplies and pc cards.

The LVC-1A crowbar switches to a short circuit whenever the voltage across it exceeds a specified level.

Any trip voltage level between 4.7V and 200V ± 10% can be selected. The unit will handle a peak current of 50 Amps (8ms) and 3A continuously. MIL Temperature range. Call Mike Coyle for applications assistance.

Full line of protection modules for every hi-lo voltage/current requirement. Write or call for Catalog 749.

279 Skidmore Road  
Deer Park, New York 11729  
Telephone: 516 - 586-5125

# MCG Electronics

INFORMATION RETRIEVAL NUMBER 68

## KEEP

Electronic Design's

## GOLD BOOK

## HANDY

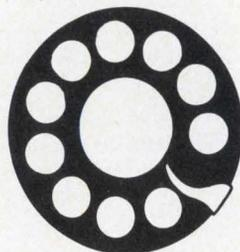

## When You Call

Save time when you contact suppliers. Check their catalog pages first in *Electronic Design's* GOLD BOOK. Maybe the information you need is right at your fingertips.

**MICROWAVES & LASERS**

**L-band amp provides 1 W**



Hughes Electron Dynamics Div., 3100 W. Lomita Blvd., Torrance, CA 90509. (213) 534-2121. \$1950; 60-90 days.

A solid-state linear microwave power amplifier, the Model 1407H, provides 1 W minimum output power between 0.75 and 1.5 GHz. Designed as a direct replacement for a 1-W L-band TWTA, the new amplifier has a minimum gain of 30 dB over the frequency range. The unit contains a regulated power supply, and the 13-lb amplifier measures 10.1 × 14.5 × 3.9 in.

CIRCLE NO. 342

**Low-loss diode switch has high isolation**

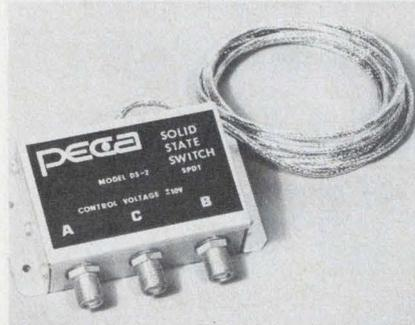

PECA, Inc., 4957 Pearson Ave., Philadelphia, PA 19114. (215) 639-3545. \$45; stock.

A coaxial SPDT diode switch combines isolations in excess of 65 dB to 220 MHz and greater than 55 dB to 300 MHz with an insertion loss of less than 0.5 dB. The Model DS-2 features self-termination of the blocked port for designs requiring a constant matched load. For video applications, the DS-2V version offers a range of dc to 10 MHz. Power consumption for the switches is 20 mA at ±10 V.

CIRCLE NO. 343

**Combine up to 36 rcvrs on one antenna**

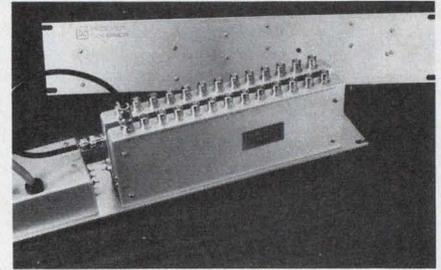

Microwave Associates Inc., 850A Stewart Dr., Sunnyvale, CA 94086. (408) 736-9330.

The manufacturer's Receiver Combiner has the capability to combine 2 to 36 receivers on one antenna with typical intermodulation levels ranging from 100 to 121 dB. These units are available in the communication bands between 25 and 512 MHz. Units operate with 12 or 24 V dc, and as an option, units may be ordered for 115 or 230-V operation with automatic switchover to a standby system. Other options include an adjustable system gain control and adaptor panels.

CIRCLE NO. 344

**ABSOLUTELY**

the world's most accurate rulings using vacuum deposit chrome, etch and fill or emulsion processes. They're produced on the world's largest 1 micro inch numerically controlled ruling engine with interferometric feedback controls. Need precision scales, grids, slits, reticles, Ronchis numbers, letters, circles, dots, or nickel mesh? We stock many items for immediate delivery. Send for brochure No. 38-36.

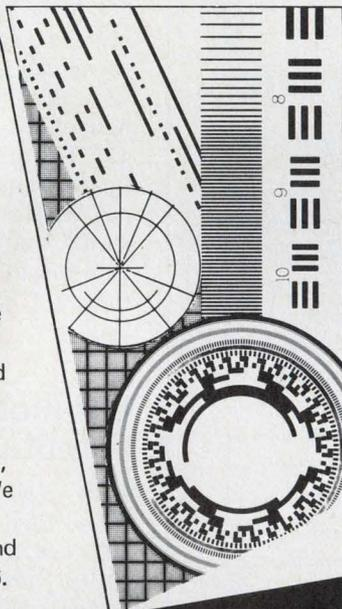

**SCALES RULINGS RETICLES & GRIDS FROM THE WORLD'S LEADING SCALE MAKERS.**



JAMESTOWN, NY 14701 716/488-1958

INFORMATION RETRIEVAL NUMBER 69

ELECTRONIC DESIGN 21, October 11, 1975

MEMORY SERIES NO. 12

**HOW MUCH MORE CAN YOU GET OUT OF OUR FPLA'S?**

Twice the speed (50ns vs. 100). Two extra inputs: 16 vs. 14, yielding a 4:1 address scan capability, compared to other Field Programmable Logic Arrays. And our bonus extra, chip enable, for expanding our 48 product terms.

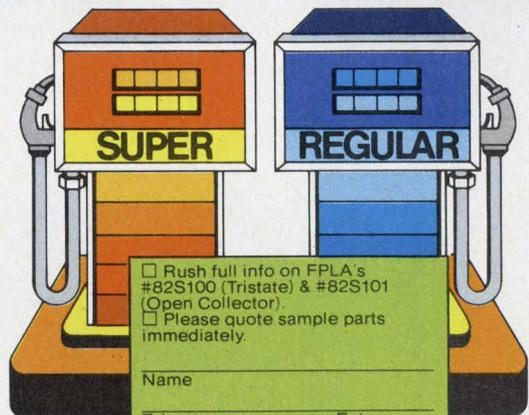

- Rush full info on FPLA's #82S100 (Tristate) & #82S101 (Open Collector).
- Please quote sample parts immediately.

Name \_\_\_\_\_

Tel \_\_\_\_\_

Ext \_\_\_\_\_

Attach coupon to letterhead.

THINK

**Signetics**

811 E. ARQUES, SUNNYVALE, CALIF. 94086

INFORMATION RETRIEVAL NUMBER 70

# SEALED CONTACT KEY SWITCH APPLICATIONS

WE'VE COVERED  
THE BOARD\*

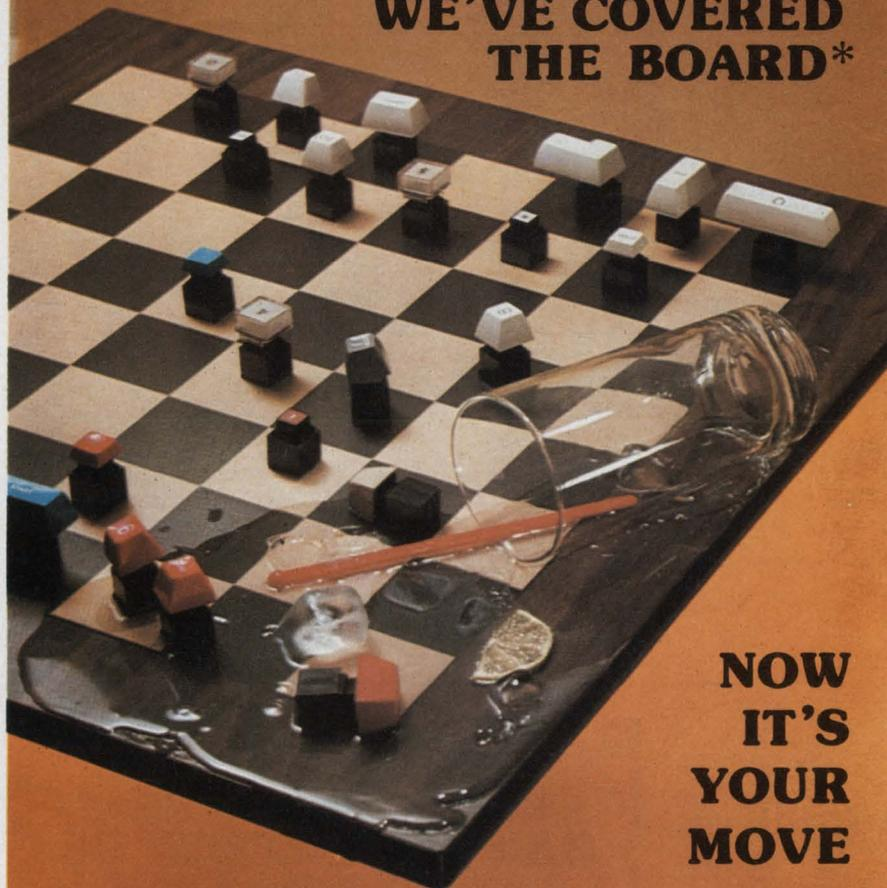

**NOW  
IT'S  
YOUR  
MOVE**

Our flexible tube, mercury contact has proven long life, reliable performance, and it provides you sealed switching at a price competitive with mechanical contacts.

We offer a large variety of keytop styles and contact configurations including front panel relampable lighted models, single and double pole versions, and alternate action type. All of our keytop switches are designed for easy and secure P.C. board mounting without requiring any sheet metal structures.

Other features of our sealed contact switches are: • Doubleshot molded keytops for 3/4" or 5/8" mounting • Easy change legend system • 0.170 plunger travel for good tactile response

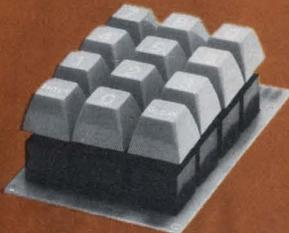

Also consider our complete line of standard small encoded and non-encoded keyboards — they may be just what will put you a move ahead.

**YOUR LETTERHEAD REQUEST OR  
PHONE CALL WILL BRING A FREE  
SAMPLE SWITCH WITH KEYTOP.**

\*Particularly P.C. boards.



**MECHANICAL ENTERPRISES, INC.**  
8000 Forbes Place Springfield, Virginia 22151  
(703) 321-8282 TWX 710-832-0942

In Germany — NEUMÜLLER GMBH, MUNICH  
In U.K — TEKDATA Ltd., STOKE-ON-TRENT

## MICROWAVES & LASERS

### 8-to-12-GHz amp uses GaAs FETs

*Watkins-Johnson Co., 3333 Hillview Ave., Palo Alto, CA 94304. (415) 493-4141.*

The WJ-5310 solid-state amplifier covers the 8.0-to-12.4-GHz frequency band, and it employs a single-ended cascaded design in which each GaAs FET stage contributes approximately 5.5 dB. The amplifier uses input/output circulators to achieve less than 1.3:1 VSWR. The unit has an over-all gain of 22 dB, noise figure of 6.5 dB and 1-dB compression power of +8 dBm.

CIRCLE NO. 345

### GaAs FET amp has 3-dB max NF

*Ancom, Inc., 1000 Ames Ave., Milpitas, CA 95035. (408) 263-4550. Start at \$1850; 45 days.*

A low-noise gallium-arsenide FET amplifier operates over the 3.7-to-4.2-GHz frequency range. The amplifier covers the entire 500-MHz bandwidth with a maximum noise figure of 3 dB. The room temperature noise figure is typically below 2.6 dB and noise figure at -55 C is less than 2.2 dB. The unit combines GaAs-FET input transistors with bipolar output transistors to achieve gains of 40-dB and higher. Integral input and output circulators provide less than a 1.1:1 VSWR.

CIRCLE NO. 346

### Vhf modules output up to 30 W

*TRW Semiconductors, 14520 Aviation Blvd., Lawndale, CA 90260. (213) 679-4561. \$39.50 to \$41.50 (1-24); stock.*

Two vhf power modules, the MV20 and MV30, provide in excess of 20 W and 30 W output power, respectively, across the 140-to-175-MHz band. The modules operate from standard 12-V supplies and withstand infinite VSWR at any angle, with 2-dB overdrive and 16-V-dc applied. The units are designed for mobile or marine transmitter applications.

CIRCLE NO. 347

## Circulators cover octave BWs

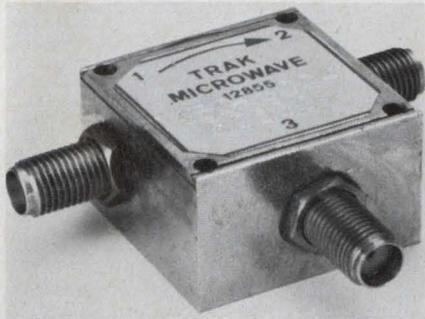

Trak Microwave Corp., 4726 Eisenhower Blvd., Tampa, FL 33614. (813) 884-1411. \$175 (suffix 1); stock.

Octave-bandwidth circulators are offered in two versions. Model 1450-1300-1 has 18-dB minimum isolation, 0.5-dB maximum insertion loss and 1.30 maximum VSWR. For the Model 1450-1300-2, minimum isolation is 17 dB, maximum insertion loss is 0.6 dB and maximum VSWR is 1.35. Both units operate from  $-10$  to  $+70$  C, measure  $1 \times 1 \times 0.625$  in. and weigh 2 oz nominal.

CIRCLE NO. 348

## Phase comparator covers 300-500 MHz

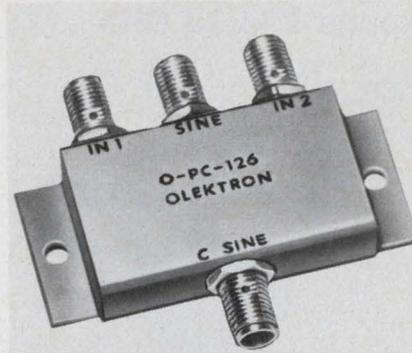

Olektron Corp., 6 Chase Ave., Dudley, MA 01570. (617) 943-7440. \$198 (1-9); 2-4 weeks.

The Model O-PC-126 phase comparator covers the 300-to-500-MHz frequency range with a nominal input of  $-23$  dBm. At this level, two input signals result in a 40-mV pk-pk output. The unit has an input impedance of  $50 \Omega$ , and it employs SMA female connectors. The basic comparator measures  $1\frac{1}{2} \times \frac{7}{8}$  in. and weighs about 1 oz.

CIRCLE NO. 349

## Compact amp offers 20-dB gain

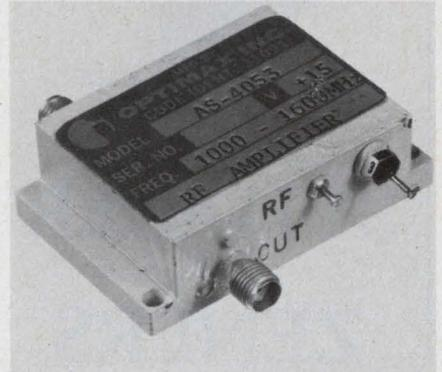

Optimax Inc., P.O. Box 105, Advance Lane, Colmar, PA 18915. (215) 822-1311.

The AS-4053 integrated amplifier can provide  $\pm 1.0$ -dB maximum gain variation over the 1.0-to-1.6-GHz frequency range. Measuring only  $2 \times 1.6 \times 0.6$ -in., the compact unit has a minimum gain of 20 dB and a maximum noise figure of 7 dB. Power output, for a 1-dB gain compression, is +6 dBm and maximum VSWR at input and output is 1.8:1.

CIRCLE NO. 350

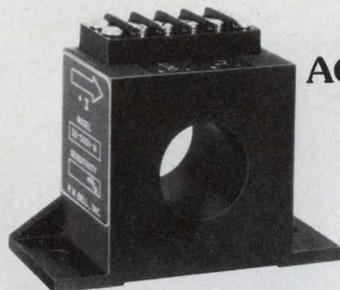

## NON-CONTACT AC & DC CURRENT SENSORS

NEW  
UNIQUE

This new Bell current sensor has unique capabilities to solve current measurement problems. The following four capabilities allow the use of ID-5001M current sensors where other current sensing methods are difficult or impossible.

- 1) Non-contact operation provides complete isolation from the bus.
- 2) The ID-5001M introduces a negligible power drain in the measured circuit.
- 3) The minimal insertion impedance has virtually no effect upon the measured circuit performance.
- 4) The dc current capability allows the measurement of dc, ac on dc, or dc on ac wave forms.

The standard current range is 350 amperes peak ac and dc. Response time is less than 50 microseconds and linearity is better than 2% of full scale. Other models are available to 2,000 amperes and to 100,000 amperes. For more detailed information, please use the inquiry card.

F. W. Bell, Inc. 4949 Freeway Drive East  
614/888-7501 Columbus, Ohio 43229  
A subsidiary of The Arnold Engineering Company



INFORMATION RETRIEVAL NUMBER 72

ELECTRONIC DESIGN 21, October 11, 1975

MEMORY SERIES NO. 13

## PICK ANY 48 WORDS FROM A 65,538 POOL

IN THE FIELD, WITH JUST ONE FPLA. And edit your program at will. In our Field Programmable Logic Arrays with 16 inputs to the decoder, product terms can be added (up to 48) or removed—or delete input variables from your terms. And outputs programmed active-high are reprogrammable to active-low.

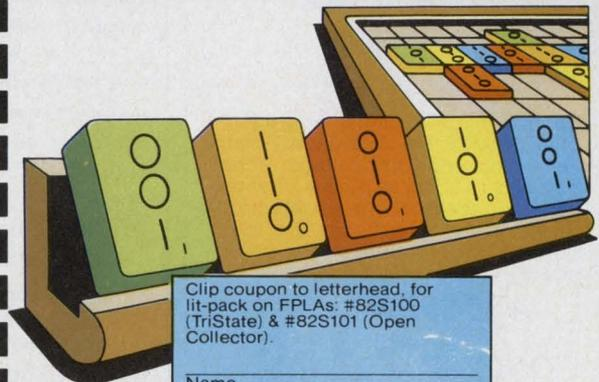

Clip coupon to letterhead, for lit-pack on FPLAs: #82S100 (TriState) & #82S101 (Open Collector).

Name \_\_\_\_\_

Tel \_\_\_\_\_

Ext \_\_\_\_\_

Call me with sample part quote.

THINK

# Signetics

811 E. ARQUES, SUNNYVALE, CALIF 94086

INFORMATION RETRIEVAL NUMBER 73

**1**  
AMERICAN MADE  
**Tolerance**  
**SCHAUER**  
**1-Watt**  
**ZENERS**

**Immediate Shipment**  
**Low Prices**

ANY voltage from 2.0 to 16.0

Quantity	Price each
1-99	\$1.07
100-499	.97
500-999	.91
1000-4999	.86
5000 up	.82



All welded and brazed assembly

No fragile nail heads

Gold plated leads

Write for complete rating data and other tolerance prices.

**Buy the kit-**  
**Save a lot**



Kit contains a 51-piece assortment of SCHAUER 1% tolerance 1-watt zeners covering the voltage range of 2.7 to 16.0. Three diodes of each voltage packaged in reusable poly bags. Stored in a handy file box. Contact your distributor or order direct.

A \$54.57 value for  
**ONLY \$24<sup>50</sup>**

Semiconductor Division

**SCHAUER**  
Manufacturing Corp.

4511 Alpine Ave. Cincinnati, Ohio 45242  
Telephone: 513/791-3030

**MICROWAVES & LASERS**

**Log periodic antenna spans 1 to 18 GHz**

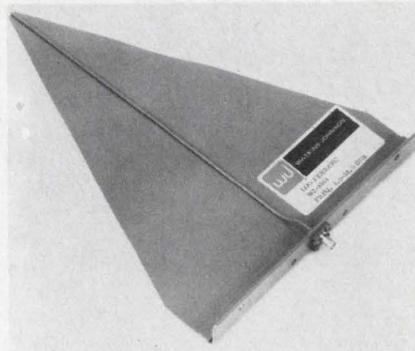

Watkins-Johnson Co., 3333 Hillview Ave., Palo Alto, CA 94304. (415) 493-4141.

The WJ-8344 log periodic antenna operates over the 1-to-18-GHz frequency range. It features a VSWR of less than 2:1 from 1 to 12 GHz and 3.2:1 from 12 to 18 GHz. Gain ranges from 5 to 8 dB with frequency. The antenna weighs less than 4 oz.

CIRCLE NO. 354

**Digital attenuator ensures monotonic steps**

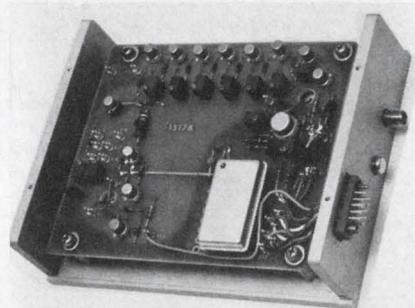

Anaren Microwave Inc., 185 Ainsley Dr., Syracuse, NY 13205. (315) 476-7909. \$1925 (1-4).

The Model 61060 digital attenuator ensures precision monotonic attenuation steps, regardless of the size of the step. Performance specs include a frequency of 8.5 to 9.6 GHz, an insertion loss of -5 dB max and a switching speed of 25  $\mu$ s max. The unit covers the -20 to +65 C temperature range with an attenuation range of 0-to-64 dB above insertion loss. It has an attenuation linearity of  $\pm 0.05$  dB over attenuation and temperature range, and an attenuation flatness of  $\pm 0.3$  dB max. over the attenuation range. Phase shift with attenuation is  $\pm 10^\circ$  max.

CIRCLE NO. 355

**30-MHz acoustic line has 220- $\mu$ s delay**

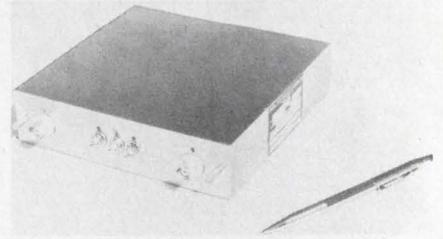

Walter M.A. Andersen & Associates, Inc., 4 Main St. Extension, Tariffville, CT 06081. (203) 658-7666.

An acoustic delay line featuring fused quartz in a hermetically sealed temperature-controlled oven offers a nominal delay time of 222.2  $\mu$ s. Called Model 0345, the unit has a center frequency of 30 MHz and a bandwidth of 8 MHz at the 6-dB points. Delay tolerance is  $\pm 0.1 \mu$ s, while delay variation is less than  $\pm 0.1 \mu$ s over the operating temperature range of -40 to +80 C. Insertion loss is 31 dB  $\pm 3$  dB into a 470- $\Omega$  load. Zero and third time responses are  $\geq 20$  dB below the main signal, while spurious responses are  $\geq 40$  dB.

CIRCLE NO. 356

**Isolator aims for comm uses**

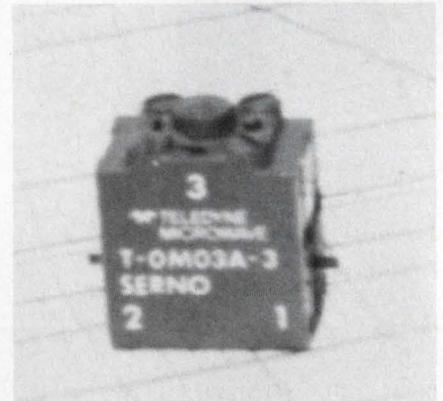

Teledyne Microwave, 1290 Terra Bella, Mountain View, CA 94043. (415) 968-2211.

Covering the 900-to-930-MHz communications band, the Model T-OMO3A-3 plug-in stripline isolator provides 23-dB minimum isolation. Insertion loss is 0.4 dB maximum and VSWR is 1.15:1 maximum. The unit weighs only 1 oz and it measures  $3/4 \times 3/4 \times 1/2$  in. Operating temperature range is -30 to +70 C.

CIRCLE NO. 357

## Spiral antenna spans 0.5 to 22 GHz

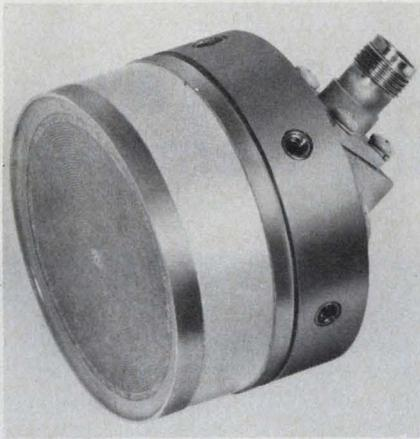

American Electronic Laboratories, Inc., P.O. Box 552, Lansdale, PA 19446. (215) 822-2929. \$395; 8 wks.

A cavity-backed Archimedes-spiral antenna features a frequency range of 500 MHz to over 22 GHz. The small antenna has a diameter of only 2.38 in. The antenna's polarization is linear at frequencies up to 1.2 GHz and circular from 2.2 up to 22 GHz; elliptical polarization prevails between 1.2 and 2.2 GHz. The antenna has an axial ratio of typically 2 dB at boresight, 10-dB beamwidth of typically 125° and 0-dBI gain only from 2 to 22 GHz. VSWR is nominally 2.5:1.

CIRCLE NO. 358

## IC simplifies FM front ends

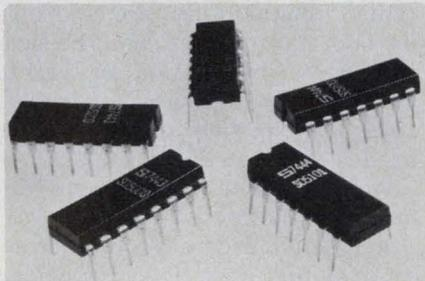

Signetics, 811 E. Arques Ave., Sunnyvale, CA 94086. (408) 739-7700. \$1.05 (100 up).

Containing an rf amplifier and mixer, the SD6000 D-MOS IC is specifically designed for FM front-end applications. The unit comes in an eight-pin plastic package and it can be incorporated into varactor or conventional FM tuners. Power gain at 100 MHz is 30 dB minimum with a typical noise figure of 2.5 dB.

CIRCLE NO. 359

## Integration-Datel Style HYBRID CONVERTERS

12 Bit, 8  $\mu$ sec A/D Converter \$49.00\*  
12 Bit, 3  $\mu$ sec D/A Converter \$24.00\*



Datel's new Hybrid Converters offer high performance in dual-in-line hermetically sealed packages and are complete. Highly stable laser trimmed thin film resistors and fast settling current switches provide monotonicity over a 0°C to 70°C temperature range plus nonlinearity errors of no greater than  $\pm 1/2$  LSB. Both models have  $\pm 30$  ppm/°C temperature stability and offer pin-programmable voltage ranges of 0 to +5V, 0 to +10V,  $\pm 2.5$ V,  $\pm 5$ V,  $\pm 10$ V. Also available in MIL-temperature range models.

### ADC-HY12BC

- 12 Binary Bit Resolution
- Programmable short-cycle operation
- 8  $\mu$ sec maximum conversion time
- 100 megohms input impedance, buffered
- \*PRICE  
\$79 (1-49)  
\$49 (100's)

### DAC-HY12BC

- 12 Binary Bits or 3 BCD Digits
- Current or voltage outputs
- 300 nsec current settling
- 3  $\mu$ sec voltage settling
- TTL compatible inputs
- \*PRICE  
\$29 (1-49)  
\$24 (100's)

**D** **DATTEL**  
SYSTEMS, INC.

1020 Turnpike St. Canton, Ma. 02021  
Tel. (617) 828-8000

SANTA ANA, CALIF. (714) 835-2751 • SANTA ANA, CALIF. (LA EXCHANGE) (213) 933-7256  
SUNNYVALE, CALIF. (408) 733-2424  
INFORMATION RETRIEVAL NUMBER 75

## If it's a thick film resistor network...

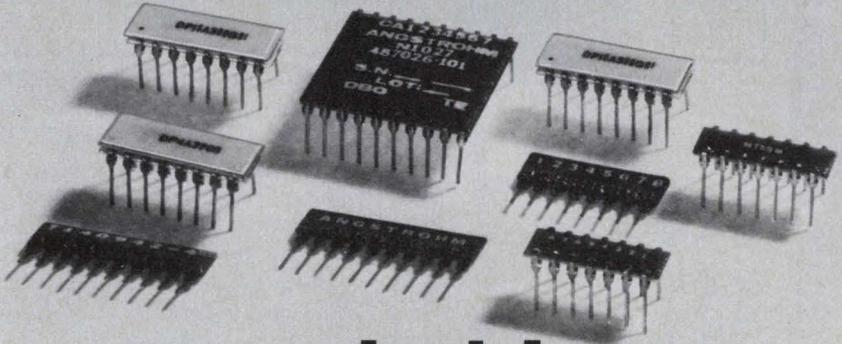

## we make it!

SIPs, DIPs, Binary Ladders, all manufactured to meet the most critical specifications. SIPs and DIPs are offered in tolerances up to  $\pm 1\%$ , Binary Ladders to  $\pm 1/2$  LSB. What's more, we can provide custom resistor networks in almost any configuration to the very tightest tolerances possible. Write for complete technical details today.



**angstrom precision, inc.**

one precision place/hagerstown, maryland 21740  
telephone: 301-739-8722 twx: 710-853-6834

INFORMATION RETRIEVAL NUMBER 76

**DATA ACQUISITION YOUR PROBLEM? WANT THE BEST PRICE/PERFORMANCE YOU CAN BUY?**

Fill in the empty block with our SERIES 2500 Amplifier/Filter per Channel Data Acquisition System. It offers high accuracy at very fast throughput rates, low noise and excellent CMR.

*You'll be amazed at its price/performance ratio!*

SENSOR

?

COMPUTER

Get more MUX For your BUS or Testim

We provide the greatest choice in Data Acquisition front ends in the business. Before you specify your next Data Acquisition System, give us a call and let us prove it.

1431 E. ST. ANDREWS PLACE  
SANTA ANA, CA. 92705  
(714) 549-0391

**TUSTIN**  
ELECTRONICS COMPANY

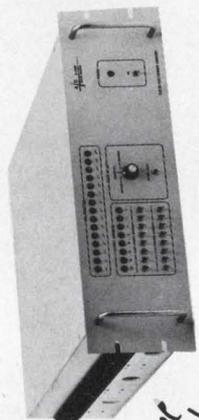

**INTEGRATED CIRCUITS**

# Fully monolithic 12-bit a/d contains all active elements

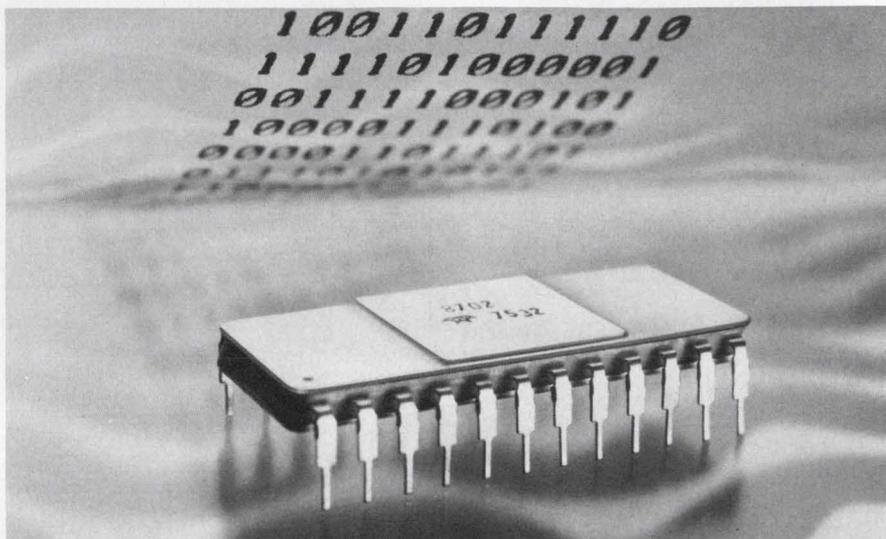

Teledyne Semiconductor, 1300 Terra Bella Ave., Mountain View, CA 94043. (415) 968-9241. See text: sample quantities available now, production in January, 1976.

A totally monolithic 12-bit CMOS a/d converter that requires no external active elements, except for a voltage reference and a power supply, uses a charge-balancing conversion technique.

Because of its CMOS construction, the converter—the 8702, from Teledyne Semiconductor—dissipates only 20 mW, typically. With an operating temperature range of -40 to +85 C, it exhibits a gain temperature coefficient of better than 10 ppm/°C. Zero drift is typically better than 30  $\mu$ V/°C.

The major limitation of the converter is its slowness. Since it uses charge balancing, the conversion time is typically 20 ms.

The closest competitor to the 8702 appears to be the AD1210 from National Semiconductor (Santa Clara, CA). The AD1210 is also a CMOS a/d. But it is a hybrid circuit that contains three chips in a metal 24-pin DIP.

The main advantage of the National converter is its 50- $\mu$ s conversion time, achieved with a successive-approximation circuit. Dis-

sipation, though, is somewhat higher—75 mW at 15 V. The Teledyne converter runs at a single voltage of between 3.5 and 7 V. National's unit can also run on a single power supply as low as 3 V.

Both converters require an external reference voltage but no external comparator.

Output coding is latched parallel binary. Either low-power TTL or CMOS compatibility are available on both the outputs and the control inputs. In addition an infinite choice of input ranges is possible, since any positive voltage can be applied via a scaling resistor.

Accuracy and linearity are defined as follows:

- Relative accuracy—the output error at the exact midpoint of the straight line from zero to full input,  $\pm 1/2$  LSB.

- Differential nonlinearity—deadband width in resolving 1 LSB transition,  $\pm 1/4$  LSB.

The 8702 is available in a 24-pin ceramic DIP. A plastic package will follow.

The price is \$29.50 in 100-piece quantities. Versions will also be available with outputs of 8 or 10 bits.

For Teledyne  
For National

CIRCLE NO. 305  
CIRCLE NO. 306

## CMOS watch ICs contain LED drivers

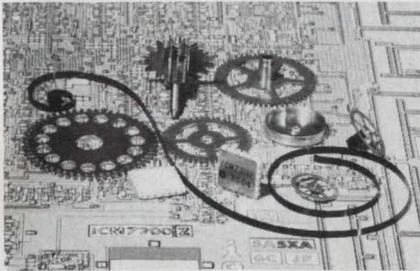

Intersil Inc., 10900 N. Tantau Ave., Cupertino, CA 95014. (408) 996-5000. \$22 to \$29 (100-999).

Two CMOS watch circuits, for use with LED displays, contain digit and segment drivers on the same chip. The ICM7200 provides a readout of hours, minutes, day, date and seconds. The ICM202, a numeric-only version of the 7200, interfaces with existing seven-segment LED displays. The ICs require a 32-kHz quartz crystal and one trimming capacitor to complete the oscillator circuit. When the circuits are powered by two silver-oxide batteries they typically require 6 mA per segment at 25% duty cycle with seven segments on. Both ICs come in 24-pin DIPs.

CIRCLE NO. 360

## 16-k ROM guarantees 550-ns access

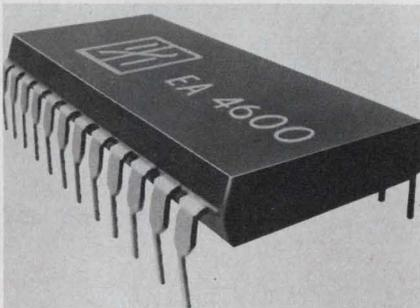

Electronic Arrays, 550 E. Middlefield Rd., Mountain View, CA 94043. (415) 964-4321. \$29.90 to \$36.20 (100); 8 wks.

A 16-k-bit ROM combines a guaranteed worst-case access of 550 ns with operation from a single 5-V supply. Organization of the EA4600 is  $2048 \times 8$  bits, convertible to  $4096 \times 4$ . The ROM has three-state TTL-compatible outputs that can be OR-wired. Power dissipation is only 0.03 mW per bit, and the memory comes in a 24-pin DIP.

CIRCLE NO. 361

# 3 HIGH VOLTAGE IDEAS FROM VICTOREEN.

## TRANSIENT VOLTAGE MEETS ITS MASTER: VICTOREEN SPARK GAPS.

If you're looking for a way to capture line transients that could damage sensitive solid state power supplies or other circuitry which is easily damaged by transients, our SGL spark gap is your answer. Excellent primary protection can be achieved without a need for complicated line conditioners. Line transients with pulse widths of 75 nsecs to 1 msec will be detected. Nominal firing voltage is 215VAC peak with ramp rates of 100V sec. Energy dissipation capability of a single pulse is 65 joules. Try it our way. Victoreen spark gaps are available with DC firing voltages from 150-25kV.

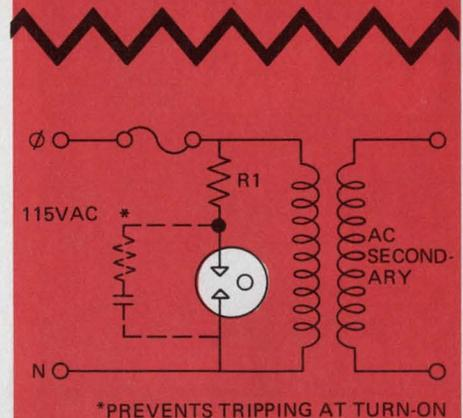

## HOW TO SIMPLIFY HIGH VOLTAGE REGULATION IN POWER SUPPLIES.

A need for fewer components is always appreciated. So, when regulating circuits where high voltage and current are required, try the excellent performance of Victoreen's HV Regulating Diodes. By combining a Victoreen 7235 triode with a GV3A-1200, a regulated range of 3-5 milliamps is achieved. Regulation of better than 0.2% is obtainable over the usable current range. Reliable regulation over a wide temperature span can be expected with a maximum temperature coefficient of 0.015%/°C from -65° C to +125° C. High voltage regulation is simple, our way.

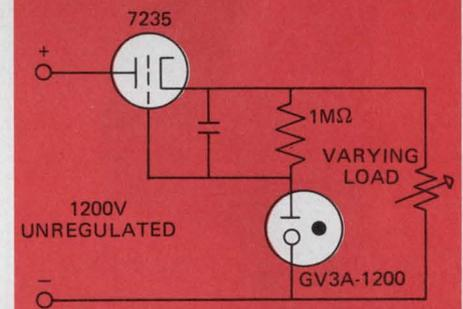

## MINI-MOX CAN TAKE IT. FROM -55° C to +125° C.

The Explorer 'C' satellite is now analyzing ultraviolet absorption in the upper atmosphere. Aboard are a Magnetic Ion Mass Spectrometer and a Retarding Potential Analyzer. In the RPA, Victoreen Mini-Mox resistors provide feedback in an auto-ranging electrometer where temperatures can vary an incredible -55°C to +180°C. But performance over a wide temperature range is only one of the many outstanding characteristics of the Mini-Mox resistor. For new design freedom in stable and dependable high voltage circuitry, explore Mini-Mox. Off-the-shelf from Victoreen.

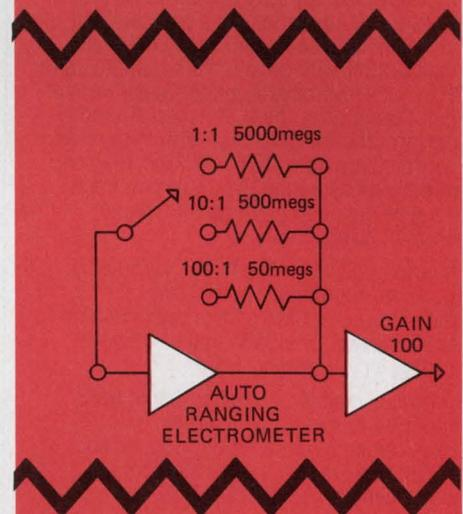

Victoreen Instrument Division,  
Sheller-Globe Corporation,



10101  
Woodland Avenue,  
Cleveland,  
Ohio 44104  
WATS Line:  
1-800-321-9990

SG SHELLER-GLOBE CORPORATION

# Ride the Crest

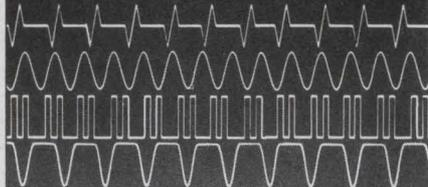

## with Intronic's R501 RMS Module

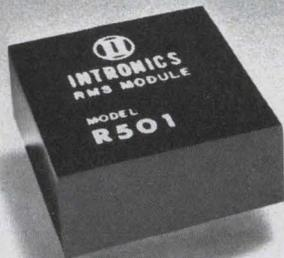

$$E_1(\text{RMS}) = \sqrt{\frac{1}{T} \int_0^T (E_1)^2 dt}$$

For accurate and reliable true RMS measurement, specify the Intronic's R501 RMS to DC converter. This compact unit provides outstanding accuracy of better than 0.25% with crest factors ranging up to 10:1, at a low industry price. Regardless of input waveform, these units will smoothly perform the RMS function with frequency components from DC to 100kHz. They will directly measure the RMS value of inputs even where an AC voltage is riding on a DC level.

If your application is audio or vibrational noise measurement, pulse train measurement, RMS sensor regulation or the front end for a DVM, it'll be smooth sailing with Intronic's R501.

Intronic makes a complete line of RMS modules to meet your specific requirements. Send for our new catalog, or for immediate assistance call Rich Sakakeeny at (617) 332-7350.

  
**intronic**

57 Chapel Street, Newton, Massachusetts 02158 U.S.A.  
(617) 332-7350, TWX 710-335-6835

Overseas call:  
Brussels, Belgium (02) 513-73-84  
Kent, England Maidstone 54224/6  
Orsay, France 9077844  
Munich, Germany 524181  
Tel-Aviv, Israel (03) 415645  
Cernusco, Italy 9041319  
The Hague, Netherlands 678380  
Wallisellen, Switzerland 01/8303161

INFORMATION RETRIEVAL NUMBER 79

## INTEGRATED CIRCUITS

### 16-k ROM has 600-ns access

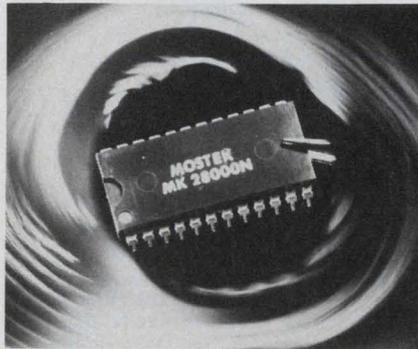

Mostek Corp., 13300 Branch View Lane, Dallas, TX 75234. (214) 620-2454. \$13.50 (1000); 6 wks.

A 16,384-bit MOS ROM—the MK2800—features a maximum access time of 600 ns and it doesn't require address lead time. Pin-compatible with Electronic Arrays' EA4900, the MK2800 has a power dissipation of typically 320 mW in the active mode and typically 110 mW in the standby mode. The PMOS memory can be organized as either a 2-k × 8-bit or 4-k × 4-bit unit, and it comes in a 24-pin DIP.

CIRCLE NO. 362

### Calculator ICs meet wide requirements

Rockwell International Corp., P.O. Box 3669, Anaheim, CA 92803. (714) 632-3729.

Three pin-compatible, single-chip calculator ICs reportedly provide the display and functional variety of virtually all present models having five-function through basic slide-rule features. All circuits have on-chip, direct segment and strobe drive for either LED or fluorescent 8-digit displays—a calculator first. Total supplemental requirements are one resistor for frequency control and eight or nine resistors, respectively, for LED or fluorescent displays. The most powerful circuit—the P/N A550X—provides basic calculating functions plus an accumulating memory with six functions. Other features include parentheses, square root and percent with automatic mark-up and discount. At the low end of the set is a five-function circuit—the P/N A591X.

CIRCLE NO. 363

### 5-V supply operates 4 × 80-bit register

SGS-ATES Semiconductor Corp., 435 Newtonville Ave., Newtonville, MA 02160. (617) 969-1610. \$5.20 to \$10.40 (100-999); stock.

Four 80-bit static shift registers constitute the M 142, a silicon-gate NMOS IC that needs only a single 5-V supply. Each 80-bit register has its own control input. Operating frequency ranges from dc to 3 MHz. The M 142 comes in a 16-lead package.

CIRCLE NO. 364

### D/a converter has linearity of 0.05%

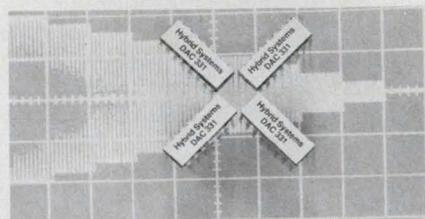

Hybrid Systems Corp., 87 Second Ave., Burlington, MA 01803. (617) 272-1522. \$9.90 to \$19.00 (1-9); stock to 2 wks.

Two d/a converters, the DAC-331-8 and the DAC331-10, use laser-trimmed thin-film networks to obtain respective linearities of 0.2% and 0.05%. The inputs accept signals with frequencies ranging from dc to over 100 kHz. Stability is better than 1-2 ppm/°C for the rated linearity and over the standard operating temperature range of 0 to 70 C. Internal CMOS switches require less than 20 mW of power.

CIRCLE NO. 365

### 4-bit S-TTL counters operate at 50 MHz

Advanced Micro Devices, Inc., 901 Thompson Pl., Sunnyvale, CA 94086. (408) 732-2400. \$1.82 (100).

A series of low-power Scottky-TTL counters operate at typical speeds of 50 MHz. These synchronous four-bit units—the Am 25LS-160 series—have a guaranteed worst case limit of 35 MHz and a minimum data hold time of 3 ns. Other features include a fan-out of 22 and 50-mV noise immunity over the full-MIL-temperature range.

CIRCLE NO. 366

## DATA PROCESSING

### Graphics terminal available for \$3795

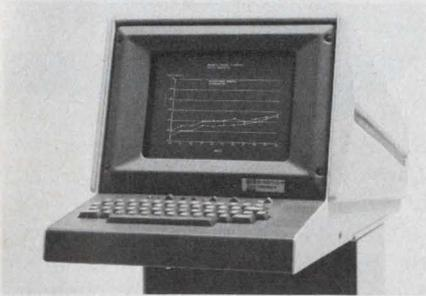

*Tektronix, P.O. Box 500, Beaverton, OR 97005. (503) 644-0161.*

Two reduced-price graphics terminals are the E4010 and E4010-1, or hard copy compatible version. The E4010, at \$3795, costs \$400 less than the present 4010 terminal. The E4010-1, at \$3995, is \$700 less than the 4010-1. Both units have all of the original features except thumbwheels to control the cross-hair cursor. Graphic input is through the keyboard. The E4010 and E4010-1 have 11-in. flicker-free storage tubes, 63-character ASCII sets (upper case), and 1024 × 1024 addressable points. All Tektronix interfaces, options and peripherals (with the exception of the 4952 joystick) are compatible with the terminals.

CIRCLE NO. 367

### Calculator vocalizes data entries and results

*Master Specialties Co., 1640 Monrovia Ave., Costa Mesa, CA 92627. (714) 642-2427. \$565.*

MSC's new ARC 9500 audio-response calculator talks to you with its solid-state natural-sounding synthesized voice. It announces each entry and the results of every calculation in a loud, clear voice, according to the manufacturer. Talking calculators are used in the vocational education of the blind and in the reinforcement of basic math concepts for sighted students. In addition, sighted users find that it permits them to concentrate full visual attention on the input figures being entered without having to shift attention back and forth to look at the visual display. The ARC 9500 is an eight-function calculator and also has an eight-digit visual display.

CIRCLE NO. 368

Victor now offers you a ready source of high quality, competitively priced miniature connectors...ruggedly built for reliable performance. Currently being used on portable, rechargeable calculators and similar small, solid state equipment. Standard configurations incorporate strain relief, but your cord set can be custom designed to your specifications...with or without strain relief.

Write or phone for details, and find out why Victor has become the standard of quality in cord sets and other wire specialty items.

**Victor Electric Wire & Cable Corp.**  
618 Main St., West Warwick, Rhode Island  
02893  
Telephone: 401 821-1700



**New  
miniature  
connector.**

**Standard and  
custom designs  
in male & female  
configurations.**

INFORMATION RETRIEVAL NUMBER 80



**hot  
stuff**

or cold, CHR's family of TEMP-R-TAPE of Kapton provides outstanding endurance. They retain their excellent mechanical and electrical properties over a wide temperature range, -100 to +500F.

Available in thicknesses from .001" to .0045" with a choice of several adhesive systems including adhesive two sides.

Find your CHR distributor in the Yellow Pages under "Tapes, Industrial" or in industrial directories. Or write for complete specification kit and sample. The Connecticut Hard Rubber Company, New Haven, Conn. 06509.



an ARMCO company

INFORMATION RETRIEVAL NUMBER 81

**DATA PROCESSING**

**Data-acquisition circuit optimizes DMA transfer**

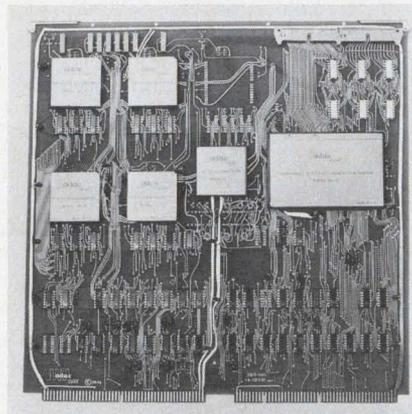

ADAC Corp., 29b Cummings Park, Woburn, MA 01801. (617) 935-6668. \$2500: 16 channels; 4 wks.

The ADAC Model 550-DGC data-acquisition and control system with direct memory access (DMA) contains a 12-bit a/d converter with high speed sample and hold. Throughput is 100,000 channels/s. When coupled with the DMA feature, the system provides a maximum transfer rate between external devices and the computer's memory. The Model 550 is both software and mechanically compatible with the Nova, Eclipse, 800 and 1200 series of minicomputers from Data General. The 550 can contain up to 64 channels of multiplexer inputs, which can be single ended or pseudo-differential or have 32 channels of true differential inputs.

CIRCLE NO. 369

**Cassette duplicator copies 100 ft in 30 s**

Sunrise Electronics, 228 N. El Molino, Pasadena, CA 91101. (213) 793-7552. \$2100 (1 to 5).

The D-200 cassette-to-cassette duplicator has a typical copy time of 30 s for a 100-ft cassette. Both tracks in all popular formats can be copied at the same time. The system meets the standards for Philips-type computer cassettes and is expandable by the addition of slaved copy stations. Signal and control inputs and outputs are available at a receptacle in the rear of the machine for slave operation and remote control.

CIRCLE NO. 370

**Modem compatible with Bell's 201 C**

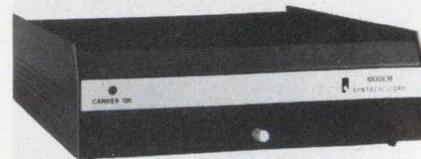

Syntech Corp., 11810 Parklawn Dr., Rockville, MD 20852. (301) 770-0550.

A Bell-201C-compatible modem, the Syntech TT-201C, is a medium speed synchronous unit capable of operating at either 2000 or 2400 bps over the direct-dial telephone network. The modem features an answer-back tone for use with auto-dial systems. Internal strap options permit users to select among a wide variety of configurations and operating modes. The complete modem consists of two PC cards housed in a stand-alone enclosure with integral power supply.

CIRCLE NO. 371

**Scientific calculator is programmable**



Sinclair Radionics, Inc., 375 Park Ave., New York, NY 10022. (212) 688-6623. \$79.95

The first programmable calculator to operate on a single IC, and also the first to sell for under \$80, has only 19 keys. It can remember a sequence of 24 steps as entered directly from the keyboard. And the sequence can be recalled at the touch of a single key. The calculator comes with a library of hundreds of programs, complete instructions on how to use them, a 9-V battery, ac adapter and carrying case.

CIRCLE NO. 372

## Shirt-pocket cartridge performs as larger unit



Hewlett-Packard, 1501 Page Mill Rd., Palo Alto, CA 94304. (415) 493-1501.

3M engineers worked closely with Hewlett-Packard to produce a shirt-pocket cartridge that performs like the larger 3M DC-300-A, though only one-third the size. The cartridge measures only 3 by 2-1/2 by 1/2 in., and it contains 140 ft of tape 0.15-in. wide. It can record more than 100,000 bytes on one track. Within the mini-cartridge, an elastic belt along the surfaces of the two tape reels drives the tape, so both speed and tension are kept constant. The mini-cartridge records at a density of 800 bpi and has a transfer rate of 8000 bits/s at a tape speed of 10 in/s.

CIRCLE NO. 373

## Tape punch operates quietly with step motor

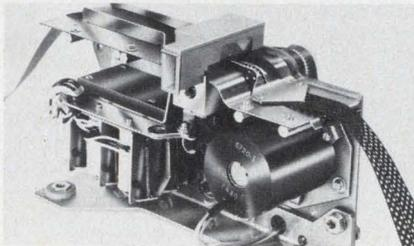

Data Specialties Inc., 3455 Commercial Ave., Northbrook, IL 60062. (312) 564-1800.

The EP series tape punch advances the tape with a stepping motor. This approach provides quiet operation, and eliminates the need for intermediate levers, links, clutches, ratchets and pawls, and the problems associated with complex mechanical elements. The die block can be replaced in less than a minute and no adjustments are required. The block can operate for a minimum of 120-million punch cycles, which is the equivalent of 1000 rolls of tape. And the unit can handle all types of tape—Mylar, oiled or unoled paper and folded or rolled tapes.

CIRCLE NO. 374

## Disc files improve $\mu$ P program development



Millennium Information Systems Inc., 420 Mathew St., Santa Clara, CA 95050. (408) 243-6652. \$5250; 30 days.

A program development system for the 8008 and 8080 microprocessors consists of the Intellec 8, an ASR-33 Teletype, an optional high speed printer, a dual drive floppy disc subsystem and features a microcomputer disc operating system called MDOS. The systems capabilities of MPD-1000 for program development are similar to that of a disc-based minicomputer system. MDOS provides the user with total file management capability and a complete set of user commands. The Text Editor and Macro Assembler incorporated into MDOS are the latest versions of the standard Intel supported programs.

CIRCLE NO. 375

In a hurry?  
try these high-performance  
**A·C·E** All-Circuit Evaluators

All solderless plug-in tie-points

7 models for fast building and testing of circuits

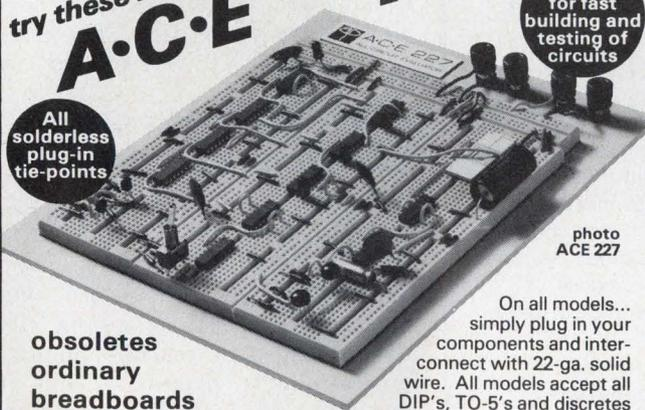

photo ACE 227

obsoletes ordinary breadboards

On all models... simply plug in your components and interconnect with 22-ga. solid wire. All models accept all DIP's, TO-5's and discretes with leads up to .032" diameter.

Order No.	ACE Model No.	Tie Points	DIP Capacity	No. Buses	No. Posts	Board Size (inches)	Price Each
923333	200-K (kit)	728	8 (16's)	2	2	4-9/16 x 5-9/16	\$18.95
923332	208 (assem.)	872	8 (16's)	8	2	4-9/16 x 5-9/16	28.95
923334	201-K (kit)	1032	12 (14's)	2	2	4-9/16 x 7	24.95
923331	212 (assem.)	1224	12 (14's)	8	2	4-9/16 x 7	34.95
923326	218 (assem.)	1760	18 (14's)	10	2	6-1/2 x 7-1/8	46.95
923325	227 (assem.)	2712	27 (14's)	28	4	8 x 9-1/4	59.95
923324	236 (assem.)	3648	36 (14's)	36	4	10-1/4 x 9-1/4	79.95

Quick phone service — call distributor number nearest you:

201/381-5700 215/698-4000 313/525-1800 415/969-9240 714/279-5281  
206/682-5025 216/587-3600 314/863-7800 513/236-9900 714/549-8611  
213/971-3721 303/761-7870 412/782-2300 617/879-0860 914/664-0088

If no distributor in your area — call the factory.



All products guaranteed to meet or exceed published specifications

**AP PRODUCTS INCORPORATED**

Box 110-F • Painesville, OH 44077 • 216/354-2101

## MEMORY SERIES NO. 14 6 THINGS TO DO WITH OUR FPLA'S.

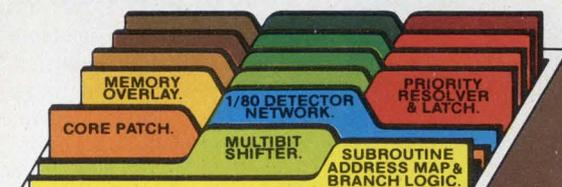

(BET YOU'LL THINK UP MORE.)

Just a few applications where the 16 inputs, 50ns speed, and optimized chip enable of our Field Programmable Logic Arrays provide major design/performance improvements.

Coupon clipped to letterhead gets you detailed applications data on FPLAs #82S100 (TriState) & #82S101 (Open Collector).

Name \_\_\_\_\_

Tel \_\_\_\_\_

Ext \_\_\_\_\_

Rush me sample parts quote.

THINK

**Signetics**

811 E. ARQUES, SUNNYVALE, CALIF. 94086

INFORMATION RETRIEVAL NUMBER 82

ELECTRONIC DESIGN 21, October 11, 1975

INFORMATION RETRIEVAL NUMBER 83

131

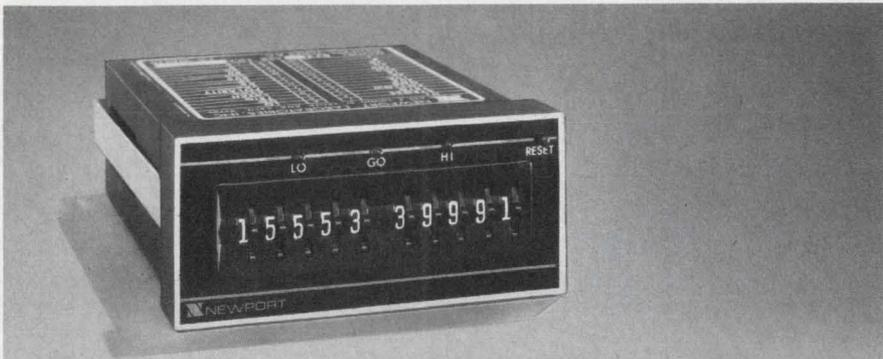

## NEWPORT'S CONTROLLER CONVERTS YOUR DATA INTO ACTION . . .

- Single or dual switching points
- Comparison to  $\pm 39999$  or  $99999$
- Two position hysteresis control
- Form C relays with 2A rating
- Input data tracked or sampled
- Continuous or latched decisions
- DIN or NEMA case
- Priced from \$115.

The new series 870 Controllers compare BCD or binary inputs with thumb-wheel switch settings and provide logic level outputs and contact closures for process control. Controller status indicated by HI, LO, and GO LED colored lights. Control action is now ensured with digital voltmeters, pyrometers, counters, and process monitors.

**For complete data call or write:**  
Newport Laboratories, Inc., 630 East Young Street, Santa Ana, CA 92705  
Call collect (714) 540-4686  
In Netherlands, call:  
Amsterdam (20) 45-20-52  
In W. Germany, call:  
Sprendlingen 6103-63041



INFORMATION RETRIEVAL NUMBER 84

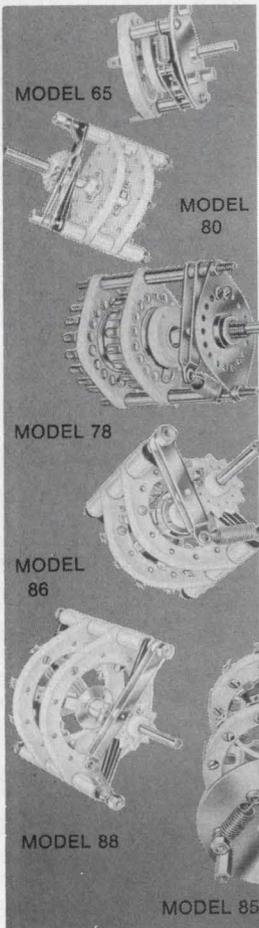

## A complete line of CUSTOMIZED ROTARY CERAMIC SWITCHES...

For RF and POWER APPLICATIONS

RSC switches are available in a variety of switching models. RSC high precision, quality built units are designed for applications requiring long life maintenance-free service. Types include shorting and non-shorting, single and multi-deck, up to 18 pole positions. Features include, 10 to 100 amp current carrying capacity, 20° to 90° detents, 2000 to 24000 volts flashover and corrosion-proof construction.

Write for catalog no. 960  
and complete information.



**RADIO SWITCH CORPORATION**

Rt. 79, Marlboro, N. J. 07746

## DATA PROCESSING

### Modem features LSI and built-in equalizer

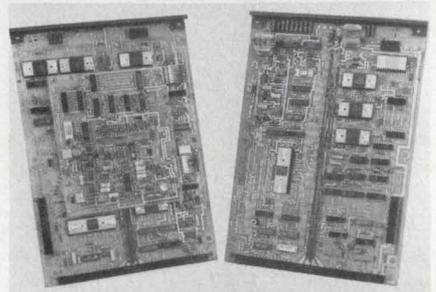

*Paradyne Corp., 8550 Ulmerton Rd., Largo, FL 33540. (813) 536-4771. \$2000 to \$3000 (OEM qty).*

The LSI-96 is a two-board, PC-set transparent modem that uses two and four-level AM-VSB modulation to provide 4800 and 9600 bps operation over voice-grade lines. It employs a 60-tap transversal automatic equalizer to allow operation on 3002 lines without C-conditioning. The bit-error rate at 9600 bps is equal to or better than  $10^{-6}$  at a signal-to-noise ratio of 22 dB on typical channels; at 4800 bps it is equal to or better than  $10^{-6}$  at a signal-to-noise ratio of 15 dB. Paradyne claims that this is the best performance available on any 4800/9600 modem and ascribes it to the modulation and equalization techniques made possible by use of the LSI technology.

CIRCLE NO. 376

### 4-bit microprocessor sells for under \$100

*Pro-Log Corp., 852 Airport Rd., Monterey, CA 93940. (408) 372-4593. See text.*

The PLS-401A, a one-card, 4004 microprocessor-based system for use in dedicated control and data processing, is priced at \$99 in quantities of 500 and up. It includes a microprocessor, crystal-controlled clock with better than 0.01% accuracy, an 80-character RAM with 320-character capacity, and external power-on reset. It has 16 TTL-input lines, 16 TTL-output lines and 4 MOS-output lines. Operating temperature range is 0 to 70 C. Instruction cycle times are 11.20  $\mu$ s. The card is 4.5 x 6.5 in. with a 56-pin edge-connector on 0.125-in. centers. It uses +5 and -10 V dc.

CIRCLE NO. 377

# Dc/dc converter shrugs off 6:1 input voltage changes

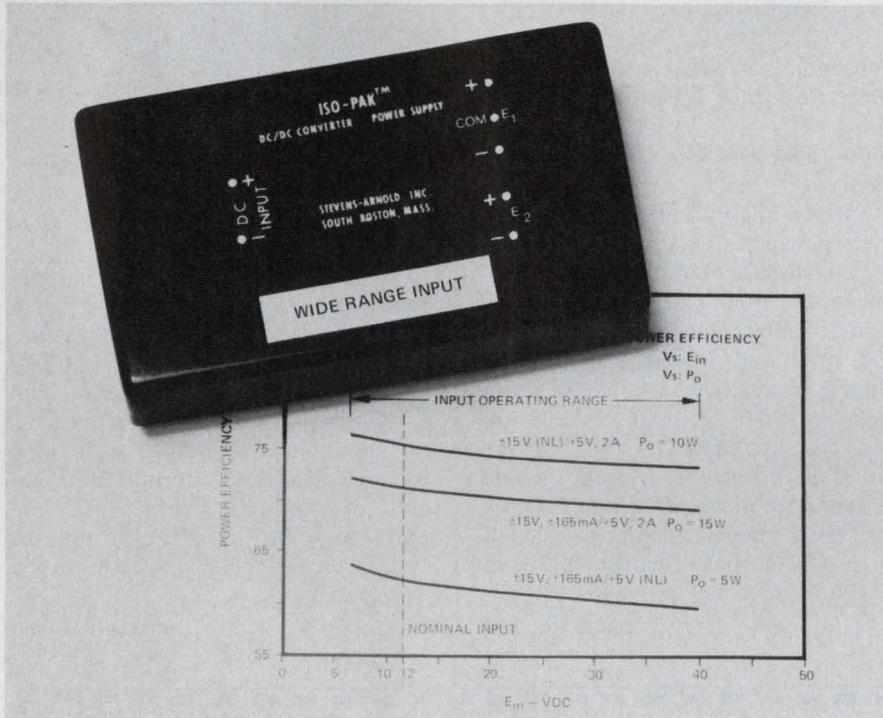

Stevens-Arnold, 7 Elkins St., South Boston, MA 02127. (617) 653-0355. 15-W Model (1-9): \$114; stock to 6 wks.

By combining a dc/dc converter with a switching regulator, Stevens-Arnold has come up with a triple-output power module that operates over a 6:1 input voltage range. That makes the WC series probably the widest-input-range converter available today. The series works over a 6.5-to-40-V-dc input, with output and other important specifications remaining substantially constant over the range. Output is 5 V at 2 A and  $\pm 15$  V at  $\pm 165$  mA.

Importantly, as the 12-V nominal input varies, the Stevens-Arnold supply stays efficient. That is, 68% to 73% of the power going into the module comes out as useful power as the line varies over the 6:1 range. Nominal efficiency is 71%. The implications of high efficiency are, of course, cooler operation and longer life for the battery that powers the converter. Also, the wide variations allowed for the battery voltage lengthen

the backup, or operate, time still further.

Other benefits: longer intervals between charges when rechargeable batteries are used, or the possibility of using low-cost dry cells as the prime source. The cells' output remains usable until their voltage drops to about half the starting level.

Key specs of the convection-cooled WC include an operating temperature range of  $-25$  to  $71$  C, with no derating or heat sink needed, and a tempco of  $\pm 0.005\%/^{\circ}\text{C}$  on the dual and  $\pm 0.01\%/^{\circ}\text{C}$  on the single output. Case temperature rise is  $25$  C at full load and 12-V input. Full load and line regulation are both  $\pm 0.05\%$  for  $\pm 15$ -V section. For the 5-V output, full-range line regulation is  $\pm 0.2\%$ , while no-load to full-load regulation is  $\pm 0.1\%$ .

All outputs of the Stevens-Arnold unit are protected against shorts. A number of source and load restrictions apply to the WC series so check the spec sheet carefully before you use the unit.

CIRCLE NO. 302

# ATC 100 SERIES QPL CAPACITORS

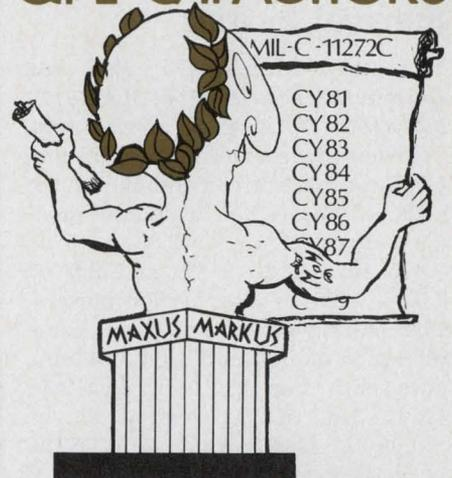

## NOW HEAR THIS..

ATC 100 UHF/Microwave Capacitors have been QPL approved since June 1974 in the following types:

- CY81 -Case A chip
- CY82 -Case A pellet
- CY83 -Case B chip
- CY84 -Case B pellet
- CY85 -Case B microstrip
- CY86 -Case B axial ribbon
- CY87 -Case B radial wire
- CY88 -Case B radial ribbon
- CY89 -Case B axial wire



## FOR INFORMATION...

just circle the number below.

For samples of any ATC 100 UHF/Microwave Capacitors, call Ralph Wood (516) 271-9600.



ONE NORDEN LANE,  
HUNTINGTON STATION, N.Y. 11746  
(516) 271-9600 • TWX 510-226-6993

INFORMATION RETRIEVAL NUMBER 85

## POWER SOURCES

### Potted modules feature thermal barrier

The Power Supply Co., Inc., 262 Border St., East Boston, MA (617) 569-6450. \$39 to \$79; stock-2 wks.

Seven models in single, dual and triple outputs are available in the new PS series encapsulated modules. Package size is 2.5 × 3.5 × 0.875 in., up to 2 W, and 2.5 × 3.5 × 1.25 in. for higher powers. The single-output supplies come in +5 V at 500 and 1000-mA outputs with line ( $\pm 10\%$ ) and load (N.L. to F.L.) regulation of  $\pm 0.05\%$ . Dual-output units come in  $\pm 12$  V at 100 mA and  $\pm 15$  V at  $\pm 50$ , 100 and 200 mA, with line and load regulation of  $\pm 0.01\%$ . A triple-output model provides 5 V at 500 mA and  $\pm 15$  V at  $\pm 100$  mA with line and load regulation of  $\pm 0.05\%$ . Output impedance for all models at 10 kHz is 0.05  $\Omega$ . Tempo is  $\pm 0.01\%/^{\circ}\text{C}$ ; and noise and ripple are 1 mV rms, 2 mV pk-pk.

CIRCLE NO. 378

### Board-mount supplies provide 10 W

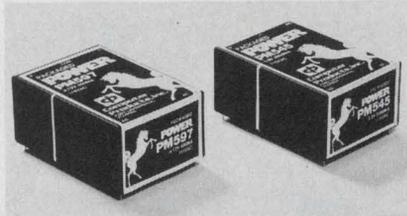

Computer Products, 1400 N.W. 70th St., P.O. Box 23849, Fort Lauderdale, FL 33307. (305) 974-5500. PM597, \$99; PM545, \$89; stock.

Two new PM500 Series modular power supplies offer direct PC-board mounting, and each delivers 10 W of dc output power. Model PM597 provides  $\pm 12$  V at 400 mA, and Model PM545 supplies 5 V at 2000 mA. These units measure 2.50 × 3.50 × 1.62 in. and are available in the popular pin configurations. Specs include a line regulation of  $\pm 0.02\%$  max for both models, load regulation of  $\pm 0.02\%$  max for the 597 and  $\pm 0.05\%$  max for the 545.

CIRCLE NO. 379

### Compact module delivers 10 W

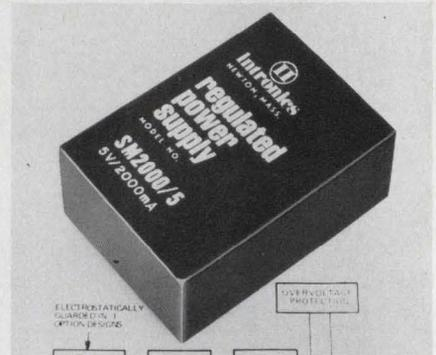

Intronics, 57 Chapel St., Newton, MA 02158. (617) 332-7350. \$85; stock-2 wks.

Model SM2000/5 power supply features 2.0-A output current at 5 V dc in a 2.5 × 3.5 × 1.56-in. encapsulated module. Static line and load regulation are 0.02% and 0.1%, respectively. Added features include: output short-circuit protection, foldback current limiting and overvoltage protection. The unit may be used with plug-in sockets or soldered directly onto a PC board.

CIRCLE NO. 380

## Do you train or retrain employees? Consider these famous courses...

### BASIC ELECTRICITY

By Van Valkenburgh, Nooger & Neville, Inc.

This simplified illustrated course is the civilian version of the Basic Electricity course used for years by the U.S. Navy and requires no previous background in electricity and little mathematics. The step-by-step approach covers basic concepts from electromagnetism to AC and DC circuits and motors. Frequently only one new concept is introduced on each page and it is amplified by at least one illustration per page. Each topical section concludes with helpful review pages. In five volumes, 624 pages.

- Paperbound set, #0033-2, \$18.40
- Combined Cloth Edition, #0039-1, \$16.70



**HAYDEN BOOK COMPANY, INC., 50 Essex St., Rochelle Park, N.J. 07662**

Please send me the book(s) checked above on 15-day free examination. At the end of that time, I will remit payment, plus postage, or return the book(s) with no further obligation. **Save Money!** Payment enclosed. Publisher will pay all shipping and handling charges—same 15-day guarantee.

### BASIC ELECTRONICS

By Van Valkenburgh, Nooger & Neville, Inc.

Any trainee with a basic knowledge of electricity (equivalent to *Basic Electricity* study) can master the fundamentals of electronics with this progressive course. *Basic Electronics* explains all vital concepts in a logical, step-by-step sequence — from power supply elements and circuits through amplifiers, transmitters, receivers and transistors. In six volumes, 680 pages.

- Paperbound, #0048-0, \$22.15
- Combined Cloth Edition, #0049-9, \$19.50

Tests (and answers) for both courses are available for group and self-study applications.

Prices subject to change without notice.

Name \_\_\_\_\_  
Firm \_\_\_\_\_  
Address \_\_\_\_\_  
City/State/Zip \_\_\_\_\_

## Twelve models form line of PC-board sources



Sola Electric, 1717 Busse Rd., Elk Grove Village, IL 60007. (312) 439-2800. \$44 to \$99; stock.

"Sola Solids" are a new lineup of Class 84, series-regulated power supplies packaged flat for printed-circuit boards. The units, available in 12 models, offer single outputs rated at 5, 12 and 15 V dc ranging from 100 to 2000 mA, and dual outputs rated at  $\pm 12$  and  $\pm 15$  V dc ranging from 25 to 400 mA. All models accept 50-to-400-Hz input at 115 V ac, and hold output regulation to  $\pm 2\%$  for input voltage fluctuations up to  $\pm 10$  V ac. Sola Solids are designed to operate at full rated load in ambients ranging from  $-25$  to  $+71$  C, and will withstand short-term overloads or output short circuiting without damage.

CIRCLE NO. 381

## Arc lamp supplies cut size & weight

Electronic Measurements, 405 Essex Rd., Neptune, NJ 07753. (800) 631-4298. Start at \$295; stock-6 wks.

The EMXE (Xenon) and EMHG (Mercury) Series of short arc power systems are switching-regulator supplies in modular enclosures said to have sizes and weights of one third to one fifth those of previous designs. Efficiency approaches 75%. Regulation and ripple is better than 1% and each unit uses a single-pulse, low-energy ignition to eliminate RF interference. Twelve ratings vary in wattage from 35 to 1000 W.

CIRCLE NO. 382

## 50-W dc/dc converters work from $-55$ to $100$ C

Abbott Transistor Laboratories, 5200 W. Jefferson Blvd., Los Angeles, CA 90016. (213) 936-8185. \$325; 10 wks.

BN Series converts 28 V dc to 50 W of regulated dc power at voltages ranging from 5 to 50 V. The new series is said to be one

of the few switching-regulated power supplies capable of operating over the full military temperature range of  $-55$  to  $100$  C. BN50 regulates to 0.5% over its full input range of 20 to 32 V. Load regulation is 0.5% for no load to full load at constant input voltage. PARD (ripple and noise) has been reduced to 25 mV rms, 100 mV pk-pk, over 25 to 100 C.

CIRCLE NO. 383

# Auto-Sert\*

## WRAPPOST™ PIN INSERTION SYSTEM

*Par Excellence.*



Auto-Swage Wrapost™ terminal pins, prepositioned on tape and coiled on standard 10,000 piece Wrapost™ reels, are fed to a fixed insertion head. Work is positioned using a template and pantograph system with an extremely well balanced and sensitive X-Y table.

The Wrapost™ pins by Auto-Swage Products, leader in the industry for straightness — burr free cone ends — minimum flat without insulation-nicking points or burrs — consistently under .003 R corners — guaranteed diagonal dimension — plated to your specification — and best of all, low cost — are now available in conjunction with a high quality, high performance insertion system.

Write or call for our Auto Sert™ brochure.



**auto-swage**  
PRODUCTS, INC.

726 River Road, Shelton, Conn. 06484 Tel. (203) 929-1401

\*A trademark of Auto-Swage Products, Inc., for its terminal pin assembly products and systems.

INFORMATION RETRIEVAL NUMBER 87

## Flat cable connectors fit wrapped-wire posts

Ansley Electronics, 3208 Humboldt St., Los Angeles, CA 90031. (213) 223-2331. From \$0.06/contact (large qty.).

The Blue Streak 609-100 M series of insulation-displacing wrap-post socket connectors terminates flat cable to PC boards. These connectors can also directly interconnect wrapped-wire posts. Up to 50 conductors can be simultaneously terminated to the connectors in a matter of seconds. The connectors are of a one piece design that minimizes the time normally required for connector assembly. An exclusive "tulip" contact design assures a maximum of four contact points per conductor. The connectors have a current rating of 1 A, a dielectric strength of 500 V dc (sea level), a temperature rating of 105 C and are available in 10, 20, 26, 34, 40 and 50-contact position versions, with or without an optional strain relief.

CIRCLE NO. 439

## Molded plastic parts offer low-cost

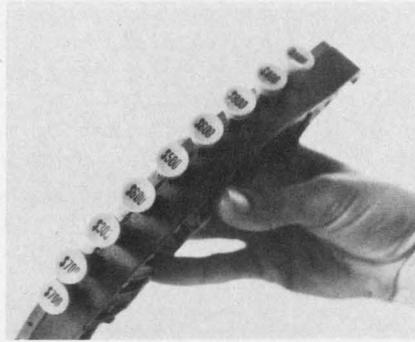

Keolyn Plastics, Inc., P.O. Box 48155, Chicago, IL 60648. (312) 439-1900.

An injection molding process called single cycle internal indicia molding (SCIIM) allows products to be molded with multiple colored characters embedded under a layer of transparent homogeneous material. The process is expected by the company to replace much of the use of simultaneous two-color molding and post mold decorating techniques. The cost of SCIIM, both in tooling and production, is claimed by the company to be substantially lower than other decorating methods.

CIRCLE NO. 384

## Component headers fit dual in-line sockets

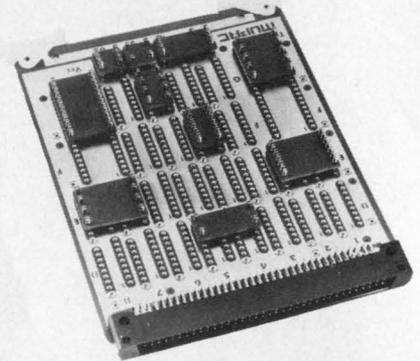

Mupac, 646 Summer St., Brockton, MA 02402. (617) 588-6110. From \$0.98 (10-up); stock.

A family of component carriers can hold discrete components such as resistors, capacitors, diodes and other electronic components. The carriers are designed with slotted-pin style contacts and 0.018 in. diameter pins for plugging directly into dual in-line sockets. Base material is FR-4 epoxy glass laminate and will not degrade during soldering or cleaning operations. Carriers are available in 14 styles and contacts are on row spacings of 0.3, 0.6 and 0.8 in. centers.

CIRCLE NO. 385

## Autoranging 80 MHz portable counter

**\$375**

Domestic U.S.A. Price



1900A

- Fast autoranging
- Multi-function - Frequency, Period, Totalize
- 5 Hz to 80 MHz, high sensitivity - 25 mV
- Six bright LED digits
- \$50 Internal battery option
- Full 12 month guarantee
- Coast to coast service centers
- Available from stock

For data out today, dial our toll-free hotline: 800-426-0361



John Fluke Mfg. Co., Ltd.  
P.O. Box 1094, Station "D"  
Buffalo, N.Y. 14210  
Phone (716) 842-0311 TWX 610-492-3214

INFORMATION RETRIEVAL NUMBER 88

## New Heyco<sup>®</sup> Nylon Cable Clamps

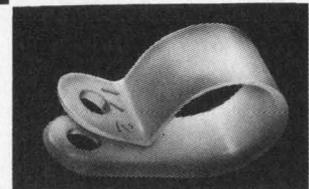

New from Heyman Manufacturing—nylon clamps for standard and heavy duty cable applications. Tough, lightweight nylon resists abrasion, aging and most chemicals. And provides excellent insulation. Standard clamps range from 1/8" thru 1/2" in 7 sizes. Heavy duty clamp holds 19 different diameter cables, from 1/8" thru 1 1/2". Both have standard locking holes. Both have full radiused inside edges that won't cut into wire insulation—and are open ended for easy entry.

**FREE SAMPLES on request from:**

**HEYMAN MANUFACTURING COMPANY**

KENILWORTH, NEW JERSEY 07033  
(201) 245-2345 • TWX: 710-996-5986

WAUKESHA, WISCONSIN 53186  
(414) 542-7155 • TWX: 910-265-3668



33 B

INFORMATION RETRIEVAL NUMBER 89

## Edgelighted panels come in many styles

*Aerospace Optics, 7112 Burns St., Fort Worth, TX 76118. (817) 284-2293. Prices start at about \$0.75/in.<sup>2</sup> depending upon size and style.*

Repairable, type V edgelighted panels use T-1 wire-based lamps that are mounted on replaceable back-panel printed-circuit boards. All panels are designed to meet MIL-P-7788 and MIL-P-83335 requirements. Other edgelighted panel styles available include: multivoltage panels with dual lighting circuits, curved pedestal panels, keyboard panels, panels with front replaceable legend strips and sunlight readable assemblies. Military and commercial colors including blue white, white, unfiltered white and aviation red are available.

CIRCLE NO. 386

## Ferrite cores designed for switch-mode supplies

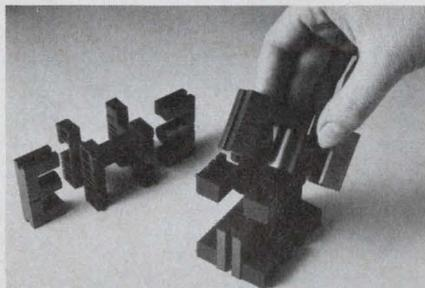

*Ferroxcube, Mt. Marion Rd., Saugerties, NY 12477. (914) 246-2811. See text.*

The Power E line of ferrite cores can meet the special requirements of switch-mode power-supply transformers. The cores are "E"-shaped with a round center leg. By adopting a circular cross-section for the center leg, the turn length is reduced, and thus holds copper losses to a minimum. Four sizes of the cores are presently available that cover transformer throughput power to 1 kW. A line of complementary bobbins is also available. The cores are slotted to accept studding for ease of assembly and mounting without special clips and attachments. Prices per set in sample quantities for the cores are: EC-35, \$1.86; EC-42, \$2.38; EC-53, \$3.04; EC-72, \$5.20. A set includes 2 E cores and a bobbin. Sample quantities are available from stock.

CIRCLE NO. 387

## Rack & panel connectors handle up to 5 A

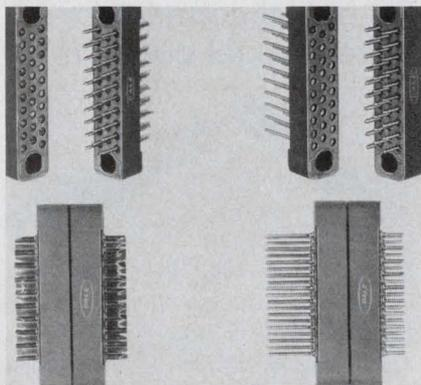

*Dale Electronics, Inc., E. Highway 50, Yankton, SD 57078. (605) 665-9301. Typical price for a 5-contact standard connector: \$2.02 (500-up); stock to 3 wk.*

The Series MM22 and MM24 microminiature rack and panel connectors are each available in two models. They can now be ordered with dip solder contacts for wave soldering, with or without guides or screwlocks, as desired. The MM Series includes dip solder and solder cup contacts of gold-plated phosphor bronze. Available connecting hardware includes fixed guides and screwlocks and turnable screwlocks. Models are available with from 5 to 44 contacts on 0.09-in. centers. Designed to meet applicable paragraphs of MIL-C-8384, the MM Series has current ratings of 5 A (MM22) and 3 A (MM24).

CIRCLE NO. 388

## Grommet strip can be cut to size, as needed

*Electrovert, 86 Hartford Ave., Mount Vernon, NY 10553. (914) 664-6090. From \$5.04/100 ft.; stock.*

The snip-n-fit Grommet Strip is available in ultraviolet/weather resistant and fire-retardant polyethylene formulations. It was formerly available only in natural polyethylene. There are five standard sizes for all plate thicknesses from 0.02 to 0.25 in. Each size is designed to fit a given range and grip the edge surface tightly without the need for special adhesives. The Grommet Strip comes in packages or reels of continuous length and doesn't require any special tools for application.

CIRCLE NO. 389

Advertisement

## Versatile enclosures come in 10 sizes

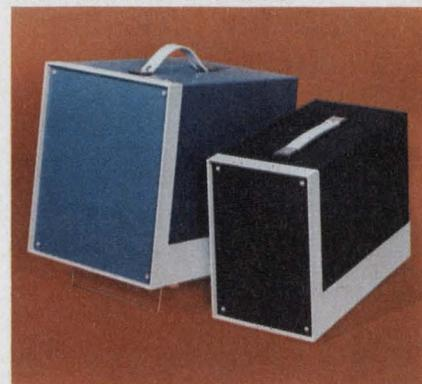

*Bud Radio, Inc., 4605 E. 355 St., Willoughby, O. 44094, (216) 946-3200. Now in stock.*

ShowCase — available at your Bud Distributor. Use as a desktop instrument case, in systems, racks or as a portable enclosure. Front, rear panels and bail included. Lightweight. Sturdy. Side gussets give additional strength. Recessed handles secured firmly into top for safe handling. Top, sides and bottom .060 aluminum; front panel, .090; rear panel, .050. Five accessory chassis. Two color combinations. For further information, phone —

1-800-321-1764, TOLL FREE  
IN OHIO, 1-800-362-2265, TOLL FREE

## Racks delivered pre-assembled; 27 sizes



*Bud Radio, Inc., 4605 E. 355 St., Willoughby, O. 44094, (216) 946-3200. Off-the-shelf delivery.*

Series 60 upright and inclined panel racks from Bud. Interiors easily accessible from front and rear. 19" panel space. Upright: 14 sizes; clear inside depths, 20½" and 24". Clear inside depth of seven extra-deep units, 29¾". Inclined: three sizes; clear inside depth, 20½". Clear inside depth of three extra-deep units, 29¾". "U" braces. Adjustable mounting rails. Available at your Bud Distributor. For further information, phone —

1-800-321-1764, TOLL FREE  
IN OHIO, 1-800-362-2265, TOLL FREE

## ELECTRONIC PACKAGING

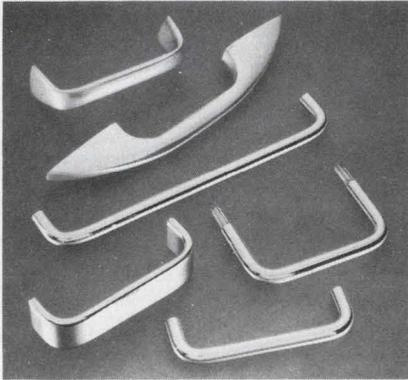
Handles for enclosures  
— a complete line

Bud Radio, Inc., 4605 E. 355 St., Willoughby, O. 44094, (216) 946-3200. 33 different types.

Handles plus hardware for electronic enclosures are in stock at your Bud Distributor: chrome plated, silver anodized, brushed chrome recessed and satin chrome lever types, chrome plated catch sets. Fasteners included. Designed for all types of applications. Construction equals that of higher priced counterparts. Range of sizes and configurations. Compare. For further information, phone —

1-800-321-1764, TOLL FREE  
IN OHIO, 1-800-362-2265, TOLL FREE

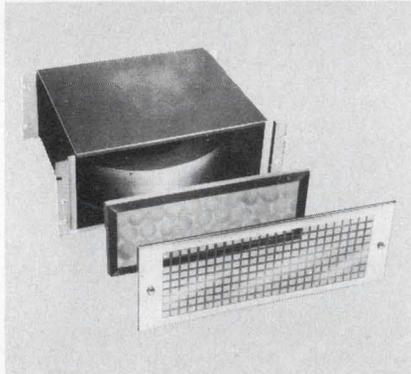
Low silhouette blowers  
cool electronic equipment

Bud Radio, Inc., 4605 E. 355 St., Willoughby, O. 44094, (216) 946-3200. Now at your Bud Distributor.

Six models. Each cools electronic equipment in racks, cabinets, consoles efficiently, economically. Panel heights: 3½", 5¼" and 7" — lowest heights, highest CFM output in the industry. Each has 19" panel width, standard E.I.A. notching for rack mounting. Filters removed through front panel; no tools required. Guaranteed for 20,000 hours. For further information, phone —

1-800-321-1764, TOLL FREE  
IN OHIO, 1-800-362-2265, TOLL FREE

## PACKAGING &amp; MATERIALS

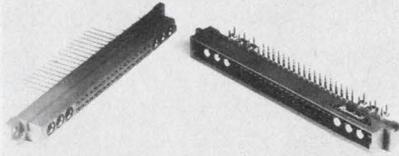
PC-board connectors  
have coaxial contacts

Radiall, 101 rue Philibert Hoffmann, zone industrielle ouest, 93116 Rosny S/Bois, France.

The Series 680 PC-board connector includes single contacts as well as coaxial contacts (male and female). These connectors conform with VG 95324 and DIN specifications. The high density connector includes 36 single contacts, spaced on 2.54-mm centers and six coaxial removable rf connectors spaced on 5.08-mm centers (0.2 in). Single contacts can handle 3 A at 20 C with a max operating voltage of 500 V. Contact resistance is less than 15 mΩ and the contact can withstand 1000 operations. The coaxial contacts have a 50-Ω characteristic impedance (75 Ω available upon request) and have a 0-to-5-GHz frequency range. The VSWR is less than 1.05 + 1 F (in GHz) and the connector loss is only 0.05 dB at 1 GHz.

CIRCLE NO. 390

Breadboarding sockets  
available in many sizes

AP Products, Box 110, Painesville, OH 44077. (216) 354-2101. From \$2 (1 to 9); stock.

A series of low-cost terminal and distribution strips for quick buildup and checkout of analog and digital circuits consists of 10 building blocks. There are three basic configurations of terminal strips and two versions of distribution strips. The Model-L terminal strips contain two rows of five-tie-point terminals, are available in four lengths, and accommodate all components and jumpers with leads that have diameters of up to 0.032 in. The Model-R terminal strips are available with either one or two rows of four-tie-point terminals and are ideal for breadboarding circuits with standard size DIPs (0.3 in. between lead rows).

CIRCLE NO. 391

Nickel conductor paste  
made for glass substrate

Electro-Science Laboratories, 1601 Sherman Ave., Pennsauken, NJ 08110. (609) 663-7777. \$0.85/gram (sample qty.); stock.

Type 2553 nickel conductive paste is designed for firing on glass substrates. The paste fires in nitrogen, but can be subsequently re-fired in air with only small change in resistivity. The paste has an as-fired resistivity of 20 to 40 mΩ per square, but upon air refiring this can change to 40 to 80 mΩ per square. Firing temperature is 580 to 620 C in nitrogen atmosphere. It can be exposed to air for 20 to 60 minutes at 450 C for sealing glass firing. Shorter air firings at higher temperature for dielectric firing are allowable. The coating also has a high adhesion to soda lime glass substrates.

CIRCLE NO. 392

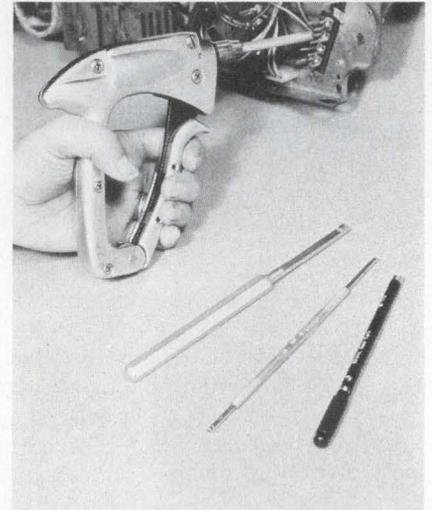
Wrapping/unwrapping  
tools easy to use

Jonard Industries, 3047 Tibbett Ave., Bronx, NY 10463. (212) 549-7600. From \$8; stock.

A comprehensive line of easy to use manual wrapping and unwrapping tools includes: hand wrapping tools, hand unwrapping tools, manual wrapping and unwrapping guns and accessories and wrap and unwrap tool kits. The wrapping and unwrapping guns are available with interchangeable bits and sleeves to accept all common wire gauges and terminal sizes. They are designed to fit comfortably in the operator's hand.

CIRCLE NO. 393

COMPONENTS

**Gas display visible to 50 feet**

Burroughs Corp., P.O. Box 1226, Plainfield, NJ 07061. (201) 757-3400. \$99.50 (1000 up); available Oct.

Burroughs new gas-plasma display, the Self-Scan II, has 20 characters that are 0.7-in. high and configured by a 5 x 7 dot matrix. The orange matrix dots are visible to 50 ft, and the horizontal viewing angle is 150 degrees. Only 18 connections are required to control all 20 characters. Modular panels are 14-in. long, 1.9-in. high and less than 1-in. deep. Several panels can be arranged vertically or horizontally to form large information displays. In addition to the conventional 128-character ASCII characters, Self-Scan II can present characters in all western languages and Cyrillic, Hebrew, Katakana and an anglicized form of Japanese.

CIRCLE NO. 394

**Permanent magnet mold to make encoder/tach**

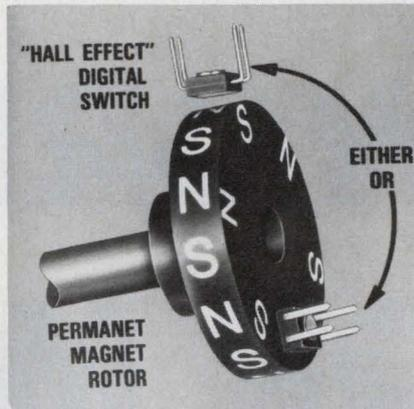

Xolox Corp., 3111 Covington Rd., Ft. Wayne, IN 46804. (219) 432-5889.

A simple rotary encoder/tachometer can now be made with Magnalox, a molded permanent magnet, when it is combined with Hall-effect switches. Pole densities to 30 poles/in of rotor diameter can provide digital outputs from dc to 100 kHz. Also, cams, gears and holes can be molded into the magnetic rotor.

CIRCLE NO. 395

**Capacitance switch has no moving parts**

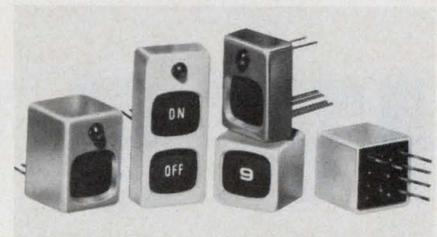

Centralab, 5757 N. Green Bay Ave., Milwaukee, WI 53201. (414) 228-2751. \$5.78 latching with LED (100 up); 2 to 4 wks.

Magic Dot capacitance switches have no moving parts and operate with just the touch of a finger. Solid-state construction provides a long lifetime. Lab tests have demonstrated a life in excess of 100 million cycles without failure. The switches are available with momentary, latching or toggle action. Options include LED visual indicators in red, yellow or green, a variety of bezel colors and custom nomenclature. Capacitance solid-state switches are offered in both single and custom arrays.

CIRCLE NO. 396

**TINY BUT SHARP!**

2 KHz BANDWIDTH AT 455 KHz\*

- CERAMIC PIEZOELECTRIC ELEMENTS
- .289" x .315" x .276"
- 6 dB MAX INSERTION LOSS
- 6 KHz BANDWIDTH AT 40 dB \* AT 6dB

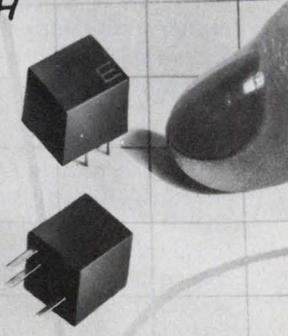

**muRata**  
CORPORATION OF AMERICA  
2 Westchester Plaza, Elmsford, New York 10523, U.S.A.  
Phone: 914-592-9180 Telex: 137332

INFORMATION RETRIEVAL NUMBER 90

ELECTRONIC DESIGN 21, October 11, 1975

MEMORY SERIES No. 5

**WE MAKE ONE FAST RAM DO THE JOB OF NINE**

Why string up nine 64-bit RAMs, when a single 64x9 package does the same job—at 45ns. Savings? Obvious: less parts to buy, less power to burn. Quantity stock available now. Ask for high-speed #82S09.



Data sheet for 64x9 RAM, the #82S09, available now: attach coupon to letterhead.

Name \_\_\_\_\_

Tel. \_\_\_\_\_

Ext. \_\_\_\_\_

THINK **Signetics**  
811 E. ARQUES, SUNNYVALE, CALIF 94086

INFORMATION RETRIEVAL NUMBER 91

# IT'S WORKING FOR ME

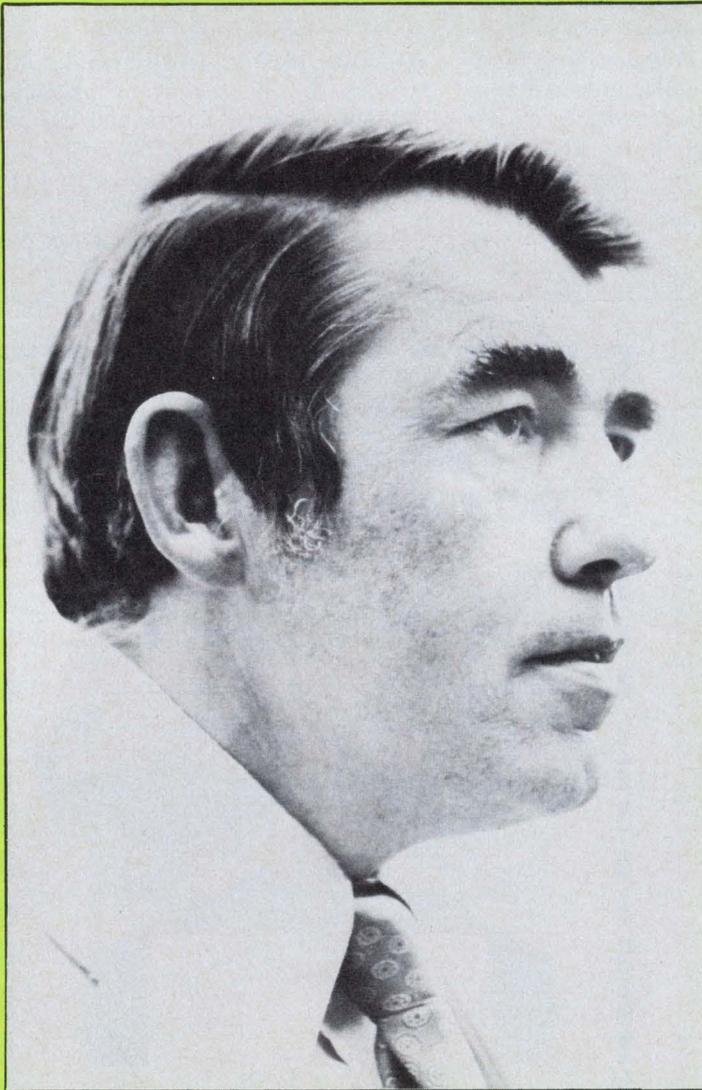

George A. O'Sullivan

## "The **GOLD BOOK** is Producing Business For Us **75 to 1**"

Back in January, George A. O'Sullivan, President, Abacus Controls, Inc. wrote:

"Our company booked its first \$30,000 for its new frequency converter line through our advertisement in the **GOLD BOOK**. Each contact was initially from a specifying engineer, who was asked where he learned about us. All of the orders came from territories in which we have neither a representative nor a distributor."

Now, six months later, Mr. O'Sullivan reports that "Business produced by the **GOLD BOOK** is running at a ratio of 75 to 1 for each dollar invested. And it's performing 3 to 1 better than EEM."

"We have a terribly complicated product. We've got to talk directly to engineers. Leads from the **GOLD BOOK** are almost always from engineers so we can swing right into our pitch. Often we are able to close orders as high as \$25,000 over the phone."

Mr. O'Sullivan adds, "We appreciate your ability to put the **GOLD BOOK** in the hands of engineers who make source selection decisions."

**THE GOLD BOOK IS WORKING . . .  
IT'S WORKING FOR USERS, AND  
IT'S WORKING FOR ADVERTISERS!**

**ELECTRONIC DESIGN/GOLD BOOK**  
50 Essex Street, Rochelle Park, N.J.

## COMPONENTS

### Thumbwheel switch claimed smallest

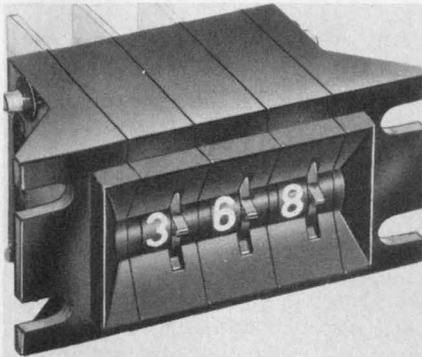

Cherry Electrical Products Corp., P.O. Box 718, Waukegan, IL 60085. (312) 689-7702. \$2.04 (2000 up); 1 wk, prototype, 10 wks, production.

The compact, Series T-50 sub-miniature thumbwheel needs only 0.315 × 0.709-in. of front panel space and 0.984 in. of depth in back of the panel. It is available in a choice of BCD, 10-position decimal, single-pole repeating, BCD-with-diode provision and various other of the most commonly used codes. Even though this is the smallest thumbwheel made, according to Cherry, the 0.158-in. high white characters are easily read. Operating force is 7 to 10 oz and mechanical life is 1-million detent operations minimum. Black gloss finish is standard. Grey or white finishes available on special order.

CIRCLE NO. 397

### Square pots isolate with plastic shafts

Allen-Bradley Co., 1201 S. Second St., Milwaukee, WI 53204. (414) 671-2000. 6 to 8 wks.

A new family of 5/8-in. sq. Mod Pot potentiometers features plastic shafts and bushings for electrical isolation. The Series 72 units offer single or dual-section controls, hot-molded carbon-composition resistive elements and optional rotary switches. Total resistances range from 50 Ω to 10 MΩ and tolerances are ±10% or ±20%. Power rating is 0.5 W at 70 C per section. Operating temperature range is -55 to 100 C. A wide variety of configurations are possible with the series' standard modular components.

CIRCLE NO. 398

### Solid-state counter rivals EMI units

Non-Linear Systems, Inc., P.O. Box N, Del Mar, CA 92014. (714) 755-1134. \$49.50 (unit qty); stock.

The PC-4 solid-state panel meter-sized event counter is priced competitively with the electromechanical types. The counter totalizes input pulses to 20,000 events from any pulse source that has a +2 to +15-V signal amplitude at rates to 200,000 per second. Also, a contact closure to a positive voltage may be used to count at rates to 3 kHz. The unit operates from a +4.5 to +7.5-V-dc supply and uses less than 0.6 W. It has a programmable decimal point to permit display in engineering units. The display uses 0.3-in.-high red LEDs in a package that is less than 1-H × 2-1/2-W × 3-1/2-D in. Standard features include multiplexed BCD output, lamp test, display dimming or inhibit and leading zero suppression.

CIRCLE NO. 399

### High-voltage xformer takes 30% less space

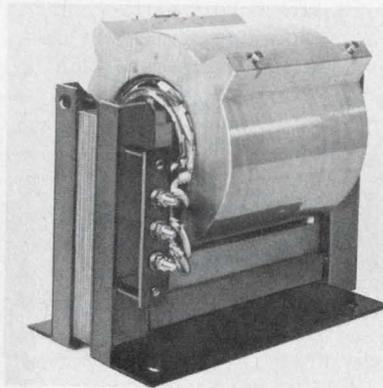

Frequency Technology Inc., Box 365, Whitcomb Ave., Littleton, MA 01460. (617) 456-3374. From \$389; stock.

Epoxy-cast high-voltage transformers develop 120/240-V output from 2400 through 14,400-V input. Single-phase units are rated for 5 to 50 KVA and three-phase types, 15 to 150 KVA. The transformer's primary is vacuum-cast in a tough epoxy resin. This affords a 95,000-V basic impulse level, which enables the transformer to withstand lightning and circuit-breaker transients and allows reduced spacing to shrink transformer size by as much as 30%.

CIRCLE NO. 400



### Visual display

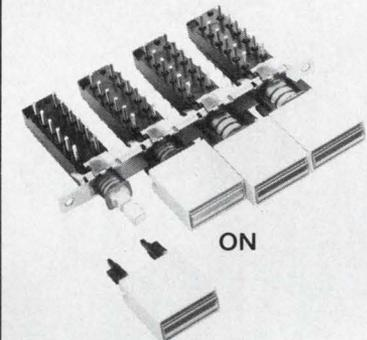

### in a non-lighted pushbutton switch

Now you can add visual display to Centralab non-lighted pushbutton switches. Our new status indicator button with a unique fluorescent reflective surface operates with ambient light to indicate switch status when activated. No power is required. There are no lamps to burn out.

Other features include:

- Choice of 6 display colors, 3 lens options and 5 button colors.
- Available with push-push or interlocking action.
- 140° peripheral viewing angle.
- Vertical or horizontal button mounting.

See your Centralab Pushbutton Distributor or send inquiry card for complete specifications.

Isostat Licensed



CENTRALAB

Electronics Division  
GLOBE-UNION INC.

5757 NORTH GREEN BAY AVENUE  
MILWAUKEE, WISCONSIN 53201

**"off the shelf"**

a rugged, well constructed, high quality switch from Capitol it has the same solid reputation as our custom ordered switches

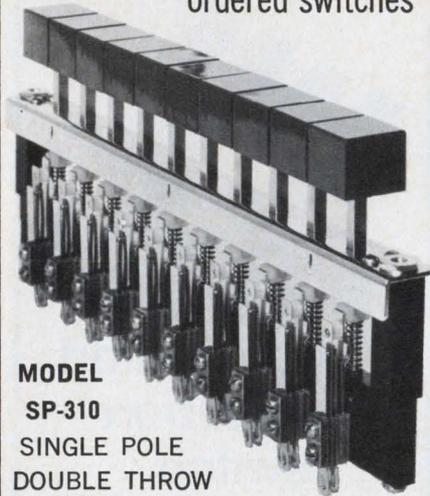

**MODEL SP-310**  
SINGLE POLE  
DOUBLE THROW  
CONTACT  
SQUARE BUTTON,  
NON-ILLUMINATED

Contacts: Palladium  
rated at 3 amp, 110VAC, non-inductive

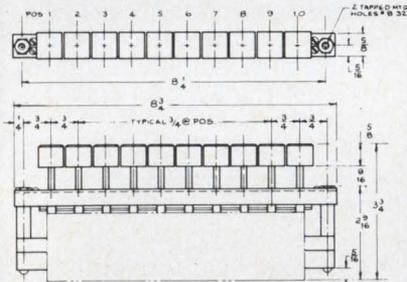

NOTES: 1. CONTACTS 1 FORM C EACH POS. SEC. 1.  
2. MECHANICAL ACTION: INTERLOCKING WITH POSITIVE LOCKOUT BETWEEN POS.  
3. BUTTONS: 23-32 SS

We manufacture top quality push button and lever circuit selector switches single switches or banked assemblies. Write for our catalog.

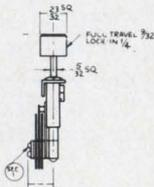

Representatives in principal cities.

**CAPITOL SWITCHES**

THE CAPITOL MACHINE & SWITCH CO.  
87 NEWTOWN RD. DANBURY, CONN. 06810  
(203) 744-3300

INFORMATION RETRIEVAL NUMBER 102

**COMPONENTS**

**Assemble keyboards with sealed contacts**



KB-Denver Inc., 526 Lincoln Circle, Loveland, CO 80537. (303) 669-3344. \$0.01 (OEM qty).

Keyboard makers can now purchase Snap Domes and assemble their own keyboards. Of course, assembled custom keyboards with two-color caps, bezel and snap dome assemblies are also available. The Snap Dome keyboard technique provides sealed contacts, tactile feel, a low profile and fast assembly. Contact bounce is 4 ms max and 1 ms typical. Contact resistance is 2 Ω at the start and approximately 10 Ω at the end of life. Available dome sizes are 0.27, 0.35 and 0.5-in. Trip force can be adjusted to meet requirements.

CIRCLE NO. 440

**Solid tantalums cost half of wet units**

Union Carbide Corp., Components Dept., P.O. Box 5928, Greenville, SC 29606. (803) 963-6300. See text.

New T252 Series solid-tantalum capacitors, which are MIL-approved equivalents to the MIL-C-39003 style CSR33 capacitors, provide an alternative to wet tantalum capacitors. They generally cost only half as much, and they are smaller in the same capacitance-voltage rating than hermetic seal wet tantalums. In addition, according to Union Carbide, they excel in temperature stability, low dc leakage, shelf life, reverse-voltage tolerance, and they are surge-current tested for low-impedance applications. Four standard military tubular case sizes come in a range of 1.2 to 1000 μF and to 50 V dc for operation from -55 to 125 C.

CIRCLE NO. 441

**Electronic timer delays on power-off condition**

Lisle-Metrix Ltd., 49 Sheffield St., Toronto, Ontario, Canada MGM 3E5. (416) 249-9151.

An electric timer, Model 0D, holds its DPDT contacts energized for any adjustable period up to 3 h after removal of power. Pneumatic timers were previously required to perform this task. Electronic-timer advantages include small size, octal plug-in, light weight, settability to ±5% of the dial, repeatability of ±1%, automatic reset, mounting in any position and transient protection. A photon-coupled isolator monitors the line voltage.

CIRCLE NO. 442

**Solid-state relay handles inductive loads**

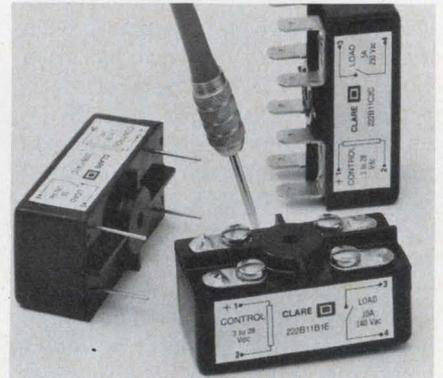

C. P. Clare & Co., 3101 W. Pratt Ave., Chicago, IL 60645. (312) 262-7700. \$13.20 to \$25.00; stock.

Series 222 modular, heavy-duty ac solid-state relays are designed for computer peripheral, process control and other inductive-load applications. The relays are SPST NO devices with load ratings of 5 or 10 A at 140 or 250 V ac, and they have built-in transient dv/dt protection. All models feature zero-crossing synchronous switching, which is designed primarily for use with resistive loads, but will accommodate most inductive loads as well. Turn-on time at 60 Hz is 8.3 ms and turn-off time is 16.6 ms. Input is DTL/TTL compatible, and opto-isolated for total input/output isolation. Dielectric withstanding voltage (60 Hz) is 1500 V rms, and insulation resistance is 10<sup>9</sup> Ω. Peak one-cycle surge current is approximately 1000% of rated current.

CIRCLE NO. 443

## Evaluation Samples

### IC panels

DIP panels and universal IC panels feature screw machined sockets with wrap-type posts and gold-over-nickel plated, seamless beryllium copper contact springs. The DIP panels are supplied in 30 or 60-position sizes for either 14 or 16-lead packages. The universal IC panels are supplied in one-group to eight-group sizes in the universal  $0.1 \times 0.3$ -in. pattern with each group consisting of nine rows of 50 sockets. A miniature version of the IC panel that holds one package is available as a sample. AMP.

CIRCLE NO. 444

### Contact cleaner

A chemically pure cleaning agent is anti-static and compatible with electrical insulation, elastomers and metals. Its dielectric qualities allow safe cleaning of electrical/electronic equipment while in operation. LPS Research Laboratories.

CIRCLE NO. 445

### Plastic parts

Durable, low-cost standard and custom plastic part samples are supplied on a compact card. Engineered Plastics.

CIRCLE NO. 446

### Switches

These switches demonstrate the principal of the LC2 mercury film design. They can be used in such critical applications as heart pacemakers, frequency converters, digital and analog computer circuits and many others. Fifth Dimensions.

CIRCLE NO. 447

### Strain-relief bushing

A strain-relief bushing anchors, insulates and protects cables entering chassis  $3/16$ -in. thick. The one-piece, all nylon bushing mounts into a  $1/2$ -in. dia. hole. It can be used at high temperatures. Heyman Manufacturing.

CIRCLE NO. 448

## Application Notes

### Programmable controllers

A series of reprint articles on the use of programmable controllers is available in a 16-page handbook. I·T·E Datametrix, Wilmington, MA

CIRCLE NO. 449

### FM subcarriers

"Amplitude Adjustment of FM Subcarriers" describes the factors that determine the optimum setup of amplitudes of subcarriers in an FM multiplex system. EMR-Telemetry, Sarasota, FL

CIRCLE NO. 450

### Cooling probes

A theoretical discussion on the operation of refrigeration systems explains a method of calculating or measuring the heat removal requirements of various applications. Three methods of temperature control are included in a four-page guide. FTS Systems, Stone Ridge, NY

CIRCLE NO. 451

### Magnetic shields

"Helpful Hints in the Design of a Magnetic Shield" covers the design characteristics of the shield. James Millen Manufacturing Co., Malden, MA

CIRCLE NO. 452

### Noise discrimination

Discrimination of signals from electrical noise caused by energization or de-energization of reactive loads in the vicinity of thyristors is the topic of Tech Tips 4-4. Westinghouse Electric, Semiconductor Div., Youngwood, PA

CIRCLE NO. 453

### P-i-n diode SPDT switch

Three basic design approaches for single-pole, double-throw diode switches are given in a two-page note. Hewlett-Packard, Palo Alto, CA

CIRCLE NO. 454



When it's  
your move  
check Centralab

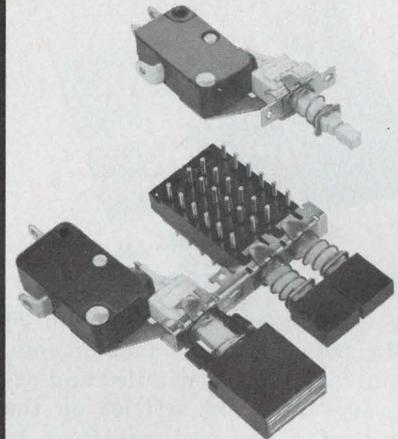

### 5 amp pushbutton switch

You'll meet even the most stringent requirements with this new line switch. It's UL listed for TV-5 rating (120V, 5A, 78A peak in-rush current).

Other features include:

- Furnished as a single station or for left or right mounting on any Centralab pushbutton switch assembly.
- Three circuit options — SPDT, SPST, normally open and SPST, normally closed.
- Button options include lighted, non-lighted or status indicator button (shown above).

See your Centralab Pushbutton Distributor or send inquiry card for complete specifications.

Isostat Licensed



CENTRALAB

Electronics Division

GLOBE-UNION INC.

5757 NORTH GREEN BAY AVENUE  
MILWAUKEE, WISCONSIN 53201

# New Literature



## Modular instruments

Specifications on more than 30 TM 500 plug-in instruments, mainframe power modules and accessory data, and articles on the application of instrumentation to laboratory and industrial needs are covered in a 48-page catalog. Tektronix, Beaverton, OR

CIRCLE NO. 455

## OEM power supplies

Specifications and prices on more than 120 OEM power supplies, ranging from 1200 mW to 750 W, are contained in a six-page reference. ACDC Electronics, Oceanside, CA

CIRCLE NO. 456

## Standard connectors

A "Handbook of Standard Connectors" includes a wealth of information on rectangular, hexagonal and miniature side-panel mounting connectors plus removable contacts and accessories. Positronic Industries, Connector Div., Springfield, MO

CIRCLE NO. 457

## Telemetry systems

In addition to detailing industrial telemetry system components and accessories, a 42-page catalog provides users with in-depth information on configuring hardware, tape recorder and vhf link systems. EMR Telemetry, Sarasota, FL

CIRCLE NO. 458

## Smith charts

Descriptions with line drawings of a packaged assortment of 12 Smith Charts are shown in a four-page brochure. Analog Instruments, New Providence, NJ

CIRCLE NO. 459

## Components

Low-cost electronic components, tools and supplies are featured in a 12-page catalog. Woas Electronics, El Cajon, CA

CIRCLE NO. 460

## Micromotors

A micromotor guide gives technical characteristics of the Escap motors. Portescap, CH-2300, La Chaux-de-Fonds, Suisse.

CIRCLE NO. 461

## Hardware

Panel and rack handles for rack-mounted instruments and systems are covered in a 48-page catalog. Unicorp, Orange, NJ

CIRCLE NO. 462

NEED A COMPETITIVE EDGE?

**CHECK OUT WESTON POTS**

FOR COST DELIVERY • PERFORMANCE

**EXAMPLE:**

Model #840P

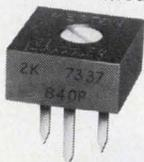

**WESTON SINGLE TURN 3/8" CERMET TRIMMER**

**PRICE** (1000 Piece Orders) **\$.49 EA.**

Comparable prices — all sizes — Square • Round • Cermet • Wirewound

WESTON

**Schlumberger**

WESTON COMPONENTS  
ARCHBALD, PENNSYLVANIA 18403  
TEL. (717) 876-1500  
TWX 510 656-2902  
TELEX 83-7443

INFORMATION RETRIEVAL NUMBER 104

INSTALLATION'S  
A BREEZE

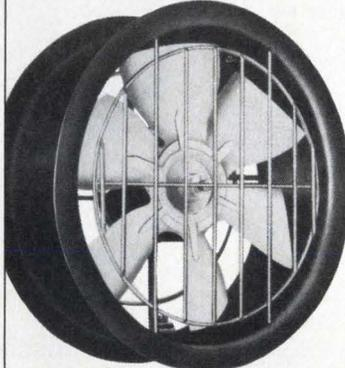

**420 CFM FAN**

**MCLEAN VENTURI**

Just bolt this fan to the enclosure opening and it's ready to go. You save space and have the performance of a centrifugal with this high-pressure, dual-purpose unit. Mounts against top, bottom, or side of a rack. Propeller and motor guards are flush with the Venturi to permit either-way airflow. Best of all, it's low cost too!

SEND FOR CATALOG

**MCLEAN ENGINEERING LABORATORIES**

PRINCETON JUNCTION, NEW JERSEY 08550  
PHONE 609-799-0100 • TELEX 84-3422

INFORMATION RETRIEVAL NUMBER 105

ELECTRONIC DESIGN 21, October 11, 1975

## Minicomputers

Features of the 32-bit Model 8/32 minicomputer, including its performance specifications, software instructions and diagrams, are described in a 24-page brochure. Interdata, Oceanport, NJ

CIRCLE NO. 463

## Rf attenuators

A 106-page, two-color catalog describes the features and specifications of attenuators and microwave components. Fifteen pages list applications, techniques and theory. It also contains decibel conversion tables, a glossary of transmission line terms and a list of reference literature. Weinschel Engineering, Gaithersburg, MD

CIRCLE NO. 464

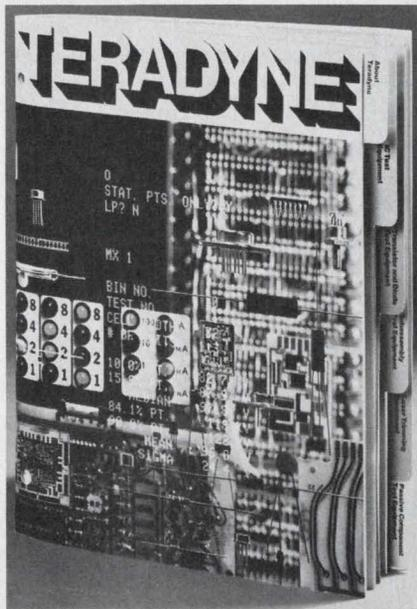

## Automatic test equipment

A 56-page catalog presents automatic test equipment for manufacturers and users of electronic devices and subassemblies. Teradyne, Boston, MA.

CIRCLE NO. 465

## Laser systems

Three major product areas—mechanical hardware to manipulate a laser beam precisely; vibration isolation system and structurally damped honeycomb tables and platforms; and laboratory and industrial holographic nondestructive testing systems—are described in a 36-page catalog. Newport Research, Fountain Valley, CA

CIRCLE NO. 466

## Test equipment

Descriptions, specifications and photos of a variety of test equipment are given in a 36-page catalog. B&K Precision, Chicago, IL

CIRCLE NO. 467

## Data handling

"Data Handling in the 70's" a 20-page report, details advances both in software and hardware to solve problems in data handling. Harris Corp., Cleveland, OH

CIRCLE NO. 468

## Data-conversion modules

An eight-page "Preferred Data Conversion Modules" brochure lists in easy-to-read tabular form key specifications and prices on a/d converters, d/a converters, sample-holds and analog multiplexers. Datel Systems, Canton, MA

CIRCLE NO. 469

## Terminal pins

Capabilities, operation, safety features and machine data specifications of terminal pin assembly products and systems are included in a catalog. Auto-Swage Products, Shelton, CT

CIRCLE NO. 470

## Function/pulse generators

Signal sources are described in a 10-page catalog. Also included is an applications selector wheel; when you dial up your application needs, it points to the models and features that suit your application. Interstate Electronics, Anaheim, CA

CIRCLE NO. 471

## Process computer course

No prior knowledge of computers is needed, the firm says, to take a do-it-yourself audio tape course on process computer concepts. Course materials consist of a 100-page illustrated workbook and four tape cassettes. Listening time is about 2-3/4 hours. Individual course copies are \$125, although the workbook without the tape cassettes can be obtained for \$25. Honeywell Process Control Div., M/D 140, 2222 W. Peoria Ave., Phoenix, AZ 85029

INQUIRE DIRECT

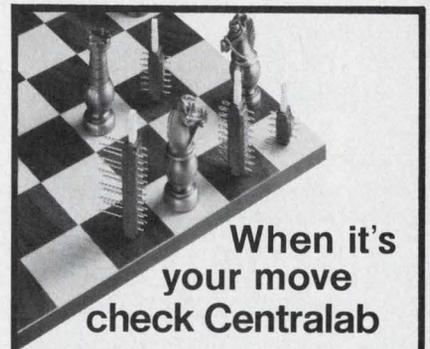

When it's  
your move  
check Centralab

NEW!

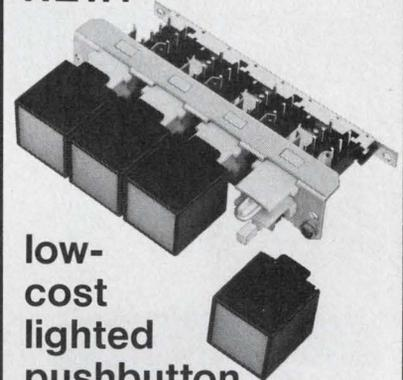

low-  
cost  
lighted  
pushbutton  
switch

Centralab reliability, low cost and new design freedom can be yours in this new lighted switch. Its T1-3/4 wedge base lamp brings the price way down\*. Its many options make it easier than ever to achieve an aesthetically harmonized panel. You get features like these:

- Flat, concave or recessed lenses with uniform light diffusion.
- Eight lens colors.
- PC terminated independent lamp circuit.
- 15mm, 17.5mm or 20mm. spacing options.
- Ganged assemblies through 16 stations.

See your Centralab Pushbutton Distributor or send inquiry card for complete specifications.

\* Per station cost at 1000 pieces, \$1.36  
... 2 PDT switch includes bulb.

Isostat Licensed

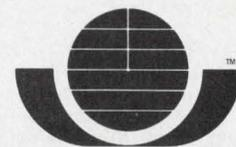

CENTRALAB

Electronics Division

GLOBE-UNION INC.

5757 NORTH GREEN BAY AVENUE  
MILWAUKEE, WISCONSIN 53201

High-Accuracy

# Phase Meters

0.5 Hz to 2 MHz

Digital or meter readouts

As low as \$1050



930 E. Meadow Dr. Palo Alto, Ca. 94303  
(415) 321-7428

INFORMATION RETRIEVAL NUMBER 107

**SUBSCRIBER SERVICE** For prompt service include the addressed label when writing about your subscription.

**CHANGE OF ADDRESS**

city	NEW ADDRESS
company address	name
division/departement	company
state	title
zip	

If you're moving, please let us know six weeks before changing your address. If you have a question, place your magazine address label here and clip this form to your letter.

MAIL TO: ELECTRONIC DESIGN Circulation Dept. Hayden Publishing Co., Inc., 50 Essex Street, Rochelle Park, NJ 07662

## NEW LITERATURE

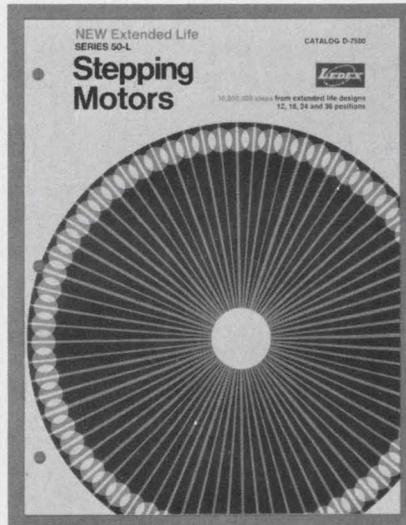

### Stepping motors

Thirty-two unidirectional and bidirectional stepping motors are introduced in a 12-page catalog. Tables and graphs show performance characteristics under varying operating conditions. Ledex, Dayton, OH

CIRCLE NO. 472

### Electronic instruments

Nine new instruments are featured in a 24-page catalog; a total of 58 instruments and 89 accessories for servicing, industrial maintenance, laboratories, schools and safety tests. RCA, Camden, NJ

CIRCLE NO. 473

### Resistors

Comparative data on wirewound resistors, metal-film resistors, thick-film resistor networks, wirewound and cermet element trimmer potentiometers, connectors, chokes and transformers can be found in a 57-page guide. Dale Electronics, Columbus, NE

CIRCLE NO. 474

### Potentiometers

Precision potentiometers, trimming potentiometers, concentric and digital turns-counting-dials and miniature switches are covered in an eight-page catalog. The catalog includes photos, specifications, application data and prices. Spectrol Electronics, City of Industry, CA

CIRCLE NO. 475

### Testing newsletter

"Testing News and Views," a monthly bulletin, discusses news, problems and current areas of interest in the testing industry. Associated Testing Laboratories, Clifton, NJ

CIRCLE NO. 476

### Rental instruments

A brochure details the ins and outs of deciding whether to buy, rent, or go without new electronic test equipment. A graph compares the costs of renting and owning on the basis of expected lifetime of the equipment. U.S. Instrument Rentals, San Carlos, CA

CIRCLE NO. 477

### Coaxial transmission lines

Rigid coaxial transmission lines and FM broadcast antennas are described in a 20-page catalog. Phelps Dodge Communications, Marlboro, NJ

CIRCLE NO. 478

### Plug-in subsystems

Computer-direct analog and digital input/output measurement and control equipment are described in an 18-page catalog. Computer Products, Fort Lauderdale, FL

CIRCLE NO. 479

### Benchtop power supplies

Single, dual and triple output benchtop power supplies are described in a four-page bulletin. Specifications and prices are included. Acopian, Easton, PA

CIRCLE NO. 480

### Optoelectronic devices

The worldwide OPTOELECTRONIC D.A.T.A.BOOK, a 252-page volume, contains electrical, optical and physical characteristics for more than 5000 devices and assemblies of 56 U.S. and international manufacturers. The book will be updated and issued as a complete volume every six months. Prices for a one-year, two-edition subscription are \$54.50 in the U.S. and \$56.20 elsewhere mailed surface rate. D.A.T.A., 32 Lincoln Ave., Orange, NJ 07060.

INQUIRE DIRECT

# NOW...

## Secure the Outstanding Source of Current Data in Your Field

# Electronic Design

## 26 Issues Each Year

Analyze—Interpret—Suggest and provide the Facts You Need for Improved Design of Products and Components

Every 14 days you, a subscriber, receive another all-new issue of **ELECTRONIC DESIGN** offering such information as . . .

- *What's New in Large Scale Integrated Circuit Technologies for Bipolar Integrated Circuits* —
- *How To Create Smaller, Less Expensive Peripherals With New LSI Circuits* —
- *Microprocessors — What They Mean to Effectiveness and Efficiency* —
- *How to Build Compact Modems into Digital Equipment* —
- *Design to Eliminate Switch Bounce in Keyboards* —
- *How to Divide a Digital Signal by any Digit* —
- *International Technology — Developments in England — Japan — Germany — Netherlands — Italy — Denmark — Spain — France . . . and other Nations.*

### JOIN THESE — AND THOUSANDS OF OTHER SATISFIED READERS

"It's just the right blend of practical experience and analysis . . . a good opportunity to brush up on new technologies and new components . . . broad scope of technical articles and up-to-the-minute technical information make **ELECTRONIC DESIGN** one of my favorite technical magazines."

*Helmut Kindl, EE Siemens, Munich, Germany*

"I read **ELECTRONIC DESIGN** because of its good information on special products, components, etc., which normally is difficult to find in Europe. I forward this information to my technicians and engineers."

*Jorgen Jansen, Managing Director, Danplex Electronics, Denmark*

"I can often apply your 'Ideas for Design' directly to solve problems in connection with my work in medically-oriented instrumentation."

*V. Halmo, Engineer, Ciba-Geigy Ltd., Basle, Switzerland*

## SECURE THE TECHNICAL AND DESIGN INFORMATION YOU NEED . . . SUBSCRIBE TO **ELECTRONIC DESIGN** . . . WRITE FOR COMPLETE INFORMATION TODAY.

**ELECTRONIC DESIGN** • Evan Phoutrides, Circulation Manager  
50 Essex Street, Rochelle Park, New Jersey 07662 USA.

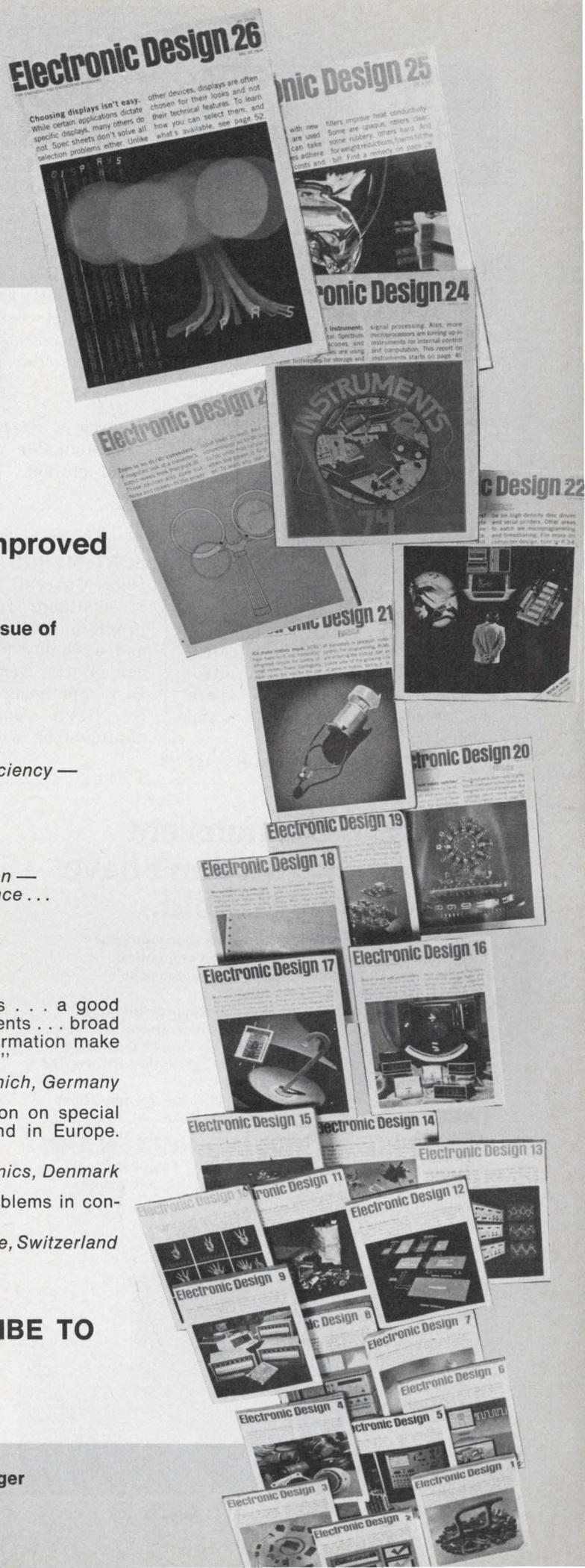

# Bulletin Board

Hewlett-Packard's computer systems group has committed its local mass storage in some upcoming computer products to the miniature data cartridge made by 3M. The mini cartridge performs like the larger 3M DC-300-A but measures only  $3 \times 2.5 \times 0.5$  in. It contains 140 ft of tape, 0.15 in. wide. On one track it can record more than 100,000 bytes. Tape control is better than is possible with a cassette, which, in turn, allows densities of 800 bpi. Transfer rate, too, is high—8000 bits/s at a tape speed of 10 ips.

CIRCLE NO. 481

A CYBERNET data service called CYBER 76 Service has been introduced by Control Data to speed the processing of scientific and other large-scale work.

CIRCLE NO. 482

Monochip D (MO-D), the fourth in a family of custom IC building blocks by Interdesign, is designed for high-operating voltage requirements. The MO-D provides an equivalent to the Exar "X-R Chip."

CIRCLE NO. 483

Applied Data Research has enhanced software for MIMIC, a system for developing minicomputer programs on a large-scale host computer.

CIRCLE NO. 484

Monroe is offering its 1800 series programmable calculators to the OEM market.

CIRCLE NO. 485

A general-purpose alphanumeric SORT/MERGE program for all Data General NOVA computers is available from Hycom. The program, written in Fortran IV and assembly language, runs under Data General's Real-Time Disc Operating System (RDOS) on NOVA computers having a minimum 8k words of core.

CIRCLE NO. 486

Harris Corp.'s Computer Systems Div. has added the "Harris 3800" to its special-purpose 38 series memory products.

CIRCLE NO. 487

Computer Automation has introduced a text editor program designed to allow programming in a natural, easy-to-use editing environment.

CIRCLE NO. 488

Broomall Industries has cut the cost of its M2000 magnetic tape incremental plotting system and the 2000 on-line plotter by more than 9%.

CIRCLE NO. 489

Two new members have been added to General Automation's DM 100 series of high-performance, network-oriented data management systems. The DM 130/1 is a minimum satellite configuration with full processing capability, priced from \$29,500. The DM 135 is an expanded version of the DM 130 satellite processor and starts at \$40,000.

CIRCLE NO. 490

## Reliable DC transient protection you don't have to design and build.

Protect your power supplies and other semiconductor equipment from sudden death with an economical Heinemann JA/Q® combination voltage-transient/overcurrent protector.

The JA/Q gives you nanosecond response to voltage transients that could destroy a transistor or an entire IC chip. Lower-level sustained overvoltages are simply absorbed by our suppressor network, while the bigger spikes are diverted before they ever reach the protected circuits.

Write for Bulletin 3372, which tells you not only about the JA/Q but about our wide range of DC and AC overvoltage and brownout protectors. Heinemann Electric Company, Trenton, NJ 08602.

 **HEINEMANN**

We keep you out of trouble.

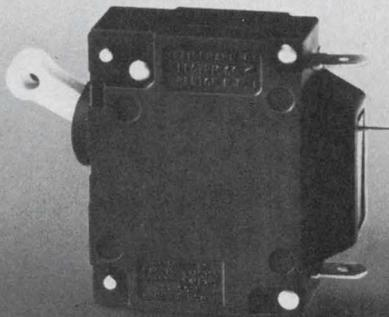

Heinemann

6166

INFORMATION RETRIEVAL NUMBER 109

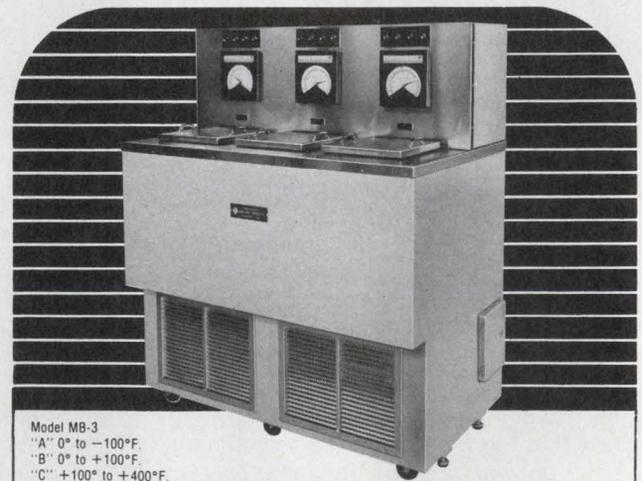

Model MB-3  
 "A" 0° to -100°F.  
 "B" 0° to +100°F.  
 "C" +100° to +400°F.

## Multi-Bath Test Stand for efficient production line testing

For chilling charpy specimens, calibration, shock testing and other special test requirements, rely on CSZ Multi-Bath test stands. Stainless steel chambers, liquid agitators, immersion heaters for high temperature operation, mechanical refrigeration systems for low temperature operation. Eye level indicating controllers and switches for each chamber. Caster mounted units for portability.

Write for literature kit

**CINCINNATI**  
**SUBZERO**  
 PRODUCTS INC.

2612 Gilbert Ave., Cincinnati, Ohio 45206  
 Phone: (513) 751-8810

INFORMATION RETRIEVAL NUMBER 110

ELECTRONIC DESIGN 21, October 11, 1975

# Electronic Design

## Advertising Sales Staff

Tom W. Carr, Sales Director

Rochelle Park, NJ 07662

Robert W. Gascoigne

Daniel J. Rowland

(Recruitment, Quick Ads, Classified)

50 Essex Street

(201) 843-0550

TWX: 710-9990-5071

## Philadelphia

Thomas P. Barth

50 Essex Street

Rochelle Park, NJ 07662

(201) 843-0550

## Boston 02178

Gene Pritchard

P.O. Box 379

Belmont, MA 02178

(617) 489-2340

## Chicago 60611

Thomas P. Kavooras

Berry Conner, Jr.

200 East Ontario

(312) 337-0588

## Cleveland

Thomas P. Kavooras

(Chicago)

(312) 337-0588

## Los Angeles 90045

Stanley I. Ehrenclou

Burt Underwood

8939 S. Sepulveda Boulevard

Suit 510

Los Angeles, CA

(213) 641-6544

## San Francisco 94040

Robert A. Lukas

3579 Cambridge Lane

Mountain View, CA 94040

(415) 965-2636

## London, Amsterdam, Tokyo, Seoul

John Ashcraft

12, Bear St.

Leicester Square

London WC2H 7AS England

Phone: 01-930-0525

W. J. M. Sanders

John Ashcraft & Co.

Herengracht 365

Amsterdam C., Holland

Phone: 020-24-09-08

Haruki Hirayama

Electronic Media Service

5th Floor, Lila Bldg.,

4-9-8 Roppongi

Minato-ku, Tokyo, Japan

Phone: 402-4556

Cable: Electronicmedia, Tokyo

Mr. O-kyu Park, President

Dongbo Int'l Corp.—

World Marketing

C.P.O. Box 4010

Seoul, Korea

Tel. 76-3910/3911

Cable: DONGBO SEOUL

Telex: EBKOREA K27286

Data General has introduced a line of software that includes operating systems with utility programs and high level programming languages for its Eclipse computers.

CIRCLE NO. 491

International Plasma Corp. has introduced an automatic impedance-matching system that maximises the electrical efficiency of its plasma-processors.

CIRCLE NO. 492

Electronic Industries Association has assigned JEDEC numbers 3N221 and 3N222 to a pair of water-cooled thyristor ac switch assemblies.

CIRCLE NO. 493

Spectronic's SE 5455 and SE 3455 series infrared sources are direct electrical and mechanical replacements for GE series SSL55B, SSL55C and SSL56 devices.

CIRCLE NO. 494

## Price reductions

RCA Solid State Div. has reduced prices from 8.3 to 60% on 27 general-purpose and 22 Darlington power transistors.

CIRCLE NO. 495

Struthers-Dunn has cut DIP relay prices by 25% and offers "DIP for a dollar" in 500-piece quantities.

CIRCLE NO. 496

Power-One has reduced prices 11% on its "B" case power supplies. Formerly \$27.95, the new price is \$24.95 (1-9) and \$20 (100-up).

CIRCLE NO. 497

An across-the-board price reduction amounts to over 27% on Cherry Electrical Products' gas discharge displays.

CIRCLE NO. 498

Precision Monolithics has announced price reductions of as much as 56% on its monoDAC-02 and monoDAC-04 complete 10-bit monolithic d/a converter lines.

CIRCLE NO. 499

INFORMATION RETRIEVAL NUMBER 111 ►

# Only with an EMR Real-Time Spectrum Analyzer...

## Change a switch setting...

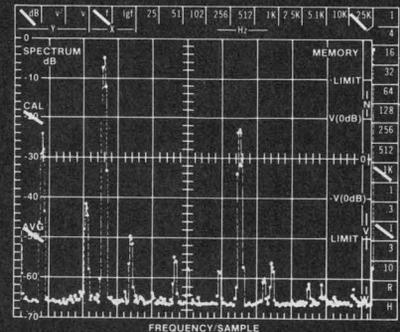

## update a unique CRT status display

Couple these facts together... most Real-Time Analyzers do not have an integral CRT display, and those that do, have no provision for an instantaneous visual readout of switch settings. It all adds up to confusion when you have to obtain a photographic record of an important test result. The EMR 1510 eliminates transcription errors when recording critical parameters.

We did it because we're all digital. But, we did not stop there... 60dB Dynamic Range, Selectable Window Functions, Digital Readout of Frequency/Amplitude/Averaging Time, Total Computer Interface, and much more!

Only  
From  
EMR!

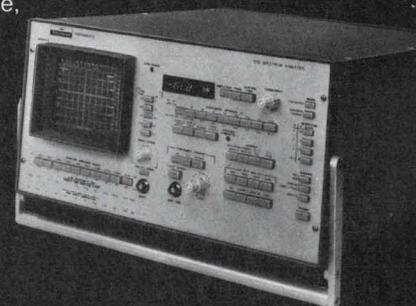

**EMR** Schlumberger

EMR Telemetry  
Weston Instruments, Inc.  
Box 3041, Sarasota, Florida 33578  
813-371-0811

ABP

BPA

## recruitment and classified ads

### SIEMENS

As the leading manufacturer of MOS circuits in the Federal Republic of Germany, we are currently seeking experienced engineers to work along with our present technical and electronic engineering staff.

For the coming years, we are devoting our efforts in IC's on large-scale integration and micro-miniaturization.

# Microprocessors

We are concentrating on the following:

- Process development for the micro-processor systems in N-Channel Silicon Gate technology.
- Design of MOS circuits (RAM, ROM, CPU, I/O)
- Logic and systems development for microprocessors.
- Development of software systems and programs for microprocessors.

If you are experienced in any of these areas, please contact:

Siemens AG  
Personalabteilung 1, D-8000 Munich 80  
Postfach 80 17 09, West Germany

Kindly send your resume in confidence, stating your experience, salary requirements and when you would be available to work in Munich. A good working knowledge of the German language is a definite requirement. Interviews can be arranged for you in the United States.

Siemens AG

CIRCLE NO. 201

### FOR EXPORT ONLY

Linear, Digital, Hybrid I/C's, FET's Semi-conductors, General Components. Electronic & Scientific Equipment.

● COMMERCIAL ● MILITARY ● HI-REL ●

### ICS ELECTRONICS CO.

9550 Gallatin Road  
Downey, California, 90240, U.S.A.

CIRCLE NO. 202

### RADAR SYSTEMS

#### TRACKING ANTENNA SYSTEMS

Nike Hercules, Nike Ajax, M-33, MPS-9, SCR-584, TPS-1E, TPS-28, FPS-6, FPS-14, FPS-18, FPS-75, UPX-6, MPQ-10A, IBM 705 Computers, HUNDREDS MORE. LARGEST INVENTORY OF RADAR AND MICROWAVE EQUIPMENT IN THE WORLD.



**RADIO RESEARCH INSTRUMENT CO.**  
3 QUINCY ST., NORWALK, CONN.  
(203) 853-2600

### GRAMOLIN —CONTACT CLEANER

"The less you use-the better it works!"  
Cleaner, Lubricant, and Corrosive for use on metal electrical contacts. Reduce contact resistance. Will bring back electronic system performance. Protects against corrosive atmospheres. Safe. Liquid or Spray. Free Data. Sample available.

**CAIG LABORATORIES, INC.**  
P.O. 64, Escondido, CA. 92025

CIRCLE NO. 203

### FREE ALARM CATALOG

Huge selection of burglar & fire systems, supplies. Motion detectors, infrared beams, controls, door switches, bells, sirens. 500 items, 99 pp. packed with technical details, notes.

(Outside U.S., send \$1.00.)



**mountain west alarm**

4215 n. 16th st., phoenix, az. 85016

CIRCLE NO. 204

### 1100 SCIENTIFIC & TECHNICAL BOOKS AT UNBELIEVEABLE PRICES

Catalog 1975-B now ready. Heavy emphasis on books on electronics, computer sciences, mathematics, physics, chemistry, and engineering. Typical discounts on hardcovers range from 40% to 60% off list price. Also, a unique collection of paperback reprints of scientific classics.

**HERBERT SHPRENTZ COMPANY**  
BOX 83-HC, IRVINGTON NY 10533

CIRCLE NO. 205

### INFRA-RED TUNNEL OVENS

Free Catalog Describing Complete Line of Bench and Floor Models.

IR Radiant Energy, the newest stage of Product Heating Evolution. Ovens tuned to the matching absorptive wave length character of product chemistry. Produces clean, fast, dry heat. Has replaced batch Hot Air types. Every Lab must have one. Many sizes.

**OAL ASSOCIATES, INC.**  
P.O. 64, Escondido, CA. 92025

CIRCLE NO. 206

**Protect Your Heart  
HAVE REGULAR MEDICAL  
CHECK UPS**



Give Heart Fund

Advertisements of booklets, brochures, catalogs and data sheets. To order use Reader-Service Card (Advertisement)

ELECTRONIC DESIGN's function is:

- To aid progress in the electronics manufacturing industry by promoting good design.
- To give the electronic design engineer concepts and ideas that make his job easier and more productive.
- To provide a central source of timely electronics information.
- To promote communication among members of the electronics engineering community.

**Want a subscription?** ELECTRONIC DESIGN is sent free to qualified engineers and engineering managers doing design work, supervising design or setting standards in the United States and Western Europe. For a free subscription, use the application form bound in the magazine. If none is included, write to us direct for an application form.

If you do not qualify, you may take out a paid subscription for \$30 a year in the U.S.A., \$40 a year elsewhere. Single copies are \$1.50 each.

**If you change your address,** send us an old mailing label and your new address; there is generally a postcard for this bound in the magazine. You will have to requalify to continue receiving ELECTRONIC DESIGN free.

**The accuracy policy** of ELECTRONIC DESIGN is:

- To make diligent efforts to ensure the accuracy of editorial matter.
- To publish prompt corrections whenever inaccuracies are brought to our attention. Corrections appear in "Across the Desk."
- To encourage our readers as responsible members of our business community to report to us misleading or fraudulent advertising.
- To refuse any advertisement deemed to be misleading or fraudulent.

Microfilm copies are available of complete volumes of ELECTRONIC DESIGN at \$19 per volume, beginning with Volume 1, 1952 through Volume 20. Reprints of individual articles may be obtained for \$3.00 each, prepaid (\$5.00 for each additional copy of the same article) no matter how long the article. For further details and to place orders, contact the Customer Services Department, University Microfilms, 300 North Zeeb Road, Ann Arbor, Michigan 48106 telephone (313) 761-4700.

**Want to contact us?** If you have any comments or wish to submit a manuscript or article outline, address your correspondence to:

Editor  
ELECTRONIC DESIGN  
50 Essex Street  
Rochelle Park, N.J. 07662



## NEW PORTABLE MINI-UBIQUITOUS® NEVER FORGETS!

For on-site instant diagnosis of noise/vibration, 440A real-time universal frequency analyzer/averager/waveform recorder **always "remembers"** to write test conditions and readings on its CRT—a Polaroid photo preserves them: perfect for inexperienced personnel.

Detects closely-spaced frequencies with 400-point resolution; senses small signals over a 60 dB (1000:1) dynamic range (greater with averaging). All-digital design means precision without recalibration. Includes digital reading of both frequency and amplitude at cursor. On-line real-time display of instantaneous frequency spectra and changing average; viewing and plotting of input time signal. Plug-in modules for special/future jobs. Annotated photos, X-Y plots, or digital recordings.

**For machine analysis:** reads frequency directly in RPM and Hz; harmonics are automatically identified. **For noise reduction:** subtracts factory background noise from a machine noise spectrum; log frequency scales available. **For machine failure prediction:** signature analysis of rotating machines in terms of orders; direct readout of differences between present and past spectra. **For automatic systems:** digital input or output, remote control/sensing. **For transients:** transient waveform can be held, viewed and plotted before analysis; spectrum of transient is undistorted because of true flat weighting.

DEMO. CIRCLE 170

LIT. CIRCLE 171

**Nicolet Scientific Corporation** (formerly Federal Scientific Corp.)

245 Livingston St., Northvale, N.J. 07647, 201-767-7100 TWX: 710 991 9619

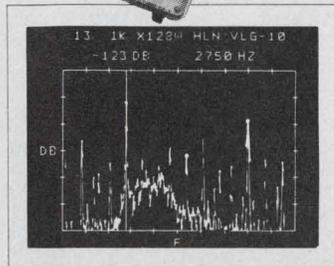

## GIANT FREE CATALOG

New 164-page catalog! Packed with 1,000's of hard-to-find buys in Optics, Science, Electronics. Loaded with optical, scientific, electronic equipment available from stock. Rare surplus buys. Many "one-of-a-kinds". Ingenious scientific tools. Components galore: lenses, prisms, wedges, mirrors, mounts, accessories. 100's of instruments: pollution test equipment, lasers, comparators, magnifiers, microscopes, projectors, telescopes, binoculars, photo attachments, alternate energy sources. Shop, save by mail! Request free Catalog "DA".

CIRCLE NO. 172

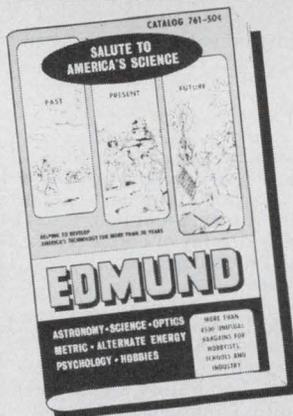

**Edmund Scientific Co.**

America's Largest Science-Optics-Electronics Mart

300 Edscorp Bldg., Barrington, New Jersey 08007 (609) 547-3488

## VERSATILE VECTOR VOLTMETER

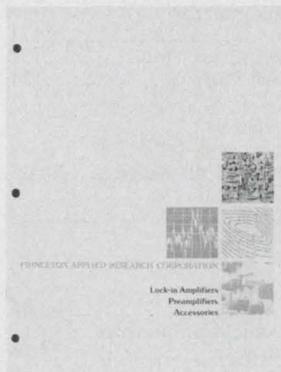

The Princeton Applied Research Model 129A Two Phase Lock-in/Vector Voltmeter permits simultaneous measurement of magnitude and phase angle even if the signal is masked by background noise. Flip a switch and measure the I and Q components of the vector; independent output expansion, offsetting, and filtering of each component are also provided. Full scale sensitivity ranges from 1 microvolt to 0.25 volts and is extendable to 25 volts with the optional compensated attenuator. Model 186/41. The Model 129A reference channel has fully automatic reference tracking capability and is phase matched to the signal channel over the operating range 0.5 Hz to 100 kHz. Complete specifications are contained in our Lock-in Amplifier Catalog No. T218.

**Princeton Applied Research Corporation**

P.O. Box 2565, Princeton, New Jersey 08540

609/452-2111.

CIRCLE NO. 173

# Advertiser's Index

- A P Products.....131  
 AMP, Incorporated .....42, 43  
 Abbott Transistor Laboratories, Inc... 6  
 Addmaster Corporation .....120  
 Airpax Electronics, Cambridge  
 Division .....109  
 Allen Bradley Co.....114D  
 American Technical Ceramics.....133  
 Angstrom Precision, Inc.....125  
 Auto Swage, Inc. ....135
- B & K Products of Dynascan  
 Corporation .....108  
 Bell & Howell, CEC Instruments  
 Division .....105  
 Bell, Inc., F. W.....123  
 Bud Radio, Inc.....137, 138  
 Burroughs Corporation ..... 81
- Capitol Machine & Switch  
 Co., Inc., The.....142  
 Centralab, The Electronics  
 Division of Globe-Union,  
 Inc. ....141, 143, 145  
 Cincinnati Sub-Zero Products, Inc.....148  
 Circuit Technology, Inc.....117  
 Clare & Co., C. P.....114B  
 Connecticut Hard Rubber  
 Company, The .....130  
 Control Products Division,  
 Amerace Corporation .....74, 75
- Dale Electronics, Inc.....Cover II  
 Datal Systems, Inc.....125  
 Delco Electronics, Division of  
 General Motors Corporation .....56, 57  
 Deltron, Inc. ....110
- EECO ..... 33  
 EMM Semi, A Division of  
 Electronic Memories &  
 Magnetics Corporation .....102  
 EMR Telemetry, Weston  
 Instruments, Inc. ....149  
 Edmund Scientific Company.....151  
 Elec-Trol, Inc.....115  
 Electronic Design .....92, 147  
 Electronic Memories, Commercial  
 Memory Products ..... 53  
 Electronic Navigation Industries.....104  
 Endicott Coil Co., Inc.....153
- Fairchild Semiconductor, A  
 Division of Fairchild Camera  
 and Instrument Corporation..118, 119  
 Fluke Mfg. Co., Inc., John.....136  
 Gold Book, The.....120, 140
- Gould Inc., Instrument Systems  
 Division ..... 66
- Hayden Book Company,  
 Inc. ....86, 134, 153  
 Heinemann Electric Company.....148  
 Hewlett-Packard .....9 thru 18, 153  
 Heyman Manufacturing Company.....136
- Industrial Timer, A Unit of  
 Esterline Corporation ..... 66  
 Intech, Incorporated .....116  
 Intel Corporation .....4, 5  
 Intersil Inc. ....39  
 Intronics, Inc. ....128
- Johanson Manufacturing Corp. ....38, 153  
 Johnson Company, E. F.....153
- Keithley Instruments, Inc..... 87  
 Kepco, Inc. ....46
- MCG Electronics .....120  
 Magnecraft Electric Company..Cover III  
 Mallory Capacitor Company.....49  
 Marconi Instruments Limited.....114D  
 McLean Engineering Laboratories...144  
 Mechanical Enterprises, Inc. ....122  
 Micro Devices Corp.....91  
 Micro-Line, Division of  
 Bausch & Lomb.....121  
 MicroSwitch, A Division  
 of Honeywell .....79  
 Mini-Circuits Laboratory, A Division  
 of Scientific Components Corp. ....25  
 Monsanto, United Systems  
 Corporation Subsidiary .....97  
 Mostek Corporation .....20, 21  
 Motorola Semiconductor  
 Products, Inc. ....1  
 MuRata Corporation of America.....139
- National Semiconductor  
 Corporation .....111  
 Newport Laboratories, Inc.....132  
 Nicolet Scientific Corp.....151
- Omron Corporation of America...34, 35  
 Optron, Inc. ....7  
 \*Oscilloquartz SA .....134
- Pehaco Corp. ....44, 45  
 \*Philips Electronic Components  
 and Materials .....22  
 \*Philips Instrumentation Recording..39  
 Philips Test & Measuring  
 Instruments, Inc. ....40, 41  
 \*Philips Test and Measuring  
 Instruments Dept. ....114B, 114C  
 Plessey Semiconductors ..... 67
- Potter & Brumfield, Division  
 of AMF, Incorporated.....69  
 Power/Mate Corp. ....153  
 Precision Monolithics,  
 Incorporated .....98, 99  
 Precision Plating Co. Inc.....80  
 Princeton Applied Research Corp.....151
- RCA Solid State.....Cover IV  
 RCS Associates, Inc.....153  
 Radio Switch Corporation.....132  
 Raytheon Company, Ocean  
 Systems Center .....68  
 Reader Service Card.....154 A, B  
 Readouts, Inc. ....153  
 Rental Electronics, Inc.....22  
 Reticon .....113  
 Rogers Corporation .....153
- SGS Ates Semiconductor  
 Corporation .....114C  
 Schauer Manufacturing Corp.....124  
 Semtech Corporation .....31  
 Siemens Corporation, Special  
 Components Division .....114A  
 Signetics Corporation .....115, 121, 123,  
 131, 139
- Singer Company, Inc.,  
 Kearfott Division .....52  
 Solitron Devices, Inc.....112  
 Sound Technology .....36  
 Specialized Products Company.....117  
 Sprague Electric Company.....19
- Tektronix, Inc. ....26, 27, 50, 51  
 Teledyne Crystalonics .....101  
 Teledyne Relays, A Teledyne  
 Company .....2  
 Teledyne Semiconductor .....54  
 \*Thomson CSF .....114A  
 Topaz Electronics .....93  
 Triplett Corporation .....95  
 Tustin Electronics Co.....126
- USCC/Centralab Electronics  
 Division, Globe-Union, Inc.....106, 107  
 United Systems Corporation,  
 a Subsidiary of Monsanto.....97
- Varta Batteries, Inc.....114  
 Victoreen Instrument Division,  
 Shellar-Globe Corporation .....127  
 Victor Electric Wire & Cable Corp..129
- Weston Components .....144  
 Wiltron Company .....146

\*Advertisers in non-U.S. edition

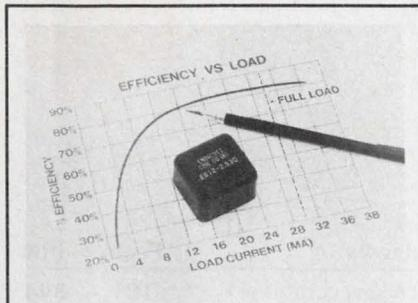

**Activate gas discharge readouts!** DC-to-DC power supplies convert low DC line voltages of 5, 9, 12 or 15 volts to nominal 200 and 250 volt DC levels required to run gas discharge information displays. Ideal for battery powered applications! Free literature. Endicott Coil Co., Inc., 31 Charlotte Street, Binghamton, N.Y. 13905

POWER SUPPLY

601

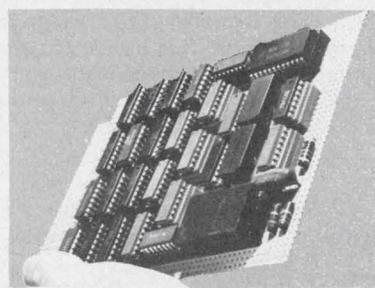

**DIGITAL MATCHED FILTERS CORRELATORS CONVOLVERS.** Ltd. quantities Model 328 (32 word x 8 bit) and Model 2561 (256 word x 1 bit) correlators available. Also custom units built to order. Inputs: Two digital signals, sampling/clock signals, 5V. Output: Correlation product. \$2/word x bit FOB ARO 90 days RCS ASSO., INC. (714) 624-1801.

PROCESSOR

604

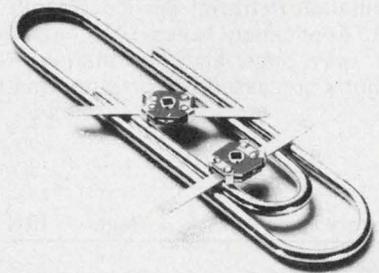

**Thin-Trim variable capacitors** provide a reliable means of adjusting capacitance without abrasive trimming or interchange of fixed capacitors. Series 9401 has high Q's and a range of capacitance values from 0.2-0.6 pf to 3.0-12.0 pf and 250 WVDC working voltage. Johanson Manufacturing Corporation, Boonton, New Jersey (201) 334-2676.

THIN-TRIM CAPACITORS

607

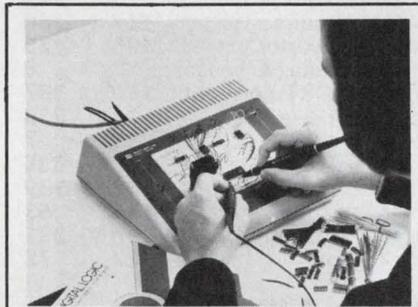

**COMPLETE, INDUSTRIAL-QUALITY IC course-Model 5035T** comes with text & workbooks, parts, fully-decoded LED numeric displays, and interconnecting wires. Handy proven HP Probe, Pulsar, and Clip included. HEWLETT-PACKARD 1501 PAGE MILL RD. PALO ALTO, CAL. 94304

IC COURSE

602

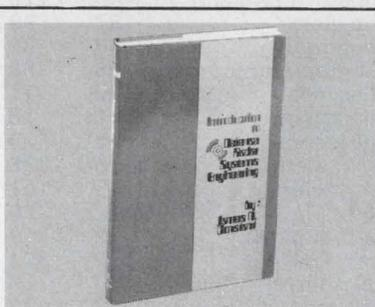

**Introduction To Defense Radar Systems Engineering.** Excellent introduction and practical reference to radar systems design and applications. #9194, 260 pp., \$22.95. Circle the Info Retrieval No. to order 15-day exam copy. When billed, remit or return book with no obligation. Hayden Book Co. 50 Essex St. Rochelle Park, N.J. 07662

RADAR SYSTEMS

605

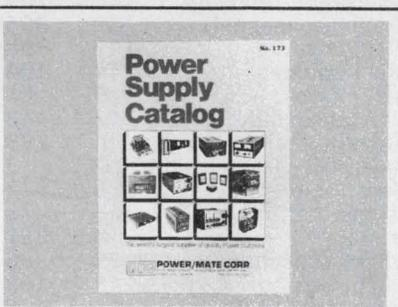

**Free catalog of 34,500 power supplies** from the worlds largest manufacturer of quality Power Supplies. New '74 catalog covers over 34,500 D.C. Power Supplies for every application. All units are UL approved, and meet most military and commercial specs for industrial and computer uses. Power Mate Corp. (201) 343-6294.

POWER SUPPLY

608

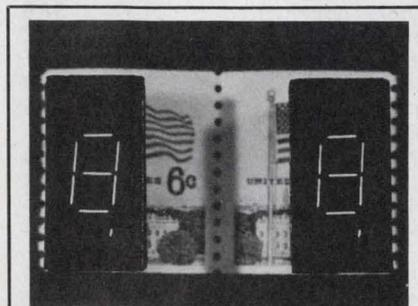

**The Proven Incandescent Readout Standard 16 Pin DIP Flat Pack.** All units 5 Volt 100,000 hrs. plus 3015F-BM 08ma/seg 700 ft/lam 3015F-BM10 10ma/seg 1700 ft/lam 3015F-BM15 15ma/seg 4500 ft/lam Field tested over 4 years in many applications. READOUTS, INC. P.O. Box 149, Del Mar, Ca. 92014 Tel. 714-755-2641 Telex 69-7992.

DISPLAY

603

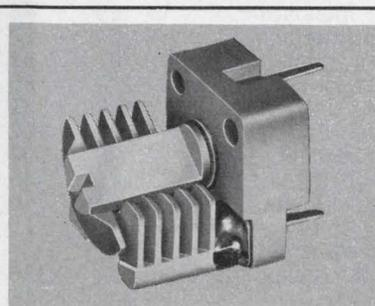

**Miniature Type "U" air variable capacitors.** Rotors and stators machined from solid brass extrusions offer excellent stability. High Q and low temperature coefficient (plus 45 ±15 ppm/°C). Available in single section, differential and special order butterfly types. Choice of PC or discreet wiring terminals. E. F. Johnson Co., Waseca, MN., (507) 835-5222.

TYPE "U" CAPACITORS

606

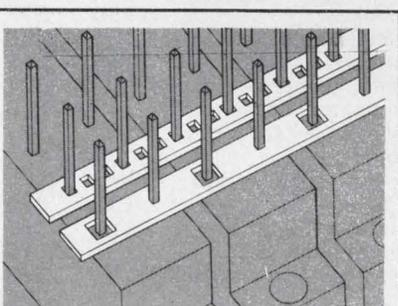

**STRIP/BUS BY ROGERS.** Low Cost Bussing Systems; easy installation, reliable solder joints; greater pin exposure. Write or call for details. Rogers Corporation, Rogers, Connecticut 06263. Phone (203) 774-9605.

STRIP/BUS

609

# Product Index

**Information Retrieval Service.** New Products, Evaluation Samples (ES), Design Aids (DA), Application Notes (AN), and New Literature (NL) in this issue are listed here with page and Information Retrieval numbers. Reader requests will be promptly processed by computer and mailed to the manufacturer within three days.

Category	Page	IRN	Category	Page	IRN	Category	Page	IRN
<b>Components</b>			zeners	124	74	receiver/combiner	121	344
capacitors	107	51	<b>Instrumentation</b>			<b>Modules &amp; Subassemblies</b>		
capacitors, solid			all-circuit evaluators	131	82	amp, instrumentation	117	334
tantalum	142	441	amplifier, wideband	110	301	amplifier/filter	126	77
ceramic piezoelectric			bar graph	113	324	amplifiers, power	116	330
elements	139	90	controller	132	84	audible signals	49	23
circuit breakers	69	33	counter	114	326	controller, phase	116	332
circuit protectors	109	54	counter	136	88	converter, a/d	119	338
circuit protectors	120	68	DPM	113	323	converters, a/d	117	335
contacts, keyboard	142	440	digital multimeter	108	52	current limiter	91	40
counter, solid-state	141	399	dual-trace adapter	114	325	current sensors	123	72
displays	81	37	dual-trace scope	108	53	decoder, data	120	340
fans	144	105	multibath test stand	148	110	detector, void & jam	120	341
overcurrent protector	148	109	multimeter	87	39	hybrid circuits	117	64
permanent magnets	139	395	oscillograph	66	30	hybrid converter	125	75
potentiometers	141	398	oscillographic recorder	105	50	infrared source/sensor	7	6
potentiometers	144	104	oscilloscopes	27	11	modules, CRT correction	119	337
reed relays	115	61	oscilloscopes	41	18	monitor, power-line	116	333
relay, solid-state	142	443	oscilloscopes	51	24	power drivers	19	7
relays	III	293	panel meters	115	328	reference, temperature	119	336
relays, DIP	2	3	phase meters	146	107	reference, voltage	119	339
relays, solid-state	39	17	printer	112	320	rms-to-dc converter	116	63
resistor networks	125	76	rental equipment	22	9	sensor, proximity	116	331
resistors	II	351	scope	112	321	spark gap	127	78
switch, capacitance	139	396	signal source	36	15	<b>Packaging &amp; Materials</b>		
switch, lighted PB	143	103	spectrum analyzer	68	32	cable clamps	136	89
switch, nonlighted PB	145	106	spectrum analyzer	149	111	connector, mini	137	388
switch, thumbwheel	141	397	thermal resistance tester	115	327	connectors	129	80
switch, 5-A, PB	141	101	thermocouple reference	112	322	connectors, flat cable	136	439
switches	79	231	transient recorder	115	329	connectors, PC	138	390
switches	142	102	VOMs	95	43	connectors, PCB	75	34
switches, ceramic	132	85	<b>Integrated Circuits</b>			contacts	122	71
synchros	52	25	a/d	126	305	cores, ferrite	137	387
terminators	43	20	calculator chips	128	363	gas character display	139	394
timer, power-off	142	442	choppers	98	45	gold plating	80	36
timers	66	29	counters	128	366	headers, component	136	385
transformers, high-volt	141	400	DAC	128	365	molding, plastic	136	384
<b>Data Processing</b>			DAC, monolithic	99	46	panels, edgelighted	137	386
calculator	130	372	HiNil interface	54	27	paste, nickel	138	392
calculator, talking	129	368	ICs	67	31	pin insertion system	135	87
data acquisition	138	369	RAMs, 4-k	119	66	scales	121	69
digital printers	97	271	ROM, 16-k	127	361	socket boards	53	26
duplicator, cassette	130	370	ROM, 16-k	128	362	sockets, breadboard	138	391
microprocessor	132	377	shift register	128	364	strip gomet	137	389
modem	130	371	voltage regulators	111	56	tapes, industrial	130	81
modem, 9600/4800			watch circuits	127	360	tool kit	117	65
b/s	132	376	<b>Microwaves &amp; Lasers</b>			tools, wrapping	138	393
printer	120	67	acoustic delay line	124	356	<b>Power Sources</b>		
programmer, $\mu$ P	131	375	amplifier	122	345	arc lamp supplies	135	382
tape cartridge, small	131	373	amplifier	123	350	batteries	114	60
tape punch	131	374	amplifier, L-band	121	342	dc/dc converter	133	302
terminal, graphics	129	367	antenna	124	354	dc/dc converters	135	383
<b>Discrete Semiconductor</b>			antenna	125	358	modular supplies	135	381
diodes	108	307	attenuator	124	355	PC-board supplies	134	379
FET, power	103	304	circulators	123	348	PC board supply	134	380
FETs	112	58	FET, amp	122	346	potted modules	134	378
indicators, snap-in	109	308	isolator	124	357	power supplies	6	5
JFETs	101	47	mixer/amp	125	359	power supplies	93	42
SCRs, high current	109	309	phase comparator	123	349	power supplies	110	55
transistor, rf	1	2	power modules	122	347	power supply	46	22
transistors	57	28						

# Introducing, a New Design Spectrum\* of Low Profile Relays.

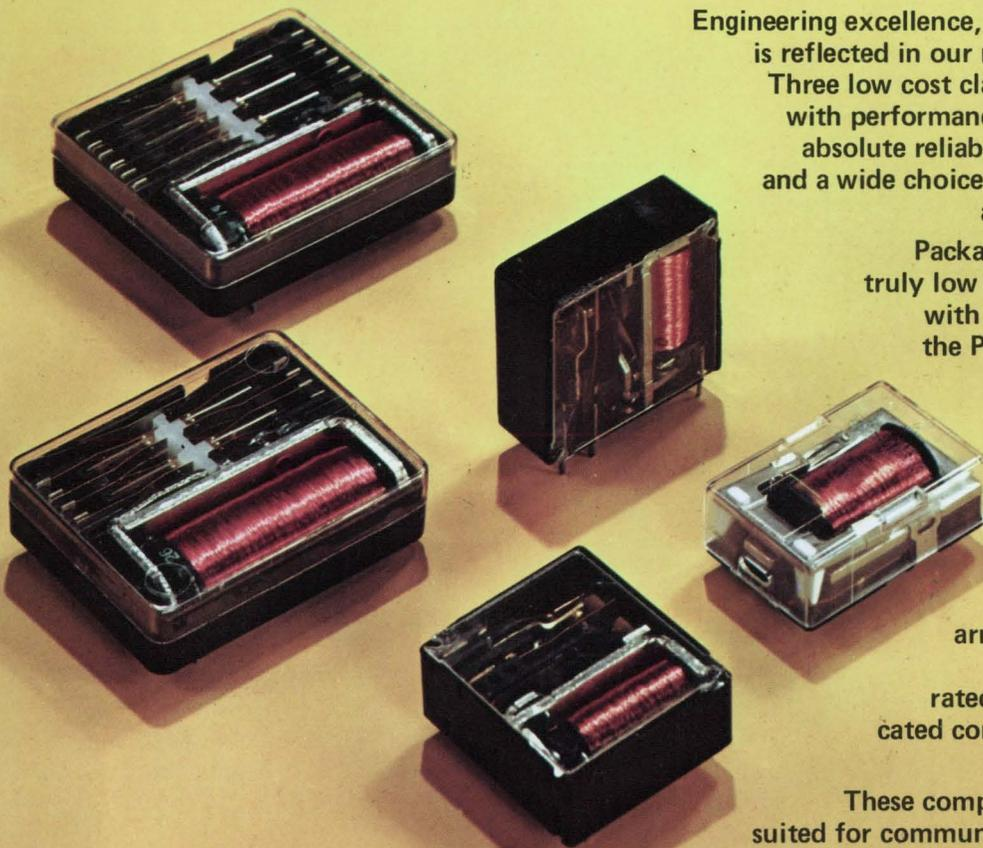

Engineering excellence, a tradition at Magnecraft, is reflected in our new printed circuit relays. Three low cost classes are available in stock with performance specifications including absolute reliability, long mechanical life, and a wide choice of contact configurations and switching capabilities.

Packaging flexibility includes, a truly low profile dust proof design, with a minimum height above the P.C. board, and a vertically mounted space saving version. The relays feature industry standard .1 inch grid spacing for terminals, and high density center to center board spacing. Contact arrangements include SPDT, DPDT, 4PDT, and 6PDT rated from 1 to 8 amps. Bifurcated contacts are optional on certain configurations.

These compact relays are particularly suited for communication systems, data processing equipment, automatic control systems, process control, automotive and consumer electronics.

\*Family of Relays

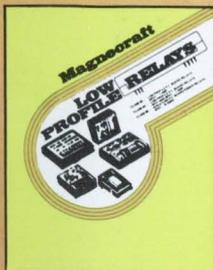

**Free!**  
LOW PROFILE  
RELAY BROCHURE

Specifications, photos, and line drawings are included in Magnecraft's latest 4 page bulletin, number 750. A 36 page stock relay catalog will accompany the bulletin for all your relay applications.

Find Magnecraft Relays in EEM and the Gold Book

**Magnecraft**® ELECTRIC COMPANY

5575 NORTH LYNCH AVENUE • CHICAGO, ILLINOIS 60630 • 312 • 282-5500 • TWX 910 221 5221

What's new in solid state...

# RCA high-voltage power transistors made our special way.



You already know RCA transistors for reliability and performance. But maybe you didn't know about our high-voltage, high-current, fast switching 2N6513, 2N6308 and 2N6251 families. Available off-the-

shelf, they're made with the special brand of advanced technology, process controls, device characterization and circuit performance you expect from RCA. Inventors of the workhorse 2N3055.

### Our special way

These transistors have multiple epitaxial base structure and 4-layer pi-nu construction, for high voltage and energy-handling capabilities. Rugged clip-lead connections for reliability and high current-

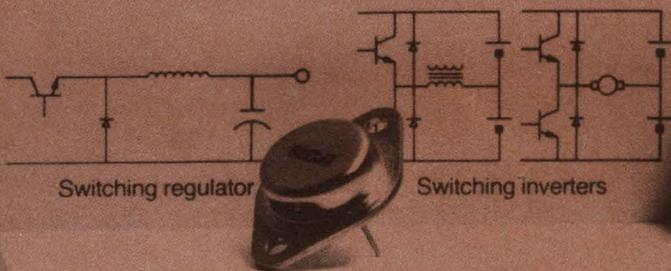

handling. Plus a thermal cycling rating that helps you design for optimum reliability vs. cost. All of which makes these devices excellent choices for 20 kHz switching regulators and inverters. Motor switches. TV monitors. Hammer, solenoid and relay drivers. Electronic ignition.

Check the specs and competitive prices below. Contact your local RCA Solid State distributor. Or RCA. Write: RCA Solid State, Box 3200, Somerville, New Jersey 08876; Ste. Anne de Bellevue 810, Canada; Sunbury-on-Thames, U.K.; Fuji Bldg., Tokyo, Japan.



Coming soon.  
A Super Switch.  
 $t_r = < 200 \text{ nsec@6 amps.}$

	$I_C$ amps	$V_{CEr}$ volts	$V_{CBO}$ volts	$V_{CEO}$ (sus) volts	$P_T$ watts	$V_{CE}$ (sat) volts	$t_r$ nsec	$t_s$ sec	$t_f$ nsec	100+ price
2N6513	7	400	400	350	120	1.5@4A	700@4A	3@4A	500@4A	\$4.44
2N6308	8	450	700	350	175	1.5@3A	600@3A	1.6@3A	400@3A	\$5.09
2N6251	10	375	450	350	175	1.5@10A	800@10A	1.8@10A	500@10A	\$6.84

RCA. Powerhouse in Transistors.