

# electronics

(Photo at right)

## “TELEMETER AWAY!”

*Acoustic system  
uses f-m/f-m, p 53*

---

## MEGAWATT MODULATORS

*Test system aids  
device design, p 56*

---

## TORSIONAL DELAY LINES

*used in function  
generator, p 62*

*In This Issue*

## NUCLEAR ATTACK AND INDUSTRIAL SURVIVAL

A MCGRAW-HILL SPECIAL REPORT

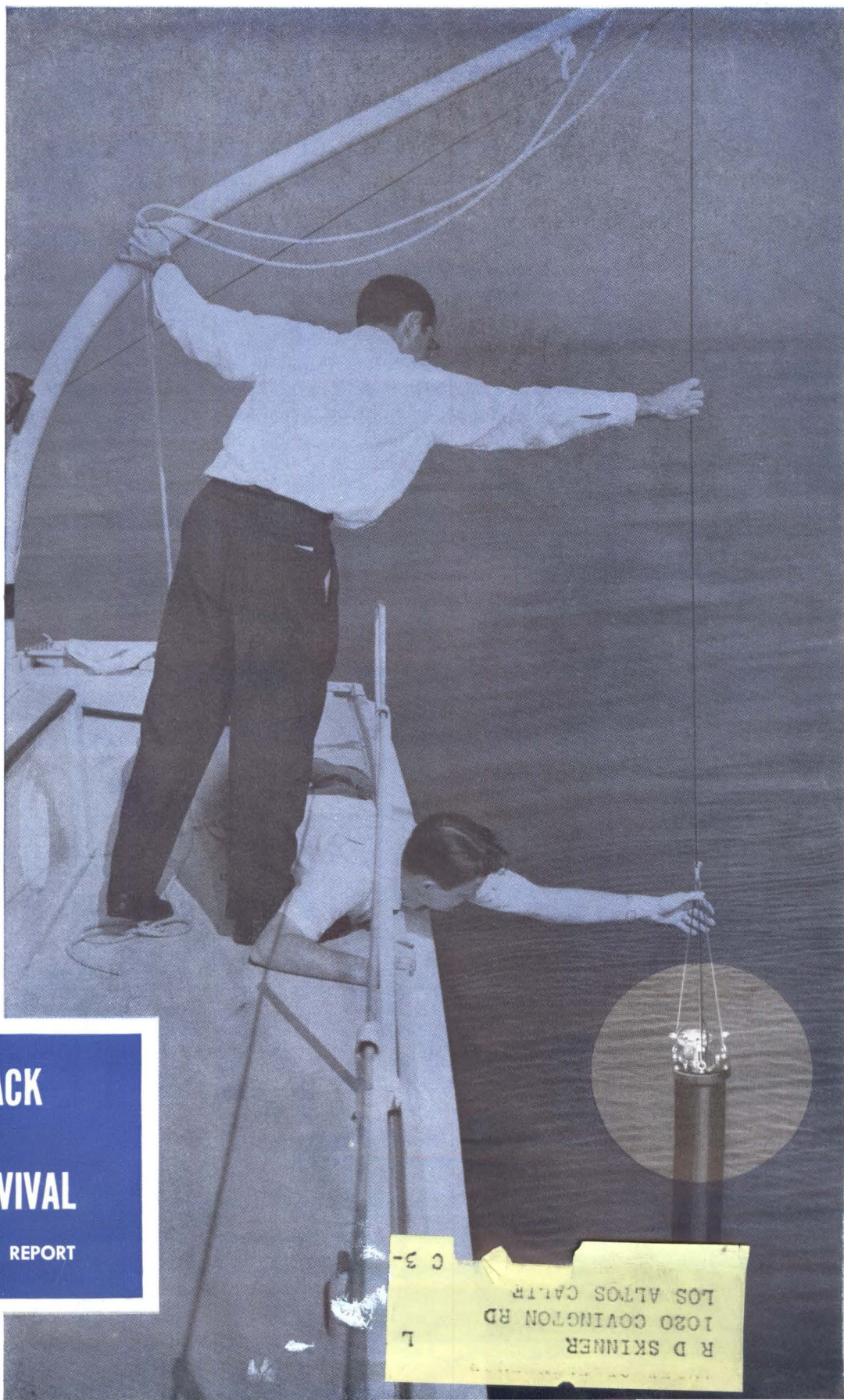

# 1 $\mu$ w to 10 mw coverage, in power meter ever produced!

This new  $\text{hp}$  Power Meter makes continual zero-setting a thing of the past, even on the 10  $\mu$ w range, with extreme temperature stability and a single zero-set covering all 7 ranges. You get a completely usable 10 db sensitivity premium over previously available equipment.

New, specially designed temperature compensated thermistor mounts are used with the  $\text{hp}$  431A. The  $\text{hp}$  478A Coaxial Mount covers 10 MC to 10 GC, and the  $\text{hp}$  X486A Waveguide Mount covers X-Band.

A dual balanced bridge technique and careful design and construction keep dc power in one bridge equal to the unknown rf power in the other. The dc power is then metered. High heat conductivity materials and matched thermistors in close proximity in the 478A and 486A mounts provide extremely close thermal tracking. Thus ambient temperature effects are automatically balanced out and the meter remains zeroed, even in the presence of thermal shock.

These advantages combine to make the  $\text{hp}$  431A unusually useful for instantaneous microwave power measurements. Microwave power standards measurements can be made to a high accuracy and resolution by using the dual bridge of the  $\text{hp}$  431A as a transfer device. A dc calibration input jack permits precise dc calibration of the thermistor mount. The grounded output jack will then drive an appropriate digital voltmeter for increased resolution. In addition, the grounded output jack, combined with the nearly drift free operation of the 431A, makes reliable long term recordings of microwave power.

The  $\text{hp}$  431A also has an optional rechargeable battery pack which will give up to 24 hours of completely portable operation, as well as regular ac line operation while recharging.

## SPECIFICATIONS

Power Range:	10 $\mu$ w to 10 mw full scale in 7 ranges. Also calibrated from -30 to +10 dbm
Accuracy:	$\pm 3\%$ of full scale 2° to 35°C; $\pm 5\%$ of full scale 0° to 55°C, all ranges
Operating Impedance:	100 or 200 ohms, negative, for operation with above Mounts
Recorder/Volmeter Output:	Phone jack on rear with 1 ma into 2,000 ohms or less
Calibration Input:	Binding posts on rear for calibration of bridge with precise dc standards
Power:	1½ watts, 115/230 v $\pm 10\%$ , 50-1000 cps
Dimensions:	7½" wide, 6½" high, 12½" deep. Weight 10 lbs.
Price:	\$345.00

or perhaps your power measuring requirements can be met by these  $\text{hp}$  meters

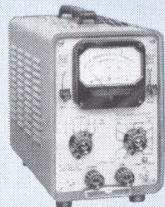

$\text{hp}$  430C Microwave Power Meter — 0.02 to 10 mw

This laboratory-proven meter gives instantaneous rf power readings direct in dbm or mw, 10 MC to 40 GC with  $\text{hp}$  proven bolometer mounts available now.  $\text{hp}$  430C operates with any bolometer operating at 100 or 200 ohms, positive or negative temperature coefficient. Fully adjustable biasing current to 16 ma available to bring bolometers to their operating range. Five power ranges are selected with a front-panel control, full scale readings of 0.1, 0.3, 1, 3 and 10 mw. Also continuous readings —20 to +10 dbm. Accuracy is  $\pm 5\%$  of full scale reading. Dimensions, (cabinet) 7½" x 11½" x 14"; (rack mount) 19" x 7" x 13½" behind panel. Price,  $\text{hp}$  430C \$250.00 (cabinet);  $\text{hp}$  430CR, \$255.00 (rack mount).



$\text{hp}$  434A Calorimetric Power Meter — 10 mw to 10 w

Here's the fastest, easiest means yet devised to measure powers accurately from 10 mw to 10 w, dc to 12.4 GC! No barretter, thermistor, external terminations or plumbing are required. Measurements are as simple as connecting to a 50 ohm type N front panel terminal and reading directly. Only two front panel controls (range and zero); seven meter ranges for full scale readings of 0.01, 0.03, 0.1, 0.3, 1.0, 3.0 and 10 w. Also provides continuous readings —30 to +10 dbw. Accuracy  $\pm 5\%$  of full scale (includes dc calibration and rf termination efficiency but not mismatch loss). Greater accuracy can be achieved through appropriate techniques. Dimensions, (cabinet) 20½" x 12½" x 14¾"; (rack mount) 19" x 10½" x 13½". Price,  $\text{hp}$  434A, \$1600.00 (cabinet);  $\text{hp}$  434AR, \$1,585.00 (rack mount).



## HEWLETT-PACKARD COMPANY

1501 Page Mill Road Palo Alto, California, U.S.A.  
Cable "HEWPACK" Davenport 6-7000  
Sales representatives in all principal areas

## HEWLETT-PACKARD S. A.

Rue du Vieux Billard No. 1 Geneva, Switzerland  
Cable "HEWPACKSA" Tel. No. (022) 26. 43. 36

Data subject to change without notice. Prices f.o.b. factory

# Unique temperature stability, the most stable microwave

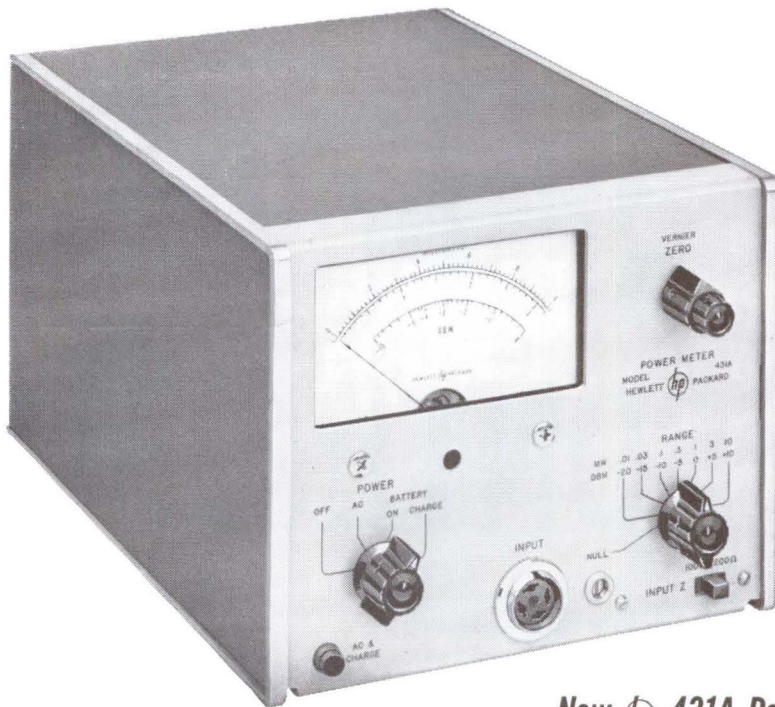

Single setting zeroes all ranges  
for hours

Easy to operate

Grounded recorder output

Optional portable operation

New **hp** 431A Power Meter

## New **hp** Thermistor Mounts assure **hp** 431A Thermal Stability



**hp** 478A  
Thermistor  
Mount

This wide-range, temperature compensated coaxial mount covers 10 MC to 10 GC, with no tuning required. Closely matched thermal environments for the two thermistor pairs for use with the dual bridge **hp** 431A assure excellent tracking, even under thermal shock. The **hp** 478A as used with the **hp** 431A provides high accuracy and virtually drift-free operation.

### SPECIFICATIONS

**Frequency Range:** 10 MC to 10 GC  
**SWR:** Less than 1.5 (less than 1.3, 50 MC to 7 GC)  
**Power Range:**  $1\mu\text{w}$  to 10 mw (with **hp** 431A)  
**Elements:** Four 100-ohm, negative temperature coefficient thermistors permanently installed.  
**Price:** \$145.00



**hp** 486A  
Waveguide  
Thermistor  
Mount

X-Band Mount, 8.2 to 12.4 GC, provides close temperature tracking with the **hp** 431A, even in the presence of thermal shocks. No tuning is required. Unusual freedom from drift is assured with extremely close temperature tracking achieved through careful matching of thermal environments for the two thermistors.

### SPECIFICATIONS

**Frequency Range:** 8.2 to 12.4 GC  
**Power Range:**  $1\mu\text{w}$  to 10 mw  
**SWR:** Less than 1.5  
**Elements:** Two permanently installed 100-ohm negative coefficient thermistors for each bridge  
**Waveguide Size:** 1" x 1½"  
**Price:** \$145.00

**STOP**  
**ZERO CHASING**  
**NOW!**

# **MEASURE RF POWER** **WITHOUT CONTINUAL** **ZERO-SETTING**

One twist of one knob zero sets all ranges... for hours!

*The new  431A Power Meter  
gives you 3% accuracy on  
all ranges, 100 times less  
thermal drift*



For details on this and other  power  
measuring equipment turn the page.

# electronics

A McGraw-Hill Publication 75 cents



W. W. MacDONALD, Editor

J. M. CARROLL, Managing Editor  
 SENIOR EDITORS: Samuel Weber, George W. Sideris. SENIOR ASSOCIATE EDITORS: William E. Bushor, Michael F. Wolff. ASSOCIATE EDITORS: Michael F. Tomaino, Sylvester P. Carter, William P. O'Brien, John F. Mason, Thomas Emma, Sy Vogel, Leslie Solomon, M. M. Perugini, George J. Flynn, Laurence D. Shergalis. ASSISTANT EDITORS: Nilo Lindgren, Stanley Froud, Stephen B. Gray, Roy J. Bruun, George V. Novotny, Leon H. Dulberger. REGIONAL EDITORS: Harold C. Hood (Pacific Coast, Los Angeles), Thomas Maguire (New England, Boston), Cletus M. Wiley (Midwest, Chicago). ART DIRECTOR: Harry Phillips; Howard R. Berry. PRODUCTION EDITOR: John C. Wright, Jr. EDITORIAL ASSISTANTS: Gloria J. Meurer, Bernice Duffy, Lorraine Rossi, Virginia T. Bastian, Lynn Emery, Laura W. Smith, Bette H. Snyder, Rosemary Abbruzzese, Judy Haskins. FOREIGN NEWS BUREAU: Director, John Wilhelm, Alyne Elias. London—John Shinn, Derek Barlow, Nicholas Landon. Bonn—Peter Forbath, James Morrison, Silke McQueen. Paris—Robert Farrell, Arthur Erikson. Milan—Gene DiRaimondo. Mexico City—Bruce Bendow. Rio de Janeiro—Leslie Warren. Moscow—Stewart Ramsey. Tokyo—Richard Hallaron, Charles Cohen, John Yamaguchi.

JAMES GIRDWOOD, Publisher

**"TELEMETER AWAY!"** Oceanographic telemetering probe is lowered 2,000 ft into the Pacific Ocean. Bendix-Pacific unit transmits water temperature and pressure acoustically, also has a leak detector. *See p 53 for system details* **COVER**

**MILLIMETER-WAVE RADAR** Is Used in Japanese Weather Station. Bad weather is located before it starts, by high-frequency reflections from mist and dust particles. *Airways could use a ground network like this to warn airliners of trouble ahead* **20**

**MODULAR COMPUTER** Design Facilitates Expansion. New systems family is introduced. *Economy size can be expanded to deluxe model in customer's office* **21**

**C-W LASER** with a New Kind of Crystal Puts Out Continuous Power. This early model needs nearly a kilowatt, only puts out a few milliwatts. *But developers bet it will lead to practical laser communications much sooner than pulse types* **26**

**THREE-DIMENSIONAL RADAR** Proposed for Air Traffic Control. Multibeam system would sort out altitude layers, digitally show heights of selected aircraft. *By cutting the sky into bite-sized slices, it reduces ppi clutter* **27**

**GAMMA RAY COMMUNICATIONS** for Outer Space. Gamma-to-photon converters may solve the main problem in using reactor byproducts to carry messages. *A whole new spectrum range could be put to work* **28**

---

**NUCLEAR ATTACK AND INDUSTRIAL SURVIVAL.** A special report by the editors of McGraw-Hill weighs the effects of a nuclear attack and tells how to plan for survival and recovery. *We do not believe a nuclear war is likely. But we do believe the possibility of one—however remote—must be faced realistically* **35**

---

**UNDERWATER TELEMETRY** for Oceanography Research. Sonar projector transmits f-m/f-m signal to hydrophone just below the surface. System will go as deep as 10,000 feet. *Question: can standard missile telemetering systems be adapted for underwater use?* D. E. Campbell, R. J. Cyr and C. Crosier **53**

Contents continued

Published weekly, with Electronics Buyers' Guide and Reference issue, as part of the subscription, by McGraw-Hill Publishing Company, Inc. Founder: James H. McGraw (1860-1948).

Title ® registered U.S. Patent Office; © Copyright 1962 by McGraw-Hill Publishing Co., Inc. All rights reserved, including the right to reproduce the contents of this publication, in whole or in part.

Executive, editorial, circulation and advertising offices McGraw-Hill Building, 330 West 42nd Street, New York 36, N. Y. Telephone Longacre 4-3000. Teletype TWX N.Y. 1-1636. Cable McGrawhill, N. Y. PRINTED IN ALBANY, N. Y.; second class postage paid at Albany, N. Y.

OFFICERS OF THE PUBLICATIONS DIVISION: Nelson L. Bond, President; Shelton Fisher, Wallace F. Traendly, Senior Vice Presidents; John R. Callahan, Vice President and Editorial Director; Joseph H. Allen, Vice President and Director of Advertising Sales; A. R. Venezian, Vice President and Circulation Coordinator; Daniel F. Crowley, Vice President and Controller.

OFFICERS OF THE CORPORATION: Donald C. McGraw, President; Hugh J. Kelly, Harry L. Waddell, Executive Vice Presidents; L. Keith Goodrich, Executive Vice President and Treasurer; John J. Cooke, Vice President and Secretary.

Subscriptions are solicited only from those actively engaged in the field of the publication. Position and company connection must be indicated on orders. Subscription rates: United States and Possessions, \$6.00 one year; \$9.00 two years; \$12.00 three years. Canada, \$10.00 one year. All other countries \$20.00 one year. Single Copies, United States and Possessions and Canada 75¢; Buyers' Guide \$3.00; Single copies all other countries \$1.50; Buyers' Guide \$10.00.

THE PUBLISHER, UPON WRITTEN REQUEST FROM ANY SUBSCRIBER TO OUR NEW YORK OFFICE, AGREES TO REFUND THAT PART OF THE SUBSCRIPTION PRICE APPLYING TO COPIES NOT YET MAILED.

Subscribers: Please address all correspondence, change of address notices, subscription orders or complaints to Fulfillment Manager, Electronics, at above address. Change of address notices should provide old as well as new address, including postal zone number if any. If possible, attach address label from recent issue. Allow one month for change to become effective.

Postmaster: Please send Form 3579 to Fulfillment Manager, Electronics, 330 West 42nd Street, New York 36, New York.



Audited Paid Circulation

CONTENTS Continued

MULTIMEGAWATT MODULATORS: How to Test Them Safely. Discusses modulation arrangements, means of coupling signals and ways to protect modulators and load tubes. *Presents the case for using high-vacuum modulators in large radars and particle accelerators.* T. E. Yingst 56

TORSIONAL DELAY LINES Generate Digital Functions. Small magnets placed close to a torsional-mode magnetostrictive delay line define as many time delays as desired. *An efficient word or pattern generator, this setup can also supply timing and control functions.* W. Perzley and M. Fishbein 62

FLICKER-FUSION TESTER for Medical Research. Flicker-fusion threshold measures frequency at which a subject perceives a flashing light change to steady. It's used in evaluating new psychiatric drugs. *This unit uses a relaxation oscillator to drive a zirconium lamp.* C. Landis, D. J. Dillon and M. Croslin 66

REFERENCE SHEET: Point-Availability Nomograph. In reliability studies, point availability is the percent of time equipment will work when needed. *Here's help for the engineer who wants to trade off reliability for maintainability.* R. R. Trachtenberg 68

DEPARTMENTS

Crosstalk. *Digits and Functions* 3

Comment. *Who's Electronic? What's Electronics?* 4

Electronics Newsletter. *USSR Outlines Space Plans* 7

Washington Outlook. *Raises for Engineers, but not for Nike Zeus Anti-ICBM System* 12

Meetings Ahead 32

Research and Development. *Solar Cell Directs Computer Card Feed* 70

Components and Materials. *Kink Effect in Bismuth Semiconductors* 85

Production Techniques. *Static Electricity Can Kill Transistors* 90

New Product Design. *Variable Bandwidth Pre-amplifier* 102

Literature of the Week 116

People and Plants. *Electrospace Opens New Plant* 118

Index to Advertisers 131

# CROSSTALK

**RADAR RENAISSANCE.** Perhaps you've noted the increasing frequency of articles on radar in our front-of-book late news columns. If you've wondered why, the answer is simply this: there is a lot of new radar equipment being developed; there are a number of radar fields in ferment. Radar for navigation, radar for aircraft defense, radar for missile defense, radar for space tracking, radar for air traffic control, radar for weather reporting—radar has come a long way since the Battle of Britain, and it is certain to go further. There is every likelihood that acoustic and optical types will supplement and be combined with r-f types in the near future. With that preamble, we would like to point out that this week we are publishing two more articles on radar: a millimeter wavelength weather system (p 20) and a 3-D system proposed for air traffic control (p 27).

**DIGITS AND FUNCTIONS.** One of the cleverest designs for a digital function generator to cross our desk in a long time is a torsional delay line that can produce a multitude of variably-spaced pulses by the use of small magnets located along its length. To adjust it, you merely move the positions of the magnet, as the engineer is doing in the photo, and watch the output pattern on an oscilloscope. That small box in the center of the coiled line houses the control electronics.

Cost of such a device would be high if a separate circuit were needed for every pulse produced. But the magnets—up to 200 of them on a one-millisecond delay line—absorb hardly any energy. All they do is induce signals as the pulse travels along. Thus, a single amplifier serves to deliver all pulses in serial form. The amplifier has a high input impedance so that pulses induced by the magnet are, to all intents and purposes, fed into an open circuit.

The basic idea and a summary of the applications for the function generator was disclosed several weeks ago by Consolidated Avionics Corp. at a press conference (*ELECTRONICS*, p 11, Nov. 17, 1961). We thought the device was worth more than passing mention, so we asked the company to prepare for our readers an ex-

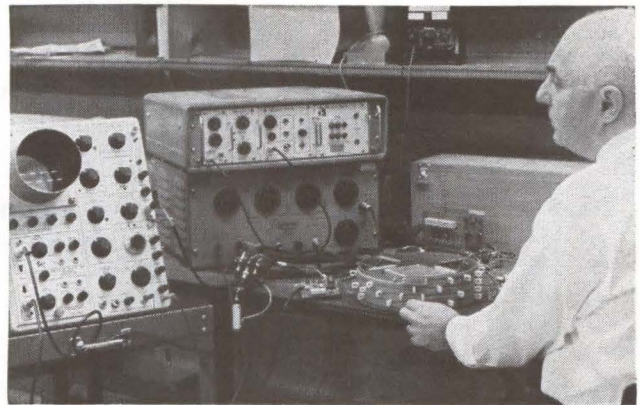

clusive article giving design principles and application information in full. The report, by William Perzley and Milton Fishbein, appears on page 63.

**NEODYMIUM.** This rare, yellowish element looks like the touchstone that will permit laser crystals to operate continuously, paving the way to laser applications in communications, weapons, metalworking, research and other fields. It works in at least two crystals (p 26).

## Coming In Our January 19 Issue

**END OF ORBIT.** If all goes as previously scheduled, a Mercury Project astronaut will have completed the first U. S. manned orbit flight just a week or so after our next issue. A system called Sarah (Search-and-Rescue-and-Homing) is responsible for pinpointing the landing and directing rescue craft to the capsule. This miniature beacon, which can also locate missiles, will be described by J. G. Richter, of Simmonds Precision Products.

Other features next week include reports on a stereo multiplex signal generator, by S. Feldman, of Motorola; a method of using the double superheterodyne technique in a carrier-operated squelch system, by J. M. Tewksbury, of Bendix; another chapter in Senior Associate Editor Bushor's series on medical electronics, and a description of the Bell Telephone System's new long-haul network, by Associate Editor Shergalis. The net, operating at frequencies around 6 Gc, incorporates a number of recent developments in microwave communications.

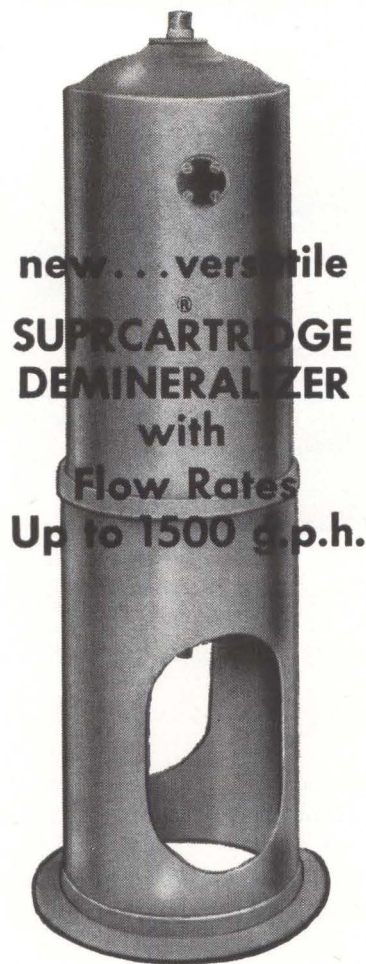

**1** Can be used anywhere in your plant under pressure up to 100 s.p.i.

**2** Combines high flow rates with convenience of cartridge operation.

**3** Permits cartridge renewal to suit individual requirements.

**4** Regenerator available for reactivating cartridges in your own plant.

**5** High flow rates at lowest equipment cost.

**6** Cartridge with holder occupies space of only 15" x 15" x 46" high.

**7** Suprcartridge may be installed at one or at several convenient locations in your plant.

Write for new Suprcartridge  
Bulletin #177.

**Barnstead**  
STILL AND STERILIZER CO.

84 Lanesville Terrace, Boston 31, Mass.

## COMMENT

### Electronic Versus Electronics

Will you please help me to clear up some confusion relative to the proper use of the words *electronic* and *electronics*?

It appears to me that *electronic* describes a *device*, such as an electronic timer or electronic organ, and that the word *electronics* describes a science or technology or field of interest or activity.

Yet I see frequently such expressions as *electronic industries*, *electronic courses* and *electronic engineers and technicians*.

Would not an *electronic technician* be one who operates on electronic principles? Would not *electronics technician*—one who works in the field of electronics—be preferred?

And if an *electronic door opener* uses principles and devices described by the term, would not an *electronic industry* use these devices and principles rather than engage in the production or sale of devices? Would not this sort of industry be more properly called *electronics industry*, connoting industry engaged in the field of electronics?

CYRUS ROHRER, JR.

Tolono, Illinois

We always try to say **electronics industry and electronic device**. Probably the reason why everyone doesn't is because that little letter is often difficult to pronounce in a phrase; also it might not sound right, even though it is. And the speech habit carries over to writing.

### Proprietary Rights

I found Robert W. Galvin's statement in the Dec. 8 *Comment* (p 6) extremely interesting and logical... that an employer (federal government) should permit an employee (engineering/manufacturing firm) to retain *all rights* in patented inventions developed during the course of employment, save for free licensing.

I wonder, however, if Mr. Galvin's firm [Motorola] "practices what he preaches" and if his firm, as an employer, permits his employees (design engineers) to re-

tain *all rights* in patented inventions which they may develop during the course of employment, save for free licensing.

If so, then I, for one, can endorse his stand and applaud his position.

EUGENE RICHARDSON

The Electratomic Company  
Wheaton, Maryland

### Subaudio Sawtooth Generator

In the very interesting article, Subaudio Sawtooth Generator Gives One-Percent Linearity (p 42, Dec. 1, 1961), the next-to-last paragraph says that the linearity error of one percent at 0.2 cps, which appears primarily at the tail end of the ramp function, seems to be caused by leakage currents delaying the achievement of the NE-2 neon firing voltage.

Leakage resistance across the base of neon lamps similar to the NE-2 can be reduced through using some of our lamps that have been subjected to the Dri-film process. This is a silicone coating that we apply to the lamp which increases considerably its leakage resistance, particularly under the conditions of high humidity.

The suggestion in the article that the lamp be shielded from light concerns me somewhat, since glow lamps are subject to "dark effect" and in classical cases we have seen the breakdown voltage of a glow lamp rise as much as 100 volts over its breakdown in light. For applications where lamps are to be enclosed in a darkened cabinet may we suggest the use of lamps containing radioactive additives, which reduce this effect markedly. However, this could theoretically increase leakage currents through the bulb, but these are extremely small, and I doubt they would be of much concern in this application.

Perhaps a better overall lamp for the job would be our NE-81, which has both a radioactive additive and the Dri-film coating for high leakage resistance.

J. W. TUTTLE

General Electric Company  
Cleveland, Ohio

The author advises us that in Fig. 2 of this article (p 42), the +300 volt supply should not connect to ground, but should go directly to R<sub>13</sub>, a one-megohm resistor. To correct: remove junction dot.



**TUNG-SOL**  
**6977**  
*subminiature  
 indicator triode  
 saves display space*

Here's an indicator triode for computer and business machine applications that will replace neon lamps in computer circuits. It has the advantage of low voltage drain with great economy of display area.

The Tung-Sol 6977 is a filamentary, high vacuum, subminiature triode with a fluorescent anode. Especially advantageous in transistorized circuits, its high input impedance and small signal requirements do not load these circuits.

Tung-Sol design and manufacturing skills are being applied constantly to the problems of improving componentry in all fields where industrial and special purpose tubes find their specialized uses.

If you have questions regarding the application of type 6977, or any tube type, you are invited to bring them to Tung-Sol. You will be pleased with the results. Tung-Sol Electric Inc., Newark 4, N. J. TWX: NK193

**TYPICAL OPERATION**

Heater Voltage <sup>B</sup> AC	1.0	Volts
Anode Voltage DC	50	Volts
Grid Resistance	100,000	Ohms
Grid Supply Voltage for max. light output	0	Volt
Grid Supply Voltage at zero light output	- 3	Volts

TECHNICAL ASSISTANCE IS AVAILABLE THROUGH: Atlanta, Ga.; Columbus, Ohio; Culver City, Calif.; Dallas, Tex.; Denver, Colo.; Detroit, Mich.; Irvington, N. J.; Melrose Park, Ill.; Newark, N. J.; Seattle, Wash. In Canada: Abbey Electronics, Toronto, Ont.

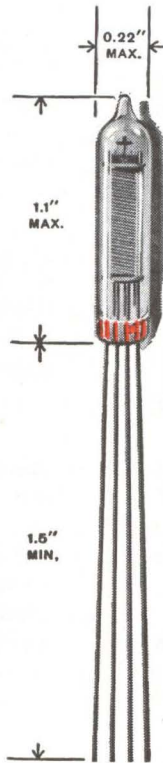

# SIX POWER SOURCES

## Unique accuracy and dependability

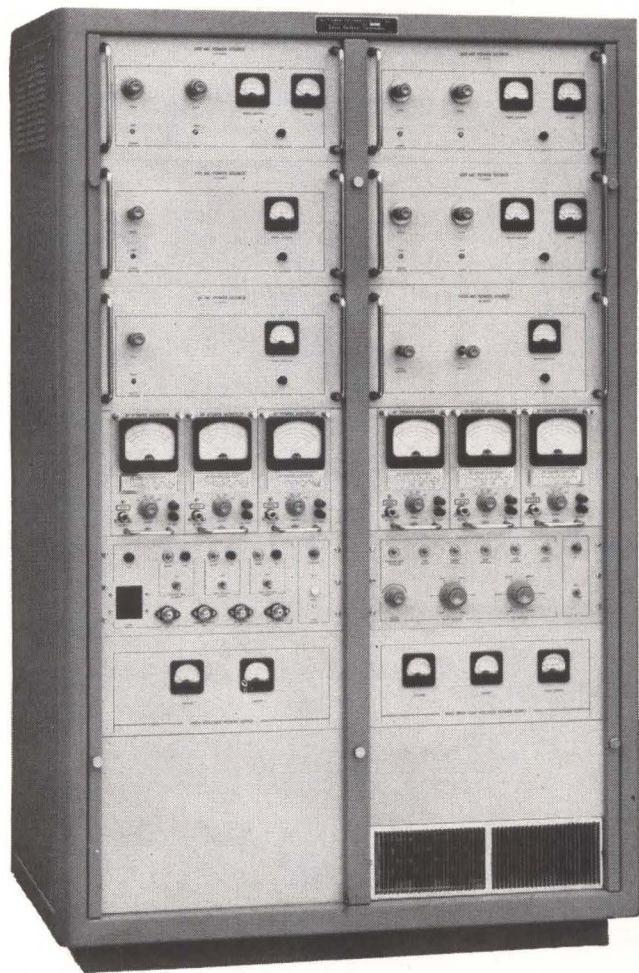

### in a versatile new Sierra RF Calibration Test Set

Think of the many applications YOU have for a single system that gives you variable power to 125 watts at RF frequencies of 30, 100, 300, 400, 500 MC, to 60 watts at 1300 MC!

Besides being able to calibrate many forms of power-measuring devices to 1% accuracy (0.5% probable accuracy), you can use this test set as a convenient precision source of high-power RF for applications such as antenna and interference measurements.

Sierra Model 1223 includes six power sources, six power monitors, power and frequency selector unit, blower unit, control unit and two regulated power supplies—all housed in a 19-inch double rack.

The crystal-controlled power sources are highly stable, providing frequency accuracy within 0.01%. For calibrating calorimeters, bolometer and thermistor type power meters, and other devices for detecting RF power levels, just connect the device, select the frequency and power level, and compare the device reading against the known power of the test set. A factory-furnished potentiometer and voltage/power table provides additional calibration accuracy over the panel-mounted power meter.

The six unique power monitors, one for each power source, attenuate harmonics and deliver dc voltage proportional to incident RF to the front-panel meter and potentiometer. Special design of a directional coupler and thermocouple detector help maintain the calibration of the monitors over a long period of time. Once calibrated, a repeatability of 0.5% can be expected.

Special control circuits protect the test set; indicators assure the operator of proper test set operation and monitor output voltages and current drains. Simple removal of individual rack-mounted units speeds calibration and routine maintenance.

### SPECIFICATIONS

<b>Frequencies:</b>	30, 100, 300, 400, 500 and 1300 MC
<b>Frequency Accuracy and Stability:</b>	$\pm 0.01\%$
<b>Power Ranges*:</b>	Six ranges (5, 15, 30, 60, 100 and 125 watts) for five lowest frequencies; four ranges (5, 15, 30 and 60 watts) at 1300 MC; all power levels adjustable by vernier control to at least $\pm 10\%$ of nominal range. Vernier resolution is greater than 0.25%
<b>Power-Monitoring Accuracy:</b>	$\pm 1\%$ maximum error with potentiometer measurement, and $\pm 4\%$ (full scale) maximum error with panel-mounted meter. Probable (rms) errors are 0.55% and 2.5%, respectively
<b>Output Impedance:</b>	50 ohms
<b>Recommended Max. Load VSWR:</b>	1.5 to 1
<b>Harmonic Content:</b>	At least 50 db below fundamental frequency
<b>Dimensions:</b>	68" high, 42.5" wide, 20" deep
<b>Price:</b>	\$15,000.00

\*Internal adjustments allow power ranges to be adjusted to any desired coverage.

Data subject to change without notice. Price f. o. b. factory.

Write today for complete information.



### SIERRA ELECTRONIC CORPORATION

A Division of Philco Corporation

7197A BOHANNON DRIVE • DAVENPORT 6-2060 • AREA CODE 415 • MENLO PARK, CALIF., U. S. A.

Sales representatives in all major areas

Canada: Atlas Instrument Corporation, Ltd., Montreal, Ottawa, Toronto, Vancouver

Export: Frazer & Hansen, Ltd., San Francisco

7197

# ELECTRONICS NEWSLETTER

## Soviets Outline Their Space Plans

MOSCOW—Soviet satellite systems for communications and tv relays, for navigation and for weather observations can be "anticipated shortly," according to a report in *Pravda*. *Izvestia* says that automatic stations will be landed on the moon "in the not too distant future," followed by establishment of a permanent scientific station and ultimately an industrial type of installation.

Flights to Venus and Mars "may well be achieved within the next few years," *Izvestia* claims.

Tass, the Soviet news agency, says manned orbital flights will be continued, but the two recent flights warrant preparations for manned flight around the moon. Present technology, Tass reported, enable dispatch of an automatic station to a soft landing on the moon.

Space experts are quoted as saying further improvements are needed in space ship design to provide better living conditions in space, improved communications and control. Such systems are now being perfected, Tass said.

## ARPA Sets Up A-Test Detection Data Center

DATA ANALYSIS and techniques evaluation center, devoted to developing a reliable method of seismically detecting underground nuclear explosions, is being established by Advanced Research Projects Agency. The Defense Department last week awarded United Electro-Dynamics a \$1.5 million contract to set up the center, near Washington, D. C. Computers at the center will process information from a network of seismic stations, as part of Project Vela (*ELECTRONICS*, p. 30, June 16, 1961).

## Japan Plans to Build Two Satellite Stations

TOKYO—Japan will build two major transmitting stations this year to cooperate with the U. S. in developing space communications, according to Shogo Namba, research chief of Denshin Denway Co. The

company and the Postal Ministry will cooperate in setting up the stations to transmit and receive signals from U. S. communications satellites.

## French Start Using Huge Radiotelescope

PARIS—The French have begun using their giant radiotelescope at Nancay, although it won't be completed for 18 months. It can track extragalactic movements for an hour and is reported to attain accuracies of several seconds of arc.

The antenna consists of two reflectors, a mobile plane and a fixed spherical segment. The plane, now measuring 130 ft square, will be enlarged to 656 ft long. The spherical segment is now 197 ft long by 115 ft high and will be enlarged to 984 ft long. The two reflectors are 1,600 ft apart. The French have

## Blubber-Borne Sonar

WHALES may involuntarily participate in antisubmarine warfare experiments, according to a Lockheed oceanographer. "We could learn a lot from a whale's underwater habits and his diving tricks," he says.

Plan is to plant—painlessly—a miniature sonar transmitter on the back of the surfaced mammal, from a low-flying airplane, then follow it by boat and record the signals.

Sperm whales dive more than 1,000 feet, deeper than most submarines. They could provide low-cost dives for R&D work in many areas of asw.

been working at 21-cm and 3-cm wavelengths and plan to add 13-cm receivers. Signals have been picked up from the planet Jupiter and about a hundred stars.

## Communications Company Enters Computer Field

COLLINS RADIO will enter the computer field late this year with equipment designed to integrate data communication and processing systems. Initial models are now being tested at the company's information science center in Newport Beach, Calif.

The line will be called the C-8000 series. One of the first types, C-8400, will have medium-scale computer capability, a 65,536-word memory, and will bring both slow and high-speed communications equipment under stored program control, Collins says.

Decision to enter computer field is reportedly outgrowth of a two-year company program to centralize its own data processing.

## Swiss Order \$70 Million British Guided Missiles

LONDON—Switzerland has signed a \$70 million contract for Bloodhound Mark 2 surface-to-air guided missiles. It is reportedly the largest foreign sale of British missiles and the largest overseas military procurement by the Swiss. Bristol Aircraft is prime contractor, Ferranti makes the guidance and launch control equipment, and Associated Electrical Industries makes target eliminating radar.

## Satellite Amateurs Plan Two More Oscar Launches

OSCAR, the amateur satellite, was squelched by battery burnout one day short of its predicted demise, after 325 earth orbits.

The Project Oscar Association (*ELECTRONICS*, p. 32, Dec. 29, 1961) plans to launch a duplicate soon and follow that with a repeater satellite around June. About 2,500 amateur radio operators have enlisted

to report signal reception.

The signal—HI—of the first two Oscars is programmed by a two-transistor free-running multivibrator followed by five identical transistor flip-flops or binary counters. Transmitter for the third will be selected in about a month, after two potential versions are flight tested in an airplane.

## Try Moon Bounce Again With Spuncast Antenna

RADAR RESEARCHERS at MIT Lincoln Laboratory are again ready to try bouncing an 8.6-mm signal off the moon. The project is expected to give data on lunar surface properties and is also part of a long-range exploration of the use of millimeter wavelengths in space communications.

The project was foiled last winter when a spuncast 28-foot parabola buckled during an extended cold snap (ELECTRONICS, p 41, Jan. 6 and p 12, Feb. 24, 1961). A new dish has been made, incorporating techniques to prevent thermal cracking.

## Old Faithful Becomes Surveillance R&D Lab

TEAM OF BOEING meteorologists and technicians this month set up instruments around the hot water geysers in Yellowstone National Park to measure the scattering of light rays by ice clouds.

The project is part of an Air Force study of cloud obscuration of tv, photographic and infrared surveillance by high-altitude vehicles and satellites.

Cirrus clouds are produced by Old Faithful and Castle geysers in the winter, when Yellowstone temperatures range from 30 F to as low as 66 F below zero.

## Ionospheric Cap Theory Confirmed by Satellite

ANALYSIS OF DATA transmitted by ionospheric sounder aboard Discoverer 36 confirms the theory that the high-latitude ionospheric cap

disturbs space signals as well as high-frequency radio communications on earth. A close relationship was found between solar events and signal fluctuations, especially in northern regions where the Aurora Borealis is found.

Ionospheric effects were determined from changes and attenuations of signals from the satellite, as received at stations in Canada, the Aleutians, Houghton, Mich., and the Urbana campus of the University of Illinois, which developed the sounder. It transmits at 20.005 and 40.010 Mc.

## Two Bmews Sites Ready, Third Under Construction

AIR FORCE Systems Command was scheduled to turn over to the Air Defense Command a few days ago the Ballistic Missile Early Warning System. Sites at Thule, Greenland, and Clear, Alaska, are completed. The third is being built at Fylingdale Moor, England.

RCA is prime contractor for the 3,000-mile radar system. General Telephone reported last week that Sylvania has completed installation of the high-speed radar data take-off and processing systems for the northern sites. Sylvania will continue as an RCA subcontractor, working on new computer programs for recently installed missile tracking radars.

## Tax Collector May Follow Satellites in Outer Space

UNITED NATIONS memo prepared by Eugene Staley, senior economist and director of basic research at Stanford Research Institute's International Development Center, proposes that the UN tax communications and television relay satellites. He also says the UN should have authority to license and regulate space traffic.

Staley says the proposal could in time solve the UN's financing problems, if member states authorize such taxes. Other sources of revenue, now outside national boundaries, are the extensive food and mineral resources in the oceans and polar regions, he says.

## In Brief . . .

NEW YORK CITY began operating its automated subway train (p 16, Dec. 22) last week—with a standby motorman and a promise that automatic controls would cost no transit employee his job.

VOICE OF AMERICA'S big broadcast relay station in Liberia will be built by Page Communications Engineers, under \$7.4 million contract from USIA.

SYLVANIA is to build and test a scale model phased array radar, for possible use in Nike Zeus system. The \$28 million order came from Bell Telephone Labs.

RAYTHEON announces \$25.3 million more in Hawk missile contracts from Army.

NAVY CONTRACTS include \$19 million to Univac for additional computers and equipment for the Naval Tactical Data System (p 30, Sept. 16, 1960); \$1.4 million to Western Electric for asw aircraft indicators; \$1.2 million to General Instrument for electronic fuzes; \$460,000 to United ElectroDynamics for drone control systems.

SATURN space rocket's guidance will be similar to Pershing missile's. Initial NASA contract to Bendix, for stable platforms using air-bearing gyros, is for \$2.1 million.

TROPOSCATTER contracts include \$1.4 million to Collins Radio, for engineering on Army system in Pacific, and \$1 million to National Co., for Air Force transportable equipment.

OTHER RECENT military and space awards include \$600,000 to Temco Electronics for Dyna Soar flight control components; \$250,000 to Remanco for radar test gear; \$200,000 to Leach for Minute-man telemetry receivers.

ADVANCED SCIENTIFIC Instruments reports its larger digital computer will be operating this month. It has two smaller computers in production, one for NASA.

# New from Sprague!

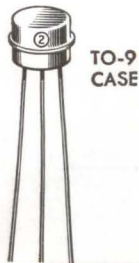

TO-9  
CASE

**The Most Widely-Used Logic Transistor,  
Type 2N1499A, Now Has a Smaller Brother...**

# TYPE 2N979



TO-18  
CASE

## LOW-COST LOGIC TRANSISTOR

Here is a new Sprague Transistor that is smaller in size, yet identical in performance with the well-known 2N1499A Logic Transistor.

Designed for use in saturated switching circuits, this low-cost, hermetically-sealed MADT® Transistor is capable of switching at frequencies in excess of 10 megacycles.

In addition to computer applications, this rugged transistor is ideally suited for data processing and instrumentation equipment.

There are two major reasons why The Sprague 2N979, as with the 2N1499A, is earning a high level of acceptance:

**1. DEPENDABLE PERFORMANCE**— Specifically designed with parameters intended for logic

circuits, these transistors consistently show low storage time, low saturation voltage, high beta, high switching speed. Their cases are cold welded to insure reliability.

**2. ATTRACTIVE PRICE**— Available in production quantities, these transistors are first-run devices, *not* "fall-outs". They are produced on FAST (Fast Automatic Semiconductor Transfer) lines with direct in-line process feedback, especially programmed to insure high production yields.

Here are some key parameters:

$I_{CBO}$ .....	1 $\mu$ a typ.
$BV_{CBO}$ .....	20V min.
$BV_{CES}$ .....	20V min.
$f_T$ .....	100 mc min.

*For application engineering assistance without obligation, write Transistor Division, Product Marketing Section, Sprague Electric Co., Concord, New Hampshire.*

*For complete technical data, write Technical Literature Section, Sprague Electric Company, 35 Marshall Street, North Adams, Mass.*

### SPRAGUE COMPONENTS

TRANSISTORS  
CAPACITORS  
MAGNETIC COMPONENTS  
RESISTORS

INTERFERENCE FILTERS  
PULSE TRANSFORMERS  
PIEZOELECTRIC CERAMICS  
PULSE-FORMING NETWORKS

HIGH TEMPERATURE MAGNET WIRE  
CERAMIC-BASE PRINTED NETWORKS  
PACKAGED COMPONENT ASSEMBLIES  
FUNCTIONAL DIGITAL CIRCUITS



'Sprague' and '®' are registered trademarks of the Sprague Electric Co.



**NOW!** Exciting news for our present and future customers.

**TWO AFFILIATED COMPANIES JOIN EXPERIENCE AND FACILITIES TO ANNOUNCE  
A NEW SINGLE SOURCE FOR SEMICONDUCTOR CLAD METALS & PARTS!**



**FROM MELTING POT TO FINISHED PART IN ONE PLANT!**

Now two affiliated companies working under one roof, Leach & Garner Co. and General Findings Inc., combine their specialized skills to produce a vital "single source" service for the **semiconductor field**. Experience tells you how important this is in terms of faster delivery, better quality, closer tolerances, lower costs and more advanced material development.

**LEACH & GARNER . . . for Clad Metals**

Over 60 years' successful experience has established Leach & Garner as a leader in the production of clad and solid alloys for a wide range of industries. Now a program, carefully developed by unique owner-management, has created a completely new, clean, **and separate** department where this experience is applied to bonding, rolling and fabrication of **clad semiconductor materials**.

**GENERAL FINDINGS . . . for Precision Parts Fabrication**

Specialized experience through production of countless miniature precision parts for the electronic industry is now combined with the most modern facilities to offer **semiconductor manufacturers** the service needed to meet the most demanding requirements at low cost with absolute assurance of complete conformity.

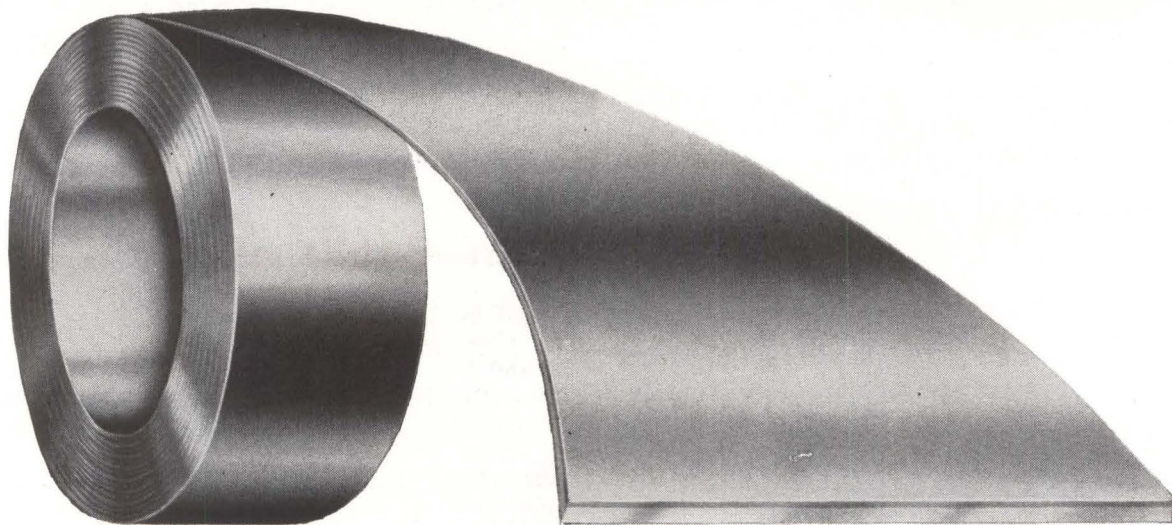

**CLAD METAL COMBINATIONS NOW AVAILABLE**  
**Single or double clad in continuous coils,**

- Tin Clad Nickel
- Lead-Tin-Antimony Clad Nickel Iron
- Tin-Lead Clad Nickel
- Tin-Antimony Clad OFHC Copper
- Tin-Gallium Clad Nickel

**NEW COMBINATIONS BEING DEVELOPED ALMOST DAILY!**

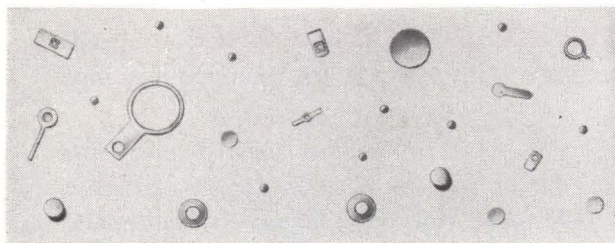

To help us service your requests for prices or further information promptly, please include specification drawings of parts, tolerance required, material specifications, quantities and samples.

**PLEASE DIRECT YOUR INQUIRIES TO:**

ALLOYS AND CLAD METALS

**LEACH & GARNER COMPANY**  
ATTLEBORO, MASSACHUSETTS

PRECISION PARTS

**GENERAL FINDINGS INC.**  
ATTLEBORO, MASSACHUSETTS

don't settle for less than a  
**DIGITAL INSTRUMENT**  
 designed with your application in mind



MODEL 650 DIGITAL VOLTMETER

greatest  
 economy

five-digit, all-electronic, 0.0001 to 1200.0 V dc, \$1850 . . . The Model 650 meets the difficult requirement of providing five-digit operation at low cost. Reliability is maintained by the use of Burroughs Corp. long-life indicators and switching tubes in a specially designed circuit. Accuracy, particularly in comparison applications, exceeds that of many bridge-type instruments (0.01%). The infinite-input characteristics found in other Franklin instruments is a standard feature of the Model 650. Automatic polarity sensing and indication are also standard. Optional features include automatic range switching.



MODEL 500C DIGITAL MULTIMETER

exceptional  
 versatility

dc, ac, ohms in one digital instrument at the flick of a switch . . . Probably the most versatile digital instrument available at any price. Uses the new Burroughs long-life Nixie® Indicators and Beam-x® Switching Tubes. All-electronic operation; modular construction throughout. Standard features include automatic polarity indication, effectively infinite input impedance, internal calibration cell, four-position noise-rejection filter, high long-term stability. Also available in standard 19" rack-mounted version. Options, as in the other Franklin instruments described here, include provision for direct printer operation.



MODEL 550 DIGITAL VOLTMETER

ultra-  
 reliability

all-electronic with exclusive Burroughs Corp. long-life Nixie® Indicators and Beam-x® Switching Tubes in counting circuits . . . Extraordinary mechanical and electrical integrity are the major features of this instrument. In all tests the Model 550 has demonstrated an almost impervious resistance to tampering and mechanical shock. Applications encountered to date, show that the instrument is capable of stable operation under a wide variety of environmental conditions. Range is from 100 microvolts to 1200 V dc. Automatic polarity sensing and indication are standard. Options include automatic range switching.

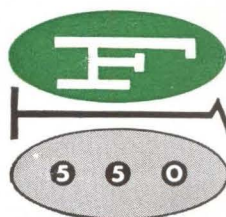

**FRANKLIN**  
 electronics, inc.  
 BRIDGEPORT • PENNSYLVANIA

®Beam-X and Nixie are trademarks of the Burroughs Corp.

# WASHINGTON OUTLOOK

**SUBSTANTIAL PAY HIKE** for scientists, engineers and top administrators will be proposed shortly by President Kennedy, to bring government pay more into line with private industry. Engineers, for instance, now average \$9,984 in industry, \$7,560 to \$8,860 in government.

Professional-level salaries reportedly would be raised about 15 percent. Top agency administrators in civil service, now getting around \$18,000, would be boosted several thousand dollars. Cabinet members' pay may be hiked from the present \$22,500 to as much as \$35,000. There would be token raises for lower level employees. Increases would be spread over three years.

Kennedy was distressed by the number of turn-downs he got for top government jobs, mainly for financial reasons, and by the difficulty of attracting and holding top professional people. The proposal is expected to get sympathetic attention in Congress.

**IN ITS STRUGGLE** to continue the B-70 project and enhance chances for the plane's production, Air Force has redesignated it the RSB-70 (Reconnaissance Strike Bomber). Air Force wants to equip the mach 3 plane with search radars, infrared sensors, and other advanced electronics gear to seek out strategic targets not already included in established targeting schedules. In effect, the plane would be both a reconnaissance aircraft and a bomber.

**FINAL DRAFT** of next year's defense budget does not give Army any production funds for Nike Zeus components. The project will continue at the current R&D level. Costs are running close to \$250 million a year.

An earlier budget draft allotted \$383 million to continue R&D and begin production of certain long lead-time components. Projected costs were \$850 million in FY 1964 and \$1.3 billion in FY 1965 for deployment of 12 Zeus batteries in six metropolitan areas.

**NIKE ZEUS' FUTURE** will depend considerably on the outcome of operational-type tests to begin this summer in the Pacific. Army originally planned non-nuclear test launchings at Kwajalein Island. Odds are that the Zeus launchings will now be made with live nuclear warheads. Kwajalein installations could be quickly modified if atmospheric nuclear testing is resumed.

There's considerable talk here that British-owned Christmas Island will be used when and if atmospheric nuclear tests begin. The motives would be political. Kwajalein is a UN trust territory. Christmas Island would need a new prototype Zeus missile-radar installation, boosting the project's costs and delaying the test launchings for several months.

**DEFENSE DEPARTMENT** awarded \$6.3 billion worth of prime contracts—28.6 percent of total military procurement—to companies in communities hard hit by unemployment during FY 1961 ending June 30. This compared with 9.6 percent in the previous year, reflecting the administration's intensified effort to channel defense business into labor surplus areas. During April-June, 1961, \$3.9 billion in prime orders went to labor surplus area companies, more than double the awards in the January-March quarter.



ALLEN-BRADLEY QUALITY

# FERRITES



HAVE SOLVED THESE DESIGN PROBLEMS

...they can also be the Answer to Yours!

From the broad line of Allen-Bradley *quality* ferrites, more and more designers are finding they can obtain the exact characteristics to meet their specific needs. Allen-Bradley's precise quality control methods insure continuously uniform electrical and mechanical properties—and A-B has the facilities for supplying ferrites in quantity. Listed below are a number of areas in which A-B ferrites have helped the manufacturer to reduce the product size or weight, or cost, and frequently the performance has been improved. If you have problems along this line, please let our engineers work with you in solving them.



APPLICATION	A-B FERRITE	PREFERRED CHARACTERISTICS
TELEVISION, RADIO Deflection Yokes	W-03 W-01	High permeability High resistivity
Flyback Transformers	W-04	Low losses, high $B_{max}$ , high permeability, high Curie temp
Convergence Cores	W-01	Low residual with large gap
I. F. Transformers	R-02	Low losses at low amplitudes. Good temperature stability of permeability
R. F. Tuning Coil (fixed or permeability tuned)	R-02	Low losses. Temperature stable permeability, minimum hysteresis for permeability tuning
TELEPHONE SYSTEMS Interstage and Matching Transformers	W-03	High permeability, low losses
H. F. FLUORESCENT LIGHTS Loading Reactors	W-07	High flux density
Transformers	W-04	High permeability, low losses, high $B_{max}$
ELECTRIC ORGANS AND HI-FI STEREO Oscillator Inductors	W-03	High permeability, temperature stable, linear B vs. H
Output Transformers	W-04	High permeability, high $B_{max}$ , low losses
AUTOMATIC MACHINE TOOLS Magnetic Amplifiers	R-03	Rectangular hysteresis loop, high $B_{max}$
Logic elements for high-power levels	R-03	Rectangular hysteresis loop, high $B_{max}$
Matching Transformers	W-04	High permeability, low losses, high $B_{max}$
MOBILE POWER SUPPLIES Static Inverters	R-03	Rectangular hysteresis loop, high $B_{max}$
RADAR, MISSILES Pulse Transformers	W-04 R-02 (for short pulses)	High pulse permeability, high $B_{max}$ , low losses
PERMANENT MAGNETS	M-01	High energy factor Good mechanical strength

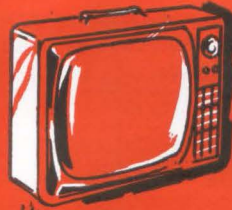

Television



Radio



Telephone Systems



Electric Organs



Hi-Fi Stereo



Missiles



Radar



Automatic Machine Tools

**ALLEN-BRADLEY** | Quality Electronic Components

Allen-Bradley Co., 110 W. Greenfield Ave., Milwaukee 4, Wisconsin • In Canada: Allen-Bradley Canada Ltd., Galt, Ontario

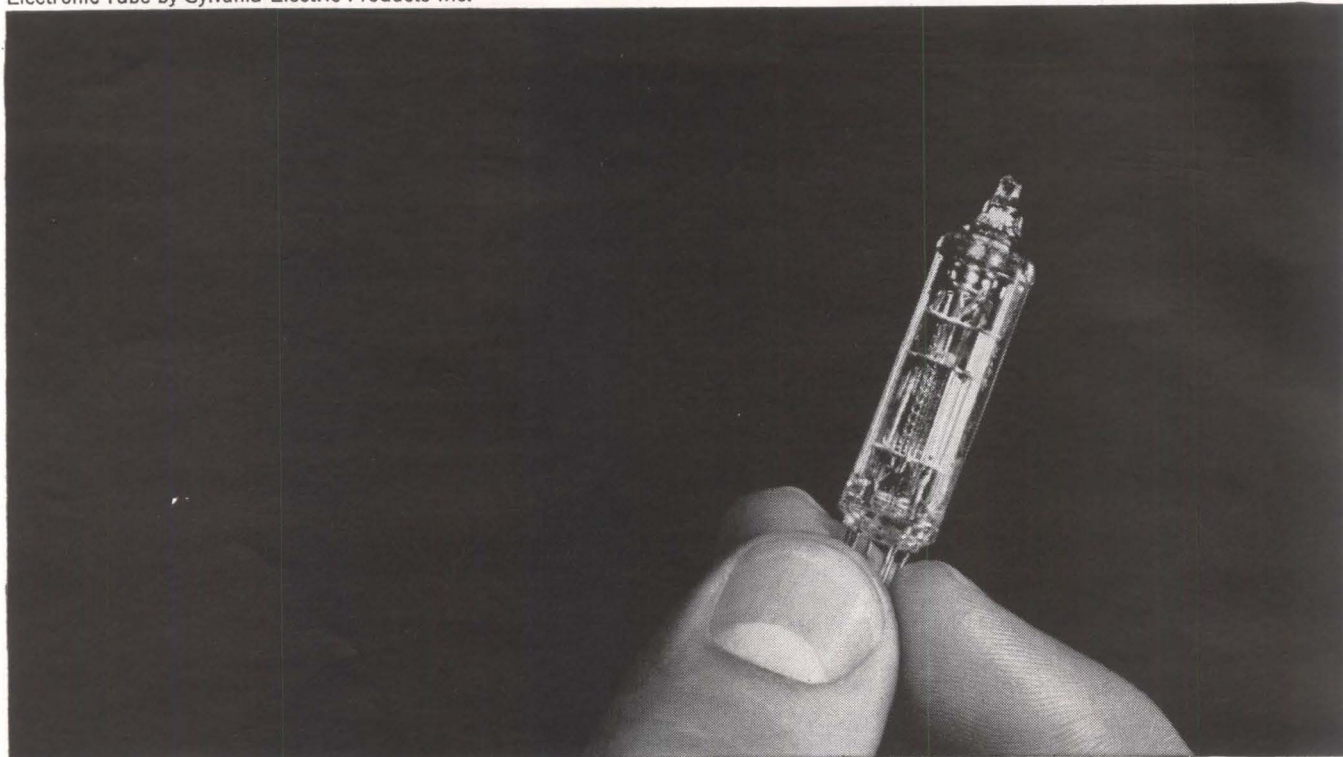

# PRODUCE IT TODAY SELL IT TOMORROW ANYWHERE IN THE U.S.A WITH



You can't do it with just any air shipping service. Only AIR EXPRESS offers you all the benefits of overnight delivery, nationwide. Only AIR EXPRESS has priority on all flights of all scheduled U.S. airlines, and 13,000 REA Express trucks for rapid pick-up and delivery. AIR EXPRESS brings revolutionary advantages to distribution. The rates are surprisingly low. 25 lbs. fly 1,000 miles door-to-door, for only \$8.12! No wonder AIR EXPRESS handled more than twice as many shipments last year as all air freight forwarders put together! One call speeds your shipment. **CALL YOUR LOCAL R E A EXPRESS OFFICE FOR AIR EXPRESS SERVICE**

# STILL INDUSTRY'S PRIME SOURCE FOR SILICON RECTIFIERS

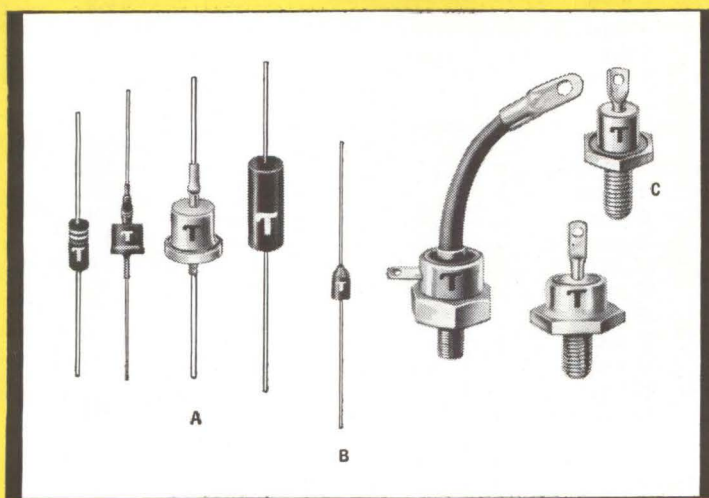

Since 1954 Transitron has led the field in providing industry with new and improved types of silicon rectifiers. Typical of this leadership is Transitron's extensive line of high voltage type rectifiers.

Transitron's success in introducing more sophisticated production processes has resulted in volume availability of a full range of single-junction silicon rectifiers capable of handling up to 1500 volts. These high voltage types increase circuit reliability while reducing design complexity by doing singly the work of two or more lower voltage rectifiers. Engineers can now safely design them into their systems with the assurance that they are available in quantity. Typical high voltage silicon rectifiers are:

TYPICAL HIGH VOLTAGE TYPES		
Type	Peak Reverse Voltage (volts)	Maximum Average Forward Current @150° C (mA)
<b>LEAD MOUNTED TYPES Package A</b>		
1N2505 (SL708)	800	100
1N2506 (SL710)	1000	100
1N561	1000	250
1N2507 (SL712)	1200	100
1N2508 (SL715)	1500	100
1N589	1500	25
<b>STUD MOUNTED TYPES Package C</b>		
1N3566 (TM84)	800	1000
1N2372 (TM106)	1000	200
TM104	1000	1000
TM155	1500	400
1N1130	1500	300*
<b>EPOXY TYPE Package B</b>		
ER81	800	300

\* @ 25° C Ambient on specified heat sink.

Transitron's complete line of silicon rectifiers provides industry with a choice of more than 750 different types in an extensive variety of widely accepted packages. The line features operation to 175°C with current ratings up to 50 amps. To assure high quality and reliability, Transitron completely tests all silicon rectifiers for all specifications before shipment. For those who require rectifiers with extremely high voltages, Transitron also offers series-junction types capable of handling up to 50,000 volts.

The engineers who have made Transitron the leader in silicon rectifiers are available to help you with special applications problems. For further information write for the following Transitron Bulletins: Lead Mounted (TE-1351G-1, TE-1351M), Stud Mounted (TE-1351G, PB-1130), Epoxy (ER-81).

CIRCLE 259 ON READER SERVICE CARD



# Transitron



electronic corporation  
wakefield, melrose, boston, mass.

SALES OFFICES IN PRINCIPAL CITIES THROUGHOUT THE U. S. A. AND EUROPE • CABLE ADDRESS: TRELCO

# Save 7% of Your electronics BUYERS' GUIDE Advertising Costs ACT NOW!

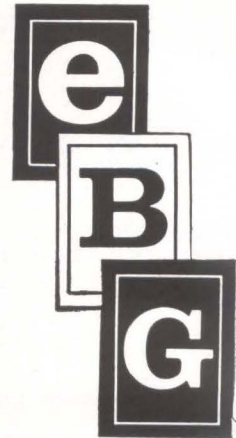

Order your advertising for the 1962 electronics BUYERS' GUIDE now. Study these exceptional discounts. You can earn up to 10% in discounts. You will see four distinct ways to save money. Here is how the "Early Bird" discount structure works:

In addition to volume discounts for Multiple Page, run-of-press, advertising, a discount of 7% on the earned rate will be allowed on ads of 1/2 page or more, provided insertion order is received by February 15, 1962, and plates are supplied to the publisher by April 25, 1962.

In addition to the volume rates for inserts, a discount of 7% of those rates will be allowed providing insertion order is received by February 15, 1962, and inserts are supplied to the publisher by May 25, 1962. See your local advertising representative, listed on the last page of this issue for complete details.

Multiple Page Discounts	
2 pages .....	discount earn 3%
4 pages .....	earn 4%
6 pages .....	earn 6%
8 pages .....	earn 7%
12 pages .....	earn 8%
16 pages .....	earn 9%

Special rates for furnished inserts	
2 pages .....	per page \$715
4 pages .....	682
6 pages .....	654
8 pages .....	616
12 pages .....	600
16 pages .....	583
20 pages .....	566
24 pages .....	550
28 pages .....	533
32 pages .....	517
over 32 pages .....	489

(Orders and complete plates to be sent to 330 West 42nd Street, New York 36, N.Y. Inserts to be shipped to National Publishing Co., Lanston Building, 24th and Locust Street, Philadelphia 1, Pennsylvania. Marked: Electronics Buyers' Guide.)

## electronics BUYERS' GUIDE & Reference Issue



A McGraw-Hill Publication / 330 West 42nd Street, New York 36, N.Y.



not for sale

This relay is headed toward destruction. It's Babcock's BR7X 10 amp crystal can relay — one of hundreds regularly pulled from assembly and life tested to determine point of failure.

Two years ago, recognizing a growing need among military users for reliability-tested components, Babcock established the relay industry's first reliability program. Under this program, each test sample is subjected to hundreds of thousands of operations at loads varying from 1  $\mu$  amp to 10 amps, temperatures from  $-65^{\circ}$  C to  $+125^{\circ}$  C, vibration of 5 g to 3,000 cps, and shock beyond 1000 g. An outgrowth of this program has resulted in elimination of the most prevalent cause of failure in hermetically sealed relays. Through use of activated getters, contaminants emitted at elevated temperatures are prevented from fouling relay contacts, the major cause of erratic performance and eventual failure. Up to 99% of organic contaminants remaining after production degassing are effectively absorbed by this desiccant.

Additionally, the BR7 Series features a highly efficient magnetic structure to provide optimum force with minimum power, and gold plated AgMgNi contacts for effectively switching widely varying loads with minimum contact resistance and bounce.

The BR7 is one good reason why Babcock relays, more than any other manufacturer's, are specified for military reliability programs. For complete reliability information, write for Failure Rate Data and Reliability Report E-012 — for BR7 product data, request Technical Bulletin BR612.

#### **SPECIFICATIONS STANDARD BR7X RELAYS**

VIBRATION: 30g, 40-2000 cycles, 10-40 cps @ 0.4" DA

SHOCK: 50g, 11 millisecond.

LIFE: 100,000 operations min. @ 10 amps and  $125^{\circ}$  C to MIL-R-5757D

MILITARY SPECIFICATIONS: MIL-R-5757D and MIL-R-25018

SIZE: .515" x 1.075" x 1.300" high

*Babcock Relays*

A Division of Babcock Electronics Corporation  
1645 Babcock Avenue, Costa Mesa, Calif.

# population -

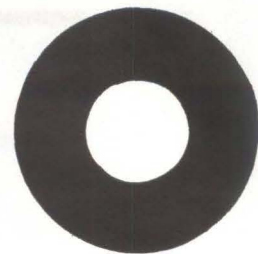

Even in the most remote areas, wings aloft are guided on their way by AeroCom's new medium range N.D. Beacon Transmitter. This transmitter was designed and built to provide long, trouble-free service with no attendants...even where the total population is Zero.

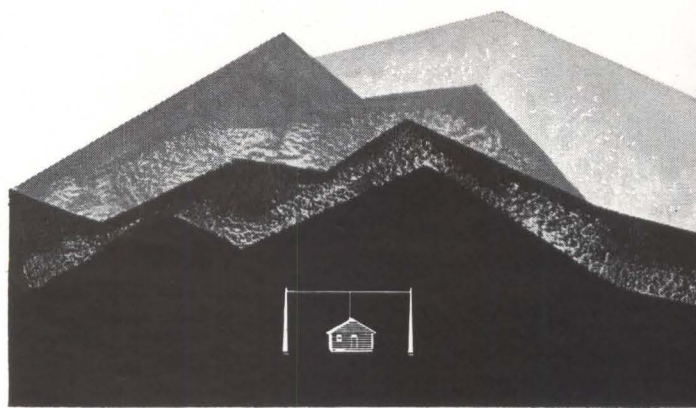

NOW — FCC type accepted — single or dual automatic—for carrier powers of 10, 12, 15, 20, 25, 50 and 100 watts.

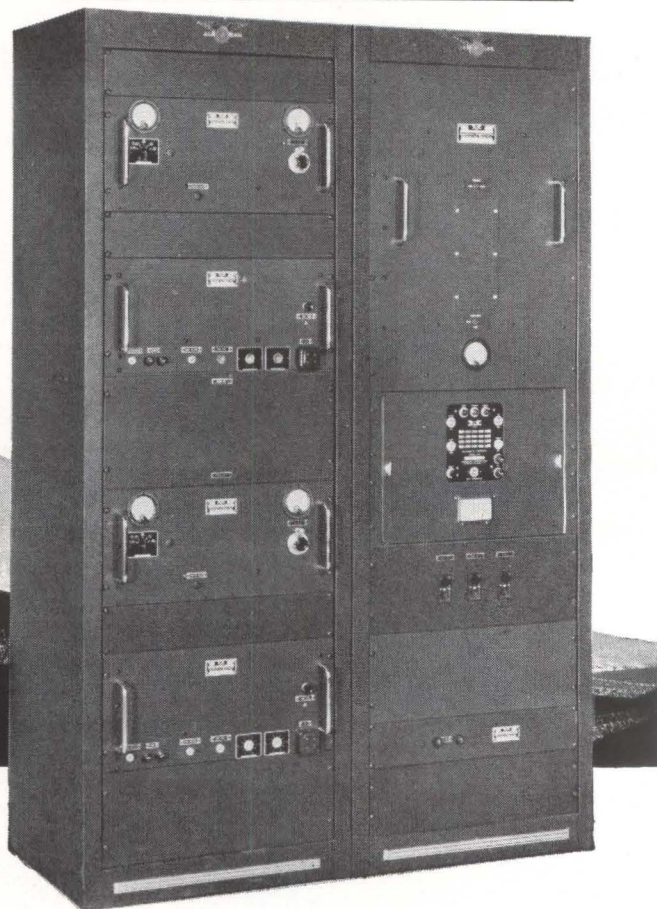

## **AEROCOM'S Dual Automatic Package-Type Radio Beacon**

for completely unattended service. This N.D. Beacon (illustrated) consists of two 100 watt (or 50 watt) transmitters with 2 keyers, automatic transfer and antenna tuner. (Power needed 110 or 220 volts 50/60 cycles, 465 V.A. for 50 watt, 675 V.A. for 100 watt.)

Frequency range 200-500 kcs.: available with either crystal or self excited oscillator coil. High level plate modulation of final amplifier is used, giving 97% tone modulation. Microphone P-T switch interrupts tone, permitting voice operation.

The "stand-by" transmitter is selected when the carrier or modulation level of main transmitter drops 3 db or more, in case of failure to transmit the identification signal or if carrier frequency changes 5 kcs. or more. Audible indication in monitoring receiver tells which transmitter is in operation.

Unit is ruggedly constructed and conservatively rated, providing low operating and maintenance costs.

Also available in 400 watt, 1 K.W. and 4 K.W. Models, 200-415 kcs.

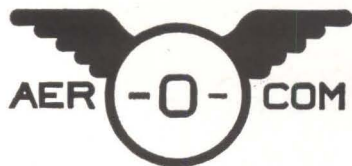

3090 S. W. 37th AVENUE • MIAMI 33, FLORIDA

# Have you seen these Silicon Rectifier developments?

**MOTOROLA**  
1N3189-91 Series  
Flangeless

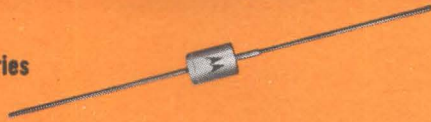

**Delivers 1-Amp @ 100°C**

Designed to meet the high-reliability standards of MIL-S-19500/155 (NAVY)

**MOTOROLA**  
1N3282-86 Series  
Subminiature



**1000-3000 PIV**

Only 1/10" in diameter. Low  $I_R$  of .001 mA @ 25°C

**MOTOROLA**  
MR-322-6 Series  
General Purpose

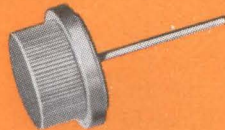

**18-Amp, 50-400 PIV**

... as low as 46¢

**MOTOROLA**  
1N3208-12 Series  
Heavy-Duty 11/16" Stud



**15-Amp, 50-400 PIV**

... as low as 83¢

... AND ... look at the typical advantages you get from each of these other types of MOTOROLA silicon rectifiers ...

**MOTOROLA SINGLE-END RECTIFIERS**  
5 types, PIV 100 to 400 volts

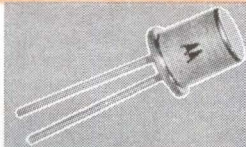

**HIGH SURGE** — exceptionally high surge handling capacity ... peak one-half cycle forward surge current 60 cps, 25°C ambient — 70 AMPS

**MOTOROLA TOP HAT RECTIFIERS**  
75 types, PIV 50 to 1,000 volts

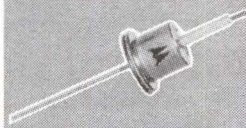

**LOW  $I_R$**  — very low maximum current at rated DC voltage — as low as 10  $\mu$ A @ 25°C.

**MOTOROLA FLANGELESS RECTIFIERS**  
11 types, PIV 100 to 1,000 volts

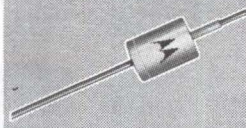

**COMPLETE PIV RANGE** — 100 thru 1,000 volts.  
**HIGH  $I_F$**  — in addition to 750 mA @ 25°C for the standard flangeless line; new types offer 1-Amp at 100°C.

**MOTOROLA 7/16" STUD RECTIFIERS**  
60 types, PIV 50 to 1,000 volts



**LOW  $I_R$**  — maximum full cycle average as half wave rectifier (resistive load) as low as .0005 mA.

## FAST SERVICE ON SPECIALS

More than 1,000 special types of silicon rectifiers have been developed and produced by Motorola to meet individual customer needs ... providing an exceptional special device production capability which assures unmatched service on any "specials" you may require.



For application assistance, Motorola's Silicon Zener Diode and Rectifier Handbook is available from the Motorola Semiconductor Distributor or District Sales Office, or by writing the factory direct — Price — \$2.00.

**IMMEDIATE LOCAL AVAILABILITY** — For your convenience, all popular types of these top-quality Motorola silicon rectifiers shown above are available from stock at the Motorola Semiconductor Distributor in your area.

**THE WORLD'S LARGEST PRODUCER OF POWER RECTIFIERS**



**MOTOROLA**  
Semiconductor Products Inc.

A SUBSIDIARY OF MOTOROLA, INC.

1781

5005 EAST McDOWELL ROAD • PHOENIX 8, ARIZONA

# Japanese Use Millimeter-Wave Radar

*High-frequency signals reflected by mist and dust indicate location of incipient storms. Military and air traffic control uses are seen*

By ROY J. BRUUN,  
Assistant Editor

JAPAN PLANS to install millimeter-wavelength radar, possibly this year, in the weather network stretching along the chain of Japanese islands. The new equipment will probably be like an 8.6-mm, vertically pointing system at the Meteorological Institute in Tokyo.

Except for the Tokyo installation, the net consists of 3.2-cm, 5.7-cm and 10.7-cm systems, oriented to pick up typhoons which generally arrive from the direction of Okinawa. Millimeter radar would increase the network's ability to detect local storms, which form rapidly over Japanese terrain.

In addition to showing local cloud buildup, the new system depicts cloud heights from 600 feet to 20

kilometers. A string of millimeter radars would provide data on a large number of local storms, contributing to watershed management and flood control.

The 8.6-mm set is not a prototype, but a proven system, according to Nobukiko Kodaira, the institute engineer who with Takashi Okada, of Oka Electric Industry, was mainly responsible for its development. It is being used for general meteorological studies and for specific services such as supplying cloud ceiling and settling rate information to the Tokyo airport.

The value of millimeter radar has long been recognized by meteorologists. It can detect mist and dust particles—present in early stages of cloud formation—that are too small to reflect longer wavelengths. Kodaira says the 8.6-mm system has

a reflection factor 200 times that of 3.2-cm sets.

However, a spokesman for the U.S. Weather Bureau says there are some disadvantages to millimeter radar. Once rain starts, the cloud base looks like it is descending. During heavy rain, cloud tops cannot be seen. But this does not detract from its usefulness in determining cloud patterns, buildup and settling before rain begins.

A major application of millimeter radar in this country would be at commercial aircraft holding points at intersections of airways. The Bureau and Air Force are considering installations along the Boston to Norfolk airway.

They could also be used to determine locations for military aircraft refueling in flight, which cannot be done effectively in clouds. A Ray-

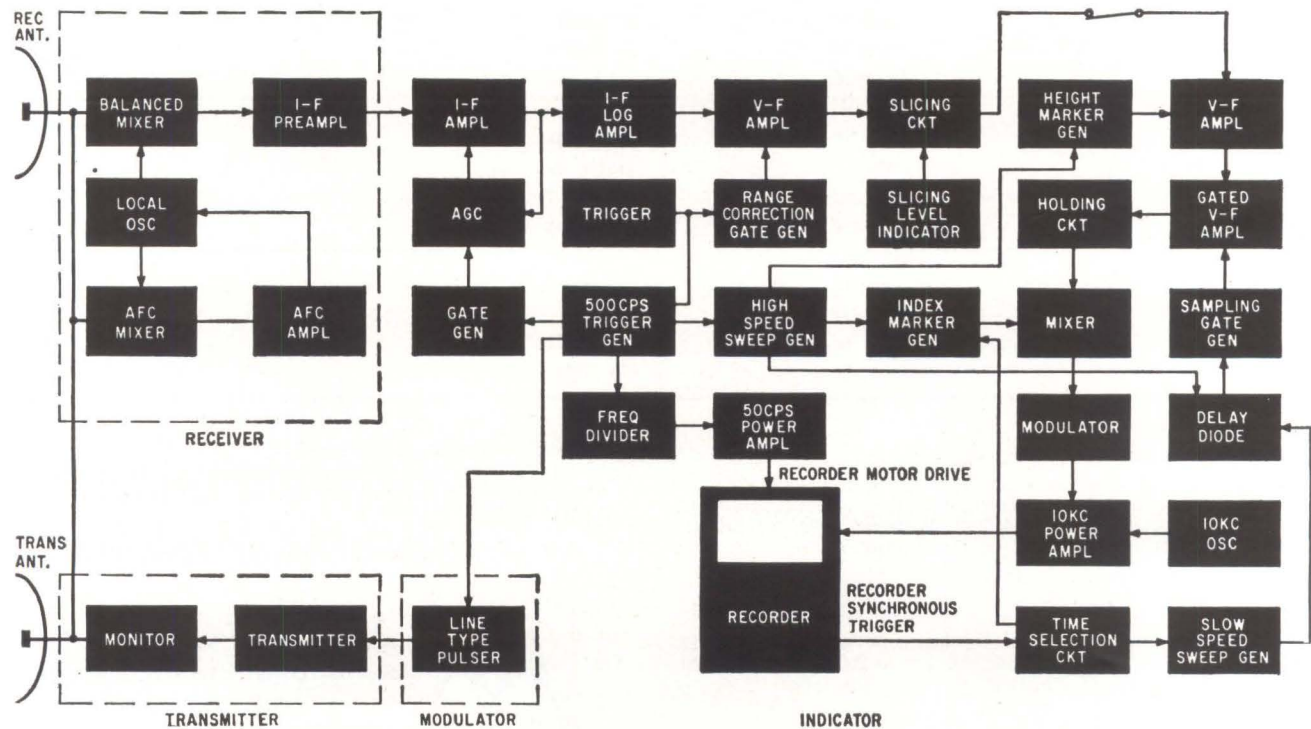

Feature of the Japanese system is range attenuation correction which makes signal reflectivity independent of range



# in Weather Station

theon spokesman says the company is investigating an 8.6-mm system that could be used for mapping, bombing and other applications as well as weather.

AN/TPQ-11 cloud height radars produced by Olympic, operating in the  $K_u$  band at about 0.9-cm wavelength (ELECTRONICS, p 62, Mar. 31, 1961, and p 28, Jan. 5, 1962), have been operating at National Airport, Washington, D. C.; Hanscom Field, Bedford, Mass.; Patrick AFB, and Air Force Cambridge Research Labs.

An AFCRL spokesman says the Japanese system has contour-mapping features not possessed by the American systems. Also, it has a range attenuation corrective feature which causes reflectivity of the return signal to be independent of range.

It operates at higher power than the American radars—32 Kw compared to 25 Kw. However, a prototype American system will operate at 100 Kw. The AFCRL spokesman says the Japanese system would be more effective without the radomes it now uses, since even a thin film of moisture on the dome presents serious attenuation problems.

Kodaira gave design information on the Japanese radar at the recent Weather Radar Conference in Kansas City. Like the TPQ-11, it uses separate transmitting and receiving antennas to avoid attenuation of a t-r switch.

Various levels of return power for various range intervals are passed through a logarithmic amplifier in the receiver. The amplifier is biased by a signal from a range correction gate generator that can be adjusted to limit signal output from the log amplifier to ranges of five, 10 or 20 kilometers. This biasing signal also provides correction for range attenuation, making reflectivity independent of range.

Range-corrected output voltage is obtained as the product of  $5 \log_{10} P_r r^2 / P_{co} r_o^2$ , where  $P_r$  is received power in watts,  $r$  is apparent range,  $P_{co}$  is minimum detectable power and  $r_o$  is the reference range to which  $P_r$  is normalized (200 meters).

Intensities of the corrected signals are detected by the slicing circuit and indicator, which provide isoecho contours (equal intensity levels).

Adjustments, at 6-db intervals, can be made for seven intensity levels. Automatic holding time for each level is 30 seconds. The intensity-detected signals are displayed as facsimile recordings of cloud profiles, buildup and settling rates. Intensity levels indicate the liquid density distribution in the cloud profile.

Video signals are slowed down for presentation by a traveling gate of 0.2  $\mu$ sec, synchronized with the recording stylus' motion. The l-f amplifier's bias voltage is regulated by the agc, using the transmitted pulse as sampled by a 30-db direc-

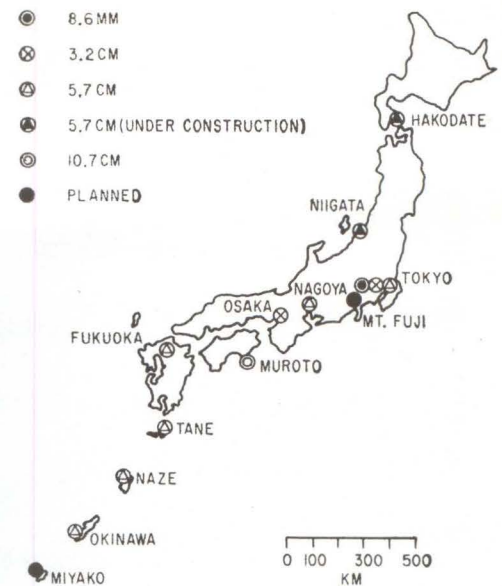

Location of weather radar stations on Japanese islands

tional coupler. This keeps overall gain of transmitter and receiver constant despite supply voltage drift. Otherwise large variation in magnetron oscillator output could prevent high definition.

## Two More Computers Bow

IBM IS INTRODUCING a new family of scientific and management function computers, the 7040 and 7044. Both are solid-state systems with modular design that permits the use of a wide variety of peripheral and satellite card, tape and disc gear.

The 7040 and 7044 are compatible with each other and both can be linked on-line with a 1401 to increase their input-output speeds. Both can function as the core of a telecomputing system using radio or wireline data inputs.

The 7040 can be expanded in stages into a 7044. The 7040 has core storage capacities of 4,096, 8,192 and 16,384 words; the 7044 capacities are twice that. Data is represented internally in 37-bit words (36 bits plus a parity bit) equivalent to 10 or more decimal units.

Memory reference time of the 7040 is eight  $\mu$ sec; that of the 7044 is 2.5  $\mu$ sec, almost as fast as the 7090's 2.18  $\mu$ sec. Either can use peripheral devices with combined storage capacity of 280 million

characters. The 7044 can perform 400,000 logical decisions a second.

As software support, IBM is offering a number of computer programming systems and languages. Prices range from \$626,700 (\$10,470 a month) for a 7040 card system to \$2,479,400 (\$47,020 a month) for a 7044 with an online 1401, including input-output units.

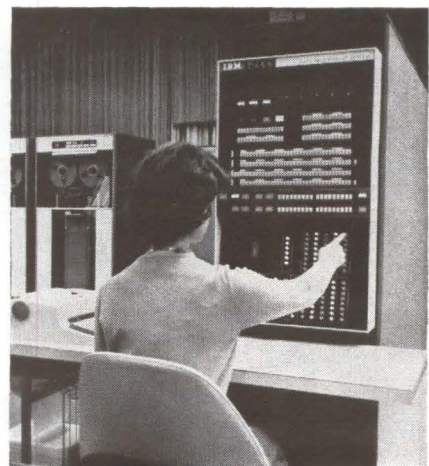

Modular design of new computers facilitates expansion

THE SCENE AT GRUMMAN  
AS VIEWED BY

THE  
*Reliability  
Engineer*

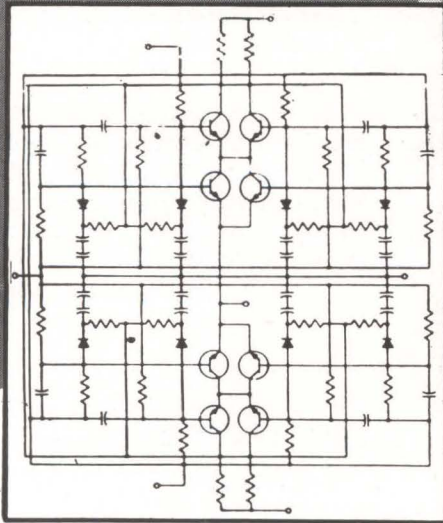
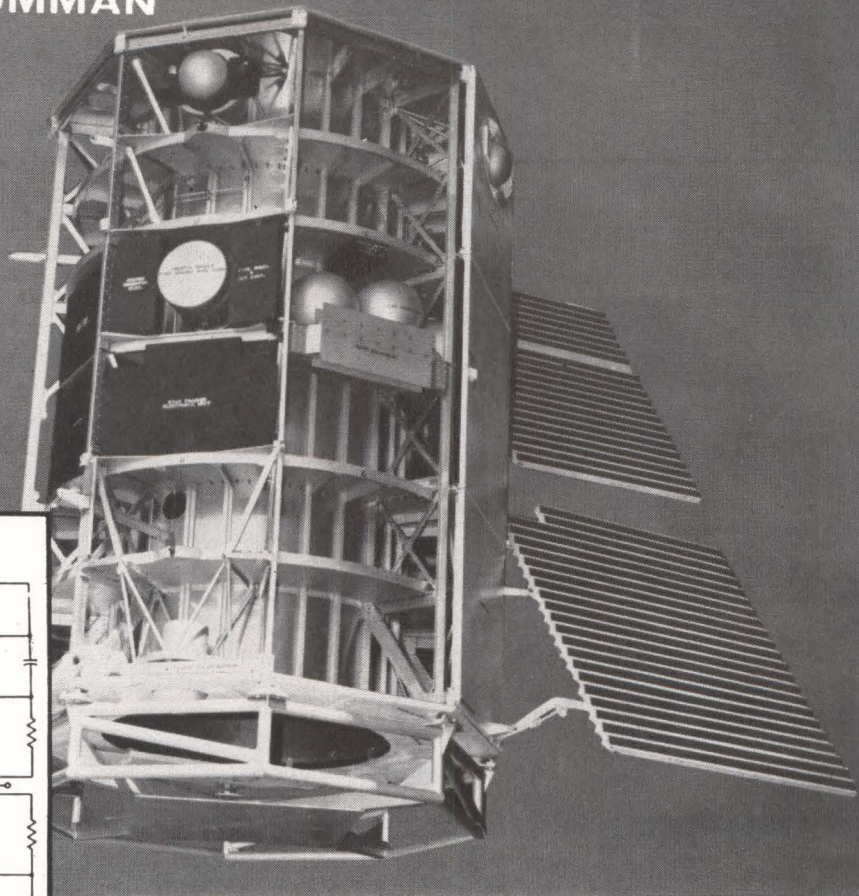

*... "Inside Story"*

Stripping the 'skin' of the Orbiting Astronomical Observatory (OAO) reveals the 'inside story' of the new NASA satellite ... basically a story of reliability. The application of redundancy to electronic circuitry is just one example of numerous techniques that are considered in the quest for high reliability.

A primary objective of this program is to design the OAO with a 70% probability of operating in orbit for one year. Achievement of this high level of reliability demands the skills of highly resourceful engineers and the application of effective reliability control techniques in all stages of the design and development program.

Here is the challenge for imaginative and inventive engineers and statisticians who can contribute ideas and solutions to the reliability problems associated with the design, development and testing of a variety of weapon and space systems. Specific opportunities exist for:

**Reliability Engineers**—To engage in reliability control activities in 1 or more of the following areas: Prediction, trade-off studies, failure mode and effect analyses, implementation of programs, design reviews, trouble data collection and analyses, and maintain ability studies.

**Electronic Parts Analysts**—To aid systems designers in the selection of parts for maximum reliability assurance; review circuits in advanced aero-space systems for adequacy of part characteristics with respect to electrical, mechanical, and environmental loads; generate approved parts list; and formulate test and procurement specifications. BSEE required and minimum of 3 years' experience associated with electronic parts applications including semi-conductor devices.

**Statisticians**—To apply statistical techniques in a variety of engineering applications in aero-space programs including the solution of problems in test design and reliability. Requires degree in statistics or mathematics and experience in design or experiments, analysis of variance and multi-variate analysis in technical fields. Machine programming desirable.

To arrange an immediate interview, send your  
resume to Mr. W. Brown, Manager Engineering  
Employment, Dept. GR-76  
(U.S. citizenship required)



**GRUMMAN**

AIRCRAFT ENGINEERING CORPORATION  
Bethpage · Long Island · New York

All qualified applicants considered regardless of race, creed, color or national origin

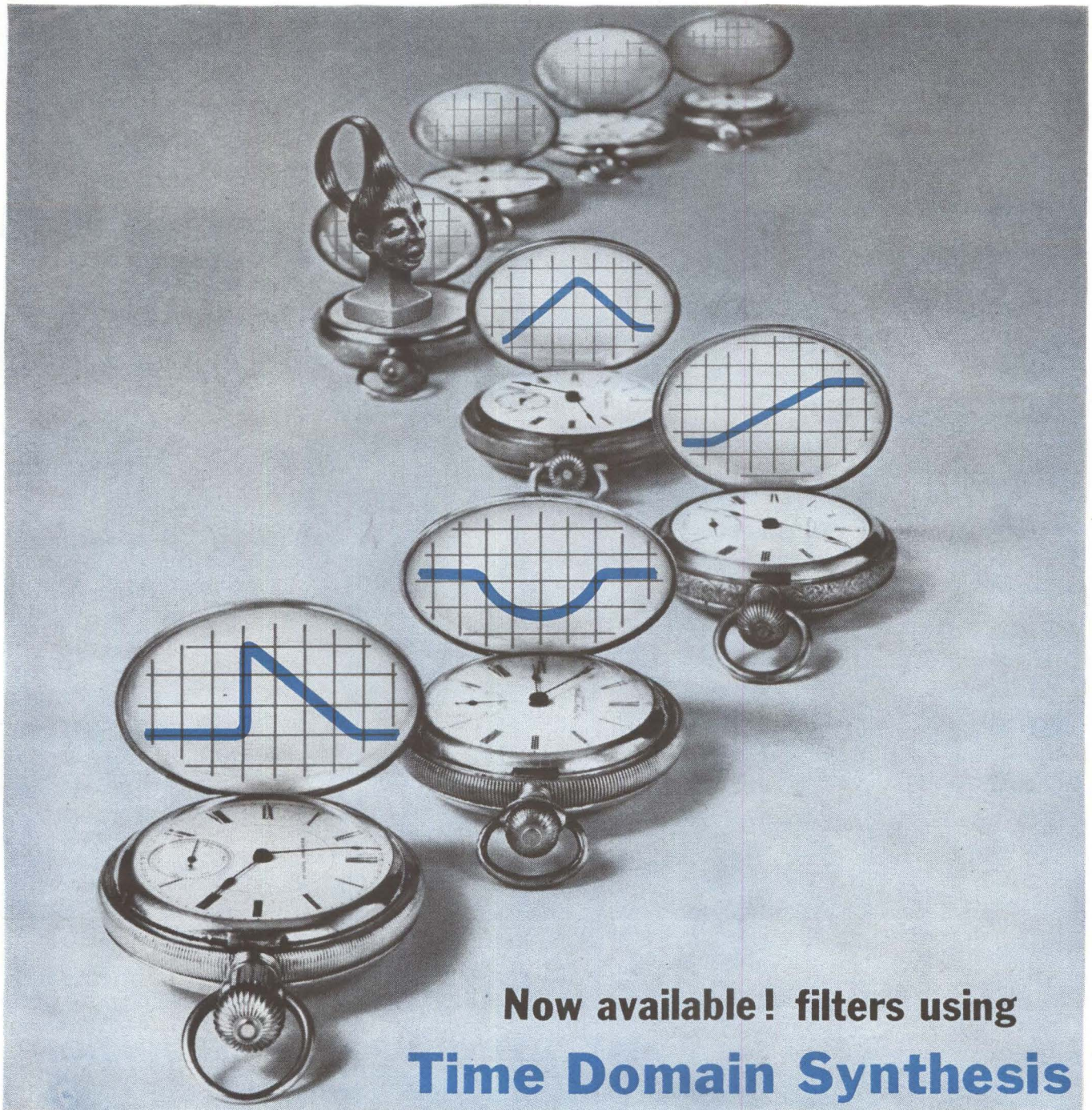

## Now available! filters using **Time Domain Synthesis**

Imagine having access to an unlimited inventory of wave forms of every conceivable shape; some so radical that they could previously only be described graphically and attained only through complex active element circuitry.

Furthering the state of the art to suit the complexities of modern electronic systems, Burnell is now prepared to design networks through the use of the Fourth Dimension of Time Domain Synthesis.

These passive networks may be designed to produce low ringing, constant delay filters, or to produce a functional

wave shaping characteristic with or without specific attenuation requirements. Examples of a low pass characteristic pulse forming network are shown above, where the networks precisely resolve the constituents of a time function to produce a variety of wave forms, with unique properties now available as a tool for new and imaginative applications.

Break the chains of conventional design, unnecessarily complex circuitry, and wasted space by contacting your Burnell sales engineer today, with your wave form application problems.

*Burnell & Co., Inc.*

PIONEERS IN microminiaturization OF TOROIDS,  
FILTERS AND RELATED NETWORKS

DIVISIONS: Gray & Kuhn, Inc., Pelham, New York • Guillemin Research Laboratory, Cambridge, Mass.

EXECUTIVE OFFICE  
AND PLANT  
DEPT. E-40  
PELHAM, NEW YORK  
PELHAM 8-5000  
TELETYPE PELHAM 3633



PACIFIC DIVISION  
SOUTH PASADENA, CAL.  
MFD. IN CANADA  
BY EDO (CANADA) LTD.  
CORNWALL, ONT.  
WELLINGTON 2-6774

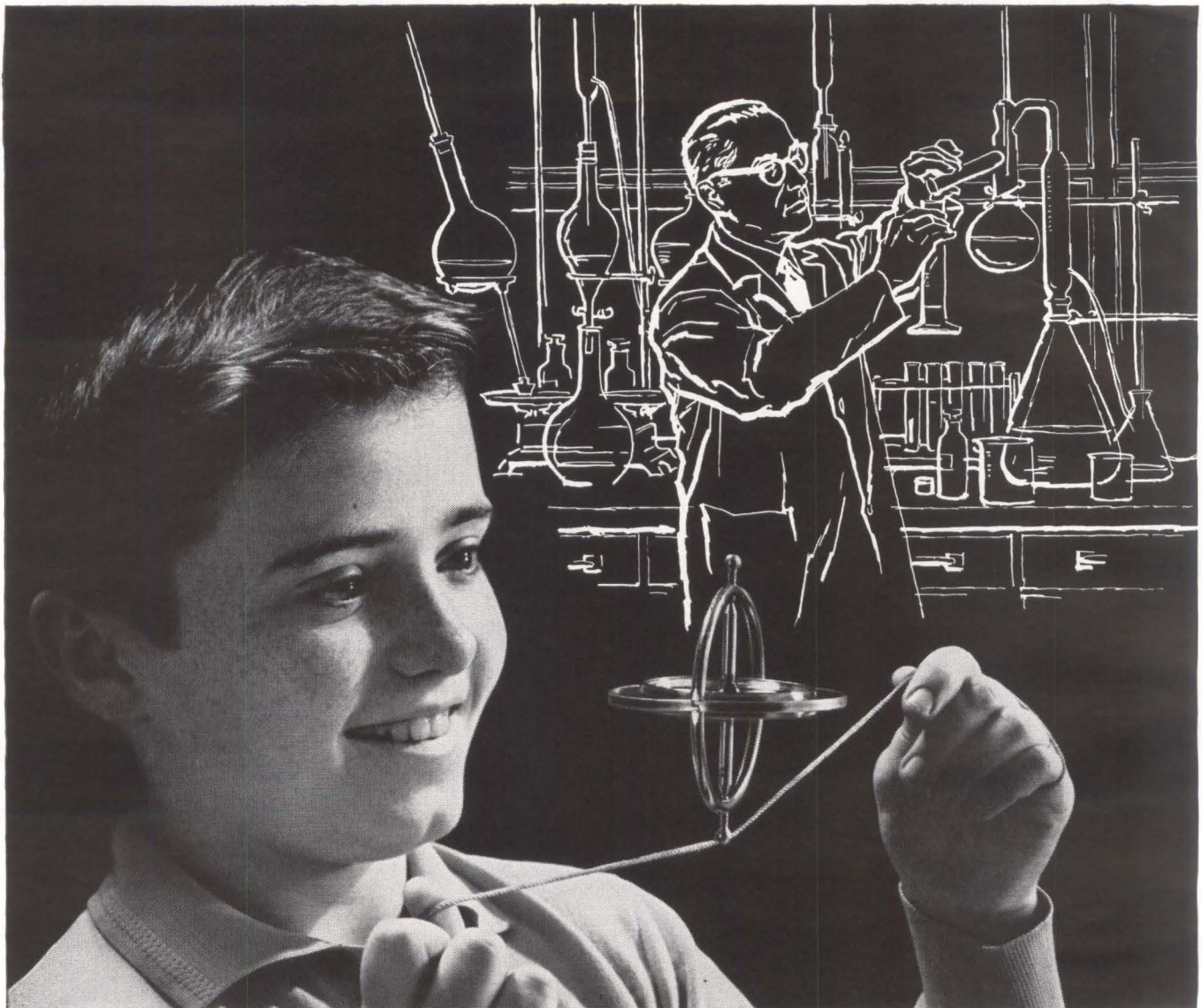

# The Future of Your Business

## MAY DEPEND UPON HIS EDUCATION

The young mind which today discovers an old principle may someday reveal a new one capable of revolutionizing your business and creating undreamed of growth. But this is possible only if he gets the finest education we can offer.

By the time today's youngsters are ready for college, business and industrial technology will be even more complicated and will require many more trained specialists. To fill this order we must provide our young people with the best possible college educations.

Unfortunately many colleges are already overcrowded. In ten years applications are expected to double. We will need more and better college classrooms and libraries, more efficient college laboratories, and additional top-quality professors. *You can help assure your own future by helping the college of your choice.*

If you want to know what the college crisis means to you, write for a free booklet, "OPEN WIDE THE COLLEGE DOOR," to Higher Education, Box 36, Times Square Station, New York 36, N.Y.



Published as a public service  
in cooperation with The Advertising Council and  
the Council for Financial Aid to Education





### Can high-power coaxial cable be really flexible?

Yes, if it's our new perforated Teflon® tape cable—type RG-281/U. Here's an extra-flexible, high-power coaxial cable originally developed for an Air Force electronic counter measures system.

Besides its flexibility, it offers many other advantages:

- *Greater Thermal Stability* of this unique dielectric construction eliminates voids between cable and connector dielectrics; thus moisture condensation at dielectric interface is minimized.
- *True Dimensional Concentricity*, impossible with semi-solid dielectrics employing filament construction, is achieved by perforated Teflon tape. Concentricity, even over small bending radii, is maintained because center conductor is continuously supported by dielectric. There are no filaments to slip and bunch under flexing.
- *VSWR less than 1.2*. The perforated Teflon tape gives a *uniform distribution* of air spaces in the dielectric.
- *Low Loss*—A dielectric constant of 1.55, compared to 2.0 for solid Teflon, assures improved power transmission.

Use Amphenol brand RG-281/U as a general purpose radio-frequency transmission line in applications involving high power, low loss, flexibility, high temperature, dimensional stability and exacting electrical characteristics.

Write today for Data Sheet to: FXR, 33 East Franklin Street, Danbury, Connecticut.

®Du Pont

# FXR

THE RF PRODUCTS AND MICROWAVE DIVISION  
AMPHENOL-BORG ELECTRONICS CORPORATION  
CIRCLE 25 ON READER SERVICE CARD

# Crystal Laser Puts Out Continuous Power

LOS ANGELES—Successful continuous operation of a solid-state optical maser was disclosed by Bell Telephone Laboratory scientists at the meeting here of the American Physical Society.

The system, which uses a continuous light source to excite the crystal, was recently operated for 20 minutes and has so far achieved

power outputs around two to three milliwatts.

Crystal lasers currently in production have pulsed outputs. Continuous output has been achieved previously, but in gaseous lasers with relatively low output power. Continuous solid-state lasers are expected to significantly narrow the gap between current technology and

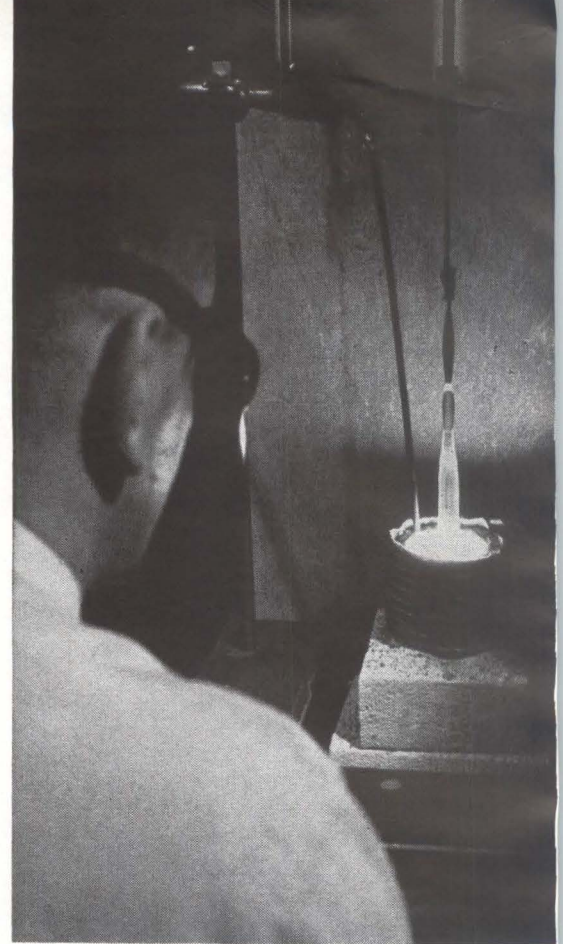

*Crystal was grown by Czochralski technique. It is composed of calcium tungstate with trivalent neodymium*

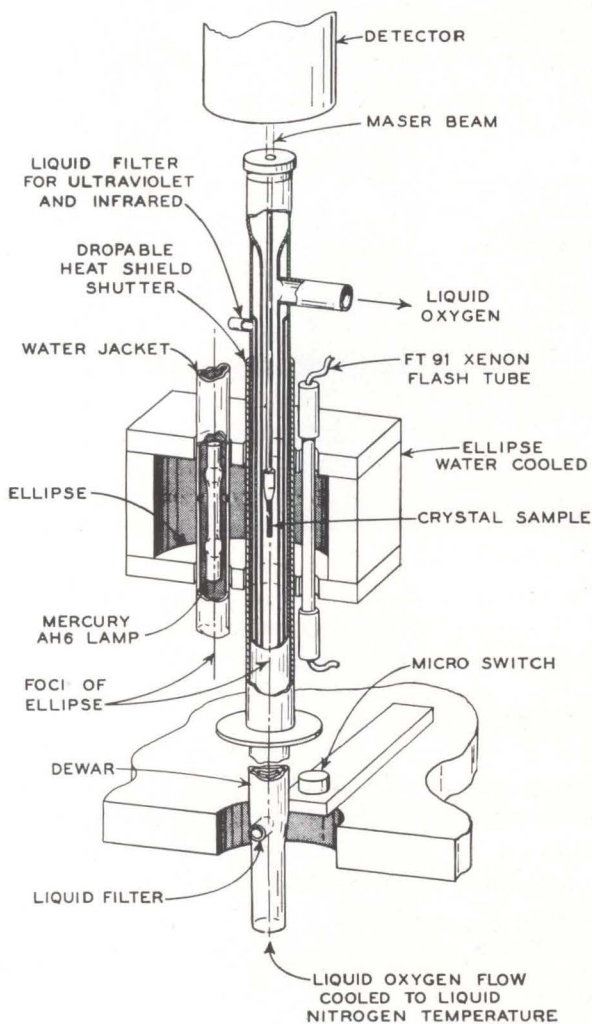

*Liquid coolant and optical filter surround crystal rod. Ultraviolet light is useless and tends to degrade the crystal*

practical applications of lasers in communications and other fields, it was reported.

Active medium of the Bell Labs laser is a single-crystal rod of calcium tungstate containing trivalent neodymium ( $\text{CaWO}_4:\text{Nd}^{3+}$ ). Pulse operation of this crystal has been previously reported (ELECTRONICS, p 12, Nov. 17, 1961). The material has a low power threshold.

The rod ends are polished to a slight convex curvature and are silvered. The crystal is mounted in one focus of an elliptical reflector, with a d-c lamp at the other focus. Input power is 900 watts.

Removing the restriction of a flash-type pumping light enables the crystal to oscillate continuously. It was reported that the laser could run for longer than 20 minutes if desired. A multiple dielectric coating on the rod end, rather than silver, could increase power output by a factor of five or 10. Although the crystal now used is cooled by liquid oxygen, continuous operation of the laser at room temperature in the

near future is anticipated.

The calcium tungstate crystal radiates in the infrared portion of the spectrum, at 10,650 Angstroms. Another promising material is strontium molybdate containing

trivalent neodymium, which radiates at 10,634 Angstroms. It will oscillate for an indefinite time with a duty cycle of 30 percent when it is pumped by a 60-cps lamp. Physical measurements suggest that this

crystal, too, should be operable continuously.

Development was reported in a paper authored by L. F. Johnson, G. D. Boyd, K. Nassau and R. R. Soden.

## Traffic Control Radar Shows Aircraft Altitude

By WILLIAM E. BUSHOR,  
Senior Associate Editor

BALTIMORE—Last week, a proposal for a three-dimensional radar system using components in production and tested antenna design was submitted to the Federal Aviation Agency by Westinghouse Electric.

Representatives of Electronics division, Westinghouse's Defense Center, say the system can be in operation within the year and can be integrated with present terminal area operations procedures. Estimated price for one system is \$1 million.

Reported advantages are: voice communications are not needed to determine aircraft altitude; display targets can be selected so only aircraft in a specific altitude range are seen; the controller can also see weather conditions in his area.

The system is independent of auxiliary ground and airborne electronic devices. It provides, in real time, range, azimuth and altitude of aircraft up to 75 n. mi away.

A stacked-beam antenna system, rotating at 12 rpm, is used. There are 10 beams of 0.8 degree each, providing coverage from the horizon to an elevation of 35 degrees. Aircraft entering the beam pattern are detected as being in one of the specific beam areas or in an overlap area of two adjacent beams. Height information is given at altitudes up to 15,000 ft, with relative accuracy of  $\pm 300$  ft and absolute accuracy of  $\pm 500$  ft.

Weather returns can also be displayed on the ppi scope to enable the controller to vector aircraft around local bad weather.

The display consists of three crt's—a main ppi and two small, auxiliary scopes—and digital indicators

which show altitude of targets.

An altitude layer control permits the operator to select on the main display either a fixed altitude layer or layers adjustable in upper and lower altitude limits. This approach eliminates a considerable amount of clutter because the only returns presented are those from aircraft within, or immediately adjacent to, the 3-D volume assigned to a controller.

By manipulating a ball-in-socket control (similar in function to a joystick positioner), the operator can position a square over a target on the scope. The altitude of the selected aircraft is shown on a digital indicator.

Another ball-in-socket control operates a second height measurement channel, except that a circle is positioned over the target. Both controls may be used simultaneously when the operator wants to compare altitudes of two aircraft.

The two small scopes show other targets in the vicinity of the aircraft whose height is displayed digitally. Since a separate height return is obtained from each target, either azimuth-versus-height or range-versus-height information in a specific area can be indicated.

Heights are automatically measured by a self-contained computer that produces an analog pulse in time correlation with the search and azimuth information from the radar.

Outputs for all hits on a target are averaged as the antenna scans past the target. The average is converted to a decimal equivalent and displayed on the console's indicators (digital counters). Any number of targets can be monitored. Height computer output can be stored and updated every five seconds.

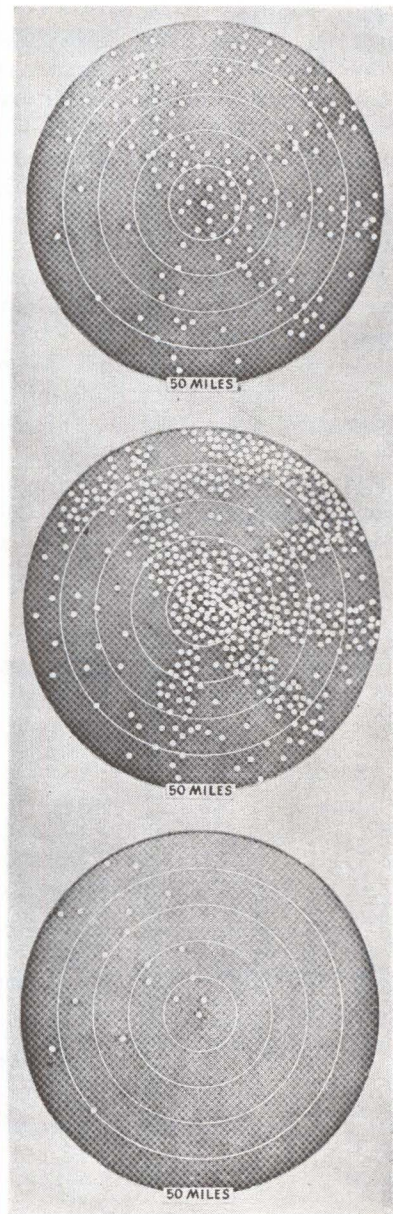

*Congested air traffic now clutters radar displays (top). Scopes will be filled with targets by 1975 (center) unless some method like separating targets into altitude layers is used (bottom), as is done by stacked-beam operation of proposed system*

# Spacemen May Communicate with Gamma Rays

By HAROLD C. HOOD,  
Pacific Coast Editor

TREND TOWARD the use of ever-higher frequencies for communications has led recently to speculation on the practicality of gamma ray communication systems. Gamma ray frequencies are up around  $10^{18}$  Mc.

J. W. Eerkens, of Aerospace Corporation, believes that such systems, using by-product gammas from nuclear reactors on future satellites or at moon bases, would be jam-proof. Because gammas are heavily scattered and absorbed in the atmosphere, their direct use would be limited to outer space.

He further predicts that by chopping it will be possible to transmit low-quality talk at 3 Kc for distances up to 10,000 miles and Morse code at 1 cps up to one million miles with typical nuclear reactors of 100 Kw power.

Probable use would be as an auxiliary communications system between two satellites or between a

moon station and an earth satellite.

Generation of radio waves requires a special electric source and wave generating equipment, but the source of gammas is "for free" since they are a by-product. Some  $7\frac{1}{2}$  percent of power produced in a fission reactor is in gammas.

## Beam Choppers Needed

Eerkens points out that historically with each new process for wave generation, "chopping" of radiation sources has preceded the generation of controlled emission. For example, wireless transmission of information was first carried out by chopping (Morse code) a spark generator. Similarly, microwave used sparking balls of metal until coherent wave generation was obtained through new inventions. He feels that the same evolutionary process will follow with gamma ray communication systems.

In the most primitive form, a gamma ray transmitter will probably use incoherent gamma beams

directly from the core of a reactor. A conical or cylindrical opening in the reactor shielding would permit the rays to "leak" from the reactor core in the desired direction.

By using a chopper consisting of a rotating disk with equally spaced vibrating shutters passing by the opening, a frequency modulated square wave pulse train of gammas could be produced. Modulation would be achieved by varying the vibration rate of the shutters on the disc. Other mechanical chopping methods such as a vibrating lever arm might be used. In a nuclear fission reactor, a total of  $7\frac{1}{2}$  percent of power produced is in the form of high energy gammas, with an average energy of approximately 1 Mev.

Main random noise in the gamma beam is due to the statistical nature of nuclear decay, and is much stronger than background noise caused by stray gammas in space. Satisfactory reception will tolerate a minimum signal-to-nuclear-noise ratio of 10. To assume that the beam-on to beam-off signal ratio is

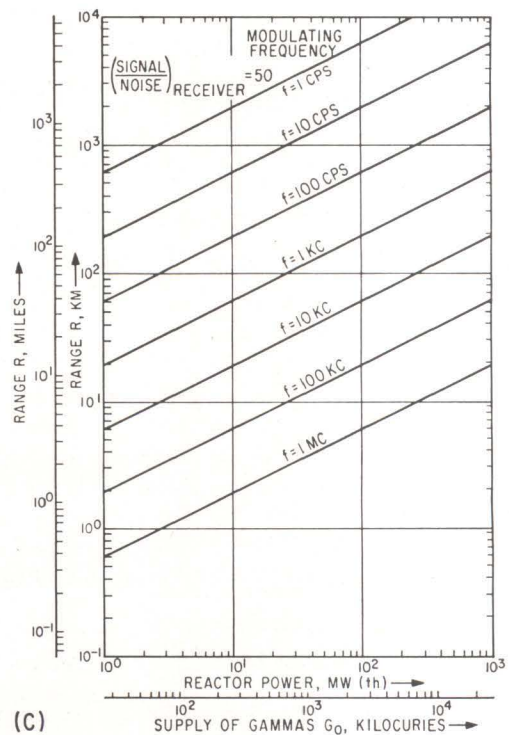
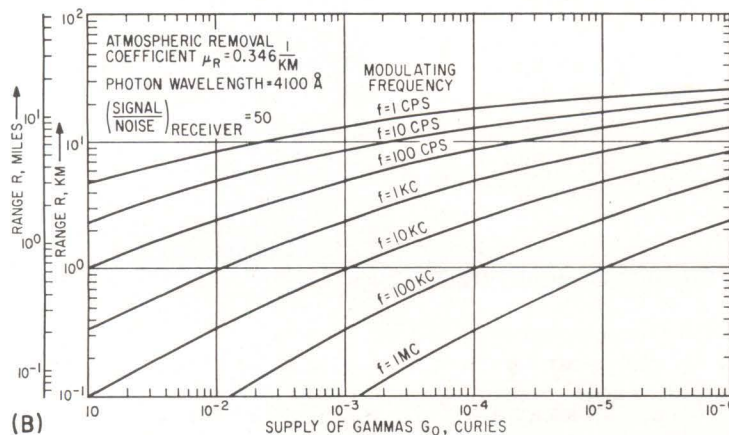
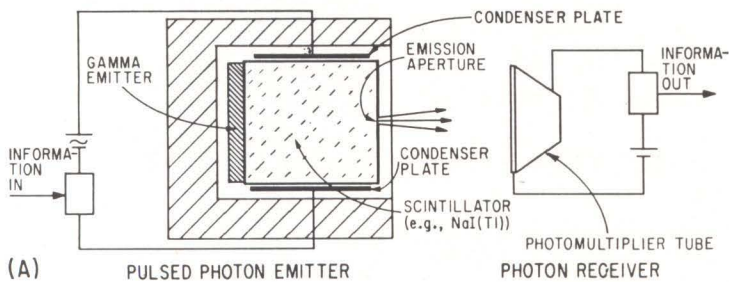

Gamma Induced Photon Emitter (A) may provide modulation for gamma ray communications systems. Graphs indicate Giper's range in the atmosphere (B) and in space (C) as function of gamma source strength and modulating frequency



at least equal to this, a two-inch thickness of lead will be required for choppers or vibrators to attenuate the beam tenfold.

Investigating possible means of getting better coherency between the gamma beam and the information-providing electronic circuit, a device similar to the Kerr cell for light photons comes to mind. If the gamma beam could be intermittently deflected as little as one second of arc, it could be oscillated on and off a receiving antenna of one square meter at a distance of 100 Km.

A gamma ray beam might also be deflected by atomic scattering with a birefringent crystal upon application of an electric field. Barium titanate might work in such an application.

#### Gamma to Photon Converters

Perhaps the most practical means for establishing coherency, suggests Eerkens, would be to convert the gammas to visible or infrared photons.

This might be done by passing the gammas into a scintillator which, except for a small window, would be coated on all sides with reflecting material. In the scintillator, gammas would excite electrons which, upon deexcitation, would emit a photon. These photons will exit from the window as a narrow beam which can be modulated by a Kerr cell. Although energy is lost in the conversion from gammas to light photons, the number of photons produced would actually be larger than the number of gammas which created them. Furthermore, these photons will be monochromatic. With a suitable crystal design, a wave length which could penetrate the atmosphere might be employed.

Nuclear Associates, of San Francisco, have developed a number of directly modulatable gamma-to-photon converting scintillators, called Gipers (Gamma Induced Photon Emitter) which could obviate the use of a Kerr cell. With a nuclear reactor or radio isotope a Giper could be employed in beacons, light radars, communications systems and similar applications. Since no moving parts and very few connections are present, the Giper is expected to be a reliable light beam generator-modulator.

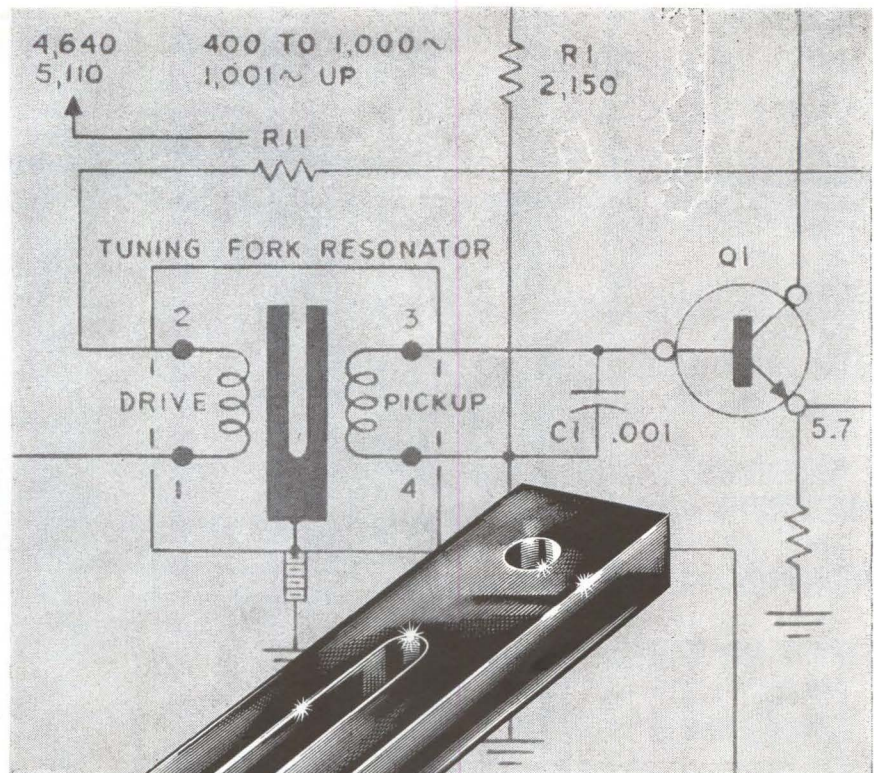

## SYMBOL of PRECISION

Why has the **PHILAMON®** Tuning Fork become the Symbol of Precision for frequency and time standards?

Because of its appearance? Hardly. You'll never see the fork—it is hermetically sealed in an evacuated steel container.

PERFORMANCE is the reason. The only reason.

Everything—Philamon's patented design, premium materials, meticulous workmanship and exhaustive testing—is aimed at one goal. Producing a Tuning Fork Resonator which will generate and keep on generating a precise signal.

It is this single-minded emphasis on performance that has given Philamon Laboratories—



For complete information,

A Reputation for Dependable Frequency Control.

Made to MIL and commercial standards, Philamon's Patented Tuning Fork Resonator is available as a separate component or as the heart of a Philamon Frequency Control Package. These silicon-transistor, modular packages give you a wide choice in preselecting a signal for frequency, accuracy, output voltage and waveshape.

If you have a problem that lends itself to the capabilities of a Tuning Fork Resonator—an instrument also superb as a narrow bandwidth filter—our engineers can, and would like to, help you solve it.

write, phone or wire:

**PHILAMON LABORATORIES INC.**

90 HOPPER STREET • WESTBURY, LONG ISLAND, N.Y.

AREA CODE: 516 EDGEWOOD 3-1700/TWX: WBRV 5103/FAX: LPU

# FILMISTOR®

**METAL FILM RESISTORS  
OFFER 5 TEMP. COEFFICIENTS  
TO MEET ALL CIRCUIT  
REQUIREMENTS**

**RUGGED END-CAP  
CONSTRUCTION  
FOR LONG TERM  
STABILITY**

**EXCEPTIONAL  
RESISTANCE TO  
MOISTURE AND  
MECHANICAL DAMAGE**

**SURPASS MIL-R-10509  
PERFORMANCE  
REQUIREMENTS**

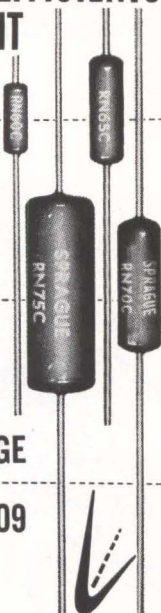

Providing close accuracy, reliability and stability with low controlled temperature coefficients, these molded case metal-film resistors outperform precision wirewound and carbon film resistors. Prime characteristics include minimum inherent noise level, negligible voltage coefficient of resistance and excellent long-time stability under rated load as well as under severe conditions of humidity.

Close tracking of resistance values of 2 or more resistors over a wide temperature range is another key performance characteristic of molded-case Filmistor Metal Film Resistors. This is especially important where they are used to make highly accurate ratio dividers.

Filmistor Resistors, in  $\frac{1}{8}$ ,  $\frac{1}{4}$ ,  $\frac{1}{2}$  and 1 watt ratings, surpass stringent performance requirements of MIL-R-10509D, Characteristics C and E.

Write for Engineering Bulletin No. 7025 to: Technical Literature Section, Sprague Electric Co., 35 Marshall Street, North Adams, Mass.

For application engineering assistance, write: Resistor Div., Sprague Electric Co. Nashua, New Hampshire



'Sprague' and '®' are registered trademarks of the Sprague Electric Co.

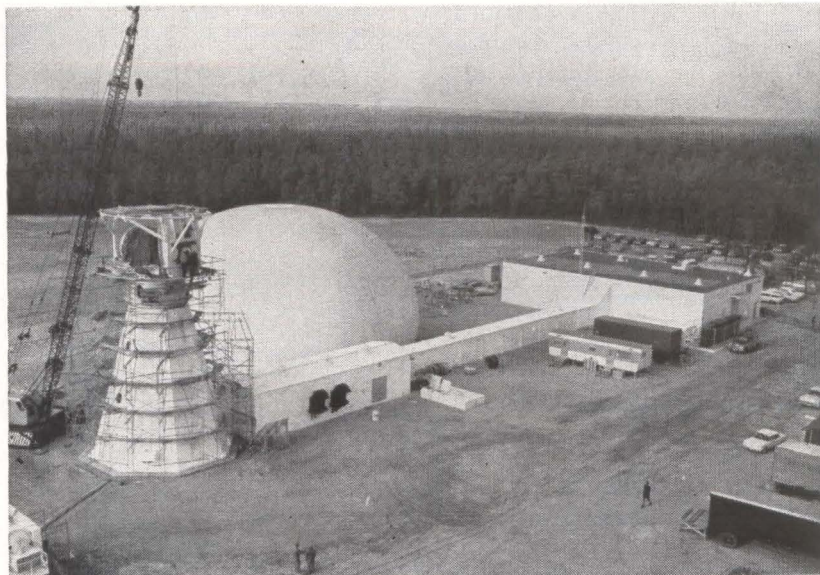

Final construction of antenna was made under inflated radome at Fort Dix site, 35 mi southwest of Fort Monmouth, N. J.

## First Advent Antenna Built

INSTALLATION of the first major component of two ground antenna stations for Army's Advent communications satellite program has been made by Sylvania at Fort Dix, N. J. A second ground station will be located at Camp Roberts, Calif., and a smaller antenna and associated communication equipment will be aboard a Navy ship.

Advent will test the feasibility of synchronous-orbit (22,300 mi) communication satellites.

The 60-ft ground station dish will receive telemetry from Advent satellites and transmit commands at high data rates. It can also track satellites automatically at both vhf and uhf.

Aim of the nine-ton antenna must be accurate to within 0.024 deg. An antenna aiming error of only one degree would miss a synchronous-orbit satellite by 385 mi. To achieve this accuracy the foundation hole is 84 ft in diameter, 30 ft deep and contains 5,000 tons of concrete. The 65-ft tower is built of 190 tons of 1-in steel plate. The turret can make a complete rotation in 60 seconds.

Prime contractor to the Signal Research and Development Lab is Sylvania. Bendix is responsible for the development of all communica-

tion equipment for satellites and ground stations. Philco is providing tracking, telemetry and command subsystems gear.

Initial tests will be conducted this year with an active communication satellite in a 6,000-mi circular orbit with a period of about six hours, boosted by an Atlas-Agena B rocket. Later launches will place Advent in a synchronous equatorial orbit.



Reflector is lowered onto pedestal

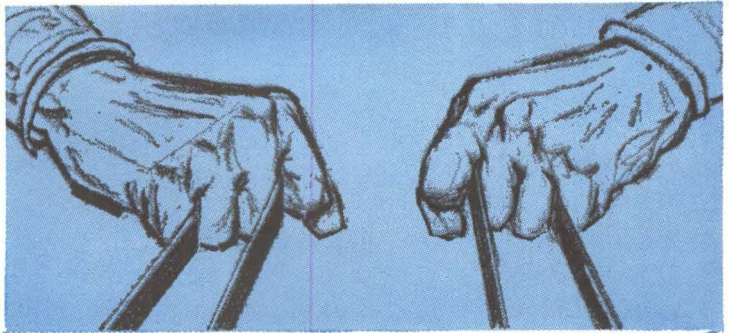

# FOR RELIABLE SYSTEM DAMPING



## CLIFTON PRECISION MOTOR RATE TACHOMETERS

Clifton Precision QUALITY is built into this versatile line of full drag cup type Tachometers. They feature high linearity, high output to null ratios, and low inertia.

Other attractive performance characteristics are a 20:1 signal to noise ratio in standard units with ratios up to 100:1 available on special order. Power consumption is also lower than average, being 1.2 watts in typical units.

Current leakage as a variation with temperature has been significantly reduced in these units by use of a new magnet wire. See performance curves below.

Write or call for further information on these quality units to: area 215 MA 2-1000, TWX LNSDWN, PA. 1122(U) or our Representatives.

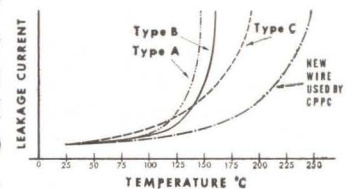

**CLIFTON  
PRECISION  
PRODUCTS  
CO., INC.**  
*Clifton Heights, Pa.*

**FULL-SCALE RANGES AS LOW AS  $2\mu\text{A}$  OR MV;  
SPECIFIED LINEARITY OF  $\pm 0.5\%$  OR BETTER**

The new Series II Stylist panel meter is probably the most precisely linear production-model microammeter or millivolt-meter you can get. It can divide  $2\mu\text{a}$  or mv into as many as 100 clearly legible slices with virtually no tracking error at all. With proper adjustment of full-scale current, it can give you infinitely accurate indication.

Its ultra-linearity is the result of individual scale calibration, made economically feasible by a newly-developed electronic calibrator. This calibrator, operating through a system of servo controls, automatically prints individually adjusted scales according to the actual measured tracking characteristics of each meter movement. Theoretically, each meter's full-scale linearity is infinite, with no tracking error at any point. (We do, however, retain a maximum  $\pm 0.5\%$  manufacturing tolerance).

Added to this, you get a taut-band suspension, which accounts for the meter's  $2\mu\text{a}$  or mv full-scale sensitivity and its near-perfect ( $\pm 0.2\%$  f.s.) repeatability. No friction. No hysteresis. High resistance to shock and vibration in any plane. Nearly impossible to wear out.

For full details on the API Series II Stylist, including ranges and prices, write for Bulletin 28.

**api ASSEMBLY PRODUCTS INC. • CHESTERLAND 4, OHIO**

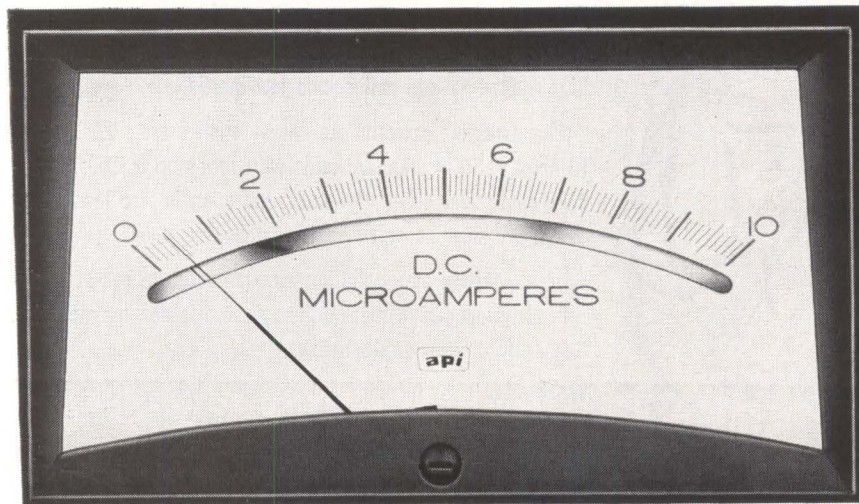

**NEW!**

**THE SERIES II STYLIST  
TAUT-BAND PANEL METER**

SA 2486

**MEETINGS AHEAD**

OPTICAL CHARACTER RECOGNITION Symposium, Nat. Bur. Stds; Dept. of Int. Aud., Wash., D.C., Jan. 15-17.

ELECTRICAL ENGINEERING Exposition for Electrical-Electronics Industry AIEE; N.Y. Coliseum, N.Y.C., Jan. 29-Feb. 2.

REDUNDANCY TECHNIQUES FOR COMPUTING SYSTEMS, Office of Naval Research; Dept. of Interior Aud., Wash., D.C., Feb. 6-7.

MILITARY ELECTRONICS, PGMIL of IRE; Ambassador Hotel, Los Angeles, Feb. 7-9.

SOLID STATE CIRCUITS, Internat. Conf., PGCT of IRE, AIEE; Sheraton Hotel and U. of Penn., Philadelphia, Pa., Feb. 14-16.

APPLICATION OF SWITCHING THEORY TO SPACE TECHNOLOGY Symp., USAF, Lockheed Missiles & Space; Lockheed, Sunnyvale, Calif., Feb. 27-Mar. 1.

SCINTILLATION AND SEMICONDUCTOR Counter Symp., PGNS of IRE, AIEE, AEC, NBS; Shoreham Hotel, Washington, D.C., Mar. 1-3.

MISSILES & ROCKET TESTING Symp., Armed Forces Communications & Electronics Association; Coca Beach, Fla., Mar. 6-8.

EXTRA-HIGH VOLTAGE COMMUNICATION, CONTROL & RELAYING, AIEE; Baker Hotel, Dallas, Tex., Mar. 14-16.

IRE INTERNATIONAL CONVENTION, Coliseum & Waldorf Astoria Hotel, New York City, Mar. 26-29.

QUALITY CONTROL Clinic, Rochester Soc. for Q.C.; U. of Rochester, Rochester, N.Y., Mar. 27.

ENGINEERING ASPECTS OF MAGNETO-HYDRODYNAMICS, AIEE, IAS, IRE, U. of Rochester; U. of Rochester, Rochester, N.Y., Mar. 28-29.

SOUTHWEST IRE CONFERENCE AND SHOW; Rice Hotel, Houston, Texas, April 11-13.

JOINT COMPUTER CONFERENCE, PGEC of IRE, AIEE, ACM; Fairmont Hotel, San Francisco, Calif., May 1-3.

HUMAN FACTORS IN ELECTRONICS, PGHFE of IRE; Los Angeles, Calif., May 3-4.

ELECTRONIC COMPONENTS conference, PGCP of IRE, AIEE, EIA; Marriott Twin Bridges Hotel, Washington, D.C., May 8-10.

NATIONAL AEROSPACE Electronics Conference, PGANE of IRE; Biltmore Hotel, Dayton, Ohio, May 14-16.

MICROWAVE THEORY & TECHNIQUES National Symposium, PGMTT of IRE; Boulder, Colo., May 22-24.

SELF-ORGANIZING INFORMATION Systems Conference, Off. Nav. Rsch, Armour Rsch. F'd.; Museum of Sci. and Ind., Chicago, May 22-24.

NEED A  
HELPING  
HANDFUL\* OF  
MINIATURE  
FASTENERS?



*\*Over 40 miniature Zip-Locs in this hand*

Mail this card today for complete information on the new Deutsch Miniature Zip-Loc fastener or contact your Deutsch Fastener Representative.

FIRST CLASS  
Permit 35965  
Los Angeles, Calif.

BUSINESS REPLY MAIL

No postage stamp necessary if mailed in the U.S.



171 AX

postage will be paid by  
**Deutsch Fastener Corporation**

P.O. Box 61072  
Los Angeles 61, California

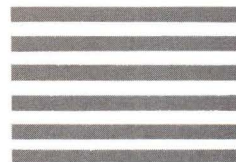

Deutsch

MINIATURE  
**Zip-Loc®**

**Stressed Panel Fasteners**

■ *Miniature size and weight* makes this new fastener your best design solution for applications requiring maximum strength coupled with ease-of-access.

■ *Dimensionally smaller than NAS #547 size 0* the miniature Zip-Loc still provides the shear strength of a size 0 fastener. And this means a *double shear strength of 5440 pounds*, plus an *ultimate tensile rating of 1000 pounds*.

■ *100% locking in any position* because it features unique serrated mating surfaces between the stud and nut. The special stud-nut design also permits considerable sheet misalignment.

■ *Receptacle contains only 6 parts*, and this means trouble-free performance and long life.

■ *Ease-of-operation* is assured too by the extremely simple design of the Zip-Loc.

If you are concerned with fastener applications, just fill in the convenient card attached for additional information on the complete line of advanced Deutsch fasteners.

1. Zip-Loc stressed panel fasteners
2. Drive pin blind rivets
3. Pawl-Loc quick release pins
4. Pres-Loc quick release panel fasteners

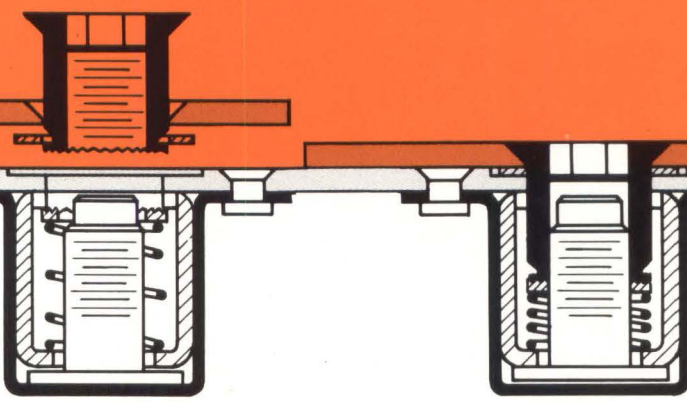

**UNLOCKED**  
Floating stud insures positive alignment with mating stud-nut.

**LOCKED**  
Spring pressure on serrated locking surfaces assures positive lock.

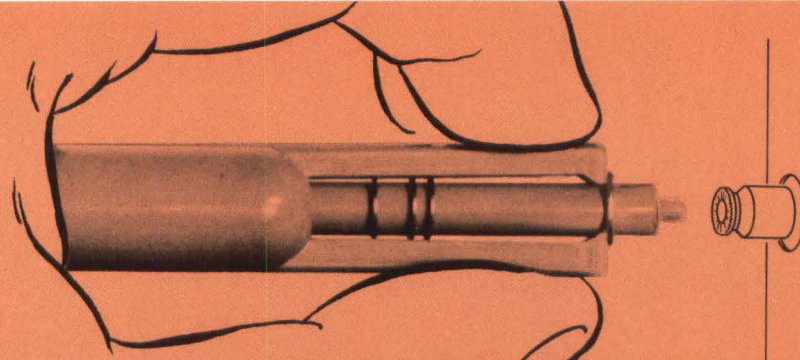

Easy-to-use tool included for retaining snap ring installation.

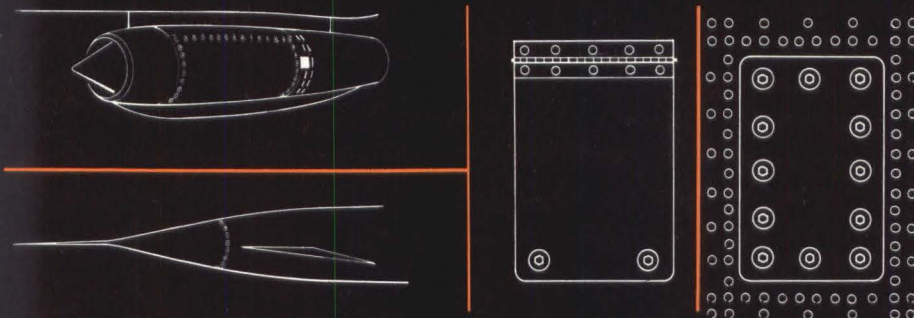

Typical design applications.

Write today for information on career opportunities in advanced fastener design.

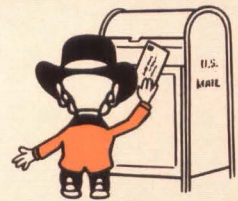

Name \_\_\_\_\_  
Title \_\_\_\_\_  
Company \_\_\_\_\_  
Phone No. \_\_\_\_\_ Ext. \_\_\_\_\_  
Address \_\_\_\_\_  
City \_\_\_\_\_  
Zone \_\_\_\_\_ State \_\_\_\_\_

- Please send me complete information on the **Miniature Zip-Loc**.
- Please have a representative call soon.

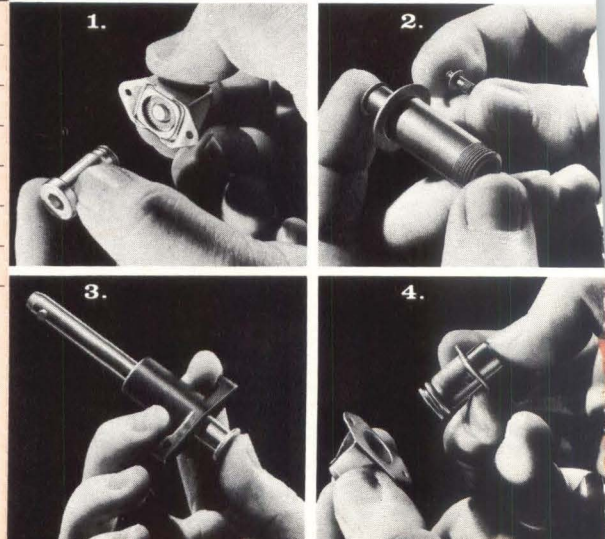
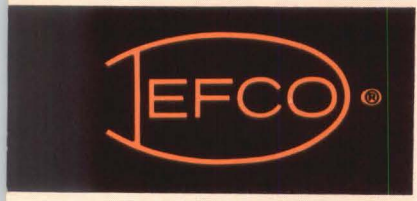

# NUCLEAR ATTACK AND INDUSTRIAL SURVIVAL

The Editors of McGraw-Hill consider this report the most critical assignment ever undertaken by our segment of the business press of this nation. In its development, at one moment or another, each member of the task force has felt the enormous contemplative weight of the subject and the almost overwhelming demands for accuracy. Rarely have we dealt with a matter of such potential import to individuals and to responsible leaders in all segments of the American economy. Never before have we volunteered as much effort, hoping it would not be needed.

However, not only now during the Berlin crisis, but probably for many years to come, the U. S. will live under threat of a nuclear attack. How well we could survive such aggression, and how rapidly we could restore a viable civilization, depends heavily on how we prepare to meet the danger.

And yet, paradoxically, we are aware that the very effort to do this work . . . or even to address this subject . . . is controversial. There are those, in highly respected echelons of our society, who say no civil defense is worthwhile . . . that the more security you feel, the more willing you are to risk the holocaust.

- Our study of nuclear attacks, and consultations with experts both within government and outside, convince us that responsible and prudent management can, and should, act on the basis that protective measures constitute a sound form of insurance.
- We believe the suggestion that a sense of security might provoke aggression libels both the intelligence and the morals of the American people. Nothing in this report, or in any other realistic appraisal of this somber subject, encourages aggression or bravado. On the contrary, the awe-full dimensions of destruction . . . despite all preparations for protection . . . compel the utmost effort for prevention of nuclear war.

This report concentrates on the problems of U.S. *industrial* survival for two important reasons. First, the excellent organization that industry already has can be a powerful force for the protection of people. Second, in the aftermath of any war, it is vital to society that production be restored as quickly as possible. Therefore, in planning for both survival and recovery, business and industry have special responsibilities . . . to employees, to the community, and to the nation.

Let us make one thing absolutely clear. If any part of the pages that follow can be accused of sensationalism, then we have failed our job. The Editors of McGraw-Hill do not believe that nuclear war is likely. But we do believe that the possibility of it . . . however remote . . . must be examined.

The Editors of McGraw-Hill

SIZE OF ATTACK (Megatons)

— 500  
— 1,000  
— 2,000  
— 4,000  
— 6,000  
— 8,000  
— 10,000  
— 12,000  
— 14,000  
— 16,000  
— 20,000

AREA OF BLAST AND THERMAL EFFECTS

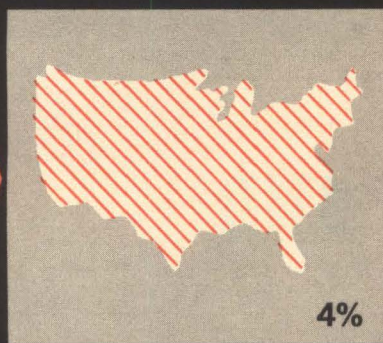

AREA AFFECTED BY FALLOUT

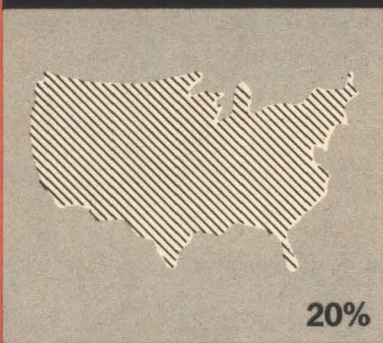

INDUSTRIAL FACILITIES MADE UNUSABLE

ATTACK ON MILITARY TARGETS ONLY

10%



HALF MILITARY AND HALF CIVILIAN TARGETS

40%

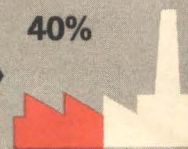

ATTACK ON MILITARY TARGETS ONLY

30%



HALF MILITARY AND HALF CIVILIAN TARGETS

80%



**ESTIMATED EFFECTS OF NUCLEAR ATTACKS** at a clearly credible present level (1000 megatons) and a possible future level (10,000 mt). Individual bombs assumed to be 10 mt with 50% fission yield; half are surface bursts, half air bursts. Area figures assume no overlap between air bursts, 50% overlap of surface bursts. Limit of thermal-

effects area taken as 2nd-degree-burn level; this automatically includes all blast-damage area. In fallout-affected area, precautions would be needed to avoid radiation sickness or death (first-day dose is 200 r, or more). In combined military and city attacks, military targets were assumed to receive all surface bursts and city targets all air bursts.

## THE DIMENSIONS OF DISASTER:

### What might nuclear attacks cost us in facilities, people?

Because no nation has ever suffered a full-scale attack employing modern thermonuclear weapons, there is no direct experience to use as a basis for appraising the damage the U.S. would suffer under such an attack—or for gaging what government, industry, and others in the community might do to provide protection.

To assess the damage in advance, you must turn to data drawn from painstaking studies of the relatively small attacks on Hiroshima and Nagasaki, and from the tests conducted in the years since.

These give reasonably precise knowledge of the effects of a single explosion. And they make it possible, with only slightly less precision, to calculate the effects of a known pattern of bursts.

**Attack estimates.** To estimate the results of large attacks, however, you must assume a range of factors: total size of attack, size of individual weapons, type of burst, and—most controversial of all—the nature of the targets. In other words, you must try to divine the enemy's strategy. Any estimates you produce reflect the assumptions with which you begin.

In the chart above, you see an attempt to picture the range of possible attack—from a level that is credible now

to one that might be credible in the future. It also shows the effects of some of the variables. For example, in this case the assumption is made that 10-megaton weapons would be used. Of course, it is possible that an enemy might employ bombs both larger and smaller than 10 mt, with somewhat different results.

Another important variable is the burst pattern. Surface bursts do the most blast damage to missile sites and airfields, hence might be chosen for military targets. They also yield radioactive fallout that can kill people and disrupt life many miles from the target. On the other hand, air bursts inflict blast and fire damage on two to three times more area. These might well be used against "soft" military targets and centers of population.

**Target selection.** Biggest variable of all is the enemy's selection of targets. The chart shows two patterns for each level of attack: one concentrated on military targets, the other divided equally between military targets and cities. In both cases, half the bursts are in the air, and half are on the surface.

The smaller attack, directed partly at cities, could actually cause more deaths and damage to industrial facilities than would the larger attack aimed solely at military tar-



# FATALITIES AS % OF TOTAL POPULATION

**FATALITY KEY**  
 Blast & Thermal  
 Fallout  
 Not Killed

( = 10 million)

## WITHOUT SHELTER

## WITH FALLOUT SHELTERS

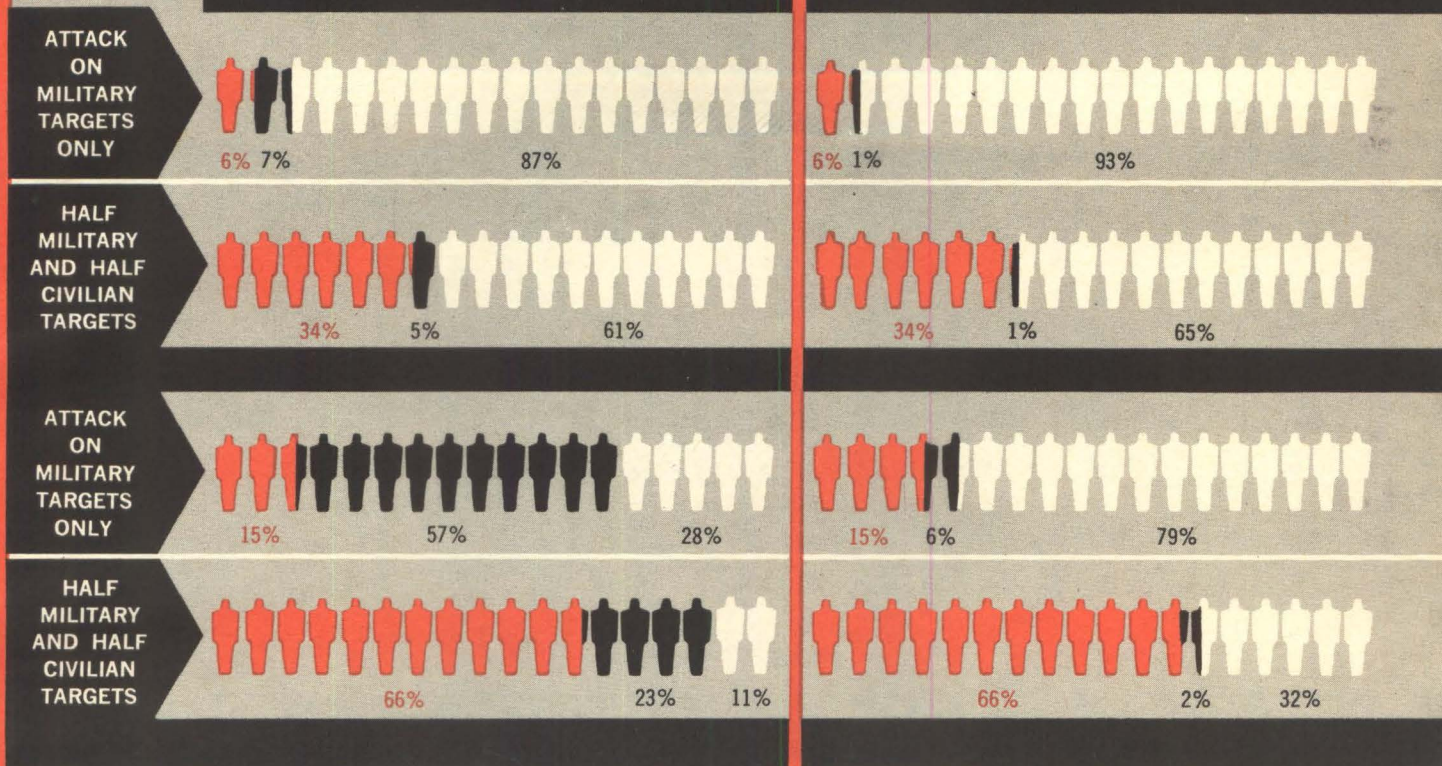

For industrial facilities, "made unusable" means destroyed or requiring major restoration after blast or fire. Fatalities "without shelters" assumes poorly instructed population with no shielding beyond ordinary housing. "With fallout shelters" assumes informed, well disciplined population fully equipped with good group shelters. No

account is taken of blast and fire protection afforded by fallout shelters. Fatality figures do not include deaths from secondary causes such as lack of medical treatment for injuries. Estimates based on data from Office of Emergency Planning, Atomic Energy Commission, Rand Corporation, and hearings of the Joint Committee on Atomic Energy

gets, because industrial facilities tend to be concentrated in or near centers of population. These figures point up the crucial role targeting would play.

The chart at right above shows what might be accomplished by a really good protective program — a goal that could be reached only by a major change in the nation's present unprepared posture. It should be noted that the chart assumes a one-day war; losses would be different — and probably greater — if a big attack were followed by several smaller ones.

Imperfect as such estimates must be, what can they teach us? How should we interpret them?

Clearly, these figures — and those of other authorities — reveal the sheer size of the problems posed by nuclear attack. Right now, a single blow could cost us 40% of our industrial facilities and, without protective measures, 39% of our population.

**Destruction varies.** In assessing this grim picture, it is important to realize that destruction would not be universal. Nor would it be uniformly distributed. Some areas would be essentially unaffected. Others, nearer targets, would be physically untouched but contaminated by fallout. Closer in, there would be areas with even greater fallout concentrations, plus fire damage. Moving in still closer, blast damage would be heavy, and fire and fallout would make conditions still worse. Finally, there would be centers of virtually complete destruction.

It should be clear that no company management can predict which of these varying degrees of destruction might hit its facilities. It is equally clear, however, that there

would be many areas in which protective measures, such as shelters, would be effective, as the casualty figures demonstrate. And the "graded" nature of the damage offers some clues to the approaches management might take in planning for survival — approaches that will be examined in more detail later in this report.

Finally, this effort to gage the dimensions of the disaster resulting from a large-scale nuclear attack gives some idea of the environment in which individuals and companies must try to rebuild. There would be no "business as usual", even in the relatively unscathed areas of an economy that has suffered major disruptions to the services on which industry depends — communications, transportation, utilities, raw materials, fuel, food, money and credit, to name some. This glimpse of the post-attack period gives urgency to efforts to plan now for the problems of the recovery.

**In the following pages, this report tells business and industrial management what it needs to know about:**

- The effects of nuclear attack — fire, blast, fallout . . . . . pages 4-8
- Plans to make in advance for surviving an attack . . . . . pages 9-13
- Preparations that can be made for post-attack recovery . . . . . pages 14-16

# FIVE STAGES OF A NUCLEAR AIR BURST

Times and distances shown are for 1-mt bomb; both would increase with larger weapons.

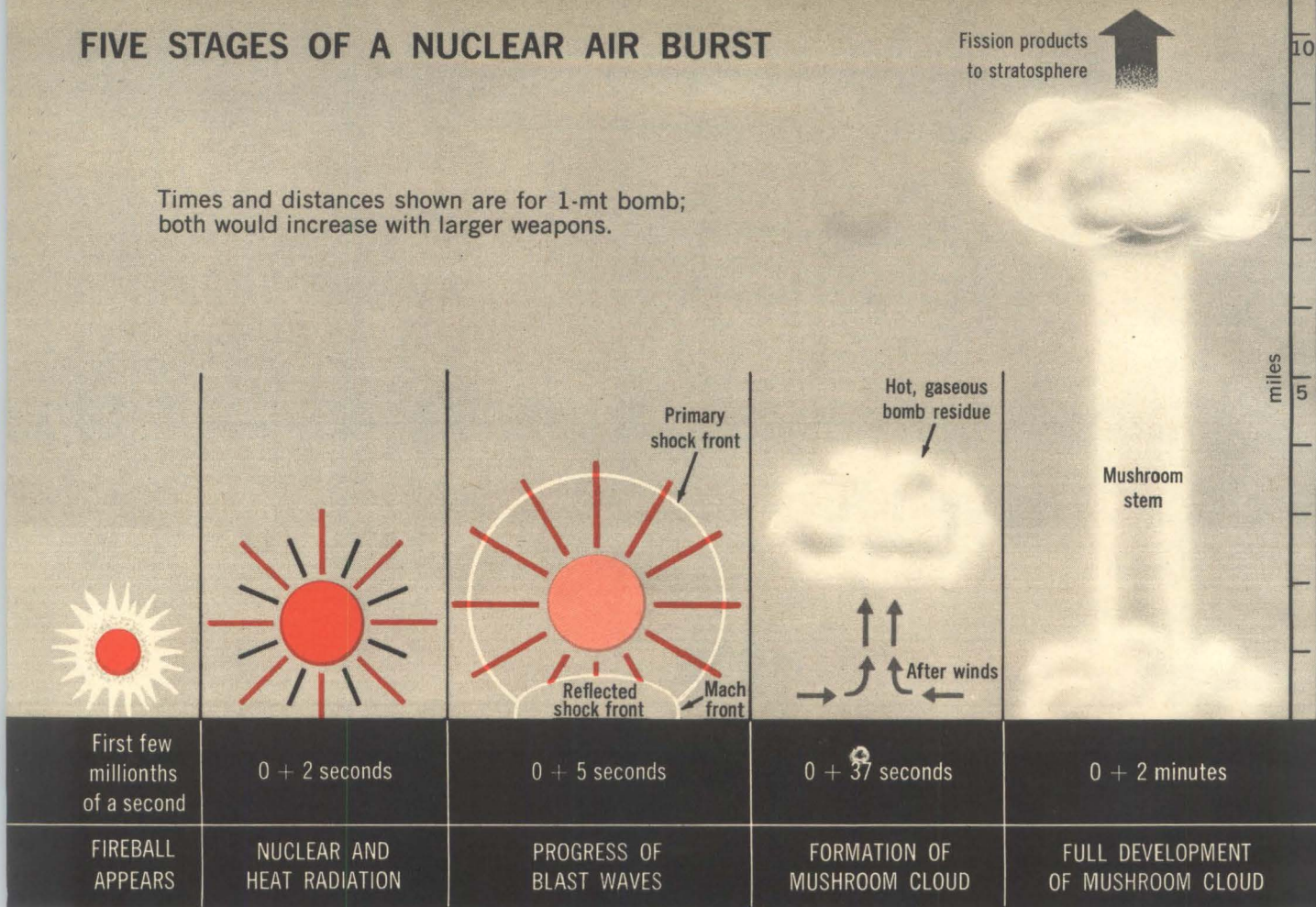

1. Instant release of bomb's vast energy raises temperature of its materials several millions of degrees, gasifies them to form a roughly spherical luminous mass. Emitting nuclear and thermal radiations, this "fireball" grows and rises. For a 1-mt weapon, maximum diameter of 1.4 mi is reached in about 2 seconds. Very shortly after explosion,

shock wave develops and moves rapidly away from fireball. When shock wave reflected from earth surface meets primary wave, the reinforced "Mach front" forms and moves outward. Rising ball of fire, no longer luminous, creates strong updraft and "after winds" that raise dust and debris. With condensed bomb residue, these form radioactive cloud

## NUCLEAR EXPLOSIONS: What are the immediate effects?

The split-second blast of a modern nuclear weapon lets loose awesome amounts of energy — so awesome, in fact, that it is usually measured by comparison with the force of thousands or millions of tons of TNT (*kilotons* or *megatons*). It would take a block of TNT the size of New York's Empire State Building to duplicate the energy release, or *yield*, of a 2-megaton nuclear bomb.

How can you pack that much wallop into the warhead of an ICBM? The answer lies in the way a nuclear explosion unlocks the vast forces inside the nucleus of the atom. There are two techniques for doing this:

- In *fission*, you split the nucleus of a heavy element — such as uranium-235 or plutonium — into two lighter nuclei, called *fission products*. If fission were 100% complete — it isn't — 1 lb of U-235 would produce the energy of 9000 tons of TNT.

- In *fusion*, you cause two light nuclei to unite into a single heavier one. Fusion will create, from the same mass of material, nearly three times as much energy as does fission. But to trigger the fusion process, you need temperatures akin to the heat of the sun. To produce this heat, you use a fission explosion. Fission triggers fusion. Then, as an extra

dividend, more fission results because fusion liberates high-energy neutrons that split some of the atoms left intact by the first fission. This combination — fission, fusion, then more fission — adds up to the terrible energies of today's thermonuclear weapons.

**Sequence of events** in a nuclear explosion appears in Fig. 1, above. First there's a flash of light that can be literally blinding — eyes turned directly toward it suffer retinal burns, even at distances of hundreds of miles with megaton blasts. How much damage is done to the eye depends on such factors as weapon size, height of burst, time of day, weather, and speed of blink reflex.

Millionths of a second after the bomb is detonated, the *fireball* forms and grows by engulfing surrounding air. In about two seconds it reaches a maximum diameter of 1.4 mi for a 1-megaton (1-mt) bomb. Maximum diameter is 3.4 mi for 10 mt, 4.6 mi for 20 mt. When the burst is low, and the fireball touches earth, all above-ground installations within it are vaporized or otherwise destroyed, except for heavy concrete structures.

Simultaneously, the explosion releases an initial burst of radiation — about 5% of the bomb's total energy — that is

## THERMAL RADIATION

Heat incident on surfaces (for 10-Mt burst)

— travels at speed of light (186,000 mps)

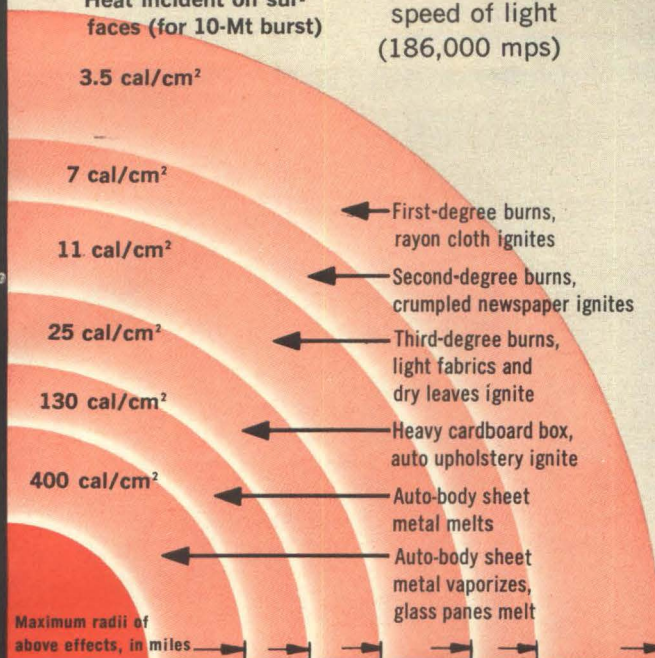

Maximum radii of above effects, in miles							
1 Mt	Air	1.5	2.7	5.5	8	9	13
	Surface	0.9	1.6	3.3	5	5.5	8
10 Mt	Air	4	7	15	22	25	35
	Surface	2.4	4	9	13	15	21
100 Mt	Air	11	19	45	60	70	100
	Surface	6.5	11.5	27	36	42	60

## BLAST

— travels faster than sound (over 770 mph)

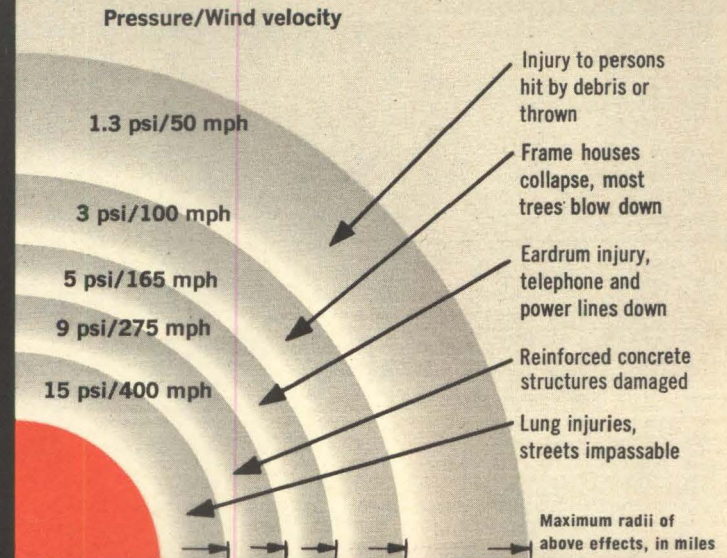

Maximum radii of above effects, in miles							
1 Mt	Air	1.4	2.6	3.9	5.3	8.8	
	Surface	1.5	2.0	2.9	4.0	7.2	
10 Mt	Air	3	5.6	8.5	11.3	18.5	
	Surface	3.2	4.4	6.1	8.5	15.5	
100 Mt	Air	6.5	12	18	24.5	40	
	Surface	6.9	9.5	13	18	33	

2. About 35% of total bomb energy goes out in a burst of heat, uniformly radiated. Heat level falls rapidly with distance, as shown in calories per square centimeter at successive circles, above. Figures below give clear-day radii of circles for three weapon sizes, two types of burst. Also shown are possible effects on materials, people

3. About 50% of bomb's total energy goes into blast; the front of the blast, called the "shock front", travels rapidly away from the fireball, behaving like a moving wall of compressed air. Chart above shows various levels of blast pressure, equivalent wind velocities, and possible effects in the annular zones between successive circles

itself lethal over an area about the size of the fireball. This radiation includes high-energy neutrons and gamma rays. Additional gamma rays come from radioactive bomb materials and fission products.

**Heat and fire.** The fireball sends out *thermal radiation* in two pulses, making up 35% of the bomb's total energy. The first pulse, a split-second ultraviolet flash, isn't a major hazard. But the second is: mostly infrared, it carries nearly all the heat of the burst, lasts several seconds. As the heat radiates from the fireball, it spreads over ever greater areas, so heat levels diminish sharply with distance (Fig. 2). Low clouds or fog tend to cut heat, but high clouds can act as reflectors, raising heat levels on the ground.

Because heat is applied only for a matter of seconds, light, easily kindled materials are most likely to ignite. But surveys show typical American cities contain 5 to 25 points per acre where fires might begin from thermal radiation. Although it's hard to predict precisely, there's a danger that many small fires might merge into single, great "firestorms", with strong updrafts at center creating violent cyclonic winds.

Thermal radiation travels like light. So ducking quickly into a shadow or covering exposed skin with clothing offers some personal protection.

**Shock pressures.** In about the time it takes for a thunderclap to follow a lightning bolt, the blast wave fol-

lows the thermal flash; about 50% of weapon energy is in this form. The blast wave starts as a high-pressure shock front, traveling somewhat faster than the speed of sound. After a few seconds, a negative-pressure phase follows. The effect is to first squeeze and then expand or explode structures and human tissues.

Along with these great swings in pressure, there would be short wind gusts of enormous velocities — up to 1000 mph near ground zero. Drag forces of these winds would inflict much of the damage to buildings and the bulk of blast injuries to humans. As Fig. 3 shows, shock pressures in themselves would be fatal over only a small area by comparison with the area in which pressures and winds would hurl people and objects through the air to cause injury and death.

Near ground zero, pressures and winds are higher in a surface burst than an air burst. Farther out, an air burst creates stronger pressures and winds because the blast wave bounces off the earth and reinforces the primary wave to create the so-called "Mach front" (Fig. 1).

In areas of heavy blast damage, fires will be started by broken gas mains and electrical short circuits. They will feed on the kindling produced by the blast.

Thanks to the relatively slow speed of the blast wave, there is often time to take evasive action, such as dropping flat, or seeking shelter below ground.

## WORLD-WIDE FALLOUT

20% of radioactive fission products go into stratosphere

Wind direction →

80% to local fallout

## LOCAL FALLOUT

Fallout starts to come down roughly 15 minutes after surface burst, continues to come down for some 6 hours.

Particles are about size of sand grains

Fallout starts to come down roughly 7 hours after surface burst, continues for 9 hours. Particles resemble fine dust or face powder

8 mi

60 mi

20 mi wide

4. In contrast to air bursts (Fig. 1, page 4), where fallout goes mainly to the stratosphere and may travel far, surface bursts are characterized by heavy local fallout. This results from great amount of debris swept up into the fireball. Like the materials of the bomb, such debris is initially vaporized. Material swept up later may be

only melted. When the vaporized materials, including fission products and materials made radioactive by neutron bombardment, condense into fine particles, many of these adhere to larger debris particles. Resulting size keeps particles from rising high, causes them to settle out over large areas as the radioactive cloud moves with the wind

## NUCLEAR EXPLOSIONS: How fallout hazards develop

A nuclear explosion vents about 90% of its total energy immediately — in initial radiation, heat, and blast. The other 10% shows up afterward, mainly as radiation from fission products that rise with the mushroom cloud. Sooner or later, they descend to earth as *fallout*.

Fallout has its origin in the fission chain reaction that triggers the nuclear blast. This forms more than 200 different radioactive isotopes, which begin at once to *decay*, each at its own rate. Some decay almost completely in a matter of minutes, others so slowly that years later they are only slightly less radioactive. The differences in decay rate are a crucial factor in determining the hazards of fallout, and also in distinguishing between the two types of fallout — global and local.

**Global fallout** is the type that has resulted from weapons tests already conducted, most of them air bursts (Fig. 1, p. 4). Fission products formed by such a burst first vaporize, then condense as extremely fine particles that rise into the stratosphere and travel with upper-level winds for long periods of time. Meanwhile, decay eliminates all but the long-lived isotopes, such as the much-discussed strontium-90. When the particles do drift down to earth,

they are widely distributed. So they raise the radiation level at any given point only minutely.

Such increases in radiation levels are considered to produce genetic effects. And strontium-90, moving from the earth's surface to plants and to food, can be selectively absorbed by the human body to cause bone cancer. Because these are all long-range effects, the impact of global fallout from nuclear tests is widely debated and will be truly known only in the future, when sufficient statistical data have been accumulated and analyzed.

**Local fallout** is much quicker to take effect — and much more dangerous. This type of fallout results from surface bursts, which would probably be part of a nuclear attack. Fission products from the explosion agglomerate with larger particles of debris (Fig. 4, above) and roughly 80% of them settle to earth in a matter of hours. Heavier particles descend in the first hour or so; lighter ones take several hours or more and winds carry them over hundreds of square miles. The major and immediate danger of this local fallout is radiation from these particles as they sift down over land and buildings.

The other 20% of the fission products from a surface

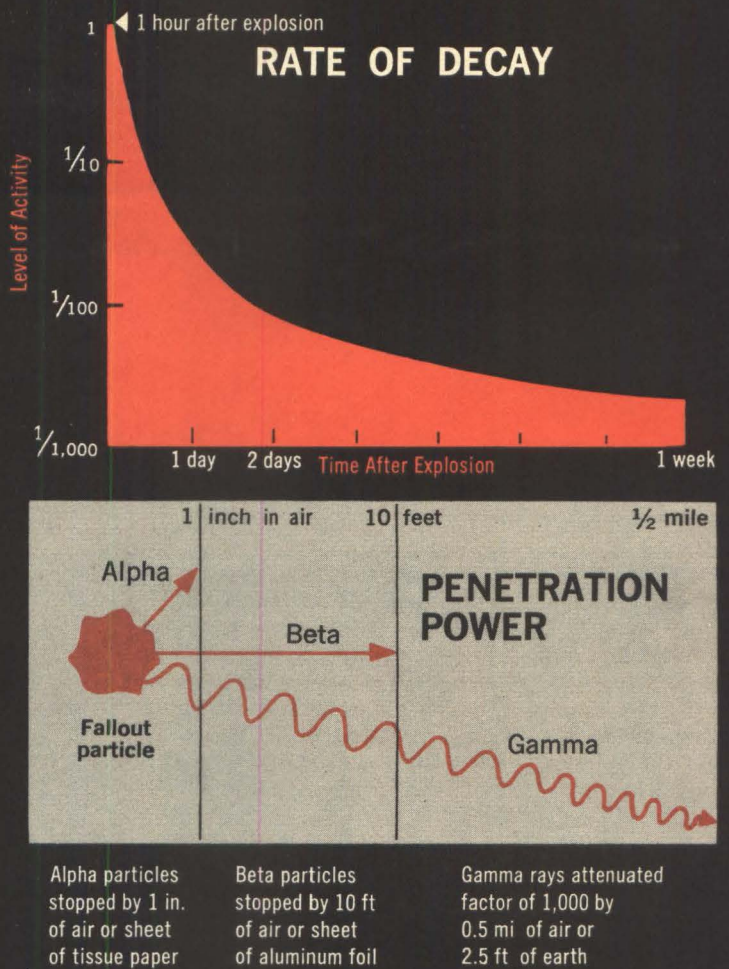
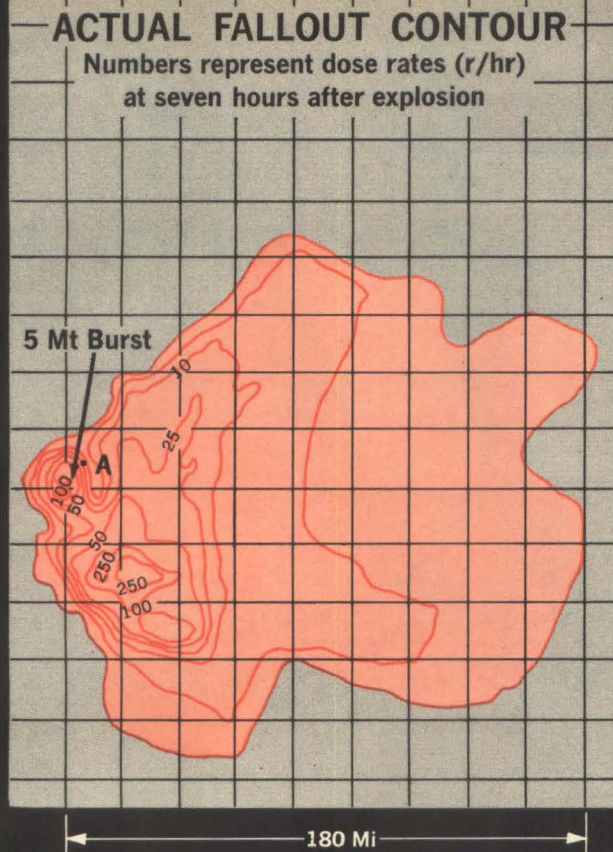

5. Theoretical pattern of fallout distribution at ground level appears at base of diagram on facing page. In contrast to this cigar-shaped pattern, actual distribution may be highly irregular, as illustrated above. Note particularly the several local "hot spots" and the fact that radiation intensities do not always fall off downwind

6. Radiation from fallout particles decays rapidly at the beginning, as shown in upper curve. This radiation takes three forms: Alpha and beta radiations consist of atomic particles that do not travel far, can be stopped easily. Gamma radiations are true rays, like X-rays. They can travel relatively far and they have great penetrating power

burst go into the stratosphere and become global, or worldwide, fallout. Because fission products are created in direct proportion to the amount of material exploded, a nuclear attack involving thousands of megatons would produce much more global fallout than has resulted from all the weapons tests so far.

Theoretical calculations to determine the distribution of local fallout usually assume that the wind blows in just one direction at 15 mph. Under such conditions, radioactive fallout will tend to settle in a cigar-shaped pattern (Fig. 4, bottom), with radiation intensity diminishing in the downwind direction and toward the outside edges.

In practice, however, winds at different altitudes move in different directions at different speeds. So actual patterns of fallout tend to be highly irregular (Fig. 5). This means that it isn't safe to use reports of general radiation levels as an estimate of hazards in your area. The only sure answer is to measure radiation locally.

**How to measure.** Fallout particles emit three kinds of radiation (Fig. 6), but only one — *gamma* radiation — is of major importance. Gamma radiation is like X-rays and you gage exposure, or the *dose*, in the same units — *roentgens*. To measure the dose *rate* or radiation intensity, you use roentgens per hour (r/hr).

An instrument called a *dosimeter* will show the radiation dose to which you have been exposed. One common type,

designed to be worn, is shaped like a fountain pen. Dosimeters of this sort usually record accumulated radiation up to about 600 r. In addition to keeping track of the total dose you have accumulated, you should also know the rate at which radiation is being received (r/hr). This can be crudely done with a dosimeter, by noting the increase in total dose over a period of time. For greater convenience and accuracy, a similar pen-shaped device is calibrated to read the rate up to 100 r/hr.

More elaborate portable *ratemeters* are on the market to indicate radiation intensities up to 500 r/hr — although at such high levels hand monitoring is dangerous. For more safety, you can install a stationary ratemeter — capable of registering levels of 1000 r/hr or more — and hook it up for reading in a protected location, such as a group shelter. To use the more elaborate instruments properly, operators would need a few hours of special training.

**Speeds of decay.** In appearance, fallout particles have a glassy surface. They range in color from white to black, and in size from clearly visible "sand" to barely visible powder (several thousand *microns* down to about 20).

In any group of fallout particles, there will be a wide variety of isotopes, each with a different decay rate. For mixed fission products, the radiation level starts high but drops quickly (Fig. 7), as the isotopes with rapid decay rates spend themselves. An easy rule of thumb is that for

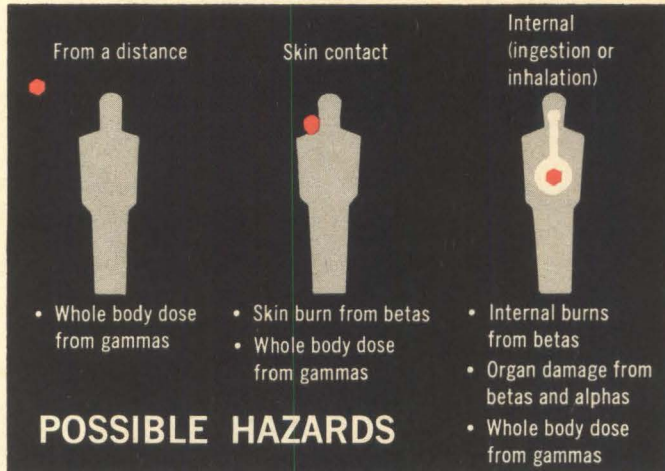
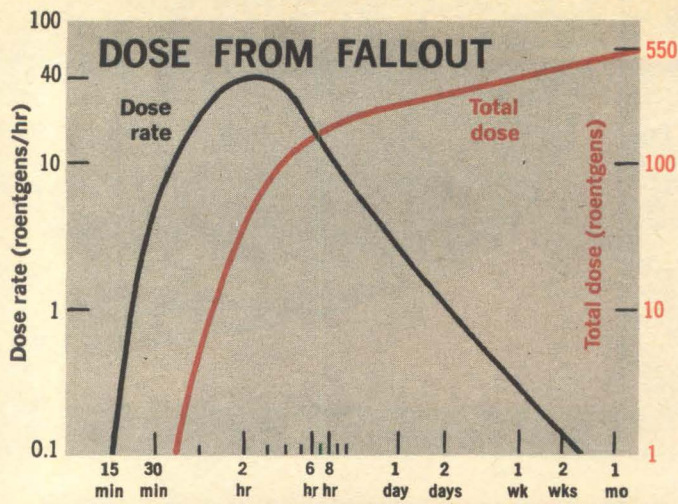

7. Radioactive fallout particles (lower diagram) can injure from a distance, on skin contact, or internally. Upper diagram shows whole-body gamma dose received by an unsheltered person at point A, Fig. 5. Dose rate reaches a peak when fallout is complete, then decreases as radioactivity decays. In contrast, cumulative dose continues to rise

each increase in time by a factor of seven, the radiation level decreases by a factor of ten: Seven hours after a burst, radiation level will be 10% of the level in the first hour.

In practice, however, it's not quite so simple. The first fallout might not arrive for 15 minutes or more after the explosion. But then fallout might keep coming for a time, and more than offset the decay that was occurring. As fallout slacked off, however, decay would begin to push radiation levels down, and after all fallout had arrived, the "rule of seven" would apply with reasonable accuracy for several months. So the rate of change in radiation would look like the humped curve in Fig. 7. But the dose accumulated by an exposed person would continue to increase, although more slowly after fallout has stopped coming down and the peak of the rate curve has been passed.

**Radiation hazards** stem from the fallout particles themselves. The air through which fallout passes, and the surfaces on which it settles, do not themselves become radioactive. Remove the particles and there is no danger.

Alpha and beta radiations from fallout particles penetrate such a short range that they are dangerous only if you cannot avoid inhaling, ingesting, or coming into skin contact with them. Gamma radiation is more perilous, however. It can be effective a considerable distance from the particle and has great penetrating power, hence ranks as a major hazard. An hour after a burst, the accumulated fall-

Incidence (percent)

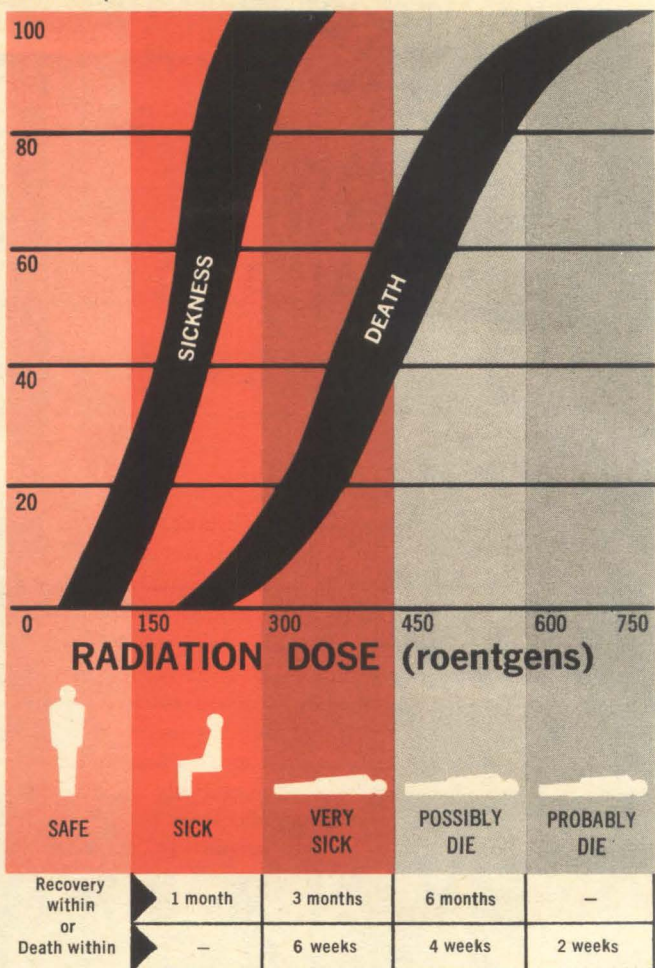

8. Effects of whole-body radiation doses can only be expressed statistically. Curves show percentage incidence of sickness and death in a group of exposed persons, for doses accumulated in a few days. Effects prove less severe if accumulated over weeks or months. As indicated at bottom, radiation sickness is usually a drawn-out process

out on a 30x40-ft lawn — measuring at most 1/10 inch deep — might subject a person standing in the center to a dose rate as high as 1000 r/hr.

Effects of radiation on humans depend on such factors as age and general health. But statistical projections (Fig. 8) show that some people would not survive a dose of 300 r received over, say, 24 hours, while a few others would recover from twice this dose. Recent studies suggest that it is possible to survive even greater total doses accumulated in small units over long periods of time.

Radiation causes sickness primarily by damaging the blood-manufacturing centers in the bone marrow and lymph glands. In early stages it is usually accompanied by nausea, diarrhea, general malaise. These symptoms usually appear during the first day. Loss of hair, and skin ulcers, may follow in more severe cases. There is no specific treatment, but antibiotics and blood transfusions may help. Recovery is slow, involving weeks or months (Fig. 8). The sickness is not communicable.

For more details, consult "Effects of Nuclear Weapons" (\$2) and "Comparative Nuclear Effects of Biomedical Interest" (CEX58.8) (\$1), both published by the Atomic Energy Commission and for sale by Superintendent of Documents, Washington 25, D. C.

There is also a wealth of information in the record of hearings conducted by the Joint Committee on Atomic Energy (June 1959) and the Committee on Government Operations (August 1961).

# SURVIVAL AND RECOVERY:

## Why industry needs to plan now; how to go about it

What can business and industry do to prepare for the possibility of nuclear attack?

If your office or plant suffers a direct hit, obviously the answer is nothing. But the likelihood is that, even in a massive assault, the degrees of destruction would vary (pages 2 and 3). So you would have some chance to survive and to recover.

**What plans should you make?** As an executive, you are responsible for seeing that your company continues to exist and to function. In the narrowest sense, this responsibility is directly to the stockholders—the owners. More broadly, you have a responsibility to your employees, their families, the community, and the nation. Your company's organization and resources could be vital in coping with the crisis an attack would bring; the services it performs could be equally essential.

In the ordinary course of business, you plan some form of insurance to protect your company against a variety of risks—fire, windstorm, and so on. A large-scale nuclear attack is a risk that has never become reality. But it differs only in magnitude from the risks you routinely take into account. It is oversimplifying only slightly to say that you can apply the principles you use in preparing for other risks.

**Seeking a balance.** In building a conventional insurance program, you would try to assess the risk as realistically as possible—the degrees of damage that might be inflicted, how likely you are to suffer each degree of damage, how much it would cost to buy different amounts of protection. From these calculations, you would then strike some sort of balance, to give you the most protection possible for the money you can spend.

How would this approach apply, for example, to protecting your company's personnel from the effects of a nuclear attack?

You can't do much to protect against a direct hit, of course. But with nuclear attack, as with other risks, you don't assume that total loss is certain. The best estimates suggest that the most widespread danger will be from fallout. Second in order of probability comes fire; last is the combination of fire and heavy blast damage.

You must consider costs as well as probabilities. In general, the closer you might be to the target, the more it would cost to provide physical protection.

Balancing these two factors, it seems relatively easy to justify steps for protection against fallout.

For a minimum investment, you can achieve some measure of protection against the most likely hazard.

But don't stop there: For comparatively little more money, you may be able to buy some degree of protection against fire and blast. It depends on your situation, of course; to find the most practical answer, you must weigh the increasing costs of greater protection against the decreasing scale of damage probabilities.

Plans such as this for protecting personnel are only part of the over-all thinking that should go into the effort to survive a nuclear attack—and recover. Ideally, you should consider every element of your company's operations—such matters as preserving its framework of organization, its assets of all kinds and the records that prove ownership, its productive knowhow. And, when new facilities are planned, you should consider the problems of survival under nuclear attack in their location and design.

**Guidelines.** To draw up an effective plan, you might think broadly along these lines:

- The plan should start with top management—and top management should give it continuing support. This means launching the preparations with a meeting of directors or key officers, assigning the planning job to responsible people, informing employees of the policy over the chief executive's signature.
- The plan should be firm. In other words, it should not ebb and flow with the tides of international tensions, as some past planning has done.
- At the same time, the plan should be frequently reviewed to keep it in tune with changing conditions. New weapons, for example, might make your previous preparations obsolete.
- The plan should suit the community. You should coordinate it with plans of local government and neighboring industries. You should also consider what to do about employees' families and nearby residents. But, in most cases, you probably shouldn't count on civil defense authorities to solve all your problems for you.
- The plan should be suited to your company—its own resources, problems, type of operations. Some companies have found that streamlined procedures devised for the emergency plan can be applied to make everyday operations more efficient.

These, in broad outline, are some of the goals to aim for in preparing a plan for your company. More details on how to plan follow.

## SURVIVAL COORDINATOR

In a typical company's organization for survival, this would be the key man, directing, with top-management support, a Plant Survival Advisory Committee composed of the heads of the functions outlined (right). He would probably be chosen from upper management, since he must be well able to plan, organize, and delegate authority. He must believe in the importance of the job.

His first task would be to master the fundamentals of the assignment, by reading and special training. Then he would select top aides—who may now be heading up departments related to survival functions.

Broadly, the coordinator must plan the complete program for survival, help organize each of the functions, spell out responsibilities, designate shelter areas in existing buildings or provide for them in new ones, set up an emergency headquarters.

Other jobs would include linking the company's program with other community plans, arranging mutual aid, spotting vulnerable points in the utilities and process areas, preparing a survival manual for employees.

Periodically, the coordinator must report to top management on the company's readiness to survive an attack and on progress and shortcomings of the program to date.

The coordinator must always be alert to keep training and drills from slipping into routine. He should groom an assistant to step into his shoes. Finally, his compensation should reflect his importance.

## ENGINEERING

Members of the company's engineering staff would form the nucleus of the survival engineering group. Its job: to design shelter areas, perhaps with consultants; to equip shelters with utilities—emergency generator, water, light, heat or cooling, ventilation and air filtration, sanitation; and to operate and maintain equipment in shelters.

Sanitation in shelters would be a major problem that engineers must carefully think through in all aspects—toilet facilities, garbage, housecleaning, burial of the dead.

Engineers would help the communications group decide what equipment is needed, then help install and maintain it.

They would also work with the radiological team on such matters as monitoring equipment, building and plant design features to make decontamination easier, radiological control of decontamination and plant repair procedures.

When an alert sounds, engineers must be ready to shut down the plant—and to reduce the risk that the halt in production might cause fire, explosion, or escape of dangerous fumes. Fuel lines should be closed, most circuit breakers tripped in main substation. However, it would be wise to use regular sources for electricity and fuel in shelters as long as they were available, to lessen the load-time on emergency sources.

Engineers must be prepared to make some repairs to shelters—from blast or fire damage, say—and to the plant after attack.

## SHELTER MANAGEMENT

The team charged with shelter management would cope with all the problems of sustaining life in close quarters cut off from outside. Key men would probably come from the personnel department, with help from specialists in other areas. They would face problems such as:

- Mass feeding. The team would decide whether to use austerity rations, canned or dried, or a more nearly normal diet prepared in a shelter kitchen. It would also decide how much food to stock.

- Water. Questions would include how much would be needed, how to dispense.

- Sleeping accommodations. The program should set up a scheme for rotation; some people sleeping, others eating, etc.

- Assigning chores. This would keep people busy, shelter operating smoothly.

- Installing lockers. In these, employees could store personal needs in advance.

- Stocking supplies. The list would include reading and recreational materials, clothing, blankets, and so on.

To help bolster morale, personnel staffers should be able to draw on employees with special talents—excellent military records, entertainment ability, religious leadership.

The shelter management team would carry out the plan—if any—for accommodating employees' families in the shelter. It would work with the transportation team to evacuate shelters if necessary. And it would handle the many human problems.

# THE SURVIVAL PLAN: How to set up the organization

Once your company decides to plan a survival program, the first step would be to appoint a coordinator, or director. Then management must work with him to form the organization he would head.

**The key areas** in such an organization are outlined above. To fit your own operation, it may be possible to eliminate or combine some of the areas; on the other hand, you might have others to add.

At the outset of planning, it would be wise to consider enrolling key personnel in the Office of Civil Defense Staff College at Battle Creek, Mich., for training in the problems they will face.

In developing your program, you can profit from a mutual-aid plan. Besides arranging to assist neighboring companies and the community in an actual emergency, you can exchange study results and balance one company's assets against another's liabilities — one may have abundant shelter space, another portable self-powered generating equipment, a third skilled disaster teams, a fourth large food supplies.

One of the first problems in your plant would be the attack warning system. Your internal system should be

hooked up to receive the national alert instantly. Several techniques are under study for a nationwide alert; closest to reality is NEAR — for National Emergency Alarm Repeater — which uses existing electric power lines. Using a high-frequency signal, NEAR would reach about 95% of U.S. buildings within one minute. After hearing signal, you would turn on a radio for more information. NEAR units — expected to be available at low prices — could be plugged into any 120-v outlet.

The alarm in your plant should trigger production shutdown, and the moving of people to shelters.

Another immediate concern would be surveying how vulnerable the plant is to damage from attack. You should look, for example, for combustible materials that might easily be ignited, for large glassed areas that could be hit by blast, for narrow entrances or passages that could hinder the movement to shelters. You should also take note of points in the production process where damage or loss might cause major, long-time shutdowns.

**Participation.** Over-all, the urgent need in your planning would be to train personnel as quickly as possible, prepare them to be self-sufficient for some time after attack,



## HEALTH

Looking after health problems would be the job of the plant physician, aided by his nursing staff and a special team trained in first aid and emergency medical care. Don't expect outside help until well after the attack.

Each shelter should contain at least one health station, stocked with drugs, oxygen, and supplies for treating the effects of possible chemical and biological warfare. There should be plans for meeting psychological problems.

With the shelter management team, the health director would plan for moving casualties to treatment stations and identifying them. This could be simplified by use of "dog tags."

## COMMUNICATIONS

The goals of this group would be to link the company with the nationwide alert program, set up a plant warning system; provide for emergency telephone, telegraph, radio equipment; staff a communications center connecting all plant shelters; keep in touch with local civil-defense authorities and the community if possible, help employees contact families.

The team might also publish some version of the company newspaper in shelters, perhaps in mimeographed form. The shelter communications center should include a public-address system; it might sometimes be advisable to hook Conelrad broadcasts into this system.

To be most effective, the company's plan should call for training all employees to take part in some way. Acceptance by employees could be encouraged by consistent management support, by constant efforts to keep the program vital and interesting, by regular checks of the coordinator's staff, by quick dissemination of the latest information on civil defense and community programs, by enlisting support from unions and community groups.

The problem of keeping a disaster team efficient — perhaps for years — challenges the resources of the most imaginative company officer.

To complicate the problem, the planning should include decisions on what to do about protecting off-duty employees, families, and such people as visitors and contractors who happen to be at the plant when attack strikes. If your community is one where families live fairly close to the plant, you might think seriously about accommodating them in the plant shelter, as part of your broad responsibility to employees and the community.

**Sustaining morale.** In setting up a shelter, you must consider more than engineering (pages 12-13): One concern — largely unpredictable — is morale and discipline. Sweden has tried to ease the problem by using color and design extensively to make shelters brighter. Morale can also be influenced by such factors as the amount of space available to the individual; providing routines and chores,

## FIRE AND RESCUE

A trained firefighter should guide this team. During attack, it would have two jobs—to control fire and to clear damage for health teams.

In the planning phase, this team would pinpoint plant areas where fire danger is greatest, such as stockpiles of flammable materials. If hazard can't be eliminated, engineering group may install sprinklers or other measures.

For effective rescue work, the team should have detailed knowledge of the plant's structure and production processes. This group would probably be last to enter shelters—and should be prepared to leave them for short, controlled periods to cope with emergencies.

## SECURITY

Built around the company's present security force, this group would be an in-plant police team. The chief could recruit as aides employees with military or similar qualifications.

The men would need training in maintaining order, handling crowds, and coping with panic, and they should be prepared to prevent looting. They would map emergency routes to shelters, both inside and outside plant grounds.

At all times, this group should be on the alert for possible espionage and sabotage. It would establish liaison with state and local police and assist them in carrying out any emergency plans for community security.

## RADIOLOGICAL

This vital team—most likely selected from the company's engineering staff—would focus on radiation problems. Among other things, it would:

- Estimate the protection from fallout that is available in various shelter areas.
- Buy radiation measuring instruments.
- Monitor radiation levels and be on alert for agents of chemical and biological warfare.
- Plot fallout patterns in surrounding areas.
- Record individual dosages of radiation.
- Analyze food and water to assess contamination—and supervise its removal.
- Working with the engineers, this group should plan, and supervise, decontamination.

## TRANSPORTATION

Trucks and manpower would be needed before and after an attack. The core of this program would be a fleet of trucks well equipped for radiological monitoring, first aid, carrying casualties and supplies, emergency repair of utilities. These vehicles would link the company with others participating in a mutual-aid plan.

In developing emergency transportation plans, this group should tie in closely with local civil-defense authorities and should coordinate its efforts with those of other plants in area.

During the early period of recovery, bulldozers — possibly shielded — would push contaminated earth and debris away from the plant.

entertainment, spiritual guidance; keeping families together; and taking action in cases of hysteria and panic.

It would probably be best to leave discipline to supervisors and others accustomed to exercise authority. With training, the plant security force could help the shelter-management group to direct routines, and the medical team to handle shock and panic victims.

You should make generous provision for food, clothing, and blankets in the shelter. For the food planner, a great deal of information is already available. Perhaps the basic study is "Food Stockpiling for Emergency Shelters," published by the Food & Materials Div. of the U.S. Dept. of Agriculture's Commodity Stabilization Service. OCD and USDA offer many other pamphlets on the subject.

Another question would be how to distribute food in the shelter. If the company cafeteria can be moved into the shelter area, mass feeding is probably the answer — although cooking in the shelter would require some source of heat. Or you might decide on stocking individual rations that supply minimum requirements in concentrated form. A variety of such subsistence foods is already available and on the market.

Study of your plant and employees would probably reveal other special needs.

Engineering points to consider in planning a shelter are discussed on the following two pages.

# FALLOUT PROTECTION FACTOR APPLIED TO BUILDING CORE LOCATIONS...

$$PF = \frac{\text{Radiation level outdoors}}{\text{Radiation reaching people}}$$

$$PF = \frac{10,000 \text{ R}}{100 \text{ R}} = 100$$

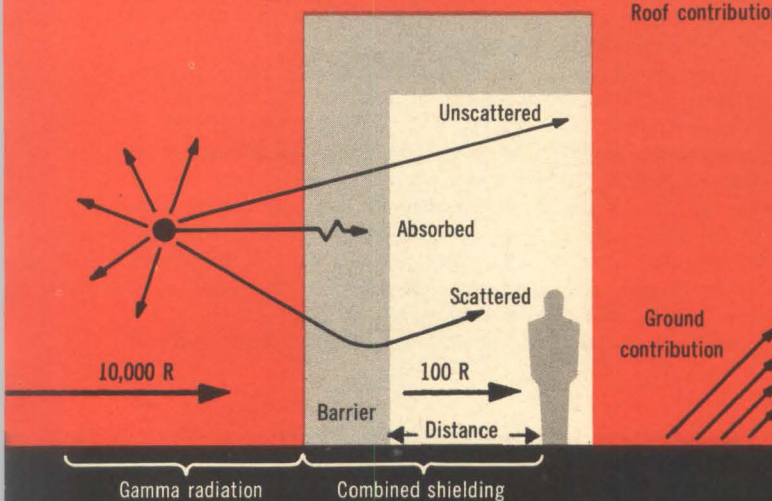

PENETRATING POWER of gamma radiation through a barrier depends on energy level of fallout components, density and thickness of barrier. No material, regardless of density and thickness, completely blocks radiation

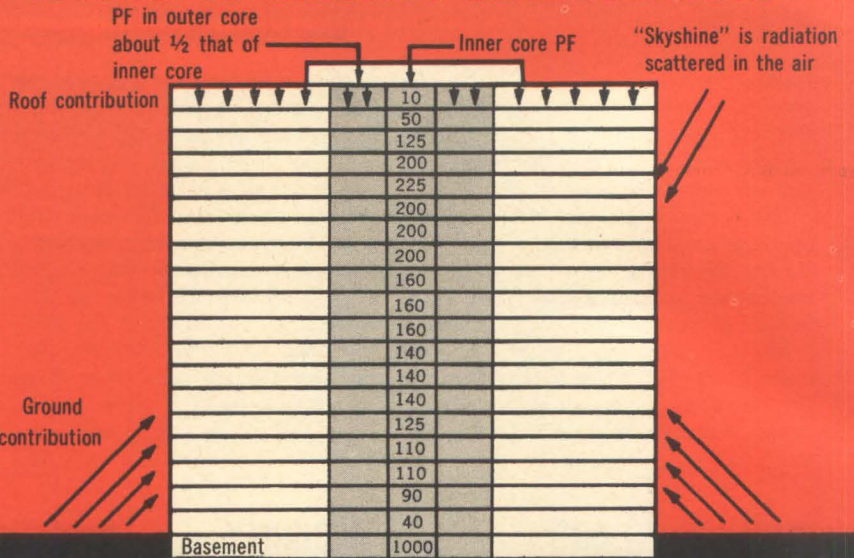

RADIATION SOURCES that must be considered are roof, ground and "skyshine". Don't overlook contribution from adjacent roofs and building setbacks. Note high PF areas in office building shown are within core on upper floors and basement. Structure studied has a steel-frame, concrete floor arches, masonry exterior walls, having 50% openings

## THE SURVIVAL PLAN: What about physical protection?

As you set up a company organization for survival, a prime ingredient in the plan would be finding the best way to protect your people against the effects of nuclear explosion — primarily against radioactive fallout, but also as much as possible against blast and fire.

After an attack, fallout would threaten you from three directions (drawing, right, above). Some would accumulate on the ground around your plant, and some on rooftops. In addition, building walls would feel the radiation scattered by the air, sometimes called "skyshine".

**Key to protection** from fallout is to place a physical barrier between it and you—steel, concrete, earth, water, or wood. How well a material screens you depends on its density and thickness. To do an equal job of absorbing radiation, you would need thicknesses of 0.3-in. of lead, 0.7-in. of steel, 2.2-in. of concrete, 3.3-in. of earth, 4.8-in. of water, and 8.8-in. of wood. These figures represent a quantity called the *half-value layer thickness* or HVL.

The HVL figure shows in inches how much thickness of each material is necessary to stop half the gamma radiation outside from penetrating the barrier. Each HVL thickness you add to the first reduces what comes through another 50%. Two HVL thicknesses side by side let in only 25% of the total gamma radiation outside; adding a third HVL thickness lets in but 12½%, and so on. This is true as a general concept, results vary with specific conditions.

Use a material's HVL figure to approximate how effectively a barrier will soak up radiation energy. But the practical value of the barrier — its *protection factor*, or PF — depends on the location of the fallout in respect to the barrier and on the area of fallout.

A building's geometry plays an important role in protection against fallout, too. For example, protection factors would differ in two tall buildings of the same height and construction if one covers a larger area than the other, neglecting roof contribution. At the center of the first floor, the PF would be higher in the structure with the larger base simply because at that point you would be farther from the outside ground radiation. Likewise, the PF would differ at first floor center of two buildings with similar base areas and construction but varying heights. Neglecting ground contribution, the taller building would offer more protection because radiation would have farther to go from roof to first floor. Of course, in such calculations you must also consider the contribution from fallout on roofs of adjacent buildings.

What is a minimum acceptable protection factor? There is no standard figure, since it is impossible to predict the radiation level to which you might be exposed. One commonly suggested minimum is 100.

For many structures it may be practical to adopt the "core" shelter plan—in which you would set aside one area of a shelter offering highest possible protection, perhaps at the well-protected center. People would be crowded into this core, however uncomfortably, during the hours of peak fallout, then rotated between the core and shelter areas with lower protection factors. Or the rotating schedule might be used from the beginning of the shelter stay.

**Spotting safe areas.** A survey of your building should reveal areas that would offer some fallout protection without radical change. The choice would quickly narrow to areas with walls and ceilings of thick, high-density mate-

# TYPICAL PLANTS, COMMERCIAL BUILDINGS AND UNDERGROUND SHELTERS

LIKELY SHELTER LOCATIONS in any building are those offering highest protection factors. Illustration below gives a general idea of the relative protection found in common structures. Use it as a guide only, to estimate protection against fallout. The PF values listed may be conservative, being based on isolated structures.

Your shelter survey starts with knowing construction detail of all your buildings, number of people normally on the property, place-

ment of utilities. Roughly estimate total group the shelter can handle by allowing 15 sq ft of gross floor area per occupant. Gross area includes columns, some fixed equipment, storage for shelter supplies. Net area per person should be 10 sq ft. Shelter occupancy time may be limited by room volume rather than area, particularly in absence of mechanical ventilation. Natural ventilation from interior stairways, shafts, extends stay. Fresh air minimum: 3 cfm per person

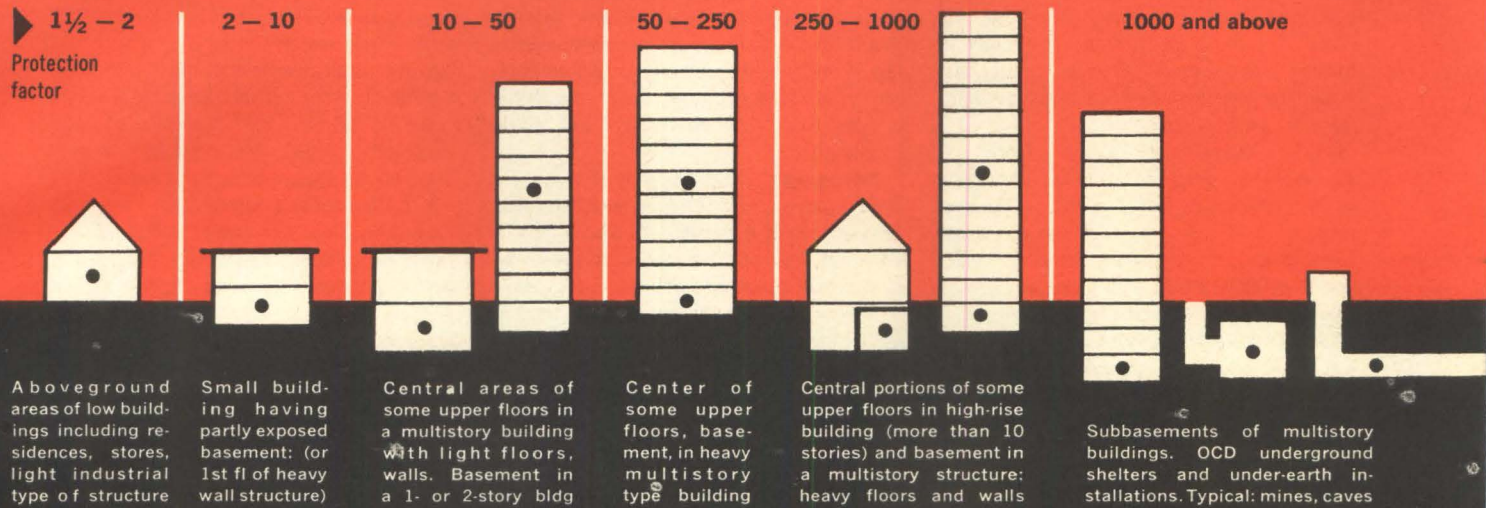

rial and few windows and doors. Some degree of safety would be available, for example, in sub-basements, basements, centers of masonry buildings. You could thicken existing walls if necessary, and concrete baffles could be placed a few feet or so in front of windows and doors to screen out radiation while leaving them in service. To further guard, primarily against roof fallout, you could erect false ceilings using supported concrete planks.

For detailed help on how to survey structures for fallout protection, consult Office of Civil Defense publication NP-10-2, *Guide for Architects and Engineers*.

**Shelters from scratch.** If adequate shelter areas cannot be created in present buildings, you would probably construct new ones designed primarily as shelters. Such a structure could be engineered to withstand some blast and fire as well as fallout. It could take one of several forms; there are many designs for combination blast and fallout shelters. Some are all concrete; others use a multiplate corrugated-steel arch set on a concrete slab. Latter shelter could be built above ground, with an earth mound completely covering it; partly underground with an earth cover, or entirely underground. An underground shelter could be designed as the sub-basement for a building to rise on this foundation later. Whatever the choice, you should try to give the shelter some peacetime use—perhaps as a plant cafeteria or recreation center.

**Typical group shelter** suggested by the Atomic Energy Commission (in its booklet CEX-58.7) would accommodate 100 persons with a protection factor of 10,000 against fallout. This shelter would withstand blast pressure of 35 psi—which should make it safe against blast effects of a 10-mt weapon to within a few miles of ground zero. Tests have shown it could withstand a firestorm.

For any shelter, you must plan utility supplies. Water would be the first need; the best bet would be to store it

in a closed system, unless you have a dependable well. Figure on a minimum of 2 quarts of water a day per person, another 2 quarts for washing. If you draw on public water supplies that might become contaminated or polluted, you should install filters for insoluble isotopes, ion-exchange for soluble ones, plus chemical treatment. You would also have to take account of buildup of radiation levels in ion exchanger and filters.

**To provide ventilation,** you could choose a variety of systems. For most fallout shelters, a simple mechanical ventilation system with filters to remove fallout particles should suffice.

A more elaborate system offers fully automatic, thermostatically controlled air conditioning for underground blast shelters. It draws 100% fresh air from outside, filters and conditions it to proper temperature and humidity, and removes used air. With an air conditioning system that removes carbon dioxide and adds oxygen, it would be possible to shut the shelter off from outside for 24 hours.

At the other extreme, in some situations you could use simple natural-draft ventilation.

**Electric supply.** You must also supply electric power to the shelter for lighting, ventilating equipment, some cooking, and possibly for sewage pumping. The answer would be an engine-driven generator and a stockpile of fuel. You should also install a separate electrical feeder from your main substation to shelter areas, so that you could use the normal power as long as it is available.

For sewage, you should include in the plans a collector tank with an ejector pump leading to a cesspool.

**Decontamination facilities,** for people who must come into the shelter after being exposed to fallout, should be installed near entrances. Recommended procedure includes removal and safe disposal of contaminated clothing, followed by a shower before donning fresh clothes.

In its day-by-day operations, your company depends on all sorts of links with the rest of the economy. It uses the services of the transportation, communications, utility, and banking systems. It relies—directly or indirectly—on outside sources for materials, fuel, food, and other supplies. It looks to the community to provide such essentials as water, sewage disposal, highways and other public works, health services, and the like.

Nuclear attack would tear that fabric and leave behind a patchwork of areas with varying degrees of damage (pages 2 and 3). For your planning, you need to visualize how this would hit your company—and what steps are under way to soften the blow and to restore services after an attack. It is impossible to predict post-attack conditions precisely, of course, and many present plans are tentative and subject to change. But here's a current summary of the probable situation in vital areas:

**TRANSPORTATION** — for moving food, fuel, medical supplies, material, and personnel — would be the service perhaps most essential to recovery. Railroads, with their fixed routes, are likely to be hardest hit. With adequate

fuel supplies, trucks and other flexible forms of transport—such as aircraft—could operate by bypassing damaged areas.

Unfortunately, planning in trucking is confused by divided authority. One federal agency would have emergency control over carriers, another over the streets and highways on which they move. And this control seems to apply only to interstate carriers; there is no authority to coordinate intrastate truckers and private company fleets.

Present plans call for carriers to take these steps in emergency: (1) Warehouse all goods, sell perishables if possible. (2) Obtain permits —from at least one, perhaps three agencies— to start hauling priority traffic.

The industry has begun to form trucking mobilization groups that may become the core of a broad emergency transport system.

**COMMUNICATIONS** has several vulnerable points — among them the network of exposed lines and the lack of protection for radio and TV personnel and equipment. In addition, high-altitude explosion of large nuclear weapons could cause temporary radio blackouts.

Major common carriers are working to

“harden” lines and equipment and to bypass likely target areas with self-contained underground communications channels. They also have repair crews, fully equipped and trained for disaster, spotted at widely dispersed points. Some radio and TV stations have launched protective measures. And there are plans for coordinating commercial and amateur radio operations to close gaps in coverage after an attack.

During the early period of recovery, communications facilities would probably be available only for highest priority messages.

**UTILITIES** are in danger because many power generating plants are concentrated geographically and because transmission lines are exposed. Suggested remedies include building multiple and interconnected lines, and dispersing switchyards. Many companies are studying ways to protect personnel and equipment, constructing alternate emergency control centers. Utilities have a major asset in personnel trained and experienced in dealing with disaster.

**MONEY AND CREDIT** is one area where plans are ready now. The Federal Reserve System has led other government agencies in preparing for the problems of recovery. It has made

## THE RECOVERY PLAN: What needs to be included in it?

Planning for recovery from a nuclear attack takes an almost staggering effort of imagination. You must try to visualize the shattering of our complex civilization, the breaking of the many links that tie our economy together (above). If you are to plan at all, somehow you must picture the problems attack would create for your company and its people — and prepare now to cope with them.

Problems of the early post-attack period would be basically similar to the problems of survival. So they could be tackled best by the same organization—which would be in control not only during an attack but in the weeks after.

**After the assault**, trained workers should be able to foray briefly into plant areas that have been damaged, or contaminated by fallout. They should work in relays, to expose each team member to minimum radiation. The purposes of such trips should be ranked by priority spelled out in your company's plan; at first, the goal should be only to take steps that would make shelter life safer.

Decontamination would be a major problem, particularly on roofs and on land surfaces around the plant. An automatic flushing system, draining to a safe distance, might help clean roofs; as mentioned earlier, a shielded bulldozer could scrape contaminated soil away from facilities. These chores must be under radiological controls.

A related job — subject to the same careful controls — would be removing debris from possible fire and blast

damage and making repairs. Here again, priority should go to steps that would yield the most immediate benefit.

You must assume that you would perforce be self-sufficient for some time after an attack. But you would try to link up as soon as possible with any interrupted utilities. You should be equipped to test your water supply for radioactivity and potability until notified that it is safe.

**Information needed.** You should plan early efforts to contact others in the community — the civil-defense organization, disaster-relief groups, neighboring plants that might offer — or need — mutual aid. In this immediate post-attack stage, there would be a desperate need for information. Employees would want to know what happened to their families, their homes, the community; you would need to know about local supplies of food, fuel, and other supplies, about casualties, about regulations to keep law and order.

In some nations with extensive civil-defense plans — Sweden, for one — martial law takes effect as soon as an attack warning sounds. U.S. plans thus far made public do not call for martial law — although it would seem possible. Instead, the approach has been to try to insure that local and state governments would continue to function. Federal agencies have already done a great deal toward specifying automatic lines of succession for officials, setting up alternate headquarters or hardening present sites, preserving essential records. All but five states have taken some legis-

lines of succession and authority clear. Member banks have been encouraged to store duplicate records in safe locations from which they could operate if necessary. More than two years' supply of Federal Reserve notes has been placed at strategic points around the U.S. The Fed itself has an emergency headquarters.

A check with the Fed and its member banks may greatly simplify your own plans for meeting emergency needs for money and credit.

**AGRICULTURE:** Food is not likely to be a critical problem early in the recovery, except for local shortages caused by transportation snarls. The grim probability: more food would survive than people.

Fallout does not harm food in cans or in non-porous bags and packages that remain closed. So most stored food would be usable, except in heavily damaged areas. Some of the standing crops that survive could be harvested and used after decontamination. Livestock killed by radiation would be edible if promptly dressed and refrigerated.

Food from current inventories and stockpiles would probably be sufficient to support the survivors while they slowly returned some

fallout-contaminated farmland to cultivation.

**PUBLIC WORKS** would present a variety of problems. According to most experts, water supply would not be a serious worry. Surface waters and open reservoirs would be contaminated by fallout, but most of this could be filtered out. Some fallout would be soluble, however, and this might require either waiting for radioactivity to decay enough for safe use, or installation of ion-exchange treatment in addition to usual treatment for potability.

Water distribution systems, sewers, and streets would suffer various degrees of damage. Removing debris would be a huge chore in areas damaged by fire and blast. OCD has briefed state and city public works agencies on their responsibilities in these jobs. Emergency equipment—including generators, pumps, water purifiers, and pipe—are already on hand at 24 spots around the country. To encourage states and cities to buy similar supplies, the federal government will put up matching funds to equip and train local personnel.

Any company registering equipment, personnel, and engineering talent with a central disaster-relief organization can obtain "Plan Bull-

dozer" from Associated General Contractors. The plan includes instructions for a cooperative program to clear debris quickly.

**HEALTH SERVICES** will present one of the gravest post-attack problems. Even with effective shelters, an attack would leave many people injured and sick. Physicians, nurses, hospitals would be lost—most heavily in the areas with most casualties. And in the aftermath of attack would come infections and disease.

The U.S. Dept. of Health, Education & Welfare has designed a basic package unit for an austere but effective 200-bed general hospital. Some 1900 of these units have been bought and placed in critical areas away from likely targets. Plans are under way to distribute another 750 units and to equip all of them with 30-day supplies of medical equipment and supplies. HEW is also responsible for stockpiling plasma, serums, essential drugs, supplies.

To offset a shortage of doctors and nurses at least partly, HEW is readying a program called "Medical Self-Help." This provides basic training in first aid and general medical treatment. The course will be given to civil defense groups and industrial disaster organizations.

lative steps along similar lines, although only a few have scored much progress.

Despite these steps, law and order could break down in some areas. So your company's plan should provide for handling such problems both inside and outside your plant. On the outside, your organization could help restore order in the community. This requires close integration of your group and local civil government.

**Long-term plan.** For the long-range recovery of your company, you face planning problems different from those of survival during and immediately after the attack. Logically, then, you should assign such planning to a separate group, usually drawn from top management. This committee's primary worry would be outlining steps to take, in advance, to preserve the company's organizational framework and the assets—tangible and intangible—on which it depends.

The bylaws of most companies tightly limit the board of directors—where it may meet, what constitutes a quorum, how new directors are elected, and so on. Such restrictions might make it legally impossible for the company to carry on if a massive disaster should incapacitate many directors, or resulting transportation snarls should prevent a quorum.

To correct this, your plan should include bylaw changes to permit surviving directors—or even a single director—

to fill vacancies without delay, pending a regular or special stockholders' meeting. You might also create an emergency management committee, empowered to act for the board of directors under specified conditions. Any such steps should be based on careful legal study. Some states have modified their laws to give you more flexibility—or plan to do so—but others have not. A good starting point for your program: the literature on corporate continuity published by the Office of Civil Defense, industry and trade associations, and other such groups.

As a next step, you should review all company functions in the light of probable conditions during the recovery. From this review, you would be able to pick the most essential jobs and allot them among the company's staff—with successors named for each post. This succession, too, may require bylaw changes.

For recovery, a company would need essential records to continue operating. Storing them safely would be the smallest problem; much more difficult is deciding which records are truly vital. Some executives recommend dividing them ruthlessly into three categories:

- *Vital records*—irreplaceable; of less value in reproduced form; necessary to recover monies promptly or to restore production, sales, and service.
- *Important records*—very expensive to reproduce, in dollars or time.
- *Useful records*—whose loss would be inconvenient, but could be replaced readily.

Records such as the following would probably qualify for safekeeping: property deeds and other proofs of ownership of assets; stockholder data; insurance certificates;

Reprints of this report are available at publisher's cost: Less than 100, 20¢ each; 100 or more, 15¢ each; 1000 or more, 10¢ each. Address all requests to "Operation Survival," P.O. Box 573, Times Square Station, New York 36, N. Y.

## FEDERAL AGENCIES AND CIVIL DEFENSE

By executive order (August 1, 1961), the President transferred basic responsibility for civil defense from the former Office of Civil Defense and Mobilization to the Department of Defense. With its remaining functions, OCDM was renamed Office of Emergency Planning.

Specifically, the Secretary of Defense is in charge of development and execution of a program to minimize the effects of attack, including informing and educating industry and the public in methods of survival. This includes a fallout shelter program, a warning and communications system, and a program to assist state and local governments in such post-attack community services as health and sanitation, maintenance of law and order, firefighting and control, debris clearance, traffic control, provision of water supplies.

The Director of the Office of Emergency Planning is responsible for planning continuity of state and local governments, the natural-disaster relief program, the defense mobilization program, the strategic and critical materials stockpiling program.

Previously established policy calls for making maximum use of

existing Federal departments. Typical civil-defense responsibilities that are assigned to other agencies include:

Dept of Agriculture: Food stockpiling, rural fire control, protection of vegetation and animals against radiological, chemical and biological hazards.

Dept. of Commerce: Restoring streets and highways; use of emergency shipping.

Federal Aviation Agency: Emergency use of civil air transport, civil airports and airways.

Dept of Health, Education, and Welfare: Medical stockpiling; care of refugees from attack, including location services.

Dept. of Interior: Emergency plans for power and petroleum.

Dept of Labor: Planning use of emergency manpower, except medical, in immediate post-attack period.

Post Office Dept: Registration of individuals and families.

Housing and Home Finance Agency: Emergency housing and community services in the post-attack period.

Interstate Commerce Commission: Plans for use of domestic service transportation in emergency.

patents, important engineering drawings and process data; records of employee pension funds and other such financial plans; important contracts, including union contracts. These would also have to be kept up to date, of course.

If you carry on business at several widely separated points, you should store duplicates of vital records at each location. You should also arrange for management personnel at each point to take control of company operations at other locations, if necessary. Plans should also be made for mutual aid between the several plants and offices.

In some cases, you should consider establishing alternate headquarters, with duplicate records and living quarters. This could give a one-plant company the advantages of a larger company with dispersed operations.

If an attack struck when employees were not at work, they would need to know where to report when conditions permitted. One answer would be to designate emergency centers, possibly in suburban homes of supervisors.

**Fiscal plans.** Your plan should set up emergency financial procedures. For example, you would probably need a simplified accounting system for use after attack. You would want funds quickly available for wage payments, advances to employees, and buying food and supplies. One solution might be to preprint checks of fixed denominations and distinctive design. They would be stored in a safe place and used only in emergency, with the signature of anyone of a list of management personnel.

Finally, you must try to prepare for restoring production in an emergency economy — probably with wage and price controls, government allocation of materials and manpower, and so on. Production would quite likely be geared to goods most useful for recovery.

You would want to analyze how your company would be suited to alternate lines of production, perhaps develop alternate sources of supply, and production techniques to make your operations as flexible as possible.

Copyright© 1962 McGraw-Hill Publishing Co., Inc. All rights reserved.

## THE TASK AHEAD

If our nation should suffer a large-scale nuclear attack, the measure of our ability to survive and recover will be the courage with which we appraise the dangers, and the vigor with which we act to prepare for them.

In such planning, business and industrial executives have a special stake and exceptional responsibilities. The organizations they direct not only provide the sinews of the economy on which recovery would depend, but can — and should — provide focal points of direction and leadership.

Some companies have already displayed commendable foresight and enterprise in preparing for the possibility — however unlikely — of nuclear war. But a big job remains to be done. I urge every responsible American executive to give these problems his immediate and earnest attention.

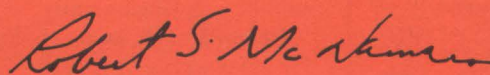

Robert S. McNamara  
Secretary of Defense





**THE SHARPEST CUT IS  
IN LACING CORD COSTS!**



## X-TYPE NYLON LACING CORDS

Look to the Linen Thread Company for the most complete line and latest types of lacing tapes and cords for electronics—including X-Type Nylon Cords, which meet Specification Mil-T-713A, cost far less, give superior performance in indicated applications. Other Specification Lacing Cords, Tapes and Braids in Nylon, Linen, Teflon, Cotton, Dacron.

Est.  
1784



Write for new illustrated catalog, "Lacing Cords and Tapes for Electronics."

## THE LINEN THREAD CO., INC.

BLUE MOUNTAIN, ALABAMA  
CIRCLE 133 ON READER SERVICE CARD

Around the world it's **KEW**

MODEL F-98

MODEL EW-16

MODEL P-22

MODEL VR-2P

MODEL VO-38

MODEL TK-20A

MODEL FL-202

MODEL PV-200

MODEL TR-A

SWR & RF WATTMETER

### KYORITSU ELECTRICAL INST. WORKS, LTD.

No. 120, Nakane-cho, Meguro-ku, Tokyo, Japan  
Cable Address: "KYORITSUKEIKI TOKYO"  
Tel: (717) 0131 ~ 5 • 0151 ~ 3

CIRCLE 134 ON READER SERVICE CARD

## OTHER FUSE POSTS MAY LOOK LIKE THESE... BUT ONLY LITTELFUSE HAS **PIQ**\*

A Fuse Post to meet every application—every requirement.

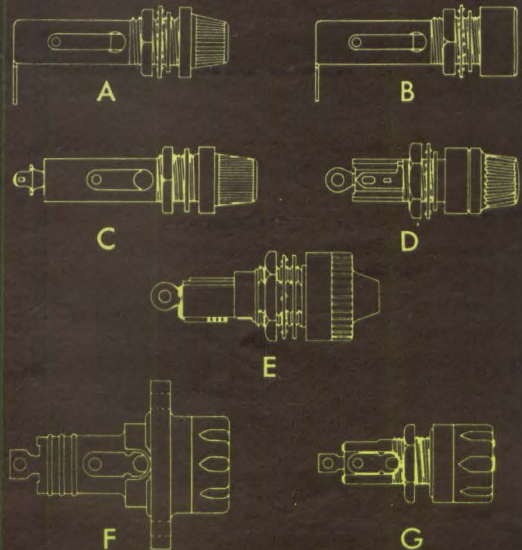

**EXTRACTING FUSE POST!** Fuse is held in end of removable knob for quick, safe and easy replacement of blown fuse. Safe "dead front" fuse mountings assured. U/L Approved.

**A**—3AG Fuse Post (finger operated knob)—No. 342001

**A**—8AG Fuse Post (finger operated knob)—No. 372001

**B**—3AG Fuse Post (Screwdriver Slot)—No. 341001

**B**—8AG Fuse Post (Screwdriver Slot)—No. 371001

**C**—4AG Fuse Post (Finger Operated Knob)—No. 442001

**D**—3AG Miniature Fuse Post (Finger Operated)—No. 342012

**E**—NEW INDICATING 3AG FUSE POSTS! (344,000 series) It Glows When The Fuse Blows. Long life incandescent bulb for low voltage ranges—2½-7V; 7-16V; 16-32V. New high degree vacuum neon lamp for high voltage ranges for greater brilliance and visibility—90-125V; 200-250V.

**WATERTIGHT FUSE POSTS** Specially designed for use where excessive moisture is a problem.

**F**—5AG Watertight Fuse Post. Has flange mounting.—No. 571004.

**G**—3AG Watertight Fuse Post—No. 342006

**G**—4AG Watertight Fuse Post—No. 442006

For complete details on these items and quotations on special application requirements, write to:

Precision Engineering  
Design Know-how  
Quality Craftsmanship

**LITTELFUSE**  
DES PLAINES, ILLINOIS

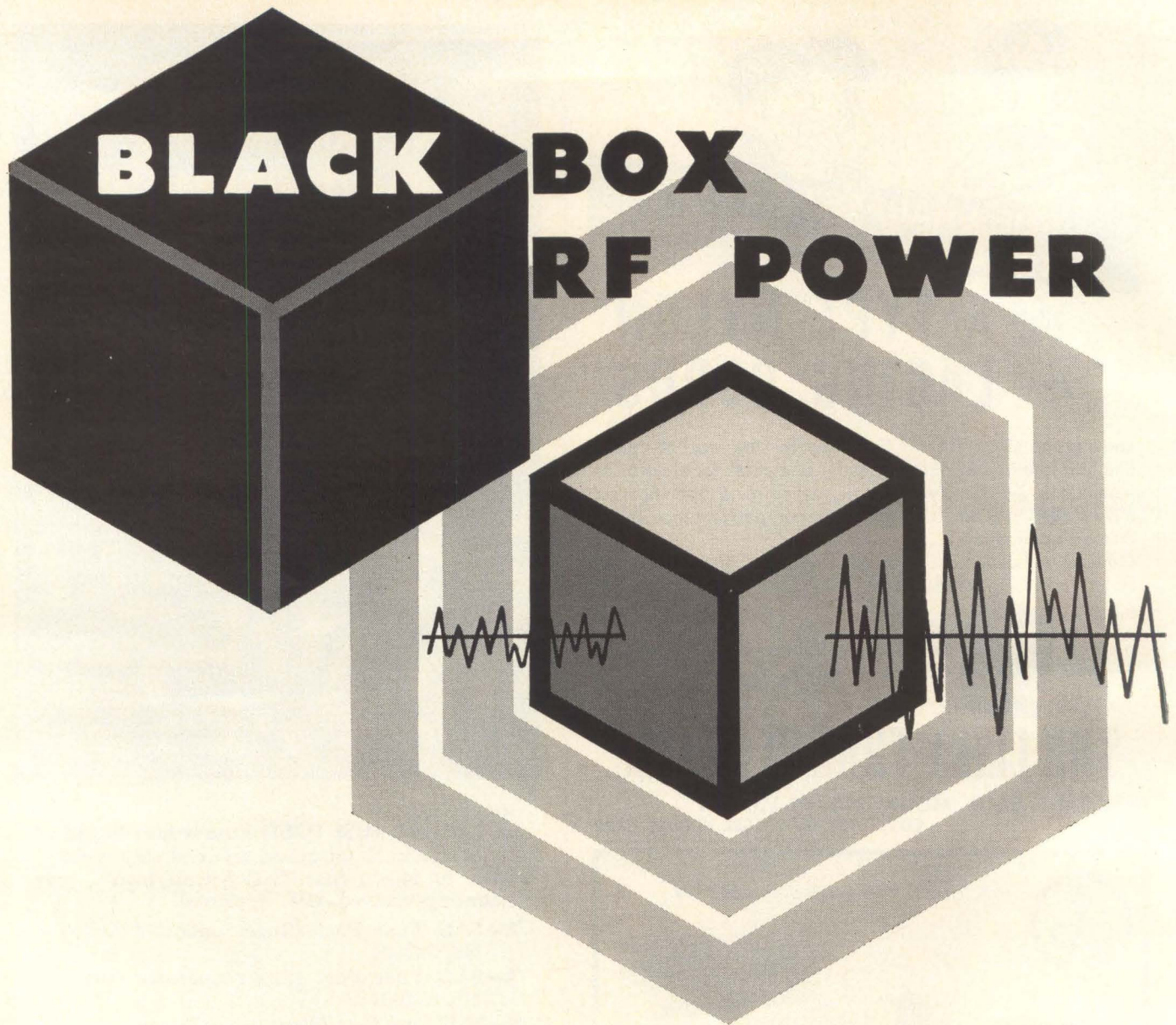

RF Generators by ITA for every power level . . . every frequency!

ITA Electronics Corporation specializes in manufacturing black box RF power generating equipment for industry and research. One of the nation's leading producers of broadcasting and communications equipment, ITA has the experience with RF equipment to supply *any* power requirement . . . design units that will meet *any* need. ITA products—30 kc to 2000 mc with power levels from a few watts to megawatts—may be modified to perform many specialized functions. Custom equipment, for highly technical applications, can be purchased at very low cost with prompt delivery assured.

For the finest in RF power generators choose ITA. It's the *best* equipment made!

**ITA ELECTRONICS CORPORATION**  
GOVERNMENT and INDUSTRIAL DIVISION • LANSDOWNE, PENNSYLVANIA

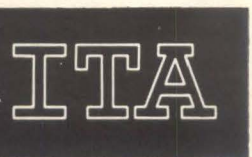

ITA SALES OFFICES: Chicago, Ill. AN 3-3797  
Cincinnati, Ohio. CH 1-6386  
Dallas, Texas. FL 7-9607

Jacksonville, Fla. EL 6-0121  
Kansas City, Mo. GR 1-2838  
Lansdowne, Pa. CL 9-8200  
Los Angeles, Cal. MA 2-8552

New York City, N.Y. CH 2-1999  
Portland, Ore. CA 2-2651  
Washington, D.C. 337-2884



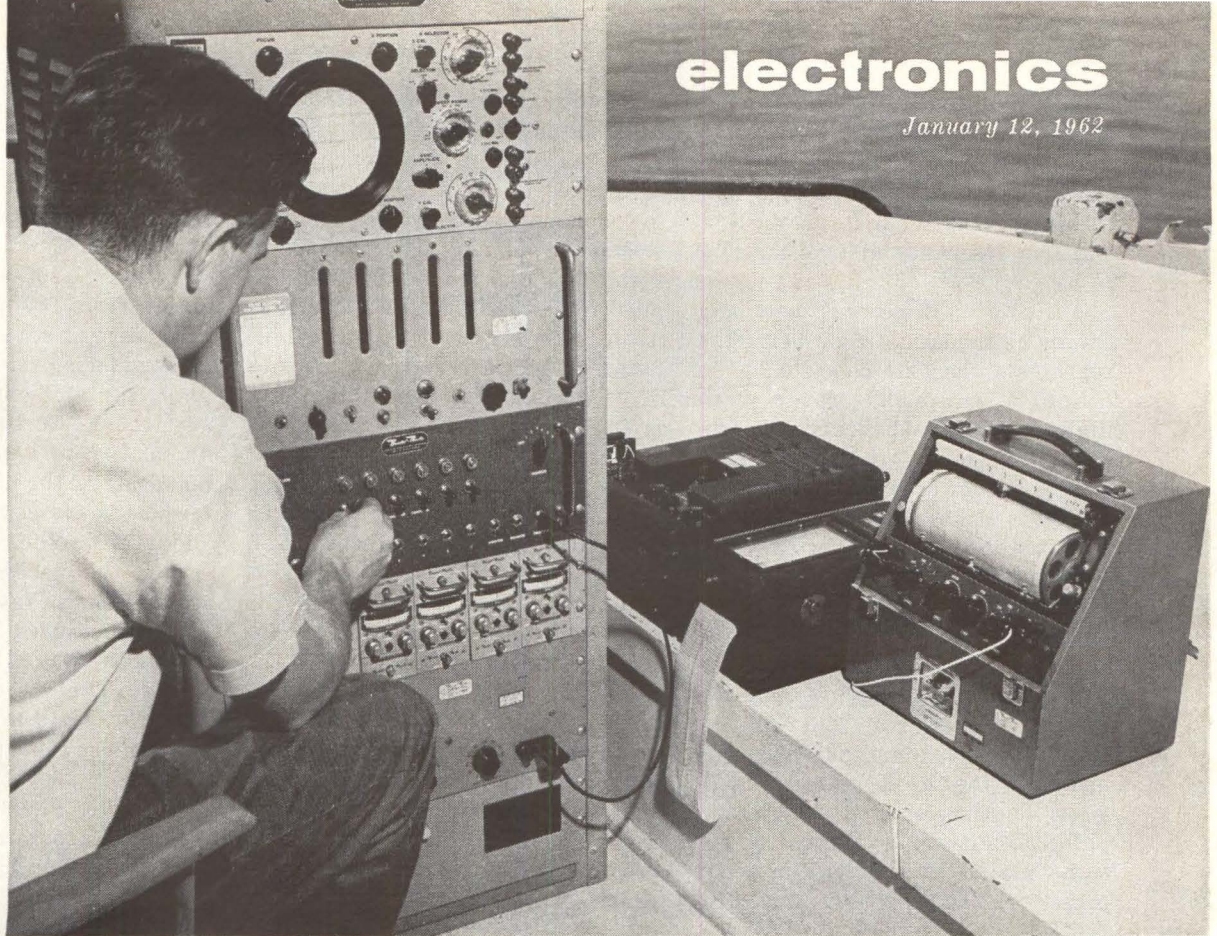

FIG. 1—Information transmitted to the receiving station aboard boat is checked by sonar technician. A probe is lowered to 2,000 feet and water temperature and pressure data telemetered

## UNDERWATER TELEMETRY for Oceanographic Research

*Experimental acoustic f-m/f-m system is scheduled for test of 10,000-foot-deep probe this month.*

*Among applications are research in underwater weapons, undersea biomedical problems and oceanographic data*

By D. E. CAMPBELL,  
R. J. CYR,  
C. CROSIER,  
Bendix-Pacific Div.,  
Bendix Corp.,  
North Hollywood, Calif.

THIS f-m/f-m telemetry system is completely acoustical and eliminates the need for cables or other connecting devices. Despite its novel application, the system combines telemetry equipment and sonar systems

now in use, with few modifications.

The most familiar and probably the widest use of telemetering is in its application to the missile and space program. However, science knows more about outer space than it does about the two-thirds of our own planet covered by water. A feasibility study program was launched, based on the adaptation and application of standard telemetry components to underwater acoustic use. The principle objective

of the program was to evaluate an underwater acoustic f-m/f-m system for fundamental limitations and to obtain basic design criteria.

Some eighteen standard IRIG (Inter Range Instrumentation Group) bands ranging in frequency from 400 cps to 70 Kc are available. These bands represent subcarriers that generally modulate a r-f carrier for transmission through air. Sonic transmission through sea water experiences a propagation

loss that can be expressed for one-way transmission as:  $N_w = 20 \log R + (0.15 f + 0.0015 f^2) R + 60$  db, where  $N_w$  = total propagation loss in db,  $R$  = sonar Range in Kyd and  $f$  = frequency of transmission in Kc.

A 40 Kc  $\pm$  15-percent band was chosen as the acoustic carrier. This represents the best compromise to obtain a reasonable range with limited power plus sufficient frequency response to handle modulation by the lower subcarriers.

Figure 1 shows the receiving system used in the test. A system block diagram is shown in Fig. 2. Two subcarrier channels, IRIG No. 4 and No. 5 (0.96 Kc and 1.3 Kc respectively), are used. The data inputs frequency-modulate their respective subcarriers, the f-m outputs of which simultaneously f-m modulate the 40 Kc carrier oscillator. The carrier frequency is amplified to a power level required for transmission and drives a sonar projector. The projector, an electro-

mechanical device, converts the electrical signals to sonic waves. At the receiving station, the sonic waves are picked up from the water by a hydrophone and converted back to electrical signals. The composite f-m/f-m signal is amplified and applied to a standard 40-Kc discriminator. The output of this discriminator, which is now the composite of the original two subcarriers, is fed to discriminators that separate and demodulate the original subcarriers. The output of these discriminators representing the original intelligence is displayed on an oscillograph.

Sea tests were conducted off the coast of Catalina Island. The receiving station was installed aboard the *Sonar Queen*, a 63-foot converted air-sea rescue boat. The transmitter was installed aboard a 14-foot dingy. Radio communication between the boats was by shortwave radiophone. Test ranges were measured by radar. All tests were programmed in the same way to allow

direct comparison of results.

Tests were conducted to obtain general information at various depths and ranges, as to the capabilities and limitations of the system design. Tests were run at 360, 600 and 1,200-foot depths and ranges from 100 to 1,400 yards. All tests were at sea states 1 and 2.

Considering sea-state 2 as a noise limit, the ambient noise at 40-Kc, over the 12-Kc bandwidth, is -24 db relative to 1 micro-bar. The attenuation of the highest modulation frequency (46 Kc) at 1,000 yards is about 72 db. The required minimum transmitted field is thus +48 db for signal-to-noise ratio of one to one.

The measured acoustical power developed was 150 milliwatts or +63 db. The +15 db of added power was allotted to provide a 5-db signal-to-noise ratio plus a 10db safety factor to allow for transmission anomalies. The receiving hydrophone incorporated a fixed 40-db solid-state amplifier that provided an overall effective element sensitivity of -47 db at 40-Kc. An additional variable-gain 60-db amplifier provided sufficient gain and filtering to insure a limiting signal for the carrier discriminator.

System performance agreed closely with design expectation. Excellent results were obtained at ranges up to 1,300 yards. Figure 3 indicates the results obtained. The oscillograph recordings show the result of manually stepping a d-c calibrator in discrete steps and then switching to a sawtooth signal generator that produced a 15-cps, 0.5-volt ramp. No attempt was made to generate a linear sawtooth waveform, the idea was to verify the reproduced waveforms at the receiver against the transmitted waveforms. The sawtooth is an accurate reproduction of the generator output with the exception of flyback which does not appear vertical due to the frequency response of the particular subcarriers. Point A in Fig. 3 (bottom) indicates that the discriminators have lost lock with the signal due to amplitude modulation (suffered in transmittal) which dropped the carrier amplitude below the minimum capture voltage. Figure 4 is a photograph of the carrier amplitude modulation noted. This amplitude modulation has two basic components:

- (1) A low-frequency component

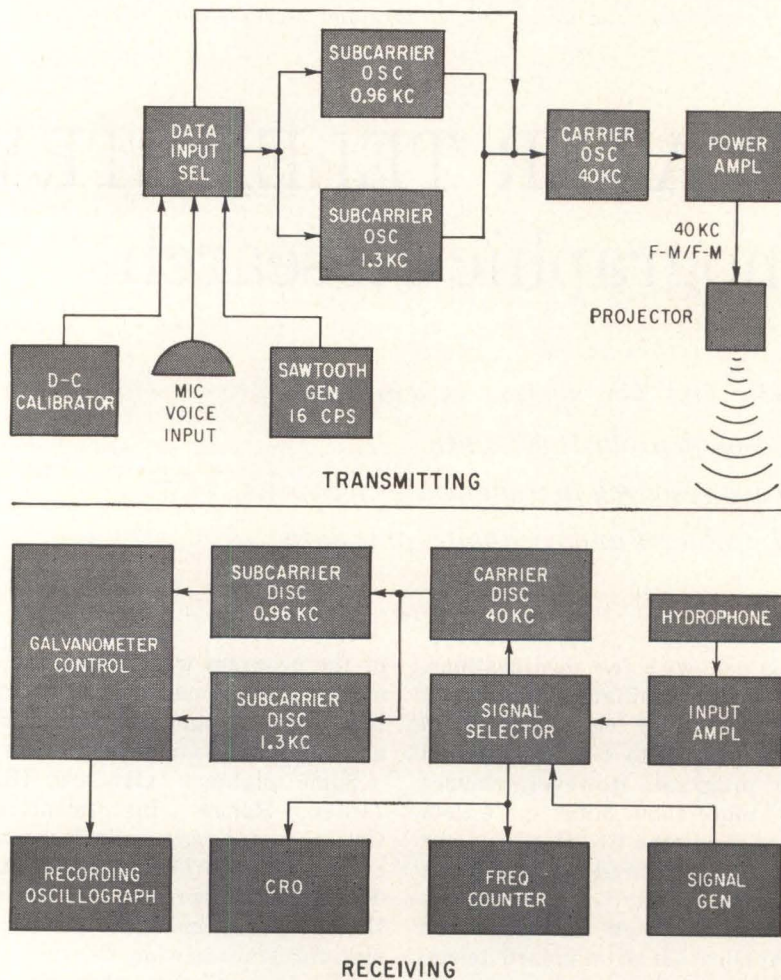

FIG. 2—Block diagram of f-m/f-m underwater telemetry system

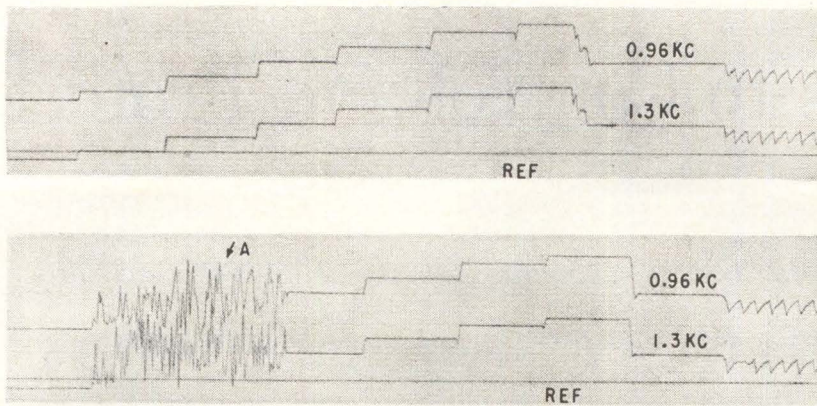

FIG. 3—Recordings of performance tests for water depth of 1,200 feet, with projector at 14-foot depth. Range 1,200 yards, hydrophone at 85 feet depth (top); range 1,300 yards, hydrophone at 130 feet (bottom)

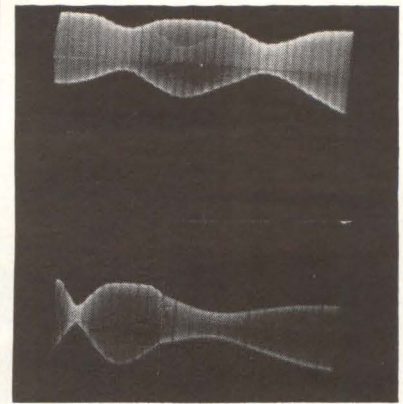

FIG. 4—Amplitude modulation of the 40-Kc carrier, which is extensive at close ranges (100 to 300 yards)

indicating variations in propagation loss with respect to time.

(2) A carrier amplitude that occasionally passed through the zero axis without changing slope indicating a 180-deg phase reversal of the carrier at that instant. This shows that much of the short-time change in amplitude is the result of multipath interference.

To further study the effects of multipath transmission, additional tests were made in shallow water. An agc system having a 100-cps response was incorporated in the receiver so that the agc system followed the low-level carrier frequency a-m. It was then noted that loss of discriminator lock occurred only during periods of extreme modulation (90 to 100 percent). Carrier fluctuations were reduced to such an extent that reliable data recovery was achieved in water depths of from 60 feet to 150 feet at ranges up to 800 yards.

A test was set up to determine the feasibility of voice communication over the f-m system. The 40-Kc carrier oscillator was frequency-modulated by a carbon microphone input. The voice was recovered at the receiving station by a loudspeaker driven by the output of the 40-Kc carrier discriminator.

Tests in deep water (1,200 feet) showed communication up to 1,200 yards range to be of excellent quality with extremely low background noise. The quality of speech was much better than that of the short-wave radiophones used as the communication link for all tests.

Signal-to-noise measurements were made with receiver gain such that limiting at the discriminator

occurred on ambient sea noise. It was determined that when the true rms values of signal and noise over the 12-Kc bandpass were equal, that is, the signal-to-noise ratio equaled 0 db, operation of the system was marginal. An increase of signal by a factor of 1.25 provided continuous lock-in of the discriminator.

The tests show that an acoustic f-m/f-m telemetering system is a practical means of data transmission through water. The quality of received data under favorable conditions is comparable to that of conventional f-m/f-m radio frequency telemetry.

As many as ten subcarrier channels can be handled simultaneously, which provides a data accuracy of 1 percent (exclusive of sensors) and a maximum frequency response of 800 cycles. Operational range is limited only by sonar conditions and available power. The effective range can be increased by utilizing sonobuoys and converting the f-m/f-m sonar signals into a f-m/f-m/f-m radio link for atmospheric transmission.

Development of underwater telemetry opens the door to new forms of underwater research. Among the applications is transmission of oceanographic research data, study of undersea biomedical problems, underwater weapons research, and geophysical experimentation for oil exploration. The system can also be reversed and used as a command system to control a unit below the surface, similar to control of a drone aircraft in flight.

With the successful completion of the feasibility study, Bendix-

Pacific has initiated the development of two deep-sea probes utilizing the acoustical telemetry technique. The first probe is designed to operate at 2,000-foot depth; the second, using pressurized components, will go to 10,000 feet.

Preliminary test on the 2,000-foot probe is presently underway. The 5.5-in. by 36-in. cylindrical housing contains standard telemetry components required for a three-channel system. Three IRIG channels, No. 3, 4 and 5 (730 cps, 960 cps and 1,300 cps), are used for subcarrier bands; a 40-Kc  $\pm 15$ -percent band is used as the carrier frequency. A platinum-wire temperature sensor and a helical bourdon pressure transducer provide temperature and pressure data. This information is displayed on a X-Y plotter at the receiving end to provide an automatic bathythermograph message. A linear ramp generator connected to the third channel provides a simulated dynamic function. The ramp generator also serves as a leak detector; the frequency of generation indicates the presence and severity of a leak, should it develop. A 14-watt, class-B, solid-state amplifier drives the sonar projector which is beamed vertically toward the surface.

The 10,000-foot probe will be oil-filled and pressure-equalized. Temperature, gauge and differential pressures will be measured and transmitted via the same telemetry frequencies utilized in the 2,000-foot probe. Component evaluation under extreme pressures has been underway for several months. Detailed sea tests are scheduled for January, 1962.

# Circuits to Control and Protect

*Practical circuits for testing modulator tubes that control megawatts. Discusses modulation arrangements, means of coupling signals to high-voltage modulator circuits, which are insulated above ground potential, and ways to protect modulator and load tubes*

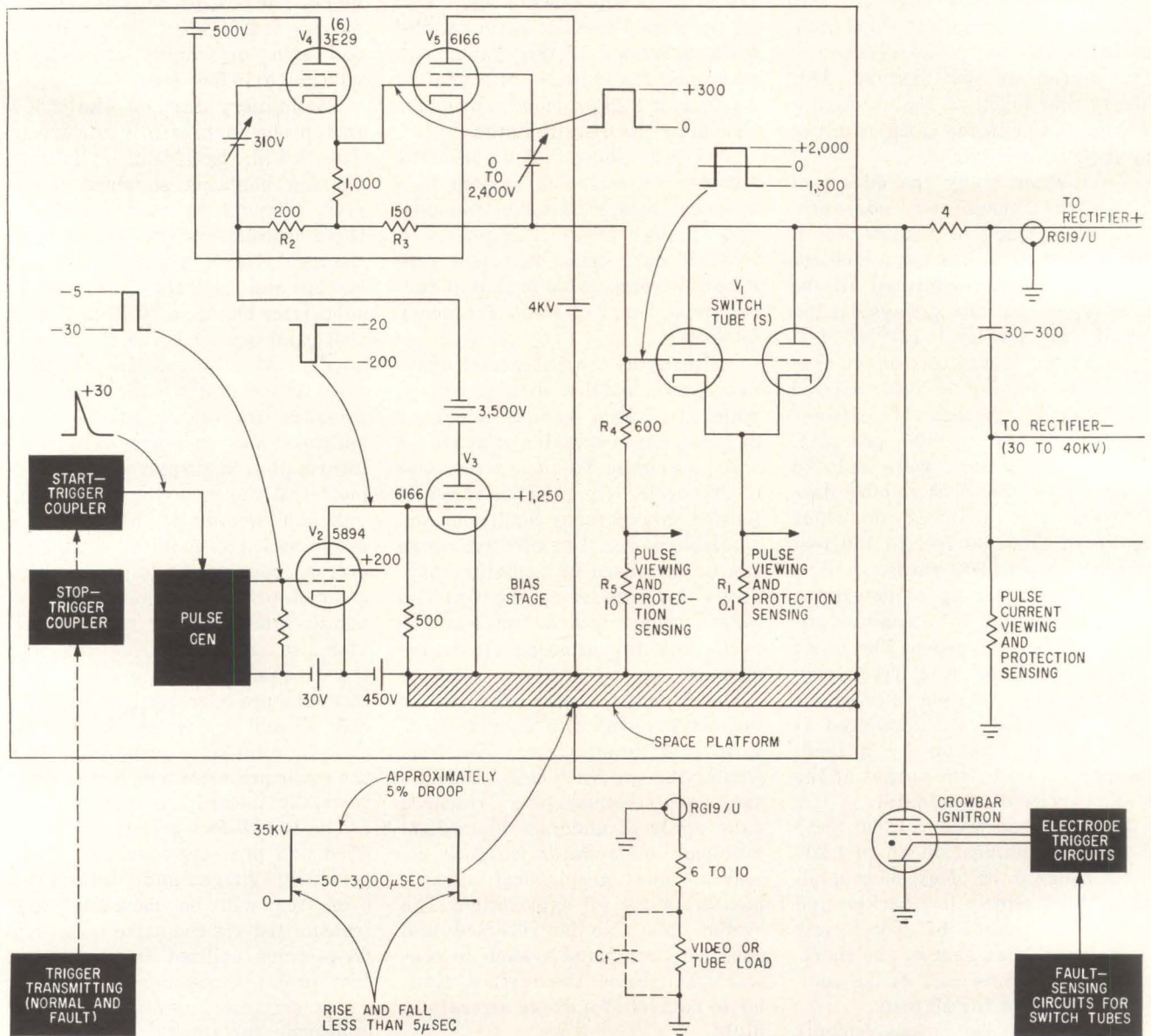

FIG. 1—Circuits (not shown) protect modulator and load tubes by switching on the crowbar ignitron

# High-Power Modulator Tubes

By T. E. YINGST,  
Power Tube Engineering,  
RCA, Lancaster, Pa.

*Author adjusts control console of  
a vacuum-tube modulator test set*



GRID-CONTROLLED high-vacuum tubes have long been used to superimpose intelligence on r-f waves at audio and video frequencies. Their linearity and stability are useful in controlling pulse modulation of large radars and particle accelerators.

Hard-tube modulators, or switch tubes, are especially useful for changing pulse length. In line-type modulators, a pulse is initiated by discharging a previously charged pulse-forming network through a switching device such as a thyatron or spark gap. The switch can only turn the current on; the length of the pulse and its rate of fall at the end are determined by the pulse-forming network and other circuits. However, in high-vacuum grid-controlled switch tubes, the positive-pulse plate current is controlled by the grid at all times. Because the pulse may be started and stopped at any interval or rate, accuracy of pulse shape and length is available. In designing high-vacuum switch tubes for modulator service cathode emission is important because full switching current must be passed by the tube as electron emission. At the time of full current flow, the plate voltage should be low because the voltage for electron flow is taken from the supply voltage. During the interpulse interval, the tube is quiescent; the plate is at full supply voltage, and the current flow is cut off by negative grid bias. No electrons or ions should flow during this interval

because such flow would initiate internal flash arcs. High power gain, desirable in switch tubes, reduces grid-drive requirements. The grid should collect few electrons, in spite of the high positive drive required for full electron emission. Good linearity in a switch tube is essential because accurate pulse shaping depends on operation on the linear part of the characteristic curve. A cathode emission characteristic having no current droop during the pulse period and low-inductance leads to permit fast rise time are also required. Moreover, the tube must be stable enough to absorb short-time bombardment by ions and yet have long life.

In a hard-tube modulator, the pulse may be terminated when a load fault is detected without diverting the remaining pulse energy into a crowbar<sup>1</sup> system. Hard-tube modulators incorporated in superpower amplifier test sets have demonstrated their ability to terminate the output pulse during several thousand simulated load faults without requiring discharge of the plate-supply capacitor bank. The bank is discharged only during

switch-tube faults.

Figure 1 shows a multimegawatt modulator test configuration. The tube load to be plate modulated is connected between the test-set's space platform (which is insulated from ground), the common plane to which all the elements of the switch-tube driver circuit are referenced, and the negative return of the capacitor-bank supply. Included is a fault and normal trigger-coupling system. An 0.1-ohm protection-sensing resistor  $R_1$  connects the switch-tube ( $V_1$ ) cathode to the space platform.

During the interval between normal pulses, tube  $V_2$  is cut off and bias tube  $V_3$  conducts current through the grid-to-cathode resistors of the modified bootstrap circuit and the grid-cathode resistor of the switch tubes; thus  $V_4$ ,  $V_5$  and  $V_1$  are cutoff.

When a trigger is coupled to the pulse generator from the start trigger coupler and trigger transmitters, the leading edge of the modulator output pulse is initiated. The output pulse from the pulse generator is inverted and amplified by  $V_2$ , thus cutting off  $V_3$ . During this

transitional period,  $V_3$ ,  $V_4$ ,  $V_5$ , and  $V_1$  are transferring from a non-conducting to a conducting state. As  $V_3$  cuts off, the positive portion of the grid signal to the switch tubes ( $V_1$ ) is formed by the conduction of bootstrap tube  $V_5$ . Peak drive currents of approximately 10 amp for each switch tube are required under typical operating conditions; therefore, cathode follower  $V_4$  drives the grid of  $V_5$  positive. The grid voltage of the switch tubes goes from a cutoff of about  $-1,300$  to  $+2,000$  v in less than  $1 \mu\text{sec}$ , typically. As the load capacitance charges to full-pulse value, the leading edge of the output pulse forms. A typical output pulse has a total rise time of less than  $5 \mu\text{sec}$ . Because charging current of the system is limited by type of switch-tube cathodes, voltage rise time ( $t_r$ ) is a function of capacitance ( $C_t$ ) across the load; that is,  $\Delta e_L/\Delta t_r = i_m/C_t$  where  $e_L$  = peak pulse voltage across the load and  $i_m$  = maximum switch-tube plate current.

During the flat-top portion of the pulse, switch-tube drive voltage is maintained at levels required for minimum plate dissipation. Pulse droop on the output pulses is determined by the switch-tube-plate storage capacitance. In Fig. 1, pulse droop is limited to approximately 5 percent of the time from the leading edge to the trailing edge of the flat-top portion of the pulse.

The trailing edge of the pulse is formed when a stop trigger is injected into the pulse-forming system, or at the time determined by the time constants of the monostable multivibrator of the pulse generator. Then  $V_5$  goes off, lowering the bias on  $V_3$ . Tube  $V_3$  starts to conduct through  $R_2$ ,  $R_3$ ,  $R_4$ , and  $R_5$ , thus biasing the driver and switch tubes to cutoff and removing the plate output-current source. This transition in the drive circuit takes place in about 1 to  $2 \mu\text{sec}$ . The trailing edge of the output pulse is formed by the discharging into the load of the total capacitance  $C_t$ . This discharge occurs in 3 to  $5 \mu\text{sec}$ .

The modulators have been operated at pulse widths ranging from 50 to  $3,000 \mu\text{sec}$  and at prf's up to 2,000 per sec. Pulse widths of  $3,000 \mu\text{sec}$  have pulse droops somewhat higher than 5 percent. When a typical modulator was operated at 2,000 pps with a pulse width of  $50 \mu\text{sec}$ , there was no evidence of malfunction. Limited operation at higher prf's and shorter pulse widths indicated that a portion of the switch-tube plate dissipation results from the charging of the total distributed capacitance for each pulse (total energy used in charging the distributed capacitance per pulse times the number of pulses per second).

At higher prf's, the energy content in the leading and trailing edges of the pulse can be destruc-

tive to the RG-19U cable in the pulse path. Operation under these conditions ruptured the cable at each end after several hundred hours of operation. This was nonexistent at lower prf's. In limited high-frequency operation, the use of proper cable termination has eliminated this type of failure.

Average power output of one type of tube modulator has been limited to the order of 750 Kw. At this power level, all components in the d-c path operate at a d-c plate-current in the order of 20 amp, and components in the pulse path at currents in the order of 100 amp rms. Pulse voltages in the order of 33 to 35 Kv were obtained.

Figure 2 shows several methods of coupling triggers to the space platform. In Fig. 2A, the light transmitter at ground potential, sends light pulses to the phototube circuit, which is at space-platform potential. The inverter triggers the pulse generator shown in Fig. 1. The argon lamp is ignited by trigger pulses of approximately 150 to 200 v peak. At these voltage levels, the argon lamp ignites and transmits low-jitter light pulses in the order of  $1\text{-}\mu\text{sec}$  widths. The collector of the multiplier phototube operates near the space platform potential. A pulse transformer inverts the received trigger and thus provides the start trigger for the modulation system. Similar systems have provided stop triggers to these modulation systems. This trigger-coupling system has also coupled triggers from the space platform to ground level. This coupling system has a distinct advantage over pulse transformers in that no special methods are required to eliminate false triggers caused by electrostatic coupling around the transformer. System delay time is in the order of  $2 \mu\text{sec}$ .

The trigger-coupling method shown in Fig. 2B uses a mercury lamp as a light transmitter. This method was chosen so that the transmitter could be up to 8 or 10 feet from the receiver without loss of response time. The lamp will operate for hundreds of thousands of operations without losing reliable firing characteristics. The input trigger fires the thyatron which in turn ignites the mercury lamp. Capacitor  $C_1$ , which is charged up

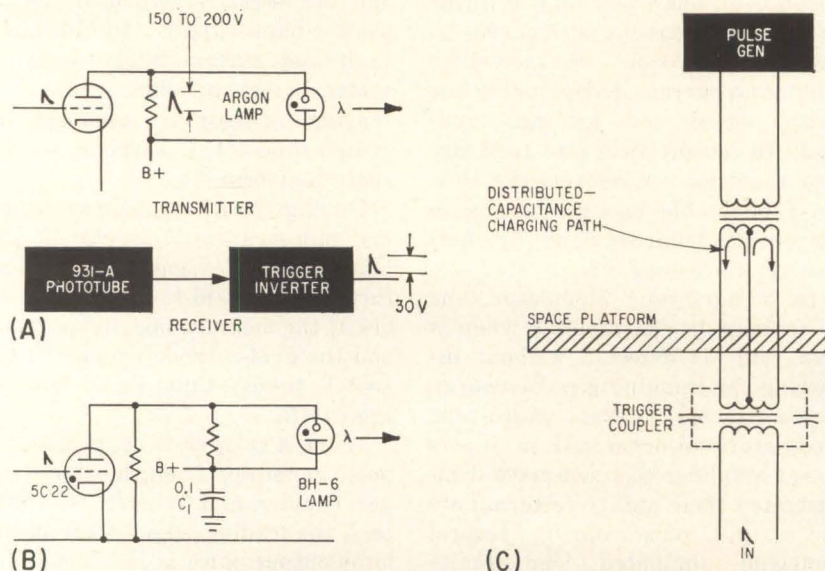

FIG. 2—Coupling signals to and from space platform. Repetitive-trigger light transmitter and receiver (A); Hg-lamp light transmitter (B); transformer coupler (C)

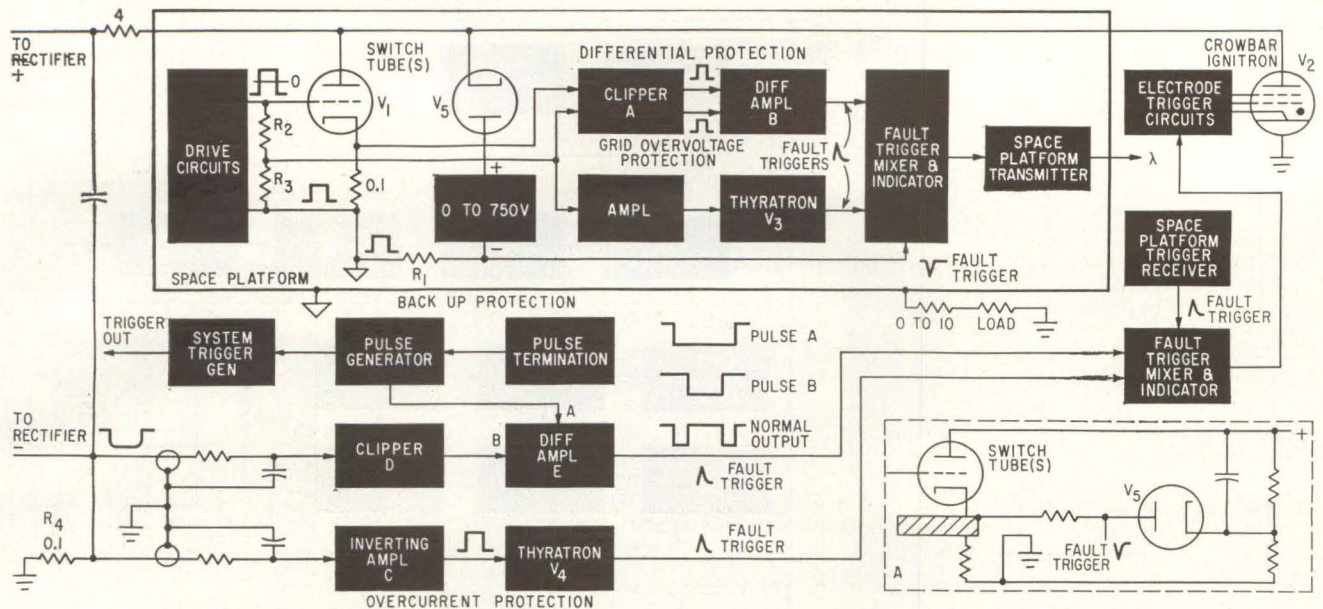

FIG. 3—Switch-tube protection circuits include two short-circuit arrangements of  $V_5$ ; one of these arrangements is shown in inset A

to 2 Kv, is discharged through the lamp and produces a firing time in the order of 1  $\mu$ sec. The receiver is the same as that in Fig. 2A, except that the sensitivity is somewhat lower. The advantage of the mercury-lamp system is in the convenience of placement of the receiver. For example, the receiver might be approximately 6 feet from the transmitter. Total response time (including fault-sensing time, light-transmitter time delay, receiver time delay, and time required to fire the ignitron crowbar) is well below 10  $\mu$ sec.

Recent developments in balanced, electrostatically shielded pulse transformers have eliminated the major disadvantages of this type of trigger coupling. When the pulse transformer is connected in the modulator circuit (Fig. 2C), false triggers due to the charging and discharging of the transformer distributed capacitance are eliminated because the magnetic effects of the capacitance charging currents are cancelled within the transformer that is on the space platform.

Figure 3 shows the major types of circuits used to protect the modulator switch tubes ( $V_1$ ). A high-voltage diode, a d-c power supply, and sensing resistor  $R_1$  are in series with switch tube(s)  $V_1$  to sense flash arcs within  $V_1$ . For typical RCA switch tubes, the minimum voltage drop is greater than 750 v d-c. With a switch-tube volt-

age drop ( $E_{bmin}$ ) greater than 750 v under all normal operating conditions,  $V_5$  does not conduct. However, if a flash arc occurs within  $V_1$ , a low-impedance path is provided for the diode current and a fault signal is developed across  $R_1$ . This signal is inverted and transmitted to the crowbar circuit, where ignitron  $V_2$  fires and diverts the destructive energy in the capacitor bank from the faulted  $V_1$ . The sensing, transmitting and receiving of the fault signal and firing of  $V_2$  collectively occur in less than 10  $\mu$ sec. Operation of the series power supply at 250 to 300 v has provided adequate protection. The system has one limitation in that the plate voltage for the switch tube must be present before pulsing is begun.

Insert A shows how the series power supply can be replaced with a capacitor-resistor divider placed between the switch-tube plate and ground reference potential. Since the protection supply voltage increases as the plate-supply voltage is raised, the protection sensitivity is improved.

In the differential protection circuit, the grid-drive signal is compared to the switch-tube cathode current. The signals are clipped in A to a low level to keep the input into differential amplifier B constant. This system, called between-pulse protection, or differential protection, provides a fault trigger

when output currents as low as 2 to 5a are detected during the interval that no drive is present on the switch tube. Fault triggers from the between-pulse system go to the crowbar system through the same transmitters used for the flash-arc protection. Between-pulse protection of this type provides protection if the switch tube arcs during the pulse-termination procedure occurring when the load faults. For example, if the load faults 20  $\mu$ sec after the start of a 2,000- $\mu$ sec output pulse being delivered to it, another protective circuit terminates the drive pulse to the switch tube; the between-pulse protection now operates because cathode current of the switch tube is present without the corresponding grid signal. This condition could also occur during loss of switch-tube bias, loss of tube control characteristics, or failure of the tube to stop conducting during the pulse-termination procedure.

In the grid overvoltage protection circuit, voltage divider  $R_2$ - $R_3$  provides a pulse signal to a fault thyatron ( $V_3$ ) when the grid voltage exceeds about 2X the operating value. This condition exists when an arc occurs between plate and grid and the grid potential starts to approach plate potential. This protection is not requisite for switch tubes with a shield grid that isolates the control grid from the plate. The over-voltage system also provides protection for circuits op-

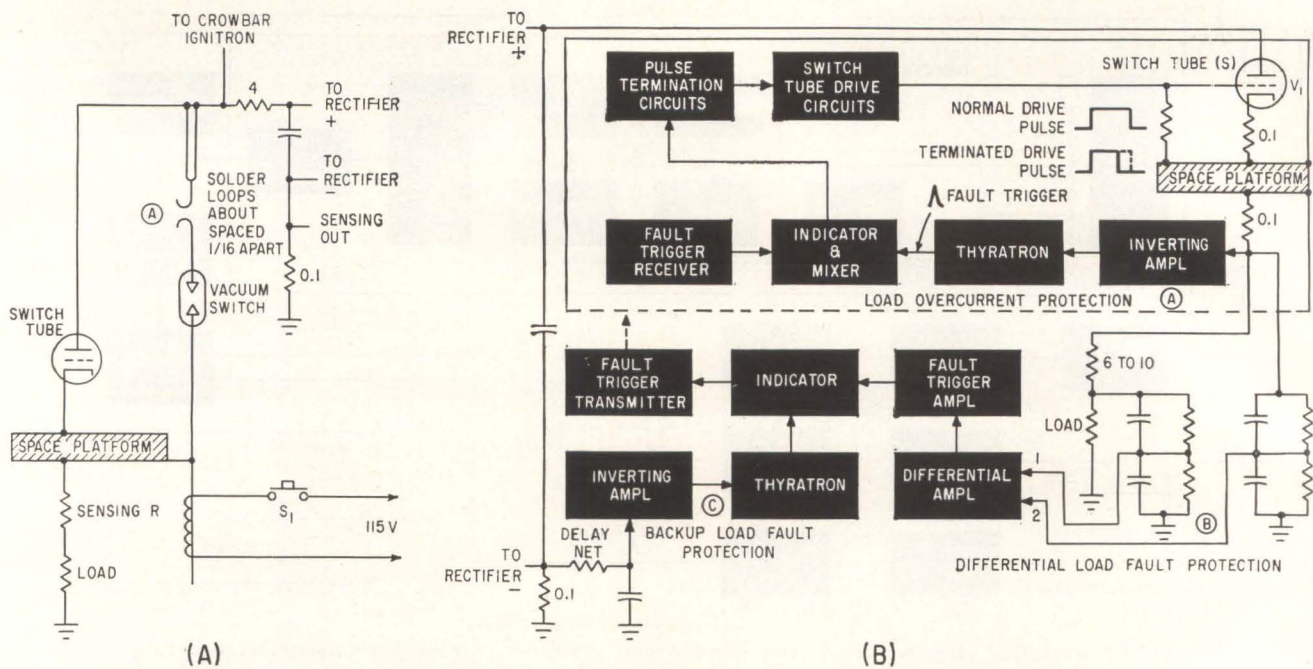

FIG. 4—Test circuit (A) checks protection circuits of modulator tube. Modulator load-protection circuits (B)

erating at grid potential on the space platform.

The over-current protection circuit, which operates at ground potential instead of space-platform potential, comprises an inverting amplifier  $C$  and biased thyatron  $V_1$ . The input signal from resistor  $R_s$  is integrated to produce a delay of approximately 20  $\mu\text{sec}$  for pulse currents up to maximum capabilities of the switch tube. This current would be in the order of 150 a for the RCA-5770. The protection circuit will not produce a fault signal under normal conditions because the thyatron is biased to fire only at current levels above the maximum operating current capabilities of the switch tube. If the switch tube flash-arcs during the time that the load is shorted (a load short is the most likely condition for a switch-tube flash arc), the peak current can be as high as 4,000 amp. Grid signal for the thyatron then reaches the firing level in a much shorter time than 20  $\mu\text{sec}$ , and thus provides high-speed protection. Response time of the system improves at higher voltage levels, where the stored energy in the capacitor bank becomes increasingly more destructive if not diverted in shorter intervals.

The back-up protection circuit backs up the protection system during the pulse and provides fast-acting protection between the nor-

mal pulses. The negative pulse across  $R_s$  is clipped ( $D$ ) at a level of 2 to 5 a to avoid sharp spikes and to provide a constant input into channel  $B$  of differential amplifier  $E$ . A second pulse is fed into channel  $A$  of the differential amplifier to cancel the effects of the clipped pulse fed into channel  $B$ . The pulse fed into channel  $A$  starts before the normal pulse current and ends after the normal pulse is completed. The inherent delay of the system does not produce an output signal. Unless a pulse termination signal (see Fig. 4B) is fed into the pulse generator, the back-up between-pulse protection will not produce a fault signal during the normal pulse interval. A fault trigger is produced at the output of amplifier  $E$ , Fig. 3 when the pulse current flowing through  $R_s$  reaches a level of 2 to 5 amp during the interval between pulses.

Figure 4A shows how to check the operation of the switch-tube protection circuits. A horn gap ( $A$ ), formed by two pieces of rosin-core solder in series with the contacts of a high-voltage vacuum switch, is placed across the switch tube. During checking, the vacuum switch is closed (by  $S_1$ ) with the load connected into the circuit at various plate voltages and brought up to maximum plate operating voltage. The stored energy in the capacitor bank destroys the solder

connection unless the protection circuits divert this energy in a short time interval. Ignitron  $V_2$  of Fig. 3 fires when a fault signal is received from any of the protection circuits shown in Fig. 3, and reduces the voltage across the switch tube and series dummy load to about 50 to 200 v within 10  $\mu\text{sec}$ . This procedure is repeated with the load short-circuited to complete the protection testing. When the protection circuits are operating, the ignitron fires in less than 10  $\mu\text{sec}$  and the solder ( $A$ , Fig. 4) shows only a slight gloss due to the flash arc, which lasts for the interval required to sense and divert the capacitor bank's stored energy; energy content in the arc across  $A$  is only a few joules, compared to the kilojoules stored in the capacitor bank.

When a load fault is detected, the modulator switch tube is returned to its nonconducting state in less than 10  $\mu\text{sec}$  after the load faults. For example, the load might short or fault at 110  $\mu\text{sec}$  after the leading edge of a 500- $\mu\text{sec}$  pulse is initiated. The load protection circuits sense this fault and terminate the pulse within the next 2 to 10  $\mu\text{sec}$ ; thus, the total pulse width is only 112 to 120  $\mu\text{sec}$  for this pulse. Depending on the system, the next pulse may arrive as determined by the system trigger generator, or the triggers may be gated out for as



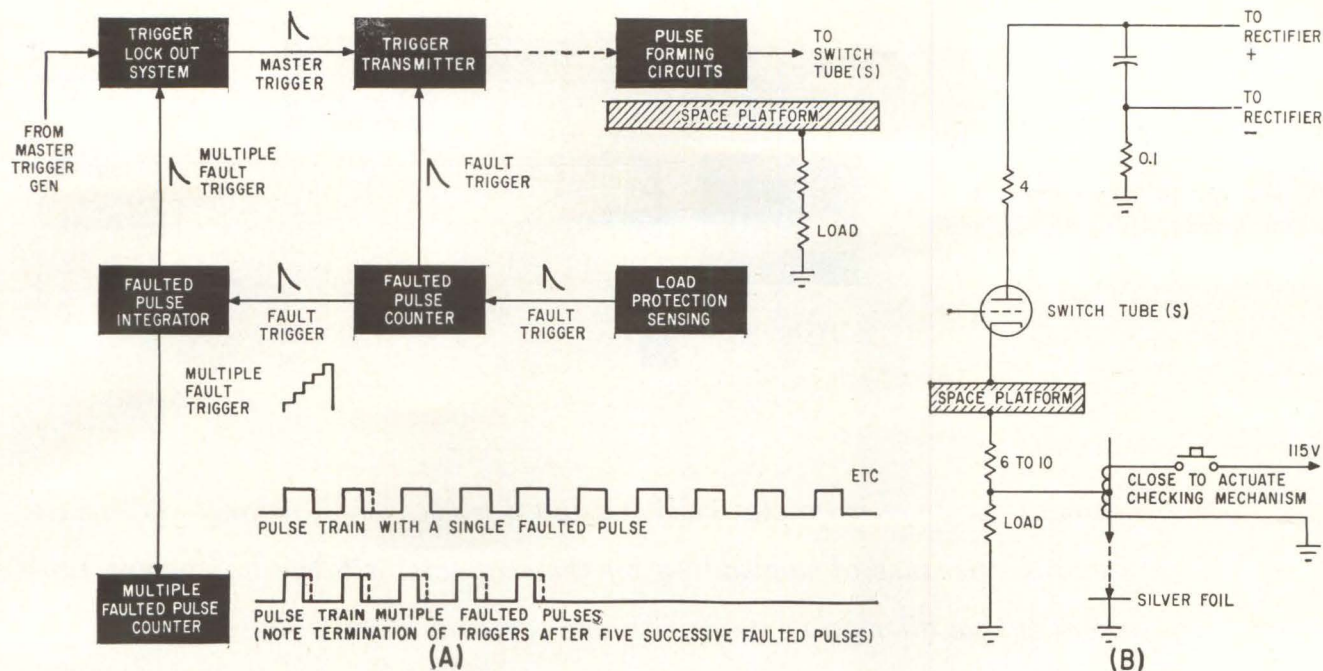

FIG. 5—Pulse-counting system (A) monitors faults. Checking setup (B) monitors load-protection circuits

long an interval as is required. An energy level of several thousand joules is available during each pulse at the load. However, the energy in the load fault is limited to several hundred joules by the arc impedance and the current limitation of the switch tubes, provided the switch tubes do not fault during the load fault. For example, the RCA-5770 switch tube is limited to a peak load current of approximately 150 a during normal operation when the load faults. At 40 Kv, the peak plate dissipation is 6 Mw. The switch tube, therefore, must be able to withstand maximum plate-supply voltage and to dissipate high peak powers while conducting maximum short-circuit current during a load fault until the fault is cleared by termination of the pulse.

Figure 4B shows three load-protection circuits (A, B, and C). Circuit A detects load faults when the load current is well below the current capabilities of switch tube  $V_1$ . This circuit terminates the pulse when the load current exceeds the normal maximum operating value.

The differential load-fault protection circuit (B) detects a voltage change across the load that is not normal for a load. Channel 1 of the differential amplifier receives a sample of the voltage across the load, while channel 2 receives a sample of the pulse output voltage at space-platform potential. During

normal operation, both inputs to the amplifier receive the same signal, and the output of the amplifier is zero. During a load fault, the signal fed to channel 1 collapses while a signal is maintained on channel 2. Hence, a signal now appears at the output of the amplifier. This signal triggers a thyatron, and the signal passes through a fault-indicator chassis; it is then coupled to the space platform, where pulse termination circuits stop the drive to  $V_1$ .

The back-up load protection circuit (C), which consists of an inverting amplifier and a thyatron to provide the fault trigger, is similar to the system for switch-tube protection. A delayed signal is provided by the storage-capacitor current passing through the 0.1-ohm resistor and the signal passing through a delay network. The signal is delayed to eliminate inherent ringing in the system and to provide protection that will operate only as a back-up system. Fault triggering level is set by the bias level on the thyatron.

Figure 5A shows a fault-counting system used with typical hard-tube modulators. When a fault is detected in the load, the fault trigger terminates the faulted modulator output pulse and produces a count signal on the faulted pulse counter. The system is arranged so that successive load faults (four to ten in

succession produce a fault signal from the faulted pulse integrator. Then the trigger lockout system is activated and the equipment must be put back into operation manually. The operator can check whether the load has faulted completely or merely flash-arced four or five times in succession. Under these conditions, normal load flash-arcs cause termination of the faulted pulse and allow the master trigger generator to deliver system triggers. Because triggers supplied to the trigger lockout system are counted by the multiple faulted pulse counter and the single faulted pulses are counted by the faulted pulse counter, this system provides a record of each faulted pulse and each group of faulted pulses.

Figure 5B demonstrates a method to check load protection. The output pulse from the space platform is short-circuited to a small sheet of thin aluminum foil such as household foil (about 0.003 inch thick). If the tested protection circuit is operating, the pulse is terminated within 10  $\mu$ sec after the simulated load flash-arc occurs and the aluminum foil shows only a small pin hole or slightly polished surface at the arc point. A mechanical device can be used to make successive checks.

#### REFERENCE

(1) W. N. Parker, and M. V. Hoover, Gas Tubes Protect High Power Transmitter, *ELECTRONICS*, 29, p 133, 1956.

Digital function generator is continuously variable between 10 and 1,000  $\mu$ sec

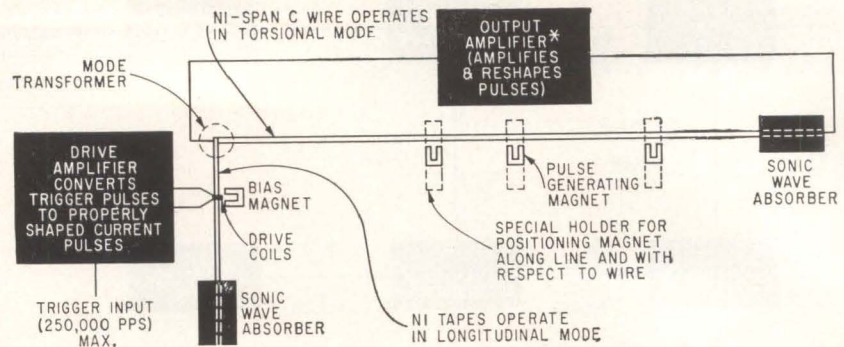

Variation of torsional magnetostriction delay line uses small magnets to replace control taps. Because of nonloading by the magnets, a large number of taps equivalent to one bit may be used with one common output

# Digital Function Generation

By WILLIAM PERZLEY,  
Vice President  
MILTON FISHBEIN,  
Senior Project Engineer  
Consolidated Avionics Corp.,  
Westbury, L. I., New York

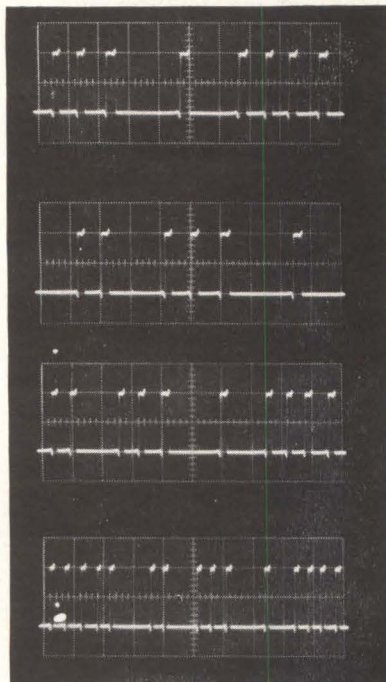

Output waveforms of function generator

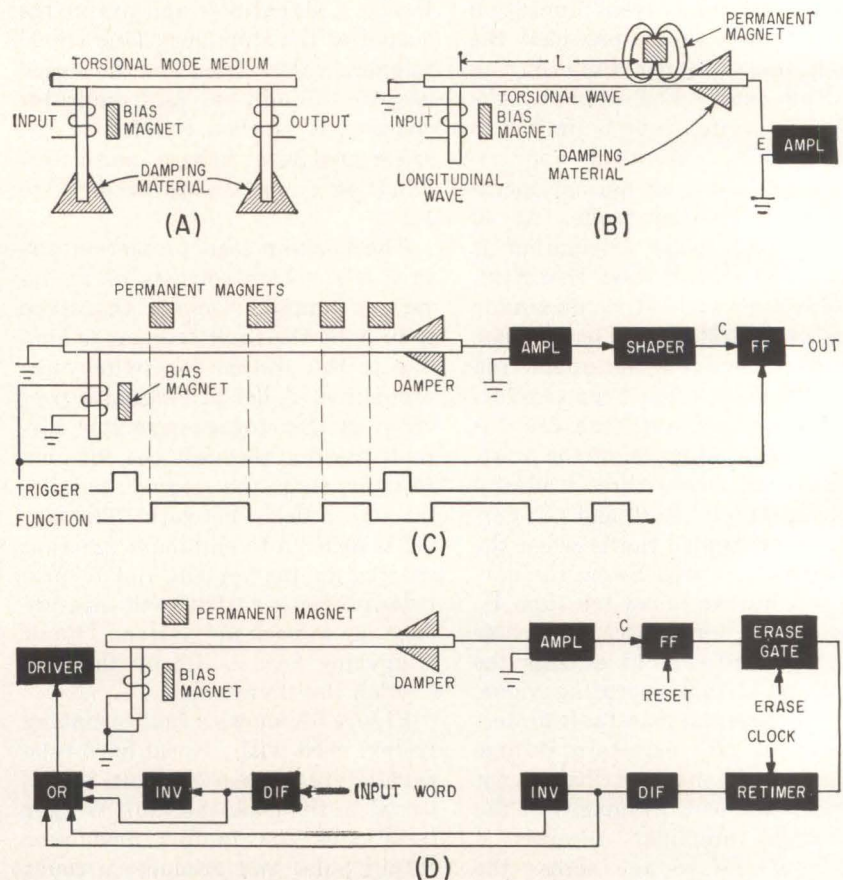
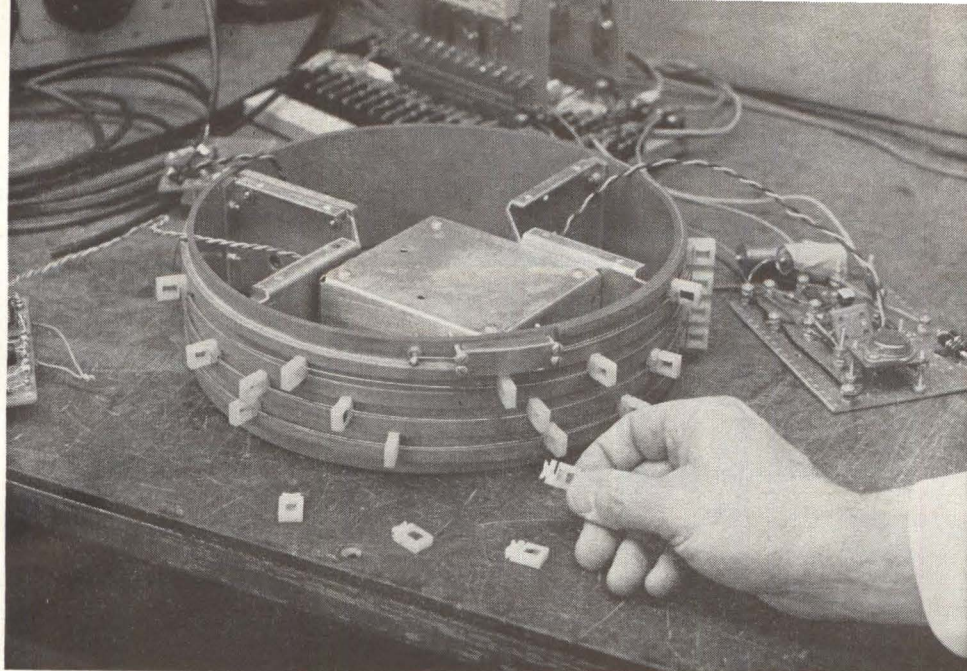

FIG. 1—Conventional delay line (A) with new digital function generator (B). Function or word generator (C) and dynamic storage of variable word length (D)



*Prototype of digital function generator showing magnet attachment*

## With Torsional Delay Lines

BASICALLY a variation of a conventional torsional mode magnetostriction delay line, this digital function generator replaces control taps by small magnets held close to the delay line. This technique embodies all the intrinsic characteristics of the delay line plus other advantages such as: simplicity and inherent low cost of the magnet transducer; ability to position the magnet at any location on the line quickly and conveniently; nonloading effect of the magnet as opposed to a conventional torsional tap, permitting a virtually limitless number of magnet taps with each magnet equivalent to one bit or pulse in any pattern; and one common output, regardless of number of magnet taps, reducing hardware since only a single low-level amplifier is required.

The ability to define as many time delays as desired by placing magnets in proximity to the line, in their respective programmed locations, provides an efficient word or pattern generator.

This magnetostrictive device represents a unique use of the torsional delay line technique.

A conventional line can be schematically represented as shown in Fig. 1A. The line is composed of a longitudinal launch transducer feeding a torsional mode medium. The input trigger current generates magnetic fields in the nickel ribbons of the launch transducer causing magnetostrictive action (Joule Effect). This produces a contracting stress in one, and simultaneously, an elongating stress in the other. These stresses produce longitudinal shock waves that travel a short distance along the tapes to where the tapes are joined to a cylindrical wire (usually Ni-Span C). At this junction, the tapes produce a couple resulting in a twist of the main delay member. Thus, a torsional wave is propagated down the torsional mode medium (delay line). This torsional wave is converted to longitudinal waves at the output. The lengthening and shortening of the output ribbons, in the presence of a magnetic field, alters the magnetization of the tapes (Villari Effect) and generates a signal across the output transducer coils. Damping materials absorb the sonic energy at the ends of the line to re-

duce reflections and insure a high signal-to-noise ratio. The advantages of the torsional mode delay line are the main delay member is chosen for good delay versus temperature properties and need not exhibit magnetostrictive properties. The materials used have a longer time delay per unit length than normal longitudinal mode lines.

If the main delay medium is considered to be the output transducer coil, the digital function generator (see Fig. 1B) is analogous to the conventional type of torsional mode delay line. However, the coils, fixed tapes, sonic damp and magnet of the conventional output transducer have all been replaced by a single magnet. Placing a permanent magnet close to the wire permits the torsional wave in the wire to move in a magnetic field, producing voltage  $E$  across the ends of the conductor. The time of occurrence of this voltage waveform is approximately equal to  $KL$ , where  $K$  is the sonic delay time per unit length in the torsional mode medium. An additional delay (deliberately kept small) is inherent in the launcher.

The material in the delay line

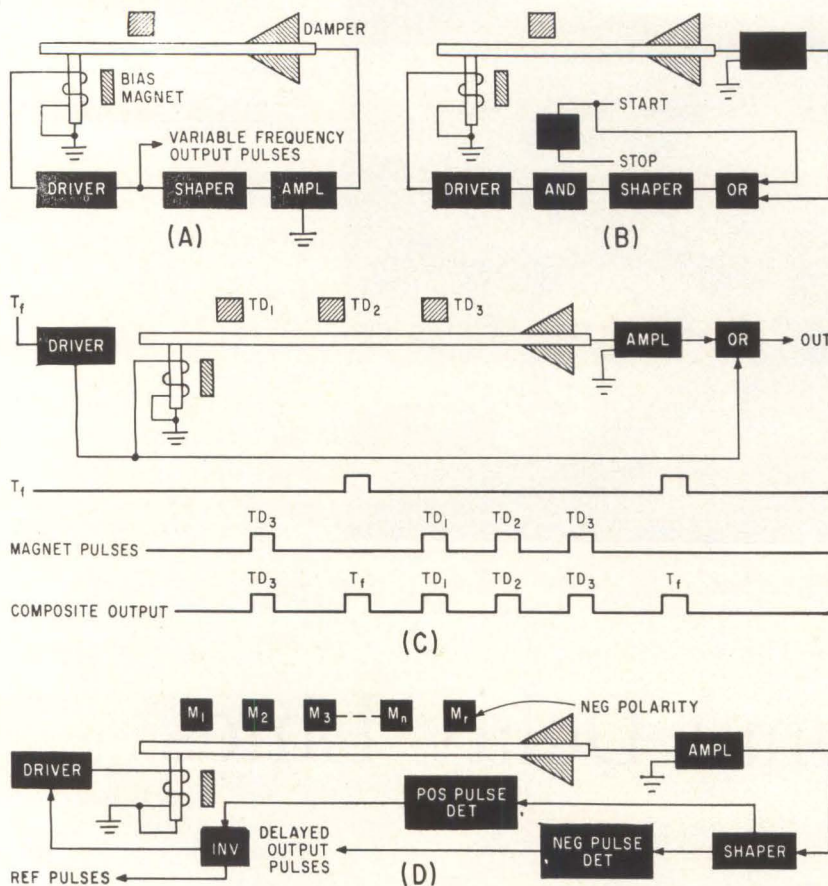

FIG. 2—Variable frequency oscillator (A) with method of pulsing on and off (B). Frequency multiplier (C) and precision delay and repetition rate generator (D)

need not have magnetostrictive properties but must be an electrical conductor and is chosen mainly for its delay versus temperature characteristics.

It is significant that infinitely variable time delay can be generated by adjusting the position of the magnet along the wire.

This device, still in early state of development, has been tested at operating rates of 250 Kc and higher. Adequate signal-to-noise ratios have

been exhibited by a 1000  $\mu$ sec line with as many as 248 magnet transducers in proximity to the line.

The use of many magnets positioned as per program requirements results in efficient function generation. Figure 1C shows such a configuration. For every input trigger, each magnet defines an exact time mark, which in turn produces an output pulse from the line. Applying each of these output pulses to the complement (toggle) input of

the flip-flop, switches the level of the flip-flop output at intervals proportional to the spacing of the magnets. The four magnets produce the four level transitions that occur in the generated function.

The arrangement shown in Fig. 1D, uses only a single timing magnet to provide a convenient digital dynamic storage device. The magnet is positioned along the line at a distance proportional to the word length. The word information, coded NRZ (nonreturn to zero), is differentiated and inverted and unidirectional spikes corresponding to positive and negative transitions in the word are OR-ed together and fed to the line driver. The line generates pulses corresponding to each transition. These pulses are applied to the complement (toggle) input of the flip-flop and the original word information is reestablished. The information is relocked to insure proper timing conditions and reinserted into the line as was originally done. The major advantage of this approach is the ease with which variation in delay can be made by repositioning the magnet when system design changes require changes in word length or clock rates. This mode of operation is functionally identical to conventional delay line equivalents, but with the all important advantage of providing complete variability of delay length without degradation of performance.

By using a single magnet and feeding the amplified and reshaped output signal back to the input driver, the configuration in Fig. 2A can serve as a stable steady-state source of pulses. Frequency is increased by moving the magnet towards the beginning of the line and

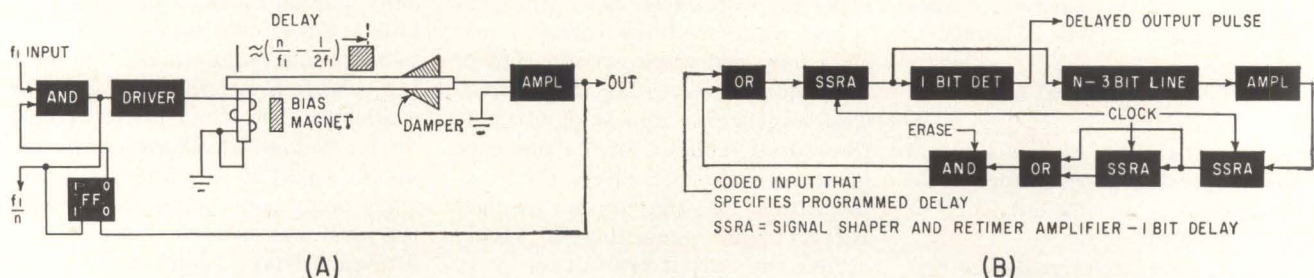

FIG. 3—Precise frequency division (A) measures the period corresponding to a divided-down pulse rate. In the coded time multiplier circuit (B), each successive zero in effect contributes one circulation time to the generated delay

decreased by moving towards the end of the line. By interposing a minimum of control logic, as shown in Fig. 2B, the circuit can also be pulsed ON and OFF.

The simple configuration shown in Fig. 2C can perform pulse rate multiplication with ease and precision. The respective magnets are uniformly positioned so that their equivalent time separation equals the final multiplied output frequency. The sample configuration shows the setup for multiplication by four. Successful multiplications into the hundreds have been successfully mechanized by this technique.

The configuration in Fig. 2D provides for variable repetition rate determined by the position of magnet  $M_r$ . Magnet  $M_r$  is oriented with opposite polarity to magnets  $M_1, M_2, \dots, M_n$ . This yields an output pulse of opposite polarity that can be separated at the output and then used exclusively for repetition-rate control. The opposite polarity pulses generated as a result of magnets  $M_1, M_2, \dots, M_n$  are collected and made available as the delayed output pulses as shown in Fig. 2D. The pulse for repetition-rate control is available as a time reference. Timing accuracy of the system is determined by the delay line stability and accuracy of magnet positioning. All of the timing can be relocked, thereby assuming the absolute accuracy of the retiming source.

Precise frequency division is achieved as shown in Fig. 3A. Here, the variable length line measures the period corresponding to a divided-down pulse rate. A single  $f_1$  input pulse triggers the delay line drive and also resets the control FF (flip-flop). Control FF in turn cuts

off the AND gate stopping the flow of  $f_1$  pulses. The position of the magnet transducer is such that  $(n-1/2)/f_1$  seconds later, an output pulse is generated, which in turn sets the control FF such that the next  $f_1$  pulse is gated through the AND gate. This provides a stable divider with little complexity of hardware.

A novel time multiplication technique that enables multiplying the delay capability of a line can also be made. Delays multiplications of from 1 to  $N$  times the basic line length, where  $N$  represents the number of bit lengths of the delay member, can be provided. The logic is demonstrated in Fig. 3B. The coded input number specifies the delay to be generated by virtue of the number of successive zeros in the coded word. Each successive zero in effect contributes one circulation time to the generated delay. Therefore, two successive zeros could result in two revolutions,—up to a maximum of  $N$  revolutions where  $N$  represents the number of bit lengths of the delay loop. The key to this mode is the extra 1-bit delay (the SSRA) element which is bypassed, both outputs feeding the control gate. This deletes the first zero of the group on each successive rotation.

The time phase position of the zero group can provide vernier control of the delay. A combination of phase and number of zeros therefore defines a specific delay.

The detector determines the existence of a single zero and generates an output pulse, which constitutes the programmed delay, when there is a zero. The single zero detector can be mechanized as shown in Fig. 4A. The leading edge

of the zero group triggers the one-shot circuit which generates a gate  $1\frac{1}{2}$  digit times wide. The information line is differentiated and the output pulses are gated with the one-shot output. An output pulse will appear only if a single zero had been presented at the information line.

The magnet transducer type delay device makes the time multiplication mode simple to implement. This results from its ability to generate the code that defines the delay. Consider the configuration shown in Fig. 4B, where magnets  $M_1$  and  $M_2$  define the delay to be programmed (positive polarity magnets) while magnet  $M_3$  (negative polarity) defines the standard read-out terminal. On the first pass, the read-out from  $M_1$  and  $M_2$  is read and recirculated. From that point forth magnet  $M_3$  readout is monitored. The system then functions in the time multiplication mode.

The system is efficient providing exact synchronous delays. Of further significance is the fact that multiple coded patterns can be generated with the same equipment and considerations, that is the number of consecutive zeros and their respective time phases will determine the delays. Thus bursts of pulses delayed in time can be readily generated. This provides a powerful long-delay pulse-generation function.

These applications show that complex functions can and have been mechanized with minimum hardware.

The ability to define and, when desired, to change an accurate time delay with a single magnet offers the advantages of cost reduction and equipment simplicity.

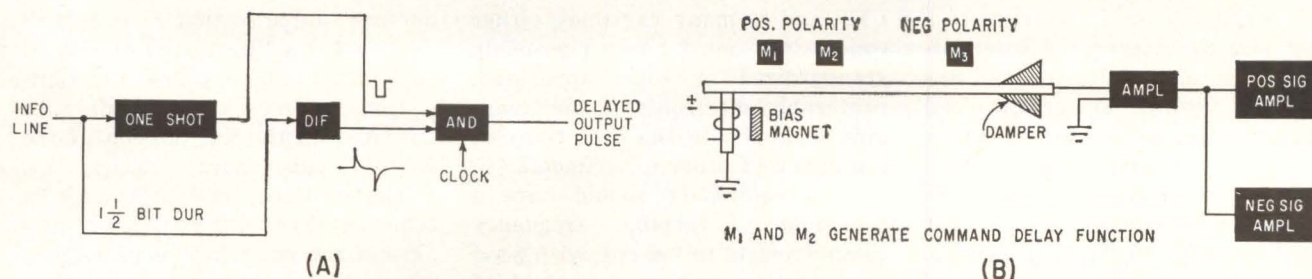

FIG. 4—Single zero detector (A) produces output only if a single zero has been presented on information line. Time multiplication circuit shown in (B)



*Flicker-fusion tester in use. Ammeter indicates light brightness, cathode-ray tube presents ratio of on and off times*

# Relaxation

*Oscillator circuit controls flashing rate of zirconium lamp; both frequency and on-off time ratio can be adjusted independently*

By CLAUDE LANDIS, and DONALD J. DILLON, New York State Psychiatric Institute  
MICHAEL CROSLIN, CGC Medical Electronics, Inc., Hempstead, N. Y.

A GREAT DEAL of research is being conducted into the relationship of flicker-fusion threshold (CFF) to various pathological conditions and to the effects of drugs, especially tranquilizers. Much of the research concerns verification of findings and a programmed manipulation of the physical parameters for standardization.

Clinically, the CFF has also been used in testing pathologic and psychopathologic conditions. The CFF has been found sensitive to toxemia of pregnancy,<sup>1</sup> certain cardiac conditions,<sup>2, 5, 6</sup> brain damage induced by such agents as surgery, injury and electroconvulsive therapy<sup>3, 4</sup> and to certain psychiatric disorders.<sup>4</sup>

The flicker-fusion threshold can be determined in the following manner: If a light beam is interrupted intermittently by a sectored disk (chopper) or if the input to a light bulb is interrupted intermittently by electronic means, the light will flash or flicker, provided that the rate of intermittence is slower than a critical rate. This critical rate, or the point at which the flickering ceases and the light appears steady, has been termed the threshold of fusion (the rate of intermittence having been increased). If this rate is decreased,

a point will be reached at which the change is from steady flicker: the threshold of flicker. The average of these two frequencies is called the flicker-fusion threshold.

This threshold is determined by a number of characteristics of the light itself. The most important of these is the luminance (brightness) of the source; the relationship between the flicker-fusion threshold (CFF) and luminance expressed in logarithms is direct and linear up to a maximum. Other factors include the area of the test patch viewed, the ratio between the on and off phases of the cycle (usually abbreviated LDR), the location of the test patch on the retina and the color (wave length) of the test patch. The age of the observer has also been found to be a factor.

With all the confirmed and unconfirmed relationships between CFF and so many variables, either conditions must be rigorously standardized or some apparatus, preferably electronic, made available to duplicate the conditions of a number of other experiments.

Such equipment should have a continuously variable frequency range from 10 to 100 cps, with good reproduction and good control of frequency. Settings must be either directly in cps or easily and quickly

convertible to cps. Frequency must be variable without a change in the duty cycle (LDR). The current to the light source (more properly, the light output itself) must be constant. A means of varying the duty cycle (LDR) independently of the frequency must be provided to be able to use as wide a range as possible. A quick and accurate means of calibrating the instrument in both frequency and LDR must be available. Portability would be desirable.

In the equipment designed, a conventional full-wave power supply provides +300 v d-c regulated and -90 v d-c regulated.

The timing frequency generator uses a gas-triode relaxation oscillator that ignites at 50 v and extinguishes at 16 v (subject to adjustment by grid bias). A capacitor is charged through a constant-current source so that  $e_c = 1/cfidt = k_1/c$  for a linear rate of rise of capacitor voltage. The constant-current source is a pentode tube operated on the flat portion of the  $E_b - I_b$  tube characteristics (A).

Thus a linear rise of voltage is achieved between the two limit voltages of the gas triode slope ( $K/C$ ), where  $K$  is constant current (B).

By a change of pentode bias,  $K$  can be varied to a new constant

# Flasher for Medical Research

$K_1$ , such that the frequency is a direct and linear function of  $K$ . Constant  $K$  is the pentode current that is inversely proportional to the grid bias over the required 10-to-1 current range. Thus frequency is proportional to rotation of the grid-bias potentiometer with a linearity of at least 2 percent. If calibrated at 15 cps and 60 cps, no other frequency in the range will be out by more than 2 percent.

This accurate and linear sawtooth wave is coupled to a Schmitt trigger stage by a cathode follower so that no load be placed on the oscillator.

The cathode-follower bias circuit and the coupling to the Schmitt stage are adjusted so as to compensate the frequency response to ensure a true and linear sawtooth into the Schmitt trigger stage.

The Schmitt trigger stage is a bistable multivibrator that stays in the second stable state only so long as the input grid voltage remains above some critical value. The bias control on the input grid sets this critical value at any point from 0 to 35 v. The input sawtooth is referenced to zero volts by a d-c restorer diode. Thus, the trigger point can be adjusted up and down in voltage such that the time the grid is above the threshold can be varied from 5 percent to 95 degrees of the full period of the sawtooth by adjusting the Schmitt bias.

The circuits for independent variation of frequency and LDR have provided a sweep voltage and a pulse output. It was therefore simple to add an oscilloscope presentation. Using the same power transformer, voltages were picked off and rectified by a high-voltage selenium rectifier so as to provide an additional -600 volts and a +400 volts. This 1,000-volt differential was then available to operate a 3BP1 cathode-ray tube. The sawtooth wave was used directly as the base line sweep and the output pulses were presented as the vertical data. Thus the LDR data is always presented directly on the face

of the scope (C).

Synchronization is automatic and only four controls were needed for the scope. These are intensity focus and horizontal and vertical positioning, all of which need be reset infrequently and represent no increased complexity of operation.

The current meter was retained for monitoring lamp brightness.

The frequency calibrator has been made more accurate and easier to use by replacing the vibrating reed with a rotating stroboscopic disk turned by a synchronous motor. By setting the LDR control for a short ON pulse and illuminating the strobe disk it is possible to stop the strobe disk apparent motion. When the black spot on the strobe disk seems to be stationary, the frequency dial is set at some multiple of 10 cps. The correct multiple is indicated by the

number of black spots visible.

The output light is created by a Sylvania zirconium crater lamp type R-1131C, designed to have a light output proportional to lamp current. A constant-current pentode circuit was used in series with the crater lamp to maintain constant lamp output even though the lamp strike voltage is considerably above its operating voltage. The pentode characteristic allows the lamp voltage to change over wide limits without any appreciable change in lamp current.

Coupling from the Schmitt stage to the output pentode is through a voltage regulator tube which provides the correct d-c potential at the pentode grid without attenuation of the pulse signal. The lamp brightness can then be controlled by adjusting the negative d-c bias on the pentode output stage. The lamp is protected from overcurrent by a limiting resistor in the pentode grid circuit. If the bias is reduced to where the grid can be driven positive, the flow of grid current clamps the grid voltage close to zero. This zero-bias condition is the same as the maximum rated current for the crater lamp.

The spectral output of the crater lamp very nearly matches the color response curve of the human eye.

The first goal of the CFF tester will be an extensive investigation into the conditions which will maximize the age-CFF relationship by the manipulation of LDR and color.

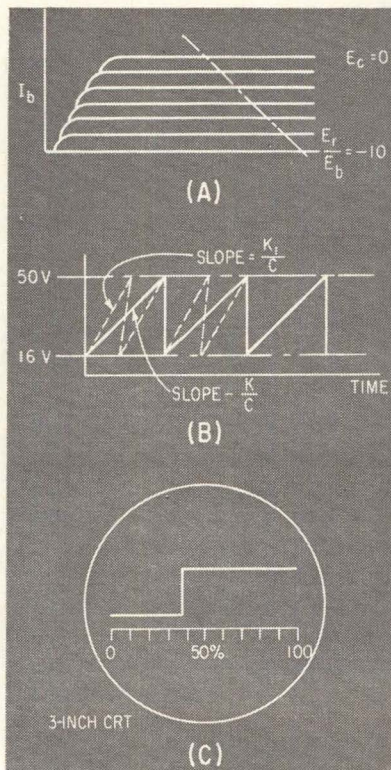

Pentode tube operates on flat portion of characteristic to provide constant current (A); linear voltage rise achieved with gas triode (B); presentation of the LDR data on face of 3-inch crt (C)

## REFERENCES

- (1) H. M. Brill, M. J. Golden, H. L. Woolf, A. H. Klawans, & J. S. Long, The preclinical recognition of toxemia of pregnancy. *Amer. J. Obstet. Gynaec.*, **62**, p 614, 1951.
- (2) L. R. Krasno and A. C. Ivy, Response of the flicker fusion threshold of nitroglycerin and its potential value in the diagnosis, prognosis and therapy of subclinical cardiovascular disease. *Circulation* **1**: p 1267, 1950.
- (3) C. Landis, D. Dillon, & J. Leopold, Changes in flicker-fusion threshold and in choice reaction time induced by electroconvulsive therapy. *J. of Psychol.*, **41**, p 61, 1956.
- (4) C. Landis, J. Clausen, Changes in sensory and motor performances induced by active psychiatric treatment. *J. of Psychol.*, **40**, p 275, 1955.
- (5) H. Misiak, Decrease of critical flicker frequency with age. *Science* **113**, p 551, 1951.
- (6) E. Simonson and J. Brozek, Flicker fusion frequency; background and applications. *Physiol. Rev.* **32**, p 349, 1952.

# Point-Availability Nomograph

*Reliability can be expressed in terms of the percent of time a system is available for use. Nomograph can determine system trade-offs*

By R. R. TRACHTENBERG  
Lockheed Electronics Co.,  
Plainfield New Jersey

MANY MILITARY CONTRACTING agencies are now writing into specifications for bids and contracts a requirement called point availability. Point availability is the percent of time the equipment will be available when an operator requires it. Ironically, it can be a two-edged sword,

working either for or against the engineer.

If *A* is the availability factor in percent, MTBF is Mean-Time-Between-Failure, MTTR is Mean-Time-To-Repair (or replace), then  $A = [MTBF / (MTBF + MTTR)] \times 100$ ; stated another way,  $A = [UPTIME / (UPTIME + DOWNTIME)] \times 100$ .

Suppose a specification requires a point availability for a

system to be no less than 99.99 percent, with a MTTR no greater than 10 minutes. In other words, the equipment must be available 99.99 percent of the time. When a failure occurs, it must not take longer than 10 minutes to locate and correct. Of course, in modern equipment, many failures are corrected by module replacement.

The problem is illustrated on the nomograph by the solid line. Provided no restrictions are made on MTBF, point availability may work for the engineer, since he can trade off MTBF for MTTR, up to the maximum allowable MTTR.

On the other hand, a system with an MTBF of 614 hours (dashed line) and an availability goal of 99.99 percent would require a low MTTR of 3.68 minutes. In this case, point availability works against the engineer, since it forces him to design a system that can pinpoint the module or modules causing a failure within a short time. Furthermore, the failing modules must be easy to replace within the mathematically determined MTTR goal. Thus, automatic checkout features may be required. Redundancy could be introduced but it in turn creates other problems.

New designs usually have a low MTBF and require careful design to achieve a low MTTR. As bugs are eliminated and the MTBF increases, point availability may also be increased by maintaining the low MTTR previously attained.

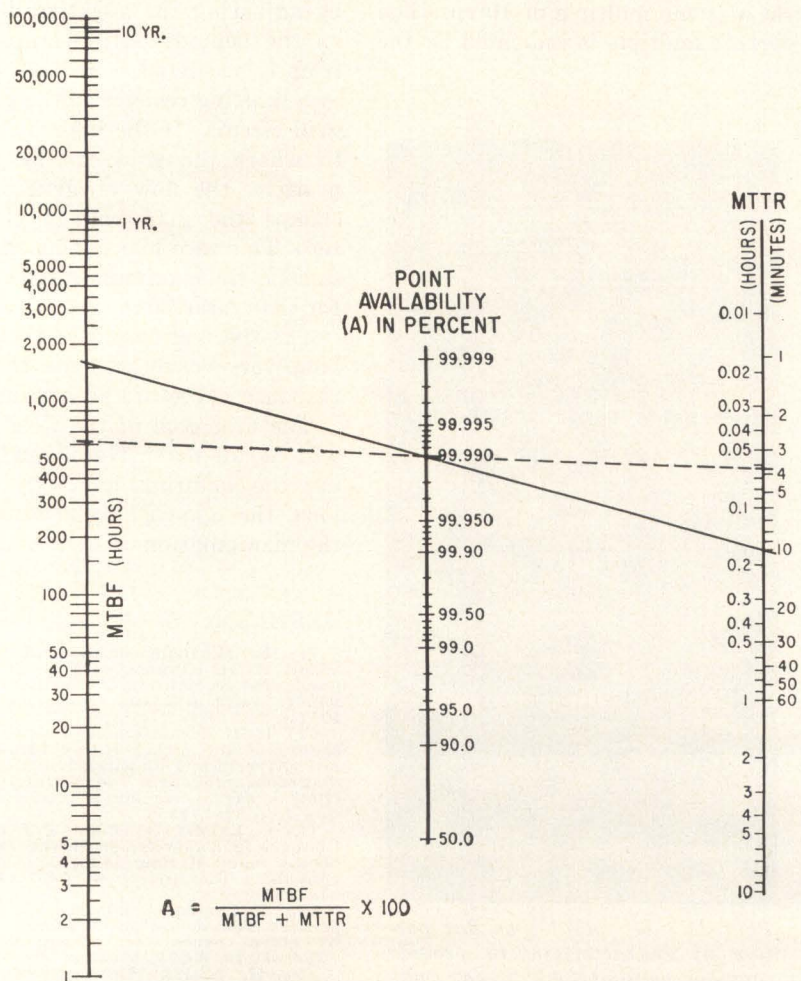



Watch carefully...  
no sleeves...

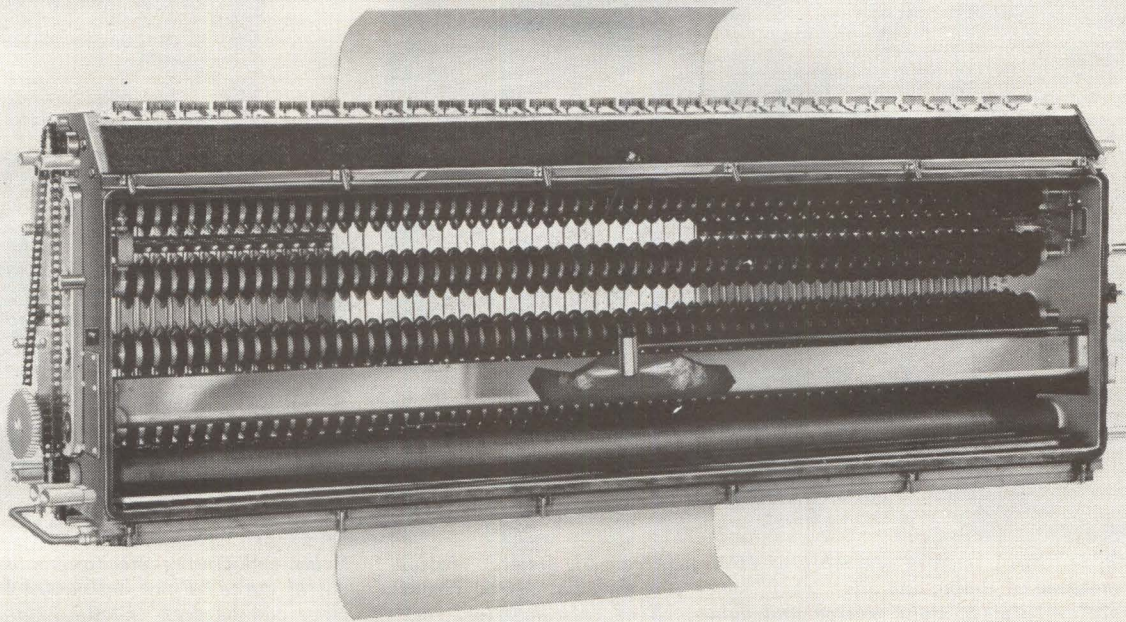

## NOW OZALID GIVES YOU FRICTIONLESS, DUAL-SIDED, WHITEPRINT DEVELOPING IN ONE PASS!

The new Printmaster® 900 whiteprinter gives you an amazing OZALID exclusive; a revolutionary developer system with no sealing sleeve, no slip screen, no perforated rollers to clog. Sealing sleeve servicing and replacement are ended. Ammonia is saved.

One pass completely develops double-coated materials. Vapors permeate both sides of prints right down to the base. No under-developed images to fade or discolor. Power-driven discs guide prints straight through the heart of the developer. No print curl or buckle.

The 900's speed (to 75 fpm), hi-intensity 150 wpi lamp, balanced cooling and simplified speed control assure unparalleled reproduction versatility. Send coupon for full details.



**The most machine for the money on the market!** All these extras at no extra cost: instant reversing switch, automatic exhaust timer, enclosed roll holder, automatic feed safety device, hi-low lamp intensity switch, instant-start variable speed control, remote ammonia supply attachment.

**OZALID**  
WE REPEAT  
**OZALID**

Division of General Aniline & Film Corporation

In Canada: Hughes-Owens Co., Ltd., Montreal.

OZALID, Dept. 181  
Johnson City, New York  
Send complete details on the  
new PM 900.

NAME \_\_\_\_\_

FIRM \_\_\_\_\_

ADDRESS \_\_\_\_\_

CITY \_\_\_\_\_ ZONE \_\_\_\_\_ STATE \_\_\_\_\_

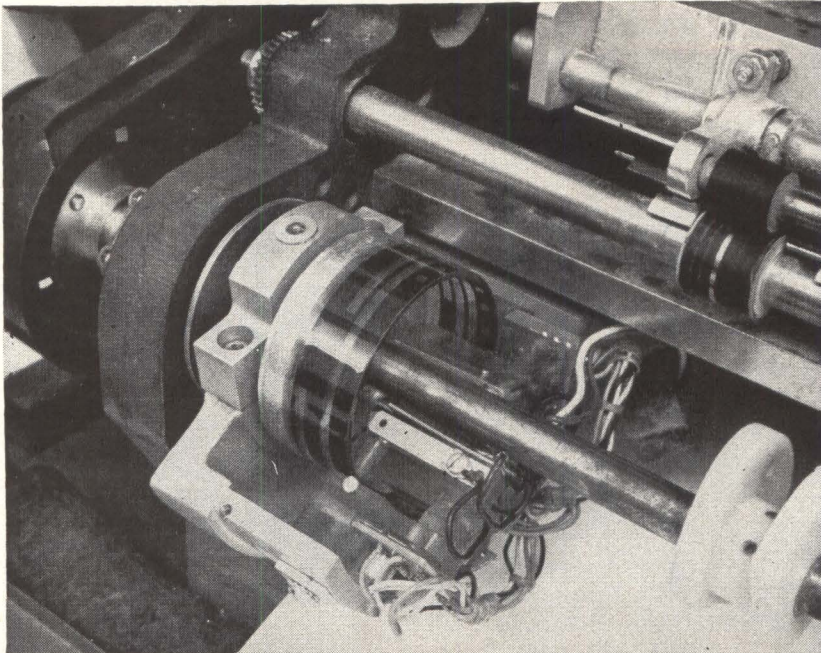

*Solar cell and light sources assembly of IBM printer. An emitter station, seen at bottom of drum, includes lamp, solar cell and transistor circuit. Drum rotates between light source and solar cell of each emitter, reading separate tracks of coded film. Card feed rollers are seen at upper right*

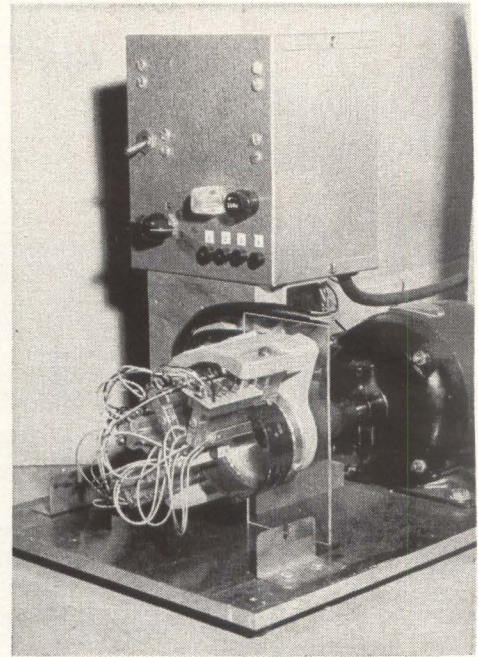

*Solar cell timing mechanism is set up on a test stand. Four individual emitter stations can be seen. Photographic film code is wrapped around drum*

## Solar Cell Directs Card Feed on Printer

By ROBERT SIMPSON,

General Products Div.,  
International Business Machines Corp.,  
Endicott, N. Y.

DEVELOPMENT of a card-feeding mechanism for a high-speed printer required a dual-purpose output from a computer to handle both individual cards and continuous forms. Design called for two document feeding stations and a movable chain-printing mechanism that would include a programable timing device of low inertia, high accuracy and low maintenance.

To obtain the desired reliability and inertia in the card feed on this high-speed printer, a solar cell emitter and transistor logic were designed for the timing task.

A special solar cell for this application was made for IBM by Hoffman Electronics Corp., Semiconductor Division, El Monte, Calif. Type number designation of the cell is EA7E3.

The existing IBM 1403 printer handles continuous forms. To per-

mit printing on cards, a card feed mechanism was installed alongside the form feed, with a carriage arrangement so that the printing mechanism can be translated from one station to another, depending on the printout requirements.

The solar cell emitter produces pulses at fixed angular positions of a shaft. Four separate operations are under the control of the solar cell device. One signals the unit to begin reading the holes in the card to verify it before printing. The other three are for running circuits. They check card levers to make sure the card is in correct position.

### *Advantages of Solar Cell*

Advantages in using a solar cell of specific sensitivity, rather than a circuit breaker approach include: a low inertia load on clutched shafts, easy accessibility, reduced maintenance problems, elimination of arcing and wearing, and higher reliability. To change the timing of the

feed mechanism, a simple change of coding film is all that is required.

Timed outputs are produced by interrupting and permitting light to pass from a light source to a solar cell. When light strikes the solar cell, a small voltage is generated. Transistor circuits amplify this voltage to a pulse that can apply power to a contact roll.

The unit consists of multiple emitter stations mounted on an emitter whose center is a clutched shaft (see photo). Inside the emitter housing a drum, clamped to the shaft, holds film with timing marks developed on it. Four emitter stations are aligned to four coded tracks on the drum. An emitter station consists of a suitable holder, prefocused lamp, solar cell and a transistorized circuit with two stages of amplification. A gap of 0.125 inch between light and solar cell allows the emitter station to slip axially to any track.

A single screw mounts the emitter station to permit axial adjust-

# NEW!

## NLS A/D CONVERTER BRINGS HIGH ACCURACY TO HIGH-SPEED MEASURING

*Model 15 Makes 15,000  
Measurements Per Second  
With Over-all Accuracy of  
 $\pm 0.01\% \pm 1$  digit*

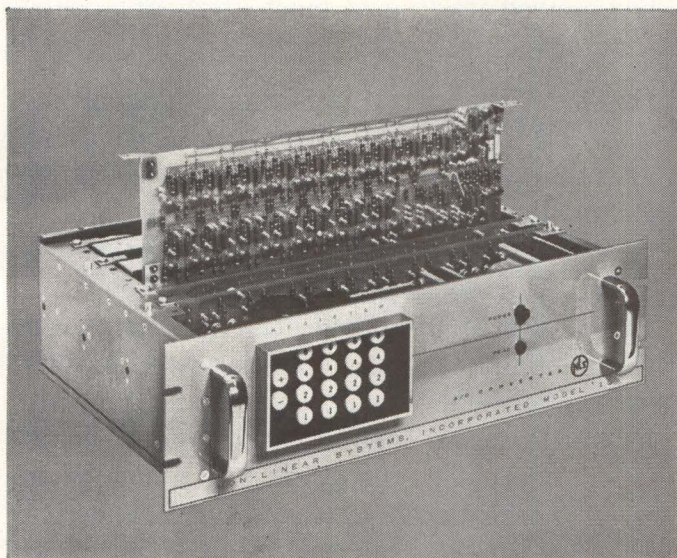

*All circuits are easily accessible.*

### BRIEF SPECIFICATIONS

**Range:** Any one fixed range from  $\pm .9999$  v to  $\pm 99.99$  v. (4 decimal digits - auto polarity).

**Total Digitizing Time:** 67 microseconds; 15,000 completely independent measurements per second.

**Over-all Accuracy:**  $\pm 0.01\%$  of full scale  $\pm 1$  digit for all error sources from  $0^\circ$  to  $40^\circ\text{C}$ . Full scale is defined as 9,999 counts.

**Input Impedance:** 62.5 kilohms for 100 volt range (625 ohms per volt). 50 megs with Model 142 accessory amplifier.

**Clock:** Internal or external. External clock rate can be from 0 to 250 kc.

**Digital Output:** 0 v. = binary "0" (10 ma. max. hold-down current); -12 v. = binary "1" (680 ohm source impedance). Short circuit does no damage. True bipolar output.

**Dimensions:**  $5\frac{1}{4}$ " high,  $15\frac{1}{4}$ " deep, 19" wide.

**Weight:** Approx. 26 lbs.

**Price:** 15 or 15B - \$6,985 F.O.B. destination in U.S.A.

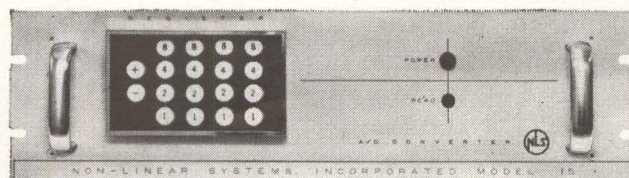

Now you can specify an A/D converter that provides high accuracy and outstanding versatility in addition to high measuring speed. That's NLS Model 15, a completely transistorized instrument designed for uses such as missile checkout, computers, process control, data reduction, wind tunnel research, and telemetering. ■ Over-all accuracy of Model 15 - all error sources included - is  $\pm 0.01\% \pm 1$  digit from 0 to full scale from  $0$  to  $40^\circ\text{C}$  - best in its speed range of 15,000 measurements per second. Also, there's no first reading error and no overload error up to twice full scale at full speed. ■ Versatile features that make it the most useful A/D converter include: true bipolar digital output in 8-4-2-1 code (not 1's or 9's complements) . . . digital readout for rapid calibration . . . high output current for versatility in driving external circuits . . . constant input impedance during entire conversion process . . . automatic polarity selection . . . operation from internal clock or from external clock from 0 to 250 kc. ■ Another version, Model 15B, provides straight binary output (14 bits and sign). Other adaptations include: decimal output instead of B-C-D, voltage peak measurements, resistance measurements, and digital to analog conversion. Contact NLS for complete data, a demonstration, or engineering aid for special applications.



Originator of the Digital Voltmeter

**non-linear systems, inc.**

DEL MAR, CALIFORNIA

*The tag indicates the 15 is an NLS "off-the-shelf" instrument. See a demo. today or take delivery on your own within 30 days.*

# WOULD YOU INVEST FOUR CENTS TO PUT MILLIONS OF DOLLARS WORTH OF ADDED ENGINEERING KNOW-HOW BEHIND YOUR COMPUTER, APPLIANCE OR COMMUNICATIONS SYSTEM DESIGNS ?

If these are your fields of electronics — Teflon\* insulated wire and cables must be of prime importance.

Most who know will agree that Brand-Rex has invested more in engineering talent and manufacturing facilities to design and produce Teflon insulated wires and cables than any other company. Result . . . you have at your beck and call (a 4¢ letter will do) a vast dimension of engineering capability. It gives you engineering help that backs up your designs with the wire or cable performance reliability that only unduplicated experience in Teflon insulation can give you. In return, you aren't even under obligation to buy from Brand-Rex.

But again, counting on our broad experience, we think you will. Why?

If the Teflon insulated wire or cable that meets your requirements is not a *standard*, Brand-Rex might well be the only manufacturer in the world that could make it for you economically. If it is a standard, chances are Brand-Rex can supply it to you fastest, right from inventory, from whichever of the three Brand-Rex plants is nearest you. U.L. approvals and military specifications aren't

a problem either. Brand-Rex has all applicable U.L. approvals and has geared its line to meet applicable military specifications.

Don't get the idea this is a monopoly situation (FTC take note, please), because there are other people in the business. It's just that Brand-Rex has matched its interest in this type of wire and cable with the biggest investment. And don't get the idea, either, that Brand-Rex will prejudice its insulation recommendations to you because of this extensive Teflon capability, cause it isn't so. Brand-Rex also insulates with vinyl, polyethylene, neoprene and nylon. With the depth of the total Brand-Rex line you can be sure of objectivity!

## SPECIFY

# TURBOTEMP®

TEFLON INSULATED WIRE & CABLE

\*DuPont registered trade name.



DIVISION OF

American ENKA Corporation  
31 Sudbury Road, Concord, Massachusetts  
Telephone: EMerson 9-9630

Vinyl, Teflon, Neoprene, Nylon, Polyethylene Wire and Cable—Electrical Tubing and Sleeving—Rexolite® Microwave Dielectrics

**NEW!** THIS COMPREHENSIVE BROCHURE DESCRIBES AND CHARTS THE ENTIRE TURBOTEMP LINE - **PLUS**, THE COMPLETE STORY ABOUT HOW THE INSULATION ADVANTAGES OF TEFLON CAN HELP YOU DESIGN MORE EFFECTIVELY. **WRITE** FOR YOUR COPY TODAY.

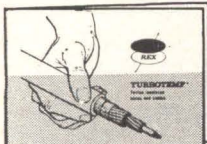

ment to the drum for maximum signal amplitude. The housing, located by a ball bearing on the operating shaft—the picker knife cam shaft—is fastened to a side frame by two screws located in slots of the housing. Loosening these two housing screws permits angular adjustment of all emitter stations to compensate for dynamic timing conditions.

Slight individual angular adjustment of cells can be made by loosening the screw holding cell to housing. By removing both mounting screws, the entire housing with emitter stations can be moved axially to expose the drum.

#### *Construction of Drum*

The drum is made of clear plexiglass 2½ in. od by ¼ in. thick by 1½ in. long. Each timing track is 0.110 in. wide and positioned 0.062 in. from the adjacent track.

The photographic film coding device is coated with an adhesive and can be wrapped around the plexiglass drum, aligned by a mark placed on the drum. Film permits easy field replacement for the timing code either when engineering changes are required or if the original coded film is damaged. Low cost of film is attractive.

The drum is positioned on a hub which is fastened in turn to the rotating cam shaft. A collar extending from the hub protrudes through the inner race of a ball bearing and extends a sufficient length to accommodate a collar. The end of this collar is split, collet fashion, to permit set screws in another collar to force the hub into intimate contact with the shaft. This arrangement also permits angular adjustment between the drum and the shaft. The outside diameter of the complete assembly is five inches.

In this application, only four emitter stations are required so that slightly over 180 deg is required for the housing, enabling the emitter to fit in a snug area. A maximum of eight emitter stations would require a full round housing.

The solar cell timing concept has many other possible applications in electronics. The cell's reliability and easy serviceability should encourage wider use. By putting several transparent areas in the same track and sensing that track with a single

solar cell, circuit breaker operation can be duplicated. By putting one transparent area in a track and sensing that track with several solar cells, emitter operation can be simulated.

Decoding of the outputs from  $n$  binary marked tracks permits sensing up to  $2^n$  angular positions from  $n$  tracks with one cell in each track.

The solar cell is oriented to turn off the transistor, thus assuring a known load current. Voltage to the light source is adjustable by means of a variable resistor in series with the output of a 6-v filament transformer. Voltage applied to the lamp is typically 1.9-v to 2.1-v for a good lamp life to performance ratio, with 2.5-v maximum voltage.

The 1404 printer, in which the card feeding mechanism is used, prints any size IBM cards from 51 to 160 columns wide. If the cards are no wider than 80 columns, two cards—either 51 or 80 column—may be printed side by side at the same time. The 1404's maximum card output is 800 per minute when two cards are simultaneously printed with one line of information on each card.

To switch from card to form printing, or vice versa, the operator moves the chain-printing mechanism to an appropriate position. Continuous forms can be printed at a maximum rate of 600 lines per minute at the forms station.

### Supersonic Generator Intensifies Galvanizing

GALVANIZING process can be intensified 2 to 30 times using supersonic energy, according to *Technika Noua*, a Rumanian technical weekly.

An a-c generator energizes a laminated transformer connected rigidly to a diaphragm. The unit is insulated and lowered into the galvanizing bath.

It was tested in a nickel-plating operation. Nickel sulphate (200 to 300 grams per liter) is used with sodium (sodium) chloride (30 to 40 grams per liter) and boric acid (25 to 30 grams per liter) with pH controlled between 4.5 and 5.6.

Optimum frequency is 20 to 40 Kc with specific density of acoustic energy from 0.2 to 0.5 watts per square centimeter.

New MICROWAVE insulation medium opens new concepts for design!

## REXOLITE<sup>®</sup> family of dielectrics continues to grow...

Breaking old design barriers, REXOLITE is today's "hottest" microwave insulation material for design engineers. A growing family of dielectrics, you should know about these thermosetting cast plastics — you should feel and see samples! Here are the highlights... complete information is yours for the asking!

**Rexolite 1422** — Available in rod, and plain or copper clad sheet — can be machined into just about any mechanical shape with precision. Dielectric properties include low dielectric constant, low dissipation factor over a wide frequency range, and of increasing importance, exceptional resistance to radiation! Under loads up to 2000 psi at temperatures to 200°C, REXOLITE shows no permanent deformation.

**Rexolite 2200** — Copper Clad, it is ideal for strip lines, directional couplers, duplexers and slot arrays. In addition it offers all the other dielectric strength and radiation resistance of REXOLITE 1422.

Complete, Up-To-The Minute Information and Samples Are Available. Qualified Technical Service is yours, too!



American ENKA Corporation  
31 Sudbury Road, Concord, Massachusetts  
TELEPHONE: EMERSON 9-9630

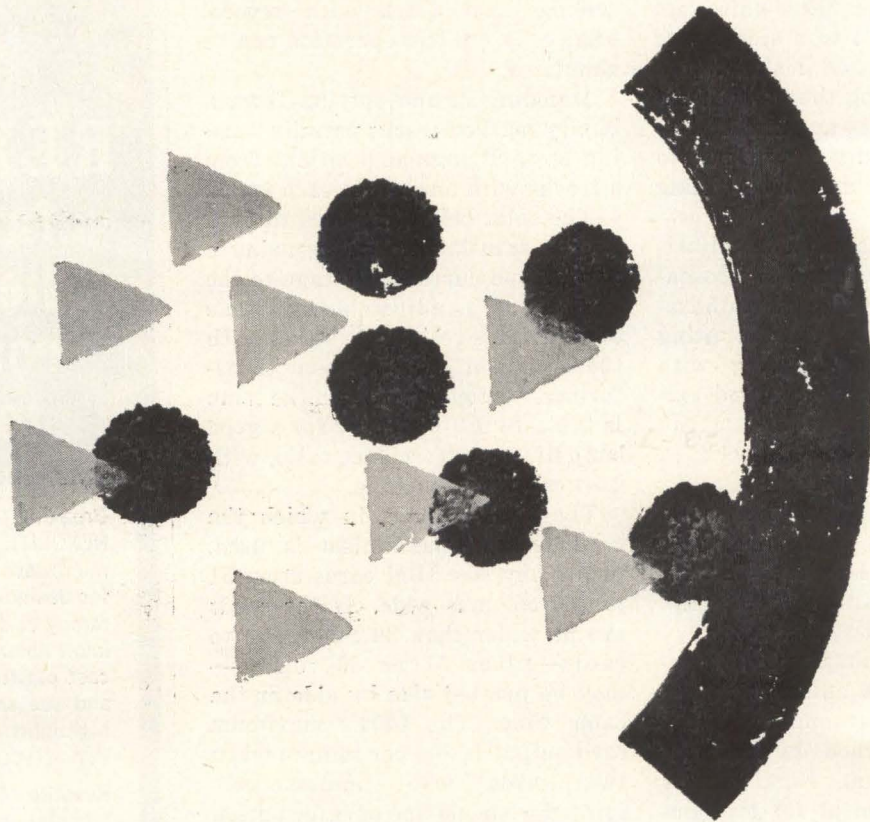

**Said Michael Faraday:** *"The amounts of different substances deposited or dissolved by the same quantity of electricity, are proportional to their chemical equivalent weights."*

Increasing requirements for pure, very thin films—especially those of ferro-magnetic elements and alloys—have become critical. To break this bottleneck, one production method under investigation is a chemical process from an aqueous solution—using metallic salts and a reducing agent.

Scientists at Lockheed Missiles & Space Company have conducted some highly successful experiments, in which extremely pure and thin ferro-magnetic film was deposited on such material as glass and plastics.

Thin film deposition is but one of many phenomena now being investigated at Lockheed Missiles & Space Company in Sunnyvale and Palo Alto, California, on the beautiful San Francisco Peninsula. Engineers and scientists of outstanding talent and ability naturally gravitate to Lockheed. For here they can pursue their special fields of interest in an ideal environment.

A leader in the aerospace field, Lockheed is Systems Manager for such programs as the DISCOVERER, MIDAS, and other satellites, and the POLARIS FBM. Why not investigate future possibilities at Lockheed? Write Research and Development Staff, Dept. M-28A, 599 Mathilda Avenue, Sunnyvale, California. An Equal Opportunity Employer.

## **LOCKHEED MISSILES & SPACE COMPANY**

*A GROUP DIVISION OF LOCKHEED AIRCRAFT CORPORATION*

Systems Manager for the Navy POLARIS FBM and the Air Force AGENA Satellite in the DISCOVERER and MIDAS programs. Other current programs include SAINT, ADVENT and such NASA projects as OGO, OAO, ECHO, and NIMBUS.

SUNNYVALE, PALO ALTO, VAN NUYS, SANTA CRUZ, SANTA MARIA, CALIFORNIA • CAPE CANAVERAL, FLORIDA • HAWAII



FEATURE I.

# Survey of the State of the Art in Microminiaturization

*Whether your concern is Packaging... Micro Components...  
Welded Circuit Assemblies... Integrated Circuits...  
here's pertinent data for YOU*



*Sid Spiegel, Vice President of Marketing for Pacific Semiconductors, Inc.*

THIS IS FIRST of a series of reports PSI plans to present on new developments and progress in the semiconductor industry.

In this fast-growing industry, much is happening and much data is available. This material is derived from PSI application notes. Because PSI has new and novel approaches to many problems, we believe these notes will be of interest.

We would appreciate your comments. If you have specific interests, please let us know so that we may cover them in future issues.

## Packaging

Everyone in the electronics business is taking a very long and serious look at a new technology—microminiaturization. There are many approaches being used and studied. One recent article quoted 27 different approaches. There are probably many more than this now. At Pacific Semiconductors, Inc., we have been intimately engaged in microminiaturization for the past three and one-half years.

As a result of techniques developed by our Surfaces Research Section—the first truly surface passivated semiconductor devices were offered to the electronics industry three years ago. These devices were micro-diodes, which were not only small (see Figure 1), but had inherent built-in reliability and could be manufactured at a lower cost than the standard glass diode.

About one year later we announced the pico and micro-transistor (see figure 2) which were several orders of magnitude smaller than the smallest transistor package.

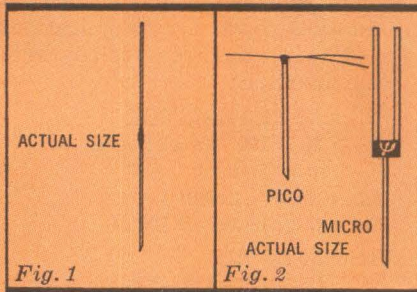

The solid-state packaging employed for protection from extreme environments used for the micro-diode was also employed for the pico and micro-transistor. Until recently, few steps had been taken by the industry to standardize on microminiature semiconductor package outlines. The smallest diode outline is still the DO-7 outline. Progress has been

made by the recent registration of the TO-46 and TO-51 microminiature transistor outlines. The TO-46 is commonly referred to as the "pancake" package. It has the same lead spacing as the TO-18 package, but occupies less volume (see Figure 3).

The TO-51 outline (Figure 4) is smaller than the TO-46, uses flat ribbon leads, and is particularly ideal for "Swiss-cheese" type packaging.

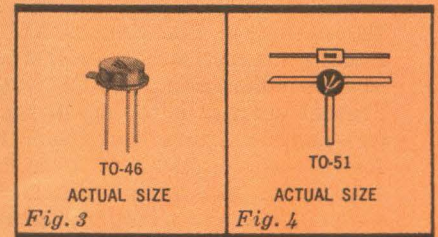

Microminiature circuits packaging approaches can roughly be divided into four categories: Welded Assemblies (Cordwood); Swiss-Cheese; Thin Film; Intergrated.

There may be cases where two or more of these categories are combined.

### WELDED ASSEMBLIES:

Another name for this type is "Cordwood" packaging. Actually, "Cordwood" is one special type of welded assembly. Welded assembly circuits as defined here employ discrete components connected by welding the components to each other, to "bus" wires, or to other connecting materials. An example of this type of packaging is shown in Figure 5.

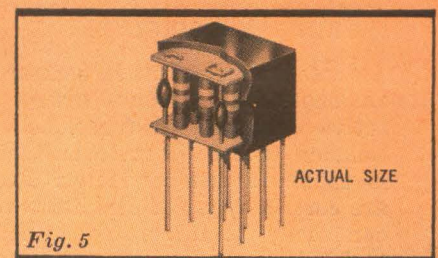

Micro-diodes and micro-transistors were designed for use in this type of packaging. Three leaded components with leads all coming out one side or radially are not particularly suited for this type of assembly, since the leads are usually used to support the structure.

#### SWISS-CHEESE:

The printed circuit board used in this type of packaging has holes punched in it for insertion of passive and active components. These boards are either .060 or .030 inches thick, the most common being .060 inches thick. Usually the components are round and have a maximum diameter of slightly less than multiples of .025 inches. An example is the TO-51 transistor outline which has a maximum diameter of .165 inches to fit in a .175 inch hole. The components employed may or may not have leads. There are two schools of thought on this subject. Connections to the printed wiring may be made by soldering, thermal compression bonding, or by using conductive epoxy.

#### THIN FILM:

A circuit which employs one or more deposited thin film components on a common substrate material would be defined here as a thin film circuit. Present practice is to deposit resistors and capacitors, and attach the active components such as micro-diodes and pico-transistors. Some companies are working to develop methods for deposition of semiconductor materials. To date this has not been successful. Common materials for substrates are ceramic and glass. The pico-transistor is ideally suited for this approach because the total device size is only slightly larger than the semiconductor material itself. An example of the thin film technique is shown in Figure 6. The circuit is a six-transistor flip-flop developed by Varo Manufacturing Company.

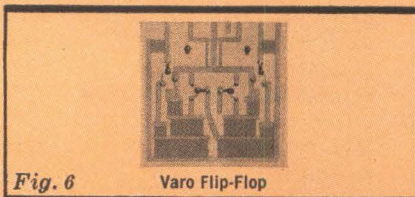

Fig. 6 Varo Flip-Flop

#### INTEGRATED CIRCUITS:

An integrated circuit is defined as an operational circuit where all active and passive functions are common to a solid material which is usually a semiconductor. There are certain types of circuits which can easily be integrated, such as logic circuits; i.e., flip-flops, NOR

gates, adders, etc. A photograph of a triple emitter transistor is shown in Figure 7.

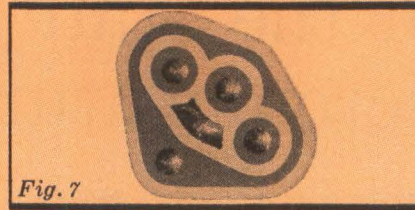

Fig. 7

Of the four approaches listed, the welded assembly is the most widely used. Several major missile programs employ them. Thin film work has been in process for a couple of years and is just now phasing into some production programs. Swiss-cheese packaging may be replaced by integrated circuits for digital application before it really gets off the ground. Availability of suitable components for Swiss-cheese has hurt this approach considerably. Several hybrid systems have been designed using the Swiss-cheese technique and some conventional packaged components. Integrated circuits should be phasing into new computer designs now. Analog circuits and non-digital circuits will probably not be replaced by integrated circuits for some time.

## Micro-Components

### 1. ELECTRICAL

#### CHARACTERISTICS:

Designs of microminiature circuits and sub-systems are being made for the most advanced systems; therefore, it is important that the electrical characteristics of the devices used be the most advanced. Two of the most advanced micro-devices just announced by PSI are the 1N3567 Micro-Diode and the 2N2214 Micro-Transistor. Both devices are diffused planar structures designed for high speed and low power logic applications.

Their characteristics, briefly summarized:

#### 2N2214 TRANSISTOR

$h_{FE} > 20$  @ 100  $\mu$ A and 3.0 volts.

$T_r < 20$  ns @ 10 mA.

$I_{CAO} < 5$  nA @ 15 volts.

$C_{CE} (sat) < .15$  volts @ 100  $\mu$ A

#### 1N3567 DIODE

$t_{rr} < 2$  ns — (10 mA to -6 volts).

$C_o < 2$  pf @ 0 volts.

$I_r > 100$  mA @ 1 volt.

Rectification efficiency  $> 60\%$  @ 100 mc.

These two advanced devices are ideally suited for digital logic circuits. Speed in excess of 10mc can be obtained in conventional diode coupled logic designs. A typical example of a high speed flip-flop circuit is shown:

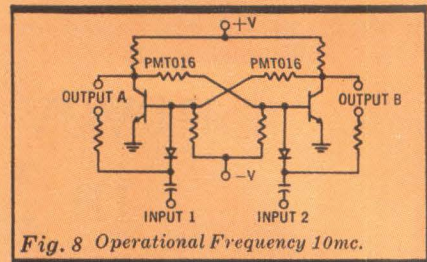

Fig. 8 Operational Frequency 10mc.

## Welded Circuit Assemblies

For several years PSI has been producing special high reliability welded assemblies of standard semiconductor components. The new logic module series has just been added to this wide line. This standard line includes the following types of circuits: PS1910, Dual Emitter Follower; PS1911, Dual Inverter; PS1912, Flip-Flop; PS1913, "AND" Gate; PS1914, "OR" Gate.

These circuits are 100% welded and are epoxy-encapsulated to give a very high shock resistance. All components used are high reliability parts. The following features apply to these products:

#### DUAL EMITTER FOLLOWER:

- Supply Voltage, +18 v., -6 v.
- Input Pulse Amplitude, +6.5 v. min. (on); +0.5 v. max. (off).
- Output Voltage Level, +6.0 v. min. (on); +1.0 v. max. (off); Fan-out, 5 flip-flops.

#### DUAL INVERTER:

- Supply Voltage, +12 v., -3.0 v.
- Input Pulse Amplitude, +4.5 to 6.0 v. (on); +0 to 1.0 v. (off).
- Output Voltage Level, +0.3 v. (off); +6.0 v. (on); Fan-out, 5 flip-flops.

#### FLIP-FLOP:

- Supply Voltage, +12 v., -3 v.
- Input Trigger, 4.5 v. to 6.0 v.
- Output Voltage Level, +6.0 v. min. (on); -0.3 v. max. (off); Fan-out, 5 flip-flops.

#### "AND" GATE:

- Supply voltage, +12 v.
- Input Level, +6.0 v. min. (on); 0.5 v. max. (off).
- Output Voltage Level: lowest amplitude level present on any of the five inputs; Fan-out, 5 flip-flops.

#### "OR" GATE

- Supply Voltage, +12 v.
- Input Level, 0 to 6 v.; Fan-in, 5 signals.
- Output Level, +6 v. min. (on); 0.5 v. max. (off).

Each circuit is designed for 2 mc operation. Photographs of the logic modules are shown in Figure 9.



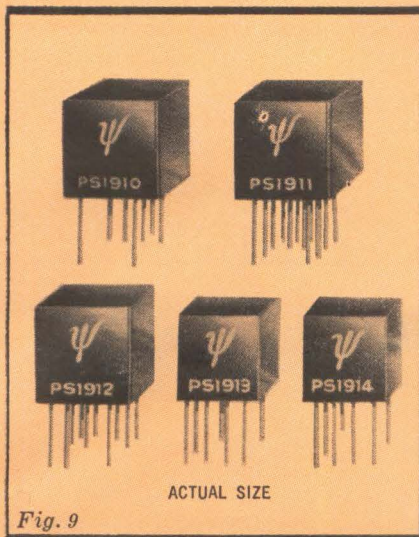

Considerable cost savings for any special digital circuit can be achieved by purchasing welded circuits from PSI. All parts are selected carefully by PSI, thus eliminating individual piece part incoming inspection testing in your plant. High direct labor costs, manufacturing overheads, and parts losses in your plant can be reduced. Fringe benefits which on the average amount to 22% of direct payroll can also be reduced. Capital equipment required for welding, testing and encapsulation is not required.

## Integrated Circuits

Within the past few months you may have seen articles describing TCL — Transistor Coupled Logic. This type of advanced design provides the same isolation and noise rejection features that have been achieved by diode coupled logic which has been widely used. TCL offers the advantages of higher speed and lower power dissipation when compared to direct coupled and resistance capacitance coupled logic techniques. A description of this technique is given below. In Figure 10 a typical diode coupled circuit is shown:

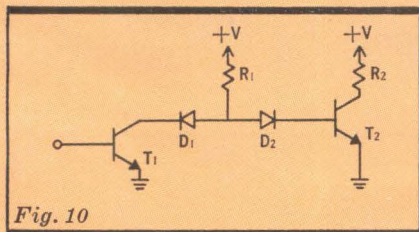

$T_1$  is initially "on" and current through  $R_1$  is steered through  $D_1$ . When  $T_1$  is turned off the current is steered through  $D_2$  to the base of  $T_2$  turning  $T_2$  "on".

By employing a transistor (see Figure 11), coupling between stages is achieved.

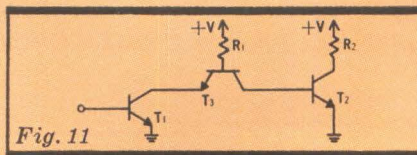

Because of the relatively large constant base current,  $T_3$  is always in saturation; this eliminates the delay caused by switching in and out of saturation. Propagation times of 1 nsec. through the coupling transistor have been measured. By eliminating the requirement for high speed and low capacitance diodes usually required in high speed digital circuitry, higher performance can be achieved in integrated circuitry at a lower cost to the user. In addition, the high forward drop of .6 volts which must be reached for conduction by silicon diodes has been reduced to a much lower voltage.

This preliminary work led to development of multiple emitter and base transistor structures. These structures, along with isolated collector regions, allow more circuitry for a given surface area of the silicon material. Since the yield of integrated circuits is a function of the area and the number of devices on a given area, it is important that the area used be relatively small. The flip-flop circuit shown in Figure 12 can be produced on dice .065" by .065".

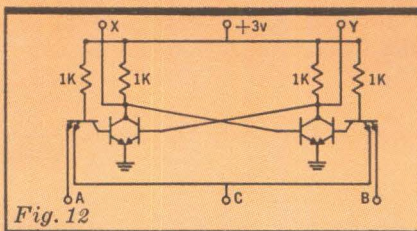

This area is approximately the size of low to medium power transistors. If integrated circuits were being produced in the same quantities as transistors are today, the cost of the integrated circuit would be comparable to today's transistor prices because of comparable yields and similar manufacturing processing.

Another circuit which has been developed is a "Universal" gate circuit. The circuit shown in Figure 13 can be used in "bread boarding" digital circuits. Various loads can

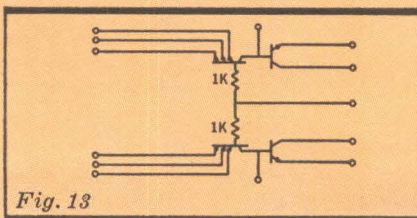

be connected to the output transistors and several fan-outs can be employed.

Flexibility of integrated circuits has been achieved by isolating each component on the "chassis" (high resistivity P-type silicon material). Circuits can be "wired" (vacuum deposition of connections) to customer requirements. Tooling to provide special customer circuits can be accomplished at relatively low costs for quantities of circuits in excess of 100. Circuit design is still the job of the circuit engineer and devices are still in the hands of component manufacturers. Circuits can be designed by the circuit designer using parts of integrated circuits and micro-components. Design tolerances can be checked and the circuit tested prior to tooling for integration.

With complete circuits available at much lower costs than today's conventional circuits and the size and weight several magnitudes less, high reliability can be achieved through redundancy at the circuit level. Special research programs studying redundant techniques are underway at PSI. Special processing of parts or circuits in extreme environments to achieve highly reliable parts may not be the answer to tomorrow's space programs. Self repairing machines employing redundant techniques may be the answer.

Typical performance characteristics of the isolated transistors and resistors are given below:

### 1. Transistor:

$$T_r < 10 \text{ ns}; T_P < 5 \text{ ns}; h_{FE} = 15 - 30$$

$$V_{CE}(\text{sat}) = 0.175 \pm .025 \text{ volts}$$

$$-55^\circ\text{C to } +175^\circ\text{C}$$

$$V_{BE}(\text{sat}) = 0.7 \pm .2 \text{ volts } -55^\circ\text{C to } +175^\circ\text{C}$$

### 2. Resistor:

$$R = 10 \text{ to } 5 \text{K}$$

$$T.C. = -0.3\%/^\circ\text{C } 0 \text{ to } -100^\circ\text{C}$$

$$= +0.2\%/^\circ\text{C } 0 \text{ to } 200^\circ\text{C}$$

$$C(\text{distributed}) \cong 3 \text{ pf}$$

### CONCLUSION:

Integrated circuits such as these can be produced to fulfill your requirements. The transistors and resistors are completely isolated. They can be wired to fulfill your circuit requirements.

Analog circuits and other non-digital circuits will not be successfully produced in integrated fashion for some time. Applications requiring special circuits can be fabricated by welded assembly techniques. Almost any semiconductor device can be produced in microminiature packages.

FEATURE II.

# Ultra-Stable Reference Units

## *New Achievements Help Overcome the Dangers of Overload Conditions*

In design of ultra-stable and reliable electronic circuits it is imperative that a specific voltage reference point be used. The relative stability of the circuits involved is then referred back to this particular reference point. We see that the ultimate reliability and stability in the circuits to be designed is therefore a function of the stability characteristics of the reference element. Recent developments have made possible an ultra-stable reference element in which ultra-stable circuit designs have been achieved. Reports show this element to possess a stability of five (5) parts per million (.0005%).

### What An Ultra-Stable Reference Unit Means in Circuit Designs:

The importance of stability can not be over stressed when designing

ultra-stable reliable circuits. Such devices make possible the design of ultra-stable constant current and constant voltage power supplies. Since these are an electronic and not a chemical device they can not be destroyed as a result of overload conditions. When used as a standard cell, such devices will recover rapidly from overloads that would normally destroy any other type of reference cell. The circuit designer can feel confident that his power supply reference element will not be susceptible to destructive overload conditions.

In regard to long term reliability, the circuit designer must be certain that his circuit will be stable over all the environmental conditions during the life of the equipment he is designing. Experiments have shown that this device may be sub-

jected to a temperature shock and still retain its stable operating point. This same stability has been achieved over long term operating conditions.

In pulse circuitry a reference element does not usually see a static load. The synchronous nature of the system places transient loading conditions on the reference source, and it is highly desirable that this element be switched from one load level to another, then back again to the original load level without shifting the operating point. This stability should be experienced throughout the operating load life and all environmental conditions of the equipment.

The availability of Ultra-Stable Reference Elements make all these and many other design goals realizable.

FEATURE III.

# For High-Speed Logic... Laminar™ Transistors

## *New data on the Performance of High Speed Logic Circuits*

Several design considerations, as well as experimental results, are presented for some commonly used logic circuit configurations. Switching time as a criteria of circuit performance is used as a basis of comparison, and the relative advantages of some commonly used circuits are presented.

The parameter most characteristic of the high frequency response of switching transistors is termed

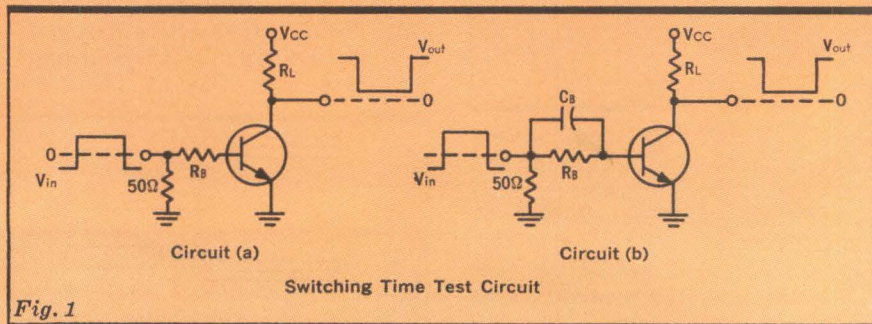

the switching time as measured in a circuit usually similar to that of Figure 1 (a). For high speed transistors, however, the circuit of Figure 1 (b) is more representative of actual circuit performance, since many high speed circuits employ either a speed-up capacitor or are dc coupled to a low impedance during turn-off such as a previous stage entering saturation. In fact, it may be shown that for most existing transistor types, it is not possible to exhibit switching times at ultrahigh speeds in the common emitter configuration for current driven switches. This is due to feedback or a "Miller effect" of the collector-base capacitance and the requirement that  $R_B$  be greater than  $h_{ie}$  in order to assure that  $I_{B1}$  and  $I_{B2}$  are constant. Thus, the resulting rise time is unduly long unless the transistor is severely overdriven. This gives a decided advantage to those transistor types which exhibit a smaller dependence of storage time upon circuit overdrive (Figure 2).

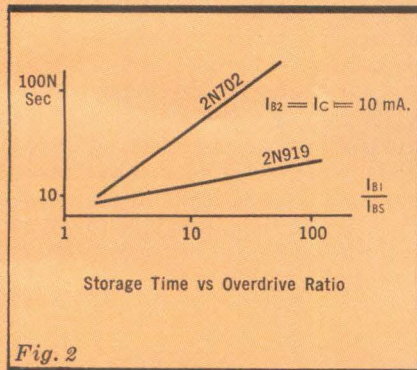

Fig. 2

$I_{B1}$  = turn-on base current.

$I_{BS}$  = base current required to just saturate the transistor under test.

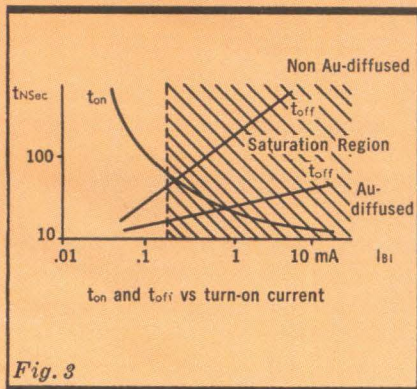

Fig. 3

Figure 3 shows the dependence of turn-on and turn-off times with turn-on current for the two transistor types indicated in Figure 2. As may be seen, the total switching time for the non-saturated type switch is minimized when the transistor is driven just to the edge of saturation. Total switching time for the transistor in which the stor-

age time has been largely reduced by gold diffusion techniques, is a minimum when the transistor is driven somewhat into saturation.

If a low impedance driving source is used, the turn-on current is initially very high, reducing the turn-on time to a minimum. The turn-off pulse may then be applied after the turn-on current has decayed to a low value, thus also reducing the turn-off time. Relative advantages of voltage driven switches is more clearly illustrated by the values indicated in Table I for the two circuits of Figure 1. The purpose of the speed-up capacitor in Figure 1(b) is to reduce the impedance of the driving source during turn-on and turn-off transients.

Circuit (a):

	$t_{on}$	$t_{off}$	$t_{total}$
m.a.d.t.	9	15	24 nSec
Epitaxial	11	27	38
Laminar	15	35	50
Mesa	20	60	80
Planar	25	75	100

Circuit (b):

	$t_{on}$	$t_{off}$	$t_{total}$
Laminar	5	5	10 nSec
m.a.d.t.	5	7	12
Epitaxial	6	8	14
Mesa	10	11	21
Planar	12	13	25

TABLE 1

It should be noted that the order of switching speed for the various transistor types is not necessarily the same, nor in the same ratio, for the two circuit conditions. It is, therefore, apparent that the specification of transistor switching time is not only device dependent, but to a great extent dependent on the type of circuitry employed.

#### RESISTOR TRANSISTOR LOGIC (RTL)

The simplest, most reliable method of coupling logic stages is with resistors in a manner similar to that shown in Figure 4.

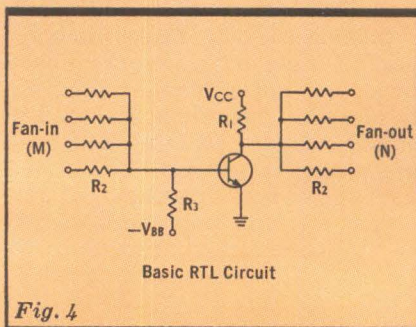

Fig. 4

Although this circuit does not readily lend itself to high speed operation for some of the reasons

just indicated, use of high speed transistors in this type of circuit may be desirable in order to reduce the effect of the storage time associated with large overdrive ratios. The severity of this problem is most easily demonstrated in the following example. Suppose it is desired to operate the transistor so that it will saturate under worst conditions, i.e., a low  $h_{FE}$  unit at low temperatures with only one input ( $M=1$ ) and a small number of outputs ( $N=Min$ ). The base current required to just saturate the transistor under these conditions would be:

$$I_{BS} = \frac{V_{CC} - V_{CE(sat)}}{R_1 h_{FE}} - N \left[ \frac{V_{CE(sat)} + V_{BB}}{(R_2 + R_3) h_{FE}} \right]$$

If all the inputs are ON simultaneously, the actual value of base current that is applied to the transistors is:

$$I_{B1} = M \left[ \frac{V_{CC} - V_{BE(sat)}}{R_1 + R_2} \right] - \frac{V_{BE(sat)} + V_{BB}}{R_3}$$

The overdrive ratio in this case would be:

$$\frac{I_{B1}}{I_{BS}} = M \frac{\left[ \frac{V_{CC} - V_{BE(sat)}}{R_1 + R_2} \right] - \frac{V_{BE(sat)} + V_{BB}}{R_3}}{\frac{V_{CC} - V_{CE(sat)}}{R_1 h_{FE}} + N \left[ \frac{V_{BE(sat)} - V_{CE(sat)}}{R_2 h_{FE}} \right]}$$

Assuming a 4 to 1 increase in  $h_{FE}$  between  $-55^\circ\text{C}$  and  $100^\circ\text{C}$  and a 3 to 1 variation in  $h_{FE}$  for a particular transistor type, the maximum overdrive ratio for a fan-in of 5 could be as high as 60. The advantage of a low storage time device under these conditions is illustrated in Figure 2.

#### RESISTOR CAPACITOR TRANSISTOR LOGIC (RCTL)

If a speed-up capacitor is used across the input resistances in a manner similar to that shown in Figure 1 (b), the effect of large overdrive factors may be largely reduced. As an example of the size of speed-up capacitor required to just neutralize the excess stored charge, consider the previous case. For a typical 2N919 with an overdrive factor of 60 the maximum excess stored charge under these conditions may be calculated from:

$$t_s \approx \frac{Q_s}{I_{B2}}$$

or

$$Q_s = t_s I_{B2} = 190 \mu\text{C coulombs}$$

The minimum value of capacitance required to neutralize this excess charge is:

$$C_{min} = \frac{Q_s}{V_{BE(sat)} + V_{i0}}$$

Since the input voltage is limited by the maximum reverse rating of the emitter-base junction, the minimum capacitance for this example will be:

$$C_{min} = \frac{190}{.85 + 5} = 33 \mu f$$

Assuming an average loop impedance during the turn-off transient proportional to the sum of the collector and base saturation resistances (approximately 100 ohms), the storage time for this example would be:

$$t_s \approx \frac{Q_s R_L}{V_{BE(sat)} + V_{in}} = \frac{190 \times 100}{5.85} \mu Sec$$

$$t_s = 3.2 nSec$$

The relative advantages of a speed-up capacitor for non-saturated type transistor switches would be equally beneficial. However, the value of capacitance required in this instance would be considerably larger. In general, it is desirable to minimize this value of capacitance in order to reduce the effect of stray noise sources.

#### DIODE TRANSISTOR LOGIC (DTL)

In the two preceding cases the transistor was assumed to be initially biased "OFF" and subsequently turned "ON" by the presence of a voltage at any one or more of the inputs. In this manner the transistor logic function may be described as a "NOR" gate for positive voltage levels.

Similarly, if the transistor were biased ON through a suitable divider network in the base circuit, any input at ground potential would turn the transistor OFF. This also may be described as a "NOR" gate only for zero or negative voltage levels (NPN transistors are assumed). Figure 5 shows the two possibilities for diode coupled NOR gates.

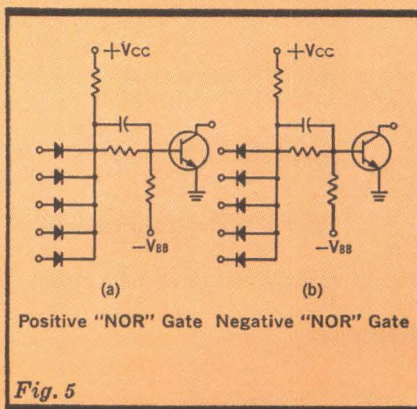

Fig. 5

Although the logic function for the two circuits are equivalent, the manner in which the transistor is turned off is not. In Fig. 5 (a) the transistor is driven off by a relatively high impedance. The speed-up capacitor in the position shown in Figure 5 (a) is therefore ineffective. The configuration shown in Figure 5 (b) is to be preferred if low switching times are desired. The requirements for the coupling diodes are high conductance as well as fast recovery in order to keep the turn-off loop impedance at a minimum.

#### DIRECT COUPLED TRANSISTOR LOGIC (DCTL)

Another technique particularly adaptable to silicon low level Laminar transistors is direct coupled transistor logic (Figure 6).

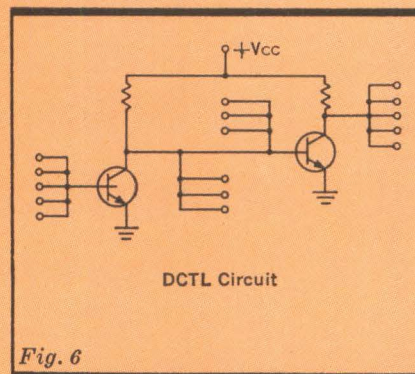

Fig. 6

Basically, the circuit operates on the principle that saturation voltage is of a sufficiently low value so the following stages are maintained in the cut-off condition. In this respect silicon transistors have an advantage over germanium since the critical base voltage is somewhat higher, approximately .7 volts for silicon compared to .3 volts for germanium. Also, the voltage levels are slightly larger for silicon transistors permitting a larger fan-out capability. Although the OFF-ON voltage margin is not as large or as well defined as in other logic systems, this circuit has the advantage of high reliability due to circuit simplicity and low operating power and is capable of very fast switching speeds. Disadvantages are the inherent lack of noise immunity and, in the case of germanium transistors, a limited reliable operating temperature range. In general, it is desirable to operate the transistor at low current levels in order to keep the collector saturation voltage to a minimum since the switching speed is proportional to  $V_{BE(sat)} - V_{CE(sat)}$ . Transistors with a low value of collector saturation voltage at low currents are, therefore, best suited for this use.

#### CURRENT MODE LOGIC (CML)

Recently, very fast switching times have been obtained by operating transistors in pairs and routing current through them alternately. In this manner the transistor is maintained out of saturation and avoids undesirable storage delay time. Figure 7 shows the basic current mode switching circuit.

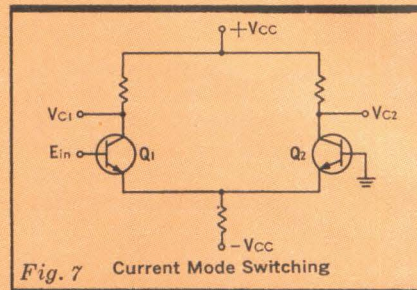
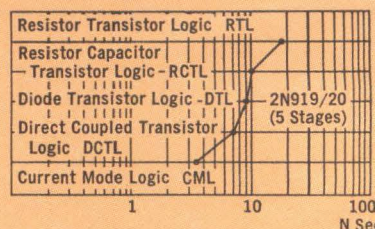

Fig. 7 Current Mode Switching

The obvious disadvantages of this type of circuit is the number of transistors required per logical input and the fact that identical stages cannot be coupled directly. This second difficulty may be overcome with the use of complimentary transistors, but few suitable high-speed transistors with complimentary characteristics are commercially available. Other than this, the circuit performance is relatively independent of device parameters, permitting a wide latitude in the selection of a transistor type for this kind of logic.

#### CONCLUSION

A summary of comparative switching speeds for a class of small geometry silicon laminar transistors, as a function of circuit configuration, is shown in the graph of Figure 8.



Propagation Delay Time vs Circuit Configuration Fig. 8

The method used to determine the propagation delay time is to cascade several stages and to measure the time interval between input and output pulses. The average propagation delay is then this value divided by the number of intervening stages. Although the circuits shown are presented in the order of increasing speed, the choice of logic configuration for a particular computer application will depend largely upon the system requirements as well as the transistor characteristics.

## FEATURE IV.

# Forward Transient Response of P-N Junction Diodes

*Now Even Faster to Meet the Demands of New Sophisticated Circuits*

Rapid advances in the design of computer systems have challenged both the semiconductor and computer industries. Where new sophisticated computer philosophies are required, so are new sophisticated semiconductor devices. Where high speed logic circuits are vitally needed, so are high speed logic semiconductors. Faster clock rates, shorter pulses and rise times are commonly encountered in computer design and it is vitally important to understand the effects of the semiconductor devices upon the circuit as well as the effects of the circuits upon the semiconductor.

Forward transient response studies are made on P-N junction diodes by rapidly switching the device from an initially unbiased condition to a condition of forward bias. The typical test circuit is shown in Figure 1. The response curve of Figure 1 is then studied as a function of the input conditions. A peak voltage is noted in the response curve and is related to the following parameters:

1. Directly proportional to input pulse current magnitude
2. Inversely proportional to input pulse rise time
3. Directly proportional to resistivity of the unmodulated bulk of silicon.

Simply stated, the peak occurs as a result of the un-modulated bulk resistance which at the instant of switching is a high impedance. As conductivity modulation occurs with mobile holes and electrons crossing the junction, the decreasing impedance hence lowers the peak voltage to the steady state. This steady state value corresponds to the voltage magnitude resulting from the forward current pulse. The area shown in Figure 1 that results at the end of the input pulse is the stored charge and will not be discussed here.

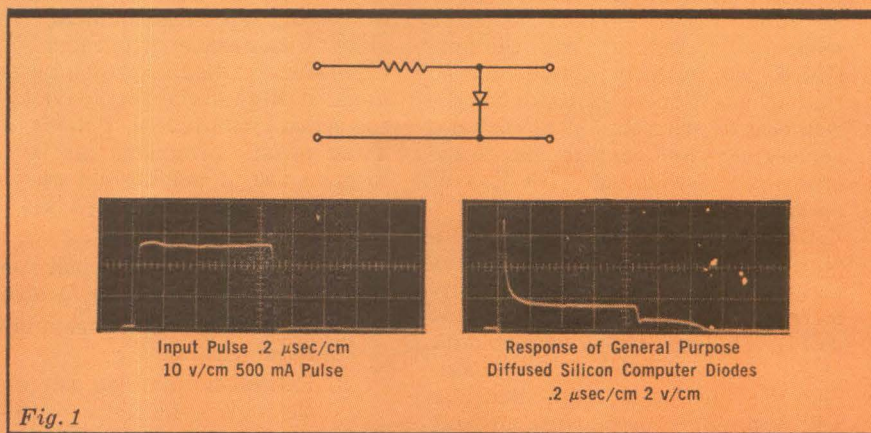

Fig. 1

This forward transient phenomena is important to all computer circuits, but particularly important in circuits where fast rise times and/or large current magnitudes are encountered. The voltage peak obtained is detrimental to computer circuits operation and it is of utmost importance that semiconductors have a minimum magnitude. The presence of this peak voltage "robs" current from the drive pulse and causes severe distortion. This can be troublesome in memory core driver applications, clamping and gating circuits.

The existence of this voltage peak has in the past been a problem to both device and circuit designers. BUT no longer is it a problem as we see in Figure 2. The left photograph shows the response of the silicon general purpose computer

device. In the right photograph we see the response of an equivalent conductance silicon Laminar computer diode.

Both diodes are medium conductance logic diodes and we see the obvious superiority of the Laminar diode to the general purpose computer diode. The response shown is that to a 20 nanosecond rise time 500 mA pulse.

The Laminar computer diodes obtain this superior response as a result of three diffusion processes which result in low resistivity. Minority carrier lifetime is killed and thus high conductance is achieved at nanosecond recovery times. Laminar computer diodes are thus capable of high speed low level logic or high conductance core driver application.

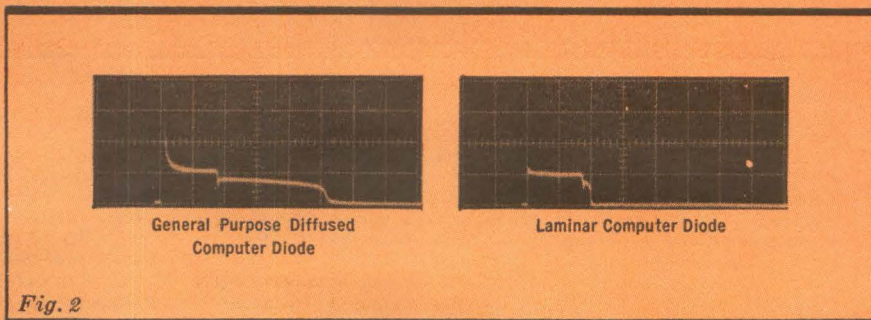

Fig. 2

## FEATURE V.

# Million Dollar Components

Recently, we read of a government official commenting on the fact that "nickel and dime" parts were causing costly missile and space failures. Perhaps the problem would be brought into focus and reliability programs taken even more seriously if these were known as "million dollar components" — because that's what they really cost when the mission failed. It must be remembered that in addition to initial cost, the real cost of any component includes replacement and maintenance costs plus costs associated with loss of operating time.

In most cases, the required reliability can be obtained by taking logical action based on reliability oriented thinking. The first thing to do is analyze the requirements. Many times the reliability assurance provided by MIL specifications will suffice and components meeting MIL standards will be adequate. However, a review of representative MIL specifications indicates that the failure rate can vary between 5% and 20% per 1000 hours. PSI can supply devices having reliability

of two or more orders of magnitude better than these figures.

For programs having stringent reliability requirements, it will pay to set up reliability assurance programs to meet the individual program need.

PSI works closely with designers in setting up semiconductor reliability assurance programs. The experience gained in providing millions of high reliability devices to the Atlas, Minuteman, Polaris, and Titan missile programs can be put to good use in helping set up your program. Five basic steps are involved:

1. Write device electrical specifications and define failure.
2. Determine device reliability requirements.
3. Establish qualified suppliers through evaluations of management, facilities, experience, etc.
4. Provide reliability assurance in your plant through close liaison with suppliers.
5. Provide failure feedback.

To make it easier for you to get parts and reduce costs, PSI has established a standard line of high-reliability semiconductors.

	Guaranteed Failure Rate (% per 1000 hours)	
	AQL	LTPD
PS 4559—Low Leakage Diode	0.008	0.02
PS 4560—High-Voltage Rectifier	0.008	0.02
PS 4725—Computer Diode	0.004	0.01
PS 4678 thru 4691 3.3 to 12 V Zener Diodes	0.004	0.01
PRT 1714—Planar Logic Transistor	0.008	0.1
PRT 499—Planar General Purpose Transistor	0.008	0.1

If your program requires high reliability silicon diodes and transistors, and you would like further information on PSI's capabilities in this area, it would be to your advantage to contact Reliability Division, 12955 Chadron Avenue, Hawthorne, California.

**FREE LITERATURE**—A PSI General Catalog as well as Specification Sheets on all PSI semiconductors discussed in these eight pages are available free on request. Write Pacific Semiconductors, Inc., 12955 Chadron Ave., Hawthorne, Calif. Attention: Frank E. O'Brien.

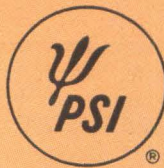

## Pacific Semiconductors, Inc.



A SUBSIDIARY OF THOMPSON RAMO WOOLDRIDGE INC.

12955 CHADRON AVE., HAWTHORNE, CALIF. • OREGON 8-4711, OSBORNE 9-2281 • TWX: HAW CAL 4270 • Cable Address: PSISOCAL

### SALES OFFICES

**NEW YORK**—870 Broadway, Newark 4, N. J. • Humboldt 4-5616  
TWX: NK 1010

**Boston**—471 Washington Street, Wellesley 81, Mass. • CEdar 5-0171  
**Syracuse**—4455 E. Genesee St., Syracuse, New York • Gibson 6-4600

**PENNSYLVANIA**—#4 Township Line Road, Philadelphia 17, Pa.  
RAndolph 5-1626 • TWX: JNKTN 1064

**Baltimore**—1811 N. Rolling Rd., Baltimore 7, Maryland • Windsor 4-3622

**ILLINOIS**—6957 West North Ave., Oak Park, Illinois • Village 8-9750

**Dallas**—P.O. 6067, Dallas, Texas • Riverside 7-1258

**Detroit**—1204 No. Woodward Ave., Royal Oak, Mich. • Lincoln 8-4722

**St. Paul**—1602 Selby Avenue, St. Paul 4, Minnesota • Midway 5-9351

**Missouri**—3100 Kingsley Drive, Florissant, Missouri • MAin 1-4353

**CALIFORNIA**—8271 Melrose Avenue, Los Angeles 46, California  
OLive 3-7850

**San Diego**—2223 El Cajon Boulevard—Room 211, San Diego, Calif.  
CYpress 7-3951

**Palo Alto**—701 Welch Road—Suite 205, Palo Alto, California  
DAvenport 1-2240

- used in communication networks in 18 countries.
- oscillator cavities and T.W.T. circuits available or 'tailored' to individual requirements.

H-wave Oscillators  
Range 5.6 to 7.8 Gc/s

Klystrons

Coaxial Line Oscillators  
Range 0.5 to 5 Gc/s

Backward Wave Oscillators  
Range 4 to 40 Gc/s

Travelling Wave Tubes  
Medium power and low noise tubes,  
Range 2.5 to 7.5 Gc/s

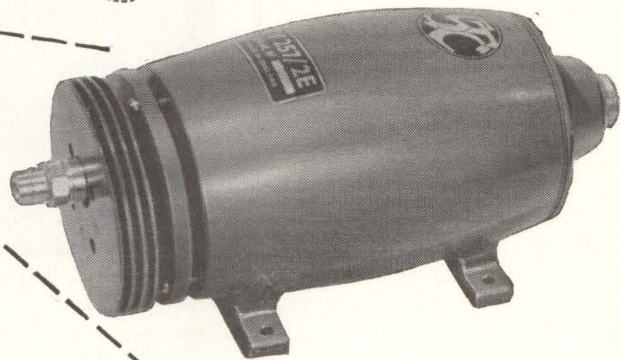
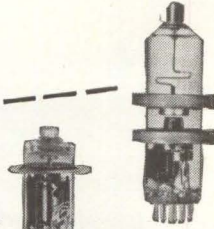
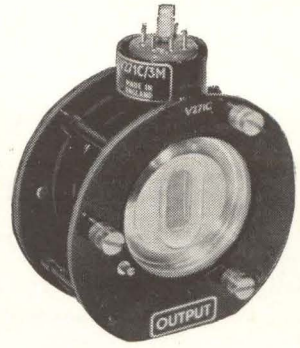

# STC

## MICROWAVE TUBES

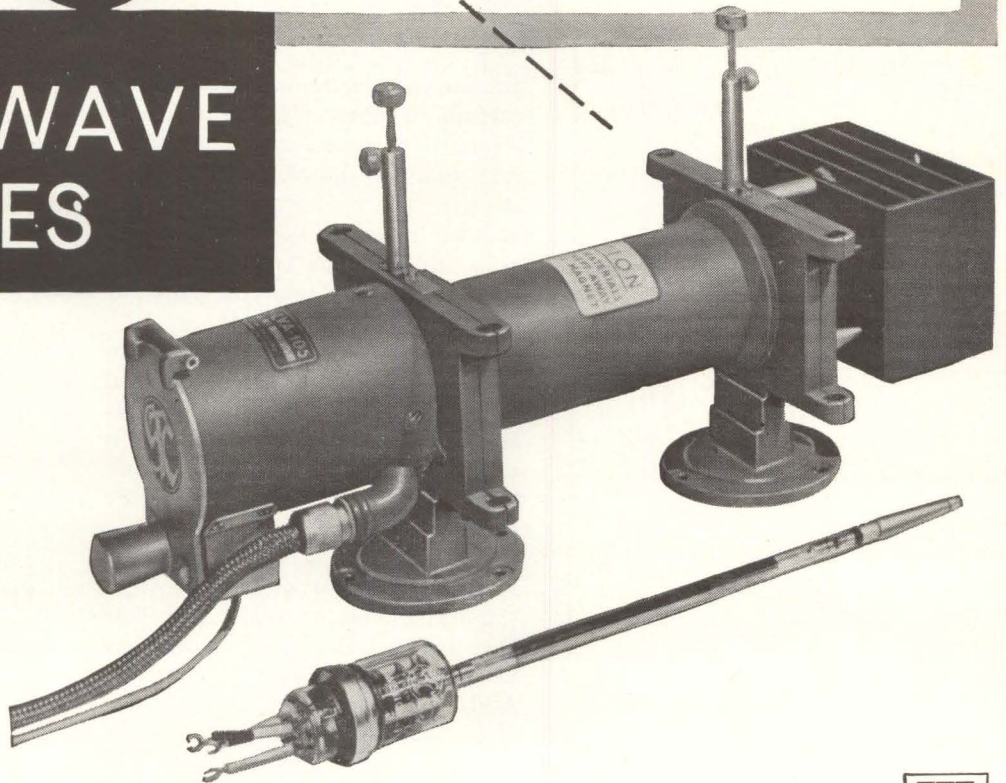

Send for brochure MS/113—  
STC MICROWAVE TUBES



61/13MS

**Standard Telephones and Cables Limited**

VALVE DIVISION: BRIXHAM ROAD • PAIGNTON • DEVON • ENGLAND



# Kink Effect in Bismuth Semiconductors

MAY LEAD TO A NEW CLASS OF HIGH-SPEED DEVICES

OBSERVATIONS of an electric characteristic of bismuth, made by Leo Esaki of the IBM Thomas J. Watson Research Center, shows that if the electrons moving in semi-metals can be controlled, new high-speed amplifiers and switches may result. This work will lead to further investigation of the semiconductive properties of bismuth, antimony and arsenic, and the application of these semi-metals to solid-state devices.

Esaki applies strong electric and magnetic fields, at right angles to each other, across a single-crystal of ultra-pure bismuth at temperatures close to absolute zero ( $-459^\circ\text{F}$ ).<sup>1</sup> Under these conditions, bismuth does not follow ohm's law, but instead, an abrupt change or kink appears in its characteristic con-

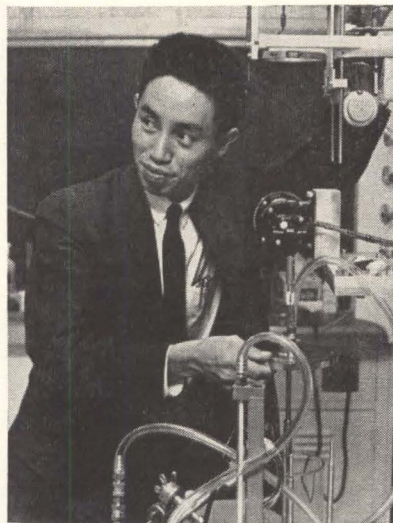

*Leo Esaki adjusts apparatus used to investigate nonlinear conduction behavior of bismuth at low temperatures and when subjected to strong electric and magnetic fields*

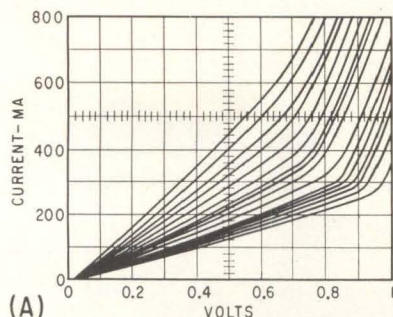

(A)

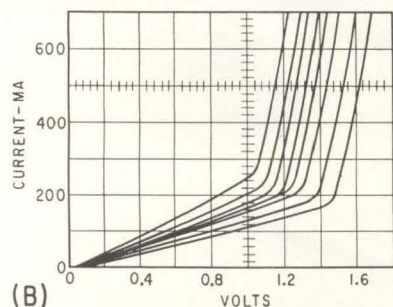

(B)

Conduction characteristics of bismuth show sharp nonlinearity at a critical electric field level. Graph (A) represents characteristic curves for a range of magnetic fields between 6 and  $13\frac{1}{2}$  kilo-oersteds taken in increments of  $\frac{1}{2}$  kilo-oersted. In (B) the curves are shown for a range of magnetic fields between 14 and 21 kilo-oersteds taken in increments of 1 kilo-oersted

duction pattern as the fields reach a certain strength, see drawing. This strong non-linear conduction behavior; that is, the sharp change in slope in the current-voltage curve at a high electric field is called the kink effect. Each trace, shown in the graphs, was taken at constant transverse magnetic fields.

Esaki's kink has never before been reported, and its origin is still to be determined. Esaki and his associates believe the kink is caused by an interaction between tiny sound waves and electrons inside the pure bismuth.

The magnetoresistance drops at least an order of magnitude from the normal magnetoresistance after the onset of the kink. The magnetic field dependency of the kink field  $E_{\text{kink}}$ , is a very simple relation,  $E_{\text{kink}} = aB$ , where the constant  $a$  is  $\approx 10^{-3}$  volt/cm oersted over the whole range of the applied magnetic field, no matter what the length of the specimen. However, both the sharpness of the kink and the kink field strength are fairly sensitive to the crystal orientation

when the transverse magnetic field is rotated.

The motion of a charged particle of mass  $m^*$  and velocity  $v$  in a strong magnetic field  $B=B_z$  and an electric field  $E=E_y$ , perpendicular to each other, is classically given by a cyclotron rotation of angular

$$\text{frequency } \omega = \frac{eB_z}{m^*c} \text{ and,}$$

$$\text{radius } r = \frac{m^*cv}{eB_z}$$

and a motion of velocity  $v_x = \frac{cE_y}{B_z}$

in the  $x$  direction, which is independent of both the particle's mass and its energy and the sign of its charge. In Esaki's experiment, this velocity  $v_x$  has turned out to be approximately  $10^8$  cm/sec at the kink electric field, no matter what the magnetic field is. This numerical value, moreover, seems fairly comparable to the sound velocity in bismuth. This fact may suggest that strong electron-phonon interaction occurs when the drift velocity  $v_d$  reaches this critical value.

Esaki can occasionally see an occurrence of high frequency oscillation when the applied field exceeds the kink field. The frequency is  $\approx 500$  to 1,000 and KC is independent of the external circuit.

## REFERENCE

- (1) Leo Esaki, New Phenomenon in Magnetoresistance of Bismuth at Low Temperatures, Physical Review Letters, Jan 1, 1962.

## Large-Scale Production Of Pure Hydrogen Gas

A PURIFYING unit with a capacity of  $3\frac{1}{2}$  million cubic feet of gas per month has been placed in operation by National Cylinder Gas Division of Chemetron, adjacent to NCG's hydrogen-producing plant in Los Angeles. Company announced that additional purifying units of this kind will be planned at other hydrogen-producing locations because of increasing demands for the ultra-



available now for the **ELECTRONICS INDUSTRY**

# COMPLETE ELECTRON BEAM SYSTEMS

## Applications:

- evaporation
- interconnection welding and joining
- epitaxial growth
- melting and zone refining
- surface conditioning
- encapsulation
- high temperature testing
- etching

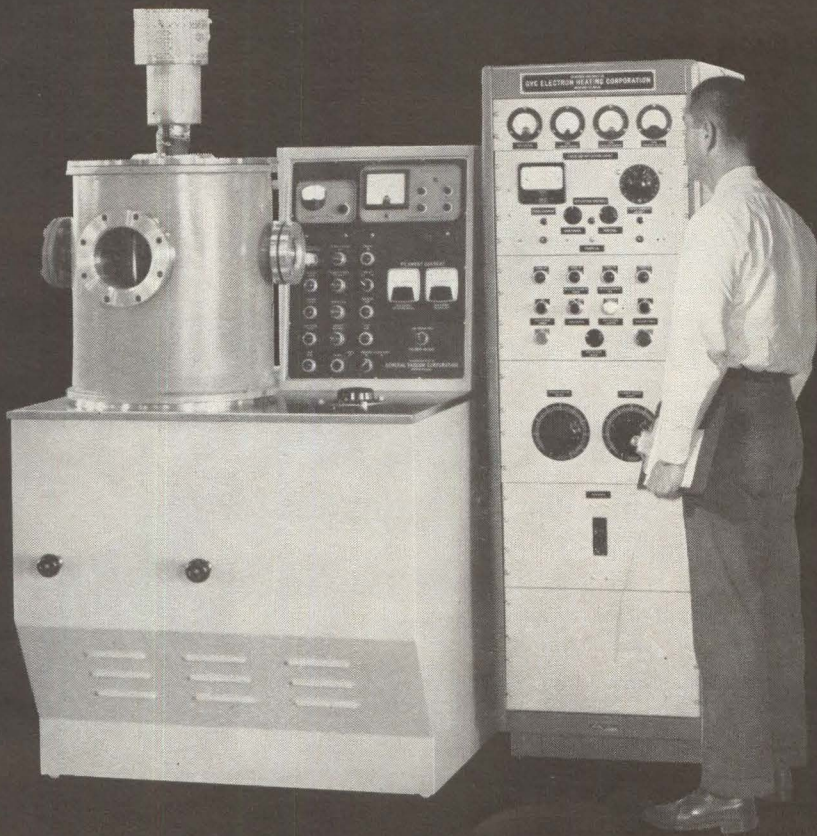

EHC — custom electron beam systems from standard modules

**Equipment features** — temperatures in excess of 7000°F • compact, modular construction • instantaneous automatic regulation of emission current • magnetic focus and deflection of beam • pulsed emission and focus • adjustable over-load current protection • no exposed high potential • system efficiency in excess of 90% • safe and easy operation • programmed operation

Headline news in electron beam systems and techniques is being made by Electron Heating Corporation. EHC has a unique application-engineering "task force" to work with you in problem-solving. Included in the "task force" are *process and application engineers* with an intimate knowledge of the field; *electronic design engineers* who have pioneered in the development of high power electron beam systems and controls; and *vacuum engineers* with an extremely broad background in all phases of vacuum technology. Important, also, is the feature that EHC Systems designs use **STANDARD PROVEN MODULES** (a variety of completely tested gun designs, power supplies, controls and vacuum systems with known characteristics). *Send for literature . . . or tell us about your requirements.*



modular design

## ELECTRON HEATING CORPORATION

an affiliate of General Vacuum Corporation

80 Hicks Avenue

• Medford 55, Massachusetts

proven electron beam systems for research, development and production

## High Vacuum Systems and Equipment

- vacuum furnaces
- pumping systems
- altitude simulation
- ultra-high vacuum
- evaporators
- inert gas welding
- leak detection
- power supplies
- components
- custom designed systems

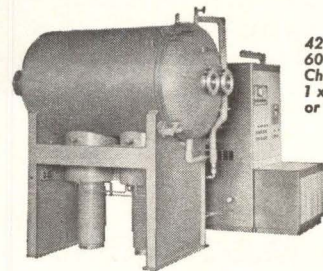

42" Dia. x  
60" Long  
Chamber for  
1 x 10<sup>-8</sup> Torr  
or Lower

**GVC GENERAL VACUUM CORPORATION**  
80 Hicks Avenue • Medford 55, Massachusetts

# 10 Megohms

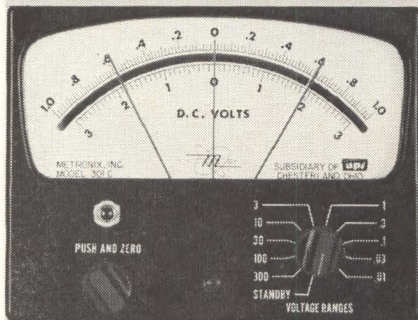

## PLUS Control

### An electronic voltmeter with a meter-relay

This happy combination makes an extremely versatile and acute instrument.

It has critical measuring ability that goes with high input impedance, in space-saving panel-mounting style.

It also has the reliable, simple control of a locking contact meter-relay, with adjustable set points.

Many difficult functions can be easily controlled: conductivity cells, life testing of components or systems, production testing and sorting, automatic Go-No Go of missile circuits.

### Ready When Needed

Metronix DC instruments such as Model 301-C-CMR (illustrated) have input resistances up to 10 megohms. AC input impedances go as high as 5 megohms. Like all Metronix panel-mounting electronic voltmeters (PMEV's), they are always connected—immediately available for continuous monitoring of critical parameters.

Send for data sheets describing Metronix PMEV's in single or multiple ranges, DC or AC, with either meter-relays or conventional indicating meters.



**METRONIX**  
The Electronic Instrument Division  
of Assembly Products, Inc.  
Chcsterland, Ohio

Telephone: HAmilton 3-4440

pure gas in transistor manufacturing, specialized welding, annealing and furnace operations, and in the production of tungsten and molybdenum.

Heart of the purifying process, used previously only on a pilot scale, is a series of cells filled with bundles of needle-size tubes made of an alloy of palladium, one of the less expensive but still rare metallic elements of the platinum group. These diffusion cells were produced for NCG by J. Bishop & Co. Platinum

Works, Malvern, Pennsylvania.

Normal-purity hydrogen is first compressed and passed through caustic driers. Then the gas is piped into diffusion cells. Only hydrogen can pass through the palladium alloy membrane, and all impurities are continuously bled off in a small stream of hydrogen to a stack where they are burned and discharged.

The hydrogen gas produced is described as completely pure by any known method of analysis.

## Massive Resistors for Project Mercury



GLASS RESISTORS four feet long serve as dummy antenna loads for testing and calibrating transmitters and as power dissipating terminations for rhombic and other transmitting antennas.

Twenty-two of these massive resistors are being used for the 16-station world-wide Mercury-tracking network. They were chosen because of their very low and almost uniform reactance at high frequencies. They can be brought instantly to full rated output at  $-40^{\circ}\text{C}$ , are effectively cooled at  $100^{\circ}\text{C}$ . They were specified for the tracking network by Technical Materiel Corp. of Mamaroneck, N. Y., the units were produced by Corning Electronic Components, a department of Corning Glass Works.

The resistors consist of a tin-oxide film fused into Pyrex glass cylinders five inches in diameter. A

silicone coating protects the unit. The resistive elements were spiraled according to specifications of Technical Materiel engineers to obtain specific ohmic values, uniform heat dissipation, and minimum series inductance and shunt capacitance for each installation.

For minimum installation effort and maintenance, the resistors are placed vertically in vented fiber glass-reinforced plastic cases designed for pole or frame mounting. Both balanced and unbalanced loads were designed, using 140 and 300-ohm resistors to obtain 70 and 600-ohm impedances. The loads are used with Technical Materiel's 10,000-watt GPT-10K transmitter and 40,000-watt GPT-40K transmitter.

Operating frequencies of the Mercury network lie between 2 and 28 Mc. Even at the top of the range, reactance is virtually flat.

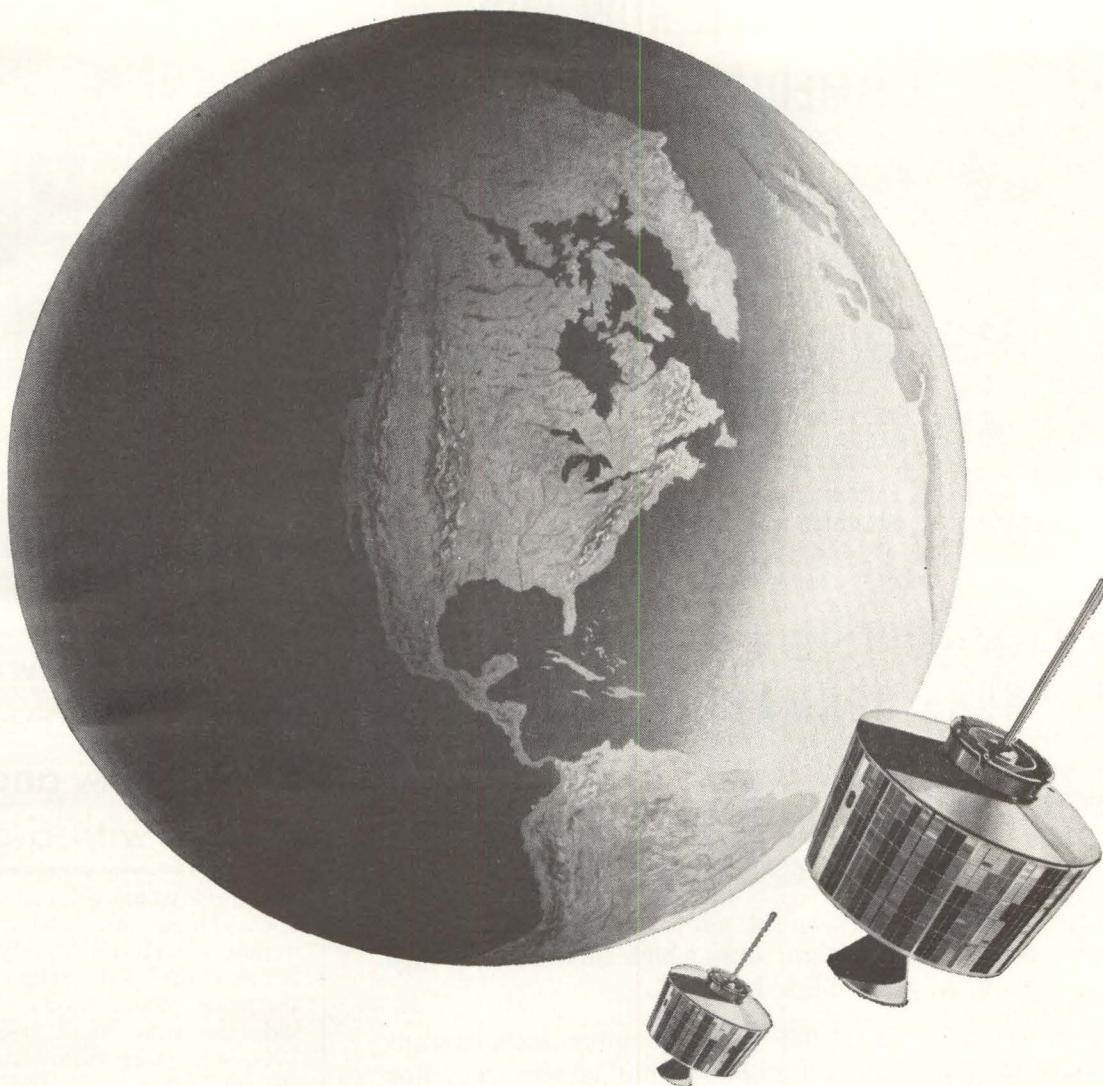

# circuit designers...is your appointment in space with Hughes?

Today at Hughes you will find one of the country's most active space-electronics organizations. Important new and continuing projects, including SURVEYOR, SYNCOM, ARPAT, BAMBI and POLARIS guidance systems are growing at unprecedented rates.

This vigor promises the qualified engineer or scientist more and bigger opportunities for both professional and personal growth.

Many immediate openings exist. The engineers selected for these positions will be assigned to the following design tasks: the development of high power airborne radar transmitters, the design of which involves use

of the most advanced components; the design of low noise radar receivers using parametric amplifiers; solid state masers and other advanced microwave components; radar data processing circuit design, including range and speed trackers, crystal filter circuitry and a variety of display circuits; high efficiency power supplies for airborne and space electronic systems; telemetering and command circuits for space vehicles, timing, control and display circuits for the Hughes COLIDAR\* (Coherent Light Detection and Ranging).

If you are interested and believe that you can contribute, make your appointment today.

Please airmail your resume to:  
**Mr. Robert A. Martin**  
**Supervisor of Scientific Employment**  
**Hughes Aerospace Divisions**  
**11940 W. Jefferson Blvd.**  
**Culver City 8, California**  
We promise you a reply within one week.

Creating a new world with ELECTRONICS

**HUGHES**

HUGHES AIRCRAFT COMPANY  
**AEROSPACE DIVISIONS**  
An equal opportunity employer.

BALTIMORE  
WASHINGTON

WINSTON-SALEM

ORLANDO  
ST. PETERSBURG

COCOA BEACH  
MELBOURNE  
W. PALM BEACH  
HOLLYWOOD-FT. LAUDERDALE  
MIAMI

**IN STOCK NOW FOR  
IMMEDIATE DELIVERY**

**FROM ALL THESE  
ELECTRONIC  
WHOLESALERS  
LOCATIONS**

## TEXAS INSTRUMENTS NEW 2N985 GERMANIUM EPITAXIALS



- Guaranteed  $V_{CE(sat)}$  of 0.3 v max @ 100 ma
- Guaranteed  $h_{FE}$  of 60 min @ 100 ma
- Guaranteed  $f_T$  of 300 mc min

These ultra-high-speed p-n-p mesas combine high dissipation and high beta at **high current levels** with low  $V_{CE(sat)}$  and high  $f_T$ .

Apply these new TI 2N985 units to your high-current logic applications wherever high fan-out is required. For **immediate delivery...factory prices...call Electronic Wholesalers now!**

### FROM WASHINGTON, D. C. TO FLORIDA... ONLY ELECTRONIC WHOLESALERS OFFERS YOU:

♦ **Doorstep delivery of TI devices in hours** — local in-depth stocks plus local delivery facilities all along the Eastern Seaboard assure availability with no delay!

♦ **TI units for every need** — high-quality, use-proved devices for virtually every application... and Electronic Wholesalers stocks all types in depth: TI silicon and germanium transistors, diodes and rectifiers, precision carbon film resistors, **sensistor®** silicon resistors, **tan-TI-cap®** tantalum capacitors, silicon controlled rectifiers.

Your Authorized  Distributor

## ELECTRONIC WHOLESALERS, INC.

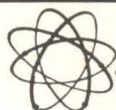

MIAMI, FLORIDA 9390 N.W. 27th Ave. Tel: Oxford 6-1620  
ORLANDO, FLORIDA Tel: GArden 3-6411  
HOLLYWOOD-FT. LAUDERDALE, FLORIDA WAbash 3-2204  
MELBOURNE, FLORIDA 1301 Hibiscus Blvd. Tel: PArkway 3-1441  
COCOA BEACH, FLORIDA Tel: SU 3-2206  
BALTIMORE, MARYLAND 3004 Wilkens Ave. WI 5-3400  
ST. PETERSBURG, FLORIDA Tel: ORange 1-5171  
WEST PALM BEACH, FLORIDA Tel: MELB 7138  
WASHINGTON, D. C. 2345 Sherman Ave., N. W. HU 3-5200  
TWX: MM 186 Tel: ORange 1-5171  
TWX: MELB 7138  
TWX: WA 663  
832-1766  
HU 3-5200  
TWX: WA 663

WINSTON-SALEM, N. C. • Dalton, Inc. • Subsidiary of Electronic Wholesalers, Inc., 938 Burke Street • Tel: PArk 5-8711 • TWX W. SAL. 373

## NEED AC-OPERATED MILITARY RELAYS?

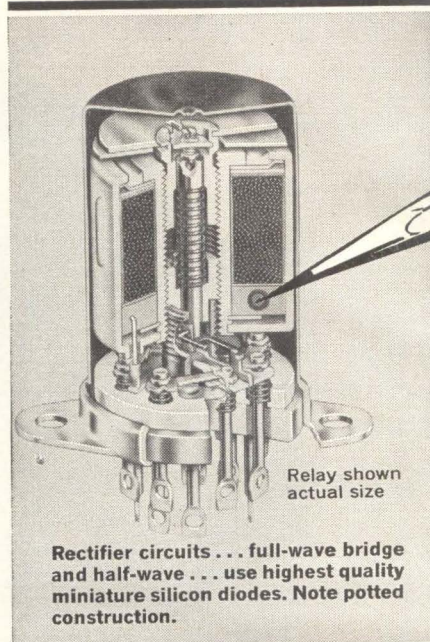

### For reliable switching ... try "Diamond H" Series RA and SA relays with a-c coils

These relays for 400 cps and 60 cps operation are identical in size and weight to Hart's widely specified Series R and S d-c relays and meet the same specifications\*. They provide the same shock resistance (to 50G), the same vibration resistance (to 20G-2000 cps), and the same performance under temperatures ranging from  $-65^{\circ}\text{C}$  to  $+125^{\circ}\text{C}$ . Contact ratings from dry circuit to 10 amps, 115 volts a-c resistive and 30 volts d-c resistive.

The "Diamond H" line includes hundreds of standard models and special variations are possible. Ask for literature and specification list.

\*Like the R and S series, they meet the requirements of MIL-R-5757C. Models are also available to fill the requirements of MIL-I-6181.



THE **HART**

MANUFACTURING COMPANY  
202 Bartholomew Avenue  
Hartford 2, Conn.  
Phone Jackson 5-3491

CIRCLE 135 ON READER SERVICE CARD  
electronics

# WE CAN HELP YOU...IF...

If you're shopping for high performance relays, Leach makes the kind of relays that best resist heat, shock and vibration ...the kind planes, missiles, computers and other electronic equipment use. And we've

been in this relay race for 42 years.

Here are some of the relays Leach makes to meet the exacting requirements in hundreds of applications. Which one do you need?

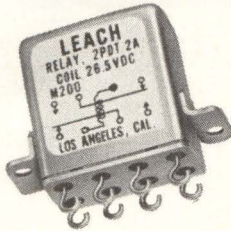

**SUBMINIATURES.** A complete line of crystal can relays gives you big performance in small packages in every standard relay configuration. Standard, Half-Size, Sensitive and Magnetic Latch in 0.20 inch grid spacing and "lazy "S" header design. Each type is capable of switching loads from low level to 2 amp in aerospace and electronic control applications. Bulletin CC-861.

**BALANCED-ARMATURE RELAYS.** Offer high resistance to shock (50 G's) and vibration (15 G's to 2000 cps) in 5 to 15 amp switching. They meet or exceed MIL-R-6106, MIL-R-25018, and MIL-R-5757D. Choice of over 4000 variations of 20 basic types. Bulletin BA-859.

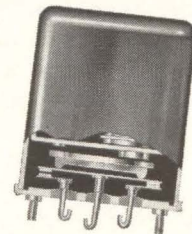

**ROUND CAN RELAYS.** This family group comes in contact configuration of 2, 4, and 6 PDT and in contact ratings ranging from dry circuit to 10 amps. Bulletin RC-300.

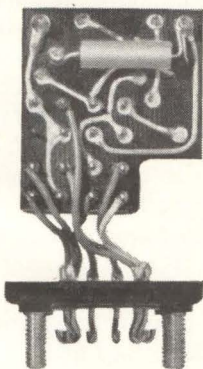
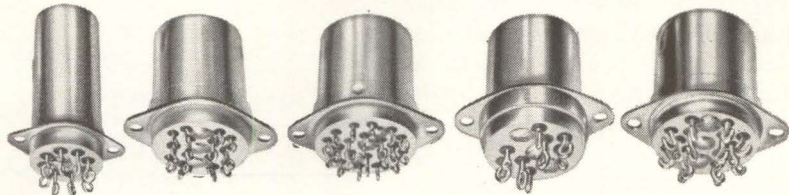

**TIME DELAY RELAYS.** This optional output, off-the-shelf line is made with precision printed circuit construction. Includes time delays on release and time delays on operate—in a timing range of 100 milliseconds to 60 seconds. Available with fixed or adjustable timing to meet your most critical requirements. And they're all 100% inspected during manufacture to insure highest reliability! Bulletin TD-200.

## THERE'S MORE...

Write Leach right now. Get all the facts and specs on all the relays above. Or call in a Leach Sales Engineer for help on any critical application problem.

# LEACH

Seattle 8, Washington  
South Annex Bldg., Room 201  
King County Airport,  
Boeing Field—PArkway 5-6978

Palo Alto, California  
814 San Antonio Road  
YOrkshire 8-4408

New York, New York  
405 Lexington Avenue  
Suite 3204  
YUkon 6-2520

Waltham, Massachusetts  
235 Bear Hill Road  
TWinbrook 9-1930

Los Angeles 17, California  
1101 Wilshire Blvd.  
HUnTley 2-0790

Dayton 2, Ohio  
333 W. First St., Room 250  
BAldwin 2-8652

Washington, D. C.  
1700 K Street, N. W.  
Suite 307 — STerling 3-1147

**LEACH CORPORATION** 18435 SUSANA ROAD, COMPTON, CALIFORNIA  
EXPORT: LEACH INTERNATIONAL S. A.

# Static Electricity Can Kill Transistors

By DONALD G. STROH

Electronics Div., B. K. Sweeney Mfg. Co., Denver, Colo.

A LARGE MANUFACTURER recently noted an extremely high reject rate on a transistorized subassembly being produced for a missile. The rejections were caused by bad transistors, although all transistors were tested by the quality control department before they were accepted. One theory of the cause of failure was that the transistors were being punctured by electrostatic high voltage generated in unpacking the assembled unit from its polyethylene wrapper. The polyethylene wrappers were replaced with a wrapper made of aluminum foil but the high reject rate continued.

A survey to determine and evaluate the source of static generation throughout the entire production assembly of the unit was then made. Although static voltages exist everywhere, the actual problem begins when a capacitance of any appreciable magnitude is allowed to store a static charge. If a capacitance becomes charged electrostatically, it is a source of stored energy and will discharge to the first object it touches.

Of the various capacitances found on the assembly line, body capacitance of the assemblers was one of the most important. The chair tops on which the personnel sat were of varnished wood, a good static generator when brushed by a non-conducting material such as cloth-

TABLE—STATIC VOLTAGE GENERATED BY WALKING.

Body was initially charged to 2,100 volts. In an independent test in which the body was not initially charged, no increase in the rate of voltage rise was noted.

Step No.	Foot Position	Time in Sec. To 80 Percent Voltage	Max. Rate of Voltage Rise Per 0.01 Sec.	Total Voltage
0	Standing with left foot flat and right heel touching floor	—	—	2,100
1	Left toe leaves floor	0.133	115	3,500
	Left heel touches floor	—	—	2,400
2	Right toe leaves floor	0.133	113	3,750
	Right heel touches floor	—	—	2,600
3	Left toe leaves floor	0.216	167	4,300
	Left heel touches floor	—	—	3,750
4	Right toe leaves floor	0.316	90	4,600
	Right heel touches floor	—	—	3,950

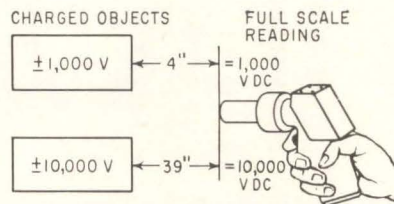

FIG. 2—Static gun indicates voltage of charged objects

ing. The floor was waxed asphalt tile, which did not provide a discharge path to ground at an adequate rate for safe dissipation. Merely walking across such a floor can generate electrostatic voltages. The difficulty in applying time formulas to problems of electrostatic hazards is that too many assumptions are often necessary. The capacitance often is not known accurately, as in the case of a person rising from a stool, and the resistance of shoe to floor varies with contact pressure. If a formula is used to determine a value of resistance for the removal of a charge in a given time, the time available often used is 0.001 second. Assembled personnel were not required to

wear special clothing; consequently, various rayons, nylons and dacrons were other sources of static generation. The tops of the assembly benches were of a high dielectric material with the same general effect as the waxed, non-conductive floor.

The human body, with a capacitance as given approximately by Fig. 1, frequently accumulates a static charge generated by contact of the shoes with floor coverings and by participation in various manufacturing operations. Charge generation due to walking is shown in the table, which illustrates the voltage available to puncture a transistor when a technician takes but four steps without conductive soled shoes. In dry weather, or in rooms where humidity is low, static charges on the bodies of workers may accumulate to a potential of several thousand volts.

Thus, in certain locations, some method of grounding the worker is necessary. Workers should wear special conducting shoes and should stand on grounded, non-ferrous metal plates or conducting floors. Care must be taken, however, not to allow the sole of the shoes, the

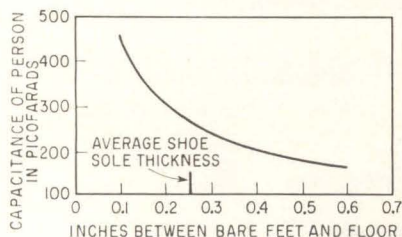
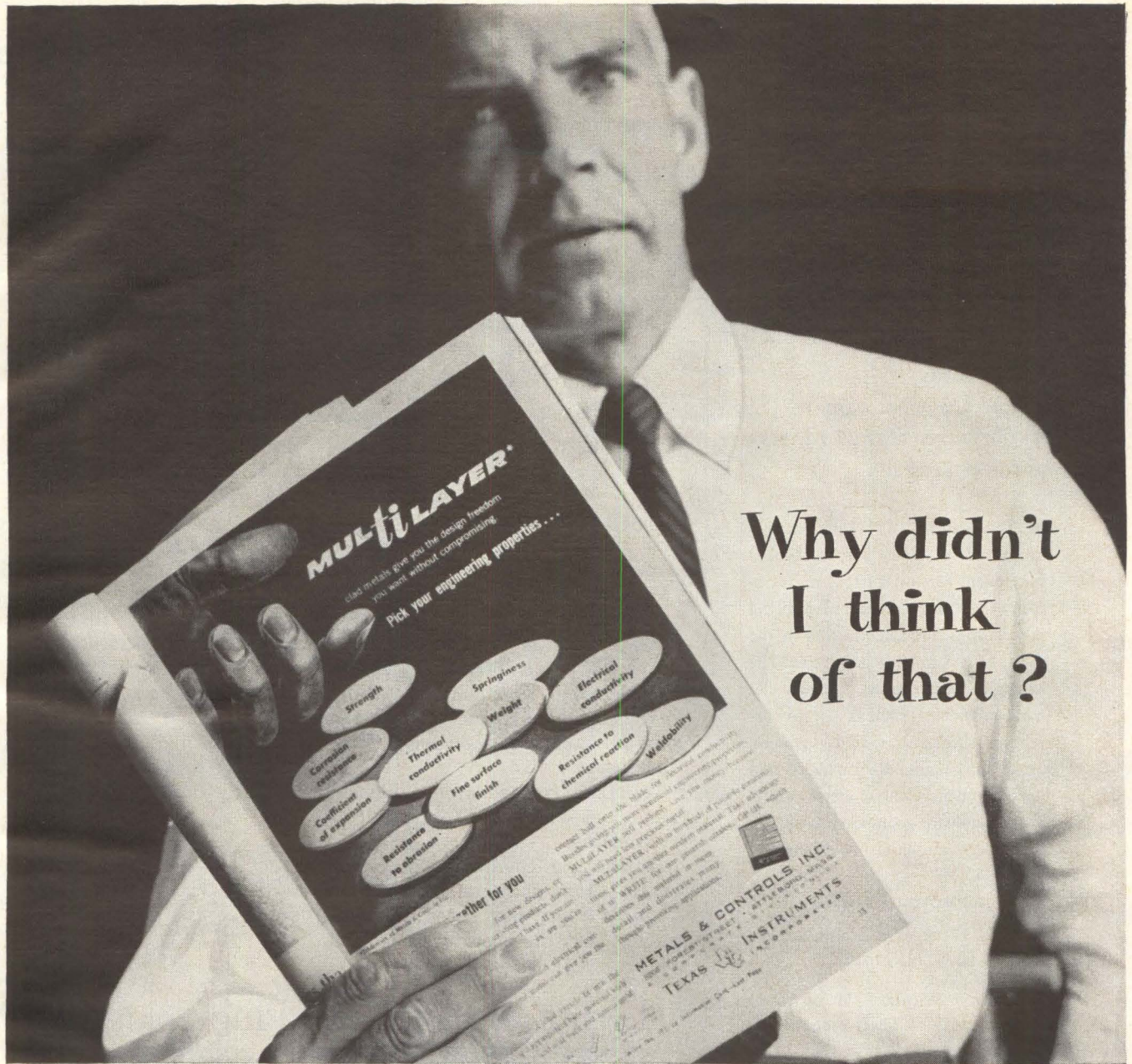

FIG. 1—Capacitance from person to floor is enough to store a charge that can puncture a transistor



Why didn't  
I think  
of that?

**MULTi LAYER\*** Clad Metals Combine The Exact Operating Properties I Must Have.

This design engineer has just realized a fact we wish more people would discover. MULTi LAYER CLAD METALS PROVIDE MORE COMBINATIONS OF OPERATING CHARACTERISTICS THAN ANY SINGLE MATERIAL OR ALLOY.

If you need a spring with high conductivity, superior elastic properties, high temperature strength and easy weldability, no single spring alloy can satisfy all the requirements. MULTi LAYER clad spring metals can!

If a tube for chemical processing must have a clean, corrosion resistant, stainless steel surface, high thermo conductivity, plus high forming ductility for flaring and bending; no

single material can satisfy all these requirements. MULTi LAYER clad tubing can!

Therefore, why compromise? Why be limited to only partial reliability in your components when, with MULTi LAYER clad metals, you can get maximum satisfaction?

You specify the engineering properties you need . . . we'll put the metals together for you — and even make the components in many cases. Find out about this modern design material. Call us or write for our illustrated brochure GP-1.



*For materials and components come to Metals & Controls*

\*Trademark of Metals & Controls Inc.



**METALS & CONTROLS INC.**  
1301 FOREST ST. • ATTLEBORO, MASS.  
A CORPORATE DIVISION OF  
**TEXAS INSTRUMENTS**  
INCORPORATED

## reliable, low-cost micro- microammeter

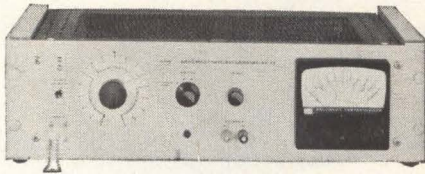

*Model 414 offers high performance over 17 ranges for just \$295.00!*

● The Keithley 414 Micro-microammeter is today's lowest-cost instrument for low current measurements in production tests, monitoring installations and experiments in the range of  $10^{-2}$  to  $10^{-10}$  ampere f.s. The 414 can be used as the amplifier element in systems, such as reverse current measurements, thickness gauges, ionization gauge control in high-vacuum equipment. Contact meter models are available for go, no-go production tests, alarm and control systems.

### SPECIFICATIONS

**Ranges:** 17 ranges in 1x and 3x steps, from 10 ma to 0.1  $\mu\text{a}$  f.s.

**Accuracy:** Within  $\pm 3\%$  of f.s. to 10  $\mu\text{a}$ ;  $\pm 4\%$  on lower ranges.

**Input Voltage Drop:** Below 5 mv all ranges with full-scale signals.

**Response Time:** Below 0.5 sec. all ranges, for any input capacitance to 5000  $\mu\text{f}$ .

**Zero Drift:** Below 2% off.s. per day.

**Recorder Output:** 5 volts with a 1 ma capability.

**Price:** Model 414 . . . . . \$295.00

For full details, write:



**KEITHLEY  
INSTRUMENTS**

**12415 EUCLID AVENUE  
CLEVELAND 6, OHIO**

metal floor plates, or conductive floors to become covered with any insulating substance.

The greatest source of transistor high voltage puncturing was traced to the following operation: The operator, completely insulated, and sitting on a varnished stool, would pick up a transistor, perform the assigned work and turn on the stool to set the unit down. This motion would charge the body capacity of 200 picofarads to an average of 2,000 volts, representing an average stored energy of 400 microjoules. Upon setting the unit down, this energy would discharge to equalize with the object it made contact with. In many cases, this discharge would occur through a transistor, resulting in a high voltage puncture. The countermeasures that will eliminate the above problem are:

1. Provide the tops of all chairs and tables with conductive surfaces. (Resistances as high as 100 megohms will prove adequate.)

2. Provide a conductive flooring material that is in contact with the operator and the stool upon which the operator sits.

3. Make it mandatory that all personnel wear static-free, soft cotton smocks.

4. Provide conductive shoes or static straps that can be worn on regular, every day shoes, thus insuring that the operator is bonded

electrically to all surrounding objects at all times.

5. Bond all objects in the assembly area, including the personnel. If all objects are bonded electrically, even though at a comparatively high resistance, it will not be possible to accumulate a difference in static potential. Bonding all objects electrically is the only precaution necessary to eliminate a differential static buildup and consequently a static discharge.

To eliminate the guess work usually found when trying to accomplish the above criteria, the entire area was tested with a static gun (manufactured by Electronics Div., B. K. Sweeney Mfg. Co., Denver, Colo.) to determine all sources of static generation and to locate all objects capable of charge accumulation. The static gun's directional capability of reading static voltages on objects, without making direct contact, makes it easy to locate static voltages. A monitoring system, basically a light and buzzer at each position, was then installed. Statics can also cause high reject rates by decreasing beta or causing unusual linearity shifts.

### BIBLIOGRAPHY

U. S. Bureau of Mines, Bulletin 520, pages 14, 33, 40.  
National Fire Protection Association, NFPA No. 77M p. 77M-9.  
Factory Mutual Engineering Division, Loss Prevention Bulletin No. 12.21, p. 4.

## Lights in Panel Aid Plug Soldering

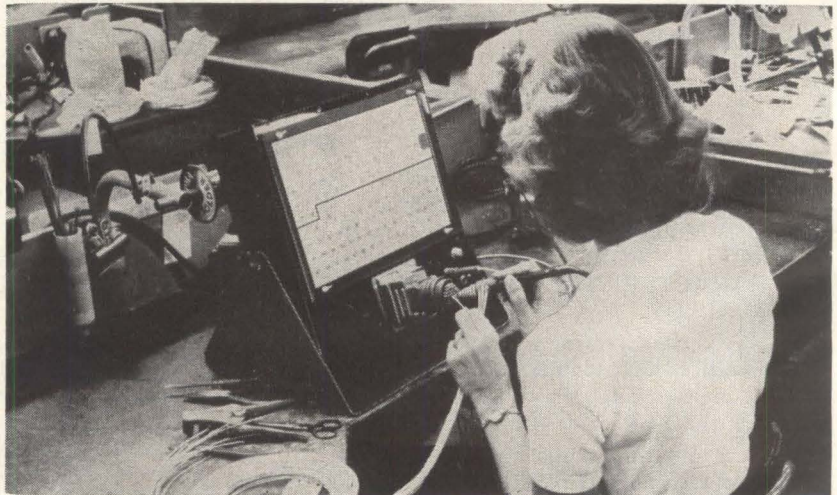

Panel helps locate pins of plugs by lights in panel. To wire a given plug, the operator selects a plug adaptor and chart to match the plug. When operator touches the soldering iron or probe to a plug pin, the corresponding number or letter lights up on the chart. The panel can also be used as a fixture for plug inspection. Panel was developed by Winslow Product Engineering Corp., Arcadia, Calif.





# TKK INDUSTRIAL MOTORS

Lowest Drain, Minimum Noise,  
Longest Life — at Low Cost

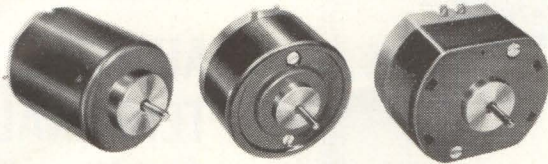

RM-170 T

FM-250 R

FM-250 N

### APPLICATIONS

- \* Tape-recorders
- \* Record-players
- \* Clocks
- \* Shavers
- \* Music Boxes
- \* Cinecameras
- \* Turntables
- \* Automations
- \* Other Appliances

type	voltage (D.C.)
RM-170 T models	1.5 ~ 3.0 V
RM-170 S models	1.5 ~ 6.0 V
RM-170 SC models	3.0 ~ 12 V
FM-250 N models	1.5 ~ 4.5 V
FM-250 R models	1.5 ~ 6.0 V

Large orders executed reliably and on schedule by the world's largest factory specializing in D.C. magnetic low current motors (Output: up to 2½ million units per month!) Your detailed inquiry is invited — your satisfaction guaranteed.

## MABUCHI SHOJI K.K.

37, Kabuto-cho 2-chome, Nihonbashi, Chuo-ku, Tokyo, Japan  
C.P.O. Box 1084, Tokyo Cables: "NIHONKAKOCO TOKYO"

CIRCLE 136 ON READER SERVICE CARD

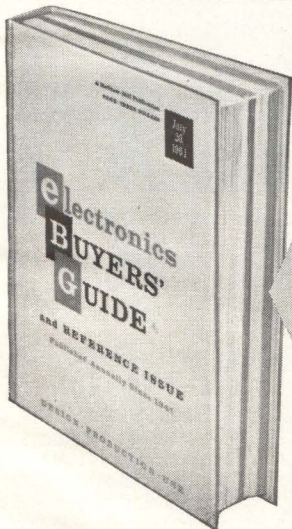

# Seen the new

# IDEA INDEX

# IN EBG?

The INDEX to the editorial articles in **electronics** magazine, previously published annually in a December issue, now appears ONLY in the EBG. Another original EBG idea that saves time and trouble for users! Keep your EBG copy on your desk!

### EXTRA!

Also in the EBG are condensed ABSTRACTS of all the editorial feature articles which have appeared to date in 1961. Another reason why EBG is used more by all four — men in research, design, production and management.



McGraw-Hill Publication,  
330 West 42nd St., New York 36, N. Y.



January 12, 1962

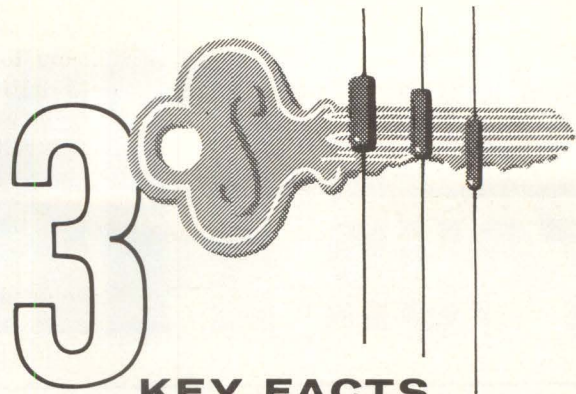

## KEY FACTS TO CONSIDER WHEN YOU SPECIFY POWER RESISTORS



**FACT 1** Many component manufacturers produce power resistors. A few specialize in precision power resistors.



**FACT 2** But only Sage has exclusively invested 100% of its technical know-how in:

- precision wound
- highly stable
- miniature

### POWER RESISTORS



**FACT 3** Only Sage has developed for welded module circuit use a truly miniature family of these resistors with weldable leads, and with optional non-inductive windings.

✓ *Check* these details for immediate production availability.

Insulation: 350° C IMPERVOHM®  
silicone resin  
TC: ±20 ppm / ° C  
Tolerance: 1% or closer

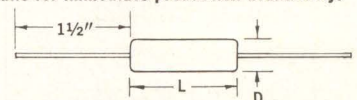

Style	Leads	Rated Watts (25°C)		Size		Resistance Range to:*
		Free Air	Block Encapsulated	"L" max	"D" max	
1002S	Weldable Alloy	1	1	.400	.125	6,000Ω
1009S	Tinned Copper	1				
1103S	Weldable Alloy	1.5	2	.400	.156	10,000Ω
1109S	Tinned Copper	2				
1203S	Weldable Alloy	2	3	.400	.220	11,000Ω
1209S	Tinned Copper	2.5				

\*Corresponding ranges to 2400Ω, 4200Ω, and 4500Ω respectively for non-inductive winding. Indicate by style suffix "NS" rather than "S."



For further technical details and prices, contact our representative in your area, or write us.

Other styles in ratings to 50 watts

# SAGE

**SAGE ELECTRONICS CORP.**  
Country Club Road • East Rochester, N. Y.

CIRCLE 93 ON READER SERVICE CARD

93

# FOR TIME FOUR

## ALL FOUR IRIG FORMATS ON ONE COMPACT CHASSIS WITH EECO 811 TIME CODE GENERATOR

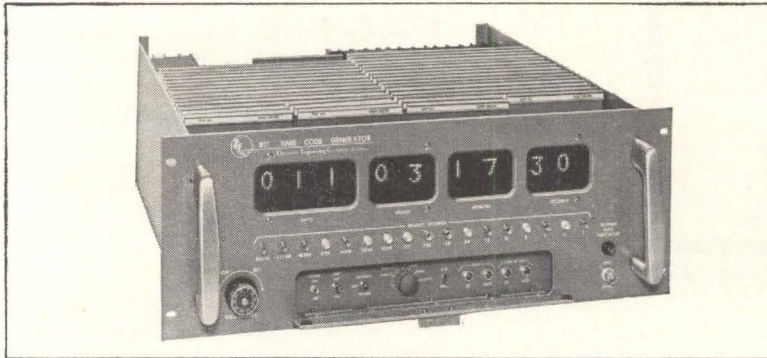

EECO 811 IRIG FORMATS

	A	B	C	D
Time Code Format	34 Bit BCD Code identifying days, hours, minutes, seconds and 1/10 seconds and a 17-bit binary code identifying time of day in seconds.	30 Bit BCD Code identifying days, hours, minutes, seconds and a 17-bit binary code identifying time of day in seconds.	23 Bit BCD Code identifying days, hours and minutes.	16 Bit BCD Code identifying days and hours.
Code Frame Length	0.1 second	1 second	1 minute	1 hour
Code Scan Rates	1000 pps	100 pps	2 pps	1 ppm
Code Carrier Frequency	10 kc	1 kc	1 kc or 100 cps (switch selection)	1 kc or 100 cps (switch selection)

An all solid state, card construction, precision "metronome" for the most demanding range or laboratory instrumentation. Supplies all four serial IRIG time-code formats with an accuracy of better than 1 second a month. Frequency stability is  $1 \times 10^{-8}$  per day at laboratory temperatures;  $3 \times 10^{-6}$  per day throughout entire operating range of  $-20^{\circ}\text{C}$  to  $+55^{\circ}\text{C}$ . Parallel code output. 10 pps and 1 pps synchronizing pulses. Synchronizing pulse for controlling external control element scanner. Both digital and resolver time shift for fast, accurate synchronization with WWV or other time standard. Operates on 115v ac  $\pm 10\%$ , 50-400 cps, 1 amp, with power supply on same chassis.

Specify small (7" x 19" x 17"), light (32 pounds) EECO 811 Time Code Generator as the heart of your instrumentation and be assured of accurate time correlation. Price \$9750, less with fewer formats. Write for EECO 811 data sheet plus information on auxiliary equipment.



### Electronic Engineering Company of California

1601 E. Chestnut Avenue, Santa Ana, California • Klumberly 7-5501, TWX S ANA 5263  
Representative in Western Europe and Israel: Electronic Engineering S.A., C.P. 142, Fribourg, Switzerland

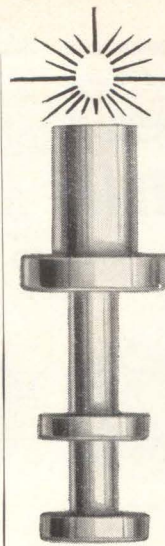

## LOOKING FOR THE IDEAL AUTOMATIC TERMINAL SETTER?

**STOP.** You've found it. Name is Electroset. Sets up to 4200 terminals per hour. Very reliable. Performance tested and proven by leading electronics firms.

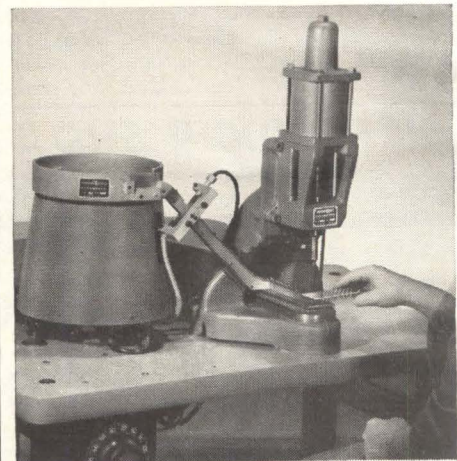

**LONG RUNS: Model FST-1** — raceway-fed, for split-lug, feedthrough, and other terminals. Up to 4200 per hour. All electric. (Model FST Automatic Terminal Setter, not shown, a tube-fed model, achieves even faster production rates.)

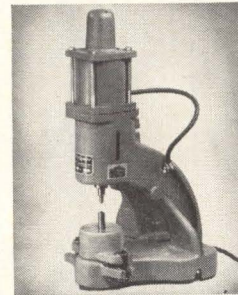

**SHORT RUNS: Electropunch** — sets hand-fed terminals twice as fast as conventional methods, solves terminal setting problems for as little as \$163. All electric. Foot-switch operation.

What's your problem? Black & Webster can help. Send sample terminal and requirements.

Write today for 14-page catalog describing our complete line of production tools.

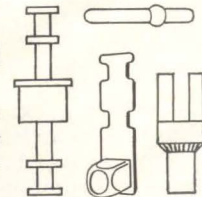

### BLACK & WEBSTER, INC.

Dept. E, 570 Pleasant St., Watertown 72, Mass.

CIRCLE 138 ON READER SERVICE CARD  
electronics

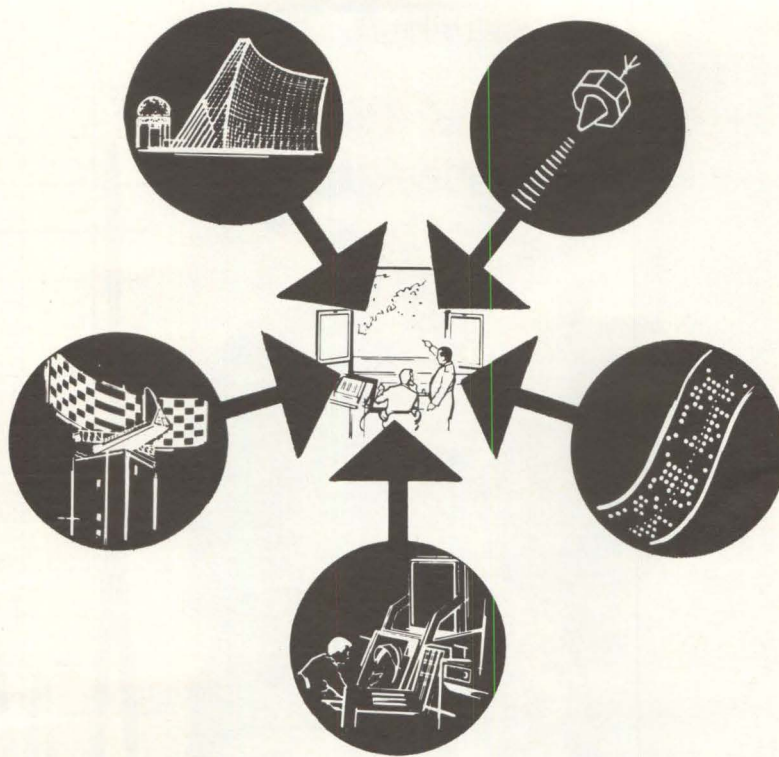

VITAL: command and control systems which collect, transmit, process and display information to military commanders responsible for compressed-time decisions.

THE  
**MITRE**  
 CORPORATION

is now engaged in designing and developing computer-based command and control systems which collect, sort, transmit, and display information vital to those who make command decisions. SAC's Command and Control System, SAGE, BMEWS, NORAD, MIDAS and other urgent military programs are all within the scope of MITRE'S system integration work.

Formed in 1958, MITRE is an independent nonprofit corporation with a growing technical

staff engaged in systems planning, engineering and management for the Air Force Electronic Systems Division.

You are invited to join this scientific community and participate in important work which is performed in an atmosphere of objectivity and free inquiry.

Engineers and scientists interested in the vital field of command and control technology may inquire about openings in:

- Operations Research
  - Communications
  - Human Factors
  - System Cost Analysis
  - Econometrics
- Radar Systems and Techniques
  - System Analysis
  - Advanced System Design
  - Computer Technology
- Mathematics
  - Air Traffic Control System Development
  - Antenna Design Microwave Components

Write in confidence to: VICE PRESIDENT — TECHNICAL OPERATIONS, THE MITRE CORPORATION, Post Office Box 208, Dept. WR17, Bedford, Massachusetts

*An equal opportunity employer*

Leonard Rose is one of the world's great cellists. He was a member of the famed N.B.C. Symphony, under Toscanini, and has been principal cellist with the Cleveland and New York Philharmonic orchestras. His performances may be heard on Columbia records.

There's  
More  
To  
Sound  
Than  
Meets  
The  
Ear

More than the marvel of tensiled tone, wrought by the practiced master, sound is also the tireless slave of the scientist . . . moving in sinewy cycles to bring him closer to new technological frontiers. Experienced ultrasonic engineers, at Dynasonics, are continually proving that there's more to sound than meets the ear. Harnessing the strength of wavelengths, they turn them into skilled manipulators whose sensitive fingers hold rigid sway over instruments, to control such delicate operations as level sensing, flow metering, metal-cleaning and others. These are now being successfully applied in the military, industrial and atomic energy fields.

*For creative ultrasonic answers to many problems in custom instrumentation, control and industrial cleaning, contact DYNASONICS CORP. . .*

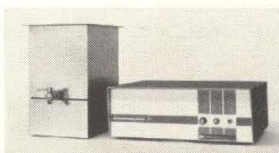

Ultrasonic Cleaners

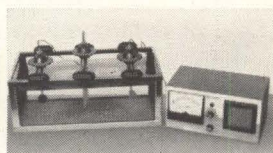

Ultrasonic Flow Measuring Devices



Ultrasonic Level Sensors

MASTERS OF SOUND FOR INDUSTRY'S MANY NEEDS



**Dynasonics**  
CORPORATION

200 Michael Drive  
Syosset, New York  
WALnut 1-7100

SUCCESSOR TO NARDA ULTRASONICS CORPORATION

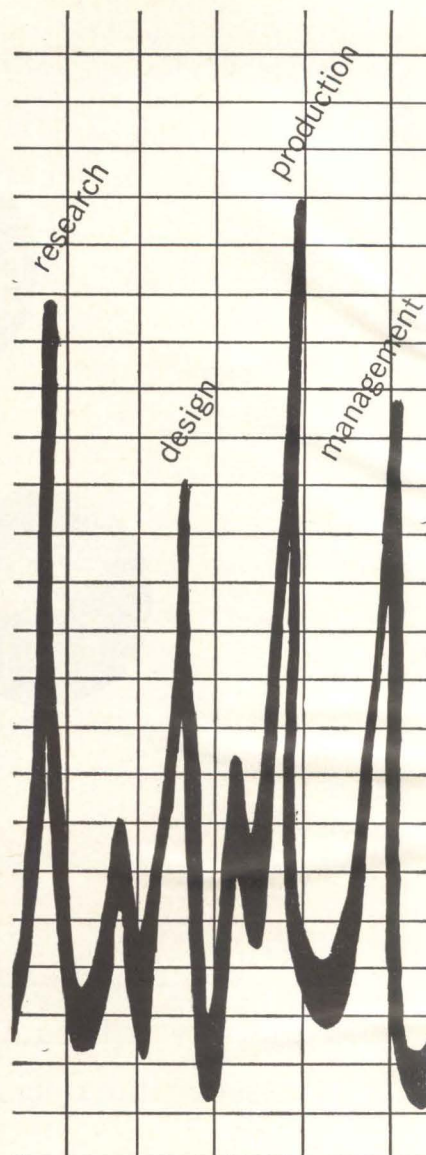

IT'S READ MORE  
BY ALL 4!

**electronics** magazine interprets electronics for electronics men every week. The latest components, economic trends, military applications. Technical data you'll want to file and keep. Get the facts first with a personal subscription (don't be low man on a routing slip). Mail the reader service card (postpaid) to **electronics**, the magazine that helps you to know and to grow! Rates: three years for \$12, one year for \$6; Canadian, one year for \$10; foreign, one year for \$20. Annual **electronics BUYERS' GUIDE** (single issue price \$3.00) included with every subscription.

subscribe today to  
**electronics**

This H-F Crossbar Switches 300 Video-Pulse Circuits with Negligible Crosstalk and Less Than 0.1 DB Distortion From DC - 10MC.

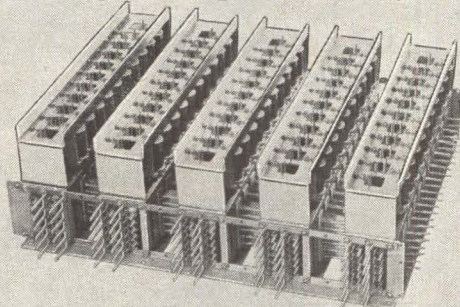

This unique\* switch behaves electrically like a matched coaxial line . . . from DC-10MC. You need no longer accept compromise performance in audio/video or high-frequency switches. 20 million operations/circuit are guaranteed—100 million are common.

The inherent versatility of the matrix format poses a real intellectual challenge. Care to accept it? Ask for Bulletin 60-115.

\*Cunningham designs are protected by U.S. and Foreign Patents.

**Cunningham**

ESTABLISHED 1836

SOPHISTICATED SWITCHING SYSTEMS  
BOX 516, ROCHESTER 2, NEW YORK

Plant & Offices:  
Honeoye Falls, N. Y.  
Phone: Honeoye Falls 485  
TWX RO 572-U

CIRCLE 147 ON READER SERVICE CARD

**ONE FLICK RESETS this  
HIGH SPEED Electric COUNTER**

Model "YE" by  
**DURANT**

(Test count-life over 70 million)

Offered in TWO STYLES:

1. Quick PUSH-BUTTON RESET
2. Electric REMOTE RESET

First high-speed electrically actuated counters with added advantage of electric reset. Clean-cut, legible 3/16" figures, white on black. Ideal for all high-speed electric counting applications—accurate at high, low or intermediate speeds.

**DURANT MANUFACTURING CO.**  
1912 N. Buffum St. 12 Thurbers Ave.  
Milwaukee 1, Wis. Providence 5, R. I.  
Representatives in Principal Cities

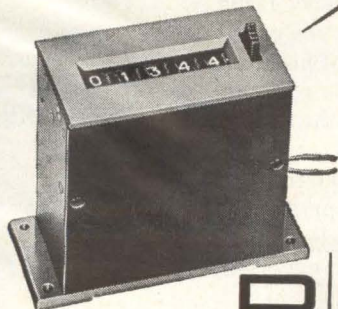

BLACK INSTRUMENT  
FINISH

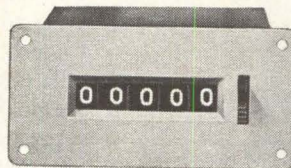

Compact, with great rigidity—entirely enclosed against dust and moisture. Base or panel mount. Speeds to 1500 C.P.M.

**DURANT**  
COUNTING INSTRUMENTS

CIRCLE 139 ON READER SERVICE CARD

January 12, 1962



## R-F FILTERS

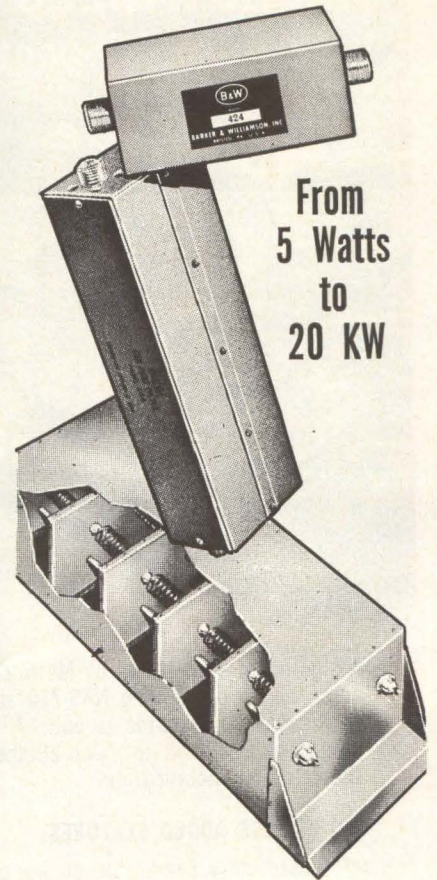

From  
5 Watts  
to  
20 KW

- Spurious frequencies radiated by HF radio transmitters can be effectively suppressed with B & W filters.
- Our Models 425 (52 ohms) and 426 (75 ohms) handle a kilowatt, start cut-off at 40 mc, provide 85 db attenuation through the TV bands.
- Our Model 424 for transmitters under 100 watts provides 60 db suppression through the TV bands.
- 10, 15 and 20 KW units have been manufactured to customers' specifications.
- If you have "spurious" and "harmonic" problems, B & W can provide a solution.

**BARKER & WILLIAMSON, Inc.**  
Radio Communication Equipment Since 1932  
BRISTOL, PENNSYLVANIA • Stillwell 8-5581

CIRCLE 97 ON READER SERVICE CARD 97

*New Improved*  
**NAS 714 — 715 Series of  
 PLUGS and  
 RECEPTACLES**  
 with 7 to 23 contacts  
 by **Methode**

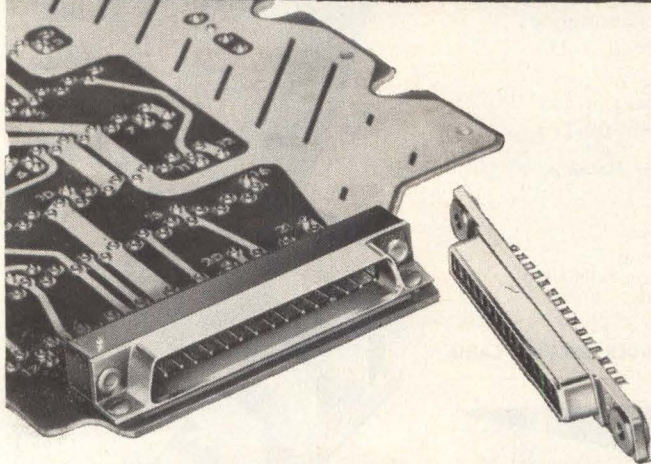

A significant step ahead by Methode — the more efficient, better performing NAS-714 and NAS-715 Series of Plugs and Receptacles with 7, 11, 15, 19 or 23 contacts. Designed to meet all the requirements of the NAS-713 specification.

**WITH THESE ADDED FEATURES:**

- ✓ Closed entry, removable socket contacts for solder crimp termination in NAS-714 type receptacle
- ✓ Crimp type sockets meet MIL-C-26636 requirements for termination
- ✓ Closed entry sockets use Berylco pressure spring for maximum reliability
- ✓ NAS-715 circuit board plugs have removable contacts for maximum economy
- ✓ Split type socket contacts optional

Typically Methode, these new, improved printed circuit connectors feature outstanding reliability and uniformity — good reasons why more industry leaders turn to Methode first, for quality that lasts!

SAMPLES and detailed literature are available.

**Methode Electronics, Inc.**

7447 West Wilson Avenue  
 Chicago 31, Illinois

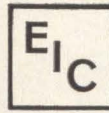

115/60-BER-12/600, in case

**50 amp power supplies  
 0.1% regulation**

Model	Output Voltage*	Ripple	Delivery	Price
115/60-BER-12/600	12	1 mv, rms	From stock	\$ 945
230/60-BER-28/1400	28	2 mv, rms	Less than 30 days	\$1750

\*Output voltage adjustable over  $\pm 17\%$  range.

These supplies have magnetic circuit breakers for overload protection, metered outputs, and remote sensing capability. Optional features include modifications for parallel operation and remote programming. Available for 19-inch racks or in case mountings.

Write for complete specifications on these and many other EIC power supplies.

**ELECTRODYNAMIC INSTRUMENT CORPORATION**

Subsidiary of Reed Roller Bit Company

JA 6-3761 • 1841 Old Spanish Trail • Houston 25, Texas

**CIRCLE 140 ON READER SERVICE CARD**

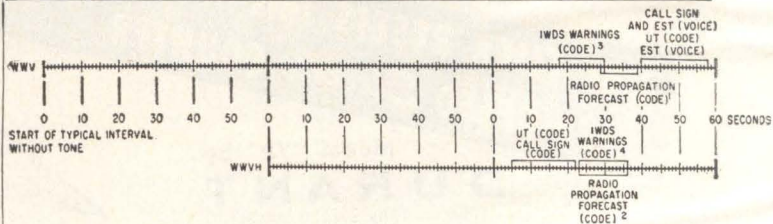

**PRIMARY STANDARDS**

Whether you want to pace a city's clocks or time the transit of an artificial satellite, you'll find the standard time intervals and frequencies broadcast by the National Bureau of Standards of vital assistance.

You'll find a complete run-down on this NBS service in your 1961 **electronics Buyers' Guide** and Reference Issue, plus information on how you can obtain NBS calibration of practically any secondary standard, from resistance to the complex elements of the tensor permeability matrix.

Wealth of information like this makes your 1961 EBG a primary reference volume in the electronics field. You'll find new uses for it every day.

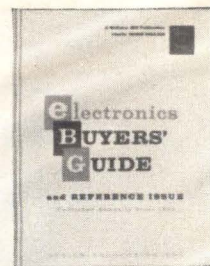

**electronics BUYERS' GUIDE** and Reference Issue

The Basic Buying Guide in Electronics since 194



*Revolutionary*  
*New Loudspeaker*  
 has been put on the market  
**MOTIONAL FEEDBACK TYPE 8"**  
**SPEAKER**  
 model **MX-8P**

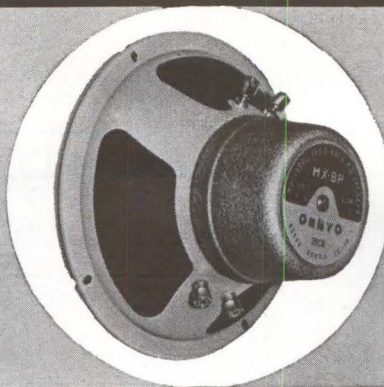

The feedback theory, which has been confined to amplifier assembling, is now extended to the field of loudspeaker engineering.

What would be the effect of motional feedback on the speaker? The most notable effect is a marked improvement in the transient response. The elimination of transient, of course, means sharpened sound. Even when heard with the naked ear, a clearer reproduction of percussion instruments is definitely achieved. Moreover, even when the speaker box is smaller than regulation size, control of motional feedback prevents over-reverberation or over-booming of the reproduced sound. This is why the motional feedback system as is considered being instrumental in bringing about the second revolutionary change in audio equipment.



**OSAKA ONKYO CO., LTD.**

Head Office: 42, Omiya Nishino-cho 5-chome, Asahi-ku,  
 Osaka Japan  
 Tokyo Branch: 18, Kanda Mitoshiro-cho, Chiyoda-ku,  
 Tokyo, Japan

CIRCLE 142 ON READER SERVICE CARD

Ammon meters reflect careful attention to design criteria, to achieve higher standards of performance with crisp new styling. Features include *self-shielded mechanism* (not a core magnet) for exceptional linearity and accuracy, allowing magnetic or non-magnetic panel mounting... *cluster mounting* bezel-to-bezel without interaction... *negligible effects* from stray fields... *gasket sealed*... non-magnetic pivots... *high torque-to-weight* ratio... long, easily-read scale with distinctive markings.

Case sizes conform to ASA/MIL mounting dimensions. Aluminum bezel in glare-free satin black or other colors. Any practical DC range, AC rectifier-types including VU. Bulletin on request. Ammon Instruments, Inc., 345 Kelley St., Manchester, N. H.

**AMMON**  
 INSTRUMENTS, INC.

**NEW**  
**choice**  
**for**  
**designers**

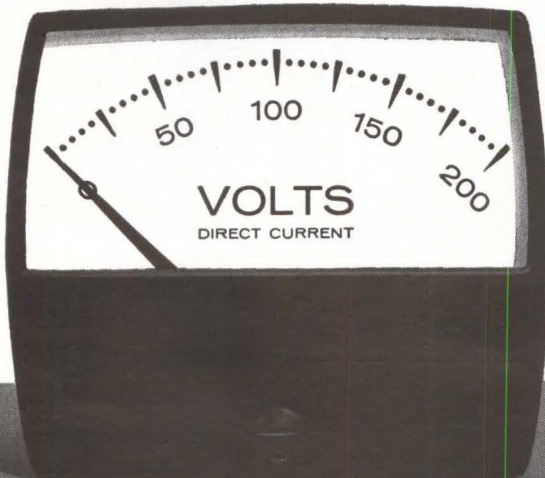

AM-2\* Shown actual size  
 \*Design patent pending

CIRCLE 143 ON READER SERVICE CARD

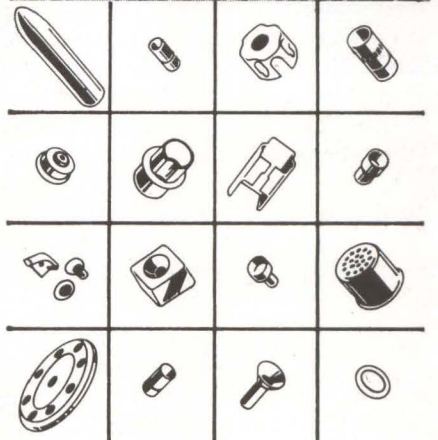
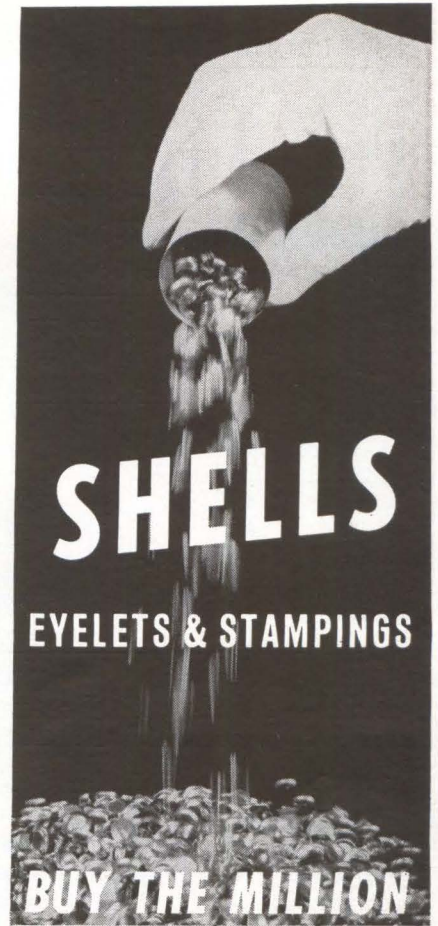

**ENGINEERING**

Just for the asking... Cly-Del engineers are available to help you plan, develop and design the parts you need.

**TOOLROOM**

Eyelet-machine tooling for your parts can be custom built at Cly-Del, used in the production line, and stored for your future use. Your production can also be stored for future release by you.

**ESTIMATES**

When you need high-volume, high-quality drawn shells, eyelets, stampings; ask Cly-Del for an estimate. You will receive fast and accurate attention.

**KNOW CLY-DEL BETTER**

ASK FOR NEW 8-PAGE BROCHURE

**CLY-DEL**  
 MANUFACTURING COMPANY  
 104 SHARON ROAD  
 WATERBURY 20, CONNECTICUT





*The best from the West . . .*

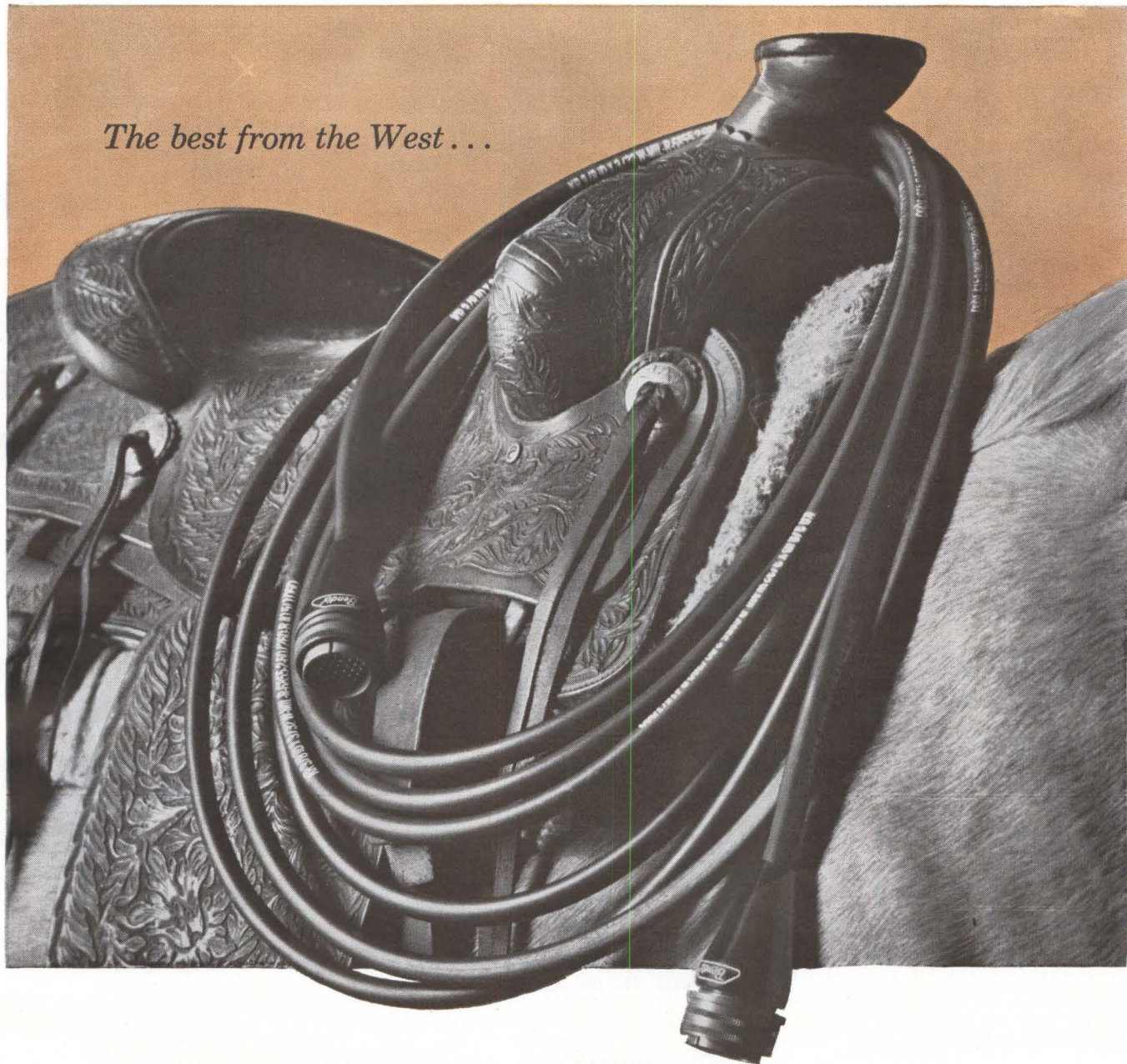

## QUALITY CABLES AND CONNECTORS NOW PRODUCED AT NEW BENDIX SANTA ANA PLANT



For users of electronic cables and connectors, Scintilla Division's new plant in Santa Ana, Calif., is an important addition to West Coast industry.

Here are the finest, most complete, environmentally-controlled, air-conditioned facilities in the area devoted exclusively to cable development and manufacture. For West Coast electrical connector users the Santa Ana plant with its complete facilities also offers "short-order" assembly service on the extensive line of Bendix connectors.

The plant is designed to meet the standard and special-purpose requirements of aircraft, missiles and ground-based electronic equipment.

Sales and service for cables and connectors and all other Scintilla Division products will still be handled out of 117 E. Providencia Ave., Burbank, Calif.

**Bendix Connectors — Bendix Cables: Designed together to work best together**

**Scintilla Division**



Canadian Affiliate: Aviation Electric, Ltd., 200 Laurentien Blvd., Montreal 9, Quebec. Export Sales & Service: Bendix International, 205 E. 42nd St., New York 17, N. Y.

# NEW 380-420 CPS AC REGULATOR



no tubes

no transistors

no equals

No exaggeration. This all-magnetic AC regulator offers better performance and far higher reliability than tube types, at the same price.

#### Note these specs:

**Input:** 100-135 Volts, 380-420 cps.  
**Output:** 115 Volts, 0-1000 VA.  
**Regulation:**  $\pm 0.25\%$ , line or load.  
**Distortion:** 2%  
**Response time:** 0.05 seconds, line or load.  
**Price:** \$575., cabinet model with meter.  
**Packaging:** As above, or custom for OEM or MIL.

When you think of AC regulators, think of TWINCO. We make the usual and many unusual types, tailored to your requirements:

Single phase, or 3 phase with balanced outputs, 50, 60, or 400 cps;  $\pm 5\%$ ,  $\pm 10\%$ .

Transistorized electronic;  
 or no tubes, no transistors.

Electromechanical,  
 with transistor or magnetic control.  
 Resonant regulators,  
 fixed or variable frequency.



OEM Units



MIL Units

For the solution to your AC regulator problems, write or call:

**twinco inc.**  
 10 Cheney Street, Boston 21, Mass.  
 HI 5-0180

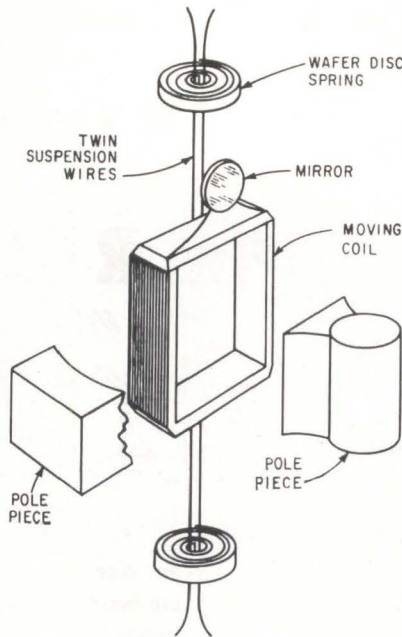

the meter. Elimination of springs, pivots and mechanical pointers makes for heavy overload capability. The meters are claimed to withstand repeated 100,000-percent overloads without damage. Full-scale sensitivities of one microampere with 1,800 ohms internal resistance can be had. An energy drain of  $4 \times 10^{-10}$  watt is also claimed. Suggested uses are testing semiconductors, diodes, vacuum tubes and amplifiers, ionization circuits, high-voltage regulation circuits and lightbeam photocell operation.

**CIRCLE 303 ON READER SERVICE CARD**

## D-C Amplifier

CRESTMONT ELECTRONICS, 2201 W. Burbank Blvd., Burbank, Calif. Small, solid state impedance and level changing d-c amplifier has a gain adjustable from zero to a maximum of at least 10.

**CIRCLE 304 ON READER SERVICE CARD**

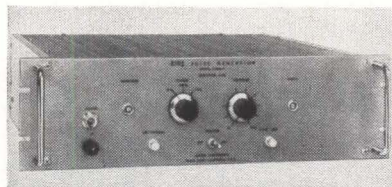

## Pulse Generator

450 V UNIT

ALFRED ELECTRONICS, 3176 Porter Drive, Stanford Industrial Park, Palo Alto, Calif., announces a pulse

generator providing 300 to 450 v for loads up to 250 ma peak, designed for modulating microwave amplifiers. Model 5-6826P may be internally modulated at repetition rates adjustable from 10 to 10,000 pps or externally triggered with a 20 v peak pulse. Pulse duration is adjustable from 1 to 12  $\mu\text{sec}$ , rise and fall time is better than 0.5  $\mu\text{sec}$ .

**CIRCLE 305 ON READER SERVICE CARD**

## Frequency Meter

COMPUTER MEASUREMENTS CO., 12970 Bradley Ave., San Fernando, Calif. Model 737C is a 500 Mc frequency meter with an all solid state 10 Mc counter section.

**CIRCLE 306 ON READER SERVICE CARD**

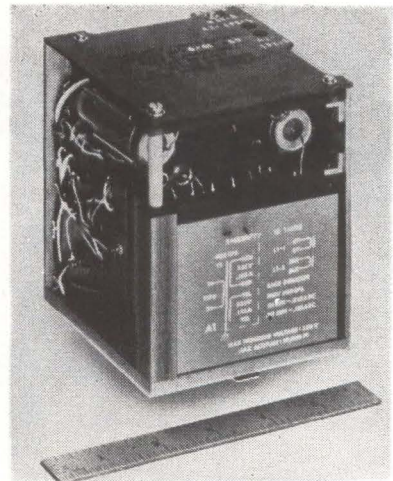

## Power Supply DUAL-OUTPUT

REED & REESE, INC., 717 North Lake Ave., Pasadena, Calif. Featuring 0.5 percent regulation and less than 15 mv p-p ripple on both positive and negative 150 v, 150 ma outputs, model 11403-150 power supply is a compact all-solid-state unit operating on 115 v 400 cps single-phase power. Outstanding overload protection, operation to 85 C and ability to withstand 10 g, 5-55 cps, make it suited to severe environments.

**CIRCLE 307 ON READER SERVICE CARD**

## Tape Certifier

UP TO 560 BITS/IN.

CYBETRONICS, INC., 132 Calvary St., Waltham, Mass., announces an auto-

matic inspection system that locates defects likely to cause loss of information in tapes used for computers, instrumentation, telemetering, and control systems. All channels of the tape are inspected simultaneously at preset densities of up to 560 bits per in., in a single pass at full transport speed.

**CIRCLE 308 ON READER SERVICE CARD**

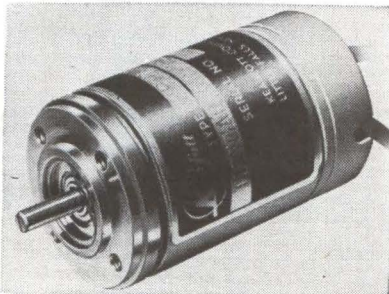

### Resolvers

#### VERSATILE UNITS

KEARFOTT DIVISION, General Precision, Inc., 1150 McBride Ave., Little Falls, N.J. Providing versatile service in such applications as computation, angle data transmission, and automatic control, the CR4 0987 00 size 11 resolvers exhibit small size, light weight, and ruggedness besides their high level of accuracy (5 minutes maximum perpendicularity). They feature 0.1 percent function error,  $\pm 3$  minutes inter-axis error, and 0.1 percent transformation ratio unbalance.

**CIRCLE 309 ON READER SERVICE CARD**

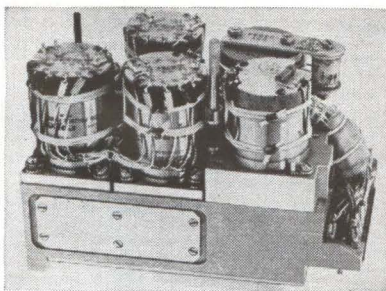

### Servo Packages

#### EASILY ADJUSTABLE

SUPERIOR MFG. & INSTRUMENT CORP., 36-07 20th Ave., Long Island City 5, N.Y. Series 0 improved line of semi-standard servomechanism packages incorporates sophisticated design features on a routine off-the-shelf basis. Basis of the improved line is a construction philosophy which facilitates the inclusion of special easily adjustable damping net-

January 12, 1962

**BETTER THAN**

**500**

**LINE RESOLUTION**

**IN A**

**1 1/4"**

**ELECTROSTATIC**

**CRT**



*A spot size less than 0.002", high brightness at low beam currents (depending on screen phosphor), highlight this new M1013 tube. The smallest high resolution electrostatic CRT ever made, it weighs only about 8 ounces when shielded, potted and with 4' flexible leads.*

*Developed originally for portable PPI radar display, the M1013's 500 line/inch resolution (minimum) also paves the way for optical magnification and projection with display area and definition equivalent to 10" or 12" tubes. For details, write for ETC Bulletin M1013.*

## paceing trends

**IN CATHODE RAY TUBE DESIGN**

**...since 1937**

The M1013 prompted one customer to write, "ETC has reduced to practice what others refuse to put on paper." It is one of many recent ETC tube developments that provide new concepts in high resolution display for improved radar tracking, fire control and instrumentation. Others incorporate fiber optic faceplates, glass rodded construction and other techniques that pace the latest state of the art. Inquiries for specific requirements will receive prompt attention.



*electronic tube & instrument division*

*of General Atomics Corporation*

1200 E. MERMAID LANE, PHILADELPHIA 18, PENNA.

(formerly Electronic Tube Corporation)

**CIRCLE 105 ON READER SERVICE CARD**

**105**

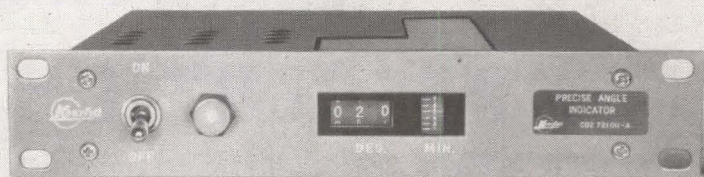

## HIGH-ACCURACY PRECISE ANGLE INDICATOR

NEW KEARFOTT UNIT ACCURATE TO  $\pm 6$  MINUTES

The new CO 2721011 Precise Angle Indicator features an accuracy of  $\pm 6$  minutes. Latest addition to the Kearfott line of standard test equipment, the unit is designed to meet a wide range of applications. Typical Applications

- Indication of gyro angle of pitch, roll, or yaw and relaying of signal to any preselected impedance or voltage level.
- Indication of shaft position of remote synchro or resolver, and transmission of this information to any impedance or voltage level.
- Display of difference between two shafts when driven by transmitter and differential synchros.

In addition to high accuracy the instrument combines a number of other prominent advantages: it requires only a single power source; it has good sensitivity; it is designed for modular application; and it offers direct automatic read-out. The unit is of extremely compact construction and is built for maximal ease of maintenance.

The low-cost CO 2721011 Precise Angle Indicator is available with a single sensor, auxiliary dual-input sensor, or an auxiliary retransmitter. For additional information on this new test instrument, write for the brochure which describes its operation and capabilities in detail.

### SPECIFICATIONS

Repeatability	$\pm 1.2$ min	Slewing Speed	7 sec/180°
Readability	0.5 min	Power (single source)	115 v, 1 $\phi$ , 400 cps
Input Power	30 va	Size	1 $\frac{3}{4}$ x 9 $\frac{1}{2}$ x 9 $\frac{1}{8}$ in.
Sensitivity	1.0 min	Weight	4 lbs.

Write for complete data



**KEARFOTT DIVISION  
GENERAL PRECISION, INC.**

Little Falls, New Jersey

works, to meet the dynamic response specifications of specific applications. Units are easily adapted to meet most military environmental specifications.

**CIRCLE 310 ON READER SERVICE CARD**

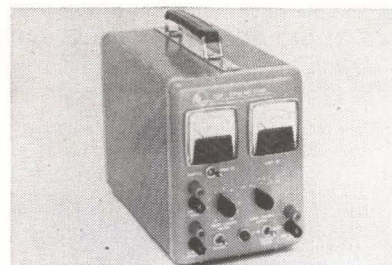

### Dynamic Load

EASY-TO-READ METERS

ELECTRONIC ENGINEERING CO. OF CALIFORNIA, 1601 E. Chestnut Ave., Santa Ana, Calif. The 705 dynamic load is for laboratory use and for incoming inspection. It measures internal a-c impedance of power supplies at frequencies from 20 cps to 1 Mc for d-c power supply voltages up to 32 v. Measurements may be taken with d-c power supply current between 50 ma and 2.5 amp, or with a-c current up to 4 amp peak-to-peak. Price is \$950.

**CIRCLE 311 ON READER SERVICE CARD**

### Wirewound Resistors

GB COMPONENTS, INC., 14621 Armita St., Van Nuys, Calif. Encapsulated high-precision wirewound resistors are available in 0.01, 0.05 and 0.1 percent tolerances.

**CIRCLE 312 ON READER SERVICE CARD**

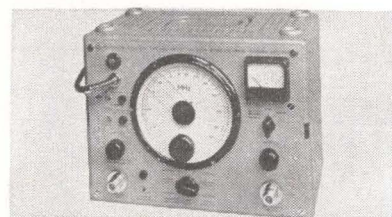

### VHF Amplifier

TUNABLE

ROHDE & SCHWARZ, 111 Lexington Ave., Passaic, N.J. Type ASV is a selective amplifier tunable from 30 to 300 Mc, a receiver and a signal generator. Combined with other vhf equipment, it will extend their measuring ranges and possibilities. It will perform as a frequency converter, null indicator, a-m demodu-

lator, audio signal generator, straight-through receiver, indicating amplifier, generator, voltage amplifier, power amplifier, buffer amplifier, f-m demodulator, limiter, and a-m modulator.

**CIRCLE 313 ON READER SERVICE CARD**

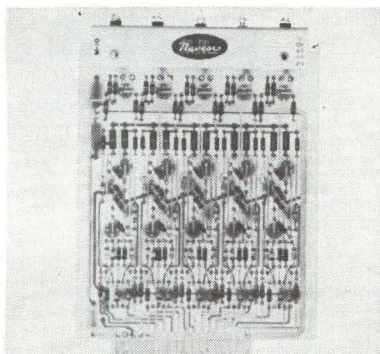

## Flip-Flops

### ONE-MEGACYCLE

NAVIGATION COMPUTER CORP., Valley Forge Industrial Park, Norristown, Pa., announces model M10 1-Mc flip-flop module. Basic module has five identical flip-flops which will operate as a counter at rates up to 2 Mc. Each flip-flop has a neon indicator. Together with a model M11 inter-stage delay module, the M10 forms a parallel-entry adder which will complete a 5-bit addition in a maximum of 4  $\mu$ sec. The sum in the adder can be shifted for serial-parallel multiplication.

**CIRCLE 314 ON READER SERVICE CARD**

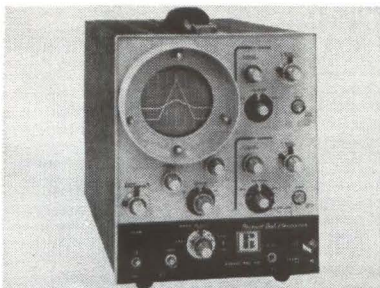

## Dual Gun Scope

### COMPACT UNIT

PACKARD BELL ELECTRONICS, P. O. Box 337, Newbury Park, Calif. Model 5 Mc-2P/R dual gun oscilloscope, priced at \$570, weighs 22 lb and contains only two types of vacuum tubes. It has two identical vertical amplifiers, each with a band pass of d-c to 5 Mc and a sensitivity of 100 mv to 100 v continually adjustable. A built in preamplifier increases the sensitivity of the lower

January 12, 1962

SHOWN ACTUAL SIZE



# SIZE 5 COMPONENTS

## FOR SERVO SYSTEM MINIATURIZATION

A complete family of Size 5 components for every servo system function is now available from Kearfott. Stainless steel housings, shafts and bearings protect the units against environmental extremes and contribute to stability under shock, vibration, and temperature fluctuations. • Standard 26-v, 400-cps excitation. • Operating temperature range  $-55^{\circ}$  to  $+125^{\circ}$ C.

## CHARACTERISTICS

### SYNCHROS

	VOLTAGE (400 cps)	T.R.	NULL (mv)	ERROR (min)
Transmitter CJO 0565 100	26	.454	34	10
Control Transformer Low Z-CJO 0555 100	11.8	1.765	34	10
High Z-CJO 0552 900	11.8	1.765	34	10
Differential CJO 0595 100	11.8	1.154	34	10
Resolver Low Z-CJO 0585 100	26	1.0	34	10
High Z-CJO 0589 100	26	1.0	34	10

### SERVO MOTORS

	J126-06	J126-02
No-Load Speed	9800 rpm	9800 rpm
Stall Torque	0.10 in. oz	0.10 in. oz
Rotor Moment of Inertia	0.175 gm cm <sup>2</sup>	0.175 gm cm <sup>2</sup>
Voltage $\phi 1 / \phi 2$ (400 cps)	26 / 36-CT	26 / 26
Power Input / Phase	1.7 w	1.7 w

### SYNCHRONOUS MOTOR

	CJO 0172 200
Pull-In Torque	0.06 in. oz
Pull-Out Torque	0.10 in. oz
Pull-Out Power	4 w

### MOTOR GENERATORS

MOTOR.	CJ40812001	CJO0812650	CJO0813200
Voltage $\phi 1 / \phi 2$ (400 cps)	26 / 36-CT	26 / 36-CT	26 / 26
Power / $\phi$	1.5 w	1.5 w	1.5 w
No-Load Speed	8000 rpm	8000 rpm	8000 rpm
Stall Torque	0.10 in. oz	0.10 in. oz	0.10 in. oz

### GENERATOR

	26 v	26 v	26 v
Voltage (400 cps)	26 v	26 v	26 v
Volts / 1000 RPM	0.1 v	0.1 v	0.5 v
Null	1.3 mv	10 mv	6.7 mv

Size 5 gearheads range in reduction ratios from 20:1 to 1019:1 for servomotors and motor tachometers above. In addition to Size 5 clutches, brakes, and brake-clutches, Size 6 are available.

Write for complete data



**KEARFOTT DIVISION  
GENERAL PRECISION, INC.**

Little Falls, New Jersey

**CIRCLE 107 ON READER SERVICE CARD**

**107**

# LOW NOISE *miniature* CHOPPERS

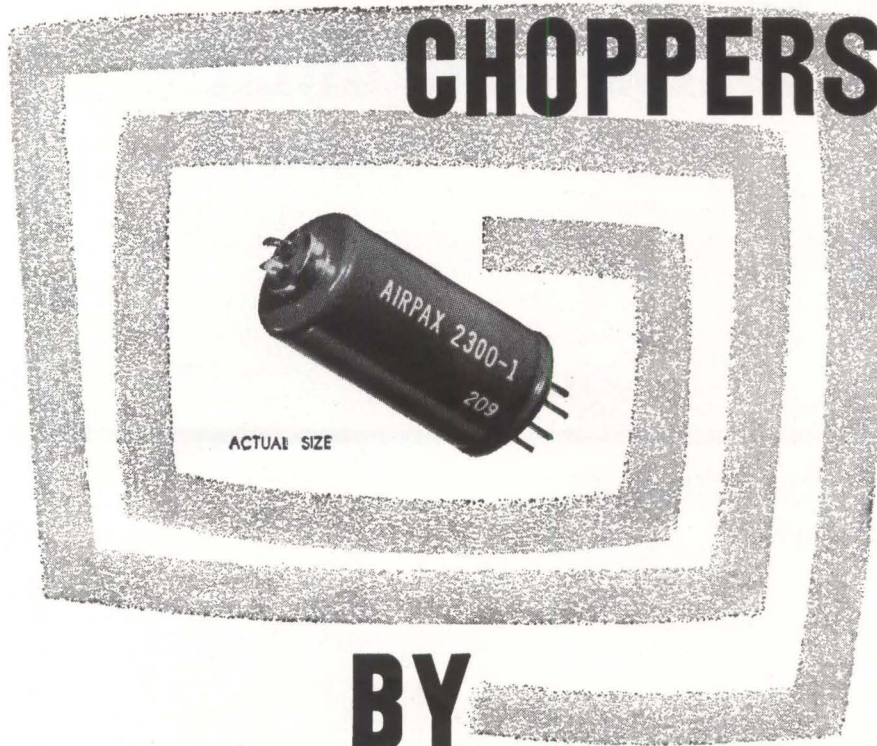

## BY AIRPAX

Airpax low noise choppers have been developed for use where exceedingly low level signals in low impedance circuits would be lost in the background noise attendant with normal chopper operation. Designed after exhaustive tests for optimum electrostatic and electromagnetic shielding, Series 2300 choppers, using a drive frequency of 400 CPS, have found wide acceptance where the noise level must be kept in the 1 microvolt region.

Illustrated is the type 2300-1, with top solder lug terminals. Also available with plug-in top terminals and external mu-metal shield.



CM33

CAMBRIDGE DIVISION, CAMBRIDGE, MARYLAND

108 CIRCLE 108 ON READER SERVICE CARD

amplifier to 1 mv/cm. The sweep is from a Schmitt Trigger with both internal and external triggering capabilities.

CIRCLE 315 ON READER SERVICE CARD

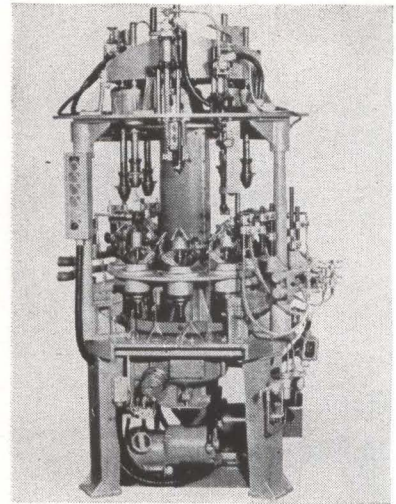

### Glass Splicer SEMIAUTOMATIC

KAHLE ENGINEERING CO., 3322 Hudson Ave., Union City, N.J. This machine seals various sizes of Pyrex or soft glass tubular spouts to funnels or bulbs. Now available are 8, 12 and 16 position machines. The 8 and 12 have manual loading and unloading. The 16 is available with automatic loader and unloader. The upper heads feature pneumatically operated universal chucks that grip and position the spouts. Both upper and lower heads rotate in the working positions, and are stationary for loading and unloading.

CIRCLE 316 ON READER SERVICE CARD

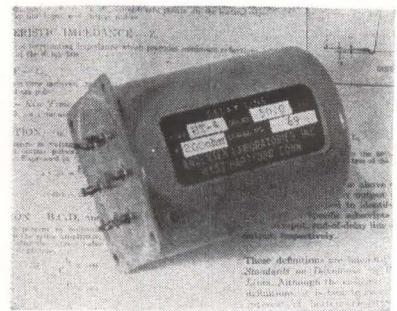

### Delay Lines ELECTROMAGNETIC

ANDERSEN LABORATORIES, INC., 501 New Park Ave., West Hartford, Conn., announces a series of electromagnetic delay lines for use in severe environments. Designed for continuous operation at 200 C, and compensated to maintain nominal

electronics

delay  $\pm 2$  percent over a temperature range of  $-55$  C to  $+205$  C, they feature delays of up to 100  $\mu$ sec, and delay to rise time ratios of up to 50. They have high dielectric withstanding ability (500 v at room temperature and 300 v at 200 C).

**CIRCLE 317 ON READER SERVICE CARD**

### Digital Data System

MONITOR SYSTEMS, INC., Fort Washington Industrial Park, Fort Washington, Pa. High-speed multiplexer and digital conversion system scans up to 50 low level inputs a sec and converts them into digital form.

**CIRCLE 318 ON READER SERVICE CARD**

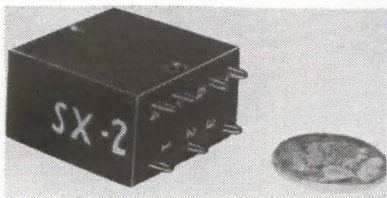

### Tiny Transformer THREE-PHASE

TITAN TRANSFORMER CO., 229 Binney St., Cambridge 42, Mass. Series SX miniature 3-phase transformers are designed for operation at 400 cps and up to 2 v-a loading. They are epoxy-encapsulated to conform to MIL-T-27A, Grade 5, Class S. Terminals are of the hook type, 0.15 in. long. Mounting is provided by two 3-48 by 0.10 in. deep inserts in the side of the unit on 0.812 in. centers.

**CIRCLE 319 ON READER SERVICE CARD**

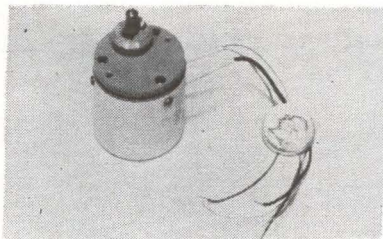

### Digital Resolver HIGHLY RELIABLE

GIANNINI CONTROLS CORP., 1600 S. Mountain Ave., Duarte, Calif. Currently being used in the Minuteman missile program to integrate shaft rotation (direction sensitive) in conjunction with appropriate computing circuits, this digital resolver has a resolution of 0.8 deg. The R-

January 12, 1962

higher and higher peaks  
of excellence

## MARKEL SILICONE RUBBER PRODUCTS



**Tubing, Sleeving  
Insulated Wire**

**High**  
ABRASION RESISTANCE  
TEMPERATURE RESISTANCE  
OVERALL STRENGTH

#### HYGRADE SR-398 SILICONE RUBBER-COATED FIBERGLASS SLEEVING

A superior silicone rubber compound over fiberglass produces a tough, nearly glass-smooth surface for higher abrasion and cut-through resistance. Tested to MIL-T-5438 specs. Tensile strength 1000-1200 psi, yet expands to slip over terminals, connections. High dielectric strength (8000v) maintained even after continuous use at rated 210°C temperature.

#### HYGRADE SR-404 FIBERGLASS REINFORCED SILICONE RUBBER SLEEVING

Highest cut-through resistance obtained by use of high strength rubber compound with embedded fiberglass braid reinforcement. Exhibits almost no longitudinal stretch, yet expands in diameter and returns to normal size; especially useful where sleeving must slip over odd shapes in installation. Excellent corona, oil resistance. Available only in larger sizes.

#### FLEXITE SR-200 SILICONE RUBBER EXTRUDED TUBING

The answer where superior flexibility is required. Rated for continuous use at 200°C, yet equally suitable for low temperature applications. Outstanding elasticity, durability, compatibility, and electricals. Excellent corona resistance makes FLEXITE SR-200 the first choice for high-voltage, high-temperature uses. Performs to MIL-R-5847C specifications.

#### FLEXLEAD SILICONE RUBBER INSULATED WIRE AND CABLE

Extruded silicone rubber insulation over a variety of conductors from solid to extra flexible. Combines outstanding electricals with high resistance to corona, oils, abrasion and weathering. Meets MIL-W-16878C (600v and 1000v ratings). Special cables with jackets of braided fiberglass or metal shielding are engineered and manufactured to your specification.

Write, phone, or wire for test samples and additional data.

L. FRANK **MARKEL** & SONS



SOURCE for EXCELLENCE in  
Insulating Tubings, Sleeveings, and Lead Wire

NORRISTOWN, PENNSYLVANIA

CIRCLE 109 ON READER SERVICE CARD

109

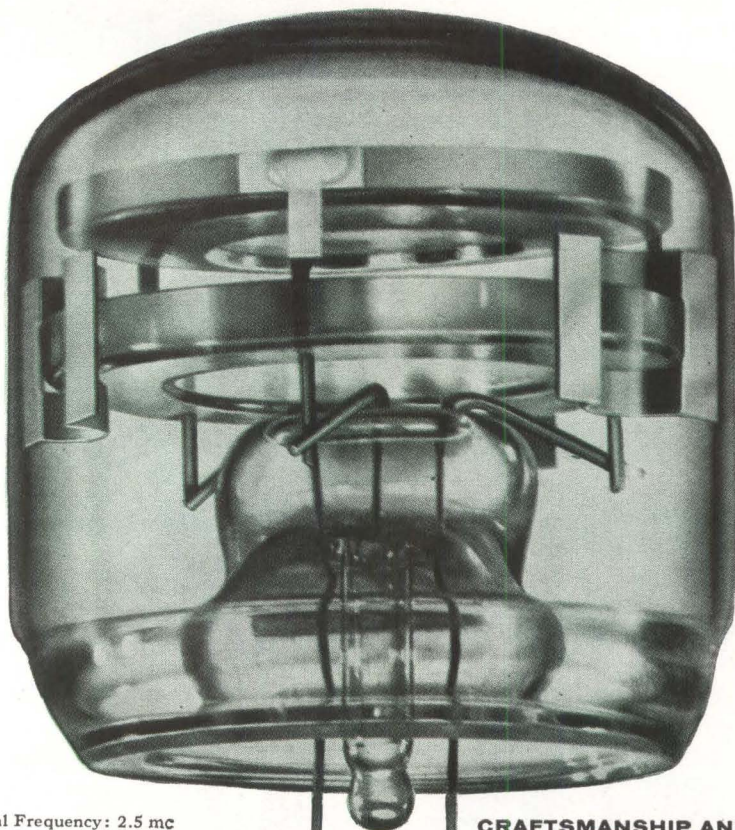

Crystal Frequency: 2.5 mc  
 Average Q: 4.5 million  
 Aging: Less than 5 parts in 10<sup>10</sup> per day  
 Type: BG11AH-5



**CRAFTSMANSHIP AND CAPABILITY**—it's the combination that counts

**BLILEY ELECTRIC COMPANY, Union Station Bldg., ERIE, PENNSYLVANIA**  
**CIRCLE 144 ON READER SERVICE CARD**

17-10-1 utilizes two capacitive pick-offs per channel arranged in a balanced bridge circuit. An ultra-low interwinding capacitance toroidal transformer converts bridge unbalance to a low output impedance a-f output.

**CIRCLE 320 ON READER SERVICE CARD**

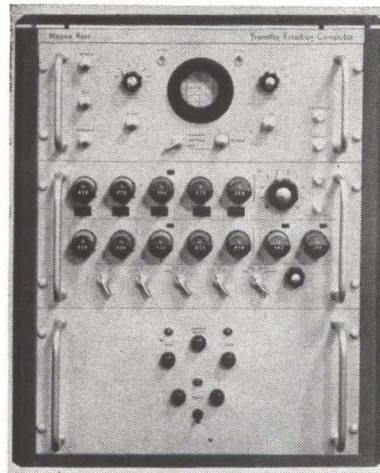

### Computer

#### TRANSFER FUNCTION

WAYNE KERR CORP., 1633 Race St., Philadelphia 3, Pa. The technique employed in this transfer function computer enables a complete control system to be analyzed in a matter of minutes to within an accuracy of 1 percent. It also provides a direct means of relating the data obtained to individual component performance even in nonlinear systems. The computer is a self-contained instrument providing sinusoidal, step, ramp and parabolic functions over the frequency range 0.015 to 500 cps. The response of the system being analyzed is fed back to the computer.

**CIRCLE 321 ON READER SERVICE CARD**

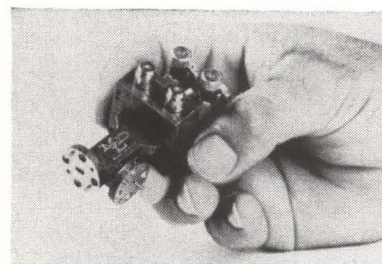

### Balanced Mixer

#### SMALL AND LIGHT

MICROWAVE DEVELOPMENT LABORATORIES, INC., 15 Strathmore Rd., Natick, Mass., has developed a side-wall hybrid balanced mixer, model

## You Get Things Done With Boardmaster Visual Control

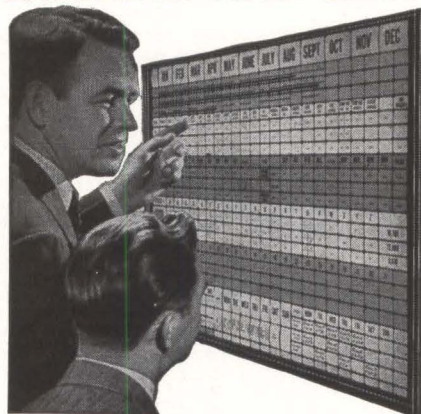

- ☆ Gives Graphic Picture of Your Operations—Spotlighted by Color
- ☆ Facts at a glance—Saves Time, Saves Money, Prevents Errors
- ☆ Simple to operate—Type or write on Cards, Snap in Grooves
- ☆ Ideal for Production, Traffic, Inventory, Scheduling, Sales, Etc.
- ☆ Made of Metal. Compact and Attractive. Over 500,000 in Use

Full price **\$4950** with cards

**FREE** 24-PAGE BOOKLET NO. C-10  
 Without Obligation

Write for Your Copy Today

**GRAPHIC SYSTEMS**  
 YANCEYVILLE, NORTH CAROLINA

**CIRCLE 145 ON READER SERVICE CARD**

# NEW

## LOW LEVEL

## SUBCARRIER

## OSCILLATOR

## FOR FM

## TELEMETERING

**SEE PAGE 119**



15MS16, using a 1N2792 crystal. The units, measuring less than 3.000 in length, cover the frequency range 68.0-72.0 Gc. Vswr is 2.0.

**CIRCLE 322 ON READER SERVICE CARD**

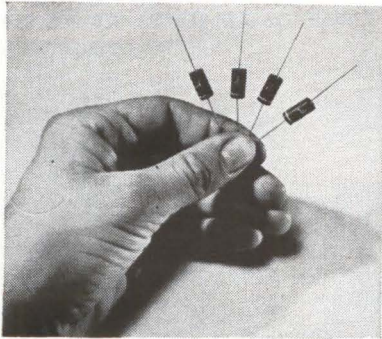

## Zener Diodes

FOR COMMERCIAL USE

AMERICAN SEMICONDUCTOR CORP., 3940 N. Kilpatrick Ave., Chicago 41, Ill. Line of Zener diodes has a voltage range of 2 through 350, a 200 mw rating, and a voltage tolerance of 20 percent. Operating temperatures range from  $-55^{\circ}\text{C}$  to  $+150^{\circ}\text{C}$ . Also available in 10 percent and 5 percent tolerances.

**CIRCLE 323 ON READER SERVICE CARD**

## Broadband TWT

HUGHES AIRCRAFT CO., Florence Ave., & Teale St., Culver City, Calif. Model 310H is a ppm focused 1 Kw X-band twt amplifier covering a bandwidth from 8.5-11.4 Gc.

**CIRCLE 324 ON READER SERVICE CARD**

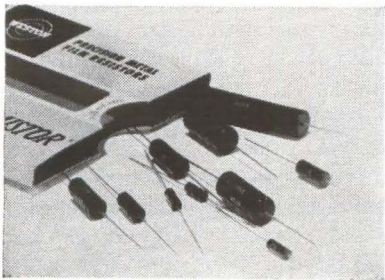

## Metal Film Resistors

HIGH ACCURACY

WESTON INSTRUMENTS DIV., Daystrom, Inc., 614 Frelinghuysen Ave., Newark 14, N. J. The Vamistor line of precision metal film resistors has been expanded to include new commercial Class C units with a temperature coefficient of  $0 \pm 25$  ppm/deg C over a range of  $+165^{\circ}\text{C}$  to  $+25^{\circ}\text{C}$  and  $0 \pm 35$  ppm/deg C

**CIRCLE 111 ON READER SERVICE CARD** →

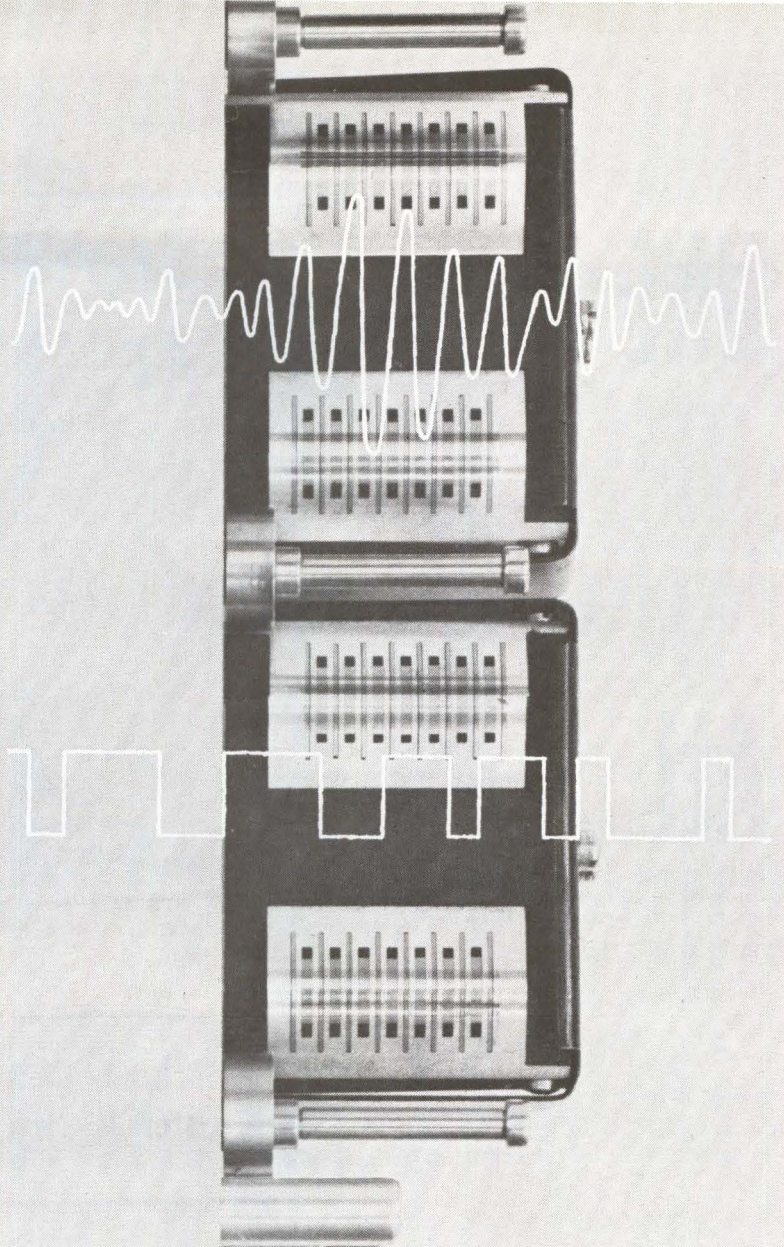

**14  
TRACK  
MIND**

This is the medulla oblongata of an instrumentation tape recorder. And like the real medulla, it acts both as a receiver and as a sender of nerve impulses. It is capable of handling any intelligence which can be converted into an electrical signal. ■ Depending upon the kind and amount of information you want to commit to magnetic memory, you can choose a recorder with a 14-track mind, a 1-track mind, or anything in between. You can feed it electrical analogs of pressure, velocity, vibration, a hundred other variables; or you can use it to scan a million or more digital "yes" or "no" bits per minute. ■ Some of the most exciting intelligence known to science today is being channeled through the recording and playback heads of PI magnetic tape recorders. We're interested in what you may be planning to record. Drop us a line and we'll be glad to assist.



**PRECISION INSTRUMENT COMPANY**  
1011 Commercial Street • San Carlos • California  
Phone LYtell 1-4441 • TWX: SCAR BEL 30  
*Representatives in principal cities throughout the world*



*P.I. Invites inquiries from senior engineers seeking a challenging future.*

# THE ONE TIMER WITH ALL THE FEATURES...

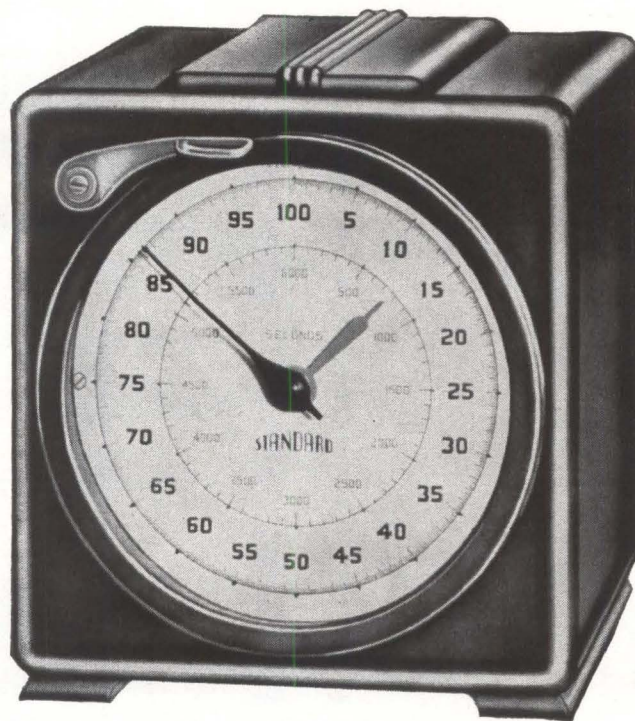

Only in a STANDARD instrument do you get all the features "most wanted" in an interval timer:

**UNEXCELLED PRECISION**—Consistent, continuous accuracy over years of use. Accuracy to  $\pm .001$  second available in standard models.

**INSTANTANEOUS ELECTRIC RESET**—A "must" in many instrument complexes—a plus benefit for all other applications.

**PROVEN MECHANISM**—Synchronous motor driven—electric clutch operated. Proved reliably accurate and dependable by years of service.

**CHOICE OF CONTROL**—Start, stop and reset can be manual, by electric circuit or output of electronic tubes.

**RANGE OF MODELS**—Portable or panel mounting—in a wide selection of accuracies and ranges.

Request Catalog No. 198-B

**THE STANDARD ELECTRIC  
TIME COMPANY**  
89 LOGAN ST., SPRINGFIELD, MASS.



over a range of  $+25$  C to  $-55$  C. This class of unit is suited to precision test equipment applications at room temperature and above, but where low temperatures are seldom encountered.

CIRCLE 325 ON READER SERVICE CARD

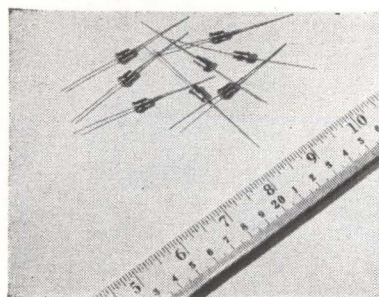

## Silicon Rectifiers AXIAL LEAD

AMERICAN SEMICONDUCTOR CORP., 3940 N. Kilpatrick Ave., Chicago 41, Ill., has available a line of axial lead silicon rectifiers designed for high reliability. Current ratings are up to 0.5 amp at 100 C with a maximum allowable peak reverse voltage from 50 to 600 v. Operating temperatures up to 150 C.

CIRCLE 326 ON READER SERVICE CARD

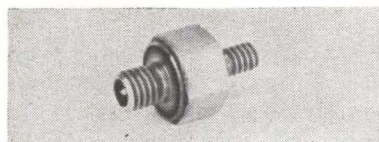

## Linear Accelerometer PIEZOELECTRIC

STATHAM INSTRUMENTS, INC., 12401 W. Olympic Blvd., Los Angeles 64, Calif. Model AK106 subminiature piezoelectric accelerometer is designed for applications requiring accurate measurements of shock and vibration in the aircraft and missile industry. It features a high natural frequency of 60 Kc and operates over a range of  $\pm 10,000$  g. Sensitivity is nominal 5 peak mv per peak g at room temperature. Instrument is encased in stainless steel and operates over a temperature range of  $-65$  F to  $+250$  F.

CIRCLE 327 ON READER SERVICE CARD

## Transistor Tester

TEXAS INSTRUMENTS INC., P. O. Box 66027, Houston 6, Texas. Model 654 go-no-go transistor tester features fast d-c sequential testing,

p-c card programming and automatic sorting.

**CIRCLE 328 ON READER SERVICE CARD**

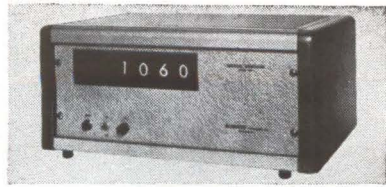

### Decimal Indicators BINARY-INPUT

HOWARD INSTRUMENT CO., Red Bank, N. J. Conversion of binary input data to decimal format and display of the decimal data are both provided in the 1000 series decimal indicators. Available from 3 to 6 decimal digits, the inputs can be static or pulse, parallel or serial. Input impedance is compatible with transistor logic circuits. Outputs can be provided to drive remote indicator or other equipment.

**CIRCLE 329 ON READER SERVICE CARD**

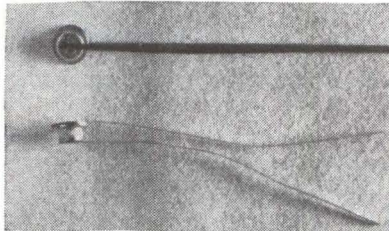

### Tunnel Diodes GERMANIUM TYPE

MICRO STATE ELECTRONICS CORP., 152 Floral Ave., Murray Hill, N. J. The MS1081-1089 series of germanium tunnel diodes have switching speeds of less than 1 nsec. The hermetically sealed pill package with tab leads enables the circuit designer to take advantage of the high speed capabilities of these devices. A wide range of peak currents (1, 5, 10, 20 and 50 ma) are available with a 5 percent tolerance. Typical peak-to-valley current ratios of 8:1 are obtained.

**CIRCLE 330 ON READER SERVICE CARD**

### Refractometer

AERO GEO ASTRO CORP., 1200 Duke St., Alexandria, Va. The AGA refractometer measures the refractive index of gases at microwave frequencies, and can be used to

ask  
**MARKEM**  
to show you  
how to  
identify  
your products  
completely  
— at  
least  
cost

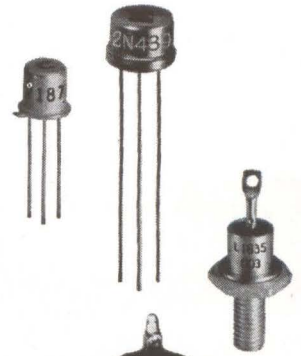

#A-104660  
4000 OHMS  
C. P. CLARE & CO  
CHICAGO, ILL

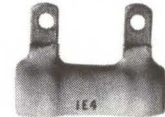
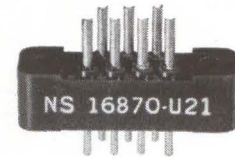

Whether your electrical and electronic products range from subminiature and microminiature components to large panels and "packages", you can identify them *all* completely and clearly, at production speeds, with economical Markem methods engineered to your particular requirements. For example: methods to mark odd shapes, sizes and surfaces with your complete, detailed legend, using quick-change type flexibility and ink to meet military specifications and withstand unusual environmental conditions—and above all, with savings in time and money—are offered by Markem, one responsible source for the entire process.

For a complete in-plant analysis of all your product identification processes—or a practical answer to a specific problem—call in your local Markem Technical Representative. Markem Machine Co., Electronics Division, Keene 5, N. H.

12-page catalog on request. Please use inquiry card.

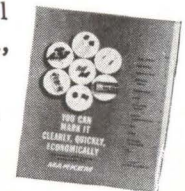

**MARKEM**

HELPS YOUR PRODUCT SPEAK FOR ITSELF

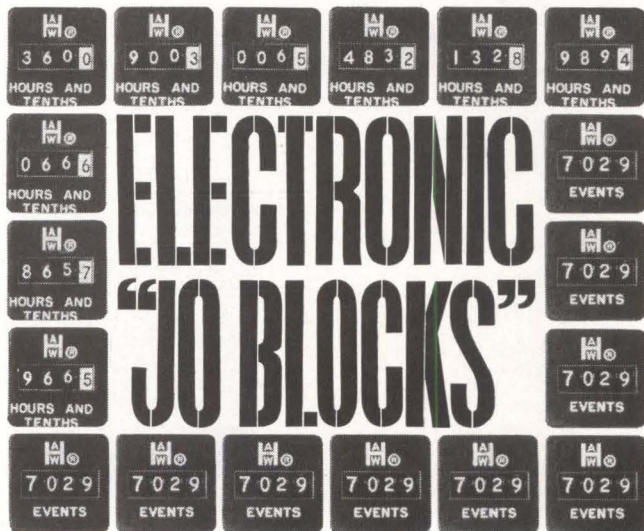

A. W. Haydon's microminiature elapsed time indicators and events counters are to electronics what "Jo Blocks" (Johanssen gages) are to metalworking—precisely accurate standards that are much more reliable than what they measure. Adapted from our earlier (and very successful) sub-miniature indicators, these microminiature timers have the unquestioned dependability that only A. W. Haydon's statistical production testing can provide...yet you can fit 100 of them into a 5" square □ We believe this new ETI is the world's smallest—only 1/4 cubic inch. We know it is better than 99.9% accurate... exceeds requirements of MIL-M-26550... withstands 20g, 2000 cycles vibration... weighs only 0.75 oz... temperature range is -65° to +250°F... and runs on a half watt, 115 v, 400-cycle power. Digital readout in hours, up to 999.9 or 9999. Companion events counters also provide 4 digit readout. Both of these units are available with a wide variety of compatible mountings □ For complete details on these tiny titans of time, or on any other electromechanical or electronic timing device to suit your special requirements, write The A. W. Haydon Company today.

**AWHAYDON**  
 THE COMPANY

235 North Elm Street, Waterbury 20, Connecticut

measure the bending of radar waves in regions above the earth's atmosphere, which might affect communications systems.

**CIRCLE 331 ON READER SERVICE CARD**



### Recorder

WITH DEMODULATOR

SANBORN CO., 175 Wyman St., Waltham 54, Mass. Model 302 single-channel oscillographic recorder with a transistorized phase-sensitive demodulator amplifier and power supply is useful for testing servo systems and components. It amplifies and records a difference signal that results from comparing an a-c error signal with an externally supplied 25-125 v rms reference signal. The heated stylus recording unit gives immediate readout via permanent, inkless traces on 40-division rectangular-coordinate charts.

**CIRCLE 332 ON READER SERVICE CARD**



### D-C Power Supply

QUADRUPLE OUTPUT

TRYGON ELECTRONICS INC., 111 Pleasant Ave., Roosevelt, L.I., N.Y. Model PAM-4 is a quadruple output regulated power supply. Four independent modular supplies comprise the power supply system furnishing any combination of three different output ranges. Available output ranges are 0-20 v d-c at 0-2 amp, 0-32 v d-c at 0-1.5 amp, 0-50 v d-c at 0-750 ma with 0.05 percent regulation and less than 0.5 mv ripple.

**CIRCLE 333 ON READER SERVICE CARD**

## PRODUCT BRIEFS

COAXIAL CIRCULATORS four-port. E&M Laboratories, 15145 Califa St., Van Nuys, Calif. (334)

GRAPHIC RECORDER solid state. Varian Associates, 611 Hansen Way, Palo Alto, Calif. (335)

SELECTIVE VOLTMETER automatic tuning. Rohde & Schwarz, 111 Lexington Ave., Passaic, N.J. (336)

T-W TUBE stable low-noise factor. Calvert Electronics, Inc., 220 E. 23rd St., New York, N.Y. (337)

MICROWAVE DELAY LINES modular. Franklin Technical Corp., Sumneytown Pike, Kulpville, Pa. (338)

PREAMPLIFIER plug-in type. The Daven Co., Livingston, N.J. (339)

RIGID URETHANE FOAM for missile, aircraft industries. Urethane Industries International, Inc., Evanston, Ill. (340)

ROTARY SWITCHES 18-position. The Electronics Division of Globe-Union Inc., 900 E. Keefe Ave., Milwaukee 1, Wisc. (341)

RADIATOR/RETAINER for TO-18 transistors. The Birtcher Corp./Industrial Division, 745 S. Monterey Pass Rd., Monterey Park, Calif. (342)

MINIATURE H-V POWER SUPPLY all solid state. Components Corp., Den-ville, N.J. (343)

COAXIAL SWITCH small, light. Bay-Roy Electronics, Inc., 16608 Madison Ave., Cleveland 7, O. (344)

ENVIRONMENTAL CHAMBER dust and vibration free. Webber Mfg. Co., Inc., P.O. Box 217, Indianapolis 6, Ind. (345)

DISCRIMINATORS solid state. Orion Electronic Corp., 108 Columbus Ave., Tuckahoe, N.Y. (346)

SILICON RECTIFIERS miniature, flangeless. Semicon, Inc., 200 Sweet-water Ave., Bedford, Mass. (347)

INCREMENTAL INDUCTANCE BRIDGE for precision lab testing. Freed Transformer Co., 1718 Weirfield St., Brooklyn 27, N.Y. (348)

D-C VOLTAGE COMPARATOR electrometer input circuitry. Binary Electronics Inc., 30-48 Linden Place, Flushing 54, N.Y. (349)

# MASSA RECTILINEAR RECORDERS

are selected for exacting applications

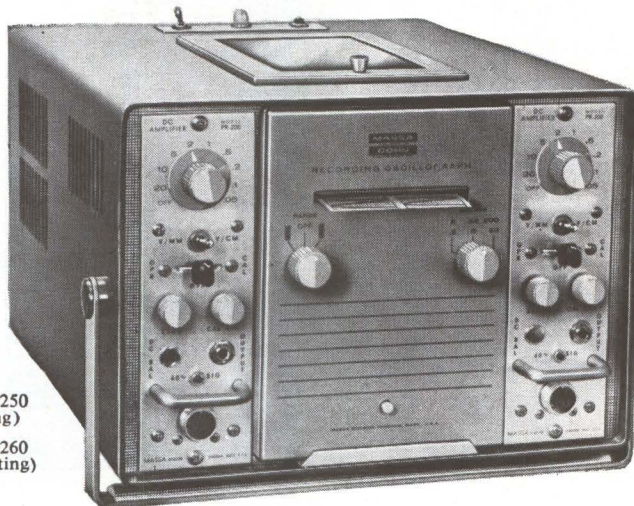

Model BSA 250  
(Ink Writing)  
Model BSA 260  
(Electric Writing)



## Precision Dimension Monitor Torpedo Velocity Measurement Process and Quality Control Inspection

Among the many exacting and varied applications in which Massa Rectilinear Recorders are used are the monitoring of precision dimensions, measuring of torpedo velocities and the inspection of process and quality control. Although unrelated in ultimate function, these different end uses have one thing in common . . . the need for a reliable, two-channel strip chart recorder, easy and economical to operate and easy to interpret.

The unique feature of interchangeable plug-in preamplifiers provides a broad application range for the "Meterite". Ink or electric writing pen motors produce permanent recordings with waveforms identical to those of the input signal. The Massa "Meterite", predominantly transistorized, provides faithful long-term operation.

Massa Division manufactures a complete line of portable and rack mounting direct ink or electric writing Rectilinear Recording Systems ranging from two to twelve channels.

Write for Technical Bulletin: BSA 250/260

**MASSA**  
A DIVISION OF  
**COHU**  
ELECTRONICS, INC.

275 LINCOLN STREET  
HINGHAM, MASSACHUSETTS

OTHER MASSA PRODUCTS  
TRANSDUCERS  
Sonar, Ultrasonic

ACCELEROMETERS  
MICROPHONES

HYDROPHONES  
AMPLIFIERS

COMPLETE LINE OF MULTI-CHANNEL AND  
PORTABLE RECORDING SYSTEMS

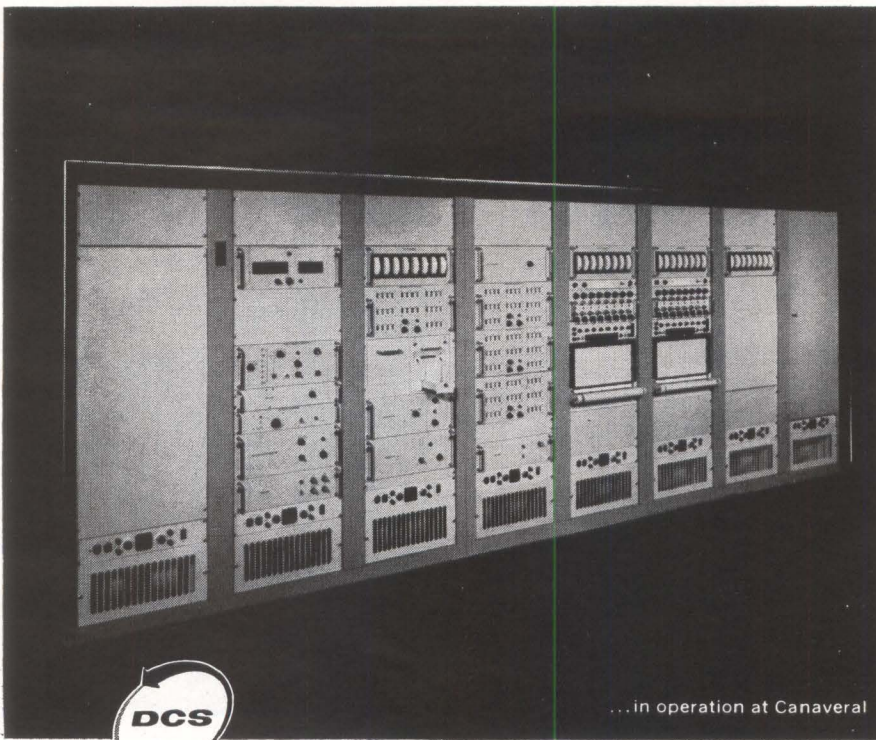

## Can you use these unique features of DCS PCM Digital Data Systems?

If you are considering PCM telemetry ground stations or any digital data system, you will be interested to learn what's available from DCS. Designed to the same standards of reliability which have built DCS's reputation in FM analog data systems, DCS digital data systems offer these unique features:

- a signal generator capable of simulating several signal modes and operating conditions
- a pulse synchronizer which optimally recovers data in the presence of severe noise and reconstitutes the pulse train
- automatic synchronization under conditions of gross time base perturbations
- provisions for conventional or majority logic for sync recognition
- a digital-to-analog converter featuring thumb-wheel selection of channel to be presented in analog form

These are only a few of the exclusive features of DCS digital data systems. We'd be pleased to assist you in adapting these proved capabilities and equipments to meet your specific requirements. Call your nearest DCS field office, or write us at Dept. E-1-9.

### DATA-CONTROL SYSTEMS, INC.

*Instrumentation for Research*

Los Angeles • Santa Clara • Wash., D. C. • Cape Canaveral  
Home Office: E. Liberty St., Danbury, Conn. • P1oneer 3-9241



## Literature of

**ULTRASONIC CLEANING EQUIPMENT** National Ultrasonic Corp., 95 Park Ave., Nutley, N.J., has available a single-page bulletin describing ultrasonic p-c board cleaning equipment. (350)

**SWEPT FREQUENCY TECHNIQUES** Hewlett-Packard Co., 1501 Page Mill Road, Palo Alto, Calif. *Application Note* No. 54 describes recent improvements in microwave swept frequency test techniques. (351)

**CAST WAVEGUIDE COMPONENTS** Microwave Associates, Inc., Burlington, Mass. A six-page folder describes a stocked line of cast waveguide components. (352)

**RELAY** Electro-Tec Corp., 1 Henderson Drive, West Caldwell, N.J. A 2-page bulletin describes type 1000 Mark II 6pdt relay. (353)

**POWER-SUPPLY MODULES** Trio Laboratories, Inc., Dupont St., Plainview, L.I., N.Y. Eight-page catalog presents a line of prefabricated regulated power-supply modules. Request a copy on company letterhead.

**SEMICONDUCTORS** International Rectifier Corp., 233 Kansas St., El Segundo, Calif. A short form catalog includes over 2,500 types of semiconductor devices. (354)

**FREQUENCY COUNTER-TIMER** Ransom Research Div. of Wyle Laboratories, 374 W. Eighth St., San Pedro, Calif. Four-page, illustrated brochure describes low-cost, fully transistorized model 1197 frequency counter-timer. (355)

**BRAKED MOTOR** Kearfott Div., General Precision, Inc., Little Falls, N.J. Catalog sheet covers a size 8 braked motor for use in systems subjected to severe shock and vibration. (356)

**THERMAL STRIPPERS** Western Electronic Products Co., 2420 N. Lake Ave., Altadena, Calif. Four-page folder illustrates and describes a line of thermal wire strippers with prices included. (357)

**TERMINALS** Concord Electronics Corp., 37 Great Jones St., New York 12, N.Y., has released a 4-page, 2-color brochure on precision machined, standard terminals for the

# the Week

military and commercial OEM markets. (358)

**HERMETIC SEALS** Uni-Seal, Inc., 477 North Ave., Garwood, N.J., has published a comprehensive guide to the selection and purchase of quality hermetic seals. (359)

**GLASS TUBING CUTTER** Kahle Engineering Co., 3322 Hudson Ave., Union City, N. J., offers a bulletin on model 3223 automatic high speed glass tubing cutter. (360)

**UHF PLANAR TRIODES** The Machlett Laboratories, Inc., 1063 Hope St., Springdale, Conn. A folder describes uhf planar triodes for the communications and aerospace industries. (361)

**INDICATORS** John Oster Mfg. Co., Racine, Wisc. A 22-page catalog contains descriptions and technical data for 16 indicators. (362)

**PASSIVATED SILICON DICE** Micro-Semiconductor Corp., 11250 Playa Court, Culver City, Calif. Bulletin 107 covers passivated silicon dice that will not degrade when subjected to MIL-S-19500 testing. (363)

**INSTRUMENT BROCHURE** Kahn & Co., Inc., P. O. Box 516, Hartford 1, Conn., has available a four-page brochure entitled "Instruments for Industrial Dynamics." (364)

**INSTRUMENT TRANSFORMERS** Weston Instruments Div., Daystrom Inc., 614 Frelinghuysen Ave., Newark, N. J. Bulletin gives features and specifications of model 605 and 607 current transformers. (365)

**FORCE/RESISTANCE TRANSDUCERS** Clark Electronic Laboratories, Box 165 Palm Springs, Calif. A 4-page brochure describes the Micro-ducer solid state force/resistance transducers for space-age use. (366)

**POWER SUPPLIES** Ferrotran Electronics Co., Inc., 693 Broadway, New York 12, N. Y. Bulletin covers solid state power supplies for military applications. (367)

**PICOAMMETER** General Electric Co., Schenectady 5, N. Y., announces a bulletin on a picoammeter for nuclear uses. (368)

## Lionized

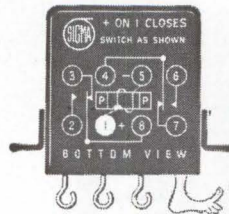

because it's  
**Polarized**

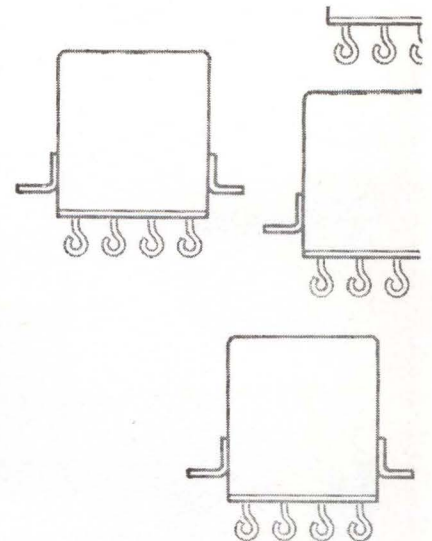

All crystal can relays do look alike and consequently the ones we make are probably thought to have about the same specs as everyone else's. Because this isn't true, we decided it was time to say what these major differences are and — since they're principally the result of a *polarized* design—perhaps do a little missionary work on behalf of polarized relays in general.

Right at the start, a polarized relay has a built-in advantage in the permanent magnet it contains. This puts a strong, continuous flux in the working gaps for all time, which not only helps the armature to remain stable under shock and vibration, but also allows a very *small* coil signal to apply strong *operating* forces to the armature. This happy situation results from the force on the armature being proportional to the *square* of the flux: if, say, 10 units of flux are already in the gap because of the permanent magnet, and you then add only 2 units by applying a coil signal, the net force will be proportional to  $(10 + 2)^2 - 10^2$ , or 44, instead of only the relatively meager  $2^2$  units supplied by the coil signal alone.\* In general, a good polarized relay design will be much more sensitive for a given size than a non-polarized type, less reactive, faster operating on suddenly-applied signals, and much more stable under shock and vibration for such a sensitive switch. Needless to say, this is

why both our "crystal can" types are polarized.

In the DPDT Series 32, the permanent magnet also accomplishes the important function of holding the armature *latched* in its last energized position—without a drop of stand-by power or any worries about power failures. The "32" needs only 50 mw. to operate, and does so on either slowly changing coil signals or abrupt energization such as short-duration pulses. In the "33", the armature is "biased" so that one pair of contacts is normally closed. Again, it is the permanent magnet—rather than a mechanical restoring spring—that does this job. The "33" will operate on as little as 100 mw.

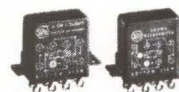

A "32" or "33" is well worth considering if 0.80" x 0.40" x 0.90" is all the room you have

for a relay, and you're looking for practical ways to do such things as the following: shrink the size, power output or number of components in your drive circuit . . . minimize heat dissipation problems in both components and relays . . . operate relays on minimum amounts of power (such as single, short-duration pulses) . . . switch loads in as little as one millisecond. The *extra* margins of safety and certainty these polarized relays can provide in your circuit can be very pleasant to behold. Bulletins on each relay on request.

\*The mathematics can be proved, but the cost of the space needed equals the square root of our annual advertising budget.



# SIGMA

SIGMA INSTRUMENTS, INC.

62 PEARL ST., SO. BRAINTREE 85, MASS.



## Electrospace Corp. Opens New Plant

ELECTROSPACE CORP. recently opened a 46,000 sq ft plant in Glen Cove, L. I., N. Y. William Brown, president, said the rapid increase of the company's sales backlog to about \$2 million last month made additional facilities necessary.

Electrospace also has a new 12,000 sq ft plant in Puerto Rico and a 3,000 sq ft facility in Valley Stream, Long Island. The Glen Cove plant, at 12 Morris Ave., is producing telecommunications and electronics equipment.

The company manufactures such products as nondestructive high potential test sets, hermetically-

sealed toggle switches, metallic sealing rings, and coil cords for telephones and other uses. Its military production includes ground support and airborne electronic components for aircraft, missiles, and space vehicles.

The General Hermetic Sealing division performs environmental tests, simulating high altitude space flights. For other electronics equipment manufacturers and its own products, Electrospace maintains a research and development division engaged in the field of environmental protection for space electronics equipment.

Corp., Richmond Hill, N. Y., has been announced.

In his new capacity, Fishbein will be responsible for systems engineering efforts and project control and liaison.



### Fishbein Assumes Capehart Post

APPOINTMENT of Samuel B. Fishbein, formerly with International Electric Corp., as director of military programs for the Capehart

### Name Plummer Chief Engineer

APPOINTMENT of Robert E. Plummer as chief engineer of the Radiating Systems division of Electronic Specialty Co., Los Angeles, Calif., is announced. Previously senior staff engineer, he will now be responsible for design and de-

velopment of antenna systems and microwave components.

From 1953 to 1960, Plummer was associated with the Hughes Aircraft Co., Culver City, Calif., as staff engineer and group head.

### Williard Advances At Dynatronics

MERWIN W. WILLIARD has been promoted to the position of data development division manager at Dynatronics, Inc., Orlando, Fla. In this post he will head research and development work on such projects as data systems for missile/space programs, telemetering equipment, timing systems, digital communications, and data processing and computation equipment.

Williard has been with Dynatronics for 3½ years in various positions including senior project engineer and section head.



### Eitel-McCullough Appoints Meyer

RAYMOND W. MEYER has been named director of quality assurance for Eitel-McCullough, Inc., San Carlos, Calif.

Before joining Eimac, Meyer was quality assurance manager for Lockheed Electronics in Los Angeles. He has also served with Burroughs Corp., Hoffman Radio Corp. and RCA.

### IRE Announces Fellow Awards

SEVENTY-EIGHT leading radio engineers and scientists from the U.S. and other countries were recently named Fellows of the Institute of Radio Engineers by the board of directors. The grade of Fellow is the highest membership grade



# LOW LEVEL SUBCARRIER OSCILLATOR FOR FM TELEMETERING

- DIFFERENTIAL FLOATING INPUT
- HIGH COMMON MODE REJECTION
- EXCELLENT ENVIRONMENTAL STABILITY

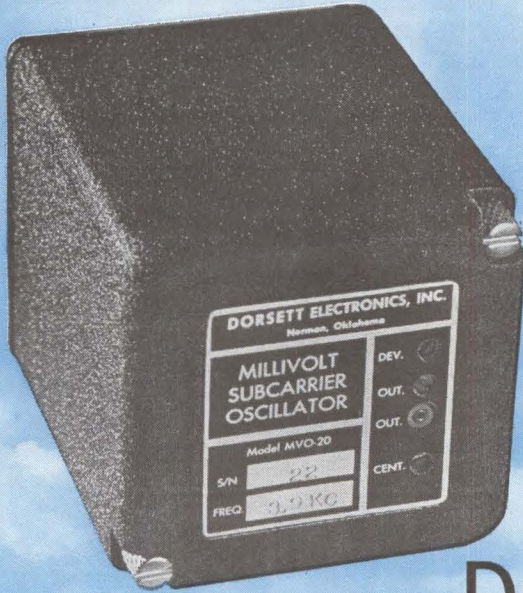

ACTUAL SIZE

## SPECIFICATIONS:

<b>Power Input Required:</b>	+28 $\pm$ 10%, 25 ma max.
<b>Modulation Sensitivity:</b>	$\pm$ 7.5% frequency deviation with $\pm$ 10 MV or 0 to 20 MV
<b>Input Impedance:</b>	10K (nominal).
<b>Linearity:</b>	Better than 0.5% DBW, best straight line.
<b>Output Voltage:</b>	0.5 VRMS minimum into 8K.
<b>Output Impedance:</b>	47 K.
<b>Harmonic Distortion:</b>	0.75% max.
<b>Frequency Response:</b>	$\pm$ 0.5 db (mod. index of 2.5)
<b>Amplitude Modulation:</b>	$\pm$ 0.5 db max.
<b>Common Mode Rejection:</b>	100 db minimum from DC to 1000 cps for common mode inputs up to 10 volts peak to peak. 140 db minimum at DC.
<b>Drift:</b>	$\pm$ 1% DBW, for 8 hours static environment
<b>Temperature:</b>	Center frequency and sensitivity stable $\pm$ 2% DBW, 0°F to 185°F. Operational -60°F to 212°F.

The center frequency and sensitivity will not vary more than  $\pm$ 1% DBW under the following environmental conditions.

<b>Acceleration:</b>	150 G, any axis.
<b>Shock:</b>	100 G, 11 ms, any axis.
<b>Vibration:</b>	20 G, 20 to 2000 cps in 5 minute sweeps in any axis.
<b>Altitude:</b>	Unlimited.
<b>Humidity:</b>	MIL-E-5272.

## NEW DORSETT MVO 20

New from Dorsett Electronics is the Model MVO-20, a realistic approach to reliability in the design of solid state, low level subcarrier oscillators.

Silicon semiconductors are used throughout a circuit which provides balanced differential input, excellent common mode rejection and stable data over a wide environmental range.

The MVO-20 is packaged in the die cast Dorsett "20" series No. 2 module compatible with other

"20" series telemetry components. Distortion and intermodulation are held to a minimum through careful package design. Components aren't cramped to rob reliability. The package is small enough to meet most system configuration requirements.

If you can't afford to take chances on reliability, be sure to evaluate the Dorsett Model MVO-20 low level subcarrier oscillator for your next telemetry requirement.



## DORSETT ELECTRONICS, INC.

P. O. BOX 862 • NORMAN, OKLAHOMA • JEFFERSON 4-3750

# SERVO IR Report

## New wide-angle, high-resolution Bowers-Maksutov infrared optical system

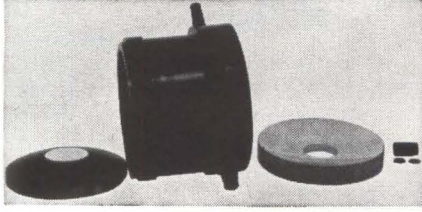

Another Servo-designed, high-precision system

Another Servo-designed optical system for a complex customer requirement of interest to the infrared industry, the Bowers-Maksutov system shown above provides wide-acceptance angle and high resolution.

Glass formulation, fabrication, grinding, polishing... all mountings... optics checkout—a Servo system throughout.

Company-sponsored R&D programs are currently in progress at Servo on optical materials, infrared fiber optics, polarization, and communications systems—as well as in a number of other areas of infrared technology.

New far-infrared transmitting glasses have been discovered by Servo scientists—all of interest to the infrared optical designer.

## From a complex infrared system to a simple infrared lens... look to the Servo solution

— IR systems — IR optics — IR achromats — IR meniscus lenses — IR bolometers — IR detectors and associated circuitry — IR lenses, windows, prisms, wedges, domes — IR SERVOFRAX® (arsenic trisulfide glass) — Other IR areas-of-glass compositions



Send for new SERVO/INFRARED brochure and handy file folder. Details Servo's IR capability in depth.



**SERVO CORPORATION OF AMERICA**

111 New South Road • Hicksville, L. I., N. Y. • WElls 8-9700

offered by the IRE and is bestowed only by invitation on those who have made outstanding contributions to radio engineering or allied fields.

Presentation of the awards will be made by IRE sections all over the world wherever the recipients reside. Recognition of the awards will be made by the president of the IRE at the annual banquet on March 28 at the Waldorf-Astoria Hotel in New York City during the 1962 IRE international convention.

Recipients of the Fellow award are as follows:

B. Adler; G. J. Andrews; H. G. Baerwald; C. K. Birdsall; F. E. Borgnis; G. A. Boutry; F. W. Brown; T. J. Carroll; R. S. Caruthers; S. S. L. Chang; E. W. Chapin; A. R. D'Heedene; A. Dorne; L. W. Erath; R. G. Fellers; L. B. Felsen; P. J. Franklin; P. E. Green, Jr.; F. T. Haddock, Jr.; R. C. Hansen; H. F. Hastings, Sr.; H. A. Haus; H. Heffner; M. W. Horrell; W. L. Hughes; J. F. Hull; H. R. Johnson; W. C. Johnson; T. F. Jones, Jr.; J. F. Keithley; H. Kihn; A. P. King; M. Knoll; H. N. Kozanowski; S. Krasik; H. L. Krauss; J. G. Kreer; D. B. Langmuir; F. W. Lehan; A. Longacre; S. G. Lutz; R. W. Masters; J. L. McLucas; B. McMillan; R. F. Mettler; G. F. Montgomery; R. K. Moore; R. B. Muchmore; G. E. Mueller; E. L. Norton; E. W. Pappenfus; A. M. Peterson; W. J. Pietenpol; R. Price; F. H. Raymond; P. A. Redhead; J. Ruze; V. Salmon; J. M. Salzer; W. Saraga; R. J. Schwarz; D. Slepian; S. T. Smith; R. L. Snyder; R. W. Sonnefeldt; A. P. Stern; D. M. Stuart; F. L. H. M. Stumpers; C. T. Tai; C. H. Townes; V. Twersky; J. L. van Soest; M. E. Van Valkenburg; J. R. Wait; W. H. Ware; F. M. Wiener; E. G. Witting; H. J. Woll.

## Set Up New Company For Subassembly Work

ORGANIZATION of Mode Electronics Inc., Cincinnati, O., is announced. The firm is engaged in custom electronic subassembly work, primarily aimed at subminiature inductances of all types.

Mode Electronics is an outgrowth of The Frank Simpson Company, which for many years has been de-

## DEVELOPMENT & AEROSPACE SPECIALISTS

International Electric, Systems Managers in the design and development of a variety of advanced, large-scale, electronic systems, seeks specialists in two areas.

*Development Specialists*, with at least six years' association with large projects. They will evolve requirements for systems users in such areas as air traffic control, ASW, satellite control and command/control systems, and for work in information retrieval, man/machine communications and advanced computer utilization.

*Aerospace Specialists*, for integration of command/control systems with weapons systems.

Please send resume to Manager of Technical Staffing, Dept. EL

## INTERNATIONAL ELECTRIC CORPORATION

An Associate of International Telephone and Telegraph Corporation  
Rte. 17 & Garden State Parkway  
Paramus, N. J.

An equal opportunity employer.

## GRC tiny parts



die cast  
ZINC ALLOY

molded  
PLASTICS

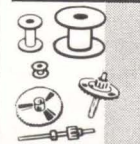

Coil Bobbins  
Gears & Pinions

## COIL BOBBIN WORK SHEET

Valuable data on wide range of sizes, shapes, designs from stock—and to specs in small bobbins of Nylon, Delrin, Kel F, etc. GRC's exclusive automatic single cavity techniques give you quality and accuracy in small parts of diecast zinc alloy, Nylon, Delrin, and other engineering thermoplastics at low cost! Write, wire, phone NOW for samples and detailed instructions. Send prints for prompt quotation. NO MINIMUM SIZE! Maximum sizes: Zinc Alloy—2" long, 1/2 oz. Plastic—1 3/4" long—.05 oz.

**GRIES REPRODUCER CORP.**

World's Foremost Producer of Small Die Castings  
151 Beechwood Ave., New Rochelle, N. Y.  
Phone: (914) NEw Rochelle 3-8600



**Have you thought of buying your own subscription to electronics?**

Only 7½ cents a week is the easy way! (\$6 one year, \$9 for two years, \$12 three years.) Just fill in the handy "For subscriptions" section of the Reader Service Card in this issue . . . and you'll get instant subscription.

**electronics:** 330 West 42nd St., N. Y. 36.

**for NON-DESTRUCTIVE DIELECTRIC TESTING**

Reduce Costs of Testing Transformers, Relays, Capacitors, Complete Assemblies, etc. with...

**ELECTROSPACE MEGPOTS**



**5600 Series MEGPOT MEGOHM-METER & HIGH POTENTIAL TEST SET**

Non-destructive testing assured through quick acting relay, cuts current from tested components in milliseconds. Provides for continuously variable current leakage test, with settings from 20 microamperes to 3 milliamperes. Rugged construction.

**Voltage Ranges:** Variable ranges to 0-5000V. Others available.  
**Megohm-Meter Ranges:** Up to 4 million megohms at 100 or 200V DC, up to 10 million megohms at 500V DC.

Ask for BULLETIN No. 158

**650 Series**

**Voltage Ranges:** High potential test 0-5000V AC & DC.  
**Megohm-Meter Ranges:** Up to 10 million megohms; voltage continuously variable 10-500V DC.

Ask for BULLETIN NO. 650



**MEGPOT HIGH POTENTIAL TEST SET - 570 Series**

Affords considerable savings in non-destructive testing, by means of its current limiting feature. Provides for a high sensitivity continuously variable test for current leakage, with settings from 20 microamperes to 3 milliamperes. Full scale output with 0.0025 mfd load capacitance.

**Voltage Ranges:** Variable ranges to 0-5000V. Others available. Standard models from 0-3000V or 0-5000V AC rms.

**Accuracy:** ±5%

Ask for BULLETIN No. 570

**E C ELECTRONICS FOR LAND, SEA & SPACE**  
**ELECTROSPACE CORP.**  
 12 Morris Ave., Glen Cove, L. I., N. Y. • Oriole 1-6100  
 MEGPOTS ■ GASEALS ■ ELECTRONIC SUB-SYSTEMS  
 TOGGLE SWITCHES ■ HERMETIC SEALING SERVICES

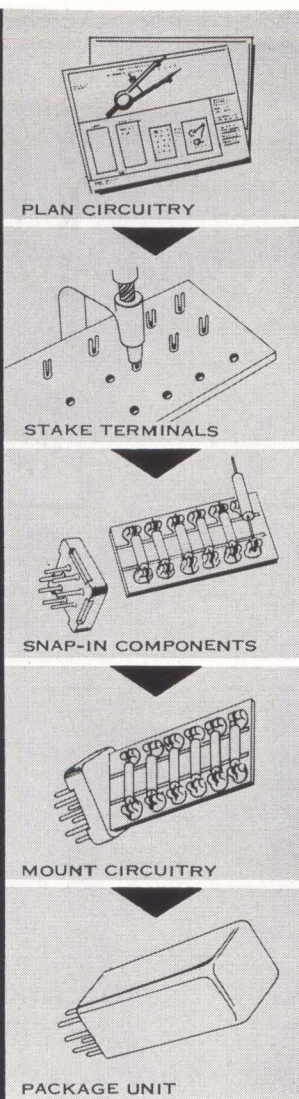
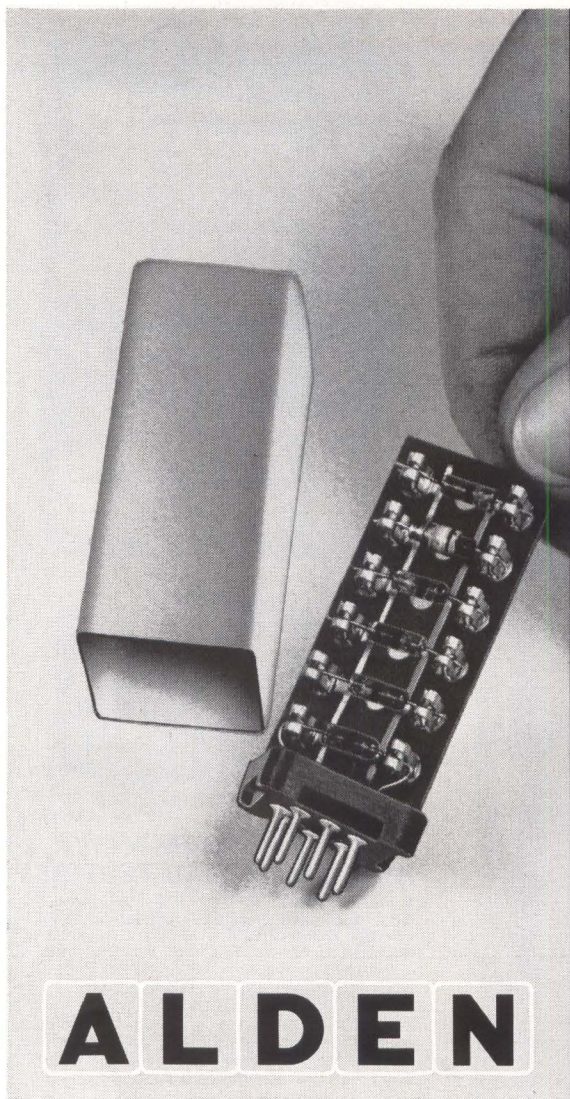

## ALDEN miniature packaging modules

Off-the-shelf building block components to simplify assembly and servicing of smaller circuits. Alden miniature plug-ins are simple to install, can be knocked down and swiftly reassembled, and allow for 30-second replacement by handy spares. Their greatest virtue: elimination of costly downtime. But they have other special assets:

- standard 7 or 9-pin off-the-shelf components
- space-saving "maximum density" package
- extra light-weight aluminum housings
- accommodates tremendous variety of circuits
- snap-in terminal setting and connecting
- open type construction for easy accessibility to components
- specially designed terminals give faster heat dissipation
- jumper strip eliminates need for leads

Alden furnishes everything you need — including planning sheets for slick, quick, layout. Ask about our plug-in module package kit. For complete information, including new micromodules, write:

**ALDEN**

PRODUCTS COMPANY  
1127 N. Main Street, Brockton, Mass.



Model 196G Germanium Transistor Amplifier by Taber Instrument Corporation — Its miniature size, light weight and ruggedness adapt it to portable and airborne instrumentation.

signing and producing complete electrical control assemblies for processing, conveying, and for the machine tool industry.

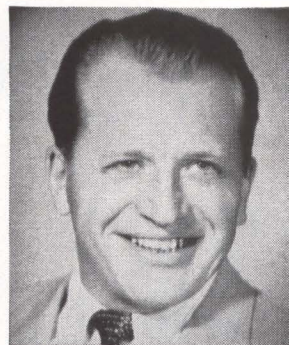

### Holtum To Head Up Andrew R&D Group

ALFRED G. HOLTUM, JR., was recently appointed chief of the newly formed government research and development group at Andrew Corp., Chicago, Ill.

He was formerly chief of the company's California operations, specializing in telemetry antenna systems.

### PEOPLE IN BRIEF

Louis Branzburg and Lester Coch move up at Waldes Kohinoor, Inc., to chief engineer and quality control manager, respectively. John Camuso, ex-Sage Laboratories, now director of engineering at Tru-Connector Corp. John M. Eagleson is promoted to president of the Baker Co., Inc. Norman Ellen leaves General Precision Laboratory, Inc., to rejoin PRD, Electronics, Inc. as senior project engineer. James H. Burrows of The Mitre Corp., is named head of its Computer Applications dept. Ralph R. Hind advances to president of Edo (Canada) Ltd. He succeeds Archibald M. Brown, who was elected board chairman. Martin E. Zernick elevated to the position of president of NYT Mfg. Co., Inc. Robert L. Tanner and Edward M. T. Jones, both formerly with Stanford Research Institute, appointed v-p and director of research, respectively, of TRG-West, a new div. of TRG Inc. Aerovox Corp. ups Carl Rentschler to director of quality control for the Hi-Q div.'s Cinema Plant.

Write for our catalogue

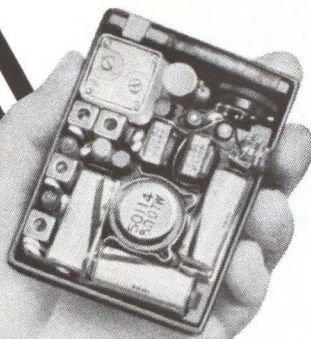

**Good parts work best!**

Intermediate Frequency Transformer IFT



The high standards of MITSUMI electronic components are insured by a fully-automated assembly system, and double-checked by rigid quality controls. Mitsumi Electric Company is Japan's largest manufacturer of components for radio, television and communications equipment.

POLYVARICON Variable Capacitor



**MITSUMI PARTS**

MITSUMI ELECTRIC CO., LTD.  
Komae, Kitatama, Tokyo



CIRCLE 148 ON READER SERVICE CARD

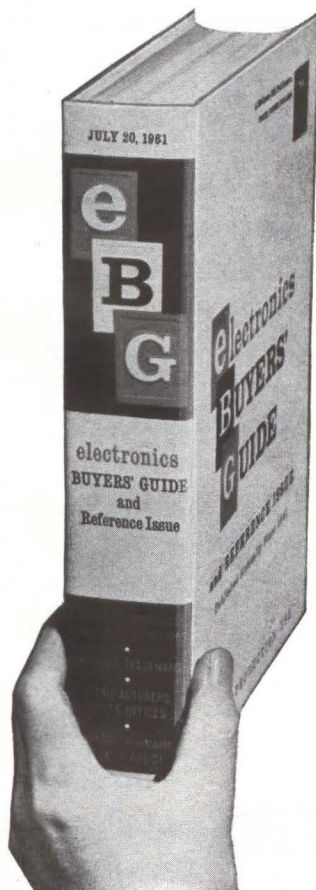

**"BEST BUY"**  
for buying or selling in  
the electronics industry

Your 1961 electronics Buyers' Guide and Reference Issue is the one book that "tells all" so far as buying or selling in the electronics industry is concerned.

Use your EBG today, and every day, and see what we mean.

**electronics BUYERS' GUIDE**  
and Reference Issue

The Basic Buying Guide in Electronics *since 1941*

January 12, 1962

*just published!*

**COMPUTER HANDBOOK**

Edited by HARRY D. HUSKEY  
and GRANINO A. KORN

Designing, using, and applying analog and digital computers is easier with this practical handbook. Here, 65 outstanding specialists give you a wealth of working information in one handy source. You get design help on formulas, techniques, circuits, components and systems. Here too, is material to further your skill in producing flow diagrams and preparing problems for computers. You will also learn all about how computers are used in the scientific, engineering, management, data-processing, and process-control fields. Treats everything from basic terminology and block/system design, to network-type direct-analogy computers and field problem analogies. You'll find special aids, such as worked-out examples of how to solve problems, adaptable circuit diagrams, special computer setup, and much more. 1251 pp., 1099 diagrams, tables & illus., \$25.00



*Also Noteworthy*

✓ **DESIGN MANUAL FOR TRANSISTOR CIRCUITS**

Provides quick answers to your design problems on transistor and other semiconductor circuits. Covers a wide range of applications and new developments. Ed. by John M. Carroll. 390 pp., over 600 illus., \$9.50

✓ **ANTENNA ENGINEERING HANDBOOK**

Helps you solve everyday problems in the design and use of antenna systems. Covers all areas of antenna engineering, from fundamentals to modern design applications. Ed. by Henry Jasik. 1013 pp., 993 illus. & charts, \$22.00

**10 DAYS' FREE EXAMINATION**

McGraw-Hill Book Co., Dept. L-1-12  
327 W. 41st St., New York 36, N. Y.

Send me book(s) checked below for 10 days' examination on approval. In 10 days I will remit for book(s) I keep plus few cents for delivery costs, and return unwanted book(s) postpaid. (We pay delivery costs if you remit with this coupon—same return privilege.)

- Huskey & Korn—Computer Handbook—\$25.00
- Carroll—Des. Manual for Trans. Cir.—\$9.50
- Jasik—Antenna Eng. Handbook—\$22.00

(PRINT)

Name .....

Address .....

City ..... Zone..... State.....

Company .....

Position .....

For price and terms outside U.S. write McGraw-Hill Intl., N.Y.C. 36

L-1-12

CIRCLE 123 ON READER SERVICE CARD 123

# electronics

## WEEKLY QUALIFICATION FORM FOR POSITIONS AVAILABLE

### ATTENTION: ENGINEERS, SCIENTISTS, PHYSICISTS

This Qualification Form is designed to help you advance in the electronics industry. It is unique and compact. Designed with the assistance of professional personnel management, it isolates specific experience in electronics and deals only in essential background information.

The advertisers listed here are seeking professional experience. Fill in the Qualification Form below.

#### STRICTLY CONFIDENTIAL

Your Qualification form will be handled as "Strictly Confidential" by ELECTRONICS. Our processing system is such that your form will be forwarded within 24 hours to the proper executives in the companies you select. You will be contacted at your home by the interested companies.

#### WHAT TO DO

1. Review the positions in the advertisements.
2. Select those for which you qualify.
3. Notice the key numbers.
4. Circle the corresponding key number below the Qualification Form.
5. Fill out the form completely. *Please print clearly.*
6. Mail to: D. Hawksby, Classified Advertising Div., ELECTRONICS, Box 12, New York 36, N. Y. (No charge, of course).

COMPANY	SEE PAGE	KEY #
AMERICAN INSTRUMENT CO., INC. Silver Spring, Maryland	168*	1
AMERICAN MACHINE & FOUNDRY COMPANY Stamford, Connecticut	126	2
ATOMIC PERSONNEL INC. Philadelphia, Pennsylvania	126	3
BOONTON RADIO CORP. Boonton, New Jersey	128	4
COLLINS RADIO COMPANY Dallas, Texas	122*	5
DALMO VICTOR CO. Div. of Textron, Inc. Belmont, California	126	6
ERIE ELECTRONICS DIVISION Erie Resistor Corp. Erie, Pennsylvania	126	7
ESQUIRE PERSONNEL SERVICE INC. Chicago, Illinois	126	8
GRUMMAN AIRCRAFT ENGINEERING CORP. Bethpage, L. I., New York	22	9
INTERNATIONAL ELECTRIC CORP. Paramus, New Jersey	121	10
JET PROPULSION LABORATORY California Institute of Technology Pasadena, California	125	11
LITTON SYSTEMS INC. Data Systems Div. Canoga Park, California	161*	12
LOCKHEED-GEORGIA CO. Div. of Lockheed Aircraft Corp. Atlanta, Georgia	94*	13
LOCKHEED MISSILES & SPACE CO. Group Div. of Lockheed Aircraft Corp. Sunnyvale, California	74	14
MCDONNELL AIRCRAFT St. Louis, Missouri	167*	15
MICROWAVE SERVICES INTERNATIONAL INC. Denville, New Jersey	126	16

CONTINUED ON PAGE 128

(cut here)

(cut here)

### electronics WEEKLY QUALIFICATION FORM FOR POSITIONS AVAILABLE

#### Personal Background

NAME .....

HOME ADDRESS .....

CITY ..... ZONE ..... STATE .....

HOME TELEPHONE .....

#### Education

PROFESSIONAL DEGREE(S) .....

MAJOR(S) .....

UNIVERSITY .....

DATE(S) .....

#### FIELDS OF EXPERIENCE (Please Check)

11262

<input type="checkbox"/> Aerospace	<input type="checkbox"/> Fire Control	<input type="checkbox"/> Radar
<input type="checkbox"/> Antennas	<input type="checkbox"/> Human Factors	<input type="checkbox"/> Radio-TV
<input type="checkbox"/> ASW	<input type="checkbox"/> Infrared	<input type="checkbox"/> Simulators
<input type="checkbox"/> Circuits	<input type="checkbox"/> Instrumentation	<input type="checkbox"/> Solid State
<input type="checkbox"/> Communications	<input type="checkbox"/> Medicine	<input type="checkbox"/> Telemetry
<input type="checkbox"/> Components	<input type="checkbox"/> Microwave	<input type="checkbox"/> Transformers
<input type="checkbox"/> Computers	<input type="checkbox"/> Navigation	<input type="checkbox"/> Other .....
<input type="checkbox"/> ECM	<input type="checkbox"/> Operations Research	<input type="checkbox"/> .....
<input type="checkbox"/> Electron Tubes	<input type="checkbox"/> Optics	<input type="checkbox"/> .....
<input type="checkbox"/> Engineering Writing	<input type="checkbox"/> Packaging	<input type="checkbox"/> .....

#### CATEGORY OF SPECIALIZATION

Please indicate number of months experience on proper lines.

	Technical Experience (Months)	Supervisory Experience (Months)
RESEARCH (pure, fundamental, basic)	.....	.....
RESEARCH (Applied)	.....	.....
SYSTEMS (New Concepts)	.....	.....
DEVELOPMENT (Model)	.....	.....
DESIGN (Product)	.....	.....
MANUFACTURING (Product)	.....	.....
FIELD (Service)	.....	.....
SALES (Proposals & Products)	.....	.....

CIRCLE KEY NUMBERS OF ABOVE COMPANIES' POSITIONS THAT INTEREST YOU

1 2 3 4 5 6 7 8 9 10 11 12 13 14 15 16 17 18 19 20 21 22 23 24 25

# JPL needs RESEARCH ENGINEERS COMMUNICATIONS

To analyze and solve telecommunication system problems in direct support of design, development and use of spacecraft telecommunication systems.

Minimum 2 years experience in communications, telemetry of radar system design analysis.

Must have BS in E. E. or Physics. M. S. highly desirable.

## TELEVISION

To monitor the performance of vendors in the execution of their contract to develop electro-optical sensors for the VOIS program.

Perform in-house environmental and functional testing to insure the devices adherence to spacecraft design specifications.

Will be responsible for integration of these devices into the overall television system.

B. S. in Electrical Engineering or Physics with a minimum of 2 years professional experience in the areas of transistorized circuit design, component development or electro-optical or infra-red instrument design. Television experience would be helpful but not required.

Submit complete resume to

**HUGH E. MARXMILLER**

## JET PROPULSION LABORATORY

CALIFORNIA INSTITUTE OF TECHNOLOGY  
4814 OAK GROVE DRIVE  
PASADENA, CALIFORNIA

"An equal opportunity employer"

# THE "YOUNG GIANT" OF THE ELECTRONICS INDUSTRY

## **SANDERS ASSOCIATES, Inc. OFFERS YOU THESE CAREER ADVANTAGES**

Creation of new engineering positions with good growth potential is as much a part of Sanders Associates as the development of new engineering techniques — upon which the Company was founded just 10 years ago.

Fresh, non-conventional approaches toward solution of both old and new problems have enabled Sanders to grow from 11 founding engineers to over 2400 employees... to open 3 new facilities within the last year... and to acquire a contract backlog in excess of \$100 million, largely for production of Sanders-developed systems.

Still further pioneering and expansion are planned in advanced areas of phased array radar, pulse doppler radar systems, space radar and communications systems, creating positions for Engineers interested in and qualified for working at the threshold of the state of the art.

### NEW FACILITIES

Plainview, L. I., New York  
Burlington, Mass.  
Washington, D. C.

### SANDERS' ACHIEVEMENTS

FLEXPRINT® flexible printed circuits, for which Sanders holds the basic patent; TRI-PLATE® microwave products; PANAR® radar

### *Positions Are Open for the Following:*

#### SENIOR SYSTEMS ENGINEERS

With 5 or more years experience in communications, reconnaissance or satellite systems and equipments, specifically in transistor circuit design, analysis or development of digital equipments, man-machine control systems, receivers (HF through UHF), data storage and display devices or mathematical analyses related to such equipment. BS or MS in EE or Physics.

#### RECEIVER DESIGN ENGINEERS

For design and development of receivers for military applications. Experience should include design of low noise front ends, IF strips, AGC circuitry and application of image rejection techniques — all transistorized. BS in EE or Physics with 3 to 8 years experience.

#### CIRCUIT DESIGN ENGINEERS

To translate conventional wire circuits into flexible and/or rigid printed circuitry and to design circuitry layout and approaches for printed circuits. EE, ME or ChE with printed circuit background.

#### TRANSMITTER DESIGN ENGINEERS

For design and development of transmitters (VHF, UHF and microwave), tubes, pulse modulators, power in excess of 1 kilowatt — for military and airborne applications.



Resumes should be addressed to R. W. McCarthy.

**SANDERS ASSOCIATES, INC.**

An Equal Opportunity Employer

NASHUA, NEW HAMPSHIRE

(About an hour from downtown Boston)

®REGISTERED U. S. TRADEMARK

# Engineers

Company sponsored programs directed towards major advances in the office machines field, have created the following career positions at our Modern Development Laboratory.

**Sr. Electronics Engineers**  
5 to 8 years development experience in the digital field, with emphasis on logical design, and systems. Masters degree preferred.

**Sr. Mechanical Engineers**  
5-8 years design and development experience in high reliability, consumer oriented products. Emphasis will be on development of new concepts, mathematical analysis, and design studies. Masters degree preferred.

**Process Engineers**  
3-5 years experience in manufacturing research of electro-mechanical components. Work will include studies of advanced methods of future product manufacture.

**Physicists**  
5 to 8 years experience in small equipment development. Work will be in the advanced machine study area and will require extensive interdisciplinary scientific knowledge. Masters degree required.

Please Submit Resume  
Including Salary Requirements  
To Mr. D. P. Claveloux  
Dept. E 81

**REMINGTON RAND  
OFFICE MACHINES DIVISION**  
Sperry Rand Corp.  
Wilson Ave., So. Norwalk, Conn.  
An Equal Opportunity Employer



A leader in . . .  
**Design, Development  
and Manufacturing of**

- MICROWAVE ANTENNAS  
SYSTEMS & COMPONENTS
- ELECTRONIC SYSTEMS
- MAGNETIC  
INSTRUMENTATION  
SYSTEMS
- SERVO CONTROL  
SYSTEMS

Invites . . .

Qualified Engineers and Scientists to explore the challenging opportunities created by increased business volume and facility expansion.

Experienced Engineers and Physicists will find stimulating assignments, career growth opportunities based on performance, and the opportunity to make significant individual contributions toward major state of the art advances in the areas indicated above.

Liberal employee benefits which include Insurance, Stock Plan, Profit-Sharing and Educational assistance, combine with the natural advantages of Northern California suburban living to offer an ideal environment in which to work and live.

For further information, please write, sending a copy of your resume to:

Technical Employment



1515 Industrial Way  
Belmont, Calif.

"an equal opportunity employer"

**COMMUNICATIONS APPLICATION ENGINEER**  
Analysis of advanced electronic communication systems including radio, carrier, telephone, microwave:  
Must have design and marketing experience with commercial and military users.  
EE degree, 5 yrs. exp. min.  
Send Resume to:  
Microwave Services International Inc.  
Consulting Engineers  
Route 46 Denville, N. J.

**COMPUTER APPLICATIONS SPECIALIST**  
\$12,000 Per Year  
Will investigate application for special purpose analog and digital computers and data processing equipment. Analyze requirements and prepare proposals and estimates. Staff opportunity. Company assumes all expenses.  
**ESQUIRE PERSONNEL**  
202 South State St., Chicago 4, Illinois

**E.E.'s**  
For professional, individualized fee-paid service write for confidential application.  
A national employment agency for the Nuclear & Scientific Fields.  
**ATOMIC PERSONNEL, INC.**  
Suite 1207L, 1518 Walnut St., Phila. 2, Pa.

## TRANSFORMER ENGINEER

With experience in the design and development of Hi-Frequency and Pulse transformers for commercial and military applications.

Ideal opportunity for ambitious man to develop full potential of present small department. Salary—open. Location—Erie, Pa. Call or send resume to Chief Engineer

**Erie Electronics Division**

Erie Resistor Corporation

645 West 12th Street Erie, Pa.  
GL 6-8592

## RFI ENGINEER

5-10 years experience, to perform system analysis on radar and communications equipment. Some knowledge of VHF instrumentation, RFI problems and computer techniques.

Please send resume including salary requirements to Mr. Charles Lubicic

**GREENWICH  
ENGINEERING DIVISION**

**AMERICAN MACHINE  
& FOUNDRY COMPANY**

737 Canal St—Stamford, Connecticut  
An Equal Opportunity Employer

## FOR INFORMATION

About Classified Advertising  
Contact The McGraw-Hill  
Office Nearest You

- ATLANTA, 9  
1375 Peachtree St. N. E. Trinity 5-0523  
D. HICKS
- BOSTON, 16  
Copley Square Congress 2-1160  
M. SHOVLIN
- CHICAGO, 11  
645 No. Michigan Ave. MOhawk 4-5800  
W. J. HIGGINS
- CLEVELAND, 13  
1164 Illuminating Bldg. Superior 1-7000  
I. C. HILL
- DALLAS, 7  
1712 Commerce St., Vaughn Bldg.  
Riverside 7-5117  
J. GRANT
- DENVER, 2  
1700 Broadway, Tower Bldg.  
Alpine 5-2981  
J. PATTEN
- DETROIT, 26  
856 Penobscot Bldg. Woodward 2-1793  
WM. H. GINDER, JR.
- HOUSTON, 25  
Prudential Bldg., Room W-724  
Holcombe Blvd. Jackson 6-1281  
J. PAGE
- LOS ANGELES, 17  
1125 W. 6th St. Huntley 2-5450  
W. C. GRIES
- NEW YORK, 36  
500 Fifth Ave. Oxford 5-5959  
H. T. BUCHANAN  
T. W. BENDER - P. BOND
- PHILADELPHIA, 3  
Six Penn Center Plaza LOcust 8-4330  
W. B. SULLIVAN - F. W. McCARTHY
- PITTSBURGH, 22  
4 Gateway Center EXpress 1-1314  
D. FARRIS
- ST. LOUIS, 8  
7751 Carondelet Ave. Parkview 5-7285
- SAN FRANCISCO, 11  
255 California St. DOuglas 2-4600  
J. A. HARTLEY





# reaching for ultimate **SIMULATION**

**THE PROBLEM:** Simulate in an earthbound facility the spatial extremes faced by men and instruments in space vehicles as they orbit the earth.

Build a single, integrated testing facility to reproduce the condition of motion in outer space: the searing heat, bitter cold, three dimensional vibration, high vacuum, temperature gradients, roll, pitch, and yaw, rotation, buffeting, variation of atmosphere—all at various controlled speeds.

Further, project a target into the instrument being tested and simulate its environment.

**THE SOLUTION:** You're looking at a scale model of Honeywell's Ordinance's three-story installation that exactly fulfills the above requirements. It is the first such facility in existence. It is simulation at the most advanced state of the art.

**YOUR ROLE:** If the challenge of creativity in the almost limitless field of Space and Electronic Simulation motivates you, consider the advanced technological positions available at Honeywell Ordinance. Write Allan J. McInnis, Employment Manager, 1724 Mountain Road, Duarte, California.



**EQUAL OPPORTUNITY EMPLOYER**

# JUNIOR SALES ENGINEER

BOONTON RADIO CORPORATION has a unique and challenging opportunity for a young Electronics Engineer to enter the field of applications and sales engineering.

BS in EE and up to 2 years engineering experience with electronic equipment required.

His responsibilities will include applications engineering, market research, product familiarization and the handling of technical correspondence.

Limited travel on a national basis.

Our sales training program offers the opportunity to work closely with engineering and production personnel, providing a basic background on our product line of precision electronic laboratory instruments.

Please send resume to Mr. David Keller  
Professional Personnel Manager



**BOONTON RADIO CORPORATION**  
P.O. Box 390 Boonton, N. J.  
An Equal Opportunity Employer

## MICROWAVE COMMUNICATIONS ENGINEERS

Ankara - Teheran - Karachi  
Bangkok - U. S.

Work involves engineering, supervision of installation, operation and maintenance of microwave communications systems.

College Degree Mandatory

## MICROWAVE COMMUNICATIONS TECHNICIANS

Must be qualified by education and experience to inspect installation, operate and maintain microwave communications systems to insure quality and performance standards.

Technical or trade school training mandatory.

Families May Accompany  
Usual Overseas Benefits  
Send detailed resumes to:

P-7950, Electronics  
645 N. Michigan Avenue, Chicago 11, Ill.

# electronics

## WEEKLY QUALIFICATIONS FORM FOR POSITIONS AVAILABLE

(Continued from page 124)

MINNEAPOLIS HONEYWELL CO. Duarte, California	127	17
MITRE CORPORATION Bedford, Massachusetts	95	18
NATIONAL CASH REGISTER CO. Dayton, Ohio	168*	19
REMINGTON RAND Office Machines Div. of Sperry Rand Corp. South Norwalk, Connecticut	126	20
SANDERS ASSOCIATES, INC. Nashua, New Hampshire	125	21
SIKORSKY AIRCRAFT Div. of United Aircraft Corp. Stratford, Connecticut	166*	22
SPACE TECHNOLOGY LABS., INC. Sub. of Thompson-Ramo-Wooldridge Los Angeles, California	169*	23
P-7950	128	24

\* These advertisements appeared in the 1/5/62 issue.

CLASSIFIED

# SEARCHLIGHT SECTION

ADVERTISING

BUSINESS OPPORTUNITIES

EQUIPMENT - USED or RESALE

### DISPLAYED RATE

The advertising rate is \$27.25 per inch for advertising appearing on other than a contract basis. Contract rates quoted on request. AN ADVERTISING INCH is measured 7/8 inch vertically on one column, 3 columns—30 inches—to a page. EQUIPMENT WANTED or FOR SALE ADVERTISEMENTS acceptable only in Displayed Style.

The publisher cannot accept advertising in the Searchlight Section, which lists the names of the manufacturers of resistors, capacitors, rheostats, and potentiometers, or other names designed to describe such products.

Send NEW ADS or inquiries to Classified Adv Div. of Electronics P. O. Box 12, N. Y. 36, N. Y.

### UNDISPLAYED RATE

\$2.70 a line, minimum 3 lines. To figure advance payment count 5 average words as a line.

BOX NUMBERS count as one line additional in undisplayed ads.

DISCOUNT of 10% if full payment is made in advance for four consecutive insertions of undisplayed ads (not including proposals.)

### SURPLUS HIGH VOLTAGE POWER SUPPLY EQUIPMENT

#### CONDENSERS HIGH VOLTAGE

0.2 mfd — 50 KV — \$40  
1 mfd — 25 KV — \$45  
.02 mfd — 250 KV — ...

many others—all at lowest prices

#### TRANSFORMERS

18 KVDC COMPLETE POWER SUPPLY 4 KVA. G.E. Output taps 9, 12, 15, 18 KV. Input 110 VAC 60C. ... \$250  
17 KVDC POWER SUPPLY. 2 AMP continuous, Output continuously variable.

35 KVDC HIGH VOLTAGE POWER SUPPLY 50 KVA. Price on request  
0-60 KV HIGH VOLTAGE TRANSFORMER 2KVA. G.E. ... \$250  
many other items. For complete information contact

#### SPELLMAN HIGH VOLTAGE COMPANY

1930 ADEE AVE., NEW YORK 69, N. Y.  
KI 7-0306

CIRCLE 460 ON READER SERVICE CARD

### FREE 32 PAGE CATALOG OF INDUSTRIAL ELECTRONIC EQUIPMENT "BUYS"

Test equipment, relays, tubes, capacitors, resistors, switches, rectifiers, transformers and hard to get items.

WE WANT TO BUY LARGE OR SMALL QUANTITIES, ESPECIALLY TEST EQUIPMENT, RELAYS, SWITCHES.

#### CAPITOL COMMODITIES CO., INC.

4757 N. Ravenswood Avenue  
Chicago 40, Illinois

ALL PHONES : LONGBEACH 1 3355

CIRCLE 461 ON READER SERVICE CARD

### TUBE & COMPONENT FREE... CATALOG BARRY ELECTRONICS

512 BROADWAY WALKER 5-7000  
NEW YORK 12, N. Y. TWX NY 1-3731

CIRCLE 462 ON READER SERVICE CARD

## LIFSCHULTZ FASTEST TO BOTH COASTS

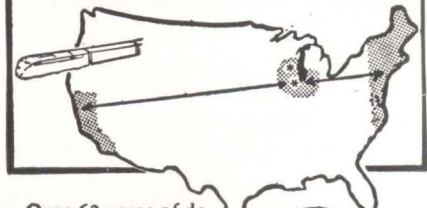

Over 62 years of dependable ON-TIME Freight Forwarding Service.

We welcome your inquiry.



PROMPT DAILY PICKUP and DELIVERY

## LIFSCHULTZ FAST FREIGHT

CIRCLE 463 ON READER SERVICE CARD

Harold Meissner

of  
AUTH  
ELECTRIC  
calls  
UNIVERSAL  
RELAY . . .

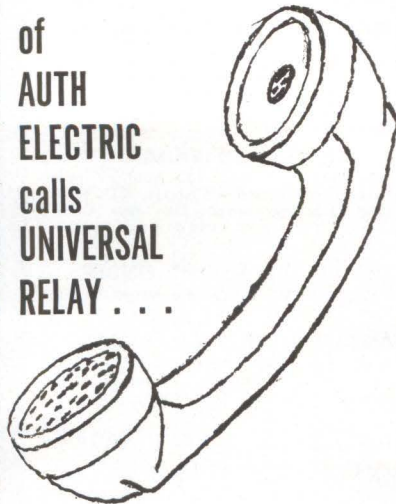

"When I need up-to-date technical data on relays—I call UNIVERSAL. In my estimation UNIVERSAL RELAY is the "House of Relay Information."

Harold Meissner, Chief Engineer  
Auth Electric Co., New York

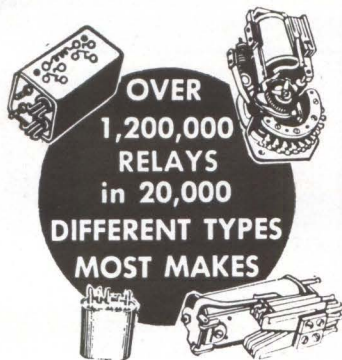

OVER  
1,200,000  
RELAYS  
in 20,000  
DIFFERENT TYPES  
MOST MAKES

- PRODUCTION QUANTITIES IN STOCK
- DELIVERY ON OFF-THE-SHELF ITEMS WITHIN 48 HOURS. DELIVERY WITHIN ONE WEEK ON RELAYS REQUIRING ASSEMBLY AND/OR ADJUSTMENT.

WE DELIVER RELAYS  
NOT PROMISES



FREE...  
SEND  
for  
NEW  
catalog  
"E-2"

**Universal RELAY CORP.**

42A White St., N. Y. 13, N. Y. WAlker 5-9257  
CIRCLE 468 ON READER SERVICE CARD

January 12, 1962

**SPECIAL PURPOSE TUBES**

OA2 . . . . .80	4-65A . . . . .10.00	25Z6WGT . . . . .1.50	725A . . . . .12.50	5751WA . . . . .1.50
OA2WA . . . . .2.00	4-125A . . . . .20.00	26Z5W . . . . .1.50	726A . . . . .3.00	5763 . . . . .1.75
OA3 . . . . .85	4-250A . . . . .32.50	FG-27A . . . . .20.00	726B . . . . .5.00	5777 . . . . .150.00
OB2 . . . . .60	4-400A . . . . .30.00	28D7W . . . . .3.50	726C . . . . .8.50	5778 . . . . .150.00
OB2WA . . . . .2.00	4-1000A . . . . .90.00	FG-32 . . . . .6.50	NL-760 . . . . .20.00	5783 . . . . .1.75
OB3 . . . . .70	4AP10 . . . . .10.00	35T . . . . .10.00	802 . . . . .5.00	5787 . . . . .2.00
OC3 . . . . .50	4B31 . . . . .12.50	35TG . . . . .1.25	803 . . . . .3.50	5796 . . . . .8.00
OD3 . . . . .30	4C27 . . . . .7.50	FP-54 . . . . .100.00	804 . . . . .15.00	5800/VX-41 . . . . .5.00
C1A . . . . .6.50	4C35 . . . . .15.00	FG-57 . . . . .6.00	805 . . . . .5.00	5803/VX-55 . . . . .2.25
1AD4 . . . . .1.50	4CX250B . . . . .35.00	RK-60/1641 . . . . .1.00	807 . . . . .1.35	5814A . . . . .1.35
1B24A . . . . .10.00	4D32 . . . . .15.00	HY-69 . . . . .3.00	807W . . . . .1.50	5829 . . . . .75
1B35A . . . . .3.00	4E27 . . . . .7.50	BL-75 . . . . .3.00	808 . . . . .1.00	5830/FG41 . . . . .100.00
1B63A . . . . .10.00	4J32 . . . . .100.00	75TL . . . . .15.00	809 . . . . .5.25	5836 . . . . .50.00
1C/3B22 . . . . .5.00	4J34 . . . . .100.00	TG-77 . . . . .7.50	810 . . . . .15.00	5837 . . . . .50.00
C1K . . . . .6.00	4J50 . . . . .75.00	HF-100 . . . . .10.00	811 . . . . .2.50	5840 . . . . .1.25
1P21 . . . . .30.00	4J52 . . . . .25.00	100TH . . . . .12.00	811A . . . . .4.00	5841 . . . . .3.25
1P22 . . . . .8.00	4PR60A . . . . .60.00	100TL . . . . .12.00	812A . . . . .4.75	5845 . . . . .4.50
1P25 . . . . .8.00	4X150A . . . . .15.00	FG-105 . . . . .15.00	813 . . . . .12.50	5852 . . . . .3.00
1P28 . . . . .15.00	4X150D . . . . .15.00	F-123A . . . . .5.00	814 . . . . .3.50	5876 . . . . .8.50
1Z2 . . . . .1.50	4X150G . . . . .25.00	FG-172 . . . . .25.00	815 . . . . .2.50	5879 . . . . .1.25
2-01C . . . . .12.50	4X250B . . . . .20.00	211 . . . . .2.50	816 . . . . .2.25	5881/6L6WGB . . . . .2.50
2AP1A . . . . .6.50	4X250F . . . . .30.00	212E . . . . .25.00	826 . . . . .3.50	5886 . . . . .2.50
2B23 . . . . .20.00	5B1P1A . . . . .9.50	FG-235 . . . . .40.00	828 . . . . .12.50	5894 . . . . .18.85
2BP1 . . . . .8.50	5C22 . . . . .15.00	242C . . . . .10.00	829B . . . . .9.50	5915 . . . . .85
2C36 . . . . .22.50	5CP1A . . . . .9.50	244A . . . . .2.50	832 . . . . .2.00	5933/807W . . . . .1.75
2C39A . . . . .9.75	5CP7A . . . . .9.50	245A . . . . .2.50	832A . . . . .7.50	5948/1754 . . . . .75.00
2C39B . . . . .18.75	5D21 . . . . .7.50	249B . . . . .10.00	833A . . . . .37.50	5949/1907 . . . . .50.00
2C40 . . . . .7.50	5J26 . . . . .50.00	249C . . . . .5.00	834 . . . . .7.50	5963 . . . . .1.10
2C42 . . . . .3.00	5LP1 . . . . .7.50	250R . . . . .10.00	836 . . . . .2.50	5964 . . . . .85
2C43 . . . . .7.50	5R4GY . . . . .1.10	250TH . . . . .25.00	837 . . . . .1.00	5965 . . . . .85
2C50 . . . . .4.00	5R4WGB . . . . .5.00	251A . . . . .50.00	838 . . . . .1.00	5981/5650 . . . . .25.00
2C51 . . . . .1.50	5R4WGY . . . . .2.75	254A . . . . .2.00	842 . . . . .7.50	5992 . . . . .2.50
2C52 . . . . .1.50	5RP1A . . . . .9.50	FG-258A . . . . .75.00	845 . . . . .7.50	5993 . . . . .5.00
2C53 . . . . .8.00	5Y3WGT . . . . .1.25	259A . . . . .3.50	849 . . . . .75.00	6002/QK221 . . . . .250.00
2D21 . . . . .5.00	5Y3WGTB . . . . .3.00	262B . . . . .3.50	850 . . . . .12.50	6005/6AQ5W . . . . .1.00
2D21W . . . . .1.00	6AC7W . . . . .35	267B . . . . .5.00	851 . . . . .35.00	6012 . . . . .3.50
2E22 . . . . .2.50	6AC7WA . . . . .2.00	271A . . . . .12.50	866A . . . . .1.90	6021A . . . . .2.00
2E24 . . . . .2.50	6AG5WA . . . . .1.50	274A . . . . .2.00	869B . . . . .50.00	6032 . . . . .10.00
2E26 . . . . .2.50	6AG7Y . . . . .90	283A . . . . .3.50	872A . . . . .4.50	6037/QK243 . . . . .50.00
2J42 . . . . .65.00	6AK5W . . . . .1.00	287A . . . . .3.00	874 . . . . .75	6045 . . . . .1.15
2J51 . . . . .50.00	6AK5 (WE) . . . . .75	QK-288 . . . . .250.00	884 . . . . .1.25	6072 . . . . .1.50
2J55 . . . . .75.00	6AL5W . . . . .60	HF-300 . . . . .35.00	885 . . . . .85	6073 . . . . .1.00
2K22 . . . . .25.00	6AN5 . . . . .1.75	300B . . . . .5.00	902-P1 . . . . .3.50	6074 . . . . .2.00
2K25 . . . . .8.50	6AN5WA . . . . .3.50	304TH . . . . .25.00	913 . . . . .8.50	6080 . . . . .3.00
2K26 . . . . .35.00	6AQ5W . . . . .1.00	304TL . . . . .35.00	920 . . . . .2.50	6080WA . . . . .5.00
2K28 . . . . .30.00	6AR6 . . . . .75	307A . . . . .40	927 . . . . .1.50	6080WB . . . . .10.00
2K29 . . . . .25.00	6AS6 . . . . .85	310A . . . . .3.50	931A . . . . .3.50	6082 . . . . .2.50
2K30 . . . . .50.00	6AS6W . . . . .1.00	311A . . . . .3.00	1000T . . . . .80.00	6087/5Y3WGTB . . . . .3.00
2K33A . . . . .200.00	6AS7G . . . . .2.75	313C . . . . .1.50	R1130B . . . . .10.00	6101/6J6WA . . . . .1.00
2K34 . . . . .75.00	6AU6WA . . . . .1.25	323A . . . . .6.00	1500T . . . . .125.00	6115/QK351 . . . . .40.00
2K35 . . . . .250.00	6B4G . . . . .3.00	328A . . . . .3.00	1603 . . . . .4.00	6130/3C45 . . . . .5.00
2K39 . . . . .150.00	6BA6W . . . . .75	336A . . . . .3.00	1611 . . . . .2.00	6136/6AU6WA . . . . .1.25
2K41 . . . . .35.00	6BE6W . . . . .1.50	337A . . . . .3.50	1614 . . . . .2.75	6146 . . . . .3.00
2K42 . . . . .125.00	6BH6W . . . . .2.75	347A . . . . .1.00	1616 . . . . .1.00	6159 . . . . .3.50
2K43 . . . . .150.00	6BL6 . . . . .20.00	348A . . . . .4.00	1619 . . . . .25	6161 . . . . .50.00
2K44 . . . . .125.00	6BM6 . . . . .25.00	349A . . . . .2.50	1620 . . . . .3.50	6186/6AG5WA . . . . .1.50
2K45 . . . . .20.00	6BM6A . . . . .30.00	350A . . . . .3.50	1624 . . . . .1.00	6189/12AU7WA . . . . .1.50
2K47 . . . . .125.00	6C4W . . . . .2.50	350B . . . . .2.50	1625 . . . . .50	6197 . . . . .1.50
2K48 . . . . .50.00	6C4WA . . . . .1.00	352A . . . . .8.50	1846 . . . . .50.00	6198 . . . . .75.00
2K50 . . . . .70.00	6C21 . . . . .17.50	354A . . . . .10.00	1855 . . . . .250.00	6199 . . . . .37.50
2K54 . . . . .10.00	6D4 . . . . .1.25	355A . . . . .10.00	2050 . . . . .1.25	6201/12AT7WA . . . . .1.85
2K55 . . . . .15.00	6F4 . . . . .3.50	371B . . . . .2.50	ZB-3200 . . . . .75.00	6202/6X4WA . . . . .1.50
2K56 . . . . .50.00	6C6J . . . . .10.00	388A . . . . .2.00	5528/C6L . . . . .2.00	6211 . . . . .75
2P21 . . . . .30.00	6C6J/A . . . . .15.00	393A . . . . .5.00	5545 . . . . .20.00	6216 . . . . .2.85
2X2A . . . . .1.00	6C6J/K . . . . .20.00	394A . . . . .3.00	5550 . . . . .30.00	6233 . . . . .100.00
3A5 . . . . .75	6J4 . . . . .1.50	395A . . . . .3.00	5552/FG235 . . . . .40.00	6236 . . . . .125.00
3AP1 . . . . .2.00	6J4WA . . . . .2.50	396A/2C51 . . . . .1.50	5553/FG258 . . . . .75.00	6248 . . . . .500.00
3B24W . . . . .3.00	6J6W . . . . .75	398A/5603 . . . . .3.00	5557/FG17 . . . . .5.00	6263 . . . . .9.00
3B24WA . . . . .5.00	6K6WA . . . . .1.00	401A/5590 . . . . .1.00	5558/FG32 . . . . .6.50	6264 . . . . .9.00
3B25 . . . . .2.50	6K4 . . . . .2.00	403B/5591 . . . . .3.00	5559/FG57 . . . . .6.00	6265/6BH6W . . . . .2.75
3B26 . . . . .2.25	6L6GAY . . . . .75	404A/5847 . . . . .7.50	5560/FG95 . . . . .20.00	6299 . . . . .37.50
3B28 . . . . .3.00	6L6WGA . . . . .1.50	407A . . . . .3.75	5561/FG104 . . . . .40.00	6316/BL800A . . . . .100.00
3B29 . . . . .5.00	6L6WGB . . . . .2.50	408A/6028 . . . . .3.25	5636 . . . . .2.00	6322/BL25 . . . . .15.00
3BP1 . . . . .3.50	6Q5G . . . . .2.50	409A/6A56 . . . . .1.00	5642 . . . . .2.00	6336 . . . . .8.75
3C/4B24 . . . . .4.00	6S17WGT . . . . .1.25	410R/2K30 . . . . .50.00	5643 . . . . .3.00	6336A . . . . .12.50
3C22 . . . . .25.00	6SK7W . . . . .75	416B/6280 . . . . .35.00	5647 . . . . .3.00	6344/QK235 . . . . .500.00
3C23 . . . . .4.00	6SK7WA . . . . .2.00	417A/5842 . . . . .9.50	5651 . . . . .75	6352 . . . . .7.50
3C24/24G . . . . .5.00	6SL7WGT . . . . .1.00	418A . . . . .9.50	5654/6AK5W . . . . .1.25	6385 . . . . .5.00
3C33 . . . . .7.50	6SN7W . . . . .50	420A/5755 . . . . .5.00	5656 . . . . .2.50	6390 . . . . .125.00
3C45 . . . . .3.50	6SN7WGT . . . . .1.00	421A/5998 . . . . .7.50	5663 . . . . .75	6394 . . . . .10.00
3CX100A5 . . . . .15.00	6SN7WGTA . . . . .2.50	429A . . . . .6.50	5665/C16J . . . . .35.00	6438 . . . . .5.00
3D21A . . . . .2.50	6SU7GTY . . . . .85	GL-434A . . . . .10.00	5670 . . . . .1.00	6463 . . . . .1.00
3D22 . . . . .8.00	6V6GTY . . . . .90	450TH . . . . .40.00	5672 . . . . .1.75	6517/QK358 . . . . .500.00
3DP1A . . . . .5.00	6X4W . . . . .75	450TL . . . . .40.00	5675 . . . . .8.50	6533 . . . . .5.00
3E29 . . . . .7.50	6X4WA . . . . .1.50	575A . . . . .15.00	5678 . . . . .1.25	6542 . . . . .5.75
3GP1 . . . . .1.50	6X5WGT . . . . .1.25	578 . . . . .5.00	5686 . . . . .1.75	6550 . . . . .3.50
C3J . . . . .7.50	5RL7F . . . . .100.00	KU-610 . . . . .5.00	5687 . . . . .1.50	6807 . . . . .20.00
C3J/A . . . . .9.50	5RL7H . . . . .100.00	NL-623 . . . . .8.50	5691 . . . . .5.00	6897 . . . . .20.00
3J21 . . . . .35.00	7AK7 . . . . .2.50	631-P1 . . . . .5.00	5692 . . . . .2.50	7034/4X150A . . . . .15.00
3J31 . . . . .50.00	7BP7A . . . . .5.00	673 . . . . .15.00	5693 . . . . .3.50	7044 . . . . .2.00
3JP1 . . . . .5.00	7MP7 . . . . .22.50	676 . . . . .25.00	5696 . . . . .75	8002R . . . . .25.00
3K21 . . . . .125.00	10KP7 . . . . .15.00	677 . . . . .40.00	5720/FG33 . . . . .17.50	8005 . . . . .7.50
3K22 . . . . .125.00	12AT7WA . . . . .1.50	701A . . . . .3.50	5721 . . . . .100.00	8008 . . . . .7.75
3K23 . . . . .250.00	12AU7WA . . . . .1.50	703A . . . . .1.50	5725/6AS6W . . . . .1.00	8013A . . . . .5.00
3K27 . . . . .150.00	12AX7W . . . . .1.35	707B . . . . .2.50	5726/6AL5W . . . . .60	8014A . . . . .30.00
3K30 . . . . .50.00	12AY7 . . . . .1.00	NL-710 . . . . .12.00	5727/2D21W . . . . .1.00	8020 . . . . .4.50
3KP1 . . . . .9.75	C16J . . . . .25.00	715C . . . . .12.50	5728/FG67 . . . . .10.00	8025 . . . . .3.00
3RP1 . . . . .7.50	FG-17 . . . . .5.00	719A . . . . .10.00	5749/6BA6W . . . . .75	8025A . . . . .7.50
3WP1 . . . . .12.50	HK-24 . . . . .2.00	721B . . . . .5.00	5750/6BE6W . . . . .1.50	9003 . . . . .2.00
3X2500A3 . . . . .150.00	25T . . . . .10.00	723A/B . . . . .3.50	5751/12AX7W . . . . .1.35	9005 . . . . .3.00

TO ORDER BY TELEPHONE DIAL: 916-685-9582

**western engineers**

ELK GROVE, CALIFORNIA

SUPPLIERS OF ELECTRON TUBES SINCE 1932

Orders for less than \$10 cannot be processed

Prices are FOB shipping point

CIRCLE 469 ON READER SERVICE CARD

**GET IT from GOODHEART!**

**ATTENTION ALL GEOPHYSICISTS! NEW AND COMPLETE MAGNETOMETERS AN/ASQ-3!**

Osc. O-3 & Converter CV-1 in Case CY-4; Head with orienters, DT-2; Dynamotor (27 v) DY-6; Control C-8; Indicator ID-5, which is a .5-0.5 ma dc meter may be paralleled by your own recorder if desired and set of intercon. cable accessories. For more info., see June 1961 SCIENTIFIC AMERICAN. With 160-page Handbook on use, adjustments, interconnections, etc. In Mfr's packing, clean & fresh as if left the factory, all in 1 wood case, 250 lbs, 22.5 cu ft. suitable for export. Net fob Philadelphia, Pa., warehouse..... **\$349.50**

**MISCELLANEOUS BARGAINS**

Please ask about SPECIFIC items of interest instead of circling Readers Service Card Number. THANKS! Scopes TS-239A, \$150, OS48/USM-258, \$195. Signal Generators #804/LX, 712-330 mc, \$180. Meas. Corp. Mod. 84, 300-1000 mc, \$250. Osc. TS-47, 40-3000 mc, \$80. Est-Ang AW recorder 212-0-212 ma dc, \$175. Spectrum analyzer/rcvr APR-2 to 1000 mc, \$155, to 2200 mc, \$214. Xmttrs TD0, TDZ, \$150. Freq. Meters LM, \$50, TS-323, \$300. Pwr sply 15/30 v dc w/vernier, 130/65 A, \$130.

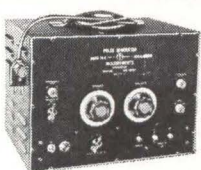

MEAS. CORP. MOD. 79-B Pulse Generator. 60, 100,000 cy + pulses 1/2-40 usecs Wtd. and a sync pulses delayed 1/2 period. Can pulse modulate an external RF source and can be synched by an external sine source. This is the most precocing the current catalog model which sells for \$495.00. Brand new in original packing, with instruction book, 40 lbs fob Harrisburg, Pa. **\$69.50**

**Tuning-Fork Low-Frequency Standards**

400-A; 400 cy ± .001% Am. Time Prod fork module supplied by regulated pwr sply and amplified by 6V6. Output at various impedances thru amplitude control. Unit also provides filtered DC and heater AC handy for powering other equipment. All controls & outputs on front panel. 6"x9" x14" dp. New, w/schematic. **\$69.50**

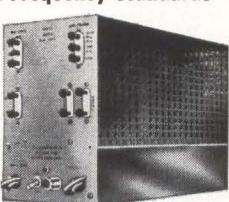

400 cy osc. module from above, includes the fork! Needs 150 vdc & 6.3 v ac. Used or new guaranteed, w/schem. 2 lbs fob Los Angeles **\$29.95**

Same but module partly cannibalized. Fork, guard; 2 lbs fob Los Angeles..... **\$9.95**

Varo 622B, 400 cy ±0.1%. Complete osc. in H.S. case; needs 210 vdc 1.2A. New, w/schem. **\$17.50**

Philamon Labs 400 cy osc. complete, ±0.05% 28 vdc, 180 ma. New, guaranteed, w/schem. **\$19.95**

Same as above except 500 cy ±0.05%. New, w/schem. 2 lbs fob Los Ang..... **\$19.95**

1000, 500, 250, 125, & 62 1/2 cy ± .02%

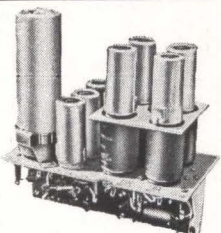

7" x 4", 1 kc plug-in fork #2003, 7 1/2AT7's, and 4 Walkert plug-in binary flip-flop count-downs, each usable from 25 kc to 0. NEW. Tested and guaranteed, ready to use. Requires external 250-300 v d.c., 25 ma., & 6.3 v a.c., 2.1 a, both handy at front panel of the #400-A described above. With schematic and circuit information. Shpg. wt 4 lbs FOB Los Angeles **\$49.50**

**Surplus Chopper-Stabil. DC Amplifier**

Reeves instr. self-contained module w/5 tubes and Brown Converter. Sophisticated modern ckt. Neat compact construction & wiring. Gain is ratio of external feedback; input resistors; may be over 1000. With ckt diagram, instr. pwr-requirements, data. Cost Navy \$366.67. Brand new now at less than Converter cost! fob Los Angeles **\$49.50**

**Surplus Brush Recorders**

Portable BL-202 (RD-2321-00) 2-pen, ink, chart 5, 25, 125 mm/sec., sensitiv. 1.1 mm/V. **\$250.00**  
certified like new fob Los Angeles.  
Same but ink or electric writing (BL-222, RD-2322-00), w/pwr sply for elect. wrtg. **\$295.00**  
BL-206 6-pen, ink 2 1/2-125 mm/sec. **\$495.00**  
BL-932 (gain 1000) DC amplifiers, pair. **\$199.00**  
Gen. Radio #715AM DC Amplifier..... **\$ 97.50**

**0.1% SORENSEN Line Voltage Regulator**

±5000S regul. against load changes 0.5 kvolt & line changes 95-130 v, 1 ph 50/60 cy; adj. output 110-120 v, holds to 0.1%. Harm. less than 3%. Recovery .15 sec. Regularly \$695.00 less spares. New, w/spares orig. pack, 285 lbs fob Utica..... **\$349.50**  
±10002S is same except 1 kva, 190-260 v in to 230 v out, 1 ph, fob Los Angeles **\$179.50**  
SOLA BARGAINS: All standard harm., 1 ph, 1% regulation, 2 kva, orig. 100% OK, 95-125 v, 60 cy in to 115 v out 0-17.4 A, fob Wash. DC on order, Calif. Shpg wt 250 lbs. Only..... **\$79.50**  
With taps for 50/60 cy, & dual primary 95-125 or 190-250 v, fob Harrisburg, Pa..... **\$89.50**  
Convert above for 230 v ±1% output with new Westinghouse Autotransformer, 5 kva, 115:230 v, 50/60 cy, fob Los Angeles. Add only..... **\$45.00**

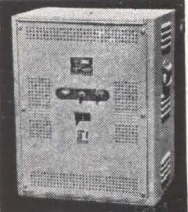

**R. E. GOODHEART CO.**

P. O. Box 1220-E Beverly Hills, Calif.

CIRCLE 464 ON READER SERVICE CARD

**ANTENNA PEDESTAL SCR 584-MP 61B**

Full azimuth and elevation sweeps 360 degrees in azimuth, 210 degrees in elevation. Accurate to 1 mil. or better over system. Complete for full tracking response. Angle acceleration rate: AZ, 9 degrees per second squared EL, 4 degrees per second squared. Angle slewing rate: AZ 20 degrees per sec. EL, 10 degrees per sec. Can mount up to a 20 ft. dish. Angle tracking rate: 10 degrees per sec. Includes pedestal drives, selsyns, potentiometers, drive motors, control amplicdynes. Excellent condition. Quantity in stock for immediate shipment. Ideal for missile & satellite tracking, antenna pattern ranges, radar system, radio astronomy, any project requiring accurate response in elevation and azimuth. Complete description in McGraw-Hill Radiation Laboratory Series, Volume 1, page 284 and page 209, and Volume 26, page 233.

**MIT MODEL 9 PULSER 1 MEGAWATT—HARD TUBE**

Output pulse power 25 KV at 40 amp. Max. duty ratio: 002. Uses 6C21 pulse tube. Pulse duration .25 to 2 microsec. Input 115 volts 60 cycles AC. Includes power supply in separate cabinet and driver. Fully guaranteed as new condition. Full Desc. MIT Rad. Lab. Series "Pulse Generators."

**500 KW PULSER**

5C22 Hydrogen Thyatron Modulator. 22KV at 28 Amps. W/HV & Fil Supplies. 3 pulse length rep rates: 2.25 usec 300 pps. 1.75 usec 550 pps. .4 usec 2500 pps. 115V 60 cy AC Input.

**MIT MODEL 3 PULSER**

Output: 144kw (12kv at 12amp.). Duty ratio: 001 max. Pulse duration: .5 1 and 2 micro sec. Input: 115v 400 to 2000 cps and 24 vdc. \$325 ea. Full desc. Vol. 5 MIT Rad. Lab. series pg 140.

**L BAND RF PKG.**

20KW peak 990 to 1040MC. Pulse width .7 to 1.2 micro sec. Rep rate 180 to 420 pps. Input 115vac. Incl. Receiver \$1200.

**225 KW X-BAND RF**

4J50 Magnetron RF Generator with dummy load & Dir. Cpr. Variable rep rates. Variable power output 115V 60-cycle AC input. New. \$2400 complete.

**SCR 584 RADARS AUTOMATIC TRACKING RADAR**

Our 584s in like new condition, ready to go, and in stock for immediate delivery. Ideal for research and development, airway control, GCA, missile tracking, balloon tracking, weather forecasting, anti-aircraft defense tactical air support. Write us. Fully Desc. MIT Rad. Lab. Series, Vol. 1, pps 207-210, 228, 284-286.

**AN/TPS—1D RADAR**

500 kw, 1220-1359 mcs, 160 nautical mile search range P.P.I. and A. Scopes, MTI, thra-tron mod. 5J26 magnetron. Like new. Complete system incl. spare parts and gas generator field supply.

**AN/TPS 10D HEIGHT FINDER**

250 KW X-Band. 60 & 120 mile ranges to 60,000 feet. Complete.

**AN/APS—15B 3 CM RADAR**

Airborne radar. 40kw output using 725A magnetron. Model 3 pulser. 30 in. parabola stabilized antenna. PPI scope. Complete system. \$1200 each. New.

**10KW 3 CM. X BAND RADAR**

Complete RF head including transmitter, receiver, modulator. Uses 2J42 magnetron. Fully described in MIT Rad. Lab. Series Vol. 1, pps. 616-625 and Vol. II, pps. 171-185 \$375. Complete X Band Radar System also avail. incl. 360-deg. antenna, PPI, syn pwr supply. Similar to \$17,000 weather radar now in use by airlines, \$750 complete.

**10 CM. WEATHER RADAR SYSTEM**

US Navy Raytheon, 275 KW peak output 5 band. Rotating yoke Plan position Indicator. Magnetron supplied for any 5 band frequency specified, incl. Weather Band. 4, 20 and 80 mile range. Price \$975. Has picked up clouds at 50 miles. Weight 488 lbs.

**CARCINOTRON**

Type CM 706A Freq. 3000 to 4000 mcs. CW. Output 200 Watts minimum. New, with full guarantee.

**RADIO RESEARCH INSTRUMENT CO.**  
550 FIFTH AVE., NEW YORK  
JUDSON 6-4691

CIRCLE 465 ON READER SERVICE CARD

**SMALL AD but BIG STOCK**  
of choice test equipment and surplus electronics  
Higher Quality—Lower Costs  
Get our advice on your problem  
**ENGINEERING ASSOCIATES**  
434 Patterson Road — Dayton 19, Ohio

**Wilgreen**  
can deliver Amphenol Bendix Cannon CONNECTORS FITTINGS & CLAMPS  
We stock more than 5,000,000 MS/AN CONNECTORS of 50,000 variations! In PRODUCTION QUANTITIES... we sell BELOW "O.E.M." PRICE... and offer IMMEDIATE "OFF-THE-SHELF" DELIVERY!  
**FREE** Send for latest brochure and list price chart  
WILGREEN INDUSTRIES, Inc.  
102 Warren Street, New York 7, N. Y.  
WORTH 4-2490-1-2 Wire: FXK  
CIRCLE 467 ON READER SERVICE CARD

**NEW INDUSTRY WANTED**  
**Community Has Cash To Help locate industry** in western Kentucky lake area. No gimmick! Plenty of water, labor, sites, gas, power. 100% plant financing. For more details call or write, West Hopkins Industries, Box 245, Dawson Springs, Ky.

**SEARCHLIGHT Equipment Locating Service** No Cost Or Obligation  
This service is aimed at helping you, the reader of "SEARCHLIGHT", to locate Surplus new and used electronic equipment and components not currently advertised. (This service is for USER-BUYERS only).  
How to use: Check the dealer ads to see if what you want is not currently advertised. If not, send us the specifications of the equipment wanted on the coupon below, or on your own company letterhead to:  
**Searchlight Equipment Locating Service**  
c/o ELECTRONICS  
P. O. Box 12, N. Y. 36, N. Y.  
Your requirements will be brought promptly to the attention of the equipment dealers advertising in this section. You will receive replies directly from them.  
**Searchlight Equipment Locating Service**  
c/o ELECTRONICS, P.O. Box 12, N.Y. 36, N.Y.  
Please help us locate the following equipment components.  
NAME .....  
TITLE .....  
COMPANY .....  
STREET .....  
CITY ..... 1/12/62

# INDEX TO ADVERTISERS



## Audited Paid Circulation

Aerocom .....	18	ITA Electronics Corp.....	52
Air Express .....	14	International Electric Corp.....	120
Airpax Electronics, Inc.....	108		
• Alden Products Co. ....	122	• Kearfott Div. General Precision Inc. ....	106, 107
Allen-Bradley Co. ....	13	Keithley Instruments, Inc.....	92
Ammon Instruments, Inc.....	101	• Kintel, A division of Cohu Electronics Inc. ....	3rd Cover
Assembly Products Inc.....	32	• Kyoritsu Electrical Instruments Works, Ltd. ....	51
• Associated Testing Laboratories, Inc..	131		
		Leach Corporation .....	89
Babcock Relays, Inc.....	17	• Leach and Garner Co.....	10
Baker Co., The.....	132	Linen Thread Co., Inc.....	51
Barker & Williamson, Inc.....	97	Littelfuse .....	51
Barnstead Still & Sterilizer Co.....	4	Lockheed Missiles & Space Co.....	74
• Bendix Corporation Scintilla Division .....	103		
• Black & Webster, Inc.....	94	Mabuchi Shoji K.K.....	93
• Billey Electric Co.....	110	• Markel & Sons, L. Frank.....	109
Brand-Rex, Division of American Enka Corp.....	72, 73	• Markem Machine Co.....	113
• Burnell & Co., Inc.....	23	• Massa, A Div. of Cohu Electronics, Inc. ....	115
		McGraw-Hill Book Co.....	123
• Clifton Precision Products Co., Inc....	31	• Methode Electronics Inc.....	98
• Cly-Del Mfg. Co.....	101	Metronix, Division of Assembly Products Inc.....	86
Cunningham .....	97	Mitre Corp., The.....	95
		• Mitsumi Electric Co., Ltd.....	123
Data-Control Systems, Inc.....	116	Motorola Semiconductor Products Inc.	19
Deutsch Fastener Corp.....	33, 34		
• Dorsett Electronics, Inc.....	110, 119	• Non-Linear Systems, Inc.....	71
• Durant Manufacturing Co.....	97		
Dynasonics Corp. ....	96	Osaka Onkyo Co., Ltd.....	101
		Ozalid, A Div. of General Aniline & Film Corp. ....	69
Electrodynamic Instrument Corporation .....	98		
• Electrospace Corp.....	121	Pacific Semiconductors Inc....	75, 76, 77, 78, 79, 80, 81, 82
Electron Heating Corp.....	85	Philamon Laboratories Inc.....	29
Electronic Engineering Co.....	94	Precision Instrument Co.....	111
Electronic Tube & Instrument Div., General Atronics Corp.....	105		
Electronic Wholesalers, Inc.....	88	• Radio Corporation of America... 4th Cover	
• FXR, A Div. of Amphenol-Borg Electronics Corp. ....	25		
Franklin Electronics Inc.....	11	• Sage Electronics Corp.....	93
		• Servo Corporation of America.....	120
• General Findings Inc.....	10	• Sierra Electronic Corp.....	6
Graphic Systems .....	110	• Sigma Instruments, Inc.....	117
Gries Reproducer Corp.....	120	Sprague Electric Co.....	9, 30
Grumann Aircraft Co.....	22		
		• See advertisement in the July 20, 1961 issue of Electronics Buyers' Guide for complete line of products or services.	
• Hart Manufacturing Co.....	88		
• Haydon Co., A.W.....	114		
• Hewlett-Packard Company .....	Inside Front Cover		
Hughes Aircraft Co. Aerospace Divisions.....	87		

**-100°F  
to  
+350°F**  
**test chamber  
for  
only \$285**



Model ELH-0.5-LC

Here it is — a quality temperature chamber at a previously unheard of budget price! The Econ-O-Line Mark II is designed specifically for components and small assemblies — gives you complete temperature test capability for production line, research or development lab. Ruggedly constructed for long, accurate service, its features include:

- Temperature control to  $\pm 2^\circ\text{F}$ .
- Liquid CO<sub>2</sub> refrigeration
- United Electric indicating controller
- 11" x 12" x 5" work area
- Rugged aluminum liner
- Fan circulation with external motor
- 1" port and plug for external connections

Delivery from stock. For complete data, write today for Bulletin C-19.

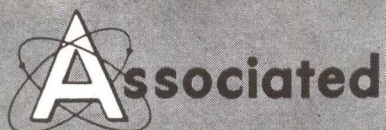

ASSOCIATED TESTING LABORATORIES, INC.  
(Manufacturing Division)  
155 ROUTE 46 • WAYNE, NEW JERSEY • CLIFFORD 6-2800  
TEST LABORATORIES  
Wayne, N.J. • Winter Park, Fla. • Burlington, Mass.

# DUST FREE PRODUCTION

with  
**STERILSHIELD**  
by  
**BAKER**

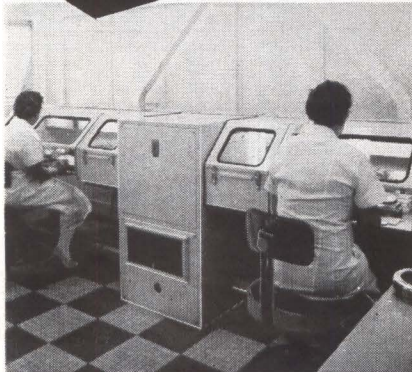

Acceleration tubes for Van-de-Graaff Particle Accelerators being assembled in the superclean atmosphere of Sterilshield Dust-free Workspaces at High Voltage Engineering Corp., South Bedford, Mass. The large unit in the center is a Model 1140 Sterilshield Air Cleaner, capable of servicing up to five Workspaces.

The Baker Co., world's leader in the development and production of clean-air equipment, also makes available Dry Boxes, Vacuum Ovens, portable self-contained Workspaces, and entire Prefabricated Dust-controlled Rooms. For complete information, send today for your copy of the Baker Sterilshield Catalog.

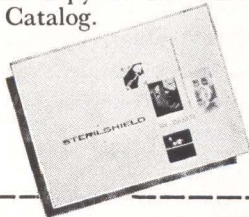

**THE BAKER COMPANY, INC.**  
106 GRANITE STREET, BIDDEFORD, MAINE

Please rush me your Sterilshield Catalog.

Name \_\_\_\_\_  
Company \_\_\_\_\_  
Address \_\_\_\_\_  
City \_\_\_\_\_  
State \_\_\_\_\_

- Standard Electric Time Co., The..... 112
- Standard Telephones & Cables Limited 83
- Texas Instruments Incorporated  
Metals & Controls Division..... 91
- Transatron Electronic Corp..... 15
- Tung-Sol Electric, Inc..... 5
- Twincoc Inc. .... 104

### CLASSIFIED ADVERTISING

F. J. Eberle, Business Mgr.

EMPLOYMENT OPPORTUNITIES 125-128

BUSINESS OPPORTUNITIES ..... 130

EQUIPMENT  
(Used or Surplus New)  
For Sale .....128-130

### INDEX TO CLASSIFIED ADVERTISERS

- American Machine & Foundry Company 126
- Atomic Personnel Inc..... 126
- Barry Electronics Corp..... 128
- Boonton Radio Corp..... 128
- Capitol Commodities Co., Inc..... 128
- Dalmo Victor Co., Div. of Textron Inc. 126

- Engineering Associates ..... 130
- Erie Electronics Division,  
Erie Resistor Corporation..... 126
- Esquire Personnel Service Inc..... 126
- Goodheart Co., R. E..... 130
- Jet Propulsion Laboratory, California  
Institute of Technology..... 125
- Lifschultz Fast Freight..... 128
- Microwave Services International Inc. 126
- Minneapolis Honeywell Co..... 127
- Radio Research Instrument Co..... 130
- Remington Rand, Office Machines Div.  
of Sperry Rand Corp..... 126
- Sanders Associates, Inc..... 125
- Spellman High Voltage Company..... 128
- Universal Relay Corp..... 129
- Western Engineers ..... 129
- Wilgreen Industries Inc..... 130

• See advertisement in the July 20, 1961 issue of Electronics Buyers' Guide for complete line of products or services.

This index and our Reader Service Numbers are published as a service. Every precaution is taken to make them accurate, but ELECTRONICS assumes no responsibilities for errors or omissions.

## electronics



Audit Bureau  
of Circulations



Associated Business  
Publications

Audited Paid Circulation

### JAMES T. HAUPTLI

Advertising Sales Manager

- R. S. QUINT:  
Assistant Publisher Buyers' Guide and  
Business Manager
- FRED STEWART:  
Promotion Manager
- B. ANELLO:  
Marketing Service Manager

- RICHARD J. TOMLINSON:  
Production Manager
- GEORGE E. POMEROY:  
Classified Manager
- HUGH J. QUINN:  
Circulation Manager

### ADVERTISING REPRESENTATIVES

- NEW YORK (36):  
Donald H. Miller, Henry M. Shaw, George  
F. Werner  
500 Fifth Avenue, OXford 5-5959
- BOSTON (16):  
William S. Hodgkinson, Donald R. Furth  
McGraw-Hill Building, Copley Square,  
Congress 2-1160
- PITTSBURGH (22):  
David M. Watson  
Four Gateway Center, Express 1-1314
- PHILADELPHIA (3):  
Warren H. Gardner, William J. Boyle  
6 Penn Center Plaza, LOcust 8-4330
- CHICAGO (11):  
Harvey W. Wernecke, Robert M. Denmead  
645 North Michigan Avenue, Mohawk 4-5800
- CLEVELAND (13):  
Paul T. Fegley  
55 Public Square, Superior 1-7000
- SAN FRANCISCO (11):  
R. C. Alcorn  
255 California Street, Douglas 2-4600
- LOS ANGELES (17):  
Peter S. Carberry, Ashley P. Hartman  
1125 W. 6th St., Huntley 2-5450

- DENVER (2):  
J. W. Patten  
Tower Bldg., 1700 Broadway, Alpine 5-2981
- ATLANTA (9):  
Michael H. Miller  
1375 Peachtree St. N.E., Trinity 5-0523
- HOUSTON (25):  
Joseph C. Page, Jr.  
Prudential Bldg., Holcomb Blvd.,  
Jackson 6-1281
- DALLAS (1):  
Frank Le Beau  
The Vaughn Bldg., 1712 Commerce St.  
Riverside 7-9721
- LONDON W1:  
Dennis McDonald  
34 Dover St.
- FRANKFURT/Main:  
Stanley R. Kimes  
85 Westendstrasse
- GENEVA:  
Michael R. Zeynel  
2 Place du Port

new  
digital voltmeter



high speed...

solid state...



modular  
construction!



*Fast and accurate.* These are the two big extras you get with KIN TEL's new Model 864A DC Digital Voltmeter. Its high speed acquisition logic permits measuring any signal from 0.000 to 999.9 volts to 0.05% accuracy within approximately 0.02 second—within 0.005 second when programed to any single range scale. After one pass, the 864A reverts automatically to tracking logic, bidirectionally following inputs changing as fast as 10 volts per second on the low range, 100 volts per second on the 100-volt range, or 1000 volts per second on the high range. You can interrogate the 864A from 0 to full scale in less than one second with up to 10,000 intermediate readings per second while tracking a signal on any range.

In short, this exceptional digital voltmeter can track and provide signals for a constant digital record as

fast as a pen recorder can draw an analog trace.

*Adaptable.* Besides a 4-digit single-plane readout, the 864A provides electrical outputs for BCD, BCD excess-3, or 10-line parallel signals.

*Programmable.* You can program the 864A to issue or withhold print commands, to free the metering circuits or continue tracking, to fix or change either range or polarity.

*Reliable.* Long, trouble-free service is assured by a sound, conservative design, and by all-electronic, all-solid-state construction. All parts are mounted on plug-in circuit boards for ease in maintenance.

Price: From \$3180 F.O.B. San Diego.

Write today for detailed technical information or demonstration. Representatives in all major cities.

5725 Kearny Villa Road, San Diego 12, California. Phone: BRowning 7-6700

**COHU**  
ELECTRONICS, INC  
KIN TEL DIVISION

MAXIMUM TUNING RATE—

**200,000 Mc/sec**

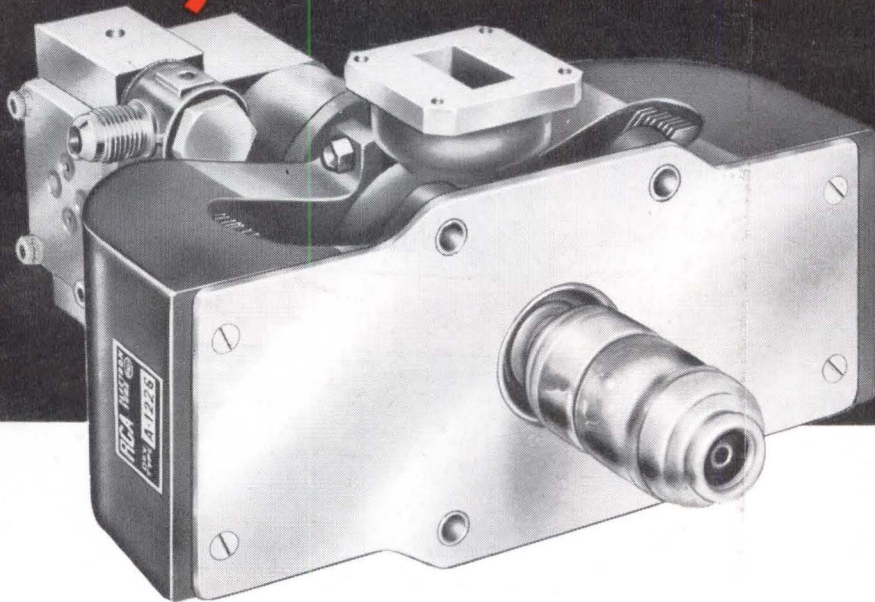

**Nine hundred megacycles in 1/120th of a second:**

This rapid tuning capability represents major progress in magnetron design. Rapid tuning is achieved in the new RCA Developmental Type A-1226 with a non-contacting, hydraulically-operating plunger outside the magnetron interaction area. A new version of the renowned RCA developed "coupled cavity" construction (and only RCA has it) gives the A-1226 its outstanding performance capability.

In other respects the A-1226 uses the field-proved electrical design parameters of the RCA-7008 and the RCA-7111 Magnetrons, and is electrically interchangeable with these two types.

Among the other features of the A-1226 are: low thermal drift, essentially flat power-output characteristic, minimum frequency drift, and low inter- and intra-pulse frequency modulation. The A-1226 has application in counter-countermeasure radar and frequency diversity systems.

The A-1226 is available for Government-End-Use applications. For further information on this new hydraulically-tuned magnetron, contact your RCA Field Representative. Or write: Manager, Microwave Marketing, RCA Electron Tube Division, Harrison, N. J.

RCA DEV. TYPE A-1226 TYPICAL OPERATION		
Peak Anode Voltage	22	Kv
Peak Anode Current	27.5	Amp
Rate of Voltage Rise	225	Kv/ $\mu$ sec
Peak Power Output	230	Kw
Pulse Width	.1-2.5	$\mu$ sec
Duty Cycle	.001	
Freq. Range	8500-9400	Mc
Stability (Missing Pulses)	.01	%
Pulling Figure	9	Mc
Maximum Tuning Rate	200,000	Mc/Sec

**INDUSTRIAL TUBE PRODUCTS  
FIELD OFFICES:**

**OEM SALES:** Newark 2, N. J., 744 Broad St., HU 5-3900 • Chicago 54, Ill., Suite 1154, Merchandise Mart Plaza, WH 4-2900  
Los Angeles 22, Calif., 6801 E. Washington Blvd., RA 3-8161  
Burlingame, Calif., 1838 El Camino Real, OX 7-1620

**GOVERNMENT LIAISON:** Harrison, N. J., 415 South Fifth St., HU 5-3900 • Dayton 2, Ohio, 224 N. Wilkinson St., BA 6-2366  
Washington 7, D.C., 1725 "K" St., N.W., FE 7-8500.



The Most Trusted Name in Electronics