

electronics

A McGraw-Hill Publication 75 Cents

Photo at right
**INFRARED
GENERATOR**

*Adjustable in
modulation, power
and frequency, p 40*

**TUNNEL-DIODE
TRANSDUCERS**

*Measure pressure
and strain, p 35*

**BEACON
MODULATORS**

*With solid-state
lockout circuit, p 44*

**POWER
SUPPLY**

*For orbiting
satellites, p 47*

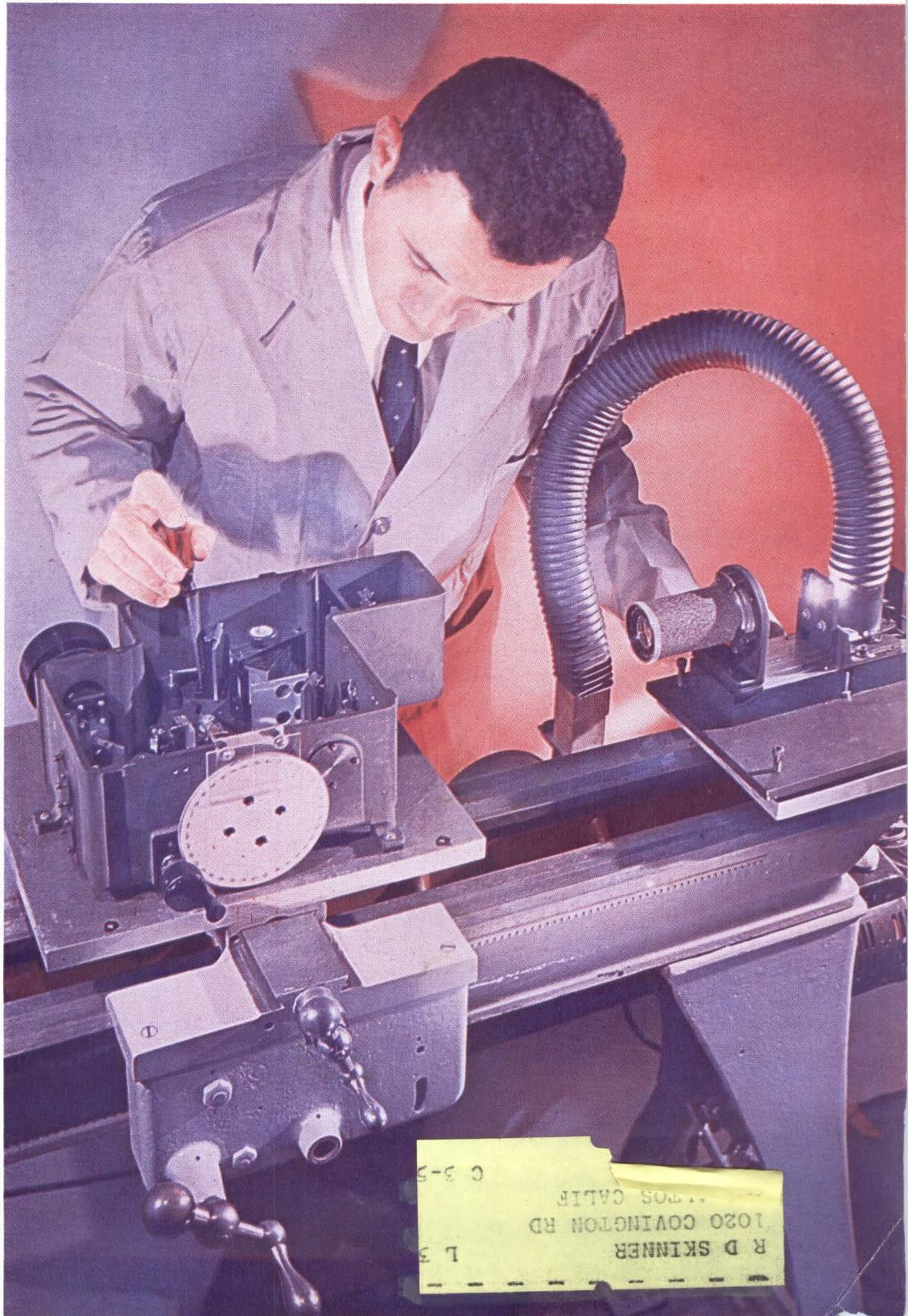



NOW -

Variac[®] AUTOTRANSFORMERS

Available from local Distributors

AT FACTORY PRICES

Now, you can get "off the shelf delivery" of famous General Radio Variac[®] Continuously Adjustable Autotransformers from your local distributor. He stocks practically all models for immediate delivery at factory prices. For extra-prompt service, write or phone the distributor nearest you.

Variac[®] Continuously Adjustable Autotransformers are the most useful devices known for the control of a-c voltages. They operate on the same principle as a transformer and do not dissipate large amounts of power in the form of heat. Yet, they have a high thermal capacity and can withstand short-time overloads as much as 1000% above their ratings. And, they do not adversely affect power factor.

Variacs are available in many sizes . . . 2-, 5-, 10-, 20-, 30-, and 50-ampere ratings . . . 115- or 230-volt models . . . single or ganged . . . cased or uncased . . . manually operated, motor driven, or remote controlled. All backed by a two-year warranty.

LAFAYETTE

INDUSTRIAL ELECTRONICS DIVISION

JAMAICA 33, N. Y.
165-08 Liberty Ave.
212 OLYMPIA 8-5050

NEWARK 2, N. J.
24 Central Ave.
201 MITCHELL 3-6868

BOSTON 10, MASS.
110 Federal St.
617 HUBBARD 2-0311



DENVER ELECTRONIC SUPPLY CO.

DENVER, Colo., 2170 S. Grape St., SKYline 7-3351



ELECTRONIC WHOLESALERS, INC.

MIAMI, Fla.
9390 N.W. 27th Ave.
OXford 6-1620

BALTIMORE, MD.
3004 Wilkins Ave.
WILKINS 5-3400

WINSTON-SALEM, N. C.
Dalton Hege, Inc.
938 Burke St.
PArk 5-8711

MELBOURNE, Fla.
1301 Hibiscus Blvd.
PArkway 3-1441

WASHINGTON, D. C.
2345 Sherman Ave., N.W.
HUDson 3-5200



ELECTRICAL SPECIALTIES CO.

DAYTON, OHIO, 3130 Valleywood Dr., AXminster 8-7461

GENERAL RADIO COMPANY

WEST CONCORD, MASSACHUSETTS

NEW YORK, WOrth 4-2722
District Office in RidgEfield, N. J.
Whitney 3-3140

CHICAGO
Oak Park
Village 8-9400

PHILADELPHIA
Abington
HAncock 4-7419

WASHINGTON, D. C.
Silver Spring
JUniper 5-1088

SYRACUSE
Syracuse
GLenview 4-9323

SAN FRANCISCO
Los Altos
WHitecliff 8-8233

LOS ANGELES
Los Angeles
HOLlywood 9-6201

ORLANDO, FLA.
Orlando
GArden 5-4671

IN CANADA
Toronto
Cherry 6-2171

electronics

A McGraw-Hill Publication 75 Cents

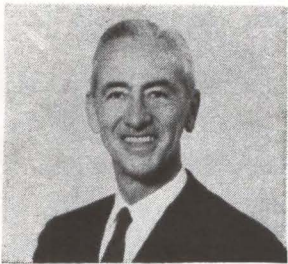

W. W. MacDONALD, Editor

J. M. CARROLL, Managing Editor
 SENIOR EDITORS: Samuel Weber, George W. Sideris. SENIOR ASSOCIATE EDITORS: William E. Bushor, Michael F. Wolff. ASSOCIATE EDITORS: Michael F. Tomaino, Sylvester P. Carter, William P. O'Brien, John F. Mason, Thomas Emma, Sy Vogel, Leslie Salomon, M. M. Perugini, George J. Flynn, Laurence D. Shergalis. ASSISTANT EDITORS: Nilo Lindgren, Stanley Froud, Stephen B. Gray, Roy J. Bruun, George V. Novatny, Leon H. Dulberger. REGIONAL EDITORS: Harold C. Hood (Pacific Coast, Los Angeles), Thomas Maguire (New England, Boston), Cletus M. Wiley (Midwest, Chicago). ART DIRECTOR: Harry Phillips; Howard R. Berry. PRODUCTION EDITOR: John C. Wright, Jr. EDITORIAL ASSISTANTS: Gloria J. Meurer, Bernice Duffy, Lorraine Rossi, Virginia T. Bastian, Lynn Emery, Laura W. Smith, Bette H. Snyder, Rosemary Abbruzzese, Judy Haskins, Ann Mella. FOREIGN NEWS BUREAU: Director, John Wilhelm, Alyne Elias. London—John Shinn, Derek Barlow, Nicholas Landon. Bonn—Peter Forbath, James Morrison, Silke McQueen. Paris—Robert Farrell, Arthur Erikson. Milan—Gene DiRaimondo. Mexico City—Bruce Bendow. Rio de Janeiro—Leslie Warren. Moscow—Stewart Ramsey. Tokyo—Richard Halloran, Charles Cohen, John Yamaguchi.

JAMES GIRDWOOD, Publisher

ALIGNING INFRARED SIGNAL GENERATOR on a precision lathe bed. A four-pass monochromator acts as an infrared band-pass filter. *For complete details and schematics of this continually variable signal source, see p 40* COVER

ULTRAVIOLET SYSTEM Will Map Space. Project Celoscope, part of the Orbiting Astronomical Observatory, will map the sky's radiant intensity and obtain uv spectra of 100,000 stars. *Project will provide practical space-tests of uv-sensitive cameras and digital television transmission* 22

RANGER'S VIDICON TV. Camera tube's electrostatic deflection and focus avoids bulk and weight of magnets. *Target surface holds the image for 10 sec so it can be slowly scanned without loss of detail* 26

RADAR TRACKER Uses Moving Ball. As ball revolves in socket, movement is translated to x and y positions and antenna follows target. *Input is operator's fingertip* 27

A-BOMB DETECTION Program Spurs Seismology and Instrumentation. Vela program is getting data analysis center and laboratory to develop seismic techniques and equipment. *Shock wave frequencies as low as 0.002 cps can be analyzed by new gear* 28

ADAPTIVE SYSTEM Controls Light Planes. Lightweight autopilot adjusts to varying flight conditions and aircraft characteristics. *It's like the computer-controlled systems developed for X-15 and Dyna Soar* 30

SEMICONDUCTOR TRANSDUCERS Measure Strain and Pressure. One type is similar to strain gage but more sensitive; another works on tunnel-diode principles. *An authoritative survey article on a new generation of transducers that can open up other exciting semiconductor applications.* W. P. Mason 35

INFRARED Signal Generator. Output varies in wavelength from one to 14 microns. Modulation frequency and power output can also be varied. *Useful in design of detectors, communications systems, target seekers and surveillance gear.* A. Glaser 40

Published weekly, with Electronics Buyers' Guide and Reference issue, as part of the subscription, by McGraw-Hill Publishing Company, Inc. Founder: James H. McGraw (1860-1948).

Indexed Annually in Buyers' Guide and Reference issue.

Title ® registered U.S. Patent Office; © Copyright 1962 by McGraw-Hill Publishing Co., Inc. All rights reserved, including the right to reproduce the contents of this publication, in whole or in part.

Executive, editorial, circulation and advertising offices McGraw-Hill Building, 330 West 42nd Street, New York 36, N. Y. Telephone Longacre 4-3000. Teletype TWX N.Y. 1-1636. Cable McGrawhill, N. Y. PRINTED IN ALBANY, N. Y.; second class postage paid at Albany, N. Y.

OFFICERS OF THE PUBLICATIONS DIVISION: Nelson L. Bond, President; Shelton Fisher, Wallace F. Traendly, Senior Vice Presidents; John R. Callahan, Vice President and Editorial Director; Joseph H. Allen, Vice President and Director of Advertising Sales; A. R. Venezian, Vice President and Circulation Coordinator; Daniel F. Crowley, Vice President and Controller.

OFFICERS OF THE CORPORATION: Donald C. McGraw, President; Hugh J. Kelly, Harry L. Waddell, Executive Vice Presidents; L. Keith Goodrich, Executive Vice President and Treasurer; John J. Cooke, Vice President and Secretary.

Subscriptions are solicited only from those actively engaged in the field of the publication. Position and company connection must be indicated on orders. Subscription rates: United States and Possessions, \$6.00 one year; \$9.00 two years; \$12.00 three years. Canada, \$10.00 one year. All other countries \$20.00 one year. Single Copies, United States and Possessions and Canada 75¢. Single copies all other countries \$1.50.

THE PUBLISHER, UPON WRITTEN REQUEST FROM ANY SUBSCRIBER TO OUR NEW YORK OFFICE, AGREES TO REFUND THAT PART OF THE SUBSCRIPTION PRICE APPLYING TO COPIES NOT YET MAILED.

Subscribers: Please address all correspondence, change of address notices, subscription orders or complaints to Fulfillment Manager, Electronics, at above address. Change of address notices should provide old as well as new address, including postal zone number if any. If possible, attach address label from recent issue. Allow one month for change to become effective.

Postmaster: Please send Form 3579 to Fulfillment Manager, Electronics, 330 West 42nd Street, New York 36, New York.



Audited Paid Circulation

CONTENTS continued

LOCKOUT CIRCUIT Protects Radar-Beacon Modulators. Transformer, two diodes, coil and resistor prevent spurious triggering from damaging controlled-rectifier modulator. On missile launching pads, it avoids trouble caused by nearby radars. V. Sacco 44
POWER SUPPLY for Orbiting Satellites. This d-c to d-c converter has its output controlled by varying period of astable multivibrator. Achieves one-percent regulation while maintaining high efficiency. E. Josephson 47
RADIATION SURVEY METER. High-voltage source for Geiger-Muller tube is blocking oscillator and Cockcroft-Walton multiplier. Pulses charge capacitor; its discharge gives meter indication. Pocket-sized unit can detect contamination of a nuclear explosion. R. W. Lehnert and J. M. McKenzie 50

DEPARTMENTS

Crosstalk. Cold War. New Generation of Transducers 3
Comment. Defining Plasma. Magnetic Core Testing 4
Electronics Newsletter. Russians on Trail of Machines That Learn 7
Washington Outlook. White House Issues New Code of Conduct for Government Consultants 12
Meetings Ahead. Biomedical Engineering Symposium 32
Research and Development. Experimental Tube Generates Millimeter Waves 56
Components and Materials. Flat Wires and Cables: Applications in Modern Electronic Circuits 64
Production Techniques. Manufacturing Molded Electron Guns 74
New Products Design and Application. Voltage and Resistance Reference. Programmed Modular Units 86
Literature of the Week 94
People and Plants. Aerospace Research Opens New Plant 104
Index to Advertisers 116

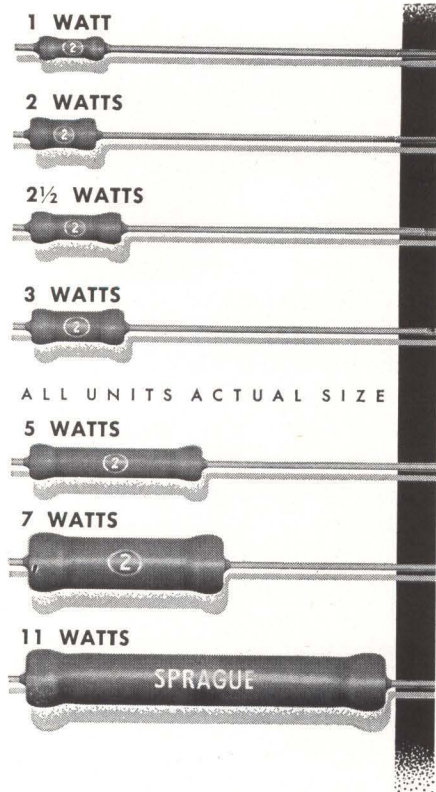

NEXT TIME ... USE TINY
Blue Jacket®
WIREWOUND RESISTORS

Sprague builds reliability... efficiency... economy right into mini-fied Blue Jackets with these important features:

- * All-welded end-cap construction with special vitreous-enamel coating for total protection against humidity, mechanical damage, heat, corrosion gives long-term dependability under severe environmental conditions
- * Available in resistance tolerances as close as $\pm 1\%$
- * Low in cost... quick and easy to install

Tiny axial-lead Blue Jackets are specially designed for use with conventional wiring or on printed boards in miniature electronic assemblies. Write for complete technical data in Sprague Engineering Bulletin 7410B.

SPRAGUE ELECTRIC COMPANY
 35 Marshall Street, North Adams, Mass.



COMMENT

Defining Plasma

The State Section is holding its next semi-annual meeting on April 13-14, 1962, in Tarrytown with a two-day symposium on Plasma Physics. With the printed program we would like to include a short statement defining the area of Plasma Physics for the benefit of the members not too well acquainted with it. This statement is to be concise and accurate.

In talking this over with the Program Chairman, Prof. K. H. Moore, we believe that the statement on p 49 of the issue of July 14, 1961, headed "Defining Plasma" [in the article Plasma Engineering—Part I: Generating and Heating Plasma] is exactly what we are looking for. I would like to ask your permission to quote it verbatim, with its source credited, as about half of the proposed statement. To this Dr. Holt of Rensselaer Polytechnic Institute then wishes to add about an equal number of words on Plasma Physics.

A. FRANCIS TURNER
 Secretary-Treasurer

New York State Section
 American Physical Society

Permission granted to use the plasma definition, which was written by Senior Associate Editor Michael Wolff for his three-part series on Plasma Engineering (p 47, July 14, 1961; p 33, Aug. 4; p 29, Sept. 1). It reads, in part:

At present the term plasma defines any mixture of particles, some of which are charged, whose spatial dimension exceeds the Debye length and where the percentage of the mixture that is ionized contains an approximately equal number of positive and negative particles so that the overall aggregate is electrically neutral.

Debye length is a measure of the distance at which a given negative particle is shielded by the surrounding positive particles.

Plasma need not be restricted to gases; in fact, there can be two kinds of plasma in solids. The first type is where there are either electrons and positively-charged donors, or holes and negatively-charged acceptors. A second type of plasma

occurs in an intrinsic semiconductor where there are only holes and electrons.

Generally, however, plasma describes a gas which in addition to meeting the criteria given above is in such a state of ionization that it becomes conductive enough to be affected by magnetic fields. At temperatures above 20,000 K, ionization is 100 percent for most gases and there are no neutral particles—only positive ions and negative electrons. This completely ionized or "true" plasma is considered a fourth state of matter and is what is most frequently meant by the term plasma.

Magnetic Core Testing

Having read with great interest the article, How Magnetic Materials Behave at Nanosecond Pulse Widths, by Gilbert A. Reeser (p 72, Sept. 8, 1961), I have attempted to obtain details of the third reference, which is V. J. Loudon, Proposed Standards For Core Test Methods For Toroidal Magnetic Amplifier Cores, *AIEE Trans Paper No. 58-71*, February, 1958, but apparently this reference is incorrect. I should be pleased if you could check the reference quoted.

D. W. DAVIES

Denis Ferranti Meters Limited
 Llangefni, Anglesey
 North Wales

Author Reeser replies:

This reference was to a preliminary Transactions paper, and was correct. The paper was later published by The American Institute of Electrical Engineers, and this would perhaps be easier to obtain. Write to AIEE, 33 West 39th Street, New York 18, New York, and ask for AIEE No. 432, January, 1959, Test Procedure For Toroidal Magnetic Amplifier Cores.

This paper is only partly applicable to the pulse testing method described in the *ELECTRONICS* article. To my knowledge, no standard test procedure exists for this type of testing.

GILBERT A. REESER

Radiation at Stanford
 Palo Alto, California

The AIEE informs us that the price of this paper is 50 cents to members, a dollar to nonmembers.

**C TYPE MAGNETS FOR
MICROWAVE APPLICATIONS**

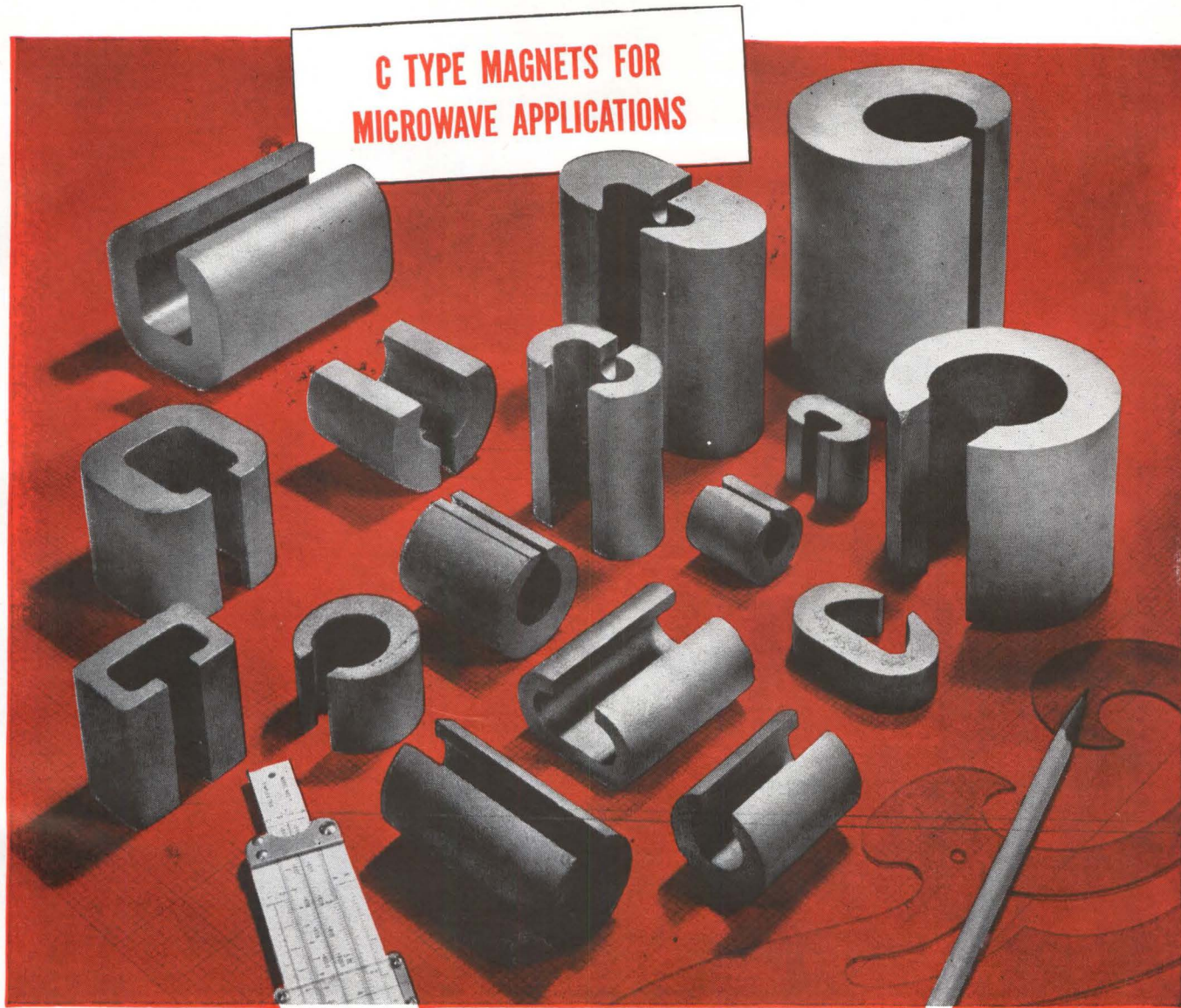

**C TYPE MAGNETS in a wide range of sizes to meet your design needs in
★ Transverse Field Isolators ★ Differential Phase Shifters ★ Duplexers**

Arnold C-type Alnico Magnets are available in a wide selection of gap densities ranging from 1,000 to over 7,500 gauss. There are six different basic configurations with a wide range of stock sizes in each group.

The over-all size and gap density requirements of many prototype designs can be met with stock sizes of Arnold C Magnets, or readily supplied in production quantities.

When used in transverse field isolators, Arnold C Magnets supply the magnetizing field to bias the ferrite into the region of resonance, thus preventing interaction between microwave networks and isolating the receiver from the transmitter. These magnets are also used in differential phase shifters and duplexers, and Arnold is prepared to design and supply tubular magnets to provide axial fields in circular wave guides.

A feature of all Arnold C Magnets is the excellent field uniformity along the length of the magnet. Versatility in design may be realized by using multiple lengths of the same size magnet stacked to accomplish the needs of your magnetic structure.

Let us work with you on any requirement for permanent magnets, tape cores or powder cores. ● For information on Arnold C Magnets, write for Bulletin PM-115. Address *The Arnold Engineering Company, Marengo, Illinois.*

ADDRESS DEPT. E-2

7428 B



ARNOLD
SPECIALISTS in MAGNETIC MATERIALS

BRANCH OFFICES and REPRESENTATIVES in PRINCIPAL CITIES
Find them FAST in the YELLOW PAGES



KEEP YOUR EYE ON EIMAC

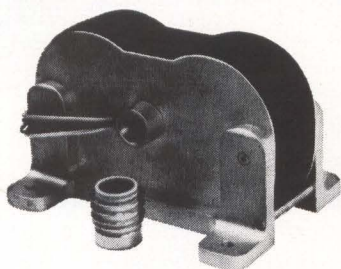

X-747C

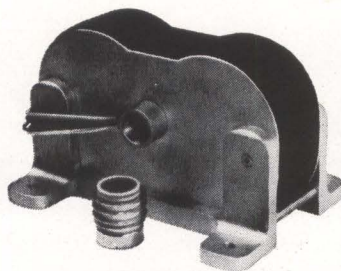

X-1080

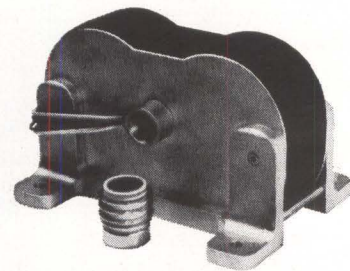

X-1081

Available now: A family of three new voltage tunable magnetrons from Eimac

Eimac brings you three new ruggedized voltage tunable magnetrons: the X-747C, the X-1080 and the X-1081. Each is a completely packaged tube and circuit assembly including the permanent magnet. And will withstand 10 g vibration at frequencies up to 2000 cycles and shock up to 100 g.

The X-747C operates in L-band and delivers a minimum power output of 50 mw CW into a 50-ohm load over the frequency range 450-1150 Mc. The X-1080 operates at the same power levels in S-band over the range 1100-2200 Mc. The X-1081 is a higher power L-band unit that provides minimum power output of 15 watts CW over a 12% bandwidth centered at 1000 Mc.

Long life, low noise performance for all three tubes is assured by an injection gun design, which minimizes back-bombardment of the indirectly heated Eimac matrix cathode. Because of the Eimac-developed output circuit design, frequency change with anode voltage is linear, with a precision much better than five parts per thousand. This design also results in reduced output power variation over its range of operation by providing a constant load on the tube, thus minimizing the effects of external load variation across the frequency band.

This is another example of the way Eimac research, development and manufacturing capability are able to meet tomorrow's tube needs today. Another reason to *keep your eye on Eimac*—for advanced high power klystrons, microwave devices and power grid tubes. Eitel-McCullough, Inc., San Carlos, Calif. Subsidiaries: Eitel-McCullough, S.A., Geneva, Switzerland; National Electronics, Geneva, Illinois.

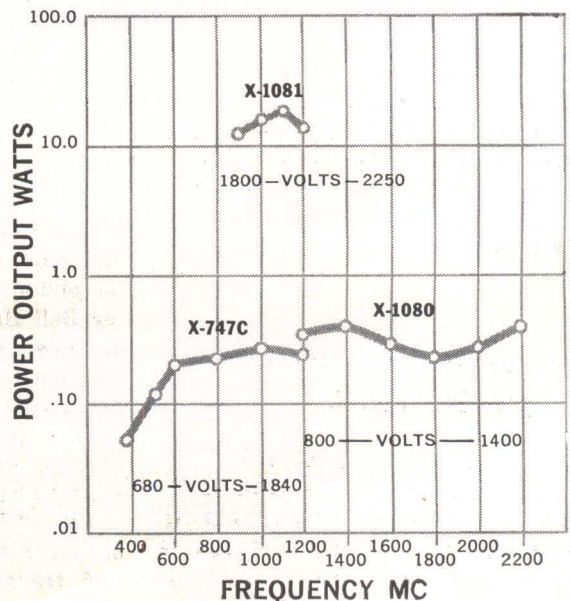

ELECTRONICS NEWSLETTER

Machine Learns to Read Handwriting

MOSCOW—Tass news agency reports that the Institute of Automation and Telemechanics has a machine that recognizes handwritten numbers and is learning to distinguish letters and portraits. The report indicates that work parallel to experiments in the U.S. is being done at the Institute.

The machine was cited, Tass said, by Vadim Trapeznikov at the recent general meeting here of the USSR Academy of Sciences. In an initial experiment with the numbers 0, 1, 2, 3 and 5, it recognized 800 samples—160 of each number—with four mistakes, after being shown samples of the numbers. The program, he said, is based on a "compactness hypothesis," now being applied to studies of animal nervous systems.

Trapeznikov envisioned future devices that could determine system states by the use of signs, which man cannot consciously evaluate. Applications would include the diagnosis, by listening to sounds, of apparatus defects or illnesses.

Single-Gas Masers Considered Feasible

EXPERIMENTS at Bell Telephone Labs have indicated the feasibility of obtaining optical maser action in pure neon. The maximum gain per unit length is considerably less than when helium is included in the system to assist pumping.

The result is important because it indicates that optical maser action will also be possible eventually in the other three rare gases, krypton, argon and xenon. It will make available masers emitting at new wavelengths. The measurements were made by C. K. N. Patel, W. R. Bennett, Jr., W. L. Faust and R. A. MacFarland.

Optoelectronic Relays, Logic Circuits Seen

PHILADELPHIA—Optoelectronic circuits might be used instead of relays in telephone exchanges, J. G. Van Santen, of Philips Research Labs, reported at the Solid-State

Circuits Conference last week. Electroluminescent - photoconductive registers would count pulses at speeds of 5 to 20 msec per step.

He also proposed EL-PC matrixes which would multiply two 10-digit numbers in 1 sec. While EL-PC logic circuits are relatively slow, Van Santen said, they avoid cross-talk, need no other type of component, are easily integrated, have small dissipation per element, give high amplification and are low cost.

Converting Carrier to National Command Ship

NAVY is converting the auxiliary aircraft transport carrier *Wright* to a national command ship. The job, assigned to the Puget Sound Naval Shipyard, will cost \$25 million, including communications and electronics equipment. Now in the reserve fleet, the ship is 683 ft long, displaces 14,500 tons and has a speed of 30 knots. Defense Department wants at least two such ships for use as alternate headquarters in case of nuclear attack (p 12, Feb. 2).

Telemetry and Autopilot Turn 'Copter into Drone

HELICOPTERS can be controlled from the ground by personnel not trained as pilots, using a system developed by Bell Helicopter Co. It has been installed in two H-13E 'copters under a Navy contract. The drones could be used to deliver antisubmarine weapons, as radar and tv scouting platforms, or as decoys for manned 'copters, Bell says.

The all-transistor system consists of an f-m/pam ground command and transmitter and an airborne

autopilot. Ground controls set heading, airspeed and altitude and include a trim stick for takeoff and landing. The craft cannot be commanded to perform any maneuver beyond its limitations.

The present system is effective only when the 'copter is in line-of-sight contact with ground, giving a 15-mi range at low altitude. Bell says range may be extended with microwave beacon and doppler equipment, airborne tv or radar tracking.

Apollo Project Checkout Contract Given by NASA

GENERAL ELECTRIC has been selected by NASA to provide integration analysis for the Apollo space vehicle, assure its reliability and develop and operate a checkout system. The study phase will take about six months and cost \$1 million. The implementation phase will last as long as the Apollo project, which is designed to land a man on the moon by 1970. Cost of the second phase will be estimated during the study. GE will work with NASA centers and their major contractors.

Autopilot for Merchant Ships Being Designed

NORDEN is building a course computer and steering system, based on autopilot electronics, for a merchant ship, under contract with the Maritime Administration. It will compute an open-sea course to a specified latitude and longitude, steer the ship there and give a constant estimate of position, distance to go and estimated arrival time. Prototype delivery is planned for late June.

British Electronics Sales Rise 12th Year in a Row

LONDON—British electronic equipment exports rose from \$161 million in 1960 to a record \$191.8 million last year, the industry's twelfth successive annual rise, the Electronic Engineering Association reported last week.

Domestic and overseas sales to-

taled about \$355.6 million last year, including \$112 million for defense programs, compared with \$327.6 million total and \$166.3 million for defense in 1960.

Exports of radio and tv broadcast transmitters fell by \$280,000 to \$2.38 million, but overseas sales of radio communication, radar and navigational equipment rose from \$47.6 million to \$57.7 million.

Industrial electronic control equipment exports increased by \$1.4 million to \$7 million while radio testing equipment climbed from \$4.5 million to \$5 million.

Computers have apparently maintained their export position at around \$5.6 million. Exports of miscellaneous equipment increased from \$7.5 million to \$11 million.

Spacecraft Reentry Study Is Launched by NASA

LANGLEY RESEARCH CENTER last week held a bidders' briefing on a new NASA research program called Project Fire. Two spacecraft, each carrying a different instrumentation system, will be launched in the next two years to study reentry problems.

Purpose is to obtain data on materials, heating rates and radio signal attenuation from vehicles reentering the atmosphere at 24,500 mph. Data will be obtained by telemetry, radar and optical tracking.

A 200-lb craft will be used. It will be carried aloft by an Atlas D booster and accelerated back to earth by an Antares solid fuel rocket motor. No attempt will be made to recover the craft.

Navy Tabulates Velocity Of Sound in All Oceans

NAVAL ORDNANCE LAB, White Oak, Md., has prepared a tabulation of the speed of sound in sea water in all oceans, for reference in underwater acoustics studies. The tables take into account the effects of salinity, temperature and pressure on sound velocity at all depths for

more than 99.8 percent of the world's oceans.

A total of 747 velocimeter measurements were made with eight seawater samples of varying salinity, at 15 temperatures and eight pressures. Data was interpolated on a computer. The tables replace earlier tables, in error by as much as 10 feet per second, which did not consider effects of temperature and pressure.

Optically Coded Altimeter Reports Aircraft Height

ANALOG-TO-DIGITAL system that enables pressure-type altimeters to report aircraft altitude to ground has been designed and ground-tested at Case Institute of Technology, Cleveland.

Bellows movement rotates an optical code disk divided into opaque and transparent sections in nine rings. There are 501 radial patterns, each representing 50 feet of altitude to 25,000 feet.

On interrogation from ground, a lamp flashes through the disk. The pattern seen through masks is detected photoelectrically and coded. The altitude code, in nine bits, and the aircraft's serial number and type code, in 19 bits, are transmitted to the interrogating ground station.

Another Group Formed to Help Science Communicate

WASHINGTON—The American Association for the Advancement of Science has formed a new subgroup, Section T—Information and Communication. So far, 10 societies dealing with documentation, computers, writing and chemical fields have become affiliates. Goal is to bring together societies and individuals interested in scientific communication, information storage and retrieval. No specific programs have been planned as yet, but society spokesmen indicate that initial efforts will be to interest scientists and information specialists in each other's problems.

In Brief . . .

U. S. R&D this year will total \$12.3 billion, with 75 percent going to aerospace programs, says AIA.

SWEDEN has selected both radar and infrared versions of Hughes' Falcon air-to-air missiles for the new J-35F Draken fighters. The missiles will be made in Sweden.

GENERAL DYNAMICS has a \$7.6 million contract for communications systems at three Titan ICBM bases. GD/E is testing a non-scanning, terrain-avoidance radar for low-flying planes.

JOINT VENTURE company has been formed in Japan by Thompson Ramo Wooldridge and Mitsubishi Electric to make and sell process control computers, semiconductor devices and other equipment.

STANDARD REGISTER will market Raytheon's DataRay data communications equipment, for use with Bell System's Data Phone.

PACKARD BELL is building two large, \$750,000 versions of its Trice digital differential analyzers for the Apollo program, also has \$300,000 contract for two ship-board data systems for Atlantic Missile Range.

RULES PROPOSED by FAA for magnetic device air shipments include labeling, keeper bars if possible and recalibration of aircraft compasses near shipment.

PHILCO contracts from Air Force include \$8.8 million for satellite control systems and \$1.5 million for air-ground communications. A \$42,000 subcontract goes to Remanco for a voice communications system for Discoverer.

NAVY has awarded Sangamo Electric \$8.5 million for sonar equipment. Union Switch & Signal has \$275,000 subcontract from Lockheed for airborne sonobouy displays.

PROTOTYPE of Nudets (Nuclear Detection and Reporting System) will be built by GE for Air Force under \$1.8 million contract. It's part of 477L program.



freeze 'em, fry 'em!

We took a dozen Hoffman 1N1357 ten watt regulators and froze them into ice cubes. Then we dumped the cubes into boiling oil. Finally, we tested the regulators in a circuit. All twelve continued to function right up to specs. No wonder. These straight-from-the-bin, standard regulators meet thermal shock requirements of MIL-S-19500 and operate at -65°C to $+175^{\circ}\text{C}$.

They are the same type device that have achieved a 99.058% / 1000 hr. Survival Rate Factor after 350,480 component operating hours at 100°C and 6 watts power dissipation. Our 1N1357 stands up in every way, like all Hoffman semiconductor devices.



We specialize in devices for control, regulation and power. You can buy them with confidence that they'll work and keep on working. Confidence that they'll be available when and where needed. That's why so many of the most successful electronics designers keep coming back to Hoffman—again and again and again. Chances are you'll do the same. Try us. Call your nearest Hoffman distributor or sales office today.

Hoffman / **ELECTRONICS CORPORATION**
Semiconductor Division

1001 N. Arden Dr., El Monte, Calif. • Cumberland 3-7191 • TWX: El Monte 9735

CIRCLE 9 ON READER SERVICE CARD

Get the exact test signal

Hewlett-Packard pioneered and developed the resistance-capacity oscillator, available today in these versatile instruments.

A feature of the R-C oscillator circuit is its automatically varied negative feedback which provides low distortion, excellent frequency response and amplitude stability. R-C oscillators are extremely simple to operate and, because of their high stability and wide frequency range, require no tedious resetting or adjustment during operation. They are light-

weight, portable, compact in size. Dependable operation is assured by clean, simple circuitry and painstaking construction from quality components.

Hewlett-Packard's years of experience in design and development of oscillators, plus continuous improvement of components and manufacturing techniques, assure you of the most dependable, rugged, useful oscillators available today.

204B Portable Oscillator, 5 cps to 500 KC.

Use it on the bench, carry it anywhere. This solid state portable oscillator offers battery or optional ac operation, is small and lightweight, gives you highly stable signals from 5 cps to 500 KC. Internal heat is small, warmup drift is negligible. Output is fully floating, isolated from both power line ground and chassis. The 204B will drive balanced and unbalanced loads and loads referenced either above or below ground.

204B maintains excellent frequency stability even with rapidly changing loads. Frequency stability over the entire 5 cps to 500 KC range is better than $\pm 0.03\%/^{\circ}\text{C}$ from 0° to 55°C . Output is flat within $\pm 3\%$ at all settings of dial and range switch. Distortion less than 1%, hum and noise less than 0.05%. Output 10 mw (2.5 v rms) into 600 ohms; 5 v rms open circuit. 204B, with batteries, \$275.00. AC operation optional, \$25.00 extra.

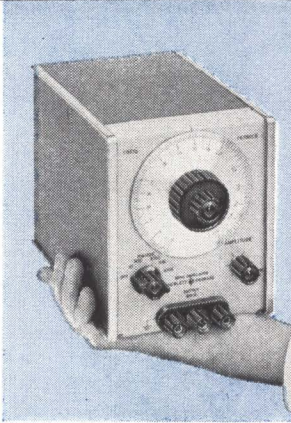

200AB Audio Oscillator, 20 cps to 40 KC.

Ideal for amplifier testing, modulating signal generators, testing transmitter modulator response. Covers its range in four overlapping bands. Simple operation, just three controls. No zero setting required. High stability, with accurate tuning circuits. Output 1 watt (24.5 v) into a 600 ohm load. 200AB (cabinet), \$165.00; 200ABR (rack mount) \$170.00.

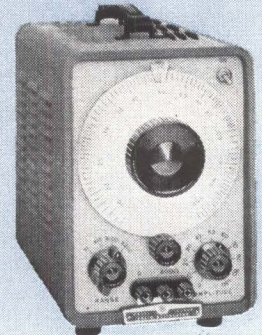

200CD Wide Range Oscillator, 5 cps to 600 KC.

Subsonic to radio frequencies covered in five overlapping decade bands. Used for testing servo and vibration systems, medical and geophysical equipment, audio amplifiers, video frequency circuits, etc. 85 dial divisions for reading convenience. Distortion rating less than 0.5% below 500 KC. Output 160 mw (10 v/600 ohms); 20 v open circuit. 200CD (cabinet), \$195.00; 200CDR (rack mount), \$200.00.

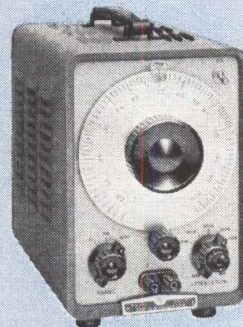

201C Audio Oscillator, 20 cps to 20 KC.

Especially designed for testing amplifiers, speakers, cross-over networks, this high power oscillator offers an output of 3 watts or 42.5 v into 600 ohms over its full frequency range. Response is 1 db full range. Attenuator adjusts output 0 to 40 db in 10 db steps, provides either low impedance or constant 600 ohm impedance. 201C (cabinet), \$250.00; 201CR (rack mount), \$255.00.

you need from hp

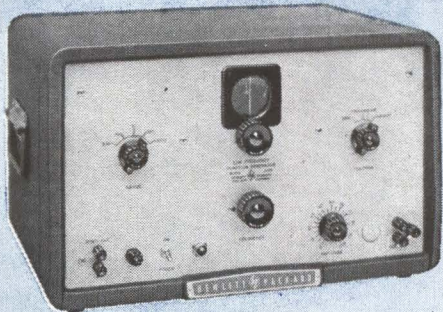

Ⓜ 202A Function Generator, 0.008 to 1,200 cps.

Source of transient-free sine, square and triangular waves, frequency continuously variable through 5 bands for electrically simulating mechanical, physi-

cal, medical phenomena. Stability within 1%, distortion less than 1% up to 100 cps. Sine, square or triangular waves selectable by front panel switch. Output 28 mw or 30 v p-p/4,000 ohms. Ⓜ 202A (cabinet), \$550.00; Ⓜ 202AR (rack mount), \$535.00.

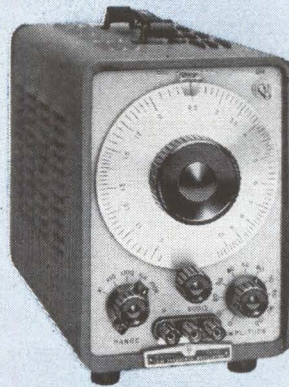

Ⓜ 202C Low Frequency Oscillator, 1 cps to 100 KC.

Especially convenient for measurements in the subsonic, audio and ultrasonic regions such as vibration, electro-cardiograph, electro-encephalograph. Distortion less than 0.5%, hum voltage less than 0.1%, short recovery time. Output 10 v/600 ohms. Ⓜ 202C (cabinet), \$300.00; Ⓜ 202CR (rack mount), \$305.00.



Ⓜ 205AG Audio Signal Generator, 20 cps to 20 KC.

Six basic instruments combined in one for high power audio tests, gain measurements. Two voltmeters measure input and output of the device under test.

Output 5 watts, adjustable. Output impedance selected by front panel switch. Ⓜ 205AG (cabinet), \$600.00; Ⓜ 205AGR (rack mount), \$585.00.

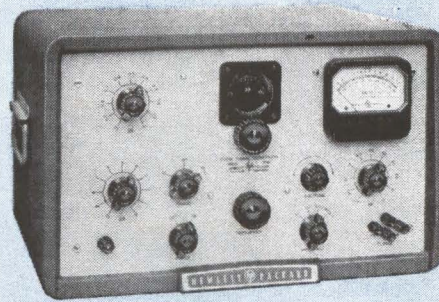

Ⓜ 206A Low Distortion Audio Signal Generator, 20 cps to 20 KC.

Distortion less than 0.1% makes the Ⓜ 206A ideal for use in testing of FM broadcasting units

and high fidelity audio systems. Metered output, variable in 0.1 db steps, +15 dbm into 50, 150, 600 ohms. Ⓜ 206A (cabinet) \$800.00; Ⓜ 206AR (rack mount), \$785.00.



Ⓜ 650A Test Oscillator, 10 cps to 10 MC.

Metered output flat within 1 db full range. Voltage range is 0.00003 to 3 v. 600 ohm impedance, voltage divider furnished

for 6 ohm impedance. Distortion less than 1% to 100 KC. Ⓜ 650A (cabinet), \$550.00; Ⓜ 650AR (rack mount), \$535.00.



HEWLETT-PACKARD COMPANY

1501 Page Mill Road, Palo Alto, California. Area Code 415, DA 6-7000
Sales and Service representatives in all principal United States areas; Europe, Hewlett-Packard S.A., Rue du Vieux Billard No. 1, Geneva; Canada, Hewlett-Packard (Canada) Ltd., 8270 Mayrand Street, Montreal.

7664

WASHINGTON OUTLOOK

McNAMARA SHUNS COST-PLUS RESEARCH

DEFENSE SECRETARY McNAMARA has ordered an internal drive within the Pentagon to get more research for the military dollar. He sent a memorandum on this to his deputy director of defense research and engineering, John H. Rubel, some months ago. Specifics are just now coming out.

McNamara admonished the three military services for a tendency to be swayed in placing R&D contracts by "slick paper" and "fancy" proposals that often are more optimistic than the company's capability. The services, too, were criticized for writing elaborate R&D requirements that show little resemblance to the initial field requests for equipment.

McNamara wants the services to use more fixed-fee contracts and trim down as far as possible cost-plus-fixed-fee contracts. Even if a contractor's initial fixed-fee bid is much higher than estimated R&D costs, experience has shown that in the end a fixed fee is usually cheaper than the final cost of a cost-plus-fixed-fee award. If it is impossible to place fixed-fee contracts on an entire R&D program, the Secretary of Defense wants the program broken down. awarding as many elements on a fixed-fee basis is possible. Incentives on cost-plus-fixed-fee awards are encouraged to improve contractor performance.

TEETH IN ETHICS CODE?

THE WHITE HOUSE has issued a new code of conduct for government consultants. Designed to tighten conflict of interest regulations and prevent consultants from using their government positions for private gain, the new code spells out what consultants can and cannot do. Consultants would have to furnish a "full disclosure" of their financial interests.

Administration-proposed legislation to update the conflict-of interest laws is now pending before Congress. It is generally conceded that President Kennedy is acting now to quell congressional moves toward a major round of congressional hearings into conflict-of-interest questions.

By and large, these center on the thousands of scientists and engineers who serve the government as part time consultants. The White House fears that hearings might needlessly cause many of its consultants to shun further government work.

TAX HELP FOR BASIC RESEARCH

TREASURY DEPARTMENT is seeking a formula that will give industry more incentive to do basic research. Less than 10 percent of total U.S. research and development expenditures goes for basic research. The administration feels this is much too small, since basic research is a key factor in the industrial innovations so necessary to economic growth. The treasury is weighing recommendations for the major tax reform program President Kennedy plans to submit to Congress this year. It won't be considered until 1963.

UHF TV HEARINGS SOON

RECENT HORSETRADING between FCC and industry (p 12, Feb. 16) increases prospects for uhf tv. Sen. John O. Pastore, Communications Subcommittee chairman, will quickly move hearings on a bill requiring that receivers be made to pick up the 70 uhf and 12 vhf channels. Hearings will let FCC see if the networks and several key manufacturers are going to back up their endorsement with action.

There is a tacit understanding that if the bill goes through, FCC will soft-pedal network regulation and deintermixture. The industry is not solidly behind the bill. EIA will fight it. Despite an NAB endorsement, many station owners don't want their tv license value diluted by new uhf stations.

Now cover the ULTRASONIC SPECTRUM with One Broad Band Power Generator 10KC to 2MC 250 Watts*

An Ultrasonics Research Laboratory at Your Fingertips

● MAY BE MATCHED TO ANY TRANSDUCER, MAGNETOSTRICTIVE OR PIEZO-ELECTRIC



APPLICATIONS

Ultrasonic Research
Transducer Testing
Medical Studies
Biological Studies
Chemical Research
Metallurgical Studies
Metal Welding Studies
Plastic Welding
Ultrasonic Cleaning Studies
Ultrasonic Drilling
Ultrasonic Soldering
Many Others

PRICE

\$4450⁰⁰ complete
\$3995⁰⁰ Less Hewlett-Packard
650-A Oscillator

F.O.B. Cranford, N. J.
Order Direct • Delivery—4 weeks

AN ULTIMATE RESEARCH INSTRUMENT

Now many valuable research studies in the diverse fields of ultrasonic applications requiring a power source that can cover the ultrasonic spectrum by the turn of a single dial are possible to the engineers and scientists skilled in the various disciplines of medicine, biology, physics, chemistry, metallurgy, plastics welding and others as well as electronics and ultrasonics. To the ultrasonics researcher it is invaluable. A cleaning tank may be powered at 20kc. An ultrasonic drill at 26kc. A plastics welder at 40kc. Other cleaning studies conducted at 90kc. A focusing transducer can irradiate a chemical solution at 400kc. Biological and chemical effects studied at 1 megacycle. Within the ultrasonic spectrum, effects of polymerization and depolymerization, metallurgical grain refinement, chemical reaction, extraction of nucleic

acids from various cultures and countless other effects may all be readily studied.

In addition to this generator, various transducers with proper impedance matching transformers are required to complete an ultrasonics research laboratory. Due to the low output impedance, magnetostrictive transducers may be driven directly by the addition of a DC polarizing source or magnetic bias. Impedance step-up transformers are required for piezo-electric or ceramic transducers at lower frequencies. At the higher frequencies, most electrostrictive transducers exhibit lower impedance characteristics enabling relatively easy transformer matching. International Ultrasonics, Inc. will furnish quotations on matching transformers to specific transducer requirements throughout the frequency range of this instrument.

*Higher Wattages available to special order

**Registered DuPont Trademarks

• Agent and Representative Inquiries Are Invited

FEATURES

Hewlett-Packard 650-A Oscillator
Push-Pull Video Amplifier
Push-Pull Cathode Follower
Grid Drivers
Push-Pull Output Stage
employing 10 matched 6550's
Untuned Broad Band Output
Transformer
All Silicon Rectifier H-V Supply
Regulated Screen Supply
Sloping Front Control Panel
Writing Shelf
Floor Mounting Wheel about
Console, Blower Cooled
Output Power Variable 0 to 250
Watts
Output Impedance 92 ohms

OTHER INTERNATIONAL ULTRASONICS PRODUCTS

Ultrasonic Flowmeters
Flow—Nonflow Alarms
Continuous Reading Liquid
Level Gauges
Plastic Welders
Ultrasonic Drills
Ultrasonic Soldering Irons
Cavitation Meters utilizing probe
to measure relative cavitation
from point to point in a tank
Ultrasonically spliced computer
tape, video tape, MYLAR**
drive and conveyor belts,
CRONAR** photographic
film splicers.

INTERNATIONAL ULTRASONICS, INC.

331 CENTENNIAL AVENUE, CRANFORD, NEW JERSEY

1U 100

Melabs

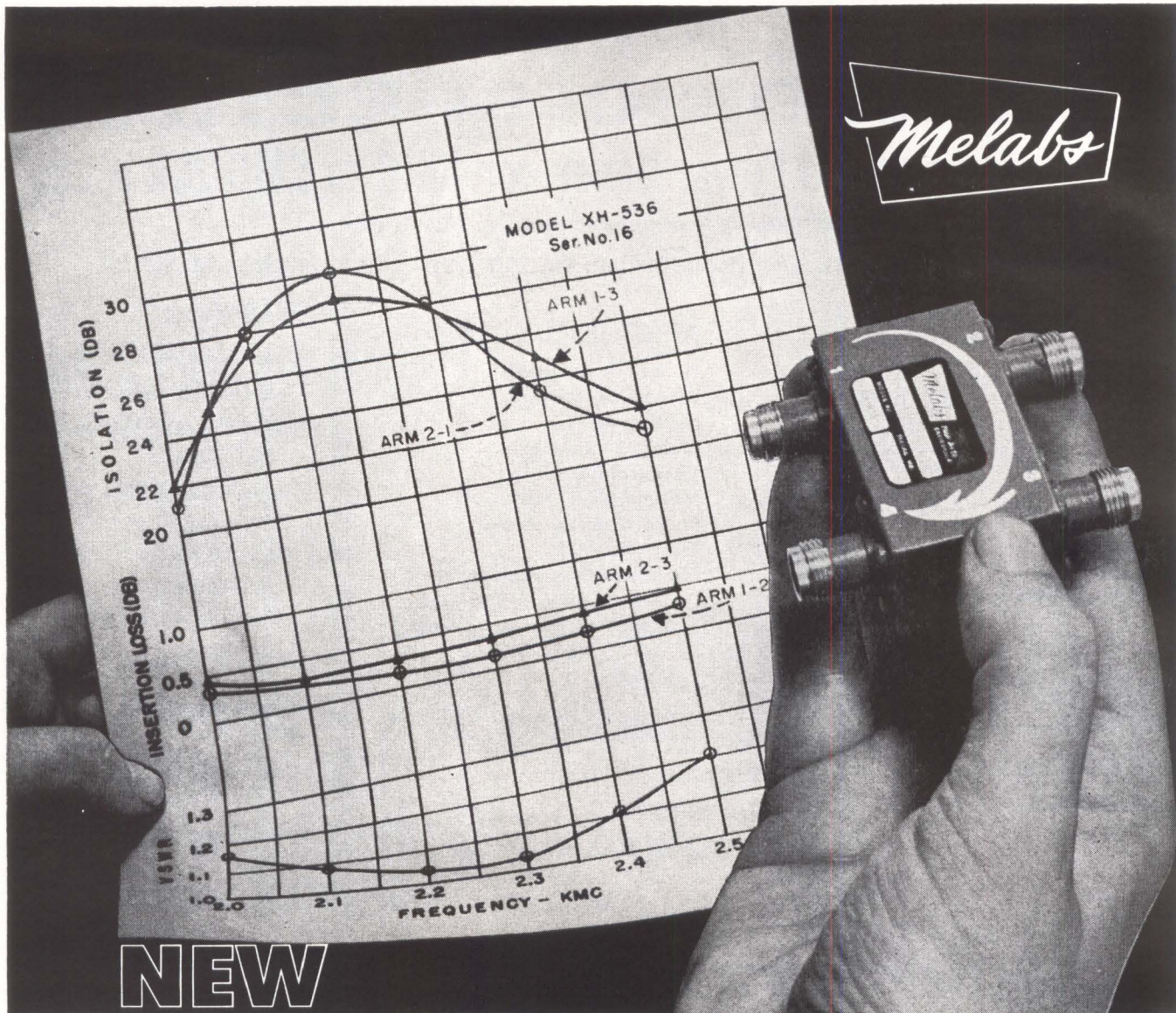

NEW

COAXIAL 4-PORT CIRCULATORS

Now available . . . a new series of ferrite 4-port circulators for operation over the frequency range of 400 mc to 8 Gc. All models feature low-loss, high isolation and broadband characteristics. All are small in physical size—ultra-miniature units also available. One of the latter, Model XH-415 (5.4-5.9 Gc) is illustrated. Measured performance for Model XH-536 (2.0-2.5 Gc) is shown on the chart. All of these 4-port models feature *insertion loss* of 0.3 db maximum (0.15 db typical), *isolation* of 20 db minimum (25 db typical), and *VSWR* of 1.2 maximum.

Some of the many standard models:

XH-351 . . . 1.25 - 1.35 Gc **XH-335 . . . 5.4 - 5.9 Gc**
XH-536 . . . 2.0 - 2.5 Gc **XH-415 . . . 5.4 - 5.9 Gc***
XH-541 . . . 2.6 - 3.0 Gc *Ultra-miniature w/TNC connectors.

Other models can be supplied at any frequency within the 400 mc to 8 Gc spectrum.

A complete line of ultra-miniature Coax Isolators from 1.7 to 8 Gc is presently under development.

OTHER IMPORTANT NEW MELABS CIRCULATORS

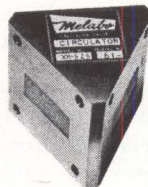

Miniature K_u Band, Broadband Waveguide Circulator Model XH-525.
 Frequency range: 15.5-17 Gc.
 Isolation: 20 db minimum.
 Insertion loss: 0.5 db max., 0.3 db typical.
 VSWR: 1.25 maximum.
 Weight: 3 ounces.

Melabs

3300 HILLVIEW AVENUE / STANFORD INDUSTRIAL PARK / PALO ALTO, CALIFORNIA

TELEPHONE: DA 6-9500, AREA CODE: 415; TWX: PAL AL 138

Employment opportunities at Melabs are exceptional for ambitious engineers and physicists; write in confidence.

AN EQUAL OPPORTUNITY EMPLOYER

DEPT. B-8



BENDIX 25-AMP DAP'S!

Bendix®25-amp DAP (Diffused Alloy Power) transistors are designed for high-temperature, high-current, microsecond switching. They're 'Dynamically Tested', an exclusive Bendix quality control process that tests each unit to assure uniform reliability. In addition to their high current switching capabilities (typically 25 amperes in 4 μ sec) Bendix 25-amp DAP® offers circuit stability over a wide range of temperatures (from -60°C to $+110^{\circ}\text{C}$). They're rated at high collector-to-emitter breakdown voltages, provide low input resistance, controlled current gain, and low saturation voltage. Write to Holmdel, N. J., for details.

Absolute Maximum Ratings:	V_{CE} Vdc	V_{CB} Vdc	I_C Adc	P_C W	T_{stg} $^{\circ}\text{C}$	T_j $^{\circ}\text{C}$
2N1651	60	60	25	100	-60 to $+110$	110
2N1652	100	100	25	100	-60 to $+110$	110
2N1653	120	120	25	100	-60 to $+110$	110

* P_C is the maximum average power dissipation. It can be exceeded during the switching time.

Bendix Semiconductor Division



Main Office: South St., Holmdel, N. J.—Ph: SH 7-5400 • New England Office: 114 Waltham, Lexington, Mass.—Ph: VO 2-7650 • Detroit Office: 12950 W. 8 Mile Rd., Detroit 37, Mich.—Ph: JO 6-1420
 • Midwest Office: 1915 N. Harlem Ave., Chicago, Ill.—Ph: 637-6929 • West Coast Office: 117 E. Providencia Ave., Burbank, Calif.—Ph: VI 9-3961 • Canadian Affiliate: Computing Devices of Canada, P.O. Box 508, Ottawa 4, Ont. • Export Office: Bendix International, 205 E. 42nd Street, New York 17, N.Y. Stocking Distributor: Contact nearest sales office for name of local distributor.

More new millimeter wave FERRITE COMPONENTS . . . This is the new TRG transistorized switch driver and circulator combination for millimeter wave radiometry. Like most TRG ferrite components, it is available nowhere else — truly a pioneering device in the true sense of that sometimes abused word. Yet, TRG offers this unique combination, as it offers all other TRG advanced components, on short delivery. You'll find the ferrite switch driver and circulator more fully described below. And please remember this: today, there is only one source for a complete line of millimeter wave components of all types, covering the entire 26.5 to 220 KMC region. That source is TRG. Whatever your problem — a component, or complete systems development — TRG has more of everything it takes, including experience, to place the answers right in the palm of your hands. Please write for Catalog 260A today.



TECHNICAL RESEARCH GROUP, 400 Border St., East Boston 28, Mass.

The new TRG transistorized ferrite switch driver and circulator combinations are available over the entire 26 to 140 KMC region. Applications: millimeter wave radiometry, spectroscopy and radar duplexing. Representative specs: Rise Time, less than two microseconds . . . Repetition Rate, 2 pps—10,000 pps . . . Duty Cycle, 50% Automatic binary reduction of input trigger pulse.

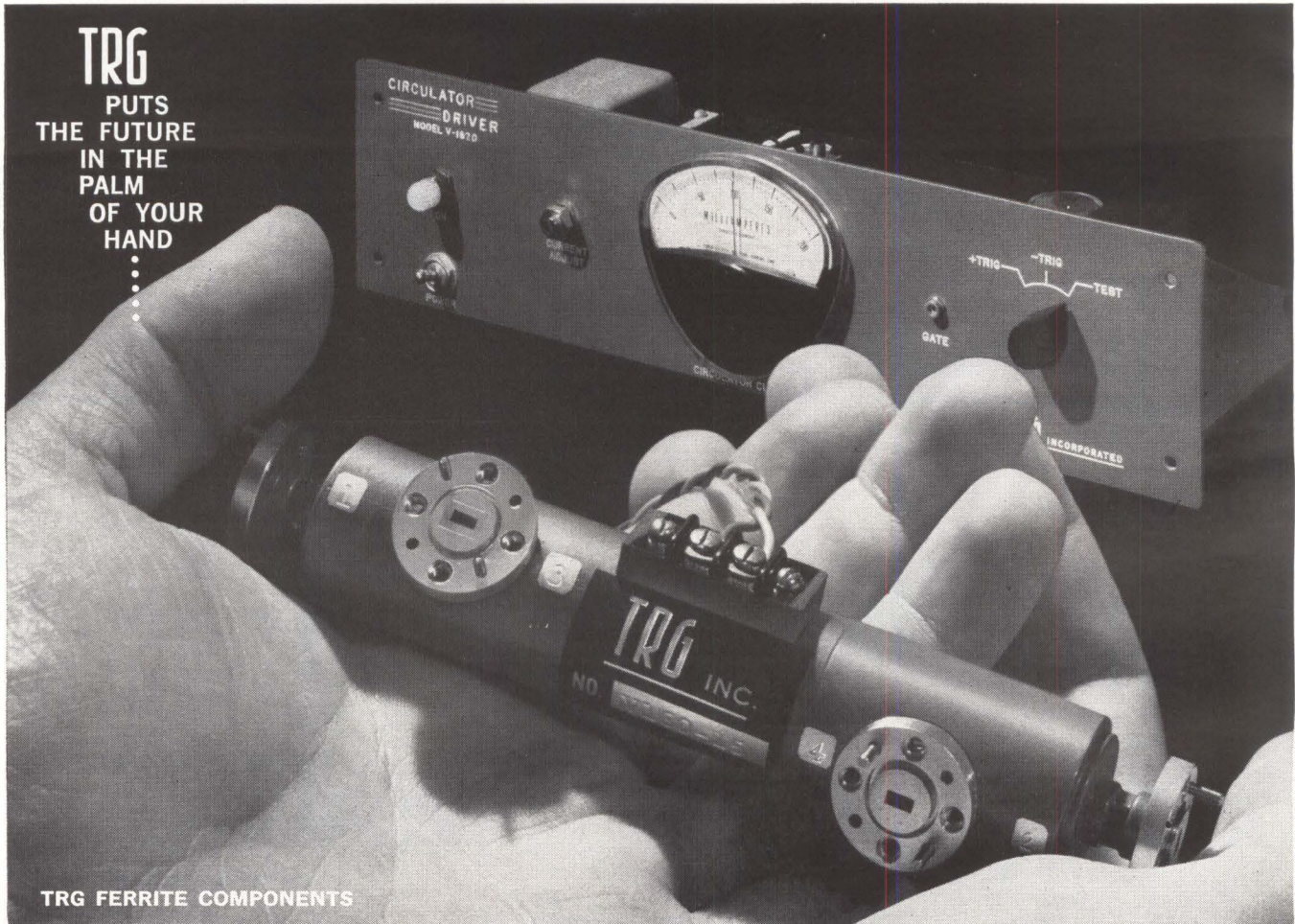

TRG FERRITE COMPONENTS

COMPONENT	A-band 26-40 KMC	V-band 50-75 KMC	E-band 60-90 KMC	F-band 90-140 KMC	TYPICAL PERFORMANCE FOR A, V, E and F BANDS		REMARKS
					A, V, E	F	
FERIMAT — Tunable Isolator	A100	V100	E100	F100	A, V, E VSWR 1.25 max. — Loss 1.5db max. — Isolation 20db min.	F Under development, present performance quoted on request	Tunes over full waveguide range
Isolator	A110	V110	E110	F110	A, V, E VSWR 1.25 — Loss 0.7db — Isolation 17db min., 25db at band center	F VSWR 1.30 — Loss 1.0db — Isolation 16db min., 22db at band center	Bandwidth: 6% A-band, 3% V and E-band, $f_0 \approx 1$ KMC F-band
On-off Switch or Variable Attenuator	A120	V120	E120	F120	A, V, E VSWR 1.25 — Loss 1.5db — Isolation 50db	F Under development, present performance quoted on request	150 ma switching current, 3 μ sec. rise time
Modulator	A130	V130	E130	F130	A, V, E 4% Band — VSWR 1.25 — Loss: on 1.5db — off 30db	F 2% Band — VSWR 1.3 — Loss: on 1.5db — off 30 db	Normally closed — Approx. 150ma switching current, 3 μ sec. rise time
Reciprocal Switch	A140	V140	E140	F140	A, V, E 3% Band — VSWR 1.25 — Loss 1db — Isolation 20db	F Under development, present performance quoted on request	High power — Approx. 150 ma switching current, 3 μ sec. rise time
Four Port Circulator	A160	V160	E160	F160	A, V, E 3% Band — VSWR 1.3 — Loss 1db — Isolation 20db	F Under development, present performance quoted on request	Utilizes two dual mode transducers and a Faraday rotator
Switchable Circulator Switch	A162	V162	E162	F162	A, V, E 3% Band — VSWR 1.3 — Loss 1db — Isolation 20db	F Under development, present performance quoted on request	High power — Approx. 150ma switching current, 3 μ sec rise time
Transistorized Driver	162D	162D	162D	162D	Rep. Rate: — 2pps to 10,000pps, Rise Time: — Less than 1.5 μ sec. with coil of 1mh or less, Duty Cycle: — 50% automatic Binary Reduction of input Trigger, Input Signal: — Plus or minus pulse or square wave, 5 volts peak		Designed for pulsing ferrite waveguide switches and modulators over 26 to 140KMC band

NOTE: TRG ferrite components can be built to operate with existing high power millimeter transmitting tubes. A custom built Model V160 circulator — entirely was successfully tested at 10 kw peak power.

TRG INC., ANTENNA & MICROWAVE DEPT., 400 BORDER ST., EAST BOSTON 28, MASSACHUSETTS • Logan 9-2110

calculated reliability

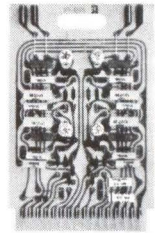

Reliability has always been a critical factor in circuit design. One way to achieve it is to calculate the circuit values for a worst case design and then throw in a multiplying factor for the crucial specs on each component. This can run the cost up considerably and generally results in an overdesigned circuit. Another way to achieve it—the way Rese does it for their 1 MC Logix Blocks—is to maximize the reliability by using an end point design. Knowing in advance the desired MTBF (mean time between failures), Rese calculates the stress ratio of every resistor, capacitor, diode and transistor in the circuit. With this information the design can be optimized for a given value of MTBF—the circuit is neither overdesigned nor overpriced.

If you would like to know more about Rese reliability calculations, send for our MTBF folder. Rese Engineering Inc., A & Courtland Sts., Philadelphia 20, Penna.

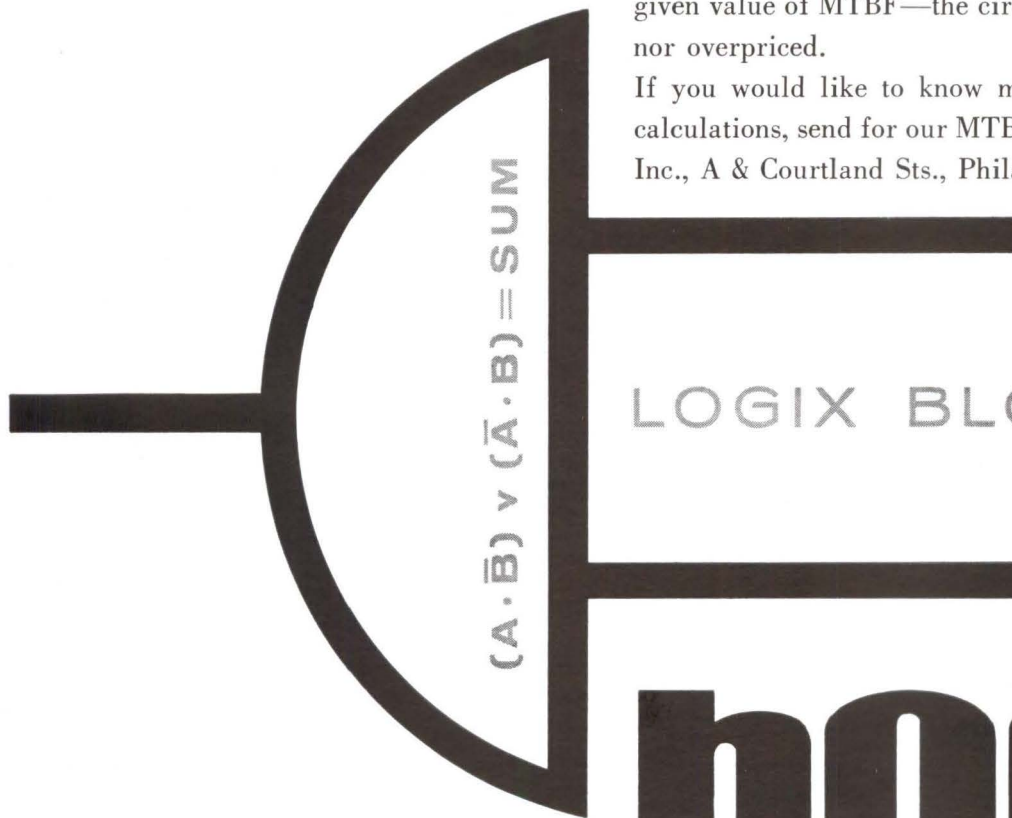

LOGIX BLOCKS

rese

rese  engineering, inc.

Be fussy

Two things determine whether or not a particular printed circuit connector is "right" for your application:

1. How the printed circuit board mates with the connector, and
2. How the connector connects to the rest of the system.

Take mating, for example. Besides having the correct number of contacts, a printed circuit connector must hold the board securely whether the board happens to fall at the high or low end of thickness tolerances.

IT TAKES THREE

These considerations convinced Amphenol engineers that no single contact design could satisfy the requirements of a wide range of applications. So they designed three contacts that will.

One, used in Prin-Cir* connectors, looks a lot like a tuning fork with lips. The circle lip design makes contact overstressing or "setting" impossible—even after repeated insertions. The contact's long spring base also enables it to accommodate boards that range in thickness from .055" to .073", while doing an excellent "wiping" job.

EASY DOES IT

But not every application requires the Prin-Cir "bite." For this reason, Amphenol engineers designed connectors with ribbon contacts that mate with a gradual wedge-like force. In

blind mating applications, gradual mating makes the feeling of *correct* mating unmistakable. (Just the thing when your equipment may eventually be maintained by less-skilled and less-concerned personnel.) Ribbon contact wedge action also makes it possible for connectors using these contacts to accept the same wide range (.055" to .073") of board thicknesses as do Prin-Cir connectors.

Finally, advances in micro-miniaturization (like Amphenol-Borg's Intercon® pre-fabricated circuitry) meant that tinier-than-ever-before connectors were needed. Amphenol's answer was the Micro-Min® receptacle and printed circuit board adapter. Micro-Min contacts are actually tiny springs of beryllium copper wire, formed in a precisely designed arc to assure firm circuit board retention. This unique design makes it possible to space contacts on .050" centers and crowd 19 connections into a little more than an inch of space.

TERMINATIONS COUNT, TOO

"How to connect connectors to the rest of the system" also merits a good deal of consideration. In some cases, hand soldered terminations will do just fine. In others, higher volume requirements call for high production rate methods like dip soldering and wire-wrapping. Some engineers prefer taper pin terminations.

Our printed circuit connectors are available with contact tails designed for each of these termination methods. In addition, adapters are available for use in connecting printed circuit boards at right angles to each other or in modular arrangements. We make printed circuit connectors with hermetically sealed contacts — still others with coaxial contacts.

Take your choice.

Any Amphenol Sales Engineer or authorized Amphenol Industrial Distributor will be happy to discuss printed circuit connectors (ours) with you. Or, if you prefer, write directly to Dick Hall, Vice President, Marketing, Amphenol Connector Division, 1830 S. 54th Avenue, Chicago 50, Illinois.

*T.M. Amphenol-Borg Electronics Corp.

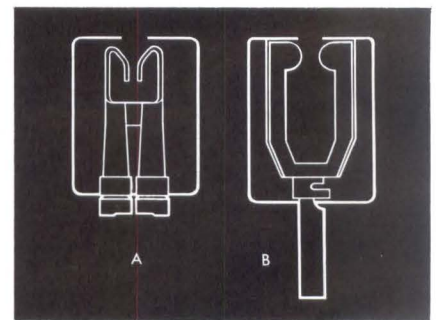

Wedging action of Amphenol ribbon-type (A) and long spring base of Amphenol Prin-Cir connectors (B) assure firm printed circuit board retention, whether board happens to fall at low (.055") or high (.073") end of thickness tolerance.



Connector Division / Amphenol-Borg Electronics Corporation

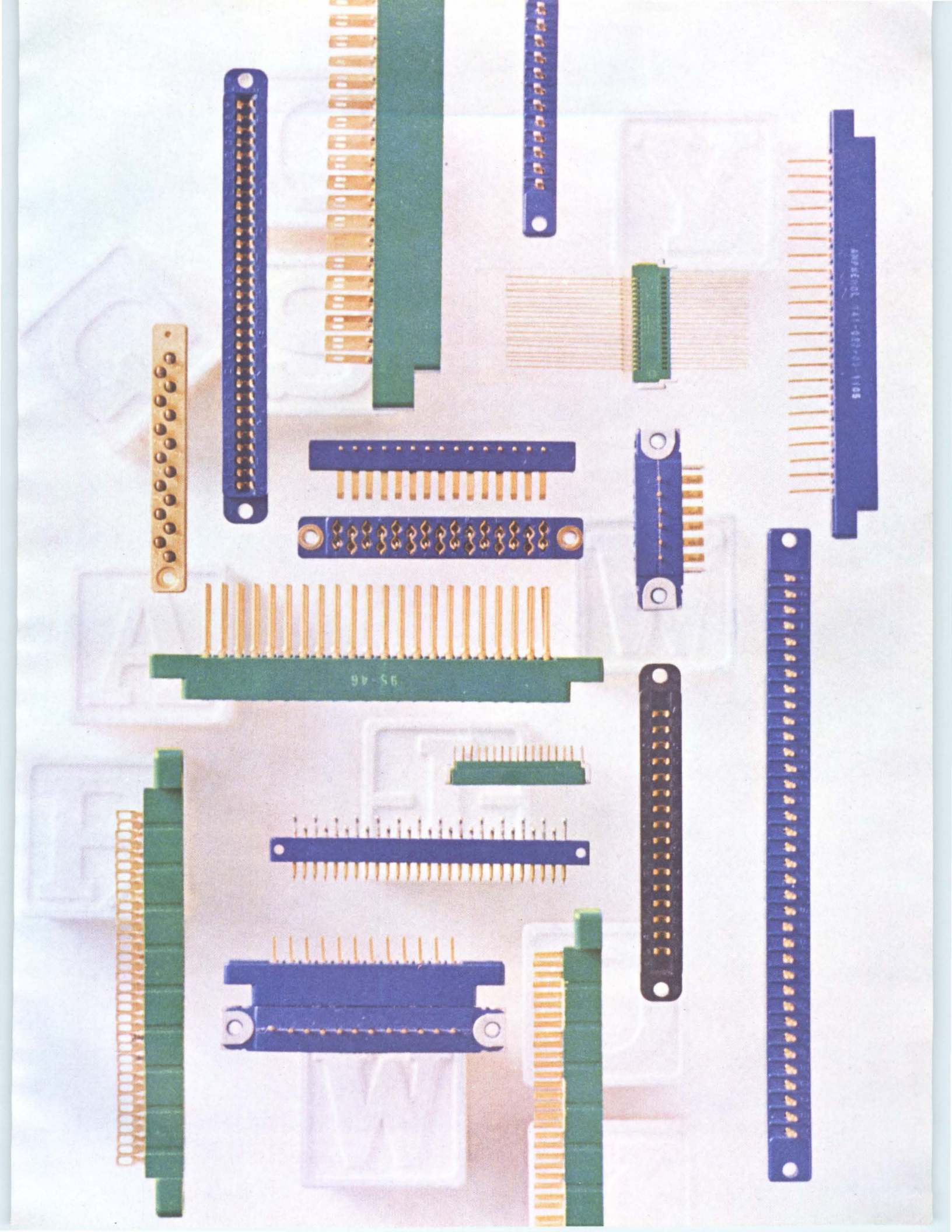

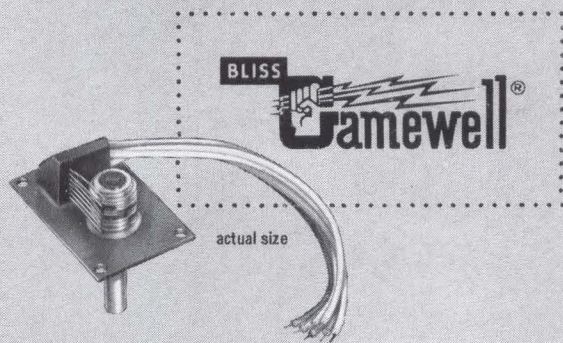

yes

* **y**our **e**ngineered **s**pecials service

Gamewell made this special completely from scratch. Every part of this rotary switch was newly designed by Your Engineered Specials service to meet a customer's special requirements. The unit provides bi-directional operation at 160 rpm max. It is rated at 28 VDC, 60 ma...has high vibration and shock resistance...and -55° to $+150^{\circ}\text{C}$. temperature range. Although this design called for only six poles and 11 switching segments, many more could have been provided. ■ Gamewell's YES service has developed answers to hundreds of special "pot" and rotary switch problems. Interested? Why not write for the full story? **y**our **e**ngineered **s**pecials service.

THE GAMEWELL COMPANY, POTENTIOMETER DIVISION, 1613 CHESTNUT STREET, NEWTON UPPER FALLS 64, MASSACHUSETTS. A SUBSIDIARY OF E. W. BLISS COMPANY

GUARANTEED

by
**"WORST CASE"
ANALYSIS**

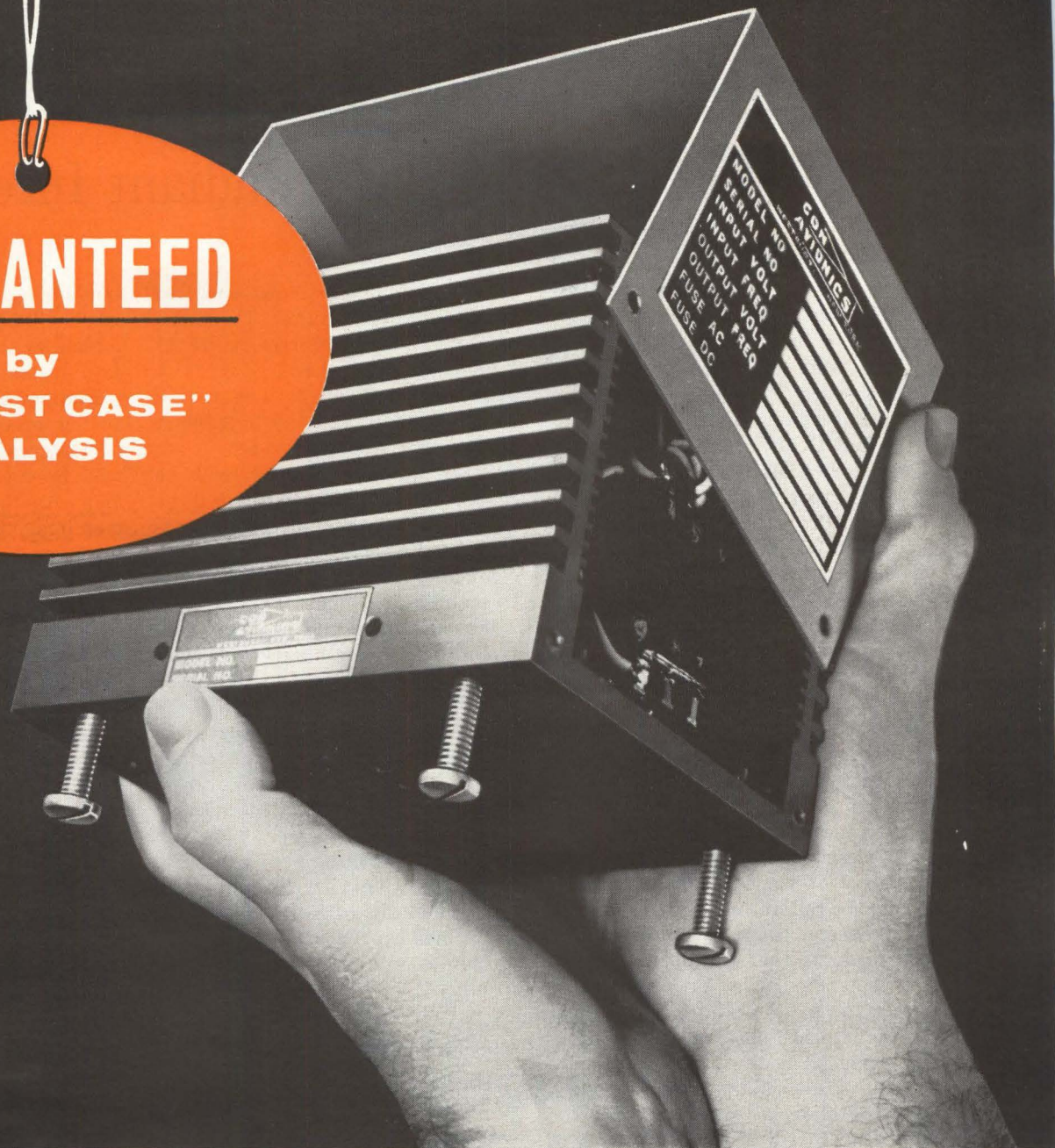

The First Transistorized Power Supplies with a 16,000-Hours MTBF*

New Design Principle. Con Avionics "Worst-Case" Analysis brings virtually failure-proof performance within the reach of everyone who uses power supplies. Here's why:

By special mathematical analysis, every Con Avionics supply is designed to reduce the probability of failure to near zero under "Worst-Case" conditions. Then the complete design is empirically verified with respect to regulation, overload and short-circuit protection, stability and all other operating parameters under "Worst-Case" operating conditions.

Before shipment, every Con Avionics Power Supply is given a 100-hour simulated operation under "Worst-

Case" conditions. The result is a supply guaranteed to give you perfect performance under any and all conditions.

Shown above is the AC-DC "Modular" Power Supply designed for easy incorporation in many electronic assemblies and systems. It features all solid state . . . unique heat sink construction . . . voltages from 2.0 to 305 VDC . . . adjustable output . . . power to 30 watts . . . regulation 0.1%.

Learn more about Con Avionics complete line of Transistorized Power Supplies. Call your local Con Avionics representative, or write to address below.

*Mean time between failure



New Low Cost General Purpose Supply available with regulated and unregulated outputs. 0-60 VDC/0-1.5 Amp.



New "Switching" Power Supply makes higher current capacities possible at low cost. 10-32 VDC/10, 20, 50 Amp.

CONSOLIDATED AVIONICS CORPORATION

800 SHAMES DRIVE, WESTBURY, L. I., NEW YORK
CIRCLE 21 ON READER SERVICE CARD

A Member
of The Condec Group

**CON
AVIONICS**

Orbiting Ultraviolet System Will Map Stars and the Sky's Radiant Intensity

DIGITAL TV, a recently-developed ultraviolet tv pickup tube and large, precision optics will get practical space tests in late 1963 or early 1964 when National Aeronautics and Space Administration launches the first Orbiting Astronomical Observatory (OAO).

The experiment using these techniques, Project Celoscope, is one of two that OAO will carry. Satellite and ground instrumentation for Celoscope will be designed and built by Electro-Mechanical Research, Inc., for Smithsonian Astrophysical Observatory, experiment supplier.

EMR is building seven subsystems: Uvicon cameras, camera controls and selector, analog and digital data processors, command and program controls, and power supplies (see diagram).

Celoscope is to obtain the uv spectra of some 100,000 stars and map the radiant intensity of the sky in three vacuum uv regions. Vacuum uv is that portion of the uv spectrum existing in vacuum. Atmospheric masking has kept ground-based observers from learning much about it.

In space, four 12-in. Schwarzschild telescopes supplied by Ferson Optics, Inc., will image an area of

the sky on four ultraviolet-sensitive Uvicon tv camera tubes. Three are optically filtered to receive uv at 1,100 to 1,600 Å, 1,600 to 2,200 Å and 2,200 to 3,000 Å. The fourth will observe uv at 1,100 to 2,200 Å from a slitless spectroscope.

Stars and nebulosities will be scanned. Video information will be transmitted to ground in both analog and digital form, according to commands from the ground to the tv scanning systems.

The command and program control unit accepts a binary-code command and provides 21 on-off and 24 parameter adjustments. Each of the 24 parameters can be adjusted to eight levels. Parameters include sweep speed, beam current, target voltage and exposure time. Exposure time is 1 to 30 sec.

Analog tv will be used primarily for qualitative viewing and scanning nebulosities. A 512-line raster is scanned conventionally and video output is transmitted directly to ground.

Digital Encoding

Under digital tv command, each of the 512 lines is scanned in 512 steps. Upon each step scan, a decision is made whether information is present. If so, the beam is held on until digital encoding is completed. Encoding includes radiant intensity and position coordinates. Collected information is transmitted to ground when the satellite passes over a receiving station.

On the ground, digital data processing equipment will automatically print a star catalogue. Experimenters expect to measure some 100,000 stars during the 12-month life of OAO. Data should tell astronomers more about the composition of interstellar dust, hot star atmospheres, planetary nebulae and, possibly, the hot outer atmospheres of cool stars.

EMR will supply two ground-support display systems to Smithsonian. A portable set will be used for preliminary system checkout

and during prelaunch phases. The other will be installed at the Smithsonian observatory for preliminary data evaluation.

Equipment includes digital and analog processors to recreate the telemetered tv scenes. One system will produce a photographic sky map. Another will display a star map image indefinitely on a storage tube, for detailed observation. Data will also be fed to a NASA computer for further processing.

Despite its complexity, the space system is expected to operate for more than a year with 95 percent confidence. High-reliability parts, micropower circuits, redundancy and parallel operation, welded connections, modular construction and encapsulation will be used.

Other OAO Experiments

OAO will also carry a second experiment, furnished by the University of Wisconsin. It will determine stellar energy distribution at 800 to 3,000 Å and measure emission-line intensities of diffuse nebulae at those wavelengths. Wisconsin will develop optics, filters, ground support and calibration equipment for seven telescopes and their detectors. Cook Electric is the hardware and electronics subcontractor.

Grumman is building the OAO spacecraft. The second OAO will contain an experiment by Goddard Space Flight Center, using equipment and a guidance system to be built by Standard Kollsman Industries.

A relatively fast, 38-in. Cassegrain telescope with a large-aperture spectrophotometer will gather data on selected stars, nebulae and galaxies. Observations will be made at 912 to 4,000 Å.

The third OAO will probably carry a Princeton University experiment to investigate absorptive characteristics of the interstellar medium. Later, Harvard University is to make spectrographic studies of solar activities relevant to sun-earth relationships.

Instant Stock Prices



Viewer of Teleregister's solid-state Telequote II system shows latest quotes for 24 stocks when interrogated by keyboard. Prices and other market news are drawn from a central computer

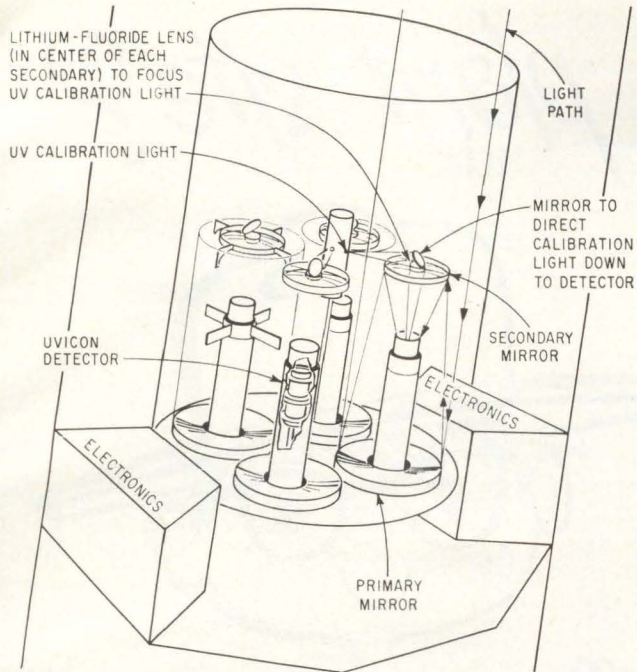

Orbiting Astronomical Observatory will carry telescopes and Uvicon tv cameras to map the sky's radiant intensity

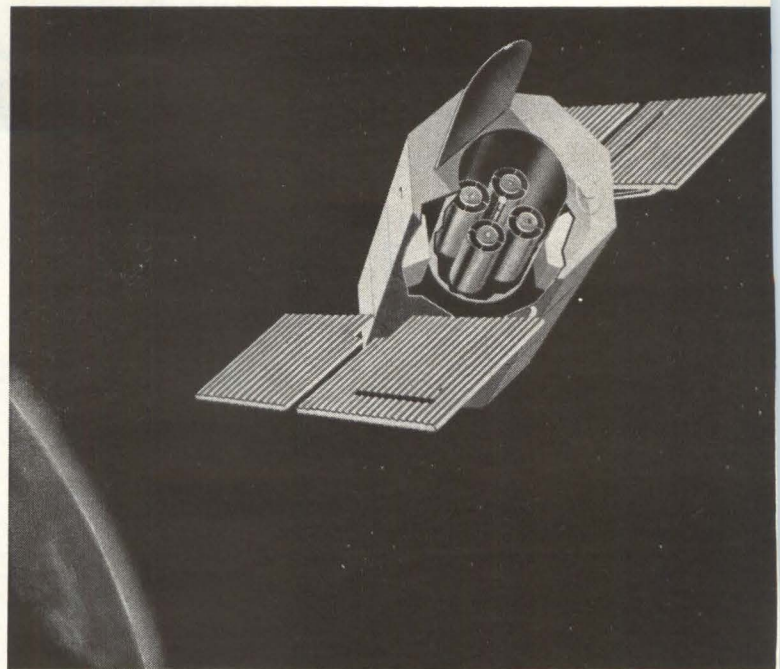

Optical system of Project Celoscope will consist of four telescopes presenting data to tv cameras

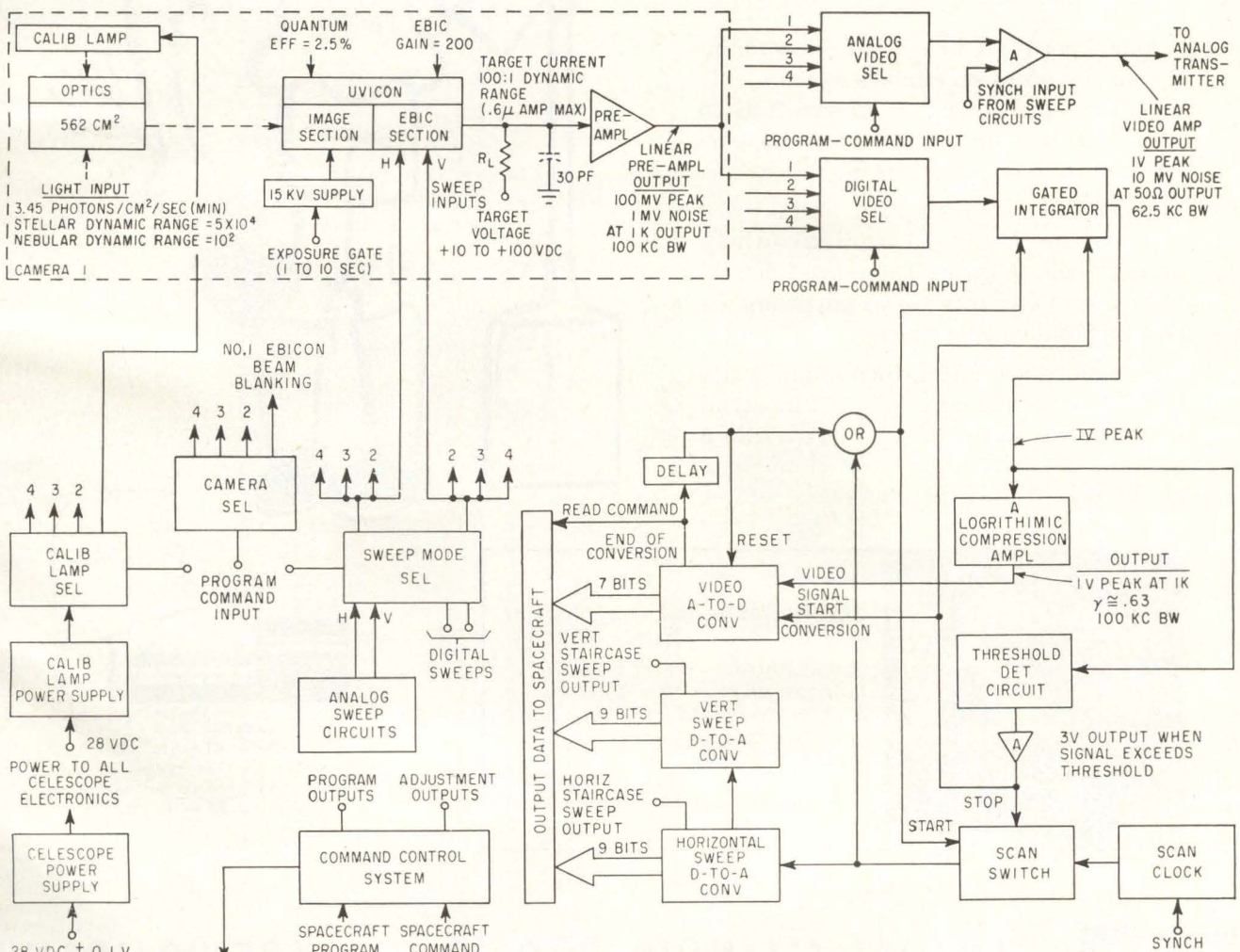

Camera calibration, command and telemetering system designed by Electro-Mechanical Research

Lookin' for a plant site?

don't

overlook

CIPStowns*

There are more than 500 small and middle-sized communities served by Central Illinois Public Service Company in downstate Illinois. Somewhere among them, there's an ideal site for your new plant.

Our Operation Brass Tacks community survey program enables us to quickly give you down-to-earth information on resources, manpower, utilities, transportation and other basic needs.

We think your new plant would prosper here in Middle America—where there's room to grow. There are friendly folks and cooperative local governments ready to make you welcome.

For more specific information, write directly to the manager of our Industrial Department. Better still . . . give him a call for the answers to your immediate questions.



"Let us give you confidential assistance in finding CIPStown plant sites which meet your requirements. There's no obligation. We're at your service!"

C. F. WAYHAM
Industrial Manager

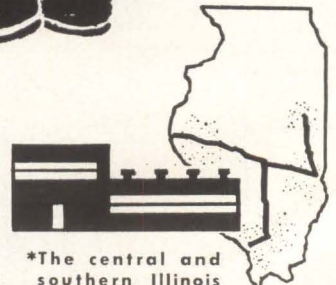

*The central and southern Illinois communities served by CIPS . . . 522 are served with electricity and 27 with gas.



CENTRAL ILLINOIS PUBLIC SERVICE COMPANY

GENERAL OFFICES: ILLINOIS BUILDING, SPRINGFIELD, ILLINOIS

**LOW LEVEL
MEASUREMENTS
WITH HIGH LEVEL
ACCURACIES**

*...with the new Bendix-Pacific
Millivolt Oscillator*



Engineered for instrumentation applications involving low level signals, the Bendix-Pacific Model TOE-304 millivolt oscillator eliminates the need to amplify the original signal...makes it possible to go directly from transducer to oscillator. The result: increased simplicity, reliability and accuracy, plus more efficient use of many recent transducer developments. Model TOE-304 is compact, lightweight and features semi-conductor circuitry throughout. It is modular and is compatible with all other Series 300 telemetry components. For further information write to Bendix-Pacific Instrumentation Facility, 11600 Sherman Way, North Hollywood, California. Bendix-Pacific area offices are located in New York, Washington and Seattle.

Specifications:

Subcarrier Bands... Standard IRIG
 Input Range... ± 10 mv. 0 to +20 mv. ± 20 mv.
 Output Voltage... 3.0 v. rms open circuit, min.
 Linearity... $\pm 0.5\%$
 Stability... $\pm 1\%$
 Common Mode Rejection... 140 db min. at dc.
 100 db min. at 400 cycles.

Power Requirements... 28 volts dc at 15 ma.
 Vibration... 25g
 Sizes... 1.512 x 1.325 x 1.605 inches
 for bands 4 and above.
 1.512 x 1.325 x 1.855 inches
 for bands 1 through 3.
 Weight... 4.5 ounces approximately.



Bendix-Pacific Division

Instrumentation • Airborne Radar • Hydraulics/Pneumatics • USW • Guidance • Electro-Mechanics

RANGER VIDICON TV CAMERA USES

Since camera worked well in Ranger 3, even if it didn't get to take pictures of the moon, it will go aloft again this year two more times

Six-lb camera and power converter unit are tested at RCA's Astro-Electronics division.



Tv system fits into package with 7-inch diameter and 3-inch depth. Box contains power converter.



By JOHN F. MASON
Associate Editor

ALTHOUGH RANGER 3 never got to the moon last month, its tv camera system did operate normally and will be used in two more tries with Rangers 3 and 4 later this year, say scientists at Cal Tech's Jet Propulsion Laboratory. JPL is carrying out the program for National Aeronautics and Space Administration.

Design details on the tv system have only recently become available. Designed by RCA for simplicity and ease of operation, it uses a vidicon sensor for imaging. Unlike conventional vidicons, which use electromagnets to deflect the electron beam, the vidicon in Ranger has all-electrostatic deflection and focus. It also has a special "sticky" target that can be rapidly erased.

To eliminate the bulk and weight of magnets, deflection is handled by charged plates on the tube's interior. The electron gun structure and deflection system is a ruggedized version of an electrostatic unit developed by General Electro-dynamics Corp. Focusing is handled by a saddle-field lens arrangement.

The target surface, also developed by RCA, is antimony sulfide oxy-sulfide, JPL reports. The latent image may be scanned for more than 10 sec with less than 10 percent loss of highlight detail. The image may be erased in 700 msec to clear the tube face for the next exposure.

After a 24-hr soak at 125 C for sterilization, surface sensitivity is maintained at light levels as low as 0.01 ft-candle-sec. The useful dynamic range of some units extends from 0.001 to 0.1 ft-candle-sec with an opening of f-6 and 20-msec exposure.

An image is shuttered on to the faceplate for 20 msec. As the image slowly decays, it is scanned at a rate which yields one complete frame in 10 sec. Each picture consists of 200

JPL technicians adjusting high-gain directional antenna. Tv camera is at left, with lens pointing up. This was Ranger 3

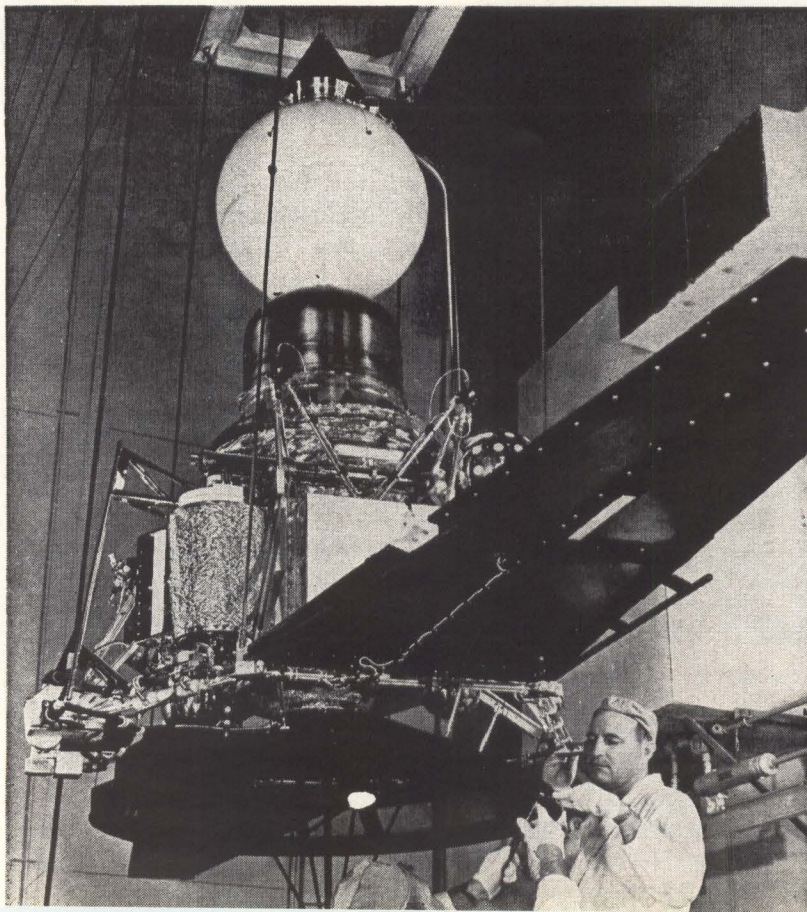

ELECTROSTATIC DEFLECTION

scanning lines. Video bandwidth is around 2 Mc.

One-msec switch closures from the command controller sequencer provide commands for shutter and era.e. The shutter command terminates erase, triggers the shutter solenoid drives and (after a fractional second delay) initiates the frame sweep. The erase command terminates the frame sweep and initiates the erase mode. This mode consists of illuminating the target with six peripheral lamps, accelerating line and frame scan rates over the target surface and increasing beam current. Although the process normally requires less than 1 sec, circuit simplicity is maintained by continuing to erase for the full 3 sec allotted for readout.

The camera is fitted into the end of a Cassegranian optical telescope, built by JPL to provide the equivalent of a 40-in. focal length instrument in a package 14 in. long. The

lunar image picked up by the primary mirror is reflected back to the vidicon photoconductive image surface, which is one-half-in. in front of the mirror. Fused quartz is used for the mirrors and the tubular structure separating the primary and secondary mirrors.

The tv system will begin transmitting when Ranger is about 4,000 Km above the moon. The last full picture telemetered to earth will be at 46 Km altitude, to allow time for transmission before the craft begins to tumble. Coverage of such a picture would be about 517 meters square, resolution about 3 meters a tv line.

One picture will be transmitted every 13 sec, a total of more than 100 pictures. To highlight surface irregularities the shot will be timed so the sun's rays will strike the lunar surface at an angle of 20 to 70 deg.

Tv data will be recorded on magnetic tape. The recorded signal is converted into digital form and re-recorded on computer input tapes. The computer creates a master photograph or cleans up sets of

photographs. JPL says photos can be printed out by reconvertng from digital to analog. This tape is fed into a film recorder.

Besides lunar photography, Ranger experiments include: gamma ray measurements, to determine approximate concentrations of radioactive materials on the moon's surface; radar reflectivity, to provide information on the character of the moon's surface; lunar seismic activity, to measure possible moon quakes and meteor impacts.

WHY RANGER 3 FAILED

Prolonged burning of the Atlas booster over-accelerated the spacecraft and Ranger 3 crossed the moon's orbital path some 22,862 mi ahead of the moon.

During the midcourse maneuver, an erroneous signal from the ground caused the craft to pitch 116 deg in the wrong direction.

An attempt was made to salvage part of the mission during the terminal maneuver. But a spurious signal generated in on-board logic circuits caused pitching to continue after it should have stopped

Space Power Tester

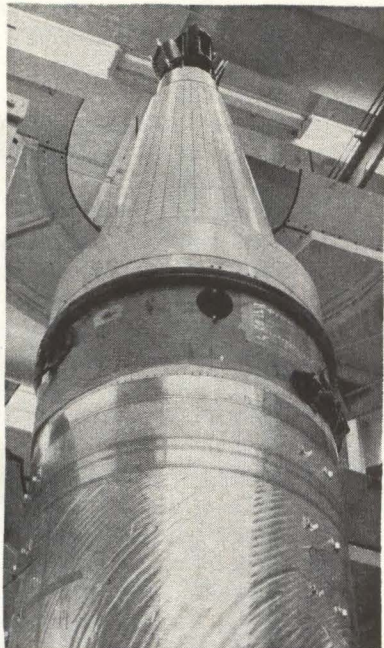

Air Force has awarded Lockheed the prime contract to test Snap 2 and 10A (System for Nuclear Auxiliary Power) systems in orbiting vehicles. Above, a mockup of Snap 10A atop an Agena satellite produced by the firm

Moving Ball Tracks Radar Target

ELECTROMECHANICAL ball tracker, developed for military applications, allows a radar console operator to track an aerial target with one fingertip, reports Hughes Aircraft Co. Movement of the Bakelite ball positions the tracking pip over the target pip.

Hughes says the tracker costs up to \$2,000 less than other types of electromechanical trackers, which frequently require motion in two directions simultaneously. Movement of the ball in any direction is converted to vertical and horizontal outputs.

The tracker was invented by William F. Alexander, of Hughes' space systems division. It is being used in Army Signal Corps and mobile air defense systems, in the

Navy's tactical data systems and, in a miniature version, in airborne systems.



Tracker input is educated thumb

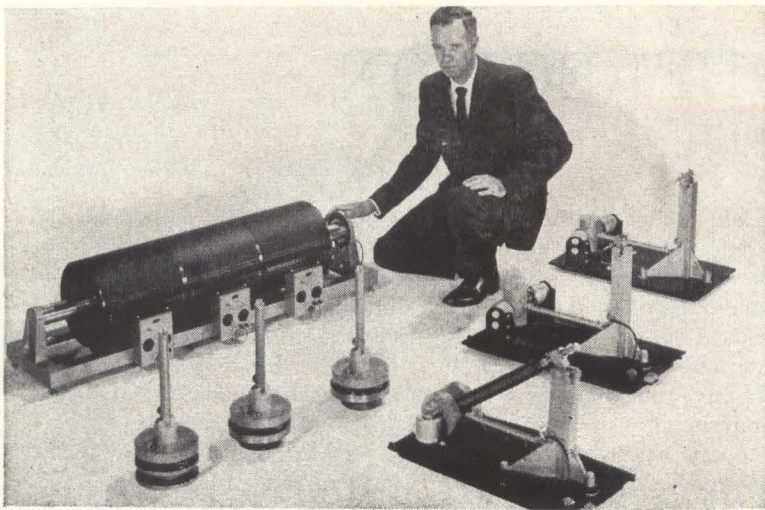

Sensitive seismograph instruments like this Press-Ewing system may solve the nuclear detection puzzle

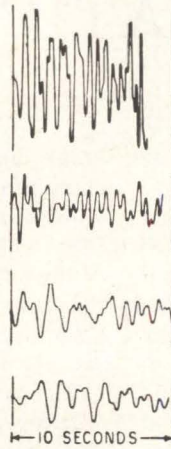

EARTHQUAKE IN NEVADA, JAN. 26, 1960, RECORDED AT RIVERSIDE, CALIF. DISTANCE 450 KM.

UNDERGROUND NUCLEAR EXPLOSION BLANCA, YIELD 19 KT, OCT. 30, 1958, AS RECORDED IN NORTHERN ARIZONA. DISTANCE 395 KM.

EARTHQUAKE IN OAXACA, MEXICO, MAGNITUDE 5.8, JAN., 1960, RECORDED AT PASEDNA, CALIF. DISTANCE 2,570 KM.

UNDERGROUND NUCLEAR EXPLOSION BLANCA, AS RECORDED IN SOUTHWESTERN OKLAHOMA. DISTANCE 1,610 KM.

Examples of similarity of earthquake and nuclear explosion signatures

A-BOMB DETECTION PROGRAM

Spurs Seismology and Instrumentation

By HAROLD HOOD
Pacific Coast Editor

ELECTRONICS IS SPEARHEADING the transformation of seismology from a skilled art to a precise, highly-instrumented science. Paper discs and ink styli in low-funded university laboratories are giving way to digital computers, magnetic tape recorders, and highly sensitive analysis equipment.

Catalyst for this transformation is the belief that seismic techniques may detect and evaluate nuclear blasts in faraway parts of the world. Based on this premise, Advanced Research Projects Agency is establishing a multimillion dollar Data Analysis and Technique Development Center in Washington, D. C., where signals from earth tremors will be collated.

Prime concern of the center will be differentiating between signals emanating from nuclear blasts and more than 20,000 earthquakes detected each year. It will also develop new techniques and hardware for more effective detection and evaluation. Seismic information will be fed from a far-flung network of 40 fixed and mobile recording stations.

As part of Project Vela Uniform, the facility will maintain a master central file of man-made disturb-

ances and earthquake recordings. It will use a large high-speed digital computer, an analog computer, cataloging, recording and playback equipment. United Electro-Dynamics Inc. has been selected to design, install, and operate the center, which will be staffed initially by 35 scientists, mathematicians, physicists and engineers.

Frank B. Coker, UED vice president, says differentiating a nuclear blast from the myriad earthquakes occurring each day is like finding a needle in a haystack. Man-made underground explosions and earthquake signals appear very similar, if not identical.

Building Seismic Lab

Closely related to the center is a huge seismic laboratory, under construction as the primary development and evaluation laboratory for systems development for Vela.

Located 90 miles northeast of Phoenix in Tonto National Forest, this 23,000-acre installation will glean information from 31 seismometers buried in the ground in steel vaults. Ultimately there may be 100. The site has an unusually low level of microseismic earth vibration.

Detectors will consist of three classes:

- High frequency instruments

spread out in a horizontal array four miles in diameter. Configuration is aimed at optimum sampling of bomb and earthquake signals arriving from distant sources while cancelling out local noise. Basic concept is analogous to antenna array theory.

- Detectors for measuring waves at frequencies as low as 0.01 cps. These instruments must be painstakingly shielded from the local environment. "They're excellent detectors of trucks on nearby highways," points out Coker.

- Miscellaneous experimental detectors. These may include ground strain seismometers set in long tunnels buried deep in the earth to measure actual differential movement between points up to 100 ft apart. Sensitive enough to measure surface deflections caused by moon-induced "earth tides," they will pick up ground shifts as slight as one angstrom. One end of a carefully designed rod is bolted to bed rock and the other actuates a capacitive pick-off device.

Also in the experimental category are one or more Kirnos seismometers which ARPA hopes to obtain from Russia. These intermediate frequency instruments measure 0.1 to 1 cps.

The Tonto Forest observatory will contain magnetic and film re-

orders for cataloguing data from any combination of detectors. Objective is experimentally determining combinations and patterns for maximum signal-to-noise detection.

The new facility will also house Vela Uniform's standards laboratory from which seismometers, galvanometers, and other critical elements will be calibrated. Specially designed vertical and horizontal vibration tables operating at 0.01 to 20 cps will produce amplitudes as low as one micron.

Low-Frequency Analysis

Target date for activation of the Washington, D.C., center is June 1. Interim operations are in a temporary facility near UED's headquarters in Pasadena, Calif. Techniques developed will be incorporated in the Washington operation.

Seismic frequencies vary from d-c to one cps. Since presently available analyzing equipment has a lower limit of approximately one cps, recording tape being scanned is sped up, usually by a factor of 100 or 1,000. This makes it possible to analyze seismic frequencies down to 0.002 cps while using filters of two-cycle width. For initial studies, UED is using one-inch, 14-channel recording tape, and is developing f-m analytic and comparative techniques. A-m is unsatisfactory for low-frequency seismics.

International Center Sought

Ultimate aim of Vela Uniform is establishing specifications for an international control center with headquarters in Vienna. A worldwide network of detection stations would be in constant communication with the analysis center, which would decide if signals were from earthquakes or bomb blasts.

One function of the center in Washington will be to seek ways of representing seismic data more simply, to reduce required communication bandwidth. One possibility is representing seismic transient waveforms with special or orthogonal function expansions.

The UED data analysis center contract is initially funded for \$12 million. The Tonto Forest observatory will cost several millions; exact funding is not disclosed. Both contracts are under technical supervision of Headquarters, Air Force Technical Applications Center.

**New Nanosecond*
Pulse Transformers
for Ultra-miniature,
Ultra-high Speed
Applications**

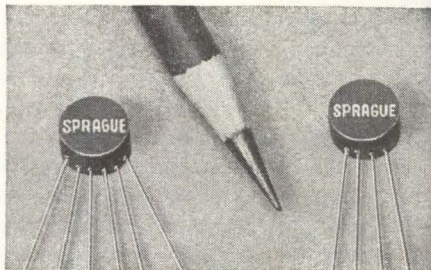

Digital circuit designers will find the new Sprague Type 43Z Nanosecond Pulse Transformers of considerable interest. These tiny transformers have been carefully designed for the all-important parameter of minimum rise time at high repetition rates up to 10 mc.

The new Type 43Z series is comprised of a broad line of 72 pulse transformers in 10 popular turns ratios. They are Sprague's latest addition to the most complete listing of pulse transformers offered by any manufacturer for use in digital computers and other low-level electronic circuitry.

Type 43Z Pulse Transformers are designed so that the product of leakage inductance and distributed capacitance is at a minimum. They are particularly well suited for transformer coupling in transistor circuits since transformers and transistors are very compatible low impedance devices. Nanosecond transformers are equally suitable for transmission line mode of operation, in twisted-pair transmission line coupling, and in regenerative circuits.

The epoxy-encapsulated "pancake" package is excellent for both etched wire board or conventional chassis mounting. To simplify etched-board design, these ultra-miniature pulse transformers are available with leads terminating at the side or the bottom of each unit.

For complete technical information on Type 43Z Nanosecond Pulse Transformers, write for Engineering Data Sheet 40235 to Technical Literature Section, Sprague Electric Co., 35 Marshall St., North Adams, Mass.

*millimicrosecond

CIRCLE 200 ON READER SERVICE CARD

New! MOST WIDELY USED LOGIC TRANSISTOR NOW IN SMALLER SIZE

LOW-COST
TYPE 2N979 MADT[®]
TRANSISTORS

Down in size from a TO-9 to a TO-18 case, the new Sprague 2N979 is solving size, cost, and dependability problems for logic circuit designers with the identical performance of the original 2N1499A, with which it is electrically interchangeable.

Designed for use in saturated switching circuits, the 2N979 Transistor is capable of switching at frequencies in excess of 10 megacycles. It consistently shows low storage time, low saturation voltage, and high beta.

Available in production quantities, the 2N979 is a first-run device, not a "fall-out." Produced on FAST (Fast Automatic Semiconductor Transfer) lines with direct in-line process feedback, high production yields make possible its lower cost.

For application engineering assistance, write Transistor Division, Product Marketing Section, Sprague Electric Company, Concord, N. H.

For complete technical data, write Technical Literature Section, Sprague Electric Company, 35 Marshall Street, North Adams, Mass.

©T.M. Philco Corp.



CIRCLE 29 ON READER SERVICE CARD



Miniature coaxial cables are designed for a particular characteristic impedance (Z_0). The size of the cables is determined by the dielectric diameter (D), which depends upon the dielectric constant (ϵ) of the dielectric insulating material together with the center conductor diameter (d).

Heretofore, many miniature coaxial cables have used polytetrafluoroethylene dielectric ($\epsilon=2.0$) and 30 AWG center conductors. While this helps to solve many problems of overall size it simultaneously created difficulties due to extremely small center conductors.

Raychem cables match the impedance (Z_0) and overall diameter of the miniature coaxial cables but offer center conductors up to twice as large through the use of Rayfoam L, an irradiated, high-strength, unicellular, modified polyolefin, having a dielectric constant (ϵ) of only 1.5. The larger conductors overcome many of the problems previously incurred in miniature coaxial cables.

Rayfoam L is resistant to soldering temperatures, and its low specific gravity permits major weight reductions in miniature coaxial cables.



RAYCHEM
CORPORATION

OAKSIDE AT NORTHSIDE
REDWOOD CITY, CALIF.

CIRCLE 31 ON READER SERVICE CARD

Adaptive System Controls Light Planes

MINNEAPOLIS-HONEYWELL this week introduced a push-button autopilot for light, twin-engine aircraft. Called the H-14, it employs a solid-state, self-adaptive computer similar in concept to those Honeywell developed for the X-15 and Dyna Soar.

For example, it will automatically compensate for a loss of power in one engine by banking the aircraft to maintain the intended flight path, without prior instructions.

The basic autopilot consists of a computer, a flight controller, three pneumatic servos, directional, vertical and turn and bank gyro indicators.

Functions include three axis stabilization and control, full-time yaw damping and turn coordination, pitch and roll attitude command, automatically synchronized heading control, all-attitude engage and single-engine recovery.

Options that permit automatic landing include automatic ILS localizer, approach and glide path; altitude control; course director tie-in; and automatic pitch trim. Including options, the autopilot weighs 31.5 pounds.

It can be installed in any light twin engine aircraft with only a minor adjustment in the servos. Honeywell has flown the Cessna 310 and 320, Beechcraft D-18 and Baron with identical model H-14 computers. Beech is offering it as optional equipment in 1962 planes.

The H-14 uses low pressure pneu-

matic servos. The servos consist of dual on-off magnetic air valves and pneumatic rolling diaphragm actuators similar to a type used in industrial and drone control systems.

Data Transmitter Links Terminals to Computers

IBM THIS MONTH announced a programmed transmission control unit, the 7750, designed to link a centrally-located computer with a network of communications lines.

Incoming business or scientific information is fed to the computer and routed to the proper terminal after processing. Up to 112 communications lines, each accommodating many terminals, may be used. Terminals may be punched tape or card, magnetic tape, telegraph, or units which link directly with another computer's memory.

The 7750 scans communication lines, strips messages of transmission codes, translate to computer code, puts the messages in priority sequence and feeds them to the computer for processing. After processing, the message is translated into transmission code and routed to the proper terminal.

Operation is controlled by a program stored in the unit's memory.

Special Computer Compares Spectrophotometer Curves

HOFFMAN ELECTRONICS is making a solid-state computer designed to eliminate the hand plotting and calculations normally associated with spectrophotometer analysis.

Calibration data, produced by operating the instrument without using a sample, is stored in the memory before the sample is analyzed. This is then compared with readings obtained from the sample. Corrected curves are printed out on a chart recorder and, in digital form, on punched tape. Nixie tube indicators are used for monitoring.

National Bureau of Standards sponsored the development and purchased the first model.

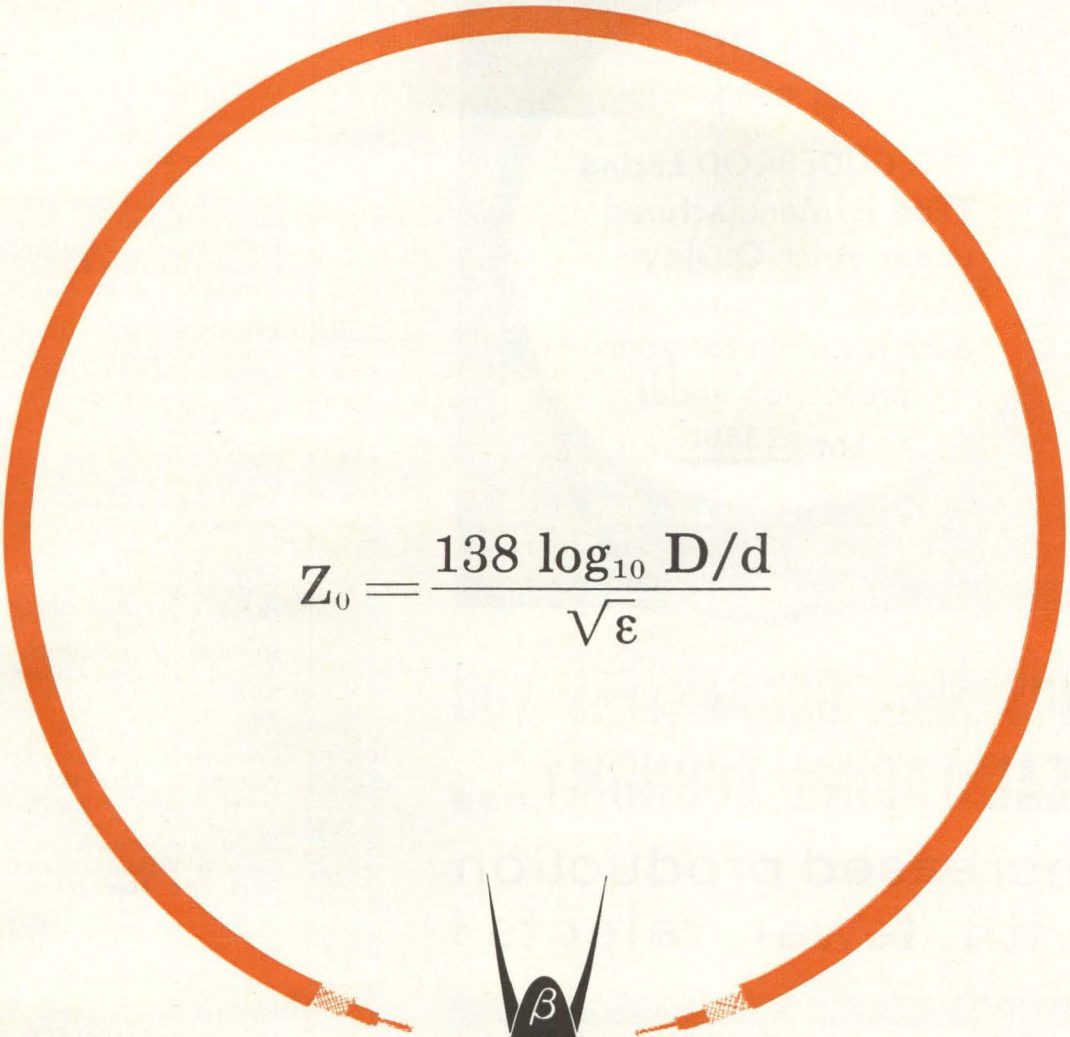

Computer's transistor circuits are contained on six plug-in cards

$$Z_0 = \frac{138 \log_{10} D/d}{\sqrt{\epsilon}}$$



RAYCHEM
CORPORATION

LEADER IN RADIATION CHEMISTRY
FOR ELECTRONIC WIRE AND CABLE



**THIS SEAL GUARANTEES YOU
REAL LACING ECONOMY...
increased production
with fewer rejects!**

Always specify Gudebrod whether you use one spool of lacing tape or thousands because Gudebrod lacing tape is produced under strict quality control. Gudebrod checks and rechecks every lot of tape to insure that it meets the highest standards . . . higher standards than those required to meet MIL-T specifications.

Gudebrod helps increase your production because we carefully test, measure and maintain close tolerances on such characteristics as slip resistance, fray resistance, breaking strength, wax content, fungistatic effectiveness. These and other tests assure you that when Gudebrod lacing tape is used production increases. *Knots don't slip . . . harnesses stay tied . . . assemblies remain firm . . . there are fewer rejects!*

Whatever your lacing needs—Teflon*, dacron†, glass, nylon, high temperatures, special finishes—Gudebrod makes it or will produce a tape to meet your special requirements. If you want a tape to meet 1500°F . . . Gudebrod Experimental Research Project 173 is the answer. If you want a tape that meets MIL-T-713A . . . Gudelace® (Style 18 Natural) is the answer.

MAKE THE H-R TEST! Write for samples of Gudelace or other Gudebrod lacing tapes and have them tested in your harness room. Compare a harness tied with a "Quality Controlled" Gudebrod tape and any other tape. This test will convince you that when you specify Gudebrod you specify *real economy*—increased production with fewer rejects.

Write for our free Technical Products Data Book. It explains Gudelace and other Gudebrod lacing tapes in detail.

*Dupont's TFE fluorocarbon fiber.

†Dupont's polyester fiber.

GUDEBROD BROS. SILK CO., INC.

Electronics Division
225 West 34th Street
New York 1, New York

Executive Offices
12 South 12th Street
Philadelphia 7, Pa.

MEETINGS AHEAD

APPLICATION OF LOW NOISE RECEPTION TECHNIQUES, Institution of Electrical Engineers (British); Savoy Pl., London, Feb. 28.

MEDICAL ELECTRONICS DISCUSSION GROUP: Methods of Measuring Man's Environment Temperature, Institution of Electrical Engineers (British); Savoy Pl., London, Mar. 2.

APPLICATION OF SWITCHING THEORY TO SPACE TECHNOLOGY Symp., USAF, Lockheed Missiles and Space; at Lockheed, Sunnyvale, Calif., Feb. 27-Mar. 1.

SCINTILLATION AND SEMICONDUCTOR COUNTER Symp., PGNS of IRE, AIEE, AEC, NBS; Shoreham Hotel, Washington, D. C., Mar. 1-3.

VACUUM COATING Conference, Soc. of Vacuum Coaters; Sheraton-Cleveland Hotel, Cleveland, Ohio, Mar. 6-7.

MISSILES & ROCKET TESTING Symp., Armed Forces Communications & Electronics Association Coca Beach, Fla., Mar. 6-8.

EXTRA-HIGH VOLTAGE COMMUNICATION, CONTROL & RELAYING, AIEE; Baker Hotel, Dallas, Tex., Mar. 14-16.

IRE INTERNATIONAL CONVENTION, Coliseum & Waldorf Astoria Hotel, New York City, Mar. 26-29.

QUALITY CONTROL Clinic, Rochester Soc. for Q.C.; U. of Rochester, Rochester, N. Y., Mar. 27.

ENGINEERING ASPECTS OF MAGNETO-HYDRODYNAMICS, AIEE, IAS, IRE, U. of Rochester; U. of Rochester, Rochester, N. Y., Mar. 28-29.

SOUTHWEST IRE CONFERENCE AND SHOW; Rich Hotel, Houston, Texas, April 11-13.

JOINT COMPUTER CONFERENCE, PGEC of IRE, AIEE, ACM; Fairmont Hotel, San Francisco, Calif., May 1-3.

HUMAN FACTORS IN ELECTRONICS, PGHFE of IRE; Los Angeles, Calif., May 3-4.

ELECTRONIC COMPONENTS Conference, PGCP of IRE, AIEE, EIA; Marriott Twin Bridges Hotel, Washington, D. C., May 8-10.

ADVANCE REPORT

SAN DIEGO BIOMEDICAL ENGINEERING Symposium, AIEE, Inter-Science Inc., Simulation Councils Inc., San Diego Naval Hosp., U. of Calif.; at Stardust Motor Hotel, San Diego, Calif., June 19-21. Papers or comprehensive summaries describing developments or potentials in the following areas (and not reported elsewhere) should be sent by Mar. 1 to The Program Committee, 8484 La Jolla Shores Drive, La Jolla, Calif.: (1) Medical and biology advances made possible by techniques or equipment of the physical sciences and engineering; (2) Physical sciences and engineering aspects applicable or closely related to medicine and biology, e.g. simulation of biological functions, neural models, intelligence machines, bionics.

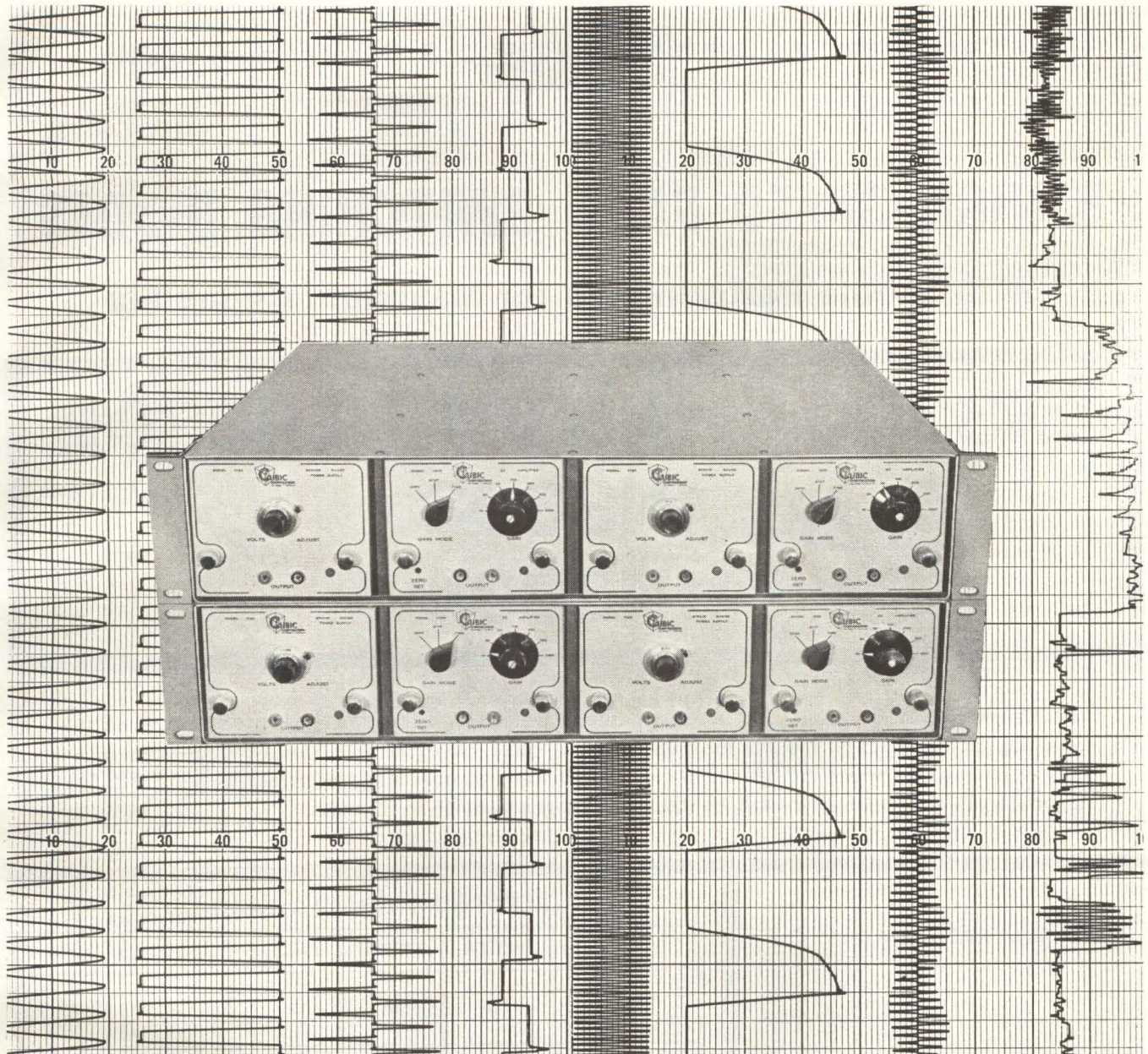

Four modules fit a standard rack. Amplifier and power supplies are shown here mixed.

You know that Cubic builds single-ended amplifiers . . .

but have you heard about our power supply that eliminates the need for differential amplifiers and saves you money?

A good, wideband differential amplifier is an expensive piece of equipment. By employing a Cubic Model 1010 Single-Ended DC-Wideband Amplifier priced at only \$650, and a Cubic Model 1120 isolated power supply priced at \$430, you can obtain superior results at considerable savings. The built-in redundancy of the Cubic system offers much greater protection from data loss in multiple channel test setups. Write for more information to Dept. A-112, Cubic Corporation, San Diego 11, California; or Cubic Europa (S.p.A.) Via Archimede 181, Rome, Italy.



cubic
CORPORATION

INDUSTRIAL DIVISION
SAN DIEGO 11, CALIFORNIA • ROME, ITALY

OTHER OFFICES: LOS ANGELES, CALIFORNIA—ROME, ITALY (CUBIC EUROPA S.p.A.) • REPRESENTATIVES IN PRINCIPAL U.S. AND CANADIAN CITIES

To Contractors and Subcontractors on U. S. Government Projects

5 HIGH-SPEED PNPN SWITCHING DIODES

With Stable Performance for Maximum Reliability

1N3300



1N3301

1N3303

1N3304

1N3302

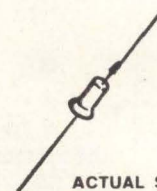

ACTUAL SIZE

The 1N3300 series is a family of environmentally tested, high-speed, PNPN, two-terminal, silicon switching diodes. Each of the five low-capacity, low-power diodes is sealed in a vacuum-tight case. They are designed for use in high-speed switching circuits at operating temperatures to 175°C. The nominal forward breakover voltage for the series ranges from 18 to 39 volts.

MAXIMUM RATING AT 25° C

I_F 200mAdc

i_f (surge) 50a

P (steady state) 400mW

ELECTRICAL CHARACTERISTICS

	1N3300	1N3301	1N3302	1N3303	1N3304
BV_F ($\pm 10\%$) Vdc	18	22	27	33	39
t_{rr} max. nsec (1)	250	200	200	150	100
t_r max. nsec (2)	80	70	60	60	50

(1) $I_{R1} = 2 I_F = 200\text{mAdc}$
 $R_g + R_L$ (@ turnoff) = 100 Ω

(2) $R_L = 10\Omega$

The 1N3300 series of diodes may be purchased in quantity from Western Electric's Laureldale Plant. For technical information, price and delivery, please address your request to Sales Department, Room 102, Western Electric Company, Laureldale Plant, Laureldale, Pa. Telephone—Area Code 215—Walker 9-9411.

LAURELDALE PLANT

MAKER OF ELECTRON PRODUCTS

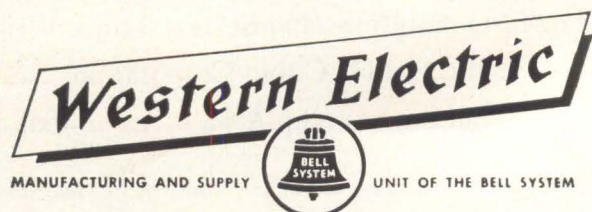

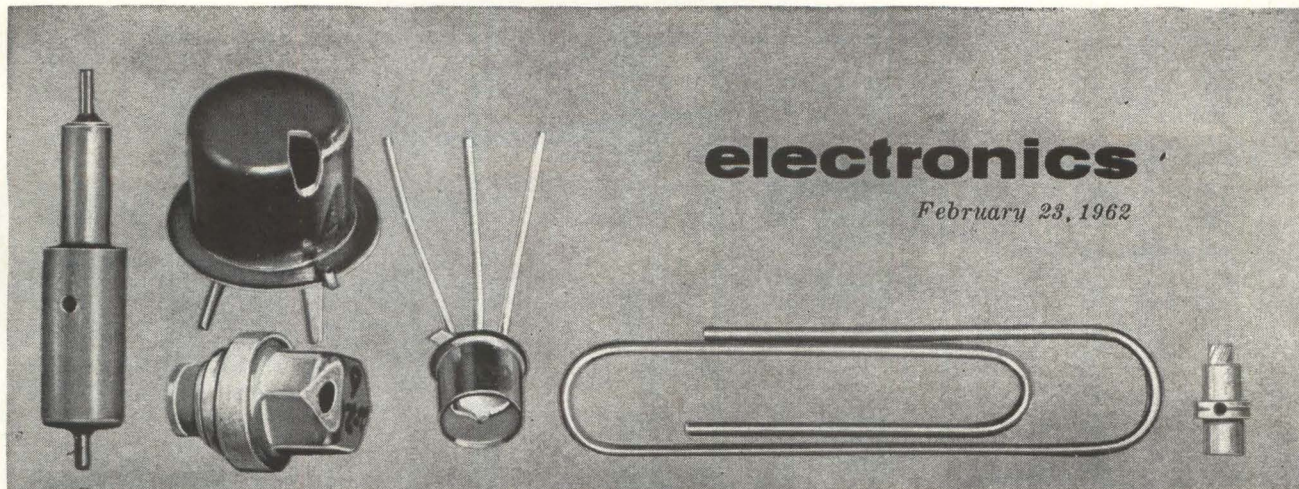

Five experimental semiconductor pressure transducers use the principle of the Esaki diode

SEMICONDUCTOR DEVICES AS Pressure Transducers

Semiconductor strain gages can give gage factors as high as 30,000. One type of semiconductor transducer which exhibits piezoelectric effects at 10^9 cps and higher may have applications in delay lines and light modulating devices

By WARREN P. MASON Bell Telephone Labs, Inc., Murray Hill, New Jersey

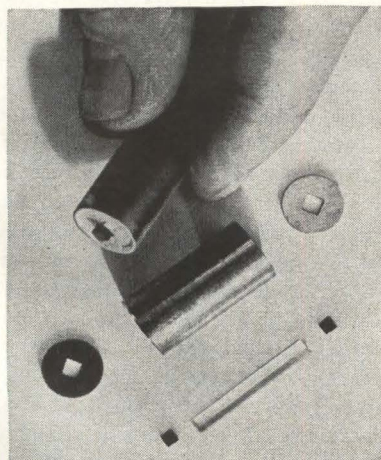

Ultrasonic transducer uses depletion layer to generate signals at 830 Mc; similar units are expected to go to 10 Gc

AN IMPORTANT PROBLEM in mechanics and acoustics is converting mechanical or acoustical pressure into electrical signals, and conversely. Uses are in the pick-up and generation of acoustic signals in air, sea water and solids (including seismic signals), in phonograph pick-ups, roughness indicators, and gages for measuring tension, compression, acceleration, pressure, shear force and torque. At the present time, transducers for the generation and pick-up of signals are usually of the magnetic, piezoelectric, electrostatic or variable carbon resistor type, while gages for measuring stress components are usually of the wire strain gage type. The wire gages can measure

static or slowly varying stresses—which cannot be measured by the other types of transducers—but they have low sensitivity.

Recently a series of semiconductor devices have been constructed that have the advantage of the static property measurement and, in addition, sensitivity comparable to other pick-up and generating devices. Two types of semiconductor pick-up devices and one semiconductor generating device have been developed. One of the pick-up devices is similar to the strain gage but has greater sensitivity. The other pick-up is an active device in which the positive and negative resistance characteristics inherent in a thin *p-n* junc-

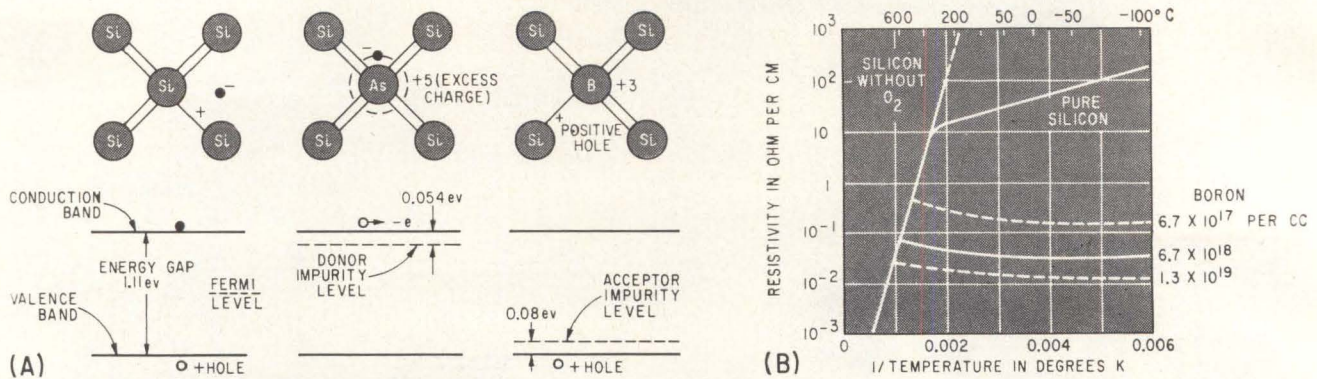

FIG. 1—Silicon, when doped with arsenic becomes *n*-type material, *p*-type when doped with boron (A). When silicon is highly doped (B), its temperature sensitivity is greatly decreased

tion (the Esaki diode) are modulated by mechanical stress.

A semiconductor such as silicon has strong bonds to four adjacent silicon atoms through the exchange of valence electrons, as shown by Fig. 1A. Thermal energy, particularly at high temperatures, can break these bonds occasionally. Then an electron is freed or raised to the conduction band and can act as a current carrier. At the same time the broken bond can move, by being completed by electrons from adjacent bonds. It then acts as a positive electron, or hole. Such material without added impurities has an intrinsic resistivity, shown by the slanted line of Fig. 1B; the intrinsic resistivity is a straight line when plotted against the inverse of the absolute temperature. The slope of the line is determined by half the energy gap value; the electrons act as though they moved from a Fermi level that is half way between the valence and conduction bands.

To be of use in semiconductor devices, semiconductors are doped with atoms that provide either an excess of electrons (*n*-type) or an excess number of holes (*p*-type). Arsenic, which has a valence of +5 compared to +4 for silicon, produces *n*-type material. For the *n*-type, four of the five electrons are used to satisfy the bonds. The one electron left is contributed to the conduction band. For low temperatures, energy will be lowered if the electron revolves in a circular orbit about the arsenic nucleus, which has a residual charge of +1. This is indicated by the dashed straight line (Fig. 1A), which is a

slight distance under the conduction band edge. For lightly doped specimens, the Fermi level at low temperatures will be along the donor impurity level. As the temperature increases more electrons are freed from their donor levels and the Fermi surface rises. For highly doped samples, such as those used in Esaki diodes, the electrons are free at all temperatures and the Fermi level rises to the top of the conduction band. To produce *p*-type material, atoms of +3 valence, such as boron, are introduced in the semiconductors. Three of the bonds are satisfied but the remaining bond acts as a positive electron and can move around in the semiconductor, producing a resistivity. Figure 1B shows the resistivity in ohm-centimeters as a function of temperature when various concentrations of boron atoms are added to the silicon melt. When the temperature is high enough to reach the intrinsic curve, more conduction results from thermal generation of holes and electrons than

from the holes introduced by the impurities. This is an important consideration in such devices. Holes also are more stable if they perform orbits about the negatively charged boron atom, but these holes become free as the temperature rises. In this case the Fermi level for lightly doped samples drops from the impurity line. There are a number of vacant levels above the Fermi surface that can accommodate electrons, which would cancel out the existing holes. This effect is important in thin *p-n* pressure transducers.

The energy surfaces plotted in Fig. 1A give the impression that they have a spherical symmetry: that is, that it takes the same amount of energy to break the bond irrespective of the directions. Experiments have shown that this is not so. Figure 2 shows the shape of the conduction band for *n*-type silicon: there are six valleys that occur along the crystallographic axes (only four are indicated in the drawing). Since these are values having low energies, electrons tend to congregate around these minimum values. Mobilities of electrons are determined by the second derivatives of the energy surfaces with respect to direction: mobilities of electrons perpendicular to the valleys are five times those parallel to the valleys.

This difference in electron mobility, together with the fact that the energy surfaces can be changed by applying a stress (deformation potential), is the cause of piezoresistance, which has been applied in semiconductor strain gages. A tension T_{11} along one of the crystal-

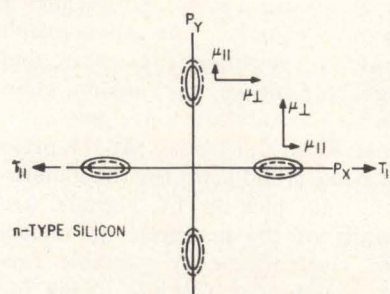

FIG. 2—Energy surfaces are distorted (dashed lines) when a tension is applied along one of the crystal axes

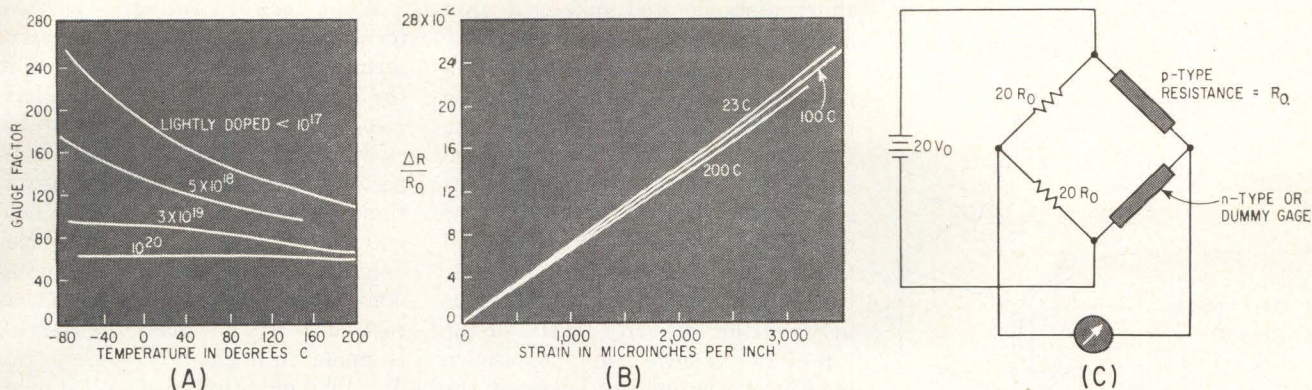

FIG. 3—Gage factor of a highly doped semiconductor is nearly independent of temperature (A) and (B). Special bridge circuit (C) improves linearity of measurement

lographic axes raises the value of the energy surfaces along the direction of stress and lowers the values for the four wells perpendicular to the stress. This is indicated by the dashed lines (Fig. 2), which show energy surfaces for like energies. Since the wells perpendicular to the stress have lower energies, more electrons congregate in these wells than in the wells parallel to the stress. If an electric field is applied in the same direction as the stress, then, since the four perpendicular wells have higher mobilities along the direction of the field and have more electrons, the resistivity decreases as the tension increases. The effect is about 90 times as large as in a metal strain gage. For a field applied perpendicular to the stress, the resistivity increases only half as much as when stress and field are in the same direction. The third type of stress that can be applied in a plane, a shearing strain in the x,y plane, is equivalent to a tension at 45 degrees to the x,y axes and a compression perpendicular to the tension. From symmetry considerations, it can be shown that such a stress affects all the valleys in the same amount and, hence, produces no effect.

For n-type germanium the energy surfaces lie along the four cube-diagonals (111 directions), and are most sensitive to a stress in this direction. Tension or compression along a crystallographic axis produces no effect. Both p-type silicon and germanium have the same symmetry relations as n-type germanium, but the change in resistance is of opposite sign; that is, resistance increases when the ma-

terial is in tension. Most sensitive of all the materials is p-type silicon. Since it has a higher yield stress and will work to higher temperatures, it is the preferred material for semiconductor strain gages.

Although piezoresistance has been known for some time, it is only beginning to be applied in practical transducers. This is partly due to the lack of sources of supply and also because the stability of available material was not as good as that of conventional strain gages. By increasing doping levels, it has been shown that the gage factor can be made nearly independent of the temperature. Figure 3A shows the gage factor (change in resistance divided by the initial resistance times the strain) plotted as a function of temperature for p-type silicon doped by boron. High doping levels produce a gage factor that changes only slightly with temperature. From Fig. 1B, the initial resistivity increases with temperature, so the change in resistance, ΔR , is more constant than either the resistivity or the gage factor. Further, high doping levels increase the linearity of the change of resistance with strain. Figure 3B shows the percentage change in resistance as a function of strain for the most highly doped sample of Fig. 3A. Linearity is good up to strains of 2,500 microinches per inch and deviates only slightly up to strains of 3,500 microinches per inch. For gages whose thickness is 0.002 or less, strains as high as 5,000 microinches per inch are possible.

One difficulty with semiconductor

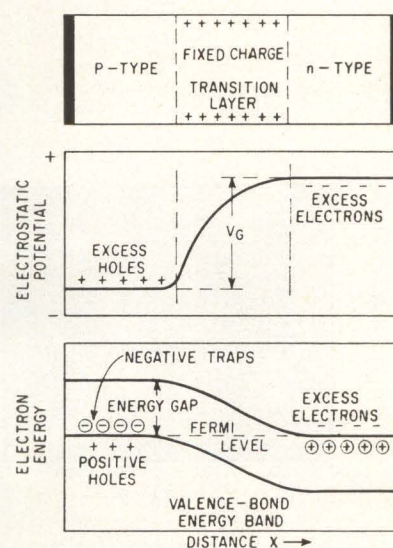

FIG. 4—Depletion layer separates excess electrons on p side from excess holes on n side

strain gages is their large change in resistance, which introduces some nonlinearities in wheatstone bridge measurements. Special circuits, such as Fig. 3C, have been devised to make use of these new types of gages.

The newest types of semiconductor transducers use the properties of semiconductor p-n junctions. A p-n junction, as shown by Fig. 4, contains a p-type region, a transition region and an n-type region. Junctions can be made by diffusing a layer of p-type material into a sample having n-type conductivity, and conversely. For thin, highly doped specimens as in Esaki diodes, an aluminum wire loaded with 1 percent boron can be alloyed into a highly doped semiconductor crystal. The boron penetrates for a

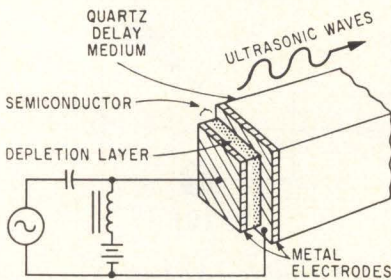

FIG. 5—High-frequency ultrasonic transducer uses depletion layer

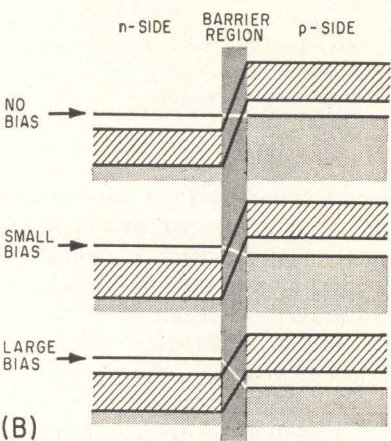
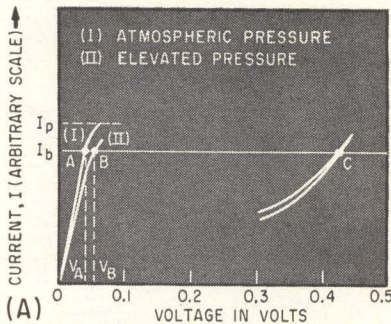

FIG. 6—Effect of pressure (15,000 psi) on Esaki diode (A). Energy relationships (B) for first positive resistance region (no bias) of Esaki diode, negative resistance region (small bias), and second positive resistance region

short distance and makes a thin p - n junction.

The energy band structure of a p - n junction is determined by the fact that the Fermi surface for the two types of materials must coincide. For lightly doped specimens the Fermi surface of the n -type material is between donor level and the bottom of the conduction band; for p -type, the Fermi surface is between the impurity level and the top of the valence band. As shown by Fig. 4, the energy levels of the p end are raised with respect to the n section by nearly the amount of the energy gap. The excess electrons on the n side are separated from the excess holes on the p side by a depletion layer, from which all electrons and holes are removed. This is the result of the high electric field set up across the layer; the field is oriented to repel both electrons and holes.

The width of the depletion layer is

$$t = \sqrt{\frac{(V - V_0) 2\epsilon}{en}} \quad (1)$$

where V is the applied field, V_0 the built-in field across the gap (V_0 is negative), ϵ the dielectric constant (farads per cm), e the electronic charge (1.6×10^{-19} coulomb), and n the number of impurity levels. For a lightly doped sample having 10^{17} atoms per cc, for example, silicon with a relative dielectric constant of 13 will have a thickness of 1.25×10^{-5} cm. The thickness can be adjusted somewhat with the applied field V .

If the semiconductor is one of the III-V compounds such as gallium antimonide, or a II-VI compound such as cadmium sulphide or zinc oxide, it will have the type of symmetry that makes it piezoelectric. Hence, an alternating voltage applied across the p - n junction will produce a piezoelectric wave that will travel down the rest of the sample. Because of the small thickness of the p - n junction, such transducers will probably operate from about 5×10^8 to 10^{10} cps. Such frequencies are applicable in delay lines carrying large amounts of information and in light modulating devices in high-frequency communication systems. Figure 5 shows a proposed transducer for such uses.

When forward voltages (positive terminals to p side and negative terminals to n side) are applied to the junction, the height of the barrier is reduced and considerable current can flow in the positive direction because of thermal agitation of the carriers. A reverse field will cause an increase in the barrier height and will reduce the current flow. Hence, p - n junctions act as rectifiers. If, however, the barrier is made thin enough, current can flow by a quantum mechanical process, which allows the electrons or holes to tunnel through the barrier. As can be seen from Eq. 1, the way to make a thin barrier is to use a high doping level, n . For example, for 5×10^{19} impurity atoms per cc, the thickness becomes of the order of 60 Angstroms or 6×10^{-7} cm.

The current through such a junction can be expressed by

$$i = AP$$

where $P = e^{-k \sqrt{M} t \sqrt{W}}$. In this equation A is a constant containing factors such as the number of carriers available to attempt the tunneling process and their frequency of attempting it; P is the probability of successful tunneling, which depends on M (the ratio of the effective mass of the electron to its mass in free space), t the thickness, and W the energy gap. For t in Angstroms and W in electron volts, k is 0.34. Hence, for germanium with a 60 A thickness the probability becomes $e^{-7.62}$, or one chance in 2,000. This tunneling probability is relatively independent of temperature.

A plot of the current of a thin p - n junction (Esaki diode) against voltage gives the typical curve I of Fig. 6A. In the first region current increase is proportional to applied voltage. The current reaches a maximum at I_p , then decreases as the voltage increases (negative resistance region) down to a lower value after which it rises again (second positive resistance region). This behavior is a consequence of factor A in Eq. 2. The value of A depends on the number of available states for tunneling, since for an electron to tunnel through the barrier there must be a vacant state on the other side to receive it.

Figure 6B is a representation of the energy-band structure for an

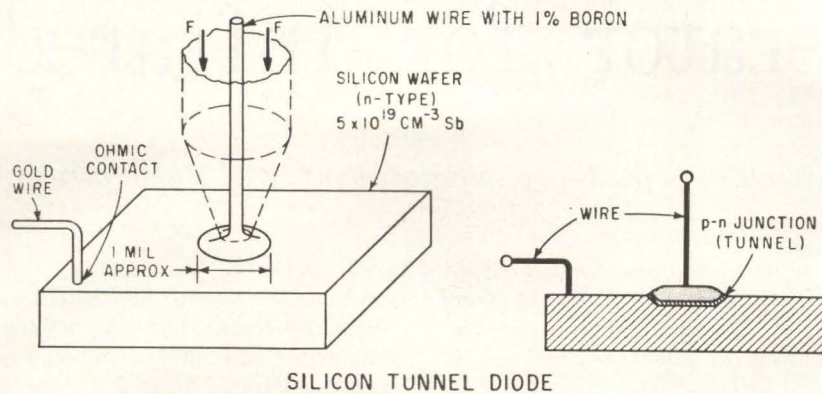

FIG. 7—Technique for making silicon tunnel diode

Esaki diode as a function of applied voltage. For the top figure, representing no bias, the n region has a filled valence band up to the forbidden energy gap (shown by the cross-hatched lines) since there are essentially no holes present at room temperature. The conduction band has a large number of electrons, shown by the shaded area, and the Fermi level is on top of this band. On the other side of the barrier region, which is raised in energy value because of the voltage gradient across the barrier, there are practically no electrons in the conduction band since the conduction is by holes. There is, however, an empty space above the valence band where electrons can exist since, in this region, if present, they would cancel holes and raise the band levels.

For no bias, electrons could flow along the line between the two sides; but since the band levels are determined by a constant Fermi level between sides there are no vacant states opposite the filled states; therefore no current flows. When small voltages are applied, the right-hand side is lowered and empty states are opposite filled states and current can flow. The maximum flow occurs when the empty state region covers the greatest area of filled regions. A still higher bias causes the empty region to be lower than the filled region and the tunneling current decreases as the voltage increases. This is the negative resistance region. Finally when the barrier gets low enough, electrons can jump the

barrier under the effect of thermal agitation and the current increases again as in an ordinary $p-n$ junction rectifier; this is the second positive region.

To be of use as a stress transducer, one or more of the parameters must change with stress. The only ones appreciably affected are thickness, energy gap and the effective mass; thus the tunneling probability is affected. The largest changes occur in the energy gap and the effective mass. For the following semiconductor materials, a hydrostatic pressure of 20,000 psi changes the peak current I_p by (in percent): Si, + 2.5; Ge, - 15; GaAs, -20; GaSb, -39.

Curve II of Fig. 6A shows the effect of a hydrostatic pressure of 1,000 atmospheres (15,000 psi) on a germanium diode. The slope changes and the peak current is reduced by about 11 percent. One use for such a device, suggested by W. G. Pfann of Bell Laboratories, is as a pressure alarm device. If a constant current I_b flows through the device (Fig. 6A), and pressure lowers the peak of the characteristic curve to the current I_b , or below, the device will switch to point C, with a much larger voltage drop across it.

The device can also be used to measure pressure. With a constant current I_b going through the device, the voltage will change from V_A to V_B as pressure is applied. Sensitivity is given by

$$\frac{\Delta R}{R \times S} = \frac{(V_B - V_A)}{V_A \times (p/B)} \approx 100 \text{ to } 300$$

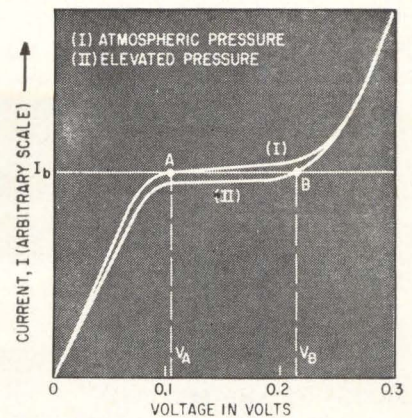

FIG. 8—Resistance in parallel with a tunnel diode allows a gage factor as high as 30,000

where 100 is typical for germanium and 300 for gallium antimonide. Quantity B is the bulk modulus for the semiconductor. Hence, these materials have the same order of sensitivity for hydrostatic pressure as silicon for a longitudinal stress. However, there is no necessity for limiting the action to hydrostatic pressure. Figure 7 shows a simple way of making these diodes by alloying an aluminum wire with 1 percent boron to a semiconductor wafer with a high doping. An active area can be made as small as 0.001 inch in diameter. By attaching this active area to a horn or diaphragm, a pressure multiplication factor of 10^6 is easily obtained; such devices are competitive with other methods of pressure measurement or pick-up.

Greater sensitivity can be obtained by using the negative resistance portion of the characteristic. By putting a resistance in parallel with the diode, the sum of the characteristics can be made equal to curve I of Fig. 8. The effect of a pressure is to lower the characteristic to curve II and the voltage change $V_B - V_A$ becomes much larger. By adjusting the input current and the paralleling resistance, gage factors as high as 30,000 can be obtained. This application requires a well-controlled, constant-input current I_b and good temperature stability of the characteristics. Such characteristics can be obtained with zener diode voltage stability coupled with a temperature insensitive tunneling probability.

Signal Generator for Infrared

Electronic and optical techniques combine to produce a monitored infrared signal between

By ARTHUR GLASER

Telewave Laboratories Inc.,
Long Island City, N Y.

GENERATION AND DETECTION of energy in the infrared region has become increasingly important in both military and industrial applications. An infrared signal generator re-

cently developed provides an output signal continuously variable from one to fourteen microns, corresponding to about 300,000 Gc to 20,000 Gc.

The infrared signal generator, photo, is used in development, testing and maintenance of infrared detectors, communications systems,

target seekers, tracking systems, surveillance systems, and satellites.

The generator has an internal modulator that amplitude modulates the output signal from 2 cps to 2.6 Kc, a step attenuator with a 10^7 -to-1 range, a 10-to-1 vernier attenuator, and an output power monitor.

Although the infrared signal

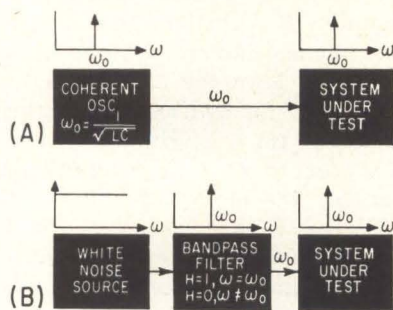
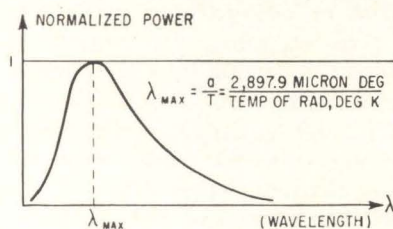
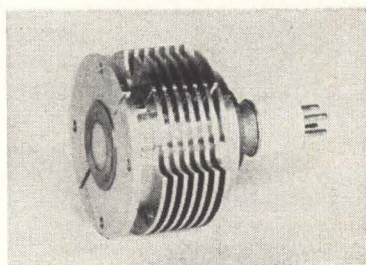

FIG. 1—Generation of a signal by a coherent oscillator, (A); by a noise source and bandpass filter, (B)



(A)



(B)

FIG. 2—(A) Black-body radiation curve, given by Planck's equation; (B), the infrared noise source

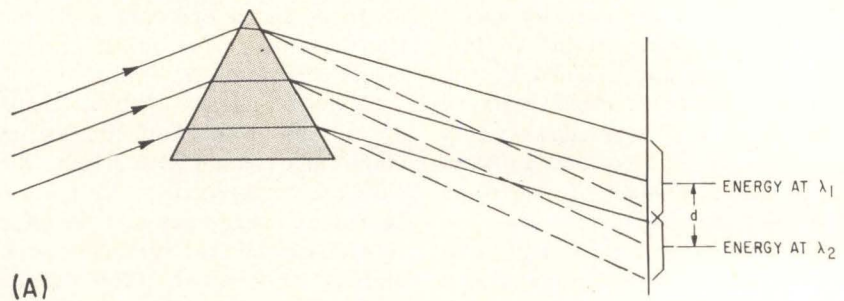

(A)

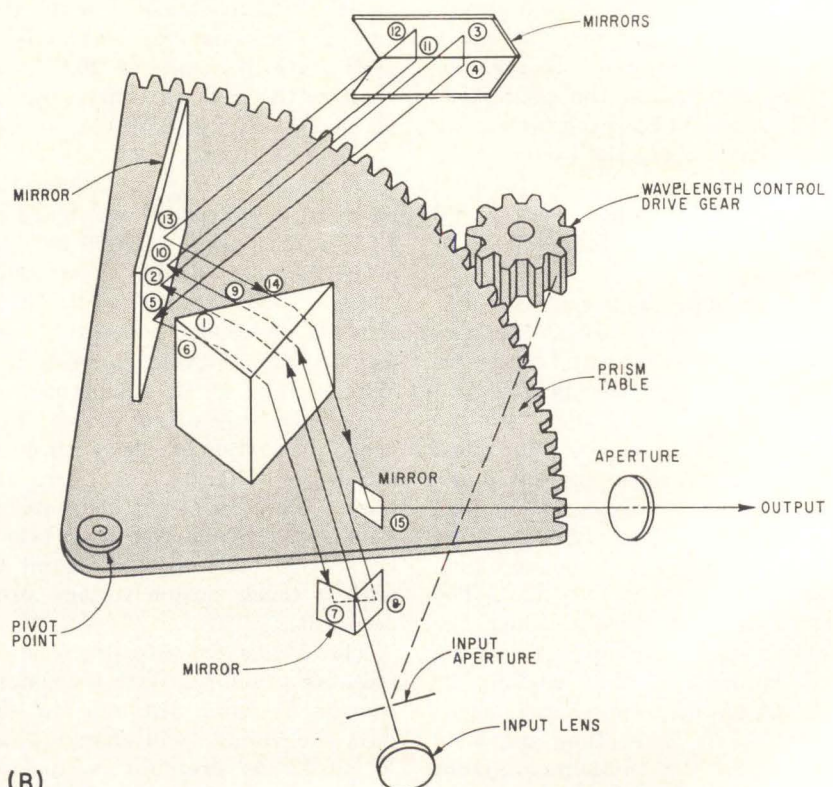

(B)

FIG. 3—(A) Single-pass monochromator. Distance d is to be kept as large as possible. This is done in the compact four-pass monochromator, (B)

Region

1 and 14 microns

generator is analogous to an r-f signal generator, the method of producing the signal is different. At radio frequencies, a tuned coherent oscillator generates the carrier signal. At infrared frequencies the values of inductance and capacitance, or the dimensions of a resonant cavity, become so small that construction is impossible.

One solution is to filter all but the desired frequency from a noise source. An ideal filter has a transfer function of zero for all frequencies except the one desired; thus the output of a noise source with filter appears to be the same as a coherent oscillator. Practically, the transfer function has a finite slope and the output is a band of frequencies whose bandwidth is controlled by the design of the filter (see Fig. 1).

Conventionally, the source is a glowing ceramic rod or a cavity-type black body. Neither of these are white-noise sources. The ceramic glower has a restricted operating range and mechanical fragility. Although the cavity source overcomes these difficulties, it takes a long time to reach a steady state because of its large thermal mass. Figure 2A illustrates the energy distribution of a black body as given by Planck's equation.

Because no suitable sources were commercially available, a new noise source was developed: a hermetically sealed tungsten filament lamp. Having a small thermal mass, this lamp offers fast response and is as rugged as a conventional photographic projection lamp. Figure 2B shows the lamp in a heat dissipating mounting. This lamp is not a white noise source; its energy is also given by Planck's equation. A true white noise source is impossible because it demands that the source supply infinite energy.

It was next necessary to design a bandpass filter to select the desired infrared wavelength. An elec-

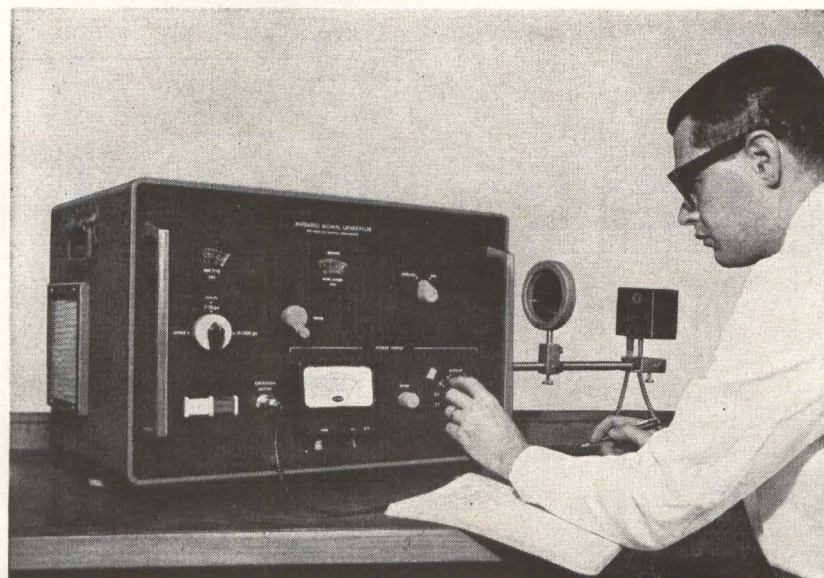

Infrared signal generator is operated by Telewave manager, Alan Ross. Wavelength dial is calibrated in 0.2-micron steps, output radiation at 5 microns has power of 1 microwatt, spectral profile 0.35 microns wide

tronic filter could not be built for the same reasons that a coherent oscillator is impractical.

The bandpass filter is a monochromator, shown in Fig. 3A. Light incident on the input surface of a prism is refracted because the refractive index of the prism material is different from that of air. The amount of bending depends on the wavelength of the light. At the exit surface, the light is again bent. This bending causes different wavelengths to travel in different directions. The amount of separation between the shortest and longest wavelengths, distance d in Fig. 3A, is related to the dispersion of the prism, which is a property of the material and the prism dimensions. If an exit plate with a small aperture is placed after the prism, then only those wavelengths that coincide with the aperture will appear at the output.

Distance d determines the resolution of the monochromator. Since the angular dispersion is a constant of the prism, the only way in which this distance can be increased is to increase the path length from the prism to the exit aperture, yielding large physical dimensions for the monochromator. Another method is to reduce the aperture size, but this reduces output power. The approach used was to pass the beam through the prism several times, as shown in Fig. 3B, thus increasing the angular dispersion

and decreasing the required path length for a given linear dispersion.

A variable aperture at the monochromator input reduces the power variation over the band and compensates for variations in prism resolution. This aperture is ganged to the wavelength control by a cam. Wavelength is adjusted by rotating the table that carries the prism, resulting in a small and mechanically simple monochromator.

Since glass does not transmit infrared, it is necessary to use materials such as rock salt or potassium bromide for all transmitting optics. These materials are water soluble and sensitive to humidity; the monochromator chamber therefore must be kept dry with silica gel.

The monochromator assembly also contains step attenuators, which are insensitive to wavelength variation and have 10-percent transmission. Three attenuators can be inserted into the optical path to attenuate the beam in steps of 10 to 10³. (The beam can pass up to four times through the same attenuator.) A vernier attenuator provides another factor of ten by varying the intensity of the source. Figure 4 shows the complete signal generator.

The infrared signal is modulated by a rotating chopper that interrupts the monochromator input. The modulation frequency is controlled by a velocity servo driving the chopper. The servo loop has a

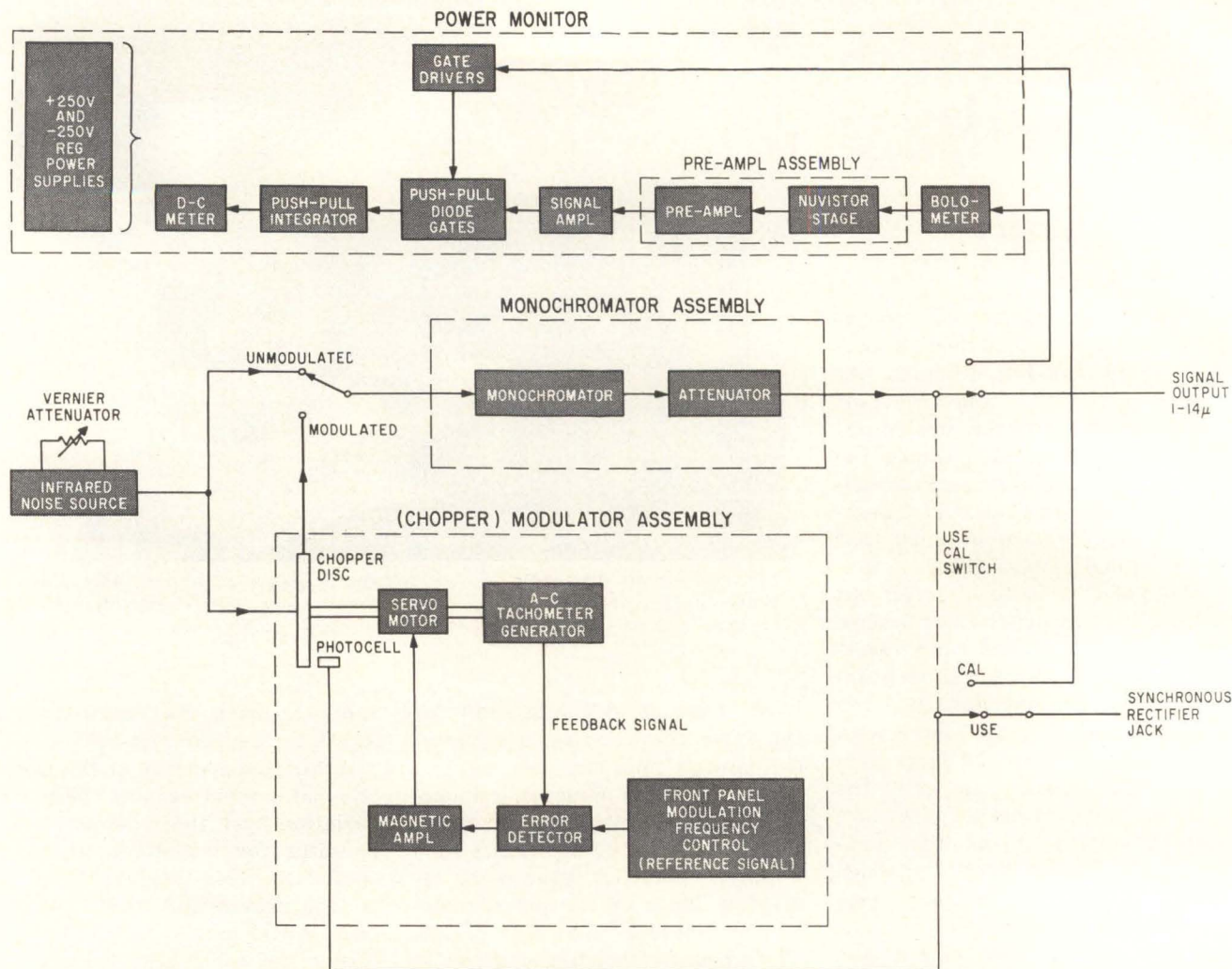

FIG. 4—Infrared signal generator, showing the principal assemblies and their circuits

two-phase servomotor, bridge-type error detector using a tachometer for the error signal, potentiometer for setting the reference voltage and a magnetic amplifier. For low-power-level measurements, a synchronous rectifier, controlled by the chopper assembly, can be connected at the front panel to an external detection system. The rectifier is a photoresistive cell with a dark-to-light resistance ratio of over 10,000 to 1, illuminated by a pilot lamp mounted at the chopper rim. The synchronous rectifier is available only in the 2 to 70-cps modulation range; it is not used at higher modulation frequencies because of bandwidth considerations.

The power monitor circuit, Fig. 5, contains a thermistor bolometer transducer, low-noise nuvistor pre-amplifier, synchronous detector meter and two highly regulated power supplies. The block diagram for this circuit is presented in Fig. 4.

The bolometer consists of two temperature-sensitive semiconducting resistors (thermistors), one exposed to the signal, and the other kept dark to cancel temperature effects. They are connected in series and biased by positive and negative 250-volt power supplies which are virtually free of hum and noise.

The signal obtained from the junction of the two thermistors is resistance-capacitance coupled to the nuvistor triode preamplifier. Because of the small size of the tube elements and the rigid mounting, the resonant frequency of the tube elements is in the kilocycle range, far above the region of interest. To improve the preamplifier's immunity to line transients that pass through the regulators, the first stage is a difference amplifier. The signal for one grid is derived from the bolometer; the other grid is connected to the output of the power supplies through

capacitors. This results in a bridge with the difference amplifier driven by the unbalance signal.

Since the bridge is initially balanced, any transient that causes the voltage of one supply to change relative to ground will cause only a shift in d-c output level, while maintaining balance across the bridge. This shift is applied to both grids of the difference amplifier as a common-mode signal and appears at the output attenuated by the common-mode rejection ratio of the difference amplifier. The desired signal affects only one arm of the bridge, resulting in an unbalance signal which is applied to only one grid and amplified. If the transient changes the total bias across the bridge, the bridge stays balanced while maintaining the same output d-c level, so that there is no signal.

Negative feedback stabilizes the gain against changes caused by component variation with aging

GATE CIRCUIT PROTECTS BEACON

Lockout circuit prevents inadvertent triggering of transponder modulators. Negative gate protects silicon controlled rectifier or power supply from effects of too closely spaced trigger pulses

By VINCENT SACCO

Engineering Section Head,
Transponder Group,
ACF Electronics Division,
ACF Industries Inc.,
Paramus, New Jersey

PREMATURE TRIGGERING can be prevented in missile-tracking beacon radars that use a conventional d-c resonance-charging type modulator. A solid-state lockout circuit has been developed that keeps strong echoes and unsynchronized radars from causing malfunctions of transponders on the launching pad.

This type of circuit failure has been eliminated by adding the lockout circuit, Fig. 1A, to the conventional modulator, Fig. 1B. This addition provides an automatic negative gate signal which prevents inadvertent triggering during the recovery time.

In the conventional modulator, the charging inductance L_c and its associated resistance, together with the total effective capacitance, C_N , of the pulse-forming network (pfn) form an underdamped RLC circuit. The inductance and resistance of the pfn and primary of the modulation transformer are negligible compared to that of the charging inductor.

Application of E_{BB} to the RLC circuit results in the familiar damped sinusoid where the initial peak voltage approaches approximately $2E_{BB}$. Diode D_c in series with the RLC circuit holds this initial high voltage at about $2E_{BB}$. Application of E_{BB} thus charges the capacitance of the pfn to V_1 of about $2E_{BB}$. The pfn stores this energy, $1/2CE^2$, so that the discharge waveshape approximates a

rectangular pulse—usually of about one microsecond duration.

The pfn may take many forms where the E type or parallel combination or series LC, are used. Frequencies associated with L_1, C_1 ; L_3, C_3 ; and L_5, C_5 in Fig. 1B represent the 1st, 3rd and 5th harmonics, respectively, of the simulated rectangular pulse. The silicon controlled rectifier scr switch replaces its thermionic counterpart, the thyatron. The scr is a pnpn device that blocks V_1 until a trigger pulse is applied at the gate.

With such a trigger, the scr appears as a low impedance so that the pfn discharges through the scr and the primary of the modulation transformer. The modulation transformer steps up the pulse voltage to a value required for transmitter operation. The scr reverts to its

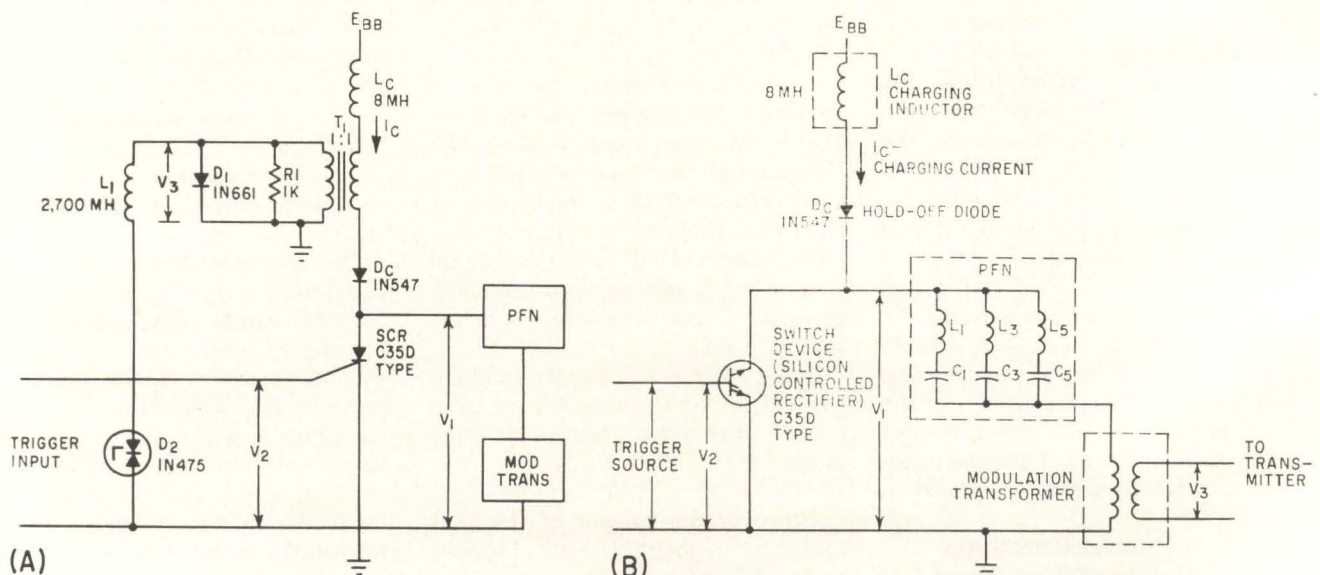

FIG. 1—Lockout circuit additions (A) to conventional d-c resonant charging type modulator circuit (B) consist of T_1, D_1, D_2, L_1 and R_1 . Added circuit introduces a negative inhibit gate at the scr gate during critical period when false triggering occur

MODULATORS

high-impedance state when the current through it drops below the holding current level. At this point, capacitance of the pfn again charges to V_1 at a rate determined by L_c and C_N .

Figure 2A shows typical waveforms associated with the conventional modulator circuit. The approximate value $2E_{nb}$ is reached at T_1 , usually in about 50 to 100 microseconds. The negative portion of V_1 is the result of the biased-diode nature of the transmitter, which, together with the shunt inductance of the primary of the modulation transformer, cause the unexpended $1/2LI^2$ to appear across the switch as a negative-going voltage.

The rate at which $2E_{nb}$ is approached must be slow enough to permit complete diffusion of the carriers from the end junctions of the scr. This rate compares roughly with the deionization time required in thyratrons. If insufficient time is allowed for recovery, the scr will not revert to its blocking state and will go into continuous conduction. This will result in destruction of the scr, damage to the power supply or temporary cessation of opera-

tion in fail-safe power supplies.

The malfunction caused by triggering during recovery can be explained by considering the charging currents. In Figure 2A the current through the charging choke is shown when the spacing between two pulses, 1 and 2, is sufficient to avoid overlap of the charging currents. In this operation, the charging current is reduced to zero prior to the second firing. In Fig. 2B, however, the spacing has been sufficiently reduced to cause considerable overlap of the charging currents. Therefore, after the completion of the pfn discharge caused

by pulse 2, considerable charging current appears at this point.

In Fig. 2B the magnitude of the charging current through the scr is not sufficient to exceed the holding current of the scr since considerable current is shunted in charging the pfn capacitor, C_N , in parallel across the low impedance of the scr, see Figure 3A. However, the presence of an I_{c1} component together with I_{c2} causes V_1 to charge to a higher value and at a faster rate.

The charging current of Fig. 2B indicates that linear charging will occur during the overlap since the

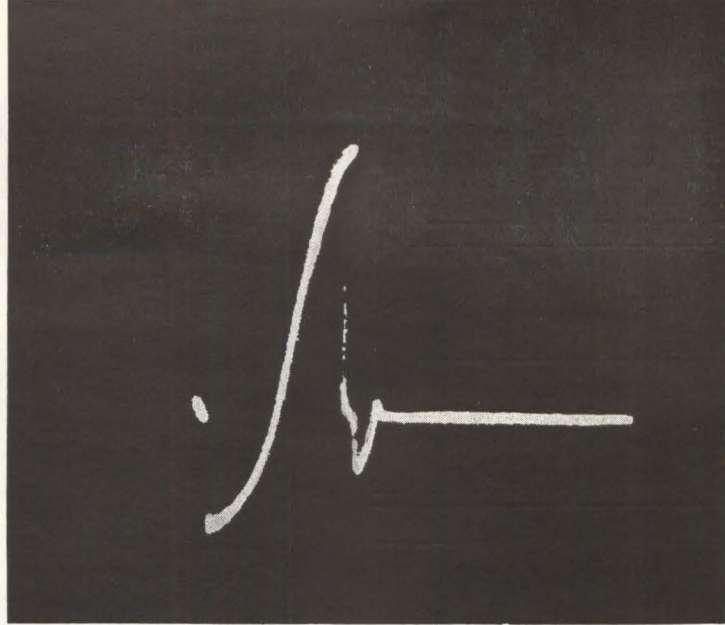

Oscilloscope sweep shows failure mode of scr caused by premature recharging

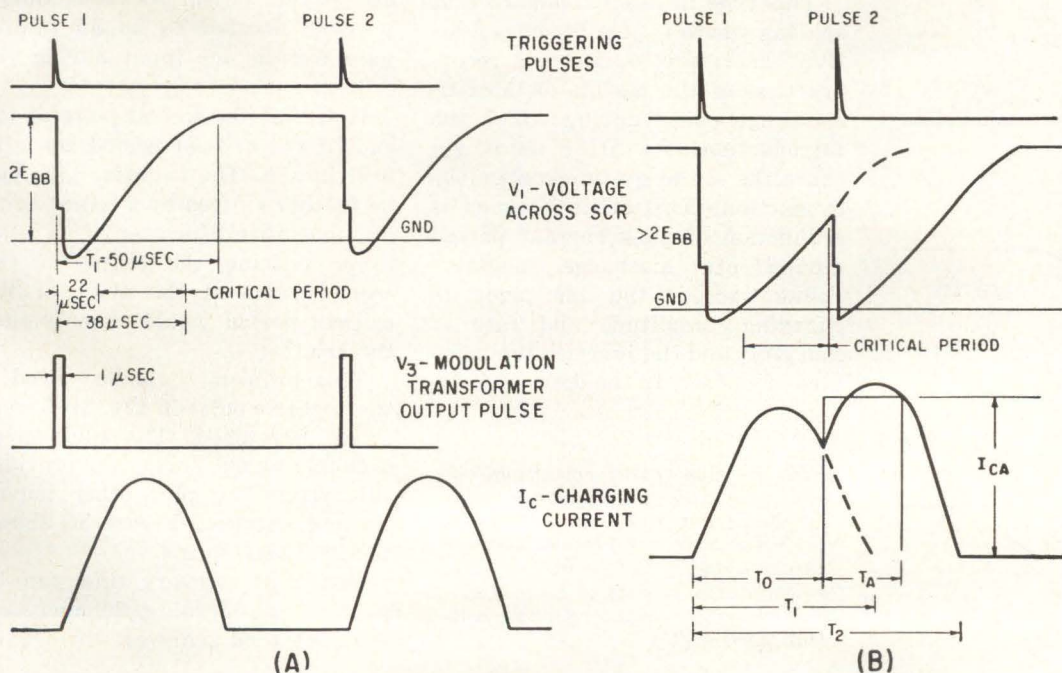
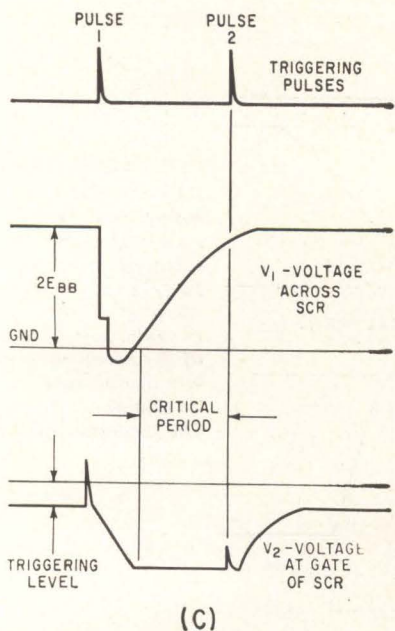
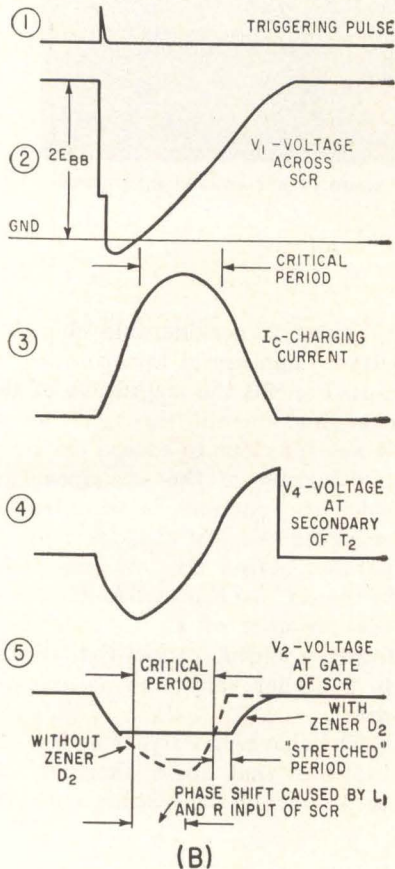
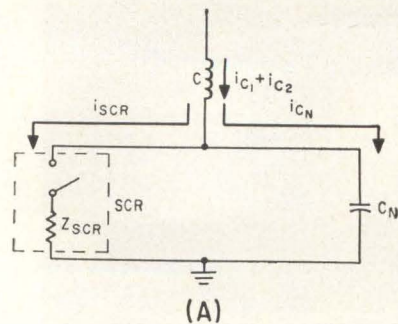

FIG. 2—Waveshapes (A) associated with conventional d-c resonant charging modulator. In (B) the reduced spacing causes considerable overlap of charging current, can destroy scr, or damage the power supply



peak current can be represented as a steady state value, as noted by the dashed lines, with a superimposed ripple.

The charging voltage can, therefore, be approximated as

$$C_o = (1/c) \int_{T_o}^{T_o+T_A} idt \cong \frac{1}{c} I_{CA}$$

during T_A if the ripple is neglected.

If the pulse spacing is further reduced from that shown in Fig. 2B, the charging rate will not permit the scr to revert completely to its original blocking state. Instead at some time during its recharging cycle the carriers in the end junction will not be sufficiently diffused and continuous scr conduction will result.

A photo of this type failure was taken with a memory oscilloscope where the single sweep was initiated by the interjection of pulse 1 before pulse 2. The pulse shows that the charging voltage actually did go above ground by about 40 volts before the failure occurred. The power supply thermal circuit breaker was energized soon after the failure, preventing destruction of the scr or damage to the power supply.

As the spacing to the second pulse is further reduced, the overlap charging current is increased until a component of the residual charging current I_{c1} is sufficient to exceed the holding current of the scr, resulting in continuous conduction immediately upon application of pulse 2.

This type failure extends to that spacing where V_1 just becomes positive. Therefore, during the recovery time of the modulator, a critical range exists during which the introduction of a firing pulse will cause the scr to go into continuous conduction. This critical period is a function of peak current passed during pfn discharge, negative voltage across the scr prior to charging, amplitude and rate of charging, and the junction temperature of the scr. In the described cir-

cuit, the critical period takes between 22 to 38 microseconds in a total recovery of about 50 microseconds.

Normally, the minimum spacing of the triggering pulses is sufficient to avoid difficulty. However, in radar transponders using the d-c resonance-charging modulator, a unique situation exists. While the spacing of the radar pulses is normally sufficient, premature triggering can occur if, at the launching pad, strong echoes appear after the main radar pulse as a result of multipath approaches to the gantry; or if unsynchronized multiple radars are used. While the latter condition is usually manageable, the former condition cannot be controlled readily owing to the proximity of other gantries or structures. The lockout circuit (see Fig. 1A), introduces a negative inhibit gate at the scr gate during the critical period. The circuit uses the voltage induced in the primary of T_1 by the charging current, Fig. 3B-3. The voltage is then transformed to the secondary, Fig. 3B-4. The tendency for ringing is damped by R_1 (Fig. 1). The positive-going portion is removed by D_1 .

With zener D_2 removed, the phase shift introduced by L_1 and the equivalent input impedance of the scr optimizes the location of the voltage in reference to the critical period.

The broken-line waveform of Figure 3B-5 shows that the voltage at the critical period is almost properly located to be an inhibit gate for the scr input during the critical period.

However, the second pulse at the end of the critical period can still fire the scr. The negative gate can be further shifted by a larger value of inductance. However, with additional shifting, the location of the second pulse at the start of the critical period would then trigger the scr.

This problem could be solved if the negative pulse in Fig. 3B-5 were merely stretched. The addition of a double anode Zener, D_2 , provides this stretching plus other important advantages. Figure 3C shows the final waveforms.

The total recovery time can be reduced considerably, 20 microseconds has been achieved.

FIG. 3—Equivalent circuit of scr and pfn during recharging with residual charging current from previous charge (A); waveshapes associated with lockout circuit (B); and final waveforms of lockout circuit showing lockout effect at critical period (C)

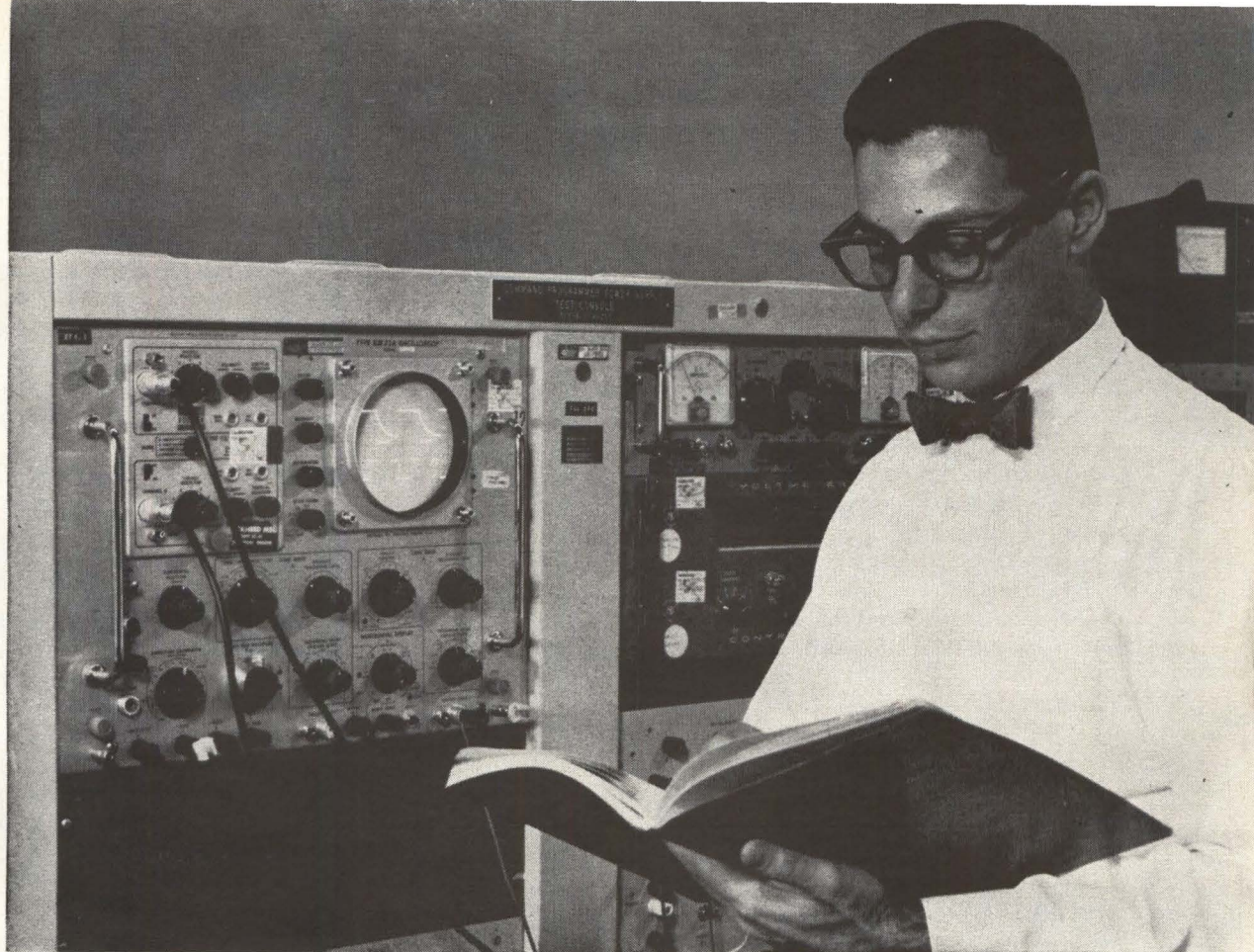

Variable pulse-width output of satellite power supply can be seen on the scope

Satellite Power Supply

HAS VARIABLE PULSE WIDTH

Power supply for satellites uses multivibrator for constant frequency and variable pulse-width for regulation. Other features of the short-circuit-proof converter are light weight and high efficiency

By **ELLIOT JOSEPHSON**
Lockheed Missiles and Space Co.,
Palo Alto, Calif.

A SATELLITE-BORNE power supply must maintain good regulation over extremes of temperature, operate at high efficiency from widely varying input voltages into changing loads, be short-circuit proof, use a minimum of parts, withstand

shock and vibration, and be light in weight.

Specifications for such a supply, shown in the table, are typical and not restrictive. Although d-c input is specified, some space vehicles provide a source of a-c power. However, for efficiency and reliability, it was decided to bypass intermediate equipment and operate directly from the vehicle battery. The

circuit is a d-c to d-c converter.

A conventional d-c to d-c converter can be built with the required efficiency, if it is unregulated. Since a series or shunt regulator was out of the question, a modified converter was developed.

In a conventional converter, as the input voltage is increased, the operating frequency also increases. This occurs because a fixed number

of volt-seconds is required to saturate the core. For a square hysteresis-loop transformer $Et = k$, where E is the voltage applied to the transformer primary, t is time to switch from one saturated state to the other, and k is determined by core material, configuration, and primary turns.

Hence the frequency changes inversely as the input voltage. If, however, the operating frequency is held constant by introducing a period of offtime after the saturation of each flux reversal,

$$E_{av} = \frac{N_s Et}{N_p T} = \frac{N_s k}{N_p T} = \frac{K}{T}$$

which indicates that the average value of the rectified output E_{av} , is independent of the input voltage.

The required constant-frequency, variable-duration waveform is developed in the circuit of Fig. 1A, where transistors Q_1 and Q_2 are fired alternately by a free-running multivibrator whose period is $2T$. At time 0, the positive-going leading edge of the multivibrator output turns on Q_1 , through C_1 . A positive voltage is induced in the turnoff winding at the cathode of D_1 to back-bias the diode. Current flows from the multivibrator into the base of Q_1 , keeping it on until

time t , when the core saturates. At this time the turnoff winding voltage drops to zero, D_1 conducts, and base drive is clamped through the winding to ground, turning off Q_1 . Diode D_{1A} compensates for the drop across D_1 , assuring a firm turnoff. At time T , the multivibrator changes state, turning on Q_2 , and the cycle is repeated.

The rectified output need only be integrated by an L-C filter to produce a regulated d-c. Regulation is thus accomplished by the transformer core itself, and is sufficient for many applications. However, changes in the output voltage are caused by changes in load, due to choke and rectifier drops; changes in temperature, due to variation of k (k varies about 10 percent from -55 to 100°C); or a change in the value of T , caused by multivibrator drift.

Since E_{av} is a function of T , T can be automatically adjusted to provide tighter regulation. The output is sampled and compared to a temperature compensated zener diode in a differential amplifier. Any error signal is used to vary the frequency of the multivibrator, adjusting T to bring the output voltage back to the desired level. Even with unmatched transistors in the differential amplifier, it is feasible to achieve ± 1 percent regulation.

Most d-c to d-c converters achieve maximum efficiency at full load only. This is undesirable in a satellite power supply, since full load capability is utilized only during ground contact, a small percentage of the duty cycle.

Declining efficiency is due not so much to the relatively minor fixed losses in the control circuits, but to the losses in driving the power stage. Since the power transistors must be driven to full-load capability, the drive circuit dissipation can be justified only when the converter is delivering maximum power. It was therefore necessary to provide a base-drive circuit for the switching transistors, that would automatically adjust the base current to the load.

The most desirable base drive mechanism conforms to $I_B = I_C / \beta_{min}$, where I_B is the desired base

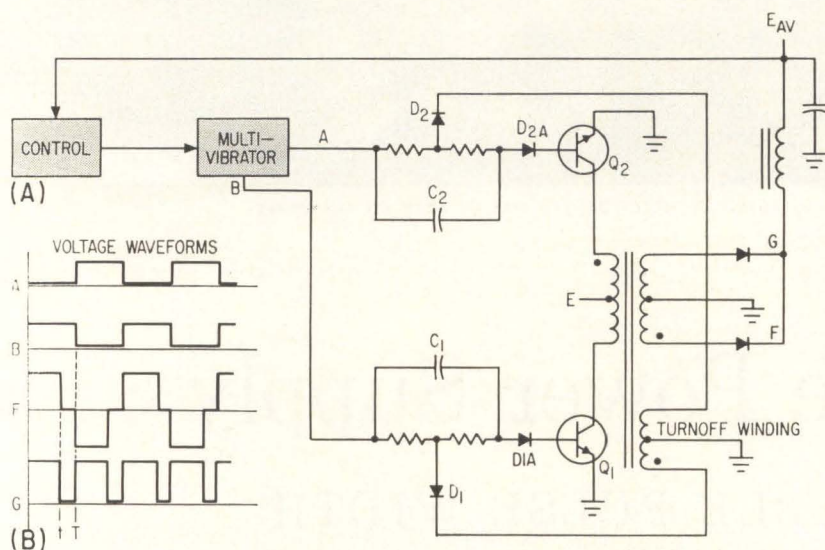

FIG. 1—Waveforms of circuit (B). When the core of the transformer saturates, base drive for the transistors is shunted to ground through D_1 or D_2 . Core saturation time is a function of load and supply voltage

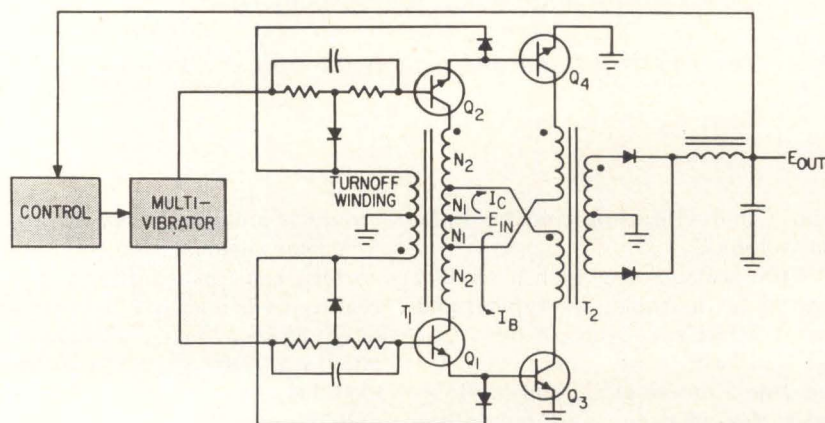
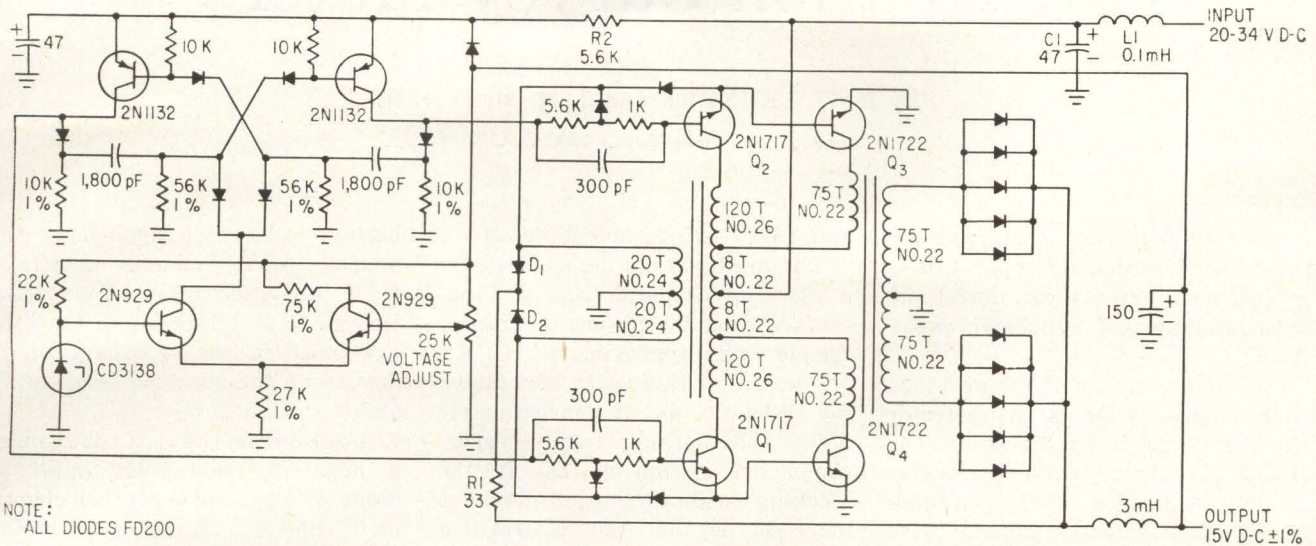

FIG. 2—Efficiency is increased and short-circuit protection is obtained by driving output stage with variable width pulses from Q_1 and Q_2 . Only transformer T_1 saturates, not T_2 .



NOTE:
ALL DIODES FD200

FIG. 3—Complete circuit uses 10-Kc multivibrator and temperature stabilized zener diode

drive current, I_c is the collector or primary current, and β_{min} is the minimum specified current gain of the switching transistor. The load current does not enter into the problem because I_c , the primary current, automatically adjusts itself to the load.

The circuit of Fig. 1 drives a power stage, as shown in Fig. 2. Voltage regulation is accomplished by transformer T_1 , and T_2 does not saturate. The input voltage is applied at the primary center tap of T_1 and tapped for the primaries of T_2 as shown. When T_1 primary current is flowing through Q_1 , to drive Q_3 , the collector current of Q_3 is reflected as a load on transformer T_1 , and the T_1 primary current automatically adjusts itself to this load according to the turns ratio. But T_1 primary current is the base drive for Q_3 . Hence $I_B = N_1 I_c / (N_1 + N_2)$. By setting $(N_1 + N_2) / N_1 = \beta_{min}$, then $I_B = I_c / \beta_{min}$. $N_2 / N_1 = \beta_{min}$, then $I_B = I_c / \beta_{min}$.

If the load current increases, the immediate result is that current I_c also increases; primary current in transformer T_1 also increases and this in turn causes current I_B to increase. Thus base drive current regulation is both instantaneous and automatic. As a further benefit from the circuit, no power has to be supplied only to be wasted by being dissipated in base drive resistors, and transistors Q_3 and Q_4 are operated at their full power gain.

The complete schematic diagram of the satellite power supply is given in Fig. 3. Operating frequency is set at the relatively high value of 10 Kc, since a high frequency reduces the size and weight of transformers and the components of the filtering portion of the circuit. The circuit is adaptable to frequencies lower than the 10 Kc actually used, and lower frequencies will actually allow somewhat better efficiencies than the curves given in Fig. 4. The input filter to the supply is formed of L_1 and C_1 . The main purpose of this filter is to prevent the sharp current steps being drawn by the converter from appearing as hash on the input line.

Diodes D_1 , D_2 , and resistor R_1 stabilize T_1 by providing a load for the turnoff spike generated at the end of each half cycle. The control circuit is operated from the output voltage, with R_2 for starting.

POWER SUPPLY SPECIFICATIONS

Input voltage—20 to 34 volts dc
Output voltage—15 volts d-c ± 1 percent
Output power—5 to 25 watts
Ambient temperature— -55 C to 100 C
Efficiency—80 percent minimum for any operating conditions
Protection—Able to withstand a continuous short circuit without damage. Resume normal operation upon removal of short

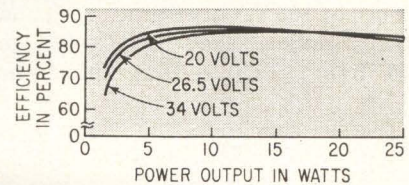

FIG. 4—Efficiency is high, even at low loads, because drive power varies with the load

For a short circuit or overload, Q_1 and Q_2 limit when demands are made for collector current beyond βI_b . In this case no voltage is induced in the turnoff winding of T_1 and the base drive is clamped through the turnoff diode. Hence an attempt is made to fire only during the charging time of the bypass capacitors. Failing this, the power stage remains quiescent for the remainder of the multivibrator half cycle, with no damage to the circuit.

Efficiency is shown in Fig. 4 for three input voltages. A further increase in input voltage serves only to decrease the efficiency. Regulation is within 1 percent until the breakdown voltage of the transistors is reached (about 50 volts input).

The completed breadboard weighs 0.75 lb. Operational size and weight depends on packaging.

The author wishes to acknowledge the assistance and encouragement of C. H. Keller.

Radiation Survey Meter

By R. W. LEHNERT and J. M. McKENZIE

Amperelex Electronic Corp., Hicksville, N. Y.

A SMALL RADIATION survey meter with two modes of operation—pulsed and current—can detect the contamination of a nuclear explosion.

In the circuit, an 18503 or 18504 G-M counter tube is the detector for the 0.5 mR to 5 R/hr range. The 18503 is a small gamma-sensitive counter while the 18504 is an end-window beta-sensitive counter with the same gamma sensitivity. The Geiger plateau extends from 425 to 650 v with a slope less than 2 percent per 100 v. Other tube types and their ranges are: 18550—0.5 to 10 R/hr; 18509—6 to 100 R/hr

and 18529—20 to 500 R/hr.

The high voltage d-c source uses a blocking oscillator and a Cockcroft-Walton multiplier. Oscillator frequency is approximately 10 Kc. Diodes D_1 to D_4 rectify and multiply the a-c to d-c of approximately 550 v. This output is stabilized by the Zener region of D_1 . If the blocking oscillator output tends to increase beyond 140 v, reverse breakdown in diode D_1 occurs.

In pulsed operation (position B of S_2), the G-M pulses are fed to Q_2 . Transistor Q_2 acts as a switch, closing every time the G-M tube fires. When firing takes place, full

battery voltage is applied to the primary of T_2 , inducing a voltage pulse in the secondary. Conduction time of Q_2 and duration of the voltage pulse in the secondary of T_2 depend on the characteristics of T_2 and the value of C_1 .

A pulse from the G-M tube causes a negative rectangular pulse at point A. Each pulse places a charge on C_1 and C_2 . As pulse repetition rate increases, R_3 slows the charging of C_2 . This gives a logarithmic output. (Removing R_3 gives a linear response). The current flows around loop C_2 , D_6 , C_1 and the secondary of T_2 . On the positive half cycle of the blocking oscillator, C_1 discharges through D_5 . Capacitor C_2 discharges slowly through R and meter M . At equilibrium, the discharge current of C_2 is equal to the charging current from the pump circuit.

Potentiometer R_4 compensates for a change in battery voltage. To calibrate the instrument, S_2 is placed in position A and R_4 is adjusted until M reads half scale. The instrument is calibrated initially by adjusting R_4 and then setting R_5 to obtain a full scale meter reading in a 50 mR/hr field. Range for pulsed operation is 0.5-50 mR/hr.

In the current mode of operation, the same G-M tube is used and the current in a given radiation field measured. This current in the range of 50 mR to 5R/hr is a logarithmic function of the radiation intensity.

In calibrating in the current mode, meter M in series with R_5 is placed across the high voltage generator when S_1 is in position C. Potentiometer R_2 is varied until the meter reads half scale. There is now 550 v at the output of the high voltage generator.

For a sample of 100 G-M tubes, the probable error of a measurement of radiation field with 550 v anode voltage is 10 percent. The instrument has been packaged in a box 3 in. \times 5 in. \times 2 in. deep.

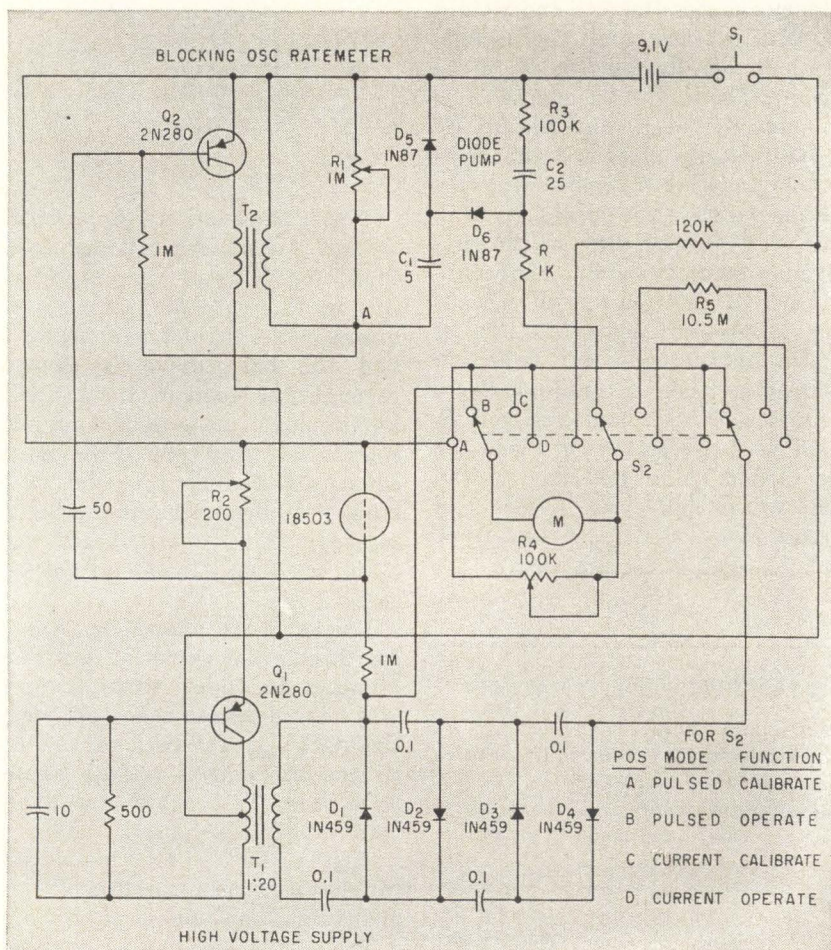

Because slope of response curve of both pulsed and current modes are the same, only one meter scale is necessary

MATERIAL OF THE MONTH (EVERY MONTH)

FIRE-RETARDANCY of PANELYTE increases preference by electrical system designers

Panelyte copper-clad sheets... both glass- and paper-base... are being used more and more in printed circuitry in radio, TV, computers, sensitive electronic and electrical systems including missile control. In addition to good machinability, dimensional stability, high electrical and mechanical strength under standard and elevated temperatures... Panelyte offers the very important factor of fire-retardancy and self-extinguishing properties. For complete information, write for our Production Values literature dealing with copper-clad Panelyte.

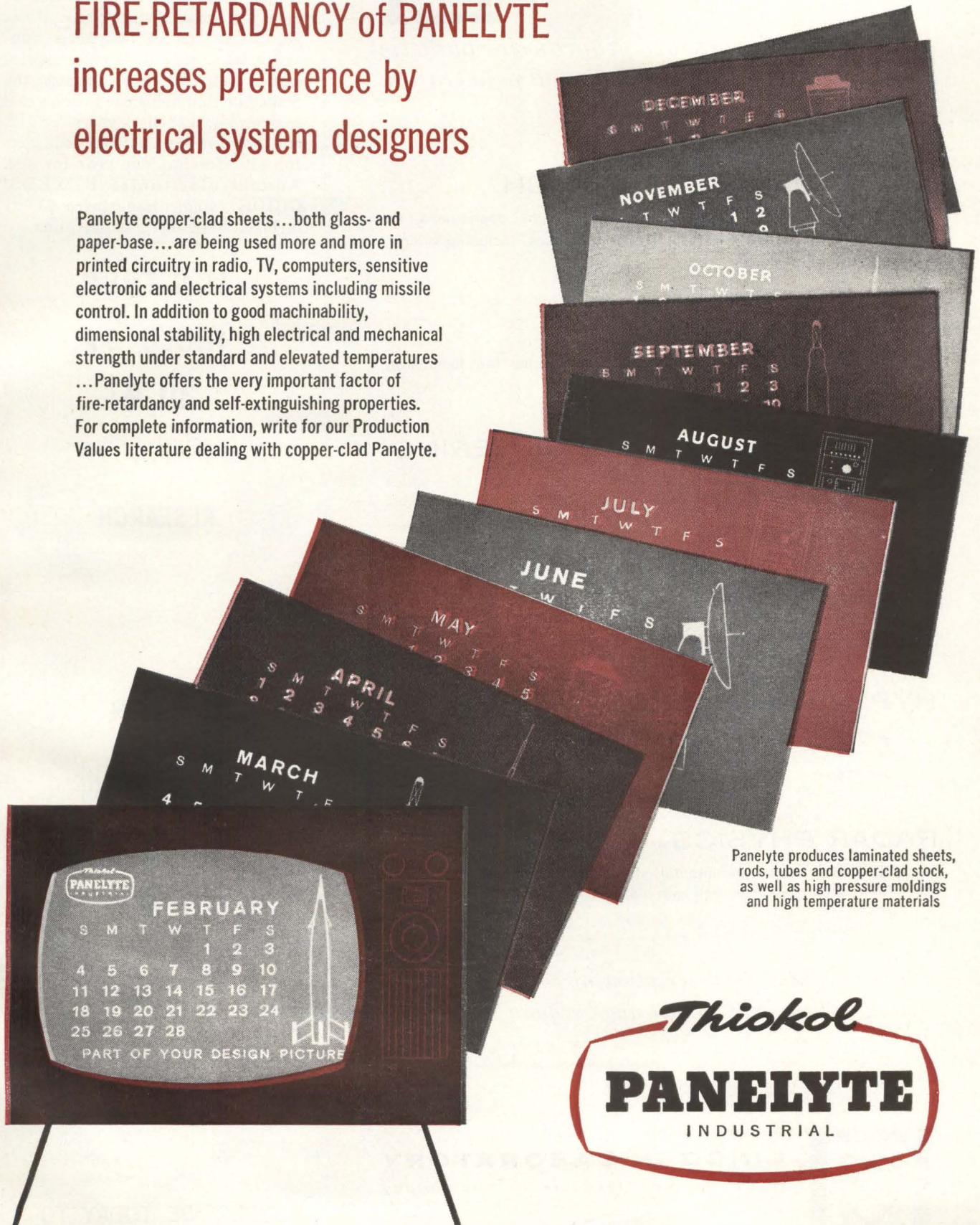

Panelyte produces laminated sheets, rods, tubes and copper-clad stock, as well as high pressure moldings and high temperature materials

Thiokol
PANELYTE
INDUSTRIAL

THIOKOL CHEMICAL CORPORATION, PANELYTE INDUSTRIAL DIVISION, N. ENTERPRISE AVE., TRENTON 4, N. J.

February 23, 1962

CIRCLE 51 ON READER SERVICE CARD 51



The Lincoln Laboratory program for ballistic missile range measurements and penetration research includes:

EXPERIMENTAL RESEARCH

Measurements and analysis of ICBM flight phenomena for discrimination and for decoy design purposes, including optical, aerodynamic and RF effects.

SYSTEM ANALYSIS

Studies to apply research findings to advance the technology of ICBM and AICBM systems.

INSTRUMENTATION ENGINEERING

Designing radar, optical and telemetry equipment with which to measure ICBM flight effects under actual range conditions.

RADAR SYSTEMS RESEARCH

Extending the theory and application of radar techniques to problems of discrimination, countermeasures and performance in a dense-target environment.

HYPERSONIC AERODYNAMICS

Study of the flow-fields around re-entering bodies for various body designs and flight conditions. Excellent computer facilities available.

RADAR PHYSICS

Theoretical and experimental studies in radar back-scattering. Interaction of RF radiation with plasmas.

- *A more complete description of the Laboratory's work will be sent to you upon request.*

All qualified applicants will receive consideration for employment without regard to race, creed, color or national origin.



Research and Development
LINCOLN LABORATORY
Massachusetts Institute of Technology
BOX 27
LEXINGTON 73, MASSACHUSETTS

electronics fills you in on every phase of the electronics industry each week featuring engineering and technical data every issue. Latest economic trends, technically interpreted, to help you make sound plans. Facts you'll want to file and keep. Subscribe now. Mail the reader service card (postpaid) to **electronics**, the magazine that helps you to know and to grow! Rates: three years for \$12, one year for \$6; Canadian, one year for \$10; foreign, one year for \$20. Annual **electronics** BUYERS' GUIDE (single issue price \$3.00) included with every subscription.

**it's read
more by
all 4!**

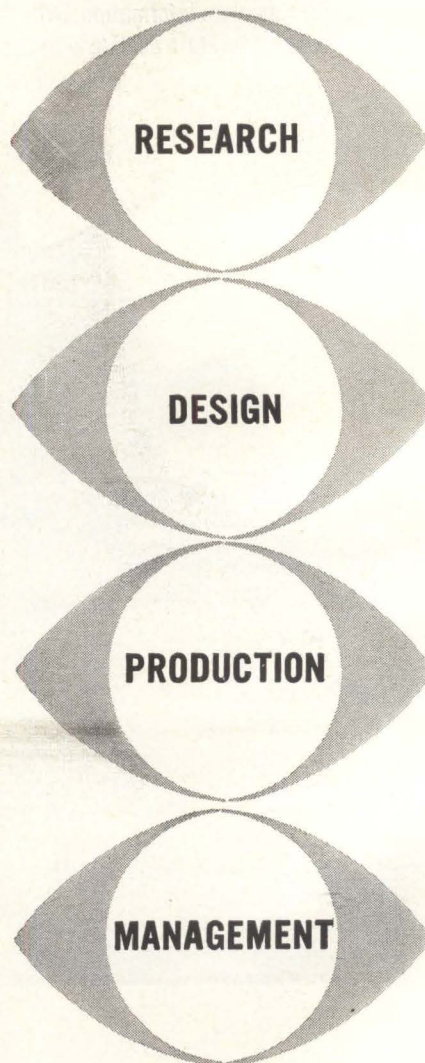

SUBSCRIBE TODAY TO
electronics!

CIRCLE 53 ON READER SERVICE CARD →

ALL SOLID STATE—BUDGET PRICED AT \$1975

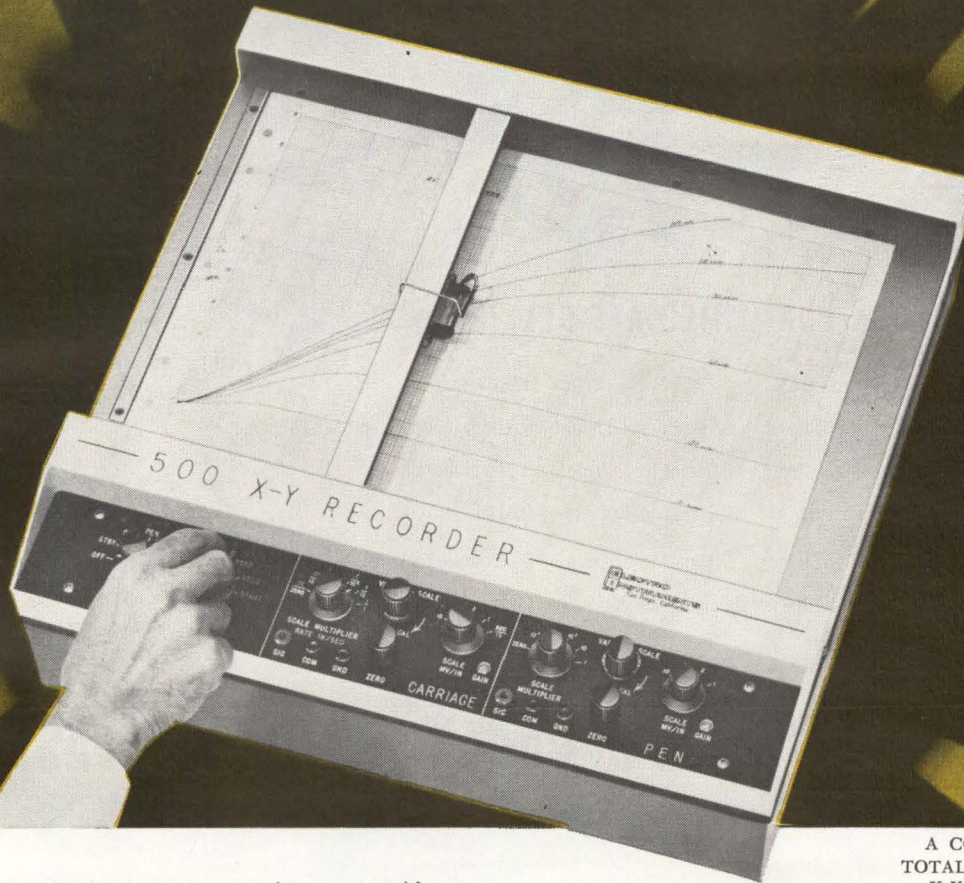

NEW EI Model 500 11" x 17" X-Y RECORDER has unparalleled performance and specifications

Place the new Model 500 alongside any competitive 11" x 17" X-Y Recorder. Check them for ease of operation, reproducibility, absence of jitter, speed of response, input sensitivity, time base accuracy, overall mechanical design and any other performance feature you need in a recorder. It's the only way we know to point up the significant design advances provided in the new 500 that will not be found in any competitive instrument. What's more, the 500 is the only totally transistorized 11" x 17" X-Y Recorder available at this low price—just \$1975, f.o.b. San Diego, Calif.

Brief specifications: 25"/sec. slewing speed, both axes; 0.15% full scale accuracy; 1 megohm input impedance, all ranges; 20 input scales from 0.5 mv/in. to 100 v/in.; integral time base; and measures 17½" x 19" x 5"; weighs only 32 pounds. May be easily rack mounted without additional fixtures.

You would be wise to get complete information on this newest addition to the only complete line of all solid state X-Y Recorders. Your EI field engineer will be happy to tell you all about it. Call him today.

Engineers: Challenging opportunity now available. Contact Mr. Harvey Fleming.

Electro Instruments, Inc.

8611 BALBOA AVENUE, SAN DIEGO 11, CALIFORNIA



A COMPLETE LINE OF
TOTALLY TRANSISTORIZED
X-Y RECORDERS AND
ACCESSORIES

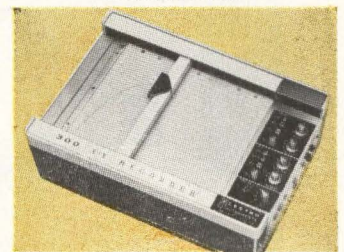

SERIES 300—A small, lightweight 8½" x 11".

SERIES 400—11" x 17" recorders with plug-in function modules for maximum flexibility.



THE MOST WELL BALANCED STOCK OF MICRO-DRILLS IN THE U.S.A.



SPHINX

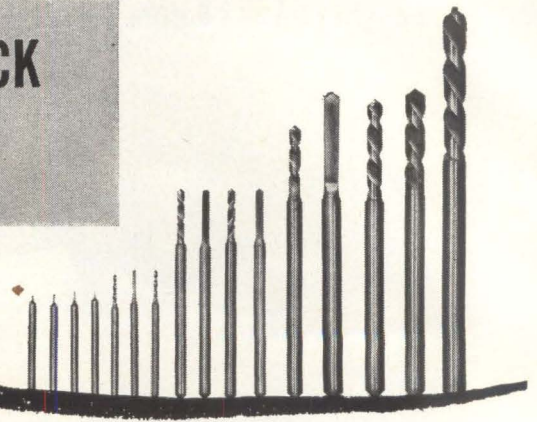
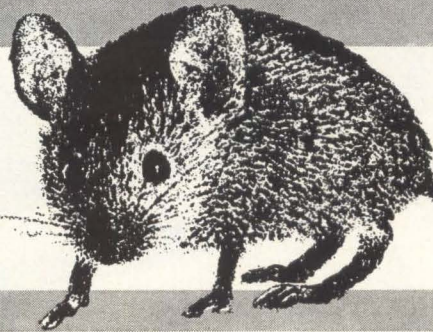

IN STOCK FOR IMMEDIATE DELIVERY

TYPE	STYLE	STOCK SIZES
Spirec Pivot Drills	Right Hand	0.10mm to 3.00mm by 0.01mm increments
Flat Pivot Drills	Right Hand	0.04mm to 1.00mm by 0.01mm increments
Spirec Pivot Drills	Left Hand	0.10mm to 1.00mm by 0.01mm increments
Spirec Center Drills	Right Hand	0.10mm to 0.70mm by 0.05mm increments

Other sizes and styles available on special request.

SPHINX known the world over as the symbol of the finest in micro-drills. Insist on them by name. Your best assurance of quality and precision.

SEND FOR COMPLETE DRILL CIRCULAR

LEVIN®

LOUIS LEVIN & SON, INC.
3573 Hayden Ave., Dept. E • Culver City, California

CIRCLE 201 ON READER SERVICE CARD

Before you order... check NYLO-FAST® FASTENERS!

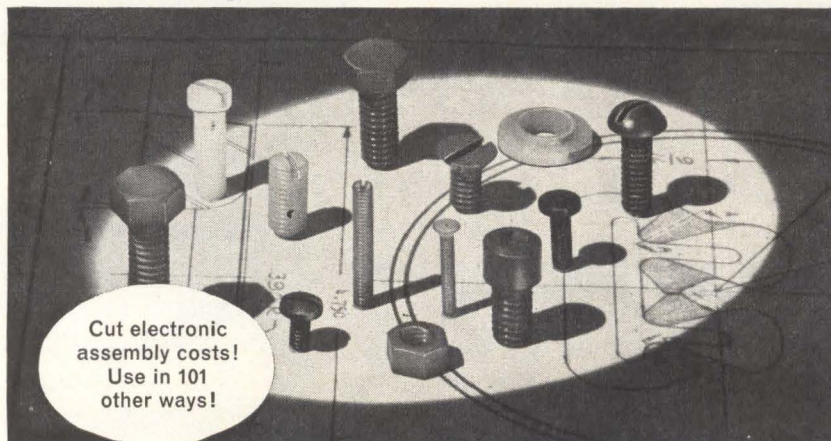

Cut electronic assembly costs!
Use in 101 other ways!

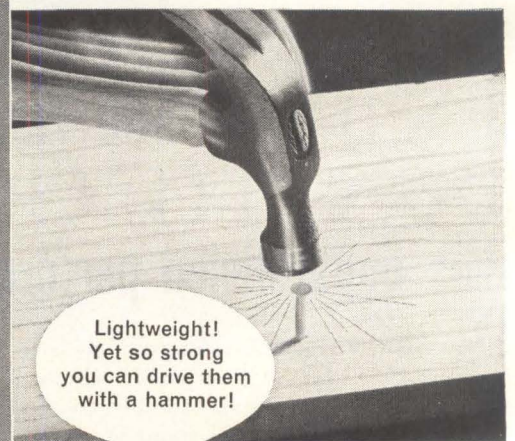

Lightweight!
Yet so strong you can drive them with a hammer!

Have you investigated what NYLO-FAST® Fasteners can do for you? They're colorful, strong — yet 1/6 the weight, chemical resistant, heat resistant, elastic, resilient, and non-conducting! You'll be surprised to discover how many ways NYLO-FAST® Fasteners can serve you—BETTER! Write for complete information.

Immediate delivery from our large stocks which include Nylon, Delrin, Teflon, P.V.C., Lexan, etc. 10 different formulations! Write, wire, or telephone today for the facts!

LEADING MANUFACTURERS OF STAINLESS STEEL AND NYLON FASTENERS!



Anti-Corrosive

METAL PRODUCTS COMPANY, Inc.

CASTLETON-ON-HUDSON 10, NEW YORK

Different potting and encapsulating problems require different solutions. That's why General Electric offers a family of eight RTV and LTV silicones. LTV-602, for instance, is transparent, resilient and very easy to repair, curing in two hours. RTV liquid silicone rubber compounds offer good physical strength, resiliency and a selection of viscosities for impregnation, potting, conformal coatings or sealing.

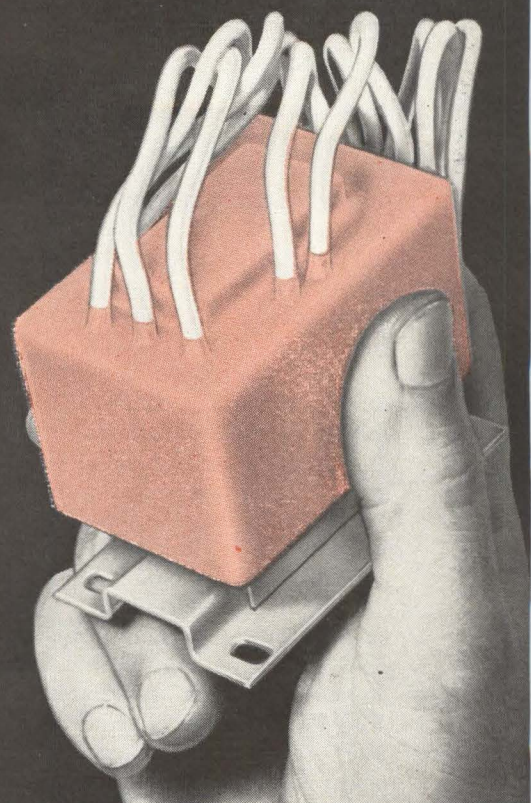
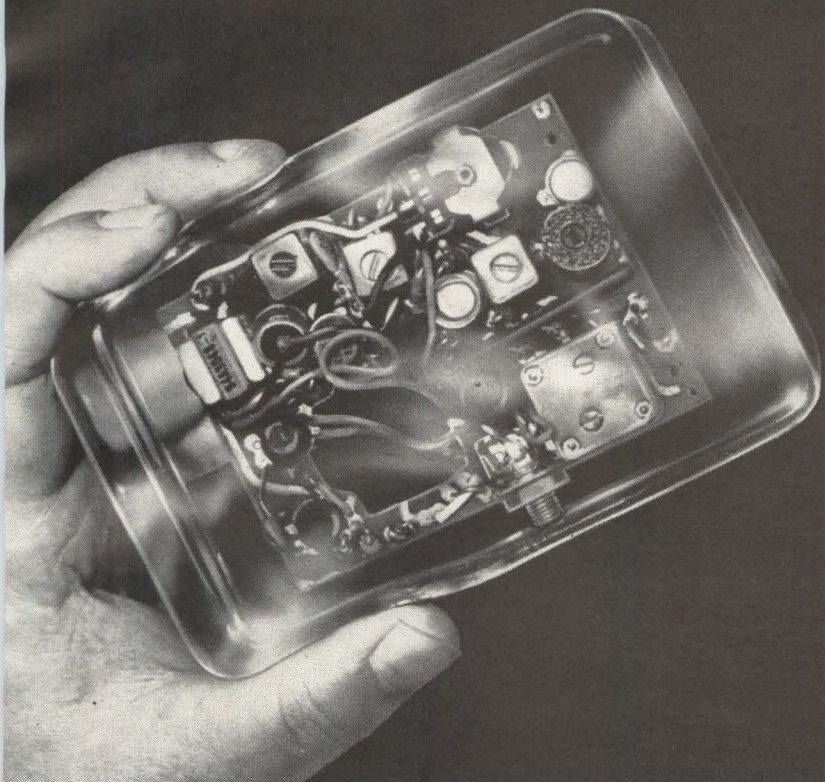

8 fast cures for potting and encapsulating problems

General Electric Silicones protect against temperature, moisture, ozone, thermal and mechanical shock

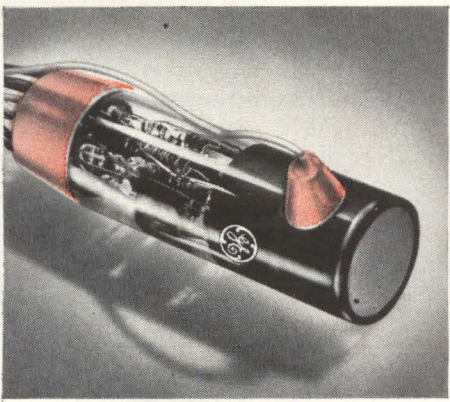

	COLOR	VISCOSITY POISES	CONSISTENCY
LTV-602	Clear	15	Easily Pourable
RTV-11	White	120	Pourable
RTV-20	Pink	300	Pourable
RTV-40	White	450	
RTV-60	Red	550	
RTV-77	White	8,000	Spreadable Thixotropic Paste
RTV-88	Red	10,000	
RTV-90	Red	12,000	Stiff Paste

Why are G-E silicones used? To protect against temperature extremes from -65°F to 600°F . . . to provide a resilient, shock-absorbing cushion for delicate parts . . . for outstanding electrical properties . . . for their very low (0.2%) shrinkage . . . for their resistance to moisture, ozone and thermal shock.

How are G-E silicones used? By dipping, pouring, spraying or buttering. Cure times can be varied from minutes to hours, depending on catalyst used and the heat applied (from room temperature to 125°C). They bond easily to properly primed surfaces, are easily removed from unprimed surfaces.

Which is best for you? G-E encapsulants vary in viscosity from a readily pourable liquid to a thick paste to fit special requirements. Applications range from deep impregnation of transformer coils to caulking of large equipment . . . from printed circuit encapsulation to making flexible molds.

Write for complete data. If you would like a free sample for evaluation, write on your business letterhead describing your proposed application. Section N264. Silicone Products Dept., General Electric Co., Waterford, New York.



Experimental Tube Generates Millimeter Waves

EXPERIMENTAL backward wave oscillator tube indicates that existing microwave concepts can be extended to the millimeter wave portion of the spectrum. The tube, designed for operation at frequencies from 50 to 75 Gc, generated 1.6 watts of c-w output power under laboratory conditions.

It has long been accepted that many interesting and useful systems for research, communications and national defense could be built using the properties of millimeter waves if suitable power sources were available. It has also been assumed that mere extension of existing microwave concepts are entirely inadequate to provide millimeter wave power. Recently it has been shown at Varian Associates, Palo Alto, Calif., that this belief is incorrect. Substantial amounts of c-w power can be generated by judicious extension of present power-tube techniques.

The experiments from which this conclusion was drawn involved testing of the first model of a backward wave oscillator tube. Although the tube was designed to provide one-half watt c-w power in the frequency range from 50 to 75 Gc, it oscillated strongly and generated 1.6 watts c-w in the laboratory tests.

Performance of the experimental tube, designated the VA-171, is shown in Fig. 1. The tube was operated over only part of the desired frequency band because of a faulty ceramic insulator that prevented the application of the full tuning voltage. However, good agreement existed between predicted low-frequency performance and that observed during actual operation. It is therefore reasonable to conclude that subsequent versions of this tube will oscillate at frequencies up to 75 Gc with equal or even greater power output than already obtained.

The significance of the partial success of this tube is that it has given affirmative answers to two basic questions about millimeter-wave power tubes. A small diameter

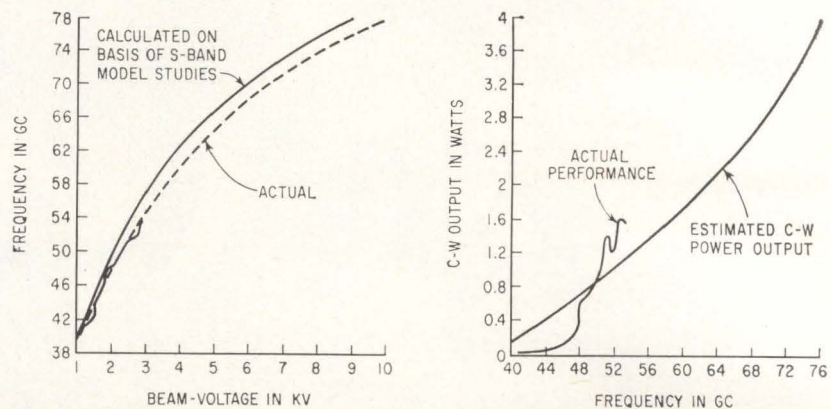

FIG. 1—Frequency as a function of beam voltage is shown at left while at right power output is shown as a function of frequency

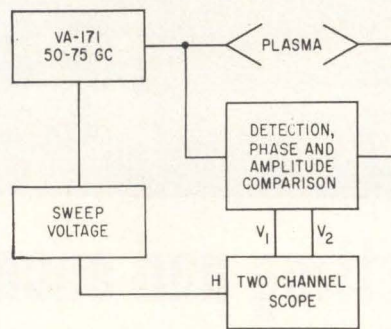

FIG. 2—Typical application of millimeter wave oscillator tube is in plasma profile studies for which a test setup is shown

electron beam can be reasonably well focused at power densities of 10^5 watts per cm^2 ; millimeter-wave circuits capable of withstanding such power densities can be designed and constructed.

Both of these affirmative answers were made possible by extending existing microwave tube techniques. For example, the high density electron beam is the result of an almost direct scale change from a 20-Kw, c-w, X-band klystron amplifier, the VA-849¹ also produced by Varian. The beam, with a diameter slightly more than 0.012 inch, was confined to the center of the interaction structure by a powerful electromagnet in the experiments. However, a permanent magnet is being designed for the tube. Unconventional fabricating techniques made pos-

sible the realization of a quite small circuit with thermal conductivity comparable to that obtained in megawatt klystrons.

Some interesting predictions have been made by Varian based on the results obtained with the VA-171. Since this device is an oscillator having about one-half percent efficiency, an amplifier of 20 percent efficiency using the same electron beam could easily produce more than 40 watts. Such an amplifier would quite probably provide 100 watts in the frequency range from 50 to 75 Gc with 3 to 5 percent bandwidth. The tube would be only slightly more difficult to achieve than the oscillator. Equally possible but requiring more development effort would be a pulsed amplifier to operate at 5 Kw peak and 500 watts average power output. Beamwidth might be 7 percent.

Among the applications of the VA-171 backward-wave oscillator tube will be plasma profile measurements, which will be made for the first time continuously from 50 to 75 Gc. A typical test setup for such studies is shown in Feb. 2. The tube will also be used for parametric amplifiers and masers and to obtain multi-channel communications in the 60-Gc frequency range both above and within the atmosphere.

With sufficient refinements in millimeter-wave oscillators and ampli-

THE
kepco
ABC
REGULATED DC SUPPLY
BEST
INVESTMENT
IN
POWER
SUPPLIES

0-30v dc/0-300 ma—\$119.00

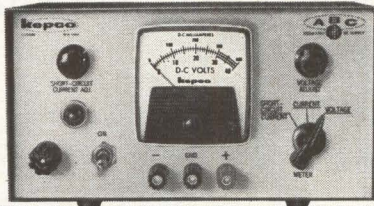

0-40v dc/0-500 ma—\$159.00

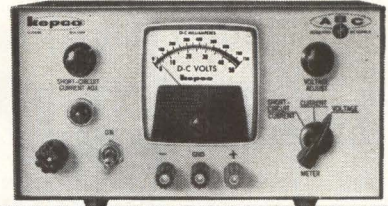

0-30v dc/0-300 ma—\$99.00



OFF
THE
SHELF

REAR VIEW FOR ALL MODELS

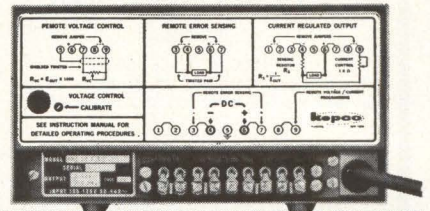

TO YOUR
BENCH

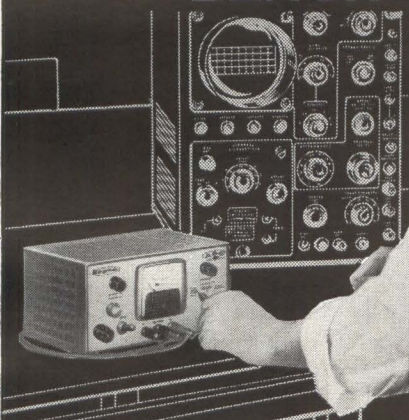

0-7.5v dc/0-2 amp—\$159.00

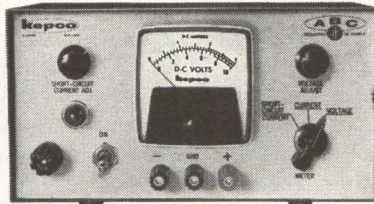

0-15v dc/0-1 amp—\$159.00



OR SYSTEM



MODEL	DC OUTPUT RANGE		DIMENSIONS			PRICE
	VOLTS	CURRENT	H	W	D	
ABC 30-0.3	0-30	0-300ma.	4¼"	8½"	5½"	\$ 99.00
ABC 40-0.5	0-40	0-500ma.	4¼"	8½"	9½"	\$139.00
ABC 7.5-2	0-7.5	0-2 amp	4¼"	8½"	9½"	\$139.00
ABC 15-1	0-15	0-1 amp	4¼"	8½"	9½"	\$139.00

For meter: add suffix "M" to Model No. and \$20.00 to price.
Rack Adapter: Model RA-4 (for 2 units), RA-5 (for 1 unit) available at \$15.00 each.

- 0.05% Line/Load Regulation and Stability
- 0.5 mv (rms) Ripple
- Adjustable Overload Protection (Front Panel)
- Input 105-125v ac, 50-440 cps
- Low Price is achieved by high volume production without sacrifice in quality and reliability.
- Control Amplifier Terminals included for:
 - Remote Constant Voltage Programming
 - Remote Constant Current Programming
 - Remote Error Sensing
 - Complementary Tracking
 - Voltage Compliance Extension
 - Series or Parallel Slave Connections

kepco
inc.

WRITE FOR COMPLETE SPECIFICATIONS

131-48 SANFORD AVENUE • FLUSHING 52, N. Y.
Area Code 212 IN 1-7000 • TWX # NY 4-5196

NEW VERSATILITY IN CONTROL APPLICATIONS

The New All Solid State ERIE MODEL 510 BI-DIRECTIONAL COUNTER



FOR CLOSED OR OPEN LOOP CONTROL OF POSITION, RATE OR SPEED

BUY ONLY THE FEATURES YOU NEED

OPTIONS:

ANTI-COINCIDENCE INPUT
Permits signals to arrive simultaneously on two or more input lines for greater accuracy.

IN-LINE READOUTS
Long life, wide angle NIXIE® tubes available to 8 digits.

ANALOG OUTPUT VOLTAGE
± 5 volts full scale DC or 60 cycle square wave — directly proportional in both magnitude and polarity to the difference count.

OVERFLOW INHIBIT CIRCUIT
Prevents continuation of count beyond + 9's and — 9's.

1-2-4-8 BCD OUTPUT
Permits use of auxiliary equipment, such as digital printers, remote readouts, etc.

The new Erie-Pacific Model 510 Bi-Directional Counter provides a new, convenient concept of digital control in industrial and military systems. This is accomplished through the ability of the counter to count either forward or backward — so that it at all times records the net + or — input supplied by a directional transducer, or the net difference between the inputs of two transducers, where one may provide command data and the other feedback. Applications include raw material processing, high speed rotary machine control, acceleration and velocity measurement, flow process control and many others. Bi-directional counting provides a faster, more efficient and more accurate method for directing these applications.

The new Model 510 is available in a 19" rack mount or industrial case (to 8 digits) and the industrial ½ rack model (to 4 digits). Standard 2 digit basic models begin at \$765.00, with additional digits priced at \$100.00 each. Complete data is available on request.

Quality Where It Counts

**ERIE
PACIFIC** 
Division of Erie
Resistor Corporation
Information

12932 S. Weber Way, Hawthorne, Calif.
ORegon 8-5418 • TWX HAW CAL 4006

fiers like the VA-171, it should be possible to make high resolution radar for amphibious operations, guided missiles, accurate station keeping in fleet formations, position information in helicopter operation, and precision gun and rocket fire control. For these and other special

applications, systems engineers will probably determine the direction of further development by the characteristics they desire in such tubes.

REFERENCES

(1) E. M. McCune, I. Maltzer and L. T. Zitelli, A 20-Kw C-W X-band Klystron Amplifier, *Microwave Jour*, **IV**, p 74, Aug. 1961.

Wire Is Superconducting in Strong Fields

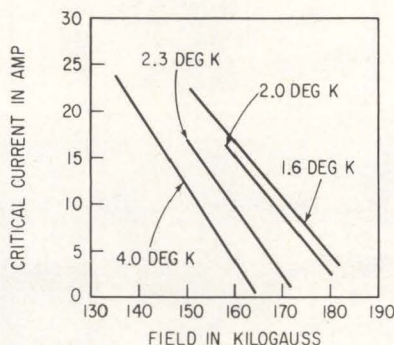

Critical current versus critical field is plotted at different temperatures for niobium-tin

NIObIUM-TIN has been shown to remain superconducting in pulsed magnetic fields up to 185 kilogauss. When extrapolated to zero measuring current, the critical field appears to be about 188 kilogauss at 1.6 degrees K. The investigation of superconductivity was conducted by NBS in cooperation with the department of physics, Univ. of Colo. and sponsored by AEC.

High magnetic fields are required for many scientific and industrial purposes, but the electromagnets generally used to produce them consume large amounts of power. By using superconductivity, strong magnetic fields can be produced with limited power. However, most metals do not remain superconductive when even small magnetic fields exceed a critical value. Development of alloys such as Nb₃Sn has resulted in wires that remain superconducting in strong magnetic fields. (See *ELECTRONICS*, p 9, Feb. 10 and p 96, Nov. 10.)

The niobium-tin wire used in this study was prepared using previously reported procedures¹ except that the wire was swaged rather than drawn to its final diameter of 0.5 mm. Measurements were made with the wire parallel to the field

of a pulsed magnet 6.4 cm long and 1.4 cm in inside diameter. The current and potential leads were left outside the magnet. The wire was immersed in a liquid helium bath, and the magnet was placed in a surrounding bath of liquid nitrogen.

Maximum current applied to the sample was 23 amp; 1,100 amp could be applied to the magnet. The critical field was determined by oscilloscope traces of both magnetic field and voltage across the wire. A transient voltage appears when the field pulse is initiated, and superconductivity is destroyed when voltage returns. A peak magnetic field is reached in 7 milliseconds. Results of measurements are shown in the figure, where critical current is plotted against critical magnetic field at different temperatures.

Eddy-current heating of the sample during the field pulse has been estimated. Above the lambda (2.17 K), the sample might warm as much as 1 degree K, but below this temperature, the rise should be less than 0.5 degree K. Attenuation of the pulsed field through the sheath was found to be negligible.²

Using niobium-tin wire in superconducting magnets requires knowledge of the critical field transverse to current flow, rather than parallel to it, as it was in these experiments. Therefore, the experiments will continue to observe transverse critical fields. Materials other than Nb₃Sn, such as solid solutions of NbZr, are being studied for possible use in superconducting magnets.

REFERENCES

(1) J. E. Kunzler, E. Buehler, P. S. Hsu and J. H. Wernick, Superconductivity in Nb₃Sn at High Current Density in a Magnetic Field of 88 Kilogauss, *Phys Rev Letters*, p 89, 6, Feb. 1, 1961.
(2) A. M. Kosevich, *J Theor Phys USSR*, **33**, p 735, 1958, Translation: *Soviet Phys—JETP*, **6**, p 564, 1958.

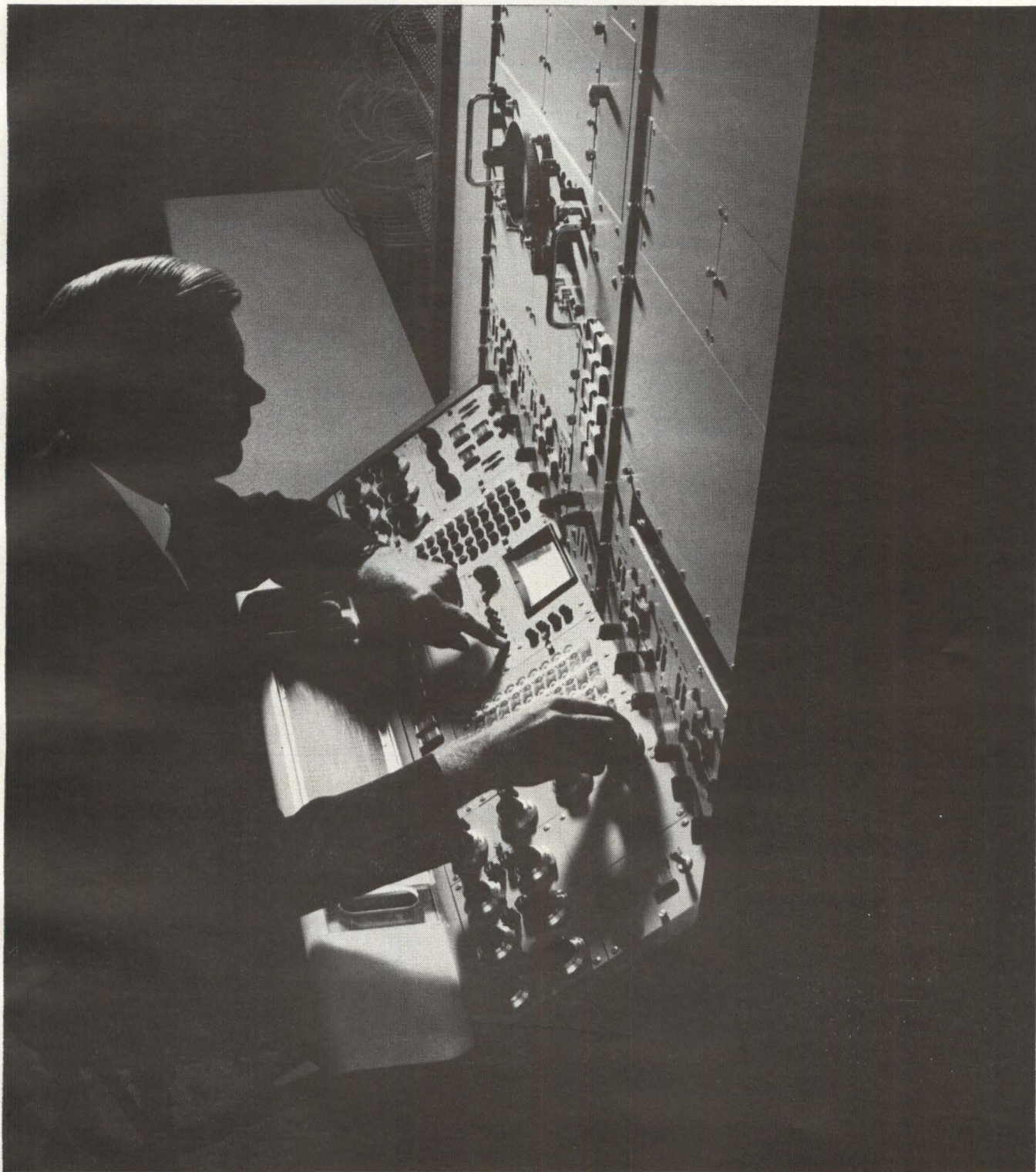

BROADEST POSSIBLE MATHEMATICAL FLEXIBILITY is now available in the new 2100 series EASE® Analog Computer. Iterative (IDA™) or non-iterative (ELDA™) operation in same machine. Up to 36 different asynchronous computing groups. Pinboard control. True modular, centralized operation. This is just a suggestion of the many innovations which make this the most flexible and complete simulation tool ever offered. Our brochure A2100 has all the facts.

See Us at IRE Booths 3515-17

Beckman®

INSTRUMENTS INC.
BERKELEY DIVISION
RICHMOND, CALIFORNIA

G-20

CERAFIL... SMALLEST CERAMIC CAPACITORS AVAILABLE



...offer extremely high capacities per unit volume

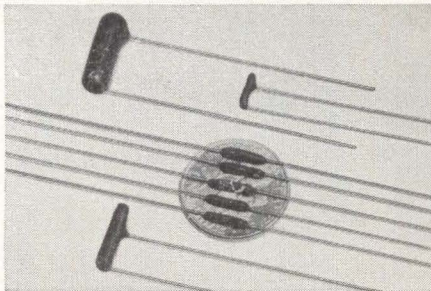

Aerovox Cerafil capacitors are the smallest ceramic capacitors available anywhere. Now, 15 new stock values are added to the line, with 29 values in each type. These rugged units range in capacity from 10 mmf to .1 mfd in the standard stock values. Sizes range from .090 x .320 inches for smallest capacity to .310 x .750 inches for largest capacity. Reliability has been proven in many critical computer and missile applications. Meet or exceed MIL-C-11015B. Type C80V made in radial and axial leads durez dipped.

ELECTRICAL SPECIFICATIONS

VOLTAGE — 100 VDCW; 300 VDCT.
TEMPERATURE COEFFICIENT (–55°C to +85°C).
No voltage +10% to –15%.
100 volts applied +10% to –35%.
OPERATING TEMPERATURE —
–55°C to 85°C at 100 volts
–55°C to 125°C at 50 volts

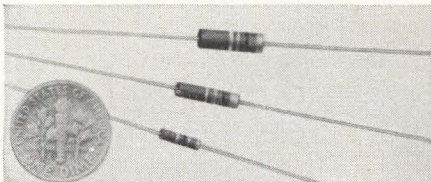

AXIAL LEAD MOLDED TYPES AVAILABLE

The rugged epoxy encapsulation and uniform dimensions make the molded Cerafil capacitors ideal for automated assembly operations of transistorized circuits. Type MC80A units meet or exceed MIL-C-11015B.

FOR PROMPT, OFF-THE-SHELF DELIVERY AT OEM PRICES

call your local Aerovox Industrial Distributor. He can deliver your prototype, maintenance and small production quantities when you need them. Write today for the name of the Aerovox distributor serving your area. For full technical data on

Cerafil capacitors ask for a copy of Bulletins NPJ-119 and NPJ-120.



AEROVOX CORPORATION
DISTRIBUTOR DIVISION NEW BEDFORD, MASS.

Compact, low-power-consumption, precision ovens for crystals, components, circuitry. Write for Data Sheets S1 and S125. James Knights Company, Sandwich, Illinois.

JAMES KNIGHTS CRYSTAL AND COMPONENT OVENS



CIRCLE 202 ON READER SERVICE CARD



Write for our catalogue

Good parts work best!

Intermediate Frequency Transformer IFT



The high standards of MITSUMI electronic components are insured by a fully-automated assembly system, and double-checked by rigid quality controls. Mitsumi Electric Company is Japan's largest manufacturer of components for radio, television and communications equipment.

POLYVARICON Variable Capacitor



MITSUMI PARTS

MITSUMI ELECTRIC CO., LTD.
Komae, Kitatama, Tokyo



CIRCLE 203 ON READER SERVICE CARD
electronics

Regulator Diodes—useful devices in electronic circuits

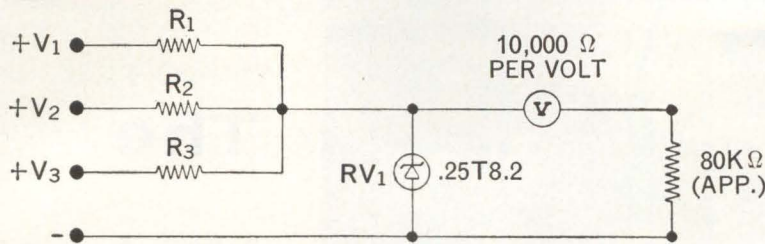

PROTECTION OF DC METER MOVEMENTS

R₁, R₂, and R₃—Meter Multipliers.
RV₁—Sarkes Tarzian Type .25T8.2 Regulator.
V=100 Microampere Meter Movement.

PROTECTION OF AC METER MOVEMENTS

R₁, R₂, and R₃—Meter Multipliers.
RV₁—Sarkes Tarzian Type .25T6.2 Regulators.
V=1 Milliampere Meter Movement.

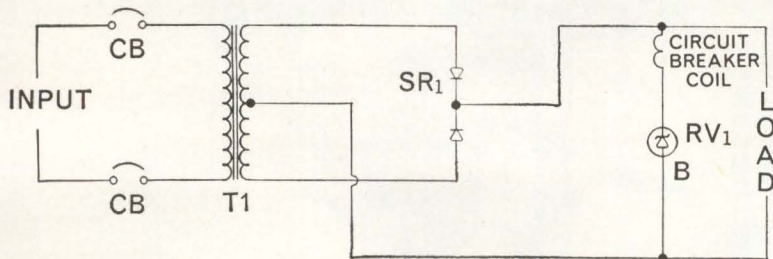
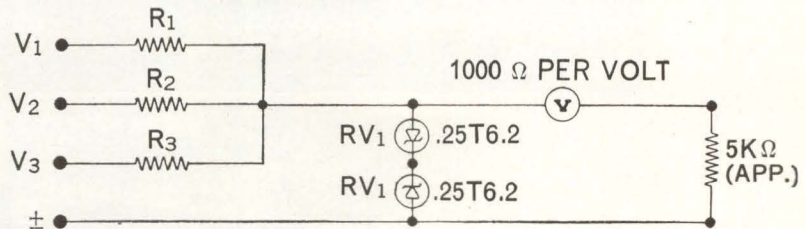

OVERVOLTAGE PROTECTION FOR SENSITIVE LOADS

RV₁—Selected to Avalanche at Critical Voltage and Cause Circuit Breaker to Open.

Not too long ago, the regulator diode (Zener) was considered a “luxurious” component, to be used only in the most sophisticated circuit. Progress in processing techniques and predictable voltage yields has made almost any application economically practical. The small size, inherent ruggedness, and physical simplicity of these devices—and their clipping, limiting, and protecting functions—can now be put to work widely.

The four applications shown here, while typical, can only suggest the usefulness of the silicon voltage regulator. We hope they will also suggest some useful answers to your problems, or new ways to improve reliability and performance. Our new catalog, 61-VR-11, contains data on five Tarzian series of silicon voltage regulators, plus design and test information. We will include prices. (You may be pleasantly surprised!) Prompt engineering service is also available.

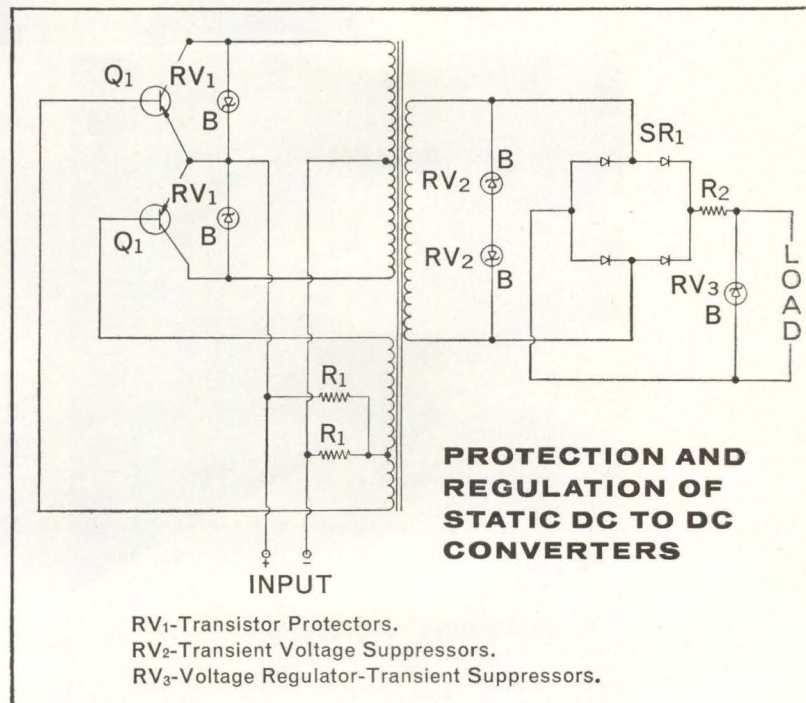

PROTECTION AND REGULATION OF STATIC DC TO DC CONVERTERS

RV₁—Transistor Protectors.
RV₂—Transient Voltage Suppressors.
RV₃—Voltage Regulator-Transient Suppressors.



SARKES TARZIAN, Inc.

World's Leading Manufacturers of TV and FM Tuners • Closed Circuit TV Systems • Broadcast Equipment • Air Trimmers • FM Radios • Magnetic Recording Tape • Semiconductor Devices

SEMICONDUCTOR DIVISION • BLOOMINGTON, INDIANA

In Canada: 700 Weston Rd., Toronto 9 • Export: Ad Auriema, Inc., New York

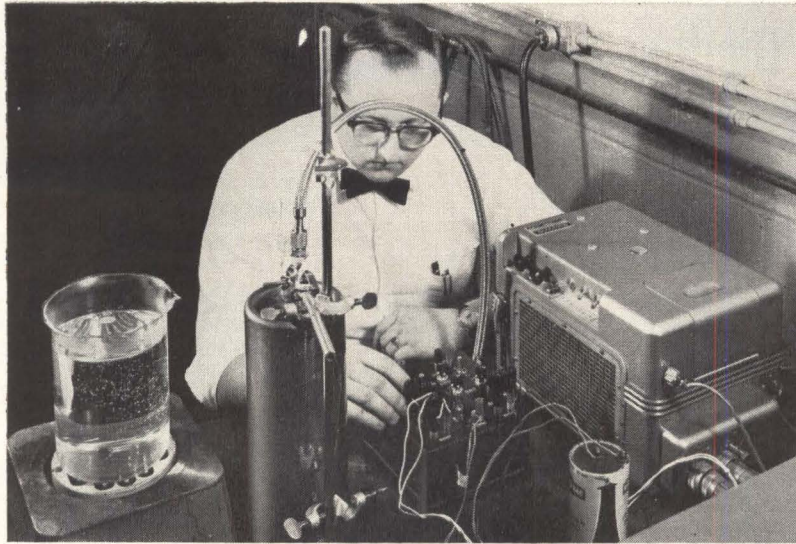

The Visicorder

1

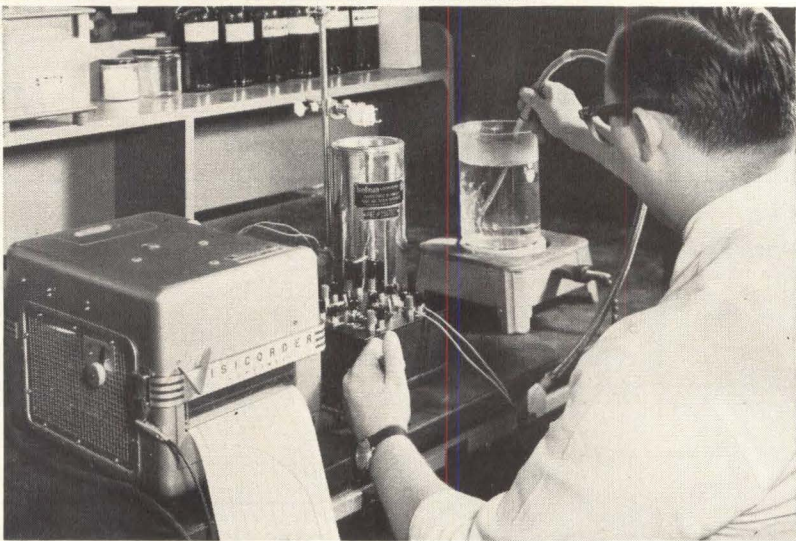

2

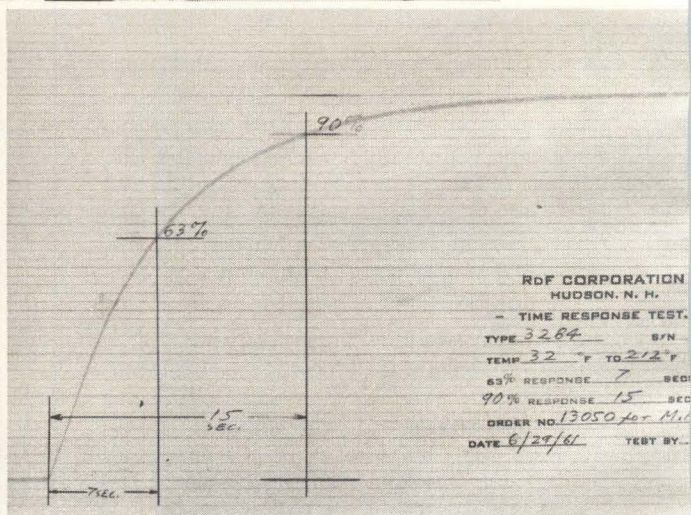
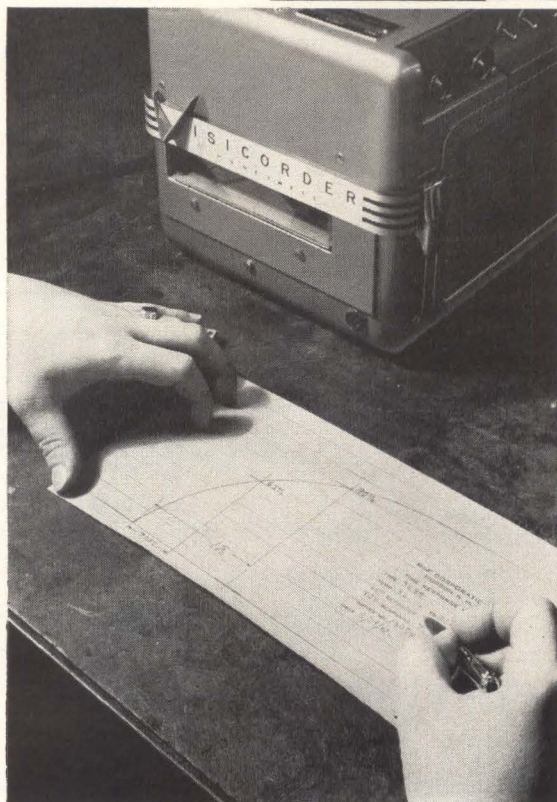

3

4

Oscillograph directly records transducer temperature response

A Type RN-100 "Stikon" temperature transducer, one of many types manufactured by the RdF Corporation of Hudson, N.H., is being tested for quality in this photo-story.

The tiny nickel grid inside the transducer—only .0007 in diameter—must be completely bonded to its silicone rubber carrier matrix. If the metal-to-silicone bond is not adequate and there is a free space between, the response of the transducer to a step change in temperature is seriously changed.

Test-proved performance of these RdF products is mandatory because inconsistencies in time response can mean failure to every mission where fast action is important.

To test the quality of this bond formed during manufacture, RdF uses a Visicorder Oscillograph.

Figure 1 shows an RdF quality control engineer immersing the transducer in an ice bath. Figure 2 shows immersion in boiling water. Figure 3 shows analysis of the response curve

that results from the step-change in temperature. Figure 4 is a closeup of the Visicorder record, which indicates that the transducer met the specified time response to the temperature change. The metal-to-silicone bond was adequate.

In countless applications, Visicorder Oscillographs can give you as many as 36 simultaneously recorded channels of information about your products—on instantly readable records, at frequencies from 0 to 5000 cps.

For details write Minneapolis-Honeywell, Heiland Division, 4800 E. Dry Creek Road, P. O. Box 8776, Denver 10, Colorado.

Honeywell



First in Control

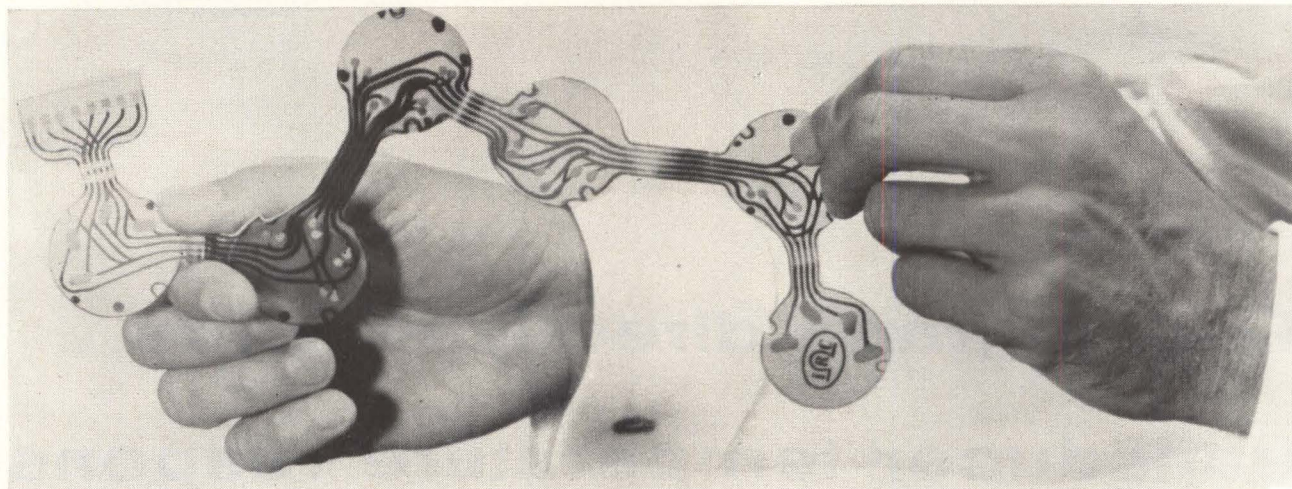

Layers of etched cable fold together, become compact wiring circuit for small switch used in a projectile. Hi-G switch in which this circuit is used, withstands 15,000 times the force of gravity

Applying Flat Wires and Cables

SPECIFIC USES IN MODERN ELECTRONIC CIRCUITS

By **GEORGE E. METTER**

Senior Applications Engineer,
International Resistance Co.,
Philadelphia

DESIGN ADVANTAGES offered by flat wires and conductor cables were outlined last week, (see **ELECTRONICS** p. 60 Feb. 16). Configurations now available are being specified and custom-designed in missile, rocket and satellite systems (Minuteman, Titan, Echo, Tiros,

Polaris), ground support equipment for defense and weapons systems, computers, test equipment, telephones and communications systems, instrument and controls, airborne electronics and wiring harnesses for various other applications.

Designers for these systems find that flat conductor cabling can solve complex wiring and interconnection problems, with imagination

increasing the scope of applications.

In the Hi-G switch shown, (bottom, left), the layers of cable are constructed with Kel-F insulation, chosen for its abrasion resistance. Where the cable is later fabricated to cast Kel-F housings, which enclose metal actuators, the cable layers are heat bonded to form a rigid area. The leads between the three components are left unbonded for flexibility. The halves of the cast housings are assembled with the etched cable using an adhesive at the same area of the cable which was formerly heat bonded.

Mylar is used as the insulating film for the two flexible etched cables used in airborne instrumentation. Pads are solder plated to facilitate assembly, and are precisely located. Final assembly is accomplished by dropping the cable unit over conductor pins and hand soldering.

In a key ICBM component, also using Kel-F insulation, certain pads of the etched cable are exposed on one side cable, others are open on the reverse side. Gold-plated pads are of different sizes with holes precisely located so that the cable unit will easily slip onto pins of mated

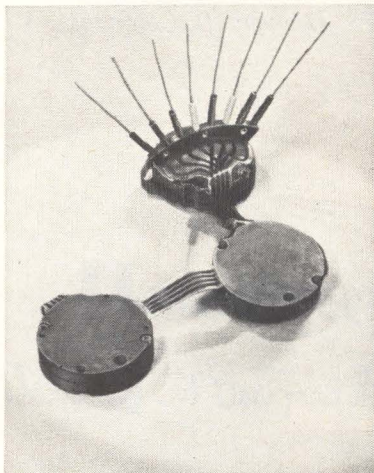

Etched cable (top of page) is installed in this Hi-G switch. Note flexible connections

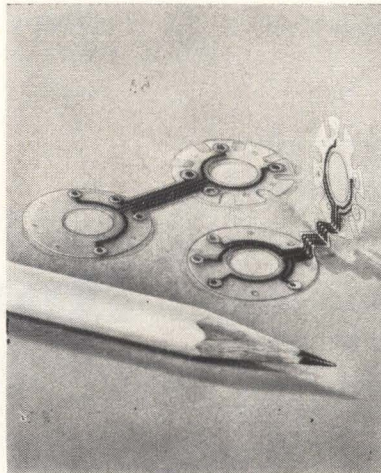

Flexible etched cable used in aircraft instrumentation improves reliability, saves space and weight

another *PEP device from General Electric

2N914

the *ultra-fast* 2N914 silicon transistor featuring:

$$t_{\text{total}} = 80\text{nsec}$$

$$V_{\text{CE}}(\text{sat}) = 0.25\text{V max.}$$

$$(I_{\text{C}} = 10\text{ mA}, I_{\text{C}} = 1\text{ ma to } 20\text{ ma}, T_{\text{A}} = -55^{\circ}\text{C to } +125^{\circ}\text{C})$$

$$I_{\text{CBO}} = 25\text{mua}$$

$$(V_{\text{CB}} = 20\text{V}, I_{\text{E}} = 0)$$

$$h_{\text{FE}} \text{ at } -55^{\circ}\text{C} = 12\text{min.}$$

$$(I_{\text{C}} = 10\text{ ma}, V_{\text{CE}} = 1.0\text{V})$$

MORE THOROUGHLY CHARACTERIZED FOR INCREASED CIRCUIT DESIGN FLEXIBILITY

The new PEP 2N914 combines low leakage, low capacitance, low $V_{\text{CE}}(\text{sat})$, high voltage and ultra high speed in a TO-18 package to give optimum switching speed in logic circuits such as flip flops, counters, multivibrators and memory or line drivers. Thorough specifications (over 17 curves on spec sheet) reflect the outstanding characteristics of 2N914, and offer unprecedented design flexibility.

PEP transistors in the 2N2192-2195 and "A" series (TO-5 package) can replace standard units without basic circuit changes. PEP diodes feature controlled conductance and ultra-fast switching over a wide current range. Ask your G-E District Sales Manager. Or write Semiconductor Products Department, Section 16B121, General Electric Company, Electronics Park, Syracuse, New York. In Canada: Canadian General Electric, 189 Dufferin Street, Toronto, Ontario. Export: International General Electric, 159 Madison Ave., N.Y. 16, N.Y.

* **Planar** for uniformity of initial characteristics

Epitaxial for low saturation resistance

Passivated for parameter immobility with life

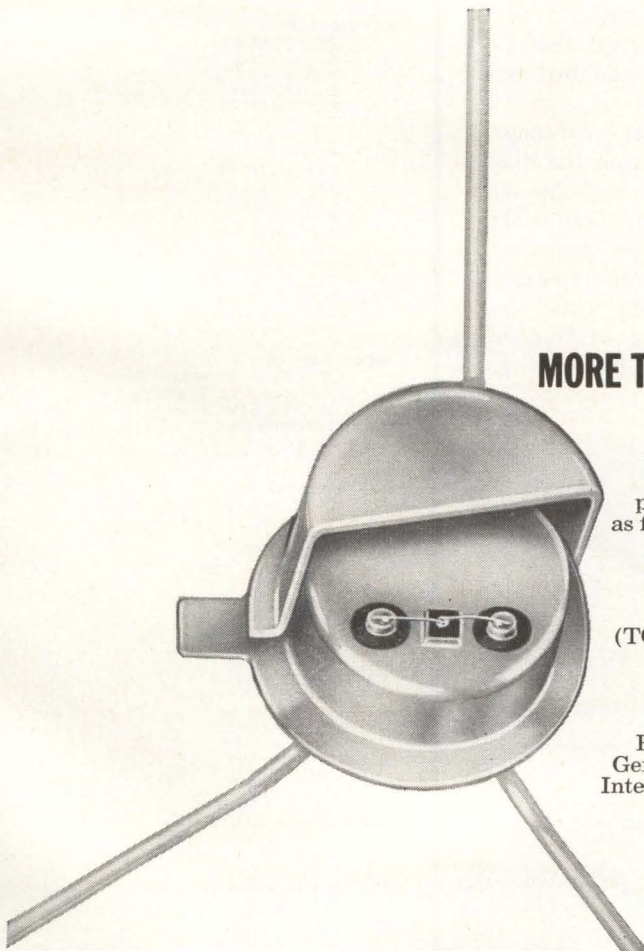

AVAILABLE THROUGH YOUR G-E SEMICONDUCTOR DISTRIBUTOR

GENERAL  **ELECTRIC**

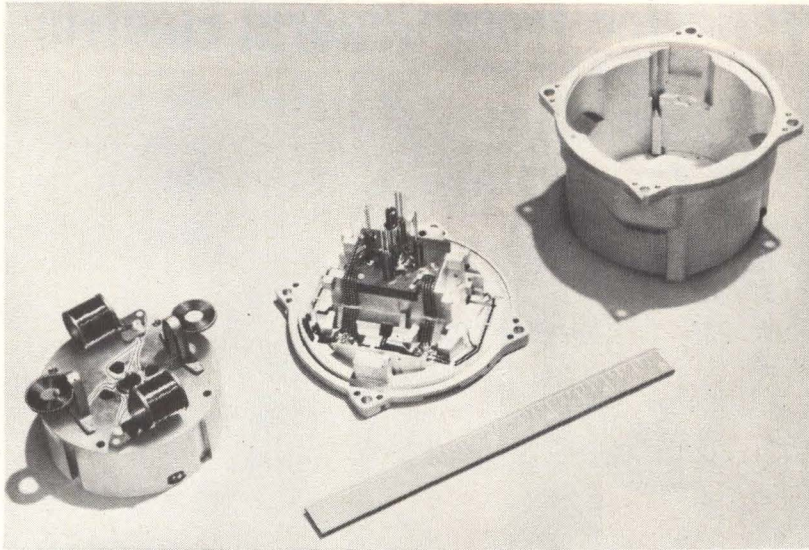

Missile system designed with etched cable. Flat wires drape neatly between components, slip onto mating elements exactly

elements in the assembly. Hand soldering completes the electrical connections. In a telephone relay, Lamoflex cable is used to connect a relay stack to internal header pins with significant size reduction of the relay. Cable for this application is constructed with 4-ounce oxidized copper and bonded with Mylar thermoplastic insulation. Cable is furnished in two portions which fit one on top of the other—a high density wiring system replacing 21 round wires. Assembly of this mass of conventional round wire was tedious, with risk of wire breakage and pulled connections.

In another application (see photo below, right), a strip of etched cable is used to test computer cir-

cuits. The flexible sheet is folded around the module board to be tested. Phosphor bronze conductors, arranged in a high-density array, are exposed on both sides through discrete insulation windows to pick up connections at the chassis socket. Cooling-air flow patterns are not disturbed, circuit electrical characteristics remain fixed, and test results are meaningful.

Each conductor in the extender strip becomes a lead from the hidden panel connection to the exposed front of the equipment. Test leads are attached to the extender through a printed-circuit connector and readings are taken while the module is functioning. Extender is used for repeated monitoring.

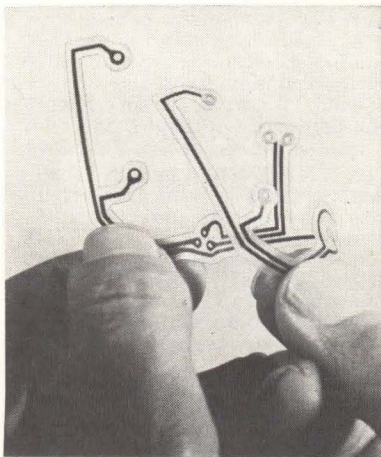

Wiring units for ICBM component

Flexible strip folds around module, permits in-place testing of printed circuit boards in operating position

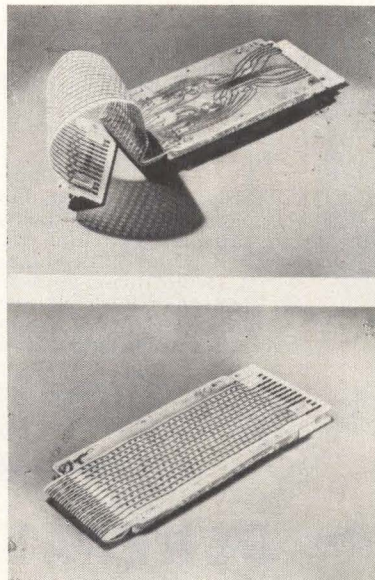

ASTRON INDEX of Sales Representatives

HENRY ABBOTT

3939 Wicks Avenue
Seaford, N. Y.
SUset 1-5256

ARTHUR E. AKEROYD COMPANY

70 Reservoir Road
Chestnut Hill 67, Mass.
REgent 4-2433

A. H. BRUNING CO.

4120 W. Peterson Ave.
Chicago 46, Illinois
AVenue 2-5171-72 & 73
Branch Office

WILLIAM H. DEAN

7110 W. Chambers St.
Milwaukee, Wisconsin
HILLtop 8-8701

PAUL HAYDEN ASSOCIATES

P. O. Box 331
East Point, Georgia
POplar 6-0261 (Atlanta)

Branch Office

MR. ART MAYO

101 W. Underwood St.
Orlando, Florida
GARden 5-8273

INTERNATIONAL RESISTANCE CO.

6020 West Diversey Avenue
Chicago 39, Illinois
889-5800

KAY SALES CO.

2600 Grand Ave.
Kansas City 8, Missouri
BALtime 1-6733

Branch Offices

KAY SALES CO.

7601 Forsyth
Clayton 5, Missouri
PARkview 7-3414

KAY SALES CO.

4407 S. Peoria
Tulsa, Oklahoma
RIVERSide 3-2919

KAY SALES CO.

2702 41st Street Place
Des Moines, Iowa
BLACKburn 5-4584

BILL KOLANS & CO.

219 California Drive
Burlingame, California
DIAMond 4-7111

NICK J. LAUB CO.

3749 W. Broadway Ave.
Minneapolis 22, Minnesota
JUNIPER 8-4663

HARRY LEVINSON CO.

1211 E. Denny Way
Seattle 22, Washington
EASt 3-5100

R. S. LOHMANN CO.

21501 W. Seven Mile Road
Detroit 19, Michigan
535-6144

LES A. MORROW CO.

530 Sixth Avenue
Pittsburgh 19, Pa.
EXpress 1-1120

NEEDLER SALES CO.

Station C, Box 2407
Fort Wayne 6, Indiana
HARRison 9726

J. Y. SCHOONMAKER CO.

5328 Redfield Avenue
P.O. Box 35266
Dallas 35, Texas
MElrose 1-8480

H. H. SEAY COMPANY

3850 Fairlington Drive
Columbus 21, Ohio
HUDson 8-9994

SHEPARD-WINTERS COMPANY

3193 Cahuenga Boulevard
Hollywood 28, California
HOLLYwood 6-2171

THATCHER ELECTRONICS

1003 Saturn Drive
Colorado Springs, Colorado
MElrose 3-2050

ASTRON

For representatives in other areas contact
Astron Corporation

CIRCLE 66 ON READER SERVICE CARD
electronics

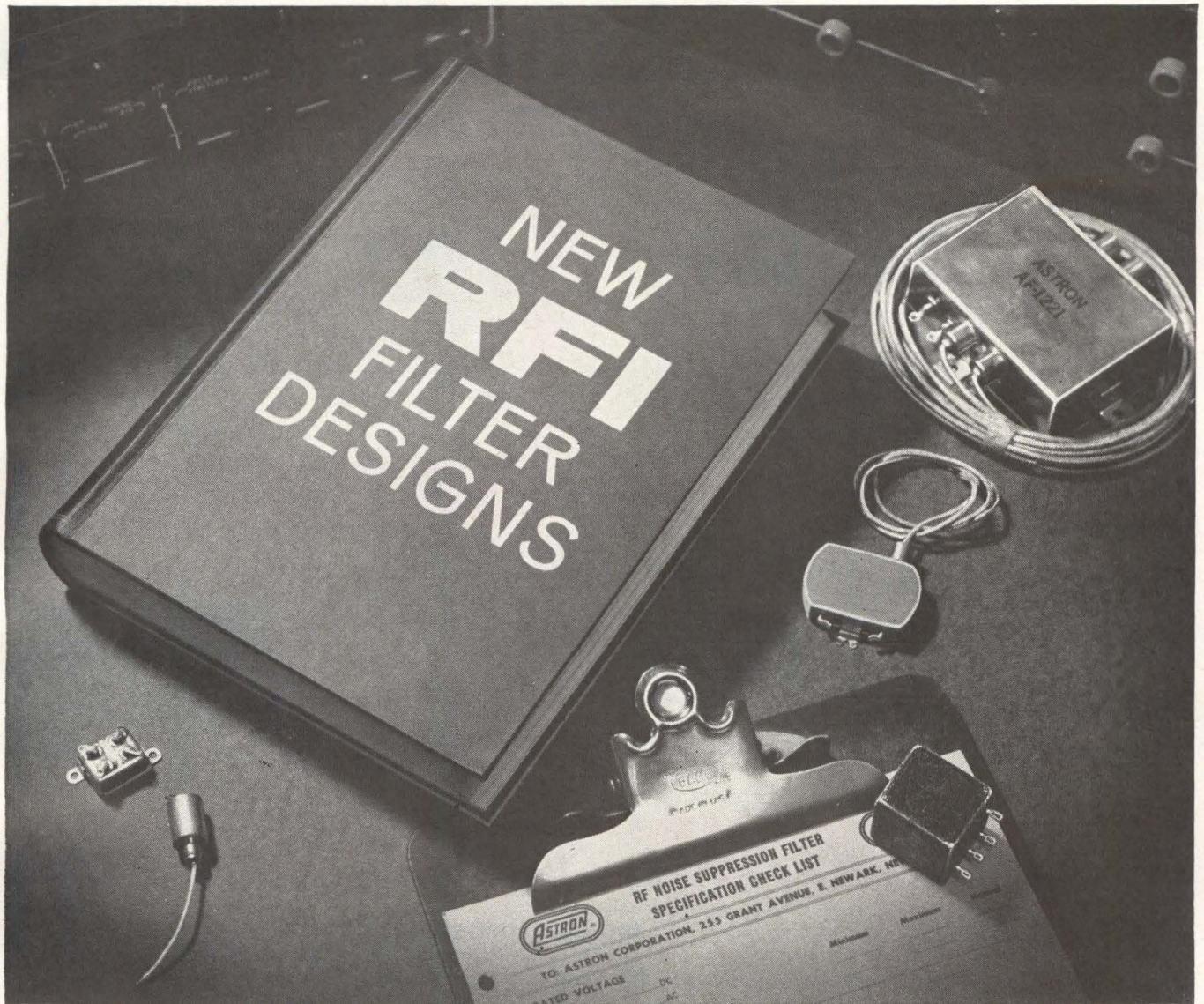

ASTRON wrote the book

- The book is our binder of original RFI filter designs. Over 3,000 of them. A highly condensed résumé of **engineering and product experience**.
- Astron's long-range **record of valuable engineering achievement** grew up with the RFI problem itself. This experience means an immediate start on the **hard core** of your RFI design challenges.
- Astron skills handle a multiplicity of circuits... **micro-miniaturization**... meet and surpass MIL-F-15733 and MIL-C-11693 B specs. Extensive know-how plus a unique combination of advanced test equipment and manufacturing facilities means **rapid service and reliable performance**.
- **For a fast start** on meeting your RFI filter requirements, Astron offers you Technical Bulletins on standard filters for immediate use at pre-design stages... plus a comprehensive and definitive catalogue for all applications.
- **Tell us what you need.** It's our business to supply it. **Write now.**

ASTRON
CORPORATION
257 Grant Avenue • East Newark, New Jersey



CHOOSE FROM THE MOST COMPLETE

Switching Applications

Complementary logic and switching series. TO-5 package. Base common to case. 150 mw free air 300 ma max

		h _{FE} at 1v, 10 ma					
		20 min	40-200	60-300	80 min		
BV CBO	25	NPN	2N1302	2N1304	2N1306	2N1308	BV EBO
	30	PNP	2N1303	2N1305	2N1307	2N1309	
		typ fhfb	4.5mc	8mc	12mc	20mc	

PNP low-level logic and switching series. TO-5 package. All leads isolated. 150 mw free air 400 ma max Guaranteed switching times.

		h _{FE} at 0.25v, I _B = 1 ma			
		30-60	40-80	60 min	
BV CBO	30	2N426	2N427	2N428	BV EBO
		typ fhfb	6mc	10mc	

General purpose logic and switching series. TO-5 package. Base common to case. 150 mw free air 300 ma max. *All leads isolated. **200 ma max

		h _{FE} at .15v, 12 ma		h _{FE} at .5v, 30 ma		
		30 min		60-180		
BV CBO	25	PNP	2N404*			BV EBO
	25	PNP	2N1404			
	25	NPN	2N1808			
	25	NPN	2N1605			
	25	NPN		**2N388		
		typ fhfb		12mc	15mc	

PNP general purpose logic and switching series. TO-5 package. Base common to case. 150 mw free air 250 ma max

		h _{FE} at 1v, 10 ma			
		20-150	30-150	40-150	
BV CBO	30	2N395	2N396	2N397	BV EBO
		typ fhfb	4.5mc	8mc	

Bi-Directional Switching Applications

NPN Bi-directional switching series. TO-5 package. Base common to case. 150 mw free air 300 ma max

		FORWARD AND INVERTED h _{FE}						
		at 3.2v, I _B = 1 ma			at 1v, 10 ma			
		20 min	35 min	50 min	15 min	25 min	35 min	
BV CBO	20	2N594	2N595	2N596			2N1996	BV EBO
	25					2N1995		
	30				2N1994			
		typ fhfb	8mc	11mc	13mc	8mc	11mc	13mc

Over 75-million devices delivered
You can rely on TI Alloy

- HIGH RELIABILITY
- ECONOMICAL PRICES
- PROMPT DELIVERY
- COMPLETE SERVICE

#18788

CIRCLE 68 ON READER SERVICE CARD

Use the parameter charts above for easy selection of the best TI germanium alloy transistor for your circuit requirements. Grouped by application for easy reference, you will find the full TI line offers the broad range of devices necessary to fit almost every design need. In addition, TI's engineering and production capabilities can provide special devices tailored to your specific requirements.

TI germanium alloy transistors deliver a level of reliability that has been achieved through unmatched experience... over 75-million devices delivered. Reliability is built into each device through rigid

TRANSISTOR
PRODUCTS
DIVISION



TEXAS

GERMANIUM ALLOY LINE IN THE INDUSTRY

Medium Power Applications

PNP medium power series.
TO-5 package.
All leads isolated.
250 mw free air
500 ma max

		h _{FE} at 1v				
		40-200 at 100ma	70-225 at 100ma 50-160 at 200ma	100-350 at 100ma 75-250 at 200ma		
BV _{CBO}	45	2N1997			45	
	35		2N1998		30	
	30			2N1999	20	
	typ fhfb 6mc		10mc	17mc		

PNP medium power series.
TO-5 package.
Base common to case.
300 mw free air
1 amp max

		h _{FE} at 0.5v, 500 ma			
		50-300	60 min		
BV _{CBO}	50	2N2000		20	
	30		2N2001	20	
	typ fhfb 4mc		9mc		

Amplifier Applications

PNP small signal amplifier series.
TO-5 package.
All leads isolated.
150 mw free air
150 ma max
*200 mw free air
*200 ma max.

		h _{FE} at 1v, 50 ma			
		30-150	50-150		
BV _{CBO}	15	2N1273		10	
	25	2N1274	2N1370	10	
	45		2N1371	10	
	25	2N1383*	2N1382*	15	
typ fhfb 5 mc		7 mc			

PNP small signal amplifier series.
TO-5 package.
All leads isolated.
250 mw free air
200 ma max

		h _{FE} at 1v, 50 ma						
		30-90	50-150	75-150	95-300	30-300		
BV _{CBO}	25	2N1372	2N1374	2N1376			15	
	45	2N1373	2N1375	2N1377			25	
	12				2N1378	2N1380	7	
	25				2N1379	2N1381	15	
	typ fhfb 6mc		8mc	10mc	13mc	11mc		

High-Frequency Amplifier Applications

DALMESA PNP high frequency amplifier series.
SO-2 package.
All leads isolated.
125 mw free air
30 ma max
1.5 db typ N.F. at 1 mc.

		h _{FE} at 6v, 2 ma			
		40-180	60-200		
BV _{CBO}	40	2N2188	2N2189	2	
	60	2N2190	2N2191	2	
	typ fhfb 125mc		150mc		

process control, and tested by TI's independent and highly experienced Quality and Reliability Assurance department.

Highly mechanized production lines are another reason for the extra reliability of TI transistors. Unique automatic equipment, much of it designed and built by TI's Mechanization department, means lower cost. And... continuous production provides you with quick delivery from a source of supply you can count on. Whether your design requirements are industrial or military, there is a TI Germanium Alloy Transistor available to fit your needs. For complete information call your nearest TI Sales Office and Authorized TI Distributor, or fill out and mail the coupon at right.

INSTRUMENTS
INCORPORATED
13500 N. CENTRAL EXPRESSWAY
P. O. BOX 5012 • DALLAS 22, TEXAS

The following TI alloy transistors meet military requirements
2N388 Meet MIL-T-19500/65 (NAVY) 2N404 Meet MIL-T-19500/20 (USAF),
2N1302 Series and 2N1303 Series Meet MIL-S-19500/126A.

Alloy Transistor Department
Texas Instruments Incorporated
P. O. Box 5012 — Dallas 22, Texas

Gentlemen:

Please send me the following data sheets on TI Germanium Alloy Transistors: (Specify device numbers) _____

Please send me reprints of this ad (number reprints requested) _____

Name _____ Title _____

Company _____

Address _____

City _____ State _____

CIRCLE 69 ON READER SERVICE CARD

NEW DIMENSIONS IN RELIABILITY

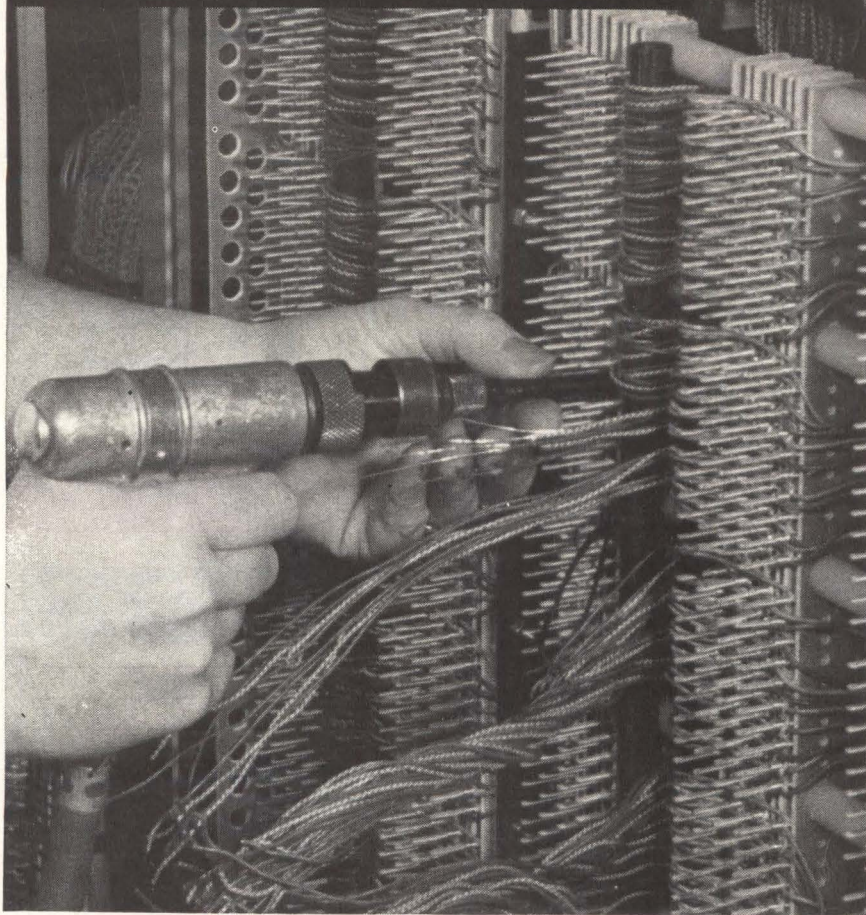

**Permanent, solderless connections
in ONLY THREE SECONDS**

... that's the solderless wrapping method—proved superior by leaders in communications and electronics. What's the proof? Over a billion connections without reported failure.

And the best way to make these connections is with Gardner-Denver "Wire-Wrap"® tools. Every bit is individually tested and inspected—every bit is individually packaged in a plastic tube. And only Gardner-Denver makes a complete line of this type equipment.

Write for Bulletin 14-1.

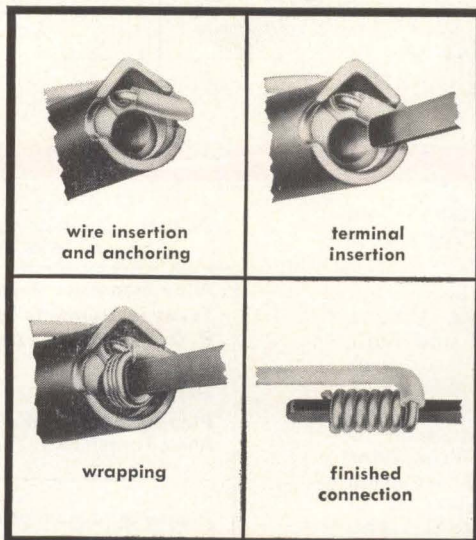

EQUIPMENT TODAY FOR THE CHALLENGE OF TOMORROW

GARDNER - DENVER

Gardner-Denver Company, Gardner Expressway, Quincy, Illinois

In Canada: Gardner-Denver Company (Canada), Ltd., 14 Curity Ave., Toronto 16, Ontario



"The light touch . . .
in automation and control"

... the
CLAIREX
Photoconductor

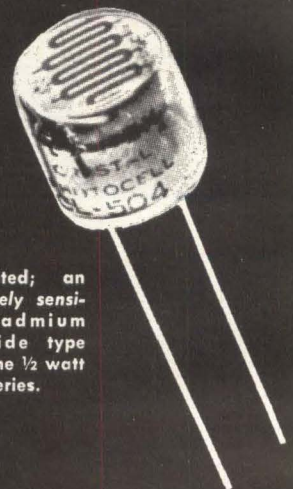

Illustrated; an extremely sensitive cadmium selenide type from the 1/2 watt 500 series.

A
Circuit
Component
Controlled by
LIGHT

For tabulated technical data on 25 different Clairex Photoconductors consult your new

- IRE Directory
- Electronic Buyers Guide
- Electronic Design Catalog
- Radio Electronic Master

CLAIREX
CORPORATION

"See us at the IRE Show, Booth 1113"

CIRCLE 204 ON READER SERVICE CARD
CIRCLE 71 ON READER SERVICE CARD→

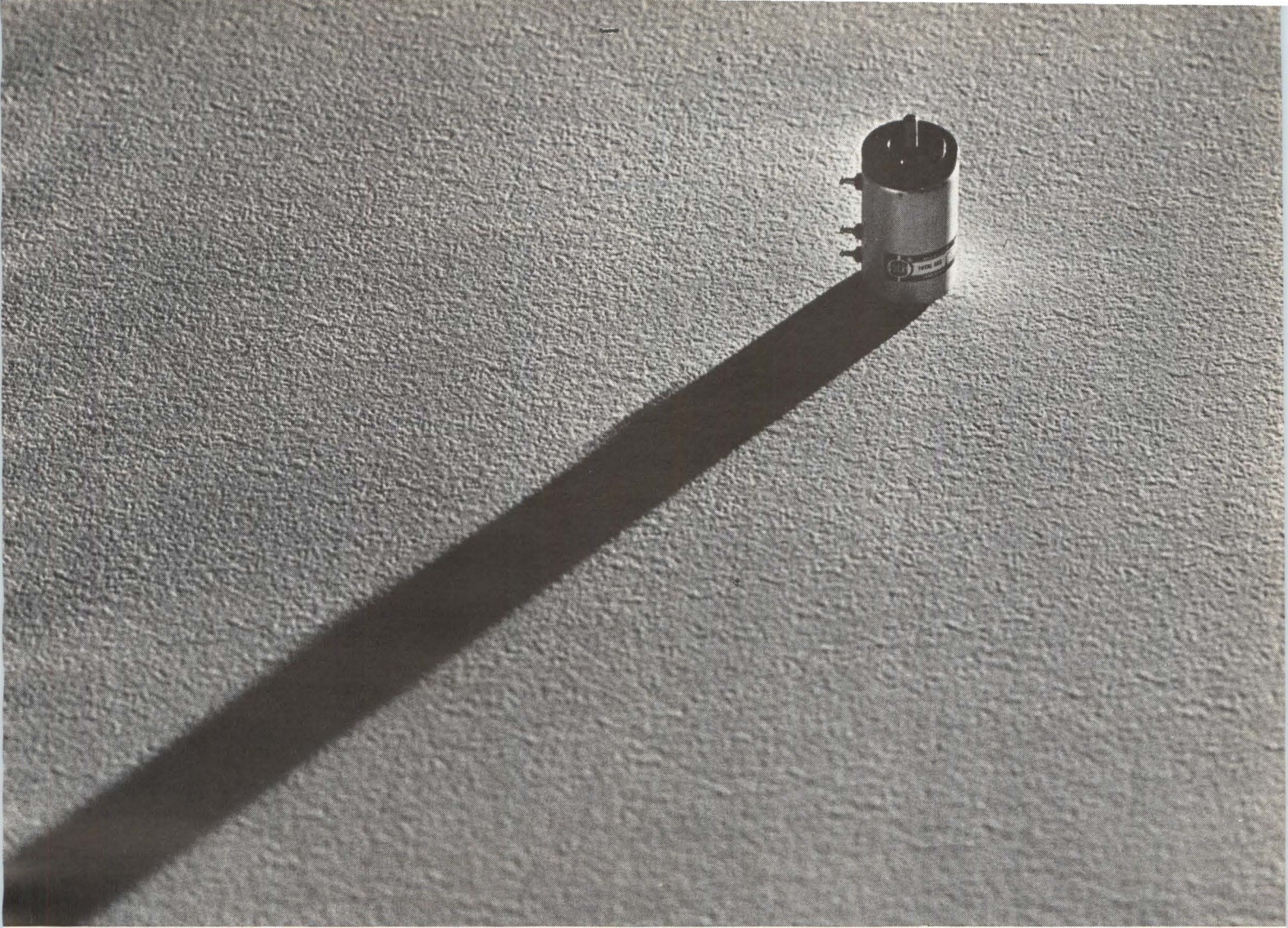

How "complete" is a complete line?

Are you as confused about all this complete line talk as we are? What, for example, is a "complete" potentiometer line? This *should* include everything from the *cheap-and-dirty* kind you'll find on a bargain table-radio to the ultra-accurate precision type shown above. By such reckoning, our line of Borg Micropot® potentiometers is far from complete.

The Borg line is "complete" in a different way. Its range of sizes, ratings, and types makes it applicable to virtu-

ally every circuit requiring potentiometers with extreme accuracy, reliability and life expectancy along with small size, wide temperature ranges, and rugged resistance to shock, vibration and atmospheric contaminants.

In other words, the Borg Micropot line is a complete line—of precision units for precision applications. This is as true of the new 2100 series shown above as of the many other series in the Borg line. As true of single-turns as of

multi-turns. As true of commercial models as of military models.

There's a lot more to the Borg line than its completeness. It is *competitive*. Borg Micropot potentiometers are competitively priced, competitively distributed (through Amphenol Industrial Distributors), and competitively delivered. Find out for yourself. Contact your nearby Borg technical representative, Amphenol Distributor, or write to R. K. Johnson, Sales Manager.



BORG EQUIPMENT DIVISION

Amphenol-Borg Electronics Corporation,
Janesville, Wisconsin.

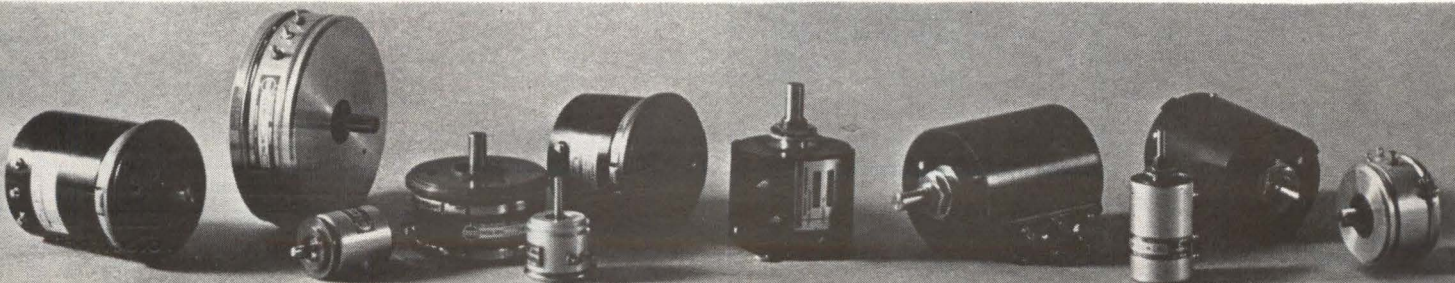

Now in production at EMI/US-Los Angeles: Model E-107 PPM-focused, gridded S-Band TWTs delivering a minimum of 1 KW peak pulse power across the band at 1% duty. As compared with competitive glass-type tubes, these TWTs are 1/3 lighter and of rugged, metal-ceramic construction that better withstands military airborne environments. Incorporating an integral ion pump, they meet all the requirements of MIL-E-5400D, Class II. For full details on these and other advanced electron tubes from EMI/US, write Executive Offices: 1750 No. Vine St., Los Angeles 28; or, Field Sales Office: 50 Swalm St., Westbury (L.I.), New York.

ELECTRON TUBE DIVISION
EMI/US

who else makes a 10-lb.
metal-ceramic S-Band TWT delivering 1 KW?

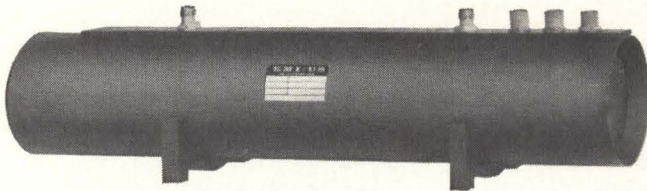

nobody.

**NEED
65-80 db
ISOLATION
BETWEEN
TRANSFORMER
WINDINGS?**

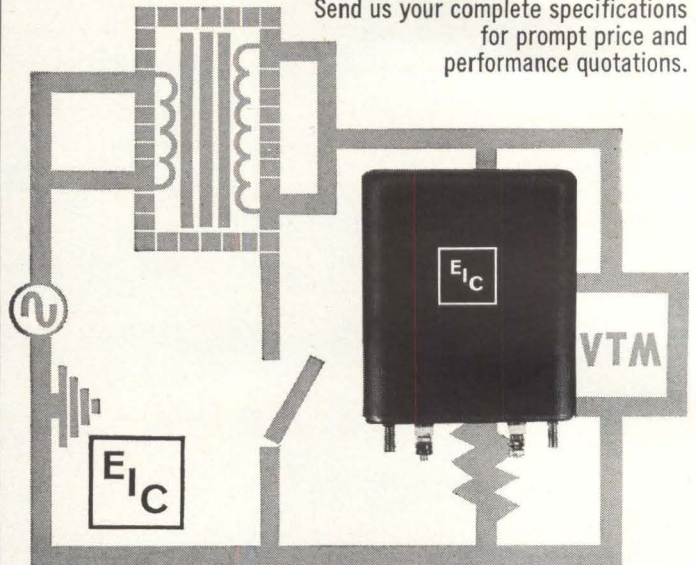

You do if your project involves very low signal levels. This was the case recently when a major transistor manufacturer specified EIC custom transformers with 65 db isolation between windings, from 60 cycles to 10 kc. (We can give you 80 db if required.) Insulation resistance specified (winding to winding and winding to case) was 300,000 megohms. Send us your complete specifications for prompt price and performance quotations.

ELECTRODYNAMIC INSTRUMENT CORPORATION

Subsidiary of Reed Roller Bit Company
JA 6-3761 • 1841 Old Spanish Trail • Houston 25, Texas
CIRCLE 205 ON READER SERVICE CARD

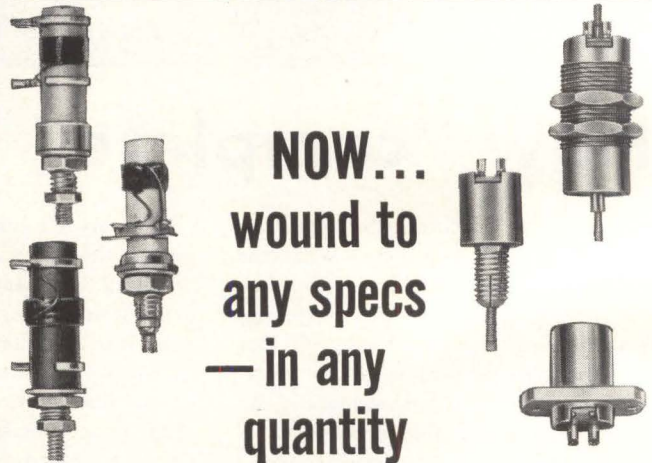

**NOW...
wound to
any specs
— in any
quantity**

Supplying exactly the coil forms you want — ceramic or phenolic; standard, printed circuit or shielded — is just one CAMBION® service. Winding them to your exact specifications is another — which eliminates all the time and much of the expense of your own coil winding. CAMBION is fully equipped to custom-wind your coils precisely, lab-test them thoroughly to your qualifications and deliver them fast in any quantities you order. Like all CAMBION components they're quality-guaranteed. For prompt technical aid in meeting your requirements for custom-wound coils, call your CAMBION Engineering Representative, or mail your blueprints to Cambridge Thermionic Corporation, 437 Concord Avenue, Cambridge 38, Massachusetts.

CAMBRIDGE THERMIONIC CORPORATION
CAMBION®
The guaranteed electronic components



CIRCLE 206 ON READER SERVICE CARD
electronics

STC MICROWAVE OSCILLATORS

- Coaxial Line Oscillators V types —
 - H-wave Oscillators V types —
 - Backward Wave Oscillators Y types —
 - Reflex Klystrons Z types —
- Excellent frequency stability.
High degree of modulation linearity.
Low working voltage.
No forced air cooling.
- Very wide electronic frequency coverage.
- Wide electronic tuning range.
High degree of modulation linearity.

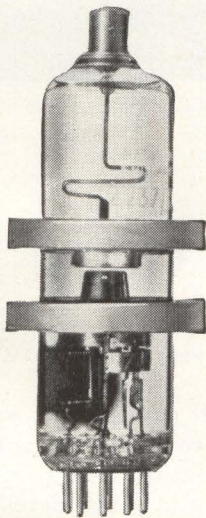

Z237/1K

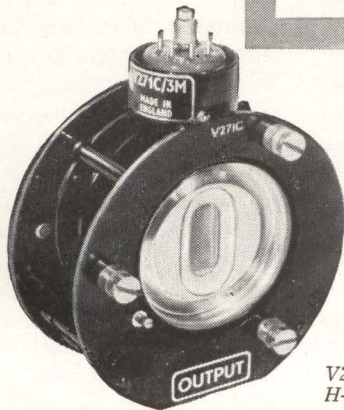
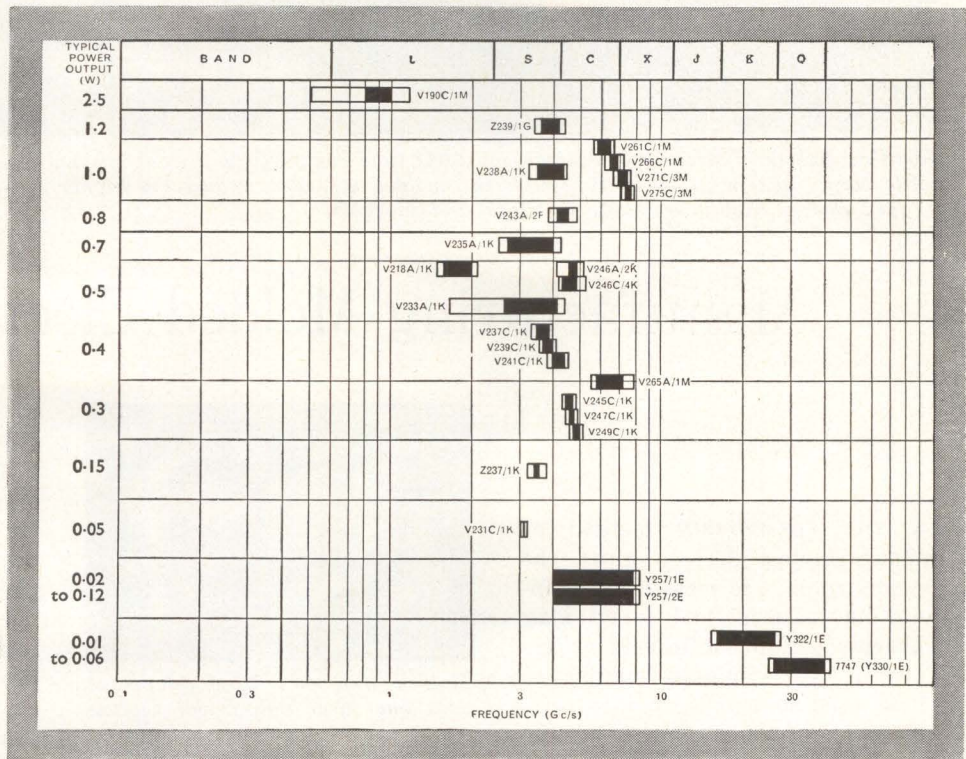

V271C/3M
H-wave Oscillator

Send for a copy of the new edition of the illustrated brochure "STC Microwave Tubes" MS/113.

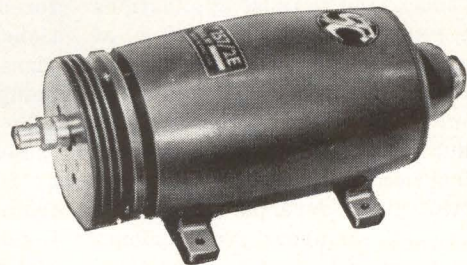

Y257/2E



61/6MS

Standard Telephones and Cables Limited

VALVE DIVISION: BRIXHAM ROAD · PAIGNTON · DEVON · ENGLAND

USA enquiries for price and delivery to ITT Components Division, P.O. Box 412, Clifton, N.J.

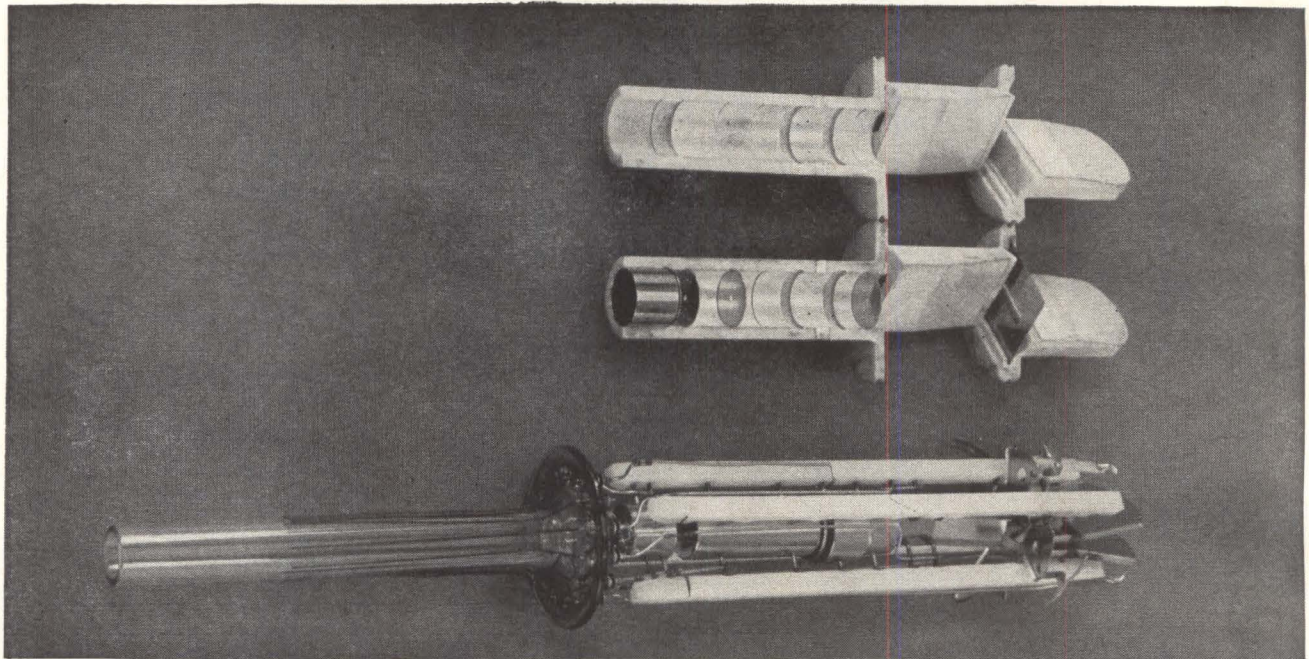

Identical halves of prototype electron for 5AQ tube compared with conventional gun. The molded gun is held together with snap rings in grooves. Although the molded structure requires a higher focus voltage, it is mechanically more rugged and is highly resistant to shock and vibration

Manufacturing Molded Electron Guns

By E. C. GEAR

General Dynamics/Electronics,
San Diego, Calif.

IN THE FORMED-GUN method of manufacturing electron guns, the basic structure is molded of an insulating material and functioning elements are either inserts or are formed by techniques similar to those used in making printed circuits. The formed gun is ideally suited to environments that expose the structure to severe vibration and shock, and to those applications that require extreme precision of assembly. But formed guns are not limited to specialized uses, and the technique has possibilities in mass production.

The economic feasibility of formed guns depends on molded parts, and stringent requirements must be placed on the material of the basic structure. The most obvious possible materials are glasses and ceramics, which rate well on most of the desired characteristics, but are poor with respect to molding precision due to a high shrink-

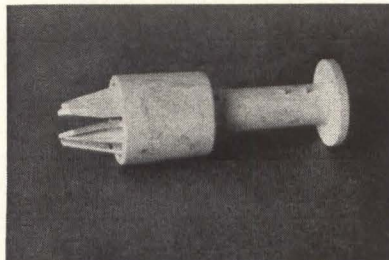

Molded gun now in development uses one piece cylindrical section

age factor that can be compensated for only by costly grinding operations. After extensive investigation, glass-bonded mica was selected as being both suitable and economically practical.

Feasibility was first established by machining simple electron guns from solid glass-bonded mica stock. Conductive areas were formed with conductive paint, and metallic apertures were pressed into grooves machined into the interior walls of the gun. Performance and life tests were satisfactory and feasibility was clearly established. The Bureau of Ships then sponsored a program

to investigate the possibilities further.

The first molded gun was designed as two identical longitudinal halves, a construction with many advantages in the development phase. The entire gun was produced in a single cavity mold; interior surfaces were accessible and production techniques could be easily explored and the results evaluated. The two halves of the gun are held together by snap rings in formed grooves.

The 5AQ was selected as a typical tube type for the study. But the 5AQ gun uses an immersion lens (a large cylinder that overlaps two smaller cylinders), a configuration with obvious problems in molding and in applying conductive coatings. The lens was redesigned for consecutive cylinders of the same diameter. Additional lens design was necessary because a lens with glass-bonded mica between elements is not equivalent to one with vacuum between elements.

Careful attention was given to the mold, with close cooperation be-

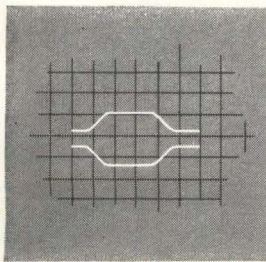

THE SERVOCIRCUIT

Published by SERVO CORPORATION OF AMERICA

Twin-Pulse Now Standard on General-Purpose Generator

Double twin-pulse instrument also available in same series

Something new has been added to the SERVOPULSE™ Model 3450D Megacycle Pulse Generator. And at *no extra cost*. Twin-pulse capability, previously available only as a factory modification extra, is now a standard feature.

Extended Applications

Wide-range performance covers all requirements, from long-duration pulses (10 milliseconds) at very low rep rates to ultra-short (50 nanoseconds) signals at multi-megacycle rates. Use of twin-pulse is optional, and can be switched in whenever it is desirable to generate two pulses on a common time base, each pulse having the same width, polarity, and amplitude. Typical laboratory applications include designing and testing radar, navigation and fire control systems, digital computer and other pulse circuitry. Equally versatile as a test instrument, Model 3450D is used for blasting cap test, shock tube spark ignition, high voltage drive of strain gages, system transient testing, and the like.

Advanced Circuit Design

Some outstanding features of this versatile instrument are: fully regulated power supplies to remove line voltage variation as a factor in critical amplitude testing; variable rise time as short as 15 nanoseconds; step attenuation plus full fill-in for clean waveform generation at levels as low as 50 mv peak; automatic overload protection; and step and

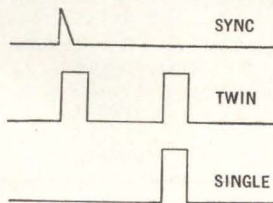

Main Pulse Outputs (93-ohm load)

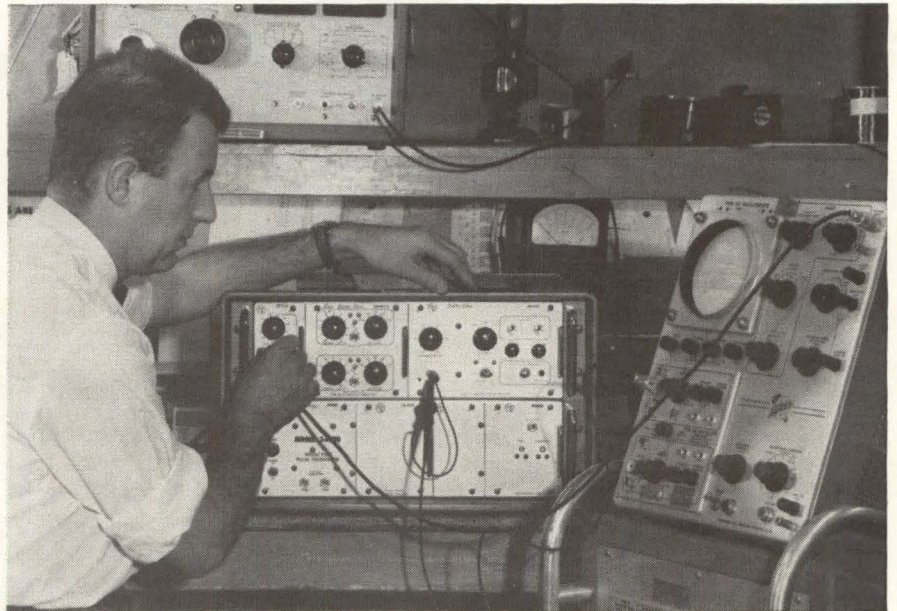

Model 3450D Generator

fill-in major controls to aid in rapid set up of critical parameters.

Modular Concept

The modular design concept, an important factor in cost reduction and built-in flexibility of all SERVOPULSE instruments, is fully realized in the new Model 3450D. Not only does the instrument now offer twin-pulse generation as a *standard* feature, but its modular construction is such that, with factory modification, extra low rep-rates of .05-5000 cps and 1 volt input trigger sensitivity may be added to the standard specifications.

Double Twin-Pulse Generator

Companion Model 3465A—in effect, two Model 3450D's operating from a single time base and housed in one cabinet providing separate or mixed outputs—has also been redesigned to furnish double twin-pulse generating capability. Unmixed output provides 2 separate pulse pairs; mixed output combines the 2 pulse pairs.

Many Standard Instruments

The broad line of SERVOPULSE instruments includes many cataloged units and over 100 standard pulse and digital circuit modules (both tube and transistor types). Traditional Servo Corporation quality and system-proved reliability prevail throughout the line. Phone or write, outlining your proposed applications, for prompt recommendations.

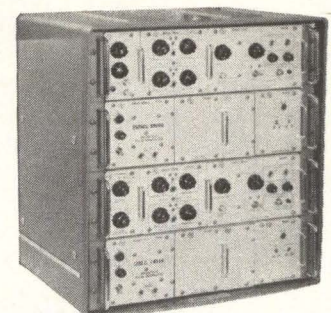

Model 3465A Double Twin-Pulse Generator with additional delay module



SERVOPULSE™ PRODUCTS

SERVO CORPORATION OF AMERICA • 111 New South Road • Hicksville, L.I., N.Y.

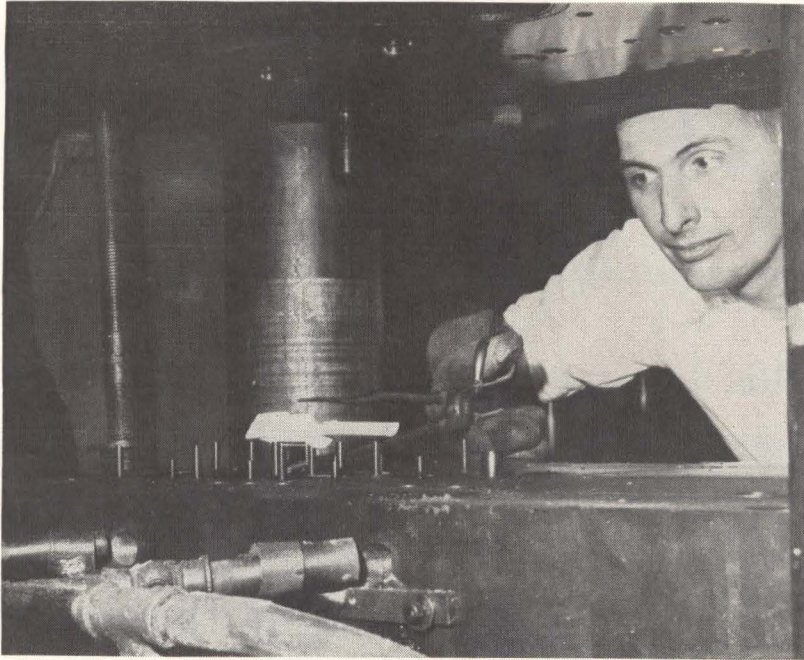

Glass-bonded mica structure is heated in air before assembly

tween Electronic Mechanics Inc. and General Dynamics/Electronics. Draft was allowed wherever necessary to assure easy release of the part; cross sectional areas were kept uniform so that warping was minimized and longitudinal fillets were provided.

Processing of the molded parts into complete electron guns required specialized techniques. Conductive areas of the gun were formed with a fired-on silver composition that proved both durable and adherent. The first molded guns warped at the temperatures required for firing but a change in molding composition and a more precisely controlled firing cycle resolved the difficulty.

Problems arose due to non-uniform coatings. The slightest ripple on a deflection surface, for example, causes faulty operation. Therefore a special miniature spray gun was devised and very uniform coatings have resulted. Dimensions of the conductive areas are critical and it was necessary to develop precision masking methods.

Early formed-gun tubes were subject to intermittent electrical breakdown. It was found that cleanliness, always essential in vacuum tube production, was even more important for formed guns. Contaminants such as weld spatter can adhere to the insulating material between elements and cause

breakdown. Degreasing, electro-polishing, and careful control eliminated this problem.

Operation of the formed-gun tubes is essentially equivalent to a high quality 5AQ. The focus voltage however, is about 760 v above cathode—as compared to above 400 v for a conventional tube—probably because of the high dielectric material between the elements instead of a vacuum. Military specifications for shock and vibration were met in tests made at the New York Naval Shipyard.

Although the split molded gun provides an excellent means for exploring techniques and evaluating results, it does not take full advantage of the inherent precision and ruggedness possible. A second molded gun now being tested has a basic structure of complete cylinders, with flanges to ensure rigid mounting in the tube neck.

At the present state-of-the-art, the molded electron gun crt is probably best suited to applications where precision and ruggedness are of first importance. Radar and instrument tubes are typical examples. Future possibilities in producing commercial tubes on a competitive basis will depend upon automation techniques and the need for guns in large volume. With proper tooling, the chances for commercial application are considered excellent.

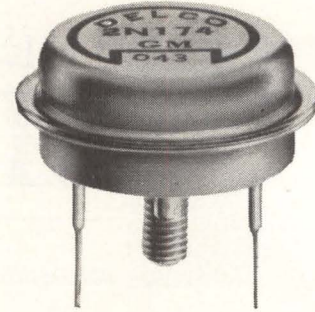

DELCO SEMICONDUCTORS NOW AVAILABLE AT THESE DISTRIBUTORS

EAST

Philadelphia, Pa.—Almo Radio Co.
913 Arch Street/WA 2-5918

Newton, Mass.—Greene-Shaw Distributing Co.
341 Watertown St./WO 9-8900

New York 36, N. Y.—Harvey Radio Co., Inc.
103 W. 43rd St./JU 2-1500

Syracuse 11, N. Y.—Harvey Electronics-Syracuse, Inc.
Pickard Drive, Box 185/GL 4-9282

Baltimore, Md.—Radio Electric Service Co.
5 N. Howard St./LE 9-3835

SOUTH

Birmingham 5, Ala.—Forbes Distributing Co., Inc.
2610 Third Ave., S./AL 1-4104

West Palm Beach, Fla.—Goddard, Inc.
1309 North Dixie/TE 3-5701

Richmond 20, Va.—Meridian Electronics, Inc.
1001 W. Broad St./EL 5-2834

MIDWEST

Detroit 3, Mich.—Glendale Electronic Supply, Inc.
12530 Hamilton/TU 3-1500

Indianapolis 25, Ind.—Graham Electronics Supply, Inc.
122 S. Senate Ave./ME 4-8486

Cleveland 14, Ohio—Main Line Cleveland, Inc.
1260 E. 38th St./EX 1-4944

Chicago 50, Ill.—Merquip Electronics, Inc.
4939 N. Elston Ave./AV 2-5400

Minneapolis 16, Minn.—George Spencer, Inc.
5305 Cedar Lake Rd./LI 5-8811

Cincinnati 10, Ohio—United Radio, Inc.
1308 Vine Street/MA 1-6530

WEST

Dallas 1, Texas—Adleta Company
1914 Cedar Springs/RI 1-3151

Phoenix 20, Ariz.—Astronics, Inc.
9310 N. Central Ave./944-1551

Seattle 1, Wash.—C & G Electronics Co.
2221 Third Ave./MA 4-4354

Houston 2, Texas—Harrison Equipment Co.
1422 San Jacinto St./CA 4-9131

Monrovia, Cal.—Lynch Electronics, Inc.
1818 S. Myrtle Ave./EL 9-8261

San Diego 1, Cal.—Radio Parts Co.
2060 India St., Box 2710/BE 2-8951

Los Angeles 15, Cal.—Radio Products Sales, Inc.
1501 S. Hill St./RI 8-1271

San Jose 13, Cal.—Schad Electronic Supply, Inc.
499 S. Market St./CY 8-0511

Denver, Colo.—L. B. Walker Radio Co.
300 Bryant St./WE 5-2401

Ask for a complete catalog

DELCO
DEPENDABILITY
RADIO
RELIABILITY

CIRCLE 76 ON READER SERVICE CARD
electronics

are the power transistors you're using as good as this one?

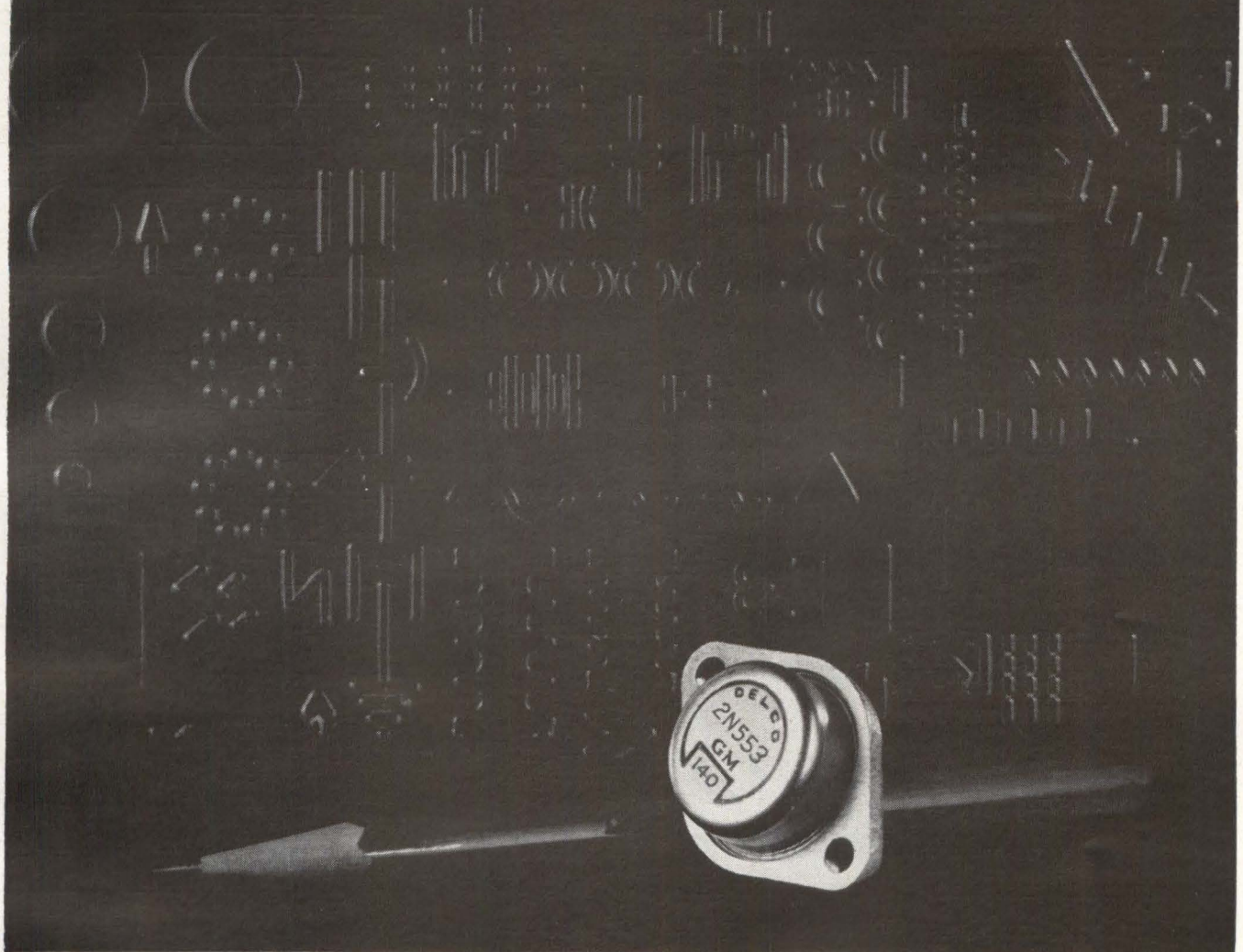

Meet the Delco Radio family of 2N553 high power transistors. They're the most sophisticated 4-5-amp. power transistors you can find . . . anywhere! The perfect choice for direct coupled circuits because of their extremely low collector diode bulk leakage current. Regulator applications? None better than Delco's 2N553. These units have unique thermal stability. Order a handful or a carload and you get uniform high quality. Prove it to yourself and improve your product as a bonus. Contact one of our Sales Offices listed below or your nearby Delco Radio Semiconductor Distributor.

Type	Ic (Max.)	Vcbo (Max.)	Vceo (Max.)	Max. Icbo @ Vcbo	Max. Icbo @ 30 Vcb @ T °C	Saturation Volts @ Ic (Max.)	Gain	Thermal Resistance (Max.)
2N553	4A	80V	40V	50µA @ 2V	2MA @ 75° C	.9V @ 3A	40/80 @ .5A	1.5° C/watt
2N1971	4A	80V	40V	50µA @ 2V	2MA @ 75° C	.9V @ 3A	25/60 @ .5A	1.5° C/watt
2N665	5A	80V	40V	50µA @ 2V	2MA @ 71° C	.9V @ 3A	40/80 @ .5A	1.5° C/watt
JAN2N665	5A	80V	40V	50µA @ 2V	2MA @ 71° C	.9V @ 3A	40/80 @ .5A	1.5° C/watt
2N297A (Sig. C)	4A	60V	40V	200µA @ 2V	6MA @ 71° C	1V @ 2A	40/100 @ .5A	1.5° C/watt
2N297A	4A	60V	40V	200µA @ 2V	6MA @ 71° C	1V @ 2A	40/100 @ .5A	1.5° C/watt

Union, New Jersey
324 Chestnut Street
MURdock 7-3770

Detroit, Michigan
57 Harper Avenue
TRinity 3-6560

Santa Monica, California
726 Santa Monica Blvd.
UPTon 0-8807

Syracuse, New York
1054 James Street
GRanite 2-2668

Chicago, Illinois
5750 West 51st Street
PORtsmouth 7-3500

SEE YOU AT IRE SHOW, BOOTH 1423

Division of General Motors • Kokomo, Indiana

DELCO
DEPENDABILITY
RADIO
RELIABILITY



ENVIRONMENT FOR ACHIEVEMENT

The Bernoulli Disk is a major LFE development in magnetic data storage. Only seven inches high, it is less expensive, more reliable, and more resistant to shock and vibration than conventional memory drums of like capacity. It is being supplied for Lockheed Aircraft Corporation's Satellite Program.

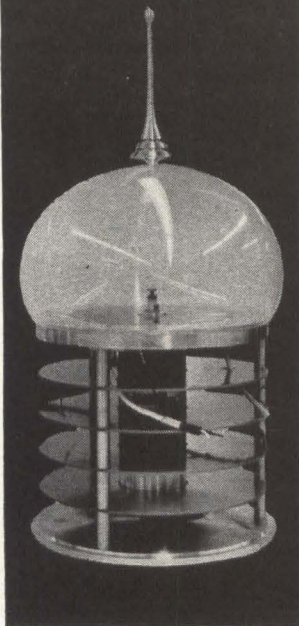

Original Bernoulli Disk

The Disk did not just "happen". It was encouraged — by company-financed research, free inquiry, easy communications, and a management that knows its technology. Over the past year, this environment helped develop new products, create new divisions. If you prefer this type environment, inquire now about select new opportunities in:

SYSTEMS, EQUIPMENT & COMPONENTS

Airborne Navigation ^{for} Automatic Controls
Radar and Surveillance Ground Support
Electronic Data Processing

Excellent opportunities are also available at our Monterey, California Laboratory

Write in complete confidence to:



C. E. Fitzgerald
LABORATORY FOR ELECTRONICS
1079 Commonwealth Avenue
Boston 15, Massachusetts

All qualified applicants will be considered for employment without regard to race, color, creed or national origin.

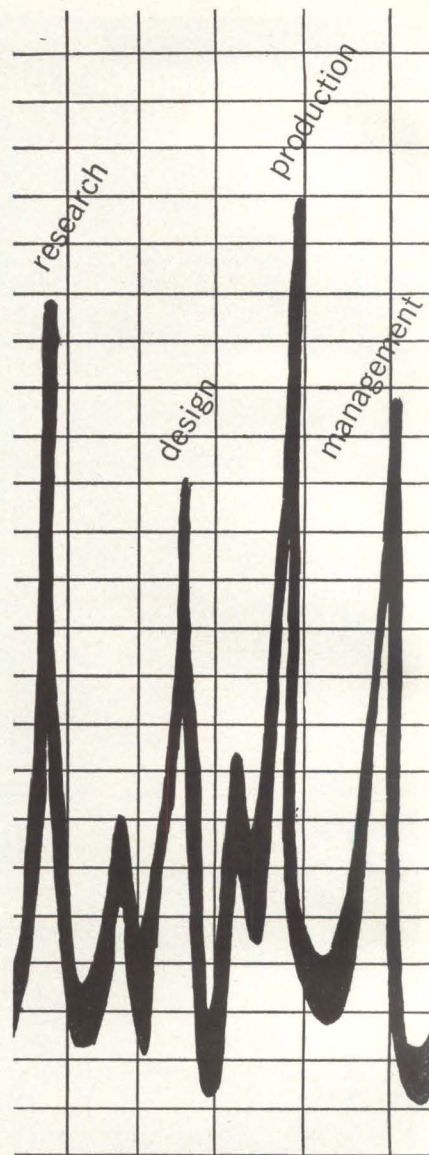

IT'S READ MORE BY ALL 4!

electronics magazine interprets electronics for electronics men every week. The latest components, economic trends, military applications. Technical data you'll want to file and keep. Get the facts first with a personal subscription (don't be low man on a routing slip). Mail the reader service card (postpaid) to **electronics**, the magazine that helps you to know and to grow! Rates: three years for \$12, one year for \$6; Canadian, one year for \$10; foreign, one year for \$20. Annual **electronics** BUYERS' GUIDE (single issue price \$3.00) included with every subscription.

subscribe today to
electronics

**STANDARD
NYLON CONNECTORS**

Molded of tough, low-loss, shock-proof nylon—will not chip or crack, even when subjected to extreme temperature changes or severe mechanical stress. Voltage breakdowns to 12,500 volts DC. Wide line: Tip Plugs and Jacks; Metal Clad and Rapid Mount Jacks; Banana Plugs and Jacks; Binding Post. Designed for fast, easy mounting—available in 13 colors for coded applications.

Other Connectors—

Johnson also manufactures a complete line of standard connectors in addition to the nylon types. For complete information write for our newest components catalog.

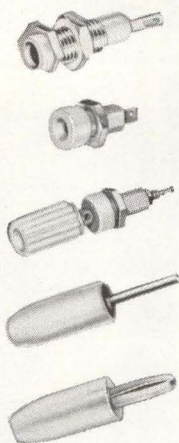

**OPERATING VOLTAGES TO 1500 VOLTS RMS...
5 AMPERES MAXIMUM CURRENT CARRYING CAPACITY!**

These tiny Johnson Nylon Tip Plugs and Jacks are ideally suited for limited space applications! Extremely compact—highly resistant to extremes of shock, vibration, temperature and moisture. Body, tough low-loss polyamide per MIL-P-17091 (Du Pont Zytel 101 nylon.) Available in 13 colors, including basis colors for MS16108C coding applications. Contact Resistance: less than 2 milliohms. Capacitance between two adjacent jacks: less than one mmf. at 1MC.

Series 105-751 Horizontal Jack—Unique design accepts .080" diameter tip plug in either end, or from top or bottom. Formed silver-plated beryllium copper contact. Two terminals.

Series 105-851 Vertical Jack—Mounts through single .052" hole, requires minimum mounting area. Formed silver-plated beryllium copper contact.

Series 105-771 Sub-Miniature Tip Plug—For use with miniature jack, only .080" diameter. One-piece nickel-plated, machined brass tip. Solder type lead connection.

Series 105-881 Long Sub-Miniature Tip Plug—Identical to tip plug above, but with 4" nylon body to permit access to "hard to reach" test points.



E. F. JOHNSON COMPANY

2802 TENTH AVENUE S.W. • WASECA, MINNESOTA

**MINIATURE
Nylon Plugs and Jacks**

DESIGNED FOR PRINTED CIRCUIT USE!

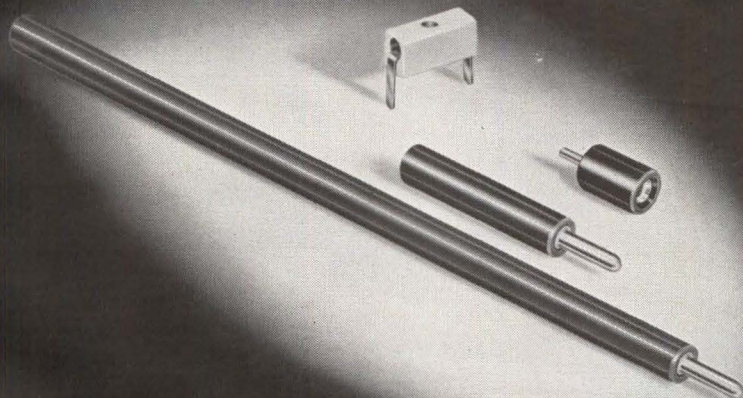

ACTUAL
SIZE

DETAILED COMPONENTS CATALOG AVAILABLE—Write today on company letterhead

• CAPACITORS • TUBE SOCKETS • CONNECTORS • PILOT LIGHTS • INSULATORS • KNOBS AND DIALS • INDUCTORS • HARDWARE

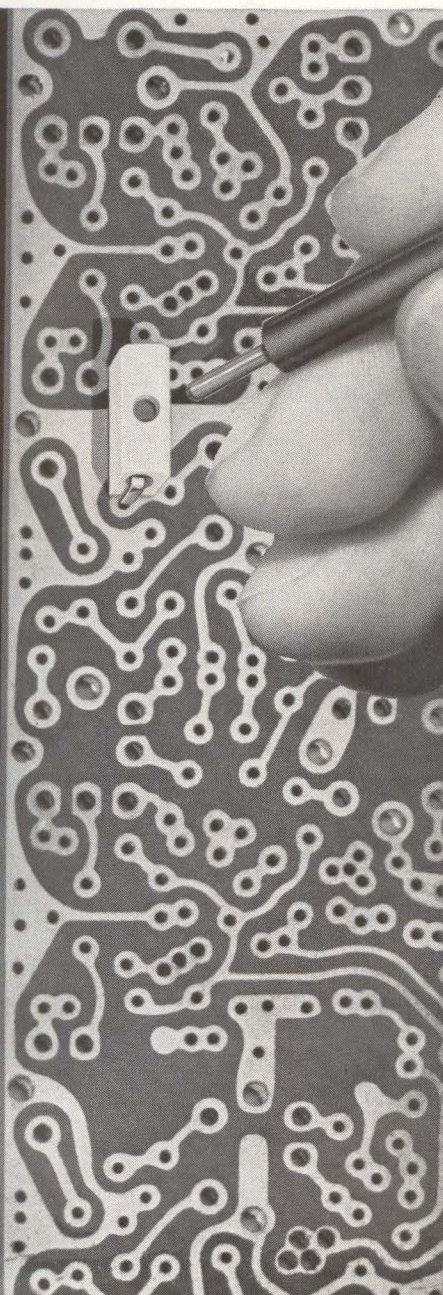

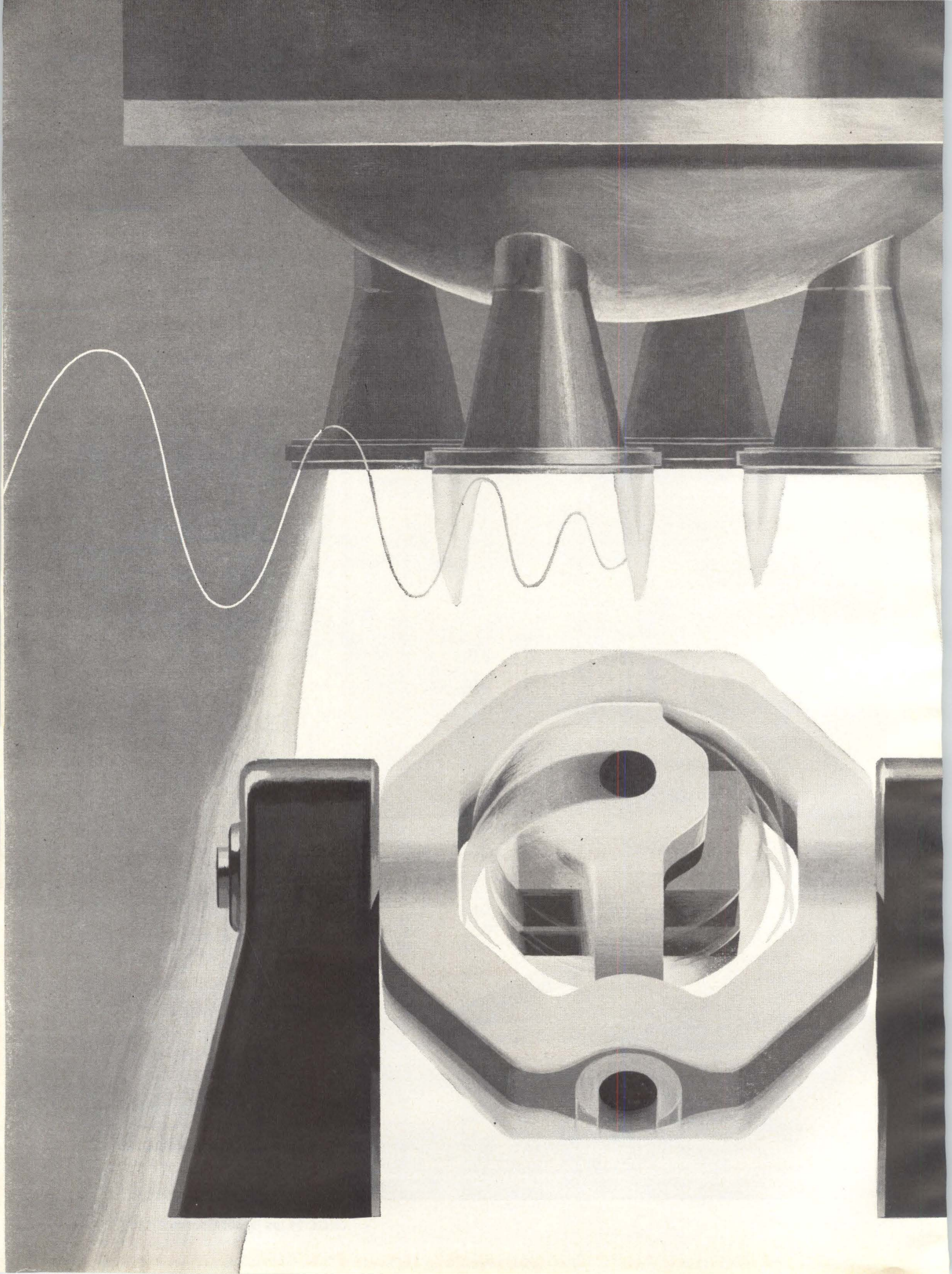

LABORATORY LAUNCH PAD

"In-house" missile flights are a daily occurrence at Lockheed Missiles & Space Company. The advantages of "flying" the POLARIS FBM inside the laboratory, on an amazing internally-developed simulator, are obvious.

The simulator performs many developmental and test functions. When the missile is first conceived, performance characteristics are cranked in; basic overall requirements are read out. Later, the simulator details the functional requirements of each subsystem and calculates specifications for hydraulic, electronic and pneumatic hardware. As each component is built, it replaces its computer counterpart.

Finally, the whole guidance and flight control package is put through simulated flights for final checkout. But that isn't all. The simulator also performs the role of post-flight evaluation detective when it is fed tapes of actual flights, and the effects are observed on earth-bound hardware.

It is with such elaborate equipment, guided by engineers and scientists of outstanding calibre, that Lockheed Missiles & Space Company has attained its place in the forefront of missile and space technology. And such progress is constantly creating key positions for other engineers and scientists of proved ability, so they may take up the exciting challenges offered by Lockheed and share in its rewards.

This unusual organization is located in Sunnyvale and Palo Alto, on the San Francisco Peninsula in California. For an informative brochure, "Your Place in Space," write to: Research and Development Staff, Department M-31A, 599 North Mathilda Avenue, Sunnyvale, California. An Equal Opportunity Employer.

LOCKHEED MISSILES & SPACE COMPANY

A GROUP DIVISION OF LOCKHEED AIRCRAFT CORPORATION

Systems Manager for the Navy POLARIS FBM and the Air Force AGENA Satellite in the DISCOVERER and MIDAS programs. Other current programs include SAINT, ADVENT and such NASA projects as OGO, OAO, ECHO, and NIMBUS.

SUNNYVALE, PALO ALTO, VAN NUYS, SANTA CRUZ, SANTA MARIA, CALIFORNIA
CAPE CANAVERAL, FLORIDA • HAWAII

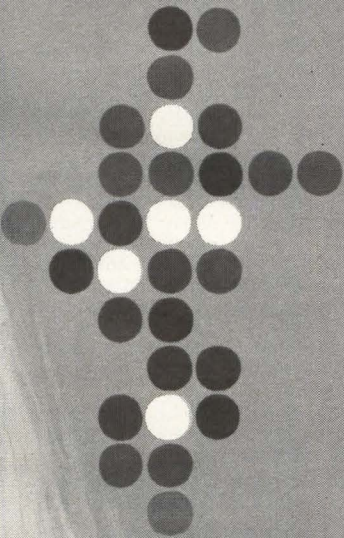

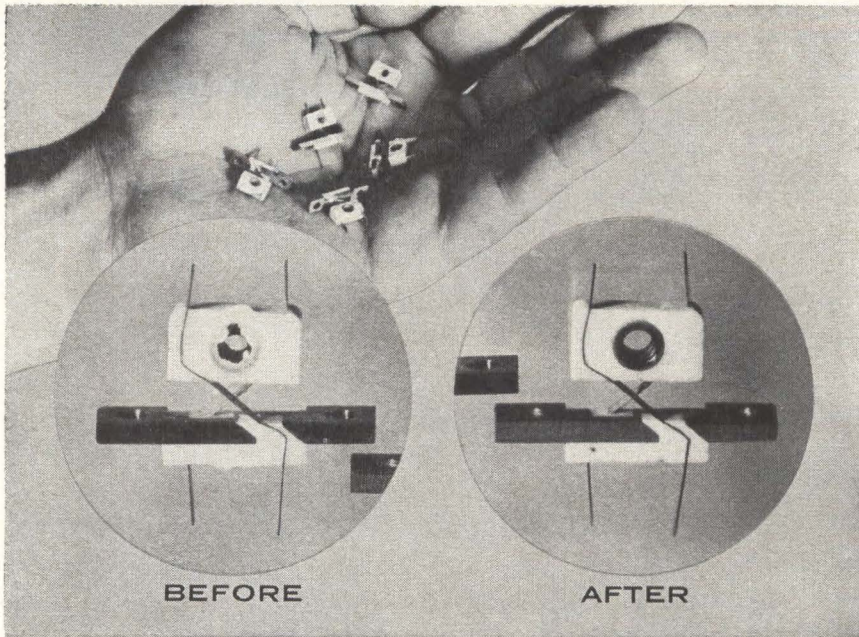

Airbrasive reduces cleaning and deburring time from 30 minutes to 1½ minutes

Molecular Dielectrics, Inc., Clifton, N.J. found that the Airbrasive paid for itself the first full day of operation! Eliminating handwork, it boosted daily output per worker from 16 parts (of which 50% were rejects) to 300 parts (of which less than 10% were rejects)!

Parts are flexural pivots for missile components. They consist of metallic inserts molded in glass-bonded mica. Deburring, deflashing, and cleaning by Airbrasive are followed by rigid inspection under 16x magnification.

MDI is not the only company to eliminate production bottlenecks with the Airbrasive. This unique industrial tool, which utilizes a super-fine jet of gas-propelled abrasive particles, is successfully performing many previously "impossible" jobs . . . cutting and shaping fragile crystals . . . adjusting microminiature circuits . . . deburring inaccessible places . . . all without shock, heat, vibration, or danger to the part!

Important too. Its cost is low. For under \$1,000 you can set up your own Airbrasive cutting unit.

Send us samples of your "impossible" jobs.
We will test them for you at no cost.

SEND FOR
BULLETIN 6006
. . . complete information.



S. S. WHITE INDUSTRIAL DIVISION
DEPT. EU, 10 East 40th St., N. Y. 16, N. Y.
Telephone MU 3-3015 collect.

1171

for superfine cutting • deburring • cleaning

hard brittle materials

S.S. White INDUSTRIAL AIRBRASIVE

actual size

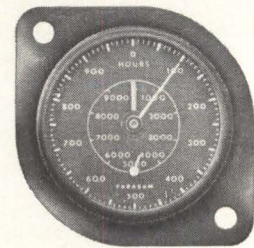

Accurate time totalizing meter

Hermetically sealed 21 jewel watch movement and spring coupled D.C. (20-35 v) torque motor gives accuracy within 1% even under most critical operating conditions. Determine reliability, prevent failures, and facilitate maintenance procedures of aircraft or missile electronic equipment and systems. 1,000 and 10,000 hour readings. Parabam's sub-miniature meter meets all requirements of MIL-M-26550.

PARABAM

DIVISION OF **HF** HOUSTON FEARLESS CORPORATION
12822 Yukon Avenue, Hawthorne, Calif./OSborne 9-3393

CIRCLE 207 ON READER SERVICE CARD

DEVELOPMENT & AEROSPACE SPECIALISTS

International Electric, Systems Managers in the design and development of a variety of advanced, large-scale, electronic systems, seeks specialists in two areas.

Development Specialists, with at least six years' association with large projects. They will evolve requirements for systems users in such areas as air traffic control, ASW, satellite control and command/control systems, and for work in information retrieval, man/machine communications and advanced computer utilization.

Aerospace Specialists, for integration of command/control systems with weapons systems.

Please send resume to Manager of Technical Staffing, Dept. EL

INTERNATIONAL ELECTRIC CORPORATION

An Associate of International Telephone and Telegraph Corporation
Rte. 17 & Garden State Parkway
Paramus, N. J.

An equal opportunity employer.

NEW RANGE • NEW SCALE LENGTH

HATHAWAY R-21 VOLTMETER



1 MV to 1000V AC and DC in 10 db steps . . .
db scale -20 to +2 • **1% ACCURACY**

SPECIFICATIONS

Resistance Range: 10 ohms—10 megohms
midscale, in decade ranges

Frequency Response: 10 cps—1 mc

Accuracy: 1% of full scale ± 0.1 MV, (DC
and 20 cps—100 kc scales); 5% of full
scale (10-20 cps, 100 kc—1 mc)

DC Calibration: Internal standard cell,
provides 1.00 volt on front panel to 10
megohms load

Input Impedance

—Millivolt Scales: 10 megohms shunted
by 25 mmf (9 megohms on AC)

—Voltage Scales: 10 megohms shunted
by 20 mmf

Power Requirements: 105-125 or 210-250
VAC, 50-60 cps, 60 watts

...this is how Hathaway's R-21 has up-
graded performance standards of the
electronic voltmeter.

"DC Distend," an exclusive Hathaway
development, expands the upper 10% or
1% of any DC volts range to cover the
full meter scale. This feature makes the
R-21 a perfect choice for measuring the
regulation of power supplies, the resolu-
tion of potentiometers, and the linearity
of amplifiers.

DC upscale readings with polarity indi-
cators give the R-21 twice the scale

length of center-zero meters. Residual
noise is less than 20 microvolts on the 1
MV AC scale; DC MV drift, less than 50
microvolts after 5 minutes warm-up.

Military reliability is why the R-21 is be-
ing specified in the most demanding de-
fense programs. The R-21 is also recom-
mended to the test engineer looking for
a more **versatile** voltmeter.

*For more information about the specifica-
tions and advantages of the R-21, contact
your Hathaway representative, or write
to us at the address below.*

- VOLTMETERS
- SIGNAL GENERATORS
- K-1 MICROSOURCE
- T-1A VIBRATION METER
- E-2 COMPARISON BRIDGE
- C-6B RESISTANCE METER
- C-6 OSCILLOSCOPE CAMERA
- A23 CALIVOLTER



See our display, including the R-21, at IRE—Booth 1920

Hathaway INSTRUMENTS, INC.
A SUBSIDIARY OF THE LIONEL CORPORATION
5802 EAST JEWELL AVENUE, DENVER 22, COLORADO



Skyline 6-8301
TWX DN 656

LET'S KEEP

Business Help For Our Colleges Going Full Speed Ahead

"Should our company fold up its program of financial help for higher education now that the Kennedy Administration plans to have the federal government provide this kind of help in a big way?" It is clear why, in the light of campaign promises and plans announced since, this question is being raised in many business firms at this juncture.

What seems far clearer, however, is the right answer to the question. It is a resounding NO! **This is no time for the business community to ease up in what have been its notably successful efforts to help our colleges and universities get out of the deep financial hole in which they are operating. On the contrary, this is the time to put more steam than ever behind the drive of business to increase its financial help for higher education.**

Massive Help Needed

It is easy to understand why any individual businessman or firm might have a rather despairing feeling about the prospect of competing with the federal government, with its almost all-embracing tax arm, in providing financial support for higher education or almost anything else for that matter. But this is not a case of competition. It is a case where our colleges and universities must have massive help all along the line if they are to be put squarely back on their feet financially—a goal of crucial and perhaps decisive national importance. **The business community will continue to have both the opportunity and the obligation to keep on increasing its help for higher education as rapidly as possible.**

To underline this proposition take a look at the chart at the top of the next page. It shows

how far the salaries of college and university faculty members continue to lag behind those of other occupational groups in the U.S.A. There has been some relative improvement in the average of faculty salaries in recent years. And the salary improvement in some fields, such as those of science and mathematics, has been very pronounced. But the chart makes clear how badly the average salary of college and university faculty members still lags.

No Federal Funds For Salaries

The plans for increased financial aid for higher education, proposed by President Kennedy, do not contemplate increased expenditure for faculty salaries. This, we believe, is wise whether or not you feel, as many do, that resort to this kind of federal financing would inevitably carry with it federal controls that would ultimately undermine academic independence. The fight over federal appropriations for faculty salaries would be so long and bitter that it would be destructive to the aid program as a whole.

However, what the federal government will not be doing to remedy the deplorable condition of faculty salaries, as reported by the chart, is one indication of the tremendous scope that remains for crucially important help for higher education from business. Manifold other indications are available.

Disaster Escape Route

One of these indications is provided by the careful calculation that the annual income of our colleges and universities must be increased by about \$4½ billion (from about \$4½ billion to about \$9 billion) over the next eight years if the tremendous wave of students

WHAT HAS HAPPENED TO COLLEGE FACULTY SALARIES

Index (1940=100)

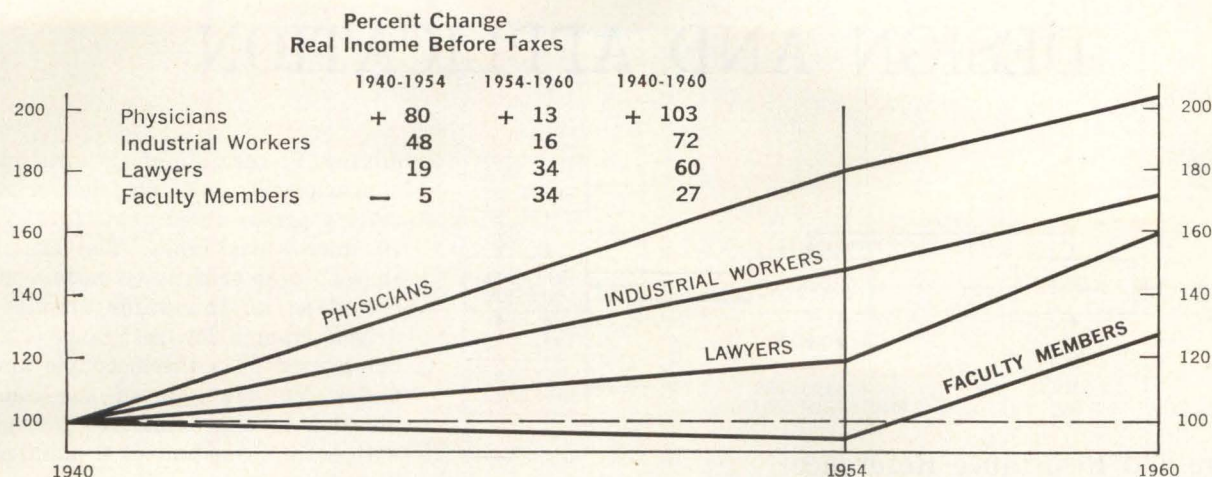

Sources: U.S. Department of Commerce; U.S. Department of Labor; National Education Association; McGraw-Hill Dept. of Economics.

now gathering to descend on these institutions is not to wind up in both a financial and an educational disaster. This wave promises to add more than 2.5 million, or 75%, to college enrollments by 1970.

Thus far, the program for financial help for higher education by business, spearheaded by the Council for Financial Aid to Education, has been a remarkable success in all dimensions. The dollars contributed have increased rapidly—from about \$100 million five years ago to about \$150 million this year. Contributions of \$500 million a year by 1970 are a clear possibility.

One of the inspiring developments increasing this possibility stems out of Cleveland, Ohio. There through their chief executives, an imposing group of business firms have established one per cent of their profits before taxes as their minimum goal for contributions to higher education, to be reached within three years. General acceptance of this goal by business would go most of the way toward getting our colleges and universities firmly on their feet financially.

Mutual Respect Increased

The mutual esteem of the academic community and the business community, an element of enormous importance to a free society, has been increased by the manner in which the program of financial aid has been carried out. In making its contribution, there has been no attempt whatsoever on the part of business to encroach upon the academic freedom of the institutions financially benefited. And the program of financial aid has greatly increased the knowledge, understanding and respect which the colleges and universities and business have for each other.

The Kennedy Administration's program to enlarge federal financial support of higher education is certain to arouse strenuous controversy. As proposed by its Task Force, it avoids some of the most controversial areas of principle. However, the very magnitude of the proposed extension of the federal government's already vast program of financing higher education involves fighting issues.

But if the enlargement of federal aid were to be deeply discouraging to the continued expansion of private aid for higher education, it would be a national misfortune of major proportions. There is no good reason why it should be. On the contrary, there is compelling reason for the business community to continue giving higher education all the financial help it possibly can, thus speeding onward a program that has been and continues to be a major constructive force for our colleges and universities, for business and for the nation.

This message was prepared by my staff associates as part of our company-wide effort to report on major new developments in American business and industry. Permission is freely extended to newspapers, groups or individuals to quote or reprint all or part of the text.

Donald C. McGraw

PRESIDENT

McGRAW-HILL PUBLISHING COMPANY

DESIGN AND APPLICATION

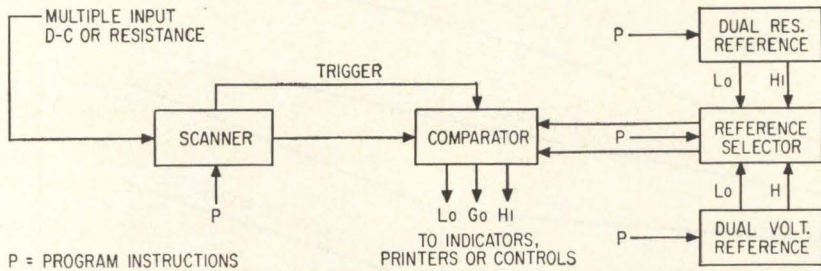

P = PROGRAM INSTRUCTIONS

Voltage and Resistance Reference PROGRAMMED MODULAR UNITS

RECENTLY announced by Binary Electronics, Inc., 30-48 Linden Place, Flushing 54, New York is a modular dual-voltage and dual-resistance reference. In the block diagram shown, the dual-resistance reference features a two-channel output, is programmable and measures zero to 10 megohms with 0.01-percent accuracy. It provides a voltage proportional to resistance under test plus high and low limits in voltage form. It also provides resistance bridge and voltage for null measurements. The dual-voltage reference also has a two-channel output, is programmable

and measures zero to ± 9.999 v in 1 mv steps with 0.02-percent accuracy. The set-up shows a test system assembled on a resistance go-no go basis and to rapidly check many different d-c voltage inputs. Program command signals control the addressing of the input scanner, selection of reference and settings of high and low reference limits for both resistance and voltage. Decision outputs of go, high or low are given by the comparator in visual, voltage or continuity form at a maximum rate of 10 tests per second.

CIRCLE 301 ON READER SERVICE CARD

mixing. Power gain of all units are approximately 43 db delivering ± 7.5 v across 1,000 ohms for 1 to 10 microwatts input. The sketch shows a high sensitivity model connected as an integrator amplifier driven from a low-resistance unit being used as a thermocouple amplifier. Voltage gain of the combination is approximately 100,000 with a time constant of 2 minutes. System provides full output for error signals of $75 \mu\text{v}$. Stability is $\pm 50 \mu\text{v}$ referred to the input. Control accuracy is therefore approximately one degree C.

CIRCLE 302 ON READER SERVICE CARD

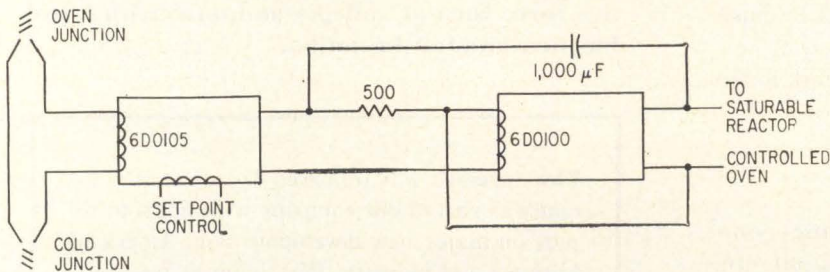

Magnetic Amplifiers

SINGLE AND DUAL CONTROL

A NEW LINE of magnetic amplifiers was recently announced by Military and Computer Electronics Corp., 900 N.E. 13th Street, Fort Lauderdale, Florida. The 100 Line Ultramag D series are d-c to d-c magnetic amplifiers powered di-

rectly from the 115 v line. Ten different control configurations are available ranging from current sensitivities of $50 \mu\text{amp}$ for full output to units with voltage gains of 1,000. Single and dual control models are provided for magnetic summing or

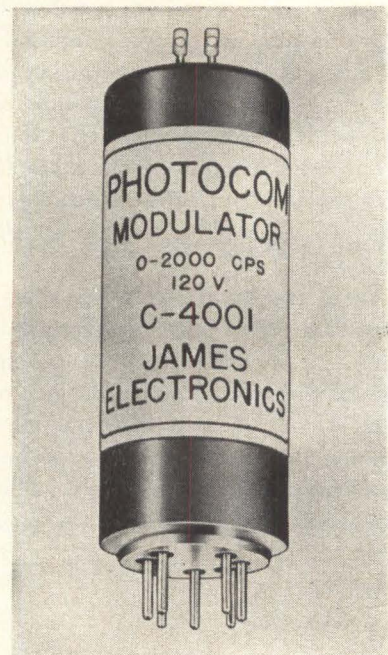

Light Actuated Chopper

ALSO RELAY AND SWITCH

THE Photocom chopper recently announced by James Electronics Inc., 4050 North Rockwell Street, Chicago 18, Illinois, is an all solid-state device for low-level instrument modulator and demodulator service. It operates on the principle of modulating a light source used to illuminate a photoconductor. The photoconductor changes resistance

FILTER DESIGNERS!

WANT TC CORE CURVES?

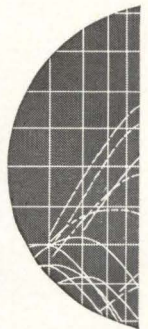
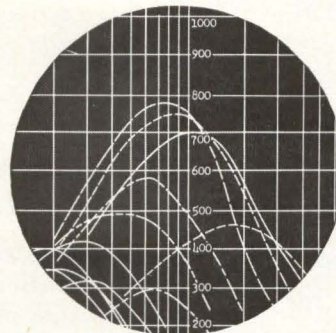
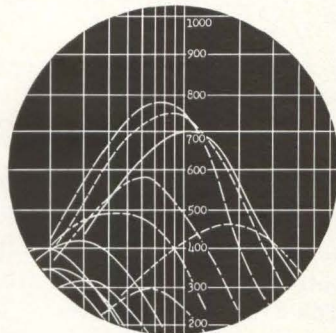
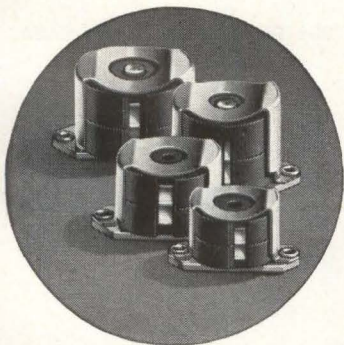

Q VS FREQUENCY

Magnetism is our business . . . so we now offer you another industry first: Complete test standards, specifications and performance curves in the International Series of temperature-compensated FERRAMIC® cup core assemblies. Designed for filter applications requiring a low and linear temperature coefficient with high Q factors, these cup cores are far superior to old-style toroid-shape cores. This detailed test data and specifications are typical of the technical leadership and application assistance we offer you. Our ferrite core experience, specialized manufacturing facilities, highly skilled engineering and production personnel can help you build more reliability into your products. ■ **Phone or write** General Ceramics Division, Keasbey, New Jersey, **for our new engineering data file on our TC cores.**

Visit us at the IRE show — Booths 1310-1316

INDIANA GENERAL

 <p>FERRITES</p>	 <p>MEMORY PRODUCTS</p>	 <p>PERMANENT MAGNETS</p>	 <p>MINIATURE MOTORS</p>	 <p>MEMORY PRODUCTS</p>
---	--	---	---	--

UNDIVIDED RESPONSIBILITY

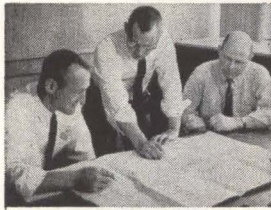

PLANNING

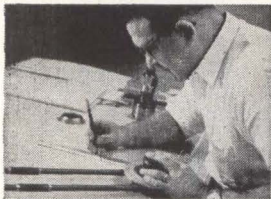

ENGINEERING



TOOLING



PRODUCTION

CLY-DEL

MANUFACTURING COMPANY
104 SHARON ROAD • WATERBURY, CONN.

SHELLS - EYELETS - STAMPINGS

KNOW CLY-DEL
BETTER . . .
ASK FOR NEW
8-PAGE BROCHURE

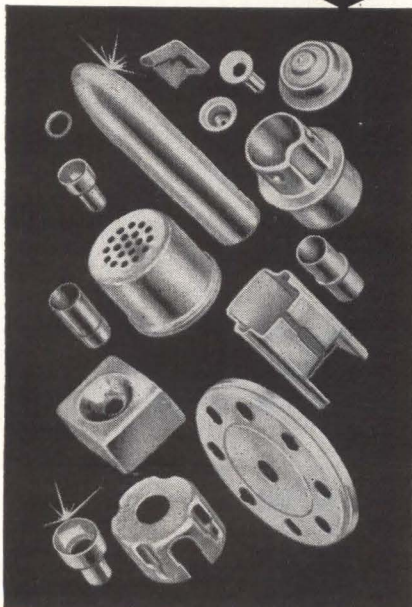

in inverse proportion to the level of illumination. The light source is electrically well shielded from the photoconductor resulting in extremely low coupling of drive voltage to signal circuit. Conversion efficiency is improved by using two photoconductive elements illuminated by each half cycle of the modulating voltage. It has a switching efficiency up to 98 percent, no magnetic or chemical switching noise and electrostatic noise less than $3 \mu\text{v}$ with a 1 megohm load. It can be driven from d-c as a relay to 2,000 cps for extreme response. It also can switch from zero to 300 v and can accommodate signals from d-c to 2 Mc r-f. Typical on resistance is 150 to 400 ohms with typical off resistance greater than 10^8 ohms.

CIRCLE 303 ON READER SERVICE CARD

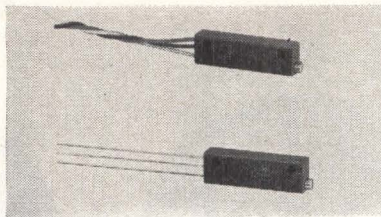

Subminiature Pot

1 W MAX POWER RATING

BORG EQUIPMENT DIVISION, Amphe-nol-Borg Electronics Corp., Janesville, Wisc. The 2700 subminiature (1 by $\frac{1}{8}$ by $\frac{1}{8}$ in.) trimming Micro-pot is able to withstand temperature extremes to 175 C, and is 100 percent humidity and moisture proof. Featuring a wirewound resistance element, the resistance range offers values from 10 to 30,000 ohms. Termination includes color coded Teflon insulated wire leads, and uninsulated copper wire leads. Actuation is leadscrew with a safety idle at each end of the resistance element.

CIRCLE 304 ON READER SERVICE CARD

Wirewound Resistor

SILICONE COATED

DALE ELECTRONICS, INC., Columbus, Neb. Type G resistor has a power rating of 5 w dissipation at 25 C ambient temperature, yet is only $\frac{1}{8}$ in. long by $\frac{3}{8}$ in. in diameter. Max continuous operating temperature

is 275 C. Resistance range is from 0.5 ohm to 20,000 ohms, depending on tolerance. Tolerances 0.05, 0.1, 0.25, 0.5, 1 and 3 percent. Temperature coefficient 0.00002/deg C.

CIRCLE 305 ON READER SERVICE CARD

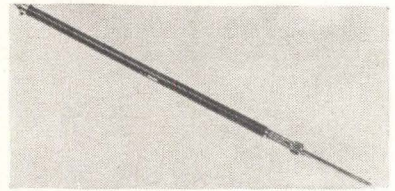

Coax Termination

SLIDING MOVEMENT

RADAR DESIGN CORP., Pickard Drive, Syracuse 11, N. Y. Model D-715 $\frac{1}{8}$ in. coaxial sliding termination has element vswr below 1.1 from 1,000 Mc to 2,000 Mc and below 1.05 from 2,000 Mc to 4,000 Mc. It has sliding movement at least half a wavelength. Connector is UG-45/U or UG-46/U. Price and delivery: \$256 each, 4 weeks.

CIRCLE 306 ON READER SERVICE CARD

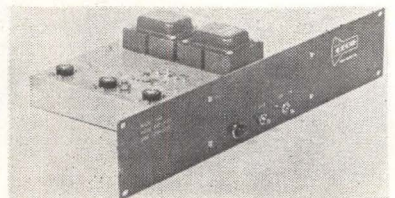

Wide-Band Amplifier

SOLID-STATE

COMMUNITY ENGINEERING CORP., 234 E. College Ave., State College, Pa. Model 1019 is designed for a frequency response of 5 cps to 12 Mc ± 0.5 db. It is able to go 12 Mc under any gain setting and as high as 25 Mc under certain conditions of fixed gain. Unit is also characterized by its high 8-v peak-to-peak output level. Minimum gain is 40 db, continually adjustable; minimum range of gain control is 25 db.

CIRCLE 307 ON READER SERVICE CARD

Parting & Release Agent

GIBRALTAR INDUSTRIES, 251 E. Grand Ave., Chicago 11, Ill. Surfak, a new non-silicone parting and release agent for epoxies, has been developed in aerosol form for the

electronics industry. The formula allows the user to deposit a uniform, microscopic film that affords excellent release.

CIRCLE 308 ON READER SERVICE CARD



Transfer Switch

FAST, FAIL-SAFE

QUANTATRON, INC., 2520 Colorado Ave., Santa Monica, Calif. The WS-01 series waveguide transfer switches are electrically-operated devices designed to switch microwave power from two inputs to either of two outputs. Two antennas may be time-shared by alternately connecting them to each of two receivers or transmitters—or one of the transmitters or receivers may be replaced by a dummy load. Switch may be used to reverse direction of power transmission in a repeater (booster) station of a microwave link.

CIRCLE 309 ON READER SERVICE CARD

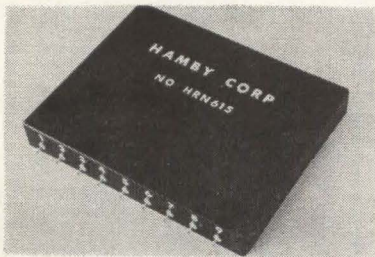

Impedance Network

LOW PHASE

HAMBY CORP., 7241 Eton Ave., Canoga Park, Calif. Model HRN615 is an encapsulated subminiature, low phase shift impedance network. Matched resistors of unequal values are available with tolerances as close as 0.01 percent over a fre-

Need more than this?

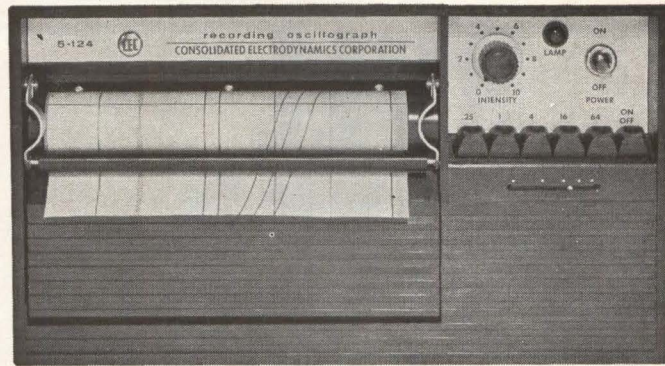

We've got it

You're looking at CEC's model 5-124 Recording Oscillograph. Even without accessories, this small, 18 channel instrument has big capabilities. With accessories, it fulfills the need for any special application requirements you might have. For example:

It can automatically expose a grid-line system on the record in either 0.1-inch increments with each tenth line accentuated or millimeter increments with each fifth line accentuated.

It can identify all traces by sequential interruption at a 12" repetition cycle.

It can place a number along the edge of the record opposite each trace interruption, corresponding to the galvanometer channel position.

It can have a full record width electronic flash timing system that provides switch selected timing intervals of 0.01, 0.1, or 1.0 second. Timing system can be synchronized from an external source at frequencies up to 100 pps.

It can stabilize the galvanometer block at 100°F.

It can provide record speeds on special order of 0.125, 0.5, 2.0, 8.0, 32.0 inches/sec. or 0.25, 1.0, 4.0, 16.0, 64.0 inches/min.

It can have a motorized record take-up unit that attaches to the front of recorder and automatically spools oscillogram.

As it is or as you want it, CEC's 5-124 Recording Oscillograph is a must in your laboratory. Ask your nearby CEC office for full details. Or write for Bulletin CEC 5124-X29.

CEC

Data Recorders Division

CONSOLIDATED ELECTRODYNAMICS
PASADENA, CALIFORNIA • A SUBSIDIARY OF BELL & HOWELL

ACCURATE PULL TESTER

for

■ leads	■ connectors
■ terminals	■ joints and bonds
■ welds	■ solderless wraps



■ Portable... Air-Operated... Laboratory Accurate... Available in Ranges up to 500 Lbs. ■ Write for Bulletin 750p.



HUNTER SPRING
A DIVISION OF AMETEK, INC.

34 SPRING AVENUE • LANSDALE, PENNSYLVANIA
ULysses 5-6815 TWX: 982-U

quency range from d-c to 1 Kc. Resistors of equal value can be matched to 0.001 percent. Temperature coefficients of 2 parts per million are available over a temperature range of -65 C to 0 C or 0 C to 135 C.

CIRCLE 310 ON READER SERVICE CARD

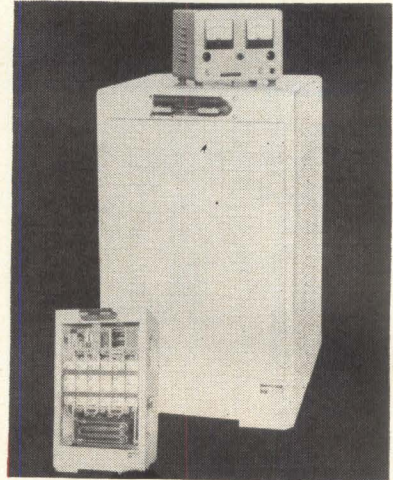

D-C Power Supply HIGH CURRENT

TYLAN CORP., Torrance, Calif., announces a d-c power supply using scr's that delivers 2,000 amp at 15 v to operate a research furnace or other types of industrial equipment. Current is regulated to ± 1 percent from 100 to 2,000 amp by a separate portable control console. Unit is water-cooled, has outside dimensions of 22 by 22 by 36 in., and weighs less than 700 lb.

CIRCLE 311 ON READER SERVICE CARD

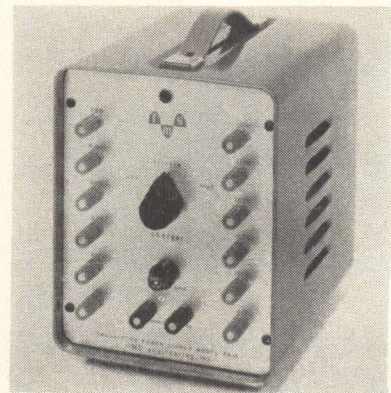

Power Supply FOR TRANSISTORS

RMS ENGINEERING, INC., P. O. Box 6354, Station H, Atlanta 8, Ga. Model PB-15 consists of 12 nickel-cadmium batteries with a trickle

charger. Both positive and negative voltages in steps of 1.25 v are available simultaneously, spanning a range of 15 v. In portable operation, capacity is 3.5 amp-hr, 10 amp peak. In a-c operation, batteries are series charged at 0.24 amp. Power supply is suited to the lab testing of transistor circuits and as an emergency power source in case of power failure.

CIRCLE 312 ON READER SERVICE CARD

Microwave Oscillator

GENERAL RADIO CO., West Concord, Mass. A continuous-tuning microwave oscillator, type 1360-A, can serve as a general-purpose power source for component and system measurements in the 1.7 to 4.1 Gc range.

CIRCLE 313 ON READER SERVICE CARD

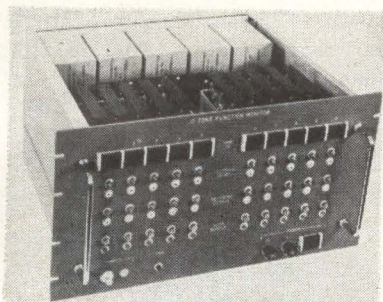

Demodulator

TEN-TONE

CASA ELECTRONICS CORP., 2233 Barry Ave., Los Angeles 64, Calif. Compact, solid-state ten-tone demodulator provides a ten channel tone separation and demodulation system for use in conjunction with telemetering systems. Each channel is fully self-contained with individual readout, filter, amplifier and precision regulated power supply. Plug-in printed circuits are used throughout. Standard frequencies range from 33 to 402 cps. Bandwidth of each channel is 20 cps.

CIRCLE 314 ON READER SERVICE CARD

Sweep Generator

JERROLD ELECTRONICS CORP., 15th and Lehigh Ave., Philadelphia 32, Pa. Model 707 precision variable rate r-f sweep generator now provides for the use of six different

TELEMETRY BY TELE-DYNAMICS

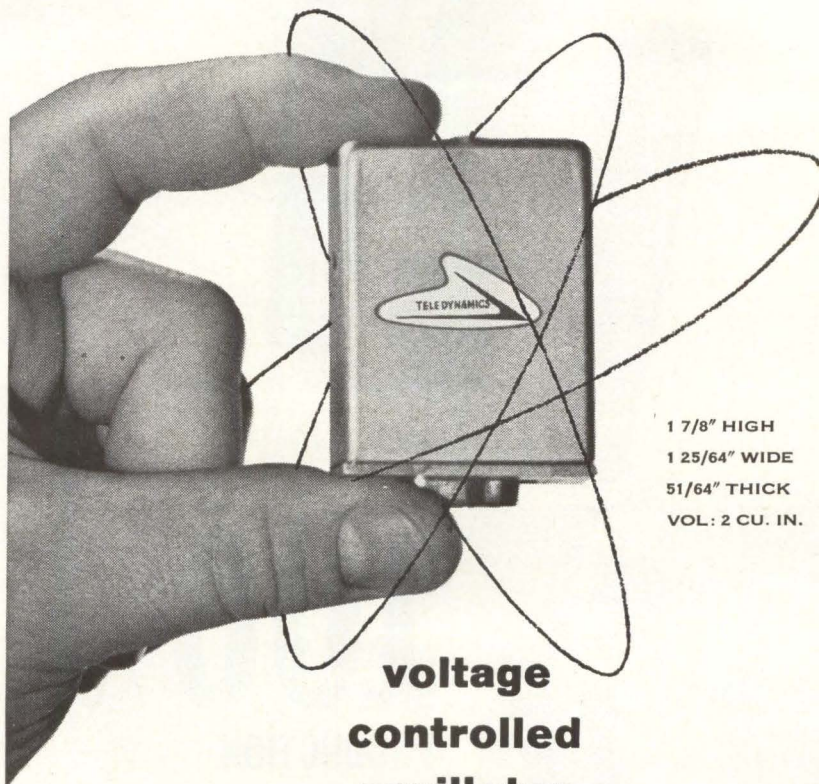

1 7/8" HIGH
1 25/64" WIDE
51/64" THICK
VOL: 2 CU. IN.

**voltage
controlled
oscillator**

Positive performance as proved by high customer acceptance characterizes Tele-Dynamics' 1270A voltage controlled oscillator. Exceptional electrical and environmental specifications, unique in off-the-shelf components at the right price, are representative of Tele-Dynamics' creative efforts in the complete telemetry field. Write for technical bulletins and a new capabilities brochure.

TECHNICAL CHARACTERISTICS

Input—0 to 5 volts or ± 2.5 volts
Linearity— $\pm 0.25\%$ BSL
Power Requirements—28 volts at 9 ma max.
Distortion—1%
Amplitude Modulation—10%

ENVIRONMENTAL CHARACTERISTICS

Thermal Stability— -20°C to $+85^{\circ}\text{C}$ $\pm 1.5\%$ DBW
Altitude—Unlimited
Vibration—30G random
Acceleration—100G
Shock—100G

TELE-DYNAMICS
DIVISION

AMERICAN BOSCH ARMA CORPORATION

5000 Parkside Avenue, Philadelphia 31, Pa.

86/0-Rev

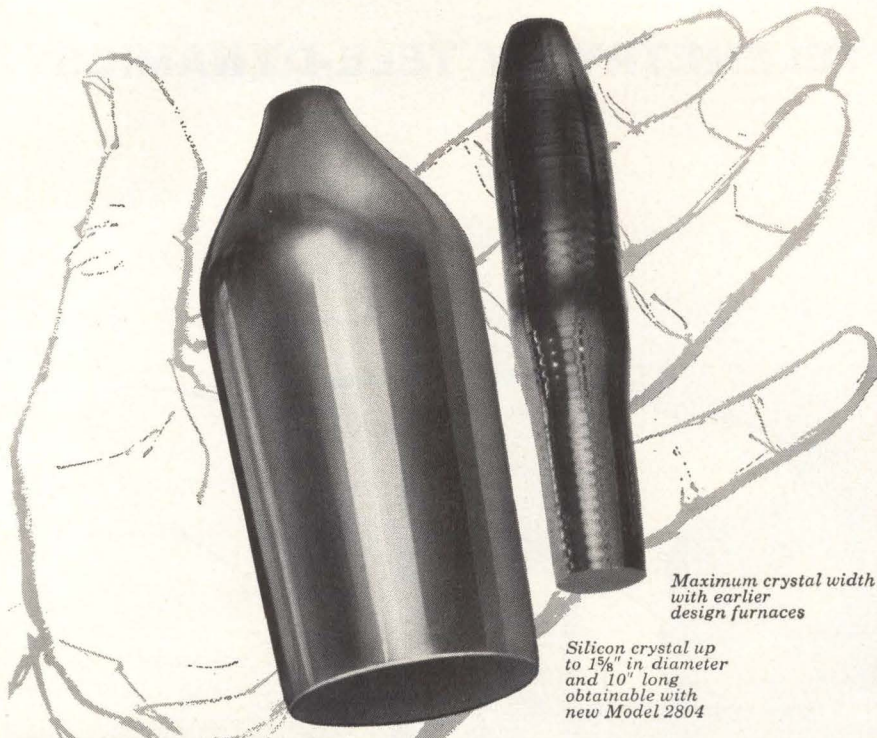

Maximum crystal width with earlier design furnaces

Silicon crystal up to 1 3/8" in diameter and 10" long obtainable with new Model 2804



100%
PRODUCTION INCREASE

with the new NRC CRYSTAL GROWING FURNACE

The new NRC Model 2804 is a "Czochralski method" crystal furnace primarily designed for making single crystal ingots of silicon for semiconductor devices. However, it is easily adaptable for use with germanium and intermetallic compounds with reliability and consistently high quality.

Because the Czochralski method of growing single crystals is a critical process, it needs quality equipment with proven mechanical, thermodynamic and control features. Only from NRC can you buy a quality crystal growing unit with a proven record for high production and more profit. Buy the NRC Model 2804 with complete assurance that you can increase your production rate 100% and own the best equipment of its type available today.

UNIQUE FEATURES OF THE MODEL 2804

- Proven design for performance and reliability
- Inert gas or vacuum operation
- Precise temperature control
- Versatility of use
- Vibrationless mechanical motion-control
- Greater productivity and higher efficiency

Write today for a data sheet on the NRC Model 2804 Crystal Growing Furnace.

SEE US AT BOOTH NUMBERS 4425 - 4427 AT THE IRE SHOW. N.Y.C.



A Subsidiary of National Research Corp.

160 Charlemont Street, Dept. 4B
Newton 61, Massachusetts

plug-in oscillator heads, permitting measurements in the 20 Kc to 270 Mc range.

CIRCLE 315 ON READER SERVICE CARD

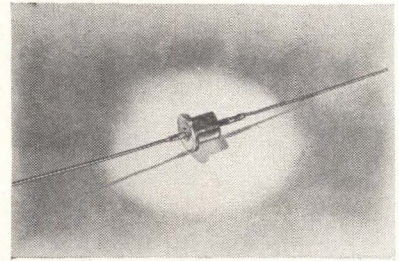

Silicon Rectifier

HIGH VOLTAGE

ELECTRONIC DEVICES, INC., 50 Webster Ave., New Rochelle, N.Y. Line of h-v top-hat silicon rectifiers are designed for medium power applications. Available in ratings from 1400 to 2000 piv, they deliver an output current of 500 ma at 25 C ambient. Maximum reverse leakage is 1.0 μ a at 25 C at rated piv. Maximum forward voltage drop at 25 C ambient and 500 ma is 1.8 v d-c. Maximum one cycle (8 μ sec) surge is 15 amp at 25 C ambient.

CIRCLE 316 ON READER SERVICE CARD

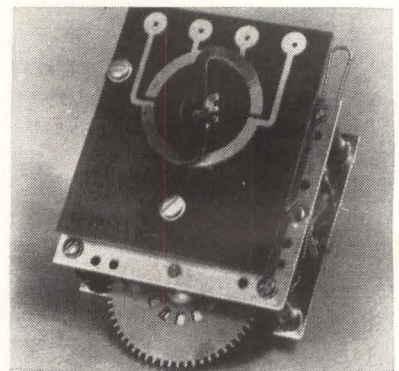

Commutator Switch

SPRING-DRIVEN

AUTOMATION DYNAMICS CORP., 255 County Road, Tenafly, N.J., offers a 4-oz commutator switch for application to balloon sondes, telemetry, multiplexing and laboratory tests. Model 93 has 4 hr running time from spring-wound motor at 1 rpm. Flush printed circuit is available with 4 conducting segments or alternate arrangements. Unit operates under environmental conditions from sea level to 120,000 ft altitude and is priced for expendable applications.

CIRCLE 317 ON READER SERVICE CARD

PRODUCT BRIEFS

ALUMINUM SHIELDING TAPE 0.004 in. thick. Alpha Wire Corp., 200 Varick St., New York, N. Y. (318)

DYNAMIC CAPACITOR ultrasensitive. The Victoreen Instrument Co., 5806 Hough Ave., Cleveland 3, O. (319)

TRANSISTOR TEST ADAPTER heavy duty molded phenolic. Pomona Electronics Co., Inc., 1500 E. Ninth St., Pomona, Calif. (320)

PROGRAMMER-COMPARATOR for automatic checkout. Hycon Mfg. Co., 700 Royal Oaks Drive, Monrovia, Calif. (321)

STRAIN GAGE POWER SUPPLY and calibration unit. Dynamics Instrumentation Co., 583 Monterey Pass Rd., Monterey Park, Calif. (322)

PRECISE ANGLE INDICATOR displays in digital readout. Clifton Precision Products Co., Inc., 5050 State Rd., Drexel Hill, Pa. (323)

VACUUM DEPOSITION SYSTEM dual bell jar. Scientific Engineering Laboratories, Inc., P.O. Box 607, Woodland, Calif. (324)

SERVO MOTORS slotted shaft construction. Bowmar Instrument Corp., 8000 Bluffton Road, Fort Wayne, Ind. (325)

MULTIPOINT DIGITAL SYSTEM automatic. Datex Corp., 1307 S. Myrtle Ave., Monrovia, Calif. (326)

BATTERY SEPARATOR gives longer life. Yardney Electric Corp., 40-50 Leonard St., N.Y.C. (327)

PORTABLE SWEEP GENERATORS two improved models. Jerrold Electronics Corp., 15th and Lehigh Ave., Philadelphia 32, Pa. (328)

SHIELDED COIL FORM immersion-proof. Cambridge Thermionic Corp., 445 Concord Ave., Cambridge 38, Mass. (329)

DUAL CENTRIFUGAL BLOWERS four models. McLean Engineering Laboratories, Princeton, N. J. (330)

GENERAL PURPOSE OSCILLOSCOPE for industry. Lavoie Laboratories, Inc., Morganville, N. J. (331)

VULCANIZED FIBRE flame resistant material. Taylor Fibre Co., Norristown, Pa. (332)

DESIGNED AND PRODUCED BY
KEARFOTT SEMICONDUCTOR CORP.
WEST NEWTON, MASS.

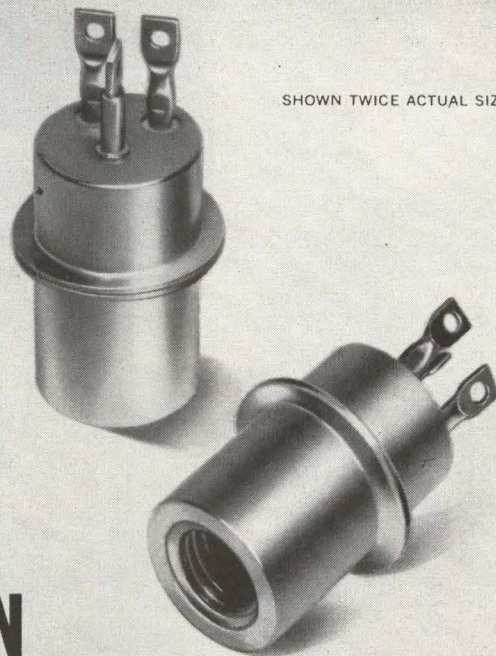

SHOWN TWICE ACTUAL SIZE

2N156
2N158
2N158A
PNP
GERMANIUM
POWER
TRANSISTORS

NOW IN WELDED TO-13 PACKAGE

**INCREASED RELIABILITY • IMPROVED PERFORMANCE
REDUCED THERMAL RESISTANCE**

Kearfott now offers 2N156, 2N158 and 2N158A Germanium PNP Power Transistors in the TO-13 welded package in accordance with new EIA requirements. The new type is completely interchangeable with the original heavier and larger MM3 package. In addition, the new package reduces thermal resistance by more than 30%.

Electrically interchangeable with currently available units, Kearfott's design achieves greater reliability and improved performance. Welded closure and improved glass-to-metal header construction provide a positive hermetic seal to eliminate all possible contamination. Widely spaced, properly tinned terminals facilitate connections. Overall plating of case eliminates possibility of thermal or electrical discontinuities through corrosion of bare metal parts.

Performance has been improved through this new Kearfott design, it makes possible specially selected I_{CBO} ratings up to 200 volts and I_{CEO} ratings up to 100 volts.

The 2N156 and 2N158 series can also be provided in a TO-10 welded package with an improved glass-to-metal header and a "Flying-leads" option.

Write today for detailed data on these devices. Complete data is also available on Kearfott's 35-watt 2N538, 2N538A, 2N539, 2N539A, 2N540, 2N540A and 2N1261, 2N1262, 2N1263, 2N1501, 2N1502, 2N1202, 2N1203 Power Transistors.

For Technical Data and Prices Contact KEARFOTT DIVISION, GENERAL PRECISION, INC., Little Falls, New Jersey. Or Your Nearest Kearfott Sales Office.



GENERAL PRECISION

6

**DIFFERENT
MEASUREMENTS
ON THIS PART
IN LESS THAN
A MINUTE!**

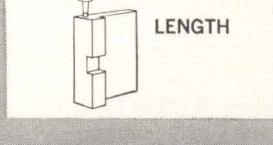
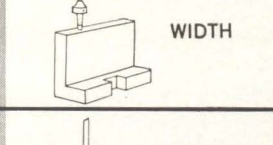
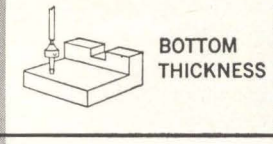
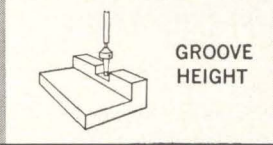
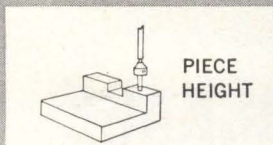

BAUSCH & LOMB



Made in America, to the world's highest standards.



Fast? You bet your life . . . but that's only part of the story. Bausch & Lomb DR-25B Optical Gage gives you *direct* measurement to 0.0001" over a 3" range on a bright, magnified scale . . . to 0.000025" if required. Designed for shop use, no other instrument of this type, at any price, achieves such precision.

Fast, easy, accurate . . . and only \$875! Put the DR-25B to work in your shop and start savings of up to 85% in gaging time (job-proved by Aeroquip Corp., Taber Instrument Corp. and many others.)

Distributed in U.S.A. through the DoALL Company

BAUSCH & LOMB INCORPORATED
61426 Bausch St., Rochester 2, N. Y.

- I'd like an on-the-job demonstration of the DR-25B with no obligation.
- Please send Catalog D-285.

NAME TITLE

COMPANY

ADDRESS

CITY ZONE STATE

Literature of

TRANSDUCER AMPLIFIER-INDICATOR Sanborn Co., 175 Wyman St., Waltham 54, Mass. Bulletin illustrates and describes the model 311 which quickly measures any physical variable to which a transducer can be attached. (333)

PACKAGED COOLING EQUIPMENT McLean Engineering Laboratories, P.O. Box 228, Princeton, N. J., has published a 16 page short-form catalog on packaged equipment for electronic rack cooling. (334)

MICROPHOTOGRAPHIC CAPABILITIES Itek Laboratories, Lexington 73, Mass. Bulletin announces a custom capability for design and production of micro-images on film, glass or metal. (335)

TEMPERATURE CONTROLS Assembly Products, Inc., Chesterland, O. Easy-to-install packages for accurate temperature control are described in bulletin 108-A. (336)

DYNAMOMETER TEST STATIONS Dunn Engineering Corp., 225 O'Brien Highway, Cambridge, Mass., has published a brochure on dynamometer test stations for multiple evaluation of inertial gyro spin motors. (337)

DIGITAL MODULES Digital Equipment Corp., Maynard, Mass. A complete listing of 86 fully coordinated computer circuit modules is included in a recently published catalog. (338)

CERAMIC STANDOFFS Centralab, The Electronics Div. of Globe-Union, Inc., 900 E. Keefe Ave., Milwaukee 1, Wisc., has announced a catalog and price list of JAN ceramic standoff. (339)

DELAY LINES PCA Electronics, Inc., 16799 Schoenborn St., Sepulveda, Calif. Catalog sheet covers PCDL series of miniature constant lumped delay lines. (340)

INTEGRATING DEVICES Leesona Moos Laboratories, 90-28 VanWyck Expressway, Jamaica 18, N. Y. Data sheet describes the Betachron series 1268 time-pressure integrating devices. (341)

SUBMINIATURE SWITCH Micro Switch, a division of Minneapolis-Honeywell Regulator Co., Freeport,

the Week

Ill. Data sheet 192 covers the 1HM1 hermetically sealed subminiature switch. (342)

CONTROLLED RECTIFIER Westinghouse Semiconductor Department, Youngwood, Pa. Bulletin 54-564 covers the Trinistor controlled-rectifiers for controlling medium power loads. (343)

HEADERS & MODULE PACKAGES Epoxy Products Div., Joseph Waldman & Sons, 137 Coit St., Irvington 11, N. J. Bulletin describes 19 different electronic headers and module packages. (344)

TEST INSTRUMENTS Sperry Microwave Electronics Co., Clearwater, Fla., announces a 112-page catalog entitled "Sperry Microline Test Instruments." (345)

ALPHANUMERIC LINE PRINTERS Potter Instrument Co., Inc., Sunnyside, Blvd., Plainview, N. Y. Data sheet covers the LP-600 series transistorized high speed alphanumeric line printers. (346)

DIODE TESTING National Transistor Mfg., Inc., 500 Broadway, Lawrence, Mass. Bulletin covers environmental testing of gold bonded germanium diodes. (347)

EPOXY CASTING RESIN Emerson & Cuming, Inc., Canton, Mass. Technical bulletin 7-2-26 describes Sty-cast 1264, a transparent high impact epoxy casting resin. (348)

VOLTMETER APPLICATIONS Boonton Electronics Corp., 738 Speedwell Ave., Morris Plains, N. J. A brochure presents engineering notes on the applications of a series of r-f voltmeters. (349)

LEVER-TYPE SWITCHES Switchcraft, Inc., 5555 N. Elston Ave., Chicago 30, Ill. Catalog S-307 covers lever-type switches. (350)

SILICON RECTIFIERS Diodes, Inc., Canoga Park, Calif. A two-page bulletin describes miniature $\frac{3}{4}$ amp silicon rectifiers designed to withstand dipsolder range temperature conditions. (351)

DECIMAL COUNTERS Bowmar Instrument Corp., 8000 Bluffton Road, Fort Wayne, Ind. Brochure covers series LC modular type decimal counters. (352)



Togetherness, with Greater Isolation... by new NEMS-CLARKE® Multicoupler

Another new addition to the Nems-Clarke line of telemetry equipment is the Solid State Multicoupler, SSM-101. It accepts the output of an antenna-mounted preamplifier and provides eight outputs with a minimum isolation between any two outputs of 50 db. The gain is held to approximately unity and is flat within 3 db across the band.

The SSM-101 is designed for use in the 225-260 megacycle telemetry band but can be supplied to cover other bands between 55 and 300 megacycles. Input and output connections are made at rear of the unit through type C connectors. Its integral power supply will also energize the Nems-Clarke Solid State Preamplifier, SSP-101.



Write for Data Sheet 899.
Vitro Electronics, 919 Jesup-Blair Dr.
Silver Spring, Maryland
A Division of Vitro Corp. of America

VISIT VITRO AT I. R. E. SHOW
Booth 3821-3823.

VITRO ELECTRONICS

Specifications

1. Pass Band 225-260 megacycles
2. Uniformity response within 3 db
3. Gain approximately unity
4. Isolation between outputs 50 db minimum
5. Receiver outputs 8
6. Impedance Designed to operate in 50 ohm system
7. Power source
115 v, 60 cps. approximately 6 watts
8. Connectors type C

Ammon meters reflect careful attention to design criteria, to achieve higher standards of performance with crisp new styling. Features include *self-shielded mechanism* (not a core magnet) for exceptional linearity and accuracy, allowing magnetic or non-magnetic panel mounting... *cluster mounting bezel-to-bezel* without interaction... *negligible effects* from stray fields... *gasket sealed*... non-magnetic pivots... *high torque-to-weight* ratio... long, easily-read scale with distinctive markings.

Case sizes conform to ASA/MIL mounting dimensions. Aluminum bezel in glare-free satin black or other colors. Any practical DC range, AC rectifier-types including VU. Bulletin on request. Ammon Instruments, Inc., 345 Kelley St., Manchester, N. H.

AMMON
INSTRUMENTS, INC.

**NEW
choice
for
designers**

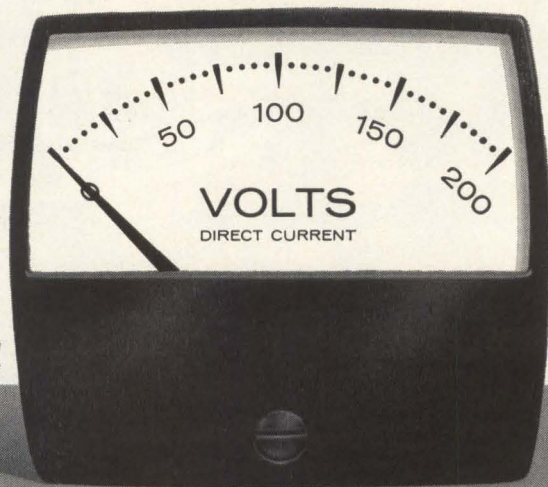

AM-2* Shown actual size
*Design patent pending

CIRCLE 213 ON READER SERVICE CARD

NEW FAMILY DC AMPLIFIERS

**LOW
COST**

**ALL
SOLID
STATE**



All units come compactly packaged in durable aluminum cases, 5 1/2" L x 2 1/2" W x 1 1/4" D. Also, two or more of the same or different types can be furnished in a single package for meeting special design requirements.

OPERATIONAL AMPLIFIER A-2... an exceptionally *fast* DC amplifier for satisfying your more exacting requirements in instrumentation, analog computing, and complex data-handling and control systems.

OPEN LOOP GAIN — 100,000
GAIN-BANDWIDTH PRODUCT — 200 KC
RISE TIME — Less than 10 μ sec. at unity gain and gain of ten; less than 100 μ sec. at gain of one hundred.
PRICE — \$195

POWER BOOSTER G-2... a compatible plug-in unit for use with the A-2 in driving heavy instrument systems, small DC servos, rotary amplifiers, etc., in process and machine control applications.

CURRENT OUTPUT — 100mA @ ± 10 V
PRICE — \$75

CHOPPER AMPLIFIER C-2... a special low drift plug-in DC amplifier for use with the wide-bandwidth A-2 where microvolt stability is required in operational amplifier and pre-amplifier applications.

DRIFT (25°-50°C) — Less than 0.5 μ V/°C
PRICE — \$195



For complete details, request Bulletins 031, 032, and 033.
RIDGEFIELD INSTRUMENT GROUP

Ridgefield 5, Conn. 101eWood 8-6571
Chicago Office: 747 Deerfield Road, Deerfield, Ill., WInsdor 5-2992

**first
choice of
all 4**

research

design

production

management

Because the BUYERS' GUIDE satisfies the buying and specifying needs of all four segments of the industry! Gives more information in less space. Easier to use.

Only the **BUYERS' GUIDE** has been *screened for usefulness* over a 20 year period... comes to you compact, complete and accurate.

gives more to all 4!

**electronics
BUYERS' GUIDE
and REFERENCE ISSUE**



ESTABLISHED 1881

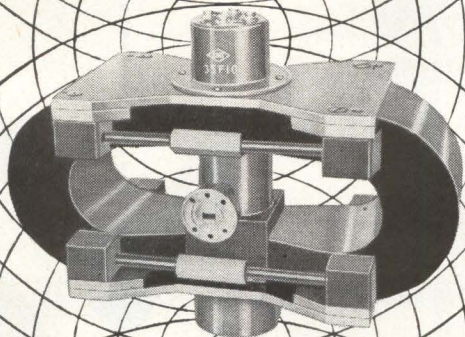

INTRODUCING LADDERTRON

A NEW TUNABLE HIGH POWER CW MM-WAVE KLYSTRON

LADDERTRON, a single cavity, multi-gap klystron, employs a strip beam system, that permits LOWER BEAM VOLTAGE CW OPERATION FOR VERY HIGH POWER USE. The frequency of the LADDERTRON is mechanically tunable over a range of 1,000 Mc, and the control electrode modulation enables the electronic tuning in a range of 40 Mc.

The 2 models now in production are the 35F10 with a frequency of 35 K Mc and an output of 5 watts, and the 50F10 with a frequency of 50 K Mc and an output of 5 watts.

Model No.	35F10	50F10
Output Power	5W	5W
Center Frequency	34,000 Mc	50,000 Mc
Mechanical Tuning Range	±750 Mc	±1,000 Mc
Resonator Voltage	1,850V	2,140V
Cathode Current	110 mA	120 mA
Electrical Tuning Range	40 M c/s	40 M c/s
Water Cooling	0.5 ℓ/min.	0.5 ℓ/min.



FOR DETAILS, WRITE TO :

Sole Distributor in U.S.A.
Butler Roberts Associates, Inc.

4471, N.W. 36th Street, Miami Springs, Fla.

202 East 44th Street, New York 17, N.Y.

Frank Thomas P.O. Box 1377, Santa Barbara, Calif.

CIRCLE 210 ON READER SERVICE CARD

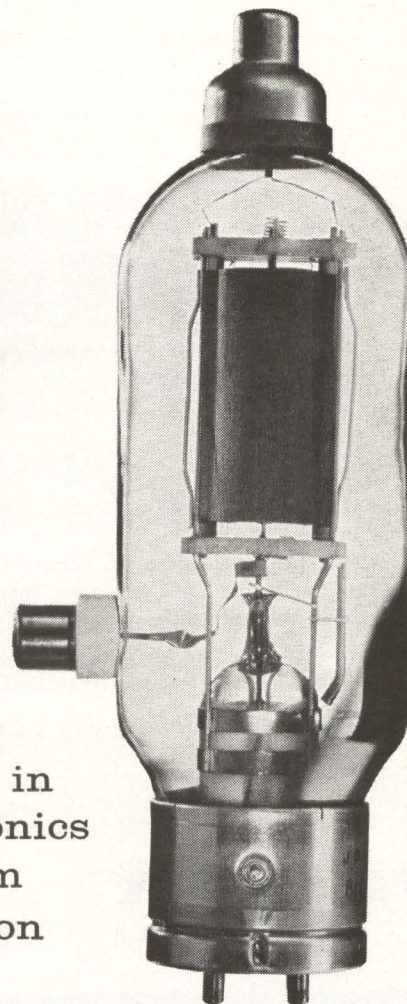

Ideas in Electronics from Norton

The electronics industry became a giant before it became a baby.

This outstanding growth has been largely due to the development of new materials — *refractory* materials with a great range of electrical properties. The prime source of these *idea refractories* is Norton Company.

For example, refractory fused alumina has high constant resistivity, to assure minimum leakage between elements in TV, radio and radar tubes. The same material is a recent innovation for transistor potting. Norton silicon carbide is an essential component in lightning arrestors and other non-linear resistors because of its variable voltage-current relationship. Silicon carbide is also finding new uses in microwave absorption, and as single crystals in high temperature rectifiers and transistors.

Fused magnesium oxide, used in most heating elements for electric ranges, has gained acceptance in such areas as advanced thermocouple design and infrared transmission.

Norton offers a wide choice of super-refined refractories, including oxides, borides, nitrides and carbides, and is ready to work with you in engineering materials to meet your needs. But above all, Norton offers ideas in every field in which refractory materials play a part.

Write NORTON COMPANY, Refractories Division, 681 New Bond Street, Worcester, Massachusetts.



REFRACTORIES

Crystallizing ideas into products

now - tin oxide trimmers



"Infinitrim" by Intellux

Resolution is stepless, TC is better than 50ppm/°C and they are great for high ambient temperatures. Yet, Infinitrims are interchangeable with ordinary trimming potentiometers.

Available in the popular 1/2" square shape as well as round, in values from 100 ohms to 10K.

Up date your circuits now . . . improve performance and reliability.

intellux

INCORPORATED

Write for complete
"Infinitrim Data"

P.O. Box 929, Santa Barbara, Calif.

CIRCLE 211 ON READER SERVICE CARD

Sub-Miniature Indicator Lights

Conform to applicable Military Specifications.

Mount from FRONT of Panel in 15/32" Clearance Hole

NEON

Assemblies with Built-in Resistor

(A patented DIALCO feature—U.S. Pat. No. 2,421,321)

Conform to MS25257... Accommodate T-2 Neon Glow Lamps: Type NE-2D (MS25252)

is recommended for general service on 105-125 volts AC or DC. The High Brightness type NE-2J (not MS) may be used on 110-125 volts AC only.



T-2

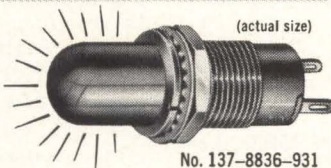

(actual size)

No. 137-8836-931

Features: Stovepipe lens molded of high-heat plastic gives 180° light spread; available in choice of signal colors... Two terminals... Rugged construction; phenolic insulation of Mil. Spec. grade... *Anti-rotation* (locking) features prevent rotation of unit while being tightened to panel... For complete data request Brochure L-159C.

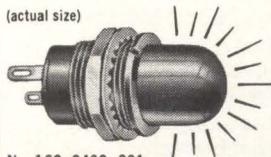

(actual size)

No. 162-8430-931

INCANDESCENT

Assemblies conform to MS25256

Accommodate T-1-3/4 Incandescent bulb with midget flanged base, in voltages ranging from 1.3 to 28 (the 6 V. and 28 V. conform to MS25237).

For complete data request Brochure L-156E.

Samples on Request—at Once—No Charge



T-1 3/4

DIALCO

PILOT LIGHTS

"The Eyes of Your Equipment"



Foremost Manufacturer of Pilot Lights

DIALIGHT
CORPORATION

58 STEWART AVE., BROOKLYN 37, N.Y. • Area Code 212, HYacinth 7-7600

98 CIRCLE 98 ON READER SERVICE CARD

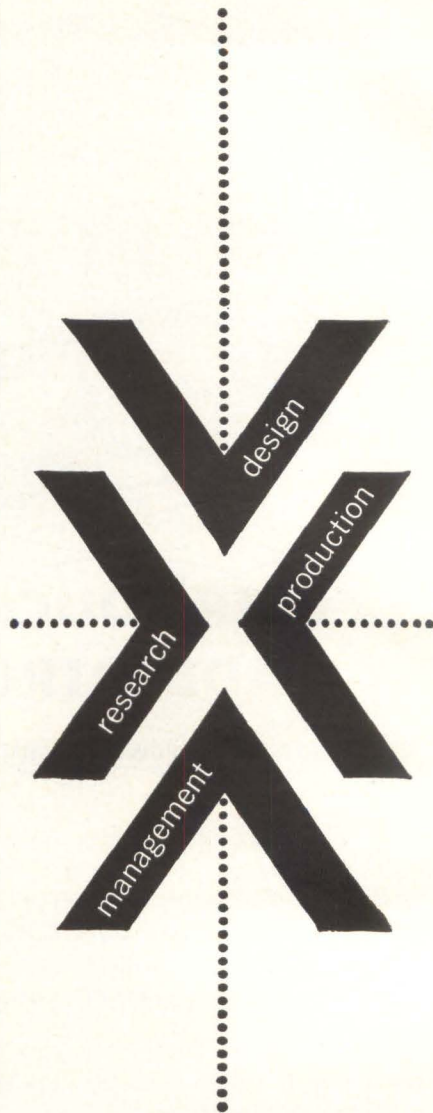

it's read
more
by all 4!

electronics magazine covers engineering and technically interpreted market trends every week. Government, military and economic developments, new applications, and technical data you'll want to file and keep. Subscribe now and read it first (don't be low man on a routing slip). Mail the reader service card (postpaid) to **electronics**, the magazine that helps you to know and to grow! Rates: three years for \$12; one year for \$6; Canadian, one year for \$10; foreign, one year for \$20. Annual **electronics** BUYERS' GUIDE (single issue price \$3.00) included with every subscription.

subscribe today to
electronics

electronics

Help put SURVEYOR on the MOON

Sometime in 1963, the first of several Hughes-built SURVEYOR vehicles will be put into lunar-impact trajectory for a soft landing on the moon. Surveyor instruments will perform a variety of scientific tasks: drills will pierce and analyze the moon's surface; high quality television pictures will be transmitted to earth; other instruments will measure the moon's magnetic and radiation characteristics. ■ To accomplish this step into space, Project Surveyor requires the talents of imaginative junior and senior engineers and physicists to augment its outstanding staff. Experience is preferred, but not required. ■ Unprecedented opportunities now exist on Surveyor and other projects, such as: ARPAT (terminal anti-ballistic missile defense system), BAMBI (anti-ballistic missile feasibility study), SYNCOM (synchronous communications satellites), POLARIS guidance and others.

CONTROL ENGINEERS—with experience in such areas as hydraulics, airborne computers, control circuitry, microwave antennas and other areas related to controls for the following areas of work: Missiles & Space Vehicles (attitude control—roll, pitch and yaw); Satellites (orbital control); Radar Tracking (hydraulic control of vertical and azimuth); Control Circuitry (preliminary and breadboard design); Control Systems (adaptive space control systems); Control Techniques (advanced non-linear); Equalization Networks (transistorized); Control Servomechanisms (design and debugging of controls, servomechanisms, sensors and other components); Missile Defense Systems (airborne computers and analog simulations of anti-ballistic missile defense systems).

SYSTEMS ANALYSTS—should be graduate physicists or engineers with a minimum of three years experience in weapon systems analysis, operation analysis, IR, physics of space, signal processing or communication theory. Involves the consideration of many basic problems such as: the proper mix of manned vs. unmanned satellites; the requirements of manned space flight; justification of system choice in terms of cost effectiveness; automatic

target recognition requirements for high speed strike reconnaissance systems or unmanned satellites; IR systems requirements for ballistic missile defense; signal processing techniques for interplanetary telecommunications; analysis of weapon systems from conception through development, test and customer use; design concepts for new airborne weapon systems.

CIRCUIT DESIGN ENGINEERS—should be experienced systems engineers capable of analysis and synthesis of systems involving the following types of circuits and components: high power airborne radar transmitters; low noise radar receivers using parametric amplifiers, solid state masers and other advanced microwave components; radar data processing circuit design, including range and speed trackers and crystal filter circuitry; high efficiency power supplies for airborne and space electronic systems; telemetering and command circuits for space vehicles; timing, control and display circuits for COLIDAR (Coherent Light Detection and Ranging).

INFRARED SPECIALISTS—to perform systems analysis and preliminary design in infrared activities involving satellite detection

and identification, air-to-air missiles, AICBM, infrared range measurement, air-to-air detection search sets, optical systems, detection cryogenics and others.

Immediate openings also exist for Power and Propulsion Engineers, Analytical and Design Engineers, Structures Engineers, Heat Transfer Engineers, Equipment Installation Engineers, Electromagnetic Theory Specialists and Antenna Specialists.

Reply today: Your inquiry will be treated with strict confidence. Please airmail your resume to: **Robert A. Martin**, Supervisor of Scientific Employment, Hughes Aircraft Co., 11940 West Jefferson Blvd., Culver City 61, California. *WE PROMISE YOU A REPLY WITHIN ONE WEEK*





Does he know what time it really is?

It's time to close ranks behind our country. And you are the one who can best tell your employees how, with your promotion of the Payroll Savings Plan for U.S. Savings Bonds. Sure, you talk in terms of their own personal stake in savings that give them security and peace of mind. You show them how easy it is. How completely painless. But then you owe it to the bigger purpose to show how much savings also help the individual's community—and his country. You can get all the facts and help you need by calling your State Savings Bonds Director. Or write to Treasury Dept., U.S. Savings Bonds Division, Washington 25, D.C.

Keep Freedom in Your Future... **U.S. SAVINGS BONDS**



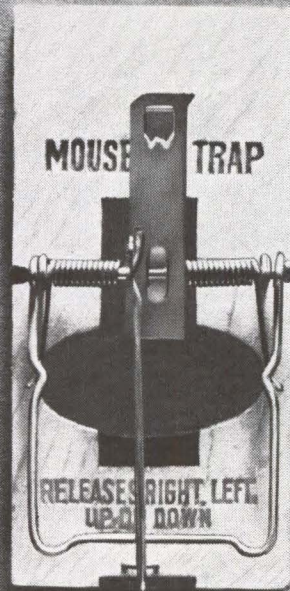

9 billion dollars to build a better one.

We're living in a needing, buying, growing America—a time for new and improved products and services—the creation of new jobs. More than ever, a businessman with an idea, with the urge for something better will move ahead with our expanding economy.

But after the idea, what follows can be a costly period of research and development. Not necessarily—if you use the immense 9-billion-dollar fund of research and patent information that's available at your U.S. Department of Commerce. Think of the saving—in time and money.

For example: there are reports on extensive research by your Government in new products and processes. A trans-

lation of data on inventions and discoveries abroad—information on over 3 million patents—a fortune in patents owned by your Government. All this is yours—for your use and your benefit.

Take advantage of the many ways in which your business can grow. In developing new products and services. In the lucrative foreign markets. In new U.S. markets. In attracting new industry to your local community. Just phone or write the U.S. Department of Commerce Office of Field Services in your city, or Washington 25, D.C. Your U.S. Department of Commerce is always ready to help you grow with America!



NOW'S THE TIME TO GET GROWING IN A GROWING AMERICA!

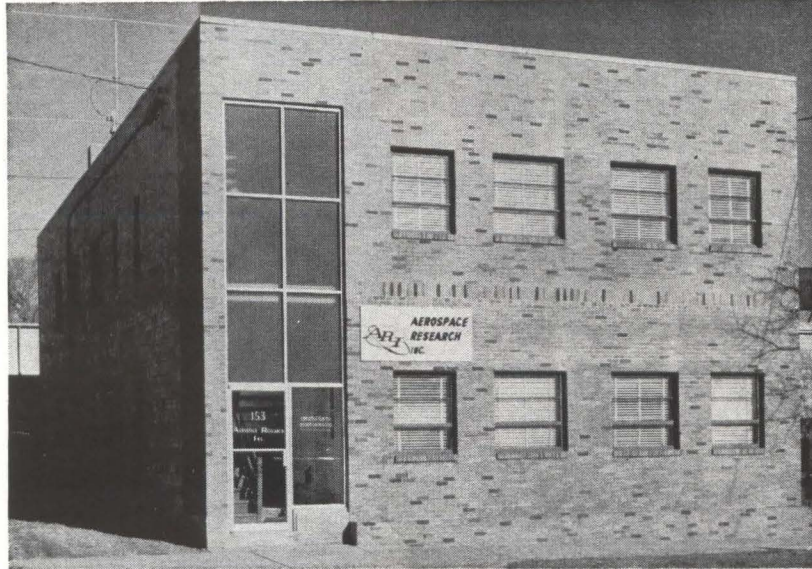

Aerospace Research Opens New Plant

AEROSPACE RESEARCH, INC., formerly of Cambridge, recently opened new laboratory, production, and office facilities at Newton, Mass. Rapid expansion in the wake of new research contracts and the necessity of production line manufacturing of company products prompted the move.

The company is engaged in research and development in radio propagation, communications, solid state instrumentation and ionospheric physics. Prime contract activity is largely with the Air Force Cambridge Research Laboratories in Bedford, Mass.

ARI manufactures products used in timing systems and in radio

propagation research. Very low frequency equipment is a specialty. Company says items such as an electrostatically shielded loop antenna, and the Caliverter, a vlf to h-f broadband converter, have found a wide market.

The company's latest development for the Air Force is an improved Riometer (Relative Ionospheric Opacity Meter), for detecting ionospheric changes. ARI is presently manufacturing these for the general industry.

L. Dennis Shapiro, president and director of research, says that the company will continue to expand along the same lines, balancing R&D and product sales.

Granger Associates Expands Staff

THREE ADDITIONS to its senior engineering staff have been announced by Granger Associates, Palo Alto, Calif.

Bernard M. Schiffman and Willis E. Moore have been assigned to the antenna department, to develop and design log periodic antennas for h-f communications and other applications.

Wayne A. Downie is engaged in

new product development in the aviation products department.

Schiffman joins Granger Associates from Varian Associates. Moore was previously associated with Convair Div. of General Dynamics. Downie was formerly with Pan American World Airways.

Victoreen Elects Vice President

JAMES P. MCMAHON, president of Tullamore Electronics Corp., a sub-

sidiary of The Victoreen Instrument Co., New York City, has been elected a vice president of that company.

After nine years with the AEC's Argonne National Laboratory as an electronics instrument designer, McMahon left to found Tullamore Electronics Corp., which early in 1959 became a wholly owned subsidiary of Victoreen.

Three Engineers Join TRG-West

TRG, INC., Syosset, N. Y., announces the appointment of Mogens Andreasen, Eugene Sharp and G. R. Hilbers to the staff of TRG, West, Menlo Park, Calif.

All were formerly with Stanford Research Institute.



Hirsch Assumes New Position

MILTON D. HIRSCH has been appointed contracts manager for Western Design & Electronics, a division of U. S. Industries, Inc., Santa Barbara, Calif.

Prior to joining WD&E, he was director of engineering liaison at Radiatronics Inc. in Van Nuys, Calif. He has also been associated with the Schutter Microwave Corp., Lindenhurst, N. Y., as executive vice president.

Hughes Aircraft Promotes Lutz

SAMUEL G. LUTZ has been appointed chief scientist of Hughes Aircraft Company's research laboratories in Malibu, Calif., where he will direct studies of satellite communications.

Since 1958 Lutz has been a senior scientist at the laboratories;

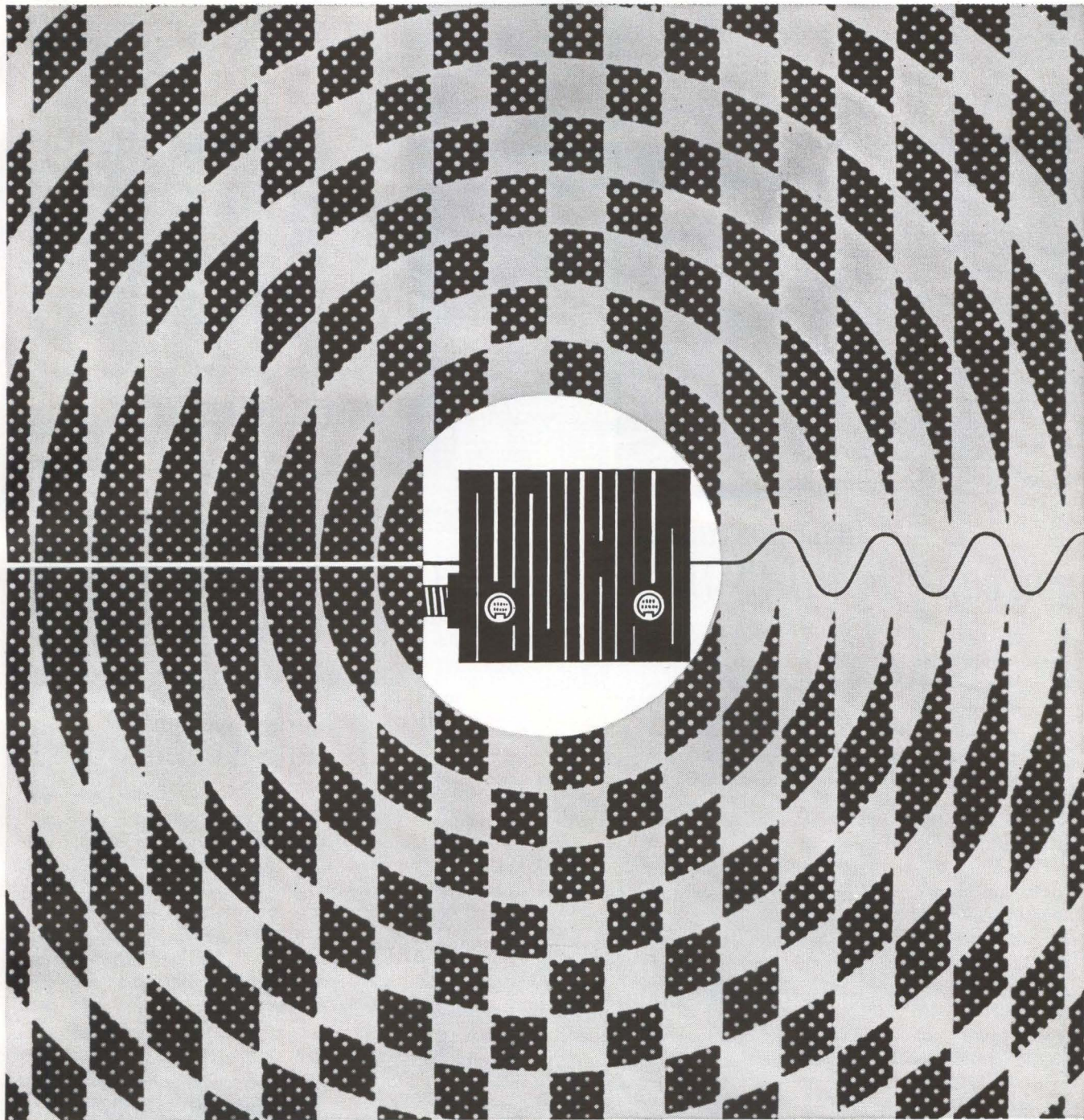

HOW 6 TRANSISTORS CAN WORK

7 TIMES HARDER WITH ONLY HALF TRYING

(a report from Delco Radio)

Sound like a riddle? Well, it was . . . almost. Here's the story.

Delco Radio engineers wanted to build a precision static inverter that was smaller, simpler, lighter, more economical and considerably more powerful than previous models.

Research hit on the idea of current feedback. Following this principle, the engineers designed an amazing inverter using only 6 transistors. Transistor utilization is stepped up 7 times, yet the transistors work at less than 50% of their capacity, run cooler, last longer.

SEE YOU AT IRE SHOW, BOOTH 1423

This new Delco 250 VA power supply converts 28 volts DC to 115 volts, 400 cps. Its circuits are a model of simplicity.

The unit is designed for continuous full-load operation at 71 degrees C. still air, yet weighs only 10 lbs., measures 6¼" x 7⅞" x 5". A minimum of components assures extra-high reliability.

The 250 VA Static Inverter is practical hardware today, awaiting your inquiry. Delco Radio may be able to solve your problem in miniaturization, modules, inverters or converters, too. Write to Delco Radio Military Sales Department, Kokomo, Indiana.



Division of General Motors • Kokomo, Indiana

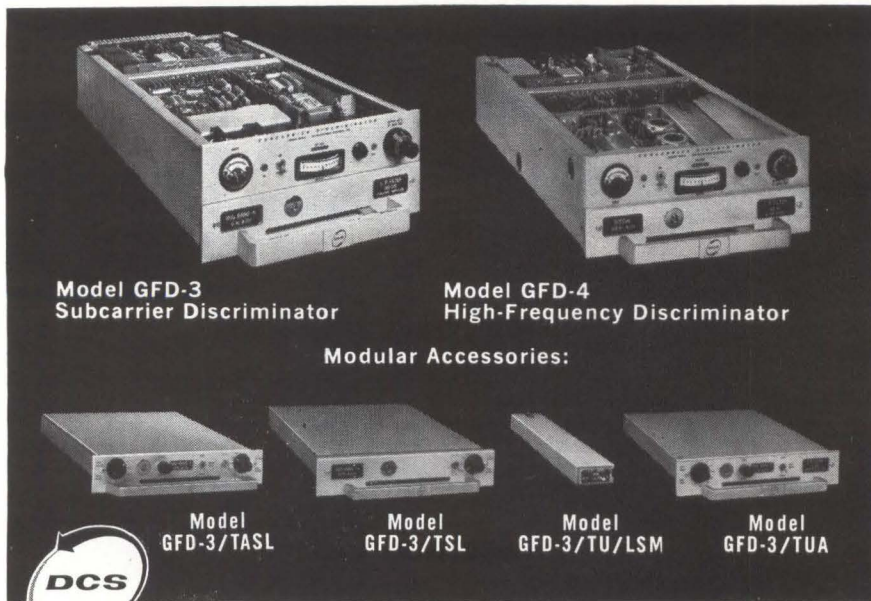

Optimum phase lock tracking!
 — — *Just one reason*
you can't beat DCS Discriminators!

COMPARE THESE DCS FEATURES:

- Super reliability — MTBF in excess of 5000 hours!
- Optimum phase-locked tracking — operator controlled.
- Widest frequency range — subcarriers to 1 mc.
- Maximum adaptability — widest variety of modular accessories.
- All solid-state — individual power supplies.
- YET — priced below many models with inferior performance!

Don't just take our word — ask our customers, who are actually using thousands of DCS Discriminators!

For example, consider reliability. Actual field data gathered by users has shown MTBF in excess of 5000 hours! What's more, we guarantee our MTBF data!

Also, DCS offers operator-controlled variable-loop tracking filters. Unlike inferior discriminators which are limited to a pre-set loop bandwidth and damping (claimed "optimum"), DCS Discriminators permit complete operator control in adapting characteristics of the phase-locked loop for *truly* optimum data reduction. A bench demonstration will quickly prove the superior performance possible with operator control. Numerous comparative customer evaluation reports attest to the superiority of the DCS operator-controlled phase-locked loop when signals are extremely weak.

The DCS family of discriminators offers the widest frequency ranges available. Discriminators to accommodate subcarriers in excess of 1 mc, intelligence frequencies in excess of 100 kc, constant-bandwidth, frequency translation, and predetection signals are standard, off-the-shelf products.

For complete information on the entire family of DCS Discriminators and accessories, call your nearest DCS Field Engineer or write: Dept. E-1-8.

DATA-CONTROL SYSTEMS, INC.
Instrumentation for Research

Los Angeles • Santa Clara • Wash., D. C. • Cape Canaveral
 Home Office: E. Liberty St., Danbury, Conn. • Pioneer 3-9241



before that, he directed the company's communications engineering from 1951 to 1958.



**Research-Cottrell
 Names Division Mgr.**

CHARLES N. HOOD II was recently appointed manager of the new electronics division of Research-Cottrell, Inc., Bound Brook, N. J.

Hood comes to his new post from Airborne Accessories Corp., Hillside, N. J., where he was engineering director.

**Loral Electronics
 Hires Horowitz**

LES HOROWITZ has been appointed product line manager at Loral Electronics Corp., New York City.

Prior to joining Loral, and since 1950, Horowitz held various supervisory engineering positions at Picatinny Arsenal. His last post was as chief, Atomic Ammunition Development Laboratory, Special Weapons Group.



**MSI, Inc., Appoints
 Wallace Anderson**

MICROWAVE SERVICES INTERNATIONAL, INC., Denville, N. J., has appointed Wallace L. Anderson to the post of chief consultant in radio

PRODUCT
NEWS
FROM



NEW SQUARE TRANSISTOR PLATE CAPACITORS

permit maximum circuit
component density
at low cost

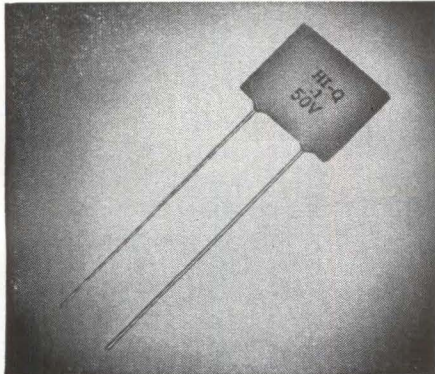

Hi-Q capabilities and advanced manufacturing facilities have once again produced an improved capacitor design to meet today's critical demands for high reliability and space savings. This new square, slim design permits maximum circuit component density, yet it is nearly in the same cost range as conventional disc capacitors.

SPECIFICATIONS

Units are available in a capacity range from .005 mfd. to .1 mfd., in sizes from .280" square to .780" square x .125" maximum thickness. Coating is a durez phenolic, wax impregnation.

Tolerance: +80% -20% standard; others available.

Working Voltage: 50 VDC

Flash Test Voltage: 150 VDC

Power Factor: 3% max. at 1 KC

Insulation Resistance: 5000
Megohms min.

Prototype Samples are available from your Hi-Q Representative or direct from the factory.



COMPLETE TECHNICAL
DATA—Write, wire or
phone today for our lat-
est catalog sheet.

AEROVOX CORPORATION

Hi-Q Division, Myrtle Beach, S.C.

Technical Leadership - Manufacturing Excellence

CIRCLE 209 ON READER SERVICE CARD
February 23, 1962

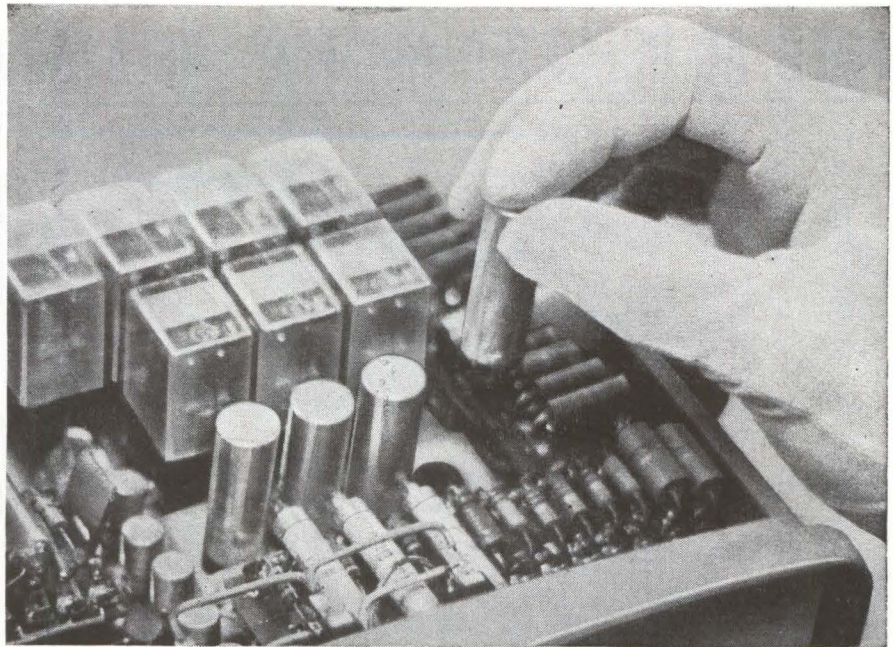

MINIATURE RESONANT REED SELECTORS

These miniaturized selectors are useful in multiplex telemetry, mobile communications, and other applications where space and weight are at a premium. Their secret is a new electro-mechanical driving system that allows both the reed and driving coil to be sealed in a case only 36mm long and 12.6mm in diameter. Each selector will respond to one of 40 audio frequencies spaced at 15 cps intervals from 262.5 to 847.5 cps, and actuate signals, counters, controls or other devices. Normal drive current is 2.5mA. Selectivity is ± 1.5 cps from standard frequency, and stability is within ± 0.5 cps of calibrated frequency from -10 to $+50^{\circ}\text{C}$. Detailed specifications and application information are available from our representatives listed below.



FUJI TSUSHINKI SEIZO K.K. Tokyo, Japan

Represented by:

■ The Nissho American Corporation □ New York 5, 80 Pine St., WH 3-7840 □ Chicago 3, 140 S. Dearborn St., CE 6-1950 ■ The Nissho Pacific Corporation □ San Francisco 4, 120 Montgomery St., YU 2-7901 □ Los Angeles 14, 649 S. Olive St., MA 7-7691

CIRCLE 107 ON READER SERVICE CARD

Is your advertising selling the same four key buyers your salesmen call on? Competition demands it! Only advertising in electronics reaches and sells the electronics man wherever he is: in Research,

TODAY YOU MUST SELL ALL FOUR!

Design, Production, and Management. Put your advertising where it works hardest...

in **electronics**

NEED AC-OPERATED MILITARY RELAYS?

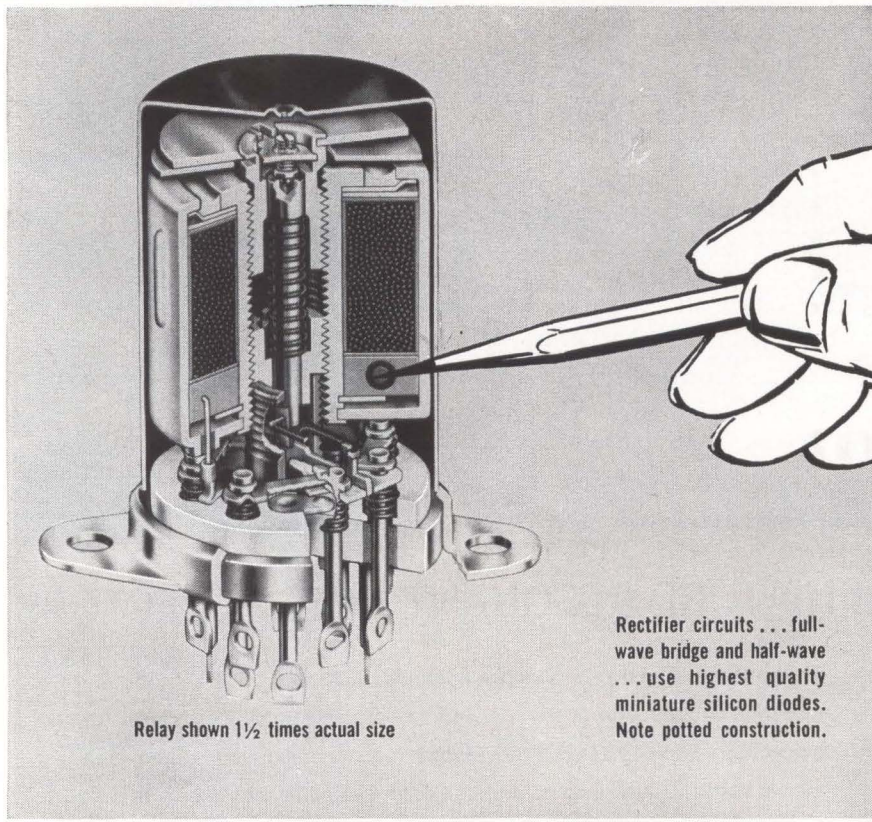

Rectifier circuits ... full-wave bridge and half-wave ... use highest quality miniature silicon diodes. Note potted construction.

Relay shown 1 1/2 times actual size

For reliable switching try "Diamond H" Series RA and SA relays with a-c coils

These relays are identical in size and weight to Hart's widely specified Series R and S d-c relays and meet the same specifications*. And, thanks to their unique design, they provide the same shock resistance (to 50G), the same vibration resistance (to 20G-2000 cps), and the same performance under temperatures ranging from -65°C to $+125^{\circ}\text{C}$. Contact ratings from dry circuit to 10 amps, 115 volts a-c resistive and 30 volts d-c resistive.

The complete line of "Diamond H" miniature hermetically-sealed relays includes hundreds of models. Contact ratings, pull-in and drop-out times, temperature, vibration and shock ratings, mounting arrangements and other specifications can be varied to meet your particular performance requirements. Ask for descriptive literature and specification list.

*Like the R and S series, they meet the requirements of MIL-R-5757C. Models are also available to fill the requirements of MIL-I-6181.



THE **HART**
MANUFACTURING COMPANY
202 Bartholomew Avenue
Hartford 1, Conn.
Phone JACKSON 5-3497

wave propagation.

Anderson is currently an associate professor of electrical engineering at New York University.

Aerospace Corp. Promotes Hansen

ROBERT C. HANSEN has been appointed associate director for satellite control in the engineering division at Aerospace Corp., El Segundo, Calif. He previously worked as senior staff scientist in the company's electronics laboratory.

PEOPLE IN BRIEF

Henry W. McMurtray, formerly with Raytheon, appointed director of quality control and reliability at Microwave Associates, Inc. **Andrew E. Trolio** and **Boyce M. Adams**, both ex-Omnitronics, Inc., are now president and vice president, respectively, of the newly formed Adtrol Electronics, Inc., in Philadelphia. **B. Cletus Kirchner**, previously with RCA, Electrons, Inc. and Cetron Electronics, has joined the Thyatron and Rectifier div. of National Electronics, Inc., as production mgr. **Herman H. Frahme**, president of Alberox Corp., has been elected chairman of the electronics division of American Ceramic Society for the year beginning in April. **Joseph P. O'Reilly** moves up from v-p and g-m to president of Ferrocube Corp. of America. **Maurice M. Rosen**, president of Progress Mfg. Co., Inc., is also named president of Progress Webster Electronics Corp. **Ivan L. Brandt**, from Rescon Electronics Corp. to Erie Resistor Corp. as director of R&D. **Morris Cohen** rejoins PRD Electronics, Inc. from Loral Electronics Corp. in the position of microwave dept. head of the Products and Components div. **G. R. Gunther-Mohr** is promoted to director of solid state engineering, International Business Machines Corp. **Urner Liddel** leaves the Department of Defense to become asst. director of Hughes Aircraft Co.'s Research Laboratories. **W. Robert Wilson**, formerly with Texas Instruments, is hired by Data-Control Systems, Inc., as mgr. of systems programs.

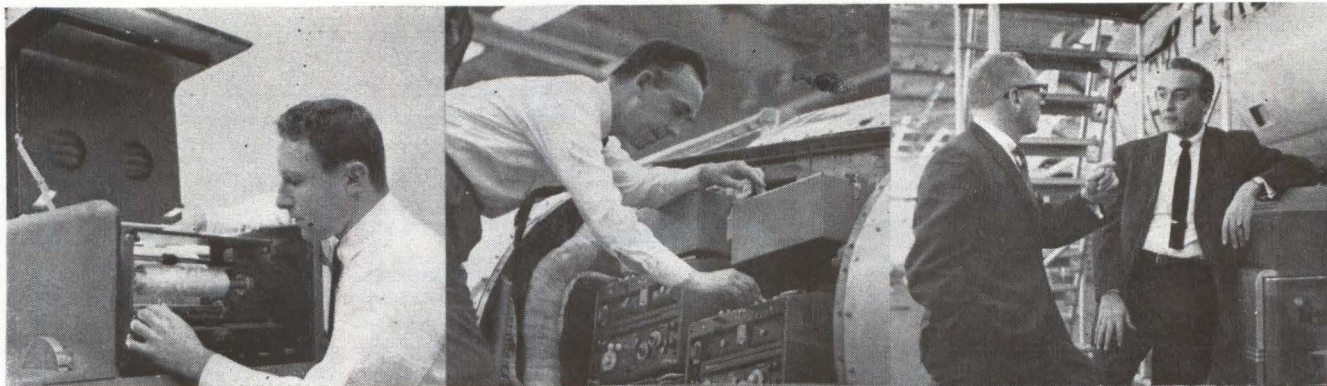

PHOTOGRAPHS — COURTESY: REPUBLIC AVIATION

The Case For Pinpoint Recruiting

Pinpoint Recruiting (the act of going directly to the most concentrated source of supply to find 'the right man' for the job) can be termed the most efficient method of recruiting engineers, and yet it is the simplest of all methods.

If you bear in mind the fact that the cream of the engineering talent you seek are presently employed and generally happy in their work, you realize that you must arouse their interest in YOUR company. As you know, engineers change jobs more frequently than does the average job holder . . . And so you ask yourself, "What motivates the engineer to do this?" To some, the answer may be surprising.

Studies in recent years have shown that the motivating factors are as follows:

1. Potential growth of company.
2. Challenging opportunity.
3. Starting salary.

4. Progressive research and development.
5. Company's prestige, reputation.
6. Regular salary increases.
7. Geographic location.
8. Permanent position.

Eight points to ponder, to weave into your recruitment advertising with skill, to attract the qualified engineers you need. When you have it all wrapped up, run your advertising in a technical publication that keeps the engineer abreast of technological developments in the industry to which he contributes his talents. It is simple reasoning that the publication the engineer pays his money to read is the one he reads most thoroughly and values most highly as his technical journal.

And there lies that "—most concentrated source of supply—" . . . of the experienced engineers you need. This is Pinpoint Recruiting. Simple, isn't it? . . . Effective, too.

Write for the new 52-page booklet "**Recruiting Engineers**"
Address: David Hawksby, Classified Advertising Division,
electronics, Post Office Box 12, New York 36, N. Y.

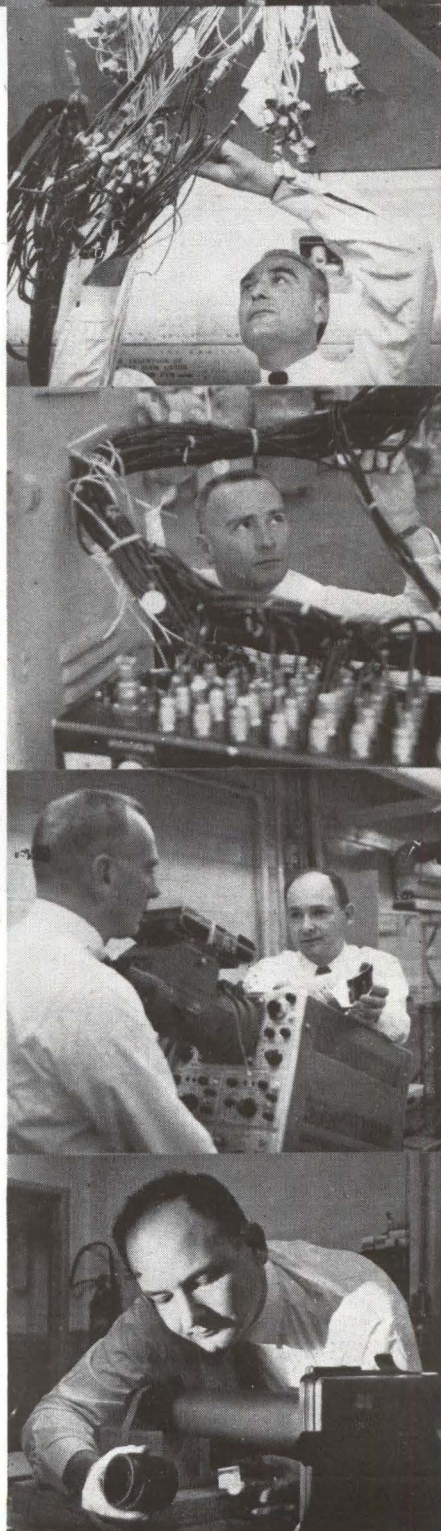

electronics

WEEKLY QUALIFICATION FORM FOR POSITIONS AVAILABLE

ATTENTION: ENGINEERS, SCIENTISTS, PHYSICISTS

This Qualification Form is designed to help you advance in the electronics industry. It is unique and compact. Designed with the assistance of professional personnel management, it isolates specific experience in electronics and deals only in essential background information.

The advertisers listed here are seeking professional experience. Fill in the Qualification Form below.

STRICTLY CONFIDENTIAL

Your Qualification form will be handled as "Strictly Confidential" by ELECTRONICS. Our processing system is such that your form will be forwarded within 24 hours to the proper executives in the companies you select. You will be contacted at your home by the interested companies.

WHAT TO DO

1. Review the positions in the advertisements.
2. Select those for which you qualify.
3. Notice the key numbers.
4. Circle the corresponding key number below the Qualification Form.
5. Fill out the form completely. *Please print clearly.*
6. Mail to: D. Hawksby, Classified Advertising Div., ELECTRONICS, Box 12, New York 36, N. Y. (No charge, of course).

COMPANY	SEE PAGE	KEY #
COLUMBIA UNIVERSITY Nevis Laboratories Irvington, New York	94*	1
ESQUIRE PERSONNEL SERVICE INC. Chicago, Illinois	111	2
GENERAL DYNAMICS/ELECTRONICS Military Products Div. San Diego, California	111	3
GILLETTE SAFETY RAZOR CO. Boston, Massachusetts	96*	4
HAMILTON STANDARD Div. of United Aircraft Corp. Windsor Locks, Connecticut	115	5
INTERNATIONAL BUSINESS MACHINES CORP. Supplies Division Vestal, New York	96*	6
INTERNATIONAL ELECTRIC CORPORATION Div. of International Telephone & Telegraph Corp. Paramus, New Jersey	82	7
LABORATORY FOR ELECTRONICS Boston, Massachusetts	78	8
LOCKHEED-GEORGIA CO. Div. of Lockheed Aircraft Corp. Atlanta, Georgia	85*	9
LOCKHEED MISSILES & SPACE CO. Div. of Lockheed Aircraft Corp. Sunnyvale, California	80, 81	10
LORAL ELECTRONICS CORP. Bronx, New York	95*	11
MARTIN MARIETTA Aerospace Division Orlando, Florida	94*	12
MICROWAVE SERVICES INTERNATIONAL, INC. Denville, New Jersey	111	13
MOTOROLA, INC. Military Electronics Div. Western Center Scottsdale, Arizona	113	14
OHIO STATE UNIVERSITY Radio Observatory Columbus, Ohio	112	15

CONTINUED ON PAGE 112

(cut here)

(cut here)

electronics WEEKLY QUALIFICATION FORM FOR POSITIONS AVAILABLE

Personal Background

NAME

HOME ADDRESS

CITY ZONE STATE

HOME TELEPHONE

Education

PROFESSIONAL DEGREE(S)

MAJOR(S)

UNIVERSITY

DATE(S)

FIELDS OF EXPERIENCE (Please Check)

2232

- | | | |
|--|--|---------------------------------------|
| <input type="checkbox"/> Aerospace | <input type="checkbox"/> Fire Control | <input type="checkbox"/> Radar |
| <input type="checkbox"/> Antennas | <input type="checkbox"/> Human Factors | <input type="checkbox"/> Radio—TV |
| <input type="checkbox"/> ASW | <input type="checkbox"/> Infrared | <input type="checkbox"/> Simulators |
| <input type="checkbox"/> Circuits | <input type="checkbox"/> Instrumentation | <input type="checkbox"/> Solid State |
| <input type="checkbox"/> Communications | <input type="checkbox"/> Medicine | <input type="checkbox"/> Telemetry |
| <input type="checkbox"/> Components | <input type="checkbox"/> Microwave | <input type="checkbox"/> Transformers |
| <input type="checkbox"/> Computers | <input type="checkbox"/> Navigation | <input type="checkbox"/> Other |
| <input type="checkbox"/> ECM | <input type="checkbox"/> Operations Research | <input type="checkbox"/> |
| <input type="checkbox"/> Electron Tubes | <input type="checkbox"/> Optics | <input type="checkbox"/> |
| <input type="checkbox"/> Engineering Writing | <input type="checkbox"/> Packaging | <input type="checkbox"/> |

CATEGORY OF SPECIALIZATION

Please indicate number of months
experience on proper lines.

	Technical Experience (Months)	Supervisory Experience (Months)
RESEARCH (pure, fundamental, basic)
RESEARCH (Applied)
SYSTEMS (New Concepts)
DEVELOPMENT (Model)
DESIGN (Product)
MANUFACTURING (Product)
FIELD (Service)
SALES (Proposals & Products)

CIRCLE KEY NUMBERS OF ABOVE COMPANIES' POSITIONS THAT INTEREST YOU

1 2 3 4 5 6 7 8 9 10 11 12 13 14 15 16 17 18 19 20 21 22 23 24 25

EMPLOYMENT OPPORTUNITIES

The advertisements in this section include all employment opportunities — executive, management, technical, selling, office, skilled, manual, etc.

Look in the forward section of the magazine for additional Employment Opportunities advertising.

— RATES —

DISPLAYED: The advertising rate is \$40.17 per inch for all advertising appearing on other than a contract basis. Contract rates quoted on request.

An advertising inch is measured 7/8" vertically on a column—3 columns—30 inches to a page.

Subject to Agency Commission.

UNDISPLAYED: \$2.70 per line, minimum 3 lines. To figure advance payment count 5 average words as a line.

Box numbers—count as 1 line.

Discount of 10% if full payment is made in advance for 4 consecutive insertions.

Not subject to Agency Commission.

MICROWAVE COMMUNICATIONS ENGINEERS

Ankara - Teheran - Karachi
Bangkok - U. S.

Work involves engineering, supervision of installation, operation and maintenance of microwave communications systems.

College Degree Mandatory

MICROWAVE COMMUNICATIONS TECHNICIANS

Must be qualified by education and experience to inspect installation, operate and maintain microwave communications systems to insure quality and performance standards.

Technical or trade school training mandatory.

Families May Accompany
Usual Overseas Benefits
Send detailed resumes to:

P-7950, Electronics
645 N. Michigan Avenue, Chicago 11, Ill.

SECTION HEAD To \$16,000 Per Year

Technical leadership and supervision of instruments section encompassing study, design and development of instrumentation systems, monitoring systems, displays, and calibration systems. 3 years of supervision required. Company assumes all expenses.

ESQUIRE PERSONNEL

202 South State St. Chicago 4, Illinois

COMMUNICATIONS APPLICATION ENGINEER Analysis of advanced electronic communication systems including radio, carrier, telephone, microwave:

Must have design and marketing experience with commercial and military users.

EE degree, 5 yrs. exp. min.
Send Resume to:

Microwave Services International Inc.
Consulting Engineers
Route 46 Denville, N. J.

ANNOUNCING:

NEW OPPORTUNITIES!

The San Diego Division of General Dynamics | Electronics, a medium-sized electronics firm in San Diego, California, has immediate, long-range opportunities in the following areas:

DESIGN ASSURANCE & RELIABILITY

The Reliability and Quality Control Department reports to the Division General Manager. This new department includes Design Assurance, Quality Assurance, Inspection, and Product Test. The products are primarily airborne radar, IR, and data display systems.

MANAGER OF DESIGN ASSURANCE

Requires experience with formal design review, design analysis, reliability analysis and prediction, human factors, maintainability, value engineering, parts application or substantial combination thereof. Requires BSEE or equivalent degree and five to ten years of electronic engineering experience. Advanced degree desirable.

SUPERVISOR OF DESIGN ASSURANCE

Same as above but for a smaller plant.

DESIGN REVIEW ENGINEERS

Requires experience with formal design review, strong mechanical or electronic design background, and BSEE or BSME or equivalent degrees. Value engineering, design analysis, reliability engineering, human factors, and parts engineering experience desirable.

RELIABILITY ENGINEERS

Requires BSEE or equivalent degree and either (a) reliability analysis and prediction or (b) good electronic product engineering design experience, preferably both or the former. Value engineering, maintainability, and parts engineering experience desirable.

RELIABILITY ANALYSTS

Requires reliability analysis and prediction experience.

PARTS AND MATERIALS ENGINEERS

Requires BSEE or BSME or equivalent degree and strong experience in the military application of electronic or mechanical parts and materials to modern circuitry, mechanisms, and packaging.

STATISTICAL ANALYST

Requires degree in math and/or statistics, and experience with reliability evaluation techniques. Experience with survival, redundancy, logistics, maintainability, availability, system evaluation, and QC very desirable.

RADAR SYSTEMS DESIGN

A number of challenging positions exist for highly qualified electronic engineers who are experienced in the creative aspects of radar system design and development. Specific openings are as follows:

RADAR SYSTEMS ANALYST

Independent analysis to determine system parameters related to airborne and surface radars. MSEE plus five years of experience in radar and associated devices desired.

PRE-DESIGN ENGINEER

Preliminary design of matched filters and correlation techniques. MSEE and five years of experience in the design of radar receivers, filters, and integrator-type circuitry desired.

PRE-DESIGN ENGINEER

System preliminary design of radar signal processing circuitry. Requires BSEE and five years of experience in design of digital circuitry for analysis of radar-type data.

MICROWAVE ANTENNA SPECIALIST

Five years of experience in research, development and design of such antennae as: shaped beam, pencil beam, horns, monopulse, scanning and tracking, or synthetic aperture types. BS degree required; MS desired.

CIRCUITRY DESIGN ENGINEER

Original design of solid state circuits for radar and similar type equipment. Will work independently and instruct junior personnel. BSEE and five years of related experience required.

MICROWAVE TRANSMITTER SPECIALIST

Design of a wide variety of radar transmitters including the megawatt power level. Must know modulators, high voltage power supplies, basic circuits using BWO's, TWT's, and Klystrons. BSEE and five years of related experience; MSEE desired.

SURFACE RADAR ANTENNA SPECIALIST

Senior technical role emphasizing preliminary engineering of large surface radar and antenna equipment. State-of-the-art antenna knowledge is essential. BS degree and ten years of experience in related field required; MS desired.

ANTENNA DESIGN ENGINEER

Design and development of a wide variety of HF, VHF, and UHF antennae including dipoles, loops, corner reflectors, spirals, arrays, and electronic scan. BS degree and four years of related experience required; MS desired.

MATHEMATICIAN

Theory and analysis of electro-magnetics and their application to the design of microwave devices, antennae, and propagation. MS in physics or mathematics required; PhD preferred.

To arrange an interview in your area or to obtain more information write at once to Mr. B. L. Dobler, Manager of Industrial Relations Administration-Engineering, Dept. 6-128, General Dynamics | Electronics, 3302 Pacific Highway, San Diego 12, California.

AN EQUAL OPPORTUNITY EMPLOYER

GD

GENERAL DYNAMICS

ELECTRONICS

SAN DIEGO DIVISION

ENGINEERS

WORK IN AN ENGINEERS' ENVIRONMENT

AT
**SPERRY
GYROSCOPE
COMPANY**

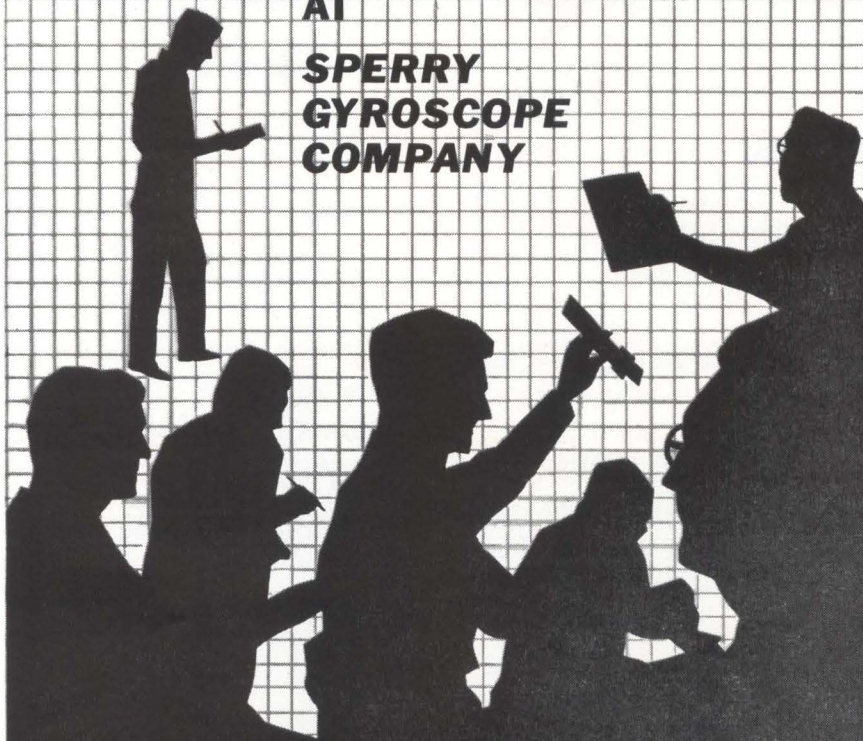

For more than fifty years engineers have acknowledged that Sperry is a good place to work. The reason? Simply stated it's because Sperry possesses a true **engineers' environment**. Here you will find the broad range of programs that insures stability and because of their advanced nature you can forget "off-the-shelf" concepts and start using your creative imagination. At Sperry you will be working with the top men in your specialty and from these men you will gain increased professional competence. Finally Sperry's management is technical management that knows an engineer's problems and recognizes his contributions.

Gain the many advantages of an engineers' environment by joining the Technical Staff at Sperry. Openings are currently available for engineers experienced in one or more of these areas:

- GYROS AND INERTIAL COMPONENTS • DIGITAL COMPUTERS • CIRCUITRY • PACKAGING • COMMUNICATIONS • SONAR • RADARS • ASW • STAR TRACKERS • CELESTIAL AND INERTIAL NAVIGATION SYSTEMS • PRECISION GEAR TRAINS • STRESS ANALYSIS • RANGE INSTRUMENTATION • MISSILE INSTRUMENTATION • FIELD ENGINEERING

Inquiries may be sent in complete confidence to:
Mr. J. W. Dwyer, Employment Manager

SPERRY

GYROSCOPE COMPANY

Division of Sperry Rand Corp.

Great Neck, Long Island, N. Y.

An Equal Opportunity Employer

ELECTRONICS TECHNICIANS

Excellent opportunities for experienced electronic technicians at large university radio observatory in development and operation of low noise radio-meters with digitized output operating at UHF and microwave frequencies. Give resume of experience, references, and salary desired. Address correspondence to:

Director
Ohio State University Radio Observatory
2024 Neil Avenue
Columbus 10, Ohio

ELECTRONIC ENGINEER

For analog to digital circuit design. Should have E.E. and 5 to 10 years experience with at least 2 years in solid state. Top position. Salary \$10,000 to \$12,000 and stock options. Philadelphia area.

P-8290, Electronics
Class. Adv. Div., P.O. Box 12, N.Y. 36, N.Y.

POSITION VACANT

The position of Chairman of the Faculty of Electronic Technology is open at Arizona State University. Electronic Technology is devoted to the preparation of Engineering Technicians in a four-year program which leads to a Bachelor of Science degree. Interested persons holding a M.A., M.S., or Ph.D., having teaching, industrial and administration experience in electronics are invited to correspond with the Division of Industrial Education, Arizona State University, Tempe, Arizona.

SELLING OPPORTUNITY WANTED

Sales Engineers—New Group Engineers to represent equipment manufacturer. Territory—Texas, Kansas, Oklahoma, Missouri—retainer or commission. RA-8391, Electronics, Classified Adv. Div., 645 N. Michigan Ave., Chic. 11, Ill.

electronics

WEEKLY QUALIFICATIONS FORM FOR POSITIONS AVAILABLE

(Continued from page 110)

COMPANY	SEE PAGE	KEY #
PAN AMERICAN WORLD AIRWAYS INC. Guided Missiles Range Div. Patrick AFB, Florida	16*	16
SCOPE PROFESSIONAL PLACEMENT CENTER Waltham, Massachusetts	115	17
SPERRY GYROSCOPE COMPANY Div of Sperry Rand Corp. Great Neck, L.I., New York	112	18
SYLVANIA MOUNTAIN VIEW OPERATIONS Mountain View, California	114	19
THIOLKOL CHEMICAL CORPORATION Bristol, Pennsylvania	95*	20
P-7950	111	21
P-8290	112	22

* These advertisements appeared in the 2/16/62 issue.

**Method for
measuring
an engineer...**

**What's his
technical
publication ?**



When an engineer pays for a technical publication, it's a safe bet that that is the one he respects most.

He makes it his business to read **electronics**. It keeps him well informed of up - to - the - minute events and developments in the electronics industry and the technology to which he contributes his experience.

Where your recruitment program calls for engineers and other technical people of this calibre, you can reach them in the **EMPLOYMENT OPPORTUNITIES** section of:

electronics

A MCGRAW-HILL PUBLICATION

CLASSIFIED ADVERTISING DIVISION

POST OFFICE BOX 12 NEW YORK 36, NEW YORK

Career opportunities at

Motorola in Phoenix

*are awaiting you now,
along with a wealth of
warm winter sun*

The sun spends more time in Phoenix than in any other major city in the United States. That's why golfing, gardening, picnics, boating and fishing can be enjoyed around the calendar. World-famed scenery and the freedom of wide open spaces are yours to enjoy. You're 90 minutes from pine-forested mountains; just four hours to Mexico; six hours to incomparable deep-sea fishing.

These advantages add considerable meaning to opportunities for personal and professional growth at Motorola. Here, you'll be given the opportunity to express your ideas in an atmosphere that encourages initiative and independence. As a member of a project team, you become a key figure at every level of creative engineering — working alongside men with proven ability and broad experience. And in addition you'll get a bonus in better living in the sunniest, healthiest climate in the United States.

- Systems Test Equipment Design
- Communications and Navigation
- Systems Analysis and Preliminary Design
- Missile and Space Guidance and Control
- Digital Circuitry Design
- Microwave and Radar
- Reliability and Components
- Solid State

**POSITIONS
IMMEDIATELY
AVAILABLE**

Write Phil Nienstedt, Dept. 252



MOTOROLA

MILITARY ELECTRONICS DIVISION — WESTERN CENTER
P.O. Box 1417, Scottsdale, Arizona

Motorola also offers opportunities at
Chicago, Illinois, and at Culver City and Riverside, California

An Equal Opportunity Employer



*Demanding Assignments for
Engineers at*

SYLVANIA

RSL

Reconnaissance Systems Laboratory
on the
SAN FRANCISCO PENINSULA

SYSTEMS ENGINEERS. System analysis and synthesis in new programs at Sylvania's RSL offer a broad spectrum of challenging problems involved in reconnaissance systems including: feasibility studies, conception and definition of optimized system solutions to basic operational requirements; application and development of advanced techniques; specification of constituent subsystems; human factors engineering; operations research; system performance analyses. A minimum of 5 years experience is required in progressive assignments in system analysis and synthesis and integration of subsystems. Should have background in receiving systems in the HF through millimeter bands. Advanced degree preferred.

DESIGN ENGINEERS. The design groups in RSL have openings for engineers at all levels with design and development background in one or more of these areas: receivers, RF components, DF equipment, antennas, magnetic tape recorders, teletype equipment, displays, data transmission, data converters and computers. Opportunities for both technical specialists and supervisors.

SENIOR RELIABILITY ANALYSIS ENGINEERS
Positions requiring systems analysis, test design, availability and effectiveness studies, proposal writing, major reliability reports. Must have BS in EE or Physics with knowledge of fundamentals of calculus or probability; a minimum of 4 years of senior responsibility in reliability engineering involving implementation of reliability programs.

THE REWARDS. Work in a compact and growing laboratory which offers the creative engineer the opportunity to grow with an expanding organization. Take advantage of the individual recognition and advancement opportunities of a small organization (approximately 500 employees) with the security, benefits and diversified opportunities of a large corporation. Enjoy the ideal Northern California climate in relaxed suburban communities with excellent schools and recreational facilities for you and your family. Live within 40 minutes of cosmopolitan San Francisco. Realize the advantages of being close to leading universities (Stanford is just five miles from the Laboratory).

An equal opportunity employer.

Complete information may be obtained by writing, in confidence, to
Roger Harlan at:

SYLVANIA RECONNAISSANCE SYSTEMS LABORATORY
P. O. Box 188, Mountain View, California



7703

**Just Published
ANTENNA ENGINEERING
HANDBOOK**

Prepared by a Staff of Specialists
Edited by **HENRY JASIK**
President, Jasik Laboratories, Inc.

A vast amount of information relating to antennas and antenna design is brought to you in this practical Handbook. From basic fundamentals to modern design applications, the book offers the kind of detailed treatment necessary for successfully working in today's complex field of antenna engineering. Important data on many types of commercial antennas, and a number of developments in the field of military applications are included. This authoritative guide includes material on long wire, slot, loop, helical, horn, reflector, and scanning antennas. Engineering applications of receiving, transmitting, radar, aircraft, VHF and UHF communications antennas are fully covered. Treated, too, are such important advances as frequency independent antennas, surface-wave antennas, scanning antennas, radio telescope antennas, and others. Transmission lines, impedance matching and broadbanding, radome problems, propagation problems, and other special topics round out the comprehensive coverage of the Handbook. 1013 pp., 993 illus. & charts, \$22.00

**ELECTRONIC PACKAGING
WITH RESINS**

Just Published. A practical guide to embedment-packaging materials and techniques for engineering and manufacturing electronic packages. Fully describes casting, potting, impregnating, and encapsulating components and systems. Covers epoxies and polyesters . . . urethanes and polysulfides . . . flame-retardant resins . . . foams . . . high-thermal compounds . . . and more. By C. A. Harper, Westinghouse Elec. Corp. 339 pp., 264 illus. and tables, \$11.00

NUCLEAR PULSE SPECTROMETRY

Just Published. Gives clear, concise explanations of electric systems, circuits, and methods used in counter and ionization chamber devices. Treats nuclear radiation detectors, pulse amplifiers, pulse-height and pulse-time distribution analyzers, coincidence systems, data storage devices, multi-dimensional instruments, and other topics. Includes circuit diagrams, engineering data, etc. By R. Chase, Instrumentation Div., Brookhaven Natl. Lab. 226 pp., 119 illus., \$8.50

FREE EXAMINATION

McGraw-Hill Book Co., Dept. FL-2-23
327 W. 41st St., New York 36, N. Y.

Send me book(s) checked below for 10 days' examination on approval. In 10 days I will remit for book(s) I keep plus few cents for delivery costs, and return unwanted book(s) postpaid. (We pay delivery costs if you remit with this coupon—same return privilege.)

- Jasik—Antenna Engrs. Handbook—\$22.00
- Harper—Electronic Pkg. with Resins—\$11.00
- Chase—Nuclear Pulse Spect.—\$8.50

Name

Address

City..... Zone..... State.....

Company

Position

For price and terms outside U. S.
write McGraw-Hill Intl., N.Y.C. 36

FL-2-23

SCIENTISTS/ENGINEERS

Career opportunities in:

- DESIGN
- RESEARCH
- DEVELOPMENT
- SALES
- MARKETING
- APPLICATION

Submit resume in confidence to:

- Alan Glou Technical/Scientific
- Sid Hopner Sales/Marketing

Specialists in the personalized placement of Electronic Engineers and Scientists, on a national basis, who have a BS or advanced degree. Client companies assume fee and relocation costs.



PROFESSIONAL PLACEMENT CENTER
1277 MAIN ST. WALTHAM, MASS



MANUFACTURERS' REPRESENTATIVES

IN THE ELECTRONIC INDUSTRY



Years of Sales Success in Electronics Products

NEW YORK • NEW JERSEY
PENNSYLVANIA

KENNETH E. HUGHES Co., Inc.

4808 Bergenline Ave., Union City, N. J.

SEARCHLIGHT SECTION

(Classified Advertising)

BUSINESS OPPORTUNITIES
EQUIPMENT - USED or RE SALE

Low Cost

SILICON RECTIFIERS

18 AMPS, 50 VOLTS

Special Price at 96¢ Ea.

SAM'S RADIO & ELECTRONICS

14401 MEYERS RD. DETROIT 27, MICH.

CIRCLE 460 ON READER SERVICE CARD

FOR INFORMATION

About Classified Advertising

Contact The McGraw-Hill
Office Nearest You

ATLANTA, 9	1375 Peachtree St. N.E.	TRinity 5-0523
	D. HICKS	
BOSTON, 16	Copley Square	COngress 2-1160
	M. SHOVLIN	
CHICAGO, 11	645 No. Michigan Ave.	MOhawk 4-5800
	W. J. HIGGINS	
CLEVELAND, 13	1164 Illuminating Bldg.	SUperior 1-7000
	I. C. HILL	
DALLAS, 2	1712 Commerce St., Vaughn Bldg.	Riverside 7-9721
	J. GRANT	
DENVER, 2	1700 Broadway—Tower Bldg.	ALpine 5-2981
	J. PATTEN	
DETROIT, 26	856 Penobscot Bldg.	WOodward 2-1793
	WM. H. GINDER, JR.	
HOUSTON, 25	Prudential Bldg., Holcombe Blvd.,	Rm. W-724
	J. PAGE	JACKson 6-1281
LOS ANGELES, 17	1125 W. 6th St.	HUNtley 2-5450
	W. C. GRIES	
NEW YORK, 36	500 Fifth Ave.	OXford 5-5959
	H. T. BUCHANAN - T. W. BENDER	
PHILADELPHIA, 3	Six Penn Center Plaza	LOcust 8-4330
	W. B. SULLIVAN - F. W. McCARTHY	
PITTSBURGH, 22	4 Gateway Center	EXpress 1-1314
ST. LOUIS, 3	7751 Carondelet Ave.	PARkview 5-7285
SAN FRANCISCO, 11	255 California St.	DOuglas 2-4600
	J. A. HARTLEY	

RESEARCH CAREER OPPORTUNITIES INSTRUMENTATION

These are openings for Senior Research Scientists with Ph D degrees to perform fundamental research in state-of-the-art instrumentation development.

Basic research is our prime interest. The Laboratory is dedicated to the thought that much of the progress in science will be attributed to new instrumentation and that substantial achievements can occur in a research laboratory such as ours.

Advanced research being conducted involves fundamental studies in mechanical, optical and electronic instrumentation to support current work in solid state and theoretical physics and to perform studies in new fields of instrumentation. The work cannot be departmentalized, as in academic work, but will range across the entire spectrum of science.

Several other excellent positions for Senior Research Scientists are open in the areas of: **SOLID STATE PHYSICS, THEORETICAL PHYSICS, AND INSTRUMENTATION.**

REQUIREMENTS: Ph D degree in one of the Physical, Chemical, or Engineering Sciences and a genuine desire to work in fundamental research.

LOCATION: the lovely, rolling countryside of North Central Connecticut. An easy drive to New York or Boston.

Confidential interviews can be arranged with our Divisional Director of Research, Dr. C. F. Squire. Please write to Dr. Squire at

Hamilton DIVISION OF **United
Standard** **Aircraft**

Windsor Locks, Connecticut

An Equal Opportunity Employer

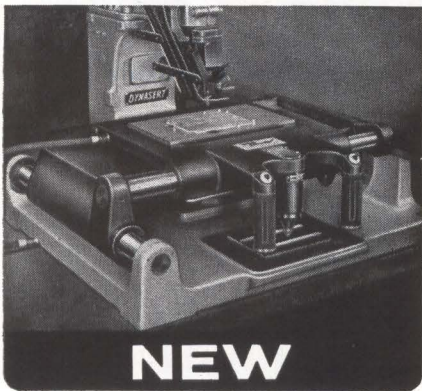

NEW PW Board Positioning Table

The use of the new Pantograph Positioning Table with Dynasert inserting machinery speeds up component insertion in PW boards. For use where multiple components of the same size are to be inserted in parallel positions. Find out more. Write or call Mr. D. R. Knight, Dynasert, United Shoe Machinery Corp., Boston 10, Mass. Area Code 617, Liberty 2-9100.

United

DYNASERT®

See us at booth #4241 at the I.R.E. Show
CIRCLE 116 ON READER SERVICE CARD



Operational guidance for buyers

That's what your 1961 electronics Buyers' Guide and Reference Issue gives you . . . this year more than ever before.

Your EBG is bigger and better this year than ever . . . and more helpful than ever . . . with more new exclusive features than ever. Keep it close at hand, you'll find it's useful day in and day out.

electronics
BUYERS' GUIDE
and Reference Issue

The Basic Buying Guide
in Electronics since 1941

INDEX TO ADVERTISERS



Audited Paid Circulation

Aerovox Corp.	60	• Hewlett-Packard Company	10, 11
• American Bosch Arma Corp. Teledynamics Div.	91	HI-Q Division of Aerovox Corp.	107
Ammon Instruments, Inc.	96	Hoffmann Electronics Corp.	9
• Amphenol-Borg Electronics Corp. Connector Division	18, 19	Hughes Aircraft Co. Aerospace Divisions	99
Anti Corrosive Metal Products Co., Inc.	54	Hunter Spring, Division of Ametek, Inc.	90
• Arnold Engineering Co., The	5	Intellux Inc.	98
Astron Corp.	66, 67	International Electric Corp.	82
Bausch & Lomb, Inc.	94	International Ultrasonics, Inc.	13
• Beckman Instruments, Inc. Berkley Division	59	Johnson Company, E. F.	79
Bendix Corporation Semiconductor Division	15	• Kearfott Div. General Precision Inc. ...	93
Bendix Pacific Division	25	• Kepco, Inc.	57
• Borg Equipment Division, Amphenol- Borg Electronics Corp.	71	• Knights Company, James	60
Cambridge Thermionic Corp.	72	Laboratory for Electronics Inc.	78
Central Illinois Public Service Co.	24	Levin and Son, Inc., Louis.	54
• Clairrex Corp.	70	Lincoln Laboratory	53
• Cly-Del Mfg. Co.	88	Lockheed Missiles & Space Co.	80, 81
Consolidated Avionics Corp.	21	Data-Control Systems, Inc.	106
Consolidated Electrodynamics Corp. ...	89	Delco Radio	76, 77, 105
• Cubic Corp.	33	• Dialight Corporation	98
Eitel-McCullough, Inc.	6	Electrodynamic Instrument Corporation	72
Electro Instruments, Inc.	53	Electro Instruments, Inc.	53
EMI/US Electron Tube Div.	72	EMI/US Electron Tube Div.	72
• Erie Pacific Div. of Erie Resistor Corp.	58	• Erie Pacific Div. of Erie Resistor Corp.	58
• Fuji Tsushinki Seizo K. K.	107	• Fuji Tsushinki Seizo K. K.	107
Gamewell Co., The.	20	General Ceramics, Div. of Indiana General	87
Gardner-Denver Company	70	General Electric Co. Semiconductor Products Dept.	65
• General Ceramics, Div. of Indiana General	87	Silicone Products Dept.	55
General Electric Co. Semiconductor Products Dept.	65	General Radio Co.	2nd Cover
Silicone Products Dept.	55	• Gudebrod Bros. Silk Co., Inc.	32
General Radio Co.	2nd Cover	Hart Manufacturing Co.	108
• Gudebrod Bros. Silk Co., Inc.	32	Hathaway Instruments, Inc.	83
Hart Manufacturing Co.	108	Helland Division, Minneapolis-Honeywell	62, 63
Hathaway Instruments, Inc.	83	• See advertisement in the July 20, 1961 issue of Electronics Buyers' Guide for complete line of products or services.	
Helland Division, Minneapolis-Honeywell	62, 63	Melabs	14
• Hewlett-Packard Company	10, 11	• Mitsumi Electric Co., Ltd.	60
HI-Q Division of Aerovox Corp.	107	NRC Equipment Co.	92
Hoffmann Electronics Corp.	9	Norton Company	97
Hughes Aircraft Co. Aerospace Divisions	99	Parabam, Div. of Houston Fearless Corp.	82
Hunter Spring, Division of Ametek, Inc.	90	• Radio Corporation of America. ... 4th Cover	
Intellux Inc.	98	Raychem Corp.	30, 31
International Electric Corp.	82	Rese Engineering Inc.	17
International Ultrasonics, Inc.	13	Ridgefield Instrument Group.	96
Johnson Company, E. F.	79		
• Kearfott Div. General Precision Inc. ...	93		
• Kepco, Inc.	57		
• Knights Company, James	60		

Sarkes Tarzian Inc.....	61
Servo Corporation of America.....	75
Sperry Electronic Tube Div. Sperry Rand Corp.....	3rd Cover
Sprague Electric Co.....	4, 29
Standard Telephones & Cables Limited	73

TRG Inc.	16
Texas Instruments Incorporated Transistor Products Division.....	68, 69
Thiokol Chemical Corp.....	51

United Shoe Machinery Corp.....	116
---------------------------------	-----

• **Vitro Electronics** 95

Western Electric, Lauredale Plant....	34
White S. S.....	82

• **Wind Turbine Company**..... 117

MANUFACTURERS' REPRESENTATIVES
Hughes, Kenneth E..... 115

CLASSIFIED ADVERTISING
F. J. Eberle, Business Mgr.

EMPLOYMENT OPPORTUNITIES. 111-115

EQUIPMENT

(Used or Surplus New)
For Sale 115

INDEX TO CLASSIFIED ADVERTISERS

Esquire Personnel Service Inc.....	111
General Dynamics/Electronics	111
Hamilton Standard, Div. of United Aircraft Corp.....	115
Microwave Services International Inc....	111
Motorola Inc., Military Electronics Div., Western Center	113
Ohio State University, Radio Observatory	112
Sam's Radio & Electronics.....	115
Sperry Gyroscope Co.....	112
Sylvania Mountain View Operations.....	114

• See Advertisement in the July 20, 1961 issue of Electronics Buyers' Guide for complete line of products or services.

This index and our Reader Service Numbers are published as a service. Every precaution is taken to make them accurate, but ELECTRONICS assumes no responsibilities for errors or omissions.

for ANTENNABILITY

LOOK TO

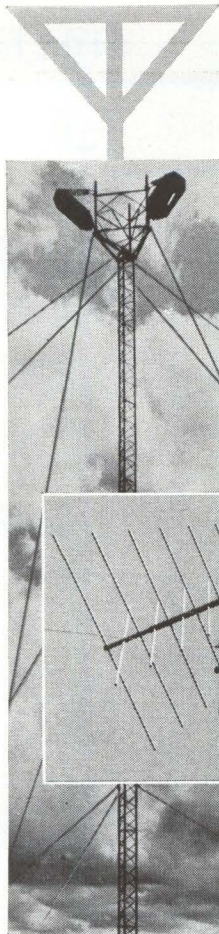

Towers in guyed and self-supporting types for Microwave, FM and TV antenna support, Vertical Radiators, Loran, etc. in all materials.

Antennas for all services from VLF to UHF including Log Periodics, Rhombics, Corner Reflector, Vertical Radiators, etc.

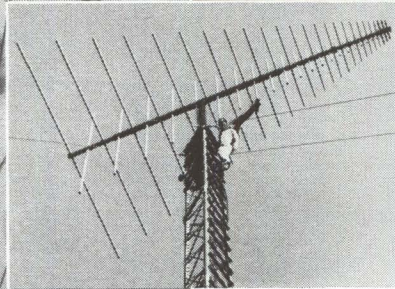

TRYLON offers outstanding Antenna and Tower capability.

Use this knowledgeable, experienced source that offers:

1. Worldwide experience in military, civilian and government applications.
2. Full service and responsibility including: research, development, manufacture and installation.
3. Resourceful, experienced personnel with outstanding records of achievement.
4. Worth-while economies because we do our own manufacturing.

Full line of accessories. Full capability and facilities for testing, research and development.

Write, wire, or phone and let us help you on your requirements.

WIND TURBINE COMPANY

WEST CHESTER, PA.

Phone: OWen 6-3110

TRYLON TOWER AND ANTENNA SYSTEMS
RESEARCH • DEVELOPMENT • MANUFACTURE • INSTALLATION

CIRCLE 212 ON READER SERVICE CARD

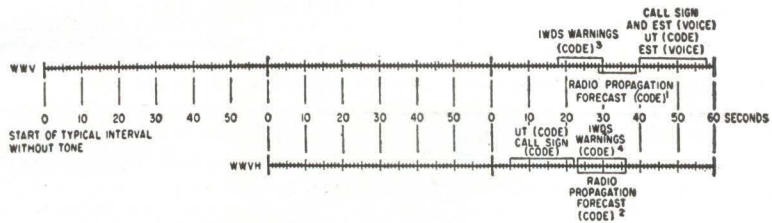

PRIMARY STANDARDS

Whether you want to pace a city's clocks or time the transit of an artificial satellite, you'll find the standard time intervals and frequencies broadcast by the National Bureau of Standards of vital assistance.

You'll find a complete run-down on this NBS service in your 1961 **electronics Buyers' Guide** and Reference Issue, plus information on how you can obtain NBS calibration of practically any secondary standard, from resistance to the complex elements of the tensor permeability matrix.

Wealth of information like this makes your 1961 EBG a primary reference volume in the electronics field. You'll find new uses for it every day.

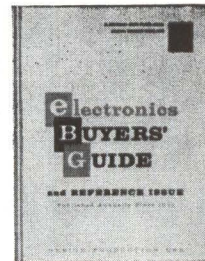

electronics BUYERS' GUIDE and Reference Issue

The Basic Buying Guide in Electronics since 1941



electronics fills you in on every phase of the electronics industry each week featuring engineering and technical data every issue. Latest economic trends, technically interpreted, to help you make sound plans. Facts you'll want to file and keep. Subscribe now. Mail the reader service card (postpaid) to **electronics**, the magazine that helps you to know and to grow! Rates: three years for \$12, one year for \$6; Canadian, one year for \$10; foreign, one year for \$20. Annual **electronics BUYERS' GUIDE** (single issue price \$3.00) included with every subscription.

it's read
more by
all 4!

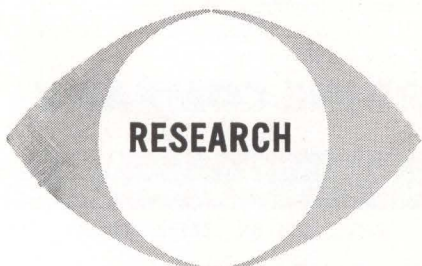

RESEARCH

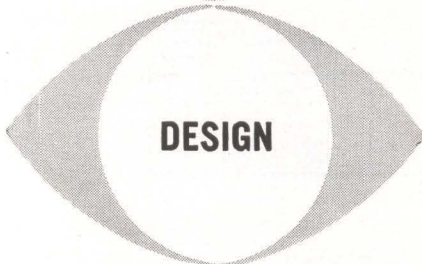

DESIGN

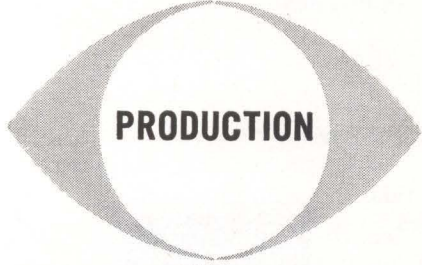

PRODUCTION



MANAGEMENT

SUBSCRIBE TODAY TO
electronics!

electronics



Audit Bureau
of Circulations



Associated Business
Publications

Audited Paid Circulation

JAMES T. HAUPTLI

Advertising Sales Manager

R. S. QUINT:
Assistant Publisher Buyers'
Guide and Business Manager
FRED STEWART:
Promotion Manager
B. ANELLO:
Marketing Service Manager

RICHARD J. TOMLINSON:
Production Manager
GEORGE E. POMEROY:
Classified Manager
HUGH J. QUINN:
Circulation Manager

ADVERTISING REPRESENTATIVES

NEW YORK (36):
Donald H. Miller, Henry M. Shaw,
George F. Werner
500 Fifth Avenue, OXford 5-5959

BOSTON (16):
William S. Hodgkinson, Donald R. Furth
McGraw-Hill Building, Copley Square,
Congress 2-1160

PHILADELPHIA (3):
Warren H. Gardner, William J. Boyle
6 Penn Center Plaza, LOcust 8-4330

CHICAGO (11):
Harvey W. Wernecke, Robert M. Denmead
645 North Michigan Avenue, Mohawk 4-5800

CLEVELAND (13):
Paul T. Fegley
55 Public Square, Superior 1-7000

SAN FRANCISCO (11):
R. C. Alcorn
255 California Street, Douglas 2-4600

LOS ANGELES (17):
Peter S. Carberry, Ashley P. Hartman
1125 W. 6th St., Huntley 2-5450

DENVER (2):
J. W. Patten
Tower Bldg., 1700 Broadway,
Alpine 5-2981

ATLANTA (9):
Michael H. Miller, Robert C. Johnson
1375 Peachtree St. N.E., Trinity 5-0523

HOUSTON (25):
Joseph C. Page, Jr.
Prudential Bldg., Holcomb Blvd.,
Jackson 6-1281

DALLAS (1):
Frank Le Beau
The Vaughn Bldg., 1712 Commerce St.
Riverside 7-9721

LONDON W1:
Dennis McDonald
34 Dover St.

FRANKFURT/Main:
Stanley R. Kimes
85 Westendstrasse

GENEVA:
Michael R. Zeynel
2 Place du Port

"Headquarters for Business Information"

McGraw-Hill Technical and Business Publications

American Machinist/Metal-
working Manufacturing
Aviation Week and Space
Technology
Business Week
Chemical Engineering
Chemical Week
Coal Age
Construction Methods and
Equipment
Construction Daily
Control Engineering
Electrical Construction
and Maintenance
Electrical Merchandising Week
Electrical Newsletter
Electrical West

Electrical Wholesaling
Electrical World
Electronics
Engineering Digest
Engineering and Mining Journal
E & MJ Metal and Mineral
Markets
Engineering News-Record
Factory
Fleet Owner
Industrial Distribution
National Petroleum News
Nucleonics
Nucleonics Week
Platt's Oilgram News
Platt's Oilgram Price Service
Power

Product Engineering
Purchasing Week
Science Week
Textile World

Overseas only:
Automobile International
(English, Spanish)
Ingenieria Internacional
Construccion (Spanish)
International Management
(English, Spanish
Portuguese editions)
Metalworking Production
(Great Britain)

Available by subscription only — to qualified persons actively engaged in the field of the publication. For subscription rates and information describing the editorial coverage of any of the above publications, write to: *Subscription Manager, Circulation Department, McGraw-Hill Publishing Company, 330 West 42nd Street, New York 36, N. Y.*

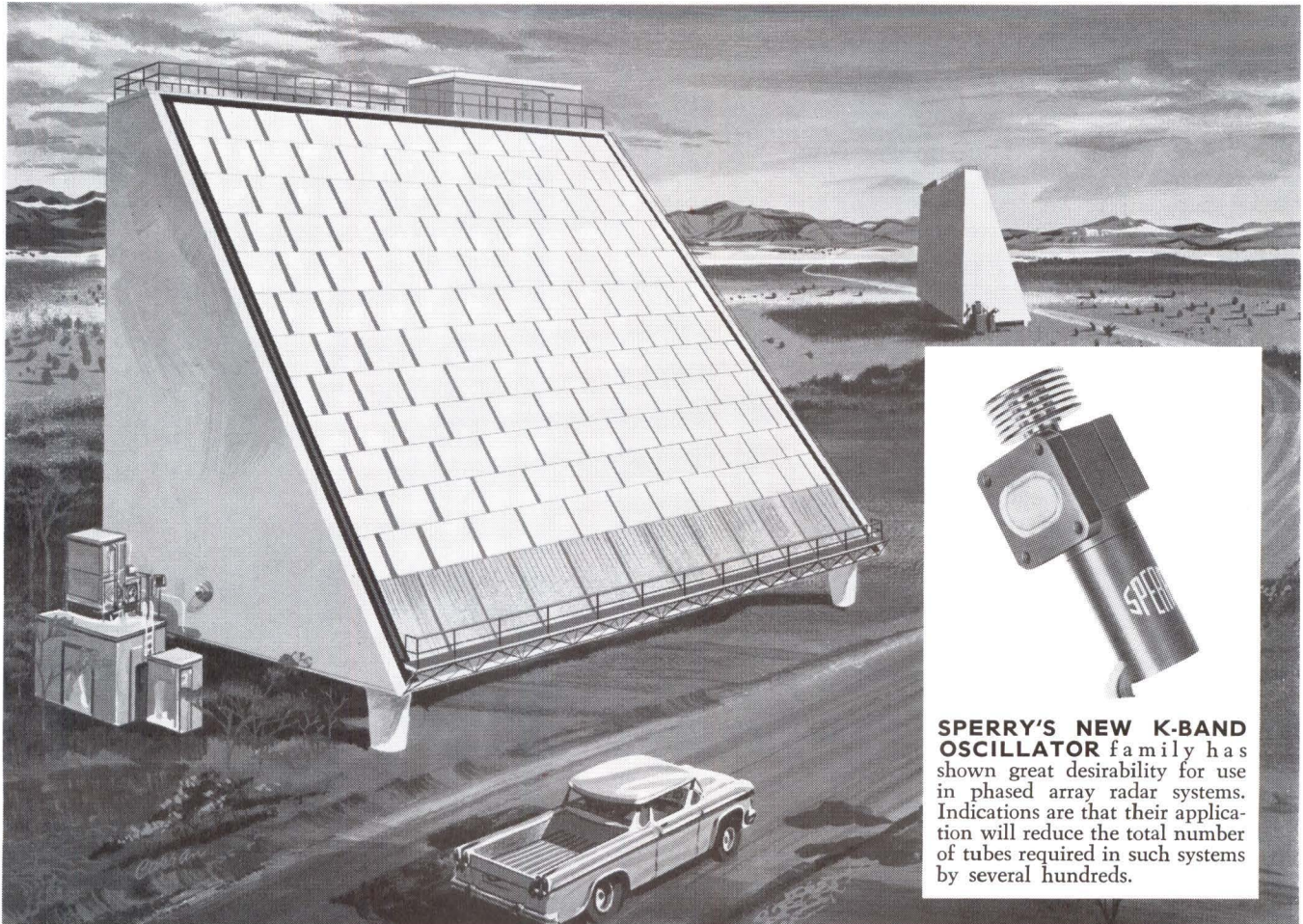

SPERRY'S NEW K-BAND OSCILLATOR family has shown great desirability for use in phased array radar systems. Indications are that their application will reduce the total number of tubes required in such systems by several hundreds.

Production-ready K-band oscillators deliver 600 mW over a 20 Mc bandwidth

A new family of K-band two-cavity oscillators is now production-ready at Sperry Electronic Tube Division, Sperry Rand Corporation, Gainesville, Florida.

The new tubes show particular promise for parametric amplifier pumping applications because of their inherent amplitude stability and high power output levels at K-band frequencies (18-26.5 Gc). Depending on voltage mode of operation, power levels from 200 to 600 mW are available. While the lower level is highly promising for single amplifier pumping, the higher outputs offer tremendous possibilities in applications where several amplifiers must be pumped simultaneously. In fact, one tube—operating on the mode which delivers 600 mW minimum power output—will pump 10 or more parametric amplifiers.

COMPONENT SAVINGS POSSIBLE

The capability of these new tubes to pump several parametric amplifiers will greatly reduce the number of tubes required in many systems. In phased array radars, for example, a net saving of several hundred tubes may result when a switching network is coupled with multiply pumped parametrics.

DESIGN ECONOMIES REALIZED

Dramatic reductions in system design costs are indicated when the new Sperry Tubes are used in doppler radars, FM communications systems, and other K-band applications. Operating in a flat-top mode these tubes have an amazing 20 Mc bandwidth. This characteristic permits tremendously increased latitude in the specification of other parts. The system designer, freed from the tedious necessity of closely matching components, works more quickly, more efficiently, and more economically.

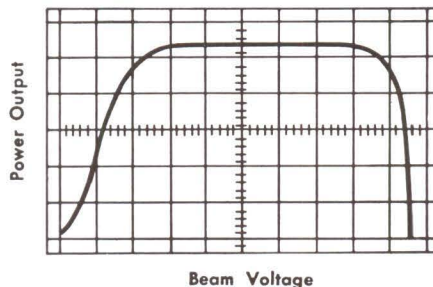

A typical main mode, adjusted for optimum flat-top operation

FREE K-BAND BROCHURE

A NEW, FREE BROCHURE DESCRIBES THE CAPABILITIES OF THE NEW SPERRY K-BAND OSCILLATOR FAMILY IN GREATER DETAIL. FOR YOUR COPY, WRITE TO SPERRY ELECTRONIC TUBE DIVISION, SEC. 113, GAINESVILLE, FLORIDA.

Since the new Sperry family is ready for volume production, you can start specifying them *now*. Unit price is \$2,995. Cain & Co., which represents Sperry Electronic Tube Division nationally, has a salesman near you. He'll be happy to help you work out the details. Call him today!



GAINESVILLE, FLA. / GREAT NECK, N. Y.
SPERRY RAND CORPORATION

RESEARCH SATELLITE DIGITAL VOLTMETER ELECTROMETER
 VIDEO TAPE RECORDER JET ENGINE FUEL SHUT-OFF CONTROL
 SWITCH VIDEO AMPLIFIER AIRBORNE BEACON TRANSPONDER
 TURBO-PROP ENGINE VIBRATION ANALYZER 60 MC IF AMPLI-
 FIER JET/RECIPROCATING ENGINE VIBRATION ANALYZER 54 MC IF
 GAIN-CONTROLLED RADAR RADIO FREQUENCY TRANSMITTER OSCILLA-
 TOR SONOBUOYS 30 MC AMPLIFIER WEATHER
 RADAR RECEIVER OSCILLATOR IF VOLTAGE REGULATOR SAFETY
 BEACON TRANSPONDER SONAR SYSTEMS VIDEO AMPLIFIERS
 HIGH-IMPEDANCE CATHODE FOLLOWER IN VIDEO AMPLIFIER IF STRIP
 IN AVQ WEATHER RADAR VIDEO PRE-AMPLIFIER CAMERAS
 RADAR AIR TRAFFIC CONTROLLER VIDEO AMPLIFIER DISCRIMINA-
 TOR FILTER SCINTILLATION COUNTER FREQUENCY MULTIPLIER
 PULSE AMPLIFIER IN FAA UHF TRANSMITTER DOPPLER RADAR
 SYSTEMS CASCADE RF AMPLIFIER INPUT CATHODE
 FOLLOWER IN OSCILLOSCOPES MISSILE LAUNCH LOCATORS

THE NUVISTORIZATION EXPLOSION!

Almost daily, it seems, equipment manufacturers come up with new applications for the amazing RCA nuvistor tube. Small wonder! This radically new type of electron tube packs unexcelled performance capabilities into a package of extremely small size and light weight. Witness these nuvistor advantages to designers and manufacturers:

- Low heater drain • Very high transconductance at low plate current and voltage • Exceptional mechanical ruggedness from all ceramic-and-metal construction
- Exceptional uniformity of characteristics from tube to tube • Operation at full ratings at any altitude
- Dependable performance in fields of strong nuclear radiation • Extremely low interelectrode leakage • Low reverse grid current • High sensitivity and stability
- Low noise figure.

Keeping pace with an expanding number of applications, RCA brings you an expanding line of nuvistors.

Commercially available types now include:

- RCA-7586** General-purpose industrial medium-mu triode
- RCA-7587** General-purpose industrial sharp-cutoff tetrode
- RCA-7895** Industrial high-mu triode ($\mu=64$)
- RCA-6CW4** TV and FM tuner high-mu triode
- RCA-2CW4** TV and FM tuner high-mu triode
- RCA-6DS4** TV and FM tuner high-mu triode with semiremote-cutoff characteristic

PLUS TWO NEW TYPES . . .

- RCA-8056** medium-mu triode for use with low-voltage power supplies in industrial and military applications. Excellent for small-signal amplifier applications up to 350 Mc.
- RCA-8058** double-ended, high-mu triode, for use in cathode-drive amplifier service up to 1200 Mc in a variety of applications.

Nuvistorization has been the answer to many critical circuit design problems; it may well be the answer to yours. For additional information, write to Commercial Engineering, RCA Electron Tube Division, Section B-19-DE-4, Harrison, N.J.



The Most Trusted Name in Electronics

Visit the RCA exhibit at the IRE

RCA ELECTRON TUBE DIVISION—FIELD OFFICES
 EAST: 744 Broad Street, Newark 2, New Jersey,
 Humboldt 5-3900 • MIDWEST: Suite 1154, Merchandise
 Mart Plaza, Chicago 54, Illinois, Whitehall 4-2900
 WEST: 6801 E. Washington Blvd., Los Angeles 22,
 Calif., RAymond 3-8361 • 1838 El Camino Real, Bur-
 lington, Calif., OXford 7-1620