

First Photos

VISIBLE-LIGHT DIODE LASER

*Light spreads
as excitation
increases, p 35*



•

SUBAUDIO PARAMP

*Used in deep-sea
seismometer, p 28*



DIODE SWITCHES SAVE RECEIVERS

*Detune cavities
to lock out pulses, p 32*

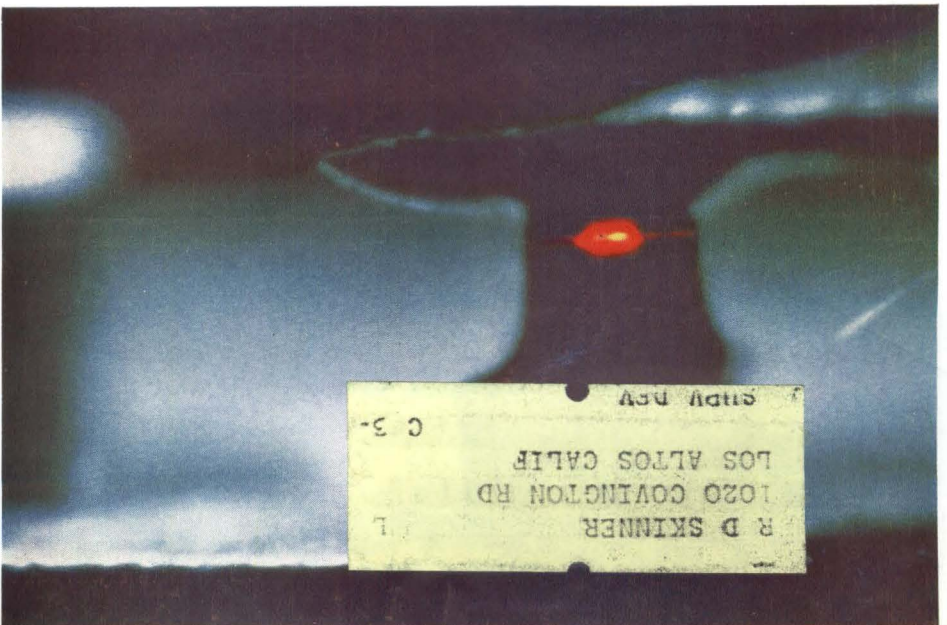

LOW-FREQUENCY FERRITES

*Borrowing microwave
techniques, p 38*

REC'D
LOS ALTOS CALIF
1020 COVINGTON RD
R D SKINNER
L
C 3-

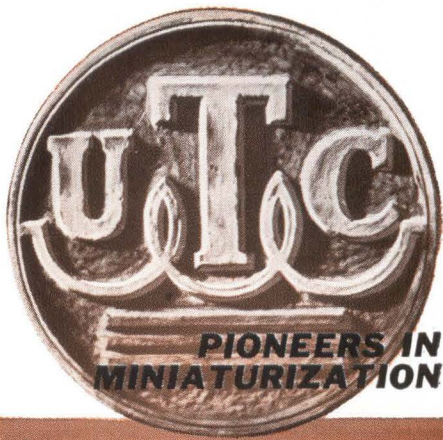

DEVELOPING NEW FRONTIERS...

**TRANSFORMERS
INDUCTORS
TOROIDS
ELECTRIC WAVE FILTERS
HIGH Q COILS
MAGNETIC AMPLIFIERS
SATURABLE REACTORS
REFERENCE UNITS
PULSE TRANSFORMERS**

Design and application engineers with unique requirements have utilized UTC's advanced research and design capabilities for over 30 years. These engineering services are supported by the most complete manufacturing facilities for military and commercial production. Both stock and special custom built iron core components are available in long and short run quantities.

TOMORROW'S PRODUCTS—NOW at UTC!

SUBMINIATURE AUDIO TRANSFORMER

Plug-in and weldable transistor type audio transformer hermetically sealed to MIL-T-27A, Grade 4, Class R, Life X. Leads spaced on .1 radius circle to conform to "TO-5" cased semiconductors and micrologic elements. Primary impedance: 10K CT ohms; secondary impedance 2K split ohms. Size: 5/16 dia. x 3/8" h; weight: 1/15 oz.



ACTUAL
SIZE

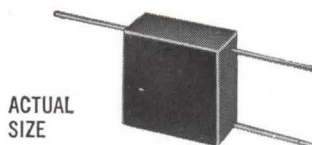

ACTUAL
SIZE

SUBMINIATURE MOLDED AUTOTRANSFORMER

Specially designed for application where space requirements were limited to a slot less than 1/4" high. Molded unit with straight pin terminals. Designed to MIL-T-27A for 6400 cycles, 250 ohms to 1K ohms. Size: 17/32" square x 7/32" tall; weight: 0.1 oz.



ACTUAL
SIZE

SUBMINIATURE PULSE TRANSFORMER

Unique subminiature PIP construction to MIL-T-21038 type TP6SX4410CZ with weldable and solderable gold plated Dumet leads. Used for transistor blocking oscillator applications. Pulse width .05 μsec, 3 windings. Size: 5/16 dia x 3/16" h; weight: 1/20 oz.

400 CYCLE ISOLATION TRANSFORMER

Ratio 1:1, 0-300 V input. Phase shift less than .1° and stable with input voltage. Electrostatic isolation greater than 200,000:1. Magnetically shielded for greater than 40 db hum reduction. Terminated with microphone connectors. Size: 3 3/8 x 2 3/8 x 4 1/8" h; weight: 4 1/4 lbs.

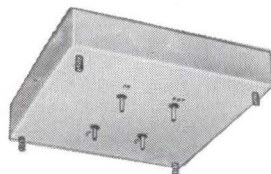
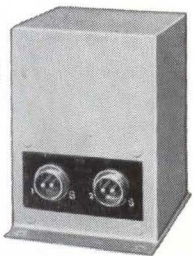

BAND PASS FILTER

Designed to MIL-F-18327A in a flat construction for use in printed circuits. Unit has a source and load impedance of 600 ohms. Attenuation ratings are: 100 cycles to 3 KC, ± 0.5 db; 60 cycles and 4 KC, 3 db; 4800 cycles more than 30 db. Size: 4 x 4 x 7/8" h.

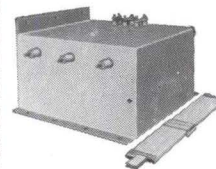

THREE PHASE HIGH VOLTAGE POWER TRANSFORMER

Primary jumper hardware for easy conversion from delta to wye inputs. Made to MIL-T-27A specifications. Primary: 440 V 60 cycles delta or wye 3 phase input. Secondary: 2100 V line to line or 1215 V line to line @ 242 ma. Full load voltage ± 2% maximum regulation 5%. Electrostatically shielded to give 20:1 ratio per MIL-T-27A test @ 20 KC. Maximum ambient 70°C, temperature rise 35°C. Size: 10 x 10 x 6"; weight: 66 lbs.

...THROUGH ADVANCED RESEARCH & DESIGN

Write for catalog of over 1,000 STOCK ITEMS with UTC High Reliability IMMEDIATELY AVAILABLE from your local distributor.

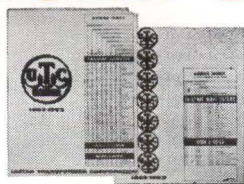

UNITED TRANSFORMER CORP.

150 VARICK STREET, NEW YORK 13, N. Y.

PACIFIC MFG. DIVISION: 3630 EASTHAM DRIVE, CULVER CITY, CALIF.
EXPORT DIVISION: 13 EAST 40th STREET, NEW YORK 16, N. Y. CABLES: "ARLAB"

CIRCLE 900 ON READER SERVICE CARD

electronics

A McGraw-Hill Weekly 75 Cents



W. W. MacDONALD, Editor

J. M. CARROLL, Managing Editor
SENIOR EDITORS: Samuel Weber, George W. Sideris. **SENIOR ASSOCIATE EDITORS:** Michael F. Wolff, John F. Mason. **ASSOCIATE EDITORS:** Michael F. Tomaino, Sylvester P. Carter, William P. O'Brien, Sy Vogel, Leslie Solomon, George J. Flynn, Laurence D. Shergalis, George V. Novotny, Leon H. Dulberger. **ASSISTANT EDITORS:** Nilo Lindgren, Stanley Froud, Stephen B. Gray, Roy J. Bruun, Barry A. Briskman. **REGIONAL EDITORS:** Harold C. Hood (Pacific Coast, Los Angeles), Thomas Maguire (New England, Boston), Cletus M. Wiley (Midwest, Chicago). **ART DIRECTOR:** Howard R. Berry. **ASSISTANT ART DIRECTOR:** John C. Wright, Jr. **EDITORIAL ASSISTANTS:** Lorraine Rossi, Virginia T. Bastian, Lynn Emery, Ann Mella, Lorraine Werner, Alice M. O'Brien. **FOREIGN NEWS BUREAU:** Director, John Wilhelm; Alyne Elias, Betsy Wilson. **LONDON—**John Shinn, Derek Barlow, Nicholas Landon. **BONN—**Bruce Bendow, Richard Mikton, Silke McQueen. **BRUSSELS—**Peter Forbath. **PARIS—**Robert Farrell, Arthur Erikson. **MILAN—**Marc A. Messina. **MEXICO CITY—**Wesley Perry, Jr. **RIO DE JANEIRO—**Leslie Warren. **MOSCOW—**Stewart Ramsey. **TOKYO—**Richard Haloran, Charles Cohen, John Yamaguchi.

W. W. GAREY, Publisher

MAKING NEWS—Usually an engineering publication like **ELECTRONICS** simply reports and interprets the technical news of its field. This week we made news. *The photos on our cover, first ever taken of a visible-light laser diode, gave GE scientists the key to an exciting new physical phenomenon. See p 35 COVER*

SOLID PROGRESS IN SOLID-STATE. The conference in Philadelphia last week made it abundantly clear that integrated circuits have now worked up a full head of steam. *Dominant theme: merging device physics with circuit theory* 12

WHAT'S NEW IN LASERS? Liquids, intermetallics and rare earths, plus nonlinear modulators, demodulators, mixers and amplifiers. *Engineers from all over the world reported in Paris this month on their work in these fields* 14

SUPERCONDUCTING MAGNETS Head for 100,000 Gauss. New techniques and synthetic superconductors may achieve the magic number this year. *Magnets that provide room-temperature fields in air are a recent advance* 18

COLOR TV Mobilizes for '63. Set makers are getting ready for sales increases. *A sign of the optimism—more manufacturers are investing more in production facilities* 21

EMULATING THE NERVOUS SYSTEM With an Experimental Neuristor. Most neuristors, or electrical analogs of neurons, lack the distributed form of the living nerve cell. This device consists of a three-layer silicon epitaxial structure with alloyed aluminum dots. *It represents another long step towards understanding basic life processes.*

By A. Rosengreen, Stanford Research Institute 25

SUBAUDIO PARAMETRIC AMPLIFIER For an Ocean-Bottom Seismometer. Parametric or variable-reactance amplifiers have long provided low-noise front ends for uhf and microwave radar and communications receivers. *This one has its 3-db cutoff point well below one cycle per second.*

By P. D. Davis, Jr., and G. D. Ezell, Texas Instruments Incorporated 28

PROTECTING RECEIVERS From High-Power Inputs. Various arrangements using relays or t-r tubes have been used to protect delicate receivers from high-power pulses from nearby transmitters. *Here diodes switch capacitors across tuned cavities, detuning them to lock out unwanted pulses.*

By H. A. Willing, Electronic Communications 32

electronics

March 1, 1963 Volume 36 No. 9

Published weekly, with Electronics Buyers' Guide as part of the subscription, by McGraw-Hill Publishing Company, Inc. Founder: James H. McGraw (1860-1948).

Title ® registered U.S. Patent Office; © copyright 1963 by McGraw-Hill Publishing Co., Inc. All rights reserved, including the right to reproduce the contents of this publication, in whole or in part.

Executive, editorial, circulation and advertising offices: McGraw-Hill Building, 330 West 42nd Street, New York 36, N. Y. Telephone Longacre 4-3000. Teletype TWX N.Y. 212-640-4646. Cable McGrawhill, N. Y. PRINTED IN ALBANY, N. Y.; second class postage paid at Albany, N. Y.

OFFICERS OF THE PUBLICATIONS DIVISION: Shelton Fisher, President; Vice Presidents: Joseph H. Allen, Operations; John R. Callahan, Editorial; Ervin E. DeGraff, Circulation; Donald C. McGraw, Jr., Advertising Sales; Angelo R. Venezian, Marketing.

OFFICERS OF THE CORPORATION: Donald C. McGraw, President; Hugh J. Kelly, Harry L. Waddell, Executive Vice Presidents; L. Keith Goodrich, Executive Vice President and Treasurer; John J. Cooke, Vice President and Secretary.

Subscriptions are solicited only from those actively engaged in the field of the publication. Position and company connection must be indicated on orders. Subscription rates: United States and Possessions, \$6.00 one year, \$9.00 two years, \$12.00 three years. Canada: \$10.00 one year. All other countries \$20.00 one year. Single copies, United States and Possessions and Canada 75¢. Single copies all other countries \$1.50.

THE PUBLISHER, UPON WRITTEN REQUEST FROM ANY SUBSCRIBER TO OUR NEW YORK OFFICE AGREES TO REFUND THAT PART OF THE SUBSCRIPTION PRICE APPLYING TO COPIES NOT YET MAILED.

Subscribers: Please address change of address notices, subscription orders or complaints to Fulfillment Manager, Electronics, at above address. Change of address notices should provide old as well as new address, including postal zone number if any. If possible, attach address label from recent issue. Allow one month for change to become effective.

Postmaster: Please send Form 3579 to Fulfillment Manager, Electronics, 330 West 42nd Street, New York 36, New York.



Audited Paid Circulation

CONTENTS continued

WHAT OUR COVER SHOWS: Active Region in Visible-Light Diode Laser. These first published color photographs of a gallium-arsenide-phosphide laser junction diode show how area of coherent light source spreads as current is increased. <i>This is a new discovery about lasers.</i>	
	By N. Holonyak, Jr., General Electric 35
UNIQUE FREQUENCY COMPARATOR Has Sense of Direction. Most instruments that compare two frequencies fail to show which frequency is the higher. <i>This circuit uses a bidirectional counter to obtain sense of direction.</i>	By J. A. Webb, Lockheed 36
FERRITES AT LOW FREQUENCIES: How to Use Them. Ferrites find wide application at microwave frequencies but they can be useful at low frequencies also. <i>These physical characteristics and performance data will help you use them in your circuits.</i>	By D. Leibowitz, General Precision 38
TROPO BETTER THAN BELIEVED; So Recent Tests Show. Up-to-date information shows that tropospheric scatter losses over long distances are not as great as earlier theory had predicted. <i>Nomographs relate data to system performance, show how large-diameter dishes have improved range.</i>	By J. L. Levatich, Bendix 42

DEPARTMENTS

Crosstalk. <i>Making the News</i>	3
Comment. <i>The RS-70. Noise Chart</i>	4
Electronics Newsletter. <i>Battle on VHF-UHF Tv Assignments before FCC</i>	7
Washington This Week. <i>Pentagon Plans Streamlining Contractor Evaluation and Bidding Procedures</i>	10
Meetings Ahead. <i>Western Electronic Show and Convention</i>	22
Research and Development. <i>Ultra-Intelligent Machines by Year 2000</i>	46
Components and Materials. <i>Waffle-Iron Shape Boosts Memory Density</i>	50
Production Techniques. <i>Radial-Lead Film Resistors Automatically Produced</i>	54
New Products. <i>Power Supply Uses Two Regulator Servos</i>	60
Literature of the Week	64
People and Plants. <i>ITT Plans to Open \$3.5-Million Plant</i>	66
Index to Advertisers	73

Making the News

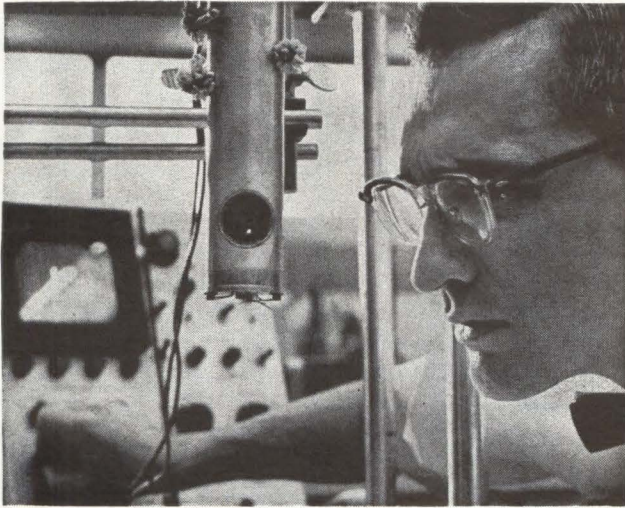

MOST OF THE COVERS for *ELECTRONICS* are derived from one of the key articles in that particular issue. It's not often that a cover becomes an important story.

This week's striking cover, with the article on p 35 by Nick Holonyak, Jr., forms a new contribution to the fast-growing literature on junction-diode lasers. The evolution of this short feature was a bit unusual, and we thought you'd find it interesting to see how it came about.

Shortly after the announcement of the first visible-light diode-injection laser (*ELECTRONICS*, p 7, December 7, 1962) by Dr. Holonyak and S. F. Bevacqua, we discussed with the GE Semiconductor Products people the possibility of a photo of the new device for use on the cover of some future issue. Photographing the laser in action is not a simple problem, since it operates at liquid nitrogen temperature. As can be seen in the photo above, observation must be made through portholes in a specially constructed cryostat. Nevertheless, they promised to give it a try. A short time later, they came up with not one, but three photos shot in sequence at various values of pulse excitation of the diode.

Holonyak and his associates took one look at the results, and realized that the photos revealed something not previously reported: namely, that as the excitation is increased, the area of the junction contributing to the laser action spreads. Holonyak deemed this worthy of more than just a caption, and wrote up his observations in the form of a short feature. Thus, as far as we're concerned these photos represent double value. Not only are they particularly striking color photos (and incidentally, the first ever published

showing the visible-light diode laser in actual operation), but they actually resulted in increased understanding of the mechanism behind this important new device.

REPRINT OF THE MONTH. Electronics is generally noted for the speed with which a novel idea becomes converted into a breadboard setup, is tested and goes out the factory door as hardware. But there are exceptions—tropospheric scatter communications equipment for one.

Troposcatter system designers—like bridge builders—may have to wait years before learning whether their design will stand up. A troposcatter system has to be evaluated for all weathers, in all seasons, and data for many different geographical locations—over mountains, oceans, deserts, jungles—have to be plotted before design criteria can be determined.

One empirical rule for designing troposcatter systems had it that large-diameter antennas failed to show the enhanced ability to collect signals that their greater surface area suggested. This, perhaps, was based on too few considerations . . . like the scientist's proof that bees can't fly.

Now, however, enough troposcatter systems have been built to supply cumulative evidence that large-diameter antennas perk up in effectiveness at ranges exceeding 300 miles. This finding is reported this week in an article, on p 42, by J. L. Levatich, of Bendix.

Levatich's report includes design charts to aid in the calculation of antenna requirements for various frequencies, ranges and operating conditions. Like all our reference sheet articles, each page can be pulled from the binding and pasted on cardboard for daily use. Or, if you want another copy, just check the box on the reader service card.

Coming In Our March 8 Issue

NEGATIVE-RESISTANCE DEVICES. If you have been looking for new ideas on how to use such solid-state devices as tunnel and four-layer diodes, our lead feature article next week is for you. You'll find it particularly valuable as a source of circuit ideas for pulse counting and waveform generators. The author is Vasil Uzunoglu, of Westinghouse Electric's Solid-State Lab.

Other feature article topics next week include:

- How to get maximum impedance with field-effect transistors
- Applications for *pin* diodes
- Squeezing a wideband signal into a narrow band
- Simplified microwave phase measurements
- Transistor modulators that simplify and increase versatility of telephone communications equipment (this one, by the way, comes all the way from Australia).



ANNOUNCING
THE VERSATILE NEW
JERROLD
VIDEO SWEEP
GENERATOR
MODEL 1015
for both wide- and
narrow-band
response testing
from 1 kc to 15 mc

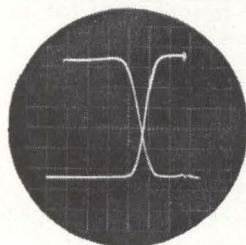

High-pass and low-pass filters swept alternately on Model 1015 Video Sweep Generator, in wide-band mode (2-15 mc.)

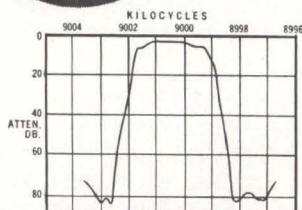

Crystal filter swept in narrow-band mode (4 kc) with Jerrold Model LA-5100 Log Amplifier, x-y recorder and Model 1015 Sweep.

FEATURES:

- Wide-band, 0-15 mc; narrow-band, 0-400 kc; CW
- Excellent stability in both narrow and wide modes
- Better than 2v metered output in both modes
- Low residual FM (20 cps on narrow band and CW)
- Continuously variable sweep rate from 60/sec. to 1 per 2½ min.
- Built-in high-output birdie-type marker generator

For fast quantitative measurements of response that otherwise would involve hours of tedious point-by-point compilation, it will pay you to investigate this stable new video sweep generator. Write for complete specifications. \$2,540

JERROLD ELECTRONICS CORPORATION
Industrial Products
Division
Philadelphia 32, Pa.



A subsidiary of THE JERROLD CORPORATION

COMMENT

The RS-70

Your article on p 18 of the Feb. 1 ELECTRONICS, Stage is Set Again For RS-70 Debate, was read with great interest by those of us in industry who have been active in the development and production of radar reconnaissance sensors and systems.

The radar map on p 18 was not taken from an RB-47. What you have illustrated is a photographic print of a portion of the film taken several years ago during the test of a Texas Instruments side-looking radar system then in production. This actually was a final checkout flight of System Serial No. 5. A DC-3 was the flying testbed, operating from the TI Avionics Flight Test Center at Addison Airport, Dallas. The map shown was made at about 9:15 p.m. on November 27th several years ago.

Your comment that the radar view "looks almost like an optical photograph" is appreciated by our engineers here. They would like to add that even the high-quality half-tone reproduction process of your magazine doesn't do justice to the details revealed on the original film.

There is an obvious question implied by your article: If this was the performance of a production system several years ago, what can we expect from a specific development program today? We at TI are familiar with the problems that must be solved to significantly improve radar mapping resolution. We are confident that no insurmountable obstacles would be met in an orderly development program. Tactical reconnaissance radar systems of great operational value are within the state of the art.

A. RAY MCCORD
Manager

Sensor & Display Systems Dept.
Texas Instruments Inc.
Dallas, Texas

Noise Chart

I was very curious to see how you would handle the Hazeltine noise chart in your Feb. 8 issue (p 64). Your staff certainly did

a magnificent job. Frankly, I didn't think it could be handled so well.

Much appreciation to your staff for making my job so much easier.

A. H. HOROWITZ

Public Relations Counsel

Hazeltine Corporation
Little Neck, New York

Scots Logic

Tut-tut. Your problem, Donald plus Gerald equals Robert (p 4, Nov. 2, 1962), was given to three females, age 17-18 years, IQ scholastically > 100, just; three males age 30-40 IQ > 100 grading when leaving school, all clerical types; three males age 40-50, IQ 100, also school grading, engineering types. Problem solved, by inspection or logic, min time five minutes, max time 20 minutes.

Reaction to the methods employed in the magazine letters (p 4, Nov. 23 and Nov. 30, 1962) was: surely simple problems have simple solutions—must one complicate them?

Of course, the biter was bitten. One of them, girl, 18, gave me the following: *nose + cone + upon + ocean = rescue*. Average time: 30 min; yours truly, 35 min. Origin of the problem not known; the choice of words suggests the United States.

A. BRUCE EWEN

Edinburgh, Scotland

Transistor Oscillators

In the article, Using a New Device: Field-Effect Transistor Oscillators (p 44, Dec. 21, 1962), the equation for $V_{AD}/V_{CD} = 1/(1 + C_2/C_1 + R_2/R_1)$, on line 9, p 44, does not agree with Fig. 1B. In the expression for $\beta = [1/(1 + C_2/C_1 + R_1/R_2)] - [R_s/(R_s + R_F)]$, the first term is in agreement with Fig. 1B.

For the condition where $R_1 = R_2$ and $C_1 = C_2$, β is given as $(\frac{1}{2}) - (R_s/R_s + R_F)$, and should be $(\frac{1}{2}) - R_s/(R_s + R_F)$.

MORRIS M. WILLIAMS

General Dynamics/Astronautics
San Diego, California

Correct. The equation that agrees with Fig. 1B is the proper one, and the parenthesis is misplaced in the other equation.



NEW—from ITT Surprenant

TEFLON*

ABRASION-RESISTANT REINFORCEMENT

TEFLON

CONDUCTOR

ITT SURPRENANT SURCODUR** superior new abrasion-resistant Teflon insulated wire—the most nearly perfect hook-up wire for critical conditions of miniaturization, weight and high temperature.

World's most nearly perfect hook-up wire: new SURCODUR in heavy duty abrasion-resistant Teflon

SURCODUR hook-up wire preserves all the exceptional electrical and thermal properties of Teflon TFE and FEP insulation: lowest dielectric constant, lighter weight, higher heat resistance, greater mechanical strength, non-flammability, no shrinkback or insulation damage from soldering, chemical inertness, and flexibility even at low temperatures.

But now ITT Surprenant Laboratories have overcome the previous weakness of TFE resins—low abrasion resistance due to poor cold flow properties. The secret: extrusion of a remarkable triple

insulation of ultra abrasion-resistant material sandwiched between two layers of pure Teflon.

Specify Surprenant Mil Spec MS 17411, MS 17412, MS 18000 and MS 18001 (WEP). Available in all types and sizes, with silver-plated or nickel-plated conductors.

See your ITT Surprenant representative for full details or write for technical information.

Surprenant Mfg. Co., a Subsidiary of International Telephone and Telegraph Corporation, Clinton, Massachusetts.

ITT

Surprenant

CIRCLE 5 ON READER SERVICE CARD

*Reg. du Pont Trademark **Surprenant Mfg. Co. Trademark



Can Hugo (6'3") and Joe (5'6") put 25 KW into 4'8"?

They can, and they did! Unheeding of the head shaking of those who said it couldn't be done, Hugo Romander (a high power engineer) and Joe Wu (a really solid circuit man) tackled it without a moment's hesitation. The assignment: to build a unique transistorized VLF amplifier for a fixed station installation, to fit it into a compact, reliable package capable of putting out 25 KW continuously in the region between dc and the broadcast band.

Before you could say "silicon transistors in unique circuit arrangements" the Sierra team came up with the answers. The resulting hardware was a delight to Hugo, Joe, and especially the customer. And as for those who said it would never fly... they'd be really impressed by the

flight time which that original "ground" unit has racked up during the past year aboard a flying test bed.

Assignments such as this one, from VLF to X-band, from 1 to 500 KW, are all in the day's work for Sierra's engineering team. If you have a challenging RF amplifier requirement you'd like us to reduce forthwith to hardware, contact your Sierra representative or call Sierra direct.

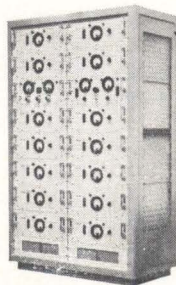

SIERRA ELECTRONIC DIV.

OF
PHILCO

A SUBSIDIARY OF *Ford Motor Company*

3885 Bohannon Drive / Menlo Park 1, California

Will 8 More VHF Stations Kill UHF Tv?

WASHINGTON—Federal Communications Commission suddenly finds itself battling about whether to assign vhf tv stations in eight cities, or wait for uhf stations to enter the markets. The proposal—hanging fire since 1961—would give the last of the 75 key markets third-network tv service by “squeezing in” the stations at spacings below FCC’s usual standards.

Commissioner Robert E. Lee says that if FCC does this it will be “the day uhf was killed.” Tv industry’s faith in FCC’s determination to get uhf going will be undermined, he says. The action would set uhf tv back 15 years in the eight markets, discourage manufacturers and broadcasters from pushing uhf and kill the effectiveness of the new uhf advisory group (p 12, Feb. 15), Lee claims.

Lee says there are broadcasters ready to build uhf stations in the eight cities if vhf stations are not added. The move to get the vhf stations in is supported by ABC, which is expected to be affiliated with most of them.

Other commissioners, including Chairman Newton H. Minow—also a strong supporter of uhf tv—point out that it may be a long time before the eight markets are saturated with all-channel sets and a consequent delay in third-network service. Six to eight years is estimated for national saturation by all-channel tv sets.

Lee argues that the “drop-in” proposal should be scrapped, just as deintermixture (removing single vhf stations from cities to foster uhf) was scrapped. Deintermixture was abandoned as part of a package deal with Congress that got the all-channel law passed (p 12, March 23, 1962; p 12, Feb. 23, 1962, and p 14, Oct. 6, 1961). Congress, Lee says, doesn’t want the vhf stations.

FCC is considering a compromise: let the eight stations begin operating at vhf, but shift to uhf when the markets have enough all-channel sets. The eight cities are Baton Rouge, Dayton, Birming-

ham, Jacksonville, Knoxville, Johnstown, Charlotte and Oklahoma City.

Liquid Laser Emits Visible Light Beam

LIQUID LASER has been operated at General Telephone and Electronics Lab. Lasing material is europium in an organic chelate, contained in a quartz cavity at a temperature of -130°C . Helical flash tube provides pumping power.

Emission is at 6,129 Å; line width, when operating above relaxation threshold, is 0.3 Å. Use of active ions dissolved in a liquid host is expected to lead to relatively uncomplicated lasers. High efficiencies of pumping are reported, as the energy is absorbed in the large organic part of the molecule, then transferred to the rare earth ion. In other systems, energy is transmitted directly to the rare earth ion.

Two-Color System Puts Tv on Theater Screens

NEW YORK—Color-tv projector for theater screens and other large dis-

plays introduced here this week by General Electric and National General Corp.

The projector is analogous to a conventional color-movie projector. However, instead of passing through moving color film, light passes through a “control layer” of viscous fluid whose surface is distorted electrostatically by an electron beam.

Light will not pass through the undistorted fluid surface, but will pass through the distorted areas of the surface. The scanning beam, in effect, “develops” color film in the projector.

Light beams, filtered green and magenta are used to produce all the primary colors. High-intensity color beams are directed at the control layer by optical filters backed up by a 5-Kw xenon lamp.

National General plans to install the system in its 220-theater pay-tv chain, beginning in 1964. It has placed a multimillion-dollar order.

Sightings May Be Syncom But NASA Doubts It

HOPES WERE KINDLED early last week that Syncom may have finally been found. Two tracking stations

Cost Study Shelves Long-Range Typhon

RECENT COST/EFFECTIVENESS study by Secretary of Defense McNamara questions “how much it is reasonable to invest simply to defend the (U. S. Navy’s) Fleet against air attack.” Result was to shelve development of Navy’s long-range surface-to-air Typhon missile, and put emphasis on the medium-range version.

Bendix, which has been working on the long-range version since June, 1961, has just received a \$25 million contract from Navy to start work on the medium-range missile.

Reduction in size of the phased-array radar, made possible by using the shorter range missile, allows the system to be installed on frigates. The longer-range missile, requiring more elements in the phased array radar, was to go on cruisers.

Design of the sophisticated radar will not have to be changed. The system is modular and can operate with a varying number of elements. Johns Hopkins University’s Applied Physics Lab conceived the radar, and Westinghouse Electric is developing it. Prototype will be installed aboard the USS *Norton Sound*

of the Smithsonian Astrophysical Observatory—one in India, the other in Netherlands West Indies—reported sightings.

NASA, however, said that the position of the sightings made it unlikely that they are Syncom.

Another Laser System Transmits Tv Signals

PHILADELPHIA—W. K. Anderson, of Bell Labs, told the Solid State Circuits conference last week (see p 12) that they had successfully transmitted tv signals over a laser beam, in an experiment resembling one demonstrated by GT&E recently (p 28, Feb. 22). Bell's prototype optical relay used a 2.1-Gc subcarrier and KDP modulator. Modulation power was about 1 w. For detection, a *pin* photodiode was used in conjunction with a microwave receiver.

Dyna-Soar Program Hangs on DOD Review

ALTHOUGH THE AX has not yet fallen on the X-20 (Dyna-Soar) program—Air Force's manned orbital glider—the kill may come soon. First indication of trouble appeared in Defense Secretary McNamara's recent statement that "I should caution that some very difficult technical problems still remain to be solved in this program, particularly in connection with the mode of re-entry."

"Technical problems" were the prelude to kills or cutbacks of Skybolt, RS-70, Midas and Satellite Inspector by DOD.

Air Force feels that technical problems have been sufficiently solved to continue with the program. Whether they can convince McNamara of this will be learned after his proposed review of the program on March 10. He will visit Edwards AFB, Calif. and prime contractor Boeing in Seattle.

England-Soviet Bounce Planned for Echo II

TRANSMISSION of radio, facsimile and other bounce signals between England and the Soviet Union via

Echo II seems the likely result of 10-day U. S.-Soviet talks to begin March 6th in Rome, Hugh L. Dryden, NASA's deputy administrator told ELECTRONICS.

Dryden denied reports that U. S. stations in Andover, Me., or in Alaska might be used since communication time would be too short during each pass (p 7, Feb. 15). The Russians will probably use the 4-dish station that is tracking the Soviet Mars probe.

Dryden will meet with Academician Anatoly A. Blagonravov of the USSR Academy of Sciences. Soviet meteorologist V. A. Bugaev will also participate to discuss Russian use of the Tiros weather satellites. Also on the agenda will be use of the Orbiting Geophysical Observatory in a cooperative effort to map the earth's magnetic field. OGO and a Soviet satellite will be equipped with magnetometers during the International Year of the Quiet Sun (1964-5) and launched into overlapping orbits to chart a complete world map of the field.

Research on Fly Feet —Toward New Sensors?

NEW YORK—At least one genus of flies can "taste" what it lands on through tiny hairs on its feet that contain the dendrites of chemoreceptors. Study on these chemoreceptors at the Naval Medical Research Institute, Bethesda, Md., was reported by M. L. Wolbarsht at last week's Biophysical Society Meeting. One of the important findings is that the chemoreceptor dendrite can undergo graded depolarization and is also electrically excitable.

Falcons Start Rolling Out of Swedish Plants

LINKOPING, SWEDEN—SAAB aircraft company has started delivery of two types of Hughes Falcon missiles—RB 327 radar target-seeking version and RB 328, with infrared. The missiles are for the Swedish Air Force fighter Draken J35-F. Working with SAAB on missile production are L. M. Ericsson Co., Svenska Radiabolaget, Bofors, Karlskrona Shipyard and the Swedish Air Administration.

In Brief . . .

ENGINEERING ENROLLMENT rose from 237,705 in 1961 to 241,613 in 1962, according to U. S. Office of Education. A decline in undergraduate enrollment was offset by additional graduate students.

IBM IS INTRODUCING its 1460 data processing system featuring a printer operating at 1,100 lines per minute. The 1460 has an internal speed almost twice as fast as the 1401 and can be used with most programming systems produced by IBM for the 1401.

CHARACTER READER, based on optical scanning by a vidicon tube was introduced this week by RCA. The on-line reader enters numeric data directly into an RCA 301 computer. Documents four inches wide or less are processed at 1,500 a minute.

BRITISH have developed an inexpensive electronic photographic plate sensitive to light and X-radiation. Plate will give an immediate picture without any developing and can be used 10,000 times, it is claimed. Manufacturer is Thorn Electrical Industries.

U. S. WILL OFFER missile-carrying ships for the proposed NATO nuclear force, as a substitute for Polaris submarines.

SYNCHROCYCLOTRON capable of accelerating protons to 600 million electron volts will be built for NASA's new Space Radiation Effects Laboratory in Newport News, Va. Contract, worth about \$5.5 million, will go to Catalytic Construction Co.

AF WILL SET UP its first research facility devoted solely to bionics at Wright-Patterson AFB.

FISCHER & PORTER have entered into a 25-year technology interchange agreement with Hokushin Electric Works, Ltd., Tokyo.

HUGHES AIRCRAFT won another contract from the Army for development of wire-controlled anti-tank missile, the TOW. Contract was for \$2.1 million, bringing total TOW awards to nearly \$4.5 million.

Now from Sprague!

 TO-5 CASE

SILICON CHOPPERS



Sprague offers this Wide Selection of Silicon Chopper Transistors in Volume Production <u>now!</u>	
2N2162 2N2165	Guaranteed 30 volt rating. Typical f_T of 20 Mc and low offset voltage make these transistors ideal where high voltage is required
2N2163 2N2166	Have 15 volt rating and same high frequency performance and low offset voltage as 2N2162
2N2164 2N2167	Highest frequency P-N-P Silicon Choppers available as standard types
2N2185	Extremely low leakage current of 1 nanoampere at 10 volts. Has 30 volt rating
2N2274	Similar to 2N2185 but has lower inverted dynamic saturation resistance
2N2276	Low-cost version of 2N2274
2N2278	Very low offset voltage of 1.75 mV at $I_B = 1$ mA
2N2187	Matched pair of 2N2185 with $\Delta V_{OFF} = 50\mu V$ max. from +25 C to +85 C
2N2275	Matched pair of 2N2274 with $\Delta V_{OFF} = 100\mu V$ max. from +25 C to +65 C
2N2277	Matched pair of 2N2276 with $\Delta V_{OFF} = 100\mu V$ max. from +25 C to +65 C
2N2279	Matched pair of 2N2278 with $\Delta V_{OFF} = 50\mu V$ max. from +25 C to +85 C



Specifically designed for use as low-level choppers, Sprague Silicon Precision Alloy Transistors are inherently stable. Every Sprague chopper transistor undergoes a rigid production conditioning of 40 temperature cycles from -55 C to +140 C, a 200-hour bake at +140 C, and a 2-hour 125 mW operational burn-in!



For additional information, write Technical Literature Service, Sprague Electric Co., 35 Marshall St., North Adams, Mass., indicating the types in which you are interested.

SPRAGUE COMPONENTS

TRANSISTORS
CAPACITORS
MAGNETIC COMPONENTS
RESISTORS
MICRO-CIRCUITS

INTERFERENCE FILTERS
PULSE TRANSFORMERS
PIEZOELECTRIC CERAMICS
PULSE-FORMING NETWORKS
TOROIDAL INDUCTORS

HIGH TEMPERATURE MAGNET WIRE
CERAMIC-BASE PRINTED NETWORKS
PACKAGED COMPONENT ASSEMBLIES
FUNCTIONAL DIGITAL CIRCUITS
ELECTRIC WAVE FILTERS

SPRAGUE[®]
THE MARK OF RELIABILITY

[®]'Sprague' and [®]'@' are registered trademarks of the Sprague Electric Co.

GET THE FULL STORY AT IEEE BOOTH 2424

WASHINGTON THIS WEEK

DOD WEIGHS CONTRACTOR REPORT CARDS

PENTAGON IS STUDYING a plan for evaluating the performance of major weapon development contractors. The evaluations, called "report cards" by officials, would assess how contractors have fulfilled contracts in terms of target costs, schedules, and technical performance. Microfilmed and in a central file, the reports would be referred to for evaluating of bidders on future contracts.

As now conceived, the evaluation reports would not contain a numerical score, nor would they be used to determine payment of special fees or profits under incentive contracts. The report card scheme was proposed by an interservice committee—headed by Robert S. Tucker, assistant director of defense Research and Engineering—studying ways to improve management of major R & D projects.

PENTAGON SEEKS FEWER BIDS FOR CONTRACTS

MANY DEFENSE OFFICIALS contend that present procedures swamp military contracting agencies with dozens of voluminous bids on new projects, many from companies that misinterpret proposal requests or that are technically unqualified. Tucker's committee is now seeking methods to improve preparation of bid invitations, solicitation of proposals from prospective contractors, and screening of contract bids.

One plan under consideration would set up a system of dual bids. The first proposal would be brief, simply outlining a potential contractor's experience, facilities, and the like (the "report cards" described above would be a check on the company's qualifications). Firms that meet the military agency's managerial requirements would then be invited to submit more detailed proposals spelling out technical ideas and cost estimates.

CONGRESS MAY CHOP FUNDS FOR COMMUNICATION SATELLITE R&D

CONGRESS MAY RED-PENCIL further NASA spending for communications satellite R & D. Strong backers of the administration's plan last year for a privately owned commercial satellite system are now expressing concern about continued government spending in this field by NASA. The issue came up during Senate Commerce Subcommittee hearings on the status of communication satellites.

Subcommittee Chairman Sen. John O. Pastore (D.-R. I.), a key backer of private communication satellite ownership, was surprised to learn that NASA plans to spend \$80 million to \$100 million on communication satellites in fiscal 1964. When the system was turned over to private ownership, Pastore said, he thought the government would stop spending money on the system's development. Pastore plans to make sure that Congress gives the matter full consideration before voting money for the program.

PUSH POSTAL AUTOMATION, SAY ADVISORS

POST OFFICE'S R & D and mechanization program was endorsed last week by a special advisory board. The board recommends generally that the department do what it is doing now, but more intensively, and asked for a substantial increase in spending. It gave special emphasis to perfecting electronic address readers and code sorters and suggested consideration of round-the-clock operation of the postal laboratory in Washington. The board also recommended that presently available machinery—specifically Rabinow-Burroughs and Keytronic letter sorting machines—be exploited now.

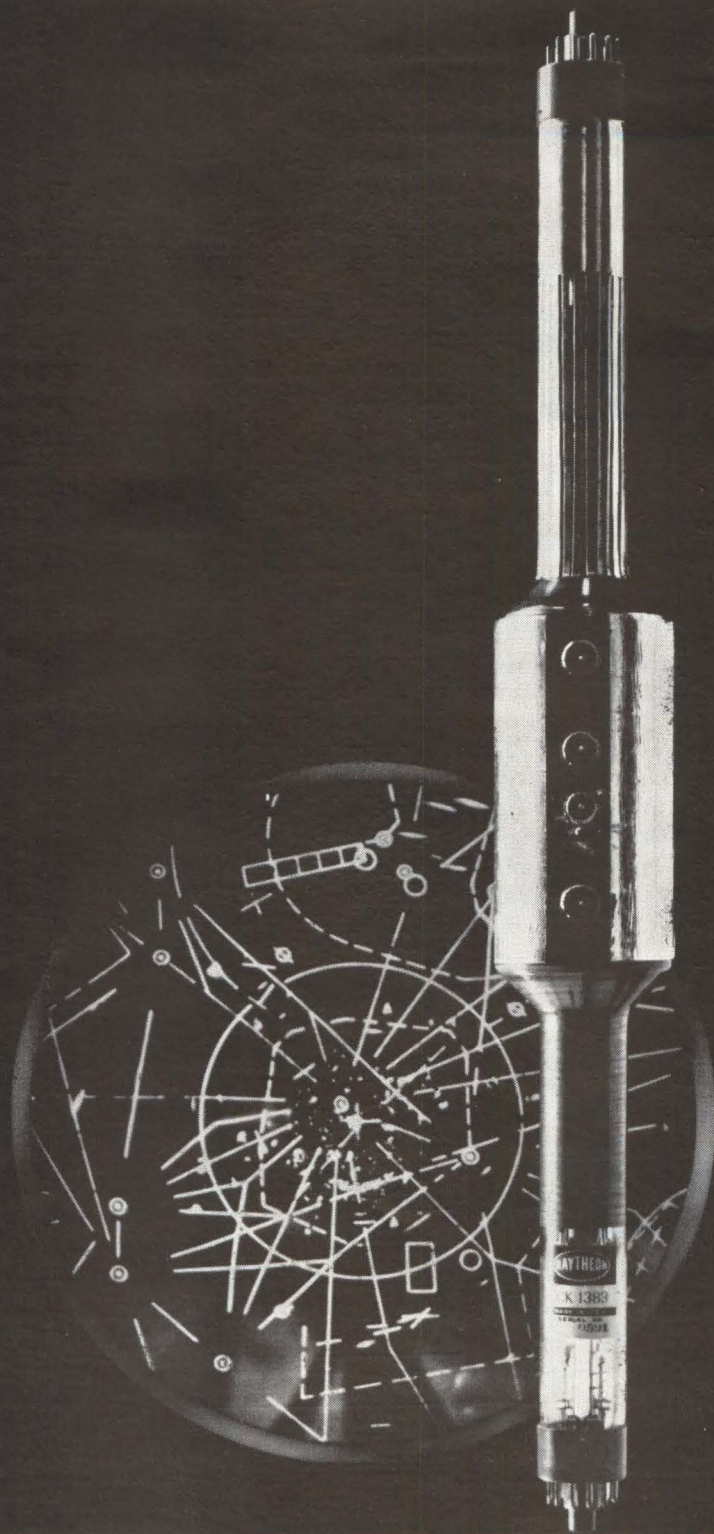

Raytheon storage tubes help FAA control air traffic more effectively, improve flight safety

Fifty-one Raytheon "bright display" electronic systems featuring Raytheon CK1383 two-gun storage tubes are being produced for the air traffic controllers of the Federal Aviation Agency. The CK1383 stores radar blips and presents them on a Raytheon CRT CK1381 display tube (Radar/PPI television-type presentation). This way, a continuous picture of a plane's flight path is available. The video can be seen in many areas at the same time, making the controllers' tasks faster and easier. Panoramic displays can depict instantaneously the status of all aircraft in a selected area. In addition, the display itself is bright enough to be seen in a normally lighted room.

Raytheon Storage Tubes are available for many other types of scan conversion and for such applications as stop motion, integration for signal-to-noise improvement, information storage for data processing systems, slow-down video, time delay, and phase shift.

Whatever your storage tube requirements, Raytheon can meet them best. Unmatched capabilities and more than a decade of experience are at your command. For complete details on Raytheon storage tubes and display devices, please write: Raytheon, Industrial Components Division, 55 Chapel St., Newton 58, Mass.

CIRCLE 11 ON READER SERVICE CARD

RAYTHEON

Solid Progress in Solid-State

Integrated-circuit types grow, but speakers call for more study of theory

By SAMUEL WEBER
Senior Editor

MICHAEL F. WOLFF
Senior Associate Editor

PHILADELPHIA—Merging of device physics with circuit theory and the growing necessity for the circuit designer to understand device and network theory, rather than being able merely to apply spec sheet data, was a pervading theme at the 1963 International Solid State Circuits conference held here last week. This concept was repeated in the formal papers and

underscored in panel sessions, particularly in the area of integrated circuits, lasers and nanosecond switching.

Status and problems of integrated linear circuits were scrutinized at a crowded evening session. R. F. Pepper, of the University of California, pointed out that high-gain, narrow-band, low-pass amplifiers are available, and low-pass amplifiers capable of operating at several Mc are needed. Integrated bandpass amplifiers are also needed, he said, and called for more work in frequency-selective feedback, active R-C networks, superregenerative techniques and sequential sampling of low-pass amplifiers.

Pepper said more research is needed in 1) distributed network transformation to simple forms; 2) developing an analog of the feedback concept, since passive compo-

nents are not stable enough; 3) compound circuits with simple system characteristics, and 4) use of thermal and other nonelectrical properties for amplification.

J. Narud, of Motorola Semiconductor, predicted that age circuits as well as wideband high-frequency feedback amplifiers would prove to perform better in integrated form than discrete components. He said a linear amplifier with better age and frequency characteristics up to about 200 Mc would be available soon.

RELIABILITY — Reliability was the focus of attention of the panel on integrated digital circuits. E. Hall, of MIT Instrumentation Laboratory, said his group was committed to using integrated gates in the Apollo guidance computer. While only laboratory devices have been built so far, he said several thousand had been used without encountering any failure rates or modes that indicate the final product should not be integrated. Although more power is required than with conventional components, he predicted integrated equipment would prove cheaper and easier to build. A design study of the two types showed 4,000 integrated gates, 3,000 resistors, 500 transistors and 1,500 diodes for the integrated system, versus 10,000 resistors, 2,500 transistors and 7,000 diodes in a conventional version.

R. Kudlich, of A-C Spark Plug, reported that 5 to 6 million device hours had been accumulated in a prototype inertial guidance computer with one integrated circuit failure, one transistor failure and one diode failure. He saw no reason why 7,000-hr mtbfs could not be reached eventually.

FIELD-EFFECT TRIODES — In scheduled papers, nanowatt logic circuits using complementary *n* and *p*-type field-effect metal-oxide semiconductor triodes were described by F. M. Wanlass, of Fairchild Semiconductor (ELECTRONICS, p 7, Feb. 22). These devices only dissipate power at a rate proportional to

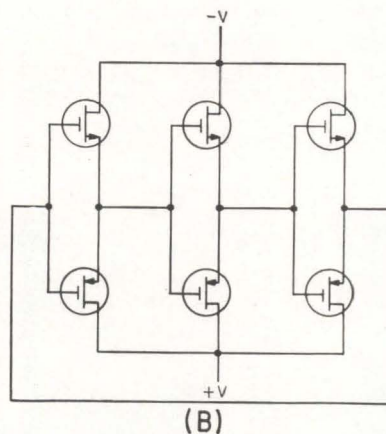
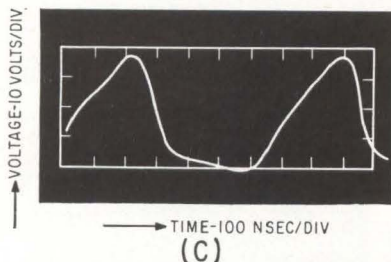
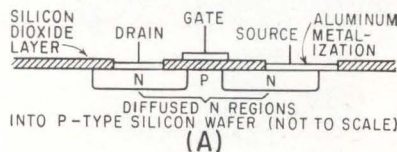

METAL-OXIDE-SEMICONDUCTOR TRIODE (A) used in ring oscillator (B) whose output voltage waveform from one state is shown in (C) (Fairchild)

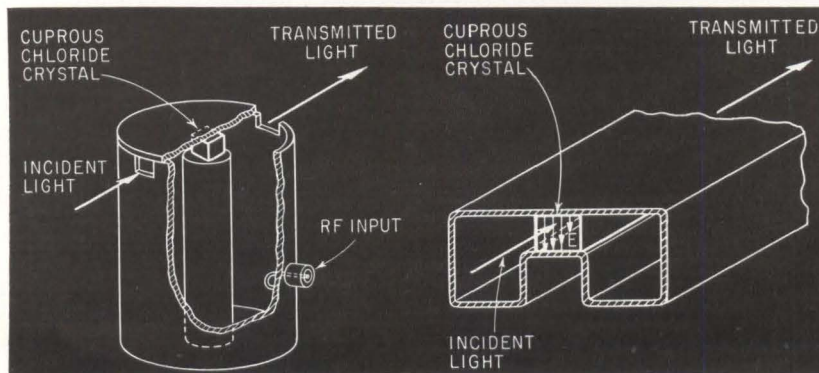

REENTRANT-CAVITY modulator (left) and traveling-wave modulator using cuprous chloride (RCA)

Seen at Philadelphia

switching speed, are seen useful for both digital and linear circuits. The figure shows a ring oscillator set up to measure the propagation delay of a complementary inverter circuit. Output of one of the stages (Fig. C) shows propagation delay to be less than 100 ns.

NSEC SWITCHES—At the panel session on nanosecond switching, the question of which device to use for such applications was heatedly debated. Considerable disagreement was apparent on the relative merits of tunnel diodes, transistors and snap-off diodes.

Although the tunnel diode was generally conceded by the panel to outstrip the transistor and snap-off diode in switching speed, consensus was that practical reliable performance from straight tunnel diode logic was extremely difficult to realize. TD's have limited fan-out capability, limited gain, and the tolerances of commercially available devices vary widely. Transistors, while affording higher gain are limited in speed by storage delay. Snap-off diodes appear to have an ultimate limit of 200-Mc operation due to the inherent recovery time required between pulses. Combinations of devices, utilizing the best qualities of each appears to be a trend in nanosecond switching.

Evaluation of devices for nanosecond switching is made difficult by the interconnection problem, both panel and audience agreed. It is one thing to specify switching capabilities of one isolated component or circuit, and quite another to achieve it when 10,000 units are connected together in a system. A member of the audience, B. Leitner, of RCA, called for establishment of a functional figure of merit to evaluate the various devices.

LASERS—One of the highlights of a panel discussion on modulation techniques for lasers was a suggestion by J. A. Armstrong, of IBM Research Laboratories, that nonlinear effects applied to modulation schemes might yield fruitful results not yet realized. Since the Manley-

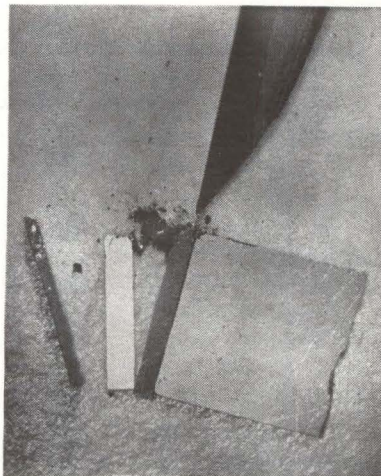

GALLIUM-ARSENIDE injection laser crystals produced with cleaving technique at IBM

Rowe relations governing the behavior of parametric circuits holds at optical frequencies, Armstrong stated, huge power gains in a parametric up-converter configuration should be possible. As an example, efficient generation of kilowatts of coherent ultraviolet should be possible in such an upconverter, Armstrong said.

Existing methods of modulation, also discussed by panel, utilize the birefringent properties of KDP and ADP crystals, either in a traveling wave type or resonant cavity structure. Disadvantages of these materials which include a limit of usable wavelength to below 1.7 microns, small angular aperture and necessity of using either transparent electrodes or ones with holes, seem to be overcome with a new optical modulator using cuprous chloride described in a paper by F. Sterzer, of RCA. Unlike the DP crystals, CuCl exhibits a transverse electro-optic effect, that is, the index of refraction changes under the influence of a transversely applied electric field. Sterzer described CuCl modulators actually used to modulate visible and infrared radiation. The highest modulation rate of 1 Gc was obtained in a reentrant cavity modulator (illustrated). A proposed wideband tw-type modulator using CuCl in a ridged waveguide is also shown in the figure.

WHAT ARE YOUR DELIVERY REQUIREMENTS?

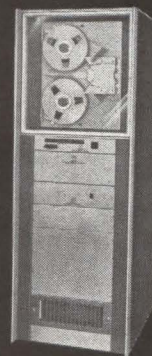

STANDARD
TAPE TRANSPORTS
4 WEEKS

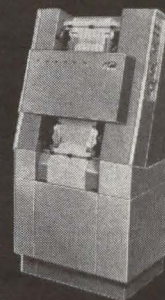

STANDARD
PRINTERS
12 WEEKS



NEW PRINTER DIVISION

Broad acceptance of our product line coupled with the fact that so many Potter "specials" are now industry standards has resulted in such dramatic growth that we have increased our plant and production capacity by more than 65%. This new production capability can directly benefit you through faster delivery.

For example, we can deliver our standard transports in 4 weeks, and standard printers in 12 weeks from receipt of order.

If you require fast delivery — with no sacrifice in performance or reliability, write us today.



POTTER INSTRUMENT CO., INC.

TAPE TRANSPORT DIVISION
151 Sunnyside Boulevard • Plainview, New York

PRINTER DIVISION
East Bethpage Road • Plainview, New York

WHAT'S NEW IN LASERS?

LIQUIDS, INTERMETALLICS, RARE EARTHS

*Nonlinear modulators,
demodulators, mixers
and amplifiers, too*

By ARTHUR ERIKSON
McGraw-Hill World News

PARIS—Along with a spate of recent laser developments, fore-runners of a whole gamut of nonlinear optical devices turned up at the Third International Symposium on Quantum Electronics this month.

One theme emerged: the laser's future now looks brighter than ever. Quantum devices now are far enough along that MIT Provost Charles H. Townes, summing up the symposium, predicted a splitup between applied technological work and basic scientific work probably will come in the next few years.

RAMAN LASER—Plenty of evidence to back up Townes' prediction cropped up at the symposium. For one thing, the spate of recent laser developments opens up a whole new range of wavelength possibilities. Most symposium goers rated recent discovery of Raman laser action in organic liquids (ELECTRONICS, p 74,

Feb. 15) as a real advance. Said one, "It points the way to very short wavelengths. Pick the right pair of Raman shifts, beat them together in a mixing crystal and you can get just about any wavelength you want." E. J. Woodbury reported on the work done at Hughes Aircraft.

Reports of successful development of gallium-arsenide semiconductor lasers late last year in the United States injected a high current of enthusiasm in the symposium.

M. I. Nathan, for one, pinned down the state of an injection laser that uses an n-type GaAs diode with a diffused Zn acceptor. It produced stimulated emission centered on 1.47 eV from temperatures of 1.90K to 300K.

Russian and French researchers reported work that indicates they're on the verge of obtaining semiconductor laser action with indium antimonide and indium arsenide.

RARE-EARTH LASER—Still a third new basic laser family is the molecular laser based on rare earth chelates. They hold the prospect of a continuous range of wavelengths from millimeter all the way to

ultraviolet. Further, they can be easily pumped optically, have high quantum efficiency and narrow emission widths.

A look at these possibilities was reported by Harold Lyons and M. L. Bhaumik, of Electro-Optical Systems. For Eu-benzolacetate in a plastic host at 77 deg K, a 6,130 Angstrom emission showed 15-A line widths, 0.5-msec decay time and 80-percent quantum efficiency. With these parameters, laser threshold is 0.01 joule, easily obtained with a low-power pump.

NONLINEAR OPTICS — Along with the spate of lasers, a groundswell of emphasis on nonlinear optics developed because of need for practical modulation and demodulation devices to put coherent light to work in communications systems.

R. W. Terhune reported a giant step forward in nonlinear optics made by his research team at Ford Motor Company—second-harmonic generation at 22-percent conversion efficiency. The 30-millijoule output of a 6,493-Angstrom giant-pulse ruby laser was focused on slabs of ADP and KDP crystal. By using index matching and holding focal

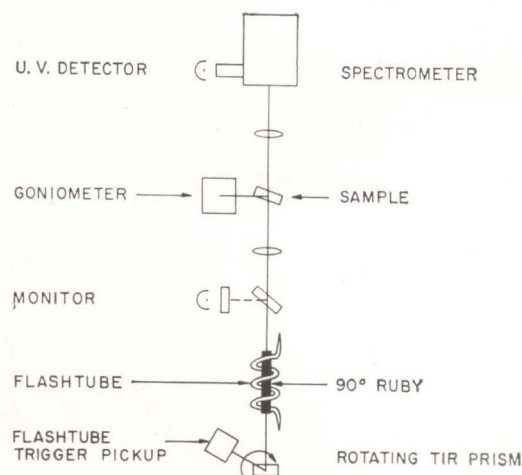
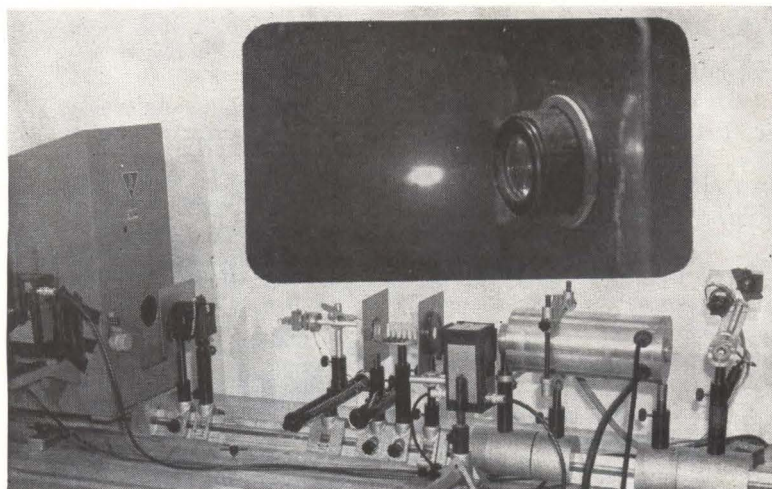

GIANT-PULSE LASER system employed by Ford to get second-harmonic generation. Large photo shows actual test setup, diagram is schematic of the experiment. Small photo (inset) shows how 120-millijoule pulse focused with 2-cm-focal-length lens creates spark as it breaks down air; the electric field strength is about 10^8 v/cm



RUBY-LASER telemeter shown by CSF directly reads out range with an accuracy of 2 meters at 10 kilometers

length as short as possible the team obtained a pulsed beam of 3,470Å light with a total energy of 6 millijoules.

Going for third harmonic generation, Terhune's team pumped a rod held near 0 deg. C with a 2,500-joule input to an FT 524 helical flash tube and used Q switching to get single pulses with width about 15 nsec and a total energy of 120 millijoules. With a focal length of 15 cm, there was third harmonic generation.

MODULATION—And the symposium brought to light a whole batch of modulation, demodulation, mixing and amplifying schemes. One that attracted considerable attention was the method of producing single-sideband suppressed-carrier modulation of light at frequencies up to microwave described by C. Bührer and co-workers, of GT&E Labs (*ELECTRONICS*, p 21, Aug. 24, 1962, and p 28, Feb. 22, 1962). Modulation at a-f was obtained with cubic zinc-sulfide single crystal.

Modulators based on birefringence change in KDP also have been developed in Germany and France. K. Gurs, of Germany's Siemens, reported on a modulator with the crystal inside the resonator of a ruby laser. Modulation at frequencies to 30 Mc has been obtained and 1,000 Mc seems possible. Full modulation occurs with only 200 volts applied to the KDP crystal; however, the advantage of low modulation voltage, is offset by a limit on bandwidth—10 Mc for resonators of conventional dimensions.

Compagnie Francaise Thomson-

Highest Sensitivity with the New Tipless **VIDICON**



ML-7351A

Highest sensitivity—less than 0.05 Ft. C. faceplate illumination required.

ML-7351A offers highest sensitivity of commercially available vidicons...operates with less than 0.05 ft. c. illumination on faceplate...using f/2.0 lens requires less than 2.5 ft. c. av. scene illumination.

Lower dark current—for slow scan television

At sensitivity equivalent to comparable tubes ML-7351A requires lower dark current...permits greater signal current accommodations in slow scan TV amplifiers...at ASA 1200 ML-7351A requires only 0.05 ua dark current, approximately ¼ that of comparable tubes.

High radiant sensitivity in the red region

High sensitivity in extreme red region for viewing incandescent materials, jet engine exhausts, etc.

Write for complete data on ML-7351A



An Affiliate of Raytheon Company

THE MACHLETT LABORATORIES, INC.

SPRINGDALE, CONNECTICUT

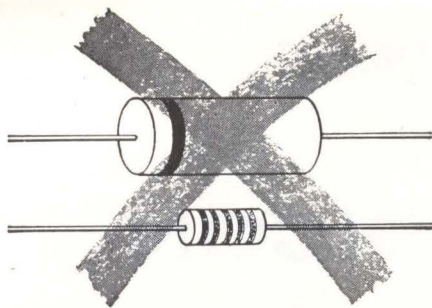

Why use TWO when ONE will do?

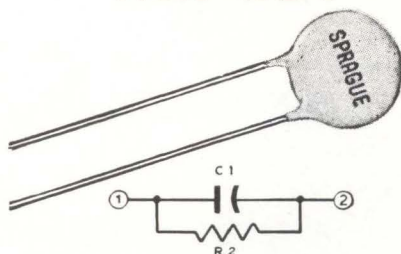

MULTI-COMP® PARALLEL RESISTOR-CAPACITOR NETWORKS effect a 50% reduction in parts procurement, stocking, inspection, installation. What's more, these tiny printed-circuit discs offer substantial savings in space and cost.

Close electrical tolerances are no problem. Multi-Comps may be obtained with resistance tolerances to $\pm 10\%$ and capacitance tolerances as close as $\pm 5\%$.

Multi-Comp R-C Discs are available in a variety of capacitance and resistance ratings—500 v capacitors range from $5 \mu\mu\text{F}$ to $.015 \mu\text{F}$; 12 v capacitors can be had from $.01 \mu\text{F}$ to $.33 \mu\text{F}$; standard resistor rating is $\frac{1}{4}$ watt, with resistance values ranging from 47 ohms to 50 megohms.

For complete information write for Engineering Bulletin 6612A to Technical Literature Section, Sprague Electric Company, 35 Marshall St., North Adams, Massachusetts.



48-375R1

MODULATOR
developed by Siemens. Pump (E) is elliptical reflector. Resonator is mirror (M_1) on ruby (R) and external mirror (M_2). KDP crystal fitted with electrodes, and detector and oscillator complete the system

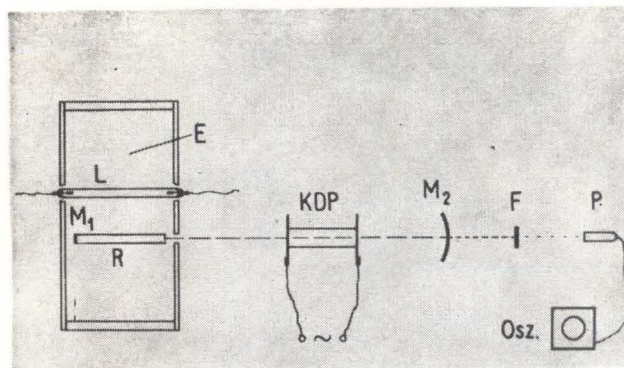

Houston, at the complementary equipment exhibition, showed an external modulator for a gaseous He-Ne laser. Here, the KDP crystal works in a high-frequency cavity and for full modulation at 3,000 Mc, 7,500 volts is necessary.

MIXERS — Several different approaches to optical mixers turned up. One of the slickest was that of Stanford Microwave Laboratories' R. H. Pantell. Key component is a slab of cadmium-selenide crystal 1.5 mm square and 0.15 mm thick.

With the crystal in a resonant cavity, Pantell obtained a 1,321-Mc beat frequency from a ruby laser. With the CdSe crystal in a waveguide matched at one end, and a crystal detector at the other, over -9 dbm output developed at 1,321 Mc and -20 dbm at 10,570 Mc, eight times the fundamental beat note. With 3 volts bias on the CdSe, corresponding to a detected microwave frequency almost 10^5 times the transit time cutoff frequency, output was approximately -41 dbm.

A mixer idea getting a tryout both in Britain and the United States beams two laser outputs on a photocathode. Beat phase velocity depends on the angle between the two beams, so it is possible to get cumulative interaction of the transverse electron current with fast waves in the millimeter and submillimeter regions that can be picked up in a waveguide.

An f-m/am optical convertor was described by S. E. Harris, of Stanford Electronics Laboratories.

Key element is an f-m discriminator made up of an optically flat and parallel crystal of calcite 5 cm long with c-axis perpendicular to its length, put between Nicol prisms. With this arrangement, optical waves travel different path lengths

and emerge with a phase difference depending on optical frequency. Polarization of the emerging light, and transmitted light amplitude, is a periodic function of frequency.

Light from a helium-neon laser at 6,323 A frequency—modulated at 2,400 Mc was passed through the discriminator. A multiplier phototube detected change of 1,000 cps modulated d-c level. Deviations as small as 30 Mc were readily detected. Backed up by a traveling-wave phototube, the discriminator demodulated c-w at S-band.

AMPLIFIERS—A Japanese team, expecting that the square-law characteristics of "external" photoelectric effect at microwave would apply "internally," verified this by detecting a 4-Gc beat frequency component in a silver-bonded germanium diode. Since the diode is a parametric diode, the detected signal can be amplified by pumping with microwave power at frequency twice the detected signal, with all the advantages of parametric amplifiers.

Another amplification method reported by B. Senitzky and G. Gould, of TRG, utilizes resonance saturation in gaseous HCN⁶. At 86Gc, the radiation spectrum consists of a strong saturating signal at the resonant frequency and two weak sidebands within the resonant linewidth. The saturating signal, from a communications standpoint, represents a local oscillator and the sidebands the incoming information signal.

Power transfer from the saturating signal to the sidebands occurs when this spectrum is transmitted through the gas as an a-m wave. Experiments at 70-cps modulation frequency showed a net 1.5-db sideband gain for the a-m sidebands, and a 5.5-db attenuation for f-m.

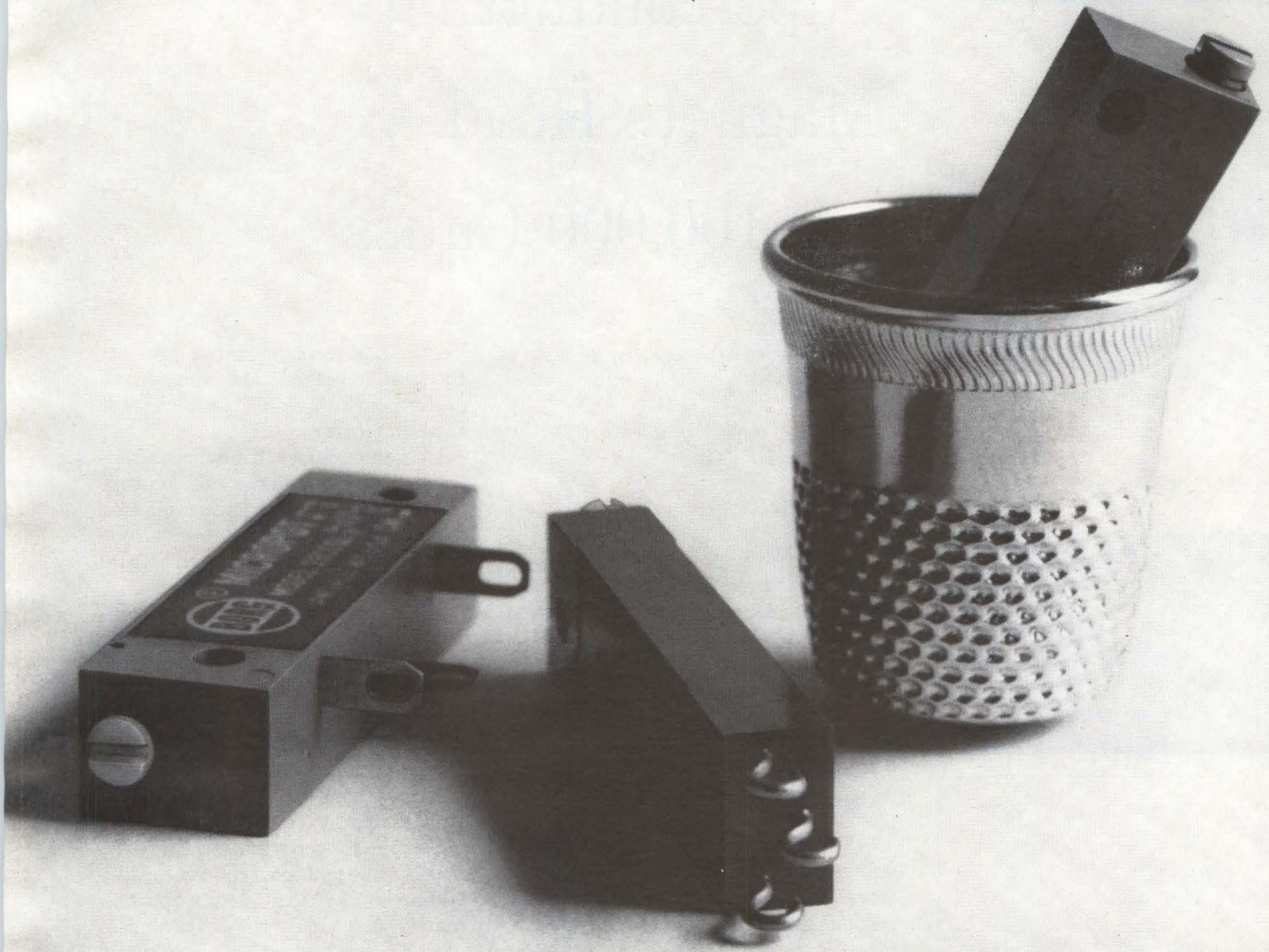

Little...

These three Micropot[®] potentiometers illustrate how you can pack as much trimmer into just about as small a space as you'll ever require.

The middle trimmer (our 1.25 x .32 x .19" 2750 series) gives you 47% more density than the one on the left (1.25 x .28 x .36" 2800 series); the trimmer on the right (1 x .32 x .19" 2700 series) offers 86% more density than the one on the left.

Environment a problem? No more. We have a trimmer to provide the solution—be it temperature, humidity, or what-have-you. (See chart at right.)

Delivery? Authorized Amphenol-Borg Industrial Distributors located through-

Littler...

out the country can now deliver as many Borg trimmers as you need from their stock at factory prices. There's bound to be one near you.

However you look at trimmers—from component density, environment, reliability, delivery, or price—the Micropot line is a good bet to meet your requirements. And if you need specials, take advantage of our *Quick Reaction Facility*. You can get prototypes built to your own specifications almost as fast as you can ask for them.

Save time, money, and embarrassing trimmer failures by contacting your nearby Borg representative or distributor. Or a

Littlest...

note to R. K. Johnson, Sales Manager, will bring you complete information by return mail.

Series	Miniature	High Temperature	Humidity Proof	Wire-wound	Carbon
2700	X	X	X	X	
2750		X	X	X	
2800		X	X	X	
990		X		X	
992				X	
993					X
994			X	X	
995			X		X

CIRCLE 17 ON READER SERVICE CARD



BORG EQUIPMENT

A Division of Amphenol-Borg Electronics Corporation
Janesville, Wisconsin

Superconducting Magnets Head for 100,000 Gauss



FIELD STRENGTHS of these magnets, being tested at Westinghouse Electric, range from 15,000 to 50,000 gauss. Core diameters range from $\frac{1}{2}$ to 2 inches

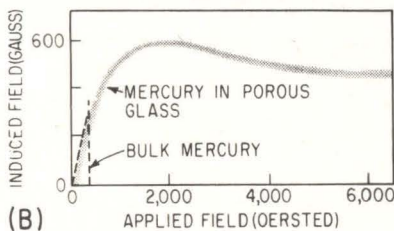
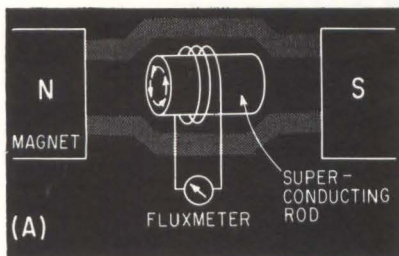

EXPERIMENTAL SETUP for synthetic superconductors (A). Varying the external field induces currents in the superconducting rod that are detected by the coil and measured. Curves (B) compare staying power of induced fields in bulk mercury and in mercury-glass filaments

New techniques may provide the magic number during 1963

RACE TO ACHIEVE a 100,000-gauss superconducting magnet may reach the finish line this year, some specialists predict. In recent months, there have been a number of advances in materials and techniques that promise to provide magnets with greater strength than 68,000 gauss—the top figure reported to date.

Superconducting magnets with field strengths up to 50,000 gauss are now commercially available. Some practical applications are already being made—for example, in masers (ELECTRONICS, p 7, Nov. 30, 1962, and p 74, Feb. 15). To extend practicality further, new types will permit use of the field at room temperature.

Westinghouse Electric has built a series of commercial magnets ranging up to 50,000 gauss. Avco-Everett Research Laboratory has a working 34,000-gauss magnet with a 5-inch diameter. Avco-Everett expects to deliver a 50,000-gauss, 10 $\frac{1}{2}$ -inch ID unit to Argonne National Laboratory late this spring for use in a bubble chamber (ELECTRONICS, p 8, Oct. 12, 1962). Bell Labs is working on an 8-inch-core magnet to reach 50,000 gauss using Nb-Zr.

METAL-GLASS MAGNETS—Synthetic superconductors may reach the highest fields yet attainable. By hydrostatically forcing melted lead, tin, mercury or indium into porous

Vycor glass, scientists at General Electric Research Laboratory have produced high-field, high-current superconductors.

Using mercury initially, researchers produced evidence to support the theory that some high-field superconductors derive their characteristics from thin structural filaments.

With lead, synthetic superconductors sustaining lossless currents of over 100,000 amp/cm² have been produced, Charles P. Bean, of GE, revealed to ELECTRONICS. The critical field of the lead filaments was 100,000 gauss, approximately 200 times the critical field of bulk lead at a temperature of 4.2 K.

Earlier mercury and glass experiments yielded a material with a 70,000-gauss critical field, approximately 200 times the critical field of bulk mercury at 2.1 K. Critical field is the point at which the material will suddenly lose its superconducting properties.

Conceivably, wire made from this synthetic material could be made into magnets with fields well in excess of 100,000 gauss. Using glass with finer pores, this material can reportedly be made to go to higher fields than intermetallic compounds.

NIObIUM-TIN — Judging from work now going on at GE, Bell Telephone Labs and others, a magnet made from niobium-tin (Nb₃Sn) wire may reach 100,000 gauss during 1963. GE is very optimistic.

RCA expects to produce a 50,000-gauss magnet shortly from Nb₃Sn ribbon produced by gas deposition (ELECTRONICS, p 62, July 27, 1962). Nb₃Sn, though superior to niobium-zirconium in many respects, is difficult to work as wire because of brittleness.

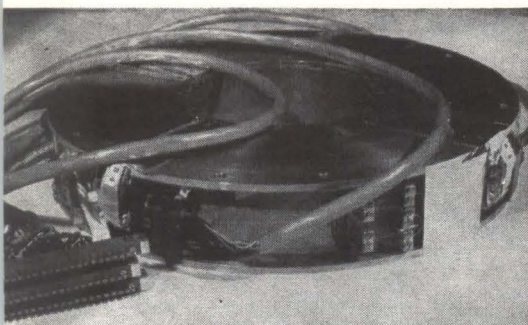

INSIDE diameter of this Avco-Everett niobium-zirconium, 34,000-gauss magnet is 5 inches. Large core will permit using field in air

National Research Corp. is reportedly producing Nb_3Sn ribbon by a dipping process. The ribbon is formed by wetting tin on niobium, and then sintering it. This ribbon is then wound into a coil. The ribbon is 60 mil wide, 1.5 mil thick and has a 0.1-mil coating. NRC won't give details on the material at this time pending further testing.

According to J. C. Lawrence, director of EM Properties Div. of NASA's Lewis Research Center at Cleveland, the present problem is that of producing a more easily formable type of Nb_3Sn , which has a critical field of 190,000 gauss.

Va_3Ga is another material that deserves attention; it has a critical field of about 500,000 gauss, Lawrence said.

EXTERNAL-FIELD MAGNETS—Westinghouse Electric and Magnion, Inc., are marketing superconducting magnets that permit extension of the high fields outside the liquid-helium bath, giving access to the field in air at room temperature.

These are high-field solenoids with sizable inside diameters and specially designed liquid-helium dewars that keep the solenoids immersed at 4.3 K while permitting access to the field through the core. The Westinghouse device gives a working diameter of 1 inch in a field of up to 50,000 gauss.

Avco-Everett Research Laboratory will soon do this with their 34,000-gauss magnet with a 5-inch core.

Using an external field magnet, Westinghouse researchers have passed high-temperature gas streams, or plasmas, through the superconducting field and produced about 1½ volts. The unit is being used to study the reaction found in magnetohydrodynamic generators and electrical space propulsion systems.

Westinghouse is also investigating the feasibility of using a modified external-field magnet to retrieve foreign particles from the eye. It is working with doctors from the University of Pittsburgh medical school, hoping to create a magnet small enough to use in delicate surgery. The magnet would provide a high field in air at room temperature.

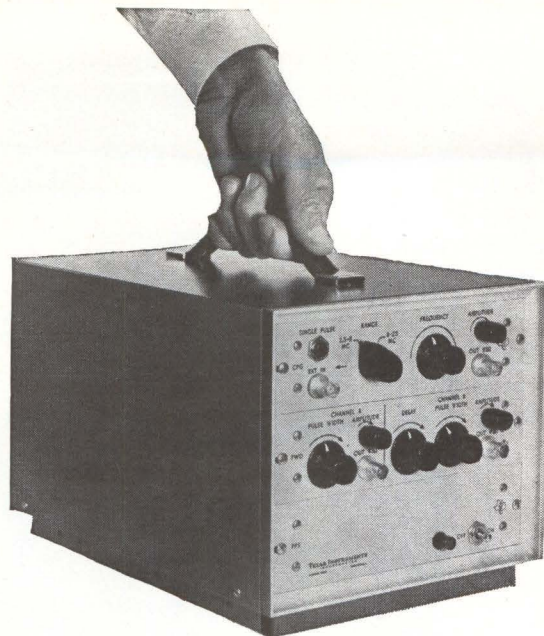

TI has what you need in pulse programming!

Versatility — Custom combination of modules for any desired performance characteristics. **Portability** — Compact, lightweight, easy to carry. **High Rep Rate** — Repetition rates of 100 cycles to 100 megacycles.

Texas Instruments Series 6000 Pulse Generators are the smallest instruments available with the advantages of modular construction plus a wide range of operating features which include variable width and delay, variable rise and fall times, plus and minus outputs, pulse mixing, programmed and random word generation.

TI Pulse Generators combine dependable performance with a high degree of versatility and convenience. Circuitry is all solid state with compact controls. Write for complete information.

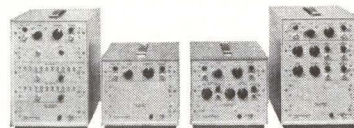

INDUSTRIAL
PRODUCTS
GROUP



TEXAS INSTRUMENTS
INCORPORATED
P. O. BOX 66027 HOUSTON 6, TEXAS

SENSING • RECORDING • TESTING • DIGITIZING INSTRUMENTS
THE INSTRUMENTS OF TEXAS INSTRUMENTS

572

CIRCLE 19 ON READER SERVICE CARD

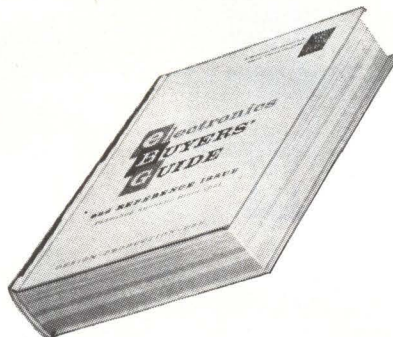

Your **electronics BUYERS' GUIDE** should be kept in your office at all times—as accessible as your telephone book.

MAIL US A PICTURE OF THE CATHODE RAY TUBE YOU NEED...

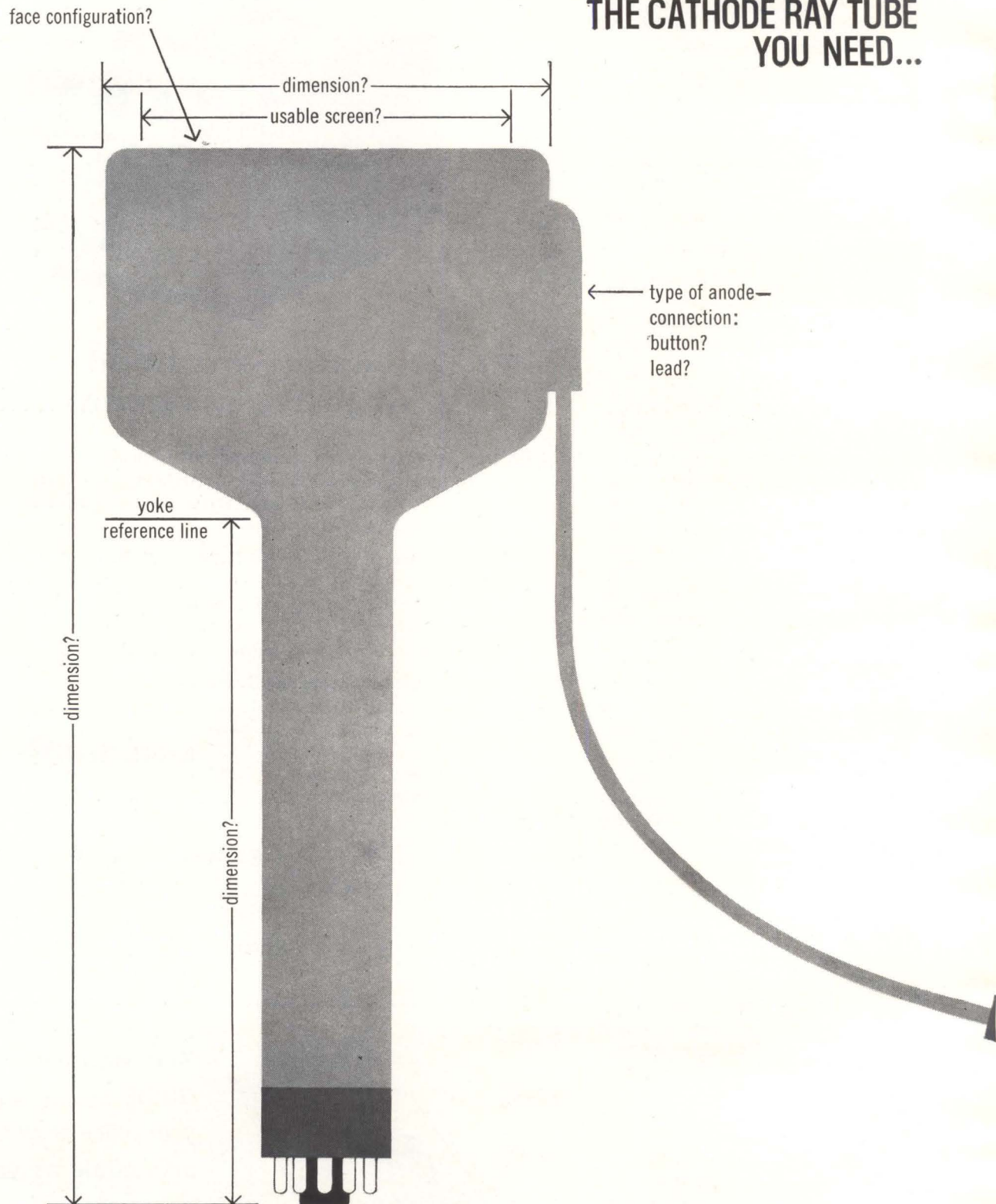

Special characteristics:

- | | | | |
|--------------------------------------|--------------|--------------------------------|---|
| anode voltage | ? | type of focus | ? |
| beam current and/or brightness | ? | type of phosphor | ? |
| spot size: center | ? edge | environmental conditions | ? |
| scan speeds and conditions | ? | application | ? |
| type of deflection | ? | quantity | ? |

Color Tv Mobilizes for '63

...and we may find it on our shelves, ready for delivery!

There's a good chance we can meet your industrial or military tube needs with one of 100 production types. Before you go into a special development program, check first with Westinghouse. Also, many special requirements can be met by only minor changes from an existing tube type.

For a better perspective of Westinghouse capabilities, revolve the page 90°.

TUBE TYPE	MAX. OUT-SIDE FACE DIA. INCHES	MAX. OVERALL LENGTH INCHES	DEFL.	FOCUS	TYPICAL OPERATION				REMARKS
					ANODE KV	LINE MILS	WIDTH @	ELEMENTS PER DIA.*	
WX 4527	0.90	7 1/2	34° Mag.	ES	8	0.75	5/16	800	Max. tube dia. 1 1/4" High res. Fiber optic face High res. aux.
WX 4949	1 1/2	11	30° Mag.	ES	10	0.75	3/16	1330	High res. Fiber optic face High res. aux.
WX 4827	2 1/2	13	40° Mag.	ES	10	0.7	3/16	2860	High res. Fiber optic face High res. aux.
WX 4916	3 3/32	12 1/2	30° Mag.	ES	10	1.5	3/16	1500	High res. Fiber optic face High res. aux.
WX 5013	3 3/32	8 1/2	ES	ES	1.5	7.0	4.5 ft. L.	160	High res. Fiber optic face High res. aux. Integral Mag. shield
WX 5062	3 15/32	12 1/2	40° Mag.	ES	10	0.8	1/16	2650	High res. Fiber optic face High res. aux.
WX 4965	4 1/2	14	42° Mag.	ES	10	1.5	3/16	2170	High res. Fiber optic face High res. aux. Post accelerator
WX 5006	5 11/32	15 1/2	ES	ES	3	9.0	4.5 ft. L.	450	High res. Fiber optic face High res. aux. Post accelerator
WX 5039	7 5/16	13 1/2	50° Mag.	ES	7	12.0	100/16	500	Laminated facoplate for implosion protection Single axis aux. ES def.
WX 4924	10 9/16	17 1/2	50° Mag.	ES	10	15.0	50/16	600	Laminated facoplate for implosion protection Single axis aux. ES def.

*Assumes no deflection defocusing

If you need a special cathode ray tube, we have the people to design it, and the facilities to manufacture it. The model shop, pilot line, engineering labs and environmental test facilities are tops—and they're flexible. From them have come: Tubes with 0.0007 inch spot sizes • Ultra-smooth cataphoretically deposited screens • Ruggedized tubes to meet extreme environmental conditions • High resolution with electrostatic micro deflection to display symbols • Practical low video drive gun adapted to transistorized circuitry.

Tear out this page and mail us a picture of your special needs or talk to your local electronic component salesman—they are in fifty-two sales offices all over the country. Electronic Tube Division, Elmira, N.Y. You can be sure . . . if it's Westinghouse.

We never forget how much you rely on



CIRCLE 21 ON READER SERVICE CARD

Set makers ready for sales increases—at same prices

"THIS IS the last year," says RCA, that it will supply its color chassis to other set manufacturers, although it will still supply components, color tubes and chassis kits. RCA says all its available space will be needed for its own production, believing—with many other set manufacturers—that color tv will really start moving this year

Color set production last year was about 400,000, but only about 200,000 sets were sold to the ultimate user, with price reportedly a major sales obstacle. Despite this, predictions for this year range from a 10 percent increase to 100 and even 200 percent, even though no significant cost reduction is now in sight. Here is a sampling of what several set manufacturers are planning to do:

• Zenith Radio has been making its own color chassis for about two years, using RCA's 21-inch color tube. But a Zenith subsidiary, Rauland Corp., will start producing a color tube shortly and this will be

phased into their sets.

• Philco has announced plans to start color set production this year, using their own chassis but also using many RCA components. Philco believes it will be able to make at least some cost reductions, primarily as a result of their in-house production plans.

• Magnavox has been building a color set for eight years, using the basic RCA chassis but modifying it at their own plant. Next month they will start building their own chassis, and a new, \$5-million plant in Greenville, Tenn. will be ready for operation next June.

• Admiral Corp. began making their own chassis in September, 1962. Olympic Radio and Television made its own chassis some years ago—as did other manufacturers—then bought from RCA, and now plans to make their own again beginning this month.

• General Electric has been making color sets since 1953 and plans no changes at this time for this year: even the base price (\$495) is the same.

• Westinghouse is not now manufacturing color sets and says it will probably sit on the fence until the marketing picture gets clearer.

Closed-Circuit Tv Links German Brokers

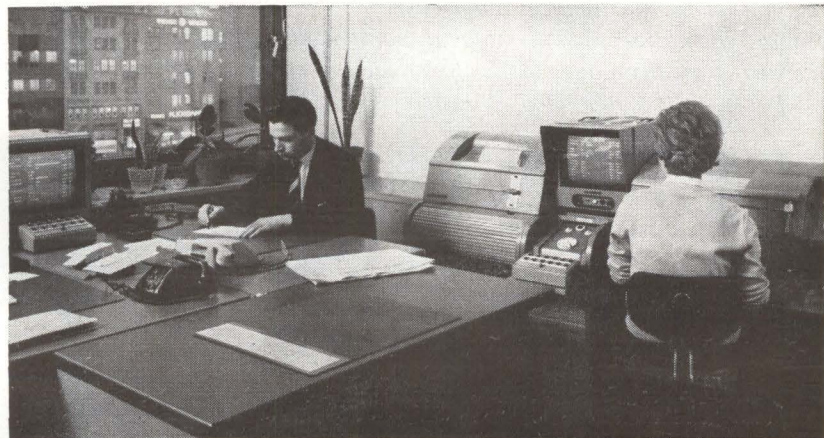

STOCK EXCHANGE in Duesseldorf, Germany, has installed stock quote display on which brokers can remotely post prices of stocks they specialize in. Brokers can also review prices with closed circuit tv system (above) that the exchange plans to extend through Ruhr region

HOW WE TOOK THE SLIP OUT OF TEFLON*

Why Gudebrod's Common Sense Approach to Lacing Problems Pays Dividends For Customers!

Motor manufacturers came to us some time ago with a problem. They required a flat-braided lacing tape that would meet temperature requirements of -100°F to 500°F . A teflon lacing tape would meet the temperature requirements but teflon is slippery . . . knots were hard to tie . . . harnesses worked loose after installation. Valuable production time would be lost!

Gudebrod's answer to this problem was to coat teflon with a special synthetic rubber finish that was non-flaking and fungistatic. We then flat-braided it—we originated the flat braiding process! The result was TEMP-LACE® H, a teflon lacing tape that met the temperature requirements of motor manufacturers and assured them that knots would not slip, harnesses would stay tied and assemblies would remain firm long after installation.

Taking the slip out of teflon is but one of many ways in which Gudebrod's common sense approach to problems pays dividends for customers. Whatever your lacing needs—nylon, glass, dacron†, fungus proofing, color coding, special finishes, Gudebrod has the answer because:

1. Gudebrod lacing tape increases production!
2. Gudebrod lacing tape reduces labor costs!
3. Gudebrod lacing tape means minimal maintenance after installation!
4. Gudebrod is quality—our standards for lacing tape are more exacting than those required for compliance with MIL-T!

Write today for our Technical Products Data Book which explains the many advantages of Gudebrod lacing tape for both civilian and military use. Address inquiry and your lacing tape problems to Electronics Division.

*DuPont registered trademark for its TFE-fluorocarbon fiber.

†DuPont trade name for its polyester fiber.



GUDEBROD BROS. SILK CO., INC.

FOUNDED IN 1870

Electronics Division

12 SOUTH 12TH STREET, PHILADELPHIA 7, PENNA.

Visit Gudebrod Booth #4032 at the I.E.E.E. Show.

MEETINGS AHEAD

RESIDUAL GASES IN ELECTRON TUBES SYMPOSIUM, Italian Society of Physics; Scientific and Technical Assoc., Milano, Italy, March 12-15.

THIN-FILM VACUUM METALLIZING CONFERENCE, Society of Vacuum Coaters; Park-Sheraton Hotel, New York City, March 14-15.

PACIFIC COMPUTER CONFERENCE, AIEE; California Institute of Technology, Pasadena, Calif., March 15-16.

BIONICS SYMPOSIUM, United States Air Force; Biltmore Hotel, Dayton, Ohio, March 18-21.

IEEE INTERNATIONAL CONVENTION, Institute of Electrical and Electronics Engineers; Coliseum and Waldorf-Astoria Hotel, New York, N. Y. March 25-28.

ENGINEERING ASPECTS OF MAGNETO-HYDRODYNAMICS SYMPOSIUM, IREPGNS, AIEE, IAS, University of California; UCLA, Beverly, Calif., April 10-11.

OHIO VALLEY INSTRUMENT-AUTOMATION SYMPOSIUM, ISA, et al; Cincinnati Gardens, Cincinnati, Ohio, April 16-17.

CLEVELAND ELECTRONICS CONFERENCE, IRE, AIEE, Case Institute, Western Reserve University, ISA; Hotel Sheraton, Cleveland, April 16-18.

OPTICAL MASERS SYMPOSIUM, IEEE, American Optical Society, Armed Services, et al; United Engineering Center, New York City, April 16-18.

INTERNATIONAL NONLINEAR MAGNETICS CONFERENCE, IRE-PGEC, PGIE, AIEE; Shoreham Hotel, Washington, D. C., April 17-19.

SOUTHWESTERN IEEE CONFERENCE & ELECTRONICS SHOW, IEEE (Region 5); Dallas Memorial Auditorium, Dallas, Texas, April 17-19.

BIO-MEDICAL ENGINEERING SYMPOSIUM, IEEE, et al; Del Webb's Ocean House, San Diego, California, April 22-24.

NATIONAL ELECTROMAGNETIC RELAY CONFERENCE; Oklahoma State University; OSU, Stillwater Okla., April 23-25.

ADVANCE REPORT

WESTERN ELECTRONIC SHOW AND CONVENTION, Western Electronic Manufacturers Association, IEEE; Cow Palace, San Francisco, Calif., Aug. 26-28. April 15 is the deadline for submitting the below-listed material to Jerre D. Noe, Technical Program Chairman, 1963 Wescon, Suite 2210, 701 Welch Road, Palo Alto, California:

- (1) Three copies of 100-200 word abstract including title of paper, name and address of author
 - (2) Three copies of 500-1,000 word summary identifying related work and new contributions
 - (3) Indication of technical field in which paper falls using IRE professional group classification to aid rapid distribution to reviewers
- Military or company clearance must be granted before submission of paper

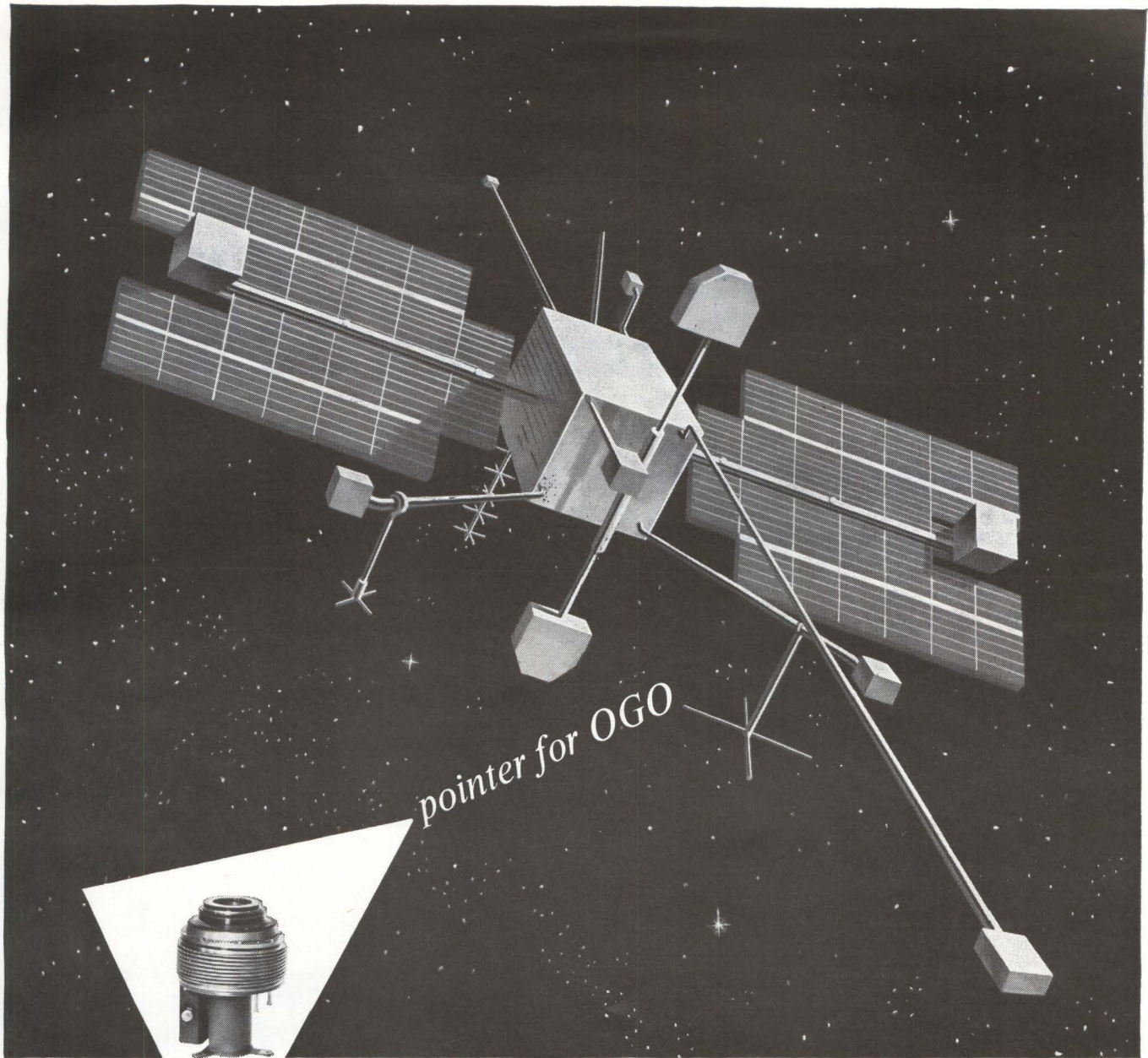

Once in orbit, OGO (NASA's Orbiting Geophysical Observatory) must orient scientific equipment in three directions. Some of its experimental packages must line up perpendicular to the sun's rays. Other experiments must turn to face the earth. Another group must seek a line parallel to OGO's own orbital plane. STL engineers and scientists have produced a hermetically sealed drive mechanism to help solve these orientation requirements. Two mechanisms are used in OGO's attitude control system. One rotates solar arrays in continuous orientation with the sun; a second keeps experiment packages fixed in desired position with respect to the orbital plane. The drive mechanism (shown above) is hermetically sealed to permit use of a conventional high-speed servo-motor without the usual problems of gear lubrication. It does its work by wobble or twist motion at a rate

of one degree per second with a final gear reduction of about 24,000 to 1. STL's many projects include building OGO spacecraft for NASA's Goddard Space Flight Center, building spacecraft for Air Force-ARPA, and continuing Systems Management for the Air Force's Atlas, Titan and Minuteman programs. These activities create immediate openings in fields such as: Space Physics, Radar Systems, Applied Mathematics, Space Communications, Antennas and Microwaves, Analog Computers, Computer Design, Digital Computers, Guidance and Navigation, Electromechanical Devices, Engineering Mechanics, Propulsion Systems, Materials Research. For Southern California or Cape Canaveral positions, write Dr. R. C. Potter, One Space Park, Dept. G-3-1, Redondo Beach, California or P. O. Box 4277, Patrick AFB, Florida. STL is an equal opportunity employer.



SPACE TECHNOLOGY LABORATORIES, INC.
a subsidiary of Thompson Ramo Wooldridge Inc.

Los Angeles • Vandenberg AFB • Norton AFB, San Bernardino • Cape Canaveral • Washington, D. C. • Boston • Huntsville • Dayton
 IEEE Delegates: Visit STL Products Booth 3237-3239

500 MAN HOURS

CUT TO 33½ HOURS IN

32,000 PRINTED CARD TESTS!

BETTER
MEASURING
FROM



Engineers of the Martin Company have developed an automatic card testing machine that electronically inspects printed circuit cards used in the firm's PERSHING, BULLPUP, GAM-83 missile systems as well as its air defense and communications systems. Key to the speed, simplicity and cost savings of the machine is the EI Digital Multimeter which displays test results of the tape program at the push of a button!

Each of the 1000 printed circuit cards produced daily by Martin can now be given 32 quality tests in less than 2 minutes — work which formerly took an experienced electronics technician and inspector 15 to 45 minutes per card!

As in the case of Martin, EI all solid state Digital Multimeters are your answer to greater speed, higher reliability, significant cost savings and a much lower investment.

Whether your interest lies in spacecraft, electronic components or industrial processes, we can demonstrate to you the advantages of EI digital instruments in measuring DC volts, AC volts, DC ratios, resistance, capacitance, inductance and impedance. Let EI all solid state Digital Multimeters provide you with swift, accurate, low cost solutions to your measurement and display problems.

For full details on EI's individual digital instruments, or our complete capabilities in the field of measurement, display and recording—write direct in care of Dept. ET-31.

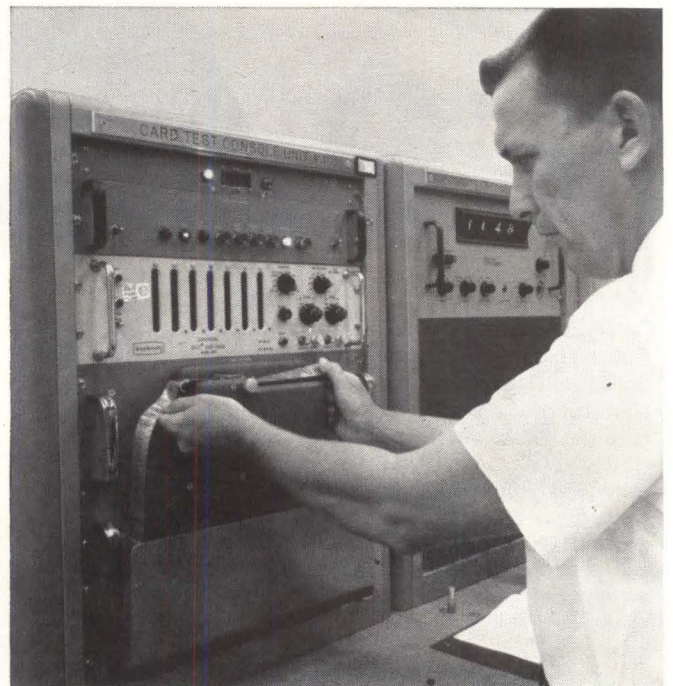

Carle W. Collins, production test engineer, Martin Company's Orlando (Fla.) Division, inserts coded Mylar tape into the reader unit of the Tape Programmed Automatic Tester which he designed.



Electro Instruments, Inc.
8611 Balboa Avenue, San Diego 12, California

ANOTHER STEP

As H. D. Crane showed in 1960, neuristors could serve as the singular elements of a complete computer logic system. Since then, much effort has gone towards the practical realization of neuristor lines, which in their purest form would have a completely distributed structure. A lumped-element neuristor was described in our October 13, 1961 issue. Now, using epitaxial techniques, a semidistributed neuristor has been fabricated . . . another step on the way



NEURISTOR STORAGE RING is adjusted by the author

Experimental Neuristor Gives Nerve-Like Pulse Propagation

By alloying aluminum dots onto an epitaxially grown 3-layer silicon structure, a semidistributed neuristor line is formed that shows some nerve-like properties. An experimental storage ring is described

By ARNE ROSENGREEN
Stanford Research Institute,
Menlo Park, Calif.

NEURISTORS or neuristor lines form a class of structures exhibiting attenuationless propagation of a signal similar to the propagation of ionic discharge along the axon of a nerve fiber.^{1, 2, 3, 4} The device described is not a neuristor in its full sense, but a step away from the lumped model toward a completely

distributed structure. It can be characterized as a semidistributed model whose individual elements can still be recognized but whose channel of propagation is inherent in the structure and is truly distributed.

DEVICE OPERATION—The device is composed of an epitaxially grown three-layer silicon structure (Fig. 1A) on top of which is evaporated a row of aluminum dots that

are then alloyed into the top *n*-type layer. Each dot with its adjacent layers forms a four-layer diode having the approximate characteristics shown in Fig. 1B. The four-layer diodes are biased monostably by external resistors, but a capacitor is added in parallel across each element so that each element becomes a monostable relaxation oscillator.

A single element of the neuristor line is shown in Fig. 1C. The diode

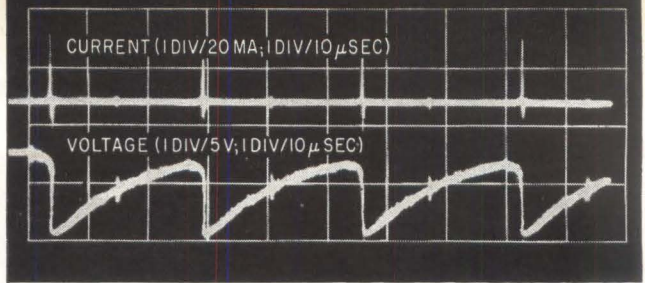
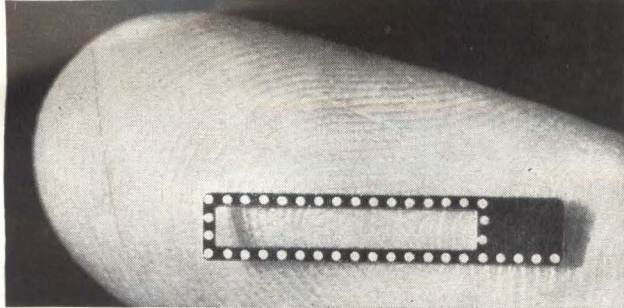

EXPERIMENTAL NEURISTOR STORAGE RING (left) and scope traces (right) of voltage and current of element of ring when a pulse is stored in it

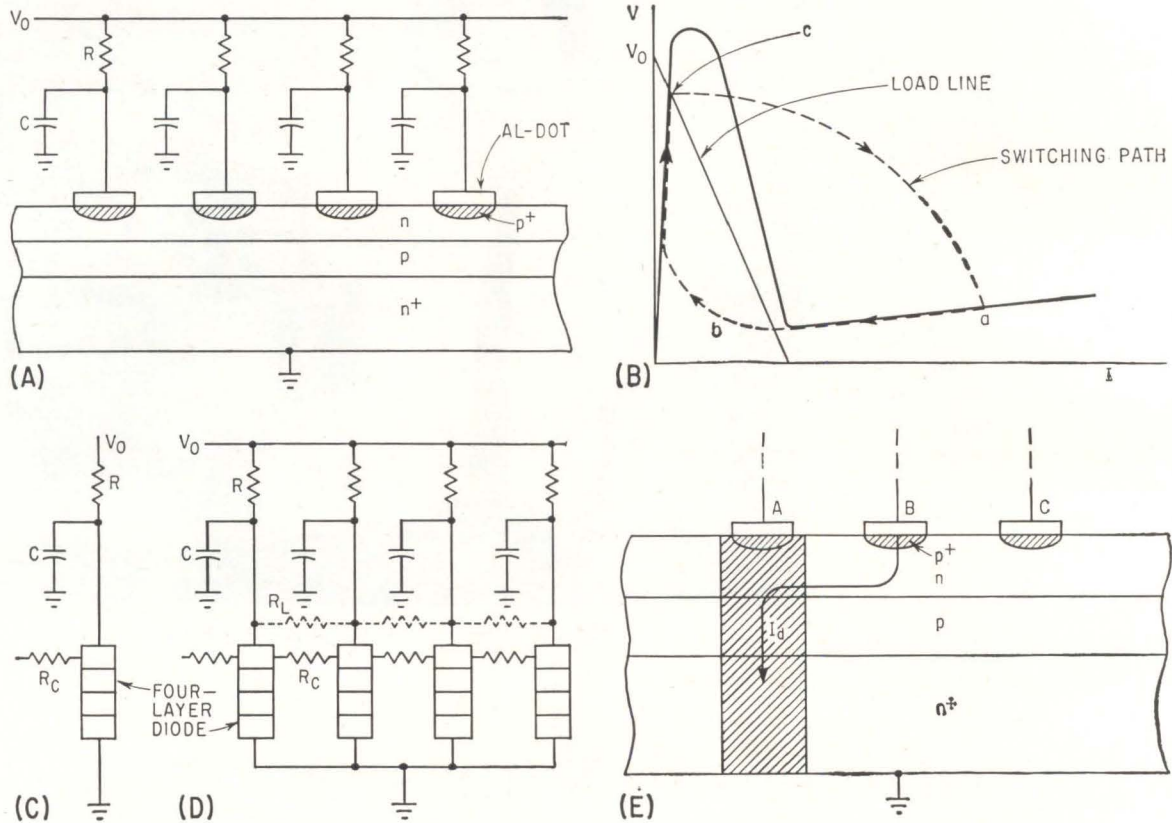

STRUCTURE of experimental neuristor line (A); characteristic of single element of neuristor line (B); simplified equivalent of single element (C) and section (D) of neuristor line; and line section (E) showing how diode A switches and triggers diode B—Fig. 1

is shown as a three-terminal device. To trigger the diode—that is, to bring the diode operation point in the negative resistance region—two methods can be used. Either a voltage pulse is applied across the diode or a current is drawn through the third terminal, the base terminal. The latter of these methods is of interest. When the diode is triggered the voltage across it will first switch to a low voltage stage indicated as point *a* in Fig. 1B, and then rise back to the original biasing point along the path *abc* with a time constant proportional to RC . The recovery interval is normally called the refractory period as the element is insensitive to a new trigger pulse during this time.

A section of the neuristor line is shown in Fig. 1E. Suppose diode A

has just been triggered and momentarily is in its low-voltage, high-current state at point *a* in Fig. 1B. Due to the increased density of minority carriers at element A, a diffusion of minority carriers takes place in the top *n* and *p*-layers. If element B is close enough to A, the density of minority carriers at B may build up sufficiently to turn on diode B. However, a stronger and more immediate process occurs. A majority carrier drift current I_d is initiated in the top *n*-layer due to the voltage difference between diodes A and B. This current corresponds to the base current of a three-terminal diode and will, if large enough, trigger diode B. The result is a pulse moving down the line leaving behind it a refractory zone where the line is recovering. A

simplified version of the equivalent circuit for the line thus consists of three-terminal four-layer diodes coupled together by resistors R_c between the base terminals as depicted in Fig. 1D. The coupling resistors R_c represent the resistance of the top *n*-layer between the dots. The speed of propagation of the pulse is determined by the turn-on time of the diodes. This is a function of the base current,⁹ which depends on the resistivity of the *n*-layer and the biasing point of the diode. The capacitance C has little effect on the propagation speed for this mode of operation, in contrast to the mode where the diffusion is the important trigger mechanism. The capacitance should be high enough to maintain the biasing voltage until the diode has been trig-

gered, but small enough to restrict the refractory length to a reasonably small value.

The refractory length is the length of the line recovering behind a propagating pulse. It is determined by the product of the propagation speed and the recovery time of the diode. It indicates the number of pulses that can exist on a given length of line and is a measure for the size of a storage ring.

NEURISTOR NET — Neuristor lines can be combined to form various junctions important in designing logic networks.² The most common junctions are the T-junction, the T-R junction and the R-junction. Consider the T-junction (trigger junction) in Fig. 2A where a pulse has been started at A. When the pulse arrives at B, two pulses are formed, one heading for C and the other for D. Let the elements close to the junction of line AB and line CB share simultaneously, element by element, their stored energy supply, the capacitance, as schematically indicated in Fig. 2B. A pulse arriving at B from A will initiate a pulse in line BD, but no pulse is sent toward C. The stored energy of line CB close to the junction has been depleted due to the coupling to line AB. The junction has been named a T-R junction, R standing for refractoriness. An important application of the T-R junction is in connection with a storage ring shown in Fig. 2C. It can simply be considered as a modification of the T-R junction in which C and D have been joined together. A pulse started at A will when it arrives at B only have one way to go, namely along path BCD. Returning, the pulse cannot escape by A and circles continuously. It can be destroyed with an R-junction (Fig. 2D). The T-connection has been removed and the two lines share only their refractoriness. If a pulse is sent from E to arrive at the R-junction at C just before the ring pulse, the ring pulse enters an energyless area.

STORAGE RING — An experimental neuristor was built as a storage ring with its associated T-R junctions (Fig. 3). The model was made from an n^+ -type substrate (10^{15} to 10^{10} carriers per cm^3) on top of which was grown by epitaxy a

0.5-mil-thick p -layer (10^{15} to 10^{10} carriers per cm^3) and a 0.5-mil-thick n -layer (approximately 10^{14} carriers per cm^3). It was shaped to the dimensions in Fig. 3 by ultrasonic drilling, after which the aluminum dots were evaporated and alloyed. The aluminum dots were 15 mils in diameter and were spaced 30 mils center-to-center. There were in all 40 dots, 36 forming the ring. Connections to the dots and the n^+ -type substrate were made by pressure contacts. The T-R junction was formed by connecting elements No. 3 and No. 4 to Nos. 39 and 40 as in Fig. 3. The breakdown voltage of the diodes was around 25 v.

With a bias point of approximately 8 v the ring was successfully operated with values of the load resistance R in the range 20 to 40 kilohms and $C = 250$ pf. A pulse was started by triggering element No. 1 with a voltage pulse which resulted in a pulse continuously circling the ring with a velocity of about 10^5 cm/sec. The photograph shows the current and voltage for a single element of the ring during storage of a pulse. The ring was just one refractory length long, the minimum required length for a ring. However, when the ring was operated using only circuit stray capacitances, the refractory length was reduced to less than half.

CONCLUSIONS — The future of the four-layer diode neuristor depends on whether it can be fabricated in a completely distributed form. This raises severe problems,

the main one being that any layer added to the three-layer structure introduces a longitudinal resistance R_L between the elements as indicated in Fig. 1D; R_L is in parallel with the coupling resistance R_c in the upper n -layer which determines the propagation of the signal. If R_L is small compared to R_c , as it would if the aluminum dots were distributed to form one continuous junction, the propagation channel (the n -layer) is effectively shorted and no triggering will take place.

This work was jointly sponsored by the Molecular Electronics Branch [Contract AF 33(657)-7801] of ASD, Wright Field, and the Information Systems Branch of ONR [Contract Nonr-3212(00)].

The three-layer epitaxially grown wafers were made available by the Research Laboratories of Merck Sharp and Dohme.

The author is indebted to T. Janusz, H. Crane and M. Green for many revealing discussions on the subject and to J. Hunt for fabrication of the device.

REFERENCES

- (1) H. D. Crane, Neuristor Studies, Tech Rep No. 150-2, AD 240 306, Stanford Electronics Lab, Stanford Univ., Calif., July 11, 1960.
- (2) H. D. Crane, Neuristor—A Novel Device and System Concept, *Proc IRE*, 50, No. 10, p 2048, Oct. 1962.
- (3) H. D. Crane and A. Rosengreen, Results from Experimental Relay Neuristor Lines, Interim Rep No. 1, SRI Project 3286, Contract Nonr 3212(00)-ONR, AD 250 826, Jan. 1961.
- (4) A. J. Cote, Jr., Simulating Nerve Networks, *ELECTRONICS*, 34, No. 41, p 51, Oct. 13, 1961.
- (5) J. Nagumo *et al.*, An Active Pulse Transmission Line Simulating Nerve Axon, *Proc IRE*, 50, No. 10, p 2061, Oct. 1962.
- (6) T. Misawa, Turn-on Transient of p-n-p-n Triode, *J Electronics and Control*, 7, No. 6, p 523, Dec. 1959.

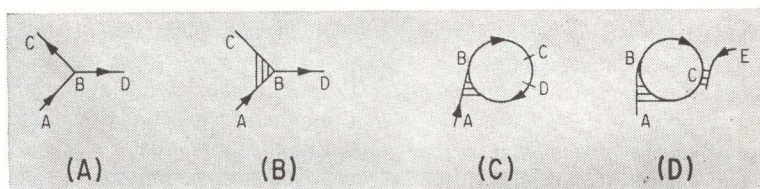

NEURISTOR NETWORKS: T-junction (A); T-R junction (B); storage ring (C); and storage ring with R-junction (D)—Fig. 2

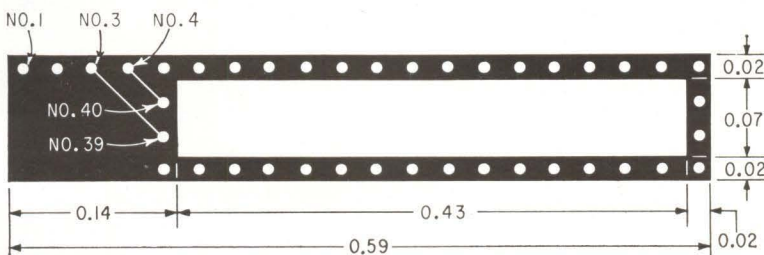

T-R JUNCTION is formed between elements 3, 4, 39 and 40 on this experimental neuristor storage ring—Fig. 3

OCEANBOTTOM SEISMOGRAPH about to be launched from test site on the west coast, (photo at right)

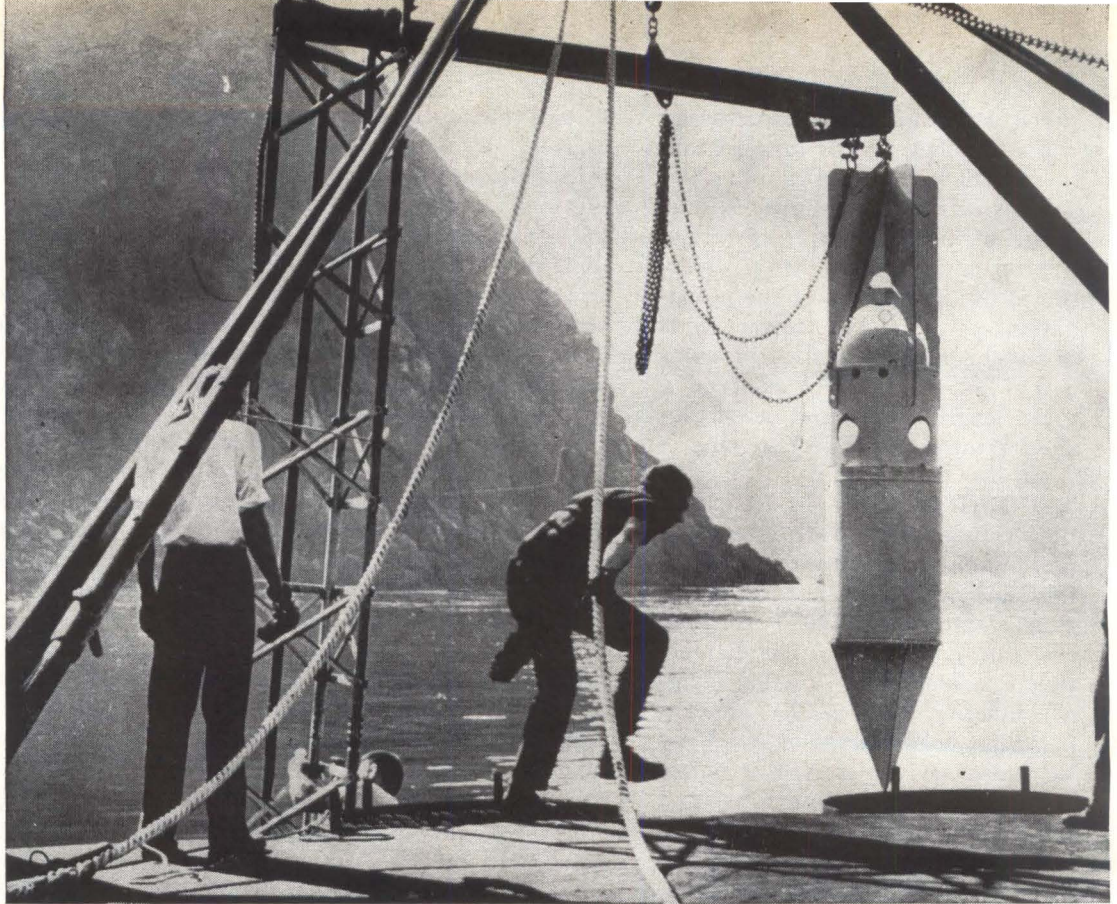

ON OCEAN FLOOR, the seismograph is in position to pick up and record seismic disturbances, (photo opposite page)

Subaudio Parametric Amplifier

Unique parametric amplifier uses two variable reactance diodes in a balanced bridge. A pump frequency of 455 Kc amplifies low-level signals such as those obtained from seismic transducers

By P. D. DAVIS, Jr. and G. D. EZELL, Texas Instruments, Incorporated, Dallas, Texas

THIS AMPLIFIER has a variety of names, the most common of which are reactance amplifier, parametric amplifier and dielectric amplifier. All these terms describe a general class of amplifiers in which a nonlinear reactance element mixes two frequencies and thus produces sum and difference frequency combinations of the two applied signals.

Reactance amplifiers have been used extensively for low-noise amplification at microwave frequencies. Relatively little work, however, has been done at low frequencies. This reactance amplifier was developed for frequencies from d-c to several hundred cycles per second. Although developed primarily

for seismic applications, it is ideally suited to many other types of instrumentation. A major application of the design was one developed and packaged especially for use in an ocean-bottom seismograph system¹.

Other important features besides low input noise which the amplifier must have for seismic use are:

- (1) small size, ruggedness and insensitivity to orientation;
- (2) low power drain and long-period operation in the smallest practical instrument power-supply package; and
- (3) gain stability with variation in temperature.

The design approach taken utilizes

a three-section amplifier whose input low-level section consists of the low-frequency reactance-amplifier circuit shown in Fig. 1A. Analytical studies², backed up by laboratory circuit breadboard investigation, showed that the $1/f$ noise, that is, the noise voltage generated internally in conventional vacuum-tube or transistor amplifiers that increases inversely with frequency, was virtually eliminated in the reactance amplifier.

THEORY OF OPERATION—The amplifier is a balanced-bridge modulator. The bridge is composed of the parametric diodes D_1 and D_2 and the secondary windings of T_1 the pump transformer. The bat-

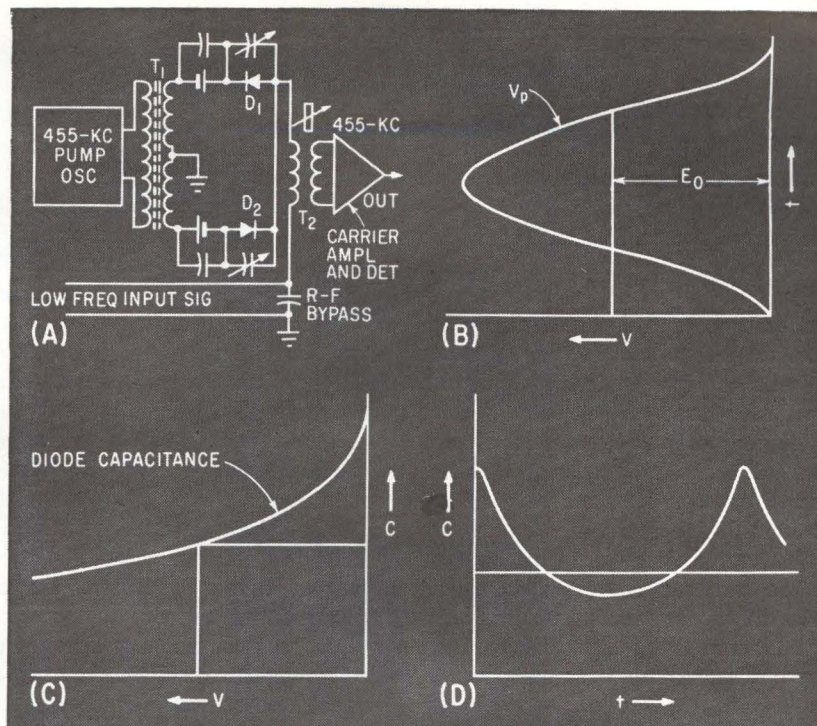
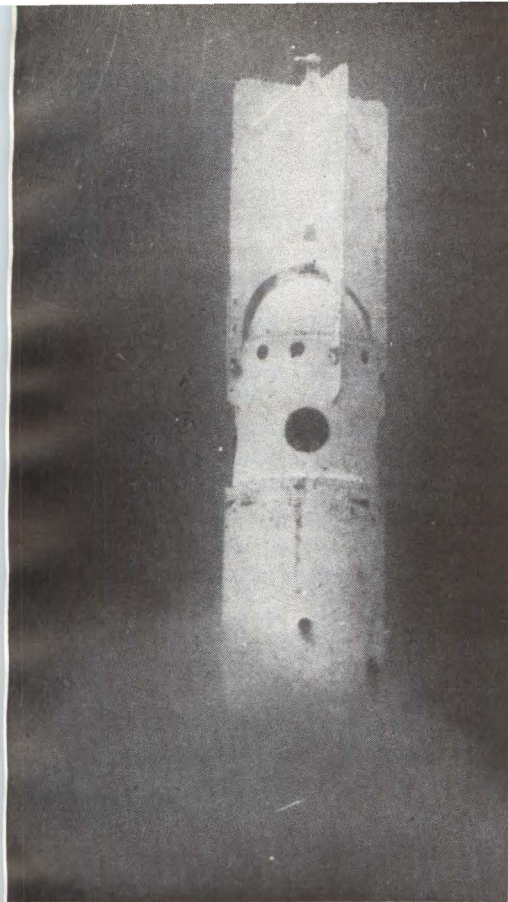

PARAMETRIC AMPLIFIER consists of balanced bridge having two variable-capacitance diodes (A). Pump voltage (B) varies diode capacitances (C), in phase, producing combined characteristic shown in (D)—Fig. 1

for Ocean-Bottom Seismometer

teries establish reverse bias on the two variable-capacitance diodes. Since low-leakage (less than 10^{-9} ampere) silicon diodes are used, operating life of the bias cells is essentially shelf life. The trimmer capacitors compensate for any slight capacitance difference in the diodes and, at the same time, provide a constant capacitance offset within the bridge circuit. This allows a controlled amount of pump voltage to exist at the output as a carrier signal for the two sidebands resulting from the application of the low-frequency signal voltage

to the variable capacitance diodes.

Pump voltage is applied to the parametric diodes through pump transformer T_1 . This transformer is tightly coupled, electrostatically shielded, and has well balanced secondary windings. Pump voltages emanating from the two secondary windings of the pump transformers are applied one hundred and eighty degrees out of phase to the two diodes. The biasing arrangement in the two legs of the bridge are opposite; thus, pump voltage so applied (Fig. 1B) results in a capacitance variation of the two diodes

which is in phase. Therefore, the pump voltage swings both diodes in unison through their capacitance versus applied voltage curve (Fig. 1C). The junction capacitance of these abrupt-junction diodes varies as the inverse square root of the applied voltage. Thus

$$C = C'(V_c + E_o + V_p \cos pt)^{-1/2}$$

where C = instantaneous junction capacitance, C' is a constant, V_c = contact potential of junction (≈ 0.9 volt at room temperature), E_o = bias voltage (positive for reverse bias), V_p = peak pump voltage, p = pump angular frequency, and t = time (in seconds).

The resulting time variation of capacitance is depicted in Fig. 1D. For proper choice of the phase angle, the time-varying capacitance can be represented as a Fourier cosine series whose coefficients are all positive.

$$C(t) = C_o + C_1 \cos pt + C_2 \cos 2pt + \dots$$

Note that the component of time-varying capacitance that is present at the second harmonic of

EVOLUTION OF AN AMPLIFIER

Originally developed as an application of reactance diodes, the first application of this low-noise low-frequency parametric amplifier was in an ocean-bottom seismographic station. Operating at depths up to 20,000 feet, the station, which includes a seismometer, parametric amplifier and a recorder, senses and records seismic signals. The seismometer responds to vertical or horizontal earth movements of less than a thousandth of a micron

the pump frequency is large.

As for signal frequencies, the bridge circuit can be represented by two parallel capacitors whose instantaneous capacitance varies with respect to time according to the waveform shown in Fig. 1D. Since this capacitance variation is in phase, the two diodes can be replaced by a single time varying capacitor whose capacitance at any instant of time is twice that of a single diode.

Figure 2 is an equivalent circuit in which the bridge has been replaced by a single time-varying capacitor ($C(t)$).

The application of signal voltage to the time-varying capacitance results in the generation of currents at the fundamental and each of the harmonics of the time-varying capacitance, plus and minus the signal frequency (a). Currents are thus generated at $p \pm a$, $2p \pm a$, $3p \pm a$, and so on. In this application, however, the output tuned circuit, which consists of L and g_r and the average value of the time varying capacitance, is tuned to the fundamental frequency of the pump. Thus, only those frequencies at $p \pm a$ produce output voltage from the reactance amplifier.

Voltage gain achieved in the modulator circuit is related to two effects.³ The first is associated with the relative impedance of circuit elements to the time-varying currents. This gain is simply the ratio of the susceptance of the fundamental component of time-varying capacitance to the admittance of the tuned output circuit. The second effect is associated with the second harmonic component of time-varying capacitance and results in a negative conductance reflected across the tuned output circuit. The negative conductance alters the effective admittance presented to the time-varying currents by the output circuit. The resultant gain expression is

$$A = \frac{2 p C_1 [g_r^2 + (p C_2)^2]^{1/2}}{g_r^2 - (p C_2)^2}$$

where A = voltage gain, p = pump angular frequency, C_1 = Fourier coefficient of fundamental component of $C(t)$, g_r = loaded conductance of output tuned circuit (includes loading effect of carrier amplifier), and C_2 = Fourier coefficient of second harmonic component of $C(t)$.

As $p C_2$ approaches g_r , the expression for voltage gain approaches infinity. In practice, when $p C_2$ is made equal to g_r , a condition of parametric oscillation occurs in which a large component of pump voltage appears at the output and bridge balance is impossible. This is similar to the condition existing in degenerate negative-resistance-type amplifiers.

For stability, $p C_2$ is kept at a magnitude sufficiently far away from g_r . Stable voltage gains of 40 db are easily obtained from the modulator.

The carrier amplifier, which follows the reactance modulator, is a simple tuned amplifier. Its noise figure must be kept as low as possible because the equivalent-input-noise-resistance of the low-level reactance stage is directly proportional to the carrier amplifier's input noise resistance, which is reflected back into the reactance stage. Also, the modulated signal carrier is still at a relatively low level when it enters the input stage of the carrier amplifier; consequently the input stage noise must be low to preclude the possibility of injecting additional circuit noise on top of the signal.

PERFORMANCE—The low-noise characteristics of the reactance amplifier are shown in Fig. 3A, B and C. The signals shown were recorded at the output of the detector stage of the carrier amplifier, and the levels shown are referred to input. In Fig. 3A, the 0.8 to 10 cps long-term noise, with the amplifier input terminated in a signal source of 6,000 ohms, is only about 0.3 microvolt peak-to-peak, or 0.05 microvolt rms, using the criteria of rms value equals $\frac{1}{2}$ long-term peak-to-peak reading.

By reducing the high frequency cut-off from 10 cps to 5 cps (Fig. 3B) the high frequency hash is materially reduced. The peak-to-peak excursions are down to about 0.18 μ v peak-to-peak, corresponding to an rms noise voltage of about 0.03 μ v.

Figure 3C shows the input noise voltage contribution of the amplifier alone in the 0.8 to 10-cps band, with zero resistance across the input. It is about 0.033 microvolt rms.

The sensitivity of a typical 12,-

000-ohm velocity seismometer is such that it gives a 1- μ v rms signal for a 1-millimicron movement at 1 cps when critically damped by a 12,000-ohm resistance. In Fig. 3D, (where $R_p = 6,000$ ohms) a 1-microvolt, 1-cps signal is amplified by the reactance amplifier. Figure 3E shows a 0.1- μ v signal, corresponding to a 0.1-millimicron earth movement, at 1 cps and Fig. 3F shows a 2-cps, 0.1- μ v signal record. Twelve thousand-ohm seismometers actually do not take full advantage of the high-input-impedance characteristics of the amplifier.

In a seismic system, as in any sensing equipment, signal-to-noise ratio is a measure of system quality. An even more useful function, which takes into account both the sensor and amplifier, is the noise factor (F). It is the factor by which the signal-to-noise power ratio is degraded when the signal passes through a network (amplifier in this case). This is expressed as

$$F = \frac{S_{in}}{N_{in}} \bigg/ \frac{S_{out}}{N_{out}} = \frac{S_i}{N_i} \bigg/ \frac{S_o}{N_o}$$

or Noise Figure = $10 \log F$ db. Thus, if the amplifier adds no noise, S_{in}/N_{in} would equal S_{out}/N_{out} and F would equal 1. Consequently, although F invariably is greater than 1, the nearer to 1 that it is, the better the system being measured.

Because of its high input impedance, the noise-factor expression for the reactance amplifier is the same as for a vacuum-tube amplifier operating at low frequencies;³ that is,

$$F = 1 + R_{eq}/R_g$$

where R_{eq} is the equivalent input noise resistance, or

$$R_{eq} = E_n^2/4KT B$$

where E_n is the measured noise voltage at bandwidth B and R_g is the generator impedance.

Thus, for best noise factor, R_{eq} (hence noise voltage) should be as low as possible, and generator impedance R_g should be as high as possible. How these characteristics apply to the reactance amplifier are shown in the table.

Figures 4A and B further illustrate the point that substantial signal-to-noise improvement, thus greater sensitivity, can be achieved by using higher impedance coils (on a given transducer). A 120,000-

ohm seismometer gives 3.16 times as much signal as does a 12,000-ohm unit. Of course, its internal noise due to thermal agitation goes up by a factor of 3.16 to 1 also, which means that the S/N into the amplifier is the same. In the 12,000-ohm seismometer, the amplifier noise is comparable to seismometer noise and contributes materially to the overall output noise. However, amplifier noise is so small in comparison to the self-generated noise of the 120,000-ohm seismometer that it adds little to the overall system noise, and the output S/N is near to the input S/N. This means that system S/N, thus sensitivity, is essentially independent of the amplifier and depends on the sensitivity of the transducer if its impedance as seen by the reactance amplifier is about 60,000 ohms or more.

Where it is practical, a low impedance transducer feeding the reactance amplifier through a step-up transformer provides outstanding sensitivity characteristics. This is shown by Fig. 4C, D and E, which show the low-level, clean signals obtained by using a refraction seismograph transformer on the input to the reactance amplifier. The 3-db cut-off point using this transformer is well below $\frac{1}{2}$ cps.

The reactance amplifier is basically a d-c amplifier. To eliminate d-c drift in the reactance bridge modulator, it is stabilized by sampling a small part of the detected output from the carrier amplifier, passing it through a filter to remove signals above 0.06 cps, and feeding it to the bridge in proper phase to maintain precision balance. Tests show that the low frequency cut-off can probably be lowered to below 0.01 cps. The high frequency cut-off is limited by the r-f by-pass circuit in the carrier amplifier detector, and this frequency can be extended to several hundred cps by a simple circuit change if desired.

Input impedance at frequencies less than 10 cps is greater than 15 megohms.

The authors express their appreciation to all the engineers at Texas Instruments who contributed to the development of the reactance amplifier. Special recognition is due James Shaw for his work on the carrier amplifier and for much of the data used here.

TABLE—NOISE FACTOR VS SEISMOMETER IMPEDANCE

R_p (ohms)	$e_n(\mu V)^a$	e_s^b (μV rms)	Noise Figure (db)	Improve- ment (db)
6,000	0.05	1.0	3.22	not ap. ^c
60,000	0.08	3.3	0.46	2.76
600,000	0.3	10.0	0.05	0.41

(a) input noise over 0.8 to 10 cps band; (b) signal for 1 millimicron at 1 cps; (c) not applicable

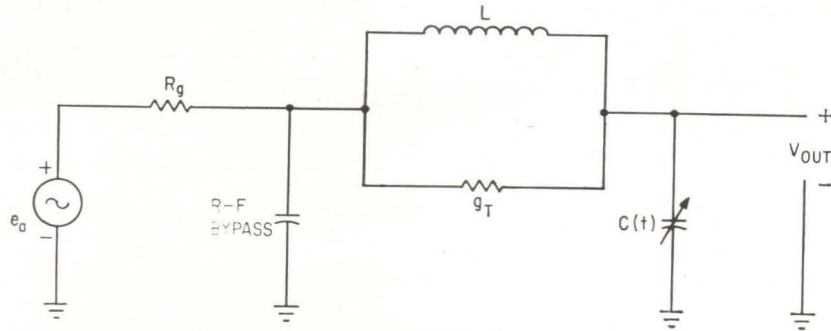

EQUIVALENT CIRCUIT of parametric amplifier—Fig. 2

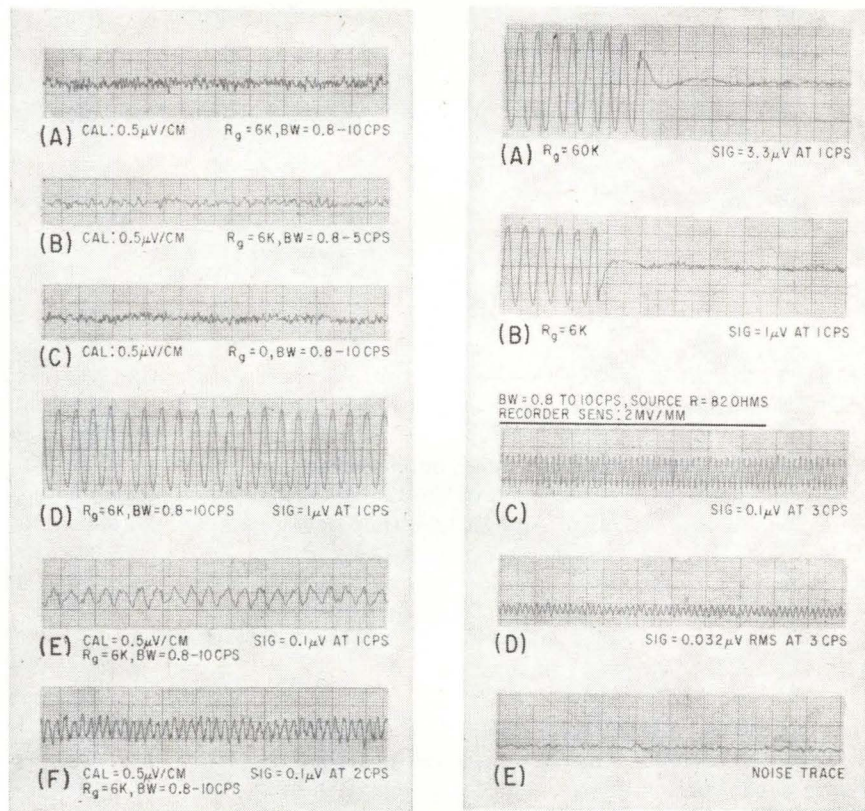

NOISE CHARACTERISTICS of amplifier are shown for different conditions (A, B and C). Records of seismic signals that were picked up by 12,000-ohm seismometer are displayed in waveshapes D, E and F—Fig. 3

SEISMOMETER RECORDINGS show that high-impedance coils (A) can provide better S/N than low-impedance coils (B). Step-up transformer can enhance S/N and sensitivity of low-impedance seismometer coils (C, D and E)—Fig. 4

REFERENCES

(1) Air Force Cambridge Research Laboratories, Contract Number AF 19 (604)-8368, supported by the Advanced Research Projects Agency, Department of Defense; Project VELA-UNIFORM.

(2) Biard, J. R., "Low Frequency Reactance Amplifier," Digest of Technical Papers for International Solid-State Circuits Conference, University of Pennsylvania, Feb. 1960.

(3) F. E. Terman, "Electronics and Radio Engineering" (Fourth edition), McGraw-Hill Book Co., N. Y., 1955.

New Technique Protects

Instead of using such devices as relays or t-r tubes to protect a receiver from high power input pulses, this circuit technique uses diodes to switch capacitors across tuned coaxial cavities, thus detuning the cavities and desensitizing the receiver

By HARRY A. WILLING, Electronic Communications, Inc., St. Petersburg, Florida

PROTECTING A RECEIVER'S FRONT END

There are many ways to protect the front end of a receiver from input pulses of much higher power than the normal input signals to the receiver—t-r tubes, coaxial relays and limiters, for example. However, the method described here is simple and fast acting, and may be a quick and convenient way to modify a receiver that was not originally designed with adequate front-end protection

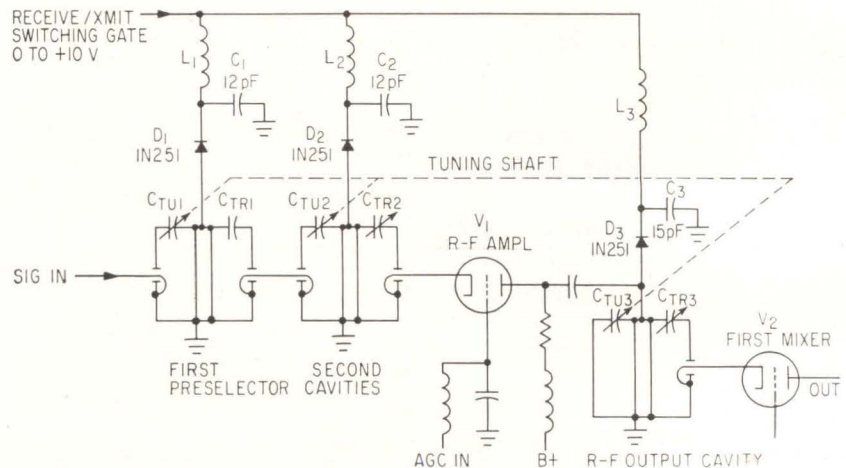

PROTECTIVE CIRCUITS and receiver's front end. A gate input (upper left) switches capacitors C_1 to C_3 across tuned cavities, thus detuning them and desensitizing receiver—Fig. 1

OPERATING an adjacent transmitter and receiver at the same time on the same frequency while using separate transmitting and receiving antennas may impose two problems: (1) it may be necessary to protect the receiver front end from the transmitting signal, which may be large enough to either destroy or degrade the characteristics of the first r-f tube; (2) it may be desirable to provide enough rejection of the high signal level in the r-f stages to prevent blocking of the succeeding stages which would affect the recovery time of the receiver.

PROTECTION METHOD — The protective technique to be described was used on a vhf-uhf receiver that is tunable from 225 to 400 Mc. It operates over a dynamic range of 100 db over signal levels of -123 dbw to -23 dbw. It contains a preselector consisting of two capacitance-tuned coaxial cavities and a capacitance-tuned cavity following the r-f amplifier. The preselector provides a front-end selectivity capable of rejecting, by greater than 60 db, the first image frequency associated with the 40-Mc first i-f. The receiver circuits can be switched to operate either in the a-m or f-m mode. In the a-m mode the agc permits the receiver to operate over the specified dynamic range with negligible distortion and has a response time of less than 0.1 second. In the f-m mode, the receiver must handle input levels ranging from 10 dbw to -123 dbw. The time allowed for

the receiver to recover from the 10-dbw input and attain maximum sensitivity, for the reception of the -123 dbw signal is less than 150 microseconds. The 10 dbw input comes from an adjacent high-power transmitter whose output is gated on and off by a gate that is also available to the receiver's protective circuits. Thus, this gate is used to control the

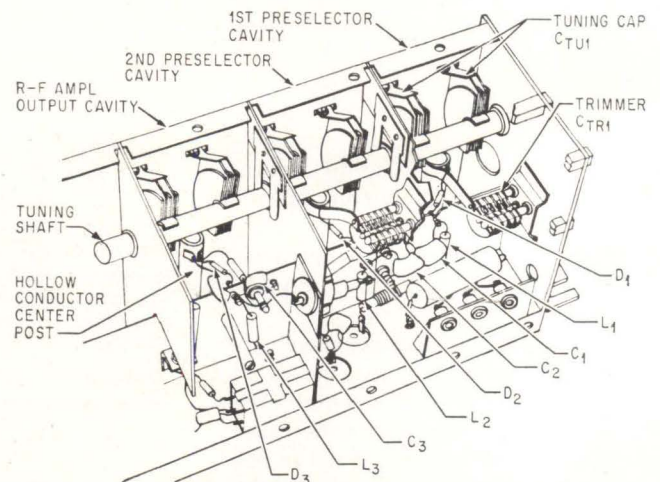

R-F STAGES of receiver are shown in this view. Coupling loops between stages and trimmer of r-f cavity are not visible—Fig. 2

Receivers From High Power

protective circuits during the time the receiver is under the influence of the 10-dbw signal.

Figure 1 shows the receiver's front end and its protection circuits. When a gate signal arrives, it biases diodes D_1 , D_2 and D_3 in the forward direction, thus switching capacitors C_1 and C_2 across the tuning ends of the r-f preselector cavities and C_3 across the r-f output cavity. This detunes the receiver input during the desired period. The diodes are 1N251's that have a more than adequate switching speed, operating satisfactorily in the uhf region, and have, with an applied reverse bias, a shunt capacitance of less than 0.8 pf. During normal receiver operation, the diodes are biased in the reverse direction, and the low shunt capacitance permits tracking of the preselector and the r-f stage over the uhf band. When the high signal level is expected at the receiver input, the diodes are biased in the forward direction, thus desensitizing the receiver.

Figure 2 shows most of the components in Fig. 1.

ESTIMATING ATTENUATION—The following approach can be used to determine the degree of attenuation expected with the protective technique. The input impedance to the detuned preselector cavities is calculated and, subsequently, the attenuation associated with this mismatched input. The attenuation associated with mismatching or detuning the output load of the r-f stage (V_1 , Fig. 1) is calculated similarly. Hence, the total attenuation, resulting from the detuning effects of r-f stages, is determined.

The input impedance (Z_{in}) to the double-coaxial-preselector combination is

$$Z_{in} = \omega M_1^2 \left\{ \left[\frac{\omega M_{12}^2}{\omega M_{12}^2 Z_L + Z_{2u}} \right] + [Z_{1u}] \right\} \quad (1)$$

where the effective electrical positions of the cou-

pling loops are the same. In the above expression

$$Z_{1u} = j \left(\omega L_{1eq} - \frac{1}{\omega C_{1eq}} \right) + R_{1u}' = j X_{1eq} + R_{1u}'$$

$$Z_{2u} = j \left(\omega L_{2eq} - \frac{1}{\omega C_{2eq}} \right) + R_{2u}' = j X_{2eq} + R_{2u}'$$

where L_{1eq} , L_{2eq} , C_{1eq} and C_{2eq} are lumped reactive circuit parameters equivalent to parameters of the first and second preselector cavities at the electrical position of the coupling loops (Fig. 3). Similarly, R_{1u}' and R_{2u}' represent the effective resistive terms of the cavities at the same point.

Terms M_1 , M_2 and M_{12} and other parameters associated with the double coaxial cavities are defined in the Table.

Since the two preselector cavities are identical

$$M_1 = M_2 = M$$

$$Q_{s1} = Q_{s2} = Q_s$$

$$X_{1eq} = X_{2eq} = X_{eq}$$

$$R_{1u}' = R_{2u}' = R_{u}'$$

thus $Z_{1u} = Z_{2u} = Z_u$

Therefore, from Eq. 1,

$$Z_{in} = \frac{\omega M^2 (\omega M^2 + Z_u Z_L)}{\omega M_{12}^2 Z_L + Z_u [\omega M^2 + (Z_u Z_L)]} \quad (2)$$

Note that at resonance and assuming lossless cavities

$$X_{eq} = 0 \text{ and } R_{u}' = 0$$

From Eq. 2

$$Z_{in} = \frac{\omega M^4}{\omega M_{12}^2 Z_L} \quad (3)$$

Since M_{12} is defined to be

$$M_{12} = L_{1eq}/Q_s$$

and for specified conditions Q_s , the singly loaded Q is defined by

$$Q_s = \omega L_{1eq} / (\omega M^2 / Z_L)$$

$$M_{12} = \frac{\omega M^2 L_{1eq}}{\omega L_{1eq} Z_L} = \frac{\omega M^2}{Z_L} \quad (4)$$

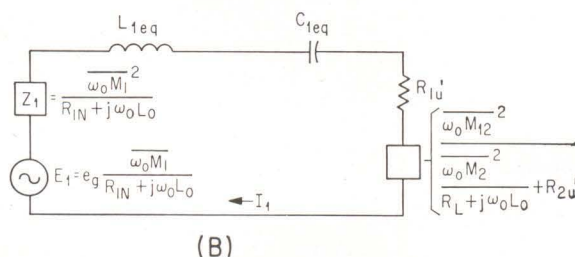
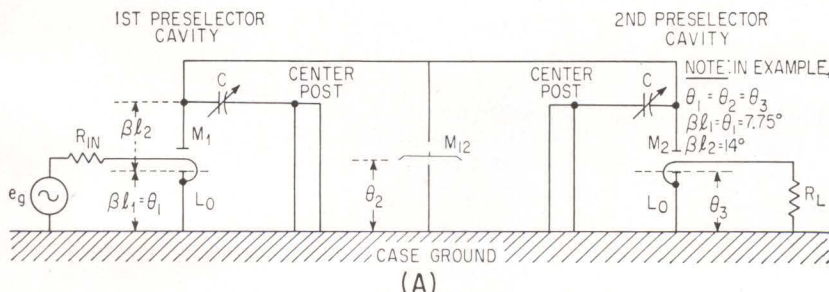

TABLE—PARAMETER DEFINITIONS

Term	Explanation of Term
Z_0	characteristic impedance
Z_{in}	input impedance to first cavity
Z_S & Z_L	source & output load impedances
Q_{s1} & Q_{s2}	singly loaded Q 's of first and second cavities
M_{12}	mutual impedance associated with coupling between cavities

EQUIVALENT CIRCUITS of pre-selector cavities are shown in (A) and (B); circuit (B) is a simplification of (A)—Fig. 3

Hence, substituting Eq. 4 into Eq. 3, $Z_{in} = Z_L$; that is, an impedance match is obtained at resonance.

When the shunt capacitors are switched across the coaxial cavities, the cavities are not in resonance and

$$X_{eq} \neq 0$$

Again assuming negligible cavity losses

$$X_{eq} = jZ_0 [\tan(\beta l_1) - \cot(\beta l_2')] \quad (5)$$

where

$$\beta l_2' = \beta l_2 + \tan^{-1} \omega C Z_0 \quad (6)$$

The term βl_1 is the electrical distance from the coupling loop to the shorted (grounded) end of the cavity (Fig. 3A), while, $\beta l_2'$ is the effective electrical distance from the coupling loop to the open end terminated in capacitance C . Capacitance C is the sum of the tuning capacitors (C_{TR}) and the trimmer capacitance (C_{TR}) shown in Fig. 1 and 2, as well as the switched capacitor (C_1).

COMPUTING CIRCUIT PARAMETERS — From the following electrical specifications of the double-tuned preselector and the associated values of the cavity parameters, the theoretical insertion loss can be found by the specified equations.

(1) The 3-db bandwidth of the double-tuned coax cavities is 1.5 Mc at 300 Mc; hence, $Q_s = 280$.

(2) The coaxial cavities are rectangular with dimensions of approximately 1.25 by 1.25 in. with a height of 1.34 in. The diameter of the center conductor is 0.25 in. It can be determined that the characteristic impedance of this cavity is approximately 96 ohms.

(3) The effective electrical position of the coupling loops in the cavities at 300 Mc is approximately 7.75 deg (Fig. 3A) the electrical length of the capacitively terminated cavities at 300 Mc is 14 deg. The input and output impedances of the cavities are 50 ohms; hence, the required mutual inductances for the input and output coupling loops is 9.2×10^{-11} h. The degree of coupling required between cavities (M_{12}) is 3.14×10^{-11} h.

(4) The insertion loss of the network is less than 1 db, reflecting an unloaded Q (Q_u') of the system of over 2,440 and an attenuation at 300 Mc of less than 1.29×10^{-3} nepers/m.

(5) The value of detuning capacitors C_1 and C_2 is 12 pf while the value of C_3 is 15 pf.

The effects of the cavity losses are minor and do not alter the approach to the problem. Similarly, the diodes are biased in the forward direction with the magnitude of forward current that establishes the minimum dynamic resistance. This dynamic resistance has a negligible effect on the effective values of the detuning capacitor. Hence, neglecting the loss terms associated with the switching diodes and cavity resistances, the attenuation of the system may be calculated by first determining the input impedance of the network from Eq. 2.

Using the parameters specified, it can be determined that the required capacitance of the terminating tuning and trimmer capacitors at resonance, when the cavities are tuned to 300 Mc, is 19.3 pf. When capacitors C_1 , C_2 and C_3 are switched across the open end of their respective cavities (Fig. 1),

the effective terminating capacitance, at the open end of the cavities, becomes 31.3 pf for both the first and second preselector cavities and 34.3 pf for the r-f output cavity.

From Eq. 5 and 6, it is found that the equivalent reactance (X_{eq}) of the detuned circuit at the position of the coupling loops is $j8.4$ ohms. At 300 Mc, for the lossless cavity, Z_{in} , as determined from Eq. 2, consists primarily of a reactance term of 0.39 ohms plus a real term of 0.136×10^{-6} ; in computing Z_{in} , $Z_u = X_{eq} = j8.4$ ohms and Z_L is the 50-ohm impedance of the r-f amplifier.

Consider a series circuit of the input signal from the receiving antenna, simulated by an equivalent voltage generator (E_g) and a source resistance (R_g) of 50 ohms, equivalent to the radiation resistance of the receiving antenna, and the input impedance, Z_{in} , to the preselector. The output of the cavity is contained in the real term of the input impedance. Since the input power to the receiver under the matched conditions is

$$P_{in} = E_g^2 / 4R_g$$

while the input power to the receiver in the mismatched, or detuned, mode is

$$P_{in}' = \left(\frac{E_g}{R_g + Z_{in}} \right)^2 R_{in} \approx \left(\frac{E_g}{R_g} \right)^2 R_{in}$$

The ratio of P_{in} to P_{in}' is

$$P_{in} / P_{in}' = R_g / 4 R_{in}$$

Therefore, the attenuation due to the detuned input is

$$L_{db} = 10 \log_{10} R_g / 4 R_{in} = 69 \text{ db}$$

Thus, the preselector cavities attenuate the 10 dbw input by 69 db.

The additional attenuation provided by the insertion of capacitor C_3 across the tuned r-f cavity can be analyzed by determining the degree of mismatch that C_3 reflects across the output of the r-f tube (V_1 , Fig. 1). In normal operation the output impedance of the r-f tube is about 7,200 ohms and the corresponding input impedance to the r-f cavity provides the proper impedance match.

During the period of high signal level, when C_3 is switched across the output of the r-f stage, the output load impedance becomes

$$Z_L' = [R_L (-jX_{C3})] / (R_L - jX_{C3})$$

At 300 Mc, where $|X_{C3}| = 35.6$ ohms and $Z_L' \approx -j35.6$ ohms, the load impedance ≈ 35.6 ohms.

The power output of the r-f stage during normal operation is

$$P_o = e_g^2 / 4Z_L$$

while the output power for the detuned stage is

$$P_o' = \left[\left(\frac{e_g}{r_p + Z_L'} \right) Z_L' \right]^2 / Z_L = \frac{e_g^2 (Z_L')^2}{(r_p + Z_L')^2 Z_L}$$

Hence, the total attenuation resulting from detuning the r-f stage is

$$L_{db} = 10 \log_{10} \frac{P_o}{P_o'} = 20 \log_{10} \frac{r_p + Z_L'}{2Z_L'} \approx 40 \text{ db.}$$

Thus, the total attenuation caused by detuning is -109db.

AT 20 AMPERES pulsed current, threshold point is passed; junction is lasing at region shown by spot

OUR FRONT COVER

FIRST COLOR PHOTOS SHOW

Active Region

in Visible-Light Diode Laser

By N. HOLONYAK, JR.

Advanced Semiconductor Laboratory
Semiconductor Products Department
General Electric Co., Syracuse, N.Y.

COHERENT LIGHT emission from a semiconductor junction, only recently reported, may have important applications in such fields as communications and computers. Like the earlier GaAs p - n junction laser¹, Ga(As_{1-x}P_x) junction lasers in many respects resemble conventional solid and gas lasers. However, there are major and distinct advantages inherent in the ternary compound Ga(As_{1-x}P_x) as a laser material. First, the material can be prepared sufficiently free of serious internal disorder effects to allow fabrication of a laser p - n junction. This implies that other ternary compounds can probably be so prepared eventually. Second, and important, the output wavelength in the visible spectrum of a Ga(As_{1-x}P_x) laser junction can be selected (for electronic systems optimization) by simply adjusting the ratio of phosphorus to arsenic in the material². At present, this is the only material in which this advantage has been established.

The purpose of this article is to show directly by color photographs (front cover) the visible light and laser beam generated by Ga(As_{1-x}P_x) laser junctions, and to show how more and more of the junction source contributes to laser action as current is increased.

PHOTOGRAPHS — These effects

are illustrated by the series of photographs on the front cover. Green light was supplied in the background for contrast. All of the red light is due to the Ga(As_{1-x}P_x) laser p - n junction.

The uppermost photograph shows the p - n junction, with 15 amperes pulsed current applied, operating below the threshold point. The device at this point is acting as an incoherent source (not yet generating a laser beam). Though not visible in the photograph, a red line extends from one side of the pellet to the other side along the junction. Because of inhomogeneity of the crystal most of the recombination radiation (light) is generated just to the right of center of the line source. (In the bottom photograph the junction can be seen extending from one side of the crystal to the other.)

The center photograph was taken at 20 amperes pulsed current applied to the device. The laser junction has now passed the threshold point and is lasing at right of center in the active region, identified above.

The lower photograph was taken at 30 amperes pulsed current and shows that the lasing portion of the junction has enlarged toward and encompassed more of the region to the left of its original position. This shows that as current is increased, more and more of the junction becomes active and contributes, accordingly, more to the laser beam.

Also, as the current is increased

the sparkling effect of the light increases.

In the middle and lower photographs, the yellowish spots in the junction region identify the laser beams, which themselves are in part due to interference effects associated with coherent sources of finite extent. The yellowish spots produced by the laser beams are due to the inability of color film to show high intensity red as red, and merely shows yellowish overexposure because of high beam intensity. The actual laser beams are a pure red near 7,000 Å and consist of a number of spectral peaks each less than 1-Å half width.

The halos (red mushroom effect) surrounding the yellowish-looking main laser beams are due to the spreading of the laser radiation patterns, and somewhat to interference effects, light striking imperfect windows in the cryostat, and scattering.

S. F. Bevacqua, C. V. Bielan, F. A. Carranti, B. G. Hess, and S. J. Lubowski contributed substantially to this work. Photographs were supplied by R. E. McKay.

This work has been supported by the Electronics Research Directorate, Air Force Cambridge Research Laboratories, Contract AF-19 (628)-329.

REFERENCES

- (1) R.N. Hall, G.E. Fenner, J.D. Kingsley, T.J. Soltys and R.O. Carlson, *Phys Rev Letters*, **9**, p 366, Nov. 1, 1962.
- (2) N. Holonyak, Jr., and S.F. Bevacqua, Coherent (Visible) Light Emission from Ga(As_{1-x}P_x) Junctions, *Appl Phys Letters*, **1**, p 82, 1962.

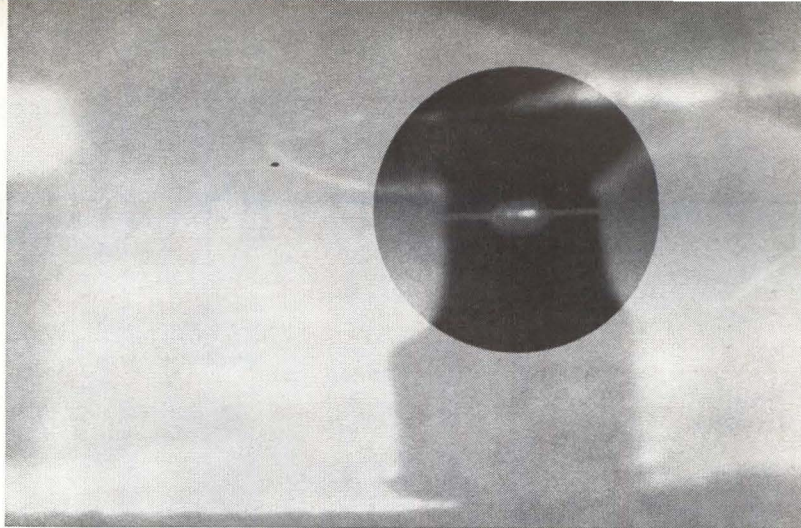

Unique Frequency Comparator

Most systems that compare frequencies fail to indicate whether the resultant is plus or minus. Here is a circuit that will show direction

UP OR DOWN?

When measuring the frequency difference between a known and unknown signal, it is often difficult to determine whether the unknown is above or below the reference frequency. This circuit will make rapid and accurate comparisons without losing direction sense

By J. A. WEBB, Lockheed Aircraft Corp., Marietta, Georgia

IT IS OFTEN necessary to measure the difference in frequency between two signals for either direct comparison, or to determine frequency drift between a signal and a standard.

A conventional method requires counting the test frequency ω_a , and the reference frequency ω_b , and subtracting $\omega_a - \omega_b$. This system, however, requires that the counter be capable of high-speed operation, since it must count both carrier frequencies, rather than the difference frequency. The two signals may be first mixed and then $\omega_a - \omega_b$ counted, but direction sense is lost because there is no means of determining whether $\omega_a > \omega_b$ or $\omega_a < \omega_b$.

COMPARATOR—A block diagram of the proposed frequency measurement system¹ appears in Fig. 1. A test signal ω_a is mixed with reference signal ω_b in a balanced modulator. The reference signal is then shifted 90-degrees in phase and remixed with the test signal in a second balanced modulator. After passing through a low-pass filter, the outputs of the balanced modulators go to a trigger circuit that converts the signals to square waves and then to a differentiating circuit for conversion to pulses. Finally, pulses and square waves are combined in a group of AND-gates, and a bidirectional counter indicates when $\omega_a > \omega_b$ or when $\omega_a < \omega_b$.

To understand the operation of this circuit, consider the resultant signal e_1 from mixing e_a and e_b , where $e_a = E_a \sin \omega_a t$ and $e_b = E_b \sin \omega_b t$

$$e_1 = e_a e_b = [E_a \sin \omega_a t] [E_b \sin \omega_b t] \\ = E_a E_b / 2 [\cos(\omega_a - \omega_b)t - \cos(\omega_a + \omega_b)t] \quad (1)$$

Consider a second mixer using the same signals with reference e_b shifted by 90 degrees. The resultant signal e_2 will be

$$e_2 = e_a e_b' = [E_a \sin \omega_a t] [E_b \sin(\omega_b t + 90)] \\ = [E_a \sin \omega_a t] [E_b \cos \omega_b t] \\ = E_a E_b / 2 [\sin(\omega_a - \omega_b)t + \sin(\omega_a + \omega_b)t] \quad (2)$$

A low-pass filter may be used to eliminate the upper sidebands, leaving the filtered terms

$$e_1' = K_1 \cos(\omega_a - \omega_b)t \quad (3)$$

$$e_2' = K_2 \sin(\omega_a - \omega_b)t \quad (4)$$

Note that when $\omega_a > \omega_b$, e_1' and e_2' are both positive. However, when $\omega_a < \omega_b$, e_1' remains positive, but e_2' becomes negative. This shows that there has been a relative phase shift of 180-degrees between these two signals in passing through zero frequency difference. Thus, a technique is available for preserving the direction sense between the two signals.

The resultant signal from plotting equations (3) and (4) in polar form is shown in Fig. 2, or

$$K_1 \cos \omega t + jK_2 \sin \omega t = K_3 \quad (5)$$

where $\omega = (\omega_a - \omega_b)$.

ANALYSIS—Signal amplitude is plotted on the x and y axes in Fig. 2, and it is assumed that $k_1 = k_2$, making Eq. 5 the equation for a circle with its center

Has Sense of Direction

FREQUENCY measurement circuit uses computer techniques and a bidirectional counter to indicate resultant direction sense—Fig. 1

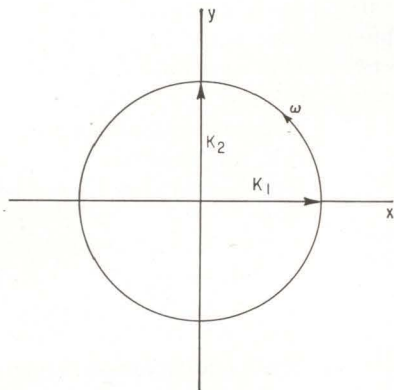

POLAR plot of Eq. 3 and 4 show resultant signal where ω is positive and $K_1 = K_2$ —Fig. 2

at the origin of the coordinate system. If $k_1 \neq k_2$, Eq. 5 represents an ellipse with its center at the origin and axes aligned along the axes of the coordinate system. Phase rotation is plotted around the periphery of the circle or ellipse, with one cycle taking place at each multiple of $\omega t = 2\pi$ radians.

Consider the case where ω is positive ($\omega_a > \omega_b$). The phase rotation is counterclockwise, since the second term of Eq. 5 is positive. Where ω is negative, however, ($\omega_a < \omega_b$) the phase rotation is clockwise because the first term of Eq. 5 is still positive but the second term is negative.

The circuit of Fig. 1 takes advantage of this phenomenon in a unique way. The zero crossings at the output of the left-hand modulator always occur at the center of the maxima and minima of the right-hand modulator, and conversely. After these signals are converted to square waves in their respective trigger circuits, the square waves from the right-hand trigger circuit are used to gate pulses obtained by differentiating the square waves from the left-hand trigger circuit. This also occurs from left to right. To obtain direction sense, the pulses are gated on one line if the trigger circuit is positive and on another line if it is negative. Pulses passing through one gate represent positive (counterclockwise) phase rotation, whereas those passing through the other gate indicate negative (clockwise) phase rotation.

In the circuit of Fig. 1, four pulses are obtained for each cycle of phase rotation or one pulse for each

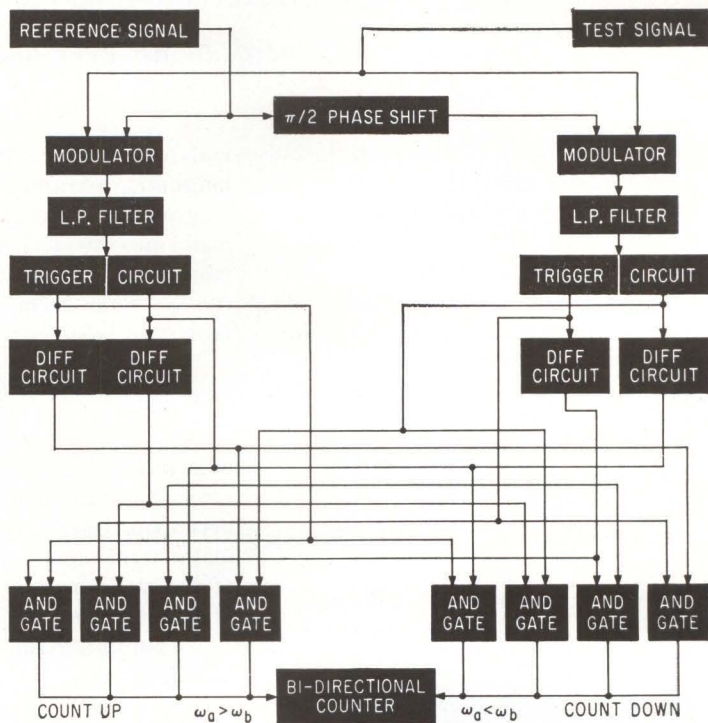

90-degrees of phase rotation. This requires 8 gates, four for clockwise rotation and four for counterclockwise rotation. Two gates are needed for one pulse-output-per-cycle and four gates for 2 pulses-per-cycle. It is also possible to obtain three pulses-per-cycle with six gates, but the pulses will not be evenly spaced.

CONCLUSIONS—This circuit has proven satisfactory in use. It is impossible to have a pulse coincidence problem even in the presence of severe noise or with pure noise on the circuit input because the pulses are spaced 90-degrees apart regardless of whether they appear on the positive or negative line. The proximity of 90-degrees in time is determined by the band-pass characteristics of the circuit. For quick phase reversals near the zero crossings, however, the inherent hysteresis in the trigger circuit is important.

Pure noise cannot cause net phase rotation. The circuit was tested with random noise as a signal source and a stable oscillator as a reference signal. The output was connected to a bidirectional counter and the noise amplitude increased to normal signal level. Although there was appreciable jitter in the counter while the noise was applied, there was a net cumulative-count, even when the noise source was connected for considerable time.

REFERENCES

- (1)—U. S. Patent 2,933,682 by A. Moulton and J. A. Webb

WHAT YOU MUST KNOW To Use Ferrites

Surveys the characteristics and capabilities of ferrites and shows how and why they are being used in an ever increasing number of electronics applications

THE PURPOSE of this article is to give engineers a clear picture of what they can do with ferrites and what ferrites can do for them. This picture will be conveyed by (a) describing the elementary theory of ferromagnetism, (b) discussing the important design criteria in the use of ferrites, (c) listing the applications of ferrites to engineering and electronics problems, and (d) discussing the possibilities and limitations in the manufacture of ferrite materials.

THEORY — Generally, all mate-

rials can be classified as being diamagnetic, paramagnetic, or ferromagnetic. These classifications are made quantitatively by giving the value of the material's susceptibility χ . This term can be derived from two basic equations of matter

$$B = \mu H \quad (1)$$

and

$$B = \mu_0(H + M) \quad (2)$$

where B is flux density, H the magnetic field intensity, M the magnetic polarization vector or material magnetization, μ_0 the permeability of free space and μ the permeability of the medium.

Combining Eq. 1 and 2 and dividing by H

$$\mu = \mu_0 + M/H(\mu_0) \quad (3)$$

The ratio M/H equals χ , the susceptibility. Susceptibility is the magnetization M of a material per unit applied field. For example, a medium is said to be diamagnetic when $\chi < 0$.

The rotation of an atom's electron in an orbit is analogous to a current in a resistanceless loop of wire. Lenz's law indicates that if a magnetic field is applied to this orbit a current will be induced in the orbit in such a manner as to oppose any change in the flux enclosed by the loop. No net magnetic moment will be present to align with the applied magnetic field. A magnetic field applied to the diamagnetic atom will cause the plane of the orbiting electron to precess about the applied magnetic field. Susceptibilities of diamagnetic substances are negative and small (-10^{-8} to -10^{-4}).

A medium whose susceptibility is greater than 0, but less than 10^{-2} , is paramagnetic. In this case, magnetic moments are already present to a certain extent and will align with the direction of an applied external magnetic field.

Ferromagnetism is attributed to materials whose susceptibilities are 10^{-2} and greater. Alignment of mo-

ments in these materials is almost complete upon the application of a magnetic field. In soft ferromagnetic materials, the net alignment may not remain when the external H is removed. However, hard ferromagnetic materials or permanent magnets will retain their electron-spin alignments even after the external field has been reduced to zero.

The class of material designated as ferrimagnetic (including ferrites) also have susceptibilities of $\chi > 10^{-2}$. However, their origin is due to antiparallel spin coupling; that is, rather than having a net magnetic moment due to the parallel alignment of the electron-spin angular-momentum vectors, ferrimagnetic materials have a resultant magnetic moment due to an inequality in magnitude of spin coupling and antiparallelism in spin-vector direction. The susceptibility of these materials does not reach the maximum value achieved by the ferromagnetic materials.

DESIGN CRITERIA — All magnetic materials require energy to rotate the internal magnets into the direction of an applied external field. This energy is obtained from the external field. The amount of energy and the characteristic process a material undergoes in becoming aligned is described in a hysteresis or magnetization curve (Fig. 1). Points on the curve are defined as

- B_r = magnetic flux density at 0 magnetic field intensity;
- B_m = max. flux density achieved;
- B_s = saturation flux density;
- H_c = coercive force or magnetic field intensity at 0 flux density;
- H_s = saturation magnetic field intensity;
- μ_m = maximum permeability or max B/H ratio.

Other factors are: μ_0 = Initial permeability, or B/H as H approaches 0; μ_r = Reversible permeability (obtained by superimpos-

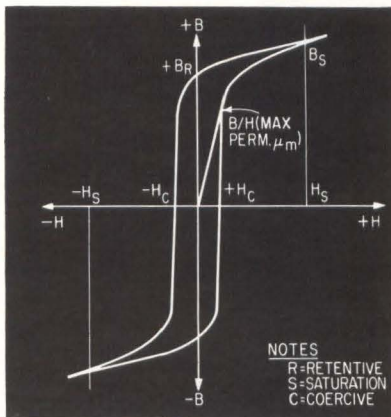

HYSTERESIS curve indicates properties of ferrite materials—*Fig. 1*

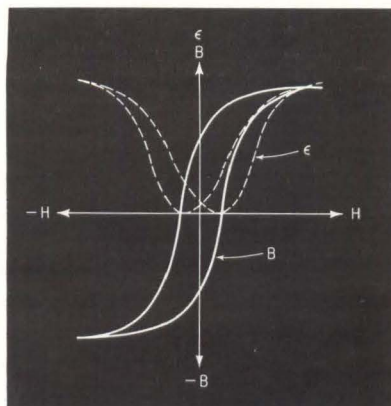

MAGNETOSTRICTIVE strain (ϵ) and flux are function of intensity H —*Fig. 2*

at Low Frequencies

By DONALD LEIBOWITZ

Kearfott Division, General Precision, Inc., Little Falls, N. J.*

ing an alternating field of small magnitude upon a dc field), the limiting permeability of the incremental $\Delta B/\Delta H$ as ΔB and ΔH approach zero.

The B - H loop of Fig. 1 is general and applies to all ferromagnetic or ferrimagnetic materials. The area within the curve indicates the energy required to magnetize the core. If a-c is used, loss is given per cps.

Data obtained from the B - H curve may be used to calculate the ampere turns required to saturate a given geometry of ferromagnetic or ferrimagnetic material. This curve will yield information concerning the squareness ratio of a core (B_r/B_s). Using the maximum permeability, obtained from the curve, an engineer can calculate the inductance of a core operating at the flux level necessary to give the maximum permeability. However, such curves are either static d-c or of a single frequency. Frequency characteristics of ferrimagnetic materials must be obtained from additional sources.

Frequency characteristics of ferrites are described by several important parameters. The most important of these is the $1/\mu Q$ product or loss tangent. This parameter includes the three basic losses occurring in ferromagnetic materials: eddy current, hysteresis, and residual. Residual loss in ferrites is generally considered as a resonance phenomenon and represents an upper frequency limitation of ferrite materials.

Residual loss manifests itself as a drop in permeability (μ), usually beginning in the low megacycle region and reaching a peak at about 50 Mc. Materials are being developed which push this loss peak to a higher frequency.

Eddy current losses can for the

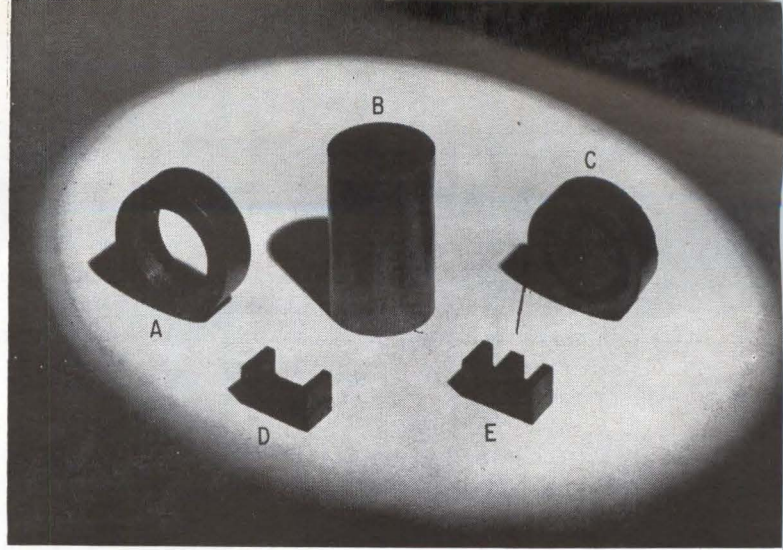

TYPICAL FERRITE shapes shown are toroid (A), cylinder (B), cup core (C), C core (D), and E core (E)

most part be neglected when considering ferrite operation below microwave regions. Since these losses are dependent upon a material's resistivity, they will be small in ferrites. Reducing cross sectional area of a device such as a recording head aids in reducing eddy current losses. Since these losses are a function of the frequency squared, it is important to reduce eddy current coefficients of some ferrites.

Hysteresis losses are acquired in alignment and rotation of domains. They are frictional or mechanical and are directly frequency dependent. The area under a d-c B - H loop gives an indication of the hysteresis coefficient.

Temperature characteristics of ferrites are usually described in terms of the temperature coefficient of μ . The saturation magnetization of ferrites reduces with temperature but this data is not generally specified.

The Curie point indicates the

temperature at which a magnetic material becomes weakly magnetic or its μ drops to 1. Most ferrite materials have Curie points of 160 C or greater. Switching and memory cores may have Curie temperatures as low as 60 C. Generally, the manganese-zinc ferrites having high μ 's exhibit the lower Curie temperatures. The nickel ferrites, which generally are useful at high frequencies, have Curie points usually higher than 300 C depending on compositional variations.

APPLICATIONS — Ferrite materials can be divided for application purposes into four major categories: (1) high μ , medium frequency, (2) high Q , high frequency, constant $1/\mu Q$, (3) magnetostrictive ferrites, and (4) hard magnetic or permanent magnetic ferrites.

Although the first two groups overlap, this grouping is the most convenient from a user's point of view. For the most part high initial

FERRITES AND FERRIMAGNETISM

The term "ferrites" describes magnetic oxides (and materials containing magnetic oxides) that contain iron (Fe) as a major component. The three most common groups of ferrites are called spinels, garnets, and hexagonal ferrites.

Ferrites are crystalline materials whose lattice structure contains two or more types of lattice "sites" or sublattices. Exchange coupling due to the interaction of electron spins between adjacent ions of two adjacent and different sites locks the magnetic moments of the ions of these sites in antiparallel directions. Since the moments of the different sites differ in magnitude, there is a net magnetic moment in one direction—this is the phenomenon of ferrimagnetism

* Now with RCA Princeton, Princeton, N. J.

μ materials are manganese and nickel zinc ferrite systems. Until recently the manganese system materials were more commonly used in the lower frequency regions. Nickel ferrites having higher resistivities have been more readily applicable to higher frequency operations. Resistivities of this ferrite system may range from as low as 160 to as high as 10^9 ohm-cm.

Materials such as these can be employed as tv flyback transformers or deflection yokes. Transformers using cores of high- μ materials are required at 15 Kc (the sweep frequency) or frequencies as high as 100 Kc.

These high- μ ferrites have replaced laminated-core rotors and stators in Microsyn pick-offs and gyros. The mechanical problem in manufacturing the laminated stator or rotor in some cases far outweighs the greater initial μ obtained by using, for example, Mumetal ($\mu_0 = 20,000$) or even Supermalloy ($\mu_0 = 100,000$).

The reduction of core losses represents a considerable gain for ferrites over ferromagnets. The loss of 0.5 w/lb for the high permeability ferrite may be compared to a value of 100 w/lb in a 17-mil-thick strip of Hiperco, at 600 cps. The limitations of the ferrite in gyro applications come from high internal stress created by large rotor rpm. The low tensile strength of ferrites limits the maximum speed of rotation.

The high initial μ is normally accompanied by a low or moderate Q value if the inductor is ungapped. This may prevent using an ungapped structure in a lumped constant filter coil or tuning coils where high Q is important. An increase in Q can be obtained by gapping the toroid, thus reducing μ to some effective value which may still be high if the gap is small. Gapping also stabilizes the inductor during temperature variations.

Magnetic recording heads usually have been made of nickel-iron alloys of high initial μ and high reversible μ . Frequency limitations in these materials have led to the acceptance of high- μ ferrite materials. Ferrites for recording heads offer large advantages over laminates as far as manufacture is concerned. Accurate laminate align-

ment procedures are required for the nickel-iron alloys. A single ferrite head eliminates this problem.

Three types of magnetic heads are available, each having its own material requirements. The erase head is used to remove the impressed signals from magnetic drum or tape. Generally, high frequencies are employed to prevent signal retention on the tape. The high frequency usually calls for the exclusion of materials from the head which would develop eddy currents. In most applications, however, the high voltages used for complete erasure require materials that have high saturation flux densities. To permit the application of ferrites, larger cross-sectional areas should be designed; this would prevent saturation problems.

The read or reproducing head must faithfully reproduce the signals impressed on the tape or drum. Limitations in the application of ferrites exist when read gaps must be small. This is the result of grain structure and porosity of presently available ferrites. At present the high μ available in some laminate materials precludes the use of ferrites at mid-range audio frequencies. Development of higher- μ ferrites may replace these laminate materials.

The write head requirements are similar to those of the read head except that greater voltages and thus saturation problems are encountered. Good wave form reproduction is important in these heads as it is in read heads. In both the read and write heads the ferrite's $1/\mu Q$ is an important parameter.

The difficulty in reducing grain size prevents the machining of the gaps to the high tolerances necessary. Possible approaches to this problem are single crystal ferrites and nickelized pole faces.

Constant $1/\mu Q$ ferrites are generally used at high frequencies where the high- μ ferrites have generally lost their effectiveness. These ferrites are usually lower in μ and have a lower μQ product at low frequencies than the high permeability materials. Above 500 Kc, the μQ product enables these materials to be used in antenna rods, magnetic heads, and high-frequency transformers.

Magnetostriction is the change of length of a ferromagnetic material with an applied magnetic field. The strain variation (ϵ) with applied field exhibits hysteresis effects which are illustrated in Fig. 2. The unidirectional nature of this strain causes the use of biasing d-c fields to prevent the effects of frequency doubling. The length change of magnetostrictive ferrites is generally small (of the order of 26×10^{-6} inch/inch). The most commonly employed magnetostrictive ferrites exhibit negative magnetostriction, that is, they contract with the applied field.

Magnetostrictive ferrites may be used as sonar transducers, hydrophones, ultrasonic delay line transducers and electromechanical filters.

Sonar transducers require high electromechanical coupling coefficients. Ferrites exhibiting good magnetostriction have coupling coefficients as high as 0.45. The overall efficiency of ferrite transducers is quite high compared to nickel magnetostrictive elements, which have large eddy losses.

Hydrophones require sensitive response to input sonic signals. The product of magnetostriction and the reversible permeability is a good figure of a material's merit for use in a hydrophone.

The time delay for unconstrained ultrasonic delay lines may be computed from

$$f_r = (E/\rho)^{1/2}/2l$$

$$\tau = 2l/(E/\rho)^{1/2}$$

where f_r = resonant frequency, τ = delay time, E = Young's modulus in dynes/cm², ρ = density in gm/cm³, and l = magnetic length.

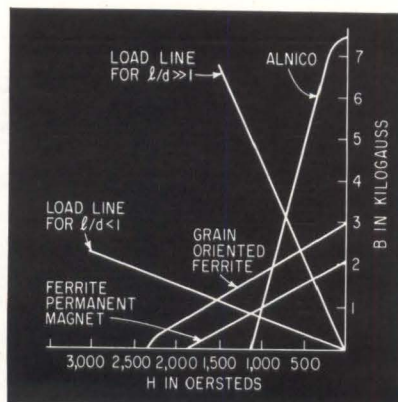

DEMAGNETIZATION section of hysteresis curve demonstrates ability of ferrite to retain field strength—Fig. 3

TABLE—SUMMARY OF FERRITE APPLICATIONS

TYPE OF COMPONENT	TYPICAL FREQ.	CHARACTERISTIC SOUGHT	FAVORABLE PROPERTIES	TYPICAL FERRITE (μ_o RANGE)	REQUIRED IMPROVEMENTS
A. LINEAR B-H CHARACTERISTICS					
Filter Inductors	100 Kc	High Q , precision, stability, low modulation	High $\mu_o Q$, low hysteresis, convenient core shapes	MnZn (1,000-6,000)	Increased $\mu_o Q$, low temp. coefficient
I-F Transformers	465 Kc	High Q , stability, adjustability	High $\mu_o Q$, low eddy losses	NiZn (100-300); Mg, MnCO, Cu, Al may be added	Increased $\mu_o Q$ to higher freq.; better stability to temp., and magnetic and mechanical shock
Antenna Cores	1,000 Kc to 15 Mc	Moderate Q and stability	High $\mu_o Q$, rod shapes	MnZn (1,000-3,000), NiZn (>500)	Very uniform magnetic and mechanical properties
Wideband Transformer		Reproducible transmission characteristics	High μ_o , low losses, assembled core structures	MnZn (1,000-3,000), NiZn (>500)	
Adjustable Inductors	various	Adjustment $\pm 20\%$	High μ_o	MnZn, NiZn	
Tuners	various	Adjustment greater than 10/1	Various constructions, μ_o variation in d-c Field		
Miniature Inductors	various	Moderate Q , small size	Inexpensive	Mn (>1,000), NiZn (>1,000)	Higher sat., less loss in moderate B_m
Loading Coil	voice	Stability, low modulations, low leakage flux	High $\mu_o Q$		Lower sensitivity to d-c fields, lower hysteresis loss
B. NONLINEAR B-H, MEDIUM TO HIGH FLUX DENSITIES					
Flyback Transformers	15-100 Kc	Low loss, moderate size, retentivity, high Curie temp.	Low tolerance cores are economical	MnZn (>750), NiZn (>750)	Higher sat., lower losses, higher Curie temp.
Deflection Yokes	pulse	Same as above	High μ_o , cup shape	NiZn (<1,000)	High sat.
Miniature Transf.	pulse	Small size, easy mounting	High effective μ	MnZn	
Carrier Power Transf.	various	Low eddy current loss, high μ	High loss above critical freq.	MnZn (>500), NiZn (>500)	
Suppression Heads		high resistive impedance		MnZn	
Recording Heads		Very high μ_o , low eddy loss, mech'l. rigidity	Rigidity, elimination of laminate structure		Higher sat., non-abrasive surface
C. HIGHLY NONLINEAR, RECTANGULAR LOOP					
Memory Cores	pulse	Two stable states, fast flux reversal, low eddy current	Small rings practical, square B-H loop	MgMn	Most memory cores and fast switching cores exhibit low Curie temp. 60-90°
Switching Cores	pulse	Fast flux reversal, high output	Square B-H loop	MgMn	High sat. for high output
Multiaperture Cores		Fast flux reversal, low eddy current			
Magnetic Amplifiers		High μ_o up to sat. and almost hor. BH line above sat.		MgMn	High sat. for high power applications
D. MAGNETOSTRICTION AND OTHER PROPERTIES					
Delay Lines					
Filters and Oscillators	100 Kc	Low B 's are o.k., high μ_o at high freq.	Higher μ at higher freq.		
Temperature Controls		Sensitivity to temp.	Low Curie temp., temp. sensitivity		
Transducers	20-30 Kc	High power out. and mech'l. robustness	Low eddy current loss	NiCo and magnetite	Higher coupling factor, higher sat. polarization, less brittleness

Eddy currents generally limit the diameter of nickel magnetostrictive delay lines and thus reduce output voltages. On the other hand, ferrite delay lines generally exhibit somewhat lower signal-to-noise ratios than nickel delay lines. In general, magnetostrictive delay lines are applicable to long delays and may be variable.

Lead ferrites and barium ferrites are used most frequently in permanent-magnet applications. The non-oriented permanent magnet ferrites have energy products of 1.1 to 1.4 million gauss-oersteds. An increase in the energy product is obtained by orienting the ferrite grain in a magnetic field while the extrusion process is taking place. This brings the energy products of ferrite magnets to 3 or 4 million.

The great advantage of ferrite permanent magnets is derived from their large coercive force. This coercive force indicates the ability of the material to maintain its field

strength under the influence of demagnetizing fields. Figure 3 shows the second quadrant of the hysteresis curve (the demagnetization curve) for an Alnico type material and a ferrite. The load lines, which are related to the length-to-diameter (l/d) ratio of the magnet, indicate that at small l/d ratios, the B field of the ferrite surpasses that of the Alnico.

The high coercive force and the greater B at low l/d enables the ferrite to be used in the periodic focusing of traveling wave tubes. Great volume savings are obtained by the use of periodically focused arrays.

Ferrite permanent magnets can also be used in any applications where length-to-diameter ratios are less than one. The high coercive forces enable the magnets to be placed in positions such that the same poles face each other, thus obtaining a magnetic suspension. The exceptionally high resistivity

of these ferrites (10⁹ ohm-cm and greater) can be employed for its properties of insulation.

The Table indicates various ferrite applications, the most desirable ferrite property for the application, some important typical parameters, and the material designation used by various manufacturers for the specific application. The right-hand column indicates where improvements can be made.

The author acknowledges the help of the Kearfott Solid State Products Laboratory and S. Chang Kang in preparing this article.

REFERENCES

- (1) Smit and Wijn, "Ferrites," J. Wiley & Sons, 1959.
- (2) C. Kittel, "Introduction to Solid State Physics," 2nd Edition, J. Wiley & Sons, 1956.
- (3) Bozorth, "Ferromagnetism," D. Van Nostrand, 1951.
- (4) Lawrence G. Rubin, Ferrites, *Elect Des*, p 20, Jan. 1, 1957.
- (5) C. Lester Hogan, Ferrites, *Sci Amer*, June 1960.
- (6) Victor E. Legg, Magnetic Measurement at Low Flux Densities, *Bell Lab Tech JI*, p. 39-61, Jan. 1936.
- (7) Soohoo, "Theory and Application of Ferrites," Prentice-Hall, 1960.

RECENT TESTS SHOW TROPO SCATTER Better Than Believed

By J. L. LEVATICH
Bendix Corporation,
Baltimore, Maryland

TROPOSPHERIC SCATTER systems are susceptible to many influences that reduce their overall effectiveness. Although some of the factors are amenable to mathematical treatment, others can be tackled only by empirical methods backed up by observations on existing installations. This article describes an accurate method of evaluating the efficiency of a new installation, where system parameters and path characteristics are known.

It was recently pointed out¹ that if all the available data on the phenomenon of loss in antenna gain are taken into consideration, this reduction turns out to be proportional to frequency, f , antenna aperture, D , and inversely proportional to distance, d . This phenomenon (also referred to as aperture-to-medium coupling loss) is the observation that large-aperture parabolic antennas do not seem to realize their full plane wave gain, as compared to small aperture reference antennas over the same path. This loss is now known to be substantially less at longer distances than had previously been assumed, making the tropospheric mode of propagation a more attractive design choice at higher frequencies for longer distances.

ANTENNA EVALUATION—Figure 1 is a nomograph for predicting reduction in antenna gain based on such system parameters as frequency in gigacycles, Gc , distance in hundreds of statute miles, d , and antenna aperture in feet, D . To determine reduction in antenna gain, a straight line is drawn between the frequency on scale B and the distance on scale C . Another straight line is drawn connecting the inter-

BLOOD SWEAT AND TEARS

Although new and revolutionary ideas in engineering often capture the popular imagination, the day-to-day role of most engineers is trying to win a few extra notches of performance for a technique that may be decades old. That last few percent improvement is hardest of all to come by.

Here's an example of success resulting from an intensive and long term evaluation of tropospheric communications—that large aperture antennas work better at long range than was formerly believed. A conclusion to state, but arduous and expensive to discover.

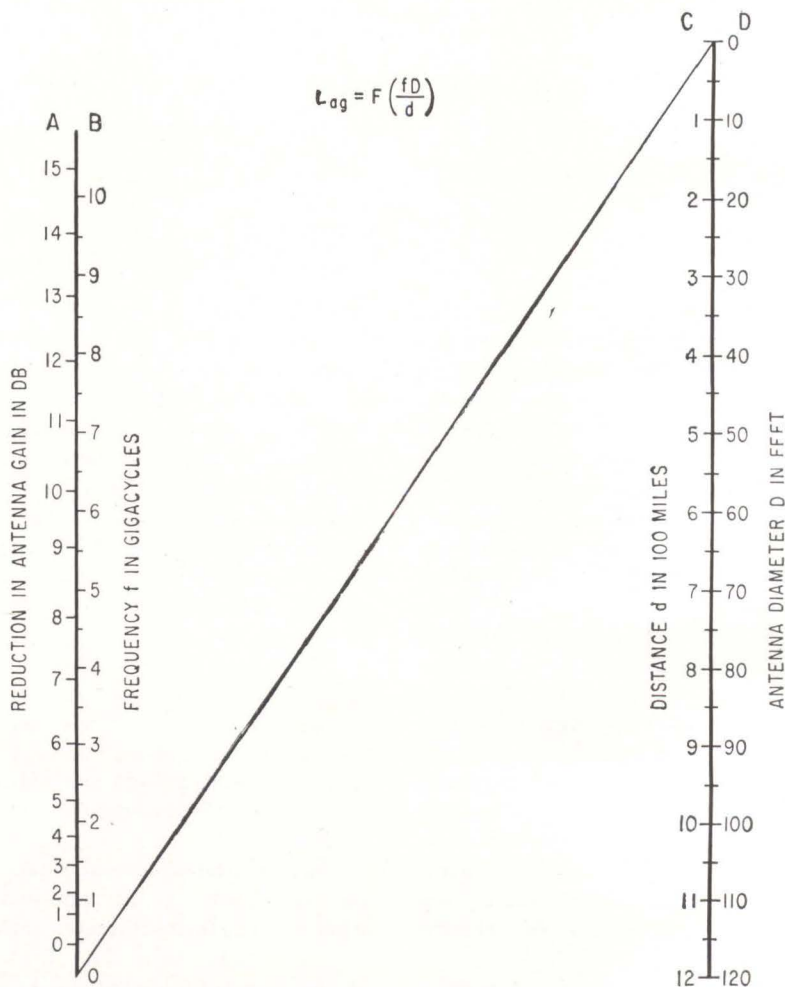

ANTENNA EFFECTIVENESS depends upon operating range as well as antenna physical characteristics; chart gives antenna gain reduction in terms of operating parameters—Fig. 1

What was Bell Telephone Laboratories doing on Monday, October 1, 1962?

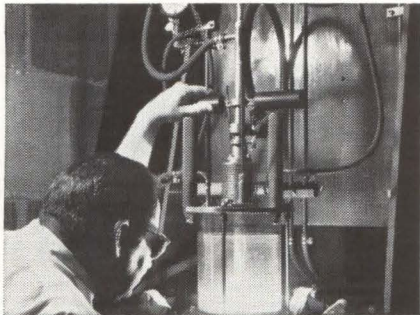

Murray Hill Laboratory, N. J. The search continued for new materials exhibiting superconductivity. Some of these materials have been used to produce very strong magnetic fields with the expenditure of very little electrical energy.



Allentown Laboratory, Pa. We were working with engineers of Western Electric, manufacturing unit of the Bell System, on the manufacture of long-life electron tubes for a new deep sea cable system.



Merrimack Valley Laboratory, Mass. We were increasing the capabilities of a new microwave system designed for low-cost telephone and television communications over distances up to 200 miles. This system is based on advances in solid state technology.



Holmdel Laboratory, N. J. We were developing an electronic switching system using new solid state devices. It will bring telephone customers a whole new range of services.



Indianapolis Laboratory, Ind. We were perfecting improved automatic dialer telephones. One model will permit the customer himself to record 50 frequently called names and numbers and then dial by simply selecting a name and pressing a button.



New York Laboratory, N. Y. We were studying the performance of a new data set which converts teletypewriter pulses into tones for transmission over regular voice circuits. Transmitting teletypewriter messages over voice circuits was introduced on August 31, 1962.



Whippany Laboratory, N. J. We were evaluating new radar technology for the NIKE-ZEUS anti-missile missile system under development for the Army. Significant improvements are further tested at four other ZEUS test sites ranging halfway around the world.

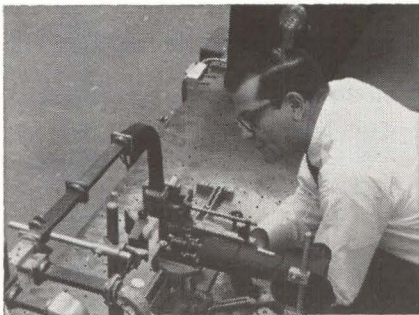

Crawford Hill Laboratory, N. J. We were experimenting with the microwave modulation of light from a helium-neon gaseous optical maser. Modulated light may someday be used to carry large volumes of information.

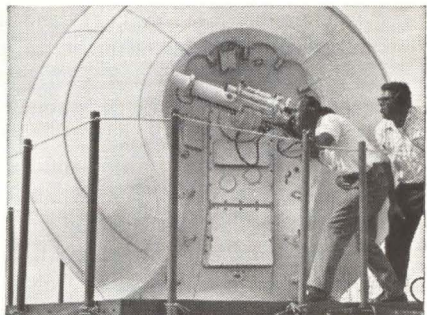

Cape Canaveral, Fla. We were preparing for the 102nd successful use of Bell Laboratories-developed Radio Command Guidance System. On July 10, it was used in the NASA launching of the Bell System's Telstar. This guidance system was originally developed for the Air Force and is operational on the Titan I ICBM.

These were some of the highlights of one day. Engineers and scientists at Bell Laboratories work in every field that can benefit communications and further improve Bell System services. Their inquiries range from atomic physics to new telephone sets, from the tiny transistor to transcontinental radio systems, from the ocean floor to outer space.



BELL TELEPHONE LABORATORIES

World center of communications research and development

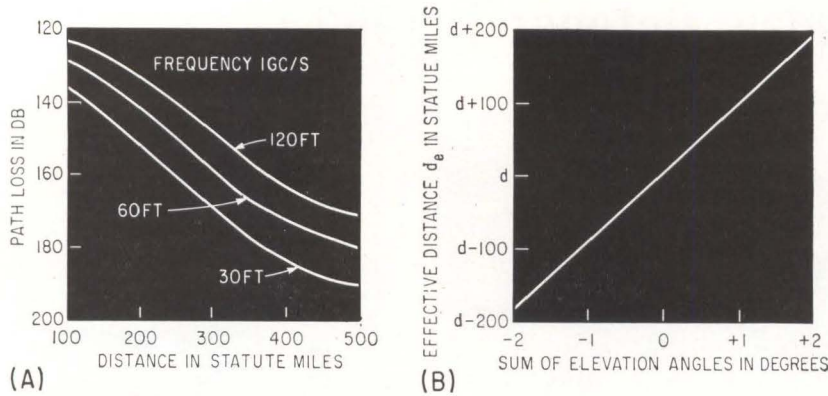

(A) DIVERGING CURVES show that large diameter antennas have relatively increased performance at long range (A), effective operating distance related to algebraic sum of terminal elevation angles (B)—Fig. 2

section of the first line and the reference diagonal with the antenna aperture on scale D . Reduction in antenna gain is read at the intersection of this last line with scale A .

PATH LOSS — Figure 2A shows path loss prediction curves for beyond-the-horizon tropospheric links based on the method shown in Fig. 1 for determining reduction in antenna gain. The distance scale of Fig. 2A is effective distance, that is, the path is assumed to be over smooth earth with zero elevation angles at both terminals. The path loss values are the medians for the worst month of the year and for temperate climates similar to the northern United States. They are based on an operating frequency of 1 Gc.

The path loss values obtained from Fig. 2A are adjusted for different installations by taking into account the variation of path loss, antenna gain, and loss of antenna gain with frequency. Path loss between isotropic antennas increases as frequency to the third power, f^3 , while the gain of antennas at two terminals increases as frequency to the fourth power, f^4 . The variations in the above three parameters are taken into account by the expression

$$\text{Frequency correction} = 10 \log \frac{1 Gc}{f Gc} - \Delta L_{ag} \quad (1)$$

where ΔL_{ag} is the change in antenna gain between 1 Gc and the desired

frequency, f , over the path considered. This change, ΔL_{ag} is determined from Fig. 1.

The effects of the terrain in the foreground can be expressed in terms of the elevation angle of the beam above the horizontal, which in turn can be converted to effective distance with Fig. 2A. For better accuracy, a correction has to be applied to the path loss value obtained from Fig. 2A to compensate for the difference in the free space loss at the actual and the effective distance. Numerically, this correction factor is

$$20 \ln(d/d_e) \quad (2)$$

where d_e is the effective distance and d is the actual distance, both in statute miles. The effect on the elevation polar diagram due to ground reflection is assumed to be negligible, so that the path geometry is the determining factor in establishing the direction of radiation.

The prediction curves in Fig. 2A can be corrected for paths with different climatic conditions, with corrections based on the new value of refractive index, as compared to the value of 301 N-units for refractive index assumed for Fig. 2A. ($N = (n - 1) \times 10^6$ where n is the refractive index of air².) The relationship of path loss and refractive index varies from location to location and with length of path, but a value of 0.4 db³ change in path loss for every N-unit change in the refractive index seems justifiable. The

correction factor is $0.4(301-N_s)$, where N_s is the surface index of refraction for the path under consideration.

EXAMPLE — Calculate the path loss for a system having the following characteristics. Frequency, $f = 5 Gc$, path length, $d = 400$ miles, antenna diameter, $D = 60$ feet, elevation angles: terminal 1 = -7 degrees, terminal 2 = $+2$ degrees, sum of elevation angles = -5 degrees, surface index of refraction, $N_s = 321$ N-units.

Correction for the difference in operating frequency $10 \log 1 Gc / 5 Gc - \Delta L_{ag}$, Eq. (1), where $\Delta L_{ag} = L_{ag1Gc} - L_{ag5Gc}$ (from Fig. 1) = $3 - 11.5 \text{ db} = -8.5 \text{ db}$, and $10 \log 0.2 = -7 \text{ db}$, resulting in a total frequency correction of $-7 \text{ db} + 8.5 \text{ db} = 1.5 \text{ db}$.

EFFECTIVE DISTANCE — From Fig. 2B and the given elevation angles at the terminals, (-5 degrees) the effective distance is $d_e = d - 46 = 364$ miles. The free space loss correction, Eq. (2), is $20 \log d/d_e = 20 \log 400/364 = 0.8 \text{ db}$. The path loss from Fig. 2A at 364 miles, at 1 Gc and using 60 ft antennas is 169 db. The climatic correction is $0.4(301-321) = -8 \text{ db}$. The predicted path loss for the above system is then = $169 \text{ db} + 1.5 \text{ db} + .8 \text{ db} - 8 \text{ db} = 163.3 \text{ db} \approx 163 \text{ db}$.

This prediction method gives path loss values more nearly correct than those obtained from other empirical prediction methods that do not take all the antenna loss factors into consideration. For even greater accuracy in path loss estimation, the planned path should be compared with long term measured data over a path similar to the desired one in length, climate, geography, and operating frequency.

REFERENCES

(1) J. L. Levatic, A New Approach to Loss in Antenna Gain and Tropospheric System Design, 8th Nat. Communications Symposium Record, Utica, N. Y., p. 127, Oct. 1962.
 (2) B. R. Bean, The Radio Refractive Index of Air, Proc. IRE, p. 260, 50, March 1962.
 (3) G. C. Rider, Median Signal Level Prediction for Tropospheric Scatter, The Marconi Review, p. 203, XXV, No. 146.

QUALITY IN INTERCONNECTION

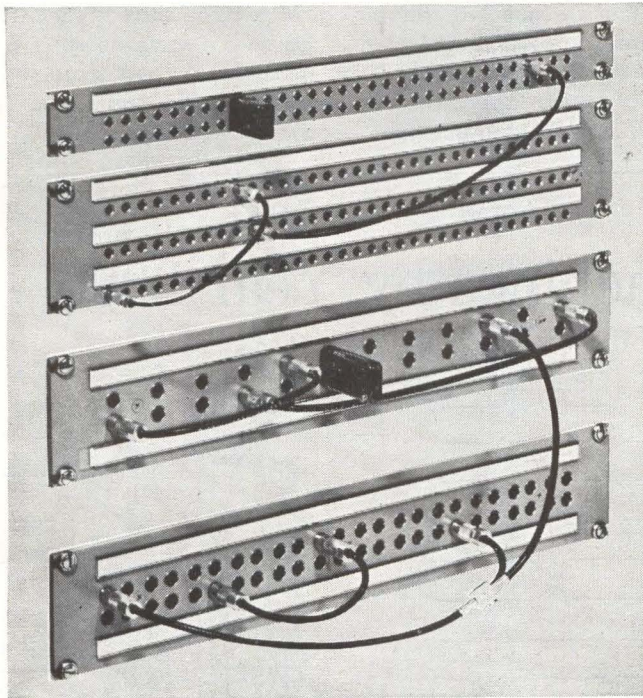

If you have requirements for patching and programming in coaxial cable systems, investigate the full Trompeter line of **standard and miniaturized** patch panels and accessories. These coaxial patching assemblies are available off-the-shelf for data, telemetry, computer, R.F., TV, nucleonics, and communications systems. Finely crafted, the standard 50- and 75-ohm cable systems (using RG-58, 59, 62, 8, 9, and 11), and the miniature RG-122 and Amphenol 21-597 systems, can be combined with compatible Trompeter accessories to make up the most complicated patch bays. Trompeter systems assure top performance and high reliability in interconnection techniques. Special configurations are available to custom order. Catalog sent upon request.

TROMPETER ELECTRONICS / 7238 Eton Avenue • Canoga Park • California • Telephone 346-1550

CIRCLE 200 ON READER SERVICE CARD

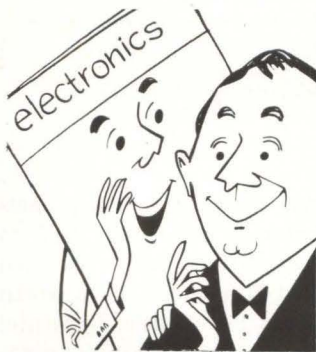

electronics
IS EDITED
TO KEEP YOU
FULLY INFORMED
— a "well-rounded"
engineer

What's your *present* job in electronics? Do you work on computers? (**electronics** ran 158 articles on computers between July, 1961 and June, 1962!) Are you in semiconductors? (For the same period, **electronics** had 99 articles, not including transistors, solid-state physics, diodes, crystals, etc.) Are you in military electronics? (**electronics** had 179 articles, not including those on aircraft, missiles, radar, etc.)

In all, **electronics'** 28-man editorial staff provided more than 3,000 editorial pages to keep you abreast of all the technical developments in the industry. No matter where you work today or in which job function(s), **electronics** will keep you fully informed. Subscribe today via the Reader Service Card in this issue. Only 7½ cents a copy at the 3 year rate.

electronics

electronics • March 1, 1963

Because you've got to SEE it to BELIEVE it
...we will send you a FREE sample!!!!



instant lettering

DRY TRANSFER TITLES

FOR PROTOTYPES AND ELECTRONIC PANELS

**NOT A DECAL — NO WATER — NO TAPES — NO SCREENS
GOES ON INSTANTLY — JUST PRESS AND IT'S THERE
MAKES PROTOTYPES LOOK LIKE FINISHED EQUIPMENT!**

"Instant Lettering" Electronic Titles transfer DRY to almost any surface—metal, glass, wood, plastic—with just a quick light pressure. Simply try the sample. You'll agree "Instant Lettering" is the easiest quickest way to get professional lettering you've ever seen.

Complete "Instant Lettering" Title Sets contain 24 sheets with thousands of preset words and phrases researched to give you the greatest variety and flexibility.

No. 958 — Black\$4.95
No. 959 — White 4.95

The complete line of standard "Instant Lettering" sheets is also available. Type sizes range from 8 point to 1½ inch display letters in a wide selection of type faces.

WRITE — WIRE — PHONE FOR FREE SAMPLE!

THE DATAK CORPORATION

63 71st STREET
N. J. 201—UN 4-6555

GUTTENBERG, N. J.
N. Y. 212—LA 4-0346

CIRCLE 45 ON READER SERVICE CARD 45

NEURONS: BIOLOGICAL AND ARTIFICIAL

As time goes by, electronics engineers will hear more about and deal more with artificial electronic neurons. These devices have properties that are modeled after biological originals such as you are using as you read this. Shown in Fig. 1 are some neuron symbols and equivalent circuits. For bibliography and more discussion of neuron operation, see February 9, 1962 issue of ELECTRONICS, p 37, and this week's lead story on neuristors, p 25

Ultra-Intelligent Machines by Year 2000

Artificial-intelligence sessions at IEEE meeting review recent progress

By NILO LINDGREN
Assistant Editor

NEW YORK—An ultra-intelligent machine will be constructed before the turn of the century; such a machine will incorporate artificial neural networks. These predictions, made by I. J. Good of the Institute for Defense Analyses, Princeton, N.J., concluded three IEEE sessions on artificial intelligence late last month.

Good pointed out that an ultra-intelligent machine, which would surpass the intellectual activities of any man (why build a machine only equal to a man?), would transform human society beyond recognition. Such a machine, he said, ought to have a linguistic facility to the point of deriving the meaning of statements and giving them

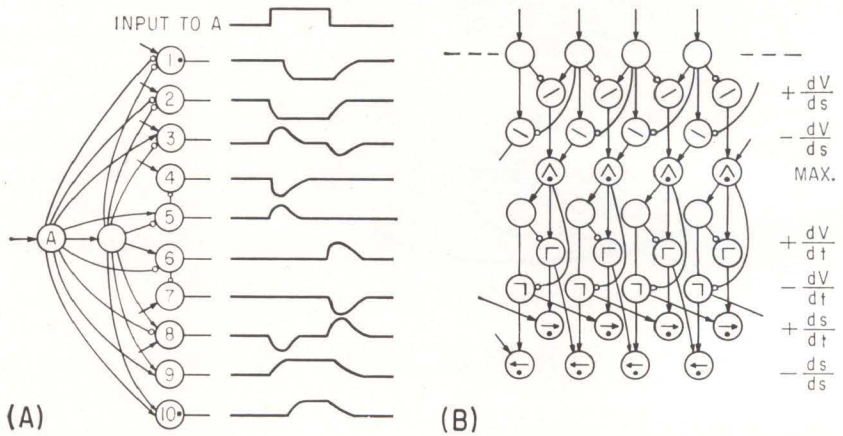

COMBINATIONS of outputs (A) from primary neuron A and the delaying neuron following it produce the final outputs shown on neurons 1 to 10. These outputs result from a single event, the voltage input shown at top. Partial neural network (B) used in phoneme recognition. Only four of ten lateral primary neurons shown. The recognized approximate functions (see text) are indicated at each level—Fig. 2

physical embodiment. A machine that was designed without taking semantic questions into account would not be sufficiently economical, especially in regard to such problems as recall. The machine would also need to be somewhat of a robot so that humans could educate it easily.

The means whereby this intelligent machine will eventually be built are still in a relatively rudimentary stage. Nonetheless, reports on recent neural work show that this area is gaining in momentum and scope.

NEURAL NETS — Two papers dealt with recent work on neural networks—one on artificial neurons in speech recognition networks, a second on a computer-simulated auditory-type network. A fine study of threshold logic was reported by R. O. Winder of RCA.

Artificial electronic neuron networks that may eventually lead to speech recognition were described by Dr. Paul Mueller of the Eastern Pennsylvania Psychiatric Institute, who has been working in cooperation with RCA (ELECTRONICS, March 16, 1962, p 60).

Although certain aspects of these neuron networks have been published recently, Dr. Mueller's chief concern was with their operation in the time domain, that is, in an analysis of time sequence and duration of events in neuron nets. A graphical illustration of how a voltage input (one event) can be modified by even a simple neural network is shown in Fig. 2A. In this network, extra inputs to neurons 1 to 4 and to 7 and 8 produce a constant output level that is suppressed at different times during the event.

Some of the principles of recognition of energy-time patterns have

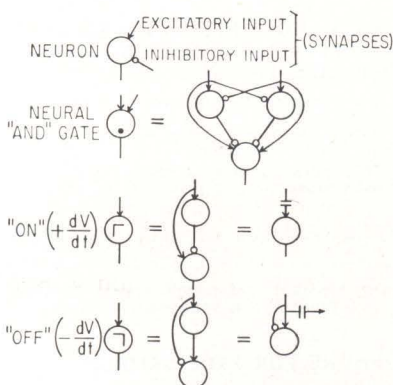

NEURON SYMBOLS and equivalent circuits—Fig. 1

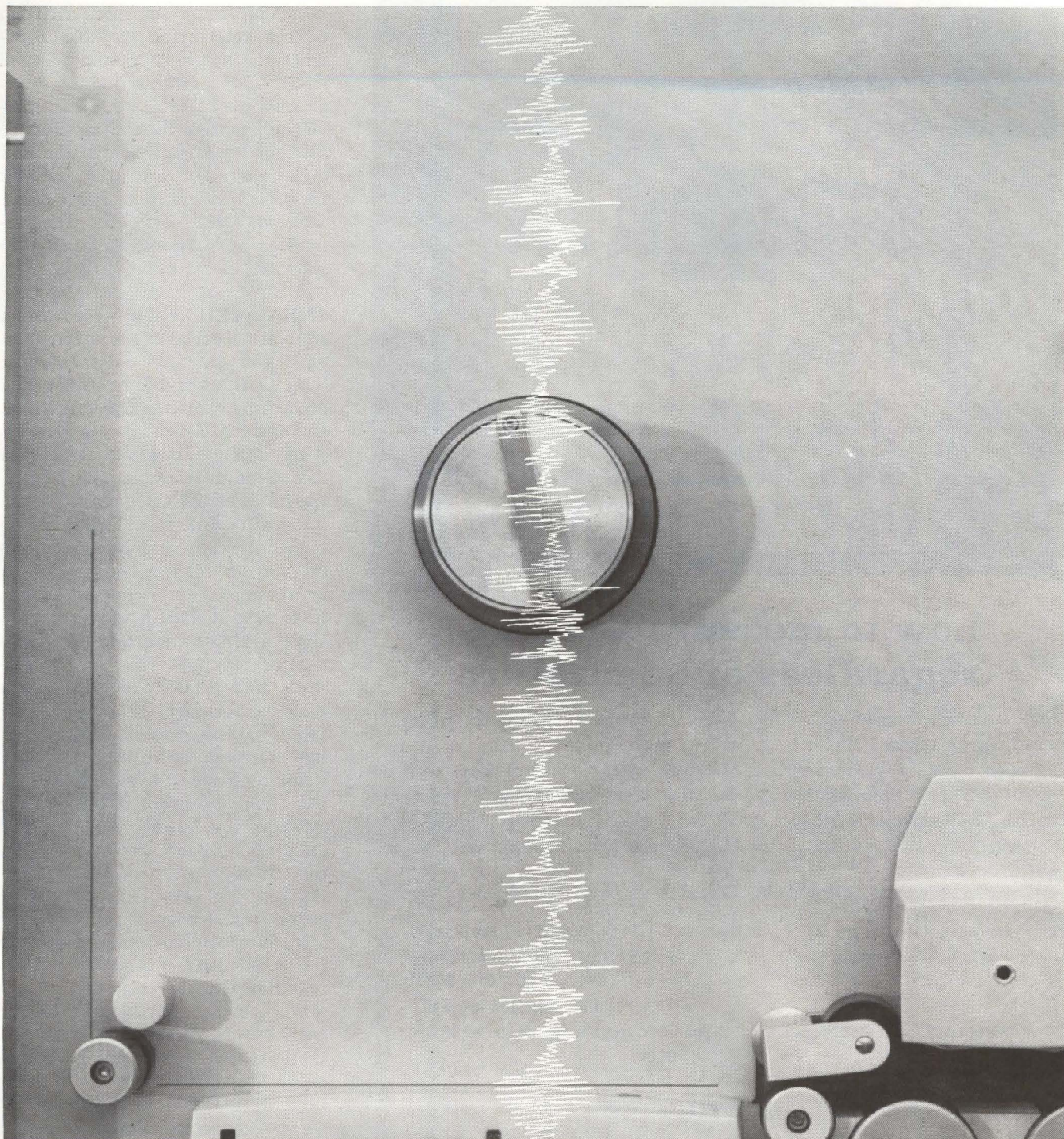

Who has both: 1.5 Mc recorder and 1.5 Mc tape?

AMPEX

We just don't like to leave things undone. Recently, our engineers developed the first 1.5 Mc per track, multi-track recorder—the FR-1400. Like every Ampex recorder, it gives you outstanding performance. We felt we had to develop a tape that equalled the FR-1400 in quality of performance. Hence: Ampex 9101—a 1.5 Mc tape. This new tape is a high resolution, heavy duty type with excellent wear characteristics. It offers high reli-

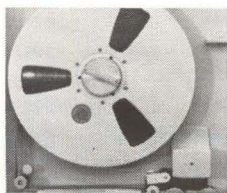

ability and superior performance. And can record 1.5 Mc of data at a speed of 120 ips. Ampex 9101 tape rounds out a recording system that gives you the highest frequency in longitudinal recording today. For more information write the only company providing recorders, tapes and memory devices for every application: Ampex Corp., 934 Charter St., Redwood City, Calif. Worldwide sales and service.

AMPEX

**Fred
Roberts
can
show
you ...**

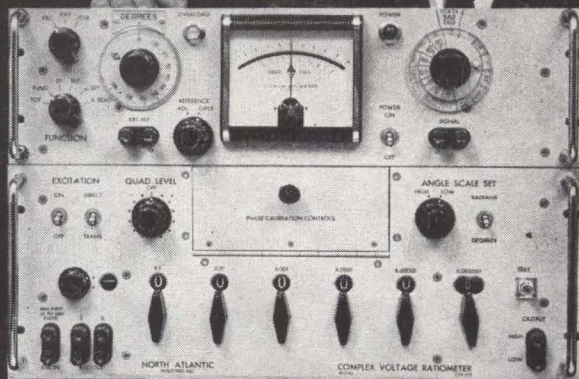

Director of Marketing, North Atlantic Industries

how to measure ac ratios regardless of quadrature

North Atlantic's **Complex Voltage Ratiometer** is a completely integrated test set for measuring grounded 3 terminal networks. By providing self-calibrated quadrature injection, the Model CVR-551 permits calibrated meter readings of phase angle up to 30° or 300 milliradians full scale, and, in addition, provides direct readings of in-phase and quadrature voltages. As an added feature, the integral Phase Angle Voltmeter* and AC Ratio Box can be used independently. Abridged specifications follow:

In-Phase Ratio Range, R_I 000000 to ± 1.111110 with full accuracy

**Phase Angle Range, α ± 1.0 to ± 300 milliradians
 ± 0.1 to $\pm 30^\circ$
(in 6 calibrated ranges)**

Frequency Any specified frequency, 50 cps to 3KC

Input Ratio Error, R_I $\pm (.001 + \frac{.0001}{R_I} + \delta \tan \alpha)$ % of reading

**Phase Angle Error, α $\pm .0003$ radians or $\pm .017^\circ$ (low ranges)
 $\pm 3\%$ full scale (high ranges)**

**Phase Angle Voltmeter* (independently used) $\pm 2\%$ full scale
1 millivolt to 300 volts
(in 12 calibrated ranges)**

**A.C. Ratio Box (independently used) 1 ppm terminal linearity
.35f (300 volts max)**

North Atlantic's CVR* line includes 2 and 3 frequency models. All models available with optional 10 ppm Ratio Box control of quadrature injection.

Send for data sheet or contact your local North Atlantic sales representative now for complete information.

**Trademarks*



NORTH ATLANTIC industries, inc.
TERMINAL DRIVE, PLAINVIEW, L. I., NEW YORK • Overbrook 1-8600

See Us At I.E.E.E.—Booth 3939

been incorporated into artificial neuron nets which are able to extract the space (s), time (t) and energy (V) patterns that are characteristic of phonemes, thus providing phoneme recognition. Figure 2B shows a partial view of the first eight stages of a neuron network for speech recognition. Inputs come from an artificial cochlea. The recognized approximate functions are shown at each level.

SIMULATED NETS—Neural-net simulation experiments carried out on a 709 computer, exploring the basic features of diffuse storage and processing, were described by S. M. Khanna of IBM.

By using extremely simplified models of neurons, having properties of variable attenuation, delay, integration, threshold and interconnectivity (with preferential direction of connectivity), and by arranging these cells in layers, Khanna said that it was possible to show a kind of learning based on auditory stimuli. That is, the network was made to behave like a complex selective filter, with different pathways developing through the network for different sets of stimuli (formation of traces). Input (from a sensor) to the topmost layers of the network was such that each cell received maximum excitation at a given tone frequency—that is, the sensor had encoding properties analogous to a cochlear transducer. Because this model was found to abstract and store (distributively) interrelations of external stimuli, and because higher degrees of abstraction could be achieved by cascading more and more layers of neurons, Khanna said, he believed this was an important key to artificial intelligence.

Sound Waves Locate Corona on Transformers

ULTRASONIC METHOD of locating potential insulation failure in transformers has been developed by GE. It enables testers to "listen in" on corona levels deep in the insulation, GE says. If discharges are indicated on a radio noise meter, a unique range-finding technique zeros in on the fault.

Corona not only emits a measur-

able electrical discharge but also sound waves which travel radially outward from the source. It is possible to measure the distance from a microphone immersed in the insulation liquid to the source of the discharge by timing the delay between the appearance of an electrical pulse from the corona on an oscilloscope and the appearance of a deflection on the scope caused by the ultrasonic microphone signal.

Gamma Ray Detector Measures Snowfall

NEW METHOD of measuring stored snowpack moisture has been developed at Montana State College. A gamma ray source (cobalt) is placed at ground level before snowfall starts. A plane containing an electronic gamma ray detector, amplifier and counter equipment flies over this after snow has fallen.

The cobalt source is used with a collimator which directs the radiation in a narrow cone upward to be detected by the airborne equipment. Officials said the method permits collection of data from areas where access is difficult.

Accelerator for Food

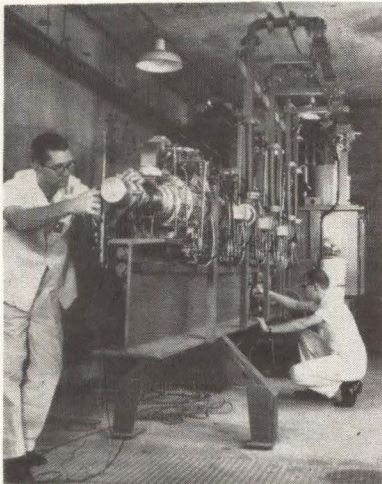

THE 18-KILOWATT, 24-million electron volt linear accelerator at Army's Radiation Laboratory at Natick, Mass., is an important component in studies to preserve food by ionizing energy. Together with a 1.3-million curie Cobalt-60 source, the world's largest concentration, it is used in tests on experimental methods of food processing under rigidly controlled conditions

Phil Greenstein can show you...

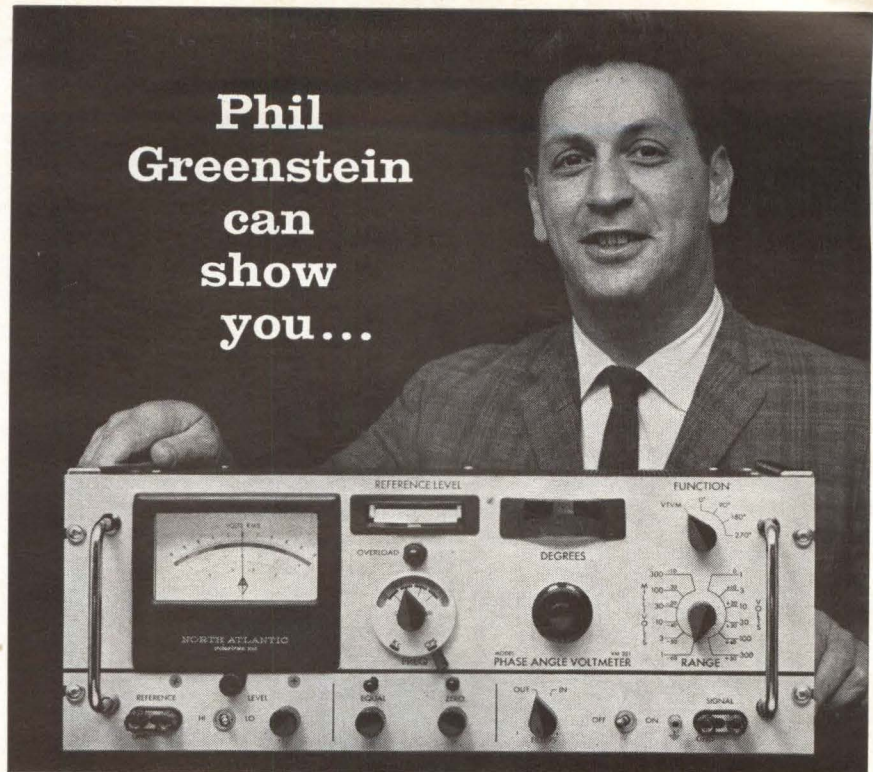

Instrumentation Sales Manager, North Atlantic Industries Inc.

how to measure in-phase, quadrature and angle while sweeping frequency to 100 kc

North Atlantic's latest addition to the PAV line of Phase Angle Voltmeters* enables you to make measurements while frequency is varying over half-decades without recalibration. The VM-301 **Broadband Phase Angle Voltmeter*** provides complete coverage from 10 cps to 100 kc, and incorporates plug-in filters to reduce the effects of harmonics in the range of 50 cps to 10 kc with only 16 sets of filters. Vibration analysis and servo analysis are only two of the many applications for this unit. Abridged specifications are listed below:

Voltage Range.....	1 mv to 300 volts full scale
Voltage Accuracy.....	2% full scale
Phase Dial Range.....	0° to 90° with 0.1° resolution (plus 4 quadrants)
Phase Accuracy.....	0.3°
Input Impedance.....	10 megohms, 30μf for all ranges (signal and reference inputs)
Reference Level Range.....	0.15 to 130 volts
Harmonic Rejection.....	50 db
Nulling Sensitivity.....	less than 2 microvolts
Size.....	19" x 7" x 10" deep
Price.....	\$1750.00 plus \$120.00 per set of filters

North Atlantic's sales representative in your area can tell you all about this unit as well as other Phase Angle Voltmeters* for both production test and ground support applications. Send for our data sheet today.

*Trademark



NORTH ATLANTIC industries, inc.
TERMINAL DRIVE, PLAINVIEW, L. I., NEW YORK • Overbrook 1-8600

See Us At I.E.E.E.—Booth 3939

Waffle Iron Shape Boosts Memory

New configuration looks promising for computers and switching systems

SHORTEST storage path for a single bit of any magnetic memory system is claimed for new design by

Bell Telephone Labs' J. L. Smith.

New memory has waffle-iron configuration, looks promising for computers and switching systems which now use ferrite cores and thin films.

Memory consists of a base plate made of a high permeability ferrite. Slots are cut in a grid pattern,

leaving a regular array of rectangular posts. This gives surface the appearance of a miniature waffle iron.

Preprinted wiring patterns are placed in the slots: a set for the read-write and a set for the digit-sense wires. Overlay of square-loop magnetic material is placed over the tops of the posts.

Information is stored in the overlay material between the posts in the direction of magnetization of the magnetic flux. Width of a slot is the effective length of the magnetic path in the storage material. A closed magnetic path is formed by the high permeability base and the square-loop material connecting a pair of posts. One type of waffle-iron memory has posts 100 mils long and 30 mils wide and a slot width of 30 mils.

OVERLAY—Both destructive and nondestructive memories, have been built; the basic difference is in the magnetic overlay.

Destructive memories use an overlay of two magnetic materials—one for storage and the other for sensing. When a nondestructive memory is read, only the sensing material is switched; thus the memory can be interrogated indefinitely without affecting storage.

Another form of waffle-iron memory, called the cubic, has been developed by Bell's A. H. Bobeck. In the cubic structure, both the selection and sense wires follow straight paths instead of weaving around the posts as in the other waffle-iron memory. Also, since these wires cross each other at right angles, a pulse travelling down one wire will not induce appreciable current in the order, thus the signal-to-noise ratio is improved. The cubic waffle iron memory has a fast read-write cycle; it can be made very small and can be assembled simply.

One experimental memory matrix of the cubic type has a capacity of 128 words of 30 bits per word. Read-write cycle time can reach 200

Rotor Floats in Magnetic Field

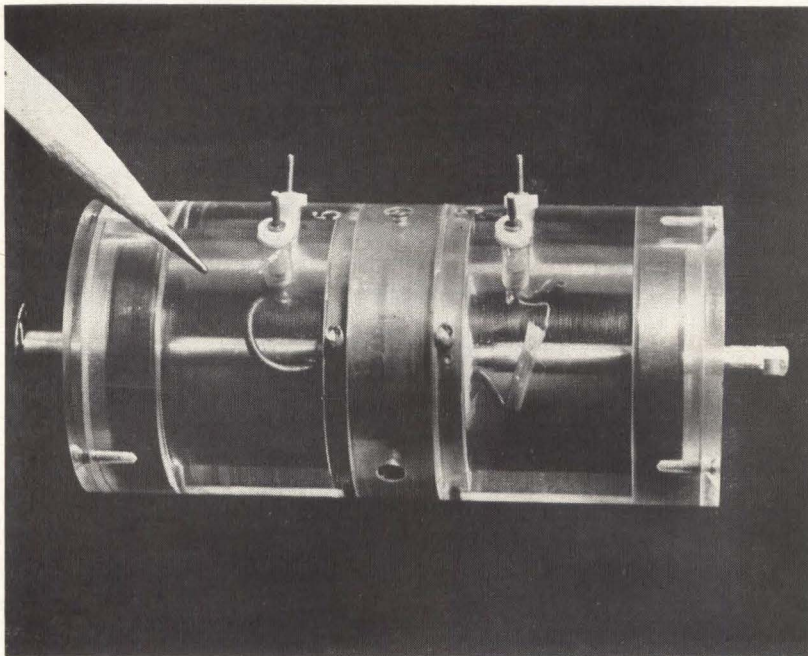

A SMALL magnetic bearing that spins in free space is now available for experimental use. Shaft of rotor is supported only by magnetic fields. Rotary motion in a vacuum is free from mechanical friction. Electrical friction does occur. But hysteresis and eddy current effects are measurable.

Device may find initial use in laboratory instrumentation and high-vacuum environments. Rotor may have applications in special atmospheres where mechanical friction and lubrication problems may impose serious difficulties.

Shaft of present models spins at 10,000 rpm. Present units can handle 2-gram loads. Hope is to attain higher speeds, carry larger

loads for driving mechanisms.

The four terminals, seen in photo, are for power input to two electromagnets. Shaft is kept concentric by applying 5 to 10 watts. A small synchronous motor can driveshaft indefinitely.

Magnetic bearing was developed by Joseph Lyman, well known for his work on gyroscopic instruments, flight trainers, radar and flight instruments. Cambridge Thermionic Corp., Cambridge Mass. is manufacturing the Magcentric bearing. Company is investigating mechanical-balance problems and magnetic materials that may enable rotor to handle larger loads at increased speeds. Device shown in photo measures $3\frac{3}{8}$ -in x $1\frac{1}{4}$ in.

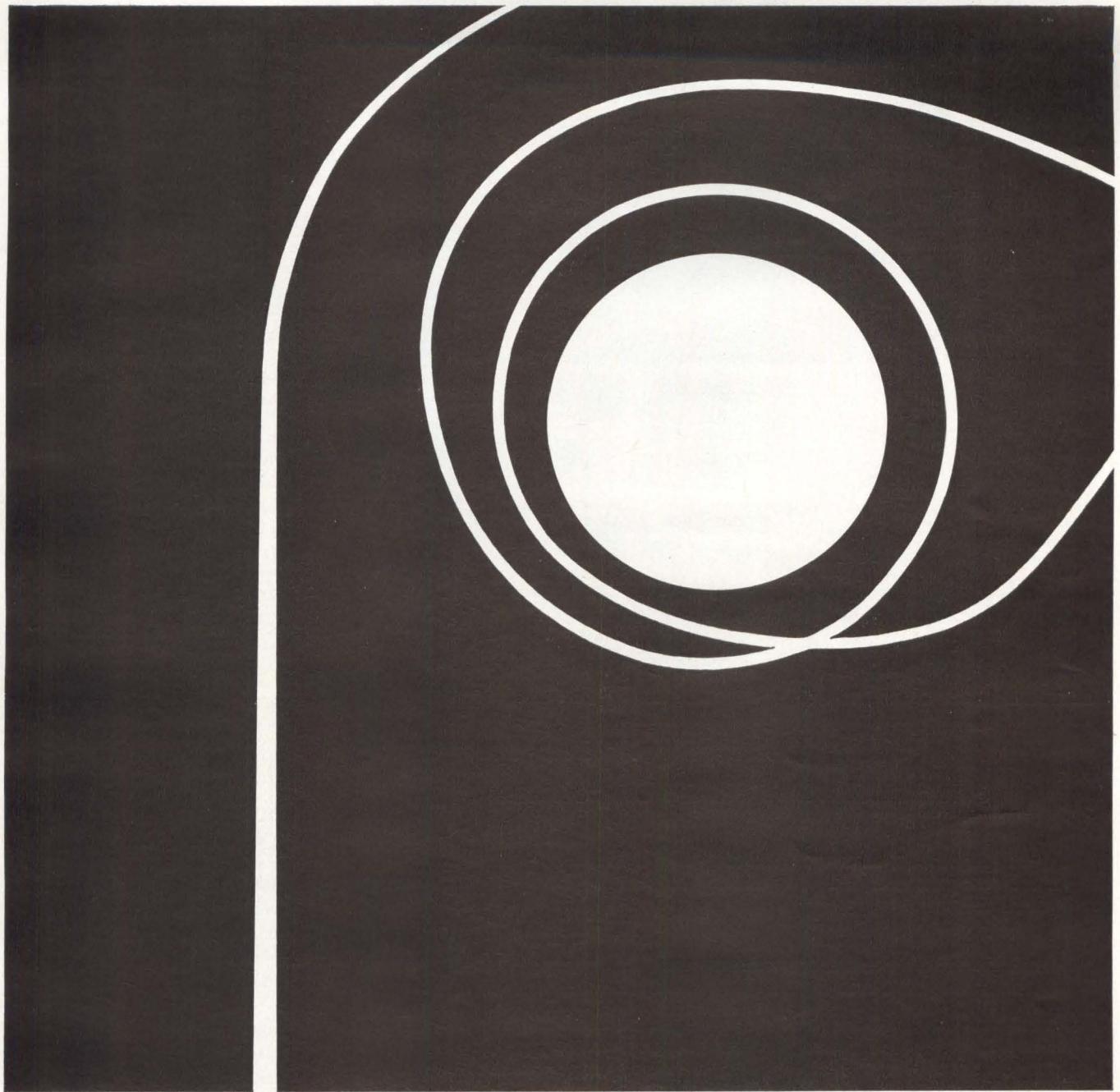

CHALLENGE FROM THE GROUND UP

At Philco Western Development Laboratories, specialists in communications sciences, space sciences and mathematical analysis begin each new space age program with analysis of mission requirements. Advance techniques in communications and control are applied to development of system demands, specifications for systems and sub-systems, and development specifications. These program-oriented efforts lead to development fabrication and test, and, finally, to installation, checkout and operation of equipment. Career opportunities for holders of B.S. or advanced degrees (electronics, mathematics, physics) offer start-to-finish challenge at Philco WDL, whose achievements include work on some of the Nation's most important satellite programs.

Write in confidence for information on how you can find your career at Philco WDL, with the additional rewards of ideal living on the San Francisco Peninsula and professional and monetary advancement commensurate with your own ability. Requirements include U. S. Citizenship or current transferable Department of Defense clearance. Address Mr. Patrick Manning, Department E-3.

PHILCO
A SUBSIDIARY OF
Ford Motor Company

WDL DIVISION • 3875 Fabian Way, Palo Alto, California
an equal opportunity employer

7759



Who moved "Friendship 7" into the Smithsonian? Bekins, of course!

When it comes to moving electronic equipment—even the most complex and delicate—Bekins engineers take up where yours left off.

A case in point is this recent move in Washington, D. C. during which Bekins electronics specialists transported John Glenn's famous space capsule into the Smithsonian Institute.

How was it done? With a combination of first-class equipment and first-class brains. At Bekins, we're justifiably proud of our vans. We're prouder still of our *men* because we believe it's men who make the big difference.

That's why we carefully train our people in the Bekins School of Certified Service. When they graduate, they're experts in every sense of the word. When they put their training to work, they're as exacting as your own engineers.

Think about it! Doesn't the *moving* of your delicate equipment deserve this kind of brainpower?

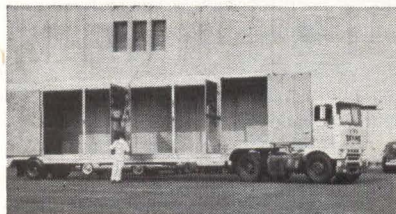

BEKINS WORLD-WIDE MOVING & STORAGE
Bekins offices and agents in all principal cities

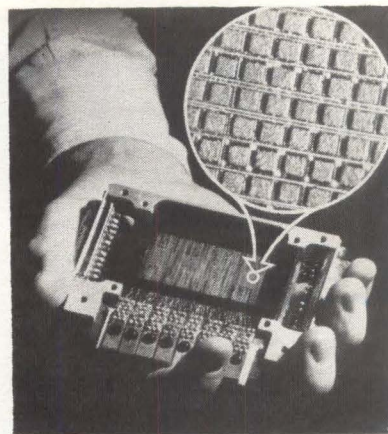

EXPERIMENTAL memory has storage density of 1,100 bits per sq inch. Bits handle information in fraction of a microsecond

nanoseconds.

The highly polished ferrite base plate used in this design is slotted to form a grid of 5-mil slots, each 10 mils deep, and spaced 15 mils apart. This matrix has a storage density of 1,100 bits per sq inch. The 5-mil slot width, combined with an overlay material that has a high switching threshold gives fast switching with modest currents.

Devices Featured At Paris Show

PARIS—In addition to new millimeter components featured at the International Electronics Show last month (see *ELECTRONICS*, Feb 22, p 24), the following devices held interest of designers:

- Brion-Leroux's "no contact" relay. Unit employs transistor oscillator circuit instead of movable contact. Galvanometer movement drives a metal blade that controls the oscillator. Output of oscillator unblocks a transistor that switches the 6-v supply onto output contacts.

- SESCO's electronic system for two-cycle motor. This is now standard equipment of mass-produced French motorbike. Three-diode circuit switches magneto output onto the spark coil. Control pulses develop in a coil excited by a magnet on the flywheel.

- Saft's Voltablock cadmium-nickel batteries. They use rolled elements, to boost ampere-hour capacity for same package size. Elements are similar in construction

to paper capacitors.

• Orega's high-voltage transformer. Unit plugs in like tube, has base that solders onto printed circuit board.

• Alkan & Sinay's program switch. Unusual drive gets snap action for contacts. Endless worm drives gear is attached to switch cam shaft. Shaft has same pitch as worm. When follower hits sharp drop on plate, cam shaft advances one notch. Motor turns continuously.

• Laboratoire Central de Telecommunications' experimental laser. Device handles ruby rods varying in length up to 250 mm.

• Short helium-neon laser developed by Philips.

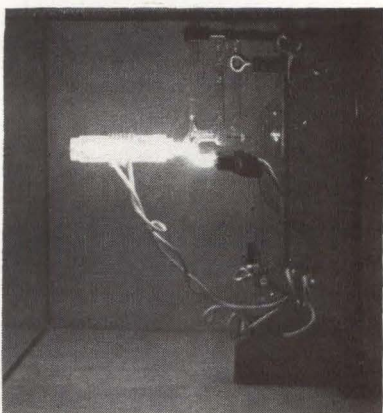

HELIUM-neon laser is only 12 cm long was developed by Philips

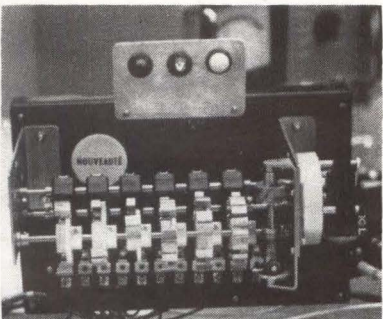

PROGRAM switch uses unusual drive developed by Alkan & Sinay

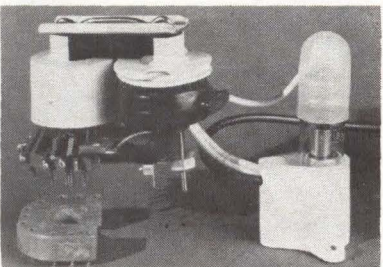

HIGH-VOLTAGE transformer is unit that plugs in board (Orega)

EXPLORE

the bright, new, oscillating,
multivibrating, logical,
computer-applicable world of

GLOW LAMPS

New technical
manual, over 100
pages, fully
illustrated, tells all
for just \$1.00



Answers to questions involving: **Physics and Characteristics of Glow Lamps.** Theory of gaseous conduction in the glow lamp. Response time. Equivalent circuits and general formulas.

Relaxation Oscillators. Basic sawtooth oscillator operation and design parameters. Operating characteristics and environmental factors. Multivibrator operation.

Applications for oscillators—time delay relays, alarm circuits, temperature and light indicators, electronic organs and variable frequency and pulse width generators.

Logic and Computer Applications. The binary number system and logic operations. Glow lamps in logic circuits. Computer and counting circuits. Memory circuits. **General Glow Lamp Applications.** Voltage regulators and level detectors. Coupling networks. The glow lamp and photo-conductive devices. Lamp test methods and circuits. Complete glow lamp specifications. General Electric Company, Miniature Lamp Department.

Progress Is Our Most Important Product

GENERAL ELECTRIC

GLOW LAMP MANUAL • General Electric Company, Dept. 17
P. O. Box 5601 • Cleveland 1, Ohio
Please send it. I've enclosed \$1.00.

(PLEASE PRINT)

Name _____

Company _____

Address _____

City _____ Zone _____ State _____

CLOSE-UP shows transfer of rare earth-type ceramic substrates containing resistor element to wire-wrap operation previous to silicone coating

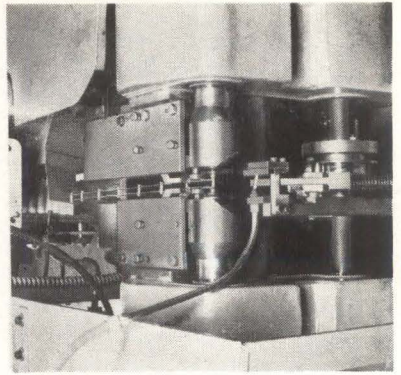

Radial-Lead Film Resistor Automatically Produced

Low-cost process imparts extremely low noise level, eliminates lead forming

NEW CONCEPT in fixed-resistor manufacturing has resulted in the availability of a radial-lead precision film resistor: metal film resistor element is deposited on a rare-earth type ceramic rod and then spiral-ground with newly-developed grinding wheels. This is followed by silicone coating, heat curing and epoxy encapsulation of resistor element and ceramic substrate. The new 5-percent tolerance units are manufactured automatically by Wilrite Products. Ceramic rod material and grinding wheels were developed by Centralab.

ADVANTAGES—The automated technique, says Wilrite General Manager William Garstang, produces a unit with four basic advantages: an extremely low noise level, a cost lower than equivalent tolerance carbon composition fixed resistors, an elimination of lead forming with resulting reduction of chassis space requirement. Primary applications, he says, are expected to be in computers, precision test equipment, high-fidelity amplifiers, instrumentation field. Current production will be limited to $\frac{1}{2}$ watt resistors ranging from 50 ohm to 1.0 megohm.

Double wire-wrap leads soldered to silvered ends of the resistor provided an essentially noise-free lead termination. Radial leads are on standard EIA 0.3-inch centers.

PROCESS EQUIPMENT — The specialized process equipment en-

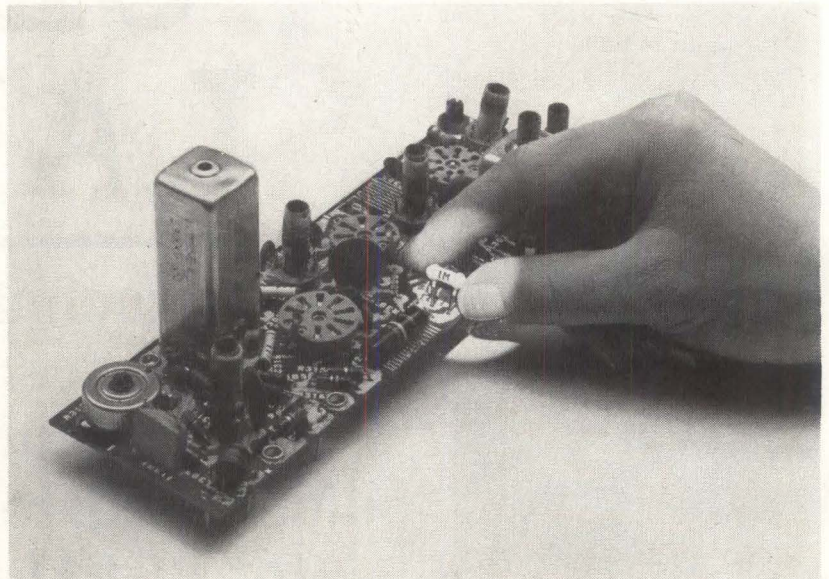

ASSEMBLY of radial-lead resistor into printed circuit boards is accomplished with a saving in chassis space

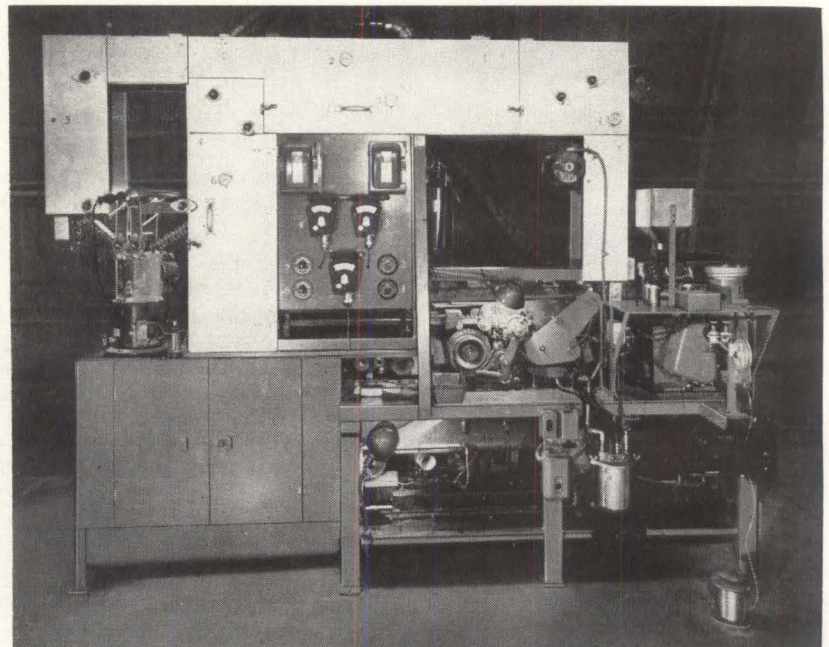

CONTINUOUS automated process for making radial lead resistors uses specialized equipment. Developed by Wilrite Products, it is modeled after equipment used by Centralab for making radial lead ceramic capacitors

- Klystrons
- Pencil Triodes
- "Lighthouses"
- "Rockets"

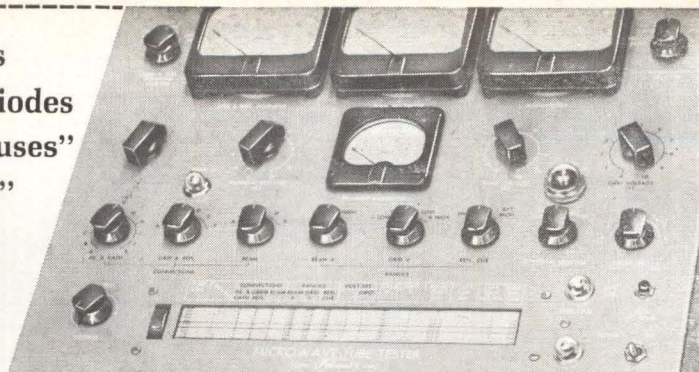

**TEST ALL MICROWAVE TUBE TYPES
...JUST PLUG IN, SET LEVELS, AND READ!**

As simply as a conventional tube checker, the Polarad Microwave Tube Tester checks internal-cavity and external-cavity klystrons, pencil triodes, rocket and lighthouse tubes for static operating levels, shorts, and filament continuity — just consult the chart, set the controls, and read! Provides and monitors cathode, anode, reflector, grid voltages and currents. Functions as universal klystron supply. Obsolescence-proof design . . .

MODEL K-200.

Call your POLARAD Field Engineer
for a prompt, free demonstration!

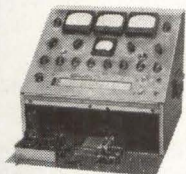

POLARAD POLARAD
ELECTRONIC INSTRUMENTS
A Division of Polarad Electronics Corporation
World Leader in Microwave Instrumentation
34-02L Queens Blvd., Long Island City 1, New York

IEEE Show Booths No. 3205-3211
CIRCLE 201 ON READER SERVICE CARD



**The perfect companion
for
professional recording**

Foster's dynamic DF-1 is an omnidirectional bar-type microphone for both professional and home use. This versatile mike weighs only 1/4 lb. including cord, and is just 3 1/4" long and 7/8" in diameter. Yet it has a range of 100 to 12,000 c.p.s. and sensitivity of -58dB (50 K Ω) \pm 3dB at 1,000 c/s (OdB=1V/ μ bar). Your choice of 600 ohm, 10,000 ohm, or 50,000 ohm impedances.

Rugged and precision made, the DF-1 assures professional results right in your living room. Used with hi-fi, stereo, or tape recorder it faithfully recreates a broad band of audio frequencies — and takes up less space doing it. The DF-1 can be hand held, suspended from its neck cord, or clipped to your lapel. A strong diecast frame gives it complete protection for long trouble-free service.

You can get this outstanding all-new microphone now at popular prices. For further information write directly to the address below.

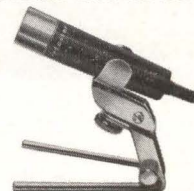

FOSTER ELECTRIC CO., LTD.

384 Shimo-Renjaku, Mitaka, Tokyo, Japan
CABLE: FOSTERELECTRIC MUSASHINOMITAKA

**Gold Wire
for Nail Head and
Thermo-Compression
Bonding**

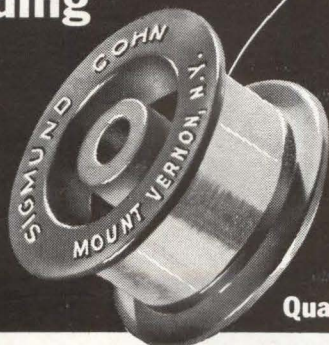

Quality with Economy

Readily available in unlimited quantities
Diameters: .0003" to .005"
Dimensionally uniform
Clean . . . Custom-spoiled

SIGMUND COHN CORP.
121 South Columbus Ave.
Mount Vernon, N.Y.



Visit Booths
4322-4324
IEEE Show

SIGMUND COHN CORP. OF CALIFORNIA • 151C NORTH MAPLE STREET, BURBANK, CALIFORNIA

CIRCLE 202 ON READER SERVICE CARD

NEW!

HIGH CAPACITY!

TWO-STAGE WELCH "DUO-SEAL" VACUUM PUMP No. 1398

50 CFM (1400 LITERS/MINUTE)

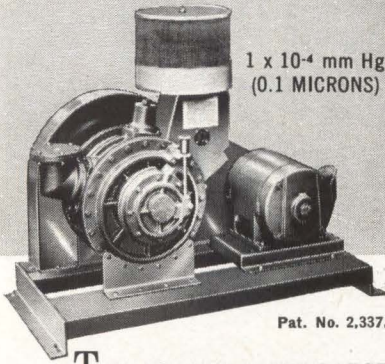

1 x 10⁻⁴ mm Hg
(0.1 MICRONS)

Pat. No. 2,337,849

THE YOUNGEST, BUT LARGEST MEMBER of the Welch family of "Duo-Seal" oil sealed rotary vacuum pumps makes its appearance as the No. 1398. This new pump offers very high capacity and excellent ultimate vacuum characteristics with no sacrifice of long life, low maintenance, freedom from vibration and minimum noise level. These features have long made Welch "Duo-Seal" pumps the most widely used of all rotary vacuum pumps. 1398's, like all Welch "Duo-Seal" Pumps, are thoroughly run-in at the factory and tested until they exceed their vacuum guarantee.

The new 1398 is highly recommended for all industrial and laboratory applications requiring high pumping capacities and low pressures. Typical uses are electron tube evacuation, vacuum distillation, dehydration, reduction, sublimation, metalizing, metal processing, leak detection, hermetic sealing and back-filling, impregnation and general scientific studies.

IMPORTANT FEATURES:

- High pumping speed — 50 CFM (1400 liters/minute)
- Low ultimate pressure — 1 x 10⁻⁴ mm Hg (McLeod)
- Quiet, vibration-free operation
- Compact, rugged design
- Air-cooled
- Vented Exhaust Valve
- Flanged, O-Ring-Sealed Intake Port
- Totally Enclosed Belt Guard
- Air Intake Screen
- Exhaust Filter
- Trouble-free, low maintenance

WELCH "DUO-SEAL" PUMPS ARE CARRIED IN STOCK BY AUTHORIZED DEALERS.

Welch Duo-Seal Vacuum Pumps are manufactured in wide variety of capacities and ultimate vacuum characteristics. They range in capacities from 21 to 1400 liters/minute and ultimates from 2 x 10⁻² mm Hg down to 1 x 10⁻⁴ mm Hg.

WRITE FOR DUO-SEAL CATALOG and BULLETIN 1398 for full description and prices.

SINCE 1880 THE WELCH SCIENTIFIC CO.
foremost manufacturers of scientific equipment
1507 N. SEDGWICK ST. • CHICAGO 10, ILL.

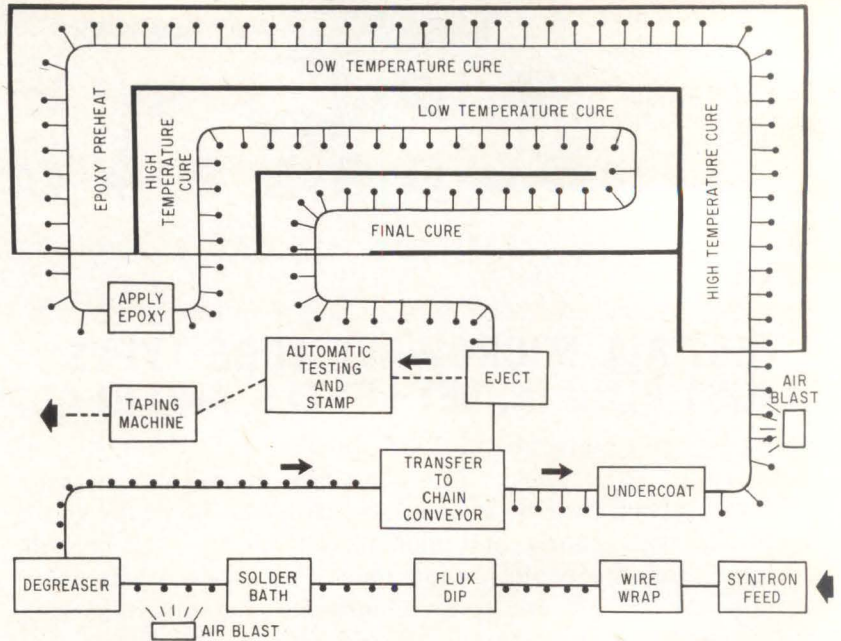

FLOW DIAGRAM illustrates how automatic equipment is used at various stages of process: wire-wrap, soldering, coating, encapsulation, testing, imprinting, taping

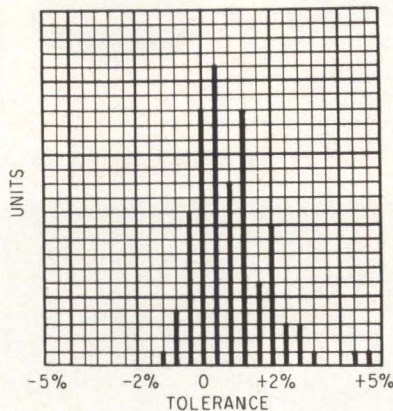

TOLERANCE DISTRIBUTION of production units shows that 84 percent were within ± 2-percent tolerance and 58 percent were within ± 1 percent

ables practical-cost construction of resistors. Centralab assisted in equipment development and has used similar equipment for many years in manufacturing radial-lead capacitors. Both companies are divisions of Globe-Union. Modification of basic Centralab equipment involved design of a special chain conveyor and controls for heat zones used in coating application and curing of protective coatings.

Conveyor's speed is approximately 10 feet per minute. When fully loaded, conveyor belt holds 900 resistors. Machine produces

one finished resistor per second. Initial temperature zone, immediately following deposition of silicone undercoat, is regulated to 350 degrees F (see flow diagram). Temperature of epoxy preheat section is set at 375 degrees F. Epoxy-cure oven is at 350 degrees F.

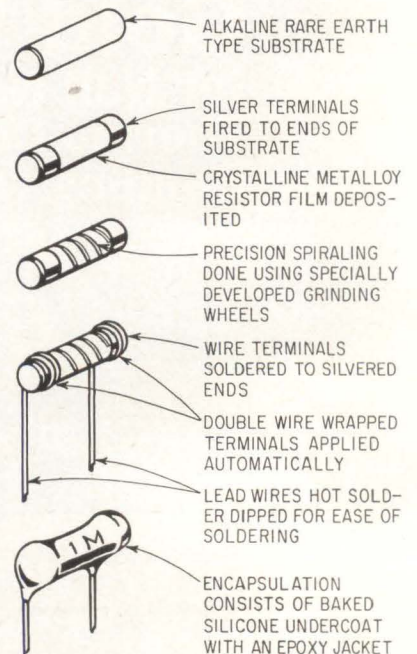

MANUFACTURING SEQUENCE includes solder application to double wire-wrapped leads facilitating later solder connections

4 electronics BUYERS' GUIDE and Reference Issue exclusives

1. Direct line of communications between buyer and seller.
2. Gives vital company statistics.
3. Contains electronics editorial Index.
4. Abstracts features from electronics editorial Index.

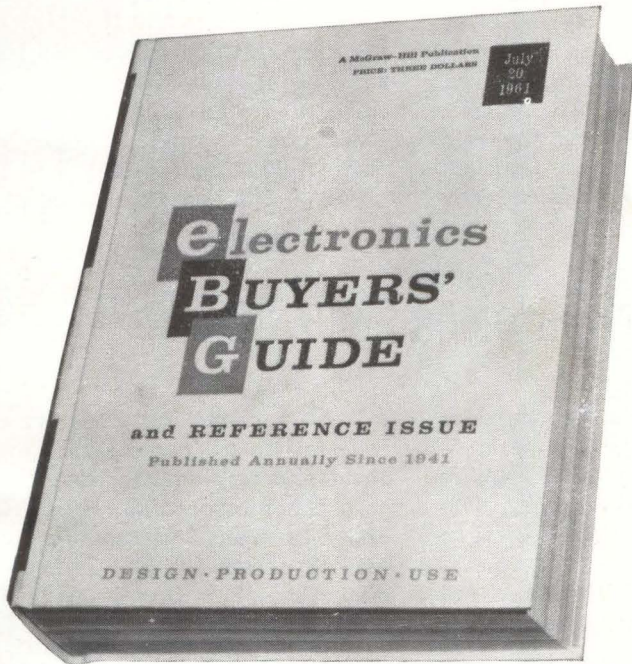

Whatever the product,
you'll find it properly listed
in the BUYERS' GUIDE

For Integrated
Communications
Systems

BUDELMAN

Microwave
and Carrier
Offers Greatest Value!*

- UHF and Multiplex Radio
- Systems Engineering

Write for free BEC Spec File Today!

BUDELMAN ELECTRONICS CORPORATION

A SUBSIDIARY OF
GENERAL RAILWAY SIGNAL CO.

375 Fairfield Ave.
Stamford, Conn.

* Because Budelman equipment performs better,
costs less to buy and maintain.

CIRCLE 203 ON READER SERVICE CARD

CYLINDRICAL OR FLAT

VK ultra precision components

TOLERANCES TO .000,005"
SURFACE FINISHES TO .5
FLATNESS TO .000,002"

Eliminate rejection problems! Special skills developed at VK over a period of nearly 50 years enable us to produce, *economically*, Precision Pivots (including carbide), Precision Valve Parts, Precision Pistons, Precision Spacers, Precision Pins and other components having *gage characteristics*.

Our special production techniques can be applied to your miniature parts . . . to assure utmost reliability. We can assist you in manufacture, finish-operations, or inspection.

Send us a print, a part, or specs. Better still, phone us, collect, at WA 6-1450 (Area Code 617).

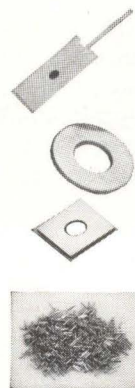

PRECISION PARTS DIVISION
THE VAN KEUREN CO.
171 Waltham Street
WATERTOWN 72, MASS.

CIRCLE 59 ON READER SERVICE CARD 59

Power Supply Uses Two Regulator Servos

Sharp switch from voltage to current regulation with independent regulators

ANNOUNCED by Electronic Measurements Co., Eatontown, New Jersey, the series PVC solid-state, d-c power supplies feature scr input control and all silicon series system. Output is constant-voltage/constant-current with sharp crossover. One model is rated for 0 to 36 v at 0 to 30 amperes and the

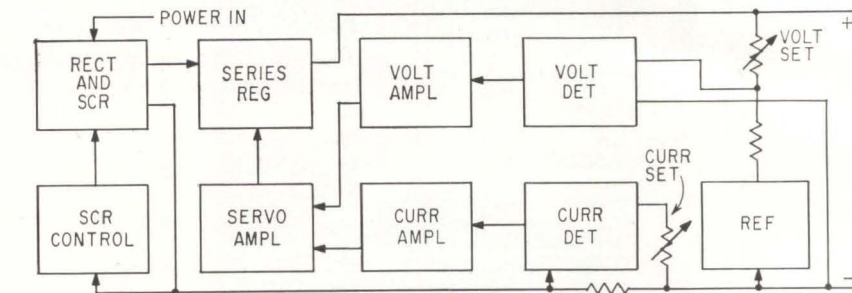
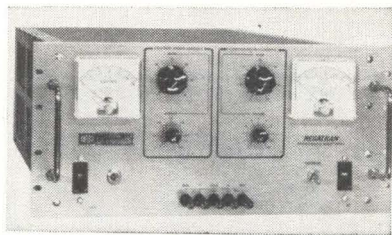

other at 0 to 60 v at 15 amperes. Constant-voltage regulation is 0.01 percent or 2 mv line or load and constant-current regulation is 0.05 percent or 8 ma line or load. Separate, independent servos eliminate dangers of loosely regulated voltage or current around the crossover point. The crossover point is set by the user. For example; with control settings of 18 v and 20 amperes, a load drawing less than 20 amperes sees a constant 18 v. If the load attempts to draw more than 20 amperes, the supply automatically

crosses over to constant current at 20 amperes. If the load resistance rises to the critical value, the supply reverts sharply to constant voltage at 18 v. Long-line remote sensing capability permits use of load leads with 3 v IR drop per lead. Thus, a load drawing 10 amperes can be used up to 300 ft away (using number 10 wire) and still have rated regulation. Other features include programmed remote control, conductance programming and master/slave operation.

CIRCLE 301 READER SERVICE CARD

Generating Waveforms From 0.008 cps to 1 Mc

MANUFACTURED by Wavetek, 8141 Engineer Road, San Diego 11, California, the model 101 function generator delivers square and triangular waveforms between 0.008 cps and 1 Mc with amplitude and frequency stability of 1-percent long term and 0.1-percent short term, and frequency response of 0.1 db to 100 Kc and 1 db to 1 Mc. Three

simultaneous outputs are available: triangular at 5-v peak-to-peak, 5-ohms output impedance; square wave at 10-v peak-to-peak, 600-ohms, rise and fall times less than 35 ns; and square waves at 1-v peak-to-peak, 50-ohms with rise and fall times less than 5 ns. Rise and fall times are independent of frequency and the waveshapes are symmetri-

cal about ground. Square-wave tilt is less than 0.5 percent with overshoot and ringing less than 1-percent for harmonics below 10 Mc, and less than 5-percent for harmonics above 10 Mc. Triangular distortion is less than 1-percent for harmonics less than 1 Mc. As shown in the sketch, a square wave, symmetrical about ground, is fed to the amplifier connected as an integrator. Frequency ranging is by various values for *R* and *C*. (302)

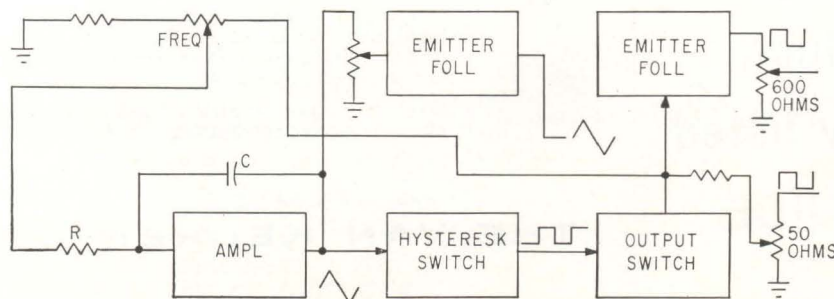

IR Detector Approaches Theoretical Noise Limit

NEW from Davers Corp., Horsham Valley Industrial Center, Horsham,

Up from alpha

α is the first letter of the Greek alphabet. In the Roman alphabet lower case α was replaced by **a**. Strictly speaking, α is not in the modern English alphabet and therefore is not on the standard typewriter. However, α is in the scientific alphabet and is a standard symbol for a number of important scientific quantities.

α is the standard symbol for:

- thermal diffusivity,
- coefficient of linear expansion,
- relative volatility,
- angular resolution of a telescope,
- specific rotation, and
- Sommerfeld constant.

If your writings involve α , or any other symbols, you have probably been inserting symbols by hand. Throw away your lettering pen, relax your palsied hand, and get **TYPIT**. Over 500 different symbols are available. **TYPIT** symbols are added to copy as it is typed in the typewriter.

Call your local office machine dealer or write to us for our catalog of symbols, or additional information.



mechanical enterprises, Inc.
3127 Colvin Street
Alexandria, Virginia

CIRCLE 204 ON READER SERVICE CARD

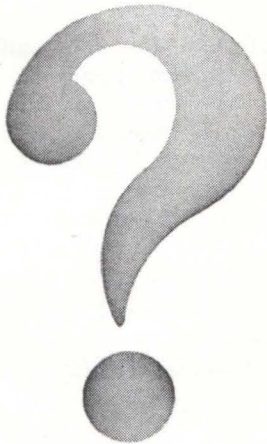

Are you selling the whole buying team

Tough competition demands that the electronics man be reached and sold wherever you find him: *Research, Design, Production, and Management*. Only advertising in **electronics** reaches all four... the same men your salesmen call on. Put your advertising where it works *hardest*....

in **electronics**

Magneline[®]
THE INDICATOR WITH INHERENT MEMORY

Two new series for digital readout, ideal for multiplex applications

SERIES 14000—FOR SOLID STATE LOGIC

Character Size..... $\frac{9}{32}$ " x $\frac{1}{4}$ "
No. of Characters.....Up to 11
Leads.....11 plus a common
Watts.....2.4

SERIES 15000—FOR RELAY LOGIC

Character Size..... $\frac{5}{16}$ " x $\frac{1}{4}$ "
No. of Characters.....Up to 10
Leads.....5 plus a common*
Watts.....1.3-1.7

*Requires switching of lead in combination with reversal of polarity to change indicator.

Units hold last reading without power. Totally enclosed, self-stacking housing for front or rear mounting. Jewel bearings, only one moving part. Standard voltages 6, 12, 24, or 28 V.D.C. Readability 12 feet at normal room lighting. Options include special voltage, special characters, and internal lighting for dark room applications.

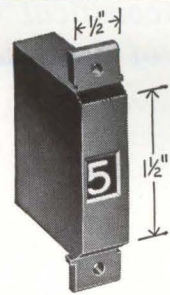

External appearance of 14000 or 15000 series

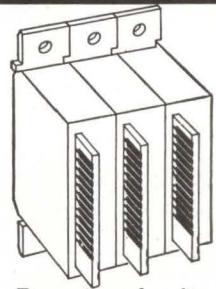

Rear view of units showing stacking and plug-in connectors

Write or teletype
(203-753-9341)
for free literature

PATWIN **ELECTRONICS**

A DIVISION OF THE PATENT BUTTON COMPANY
WATERBURY 20, CONNECTICUT
CIRCLE 205 ON READER SERVICE CARD

0.000,000,001 WATT DC RELAY

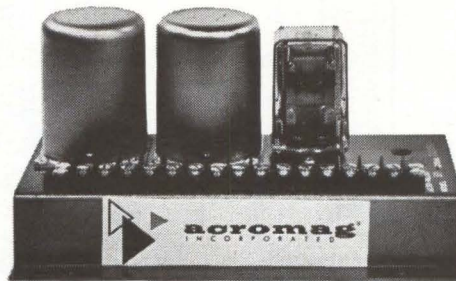

Model 301 Acro-Relay

Any DC signal of 1 microampere, 1 millivolt operates the DPDT output relay. Controls up to 1800 watts directly. Uses ultra-reliable magnetic amplifier and transistors. Ideal for temperature, vacuum and nuclear systems, liquid level, photocells, current and voltage monitors. Immediate delivery. List price: \$98.75.

OPERATES
ON DC INPUT
OF ONLY
ONE Microampere
or
ONE Millivolt!

Request Technical Bulletin No. 30

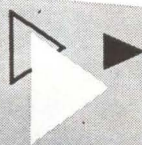

acromag[®]
INCORPORATED

15360 TELEGRAPH RD.

DETROIT 39, MICH.

Phone: 538-4242, Area Code 313

TELETYPE:
313-
538-4536

Acoustical Components of Superior Quality

JAPAN PIEZO supplies 80% of Japan's crystal product requirements.

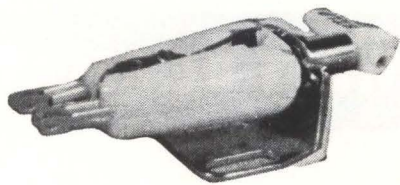
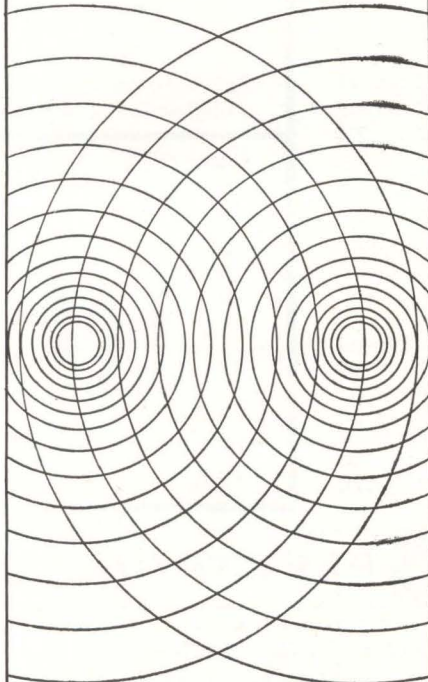

STEREO CARTRIDGE Crystal — "PIEZO" Y-130 X'TAL STEREO CARTRIDGE

At 20°C, response: 50 to 10,000 c/s with a separation of 16.5 db. 0.6 V output at 50 mm/sec. Tracking force: 6 ± 1 gm. Compliance: 1.5×10^{-6} cm/dyne. Termination: $1M\Omega + 150$ pF.

Write for detailed catalog on our complete line of acoustical products including pickups, microphones, record players, phonograph motors and many associated products.



JAPAN PIEZO ELECTRIC CO., LTD.

Kami-renjaku, Mitaka, Tokyo, Japan

Pennsylvania, the series A-10 infrared detectors have sensitivity approaching the theoretical photon noise limit with response from the visible to $5\frac{1}{2}$ microns. The liquid nitrogen cooled, photovoltaic indium antimonide detector is available as single or multiple elements

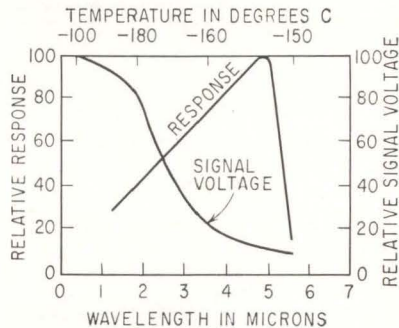

with D^* at 5 microns up to 1×10^{11} cm per watt. Element sizes are from 0.1 to 8 mm in one dimension with a wide variety of shapes available. Signal output remains linear with the ir radiation intensity incident on the detector from the lower limits of detectability to flux densities in excess of 10 mw per square centimeter.

CIRCLE 303 READER SERVICE CARD

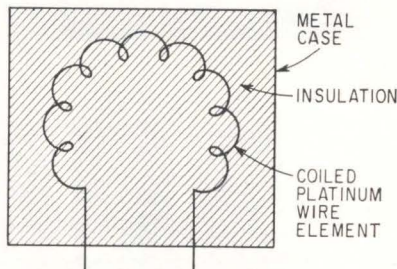

Temperature Sensing From -435 to +1,800 F

RECENTLY announced by Rosemount Engineering Co., 4900 West 78th St., Minneapolis 24, Minnesota, are a series of platinum resistance sensors covering the range between -435 and +1,800 F. Smallest sensor is 0.025-in. thick with a 0.2-in diameter. Largest is 1.5-in. long. Mounting is by cementing, spot welding or clamping. Repeatability after 10 consecutive shocks from -320 to +300 F is within ± 0.1 degree F. The sensors are high-purity platinum wire, fully annealed and mounted with the resistance wire isolated from strain. (304)

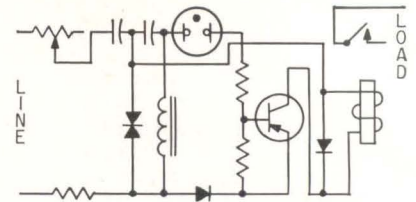

Tone-Operated Relay For Remote Applications

ON THE MARKET from United States Instrument Corp., Charlottesville, Virginia, the transistorized, tuned, high-impedance multi-frequency signalling relay responds to all established levels of decimonic, harmonic and synchronomic frequency ranges up to 66.6 cps. Bandwidth is 4 cps at ringing frequencies and is unresponsive to side frequencies or transient voltages. The relay permits signalling devices such as loud-ringing bells, horns or chimes to be placed on overburdened subscriber lines without excessive power requirements. (305)

Plastic EL Panel Can be Machined

RELEASED by the Sierracin Corp., 2202 S. Wright St., Santa Ana, California, the Sierraglo electro-luminescence panel operates in any two-wire circuit providing 115 v with a special type for operation at 250 v. The plastic panels are available in three colors (green, aviation red and white) with panel sizes up to 30 by 42 inches, finished thickness of 0.170 to 0.220 inch and weight up to 0.141 ounce per square inch (1.27 lb per square foot). Flatness is within 0.002-in. per

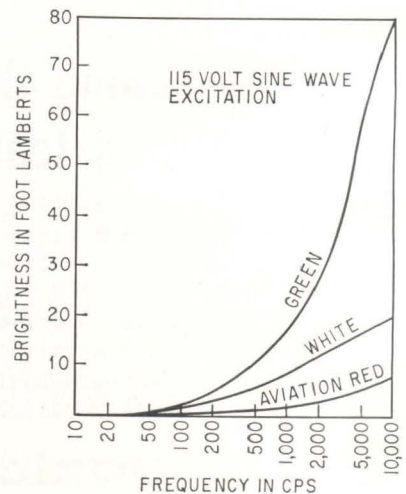

linear inch along all edges. Threshold voltage for light emission is 20 v and uniformity is less than 10 percent variation from brightest to darkest spot on unmarked panel, and less than 20 percent on a marked panel. Breakdown voltage is 350 v, current drain is 1.7 ma per square inch, phase angle is up to 70 degrees and capacitance is 2,500 pF per square inch. The panels can be machined, drilled, sawed or routed. Surface markings can be applied by photo etching, silk screen, vinyl engraving, deep engraving or other methods. The graph (p 62) shows brightness as function of 115-v, variable-frequency excitation. (306)

Fixed Air Lines With Low VSWR

ASTROLAB INC., 120 Morris Ave., Springfield, N. J., announces air-dielectric 50 ohm coaxial lines used as extensions where rigid spacing between components in a microwave system or test set are required. Available in 4 in., 6 in., 12 in. overall lengths. Frequency is d-c to 10 Gc; vswr, 1.2; insertion loss, 0.2 db; impedance, 50 ohms. (307)

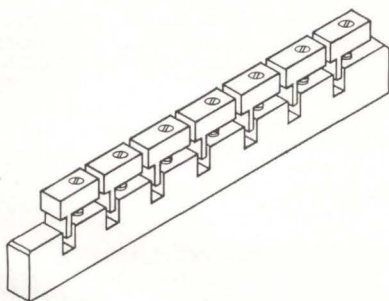

Wire Connectors In Any Size

LOUDIN ELECTRICAL CO., 5 Willowbrook Place, Stamford, Conn., has available wire connectors in any size from strand to solid; all include the new Loudin Spring Screw. They may be had in single connections or any number multiple connections. Overall size of the connector depends upon its use. Company research staff is available to assist in a specific job, and connectors can be made, tested and proven to a specific need before order is placed. Price lists upon request. (308)

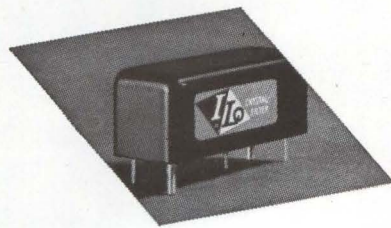

An important announcement



During the past year and a half, Midland Manufacturing Company has developed a radically new design concept which obsoletes substantially all conventional image parameter crystal filters.

Strong words, but true nevertheless.

These new filters are designed by so-called insertion loss methods, and bear the Midland trademark ILo.

ILo crystal filters, at most narrow fractional bandwidths, have nominal insertion losses of 0.5 db, compared with 3 or 4 db losses in image parameter filters. ILo filter techniques permit exact prediction of the 0-6 db passband characteristics, and extremely close approximations of square corner Chebbychev, or round nose Butterworth functions. ILo crystal filters have near perfect symmetry about center frequency.

More. ILo filter design permits tight control over amplitude and phase characteristics. High selectivity begins at the bottom of the passband. Shape factors of 1.5:1 measured from 60 to 1/2 db, and ultimate attenuations of 100 db, are realizable. Improved control of spurs is a by-product of the design.

Any center frequency, and almost any fractional bandwidth, suitable for conventional crystal filters, are also suitable for an ILo filter. And prices are comparable, too.

Experimental? Not any more. Midland has built, tested, and delivered more than 35,000 ILo crystal filters before making this announcement — your guarantee of reproducibility.

Write the world's largest producer of crystals and crystal filters.

MIDLAND MANUFACTURING COMPANY

3155 FIBERGLAS ROAD

KANSAS CITY 15, KANSAS

An electronics division

of Pacific Industries, Inc.



MOISTURE RESISTANCE TEST
per MIL-R-10509D Characteristics C and E

TEMPERATURE CYCLING TEST
per MIL-R-10509D Characteristics C and E

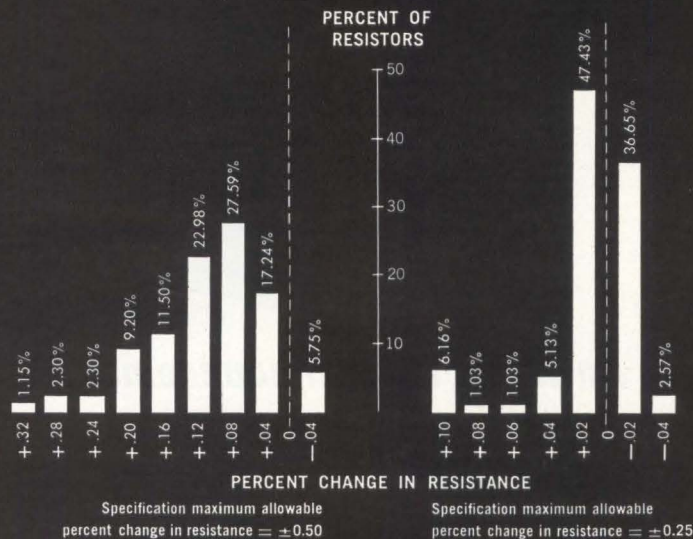

METOHM—charts new plateaus in metal film resistor performance

Ward Leonard reports unmatched test results

Top reliability in metal film precision resistors—highest known today—is proved in Ward Leonard's new Bulletin 50A. Ward Leonard tested over 700 resistors over a 12 month period to document these results.

Example: take two critical tests (of the 22 run)—moisture resistance and temperature cycling.

Here's the MIL Spec and the Ward Leonard Result—

Test	MIL-R-10509D Maximum Deviation	METOHM Performance
Moisture Resistance	±0.5%	-0.04 to +0.32
Temperature Cycling	±0.25%	-0.04 to +0.10

Other rigorous tests such as vibration, load life and shock show equally impressive results. In addition, each METOHM® resistor logs 7 inspections, 8 quality-control checks, and 7 tests prescribed by MIL-R-10509D and MIL-STD 202B specifications.

Write for Bulletin 50A and ask for samples—available in these ratings: RN55-1/10 W; RN60-1/8 W; RN65-1/4 W; RN70-1/2 W.

For Stock Orders call your nearest Authorized Industrial Distributor. Ward Leonard Electric Co., Metal Film Division, 30 South Street, Mount Vernon, N. Y.

2.29



METAL FILM DIVISION
WARD LEONARD
ELECTRIC CO. MOUNT VERNON NEW YORK
RESISTORS • RHEOSTATS • RELAYS • CONTROLS • DIMMERS

Literature of the Week

ANALOG-DIGITAL CONVERTER Texas Instruments Inc., 3609 Buffalo Speedway, Houston 6, Texas, has published a one-page bulletin describing model 834 analog-digital converter. **CIRCLE 309 READER SERVICE CARD**

FORMAT CONTROL UNIT Westinghouse Electronics Division, Box 1897, Baltimore 3, Md. Four-page booklet describes a unit designed for data transfer between a magnetic tape unit and a computer. **(310)**

STRIP CHART RECORDERS Massa Division of Cohu Electronics, Inc., 280 Lincoln St., Hingham, Mass., offers a booklet entitled "Pitfalls to Avoid When Purchasing Strip Chart Recorders." **(311)**

TUBE SOCKETS Connector Corp., 6025 N. Keystone Ave., Chicago 46, Ill. Data sheet 21A covers a line of industrial, commercial and military tube sockets for either Novar or Magnavol tubes. **(312)**

PLUG-IN CHOPPER Solid State Electronics Co., 15321 Rayen St., Sepulveda, Calif. Catalog sheet describes model 75 silicon transistor high temperature plug-in chopper. **(313)**

PHOTOGRAPHIC DATA HANDLING Photo-mechanisms Inc., 15 Stepar Place, Huntington Station, L. I., N. Y. A 4-page illustrated brochure describes the company's facilities in the field of photographic data handling. **(314)**

MINIATURE SOLENOIDS Anderson Controls, Inc., 9959 Pacific Ave., Franklin Park, Ill., offers a specification sheet showing a line of miniature solenoids. **(315)**

CHOPPER TRANSFORMERS Microtran Co., Inc., 145 E. Mineola Ave., Valley Stream, N. Y., offers a technical bulletin on low level chopper input transformers. **(316)**

SILICON LOGIC CIRCUIT MODULES Scientific Data Systems, 1649 Seventeenth St., Santa Monica, Calif. A 20-page catalog details a line of all-silicon semiconductor digital logic modules. **(317)**

FIXED PATCHBOARD Virginia Electronics Co., Inc., River Road & B. & O. Railroad, Washington 16, D. C. Bulletin illustrates and describes a compact programming system which is designed to fit on a 19-in. rack panel. **(318)**

MINIATURE RESISTORS Corning Electronic Components, Raleigh, N. C., has published specifications on 1/4-watt miniature precision metal oxide film resistors. **(319)**

FORCED AIR COOLING The Henry G. Dietz Co., Inc., 12-16 Astoria Blvd., L. I. C. 2, N. Y. Pocket size handbook is intended for the electronic engineer who must design a forced air cooling system for electronic

equipment. It may be obtained by request on company letterhead.

DEPOLYMERIZED RUBBER D.P.R., Inc., 571 Cortlandt St., Belleville 9, N. J., announces an eight page technical bulletin on depolymerized rubber and its uses. (320)

LOGIC MODULES Engineering Electronics Co., 1441 E. Chestnut Ave., Santa Ana, Calif., has published data sheets on nine new silicon transistor NOR logic modules. (321)

EVENT MARKING GALVANOMETER Consolidated Electrodynamics Corp., 360 Sierra Madre Villa, Pasadena, Calif. Bulletin describes capabilities of an event marking galvanometer which will permit light-beam oscillographs to double as event recorders. (322)

FOIL TANTALUM CAPACITORS General Electric Co., 392 S. Stratford Rd., Winston-Salem, N. C. GET-2979 is a 12-page brochure on a line of rectangular-shaped KSR Tantalum capacitors. (323)

RECTIFIER INTERCHANGEABILITY Power Components, Inc., P. O. Box 421, Scottsdale, Pa., has available an interchangeability listing covering its three E series "Powercomp" rectifier lines. (324)

RING CORES Westinghouse Specialty Transformer Division, Greenville, Pa. High-efficiency Cubex ring cores for use in transformers and reactors are described in technical data 44-561. (325)

PRECISION STAMPINGS Zero Mfg. Co., 1121 Chestnut St., Burbank, Calif. Catalog M62 describes precision stampings and impact extrusions for electronics, aerospace and general applications. (326)

WIRE TERMINALS The Thomas & Betts Co., 36 Butler Street, Elizabeth, N. J. Wall chart illustrates solderless Sta-Kon wire terminals, nylon-insulated and non-insulated. (327)

HANDLING RADIOISOTOPES Picker X-Ray Corp., White Plains, N. Y., has published a brochure setting guidelines for eliminating radiation risks in industry. (328)

MEMORY CORE TEST SYSTEM Computer Instrumentation Corp., Route 38 & Longwood Ave., Cherry Hill, N. J. Technical bulletin describes the model 2045A automatic memory core tester. (329)

ARC SUPPRESSORS Presin Co., Inc., 226 Cherry St., Bridgeport 5, Conn., has available a bulletin on RC network units for contact protection and noise suppression. (330)

EPOXY CURING AGENT Harchem Division, Wallace & Tiernan Inc., 25 Main St., Belleville 9, N. J. Harchem A, a flexibilizer and curing agent for epoxy resins, is the subject of a new bulletin. (331)

NYLON PLASTIC RESINS Adam Spence Corp., U. S. Route 22 at Madison Ave., Union, N. J., has available a 2-page brochure on qualities and uses of nylon plastic resins. (332)

ELDORADO 780 SERIES

10ns TIME MEASUREMENT- 100mc PULSE COUNTING



MODEL 783G

SOLID-STATE and IN-LINE READOUT for less than \$3100

Reliable, second generation instruments, Eldorado 780 Series 10ns/100mc Counters offer START/STOP channels relatively insensitive to rise time; in-line readout (3 to 9 decades) with high readability, polarized screen. Incorporates ultra-precise, "Twisted Ring" binary principle—original with Eldorado. Operates from internal (optional) or external 1mc reference.

- **MODEL 781A 100mc GATED PULSE COUNTER**
Pulses 0 to 100mc, sine waves 100mc \pm 10mc
Base Price, 3 Decades.....\$2850
- **MODEL 783G 10ns TIME INTERVAL COUNTER**
100mc pulses from internal or external 1mc standard
Base Price, 3 Decades.....\$2755
- **MODEL 786B 10ns TIME INTERVAL/100mc PULSE COUNTER**
Dual purpose—combines Model 781A & 783G functions
Base Price, 3 Decades.....\$3030

Eldorado 780 Series • research capability for everyday usage!

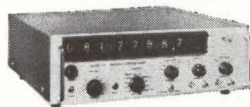

710 SERIES 10mc COUNTER/ 0.1 µsec TIMER

Measure frequency, ratio f1/f2, period, time interval. Exclusive MU Window, Auxiliary Function Lights. In-line readout, digital time base, start sync. From \$1350

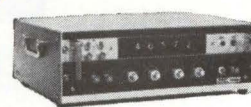

720 SERIES 220 Kc range

In-line readout all models. Individual frequency, frequency period, time interval, preset and Universal Counter-Timer models. Priced from \$625.00.

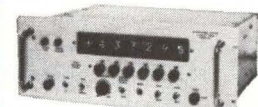

SOLID-STATE INDUSTRIAL COUNTERS

Bi-directional, preset, and in combination. Optional in-line readout. Rugged industrial case.

Prices F.O.B. factory.

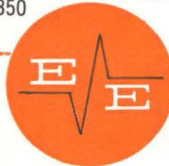

Prices and technical data subject to change without notice.

Counters you can count on!

ELDORADO ELECTRONICS • 1832 Second Street • Berkeley 10, California, U.S.A.

ITT Plans to Open \$3.5-Million Plant

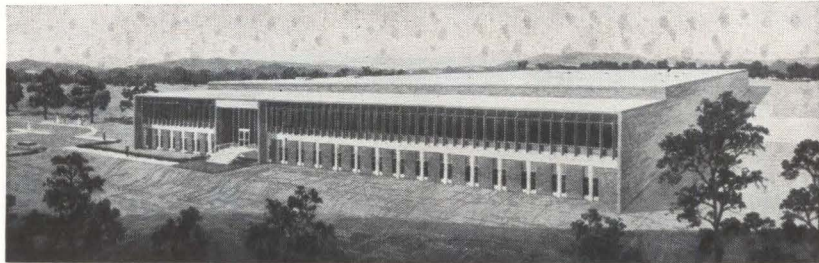

INTERNATIONAL Telephone and Telegraph Corporation has announced plans to open a \$3.5-million manufacturing and research plant, a unit of its Electron Tube division, in the Easton, Pa., area.

Announcement of the project was made by John J. Graham, ITT's area general manager — North America, who said that the new 115,000-square-foot structure eventually will employ 500 to 550 persons.

Ground breaking is expected in late spring and by the end of 1963 about 250 persons are expected to be at work in the plant. The number will rise to approximately 450 by the end of 1964.

Financing was a joint venture with the Easton Area Industrial Promotion Corporation, the Chamber of Commerce, the Pennsylvania Industrial Development Authority and local banks and interests. ITT will lease the building from the Easton Area organization.

The new building, to be located on a 24-acre plot of ground, will be basically a one-story structure with glass and brick front and three sides of masonry and cinder block. A two-story front section will house offices and laboratories. By the end of 1964 the plant is expected to have a payroll of \$1.3 million per year.

Options have been taken on an adjoining plot of 27 acres for future expansion.

ITT has 149,000 employees in 49 countries in its 142 factories, laboratories and service units, and 11 telephone and telegraph operating companies.

Simultaneously, ITT will gain valuable technical skills from the engineering and electronic capability in the area. The reservoir of ability stems from the proximity to Lafayette College in Easton and Lehigh University in Bethlehem. In addition, Pennsylvania State University maintains a training center in the area where office staffs, clerks, industrial relations employees and electronic technicians are trained.



Raytheon Company Advances Lovett

J. LEONARD LOVETT has been named manager of Raytheon Company's Marine Product Operations. He was promoted to the post formerly held by Sidney S. Konigsberg who has resigned. Lovett will direct all engineering, manufacturing, and marketing activities for the company's several brands of marine electronic products.

Marine products manager for Raytheon electronic products for the past two years, Lovett will continue to make his headquarters in

South San Francisco, Calif., where the Marine Product Operations maintains a 100,000-sq ft plant employing 300 people.

Howell Instruments Elects Doyle

JOSEPH A. DOYLE has been elected a director of Howell Instruments, Inc., Fort Worth, Texas. He also is a vice president of the company and heads its military marketing division.

Howell Instruments develops and manufactures automatic instruments and instrument systems for both military and industrial applications.

Endevco Corporation Hires Whittier

ROBERT M. WHITTIER has joined the engineering department of Endevco Corp., Pasadena, Calif., as manager, special products.

He was formerly employed as transducer engineer with Wiancko Engineering Co.

Fonda Joins Philco In Palo Alto

EDWIN G. FONDA recently joined Philco Western Development Laboratories, Palo Alto, Calif. He will manage and direct the Multisatellite Augmentation Program support implementation section.

Fonda's previous affiliation was with Lockheed Missile & Space Co.

Gifford Promoted to Key GE Position

RICHARD P. GIFFORD was recently named to head General Electric's world-wide, multi-million dollar communications business.

Appointed general manager of the GE Communication Products

department, with headquarters in Lynchburg, Va., he will have full responsibility for all product lines of the department.

Gifford previously was manager of engineering for the department. He succeeds Harrison Van Aken, former communications general manager, who recently was named head of GE's computer business at Phoenix, Ariz.



**Motorola Promotes
Ralph McCreary**

RALPH L. MCCREARY, manager of the Motorola Systems Research Laboratory in Riverside, Calif., has been appointed director of research and development for the company's Military Electronics division, Scottsdale, Ariz.

In addition to the new appointment, McCreary will retain his other position.



**Sanders Associates
Elects Coffin**

SANDERS ASSOCIATES, INC., Nashua, N.H., has elected David D. Coffin a vice president. He has been currently assigned to the post of man-

LAPP ANTENNA INSULATORS

*...in all these standard sizes to save
you time and money*

RECTANGULAR STRAIN INSULATORS

Porcelain or steatite, in standard "P" dimensions of 4, 6, 8, 10, and 12 in.—other spacings available.

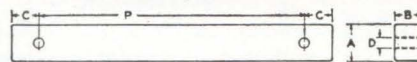

TYPE A

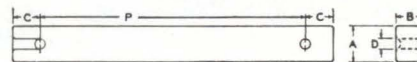

TYPE B



TYPE C

DIMENSIONS IN INCHES

Catalog Number	Material	Type	A	B	C	D	Strength Lbs.
9178	Porcelain	A	1½	1	⅞	1⅜	1500
25381	Steatite	A	1½	1	⅞	1⅜	1800
23959	Porcelain	B	1½	1	1	⅞	1500
25380	Steatite	B	1½	1	1	⅞	1800
26766	Porcelain	C	1½	1	1	⅞	1500
25374	Steatite	C	1½	1	1	⅞	1800

ROUND STRAINS

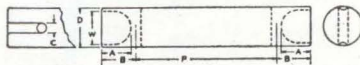

Porcelain units available in "P" dimensions of 12, 16 and 20 inches. Steatite, in "P" dimensions of 12 and 16 inches.

DIMENSIONS IN INCHES

Catalog Number	Material	A	B	C	D	Strength Lbs.
9175	Porcelain	1⅞	1⅜	⅜	1½	2000
26239	Steatite	1⅞	1⅜	⅜	1½	2300

SPREADERS

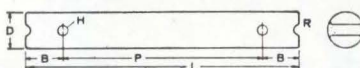

No. 26036 and No. 26223 available in lengths of 4, 6, 8, 10 and 12 inches. No. 9181 and No. 24811 available in lengths of 6, 10 and 12 inches. Other lengths available on special order.

DIMENSIONS IN INCHES

Catalog Number	Material	B	D	H	R
26036	Porcelain	¾	¾	⅛	⅛
26223	Steatite	¾	¾	⅛	⅛
9181	Porcelain	1	1	⅜	⅜
24811	Steatite	1	1	⅜	⅜

SHAPED ANTENNA INSULATORS

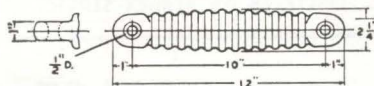

No. 5993, porcelain, 1750 lb. strength; radio rating 25 kv eff.; 60 ϕ wet flash-over 65 kv eff.

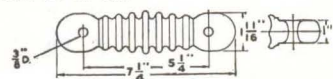

No. 23800, porcelain, 1250 lb. strength; radio rating 18 kv eff.; 60 ϕ wet flash-over 52 kv eff.

RATINGS FOR RECTANGULAR, ROUND AND SPREADER INSULATORS

"P" Inches	WET FLASHOVER 60 ϕ kv eff.	RADIO RATING kv eff.	
		Porcelain	Steatite
4	26	18	36
6	36	22	44
8	45	24	48
10	55	25	50
16	80	25	50
30	125	25	50

Lapp

WRITE for Bulletin 301-R
Lapp Insulator Co., Inc.,
202 Sumner Street, LeRoy, N. Y.

G. L. COLLINS CONTROLS

Missile guidance and control functions are created, tested and proven accurate . . . by the G. L. Collins Corporation. G. L. Collins has a diversified line of AC transducers, and DC transducers, associated controls and systems for aerospace and industrial applications.

A recognized leader in the design of missile control feed-back elements, the G. L. Collins Corporation have been proven in major aircraft and missile programs.

Programs: Minuteman, Atlas, Polaris Dynasoar, Nike-Zeus, Saturn, Typhon, Gemini, RS-70, A3J, X-15, F8U, Hound Dog and many others.

Write for brochure describing capabilities, call or write our engineering sales office.

G. L. COLLINS CORPORATION

2820 Hullett Street, Long Beach 5, California
(213) NEvada 6-8141 • (213) MEtcalf 0-3121
TWX: 634-4095



CIRCLE 68 ON READER SERVICE CARD

**HELP YOUR POST OFFICE
TO SERVE YOU BETTER
BY
MAILING EARLY IN THE DAY
NATIONWIDE IMPROVED MAIL SERVICE
PROGRAM**

ager of the Sanders Advanced Systems Laboratories in Burlington, Mass.

Previously, Coffin was a senior vice president of Raytheon Co.

Gombos Microwave Elects deRosa

LOUIS A. DEROSA, vice president and director of engineering at ITT Communication Systems, Inc., Paramus, N.J., was recently elected to the board of directors of Gombos Microwave Inc., Clifton, N.J.

PEOPLE IN BRIEF

Reinhold Halbeck, formerly with Hawthaway Instruments, appointed senior engineer of Kurman Electric Co. **Stuart Ridgway** promoted to technical director of General Technology Corp. **William A. Porter** leaves GE to join Dalmo Victor Co. as mgr. of product research. **L. B. Bohnstedt**, previously with Ampex Corp., now mgr. of quality control at Datamec Corp. **Earl A. Miller**, from Motorola to The Hickok Electrical Instrument Co. as v-p, engineering. Formerly a private consultant in quality control, **Ralph E. Fleischman** appointed corporate director of quality assurance at Transitron Electronic Corp. Two senior specialists, both ex-Remington Rand Univac, added to Auerbach Systems Sciences div.: **Robert J. Rosshelm**, as a program mgr. and computer programming coordinator; **William F. Schmitt**, as a member of the technical staff. **H. C. Macnamara** moves up to v-p, engineering, at National Connector Corp. **William R. Martin** advances to g-m of the Hytech div. of The Bissett-Berman Corp. Aerospace Corp. ups **John M. Nilles** to mgr., Special Projects Office in the Systems Research and Planning div. **Dwain B. Bowen**, formerly with Autonetics, and **Abraham Jacoby**, previously with Alfred Electronics, join Electro-Optical Systems, Inc., as mgr., laser applications, and a senior engineer, respectively, in the Quantum Physics div. **Donald Sheldon**, from Raytheon Co. to Polarad Electronic Instruments as dept. mgr. of the microwave tube laboratory.

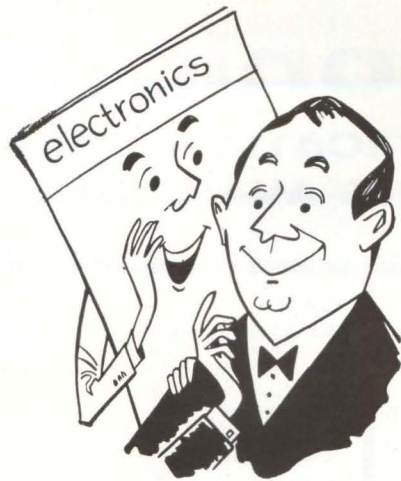

**electronics IS EDITED
TO KEEP YOU FULLY INFORMED**
— a “well-rounded” engineer

What's your *present* job in electronics? Do you work on computers? (**electronics** ran 158 articles on computers between July, 1961 and June, 1962!) Are you in semiconductors? (For the same period, **electronics** had 99 articles, not including transistors, solid-state physics, diodes, crystals, etc.) Are you in military electronics? (**electronics** had 179 articles, not including those on aircraft, missiles, radar, etc.)

In all, **electronics'** 28-man editorial staff provided more than 3,000 editorial pages to keep you abreast of all the technical developments in the industry. No matter where you work today or in which job function(s), **electronics** will keep you fully informed. Subscribe today via the Reader Service Card in this issue. Only 7½ cents a copy at the 3 year rate.

electronics

PROJECT ENGINEER
(Electronic)

Construction of a rapid data processing system to be used in elementary particle physics research. System involves digital electronics, mechanical-optical flying-spot scanner, precision measuring engines, high speed automatic film transport, fast magnetic-core memories, on-line 7090 computer. Academic atmosphere. Tuition exemption plan. An equal opportunity employer.

Send resume to Dr. Tycko,

COLUMBIA UNIVERSITY

Nevis Labs.

Box 137, Irvington-on-Hudson, N. Y.

**SEARCHLIGHT
SECTION**

(Classified Advertising)

BUSINESS OPPORTUNITIES

EQUIPMENT - USED or RESALE

DISPLAYED RATE

The advertising rate is \$27.25 per inch for all advertising appearing on other than a contract basis. Contract rates quoted on request. AN ADVERTISING INCH is measured 7/8 inch vertically on one column, 3 columns—30 inches—to a page. EQUIPMENT WANTED or FOR SALE ADVERTISEMENTS acceptable only in Displayed Style.

UNDISPLAYED RATE

\$2.70 a line, minimum 3 lines. To figure advance payment count 5 average words as a line.

PROPOSALS, \$2.70 a line an insertion.

BOX NUMBERS count as one line additional in undisplayed ads.

DISCOUNT OF 10% if full payment is made in advance for four consecutive insertions of undisplayed ads (not including proposals).

**FOR RESEARCH — DEVELOPMENT
& EXPERIMENTAL WORK**

Over 10,000 different electronic parts: waveguide, radar components and parts, test sets, pulsers, antennas, pulse xmfrs, magnetrons. IF and pulse amplifiers, dynamotors, 400 cycle xmfrs, 584 ant. pedestals, etc.
PRICES AT A FRACTION OF ORIGINAL COST!
COMMUNICATIONS EQUIP CO.
343 CANAL ST., N. Y. 13, WO 6-4045
CHAS. ROSEN (Formerly at 131 Liberty St.)

CIRCLE 950 ON READER SERVICE CARD

RADIO RESEARCH INSTRUMENT CO.

AUTO-TRACK & TELEMETRY ANTENNA PEDESTALS
3 & 10 CM. SCR. 584 AUTOTRACK RADARS
AN/TPS-10 SEARCH, AN/TPS-10 HT. FINDERS,
AN/FPN-32GCA, AN/APS-10 NAVIG. & WEATHER,
AN/APS-15B PRECISION, AN/APG-35B PRECISION,
AN/APS-31A SEARCH, DOZENS MORE,
5-12 MEGAWATT HIGH POWER PULSERS.

RADIO RESEARCH INSTRUMENT CO.
550 Fifth Ave., New York Judson 6-4691

**RADAR SYSTEMS & COMPONENTS/ IMMEDIATE
DELIVERY**

CIRCLE 951 ON READER SERVICE CARD

electronics

WEEKLY QUALIFICATION FORM FOR POSITIONS AVAILABLE

ATTENTION: ENGINEERS, SCIENTISTS, PHYSICISTS

This Qualification Form is designed to help you advance in the electronics industry. It is unique and compact. Designed with the assistance of professional personnel management, it isolates specific experience in electronics and deals only in essential background information.

The advertisers listed here are seeking professional experience. Fill in the Qualification Form below.

STRICTLY CONFIDENTIAL

Your Qualification form will be handled as "Strictly Confidential" by ELECTRONICS. Our processing system is such that your form will be forwarded within 24 hours to the proper executives in the companies you select. You will be contacted at your home by the interested companies.

WHAT TO DO

1. Review the positions in the advertisements.
2. Select those for which you qualify.
3. Notice the key numbers.
4. Circle the corresponding key number below the Qualification Form.
5. Fill out the form completely. Please print clearly.
6. Mail to: Classified Advertising Div., ELECTRONICS, Box 12, New York 36, N. Y. (No charge, of course).

COMPANY	SEE PAGE	KEY #
ACF INDUSTRIES INC. Albuquerque Division Albuquerque, New Mexico	72	1
ATOMIC PERSONNEL INC Philadelphia, Penna.	112*	2
BRISTOL COMPANY, THE Waterbury 20, Conn.	112*	3
COLLINS RADIO COMPANY Cedar Rapids, Iowa	72*	4
COLUMBIA UNIVERSITY Nevis Labs. Irvington-on-Hudson, N. Y.	69	5
ESSO RESEARCH & ENGINEERING CO. Linden, N. J.	110*	6
GENERAL DYNAMICS, ELECTRIC BOAT Groton, Conn.	72	7
GENERAL DYNAMICS/ELECTRONICS Rochester 1, N. Y.	71	8
HONEYWELL St. Petersburg, Fla.	94*	9
NORDEN Div. of United Aircraft Corp. Norwalk, Conn.	111*	10
PERSPECTIVE Needham, Mass.	72	11
PHILCO WESTERN DEVELOPMENT LABS. Palo Alto, California	51	12
SPACE TECHNOLOGY LABORATORIES, INC. Sub. of Thompson Ramo Wooldridge Inc. Redondo Beach, California	23	13

* These advertisements appeared in the Feb. 22nd Issue.

(cut here)

electronics WEEKLY QUALIFICATION FORM FOR POSITIONS AVAILABLE

(cut here)

(Please type or print clearly. Necessary for reproduction.)

Personal Background

NAME

HOME ADDRESS

CITY ZONE STATE

HOME TELEPHONE

Education

PROFESSIONAL DEGREE(S)

MAJOR(S)

UNIVERSITY

DATE(S)

FIELDS OF EXPERIENCE (Please Check)

3163

- | | | |
|--|--|---------------------------------------|
| <input type="checkbox"/> Aerospace | <input type="checkbox"/> Fire Control | <input type="checkbox"/> Radar |
| <input type="checkbox"/> Antennas | <input type="checkbox"/> Human Factors | <input type="checkbox"/> Radio—TV |
| <input type="checkbox"/> ASW | <input type="checkbox"/> Infrared | <input type="checkbox"/> Simulators |
| <input type="checkbox"/> Circuits | <input type="checkbox"/> Instrumentation | <input type="checkbox"/> Solid State |
| <input type="checkbox"/> Communications | <input type="checkbox"/> Medicine | <input type="checkbox"/> Telemetry |
| <input type="checkbox"/> Components | <input type="checkbox"/> Microwave | <input type="checkbox"/> Transformers |
| <input type="checkbox"/> Computers | <input type="checkbox"/> Navigation | <input type="checkbox"/> Other |
| <input type="checkbox"/> ECM | <input type="checkbox"/> Operations Research | <input type="checkbox"/> |
| <input type="checkbox"/> Electron Tubes | <input type="checkbox"/> Optics | <input type="checkbox"/> |
| <input type="checkbox"/> Engineering Writing | <input type="checkbox"/> Packaging | <input type="checkbox"/> |

CATEGORY OF SPECIALIZATION

Please indicate number of months experience on proper lines.

	Technical Experience (Months)	Supervisory Experience (Months)
RESEARCH (pure, fundamental, basic)
RESEARCH (Applied)
SYSTEMS (New Concepts)
DEVELOPMENT (Model)
DESIGN (Product)
MANUFACTURING (Product)
FIELD (Service)
SALES (Proposals & Products)

CIRCLE KEY NUMBERS OF ABOVE COMPANIES' POSITIONS THAT INTEREST YOU

1 2 3 4 5 6 7 8 9 10 11 12 13 14 15 16 17 18 19 20 21 22 23 24 25

IMMEDIATE OPENINGS

WITH

GENERAL DYNAMICS / ELECTRONICS

The large number of diversified development contracts now in the house at General Dynamics/Electronics provide immediate assignments for additional professional personnel in the following disciplines:

SYSTEMS ENGINEERING

SENIOR DESIGN ENGINEER. To assist in evaluation of complex electronic reconnaissance systems. Requires experience in 2 or more of the following: digital, RF, pulse, audio, CRT, photorecorders, magnetic recorders, pulse multiplex and frequency multiplex.

SENIOR ENGINEER. With broad knowledge of Aerospace Ground Electronic design. Will analyze aerospace electronic subsystems for test requirements and determine test equipment needs. Experience in Air Force shop or Naval carrier installations desirable, with emphasis on equipment layout, intercabling, work flow analysis, and operational and calibration procedures.

PROJECT ENGINEERS. To supervise design and integration of test equipments and test stations. Should be familiar with all types of testing equipment and techniques in one or more of the following areas: flight control systems, radar, HF-UHF navigation and communication equipment, microwave equipment, antenna systems and electronic countermeasures.

DIGITAL EQUIPMENT DESIGN

SENIOR ENGINEERS. To supervise and do design work on MODEMS, logic and in-put/out-put devices for data communication equipment used in industrial and military systems. Work includes transistor circuit design, logic design, modulation techniques for radio and wire line data transmission, mechanical design of in-put/out-put devices, packaging design and integration of complete communications systems.

CIRCUIT DESIGN ENGINEERS. With experience in the design of transistorized logic circuits, pulse generators and other digitally controlled circuits such as numerical indicators.

MAINTAINABILITY

Long Range Programs in Development/Test/Evaluation/Production of Aerospace Electronic Equipment for:

PRINCIPAL ENGINEER. To establish and operate elite group — experience with all phases of MIL-M-26512; maintenance engineering analysis; principal practices and techniques in the design, maintenance and use of Aerospace Electronic equipment.—Supervisory Position.

SENIOR ENGINEERS. To implement maintainability tasks — experience with design principles, practices and techniques on Aerospace Electronic hardware; analysis, control and demonstration means; familiar with aerospace ground equipment specifications and Government maintenance procedures.

ENGINEERS. To maximize maintainability on Aerospace Electronic Equipment; perform analysis, monitor, audit and review designs; coordinate demonstration testing, simulations; reporting and documentation responsibilities.

Please send your resume to Mr. R. W. Holmes, Dept. 22.

GENERAL DYNAMICS | ELECTRONICS

1400 N. GOODMAN ST., ROCHESTER 1, NEW YORK

An Equal Opportunity Employer

RF EQUIPMENT DESIGN

MICROWAVE ENGINEERS. Experienced in the design of signal generators and receivers in the following frequency bands: L, S, C, T, Ku, Ka. Should also know techniques for remote control of frequency and signal amplitude.

ENGINEERS. Experienced in the design of RF and microwave receivers, digital display circuits, data handling and CRT displays including storage tube circuits.

ENGINEERS. Experienced in the design and development of solid state receivers for reconnaissance telemetry, Doppler and communications equipment. Knowledge of tracking filters, phase lock, and synthesizer circuits desirable.

LOW FREQUENCY DESIGNERS. Experienced in the design of audio and sweep signal generators and servo systems test equipment. Senior engineers are also required with experience in the design of LF receivers and transmitters.

HF-UHF ENGINEERS. With experience in design of signal generators, using both transistorized and vacuum tube circuitry. Knowledge of techniques for digital selection of frequency such as frequency synthesis and remote control of signal amplitude is required.

SENIOR ENGINEERS. Experienced in the design and development of single side band receivers and transmitters.

RELIABILITY

Long Range Programs in Aerospace Electronic Equipment. Positions available in staff functional areas and state-of-the-art systems programs for:

PRINCIPAL ENGINEERS. To provide reliability technical group support and program project task support—experience in reliability activities of the following: Analysis, Design Review, Surveillance, Audit, Sub-Contractor Liaison, Apportionment, Allocation and Assessment. Responsible for the application of techniques on Aerospace Electronic programs and generation of methods and procedures. Staff and program positions available.—Supervision.

SENIOR ENGINEERS. To implement reliability engineering and reliability services group tasks. Experience required in Aerospace Electronic equipment reliability activities. Positions available in all reliability areas including: Analysis, Review, Audit, Surveillance, Monitoring, Sub-Contractor Liaison, Statistical Demonstration Testing Studies, etc. Staff and program positions available.

ENGINEERS. To perform reliability tasks of all kinds on Aerospace Electronic equipment.

GD

Look what EE's are doing

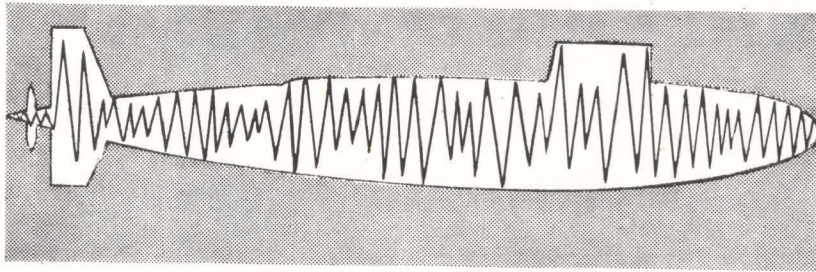

at ELECTRIC BOAT

- Design of Special Instrumentation for Measurement of Acoustic & Vibration Data
- Design & Installation of Interior Communication Systems, Navigation Systems, Ship Control Systems, Depth Control Systems, Steering & Diving Devices
- Application and Systems Engineering of Radio, Radar, Sonar & Countermeasures Systems & Components
- Design and Installation of Electric Power Plants & Distribution Systems
- Quality/Reliability Control & Assurance
- Nuclear Power Plant Systems Schematics Review
- Advanced Circuit Design
- Electronic Systems Engineering
- Missile Fire Control, Guidance and Checkout Systems & Equipment
- Installation and Test of Reactor Plant Auxiliary Power Supplies
- Integration of Control and Instrumentation Systems
- Navigation Systems and Equipment
- Procurement • Signal Systems Analysis
- Vendor Product Application Design
- Electrical Power & Control Systems & Component Design
- Test Development & Instrumentation Design
- Vendor Performance Analysis
- Process Control Engineering & Instrumentation
- Sound, Shock & Vibration Analysis

As a world of technology in miniature—incorporating missile launching systems, a nuclear propulsion plant, and life support systems—the nuclear submarine is an engineering challenge of the highest order. The Electrical and Electronic Engineer working at Electric Boat has a unique opportunity for professional development, not only in his own specialty but through broad knowledge gained in the unity of all technologies.

Your resumes are invited. Please address Mr. Peter Carpenter.

GENERAL DYNAMICS
ELECTRIC BOAT

Groton, Connecticut

AN EQUAL OPPORTUNITY EMPLOYER

SUPERVISORY POSITIONS

in the Southwest with Albuquerque Division

ACF INDUSTRIES, INC.

A prime contractor for the Atomic Energy Commission

SENIOR ELECTRONICS ENGINEER

To be responsible for maintenance of all electronic equipment in the plant, which includes electronic tape controlled machine tool equipment, gaging equipment, and production processing equipment. BSEE with five years experience required.

ELECTRONICS ENGINEER

To supervise hourly electronic technicians engaged in maintenance of above mentioned equipment. BSEE with two years experience required.

Salary will be commensurate with training and experience. Relocation costs paid. U. S. citizenship required.

Mail resume to:

General Supervisor, Professional Recruiting
Albuquerque Division, ACF Industries, Inc.
P. O. Box 1666, Albuquerque, New Mexico
"ACF IS AN EQUAL OPPORTUNITY EMPLOYER"

FREE TRIP IEEE (IRE) SHOW NEW YORK CITY MARCH 25-28TH

Electronic Scientists and Engineers you can have an all expense paid trip and confirmed selected interviews with national electronic companies if you qualify. Requirements: BS, MS, or PhD and one year experience. Opportunities available in: Research—Design—Development—Sales—Marketing—Applications.

Air Mail Resume in Complete Confidence—No Obligation

Write or Call Collect Dept. E for Full Details
Boston (617) 444-7113

Alan Glou—Technical/Scientific
Sid Hopper—Sales/Marketing

PERSPECTIVE

A PROFESSIONAL PLACEMENT ORGANIZATION
TEN KEARNEY ROAD, NEEDHAM, MASS.
Highland Ave., Exit #56W Off Rte. 128—Marr Bldg.

EMPLOYMENT OPPORTUNITIES



The advertisements in this section include all employment opportunities — executive, management, technical, selling, office, skilled, manual, etc.

Look in the forward section of the magazine for additional Employment Opportunities advertising.

— RATES —

DISPLAYED: The advertising rate is \$40.17 per inch for all advertising appearing on other than a contract basis. Contract rates quoted on request.

An advertising inch is measured 3/4" vertically on a column—3 columns—30 inches to a page.

Subject to Agency Commission.

UNDISPLAYED: \$2.70 per line, minimum 3 lines. To figure advance payment count 5 average words as a line.

Box numbers—count as 1 line.

Discount of 10% if full payment is made in advance for 4 consecutive insertions.

Not subject to Agency Commission.

electronics



Audit Bureau
of Circulations



Associated Business
Publications

Audited Paid Circulation

JAMES T. HAUPTLI

Advertising Sales Manager

R. S. QUINT:
General Manager,
Electronics Buyers' Guide
DAVID CUNNIFF:
Promotion Manager
B. ANELLO:
Market Services Manager

RICHARD J. TOMLINSON:
Business Manager
GEORGE E. POMEROY:
Classified Manager
HUGH J. QUINN:
Circulation Manager

ADVERTISING REPRESENTATIVES

ATLANTA (9):
Michael H. Miller, Robert C. Johnson
1375 Peachtree St. N.E., Trinity 5-0523
(area code 404)

BOSTON (16):
William S. Hodgkinson, Donald R. Furth
McGraw-Hill Building, Copley Square,
Congress 2-1160 (area code 617)

CHICAGO (11):
Harvey W. Wernecke, Robert M. Denmead
645 North Michigan Avenue, Mohawk 4-5800
(area code 312)

CLEVELAND (13):
Paul T. Fegley
55 Public Square, Superior 1-7000
(area code 216)

DALLAS (1):
Frank Le Beau
The Vaughn Bldg., 1712 Commerce St.
Riverside 7-9721 (area code 214)

DENVER (2):
J. W. Patten
Tower Bldg., 1700 Broadway,
Alpine 5-2981 (area code 303)

HOUSTON (25):
Joseph C. Page, Jr.
Prudential Bldg., Halcombe Blvd.,
Riverside 8-1280 (area code 713)

LOS ANGELES (17):
Ashley P. Hartman, W. C. Gries,
John G. Zisch
1125 W. 6th St., Huntley 2-5450
(area code 213)

NEW YORK (36):
Donald H. Miller, Henry M. Shaw,
George F. Werner
500 Fifth Avenue, LO-4-3000
(area code 212)

PHILADELPHIA (3):
Warren H. Gardner, William J. Boyle
6 Penn Center Plaza, LOcust 8-4330
(area code 215)

SAN FRANCISCO (11):
R. C. Alcorn
255 California Street, Douglas 2-4600
(area code 415)

LONDON W1:
Edwin S. Murphy Jr.
34 Dover St.

FRANKFURT/Main:
Matthée Herfurth
85 Westendstrasse

GENEVA:
Michael R. Zeynel
2 Place du Port

TOKYO, George Olcott, 1, Kotohiracho, Shiba, Minato-ku

"Headquarters for Business Information"

McGraw-Hill Technical and Business Publications

American Machinist/Metal-
working Manufacturing
Aviation Week and Space
Technology
Business Week
Chemical Engineering
Chemical Week
Coal Age
Construction Methods and
Equipment
Construction Daily
Control Engineering
Electrical Construction
and Maintenance
Electrical Merchandising Week
Electrical Newsletter
Electrical West

Electrical Wholesaling
Electrical World
Electronics
Engineering Digest
Engineering and Mining Journal
E & MJ Metal and Mineral
Markets
Engineering News-Record
Factory
Fleet Owner
Industrial Distribution
National Petroleum News
Nucleonics
Nucleonics Week
Platt's Oilgram News
Platt's Oilgram Price Service
Power

Product Engineering
Purchasing Week
Science Week
Textile World

Overseas only:
Automobile International
(English, Spanish)
Ingenieria Internacional
Construccion (Spanish)
International Management
(English, Spanish
Portuguese editions)
Metalworking Production
(Great Britain)

INDEX TO ADVERTISERS

• Acromag Inc.	61
Ampex Corporation	47
Bekins Van Line.....	52
Bell Telephone Laboratories.....	43
• Borg Equipment Division Amphenol-Borg Electronics Corp....	17
• Budelman Electronics Corp.....	59
• Cohn Corp., Sigmund.....	55
Collins Corp., G. L.....	68
Datak Corp., The.....	45
Eldorado Electronics	65
Electro Instruments Inc.....	24
• Fairchild Semiconductor Corp.	74, 3rd Cover
• Foster Electric Co., Ltd.....	55
General Electric Co. Miniature Lamp Dept.....	53
Gudebrod Bros. Silk Co., Inc.....	22
ITT Surprenant	5
• Japan Piezo Electric Co., Ltd.....	62
Jerrold Electronics Corp.....	4
• Lapp Insulator Co., Inc.....	67
Machlett Laboratories Inc., The.....	15
Mechanical Enterprises Inc.....	61
Midland Mfg. Co.....	63
• North Atlantic Industries, Inc.....	48, 49
Patwin Electronics	61
Philco Western Development Labora- tories Sub. of Ford Motor Co.....	51
• Polarad Electronic Instruments Div. of Polarad Electronics Corp....	55
• Potter Instrument Co., Inc.....	13
• Radio Corporation of America...4th Cover	
• Raytheon Company	11
• Sierra Electronic Div. of Philco.....	6
Space Technology Laboratories, Inc....	23
Sprague Electric Co.....	9, 16
Texas Instruments Incorporated Industrial Products Group.....	19
Trompeter Electronics	45
• United Transformer Corp.....2nd Cover	
Van Keuren Co., The.....	59
• Ward Leonard Electric Co.....	64
Welch Scientific Co., The.....	56
• Westinghouse Electric Corp.....	20, 21

CLASSIFIED ADVERTISING

F. J. Eberle, Business Mgr.

EMPLOYMENT OPPORTUNITIES	69, 71, 72
EQUIPMENT (Used or Surplus New) For Sale	69

INDEX TO CLASSIFIED ADVERTISERS

ACF Industries Inc.....	72
Columbia University	69
• Communications Equipment Co.....	69
General Dynamics/Electric Boat.....	72
General Dynamics/Electronics	71
Perspective	72
• Radio Research Instrument Co.....	69

• See advertisement in the July 25, 1962 issue of Electronics Buyers' Guide for complete line of products or services.

This Index and our Reader Service Numbers are published as a service. Every precaution is taken to make them accurate, but **electronics** assumes no responsibilities for errors or omissions.

Available by subscription only — to qualified persons actively engaged in the field of the publication. For subscription rates and information describing the editorial coverage of any of the above publications, write to: *Subscription Manager, Circulation Department, McGraw-Hill Publishing Company, 330 West 42nd Street, New York 36, N. Y.*

A CASE HISTORY: THE LITTON CUSTOM TOGGLE CIRCUIT

FROM SCHEMATIC TO FAIRCHILD

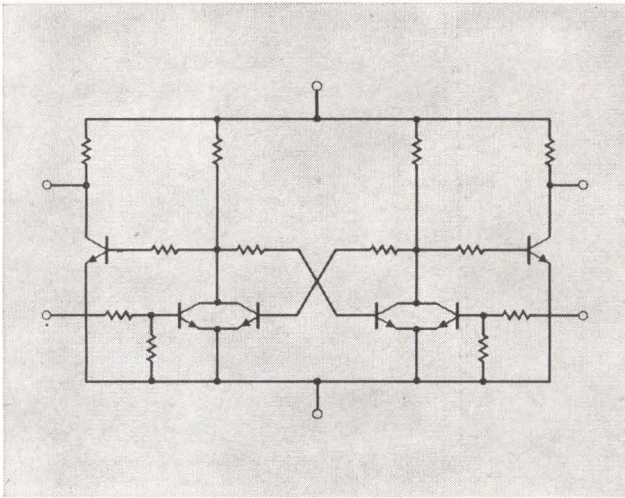

SCHEMATIC Engineers at Litton Industries' Guidance and Control Systems Division in Woodland Hills, California, designed this complex toggle circuit for use in the digital computer section of a high reliability control system. Working closely with Fairchild personnel, they learned that their circuit could be mass produced as a microcircuit—completely integrated within a single chip of silicon.

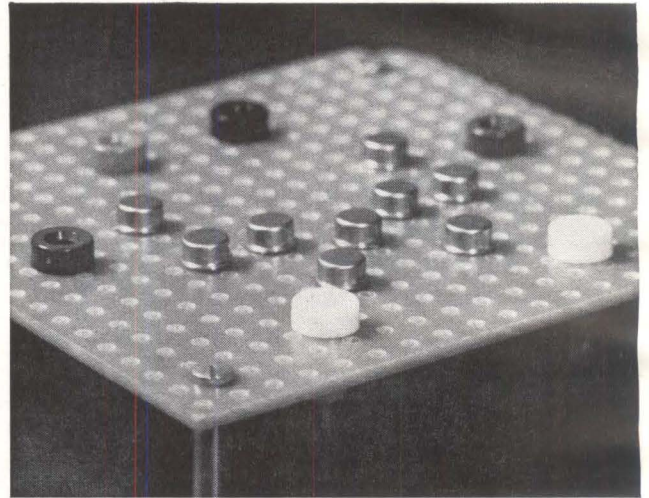

BREADBOARD Using microcircuit design components from Fairchild, the Litton project team built a breadboard of the circuit. With this they accurately determined the electrical characteristics of the circuit before committing the single-chip version to production. With design and specifications thoroughly proven, Litton gave Fairchild the production order on November 14, 1962.



ASSEMBLY LINE Final production wafers were then diced to separate individual circuits. A single wafer produces approximately 200 Microcircuits—each incorporating six transistors and 12 resistors. The circuit chips were mounted with leadwires attached, capped and electrically tested in accordance with standard procedure. One of Fairchild's microcircuit production lines was used.



TESTING Fairchild designed and built special instruments (shown above) to test electrical performance of the finished units. Samples of each batch are also submitted to Fairchild's environmental quality assurance test programs. Fairchild's Planar* process results in high, economical yields even after this thorough testing procedure.

PRODUCTION MICROCIRCUIT...IN 5 WEEKS



MASK MAKING From Litton's pre-tested circuit, Fairchild engineers designed and made the masks used to photo-etch precisely indexed patterns for the multi-diffusion process. Fairchild's highly developed photo-optical techniques are the result of five years experience in producing semiconductor devices, including two years of microcircuit production.

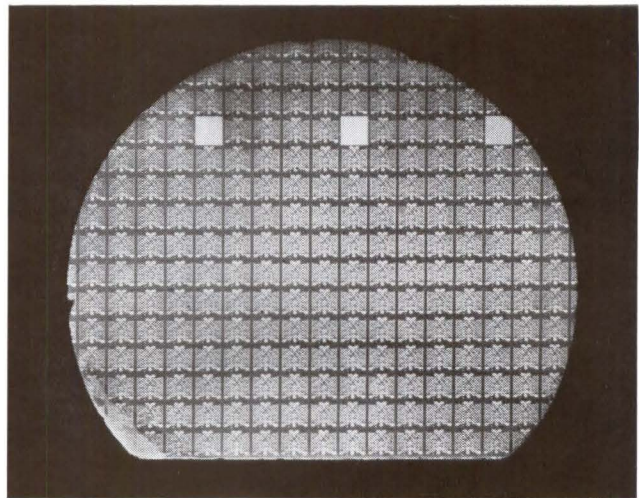

MULTI-DIFFUSION Next, the processing of silicon wafers was begun: etching and triple diffusion followed by deposition of the evaporated metal-over-oxide intraconnections*. Fairchild's Planar* process was utilized: a protective layer of silicon dioxide is grown into the wafer *before* any junctions are formed. Production begins after several trial diffusion runs in which run-to-run variations of performance parameters are established.

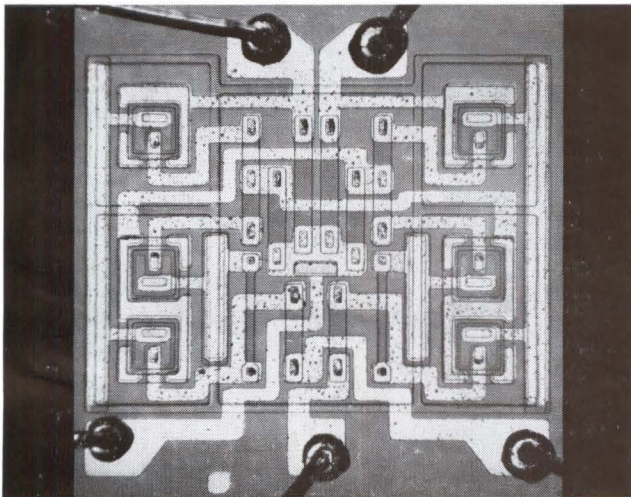

FIVE WEEK DELIVERY By December 20, 1962, five weeks after receiving firm specifications, Fairchild delivered an initial shipment to Litton—50 production microcircuit toggles—seven weeks before the promised date. The microphotograph above is the finished circuit mounted in a TO-5 can with cap removed. Actual size of the chip is .060" square.

This case history demonstrates Fairchild's "maximum circuits per wafer" concept. Made possible by the Planar* process, it is the key to reliability and economy. The Litton toggle—like every custom microcircuit produced by Fairchild—was a separately processed product from start to finish. Fairchild manufactures custom microcircuits this way because only through complete customizing can individual design goals be met efficiently—with the highest reliability at lowest cost.

*Patented Fairchild processes.

FAIRCHILD
SEMICONDUCTOR
A DIVISION OF FAIRCHILD CAMERA AND INSTRUMENT CORPORATION
545 WHISMAN RD., MOUNTAIN VIEW, CALIF. • YORKSHIRE B. 8161 • TWX-415-969-9165

CIRCLE 901 ON READER SERVICE CARD

RCA-A2696

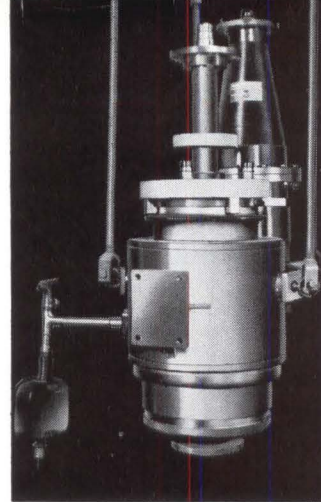

RCA-A15048

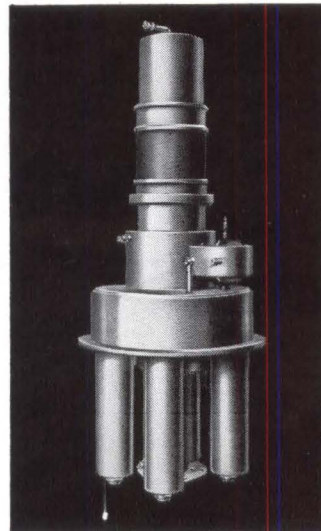
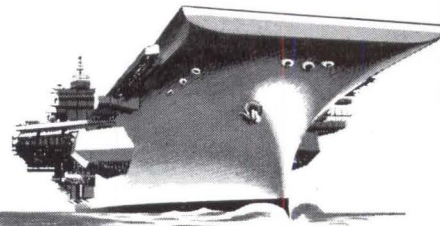

RCA-A15038



RCA SUPER-POWER COAXITRONS

Integral Circuitry Offers Pulse-to-Pulse Frequency Agility as a Result of Inherent Broad Bandwidth

The Coaxitron is an electronic concept that integrates the radio-frequency input and output circuitry, high-voltage blocking circuit, and the gridded tube structure. The integral circuitry, requiring no external tuning, offers high efficiency, broad bandwidth, high power gain, and high reliability.

The RCA family of Coaxitrons now includes three developmental types—A15038, A15048, and A2696. These tubes are suited to a variety of systems applications including long-range radars, broad-band multichannel communications, and particle accelerators. These tubes

excel wherever operation in a counter-measures environment is necessary since the broad bandwidth permits pulse-to-pulse frequency variation without tuning.

The RCA-A15038 was developed by RCA under contract to the Rome Air Development Center. The RCA-A2696 was developed by RCA under contract to the Bureau of Ships, U.S. Navy.

For further information, consult your RCA Industrial Tube Representative, or write: Marketing Manager, Industrial Tube Products, RCA Electron Tube Division, Lancaster, Pa.

Typical Operating Conditions of RCA Coaxitrons

Tube Type	Freq. Pass-band Mega-cycles	Peak Power Mega-watts	Gain db	Pulse Width Micro-seconds	Duty Factor
RCA-A15038	400-450	5	15	25	.008
RCA-A15048	860-940	1	13	20	.006
RCA-A2696	205-225	1	15	15	.004



The Most Trusted Name in Electronics

INDUSTRIAL TUBE PRODUCTS FIELD OFFICES

OEM SALES: Newark 2, N. J., 32-36 Green St., (201) 485-3900 • Chicago 54, Ill., Suite 1154, Merchandise Mart Plaza, (312) 527-2900 • Los Angeles 22, Calif., 6801 E. Washington Blvd., (213) RA 3-8361 • GOVERNMENT SALES: Harrison, N. J., 415 South Fifth St., (201) 485-3900 • Dayton 2, Ohio, 224 N. Wilkinson St., (513) BA 6-2366 • Washington 6, D. C., 1725 "K" St., N. W., (202) FE 7-8500 • INTERNATIONAL SALES: RCA International Div., Clark, N. J., (201) 382-1000