

**MISSION TO MARS**—*Mariner C will carry television, p 16*

*photo shows*

## SIPHONING HELIUM

*Survey of latest  
cryogenic gear, p 29*

## LAST WEEK AT WESCON

*Harmonic generation  
in plasmas, p 16*

## DIGITAL CONVERTER

*Tunnel diodes raise  
operating speed, p 37*

## COAXIAL FILTERS

*Tackling indeterminate  
design, p 35*

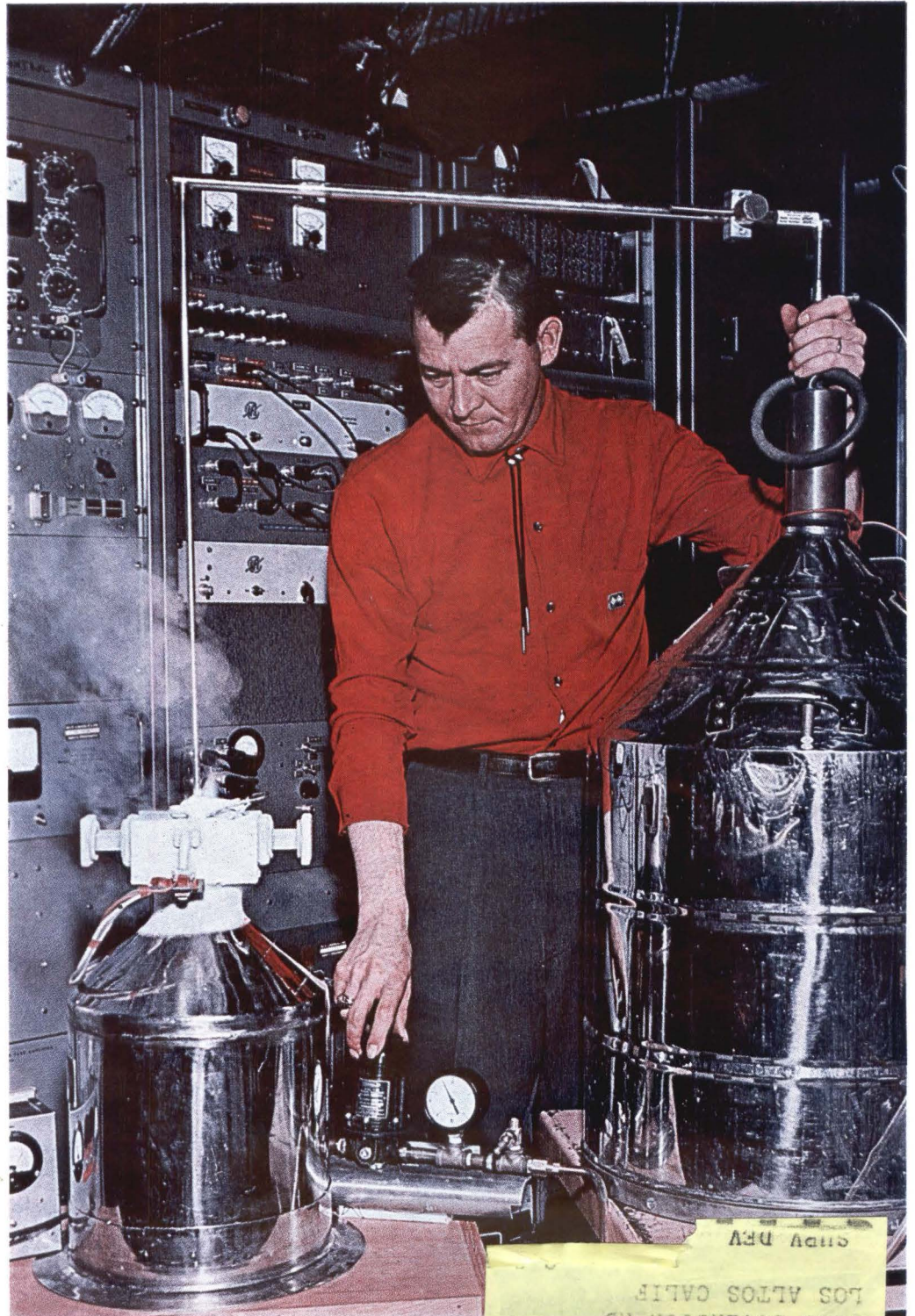

R D SKINNER  
1020 GOVINGTON RD  
LOS ALTOS CALIF  
94024



**MEMBER** — See page 28 for dates we will be in your area

# New DC to 1500 Mc Voltmeter

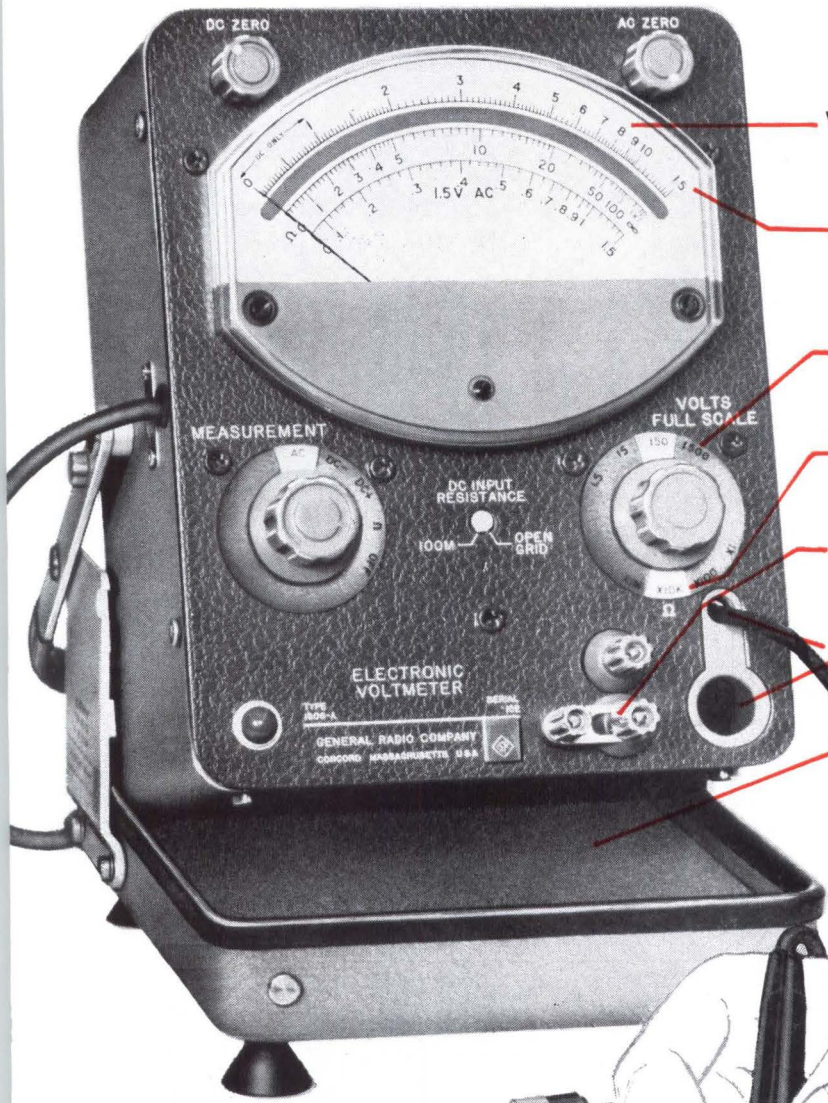

**Voltage Accuracy:**  $\pm 2\%$  of reading above one-tenth of full scale. 0.005v minimum dc reading

**Only one scale** for all voltage measurements. Prevents reading wrong scale. Expanded scale for measurements below 1.5v ac.

**Measures up to 1500 volts directly**, ac or dc; no external multipliers required.

**Wide-range ohmmeter** — 0.2 ohm to 1000 megohms in four ranges.

**Input Impedance:** AC, 25 megohms, DC, 100 megohms or "open grid" (on all but 1500v range). Grid current is less than  $10^{-10}$  ampere.

**Built-in storage socket and reel** for probe and its cable.

**Handy storage compartment** for accessories.

**Calibration Stability is Excellent.** The heart of the Voltmeter is a stable tube-and-transistor amplifier. There is so much feedback that changes in tube transconductance or transistor current gain have practically no effect.

**Wide Frequency Range** — within  $\pm 3$  db up to 1500 Mc; resonant frequency of probe is above 3000 Mc.

**Input Impedance:** 25 megohms in parallel with 2 pf.

**Accessory Tee Connector** available for uhf measurements in coaxial systems (Type 1806-P1, \$35.00).

**Type 1806-A Electronic Voltmeter** . . . in convenient flip-tilt case for portability, doubles as an adjustable stand — also available in rack model. Price either model **\$490** (in U.S.A.)

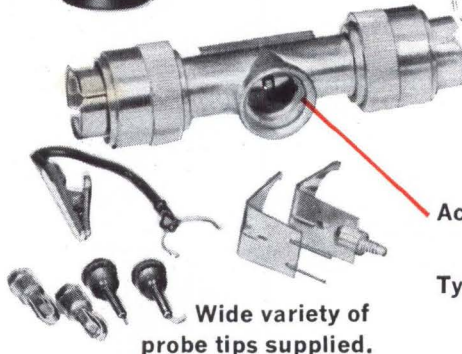

**Wide variety of probe tips** supplied.

IN CANADA: Toronto 247-2171, Montreal (Mt. Royal) 737-3673  
IN EUROPE: General Radio Overseas, Zurich, Switzerland

## GENERAL RADIO COMPANY

WEST CONCORD, MASSACHUSETTS

NEW YORK, N. Y., 964-2722  
(Ridgefield, N. J.) 943-3140

CHICAGO  
(Oak Park) 848-9400

PHILADELPHIA, 424-7419  
(Abington) 887-8486

WASHINGTON, D. C.  
(Rockville, Md.) 946-1600

SYRACUSE  
454-9323

DALLAS  
FL 7-4031

SAN FRANCISCO  
(Los Altos) 948-8233

LOS ANGELES  
469-6201

ORLANDO, FLA.  
425-4671

CLEVELAND  
886-0150

CIRCLE 900 ON READER SERVICE CARD

# electronics

A McGraw-Hill Weekly 75 Cents

W. W. MacDONALD, Editor (2645)

J. M. CARROLL, Managing Editor (2293)

**SENIOR EDITORS**Samuel Weber (2371)  
George W. Sideris (3444)**SENIOR ASSOCIATE EDITORS**Michael F. Wolff (2600)  
John F. Mason (2666)**ASSOCIATE EDITORS**Michael F. Tomaino (2071)  
William P. O'Brien (2297)  
Sy Vogel (2467)  
George J. Flynn (2188)  
George V. Novatny (3151)  
Leon H. Dulberger (3446)  
Alexander A. McKenzie (2685)**ASSISTANT EDITORS**Stanley Froud (2710)  
Stephen B. Gray (2245)  
Barry A. Briskman (2306)  
Dan Smith (2472)  
Joel A. Strasser (2127)**REGIONAL EDITORS**Harold C. Hood  
(Pacific Coast, Los Angeles)  
Laurence D. Shergalis  
(Pacific Coast, San Francisco)  
Thomas Maguire  
(New England, Boston)  
Cletus M. Wiley  
(Midwest, Chicago)**ART DIRECTOR**

Howard R. Berry (2430)

**ASSISTANT ART DIRECTOR**

John C. Wright, Jr. (3430)

**EDITORIAL ASSISTANTS**Lorraine Rossi, Virginia T. Bastian,  
Lynn Emery, Ann Mella, Lorraine  
Werner, Alice M. O'Brien, Sharon  
Parks, Patricia Mitchell, Claire  
Benell, Kay Fontana**FOREIGN NEWS BUREAU**DIRECTOR, John Wilhelm;  
Lawrence Mihlon, Alyne Elias  
LONDON—John Shinn, Derek  
Barlow, Nicholas Landon  
BONN—Bruce Bendow,  
Richard Mikton, Silke McQueen  
BRUSSELS—Peter Forbath  
PARIS—Robert Farrell,  
Arthur Erikson  
MILAN—Marc A. Messina  
MEXICO CITY—Wesley Perry, Jr  
RIO DE JANEIRO—Leslie Warren  
MOSCOW—Stewart Ramsey  
TOKYO—Richard Halloran,  
Charles Cohen, John Yamaguchi**CIRCULATION MANAGER**

Hugh J. Quinn (2310)

W. W. GAREY, Publisher (2016)

**NEW YORK TELEPHONE:**Dial Direct: 971 plus extensions shown  
above in parentheses. Area Code 212

**NOT A STILL.** Our Kentucky-bred art director suspicioned when he looked our cover over that scientists at MIT's Lincoln Lab had taken to making "mountain dew." It isn't so. *The fellow is just siphoning liquid helium out of a storage dewar into the dewar of a maser.* See p 29

COVER

**PLASMA HARMONICS**—Key to High Power at Millimeter Wavelengths? WESCON speaker sees "good chance" for tens of watts. *Another plasma development: beam welder for exotic metals*

16

**MARINER C** Shaping Up for '64. Spacecraft's mission requires system changes. *It will seek life on Mars*

16

**CRYOGENICS** for the Electronics Engineer. The roster of electronic devices that like to operate down near absolute zero is growing every day. This article will help you select and use the special equipment needed to operate them. *Jim Meyer, one of the authors, was an inventor of the solid-state maser amplifier.* By J. W. Meyer and A. M. Rich, Lincoln Lab, MIT

29

**COAXIAL FILTERS**—A Practical Design Technique. Multiple resonator coaxial filters used in microwave multiplex are short-circuited quarter-wave lines inductively coupled by apertures in their common walls. *But the size of the apertures presents an area of indeterminacy.*

By J. F. Lally and R. R. Ciehowski, Litton Industries 35

**UHF DIGITAL CONVERTER** Uses the Latest Semiconductor Circuits. This analog-digital converter can handle video signals with a bandwidth of 25 Mc but it requires a bit rate of 300 Mc. *The converter uses a parallel-serial layout to keep speed requirements reasonable.*

By H. R. Schindler, GE Electronics Lab 37

**DEPARTMENTS**Components and Materials. *Nonwirewound Potentiometers* 44Production Techniques. *Sequential Kitting* 46New Products. *Amplifier Extends Photomultiplier Range* 48

Crosstalk 3 Meetings Ahead 20

Comment 4 Literature of the Week 49

Electronics Newsletter 7 People and Plants 50

Washington This Week 12 Index to Advertisers 56

**Brian  
Clare  
can  
show  
you...**



*Sales Engineer, North Atlantic Industries*

## how to measure in-phase, quadrature and angle while sweeping frequency to 100 kc

North Atlantic's latest addition to the PAV line of Phase Angle Voltmeters\* enables you to make measurements while frequency is varying over half-decades without recalibration. The VM-301 **Broadband Phase Angle Voltmeter\*** provides complete coverage from 10 cps to 100 kc, and incorporates plug-in filters to reduce the effects of harmonics in the range of 50 cps to 10 kc with only 16 sets of filters. Vibration analysis and servo analysis are only two of the many applications for this unit. Abridged specifications are listed below:

Voltage Range.....	1 mv to 300 volts full scale
Voltage Accuracy.....	2% full scale
Phase Dial Range.....	0° to 90° with 0.1° resolution (plus 4 quadrants)
Phase Accuracy.....	0.3°
Input Impedance.....	10 megohms, 30µf for all ranges (signal and reference inputs)
Reference Level Range.....	0.15 to 130 volts
Harmonic Rejection.....	50 db
Nulling Sensitivity.....	less than 2 microvolts
Size.....	19" x 7" x 10" deep
Price.....	\$1750.00 plus \$120.00 per set of filters

North Atlantic's sales representative in your area can tell you all about this unit as well as other Phase Angle Voltmeters\* for both production test and ground support applications. Send for our data sheet today.



**NORTH ATLANTIC industries, inc.**  
TERMINAL DRIVE, PLAINVIEW, L. I., NEW YORK • OVERbrook 1-8600

*\*Trademark*

## electronics

August 30, 1963 Volume 36 No 35

Published weekly, with Electronics Buyers' Guide as part of the subscription, by McGraw-Hill Publishing Company, Inc. Founder: James H. McGraw (1860-1948).

Title ® registered U.S. Patent Office; © copyright 1963 by McGraw-Hill Publishing Co., Inc. All rights reserved, including the right to reproduce the contents of this publication, in whole or in part.

Executive, editorial, circulation and advertising offices: McGraw-Hill Building, 330 West 42nd Street, New York, N. Y., 10036. Telephone Area Code 212 971-3333. Teletype TWX N. Y. 212-640-4646. Cable McGrawhill, N. Y. PRINTED IN ALBANY, N. Y.; second class postage paid at Albany, N. Y.

OFFICERS OF THE PUBLICATIONS DIVISION: Shelton Fisher, President; Vice Presidents: Joseph H. Allen, Operations; John R. Callahan, Editorial; Ervin E. DeGraff, Circulation; Donald C. McGraw, Jr., Advertising Sales; Angelo R. Venezian, Marketing.

OFFICERS OF THE CORPORATION: Donald C. McGraw, President; Hugh J. Kelly, Harry L. Waddell, L. Keith Goodrich, Executive Vice Presidents; John L. McGraw, Treasurer; John J. Cooke, Vice President and Secretary.

Subscriptions are solicited only from those actively engaged in the field of the publication. Position and company connection must be indicated on orders. Subscription rates: United States and Possessions and Canada, \$6.00 one year, \$9.00 two years, \$12.00 three years. All other countries \$20.00 one year. Single copies, United States and Possessions and Canada 75¢. Single copies all other countries \$1.50.

THE PUBLISHER, UPON WRITTEN REQUEST TO OUR NEW YORK OFFICE FROM ANY SUBSCRIBER AGREES TO REFUND THAT PART OF THE SUBSCRIPTION PRICE APPLYING TO COPIES NOT YET MAILED.

Subscribers: Please send change of address notices, subscription orders or complaints to Fulfillment Manager, Electronics, at the address below. Change of address notices should provide old as well as new address, including postal zone number if any. If possible, attach address label from recent issue. Allow one month for change to become effective.

Postmaster: Please send Form 3579 to Fulfillment Manager, Electronics, P. O. Box 430, Hightstown, New Jersey, 08520.



Audited Paid Circulation

# The Uses of Secrecy

**IN CONGRESS**, a new investigation of military research and development has begun and there is mounting pressure for a full-dress probe into all federal R&D—military and nonmilitary. One of the main objectives of the probe will be to determine if the nation is getting full value from federal R&D. To answer this question fully, we think, the probe should include an investigation of the ways by which R&D results are disseminated to industry and whether the security restrictions that block dissemination in some cases are necessary or realistic.

Total expenditure for research and development by the federal government is now about \$14 billion a year and is expected to keep rising. The work is being paid for by the American people, at the rate of about \$75 per capita.

Two main objectives are implicit in the expenditure: First, national security and defense; second, national improvement, which can be loosely taken to mean improved living conditions and personal development.

Obviously, many R&D results must be kept secret, especially those relating to weapons and national defense. But secret results can be applied only to specific projects; they cannot be applied broadly to defense development nor to the national economy so long as they remain known only to a few.

When technical results are not published it means we are limiting their application to a select group—those with the need to know. Classified publications ease this problem for defense systems developers, but these publications necessarily have a limited circulation.

The question of secrecy, then, becomes one of whom are we trying to keep in the dark about a given development—other nations or ourselves?

The decision to release research results to the public or not must be finely balanced on whether publication will help a potential enemy more than failure to publish will hurt us. Published research results may or may not help a potential enemy, depending on his ability and desire to put the results to work quickly, or upon what

they reveal about our national defenses. Unpublished and therefore little-used research results may well represent a substantial waste of technological effort and money.

Only the officials charged with the responsibility for national security can make the decision to publish or not in a given case, but they must keep in mind that unpublished research may represent one or two billions of taxpayer money wasted each year.

Is it possible that hidden in some secret file there is an unborn industry that would help solve part of our unemployment problem? If there is, we are not using secrecy, we are abusing it.

---

## NEXT WEEK IN *electronics*

... you will find an easy-to-complete questionnaire which we will ask you to return to us. Please take a minute to do so, as completely and as accurately as you can. The more we know about your needs the better we can serve you

---

## Coming in Our September 6 Issue

**TELEMETRY TODAY.** There's no substitute for a fresh, overall look at a fast-moving technology. Gives a man a sense of perspective, especially when that technology—like telemetry today—embraces such varied applications as industrial control and space-system monitoring, medical checkups and missile checkout.

To help you gain that perspective, we recommend next week's staff-written report on what's new in telemetry. Among the topics it covers are modulating, coding, error-correction and bandwidth-widening techniques, how to handle the data, what frequency changes are coming up, and more.

Other timely articles next week will include:

- Tunnel-diode circuits for magnetic-core readout. A parts savings up to 80 percent was made in one application

- New telecasting technique. Japanese broadcast engineers developed this to get special video effects

- Reliability sliderule. Cut out the pages, paste them on cardboard and you'll be all set to figure out equipment reliability in quick-time.

now  
available  
for  
immediate  
delivery:

**JERROLD  
RF SWEEP  
EQUIPMENT  
...the industry's  
finest!**



**Model 900B  
Super Sweep Generator**

Wide plus narrow band in one versatile instrument. Handles all 1F, VHF, UHF sweep requirements. Sweep widths from 10kc to 400mc. Frequency range from 500kc to 1,200mc. Built-in crystal-controlled harmonic markers, dc or ac scope preamplifier, precision attenuator. **\$1,980.00**



**Model LA-5100  
rf Log Amplifier**

Accurate within  $\pm 1$ db over 80db dynamic range. Frequency range 500kc to 100mc. Lets you make exact measurements of attenuation in networks, filters, amplifiers with dynamic ranges down to 85 db. Total rf response displayed in precise log ratio on standard dc-coupled scope. **\$795.00**

**Model 900A Wide-Band Sweeper**

Sweep widths from 100kc to 400mc. Frequency range from 500kc to 1,200mc. **\$1,260.00**

**Model 707 Ultra-Flat Sweeper**

Flatness of  $\pm 0.05$ db in highest single octave. Plug-in oscillator heads. **\$840.00**

All for immediate delivery. Prices f.o.b. Philadelphia. Write for complete technical data on these and other Jerrold rf test instruments.

**JERROLD  
ELECTRONICS**

Industrial Products  
Division,  
Philadelphia 32, Pa.

A subsidiary of THE JERROLD CORPORATION

COMMENT

**Industrial Espionage**

This is in regard to your articles on industrial espionage (p 22, July 12, and p 32, July 19).

Much of the so-called "pirating" of employers' secrets is not pirating. An engineer working for a company gets an idea. Management [does] nothing with the idea and reprimands him for wasting time.

Finally he quits and forms his own company and manufactures the item . . . Presently he is sued for stealing the idea. He is denounced—for doing something with the idea he was formerly denounced for getting . . .

GEORGE E. ROW  
Rowco Engineering Co.  
Indianapolis, Indiana

**RFI**

Congratulations on your special issue on rfi (p 37, June 21). You can be justifiably proud of the results of your efforts.

As is bound to happen in an effort involving so many details and the coordination of information received from a multitude of sources, some small errors have crept in. In the section entitled Suggested Definitions of Shielding Terms (p 56), the formula  $A = 3.34t\sqrt{f\sigma\mu}$  was given incorrectly as  $A = 3.34t(f\sigma\mu)$ .

Early in June, at about the time that these suggested definitions were being printed, they were being discussed at the National Symposium for PTG-EMC (formally PGRFI) in Philadelphia. A special "work-shop" session had been set up to try to come to some agreement on these definitions. As of this writing, no concrete results have yet come forth. Much work will be needed before an agreement can be achieved.

I also believe that you may have, inadvertently, failed to mention that the background photograph of a shielding honeycomb, used on the frontispiece of this article, was supplied by Technical Wire Products Incorporated.

O. P. SCHREIBER  
Technical Wire Products, Inc.  
Cranford, New Jersey

**RFI**

The special report on r-f interference (p 37, June 21) listed d-c power supplies as a source of rfi but did not dwell sufficiently on this aspect. While many engineers are concerned with the rfi generated by d-c power supplies (particularly high-current d-c power supplies using switching circuits including scr's and magamps), very little consideration is given to rfi generated by d-c series regulator-type power supplies.

We have found, while developing a series of high-current (4 amp to 60 amp) d-c power modules per MIL-I-26600 and MIL-I-6181D, and using the d-c series regulator technique, that unless preventive steps are taken, considerable conducted rfi is generated. The major source is the input rectifier section, due to the high reversed currents that flow at the time the rectifier is turning off. These high-current transients cause considerable rfi to be conducted back into the a-c line, from which point it may be conducted to other equipment powered from this a-c line.

To remedy this situation, we provide a filter between the power transformer secondary and the rectifier bridge, which greatly attenuates the conducted rfi to the point where it falls well within the specification limits of MIL-I-26600 and MIL-I-6181D.

WILLIAM O. MCGREW  
Valor Instruments, Inc.  
Gardena, California

**Avalanche Transistors**

We are pleased to read in your review the description of our pulse generator, Avalanche Transistors Test 10-Nsec Logic (p 46, July 12).

Please note that the published diagram is incorrect: the OA95 diodes and 6.2K resistors, shown grounded on the emitter connection of transistors  $Q_5$ ,  $Q_6$  and  $Q_7$ , should be connected to the bases of these transistors, the bias of which they provide, together with the three 1.5K resistors connected to the emitter of  $Q_1$ .

R. CHARBONNIER  
Rochar Electronique  
Montrouge (Seine)  
France

# new power photocell from Delco

## 25 watts

Here's a cadmium sulphide photocell with muscle. It's Delco Radio's new LDR-25—a light dependent resistor equipped to dissipate 25 watts at  $\frac{1}{2}$  ampere and with a 200 DC or peak AC voltage capability.\* Dark resistance

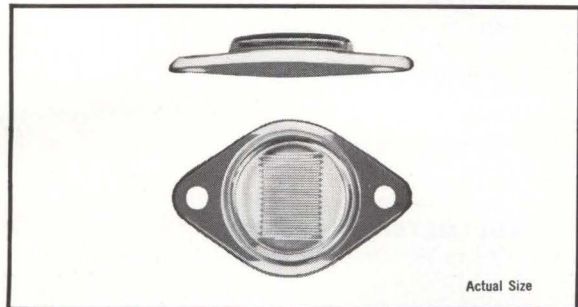

Actual Size

LDR-25

value of the device exceeds .5 megohm while 1,000 foot candles of illumination will reduce its resistance to 15 ohms.

Characteristics of the LDR-25 make it ideally suited for direct-to-line control of 115 VAC powered appliances. It can be used as a "variable relay" in series with an inductive load operating

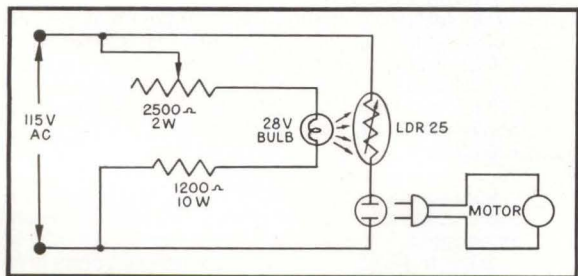

LDR-25 in series motor control using potentiometer controlled light source.

\*When properly mounted on heat sink.

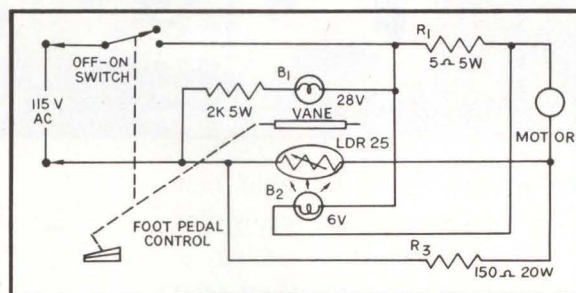

LDR-25 in series control circuit using foot operated mechanical vane to regulate light—eliminates need for moving contacts. Dual light source provides feedback for constant motor speed under varying loads.

at power levels up to 100 watts. Its medium and high power switching abilities are ideal for inductive loads where voltage surge from breaker points or junction devices is a problem.

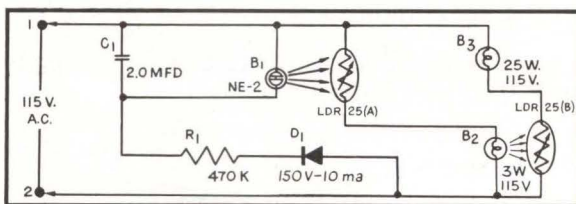

Flasher circuit in which chain of lamps and LDR-25s provide power amplification with a gain of 100.

The amazingly low-priced LDR-25 is available now.

Contact any of our sales offices listed below for more information.

Union, New Jersey  
324 Chestnut Street  
MURdock 7-3770  
AREA CODE 201

Palo Alto, California  
201 Town & Country Village  
DAvenport 6-0365  
AREA CODE 415

Syracuse, New York  
1054 James Street  
GRanite 2-2688  
AREA CODE 315

Detroit, Michigan  
57 Harper Avenue  
TRinity 3-6560  
AREA CODE 313

Santa Monica, California  
726 Santa Monica Blvd.  
UPTon 0-8807  
AREA CODE 213

Chicago, Illinois  
5151 N. Harlem Ave.  
775-5411  
AREA CODE 312

General Sales Office: 700 E. Firmin, Kokomo, Ind., Gladstone 2-8211—Ext. 500 • Area Code 317



Division of General Motors, Kokomo, Indiana

# SIMPLIFY communications maintenance

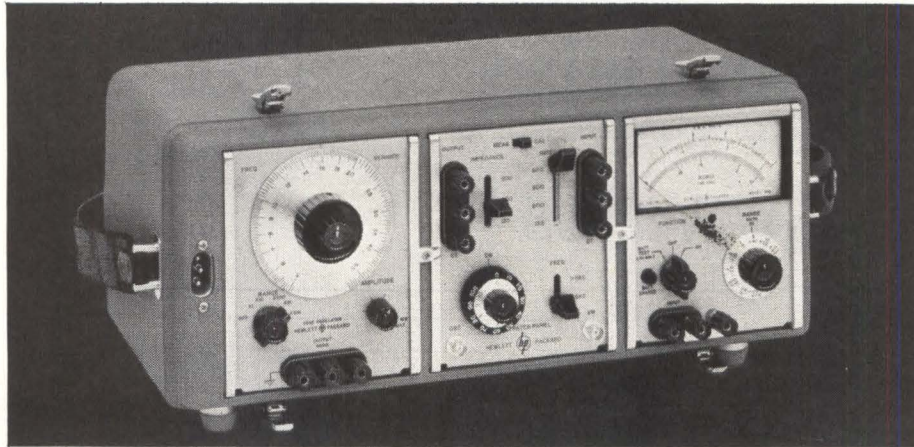

**NEW  
portable  
test set  
measures  
gain,  
attenuation,  
frequency  
response**

## SPECIFICATIONS

**T**he new  $\text{hp}$  3550A Portable Test Set, designed specifically for transmission system testing, is especially useful for alignment and maintenance of multichannel communication systems. It incorporates a 5 cps to 560 kc oscillator with fully floating output, a 1 mv to 300 v 5 cps to 2 mc voltmeter, and attenuator and impedance matching networks to individually match the oscillator and voltmeter to 135, 600 and 900 ohm lines.

The solid state instruments are housed in a compact case with a splash-proof cover, and both the oscillator and voltmeter operate from internal rechargeable batteries or from an ac line. The three instruments may be used separately in or out of the case.

The oscillator provides flat frequency response and excellent amplitude and frequency stability. The highly accurate voltmeter provides a db scale for easy measurement  $-72$  to  $+52$  dbm. The attenuator and impedance matching unit includes calibrate features to eliminate insertion loss. Oscillator and voltmeter batteries recharge during ac operation.

Check the specifications for the remarkable versatility and convenience of this test set, then contact your  $\text{hp}$  representative or call direct for a demonstration on your bench or in the field.

<b>Frequency Range:</b>	<b>OSCILLATOR (<math>\text{hp}</math> H07-204B)</b>
<b>Dial Accuracy:</b>	5 cps to 560 kc, 5 ranges
<b>Frequency Response:</b>	$\pm 3\%$
<b>Output Impedance:</b>	$\pm 3\%$ into rated load
<b>Output:</b>	600 ohms
	10 mw (2.5 v rms) into 600 ohms, 5 v rms open circuit, completely isolated
<b>Distortion:</b>	Less than 1%
<b>Hum and Noise:</b>	Less than 0.05%
<b>Temperature Range:</b>	$-20^\circ$ to $+50^\circ$ C
	<b>VOLTMETER (<math>\text{hp}</math> 403B)</b>
<b>Range:</b>	0.001 to 300 v rms full scale; $-72$ to $+52$ dbm
<b>Frequency Range:</b>	5 cps to 2 mc
<b>Accuracy:</b>	$0^\circ$ C to $50^\circ$ C, within $\pm 2\%$ of full scale from 10 cps to 1 mc, within $\pm 5\%$ of full scale from 5 to 10 cps and 1 to 2 mc (on 300 v range, accuracy is $\pm 10\%$ from 1 to 2 mc; AC-21A 10:1 Divider Probe allows measurements to 300 v in the 1 to 2 mc range with an accuracy of $\pm 5\%$ ; $0^\circ$ C to $-20^\circ$ C, $\pm 8\%$ of full scale from 5 cps to 2 mc
<b>Nominal Input Impedance:</b>	2 megohms, shunted by approximately 40 pf on 0.001 v to 0.03 v ranges, 20 pf on 0.1 v to 3 v ranges, 15 pf on 10 to 300 v ranges
<b>DC Isolation:</b>	Signal ground may be $\pm 500$ v dc from external case
<b>Noise:</b>	Less than 4% of full scale on 1 mv range, 3% on other ranges
	<b>ATTENUATOR/PATCH PANEL</b>
<b>Attenuation:</b>	110 db in 1 db steps
<b>Accuracy:</b>	10 db section, error less than $\pm 0.125$ db at any step, dc to 100 kc; less than $\pm 0.25$ db, 100 kc to 1 mc. 100 db section, error less than $\pm 0.25$ db at any step up to 70 db, less than $\pm 0.5$ db above 70 db, from dc to 100 kc; less than $\pm 0.5$ db up to 70 db, less than $\pm 0.75$ db above 70 db, 100 kc to 1 mc
<b>Impedance:</b>	600 ohms
<b>Input and Output:</b>	50 cps to 560 kc; balance better than 40 db; frequency response $\pm 0.5$ db, 50 cps to 560 kc; impedance, 135, 600, 900 ohms center tapped. Input includes 10K bridging impedance; insertion loss, less than 0.75 db at 1 kc; maximum level $+10$ dbm (2.5 v into 600 ohms)
	<b>GENERAL</b>
<b>Power:</b>	Voltmeter and oscillator each use a power supply of 4 rechargeable batteries (furnished, 40 hr. operation per recharge [20 hours at $-20^\circ$ C], up to 500 recharging cycles). Automatic recharging during ac operation
<b>Dimensions:</b>	8 $\frac{3}{8}$ " high, 19 $\frac{1}{4}$ " wide, 13 $\frac{1}{4}$ " deep. Weight 30 $\frac{1}{2}$ lbs.
<b>Price:</b>	\$990.00

Data subject to change without notice. Price f.o.b. factory.



## HEWLETT-PACKARD COMPANY

1501 Page Mill Road, Palo Alto, California, Area Code 415, DA 6-7000  
Sales and service representatives in all principal areas; Europe, Hewlett-Packard S. A., 54-54bis Route des Acacias, Geneva; Canada, Hewlett-Packard (Canada) Ltd., 8270 Mayrand Street, Montreal



## Platters Play Pictures on Tv Set

LONDON—Colin Mason, a Wolverhampton inventor, claims he has developed a record player that plugs into a tv set and reproduces animated video and monaural or stereo sound. Estimated sales price for the device is \$100 in Britain; the records would cost no more than conventional ones. No tape is involved.

The company that backed development, Wolverhampton Radio and Supplies Co., is said to be negotiating a license with a "large British company with U. S. contacts"—the company may be EMI, but this has not been confirmed.

Few technical details are available yet. Composite signals on the disc are separated in the pick-up head, providing a capacity for two channels of video and two channels of audio. Two separate systems have been evolved, one compatible with ordinary record players, and one not compatible. It has not yet been disclosed which system will be adopted.

Since practical stereo viewers have not been developed, the first recordings will probably be monaural sound and single-channel video. The company says disc wear has less effect on video than sound reproduction.

In the present design, the video signal gives a bandwidth of 3.5 to 4 Mc, suitable for Britain's 405-line tv system. The company says bandwidth could be up to 35 Mc.

### School Video in 2.5-Gc Band Approved

EFFECTIVE Sept. 9, a new instructional tv fixed service is authorized by FCC "for accredited public and private schools, colleges and universities in the formal education of students." Systems so licensed can also transmit special training material to hospitals, training centers, rehabilitation centers, industrial establishments and the like. Six groups of frequencies totaling 31 channels from 2,500 to 2,686 Mc are

provided to operate at a nominal maximum power of 10 watts. Each channel is 6 Mc wide. An experimental system developed by Adler Electronics for the Plainedge, N. Y. schools (p 7, Aug. 3, 1962) has been operating about a year.

### Liquid-Cooled Computer Attains 3-Million Rate

CHIPPEWA FALLS, WISC.—Control Data's 6600 digital scientific and engineering computer can run 11 different programs simultaneously and without time sharing, achieving more than three million operations a second.

Multiple-level concurrent processing is the only answer to transmission-line limitations, Control Data says. To avoid time loss in interconnections, the computer is built in a cruciform shape that keeps all interconnections under 8 feet long. Cordwood modules use silicon planar transistors. Heat transferred to a cold plate is picked

up by circulating Freon and carried to a water exchanger.

Each of the 11 independent computers in the 6600 has its own memory, and each can execute programs independently of each other or of the central processor. Concurrent operations speed up the computer by assigning the memory a secondary role of refill and empty.

The new model will become part of the Control Data standard line, following delivery to Lawrence Radiation Laboratory next spring. Cost is \$7 million to \$8 million or \$150,000 to \$175,000 a month rent.

### All the Missile Ranges May Merge

CAPE CANAVERAL—Range Control Center scheduled to become operational here late next year will probably become the nerve center of a globe-girdling missile and space vehicle tracking range that would include the Atlantic, Pacific and White Sands Missile Ranges.

Air Force has awarded an \$850,-

### Washington-Moscow Hot Line Working

NEW YORK—The diplomatic "Hot Line" providing instant White House-Kremlin teleprinter communication will meet the formal Sept. 1 opening deadline. Starting Aug. 17, the radio circuit through Tangier relay has been operating well in the equipment-shakedown phase. Continuous transmissions were sent for the first few days; checkouts are now made daily.

RCA Communications spokesmen, in describing the radio link to ELECTRONICS, emphasized that they have been operating a circuit with Moscow since 1930. RCAC now provides private leased-channel service to Tass and the Soviet delegation to the United Nations (p 18, June 28).

Under the U.S.-USSR agreement, the hot line comprises both a cable link and the radio circuit (p 7, Aug. 23). Teleprinter messages are routed through RCA transmitters at Rocky Point, Long Island, using frequency-shift tones on single-sideband, to Tangier, Morocco. The Tangier receiver automatically keys the fsk twinplex transmitter. Signals are picked up near Moscow by facilities of the Soviet Ministry of Posts and Telecommunications.

Virtue of the Tangier two-hop circuit is that transmissions into Moscow on frequencies in the order of 5 to 16 Mc are southerly to northerly rather than west-east across the auroral zone in which communications failures can occur

000 contract to Sperry Piedmont for an advanced Range Control Center (RCC) to replace the presently overcrowded Central Control.

Lt. Col. Max Findell, RCC project officer, said that if present studies being conducted in Washington result in combining the three ranges under one cognizance, Canaveral would monitor and control all tracking and telemetry instrumentation on all ranges, including ships, planes and even satellite-borne instrumentation. Findell emphasized that as yet there was no definite decision.

There are strong indications that the move will be made, however. Maj. Gen. L. I. Davis, AMR commander, has been in Washington several weeks in connection with the establishment of an Air Force Systems Command organization that would control all the ranges. Gen. Davis is the most likely candidate to head the new range organization.

The Sperry Piedmont system will be able to monitor two countdowns simultaneously and keep tabs on an orbiting space vehicle as well. Sixty-four men operating 137 consoles will control 800 instrumentation status displays coming in from the entire range. High-speed real-time computers will automatically plot trajectory measurements and impact prediction points.

## Japanese Firms Set Minimum Tv Prices

TOKYO—Japanese firms ratifying the agreement on minimum floor prices for tv sets exported to the U. S. (p 7, Aug. 2) have increased to 23. Violators would be subject to a fine of up to 30 percent of the transaction. The agreement is now expected to be approved by the Ministry of International Trade and Industry and to take effect sometime in September. Manufacturers have agreed to a minimum export price three percent over the manufacturer's price. Manufacturers' prices set to date are as follows: 16-inch vhf sets, \$45; 16-inch uhf sets, \$55; 19-inch vhf sets, \$55; 19-inch uhf sets, \$63; 5 and 6-inch transistor vhf, \$70; 5 and 6-inch transistor uhf, \$80; smaller than 5-inch transistor uhf, \$75.

## Raytheon Develops Cold-Cathode TWT

RAYTHEON has developed an experimental 2 to 4-Gc traveling-wave tube with a heaterless tunnel cathode of semiconductor material. The hollow electron beam is preshaped and focused during fabrication—masks are employed while depositing layers of semiconductor materials on the cathode. Emission current has been measured at 100  $\mu$ amp when pulsed—500  $\mu$ sec pulses with a 5-percent duty cycle. Fast-starting twts are envisioned.

## Side-Tone Ranging to Track EGO and OAO

FIRST OF THREE tracking systems built by Motorola for NASA was shipped to the space-tracking station at Carnarvon, Australia, last Thursday. The system—intended for use with such programs as the OAO and EGO—will track highly elliptical orbits out to 70,000 miles in perigee. Satellite transponders will be interrogated from the ground. Side-tone ranging techniques will determine range and range rate by doppler shift, to pinpoint spacecraft range to within 16 yards and speed to within 4 inches per second.

## Two Companies Expand Microcircuit Activities

SAN FRANCISCO—H. C. Lin, of Westinghouse Molecular Electronics division, disclosed at Wescon that the company expects to market next year the following devices in functional block form: surface-field-effect, metal-base and light-actuated transistors; *pnpn* switches; i-f and a-f strips; a-f amplifier with response from 1 cps to uhf; tuning device; piezoelectric resonators.

M. W. Newell, Philco vice president, announced Philco expects to triple microelectronic engineering facilities in the next six months, and to be producing 10,000 silicon microcircuits by next spring. Philco is now producing Micrologic circuits under a Fairchild license.

## In Brief . . .

CONTROL system components for the Sprint antimissile missile will be designed by Honeywell under a contract from Martin.

TORONTO traffic signals are now controlled by a Univac 1107 thin-film memory computer. By 1965, all timed traffic signals in Toronto will be computer controlled.

GENERAL ELECTRIC has received a \$19-million NASA contract to develop, assemble and test six 1,000-lb flight-model biosatellites plus ground-test spacecraft. Flights begin in 1965.

FREDERICK E. TERMAN, vice president and provost of Stanford University, received the 1963 Western Electronic Medal of Achievement, at WESCON.

AUDIO DEVICES has arranged to buy Sound Corporation of America.

COMPUTER PRODUCTS, INC. and Packard Bell Computer will jointly design and install hybrid computers. Likeliest hybrid is CP's Mark III analog model plus the digital PB440.

HIGH-SPEED auxiliary arithmetic unit has been developed by GE to extend ability of the GE-235 computer. Execution time is as low as 18  $\mu$ sec for add or subtract instructions.

XEROX is planning to buy Electro-Optical Systems.

CANADA will build a \$5-million ground station to conduct satellite communications experiments with NASA.

ACCIDENTAL break in transmission line last Friday aboard the *USNS Kingsport*, in Lagos Harbor, Nigeria, interrupted use of Syncom II. Service was expected to be restored late this week.

RELAY MARKET is pegged at \$200 million by Carl Martin, Babcock Relays vice president. He predicts \$250 million total by 1969.

**QUICK DELIVERY FROM SPRAGUE**

*AND ITS KEY INDUSTRIAL DISTRIBUTORS*



# THIS IS A ONE-WATT BLUE JACKET RESISTOR

**P. P. S.** For complete technical data write for Engineering Bulletin 7410D

**SPRAGUE ELECTRIC COMPANY • 35 MARSHALL STREET, NORTH ADAMS, MASS.**

*For application engineering assistance write:*

*Marketing Dept., Resistor Division, Sprague Electric Co., Nashua, New Hampshire.*

## **SPRAGUE COMPONENTS**

RESISTORS	PULSE TRANSFORMERS	CERAMIC-BASE PRINTED NETWORKS
CAPACITORS	PIEZOELECTRIC CERAMICS	PACKAGED COMPONENT ASSEMBLIES
TRANSISTORS	PULSE-FORMING NETWORKS	BOBBIN and TAPE WOUND MAGNETIC CORES
MICROCIRCUITS	TOROIDAL INDUCTORS	SILICON RECTIFIER GATE CONTROLS
INTERFERENCE FILTERS	ELECTRIC WAVE FILTERS	FUNCTIONAL DIGITAL CIRCUITS

**SPRAGUE®**  
THE MARK OF RELIABILITY

'Sprague' and '®' are registered trademarks of the Sprague Electric Co.

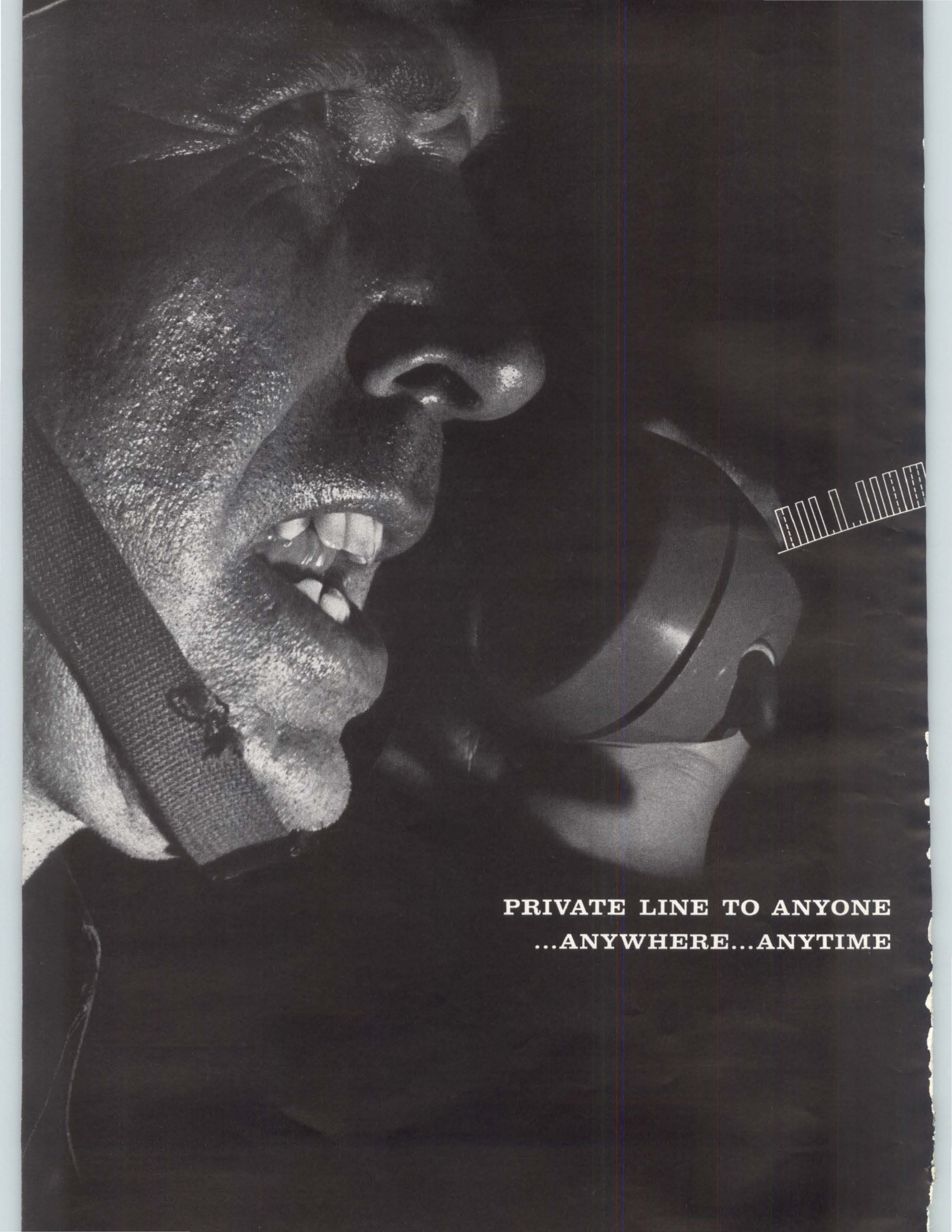

**PRIVATE LINE TO ANYONE  
...ANYWHERE...ANYTIME**

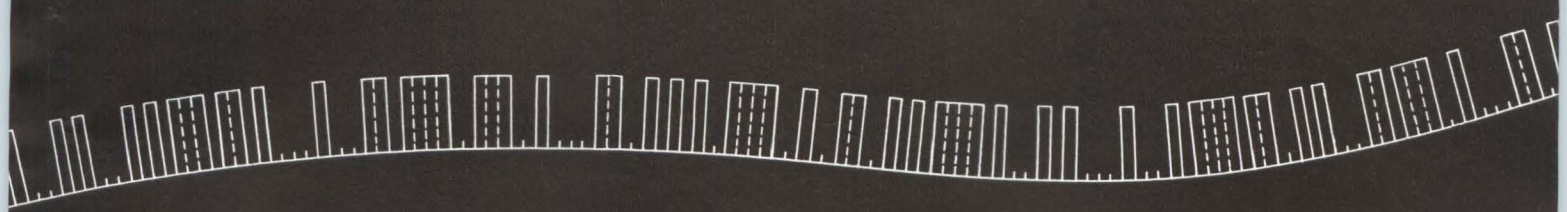

**MOTOROLA'S RADEM\*** concepts, being applied to the most important recent advance in military communication systems...will carry many high-priority radio messages simultaneously in a single wideband frequency channel; maintain private-line direct dialing without central exchanges or fixed nets; do this without interference between concurrent messages transmitted from different locations within the system; and perform these tasks with designs that lend themselves to the application of advanced, integrated electronic circuitry. (M) RADEM is one of the many major military and space electronic programs in progress at Motorola. Scientists and engineers interested in joining the men who are making basic contributions to both research and applications in advanced electronics write today describing your background and experience in:

**Systems Design** • operational and functional systems analysis, economic analysis, optimum time-bandwidth utilization, digital, voice and data communications, secure communications.

**Advanced Equipment Design** • solid state receivers, transmitters and repeaters, digital modems, digital data processing and display units, voice processing and reproduction equipment.

**Familiarity with State-of-the-Art** • statistical theory of communications, spread-spectrum techniques, coding theory, integrated circuit applications, digital logic design, solid state RF circuit techniques, auto correlation and cross correlation techniques.

We are particularly interested in programs on which your experience was obtained and the extent of your technical responsibility. Please address this information to our Manager of Engineering at the location of your choice for immediate and confidential attention.

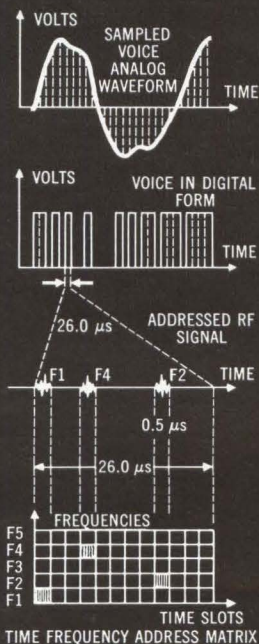

\*RADEM (Random Access Delta Modulation) principle diagramed above is the result of 5 years of independent Motorola research.

**MOTOROLA**  **Military Electronics Division**  
An equal opportunity employer

CHICAGO 51, Illinois, 1450 North Cicero Avenue / SCOTTSDALE, Arizona, 8201 East McDowell Road

# WASHINGTON THIS WEEK

## BEHIND THE TREATY ROW: ANTI-ICBM BLACKOUT?

TEST-BAN TREATY controversy is lining up the sides on the probability of developing effective antimissile defenses. On one side are the Administration backers who say that missile defense is still beyond the technical capability of the U. S. and USSR, and that atmospheric tests are not needed to work on an effective defense. Opponents, especially Edward Teller, insist tests are needed, that Russia gained knowhow in its sneak tests of 1961-62, and that you can't be sure of a system until it is integrated and tested realistically.

Developing the antimissile warhead is not the main problem. The knottier question, which test ban questions relate to, is the rest of the system. Because Nike Zeus is considered too slow for sifting incoming warheads from decoys and then making the kill, R&D emphasis has shifted to Nike X. Nike X would have discrimination radar and a speedier missile. But the question still remains whether Nike X can make its kill high enough to protect ground installations and population. And what happens after the first explosion—either offensive or defensive—blinds the radar to subsequent ICBM salvos has the scientists wringing their hands.

## PENTAGON OK'S MOST BUDGET CUTS

DEFENSE DEPARTMENT has asked the Senate to restore only \$239.2 million of the \$1.1 billion trimmed from this year's military procurement appropriation by the House and only one-quarter of the \$400 million cut from the R&D request. The Pentagon's original budget plan called for \$16.7 billion in procurement and \$7.3 billion in R&D.

The Pentagon wants \$44.6 million back of the \$59.6 million the House carved out of the appropriation for Army R&D on communications satellite systems, and restoration of the \$25-million cut for Phantom II tactical recon planes. It did not seek restoration of the \$58.3-million reduction in the procurement appropriation for electronics and telecommunications, the \$100-million reduction in the MMRBM (mobile medium-range ballistic missile) program, nor the 1-percent across-the-board reduction in all procurement programs. The last cut was aimed to pressure the military services into tighter contracting policies.

## PHANTOM'S SIDE-LOOKING RADAR READY

THE HOUSE cut procurement funds for McDonnell's RF-4C version of the Phantom II aircraft to "slow down" production "pending solution of development problems in the plane's electronic systems." Deputy Defense Secretary Gilpatric now argues that there is no reason for delaying procurement. He told the Senate that the plane's side-looking radar subsystem "is on schedule and in phase with the planned air-frame production schedule" and will be delivered in September. The framing camera's most critical component, the shutter, has operated successfully in X-15 flights.

## MMRBM WAITS ON ELECTRONICS

IN ACCEPTING the MMRBM cutback, Gilpatric disclosed that the Air Force will "concentrate its efforts for the time being on the pacing elements of this system, namely, the guidance and command and control components." He said the existing budget will be "sufficient to carry out that phase of the work."



ACTUAL  
SIZE

***Electronic technology that works...***

## **FERROELECTRIC CERAMIC MODULE COMBINES LOGIC WITH POWER CONTROL**

A new product of Erie Resistor with a potentially tremendous commercial value: a ferroelectric ceramic material able to perform any function presently accomplished with variable reactors such as magnetic amplifiers or frequency multipliers.

***Performance features of this unusual material include:***

- Hysteresis curve characteristic
- Low coercivity
- High K values
- High frequency efficiency
- High leakage resistance, allowing DC control charge to remain even when control circuit is not continually energized.

This unique material is presently being used as the substrate for an RC network. Here, it performs an analog function as an adjustable gate valve in the control of an electroluminescent panel.

Potentially, this material can help provide a flat television screen, eventually eliminate the need for the conventional bulky TV picture tube, permitting the design of a picture-frame-thin TV receiver with no flicker.

This is another example of advanced research and production technologies at work at Erie Resistor . . . where reliability goals are assured.

Tell us your requirements. Address:

**ERIE RESISTOR CORPORATION**



644 West 12th Street  
Erie, Pennsylvania

**DESIGNER, PRODUCER AND MARKETER OF TECHNOLOGICAL PRODUCTS**

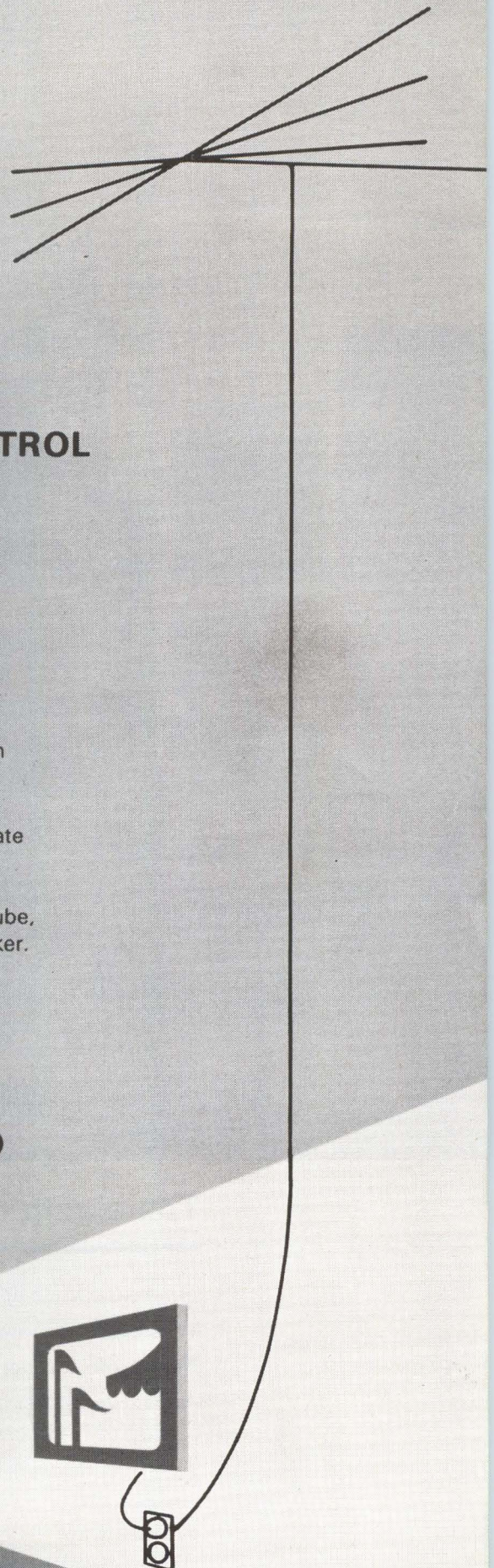
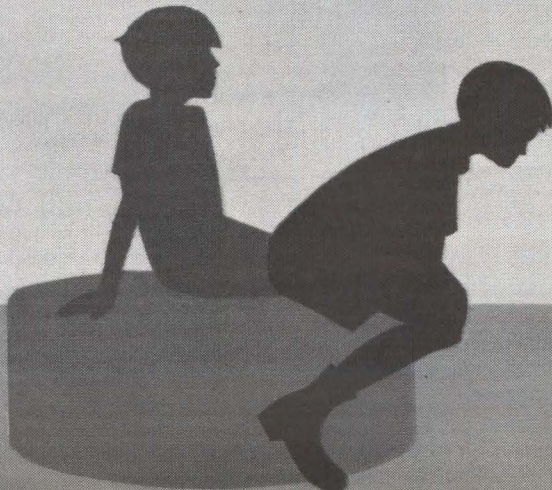

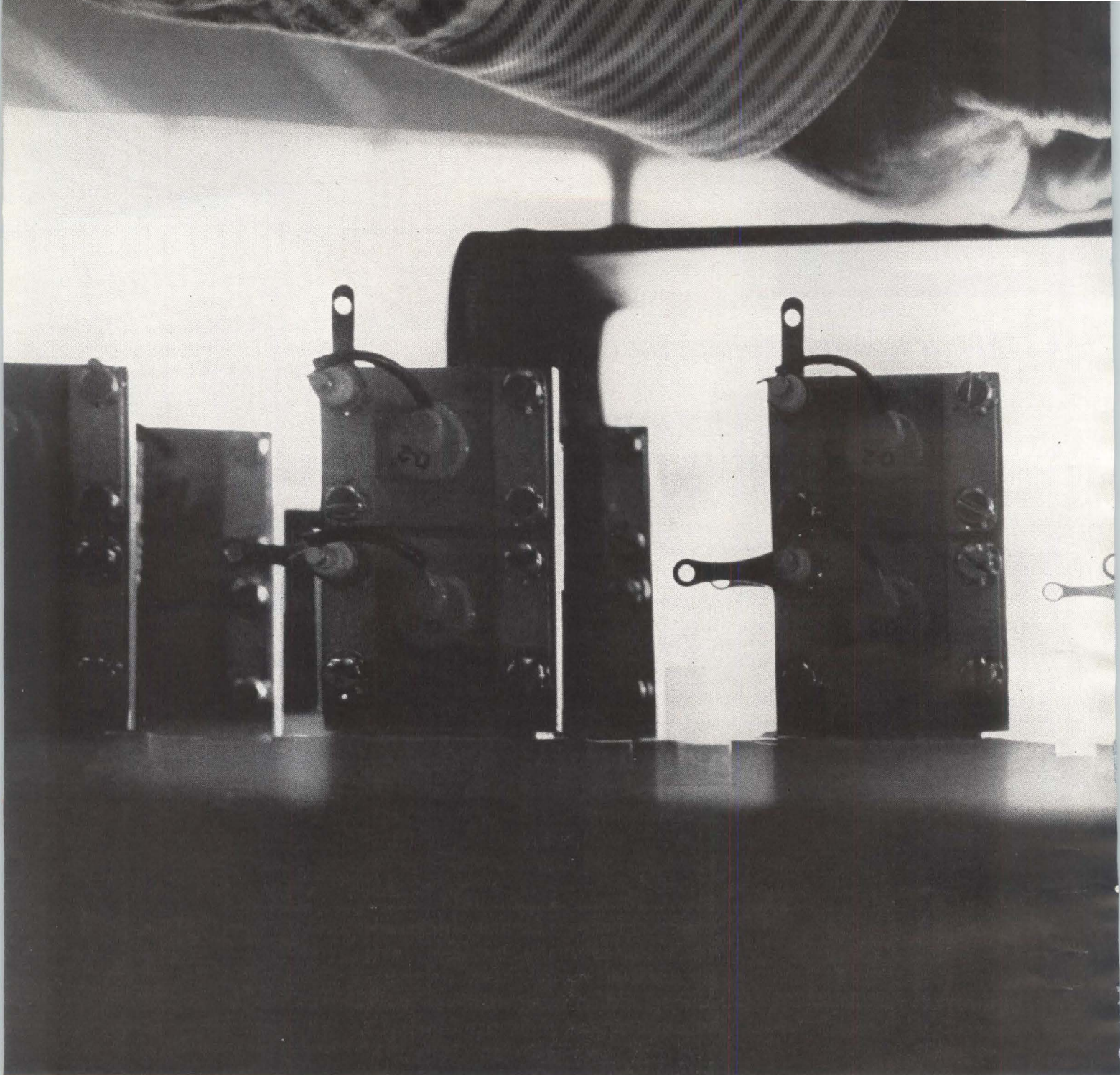

## **The eighth one is no good. Do something about it—now.**

---

Before the same defect shows up in #12 or #14.

While the component is still on the line.

Before the component goes into a sub-assembly.

An IBM computer can help you. It brings the speed and accuracy of electronic data processing to in-process production quality assurance. Right on your production line.

An IBM Industrial Testing System—your present testing equipment coupled with an IBM computer—collects, analyzes and evaluates mass test data on a real-time, on-demand basis. Problems are caught, corrections made *immediately*.

Product quality and production efficiency go up. Waste and rejects go down.

Do something about your quality assurance now. Call IBM.



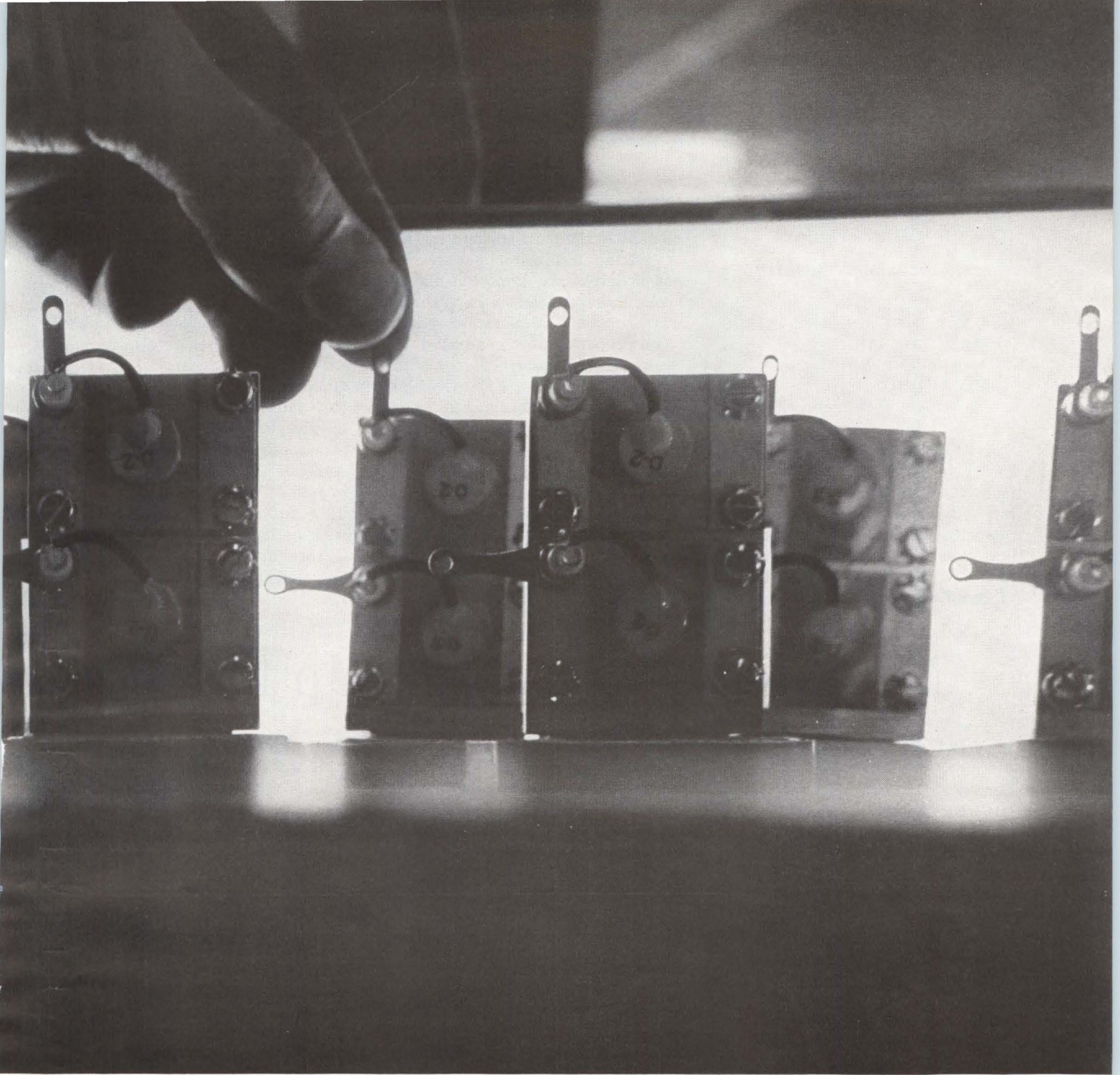

IBM's new Industrial Testing System can help you with your quality assurance program. Several different IBM computers, such as this 1710 Control System, are available to meet your exact requirements in collecting, analyzing and evaluating mass test data.

**IBM**<sup>®</sup>  
DATA PROCESSING

CIRCLE 15 ON READER SERVICE CARD

# High Power at Millimeters—Plasma

*WESCON speaker sees tens of watts. Another plasma prospect: welding*

By LAURENCE D. SHERGALLIS  
HAROLD C. HOOD  
Pacific Coast Editors  
ED ADDEO  
McGraw-Hill World News

**SAN FRANCISCO**—In the near future, harmonic generation in plasmas has a good chance of becoming one of the most efficient, high-power schemes for generating power at frequencies in the millimeter wavelengths, J. H. Krenz, of Stanford University, told ELEC-

TRONICS last week.

Presently, he said, varactor diodes are the most efficient method of getting millimeter power. But power levels are low. Plasma devices, however, can be driven with watts or tens of watts of power.

In experiments conducted at Stanford and described in his paper presented at WESCON last week, Krenz has obtained 25 to 30-percent efficiency at the second harmonic using a 3-Gc source. His paper, coauthored with G. S. Kino, described measurements made on a spherically shaped discharge. Strong harmonic outputs up to the seventh harmonic were observed. Because there is resonance, and the interaction is reactive, parametric

oscillations are also present. By driving the plasma at twice the resonant frequency, parametric oscillations were observed at about 1.5 Gc. This is reportedly the first time that such parametric oscillations have been obtained using a plasma as a nonlinear reactive medium.

**MOSTLY THEORY**—Krenz told ELECTRONICS that most of the work in generation of harmonics in a plasma discharge is still theory. Analysis is not complete enough to permit prediction of uses in the near future. But plasma devices with high power outputs up to 100 Gc are desirable because of their simplicity and high power capability.

## MARINER C Shaping Up for '64

By JOEL STRASSER  
Assistant Editor

**DIFFERENCES** between Mariner C's mission to Mars and Mariner II's mission to Venus will require extensive changes in the new Mariner's electronics, according to NASA project officials. The spacecraft is to be launched in November, 1964 from Cape Canaveral.

Mariner C's primary objective is to determine if life exists on Mars. It will attempt to take high-quality television pictures of Mars' surface, to study Martian magnetic fields and trapped particle regions, and to determine the existence and extent of cosmic dust close to the planet.

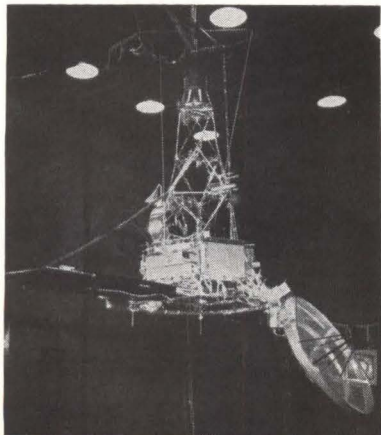

Interplanetary experiments are also planned.

Mariner C requires greater reliability because its mission will take twice as long as the Venus probe's. Project officials expect Mariner C to reach the vicinity of Mars in about 220 to 240 days. Mariner II took 110 days to reach Venus (ELECTRONICS, p 42, Dec. 14, 1962).

**COMMUNICATIONS**—Because of the greater communication distances on the Mars mission, Mariner C will have a power output of 10 w; Mariner II's output was 3 w. To compensate for the loss of solar energy near Mars, Mariner C's solar cells will occupy approximately 70 sq ft compared to 22.5 sq ft for Mariner II.

Mariner C will communicate at S-band, transmitting at 2,295 Mc and receiving at 2,115 Mc. Mariner II operated at L-band receiving at 890 Mc and transmitting at 960 Mc. Mariner C will have a fixed rather

than adjustable antenna to save weight. The Mars orbit does not change appreciably with respect to the earth-sun line.

**GUIDANCE**—On Mariner II, sensors were used to line it up with the earth and sun during the initial guidance phase. The Venus probe had no midcourse guidance system because it could not be relied upon at the time.

Subsequent advances in the state of the art have changed that. A star tracker will provide initial and midcourse guidance. Built by Barnes Engineering, the tracker will acquire the star Canopus, which provides a more stable reference than the constantly moving earth. No terminal guidance is planned.

**WEIGHT**—Mariner C will weigh 570 lb, an extra 123 lb. To keep weight down, there are no infrared radiometers and two scheduled experiments have been cancelled: California Institute of Technology's infrared spectrometer experiment and Stanford University's radio propagation experiment. A NASA spokesman indicates Mariner is still too heavy, so more may be cut.

*MARINER C prototype undergoes tests in high-altitude environmental chamber at Lockheed in California*

## Harmonics the Key

C. B. Swan, of Bell Laboratories, indicated that the average power capability of a gas-discharged device is one or two orders of magnitude greater than varactor diodes. Swan described experiments in the generation of harmonics in a plasma having a large electric field gradient. High efficiency, he said, requires such a gradient in the discharge. Swan analyzed the effect of the r-f field gradient in a co-

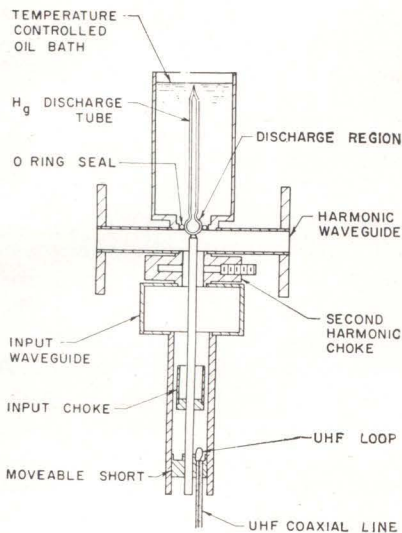

**PLASMA-DISCHARGE generator** used at Stanford to observe harmonic output and parametric oscillations in a spherical r-f discharge

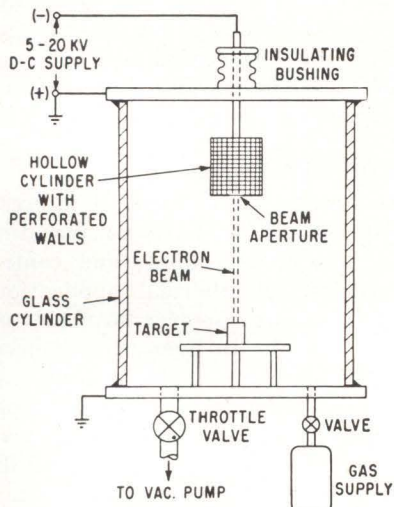

**WELDING** is one use seen for GE's plasma-electron-beam device. This is experimental arrangement

# X-Ray Vidicon

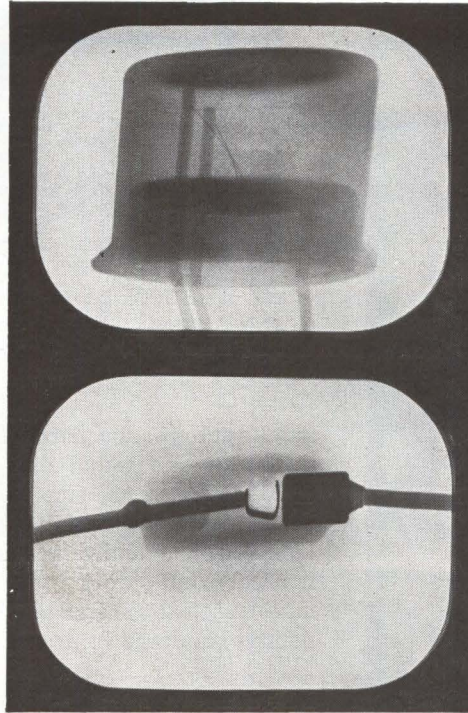

X-ray TV image of metal-clad transistor and encapsulated diode—a typical non-destructive testing application.



## High quality—static and in-motion—X-ray TV images...

The New ML-589 DYNAMICON is a 1" x-ray-sensitive vidicon camera tube which is capable of providing high contrast images with detail resolution down to 0.0005", and penetrameter sensitivities up to 2%, when used with an adequate CCTV system and x-ray source. Magnifications to 50X are easily obtainable. ML-589 is particularly suited for non-destructive testing and biological applications, permitting both static and in-motion examinations of small encapsulated components and materials such as plastics, ceramics, steel, aluminum, and rubber. For complete details write The Machlett Laboratories, Inc., Springdale, Conn. An affiliate of Raytheon Co.



measure dc



100mv to 500v



within 0.02%

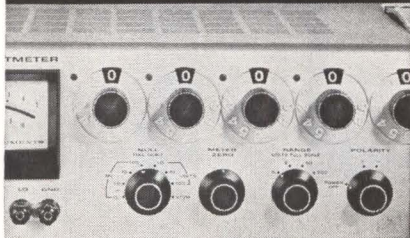

## New Differential Voltmeter

Keithley 660 measures dc voltages with the accuracy and stability of a laboratory standard and the ease and low cost of an ordinary VTVM.

### Features include:

- 0.02% limit of error
- reference supply stable to 0.005% indefinitely, without periodic re-standardization
- 100 $\mu$ v f.s. null range
- 2 $\mu$ v resolution
- infinite resistance at null, to 500v
- 0.005% repeatability
- 25 mv recorder output
- fully guarded input
- positive, negative or floating

Model 660 Differential Voltmeter . . . \$575  
Model 6601A Voltage Divider . . . \$175

Send for four page Engineering  
Note on the Model 660

latest catalog available  
upon request



**KEITHLEY  
INSTRUMENTS**

12415 Euclid Avenue • Cleveland 6, Ohio

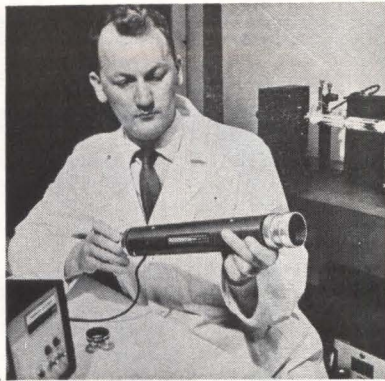

AT WESCON, visitors saw some 39 operating lasers compared to 4 last year. Among the small ones are these from Perkin-Elmer (left) and TRG's setup for biomedical research

axial type gas-discharge harmonic generator and found that the conditions for high efficiencies can be achieved at millimeter wavelengths. The analysis was mathematical and work to correlate mathematical analysis with experimental results is in progress.

**PLASMA WELDER**—"First practical application of plasmas" was disclosed by L. H. Stauffer of General Electric's Advanced Technology Laboratories. GE obtains large amounts of power in an electron beam produced from a plasma inside a hollow cold cathode. The obvious application is for welding exotic metals, now welded by electron-beam techniques that require high-vacuum. The plasma technique reportedly reduces sensitivity to contamination, eliminates the need for high vacuum, and uses rugged and simple equipment.

The cold cathode source is a hollow metal cylinder several inches long. When the cylinder is charged negatively to about 20 kv in the presence of argon at low pressure, a plasma of positive gas ions and free electrons forms within the cylinder. The few positive ions initially present in the gas knock electrons off the cathode. Also, the plasma glows with both visible light and ultraviolet, and emits short-wave radiation. High-energy ultraviolet radiation helps maintain the supply of electrons.

The electron beam emerges from the cathode as a parallel beam of electrons accelerated toward the work piece. Adjustment of gas pressure and cathode voltage are not critical. Electromagnetic focusing concentrates the beam to

about 10 mils diameter. Energy densities up to 40-Mw/sq in. will vaporize any known material.

GE has built a 2-kw beam source and is working on a 60-kw unit. Tests have been run using cathode voltages from 700 v to 150 kv and with gas pressures considerably higher than pressures used in vacuum systems. Conversion efficiency of cathode input to the thermal energy in the target is about 70 percent.

Control of beam intensity is an innovation of the device, Stauffer says. Control electrode or grid is an open mesh cylinder through which the beam passes. Varying grid voltage varies beam intensity. The beam has been pulsed with rise times of about 0.2 $\mu$ sec.

Much of this development is still in the R&D stage. Some of the phenomena occurring in the device are still not fully understood, Stauffer admits. However, the modulated plasma beam has application wherever a controlled, concentrated heat input is needed. A variety of beam configurations can be used, depending upon the application.

**CIRCUIT USES**—Grid control of the beam lends itself to interesting circuit applications including oscillators, amplifiers, and control circuits. Nonthermal applications of the plasma electron beam also include x-ray. In microwave generators, the beam could be fired into a traveling-wave tube. Other applications, said Stauffer, must wait for a better understanding of the mechanisms of beam formation.

Martin Marietta is also conducting research on a device of this type.

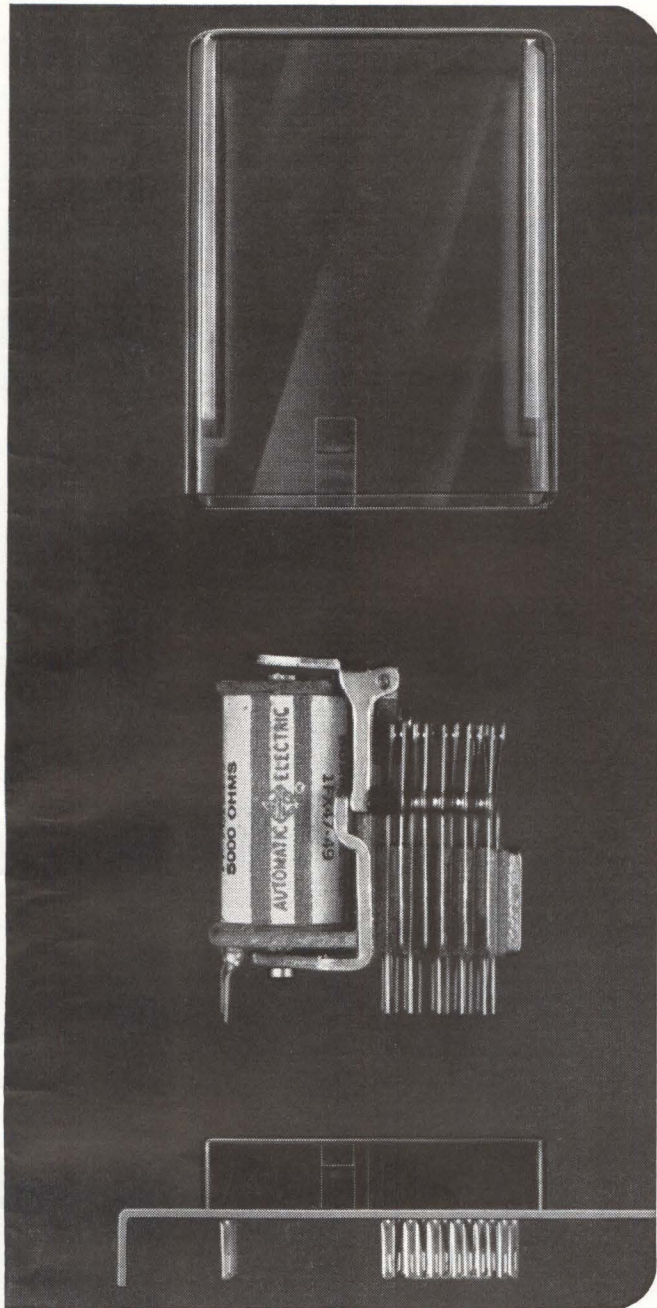

**IT  
SOCKETS  
LIKE A  
TUBE!**

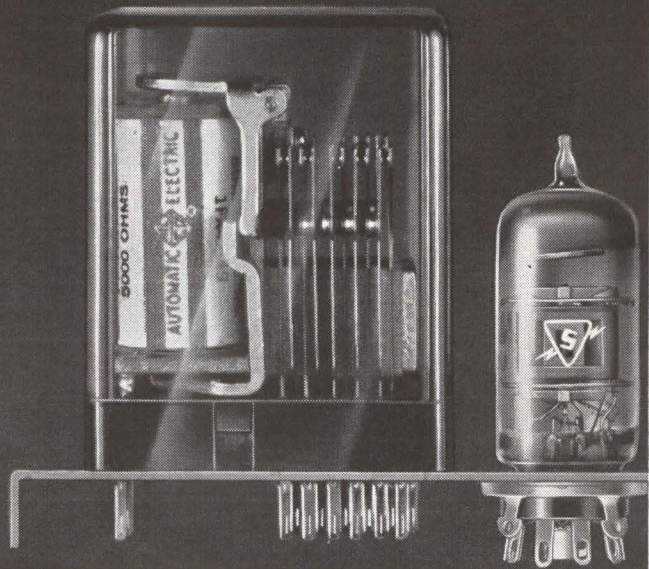

## This new relay concept saves you time, stocking and money

AE's new Series EIN relay, that plugs in like a tube, has taken the field by storm—and no wonder:

It's the first telephone quality relay having all the conveniences of octal-type plug mounting, with savings of \$1.93 or more per relay!

The special sockets are available separately from AE stock. You can order the number you need for a complete production run, and buy the relays and plastic covers "off the shelf" to meet delivery schedules. There's no need to maintain large relay inventories.

The EIN's modern, low silhouette design improves the

appearance of your product and cuts space requirements up to 20%.

EIN relays are available in various spring combinations to meet most design requirements. Sockets are available for taper tab, solder, or printed circuit board terminations.

In initial cost and versatility, the EIN can solve many of your design, production and inventory problems.

• • •

For full information, write the Director, Control Equipment Sales, Automatic Electric, Northlake, Illinois.

# **AUTOMATIC ELECTRIC**

Subsidiary of

**GENERAL TELEPHONE & ELECTRONICS**



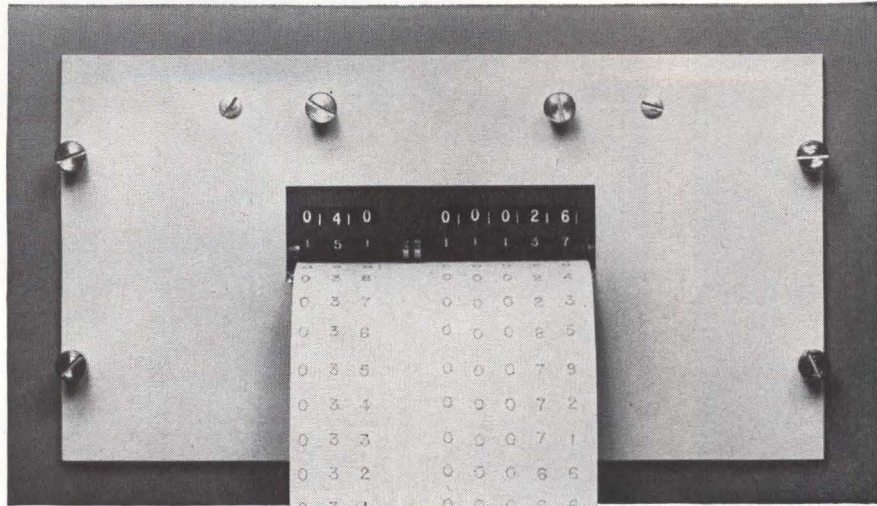

## A Digital Printer for as little as \$258

Designed for custom use, the Texas Instruments Count Printer is a simple, low cost instrument capable of accumulating sequential input pulses at 600/minute. The accumulated total can be printed up to 60 times/minute on ordinary 3-inch adding machine tape . . . both dial total and last printed total are immediately vis-

ible. Compactly assembled on a 4 $\frac{3}{8}$ " by 7 $\frac{1}{8}$ " panel, the Count Printer is less than 7" deep and weighs only 3 $\frac{1}{2}$  pounds. It is available with either one or two in-line count channels for a-c or d-c operation. Each channel has independent count and reset functions. Prices start at \$258 list. Write for full information.

INDUSTRIAL  
PRODUCTS  
GROUP



**TEXAS INSTRUMENTS**  
INCORPORATED  
P. O. BOX 66027 HOUSTON 6, TEXAS

SENSING • RECORDING • TESTING • DIGITIZING INSTRUMENTS  
THE INSTRUMENTS OF TEXAS INSTRUMENTS

664

CIRCLE 20 ON READER SERVICE CARD

**HELP YOUR POST OFFICE  
TO SERVE YOU BETTER  
BY  
MAILING EARLY IN THE DAY  
NATIONWIDE IMPROVED MAIL SERVICE  
PROGRAM**

## MEETINGS AHEAD

MILITARY ELECTRONICS NATIONAL CONFERENCE, IEEE-PTGMIL; Shoreham Hotel, Washington, D. C., Sept. 9-11.

ELECTRICAL INSULATION CONFERENCE, IEEE, NEMA; Conrad-Hilton Hotel, Chicago, Sept. 10-14.

JOINT ENGINEERING MANAGEMENT CONFERENCE, IEEE, ASME; Biltmore Hotel, Los Angeles, Sept. 12-13.

INTERNATIONAL ASSOCIATION FOR ANALOG COMPUTING, AICA; Brighton College of Technology, Lewes Rd., Brighton, England, Sept. 14-18.

INDUSTRIAL ELECTRONICS ANNUAL CONFERENCE, IEEE, ISA; Michigan State University, East Lansing, Mich., Sept. 18-19.

NATIONAL POWER CONFERENCE, IEEE, ASME; Netherland-Hilton Hotel, Cincinnati, Ohio, Sept. 22-25.

INTERNATIONAL TELEMETERING CONFERENCE, IEE, IEEE, ISA, ARS, IAS; London, England, Sept. 24-27.

PHYSICS OF FAILURE IN ELECTRONICS SYMPOSIUM, Armour Research Foundation and Rome Air Development Center, Illinois Institute of Technology, Chicago, Sept. 25-26.

ELECTROCHEMICAL SOCIETY FALL MEETING, ECS; New Yorker Hotel, New York, Sept. 29-Oct. 3.

CANADIAN ELECTRONICS CONFERENCE, IEE REGION 7; Automotive Bldg., Toronto, Ont., Canada, Sept. 30-Oct. 2.

SPACE ELECTRONICS NATIONAL SYMPOSIUM, IEEE-PTG-SET; Fontainebleu Hotel, Miami Beach, Fla., Oct. 1-3.

PHYSICS & NONDESTRUCTIVE TESTING SYMPOSIUM, Southwest Research Institute; El Tropicana Hotel, San Antonio, Texas, Oct. 1-3.

ELECTROMAGNETIC RELAYS INTERNATIONAL CONFERENCE, IEEE, ICER, IEE, Tohoku University, Science Council of Japan; Sendai, Japan, Oct. 8-11.

ELECTRICAL-ELECTRONICS CONFERENCE, Aerospace Electrical Society; Pan Pacific Auditorium, Los Angeles, Calif., Oct. 9-11.

NATIONAL AEROSPACE CONFERENCE, National Society of Professional Engineers; Lafayette Hotel, Long Beach, Calif., Oct. 10-11.

## ADVANCE REPORT

MILITARY ELECTRONICS NATIONAL WINTER CONVENTION, PTGMIL-IEEE; Los Angeles, Calif., Feb. 5-7, 1964; Oct. 4 is deadline for submitting papers, 100-word unclassified abstract, short autobiography to Dr. Nicholas A. Begovich, technical program committee chairman, Hughes Aircraft Co., Fullerton, Calif. Papers in line with the theme, "Weapons Systems Selection—1964," should stress systems, technology advances. Authors submitting classified material must obtain prior clearance.



**What new data recorder can be simple — or sophisticated?      AMPEX FR-1200**

Here's the newest recorder from Ampex—the FR-1200. It's a medium-priced, basic data recorder that's modular in design and built for long-term reliable operation. With the FR-1200, you're offered various types of electronics and accessories, and with these you can tailor a recorder as simple or as sophisticated as you want—one that meets your needs and budget now, and can be expanded as you grow. You can start at the simplest level—a one-speed, record-only recorder—and build all the way to a 14-track, record/reproduce system with six-



speed (1½ ips to 60 ips) electrically switchable electronics and transport. Ampex ES-100 solid state electronics offer Direct recording to 300 KC, FM recording to 20 KC, or IRIG compatible PDM. The FR-1200 also features a new tape transport. Rugged and reliable, it offers low flutter, prevents tape stress during fast starts, provides constant tape tension on both reels and has new tape braking and guidance systems. For details write: Ampex Corporation, Redwood City, California. Sales and service engineers throughout the world.

**SEE THIS AND OTHER AMPEX PRODUCTS AT EIME**

**CIRCLE 21 ON READER SERVICE CARD**

For a quarter century, Panoramic instruments have been the pioneers and leaders in automatic scanning instruments and other test equipment. Facilities are well-equipped and staffed to supply standard off-the-shelf items as well as more specialized instruments and systems to meet military and commercial requirements. The broad range of Panoramic electronic instruments for rapid graphical presentation of energy-frequency distributions covers the electromagnetic spectrum from 0.5 cps to 64,000 mc. These versatile, economical, and easy-to-use instruments speed lab projects and simplify production testing. Offering visual, directly calibrated measurements, they are designed for accurate, practical use. Measurement capabilities are consonant with the latest advances in their fields of application.

**SPECTRUM ANALYZERS**  
0.5 cps to 64,000 mc

- Broad Band (0-25 mc)
- Power Spectral Density
- Vibration and Noise
- Systems for Sonic Analysis
- Time-Frequency-Amplitude
- Telemetry, Subcarrier Band
- RF, Communications
- Microwave to 64,000 mc

**COMMUNICATIONS SYSTEMS ANALYZERS**

- RF, VHF, UHF
- Panadaptors (for receivers)
- Panalyzers (transmitter testing)
- Single Sideband Systems
- Microwave

**FREQUENCY RESPONSE PLOTTERS**

- Sweep Generators used with Spectrum Analyzers 0-15 mc
- Phase Shift Curve Tracer
- Crystal Filter Curve Tracer

**TELEMETRY SYSTEM TEST INSTRUMENTS**

- Subcarrier Analyzers
- Multipoint Channel Calibrators
- Channel Selectors

**TELEPHONE SYSTEM MEASURING SETS**

- Carrier Band Analysis
- Voice Frequency Test Sets
- RF Band Monitoring
- RF-Microwave Signal Analysis

**SIGNAL GENERATORS**

- 50 kc - 11 gc in 7 units

**TEST METERS**

- Broadband Voltmeter
- Broadband Voltmeter-Ohmmeter
- RF Power Meter
- SWR Indicator

**ACCESSORIES**

- Oscilloscope Camera
- Chart Recorder
- Instrument Carts

WRITE FOR DETAILS

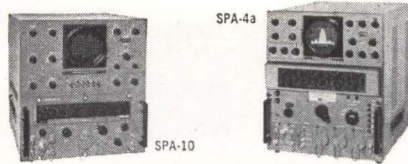

**MICROWAVE SPECTRUM ANALYSIS**  
10-64,000 mc

Four Panoramic instruments provide an unmatched choice of performance in the RF through microwave region. Offering unexcelled performance, versatility, and economy, they are also reliable and easily maintained. The unmatched SPA-4a, 10-44,000 mc, has many special features for maximum versatility and applicability, includes separate broadband 0-70 mc and stable narrow-band 0.5 mc sweeps and a sensitivity as great as -110 dbm at 10 kmc. The new SPA-12 features 10-64,000 mc range and high sensitivity in a versatile, reasonably priced unit. The low cost SPA-10 offers frequency coverage 10-43,000 mc, dispersion 200 kc to 80 mc (100 mc optional), high sensitivity. Above units cover frequency range in one composite tuning head. The SPA-1, 10-4000 mc with three plug-in tuning heads, is very low in cost and exceptionally stable.

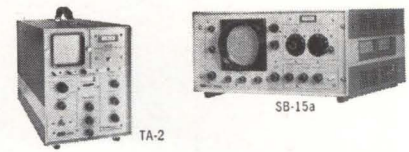

**BROADBAND SPECTRUM ANALYSIS**  
5 cps - 25 mc

Panoramic Broadband spectrum analyzers supply an unmatched selection of frequency-analysis instruments. Model TA-2 is a new portable transistorized universal spectrum analyzer. With AR-1 plug-in module, it covers 20 - 35,000 cps, with other modules, up to 25 mc. Other units include the high-reliability LP-1a, 20 - 22,500 cps, the wide range SB-15a, 100 - 600,000 cps, the low cost SP-7bZ, 200 - 300,000 cps, and the high-frequency SPA-3a and SPA-3/25a, 1 kc to 15 mc and 25 mc respectively. Uses include vibration and acoustic waveform analysis, digital or other pulsed signal analysis, telemetering subcarrier monitoring, distortion measurements, and dynamic analysis of communications signals. Special (SY) systems combine several sonic analysis instruments in integrated assemblies, affording great versatility.

# Panoramic\*

## ELECTRONIC MEASURING INSTRUMENTS



\*A Trademark of THE SINGER COMPANY

915 PEMBROKE ST., BRIDGEPORT 8, CONN.  
(203) FO 6-3201 • TWX 710-453-3483

SSB-3b

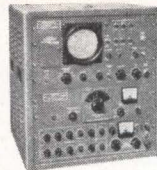

**COMMUNICATIONS SYSTEMS ANALYSIS**  
10 cps-40 mc

Panoramic provides spectrum analyzers for AM, FM, SSB, and pulsed communications analysis. Using Panalyzer SB-12b in a compatible instrumentation system, the SSB-3 incorporates all necessary analysis facilities to set up, adjust, monitor, and trouble-shoot SSB transmission. It has virtually uniform sensitivity over the complete 2-40 mc band. With a 60 db dynamic range (65 db opt.), selectivity to 10 cps, simple pre-set operation, and self-checking facilities, it offers unequalled performance and versatility. Component SSB instruments are two-tone audio generator TTG-2, dual RF tone generator TTG-5, and Range Extending Converter REC-1 to extend analysis to 10 cps.

SA-8bZ



**PANADAPTORS\***  
(Models SA-8b and SA-3, over 20 types)

**PANALYZERS\***  
(Models SB-8b, SA-3, and SB-12b)

Panadaptors operate with communications receivers for spectrum analysis of the band centered at the frequency tuned in by the receiver for pinpointing analysis of interference, band occupancy, off-channel radiations, and as a graphic tuning aid. Panadaptors are available for use with receiver IF outputs from 450 kc to 30 mc with a wide variety of scan and resolution capabilities. Low cost Panalyzers are RF and UHF spectrum analyzers used with an external VFO. They are used for signal analysis in the testing of transmitters, signal generators, etc. Model SB-12b provides 10 cps resolution and 65 db dynamic range for IM tests. The versatile Models SB-8b and SB-3 are available in many types.

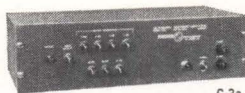

G-3a

**FREQUENCY RESPONSE PLOTTING**  
20 cps - 15 mc

Panoramic Companion Sweep Frequency Generators provide swept-band single line plots of response level vs frequency of amplifiers, speakers, lines, filters, etc. Used with Broadband analyzers above, the response plots are usable over a virtually unlimited dynamic range. Models G-2a, G-3a, G-15a, and G-6 cover the 20 cps to 15 mc range. Other Panoramic plotters include the ultra-stable Model SGR-3, 100 kc - 15 mc, ideal for crystal filters, and the Sonic Phase and Amplitude Response Plotter PA-1, used with Model LP-1a.

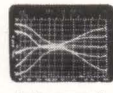

Audio preamplifier response for several tone-control settings.

TMC-505

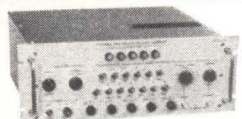

**TELEMETRY TEST INSTRUMENTS**  
12.5 cps-190 kc

Panoramic is the industry's leader in telemetering test instruments. Telemetering Subcarrier Indicators used from 12.5 cps to 190 kc provide rapid and precise subcarrier analysis for pre-emphasis, noise, distortion, VCO deviation, and related tests. Models TMI-1b, TMI-1b/120, TMI-23, TMI-4/120, TMI-2L, and TMI-3LI provide an unsurpassed choice. Panoramic solid-state, crystal-controlled Telemetering Calibrators Models TMC-411E and TMC-505 provide five simultaneous markers (TMC-411E provides eleven) for each sub-carrier channel for up to 18 channels (21 optional), with 0.002% long-term frequency accuracy, manual deviation selection and many other features.



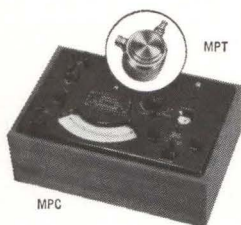

**MODEL MPT MICROPOTENTIOMETER**

DC — RF calibration standard provides true rms voltages from 1  $\mu$ v to 660,000  $\mu$ v. Interchangeable radial resistors supplied in type N connectors. Certifiable by NBS to  $\pm 2\%$  up to 100 mc;  $\pm 3\%$  to 500 mc;  $\pm 5\%$  to 900 mc. Model MPC, Micropot Calibrator, is an instrument for the rapid readout of micropotentiometers and their calibration at time of use.

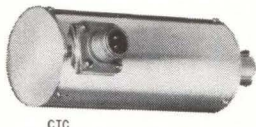

**MODEL CTC COAXIAL THERMAL CONVERTER**

DC — RF voltage transfer standards for true rms measurement or calibration. Ranges: 0.5, 1, 2, 5, 10, 20, 50 and 100 volts; usable from 20% to 135% of nominal value. Certifiable by NBS at  $\pm 0.02\%$  to 50 kc  $\pm 0.1\%$  to 10 mc;  $\pm 0.2\%$  to 30 mc;  $\pm 1.0\%$  to 100 mc.

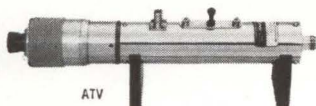

**MODEL ATV A-T VOLTMETER**

RF voltage standard having true rms response. Ranges and frequency: from 0.2 to 20 volts up to 1000 mc; 1 to 300 volts up to 100 mc; 10 to 500 volts up to 10 mc. Accuracy 1%  $\pm$  of NBS calibration. Features 1 3/4" diameter micrometer readout with direct resolution of 0.0001" per division.

The comprehensive array of **Sensitive Research\*** high accuracy AC/DC electrical instrumentation ranges from portable and panel type indicating instruments to the most sophisticated laboratory standards. The calibration of all **Sensitive Research** instruments is traceable to the National Bureau of Standards.

- AC/DC TEST SETS
- AMMETERS
- AMPLIFIERS
- CALIBRATION CONSOLES
- CHOPPERS
- COAXIAL THERMAL CONVERTERS
- COMPENSATING INDUCTORS
- CORE LOSS TEST SETS
- CORROSION INSTRUMENTS
- CONSTANT TEMPERATURE ENCLOSURES
- CURRENT CONTROLLERS
- DIFFERENTIAL INSTRUMENTS
- DUAL CONTACT SWITCHES
- ELECTROSTATIC VOLTMETERS
- FLUXMETERS
- FLUXMETER CALIBRATORS
- FORM FACTOR INSTRUMENTS
- FREQUENCY METERS
- GALVANOMETERS
- GAUSSMETERS
- HIGH VOLTAGE DIVIDERS
- HIGH VOLTAGE PROBES
- INCREMETERS
- INDUCTORS
- ISOLATING POTENTIAL COMPARATORS
- KILOVOLTMETERS
- LINDECK MICROVOLT SOURCES
- LOW THERMAL NOISE SWITCHES
- MAGNETIC TEST INSTRUMENTS
- MICROAMMETERS
- MICROPOTENTIOMETERS
- MILLIAMMETERS
- MILLIVOLTMETERS
- MULTIPLIERS
- POLYRANGERS
- POTENTIOMETERS
- POWER FACTOR INSTRUMENTS
- POWER SUPPLIES
- RATIOMETERS
- REVERSING SWITCHES
- SHUNTS
- STANDARD CELL ENCLOSURES
- STANDARD RESISTORS
- TEMPERATURE MEASURING EQUIPMENT
- TEST CONSOLES
- THERMOCOUPLES
- THERMOMETER BRIDGES
- TRANSFORMERS
- THERMAL COMPENSATORS
- VOLT-AMP-MILLIAMMETERS
- VOLT-AMP-WATTMETERS
- VOLTMETERS
- VOLT RATIO BOXES
- VOLTAGE REFERENCE SOURCES
- WATTMETERS
- "V" BOXES

**Sensitive Research\***  
ELECTRICAL MEASURING STANDARDS



915 PEMBROKE ST., BRIDGEPORT 8, CONN.  
(203) FD 6-3201 • TWX 710-453-3483

\*A Trademark of THE SINGER COMPANY

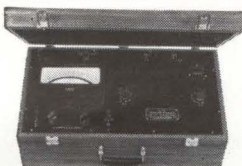

**AC/DC TRANSFER STANDARDS**

MODEL FLH is a precision, true RMS, voltage standard, designed to measure in percentage of reading the influence of frequencies (AC/DC differences) between 20 cps and 50 kc on the indication of voltmeters, voltage calibrators and other transfer standards over a range of 1.5v to 1125v. Accessory units available to measure currents from 1.5ma to 100 amps. Supplied with NBS certificate. Accuracy: 0.01% of reading from 20 cps to 20 kc; 0.02% to 50 kc.

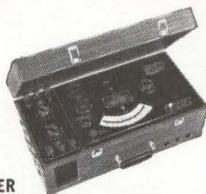

**AC/DC "SELF CHECKING" VOLT-AMP-MILLIAMMETER**

MODEL THACH Combs. 1x and 3x contain an internal standard cell and galvanometer for "Self Checking". Ruggedized Comb. 5x substitutes an internal .02% stable, solid state reference source for autocalibration, 1000% overload protection. Accuracy:  $\pm 0.1\%$  of fs at "Self Check" points and  $\pm 0.2\%$  of fs at all other points. Frequency range: DC and 7 cps to 4 kc at full accuracy. Ranges: 19 overlapping full scale ranges from 10 ma to 5 amps and 1v to 1000v.



**AC-DC PANEL INSTRUMENTS**

Most SRI precision portables are available as edge-wise panel instruments with no loss in accuracy or sensitivity. Scale lengths 4" (Models JW-4A and JWSP), 5" (Type EW-5A) and 7" (Type EW-7A). Switched controlled. Single or multirange. In some cases, such as Polyangers, they are supplied mounted in standard 19" rack panels. Rectangular panel mounted models with scale lengths of 4" (Model UPP) and 6" (Model NP) are also available.



**MODEL PARK HIGH VOLTAGE DIVIDER**

Precision high voltage measuring or calibration standard. Constructed to a design by Howard Park of the National Bureau of Standards. Total resistance: 100 megohms. DC ratio accuracy: 100 kv to 1 v  $\pm 0.05\%$ . AC ratio accuracy (60 cps): 50 kv to 500 v  $\pm 0.5\%$ . Units may be stacked for higher voltage measurements.

WRITE FOR DETAILED SPECIFICATIONS OR CATALOG 75

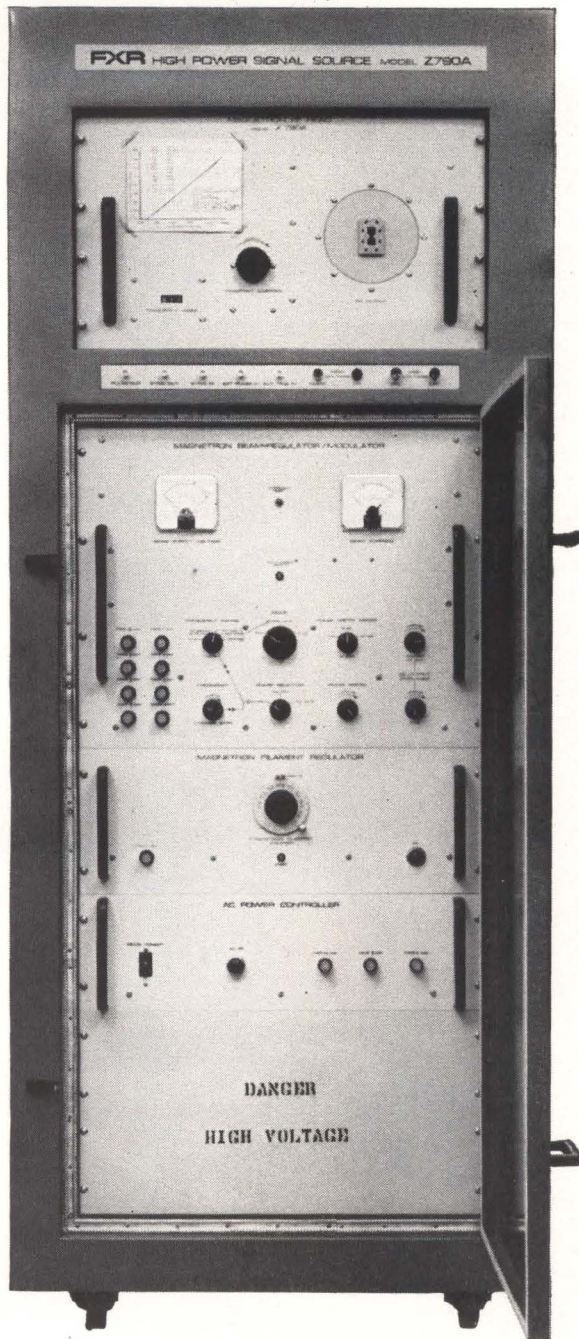

**up to 100 watts CW**

FXR's new Z790A signal source is RF-tight. No stray radiation to interfere with precision measurements, thanks to full wrap-around RF shielding.

Magnetron tuning? Precision calibrated frequency control, right on the front panel.

Besides 100 watts CW, the Z790A delivers 900 watts pulse and 200 watts square wave, with a variety of internal and external modulation capabilities.

Eight easy-change RF magnetron heads span the frequency range from L through X bands (0.975 Gc to 10.475 Gc). Factory-calibrated for front panel read-out, each head also has its own calibration chart

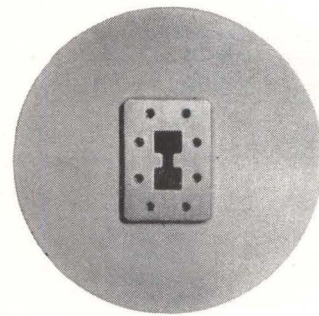

**but only where you need it**

and frequency index front panel control. And you can change heads easily—don't even need a screwdriver.

Extras? Well there's the full-size RF-tight rear door for easy access to all components, complete interlocking and overload protection, monitoring lights and meters, modular construction and a mobile cabinet.

Ed McDonald, our product planner, will be glad to supply you with the complete specs and, if you'd like, set up a demonstration. Call him at FXR, 25-26 50th St., Woodside 77, N. Y.

**FXR**<sup>TM</sup> THE RF PRODUCTS AND MICROWAVE DIVISION  
OF AMPHENOL-BORG ELECTRONICS CORPORATION



**MEMBER** — See page 28 for dates we will be in your area

## NEED A POWER SUPPLY TO MEET SPECIAL REQUIREMENTS?

# See how LAMBDA modifies standard models at low cost

Enlargements show some typical modifications made to a standard Lambda LA Series Power Supply.

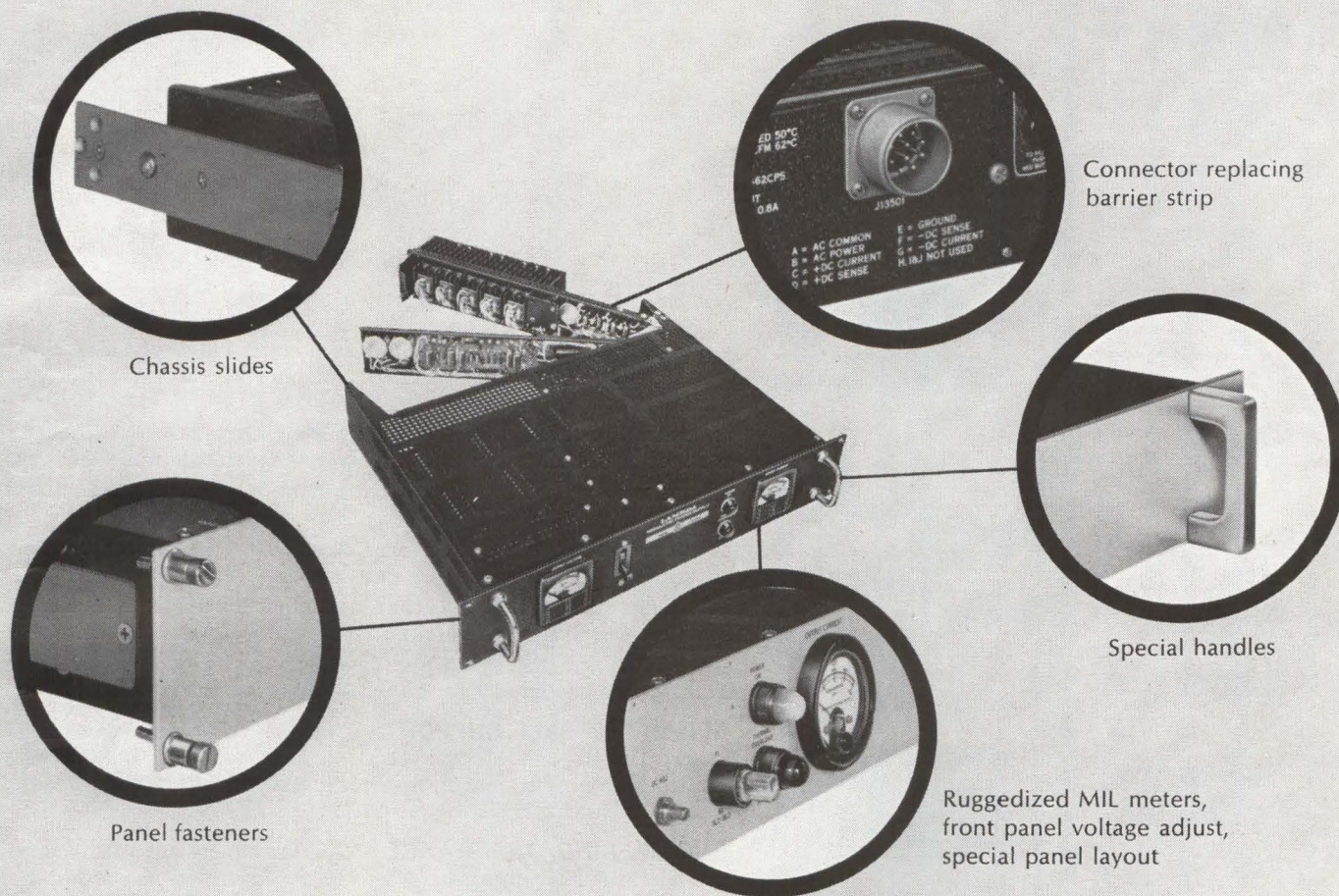

Now you can have Lambda power supply quality and reliability even if you must have a unit tailored to your needs. In most cases, Lambda can meet your special requirements by making simple, fast, low-cost electrical and mechanical modifications to any of its transistorized and tube regulated power supplies. Illustrated are just a few of the many modifications that Lambda makes

to a standard LA Series transistorized power supply.

Lambda's 5-Year Guarantee of performance applies to all modified units, as well as standard models. Write for bulletin listing typical modifications that can be made to Lambda's LE, LA, LT and Com-Pak® Series power supplies.

SEND FOR COMPLETE LAMBDA CATALOG.



# LAMBDA ELECTRONICS CORP.

515 BROAD HOLLOW ROAD • MELVILLE, L. I., NEW YORK • 516 MYRTLE 4-4200

CIRCLE 25 ON READER SERVICE CARD



**MEMBER** — See page 28 for dates we will be in your area

## What's behind your digital voltmeter (or system)?

### It could be as important as what's in it . . .

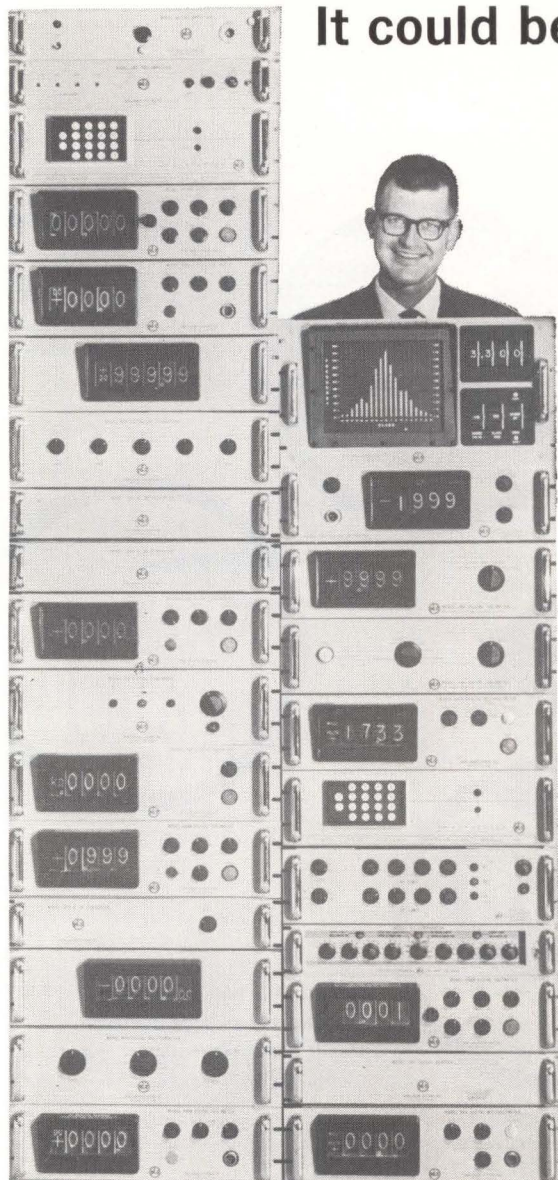

Can the manufacturer of your digital voltmeter (or digital measuring system) repair or replace its circuit modules within hours after you call?

Is repair service handled by a full-time employee paid by the manufacturer or someone who divides his time among several lines?

How much engineering help does the manufacturer provide and how good is it?

Is there a full range of compatible accessories to choose from to insure instrument versatility and prevent obsolescence?

Important questions? You bet. In fact, engineers tell us that back-up after the sale is almost as important as the quality of the hardware itself.

Point by point, here's how NLS answers each need:

**AFTER-THE-SALE SUPPORT.** With 23 full-time engineering-service centers (40 by year's end) staffed with full-time factory-trained NLS people, your instrument investment is protected by fast, competent service right in your area.

**ENGINEERING ASSISTANCE.** NLS field men are qualified to provide valuable engineering assistance. Example: in most cases, they'll draw upon years of experience to help design a digital system to meet your specific needs, and quote a firm price on the spot.

**INSTRUMENT SELECTION.** From the NLS line, you can specify the one instrument or system that best answers your measuring needs

at the lowest possible price. It is an undisputed fact that NLS has the world's broadest line of digital voltmeters, ohmmeters, ratiometers, multi-purpose instruments, accessories and standard systems—broadest by both purpose and price.

**LONG-TERM INSTRUMENT USEFULNESS.** There's a reason you see more NLS digital voltmeters in use than any other make—apart from the fact that NLS originated the DVM and remains the only major company specializing in DVMs. NLS digital voltmeters have been *proved in use* by the toughest judges in the business. Most of these companies have specified NLS again and again, many owning 50 or more.

**INNOVATION IN DESIGN.** Already this year, NLS has introduced 20 new (not simply updated) instruments—more than the complete lines of most manufacturers. For the new catalog that covers them all, simply call your local NLS engineering-service center or circle the reader service number.





**MEMBER** - See page 28 for dates we will be in your area

PHILBRICK produces a wide variety of cool, reliable, solid state operational amplifiers to meet the gamut of application requirements in measurement, computing, control, data processing, and testing. The units shown in this chart are a few of the most popular differential types now in production. In addition to these, Philbrick is developing new and improved types to meet the ever-increasing challenges to operational amplifier performance. Besides basic amplifiers, one can obtain voltage and current boosters, regulated dc power supplies, and operational manifolds from Philbrick. You are invited to discuss the application of operational amplifiers to the solution of your problems with Philbrick or our nearest Representative.

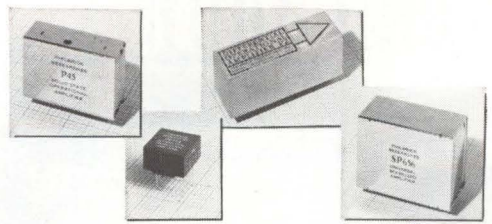

# PHILBRICK ALL-SOLID-STATE OPERATIONAL AMPLIFIERS

CHARACTERISTICS	TYPICAL MODEL	P45 All-Silicon Wide bandwidth High performance Plug-in ±20 ma Output	P55A All-Silicon Utility Modest performance & price Plug-in	PP55A All-Silicon Utility Modest performance & price Wire-in Compact	P65A All-Silicon General Purpose Plug-in	PP65A All-Silicon General Purpose Wire in (Compact)	P2 Floating differential inputs High input impedances negligible common mode error Built-in adjustment	P75 All-Silicon High impedance Low input current Plug-in	SP656 All-Silicon Chopper stabilized High Gain/Low Drift Mechanical or photochopper Plug-in
1. Application features									
2. Voltage gain (dc open loop)		20,000 +25°C, rated load, minimum 30,000 +85°C, " " " , typical 10,000 -25°C, " " " , minimum 200,000 +25°C, no load, typical	20,000 35,000 5,000 60,000	20,000 35,000 5,000 60,000	20,000 40,000 10,000 80,000	20,000 40,000 10,000 80,000	30,000 — — 30,000	20,000 40,000 10,000 80,000	10* 2×10* 5×10* 2×10*
3. Response (open loop, as inverter, 25°C)		300 Kc Full output (worst case) 100 Mc Small signal unity gain-bandwidth Gain at 1.0 Mc, typical Gain at 10 Mc, typical	10Kc 1Mc 1 —	10Kc 1Mc 1 —	10Kc 1.3Mc 1.3 —	10Kc 1.3Mc 1.3 —	0.6Kc 60Kc — —	10Kc 1Mc 1 —	10Kc 1Mc 1 —
4. Rated output (-25°C to +85°C)		±10V ±20ma 500Ω	±11V ±2.2ma 5K	±11V ±2.2ma 5K	±11V ±2.2ma 5K	±11V ±2.2ma 5K	(+20°C to +45°C) { ±10V } { ±1ma } { 10K }	±11V ±1ma 10K	±11V ±20ma** 500Ω***
5. Suggested booster type:		— for 20-100 ma @ ±10V " 10 ma @ ±25V * " 5 ma @ ±50V * " 50 ma @ ±50V *	P66 * * *	PP66 * * *	P66 * * *	PP66 * * *	P5 or P66 * * *	P66 * * *	* * *
6. Input voltage offset		External 10mV** Max. vs Temp. (-25°C to +85°C) 2.5mV** Max. vs Temp. (+10°C to +60°C) vs Time (per day) 100µV** vs Time (½ hour) 15µV** Narrow-band noise (p-r)	External 20mV 5mV 100µV 25µV 10µV	External 20mV 5mV 100µV 25µV 10µV	Built-in 6mV 1.5mV 50µV 10µV 2µV	External 6mV 1.5mV 50µV 10µV 2µV	Built-in 5mV 100µV 50µV 4µV	Built-in 12mV 3mV 100µV 25µV 10µV	External 50µV 20µV 1µV 1µV 10µV
7. Input current offset		External trim 600na 100na 25°C worst case (nominal trims) Max. vs Temp. (-25°C to +85°C) 300na** vs Time (per day) typical 3na** Narrow-band noise (p-r) typical 1na	Built-in trim — 200na 4na 1na 100na 10na 1na	External trim 2na 200na 4na 1na 10na 10na 1na	Built-in trim — 100na 80na 200na 20na 2na 0.5na	External 400na 100na 800na 200na 20na 2na 0.5na	N/A — — 5×10 <sup>-12</sup> amp 10 <sup>-12</sup> amp 10 <sup>-12</sup> amp 10 <sup>-12</sup> amp	No trims used 10na 1na 20na 5na 1na 0.2na 0.05na	N/A 10 <sup>-12</sup> amp — 10 <sup>-12</sup> amp 3×10 <sup>-12</sup> amp 10 <sup>-12</sup> amp <10 <sup>-12</sup> amp 10 <sup>-12</sup> amp
8. Input impedance (25°C) (resistive comp.)		100K >20M	75K >10M	75K >10M	150K >20M	150K >20M	>100 M >10,000M	5-10M >100M	440K DC —
9. Common mode		±10V Input range Max. dc error (25°C) ±10mV	±10V ±20mV	±10V ±20mV	±10V ±10mV	±10V ±10mV	±200V <0.0001%	±10V ±10mV	— —
10. Temperature range (in ° Centigrade)		Max. operating -25 to +85 Max. storage -55 to +85 Typical operating (best performance vs. reliability) +10 to +55 Max. operating, with derated specs. -45 to +85	-25 to +85 -55 to +85	-25 to +85 -55 to +85	-25 to +85 -55 to +85	-25 to +85 -55 to +85	+20 to 45 -55 to +65	-25 to +85 -55 to +85	-25 to +85 (M) -55 to +85 (M) +10 to +60 -45 to +85 (M)
11. Power requirements (+25°C)		±15V Voltage 4.5 ma Current at +15V (Quiescent) 24 ma Current at +15V (Full load) 4.5 ma Current at -15V (Quiescent) 24 ma Current at -15V (Full load)	±15V 5.5ma 8ma 5.5ma 5ma	±15V 5.5ma 8ma 5.5ma 5ma	±15V 5.5 ma 8ma 5.5 ma 5ma	±15V 5.5 ma 8ma 5.5 ma 5ma	±15V 12ma 16ma 12ma 13ma	±15V 4ma 5ma 4ma 4ma	**AC for chopper plus ±15V 6.5ma 21ma 6.5ma 21ma
12. Outline dimensions & connections		A	A	B	A	B	P2	A	C
13. Price (subject to change)		1-4 \$135 5-14 125 15-24 110 25+ *	\$54 53 51	\$57 56 54	\$85 83 80	\$85 83 80	\$227(1-9) 218(10-24) *	\$135 127 112 *	\$247(1-4) 239(5-9) 229(10-14) *

\*Philbrick or your nearest Philbrick Representative will welcome your inquiry

\*\* (Quiescent)

\*\*\* Corresponding figures for early units are ±15ma, 667Ω

(M) Mechanical chopper

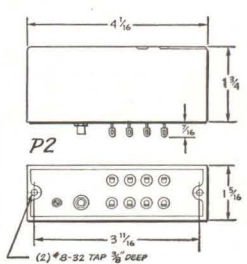
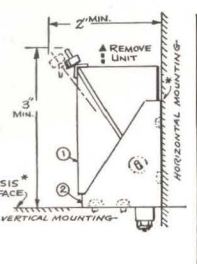
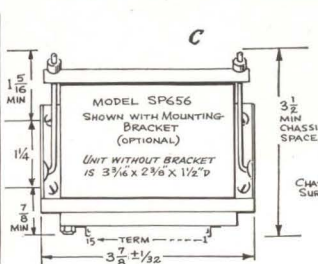
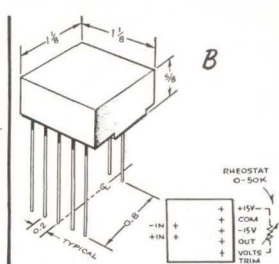
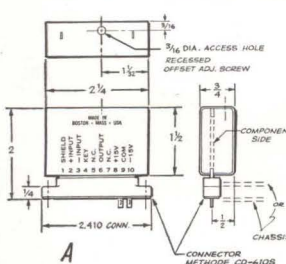

**GEORGE A. PHILBRICK RESEARCHES, INC.**  
127 CLARENDON STREET BOSTON 16, MASSACHUSETTS  
TEL: (617) 262-1500 TELEX: 094-6236 TWX: 617 262-9279

# 4TH ANNUAL ROAD SHOW

SEPT.-OCT. 1963

SEE PAGES 18, 21, 22, 23,  
24, 25, 26, 27 & 2nd Cover

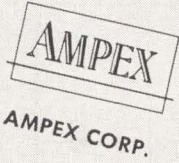
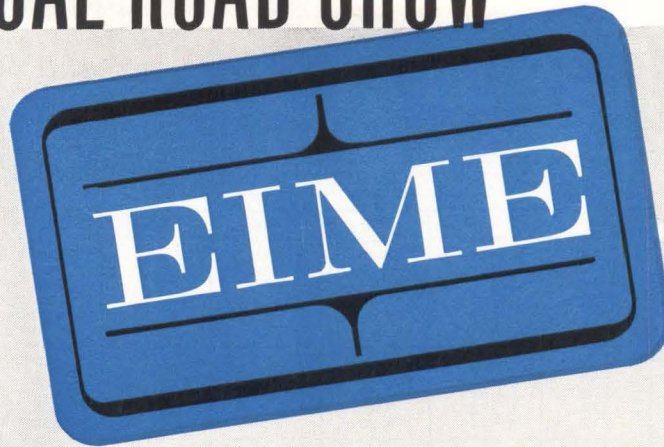

## Electronic Instrument Manufacturers Exhibit



GENERAL RADIO COMPANY



LAMBDA ELECTRONICS CORP.



KEITHLEY INSTRUMENTS



NON-LINEAR SYSTEMS, INC.



GEORGE A. PHILBRICK  
RESEARCHES, INC.



SINGER METRICS DIV.  
MFRS. OF SENSITIVE RESEARCH INSTRUMENTS



SINGER METRICS DIV.  
MFRS. OF PANORAMIC INSTRUMENTS

<p><b>BOSTON, MASS.</b> September 9th Charter House Route 128, Waltham, Massachusetts Hours: 12 noon—7:30 pm</p>	<p><b>GREAT NECK, L. I., N. Y.</b> September 11th Leonard's of Great Neck 380 Northern Boulevard Hours: 12 noon—7:30 pm</p>	<p><b>BETHPAGE, L. I., N. Y.</b> September 12th Holiday Manor 345 Hicksville Road Hours: 12 noon—7:30 pm</p>	<p><b>EATONTOWN, N. J.</b> September 16th Civic Auditorium Monmouth Shopping Center Hours: 12 noon—7:30 pm</p>	<p><b>TOTOWA, N. J.</b> September 17th Gladiator's Arena Route 46 Hours: 12 noon—7:30 pm</p>
<p><b>PHILADELPHIA, PA.</b> September 23rd Marriott Motor Hotel City Line Avenue &amp; Monument Road Hours: 12 noon—7:30 pm</p>	<p><b>PRINCETON, N. J.</b> September 24th Flagpost Motor Lodge Route U. S. 1 Hours: 12 noon—7:30 pm</p>	<p><b>SYRACUSE, N. Y.</b> September 26th Randolph House Exit 37, N. Y. State Thruway Hours: 12 noon—7:30 pm</p>	<p><b>WATCHUNG, N. J.</b> September 30th Wally's Tavern 154 Bonnie Burn Road Hours: 12 noon—7:30 pm</p>	<p><b>WASHINGTON, D. C.</b> October 2nd International Inn Thomas Circle, 14th &amp; M Sts., N.W. Hours: 12 noon—7:30 pm</p>

SEE LATEST DEVELOPMENTS IN ELECTRONIC INSTRUMENTS BY 9 LEADING MANUFACTURERS. The EIME road show will again feature practical operating displays of electronic instruments manufactured by nine leading companies. Typical applications will be demonstrated. Engineering personnel from participating companies will be available to answer your technical and application questions in a completely casual atmosphere. We cordially invite you and your associates to attend. Please check the schedule and note when the EIME road show will be in your area.

**FREE PARKING • NO TICKETS REQUIRED • BUFFET**

# CRYOGENICS

## FOR THE ELECTRONICS ENGINEER

*More and more electronics engineers are getting their feet wet, figuratively, in liquid nitrogen. This article combines some theory of refrigeration cycles with practical considerations for the handling of fluids and the selection of equipment*

By JAMES W. MEYER and ABRAHAM M. RICH, Lincoln Laboratory\*  
Massachusetts Institute of Technology, Lexington, Mass.

**APPLICATIONS** of low-temperature techniques to electronics are increasing apace with this burgeoning field. Most of the exciting new developments in electronics from ultrasensitive detectors: masers, paramps, infrared detectors, to new sources of electromagnetic energy: optical masers, diode luminescence, either must operate at low temperatures or their operating characteristics are markedly improved when operated there. We are rapidly approaching the time when few systems will not have some cryogenic part for the advantages to be gained, and the increased ease of field application can put the solution of challenging systems problems within reach. As a result the electronic systems engineer needs an understanding of cryogenics engineering as part of his professional bag-of-tricks.

Slightly over a half century ago, Kamerlingh Onnes discovered that certain metals lost their resistance to the flow of current at temperatures near absolute zero. Since then, we have learned much about the properties of matter at low temperatures where the restless atoms and molecules are more quiescent. Probably the most significant turning point in the microwave art was the development of the solid-state maser amplifier, which not



TRANSFER from storage dewar to operational maser dewar

\* Operated with support from the U. S. Army, Navy, and Air Force.

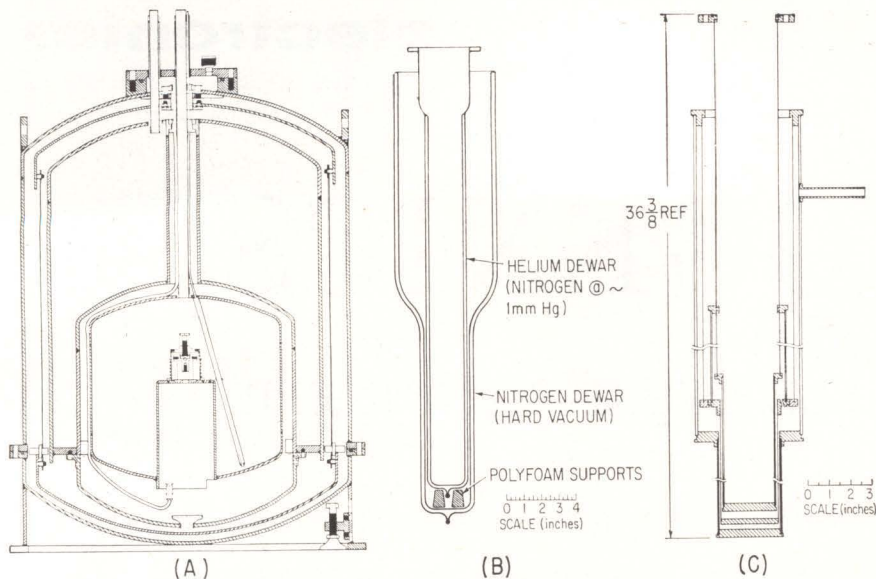

INTEGRAL cryostat can store liquid helium for 26 days or liquid nitrogen for 12 days (A). Glass double dewar system necked down to allow use of magnetic poles (B). Metal double dewar system allows thermal conduction between liquid helium and liquid nitrogen (C)—Fig. 1

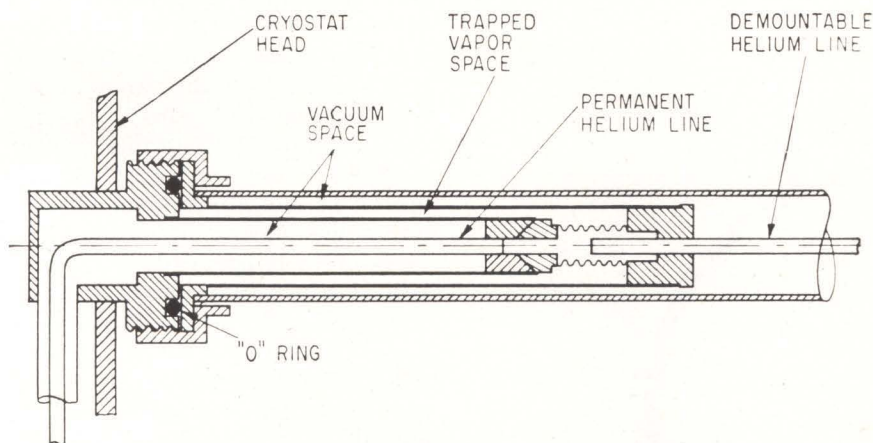

DEMOUNTABLE transfer siphon provides for the addition of liquid helium with no increase of transfer losses—Fig. 2

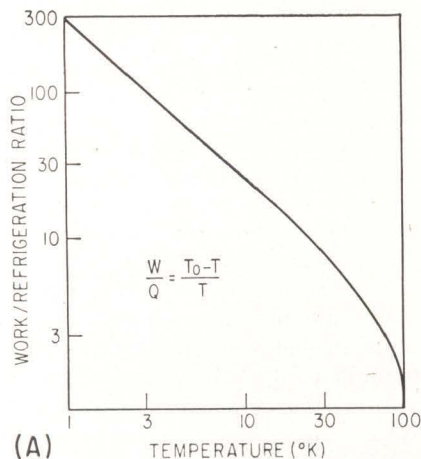

CARNOT CYCLE diagram is a reference for refrigeration-cycle efficiency (A) Regenerative liquifying process must take place below the inversion temperature of the working gas (B)—Fig. 3

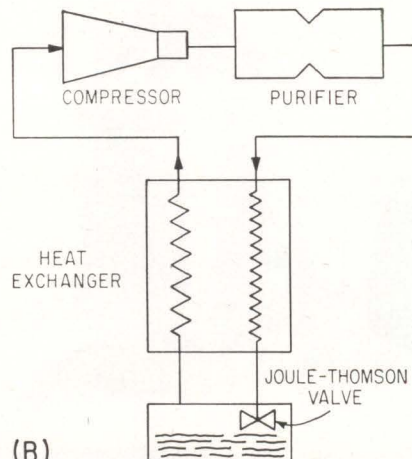

only permitted us to approach the ultimate in microwave receiver sensitivity, but also prodded the competitive devices to new degrees of excellence. Now we have varactor-diode parametric amplifiers capable of being operated at extremely low temperatures where their performance closely approaches that of the maser. Other applications of cryogenic techniques to microwave engineering are manifold, and include low-loss isolators and circulators operated in magnetic fields produced by superconducting electromagnets, and the establishment of noise performance of microwave amplifiers in terms of an absolute noise temperature.

**CRYOGENIC FLUIDS**—The most straightforward and most frequently used method of thermostating microwave devices is to immerse them in a cryogenic fluid. The boiling points and fusion temperatures of the most commonly used fluids are given in Table I.

The temperatures are given for one atmosphere pressure. A vacuum pump reducing the vapor pressure above the liquid permits operation at temperatures intermediate to the boiling point and fusion temperatures. The use of hydrogen or oxygen in the laboratory is hazardous, and their use in field installations more so. Although neon is expensive, it has interesting properties in the temperature gap left between helium and nitrogen if hydrogen is not used.

The range of temperatures between the boiling point and the freezing point is not large, and clearly hydrogen temperatures cannot be reached by pumping on liquid neon. The cooling capacity, on the other hand, of liquid neon is large. Another rare gas, helium 3, provides easier access to temperatures below 4 K than helium 4. Because the vapor pressure of <sup>3</sup>He (8.6 mm Hg at 1 K) is much larger than that of <sup>4</sup>He (0.12 mm Hg at 1 K), the pumping required for operation at temperatures near 1 K is not nearly as large. The high cost of <sup>3</sup>He requires closed systems for gas recovery.

**CONTAINERS**—An early application of cryogenics to microwave problems was made by Maxwell and Schmidt,<sup>1</sup> who devised a supercon-





MASER dewar being hoisted to antenna

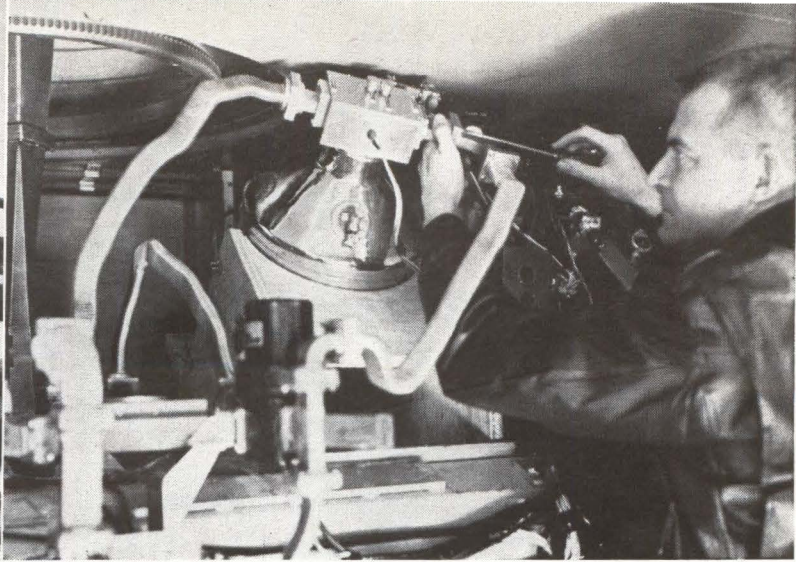

INSTALLATION of maser on dewar

ducting echo box having a Q of about a half-million. The integral cryostat unit was capable of storing liquid helium for periods of 26 days and liquid nitrogen for 12 days. A cross section of the dewar design is shown in Fig. 1A. A common laboratory design is in glass as shown in Fig. 1B. It is a helium dewar within a nitrogen dewar that is necked down to allow insertion between the pole pieces of an electromagnet. A more rugged version is made of metal, Fig. 1C. A metal heat shield between the wall of the helium container and the outer wall of the cryostat is cooled by thermal

conduction from the liquid nitrogen bath. Designs, in metal, for longer term operation are available from commercial firms such as Cryogenic Engineering Company, Sulfrian Cryogenics Incorporated, Hoffman Laboratories, Janis Manufacturing Company, Superior Air Products and Standard Air Products. These companies offer a wide variety of dewars as stock items and will produce custom designs to meet individual needs.

The insulation in the containers discussed has been the high vacuum which have been silvered or pol-

ished to reduce radiation losses. Recent advances in super insulation make solid dewars possible with their improved mechanical properties for field installations.

**TECHNIQUES**—Two other important experimental techniques relative to the handling of liquid helium are the transfer siphon and the means of measuring the liquid helium level. These items are important for storage vessels. It is not always possible to remove the helium transfer siphon from a storage dewar. An excellent demountable transfer siphon has been developed by Stickler and Rauch at Lincoln Laboratory, Fig. 2. Part of the siphon tube remains permanently in the cryostat. The other half is connected only when it is desired to fill the cryostat with liquid helium. This unit suffered no greater transfer losses than its nondemountable equivalent.

The liquid level indicator problem is solved in the laboratory by a polyfoam float on a balsa stick, a carbon resistor, or a mechanical vibration indicator.

The carbon resistor with its negative temperature coefficient of resistance is a convenient way of measuring liquid helium level in the field. Helium vapor is not as efficient in carrying away heat as the liquid and the resistance of a carbon resistor changes markedly as it is raised through the liquid-vapor interface. This change can be observed with a meter or used in connection with an automatic alarm

### WHY CRYOGENICS?

The maser was one of the first electronic devices to require an operating environment down near absolute zero. Infrared sensors also operate in this region as do many lasers. Perhaps many other devices would benefit from the intense cold of liquid helium or liquid nitrogen if more electronics engineers knew how to handle these fluids

PROPERTIES OF LIQUEFIED GASES—TABLE I

Gas	Boiling Point	Fusion Temperature
Helium..... <sup>4</sup> He	4.2 K	.....
Hydrogen.....H <sub>2</sub>	20.4 K	14 K
Nitrogen.....N <sub>2</sub>	77.3 K	63.2 K
Oxygen.....O <sub>2</sub>	90 K	54.4 K
Carbon Dioxide.....CO <sub>2</sub>	195 K	(normal sublimation temperature)
Neon.....Ne	27 K	24.6 K

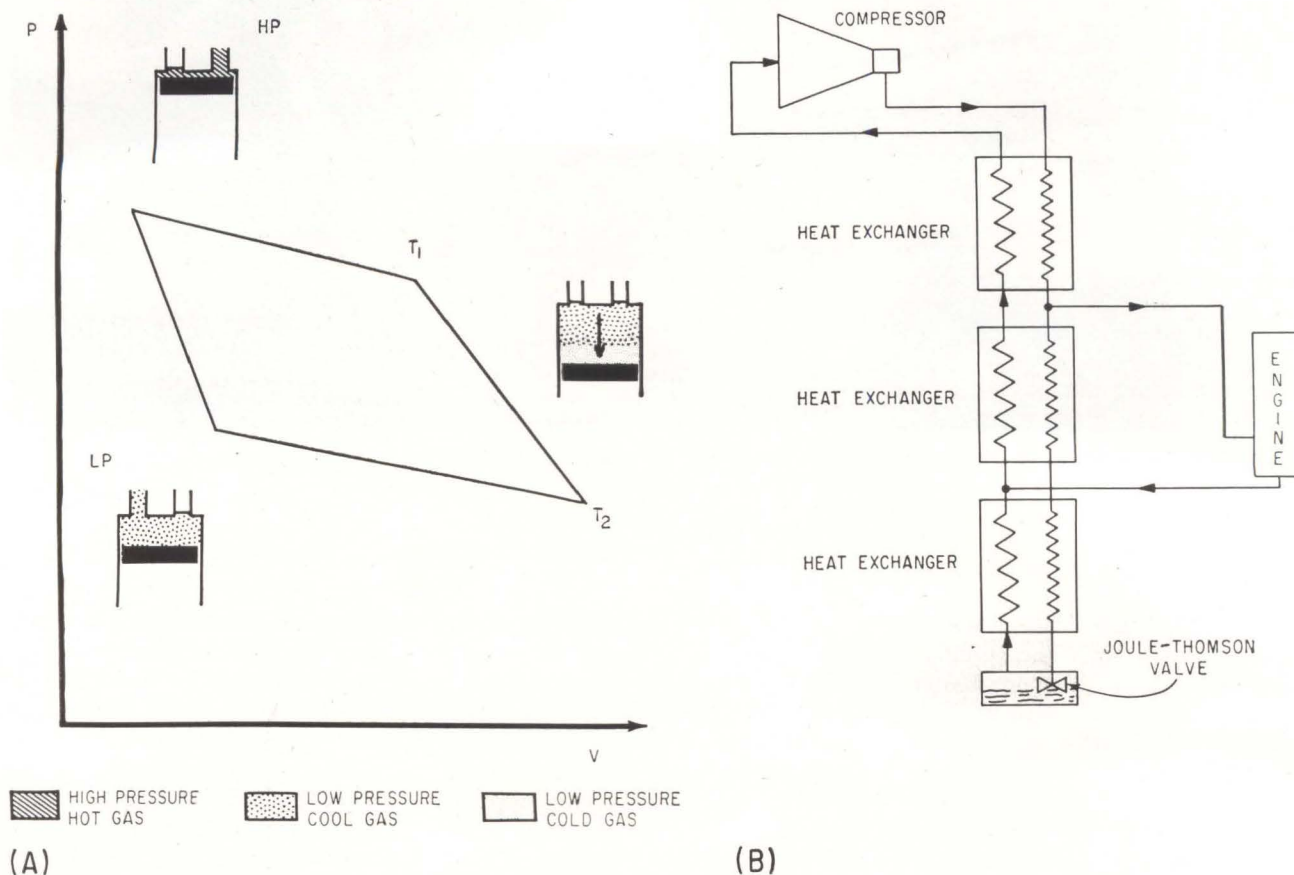

CLAUDE EXPANSION engine pressure-volume diagram (A). Two process machine employs a Claude cycle engine for precooling and a Joule-Thomson expansion for liquefaction (B)—Fig. 4

circuit to give direct indications of level. While this is not a continuous indication, a few resistors placed at strategic points will give all the information necessary for field operation.

Flexible transfer siphons and special units for transfer of liquid helium or its vapor for a distance of one hundred feet have been designed and constructed successfully.

**LIQUEFACTION**—In any refrigerative process a compressed gas does work, and is thereby cooled, the work being done against internal forces as occurs in a free expansion or against external forces as occurs in piston engines or turbines. The expansion of a gas through a valve without doing external work, the Joule-Thomson process, is most commonly used as the final stage of a liquefier because the relative incompressibility of the liquid would cause problems in a piston or displacer engine.

Refrigerator efficiency can be rated relative to the ideal (Carnot)

cycle. The work input for refrigeration output as a function of temperature is shown in Fig. 3A. Other refrigeration processes are less efficient, ranging from 10 to 50 percent of the Carnot value, depending upon the cycle and operating temperature.

A system employing only a Joule-Thomson expansion often referred to as a Linde or Hampson system, Fig. 3B, uses compressed, purified gas cooled by a counter flow heat exchange by the lower temperature low-pressure gas. If the process takes place below the so-called inversion temperature of the working gas, cooling and eventual liquefaction will occur. The inversion temperature is a function of the internal gas forces and for many gases lies above room temperature. Helium, on the other hand, has a low inversion temperature and must be cooled by other means before J-T cooling can occur.

An expansion engine, doing external work on a piston, and employing a heat exchanger is called a

Claude cycle system. A pressure-volume diagram of the Claude engine is shown in Fig. 4A. A two-process machine employing a more efficient Claude cycle for precooling, and a J-T expansion for liquefaction is shown schematically in Fig. 4B. The piston engine in this system could be replaced by an expansion turbine as was done by Kapitza for an air liquefier.

In the counter flow heat exchanger, the two gas streams do not intermix. In a regenerator, heat is alternately stored or removed from the regenerator. The regenerator is filled by a mass of metal having a large surface area to permit rapid and effective heat transfer to and from the gas. A cycle employing a piston displacer, regenerator and room temperature valving has been described by McMahon and Gifford,<sup>2</sup> and incorporated into the ADL Cryodyne. The operation of the system is shown in Fig. 5A. In this cycle the piston does not work, rather it displaces the gas in and out of the regenerator that has been

cooled by adiabatic expansion.

The Philips Company of Holland has devised an efficient gas refrigerating machine based on the Stirling cycle, employing an integral regenerator and component piston displacer-compressor. This hybrid unit is the most efficient process between temperatures of  $-80^{\circ}\text{C}$  and  $-180^{\circ}\text{C}$ , where it exceeds 40 percent of Carnot. The Claude cycle does not exceed 30 percent and the J-T expansion is less than 20 percent of Carnot efficiency. The cooling process is described in Fig. 5B.

**SOLID STATE** — Thermoelectric coolers for use at moderately low temperatures are now available from Pesco Products Division of Borg-Warner Corporation, Jepsen Thermoelectrics Incorporated, Whirlpool and Westinghouse and others. These coolers are for milliwatt loads at temperatures in the vicinity of  $-80^{\circ}\text{C}$ . Since the properties of materials change at levels below  $-80^{\circ}\text{C}$ , the problem of thermoelectric cooling is one of materials research.

Contemporary research is addressing itself to the problem of thermoelectric cooling at much lower temperatures, and the behavior of material in magnetic fields at low temperatures leads to the belief that such cooling at temperatures in the liquid helium-liquid hydrogen range will become practical.

**FIELD USE** — Sophisticated low-temperature microwave devices must serve their function in the field. Consider the problem of systems for such field operation. It has been shown that it is possible to design dewars capable of holding their liquefied gases over long periods of time. Even so, the requirement of periodic refilling is not likely to be relished by the system engineer or operator. The availability of long, flexible, transfer tubes and of low-temperature valves makes an on-line transport system practicable. One such arrangement is shown in Fig. 6 where a relatively compact working dewar is connected to a remote, large capacity storage vessel which might in turn be kept full by an integral machine. The liquid level is maintained in the working dewar by au-

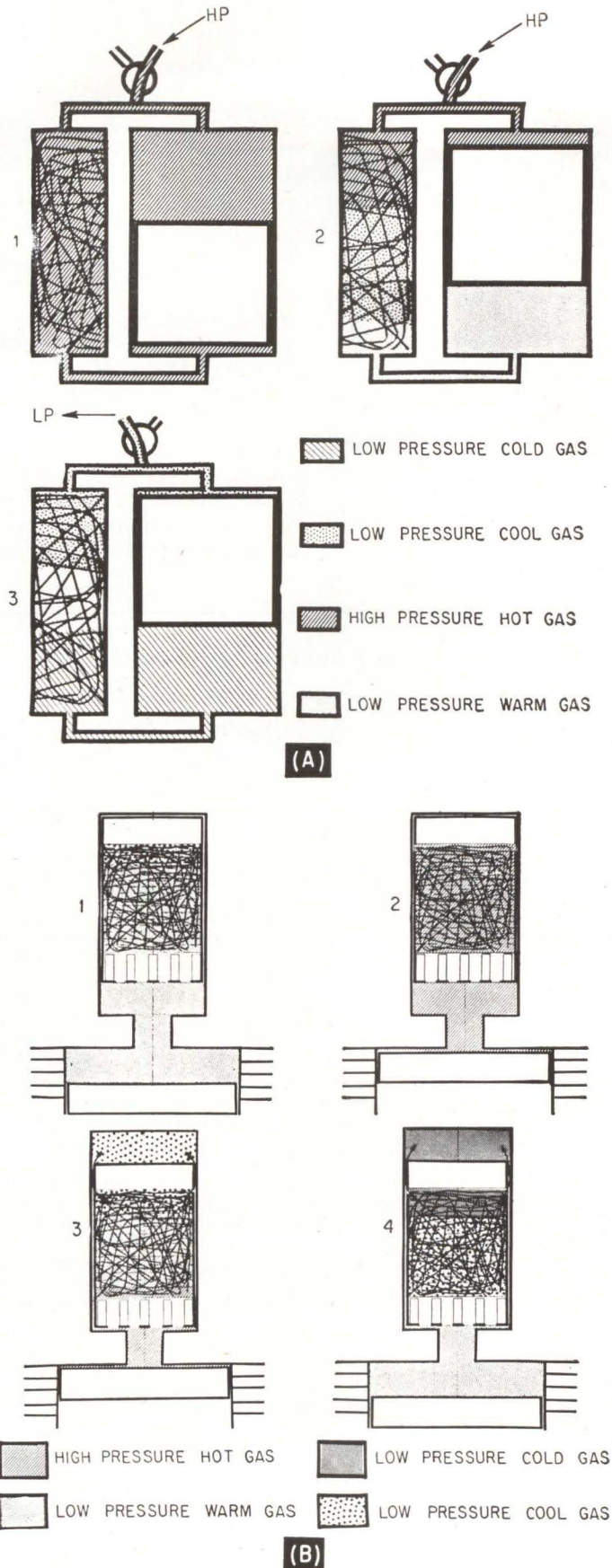

DISPLACER REGENERATOR piston displaces gases in and out of regenerator previously cooled by adiabatic expansion (A). Hybrid cooling system is most efficient for the range of  $-80$  to  $-180^{\circ}\text{C}$  (B)—Fig. 5

omatic valving or siphoning.

The convenience of a compact, closed-cycle system for on-site use makes it most attractive. Its portability, adaptability to field site logistics, and inherent conservation of helium are important considerations. However, refrigeration capacities in excess of a watt are not required but rapid cool-down from room temperature is necessary. Thermal mass in the system does not decrease with size so rapidly as capacity. Hence small capacity often means slow cool-down. There are methods of precooling which can shorten the cool-down time. Bypassing arrangements can be made in some systems which have the same effect. An obvious answer to the problem is the extremely reliable, long-lived system.

Important problem areas are de-

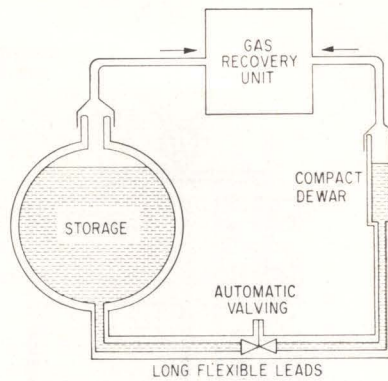

REFRIGERATION TRANSPORT system makes on-line applications feasible. Long, flexible, transfer tubes and low-temperature valves are available—Fig. 6

signing compressors capable of extended operation, highly efficient and free from contamination. Other areas are in making heat exchang-

ers and regenerators that are highly efficient and have a small insertion pressure drop, also in designing engines having high efficiency consistent with low temperature cycles, easy valving, adequate lubrication, small heat leaks, effective coupling of engine output and easy maintenance.

#### REFERENCES

- (1) E. Maxwell and A. F. Schmidt, Bulletin de l'Institut International du Froid, Commission 1, Delft 1958, Annex 1958-1, p 95, "Liquid Helium Cryostat with an Integral Superconducting Resonator."
- (2) Howard O. McMahon and William T. Gifford, Proceedings of the Cryogenic Engineering Conference, Sept. 1959, Vol. 5, "A New Low Temperature Gas Expansion Cycle: Parts I and II."

#### BIBLIOGRAPHY

- F. E. Hoare, L. C. Jackson, and N. Kuiti, "Experimental Cryophysics," Butterworths, London, 1961.  
 Russell B. Scott, "Cryogenic Engineering," D. van Norstrand, New York, 1959.

\* CLOSED CYCLE REFRIGERATOR SUPPLIERS—TABLE II

SUPPLIER	COOLING MEDIA	REFRIGERATION (Milliwatts)		TEMPERATURES (deg K)		POWER (Kw)	WT OF SYSTEM (LB)	CARNOT EFFICIENCY (PERCENT)
		AT-TAINED	PRO-JECTED	AT-TAINED	PRO-JECTED			
Air Products and Chemicals, Inc.								
80 K Closed Cycle Cooler	Nitrogen	2,000	5,000	80	30	0.3 to 1	16 to 35	1.83
30 K IR Cooler	Nitrogen and Neon	.....	350	.....	30 or 17	0.850	40 to 50	50
C-102	Nit., Hyd., Helium	1,000	1,000	4.4	4.4	7.5	5,100	20
2.5 Req.	Helium	215	1,000	2.48	.....	5.7	250	0.50
173 K Cooler	Freon	.....	1,500	.....	173	300	6	
Arthur D. Little								
Model 100	Helium	500 at 3 to 4.5K	750 at 3 to 4.5K	2.9	2.6	7	1,600	6.3
Model 110	Helium	1,750 at 3.4K	2,500 at 3.4K	.....	3.0	9	1,400	5.3
Model 200	Helium	750 at 4.2K	1,000 at 4.2K	3.8	3.5	4	950	6.3
Cryogenerators								
Model 42300	Helium	1,000 at 30K 10,000 at 80K	.....	25 to 300	.....	0.2 to 0.1	12	
Garrett Corporation								
1 Watt Nitrogen	Nitrogen		1,000		77	0.130	20	2.2
50 Watt Nitrogen	Nitrogen		50,000		77	2	53	8
2 Watt Neon	Neon		2,000		25	0.730	30	3.41
1 Watt Helium	Helium		1,000		4.2	5	178	1.42
General Electric								
	Helium		50-5,000		3.6	2.5/watt refrigeration	Less than 100	
Hughes Aircraft Co.								
Mark III	Helium	.....	2,000 5,000	.....	4.2 2.5	5	120	6-10
Malaker Laboratories								
	Helium	2,080 at 92K	1,000 at 30 K	78	30	0.130	9.8	
Stratos								
Model 7500	Nitrogen and Helium		200		22	0.550	27	0.51
Linde								
	Nitrogen and Helium Hydrogen Neon		Fraction to Several		2 to 80			

\* As of January 1963

FINDING the size of a two-section filter aperture. Test jig (A) and equipment setup (B)—Fig. 1

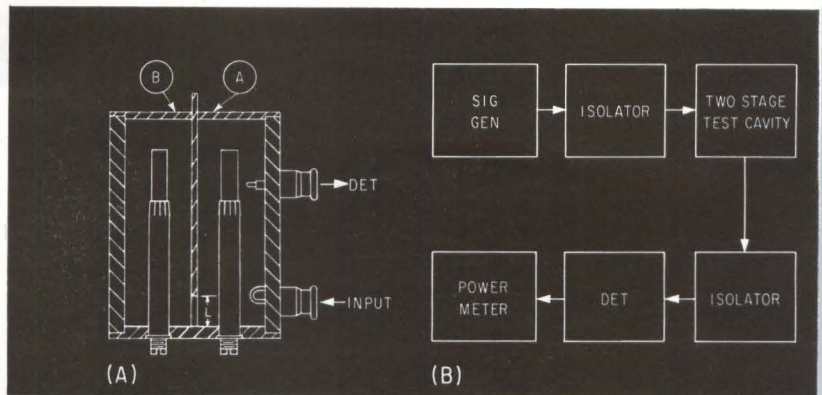

## Coaxial Filters—

# A Practical Design Technique

*Here's a method for determining the dimensions of multistage filter coupling apertures that provide required coupling coefficients between filter sections*

By J. F. LALLY  
R. R. CIEHOSKI  
RADCOM Div., Litton Industries,  
College Park, Md.

**MULTI-RESONATOR** coaxial filters are commonly used in microwave multiplex systems. Actually, these resonators often are short-circuited quarter-wavelength coaxial transmission lines inductively coupled by an aperture in their common walls. Thus, this construction comprises a multi-stage filter whose over-all response is determined by the interstage couplings.

Excellent design equations for both Butterworth and Tchebycheff type responses are in the literature<sup>1, 2</sup>, but the actual technique for designing multi-resonator coaxial bandpass filters is not as clearly defined as are other designs which utilize a strip transmission line or waveguide. The area of indeterminacy in the design of this type filter is the size of the interstage coupling apertures needed to obtain the desired bandpass response. Since these coupling apertures normally turn out to be relatively large,

calculations based on Bethe's small-aperture theory<sup>3</sup> do not yield useful results. The purpose of this article is to demonstrate how practical design information is obtained and used.

**GETTING EMPIRICAL DATA**— Consider the problem of designing a coaxial filter of the type previously described. After the type of response and the number of stages required have been determined, the interstage coupling coefficients may be calculated using the following general expression derived by Cohn<sup>2</sup>

$$k_{i, i+1} = \frac{1}{\omega_1' (g_i g_{i+1})} \left( \frac{f_2 - f_1}{f_0} \right) \quad (1)$$

### FILTER SPECIFICATIONS

$f_0 = 762.5$ Mc	
$f_2 - f_1 = 25$ Mc (measured at 1-db points on filter skirt)	
$g_1 = 2.0991$	$k_{12} = 0.0219$
$g_2 = 1.0644$	$k_{23} = 0.0189$
$g_3 = 2.8311$	$k_{34} = 0.0219$
$g_4 = 0.7892$	

where  $k_{i, i+1}$  is the coupling coefficient between two adjacent resonant circuits,  $\omega_1' = 1$  for Tchebycheff or Butterworth response,  $g_i =$  low-pass prototype element values, and  $(f_2 - f_1)/f_0 =$  fractional bandwidth.

How can the designer practically realize the coupling coefficients that were computed by the above equation? With a minimum of effort it is possible to obtain empirical data of aperture size and location versus coupling coefficient which is sufficiently accurate for most filter designs. For the purpose of the present discussion, the type of aperture shown in Fig. 1A will be considered, but the method is generally applicable to any type of aperture. The test jig shown in Fig. 1A consists of two resonators (A and B) having the exact internal dimensions as the desired filter, with the wall between the two resonators variable in precise increments. To prevent direct coupling between the coupling circuits, a loop is used to magnetically couple into the cavity and a capacitive probe to electri-

cally couple out of the cavity. The technique for making this measurement follows:<sup>4</sup>

1. Set up the equipment as shown in Fig. 1B.
2. Designate as *A* and *B* the two adjacent resonators between which the coupling coefficient is to be determined.
3. Couple a non-resonant signal generator directly and very loosely to resonator *A*.
4. Couple a non-resonant detector to resonator *A*.
5. Tune resonator *A* for maximum output from the detector at frequency  $f_0$ .

6. Tune resonator *B* for minimum output from the detector at frequency  $f_0$ .
7. Measure the peak bandwidth ( $\Delta F_A$ ) between the response peaks on the primary side.

The coupling coefficient,  $k$ , may then be calculated by using the following approximate equation by Dishal.

$$k = 0.96(\Delta F_A)/f_0 \quad (2)$$

Thus, by changing the physical aperture in precise increments and repeating the above procedure at each setting, the curve of coupling coefficient versus aperture size is obtained.

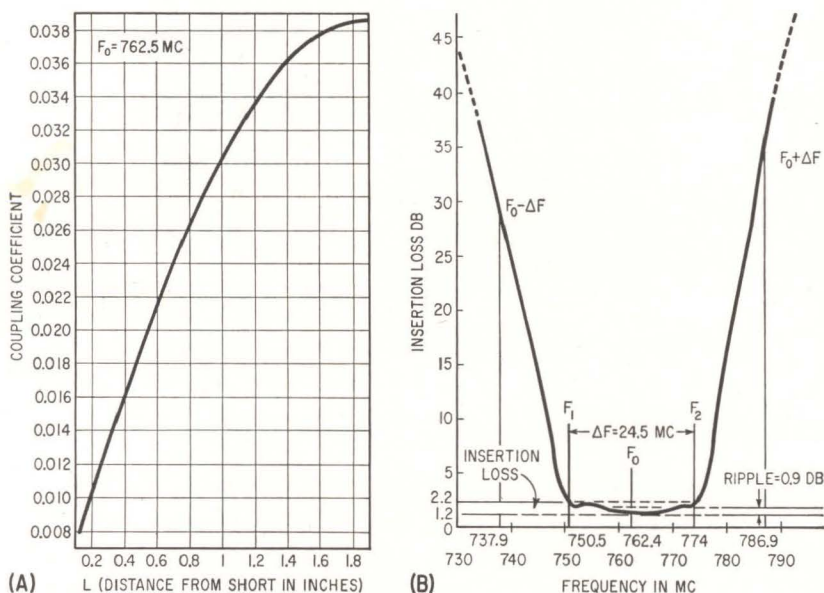

COUPLING COEFFICIENT is plotted against gap in (A). The response curve of a filter that was fabricated according to data of (A) is shown in (B)—Fig. 2

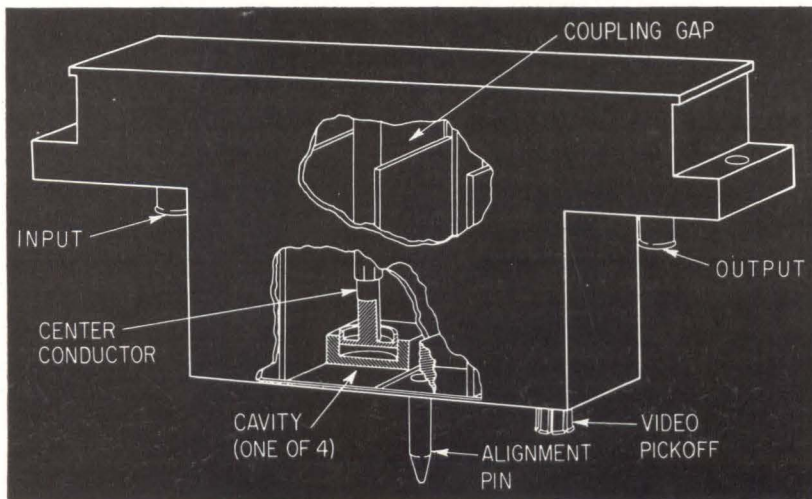

FOUR-SECTION FILTER sketch. Internal view shows center conductor of one of the four sections of the filter—Fig. 3

**EXAMPLE** — The practicality of such empirical curves can be best demonstrated by an example. Consider a four-stage, direct-coupled coaxial bandpass filter that has a Tchebycheff response with a 1-db passband ripple and the specifications listed in the Table on p 35.

Having first computed the required coupling coefficients, the curve of coupling coefficients versus gap dimension shown in Fig. 2A was next obtained using the above procedure. From this curve, the necessary gap dimensions between the four resonator sections were determined to be:

$$L_1 = 0.620, L_2 = 0.510 \text{ and } L_3 = 0.620.$$

The filter was then fabricated using these gap dimensions and the resultant bandwidth was within one megacycle of the design value without any adjustments being made to the coupling apertures. A plotted response of this filter is shown in Fig. 2B. A sketch of a four-stage (four resonant circuits) filter is shown in Fig. 3.

During the course of this work it was desired to extend this design information to cover a frequency octave. Since the accumulation of all this data by direct measurement would consume a prohibitive amount of time, it was decided that a family of five such curves would be experimentally obtained. By careful measurement, an excellent set of curves was obtained. From these curves, all the intermediate frequency design data was easily interpolated. Several filters were designed and built using the interpolated information and all filters tested had bandwidths which were close to the design value. Thus, it is possible to come up with a theoretical design for a series of narrow-band filters that covers a complete octave of frequencies and then to construct them without any adjustments of the interstage coupling apertures.

#### REFERENCES

- (1) M. Dishal, Two New Equations For The Design of Filters, *Electrical Commun.*, p. 324, Dec. 1953.
- (2) S. B. Cohn, Direct-Coupled-Resonator Filters, *Proc IRE*, p. 187, Feb. 1957.
- (3) H. A. Bethe, "Lumped Constants for Small Irises," Radiation Laboratory Report No. 43-22, Mar. 24, 1943.
- (4) M. Dishal, Alignment and Adjustment of Synchronously Tuned Multiple-Resonant-Circuit Filters, *Proc IRE*, p. 1,448, Nov. 1, 1951.

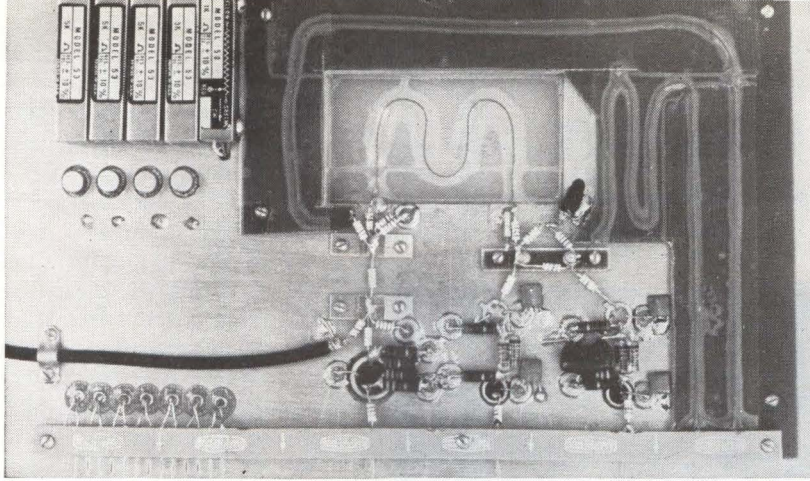

CONVERTER consists of nine boards like this one

By HANS R. SCHINDLER  
 Electronics Laboratory,  
 General Electric Co.,  
 Syracuse, New York

## USING THE LATEST Semiconductor Circuits in a UHF Digital Converter

*Hybrid serial-parallel system splits the signal into nine subchannels.*

*Analog-digital converter works at 300 Mc, has a 25-Mc bandwidth. Level decisions introduce weighted currents into lower channels*

CONVERSION of wideband analog signals into digital becomes possible using new high-speed semiconductor devices such as tunnel diodes, charge storage diodes,<sup>1</sup> computer diodes and uhf transistors. Specifically, this converter converts video signals having a bandwidth of 25 Mc and has a level resolution of 64 steps.

Such a converter must have a minimum sampling rate of 50 Mc. To describe the 64 levels in binary language, 6 bits are needed. Thus, a bit rate of 300 Mc is required.

The analog and the digital waveform and the corresponding time scale are shown in Fig. 1A. The interval between two succeeding instances where samples are taken is 20 nsec and the interval between two succeeding bits is 3.3 nsec.

Approaches to analog-digital conversions vary from all-serial through serial-parallel to all-parallel. In serial analog-digital conversion, the mechanism of encoding involves a sequence of comparisons to obtain successively closer approximations. In a parallel encoder

all the level comparisons are done simultaneously. Several series realizations are possible. Figure 1B shows a scheme using a staircase generator, threshold element, gate and counter. It affords circuit simplicity, but in high-speed conversion it requires extremely fast counter circuits. In this converter a counter capable of counting up to 3,200 Mc would be required. This is at present unrealistic.

Another series realization consists of a sequence of a first-level comparison, level shifting or weighting, second-level comparison, another level shifting and so on until the required resolution is obtained. This technique is adaptable to high-frequency operation. However, an all-parallel approach involves complex circuits and a large number of threshold elements. In 6-bit conversion, 64 threshold gates would be required. In addition, a complex logic circuit would become necessary to convert the output of

---

### WHAT'S IT GOOD FOR?

This analog-digital converter was designed to be used in a satellite, which transmits data digitally because such signals are less affected by noise over long distances.

The 25-Mc bandwidth of the converter makes it useful for transmitting up to four television channels simultaneously

---

the 64 parallel lines into series.

The third possibility is a hybrid parallel-serial solution. It was selected for simplicity and reliability. Furthermore, the speeds needed

are within reasonable limits.

**SYSTEM**—Figure 2 is the block diagram of the system. The signal is split into three main channels,

each of them being split again into three subchannels. In the first three subchannels, three level decisions are made simultaneously to determine if the signal level lies in the first, second, third or fourth quarter of the maximum signal range. As a result of these decisions a weighted current is introduced into the second and third main channels, at points P and Q. A few nanoseconds later three level decisions are made in the second main channel. The outcome of the second series of three decisions introduces a weighted current into main channel three, at point Q. Finally, the last level decisions are made. All the outputs of the nine subchannels have to be processed logically and then converted into a serial form.

In such a high-speed system, there are two special considerations. First, every wire that connects different parts in the circuit is a transmission line. It has an impedance that should not vary along the line and it should be properly terminated at least at one end to avoid reflections bouncing forth and back and distorting the waveforms. Two different types of transmission lines are used, 50-ohm coax cables for the distribution of pulses for interrogation and reset and 150-ohm strip lines for the logic outputs of the subchannels.

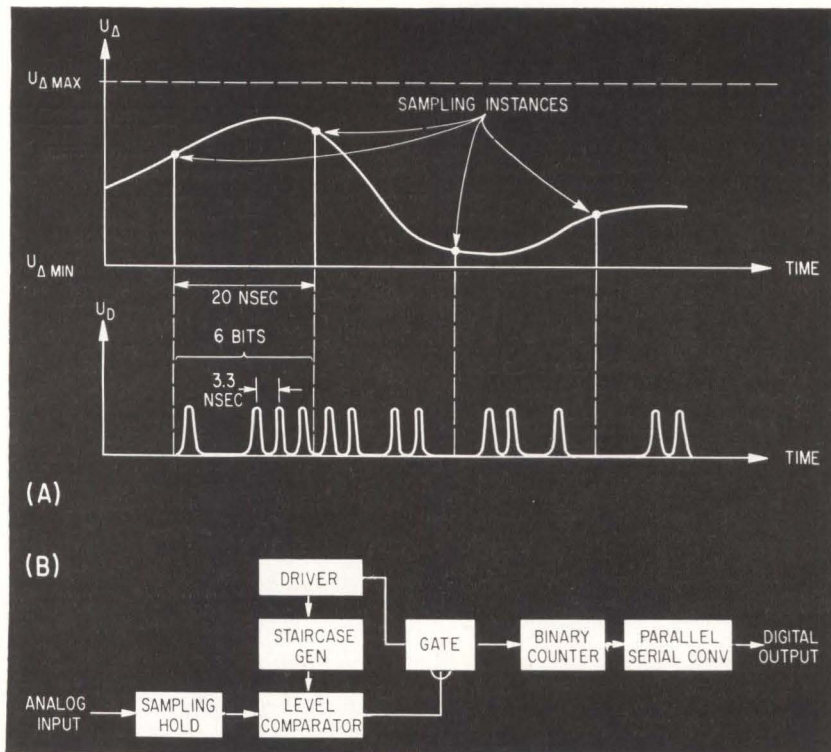

WAVEFORMS of converter (A), with analog at top, digital below; serial converter approach (B). Symbol below gate is inhibitor—Fig. 1

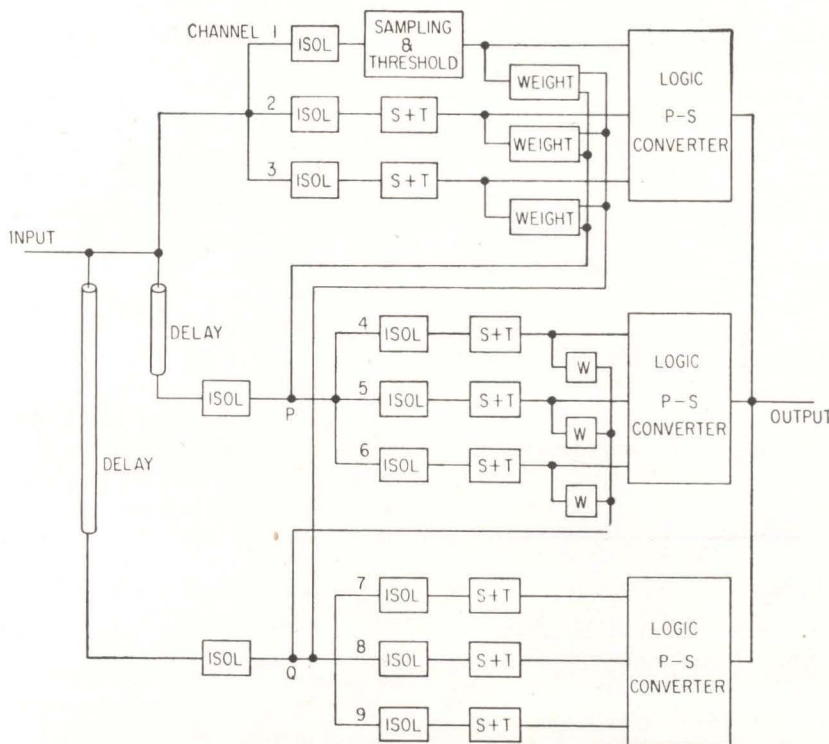

CONVERTER shows signal split into three channels and then into nine subchannels—Fig. 2



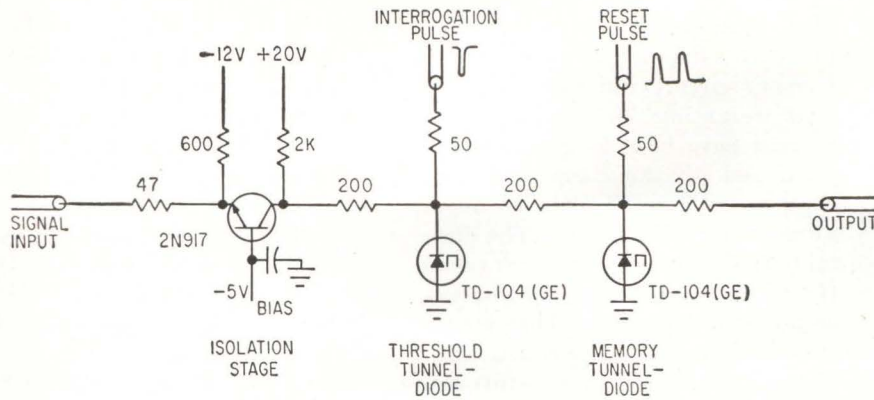

**SAMPLING and threshold circuit.** Waveform is of the interrogation pulse (vertical scale of 2 v per cm; horizontal, 4 nsec per cm). The base-line noise is about 6 percent of the pulse amplitude; the pulse width is about 1 nsec at 10 percent from the base line—Fig. 3

diode fires. It remains there until reset by another positive-going current pulse. The relative current levels in the threshold tunnel diode are shown in Fig. 4 (left).

The waveforms across the threshold tunnel diode for signal currents below and above the threshold level and the corresponding waveforms across the memory tunnel diode are reproduced in Fig. 4. The threshold tunnel diodes can resolve current level differences of less than  $50 \mu\text{a}$  within 0.3 nsec. It corresponds to a charge of less than 0.015 pc. This is equal to 100,000 electrons. The theoretical limit determined by the tunnel-diode shot noise was calculated to be about 0.004 pc, or 25,000 electrons. The measured value is about four times larger than the theoretical value. It is due mainly to noise and hum in the pulse generator.

For a signal with 25-Mc bandwidth and a maximum amplitude of 8 ma, this resolution in time and level is more than sufficient for the conversion into 6 bits corresponding to 64 levels.

**WEIGHTING**—Figure 5 shows the weighting circuit, which, according to the decision of the threshold tunnel diode, introduces within a few nanoseconds a precise amount of current into the points P or Q of the block diagram.

The circuit uses a transmission-line transformer, consisting of a twisted pair of wires, for phase inversion. The lower cut-off frequency of the transformer has been chosen so that the signal gets differentiated, to avoid problems of

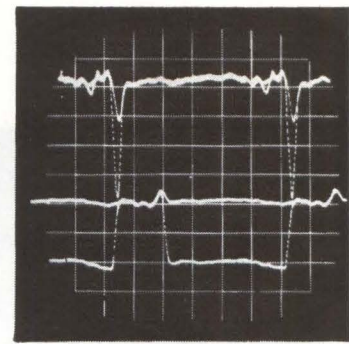
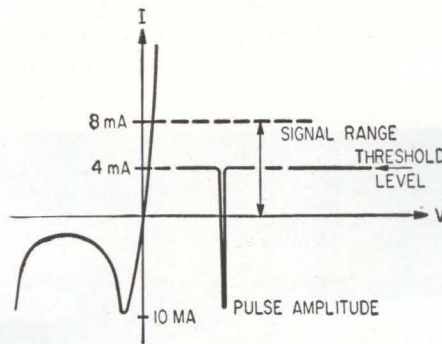

**CURRENT LEVELS in the threshold tunnel diode.** Waveforms (3.3 nsec per cm) are taken across the threshold tunnel diode for signal currents below and above the threshold level (upper trace); across the memory tunnel diode (lower trace)—Fig. 4

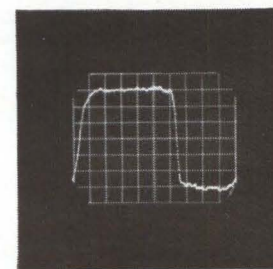
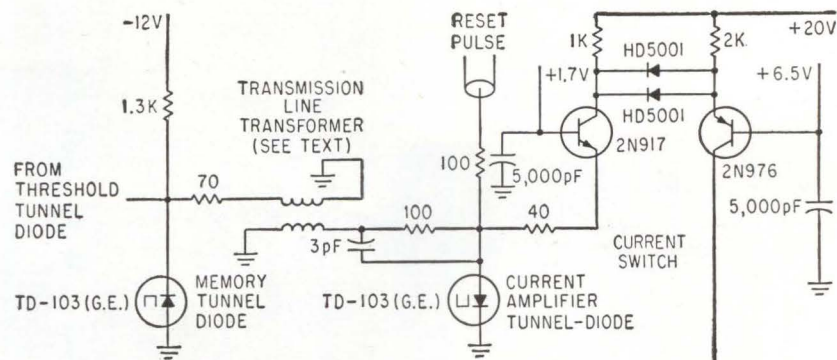

**WEIGHTING CIRCUIT and waveform of current step it generates** (horizontal scale, 2 nsec per cm; vertical, 1 ma per cm). The current becomes constant within  $\pm 1$  percent in less than 4 nsec, measured from the instant of decision—Fig. 5

d-c restoration. The delay in the transformer is about 0.3 nsec and the signal risetime at its output is less than 0.2 nsec. The transformer is connected to a third tunnel diode for current amplification. Its output feeds an *n*pn common-base transistor which drives the switching network consisting of ultrafast computer diodes and a *p*np common-base stage. The precision of the current is achieved by choosing a high value for the emitter-resistor of the second transistor. The current step gets flat within  $\pm 1$  percent in less than 4 nsec (Fig. 5). It gets fed to point P, where the delayed and isolated input signal is split into the second series of sub-channels. There the next series of level decisions will be made.

The whole converter consists of

nine boards (photo). Each contains a sampling, threshold and memory circuit and NONE, ONE or TWO weighting circuits. All lead lengths have been kept to a minimum and all the components are close to the ground plane to avoid unnecessary inductances. The digital output from the circuit is taken from the memory and the current amplifier tunnel diode. That means that both polarities are available. The digital signal is fed through 150-ohm strip transmission lines and a matched strip-line connector into the main board. The outputs from the nine boards are not yet in the proper binary form.

**LOGIC**—A simple logic operation is needed as shown in Fig. 6A. On the left side a truth table relates

the channel outputs to the binary form for all the possible combinations. The output of the second channel corresponds to the first bit. The second bit is related to all the three channel outputs by the simple equation shown on the right side. This equation can be realized by an adder network as both signal polarities are available. This logic has to be performed three times, once for each main channel.

By now, the binary output is available in six parallel channels. But a serial output is needed. That means that the information of the six channels has to be transformed into a time series of six bits. This is done using the technique developed for a computer circuit having a clock rate of 200 to 500 Mc.<sup>2</sup>

**COMPUTER**—The computer is based on pumped tunnel-diode-transistor logic (Fig. 6B). It uses two basic modules that are d-c coupled, the Nipo and the Pino element: Nipo means "negative input-positive output" and Pino "positive input-negative output." In a Nipo element, for example, one or more negative pulses at the input inhibit the positive-going pulse at the output; Pino and Nipo elements operate at opposite half-cycles of the pump source and follow each other. Delay from one module to the next is one-half cycle of the pump frequency. For the 300-Mc pump, the delay per logic step is 1.6 nsec.

Figure 6C shows the layout of the parallel-serial converter. At left are the six parallel channels, at right the serial output. The delta symbol means an additional delay of the signal of 3.3 nsec. This is done by making the strip-type transmission line connecting the modules about two feet longer. The parallel-serial converter uses 10 Pino and 6 Nipo elements, which can be placed on one circuit board.

The author thanks the Aeronautical Systems Division of the Air Force Systems Command, Wright-Patterson, for the support of this work and William Peil and Fred King from the Electronics Laboratory for their assistance.

#### REFERENCES

- (1) J. L. Moll, S. Krakauer, R. Shen, P-N Junction Charge-Storage Diodes, *Proc IRE*, Jan. 1962.
- (2) Y. C. Hwang, R. A. Marolf, W. Peil, H. Raillard and E. P. Stabler, Analysis of a Pumped Tunnel Diode Logic Circuit, *IRE Trans PGCT*, CT-9, 3, Sept. 1962.

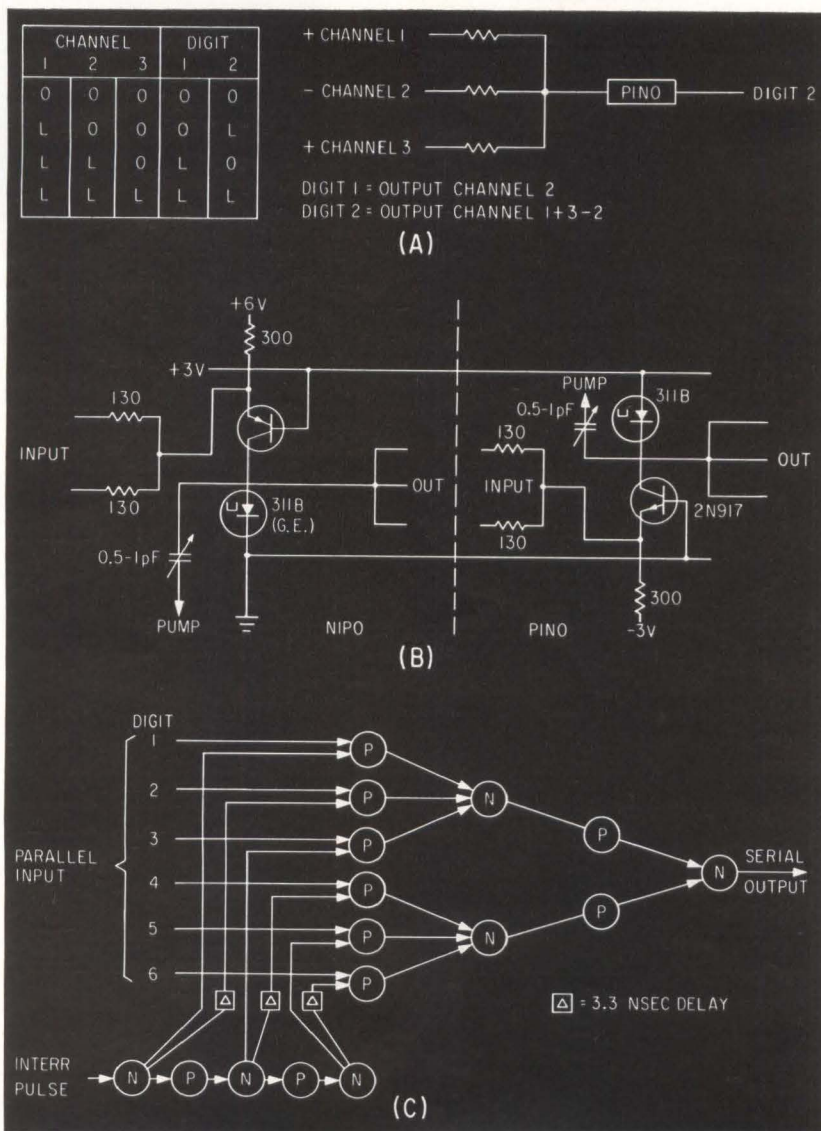

LOGIC for generating the digits from channel inputs (A); d-c coupled pumped tunnel-diode transistor logic circuit (B); parallel-serial converter (C)—Fig. 6

# POT-

*with a pedigree!*



NOW—

3, 5 or 10 turn  
MODELS

THE FABULOUS SERIES

62

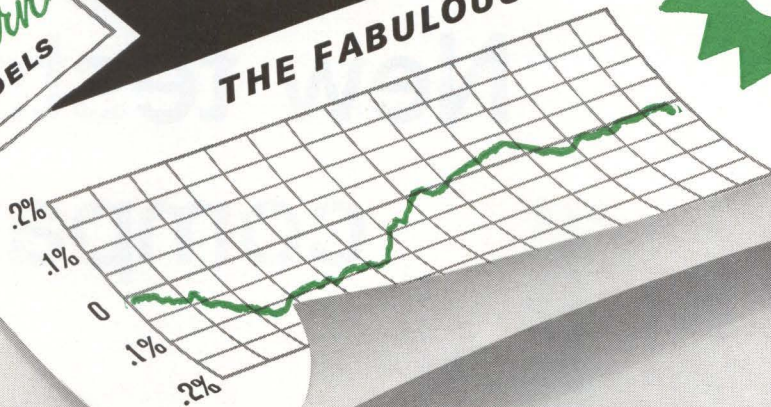

Clarostat offers another plus feature on the fabulous Series 62 Precision multi-turn potentiometer: For the design and

evaluations engineer, an X-Y-plot chart indicating the exact linearity characteristics of the prototype potentiometer. The chart is packaged with the potentiometer, enabling the engineer to conduct the most exacting tests with the specific unit.

This, added to the outstanding electrical precision and low cost (as little as \$5.00 each in quantity) and the recently announced choice of any number of turns to ten makes the Series 62 your best buy for every industrial and instrument application.

Write for complete technical details . . .

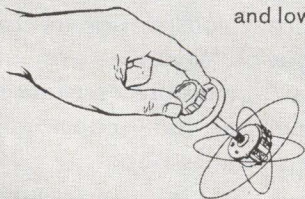

PRECISION POTENTIOMETER DIVISION

# CLAROSTAT

CLAROSTAT MFG. CO., INC. DOVER, NEW HAMPSHIRE

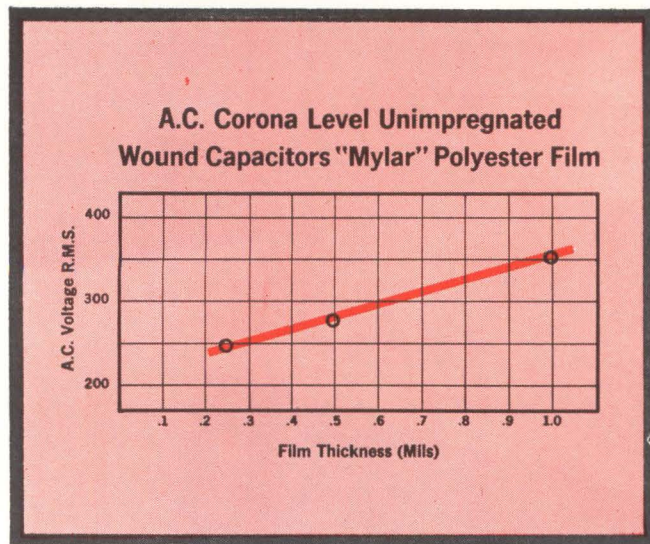

## AC CORONA LEVEL

Corona levels for various gauges of "Mylar"\* in capacitors were determined in life tests and are shown above. AC corona level is defined as the r.m.s. voltage below which corona does not exist.

**Unimpregnated Single Layer 25 Gauge Capacitors of "Mylar"**

D.C. Bias (Volts)	0	100	300
A.C. Volts R.M.S. necessary to produce corona at 25°C	290	290	290
at 125°C	285	285	280

**Unimpregnated Single Layer 50 Gauge Capacitors of "Mylar"**

D.C. Bias (Volts)	0	200	400
A.C. Volts R.M.S. necessary to produce corona at 25°C	345	350	350
at 125°C	315	320	310

## AC/DC CORONA LEVEL

Corona is a function of AC voltage only. Table shows full AC voltage must be applied before corona can exist, whatever the DC bias may be.

# AC/DC Capacitor study... New tests show compatible in

**N**ow designers can apply the high reliability and low cost of capacitors of "Mylar" to AC and AC/DC circuits. Capacitors with "Mylar"\* polyester film as the dielectric are completely compatible in these circuits in home entertainment equipment and similar circuits in other equipment. Data proving compatibility was developed in Du Pont's test at the Film Department Sales-Service Laboratory and at Inland Testing Laboratory.

Briefly, the tests showed that for a capacitor with a dielectric of dry "Mylar" it does not matter whether the voltage is DC, or AC, or combinations

of these voltages. There are only two limitations: (1) the AC voltage or AC component in an AC/DC situation should not exceed the corona level, and (2) the total of the DC voltage plus the r.m.s. AC should not exceed the rated DC working voltage.

Now that it's assured that these capacitors are completely functional in such circuits, designers can utilize the other advantages of "Mylar"—over-all reliability, high IR, small size, moisture resistance, capacitance stability. Remember, too—capacitors of "Mylar" cost about the same as paper.

\*Du Pont's registered trademark for its polyester film.

**TO APPLY THESE IMPORTANT FINDINGS TO YOUR DESIGN, CLIP AND MAIL THIS COUPON:**

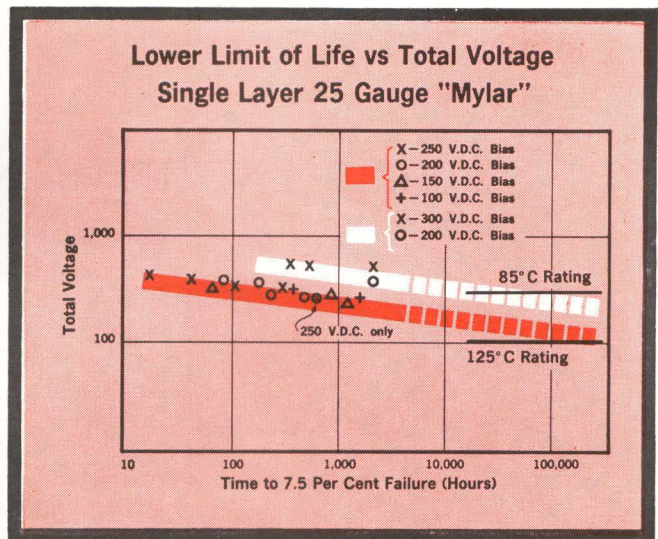
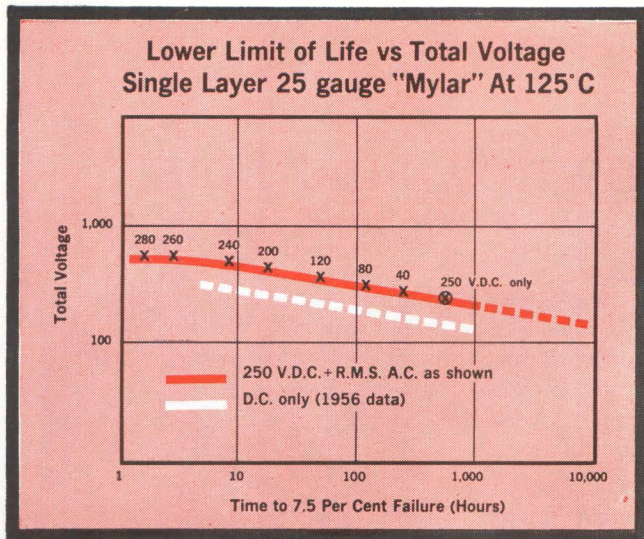

## AC/DC LIFE

Below AC corona level, life is a function of total voltage. AC/DC total voltage life performance is identical to DC life performance.

Regardless of AC/DC combinations, the basic voltage-life law is maintained, and the law applies to various operating temperatures as shown.

# capacitors of **MYLAR**<sup>®</sup> AC/DC circuits

E. I. DU PONT DE NEMOURS & COMPANY (INC.)

### FILM DEPARTMENT

BOX 22B—RM. N10452 WILMINGTON 98, DELAWARE

Rush me your *Pocket Report* on "Mylar" polyester film as a capacitor dielectric for AC and AC/DC voltages.

NAME \_\_\_\_\_ TITLE \_\_\_\_\_

FIRM \_\_\_\_\_ EQUIPMENT \_\_\_\_\_

ADDRESS \_\_\_\_\_

CITY \_\_\_\_\_ STATE \_\_\_\_\_



BETTER THINGS FOR BETTER LIVING  
... THROUGH CHEMISTRY

only **DU PONT** makes

**MYLAR**<sup>®</sup>  
POLYESTER FILM

## Experts Evaluate Nonwirewound Pots

*Speakers bring engineers up to date on capabilities and use of new technology*

**STATE-OF-THE-ART** report on nonwirewound pots, was given last week in San Francisco at a symposium sponsored by the Precision Potentiometer Manufacturers Association. Symposium was planned to time with the WESCON show.

Tom Peart and Stanley Schneider, of Helipot Division, Beckman Instruments, brought engineers up to date on a new technology for pots that incorporates a steatite ceramic frame with their cermet resistance material.

Since Helipot also manufactures both wirewound and conductive plastic unit, these two were chosen as a point of reference for their cermet pots.

Authors say that the major prod-

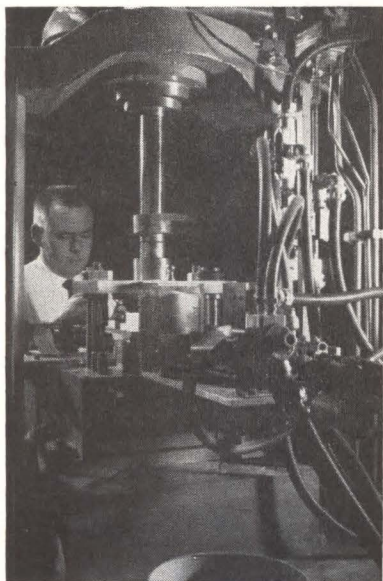

*RESISTANCE film for cermet potentiometer is composed of glass and precious metals, and screened onto the base. Oven firing at high temperatures forms a permanent bond*

ucts ideally suited to their cermet technology are precision potentiometers in both rotary and translatory designs, trimming potentiometers, and fixed resistors. The high wattage characteristic and the ability to obtain a wide range of resistance values in very short lengths and small total areas with excellent resolution characteristics allow extreme miniaturization in cermet trimming pots, according to report.

**ADVANTAGES**—In addition to the obvious capability of improved resolution, “essentially infinite,” the outstanding capabilities of the ceramic units are their immunity to catastrophic failures, high temperature and wattage capacity, chemical and electrical resistance to water vapor and most other liquids, authors say. Another characteristic is long life, during which the ceramic pot experiences little degradation in functions such as linearity, total resistance, noise, and electrical angle.

The cermet pots are also well suited to “dither” operation, since there is virtually no wear on the resistance element, according to report. The major wear is in a contact designed to retain its mechanical configuration with the resistance element during life. Integral resistors can be made with matching temperature coefficients for both precision and trimming potentiometers, authors say.

Both cermet and conductive plastic pots are capable of satisfactory operation into the megacycle region. Authors rate cermet a plus over both their conductive plastic and wirewound pots for resistance stability.

Authors said that their cermet 3-inch diameter single turn operated continuously at 30 watts, with short time overloads to 140 watts. Although cermets can be operated safely at many times their rated wattages, they are susceptible to extremely high voltage or current



*AUTOMATIC processing equipment is employed in the Helipot Ceramic Engineering department to form the basis of cermet resistance elements*

transients, even though of very short duration. Thus ohmmeters and digital ohmmeters should not be used. Authors advise making voltage divider measurements for test or operational procedures.

Peart and Schneider say that high-temperature exposure and operation is one of the outstanding capabilities of their cermet. Operation at 300 C is feasible for short periods, and 200 C is the standard upper operating limit for some of their trimming potentiometer models. As temperatures move above 150 C towards 200 C, the cermet pot is said to not only maintain stability, but essentially becomes the only one of the three types of pots to operate at this extreme. Temperature and electrical load tests over 10,000 hours have shown the cermet units to remain within 0.5 percent to 1 percent with most of the shift within the first 100 hours.

**CONSIDERATIONS**—After stating the characteristics of their cermets, authors caution that “no

product can be everything to everybody." Some of the capabilities are superior over certain resistance ranges, have limits in compatibility with other needed parameters, and are influenced by mechanical design considerations such as size, weight, shape and standardization criteria. Development aim for the future, authors say, lies not only in improvement of individual characteristics, but also in the summation of all these characteristics into each requirement for a particular application.

Other papers given at the symposium included a method used for linearity correction of conductive plastic potentiometers, by Richard D. Ward, of New England Instrument; a paper on the use of conductive plastic potentiometers, by A. A. Vercesi, of Fairchild Controls; a discussion of resistive metal glaze potentiometers, by H. Casey, W. Mulligan and J. Woods, of International Resistance; a paper on output characteristics of conductive plastic precision pots and their relation to system circuitry and environment, by Kenneth H. Hardman, of New England Instrument; and a discussion of recent studies in output smoothness by Hans H. Wormser, of Markite Corporation.

### Tube Permits Quick Warmup of Transceiver

POWER tetrode develops 70 percent of full plate current in 100 milliseconds from a new directly-heated oxide cathode. Eimac's new tube, X2013 will have its first application in the government's AN/PRC-38 multimode pack set, built by Collins. The transceiver is a high-power, battery-operated set with solid-state circuits. Primary use is for military ground forces, although set can be used in aircraft and ships. The set operates without standby power and the transmitter section draws no power during receiving operations.

The X2013 is available in three versions: convection cooled, conduction cooled or forced air cooling type.

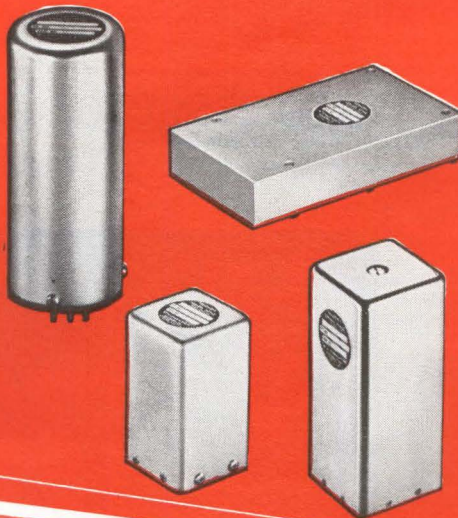

#### FREQUENCY/TIME CONTROLS

- 30 cps to 100 mc
- Choice of stability (commercial to  $1 \times 10^{-8}$ )
- Standardized models for greatest economy
- Completely solid state oven control (no noise-generating thermostats!)
- Modest power demand
- Buffered output (no change in stability as load changes)
- Mount in any position
- Individual test documentation shipped with each unit
- Compact packaging

## FRONTIER STAYS AHEAD...

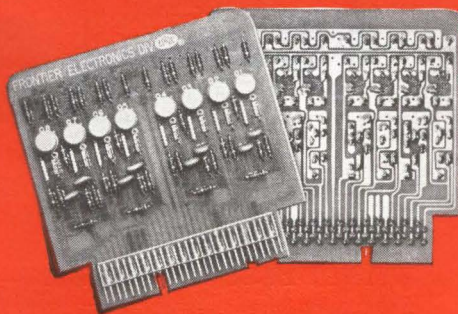

#### LOGIC BOARDS

- Five series in silicon or germanium: 100 kc, 500 kc, 1 mc, 2 mc, and 5 mc.
- Practical, universally-used four-bit logic
- 14 basic functions meet fully any system design requirement
- Standard pin numbering and circuitry for same functions in all series
- Same power supply and pulse voltages for all functions
- Each function compatible with all others
- Sections of system may be high-speed, others low for greatest economy
- Two to 9 identical circuits per board

## FREQUENCY/TIME CONTROLS\*LOGIC BOARDS AVAILABLE...RIGHT NOW!

Frontier's Total Systems Capability provides you with high-quality, proven systems components that meet today's needs today. ■ We offer conservatively-rated standardized units that fill an amazing number of special applications. And we make specials based on those standard units. Our prices might be quite attractive to you considering that all R & D work has been done, and the production line set up and running. You can count on swift delivery, usually off the shelf, though specials may take a little longer. ■ Engineering aid? It's yours for the asking. ■ Write today on your company letterhead for a copy of our catalog.



**FRONTIER ELECTRONICS DIVISION**  
INTERNATIONAL RESISTANCE COMPANY  
401 N. BROAD STREET • PHILADELPHIA 8, PA.

# Kitting Cuts Assembly Errors

*Sequential kitting  
saves time and space  
for circuit assembly*

**SKIN-PACKAGED** components kits have provided potential savings of \$600,000 in one missile system manufacturing area reports the Lockheed Missile and Space Company. The components attached to a fibre board in the order they are used by circuit board assemblers. Lockheed expects further applications in electronics to increase potential annual savings to almost \$2 million for its customers.

Kitting has helped overcome problems caused by volume and complexity of circuit boards. LMSC's contribution to the launching of a Polaris missile, for example, is approximately 3,000 electronic parts and assemblies. Problems have been created for LMSC's personnel: for the design engineer, for the stores and stock people who kit or batch the parts assemblies to

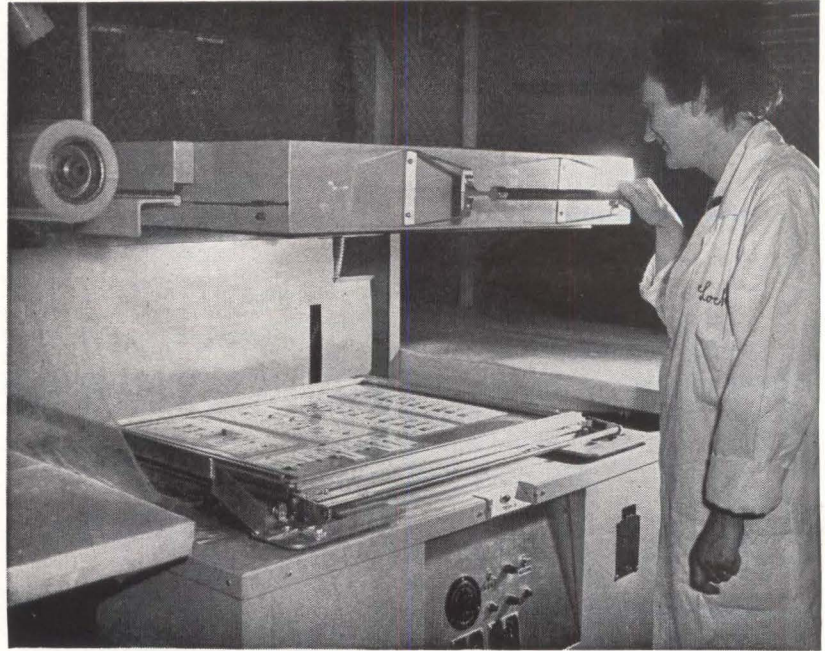

*SKIN-PACKAGING machine drapes the film tightly around the parts and adheres it to the fibre backing board*

be joined to the circuit board, and for the assembler.

**WITHOUT SEQUENTIAL KITS**—Formerly the assembler received

a step-by-step operation sequence sheet, a tote box containing a circuit board and, on the average, 50 plastic bags, each containing the total required number of identical parts for the assembly run. The assembler would consult the sequence sheet to determine the part number and part quantity required for a given assembly step. After selecting the part from the bag, he would again check his sequence sheet to determine the location of the part on the board. Then he would find this location on the board and attach the part. Interruptions in assembly caused by sorting and look-up functions, and the requirement that sorting be done by part number, resulted in a slow and painstaking operation with inherent possibilities for error. The apparent solution was an improved method of kitting the parts for sequential selection.

**SEQUENTIAL KITTING**—Methods now developed includes the skin-packaging process, in which parts are secured by a transparent

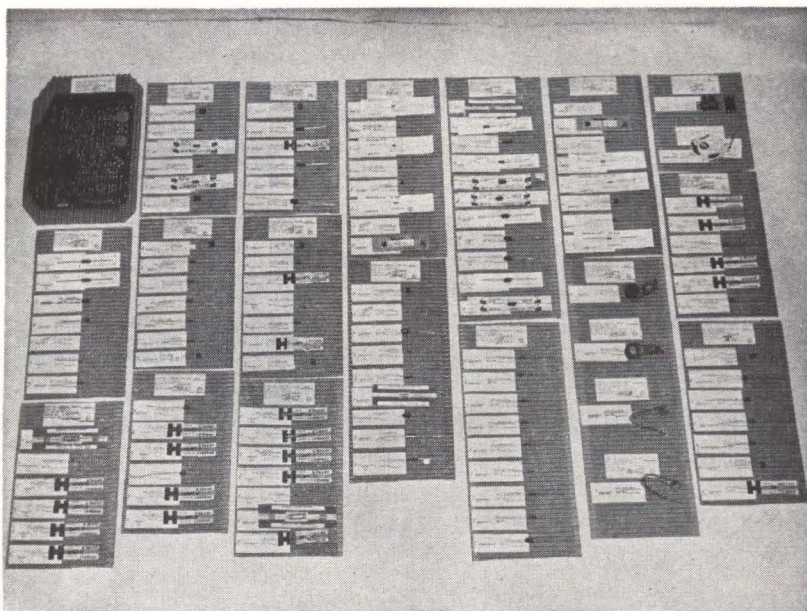

*SEQUENTIAL KITTING method delivers assembled kit of electronic parts, in sequence by operation and use, to electronic assembly area. Parts sequence is certified by quality control and assurance departments*



plastic film to a neutral piece of single-faced corrugated fibreboard. Before the work order is given to the assembler, the required parts are obtained and each part is affixed to a length of fibreboard in the order of its use on the circuit board. These board units consist of parts limited to one operation of the work order. The lengths of fibreboard, or backing boards, with sequentially placed parts are inspected and stamped by the quality assurance department to certify their correctness before the parts are fixed to the backing board.

This new method eliminates parts-sorting and simplifies operation-sequence look-up by the assembler, and provides a visual aid to assembly sequence, protects the parts from degradation and provides rapid identification of the parts. Also it resolves the problem of reorientation after interruption. Human error is reduced through simplification of work functions and decreases in handling operations. Also provided is product assurance verification that a complete package is checked before it goes to the work station. Each of these factors improves the reliability of the product, which is the basic premise of high reliability programs.

### Data On Polaroid Prints

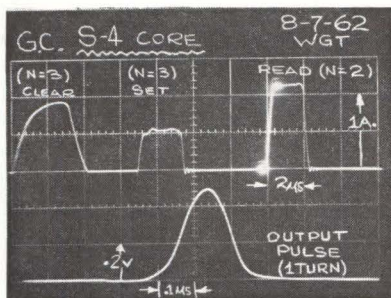

*SIMPLE method of inscribing data on Polaroid scope pictures is illustrated. Before the print is coated, the emulsion is very soft and can be scribed by a stylus. The stylus should be rounded and have a fine toothed surface. W. G. Trabold, of GM research laboratories, Warren, Mich. says the technique is to abrade the emulsion without digging into the support*

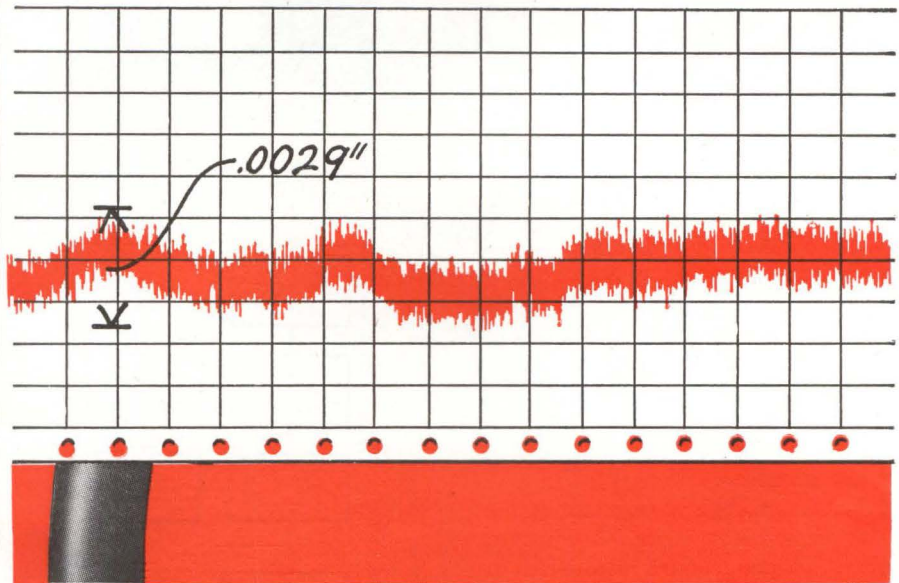

## Gov't spec tolerances $\pm .004$ ; Royal RG-59/U coax twice that good!

The graph above shows the variation in diameter for nearly one mile of ITT Royal coax, type RG-59/U. Over the entire length the maximum variation was less than  $\pm .0015$ .

This kind of mechanical perfection is important. Every variation in coax dimension means a variation in impedance and capacitance. Every impurity of materials or lack of homogeneity of the dielectric changes the specified electrical values of the cable.

Whether it's RG-59/U or any of the other 69 standard types of coax, ITT Royal consistently produces superior cable and wire at competitive prices.

Write for information, or see your nearest ITT distributor. Royal Electric Corporation, a subsidiary of International Telephone and Telegraph Corporation, Pawtucket, R. I.

# ITT ROYAL

## Amplifier Extends Photomultiplier Range

*Unit delivers output between 0 and 5 volts d-c*

**ANNOUNCED** by Block Engineering, Inc., 385 Putnam Ave., Cambridge, Mass., model BA-040 amplifier will extend the range of a photomultiplier tube to better than 1,000 to 1 by automatically controlling cathode voltage. Unit is designed for use with tubes having a dark current below 0.02  $\mu$ amp at 1,200 volts and has an output of 0 to 5 volts d-c for telemetry or recorder use.

Model BA-040 is designed to operate from unregulated supplies delivering between 24 and 32 volts d-c and is packaged in an encapsulated module. It can withstand shock, vibration and environmental requirements of military specifications and occupies only 4 x 4 x 2 inches of space.

Unit has a high voltage maximum load of not less than 5 megohms, high voltage at dark condition of -1,200 v at  $\pm 3\%$ , input impedance above 10 megohms, output impedance less than 1,000 ohms and a frequency response between d-c and 100 cps. Moreover, it will operate between -25 C and 75 C and has high-voltage at saturation of -400 v,  $\pm 3\%$  with a 5 megohm

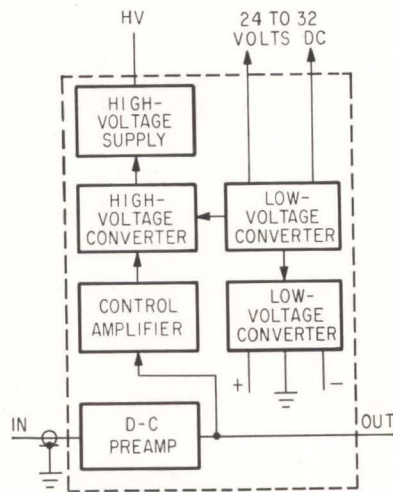
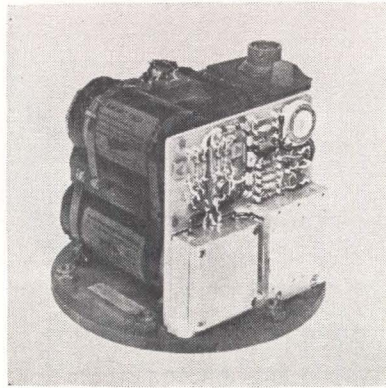

load. Model BA-040 is priced at \$1,400.

CIRCLE 301, READER SERVICE CARD

## Filter Connectors Suppress RFI

**MANUFACTURED** by Loral Electronics Corp., 825 Bronx River Ave., Bronx 72, N. Y., new filter-connectors use lossy epoxy that is effective in reducing and suppressing undesirable

radiation in the uhf and microwave spectrum, while exhibiting minimum reactive effect. Designed to meet military specs above 1 Gc, these units have applications in

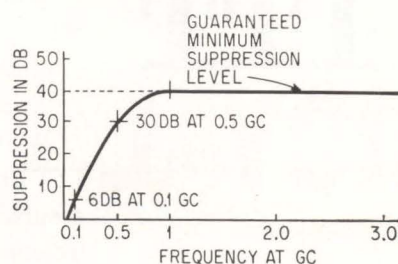
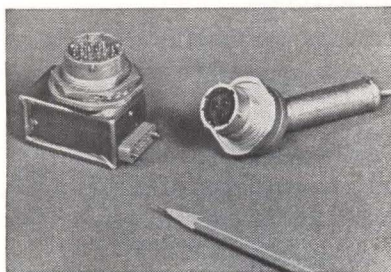

microwave tuners, high-voltage klystrons, oscillators and signal generators that exhibit r-f leakage on power and interconnecting wiring. According to company engineers, filter-connectors require less than  $\frac{1}{3}$  the volume associated with conventional suppression techniques, are applicable to any connector type and cause no phase shift when used in servo circuits. The diagram shows typical suppression characteristics between 0.1 and 3.0 Gc. (302)

## Triggered Spark Gap Features Long Life

**NOW** being offered is a triggered spark gap, type GP-200, with a life of millions of discharges in the 5 Kv to 25 Kv operating range with a pulse duration capability of 3 milliseconds and up to 1500 joules energy input. Edgerton, Germeshausen & Grier, Inc., P. O. Box 98, Goleta, Calif. (303)

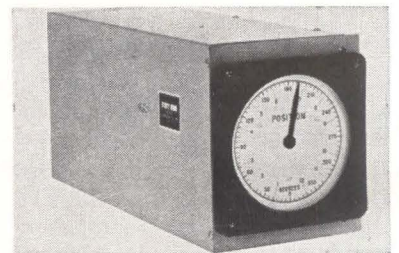

## Servo Indicator Has High Accuracy

**MODEL CS106** versatile servo system indicator is announced. Accuracy of the overall system is 0.04 percent. This accuracy has been achieved by a built-in high-gain transistorized amplifier with a low output impedance coupled to the motor which drives the indicator through a low-friction high-accuracy gear train incorporating anti-back lash gearing. Coupled to the indicator is a continuously and individually adjustable 14 cam and switch module. Model CS106 is also available with an auxiliary potentiometer or synchro output. An output shaft that can be loaded with a maximum of 500 oz in. can be supplied. Control Technology Co., Inc., 41-16 29th St., Long Island City 1, N. Y. (304)

## Literature of the Week

**MICA CAPACITORS** Erie Resistor Corp., 644 W. 12th St., Erie, Pa. Bulletin 528 presents specifications of a new line of miniaturized Mica capacitors. (305)

**COAXIAL CABLE** Phelps Dodge Electronic Products Corp., 60 Dodge Ave., North Haven, Conn., has available a data sheet listing RG-189/U to RG-306/U numbers applicable to air dielectric coaxial cable. (306)

**CONNECTOR SELECTOR** Microdot Inc., 220 Pasadena Ave., South Pasadena, Calif., is offering a connector selector circular slide rule that enables the design engineer to choose from 40 parts in designing his own crimp-type connector. (307)

**PRECISION POTENTIOMETERS** New England Instrument Co., Kendall Lane, Natick, Mass. New brochure illustrates and describes the company's lines of conductive plastic and wire-wound potentiometers. (308)

**TIME INTERVAL COUNTER** Eldorado Electronics, 1832 Second St., Berkeley, Calif., has released technical data literature on the model 783G 10 nanosecond time interval counter. (309)

**SEALED CAPACITORS** The Gudeman Company of California, Inc., 7473 Avenue 304, Visalia, Calif. Six-page folder covers the 68 series of hermetically-sealed Mylar capacitors. (310)

**TELECOMMUNICATIONS SERVICES** Microwave Services International, Inc., U. S. Route 46 & Cisco Road, Denville, N. J., offers a brochure describing its services, capabilities and experience in the telecommunications systems engineering environment. (311)

**SPRAY SYSTEM** Zicon Corp., 63 East Sandford Blvd., Mount Vernon, N. Y. A new system which enables a manufacturer to spray conformal and protective coatings on p-c boards and electronic components is detailed in a report. (312)

**REMOTE ANGLE INDICATION** Theta Instrument Corp., Saddle Brook, N. J., has published a 28-page catalog giving details on new angle-repeating instruments. (313)

**MODULAR COUNTERS** Computer Measurements Co., 12970 Bradley Ave., San Fernando, Calif. Six-page brochure covers line of modular digital test instruments. (314)

**COMPOSITE SUPERCONDUCTIVE WIRE** Superior Tube Co., Norristown, Pa. Superconductive wire made by drawing columbium tubing as a barrier sheath and Monel Alloy 400 tubing as an outer sheath over a superconductor core of columbium-tin powders is described in Data Memorandum No. 3. (315)

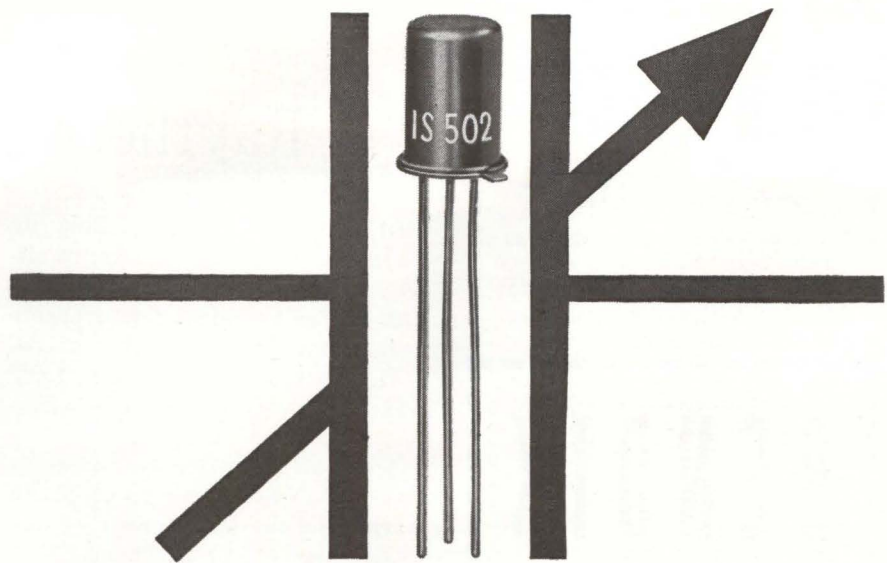

### WIDE-RANGE, HIGHLY-SENSITIVE VARIABLE CAPACITANCE DIODE

( Brand: Varipico )

Fujitsu Varipico is a new diode designed to serve especially as a variable capacitor. Having a "hyper-abrupt" junction, a wide range of capacitance variation is made possible by simply varying a small negative bias voltage. The relationship of capacitance to bias voltage is:  $C \propto \frac{1}{\sqrt{n}}$ . Since  $n$  can be set anywhere between 1 and 5, the capacitance range is very large. This makes the Varipico extremely useful in many applications such as frequency modulators, sweep generators, signal generators, frequency meters, phase shifters, converters and multipliers, and parametric amplifiers. The Varipico, hermetically sealed in a metal case, measures only 5.7 mm in diameter and 8mm in length, exclusive of leads. For full technical data and application information write to our representative shown below.



## FUJITSU LIMITED

Communications and Electronics

Tokyo, Japan

Represented by: U.S.A. HAR-WELL ASSOCIATES, INC.: Southbury, Connecticut, Phone: 264-8222 THE NISSHO PACIFIC CORP. 120 Montgomery St., San Francisco 4, California, Phone: YUkon 2-7901, 7906 Canada: NISSHO (CANADA) LTD. 100. University Avenue, Toronto, Phone: EMpire 2-4794 United Kingdom: WALMORE ELECTRONICS LIMITED 11-15 Betterton Street, Drury Lane, London W.C. 2, Phone: TEMplebar 0201-5 Germany: NEUMÜLLER & CO. GMBH 8 München 13, Schraudolphstr, 2a, Phone: 29 97 24

CIRCLE 49 ON READER SERVICE CARD

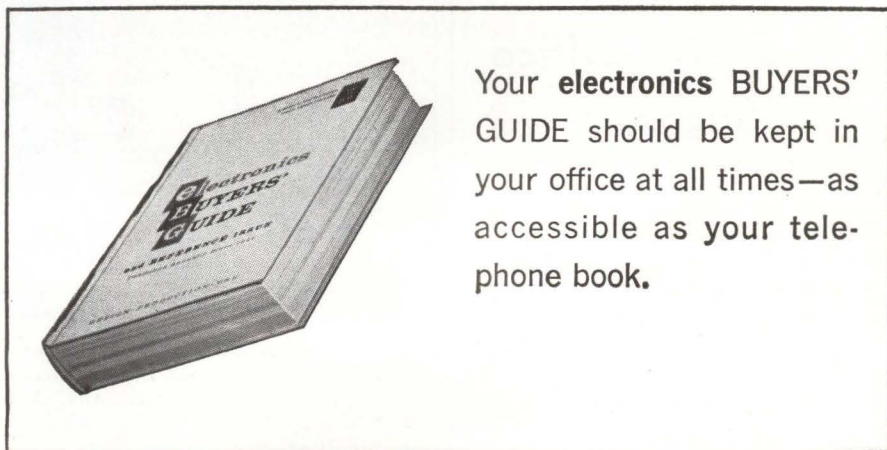

Your electronics BUYERS' GUIDE should be kept in your office at all times—as accessible as your telephone book.

specify the new Bendix\* Products

# AVNET

contact Avnet for best service

Pygmy\* types PT, SP; Pygmy crimp types PTCE, PTSE; MS, MS-E, MS-R, QWLD, SR rack and panel

on-time delivery of emergency

# BENDIX

and prototype connector needs

Reg. T.M. Bendix Corp.



call your Local Avnet Headquarters

# AVNET

The Avnet System, coast to coast

CIRCLE 50 ON READER SERVICE CARD

## NIMS

NATIONWIDE IMPROVED  
MAIL SERVICE PROGRAM

For Better Service  
Your Post Office  
Suggests

That You Mail Early  
In The Day!

## PEOPLE AND PLANTS

### Raytheon Elects Levy

**ELECTION** of Lawrence Levy by Raytheon Company's board of directors to the newly created position of vice president for corporate development has been announced.

During the past two years, Levy was headquartered in Paris where he served as principal civilian representative of Defense Secretary Robert McNamara in Europe, North Africa and the Middle East as well as defense advisor to Thomas Finletter, U.S. Ambassador to NATO.

Reporting to Levy in his new assignment will be the director of marketing, the director of advance systems planning, the director of

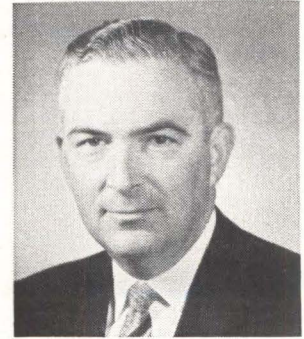

market planning, the director of management sciences and the group assigned to the company's acquisition program.

### Lockheed To Build Research Complex

LOCKHEED-GEORGIA CO., division of Lockheed Aircraft Corp., announces plans to build an extensive research facility to cost between \$3 million and \$3.5 million, fully equipped, on a 45-acre company-owned tract in Marietta, Ga. Best present estimates indicate there will be five buildings. Facilities will be broken down into these

general categories—physical sciences, material sciences, applied aerospace, and systems research. Lockheed planners expect to move researchers into the first building by mid-1964. The entire project is expected to be completed in 1965.

### Sperry Canada Elects King to Top Post

B. WENSLEY KING has been elected president and chief executive officer

### Scionics Occupies New Facility

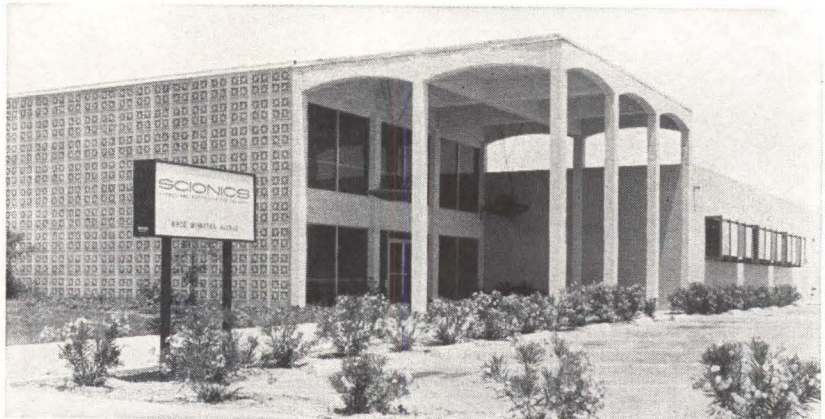

SCIONICS CORPORATION of Canoga Park, Calif., manufacturer of capacitors and telemetry devices, has occupied a new 27,000-square foot building in Northridge, Calif. New facility will house the corporate offices and the Instrumentation and Information Systems divisions. The Capacitor division will be expanded in its Canoga Park location

of Sperry Gyroscope Co. of Canada, Ltd. and its affiliated company, Sperry Gyroscope Ottawa, Ltd. He was formerly managing director of both companies.

### Leon Accepts New Position

APPOINTMENT of Herman I. Leon as director, Systems Research and Technology Center, has been an-

### PEOPLE IN BRIEF

Ned E. Garlock promoted to director of science and engineering applications at Northrop's Ventura div. Warren Bacigalup, g-m of the Cableaire div., elected a v-p of Computer Equipment Corp. Four research directors elevated to v-p's at IIT Research Institute: Virgil H. Disney, Electronics Research div.; George S. Gordon, Chemistry Research div.; Donald J. McPherson, Materials Research div.; and Leonard Reiffel, Physics

nounced by Norman E. Friedmann, vice president, California Operations, of ITT Federal Laboratories in San Fernando.

Leon was previously with Space Technology Laboratories. In his new post, he will direct the research, analysis and preliminary design activities for missile and space systems at the San Fernando facility of the research and manufacturing division of ITT Corp.

Research div. Alexander Alexandrovich, formerly with GE, now asst. to the v-p for engineering technology at Grumman Aircraft Engineering Corp. George W. Mousel advances to asst. g-m of Perkin Electronics Corp. Jack Pinner moves up to director of engineering of Rotating Components, Inc. Richard H. Frost elected chairman of the board of Holtzer-Cabot Corp. James W. Tweedy, formerly exec v-p, succeeds him as president. Earle M. Knibiehly leaves U.S. government service to join LogEtronics, Inc., as director of R&D.

specify the new U.S. Semicor Products

# AVNET

contact Avnet for best service

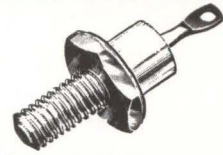

on-time delivery of

# SEMCOR

diodes and capacitors

5 watt miniature Zener Diodes, high voltage temperature compensated Reference Elements, non-polar solid and hermetically sealed wet Tantalum Capacitors, 400MW Glass Zeners Mil Types USN 1N 962BM -USN 1N 984BM

call your local Avnet Headquarters

# AVNET

The Avnet System, coast to coast

CIRCLE 201 ON READER SERVICE CARD

### TO ORDER REPRINTS

Fill in, cut out coupon below  
insert in envelope and mail to:

**electronics** Reprint Dept.  
330 W. 42nd Street, New York, N. Y. 10036

### REPRINT ORDER FORM

(To help expedite mailing of your reprints please send cash, check or money order with your order.)

For Listing of Reprints Available see the Reader Service Card.

For Reprints of the latest Special Report:  
Radio Frequency Interference

Send me.....Reprints of Key No. **R-39** 1-10 copies 75¢ each, 11-24 copies 60¢ each, 25 or more 50¢ each.

For Reprints of previous **Special Reports** or **Feature Articles** fill in below:

Send me.....Reprints of Key No.(s).....@.....¢ each.  
(For prices, see Reader Service Card.)

\*For orders of **Bulk Reprints** of other editorial articles in this issue or past issues:

Send me....Reprints of page No.(s)....of issue date....  
of article entitled.....

\*Minimum bulk order 100 copies. You will be advised of costs by return mail.

Name .....

Number of Street .....

City, Zone No., State .....

## The DECI-DUCTOR

new subminiature molded inductor — 24 Hour Delivery  
up to 1000 uH in 1/10" dia. x 1/4" lg. envelope  
10X the inductance available in the same size

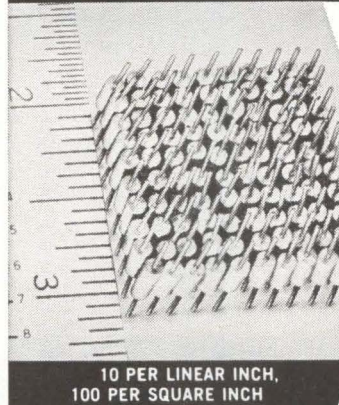

10 PER LINEAR INCH,  
100 PER SQUARE INCH

Epoxy molded for  
highest reliability

Meets MIL-C-15305B

Forty nine inductance  
values in stock

### FEATURES

24 hour delivery

1/10" dia. x 1/4" lg.

0.10 uH to 1000 uH

DECI-DUCTOR is the latest addition to Nytronics' DECI Series—a series that consists of inductors, capacitors and resistors in a uniform (¼ watt resistor and diode size) envelope to facilitate point-to-point assembly in cordwood, printed circuit and other high density module assemblies.

For complete engineering data, write Dept. WL-38, or phone 201-464-9300.

## NYTRONICS, INC.

550 Springfield Ave., Berkeley Heights, N. J.

Design Leaders STANDARD components to meet CUSTOM requirements

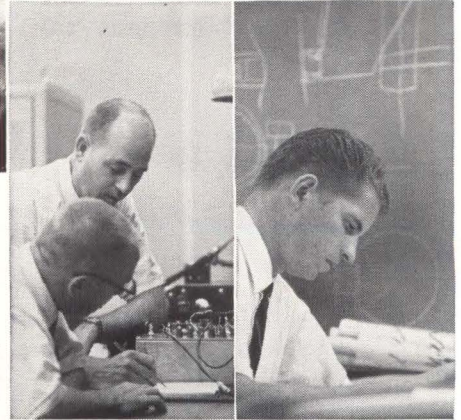
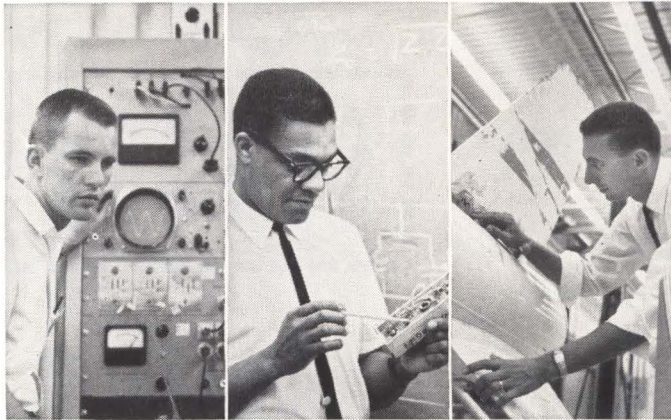

## Space- the youthful outlook

Space-General offers unlimited opportunities for engineers and scientists who want to move ahead quickly in a dynamic young organization dedicated to space projects. ■ Less than three years old, Space-General now has grown to almost 1,200 employees and occupies one of the newest, best-equipped facilities in the industry. Location is ideal...in the San Gabriel Valley, 15 minutes by freeway from downtown Los Angeles. ■ Our current interests are broad: electronics, guidance and control systems, space telemetry, survivable communications, satellite and military systems, space vehicles, lunar and planetary exploration craft, inflatable reentry vehicles, and nuclear detection studies. ■ Our employees tell us they prize Space-General's unusually heavy emphasis on *individual* work and ideas. As a matter of fact, every member of our technical staff is expected to make a creative contribution to the growth of our technological capability.

*There are many outstanding career opportunities at Space-General for engineers and scientists with a B.S. degree or higher and at least two years of experience in any of the following fields:*

Communication Systems Analysis • Circuit Design • Heat Transfer-Thermodynamics Analysis • Stress Analysis • Trajectory Analysis and Aerodynamics • Hydraulic-Pneumatic Controls Development • Structural Test Analysis • Space Vehicle Design • Guidance and Control Analysis • Advanced Sensor Research • Microwave Research • Nuclear Test Instrumentation • Bio-Sensor Research. ■ Your resume will receive immediate confidential attention. *Send to:* Donald L. Craig, Employment Mgr., Space-General Corp., Dept. No. NP-14, 9200 E. Flair Drive, El Monte, California.

An equal opportunity employer.



**SPACE-GENERAL CORPORATION**

El Monte, California

A subsidiary of Aerojet-General Corporation



# electronics

## WEEKLY QUALIFICATION FORM FOR POSITIONS AVAILABLE

### ATTENTION: ENGINEERS, SCIENTISTS, PHYSICISTS

This Qualification Form is designed to help you advance in the electronics industry. It is unique and compact. Designed with the assistance of professional personnel management, it isolates specific experience in electronics and deals only in essential background information.

The advertisers listed here are seeking professional experience. Fill in the Qualification Form below.

#### STRICTLY CONFIDENTIAL

Your Qualification form will be handled as "Strictly Confidential" by ELECTRONICS. Our processing system is such that your form will be forwarded within 24 hours to the proper executives in the companies you select. You will be contacted at your home by the interested companies.

#### WHAT TO DO

1. Review the positions in the advertisements.
2. Select those for which you qualify.
3. Notice the key numbers.
4. Circle the corresponding key number below the Qualification Form.
5. Fill out the form completely. Please print clearly.
6. Mail to: Classified Advertising Div., ELECTRONICS, Box 12, New York, N. Y. 10036. (No charge, of course).

COMPANY	SEE PAGE	KEY #
ATOMIC PERSONNEL, INC. Philadelphia, Penna.	55*	1
BELL AEROSYSTEMS CO. Div. of Bell Aerospace Corporation A Textron Company Buffalo, New York	54	2
LOCKHEED MISSILES & SPACE CO. Div. of Lockheed Aircraft Corp. Sunnyvale, California	47*	3
NORTH AMERICAN AVIATION INC. Space & Information Systems Div. Downey, Calif.	38*, 51*	4
PAN AMERICAN WORLD AIRWAYS, INC. Guided Missiles Range Division Patrick Air Force Base, Fla.	55	5
SNELLING & SNELLING Professional Placement Center Waltham, Mass.	55*	6
SPACE-GENERAL CORP. A Subsidiary of Aerojet-General Corp. El Monte, Calif.	52	7
UNION CARBIDE NUCLEAR COMPANY A Division of Union Carbide Corp. Oak Ridge, Tenn.	54	8

\* These advertisements appeared in the August 23rd issue.

(cut here)

### electronics WEEKLY QUALIFICATION FORM FOR POSITIONS AVAILABLE

(cut here)

(Please type or print clearly. Necessary for reproduction.)

#### Personal Background

NAME .....

HOME ADDRESS .....

CITY ..... ZONE ..... STATE .....

HOME TELEPHONE .....

#### Education

PROFESSIONAL DEGREE(S) .....

MAJOR(S) .....

UNIVERSITY .....

DATE(S) .....

#### FIELDS OF EXPERIENCE (Please Check)

83063

- |  |  |                                       |
|--|--|---------------------------------------|
| <input type="checkbox"/> Aerospace           | <input type="checkbox"/> Fire Control        | <input type="checkbox"/> Radar        |
| <input type="checkbox"/> Antennas            | <input type="checkbox"/> Human Factors       | <input type="checkbox"/> Radio-TV     |
| <input type="checkbox"/> ASW                 | <input type="checkbox"/> Infrared            | <input type="checkbox"/> Simulators   |
| <input type="checkbox"/> Circuits            | <input type="checkbox"/> Instrumentation     | <input type="checkbox"/> Solid State  |
| <input type="checkbox"/> Communications      | <input type="checkbox"/> Medicine            | <input type="checkbox"/> Telemetry    |
| <input type="checkbox"/> Components          | <input type="checkbox"/> Microwave           | <input type="checkbox"/> Transformers |
| <input type="checkbox"/> Computers           | <input type="checkbox"/> Navigation          | <input type="checkbox"/> Other .....  |
| <input type="checkbox"/> ECM                 | <input type="checkbox"/> Operations Research | <input type="checkbox"/> .....        |
| <input type="checkbox"/> Electron Tubes      | <input type="checkbox"/> Optics              | <input type="checkbox"/> .....        |
| <input type="checkbox"/> Engineering Writing | <input type="checkbox"/> Packaging           | <input type="checkbox"/> .....        |

#### CATEGORY OF SPECIALIZATION

Please indicate number of months experience on proper lines.

	Technical Experience (Months)	Supervisory Experience (Months)
RESEARCH (pure, fundamental, basic)	.....	.....
RESEARCH (Applied)	.....	.....
SYSTEMS (New Concepts)	.....	.....
DEVELOPMENT (Model)	.....	.....
DESIGN (Product)	.....	.....
MANUFACTURING (Product)	.....	.....
FIELD (Service)	.....	.....
SALES (Proposals & Products)	.....	.....

CIRCLE KEY NUMBERS OF ABOVE COMPANIES' POSITIONS THAT INTEREST YOU

1 2 3 4 5 6 7 8 9 10 11 12 13 14 15

# EMPLOYMENT OPPORTUNITIES



The Advertisements in this section include all employment opportunities—executive, management, technical, selling, office, skilled, manual, etc. Look in the forward section of the magazine for Additional Employment Opportunities advertising.

Positions Vacant	Civil Service Opportunities	Employment Agencies
Positions Wanted	Selling Opportunities Wanted	Employment Services
Part Time Work	Selling Opportunities Offered	Labor Bureaus

## DISPLAYED

The advertising rate is \$40.17 per inch for all advertising appearing on other than a contract basis. Contract rates quoted on request.

An advertising inch is measured  $\frac{7}{8}$ " vertically on a column—3 columns—30 inches to a page.

Subject to Agency Commission.

## RATES

\$2.70 per line, minimum 3 lines. To figure advance payment count 5 average words as a line.

Box Numbers—counts as 1 line.

Discount of 10% if full payment is made in advance for 4 consecutive insertions.

Not subject to Agency Commission.

## UNDISPLAYED

Send NEW ADS to CLASSIFIED ADV. DIV. of ELECTRONICS, P. O. Box 12, N. Y., N. Y. 10036

## ENGINEERING SPECIALIST

### SECURE RADIO COMMAND & NAVIGATION SYSTEMS

Salary to \$15,000

The Avionics Division at Bell Aerosystems, which is currently grossing \$30 million, is working in 5 major areas: command and control, inertial guidance, radar, simulation and control, and air traffic control. With increased company-funded R&D in electronics, the Division is expanding, creating an immediate opening for a graduate EE with a minimum of 5 years experience.

The man selected must be qualified to direct and/or participate in proposal preparation, R&D projects and prototype development of secure command links, data links and radio position-fixing systems for military airborne vehicles.

Resumes are invited. Please address

Mr. Thomas Fritschi, Dept. G-34.

**ba** BELL  
AEROSYSTEMS  
COMPANY

DIVISION OF BELL AEROSPACE CORPORATION—A **WESTINGHOUSE** COMPANY

P.O. Box #1, Buffalo 5, New York

An Equal Opportunity Employer

### SELLING OPPORTUNITY WANTED

**NASA/Houston Representation. Qualified** technical space consulting company. Presenting your capabilities at lower fixed sales cost. RA-2778, Electronics, Classified Adv. Div., 645 N. Michigan Ave., Chicago, Ill. 60611.

### EMPLOYMENT PROBLEM?

When you are in need of specialized men for specialized jobs, contact them through an employment ad in this publication.

### Electronic Instrument Technicians

The Oak Ridge National Laboratory  
operated by

### UNION CARBIDE NUCLEAR COMPANY

at  
Oak Ridge, Tennessee

Has Openings for

Highly skilled electronic instrument technicians to work with electronic engineers in the development, installation and maintenance of electronic systems. Digital data handling, transistorized pulse height analyzers, analog and digital computer systems are only a few examples.

Minimum high school education, with additional training in electronics and at least three years' experience in installation and maintenance of complex electronic systems. Entrance rate \$3.19 per hour; \$3.25 per hour after six months. Reasonable interview and relocation expenses paid by Company.

Excellent Working Conditions  
and

Employee Benefit Plans  
An Equal Opportunity Employer  
Send detailed resume to:

Central Employment Office

### UNION CARBIDE NUCLEAR COMPANY

A Division of Union Carbide Corporation  
Post Office Box M Oak Ridge, Tennessee

Put Yourself in the Other Fellow's Place

### TO EMPLOYERS - TO EMPLOYEES

Letters written offering Employment or applying for same are written with the hope of satisfying a current need. An answer, regardless of whether it is favorable or not, is usually expected.

Mr. Employer, won't you remove the mystery about the status of an employee's application by acknowledging all applicants and not just the promising candidates.

Mr. Employee you, too, can help by acknowledging applications and job offers. This would encourage more companies to answer position wanted ads in this section.

We make this suggestion in a spirit of helpful cooperation between employers and employees.

This section will be the more useful to all as a result of this consideration.

Classified Advertising Division

McGraw-Hill Publishing Co., Inc.

330 West 42nd St., New York 36, N. Y.

## SEARCHLIGHT SECTION

(Classified Advertising)

BUSINESS OPPORTUNITIES

EQUIPMENT - USED or RESALE

### DISPLAYED RATE

The advertising rate is \$27.25 per inch for all advertising appearing on other than a contract basis. Contract rates quoted on request. AN ADVERTISING INCH is measured  $\frac{7}{8}$  inch vertically on one column, 3 columns—30 inches—to a page. EQUIPMENT WANTED or FOR SALE ADVERTISEMENTS acceptable only in Displayed Style.

### UNDISPLAYED RATE

\$2.70 a line, minimum 3 lines. To figure advance payment count 5 average words as a line.

PROPOSALS, \$2.70 a line an insertion.

BOX NUMBERS count as one line additional in undisplayed ads.

DISCOUNT OF 10% if full payment is made in advance for four consecutive insertions of undisplayed ads (not including proposals).

## CHARLIE:

D.A.T.A. Tabulations keep you current

on all Transistors • Semicon. Diodes

• Microwave Tubes in the world.

Characteristics, type numbers, manu-

facturers. For free literature write:

D.A.T.A., INC., 43-15 S. Day St.,

Orange, N. J. 07050

CIRCLE 950 ON READER SERVICE CARD

### VARIAN KLYSTRONS—BRAND NEW!

Immediate delivery from stock		
V-28	KU	\$700
VA-64F	KU	\$700
VA-64G	KU	\$500
VA-67B	KU	\$700
VA-201 H, J	X	\$200
VA-217F	X	\$220
VA-242 E, F, G	X	\$130

U. S. MICROWAVE

P. O. Box G, Collingswood, N. J. 609—W06—2929

CIRCLE 951 ON READER SERVICE CARD

### RADIO RESEARCH INSTRUMENT CO.

AUTO-TRACK & TELEMETRY ANTENNA PEDESTALS  
3 & 10 CM. SCR. 584 AUTOTRACK RADARS  
AN/TPS-10 SEARCH. AN/TPS-10 HT. FINDERS.  
AN/FPN-32GCA. AN/APS-10 NAVIG. & WEATHER.  
AN/APS-15B PRECISION. AN/APS-35B PRECISION.  
AN/APS-31A SEARCH. DOZENS MORE.  
.5-1-2 MEGAWATT HIGH POWER PULSERS.

RADIO RESEARCH INSTRUMENT CO.  
550 Fifth Ave., New York Judson 6-4691

RADAR SYSTEMS & COMPONENTS/ IMMEDIATE DELIVERY

CIRCLE 952 ON READER SERVICE CARD

## LOOKING FOR

USED/SURPLUS ELECTRONIC  
EQUIPMENT/COMPONENTS?

For an up-to-date listing of such equipment see Searchlight Section of August 19th issue.



# ALL CHIEFS, NO INDIANS !

With tongue in cheek, this phrase might be applied to the scientists and engineers of Pan Am's Guided Missiles Range Division. Under the direction of the U.S. Air Force Missile Test Center, GMRD has, since 1953, been responsible for conceptual planning, specifications, and operation of the range instrumentation systems developed by industry for the Atlantic Missile Range. The decisions made by Pan Am's technical staff are vital... directly affecting the success of each missile, space vehicle, and scientific probe launch operation at Cape Canaveral.

**RANGE PLANNING** analyzes projected program requirements up to 15 years ahead, predicts range support capability required and develops the advanced instrumentation system concepts.

**SYSTEMS ENGINEERING** utilizes these range plans to develop detailed specifications for all range instrumentation, data, and support systems. They then evaluate bids from industry to insure that capable industry sources will furnish such systems. This is only the beginning of their task—they follow and monitor the development of this equipment through installation and checkout.

**RANGE OPERATIONS** plans and evaluates range support for all launches, coordinates all range support activities, provides data and command/destroy for range safety, and manages the operation of down-range stations.

*Individually and as team members, the men in these groups have become authorities in range technology. To add to the capability of the range, the following typical assignments are under way in Range Planning, Systems Engineering, and Range Operations:*

**CW and Pulse Radar:** modify and improve sensitivity of Mistrac, Glotrac, AN/FPQ-6, and AN/TPQ-18; develop velocity measuring system with an accuracy of 0.1 fps.

**Telemetry:** increase the operating range of antennas to cover frequencies up to 2300 mc; design a system which, upon command, will select the most important data from each station.

**Optics:** devise and install an orientation system for both CZR and cinetheodolites; improve ballistic cameras with respect to random errors, shutter speed, exposure time and time correlation.

**Infrared:** develop high resolution spectrometer for launch and re-entry coverage; implement a complete infrared measurement system for mid-range coverage.

**Underwater Sound:** introduce a nuclear battery power supply into the ship-tended acoustic relay (Star) and extend the range of this system.

**Data Processing:** add automated methods to enable more efficient handling of larger volumes of data with minimum degradation; convert processing of weather information to near realtime.

**Meteorology:** improve cloud height and growth indication instrumentation; develop a system to measure atmospheric electrical potential and cloud movement.

**Instrumentation & Vehicle Control:** automate the entire tracking network through a Range Instrumentation Control System; add space diversity to the Cape Canaveral command control system by adding a van-mounted 10 KW fast-reaction command control system.

**Correlation:** reduce time correlation uncertainty across the range to less than 100 microseconds; standardize the timing signal format on the AMR.

**Radiometry:** schedule and control all electromagnetic radiation within the missile test area with a Spectrum Surveillance System; automate, where possible, instrumentation for interference control, spectrum signature collection and quality analysis.

**Data Handling:** design equipment to permit very high density realtime data transmission over RF lines or submarine cable; increase the digital data equipment available at off-cable sites to provide more efficient on-site computer programming.

**Range Safety:** increase the electronic monitoring of launch hazard areas and of missile and spacecraft performance; install a second Range Acquisition Data Distribution & Control system to permit handling of dual missions; develop instruments to measure blast parameters and fireballs resulting from exploding missiles.

**Ship and Aircraft Instrumentation:** improve the instrumentation to meet more stringent telemetry, navigation, tracking, communications, and data handling requirements; phase into operation new and/or modified tracking ships and aircraft.

Capable engineers and scientists with applicable experience are invited to write in confidence to Manager, Range Development, Dept. 28H-5



## GUIDED MISSILES RANGE DIVISION

PAN AMERICAN WORLD AIRWAYS, INC.  
P. O. BOX 4465, PATRICK AIR FORCE BASE, FLORIDA  
An Equal Opportunity Employer

# INDEX TO ADVERTISERS

Ampex Corporation .....	21	• Hewlett-Packard Company .....	6	• Singermetrics Div. The Singer Mfg. Co.....	22, 23
Automatic Electric Sub. of General Telephone & Electronics .....	19			Sprague Electric .....	9
• Avnet Electronics Corp.....	50, 51	IBM Corp. Data Processing Div.....	14, 15	Texas Instruments Incorporated Industrial Products Group.....	20
Brush Instruments Div. of Clevite Corp.....	3rd cover	Jerrold Electronics Corp.....	4		
• Clarostat Mfg. Co., Inc.....	41	• Keithley Instruments, Inc.....	18	CLASSIFIED ADVERTISING F. J. Eberle, Business Mgr. (2557)	
Delco Radio .....	5	• Lambda Electronics Corp.....	25	EMPLOYMENT OPPORTUNITIES .....	53-55
duPont de Nemours & Co., Inc., E. I. ....	42, 43	Machlett Laboratories, The.....	17	EQUIPMENT (Used or Surplus New) For Sale .....	54
Electronic Instrument Manufactur- ers Exhibit .....	28	Motorola Military Electronics Div. ....	11	CLASSIFIED ADVERTISERS INDEX	
• Erie Resistor Corp.....	13	• Non-Linear Systems, Inc.....	26	Bell Aerosystems Co. Div. of Bell Aerospace Corp....	54
• FXR A Div. of Amphenol-Borg Elec- tronics Corp. ....	24	• North Atlantic Industries, Inc....	2	D.A.T.A. Inc. ....	54
Frontier Electronics Co.....	45	Nytronics Inc. ....	51	Pan American World Airways, Inc.	55
• Fujitsu Ltd. ....	49	Philbrick Researchers, Inc., George A. ....	27	Radio Research Instrument Co....	54
General Radio Co.....	2nd cover	Radio Corporation of America. 4th cover Royal Electric Corp. Sub. of ITT Corp.....	47	Space-General Corp. ....	52
				Union Carbide Nuclear Company..	54
				U.S. Microwave .....	54

CLASSIFIED ADVERTISING  
F. J. Eberle, Business Mgr. (2557)

EMPLOYMENT OPPORTUNITIES .....53-55

EQUIPMENT  
(Used or Surplus New)  
For Sale ..... 54

CLASSIFIED ADVERTISERS INDEX

Bell Aerosystems Co. Div. of Bell Aerospace Corp....	54
D.A.T.A. Inc. ....	54
Pan American World Airways, Inc.	55
Radio Research Instrument Co....	54
Space-General Corp. ....	52
Union Carbide Nuclear Company..	54
U.S. Microwave .....	54

• See advertisement in the July 25, 1963 issue of Electronics Buyers' Guide for complete line of products or services.

This Index and our Reader Service Numbers are published as a service. Every precaution is taken to make them accurate, but **electronics** assumes no responsibilities for errors or omissions.

## electronics



Audit Bureau  
of Circulation



Associated Business  
Publications

Audited Paid Circulation

**JAMES T. HAUPTLI (2210)**

Advertising Sales Manager

**DAVID CUNNIFF (3139)**

Promotion Manager

**HENRY M. SHAW (3485)**

Market Research Manager

Electronics Buyers' Guide

**R. S. QUINT (2335)**

General Manager

**RICHARD J. TOMLINSON (3191)**

Business Manager

**THEODORE R. GEIPEL (2044)**

Production Manager

NEW YORK TELEPHONE: Dial Direct:  
971 plus number in parenthesis, Area Code 212

## ADVERTISING REPRESENTATIVES

ATLANTA, GA. 30009

Michael H. Miller, Robert C. Johnson  
1375 Peachtree St. N.E., Trinity 5-0523  
(area code 404)

BOSTON, MASS. 02116

William S. Hodgkinson  
McGraw-Hill Building, Copley Square,  
Congress 2-1160 (area code 617)

CHICAGO, ILL. 60611

Harvey W. Wernecke, Robert M. Denmead  
645 North Michigan Avenue, Mohawk 4-5800  
(area code 312)

CLEVELAND, OHIO 44113

Paul T. Fegley  
55 Public Square, Superior 1-7000  
(area code 216)

DALLAS, TEXAS 75201

Frank Le Beau  
The Vaughn Bldg., 1712 Commerce St.  
Riverside 7-9721 (area code 214)

DENVER, COLO. 80202

John W. Patten  
Tower Bldg., 1700 Broadway,  
Alpine 5-2981 (area code 303)

HOUSTON, TEXAS 77025

Kenneth George  
Prudential Bldg., Halcombe Blvd.,  
Riverside 8-1280 (area code 713)

LOS ANGELES, CALIF. 90017

Ashley P. Hartman, John G. Zisch,  
1125 W. 6th St., Huntley 2-5450  
(area code 213)

NEW YORK, N. Y. 10036

Donald H. Miller (212) 971 3615  
George F. Werner (212) 971 3617  
Donald R. Furth (212) 971 3616  
500 Fifth Avenue

PHILADELPHIA, PA. 19103

Warren H. Gardner, William J. Boyle  
6 Penn Center Plaza, LOcust 8-4330  
(area code 215)

SAN FRANCISCO, CALIF. 94111

Richard C. Alcorn  
255 California Street, Douglas 2-4600  
(area code 415)

LONDON W1:

Edwin S. Murphy Jr.  
34 Dover St.

FRANKFURT/Main:

Matthee Herfurth  
85 Westendstrasse

GENEVA:

Michael R. Zeynel  
2 Place du Port

TOKYO:

George Olcott,  
1, Kotohiracho, Shiba, Minato-ku

Brush  
lightbeam  
recorder  
eliminates  
RFI with  
silent light!

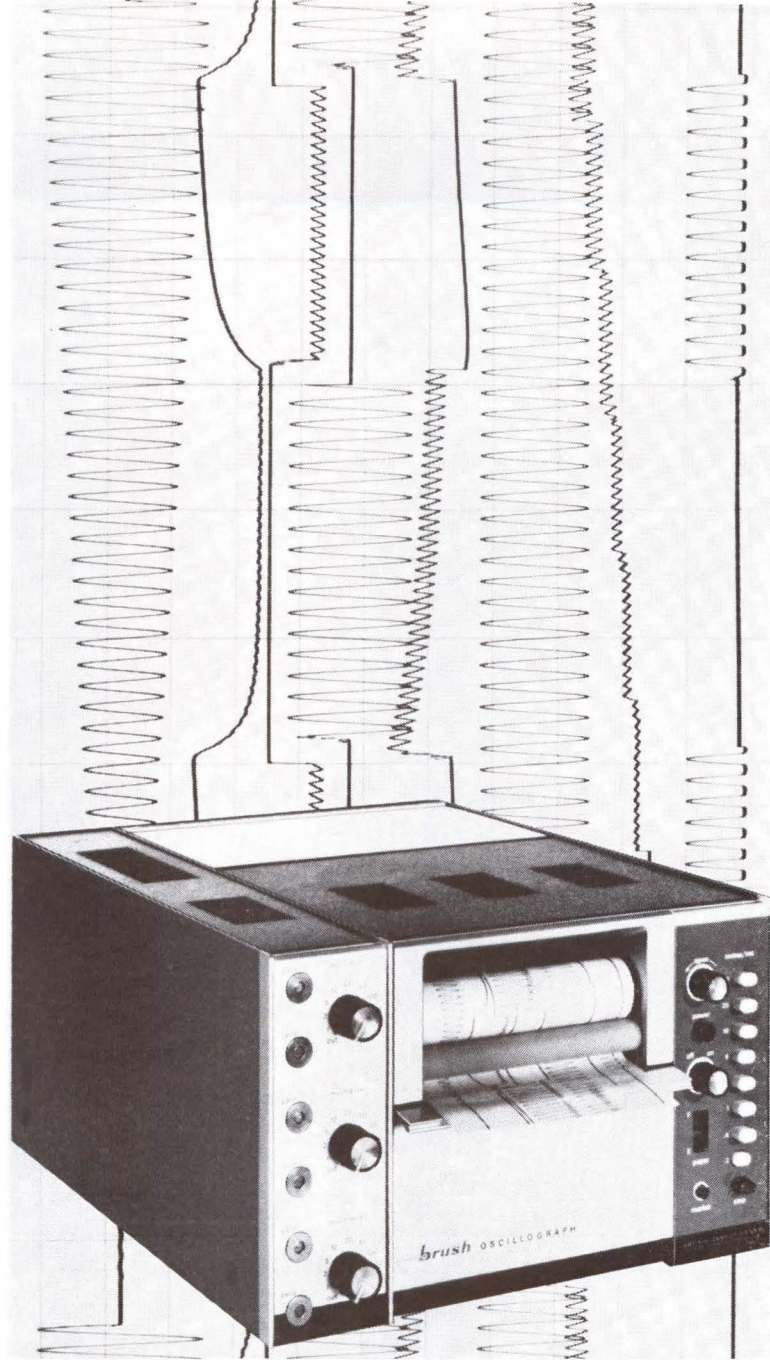

The unique incandescent optical system of this new direct-print oscillograph completely eliminates confused data caused by generation of RF interference into associated equipment. It is the only lightbeam recorder that meets RFI specs . . . MIL-I-26600 and MIL-I-6181D. Whether your application is industrial or aero-space, check out these important facts.

**Start and Re-start Recording time . . . 50 milliseconds**  
**Writing Speed . . . Greater than 30,000 in./sec.**  
**Companion Amplifiers . . . Especially Designed**  
**Complete Line of Accessories**  
**8 Pushbutton Record Speeds**  
**Internal Chart Take-up**  
**High Contrast Traces**  
**16 Channels**

Now you can record over the whole range of most-used frequencies with Brush systems incorporating all the known refinements in oscillography. Write for full details.

**brush** INSTRUMENTS  
DIVISION OF CLEVITE 37TH AND PERKINS, CLEVELAND 14, OHIO



## RCA-A15288 PENCIL TRIODE

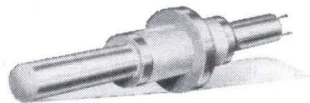

### MORE TUBE POWER FOR MINIATURIZED MICROWAVE DESIGNS

Increased power per unit weight—that's the challenge successfully met by the RCA-A15288. An excellent example of recent advances in Microwave tube design, this tiny pencil triode can provide 1 Kw of useful peak power output at 5 Gc as a plate-pulsed oscillator.

For use in telemetry, altimeters, and UHF transceivers, the ceramic-metal RCA-A15288 is designed to operate at altitudes up to 25,000 feet at 3.5 Kv without pressurization. Furthermore, the coaxial arrangement of electrodes around the RCA-A15288 heater practically eliminates tube characteristic

changes caused by heater-voltage variations.

If your design involves miniaturized Microwave equipment for application in the 5 Gc region, consider the RCA-A15288. It offers exceptional reliability in vibration and shock environments. Heater power requirement is a low 1.6 watts; warm-up time is 4 seconds.

For information on how the RCA-A15288 can be used in your design circuits, see your RCA Industrial Field Representative, or write: Manager, Microwave Marketing, RCA Electronic Components and Devices, Harrison, New Jersey.

RCA-A15288

Plate-Pulsed Oscillator at 5 Gc	Typical Operation
Peak Positive Plate Supply Voltage	2,500 volts
DC Plate Current	0.0022 amp
DC Grid Current	0.0015 amp
Grid Resistor	2,000 ohms
Useful Power Output at Peak of Pulse	1,000 watts
Pulse Duration	1.0 $\mu$ sec
Pulse Repetition Rate	1,000 pps
Plate Efficiency	20%

#### RCA FIELD OFFICES:

OEM SALES: Newark 2, N. J., 32-36 Green St., (201) 485-3900 • Chicago 54, Ill., Suite 1154, Merchandise Mart Plaza, (312) 527-2900 • Los Angeles 22, Calif., 6801 E. Washington Blvd., (213) RA 3-8361 • GOVERNMENT SALES: Harrison, N. J., 415 South Fifth St., (201) 485-3900 • Dayton 2, Ohio, 224 N. Wilkinson St., (513) BA 6-2366 • Washington 6, D. C., 1725 "K" St., N.W., (202) FE 7-8500 • INTERNATIONAL SALES: RCA International Division, Clark, New Jersey, (201) 382-1000



THE MOST TRUSTED NAME IN ELECTRONICS