

electronics®

ELECTRON BEAM DRILLS PLATE

Low anode voltage
cuts x-ray hazard

(photo below)

ELECTRO-OPTICAL WAR MANEUVERS

Infrared and r-f
links team up

ORTHICON-LIKE STORAGE TUBE

Device stores pictures
for ten hours



R. D. SKINNER
1020 GINGLON RD
LOS ALAMOS CALIF

Specifications

tell the story

Output:

5 mc, 1 mc, 100 kc sinusoidal; 100 kc clock drive

Stability as a function of:

Line voltage, $\pm 10\%$: $< 1 \times 10^{-11}$

Ambient temperature (107BR), 0–50°C: $< \pm 1 \times 10^{-10}$

Load, short to open: $< \pm 2 \times 10^{-11}$ for any resistive change

Humidity: instruments are hermetically sealed

Aging rate:

$< \pm 5$ parts in 10^{10} per 24 hours

RMS deviation of 5 mc output (due to noise, frequency fluctuation):

Averaging Time	RMS Fractional-Frequency Deviation ($\Delta f/f$)	RMS Phase Deviation (milliradians)
1 msec	8×10^{-10}	0.03
10 msec	1.5×10^{-10}	0.04
0.1 sec	1.5×10^{-11}	0.04
1 sec	1.5×10^{-11}	0.4
10 sec	1.5×10^{-11}	4

Noise-to-signal ratio (5 mc):

At least 87 db below rated 5 mc output

Harmonically related output:

Down more than 40 db from rated output (5 mc, 1 mc, 100 kc)

Non-harmonically related output:

Down more than 80 db from rated output (5 mc, 1 mc, 100 kc)

Environmental:

Storage temperature: -62 to $+75^\circ\text{C}$ (-40°C limit for 107BR battery)

Operating temperature: 0°C to $+50^\circ\text{C}$

Humidity: hermetically sealed

Vibration and shock: prototype models have passed requirements of MIL-E-16400E

Altitude: 50,000 feet non-operating, 20,000 feet operating

Data subject to change without notice. Prices f.o.b. factory.

An ultra-stable source for primary frequency and time standard systems; also particularly suitable for spectroscopy, doppler measurements and a host of applications in advanced communication and navigational systems. Rugged construction permits operation under a wide range of environments.

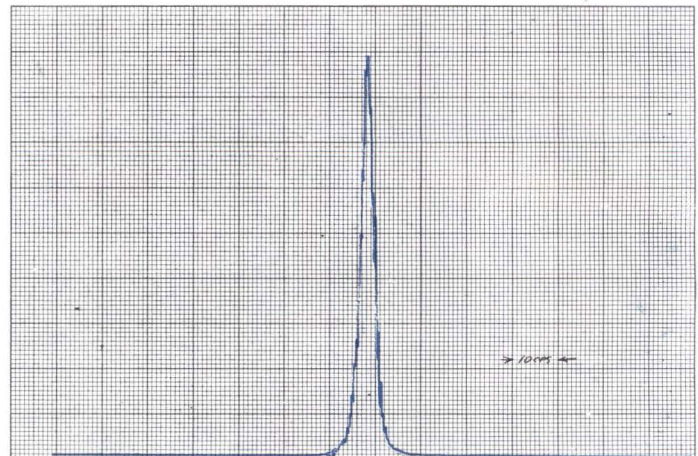

Spectral Purity—This power spectrum shows the excellent spectral purity of the hp 107A Quartz Oscillator. The output was multiplied to 24 gc, compared with the NBS ammonia maser, and the beat note analyzed using a narrow bandwidth analyzer. The vertical axis is in units of power, each division on the horizontal axis is 10 cps, analyzer bandwidth is 3 cps. Note the virtually nonexistent noise pedestal, narrow line width, and the absence of power line sidebands even when multiplied nearly 5000 times.

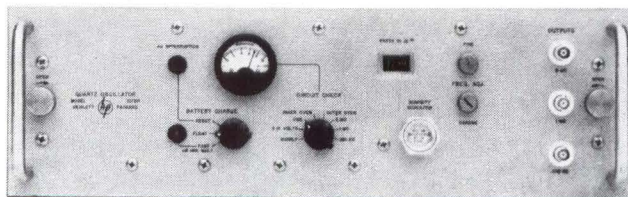

a new 5 mc quartz oscillator from hp

The 107AR and 107BR 5 MC Quartz Oscillators offer a combination of unprecedented specifications, output of extreme spectral purity, top performance in a wide range of environments, and moderate price. The 107AR, only \$2400, operates from 26 ± 4 v dc; the 107BR, only \$2750, operates from the ac line and includes a 2-hour standby battery mounted within the instrument.

Both are rugged, hermetically sealed oscillators which provide outputs of 5 mc, 1 mc and 100 kc with excellent short term stability and long term drift rate.

Principal specifications—and what they mean to you—are outlined here. Call your Hewlett-Packard field engineer for complete specs and a demonstration.

HEWLETT
PACKARD



An extra
measure
of quality

1501 Page Mill Road, Palo Alto, Calif. 94304, (415) 326-7000.
Sales and service in all principal areas. Europe, Hewlett-Packard S.A., 54 Route des Acacias, Geneva, Switzerland; Canada, Hewlett-Packard (Canada) Ltd., 8270 Mayrand St., Montreal, Que.

CIRCLE 900 ON READER SERVICE CARD

LEWIS H. YOUNG, Editor
Dial Direct: (971-2645)
Area Code 212

MARCH 6, 1964

J. M. CARROLL, Managing Editor (2293)

SENIOR EDITORS
Samuel Weber (2371)
George W. Sideris (3444)

SENIOR ASSOCIATE EDITORS
Michael F. Wolff (2467)
John F. Mason (2666)

ASSOCIATE EDITORS
Michael F. Tomaino (2071)
William P. O'Brien (2297)
George J. Flynn (2188)
George V. Novotny (3151)
Leon H. Dulberger (3446)
Alexander A. McKenzie (2685)

ASSISTANT EDITORS
Stephen B. Gray (2245)
Barry A. Briskman (2306)
Joel A. Strasser (2127)
Vincent S. Acunto (2592)
C. R. Whetstone (3495)
Louis S. Gomolak (2472)
G. G. Tirellis (2710)

REGIONAL EDITORS
Harold C. Hood,
1125 W. 6th St., Los Angeles 90017, Calif.
(213-482-5450)
Laurence D. Shergalis,
John Hancock Bldg., 255 California St.,
San Francisco 94111, Calif. (415-362-4600)
Thomas Maguire
McGraw-Hill Bldg., 607 Boylston St.,
Boston 02116, Mass. (617-262-1160)
Cletus M. Wiley,
Blair Bldg., 645 N. Michigan Ave.,
Chicago 60611, Ill. (312-664-5800)

ART DIRECTOR
Howard R. Berry (2430)

ASSISTANT ART DIRECTOR
John C. Wright, Jr. (3430)

EDITORIAL ASSISTANTS
Lorraine Rossi, Virginia T. Bastian,
Lynn Emery, Ann Mella, Lorraine Werner,
Alice M. Moyer, Sharon Parks,
Claire Benell, Kay Fontana,
Sandra A. Le Mond, Mary Jo Jadin

FOREIGN NEWS BUREAU
DIRECTOR, John Wilhelm, (2532);
Lawrence Mihlon (2997), Alyne Elias
(2998)
LONDON—John Shinn, Derek Barlow,
Nicholas Landon, 34 Dover St., London
W.1, England
BONN—Richard Mikton,
Silke McQueen, Mittelstrasse 39, Bad
Godesberg, Germany
BRUSSELS—Arthur Erikson, 27 Rue Ducarle,
Brussels, Belgium
PARIS—Robert Farrell, 17 Ave. Matignon,
3rd Fl., Paris 8, France
MILAN—Bruce Bendow, Via Manzoni
No. 12, Milan, Italy
MEXICO CITY—Wesley Perry, Jr.,
Lafregua 4-314, Mexico 1 D.F. Mexico
RIO DE JANEIRO—Leslie Warren, Rua
Mexico 3-S/1507 1509, Rio de Janeiro,
Brazil
MOSCOW—Donald Winston,
Kutuzovsky Prospekt 19, Apt. 28-29,
Moscow, USSR
TOKYO—Richard Halloran, Charles Cohen,
John Yamaguchi, Toranomon Sangyo
Bldg., 1 Kotohiracho Shiba, Minato-Ku,
Tokyo, Japan

CIRCULATION MANAGER
Hugh J. Quinn (2310)

C. C. RANDOLPH, Publisher (3996)

electronics

A MCGRAW-HILL PUBLICATION 75 CENTS

DRILLING METAL PLATE — Electron-gun assembly seen in operation through the porthole in the vacuum chamber discloses absence of cumbersome conventional focusing electromagnets. The gun is drilling a series of holes through metal plate. *It has drilled through aluminum, tantalum, copper, stainless steel and even Pyrex. It has also done welding and soldering.* see p 32

COVER

GLAMOUR STOCKS SLIDE. Investors in the over-the-counter stock market are much more careful today about what issues they buy. They now favor solid-earning industrial electronics firms rather than the glamour companies and military electronics companies. *If there is any investor fad today, it's for data-processing companies*

10

ELECTRO-OPTICAL WAR GAMES. Use of electro-optical hit simulators by the Army on maneuvers saves costly munitions and avoids accidental casualties. Weapons simulated now include the M-14 rifle, the 90 and 106-mm recoilless rifles and 90-mm tank gun. Attacker's omnidirectional infrared transmitter triggers omnidirectional ir beacons on all potential targets. *When an ir flash is received by gun's optics, an r-f transmission is initiated that triggers pyrotechnic displays.*

By J. A. Houston, Aircraft Armaments Inc. 27

LOW-VOLTAGE BEAM WELDER. Here is a useful industrial tool to come out of a nuclear-fission research program. This pulsed electron gun with oxide cathode has proved valuable for precision drilling, welding and soldering bulk materials. *Use of low anode voltage reduces x-ray danger to operator.*

By K. Aalund and R. Hill, Univ. of Calif. 32

STORAGE TUBE HOLDS TEN HOURS. The tube construction is similar to the image orthicon but the target is a fine metal screen, not a glass membrane. There is an insulation on the photocathode side of the screen and thin metal on the other. *It can also reproduce an excellent picture for 10 minutes of continuous readout.*

By K. Odagawa and Y. Nakayama, Tokyo Shibaura Electric Co., Kawasaki, Japan 36

Contents continued

March 6, 1964 Vol. 37, No. 10

Published weekly, with Electronics Buyers' Guide as part of the subscription, by McGraw-Hill, Inc. Founder: James H. McGraw (1860-1948).

SUBSCRIPTIONS: Available only by paid subscription. Publisher reserves the right to refuse non-qualified subscriptions. Subscriptions to Electronics solicited only from those actively engaged in the field of the publication. Position and company connection must be indicated on subscription orders forwarded to address shown below. Subscription rates for individuals in the field of the publication: U. S. and possessions and Canada \$6 one year, \$9 two years, \$12 three years (single copies 75¢). All other countries \$20 one year (single copies \$1.50).

EXECUTIVE, EDITORIAL, CIRCULATION AND ADVERTISING OFFICES: McGraw-Hill Building, 330 West 42nd Street, New York, N. Y., 10036. Telephone Area Code 212. 971-3333. Teletype TWX N. Y. 212-640-4646. Cable McGrawhill, N. Y. Printed in Albany, N. Y. Second class postage paid at Albany, N. Y. Title reg. ® in U. S. Patent Office. Copyright © 1964 by McGraw-Hill, Inc. All Rights Reserved. The contents of this publication may not be reproduced either in whole or in part without consent of copyright owner.

OFFICERS OF MCGRAW-HILL PUBLICATIONS: Shelton Fisher, President; Vice Presidents: Joseph H. Allen, Operations; John R. Callahan, Editorial; Ervin E. DeGraff, Circulation; Donald C. McGraw, Jr., Advertising Sales; Angelo R. Venezian, Marketing.

CORPORATION OFFICERS: Donald C. McGraw, President; L. Keith Goodrich, Hugh J. Kelly, Harry L. Waddell, Executive Vice Presidents; John J. Cooke, Vice President and Secretary; John L. McGraw, Treasurer.

UNCONDITIONAL GUARANTEE: The publisher, upon written request, agrees to refund the part of the subscription price applying to the remaining unfilled portion of the subscription if service is unsatisfactory.

SUBSCRIBERS: Please address all correspondence regarding subscriptions, change of address notices, and subscription orders to Fulfillment Manager, Electronics, P. O. Box 430 Hightstown, N. J., 08520. Change of address notices should be sent promptly; provide old as well as new address; include zip code or postal zone number if any. If possible, attach address label from recent issue. Please allow one month for change of address to become effective.

POSTMASTER: Please send Form 3579 to Fulfillment Manager, Electronics, P. O. Box 430, Hightstown, N. J., 08520.

FRENCH ELECTRONICS BOOM. De Gaulle's grand design to rebuild France's prestige and world position has sent the industry soaring past the billion-dollar-a-year level. His ambitions for a nuclear strike force and French leadership in European space technology have set the stage for advances in electronics. *Opportunities, and problems, are being created for electronics companies in this important market.* By Derek Barlow 41

WEAPONS BREAKTHROUGHS WANTED. Air Force wants to begin work on a new bomber that will hedge-hop through enemy territory, on a new long-range interceptor aircraft and on a short-range attack missile. *New generation of electronic equipment would be required. The bomber, for example, would locate radar hidden by hills and destroy it with missiles* 46

LIGHTWEIGHT RADAR. For night-fighting soldiers, a 10-lb radar has been designed around a low-power klystron. *When the c-w doppler set locates a target it alerts the operator by giving him a mild shock* 48

DEPARTMENTS

Crosstalk. Maturity or Else	5
Comment. Light-Beam Modulation	6
Electronics Newsletter	17
Meetings Ahead. Precision Electromagnetic Measurements Conference	18
Washington This week. New Puzzle: Is the A-11 Airplane an Interceptor or Isn't It?	20
Research and Development. Laser Aids Rocket Studies	51
Components and Materials. New French Devices Debut at Components Show	54
Production Techniques. Redesign of Waveguide Speeds Manufacturing	56
New Products. Electrometer Measures Solar Winds	58
Literature of the Week	66
People and Plants. Raytheon Promotes Executives	68
Index to Advertisers	72

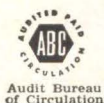

DOUBLE-BARREL NEWSBREAK IN INFINITE-RESOLUTION POTENTIOMETERS

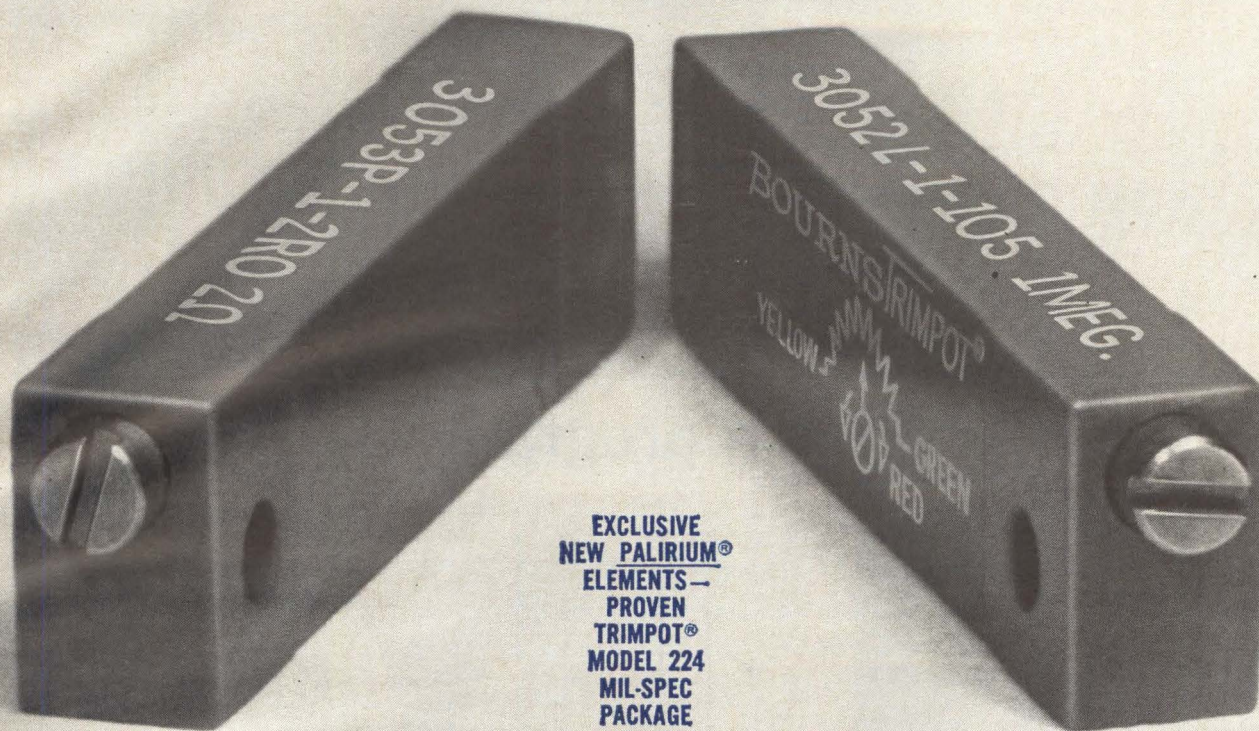

**EXCLUSIVE
NEW PALIRIUM®
ELEMENTS—
PROVEN
TRIMPOT®
MODEL 224
MIL-SPEC
PACKAGE**

NOW — INFINITE ADJUSTABILITY IN A 2-OHM POTENTIOMETER!

Now you can bring the convenience of infinite adjustability to applications that have always required an arduous fixed-resistance approach. The new TRIMPOT Model 3053, with its exclusive PALIRIUM film element, overcomes the problems in resolution and contact resistance that heretofore have made a low-resistance unit of this kind impossible. Stability of the infinite-resolution Model 3053 is outstanding, enhanced by an unusually low temperature coefficient and the time-proven Mil-Spec configuration of Bourns' famous TRIMPOT Model 224. This potentiometer should help you develop new circuit-design approaches.

Total resistance range:	2 Ω to 100 Ω
Resolution:	Infinite
Power rating:	1/2 W @ 70°C
Contact resistance variation:	3% or 1 Ω max.
Temperature coefficient (2,5 Ω):	+400 PPM/°C max. -100 PPM/°C max.
Temp. coefficient (10 to 100 Ω):	+300 PPM/°C max. -100 PPM/°C max.
Max. operating temperature:	175°C
Environmental stability:	1% or less
Load life stability:	2% or less

NOW — TWICE THE STABILITY IN RESISTANCES UP TO 1 MEGOHM!

At the other end of the scale, TRIMPOT Model 3052 offers you two to four times the stability of competitive high-performance potentiometers over the resistance range of 100K to 1 megohm. Like the companion low-resistance unit, Model 3052 features the approved Mil-Spec configuration of Bourns' high-temperature, humidity-proof Model 224. Its spec of 500 maximum applied volts is approximately 60 per cent better than that of other available units, and its total resistance tolerance of ±10% cuts the usual competitive figure in half. The new high-resistance, infinite-resolution element is also available in Model 3012 with the popular 1 1/4" x 3/8" x 1/4" package. The prices? Less than you've been paying!

Total resistance range:	20K to 1 Meg.
Resolution:	Infinite
Power rating:	1 W @ 70°C
Contact resistance variation:	2.5% max.
Temperature coefficient:	Less than 300 PPM/°C
Max. operating temperature:	175°C
Environmental stability:	2% or less
Load life stability:	3% or less

AVAILABLE IMMEDIATELY FROM FACTORY STOCK AT COMPETITIVE PRICES.



ACTUAL SIZE

Write for latest TRIMPOT
potentiometer summary brochure.



BOURNS, INC., TRIMPOT DIVISION
1200 COLUMBIA AVE., RIVERSIDE, CALIF.
PHONE 684-1700 · TWX: 714-682 9582
CABLE: BOURNSINC.

MANUFACTURER: TRIMPOT® & PRECISION POTENTIOMETERS, RELAYS; TRANSDUCERS FOR PRESSURE, POSITION, ACCELERATION. PLANTS: RIVERSIDE, CALIFORNIA; AMES, IOWA; TORONTO, CANADA

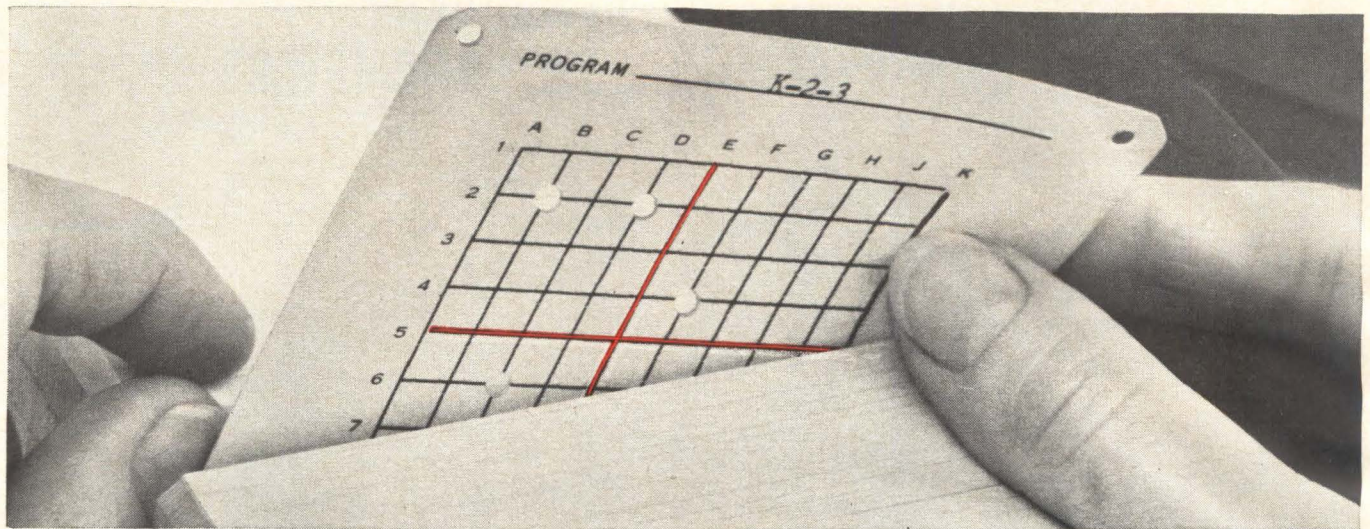

Pick a program...

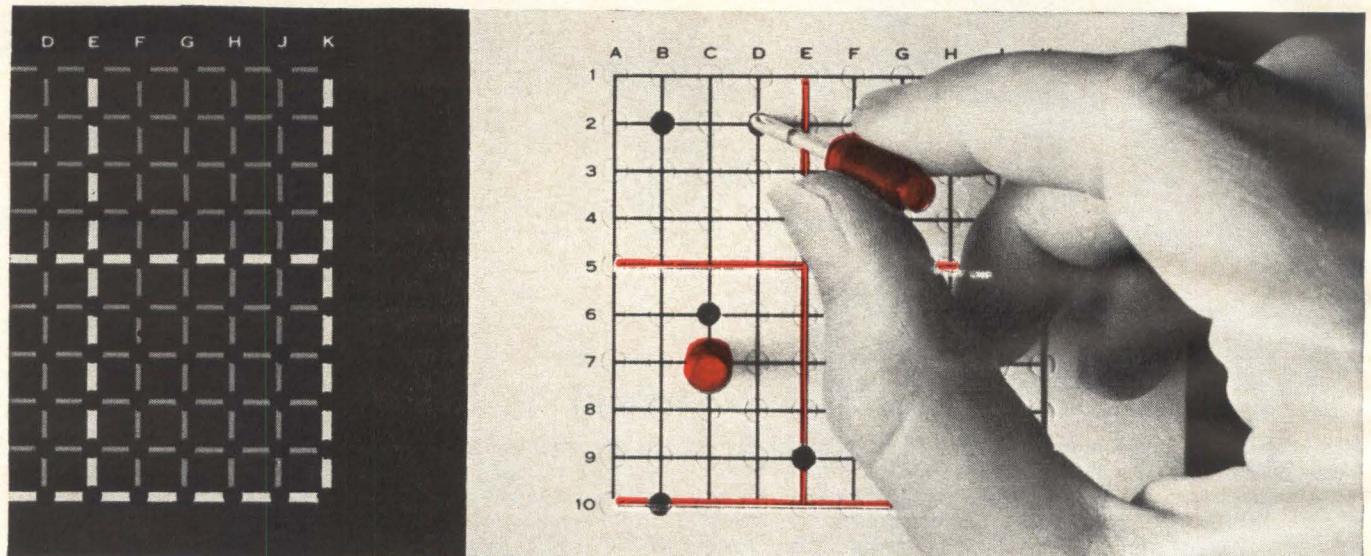

Pin it fast!

Easily done with this new A-MP* **Matrix Pinboard** accessory. The **templates** let you pre-program and file hundreds of intricate switching combinations... finger-tip ready for instantaneous recall and error-free change.

Re-program time is significantly reduced. Installation of pins in required locations is faster and simpler than by reference to program identification on pinboard assembly or supplemental program log. The template hole pattern is easily punched with an ordinary pencil or similar sharp object.

The Pinboards themselves reduce complex switching operations to the simple insertion of a pin. Since all pins are immediately accessible for quick program changes, you gain patchcord flexibility without its complexity. **The pins**—shorting, diode and other component carrying types—won't bend or buckle regardless of repeated insertions and extractions. Gold plated pins are available for dry circuit applications.

Visit us at the IEEE Show Booths 2527-2531 and 2438 March 23-25

Possible applications for this Matrix Pinboard range from vending machines on through digital computers and include such functions as digital memory, sequencing and input-output switching. The standard modules can be easily grouped for unlimited matrix capacity.

Compared to the manipulation of conventional switches, A-MP Matrix Pinboards yield greater density, improved reliability and more convenient programming at lower cost. Find out the facts today. Send for our detailed Matrix Pinboard Catalog.



AMP products and engineering assistance are available through subsidiary companies in: Australia • Canada • England • France • Holland • Italy • Japan • Mexico • West Germany

*Trademark of AMP INCORPORATED.

MATURITY OR ELSE

ELECTRONICS as a technology is finally reaching adulthood.

For years it has been the upstart of the technical world. New phenomena have been discovered at a dizzying rate and companies have promptly turned the new effects into devices. In fact, new components and devices have streamed out of development laboratories at such a pace they have made older devices obsolete sometimes even before the older products could be marketed. Young companies have shot from rags to riches, from garages to industrial complexes, almost overnight. Only in an infant technology could progress be made at such speed.

Now the innovation growth curve is bending over and leveling off. True, new phenomena are still being uncovered, but they turn out to be secondary effects, and working devices sometimes cannot be made from them.

Nowhere was this maturing more clearly evident than at the annual Solid-State Circuits Conference several weeks ago. Traditionally, this meeting has been the platform for announcing radical new developments. This year, however, there were no such announcements. Keynote speaker H. B. G. Casimir, director of Research at Philips Research Laboratories, stated the case clearly. He told the conference, "Research has been hunting with ever increasing zeal for new phenomena and effect. In a way the effort has been successful, and yet, there is in many quarters an undertone of disappointment and worry about diminishing returns."

He suggested, "The main task in store for us may involve a fuller exploitation of the wealth of existing possibilities rather than adding entirely new possibilities."

Casimir was saying that the day of the razzle dazzle revolutionary development is past in electronics. Does that mean the technology will demand only refining the design of devices—making smaller and smaller transistors? faster and faster diodes?

Not at all. There are plenty of huge challenging fields that need conquering: radiation-resistant devices, optoelectronics, micropower circuits. And the area of integrated circuits is a Pandora's box whose contents nobody yet knows for sure.

But the maturing of technology is likely to end the near-hysterical fervor physicists and electronic engineers have demonstrated about a lot of developments which turned out to have more pizzazz than value. The chemical relay, the tunnel diode, cryotrons—all have disappointed their proponents. Even the laser, still a glamor child, has been called by at least one physicist "The greatest toy scientists ever invented, but with damn little practical use in sight."

Adulthood is likely to be important to engineers professionally and the companies they work for. Business is likely to be more stable. On page 10, you can read a story of shattered dreams of electronics companies, blossoming, exploding, and then drying up as measured by the hard-hearted indicator of stock market prices. Almost each of these companies which enjoyed meteoric rises was hitched to what was thought to be a radical bit of technology. Obviously, the technology turned out not to be good enough.

A lot of these disappointing firms were what their owners liked to call "think tanks" or "R&D farms." They produced no hardware or only prototypes; their main outputs were thick reports. An engineer at them prospered and suffered as the demand for R&D work rose and fell.

Even the best of them discovered it was a hard way to make money, and most found it an impossible way. The answer, more and more companies have found, is in the shipping room—at least in having a shipping room through which hardware moves on its way to customers.

From a technology standpoint maturity in electronics means putting well-defined phenomena to work in imaginatively created devices. From a business standpoint, it means developing products that can be manufactured and sold in volume. Engineers or companies that don't are not going to make the grade in 1964.

Only from Sprague!

LABORATORY CAPACITANCE STANDARDS



to a certified accuracy of



±0.1%

STYRACON® PRECISION CAPACITORS

Components for highly precise electronic equipment as well as laboratory standards of capacitance • Measurements are correlated with similar capacitors certified by National Bureau of Standards • Maximum capacitance stability possible in the state of the art • Capacitance values from .001 to 100 μ F • Specially-processed polystyrene dielectric • Hermetically-sealed.

STYRACON® DECADE CAPACITORS



Triple decade capacitors with direct in-line readout • Accurate to $\pm 0.5\%$ of nominal capacitance for any dial setting • Two basic ranges of capacitance — 0.0001 to 0.1099 μ F and 0.001 to 1.099 μ F • Available in bench or panel mounting styles.

For complete technical data, write for Engineering Bulletins 90,600 and 90,605 to Technical Literature Service, Sprague Electric Company, 35 Marshall St., North Adams, Mass.

SPRAGUE®

THE MARK OF RELIABILITY

Sprague and  are registered trademarks of the Sprague Electric Co. 450-168-0391

GET THE FULL STORY AT IEEE BOOTHS 2416 THRU 2426

6 CIRCLE 6 ON READER SERVICE CARD

COMMENT

LIGHT-BEAM MODULATION

Permit me to tell you that the method of light modulation referred to in the article. Solid Crystal Modulates Light Beam (p 58, Dec. 29, 1963) is exactly described in my papers 1938/39: Methoden und Anordnungen zur Speicherung beim Fernsehempfang, *Telegraphen-Fernsprech-Funk- und Fernseh Technik*, Sonderheft 1938, S.518; Die Verwendung von Zinkblende-Relaisschirmen im Speicher-Projektionsempfänger mit Elektronenstrahlröhre, *ibid.*, 28, 108, 1939; Ein neues Grossflächen-Lichtrelais für Intensitäts-, Farb- oder Polarisations-ebenen-Steuerung, *ibid.*, 28, 226, 1939.

My invention from 1938/39 is also mentioned in my book, "Tabellen der Elektronenphysik, Ionenphysik und Übermikroskopie," Deutscher Verlag der Wissenschaften, Berlin, 1956, Vol. I, page 202 and Vol. II, page 924. In the second place you will find even the crystal material applied in your tube.

MANFRED VON ARDENNE

Forschungsinstitut Manfred von Ardenne
Dresden-Weisser Hirsch, Germany (East Zone)

In the Dec. 20, 1963, issue of *ELECTRONICS* a paper appeared entitled, Solid Crystal Modulates Light Beam, by Evert Lindberg, Motorola, Inc. Since the author does not make reference to any previous work, and since I developed and patented a light valve as early as 1934, I wish to complement the above-cited paper and shed light on previous work which has been done based on my patent by Scophony Limited, London, with which company I was a consultant and had a general agreement on the development and exploitation of a new revolutionary concept of light-control devices. The development started in Budapest, Hungary, where a light valve of this type was used for years in a sound recording device. This light valve was patented in Hungary, England, Canada, France, etc.

The first publication on the development appeared in the magazine *Television and Shortwave World*, in May of 1936, entitled, Large Pictures With Cathode Ray Tube, by L. S. Kaysie, and later in the "Television Engineering" textbook by Dr. Victor A. Babits. This book was a textbook used at Rensselaer Polytechnic Institute where he taught for thirteen years. An English edition is available in the Institute library. The original book can be found in the Library of Congress under No. TK6642B3-1947, Card No. 52-43225.

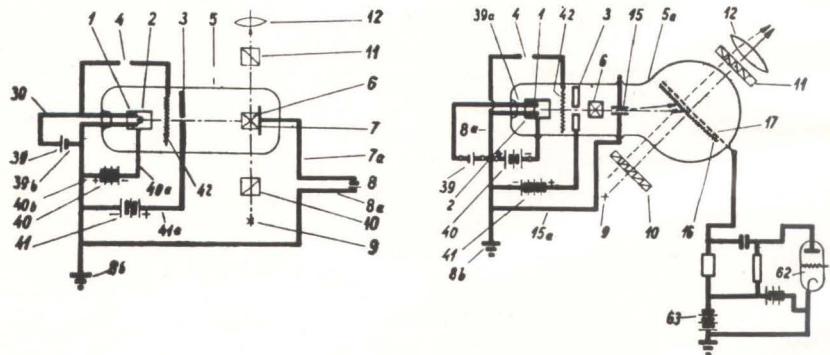

The two figures from the original edition on pages 168 and 169 show clearly a simple light valve and a display tube. The basic principle of the light valve developed by Professor Pulvari is based on the properties of some crystals which split light rays into two components with different planes of polarization. The control crystal screen itself is placed between a polarizer and an analyzer and the field on the crystal surface is produced by charging the crystal surface with an electron gun and applying a transparent electrode on the opposite side of the crystal which represents the light-modulating elements. Different modes of operation were possible. The two figures show clearly the identity of my device with the device presented by Lindberg and it was the first electron-gun-operated light valve practically operated. It is felt that this early development may be of value to a number of scientists in this field.

CHARLES F. PULVARI, Professor
Dept. of Electrical Engineering

Catholic University of America
Washington, D. C.

• Author Lindberg reports that he was unaware of the work of either Prof. Dr. h.c. Von Ardenne or Prof. Pulvari, and that what he wanted to bring out in the article was that two vacuum chambers were used, one to contain the crystal to keep the outgassing of the crystal from contaminating the electron gun and also to keep the electron beam from destroying the crystal surface.

MORE CAPACITANCE

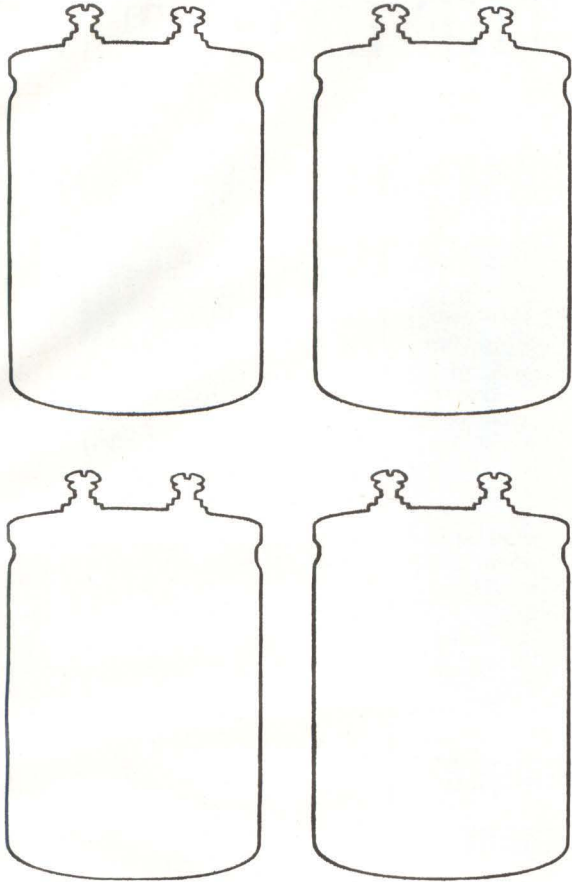

IN LESS SPACE

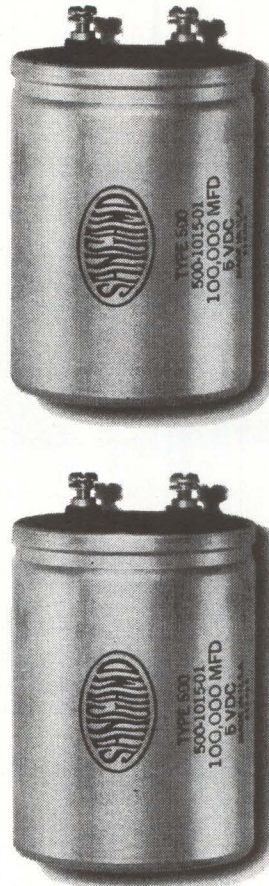

**HANDLE
HIGHER
RIPPLE
CURRENT
THAN EVER
BEFORE
AT
85° C.**

New Sangamo TYPE 500 capacitors for filter and power supply applications

A new computer grade electrolytic capacitor with ratings from 3 to 450 volts D.C. Available in 8 case sizes . . . each with higher capacitance per case size (from 60 to 220,000 microfarads) plus lower ESR. See the Type 500 demonstrated at the IEEE Show

Booth
2714-2716



SANGAMO ELECTRIC CO.
Springfield, Illinois

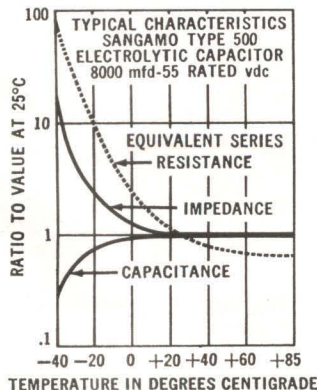

EXAMPLE: Power Supply

REQUIRED: 300,000 MFD—25 volts D.C.—80 RMS amps ripple—65°C. ambient

SOLUTION A: (Sangamo Type 500) 9 capacitors—35,000 MFD—25 volts D.C.—9 RMS amps ripple

SOLUTION B: (Competitive Type) 18 capacitors—17,000 MFD—25 volts D.C.—6.6 RMS amps ripple

SUMMARY: Eighteen of even the closest competitive capacitors . . . all having larger case sizes . . . would be required to equal only 9 Sangamo Type 500's! Why? The Type 500 has more anode surface and a new, improved electrolyte. Check now with your Sangamo representative for additional details.

EC64-1

SINCE 1924 A LEADING MANUFACTURER OF CAPACITIVE COMPONENTS . . . NOW THE LEADING DESIGNER AND MANUFACTURER OF NEW CAPACITORS FOR DISCHARGE AND LASER APPLICATIONS.



TIPS (Technical Information & Product Service)

NINE OF THE LATEST NEW

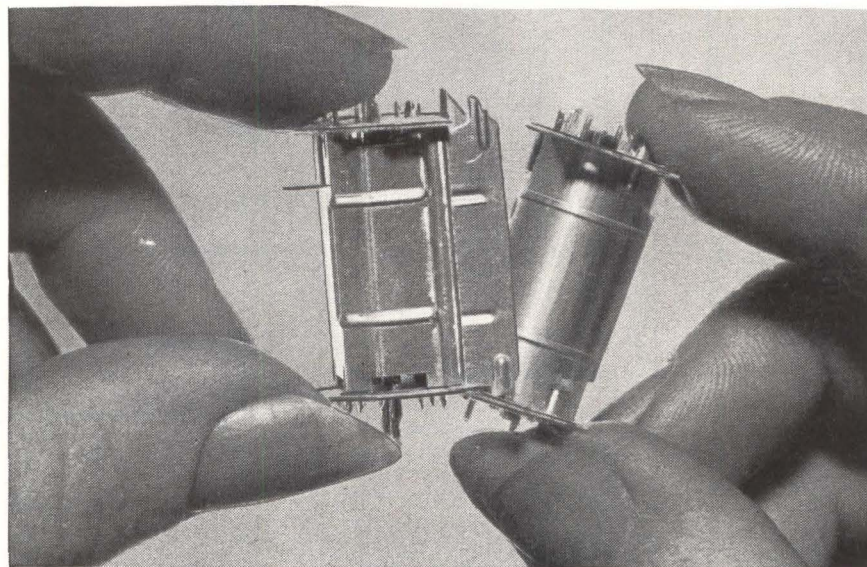

New compactron building block technique helps designers of electronic equipment

G.E.'s new concept in the design of electron tubes promises to be a boon to large and small electronics manufacturers. Termed the "building block concept," it involves the standardizing of basic tube sections—diodes, triodes, pentodes—clipping them together according to the customers' requirements and sealing them in a single envelope.

The building block concept holds these advantages:

1. It exploits the economy of mass production for the benefit of the small volume user.
2. It enables G.E. to offer designers a wider variety of space-saving multi-function tubes.
3. Actually speeds circuit design by use of standardized sections with which circuit designers are quite familiar.
4. Thereby, it eases circuit and product evaluation by equipment manufacturers.
5. It contributes to reliability by employing time-proven tube designs.
6. Retains flexibility so that G.E. may employ modern materials and tube construction techniques to make old designs even better.

Thus, with the standardization of basic tube sections, and the resulting manufacturing economies, the circuit designer and the smaller manufacturer will be freed from the high cost of less common or "odd-ball" tube types.



ZP-1034 metal-ceramic tetrode increases range and capability of electronically-scanned radar

Because of emphasis on the use of negative-grid tubes in broadband circuits at L-band, G.E. has developed the ZP-1034 for use as the final output or driver stage of the amplifier module of a typical steerable array radar. Modern defense systems are trending toward the use of electronically steerable array radar not only to increase range but to provide an active radar capability in a high-density countermeasures environment. Here are some of the features that make the ZP-1034 ideally suited for new applications requiring up to several hundred watts (average) or several kilowatts (peak) output at high duty in bandwidths of 10% in the 1300 mc region:

1. A strap resonance of approximately 1500 mc allows the use of practical $\lambda/4$ circuitry in the vicinity of 1300 mc with resultant benefits in gain, bandwidth and efficiency.
2. A cathode area about 40% greater than that of the only known competitive type improves performance and life.
3. A gain-bandwidth product greater than 4000 gives optimum performance for bandwidth requirements in the order of 10%.
4. Grid-pulsed amplifier service can be used to simplify modulator requirements.
5. An integral water jacket allows dissipation levels to 750 watts average (air-cooled version available).
6. Demonstrated life capability beyond 10,000 hours enhances system reliability.

CIRCLE 200 ON READER SERVICE CARD
March 6, 1964 electronics

DEVELOPMENTS FROM G-E RESEARCH

Photoconductive cell developments offer new design opportunities



SIAMESE TWIN: Center tap photocell permits simultaneous control of two separate electrical circuits.



PHOTOCELL-LIGHT COMBINATION: Lamp and photocell sealed together in light-tight package. Variations of voltage on lamp change resistance on photo-cell. Good circuit isolation and mechanically noiseless potentiometry.



PLUG-IN BASE: Special base eases replacement of cell, eliminates soldering and prevents heat damage during installation. Ideal for metering and control equipment. Now available in 1/2-inch size.



NEW CONSTRUCTION: Sealing ceramic substrate to base conducts heat more efficiently and reduces need for heat sinks. Tests show over 100% increase in power dissipation: 250 to 500 mw max. on 1/2-inch cell; 30 to 75 mw max. on 1/4-inch cell (TO-3 package).

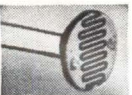

PLASTIC ENCAPSULATED CELL: Y-1136, available in limited quantities, measures 1/2-inch dia. x 1/16-inch thick. Max. ratings: 250v; 200 mw; 9,000 ohms @ 2 ft-c; 480 ohms @ 100 ft-c, 6100 ang. max. response.

CIRCLE 201 ON READER SERVICE CARD
electronics March 6, 1964

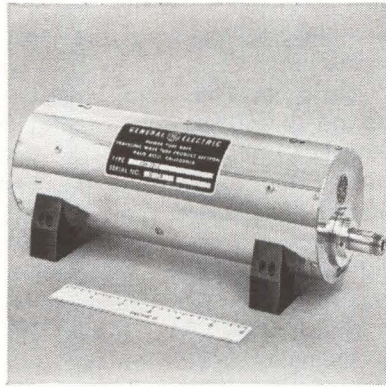

New C-band single reversal focused TWT's outperform others twice their weight

Now G.E. offers five low-noise, C-band, single reversal focused traveling wave tubes—each less than half the weight of PM-focused tubes.

This new family of TWT's features a unique combination of advantages. They're not only rugged, but give you outstanding performance:

Type	Frequency (Gc)	Noise (db, Max.)	Power Output (mw)	Small sig. gain (db min.)
ZM-3212	4-8	9	5	25
ZM-3235	4-8	8	5	25
ZM-3250	4.4-5.0	6.5	5	25
ZM-3237	5.4-5.9	6	5	30
ZM-3238	5.9-6.5	7	5	30

All five tubes are of metal and ceramic construction, with the same dimensions and weight: 8.2 pounds; 13" overall length, 4.5" diameter. The whole family has survived shock of 30 G's for 11 milli-seconds. They're built to withstand severe vibration; altitudes of 100,000 feet; and temperatures ranging from -65°C to +71°C. These rugged little light-weights can improve a lot of designs for advanced radar, countermeasures, and aerospace telemetry.

CIRCLE 202 ON READER SERVICE CARD

G.E. cuts 'interface' resistance of receiving tubes—Solves difficult design problem



Critical applications, such as computer and instrument circuits, need stability throughout life, a characteristic that can be upset if unwanted interface resistance develops in the tubes. But to measure this resistance accurately has been a problem—and to measure it in a production test to values less than 1 ohm has in the past been impossible. G.E. solved this problem by developing a special test set that simultaneously measures transconductance at 8 kc and 10 mc. The operator then reads interface resistance, through a bridge circuit.

To reduce interface to heretofore impossibly low levels, G.E. perfected cathode base alloys and coating materials—and refined each detail of tube processing to insure good bonding of the coating to the cathode sleeve. G.E. now can consistently supply tubes free of interface up to at least 2,500 hours of operation—whereas five years ago the best any manufacturer could achieve was to limit the resistance to about 20 ohms at 1,000 hours.

Constant emphasis on improved materials and new processing techniques plus continual refinement—and re-refinement—of receiving tube designs permits G.E. to offer customers the best value for their dollar.

Progress Is Our Most Important Product

GENERAL ELECTRIC

For more information: Write G.E. Tube Dept., Technical Information and Product Service (TIPS), Room 7002D, Owensboro, Kentucky. Please specify product(s).

CIRCLE 9 ON READER SERVICE CARD 9

It's a Long Slide for Glamour Stocks

Solid-earning industrial electronics now favored by over-the-counter buyers

By **LEON H. DULBERGER**
Associate Editor

NEW YORK—Over-the-counter (o-t-c) electronics stocks may never boom again as they did in the 1950's and early 60's. The investing public has generally stayed away

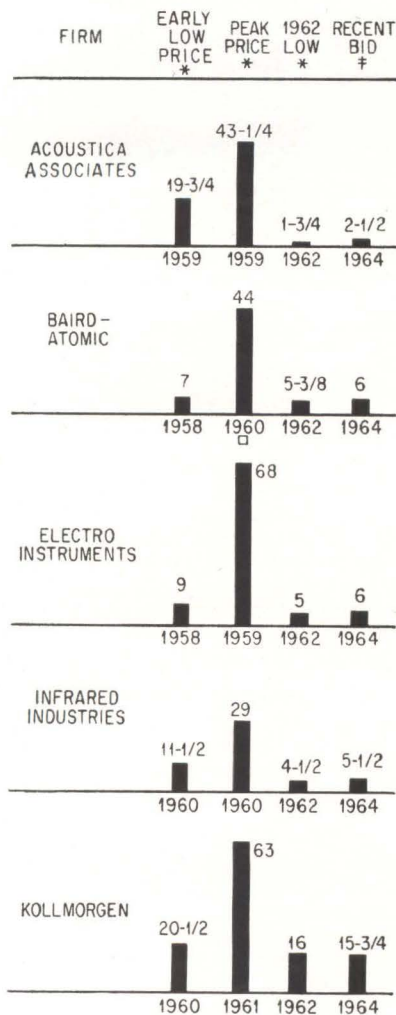

† SOURCE: NATIONAL ASSOCIATION OF SECURITIES DEALERS FEB 1964

* SOURCE: MOODY'S INDUSTRIAL MANUAL 1963

□ SPLIT IN 1959

SAMPLING of some of the over-the-counter issues that temporarily reached high levels. They reflected the public's enthusiasm for glamour technologies of the last decade

from the stock market since the May 1962 break. The high trading volumes in evidence on Wall Street are due to the activities of funds, trusts, and floor traders.

Particularly hard hit are the so-called glamour technology stocks which attracted so many inexperienced investors during the post-Sputnik era.

Security analysts and large-volume o-t-c traders don't expect a recurrence of the climate that followed the orbiting of the first Sputnik. The U. S. government's efforts to catch up with the USSR resulted in a shotgun approach to technology that benefited many electronics firms. Also, heavy military spending boosted many o-t-c electronics securities through the last decade.

In over-the-counter electronics securities a pattern of selective investment is forming. Most desired are stocks of electronics firms serving industrial markets.

No longer the glamour leaders, electronics firms must have solid attributes to appeal to investors. The days of electronics issues trading for 40 or more times earnings appears past. Solid earnings, a good technical position, an effective management team, and a healthy backlog of orders are considered musts.

Military Out, Industrial In—For the most part electronics firms selling primarily or exclusively to the military hold little appeal to investors right now. The reduced defense-spending goals the Administration has publicized, plus the sorry performance of many military-oriented electronics firms has damped the public's desire to own these issues. There is some appeal, however, in exceptionally well-managed firms that are able to capture military contract business that continues to be available.

Right now, investors favor electronics companies geared to industrial sales, in any of a broad range of specialties.

EDP the Magic Word?—In particular, firms active in data processing are attractive to the public, analysts

report. In the Wall Street definition of the phrase, data processing includes a wide range of equipment and techniques: computers of every description, but primarily digital or hybrid digital-analog types; data reduction; information storage, retrieval and readout; industrial machine control; and data communications.

However, one Wall Streeter notes a hint of unreality in the public's enthusiasm for securities of firms serving the total data-processing industry. He notes that much of the lay investors' eagerness for these o-t-c electronics stocks is due to their inability to understand the technology involved in what these firms offer. Part of the public appears to be exhibiting a blind trust in the "magic" that data processing can effect on a plethora of problems. Other experts insist that nothing like a "craze" of interest in data processing issues even exists. They hold that selective interest in industrial electronics is the only definable trend.

Automation Attractive—Within industrial electronics, firms producing equipment demanded by new plant expansion are favored by investors. Thus, instrumentation and automation producers are expected by some to benefit from the anticipated uphill movement of the general economy.

In addition to data processing, medical electronics stocks have shown spurts of brief interest based on news breaks that catch the public fancy. This indicates to some analysts that—in the hope of sudden trading gains—the public is still eager to invest in firms which achieve a promising technical breakthrough.

Wall Street analysts are advising their clients that merely being non-military will not be enough to ensure the growth of an electronics firm. They look for fierce competition between companies in the years ahead, limiting profits in all but the best-run organizations.

While consumer electronics offers a powerful lure to the public, particularly firms featuring color tv, few

electronics stocks of consumer-oriented firms are traded over-the-counter. Most are listed on stock exchanges. A general fillip to an electronics o-t-c stock is achieved just before an issue is listed on a major exchange. The information that this will happen is usually abroad weeks before the shift and it results in aggressive investor interest.

Growth Is Slower—Generally, Wall Street experts expect a slower growth of the electronics industry in the 1960's than was experienced in the 1950's. One analyst estimates the annual growth rate for this decade will be about one half that of the last; some 7½ percent instead of 15 percent, he states.

Wall Street activity in terms of the general investor is down to some 30 percent of what it was before the mid-1962 break, by one trader's estimate. He believes an unequivocal action by the President, to characterize his attitude toward business, is awaited by the business community and Wall Street investors. However, a major change in military funding might have a vast effect on the investing public's attitude. This could take the form of spending in large amounts on long-delayed weapons projects or even on projects that are right now considered to be eliminated.

Underground Radio



POMONA, CALIF., claims to be the only U. S. city to have consolidated all city communications in an underground fallout shelter. Above, the central radio console. Facilities were dedicated Feb. 24



we've got your number

... in binary coded decimal format at 50,000 conversions per second, including sample and hold. Texas Instruments new Model 846 A-D Converter features 100 megohm input impedance, voltage ranges from 1 to 10 volts (manual or external selection) and 100 nanosecond aperture time.

Available options include three digits (± 999) or four digits ($\pm 1,999$), differential input, decimal or BCD display and digital to analog conversion capability. The 846 is another high-speed, high-accuracy instrument in TI's line of digital data handling equipment.

Model 844 and 845 high-speed Multiplexers are ideal companion instruments for use with TI A-D Converters.



Addressable, sequential and addressable/sequential models are available, sampling at 50,000 channels per second. Features up to 160 channels, variable frame length, accuracy $\pm 0.02\%$ full scale with input levels to ± 10 volts.

Write for complete information.

INDUSTRIAL
PRODUCTS
GROUP



TEXAS INSTRUMENTS
INCORPORATED
P. O. BOX 66027 HOUSTON, TEXAS 77006

a complete range of quality **NUVISTORS** *by*

HITACHI

RELIABLE
LOW POWER REQUIREMENTS

SELF-SHIELDING

UNIFORM

STABLE

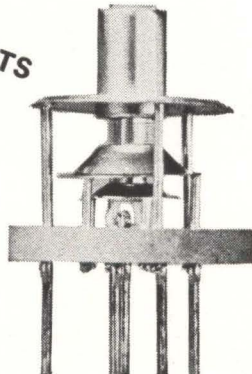

HITACHI now offers a complete range of nuvistors to the radio and television industry. Included are useful new HITACHI designed types. They are made with the precision, care and pride that go into every HITACHI product. Every nuvistor is carefully inspected before leaving the factory. Write HITACHI for detailed technical information and prices. Discover the advantages of specifying HITACHI nuvistors for your product.

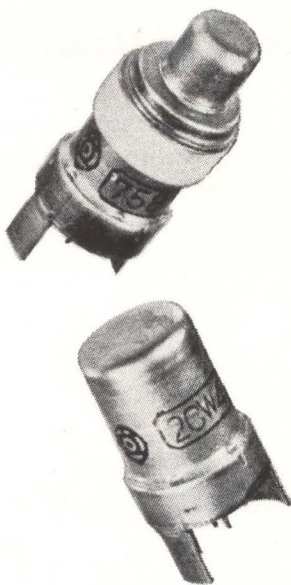

HITACHI	
6CW4	TRIODE, FOR VHF-AMPLIFIER IN STANDARD TV.
2CW4	SAME AS 6CW4, FOR 450 MA TRANSFORMERLESS TV.
2B-H5	SAME AS 6CW4, FOR 600 MA TRANSFORMERLESS TV.
6DS4	SEMI-REMOTE TRIODE, TV VHF-AMPLIFIER.
2DS4	SAME AS 6DS4, FOR 450 MA TRANSFORMERLESS TV.
2N-H11	SAME AS 6DS4, FOR 600 MA TRANSFORMERLESS TV.
6DV4	TRIODE, FOR UHF-OSCILLATOR IN STANDARD TV.
2DV4	SAME AS 6DV4, FOR 450 MA TRANSFORMERLESS TV.
2N-H12	SAME AS 6DV4, FOR 600 MA TRANSFORMERLESS TV.
6N-H10	LOW NOISE TRIODE, AUDIO PRE-AMPLIFIER.
6N-L7	TRIODE, FOR VERY LOW-B ⁺ APPLICATIONS.
7586	TRIODE, FOR INDUSTRIAL APPLICATIONS.
7587	TETRODE, FOR INDUSTRIAL APPLICATIONS.
8056	TRIODE, FOR LOW-B ⁺ APPLICATIONS.
8058	TOP-PLATE TRIODE, FOR UHF APPLICATIONS.

 **Hitachi, Ltd.**

TOKYO, JAPAN

CABLE ADDRESS: "HITACHY" TOKYO

666, 5th Ave., New York 19, N.Y., U.S.A. Tel: JUDSON 6-4757
100 California St., San Francisco, Calif., U.S.A. Tel: YUKON 1-7871

333, N. Michigan Avenue, Chicago 1, Ill., U.S.A. Tel: 726-4572/4
Graf Adolf Strasse 37, Duesseldorf, West Germany Tel: 10846

ASTRODATA

ADVANCED SOLID STATE AMPLIFIERS FOR YOUR CONTROL AND INSTRUMENTATION APPLICATIONS

Astrodata advanced design instrumentation amplifiers raise state-of-the-art standards to higher levels for measurement... conditioning... monitoring... indicating... control.

Many standard options are available to adapt these amplifiers to your individual requirements.

For custom designs, Astrodata's extensive experience provides a well-qualified capability for satisfying your specific performance needs.

Model 884 Wideband (dc-150kc) Floating, Guarded Amplifier...
Model 885 Wideband (dc-10kc) Differential Amplifier...

high-gain/high-performance amplifiers for low-level wideband systems. Completely transistorized, these state-of-the-art amplifiers use field-effect transistors in place of the mechanical choppers to achieve lowest drift rate, low power consumption and maximum reliability. Standard gain steps include "OFF," 3, 10, 30, 100, 300 and 1,000. Continuously adjustable 10-turn vernier control is available as a standard option. An optional ± 10 ma or ± 100 ma output current (at ± 10 volts), supplied from low output impedance, can be supplied to drive A to D converters, multiplexers, galvanometers or tape recorders. The Model 885 provides a choice of transfer characteristics, including (A) Maximally Flat Amplitude (Butterworth) for widest frequency response in high-level multiplexed, galvanometer or tape recorder systems, or (B) Linear Phase (Bessel) for fastest settling time and overload recovery time in low-level multiplexed systems.

Both models have built-in power supplies, feature drift less than $2\mu\text{V}$ per week, noise less than $4\mu\text{V}$ rms, linearity better than 0.02%.

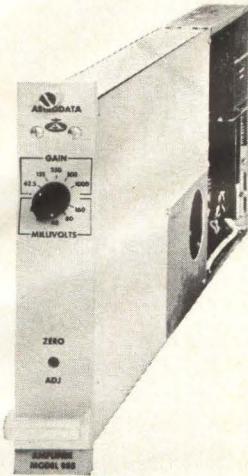

Model 117 100-volt Operational Amplifier for analog control or computer systems.

OUTPUT: ± 100 volts
 at ± 50 ma
 BAND WIDTH: dc to 200kc
 GAIN: Greater than 10^5
 NOISE REFERRED TO INPUT: 2 mv rms
 INPUT RESISTANCE: 3 megohms at dc, 1 megohm above 5 cps



Model 133B Dual-Channel Galvanometer-Driver Amplifier provides 18 independent amplifier channels in 7 inches of panel space.

GAIN RANGE: Zero to 4, with ten-turn, continuously variable, locking control
 INPUT IMPEDANCE: 10,000 ohms
 FREQUENCY RESPONSE: ± 0.5 db from dc to 20 kc
 OUTPUT LIMITING: ± 100 ma maximum output current prevents galvanometer overload or burnout.



Model 880 Differential Amplifier for low-level, low-frequency systems.

BANDWIDTH: dc to 100 cps; also available with switch-selected active filters.
 LOW NOISE: less than $1\mu\text{V}$ rms
 GAIN RANGE: 50-1000
 MOUNTING: Portable case or 8-in standard rack mounting frame



Model 112 Chopper-Stabilized Operational Amplifier. Versatile, modular for analog control systems.

BANDWIDTH: dc - 250 kc
 Long-term stability, constant gain-bandwidth
 OPEN LOOP GAIN: Adjustable from 10^7 to 2×10^8 for constant gain-bandwidth.
 Offset adjustable to zero (± 1 mv. nom. range)
 VOLTAGE OFFSET DRIFT: Less than $6\mu\text{V}$ per hour
 INPUT CURRENT: Less than 1 na

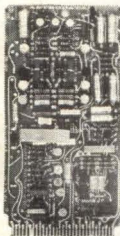

Model 120 Nanovolt Amplifier gives you high-gain/low-noise amplification for seismic transducer signals, cryogenic studies, thermocouple or strain gage signals.

GAIN RANGE: 200 to 1,000,000
 BANDWIDTH: dc - 100 cps
 NOISE: $0.05\mu\text{V}$ rms referred to input
 INPUT RESISTANCE: 1 megohm
 OUTPUT LEVEL: 0 to ± 5 volts at ± 5 ma



Model 121 Nanovoltmeter provides $0.1 \mu\text{V}$ full scale bridge balance detector or thermocouple indicator for standards and calibration work, in the field as well as in laboratories.

FULL SCALE RANGES: $\pm 0.1 \mu\text{V}$ to ± 100 mv
 INPUT RESISTANCE ALL RANGES: 1 megohm
 Built-in Overload Indicator
 Self-Contained Batteries and AC Power Pack

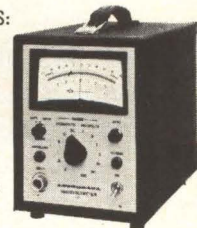

Contact your Astrodata engineering representative for a demonstration... or write today for technical literature giving complete specifications.



ASTRODATA INC.

P.O. Box 3003 • 240 East Palis Road • Anaheim, California 92803

Phone (714) 772-1000 TWX 714-776-3760



Investment Opportunity

The skills he's learning today he will someday put to use for you.

But it is going to take a substantial investment before the strides he takes will be sure and swift and strong. An investment of time, of love, of money and thought.

You have a stake in that investment.

You can protect it by joining with other leading American businessmen to promote the Treasury's Payroll Savings Plan for U. S. Savings Bonds. The Treasury Department's Plan encourages habits of prudence and diligence and responsibility that are

the most valuable currency of a free society and a free economy.

When you bring the Payroll Savings Plan into your plant—*when you encourage your employees to enroll*—you are investing in the skills of tomorrow's workers. In the energy and ability of youth that is our real wealth. You are investing in America's future. In freedom itself.

Don't pass this investment opportunity by. Call your State Savings Bonds Director. Or write today to the Treasury Department, U. S. Savings Bonds Division, Washington, D. C. 20226.



in your plant...promote the PAYROLL SAVINGS PLAN for U.S. SAVINGS BONDS





What in the world will you think of next?

We are continually amazed by the ingenious things equipment designers do with Heinemann special-function circuit breakers.

You, yourself, might be less impressed. You could probably think up dozens of possible uses just by looking at the schematics of the breakers' internal circuits.

Our picture shows five of our most commonly used circuit arrangements. Four are special-function designs. (The one in the middle is our conventional series-trip model, used for run-of-the-mill protection jobs.)

The two breakers on the left are applicationally similar, but function-

ally different. The first, a shunt-trip model, is designed for remote tripping through some other device. The one next to it, a relay-trip breaker, will do the same thing, but at a voltage or current different from the line supply.

On the other side of the series-trip breaker is a calibrating-tap breaker. It permits you to control two circuits, with tripping in response to main-circuit overloads only. The last in line is a breaker with auxiliary contacts. You can use the breaker-coupled auxiliary contacts (SPDT) to switch just about anything you like.

All of these special-function circuits can be supplied in most any

Heinemann breaker type. Shown here is the Series VP, which is a subminiature model, exceptionally light in weight and extremely compact. Like our other breakers, it is magnetically actuated and so does not require derating for high-ambient operation. It can be had in fractional as well as integral current ratings, to your precise specification, and is available with a choice of time delays or instantaneous response. Our Bulletin VP will tell you more about it.



**HEINEMANN
ELECTRIC COMPANY**
2600 BRUNSWICK PIKE
TRENTON 2, NEW JERSEY

CIRCLE 15 ON READER SERVICE CARD



SAAB beats seven Fords in 1964 Monte Carlo!



Sweden's SAAB this year again proved its remarkable performance superiority in the legendary Monte Carlo Rally—84 hours and 2,700 miles of the toughest tests any car can be expected to endure.

For the third year in a row, Erik Carlsson brought his red 5-passenger SAAB home first in its class. Close behind in another SAAB, Pat Moss Carlsson, his wife, finished first among all women drivers and won the Women's Trophy for the fourth time.

Matched against 297 of Europe's most powerful

sports cars and superpowered Fords and Chryslers, the two SAABs confirmed what SAAB owners around the world already know.

There are many good reasons why SAAB consistently performs so well—in or out of competition. Engine power is applied directly to the front wheels: every stroke is a power stroke, and you get amazing traction.* SAAB has a near-perfect center of gravity for flatter cornering. Two separate hydraulic braking systems. And the durability and high efficiency of the SAAB engine mean more miles with minimum maintenance.

Go to your nearby SAAB dealer and test drive the car that repeatedly wins at Monte Carlo. Only **\$1,895** (p.o.e.)

*Engine, transmission and differential warranted for 2 years or 24,000 miles.

SAAB

NEW YORK • NEW HAVEN • DENVER • JACKSONVILLE

WORLD'S ONLY CAR ENGINEERED TO AIRCRAFT STANDARDS

UK May Go With NTSC Color Tv

LONDON — British Broadcasting Corp. last week was pressuring for Britain's immediate adoption of the American NTSC color-tv system.

BBC's action came after the failure of the fourth meeting of the International Radio Consultative Committee (CCIR) to come any closer to an agreement on what color-tv system should be adopted in Europe than its first three conferences. Next year, CCIR will try its luck in Vienna.

A current policy review may result in the BBC, with government backing, taking a unilateral action in starting an NTSC color service in 1965-66. The British Television Advisory Committee will meet this month to advise the government whether or not to proceed with an NTSC service.

The CCIR meetings have dragged on over several years, without a choice between the three rival color-tv systems: NTSC, SECAM (French) and PAL (German). At the London meeting, the 100 committee members representing 19 countries examined technical performance tests made in various European countries. They concluded, said the British Post Office, that "many countries did not consider that sufficient work had been done to enable a definitive choice of systems to be made."

CCIR's consistent lack of decision was attributed by a British electronics industry spokesman to the lack of saturation of the European black-and-white-tv market. "This is holding back many countries from launching a new service. In the UK," he said, "monocolor market penetration is virtually complete. Consequently, while the British are pressing to start color, other European countries feel there is no hurry and are more concerned . . . on a long-term basis."

Also clouding the picture are political implications in the various systems. It is thought unlikely that France will agree to any other system than their own SECAM system. SECAM has also received backing from the Russians and Swiss.

USSR Begins Echo Tests, A-m Reception Is Poor

WASHINGTON — Transmission tests between Jodrell Bank in Britain and the Soviet station at Gorki using the Echo II communications satellite began Feb. 21 and have been only moderately successful. Experimenters had no success with teletype, fair success with facsimile, got readable but noisy signals at Gorki on 400-cps a-m and have had as high as 10 db s/n ratio with unmodulated carriers signals. Line drawings transmitted last week were received fairly clearly. Cooperative tests were conducted during 25 passes of the satellite. To improve reception, Jodrell Bank may add f-m gear to replace the a-m tests

New Computer Picks Signals Out of Noise

PALO ALTO—A time-averaging computer that can dig very faint signals out of a random-noise background sounds like something aimed at the military countermeasures market. But that isn't why Varian Associates is introducing it.

The special-purpose 1,024-channel computer will be sold as an accessory to Varian's nuclear magnetic resonance (NMR) and electron paramagnetic resonance (EPR) spectrometers. Chief applications will be in biomedical and other research.

When the spectrometer is used to analyze biomedical compounds, signals of interest may be so faint they are lost in noise. By running the taped signals through the computer several times, the noise is cancelled and filtered out and the signal amplified until a signal strong enough to be read is built up.

The computer is built for Varian by Mnemotron division of Technical Measurements Corp., White Plains, N. Y.

Process Control Crashes Three More Plants

THREE MORE plants jumped on the process-control bandwagon this week.

- Mobil Oil Co., London, is installing a punch-card computer to control lubrication schedules of machines producing nickel rods.

- Bunker-Ramo and Container Corp. of America will install and develop controls for stock refiners and linerboard machines at CCA's Ferdinandina, Florida, plant.

- Steel Co. of Wales is installing a process-control computer on a hot strip mill. An automatic x-ray gage is the dimension sensor.

Another Company Makes Alphanumeric Gas Tube

SHOWN at the Society for Information Display meeting in Los Angeles last week was a Sylvania display tube, the 1303, that looks very much like Burroughs' big Nixie tube (B-7971). Sylvania plans to show its gas-glow-discharge alphanumeric tube at the IEEE Show, too. Reports say Sylvania may be working on licensing arrangements with Burroughs. Implied in Sylvania's move is a desire to gain a share of the flat-panel display market with tube technology. Sylvania has been pioneering in solid-state display panels. Sylvania spokesmen say their new display lends itself perfectly to their manufacturing experience.

Air Force Readies Plans For Tactical C&C System

BEDFORD, MASS.—The newest Air Force "L" system, in the final stages of organization at the Electronic Systems division here, will tackle the job of modernizing the command and control system of the Tactical Air Forces. To be designated 407-L, TACS (Tactical Air Command System) will include in its job the de-

velopment of systems for communication, air-traffic control (ATC) and aircraft warning and control for fighter aircraft under TAC or under overseas commands.

It is expected that mobile components of "Baby Sage", the 412-L overseas-theater tactical air weapons control and warning system, will be incorporated in 407-L. Acting director of the new System Program Office (SPO) is Col. George Guy. Meanwhile, the oldest SPO in the Air Force, 431-L, has been phased out. Created in 1956, 431-L has had the task of updating ATC and landing systems for AF bases throughout the world. It developed the lightweight Tacan system now in use at AF bases overseas. Remaining development work in this area has been transferred to 482-L, the emergency support system.

GE Sets Royalties for F-M Stereo Equipment

GENERAL ELECTRIC last week announced the royalties it will charge producers of f-m stereo broadcasting, receiving and service equipment.

The Patent Office has issued GE a patent covering the stereophonic f-m broadcasting system that was adopted as the nationwide standard in 1961.

GE said it has sent licensing offers to approximately 100 radio and electronics producers. It plans to charge transmitting stations \$50 for a license covering the 17-year life of the patent. Manufacturers would be charged 50 cents for each reception device, such as a radio, tuner or adapter, or parts kit, and \$50 for each transmitter built. The royalty for test signal generators or kits would be \$1.

Time-Sharing Computer Can Have Several Operators

BOSTON—A general purpose digital computer introduced here this week is reportedly the first commercially available computer offering time-sharing capability as a standard feature. Digital Equipment Corp., of Maynard, Mass. unveiled its Programmed Data Processor 6 at the annual meeting of American Research and Development Corp. Be-

sides the capability of simultaneous use by several persons, the PDP-6 has multipath bus connectors between subsystems, eliminating conventional subsystem synchronization and permitting the use of processors, memories and input-output devices of any size, speed or purpose. Among other features: a 262,000 word memory, 36 bits to the word; fast floating-point arithmetic, with multiply time of 11.7 microseconds; and a seven-channel priority-interrupt system.

SEC Seeks Injunction Against LTV Chairman

SECURITIES and Exchange Commission is seeking a permanent injunction that would bar James J. Ling from acting as officer of any SEC-registered investment company. The suit does not involve Ling-Temco-Vought, Inc., of which Ling is board chairman.

SEC claims that Ling profited personally—to the tune of \$485,000—from his corporate position in Electro-Science Investors, Inc., a Small Business Investment Firm, by buying and selling a large block of stock in Tamar Electronics Industries, Inc., in which ESI had invested. It also claims that Ling now owns \$1,384,000 in Tamar stock.

Ling expressed surprise at SEC's action, saying that he bought the Tamar stock after ESI had advised him it could not buy it. He said his actions have helped establish Tamar Electronics as a "solid" company.

Integrated Circuits Going Into Business Machines

SAN FRANCISCO—Litton Industries will, in the near future, incorporate integrated circuits in its business machines and desk calculators, according to Roy L. Ash, Litton president. Other forecasts by Ash: Litton will win the \$10 million to \$20 million contract for the proposed Air Force emergency communications system; by 1974, Litton's business would be 75 percent commercial and only 25 percent military.

MEETINGS AHEAD

ELECTRONIC INDUSTRIES ASSOCIATION SYMPOSIUM, EIA; Statler Hilton Hotel, Washington, D. C., March 9.

IRON AND STEEL INDUSTRY INSTRUMENTATION CONFERENCE, ISA; Roosevelt Hotel, Pittsburgh, Pa. March 11-12.

NUMERICAL CONTROL SOCIETY MEETING, NCS; Hotel Commodore, New York, N. Y., March 19-20.

IEEE INTERNATIONAL CONVENTION, IEIEE; Coliseum and New York Hilton Hotel, New York, N. Y., March 23-26.

RADIO TECHNICAL COMMISSION FOR MARINE SERVICES MEETING, RTCMS; Boston, Mass., March 31-April 2.

JOINT COMPUTER CONFERENCE, British Computer Society, IRE, IEE; Edinburgh, Scotland, March 31-April 3.

SYMPOSIUM ON ENGINEERING ASPECTS OF MAGNETOHYDRODYNAMICS, IEIEE, MIT; Massachusetts Institute of Technology, Cambridge, Mass., April 1-2.

NAB ANNUAL CONVENTION, National Association of Broadcasters; Conrad Hilton Hotel, Chicago, April 5-8.

NONLINEAR MAGNETICS INTERNATIONAL CONFERENCE, IEIEE; Shoreham Hotel, Washington, D.C., April 6-8.

CLEVELAND ELECTRONICS CONFERENCE, IEIEE, ISA, Cleveland Physics Society, Western Reserve University, Case Institute of Technology; Public Hall, Cleveland, Ohio, April 7-9.

MEASUREMENT AND CONTROL INSTRUMENTATION SYMPOSIUM, ISA; Hotel Floridian, Tampa, Fla., April 8-10.

SMPTE TECHNICAL CONFERENCE, Society of Motion Picture and Television Engineers; Ambassador Hotel, Los Angeles, April 12-17.

MICROELECTRONICS SYMPOSIUM, IEIEE; Chase Park Plaza Hotel, St. Louis, Mo., April 13-15.

FLIGHT TEST INSTRUMENTATION INTERNATIONAL SYMPOSIUM, College of Aeronautics, Cranfield, Bedfordshire, England, April 13-16.

ADVANCE REPORT

PRECISION ELECTROMAGNETIC MEASUREMENTS CONFERENCE, IEIEE, NBS, URSI; National Bureau of Standards, Boulder, Colo. March 15 is deadline for submission of 200-word abstracts in triplicate to Charles F. Hempstead, Bell Telephone Laboratories, Inc., Murray Hill, N. J. Topics include: quantum electronics for measurement; frequency and time standards; r-f microwave and millimeter-wave measurements; d-c and low-frequency measurements; materials, new standards.

VAL Subsystems Will Create Big Off-The-Shelf Market

WASHINGTON — Navy has already told Ling-Temco-Vought (LTV), prime contractor for the VAL project, what electronic subsystems will go into the light attack plane. All but one item will be off-the-shelf hardware; many of the subsystems will be government-furnished equipment (GFE), bought by Navy and given to LTV; and some will be bought by the contractor (CFE). In many cases, specific gear has been specified, including model and manufacturer.

- **CNI**—Communications, navigation, identification package will be RCA's AN/ASQ-85. This may be delivered as an integrated package or as individual components. RCA will buy some of the components from other firms. They include uhf communications, data-link receiver, direction finder, IFF, auxiliary homing receiver.

- **Terrain - Following Radar** — Navy has specified that the TFR will be contractor furnished (CFE) and will be of the AN/APQ-99 type, a unit built by Texas Instruments that is now going into the reconnaissance version of the Phantom II, the RF4B and RF4C. Other firms build TFR similar to the APQ-99 and the contractor, LTV, is free to buy from any of them. They include Emerson Electric, Autonetics, Norden, Raytheon, Hughes and GD/E (p. 10, Feb. 21). The APQ-99 evolved from the APN-149 terrain clearance radar. The 99, however, is a manual terrain-following set. It is also capable of ground mapping and air-to-ground ranging.

- **Bombing**—The pilot must sight the target visually to bomb, but for actual release will have a CP-741 bombing computer. Development of the computer is now underway at Navy Avionics Facility Indianapolis (NAFI) and will be GFE. Production, however, will be farmed out to industry.

- **Doppler Navigation**—Navy has selected General Precision Laboratory's AN/APN-153 doppler navi-

gator for a number of aircraft. This GFE unit will also be used in VAL.

A visual map display that shows the pilot his aircraft's position on a strip map in front of him will be driven by the APN-153. This display device which is manufactured by a number of firms will be CFE.

Navigation computer, AN/ASN-41, to be used is built by both Bendix Pacific and Kearfott. Navy has not decided whether the computer will be CFE or GFE. Navy is buying the same computer for other aircraft CFE.

- **Radar Altimeter** — AN/APN-41 already used in a number of Navy planes, will go into VAL. It is built by Bendix Pacific.

- **Tacan**—AN/ARN-52 sets will be GFE. They are built by ITT and Stewart Warner. VAL's ecm equipment, which as usual is classified, will be highly efficient.

Navy Will Get COIN Aircraft Bids March 9

WASHINGTON — Electronic equipment slated for COIN, the counterinsurgency aircraft Navy will build for the Defense Department, will include uhf communications, AN/ARC-51; uhf direction finder, AN/ARA-25; F-m air-to-ground communication units to talk with ground troops, AN/ARC-44; IFF; Tacan, AN/ARN-52. All will be government furnished equipment (GFE). Armament will consist of machine guns, light-weight bombs and rockets. Bids from prime contractors are due March 9.

The plane will be capable of short takeoff and landing; it will be used for armed reconnaissance and surveillance, helicopter escort, liaison and target marking missions. It will also provide limited logistics capability, for both cargo and personnel, and could be used for civil action—which presumably means policing disarmed areas.

IN BRIEF

HARRIS-INTERTYPE has developed three transistorized computers designed specifically to process copy for typesetting. They decide on hyphenating and line justifying.

NASA is negotiating a \$30-million-plus contract with Hughes Aircraft for five advanced technological satellites. Concepts to be tested include gravity-gradient and spin stabilization at synchronous altitude.

FOUR FIRMS—IBM, North American Aviation, TRW Space Technology Labs, and Sperry Gyroscope—will share Air Force contracts totaling \$2.1 million for studies of a standardized space guidance system. Contracts for developing working units will be open to industry-wide competition.

FAIRCHILD Semiconductor will supply about \$1 million worth of epitaxial micrologic elements in flat packages to Sperry Gyroscope for its Loran-C AN/ARN-76 and AN/ARN-78 Receivers

CRYSTAL GROWING by newly discovered vapor-liquid-solid mechanism is reported by Bell Labs in March 1 **Applied Physics Letters**. Low-temperature method yields near-perfect crystals in rod, whisker, epitaxial layers and other forms.

AMERICAN OPTICAL CO. says it is the first to achieve solar pumping of a laser at room temperature. Sunlight was focused by two-foot parabolic mirror and lenses into reflecting cavity containing neodymium-doped glass rod. Laser power output was on the order of 10 microwatts. Air Force sponsored the two-year research program.

BASKETBALL-SIZED antenna without moving parts capable of scanning a 60-trillion-mile cube of space is the aim of Rome Air Development Center in awarding feasibility study to Sylvania. Housing might be dumbbell shaped to maintain orientation.

AUTONETICS will provide 11 ship's inertial navigation systems (SINS) for the four Polaris submarines that England is building.

AERONAUTICAL radio conference of ITU meeting at Geneva to study technical criteria of new frequency plan found it was premature to decide on converting to single sideband although eventual use must be planned in the aeronautical mobile service.

A-11 Jet: Is It Really the New Interceptor That Air Force Wants?

U.S. development of a mach-3, long-range, interceptor-type jet plane represents a major leap forward in aircraft design, materials and electronic controls. However, a host of questions about the hitherto-secret Lockheed A-11's performance, significance and future remain unanswered by the sketchy description given by President Johnson on Saturday. He said only that it can fly 2,000 mph at altitudes over 70,000 feet and has a range of thousands of miles. About a dozen A-11's are being tested at Edwards Air Force Base to determine the plane's capabilities as a long-range interceptor. An air-to-air missile and fire-control system has been developed by Hughes Aircraft.

These questions immediately arose concerning the new plane:

- Is it really an interceptor, or a successor to Lockheed's U-2 reconnaissance plane?

The Air Force has been pushing Congress for money to develop an improved manned interceptor, IMI (see earlier report, p 46). The House voted \$40 million for IMI, but not the Senate. If the A-11 is not really meant to be an interceptor, this explains why the Air Force continues to push for an interceptor even though the A-11 has been in development five years. If it is considered to be the IMI, then presumably the Air Force has used a pressure campaign in Congress to try to force it into production or further development. Air Force may want the money to begin work on an operational—as opposed to experimental—plane. Or, the A-11 may be more advanced or expensive than needed to cope with the Soviet bomber threat.

- Will Defense Secretary McNamara accept the A-11 as a new weapons system?

No commitment has been announced. A production program would cost billions. McNamara has refused—publicly at any rate—to support a new interceptor, citing lack of evidence that the Russians are pushing advanced bomber development.

Budget Cuts May Cancel MMRBM

The Mobile Medium Range Ballistic Missile (MMRBM) project is still not out of the woods. McNamara had sought \$110 million in the new defense budget for MMRBM. The House cut this request by \$35 million and the Senate by \$70 million. McNamara says either of these cuts would have the effect of canceling the program. The Senate Armed Services Committee feels the only spending justified in fiscal 1965 is on the stellar-inertial guidance system. Work on this system antedates MMRBM, and it could be adapted to other missiles. Major contractor for the system is General Precision.

Tax Cut Will Give Home Electronics A Boost—But Later

Electronics can look for substantial gains from the \$11.5-billion tax cut, if government economists are forecasting correctly. Nobody really knows how consumer spending will be affected, but the consensus now is that low-bracket taxpayers will tend to spend first on soft goods and services. After several months, demand for hard goods will surge. One estimate is that consumers will spend an extra \$2.5 billion for durables—autos, appliances, tv, stereo and the like.

One result of the corporate tax cut is expected to be increased spending on productive equipment. Estimates range from an official 8 or 9 percent to guesses of 15 percent over last year's \$39 billion. Companies faced with tightening profit margins are less optimistic. Because of the plan to speed up tax payments, companies with steady profits will break about even, and only firms with advancing profits will benefit substantially. However, repeal of the Long amendment, which required reduced depreciation when the existing 7-percent investment tax credit was taken, is expected to stimulate buying of such capital equipment as computers.



PAKTRON

PRESENTS
YOUR
COMPLETE
SPEC SHEET
FOR AN ENTIRELY
NEW
CAPACITOR



filmatic[®] capacitors

with

RIPPLEWELD[™] lead assembly

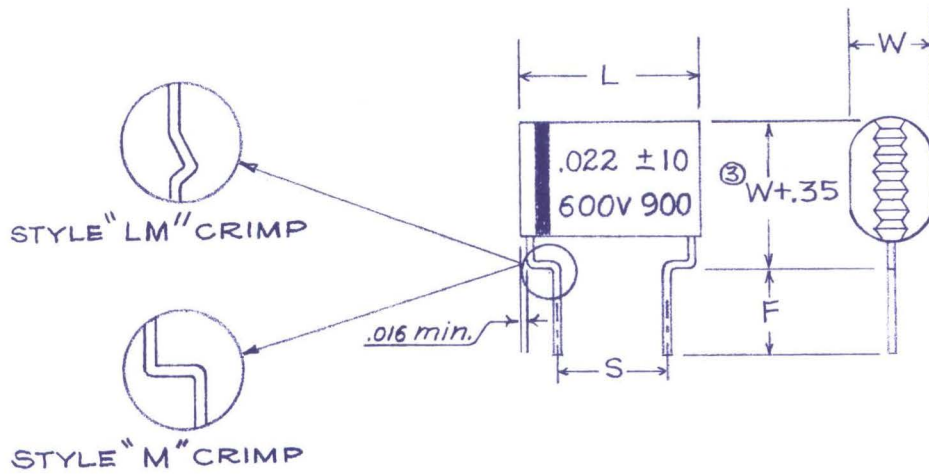

SERIES	VALUE IN MFD ^②	200V	400V	600V	L MAX. ^④	S $\pm .032$ ^④	CRIMP STYLE	F $\pm .01$ OR $\pm .04$
		W MAX.	W MAX.	W MAX.				
470	.001	.20	.20	.20	.470 MAX.	.250 .312	LM LM	.187 OR .312
	.0015	.24	.24	.24				
	.0022	.22	.22	.23				
	.0033	.22	.22	.22				
	.0047	.20	.20	.25				
	.0068	.22	.22	.31				
	.01	.26	.26	.20				
720 ^①	.015	.24	.31	.24	.720 MAX.	.312 .375 .400 .437 .500 .562	M M M LM LM	.187 OR .312
	.022	.20	.20	.30				
	.033	.25	.25	.25				
	.047	.20	.21	.29				
	.068	.20	.25	.35				
1100 ^①	.1	.24	.29	.43	1.10 MAX.	.718 .843 .937	M M LM	.187 OR .312
	.15	.22	.38					
	.22	.25	.43					
	.33	.30						
	.5	.43						

NOTE ^④ OTHER S AND F DIMENSIONS AVAILABLE BY REQUEST.



NOTES

- ① CAPACITORS OF THE 720 AND 1100 SERIES ARE AVAILABLE IN THE NEXT SHORTEST SERIES BY REQUEST.
- ② ANY CAPACITANCE VALUE IS AVAILABLE BETWEEN THE DISCRETE VALUES SHOWN.
- ③ PARTS USING THE LM STYLE CRIMP REQUIRE AN ADDITIONAL .050" BE ADDED TO THE $(W+.35)$ DIMENSION.

SPECIFICATIONS

- INSULATION RESISTANCE _____ GREATER THAN 10^4 MEGOHM MICROFARADS WHEN MEASURED AT 25°C. WITH TWO MINUTES ELECTRIFICATION AT RATED VOLTAGE.
- DISSIPATION FACTOR _____ LESS THAN .004 AT 25°C. WHEN MEASURED AT 1KC.
- TEMPERATURE RANGE _____ -55°C. TO 125°C. WITH VOLTAGE DERATING ABOVE 85°C. DERATE LINEARLY TO 50% OF 85°C. RATED VOLTAGE AT 125°C.
- TEMPERATURE STABILITY _____ LESS THAN 3% DEVIATION FROM THE 25°C. VALUE IN THE RANGE OF 0°C. TO 85°C. WHEN MEASURED AT 1 KC.
- RECOMMENDED THERMAL LIFE _____ 500 HOURS, AT 85°C. WITH 150% OF RATED VOLTAGE APPLIED.
- DIELECTRIC STRENGTH _____ WILL WITHSTAND A D.C. POTENTIAL OF 250% OF RATED D.C. VOLTAGE FOR 1 SECOND WHEN TESTED AT 25°C.
- RECOMMENDED MOISTURE TEST _____ SUBJECT UNITS TO A STEAM ENVIRONMENT OF 10 PSI FOR 16 HOURS. MEASURE IR AT RATED VOLTAGE WITH 2 MINUTES ELECTRIFICATION TIME AFTER 1 HOUR AIR DRY. IR WILL TYPICALLY DROP LESS THAN 1 DECADE.
- LEAD STRENGTH _____ WILL SUPPORT A RADIAL FORCE OF 6 POUNDS FOR A 1 MINUTE DURATION.

- MARKING _____ OUTSIDE FOIL, EIA NUMBER (900) VALUE IN MICROFARADS, VOLTAGE RATING AND TOLERANCE. OTHER MARKING AVAILABLE ON REQUEST.
- LEAD MATERIAL _____ #20 AWG TINNED COPPER CLAD STEEL.
- DIELECTRIC AND CASE MATERIAL _____ POLYESTER FILM.
- LEAD TO FOIL CONTACT _____ LOW RESISTANCE, NON INDUCTIVE CONNECTION PRODUCED BY THE RippleweldTM LEAD ASSEMBLY PROCESS.
- TOLERANCE _____ UNITS AVAILABLE WITH $\pm 10\%$ AND $\pm 20\%$ TOLERANCE.

REQ'D	DRAWING NO.	DESCRIPTION	MANUFACTURER	ITEM
LIST OF MATERIALS				
	BY	DATE		
MECH DESIGN	JGB	5/1/63		
ELECT DESIGN	KP	5/1/63		
DRAWN	KS	6/3/63		
CHECKED	JP	6/3/63		
PROJECT ENG	KC	6/10/63		
APPROVED FOR RELEASE <u>CCR</u> DATE <u>6/10/63</u> <u>CB</u> DATE <u>6/11/63</u>			 DIVISION ILLINOIS TOOL WORKS INC. ALEXANDRIA, VIRGINIA	
			DO NOT SCALE DRAWING	DWG. SIZE <u>322-011-R-C6</u>
			SCALE	C SHEET OF

← SPEC.

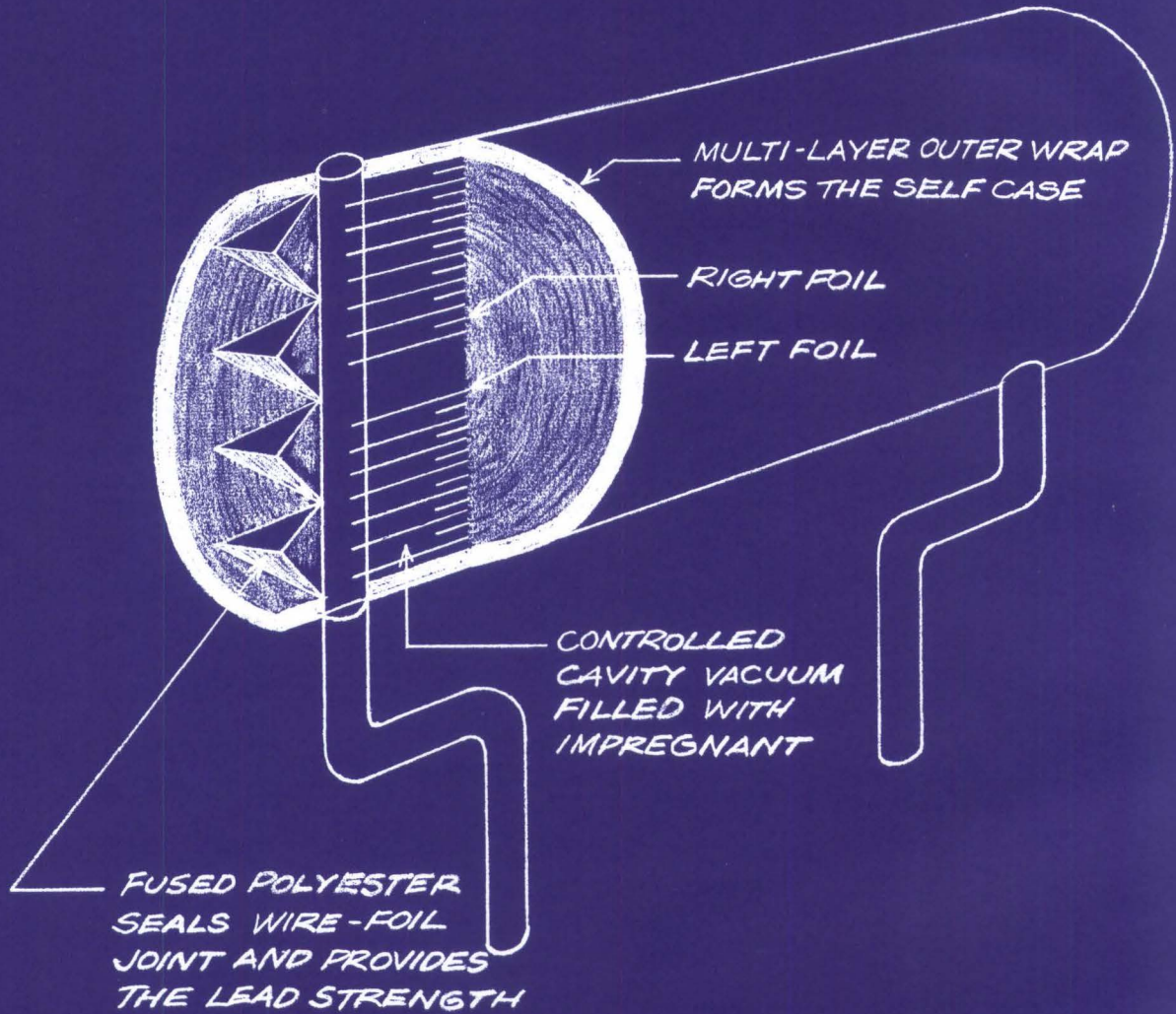

PAKTRON

DIVISION ILLINOIS TOOL WORKS INC.

1321 LESLIE AVENUE • ALEXANDRIA, VIRGINIA

EE's & ME's—Find Your Opportunity in Product Design and Development From These New Openings at Delco Radio

■ A constant flow of new electronic products has helped Delco Radio Division, General Motors Corporation, establish a position of leadership in the electronic field. From Delco research come such exclusive developments as the unique 1964 Cadillac Comfort Control. With only one setting of the thermostat, this recent Delco development automatically maintains a constant, comfortable atmosphere within an automobile, regardless of changes in the weather outside.

As the search for new products continues at Delco, challenging opportunities prevail—in many areas—for capable engineers:

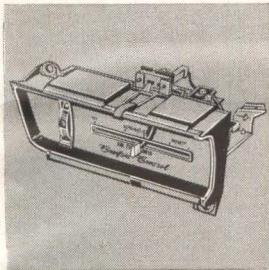

HEATER, AIR CONDITIONER, AND VENTILATION CONTROL

ME's—with 3-5 years experience, for development, engineering production liaison, and re-designing of comfort control systems including vacuum valves and mechanical controls.



SUBMINIATURE MILITARY COMMUNICATIONS EQUIPMENT

EE or ME—for assignment to development group designing all-transistor portable transmitters and receivers, operat-

ing in 2-100 mc range. FM—AM—FSK—CW—SSB modulation.

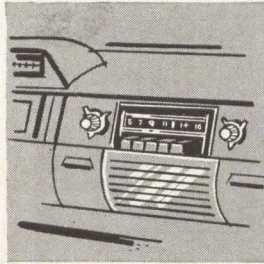

AUTOMOTIVE RADIO DESIGN AND DEVELOPMENT

EE—to work with Senior Engineer on advanced development of auto radios and other entertainment devices, including FM-AM, miniaturized circuitry and components.

ME—for design of small electronic mechanisms, including FM-AM, Signal Seeking and push-button tuners, and components modules.

EE or ME—for packaging of auto radios and associated tuners, solenoids, etc. Required to make some engineering contacts with automobile manufacturers.

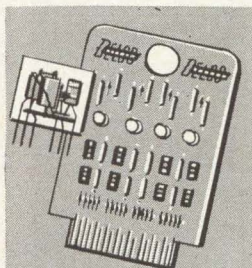

DIGITAL CIRCUITS AND SYSTEMS—includes card, module and digital systems design, and production liaison involving components and special purpose systems operating from 200 kc to 10 mc.

Project Engineer—to direct efforts of design engineers and technicians in designing and releasing digital circuits for production. Supervisory experience highly desirable.

EES—for design and development testing and packaging of transistorized digital switching circuits from 200 kc to 10 mc.

RELIABILITY ASSURANCE

Project Engineer—to handle tests and evaluations of transistorized systems and components, both power and small signal type. Must evaluate results and associated statistical data. Also includes failure analysis work with suppliers and production.

EE—for design and development work on test equipment for semiconductors and special products.

ME or METALLURGIST—for specification writing and testing of materials and finishes. Experience in this area desirable.

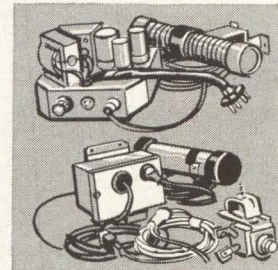

AUTOMOTIVE ELECTRONICS—nonentertainment automotive electronic development including radio control for Garage Door Operators; other transistor applications in automobile, usually involving electromechanical transducers—**ME**—for advanced development work in electromechanical systems used in automotive field.

EE—for design and development of transistorized automobile equipment.

EE or ME—with electromechanical interests for development of electronic equipment for the automotive service market.

● If your interests and experience fall in the above areas and if you're looking for an opportunity to fully exercise your personal competence . . . among men of like talent . . . in unmatched facilities . . . then let's talk. Send your resume today to the attention of Mr. Carl Longshore, Supervisor Salaried Employment.

An equal opportunity employer

solid state electronics



DELCO RADIO DIVISION OF GENERAL MOTORS
KOKOMO, INDIANA

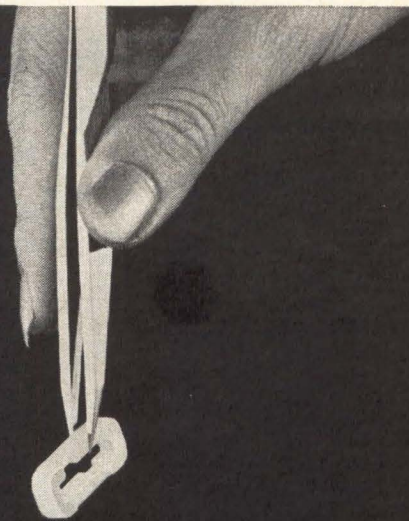

What good is a getter?

Babcock uses them to increase relay reliability.

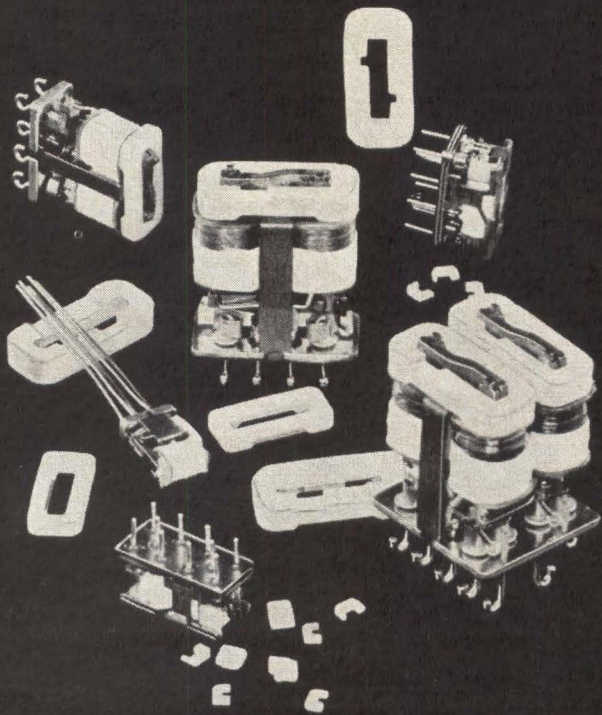

Exclusive Babcock Design Feature Provides Lower Contact Resistance & Longer Relay Life

Contact contamination from vaporization is one of the major causes of erratic performance and eventual failure of hermetically sealed relays. After extensive investigation Babcock Relays, in conjunction with Corning Glass Works, has developed an activated getter from Corning's Vycor brand porous glass. During operation, the activated getters prevent relay contacts from being fouled by contaminants emitted at elevated temperatures.

Babcock has subjected relays using Vycor getters to hundreds of thousands of operations at loads varying in excess of 200G's for 11 milliseconds and vibration at 35G's, 3-5,000 cps. It has been determined that up to 99% of organic contaminants remaining after production degassing are adsorbed by the dessicant. Conclusive life testing at 125°C has proven that contact erosion and contamination accumulation on all vital areas within hermetically sealed relays has been substantially reduced. Consistently lower contact resistance is also exhibited due to the reduction in contamination.

The end result provides Babcock relays with increased performance and efficiency, higher temperature application, and longer, more reliable life.

Babcock reliability rated relays featuring Vycor getters include:



BR-5—Transistor-sized dry circuit to one amp



BR-13—Microminiature, all-welded for dry circuit to 3 amp



BR-17—Half-size magnetic latching for dry circuit to 2 amp operation. Also available as non-latching model.

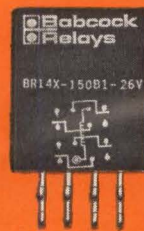

BR-14—Subminiature 4 PDT available in 10, 7.5 and 5 amp



BR-19—Subminiature all-welded 10 amp relay. BR-20 magnetic latching version also available.

Booth 2808—IEEE

BABCOCK RELAYS

A DIVISION OF BABCOCK ELECTRONICS CORPORATION
3501 HARBOR BLVD., COSTA MESA, CALIF. • 546-2711

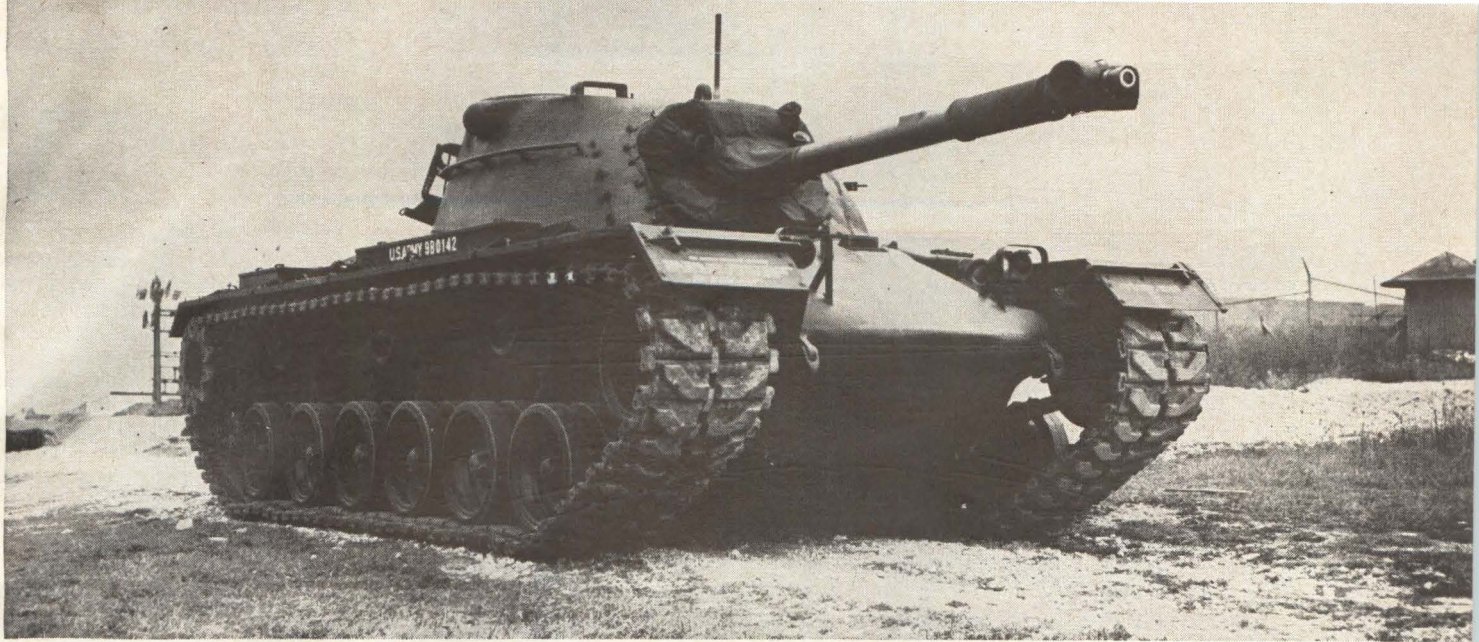

INFRARED photoelectric telescope is mounted in the M-48's gun. Radio antenna and infrared beacon assembly are mounted atop the turret

ELECTRO-OPTICS

MODERN WAR GAME MUNITIONS

The archaic sack of flour thrown against soldier or tank for a kill in war games of yore is gone. An infrared/r-f electro-optical hit blows a fuse, disabling equipment and painlessly filling casualty lists

By J. A. HOUSTON, Manager Electronics Engineering,
Aircraft Armaments, Inc., Cockeysville, Md.

REALISTIC COMBAT training is dangerous and expensive. Men have been accidentally wounded or killed crawling through the raucous explosions of the infiltration course. The amount of large caliber munitions expended in open field maneuvers is costly. As part of its safety program the Army is simulating live-firing weapons with electro-optical hit indicators. This realistic simulation allows full tactical flexibility, with safety and economy. Synthetic hit indicators, in maneuvers, fill the gap between live-fire instruction and actual combat. Simulated are such weapons as the M-14 rifle, the 90 and 106-mm recoilless rifles and the 90-mm tank gun.

These simulators not only solve training problems, but aid in developing battlefield tactics. Possible deployment of men and equipment can be quickly and inexpensively evaluated with positive results. The design techniques can also be used in other applications.

Operation—System operation is based on using an infrared (ir) link, having a narrow field-of-view (to simulate the pointing accuracy of the weapon) and an r-f link which activates the ir link. Emphasis in this article is placed on parameters effecting design of the ir link, which limits overall system effectiveness.

The basic operation can be followed in Fig. 1. In step 1 the tank fires when the gunner pulls his trigger. Several things happen. An f-m transmitter is turned on (step 2) transmitting an omnidirectional signal received by all potential targets in the area. Receiving this c-w signal causes potential targets to go from standby to target mode. In the target mode (which lasts for about half a second) the target tank's circuits are interlocked; the gunner cannot fire his weapon. An interrogation pulse of 250- μ sec is then transmitted by the firing tank, which activates a counter in each possible target. In step 3 each target flashes an omnidirectional ir flashlamp when its

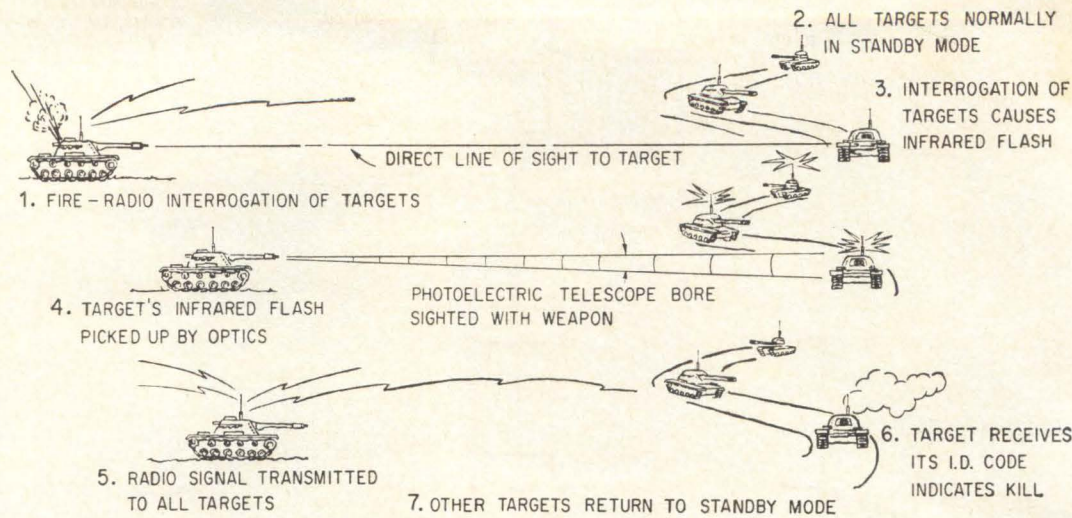

WEAPON/TARGET CYCLE operation is based on using an infrared link with a narrow field-of-view simulating pointing accuracy of the weapon. The r-f link activates the ir link. Smoke and loud boom add realism—Fig. 1

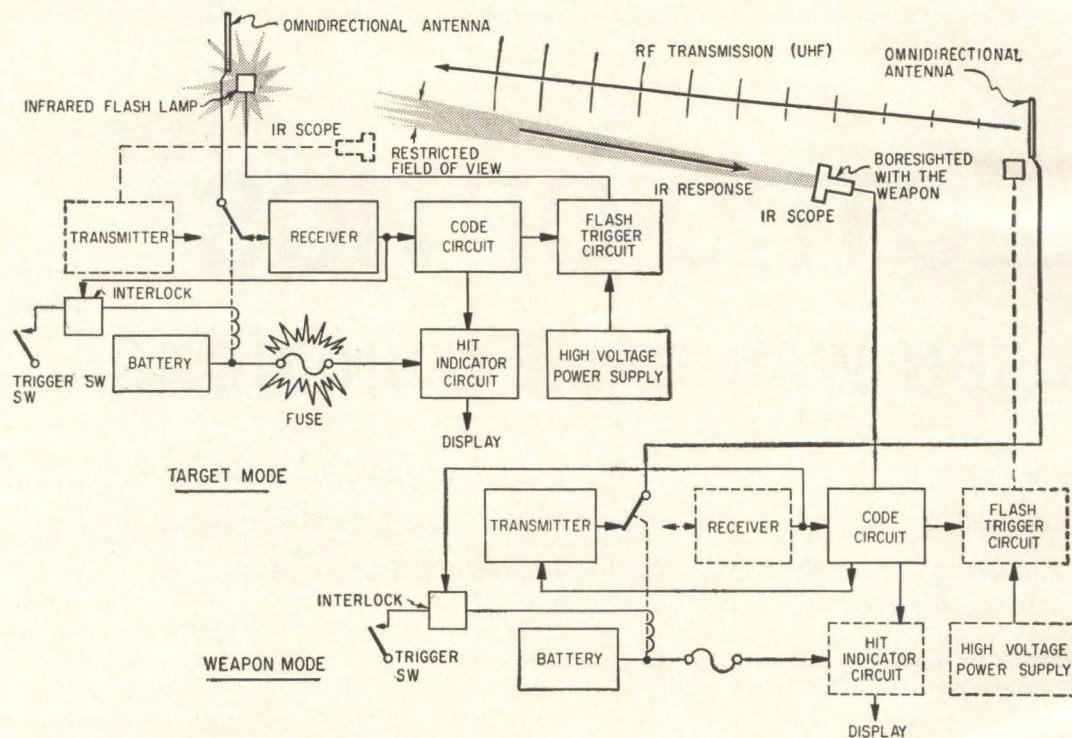

TARGET-WEAPON MODE for simplified hit indicator system. Pulling trigger turns-on weapon's transmitter and connects it to antenna. Target's weapon is locked-out of weapon mode. R-f signal blows a disabling fuse gun—Fig. 2

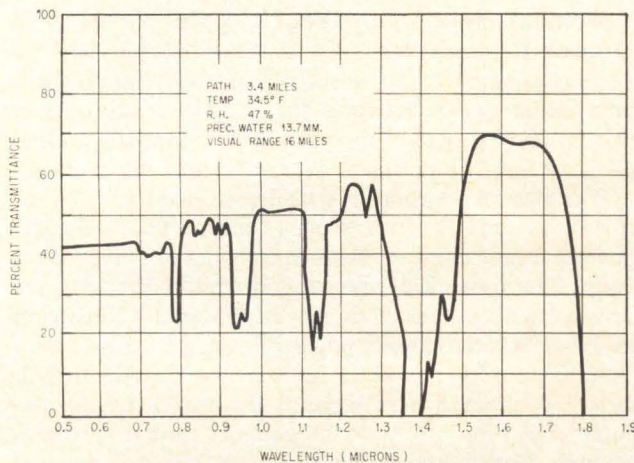

CARBON DIOXIDE, and water, absorption is small in window or low attenuation spectral regions. Windows are used for ir transmission over 2,000-meter paths—Fig. 3

counter reaches a preset code number (all targets have different code numbers). 10- μ sec ir flash from the sighted target is received by the firing tank's optics (step 4).

This weapon generates a second r-f pulse, one count or 500- μ sec after receiving the ir flash from its target. (All targets receive the second pulse, but only that target whose code number is correct responds.) In step 6, when the r-f transmission is correct for a particular target, noise and smoke displays are activated indicating a kill and the target's weapons remain interlocked, his equipment is disabled. All other targets and the just-fired weapon go back to the standby mode until one of the tanks pulls his trigger to fire at a target. The cycle is then repeated.

Basic System—Figure 2 shows the basic system. The units are normally in a standby mode with receivers

PULSED LIGHT from xenon arcs measured over one-mile path shows average fluctuation from 3 to 1 to 6 to 1. Xenon source used to obtain this test data is compared with a typical 500-w tungsten light bulb—Fig. 4

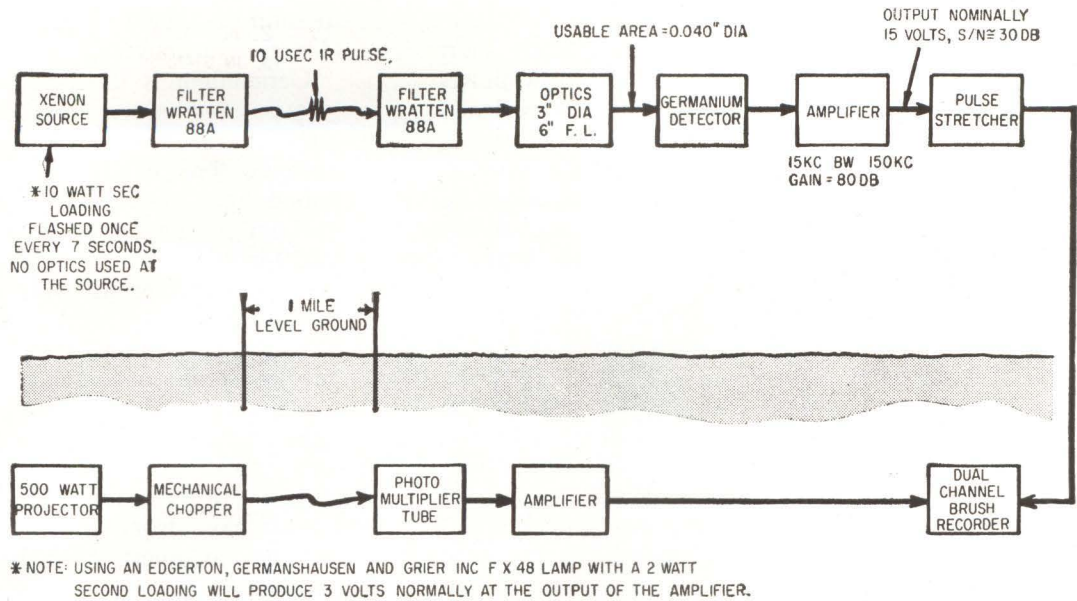

connected to the antenna. When the trigger is pulled, the firing weapon's transmitter is turned on and connected to the antenna. The target's antenna relay is interlocked so the unit cannot go into a weapon mode.

Hit indicators have been developed with code circuits capable of handling more than 100 devices in the field. The entire sequence of operations can be accomplished in 1/2 second or less depending on the number of identification codes built into the system. When an electro-optical hit has been scored a fuse in the target is blown, turning the equipment off and also providing a permanent indication that it was hit.

Most of the solid-state circuits used are reasonably straight-forward with special attention given to circuit reliability and low power consumption. The latter is required since all systems are battery operated.

Infrared Link—The most critical design problems were in the ir link. System effectiveness directly depends upon reliability of the ir transmission, and maintaining an optical field of view equivalent to the target's vulnerable area. Maximum operating range for the simulated weapons varies from 500 meters for the M-14 rifle to 2,000 meters for the 90-mm tank gun.

The near-ir frequency spectrum between 0.7 and 1.7 microns was chosen for the hit indicators. Several factors determined this selection. This range is not widely used and the devices are not likely to interfere with other systems. It is possible to obtain sensitive, fast-responding detectors such as germanium and silicon in this region. Off-the-shelf ir sources, such as xenon lamps, are available and capable of generating short duration pulses (working the system in a pulsed mode greatly reduces the detrimental effects of high background radiation from the sun and other sources).

IR Transmission—Transmission of ir over 2,000-meter paths poses novel and perplexing problems caused primarily by atmospheric conditions. Fog,

haze, water vapor, dust, wind and thermal conditions markedly effect ir transmissions.

A first order approximation of the atmosphere attenuation is

$$P_R = P_T \frac{e^{-\sigma R}}{R^2}$$

where: P_R = power received; P_T = power transmitted; R = range; and σ = attenuation constant. (This equation does not hold for narrow-beam laser work in this spectrum.)

The $e^{-\sigma R}$ term is an approximation of the average attenuation due to the above factors. The σ factor may vary over a 1,000 to 1 ratio for a given atmospheric condition, neglecting dense fog. This equation also does not take into account monochromatic sources but is valid only for the integrated region including the visible and near ir.

Figure 3 shows the attenuation due to atmospheric conditions in this region. The atmosphere is anything but a homogeneous mass. The bands of high attenuation are due to CO_2 and H_2O absorption and will vary at different locations depending upon whether the range is over ground or is a slant range. It is therefore imperative to work in one of the windows (minimum attenuation spectral regions) or to work over a wide spectrum to account for these losses.

The second-order terms neglected in the equation are commonly known as atmospheric twinkle, scintillation or boiling. This is similar to the effect when viewing stars or can be seen when observing a distant object over a hot road.

IR Measurements—Measurements with pulsed light from xenon arcs over one mile paths with 1-inch sources and 3-inch diameter receiving optics have shown that average fluctuation from 3 to 1 to 6 to 1 can be obtained which shows relative agreement with classical methods. The test setup used to obtain the data is shown in Fig. 4.

Most of the signal variation is due to the attenuation in the atmosphere, but light refraction due to varying air masses also contributes to this effect. The hit indicator systems are designed to accommo-

date these fluctuations.

The pulsed xenon arc can be of extremely short duration, about 5 to 25- μ sec. With narrow pulses the problem of distinguishing the signal from background radiation is virtually eliminated. Low-frequency modulation due to movement of the receiver, wind blowing in trees or moving cloud edges can be easily filtered out in the receiver without degrading the intelligence. Power consumption of the ir transmitter is low since the energy-storage capacitor, once charged, needs only idling currents. The saving in power consumption over a typical non-ir system is shown in Fig. 4.

Power of approximately 30-w average can be used on continuous flashing systems over 2-miles and 0.5-w average while the system is idling (during periods when the lamp is not flashing). Tungsten bulbs of 40 to 500-w, plus the power for a mechanical modulating system, would be needed to achieve the same performance range.

Xenon plasma has a combined line and continuous spectrum which peaks at 1 micron, the spectrum of the arc is shown in Fig. 5A. The lamp does have an output in the visible region. Since the visible portion is not needed, filters such as the Wratten 88A dye filter are used.

Detectors—Wide spectrum and short pulses require the detecting system have sufficient bandwidth to respond to a 5 to 25- μ sec pulse and a spectral response matching the xenon output. Two types of detectors are shown in Fig. 5A and B.

Silicon, with a much longer time constant than germanium, extends out to 1.1 microns. A peculiar phenomena exists with silicon. Its low-frequency a-c sensitivity, much higher than germanium, is dependent on background (d-c) radiation from the sun and other sources, which can cause a silicon detector



PHOTOELECTRIC telescope is attached to infantryman's rifle giving 500-meter range. Helmet mounts the combined quarter-wave antenna and beacon unit

to saturate. This is particularly true in wide-angle (1-degree or above) receiving systems.

Germanium is the best compromise. It has the greatest effective sensitivity in this region and extends out to 1.7 microns before becoming transparent. Also, response time is more than adequate to match the pulsed light source. The major problem with germanium is obtaining large-area detectors (above 0.050-inch diameter), as there is not as much freedom in manufacturing as with silicon, where epitaxial techniques can be used. Alloy junctions, normally used with germanium, produce detectors which do not have constant sensitivity across the active area.

Since xenon transmission in the ir region is line-of-sight, the receiving system need only have a field view ensuring the proper ir transmitter has been sighted. In operation, transmitters or targets can be located close together and by proper sighting there will be no interference between the two at the receiver.

Video amplification of the received ir signal is straightforward. The low-frequency response need not extend below 5-kc to accept the ir transmitter pulse. This eliminates the background modulation mentioned earlier as well as transistor 1/f noise. Measurements show that the modulation due to scintillation and vibration of the receiver lies below 1,000-cps.

F-M R-F Links—Two types of r-f links have been used with the hit indicators. Pulsed f-m is used in the earlier versions, operating at 230-Mc. System operation described earlier uses this f-m system. Transmitter power output is 2-w, receiver sensitivity 2-mv and the overall r-f bandwidth is 40-kc. The transmitted pulses (interrogation and ir reply) are 250- μ sec long. Since the r-f transmission is non-periodic, the carrier is tuned about 6-kc lower than center-frequency and deviated + 12-kc when the pulse is being transmitted. The remaining unused bandwidth is required to accommodate oscillator drifts in the transmitter and receiver.

PPM R-F Links—The later versions of the hit indicators use a ppm (pulse position modulation) system operating at 140-Mc. This is a more efficient system than the f-m type. The transmitter and receiver have a 2-mv sensitivity for a 20-kc bandwidth. Again a 250- μ sec pulse is used to transmit the start, interrogation, and the ir reply pulses. In this system an additional start pulse is required to make a unit go into the target mode, whereas in the f-m system, this resulted from the c-w signal operating receiver-squelch.

Antennas—Simple quarter-wave dipoles or half-wave coaxial types are used. One restriction placed on the antenna design, particularly for the M-14 rifle and other man-portable systems, was the necessity to keep the antennas small and rugged, thus quarter-wave dipoles. The vehicle mounted systems have used both the quarter-wave dipole and the half-wave coaxial types.

Applications—The photo of the M-48 tank shows a

FILTER CHARACTERISTIC WRATTEN 88A

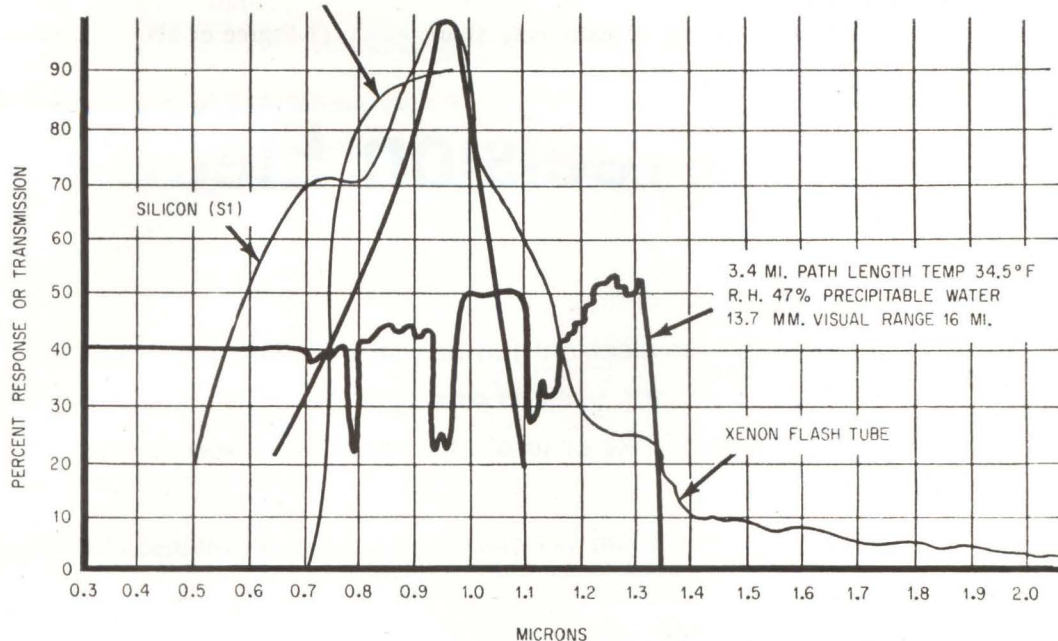

(A)

XENON PLASMA plotted in comparison of (A) silicon and (B) germanium detectors. Combination of xenon line and continuous spectrum peaks at 1 micron for silicon and 0.95 for germanium. Germanium is the better choice—Fig. 5

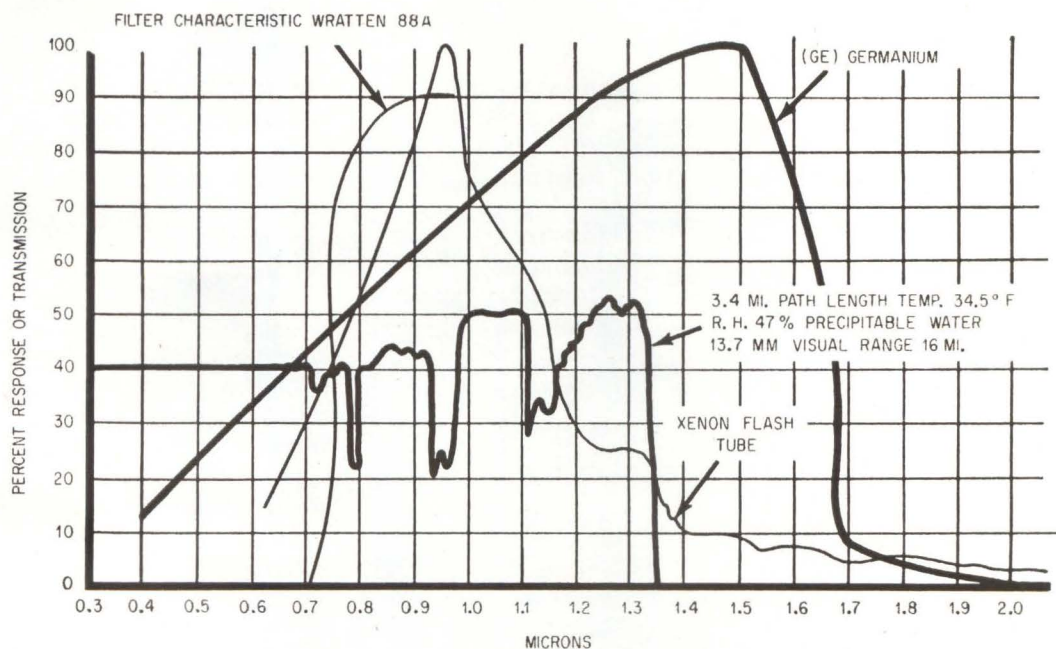

(B)

hit indicator system installed in its 90-mm gun. This same equipment also mounts without modification on the M-60 tank. The radio antenna and infrared beacon assembly are shown mounted on the turret. Mounted in the bore of the gun is the target-weapon unit, which contains the radio transceiver, power pack, and coding circuits. Also contained in this unit is the boresighted infrared photoelectric telescope, which can be seen extending from the barrel.

The infantryman's M-14 rifle hit indicator enables the trainee to score hits on live targets in simulated combat at ranges up to 500 meters. A photoelectric

telescope mounted on the rifle, the electronic pack carried on the trainees belt, and the helmet-mounted antenna/beacon assembly provide the infantryman with both target and weapon capabilities.

The systems discussed thus far have been used in the simulation of ground-to-ground direct (live) firing weapons. The system can be extended to include ground-to-air and air-to-ground weapons. Not only can weapons of various types be simulated, but the technique can be applied to beacon systems where it is necessary to locate and possibly identify a position on the ground for an air drop.

Precision Electron Welder

High-power electron gun has sharp beam focusing for precision work, uses an oxide cathode. The design permits a beam voltage of 25 kv or less, and requires no focusing magnets

By **KRISTIAN AALAND** and **RONALD HILL**, Lawrence Radiation Laboratory, University of California, Livermore, Calif.

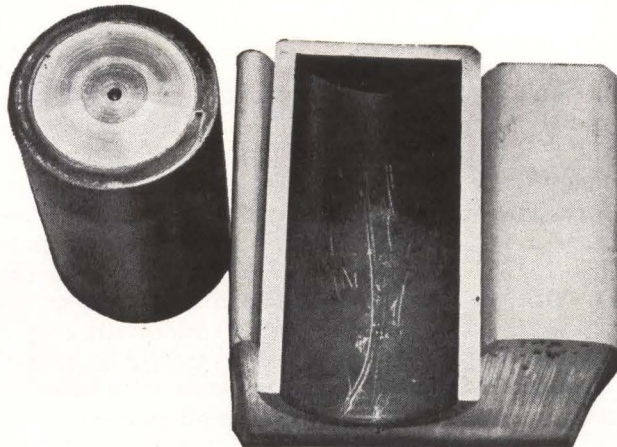
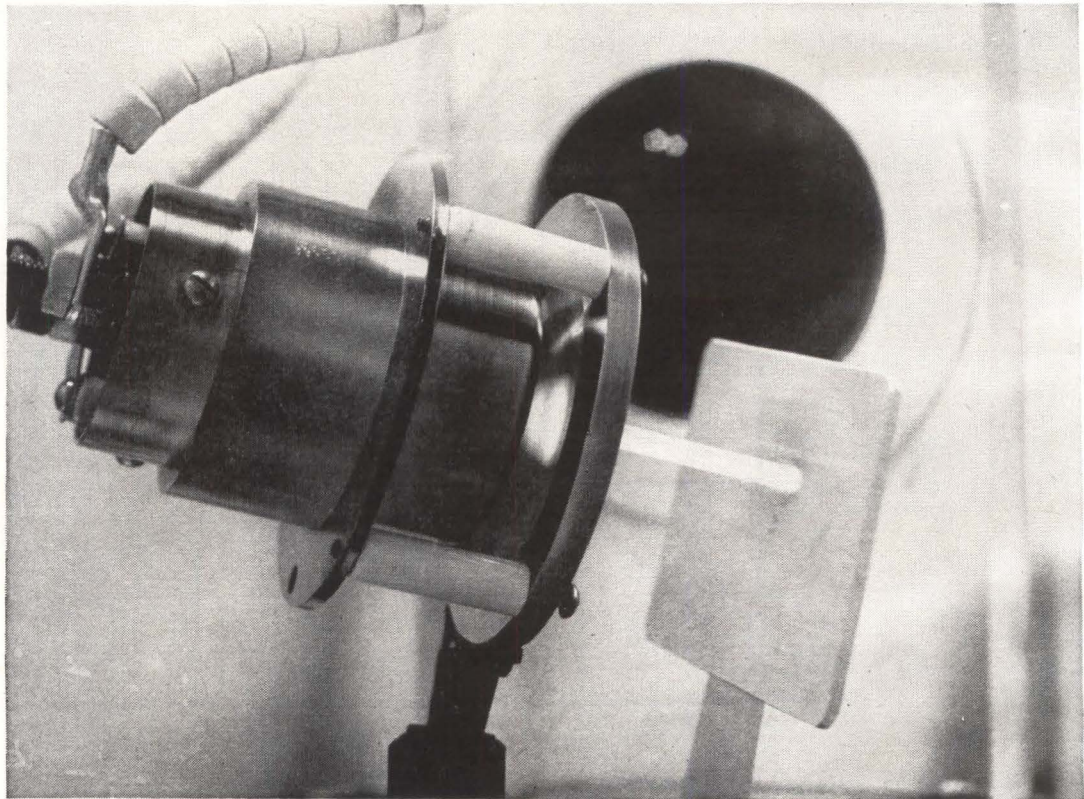

STAINLESS STEEL cylinder (walls 0.125 inch thick) with end disk welded on, and cross-section showing clean welds (left); close-up of electron gun shown on cover, drilling holes in a metal plate (above)

Uses Low Beam Voltage

A NEW electron-beam machining tool superior to conventional devices of this type has come as a side discovery in this laboratory's nuclear fusion research program.

Originally developed for plasma diagnostics, a pulsed electron gun with an oxide cathode has proved valuable for precision drilling, welding and soldering of bulk materials (p 18, Sept. 20, 1963). It thus joins a growing family of new electronic devices for machining (p 31, Oct. 25, 1963).

The machine is superior to other electronic machining apparatus in several ways: (1) it uses a relatively low pulsed-beam voltage of 25 kv or less and thus avoids x-ray hazards to the operator; (2) it has a relatively contamination-free cathode; (3) it requires no cumbersome focusing magnets; and (4) it produces sharp beam focusing, which permits precision machining of relatively large pieces.

Clean, tight welds were made with a d-c supply operating the gun. For instance, the seam weld made on the closed-end cylinder shown in the bottom photo was made in one pass of the electron beam, although no degradation of the seam would have resulted from two or three more "insurance" passes, depending on the type and thickness of the metal being worked.

Soldering is done at points of relatively great divergence from the focal point of the beam. Use of this beam tool depends greatly on technique, as with conventional types of welding apparatus. The permissible size and bulk of the work piece is limited only by the size of the available work chamber. However, this tool is especially suited for fine, precision work in appreciable bulk of material, not electronic microcircuits.

Of the metals worked to date with this tool, only copper has exhibited a detrimental effect on this type of oxide gun. The cathode is

made of nickel coated with a mixture of barium and strontium oxide.

Design Approach—The main goal in the development of this electron gun was the attainment of a narrow, high-density intense beam. While such a beam is easily obtained by the use of electrons accelerated by voltages above 100 kv (at currents of 100 to 250 ma), this method results in x-ray danger to the operator. x-rays with accelerating voltages of 25 kv or less are soft, and easily stopped by the vacuum vessel. Also, the use of lower voltage lessens insulation problems.

An oxide cathode solves the voltage problem by its high electron emission (perveance), and low exit energy spread.

Electrostatic beam focusing is used within a chamber of specified geometry—or Pierce-type geometry—through which the beam passes on its way to the anode. The work is performed in an evacuated chamber along with the gun, and the work (and the chamber) are at anode potential, which is ground.

The complete beam tool is shown in Fig. 1. The basic system consists of a pulse generator, pulse amplifier, filament gate and the electron gun. Additional units are an oscilloscope monitor, an a-c line scaler and associated power supplies. The pulse generator in the system has variable control of pulse width and repetition rate, allowing the pulse to be adjusted consistent with the geometry and heating curve of the work

UNIQUE FEATURES OF THIS TOOL

- Oxide-cathode contamination problems are reduced by using a large barium-strontium oxide cathode (1 inch in diameter)
- No focusing magnets are needed with the stainless-steel Pierce-type lens system
- Operating voltage is below the x-ray level to avoid operator hazards
- Filament voltage is gated to keep the filament's magnetic field from defocusing the beam

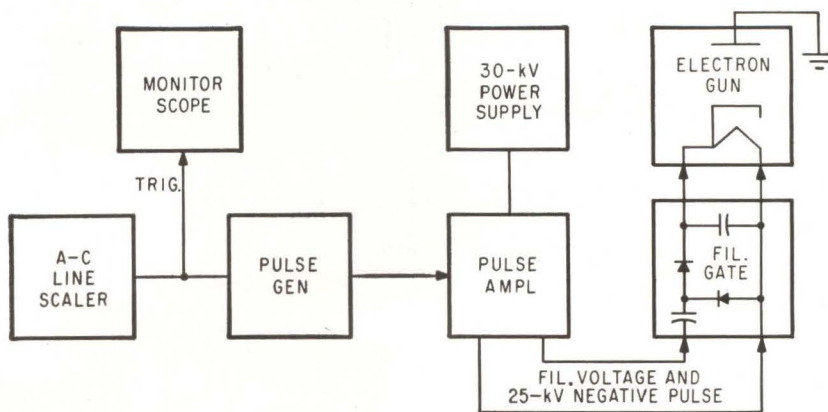

ELECTRON-BEAM welding and machining tool. Oscilloscope permits monitoring pulse width and repetition rate settings—Fig. 1

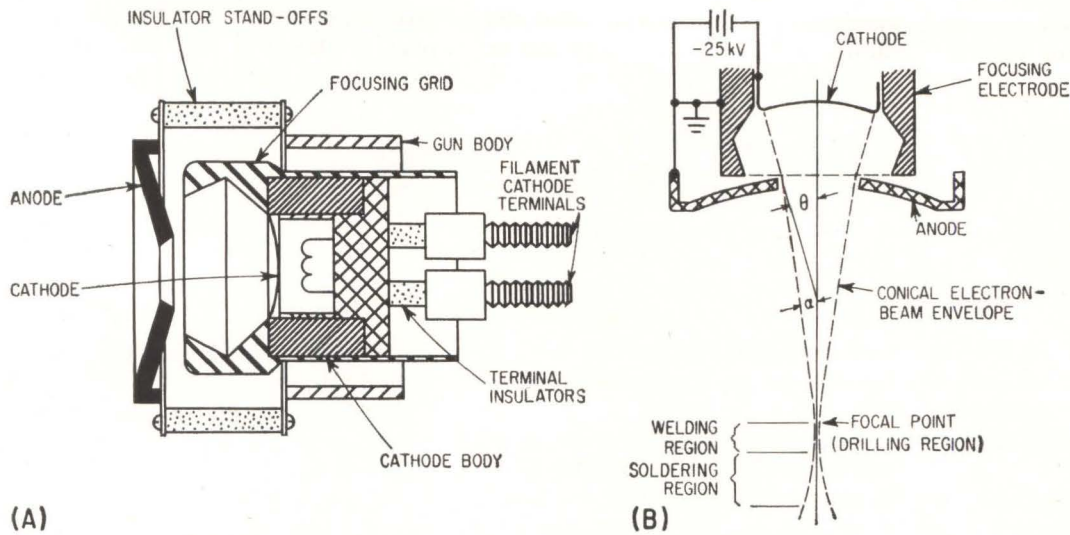

ELECTRON GUN (A) and electron beam envelope (B), showing the relationship of the gun electrodes required to obtain a sharp, electrostatically-focused beam—Fig. 2

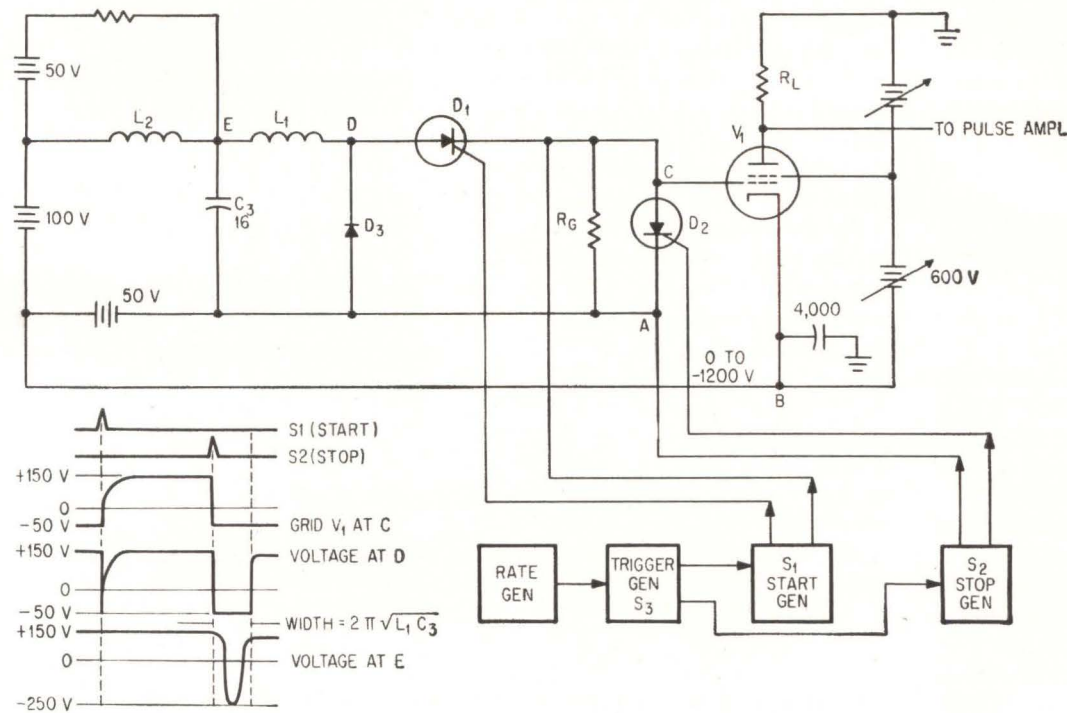

PULSE GENERATOR, in which the last three waveforms are measured with respect to point B—Fig. 3

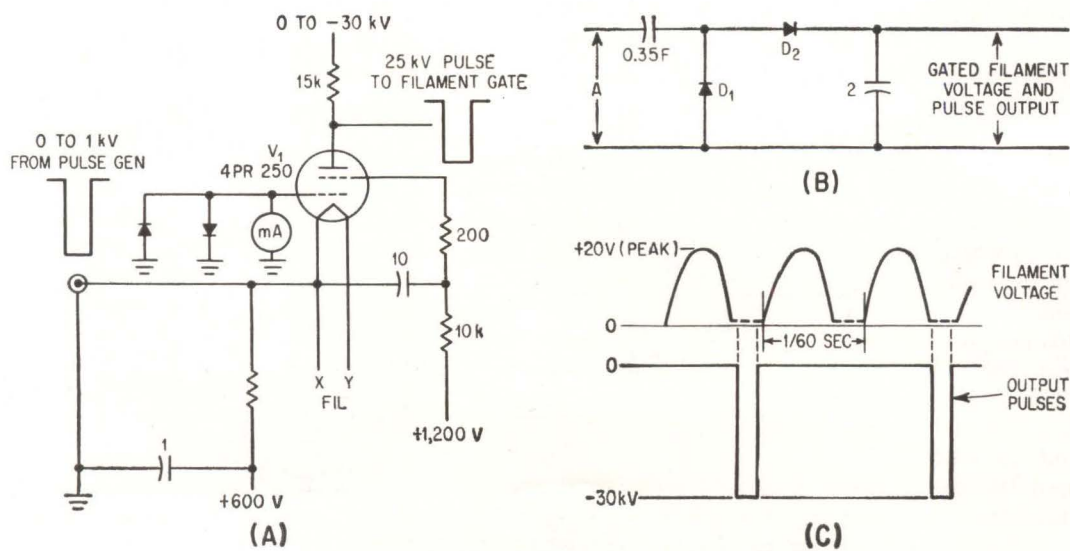

PULSE AMPLIFIER (A), with adjustable bias and screen voltages; filament gate (B) and waveforms (C), with output pulses selected during filament dead time—Fig. 4

to be performed. For instance, relatively thick metals require several pulses from the gun for hole penetration, while for welding purposes, the beam of high repetition rate in a defocused configuration may be desirable.

Electron Gun—Commercial-type guns operate in ranges upwards of 130 kv at around 250 ma, whereas, with the 25-kv, 1.5-ampere pulsed beam produced by this gun, only soft x-rays are produced, resulting in safe personnel environment.

The beam is focused by an electrostatic field shaped by the Pierce-type geometry of the focusing electrode as shown in Fig. 2. At its focal point this beam is capable of cutting holes of one-mil diameter. At a short distance away from the focal point, it will perform welds that are completely clean due to the absence of oxidizing gases. (Note cleanliness of weld on edge of the closed-end cylinder in the bottom photo, and the vacuum-tight seal obtained on a cutaway section of the cylinder.)

The Pierce-type geometry¹ of this gun eliminates the need of magnetic-beam focusing on the condition that a relatively short beam focal length is adequate for the types of work for which the gun is intended (see Fig. 2B).

If the diameter of the cathode is larger than the anode aperture by a factor of at least two, the beam will continue to converge as it leaves this aperture, but will do so at a decreasing rate. That is, the beam will in fact tend to diverge once it is free of the gun structure as would be expected, but will not fan out before it has formed a conical, one-mil spot (applied to the "hard core" of the beam—as verified by impulse drilling) at the focal point. This focusing action beyond the gun structure is due to high electron acceleration.

Once the beam passes through the focal point, however, it diverges rapidly. It is within this divergent region that the beam is found to be well suited for welding and soldering operations.

Figure 2B shows that the convergent angle θ and the divergent angle α are varied by moving the anode axially with respect to the cathode to establish different focal lengths. To accomplish anode

movement, the insulator stand-offs shown in Fig. 2A are shortened or lengthened.

The shape of the focusing electrode plays a vital role in forming the beam into its conical shape. This is Pierce-type geometry, brought to its final shape by trial and error.

Pulse Generator—This unit uses a start-stop pulse generating principle. The output is a variable 3 to 60 pps, 0.2 to 2-msec signal to the pulse amplifier.

The repetition rate and pulse width are controlled by three plug-in timing devices labeled S_1 , S_2 and S_3 in Fig. 3. The timers are connected so that S_3 is triggered from a repetition rate timer, and then triggers S_1 and S_2 . The time difference between S_1 and S_2 at the gates of D_1 and D_2 (point C) determines the pulse width applied to the control grid of V_1 (Tube V_1 in Fig. 3 actually represents four tetrodes connected in parallel.)

At first, the "start" scr (D_1) is positive with respect to the most negative d-c voltage available at point A, which is applied to the control grid of V_1 . The STOP pulse then gates D_2 , which shorts out the output of D_1 , removing positive voltage from the V_1 grid. Then D_1 is shut off by the single cycle swing of L_1 , a 40- μ h choke, and C_3 , a 16- μ f capacitor. Thus, a small negative voltage is applied to the anodes of D_1 and D_2 , allowing them to recover during the second half of the cycle. The second half of the cycle passes through D_3 ; C_3 will then be recharged to approximately the original voltage, at which time the operation is ready to repeat itself.

Amplifier bias is obtained by returning the grid of V_1 to the potential at point A through resistor R_G . The screen grid is tied to a point 600 volts positive with respect to the cathode. A negative, adjustable (−600 to −1,200) voltage applied to the cathode of V_1 sets up plate voltage through resistor R_L to ground (ground is the most positive point in the circuit). The large, 4,000- μ f capacitor from cathode to ground supports current drain for long pulses.

Pulse Amplifier—The pulse amplifier consists of a type 4PR250, high-voltage tetrode amplifier and

associated circuits and power supplies as shown in Fig. 4A. It has direct cathode coupling and biasing to avoid pulse-width limitations which would result from the use of coupling components.

The output is a −30 kv maximum signal rated at two amperes, with the repetition rate, pulse width and variable amplitude governed by the inputs. Rise time is 0.5 μ sec, independent of pulse width, with maximum droop of ten percent at rated output.

Filament Gate—The gun that produces the electron beam includes an indirectly heated cathode, a filament and the anode. When a-c current was applied to the filament heater, a magnetic field was set up in the vicinity of the cathode, disturbing the fine focusing of the beam. For pulsed operation, some means was required whereby filament current could be interrupted during the time when the cathode of the gun was pulsed. The solution arrived at is a 60-pps pulsating heater current produced by the circuit shown in Fig. 4B, the filament gate.

In this circuit the input heater voltage, supplied by an isolation filament transformer, is applied at A, shown in Fig. 4B by an arrow across terminals. The large input capacitor (0.35 farad) charges to the peak value of the a-c voltage applied (Fig. 4C). This voltage then appears, superimposed on the a-c voltage, as a "unidirectional a-c" output. One volt is subtracted by the series diode, assuring zero output over a certain positive phase angle.

Therefore, what is effectively accomplished is the heating of the filament during the positive 16-volt swing, after which there is a resting period of approximately three msec, during which the cathode is pulsed with the beam signal from the pulse amplifier. Electron emission thus results from the residual heat on the cathode of the gun.

The development of this tool was performed under the auspices of the U.S. Atomic Energy Commission.

REFERENCE

(1) L. H. Lawrence, "Introduction to Electron Beam Technology," pp 85-88, R. Bakish, Editor, Wiley & Sons, Inc., New York, 1962.

THE DIFFERENCE

Previously announced storage tubes, both of the image-conversion type and the direct-viewing type, all use an electron beam from the electron gun to write the signal. In the Toshiba tube, the image is written on the storage surface by the photoelectric current caused by the incident illumination. Other grid-control-type storage tubes use the electron current that gets past the storage electrode. This tube resembles the image-orthicon, as it uses the return electron current to reproduce the image; it is the first storage tube to do so

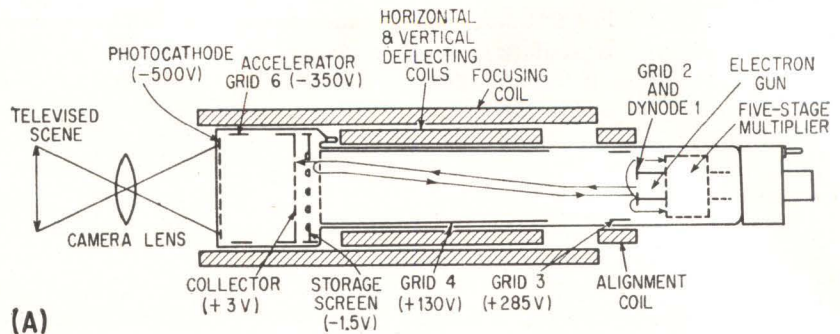

(A)

STORAGE PICKUP TUBE, with voltage values at read-during-write operation (A); model (B) of transmission modulation by storage tube during reading—Fig. 1

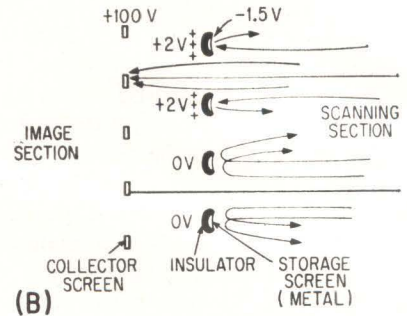

(B)

STORAGE ORTHICON Holds Image for Hours

Tube with an electronic shutter provides a succession of still images immediately after exposure, can be read out as long as ten minutes later, or stored unused for ten hours

By KAICHIRO ODAGAWA and YOSHIKI NAKAYAMA

Central Research Laboratory, Tokyo Shibaura Electric Co., Ltd., Kawasaki, Japan

NEW pickup storage tube works as a photographic film that needs no developing, and is both a camera tube and a storage tube. Immediately after this tube shoots a scene, it can continuously reproduce an excellent picture signal for at least 10 minutes, or it can store the scene without reproducing it for more than 20 hours. If some degradation is permissible, the image can be reproduced continuously for up to 30 minutes.

Signal-to-noise ratio is more than twice as good as that of the standard image orthicon type 5820; gray-scale and resolution characteristics are also good. This tube is similar to the 3-inch standard image orthicon except the target, and it

can be used in commercial television cameras with some simple circuit modifications. If only the read-while-write mode of operation is required, this tube may be inserted in the camera in place of an image orthicon without modifying the camera; for use in other modes, a rotary switch must be added for changing electrode voltages. The image section of the tube can be used as an electronic shutter. Its sensitivity is about ASA 30 at present, but this will be increased to 100 with a multi-alkali photocathode, and to 1,000 with image intensification as in the intensifier orthicon. The tube with an image-intensifying section may be called an intensifier pickup storage tube.

Construction—The tube construction is shown in Fig. 1A. It is similar to the image orthicon except for the target. The storage electrode is a fine metal screen (750 to 1,000 mesh) instead of the glass membrane of the image orthicon. An insulator such as CaF_2 is evaporated on the photocathode side of the screen, and thin metal (aluminum) on the other side.

Operation—This tube operates on two principles that differ from those underlying ordinary storage tubes.¹⁻⁴ Writing is done with photoelectrons rather than with an electron beam from an electron gun. Reading is by electrons that cannot pass through a storage screen, rather



AUTHOR Odagawa observes monitor display of test pattern image from pickup storage tube signal

than by those that do.

The tube is operated in four steps: writing, reading, erasing and priming.

Writing is the same as in the image orthicon. The photoelectrons strike the insulator of the storage mesh, and emit some secondary electrons, which are collected by the collector whose potential is +10 volts. The potential of the insulator surface is zero at first, and builds up to a few volts positive corresponding to the quantity of photoelectrons involved. Thus, a positive-charge pattern is built up on the storage target.

When this pattern is read by a scanning beam from the scanning side, the potential of the insulator surface controls the transmission of the beam as shown in Fig. 1B. The beam electrons that cannot pass through the storage screen return to the electron-gun end of the tube and into the multiplier, as in the image orthicon. (Note that the same piece of metal is both electron-gun grid 2 and electron-multiplier dynode 1; this combination is only for convenience in tube manufacture: the two functions are not interrelated.) The electrons that pass through the storage mesh are collected by the collector, whose potential is about +100 volts. These electrons do not destroy the stored charge, and the picture can be reproduced more than ten thousand

times. The photocathode is kept positive in this operation, so as not to repel electrons to the storage surface. The output signal current is several microamperes.

Erasing can be done by a light flash or with electron-beam scanning. If uniform light is flashed on the photocathode when the electrodes are biased for writing, the potential of the insulator surface of the storage mesh rises uniformly, and the stored charge pattern is erased.

To erase with electron-beam scanning, the storage-mesh potential should be raised to about +100 volts, and the potential of the collector decreased to -3 volts. In this case, the electrons that pass through the storage mesh are repelled, strike the insulator, and uniformly bring the potential slightly positive with respect to the back metal screen voltage. This operation takes nearly one second.

Priming is necessary to produce a good picture. The collector mesh is kept at -3 volts, and the storage electrode at -1.5 volts. The scanning-beam electrons that can pass through the storage mesh are repelled, attach to the surface of insulator and decrease the potential of the surface to about zero volts. In this case, it takes nearly 3 seconds to finish the operation. After this, a new scene can be written.

This is a "read-after-write opera-

tion." But the tube can also be operated under "read-during-writing operation," as can the image orthicon. That is, reading is possible while writing. The electrode voltages are the same as for writing, but the collector voltage is made lower; for example, +3 volts. Then, a continuous signal of good quality can be obtained for a stationary scene. When the scene is changed, the old signal decays and the new signal is built up in a few seconds, which is convenient for adjusting optical focus.

This tube can be used with or without a mechanical shutter. The image section of the tube is used as an electronic shutter. When the photocathode is kept positive with respect to other electrodes, the photoelectrons return to the photocathode. When the photocathode voltage is changed to the same negative value as in the writing and read-while-writing operations, the photoelectrons reach the target and store an electronic pattern. Thus, a negative pulse of several hundred volts is used for the electronic shutter.

Performance—The sensitivity of this tube is about ASA 30, compared to photographic film. Numerically, this is two orders of magnitude lower than that of an image orthicon, due to the larger capacitance between the surface of the insulator and the metal of the stor-

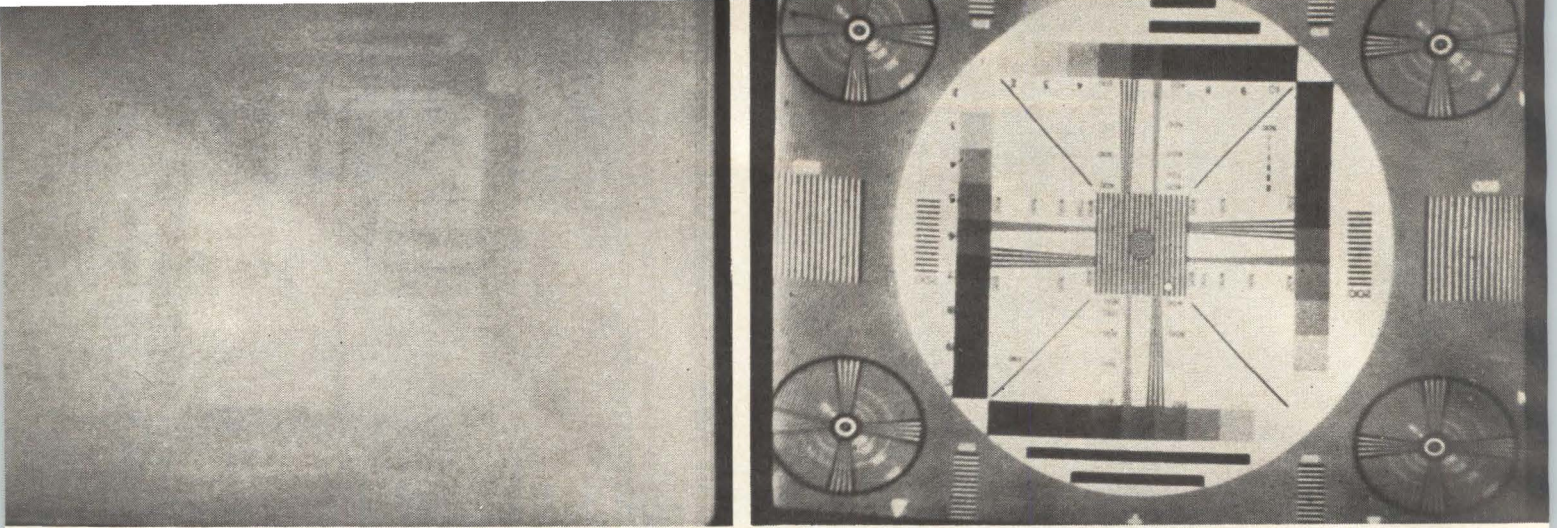

COMPARISON of seeing capability of image orthicon, type 5820, in normal operation (left) and pickup storage tube (right, 12-minute exposure) for low-light-level object, with 0.01-lux pattern illumination, $f/2$ lens opening. Diagonal bar in left photo is due to slow speed of focal-plane shutter; moire pattern in right photo, by interference from nearby station—Fig. 2

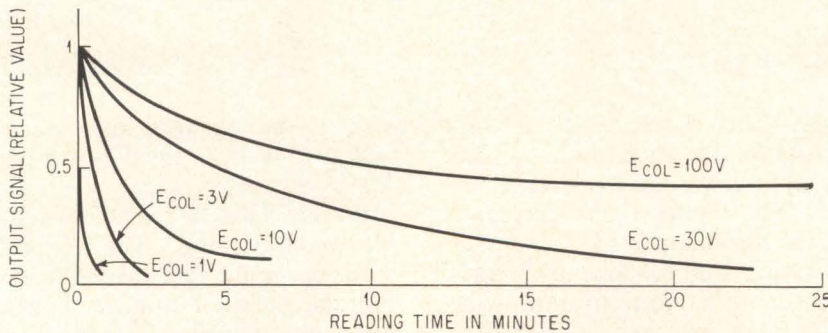

CHARACTERISTICS of output-signal decay during good operation—Fig. 3



REPRODUCED IMAGE from pickup storage tube, with 1,500-lux illumination, $f/2$ lens opening, 0.1-sec exposure—Fig. 4

age electrode. But when the image is stationary and a longer exposure time is allowed, the pickup storage tube can see a darker scene than can the image orthicon (see Fig. 2).

While the stored charge is being read, the output signal decays slowly. This speed can be controlled by changing the collector mesh voltage as shown in Fig. 3. The time required for the output signal to fall to the half of the initial value varies from several seconds to more than ten minutes.

This long persistence makes it possible to observe an image not only after exposure, but also at any time during the exposure, which is convenient for the observation of dark objects as in astronomical observations.

When the scanning beam is off, the stored charge pattern is held for more than 20 hours, which is much longer than pickup tubes such as image orthicons and vidicons.

The contrast range is wide, and better than that of the image orthicon (see Fig. 5A). An example of a reproduced picture is shown in Fig. 4.

The resolution is about 600 tv lines.

In this tube, the signal current increases as the beam current is increased (Fig. 5B), a characteristic that is different from ordinary pickup tubes. There is a maximum in the output signal current when the beam current is increased. The signal current decreases for too much beam current; this may be due to the velocity distribution of the scanning electrons.⁵

The noise in the output signal is due mostly to the noise in the beam current. The noise increases in proportion to the square root of the beam current value. Thus, the signal-to-noise ratio reaches a maximum at some particular beam current (see Fig. 5C). The maximum value is about 70, twice that of the image orthicon type 5820.

Applications—The television camera with this tube serves as a “sixty-second” camera, but it produces an image faster than the latter. Moreover, this tube can be used repeatedly. Like a photographic camera, the tube can be widely used in industry and science.

This tube will be used for astronomical observation: star images, night light distribution, or special distributions of these. The magnitude of the output signal can be readily measured with a line-selector oscilloscope. The photocathode is more sensitive than photographic film. An intensifier pickup storage tube will be able to see darker objects than can photographic film.

The tube will also be used for nondestructive inspection television utilizing x-rays, which may be generated from an x-ray tube, a betatron or a linear accelerator. When an object is still and a longer exposure period is allowed, this tube can pick up dark scenes which the image orthicon cannot.

In an experiment with an x-ray television system that used a betatron energy source and an image intensifier tube, an image orthicon could produce only a noisy picture. Bright areas several millimeters in size on a 10-inch monitor moved randomly, showing the fluctuation of quanta of x-ray. When this tube was used read-during-writing operation in place of the image orthicon, a smooth and noiseless picture was obtained. This was due to the S/N improvement by the integration of the input signal. For the image orthicon, the exposure time was fixed at 1/30 sec. But this tube has a persistence character. Then the effective exposure time was varied between several seconds and more than ten minutes, depending upon the brightness of the image.

For x-ray television, an image orthicon or a vidicon camera tube and a signal converter storage tube may be used together, to minimize

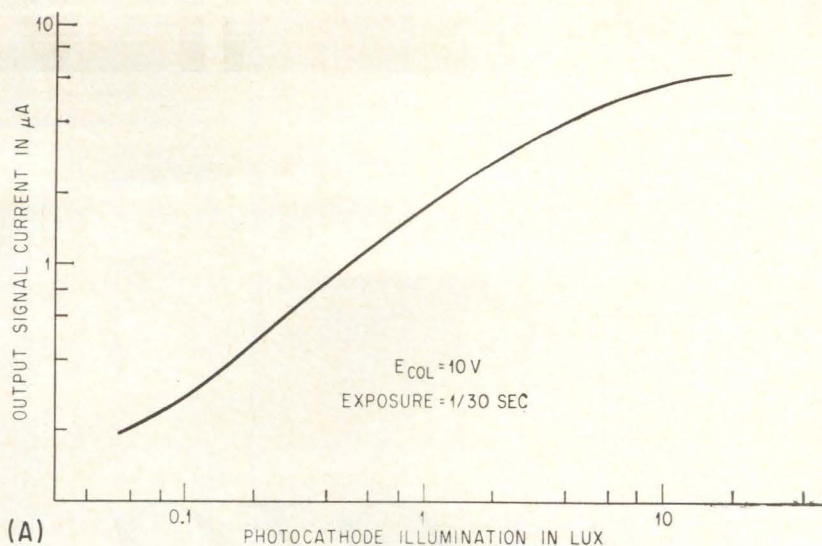

(A)

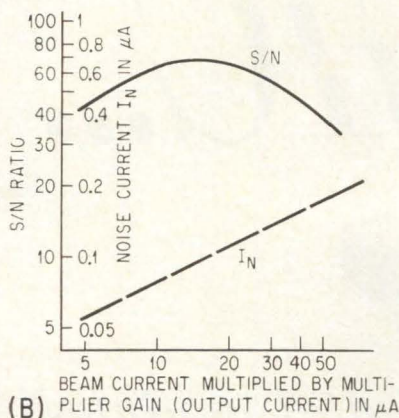

(B)

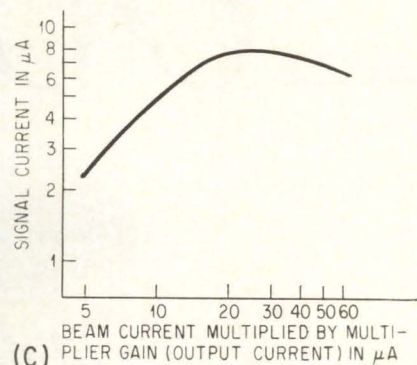

(C)

LIGHT-TRANSFER CHARACTERISTICS of the pickup storage tube (A); plot of S/N ratio and noise current as a function of beam current (B); signal output as a function of beam current (C)—Fig. 5

the x-ray dose. In this case, this tube offers a signal with better signal-to-noise ratio. In the former case, the camera tube or the circuit increases the noise in the signal. But in the latter case, the photoelectrons accumulate directly on the storage surface. Therefore the reading process brings no obstructive noise.

A bright image such as an explosion can be seen with a short exposure time. This tube may also be used for sports and exercises. An instantaneous observation is possible.

With strong flash of light such as a laser, the tube will be used for an optical radar that gives the image of a target in addition to its distance and direction. The distance of the target is measured precisely by knowing the time between the light flash and gating of the image section to open the shutter. When the light is insufficient, repetition of flash and gat-

ing will provide a picture of good signal-to-noise ratio.

The tube is a prototype. Some developments on this tube, such as attaching an image intensifier section or a control grid for photoelectrons, are possible if required.

Sincere gratitude is extended to Toyohiko Okabe for his guidance, to the people who made the experimental tubes, and to Teruaki Doi for his assistance.

REFERENCES

- (1) R. C. Hergenrother and B. C. Gardner, The Recording Storage Tube, *Proc IRE*, Vol. 38, p 740-747, July 1950.
- (2) Y. Nakayama and K. Odagawa, Signal converter storage tube M7021, *J of the Institute of Television Engineers of Japan*, Vol. 15, p 135-142, March 1961. (In Japanese)
- (3) Y. Nakayama and K. Odagawa, Scan-conversion storage tube, *J of the Institute of Television Engineers of Japan*, Vol. 15, p 401-404, July 1961. (In Japanese)
- (4) K. Odagawa, Beam-landing in an image orthicon, *J of the Institute of Electrical Communication Engineers of Japan*, Vol. 46, p 850-856, Nov. 1958. (In Japanese)
- (5) K. Odagawa and Y. Nakayama, A new method to measure of noise in an image orthicon, *1961 National Convention Record of the I.E.C.E. of Japan*, 264, Oct. 1961.

LOGIC...

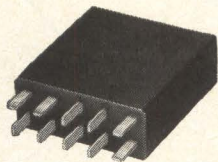

*New line of digital modules
offers flexibility, economy
and high packaging density*

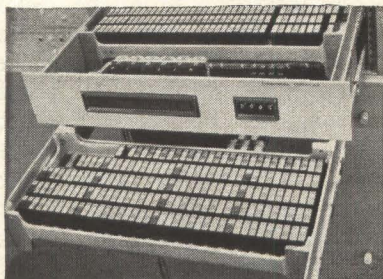

horizontal drawer mounting

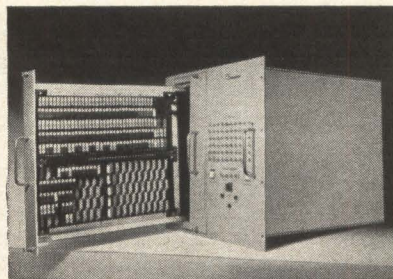

vertical drawer mounting

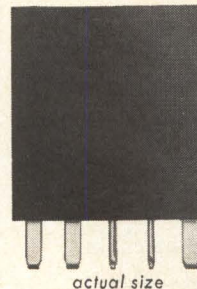

actual size

Radiation Incorporated now provides the most versatile and reliable line of logic modules available today. Superior electrical design and unusual stability have been proved through use in a wide range of digital applications. Calculated mean time before failure indicates a significant breakthrough in high reliability design. For example: based on extensive tests, MTBF for Radiation's low-speed NOR Module is in excess of 2,940,000 hours!

FLEXIBILITY...

Two sets of fully compatible resistor-transistor logic circuitry are available. One operates at bit rates up to 200 kc, the other at rates up to 1 Mc. More than a dozen standard modules are available from stock. Types include: 4-input NOR; Counter Shift Register; Power Inverter; Emitter Follower; Complementary Driver; Differential; and Filter (Decoupler).

ECONOMY...

Radiation Logic Modules provide unusual economy of use. Each module represents a fraction of the entire digital system, and is designed for easy interrogation. Replacement or circuit changes is achieved by simply plugging in another unit. Downtime is greatly reduced, and bench work is completely eliminated!

PACKAGING DENSITY...

Construction consists of welded circuitry molded in epoxy, and mounted with high-density module connectors on cast aluminum frames. The resulting positive-contact module measures only 0.4x1x1.1 inches, with a 1/4-inch pin protrusion. This configuration permits packaging densities of 113 to 137 modules per inch of panel space in standard racks. In addition, the units may be mounted in any manner—vertical or horizontal drawer, removable or fixed.

Write or phone for technical information on these unique logic modules. Radiation offers the services of its experienced engineering staff in the application of logic modules. We will also be glad to help solve your unique data problems. Radiation Incorporated, Products Division, Dept. EL-03, Melbourne, Florida. Telephone: (305) 723-1511.

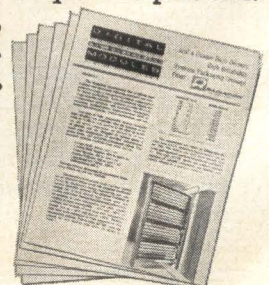

RADIATION
INCORPORATED

DeGaulle's Grand Design

Booms French Electronics

France's nuclear and space ambitions create opportunities and problems for U.S. firms

By DEREK BARLOW, McGraw-Hill World News

PARIS—France's electronics industry is, like French politics, a rapidly growing power in Europe. President Charles de Gaulle's grand design to rebuild France's prestige and world position has sent the industry soaring past the billion-dollar-a-year mark.

Like a philosopher's stone, de Gaulle's ambitions have transmuted normal, planned industrial growth into a renaissance.

France's economic recovery was begun after World War II by planning priorities that concentrated on the rebuilding of heavy industry. However, effects of the plans were often obscured by the ups and downs of French politics.

When de Gaulle took charge he gave French technology a forceful focus and impetus by giving priority to ambitions. Among these are France's own nuclear *force de frappe* complete with air and submarine delivery systems, and the biggest space program in Europe.

France's relatively sophisticated electronics industry would probably have prospered anyhow, in the general European business boom and in the Common Market's trend to single-market orientation. But de Gaulle intends that France shall lead the European community.

His challenge—that his countrymen live up to his

TANK CARS are automatically filled up with the right products and are identified by control system installed at Strasbourg refinery (Compagnie Generale d'Automatisme)

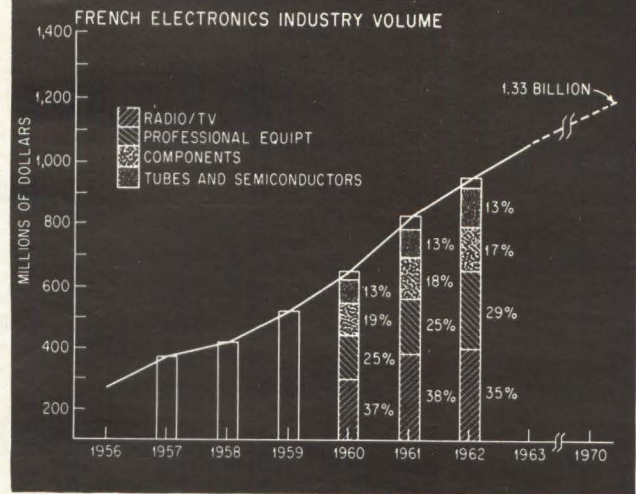

concept of France—has set the climate for expansion, experimentation and advancement in electronics and other technologies. Research investments have been phenomenal for a country the size of France. Earmarked for the nuclear strike force alone over the next five years is an estimated \$10 billion.

De Gaulle's political, economic and technical policies create both opportunities and problems for American electronics companies. Where France cannot supply its needs, it welcomes U.S. products and technology. But American participation is resisted in fields where the French are competent.

Even American electronics companies with little stake in the French market may soon feel the effect

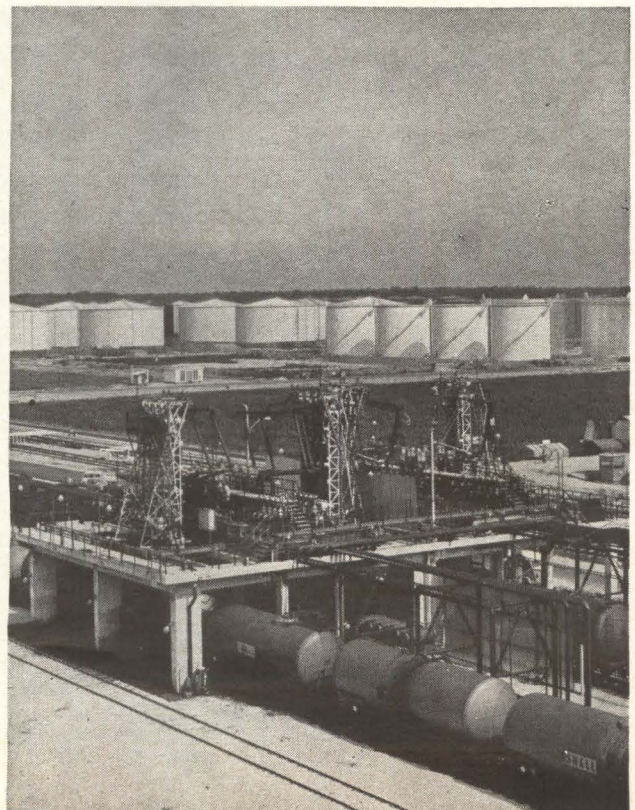

Announcing



Modern Design Contest

FIRST PRIZE

\$ 1 0 0 0 00

SECOND PRIZE

\$ 5 0 0 00

THIRD PRIZE

\$ 2 5 0 00

BUD RADIO, INC. is the nation's largest producer of standard sheet metal enclosures for the electronic industry. Although we have our own design staff, we are always looking for new, fresh ideas for products that can be incorporated into our extensive line.

Those who are eligible to enter this contest include students of industrial design, practicing industrial designers, or any person familiar with the design or fabrication of sheet metal enclosures.

In addition to cash awards, royalty arrangements will be entered into as, if and when any design submitted is produced and marketed.

The contest opens on February 1st and closes on August 31, 1964. For full information and entry form, write to Contest Manager.

BUD RADIO, INC.

Dept. D

P. O. Box 341 • Willoughby, Ohio 44094

of de Gaulle's policies. French salesmen follow French diplomats, not only to Moscow and Peking, but to such "U.S." markets as Latin America.

Emphasis on Standards—Spurred on by NATO requirements and their own program, the French have set up a complex standardization system for electronic components. Regularly used components, such as resistors and capacitors, now have much in common in size, ratings and reliability with U. S. counterparts.

The program is operated by the Comite de Co-ordinations des Telecommunications (CCT) representing the military and other professional users, and the Federation Nationale des Industries Electroniques (FNIE) for the manufacturers.

One set of specifications, designated CCTU, are like U. S. military specs. A second set, covering commercial components, are FNIE and Union Technique de l'Electricite specifications. There are now 71 CCTU and 49 commercial specs. The Laboratoire Central des Industries Electroniques, near Paris, tests components, awards acceptance certificates and maintains continuous quality control over CCTU parts.

European Space Race—France is trying to push its own space program ahead of the all-European project. Plans are to launch the first French satellite with a Diamant rocket in 1965. Going into equatorial orbit, it would be tracked by French stations. In a few months, tracking equipment now being designed will be ready for installation. France is also in the all-European project. The European Launcher Development Organization is based in Paris.

Although France's space budget is small compared to the U.S., it is technically ambitious and creates opportunities for tracking and telemetry advances.

One of these is the Diane tracking antennas that Societe Technique d'Application et de Reserche Electronique (Starec) is developing for the main system designers, Compagnie Francaise Thomson-Houston.

Starec is organized like a small specialist firm in the U.S.—which makes it unique in France. One third of its 70 employees are engineers, and it is not tied to one of the big French firms. Small development firms have a survival problem in France because the government generally lets contracts to the big ones.

Industrial Electronics—As the effects of new industrialization are felt, more computer and advanced process controls will be installed. Already in the works are such systems as optimizing computer controls for a chemical plant and a blast furnace (ELECTRONICS, p. 14, Nov. 29, 1963). Under investigation are computer control of the nationwide electrical dispatching system, and a Paris subway.

Discovery of natural gas in the southwest and oil in the Sahara has spurred investment in the chemical and petrochemical industries. The Anglo-French Concorde supersonic airliner project is giving commercial avionics a push. Sud Aviation is responsible for all navigation, radio and flight-control systems.

Consumer Electronics—While it will probably be at least four years before color-tv-broadcasts begin in France, a prime question now is which system will



FOR ELECTRONICS, TOP PRIORITY

At the International Components Show in Paris last month, the introduction of several new semiconductor devices (see p 54, this issue) illustrated one of the secondary effects of Gaullist policies. By providing additional money for research and by giving the electronics industry buildup top priority, the government set the scene for more rapid advances in component design and production.

The industry has pushed ahead far more rapidly than the French economy in general. Over the past decade, France's gross national product has grown by 4.7 percent a year to a current total of \$71 billion. Electronics has doubled in just five years (see graph, p 41) and shows every indication of surpassing the \$1.3-billion goal for 1970. The industry now has over 100,000 employees.

The most spectacular growth has been in professional equipment, due to the emphasis on research. Nuclear instrumentation alone clocked up \$20 million in 1962. In 1962—the latest year for which complete figures are available—France spent \$820 million on research. Of this, \$310 million went to the military and \$280 million went into general research including atomic and space efforts.

The nuclear strike force plans are bound to increase these sums. Of France's 14,000 research engineers and scientists in 1962, 3,300 were working on electronics and another 3,300 in aeronautics. These two fields account for 27 and 29 percent, respectively, of research.

The industry's surge has been of particular benefit to the semiconductor field, because of emphasis on solid-state in new designs. French semiconductor device sales rose from \$32 million in 1961 to close to \$40 million in 1962 and were showing a six percent gain in the first six months of 1963. With imports, the market is now over \$50 million. Most of the sales are still for industrial applications. According to Michel Dusolier, of Texas Instruments' French operation, consumer electronics accounts for only 25 percent of sales, and germanium transistors still lead silicon types in the industrial market.

THE MOST RELIABLE
MODULES ARE POTTED
IN **TIMONIUM**

2 Mcps

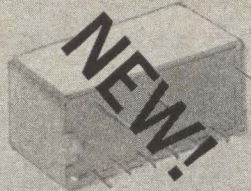

SILICON

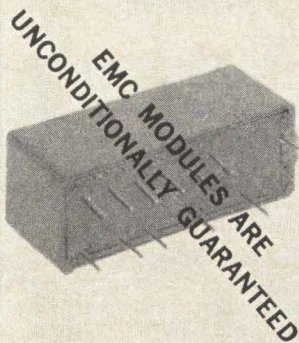
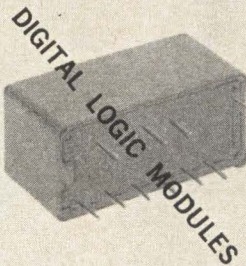

250 Kcps & 2 Mcps

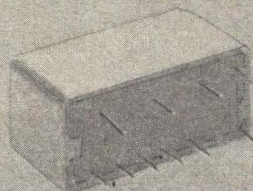

GERMANIUM

D.O.D. LOW SPEED
DIGITAL MODULES

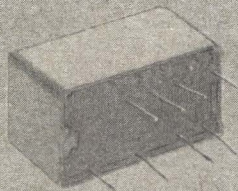

FLYBALL FAMILY

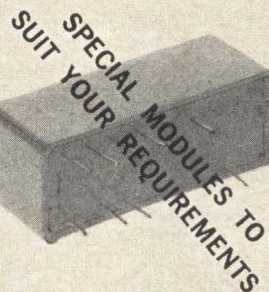

SPECIAL CIRCUIT AND PACKAGE DESIGN FROM
INCEPTION TO A PRODUCTION UNIT IN THE
SHORTEST TIME AND AT THE LOWEST COST

ELECTRONIC
MODULES
CORPORATION **EMC**

1949 GREENSPRING DRIVE • TIMONIUM, MD.
Clearbrook 2-2900

ellipses • • no. 70 series

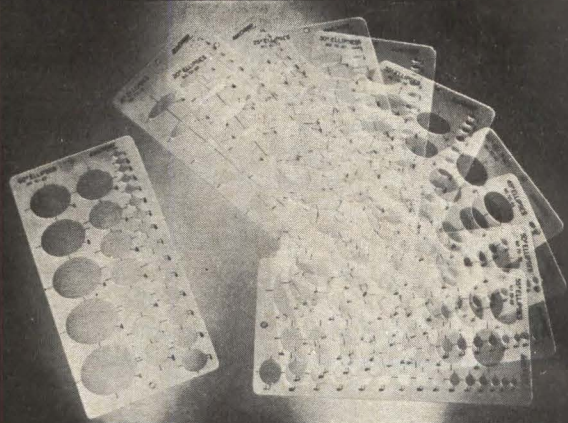

TEN TIME-SAVER TEMPLATES
FROM 15° TO 60° IN INCREMENTS OF 5°
MAJOR AXES FROM 1/4" TO 2"
INDIVIDUAL TEMPLATES — \$2.00 EACH
SET OF TEN TEMPLATES — \$18.00

*There are more than 100
Rapidesign Templates—all of
which are better made...more
useful and lesser priced.*

CATALOGUE NO. 60 AVAILABLE UPON REQUEST

RAPIDESIGN INC.

P. O. BOX 429, BURBANK, CALIFORNIA

CIRCLE 203 ON READER SERVICE CARD

50 WATTS
FROM A SMALL,
COOL PACKAGE

3 DIGIT CURRENT AND VOLTAGE SETTING

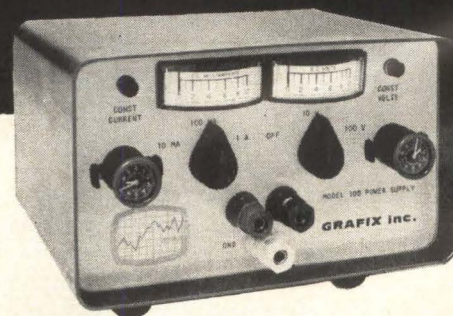

Duty cycle control for superb regulation at high efficiency
• ten turn knob pots for precision settings • automatic transfer
from current to voltage regulation or vice-versa at any
operating point • smooth, tough case for handling ease — no
protruding heat sink to interfere or be damaged.

REGULATION .03%, voltage or current • OUTPUT 0 to 100V
at 1.0A to 0.5A or 0 to 10V at 1.0A • RIPPLE 200 μ V RMS
(voltage), 20 μ A RMS (current).

For Details, Price & Delivery,
Request Specification #100

GRAFIX inc.

Dept. 64-21, P.O. Box 3296
2014 Ridgecrest Dr. SE
Area Code 505, 265-6903
Albuquerque, New Mexico



be installed. The European Broadcasting Union can't make up its mind which of three competing systems to adopt: the U.S. NTSC system, France's SECAM, or the new German PAL system (for comparisons, see *ELECTRONICS*, p 22, Aug. 2, 1963). The French, naturally, are rooting for SECAM because of CSF's (Compagnie Generale de Telegraphie sans Fil) heavy investment in it. They may adopt SECAM, if another is chosen. SECAM is also favored by the Russians and Swiss. The British want NTSC and may go it alone if no choice is made soon.

Meanwhile, the black-and-white tv market has reached about 1 million sets a year with no end in sight. Only 3 million tv sets are in service, compared to 10 million radios. Radio production has stabilized at 2.9 million sets a year.

Import-Export—At the International Components Show last month in Paris, more than 100 U.S. companies were offering products. They reported business was good. U.S. firms have captured the lion's share of component imports, particularly semiconductors.

They also have a large share of the instrument market, especially oscilloscopes. In 1962, the U.S. sold \$4 million worth of cro's to France. Tektronix sells the most. French manufacturers like Ribet-Desjardins are trying hard to recapture this market. They hope to overcome Tektronix' beam-switching advantage with a new precision dual-gun cathode-ray tube. Six French firms are designing scopes around this tube from M. O. Valve Co., of England.

The flow is not all one way. French microwave is advanced and the U.S. bought \$1.5 million in tubes in 1962. Exports are expected to increase, particularly millimeter-wave tubes.

While the rigid import restrictions of three to five years ago have been lifted, they may come back soon. France is having trouble overcoming adverse export-import balances and rising production costs.

Exports have risen quickly to \$120 million a year, but imports are rising faster. Net profit to France was only about \$9.6 million in 1963 compared to \$25 million in 1962.

Production costs go up with the French cost of living, which jumped 6 percent in the last year. Gov-



DIANE ANTENNA for tracking satellites. Eight antennas, separated by 50 wavelengths to operate as an interferometer, are flat-plate slot elements. Folded dipoles determine ambiguity. Diane is similar to Minitrac, but its angular coverage will be twice the U.S. system's and its accuracy around 200 microradians. This sketch was shown at the Paris show

ernment action to hold down prices has been rigorous. At the end of 1963, for example, it drastically cut back on the issuing of contracts.

French manufacturers are looking for new world markets, in or out of the Free World. There'll be a components exhibition in Moscow. De Gaulle's recognition of Communist China is being followed carefully. The new target that French electronics salesmen talk about is Latin America—traditionally a market for U.S. suppliers.

L'Affaire Bull—The welcome given U.S.-sponsored plants in France seems to conflict with France's do-it-yourself attitude. But France, remember, is anxious to gain technical knowhow to speed its military, industrial and space programs. Preference is still given French suppliers, but when French firms cannot supply the need, equipment or technology is imported. Sometimes, a product is redeveloped to keep French technology current.

The recent experience of Compagnie des Machines Bull, the French computer firm, indicates how far de Gaulle will go to prevent dilution of the French electronics industry. De Gaulle vetoed Bull's attempt to gain needed capital and computer technology by selling 20 percent of its stock to General Electric (*ELECTRONICS*, p 17, Feb. 21).

Indirectly, the government took over Bull rather than let the American company buy in. Bull, CSF and Compagnie Generale Electricite (CGE) were told to form a consortium with a finance house. The government will take a seat on Bull's board and pump fresh money and contracts into Bull. De Gaulle may yet have to compromise. CSF and CGE are not keen on de Gaulle's solution.

If the plan works, the American GE will be kept out and IBM will be discomfited. The French government buys 75 percent of its computers from IBM, but government buyers will doubtless favor the government's own brand of computer.

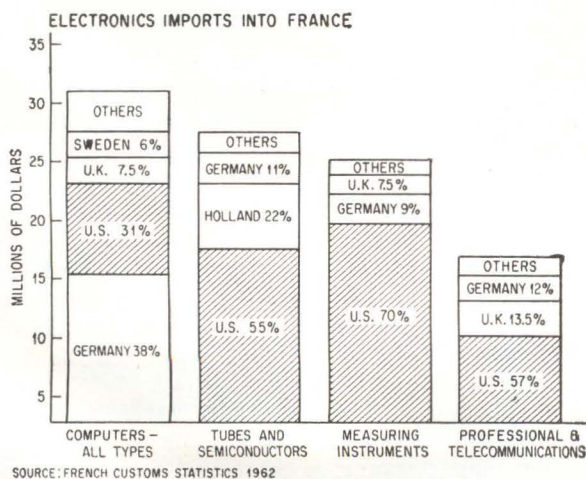

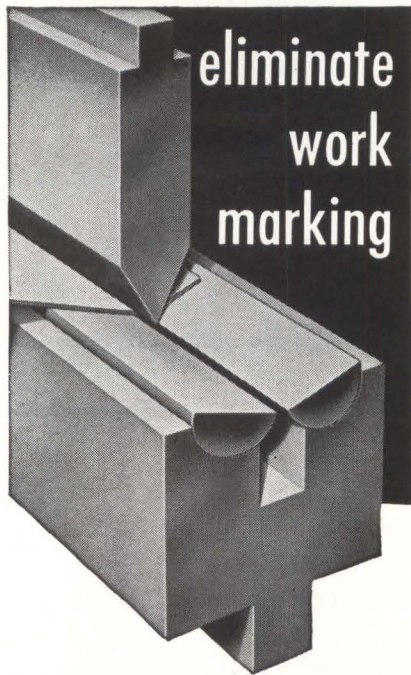

with a DI-ACRO ROL-FORM DIE

Workmarking from forming sheet materials in press brakes and punch presses is greatly reduced and in many metals completely eliminated when formed with the Di-Acro Rol-Form Die. Hardened and precision ground rolls pivot smoothly in the die block to fold material without strain. You save costs by discarding elaborate and time-consuming preparation and work methods, reducing polishing time, eliminating scrap parts. You also cut costs in press brakes and punch presses by reducing the number of dies needed and the set-up time.

One Di-Acro Rol-Form Die with a 60° upper die forms any angle to 60° and any thickness of metal to 1/8" just by adjusting the ram or bed of the brake. Where ultra-high finish material is to be formed, nylon inserts can be used in the die block to further reduce the possibility of work marks.

The Rol-Form Die is offered in five styles and in lengths from 6 inches to 12 feet for use in all sizes and models of press brakes and punch presses.

For ordinary press brake forming ask about Di-Acro Standard Press Brake Dies.

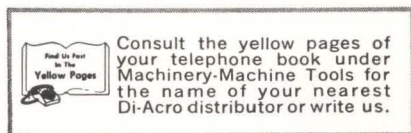

pronounced die-ack-ro



DI-ACRO CORPORATION
Formerly O'Neil Irwin Mfg. Co.
433 Eighth Avenue
Lake City, Minnesota

Air Force Seeks New Weapons Breakthroughs

Wants radar-busting missiles, besides new bomber and interceptor

By **JOHN F. MASON**
Senior Associate Editor

WASHINGTON — A new generation of electronic hardware will have to be developed if Air Force gets approval to build the new bomber, manned interceptor, and air-to-ground missile it wants.

All three will operate differently from existing systems, and the requirements will be tougher than ever before: the bomber will hedge-hop through enemy territory, the interceptor will fly without aid from ground-based command and control, and the missile will be super accurate.

Bomber for the 1970's—The advanced manned precision strike studies (AMPSS), as the project is called, will result in a bomber for the early 1970's. It will fly best at low altitude but would also fly at high altitude as well. It will be capable of intercontinental range, and will carry missiles and lay-down weapons (bombs with retarded detonation to let the plane get away).

One requirement that will undoubtedly call for a new approach is equipment that will enable the pilot to locate enemy radar on the other side of a hill. Terrain-following radar would take the plane over the hill, and down to "tree top" level again. A missile would then be launched to get rid of the enemy radar. It would proceed at low level, then arc up into a ballistic trajectory and down on the target. The bomber would run its own interference with missiles and finally drop a delayed bomb on the target. Although easier to envision than

radar that sees over hills, the bomb-
nav system is also expected to strain
the state of the art.

Air Force has been working in-house on AMPSS for a long time and has also farmed out three study contracts to General Dynamics, Boeing, and North American. Results of the contractors' studies have now been turned in to Air Force Systems Command and will be presented to Air Force headquarters this week.

Long-Range Interceptor — The improved manned interceptor (IMI) would be a long-range interceptor/fighter that would meet enemy bombers before they were in missile-launching range of the United States. The IMI would be divorced from U. S. ground control networks (Sage) to a great extent, using them only to get to the general target area. Once within 150 to 200 miles of the target the IMI would use its own long-range detection and tracking radar (200-mile range at least), similar to that proposed for the cancelled F-108. If a dish antenna is used it would be large—probably up to 4 feet in diameter. The kill missile would be of the advanced GAR (guided air-to-air missile) type.

Air-to-Ground Missile — Air Force requires radar-homing missiles for present (B-52) and future manned bombers. In-house studies refer to such a missile as SRAM (short range attack missile) as well as a variety of other names. Exact performance requirements are not yet determined. There are, in fact, four missile designs to date. Air Force Systems Command will soon go to Air Force headquarters to ask authority to award study contracts to industry for help on boiling down the four missiles to one or two.

It is generally agreed that the radar-seeking missile should have a range of 50 to 60 nautical miles,

WHERE THESE PROJECTS STAND

- **Bomber**—To begin work on this, Gen. LeMay requested \$52 million from House Armed Services Committee. The Committee, then the entire House, and now the Senate have voted him the money. Defense Secretary McNamara wants no new bomber.
- **Interceptor**—As these pages went to press, President Johnson had just revealed the new A-11 interceptor, and its relationship to IMI was still unknown. Last-minute information on IMI and A-11 will be found on p 20, in our late news section. Over McNamara's objections, the House had voted \$40 million for IMI, but the Senate had voted against it.
- **SRAM**—Funds not yet requested for SRAM as a project.

launched at low or high altitudes—primarily low. It would be lofted and proceed toward its target by inertial guidance. Terminal guidance would be homing on the enemy ground-based radar. Small nuclear warheads or a conventional warhead could be used.

Later versions could be built for different targets—a bridge or warehouse, for example.—Of course, terminal guidance would be different—tv or some other technique. Tv guidance for the missile would be reminiscent of the old Rascal, built by Bell Aircraft. Rascal was 4 feet in diameter, very heavy, and was carried under the wing of the B-47. Needless to say, it degraded the planes' performance severely, and was finally cancelled, some seven or eight years ago. Rascal did perform an interesting feat. Sent out ahead of the bomber, it looked over the horizon at the target area with a tv scanner, and transmitted the picture back to the plane. The pilot picked out the exact target he wanted and used command override to correct Rascal's course to zero in.

Air Force has started and stopped development work on several anti-radar missiles: Crossbow, Penetration System No. 1, and Wagtail. Navy is currently working on two: Shrike for short range, and Condor.

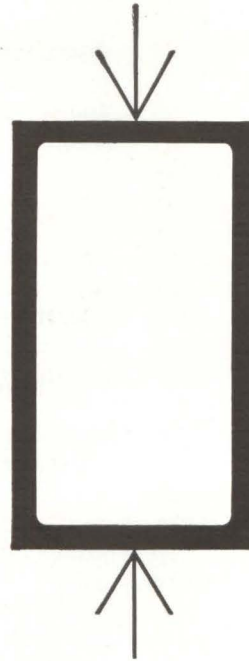

How to get lasting precision in laboratory data recording

Precise data recording takes a precise data recorder. Most recorders are precise when shipped. After a few months on the line, most aren't. PI changed all that by designing a full-scale lab recorder with studied simplifications that give it the most sophisticated tape-handling system in the general data field. We call it the PI-400A. It starts out precise and stays precise. So does your data. Here's how we did it.

First requirement was *permanently* precise tape guiding. And first thing rejected was the concept of an edge-hinged frame with all its inherent torsions, stresses and progressive distortions. In its place came a stress-relieved, heavily-ribbed, cast-aluminum box frame 5 inches deep. Everything fits inside, including printed-circuit motors $\frac{1}{4}$ the length and weight of conventional motors. This frame is pivoted, too, but through its center of gravity, on its vertical axis. Just like the symbol above. Perfectly balanced. Simple. Logical. Heads are perpendicular to the tape axis within one minute of arc. They stay that way.

Second requirement was *repeatable* accuracy of tape timing. Out went belts, pulleys and the like. The motor shaft is the capstan, with 7 bi-directional, crystal/servo-controlled, electrically-switchable speeds. With its closed-loop tape circuit, it has a timing accuracy of .02%. And all done with just 8 moving parts in the tape path, excluding reel hubs.

Third requirement was *gentle* tape handling, because distorted tape means distorted data. This took full-servo tensioning and full-dynamic braking. It achieves 6-ounce tape tension outside the loop—2 within. Half that of other recorders. Control logic engages tape, capstan and pinch rollers *only* when all three are fully stopped. Operator-proof.

Our engineers took 23 pages of text and diagrams to explain the system. Our marketing staff did it in 12. We'll send you either or *both* reports if you are interested in the how and why of lasting precision in data recording. Just write. Precision Instrument Company, Stanford Industrial Park, Palo Alto 20, California. 

Radar Sees Target, Buzzes Operator

Wristwatch-like device alerts operator by giving him mild shock

CHICAGO—Innovation that night-fighting soldiers should find useful has been built into a 10-pound doppler-radar set newly developed by Motorola Military Electronics Center.

The operator wears a wristwatch-like device that contains a piezoelectric crystal. When the set picks up a target, the transducer give the operator a mild shock to alert him. Then he flips a spring-loaded switch that momentarily illuminates range and azimuth readouts.

The skin sensor reports targets moving up to 35 mph, identifies the type of target, which way they are going, and how fast, according

to Al Berg, program manager. At ranges up to a mile, the set can discriminate between tanks and jeeps, walking and crawling figures, and tell men from animals, or even women. Discrimination is handled by a special modulation-demodulation system, Berg said.

Low-Power Beam—Another feature of the set is its low-power, c-w operation. Radiated power is in the milliwatt range. Berg points out that this decreases possibility of enemy detection and reduces mutual interference between electronic equipments. The c-w source is a klystron that draws about 10 mw.

The antenna is an X or K-band printed-circuit slotted array, measuring 10 by 16 inches. A 60-degree beam is used for surveillance and a 5-deg beam for pinpointing targets.

Klystron Cuts Weight—The 10-pound package, little bigger than an attache case, includes a steady tripod. Tripod support, or even using straps to suspend the array on the operator's chest, gives the system greater accuracy than the "flashlight" type of hand-held radar, Berg says. The package include 3½ lbs of batteries.

Weight reductions were realized by using the low-power klystron rather than the conventional pulse magnetron, and by circuit commonality. Production costs were also cut—to 70 percent of conventional pulse doppler systems. The integration of the microwave components with the solid-state circuit modules is expected to provide reliability sufficient to insure a 0.97 probability of the set's going 30 12-hour combat missions without failure.



**IEEE
SHOW
'64**



**march 23-26
9:45 A.M. - 9 P.M.**

TWO BIG SECTIONS

at the

**NEW YORK
COLISEUM**

all 4 floors!

- **ELECTRONICS EXHIBITS**
- **CONVENTION PAPERS**

See the finest products of industry,
hear famous men speak! Just one entrance
fee lets you visit both sections.

Buses to the N. Y. Hilton every few minutes

PRODUCTS • PAPERS • PEOPLE • PRODUCTS • PAPERS • PEOPLE

Syncom Design Changing

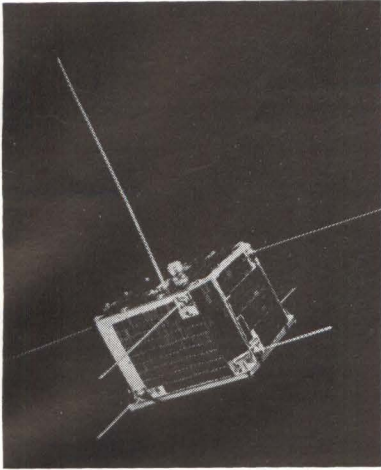

Mapmakers' Satellite

IN ORBIT as part of Army program to accurately locate landmarks is new geodetic satellite built by ITT. Network of ground stations pick up satellite signals. Range and angle data is then processed to provide ground positions. The satellite is also expected to provide measurements on the shape of the world. Program is called SECOR, for Sequential Collation of Range

WASHINGTON—The next synchronous communications satellite that NASA will launch, Syncom III, will be different from Syncom II. The changes are being made to improve the spacecraft's reliability and performance. Syncom III's launch will probably be in May.

Like Syncom II, the new satellite will have two transponders. But one transponder's bandwidth is being increased to 10 Mc. This would permit tv transmission. Tv, however, would not be of commercial quality because the signal-to-noise ratio does not meet commercial standards. The other transponder will probably have a bandwidth of 5 Mc.

Syncom II had one 5-Mc transponder and another with two 500-kc channels. No changes in frequency or power output are contemplated for Syncom III. To lengthen Syncom III's life, *n-on-p*

solar cells, which are radiation-resistant, will be used instead of *p-on-n*.

The only propellant that will be used for the station-keeping attitude controls on Syncom III will be hydrogen peroxide, in four tanks. Earlier Syncoms used both hydrogen peroxide and nitrogen. An explosion of a nitrogen tank aboard Syncom I has been pinpointed as the most probable cause of that satellite, the first synchronous communications satellite launched by NASA. (ELECTRONICS, p 18, July 19, 1963).

NASA officials hope to place Syncom III in an ideal orbit—at exactly 180 degrees longitude right over the equator, above Baker Island in the Pacific. This type of orbit would eliminate the necessity to constantly adjust satellite position to keep it on station.

ONE GREAT SHOW!

at the
**NEW YORK
HILTON**

2 floors, including Hilton's
main exhibition area

- ELECTRICAL EXHIBITS
- CONVENTION PAPERS

IEEE Members: \$1.00
Non-members: \$3.00
Minimum age: 18

Buses to the N. Y. Coliseum every few minutes

● PRODUCTS ● PAPERS ● PEOPLE ● PRODUCTS ● PAPERS ● PEOPLE



IEEE SHOW '64

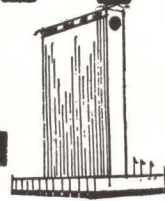

march 23-26
9:45 A.M. - 9 P.M.

**Get
constant
1000 megohms
input impedance.**

**Worth \$1,000 more
than its price.**



The new Hughes Model 5100 Digital Voltmeter is an integrating 5 digit, all solid state instrument priced at \$2695.

We can bring you this new voltmeter, equal or superior to devices costing \$4000 or more, at a low price because of an entirely new concept in circuitry design.

The Hughes 5100 Digital Voltmeter incorporates a new and unique voltage to frequency converter* as the heart of the machine. This device practically eliminates the use of critical or trouble-making components. The result is a voltmeter offering remarkable reliability, accuracy, ease of maintenance, and high noise rejection.

The Model 5100 can be used with the Model 1100 AC-DC Converter. Precise measurements of AC voltages from 30 cycles to 10 KC can be made simply, with 10 megohms input impedance on all ranges.

We would like to demonstrate the Hughes 5100 Digital Voltmeter and prove to you that it is the best value on the market. For full information, write or call HUGHES INSTRUMENTS, 2020 Ocean-side Boulevard, Oceanside, California. For export information write Hughes International, Culver City, California. *Patent Pending

HUGHES
HUGHES AIRCRAFT COMPANY
HUGHES INSTRUMENTS
OCEANSIDE, CALIF.

Visit us at the IEEE Show—Booth 2503

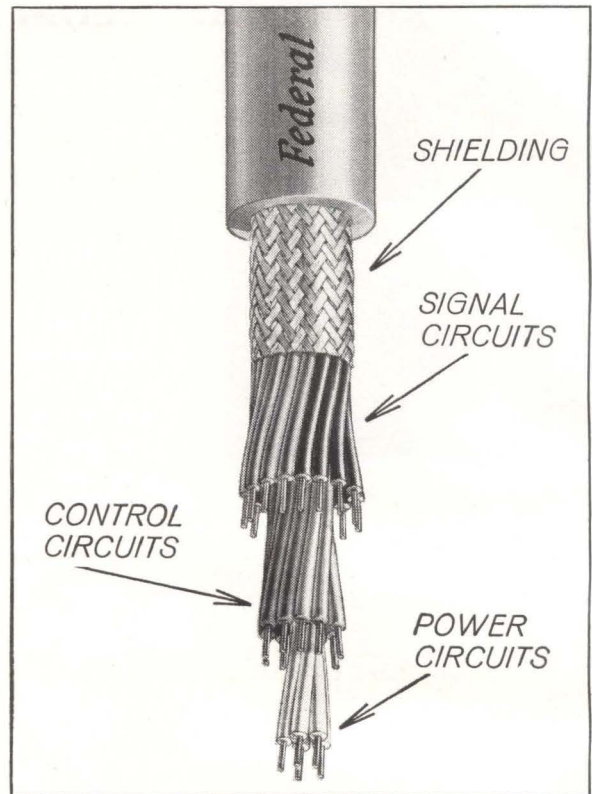

32 power, control & signal circuits in one Federal cable

This Federal multi-conductor cable will handle:

- 16 signal circuits
- 11 control circuits
- 5 power circuits

... all within one shielded jacket! This is a standard Federal cable available from stock.

Royal Electric has designed and built multi-conductor cables for a variety of applications ranging from office intercom systems to the vast BMEWS network.

For more information, contact your nearest Royal representative, or write Royal Electric Corporation, a subsidiary of International Telephone and Telegraph Corporation, Pawtucket, Rhode Island.

ITT ROYAL

Exhaust Gas Pictures

Ruby laser light increases resolution in interferometer patterns

A RUBY LASER has been found to be an ideal light source for interferometric studies of rocket motor exhausts, performed at the U. S. Naval Ordnance Test Station in China Lake, California. The studies relate to rocket guidance by controlling the direction of the motor exhaust gases. When the pulsed ruby laser was substituted for a conventional light source, it was found that the interferometer photographs had greatly improved resolution and the promise of a fairly complete characterization of flow field and jet deflection processes.

Currently prominent among the various means for accomplishing exhaust gas rocket control is the injection of a gas or liquid into the supersonic section of the exhaust nozzle, thus creating a standing shock wave followed by a non-symmetric pressure distribution on the inside of the nozzle wall, and giving rise to a side force that can be used for vehicle guidance.

The supersonic flow fields produced when gas is the secondary injectant have been simulated using cold, high-pressure air in a two-

dimensional, glass-walled nozzle, and photographed with a Mach-Zehnder interferometer.

The air-to-air injection pattern at the Mach 2.3 station, using a conventional BH-6 filtered high-pressure mercury arc as a light source, is shown in (A). Main nozzle flow is from left to right, with the secondary gas entering through a 0.01-inch inlet on the lower wall. The light and dark bands in the picture are a measure of the change of gas density in the nozzle; if the picture is superimposed on a similar "no-flow" photograph, the lines of constant density are obtained. Using such data and a knowledge of the temperature and pressure at reference points in a shock-free region, the pressure, temperature or velocity fields can be solved for.

As can be seen in (B), there is considerably more detail in the stagnation region on the lower wall before the secondary jet than in the conventional photograph, as well as a delicate fine structure showing the expansion of the secondary jet.

The image improvement is due to the total monochromaticity of the laser light at 6,943 Å, its bandwidth being about 0.3 Å, while with a conventional BH-6 lamp the spread of wavelengths causes the fringes to become indistinct and finally disappear in the finer structures.

The larger number of usable



CONVENTIONAL interferogram, (A), was taken with filtered BH-6 mercury arc, air-to-air injection at Mach 2.3 station, 250 psi chamber pressure, 150 psi injection pressure. Laser interferogram (B) shows improved resolution, was taken with argon-to-air injection at Mach 2.3/station (point where flow reaches 2.3 Mach speed) 105 psi chamber pressure, 35 psi injection pressure

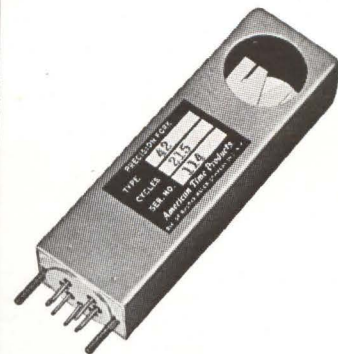

AMERICAN TIME PRODUCTS 10 to 1000 CPS LIGHT CHOPPER

NO LUBRICATION NEEDED

Unlike motor driven types, American Time optical choppers and modulators function without lubrication — no wear, with reliability multiplied several-fold. Based on the balanced, vibrating members of a tuning fork, the chopper also has the advantage of drastically reduced power requirements. These inherent benefits are obvious for space and other applications. IR, UV and other radiation are controllable.

Operated by an external 2 transistor circuit, signal voltage is available from the fork circuit as a reference. Accuracy of .05% in ranges from -55 to +85°C — higher accuracies can be obtained. Input power is 150 m.w. @ 28 volts into external circuit. Lower powers and lower voltages can be worked out. Operational altitude is up to space vacuum. And physical size is 1" x 3/4" x 3", with a 3/4" diameter window — the unit weighing a maximum of 3 oz.

Applications include spectrophotometers, mass spectrometers, radiometers, bolometers, IR detectors, star trackers, burglar alarm systems, intrusion systems, telemetry systems, colorimeters, and densitometers. Write Bulova, American Time Products, 61-20 Woodside Ave., Woodside 77, New York.

INDUSTRIAL/DEFENSE GROUP

BULOVA

AMERICAN TIME PRODUCTS

HOW MUCH MORE WILL THE COST BE IF YOU SPECIFY GUDEBROD LACING TAPE?



GUDEBROD FLAT BRAIDED LACING TAPES FOR EVERY NEED

Strict manufacturing control guarantees the quality of Gudebrod Tapes. There are many different types meeting wide range of needs, including:

GUDELACE®-non-slip—Nylon with microcrystalline wax finish—complies with MIL-T-713A.

GUDELACE-H®. Nylon with special coating of fungistatic synthetic rubber.

STUR-D-LACE-FLH®. Dacron* fibers impregnated with fungistatic, burn proof finish. Tem. -100°F. to 350°F.

TEMP-LACE PRE-SHRUNK® Teflon*—virtually unaffected by temperatures from -100°F to 425°F.

GUDE-Q®-Extreme Temperature—excellent tying qualities. Essentially stable in excess of 1500°F.

The Gudebrod Cable-Lacer speeds and eases the Harness tying operation. Inquire about it.

*Du Pont registered trademarks

Lacing tape might represent as little as 1/100,000th part of the total cost for producing a standard electronic unit. The labor cost for tying the harness with this tape could be as much as 500 times greater than the material cost. Where then, can the economy of saving a few cents on wire lacing be profitable? Of much more worth is the confident knowledge that in specifying Gudebrod Flat Braided Lacing Tapes you are providing the very best for your wire harness lacing work.

Specifically made for wire harness lacing, Gudebrod Lacing Tapes meet many particular requirements for fungus resistance, temperature fluctuations, chemical content, as well as meeting or exceeding MIL-T-713A specifications.

In addition Gudebrod Lacing Tapes are soft and flat. Stress is distributed over the full width without cut-through or harshness to injure insulation or fingers. Knots stay tied. The good handle of Gudebrod Tapes pleases harness room workers—assures production improvement.

For samples, for further information, for the Technical Data Book, get in touch with your local Gudebrod representative, or write to the Electronics Division.



GUDEBROD BROS. SILK CO., INC.

FOUNDED IN 1870

Electronics Division

12 SOUTH 12TH STREET, PHILADELPHIA, PENNSYLVANIA 19107

Visit the GUDEBROD Booth No. 4032 at the IEEE Show

fringes when using the laser source greatly facilitates the adjustment normally involved, in addition to giving a wide working path length range so that these can be made under no-flow conditions. Also, the laser light beam is already parallel, simplifying the optics, and appears to give greater illumination of the test region using the present lens arrangement.

Gas Discharge Yields R-F Harmonics

LONDON—A system of gas-discharge harmonic generation, currently investigated at the Government Royal Aircraft Establishment, uses the non-linear electrical characteristics of a low-pressure gas discharge in air to generate harmonics of an 8-mm input. Ten watts of 8-mm cw power are fed to the electrodes of the generator mounted in an evacuated waveguide. An external d-c source feeds the discharge gap with positive ions to maintain the discharge at low power inputs. Harmonic generation occurs when the glow discharge is replaced by an arc; the lower tip of the electrode then produces an intense source of electrons in a region of non-uniform electric field.

Output powers of about one milliwatt at the first harmonic have been achieved when driven with ten watts at 8.6 mm. The power output varies with pressure, a maximum occurring at one cm mercury. Conversion efficiency is of the order of -40 db.

An alternative approach under investigation uses electrodeless discharges, which have given efficiencies over 30 percent when doubling from 3,000 Mc. The discharge is excited in a quartz bulb small compared with the wavelength of the required harmonic but large in relation to the ionizing mean free path.

Flight Simulator Eases Missile Antenna Tests

NEW technique for making tests on missile antennas, which obviates the need for actually firing a missile, has been developed at the Army's Redstone Arsenal, Ala., by the In-

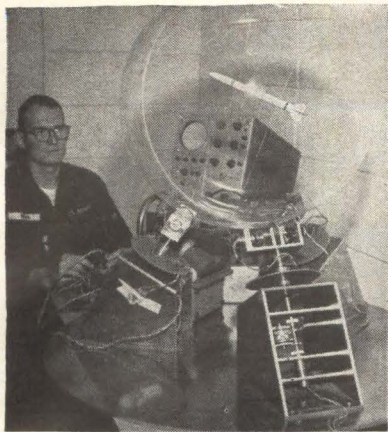

MISSILE antenna flight-simulating tester shown with inventor, Sp4 Collins Smith

erial Guidance and Control Laboratory.

Consisting of a missile model with a subscale antenna model, suspended in a plastic sphere and a driving mechanism, the testing unit can duplicate the changes in position from nose-up at launch to nose-down at impact in a smooth continuous curve. Data on antenna performance is thus gathered continuously, while an attenuator copies the effect of decreased antenna signal strength as the missile moves away.

Hydrogen Maser Clock At Harvard Timed Accurately

POTENTIALLY the most accurate atomic clock in the world, an atomic hydrogen maser has been accurately timed by Harvard physicists to within two parts in 100 billion.

The maser frequency was compared with that of the standard clock controlled by the U. S. Naval Observatory, and found to be 1,420,405,751.800 cycles per second, with an uncertainty of 0.028 cps.

Since the hydrogen maser is more accurate than any other atomic clock, it was necessary to build two identical masers and run them together for 24 hours to see how well they kept time with respect to each other, and with respect to the Naval Observatory's standard cesium atomic beam clock, which is broadcast all over the world on Loran C.

The hydrogen maser radiates at 21 cm, and can be used as either an amplifier or an oscillator. The radiation is much purer than that of other masers.

WHAT THIS DATA-FILE CAN DO FOR YOU...



It can help you to buy exactly the Power Supply you want and need—faster and at lower cost.

It can help you to specify a Power Supply that will enhance the reliability of your system—instead of reducing it.

It can save you the time, expense, pain, and possible embarrassment of writing a specification that contains a loop-hole or potential misunderstanding.

It can help you to understand where the cost lies in your Power Supply specification, — so that you (a) can minimize that cost; (b) don't accuse your vendor of overcharging you.

WHAT THIS DATA-FILE CANNOT DO FOR ANYONE

It cannot make you into a competent Power Supply designer, unless you already have a great deal of experience in the field.

It cannot show you how to overcome the basic physical realities of thermodynamics, electrokinetics, or the principal of conservation of energy.

It cannot change the density of steel, the melting point of germanium, or the specific heat of air.

Finally, it cannot show you how to "cut corners" on quality or reliability—because we have never made a study of either practice.

CONTENTS

SOLID-STATE POWER SUPPLIES: TYPES AND TECHNIQUES
HOW TO CHECK YOUR POWER-SUPPLY SPECIFICATION FOR VALIDITY.
PROTECTING THE POWER SUPPLY AND ITS LOAD FROM EACH OTHER
THE PRIMARY-BRIDGE AND PRIMARY-CLIPPER REGULATORS —TWO NEW APPROACHES
LOW-DISSIPATION REGULATORS AND PROTECTIVE CIRCUITS
HOW BIG? HOW HEAVY? HOW EFFICIENT? HOW HOT? HOW MUCH?
REFERENCE SUPPLIES—CURRENT AND VOLTAGE
PROGRAMMING POWER SUPPLIES—ANALOG AND DIGITAL TECHNIQUES
CASE HISTORIES—ALL OF THEM WITH HAPPY ENDINGS!
HOW FAR—THE CUSTOM/POWER RANGE OF SIZES AND TYPES DEFINED—AT LAST!

custom power

A DIVISION OF TRIO LABORATORIES INC.
Plainview, L.I., N.Y., (516) Overbrook 1-0400, TWX: 516-433-9573

Shown first time at IEEE

1% tracking
is now standard for
API taut-band meters
—at no extra cost!

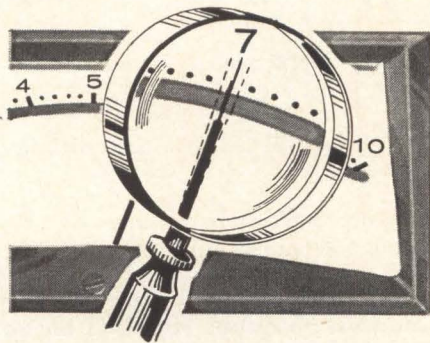

You get an inherently better meter—and it costs us less to make it. Hence it'll cost you less too.

That's the net result of exciting design and production improvements in taut-band panel meters now being offered by Assembly Products. Effective April 1.

**When you order
an API taut-band meter,
you'll automatically
get 1% tracking**

The only exceptions will be extremely sensitive and extremely small meters. Please ask about these.

**1% tracking gives you
better measurement**

1. You can measure very precisely the fractions of a full-scale signal.
2. Therefore, as long as you know (and can control) the current that makes the meter read full-scale, you will read very accurate absolute values anywhere on the scale.

**See and test these meters
at Booth 2921-2923, IEEE Show**

Ask for Bulletin 38



Assembly Products, Inc.
CHESTERLAND, OHIO • AREA CODE 216 HA 3-3131

— COMPONENTS AND MATERIALS —

New Devices Debut At French Components Show

Bilateral switch,
overload-resistant diode
are featured

PARIS—Over 700 companies exhibited their wares here last week at the annual International Component Show. Already the component show for all Europe, the exhibition is fast becoming the top annual international component event. This year nearly half the exhibitors were from outside France. Of the 314 overseas firms showing, 96 were from the U. S. In addition many other U. S. firms were exhibiting through their agents.

The show reflected the booming French and European sales possibilities for U. S. manufacturers, and components standards that frequently match U. S. standards (see p 41, this issue). More miniaturization was apparent particularly as applied to resistors and capacitors.

Semiconductors—Newest developments in the show came in the tube

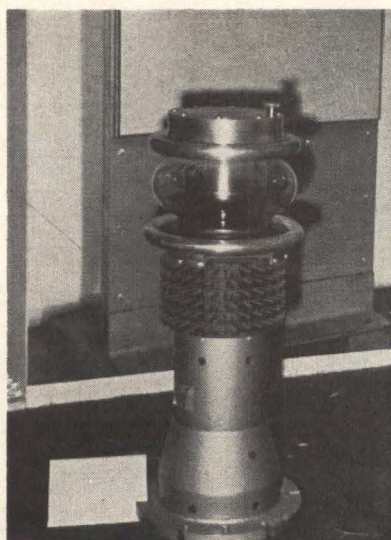

HEDGEHOG EFFECT at middle of tube is the magnet assembly and cooling fins of CSF's Artatron

and semiconductor areas. From Compagnie Generale d'Electricite came news of a semiconductor thyatron-like device called the Symmistor. Similar in operation to the GE Triac, and to the Battelle Memorial Institute's bidirectional switch (p 63, Dec. 20), the Symmistor is, as the name suggests, a symmetrical structure which comprises an *n-p-n* junction assembly with inverse diode units (unitunnel) at each end of the assembly. When inversely polarized, each of the junctions then acts as a low value resistance in series with a classical thyristor. Thus the Symmistor provides symmetrical electrical characteristics to either polarity and can be used as a static bidirectional switch on a-c control circuits. A single unit will control on both halves of the a-c cycle so that a single unit can replace conventional dual-unit scr circuits.

Reduction in the possibility of accidental diode destruction from inverse voltage overloads will result from a new semiconductor space-charge limited diode developed at CGE's Research Center. By a new electrode design CGE obtains an almost 1:1 voltage-current relationship that commences only at the working inverse voltage point. Below this point the diode behaves conventionally. This space-charge limiting effect allows accidental inverse voltages of up to 2.5 times the rated inverse voltage to be applied without destroying the diode. At present only applicable to a single diode carrying 220 amps mean current, the diode will survive repeated accidental inverse voltages of 1,500 to 2,000 volts.

Field Effect Device—Another new semiconductor shown is the Statistor developed by Compagnie Generale de Telegraphie sans Fil (CSF) and now in production. This is a field effect device producing input impe-

Couch

ROTARY
RELAYS

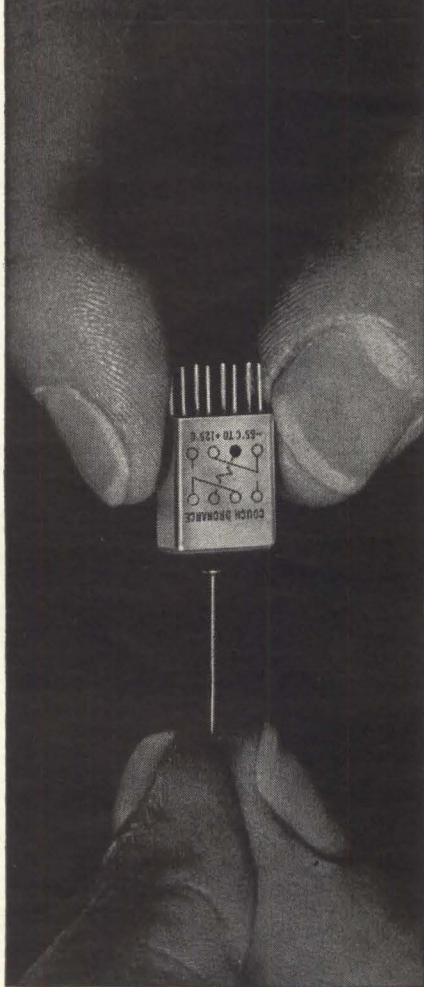

good and small

This new Couch rotary relay is surprisingly microminiature when you consider the rugged construction inside and the specifications

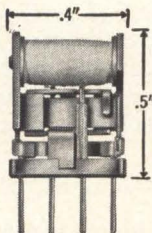

SIZE2" x .4" x .5"
TERMINAL SPACING	1/10" grid
RATING5 amp @ 30 VDC
COIL OPERATING POWER	150 mw
COIL RESISTANCE	60 ohms to 1,000 ohms
TEMPERATURE	-65°C to +125°C
VIBRATION	20 G
SHOCK	75 G

Write for Data Sheet No. 9

RUGGED ROTARY RELAYS  Dynamically and Statically Balanced

COUCH ORDNANCE INC.

3 Arlington Street, North Quincy 71, Mass., Area Code 617,
Cypress 8-4147 • A subsidiary of S. H. COUCH COMPANY, INC.

PRODUCTION TECHNIQUES

Redesign of Waveguide Speeds Manufacturing

Switching from castings
to extrusions triples
output, company says

DANBURY, CONN. — Systems combining network for relay stations previously required hand-matching of thirteen aluminum castings that were individually machined before being bolted together. Redesigning the manufacturing process around

aluminum extrusions yielded a product that was of better quality and, at the same time, cheaper and easier to manufacture, according to Frank Fallon, Director of Manufacturing, FXR Division of Amphenol Borg. As a result of the redesign, production capacity of the plant was tripled without any increase in space or personnel, and the thirteen piece construction was reduced to an assembly of six pieces. Previously, twenty-five units per

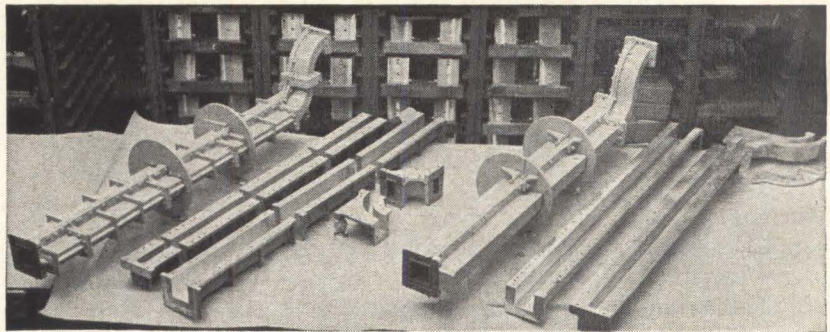

OLD UNIT (left) was made up of castings matched to form a continuous, unbroken channel. New unit (right) requires less milling and hand labor

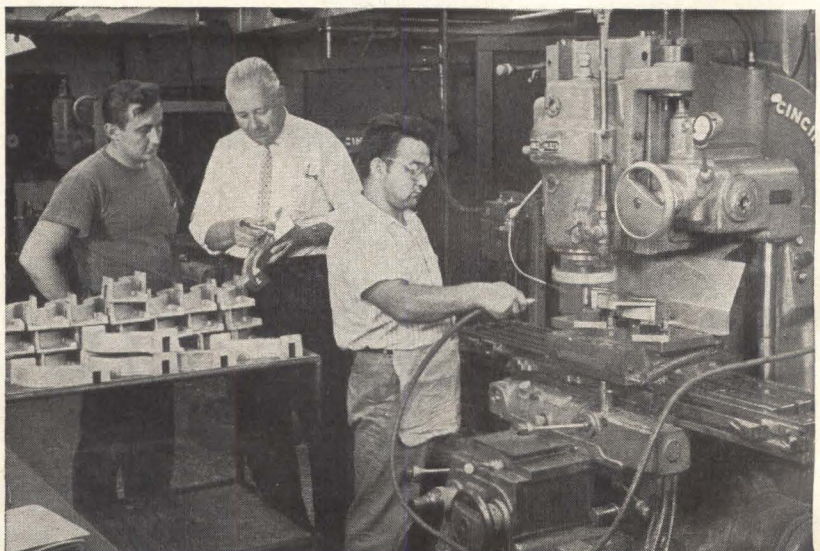

SPECIAL CAM network—behind shield—moves milling table in two dimensions to mill S-bend units to one-thousandth inch tolerance

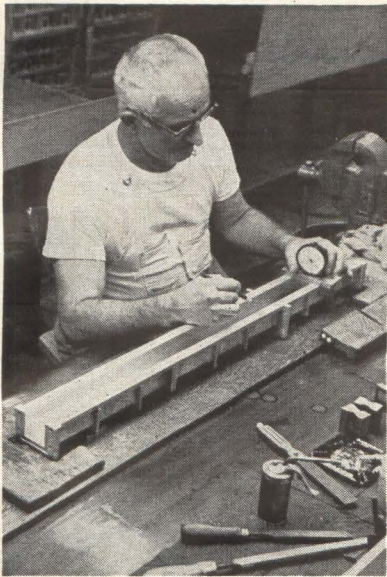

HAND LAPPING was used to obtain critical surface tolerances with old design

month could be made at full capacity. Without expanding facilities, capacity is now 65 units per month, and — because of urgent requirements—as high as 80 units have been manufactured in one month, an increase of over three hundred percent.

Redesign — A single piece of extruded aluminum channel was substituted for the multiple castings used previously. Flanges were welded to the channel. The milling, assembly, and finishing times for the unit were drastically reduced. The finished waveguide had better electrical characteristics, since the extrusions had virtually none of the porosity of the castings, the company says.

S-bend—Originally, two separate, 90-degree curved castings were joined in opposite orientation to form an “S” bend. Milling the same channel out of a single casting in an uninterrupted pass would be another improvement—if tolerances of plus or minus one thousandth of an inch could be held. Various trace milling machines were evaluated, but none could hold the exacting tolerances needed. Finally — using a technique dating back to the 1800’s—a cam system was used to move the milling table simultaneously in two dimensions. A bearing follows in an S-shaped groove, and strong spring prevents backlash.

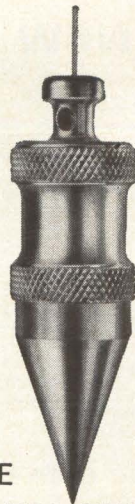

THE
EXTRA MEASURE
OF JULIE
IS

ACCURACY

The Julie VDR-106 is the first and only voltage divider with 1 part per million accuracy—guaranteed. That’s an absolute figure you can rely on. In fact, Julie guarantees it for five years—in writing. Such accuracy is the extra measure of Julie, the company that developed the RATIOMETRIC™ System of Calibration. Ratiometry is stable, simple, reliable and versatile. The VDR-106 and the other certifiably accurate Julie instrument modules have been developed to meet the demands of the Ratiometric System. They are, of course, unequalled as individual instruments for all your instrumentation requirements. They perform to specifications without excuses, double-talk or cumulative error.

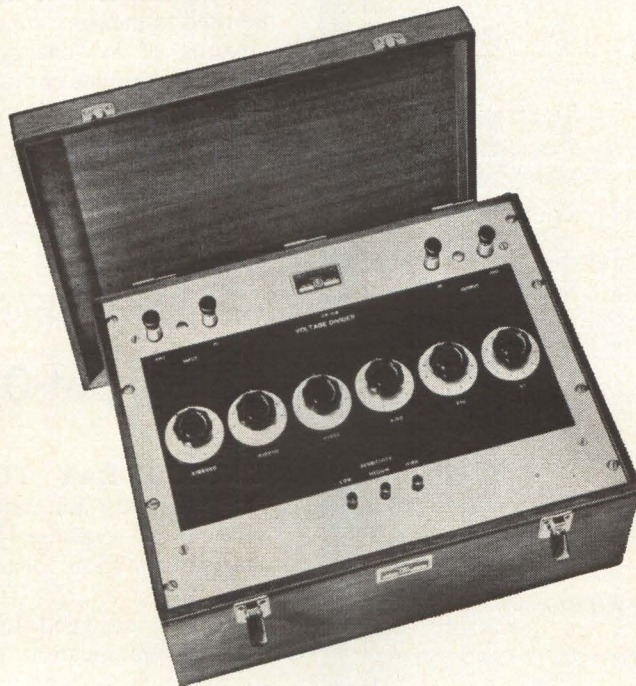

Write or call collect for a no-obligation demonstration in your office, as well as complete information on the VDR-106 and details of the Julie RATIOMETRIC™ System. You’ll also learn how to institute your own DC primary standards laboratory.

SEE US AT THE IEEE SHOW BOOTH 3228

JULIE RESEARCH
LABORATORIES, INCORPORATED



211 WEST 61st STREET, NEW YORK 23, NEW YORK • 212 CI 5-2727 © Julie Research Laboratories, Inc., 1963

KEITHLEY

503 MILLIOHMETER

MILLIOHMETER

The Model 503 provides fast, accurate direct-readings from 10 micro-ohms to 1000 ohms. The measurement technique involves a four terminal ammeter-voltmeter method. By using an ac test current maximum power dissipation through the sample is 10 microwatts. Thus, the 503 is useful in dry-circuit testing of contact resistance and safe measurement of fuses and squibs.

- **Range:** 0.001 to 1000 ohms fs on linear scales with 13 overlapping ranges
- **Accuracy:** 1% of fs on all ranges
- **Output:** 100 millivolts
- **Line Operated**
- **Max. Sample Dissipation:** 10 microwatts
- **Price:** \$675

also available
 MODEL 502 Milliohmeter:
 Battery operated . . . \$390

Send for catalog giving full details

**KEITHLEY
INSTRUMENTS**

12415 Euclid Avenue • Cleveland 6, Ohio

NEW PRODUCTS

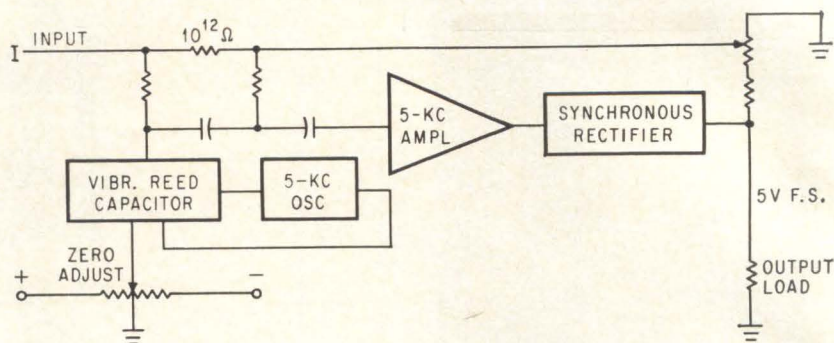

Electrometer Measures

Instrument features
 linear range from
 10^{-9} to 5×10^{-16} amp

VIBRATING-REED electrometer that was designed for space exploration has now been made commercially available. Instrumentation can be used to measure solar winds—the streams of low-energy, electrically charged particles emitted by the sun—and can accurately measure a current as small as 5×10^{-15} amperes.

Company says that modifications to the basic instrument can be made to meet customer's specific requirements.

The VRE converts d-c input signal to a-c by using mechanical energy to move impressed charge through an electrostatic field. As shown in the block diagram, charge to be measured, applied at I, produces d-c voltage across the vibrating reed capacitor. Oscillator causes reed to vibrate at 5-kc voltage across the capacitor proportional to impressed d-c signal. The a-c voltage is amplified in a-c amplifier, then rectified in synchronous rectifier. Rectifier output which is proportional to input d-c voltage, is filtered, and causes current to flow through feedback resistors and through output circuit.

In addition to its high sensitivity,

CRT Input-Output Station for Computers

CATHODE-RAY TUBE storage for setting up an inquiry and for viewing the response is a feature of two information distribution systems now available. The series 100 system is designed for large-scale data communication networks requiring high concentrations of input-output devices at several geographical points; the series 200 is a flexible, general-purpose system for a wide range of applications.

The model 101 crt Inquiry Station displays up to 288 characters (up to 8 lines of 36 characters each) on a 10-inch rectangular crt. Data entered from the standard

typewriter keyboard is presented on the screen for pre-transmission verification, and may be edited and modified by using special keys that position an entry marker blip to indicate the "writing" position on the screen, then depressing either a new character key, or special keys to erase a single character or an entire line. Also available are procedure sequencing and program identifier keys. This "video typewriter" communicates with a computer at 240 characters a second.

Up to 24 model 101 stations plus two print stations may share a common local control unit. As the

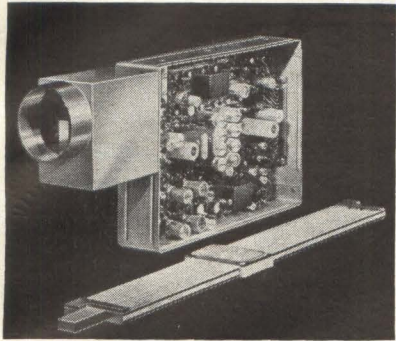

5 Femtoamp

the new VRE will have very low output drift—only 0.1 mv per day, non-cumulative, at constant temperatures. Currently used vacuum-tube amplifiers have a maximum practical detection limit of 10^{-12} amp and have drifts of as much as 150 mv incurred by launching alone.

The instrument has a 1-sec response, critically damped, and a linear range from 10^{-9} to 5×10^{-10} amp with one range change, utilizing a 5×10^9 and a 10^{12} ohm resistor. Inherent accuracy is ± 1 percent full scale. Dimensions are 4 by 6 by $1\frac{1}{2}$ in., with max weight of 1,000 grams. Applied Physics Corp., 2724 S. Peck Road, Monrovia, Calif.

CIRCLE 301, READER SERVICE CARD



message is keyed in, the data is stored in an associated buffer of this station control unit. The Inquiry Station is 15 inches wide and 22 inches in depth. Several models of communications and interference

New G-E glow lamp circuit reduces cost of SCR power control

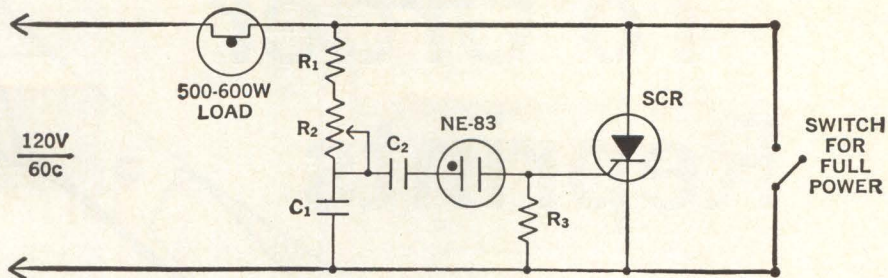

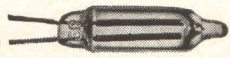
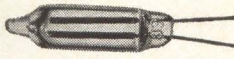
Here's a tiny General Electric glow lamp, , the NE-83, that can save you up to 30¢ over conventional means—with no sacrifice in performance. The glow lamp half-wave control circuit shown above will fire and control between 5° and 165° of the full 180° half cycle. It can handle the job of controlling power into resistive loads for many applications. A few possible applications are: variable speed control on mixers, low-torque sewing machines, hand tools and blenders—and as a simple, lamp-dimming device. If you'd like to know more about the NE-83  and this new power control application, write today for Bulletin 3-3474. General Electric Company, Miniature Lamp Department M-46, Nela Park, Cleveland, Ohio 44112.

Progress Is Our Most Important Product

GENERAL  ELECTRIC



To Order Reprints

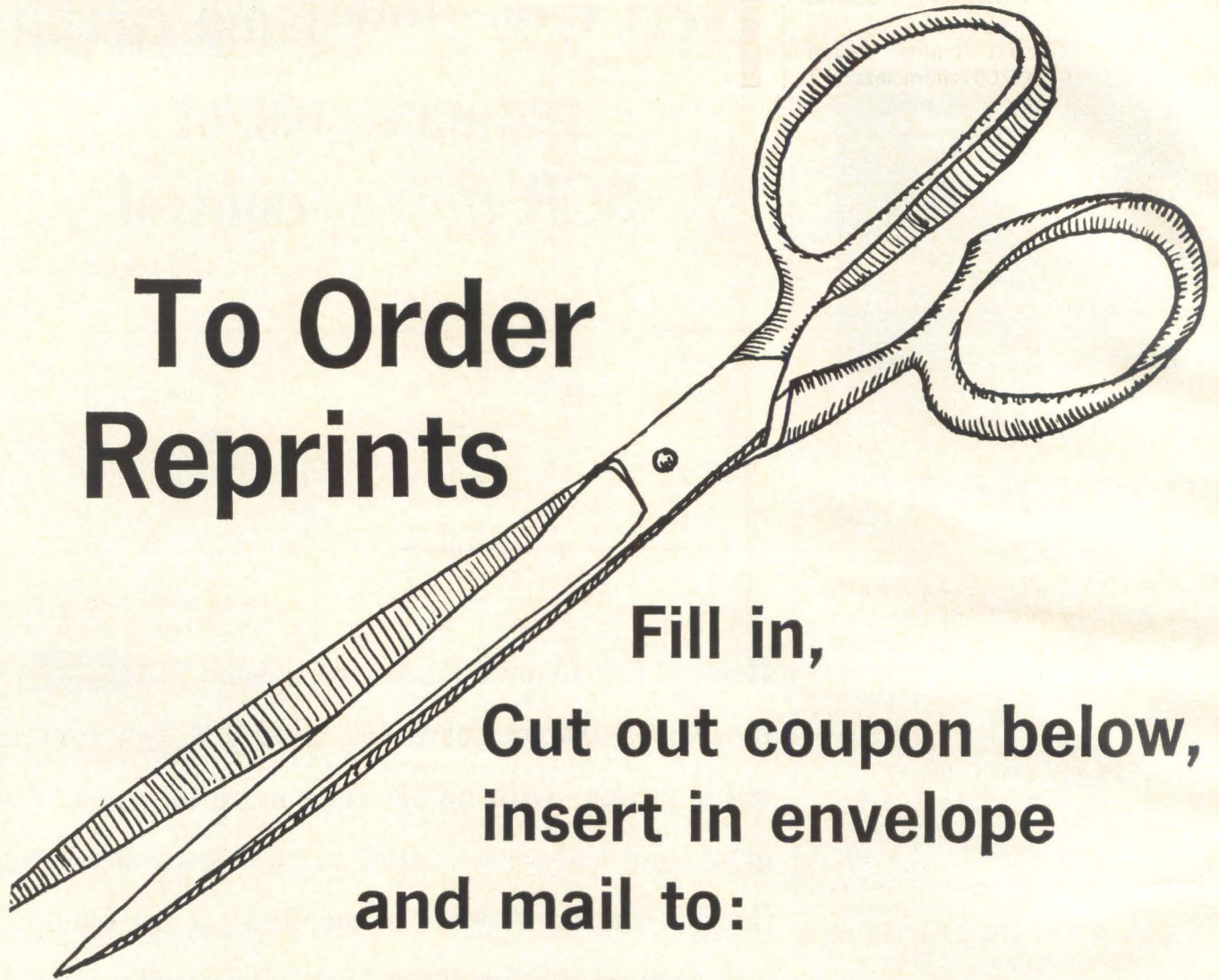

Fill in,
Cut out coupon below,
insert in envelope
and mail to:

electronics Reprint Dept.
330 West 42nd Street,
New York, N. Y.—10036

REPRINT ORDER FORM

For Listing of Reprints Available See Reader Service Card

(To help expedite mailing of your reprints please send cash, check or money order with your order.)

For Reprints of the latest Special Report:

Modern Electronic Packaging

Send me Reprints of Key No. R-48 at 50¢ each.

For Reprints of previous **Special Reports** or **Feature Articles** fill in below:

Send me Reprints of Key No.(s) @ ¢ each. (For prices, see chart above.)

*For orders of Bulk Reprints of other editorial articles in **this issue** or **past issues**:

Send me Reprints of page (no.(s)) of issue
of article entitled

*Minimum bulk order 100 copies. You will be advised of costs by return mail.

Name

Number and Street

City, Zone No., State

terminals are available for connecting the control units to a central processor.

Model 201 crt Inquiry Station displays up to 768 characters (12 lines of 64 each) on a 21-inch rectangular tube, and up to six of these stations may share a common local control unit. Other models in the 200 series are available with smaller crt's (14 and 10 inches) and correspondingly fewer characters. Tele-register Corp., 445 Fairfield Ave., Stamford, Conn.

CIRCLE 302, READER SERVICE CARD

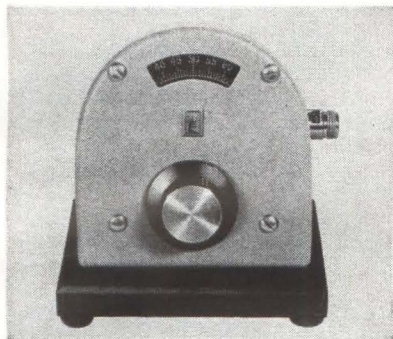

Variable Attenuator Covers Wide Range

PRECISION variable attenuator model 933 has a direct-reading dial calibrated in approximately linear increments of 1 db from 6 db to 120 db. Frequency range of the instrument is d-c to 1 Gc but its low frequency sensitivity makes it useful up to 3 Gc in many applications. Basically, model 933 consists of a curved section of stripline to form an attenuator with distributed series and shunt loss. A long-wearing, self-lubricating carbon brush is used to tap off the output in a manner similar to a potentiometer. Long time stability is assured by use of a special resistive film on a stable ceramic base. Price is \$550 with lab stand, or \$530 for panel mounting. Weinschel Engineering, Gaithersburg, Md. (303)

Pressure Transducer Has Variety of Uses

AN ABSOLUTE PRESSURE TRANSDUCER of minute size that accurately measures static pressures, as well as pressure fluctuations of relatively

IMPACT OF MICROELECTRONICS

Edited by George T. Jacobi,
IIT Research Institute
and Samuel Weber, electronics



The Proceedings of the Conference on the Impact of Microelectronics, co-sponsored by the Armour Research Foundation (now IIT Research Institute) and electronics, a McGraw-Hill Publication, has just been published by electronics. The Conference, held last June 26-27 at the Illinois Institute of Technology, was acclaimed by the attendees and the industry at large. Now, in book form, all the invited papers and talks presented at the conference are available to you.

To whet your appetite, here are some of the contents:

- The Electronics Components Industry and Microelectronics**
by Robert C. Sprague, Chairman of the Board, Sprague Electric Company.
- Profit and Loss in Microelectronics**
by Robert W. Galvin, President, Motorola Inc.
- Government Needs and Policies in the Age of Microelectronics**
by James M. Bridges, Director of Communications and Electronics, Department of Defense.
- Management of Research and Engineering for Microelectronics Systems**
by Dr. Peter B. Myers and Arthur P. Stern, Electronic Systems and Products Division, Martin Company.
- In House or Not: The Changing Buyer — Vendor Interface**
by F. J. Van Poppelen, Jr., Vice President-Marketing, Signetics Corporation.
- Current Technical Status and Problems in Microelectronics**
by Jack S. Kilby, Integrated Circuits Dept., Texas Instruments, Inc.
- Ultimate Limits of Microelectronics**
by Dr. J. T. Wallmark, RCA Laboratories, David Sarnoff Research Center
- Reliability in Microelectronics**
by Ernest R. Jervis, ARINC Research Corporation.
- Engineering Education in an Era of Changing Technology**
by Dr. John Bardeen, University of Illinois.

IMPACT OF MICROELECTRONICS is must reading for men with a marketing and technical interest in this dynamic field of activity. Crammed with useful information, this neatly designed, 120 page volume keeps you up-to-date on this fast moving technology. Order today. Only \$3.50 per copy.

ORDER FORM

electronics Reprint Department
McGraw-Hill Publishing Co., Inc.
330 West 42nd Street
New York, N.Y. 10036

Dear Sirs:

Send me _____ copies of **IMPACT OF MICROELECTRONICS**
(\$3.50 per copy)

I am enclosing _____ (cash or check)

Bill me later _____ Bill my company _____

MY NAME _____ POSITION _____

COMPANY _____

ADDRESS _____

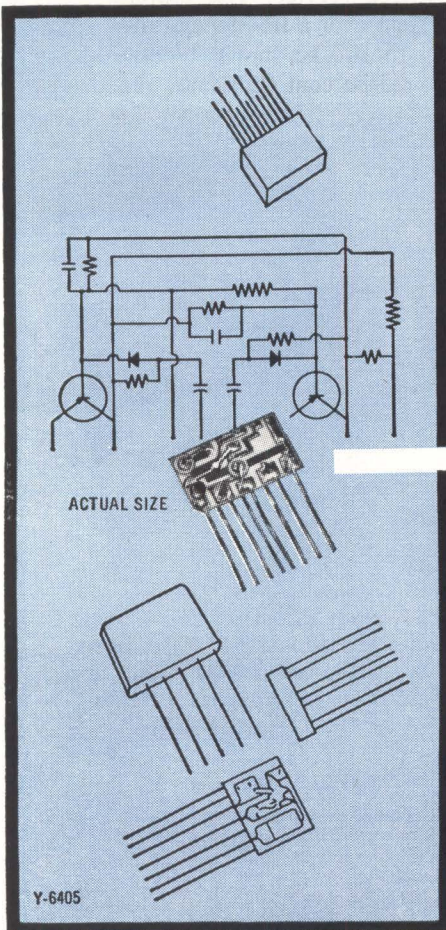

Thin-Film Integrated Circuits

AVAILABLE NOW FROM CENTRALAB

Proven and practical, here and now—Centralab PEC Integrated Circuits with active and passive components. More than a quarter of a billion have been used in two decades of military and commercial application.

PEC's offer you these advantages: Complete flexibility of form and circuit design, extremely high reliability, ability to include a wide variety of components and values, simple interconnections, costs comparable to and frequently lower than discrete components.

Centralab offers you these advantages: Complete engineering assistance, ability to supply integrated circuits in production quantities, realistic delivery schedules.

Write for Centralab's brochure, PEC Basic Data.

Centralab®

THE ELECTRONICS DIVISION OF GLOBE-UNION INC.
P.O. Box 591, Dept. 14B • Milwaukee, Wisconsin 53201
In Canada: Centralab Canada Ltd., P.O. Box 400, Ajax, Ont.

CIRCLE 206 ON READER SERVICE CARD

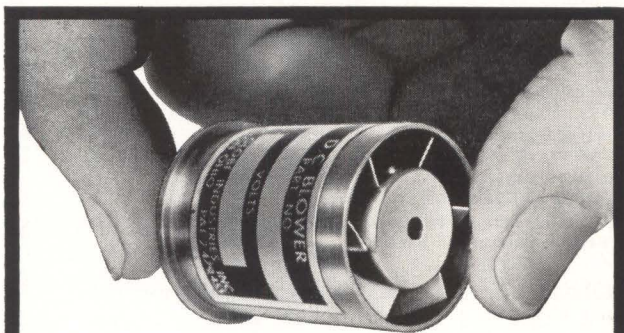

NEW SMALLEST VANEAXIAL BLOWER

Only 1 1/8" in diameter by a maximum 1 3/4" long, this smallest d.c. blower moves 10 cfm of air against 0.4" H₂O back pressure! Use this rugged sub-miniature blower for spot cooling of critical components where space is cramped and weight is important.

VAX-1-DC blower operates on 28 v.d.c. or less, using a maximum of 200 milliamps. Weight is 1.4 ounces. Mounts with standard servo ring clamps. (Globe makes larger blowers also.) Request Bulletin VAX-1 from Globe Industries, Inc., 1784 Stanley Avenue, Dayton 4, Ohio.

GLOBE INDUSTRIES, INC.

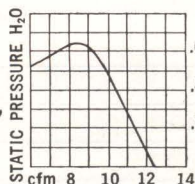

62 CIRCLE 62 ON READER SERVICE CARD

When you need INTERCHANGEABLE thermistors or thermistor probes...

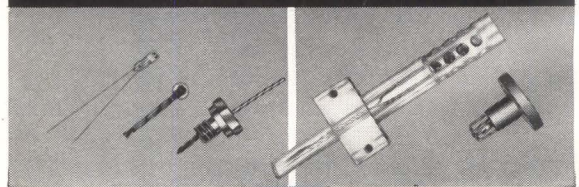

... Check F. E. I. ISO-CURVE Thermistors*

(the only thermistors with identical characteristics)

- Standardized resistance/temperature characteristics
- Completely interchangeable no calibration or compensation
- Direct readout of absolute temperature
- High sensitivity
- Fast response
- Broad resistance range

GET THE FACTS — Send for this new brochure which gives complete specifications, selection, and application data on the only available line of completely interchangeable thermistors and thermistor probes.



*Made under Pat. 3109227 and others. ISO-CURVE is a trademark of F.E.I.

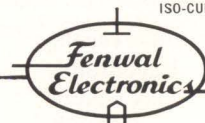

FENWAL ELECTRONICS, INC.
Dept. B, 63 Fountain St., Framingham, Mass.

CIRCLE 207 ON READER SERVICE CARD
March 6, 1964 electronics

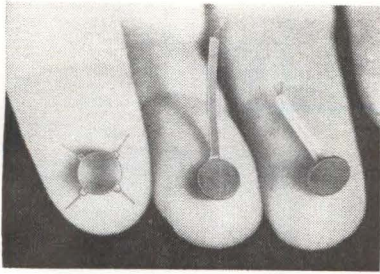

high frequency, is being produced. Designed for external mounting without interference to air or fluid flow, the unit has already been adapted to a variety of experimental and investigative applications including medical research, wind tunnel analysis, and hydrodynamic studies. Only 0.0250 in. in diameter and extremely thin (0.020 to 0.027 in. depending on the model), the transducer is currently available in 3 models offering 4 different pressure ranges: ± 2 psi, 0-15 psia, 0-30 psia, and 0-100 psia. It can be easily attached to a variety of surfaces without requiring structural alterations to the unit being tested. Scientific Advances, Inc., 1400 Holly Ave., Columbus 12, O.
CIRCLE 304, READER SERVICE CARD

Tunable Oscillator Covers L-F Range

EXTERNALLY TUNABLE model S-300 silicon transistor sinusoidal oscillator is an epoxy-encapsulated unit designed to create a stable sine wave signal source. It makes possible the concentration of a large number of discrete control and information functions per unit volume and weight. It has an inherently long life and should provide years of trouble-

free service. The oscillator can be set over a frequency range of 25 cps to 100 kc, and is tunable over a ± 25 -percent frequency range. Output amplitude is greater than 2 v rms for load impedance greater than 35 kilohms. Nominal output impedance is 2.5 kilohms. Nominal size is 0.97 by 1.60 in. Height varies from 2.30 in. to 4.10 in. max as frequency decreases. Weight is nominal 2.5 to 7 oz, as frequency decreases. Unit can be mounted on any chassis. Solid State Electronics Co., 15321 Rayen St., Sepulveda, Calif. (305)

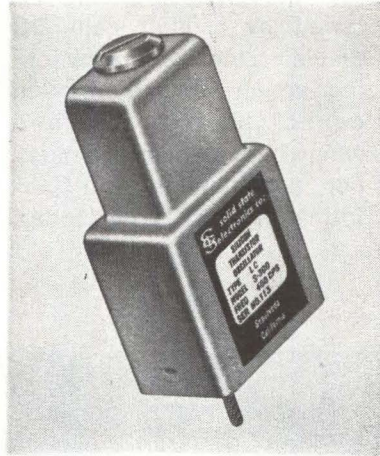

Ultrasonic Cleaner Uses Multi-Frequencies

SIMULTANEOUS multi-frequency ultrasonic cleaning systems are available in standard console models. Greater cleaning efficiency is obtained because of the simultaneous presence within the tank of a wide band of ultrasonic cleaning frequencies, ranging from 20 to 100 kc. The higher frequencies generate small scrubbing bubbles that pene-

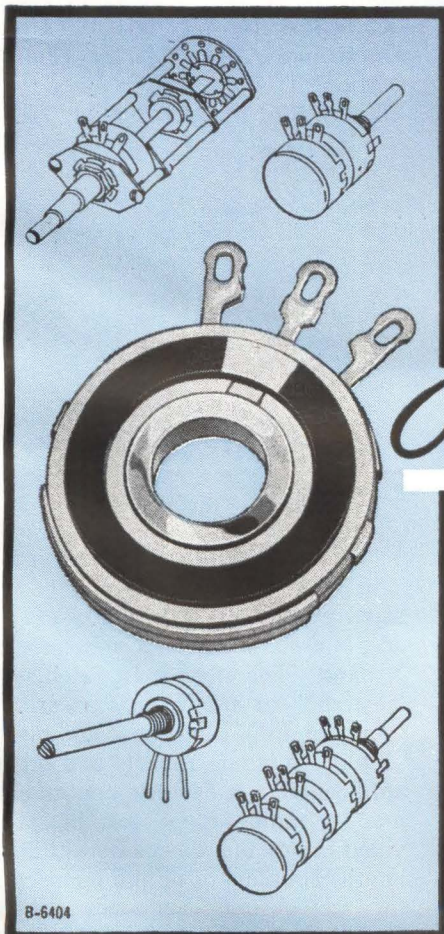

RV4 style Centralab potentiometers

THE INDUSTRY'S BROADEST LINE

These low-noise, hot molded element, back-lash-free units are available as singles, twins, dual concentrics, triples, quads, attenuators, and singles with front or rear mounted rotary switches. Five shaft styles, three bushing types, with wire-wrap or standard terminals, as well as encapsulated units, are standard.

Rated at 2.25 W at 70°C, a complete range of resistances and tapers can be supplied. Write for detailed engineering data.

For Immediate Delivery—3 styles, 91 popular values are available from Centralab Industrial Distributors in quantity, at factory prices.

Centralab®

THE ELECTRONICS DIVISION OF GLOBE-UNION INC.
P.O. Box 591, Dept. 14B • Milwaukee, Wisconsin 53201
In Canada: Centralab Canada Ltd., P.O. Box 400, Ajax, Ont.

LOW COST PROPORTIONAL CONTROL OVEN



JKO-44 Proportional Oven:

A compact, plug-in oven designed for use with both crystals and components requiring precise temperature control. Advanced circuit design, excellent performance at modest cost. Utilizes a thermistor sensing unit followed by a high gain DC amplifier. Ideal where switching action of a thermostat cannot be tolerated and where high stability is a must. For specification and performance data, write today.



THE
JAMES
KNIGHTS
COMPANY
SANDWICH, ILLINOIS

CIRCLE 208 ON READER SERVICE CARD

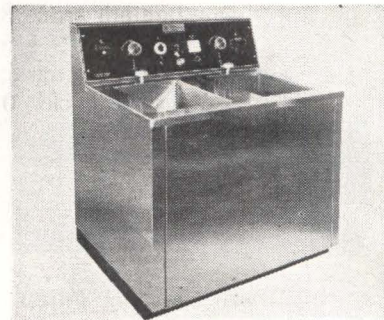

trate into all small crevices and reach under and loosen the contaminate so that the lower frequencies, with their larger cavitation bubbles and greater cleaning power, can rapidly and thoroughly complete the cleaning operation. Undesirable standing wave pattern is eliminated because all frequencies are co-existing and going in all directions at the same time. Transducers employed in the model 905 illustrated are high efficiency devices employing a new class of special high temperature titanate alloys which overcome previous difficulties of low transducer efficiency and poor reliability. A typical example where multifrequency cleaning has made possible production usage of electronics is in the cleaning of semiconductors on p-c boards. Crest Ultrasonics Corp., Mercer County Airport, Trenton, N.J.

CIRCLE 306, READER SERVICE CARD

Type SM-8512

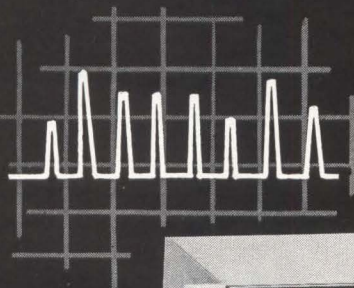

SIGNAL MONITOR



The type SM-8512 Signal Monitor was specifically designed for operation with communication receivers having an IF frequency of 455kc. It provides a visual display of signals on a 1½" x 3" CRT in a band around which the companion receiver is tuned. Adjacent channel signals as far as 25kc from the frequency tuned by the receiver are displayed. Sweepwidths of 5kc, 20kc, and 50kc are provided. The high resolution permits the modulation structure of a signal to be viewed and analyzed.

IF Frequency.....455kc
Input Impedance...50 ohms
Sweepwidth.....5kc, 20kc, 50kc
Crystal Marker.....455kc

Resolution.....250 cps w/5kc sweepwidth
1.2kc w/20kc sweepwidth
2.5kc w/50kc sweepwidth

Communication Electronics Incorporated

4908 HAMPDEN LANE, BETHESDA 14, MARYLAND

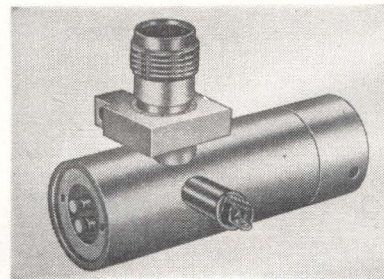

Triode Oscillators Offer Pulse Service

BOTH PLATE AND GRID pulse service are offered in triode oscillators at X-band. The new pulse oscillator is suited for use as a transmitter oscillator in X-band beacons, high-altitude sounding rockets and other applications. A 500-Mc continuous manual tuning range can be provided in any one device by optimizing the coupling of output connector for the desired frequency range. Grid pulse service has a power out-

put of 2 w minimum from 8.5 to 9.4 Gc; 1 w minimum, 9.4 to 9.6 Gc. Pulse width is 40 nsec; rise time, 16 nsec; duty cycle, 0.001. Plate pulse service has a power output of 25 w minimum from 8.5 to 9.4 Gc; 10 w minimum from 9.4 to 9.6 Gc. Pulse width is 0.5 μ sec, rise time is 25 nsec, and duty cycle is 0.001. Trak Microwave Corp., Tampa, Fla. (307)

Switching Time Tester Is Easily Operated

PROGRAMMED switching time set, model 505A, is designed for the reproducible testing of nanosecond transistors and diodes in quantity by inexperienced personnel. The switching times—rise time, turn-on delay, turn-on-time, fall-time, stor-

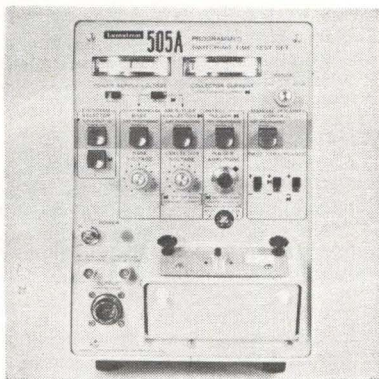

age and turn-off time—can be read on a dual channel sampling oscilloscope, such as the Lumatron model 120, or any similar fast waveform readout system. The test set is a complete system, engineered for nsec testing, with a built-in 0.3 nsec r-t pulser and two built-in precision power supplies—0-40 v at 500 ma for the collector and 0-40 v at 200 ma for the base. In addition to the signal out of the semiconductor under test, two other signals are provided by front panel connectors: (1) The trigger is always positive, so that the operator never has to switch the readout instrument's input trigger polarity; (2) the ref pulse represents the drive pulse into the transistor, and is used as a zero time reference for delay measurements. General Applied Science Laboratories, Inc., Merrick & Stewart Aves., Westbury, Long Island, N. Y. (308)

Announcing the new line of world-famous Schober Organ Kits...

ASSEMBLE YOUR OWN ALL-TRANSISTOR SCHOBER ELECTRONIC ORGAN



Designed by organists for organists, the new Schober Recital Organ actually sounds like a fine pipe organ. The newly-invented Schober Library of Stops provides you with an infinite number of extra voices so that you can instantly plug in the exact voices you prefer for a particular kind of music. Thirteen-piston, instantly resettable Combination Action makes the

All-New, All-Transistor Schober Recital Organ

- 32 voices, 6 couplers delight professional musicians... make learning easy for beginners.
- Standard console, pedals, keyboard correspond exactly to pipe-organ specifications.
- Printed circuit construction and detailed, illustrated instructions make for easy assembly... no previous experience necessary.
- Highly accurate church and theatre pipe tone in 5 pitch registers make every kind of organ music sound "right".
- Optional: Combination Action, Schober Reverbatape Unit, Repetitive Theatre Percussions.
- All-transistor circuitry makes possible full 5-year guarantee.

Recital Organ suitable for the most rigorous church and recital work. The Schober Reverbatape Unit gives you big-auditorium sound even in the smallest living room. An instrument of this caliber would cost you \$5000 to \$6000 in a store. Direct from Schober, in kit form (without optional percussions, pistons, Reverbatape Unit) costs you only \$1500.



New, All-Transistor Schober Consolelette II

Here's the most luxurious "home-size" organ available today... with the same circuitry and musical design as the impressive Recital Organ. Full 61-note manuals, 17 pedals, 22 stops and coupler, 3 pitch registers, and authentic

theatre voicing leave little to be desired. Musically much larger than ready-made organs selling for \$1800 and more... the Consolelette II, in kit form, costs only \$850.



New Schober Spinet

The Schober Spinet is among the very smallest genuine electronic organs; only 39 1/4 inches wide, it will fit into the smallest living room or playroom—even in a mobile home. Yet it has the same big-organ tone and almost the

same variety of voices as the larger Consolelette II. The Schober Spinet far exceeds the musical specifications of ready-made organs selling for \$1100 and more. In easy-to-assemble kits... only \$550.

HERE'S WHY YOU SHOULD BUILD A SCHOBER ORGAN!

You cannot buy a finer musical instrument for over twice the price. You get the finest in musical and mechanical quality.

It's easy to assemble a Schober Organ. If you can read and use your hands, you can easily make your own superb organ. Everything you need is furnished... including the know-how; you supply only simple tools and time—no knowledge or experience is required.

You can buy the organ section by section... so you needn't spend the whole amount at once.

You can begin playing in an hour, even if you've never played before—with the ingenious Pointer System available from Schober.

Thousands of men and women—teenagers, too—have already assembled Schober Organs. We are proud to say that many who could afford to buy any organ have chosen Schober because they preferred it musically.

Schober Organ Kits are sold in the U.S. only by...

THE *Schober Organ* CORPORATION

43 West 61st Street, New York, N.Y., 10023

Dealers In Canada, Australia, Hong Kong, Mexico, Puerto Rico and the United Kingdom.

SEND FOR FREE SCHOBER BOOKLET

... Describes the exciting Schober Organ and optional accessories in detail; it includes a FREE 7-inch "sampler" record so you can hear before you buy.

Also available: 10-inch high-quality, long playing record... fully illustrates all three models with different kinds of music. Price is refunded with first kit purchase... \$2.00



The Schober Organ Corp., Dept. EL-6
43 West 61st St., New York, N.Y., 10023

Please send me, without cost or obligation, the Schober Organ Booklet and free 7-inch "sampler" record.

Enclosed find \$2.00 for 10-inch quality, LP record of Schober Organ music. (\$2.00 refunded with purchase of first kit.)

Name _____
Address _____
City _____ State _____ Zip No. _____

Magneline[®]
THE INDICATOR WITH INHERENT MEMORY

NEW DIGITAL INDICATORS FOR DIFFICULT SYSTEMS

SERIES 14000—FOR SOLID STATE LOGIC

Character Size..... $\frac{9}{32}$ " x $\frac{1}{4}$ "
No. of Characters.....Up to 11
Leads.....11 plus a common
Watts.....2.4

SERIES 15000—FOR RELAY LOGIC

Character Size..... $\frac{5}{16}$ " x $\frac{1}{4}$ "
No. of Characters.....Up to 10
Leads.....5 plus a common
Watts.....1.0 - 1.7

RUGGED

UNITS MEET OR EXCEED MIL E 5272. HAVE BEEN LIFE TESTED AT 28 MILLION CYCLES. NEED NO MAINTENANCE.

COMPACT

UNITS REQUIRE ONLY 1.12 CUBIC INCHES, WEIGH ONLY 1.5 OUNCES.

READABLE

DISTINCT WHITE CHARACTERS STAND OUT AGAINST DULLED BLACK BACKGROUND IN NORMAL ROOM LIGHTING. ILLUMINATED MODELS AVAILABLE.

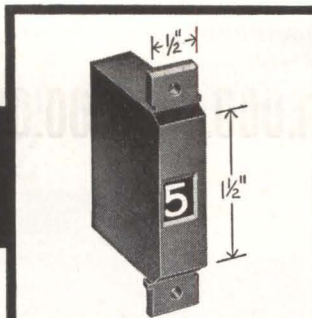

External appearance of 14000 or 15000 series

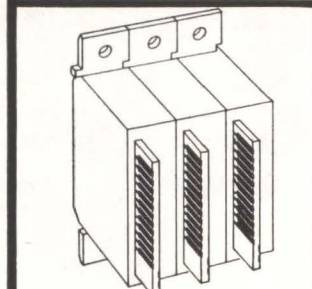

Rear view of units showing stacking and plug-in connectors

VISIT US AT
BOOTH 3050
IEEE SHOW

PATWIN[®] ELECTRONICS

A DIVISION OF THE PATENT BUTTON COMPANY
WATERBURY, CONNECTICUT • 06720
CIRCLE 209 ON READER SERVICE CARD

NEW → 40 MC PULSE GENERATORS

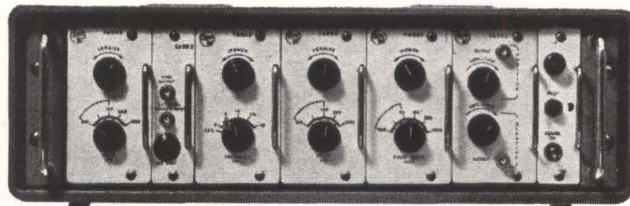

Feature Modular Expandability, Rise / Fall to 5 ns

The new SERVOPULSE[®] 9000 Series offers general-purpose pulse generators conveniently modularized to provide special capabilities. Among their outstanding features are very high clock rates, rise times to 5 ns and expandability which defies obsolescence. They deliver clean, sharp waveforms, and permit multi-pulse functions. Several Modules are available for each function of time delay, pulse width, frequency, and amplification. The units are packaged for either rack-mount or benchwork, with integral power supply. A wide spectrum of special functions is possible at prices you would expect for standard generators. Detailed information on request.

	MODEL 9350	MODEL 9450	MODEL 9455	MODEL 9550
Frequency Range	.2 cps - 5 kc	100 cps - 2 mc	100 cps - 10 mc	2 mc - 40 mc
Delay	.1 ms - 1 sec.	0 - 1 millisecond.	0 - 1 microsec.	0 - 1 microsec.
Pulse Width	.1 ms - 1 sec.	.1 μ s - 1 ms.	25 ns - 1 μ s	25 ns - 1 μ s*
Simultaneous Pos & Neg Outputs	10V open circuit 7V into 93 ohms	10V open circuit 7V into 93 ohms	10V open circuit 7V into 93 ohms	10V open circuit 7V into 93 ohms
Rise & Fall Time	Under 5 nanosec.	Under 5 nanosec.	Under 5 nanosec.	Under 5 nanosec.
Max Duty Cycle At Full Amplitude	70%	70% - 40% at 2 mc	90%	90% - 60% at 40 mc
One Shot/Sync & External Trigger	Yes	Yes	Yes	Yes
Price	\$660.00	\$835.00	\$975.00	\$1,390.00

FLAT TOP FOR ALL INSTRUMENTS LESS THAN \approx 2% AT MAX. PULSE WIDTH.

* 15 ns at 40 mc



SERVO CORPORATION OF AMERICA SERVOPULSE[®] PRODUCTS
111 New South Road • Hicksville, L. I., New York • Wells 8-9700

LITERATURE

SILICON RECTIFIER STACKS Westinghouse Electric Corp., Youngwood, Pa. Technical data bulletins 54-261, -2, -4, -5 and -8 describe high-voltage silicon rectifier stacks in a variety of modules. CIRCLE 360, READER SERVICE CARD

E/I REGULATED SUPPLIES Kepco, Inc., 131-38 Sanford Ave., Flushing, N.Y. 11352. Short form catalog No. 146-1029 lists 132 voltage/current regulated power supplies subdivided into 11 design groups. (361)

BERYLLIUM COPPER POWDERS The Brush Beryllium Co., 17876 St. Clair Ave., Cleveland 10, O., has published a 4-page folder describing properties and uses of its new beryllium copper powders. (362)

MAGNETIC SHUNT RING Magnetic Shield Division Perfection Mica Co., 1322 No. Elston Ave., Chicago, Ill. 60622. Data sheet 167 pictures and describes a Netic or Co-Netic magnetic shunt collector ring with corona guards. (363)

ULTRASONIC INTRUSION ALARM Walter Kidde & Co., Inc., Brighton Road, Clifton, N. J. 07012. Catalog sheet No. AL614 describes model MC-125B ultrasonic intrusion alarm. (364)

COATING MATERIAL Metco Inc., Westbury, N.Y. No. 404 Nickel Aluminate, a new coating material that performs well at high temperatures, is discussed in a technical report. (365)

MAGNETIC TAPE RECORDER Kinelogic Corp., 29 S. Pasadena Ave., Pasadena, Calif. Bulletin 102 discusses model C magnetic tape recorder, a miniature, dual-speed, special-purpose unit which operates at two widely different tape speeds in either direction. (366)

WIREWOUND RESISTORS Ultronix, Inc., 111 E. 20th Ave., San Mateo, Calif., has prepared a four-page brochure discussing reliability concepts and procedures in the manufacture of precision wirewound resistors. (367)

MINIATURIZED CAPACITORS Gudeman Co. of California, Inc., 7473 Avenue 304, Visalia, Calif. 93278. Catalog entitled "51 Series Hermetically Sealed Combination Metallized Capacitors" covers a line of miniaturized units designed for use in airborne and transistorized equipment. (368)

TRANSISTORIZED LOGIC CIRCUITS Radiation Instrument Development Laboratory, 4501 West North Ave., Melrose Park, Ill. A pocket-sized booklet explains in easily-understood terms the fundamentals of transistorized logic circuits. A complimentary copy can be obtained with a letterhead request.

HIGH-SPEED LIGHT PEN Digital Equipment Corp., 146 Main St., Maynard, Mass. Technical bulletin describes type 370 high speed light pen for use with crt displays with rapid plotting rates. (369)

HIGH VACUUM SYSTEM Vacuum-Electronics Corp., Terminal Drive, Plainview, L.I., N.Y. Catalog describes the 775 series automatic high vacuum system with high pumping capacity at the port. (370)



PUREST OBTAINABLE

ALL YOU NEED

—from the foremost producer of atmospheric gases!

- Produced under continuous mass spectrometer control.
- Fast nationwide delivery.
- Guaranteed ultra-high purity.
- Scientifically blended and tested mixtures for any need.
- Quality based on more than 50 years of rare gas know-how.
- Complete technical service.

SEND FOR NEW 20-PAGE ONE-SOURCE RARE GAS BOOKLET

First comprehensive price and specification list for all rare gases and mixtures...



CLIP COUPON — ATTACH TO BUSINESS LETTERHEAD

Rare Gases, Dept. E-31
Union Carbide Corporation
Linde Division
270 Park Avenue, N. Y., N. Y. 10017

- Please send a copy of your booklet listing prices, specifications, and information on LINDE Rare Gases.
- Have a representative contact me.

UNION CARBIDE LINDE DIVISION

"Linde" and "Union Carbide" are registered trade marks of Union Carbide Corporation.

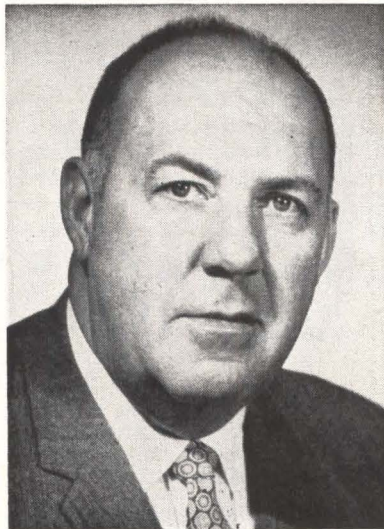

K. M. Lord

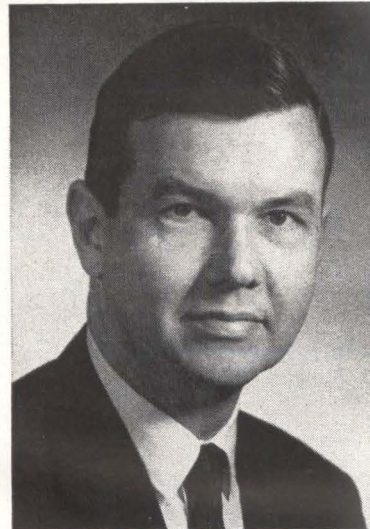

C. R. Rockwood

Raytheon Promotes Executives

A NEW POST, vice president-commercial, has been created by Raytheon Company, Lexington, Mass., to insure the firm's fullest participation in commercial markets by new ventures, including acquisitions, and from internal growth.

Kenneth M. Lord has been named to the new position. For the past year he has been vice president and general manager of Raytheon's Semiconductor division.

Succeeding Lord as general manager of the Semiconductor division is Clyde R. Rockwood, formerly division operations manager.

In his new post, Lord will manage the company's commercial acquisition program, as well as study the firm's commercial products, markets, distribution methods, and long range plans. He will make recommendations to advance the company's commercial business.

Raytheon's commercial product lines presently include marine electronics, microwave cooking, power supplies, industrial and communications equipment, lasers, and a broad line of tubes, transistors, diodes and integrated circuits.

Daystrom Acquires Boonshaft & Fuchs

THE BOARDS of directors of Daystrom, Inc., a subsidiary of Schlumberger Limited, and Boonshaft and Fuchs, Inc., have jointly announced the approval in principle of the acquisition by Daystrom of Boonshaft and Fuchs, a Hatboro, Pa., designer and producer of dynamic measurement and test equipment.

The announcement said the acquisition was subject to final approval by Boonshaft & Fuchs stock-

holders. Details of the purchase were not disclosed.

Jack Boonshaft, president of Boonshaft & Fuchs, said the activity would continue in Hatboro and would retain the present management.

Douglas Aircraft Appoints Moe

APPOINTMENT of George Moe as director of Astropower Laboratory, a research facility of Douglas Air-

why your electronics plant belongs in Atlanta

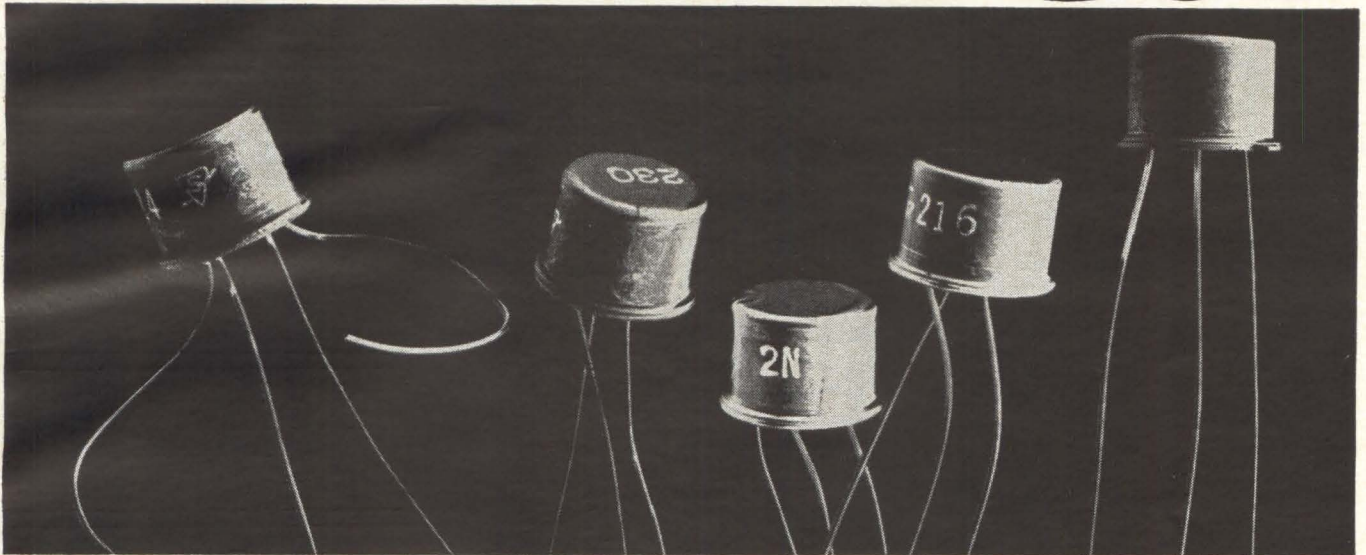

High productivity. For every dollar of wages paid, an Atlanta manufacturer of electronic measuring instruments can expect \$3.76 in value added by manufacture. In Chicago he would gain only \$2.90; in New York-New Jersey, \$2.64 (U. S. Census figures). Atlanta's large labor pool also permits a high degree of selective hiring.

Trained engineers and technicians. In 1962 Atlanta's 19 colleges and universities granted over 1,000 Bachelor of Science degrees — more than 200 in electrical engineering and physics. Nearly 300 technicians graduate here yearly.

Proximity to aerospace and atomic energy installations. Atlanta is at the center of some 26 military, NASA, AEC, and airframe manufacturing installations, including Thiokol Solid Rocket Booster Plant, Marshall Space Flight Center, Cape Kennedy.

Transportation. Close liaison between manufacturer and customer and rapid freight service are guaranteed by Atlanta's transportation facilities. Seven airlines offer non-stop service from Atlanta to more than 50 cities; 75 truck lines provide scheduled service to every major market in the nation; 7 railroads operate into and out of the city over 13 main lines.

Independent research capabilities. Georgia Tech's Engineering Experiment Station, Emory University, the University of Georgia, plus a number of private companies, offer a wide range of research capabilities on a contractual basis to business and industry.

Ask for an analysis of your company's probable success in Atlanta as prepared by Georgia Tech's Industrial Development Division. Check coupon; mail with your company letterhead. All inquiries confidential.

Please send me the following reports and other information as checked below.

1. Calculators and Computers—A Manufacturing Opportunity in Atlanta
2. Electronic Testing and Measuring Instruments—A Manufacturing Opportunity in Atlanta
3. Electronics—A Manufacturing Opportunity in Georgia
4. I would like information on the following aspect(s) of Atlanta's economic and general make-up (list) _____
5. I want to know my company's prospects for success in Atlanta as analyzed by Georgia Tech's Industrial Development Division. We would be interested primarily in a new plant warehouse sales office other _____



"Forward Atlanta"
Paul Miller, Development Manager
Atlanta Chamber of Commerce
1318 Commerce Building
Atlanta, Ga. 30303 Phone: 521-0845

Name _____ Title _____

Company _____

Product _____

Street _____

City _____ Zone _____ State _____

CONFIDENTIAL

SPECIFY Stromberg-Carlson TELEPHONE-TYPE RELAYS

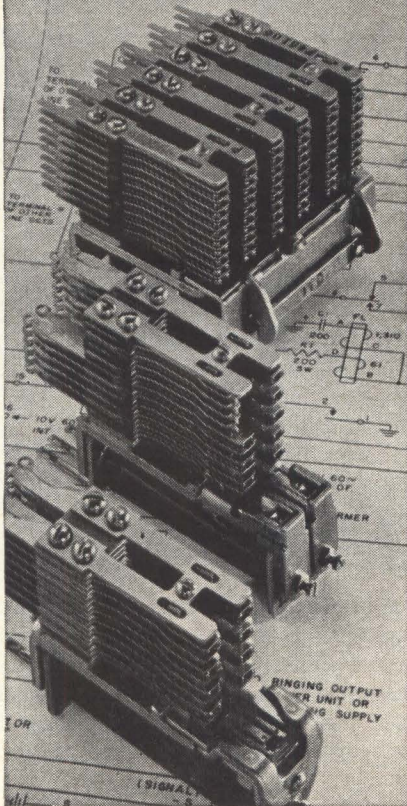

The sound design and long, reliable life of these Stromberg-Carlson relays have been proved by many years of successful use in the exacting field of telecommunication:

Type A: general-purpose relay. Up to 20 Form "A" spring combinations.

Type B: multi-contact relay. Up to 60 Form "A" spring combinations.

Type BB: multi-contact relay. Up to 100 Form "A" springs.

Type C: two relays on one frame; mounts in same space as one Type A.

Type E: general-purpose relay; universal mounting; interchangeable with relays of other manufacturers.

All standard spring combinations are available in these telephone-quality relays. For complete technical data and details on special features, write to Industrial Sales Department.

STROMBERG-CARLSON
A DIVISION OF **GENERAL DYNAMICS**
114 CARLSON ROAD • ROCHESTER 3, N. Y.

craft Company's Missile & Space Systems division, Santa Monica, Calif., has been announced.

Moe joined Astropower as vice president in charge of research when it was founded in 1960 as a Douglas subsidiary. The firm was integrated into the parent company last January 1, and its facilities assigned to Douglas MSSD.

PEOPLE IN BRIEF

Alfred B. Lang, ex-GE, named mgr.-mfg. engineering at Fenwal, Inc. **Richard G. DiPaola** promoted to test and reliability mgr. by National Semiconductor Corp. **Wayne E. Phillips**, formerly with Beckman Instruments, appointed mgr. of engineering for the Vacuum Products div. of Varian Associates. **George G. Pagonis**, previously president of Ortho Industries, Inc., joins Bogue Electric Mfg. Co. as v-p and mgr. of marketing. **A. J. Vaughan** moves up to chief engineer of RCA's Astro-Electronics div. **Theodore W. Cooper**, from Electro-Optical Systems, Inc., to Centralab as mgr., development engineering, PEC integrated circuits and capacitors. **A. J. Arnold** advances at Barber-Colman Co. to head up its newly formed Electro-Mechanical Products div. **Milton F. Pravda** raised to director of engineering and research for Martin Co.'s Nuclear div. **Stewart W. Swacker** Capt., U. S. N. Ret., appointed director of research at Manson Laboratories, Inc. **Thomas J. McLaughlin** leaves Loral Electronics Corp. to join Lavoie Laboratories, Inc., as g-m. **M. Moskowitz**, ex-Belock Instrument Corp., now director of mfg. for Victory Electronics, Inc. **Floyd M. Cate**, formerly with Cannon Electric Co., appointed v-p, marketing, of Cinch Mfg. Co. **A. F. Bongarzone**, previously with System Development Corp., named a senior member of the technical staff at Computer Sciences Corp. **E. E. Hotchkin** promoted to director of engineering for the Data Recorders div., Consolidated Electrodynamics Corp., succeeding **Herbert I. Chambers**, who moved up to asst. g-m of the div.

SEARCHLIGHT SECTION

(Classified Advertising)

BUSINESS OPPORTUNITIES

EQUIPMENT - USED or RESALE

DISPLAYED RATE

The advertising rate is \$27.25 per inch for all advertising appearing on other than a contract basis. Contract rates quoted on request. AN ADVERTISING INCH is measured $\frac{3}{4}$ inch vertically on one column, 3 columns—30 inches—to a page. EQUIPMENT WANTED or FOR SALE ADVERTISEMENTS acceptable only in Displayed Style.

UNDISPLAYED RATE

\$2.70 a line, minimum 3 lines. To figure advance payment count 5 average words as a line.

PROPOSALS, \$2.70 a line an insertion.

BOX NUMBERS count as one line additional in undisplayed ads.

DISCOUNT OF 10% if full payment is made in advance for four consecutive insertions of undisplayed ads (not including proposals).

RADAR AUTO-TRACK & TELEMETRY ANTENNA PEDESTALS 3 & 10 CM. SCR 584 AUTOTRACK RADARS. M-33 RADAR TPS-1D SEARCH. APS-45 TPS-10D HT. FINDERS. WX RADARS. FPN-32GCA. APS-10 APS-15B APS-27 (AMTI) SEARCH. APN-102 DOPLER. DOZENS MORE. CARCINOTRONS. PENS. 25-5-1-2-3-6 MEGAWATT PULSE MODULATORS. CAVITIES. PULSE TRANSFORMERS. IF STRIPS. WAVEGUIDE. BENDS 200 MC. 1 KMC. 3 KMC. 6 KMC. 9 KMC. 24 KMC. RF PKGS.

RADIO RESEARCH INSTRUMENT CO.

550 5TH AVE., NEW YORK 36, N. Y.

JU 6-4691

CIRCLE 952 ON READER SERVICE CARD

PROFESSIONAL SERVICES

GIBBS & HILL, Inc.

Consulting Engineers

Systems Engineering

Operations Research • Development

Field Studies • Design • Procurement

Power • Transportation • Communications

Water Supply • Waste Treatment

393 Seventh Avenue

New York 1, N. Y.

EMPLOYMENT OPPORTUNITIES

The advertisements in this section include all employment opportunities—executive, management, technical, selling, office, skilled, manual, etc. Look in the forward section of the magazine for additional Employment Opportunities advertising.

— RATES —

DISPLAYED: The advertising rate is \$52.00 per inch for all advertising appearing on other than a contract basis. Contract rates quoted on request.

An advertising inch is measured $\frac{3}{4}$ inch vertically on a column—3 columns—30 inches to a page.

Subject to Agency Commission.

UNDISPLAYED: \$2.70 per line, minimum 3 lines. To figure advance payment count 5 average words as a line. Box numbers—count as 1 line.

Discount of 10% if full payment is made in advance for 4 consecutive insertions.

Not subject to Agency Commission.

LIVEWIRE ENGINEER

Needed for small, transducer system development and application group in rapidly growing activity within a moderate size growth company. Unusual flexibility required in a position with excellent technical and financial future. Desired man probably is an E. E., experienced with both industrial electronic instrumentation AND cold finishing operations of steel sheet mills. Personality must be suitable for both customer relations and development lab. Travel up to 50% of the time, but usually home (Cleveland area) weekends.

Air mail resume, including home phone number, references, availability and salary requirements, in first communication to R. Petruschke,

ASSEMBLY PRODUCTS, INC.

Chesterland, Ohio

PUSHBUTTON SKY

Push a button. You're in space! There are the stars and constellations . . . visual reference for orbital rendezvous. This is Link's Star Field Projector, designed as support equipment for manned space flight research programs. Push another button and you're riding in space in an all-purpose flight simulator for the Air Force which "makes believe" any spacecraft yet conceived. Or it could be in the Apollo Mission Simulator which Link is developing for the moon flight. Link's activities run

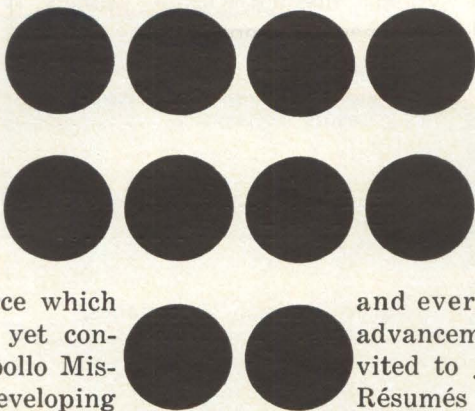

the gamut from development of systems for photo-grammetry and optical scanning to production of a complex weapons system trainer like the F-4C and the digital 727 airline simulator. Our scientists and engineers enjoy salaries that are among the best in the field, unusual job stability, and every opportunity for professional advancement. Qualified individuals are invited to join the Link professional staff. Résumés to Mr. J. J. Robilotto will receive prompt attention.

IEEE INTERVIEWS

For advanced appointment during IEEE
forward complete resume or visit our suite at the Convention Hotel

PROJECT MANAGEMENT—Direct and economically administer a project—technical and industrial programs. Engineering degree. Work will be on simulation equipment.

ELECTRONIC SYSTEMS—Perform electronic systems design for space and aircraft simulation systems utilizing digital and analog computers.

FLIGHT ANALYSIS—Investigate orbit determination, rendezvous and navigation techniques, and atmospheric reentry.

CIRCUITS—Logic design of special purpose digital computers for aircraft and space vehicle simulation applications.

MECHANICAL SYSTEMS—Perform analysis and design of mechanical systems pertaining to instrumentation and precision measurement equipment.

VISUAL SYSTEMS—Design and development functions on complex visual systems utilizing closed circuit TV techniques.

AERONAUTICS—Contribute technically to analysis and design of aeronautical systems simulation equipment. Intensive activity with equations of motion pertaining to space vehicles.

OPTICS—Performs high-level geometrical design of optical systems in instrumentation and visual display programs.

SCIENTIFIC PROGRAMMING—Analysis of electronic systems, generation of equations, coding and programming on multi-computer complex. Develop input-output, computer-to-computer, control and operational programs.

An equal opportunity employer

LINK GROUP

 **GENERAL
PRECISION INC.**

BINGHAMTON, NEW YORK

INDEX TO ADVERTISERS

• AMP Incorporated	4	Heinemann Electric Co.	15	Texas Instruments Incorporated Industrial Products Group	11
• American Time Products, Div. of Bulova Watch Company, Inc.	51	• Hewlett-Packard Company 2nd cover		Trio Laboratories, Inc., Custom Power Div.	53
Assembly Products Inc.	54	• Hitachi, Ltd.	12		
Astrodata Inc.	13	• Hughes Aircraft Co., Instru- ments Division	50	Union Carbide Corp., Linde Division	68
Atlanta Chamber of Commerce	69			• United Transformer Corp. 4th cover	
		IEEE	48, 49		
Babcock Relays, Inc.	26	ITT Royal Electric	50		
• Ballantine Laboratories, Inc.	55			CLASSIFIED ADVERTISING	
• Bourns Inc.	3	Julie Research Laboratories, Inc.	57	F. J. Eberle, Business Mgr. (2557)	
Bud Radio Inc.	42			PROFESSIONAL SERVICES	70
		• Keithley Instruments, Inc.	58	EMPLOYMENT OPPORTUNITIES	71
• Centralab, The Electronics Div. of Globe-Union Inc.	63	Kin Tel, A Division of Cohu Electronics Inc.	3rd cover	EQUIPMENT	
• Cominco Products, Inc.	67	• Knights Company, James	64	(Used or Surplus New)	
Communication Electronics Inc.	64			For Sale	70
• Couch Ordnance Inc.	56				
		Paktron, Div. of Illinois Tool Works	21, 22, 23, 24	CLASSIFIED ADVERTISERS INDEX	
Delco Radio	25	Patwin Electronics	66	Assembly Products	70
Di Acro Corp.	46	Precision Instrument Co.	47	General Precision Inc.	71
				• Radio Research Instrument Co.	70
Electronic Modules Corp.	44				
• Fenwal Electronics, Inc.	62	Radiation Inc.	40		
Frederick Electronics Corp.	67	Rapidesign, Inc.	44		
• General Electric Co. Miniature Lamp Dept.	59	SAAB Motors Inc.	16		
Tube Dept.	8, 9	• Sangamo Electric Co.	7		
• Globe Industries Inc.	62	Schober Organ Corp., The	65		
Grafix Inc.	44	Servo Corporation of America	66		
Gudebrod Bros. Silk Co., Inc.	52	Sprague Electric Co.	6		
		Stromberg-Carlson, A Division of General Dynamics	70		

CLASSIFIED ADVERTISING
F. J. Eberle, Business Mgr. (2557)

PROFESSIONAL SERVICES 70
EMPLOYMENT OPPORTUNITIES 71
EQUIPMENT
(Used or Surplus New)
For Sale 70

CLASSIFIED ADVERTISERS INDEX
Assembly Products 70
General Precision Inc. 71
• Radio Research Instrument Co. 70

• See advertisement in the July 25, 1963 issue of electronics Buyers' Guide for complete line of products or services.

This Index and our Reader Service Numbers are published as a service. Every precaution is taken to make them accurate, but electronics assumes no responsibility for errors or omissions.

electronics



Audit Bureau of Circulation



Associated Business Publications

AUDITED PAID CIRCULATION

JAMES T. HAUPTLI (2210)
Advertising Sales Manager

HENRY M. SHAW (3485)
Market Research Manager

DAVID M. TEMPEST (3139)
Promotion Manager

electronics Buyers' Guide

R. S. QUINT (2335)
General Manager

RICHARD J. TOMLINSON (3191)
Business Manager

THEODORE R. GEIPEL (2044)
Production Manager

NEW YORK TELEPHONE: Dial Direct:
971 plus number in parenthesis,
Area Code 212

ADVERTISING REPRESENTATIVES

ATLANTA, GA. 30309
G. Krimsier, Michael H. Miller
1375 Peachtree St. N.E.,
Trinity 5-0523 (area code 404)

BOSTON, MASS. 02116
William S. Hodgkinson
McGraw-Hill Building, Copley Square,
Congress 2-1160 (area code 617)

CHICAGO, ILL. 60611
Robert M. Denmead
Daniel E. Shea, Jr.
645 North Michigan Avenue,
Mohawk 4-5800 (area code 312)

CLEVELAND, OHIO 44113
Paul T. Fegley
55 Public Square,
Superior 1-7000 (area code 216)

DALLAS, TEXAS 75201
Frank Le Beau
The Vaughn Bldg.,
1712 Commerce St.
Riverside 7-9721 (area code 214)

DENVER, COLO. 80202
David M. Watson
Tower Bldg., 1700 Broadway,
Alpine 5-2981 (area code 303)

HOUSTON, TEXAS 77025
Kenneth George
Prudential Bldg., Halcombe Blvd.,
Riverside 8-1280 (area code 713)

LOS ANGELES, CALIF. 90017
Ashley P. Hartman, John G. Zisch,
1125 W. 6th St., Huntley 2-5450
(area code 213)

NEW YORK, N. Y. 10036
Donald R. Furth (212) 971 3616
Donald H. Miller (212) 971 3615
George F. Werner (212) 971 3617
500 Fifth Avenue

PHILADELPHIA, PA. 19103
William J. Boyle, Warren H. Gardner
6 Penn Center Plaza,
LOcust 8-6161 (area code 215)

SAN FRANCISCO, CALIF. 94111
Richard C. Alcorn
255 California Street,
Douglas 2-4600 (area code 415)

LONDON W1:
Edwin S. Murphy Jr.
34 Dover St.

FRANKFURT/Main:
Matthee Herfurth
85 Westendstrasse

GENEVA:
Michael R. Zeynel
2 Place du Port

TOKYO:
Shigeo Chiba,
1, Kotohiracho, Shiba, Minato-ku



DELIVERS CLOSED-CIRCUIT TELEVISION SYSTEMS TO MEET YOUR REQUIREMENTS

COLOR cameras

ENVIRONMENT-RESISTANT cameras

HIGH-RESOLUTION cameras

INDUSTRIAL cameras

MINIATURIZED cameras

RADIATION-RESISTANT cameras

SELF-CONTAINED cameras

SPACE cameras

TEMPERATURE-EXTREME cameras

UNDERWATER cameras

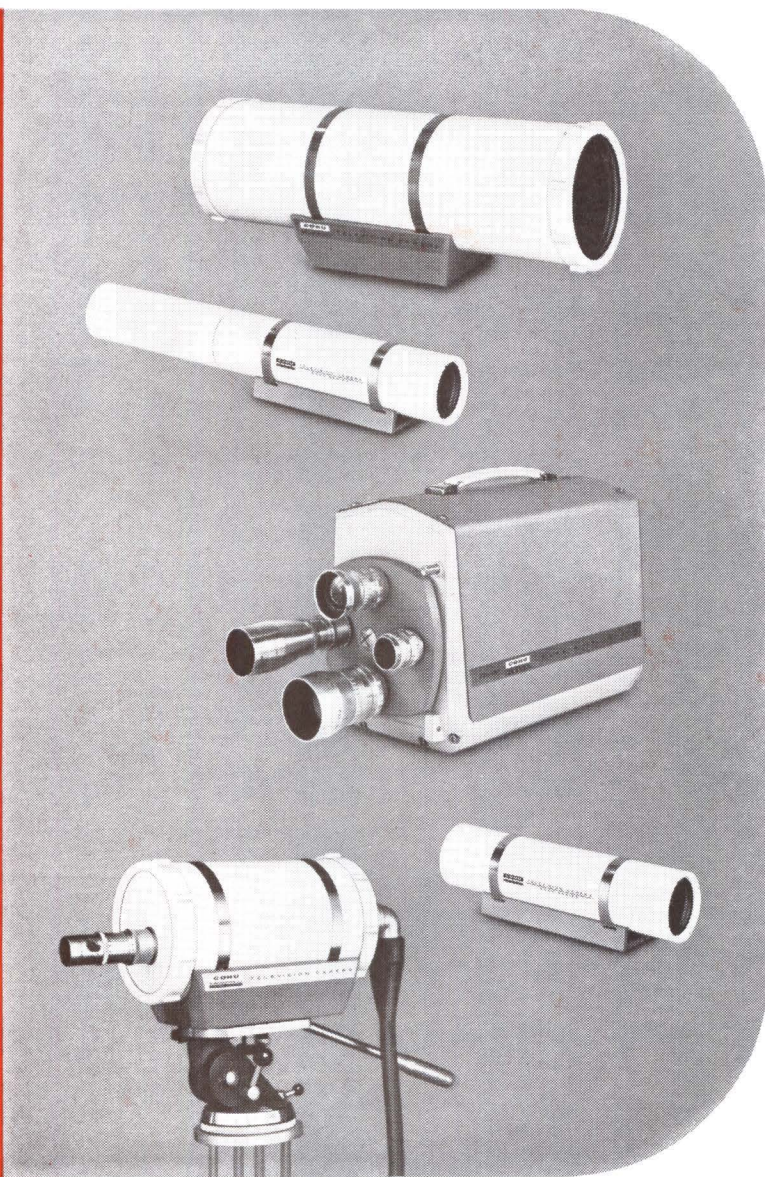

See us at the **IEEE Show**
March 23-26, Booth 3601

and ALL ACCESSORIES including monitors, control units, fixed-focus and zoom lenses, pan/tilt units, video cable, video switchers, synchronizing generators, cabling, tripods, vidicons...

WRITE for technical information and systems engineering. Representatives in all major cities.



5725 Kearny Villa Road
San Diego, California 92112
Phone (714) 277-6700

CIRCLE 901 ON READER SERVICE CARD



**PIONEERS IN
MINIATURIZATION**

"SPECIAL" (CUSTOM BUILT) FILTERS

TO YOUR SPECIFICATIONS

Over thirty years of experience in the design and production of special filters have resulted in UTC being a first source for difficult units. Present designs both military and commercial incorporate a wide variety of core structures, winding methods, and capacitors to provide maximum performance, stability, and reliability. Fully experienced, top engineering talent backed by complete environmental testing and life testing facilities assure the highest standard in the industry. Full analysis and evaluation of materials are conducted in UTC's Material and Chemical Laboratories. Rigid quality control measures coordinated with exhaustive statistical findings and latest production procedures results in the industry's highest degree of reliability. The units illustrated show a few of the thousands of specials produced by UTC, to customers' requirements, and only slightly indicate the possibilities in present special filter design. Range of frequencies on special units is from .1 cycles to 400 MC.

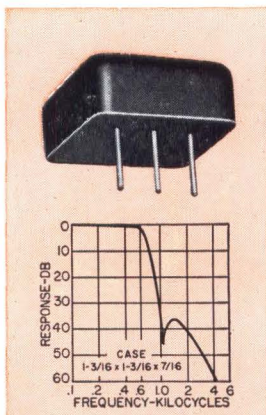

560 \sim Telemetering low pass filter. Available from 400 \sim to 70 KC. \pm 7.5% bandwidth flat to 1 db. Attenuation greater than 35 db beyond the 2nd harmonic of 7.5% frequency. Impedance 47K ohms. MIL-F-18327B. Wt. 0.8 oz.

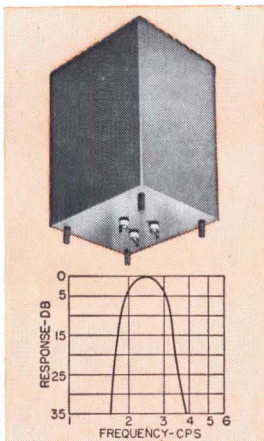

Low frequency band pass filter. Designed for 2.5 cps center frequency. At 2 to 3 cps within 3 db. At 1.5 cps and lower, and 4 cps and higher, greater than 30 db. Source and Load 10K ohms. Size: 4 x 4-11/16 x 6". MA MIL case, MIL-F-18327B.

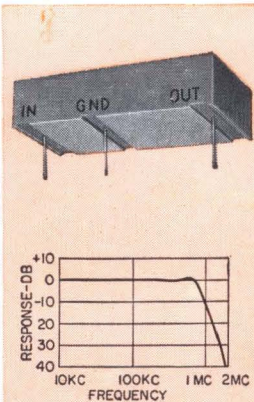

High frequency low pass filter. Zero to 700 KC within 1 db. 1.95 mc to 10 mc 40 db minimum. Source and Load 1000 ohms. Molded flat construction for printed circuit applications. Size: 1 x 2 x 1/8"; Wt: 1 oz. MIL-F-18327B.

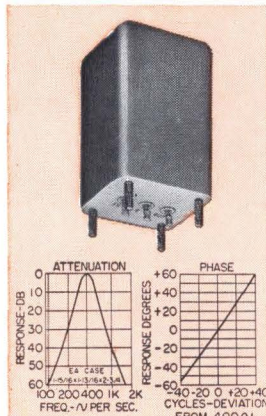

Band pass 400 cycle Gaussian filter. Linear phase response in pass band. Attenuation 380 cps to 420 cps within 0.5 db. 2nd harmonic down 25 db, 3rd harmonic down 45 db. Source and load 5K ohms. MIL-F-18327B Wt., 0.9 lbs.

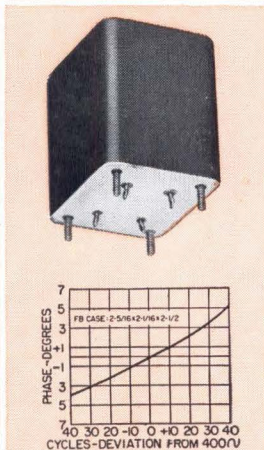

Minimum phase shift 400 cycle band pass filter. Within \pm 1.5 db 370 to 430 cycles, greater than 45 db beyond 1100 cycles. 1K ohms to 100K ohms. MIL-F-18327B; 1 lb.

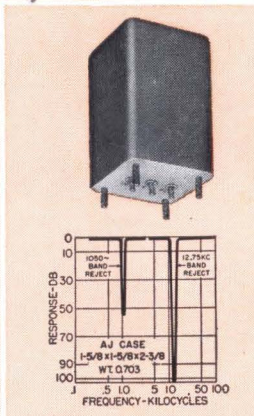

Band reject filters (two shown). The 1050 \sim filter has 50 db attenuation and is only 3 db at 950 and 1150 cycles. The 12.75 KC filter has more than 100 db attenuation and is only 3 db at 10.8 and 15 KC. Source and load 600 ohms, both are MIL-F-18327B.

MILITARY AND COMMERCIAL TYPES FOR EVERY PHASE OF THE ELECTRONICS ART

POWER TRANSFORMERS • AUDIO TRANSFORMERS • INDUCTORS • PULSE TRANSFORMERS • ELECTRIC WAVE FILTERS • LUMPED CONSTANT DELAY LINES • HIGH Q COILS • MAGNETIC AMPLIFIERS • SATURABLE REACTORS • REFERENCE UNITS

Write for catalog of over 1,200 UTC HIGH RELIABILITY STOCK ITEMS IMMEDIATELY AVAILABLE from your local distributor.



UNITED TRANSFORMER CORP.

150 VARICK STREET, NEW YORK 13, N. Y.

PACIFIC MFG. DIVISION: 3630 EASTHAM DRIVE, CULVER CITY, CALIF.
EXPORT DIVISION: 13 EAST 40th STREET, NEW YORK 16, N. Y. CABLE: "ARLAB"