

Electronics[®]

Using feedback in integrated circuits: page 67

A look at Yaou's tiny color tv set: page 81

Ground stations for military satellites: page 86

May 31, 1965

75 cents

A McGraw-Hill Publication

Below: inductors that fit
integrated circuits, page 62





SPECIAL CUSTOM BUILT TO YOUR SPECIFICATIONS

The bulk of UTC production is on special units designed to specific customers' needs. Illustrated below are some typical units and some unusual units as manufactured for special applications. We would be pleased to advise and quote to your special requirements.

FILTERS

All types for frequencies from .1 cycle to 400 MC.



400 \sim telemetering, 3 db at $\pm 7.5\%$, 40 db at 230 and 700 \sim , $\frac{5}{8}$ x $1\frac{1}{4}$ x 2"



15 \sim BP filter, 20 db at 30 \sim , 45 db at 100 \sim , phase angle at CF less than 3° from -40 to $+100^\circ\text{C}$.



LP filter within 1 db to 49 KC, stable to .1 db from 0 to 85°C ., 45 db at 55 KC.



LP filter less than .1 db 0 to 2.5 KC, 50 db beyond 3 KC.

PULSE TRANSFORMERS

From miniature blocking oscillator to 10 megawatt.



Wound core unit .01 micro-second rise time.



Pulse current transformer 100 Amp.



Pulse output to magnatron, bifilar filament.



Precise wave shape pulse output, 2500 V. 3 Amps.

HIGH Q COILS

Toroid, laminated, and cup structures from .1 cycle to 400 MC.



Tuned DO-T servo amplifier transformer, 400 \sim .5% distortion.



Toroid for printed circuit, Q of 90 at 15 KC.



Dual toroid, Q of 75 at 10 KC, and Q of 120 at 5 KC.



HVC tapped variable inductor for 3 KC oscillator.

SPECIALTIES

Saturable reactors, reference transformers, magnetic amplifiers, combined unit.



RF saturable inductor for sweep from 17 MC to 21 MC.



Voltage reference transformer .05% accuracy.

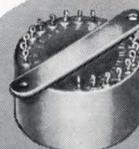

Multi-control magnetic amplifier for airborne servo.



Input, output, two tuned interstages, peaking network, and BP filter, all in one case.

POWER COMPONENTS

Standard and high temperature . . . hermetic, molded, and encapsulated.



Multi-winding 140 VA, 6 KC power transformer $1\frac{1}{4}$ x $1\frac{1}{4}$ x 1"



200° C. power transformer, 400 \sim , 150 VA.



400 \sim scope transformer, 20 KV output.



60 \sim current limiting filament transformer, Sec. 25 Mmfd., 30 KV hipot.

plus
OVER 1,000
STOCK ITEMS
with UTC
High Reliability



→ write for catalog

UNITED TRANSFORMER CORP.

150 VARICK STREET, NEW YORK 13, N. Y.

PACIFIC MFG. DIVISION: 3630 EASTHAM DRIVE, CULVER CITY, CALIF.
EXPORT DIVISION: 13 EAST 40th STREET, NEW YORK 16, N. Y.

CABLE: "ARLAB"

Circle 900 on reader service card

Spectrum analysis techniques for work in semiconductors, parametric devices, distortion analysis and what have you.

If you are working with harmonic generation, spectrum analysis can help you. Harmonic generating devices, such as the varactor and step recovery diodes, have become exceedingly popular because of their reliability and frequency stability.

With the step recovery diode, for example, it's easy to obtain frequency generation in a single step from hundreds of milliwatts at S-band to tens of milliwatts at X-band.

However, strong non-linear interactions are involved in the marriage of the diode into the circuit. Both the input and output circuits of the circuit must be tuned properly or parametric and noise oscillations can result. Formerly this tuning could only be accomplished by tedious trial and error methods.

With spectrum analysis it is convenient and easy to optimize the diode into the circuit. The 2 gc sweep and the 4 gc image separation display all the signals from the circuit. Adjustment follows naturally.

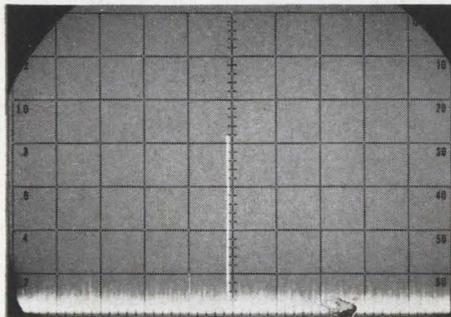
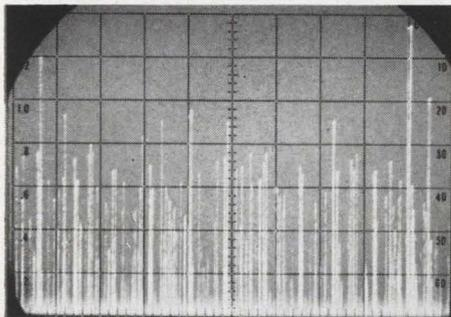

Improper adjustment of harmonic generator shows spurious signals (above) and final desired output (below) of 3.8 gc. Spectrum width, 200 mc/cm. Vertical, 10 db/cm.

If you're working in parametric amplification, spectrum analysis makes it easy for you to see the output, pump, idler and upper sideband frequencies on one display since signals from 10 mc to 10 gc can be handled. This is especially useful because the spectrum displays the interdependence of adjustments for optimum gain and low noise operation, as well as suppression of the upper sideband and spurious signals.

If you're working in distortion analysis, spectrum analysis offers new capabilities in such applications as high-frequency transistors used as amplifiers. The ana-

new uses for SPECTRUM ANALYSIS

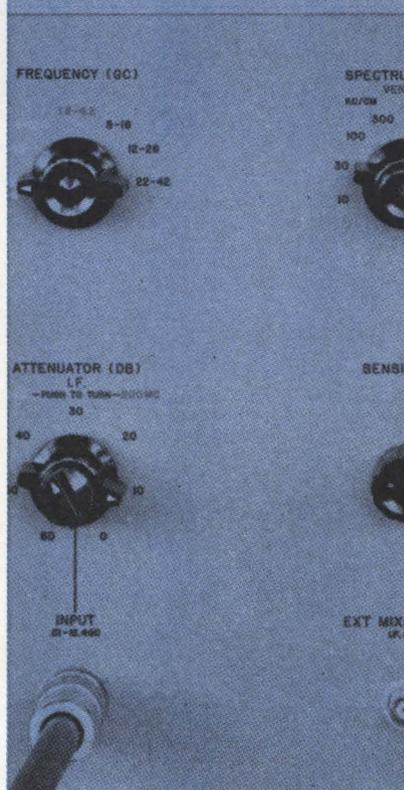
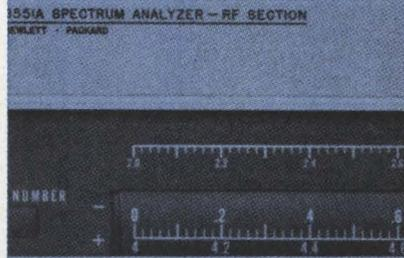
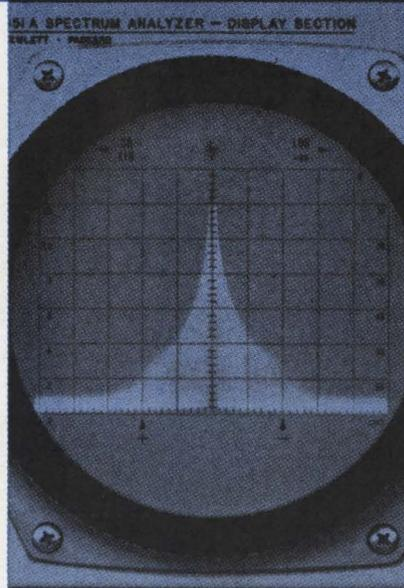

lyzer's tuning range from 10 mc to 40 gc, its sweep bandwidth to 2 gc and its image separation of 4 gc make it an extremely useful tool to find distortion and intermodulation products. Add to this a flat frequency response, completely calibrated controls and display dynamic range of 60 db, internal phase lock, high accuracy and resolution and x-y output for recording... and you come up with a truly versatile and helpful tool.

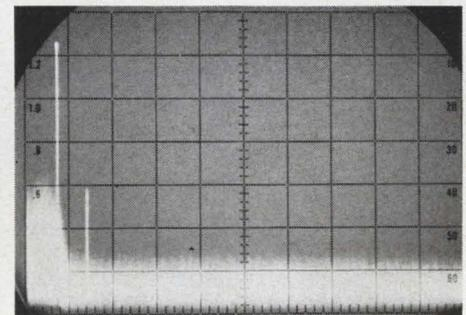
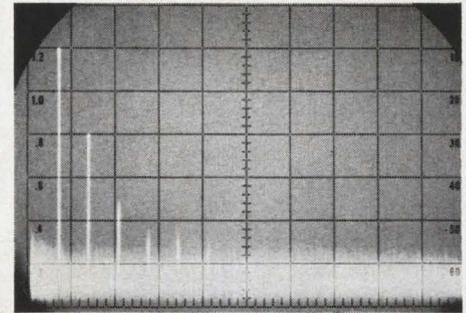

Overdriving transistor amplifier at 150 mc generates output with distortion products (above). Same amplifier operating normally (below) with second harmonic at 35 db down. Scales for both figures, 200 mc/cm and 10 db/cm vertical. Note passband noise below 150 mc.

The new Hewlett-Packard 851/8551A Spectrum Analyzer is described in detail in hp Application Note 63. A copy, along with complete performance specifications, is available from your hp field engineer. Or write: Hewlett-Packard, Palo Alto, Calif. 94304, (415) 326-7000; Europe: 54 Route des Acacias, Geneva; Canada: 8270 Mayrand Street, Montreal.

Data subject to change without notice.

HEWLETT *hp* PACKARD

An extra measure of quality

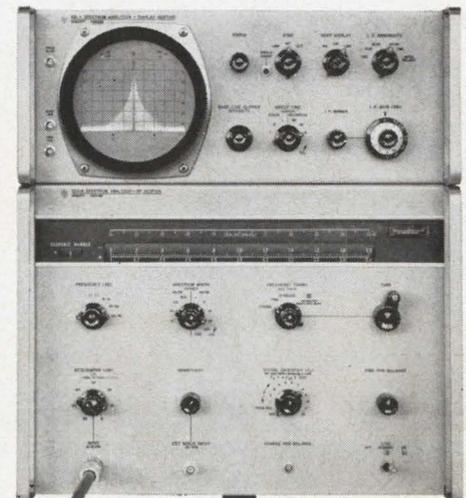

NOW!
10 Mc -
1000* Mc



MODEL
3200A

VHF OSCILLATOR

*With NEW Frequency Doubler Probe MODEL 13515A

Features:

- ±0.002% Frequency Stability
- External AM and Pulse Modulation
- Waveguide-Below-Cutoff Output Attenuator
- Solid-State Power Supply

The VHF Oscillator Model 3200A is designed for general purpose laboratory use including receiver and amplifier testing, driving bridges, slotted lines, antenna and filter networks, and as a local oscillator for heterodyne detector systems in the frequency range from 10 to 500 mc.

The push-pull oscillator is housed in a rugged aluminum casting for maximum stability and extremely low leakage; six frequency ranges are provided for adequate bandspread on the slide-rule dial. Internal CW operation is provided; AM and pulse modulation may be obtained through the use of a suitable external source. The RF output is coupled through a waveguide-below-cutoff variable attenuator; in addition, an electrical RF level vernier is included as a front panel control.

An optional accessory Frequency Doubler Probe, Model 13515A incorporates a solid-state doubler circuit and provides additional frequency coverage from 500 to 1000 mc.

Specifications Model 3200A

Radio Frequency Characteristics

RF RANGE: 10 to 500 mc

RF ACCURACY:

±2% (after ½ hour warmup)

RF OUTPUT:

Maximum Power:

- > 200 mw* (10-130 mc)
- > 150 mw* (130-260 mc)
- > 25 mw* (260-500 mc)

*Across external 50 ohm load

Range: 0 to > 120 db attenuation from maximum output

Load Impedance: 50 ohms nominal

RF STABILITY:

Short Term: ±0.002° (5 minutes)

Long Term: ±0.02° (1 hour)

Line Voltage: ±0.001% (5 volts)

*After 4 hour warmup, under 0.2 mw load

RF LEAKAGE: Sufficiently low to permit measurements at 1 μv

Amplitude Modulation Characteristics

AM RANGE: 0 to 30% (External)

AM DISTORTION: <1% at 30% AM

EXTERNAL AM REQUIREMENTS:
Approx. 30 volts RMS into 600 ohms for 30% AM

Pulse Modulation Characteristics

EXTERNAL PM REQUIREMENTS:

140 volts peak negative pulse into 2000 ohms for maximum power output; typically 10 volts peak (except 50 volts on 260-500 mc range) for 1 mw peak power output

Physical Characteristics

DIMENSIONS:

Height: 6½" (16.5 cm)

Width: 7½½" (19.8 cm)

Depth: 12½" (31.8 cm)

Power Requirements

105-125/210-250 volts, 50-60 cps, 30 watts

Price: 3200A: \$475.00

F.O.B. Rockaway, New Jersey

Specifications Model 13515A

Radio Frequency Characteristics

RF RANGE: 500 to 1000 mc*

*With 3200A operating 250-500 mc

RF OUTPUT:

Maximum Power: > 4 mw*

*Across external 50 ohm load with VSWR <1.1

HARMONIC SUPPRESSION:

Fundamental: > 16 db*

Higher Order: > 16 db* (500-800 mc)

> 14 db* (800-1000 mc)

*Below desired signal

Price: 13515A: \$95.00

F.O.B. Rockaway, New Jersey

GREEN POND ROAD
ROCKAWAY, NEW JERSEY 07866
Telephone: (201) 627-6400
TWX: (510) 238-8461 Cable Address: BOONRACO

HEWLETT
PACKARD  BOONTON
DIVISION

Electronics

May 31, 1965
Volume 38, Number 11

Page 4	Readers Comment
8	People
10	Meetings
15	Editorial
17	Electronics Newsletter
43	Washington Newsletter
126	New Products
161	New Books
162	Technical Abstracts
167	New Literature

Electronics Review

Page 31	Bouncing beam	34	The tax cut
31	Visible man	34	Pasting up circuits
32	Like clockwork	36	Multifunction packs
32	Draftsman's helper	37	Quick turnaround
33	Sign language	38	Soaring market
33	Point system threatened	39	New star for ABC

Electronics Abroad

169	Counterattack	171	Floating relays
169	Air show	171	Fog index
170	Advances in components	172	Dial L for Lagos
170	Trade with the East	172	Digital dialogue
		173	Electron tracer

Probing the News

111	Saturn V's best friend
116	Creative engineers, by multiple choice
121	Solutions to the riddle of jungle communications

Technical articles

I. Design

Integrated circuits	62	Inductors that fit integrated circuits Contrary to popular belief, small inductors are available Steven Slenker, Piconics, Inc.
Solid state	67	Feedback: perils and potentials in designing integrated circuits Methods of coping with feedback and putting it to work Vasil Uzunoglu, Johns Hopkins University
Circuit design	72	Designer's casebook Photodiodes control pulse intervals; continuously variable delay line for frequencies below 100 Mc; foil and styrofoam polarize radar beam

II. Applications

Military electronics	76	Detonators that tune out stray r-f Ferrites can absorb radiation that might fire electroexplosive devices Stanley M. Adelman Sr., Picatinny Arsenal, N.J.
Consumer electronics	81	From Japan, a startling new color tv set It has a single gun tube and solid state circuitry Y. Sugihara and A. Horaguchi, Yaou Electric Co.
Space electronics	86	Ground stations for the military's communication satellite system They'll tie together a network of 24 nearly synchronous orbiting relays John F. Mason, military electronics editor

III. Manufacturing

Production	94	Dip soldering in miniature—a new way to assemble modules Melting the solder first protects semiconductor devices from thermal shock Herbert M. Isaacson, General Electric Co.
-------------------	----	--

Electronics

Editor: Lewis H. Young

Senior editors

Technical: Samuel Weber

News: Kemp Anderson, Jr.

Senior associate editors: John F. Mason, George Sideris

Department editors

Advanced technology: Joan Blum

Avionics: W.J. Evanzia

Circuit design: Michael Elia

Components: Michael F. Tomaino

Computers: Wallace B. Riley

Consumer electronics: Richard Lipkin

Instrumentation: Carl Moskowitz

Manufacturing: George Sideris

Military electronics: John F. Mason

New products: William P. O'Brien

Solid state: Jerome Eimbinder

Space electronics: Peter R. Sigmund

Staff writer: Stanley Zarowin

Regional editors

Boston: Thomas Maguire, editor; Robin Carlson

Los Angeles: William B. Wallace, editor; June Long

San Francisco: Laurence D. Shergalis, editor; Mary Jo Jadin

London: Derek Barlow, editor

Copy editors

Howard Rausch, Sally Powell, Walter Barney

Graphic design

Art director: Saul Sussman

Assistant art director: Donna M. Marchyn

Editorial production: Ann Mella

Production editor: Arthur C. Miller

Editorial secretaries: Claire Benell, Mary D'Angelo, Lynn Emery, Kay Fontana, Carolyn Michnowicz, Lorraine Rossi, Lorraine Werner

McGraw-Hill news service

Director: John Wilhelm; **Atlanta:** Fran Ridgeway; **Chicago:** Bruce Cross;

Cleveland: Arthur Zimmerman; **Dallas:** Marvin Reid;

Detroit: Donald MacDonald; **Los Angeles:** Michael Murphy,

Ron Lovell; **San Francisco:** Margaret Ralston, Ed. Addeo;

Seattle: Ray Bloomberg; **Washington:** Arthur L. Moore, Glen Bayless,

Charles Gardner, Herbert W. Cheshire, Seth Payne

McGraw-Hill world news service

Bonn: Richard Mikton; **Brussels:** Arthur Erikson; **London:** John Shinn;

Mexico City: Wesley Perry; **Milan:** Bruce Bendow;

Moscow: Donald Winston; **Paris:** Dan Smith;

Rio de Janeiro: Leslie Warren; **Tokyo:** Marvin Petal, Charles Cohen

Circulation manager: Hugh J. Quinn

Reprints: T.M. Egan

Publisher: C.C. Randolph

Electronics: May 31, 1965, Vol. 38, No. 11

Printed at 99 North Broadway, Albany, N.Y.
Second class postage paid at Albany, N.Y.

Subscriptions are solicited only from those actively engaged in the field of the publication. Position and company connection must be indicated on orders. Subscription prices: United States and Possessions and Canada, \$6.00 one year, \$9.00 two years, \$12.00 three years. All other countries \$20.00 one year. Single copies, United States and Possessions and Canada 75¢. Single copies all other countries \$1.50.

Published every other Monday by McGraw-Hill Inc. 330 West 42nd Street, New York, N.Y. 10036. Founder: James H. McGraw, 1860-1948.

Subscribers: The Publisher, upon written request to our New York office from any subscriber, agrees to refund that part of the subscription price applying to copies not yet mailed. Please send change of address notices, subscription orders or complaints to Fulfillment Manager, Electronics, at the address below. Change of address notices should provide old as well as new address, including postal zone number if any. If possible, attach address label from recent issue. Allow one month for change to become effective.

Postmaster: Please send Form 3579 to Fulfillment Manager, Electronics, P.O. Box 430, Hightstown New Jersey 08520

Readers Comment

Amplification requested

To the Editor:

With reference to the article "Stable differential amplifier designed without choppers," by David F. Hilbiber, [Jan. 25, p. 73], I would like to point out that an amplifier using exactly the same basic principle of temperature-drift compensation was exhibited by STC at Zurich, Switzerland, in December, 1961, and is described in STC Application Report MK/173X (May, 1963). The circuit was as shown in figure 3 of that report.

This early amplifier was purely experimental, and design was not fully optimized. Nevertheless it was possible to reduce the over-all voltage drift, between 25°C and 85°C, to less than 16 μ V (measured as the maximum departure from the 25°C value at any temperature within that range and referred to the input).

A feature of the amplifier, which simplified the process of adjusting experimentally for minimum drift, was provided by the two 470K resistors cross-connected between the emitter and collector circuits of the two halves of the input transistor. These greatly reduce the effect of the "temperature-coefficient" adjustment on the zero of the system. If necessary a similar technique could be applied to the amplifier described by Hilbiber.

One point which is not mentioned explicitly in the article is the fact that this method of voltage-drift reduction does nothing to reduce current drift. The amplifier is therefore restricted to operation from a relatively-low-impedance source if the full stability is to be realised in practice. It would be interesting to know how much its stability does vary with source resistance.

E. L. Jones
Chief Applications Engineer
Semiconductor Division
Standard Telephones and Cables Ltd.
England

▪ The method of temperature compensation described by STC

(Advertisement)

Operating Temperature Range of Aluminum 'Lytic Capacitors Extended to -55 C, +125 C

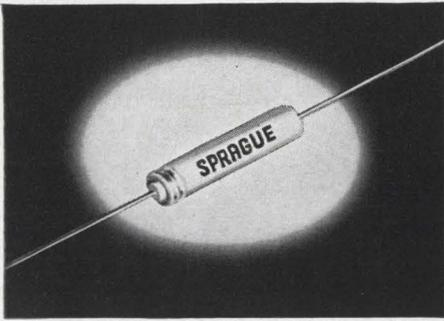

Type 600D Extralytic® Capacitors are the first commercially-available aluminum electrolytics to extend their operating temperature range to -55 C, +125 C at voltage ratings up to 150 volts d-c.

Although Type 600D Capacitors, a recent development of the Sprague Electric Company, cost only half that of corresponding tantalum foil units, they have comparable performance characteristics and offer the advantage of generally being smaller and significantly lighter than military-grade tantalum foil capacitors of equivalent ratings.

Sprague Type 600D Extralytic Capacitors are only one-third the weight of their tantalum equivalents. In a case size of 3/8" x 2-3/16" it is possible to obtain a capacitance of 850 μF at 5 WVDC or 26 μF at 150 WVDC.

This significant advancement in the manufacture of aluminum electrolytics was made possible by increased foil purity, improved oxide systems, and newly developed methods of etching that yield higher etch ratios. An improved capacitor seal design and the development of a unique new electrolyte are two other factors contributing to their outstanding performance characteristics.

Extralytic Capacitors display excellent stability over their entire temperature range. Even at -55 C, their capacitance drop is very small. The operating and shelf life of 600D Capacitors is comparable to or better than that of foil tantalum capacitors.

For complete technical data, write for Engineering Bulletin 3455 to Technical Literature Service, Sprague Electric Company, 35 Marshall St., North Adams, Massachusetts 01248.

45C-4146R1

Circle 5 on reader service card

Did you know Sprague makes...?

MAGNETIC LOGIC DEVICES

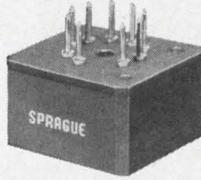

Core-diode and core transistor magnetic shift registers and magnetic counters for switching and storage applications in computer and logic circuitry.

CIRCLE 277 ON READER SERVICE CARD

MOLDED PULSE TRANSFORMERS

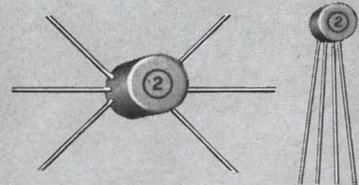

Miniature Pulse Transformers with tough molded cases for increased protection against physical damage and severe atmospheric conditions.

CIRCLE 278 ON READER SERVICE CARD

NANOSECOND PULSE TRANSFORMERS IN TO-5 TRANSISTOR CASES

Special design offers distinct advantages: (1) Mini-fied size. (2) Welded hermetic seal. (3) Increased reliability. (4) Compatibility with transistor mounting techniques.



CIRCLE 279 ON READER SERVICE CARD

SOMETHING NEW IN COUNTING TECHNIQUES

Simple yet versatile, low-cost yet reliable counters available for predetermined (2 to 11) or selectable (5 through 10) counting cycles.



CIRCLE 280 ON READER SERVICE CARD

DYNACOR® BOBBIN CORES



Series "300" Cores with logical flux values in popular physical sizes are stocked in production quantities for fast delivery. They're value engineered for quality with economy!

CIRCLE 282 ON READER SERVICE CARD

HERMETICALLY-SEALED TO-5 ENCASED SWITCH CORES

Designed especially for high-speed, low-power switching up to 100 kc, adaptability with conventional transistor packaging techniques, and performance under MIL-S-21038 environmental conditions.

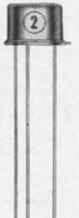

CIRCLE 281 ON READER SERVICE CARD

ELECTRONIC MODULES TO CUSTOMER REQUIREMENTS



Custom packaging is no novelty at Sprague's Special Products Division, where "specials" are continually being developed and produced with countless variations in electrical characteristics and mechanical configurations.

CIRCLE 283 ON READER SERVICE CARD

For application engineering assistance (without obligation, of course) on any of the above products, write or call the Special Products Division, Sprague Electric Company, 35 Union Street, North Adams, Massachusetts.

45SP-111-63 R4

SPRAGUE®

THE MARK OF RELIABILITY

'Sprague' and '2' are registered trademarks of the Sprague Electric Co.

Only from Sprague!

DOUBLE FEATURE!

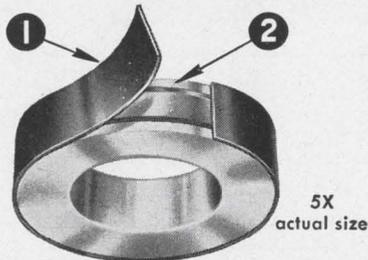

**Dynacor® Bobbin Cores
have 2 built-in reasons
for long operating life
without degradation...**

1 TOUGH ARMAG® JACKET. Withstands ambient temperatures to 180 C and is compatible with poured potting compounds, permitting Dynacor Cores to be used with normal encapsulation techniques.

2 JET-SMOOTH BOBBIN. Finely-polished stainless steel, completely eliminating sharp protrusions, square corners, or other abrasive action on copper wire windings. Improved manufacturing process results in a bobbin with a more uniform radius than that of an ordinary machined bobbin.

Dynacor Bobbin Cores are also available with ceramic bobbins where needed.

A large stock of popular sizes and flux values insures prompt delivery.

Special cores to customer specifications are quickly and accurately processed.

**For complete technical data,
write for Engineering Bulletins
on Dynacor Bobbin Cores to
Technical Literature Service,
Sprague Electric Company, 35
Marshall St., North Adams, Mass.**

SPRAGUE®
THE MARK OF RELIABILITY

® Sprague and '2' are registered trademarks of the Sprague Electric Co.

ISSP-170-43

is essentially the same as that given in two references in our article. The first was a paper entitled "Nanovolt transistor d-c amplifier" by R. D. Thornton and A. H. Hof-fait in the IEEE Proceedings, August 1963, p. 1147. The second reference was to an article by W. E. Earle in the Nov. 8, 1963 issue of Electronics, pages 66 to 70, entitled "Designing zero-drift differential amplifiers."

Like the others, however, the method of STC does not provide the means of determining the singular operating point of minimum temperature dependence, without cut-and-try approaches.

The restriction of operation of transistor differential amplifier, to low impedance sources is well recognized. Amplifier performances will degrade considerably if operation from sources higher than 10^4 ohms is considered. For this reason the Fairchild Instrumentation amplifier ADF-1 is specified only for $R_s = 350$ ohms.

This restriction arises from the fact that the behavior of h_{FE} with temperature is not as well ordered as that of V_{BE} . However, if it is necessary to operate from high source impedance, it is possible to do so by providing the specified input resistance during the compensating operation.

It is duly noted that this compensation is useful only for the given source impedance.

D. F. Hilbiber
Fairchild Semiconductor Division,
Fairchild Camera & Instrument
Corp.

Too personal

To the Editor:

Ted Maiman is a bit shook up (he's lost some of his spatial coherence, you might say) over a change one of your editors made in the article Ted wrote for your 35th anniversary issue.

The change was the insertion of the first person ("I") in the part of the article referring to Maiman's development of the first laser. As you know, Ted didn't directly refer to himself at all, when he wrote the original draft of that article . . . and, when he saw the more personalized tack your editor had taken, he asked that the "I" be de-

leted. Unfortunately, however, something went awry, and the "I" remained "I".

As you know, the scientific community is afflicted with extraordinary public modesty. Many scientists won't even use the editorial "we" when referring to themselves, preferring to use the third person. "When Maiman developed the laser," says Maiman, etc. Awkward, of course, and about as impersonal as you could get . . . but it's all part of tradition, or something.

Both Ted and I realize that your editor was just trying to make Ted's article warmer and more personal . . . but Ted's scientifically sensitive skin already is getting pricked with darts (friendly, so far) over his sudden display of tradition-breaking.

James B. Marine
Public Recognition, Inc.
Los Angeles

Shock protection

To the Editor:

I was surprised to read "no more shock" [March 8, page 42]. It would appear from this that equipment which protects the user against electric shock is not in use in the home or in industry in the U. S. A.

Here in the Republic of South Africa devices are manufactured by several companies and both single phase 220 volt and 3-phase 380-v units have been on the market for a number of years. Generally these have a sensitivity of 20 milliamperes (lower values are not unknown) as it has been established that because of inherent leakage currents due to hot plates, geysers etc., sensitivities of less than 20 milliamperes give rise to "nuisance tripping."

It is of course most difficult to establish the lowest current which will cause a lethal shock, as this will vary from subject to subject and depend on the particular circumstances, but we would consider the figure of 9 milliamperes much too low and accept 20 milliamperes as adequate protection to human life.

E. A. Hohls
Dundee, Natal
Republic of South Africa

NEW Decade Scaler



Extends the Range
of Frequency Measurements
by a Factor of 10...
up to a maximum
of 100 Mc/s

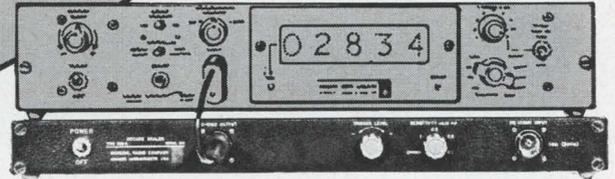
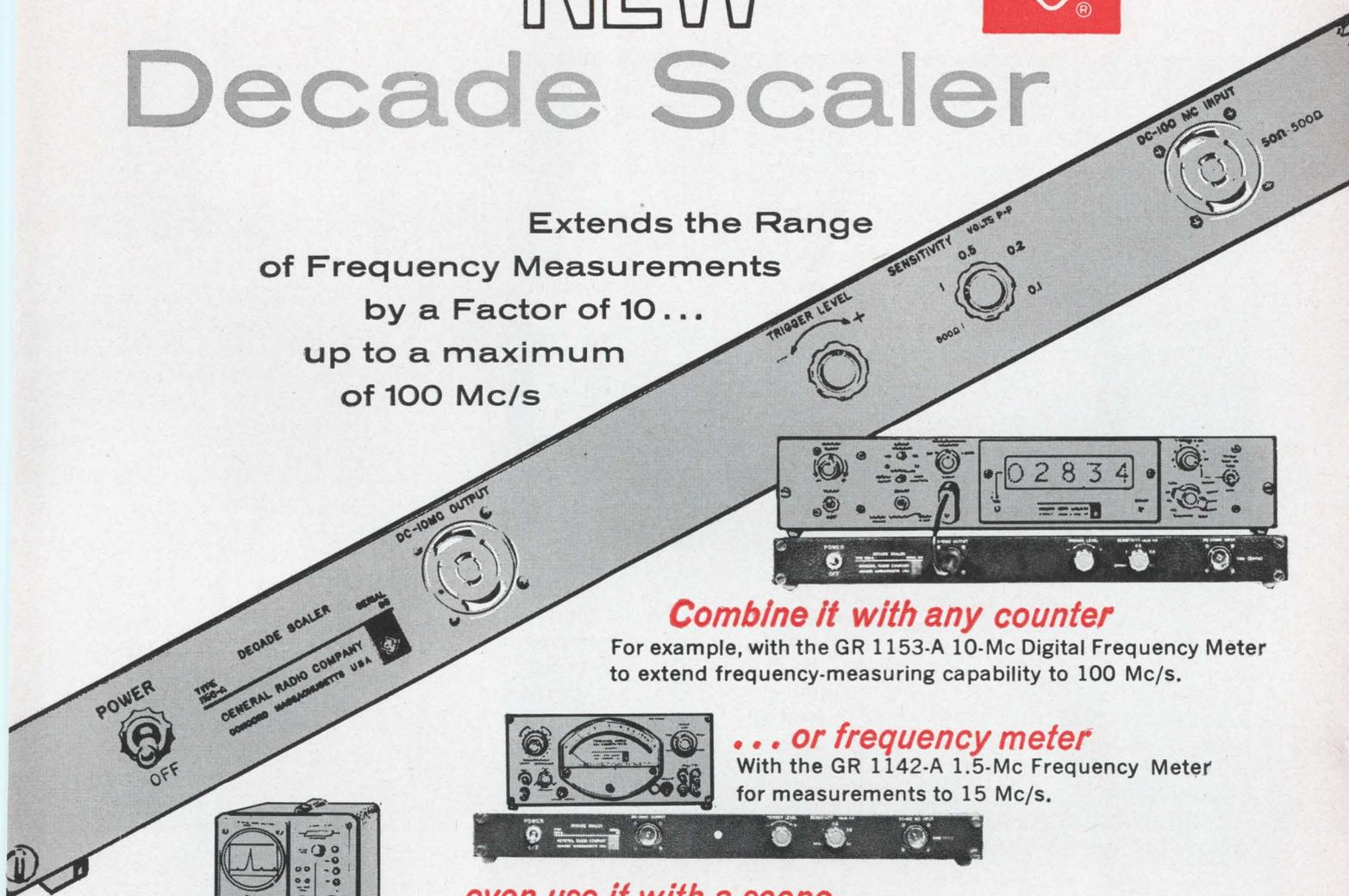

Combine it with any counter

For example, with the GR 1153-A 10-Mc Digital Frequency Meter to extend frequency-measuring capability to 100 Mc/s.

... or frequency meter

With the GR 1142-A 1.5-Mc Frequency Meter for measurements to 15 Mc/s.

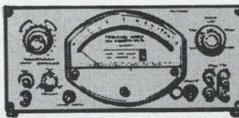

... even use it with a scope

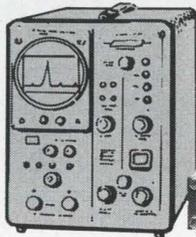

Useful for stable sweep triggering when working with high-frequency signals...

... Use it whenever you need 10:1 frequency division below 100 Mc/s

The new 1156-A Decade Scaler — a mere 1 3/4 inches high — is a completely self-contained, 100-Mc direct-counting, 10-to-1 frequency divider. Input sensitivity is better than 100 mV, peak-to-peak. An attenuator provides four 50-ohm input positions (0.1, 0.2, 0.5, and 1 V) and a 1 V, 500-ohm position. VSWR at input is less than

1.1 at 100 Mc/s. A level control lets you set the trigger level for a wide variety of input signals and minimizes the effects of noise. Amplitude of the 20 mA square wave is 1 V into a 50-ohm load. Input and output connections can be made at either the front panel or at the rear of the Scaler. Price is \$490 (in U.S.A.).

Write for Complete Information



GENERAL RADIO COMPANY

WEST CONCORD, MASSACHUSETTS

IN CANADA: Toronto 247-2171, Montreal (Mt. Royal) 737-3673
IN EUROPE: Zurich, Switzerland — London, England

BOSTON (W. Concord) 646-0550 NEW YORK, N. Y., 964-2722 (Ridgefield, N. J.) 943-3140 CHICAGO (Oak Park) 848-9400 PHILADELPHIA (Ft. Washington) 646-8030 WASHINGTON, D.C. (Rockville, Md.) 946-1600 SYRACUSE 454-9323 DALLAS FL 7-4031 SAN FRANCISCO (Los Altos) 948-8233 LOS ANGELES. 469-6201 ORLANDO, FLA. 425-4671 CLEVELAND 886-0150

Circle 7 on reader service card

World's Highest Power Tetrode — Machlett's ML-8545



The Machlett ML-8545 general-purpose, vapor-cooled tetrode delivers 16% more power with 25% less plate voltage (plate modulation service) than the closest competitive tube. It is capable of 300 kW continuous output as a Class C amplifier or oscillator at frequencies to 50 Mc. Maximum plate input is 420 kW. Applications include: High-power broadcast and communications; all-purpose rf generation; particle acceleration. For details on the ML-8545 and the ML-8546 water-cooled version, write: The Machlett Laboratories, Inc., Springdale, Conn. 06879. An affiliate of Raytheon Company.

MACHLETT
ELECTRON TUBE SPECIALIST

People

Robert C. Langford takes over this week as head of guidance and control research at the National Aeronautics and Space Administration's new Electronics Research Center in Cambridge, Mass. The 44-year-old scientist-administrator hopes to



bring together some of the top talents in the aerospace field. The aim, he explains, is to create an atmosphere for "dialogue between scientists" because no individual has the breadth of knowledge needed for the aerospace field.

Langford, who was born in Great Britain, has a doctorate in electrical engineering. Earlier in his career he worked on instruments for the British jet airliner, the Comet.

For four years Langford has been director of General Precision, Inc.'s Aerospace Research Center.

The Fairchild Camera & Instrument Corp., in its first step toward "making the company as significant in instrumentation as it is in semiconductors," recently named **Robert N. Noyce** group vice president of the reorganized semiconductor and instrumentation divisions.



The aim, explains Noyce, a 37-year-old physicist who holds a doctorate from the Massachusetts Institute of Technology, is to make specialized semiconductors available for higher-performance, lower-cost instruments. The best way to do that, he adds, is to tie the two divisions together.

With the change in organization, he says, "I hope to create an atmosphere in which any product idea will be well nurtured and have a chance to grow. Noyce adds that work being done now in the semiconductor labs is expected to result in products other than semiconductors.

WARNING: Did you buy power semiconductors a year ago?

Unless they were Westinghouse, chances are your warranty has already expired.

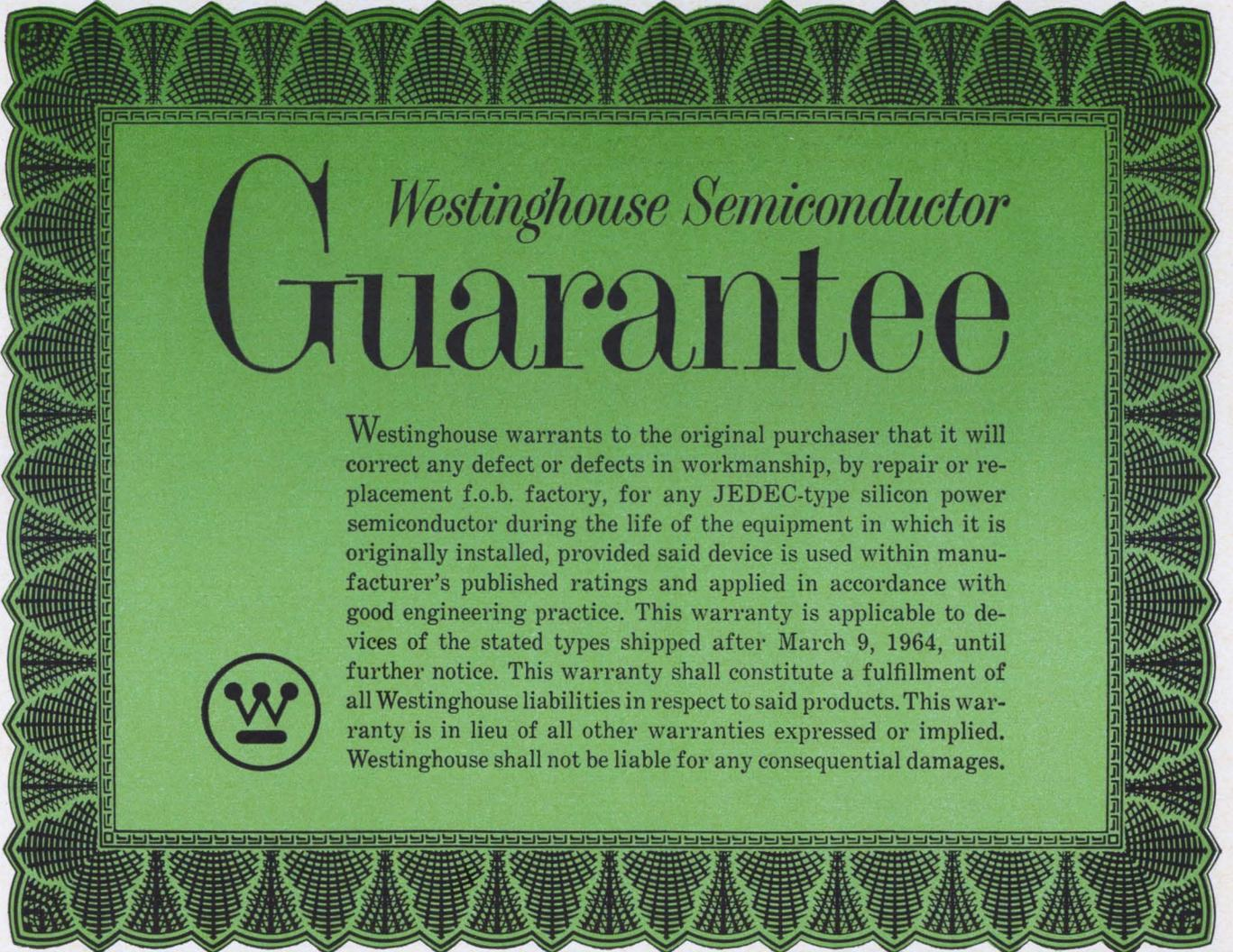

Westinghouse Semiconductor
Guarantee

Westinghouse warrants to the original purchaser that it will correct any defect or defects in workmanship, by repair or replacement f.o.b. factory, for any JEDEC-type silicon power semiconductor during the life of the equipment in which it is originally installed, provided said device is used within manufacturer's published ratings and applied in accordance with good engineering practice. This warranty is applicable to devices of the stated types shipped after March 9, 1964, until further notice. This warranty shall constitute a fulfillment of all Westinghouse liabilities in respect to said products. This warranty is in lieu of all other warranties expressed or implied. Westinghouse shall not be liable for any consequential damages.



SC-2037-A

You can be sure if it's Westinghouse

In Volume Production!

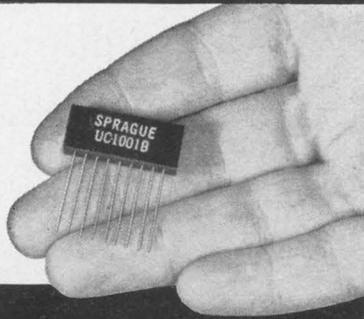

a compatible line of DTL Logic **CERACIRCUIT**[®] Thin-film Microcircuits

5 Mc DTL LOGIC CIRCUITS

The basic member of the Sprague series of DTL Logic Modules is the UC-1001B NAND/NOR Gate (see schematic), with typical propagation time delay of 10 nsec per stage over a temperature range of -55°C to $+125^{\circ}\text{C}$. Other DTL Logic Ceracircuits include SCT Flip-Flop, Buffer-Driver, Exclusive OR/Half-Adder, 8-Diode Gate, and 5-Diode Gate.

To facilitate contact packaging and assembly on printed wiring boards, all 5 Mc DTL Modules are encapsulated in one standard case, 1.0" wide x 0.4" high x 0.2" thick.

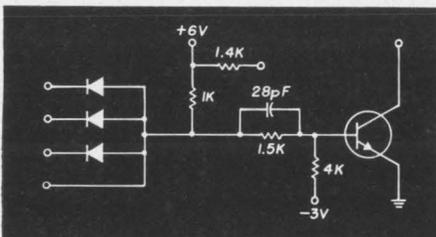

Circuit schematic, UC-1001B NAND/NOR Gate.

CUSTOM-TAILORED CERACIRCUITS

Ceracircuit Ceramic-base Microcircuits provide the circuit designer with desirable features — component familiarity, design versatility, increased reliability, circuit economy. Thin-film technology permits wide ranges of resistance and capacitance values, holding close tolerances without high-cost penalties. Each passive component keeps its identity, allowing conventional design procedures.

For complete technical data, write to Technical Literature Service, Sprague Electric Co., 35 Marshall St., North Adams, Mass. 01248.

45M-5104

SPRAGUE[®]
THE MARK OF RELIABILITY

[®]Sprague and [®] are registered trademarks of the Sprague Electric Co.

Meetings

Photographic Techniques and Measurements for Engineers, SPSE; Hotel Plaza, N.Y.C., June 3-4.

Biomedical Computer Applications Conference, BIO/New York Academy of Sciences; Waldorf-Astoria, N.Y.C., June 3-5.

IEEE Annual Communications Convention (Including GLOBECOM VII), CTG/IEEE; University of Colorado, Boulder, Colo., June 7-9.

National Electronic Packaging and Production Conference (NEP/CON'65), EPP; Long Beach Arena, Long Beach, Calif., June 8-10.

National Symposium on Aircraft Noise, Federal Aviation Agency; International Hotel, J. F. Kennedy International Airport, N.Y.C., June 9.

Broadcast and TV Receivers Conference, G-BTR/IEEE; O'Hare Inn, Des Plaines, Ill., June 14-15.

Midwest Symposium on Circuit Theory, G-CT/IEEE; Colorado State University, Ft. Collins, Colo., June 14-15.

Ocean Science and Ocean Engineering National Conference/Exposition, ASLO, MTS; Washington Hilton Hotel, Washington, June 14-17.

Simulation, A Management Tool, AMA; AMA Headquarters, N.Y.C., June 16-18.

National Navigational Meeting, Institute of Navigation; Edgewater Inn Marina Hotel, Long Beach, Calif., June 21-23.

Solid State Device Research Conference, IEEE; Princeton Univ., Princeton, N.J., June 21-23.

Aerospace Technical Conference and Exhibit, PTGAS/IEEE; Shamrock-Hilton Hotel, Houston, Tex., June 21-24.

Joint Automatic Control Conference (JACC), ASME, IEEE, ISA, AIAA, AICE; Rensselaer Polytechnic Institute, Troy, N.Y., June 22-25.

Electronic Standards Committee F-1 Meeting, ASTM; Randolph House, Syracuse, N.Y., June 23-24.

Fluid Mechanics & Heat Transfer Symposium, USAF, Lockheed Co.; Lockheed Research Labs, Palo Alto, Calif., June 24-25.

Summer Power Meeting, G-P/IEEE; Detroit, Mich., June 27-July 2.

Electromagnetic Compatibility National Symposium, G-EMC/IEEE; Waldorf-Astoria Hotel, New York, June 28-30.

Physics of Quantum Electronics Conference, ONR; San Juan, Puerto Rico, June 28-30.

International Data Processing Conference and Business Exposition, DPMA; Benjamin Franklin Hotel and Convention Hall, Philadelphia, June 29-July 2.

Microwave Applications of Semiconductors Meeting, IERE-IEEE; University College, London, June 30-July 2.

Biomedical Engineering Symposium, IEEE, US Naval Hosp.; San Diego, Calif., July 6-8.

Technical Communications Conference, CSU; Colorado State Univ. Campus, Fort Collins, Col., July 6-10.

Nuclear and Space Radiation Effects Conference, G-NS; Univ. of Michigan, Ann Arbor, Mich., July 12-15.

Chemistry and Metallurgy of Semiconductors, Gordon Research Conferences, Univ. of Rhode Island; Proctor Academy, Andover, New Hampshire, July 12-16.

Educational Technology Conference, American Management Association; Americana Hotel, N.Y.C., July 12-16.

Nuclear & Space Radiation Effects Annual Conference, G-NS/IEEE; University of Michigan, Ann Arbor, Mich., July 12-16.

Call for papers

National Communications Symposium, Mohawk Valley Section of IEEE; Utica, N. Y., Oct. 11-13. **June 7** is deadline for submission of five copies of 100 word abstract and five copies of 500 word summary to Mr. George E. Burnette, Technical Program Chairman, Communications Div. (EMCT), Rome Air Development Center, Griffiss AFB, N. Y.

International ISA Aerospace Instrumentation Symposium, ISA, College of Aeronautics; College of Aeronautics, Cranfield, England, March 21-24, 1966. **Sept. 15** is deadline for submission of a 300-500 word summary to Mr. E. K. Merewether, Chairman, International Affairs Committee, ISA Aerospace Industry Div., 4515 Canoga Avenue, Woodland Hills, Calif.

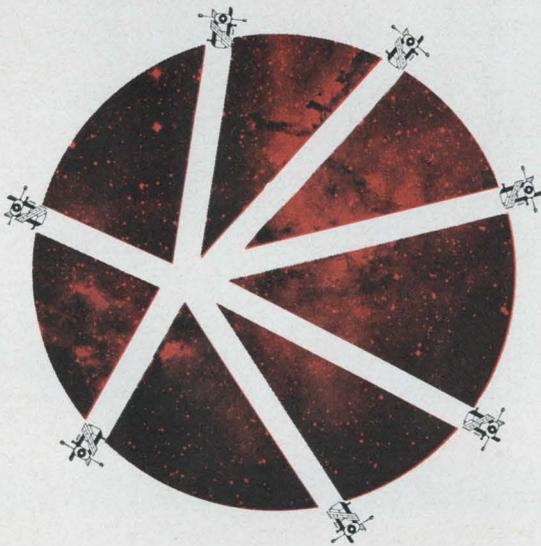
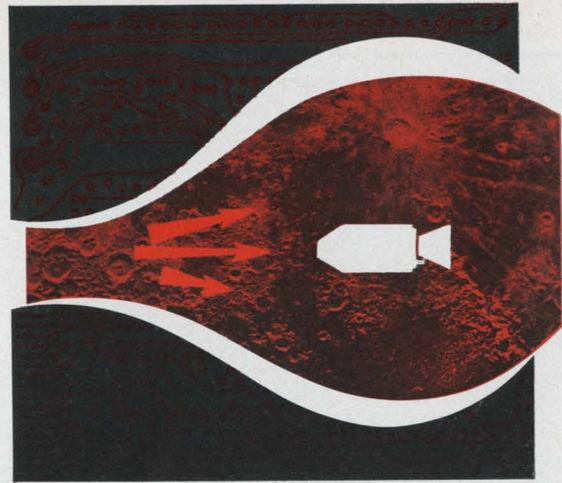

Spanning the Spectrum of Systems and Instrumentation

ASTRODATA's capabilities span a very broad spectrum of systems and instrumentation applications. Examples: a high-speed digital data system samples information from rocket engine tests at 15,000 channels per second, conditions, amplifies and digitizes analog data and records the results on tape with high accuracy, for entry into an off-line computer. Or, a system under computer control for acquiring test data from a mach 15 wind-tunnel; performance of this over-all system indicates end-to-end uncertainty, using 2.5 mv full-scale signals, is less than $0.75 \mu v$, or 0.025% of full scale (3 sigma). As far as we know, that's the most accurate low-level data system ever built. Or, a computer-centered system, used for the remote control of an astronomical

telescope. This system acquires 30 channels of analog information from the telescope and transmits data received on various experiments as they are conducted, to an on-line computer. Or, a hybrid computer system used for complex simulation studies. This hybrid system, the largest ever built, has over 400 operational amplifiers, 30 function generators, 40 multipliers and 60 summing amplifiers — all solid-state, field-proven equipment.

For more information on ASTRODATA's extensive experience in data acquisition and processing, telemetry, range timing instrumentation or hybrid computer techniques, please write for our 20-page brochure, "Systems Experience."



ASTRODATA

P.O. Box 3003 ■ 240 E. Palais Road, Anaheim, California ■ 92803

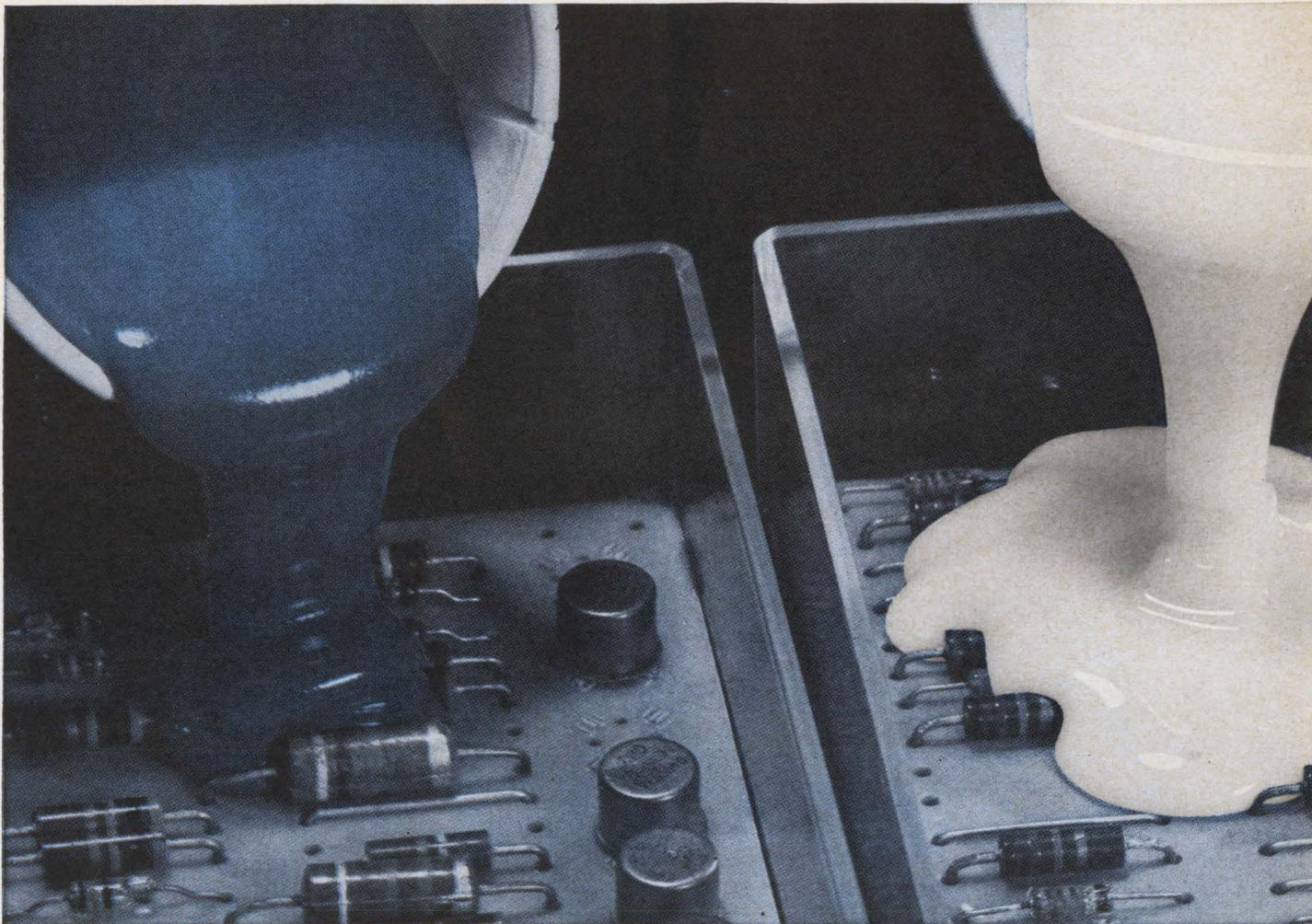

News Briefs

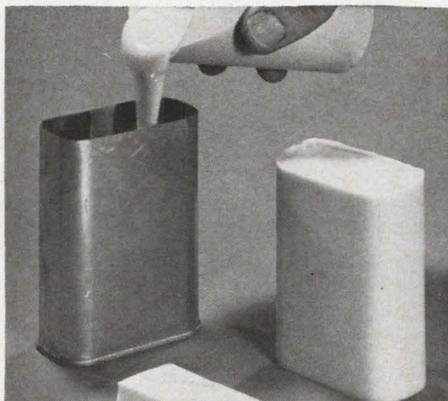

For potting sealed units specify Dow Corning® 3118 RTV encapsulant to assure reliable performance. This deep-section-curing compound is *completely reversion resistant without post cure*. It's easy to use, free flowing and easy to mix. Because it cures without heat and does not produce volatiles or exothermic heat during cure, specify this material where equipment must operate in confined environments.

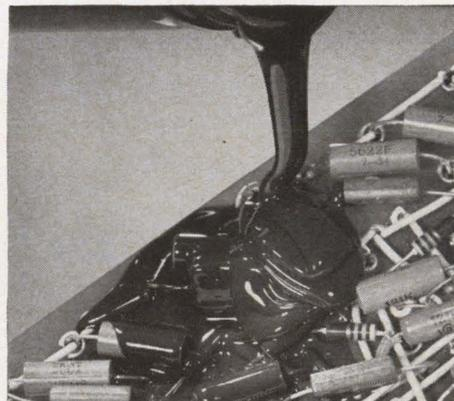

Where high strength is a factor in encapsulation, Dow Corning® 3120 RTV encapsulant has a tensile strength of 650 psi. It has excellent damping qualities that absorb mechanical shock and vibration. The low shrinkage characteristic inherent in all these encapsulants insures that no internal stresses develop . . . memory planes or similarly sensitive devices will not be crushed or deranged. Specify this medium viscosity, deep-section-curing compound where maximum protection from shock and vibration is required.

Now, a family of six new Dow Corning® RTV encapsulants offers a wide processing choice

Six new encapsulants of varying viscosities and characteristics have been developed by Dow Corning to provide for the selection of the material best suited to your electronic application or processing requirements. All are room temperature vulcanizing pourable silicone rubber compounds designed for potting, encapsulating and embedding.

Dow Corning® 3110 RTV encapsulant is a low viscosity compound that cures in deep sections and can be color coded. Fourteen different color pigments are available . . . have no effect on the properties of the silicone rubber.

All encapsulants in this series will remain rubbery from -50 to 250 C

(-67 to 482 F), all have excellent dielectric and good heat transfer properties. They cure without heat to form a rubber jacket that efficiently protects components and assemblies from dust, moisture, weathering, oxidation and corrosive atmospheres.

Repairability of encapsulated components is simple. The compound can be cut away for access and resealed with fresh encapsulant after repairs are made.

Other uses include: (1) coating of printed circuit boards, (2) precoating of assemblies prior to embedment in rigid compounds, and (3) mold making. The properties of these materials suggest almost endless additional uses.

CIRCLE 289 ON READER-SERVICE CARD

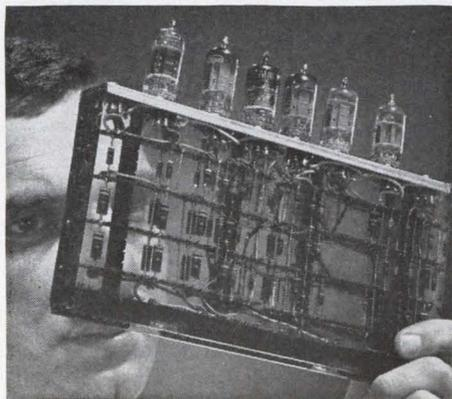

For a transparent encapsulation, specify Sylgard® 184 resin. It is a solventless, low viscosity fluid that cures, in deep sections, in 24 hours at room temperature . . . needs no post cure. Serviceable over a wide temperature range, it is designed for electronic packaging applications requiring low dielectric losses and self-extinguishing characteristics. Its companion product, Sylgard® 182 resin which cures at 65 C, is specified where longer pot life can give processing cost savings.

We'll be pleased to forward full information on these and other materials that aid reliability and performance. For details or prompt technical assistance write to Dept. 3917, Electronic Products Division, Dow Corning Corporation, Midland, Michigan 48641. For a free sample, write on company letterhead describing your application . . . or phone for the name of the Dow Corning representative in your area.

DOW CORNING

CIRCLE 292 ON READER-SERVICE CARD



The first DVM with integrated circuits — higher accuracy and stability at lower cost

MODEL 7100 DUAL-SLOPE INTEGRATING* DIGITAL VOLT-OHM-RATIOMETER

■ the only DVM with new Dual-Slope Integrating which makes inaccuracies self-canceling

■ the only DVM available that takes advantage of high stability integrated circuitry

■ the only integrating DVM in its price range.

No other digital voltmeter offers the precision, stability and noise immunity at the low price of Fairchild's Model 7100. The unique Dual-Slope Integrating technique, newly developed by Fairchild, makes the accuracy of the Model 7100 virtually independent of long-term drift or instability. Yet the price is low, because of the economy of integrated circuit construction and simplified circuit design.

Here are some of the other key reasons why the Dual-Slope Integrating DVM (DSI/DVM) sets a new standard in cost/performance ratios:

- Measures voltage, resistance and ratio
- High-performance readout: 0.01% accuracy, 10 μ V resolution
- Digital display plus BCD readout
- 4-digit readout with a fifth-digit over-range
- Ranges: 10 μ V to 1000V; 1 ohm to 15.000 megohms
0.0001:1 to 1.5000:1 voltage ratio
- In-cabinet space available for custom adaptation to systems
- Dimensions: 5 $\frac{1}{4}$ " x 17" x 18"

The Model 7100 is available with any single test capability or any combination of tests.

D. C. Volts — Ohms — Ratio

Any single test \$1900.00

Any two tests 2250.00

All three tests 2500.00

Plus manual range plug-in. 75.00

Optional plug-in modules include auto ranging, high input impedance and AC to DC converter.

FAIRCHILD
INSTRUMENTATION
A DIVISION OF FAIRCHILD CAMERA AND INSTRUMENT CORPORATION

For complete details on the Model 7100 write for comprehensive data sheet or contact the nearest Fairchild representative (below).

FAIRCHILD SEMICONDUCTOR INSTRUMENTATION REPRESENTATIVES

ALABAMA Huntsville: Gentry Associates, Inc., 534-9771. ARIZONA Scottsdale: G. S. Marshall, 946-4276. CALIFORNIA Los Angeles: Fairchild Semiconductor, 464-7464/Palo Alto: Fairchild Sales Office and Factory, 962-2451/San Diego: G. S. Marshall, 278-6350/San Marino: G. S. Marshall, 681-3292. COLORADO Denver: Hyer Electronics, 771-5285. CONNECTICUT Greenwich: Circuit Sales, 869-2244. FLORIDA Orlando: Gentry Associates, Inc., 424-0730/St. Petersburg: Fairchild Semiconductor, 867-1824. GEORGIA Atlanta: Gentry Associates, Inc., 233-3816. ILLINOIS Oak Park: Fairchild Semiconductor, 848-5985. IOWA Cedar Rapids: Engineering Services Co., 366-1591. MARYLAND Bethesda: Bartlett Associates, Inc., 656-3061. MASSACHUSETTS Watertown: Circuit Sales, 926-1031. MICHIGAN Detroit: WKM Associates, Inc., 892-2500. MINNESOTA St. Paul: Northport Engineering, Inc., 698-3941. MISSOURI Kansas City: Engineering Services Co., 363-6000/St. Louis: Engineering Services Co., 726-2233. NEW MEXICO Albuquerque: Hyer Electronics, 268-6744. NEW YORK Elmsford: SBM Associates, Inc., 592-8850/Long Island: CDB Enterprises, 692-5200/Massapequa, L.I.: Fairchild Semiconductor, 799-4590/Rochester: SBM Associates, Inc., 271-7430/Syracuse: SBM Associates, Inc., 454-9377. NORTH CAROLINA Burlington: Gentry Associates, Inc., 227-7916. OHIO Cleveland: WKM Associates, Inc., 885-5616/Dayton: WKM Associates, Inc., 298-7203. PENNSYLVANIA Pittsburgh: WKM Associates, Inc., 892-2953/Wayne: Bartlett Associates, Inc., 688-7325. TEXAS Dallas: Norvell Associates, Inc., FL 7-6451/Houston: Norvell Associates, Inc., MO 5-0558. WASHINGTON Bellevue: Cane-Jessup Co. Inc., GL 4-0691. CANADA-ONTARIO Ottawa: Whittaker Electronics Ltd., 722-7658/Weston: Whittaker Electronics Ltd., 247-7454. QUEBEC Roxboro: Whittaker Electronics Ltd., 648-3000.

*PATENT PENDING

844 CHARLESTON RD., PALO ALTO, CALIFORNIA, 962-2451 ■ TWX: 415-492-9414 ■ FAIRCHILD INSTRUMENTATION, A DIVISION OF FAIRCHILD CAMERA AND INSTRUMENT CORP.

Editorial

The long night is ending

For the first time in nearly two and a half years, a spirit of optimism pervades the electronics industry. Some of it undoubtedly springs from the boom in color television sets—and the associated prosperity of tube and component suppliers. As the summer starts, sales of color sets are exceeding the rosier predictions made during the winter months.

Some of the healthiest signs of optimism are showing up in the military electronics segment which has suffered almost depression conditions for nearly 30 months. Many companies say the long night of recession is nearing its end.

There is no increased spending behind the feeling of encouragement. Rather, the optimism springs from the realization that the industry can live with the reduced level of spending and the changed direction of military procurement. A lot of companies have finally adapted to the new conditions. They are leaner, having pared their engineering staffs so there is little extravagant specialization. They are more aggressive marketers. They are doing a lot more planning. And they are putting some of their own money into research and development.

Despite the cutbacks in spending, there is plenty of military money around for companies oriented in the right direction. That doesn't mean the days of easy government money have returned. On the contrary, the services are notably short of the giant sums they used to have for sweeping changes. To stretch their dollars farther, the military men shun making the big change in a lot of electronic equipment.

More and more, the military is buying equipment off-the-shelf that meets military specifica-

tions, rather than having it new-built. Belatedly, the government has learned it doesn't need ruggedized equipment, built to withstand the extremes of heat and cold, for ground support gear that spends its entire life in an air-conditioned trailer.

Incidentally, such purchases have resulted in better quality too. To nobody's surprise, the tenth, hundredth or hundred and fiftieth device built is always better than the first or second. Buying off-the-shelf, the military is getting gear whose manufacturing bugs were ironed out before the order was placed.

At the same time, the services have realized that some of their electronic equipment can be modernized at a far smaller cost than that required to replace it.

The glow of optimism has spread even to the microwave portion of the industry where sales statistics still leave little cause for joy. Conditions are better. A shakeout of companies has relaxed the cut-throat competition that drove the price of components and systems far below cost. And the overcapacity that existed has been reduced.

Probably the driving force behind today's microwave optimism is the prospect for rapid technological advances in the field. Solid state is about to sweep the microwave business. In almost every company, engineers are working on a lot of exciting new devices and the businessmen remind you that an advance of technology like this usually spurs sales too.

Though the last 30 months have been near catastrophic for many companies and many engineers, the hardships may have been worthwhile. If engineers remember the lessons of those months they will never again fall into the trap of becoming technicians in a narrow specialization solely for a big paycheck that vanishes when the project is over.

And perhaps companies have learned they cannot leave their well-being and futures to the government. They have to do their own planning; they have to spend some of their own money to develop products they can sell to the government and elsewhere; and they have to be concerned with efficiency.

With its newfound optimism, today's electronics industry is stronger than it was before the cutback in defense spending brought on the long night.

This P&B relay switches 20 amperes, costs only \$3.90* each, is available from leading parts distributors...

and it's this small

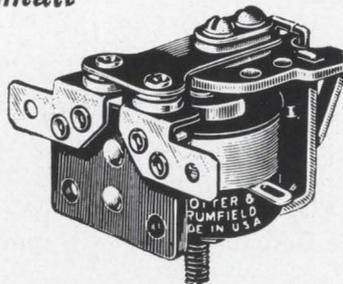

Here is a real space-saving power relay—ideal for applications where limited space is a factor. *Three* KR3 relays will fit in the space required for *one* 20-ampere relay of most other makes. The KR3 occupies only little more than one and a half cubic inches.

Installation is simple, too. Standard KR3 relays have a convenient stud and mounting tab—and the contact terminals will accept $\frac{1}{4}$ " quick-connects or solder connections.

Field-proved for more than a year, the KR3 is available for immediate

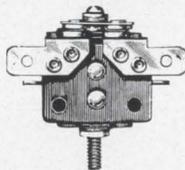

shipment from authorized P&B distributors. Tests show mechanical life will exceed one million operations . . . and the twin contacts are rated at 20 amperes at 115V AC, 60 cycles resistive or 28V DC, 1 HP 115/230V 60 cycles.

Relays ordered from the factory can be supplied in clear, high-impact polycarbonate case with octal plug.

For complete information, call your nearest P&B sales representative or write direct. Remember . . . you can buy cheaper relays but you cannot buy P&B quality for less.



ENGINEERING SPECIFICATIONS

GENERAL:

Insulation Resistance: 1000 megohms.
 Expected Life: 1 million mechanical operations, min.
 Breakdown Voltage: 500V rms 60 cycles bet. all elements.
 Temperature Range | AC and DC: -45°C min.
 Open Relay | AC: +70°C max.
 DC: +85°C max.

CONTACTS:

Arrangements: SPST-NO-DB (1 Form X) only.
 Rating: 20 amps @ 115V AC, 60 cycles resistive, or 28V DC; 1 HP 115/230V 60 cycles.

COILS:

Voltage: DC: to 110V
 AC: to 230V
 Power: DC: 1.2 watts min.
 AC: 2.0 volt-amps.

Resistance: 16,500 ohms maximum.
 Duty: Continuous.

MOUNTING:

Open: One 6-32 stud and $\frac{1}{4}$ " locating tab on $\frac{7}{16}$ " centers,
 Enclosed: Octal socket.

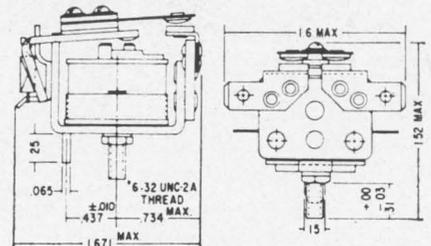

*Unit price for 6 to 115V AC models.
 Quantity discounts available.

RIDE THE AMF MONORAIL AT THE NEW YORK WORLD'S FAIR



POTTER & BRUMFIELD

Division of American Machine & Foundry Company, Princeton, Indiana
 In Canada: Potter & Brumfield, Division of AMF Canada Ltd., Guelph, Ont.
 Export: AMF International, 261 Madison Avenue, New York, N.Y.

Electronics Newsletter

May 31, 1965

Integrated circuits find more buyers

Business has suddenly picked up in integrated circuits. Many instrument makers will soon offer new products with a few integrated circuits, though most are still frustrated because the kind of analog circuitry they need is not available yet.

On the West Coast, the Hewlett-Packard Co., the United States' biggest maker of instruments, has just about decided it must have its own integrated-circuit manufacturing facility. H-P sees no other ways to guard its instrument-design secrets.

A few IC makers are rushing development work on linear circuits, hoping to head off Hewlett-Packard's investment in IC manufacturing equipment. If H-P adds an integrated-circuit capability, producers of circuits are afraid a trend might be started eliminating a larger potential market.

But the price of admission into the IC-manufacturing field is steep. H-P planners think an instrument company must have annual sales of at least \$125 million to justify its own IC facilities.

Connector makers seek better tests

New tests and guidelines designed to establish the reliability of connectors have been prepared by the industry. The new standards and tests, prompted by complaints from both military and industrial users, were drafted by a committee representing the connector industry, under the aegis of the Electronic Industries Association. The report is being reviewed by the Defense Electronic Supply Center in Dayton, Ohio.

Laser losing favor with eye surgeons

Initial enthusiasm for the laser as a tool in eye surgery has cooled in some medical circles. The use of lasers to weld detached retinas will be discussed June 3 to 5 in Houston at the International Symposium on Retinal Detachment. Researchers at the Retina Foundation in Boston will report on a comparative study of the laser versus a xenon lamp system; they conclude that in the pulsed ruby lasers available today, the energy density is too high, the light too nearly monochromatic and the control requirements too complex.

Bill raises limit on arms buying

The Senate and House have resolved their differences on one of the defense authorization bills for the fiscal year starting July 1, and have fixed a \$15.4-billion ceiling that is higher than either had originally voted. The bill—covering the purchase of planes, ships and missiles, and research and development—sets a limit on appropriations for procurement and R&D that will be voted later.

The bill includes \$99 million for buying 10 E-2A Hawkeye carrier-based early-warning aircraft. The Senate had knocked out this item because the plane's electronic subsystems had run into development problems. But the money was restored after the Defense Department gave assurance that solutions are in sight. The bill also includes \$150 million for a nuclear missile frigate that was not sought by Defense Secretary Robert S. McNamara, and \$134 million for two nuclear attack submarines in addition to the four McNamara requested. It included an extra \$7 million to begin project-definition work on a new manned bomber.

Electronics Newsletter

Raytheon to buy 6th firm in year

The Raytheon Co. continues on the acquisition road to diversification. Raytheon will buy the assets and business of the Dage-Bell Corp. of Michigan City, Ind., which manufactures closed-circuit and broadcast television equipment for educational and other markets. **In its sixth acquisition during the past 12 months, Raytheon will pay about \$4 million for Dage-Bell.**

California court voids pay-tv ban

A California court has found unconstitutional the state's referendum which banned pay television. The ruling, still open to appeal, may breathe life into Subscription Television of California, Inc., which had been in operation when the system was outlawed last November by the initiative measure.

Short circuits mar Pegasus I action

Pegasus I, the satellite that's orbiting the earth collecting data on the danger posed by micrometeoroids in space, has been operating at half capacity for the last few months. The National Aeronautics and Space Administration says **207 of Pegasus' sensing panels aren't working because of short circuits**; when one capacitor shorts, it blocks data from other nearby capacitors.

Pegasus II, fired last week into a 300-mile orbit similar to Pegasus I's, has been redesigned to avoid the short-circuiting problem. **Each capacitor has been fitted with a 200-milliampere fuse, so that if one capacitor fails it won't affect its neighbor.**

U. S. to merge science agencies

Three Commerce Department agencies will be merged into a single scientific office, similar in organization to the National Aeronautics and Space Administration or the Atomic Energy Commission, as the first step in what President Johnson has called a "functional reorganization of government."

The agency will be called the Environmental Science Services Administration and will be made up of the Weather Bureau, the Coast and Geodetic Survey and the Central Radio Propagation Laboratory. The new office will oversee major civilian efforts in meteorology, hydrology, climatology, seismology, geodesy, geomagnetism, oceanography, hydrography, aeronomy, and telecommunications.

Record that plays for hours studied

The Raytheon Co. is investigating a technique for making a recording system that can hold several hours of sound on a single record. The grooves are much narrower than those of records that rotate at 33 $\frac{1}{3}$ revolutions per minute, **and the pickup stylus is mounted directly in a stress-sensitive integrated circuit** that converts the mechanical energy of the stylus into electrical energy. In conventional pickups, a piezoelectric material or coils convert mechanical into electrical energy.

Addendum

The Air Force is working on a suitcase-size communication package to receive and transmit in all bands between very low frequencies and the gigacycle range. The unique system, which is being developed at Wright-Patterson Air Force Base, Ohio, would have a maximum output of 1,000 watts.

from SYLVANIA Electronic Components Group

INTEGRATED CIRCUITS

New 20-megacycle "OR" J-K flip-flop simplifies system design

Newest addition to the SUHL (Sylvania Universal High-level Logic) line of integrated circuits is this new SF-60 J-K flip-flop that provides the OR function on both J and K sides.

The extent to which this new circuit can simplify systems functions, reduce can count and lower cost is suggested by the typical arithmetic shift register shown on page 4. Its particular suitability for this application is, of course, related directly to its Dual 2-input AND gates which are wired OR'ed for both the J and K sides (see schematic).

This new J-K flip-flop incorporates all of the high-performance characteristics of SUHL logic and offers the

computer circuit designer much needed flexibility.

Characteristics

Here in summary form are the outstanding characteristics of the new SF-60 series J-K flip-flop (OR input).

Operates at clock speeds up to 20 mc. Has a determinate state on the output for every input condition. Complementing is done internally; thus, all inputs are usable as data inputs. Triggers on clock edges as long as 200 nsec. Triggers on negative edge of clock which inhibits input terminals as well as other gates in the system. Raceless, since inhibiting of the input terminals is done by the clock directly, not through feedback. Insensitive to noise on the clock line.

Toggles if inputs are at logic 1. Provides D.C. Set, which can be activated while the clock is low so that following elements are inhibited. Low loading factor (data inputs are 1.0 gate load, clock is 2.0 gate loads). High noise immunity, excellent radiation resistance, high fanout, capacitance drive, low power—plus all the other characteristics for which SUHL has become known.

CIRCLE NUMBER 300

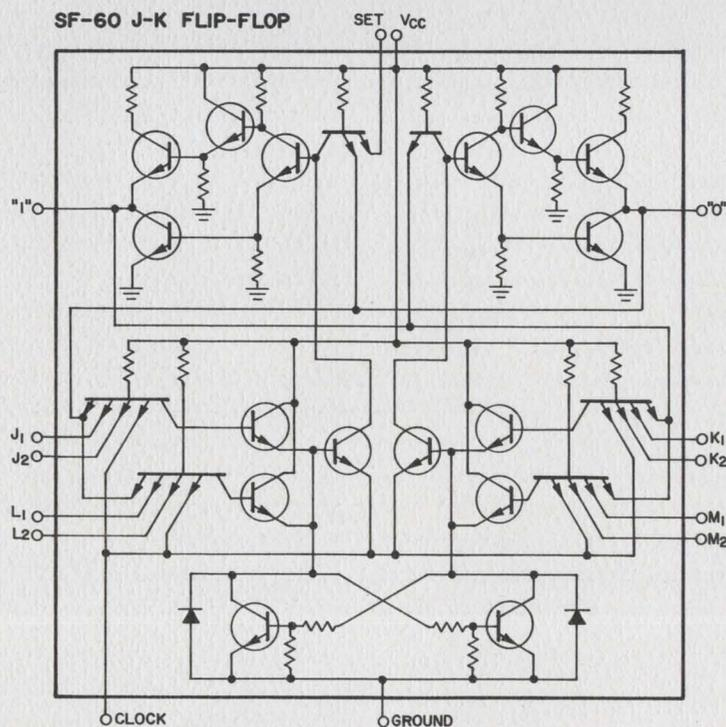
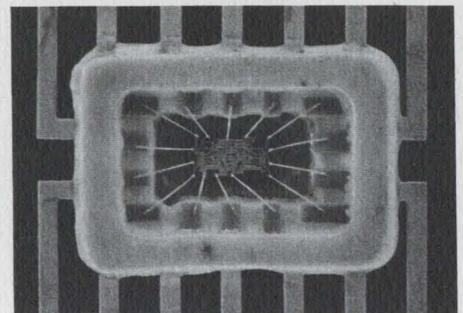

This issue in capsule

Electroluminescence—hermetic seal provides reliability needed for space flight.

Photoconductors—new street-lighting cell features Blue Dot.

Integrated Circuits—WIRED-OR functions can be achieved at relatively low cost with new SUHL unit.

Microwave Diodes—new mixer diode covers the Ku-Band, has lower noise figure.

CRT's—6-gun tube exemplifies custom approach to display problems.

Readouts—new series of solid-state translator/drivers for gas-glow tubes.

Diodes—2-nanosecond unit is work-horse for switching, clamping, chopping.

EL units hermetic-sealed for space ride

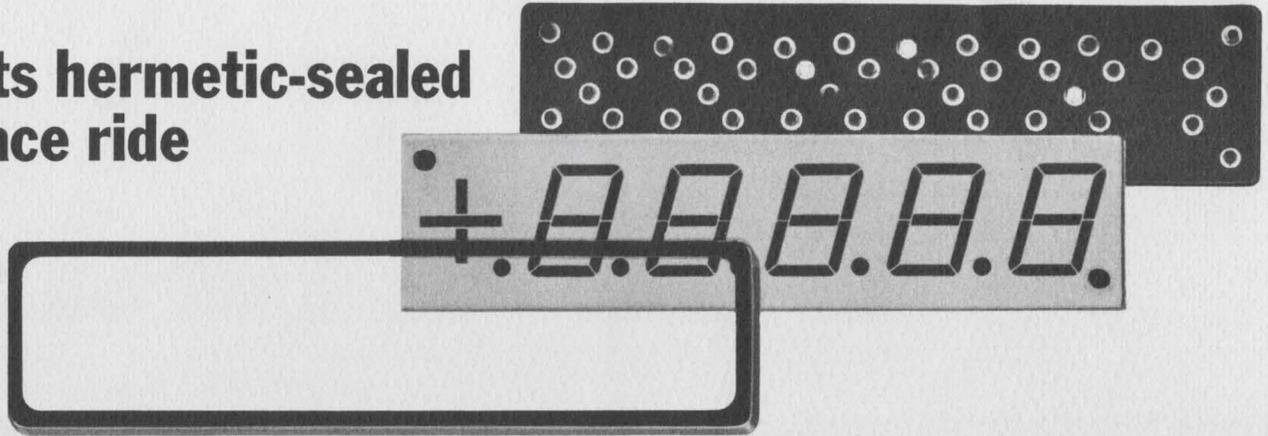

The only fully solid-state readout system has been selected for inclusion in one of the nation's major space programs. The electroluminescent units being supplied by Sylvania will be made up of five-digit panels, hermetically sealed to assure protection to phosphors that can be sensitive to moisture.

By its inherent nature, EL's characteristics are particularly suited to aerospace application. With its sandwich-type compactness it takes up only a minimum of valuable space.

Because of its light weight and low power requirement, it neither consumes much power nor adds substantially to the total weight of the airborne missile.

Due to their solid-state nature, EL substrates are both extra-reliable and capable of withstanding heavy G-forces.

All of the electroluminescent panels were subjected to a stringent list of environmental conditions before shipment. To test EL performance under temperature extremes, all of

these units were required to function perfectly during a temperature cycle running from -55°C to $+94^{\circ}\text{C}$. A 4-pound axial pull was also applied to verify the integrity of all leads.

Separate sealing and humidity tests, both stringent, verified that all units had true hermetic seals. The panels were then given a 50-G, 6-millisecond shock-mounted test. All of these special tests were over and above Sylvania's own quality control program.

PRODUCT MANAGER'S CORNER

Two for the seesaw

Over the past several years a major change has taken place in the means and method of quoting on simple device requirements. It is no longer a fifteen-minute task. Properly done it could easily consume several man-days. Whatever happened to the "good old days" when a fine cigar cost \$.15, TV was just "blooming" and one-page specifications were in vogue? I'm afraid they have vanished, like the cigar store Indian, to be replaced by full-blown documents bristling with A.Q.L.'s. This change has turned a quote into a proposal and all because specifications are now so broad in scope and complexity that an adequate response to an R.F.Q. turns into a major effort. Space Age Electronics and associated space programs demand assurance levels previously not required. The result — "Space Age Specifications" and some very interesting problems for the customer-vendor seesaw.

The customer is faced with the task of attempting to buy components having zero failure rates, at standard

prices, with immediate delivery. This sounds perfectly normal (well, almost) except that specifications which are required to produce this reliability are not conducive to short deliveries or standard prices.

The vendor must consider such things as yields, traceability, process controls, test plans, expensive test equipment, life racks, etc., etc., only to discover that there are only ten "widgits" per satellite with a few more for spares. How can this type environment produce a "low"-cost item? It cannot. However it is possible to obtain the required assurance levels in these quantities and still maintain reasonable costs by establishing face-to-face customer-vendor meetings which would permit an item-by-item appraisal before the specification is sent out for bid. This cooperative effort will always produce the best results by reducing the number of revisions and requotes.

Only a short time ago, having a specification over two pages long on a simple component was being

"pushy," but now two pages just covers the introduction. Possibly a little dramatic, but the fact remains that our industry is being swamped with bundles of documents with an R.F.Q. attached.

It is quite apparent that complex proposals are now established as a way of life in the microwave semiconductor industry. We at Sylvania have had to recognize this fact and solicit the support of all factory departments to be able to make meaningful proposals.

If these specifications are not compatible with the vendor or his product, spec changes are made and new quotes are required. Close cooperation of customer and vendor in establishing specifications is still the best solution to the problem of requoteing to "Revision 8."



Marvin Groll
M. E. GROLL

Sylvania Blue Dot reliability comes to street-lighting control

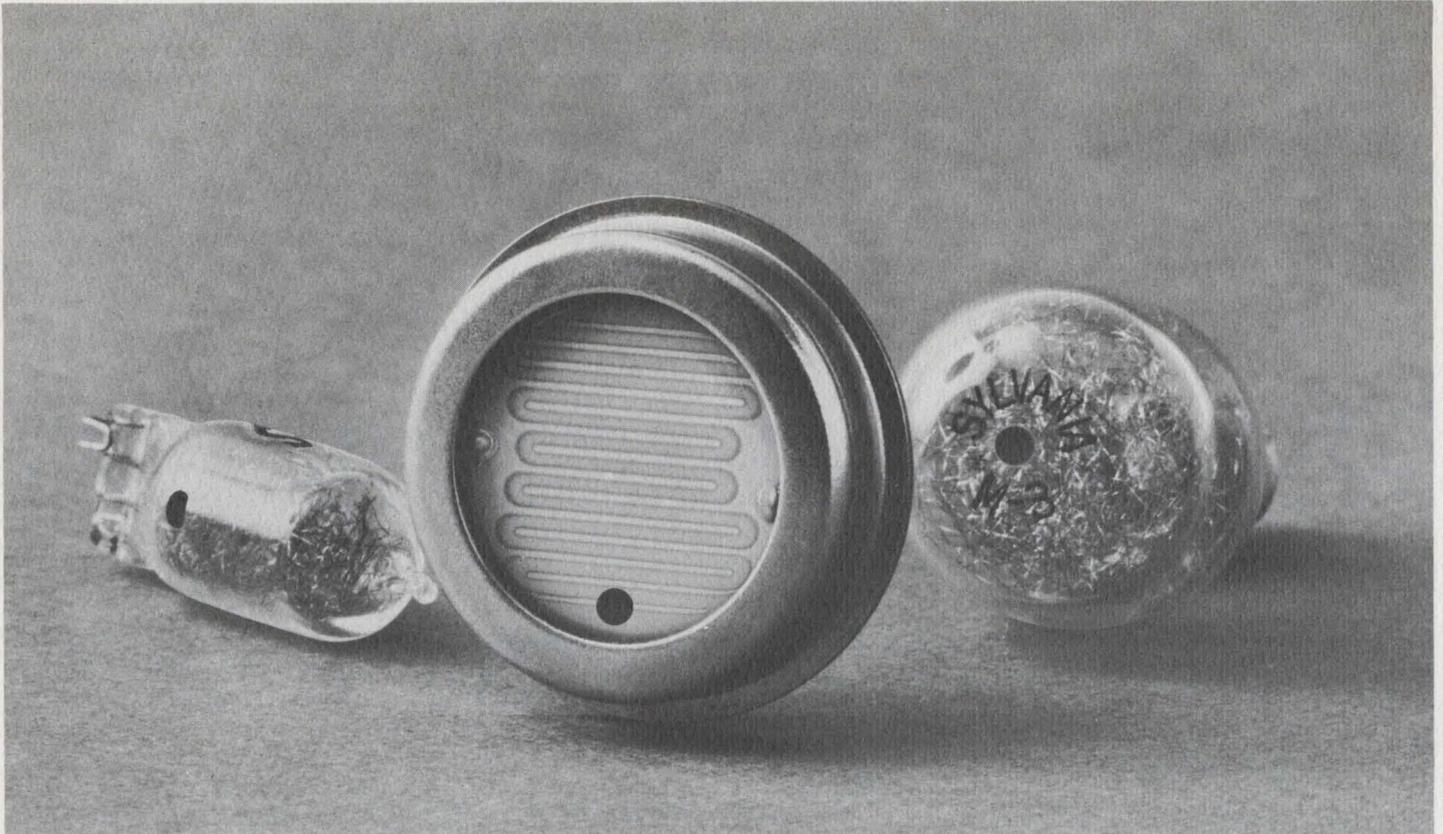

Conservatively rated at 0.5 watts on demand, with a breakdown voltage rating of 600 volts, Sylvania's new SRP-4204 photoconductive cell easily meets the power handling requirements for automatic lighting controls. In addition, cell characteristics are tailored to controller relay operating requirements and testing is accomplished under simulated north-sky conditions.

An *end-on* design, the cell employs a hermetically sealed metal and glass envelope 1¼ inch in diameter with a 2-pin base. The cell's metal and glass encapsulation provides a true hermetic seal. This protection from moisture, a frequent cause of failure in outdoor usage, is further enhanced by the exclusive Sylvania Blue Dot indicator. The Blue Dot is built-in quality assurance, both at the time of installation as well as in use, that the atmosphere within the envelope is dry. Should the envelope become damaged and moisture enter, the Blue Dot will change color to pink. Its extremely high sensitivity provides an early warning, permitting

replacement before equipment malfunction.

Mechanical ruggedness is another feature of the SRP-4204. Contributing to this property, as well as the cell's ability to meet its demand power rating, is high-alumina ceramic as the substrate for the photosensitive

material. Important characteristics of the Sylvania SRP-4204 include:

Cell Voltage	600 volts max.
Resistance	25,000 ohms at 1FC*
Dissipation	0.5 W Demand max. 0.3 W Continuous max.
Construction	glass/metal 1.25" diameter

*Simulated north sky illumination.

CIRCLE NUMBER 301

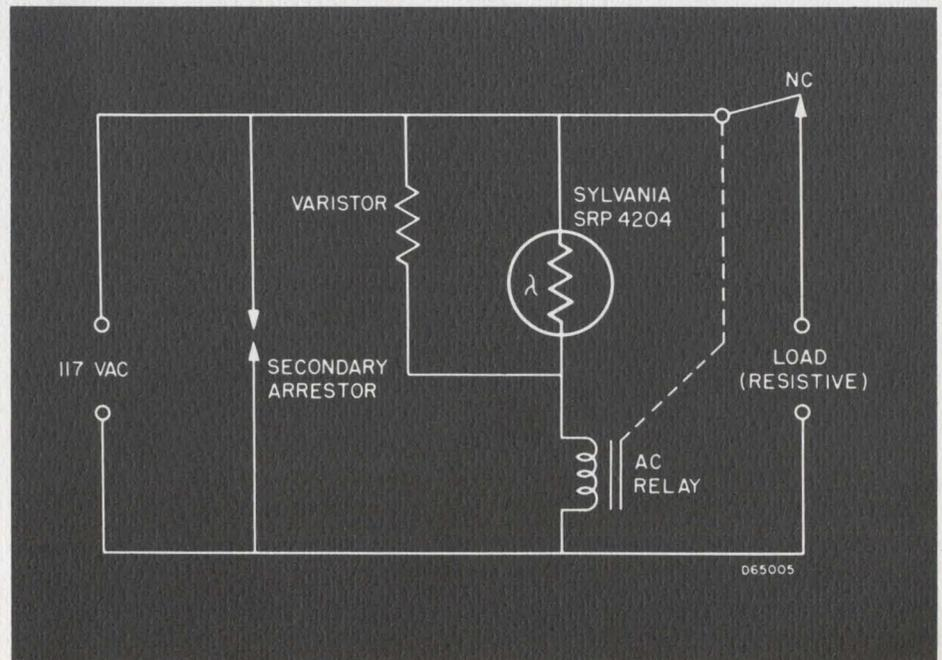

Simple shift right-shift left register circuit

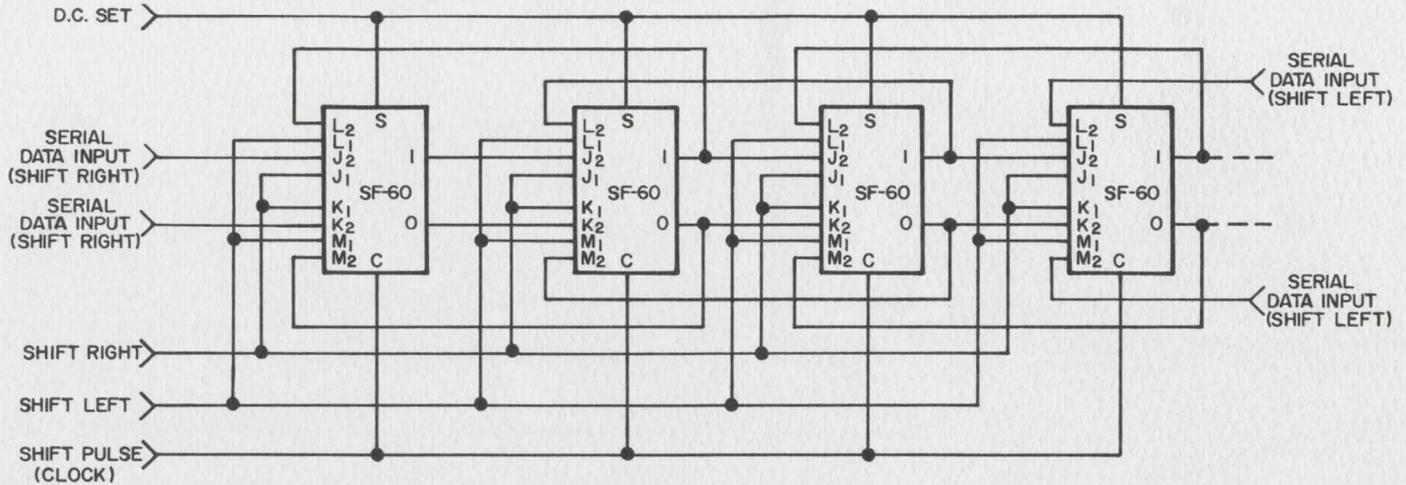

The 20-megacycle shift right-shift left register above can be built with just four SF-60 integrated circuits. The SF-60 is the new SUHL J-K flip-flop (OR input) described on page one of this issue of IDEAS.

This register is the newest addition to the growing examples of how the benefits of SUHL (Sylvania Universal High-level Logic) can be put to work to simplify systems design. And the list keeps growing day by day.

The circuit shown can be used as a count-up/count-down counter or as an accumulator in the arithmetic portion of a computer.

CIRCLE NUMBER 302

SUHL line offers a low-cost approach to "wired-OR" circuitry

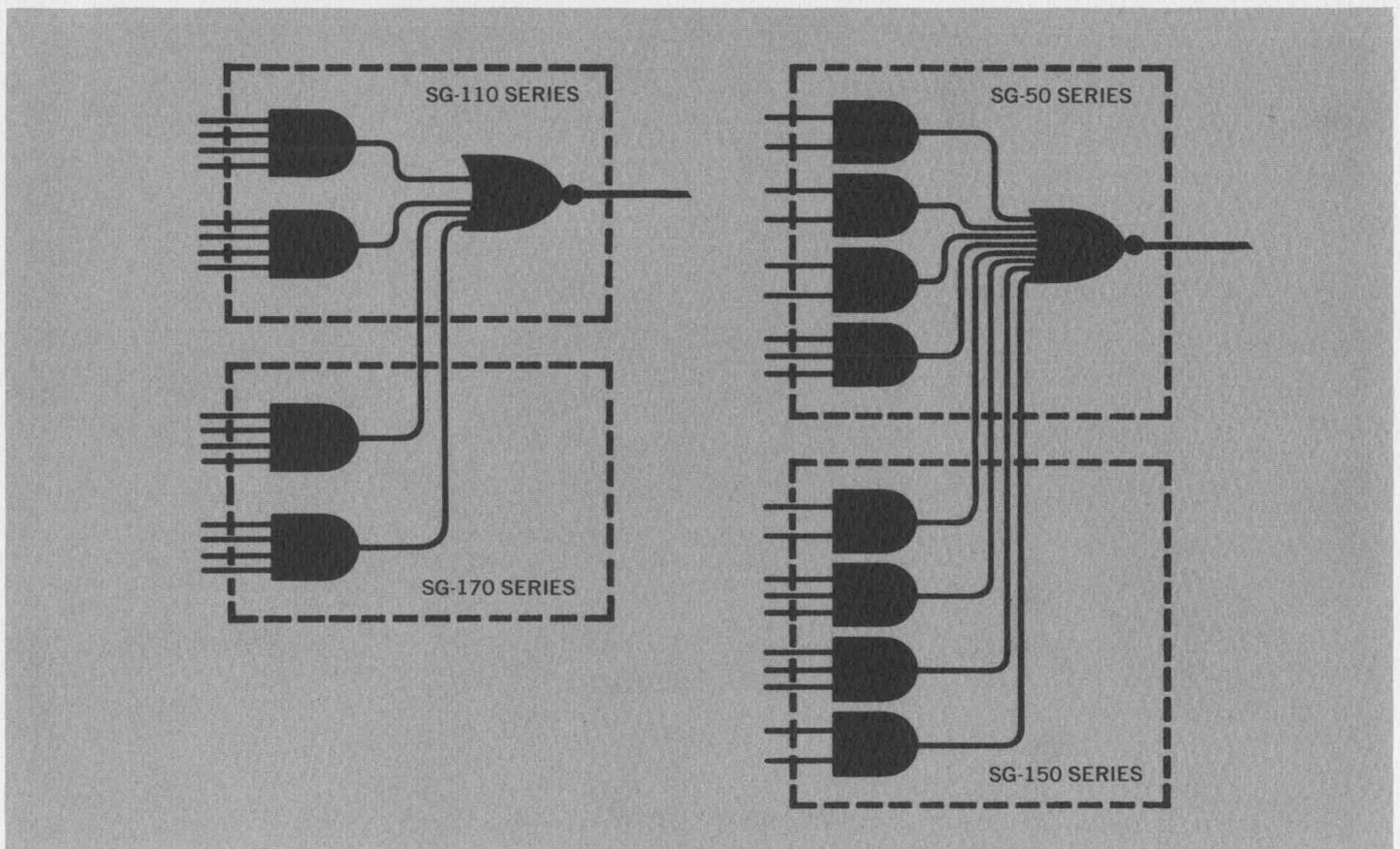

The logic diagrams shown demonstrate how the low-cost SG-170 series OR Expanders can produce up to

eight gates wired OR'd together.

Where the highest wired-OR is required use the Sylvania SG-110 or

the SG-50 series quad OR gate with the SG-150 quad OR expander. Either way, the fan-out capability of

the gate is retained and lower can count results.

The SUHL family offers a whole series of gates for accomplishing wired-OR's of 2 to 8 gates. Power savings can be as high as 55% without any change in fan-out, or significant sacrifice in speed.

SUHL circuits include: SG-100 Expandable Triple 3-Input OR Gate. The SG-110, Expandable Dual 4-Input OR Gate. The SG-50, Expandable Quad 2-Input OR Gate. The SG-150 Quad 2-Input OR Expander. And the SG-170 Dual 4-Input OR Expander.

CIRCLE NUMBER 303

SYLVANIA'S COMPLETE LINE OF DIGITAL INTEGRATED CIRCUITS				
FUNCTION	MILITARY -55°C to 125°C		GROUND SYSTEM AND INDUSTRIAL 0°C to 75°C	
	MP* FO 15	MS* FO 7	IP* FO 12	IS* FO 6
Dual 4-Input Nand/Nor Gate	SG-40	SG-41	SG-42	SG-43
Expandable Quad 2-Input OR Gate	SG-50	SG-51	SG-52	SG-53
Single 8-Input Nand/Nor Gate	SG-60	SG-61	SG-62	SG-63
Exclusive-OR with Complement	SG-90	SG-91	SG-92	SG-93
Expandable Triple 3-Input OR Gate	SG-100	SG-101	SG-102	SG-103
Expandable Dual 4-Input OR Gate	SG-110	SG-111	SG-112	SG-113
Expandable Single 8-Input Nand/Nor Gate	SG-120	SG-121	SG-122	SG-123
Line Driver (Double Fan-out Minimums)	SG-130	SG-131	SG-132	SG-133
Quad 2-Input Nand/Nor Gate	SG-140	SG-141	SG-142	SG-143
Quad 2-Input OR Expander	SG-150	SG-151	SG-152	SG-153
Dual 4-Input OR Expander	SG-170	SG-171	SG-172	SG-173
Dual 4-Input AND Expander	SG-180	SG-181	SG-182	SG-183
Set-Reset Flip-Flop	SF-10	SF-11	SF-12	SF-13
Two-Phase SR Clocked Flip-Flop	SF-20	SF-21	SF-22	SF-23
Single-Phase SRT Flip-Flop	SF-30	SF-31	SF-32	SF-33
J-K Flip-Flop	SF-50	SF-51	SF-52	SF-53

*MP—Military Prime, MS—Military Standard, IP—Industrial Prime, IS—Industrial Standard

MICROWAVE DIODES

New low-noise, high-temperature coverage for the Ku-band

Sylvania's newest mixer diode (D-5282) covers all of Ku-band in a matched holder with an unusually high degree of efficiency. Recommended for high-temperature use, this silicon point contact series operates over a temperature range of -65° to +150°C. Its noise figure is as low as 7.5 db max., the result of silicon epitaxial construction.

Ku-band comparison with a standard high-temperature 1N78 proves the difference. (see curve)

The device's broad band capability is the result of a special glass pin bead inside the diode package itself. To get this frequency coverage, Sylvania's new diode features an undercut compensated center pin sealed in a special glass support. This glass bead is fused to the coaxial cartridge providing the advantage of both a hermetic seal and a low-loss dielectric material necessary for broad band performance.

The new mixer diode's RF impedance, with typical VSWR values of 1.5 max., provides unusual holder matching possibilities. Across the entire 12.4-18 GHz band, VSWR is specified to be no greater than 2.5 max.

Reliable operation of the D-5282 series is assured by a *true* hermetic glass-to-metal seal.

CIRCLE NUMBER 304

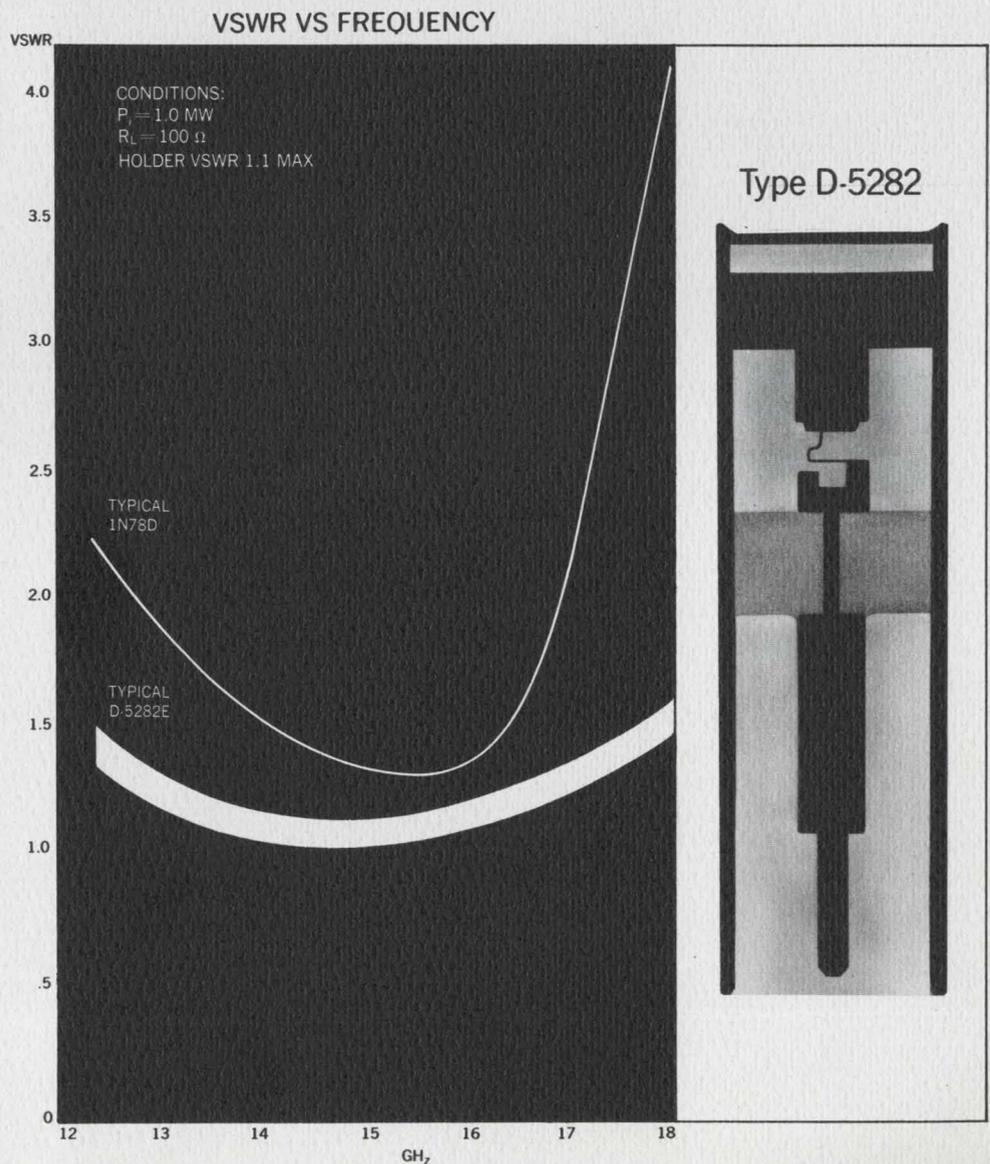

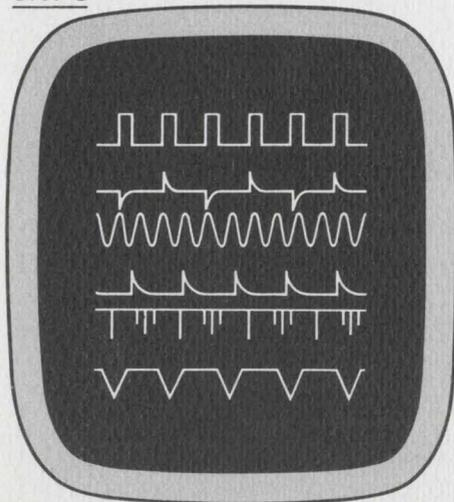

Problem: Design a CRT with six simultaneous, precisely zoned 1" x 8" traces, each trace to be independent of the others.

Given this assignment, Sylvania custom-built a tube based largely on the design and placement of six guns in a specially engineered tube mount.

The individual guns within the

Multi-gun CRT zones 6 related inputs

mount were placed to be parallel within 1° of each other. The guns were electrostatically focused and deflected for zone display application. Each gun then provided an area one-inch high by eight-inches wide in which the six independent signals were displayed.

The horizontal-to-vertical trace alignments of each gun were 90°, plus or minus 1°. A monoaccelerator design assured maximum pattern linearity as well as deflection factor uniformity. In short, the SC-3814 tube was near-perfect—because it had to be, and because Sylvania produced it.

Theoretically, there is no limit to the number of guns that can be put into a single tube. Sylvania has made

multi-gun CRT's with face diameters ranging from 3 to 16 inches, and in lengths of 8 to 36 inches.

Generally speaking, multi-gun tubes are used where:

1. There is a need for simultaneous displays.
2. Time sharing of the single beam is not feasible.
3. Space is limited, and parallel stacked tubes cannot be used.
4. There is a need for superimposing spots, as in tracking applications.
5. A larger display area is needed, as in spectrum analyzing where the trace length can be increased by using more than one gun, each covering a part of the screen.

CIRCLE NUMBER 305

GAS-GLOW READOUTS

Standard translator/drivers? Or custom solutions? Now Sylvania offers both

With the introduction of a new series of solid-state translator/driver modules, NS-142 and NS-143, Sylvania offers you a ready and reliable solution for the conversion from a four-bit binary code to a digital readout on a planar gas-glow numeric tube. Sylvania will also undertake custom design problems involving special codes.

The use of the diode logic circuits and silicon controlled switches results in a solid-state design with many advantages. These modules require a logic level input of only 6 volts at 2 ma maximum per data bit, and are capable of driving gas-glow readouts up to 2½ inches. They are compact, measuring approximately 3¼" x 2½" x 1", and are constructed on plug-in printed circuit boards.

Both units consist of a logic translator and switching circuit. In addition, the NS-143 features a storage or memory circuit that enables the display of one character while the next is being compiled.

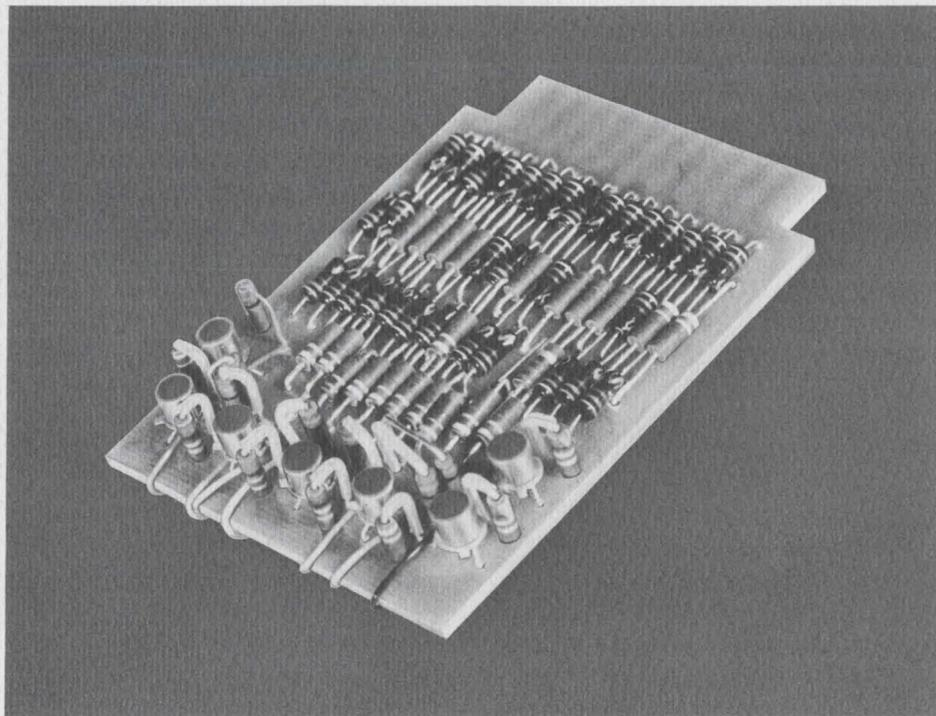

ELECTRICAL DATA

Positive Supply Voltage	6.0 VDC	Logic Levels Voltage	0 and +6 VDC
Current	7.0 Ma	Current	2.0 Ma
Readout Supply Voltage	170 VDC	Memory (NS-143 Only) Reset Voltage	6.0 VDC
Current*	8 to 20 Ma	Reset Current	5.0 Ma

*Note: Current depends on size readout used.

CIRCLE NUMBER 306

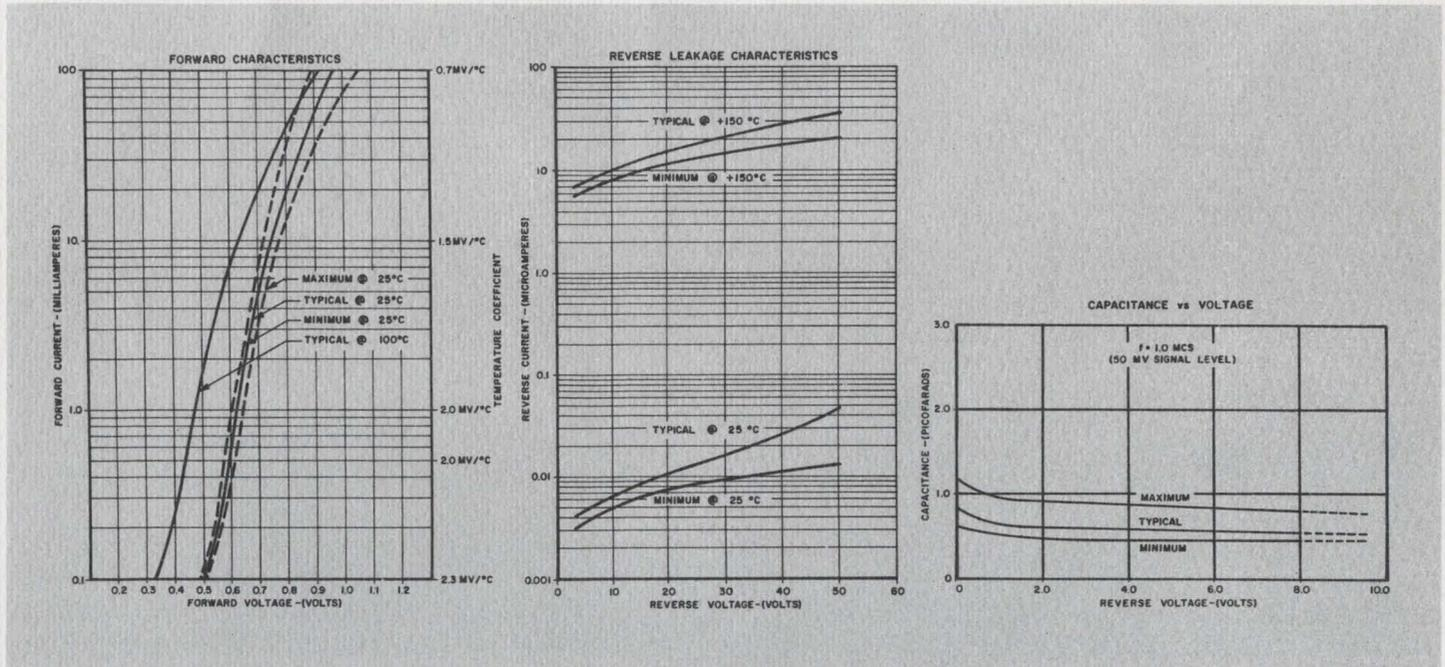

2-nanosecond silicon epitaxial diode switch is ready-made for projects that can't wait

Here's a reminder that might prove timely for the computer circuit project that has to get out in a hurry.

The workhorse diode for switching, clamping, chipping, clipping functions is the Sylvania 1N3731. The 1N3731 and its family types are available *in quantity* on an off-the-shelf basis.

Chief reason for its plentitude is its popularity which, in turn, stems from its unusual combination of characteristics.

Its speed (2 nanoseconds typical), its dissipation (400 milliwatts), its forward current (100 milliamperes at 1

volt) and its peak inverse voltage (100 volts minimum) still represent the best parameters combined in a single unit.

Reliability is an inherent quality of Sylvania's epitaxial process. And reliability is further enhanced by rugged one-piece construction and a double hermetic seal, 100% ZygCo

tested. Note that two types have QA approval.

Check either your Sylvania Distributor or Sales Representative for immediate delivery. You'll find the 1N3731 and its family types available in standard pack or reel. If you have a custom packaging requirement let us hear about it.

	Avg. Fwd. Current mA (min.)	Fwd. Current at +1 v ma (min.)	Reverse Current μA (max.)	Capacitance at 0 v μμf (max.)	Reverse Recovery time nsec. (max.)	Reverse Peak Voltage v (min.)
1N3731	275	100	0.05 at -50 v	2.0	3.0	100
1N3604	75	50	0.05 at -50 v	2.0	2.0	75
1N3064*	115	10	0.1 at -50 v	2.0	4.0	75
1N914†	75	10	.025 at -20 v	4.0	4.0	100
1N914A	75	20	.025 at -20 v	4.0	4.0	100
1N916	75	10	.025 at -20 v	2.0	4.0	100
1N916A	75	20	.025 at -20 v	2.0	4.0	100
1N4087	75	30	.09 at -50 v	1.8	5.0	60

CIRCLE NUMBER 307

*USN 1N3064
†JAN 1N914



HOT LINE INQUIRY SERVICE

Use Sylvania's "Hot Line" inquiry service, especially if you require full particulars on any item in a hurry. It's easy and it's free. Circle the reader service number(s) you're most interested in; then fill in your name, title, company and address. We'll do the rest and see you get further information almost by return mail.

FIRST CLASS
Permit No. 2833
Buffalo, N. Y.

BUSINESS REPLY MAIL

No Postage Stamp Necessary if Mailed in the United States

POSTAGE WILL BE PAID BY

SYLVANIA ELECTRONIC COMPONENTS GROUP

Sylvania Electric Products Inc.
1100 Main Street
Buffalo, New York 14209

Bullet-shaped epoxy package identifies polarity

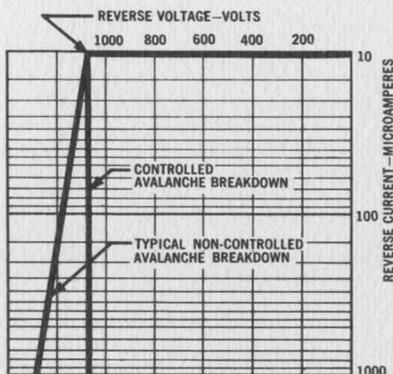

CONTROLLED AVALANCHE RECTIFIER 1 Ampere, Molded Package (Readings at 25°C)						
ELECTRICAL CHARACTERISTICS	SR 6587	SR 6588	SR 6589	SR 6590	SR 6591	Unit
Peak Reverse Voltage	200	400	600	800	1000	Volts
RMS Input Voltage	140	280	420	560	710	Volts
Max. DC Forward Voltage Drop @ 1a	1.0	1.0	1.0	1.0	1.0	Volts
Max. DC Rev. Current @ PRV	1.0	1.0	1.0	1.0	1.0	μA
Max. DC Rev. Current @ 100°C	50	50	50	50	50	μA
ABSOLUTE MAXIMUM RATINGS						
Max. Peak Rev. Working Voltage	200	400	600	800	1000	Volts
Max. Peak Forward Current	1.0	1.0	1.0	1.0	1.0	Amps
Max. Fwd. Peak, Non-Recurrent Surge	50	50	50	50	50	Amps
Max. Fwd. Peak, Recurrent Surge	20	20	20	20	20	Amps

NEW 1-AMPERE RECTIFIER Molded Package (Readings at 25°C)			
ELECTRICAL CHARACTERISTICS	SR 6592	SR 6593	Unit
Peak Reverse Voltage	800	1000	Volts
RMS Input Voltage	560	710	Volts
Max. DC Forward Voltage Drop @ 1a	1.0	1.0	Volts
Max. DC Rev. Current @ PRV	1.0	1.0	μA
Max. DC Rev. Current @ 100°C	50	50	μA
ABSOLUTE MAXIMUM RATINGS			
Max. Peak Rev. Working Voltage	800	1000	Volts
Max. Peak Forward Current	1.0	1.0	Amps
Max. Fwd. Peak, Non-Recurrent	30	30	Amps
Max. Fwd. Peak, Recurrent	10	10	Amps

Available now from Sylvania is a broad line of silicon rectifiers for application in the commercial, computer, military and entertainment fields.

These devices have peak reverse voltages up to 1,000 volts, forward rectified current to 1 amp, and power dissipation of 1 watt. The units are available in a bullet-shaped, molded epoxy package with the cathode lead

in the pointed end for easy identification of polarity. Extensive tests have been conducted on life, moisture, shock and temperature, to assure quality, and reliability has been designed and manufactured into these units.

Included in this broad line is a series of controlled avalanche rectifiers for high-surge application capable of handling 1,000 amp surges.

These units have peak reverse voltages of 200 to 1,000 volts, with peak forward current of 1 amp. The forward peak non-recurrent surge is rated at 50 amps and forward peak recurrent surge at 20 amps.

Whatever rectifier is required in your circuit application, call upon Sylvania's quality product to assure reliability in your design.

CIRCLE NUMBER 308

SYLVANIA

SUBSIDIARY OF
GENERAL TELEPHONE & ELECTRONICS GTE

NEW CAPABILITIES IN: ELECTRONIC TUBES • SEMICONDUCTORS • MICROWAVE DEVICES • SPECIAL COMPONENTS • DISPLAY DEVICES

NAME _____
 TITLE _____
 COMPANY _____
 ADDRESS _____
 CITY _____ STATE _____

Circle Numbers Corresponding to Product Item

- | | | | | |
|-----|-----|-----|-----|-----|
| 300 | 301 | 302 | 303 | 304 |
| 305 | 306 | 307 | 308 | |

Please have a Sales Engineer call



HOT LINE INQUIRY SERVICE

Need information in a hurry? Clip the card and mail it. Be sure to fill in all information requested. We'll rush you full particulars on any item indicated.

You can also get information using the publication's card elsewhere in this issue. Use of the card shown here will simplify handling and save time.



GENERAL ELECTRIC

Who put the "Cad" on TV?



New Cerro Cadmium Ball Anodes — more "throwing" power — better, faster plating.

Leading television and stereo set manufacturers did it!

They use cadmium plating on chassis and vital components for superior corrosion resistance and sales-stimulating eye appeal. Cadmium plating is also specified on military-grade gear which must operate reliably in environments that would humble other platings.

Leading fastener manufacturers, too, feature cadmium plating — both they and their customers know its intrinsic value.

Cerro produces quality cadmium high in the Peruvian Andes . . . and availability is excellent. To find out more about Cerro cadmium or the other high-purity, nonferrous metals we produce, contact us.

CERRO SALES CORPORATION

SUBSIDIARY OF **CERRO CORPORATION**

300 Park Avenue, New York, N.Y. 10022

CERRO

CONSIDER YOUR HARNESSING OPERATION . . .

SURVEY of HARNESS
TYING OPERATION
for
Your COMPANY



GUDEBROD BROS. SILK CO., INC.
FOUNDED IN 1870
Electronics Division

Area Code 215, WA 2-1122 • TWX 215-589-8891

12 SOUTH 12TH STREET, PHILADELPHIA, PENNSYLVANIA 19107

• BRANCH OFFICES •

BOSTON, MASSACHUSETTS 02111
115 Chauncey Street, Area Code 617, MA 6-5347

CHICAGO, ILLINOIS 60654
1362 Merchandise Mart, Area Code 312, DE 7-3028

NEW YORK, NEW YORK 10001
225 West 34th Street, Area Code 212, LA 4-8888

BURBANK, CALIFORNIA 91804
2638 Ontario Street, Area Code 213, 848-3968
TWX 213-646-7691

PLANT: Pottstown, Pennsylvania 19464

Mr. Executive . . . Would you like to save money while improving the product?

(Take only a minute to read this unique, no cost offer of a survey and report)

There is available at Gudebrod a wealth of experience, gained in a specialized attention to the harnessing of wire cables since the earliest days of electronic equipment. Gudebrod has the latest information on tools and techniques, the latest information on materials and layout, the latest information on government requirements and industry trends. There is no comparable source for such information in the industry. Some companies, in the course of normal business have taken advantage of this Gudebrod experience and knowledge. You, too, can benefit from them. We can recommend ways in which to improve the operation of your harness room—and ways to save money at the same time. Here is what we propose—there are three parts.

First, we arrange, at your convenience, to have a Gudebrod representative make a

thorough survey of your harness operation—specifications, methods, materials.

Then, this survey is sent to the Gudebrod Home Office for review by an experienced consultant.

Finally (and most important), a Consultant's Report (as illustrated on the left hand page) is delivered to you. This will contain special, written, confidential recommendations on how *your* harnessing can be improved, how *you* can save money.

With self-interest, Gudebrod believes that by improving the state of the art throughout the industry, they will also improve their own business atmosphere. In your own concern for your company, why not talk to us about a survey of your harness operation—to improve it—to save money? To repeat—you will be involved in no cost or obligation.



GUDEBROD BROS. SILK CO., INC.

FOUNDED IN 1870

Electronics Division

12 SOUTH 12th STREET, PHILADELPHIA, PENNSYLVANIA 19107

Area Code 215, WA 2-1122

... up to your neck? ... trying to find a weak signal in a gooey background of noise.

The story is told that when the first crude version of the Dicke Microwave Radiometer — the heart of most present day radio telescopes — was being tested, one of the division heads expressed doubt that a piece of electronic hardware could be cajoled into responding to ordinary thermal radiation at microwave frequencies. The noise level in the primitive receivers of that time was at least 10 db above ambient thermal radiation levels, and it had been claimed that the Dicke radiometer had a sensitivity of $1/2^{\circ}\text{C}$. To make his point, this well-known physicist took his lighted cigar and held it up to the input wave guide of the receiver. When to his surprise the meter banged off scale, he smiled like a Cheshire cat in a cage full of ducklings.

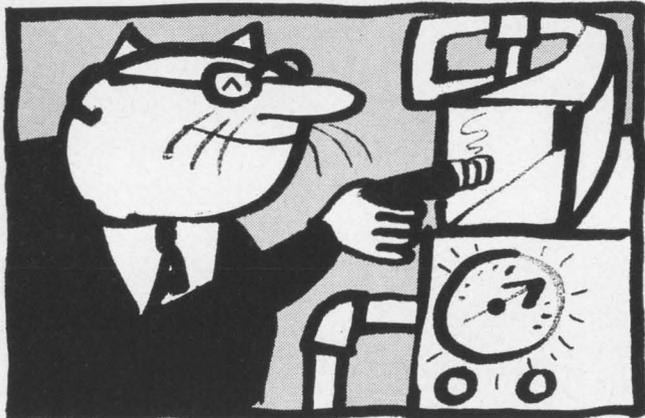

The heart of the radiometer was the lock-in amplifier, and the technique of fishing a small signal out of a thick porridge of noise became known thereafter as the "lock-in amplifier technique." After the initial success with a lock-in amplifier the technique was used in a variety of places, including nuclear magnetic resonance measurements and microwave spectroscopy experiments. The practitioners of this black art have now increased to a reasonably large number, but a far larger number of scientists in all fields are still up to their necks trying to find a weak signal in a gooey background of noise.



Possible applications for the lock-in amplifier technique are almost endless, but in some scientific fields the amplifier is not even known, much less appreciated. The biological sciences offer many interesting challenges. Has anyone ever shone a light in a cat's eyes to see if it elicits a motor response? If the light were chopped at 5 cycles/sec. and a lock-in amplifier were connected to an appropriate strain gauge, this response could be studied, not only under conditions of very weak signal, but also as a function of chopping frequency.

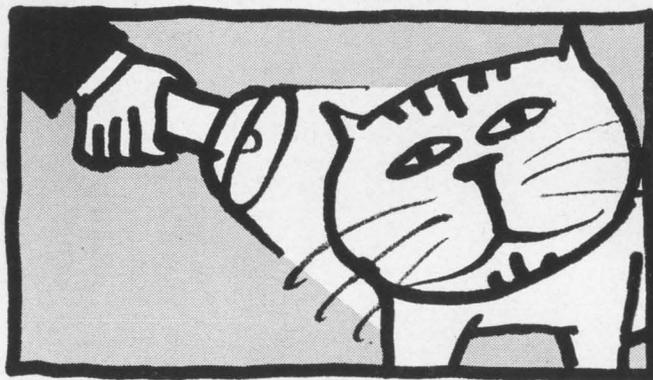

Do astronomers realize that the lock-in amplifier can be used to "see" dim stars during the day? A rotating transparent disc carrying many tiny opaque spots can be used to modulate the light from the star while ignoring the background light.

These are only two of many possible applications of the lock-in amplifier technique. If you have a problem which you think might be solved by this instrument, our staff of experts would be happy to assist you.

Surprisingly, in spite of the increased use of the lock-in amplifier technique during the past 18 years, it has only recently become possible to buy such an amplifier.

Should one wish to add such an instrument to his quality research line, we would be glad to offer him a choice of units (ranging from \$990.00 to \$2100.00) and some application help (free!).



Transistorized Lock-In Amplifier — Model HR-8



Write for Bulletin 109 to:

PRINCETON APPLIED RESEARCH CORP., Dept. D, Box 565, Princeton, N. J./Tel. (609) 799-1222

Advanced technology

Bouncing beam

The development of an optical delay line that introduces virtually no distortion to the data it stores is expected to open new areas of research in the microwave, computer and radar fields.

In the delay line developed by

the other mirror. The period of delay—10 microseconds in the prototype—can be adjusted by changing the number of reflections or the distance between the mirrors.

Since the large bandwidth of laser beams lets them store a huge amount of information, the system may be developed into a new type of computer memory.

The delay line has a frequency response in the gigacycle range,

Medical electronics

Visible man

In some modern operating rooms, computers are being used to monitor a patient's heart, blood pressure and other physical functions. The instrument alerts the surgeon quickly to danger signals, but it's up to him to make a diagnosis and take corrective action such as increasing oxygen flow or administering drugs. Within a decade, though, the computer may do the whole job.

Human maze. No two human bodies are exactly alike, and each is a complex maze of interdependent functions, facts which make it difficult to program a computer to fit everyone. Biomedical researchers want to construct a universal mathematical model of a human, but at present their data is insufficient.

To collect data, they are pinning their hopes on a device no bigger than a dime, which would be implanted in human bodies to monitor body functions and telemeter the information to an exterior receiver.

Research on tiny and reliable transducers-transmitters for insertion in the body is being done by the Case Institute of Technology in Cleveland, by the Franklin Institute Research Laboratories in Philadelphia and by the Air Force. The aim is to develop a device that can function for several months inside the body, without disrupting the body's activities.

So far, such f-m transmitting devices have been implanted only in animals, but within a year, researchers hope to test the units inside humans.

The major problem was finding a material that wouldn't be rejected by the body. Case Institute is experimenting with transducers

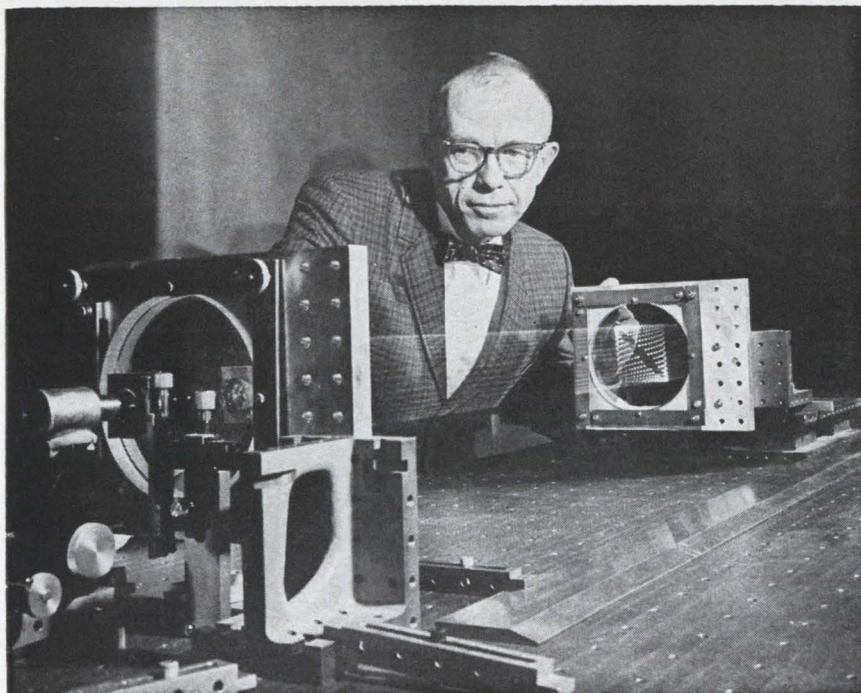

Optical delay line introduces 10-microsecond delay as laser beam bounces back and forth between two concave mirrors.

Bell Telephone Laboratories researchers Donald Herriott and Harry Schulte, a two-mile long laser beam is "folded" into a 10-foot long space by bouncing the beam back and forth more than 1,000 times between two concave mirrors.

Back and forth. The mirrors are curved so that a laser beam entering through a hole, or an unsilvered area on one mirror, is bounced between the mirrors and

then exits through another hole in two or three orders of magnitude greater than that of electronic or ultrasonic delay lines.

The limiting characteristic of the optical delay line is the speed with which the input laser can be modulated. Conventional delays are limited by the delaying medium—a vibrating crystal, a transmission line—and the distortion introduced by the characteristics of the medium.

covered with silastic rubber, while Franklin is working on paraffin-covered devices. In both cases, researchers say, the transmitters have functioned well for several months in rats and monkeys.

Source of power. Case, in an effort to extend the useful life of the transmitter, is experimenting with a technique for supplying power from outside the body with a radio-wave technique. Under the system, an inductive core in the transmitter would receive the power from an outside radio field. So far, the transmitter can only operate while the radio field is being applied, but scientists hope to be able to store a sufficient charge in the transmitter to extend its operation for some time.

Other researchers are seeking ways to power the transmitters from temperature differences in the body, from chemical potentials, from body-fluid fuel cells and from mechanical converters, such as piezoelectric transducers attached to moving muscles.

Space electronics

Like clockwork

Space telemetry systems have two particularly vulnerable points: the power supply and the commutator. If the power fails, the satellite won't transmit any data and the craft will become a hunk of junk in orbit.

The commutator, which periodically samples each data channel so a concentrated stream of information can be sent to earth, can introduce signal leakage, unwanted capacitance and transient noises.

Engineers at TRW Space Technology Laboratories in Redondo Beach, Calif., believe they've found a way to overcome these problems by introducing redundancy to increase reliability. The laboratories are part of TRW, Inc.

Sampling themselves. Their approach is to design the telemetry system so it will use integrated cir-

cuits that sample their own data and power themselves with tiny battery cells. If the power supply in one circuit fails, the others won't be affected.

The input circuits take signals from a sensor, condition them and present them to the commutator. To eliminate the commutator, they have incorporated a clock circuit into each input circuit. The circuits are turned on and off by the clock at a rate required for sampling the sensor signals.

TRW plans to go a step further. If a clocked comparator circuit is used to compare each transducer's signal level with a reference, the analog voltage generated by the transducer can be transmitted as a digital value. This approach overcomes the difficulty of switching low-level analog voltages.

Each comparator circuit could be turned on and off by an individual power-supply circuit, which would be between a rechargeable battery cell and the comparator circuit. The comparator would feed data into the transmission system only while getting power from the battery. The power-supply circuit would also monitor the cell's output and connect the cell to the spacecraft's solar cells for recharging when necessary.

Unique approach. Experimental integrated circuits to test the approaches are being made. Henry Low, director of TRW's product engineering and microtechniques lab, considers this the most important use yet for microcircuits in telemetry systems; he adds that the approach can be applied to other types of equipment.

The system capitalizes on a unique advantage of microcircuits—their ability to improve system performance by increasing the number of functions performed by a circuit. If the approach were tried with discrete-component circuits, the penalties in cost, weight, volume and power consumption would be high. But with microcircuits, such functional redundancy costs little.

If a spacecraft has 100 data inputs served by a single power sup-

ply, all data is lost if the power supply fails. If one of the microcircuit's power supplies should fail, however, the other 99 data lines would continue operating.

Development of the system, Low says, proves the effectiveness of interdisciplinary design teams, which TRW favors. The idea for the system came out of a brainstorming session attended by telemetry engineers and members of the microelectronics staff.

Computers

Draftsman's helper

Much of a draftsman's work consists of drudgery. Gradually, computers are being designed to take over a number of time-consuming routine tasks.

Perspective, Inc., of Seattle, is offering a machine, called the Illustromat 1100, that takes data from any orthographic projection and swiftly draws the object in any three-dimension projection.

And the Meiscon Corp., a subsidiary of the Control Data Corp., has developed a system that takes, from sketches, raw data on the framework of a building and then proceeds to design the steel skeleton in detail. Similar computer-operated drafting machines are being used by some automobile companies [Electronics, Nov. 16, 1964, p. 25].

A drawing a minute. The Illustromat, which costs \$52,500, consists of a tracing table, a control panel, a solid state analog computer and a motor-driven X-Y plotter. Within a minute, the machine can perform the work that would take a skilled draftsman an hour.

The operator sets up, on the control panel, the perspective view he wants. With the plotter's double stylus, he then traces the orthographic view of the parts he wants to project. The styluses are connected to the plotter through the analog computer, which converts the two-dimensional information

into three-dimensional data so it can direct the drawing of the perspective view.

Aside from being able to draw a perspective view, the Illustromat can enlarge sections of a drawing, make a bird's-eye view from a topographical map, or produce a third orthographic projection from two other projections.

In the Meiscon system, called Constructs, rough sketches are prepared by an engineer, showing the shapes and weights of all the steel in the building. This data is converted into digital form, fed into a computer and recorded on magnetic tape. The data is then analyzed by a large CDC 3600 computer, forming a mathematical model of the building's framework. The model specifies the size of each beam and column and pin-points the location of each bolt, rivet and welded area; directions also are given for cutting the steel in the fabricating shop.

The data on the model is then

hour and perform 40% of the drawing that's required in designing the steel structure.

Consumer electronics

Sign language

Some traffic signs were "talking" briefly in New York and Boston last month. Eventually, the Ford Motor Co., developer of the electronic signs, hopes to see them at roadsides all around the country.

The talking-sign system, akin to an electronic backseat driver, consists of roadside transmitters and solid state tape recorders that are connected to a car's radio amplifier and contain prerecorded traffic signs, such as "curve ahead" or "dangerous crossing." The transmitters continuously broadcast one of several coded signals that correspond to one of several channels in the car's recorder. When a car passes a transmitter, the signal is picked up by the car's antenna, automatically turning on the recorder and triggering the corresponding tape channel to play the traffic message over the radio's speaker.

Advance warning. Although the system may appear unnecessarily complex for the simple task it performs—like using a digital computer to add up a shopping list—the talking traffic sign may be an effective tool on high-speed roadways. It could, for example, alert drivers to fog patches, icy surfaces, or an accident up the road. The system's biggest advantage is its ability to warn a driver of changes in highway conditions, even if rain or snow should blot out road signs.

The tape recorder and receiver will cost about \$35, Ford says, while the transmitter would eventually cost no more than \$10.

The tape recorder is connected to a car radio's amplifier and loudspeaker. If the radio is on when a traffic signal comes in, a switch in the recorder momentarily opens the radio circuit, giving priority to the tape recorder. If the radio is

off, the incoming signal turns on the radio's amplifier; when the car leaves the immediate area of the electronic sign, the radio is shut off automatically. Rapid turn-on time is possible because today's transistor radios need no warming up before they begin to operate.

No garble. Since the actual message is stored in the car, communication won't be interrupted or garbled by static or bad weather.

The message track in the tape recorder is selected by reed relay logic circuits that respond to the sign's coded signals—carried on the 27.195 megacycle transmission band.

Point system threatened

Bidding for a share of the \$50-million automotive-ignition market is a system that uses a light beam instead of breaker points. It's being offered by the Mallory Electric Co. of Detroit and is being tested on police cars, taxicabs, fork-lift trucks and racing cars.

Photocell ignition might replace not only mechanical breaker-point systems, which dominate the market, but other ignition innovations as well. Both the silicon controlled rectifier ignition systems, which are still being tested [Electronics, Oct. 5, 1964, p. 68], and the recently introduced transistorized systems use breaker points. On most cars, points have to be replaced after every 10,000 or 15,000 miles. Mallory seems confident, despite the whopping \$150 price, that the photocell system will pay for itself over long use through reduced gasoline consumption and savings on breaker-point replacements, and will give the driver a trouble-free ignition system.

Turn on the light. A photocell breaker, a five-stage amplifier and the ignition coil make up the system. Turning the ignition key applies power to the amplifier and a small light bulb.

As the starter turns over, a shaft rotates in the distributor housing. On the shaft, a horizontally mounted cap with slits around its

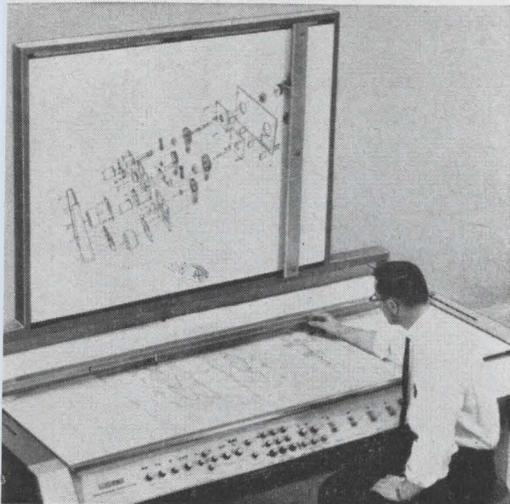

Drawing machine uses computer to convert orthographic drawings into three-dimensional sketches at any perspective.

fed into an electromechanical plotter, built by Electronic Associates, Inc., of Long Branch, N. J., which produces the drawings for the construction men at the building site.

The developer says the program can reduce three days' work to an

circumference rotates around a silicon photocell. The continuously lighted bulb shines on the photocell as the slotted cap rotates.

The photocell output pulse of 0.2 volts is amplified to 15 volts, 15 amperes, at typical pulsewidths of 1.2 milliseconds; the time between pulses is 2.3 milliseconds. These pulses are voltage-stepped within the ignition coil to about 35,000 volts, and the usual mechanical rotary switch distributes the firing voltage to each of the spark plugs. The ignition current delivered to the plugs is at 30 to 40 milliamperes, or about 33 millijoules, compared with conventional ignition system's 22 millijoules.

The tax cut

The electronics industry will get sizable benefit from excise tax cuts that may total \$4.8 billion by 1969. President Johnson asked Congress for the cut May 17 and the bill is moving through the legislative body swiftly.

The House Ways and Means Committee went beyond the President's \$3.9-billion request by voting to eliminate excise taxes on passenger cars by 1969. Johnson wanted to reduce the 10% tax to 5% by 1967.

Business costs will be reduced by the excise cuts on telephone, teletype and telegraph service and by the automobile industry's decision to reduce prices by the amount of the excise-tax reduction. Also, the cost of business entertainment may decrease as a result of the cut in taxes on cabaret tabs and on club dues. And the accounting costs involved in filing excise-tax returns will be eliminated.

Some increases. But some business costs may increase because of Johnson's requested \$300 million yearly addition to transportation user taxes; this provision affects truckers and airlines.

The following taxes directly affecting the electronics industry will be repealed on the following dates:

- July 1, 1965: manufacturers' excises on consumer electronics.

This 10% tax currently adds \$135 million a year to the price of television sets and \$90 million a year to radio and phonograph prices.

- July 1, 1965: the 10% manufacturers' excise on business machines, including some electronic business machines. This tax totals \$75 million a year, but the Treasury Department has no breakdown on the amount coming from electronics equipment.

- Jan. 1, 1966: excises on telephone and teletypewriter services will be cut to 7% from 10%, saving users \$730 million a year. In steps, the tax will be eliminated by Jan. 1, 1966—a further saving of \$270 million. Also on Jan. 1, 1966, taxes on telegraph service and on wire and equipment services will be repealed.

Sales gains. The results of the tax cuts, Treasury officials believe will be higher sales of electronic products, because of a lowering of prices to consumers. Although the manufacturer pays these taxes, he passes it on to consumers, and officials hope the pressure of competition will force manufacturers, in turn, to pass the tax savings on to consumers. Johnson set this tone when he called on business "to translate lower excise taxes promptly into lower retail prices for consumers."

The effect on consumer electronics, according to Commerce Department officials, should be to boost sales by more than the proportion of the price cut. Their studies show that a 10% cut in television set prices, for instance, brings more than a 10% increase in sales.

For the makers of telephone system equipment, officials believe the tax cut will have a substantial, if indirect, effect. The telephone industry has argued that the cut would stimulate telephone use enough to force a considerable rise in capital investment in the industry's facilities.

Postponement of consumer purchases on television and other major products, officials concede, might be a problem between now and July 1 as consumers await the

lower prices. For two major products—autos and air conditioners—the law tries to prevent a halt in purchases by making the tax cut retroactive to May 15.

More advertising. For other products, officials suggest retailers might advertise more heavily in the interim to offset any buyer resistance.

To prevent dealer postponement of inventory buying, the tax bill would provide for tax refunds on floor stocks as of June 30.

Manufacturing

Pasting up circuits

Electrochemists at E. I. du Pont de Nemours & Co. are working on a new class of material for hybrid microcircuits—etchable resistive and conductive pastes that are made of particles of metals and ceramics in a photosensitive binder. If the pastes are successful, such circuits, du Pont researchers say, could be made without the expensive step of vacuum deposition.

Du Pont's customers would be manufacturers who now make monolithic hybrid circuits by forming high-value, precise thin-film resistors and their connections on top of silicon crystals that contain active devices. The resistors, expected to be used widely in linear integrated applications, are generally made by vacuum-depositing thin films and then etching them.

Etchable pastes may also revolutionize the methods of attaching silicon dice—either transistors and diodes or integrated circuits—to substrates to form hybrid circuits.

Ready in a year. Closer to fruition are several new pastes that du Pont's electrochemicals department is developing for screen-printed hybrid circuits. To the basic resistor and conductor pastes that du Pont now sells for such hybrids, the company will add compositions suitable for printed capacitors, inductors, conductor crossovers and glass encapsula-

TRW zeners for relief of diode flake-out!

**Only TRW protects
against internal
particles with an
invisible shield.**

- 1.** **PROTECTS 24 HOURS
A DAY!**
Siloxane polymer coating
shields junction 100%.
Proved in 30 billion Min-
uteman diode hours.

- 2.** **RELIEVES FLAKING!**
Eutectic alloy bond—no
flaky paste, no solder pre-
forms, nothing to rattle
around.

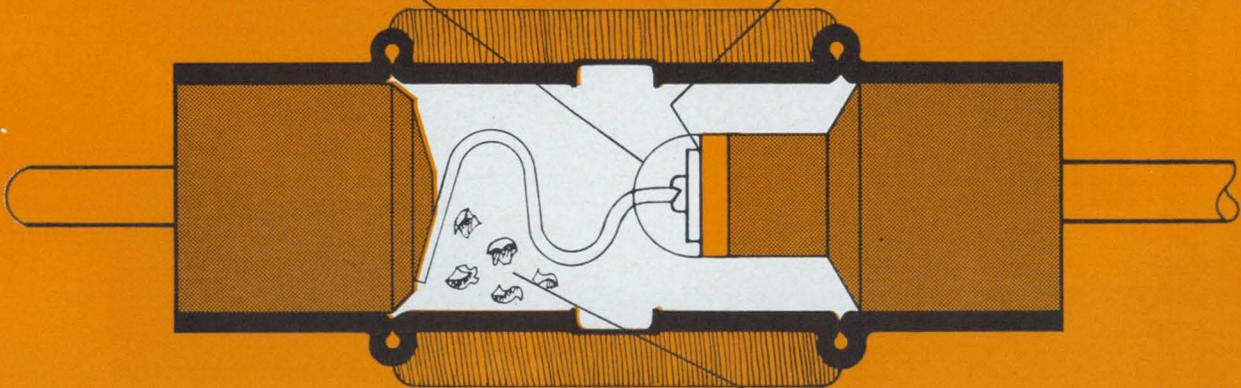

- 3.** **FREE OFFER!**
We will put several large
conductive particles in a
zener—on purpose—and
send it to you for your trial
examination.

For fast, fast, fast relief, write us at 14520
Aviation Blvd., Lawndale, California,
or call 213-679-4561 (Ext. 263). TRW
zeners are products of TRW Semicon-
ductors Inc., a leading manufacturer of
specialized semiconductor devices.

TRW SEMICONDUCTORS
A SUBSIDIARY OF THOMPSON RAMO WOOLDRIDGE INC.



**2500 Mc
ETV
TACO 15 DB
OMNI-
DIRECTIONAL
TRANS-
MITTING
ANTENNA**

Now in production! TACO field-proven 15 db omni-directional transmitting antennas for INSTRUCTIONAL TELEVISION FIXED SERVICE in the 2500-2690 Mc range.

SPECIFICATIONS INCLUDE:

- 50 ohm impedance
- VSWR 1.3:1 max.
- 15 db gain
- Excellent color response
- Horizontal polarization
- Lightning protected
- Beacon light (optional)

As you shape your complete ETV system, be sure to include reliable, field-installation-proved TACO antennas. Complete data on all ETV antennas, including parabolic and cylindrical parabolas for receiving or transmitting applications will be forwarded on request.

TACO ETV

A subsidiary of THE JERROLD CORPORATION
TECHNICAL APPLIANCE CORPORATION
Defense & Industrial Products Division
SHERBURNE, N. Y.

tion. These compounds should be ready within a year. The du Pont materials for screen-printed hybrids won't do for linear integrated circuits because those circuits can't be applied with the required precision.

Screen-printed circuits are made by forcing paste through open patterns in a metal mesh. The material deposited on ceramic substrates is then fired to bind the material to the substrate and alloy the particles. Discrete components are added to the resistor network by soldering or welding.

This process works fine on a relatively large ceramic substrate. Resistors can be screened and fired to a tolerance of 10% and trimmed by mechanical abrasion to 1%. But the process is too crude for integrated circuits, which are typically one-hundredth the size of hybrid circuits. Top precision of screen printing is line width and spacing of 0.003 inch. If the etchable pastes are effective, the level of geometrical precision—which determines component tolerances—would be raised several times.

Glue a stamp. Another potential application for etchable pastes is registrative bonding of integrated circuits to substrates. Registrative bonding is akin to gluing a postage stamp on a letter—the terminals on the chip are bonded directly to conductors on the substrates, avoiding the need to use individual wire leads.

Several companies have developed registrative bonding methods, but those now in commercial use have to provide thick bonding pads on the silicon chip for accurate location.

Most companies making hybrid circuits would rather have a technique that permits any supplier's chips to be used for registrative bonding. The trick is to develop a material that will put exactly the right amount of solder at exactly the right place on the substrate to mate with the tiny thin-film terminals on the chips.

Greater versatility. At present, resistors are the only mass-produced components for screen-printed circuits. Capacitors are

sometimes made by screening electrodes on either side of the ceramic substrate, and a few hybrid-circuit makers have proprietary compositions for printed circuits. Inductors cannot be made. Yet in its labs, du Pont has printed oscillator circuits with screened capacitors and inductors.

The new capacitor paste is a glass-bonded titanate, which can be applied in layers, alternating with electrode pastes, to make multilayer capacitors. Capacitors of up to 20,000 picofarads per square inch have been produced. Efforts are now being made to reduce the dissipation factor below the present level of 1% to 1.5%.

Work on inductive materials has just begun. Already inductances of 100 microhenries have been obtained. The insulations for conductive crossovers have adequate voltage breakdown capacities—200 to 300 volts per mil—and the goal now is to make capacitance low. The encapsulating glasses, du Pont believes, would be used widely. They can be fired at low temperature, about 450°C, are impervious to moisture and reduce drift in resistor values.

Integrated circuits

Multifunction packs

Texas Instruments Incorporated has added a seventh line to its family of silicon multifunction integrated circuits. Series 70, two fore-runners of which were introduced last week at the meeting of the International Federation of Information Processors in New York, is aimed specifically at producers of large ground-based computers.

Circuits SN7000 and SN7001 are dual logic gates operated in the unsaturated switching mode. They feature response speeds as fast as five nanoseconds; previous saturated logic gates made by TI had speeds in the order of 13 to 15 nanoseconds. Each integrated circuit contains a 3-input and a 2-input gate.

50 components. Customers can use the new circuits for NOR or OR outputs, depending on which output leads are used. About 50 components are available for a variety of interconnection schemes.

At first, units will be available in 16-lead flatpack cases. Later, for further flexibility, TI plans to build 16- to 40-pin units in metal-ceramic plug-in packages. Charles Phipps, marketing manager, says TI expects a large demand this year.

The SN7000s have power dissipation per gate of 40 milliwatts plus dissipation from output resistors of 25 milliwatts per output resistor. The SN7001s may have one, two or no output resistors. They will operate between 0° and 70°C. The SN7000 has four output resistors.

Avionics

Quick turnaround

When one of the new breed of military aircraft taxis into a maintenance shop for a periodic examination of its complex electronics hardware, it may stay there for a full day while technicians swarm over it, setting up test equipment and evaluating results. But tests for the supersonic F-111 should take only a few hours.

The difference is in the computer-controlled diagnostic equipment that was tailored for the F-111 by the General Dynamics Corp., which designed both the plane and the testing package. With the F-111 order from the Air Force and Navy exceeding \$1 billion, it became economically sound to develop computer-controlled testing gear for one type of craft.

Planning started early. While the F-111 design was still on the drawing board, General Dynamics' engineers began working on the testing package. As a result, the first set of equipment was delivered in March to the company's Ft. Worth division, while earlier this month the plane itself underwent its first test flight.

Go-no-go. The test equipment's

"THIS BETTER BE GOOD!"....

... I wouldn't have taken the time, if Standards hadn't sent you. As I understand it, you sold them an oscillator, which they think can help *me!* Did they fill you in?

Yes — they tell me the final test on your new line of amplifiers seems to be chewing up a lot more time than you'd like.

Time? Please! Every time the brass walks through here and sees those unshipped instruments, I get visions of my merit file being stuffed with nasty little notes! Big problem's been in checking for frequency response and harmonic distortion. Just too bloody long on each instrument!



Take the tests one at a time. Frequency response. Been feeding preset amplitudes at frequency steps, reading amplifier output and comparing? Have to go back to the signal source each time to check and reset its output amplitude at every frequency?

Sure! Otherwise, I've got oscillator amplitude error in my gain figure.

OK. You don't have to. The frequency response of the Krohn-Hite 446 oscillator is within 0.01 db up to 20 kc, within 0.05 db all the way to 100 kc. And amplitude stability within 0.01% for a full hour! So, forget about resetting voltage every time you change frequency.

Beautiful! Eliminating rechecking the source and re-setting will really speed things up.

Now — what are you doing to the input signal when you measure harmonic distortion of the amplifier? Have to purify the oscillator output?

Naturally!

Not at all... use the 446 as your source and forget about harmonic distortion — it's less than 0.02% from 400 cps to 10 kc, 0.05% at 20 kc — 0.2% at 20 cps. Another thing — the 446 is available fully programmable for automatic check-out — including self-checking, "enable" and "completed" circuits.

Brother — you've just saved me 8 hours an instrument! I'm going upstairs right now and pinch a 446. We can ship some amplifiers tonight!

Hold it! They're right in the middle of DVM calibrations with their 446's. But I'll let you buy your own from me.

Dammit, progress always costs!



**KROHN-HITE
CORPORATION**

580 Massachusetts Avenue, Cambridge 39, Mass.
Area Code 617 491-3211

Pioneering in Quality Electronic Instruments

computer automatically sets up examinations for each of the plane's electronic systems. Within three or four minutes, the comparator reports, on a go-no-go basis, a system's ability to perform its task.

Each test package costs \$1.7 million. Six additional sets of equipment will be completed by September.

Although this is the first time that a ground-support test package was designed concurrently with a craft's prime components, General Dynamics' engineers say they ran into no major obstacles. Work on the test gear was performed at the company's electronics division in Rochester, N. Y.

About 40% of the equipment was off-the-shelf gear — oscilloscopes, pulse generators, digital voltmeters. The rest had to be designed for the F-111 package.

Eventually, the General Dynamics engineers hope, the tester will be modified so that it can diagnose the electronic problems of other aircraft.

Soaring market

A multimillion-dollar market for electronic navigation and communication equipment for airplanes will be opened if the Federal Aviation Agency goes ahead with plans for avionics requirements.

What the FAA proposes, in effect, is that aircraft used for private, business or pleasure flying be required to install much the same navigation and communication equipment that now is being used in, or will soon be required for, commercial airliners.

This would include two-way radios, very-high-frequency omnirange receivers (VOR) together with localizers, distance-measuring equipment (DME) and radar beacon transponders. Under the proposal, requirements would become effective gradually over a ten year period.

85,000 planes affected. The market is substantial. The FAA says there are some 85,000 such aircraft now in use, and it expects the number to grow to more than 105,000

within 10 years. According to FAA figures, 23% of the planes now in this field of aviation would need vhf radios, 78% would need distance-measuring gear and more than 50% would need vertical omnirange receivers.

Comments on the FAA's proposal can be filed with the agency until July 28. No ruling is expected before year's end.

Under the advance notice, three kinds of airspace are envisioned: controlled, uncontrolled, and area positive control (APC). The idea is to prevent any traffic jams by bringing general aviation under the same control as commercial aviation.

Visual flight rules. The new rules for controlled airspace are intended to permit general-aviation pilots to operate under visual flight rules in APC airspace. These pilots would be expected to be proficient enough to receive and comply with air-traffic control instructions while operating in APC airspace but, unlike commercial pilots, they would not be required to hold a commercial rating.

Planes used in general aviation would not have to meet any of the proposed equipment requirements if they remained in uncontrolled airspace and if they did not fly in and out of airports that are equipped with federal control towers. These exempt planes would be mostly small, pleasure craft.

The airborne equipment requirements proposed by the FAA and the target dates are: vhf radio transmitter and receiver with 50-kilocycle frequency, Jan. 1, 1966; VOR-localizer receivers with 100-kc spacing, and perhaps DME, July 1, 1963.

For APC airspace only, the same equipment would be required in addition to a 4096-code radar beacon transponder after July 1, 1968; and an automatic altitude reporting encoder capable of reporting 100-foot altitude increments to ground control facilities after Jan. 1, 1970. Neither of these last two pieces of equipment is yet operational, even in commercial aviation.

Currently, the DME requirement for general aviation applies only to



PLATINUM BY BISHOP BECAUSE NOTHING ELSE DOES IT AT SO LITTLE COST

Platinum, the miracle metal of so many uses, is surprisingly economical to use.

Platinum metals resist high temperatures, provide exceptional resistance to corrosion and erosion, perform catalytic actions. Yet, after years of service, the original metal can be recovered at a dollar value almost equal to original cost. This makes Platinum the soundest possible investment.

Bishop's broad line of lab ware, tubing, wire, gauze, sheet, strip, salts, and chemicals are described in detail in our Catalog P-7. Request a copy. Also P-5B, CD-6 and P-12.

BISHOP



J. BISHOP & CO.

platinum works

MALVERN, PENNSYLVANIA

IN CANADA:

Johnson Matthey & Mallory Limited
110 Industry Street, Toronto 15.

IN THE U.K.:

Johnson Matthey & Co., Limited
73-83 Hatton Garden, London E.C. 1

VOR-equipped civil aircraft operating above 24,000 feet over the continental United States. Under the FAA proposal, this requirement could be extended to all VOR-equipped civil aircraft operating at lower altitudes.

Communications

New star for ABC

The law creating the Communications Satellite Corp. in 1962 states specifically that it does not preclude the creation of additional communications satellite systems "if required to meet unique government needs or if otherwise required in the national interest." The question before the Federal Communications Commission—put there by the American Broadcasting Co.—is how to interpret that law.

ABC wants to put up a television satellite. Leonard H. Goldenson, network president, envisions using the satellite to distribute programs of other networks.

Hot potato. The issue has stirred up several Washington offices. The FCC, whose job it is to interpret the law, has asked Comsat to comment on the request. Comsat has held hurried discussions with ABC. And in the board rooms of the common carriers that now distribute most telecasts in the United States, the subject is presumably receiving careful attention.

The major carrier, the American Telephone and Telegraph Co., owns 29% of Comsat's stock; presumably, AT&T is not anxious to lose any of the \$50 million a year it receives for handling tv transmissions. If the issue boiled down to a choice between Comsat and an independent system such as that proposed by ABC, presumably AT&T would favor Comsat. There is nothing in the law that prevents Comsat from entering the domestic communication business.

Goldenson says ABC pays \$15 million a year to have its telecasts distributed by conventional land-based methods. A satellite system could be created for a fraction of this cost and last for several years.

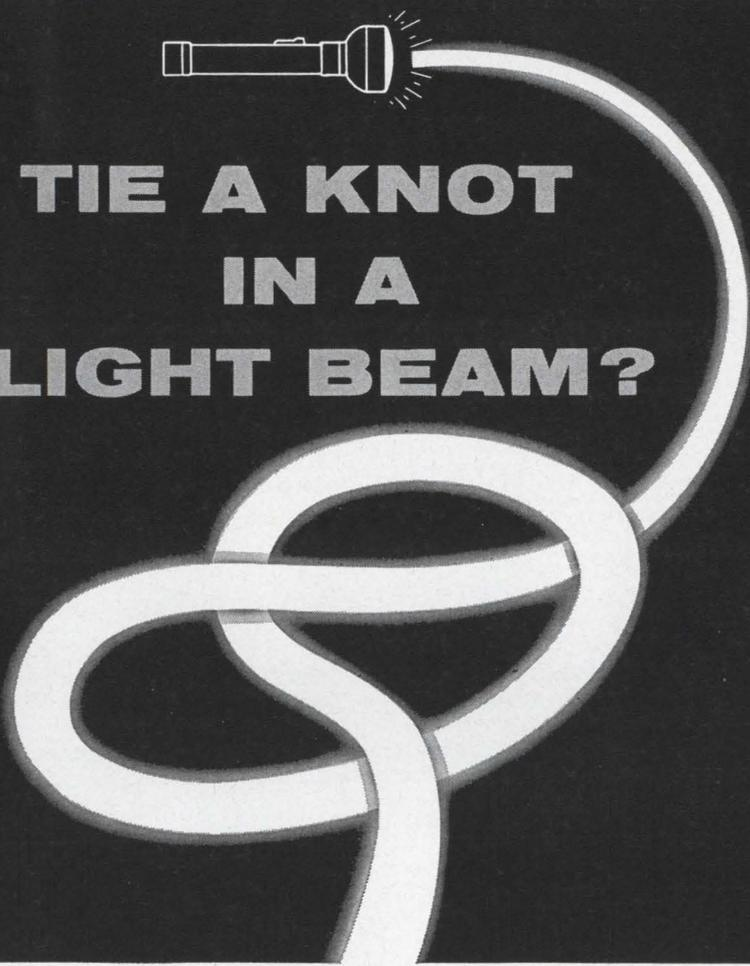

TIE A KNOT IN A LIGHT BEAM?

YOU CAN WITH BAUSCH & LOMB LIGHT WIRES

AND YOU CAN DO MANY OTHER
AMAZINGLY USEFUL THINGS TOO!

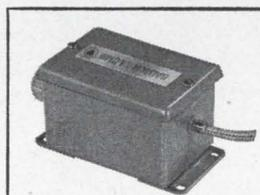

Fiber Optics Light Switch counts objects at a rate of 400/min, measures angular velocity, detects size of objects, acts as a limit switch, can be made sensitive to color with filters, monitors ambient light conditions, and be used in safety and burglar alarm systems. Catalog D-2057 gives the full story.

- Slice the original beam into several beams.
- Pipe the beams under, over and around all kinds of obstacles.
- Pipe the beams into tiny openings.
- Shape the circular beam so that it comes out the other end as a square □, a circle ○, a line — or any shape you can think of }
- Monitor the face of a CRT tube or radar screen.
- Safely pipe light into explosive areas.

**You can mold light to do your bidding
for practically any application**

Write for Catalog 32-2045. It has much information to excite your creativity. Bausch & Lomb, 61417 Bausch Street, Rochester, New York 14602.

BAUSCH & LOMB 

New linear integrated core-memory sense amplifier... video differential

New Series 55 high-frequency amplifiers

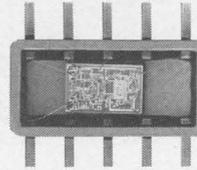

This new series of TI linear integrated circuits*, offers excellent high-frequency performance and low power dissipation. The first two

networks in the series are SN5500, a sense amplifier for magnetic-core memory applications, and the SN5510, a video differential amplifier.

SN5500 The SN5500 is a complete sense amplifier, including strobe gate and pulse-shaping output circuits as shown in the logic diagram, Figure 1. It detects bi-polar (positive or negative) differential input signals from a magnetic-core memory, and provides the interface circuitry between memory and logic circuitry.

The network is recommended for core-memory applications with cycle times as low as two μ sec. At 25°C, sensitivity is 15 to 19 mv.

A strobe input activates the threshold detector during the "read" cycle and inhibits it during the "write" cycle.

An internal one-shot pulse amplifier provides a standard-width, negative-going output pulse when triggered by the threshold detector.

Overload recovery of the sense amplifier is 150 nsec, and output propagation delay is 75 nsec. Operating temperature range is -55° to +125°C.

Seven circuits — including amplifiers, logic gates and strobe circuitry — are formed on a single silicon substrate. This reduces costs and improves reliability over that realized with discrete components or simpler integrated circuits.

SN5510 This video amplifier features a flat frequency response and low phase-shift from dc to 40 mc, as shown in Figure 2. Typical single-ended gain at mid-band is 40 db.

Differential inputs (Figure 3) are provided which can be direct-coupled to ground. The differential outputs permit the amplifier to be used as a high-frequency differential amplifier or as an operational amplifier.

Common-mode feedback gives common-mode rejection ratios of 60 db or greater. Typical input impedance is 2000 ohms, and typical output impedance is less than 300 ohms.

Series 55 amplifiers use transistors with f_T as high as 1.2 Gc under low current and low V_{ce} conditions. Circuit frequency response from dc to 100 mc is possible.

The large numbers of elements on the two Master Slice bars make possible the fabrication of very complex circuits. Customized variations can be built economically simply by changing

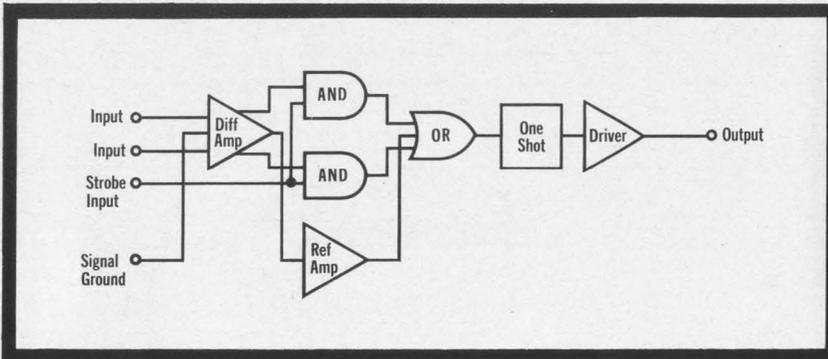

Figure 1. Functional diagram shows that the SN5500 is a complete sense amplifier, including differential preamplifier, reference amplifier, strobe gate, and pulse-shaping output circuit.

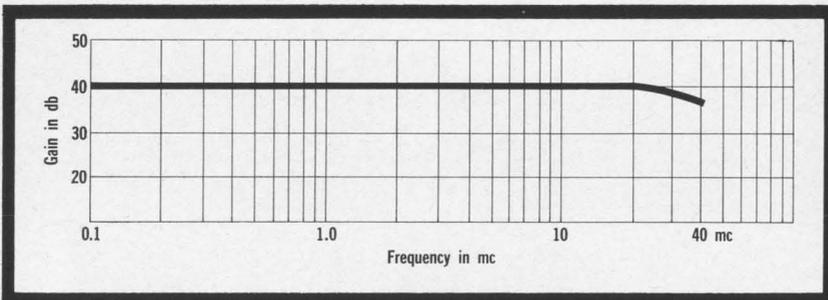

Figure 2. Frequency response of SN5510 integrated-circuit amplifier is flat from dc to 40 mc.

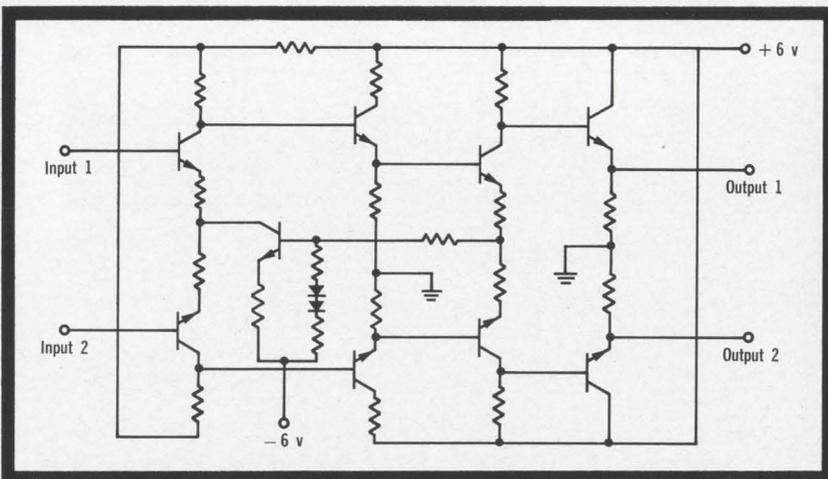

Figure 3. Circuit diagram of SN5510 video differential amplifier shows differential output and common-mode feedback amplifier.

circuits from TI...

amplifier... high-gain operational/differential amplifiers

the metallic interconnection patterns.

Applications include all types of sense amplifiers, IF amplifiers up to 100 mc, and video amplifiers.

Circle 88 on the Reader Service Card for full information on Series 55 linear integrated circuits.

Two new Series 52 operational/differential amplifiers

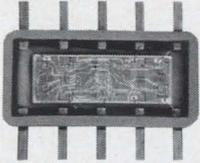

Two high-performance additions to the Series 52 line of linear integrated circuits from TI are the SN525A and SN526A.

SN525A This amplifier (Figure 4) features an open-loop gain of 88 db, yet it is unconditionally stable when used with two external capacitors in the frequency-response-shaping circuit. Typical differential input-voltage offset is only one millivolt. Two feedback loops provide a common-mode rejection ratio of 100 db.

SN526A This general-purpose operational amplifier incorporates a class-B output stage formed by a complementary pair of npn and pnp transistors. The circuit is capable of a 10-v signal swing with a 600-ohm load. Output-current peak is 10 ma.

Differential input offset is six millivolts maximum over the full -55° to $+125^{\circ}\text{C}$ temperature range. A Darlington-connected transistor pair gives an input impedance of two megohms. Common-mode feedback provides more than 75-db rejection to common-mode signals.

Improved Network Bar The improved Series 52 bar features twice as many transistors as earlier versions — 10 npn and four pnp. There are 68 resistors totaling 300,000 ohms — making 82 components in all.

Transistor pairs are close together for improved differential-input voltage offsets and temperature-drift characteristics. Improved collector saturation resistance provides high output current and voltage capability. Both SN525A and SN526A amplifiers allow ± 5 v common-mode input signals before overloading, and there is no danger of latch-up from noise or output feedback.

The chart shown in Figure 5 gives performance comparisons between the new devices and a typical amplifier assembled from discrete components, as well as the SN521A which was announced late in 1962.

These new amplifiers bring to six the number of standard devices in the Series 52 line. In addition, Master Slice variations may be designed to meet special requirements.

Circle 89 on the Reader Service Card for more information on Series 52 linear integrated circuits.

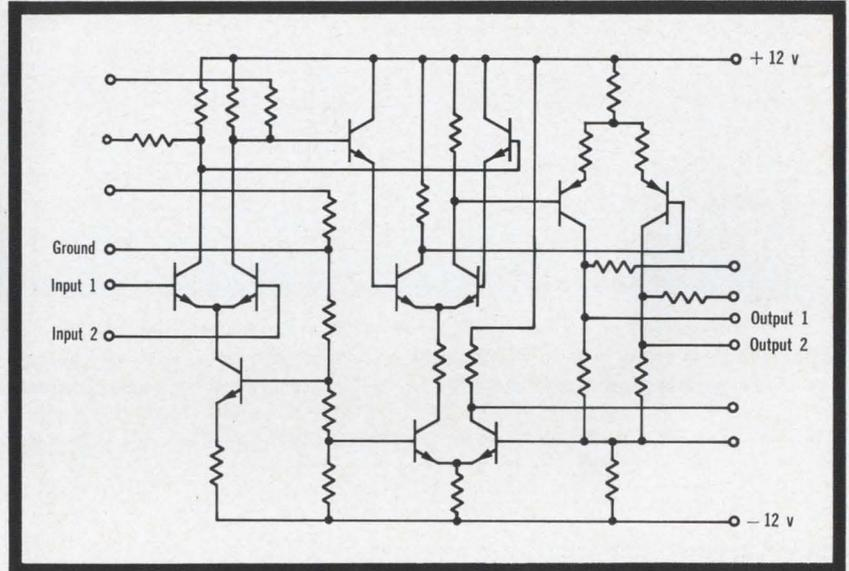

Figure 4. Circuit diagram of SN525A differential amplifier shows the configuration for unconditional stability with an open-loop gain of 88 db.

Characteristic	Typ. Discrete-Component Amplifier	1965		
		SN521A	SN525A	SN526A
Gain, Open-loop, db	94	62	88	60
Input-voltage Offset, mv	1	2	1	3
Temp. Coefficient, Input-voltage Offset, $\mu\text{v}/^{\circ}\text{C}$	5	8	5	10
Input-current Offset, μa	0.2	0.5	0.3	0.03
Common-mode Rejection, db	92	60	100	80
Output-voltage Swing, v	± 11	± 4.5	± 8	± 5
Output-current Peak, ma	2	1	1	10
Input Impedance, megohm	0.3	0.01	0.07	2

Figure 5. Performance comparisons of discrete-component and integrated-circuit operational/differential amplifiers.



TEXAS INSTRUMENTS
INCORPORATED
 13500 N. CENTRAL EXPRESSWAY
 P. O. BOX 5012 • DALLAS 22, TEXAS

IR EPITAXIAL CONTROLLED RECTIFIERS

PREMIUM PARAMETERS AT STANDARD PRICES

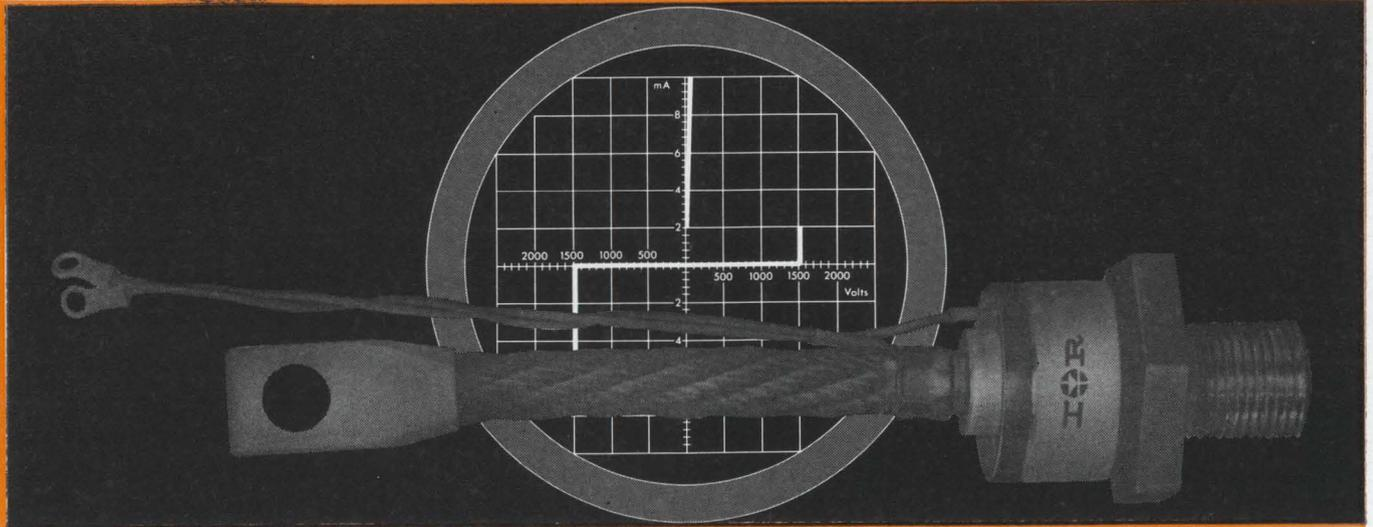

These Premium Parameters Now Available in Production Quantities in 35, 70, 100 and 150 Ampere Ratings through 1300 Volts

1. HIGHEST VOLTAGES The only complete line up to 1300 volts rated (1400 volts transient). Available with extremely high dV/dt (1000 V/μ sec.), short turn-off time, or 150°C. capability. Typical leakage currents: For the 70 ampere device, less than 100 microamperes at 25°C.

2. HIGHEST di/dt Repetitive turn-on tests to 300 amperes show rate of rise capability in excess of 1000 amperes per microsecond.

3. HIGHEST TRANSIENT ABSORPTION CAPABILITY No transient protection required when used within power ratings. Effective clamping by bulk avalanche characteristics.

4. UNLIMITED FORWARD BREAKOVER RELIABILITY IR's **SCR**'s when subjected to any magnitude of transient forward voltage will turn on without any deterioration.

5. SHORTEST TURN-ON TIME Turn-on time is less than 2.0 microseconds to 100 ampere level.

6. HIGHEST TEMPERATURE CAPABILITY Operation at 150°C. without voltage derating. Devices also available with short turn-off time and dV/dt with voltage ratings through 1300 volts, at 150°C. Other characteristics: dV/dt , gate firing, holding current and turn-off are not sensitive to extreme temperature.

7. POSITIVE TEMPERATURE COEFFICIENT Both forward and reverse breakover voltages increase with increasing temperature, providing increased safety at higher temperatures.

New areas of application are virtually unlimited with IR's unmatched combination of epitaxial **SCR** parameters. For further information and application assistance, contact your local International Rectifier sales office or write to 233 Kansas Street, El Segundo, California.

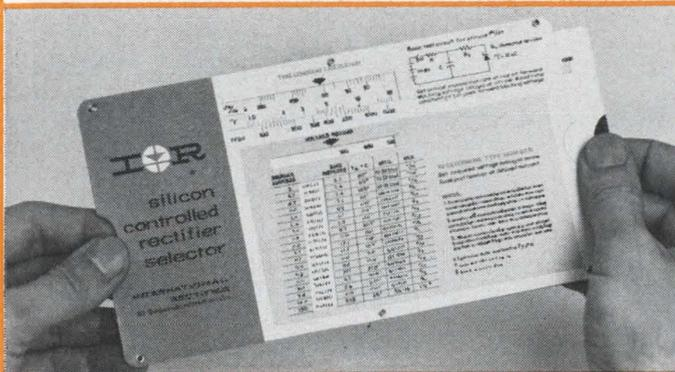

NEW TIME-SAVING SCR CALCULATOR NOW AVAILABLE FROM INTERNATIONAL RECTIFIER

This **SCR** Calculator provides a convenient compilation of common rectifier circuit design constants, and is a reference tool to help you determine quickly...

...what and how many controlled rectifiers are needed in a given piece of rectifier equipment.

...the dV/dt imposed by an R-C circuit on an **SCR**.

...the range of phase shift a gate triggering circuit should have for a given amount of voltage control in common rectifier circuits when feeding both resistive and inductive loads.

Price: \$1.00 postpaid

Send check or money order to International Rectifier Corporation, 233 Kansas Street, El Segundo, California.

WORLD'S LARGEST RECTIFIER SPECIALISTS



INTERNATIONAL RECTIFIER

INTERNATIONAL RECTIFIER CORP., EL SEGUNDO, CALIF., PHONE OR 8-6281 • CABLE RECTUSA • REGIONAL OFFICES IN NEW YORK CITY, CH 4-0748 • FORT LEE, N. J., WI 7-3311 • SYRACUSE, N. Y. HE 7-8495 • CAMBRIDGE, MASS., UN 4-6520 • ARDMORE, PA., MI 9-3667, GR 3-3932 • SILVER SPRING, MD., JU 9-3305 • MIAMI, FLA., 445-5201 • CHICAGO, ILL., OR 6-4090 • CLEVELAND, OHIO, 734-4100 • DAYTON, OHIO, 223-7691 • HUNTINGTON WOODS, MICH., LI 8-1144 • ST. LOUIS, MO., TE 8-6333 • MINNEAPOLIS, MINN., 920-1200 • RICHARDSON, TEX., AD 1-2504 • LOS ANGELES, CALIF., 750-0550 • IN CANADA: TORONTO, ONT., 421-5970 • MONTREAL, QUE., 861-0562

EUROPEAN GENERAL SALES OFFICE: 38 AVENUE DES ARTS, BRUSSELS 4, BELGIUM • TELEPHONE: 111774

Washington Newsletter

May 31, 1965

Electronics share of that \$700 million is cut by Pentagon

The electronics industry's already-small share of the \$700 million voted by Congress to beef up procurement of military supplies for the war in Vietnam is being cut. The Defense Department originally earmarked \$180 million for aircraft—the largest single electronics market—but that sum was cut to \$54.7 million when the military reevaluated its needs.

Part of the \$54.7 million will be spent for additional UH-1B helicopters made by the Bell Helicopter division of Textron, Inc., and for a training version of the A-4E, a Douglas Aircraft Co. fighter-bomber that operates off aircraft carriers. The A-4E's now used for training purposes will be used in combat.

Contract-dispersal policy is rebuffed

Any move to spread federal research and development contracts more evenly around the country is going to have to wait for a broad Administration effort.

The House's attempt to nudge it into law through a "dispersion amendment" to the National Aeronautics and Space Administration's authorization bill is being blocked by the Senate.

The House inserted language to the effect that Congress wanted NASA to distribute its contracts on a geographical as well as on a technological basis. But the Senate Space Committee amended the bill again, to insure against any change that the existing value-for-money base of federal procurement policy might be "altered by an overriding consideration being given to a geographical distribution of government funds."

Early Bird may go commercial soon

The first commercial operation of a communications satellite will probably begin on June 8. That's the unofficial word in Washington. The Communications Satellite Corp., after a long delay, is expected to file its tariffs with the Federal Communications Commission this week. But instead of having to wait the full 30 days for them to become effective, Comsat probably will ask for—and receive—a June 8 date to begin commercial service with its Early Bird satellite.

There is still confusion on what form the new tariffs will take. There is speculation that there will be a split tariff—one for television and another for other uses.

The FCC finally has made public its April decision to grant Comsat authority to own and operate three ground stations in the United States for two years [Electronics, April 19, p. 33]. And Comsat has announced that random-orbit satellites will not be considered for the future communication system. Two choices are left for the operational system: three synchronous-orbit satellites or about 16 phased-orbit satellites.

Congress to explore patent-rights fight

The long-simmering controversy over patent rights growing out of government-financed research and development goes on the congressional front burner this week. On June 1, the Senate Judiciary Committee opens two weeks of hearings on three proposals to tighten present practices. A bill is expected to be ready for Congressional action by midsummer.

The proposals the committee will consider are:

- One by Sen. Leverett Saltonstall (R., Mass.), leaning toward tradi-

Washington Newsletter

tional Defense Department policies of leaving patent rights in the hands of contractors, wherever possible.

- One by Sen. Russell Long (D., La), providing for tight government ownership of virtually all such patent rights.

- One by Chairman John McClellan (D., Ark.), reflecting policies laid down by Presidents Kennedy and Johnson, setting up guidelines for patent proprietorship but generally easing the federal grip on patent rights.

House to hear GAO critics

Pentagon and defense contractor complaints about the General Accounting Office (GAO) have touched off a congressional hearing. The House Military Operations subcommittee wants to know whether GAO reports of waste, mismanagement and overpricing are exaggerated; whether GAO goes too far in invading contractor privacy; and whether GAO tries to enforce its own procurement standards on government and industry, though lacking necessary technical and business experience [Electronics, April 5, p. 129]. Industry witnesses will testify early next month.

Even while under attack, GAO is considering seeking broader authority. It may ask Congress for stronger legal weapons to enforce its right to inspect records of companies working under negotiated contracts. Present law gives GAO auditors permission to look at "directly pertinent" records. But the issue of document relevance is a source of frequent controversy and is before the courts in a suit involving the Hewlett-Packard Co. [Electronics, Jan. 25, p. 34]. GAO feels that the case, even if decided in its favor, won't settle the issue definitely and says Congress may have to make the determination.

Minuteman II force to increase by 800

The Air Force will carry out a \$1-billion program to increase the accuracy, range and power of the Minuteman intercontinental missile force. The Air Force plans to replace its 800 Minuteman I missiles with the more advanced Minuteman II. With the 200 new models it already has or soon will have, this will bring the force to 1,000 missiles.

Originally, the Air Force had planned a 1,200-missile force, representing a mix of Minuteman I and II. But Defense Secretary Robert S. McNamara contended that qualitative improvements in Minuteman II would make the 1,200-missile force unnecessary.

The Boeing Co. is the prime contractor for the missile; the Autonetics division of North American Aviation, Inc., will provide the guidance system and Sylvania Electric Products, Inc., a subsidiary of the General Telephone & Electronics Corp., the ground electronics system. The modernization will involve not only replacing the Minuteman I, but also modifications in existing silos and launch control centers.

Four test SST's may be ordered

President Johnson is expected to approve shortly a recommendation that all four competitors for a development contract on a supersonic airliner be allowed to start building test planes. Under the plan, the President would seek \$200 million from Congress for fiscal 1966 to finance work by the Boeing Co., Lockheed Aircraft Corp., General Electric Co. and Pratt & Whitney Co., a division of the United Aircraft Corp. Contracts would include a provision to halt work if any contractor clearly was developing a better version.

You can cool with air...

(if you have a lot of space)

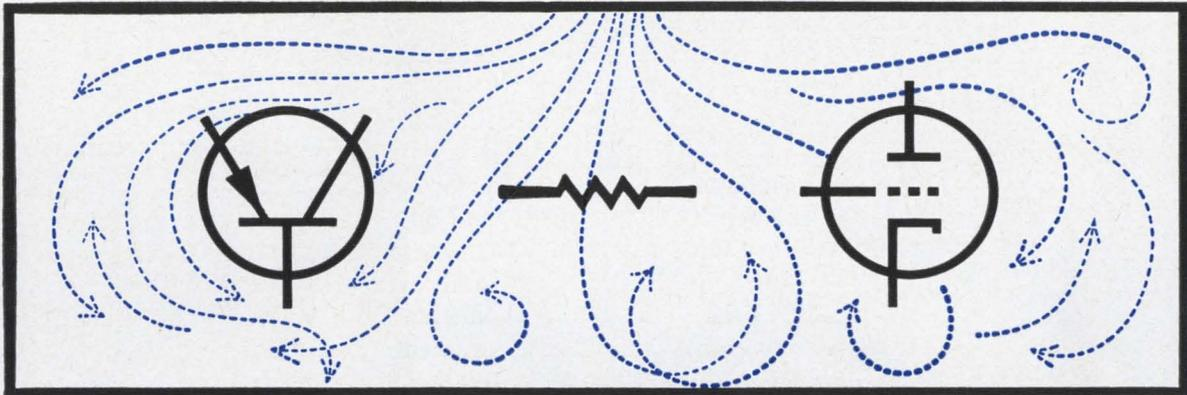

or

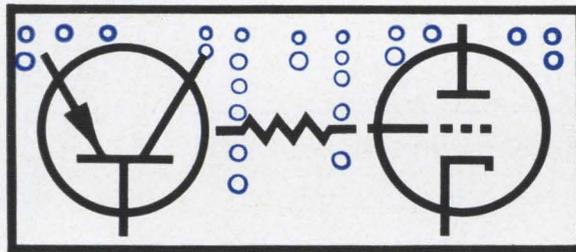

use FREON® dielectric coolants

(if you don't)

FREON carries heat away hundreds of times better than air. Close-packed assemblies can operate efficiently at safe temperatures. FREON compounds have outstanding characteristics as heat transfer media either by boiling or by convection.

These inert coolants will work for you in your high-density electronic equipment—wherever you have a reliability problem from “hot spots” in power tubes, transistors, resistors, transformers, packaged electronics, etc. FREON coolants can make your design more compact—at low to moderate cost, while improving reliability through close thermal control.

These five FREON dielectric coolants range in boiling point from +38.8°F. to +237.0°F., offering a wide range of use:

FREON-114	CClF ₂ CClF ₂	B.P. + 38.8°F.
FREON-113	CCl ₂ FCClF ₂	B.P. +117.6°F.
FREON-215	CCl ₂ CF ₂ CF ₂	B.P. +165.0°F.
FREON-112	CCl ₂ FCClF	B.P. +199.0°F.
FREON-214	CCl ₂ CF ₂ CF ₂ Cl	B.P. +237.0°F.

Send the coupon for complete technical information based on our 33 years' experience with cooling problems.

DU PONT **FREON**[®]
dielectric coolants
REG. U.S. PAT. OFF.
Better Things For Better Living . . . through Chemistry

Du Pont Company
Room, 2789
Wilmington, Delaware 19898

Please send me complete technical information on FREON dielectric coolants.

Name _____

Address _____

City _____

State _____ Zip _____

Offer good in U.S.A. only.

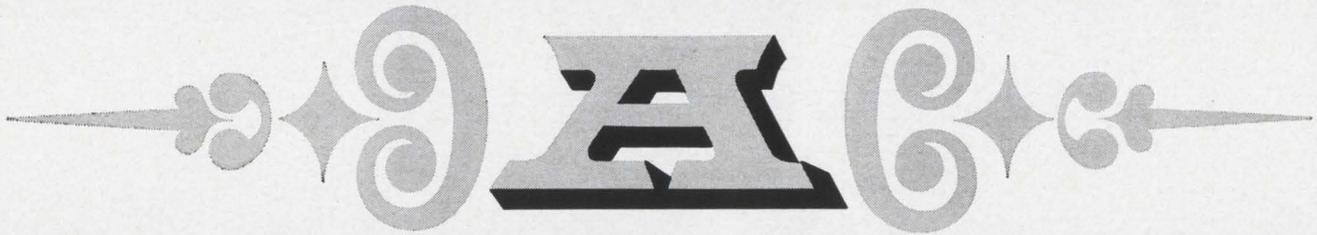

BLATANT APPEAL



TO YOUR EMOTIONS and your wallet

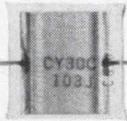

CORNING CYFM Capacitors: CYFM 10, 0.5—300 pf; CYFM 15, 220—1200 pf; CYFM 20, 560—5100 pf; CYFM 30, 3600—10,000 pf; VDCW, 300 and 500 volts.

Here's a chance to exercise your American sense of fair play and sportsmanship—and, at the same time, do a shrewd bit of capacitor-reliability buying.

Specify CORNING® CYFM Capacitors. Is it that simple? Yes.

Look at the rewards for you first. Our glass-dielectric CYFM capacitors give you *stability* that's invariable with time, temperature, and environment, and a TC that's always retracable within 5 ppm on the curve.

You get *reliability* that's inherent from

the way they're made—in basically the same process that turns out our ultra-high-reliability CORNING CYFR Capacitor.

But you can save *dollars* on the CYFM because we don't put it through all the rigorous CYFR testing.

pf for pf, you can't buy more stability and reliability for fewer dollars than you get in the CORNING CYFM Capacitor.

Now, the emotional. Our CYFM lives constantly in the shadow of its glamorous Autonetics/Minuteman CYFR older brother. The CYFR has just successfully completed over 41 million unit test hours and 45 months of continuous testing!* You can well understand the

frustration, the second-best, underdog feelings of the CYFM.

Have a heart. Use your head. Specify CORNING CYFM Capacitors. You will make everybody happy—reliability engineers, comptrollers, and us.

For complete data and for parts, send to Corning Glass Works, 3909 Electronics Dr., Raleigh, N. C., or call your Corning distributor.

*Autonetics lot-acceptance testing program.

CORNING
ELECTRONICS

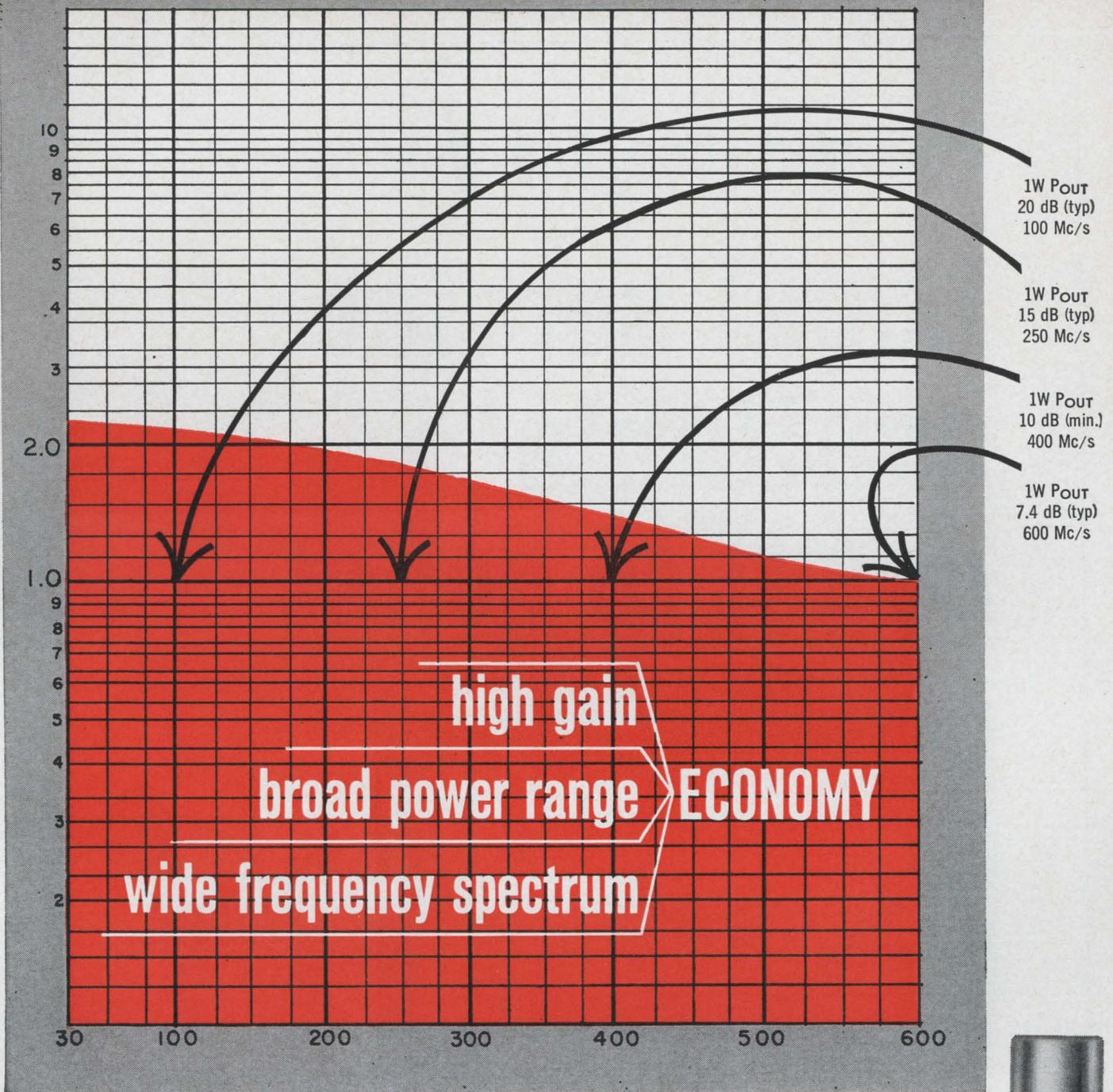

Another overlay breakthrough:
2N3866 now in mass production

for CB to UHF
 $f_T = 800$ Mc/s (typ)

Another RCA breakthrough in "overlay" technology now brings you a new generation of transistors for 1 and 1.8 watts output across a broad band of frequencies from 27 Mc/s to above 400 Mc/s. RCA-2N3866—first of the new high-gain, high-frequency "overlay" family—offers a guaranteed minimum of 1 watt power output at 400 Mc/s (10dB gain) from a 28-volt supply.

Geared for pre-driver, driver and output applications from Citizen's Band to UHF, 2N3866—for operation from 8 to 28-volts—can bring a new combination of economy and "overlay" performance to all these applications:

- Citizen's Band • Community Antenna TV • Sonobuoy • Military Tactical Communications • Rescue Beacons • Instrumentation
- Portable Equipment • Mobile Units • Aircraft Communications • Microwave Power Sources.

Discuss the new RCA-2N3866 and other RCA "overlay" transistors with your RCA Representative or your RCA Distributor. For technical bulletins, write: RCA Electronic Components and Devices, Commercial Engineering, Section 1N5-5, Harrison, New Jersey.

Also Available Through Your RCA Distributor

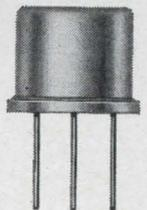

CHARACTERISTICS
INCLUDE:

- $I_C = 400$ mA (max)
- $V_{CE} = 55$ V (max)
- $C_{ob} = 3$ pF (max) at 30V
- $P_T = 5$ W (max) at $T_C = 25^\circ$ C



The Most Trusted Name in Electronics

Circle 47 on reader service card

The next time, buy Weston

Local service available coast to coast

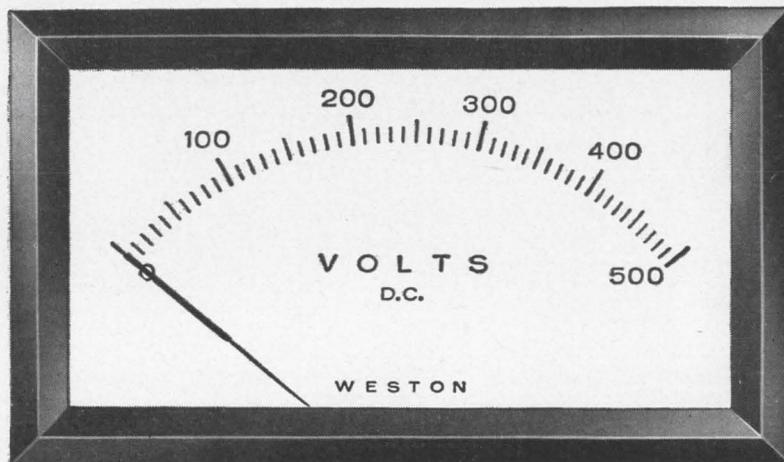

- Available off the shelf ■ Competitive prices
- Same-day delivery ■ Fastest delivery on custom designs

Ask for Weston... Call your local Weston distributor or Sales-Servicenter today.

QUALITY BY DESIGN
 **WESTON INSTRUMENTS, INC.**
614 Frelinghuysen Avenue, Newark, New Jersey 07114

New High-reliability aluminum electrolytics at new economical price

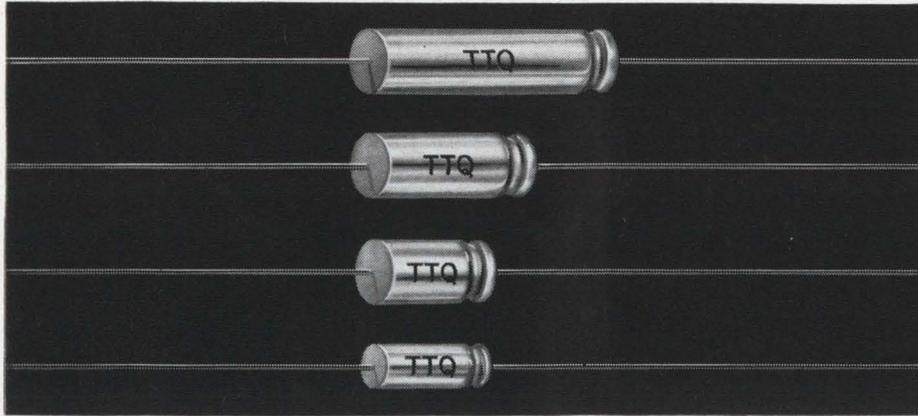

If you think you have to pay a big premium for high reliability in an electrolytic capacitor, the new Mallory type TTQ has some pleasant surprises for you.

The TTQ is a different kind of miniature aluminum electrolytic. One thing that makes it different is the extra care we take in manufacturing it, using special electrolytes for good high and low temperature performance, and all-welded construction to assure reliability under vibration and shock conditions. And another is the quality control production and sampling tests it gets . . . which can be as much or as little as you decide you need for your specific reliability requirements. Our Quality Control Department maintains a record of test data on each lot.

The result: Type TTQ capacitors have an expected life of 10 years or more when operated at normal temperatures within rated conditions. Their DC leakage and equivalent series resistance are exceptionally low and stable.

The TTQ comes in an aluminum case with special rubber end seal, with Mylar* or thermoplastic sleeve if desired. Temperature range is -40°C to 85°C . Ratings are 300 mfd, 3 VDC to 2 mfd, 150 VDC. Seven case sizes from $\frac{1}{4}$ " diameter, $\frac{1}{16}$ " long to $\frac{3}{8}$ " diameter, $1\frac{1}{2}$ " long. For data, write to Mallory Capacitor Company, Indianapolis, Indiana 46206—a division of P. R. Mallory & Co. Inc.

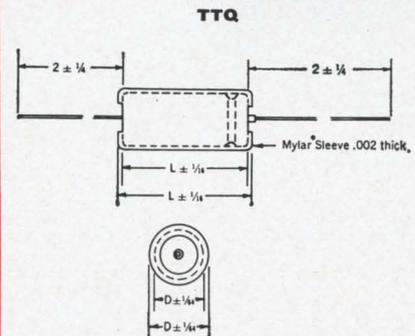
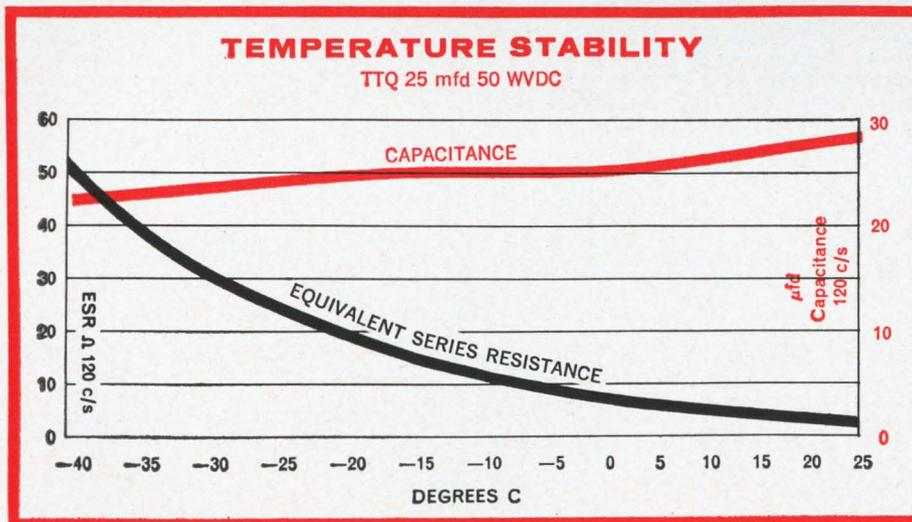
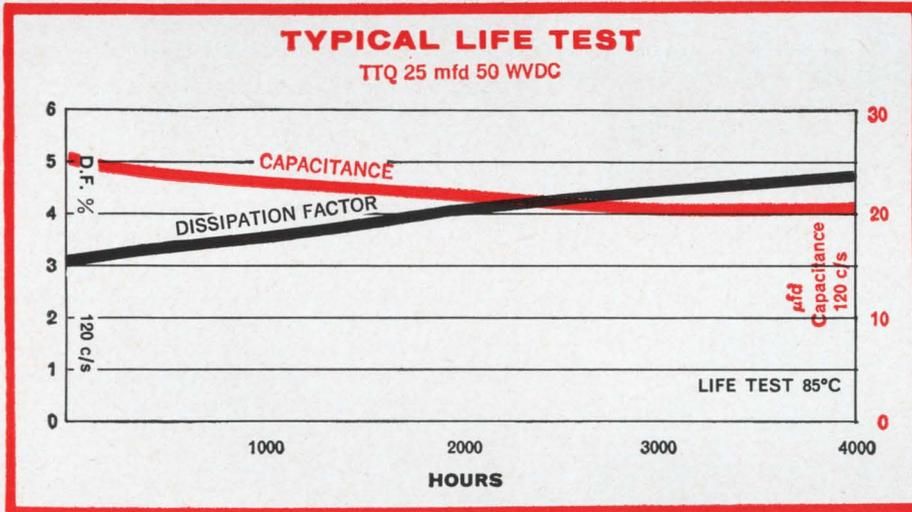

*Du Pont trademark



“a gift from Tupa the sun god?”

Dr. D. E. Noble, Motorola's Group Executive Vice President, submits a somewhat historical approach to integrated electronics, plus a little proselytizing.

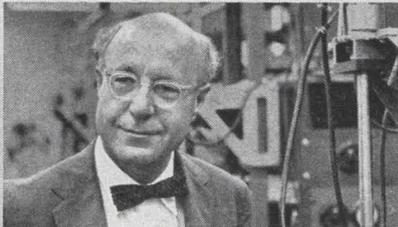

One can only imagine what the Brazilian native thought when he unearthed the first large piece of quartz crystal in Minas Gerais. Puzzled by the effects of double diffraction as he peered through the depths of the transparent crystal, he undoubtedly attributed the phenomenon to supernatural, sun-god magic. Whatever his thoughts, they certainly did not do justice to the true magic of the material, for the quartz crystal, in today's technology, represented not only hundreds of highly stable resonators, but material for morphological integrated circuits, as well.

The usual integrated circuit is a slab of silicon crystal with materials in inseparable association diffused into the structure to form transistors, resistors, and capacitors. The true morphological integrated circuit, represented by the quartz crystal filter, however, is substantially different. It has no identifiable circuit component areas, performing its function by virtue of the structural or molecular arrangement of the material.

Some knowledge of crystal electrical behavior has been with us for nearly two hundred years. First suggested by Coulomb, later defined as piezoelectricity by Hankel, and finally demonstrated in 1880 by the brothers Jacques and Pierre Curie, the quartz crystal integrated circuit has been a hard-working circuit element

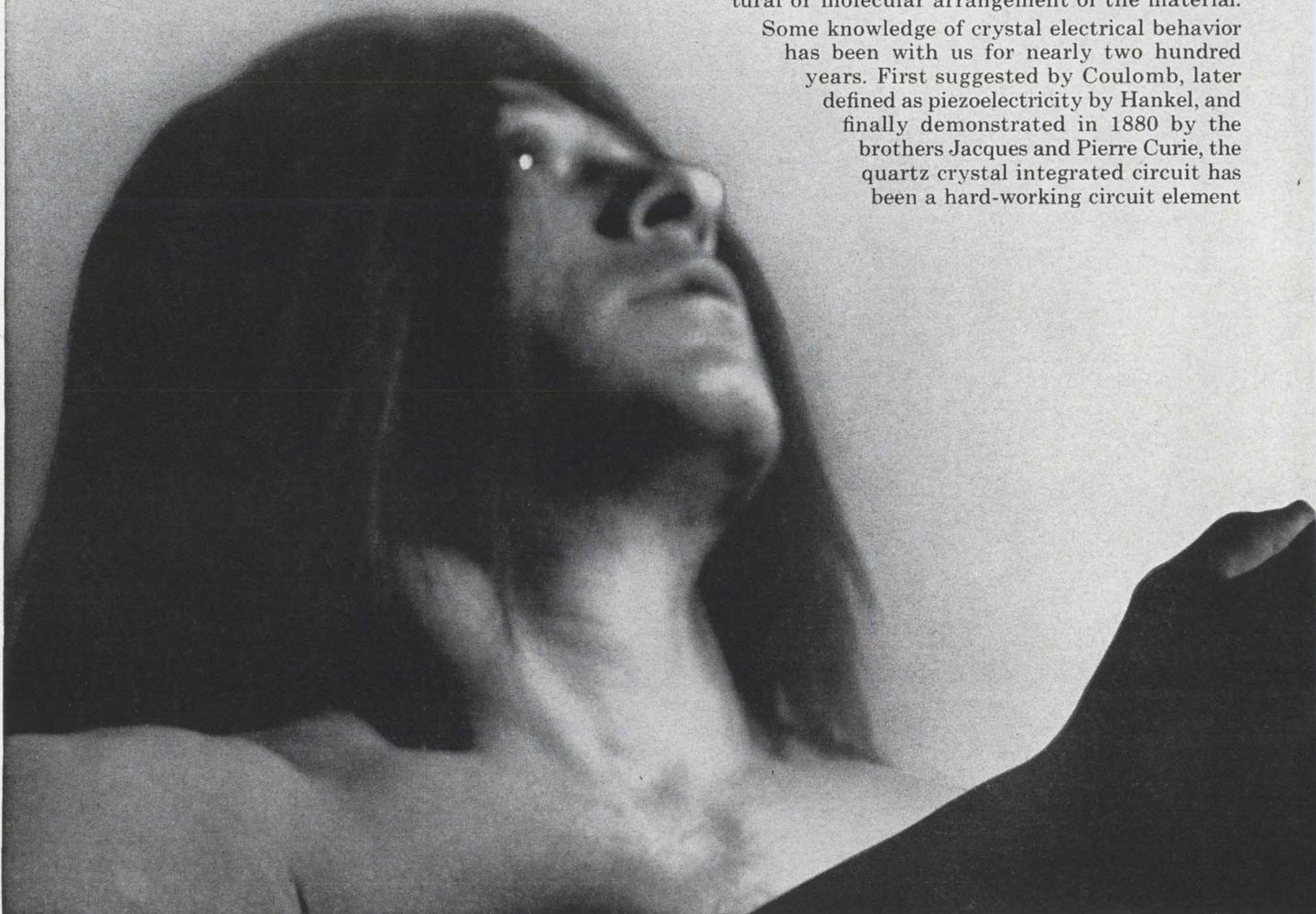

since World War I. It is interesting to note that, while approximately one-fifth of the quartz used in electronic devices is now man-made hydrothermally, the main source of natural crystal is still the Golconda Mine in Brazil. One of the best sources of man-made integrated circuits, I might add, is the Motorola laboratories in Arizona.

Motorola is not only one of the largest manufacturers of quartz resonators and filters in the country, but is also a leader in the development, manufacture, and application of silicon integrated circuits. As a leader, we not only anticipate the trends, but seek to make contributions which lend significance to the trends.

Motorola's Military Electronics Division is constantly exploring applications of the new integrated electronics technology to the design of military and space equipment. Some of these include:

DIGICOM: A Chance To Dial-Twist

The digital communications system we packaged for the Air Force at Dayton is a good starting point. A research vehicle, DIGICOM is a two-terminal, four-channel, PCM Telemetry System using about 100 analog, and 200 digital integrated circuits. The Air Force loaned it back to us for display at our booth at the AFCEA show. Drop around (with or without your résumé) and we'll demonstrate it for you.



Complete Air Force DIGICOM equipment uses new high density I/C packaging.

AFCEA, May 25, 26, 27: Bring Your Artillery

Speaking of AFCEA, we are sponsoring a panel discussion there on integrated circuit applications. Participants will include prominent scientists in DOD, the Army, Navy, and Air Force—authorities on integrated electronics. I'll be acting as moderator, and joining me from Motorola will be Dr. C. L. Hogan, an expert in the development and manufacture of integrated circuits, and Dr. R. E. Samuelson, a leader in I/C applications.



Application of integrated circuitry is essential to NASA's new AROD system.

AROD: A Unique Reversal

We are currently involved with the NASA/Marshall SFC Airborne Range and Orbit Determination (AROD) System. For logistical and other reasons, this NASA concept reverses the normal procedure by placing Doppler equipment in the vehicle, and a relatively simple transponder unit on the ground. To do this within the existing payload limitations requires extensive application of integrated circuitry aboard the space vehicle.

RADEM: Private Radio Telephones

You may recall our RADEM (Random Access, Delta Modulation) communications studies. Thin film integrated circuitry played a major role in this state-of-the-art development.

AM-UHF COMMUNICATIONS: A 4-in-1 Transceiver

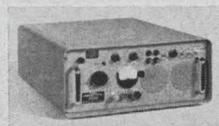

New standards of reliability for Navy shipboard equipment are set by redundant I/C transceiver.

Spurred by an entirely different set of considerations is an ultra-reliable integrated circuit UHF transceiver featuring redundant circuitry, which we recently designed for the Navy. Four I/C technologies were employed: hybrid, thin film, monolithic and the combined monolithic/thin film (compatible).

APOLLO: I/E By The Yard

We are under contract to NASA's Manned Space Center, Houston, to build an I/C version of the Apollo spacecraft up-data link. We have also been picked by North American Aviation to build the Apollo DTCS (Digital Test Command System). We anticipate the use of about 200,000 Motorola MECL Logic Circuits in the fabrication of these Acceptance Checkout Systems for many of the spaceborne systems.

BARE YOUR TEETH

Now, if participation in integrated circuit applications is something you've been waiting to get your teeth into, there might well be an opening for you in our Military Electronics Division. Incidentally, at Motorola, this work is not isolated; we permeate all of our labs with integrated electronics thinking. So no matter where you wind up with us, you'll get your chance to prove that Coulomb and Hankel were on the right track.



MOTOROLA

An equal opportunity employer.

Military Electronics Division

SCOTTSDALE, Arizona, 8201 E. McDowell Road
CHICAGO 51, Illinois, 1450 N. Cicero Avenue

FREE... THE LATEST IN I/E THINKING

If you're really interested in integrated electronics, let me send you the complete and unexpurgated transcripts of our AFCEA panel. And at the show, drop by booth 214. Also, don't be surprised if I toss in some recruiting propaganda, together with additional information about our latest advances in I/C applications. Attach this to your letterhead and mail to me at our Scottsdale address, Dept. 204.



No matter how big the ferrite piece,
**WHEN MECHANICAL AND ELECTRICAL
 SPECS ARE TIGHT... SPECIFY STACKPOLE**

Stackpole makes them all:

- Toroids over 6.000" OD x .500" Long
- Cup Cores 2.500" OD x .960" O Hgt.
- Rods to 1.000" D x 2.812" Long
- Sleeves to 4.050" OD x 2.500" long
- Rectangular Solids of nearly 6" Length x 4.175" Width x .750" Thick.

But gross size isn't Stackpole's only claim to fame in ferrites. As one customer put it, "Your ferrite cores are more consistent from order to order than any of your competitors."

Over 30 grades. Isn't that what you're looking for?



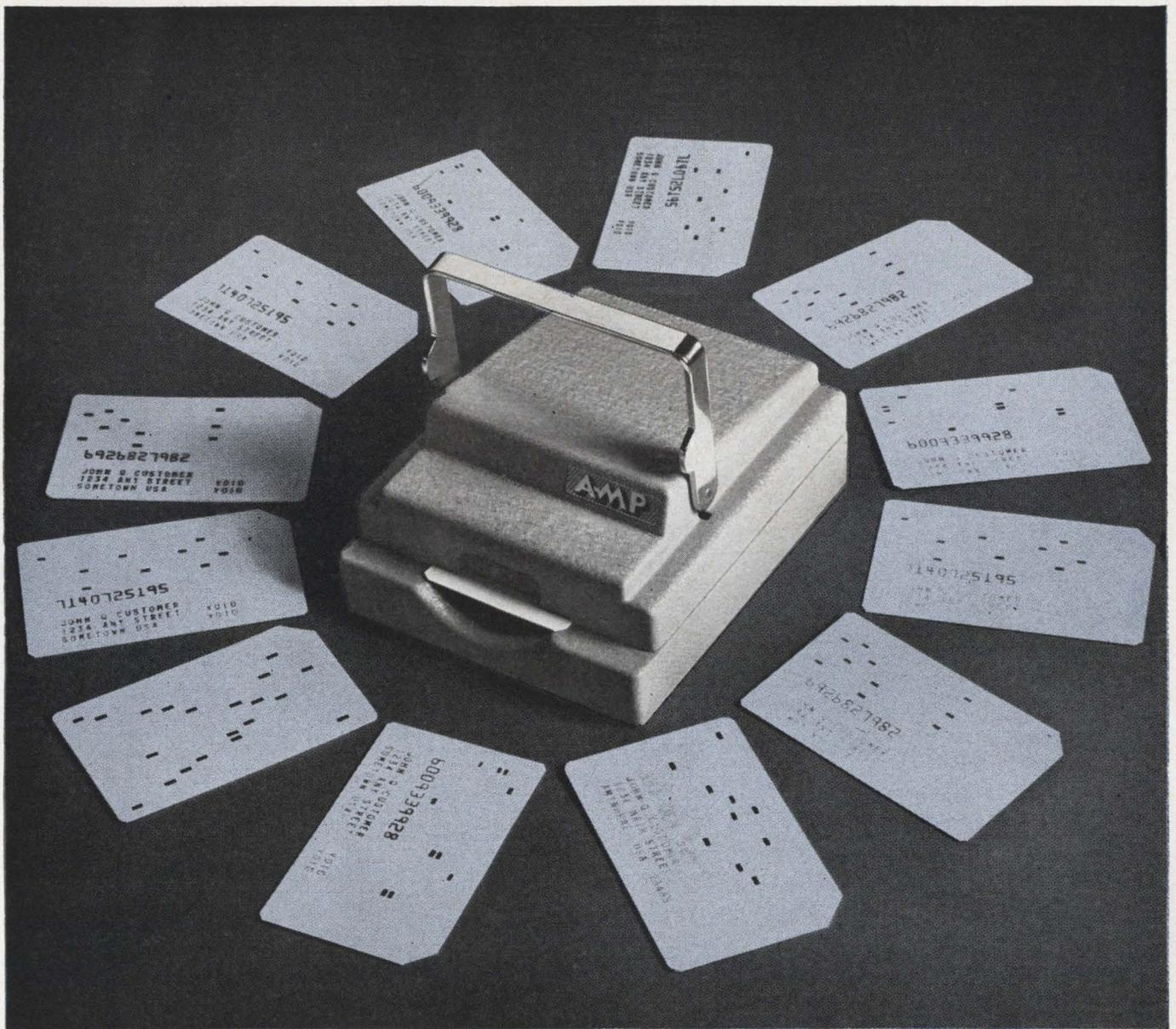

Credit's good here . . . over 1,000,000 times

This new, attractive card reader can register over a 1,000,000 insertions of various credit-type cards and translate the card information to electrical output circuits.

It's fast . . . it's reliable . . . it's foolproof!

Compact and rugged, the A-MP★ Credit Card Reader can be used as an input device for credit handling systems, validating systems, security systems or other data collection and control applications. Available in either desk top or rack mount models, this versatile reader is supplied with either manual or automatic operation. Long, trouble-free operation is assured by the quality features built in this rugged unit. Electrical and mechanical interlocks provide foolproof operation. Redundant contacts with exclusive double wiping action insure a clean electrical surface for reliable sensing.

Here's a sample of other quality features which are engineered into this new product.

- Semi-automatic or automatic card ejection
- Reads plastic credit-type cards 2½" x 3¾"
- 250 ma, 500 V operation
- Pre-wired or wired to customer's specifications
- Redundant contacts with double wiping action for reliable sensing
- Long life—over 1,000,000 cycles
- Compact size—5" x 6" x 2¾"

Check the applications this item might find in your system, then write for complete information.

*Trademark of AMP INCORPORATED



A-MP★ products and engineering assistance available through subsidiary companies in: Australia • Canada • England • France • Holland • Italy • Japan • Mexico • Spain • West Germany



NRC EQUIPMENT ... A WINNING HAND ... IN MICROCIRCUITRY

Whether your microcircuit project requires a small bell jar coater for thin film research or complete deposition systems for high volume production, NRC has equipment that does the job. We start at the heart of any vacuum system — **with the pumps**, and build up from there, manufacturing a whole range of coat-ers, heat sources, feedthroughs, pumping systems, and back-up equipment.

The payoff comes in the performance. NRC evaporators produce the highest net pumping speed **while the process is underway**, not just low pressure in an empty chamber. Net pumping speed in microelectronics can mean net profit for business. This business end of high vacuum is just one advantage in getting an NRC system. For detailed information on our complete line of evaporators and associated equipment for microelectronics, write or call today. Just a few of these products are listed below.

**EVAPORATORS • PUMPING STATIONS • POWER SUPPLIES • FEEDTHROUGHS • CRYSTAL PULLERS
TUBULAR FURNACES • ELECTRON BEAM HEAT SOURCES • LEAK DETECTORS**



EQUIPMENT DIVISION
NATIONAL RESEARCH CORPORATION
A SUBSIDIARY OF NORTON COMPANY

160 Charlemont Street, Newton, Massachusetts 02161



Read to 1/1000 Turn Accuracy

With New Spectrol Dials for
Potentiometers and Other Rotating Devices



Model 11 * diameter 1"
* number of turns 11
* protrusion from panel $\frac{7}{8}$ "
* numbers snap into the window as each turn is completed * base price in 1-9 quantities, \$7.75.

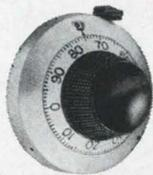

Model 30 * diameter $1\frac{13}{16}$ "
* number of turns 10
* protrusion from panel 1"
* numbers snap into the window as each turn is completed * base price in 1-9 quantities, \$5.75.

Model 25 A new turns-counting dial with DIGITAL readout for multi-turn applications * 3-digit dial reads to 1099 (11 turns) * 4-digit dial reads to 9999 (100 turns) * fine calibrations allow setting to 1/1000 of a shaft turn * 2 to 1 gear ratio between setting knob and device shaft allows extremely fine settings * diameter $1\frac{13}{16}$ " * standard 11-turn, 3-digit dial price, 1-9 quantities, \$14.25 * standard 100-turn, 4-digit dial price, 1-9 quantities, \$19.75.

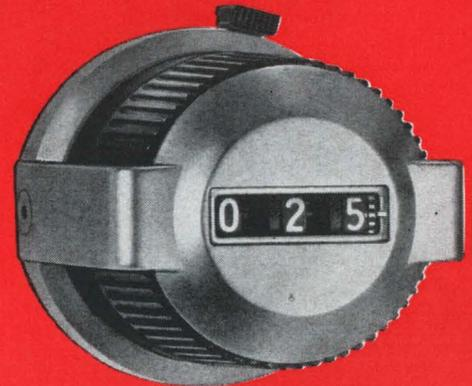

Spectrol Multidial® turns-counting dials offer these unique features: **Finely marked scale graduations** enable the operator to read settings with high accuracy. **Easy installation.** No disassembly, extra panel drilling or mounting hardware required. **Easy locking** with a finger touch that grips or releases without disturbing the setting. Settings are unaffected by vibration or shock. **Universal application** to any type of multi-turn potentiometer or other device. **Attractive satin chrome finish** with black plastic turning knob. Available for $\frac{1}{4}$ ", $\frac{3}{16}$ " and $\frac{1}{8}$ " diameter shafts.

Call your nearest Spectrol distributor for immediate off-the-shelf delivery at factory prices, or write for complete specifications.

50

SPECTROL ELECTRONICS CORPORATION

1704 South Del Mar Avenue
San Gabriel,
California

Adams Court
Plainview, L. I.
New York

Circle 55 on reader service card

Sigma relay idea of the month

A dual keying circuit that switches one load only when a second load is fully energized.

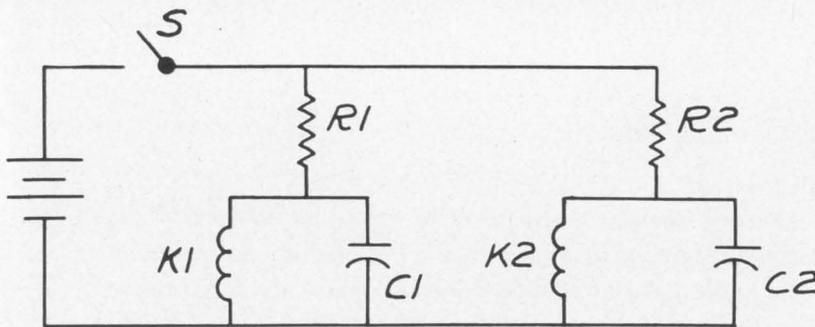

This simple dual keyer utilizing two Sigma Series 41 relays, assures connection and disconnection of one load during the interval that a second load is on. For example, in keying a transmitter, it energizes the oscillator permitting it to stabilize in frequency before the final amplifier is switched on or off.

Time constants for the circuit are chosen so that when S is closed, the contacts of relay K1

close before the contacts of relay K2; and when S is opened, the contacts of K1 open after the contacts of K2. C1 is large and R1 is small so that relay K1 has a fast pick-up and a slow drop-out. C2 is small and R2 is large, so that C2 has a slow pick-up and a fast drop-out.

If you have a relay idea or can show us how to improve this one, we'd like to hear from you. Your idea could be the next one we publish.

Sigma relays of the month

New 40 mw DPDT crystal-can relays. No pivots. No pushers. 100 million operations.

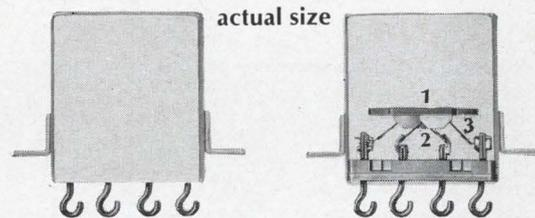

New, low-friction Sigma Series 34 and 35 feature (1) balanced armature design, (2) flexure elements instead of conventional pivots, (3) direct-connected contact members instead of pushers.

Two new Sigma relays combine high sensitivity with exceptional mechanical life in true crystal-can size.

The 35, a general purpose relay, has a sensitivity of 40 mw. The 34, a magnetic latching relay, has a sensitivity of 40 mw (dual coil) and 20 mw (single coil). Typical mechanical life for each relay is 100 million operations.

The outstanding, long-life performance of these highly sensitive relays is achieved through balanced armature construction. Flexure elements are used instead of conventional pivots, and direct connected contact members instead of pushers. This means the

relays are free of the usual sources of friction and wear. As a result, longer, trouble-free, performance is assured even under severe environmental conditions. Both relays meet and exceed MIL-R-5757D requirements.

There are more superior features in Sigma Series 34 and 35 relays including TIG welded seal construction to eliminate flux contamination, and excellent shock and vibration immunity. Test all of these features for yourself against the type you may be using now—free of charge. Just send for the Sigma Series 34 and 35 bulletins and a free relay certificate.

SIGMA DIVISION  SIGMA INSTRUMENTS INC
Assured Reliability With Advanced Design/Braintree 85, Mass.

New Solid State Operational Manifold! For a wide variety of feedback operations, use its four plug-in all-silicon Philbrick Differential Operational Amplifiers with simplicity, accuracy, economy.

DESCRIPTION

Highly versatile, the new Philbrick Model MP benefits greatly by the inherently high reliability, small size, low drift and noise, light weight, and low power requirements of all-silicon solid state amplifiers. It contains: a Philbrick Model OSPR-30 power supply; a captive line cord, a jack panel on which circuitry may be conveniently assembled; a pair of accessory sockets for Philbrick SP-sized plug-in operational units, such as the PSQ Quadratic Transconductor; and four plug-in differential operational amplifiers. "Starter kits" of tip jack hardware and passive electrical components are available for the new user at small additional cost. Though Model MP is normally furnished with four economical Model P65AU amplifiers, any permutation or combination of Philbrick P-size amplifiers may be used. The amplifiers can be interchanged instantly to fit the needs of any given application. Model MP is sturdily built, attractively packaged, and wired to Philbrick's usual high standards of quality. The simple sheet-aluminum enclosure with clear iridite finish on the panel provides effective shielding and solid mounting of electrical components — Dimensions are 11¾" wide x 7⅞" deep x 4¾" high. Price \$425.00 equipped with 4 P65AU and OSPR-30.

CHARACTERISTICS

For complete information, consult your nearest Philbrick Representative or Philbrick Researches, Inc.
22 Allied Drive at Route 128
Dedham, Massachusetts 02026
Telephone: (617) 329-1600
TWX: (617) 326-5754

Philbrick Engineering Representatives

Ala.: Huntsville 536-8393; Ariz.: Phoenix 265-3629; Cal.: Los Angeles 937-0780, Palo Alto 326-9800, San Diego 222-1121; Colo.: Denver 733-3701; Conn.: Stratford 378-0435; Fla.: Ft. Lauderdale 564-8000, Orlando 425-5505; Ill.: Chicago 676-1100; Ind.: Indianapolis 356-4249; La.: New Orleans 242-5575; Md.: Baltimore 727-1999; Mass.: Wakefield 245-5100; Mich.: Detroit 838-7324; Minn.: Minneapolis 545-4481; Mo.: Kansas City 381-2122, St. Louis 966-3646; N.M.: Albuquerque 268-3941; N.Y.: DeWitt 446-0220, Lancaster TF 5-6188, Valley Stream 561-7791; N.C.: Winston-Salem 725-5384; Ohio: Dayton 298-9964, Westlake 871-8000; Pa.: Norristown 735-3520, Pittsburgh 371-1231; Tex.: Dallas 526-8316, Houston 781-1441; Utah: Salt Lake City 466-4924; Va.: Alexandria 836-1800; Wash.: Seattle 723-3320; EXP: N.Y.: New York 246-2133.

CANADA: Que.: Montreal 482-9750, Ont.: Toronto RU 9-4325.

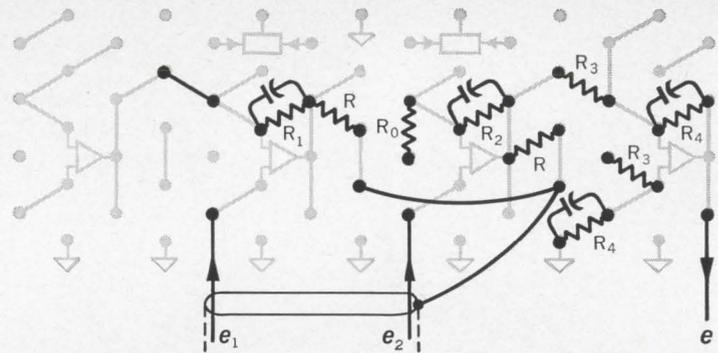
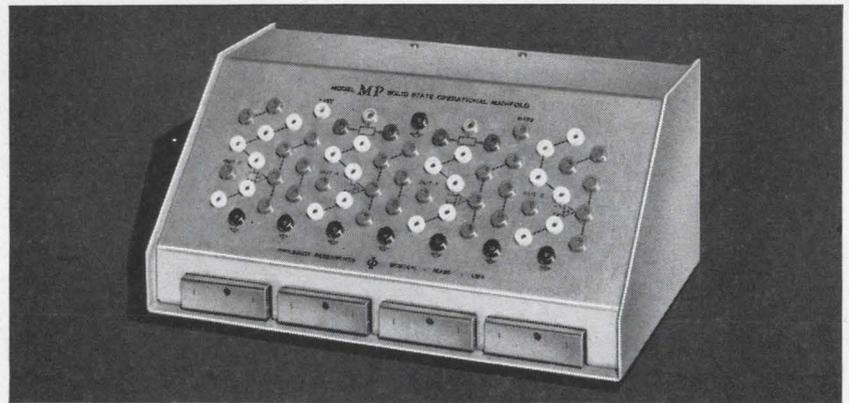

APPLICATIONS

Model MP is useful in the laboratory for instrumentation, on-line analog data processing, circuit development breadboards, and for teaching feedback technology. A typical application in the biological laboratory is the differential instrument amplifier circuit illustrated. A variety of circuit structures described in Philbrick's many applications publications also can be constructed with the Model MP.

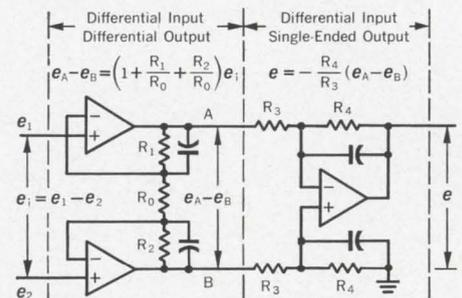

*electronic analog computing equipment
for modelling, measuring,
manipulating and much else*



PHILBRICK

AIRPAX announces the **UGON** Relay

The UGON relay is a product of AIRPAX ELECTRONICS and in stock at Cambridge, Maryland. Production quantities and special designs will be built in the United States. This precision relay is offered by arrangement with Le Prototype Mécanique of L'Étang-La-Ville, France.

UGON-3
Sensitivity, 5 mw
Volume, 2 cubic cm



UGON MICRO
Volume, 1 cubic cm

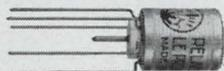

UGON-7
Insulation Resistance,
> 10⁸ megohms
Capacity, < 1 picofarad

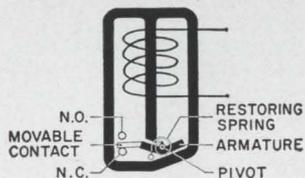

UGON
Magnetic Circuit

The UGON relay has an extremely high sensitivity due to the uniquely high efficiency of the magnetic circuit. Extreme resistance to shock and vibration is also provided by the rotating armature, which is statically balanced and magnetically balanced.

This is a uniquely different precision non-polarized relay with some remarkable qualities.

SENSITIVE

The UGON relay appears to be the smallest non-polarized sensitive — or the most sensitive small — relay in the world. The unique mechanism was invented in France and patented in the United States by Pierre Ugon. The operating power demand can be 5 milliwatts, or 200 MICROAMPS at 25 volts!

METERING

The entire UGON series of relays are precision instruments. The operate current is adjusted to a 5% tolerance, and this is maintained for the relay life, and during extremes of temperature and other environment change. In like manner, the release current is also held precisely, usually at 70% of operate. Thus, this is a measuring instrument.

MINIATURE

The UGON-3 standard has a volume of 2 cubic centimeters, and in this volume a coil resistance as high as 60,000 ohms is a practical reality. The small UGON MICRO size has a volume of about one cubic centimeter, and is arranged for printed circuit board assembly. The contacts are rated up to 700 ma and 50 V DC maximum with a 15-watt product, a practical power gain of 3000.

HIGH SPEED

The UGON relay is fast in spite of the extreme sensitivity. It can readily be driven up to an operate time of 1/2 millisecond, and is only a few milliseconds, even near the operating threshold. This presents a favorable comparison with the average sensitive relay, which is likely to require 50 to 100 milliseconds. On AC the relay doubles frequency, and will follow a driving signal to above 800 cycles.



Phone 301—228-4600

TWX 301—228-3558

CAMBRIDGE DIVISION • CAMBRIDGE, MARYLAND

COMPONENT COMMENTS *From Speer*

Take an armchair tour of our resistor plant

We were recently rather surprised to discover just how fanatical we've become on the subject of quality. Did you know, for example, that we test samples of every lot of our fixed carbon composition resistors in live steam? It's a fact. The resistors are exposed to steam pressure for four hours as an accelerated control test for moisture resistance.



Scenic view of our free, 16-page, lavishly illustrated "Resistor Handbook."

For a more comprehensive revelation of our fanaticism, we refer you to "The Speer Resistor Handbook." This colorful new 16-page illustrated brochure is actually an armchair tour of our entire resistor operation. You'll see how our resistors are made and how we assure quality at every stage — in raw materials, in manufacturing and in meeting military standards. You'll see the wide range of specifications we offer. And you'll see how our resistors have performed under MIL-R-11 test conditions.

Browsing through "The Speer Resistor Handbook" is almost as fascinating as touring our plant in person. (And it's decidedly easier on the feet.) If you'd like a copy just mail the coupon.



The comprehensive reliability program at our Jeffers Electronics Division assures that all of our non-shielded inductors (and our shielded ones too) meet MIL-C-15305 specs.

The heart-warming comeback of the non-shielded inductor

Don't get us wrong. On the issue of shielded versus non-shielded inductors, we're completely unprejudiced.

We'd be delighted to sell you either type.

We have felt distressed, however, to think that you might be using shielded inductors in more applications than you need to. After all, while the non-shielded inductor may be thin-skinned, it does offer the advantages of lower cost, higher reliability and higher stability.

We've therefore taken steps to help this useful inductor make the comeback it deserves.

Step one: Our Jeffers Electronics Division has developed a number of non-shielded inductors that provide high inductance values in a small case size. Example? Our unshielded-molded jacket

inductors now offer values through 1800 microhenries, in a case size of 0.156" x 0.375". This size conforms to the new MIL standard MS90537 for shielded coils, which specifies a 0.157" x 0.385" case size.

Step two: A suggestion. Consider rearranging your components. This will sometimes enable you to switch to non-shielded inductors.

Step three: We've prepared an essay that deals with this whole subject at greater length. It's entitled "Can Non-Shielded Inductors Save You Money?" and you can get a copy by merely mailing this coupon.



Do we have your name?

To receive reprints of "Component Comments," use the coupon. We'll place you on our mailing list.

JEFFERS ELECTRONICS DIVISION,

Speer Carbon Company
DuBois, Pennsylvania

Speer Carbon Co. is a Division of Air Reduction Company, Inc.

- Rush "Can Non-Shielded Inductors Save You Money?"
- Rush "The Speer Resistor Handbook."
- Arrange for me to receive reprints of "Component Comments."

Name _____

Title _____

Company _____

Address _____

City _____

State _____ Zip _____

Technical Articles

**Inductors that fit
integrated circuits:
page 62**

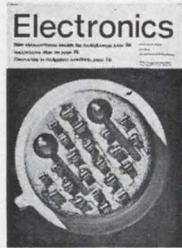

When designing integrated circuits, many engineers leave out inductors and create elaborate circuits with as many as 20 components to take their place. Now this approach is no longer necessary. Miniature inductors can be made for about 80% of all integrated circuit applications. For the cover, this TO-5 transistor package, with 22 micro-inductors attached, was bathed in red light by photographer Vincent Pollizzotto.

**Feedback—perils and
potentials in designing
integrated circuits:
page 67**

If you work with integrated circuits, you'll have to learn to live with feedback. It can be an advantage as well as a disadvantage. Here are ways to put feedback to use to help improve performance.

**From Japan,
a startling new
color tv set:
page 81**

In the U.S., the boom is on in color tv, but only big sets are offered. A Japanese company has designed a small 7 $\frac{1}{2}$ -in. set whose circuitry is all solid state. A single-gun picture tube helps keep the cost down.

**Putting together the
ground stations for
the military satellite
system:
page 86**

Last August, after the Bay of Tonkin incident, the Defense Department finally decided to go all-out for its own communication satellite system. Eleven ground stations are being put together now to tie continental U.S. headquarters to military outposts around the world.

**Coming
June 14**

- **Special report: the unijunction transistor comes into its own**
- **How to specify potentiometers**
- **Life sciences beckon the engineer**

Inductors that fit integrated circuits

Contrary to popular belief, small inductors are available and can be designed for microelectronics, eliminating the need for complicated R-C networks

By Steven Slenker

President, Piconics, Inc., North Billerica, Mass.

Inductors, transformers and chokes are no longer the missing links in the chain of small components available for integrated circuits. Right now, tunable inductors not much larger than transistor dice are available for use in hybrid circuit design.

Many designers, believing that such small units could not be made, have kept inductors out of integrated circuits. They have constructed elaborate circuits with as many as 20 components to do the job of a simple inductor. These circuits often have poorer electrical characteristics than an equivalent inductor.

Miniature inductors can replace their much larger counterparts in about 80% of all circuit applications. They generally permit circuit reductions of 20% to 80%; the devices themselves are only 1/1,000th the size of the smallest adjustable inductors previously made (see photos on p. 63). Tunable inductors with Q's of 50 and values of 100 microhenries have been made 0.070 inch in diameter and 0.155 inch long. Their most widespread application is in r-f and i-f amplifiers that operate between 1 megacycle and 1 gigacycle. Inductors tunable over a range of 5 to 7 nanohenries are being used in stripline amplifiers. Series chokes are being used in 2-Gc amplifiers.

Low stray capacity, wide tuning range, and high stability permit their use in microwave applica-

tions. In certain microwave circuits, microelectronic inductors achieve stabilities of ± 8 ppm per degree centigrade.

The inductance problem

Designers of miniature components have taken several approaches to make inductors for integrated circuits.

Thin-film inductors have proven unsatisfactory because of their low values of inductance and low Q's. Integrated R-C networks with resonant characteristics have had poor stability and poor Q.

Mechanically resonant filters, such as piezoelectric and magnetostrictive devices, have extremely high Q's, but generally cannot be adjusted for the resonant frequency, and for Q.

Some designers have combined small inductors which have low Q's with high gain integrated feedback networks to produce active tuned circuits whose performance is equivalent to or superior to that of circuit using conventional inductors. Electrical characteristics of inductors have been improved by using circuits that multiply Q.

Maintaining permeability

The problem of miniaturizing inductors lies in reducing the size of the device without reducing the permeability of the magnetic core. Permeability is a measure of how much a given material will enhance a magnetic field; it is given by the ratio of magnetic induction to magnetizing force.

An inductor consists of several turns of wire around a core of magnetic material (see diagram on p. 64). This material has built-in magnetic fields, which can be thought of as tiny magnetic particles or magnetic dipoles. Current passing through the wire can be pictured as a sheet of current flowing around the core. To store energy in the material, the magnetic particles must be easily oriented by the current flowing through the wire, and the par-

Author



As a consultant on microelectronic circuit design, Steven Slenker encountered applications that required sophisticated inductance elements. The prototypes he made were so successful that he formed Piconics, Inc. to generate a complete line of microelectronic inductors, transformers and chokes. He received his basic engineering training and a master's degree from

the Massachusetts Institute of Technology in 1956.

ticles must not exhibit a great loss of orientation.

The magnetic particles in the core material may be held together by a binder—epoxy for powdered iron, ceramic for ferrite ores. The binder is necessary to insulate the conductive magnetic particles from each other, so as to prevent the flow of bucking or eddy currents within the core, which reduce the magnetic field and lower the Q.

Core factors

The permeability of the core is dependent upon the type of binder used, the ease with which the magnetic particles can be oriented, the amount of energy required to accomplish this orientation, and the time it takes for the magnetic particles to change from one magnetic orientation to another.

The Q of an inductor may be defined as the ratio of the energy stored to the energy dissipated per cycle. The energy stored is in the form of the magnetic field; if a high permeability core is used, reducing the size of the core may not affect the permeability of the over-all device.

Size reduction means using finer wire, which need not lower the Q of the inductor. Q may be maintained or even increased in some cases, if the effective permeability of the magnetic material can be increased. This can be accomplished by an extremely simple technique.

If the wire—and thus the effective sheet current—is brought closer to the core, then the air gap between the current sheet and core is reduced (see diagram on p. 64). A greater portion of the medium inside the inductor can be filled with magnetic material, and the permeability of the medium with a smaller air gap will be increased.

Reducing the air gap

This is the key to reducing the size of inductors: reduce the air gap and increase the average internal permeability of the core.

When the size of the inductor is reduced, it is possible to obtain almost the same inductance and Q by increasing the sheet current density (by increasing the number of turns of wire), and obtaining better orientation of the magnetic particles in the core. The only parameter sacrificed is power rating. But in microelectronics, less power handling capacity is required. Standard inductances are usually operated at a small fraction of their available power handling capacity.

The properties of magnetic materials have not been analyzed to prove the absolute limits of field enhancement that can be obtained. It is reasonable to expect that improved magnetic materials will permit even further size reductions of inductors, and will possibly improve electrical characteristics.

Standard fixed inductors and transformers now available are 0.075 inch in diameter and 0.175 inch long, tunable units are 0.325 to 0.475 inch long and 0.095 inch in diameter. The smallest inductors made to date have cores that are 0.012 to 0.130 inch in diameter, and 0.030 to 0.150 inch long. The Q's of the smallest range from 7 to 25 in values to 5

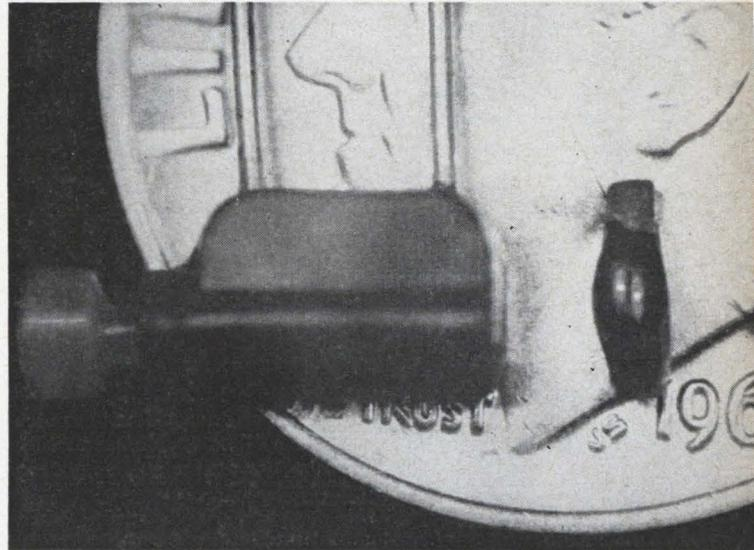

Three tunable devices, made as inductors or transformers. The two units, left, are available in values from 6 nanohenries to 6 millihenries. Experimental design is at right.

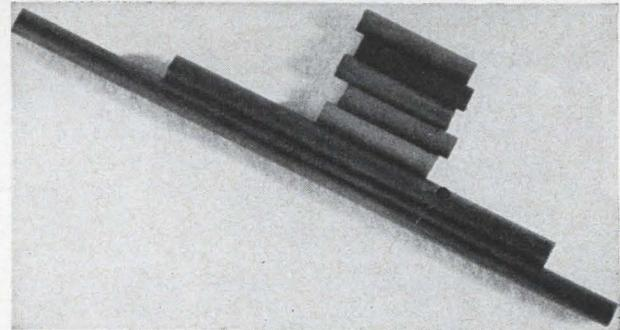

Rod cores have diameters thinner than fine-line pencil lead, shown at bottom. Core materials are selected to optimize electrical parameters under varying operating conditions and at extremes of temperature.

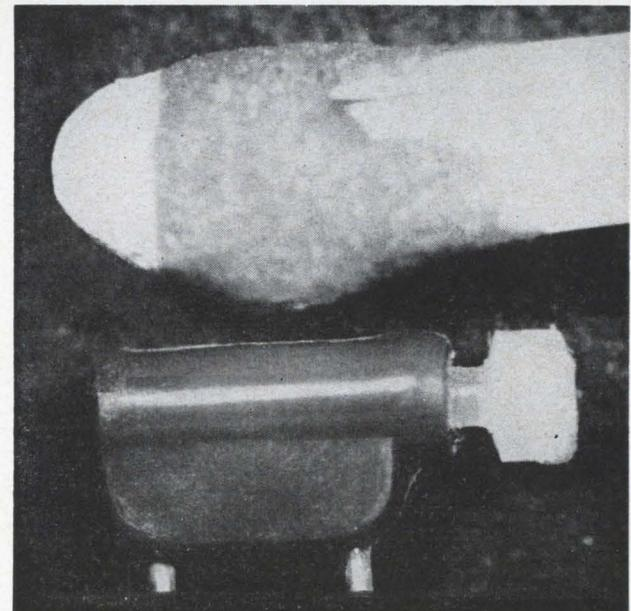

Standard tuned inductor is molded in diallyl phthalate. Unit withstands 125°C operating temperature.

Typical values of tunable microelectronic inductors

Inductance range in Microhenries		Q min at L_{max}		D-c resistance in ohms	I_{max} in ma	F_s in Mc	I(d-c) for 5% ΔL_{max}
L_{max}	L_{min}	Q	Mcs				
0.007	0.005	90	50	0.001	300	3000	burnout
0.1	0.05	45	25	0.1	100	700	"
0.68	0.34	40	25	0.7	70	240	"
4.7	2.4	30	7.9	4.7	50	50	"
33.0	16	20	2.5	11	50	8	37
220.0	100	20	0.79	40	50	4.5	21
1500.0	400	10	0.25	275	30	1.5	11
5800.0	1160	10	0.25	800	15	.6	4

Fixed inductors have the same values; inductance is fixed at L_{max} . F_s is the self-resonant frequency. The last column shows value when d-c current is increased 5% at L_{max} . At lower values, burnout occurs before the current can change the inductance by 5%.

microhenries. The problem of actually constructing such small devices lies in production techniques for making small cores, winding wire around the core, threading cores and plastics to accuracies better than one ten thousandths of an inch, and molding devices to the same tolerances.

Small package, big job

Most large inductors used for i-f amplifiers have a Q of about 40 and values of inductance from 1 to 15 microhenries. Small devices have exactly the same electrical characteristics, except for slight reduction in Q—to 25 or 35. However, when placed in a circuit loaded by transistor impedance, this difference is generally undetectable. For all practical purposes, the small inductor does the same job as its larger counterpart. Reduction in size often enhances performance characteristics, rather than degrading them.

The tuning range of adjustable units depends upon the value of inductance, and the core material (see table above). Generally, a tuning range of 2 to 1 can be provided. A tuning range of 5 to 1 can be achieved in devices that have large values of inductance; for example, a single inductor will tune from one millihenry to five millihenries. Gen-

erally, microelement inductors can attain higher frequencies than conventional units.

In circuits where the inductor is loaded by a transistor, transistor impedance is so low that the Q of the inductor can be varied over a wide range without measurable circuit gain or bandwidth changes.

Little straying

Microelectronic devices have lower stray capacitance than conventional devices because of a smaller surface area of wire. The effective dielectric thickness is not reduced proportionally.

The stability of the miniature inductor is the same as a conventional inductor operating under identical circumstances. Inductors can be made in microcircuit sizes with temperature coefficients in the range of ± 15 ppm to ± 300 ppm per degree centigrade.

The tiny inductors do not have large magnetic fields and can be placed very close together without causing parasitic generation or circuit oscillation. Two inductors can generally be placed close together, with their magnetic fields oriented for positive feedback, without causing oscillation. In a 20-db gain stage, they can be as close together as

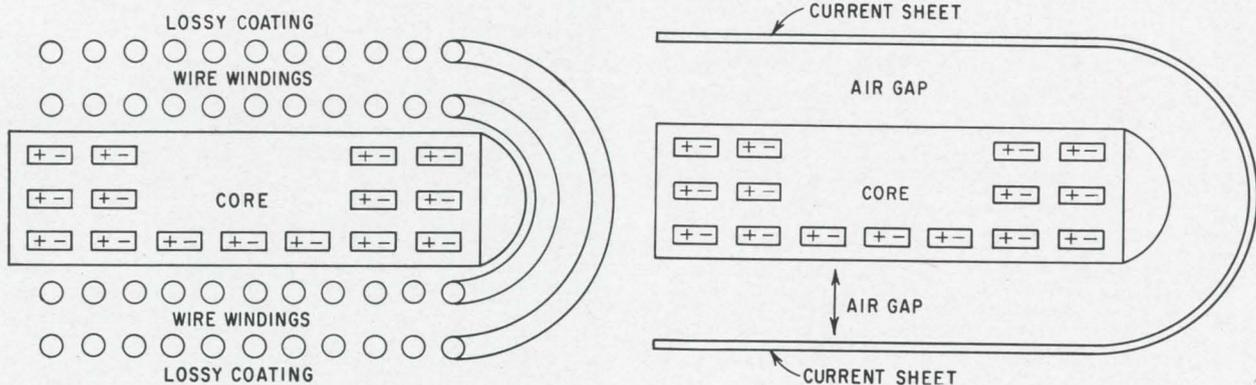

Cross-section of inductor (left) with wire windings and magnetic dipoles oriented in the core. Simplified drawing at right shows how current passing through the wire can be visualized as a sheet of current flowing around the core. The key to making miniature inductors lies in reducing the air-gap space by bringing the sheet current closer to the core, thus obtaining better orientation of the magnetic dipoles.

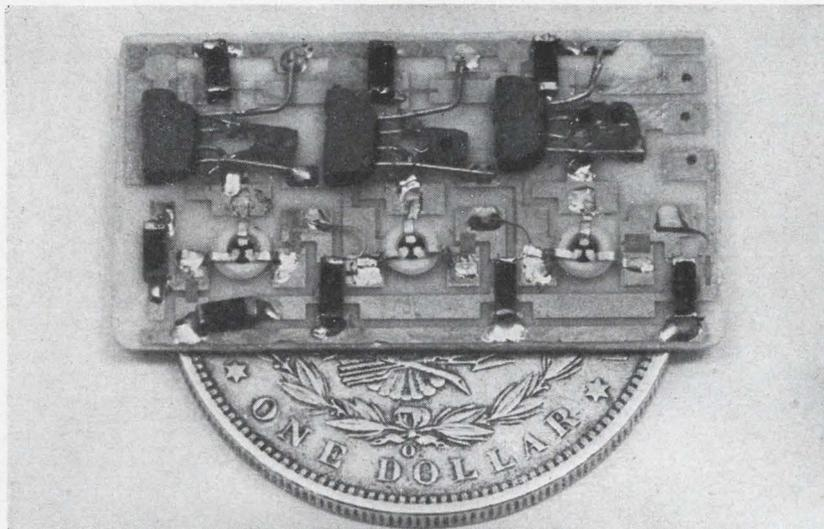

Sanders, Associates, Inc.

Miniature thin-film i-f amplifier uses three tunable transformers. Basic circuit shown can be used from 500 kc to 100 Mc with appropriate changes in component values.

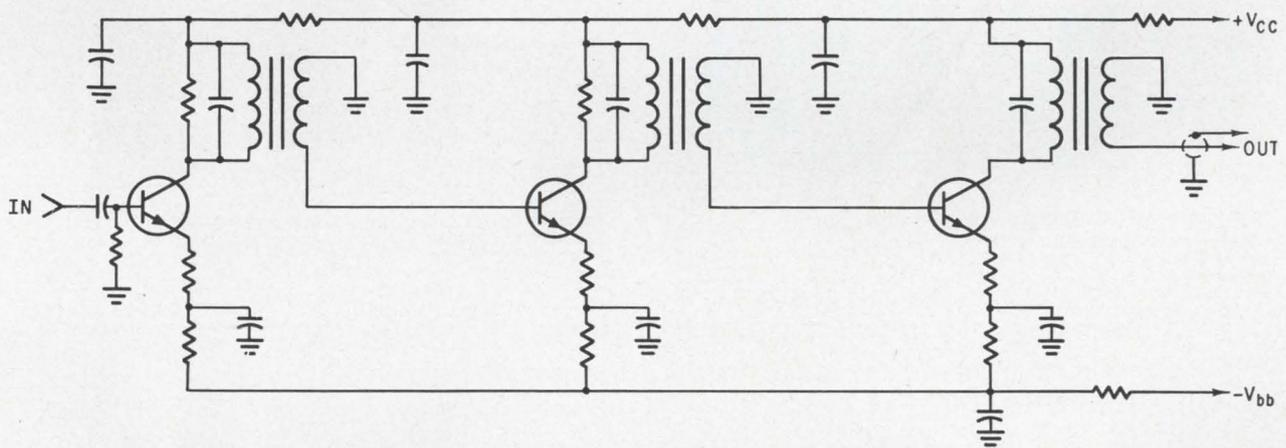

four times the diameter of the inductor cores, measured between coil axes and produce less than 1 db of gain change. This space shielding is extremely effective for high-density packaging, and eliminates the need for shielding hardware in most cases. Metal tuning tools or hand capacitance have no detuning effects on the devices.

Mounting and bonding

The inductors are encapsulated in epoxy or covered with varnish to keep the wire in a coil. These materials cannot be bonded by soldering, welding, brazing, or thermal compression. It is therefore necessary to fasten them with an adhesive, usually an epoxy cement. The leads themselves may be soldered or welded to the circuit.

The materials used to construct the inductors withstand severe environments. Ferrite core inductors can take temperatures up to 125°C, and can be stored at 210°C. Inductors made with powdered iron cores operate at up to 85°C, and can take storage temperature up to 150°C. Materials used for insulating wires and for cementing and encapsulating the inductors are chemically compatible and will not cause corrosive reactions. The materials retain their dimensional stability.

Basic building blocks

The exact needs of all circuit designers cannot be generalized, but a few basic circuits may satisfy almost a third of all applications. The first is the r-f or i-f amplifier, essential to any radio receiver. A typical miniaturized version is shown above.

This basic amplifier circuit can be used from 500 kilocycles to 100 megacycles with changes in component values. The small tunable transformers used present no unusual problems. This miniaturized circuit performs as well as its conventional counterpart. The Q of the small devices is 25, slightly lower than larger types; but because transistor input impedances are extremely low, the increased loss in the transformer is not noticeable.

The tunable transformers may be placed between transistor cans with little loss of extra space, as shown in the photo on page 66.

Critical tuning simplified

At very high frequencies of 200 Mc to 300 Mc, the complex nature of transistor impedance in a circuit requires that the coupling networks of interstage transformers used in r-f and i-f amplifiers be adjusted to optimize power transfer (see diagram on p. 66). This adjustment is usually made by

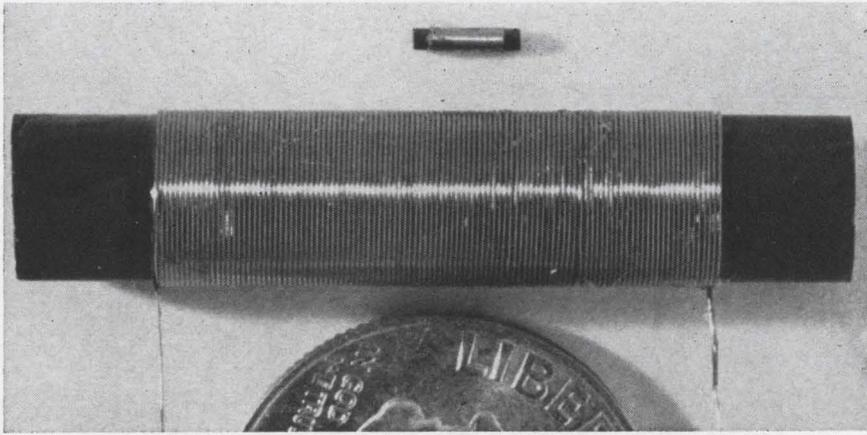

Two inductor coils identical in every respect except size. Core and wire are made from the same material, and turns are identical. Large coil is 7.4 times the size of the miniaturized inductor. In this case, size reduction lowered Q from 82 in the larger coil to 19 for the smaller coil. Research into core materials and winding techniques has made it possible to reduce size without appreciable decrease in Q.

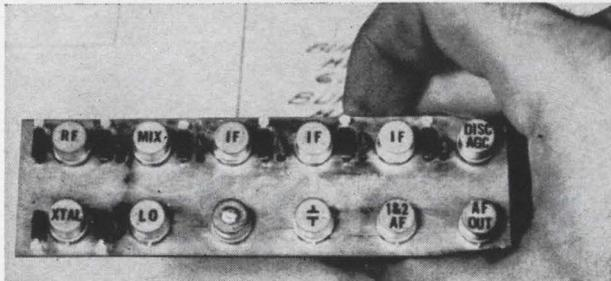

Sanders Associates, Inc.

Inductors are positioned between amplifier stages in a microelectronic f-m receiver.

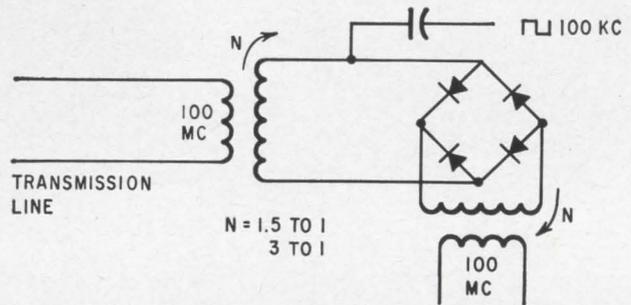

Variable turns ratio transformer is used to balance the load in a two-phase switching network.

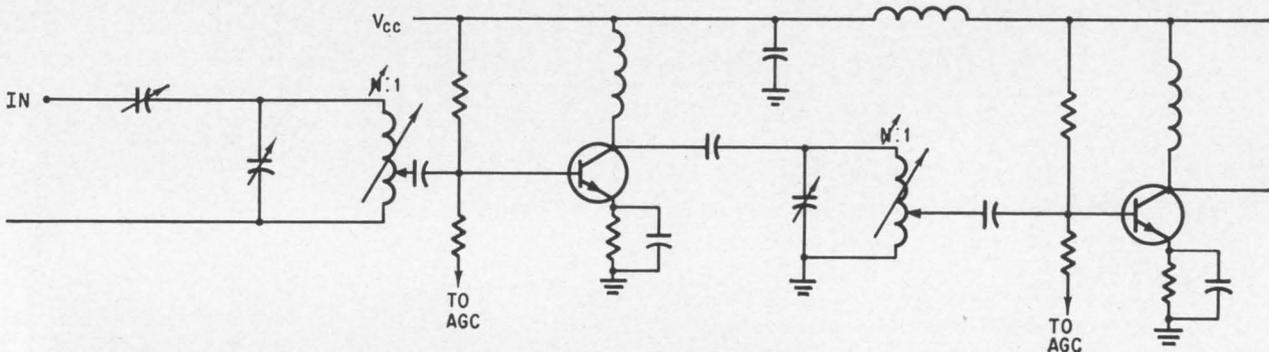

Miniature autotransformers in 300 Mc i-f amplifier circuit not only shrink circuit to a fraction of its normal size, but eliminate the tedious job of adjusting coupling networks.

changing the turns ratio or tap point of the inductor.

It was previously necessary to find this point, which is often critical to an eighth of a turn or less, by soldering and unsoldering the tap all around the edge of the inductor. This time-consuming process, next to impossible on the production line, was eliminated by using a miniature variable turns ratio transformer, which can be varied continuously by screw adjustment while other transformer parameters are maintained constant. The turns ratio can be varied by a minimum factor of 2 to 1 and in some cases by a larger factor.

In another application using small inductors, it was possible to balance the load to a transmission line so that no reflections occurred. This circuit is shown above.

Microelectronic inductors can be used to balance

critical bridge circuits. They have been used successfully in the frequency range between 100 kc and 500 Mc. Adjustments can be made with the tiny tuning screw.

Reliability and cost

The reliability of small inductors should be greater than that of conventional units. Several military systems, using the inductors, have passed preliminary field tests, and no failures have been reported.

Prices are still high, but units now selling for \$4 should sell for 10 cents each within the next five years, if they follow the pattern of other micro-component developments. Construction techniques for making the small devices lend themselves to a high degree of automation.

Feedback: perils and potentials in designing integrated circuits

It's inevitable, so why not learn to live with it?

Here are analyses of the 4 basic types, methods for coping with them and ways of putting them to work

By Vasil Uzunoglu

Johns Hopkins University, Silver Spring, Md.

In the tight little world of integrated circuits, feedback can enhance or destroy a system's effectiveness. The designer must face the fact that feedback paths are inevitable. By learning how to cope with them, he can not only overcome their detrimental effects, but also put feedback to work for him.

Feedback can come in one or a combination of four basic types: series-positive, series-negative, shunt-negative and shunt-positive. Using it, or designing against it, requires an understanding of these four categories.

Series-positive feedback

Series-positive feedback occurs when a contribution from the output is returned in phase with the input signal. Primary series-positive feedback paths are traced by the arrows in the integrated circuit on page 68. The feedback current results from voltages across resistors R_E and R_K . In addition to the feedback current flowing in the paths shown, a small additional feedback current may also flow through R_1 and R_2 . R_E represents the emitter resistance of both Q_1 and Q_2 ; similarly R_K

represents the collector resistance of both Q_1 and Q_2 .

Theoretically, in an ideal integrated circuit the resistance of both R_E and R_K would be zero; there would be no series feedback. However, finite resistance values for R_E and R_K are always produced during fabrication of the circuit. These resistance values include contributions from resistive interconnection paths and imperfect ohmic contacts. Both R_E and R_K appear as lumped resistances, whereas the diffused resistors of the circuit are distributed resistances contributed by a resistive-capacitive distributed network.

Network analysis¹ of the circuit shows that the feedback voltage V_E , developed across R_E is

$$V_E = \frac{\beta_2 i_1 Z_{L1}}{Z_{L1} + Z_{2in}} (R_E) - \beta_1 i_{in} R_E \quad (1)$$

$$\text{where } Z_{L1} = \frac{2Z_o \sinh \gamma}{\cosh \gamma - 1} \quad (2)$$

β_1, β_2 = beta of Q_1, Q_2

i_1 = Q_1 collector current

i_{in} = input current to base of Q_1

Z_{L1} = Q_1 collector load impedance

Z_{2in} = input impedance of second stage as seen by first stage

$Z_o = \sqrt{R/j\omega C}$

$\gamma = \sqrt{jR\omega C}$

$\omega = 2\pi f$

R and C = resistance and capacitance of distributed network

The phase shift contributed by Z_{L1} approximates 45° when values of γ (or ω) approach infinity.² With lumped components, the phase shift will always be 90° because either the input or the output is shunted by a capacitor. This means that less phase

The author



Vasil Uzunoglu, a Greek, owned an industrial-control manufacturing plant in Turkey until 1955, when it was looted and burned by a mob. He came to work at Bell Telephone Laboratories, and now works in the microelectronics group of the Applied Physics Laboratory at Johns Hopkins University. His book, *Semiconductor Network Analysis and Design*, was published last year by the McGraw-Hill Book Co. He holds six patents.

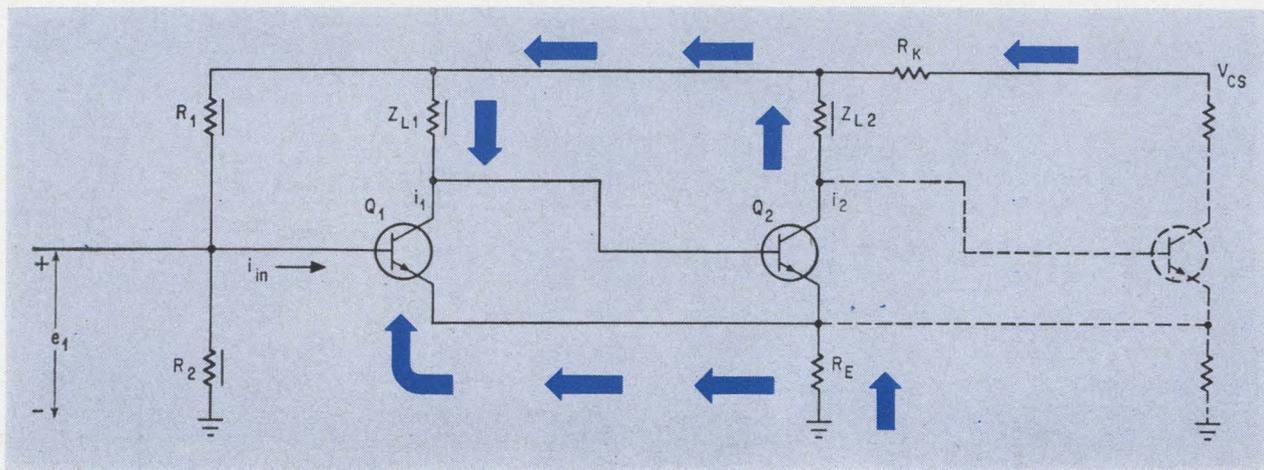

Two-stage integrated-circuit amplifier with temperature compensation. A typical power gain of 20 db is provided by the circuit at 80 Mc. Only three layers are needed to construct the device in monolithic form.

shift occurs with the distributed R-C constants than would occur if the circuit consisted entirely of lumped components. With less phase shift, therefore, the problems created by series-positive feedback are reduced if the same amount of capacitance is present in both cases.

However, in an oscillator circuit, the designer may wish to take advantage of this feedback and may even want higher values of R_E and R_K . However, the value of R_E cannot be increased without limit; if R_E is too large, the current flowing through Q_2 may be reduced sufficiently to halt oscillation.

A helpful parameter in analyzing and comparing interaction effects in various integrated circuits is the feedback factor or return ratio. The feedback factor is a function of two phase shifts: that caused by the distributed resistors, and that contributed by the transistors. The expression³ for the phase shift ϕ is:

$$\phi = e^{j(m\omega/\alpha)} e^{j\theta(\omega)} \quad (3)$$

where m = phase shift in excess of 45° measured at the 3-db point for the transistors

$\theta(\omega)$ = phase shift contributed by the R-C distributed network.

The study of all types of feedback in integrated circuits should include ϕ if a considerable amount of excess phase shift is present. Working with complex feedback factor is complicated and requires rigorous mathematical treatment. Feedback voltage in this case is a fairly easy parameter to work with, particularly since at lower frequencies (up to a few megacycles per second) the expression for feedback voltage V_E given in equation 1 reduces to:¹

$$V_E = \frac{\beta_2 i_1 R_{L1}}{R_{L1} + R_{2in}} R_E - (\beta_1 i_{in} R_E) \quad (4)$$

where $R_{L1} = Q_1$ collector load resistance
 R_{2in} = input resistance of next stage

Even with very low values of R_E , the feedback voltage developed across R_E can be very large, resulting in considerable positive feedback. Values of R_E less than one ohm may be enough to cause

appreciable feedback voltage and resulting instability, especially if the value of R_2 in equation 4 is large. For linear operation, large feedback voltage is especially undesirable.

If the circuit is to be used as a sinusoidal oscillator, a frequency selective network (crystal or tuned circuit) may be placed between the collector of Q_1 and the base of Q_2 . The frequency-selective network must have a resonant frequency higher than the natural fundamental frequency of the amplifier.

Since the frequency of oscillation is dependent upon the capacitance in the circuit, the integrated circuit can be used as a capacitance-sensing oscillator. In such an application, any capacitive change at the base of Q_2 would vary the frequency of oscillation. In a space-medical application, for example, the circuit could be used to detect changes in moisture on an astronaut's body.

Series-negative feedback

If a third stage is added to the above circuit, as shown by the dashed lines, the feedback can be converted from series-positive to series-negative. The third stage behavior is similar to the first, and the emitter of Q_3 should be connected to R_E . This makes the feedback negative.

Use of the third stage also removes the possibility of reduced input impedance resulting from the positive feedback.

Shunt-negative feedback

In the top, left circuit, on the next page, all resistors are provided by distributed resistor-capacitor construction. The shunt-negative feedback paths are through an array of feedback resistors connecting the load impedance Z_L with the bias impedance Z_B .

Without the presence of the feedback resistance R_K , and when current is low, voltage gain is high and the values of Z_B and Z_L are large, the amplifier cutoff frequency is primarily determined by Z_B

and Z_L . Too low a value of R_K is not desirable; values of a few hundred ohms can be achieved in practice, but such low values produce a high current drain on the battery. Too high a value of R_F is also detrimental since it limits the frequency response of the amplifier. Typical values for an amplifier useful to 10 megacycles per second are: $R_F = 8$ to 10 kilohms, $Z_B = 30$ to 40 kilohms, and $Z_L = 1$ kilohm.

Because the network components are distributed rather than lumped, the amplifier gain drops off at 3 db per octave instead of 6 db. Since the slope of the dropoff in gain is not as steep, the upper frequency limit is extended provided in both cases the effective value of capacitance is the same. The presence of distributed resistance instead of a pure resistor causes, of course, a reduction of the available gain-bandwidth product of the amplifier. Thus, while the existence of R_K in distributed-component networks reduces the gain at all frequencies, it increases the frequency range of usable gain. The phase shift of 45° provided by the distributed network, as opposed to 90° with a lumped network, reduces phase distortion. Signal current to the transistor increases at higher frequencies, thus

reducing the loss of gain. This additional signal current is a result of a reduction in the capacitive reactance component of Z_S .

Proper balance between Z_S and Z_B can cancel the reduction of gain caused by Z_B as frequency increases. This makes the upper cut-off frequency mainly dependent on Z_L . A high value of Z_S is necessary to make the feedback effective which also minimizes the reduction in input impedance caused by the shunt feedback.

The upper left circuit shown is effective in achieving low-frequency compensation; that is, it extends the frequency response at low frequencies. In video amplifiers, low-frequency compensation is important because amplitude distortion at low frequencies is reflected as phase distortion at high frequencies.⁴

For analysis of low-frequency compensation, this circuit can be redrawn as shown at the lower left. The key to proper design of this integrated-circuit amplifier is determination of the correct location of R_K between R_L and R_B . The best way to do it is to build the circuit with conventional passive components and the transistor in question. Then, one terminal of R_K should be fixed across R_B , close

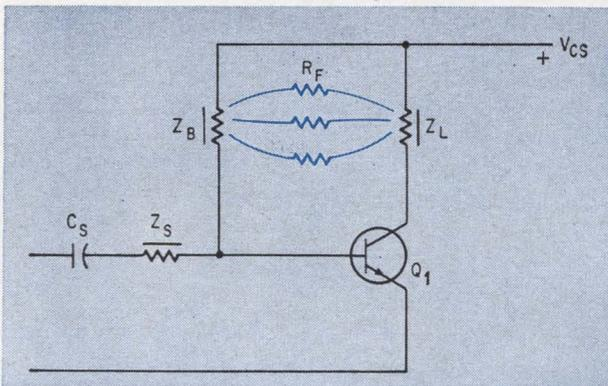

Shunt-negative feedback flows from load impedance Z_L of the integrated circuit to base-biasing impedance Z_B . Feedback current is conducted by an array of feedback resistors designated R_F .

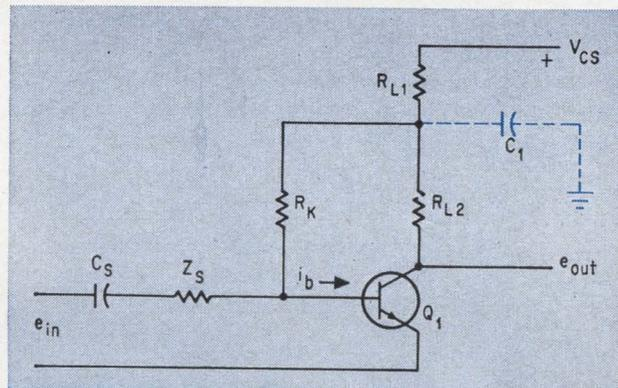

A-c small-signal equivalent representation of the integrated circuit using lumped components. Capacitor C_1 has been added to improve the gain at low frequencies.

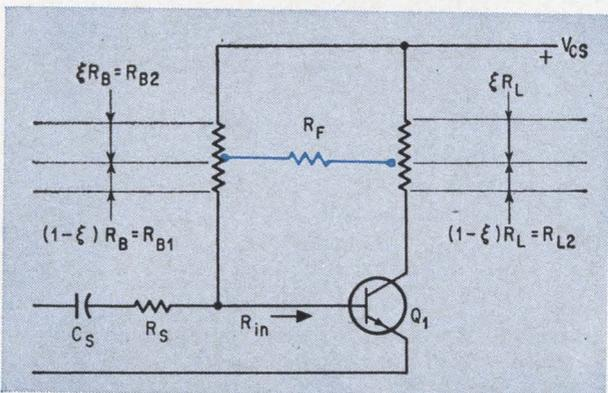

Conventional circuit components are used to determine where R_F should be located in the equivalent circuit. Several attempts may be required before the conventional circuit is duplicated in integrated-circuit form.

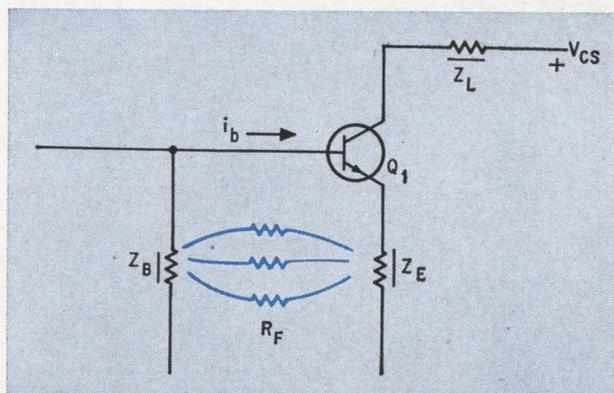

Positive-shunt feedback current flows from Z_B through R_F to Z_E . This useful type of feedback, when combined with series-negative feedback, can increase input impedance.

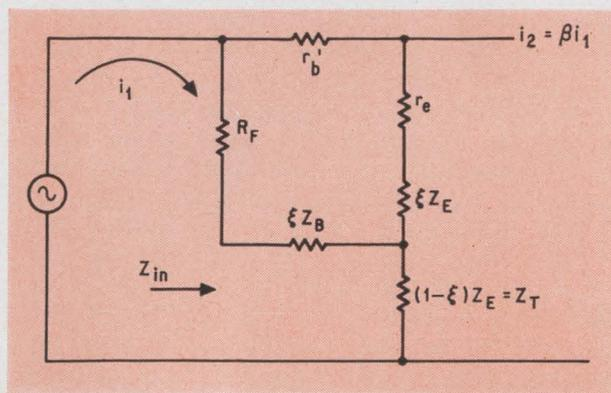
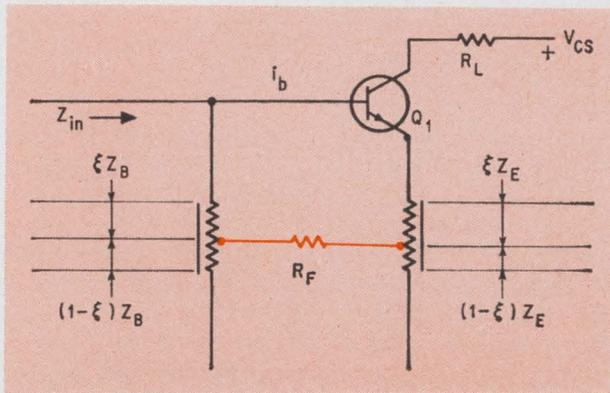

Lumped constants (left) represent return path for positive-shunt feedback current. Location of R_F is usually made close to the base of the transistor. At right is small-signal equivalent circuit for the integrated circuit above.

to the base, and the other terminal should be moved up and down R_L until the operating point obtained with a trial integrated circuit is duplicated. Then by proper choice of capacitance in the integrated circuit, the desired low-frequency compensation is obtained. Resistor R_K includes a small portion of R_B . The location of R_K is difficult to obtain by computation because so many complex functions are involved and so many feedback paths exist.

To simplify further analysis of the circuit (p. 69, upper, left), the a-c small-signal equivalent circuit is useful. This is shown on page 69. Compensating capacitor C_1 has been added to improve gain at low frequencies. By loop or node analysis, the equation for voltage gain is obtained:

$$\frac{e_{out}}{e_{in}} = \frac{-\beta R_K R_{L2} + \beta(R_{L2} + R_K) \left(\frac{R_{L1}/sC_1}{R_{L1} + 1/sC_1} \right)}{(R_S + 1/C_S)(R_K + \beta R_{L2}) + R_{in} R_K} \quad (5)$$

where $s = j\omega$
 $R_K =$ feedback resistance

This equation can be rewritten in the form:

$$\frac{e_{out}}{e_{in}} = K \frac{s(s + z_1)}{(s + p_1)(s + P_2)} \quad (6)$$

where $K =$ amplification constant

$$z_1 = \frac{\beta R_K R_{L2} + \beta(R_{L2} + R_K) R_{L1}}{\beta R_K R_{L2} R_{L1} C_1} \quad (7)$$

$$\begin{aligned} p_1 &= 1/R_{L1} C_1 \\ p_2 &= 1/R_S C_S \end{aligned} \quad (8)$$

The low-frequency response will be improved if Z_1 is made equal to p_2 . This can be achieved if:

$$\frac{e_{out}}{e_{in}} = \frac{\beta(R_{L2} + R_K) R_{L1}}{\beta R_K R_{L2}} = \frac{R_{L1} C_1}{R_S C_S} \quad (9)$$

Shunt-positive feedback

The lower, right diagram, p. 69 shows another feedback path. This path carries positive-shunt feedback from Z_E through R_F to Z_B . In conjunction with series-negative feedback through Z_E , this feedback acts to increase the input impedance. The two feedback actions may be used together to enhance

circuit operation. In achieving higher input impedance, they reduce the loading on coupled circuits. As before, trial and error is used in determining the location of R_F between Z_B and Z_E . This circuit, too, should be constructed with discrete resistors, then experimentally duplicated in monolithic form. Many attempts may be necessary before the same operating conditions provided by the discrete components are duplicated.

By experimental adjustment, this circuit can be represented as shown above, left with lumped constants. For further study, the location of R_F may be made close to the base of the transistor.

In this circuit, the direct feedback from the collector to the input is neglected. The small-signal equivalent circuit is shown above.

By using loop equations and determinants, the input impedance is calculated as $Z_{in} =$

$$\frac{\beta(r_e + \epsilon Z_E)(Z_T + R_F + \epsilon Z_B) + Z_{TB}(R_F + \epsilon Z_B)}{\beta r_e + R_F + \epsilon Z_B} \quad (10)$$

In this equation it is assumed that $B \gg 1$, and the distributed base resistance $r'_b \ll \beta r_e + R_F$; r'_b and the distributed emitter resistance r'_e are assumed to be in lumped form (this assumption is valid since transistor frequency cut-off points are higher than those of external parameters. Lumped constants are assumed here only because the use of distributed constants would result in considerably more complex mathematics. Although the use of the lumped constants does affect the calculated value of Z_{in} , the value of Z_{in} obtained is adequate for the designer's use to indicate the increase in driving point impedance. In arriving at equation 10, the term $(1 - \epsilon)Z_B$ has been neglected because it can be assumed that nearly all the feedback current flows through Z_B , which is much smaller than $(1 - \epsilon)Z_B$.

A circuit similar to the one previously described but with $R_F + Z_B$ returned to ground rather than to the emitter, will have no feedback through R_F . Its input impedance is given by:

$$Z_{in} = \frac{\beta(r_e + Z_T) \cdot (R_F + \epsilon Z_B)}{\beta(r_e + Z_T) + (R_F + \epsilon Z_B)} \quad (11)$$

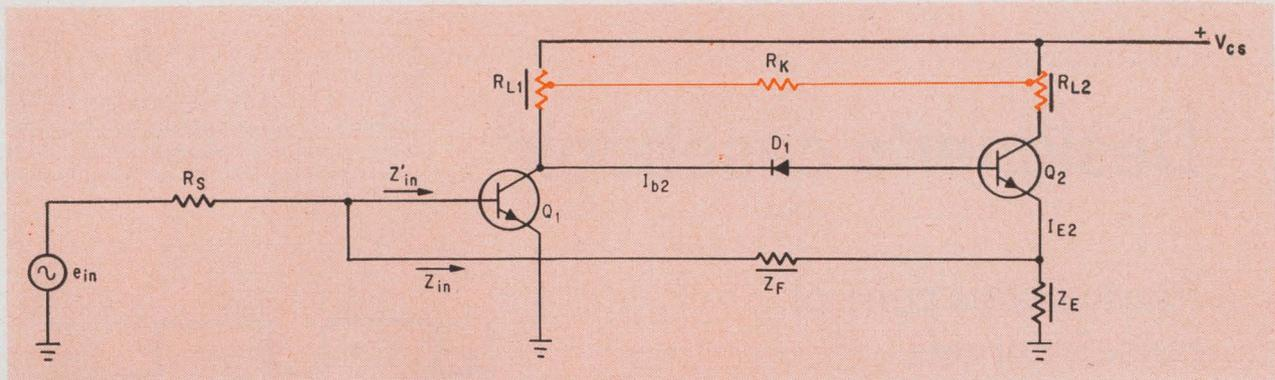

Two-stage integrated circuit. All resistors except R_E and R_K are distributed resistances. Series-positive feedback is obtained if the Q_2 emitter current is greater than the emitter current for Q_1 . Series-negative feedback occurs when the Q_2 emitter current is less than Q_1 emitter current.

Under normal operating conditions, larger input impedances will be obtained by the circuit whose impedances is defined by equation 10. This is useful at low operating frequencies since the impedances given in equation 10 may be expressed in pure resistance values.

Temperature compensation for the circuit may be accomplished the same way as in conventional circuits—that is, a temperature-compensating diode may be used. The diode replaces a portion of ϵZ_B .

The circuit shown above, with improved temperature compensation over the previous two circuits mentioned, has other advantages too.

The input current I_{b1} flowing into the base of transistor Q_1 is, in effect, the feedback current under normal operation, provided the open-loop input impedance (feedback not included) is low compared to the source impedance R_S , and the amplifier has high gain. Since the voltages across R_E and Z_F are nearly equal, the current gain and feedback current factor (also called return factor) can be written as:

$$\text{Current gain} = \frac{I_{C2}}{I_{b1}} = \frac{Z_E + Z_F}{Z_E} \quad (12)$$

$$\text{Feedback current factor} = \frac{I_F}{I_{E2}} = \frac{Z_E}{Z_E + Z_F} \quad (13)$$

An important advantage of this circuit is the simplicity with which it may be constructed on a double-diffused structure with only three layers.⁵ Extra biasing resistors are not required; this adds to the circuit's simplicity. All resistors as well as the transistor bases are made in the same diffusion step. This is normal practice in monolithic technology. With this method of fabrication, the junctions that form R_{L1} and R_{L2} receive forward biasing. Care should be exercised to achieve good isolation between R_{L1} and R_{L2} . One way to improve the isolation between these two components is to locate them as far apart as possible.

As shown in the above diagram, bulk resistance R_K is employed between R_{L1} and R_{L2} to provide sufficient isolation. Resistor R_K actually also acts

as a transmission line between the collectors of Q_1 and Q_2 to provide forward transmission and phase shift. If R_K provides a phase shift of 180° at normal frequencies, the signal supplied by R_K to R_{L2} will be in phase with the signal R_{L2} receives from the collector of Q_2 . This is the desired method of operation for a distributed amplifier. Under such operating conditions, the output is:

$$e_{out} = e_{in}G_T(\omega) + \delta e_{in}G_1(\omega) \quad \text{where} \quad (14)$$

$G_T(\omega)$ = total amplification of both stages

$G_1(\omega)$ = amplification of first stage

δ = attenuation factor through R_K

The proper phase shift for R_K to provide at low frequencies is 180° . In a typical monolithic semiconductor block using this circuit, typical power gains of 20 db and higher can be obtained at 80 Mc. Although power dissipation in the block is high, it has the advantage that it tends to reduce undesirable feedback between elements such as R_E and either R_{L1} or R_{L2} , and also reduces shunting parasitic effects. The circuit also offers good thermal stability.

In circuit operation, suppose the temperature increases, thereby increasing B_1 and consequently I_{C1} . The increase in I_{C1} reduces V_{CE1} and therefore also reduces I_{b2} . In turn, I_F drops, also reducing the biasing current I_{b1} . At the same time β_2 increases, tending to increasing I_{C2} or I_{E2} . To compensate for this tendency, a zener diode with a positive temperature coefficient may be placed in series with either the base or the emitter. A zener diodes with breakdown voltage rating over 4.2 volts usually has a positive temperature coefficient.

References

1. Vasil Uzunoglu, "Semiconductor Network Analysis and Design," McGraw-Hill Book Co., 1964, Chapter 3.
2. Ibid, p. 44.
3. Vasil Uzunoglu, "A Transistor Equivalent Circuit," Proceedings of the IRE, Correspondence, December, 1961, pp. 1957-1958.
4. H.W. Bode, "Network Analysis and Feedback Amplifier Design," D. Van Nostrand Co., 1945.
5. J.R. Cricchi, Wesley N. Jones, "A Silicon Planar Double Diffused Monolithic Amplifier," Conference Proceedings, MIL-E-CON 7, Washington, Sept. 9-11, 1963.

Designer's casebook

Designer's casebook is a regular feature in Electronics. Readers are invited to submit novel circuit ideas, packaging schemes, or other unusual solutions to design problems. Descriptions should be short. We'll pay \$50 for each item published.

Photodiodes control pulse intervals

By A. Kis Horvath

Zurich, Switzerland

The intensity of light on a pair of photodiodes, determining the amount of current that passes through them, can set pulse and interpulse periods at any value from 0.2 to 300 seconds in the circuit diagram shown at the bottom of this page.

The elements of the circuit are a Schmitt trigger consisting of transistors Q_1 and Q_2 and a capacitor C that is charged and discharged through photodiodes D_1 and D_2 , respectively. The sawtooth voltage, across the capacitor is coupled to the base of Q_1 by the emitter-follower Q_3 . (Sawtooth voltage amplitude depends on Schmitt trigger hysteresis). The capacitor charges when photodiode D_1 is illuminated and discharges when D_2 is illuminated. The lamps are switched on and off alternately by the relay in the collector circuit of Q_2 .

Pulse width t_f is the time required for C to discharge from the Schmitt trigger's turn-on voltage to its turn-off voltage. The interval between pulses, t_r , is the time it takes C to charge from the Schmitt's turn-off to its turn-on voltage.

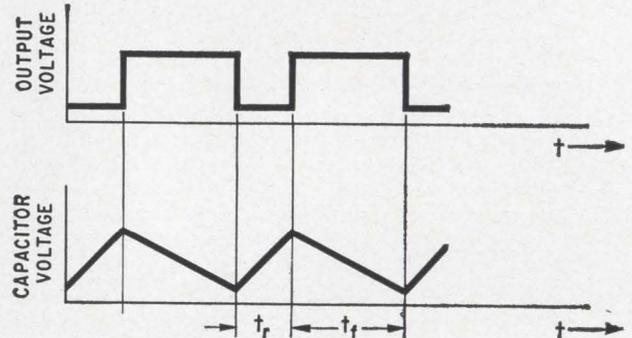

Free-running circuit produces square wave whose pulse and interpulse periods vary according to intensity of illumination on the photodiodes.

Capacitor charging rate depends on the current through D_1 when it is illuminated; discharging rate depends on current through illuminated D_2 .

The current through the photodiode is a function of illumination intensity and not (in the linear region of the V-I characteristics) on the voltage impressed across it.

Illumination intensity can be varied by changing the distance between a diode and its lamp or by the power applied to the lamp filament. The light from adjacent lamp-diode channels must be isolated.

The capacitor voltage can be made extremely linear by replacing the Q_3 emitter-follower with a field effect transistor circuit.

If sufficient power is available, incandescent lamps could be energized from the d-c source.

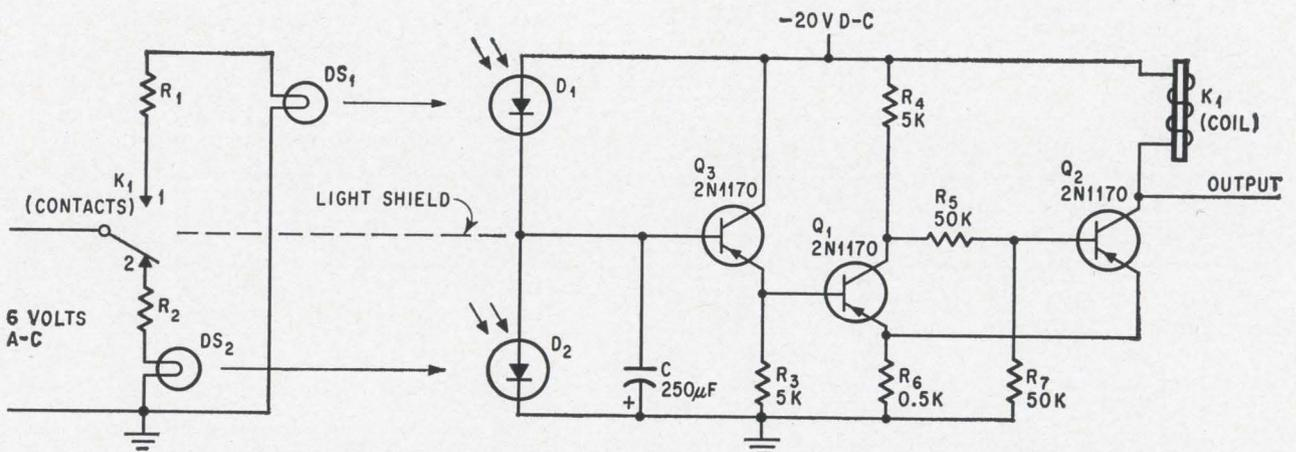

Photodiodes D_1 and D_2 in this circuit were collector-base junctions of 2N1393 phototransistors. When capacitor voltage is too low, Q_1 is off, Q_2 conducts, and the relay is energized, connecting 6-volts a-c to lamp DS_1 and illuminating D_1 . Capacitor charges to a voltage sufficient to turn on Q_1 , which turns off Q_2 and deenergizes K_1 .

Continuously variable delay line for frequencies below 100 Mc

By H. Brueckmann and D.V. Campbell

Army Electronics Laboratories, Fort Monmouth, N. J.

The disassembled variable delay line in the photograph at the right (similar to the trombone-shaped line stretcher) is useful at frequencies below 100 megacycles per second for phasing the elements of antenna arrays, measuring delay and phase, measuring vswr, or delaying signals in fast computers.

At frequencies below 100 Mc, this line stretcher is better than other variable delay lines because it has truly continuous control of delay or electrical stub length without change in characteristic impedance; reduced size, making a line stretcher at hf and vhf practical; low attenuation per unit time delay; relatively high power-handling capability; reliability through the absence of the sliding contacts; and little variation of delay with frequency.

The design was based on the fact that in a line whose propagation medium is air, the characteristic impedance does not change if the air is replaced by a medium with a relative permeability equal to its relative dielectric constant. However, the propagation velocity of the line varies inversely with the square root of their product, $v = 1/(\mu\epsilon)^{1/2}$; and the time required for a signal to travel through a unit length of the line is, $t = (\mu\epsilon)^{1/2}$.

The bottom of the photo of the disassembled experimental model shows the outer conductor with connectors at both ends; the center of the photo shows the inner conductor, which is suspended from the connectors by short metal straps at its ends; the top shows a cylinder with a longitudinal slot. This cylinder is composed of alternately stacked ferrite and ceramic disks. Cross-sectional views of the assembled line stretcher are on next page.

The delay time is varied by moving the ferrite slug axially; it is a maximum when the slug is fully inserted into the line, and a minimum when the slug is removed. The delay varies linearly with the position of the slug.

The effective permeability μ_F is the ratio of the inductance of a line filled with a magnetic material, to the inductance of the same line filled with air. Similarly, the effective dielectric constant ϵ_F is defined as a ratio of capacitances per unit length.

The μ_F and ϵ_F of a line filled with a slug made entirely of ferrite having a relative permeability $\mu_R = 40$ and a relative dielectric constant $\epsilon_R = 10$, have been calculated as a function of the angular slotwidth ϕ . The characteristic impedance of the line is 50 ohms because $D/d = 2.3$. Both, μ_F and

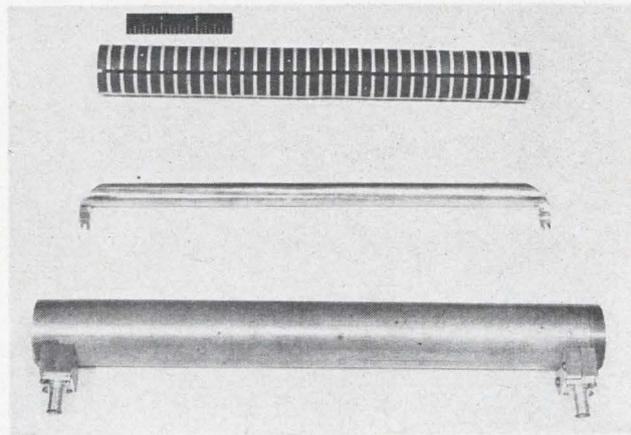

Disassembled view of variable delay line shows dielectric stack of slotted ferrite and ceramic disks (top), inner conductor (center) and outer conductor (bottom). Time delay variation is continuous, but characteristic impedance is constant.

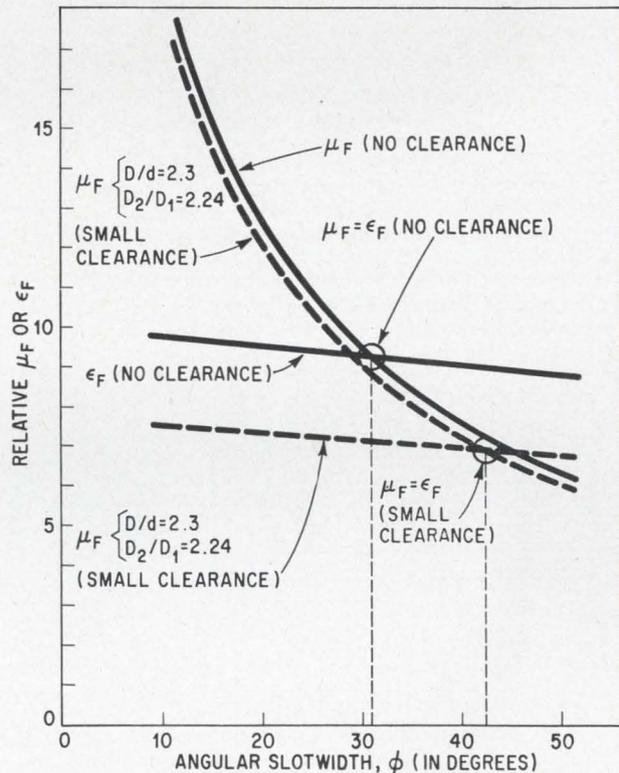

Graphical solution of design criterion to obtain angular slotwidth at which $\mu_F = \epsilon_F$. Solid curves relate to dielectric cylinder that occupies the entire space between inner and outer conductor (no air gap). Dashed curves relate to dielectric cylinder with air gap.

ϵ_F , decrease with increasing slotwidth at different rates, coinciding at $\phi = 30.8^\circ$. This is the slotwidth for a line whose characteristic impedance does not change when the ferrite is removed while the propagation velocity is reduced to about

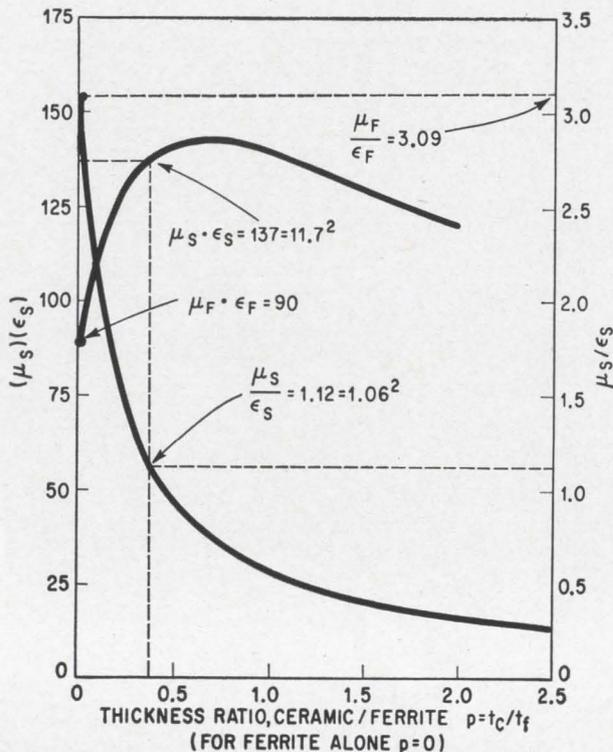

Products $\mu_s \epsilon_s$ and ratio μ_s / ϵ_s as a function of thickness ratio p of ceramic to ferrite, for ferrite having $\mu_R = 40$, $\epsilon_R = 10$, $\mu_F = 16.7$, $\epsilon_F = 5.4$ and ceramic having $\epsilon_R = 85$, $\epsilon_C = 26.1$ (ϵ_c is the relative dielectric constant of the ceramic, including the effects of the slot and clearances). Value of p chosen for this experimental model is indicated by dotted line.

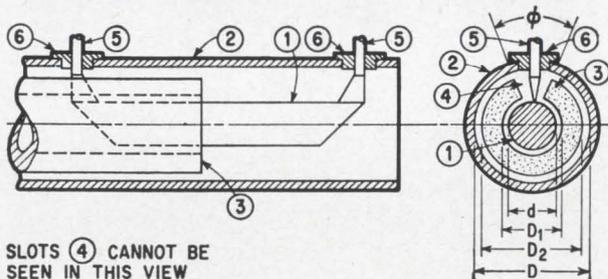

SLOTS (4) CANNOT BE SEEN IN THIS VIEW

FOR A COMPOSITE SLUG

- $d = 1.525$ CM
- $D_1 = 1.59$ CM
- $D_2 = 3.42$ CM
- $D = 3.53$ CM
- $\phi = 10.8$ DEGREES
- $t_C = 0.238$ CM (CERAMIC THICKNESS)
- $t_F = 0.635$ CM (FERRITE THICKNESS)
- INNER CONDUCTOR LENGTH = 30.0 CM
- OUTER CONDUCTOR LENGTH = 32.4 CM

Assembly drawing of line stretcher showing: (1) inner conductor, (2) outer conductor, (3) hollow cylinder composed of alternately stacked slotted disks of ferrites and ceramic, (4) slot—angular slot width designated by ϕ , (5) metal straps that support inner conductor, (6) insulator between inner and outer conductors.

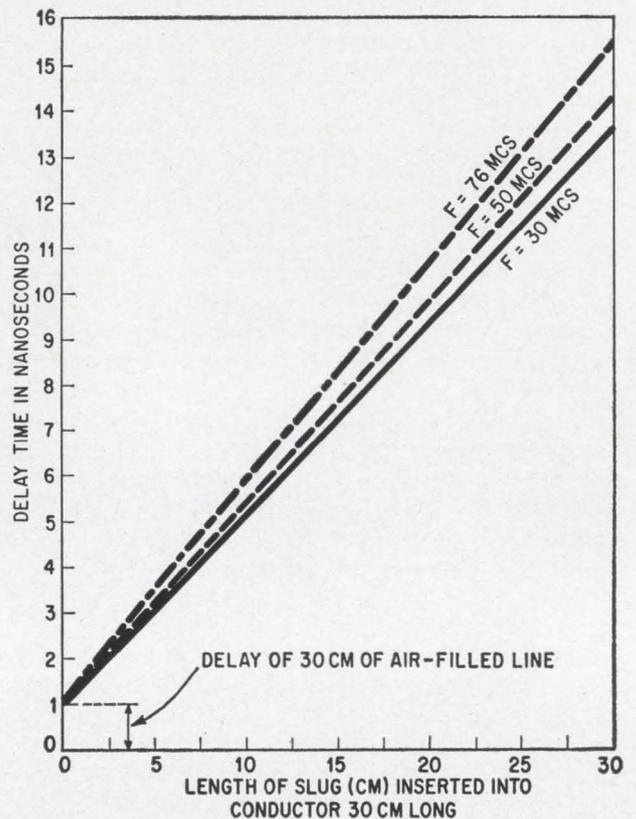

Time delay of line stretcher versus length of inserted ferrite-ceramic slug measured at three frequencies. Time delay varies with frequency probably because permeability of the ferrite in the slug begins to show a dependence on frequency at around 30 Mc.

1/9 the propagation velocity of free space.

The propagation velocity can be reduced further by alternately stacking disks of ferrite and high-permittivity ceramic. The disks can be made very thin to simulate a uniform line. The effective permeability and dielectric constant of a combination of materials, μ_s and ϵ_s , are the weighted averages of the respective values of the two materials. The weighting factor is the ratio of the thickness of ceramic to ferrite. The product ($\mu_s \epsilon_s$) is a measure of the delay.

The ceramic material is titanium dioxide with $\epsilon_R = 85$, and the slotwidth is about 11° . The product ($\mu_s \epsilon_s$) reaches a maximum 1.5 times higher than ($\mu_F \epsilon_F$).

The ratio μ_s / ϵ_s decreases with the thickness ratio and is a measure of the characteristic impedance. The ratio (μ_s / ϵ_s) equals unity at about the same thickness ratio for which the product ($\mu_s \epsilon_s$) is a maximum. This coincidence can always be achieved by proper selection of materials and dimensions.

The maximum delay for the experimental 30-inch line was measured at about 13 nanoseconds. The minimum delay was one nanosecond (propagation

in free space). At constant frequency, the measured deviation from linearity between the time delay and slug position was less than 0.3 nanosecond. The measured delay increased about 14% with frequency over the range of 30 to 76 Mc. Standing wave ratio measurements indicated that the

characteristic impedance was higher than 50 ohms and was slightly frequency dependent. The unit itself has a vswr less than 1.05.

Attenuation measurements at each of three frequencies were 0.005 db/ns at 30 Mc, 0.018 db/ns at 50 Mc, and 0.18 db/ns at 76 Mc.

Foil and styrofoam polarize radar beam

By H.E. Ober and J.J. Hartka

Applied Physics Laboratory, Johns Hopkins University,
Silver Spring, Md.

Targets can be more clearly distinguished from their immediate environment with a radar beam whose polarization is variable. For example, such a beam makes it easier to detect an airplane flying through clouds, or above rolling ocean waves. A noncoherent radar beam can be polarized by a lens mounted directly in front of the antenna.

A polarizing lens can be assembled from inexpensive materials to provide a means of building a variety of experimental lenses of different shapes. The lens consists of evenly spaced, parallel metal strips—similar to the slats of an open venetian blind. Width and spacing of the strips is a function of the radar operating frequency; number and length of strips is determined by beamwidth.

The strips should be as thin as is practical, although this dimension is not critical. Aluminum foil strips from adhesive backed rolls are suitable. Because it has no mechanical strength, the foil must be rigidly supported by a dielectric that introduces little attenuation in the lens. The support maintains accurate spacing between the parallel foil strips. The spacer in the experimental lens in the photo at right, is styrofoam—a low-loss dielectric.

To assemble the lens, the masking is stripped from the foil's adhesive backing and the foil is pressed on to the Styrofoam support. Then a strip of masking tape with adhesive on both sides is placed over the foil tape. Each sandwich—Styrofoam, aluminum foil and masking tape—is an element of the polarizing lens.

To assure minimum bending, the elements are laid on a flat surface with the foil side perpendicular to the surface. The protective paper backing is stripped from the masking tape of an element and the elements are pressed together to form a lens assembly. The complete lens is enclosed in a frame that protects the foam edges and mechani-

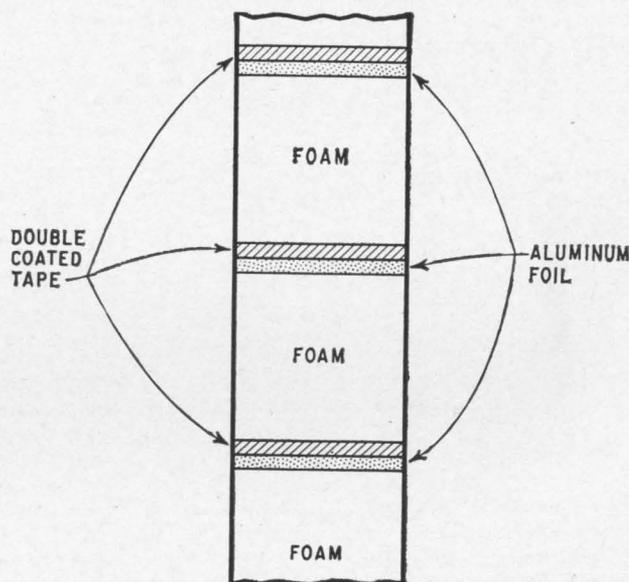

Styrofoam in a lens "sandwich" can be easily cut to tolerances of 0.01 inches for accurate spacing between foil strips. Strip width and spacing is a function of the radar frequency.

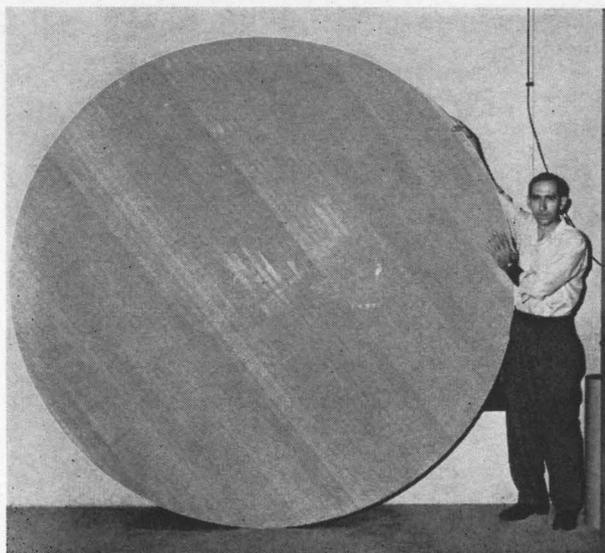

Circular lens is simple, cheap and lightweight, and can be rotated to obtain any degree of polarization.

cally strengthens the unit. The circular lens is suitable for varying polarization because it can be easily rotated.

Detonators that tune out stray r-f

Ferrites can absorb radiation that might fire or degrade electroexplosive devices. Using a new technique, it is now possible to build the attenuator right into the lead without appreciably increasing its size

By Stanley M. Adelman Sr.

Picatinny Arsenal, Dover, N.J.

The "no radios allowed" signs seen at blasting sites are just one protection against the premature firing of a detonator by stray r-f radiation. Electroexplosive devices, which can deteriorate under such radiation if they do not actually go off, can be guarded by shields, filters, and attenuators. The latter approach works best, but until recently it has been difficult to make the ferrite attenuators that are useful for lower frequencies without greatly increasing the size of the device. Now a joint effort by the Picatinny Arsenal and the Franklin Institute in Philadelphia has produced an assembly technique so successful that Picatinny is incorporating ferrite attenuators in many Army electroexplosive devices.

Both industry and the military have been investigating the problem of keeping r-f signals away from detonators. Industry uses the devices in excavation and demolition work, in seismic research and metalworking, and in oil drilling. The military puts them in everything from blasting caps to ICBMs—and the missile men use the devices at launch sites surrounded by radars that are powerful sources of radio-frequency radiation.

Filtering the signal

The best way to overcome the spurious radiation is to absorb the r-f energy as it passes through the

Author



Stanley M. Adelman has worked in ammunition research since 1951. Now project officer at the Ammunition Engineering Directorate, Picatinny Arsenal, Dover, N.J., he directs a group engaged in design and development of initiators, initiation systems and destruct systems, and the protection of electroexplosive devices from electrical hazards.

lead wires of the detonator, without affecting the firing current. An attenuator can be substituted for the usual plastic plug through which the lead wires pass.

The first material successfully used as an r-f attenuator for electroexplosive devices was powdered iron, coated with iron phosphate. The material was compressed into a plug, and then directly substituted for the end plug in the T24E1 (shown on page 77), one of the smallest detonators in the armament inventory. When subjected to performance, stability and environmental tests, the device kept the same detonating characteristics. Larger

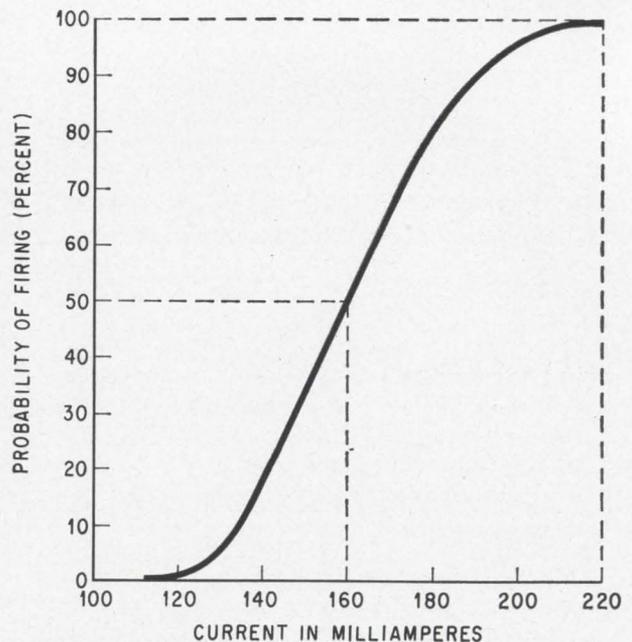

Reliability vs. firing current for a hypothetical electroexplosive device. A current decrease of only 60 milliamperes reduces firing probability to 50%.

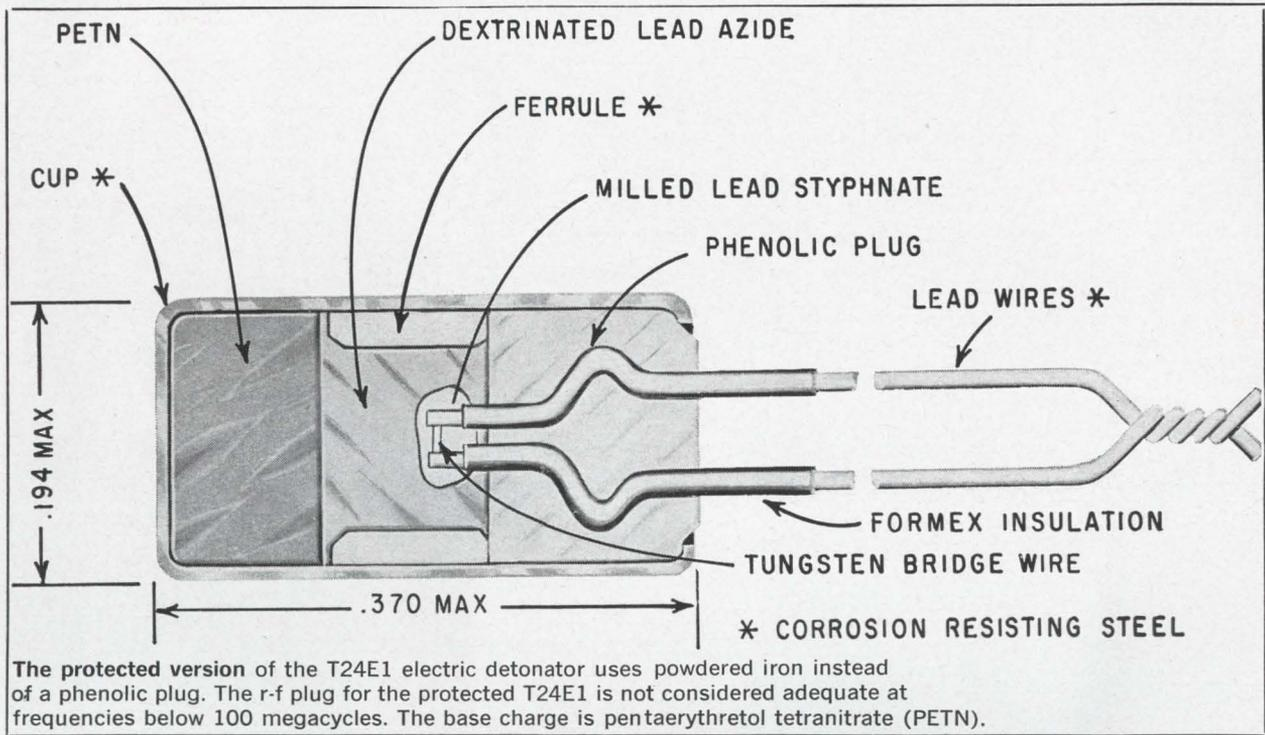

devices were also tested with powdered iron plugs, and comparable results were obtained.

The curve in the graph at left shows that for typical powdered iron plugs, the higher the frequency, the greater the attenuation. However, the powdered iron plug cannot provide protection below 50 megacycles unless the device is made bigger. Also, this method does not have good voltage breakdown or insulation resistance characteristics.

Ferrites take the low road

For some time ferrites have been considered a likely source of r-f attenuating materials, especially at the lower frequencies. [Electronics, May 17, p. 65.] Tests have been conducted to determine performance characteristics of carbonyl iron and a typical ferrite (manganese-zinc). The table at left indicates that ferrites are more suitable than iron for r-f attenuators, at both low and high frequencies.

But ferrites do present a problem of assembly. Powdered iron is readily molded over the lead wires, and wire breakage is rare even though extremely high pressures are required during the assembly process. The same assembly technique cannot be used for ferrites because the high curing temperatures required can melt most lead wires.

Beads do the trick

The Picatinny-Franklin Institute method calls for the use of ferrite beads about 0.1 inch long and 0.1 inch in diameter, each having an annular cavity slightly larger in diameter than the lead wire. These beads are silver-plated and fired at 1,200-1,400°C. They are slipped inside a lead zirconate or barium titanate ceramic sleeve that has also been silver-plated and fired, and bonded to the ceramic with a conductive silver-filled epoxy cement. The electric

Comparison of powdered iron and ferrite attenuators

	Iron	Iron with insulation	Ferrite	Ferrite with insulation
Resistance (ohms)	10 ⁶	infinite	100	infinite
Breakdown voltage	30 v	1500 v	—	1500 v
α at 1 Mc	0.01	0.01	4	0.8
α at 10 Mc	0.25	0.25	34	7.5
α at 100 Mc	6	6	160	52
α at 500 Mc	50	50	170	100
Temperature	65° F to 300° F		65° F to 500° F	
Effect on capacitor discharge	none	none	shunts load	none
Effect on square wave pulse	none	none	shunts load	none

* α = attenuation in db/cm

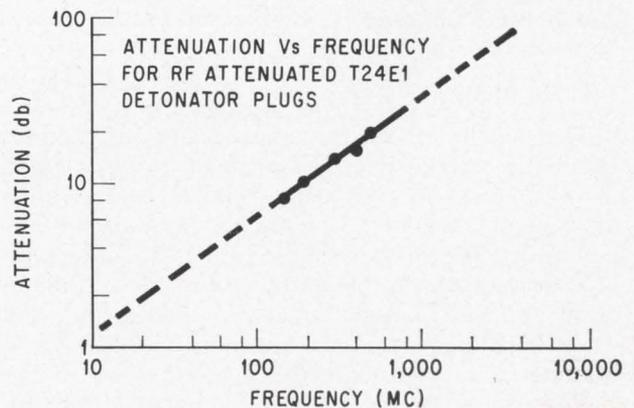

Powdered iron in the T24E1 detonator is effective only between 150 and 600 Mcs. The dashed line are extrapolated values.

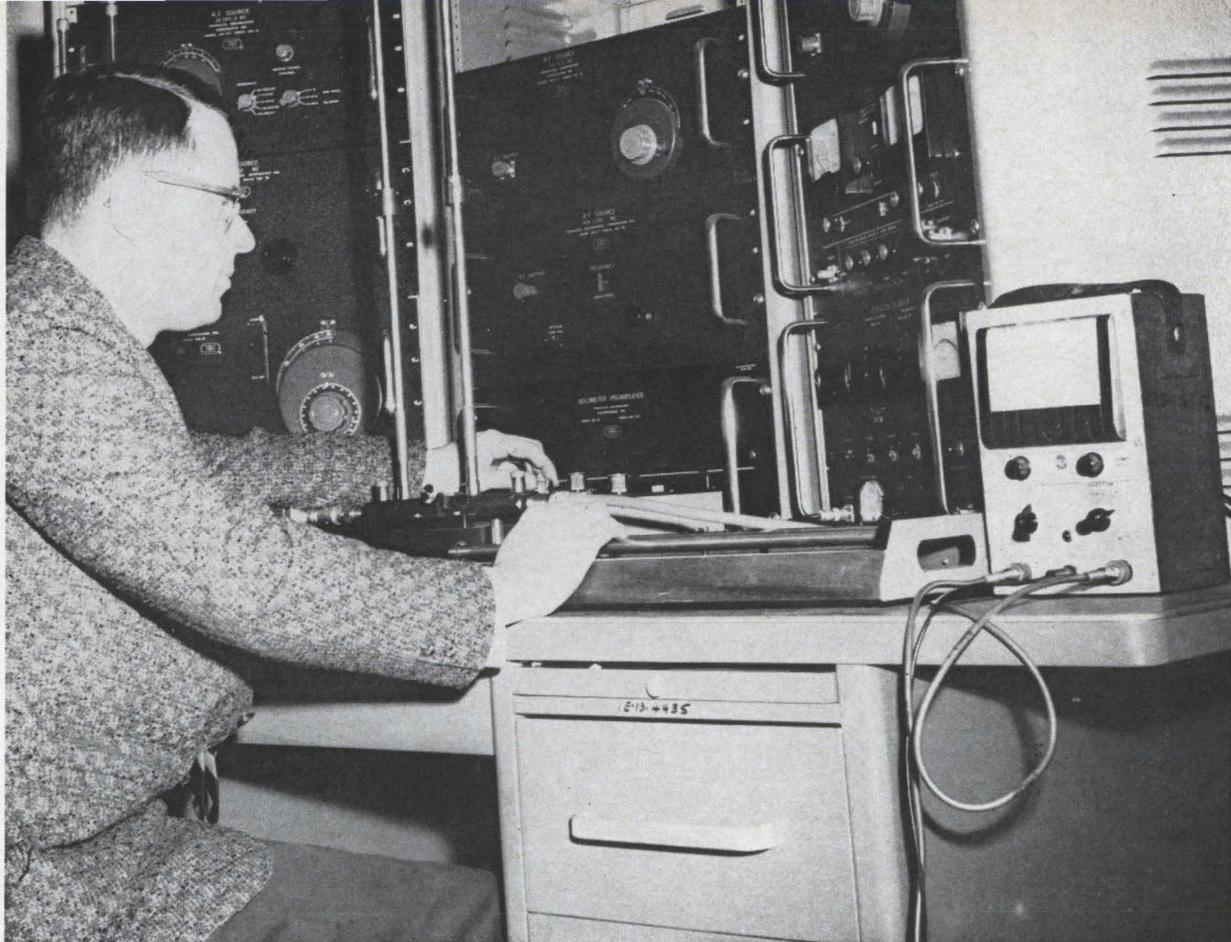

New, highly accurate calibration equipment at Picatinny Arsenal measures r-f attenuation as high as 70 db. quickly and simply.

lead-in wires are bonded in turn to the assemblies with a conductive silver-filled cement. A thin Teflon washer is placed between each assembly.

The entire assembly—the electrical conductor, ferrite beads and ceramic insulators and washers—forms one lead for the detonator. Two such assemblies are placed into the attenuator body, which is also of conductive material. During the curing process a special fixture exerts pressure on the end beads. This prevents the epoxy from leaking and short-circuiting the attenuator. The figure on page 79 shows a ferrite device designed to protect squib switches. Such attenuators are now being made in production quantities by Culbertson Products, Inc., in Bernardsville, N. J.

Inching along

This type of attenuator is now being designed for use with explosive switches of the type used in many missiles. A typical mechanical configuration allows one inch of space for the attenuator. The amount of ferrite used here results in 17 decibels of attenuation at 10 Mc and about 1.8 db of attenuation at 1 Mc. Larger devices, 3 inches long and $\frac{3}{4}$ inch in diameter, have resulted in 70 db of r-f attenuation at 10 Mc and 10 db at 1 Mc.

The use of presently available ferrites and improved application techniques should eventually make possible adequate r-f protection down to about 100 kilocycles.

Shielding helps

Detonators should be shielded wherever possible. However, it is extremely difficult to maintain a completely effective r-f shield, since access to the device is necessary to provide a firing current. For example, a shielding of a missile by means of an r-f tight skin, with soldered joints or gasketing of silver or copper woven strands, has limitations because of the necessity for providing access doors to circuits to make settings and checks.

If the devices were made so insensitive that they required extremely large firing currents, the danger of r-f interference would be reduced, but large and heavy power supplies would be needed to supply the firing current. This method is impractical in most cases; but even when it is used, devices can be fired or desensitized by prolonged r-f radiation exposure or arc-over.

Firing sensitivity

Before attempting to design protection against radiation into a particular electroexplosive device it is necessary to determine its sensitivity to d-c and r-f stimuli.

The response to radiation can be determined in the laboratory by making the device a part of a matched transmission line. R-f power is then fed from a transmitter directly to the lead wires. Because the system is matched, maximum power

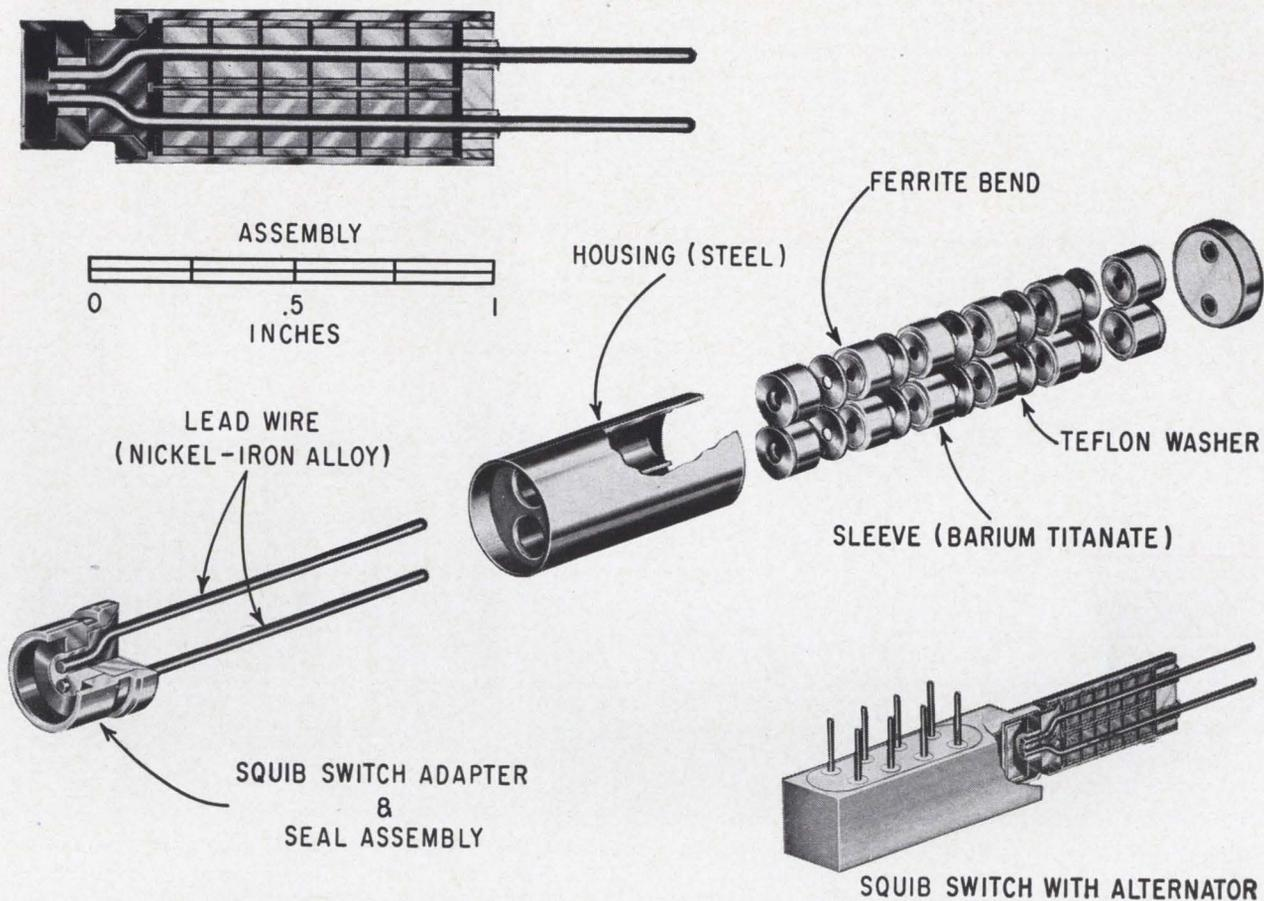

Stacked ferrite beads with Teflon washer separators attenuate r-f before it gets into squib switches.

transfer is obtained. Although this is the best possible arrangement for firing, it is the worst from the standpoint of reliability and safety. Fortunately, in an actual weapon, the chance of achieving such an impedance match is remote.

The usefulness of the test lies in its ability to establish the sensitivity of the device to r-f stimuli, and to establish firing thresholds.

Since the impedance of the transmission line is known and that of the device (typically about 0.1 ohm) is measurable, the power reflected can be calculated by using the following equation:

$$V_R = \frac{Z_L - Z_o}{Z_L + Z_o} = \frac{1.0 - 50}{1.0 + 50} = -0.98$$

$$P_R = V_R^2 = (-0.98)^2 = 0.9604 = 96.04\%$$

Releasing the energy

An electroexplosive device is a highly concentrated source of energy which is fired by an electrical signal. In its simplest form, the device consists of a firing circuit, a power source, bridgewire (or resistance), lead wires and explosive charges. The electroexplosive is fired when current passing through the bridgewire heats it, and causes a thin film of heat-sensitive explosive wrapped around the bridgewire to be raised to ignition temperature. When this explosive, the spot charge, detonates, a shock is generated that ignites a less sensitive priming charge, which in turn fires the base charge.

When a continuous source of r-f radiation encounters the lead wires or associated circuitry of an electroexplosive device, current is induced which passes through the circuit and eventually through the bridgewire. The current level is related to the intensity of radiation, the efficiency of the antenna structure

(represented by the lead wires and circuits), the impedance match between the antenna and load, and the reflective or absorptive losses. If the frequency of the r-f radiation is one to which the antenna structures respond efficiently, and the intensity of the radiation is high enough to overcome losses in the circuit and still approximate the firing requirement for the electroexplosive device, the consequence may be loss of life or property damage, or both.

If the current remains below the firing level, but is applied for some time, desensitization of the spot charge or changes in the bridgewire may take place, and the device will become unreliable. Detonators which fail to fire not only result in expensive time delays, but also increase the danger to personnel, since they must be removed and replaced.

Pulsed radar signals may also be a hazard even if the current induced is well below the danger level. The heat generated during the pulse cannot be entirely dissipated in the time between pulses. Thermal stacking can cause the charge to be either desensitized or fired.

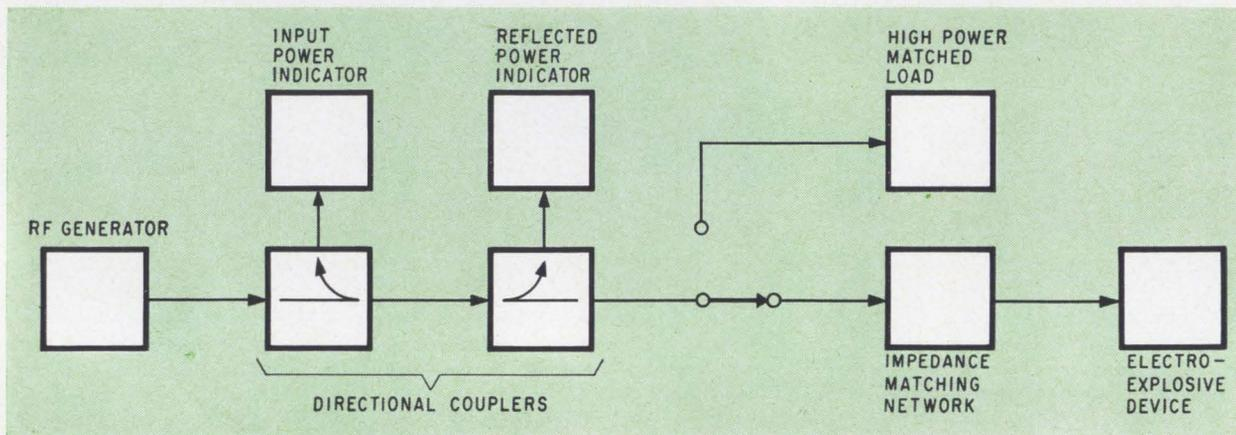
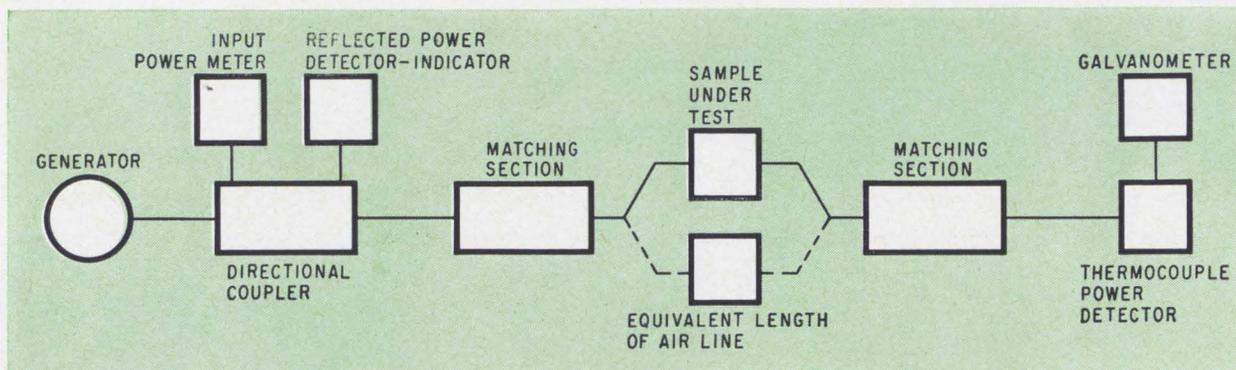

Attenuation of ferrite and powdered iron samples were measured by the "sample substitution" technique shown in the diagram at the top. Sample attenuation is the difference in the galvanometer power reading when an air line or sample is inserted in the system. The system in the lower diagram measures the r-f power necessary to fire the electroexplosive devices by comparing r-f power levels in ideal and real loads.

Where:

- V_R = Voltage reflection coefficient
- Z_L = Input impedance of electroexplosive device
- Z_o = Characteristic impedance of transmission line
- P_R = Power reflection coefficient

This indicates that a maximum of only 3.96% of the power actually reaches the bridgewire.

The influence of r-f radiation on sensitivity is determined by subjecting the electroexplosive device to r-f energy below the firing level, and then evaluating it for d-c firing sensitivity. Such tests have shown that electroexplosive devices may become less sensitive after exposure to r-f; thus the reliability of any weapon, warhead, or missile using the device may be degraded if it has been exposed to r-f radiation.

High performance tests

To assess the performance of materials and devices as r-f attenuators, the arrangement shown in the diagram above has been used. It permits the precise determination of power loss in the material or device without the inaccuracy introduced by mismatched impedances. Attenuation values of 60 db have been claimed by manufacturers on the basis of insertion loss measurements. That figure included the reflected power resulting from impedance mismatch. Attenuation measurements at Pica-

tinny have shown the actual values to be as low as 3 db or less in some cases.

Complex design problems

The design of r-f suppression methods would be relatively simple if the r-f environment in which the electroexplosive must survive could be completely defined. The frequencies and power output of r-f transmitters such as tracking radars, command and guidance equipment, telemetry, and other similar equipment which are part of a particular system are known, and the intensity of the emitted wave at a particular point in space may be calculated or measured. However, there may be other sources of radiation whose frequencies are not known. The goal is to provide r-f protection against radiating devices whose frequencies are in the range of 10 kilocycles to 40 gigacycles.

Filters can give protection, but they may be resonant at certain frequencies at which r-f energy would be unimpeded. Also, since filters tend to spread out the energy in the d-c firing pulse, reliability of the device may be impaired. For many electroexplosive devices, the current level that corresponds to low firing probability is not widely separated from the high probability level. Relatively small changes in current may result in a significant reduction in reliability (see graph, p. 76). However, filters are useful at specific frequencies.

From Japan, a startling new color tv set

With a single gun tube and solid state circuitry, this 7½-inch set boasts economy and simplicity of design

By Yasumasa Sugihara, Hisao Ito, and Akira Horaguchi

Yaou Electric Co. Ltd.,
Kanagawa, Japan

There's big news in the small all-transistor color television set developed by the Yaou Electric Co. of Japan. Called the Colornet, it is the first such set in the world. Both its 7½-inch color picture tube and its method of color presentation are markedly different from those of conventional color receivers.

The picture tube, for example, has one electron gun that presents the red, blue and green information sequentially. Conventional three-gun shadow mask tubes present all three colors simultaneously. With the exception of the high voltage rectifiers and picture tube, the new receiver has no vacuum tubes. Power consumption has been held to 30 watts from an a-c supply, 20 watts when operated from d-c. Shadow mask sets use about ten times more power.

Two views of the 16-pound receiver are at the right. The color picture tube, called the Colornetron, is one version of the Lawrence tube developed independently at the Kobe Kogyo Corp. Yaou gets its Colornetron tubes from Kobe Kogyo. Another version of the Lawrence tube, the Chromatron, is used in the Sony Corp.'s color tv sets. However, Sony manufactures its own color tubes.

Problem of purity

Like the Chromatron, the Colornetron has one electron gun which horizontally scans very narrow vertical stripes of red, blue, and green phosphors. The voltage across two coplanar fine-wire grids behind the stripes switch the electron beam to the appropriate phosphor.

Differences between the Colornetron and the Chromatron are primarily in the method of fabrication and the method of assuring color purity [Electronics, June 1, 1964, p. 86].

In the Chromatron, to guarantee purity—which means to assure that the electron beam will always

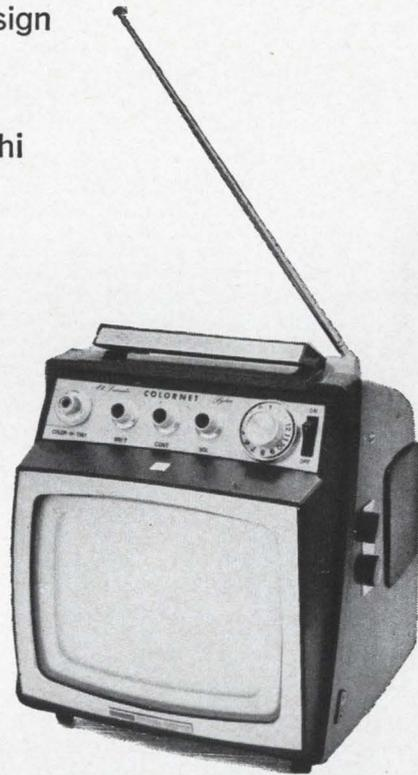

Colornet set is designed to sell initially for approximately \$385. It will be introduced this summer in Japan and in the fall in the United States. With increased production about a year later, Yaou plans to drop the price to \$275.

Rear of compact Yaou set with cabinet removed shows the density of the solid state circuitry. The 16-pound receiver measures about 9.4 inches wide, 10.2 inches high and 10.5 inches deep.

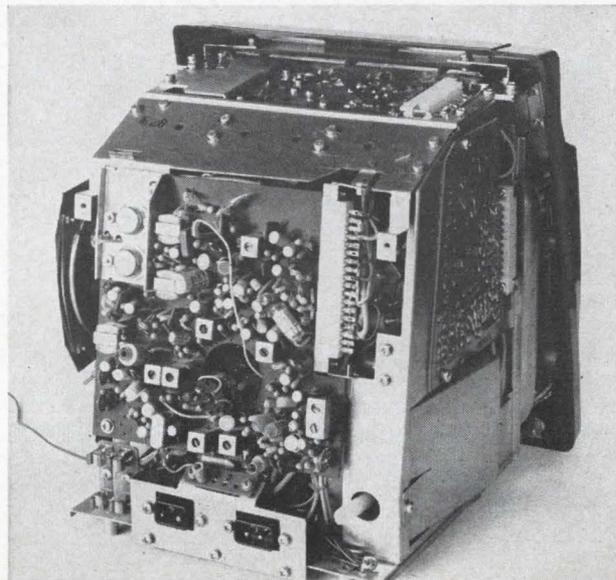

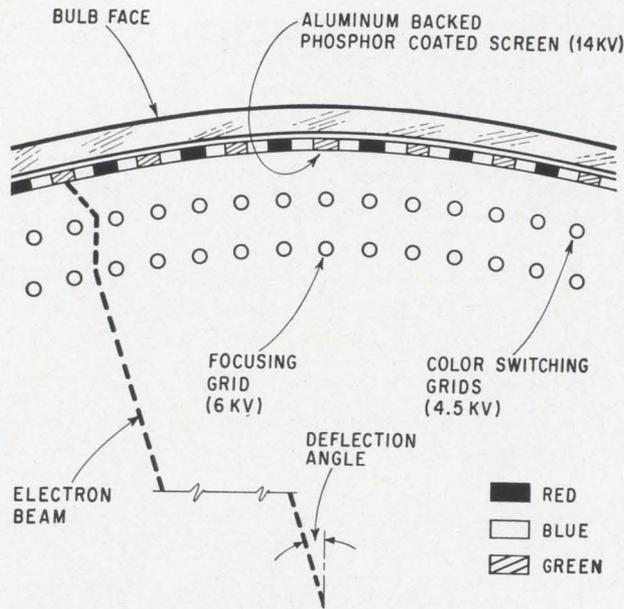

Color purity in the Colornetron tube is assured because of the focusing grid. The approach of the electron beam to the screen is always the same regardless of its deflection angle. The potential between the color switching grids then determines which colored phosphor the beam will strike.

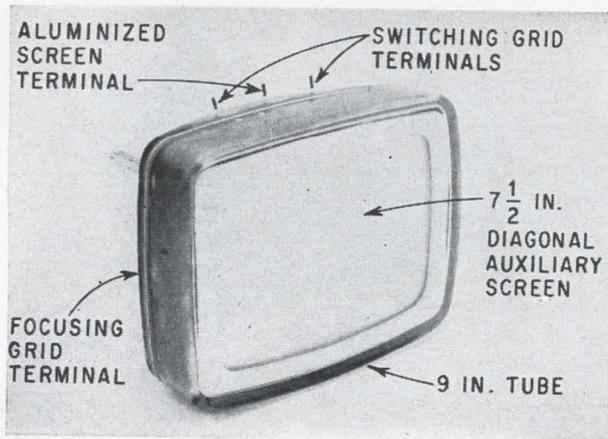

Phosphors are applied to a 7½-inch screen which is then put in this standard black-and-white nine-inch tv bulb. The tube was developed by the Kobe Kogyo Corp. of Japan.

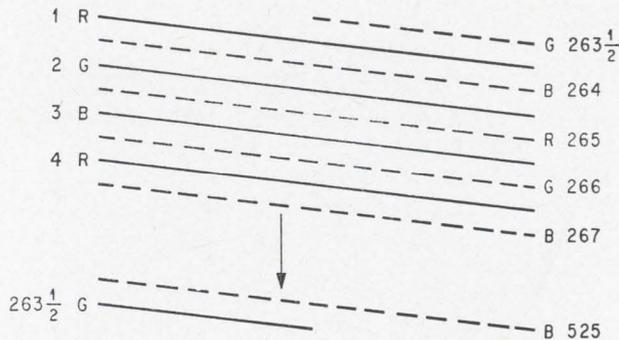

Line sequential scanning sequence is shown above. The solid lines represent the first scanned field; the dotted lines, the second. Notice that even with interlocking scans, each color is repeated every third line.

hit the right phosphor—the tube's own electron beam is used to bake on each phosphor in the appropriate position. For instance, to deposit the red phosphor, the inside of the tube is coated with phosphor, and then evacuated. The voltage representing red is then applied to the color switching grid and the electron beam is made to scan the screen. The red phosphor will stick only on that portion of the screen that has been scanned. For each color, the tube must be evacuated to deposit a phosphor and then opened again to wash out the excess phosphor.

Kobe Kogyo eliminates this expensive process by depositing the phosphors on an auxiliary glass plate outside of the tube and using masked ultraviolet light to bake on the phosphor stripes. They solve the problem of purity with a special wire focusing grid directly behind the color switching grid. The focus grid makes each electron's angle of approach to the screen the same, regardless of the angle of beam deflection. The illustration at the left shows how the focus grid works.

The screen—7½ inches across—is installed in a standard, inexpensive, 9-inch, 90° bulb (shown at the left) commonly used in Japanese black and white sets.

Change of center

Originally, Colornetron tubes had a red-centered color stripe pattern; that is, every other stripe was red. Color order was red-blue-red-green-red-blue-red-green. But a red-centered pattern will not give a truly white level for black and white picture reception. Instead, the screen tends to have a low color temperature resembling warm-white fluorescent bulbs.

Yaou feared that its customers might not accept a picture that differed greatly from the normal blue-white of conventional sets. The red fluorescent phosphor was changed from a low-efficiency zinc-phosphate phosphor to a higher efficiency zinc sulphide phosphor. As a result, Colornetron tubes now have a blue-centered pattern.

Switching the colors

With the blue-centered pattern, color switching grid wires lie over the red and green stripes. There is one terminal for the wires over the red stripes and another for those over the green stripes. The voltage applied between these two terminals determines which color the electrons will strike.

Red, green and blue signals are sampled sequentially to modulate the electron beam. In the same sequence, the voltage between the grids is switched so that each color signal illuminates only its respective colored phosphor.

The Colornetron is operated line sequentially. That means that color is switched after a line is scanned. The colors are scanned in the order, red, green, blue, as shown in the diagram (left). The solid lines represent the first field, the dotted lines the second field.

In the Sony Chromatron set, color switching is



Scene photographed from the Yaou receiver shows how horizontal scanning across vertical phosphor stripes produces net-like appearance; hence the name, Colornet.

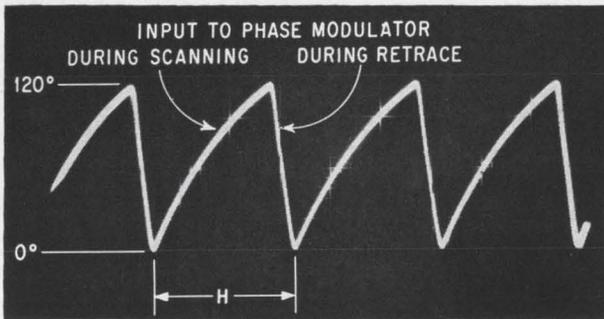

Sawtooth wave is the modulating voltage to the phase modulator. During the scanning of one horizontal line, the rise of the sawtooth retards the phase of the local subcarrier 120°; during beam retrace, the modulating voltage drops to zero, allowing the local subcarrier to advance back to 0°.

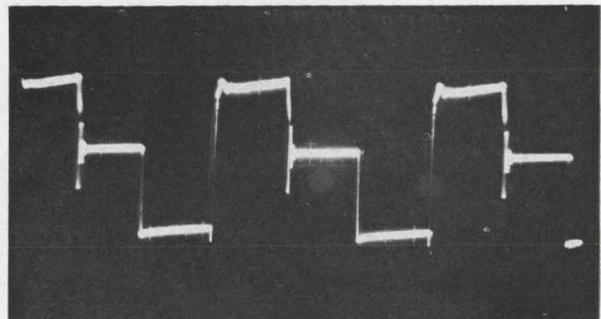

Each step of the staircase voltage when amplified changes the potential between the color switching grids to deflect the electron beam to one of the colored phosphors. The period of the three-step staircase is 3H.

be encountered with transistorized circuits. Also, unlike the dot sequential Chromatron picture tube, there is no problem of spurious radiation from 3.58-Mc switching.

Phosphor spacing

Low power dissipation in the switching grids reduces the possibility that grid wires will heat up and expand. An expanded wire is susceptible to vibration that may cause the wire to bow away from its normal position. A displaced wire may affect color purity or short-circuit neighboring wires.

Even in the Colornetron, grid bowing is a problem that limits the picture definition of the tube. The spacing between phosphor stripes on the screen is limited by the necessary spacing between grid wires. Monochrome resolution, which is approximately 200 lines, is limited by the spacing between phosphor stripes rather than by the bandwidth of the receiver. This can be seen in the photo-

graph of the screen above. In a color picture, the lack of definition is a lot less noticeable.

The Colornet receiver uses many special circuits not found in other color sets. The operation of the complete receiver is described on page 83.

One color demodulator

Hue information phase-modulates the transmitted color subcarrier which is then suppressed at the transmitter. The hue information is then transmitted as the phase angle of the chrominance signal. The constant phase of the color burst, transmitted during the blanking period, serves as a reference. To recover any one color at the receiver, the subcarrier generated in a local oscillator, must be reinserted at the demodulator; and its phase must be shifted to the angle which represents that color. The phase displacement of the local subcarrier is known as the demodulation axis.

An important feature of the Colornetron tv set is the use of only one demodulator rather than two

or three as in conventional color sets.

In a simultaneous color set, to recover all colors, there must be either two demodulators whose axes are at right angles or three demodulators whose axes are at the angles which represent the red, green and blue difference signals.

The Colornet, however, is sequential and only one color need be demodulated at a time. With one demodulator (shown below), the axis is made to change for every horizontal line to recover each primary color.

A major design feature of the Yaou receiver is the simplicity and economy with which the local subcarrier phase, and hence the demodulation axis, is, shifted every line.

Rotation

The local crystal oscillator does not reproduce the transmitted subcarrier frequency exactly. Instead it generates the subcarrier frequency plus one-third the horizontal scanning frequency, $\frac{1}{3} H$. (That is, 3,579,545 plus 5250 cps or 3,584,795 cps). The resulting oscillator output advances 120° in phase each period H with respect to the fixed phase of the color burst. The burst and the local oscillator will, however, be in phase every third line. This is illustrated below.

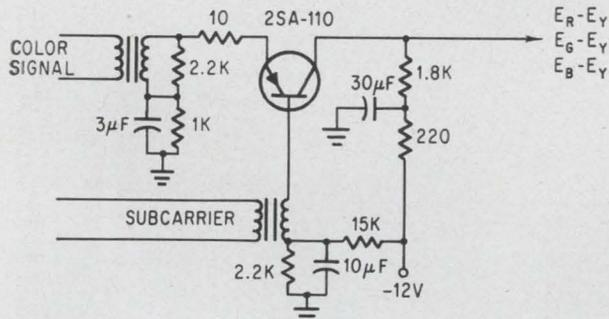

One color demodulator recovers close approximations of all three difference signals in sequence. This is done by impressing the color signal with the local subcarrier which is advanced 120° in phase each line.

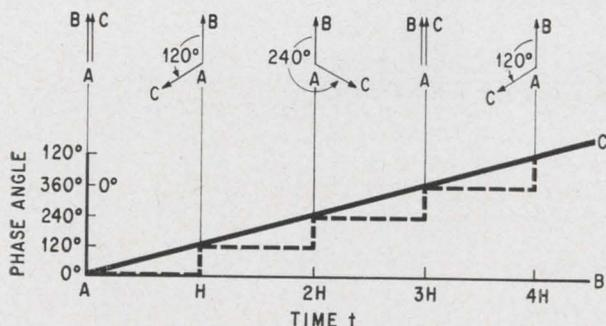

Crystal oscillator output (line AC) advances continuously 120° in phase during each horizontal line (time H) with respect to the transmitted reference subcarrier burst, (line AB). The oscillator's output phase, however, must be kept constant during each time H (as shown by the dotted line and the phasors) to provide axes for demodulation. This is done by phase modulating the oscillator output in the opposite direction to its phase advance for a period H .

Line AC and phasor AC represent the oscillator output phase which advances counter clockwise at the rate of one revolution per $3H$ with respect to the fixed reference color burst AB. However, to demodulate one color per line, the phase must be held constant during each horizontal line scan as shown by the dotted lines. Holding the phase constant for period H establishes axes for demodulation.

To keep the phase of AC constant for one horizontal scan, the oscillator output is retarded clockwise in a phase modulator at the same rate that it is advancing counterclockwise with respect to AB. The input to the phase modulator is a sawtooth wave whose period is H , as shown on page 84. The rise of the sawtooth retards AC to a maximum of 120° during horizontal scanning. The second part of the sawtooth advances AC quickly to its unmodulated position during beam retrace. In this way AC moves in 120° steps with respect to AB.

The Yaou receiver, therefore, demodulates the chrominance signal each horizontal line along axes which are 120° apart. These are very close approximations of the axes of the original difference signals.

The small difference in frequency between the local oscillator and the transmitted reference subcarrier does not affect the demodulation process. If the oscillator reproduced the exact subcarrier frequency, the receiver would require a phase modulator for the local subcarrier capable of shifting the phase by a maximum of 240° to provide the three demodulation axes. In its present form, the phase modulator need only shift the phase of the local subcarrier a maximum of 120° , resulting in much simpler circuitry.

The authors have built an experimental receiver which operates at the same frequency as the subcarrier and which demodulates exactly on the color difference axes. The experimental receiver, though considerably more expensive, did not perform significantly better.

The color switching circuitry, which switches the voltage on the color grids, consists of a staircase wave generator whose output wave shape is shown in the photograph on page 84 and an amplifying circuit that raises the voltage change to 100 volts per step. The amplified staircase rides on a 4.5 Kv d-c voltage. The staircase wave generator also generates the $3H$ gate pulse used to synchronize the oscillator.

No degaussing necessary

Of major concern to manufacturers of portable color tv sets are the effects of the earth's magnetic field. In the Colornet receiver, the phosphor is deposited in the form of vertical stripes. As the set is moved in a horizontal direction the earth's magnetic field causes a slight deflection of the electron beam in the vertical direction. Thus, the entire image slides a very small amount in a vertical direction. This effect is not noticeable, so the set may be moved around at will.

From communication centers in the U.S. . . .

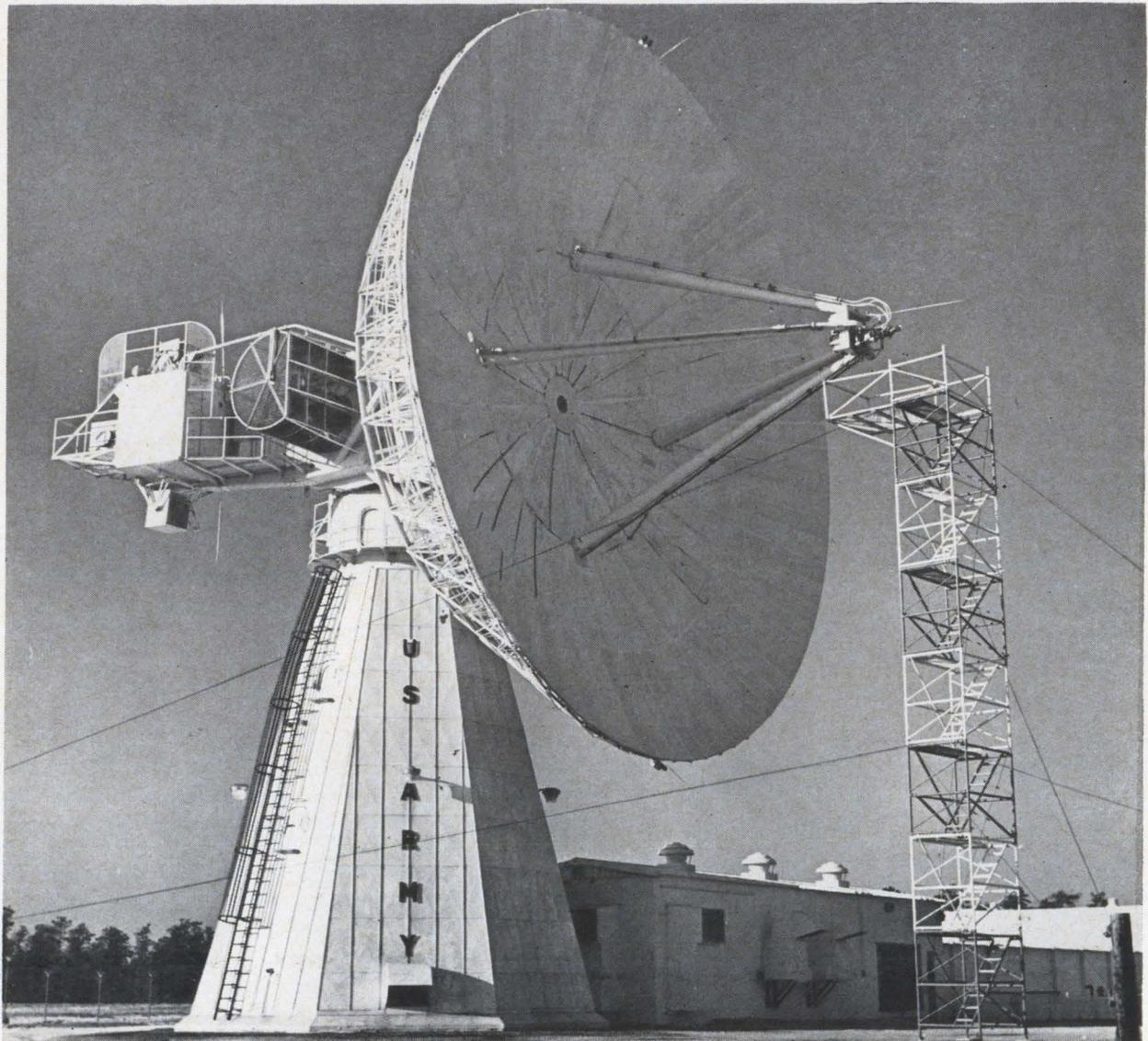

Army lays the groundwork for satellite communications

Soon the Pentagon will be able to dial an outpost as if it were next door, using a 24-satellite system. Work has already begun on a network of 11 ground stations

By John F. Mason
Military Electronics Editor

... to jungle outposts



▲ The 15-foot Mark IV (X) antenna was flown by one C-130 to Saigon, and set up within hours to communicate with Syncom. Eventually, the Army hopes to have antennas for satellite communication much smaller than this one.

◀ The 60-foot AN/FSC-9 at Fort Dix, N.J., and its twin at Cape Roberts, will be modified to operate with the new military communications satellite system. The two rings around the center hole will be removed and a pylon installed which will carry the new 7- and 8-Gc feed horns, preamplifiers, and diplexers. A Cassegrain subreflector will also be installed just inboard of the present feed.

When North Vietnamese patrol boats fired torpedoes at U.S. ships in the Bay of Tonkin last summer, Pentagon brass found their normal high frequency radio channels to Saigon cut off by atmospheric disturbances, something that happens often in that part of the world. Fortunately, the National Aeronautics and Space Administration's Syncom II satellite was available; it supplied the only operating circuit between Saigon and Washington, via the Army Materiel Command facility at Fort Monmouth, N.J.

During that crisis, satellite communications performed so well that Defense Secretary Robert S. McNamara abandoned the idea of using the Communications Satellite Corp.'s system and decided to proceed with an all-military network. The 24 satellites will be orbited by three Titan C boosters next year; but work on the ground stations is already under way.

In carefully selected locations around the earth, many of them secret, the first network of 11 stations is coming into being. Three stations, now being used with NASA's Syncom II and III satellites, will be modified for military use. The remaining eight are being built from scratch by the Hughes Aircraft Co. In charge of developing the surface terminals is the U.S. Army Satellite Communications Agency, an organization set up by the Army Materiel Command.

Unquestionably, the thorniest technical problems are posed by the military's requirement for multiple access. The satellite will have to receive many signals transmitted simultaneously from a number of independent stations, while Syncom satellites operate in a simple duplex mode over a single channel.

The system has to have a capacity of about 60 multiplexed 4-kilocycle channels. Because each satellite is really a simple frequency translator, to relay speech, printed messages, facsimile and data in both analog and digital form, most of the complexity is in the ground stations.

Since Syncom II went up on July 26, 1963 and Syncom III on Aug. 19, 1964, military ground stations have logged more than 11,000 hours of communications time with them. All results went to SatCom, thus providing the engineers there with experience that has resulted in the redesign of many electronic components.

Station modifications

Two of the stations to be modified are fixed AN/FSC-9 terminals with 60-foot antennas and 20-kilowatt transmitters—one at Fort Dix, N. J., and the other at Camp Roberts, Calif.

Radiation, Inc., is under contract to the Army Materiel Command to modify these units.

The major modification will be to switch to the new frequencies: 7.9 to 8.4 Gc to transmit, and 7.25 to 7.75 Gc to receive. A Cassegrainian feed with a removable subreflector located just inboard of the existing primary focus feed will be installed to provide the new operating frequency ranges.

A unique feature of the design is that the new subreflector is transparent to 400 megacycles and therefore permits simultaneous use of the 400-Mc telemetry frequency from the primary focus feed with the new satellite communications frequencies from the Cassegrainian feed. The Syncom frequencies will be retained (7.3 Gc for transmitting and 1.8 Gc for receiving) and can be used by removing the subreflector and switching the transmission lines for the Cassegrainian feed to the primary focus feed.

The new Cassegrainian feed will utilize a pseudomonopulse system for generating automatic tracking information. The first r-f amplifier will be a cryogenically cooled parametric device located in the new feed assembly. After further amplification by a low-noise traveling wave tube, the re-

The control center will look very much like this test operations center at Fort Monmouth. The big figure 8 on the illuminated map shows the positions of both Syncom satellites at all times. Via one or both of these satellites, Saigon can be dialed as easily as a local telephone number.

ceived signal will be translated to the 1.8-Gc band to make use of the existing antenna rotary joints. After being brought down from the antenna, the 1.8-Gc signal will be converted to an i-f frequency of 70 Mc for use by the communications receivers.

The existing transmitter exciter is being replaced by a broad-band exciter that will provide the transmit frequencies for Syncom as well as for the military satellites. The 20-kw power amplifier will be modified to cover both transmit bands.

New modulators and demodulators will be supplied by the Hughes Aircraft Co. to be compatible with the new 40-foot antennas. Also to be used in the network is the AN/TSC-55, 15-foot antenna with a 5-kw output in Saigon.

Terminal links now being used with Syncom that might be converted to the military system at a later date are: the transportable AN/MS-C44 with its 30-foot antenna and 30-kilowatt transmitter—one at Clark Air Base, the Philippines, and the other at Asmara, Ethiopia; the AN/MS-C45 with a 30-foot antenna and 10-kw output at Helemano, Hawaii; the 30-foot antenna with a 20-kw output on the USNS Kingsport; and the Mark IV(X) 15-foot inflatable antenna with a 2.5-kw output, also in Saigon.

The new link terminal, designated AN/MS-C46, consists of a 40-foot Cassegrain antenna, with 10-kw output, a dual-wall radome, electronic equipment housed in three modified M-373 cargo vans, and three diesel engine-driven power generators. Minimum antenna gain at 8 Gc is 57 db. Reliability goals are a mean-time-between-failures of 200 hours and mean-time-to-repair of two hours.

Hughes will deliver the first AN/MS-C46 to Fort Monmouth in August, the next one in October, and the remaining six at monthly intervals.

Control center

The control center for the system is the gateway for all Defense Communications System traffic to be transmitted via the satellite. The center will assign individual ground terminals to a particular satellite, and tell the selected ground terminal when and where to find the satellite, and when to switch to a new satellite. A handover system that will do this has not yet been built. Requests for proposals to bid on a contract to design and build a model of such a system have been in at Fort Monmouth for a little more than two weeks.

The center will also indicate when the circuits are inoperative, and it will connect the communications traffic to the ground station via cable or

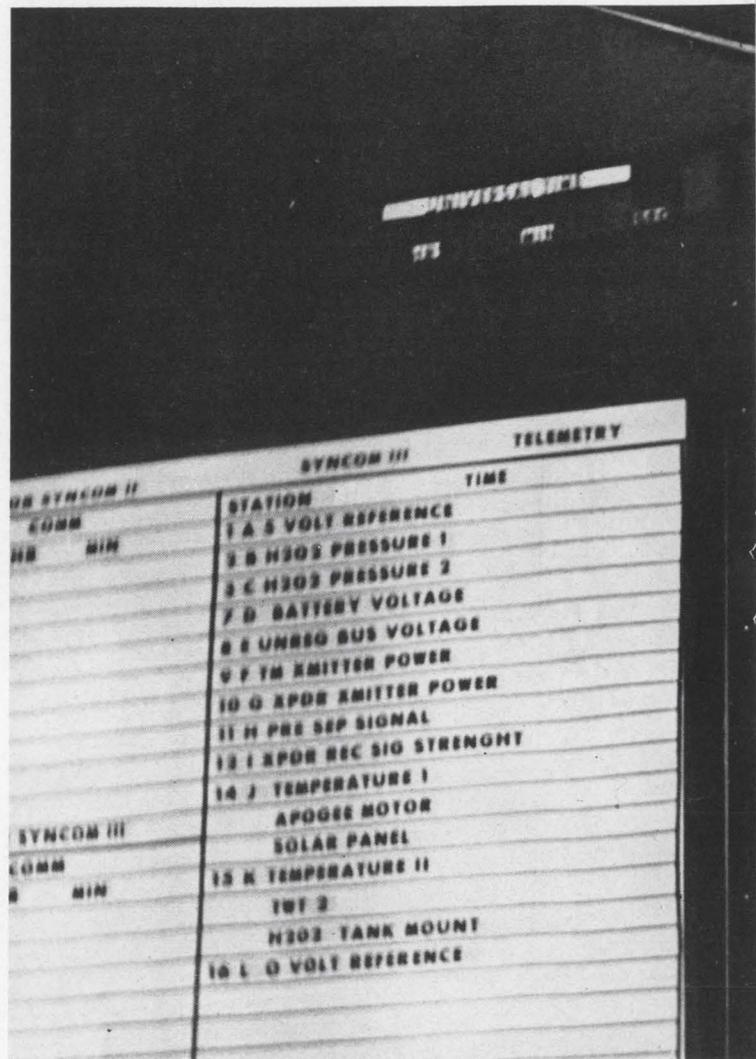

radio. It will provide communication scheduling, technical monitoring, data processing and display.

The control room, which will be similar to the Ft. Monmouth room shown above, will probably be in the Washington, D. C. area.

Multiple access

The military system cannot operate in a simple duplex mode over a single channel, as Syncom does. The military satellite must receive from a number of independent links, signals transmitted simultaneously and sharing the same power. The system will therefore need the 60-odd multiplexed 4-kc channels.

But with this multiple-access system come problems. The signals received at the satellite are unequal. They come from different places and have different path losses. Antennas at various stations vary in size, and the power output is not consistent. The inequality in signal levels is further affected by the hard limiter in the satellite which enhances the stronger signal and suppresses the weaker.

To solve this problem and provide a good balance of signal power, SatCom is investigating



various techniques to control the transmitting output power. A study is being made of all the factors that contribute to the imbalance: up-link and down-link propagation characteristics, the input and output of the satellite, the optimum number of carriers, and the sensitivity of the receiver at various ground sites. Once these measurements are made, SatCom will look at several automatic techniques for balancing the up-link power of the ground terminal so that the satellite output power is shared by the ground terminals for best reception.

Time division multiplexing

A possible alternative to power control to achieve a multiple-access system is the use of time division multiplexing (tdm). With tdm, each ground terminal is assigned an exclusive time slot, in sequence, and only one terminal has access to the satellite at a time.

Tdm requires accurate synchronization of the network to eliminate overlapping or intersymbol interference. Besides precise timing by a worldwide system of clocks, guard times between station transmission are necessary due to variations

in propagation time. To cut the number of guard times, which are dead periods and therefore wasteful, interleaving may be put on a block-by-block basis rather than bit-by-bit. This will be a little more expensive initially, because storage devices will be needed at the transmitter and receiver.

A way to synchronize the ground terminals without clocks is to have the central control station transmit pulses at a stable rate. The satellite retransmits these pulses by means of a separate channel. The signal is received on the ground and after processing becomes the time frame pulse that establishes the zero time from which time slots are assigned.

Other possibilities

SatCom plans to investigate other multiple-access techniques, both orthogonal and nonorthogonal.

Orthogonal systems employ techniques that do not cause any interference between the different users because signals arrive 90° out of phase. The Air Force Eastern Test Range is studying orthogonal techniques for both telemetry and communi-

cations [Electronics, Feb. 22, p. 96].

Nonorthogonal systems use a common time or frequency space with signals superimposed, wholly or in part, and each signal carrying a characteristic signature. Examples of this system are pseudo-noise modulated carriers in the same frequency domain (spread spectrum), pulse coincidence in the same frequency domain, and frequency hopping. These systems will be evaluated from the standpoint of error rate, intelligibility, sensitivity in detecting weak signals, spectrum utilization, rate of transmission, and synchronization.

Making a choice

Present ground terminals operate as fdm/f-m or fdm/p-m systems. Essentially the same, either of the techniques can be used with the aid of pre-emphasis and deemphasis networks. A choice between tdm and fdm will eventually be made. Tdm is attractive because it uses digital techniques; it is also simpler, more readily adaptable to security, amenable to adaptive techniques, and capable of accepting analog traffic as well.

The selection won't be made solely on a comparison of multiplexing techniques, however. Consideration will also be given to the type of modulation and detection to be used.

More work on phase lock and detectors using frequency modulation with feedback for wideband signals, for example, may well improve the quality and quantity of traffic. The whole area of detection will be thoroughly exploited because of its cost and reliability advantages.

The Army will also look into the feasibility of using error detection and correction techniques to protect against random as well as burst errors.

Adaptive communications

A system that will automatically adjust the rate of transmission and the traffic capacity of a system to prevailing conditions would be ideal for communications satellites. A system might automatically trade off carrier-to-noise margin for receiver bandwidth. As the margin improved, bandwidth would automatically increase. For full duplex operation, however, power control would be needed to balance and equalize the received carrier signals at each end of the satellite link.

Automation in the control center, while not planned initially, would enhance the ability to handle the satellite network. Computers will be needed to keep track of satellite positions and advise ground antennas where and when to acquire the satellite.

Electronic components

To obtain higher efficiencies and wider bandwidths than are possible with the klystrons now being used, the Army Electronics Command's laboratory at Monmouth developed a high-power (12.5 kw), X-band traveling wave tube that will be used with the military system. These tubes operate between 7.7 to 8.4 Gc with an efficiency of 21% in the normal mode and 32% in a depressed collector mode over the same band. The life of the tube has not been determined; the goal is 10,000 hours.

Isolating the receiver is a problem because the transmit and receive frequencies are relatively close together and also because link terminal transmitter powers are high (up to 20 kw continuous wave). To alleviate this situation, the Army is developing a preselector designed to result in 90 db rejection

This servo control console for the AN/FSC-9 will be used without modification with the military satellite. The antenna supervisor, Sgt. 1st Cl. Roy L. Canter, can move the 60-foot dish from -5° elevation to $+185^\circ$, with 360° continuous azimuth.

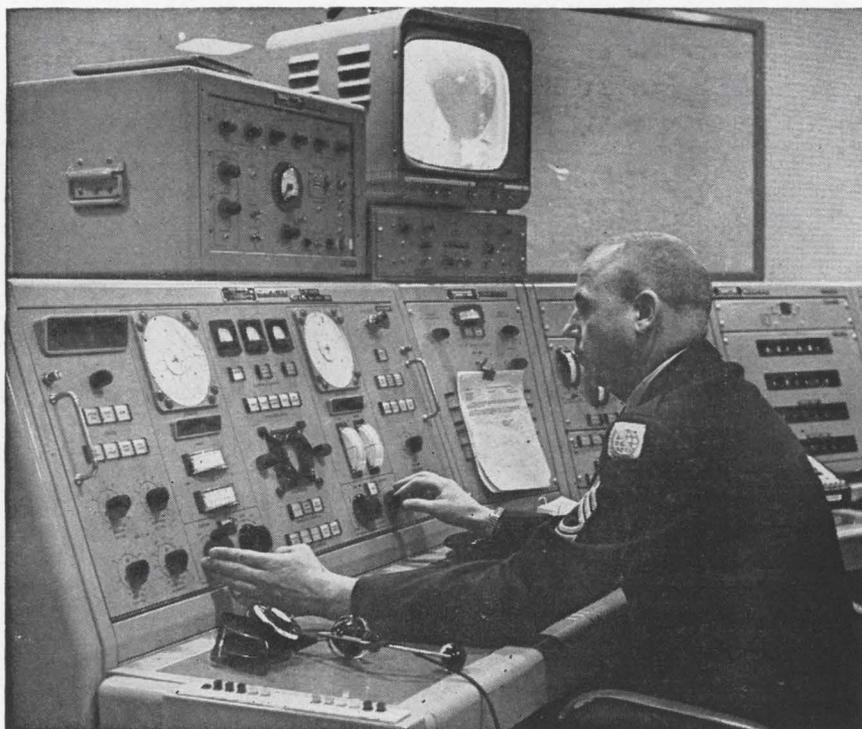

SatCom's experienced team

When the Defense Department finally decided last fall to build its own communication satellite system, research and development of the ground portion was already well under way.

Personnel of the Army's Satellite Communication Agency (SatCom) at Fort Monmouth, N.J. had been working on this job since SatCom's formation in August, 1962, and on the Advent communications satellite program—both satellite and ground portion—since Sept. 1960. On the Advent program, the group was called the Army Advent Management Agency.

It was when Advent ran into technological trouble and the program was canceled that the agency's name was changed, and it was made responsible for the ground stations only. The Air Force was given the job of putting the satellites into orbit.

Many of the men at SatCom are engineers from the old Signal Corps Engineering Laboratories who brought with them experience from projects much older than Advent. In 1946, they bounced signals off the moon with a radar called Diana; in 1958, they worked on the first active communications relay station in space, an Atlas missile called Score; in 1960, some of them orbited a delayed relay satellite called Courier.

They had some uneasy moments when Defense Secretary Robert McNamara was thinking about junking the whole military communication satellite program and leasing channels on the Commercial Satellite Corp.'s system. But the work never stopped. Research and development



Brig. Gen. J. Wilson Johnston

for a military system continued, and under instructions from the Defense Department, participation in the National Aeronautics and Space Administration's Syncom II satellite project began. Only 81 minutes after launch on July 26, 1963, the crew at SatCom began communicating via Syncom II. Less than four hours after Syncom III went up on Aug. 19, 1964, SatCom began work with it.

In charge of SatCom is Brig. Gen. J. Wilson Johnston, who was chief of the Signal Corps Research and Development division—before joining the communication satellite program. He took over the Army Advent Management Agency in 1962, and stayed on when it became SatCom.

Of the 16 engineers who formed the Advent group in 1960, nine are still with SatCom, sharpened by nearly three years of work with the Syncom program. They are technical director Samuel P. Brown, deputy ground system director George F. Senn, assistant technical director Alan S. Gross, deputy engineering director Peter J. Maresca, plans director James T. Evers, and engineers Peter J. Kennedy, Dudley E. Cline, George T. Brazee and Edward A. Stega.

Gen. Johnston's deputy, Col. Arthur W. Reese, has broad communications and development experience; and Col. Robert E. Warren, SatCom's engineering director, has a Ph. D. degree in physics and served for five years with NASA's space sciences office before joining SatCom. Col. Eugene B. Datsis, ground system director, had developed communication subsystems for Army missile and space systems while on assignment at Redstone Arsenal. And Col. Robert H. Scales, the program director, is an engineer officer who specialized in operation and management.

SatCom has a unique position in the Defense Department. Johnston reports to the commanding general of the Army Materiel Command in Washington, but technical guidance flows from the Army's Chief of Research and Development and the Director of Defense Research and Engineering.

Meanwhile, over-all coordination of the defense communications satellite program is entrusted to the Defense Communications Agency. SatCom is charged with designing the ground stations; the Air Force will launch the satellites into position, and the Army Strategic Communications Command will man and operate the terminals.

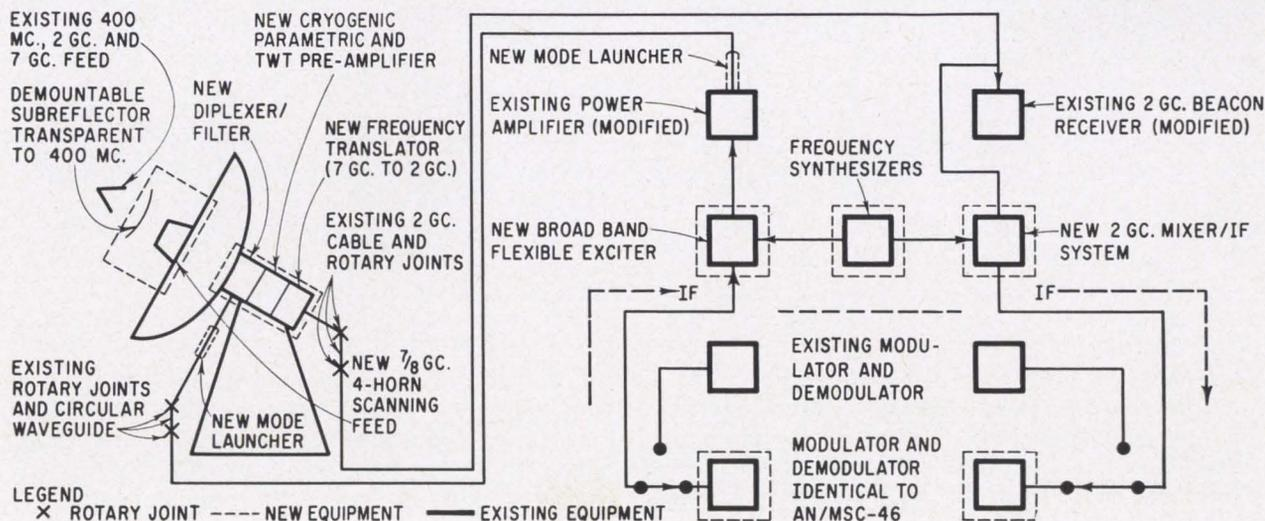

Modification plan that will permit the Army's terminal at Fort Dix, N.J. and its twin at Camp Roberts, Calif. to operate with the military satellite communication system.

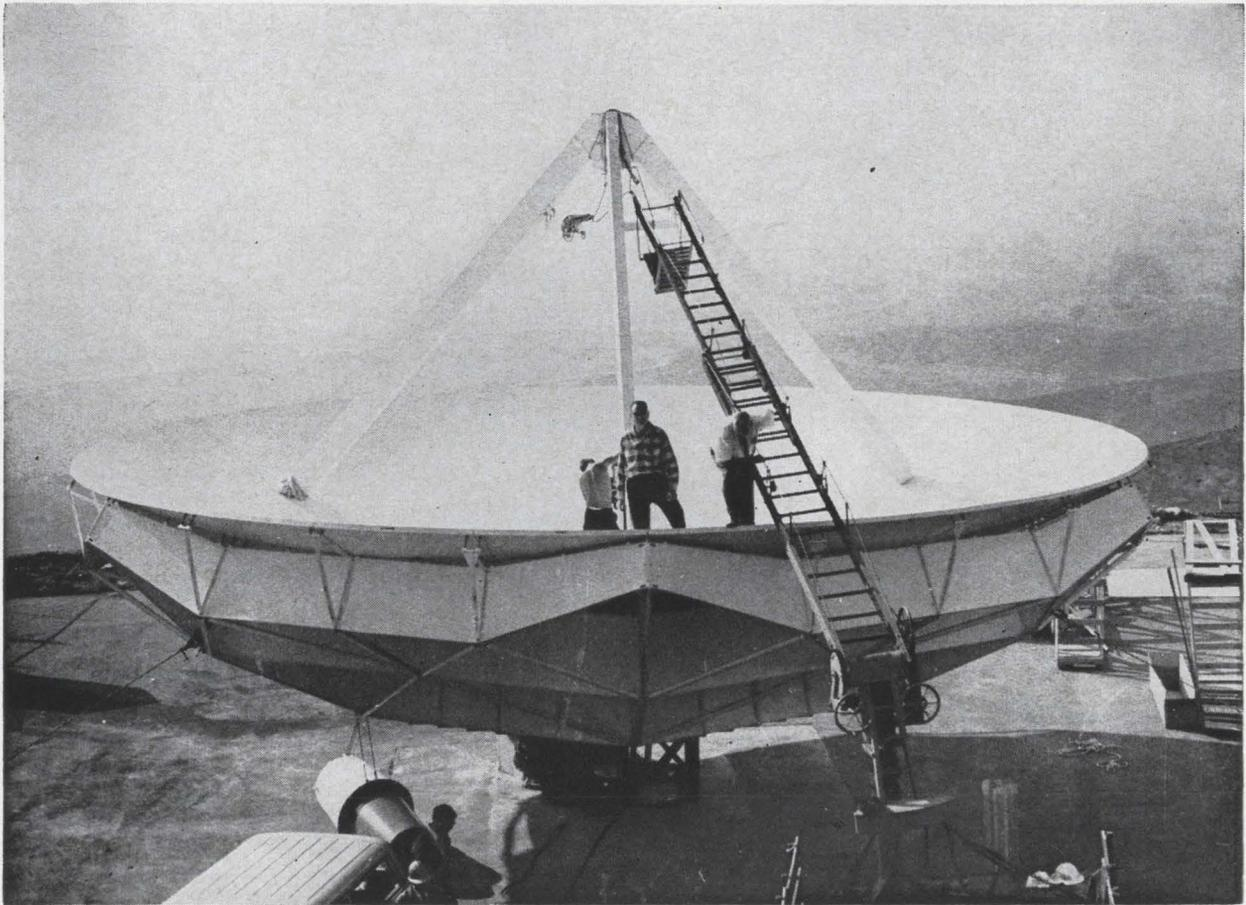

The first of the new 40-foot antennas, AN/MSC-46, will be delivered to Fort Monmouth in August by the Hughes Aircraft Co. The present order is for eight.

of transmitter signals with a maximum of 0.2 db insertion loss over the receiver band.

Maximum system performance or channel capacity greatly depends upon keeping the system noise temperature low. One way to reduce noise temperature in the system is to improve the pre-amplifier.

Last month, the Army installed a new low-noise receiving system on a 60-foot dish at Fort Dix. The system, built by TRG, Inc., a subsidiary of Control Data Corp., provides an over-all noise temperature below 40°K, and an over-all bandwidth of 50 Mc, and is expected to operate continuously for more than 2,500 hours between maintenance periods. This receiver could also be used on an antenna 15 feet or less in diameter.

The antenna-mounted portion of this system contains an integrated parametric amplifier/cryogenic refrigerator combination, an automatically stabilized pump source, and a post-receiver consisting of a double-conversion superheterodyne system. This entire unit weighs 70 pounds and fits into a weatherproof enclosure measuring 21 inches by 26 inches by 8 inches. The parametric amplifier provides a gain of 30 db and an instantaneous bandwidth of 150 Mc that can be d-c bias-tuned over the 7.25 to 7.75 Gc band. It operates continuously from 30°K to 340°K without retuning.

Thus, the system remains operational during refrigerator cool-down or in case of refrigerator failure (with the refrigerator off, the over-all receiver noise temperature is 260°K).

The remote control portion of the system weighs 30 pounds and fits into a standard relay rack panel 12 inches high. It provides meter indications of system voltages, refrigerator temperature and pump level. It also contains the single tuning knob that controls the center frequency of the receiver passband.

Maser amplifier

SatCom is considering development of a maser amplifier which, if combined with the liquid helium refrigerator, would result in an excess noise temperature of approximately 10°K. This would be a big improvement over the parametric amplifier being developed for the new AN/MSC-46 link terminal; it is cooled to approximately 60°K, with a resulting excess noise temperature of 80°K.

For applications which can tolerate higher noise temperature but which require higher reliability than can be obtained with a mechanical refrigerator, SatCom is studying the possibility of using thermoelectric cooling to produce a maintenance-free, highly reliable miniaturized cooling system that will be capable of maintaining 100°K temperature

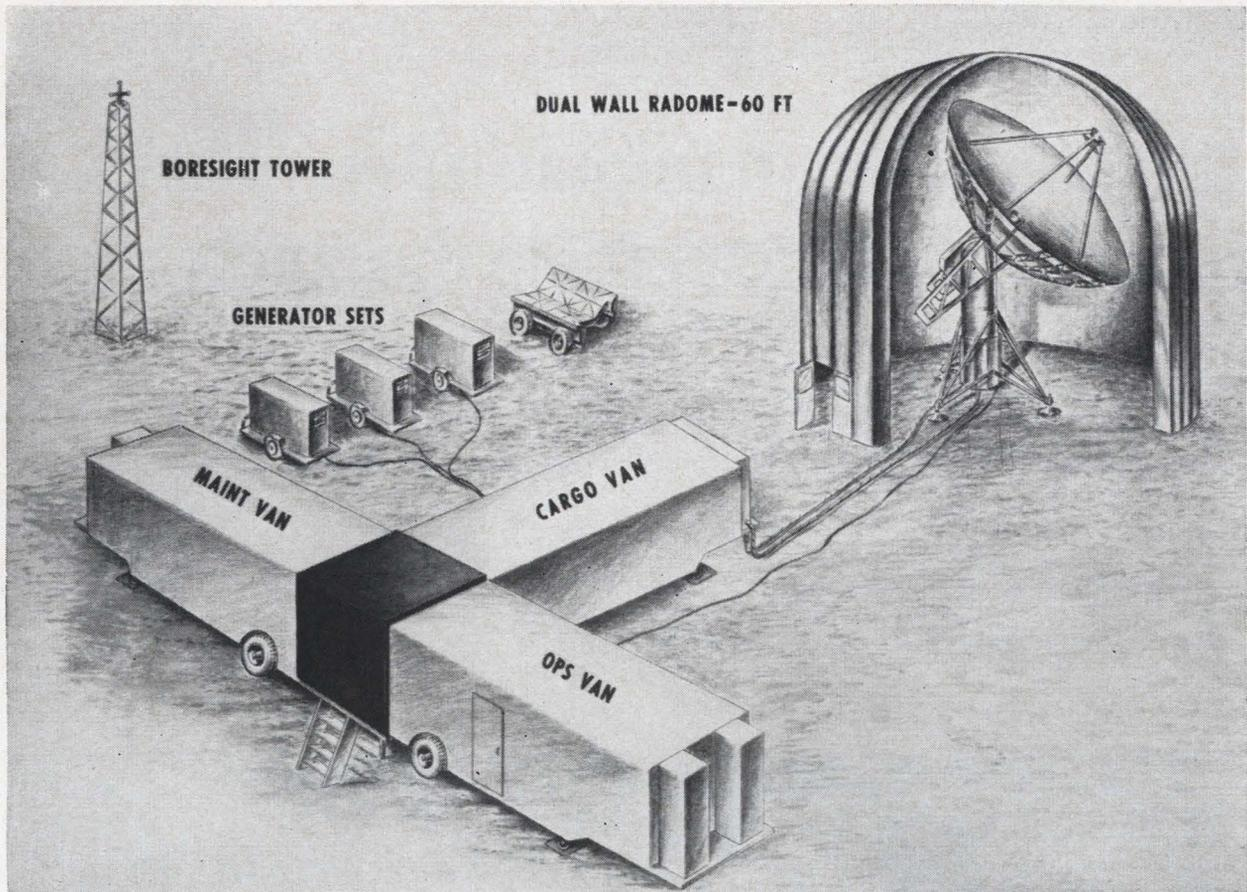

The air-transportable communications terminal, AN/MS-46, consists of three vans, three generator sets, a boresight tower, and a 40-foot antenna enclosed in a dual wall radome.

for a 1-watt power dissipation.

To eliminate the problems inherent in operating gigantic parabolic antennas that must turn rapidly and withstand high winds, SatCom is working with refined antenna radiation beam-shaping techniques to fabricate a planar phased array. Results thus far indicate the possibility of antennas with a ten-fold reduction in size and weight for equivalent performance. Phased arrays, possibly with electronic steering, will probably be used in future link terminals.

The agency plans to test two experimental space communications bands, 15 Gc and 31 Gc, assigned by the Extraordinary Administrative Radio Conference. A high power (10-kw and possibly 25-kw) transmitting tube in the 15-Gc range is being developed. A tube to operate at 31 Gc hasn't been started, but is under consideration. Work in this range would be coordinated with similar work being done by the Lincoln Laboratory at the Massachusetts Institute of Technology.

Tactical link terminals

Since high altitude satellites are within sight of so much of the world at one time, they are particularly useful in isolated spots. A U.S. field commander in South Vietnam, with a small ground terminal, could conceivably operate in response to command and control headquarters in Washington

rather than Saigon. Satellite communications might also be used for short, 100-mile hops in dense jungle.

To do this, much smaller antennas must be developed. The smallest now in use are the two 15-foot antennas in Saigon. SatCom has studied a two-foot antenna that can be carried on a jeep, and the agency has a contract with the Philco Corp. to investigate the possible applications of small antennas in general.

The Navy is also working on a number of tactical systems that would enable it to hook into a high altitude satellite network. The Army and the Navy are looking beyond teleprinter and voice capability to facsimile and other ways of transmitting visual data.

One approved program is the Mark V antenna—an air-transportable tactical terminal. Whether it will be bigger or smaller than the Saigon gear depends on how the transport and assembly problems are solved.

Eugene G. Fubini, Assistant Secretary of Defense and Deputy Director of Defense Research and Engineering, says the push for tactical ground terminals is more urgent than for strategic gear. "We are vitally interested in new tactical antenna systems." There are many problems inherent in building such systems. Solutions, Fubini says, will be warmly received.

Dip soldering in miniature— a new way to assemble modules

Melting the solder first—on the iron—reduces processing time
and protects heat-sensitive semiconductor devices from thermal shock

By Herbert M. Isaacson

Defense Electronics division, General Electric Co., Utica, N.Y.



View through magnifier shows how joint in cordwood module is made by touching it to drop of solder on iron.

As the size of electronic modules shrinks, the problem of protecting components from thermal damage during assembly becomes greater. Hand soldering can damage heat-sensitive components, such as semiconductor devices, in microminiature assemblies because the bodies of the components are placed so close to the solder joints.

Such thermal shock can be avoided by a new method of hand soldering which reverses the usual procedure. The joint between the component lead and the connecting wire is dipped into a small globule of melted solder instead of the lead being heated until it melts the flux and solder. In this way, the joint is heated only to the temperature of the molten solder, not higher.

Heat affects semiconductors two ways: electrically and structurally. As the device heats up, contaminants trapped within the package can evaporate and move from nonsensitive areas, such as the inside of the cap, to the semiconductor pellet. This usually changes the reverse leakage current or other parameters. And since the materials in the device have different coefficients of expansion, fast heating can cause physical stress, which produces structural damage and catastrophic failure. Distortion can also cause intermittent operation or damage the hermetic seal so that performance characteristics shift.

The new technique is particularly useful in the assembly of cordwood modules—widely used in military and aerospace applications—because joints are usually very close to component bodies, and the modules are small enough to be handled easily during soldering. There is another advantage in that joints in small modules can be made faster by this method than by conventional hand soldering.

Old methods vs. new

Under the conventional method given in the National Aeronautics and Space Administration's Specification MSFC-PROC-158B, "Procedure for Soldering of Electrical Connections (High Reliability)," the soldering iron is applied near the joint and the solder is applied to the joint until the flux and solder melt. The joint, at a temperature above the solder's melting point, is wetted and a cold-solder joint is avoided. The procedure takes several seconds.

The improved method reduces the time the iron

is in contact with the parts, and therefore does not raise the temperature of the components as much.

A work station for the new method consists of an iron whose temperature is controlled to 600°F; a fixture to hold the iron with its tip down at a 45° angle; a bench-mounted, illuminated magnifier; a container and applicator for liquid rosin flux; a glass-fiber brush or a wet cellulose sponge to keep the tip clean, and a 60-40 tin-lead, rosin-cored solder wire.

As a preliminary step in the improved method, flux is applied to the joints to be soldered.

A globule of solder is melted on the iron tip. The lower side of the joint is touched to the globule and moved slightly from side to side in a scraping motion to help break away oxides and promote solder flow. As soon as the solder flows up and completely around the joint, the joint is taken off the iron. The globule is replenished as needed, usually every 1 to 3 joints.

Since the iron is under the joint, the solder flow is easily seen through the magnifier. That the flow is upward, against gravity, is proof of good wetting. In conventional hand soldering, the solder wire and the boiling, smoking flux obscure the joint. The operator cannot see the solder flow to the bottom of the joint and may have to apply the iron for an unnecessarily long time—several seconds—to make sure that the joint is heated sufficiently.

The better visual control provided by the new method is one reason that heating time is shorter. Another is that the iron, not the component lead, melts the solder and the flux, so that the lead need not be heated above the solder melting point. In addition, it is easier to hold and position a small module than a soldering iron.

The iron tip can be as small as needed, though 10-watt miniature irons should not be used. The work tends to cool the iron, so to avoid large temperature variations, the heat reservoir of a 40- to 50-watt iron is desirable.

Time and temperature tests

For several hundred joints with the improved technique, the average time was 0.9 seconds, compared to 2 to 4 seconds for conventional hand soldering and 8 seconds for dip soldering. The time, measured with a circuit actuated when the joint touched the iron, ranged from 0.75 seconds to 1 second.

Simulated cordwood modules, illustrated on page 96, were used to determine soldering temperature and thermal effects. The components were glass-bodied diodes and transistors in T0-5 packages. All joints were 0.030 inch from the component body, except in configuration B, when they were against the pallet.

The bar chart on page 96 compares temperatures of each joining technique. Only diode junction temperatures are shown; these junction temperatures are higher than those of transistors since the

The author



Herbert M. Isaacson has specialized in electronics manufacturing processes for 35 years. His assignments with the General Electric Co. during the past 10 years have included process and development for the cathode ray tube, television receiver, semiconductor products, light military electronics and, at present, radio guidance departments.

°C °F
180 356

160 320

140 284

120 248

100 212

80 176

60 140

40 104

20 68

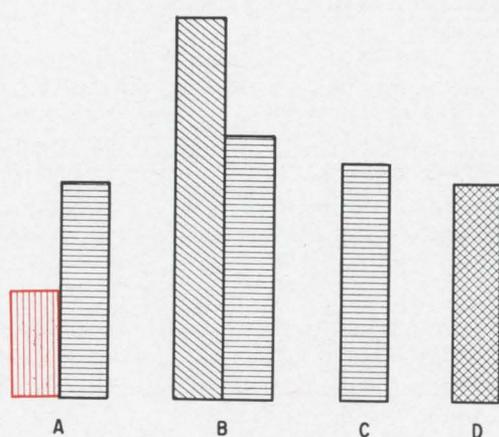

IMPROVED HAND SOLDERING CONVENTIONAL HAND SOLDERING
 WELDING DIP SOLDERING

Soldering temperatures attained by different techniques. Lowest temperature is that of new technique (color). The letters A, B, C, D refer to module configurations shown in the illustration below.

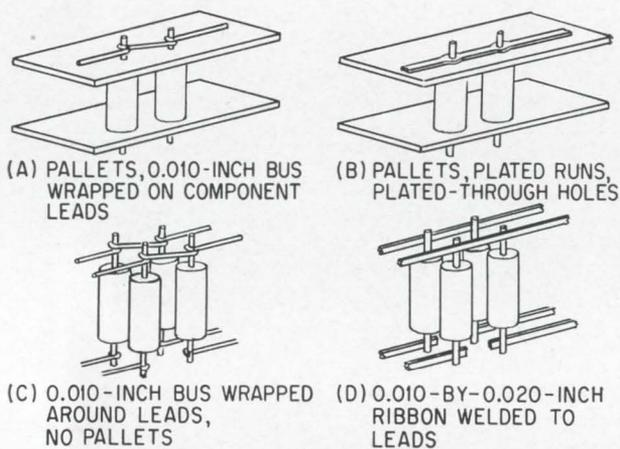

Cordwood module configurations used in thermal tests.

transistors' metal cans act as heat sinks.

To measure temperature, the forward voltage drop of the diode and transistor junctions were precalibrated as a function of temperature. The junction temperatures during soldering were recorded by a millivoltmeter, as shown in the circuit diagram at right, above.

The slopes of the curves in the graph indicate the rate of temperature change and thermal shock. This technique is more accurate and responsive than using thermocouples, since it eliminates their heat-sinking effect and measures the temperature at the point most sensitive to heat, the semiconductor junction.

The improved hand technique clearly results in the lowest temperature and least thermal shock. The shock induced by welding is more severe than that of soldering, as indicated by the steepness

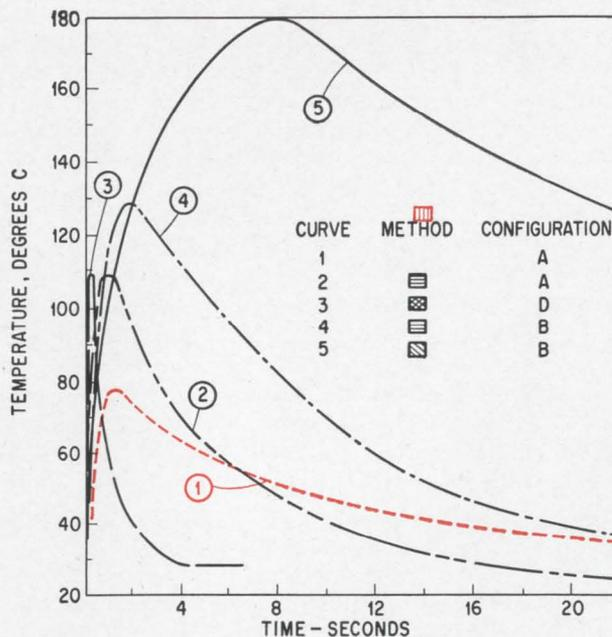

Thermal shock imposed on semiconductor devices by the new soldering method (curve 1, in color) is less than that of other methods. The methods and configurations are the same as those illustrated at left.

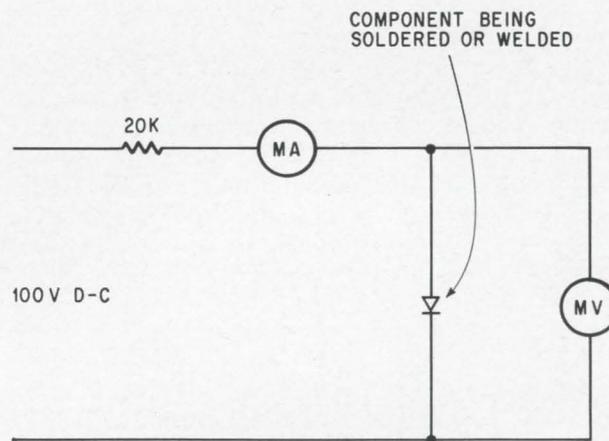

Circuit used to obtain temperature-time curves.

of its curve, though it is generally assumed that welding imposes less thermal stress.

Effect on reliability

The correlation between lower joining temperatures and stresses on components can only be firmly established by extensive life testing. However, one can expect lower stress to help reliability. All other factors being equal, the method that imposes the least heat and thermal shock on sensitive components should be the preferred technique.

The new technique satisfies military specifications concerned with the nature of a solder joint, though not with the technique for making it. Conformance with specifications such as NASA's 158B, which describes the soldering technique, might be questioned, but the intent of the spec—a high-quality joint—is met.

Insulation of MYLAR[®] on Sigma relay increases thermal range 50% ...costs remain the same

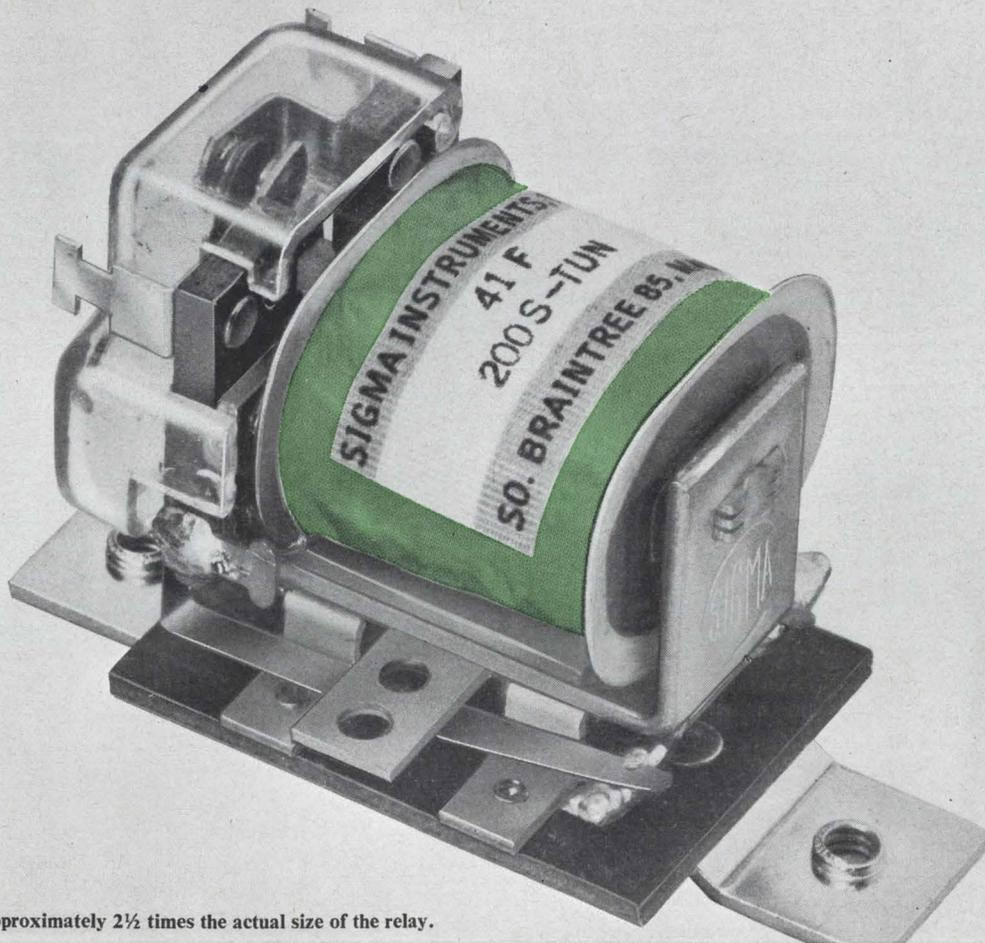

This photo is approximately 2½ times the actual size of the relay.

Sigma met the problem of increased thermal specifications by switching to insulation of MYLAR* polyester film. With its higher temperature rating, MYLAR upgraded the thermal range of Sigma's Series 41 relay by 50%. This surpassed the specifications required and broadened applications for the relay.

In addition, the switch from acetate film to MYLAR in other relays made by Sigma Instruments, Inc., of Braintree, Massachusetts, also meant:

- a smaller coil, since the high dielectric strength of MYLAR permits the use of thinner, more pliable film.
- longer life is designed into the coil by the use of MYLAR, which does not dry

out or change characteristics with age.

- insulation costs remain the same, because less MYLAR is needed for equivalent dielectric strength, as compared with most other insulators.

As a result, relays are now more reliable and versatile and are used in a wide array of applications ranging from furnace flame-out safety controls to automatic traffic and street-lighting controls.



*Du Pont's registered trademark for its polyester film.



For information on how MYLAR can probably help you design a better product—lighter, smaller, lower in cost—mail coupon today.

Du Pont Company, Room 2200B
Wilmington, Delaware 19898
Please send me information about MYLAR[®]
I am especially interested in its application for

Name _____

Title _____

Company _____

Address _____

City _____ State _____ Zip Code _____

In Canada: Du Pont of Canada Limited, P.O. Box 660, Montreal

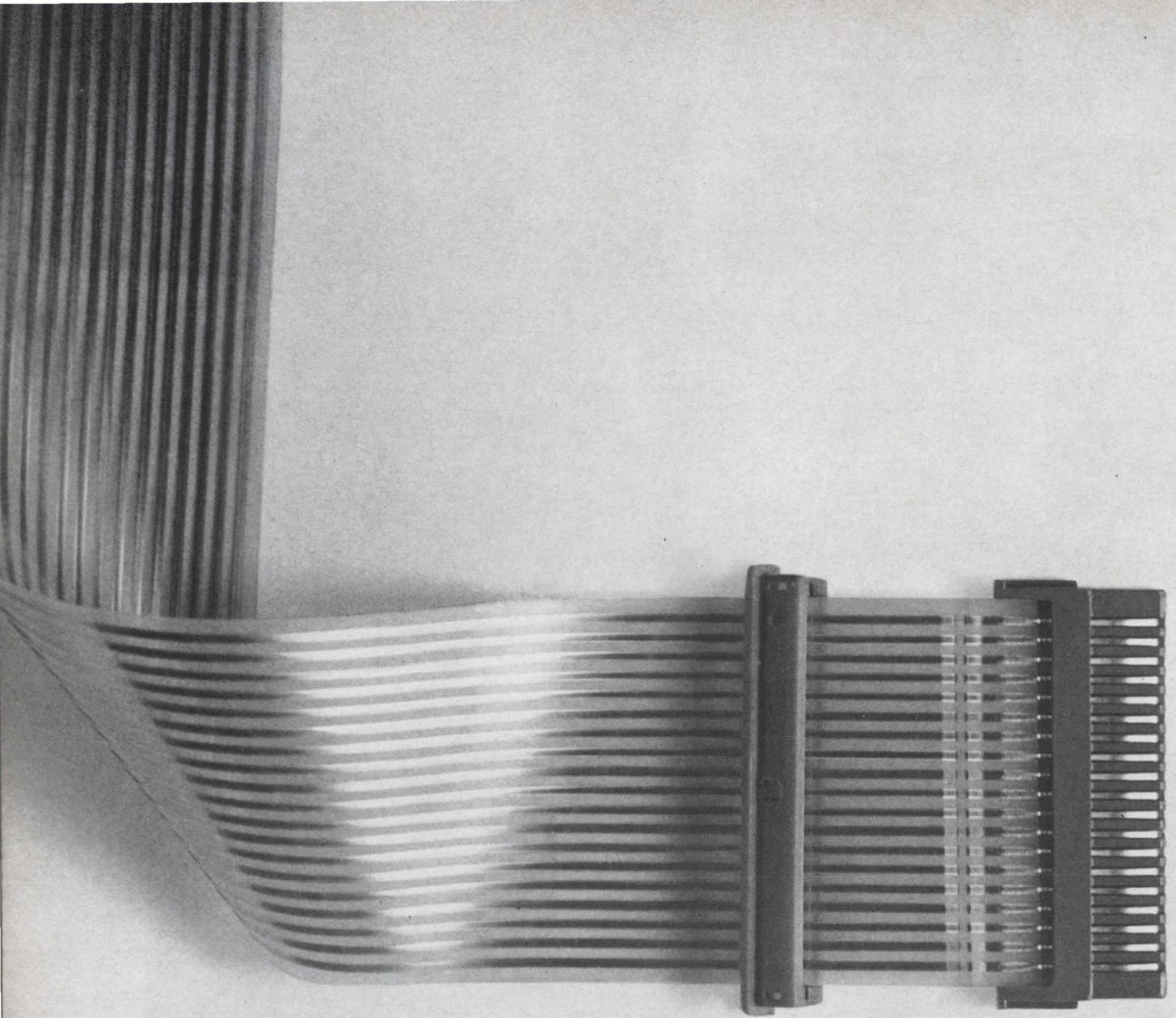

***Now for the first time . . .
quick, rugged, low-cost
terminations for flat cable***

If you use or plan to use flat, flexible cable, here's a completely new, more reliable termination method. This Amphenol Flex-1 connector has ribbon contacts that weld through the insulation directly to *unstripped* flat cable. As you can see in the picture, the insulation hugs the welded, solid-metal terminations. Each termination is a *gas-tight bond* that won't deteriorate.

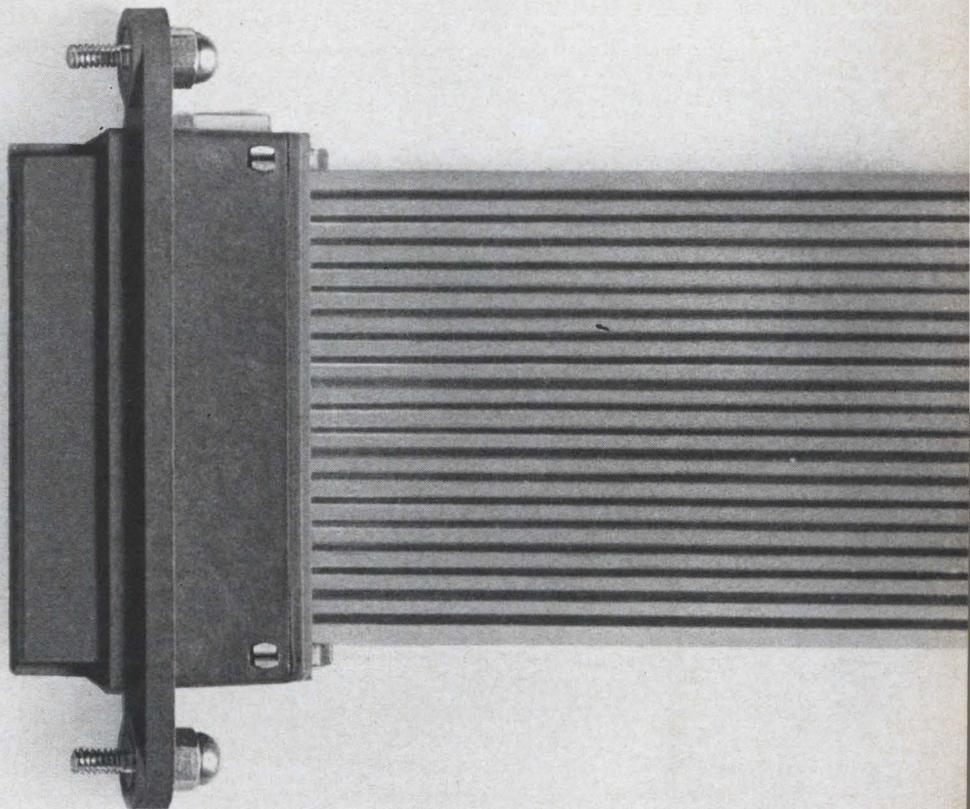
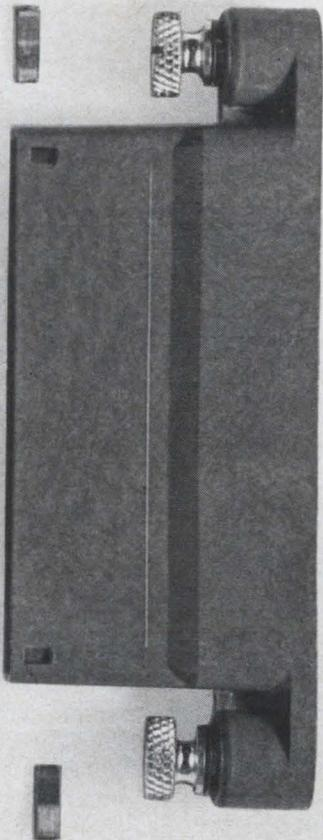

rate with age or prolonged use.

Yet this entire 19-contact connector was welded in less than 30 seconds!

How's it done? Amphenol's new flat-cable connector introduces a welding process that melts insulation at the piercing point. There's no stripping. Conductors aren't exposed or damaged during termination.

Now as never before, you get a

connector that matches the reliability and economy of flat, flexible cable. (Flat cable bends, twists, runs serpentine style, or stacks like layer cake . . . in less space and with less weight than ordinary round cable, and with no performance sacrifice.) Three years of research and testing proved the reliability of the Flex-1 termination. Connectors can with-

stand a *minimum* of 500 mating cycles without mechanical degradation.

With all this reliability, a 19-contact Flex-1 connector still measures only 1/2" thick and weighs less than 2 oz. Have your Amphenol Sales Engineer show you the Flex-1; and write for our catalog. Amphenol Connector Division, 1830 South 54th Avenue, Chicago, Illinois 60650.

Amphenol [®] **CONNECTOR DIVISION**

AMPHENOL-BORG ELECTRONICS CORPORATION

Specify Amphenol . . . the leading name in cable, connectors, assemblies, RF switches, potentiometers, microelectronics



YOUR MOVE, GENERAL...

Imagine, if you will, an advanced weapons system that permits battle commanders of joint services and their staffs to conduct complete combat operations in a "see-for-yourself" situation from inside an electronic war room that works equally well from the air or from a strategic ground location. In short, view on television screens battle as it takes place, know at every moment exactly what the enemy is doing, make moves and counter moves, and have complete communications with all forces.

Science fiction? Impossible? Not at all.

There is just such an advanced weapons system now undergoing evaluation. It is known as ABC³ — short for Airborne Battlefield Command and Control Center. This vitally needed system is available for production in quantity immediately.

The first such system of its kind, ABC³ was produced and delivered to the Air Force by LTV ElectroSystems, Inc. It was done from scratch in 98 days — well within the cost and time limitations of its contract.

Essentially ABC³ has two capabili-

ties: (1) Through the use of sensor aircraft and television, SLR (side looking radar), infrared and photographic devices, ABC³ reconstructs reconnaissance information and provides it for near-real time display for the battle commanders. (2) Through HF, VHF, and UHF, battle commanders communicate with and control all strike forces, air, sea and ground, for total and maximum effectiveness.

An additional advantage to ABC³ is that as a self-contained unit, it is operational either from the air or on the ground, can be slipped in or out of a C-130 in two hours. With the ABC³ operating from the ground, the C-130 transport can be released for troop or cargo transport. Ground mobility for ABC³ is provided by retractable wheels or a flatbed truck.

To develop and produce such sophisticated systems as ABC³ represents only one example of LTV ElectroSystems unusual capability to produce the finest electronics systems available at reasonable cost and within time limitations.

LTV ElectroSystems, Inc. / Post Office Box 1056 / Greenville, Texas / A subsidiary of Ling-Temco-Vought, Inc.

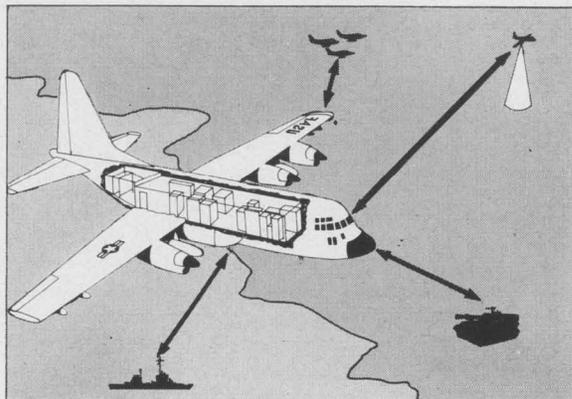

LTV ELECTROSYSTEMS, INC.

compact
Tektronix
oscilloscope

easily adapted to particular needs

Here's a high-performance oscilloscope featuring operational simplicity and versatility through a new series of plug-in units. Presently, you can select from 12 amplifier units and 5 time-base units.

Knowing your application area, you select those units that fit your needs. Some of the plug-in unit combinations available include those for low-level, differential, multi-trace and sweep-delay applications.

Special-purpose plug-in combinations equip the oscilloscope for sampling applications, in which the instrument becomes a low-drift sampling system as easy to operate as a conventional oscilloscope, but with sensitivity and bandwidth possible only through sampling.

With any combination of plug-in units in the oscilloscope—including the same type amplifier units in both channels for X-Y displays—this new value package provides you with "no-parallax" displays and sharp trace photography.

OSCILLOSCOPE FEATURES

NEW CRT with an internal graticule and controllable edge lighting
 • regulated power supplies • regulated dc heater supply • Z-axis input • 3.5-kv accelerating potential • amplitude calibrator • and operation from 105v to 125v or 210v to 250v. (The Type 561A operates from 50-400 cps and the Type RM561A operates from 50-60 cps.)

Type 561A (shown in four-trace application) \$500
 Type RM561A (shown in sweep-delay application) \$550
Oscilloscope prices without plug-in units.

Plug-In Units: Prices as low as \$105 for vertical amplifier and \$210 for time-base generator.

U.S. Sales' Prices f.o.b. Beaverton, Oregon



Type 3A74/2B67 Plug-In Unit combination — illustrated with Type 561A — equips the oscilloscope for up-to-four-trace applications.

The 3A1/3B3 Plug-In Unit combination—illustrated with the rack-mount model, Type RM561A—equips the oscilloscope for high-sensitivity, dual-trace operation and sweep-delay applications.

The rack-mount model occupies only 7 inches of standard rack height.



FOR MORE INFORMATION ON EITHER MODEL OF THIS NEW OSCILLOSCOPE AND ANY COMBINATION OF PLUG-IN UNITS, PLEASE CALL YOUR TEKTRONIX FIELD ENGINEER.

Tektronix, Inc.

P.O. BOX 500 • BEAVERTON, OREGON 97005 • Phone: (Area Code 503) 644-0161 • Telex: 036-691
 TWX: 503-291-6805 • Cable: TEKTRONIX • OVERSEAS DISTRIBUTORS IN OVER 30 COUNTRIES
 TEKTRONIX FIELD OFFICES in principal cities in United States. Consult Telephone Directory

Tektronix Australia Pty., Ltd., Melbourne; Sydney • Tektronix Canada Ltd., Montreal; Toronto

Tektronix International A.G., Zug, Switzerland • Tektronix Ltd., Guernsey, C.I. • Tektronix U. K. Ltd., Harpenden, Herts



Imagine a 15 kva, 400 to 60 cycle frequency converter that weighs only 150 pounds. It's not imaginary at Garrett.

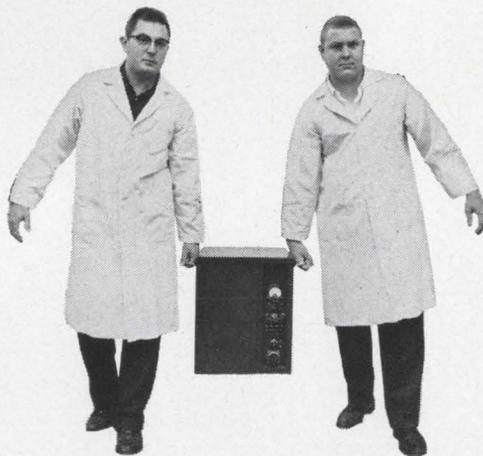

If you have electronics equipment that must use precise 60-cycle power – and if light weight and mobility are important – you should talk to Garrett.

Our new static frequency converter's power-to-weight ratio is several times better than any other static converter.

When you compare it to a typical motor generator set or rotary converter, the difference is phenomenal.

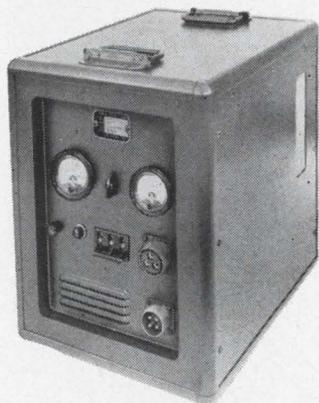

This new converter, now in production, changes 400-cycle power to regulated 60-cycle power. Converters also can be built to take 50, 60, or 400-cycle in or out. Or they can be designed to split the power

so that 400 and 60-cycle outputs are available simultaneously.

Our static converters work well with standard piston engine generator sets – but when combined with Garrett-AiResearch 400-cycle gas turbine generator sets, they are the lightest weight and most compact dual frequency power sources available anywhere.

Garrett's secret is solid state circuitry built around silicon controlled rectifiers in an entirely new way. The design incorporates a highly efficient commutation system that keeps power loss to a minimum. Total unit efficiency is better than 90 per cent.

Garrett static converters are rugged and dependable. The converter circuits have no moving parts, no bearings to fail or commutators to wear out. A proved circuitry technique insures SCR reliability.

Electronic components are mounted on unique cold plates for cooling, so that sensitive parts are

never exposed to outside air contamination.

Need higher power? We also have systems up to one megawatt.

For more details on Garrett's solid state converter capability, write to: Clarence Frere, Manager, Electrical and Electromechanical Systems Sales, AiResearch Manufacturing Division, Torrance Facility, 2525 W. 190th Street, Torrance, California.

PERFORMANCE SPECIFICATIONS

INPUT: 400 cps $\pm 5\%$
120/208 volts $\pm 5\%$

OUTPUT: 60 cps $\pm 0.5\%$
120 volts $\pm 1\%$
single phase
sine wave, less than
5% total distortion.
15 kva continuous
22 kva overload

Garrett is experience



AiResearch Manufacturing Divisions
Los Angeles • Phoenix

Cinch achievements in selective plating reduce your connector costs

REDUCES GOLD
REQUIREMENTS
OVER 60%



This revolutionary selective plating technique can reduce gold requirements over 60%, with no adverse effects on contact reliability, durability or electrical performance. Cinch puts the gold plating only where you need it—at the area of contact. (A gold "flash" may be applied to the rest of the connector if desired.)

The new Cinch .045" square tail connector (patent pending) utilizing this selective plating, combines the contact reliability of a flexing bifurcated contact with the stability of a rigid .045" square tail. This is achieved by inserting a wire core into the tail section and forming the flexible contact material into a .045" square tail with the sharp corners so necessary for reliable wire wrap attachments.

For additional information of this connector, with selectively plated contacts, write to Cinch Manufacturing Company, 1026 S. Homan Avenue, Chicago, Illinois 60624.

CM-6509



CINCH
DIVISION OF UNITED-CARR

Circle 103 on reader service card

Now...a new step upward in performance for wire and cable jacketing for general purpose electronic and aerospace applications. It's made of irradiated KYNAR*—Pennsalt's polyvinylidene fluoride—combining superior mechanical toughness and excellent chemical resistance. Jacketing of irradiated KYNAR is free from outgassing, withstands gamma radiation. MIL-W-81044 wires operate at 135°C continuously, take 300°C for limited periods; are available in long lengths, and are smaller, weigh less and cost less than most alternative constructions.

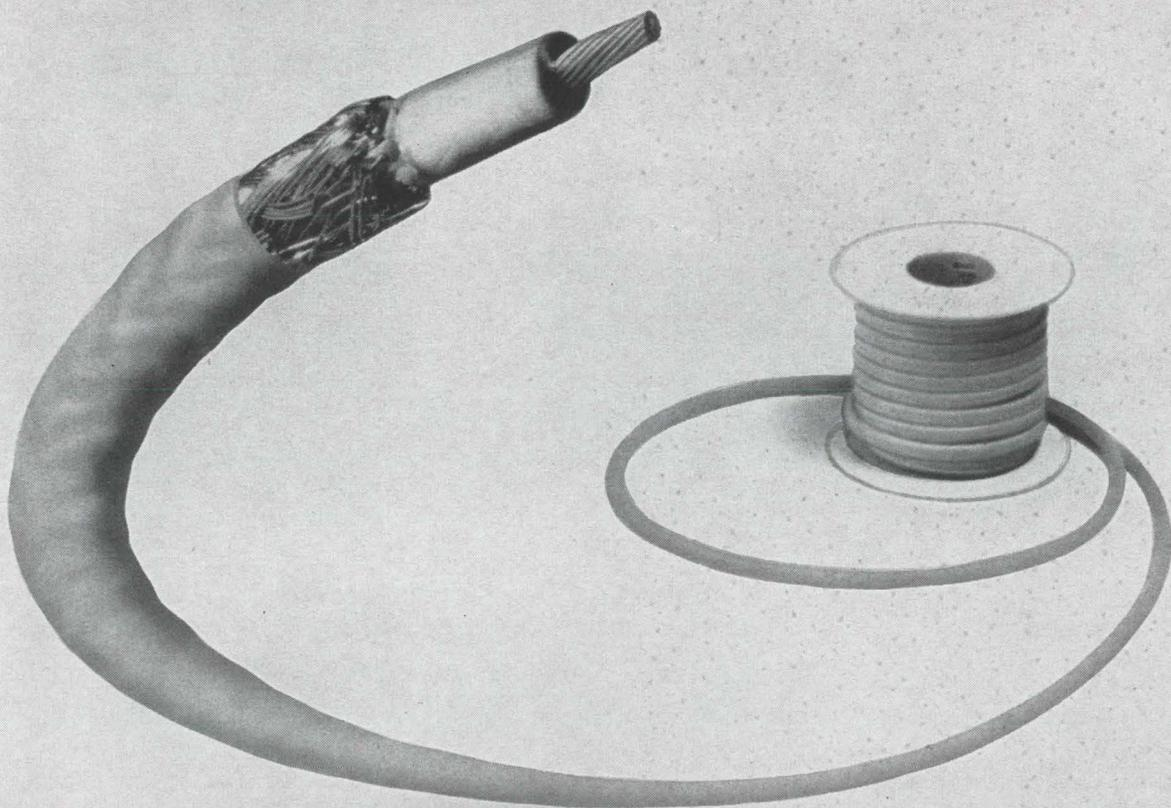

Write for information and the names of leading manufacturers who supply wire and cable jacketed with irradiated Kynar to Plastics Department, Pennsalt Chemicals Corporation, 3 Penn Center, Philadelphia, Pa. 19102.

Kynar...a fluoroplastic that's tough!

*KYNAR is a registered trademark of Pennsalt Chemicals Corporation.



Report from

**BELL
LABORATORIES**

SUPERCONDUCTING MAGNET FOR MASERS PROVIDES UNIFORM FIELD, ADJUSTABLE BANDWIDTH

For efficient operation, a low-noise traveling-wave maser needs a very low-temperature environment such as that of liquid helium (4.2°K) and a uniform magnetic field which determines the maser's operating frequency. These requirements suggest using a superconducting magnet for providing the field.

A compact maser amplifier based on this concept has been developed at Bell Laboratories. It incorporates an 8-pound superconducting magnet immersed in liquid helium, replacing an earlier

500-pound Alnico magnet mounted outside the dewar. This maser also provides the desirable feature of an adjustable bandwidth of amplification.

As shown in the illustrations, the uniform field is obtained with a superconducting solenoid enclosed in a close-fitting box of high-permeability iron. Adjustable bandwidth is obtained with an auxiliary superconducting trimmer coil which overlays one half the solenoid cross section. This coil modifies the main field, creating two discrete and individually uni-

form field regions. Changing the current in the coil adjusts the "step" between the two fields and thereby changes the bandwidth.

The two fields are each uniform to one part per thousand near 3300 gauss, and the maser bandwidth can be adjusted smoothly from 14 to 55mc centered at an operating frequency near 4170mc.

At the broadest band, its gain is 34db with an effective noise temperature of 5°K. The maser has demonstrated stable low-noise performance in a variety of satellite communications experiments.

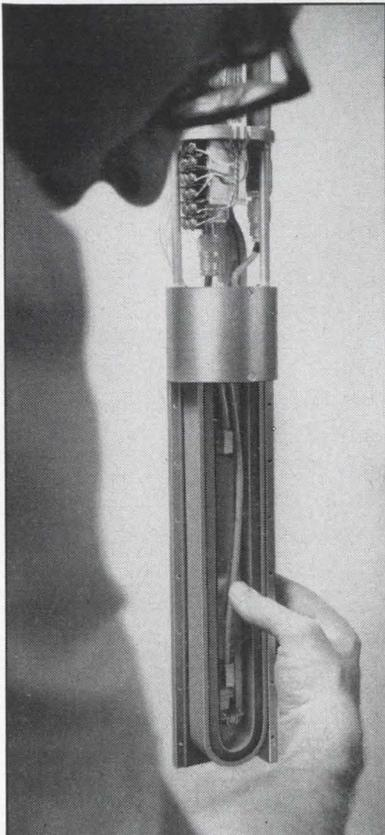

New maser magnet (left) has front and left side of enclosure removed to expose superconducting solenoid. Drawing (center) corresponds to photograph and shows solenoid inside box enclosure. Solenoid is wound on U-shaped nonmagnetic form and is spread apart at top to permit insertion of the maser. Dotted line indicates position of trimmer coil. Drawing at right indicates how front and rear plates of enclosure act as "image planes." These high-permeability plates are made to appear very large by the magnetic return paths provided by the sides of the box. The resulting magnetic field approximates the ideal uniform field of a solenoid of infinite length.

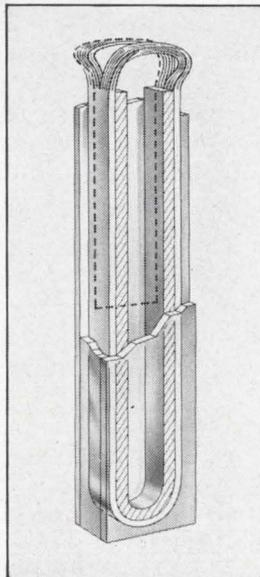

Bell Telephone Laboratories

Research and Development Unit of the Bell System

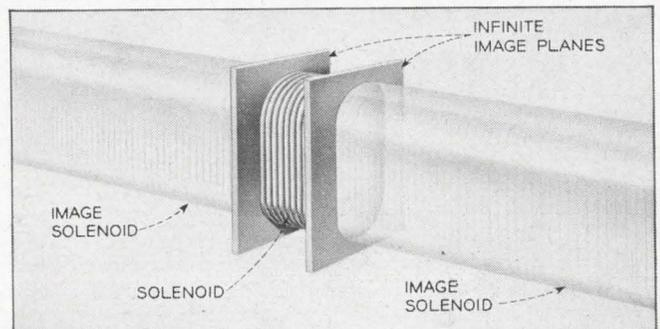

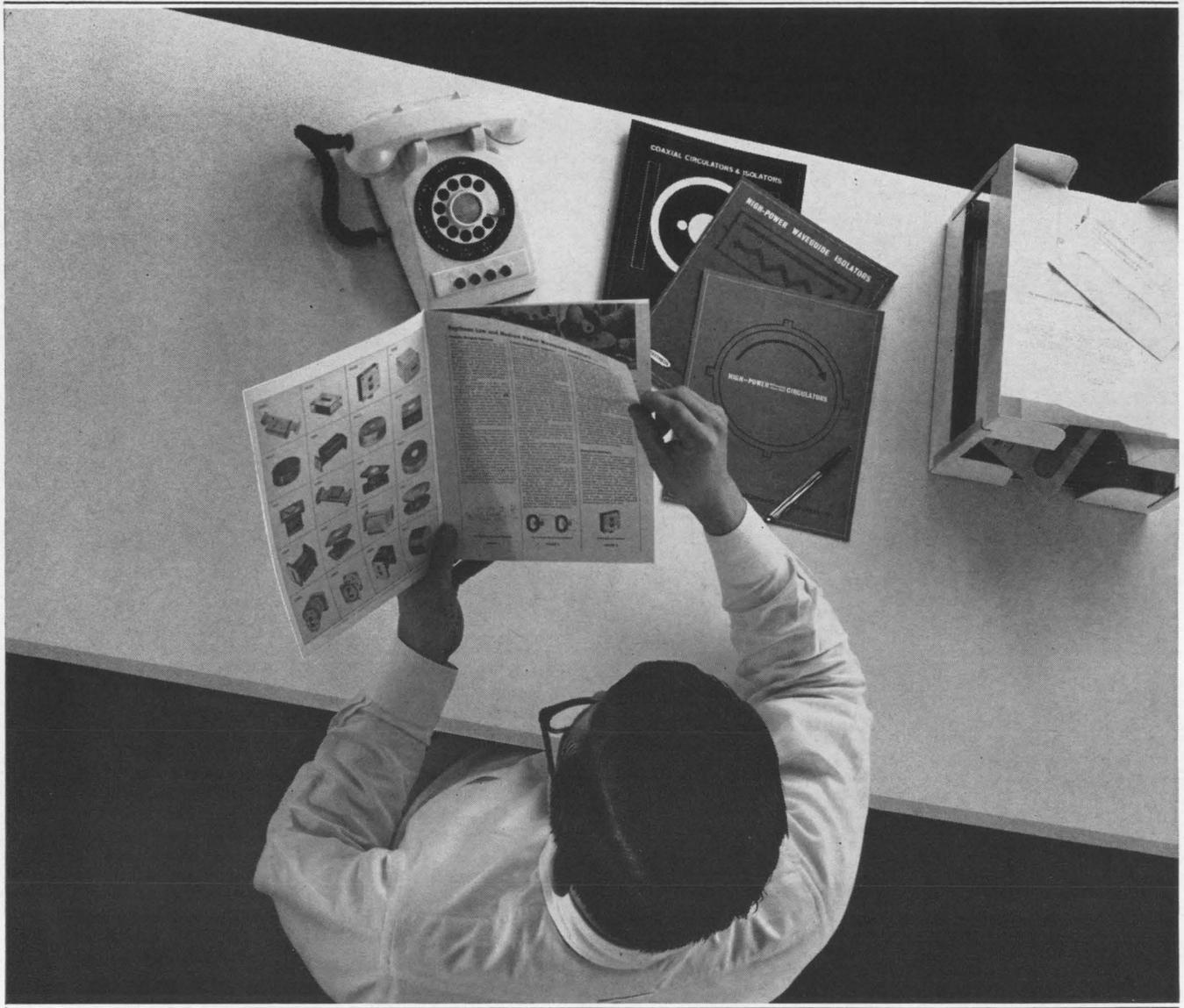

These new ferrite device catalogs belong on your desk!

And here's why: 1. The catalogs describe the hundreds of standard isolators and circulators available to you from Raytheon. 2. They indicate Raytheon's in-depth capabilities for providing custom units at all power levels and frequencies. 3. They present information about the Raytheon line in a few fact-filled, easy-to-use pages.

For example: The catalog being read, **Low and Medium Power Waveguide Isolators**, contains specs for 112 different models, including Faraday rotational, H-Plane resonance and miniature

types. Descriptions cover frequency ranges, electrical characteristics, mechanical data.

A second catalog, **High Power Differential Phase-Shift Circulators**, offers data on the more than 75 units Raytheon makes as stock items. **High Power Waveguide Isolators** provides data on more than 70 Raytheon UHF, L, S, C, X and Ku-Band isolators.

The fourth catalog describes our complete line of standard **Coaxial Circulators and Isolators**.

For copies of all four catalogs, call or write:

Raytheon Company, Special Microwave Devices Operation,
Waltham, Massachusetts 02154. Telephone 617 899-8080.



There's only one Air Express. It goes under this stamp.

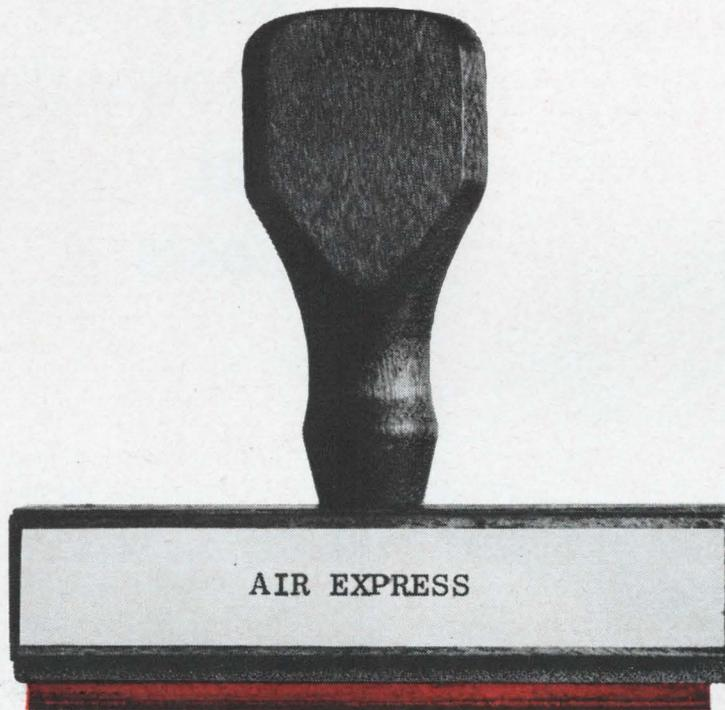

Air Express

Division of R E A Express



Air Express is not a type of service. It's the *name* of a service. An important name to remember when you want *express* service for your air shipments. Here's why.

Air Express is a joint venture of all 39 scheduled airlines and R E A Express. Your shipments get top priority after air mail on every scheduled airline in the country. (Figure what that means during night rush hours!) And you are

assured of next-day delivery to 21,000 U.S. cities, towns and communities.

Thanks to the thousands of R E A trucks, Air Express serves you fastest on the ground, too. You get 2 hour pickup, swift delivery. And rates are door-to-door, not airport-to-airport. You only make one call, fill out one waybill.

Price? Air Express is often cheapest. For example, it costs \$6.50 to

ship 20 lbs. by air from New York to Chicago, airport-to-airport. Air Express will do it door-to-door for \$6.20...less than even motor carrier (\$6.82)!

So if you ship from 5 to 50 pounds anywhere in the U.S.A., you're missing a bet unless you check Air Express. Call your local R E A Express office and see.

Air Express outdelivers them all ...anywhere in the U.S.A.

Air Express

Division of R E A Express



NEW

**CROSS BAR
TYPE
SELECTOR
SWITCH**

10 Sliders

20 Contacts

200 Switching
Combinations

- PROGRAMMING
- CIRCUIT DESIGNING
- TESTING
- BREADBOARDING

Each module
1 3/4" x 3 1/2" x 5 3/4"

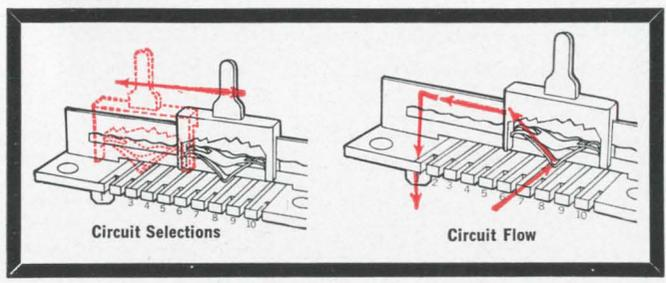
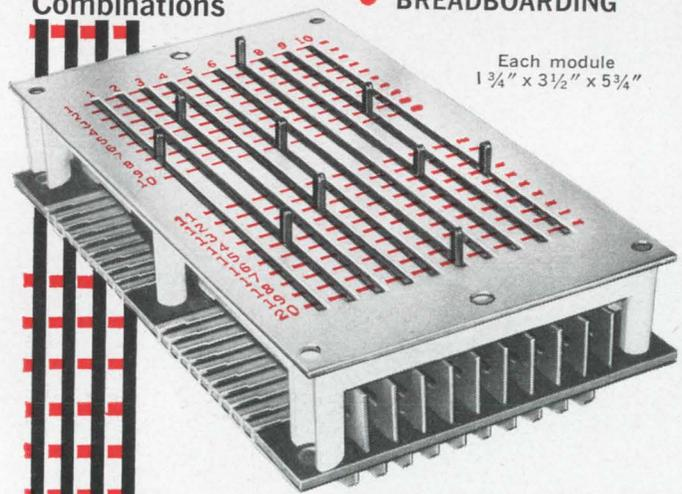

Electrical capacity:

1. Current carrying only (no make or break)
3 amp 125 V AC or DC
2. Make or break
1 amp 15 V DC, 150 m.a. 125 V AC



The complete snap-action switch line
Cherry Electrical Products Corporation

P.O. Box 437-12 Highland Park, Ill.
IN CANADA: BARRY ELECTRIC LTD., REXDALE, ONTARIO

Tung-Sol Subminiature Lamp Assemblies Improve Production, Cut Costs

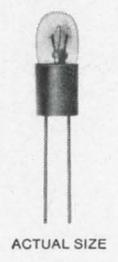

Do you have bulb shrinkage problems where small lamps are wired into circuit boards?

Tung-Sol lamps with molded nylon bases can save you money. The nylon base absorbs mounting strains to permit firm seating of the lamp. Lead wire breakage and bulb damage are eliminated. Production goes up. Costs go down. Inventory is reduced. When you order 1000 lamps, you get 1000 useable lamps. Nylon bases can be color-coded for production identification.

In addition to molding bases to any configuration, Tung-Sol can provide special harnessing. Write for free suggestions about how Tung-Sol can handle your lamp requirements.

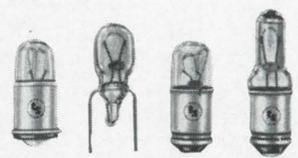

If your application requires only bulbs, ask for a quotation from Tung-Sol. The Tung-Sol line of miniature and subminiature lamps is extensive. Quality is the best that more than half a century of know-how can produce.

TUNG-SOL INSTRUMENT LAMPS

Tung-Sol Electric Inc., Newark, N. J. 07104



SCREEN PRINTED MICROCIRCUITRY NEWS

Information and ideas on the manufacture of screen printed microcircuitry. Published periodically by E. I. du Pont de Nemours & Co. (Inc.), Electrochemicals Department, Wilmington, Delaware 19898.

DU PONT PLATINUM-GOLDS

Give Superior Conductors

Complicated conductor patterns in small, precisely controlled dimensions can be made by the screen printing process. Principal properties required of the conductor are: low resistivity over a wide range of frequencies; ohmic contact with active and passive components; good adhesion to the substrate; compatibility with soldering, welding, or other techniques used for joining devices to the conductor.

CONDUCTOR PROPERTIES

(Platinum-Gold)

RESISTIVITY:

BEFORE SOLDERING	AFTER SOLDERING
0.05-0.1 ohms/square	0.005 ohms/square
10-20 ohms/inch/ 5 mil wide line	1 ohm/inch/ 5 mil wide line

ADHESION:

Tensile Strength-2400 psi
Fired on 96% alumina at 1900°F

Less than 10% decrease
after 1000 hours @ 125°C

SOLDERABILITY:

Excellent	
62 Tin-36 Lead-2 Silver	(210°-215°C)
70 Lead-30 Tin	(330°-350°C)

The table shows that Du Pont's Platinum-Golds have these properties to a large extent. It shows the excellent conductivity of Platinum-Gold and how it is improved by solder coating. The tensile strength of approximately 2400 psi can be compared with 1600 psi for copper clad circuitry determined by the same peel test. The two types of solder presently used are shown. The eutectic solder, with a small silver content, is excellent for its soldering properties, but lower solder costs can be realized with the higher temperature solder.

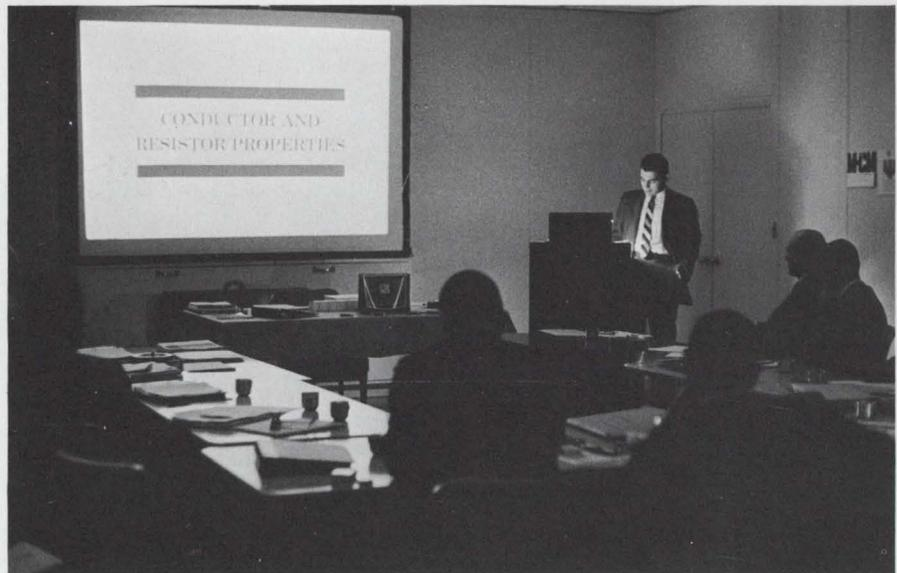

A presentation of Du Pont's technical seminar on microcircuitry.

NEW DU PONT SEMINAR ON SCREEN PRINTED HYBRID MICROCIRCUITRY

A 45-minute technical seminar on screen printed microcircuitry is now being presented to leading manufacturers of microcircuits. Audiences acclaim it for its broad perspective and frank discussion of the three major systems now being used or considered by the electronics industry.

The seminar is conducted by a panel of Du Pont technical and sales personnel, all authorities in their field. The speakers point out that the use of microcircuitry has penetrated many areas of the electronics industry, such as computer and data processing systems, communication and control equipment, and military electronics—and that dozens of other uses are under consideration. As the seminar progresses, it becomes apparent that while the applications represent specific and varying requirements, one characteristic remains constant, "the continuing need for reliable, low-cost microcircuitry."

The common types of microcircuits are compared for versatility, cost and manufacturing ease. The panel shows by means of slides how screen printed microcircuits are made and gives an estimated cost for equipment. In the closing sections, the panel takes a look at the present status of microcircuits and Du Pont's position today and its plan for the future.

Companies who wish to discuss the availability of the seminar should contact their Du Pont electronics industry representative. His name appears on page 2.

A seminar speaker suggests a program for evaluating screen printed microcircuits.





COMPLETELY NEW! BOOKLET ON SCREEN PRINTED MICROCIRCUITRY

A completely new booklet has just been released on "Screen Printed Hybrid Integrated Circuitry". It was written to fill the need for source and manufacturing information on screen printing.

The 16-page booklet covers such important subjects as Processing Techniques for Circuit Preparation, Substrate Materials, Resistor and Conductor Compositions, and includes a Directory of Equipment Types and Suppliers.

Copies can be obtained by writing to your nearest Electrochemicals Department office, or sending in the coupon below.

E. I. du Pont de Nemours & Co. (Inc.)
Electrochemicals Department
Ceramic Products
Wilmington, Delaware 19898

DATE _____
Please send me a copy of your booklet (Serial A-40945)

"Screen Printed Hybrid Integrated Circuitry"

NAME _____

BUSINESS ADDRESS _____

TITLE _____

A COMPARISON OF THREE SYSTEMS USED FOR PRODUCING MICROCIRCUITS

A comparison of the advantages of the three common systems reveals many interesting facts. These must be given serious consideration by companies in the process of making a decision to adopt one of these systems.

As can be seen in the table, the cost of screen printed circuits is low, in fact, the lowest of the three types. Both silicon monolithic and thin film systems require high investment cost. Because the basic research on the screen printed process has already been done by Du Pont, and this information is available, development costs are lowest with the screen printed circuits. Although silicon monolithics have higher packing density than the others, screen printed and

thin film circuits provide excellent isolation because the active components are added as discrete elements. This feature also provides unusual design flexibility. The wide range of resistance values obtainable with screen printed resistors provides an important advantage over thin film and silicon monolithic circuits.

ADVANTAGES & DISADVANTAGES

	SCREEN PRINTED	THIN FILM	SILICON MONOLITHIC
COST	low	medium	high
PACKING DENSITY	0.5MM/ft. ²	0.5MM/ft. ²	1MM/ft. ²
PRESUMED RELIABILITY	excellent	excellent	excellent
ISOLATION AND SPEED	excellent	excellent	poor
DESIGN FLEXIBILITY	excellent	excellent	poor
RESISTANCE RANGE	excellent	fair	poor
ACTIVE COMPONENT PARAMETERS	excellent	excellent	excellent

RECENT SCREEN PRINTED HYBRID MICROCIRCUITS

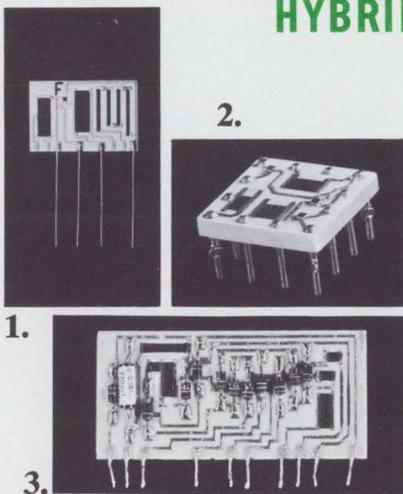

Every day, new applications for screen printed microcircuits are found. Below are three excellent examples of such circuits.

1. Circuit used as memory element for NIXIE tubes. It contains 1 SCS and 3 resistors (Courtesy Burroughs Corp.).
2. Solid Logic Technology Module used in IBM's System 360 computers. Note 3 resistors (large dark areas) and tiny "chip" transistors and diodes (small squares) (Courtesy IBM Corp.).
3. DC power supply for Minuteman missile. Unit has 11 diodes, 1 capacitor and 9 resistors (Courtesy North American Aviation, Autonetics Division).

FOR MORE INFORMATION ON DU PONT CONDUCTOR AND RESISTOR COMPOSITIONS, contact any of these Du Pont Electronic Industry Representatives:

SPECIALIST	AREA	AREA CODE—PHONE
Jerry Carson	Philadelphia	215—TR 8-2700
Jim D'Andrea	New York	212—971-4000
Bill Dawson	Cleveland	216—561-1580
Red Kauffmann	Chicago	312—IN 3-7250
Bill Wood	San Francisco	415—JU 6-5141
	Los Angeles	213—283-0741
Jim Mitchell	Atlanta	404—873-6101
	Charlotte	704—375-5561
	Dallas	214—ME 1-4140
Wolly Hille-Dahl	Europe	Geneva 42 16 00

Ceramic Products
Electrochemicals Department
E. I. du Pont de Nemours & Co. (Inc.)
Wilmington, Delaware 19898



Better Things for Better Living
... through Chemistry

Probing the News

Space electronics

Saturn V's best friend

Success of the manned moon shot will depend on the performance of a ring-shaped instrument unit that will guide and control the launch vehicle during the first crucial hours

By Peter R. Sigmund

Space Electronics Editor

Several hours before Saturn V lifts the Apollo spacecraft toward the moon, an instrument unit, housing most of the electronics for the entire three-stage, 9-million-pound-thrust rocket, will get to work.

Packaged between the S-IVB third stage and the three-module Apollo spacecraft, the instrument unit will be busy before, during and after the launch with the largest number of jobs ever assigned a unit of its type. And it will be on the job longer—possibly as many as six hours.

I. Sequence of events

The unit's work begins long before liftoff when its digital computer runs a simulated mission. That's when the unit's various subsystems go through their paces. The performance of the subsystems is monitored by the master computer in the launch control center. The unit's own computer also receives and stores navigation and guidance information for use after launch.

As launch time approaches, a theodolite aligns the inertial platform in the unit. The digital computer will base all navigational measurements on that alignment.

Blast off. During liftoff, the instrument unit points the launch vehicle toward the sky positioning it for entry into earth orbit. As the first stage, which has a 7,500,000-pound thrust, is fired, the unit

measures pressure, temperatures and other conditions.

If there are serious malfunctions, the unit flashes a warning on a display panel in the Apollo command module.

T + 2.5 minutes. The unit commands first stage cutoff and ignition of the 1-million-pound-thrust S-II second stage.

T + 8.7 minutes. At an altitude of 90 miles and a speed of 14,000 miles an hour, it commands ignition of the 200,000-pound-thrust S-IVB third stage. Simultaneously it continues to carry out the highly critical task of keeping the 47-ton Apollo spacecraft on the exact path to put it into earth orbit.

T + 10.7. The spacecraft, still attached to the third stage, is circling the earth.

In orbit. During earth orbit, which may last from 90 minutes for one orbit to 225 minutes for 2½ orbits—depending on how long it takes to check out subsystems in the Apollo spacecraft—the unit has two main functions. The first is to channel checkout signals, transmitted from the ground, to its own subsystems and to certain subsystems in the launch vehicle and send back the results. The second task is to compute the angle the vehicle must take for its trip to the moon, actuate the vehicle's controls for a lunar trajectory, and refire the third stage rocket.

Last job. At T plus a maximum

of 6½ hours, the unit will stabilize the S-IVB stage and the lunar landing module while the Apollo command and service modules swing around to the position they will maintain as they go into orbit around the moon.

The instrument unit—its job completed—will then fall away with the third stage rocket. Apollo's three modules will continue toward the moon at about 25,000 miles per hour.

II. Hardware and contractors

Almost 22 feet in diameter and three feet high, the unit weighs approximately 4,405 pounds; this includes almost 260 pounds of cooling fluid, some of which boils off during flight.

Subsystems. The center of the unit is hollow to accommodate the legs of the lunar excursion module and the six major subsystems are mounted on panels around the inside perimeter. They are: the structural portion, guidance and control, environmental control, measuring and telemetry, radio frequency, and electrical.

Responsibility. The instrument unit was developed, from concept to its present stage, by the Astrionics Laboratory of the National Aeronautics and Space Administration's George C. Marshall Space Flight Center, at Huntsville, Ala. The International Business Machines Corp. is assembling the first

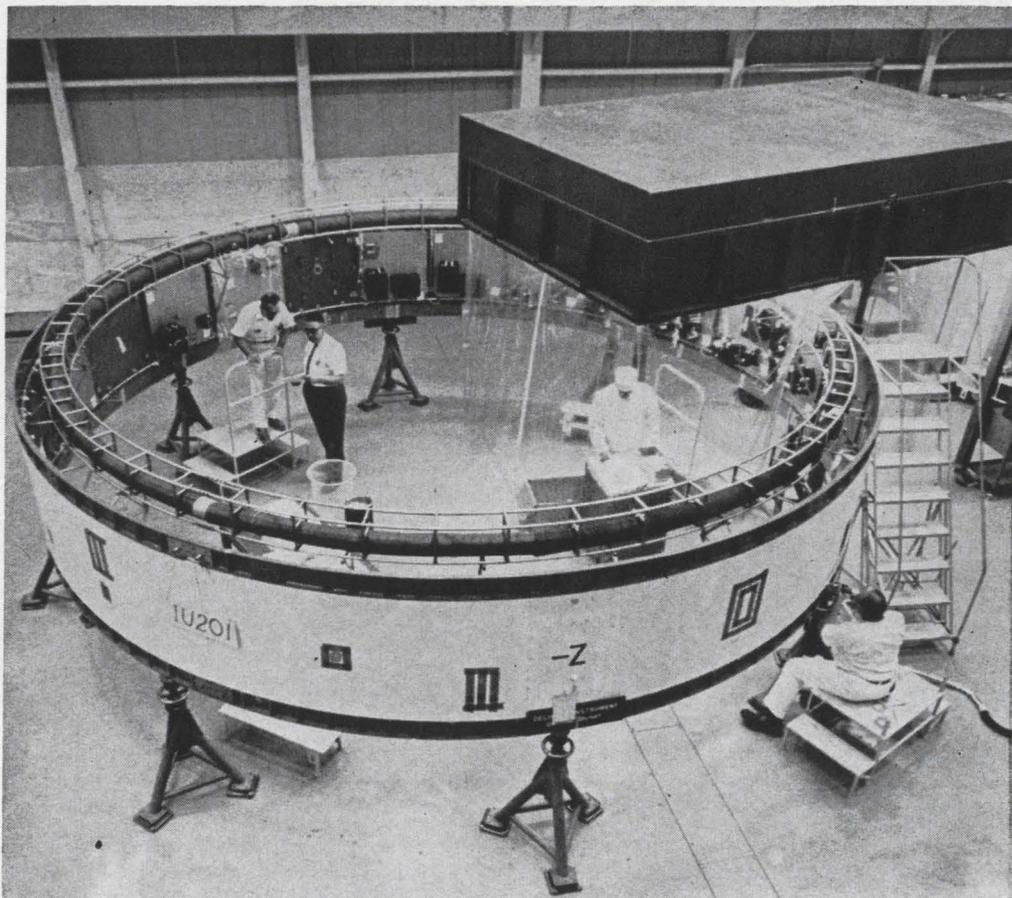
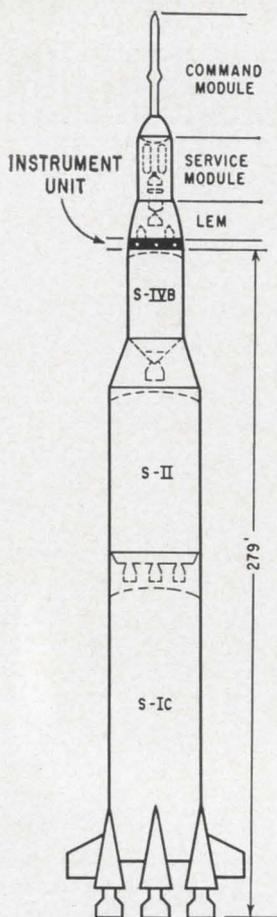

Instrument unit that will guide and control the 279-foot Saturn V is basically the same as the unit above that will fly next year in the Saturn 1B. The ring-shaped unit is wedged between the manned Apollo spacecraft and the launch vehicle's third stage. A movable clean room, made of polyethylene, protects the electronic equipment, already sealed in 57 modules, when it is being installed. The unit is being assembled at the Huntsville, Ala. facility of IBM.

four flight models, under Marshall's direction, at the Federal Systems division's Huntsville facility. IBM bought some of the components but most were bought by Marshall from more than 200 companies.

With the fifth unit, IBM will take complete responsibility for procurement, integration and checkout. The contract for this work amounts to \$175,125,000.

IBM will use some of the same suppliers Marshall used: Electronics Communications, Inc. for the control computer; Bendix Corp., for the inertial platform; and IBM Federal Systems division, for the digital computer and the data adapter.

Subcontracts have been negotiated with the Space and Information Systems division of North American Aviation for structural elements; the Aerospace Structures division of Avco Corp. for thermal conditioning panels; Hayes International Corp. for network cables; and the Engineered Magnetic divi-

sion of Gulton Industries for a five-volt master measuring voltage supply.

It is expected that IBM will do considerably more subcontracting as work proceeds.

III. Stringent tests

The instrument unit has the most comprehensive reliability features of any thus far. Before a component is chosen, it is tested under environmental conditions far worse than those it will encounter on an actual flight. It has to operate under extremes of temperature and vibration and in a vacuum.

Once the component has qualified, more tests are given the finished product before it is accepted.

Reliability requirements for the whole program are so severe that contractors have often been hard to find. Besides the exhaustive testing, the volume of work is usually low, and doesn't promise big profits.

Safety factor. Before every op-

eration, the critical modules are checked for reliability in a triple redundant procedure. The outputs from three rate gyros, for example, are compared, and the two most similar are used. Also subjected to triple redundant testing are modules in the unit's computers, the stabilized platform and the battery.

Redundancy obviously requires more parts. The Saturn V computer, for example, uses 80,000 components—3.7 times the number it would need if triple modular redundancy were not used [Electronics, Nov. 2, 1964, p. 82]. It has 20 times more reliability than a nonredundant computer. Because of advances in subminiaturization, weight and volume have not become a problem.

Cooling. Another reliability feature is the Saturn V's unique cooling arrangement. Electronic components are kept at 68°F by a system that circulates a methanol-water mixture, similar to antifreeze,



RELIABILITY
TOTAL CAPABILITY
IN PRECISION RESISTANCE

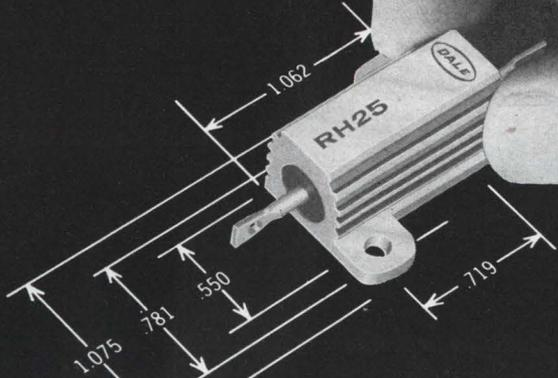

25 watt POWER in
15 watt Mil Size equals
10 watt **DALE BONUS!**

**All new Dale RH Housed Wirewound design
dissipates 25 watts from 15 watt Mil Size**

This superior heat dissipation is typical of Dale's all-new RH line. It means extra design flexibility plus unprecedented stability when operated at MIL-R-18546C levels. It stems from: (1) New, specially conductive extruded aluminum housings; (2) A new Dale-developed molding compound which binds resistance unit and housing together in a homogeneous void-free mass with exceptional heat transfer ability.

COMPLETE HOUSED RESISTOR CAPABILITY

In addition to RH resistors, Dale produces PH Housed wirewounds for through-chassis mounting in 10, 25 and 100 watt sizes. Both RH and PH lines are available in non-inductive styles and with special mounting methods, terminals and other variations to suit your application.

RH RESISTOR SPECIFICATIONS					
DALE TYPE	EQUIV. MIL. TYPE	DALE RATING*	MIL. RATING	RESISTANCE RANGE (OHMS)	STANDARD HEAT SINK
RH-5	-	7.5	-	.1 - 24K	4x6x2x.040 AL CHASSIS
RH-10	RE-65	12.5	10	.1 - 47K	
RH-25	RE-70	25	15	.1 - 95K	5x7x2x.040 AL CHASSIS
RH-50	RE-75	40	20	.1 - 273K	
RH-100	-	100	-	.1 - 50K	12x12x.125 AL PANEL
RH-250	RE-80	250	120	.1 - 75K	

ELECTRICAL & ENVIRONMENTAL SPECIFICATIONS

Tolerance: 3%, 1%, .5%, .25%, .10%, .05%
Load Life: 1% max. Δ R (RH-5-50) 3% max. Δ R (RH-100-250) in 1000-hour load life
Operating Temp: -55° C to +275° C
Overload: ± .5% max. Δ R per MIL-R-18546C
 *Power Rating based on 275°C max. internal hotspot temperature with resistor mounted on proper heat sink as specified by Mil. Spec.

WRITE FOR RESISTOR CATALOG A



DALE ELECTRONICS, INC.
1300 28th Avenue, Columbus, Nebraska
Also Sold by Dale Electronics Canada, Ltd., Toronto, Ontario, Canada



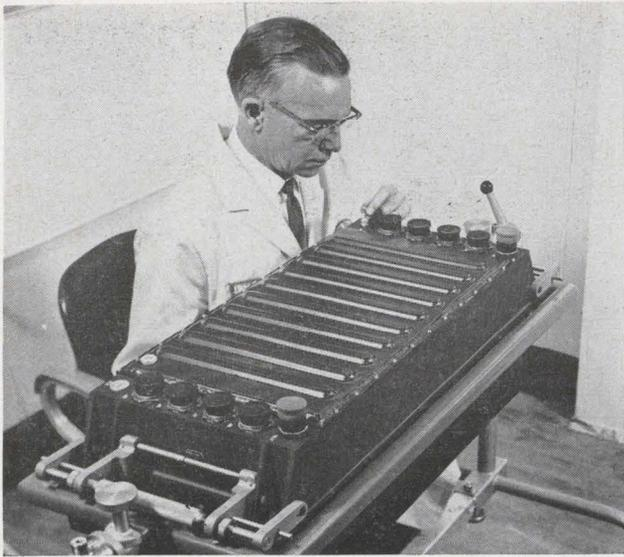

Triple redundant digital computer, with 80,000 components, is 20 times more reliable than a simplex computer.

through the 16 plates on which they are mounted.

IV. Guidance

The Saturn V's guidance system consists of three main elements.

An inertial platform supplied by Bendix Corp. that serves as the frame of reference for all navigation computations. It will operate in a three-gimbal configuration with the option of using a fourth for missions in which doglegs (sharp changes in direction) are required.

The digital computer developed by IBM determines steering commands, vehicle sequence commands, thrust cutoff, reignition of the third stage engine, orbital checkout and other functions. It is preprogrammed but will accept new information from the ground or on-board.

"The memory for the Gemini computer was considered the smallest yet," Fritz H. Weber, chief of the Instrument Unit Project Office at Marshall's Astrionics Laboratory, said. "But this is a step further." The memory has a magnetic core with an inside diameter of 0.019 inch and an outside diameter of 0.03 inch.

The data adapter is an input-output unit that provides an interface with nearly all components of the system. One of its functions is to convert analog data to digital form and digital to analog.

V. Control

The guidance system acts on the engines to change flight direction by means of the control system.

The guidance system includes:

- An analog computer that controls yaw, pitch, and roll. The computer mixes information from rate gyros with navigational data supplied by the digital computer, and transmits the information to the stage which is operating.

- High precision rate gyros that supply the control computer with attitude change data. Gyro outputs also spot excessive angular rate for the emergency detection system.

- A control signal processor that contains the electronics associated with the rate gyro package.

VI. Measurement and telemetry

During flight, about 40 transducers will measure temperature, pressure, vibration and other conditions in the instrument unit.

Measurement signals are fed to a measuring distributor and directed to preassigned telemetry channels.

VII. Tracking and command

Saturn V carries two radio beacon transponders that allow ground stations to track it. One is an Azusa transponder for measuring slant range and direction from the ground station; the other is a C-band transponder to aid ground radar measure range, azimuth and elevation.

For emergencies, the instrument unit carries two high-frequency radio receivers. These will accept commands from the ground ordering the unit to cut off power or to set off explosive charges to destroy Saturn V.

**AUTHORIZED
ERIE
DISTRIBUTOR**

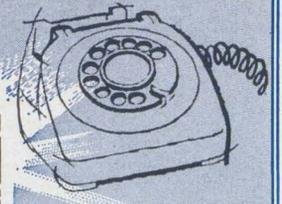

For Erie Components In-Stock Call

ARIZONA

Phoenix
Kierrulff Electronics Corp.—273-7331

CALIFORNIA

Glendale
R. V. Weatherford Co.—849-3451
Inglewood
Newark Electronics Corp.—OR4-8441

Oakland

Elmar Electronics, Inc.—TE4-3311

Palo Alto

R. V. Weatherford Co.—DA1-5373

San Diego

R. V. Weatherford Co.—BR8-7400

South Pasadena

Capacitors, Inc.—MU2-3541

COLORADO

Denver
Newark-Denver Elect. Supply—757-3351

DISTRICT OF COLUMBIA

Hyattsville, Maryland
Milgray/Washington, Inc.—UN4-6330

FLORIDA

Orlando
Crescent Elect. Sales Co.—423-8586

ILLINOIS

Chicago
Newark Electronics Corp.—ST2-2944

INDIANA

Indianapolis
Graham Elect. Supply, Inc.—ME4-8486

MARYLAND

Baltimore
Whlse. Radio Pts. Co., Inc.—MU5-2134

MASSACHUSETTS

Boston
DeMambro Electronics—783-1200

Newton

Cramer Electronics, Inc.—WO9-7700

MICHIGAN

Detroit
Newark-Ferguson Elect., Inc.—548-0250

MISSOURI

St. Louis
Electronic Components for Industry
Co.—647-5505

Kansas City

ECl Semiconductor, Inc.—931-0829

NEW MEXICO

Alamogordo
Kierrulff Electronics Corp.—437-0370

Albuquerque

Kierrulff Electronics Corp.—268-3901

NEW YORK

New York
Arrow Electronics—MY4-6800

Newark Electronics Center—255-4600

Milgray Electronics, Inc.—YU9-1600

Rochester

Rochester Radio Supply Co.—454-7800

NORTH CAROLINA

Winston-Salem
Electronic Wholesalers, Inc.—PA5-8711

OHIO

Cincinnati
Newark-Herrlinger Elect. Corp.—
421-5282

Columbus

Electronics Marketing Corp.—299-4161

OKLAHOMA

Tulsa
Engineering Supply Co.—LU3-8121

PENNSYLVANIA

Philadelphia
Radio Elect. Serv. Co. of Pa., Inc.—
WA5-5840

Pittsburgh

Cameradio Company—391-4000

TENNESSEE

Nashville
Electra Distributing Co.—AL5-8444

TEXAS

Dallas
Engineering Supply Co.—
FL7-6121

Houston

Engineering Supply Co.—
MO6-2175

WASHINGTON

Seattle
Universal Electronics
Co.—MA3-2783

FORMERLY ERIE RESISTOR CORP.



644 West 12th Street
Erie, Pennsylvania

DESIGN ENGINEERS:

NOW . . . Capacitance-to-volume ratio to 20 mf/cu. in.
in Subminiature, Highly Reliable Ceramic Capacitors

SUBMINIATURE MONOBLOC* CAPACITORS



Featuring HIGH CAPACITANCE . . . HIGH RELIABILITY

Erie's new Monobloc ceramic film Capacitors represent the most significant design advance in more than a decade. Now, Erie's exclusive Monobloc Process, in which very thin films of ceramic can be bonded into solid structures, permits virtually unlimited range of capacitance values, characteristics and sizes to suit exacting design requirements. Monobloc Capacitors provide volumetric efficiencies from 10 to 100 times the capacitance (to 20 mf/cu. in.) attainable in conventional components of the same size . . . and still meet Established Reliability specifications for Aerospace, Military and Commercial applications.

These proven subminiature Monobloc Capacitors are encapsulated to suit the design engineers' need; hermetically sealed, glass encased . . . precision molded . . . and phenolic coated as illustrated at right. No other manufacturer produces a true hermetically sealed, glass encased capacitor . . . and in capacitance values to 10,000 pf.

Write TODAY, for literature and samples to: Monobloc Dept., Erie Technological Products, Inc., Erie, Pa.

Design Advantages . . .

- Volumetric efficiency to 20 mf/cu. in.
- Capacitance values 5 pf. to .5 mfd . . . higher values upon request.
- IR at room temperature . . . 100 K megohms.
- Working Voltage . . . 50 V, 100 V and 200 V.
- Inherent stability due to monolithic construction.
- Conservatively rated for long, trouble-free life.
- Available to Established Reliability or to your custom specification.

*Trade name for Erie Technological Products, Inc.

Another series of components in Erie's Project "ACTIVE" . . .
Advanced Components Through Increased Volumetric Efficiency.

ERIE MONOBLOC CAPACITORS . . .

- Hermetically Sealed Glass Encased Types



- Precision Molded Types

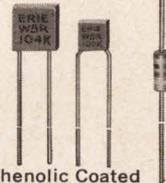

- Phenolic Coated Types Weecon

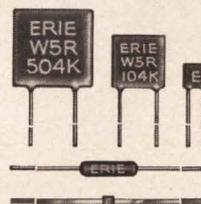

ERIE

TECHNOLOGICAL

PRODUCTS, INC.



Formerly
Erie Resistor
Corporation

644 West 12th Street
Erie, Pennsylvania



Employment

Creative engineers, by multiple choice

Test developed by University of Utah psychologists asks 300 questions in attempt to predict future creativity of job applicants

By Seth Payne

Washington News Bureau

If you said you disliked doing repairs around the house when you were a teenager, it would be the right response to one of 300 questions in a NASA-sponsored test of engineer creativity.

But what do you do when you're depressed? Do you want to be alone? The creative person might shun other people when he's feeling low or, the test suggests, he might want to tie one on, seek the company of friends, or go to sleep.

The "right" answer to this and the other multiple-choice questions is known only to the scientists who developed the test. The long questionnaire is intended to help employers select engineers and scientists to fill jobs that require creative talent.

I. How test evolved

Developers of the Biographical Inventory, as the test is called, say their test is far better than the psychological tests now being given in industry and government personnel rooms and at psychological testing agencies. Their test, they say, is more extensive than

Sample questions . . .

1. How interested were you in making repairs around the house up to the age of 18?
Strong interest. Mild interest. Indifferent. Mild dislike. Strong dislike.
2. How much freedom did your mother give you during your childhood and adolescence?
Not very much. Fair amount. Practically all I wanted. All I wanted. More than I wanted.
3. During your undergraduate years in college how often did you visit your library or read material not directly related to your classwork?
Frequently. Occasionally. Rarely. Never.
4. What do you consider to be your capacity or ability to succeed in research?
Superior. Above average. About average. Slightly below average. Does not apply.
5. How often do you have a desire to be alone, to pursue your own thoughts and interest?
Very frequently. Frequently. Occasionally. Rarely. Very rarely.
6. How would you rate yourself on self-discipline?
Very high in self-discipline. Above average. About average. Probably below average.
7. If you were working in a situation where some restrictive regulations or policies had a negative influence on your work, would you try to get them changed?
No—probably not. Yes—but probably not very hard. Definitely yes. I would probably just ignore them as much as possible.
8. If you were to feel miserable and blue what would you least prefer to do?
Have a few drinks. Be by myself. Be with my friends. Try to sleep it off.
9. How often do you tend to suggest somewhat "wild ideas" during a discussion with your associates?
Frequently. Occasionally. Rarely. Never.
10. How do you feel about filling in a questionnaire such as this one?
I enjoyed it; I would enjoy a discussion with those who constructed it. It was interesting. I found it somewhat interesting. I found it neither interesting nor too distasteful. It was a nuisance; I resented it.

other tests for scientists and engineers; and, they declare, it is more reliable.

Under a \$40,000 grant from the National Aeronautics and Space Administration a group of researchers at the University of Utah, headed by C. W. Taylor and R. L. Ellison, made a four-year study of 1,400 scientists and engineers from three NASA research centers who had demonstrated productive creativity.

A thousand questions. With a group of assistants Taylor and Ellison asked the successful and talented guinea pigs literally a thousand questions. They asked about their parents and early family life, academic background, their adult life and interests, how many technical papers they wrote each year, and how they felt about almost everything they had ever done.

As the research continued, the group eliminated some questions, modified others, and initiated new ones. Finally, the test was boiled down to 300 questions that were answered either in the same way or in a consistent pattern.

The biographical approach attempts to measure the effect of previous life experiences and past environmental effects and to project the outward manifestations of certain combinations of heredity and environment.

The multiple-choice format was chosen for a number of reasons: it is most suitable for describing life experiences; most acceptable to scientists; lends itself to statistical analysis; and, provides the opportunity to study complex or simple relationships existing between the alternatives of an item and the criteria.

Scoring. Taylor and Ellison say that 8 out of 10 of the scientists and engineers who score in the upper 20% of the biographical inventory test will be above average in future creativity; of those in the next 20%, 7 out of 10 will be above average. Of those scoring in the bottom 20%, only 2 out of 10 will ever do better than average in creativity.

To confirm the validity of the questions and the interpretations given the answers, the Utah group is giving the test to 600 more scientists and engineers who are

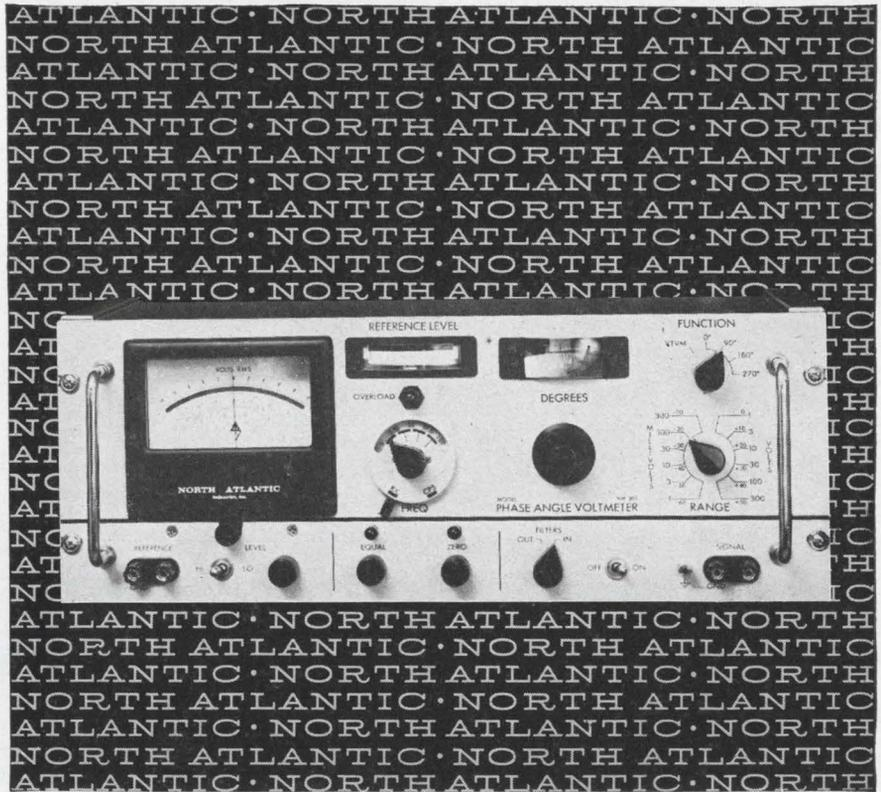

how to measure in-phase, quadrature and angle while sweeping frequency to 100 kc

North Atlantic's latest addition to the PAV line of Phase Angle Voltmeters* enables you to make measurements while frequency is varying over half-decades without recalibration. The VM-301 **Broadband Phase Angle Voltmeter*** provides complete coverage from 10 cps to 100 kc, and incorporates plug-in filters to reduce the effects of harmonics in the range of 50 cps to 10 kc with only 16 sets of filters. Vibration analysis and servo analysis are only two of the many applications for this unit. Abridged specifications are listed below:

Voltage Range.....	1 mv to 300 volts full scale
Voltage Accuracy.....	2% full scale
Phase Dial Range.....	0° to 90° with 0.1° resolution (plus 4 quadrants)
Phase Accuracy.....	0.25°
Input Impedance.....	10 megohms, 30μmf for all ranges (signal and reference inputs)
Reference Level Range.....	0.15 to 130 volts
Harmonic Rejection.....	50 db
Nulling Sensitivity.....	less than 2 microvolts
Size.....	19" x 7" x 10" deep
Price.....	\$1990.00 plus \$160.00 per set of filters

North Atlantic's sales representative in your area can tell you all about this unit as well as other Phase Angle Voltmeters* for both production test and ground support applications. Send for our data sheet today.

*Trademark



NORTH ATLANTIC industries, inc.
 TERMINAL DRIVE, PLAINVIEW, L. I., NEW YORK • Overbrook 1-8600

Lambda Announces

a complete line of

all-silicon MODULAR power supplies

**VOLTAGES UP TO 60 VDC
0.08 AMPS. TO 8.3 AMPS.**

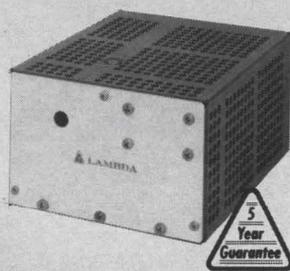

PATENTS PENDING

**4 DC
outputs in
3 1/2" rack
adapter
LRA-4**

MOUNTED THIS WAY

MOUNTED THIS WAY

MOUNTED THIS WAY

MOUNTED THIS WAY

**Full ratings
on 3 vertical
chassis
mounting
surfaces**

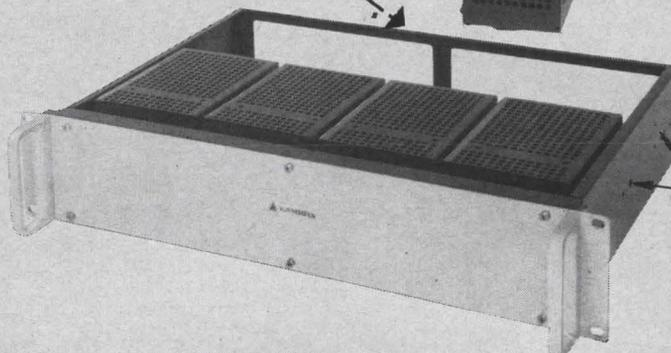

**Rack
mounting for use
with chassis
slides**

Mounting provisions made for
all popular brands of
chassis slides.

- **Maximum amps per dollar—starting at \$79.00**
- **Multi-Position-Rated™—3 mounting surfaces**
- **Multi-Current-Rated™ for 40°C, 50°C, 60°C, 71°C ambients**

- A-C INPUT 105-132 VAC, 45-440 cps
- REGULATION—Line .05% + 4 mv
—Load .03% + 3 mv
- RIPPLE — 1 mv rms — 3 mv
peak-to-peak
- REMOTE PROGRAMING
200 ohms/volt over voltage range
- NO VOLTAGE SPIKES OR OVERSHOOT
on "turn on, turn off" or power failure

- TEMPERATURE COEFFICIENT — .03%/°C
- MEET RFI SPECIFICATIONS — MIL-I-16910
- THERMALLY PROTECTED AND SHORT
CIRCUIT PROOF — CURRENT LIMITING
- REMOTE SENSING
- RACK ADAPTERS AVAILABLE
- MAXIMUM RATINGS WITHOUT EXTERNAL
HEAT SINKING OR FORCED AIR



LAMBDA ELECTRONICS CORP.

515 BROAD HOLLOW ROAD, MELVILLE, L. I., NEW YORK • 11749

Circle 118 on reader service card

LM Series available in 4 package sizes for chassis and rack mounting

Package A 3 1/8" x 3 1/8" x 6 1/2"

Model Number	VDC	CURRENT RANGE AT AMBIENT OF: (1)				Price
		40°C	50°C	60°C	71°C	
LM 201	0-7(2)	0-0.85A	0-0.75A	0-0.70A	0-0.55A	\$ 79.00
LM 202	0-7(2)	0-1.7A	0-1.5A	0-1.4A	0-1.1A	99.00
LM 203	0-14(3)	0-0.45A	0-0.40A	0-0.38A	0-0.28A	79.00
LM 204	0-14(3)	0-0.90A	0-0.80A	0-0.75A	0-0.55A	99.00
LM 205	0-32(4)	0-0.25A	0-0.23A	0-0.20A	0-0.15A	79.00
LM 206	0-32(4)	0-0.50A	0-0.45A	0-0.40A	0-0.30A	99.00
LM 207	0-60	0-0.13A	0-0.12A	0-0.11A	0-0.08A	89.00
LM 208	0-60	0-0.25A	0-0.23A	0-0.21A	0-0.16A	109.00

Package B 3 1/8" x 4 7/8" x 6 1/2"

LM 217	8.5-14	0-2.1A	0-1.9A	0-1.7A	0-1.3A	\$119.00
LM 218	13-23	0-1.5A	0-1.3A	0-1.2A	0-1.0A	119.00
LM 219	22-32	0-1.2A	0-1.1A	0-1.0A	0-0.80A	119.00
LM 220	30-60	0-0.70A	0-0.65A	0-0.60A	0-0.45A	129.00

Package C 3 1/8" x 4 7/8" x 9 1/2"

LM 225	0-7(2)	0-4.0A	0-3.6A	0-3.0A	0-2.4A	\$139.00
LM 226	8.5-14	0-3.3A	0-3.0A	0-2.5A	0-2.0A	139.00
LM 227	13-23	0-2.3A	0-2.1A	0-1.7A	0-1.4A	139.00
LM 228	22-32	0-2.0A	0-1.8A	0-1.5A	0-1.2A	139.00
LM 229	30-60	0-1.1A	0-1.0A	0-0.80A	0-0.60A	149.00

Package D 4 7/8" x 7 3/4" x 9 1/2"

LM 234	0-7(2)	0-8.3A	0-7.3A	0-6.5A	0-5.5A	\$199.00
LM 235	8.5-14	0-7.7A	0-6.8A	0-6.0A	0-4.8A	199.00
LM 236	13-23	0-5.8A	0-5.1A	0-4.5A	0-3.6A	209.00
LM 237	22-32	0-5.0A	0-4.4A	0-3.9A	0-3.1A	219.00
LM 238	30-60	0-2.6A	0-2.3A	0-2.0A	0-1.6A	239.00

(1) Current rating applies over entire voltage range and at 55 to 65 cps. For operation at AC input of 45-55 cps and 360-440 cps, derate output current 10%.

(2) Can be operated at 0-10 VDC—derate output current 30%.

(3) Can be operated at 0-20 VDC—derate output current 30%.

(4) Can be operated at 0-40 VDC—derate output current 30%.

 **LAMBDA**
ELECTRONICS CORP.

working successfully in creative jobs. The results of this follow-up study will be in soon.

II. Who uses it

Although NASA sponsored the project, it is still taking a wait-and-see position. When the results are in next month from the tests being given the 600 new engineers, NASA will study them, and make a decision by September.

If the Utah group is right, and their results are confirmed, NASA might use the test along with its present hiring procedures. It is expected that if the applicant scores well on the biographical inventory test but low on the other tests, he will be hired. If he scores low on the inventory but high on the others, he still may be hired. Hiring chances would be slim with a low score on both tests.

While NASA continues to be cautious, interest is picking up elsewhere. The Utah group says the Public Health Service of the Health Education and Welfare Agency wants a creativity test made for it.

Extension. And even though the tests were intended to identify promising scientists and engineers to fill posts in the National Aeronautics and Space Administration programs, its originators say that a national drug organization has given the test to 180 of its researchers. The preliminary results, according to Taylor and Ellison indicate the test can be applied to chemists and biologists, as well as to space-oriented scientists and engineers.

This is exactly the goal the two psychologists have been trying to reach. Taylor hopes to see the establishment of a testing center to advance research in the field and to make whatever variations are needed for tests that will be useful in different industries or disciplines. For example, Taylor wants to do more work on the relationship between the biographical inventory and such conventional measures of ability as intelligence quotient, aptitude, and standard personality tests.

The result of this research, Taylor believes, will ultimately provide a hiring guide for many kinds of jobs, including administrative jobs where it is necessary to foster creativity in others.

III. Biography

When the University of Utah undertook its study, there was considerable evidence collected over the years suggesting that biographical information might be used to predict future creativity in scientists and engineers.

Researchers in the field had long held that heavy reliance on scholastic standings was a poor method of predicting a person's future creativity. Indeed, limited studies conducted by the National Advisory Committee for Aeronautics (NACA), the predecessor of NASA, Hughes Aircraft Co., Western Electric Co., and others, showed that there was no correlation between the academic rating of a person and his later job performance.

These studies showed too that there was no correlation between the college or university a person attended, whether it was MIT or Podunk, and job performance.

So far, however, scholastic standings have been the means of selection. The biographical inventory is considered by many to be a first step toward perfecting a better system.

IV. The creative engineer

In selecting the scientists and engineers to be used with the program, the research team used the various methods of evaluating performance used at the three NASA centers. These included a range of inputs such as salary level, ratings on cooperation, knowledge of work, initiative, judgment, and the quantity and quality of work output.

The composite portrait of the creative engineer painted by the research team reveals a number of solid traits:

He is professionally self confident in his primary responsibilities or in extra ones he may be called upon to assume.

He is not dependent on others or on the general consensus when evaluating a situation.

He is intellectually oriented—a trait that usually became apparent in early adolescence.

He is dedicated to his work—often to the exclusion of everything else, including his family.

His aspirations are high and he fully expects to realize them.

ANOTHER EXAMPLE OF "TOTAL VALUE" ASSURANCE...

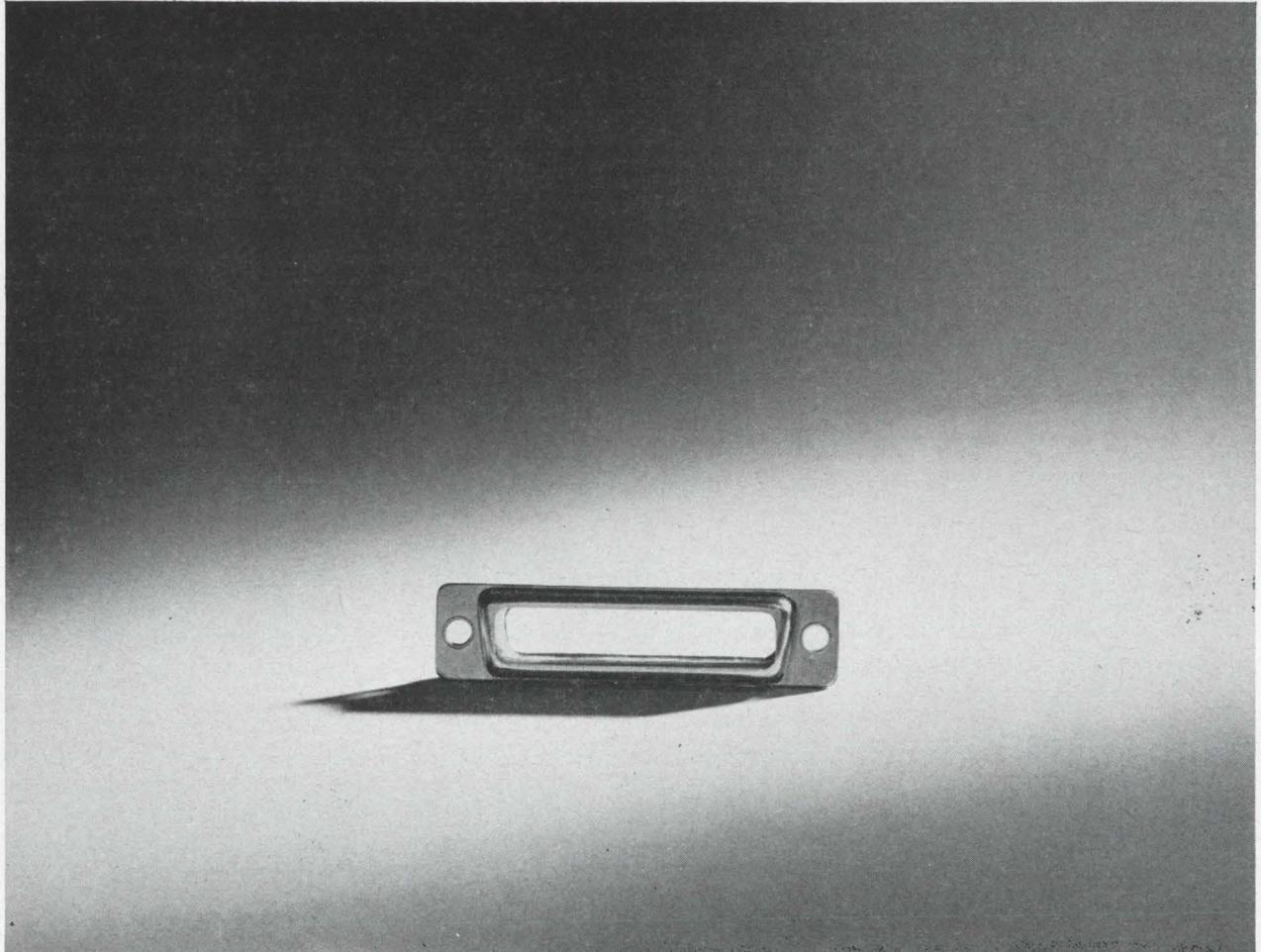

This is a picture of 118,752,610 different D Subminiature Connectors

The CANNON® D SUBMINIATURE SERIES, utilizing just one shell size of the five available, can provide you with as many as 118,752,610 different subminiature connectors . . . without considering modifications for finish, insulating materials, mounting holes or accessories. The number is the result of different combinations utilizing the following variations: Solder Pot Contacts • Crimp Removable Snap In Contacts • Crimp Rear-Release Contacts • High Power Contacts • High Voltage Contacts • Coaxial Contacts • Combination Layouts • Hermetics. This versatility is inherent in CANNON D Subminiatures and provides you with the widest selection of subminiature connectors available. CANNON D Subminiature Connectors are in use

around the world in thousands of custom and standard applications. During their fifteen years of design growth and development, Cannon has diligently maintained interchangeability between all five major D Subminiature types to avoid the hazards of mismatching and to insure universal use. CANNON D Subminiatures are also available with weldable or filter contacts, non magnetic properties and for printed circuit or custom applications. For more information, write to: ITT Cannon Electric Inc., 3208 Humboldt St., Los Angeles, Calif. A subsidiary of International Telephone & Telegraph Corp.



Our 50th Year

© "CANNON" IS A TRADEMARK REGISTERED IN U.S. PAT. OFF. AND FOREIGN COUNTRIES BY ITT CANNON ELECTRIC INC. © 1964 ITT CANNON ELECTRIC INC.

ITT CANNON

Solutions to the riddle of jungle communications

Studies under way in Thailand may provide a formula to predict radio propagation range in any tropical environment

By John F. Mason

Military Electronics Editor

A small group of United States engineers in a Thailand outpost are working on communications problems that have plagued and even cost the lives of American and allied troops in Southeast Asian jungles.

They, along with Thai military engineers, are seeking a reference guide that will enable military commanders in any jungle in the world to predict quickly the probable propagation range of their radio gear. The reference guide will also help in the selection of the best frequency, antenna height, or antenna orientation.

Such a key to actual propagation conditions in a particular place at a specific time would prevent errors resulting from the highly deceptive conditions in the jungle. For example, a forest in the United States might be as dense as one in South Vietnam but because of the magnetic equatorial belt in which Southeast Asia lies, the same radio gear might be one-tenth as effective there as it was at Fort Bragg, N. C.

I. Seacore

Sponsored by the Defense Department's Advanced Research Projects Agency as part of its Project Agile, which provides research and development for equipment for guerrilla warfare, the tropical propagation research program in Thailand is being carried out by the U. S. Army Electronics Command Laboratories, Fort Monmouth, N.J. The project is called Seacore, for Southeast Asia Communications Research. The test site lies about 100 miles from Bangkok in the Korat National Forest.

The terrain near the site permits propagation tests in three surface environments: flat, rolling and rough—all heavily vegetated.

The data collected is complex but, in general, falls into two categories: propagation characteristics are measured and analyzed, and the environmental conditions themselves are measured and analyzed; these include hourly rainfall, barometric pressure, relative humidity, foliage density, terrain profiles and soil characteristics.

Contractors. The work is being done by two U. S. organizations under Army contract. The Jansky and Bailey Research and Engineering division of the Atlantic Research Corp. makes the basic propagation measurements. Stan-

ford Research Institute measures atmospheric noise, ionospheric density and altitude during various seasons and hours of the day, and the effects of terrain and vegetation on particular antennas. Stanford also tests equipment and techniques and operates an electronics laboratory in Bangkok.

II. Objectives

Seacore has set a difficult goal. Its engineers want to characterize and identify a location, 50 by 100 miles in area, for example, for its precise propagational performance. A group of standardized environments, each of which has a different effect on radio propagation, will be evolved. A military planner would compare the environment of the area that interests him with these standardized environments to determine the probable effects on radio communications.

Information about an area is being obtained by aerial photographs or survey, weather data stations and from general intelligence. Tests will be made in other parts of the world to see if the profile can be used in other areas.

Prediction guide. The final result will be a set of numbers that give the measure of the environmental influences upon propagation path losses for specific frequencies, distances and antenna elevations.

The frequencies being measured

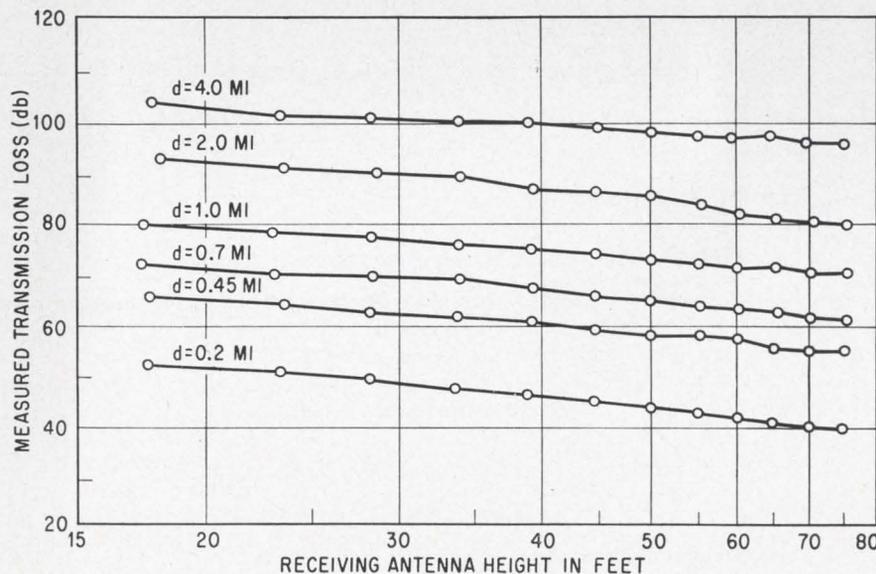

What happens in the jungle with a transmitting antenna using horizontal polarization, 80 feet above the ground but still immersed in vegetation: As the receiving antenna—also immersed in vegetation throughout the test—is elevated, the transmission loss decreases. Over a transmission distance of one mile, a receiver elevated to 20 feet suffers a transmission loss of almost 80 db; if the receiver is raised to 75 feet, the transmission loss drops to 70 db.

GMW FUSE
and HWA
FUSEHOLDER



FUSE SIZE
ONLY .270 x .250
INCHES

BUSS
VISUAL
INDICATING

Sub-Miniature FUSE-HOLDER COMBINATION

For space-tight applications. Fuse has window for inspection of element. Fuse may be used with or without holder.

Fuse held tight in holder by beryllium copper contacts assuring low resistance.

Holder can be used with or without knob. Knob makes holder water-proof from front of panel.

Military type fuse FM01 meets all requirements of MIL-F-23419. Military type holder FHN42W meets all military requirements of MIL-F-19207A.

BUSS

Write for BUSS
Bulletin SFB

BUSSMANN MFG. DIVISION, McGraw-Edison Co., St. Louis, Mo. 63107

Screw type knob
designed for easy
gripping, even
with gloves. Has
a "break-away"
test prod hole
in knob.



Screw type slotted
knob that is
recessed in holder
body and requires
use of screwdriver
to remove or insert it.

BUSS Space Saver Panel Mounted Fuseholders

- Fuseholder only $1\frac{1}{8}$ inches long, extends just $\frac{29}{32}$ inch behind front of panel. Takes $\frac{1}{4} \times \frac{1}{4}$ inch fuses. Holder rated at 15 ampere for any voltage up to 250.

- Military type available to meet all requirements of MIL-F-19207A.

BUSS

Write for BUSS
Bulletin SFH-10

BUSSMANN MFG. DIV., McGraw-Edison Co., ST. LOUIS, MO. 63107

BUSS®: The Complete Line of Fuses..

Circle 123 on reader service card

Circle 123 on reader service card

To order reprints from Electronics

Fill in, cut coupon below, insert in envelope and mail to:

Electronics reprint dept.

330 West 42nd Street, New York, N. Y. 10036

Reprint order form

For listing of reprints available see the reader service card

To help expedite mailing of your reprints please send cash, check, or money order with your order.

Communications on Gemini

Send me copies of Key no. R-73 at 50¢ each.

For reprints of previous special reports fill in below:

Send me reprints of Key no. (s) @ ¢ each

For prices see the reader service card.

Name

Number and Street

City, Zone No., State

are from 100 kilocycles to 10 gigacycles. Antennas are tested at elevations from six feet above the ground—equivalent to a man-carried set—to 80 feet.

III. Findings

Although considerable data must be compiled before hard conclusions can be drawn, measurements during the first six months have already produced several interesting indications:

The rate of attenuation due to vegetation per unit distance seems to decrease as the distance is increased between the transmitter and receiver.

Skywaves may be the solution for high-frequency communication in heavily vegetated areas. This immediately poses an antenna problem. Antennas usually carried by troops aren't designed for sky-wave modes.

Wet and dry seasons. An investi-

gation is being made of the consistency of conditions in succeeding seasons. Data has been collected during two wet seasons and they are just now going into their second dry season.

Sometimes the researchers pick up unusual interference. At certain hours, they've received high-frequency skywave signals from a transmitter 2,000 miles away.

All data from Seacore goes to the Defense Documentation Center in Washington for dissemination, on request, to other government agencies and to qualifying companies.

IV. New equipment

Findings from Seacore and from experience in South Vietnam and other Southeast Asian countries have already dictated the design of several new pieces of electronic equipment for jungle wars.

A jungle communications equipment team, in the transmission di-

vision, communications department, of the Army Electronics Command Laboratories, at Fort Monmouth, is working on:

▪ A 100-foot inflatable mast, six inches in diameter, made up of four 25-foot sections, for use in supporting a vhf antenna above jungle foliage. One 25-foot section is inflated by a foot pump and pushed upwards through the branches of the trees. The other three sections are added, one at a time by means of a uniquely designed connecting sleeve, to the lower end of the mast structure; each section is inflated and thrust up through the branches. The Applied Sciences division of Litton Systems, Inc., is working on this project.

▪ A dipole antenna formed by two 75-foot inflatable structures; each of which may penetrate jungle foliage. The material used is a Dacron-Mylar laminate with aluminum foil providing electrical con-

of Unquestioned High Quality...

BLOCKS for BUSS FUSES

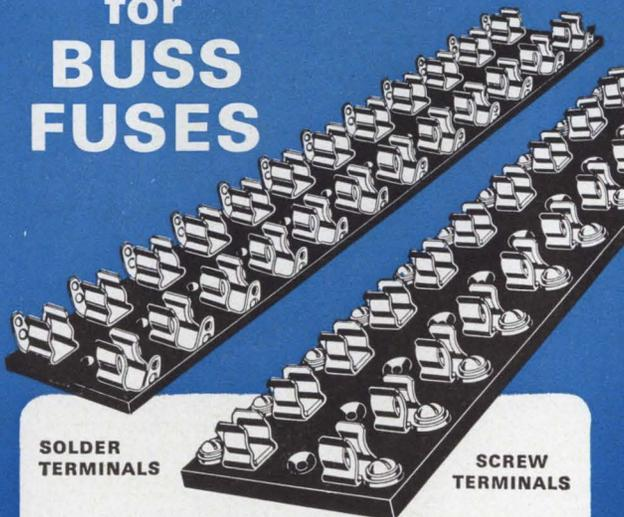

SOLDER
TERMINALS

SCREW
TERMINALS

Above standard types available in any number of poles—
From 1 to 12... plus other types for every application....

BUSS

Write for BUSS
Bulletin SFB

BUSSMANN MFG. DIV., McGraw-Edison Co., ST. LOUIS, MO. 63107



SIGNAL
ACTIVATING
•
LAMP
INDICATING
•
SERIES
HKA

BUSS FUSEHOLDERS

FOR 1/4 x 1 1/2 INCH BUSS GLD FUSES, 1/4 TO 5 AMPS.

When fuse opens, indicating pin completes a circuit that lights indicating lamp in holder and makes contact on external signal circuit. External signal can be an audible alarm or another lamp mounted at a distance, or it can operate a relay.

BUSS

Write for BUSS
Bulletin SFB

BUSSMANN MFG. DIVISION, McGraw-Edison Co., St. Louis, Mo. 63107

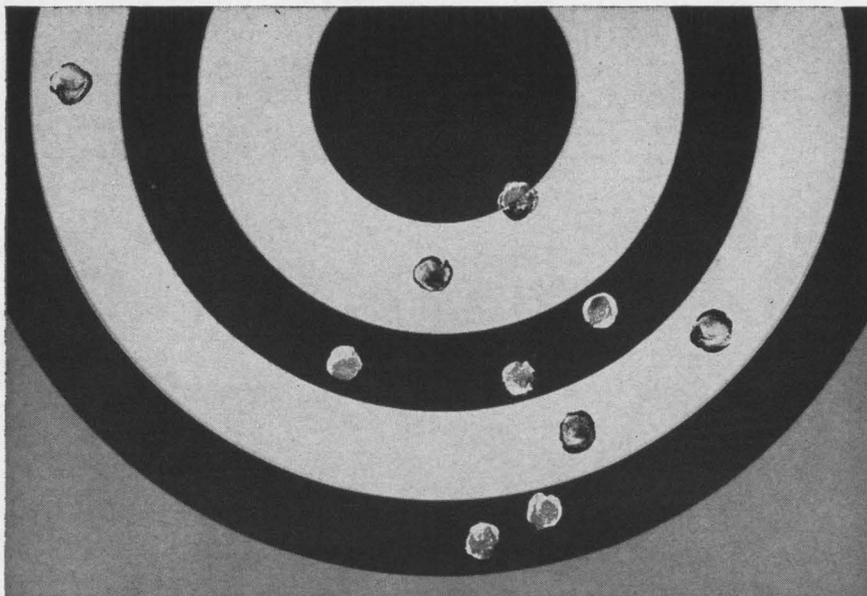

NO NEAR MISSES



with computerized filter and transformer design

On-target design—with no false starts and no near misses—is one big advantage you get in Genisco filters and transformers designed with the help of computers.

You get faster solutions because computer designs are achieved in minutes instead of hours—and you get on-time delivery and lower shipping costs because Genisco plants are spotted in key market areas.

Computer design also means greater accuracy and the elimination of guesstimation. You never have to settle for the first solution when you're pressed for time because our computer method investigates several design approaches almost instantaneously.

Trial-and-error prototype costs are cut out because designs are automatically "performance tested" before production starts. And price quotations are fast and accurate. There's never any guessing about costs with Genisco computer design of filters and transformers.

Zero in on this new filter and transformer design capability. Write for complete information today.

COMPONENT DIVISIONS: Combined Sales and Application Engineering Departments		
WESTERN UNITED STATES		EASTERN UNITED STATES
6320 West Arizona Circle Los Angeles, Calif. 90045		111 Gateway Road Bensenville, Ill. 60106
Phone: (213) 776-1411 TWX: 213-670-4765		Phone: (312) 766-6550 TWX 312-766-7048
Genisco	TECHNOLOGY CORPORATION	

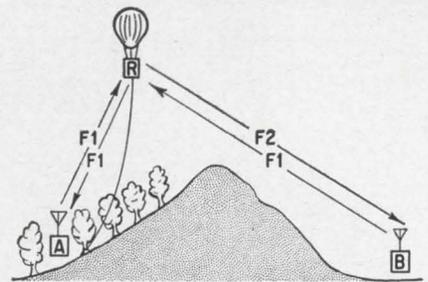

Balloon-lifted relay to communicate 25 miles in the jungle using vhf, line-of-sight frequencies.

duction for the antenna elements. Intended for use between 2 to 12 megacycles, the sausage-like structures will be in sections of 25-foot lengths, four inches in diameter. An inflatable matching network consisting of an inductor and capacitor formed of copper foil strip material affords a means of coupling the two antenna elements to the radio set. The Army is looking for a hardier material that cannot be punctured by sharp thorns. The Kearfott division of General Precision Inc. has this contract.

- A four-pound radio repeater attached to a balloon. To communicate 25 miles in the jungle using vhf, line-of-sight frequencies, the Zenith Radio Corp. is working on an $F_1 - F_2$ relay station, one that will transmit on one frequency and retransmit on another. A thin tethering string will hold the balloon at an altitude of from 400 to 500 feet. The station will be used with the PRC-10 and PRC-25 ground radio sets. The contract calls for delivery next January.

- A device to enable the PRC-10 and PRC-25 to transmit and receive Morse code. This capability will increase the range of the set. The Radio Corp. of America delivered experimental models to Fort Monmouth in March.

- A ferrite receiving antenna, 10 inches long and two inches in diameter. The ferrite antenna will replace the whip antenna whose polarization makes it almost useless in the jungle. Coupled with a tunnel diode, the ferrite antenna will be almost as effective as a half-wave dipole. A varactor diode—one which has the property of changing capacity by the application of voltage—will handle sharp tuning. Kearfott will deliver an advanced development model to Fort Monmouth in August.



if it's a
rheostat, you
can get it
from Ohmite

Need a miniature 7½-watt rheostat? Or something at the other extreme, say, 1000 watts? Ohmite makes all 12 basic sizes. With these as a starting point, you can branch out into literally hundreds of electrical, mechanical, and motor-driven variations . . . too many to even begin listing here.

Ohmite is the *only* rheostat supplier who can fill 100% of your requirements (plus many you probably will never run into).

As Near As Your Distributor—There are thousands of stock Ohmite rheostats in distributors' inventories from coast to coast backed up by the world's largest factory

stock. So if you need standard rheostats in a hurry, you'll find Ohmite units are the easiest and quickest to lay your hands on . . . no matter where you are located . . . no matter what size you need.

Motor-Driven Rheostats: Technically, these are classified as specials. But Ohmite makes so many of them that some models are practically standard.

"Way Out" Specials? No matter how unusual your requirement, contact the factory. For over 30 years, Ohmite has been solving tough rheostat problems. Maybe yours is even among them.

Write for revised Stock Catalog 30.



OHMITE

MANUFACTURING COMPANY

3610 Howard Street, Skokie, Illinois 60076

Phone (312) ORchard 5-2600

An efficient solid state delay line

Two-ounce device, operating at room temperature, gives 5- μ sec delay at 2 Gc with insertion loss of only 45 db

In airborne radar systems, where size and weight are at a premium, there are obvious drawbacks to the use of large, heavy coils of coaxial cable or wire as delay lines. A solid state delay line, developed by the Microwave Electronics Corp. in Palo Alto, Calif., is the first such device to become commercially available.

The two-ounce device works on the principle of generation, detection and propagation of an elastic vibration at a microwave frequency through an acoustic material, in this case a single small crystal. Such transmission results in the low-velocity propagation of the signal through the solid, permitting controllable real-time delay in the microwave region.

Operating at room temperature without any cryogenic equipment, it attains a typical delay of five microseconds at two gigacycles, with insertion loss of 45 decibels.

Suitable crystals, such as sapphire, ruby, rutile and quartz, have been investigated in recent months. Other materials are also suitable, but their properties are not fully understood. While the electromag-

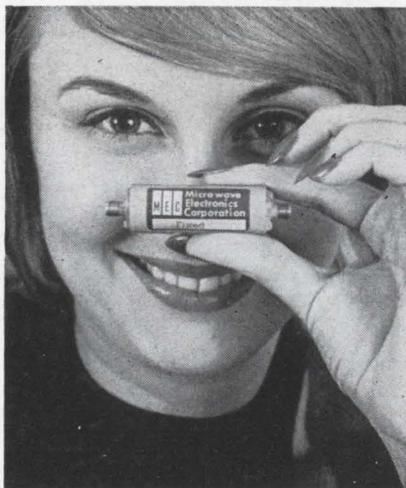

Microwave solid state delay device is 1/2 in. in diameter, 1 in. long and weighs less than 2 oz.

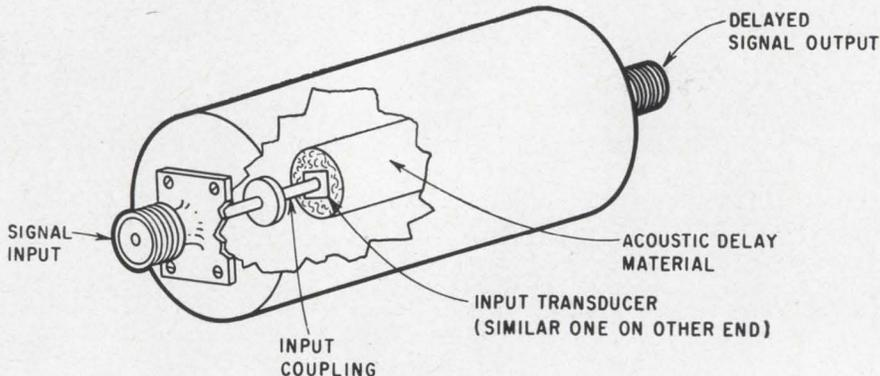

Solid state device has input and output transducers coupled to a crystal of acoustic material. Signal delay is accomplished by the delay crystal.

netic signal-to-acoustic signal conversion must occur in a piezoelectric or magnetic medium, the problems of transduction and impedance-matching have also held back development of a working device.

Microwave Electronics' most active development is in the L-band and S-band regions, but work is taking place across the entire frequency spectrum. Delays on the order of 500 nanoseconds to about 10 microseconds are possible, the company says.

Both fixed and repetitive delay devices are available. The repetitive delay device operates on a signal-storage principle that provides repetitive output pulses at fixed intervals determined by the length of the delay crystal. In the fixed device, the delay time is unchangeable and equivalent to the length of coaxial cable used to achieve delay in previous methods.

In the Microwave Electronics delay line, an input pulse is introduced through a circulator into the delay device, where it is converted to an acoustic wave. The wave travels the length of the delay crystal, is reflected, and travels back to the input-output port. Part of this reflected pulse, exactly the same as the original pulse except

reduced in amplitude, appears as an output signal. The remainder continues to traverse the length of the delay crystal, providing a series of output pulses separated by the round-trip travel time through the delay crystal. The output pulses are at specific, discrete and constant spacings; each output pulse is a replica of the input pulse except for amplitude. Because of the propagation loss within the acoustic material, the pulse amplitude is exponentially decreased with each pass through the crystal.

Variable delay devices are currently under development. These use velocity changes for delay variation. The velocity, and hence the delay, is dependent on a magnetic field. The field is provided by an internal permanent magnet and an adjustable control coil.

Specifications (fixed delay devices)

Frequency	0.1-1.0 Gc to 5.2-11 Gc
Typical delay	20 μ sec to 2 μ sec
Typical bandwidth/loss	10%/40 db-octave/60db to 3%/95 db-20%/95 db
Size	2 by 7 in. to 1 by 3 in.
Weight	6 oz. to 14 oz.
Price	About \$3,000
Delivery	60 to 90 days

Microwave Electronics Corp., Palo Alto, Calif.
Circle 350 on reader service card

THINK COPPER...for high-performance alloys



Electricity travels first class via modern coppermetals

Tiny printed circuit or giant bus bar—modern coppermetals developed at Anaconda's Research and Technical Center have what it takes to carry current best. In addition, today's conductive copper alloys offer the electrical/electronic designer a full range of physical and mechanical properties—almost limitless combinations to meet your most sophisticated design requirements.

When you think electrical conductivity, think copper. And take a fresh look at the versatile, high-performance alloys Anaconda offers today.

64-0962

ANACONDA[®]
AMERICAN BRASS COMPANY

Think copper. And when you do...

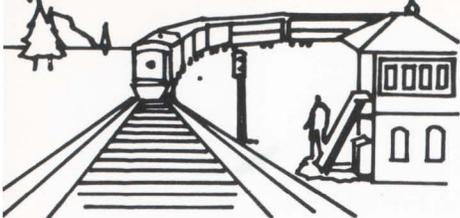

... THINK ANACONDA

for the broadest range of copper alloys and sizes and for experienced technical services

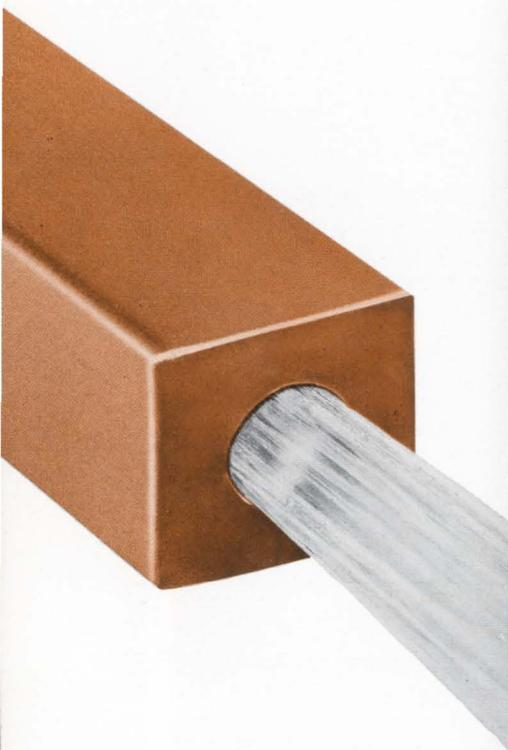

liquid-cooled hollow conductors

To meet needs of heavy current density applications, especially where space limitations confront the designer, Anaconda provides liquid-cooled hollow conductors in a wide variety of sizes, types and cross sections.

Among recent advances made possible by conductors of this type are high-field magnets for basic research, synchrotrons and other particle accelerators for atomic studies, bus systems for electromechanical operations requiring currents of 100,000 amp or more, and silicon-diode rectifier heat sinks.

With water-cooled conductors in stator bars, ratings of turbo-generators have been increased 2½ times without increasing the floor space they occupy.



"ELECTRO-SHEET" for R.F.I. shielding

Economical Anaconda "Electro-Sheet" copper foil is proving itself to be highly effective in radio frequency interference (R.F.I.) shielding applications.

One recent series of tests (complete data on request) followed the procedures of MIL-Std-285. Over the entire frequency spectrum, copper foil by Anaconda showed attenuation characteristics as good as those of copper mesh and galvanized steel.

"Electro-Sheet" is available in long lengths and easily joined widths from 6" to 64". Joints are simpler to make and more dependable than those made in other shielding materials. In addition, this low-cost copper foil is readily bonded to a variety of building materials, using any of a number of different types of adhesives.



conductive and springable coppers

Some coppermetals have extraordinary springability. Duraflex® superfine-grain phosphor bronze, for example. In special fatigue-test apparatus, Duraflex contact springs were deflected at 1 cps from the initial free position to 77,000 psi bending stress. After 4,000,000 deflections—no permanent set, no loss of load, no breakage.

In applications where cost is an important factor, check the performance of Ambronze 430—one of the most economical of the fine spring alloys available from Anaconda. Its average electrical conductivity: 27% IACS. Its modulus of elasticity in tension: 16,050,000 psi hard, 17,300,000 annealed.

Tube displays miniature numbers

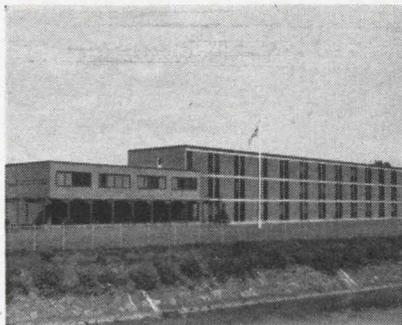

THE HOUSE YOUR NEEDS BUILT

Since its establishment in 1961, Anaconda's impressive Research and Technical Center has been dedicated to finding new ways for coppermetals to serve you better.

The results? New alloys. New mill forms. A new world of facts about coppermetals and their unique capacity for meeting industry's fast-changing needs.

Here is the taproot of Anaconda technical assistance in the field.

If there is a coppermetal answer to your problem, the man from Anaconda has it or can get it for you quickly through the Research and Technical Center. Anaconda field metallurgists are ready to serve you in offices from coast to coast.

Write today for handy, helpful technical information on any of the following alloys and products:

Liquid-cooled hollow conductors
Electro-Sheet
Spring alloys

Anaconda American Brass Company, Waterbury, Connecticut 06720. In Canada: Anaconda American Brass Ltd., New Toronto, Ontario.

64-0952

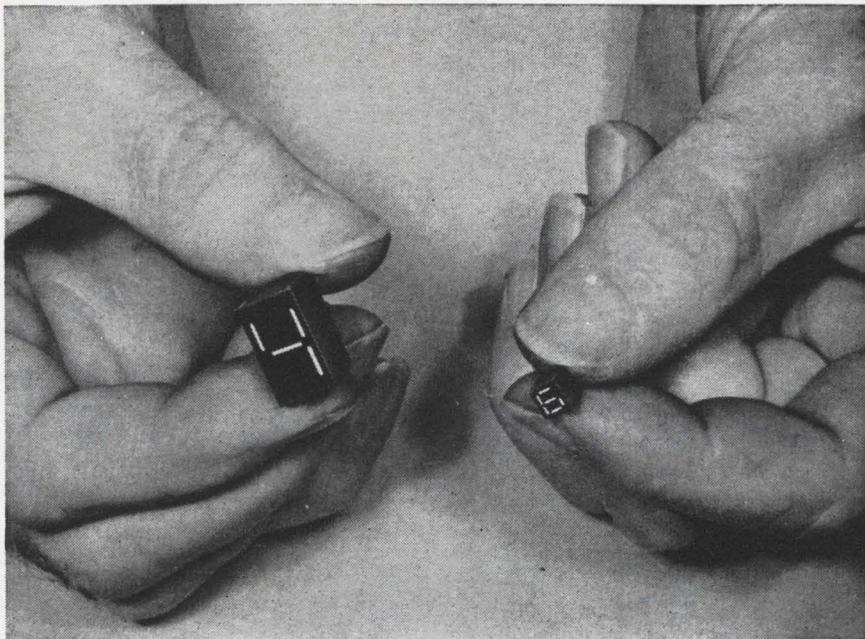

Numerical indicators that can display characters not much larger than small type on a printed page are expected to find wide use in small desk displays, computers, instruments, and many kinds of office equipment and industrial control systems.

The most recent family of small digital display devices includes what is believed to be the smallest numerical indicator ever developed. It displays numbers $\frac{1}{8}$ of an inch high and works from a one-volt source. The indicators contain an array of 7 tiny incandescent filaments, arranged to form any digit. The digit display can be changed in milliseconds. Used in multiples, a series of lamps can display any number of digits. A six-digit array occupies a space $\frac{3}{16}$ high and one inch long. Some 3,400 of the indicators will fit on a page of this size. Four models have been developed that display numbers up to $\frac{1}{2}$ inch high. The photo shows the smallest and the largest model. Specifications of four models are given in the table.

Illuminated characters are easily read, even in sunlight. Brightness depends upon the size of the characters, and the lamps can be ad-

justed to maintain the proper brightness-to-contrast ratio under varying ambient light conditions.

The incandescent filaments are all mounted in the same plane, and provide a wide viewing angle. The filaments are made of tungsten wire, only a few thousands of an inch in diameter. Life expectancy of each bulb segment varies from 20,000 to 100,000 hours, depending upon size.

At the present time, the display lamps are available in numbers 1 to 9 and 0. The same system will eventually be used to read out the entire alphabet.

A special code converter is required to read out digital data, which must be converted from binary or decimal logic form to a code appropriate to the 7-segment display unit. This is said to pose no problems for circuit designers. The company plans to supply code translators at a later date.

Specifications

Model numbers	02-10, 03-15, 04-30, 08-60
Over-all dimensions	
height	3/16 to 5/8 inch
width	5/32 to 3/8 inch
depth	1/4 to 3/8 inch
Character height	1/8 to 1/2 inch

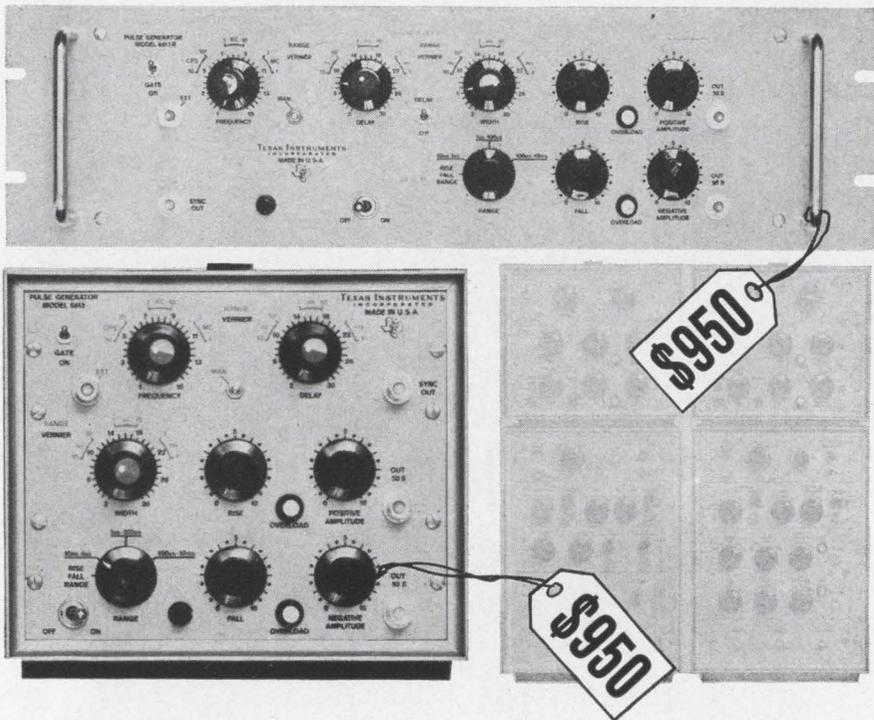

more general-purpose features, higher performance and quality with TI's 6613 pulse generator

The Model 6613 General Purpose Pulse Generator fills the need for a low-cost, high-quality test instrument with exceptional performance specifications. It is a general purpose instrument ideal for most pulse applications such as testing integrated circuits, digital circuit design, system design and checkout, testing of diodes and transistors.

The 6613 provides coincident positive and negative pulses determined by an internal clock generator or external source, with rep rate variable in 6 steps. Pulse width and delay are also variable in 6 steps. Amplitude is variable from near zero to 10 volts, with overload protection provided. Solid-state circuitry is utilized throughout. The compact unit measures 8½ in. high, 8½ in. wide, 12 in. deep and weighs only 10 lb.

SPECIFICATIONS

Clock Pulse Repetition Frequency

15 cps to 150 cps	15 to 150 kc
150 to 1500 cps	150 kc to 1.5 mc
1500 cps to 15 kc	1.5 mc to 15 mc

Delay

30 to 300 nano-sec	30 to 300 microsecs
300 nanoseconds to 3 microsecs	300 microsecs to 3 milliseccs
3 to 30 microsecs	3 to 30 milliseccs

Width

30 to 300 nano-sec	30 to 300 micro-sec
300 nanoseconds to 3 microsecs	300 microsecs to 3 milliseccs
3 to 30 microsecs	3 to 30 milliseccs

Pulse Amplitude—10 v into 50 ohms

Rise and Fall Times—variable: less than 10 nanosecs to 1 microsec, 1 microsec to 100 microsecs, 100 microsecs to 10 milliseccs, minimum rise time typically 8 nanosecs

New Components

Input power, each segment	1 to 6 volts, 10 to 30 ma
Life expectancy, each segment	20,000 to 100,000 hours
Display speed	5 to 20 millisecc
Max. viewing distance	10 to 40 ft
Brightness	50 to 200 lamberts
Price	\$50 to \$35 each, depending upon size. Quantities over 1,000, from \$19 to \$15

Pinlight Division, Kay Electric Company, 1275 Bloomfield Avenue, Fairfield, New Jersey. [351]

High-voltage coil driven by transistor

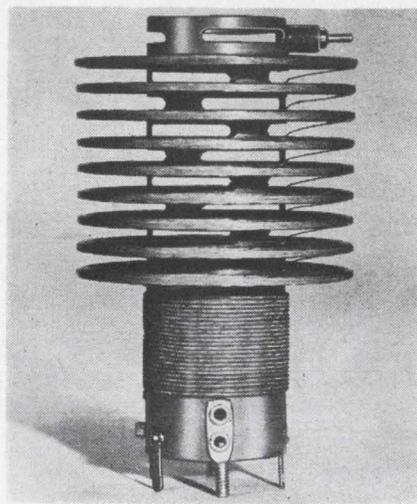

A step-up coil, model TRF-15, is available with an output of 15 kv at 2 ma. The coil is driven by a pair of transistors in push-pull. Approximate frequency with single rectifier is 120 kc; in tripler circuit, 78 kc. The coil is 4¼ in. high and 2⅝ in. in diameter, and its net price is \$15 complete with operational circuit diagram and data. Spellman High Voltage Co., 1930 Adee Ave., Bronx, N.Y. 10469. [352]

Hermetically sealed I-f bandpass filters

A series of low-frequency bandpass filters has been introduced for interstage and other uses. Typical of the series is model BP840 which has a center frequency of 60 cps with a gain of 2/1. The 1 db bandwidth ratio is 6%, and attenuation at 30 cps and

INDUSTRIAL
PRODUCTS
GROUP



**TEXAS INSTRUMENTS
INCORPORATED**
P. O. BOX 66027 HOUSTON, TEXAS 77006
7 RUE VERNONNEX GENEVA, SWITZERLAND

712

120 cps is a minimum of 38 db. Input impedance is 10,000 ohms with the output into a high impedance such as a grid. The filter is hermetically sealed in a can $1\frac{3}{16}$ in. by $1\frac{1}{8}$ in. by $1\frac{5}{8}$ in. high. The units are MIL type FR4RX-22YY manufactured to MIL-F-18327. Similar filters are available up to 100 kc.

Electronics Division, Bulova Watch Co., Inc., 61-20 Woodside Ave., Woodside, N.Y., 11377. [353]

Military relay in crystal-can size

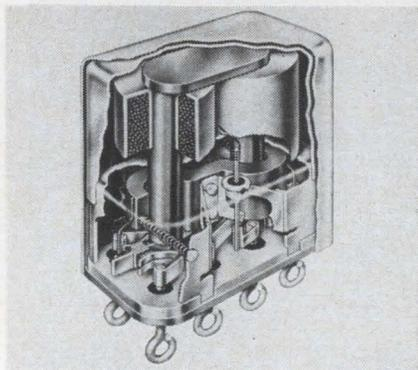

A new series T crystal-can military relay has been designed specifically for long-life reliability at dry circuit switching levels. The device incorporates five major features: a hermetically sealed coil chamber; hinged armature suspension; bifurcated contacts; welded construction, and improved sensitivity (under 100 mw at pull-in). Rated at 2 amps at 28 v d-c, with standard 0.2 in. grid spacing, the series T is designed to meet requirements of MIL-R-5757D.

Hart Mfg. Co., a subsidiary of Oak Electro/Netics Corp., 110 Bartholomew Ave., Hartford, Conn. [354]

Rod thermistors offer low resistance ratios

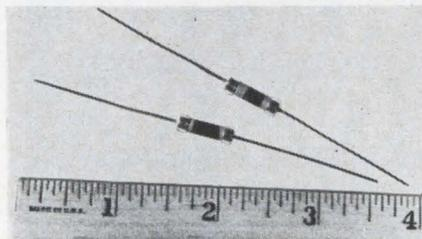

A line of rod thermistors with low resistance ratios has been devel-

for torque, strain,
acceleration, pressure,
any rapidly changing signal...
one- and two-pen
'oscillo/riter'* recorders
offer more extras at a
significantly lower price!
rectilinear heat-writing,
Z-fold chart,
push-button controls,
plug-in amplifiers.

*Trademark of Texas Instruments

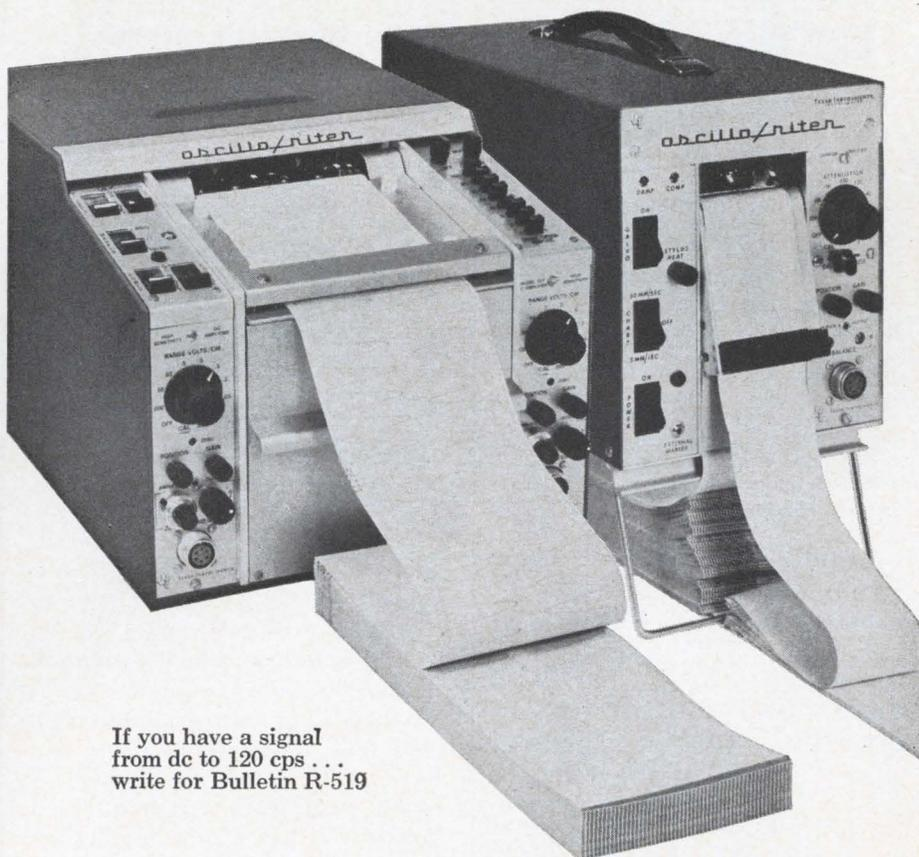

If you have a signal
from dc to 120 cps . . .
write for Bulletin R-519

INDUSTRIAL
PRODUCTS
GROUP



TEXAS INSTRUMENTS
INCORPORATED
P. O. BOX 66027 HOUSTON, TEXAS 77006
118 RUE du RHONE GENEVA, SWITZERLAND

ONE OF 25 NEW 3 WATT MINIATURE POWER SUPPLIES

from **t**ransformer
electronics
Company

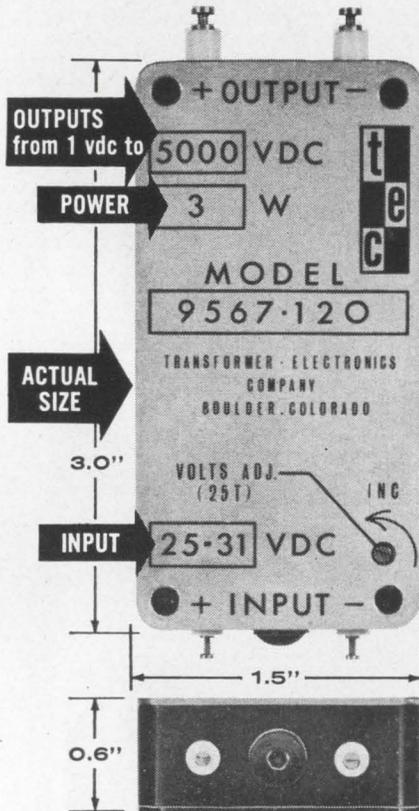

THE 9567 SERIES fulfills many requirements where DC-DC and DC-AC voltage conversion is required. Predominant features are: light weight (4 oz.) ... low cost (prices start at \$150.00) ... all silicon semiconductors ... black anodized aluminum case ... silicon rubber encapsulation ... transient, reversed polarity and short circuit protection ...

INPUT: 25-31 VDC (output regulated to 0.25%)

OUTPUTS: 1.5 VDC to 5000 VDC
± 15 VDC to ± 100 VDC
(dual output)
1.5 VAC to 1000 VAC (3 to 5 kc)
(adjustable ± 10%)

POWER: 3 WATTS

TEMPERATURE: -55 to 100°C

FOR ADDITIONAL INFORMATION CONTACT:

**TRANSFORMER
ELECTRONICS
COMPANY**

BOULDER INDUSTRIAL PARK
BOULDER, COLORADO
TWX 303 443-2561 • PHONE (303) 442-3837

**POWER SUPPLIES • INVERTERS
CONVERTERS • TRANSFORMERS**

New Components

oped for use by designers in temperature measurement, control and compensation in electronic and electrical equipment. The new units offer usable resistances at lower temperatures. They also provide for a more linear output to make it simpler to compensate for voltage changes in other temperature-sensitive components. Resistances available with the new rod thermistors range from 3.9 to 27,000 ohms at 25°C, with R_{25}/R_{125} resistance ratios of 3.25, 4.36 and 4.69. They have a 35-second time-constant response to thermal changes, and a power-dissipation constant of 10 mw per degree centigrade. The new rods are 0.15-in. diameter by $\frac{9}{16}$ in. in length, with 1½-in. radial end-capped type leads which facilitate their automatic insertion into p-c boards.

General Electric Co., Magnetic Materials Section, P.O. Box 72, Edmore, Mich. [355]

Potentiometer offers expanded resistances

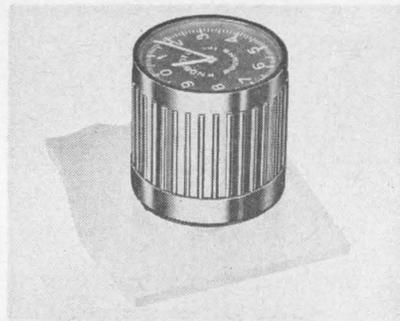

The Knobpot Sr. potentiometer, which combines a precision pot, knob, and turns-counting dial in a single package, is now available in extended resistance ranges. Model 3640, formerly available from 250 to 250,000 ohms, is offered in resistances ranging from 100 to 500,000 ohms. It is phased at the factory to 0.1% accuracy which is better than 0.1% terminal based linearity. It has a repeatability accuracy of ± 0.05%. The easy-to-read clock dial face provides excellent readability and setting accuracy. Resolution is 0.03 to 0.006%; power rating, 2.5 w at 25°C; maximum operating tem-

POLYESTER FILM CAPACITOR:

	Capacitance Range:	Voltages
TYPE MFL Dipped Flat Shape	001 MFD to 47 MFD	35v, 50v, 100v, 200v, DC
TYPE MFK Dipped Flat Shape Non-Inductive Construction	01 MFD to 22 MFD	100v, 200v, 400v, 600v, DC
TYPE MXT In Plastic Tube	001 MFD to 22 MFD	100v, 200v, 400v, 600v, DC

METALLIZED POLYESTER FILM CAPACITORS

TYPE FNX-H Mylar Wrapped Semioval With Epoxy End Seal	1 MFD to 10MFD	50v DC
---	----------------	--------

SOLID TANTALUM CAPACITORS

TYPE TAX MIL-C-26655A Hermetically Sealed	1 MFD to 220MFD	3v, 6v, 10v, 15v, 20v, 25v, 35v, DC
TYPE TAS Sealed with Epoxy Resin		

MATSUO ELECTRIC CO., LTD.

HEAD OFFICE:

3-5, 3-CHOME, SENNARI-CHO, TOYONAKA-SHI,
OSAKA, JAPAN

TOKYO OFFICE:

25-2-CHOME, KANDA AWAJI-CHO, CHIYODA-KU,
TOKYO, JAPAN

Cable Address "NCC MATSUO" OSAKA

perature, 125°C; dimensions (in front of panel), 1½ in. long by 1¼ in. diameter; weight, 1¾ oz.

The Knobpot potentiometer concept eliminates the need for phasing a separate turns-counting dial in front of the panel with a precision potentiometer behind. The entire unit is in front of the panel with only the solder terminals behind.

Bourns, Inc., Trimpot division, 1200 Columbia Ave., Riverside, Calif. [356]

Stepper motor is bidirectional



A stepper motor with directional reversibility and high step rate has been designated the 44100 series. It responds to d-c pulses in discrete 15° steps of angular rotation with positive magnetic detaining at each increment. It will operate at up to 80 pulses per second with a corresponding rotor speed of up to 200 rpm. Pulse duration can be in the order of milliseconds or sustained for long periods without damage to the windings. Reversal is obtained by a simple switch. Operating voltage is 27 v d-c ±10%. Other voltages are available on order. Power input is 6 w nominal; rotor torque, 0.2 oz-in.; temperature range, -10° F to 180° F ambient; weight, 8 oz.

In addition to direct drive, more than 150 different gear ratios are available to increase load capacity and provide smaller step angles. Since no ratchets, pawls, contacts, springs or linkages are employed, operation is extremely quiet and the motor has a long service life. The A.W. Haydon Co., 232 North Elm St., Waterbury, Conn., 06720. [357]

For the Finest Multilayer Printed Circuitry...

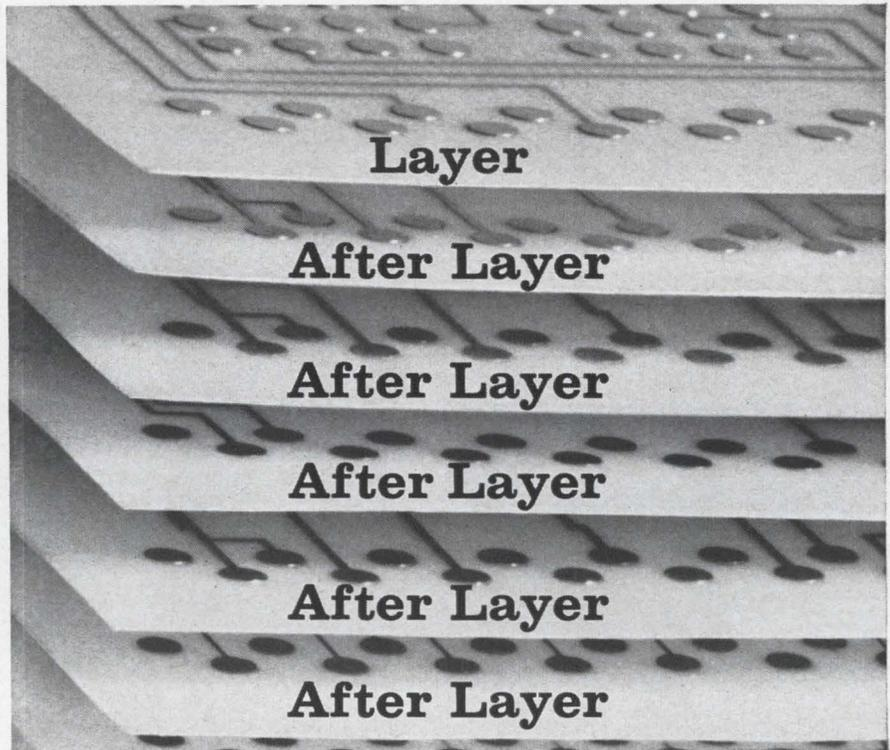

...Specify Cinch-Graphik

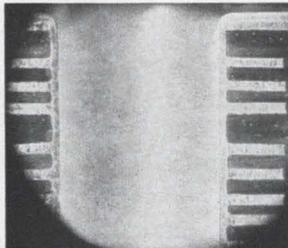

When you specify Cinch-Graphik, you specify unequalled quality. The cross-section microphoto shows why... uniform wall thickness throughout the entire length of the hole and complete interface bond between individual layers and the plated wall. High density circuitry like this is the result of precision production processes such as the Cu-C Plated Thru-Hole, controlled lamination and ultra-precise multilayer registration ($\pm .005''$ layer to layer for 30 layers or more!). Years of experience in pioneering and perfecting multilayer techniques has made Cinch-Graphik the world's leading producer of advanced multilayer circuits. Write for our new, illustrated brochure.

CINCH-GRAPHIK
DIVISION OF UNITED-CARR

200 South Turnbull Canyon Road, City of Industry (Los Angeles), Calif. 91744 • Phone (213) ED 3-1201. Offices in 22 Principal Cities throughout United States, Canada, England and Australia listed under Cinch Mfg. Co. or United-Carr Incorporated • Cinch • Cinch-Monadnock • Howard B. Jones • Ucinite • Palnut

maintenance

tools for the

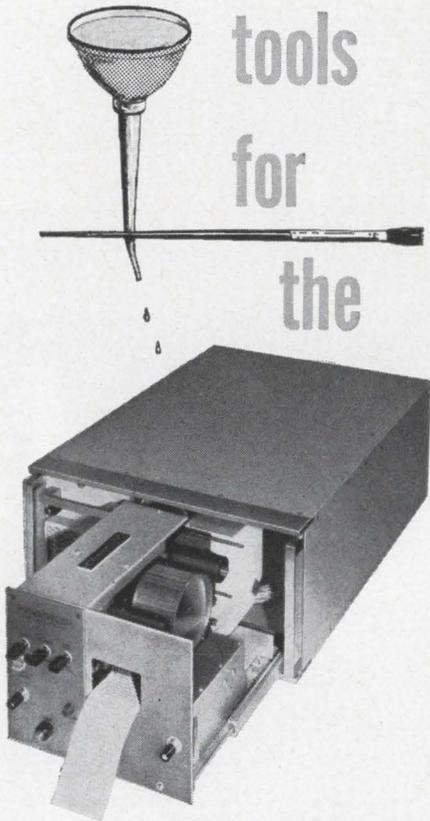

World's Fastest, Low-Cost Digital Printer

Apply several drops of oil to the drive-motor shaft-ends each year (or every fifty-million lines). Brush out any accumulated dust or lint. Clean the air filter periodically.

That's the extent of maintenance for a Franklin Model 1000 . . . the only digital printer that offers a printing rate of 40 lines per second (or less) at low, low, OEM prices.

REQUEST BULLETIN 2301

FRANKLIN
electronics, inc.

East Fourth St. • Bridgeport, Pa. 19405
A Division of the Anelex Corporation

New Instruments

Counting dust particles accurately



For precise measurement of the concentration of dust particles, Bausch and Lomb, Inc., has introduced a dust counter that contains optical, electronic and mechanical components. Model 40-1 is said to be capable of detecting particles as small as 0.3 micron, and directly reading concentrations of 1,000 to 1,000,000 particles per cubic foot.

Such measurement is especially important in fighting air pollution and in industrial "white rooms" where precision components are assembled for aerospace projects.

In the model 40-1, a size selector, calibrated in particle diameters from 0.3 to 10 microns, permits a selective count of all particles above any of the seven preset sizes. This allows size to be plotted against concentration.

Air is drawn into a sampling volume and exposed to a light beam. A concentric optical system collects only the light scattered by the individual particles in the sample. Pulses, generated in a photodetector in response to the near forward-scattered light, are amplified and detected in a pulse-amplitude discriminator. The amplifier's sensitivity is adjusted by the particle-size switch, and the discrim-

inator passes only those pulses greater than the predetermined size. The pulse frequency, averaged to create a d-c value proportional to the particle concentration, is read directly on the output meter in tens of thousands of particles per cubic foot and in pulses per second average.

The instrument is calibrated at the factory, using transparent polystyrene latex spheres of known size. A secondary calibration standard, which utilizes optical fibers, is incorporated to permit a periodic check of the instrument's calibration. The solid-state circuitry is designed to eliminate effects of temperature and line-voltage fluctuations. Optional features are available that will allow the device to drive an X-Y recorder or electromechanical counter to monitor high and low concentrations respectively. An output is also available for activating an alarm when a given concentration limit is reached.

Specifications

Power requirement	115 v, 50 or 60 cps
Weight	34 lbs.
Particle size	0.3 to 10 microns
Readout	Three-decade logarithmic scale with full scale read-

Now...available through Printed Motors, Inc. for

MAXIMUM SERVO PERFORMANCE

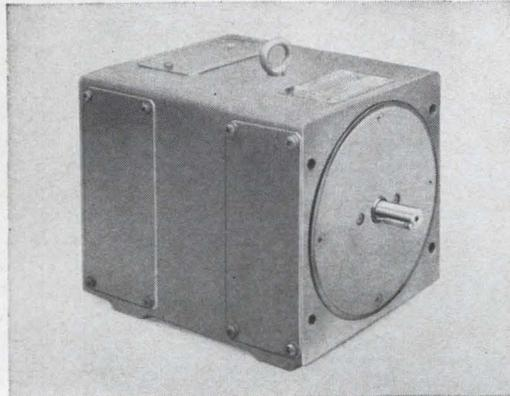

MINERTIA MOTORS

Now, available in stock from Printed Motors, Inc., MINERTIA MOTORS—with the highest speed of response available in any industrial servo motor.

The unique, slotless armature of MINERTIA MOTORS combines low inertia with high pulse torque capability, resulting in unequalled performance for applications requiring fast acceleration, high frequency reversing and rapid start-stop capability. The smooth, cogging-free torque of MINERTIA MOTORS through a wide speed range (3000 to 1) makes them ideal for direct drive use in machine tools, indexing machinery and similar industrial equipment.

Designers of industrial controls are no longer

restricted by the lack of high-power dc servo motors — standard MINERTIA MOTORS are available in eight sizes up to 8 h.p., specials up to 200 h.p.

If you need high-power dc drives with maximum performance, be sure to find out about MINERTIA MOTORS. Call or write: Printed Motors, Inc., 33 Sea Cliff Avenue, Glen Cove, N.Y. Telephone: (516) ORiole 6-8000.



PRINTED MOTORS, INC.

GLEN COVE, NEW YORK

Exclusive U.S. and Canadian Sales Agent for

MINERTIA MOTORS

MANUFACTURED BY YASKAWA ELECTRIC MANUFACTURING CO. LTD., TOKYO, JAPAN

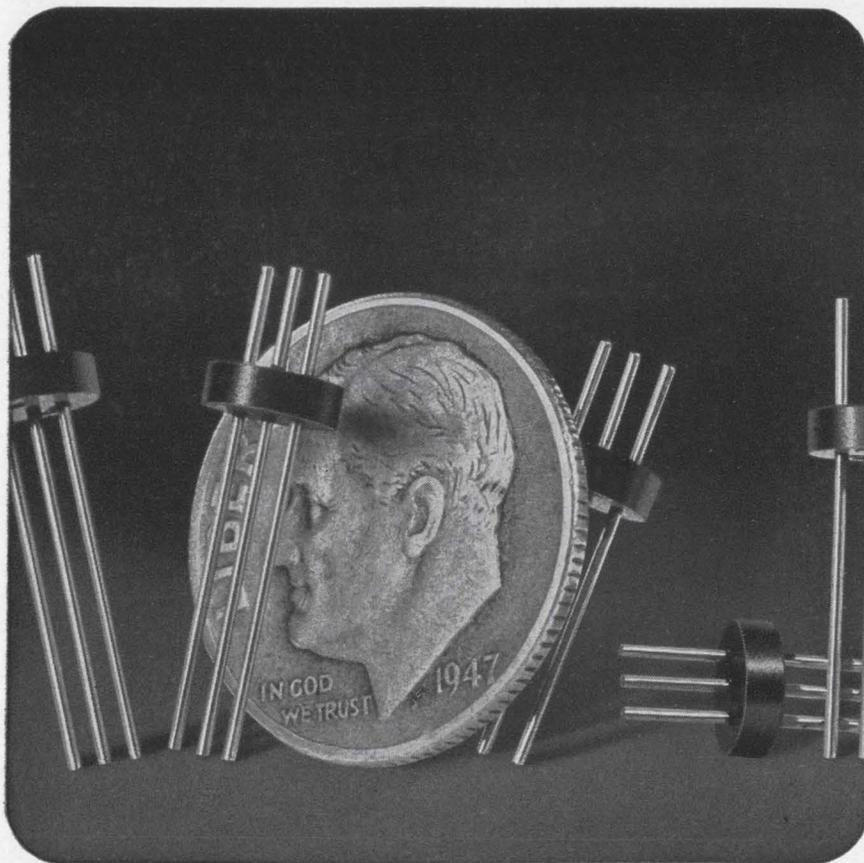

Less than 10¢ a dozen

...when you buy a quarter-million or more. Yesterday, platform headers were made of glass. Prices were high.

Today, General Electric produces plastic platform headers for roughly three-quarters of one cent each. Want to figure your savings? Better plug in a calculator.

The new General Electric plastic platform header is an exceptional product designed for the new plastic encapsulated devices. It's available with virtually any type wire desired, including gold plated Dumet. You have flexibility in number of leads and in pin configuration. The plastic header is ideal for silicon transistor applications. Continuous temperatures to 400°F are taken in stride. Ideal for making transistors used anywhere in home entertainment equipment and in a wide range of other circuit applications.

Plastic transistor platform headers. A breakthrough. The kind of progress you've come to expect from General Electric.

For more information, or for a quote on your requirements, call or write: General Electric Company, Lamp Metals & Components Dept., 21800 Tungsten Road, Cleveland, Ohio 44117. Tel: (216) 266-2971.

Progress Is Our Most Important Product

GENERAL  ELECTRIC

New Instruments

ing of one million particles per cubic foot.
Price \$2,000
Availability From stock

Bausch & Lomb, Inc., 61464 Bausch St., Rochester, N.Y. [381]

Frequency counter is easy to operate

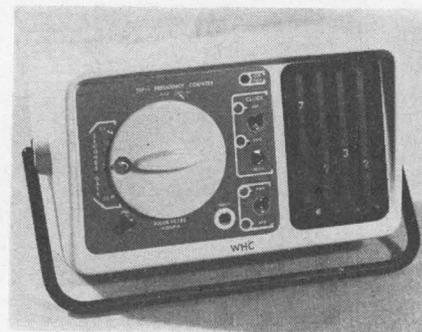

Covering the range of 10 cps to 100 kc nominally, the TCF-1 transistorized frequency counter has a sensitivity of better than 0.5 v rms with an input impedance in excess of 150,000 ohms. No sensitivity adjustment is required in the input range of 0.5 v to 250 v rms. A double shielded case and truly floating input provide d-c isolation in excess of 500 v. The unit features simplicity of operation for convenient use by both technical and non-technical personnel. Both line and internal clocks are provided for a measuring accuracy in excess of 0.01%. Resolution of 0.1 cps is provided over the full 7 cps to 120 kc measuring range. A register overload indicator provides unambiguous 6-digit resolution over 10 kc. The unit is 10 in. by 6 in. by 6 in. deep and weighs less than 7 lbs. Power consumption, including oscillator heater, is less than 8 w. Price is \$395, availability immediate.

W.H. Clark, Inc., 2830-46th Ave. N., St. Petersburg, Fla. [382]

Frequency changers offered in 3 models

Solid state frequency changers are available in three models with 100-v, 250-v and 500-v outputs, re-

spectively. Frequency is regulated to 0.5% and voltage regulation is 1%. Output is sinewave with less than 3% distortion under all rated load conditions. Units can be used as laboratory instruments, but are also designed to be incorporated into systems operating from 60-cps sources and requiring a certain amount of 400-cps power. They are supplied with front panels for rack mounting. Prices are \$490 for model P-6410(R), \$785 for P-6425(R) and \$1,260 for P-6450(R). Delivery is 10 days after receipt of an order for the P-6410(R) and 30 days for the P-6425(R) and P-6450(R). The Linton Co., Inc., 2412 Reedie Drive, Wheaton, Md. [383]

Instrument plots frequency response



The Panoramic model FRP-3 frequency response plotter is a single compact unit providing rapid, accurate, stable swept-band measurements of modern, steep-skirted, narrow-band networks, such as crystal filters, in the r-f frequencies of 10 kc to 15 Mc. In use, the FRP-3 is tuned to the frequency of interest with a band switch, calibrated in 500-kc steps, and a smooth tuning control for fine center frequency setting. It consists of sweep generator and selective receiver-indicator sections. Tests can be performed more accurately and in a fraction of the time previously required by point-by-point measurements. Spotting of critical resonances and other narrow-band effects are simplified by the swept band measurement techniques. Chances of overlooking an unwanted response are minimized. Features include: less than 5 cps short-term drift; single line re-

three Keithley solid state picoammeters



HIGH SPEED

Models 417/416

provide a ten-fold increase in speed of response over other instruments. Speed is maintained by the unique plug-in design which allows the amplifier input to be located up to 100 feet from the instrument chassis. Rise times may be adjusted with a front panel damping control. Both models are identical except the 417 provides calibrated current suppression from 10^{-4} to 10^{-13} ampere. Applications include use in mass spectrometry, vacuum studies and plasma physics studies.

- **Ranges:** 10^{-13} to 3×10^{-5} ampere fs
 - **Accuracy:** $\pm 2\%$ fs to 10^{-8} ampere; $\pm 3\%$ beyond
 - **Zero Drift:** less than 1% per 8 hours, with one volt source
 - **Output:** ± 3 volts for fs meter deflection
 - **Rise Time:** 30 milliseconds on 10^{-12} ampere range at critical damping
- Model 417 High Speed Picoammeter \$850
Model 416 High Speed Picoammeter 650

LOW ZERO DRIFT

Model 409

allows long term measurements of currents as low as 10^{-13} ampere. Circuitry is completely solid state, except for electrometer tube input, assuring reliability and low power consumption. Zero check switch permits zeroing the meter without disturbing the circuit. Applications include use with photocells, photo-multipliers, and ion chambers. With the Model 4103 Electronic Trip, the 409 is excellent for nuclear reactor control.

- **Ranges:** 3×10^{-13} to 10^{-3} ampere fs
 - **Accuracy:** $\pm 2\%$ fs to 10^{-8} ampere; $\pm 3\%$ beyond
 - **Zero Drift:** less than 1% per 24 hours, with one volt source
 - **Output:** ± 3 volts for fs meter deflection
 - **Rise Time:** 1.5 seconds on 10^{-12} ampere range
- Model 409 Low Zero Drift Picoammeter \$525
Model 4103 Electronic Trip (installed) 185

Send for Engineering Notes on New Picoammeters

OTHER KEITHLEY PICOAMMETERS

- Model 410—high sensitivity, 20 linear ranges. \$ 490
- Model 411—exceptional stability, 17 linear ranges 535
- Model 412—log n amplifier, 6 decade span 485
- Model 413A—log n amplifier, 8 decade span 485
- Model 414—high performance over 17 linear ranges 295
- Model 418A—programmable picoammeter 1375
- Models 420A/421—log n period amplifiers 1050



**KEITHLEY
INSTRUMENTS**

12415 Euclid Avenue • Cleveland 6, Ohio

dc microvoltmeters • differential voltmeters • wideband voltmeters

FAMOUS ENCAPSULATING TECHNIQUES

with hull



... and by **HULL**

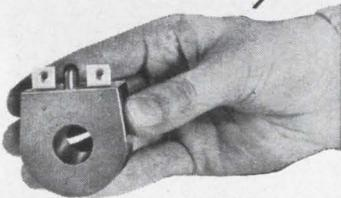

for **BIG** coils, too!

Not all electrical or electronic components for encapsulation by transfer molding are peanut-size! Take coils, for example, as used in transformers, solenoids, and motors. Hull has the field-proven process for your component . . . whether it's a tiny diode, or a coil 5" in diameter!

Whatever your encapsulating problem, Hull engineers can help you choose the most profitable solution. Hull techniques include direct encapsulation by transfer molding, by vacuum potting, and by continuous dispensing with the Blendmaster.

Get the "Hull Package"

From Hull, you get a complete service package: engineering, compound selection, design of mold and fixtures, presses, the work set-up, and assistance in start-up. Why not call or write us today to find out how Hull can help keep your quantity/quality ratios in line?

HULL CORPORATION, 5034 Davisville Road, Hatboro, Pa. 19040. Phone (215) 675-5000. H-21R

See us at **Booth No. 365**
at the **NEPCON Show**



New Instruments

sponses on calibrated high persistence crt (or optional chart recorder); at least 80 db dynamic range permits accurate measurements in high attenuation (step) bands; wide range 40 db log and expanded 3 db crt scales.

The Singer Co., Metrics Division, Bridgeport, Conn. [384]

Line-voltage monitor has compact design

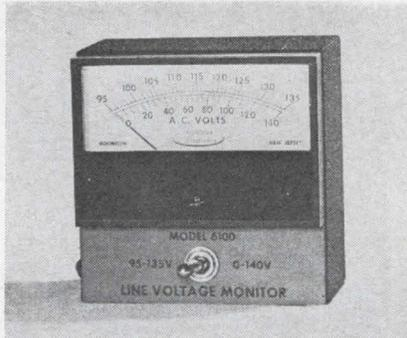

Model 6100 can be used to monitor a-c line voltages at frequencies from 50 cps to 400 cps. It features a new, rugged, dual-range meter, with large, easy-to-read scales of 95 v to 135 v at $\pm 1\%$ and 0 v to 140 v at $\pm 3\%$. The expanded range uses a solid state reference for long term stability and freedom from temperature errors. Measuring 4 in. by 4 in. by 2 $\frac{5}{8}$ in. deep, it can be used in any location. Units are available from stock for \$50.

Associated Electronics, Inc., P.O. Box 104, Boonton, N.J. [385]

D-c power supplies for lab applications



Three silicon half-rack power supply models were designed specifically for laboratory applications. They are the SHR20-3A, 0 to 20 v d-c at 0 to 3 amps; SHR40-1.5A, 0 to 40 v d-c at 0 to 1.5 amps; and the

To order reprints
from Electronics
fill in, cut out
coupon below,
insert in envelope
and mail to:

Electronics Reprint
Dept.

330 West 42nd Street
New York, N. Y. 10036

Reprint order form

For listing of reprints available see the reader service card

To help expedite mailing of your reprints please send cash, check or money order with your order.

For reprints of the latest
Special report:

Communications on Gemini

Send me reprints of key
no. R-73 at 50¢ each.

For reprints of previous special
reports fill in below:

Send me reprints of key no.(s)

. at ¢ each.

For prices see the reader service
card.

Name

Number & Street

City, State

Zip Code

SHR60-A1, 0 to 60 v d-c at 0 to 1 amp. Featuring 0.01% regulation with a recovery time of less than 25 μ sec with less than 0.5 mv ripple, the units are completely siliconized for optimum temperature capabilities. The SHR supplies furnish constant voltage as well as constant current operation by means of an automatic crossover network. A front-panel mode indicator light is provided to simplify operation. Coarse and fine front-panel controls allow precise voltage and current settings, with rear-panel capabilities for remote voltage and current programming. The supplies measure 5 in. high by 8 in. wide by 7 in. deep, thus minimizing the amount of bench space required. Rack adapters are available to mount two units side by side. Prices range from \$199 to \$235 and delivery is two to three weeks after receipt of order.

Trygon Electronics, Inc., 111 Pleasant Ave., Roosevelt, N.Y. [386]

Analyzer system has modular design

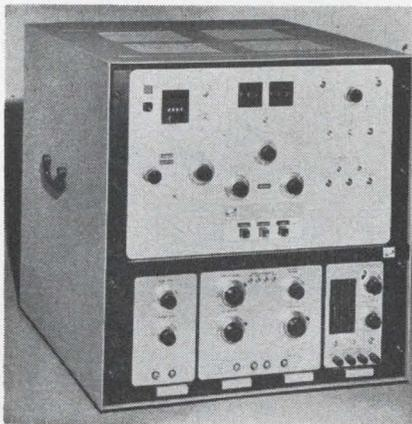

The 34-27 series is a family of analyzer systems each of which is tailored to a specific application. It is not limited to multichannel pulse height analysis alone, but expandable to include such applications as Mossbauer, NMR, pulsed neutron, time of flight, spectroscopy, etc. The system uses a basic 400 word memory with wired program master controls. Modules for specific requirements such as input amplifiers, analog-to-digital converters, display controls, and system power supplies have been packaged permitting complete flexibility. ADC's with and without

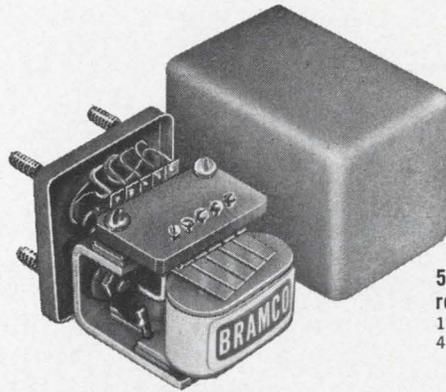

5-channel resonant reed relay
1½ x 1¾ x 2,
4½ oz.

REMOTE CONTROL SWITCHING WITH AUDIO SIGNALS

An audio tone can be generated by an electronic oscillator or resonant reed encoder circuit, then transmitted by wire or radio. The tone activates a resonant reed relay to perform a control function.

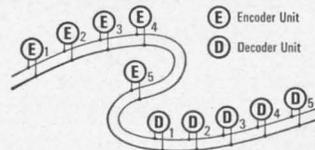

A single pair of wires, or a leased telephone line, can carry the audio signals for a complete control system.



For inaccessible areas or mobile installations, a radio transmitter and receiver system can carry the signals.

Bramco reeds permit over 50 selective control frequencies within the 67 to 1600 cps spectrum. This is assured by: (1) the narrow response bandwidth of about 1% for decoders and (2) the high accuracy of Bramco reed encoders (1/10 of 1% of design frequency).

A big advantage of reeds in control switching is that they are ideally suited for simultaneous and sequential coded tone systems. The actual number of control functions possible in such a system is virtually unlimited. For example, over 3300 individual control functions are possible with only 16 frequencies coded sequentially in groups of three.

Compared to other types of tone filters, resonant reeds are small and inexpensive. They give more control functions per spectrum, per size, per dollar.

If you work with controls that select, command, regulate, or indicate, you should know about how it can be done with audio signals. We custom design and stock a broad line of encoder/decoder components and modules.

For literature write Bramco Controls Division, Ledex Inc., College and South Streets, Piqua, Ohio, or call 513-773-8271.



BRAMCO CONTROLS DIVISION, LEDEX INC.
College and South Streets, Piqua, Ohio 45356

instant lettering[®]

dry transfer

ELECTRONIC SYMBOL DRAFTING SET

... a fast new way to better, more readable schematics and drawings!

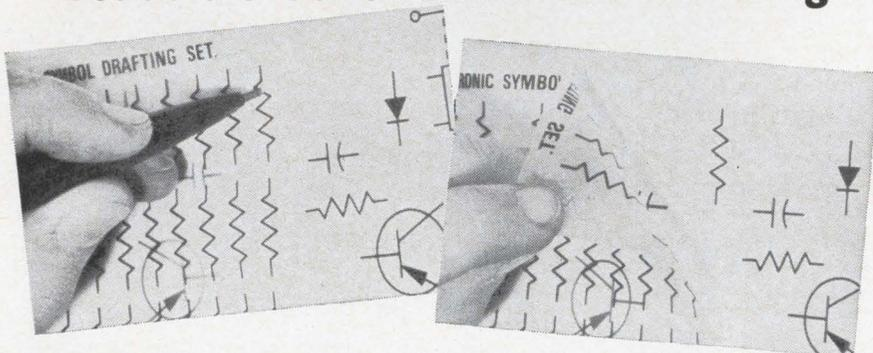

INSTANT LETTERING[®] dry transfer drafting symbols are printed on a special transparent plastic carrier sheet. Rubbing over one of these symbols releases it from the carrier sheet and adheres it to your drawing.

INSTANT LETTERING[®] dry transfer symbols are uniform and correct in every detail according to military and A.S.A. drafting standards ■ Easily erased yet will not come off in diazo machines ■ Completely opaque, reproduction quality ■ Faster than lettering guides and templates plus no chance of blots or smears ■ Letter and numeral sheets take the tedium out of labeling components ■ ALSO INCLUDED — a 16-page booklet on drawing with dry transfer symbols.

Complete set contains 40 sheets of dry transfer symbols, letters and numerals plus instruction booklet. Price \$15.95.

SEND FOR YOUR SET TODAY

See our demonstration at Booth 111, NEPCON

Circle 212 on reader service card

THE DATA CORPORATION

63 71st Street — Dept. 633
Guttenberg, New Jersey

- Enclosed is my check for \$15.95. Please send me a complete drafting set.
- Please send me free sample and literature on the entire line of INSTANT LETTERING[®] dry transfer sets for the electronics industry.

Name _____

Company _____

Address _____

City _____ State _____ Zip Code _____

New Instruments

buffered outputs are available. Display control modules offer vertical display offset of subgroups or typewriter drive circuitry. Standard features of the scientific analyzer systems include region-of-interest logic for data display and readout, internal time base for time sequence scaling, elapsed time storage and readout, flexible preset count control, push-button control logic, and X-Y plotter calibration. Optional features include spectrum stripping and peak area integration. Optional accessories are practically unlimited.

Radiation Instrument Development Laboratory, 4501 West North Ave., Melrose Park, Ill. 60160. [387]

21-range picoammeter is remotely controlled

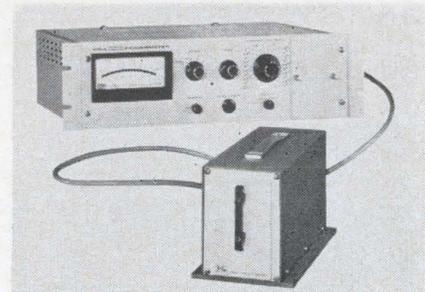

Model 418A is a high-speed picoammeter that can be remotely controlled and is called suitable for external programming. It offers 21 ranges from 10^{-12} ampere full scale to 10^{-2} ampere; rise time of 6 milliseconds at 10^{-11} ampere; zero drift of less than 1% of full scale per 24 hours; remote location of input head up to 100 ft. from chassis; and reduced noise with variable damping control. The unit has reed relays that can be used with external programming to control range selection. The range selection is commanded by means of a 5-bit binary code, which is compatible with most computer outputs. Applications for the model 418A include automatic component testing and nuclear reactor monitoring. Price is \$1,375. Delivery is 90 days after receipt of order.

Keithley Instruments, 12415 Euclid Ave., Cleveland 6, Ohio. [388]

TWEEZERS

SUPER FINE TWEEZERS FOR PRECISION WORK A REVOLUTIONARY NEW TWEEZER

It firmly grips and holds the most delicate objects. Object can't slip because of special diamond grip. Gripping points lined with diamond-powder (fine grit). The diamond particles are firmly welded to stainless steel metal. These tweezers are used for micro-fine work and micro surgery.

No. 770. Blades taper gradually to very fine point — length $4\frac{1}{4}$ inches. Stainless steel — non magnetic. **\$8.50 each**

No. 774. Blades taper sharply from body to very fine points length $4\frac{3}{4}$ inches. Stainless steel — non magnetic. **\$10.00 each**

No. 772. Angled superfine points — Points on 45° angle. Length $4\frac{1}{4}$ inches — Stainless steel — non-magnetic. **\$10.00 each**

No. 777. Curved, superfine points length $4\frac{3}{8}$ inches. Stainless steel — non magnetic. **\$10.00 each**

I. KASSOY INC. 30 WEST 47th ST., N. Y. 36, N. Y.

For additional types of tweezers — see circular

UNIQUE

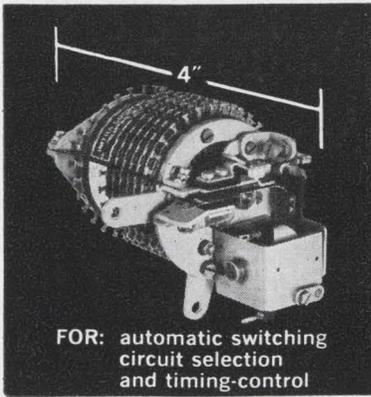

FOR: automatic switching
circuit selection
and timing-control

The
Genalex
Miniature
High-Speed
Stepping Switch

FEATURING: 80 steps per second on impulse drive **30** contacts per bank **12** banks maximum **17** oz. light-weight **7** levels sequence switching.

Over 5,000,000 Steps Without Replacements

Write today for complete data — Also, data available on Genalex one-way and two-way stepping switches.



11 UNIVERSITY ROAD, CAMBRIDGE 38, MASS.

U. S. AGENTS FOR THE GENERAL ELECTRIC COMPANY, LTD. OF ENGLAND

Circle 213 on reader service card

HIGH POWER

FROM 20W
UP TO... **4 KW**

DC SERVO AMP

For driving DC motors & torquers

Features:

- ★ Small Size 2³/₈ x 8 x 3¹/₂
- ★ SCR Control
- ★ Adjustable Current Limiting
- ★ AC or DC Signal Inputs
- ★ 50, 60, or 400 CPS Power Supply
- ★ Full Wave, Bi-directional Output

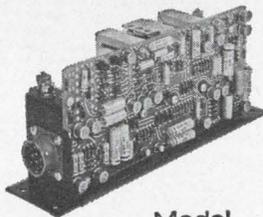

Model
A570

Servo Amplifiers / Static Inverters / Power Supplies

WESTAMP

11529 Pico Blvd., Los Angeles 64, Calif., GR 8-8894

Circle 214 on reader service card

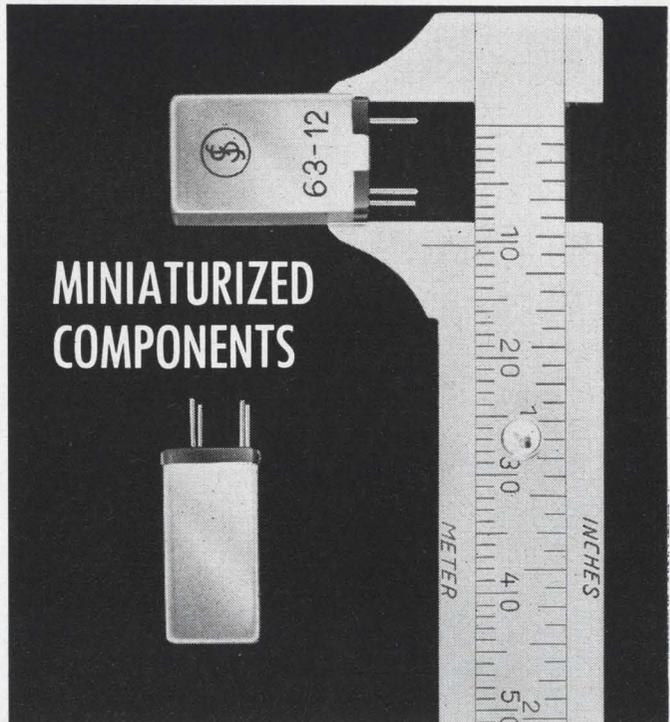

MINIATURIZED COMPONENTS

Micro Resonant Reed Selector

FUJITSU micro resonant reed selector of the single-reed plug-in type, composed of a composite tuning-fork type vibrator, driving system, contacts, and their supporting structures. Possessing a high degree of sensitivity and stability, it serves all phases of usages as the conventional reed selector in diverse types of tele-controlling and mobile radio systems.

Frequency: 50 channels in 15 c/s spacing in the frequency range of 472.5 c/s~1207.5 c/s
 Coil impedance: 280 ohms $\angle 35^\circ \pm 15\%$ at 1000 c/s, 20°C **Standard driving current:** I_s : 2.5 ma **Selectivity:** Inoperative at a current of less than 7 ma in a frequency range deviating more than ± 15 c/s from the nominal frequency f **Band width:** Class A: $f \pm 1.5$ c/s min at standard driving current. Class B: $f \pm 1.3$ c/s min at standard driving current **Temperature range:** Class A: $-10 \sim 50^\circ\text{C}$. Class B: $0 \sim 40^\circ\text{C}$ **Contact ratio:** 2% min at f and 2.4 ma **Life:** Over 100,000 operations when driving current is turned on for 1 second and turned off for 2 seconds in an ordinary circuit **Insulation and dielectric withstanding voltage:** 10 megohms min at dc 100V, dc 100V 1 minute at 20°C, 80%

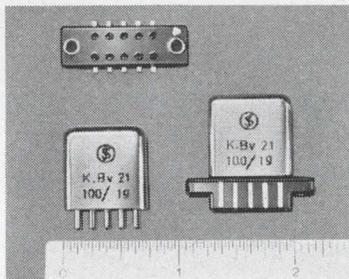

Polar Relay Type 21

Fujitsu Polar Relay Type 21 is a hermetically sealed, highly sensitive subminiature polar relay with high speed and long service life. The size of this Type 21 is only 1/10th as large as the conventional polar relays. It has extremely efficient magnetic circuits, high stability against external magnetic

fields and unique chatter-free contact mechanism. This polar relay is widely applicable to small size, lightweight communication equipment and control equipment for carrier telephony, telegraphy, data transmission in telemetry, automatic control and data processing.

Subminiature Type: 3cm³ **High Sensitivity:** 0.7 mw **Long Life:** 100 million operations **High Speed:** 1.5 ms



FUJITSU LIMITED

Communications and Electronics

Marunouchi, Chiyoda-ku, Tokyo, Japan

THE NISSHO AMERICAN CORP., 80 Pine St., New York 5, N.Y. Phone: Whitehall 3-7840. THE NISSHO PACIFIC CORP., 120 Montgomery St., San Francisco 4, Calif. Phone: YUkon 2-7901, 7908. NISSHO (CANADA) LTD., 100 University Ave., Toronto. Phone: EMpire 2-4794.

Circle 141 on reader service card

141

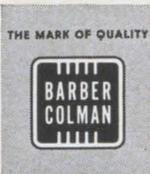

Ultra-sensitive relays

HELPFUL DATA FOR YOUR CIRCUITRY IDEA FILE

The circuit drawing below indicates just one of the hundreds of ways many manufacturers utilize Micropositioner® polarized relays to solve complex control problems.

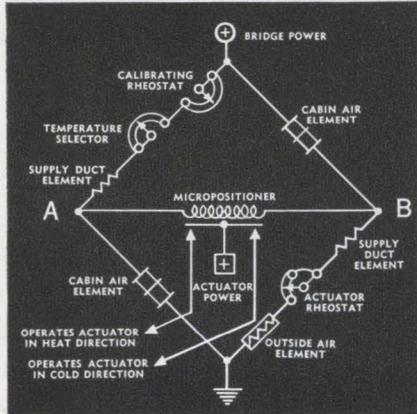

TEMPERATURE CONTROL

One of the most common applications of the Barber-Colman Micropositioner is in Wheatstone Bridge control circuits. In the above diagram of a temperature control application, the bridge arms incorporate temperature-sensitive transducers.

The Micropositioner is a polarity sensitive relay, so the direction of current flow in AB will close one or the other of its contacts from the normally floating neutral position. This causes a reversible control valve actuator to make desired temperature corrections in the supply air. A rheostat coupled to the actuator provides position feedback.

The same technique can control cycling (on-off) of an electrical heater. By using potentiometers or fixed resistors, the basic Wheatstone Bridge circuit adapts to positioning and synchronizing controls, or to automatic impedance test instruments.

BARBER-COLMAN MICROPOSITIONER® POLARIZED D-C RELAYS

Operate on input power as low as 40 microwatts. Available in null-seeking and magnetic-latching "memory" types of adjustment. Also transistorized types with built-in preamplifier. Write for our latest catalog with full information on polarized relays.

BARBER-COLMAN COMPANY
Electro-Mechanical Products Division
Dept. E, 1259 Rock Street, Rockford, Illinois

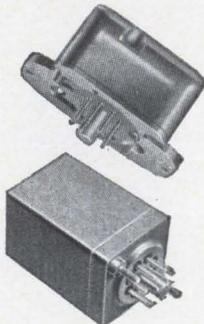

New Semiconductors

Now, uhf silicon transistors in plastic

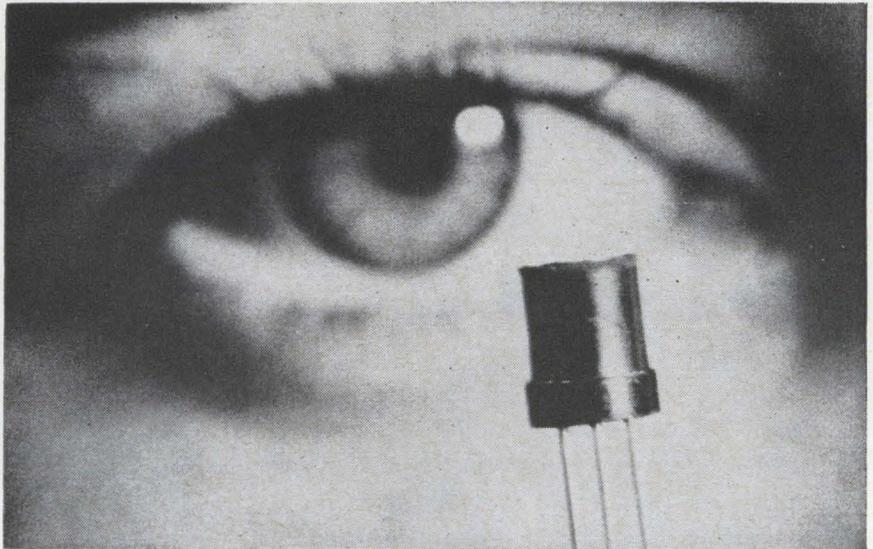

The General Electric Co. has made a major move into the industrial market for plastic-packaged silicon transistors with the announced availability of three high-speed switching devices: the 2N3605, 2N3606, and 2N3607, for saturating, inverting digital logic applications such as flip-flops, NOR circuits, NAND circuits and multivibrators.

For more than two years General Electric has been producing plastic-package transistors for automobile radios, television receivers and other consumer applications. It says that it has sold more than two million of these units. Earlier this year it offered a line of 100-Mc silicon plastic-packaged transistors to test the market. Interest generated by these devices was substantial.

The new epoxy-encapsulated npn units have planar epitaxial construction. One of the devices, the 2N3605 has a typical storage time of 14 nanoseconds and a typical gain-bandwidth product of 300 Mc. at 10 milliamperes. The 2N3606 and 2N3707 have storage times of 20 nanoseconds.

The new transistors, says George B. Farnsworth, marketing manager for the Semiconductor Products department are direct plug-in replacements for many higher-priced metal-can transistors. Farnsworth

says the 2N3605 and 2N3606 will replace the 2N706, 2N708, 2N753 and 2N834 transistors in many applications. In some applications, he also says, the 2N3605 can replace the 2N914.

The 2N3605-6-7 are housed in the Jeced TO-18 case but have an in-line lead configuration. Other lead configurations, however, are also available.

Specifications

Collector-to-emitter voltage	14 volts
Emitter-to-base voltage	5 volts
Collector current	200 ma
Dissipation at 25°C	200 mw
Collector saturation voltage at 10 ma.	0.16 volt
Prices in 1,000 lot orders	
2N3607	\$0.32 per unit
2N3605	\$0.43 " "
Delivery	Immediate

General Electric Co., Syracuse, N.Y. [371]

Glass-passivated zener chip diodes

New zener chip diodes measuring only 0.50 by 0.30 in. have electrical characteristics that meet or exceed the 400 mw glass diode series. A big advance, the company says, is the new technique of passivation in which the surface is passivated at below 70°C. This involves a combination of low temperature

WRITE A SPEC FOR YOUR IDEAL POWER SUPPLY

YOUR REQUIREMENTS

(Fill in and compare with our standard specifications)

VOLTAGE REGULATION _____

CURRENT REGULATION _____

VOLTAGE RIPPLE (RMS) _____

CURRENT RIPPLE _____

OTHER REQUIREMENTS _____



THEN Compare* IT WITH SORENSEN'S NEW QRC SERIES

First, start with voltage regulation of $\pm 0.005\%$ line and load combined ■ Then, add voltage ripple of 1 mv RMS ■ Current regulation of $\pm 0.05\%$ of maximum current output ■ Current ripple as low as 1 ma RMS ■ Transient response 50 μ sec. to return to ± 20 mv band ■ Excellent stability, typically 0.05% for 8 hours (after warm-up) ■ Resolution approximately 0.01% ■ Input versatility 105-125/200-240 VAC, 50 to 400 CPS ■

Then, build in every conceivable design feature like: High efficiency ■ Constant voltage/constant current crossovers (so sharp the units never leave the specified regulation bands) ■

Constant voltage/constant current indicator lights ■ Vernier controls on both voltage and current adjustments ■ Output voltage and current meters ■ Voltage and current programming ■ Series parallel operation ■ Remote sensing ■ No turn-on, turn-off overshoots ■ Plug-in control boards ■

Price? How about \$450 for 0-40 volts, 0-8 amps, in a 3½" high package? Still want to compare? For more information on the QRC series, call your local Sorensen representative, or write: Sorensen, A Unit of Raytheon Company, Richards Avenue, South Norwalk, Conn. ■ Or use Reader Service Number 200 ■



ELECTRICAL AND MECHANICAL SPECIFICATIONS

MODEL NUMBER	OUTPUT VOLTAGE RANGE (VDC)	OUTPUT CURRENT RANGE (AMPS)	VOLTAGE REG. (LINE & LOAD COMBINED)	VOLTAGE RIPPLE RMS	CONSTANT CURRENT RANGE	CURRENT REGULATION	CURRENT RIPPLE RMS	RACK HEIGHT (INCHES)	PRICE
QRC20-8	0-20	0-8	$\pm 0.005\%$ or ± 1 mv	1 mv	0-8	$\pm .05\%$ or ± 4 ma	2 ma	3½	\$410
QRC40-4	0-40	0-4	$\pm 0.005\%$ or ± 1 mv	1 mv	0-4	$\pm .05\%$ or ± 2 ma	1 ma	5¼†	315
QRC40-8	0-40	0-8	$\pm 0.005\%$ or ± 1 mv	1 mv	0-8	$\pm .05\%$ or ± 4 ma	2 ma	3½	450
QRC40-15	0-40	0-15	$\pm 0.005\%$ or ± 1 mv	1 mv	0-15	$\pm .05\%$ or ± 8 ma	4 ma	5¼	575

†Half rack.

MICROWAVE NOISE MEASURING EQUIPMENT

FEATURES:

- RF Frequency Ranges:
1.0 Gc/s to 32 Gc/s
- Self Calibrating:
AM & FM
- Broad Video Frequency Band:
1 Kc/s to 150 Kc/s
- Residual FM Monitor:
10 cps to 1Kc/s
- Spectrum Analyzer Bandwidth:
100 cps and 1 Kc/s
- High Sensitivity:
AM, 135 DB below the carrier
FM, .0032 cps rms deviation
- Minimum RF Input Power:
1.5 milliwatts
- Microwave Spectrum Analyzer
- Phased-Locked Local Oscillator

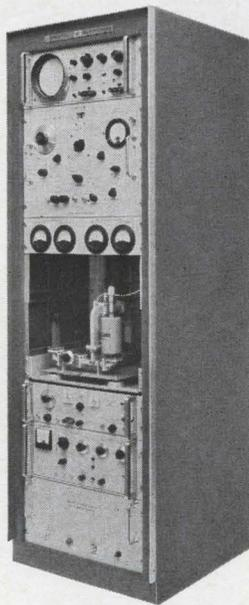

SPECTRA ELECTRONICS

Post Office Box 85 / Los Altos, Calif. 94023 / (415) 948-4998

Circle 215 on reader service card

we are your best bet
for electronic materials

“What did you say?”

**“WE SAID, WE ARE
YOUR BEST BET
FOR ELECTRONIC
MATERIALS!”**

We are a primary fabricator and supplier of high purity metals and alloys, compound semiconductors and thermoelectric cooling materials.

PHONE AREA CODE 509 747-6111
TWX 509-328-1464 Telex 032 610

IMMEDIATE SHIPMENT BY AIR PRE-PAID

COMINCO PRODUCTS, INC.

electronic materials division

818 West Riverside Ave.,
Spokane, Washington 99201

5603

SHIZUKI CAPACITORS

Injection Polypropylene Resin
Molded Metallized Lacquer Film
Capacitors (-30°C +85°C)

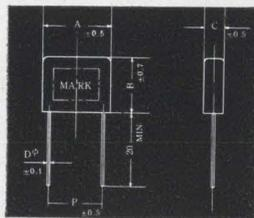

50 volts D.C. Working unit: mm

TYPE	CAP	A	B	C	D	P
PML-0.47/50	*0.47 μ F	14.0	14.0	5.0	0.6	10.0
PML-0.5/50	0.5 μ F	14.0	14.0	5.0	0.6	10.0
PML-0.68/50	*0.68 μ F	19.5	16.0	5.5	0.6	15.0
PML-1.0/50	*1.0 μ F	19.5	16.0	5.5	0.6	15.0
PML-1.5/50	*1.5 μ F	24.0	19.0	6.5	0.7	19.0
PML-2.0/50	2.0 μ F	24.0	19.0	6.5	0.7	19.0
PML-2.2/50	*2.2 μ F	24.0	19.0	6.5	0.7	19.0
PML-3.3/50	*3.3 μ F	30.0	20.0	7.0	0.7	25.0
PML-6.8/50	*6.8 μ F	31.0	23.0	10.0	0.8	25.0

*STANDARD

- ◇ Lacquer Film Capacitors ◇ Mylar Capacitors
- ◇ Metallized Paper Capacitors for Motor running, fluorescent ballasts ◇ Noise Suppression Capacitors ◇ Ignition Capacitors ◇ Miniature Electrolytic Capacitors



SHIZUKI ELECTRICAL MFG. CO., LTD.

HEAD OFFICE: TAISHA-CHO, NISHINOMIYA, JAPAN
CABLE ADDRESS: "CAPACITOR" NISHINOMIYA
TOKYO FACTORY: 10-7, ARAJIYUKU, OTA-KU, TOKYO

New Semiconductors

and high vacuum. Previously, devices had to be passivated at much higher temperature and high vacuum. The chip is coated with a glass passivation which makes it truly hermetic. Ease of mounting is also featured, and the diffused type can be soldered into place while the alloy series can be soldered on one side and a spring contact made to the other side. Voltages in the alloy series range from 3.3 to 12, and the diffused series range from 7.5 to 100. Applications are where space is most important.

U.S. Semcor, Solid State Division, Nuclear Corp. of America, Phoenix, Ariz. [372]

Tiny p-i-n rectifiers from 50 to 2800 piv

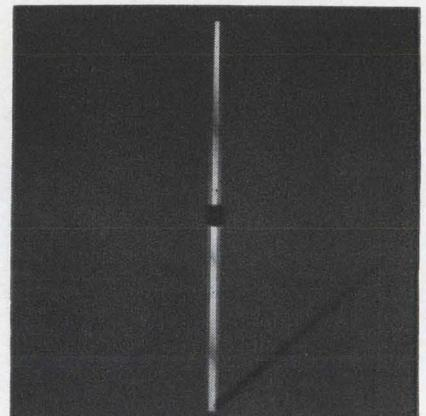

Series MM microminiature p-i-n rectifiers exhibit extremely sharp breakdown characteristics, fast recovery time, high efficiency, and low capacitance. Output current varies from 500 ma for 50 piv to 125 ma for 2800 piv. Leakage current is only 0.1 μ a at rated piv. The devices are particularly well suited for voltage multipliers, infrared image intensifiers, r-f diodes, coaxial switches, and similar devices.

Solitron Devices, Inc., 256 Oak Tree Road, Tappan, N.Y., 10983. [373]

Silicon varactors designed for paramps

Two new series of silicon varactors are announced for parametric am-

plifiers. The D5046 series offers unusually high cutoff frequencies, up to 250 Gc minimum, combined with a minimum beta of 3 at -3 v. These varactor diodes were designed specifically for paramps, where a low noise figure is the prime consideration. For broadband applications, the manufacturer has developed the D5146 series. This group has a minimum beta of 8 with cutoff frequencies up to 125 Gc minimum at -3 v. All of these silicon epitaxial mesa varactors use a new diffusion technique, and low inductance bonded contacts to the mesa.

Sylvania Electric Products Inc., Semiconductor Division, Woburn, Mass. [374]

Selenium rectifiers for high-voltage use

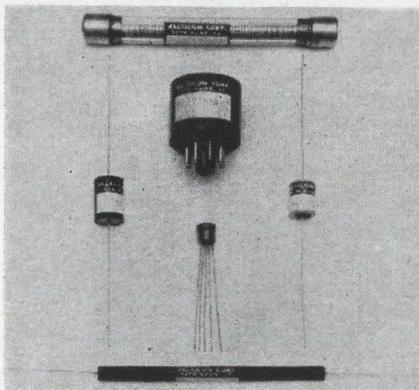

A line of cartridge type high-voltage selenium rectifiers has been introduced for commercial and military applications. The rectifiers, long-lived and low in cost, take current and voltage overloads (as much as 50% over piv ratings) with no need for special protective circuitry. Piv range for the units is from 500 to 20,000 v. High stability is exhibited at voltages as great as 50 v per cell, thereby permitting the smallest possible assembly for a given voltage rating, the company says. Current range is 1 ma to 20 ma, with superior reverse current characteristics. Ambient temperature range is from -65° C. to +100° C. Epoxy sealed to eliminate end caps and reduce arcing, the units are fully operable in any environment. Immediate delivery is available in all sizes.

Recticon Corp., 22 Summit Grove Ave., Bryn Mawr, Pa. [375]

This \$5,000 Mathatron digital computer needs one more significant digit

Your index finger. Some people use the third finger. That's all right.

Program the formula: $\frac{R_1 \times R_2}{R_1 + R_2} \times R_3$ for $R_1 = 6.2$
 $\frac{R_1 \times R_2}{R_1 + R_2} + R_3$ for $R_2 = 3.8$
 $R_3 = 9.1$

Switch to Learn:

Tap $S1 \times S2 \div (S1 + S2) \ominus 4$ $S4 \times S3 \div (S4 + S3) =$

Switch to Normal:

Tap 6.2 $\ominus 1$ 3.8 $\ominus 2$ 9.1 $\ominus 3$

The printed tape reads 1.87147346

Four or eight independent storage registers, 24 or 48 step ferrite core memory, automatic printed output, 100 column number capacity, 8 to 9 significant digit accuracy, automatic decimal placement, electronic speeds, optional pre-wired programs, all solid state logic and circuitry. It won't solve everything, of course.

If you already have a large data processor, consider this: 80% of the Mathatron owners have big computers, too. But they can't stand the time lag, or the hourly cost, or the gaff. The Mathatron is twice the size of a typewriter and is accessible, immediately, to the whole department.

Write for further information.

MATHATRONICS, INC.

257 Crescent St., Waltham, Mass. 02154 (617) 894-0835



Yes, we deliver...

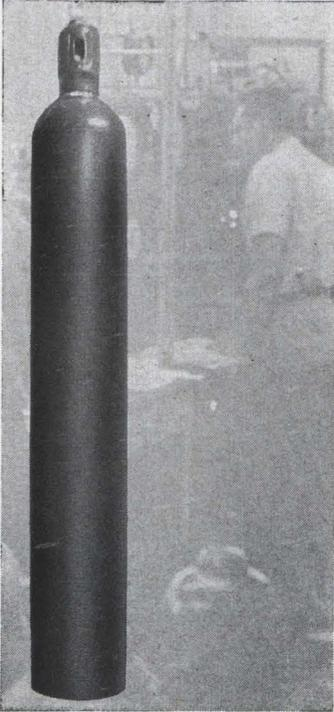

doping gases!

- of ultrahigh purity, for semiconductor manufacture.
- in standard or custom-blended mixtures up to 10% concentration.

Air Products—the single source for all your industrial gas and specialty gas requirements—supplies doping gases to meet your rigid specifications.

Air Products dilutes doping gases with ultrahigh-purity compatible carrier gases such as nitrogen, hydrogen, helium or argon to prevent contamination of semiconductors. Standard doping gases include antimony pentachloride, boron trichloride, phosphine, arsine, silane, and diborane. Special blends are also available per customer specifications.

Air Products professional knowledge of cylinder preparation compatible with the particular nature of each dopant aids in stabilizing mixtures. In addition, the Company's state of the art experience in IR Spectroscopy and gas chromatography provides accurate analysis of each cylinder.

For further information on Air Products doping gases, or to have a sales engineer call, please contact:



Air Products and Chemicals
INC.

Allentown, Pennsylvania
SPECIALTY GAS DEPARTMENT

New Subassemblies and Systems

Medium-scale computer shown

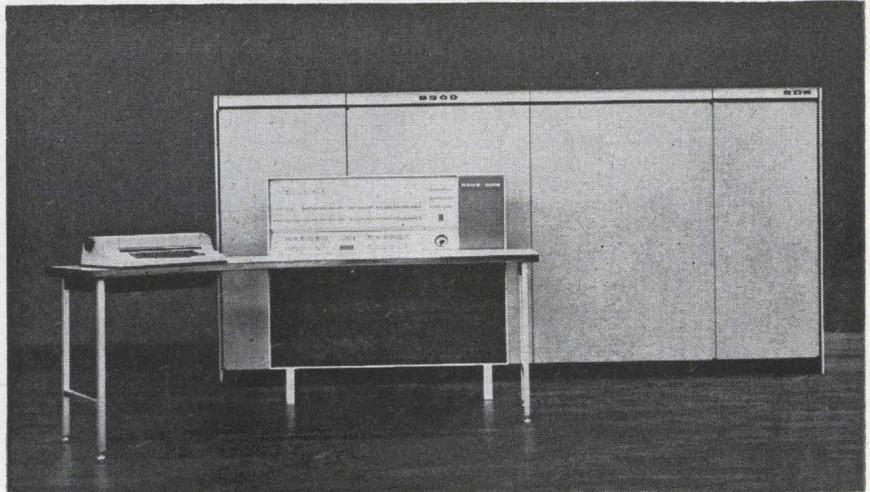

Visitors to the International Federation for Information Processing (IFIP) Congress last week had the first public view of the SDS 9300 computer built by Scientific Data Systems, Inc. of Santa Monica, Calif.

An unusual feature of the machine is its ability to handle as many as 1,024 real-time priority interrupts. The interrupts can be generated by any external event, such as depression of a push-button, completion of a process, or occurrence of an emergency situation of some kind. For instance, the SDS 9300 could be used as the central processor for a system containing a large number of remote data-transmission terminals. Whenever a remote terminal wanted to transmit data, it could signal an interrupt to the central processor, which would stop whatever it was doing, receive the incoming message, take appropriate action, and then pick up wherever it left off.

These interrupts are serviced according to strict hardware priority, meaning that the highest order interrupt will always be serviced almost immediately (within microseconds) but that low-order interrupts will be serviced only after all higher-order interrupts have been completed. This could mean that the low man on the totem pole might have to wait indefinitely for service, if interrupts

came in fast enough. To handle this eventuality, there is provision for any of the interrupts to be masked off under program control. Thus the program may from time to time mask off any number of high-priority interrupts to make sure that lower-priority interrupts are serviced. Use of interrupt masking is not limited to this purpose.

Another unusual feature of the system is its use of Magpak cartridge-loaded magnetic tape. This might be described as the poor man's magnetic tape. It is a low-speed magnetic tape with a data rate of 1.5 kilocycles using pairs of tape cartridges. Each tape cartridge contains two tracks; data is recorded serially on the tracks. From the system's point of view two tracks on each of two cartridges look like four of the usual higher-speed magnetic tape drives. The tape runs at 7.5 inches per second and has a recording density of 200 bits per inch. Data is recorded on the tape and read back using the same instructions as with the larger, faster Ampex and Potter tape drives which are more frequently seen in computer installations.

The manufacturers refer to the SDS 9300 as a medium-scale computer and compare it in performance to such competitive equipment as the CDC 3200 and the IBM System/360 Model 50. Both of these machines rent for con-

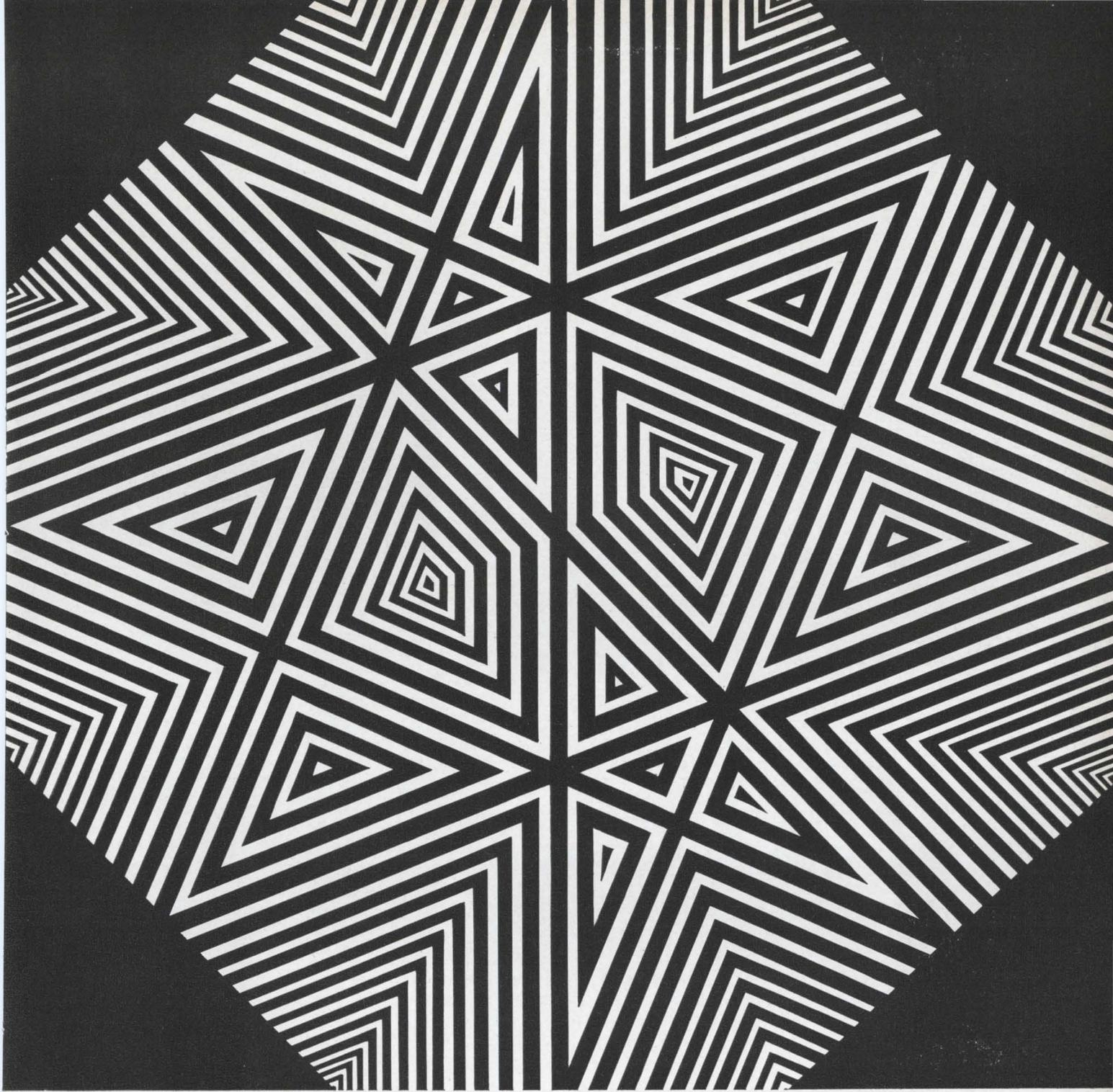

Optimizing the art... in delay lines

Typical problems we've made look easy: 32-module isothermal multidelay package (0.01°C temperature stability) — 150 microsecond digital delays with 20-80 db attenuation. We can do even better to meet your special needs — 60 modules? 100? 0.001°C thermal stability? 300-microsecond Zero T. C. (Temperature Coefficient) Memory System? So come to us for unusual requirements in glass, quartz, electromagnetic and magnetostrictive delay lines, or in associated electronics — transformers, amplifiers, temper-

ature controllers, serial ultrasonic memories, and other advanced components.

In the microwave field, we've done tricky things in phase-locked and other oscillators, frequency and pulse stability testers, noise measurements, and other advanced instrumentation. Oh, yes, since LFE "wrote the book" on delay lines, we'll be happy to send you copies of our brochures defining common terms and basic measurement techniques. To Optimize your design, OPT LFE.



LFE ELECTRONICS

A DIVISION OF LABORATORY FOR ELECTRONICS, INC.
WALTHAM, MASSACHUSETTS 02154

Delay Lines • Filters • Transformers • Amplifiers, and Associated Electronics
Microwave Measurement & Signal Generation Equipment

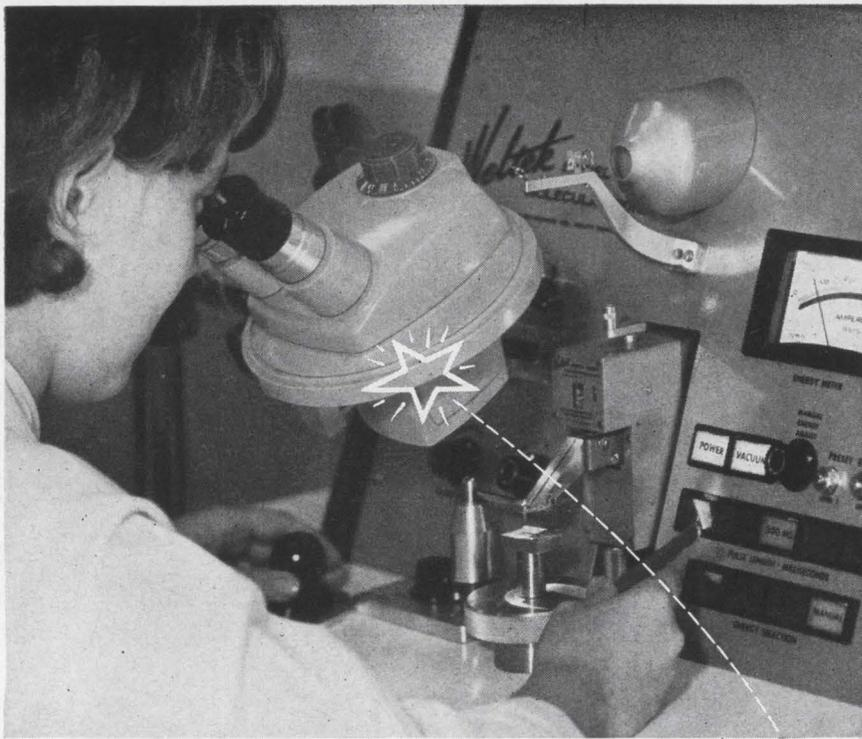

*For Their High-Speed
Microminiature Bonding,
Welding and Soldering Units...*

**Weltek prefers
Bausch & Lomb StereoZoom®**

The Weltek Division of Wells Electronics, Inc., South Bend, Ind., has just introduced its new Model 800 Molecular Bonder (pictured above). The "800" bonds wire as small as .0007"—in less than 1/2 second—to microcircuits, thin films, integrated circuits and other semiconductor devices.

Another new Weltek unit, Model 750, combines all microminiature joining operations in one master console. Two StereoZoom microscopes are built into this model.

In fact, Weltek engineers have designed the StereoZoom Microscope into all of their equipment. They believe its bright, sharp, three-dimensional images and continuously variable magnification save operator's time, increase production, prevent fatigue. And they know StereoZoom is tough and durable... built to withstand hard industrial usage.

Whether your need is for complete microscopes or just certain components—for production or quality control—the extensive StereoZoom line has what's right for you.

Call your dealer, or write for Catalog 31-15, Bausch & Lomb, 62317 Bausch Street, Rochester, New York 14602.

BAUSCH & LOMB 

New Subassemblies

siderably more than the 9300, however. The cycle time of 1.75 microseconds for the 9300 is unusually fast for a medium-scale machine.

The 9300 hardware is compatible with all smaller SDS machines, including the 930, 925 and 920. This means that peripheral equipment used with the smaller machines may also be connected directly to the larger machine without modification. The programs are nearly compatible, although due to the size of the 9300, program compatibility was not a major design consideration.

The first SDS 9300 was delivered to a customer in December of 1964; systems are now in use in numerical analysis, hybrid space-technology work, time-sharing research, and other scientific and engineering applications.

Specifications:

Storage cycle time	1.75 microseconds
Add time	1.75 microseconds (overlapped memory banks)
Max. storage capacity	32,768 words
Word size	24 bits
Magnetic tape	Minimum 1.5 kc Maximum 96 kc (IBM compatible) Multiple read, write, compute available
Disk storage capacity	67 million words
access time	199 milliseconds maximum
Drum storage capacity	96,000 words
access time	8.3 milliseconds
Punched card speeds	Read 800 cards/min, punch 300 cards/min
Paper tape speeds	Read 300 char/sec, punch 60 char/sec
Printer	900 lines/min
Index registers	3
Typical rental	\$4,875/month, including 1.5 kc tape
Other features	Program interrupt, indirect addressing, floating-point arithmetic, memory protection, byte manipulation, console typewriter
Software	Algol, Fortran II and IV, business compiler

Scientific Data Systems, Inc., 1649 Seventeenth St., Santa Monica, Calif. [401]

E/I programmer reads out in analog form

Model 594 precision E/I programmer can be programmed by dry contacts or logic to provide either an accurate constant voltage or constant current output and a simultaneous

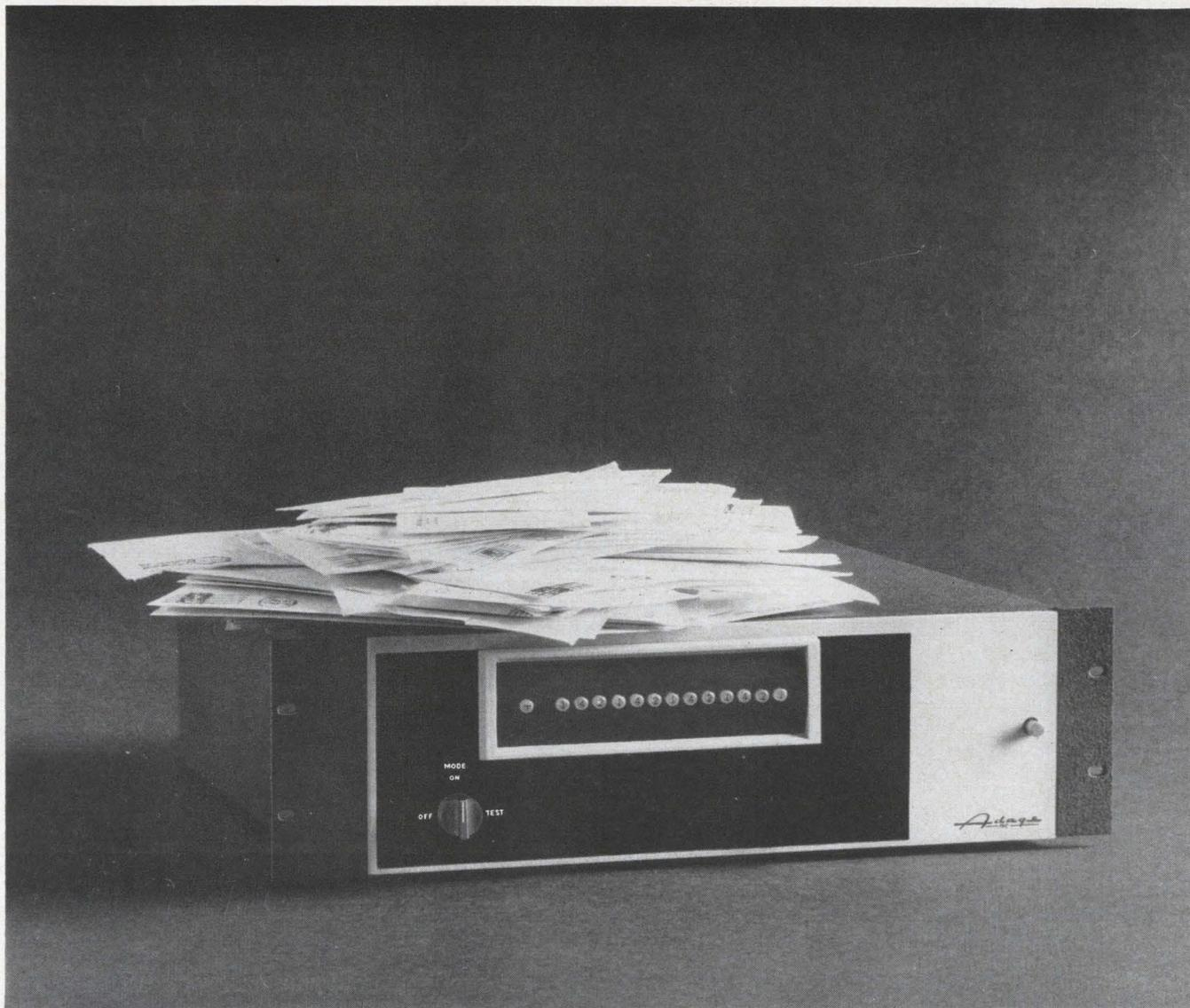

A complete 14-bit A-to-D conversion in under 4 μ sec... that's something to write about!

We're delighted with the overwhelming number of inquiries we've received about our two new additions to the Adage VOLDICON™ line of voltage digitizers.

The high-speed, high-resolution VT13-AB and ultra high-speed VT7-AB are based on a novel design combining techniques of successive approximation and parallel threshold decoding. The VT13-AB ac-

complishes a 14-bit analog-to-digital conversion in less than 4 microseconds. The 8-bit VT7-AB performs a complete conversion in under 800 nanoseconds.

A full line of data systems components, including other A-to-D converters, D-to-A converters, multiplexers, operational amplifiers, and digital logic, is available from Adage, Inc. These components use

all-solid-state circuitry and are designed and tested to meet the most demanding requirements for accuracy and reliability.

Why not add your inquiry to the many we've already received? We would be pleased to send you a technical brochure on the VT13-AB and VT7-AB. Call or write I. R. Schwartz, Vice President 783-1100, area code 617.

Adage, Inc. welcomes employment inquiries from professional engineers.

Adage
INC.

1079 Commonwealth Avenue Boston, Massachusetts 02215



You get what you see with a FAIRCHILD SCOPE CAMERA

The highest precision and clarity in oscilloscope photography are insured by a long list of Fairchild design features. Pinpoint focusing at any object-to-image ratio within lens range is one. Heavy duty synchro shutters with jam-proof activation are others. With Polaroid Land Back, 6 x 10 cm field can be recorded 0.9 actual size. Option of f/1.9 or f/2.8 lens. Prices start at \$350. For specifications or a demonstration, contact your local Fairchild Field Engineer, or write to Fairchild Scientific Instruments, 750 Bloomfield Avenue, Clifton, N.J.

FAIRCHILD

DU MONT LABORATORIES
SCIENTIFIC INSTRUMENT DEPARTMENT

Circle 217 on reader service card

Distinctively Styled

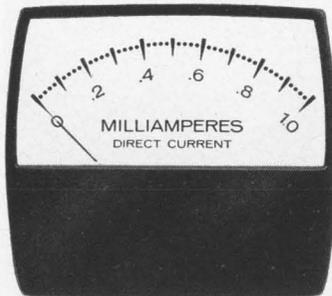

1½ in. AM-1 (actual size)

high torque, self-shielded panel meters

Clean, modern styling... easy scale readability... sizes 1½ to 4½". High torque mechanism gives 1% linearity, 2% accuracy and sensitivity to 20 ua. Magnetic system completely shields external field influences, permitting bezel-to-bezel mounting on any material without interaction or effect on calibration. Choice of colors or finishes, custom dials—ASA/MIL 4-stud mtg.

AMMON

AMMON INSTRUMENTS, INC.
345 Kelley Street, Manchester, N. H. 03105

150 Circle 150 on reader service card

LOCAL OSCILLATOR SYNCHRONIZER

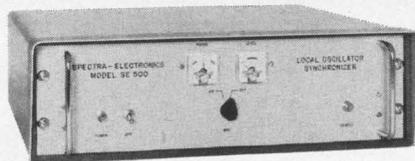

The SE-500 Local Oscillator Synchronizer is used with the klystron local oscillator in microwave receivers and test equipment to provide a constant frequency 30 mc/s IF signal.

Its primary use is in AM systems, although two channel differential phase receivers can also utilize this synchronizer by obtaining the IF input signal from the reference channel.

Other optional IF frequencies are available.

Price for the SE-500 in Rack Mount is \$925.

SPECTRA ELECTRONICS

P.O. Box 85 • Los Altos, Calif. 94023 • (415) 948-4998

Circle 218 on reader service card

New Subassemblies

display of current or voltage, respectively, using Kelvin connections. It was designed for high-speed testing of integrated circuits and can be programed to operate within two milliseconds. The analog display is always within a range of 0 to 10 volts and, through the use of operational amplifiers, provides no programming error at the load, according to the manufacturer. The programmer is 7½ by 19 by 15 in. (relay rack mount). Shipping weight is about 20 lbs.

Aerotron Associates, Inc., Contoocook, N.H. [402]

Operational amplifier has modular design

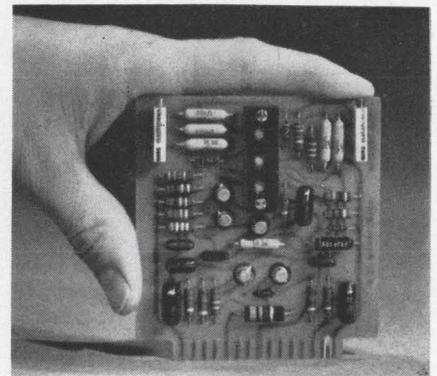

A new line of analog circuit modules has been announced. The first unit, model 901 operational amplifier, at \$49.50, offers silicon open-board module with drift specifications of $\pm 15 \mu\text{v}$ per degree Centigrade and $\pm 0.5 \text{ na}$ per degree. The output is capable of $\pm 15 \text{ ma}$ at $\pm 10 \text{ v}$ and $\pm 30 \text{ ma}$ at $\pm 5 \text{ v}$. With an open-loop gain of 200,000 minimum and a 2-Mc unity-gain crossover frequency, this module is suitable for low-cost commercial and industrial applications.

RO Associates, Inc., 917 Terminal Way, San Carlos, Calif., 94070. [403]

Wideband amplifier boasts high stability

This solid state wideband amplifier uses all silicon transistors. Priced at \$95, the model 1202 uses

Electronics | May 31, 1965

feedback for exceptional gain stability with gain adjustable from 10 to 100. The frequency response is 5 cps to 10 Mc at 20 db gain and 10 cps to 1 Mc at 40 db gain. Operating temperature is -55° to $+75^{\circ}\text{C}$; output voltage, 6 v peak-to-peak across 1,000 ohms; input impedance, greater than 100,000 ohms shunted by 25 pf; noise, less than 50 μv rms referred to the input with a 10,000-ohm source. Designed as a building block for instrumentation and systems engineers, the model 1202 may be used as a telemetry pulse amplifier, transducer or tape-recorder amplifier, and to increase the sensitivity of oscilloscopes and voltmeters.

California Electronic Mfg. Co., P.O. Box 355, Alamo, Calif. 94507. [404]

Regulated supplies have fixed voltages

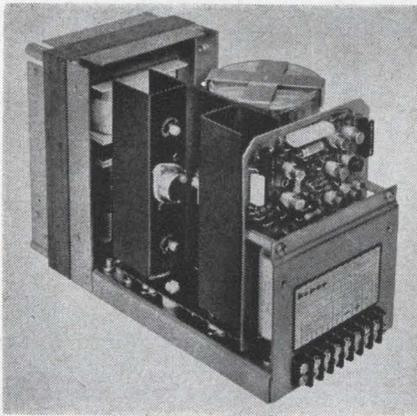

Series PWR line/load regulated power supplies have the following voltages and currents: 12 v, 7 amps; 15 v, 6 amps; 24 v, 4 amps; 28 v, 3.3 amps; 48 v, 2 amps; and 60 v, 1.5 amps. Line regulation is less than 0.01% output voltage change for 100 to 130 v line variation. Load regulation is less than 0.05% no load to full load. Long term stability is less than 0.05% or 3 mv; ripple, less than 0.5 mv rms; recovery time, 50 μsec ; ambient operating temperature, -20°C to $+65^{\circ}\text{C}$. Input is 100 to 130 v, 60 cps ± 1 cps single phase; control, trimmer voltage adjustment $\pm 5\%$ from nominal output voltage. Price is \$199 uncased; delivery, 30 to 60 days. Kepco, Inc., 131-38 Sanford Ave., Flushing, N.Y. [405]

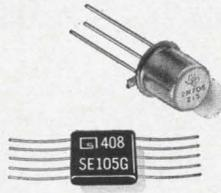

Need to say a lot
in a little space?

(or make markings
more **durable**...or
more **economical**...
or at **higher rates**?)

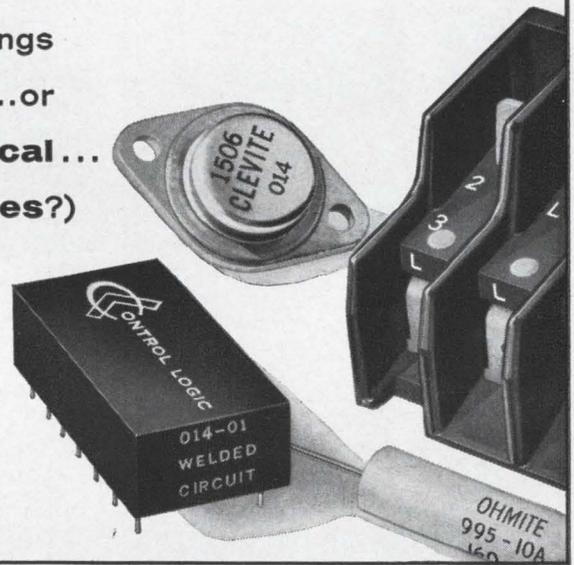

We can show you how

We can show you how to identify products so they will resist extreme amounts of handling, abrasion, many solvents and other atmospheric conditions . . . or how to sequentially number and identify components with savings of more than \$50 per 1000 . . . or how to print trademark, type number, value and date code on 90 units a minute . . . or how to produce an imprint that remains readable after 1000 hours at 200°C . . . or get 10 digits and 2 letters in a micro-circuit area of 0.090" — or 21 characters on a TO-5 case with interchangeable type number and date code . . . or save 75 cents of every dollar you now spend on buying, applying, inventorying and discarding obsolete preprinted labels.

The answers are in proven Markem machines, type and specialty inks, which daily produce better product or package identification by reducing costs, smoothing production control and increasing customer acceptance. And while Markem machines, type and inks are helping to produce better products through more complete and lasting identification, they frequently pay for themselves in the savings they make possible. Tell us what you make, what it must say, and for how long: we'll give you a specific recommendation and cost estimate right away. Write Electrical Division, Markem Machine Co., 305 Congress St., Keene, New Hampshire 03431.

MARKEM

Here's the tunable Coil to fit the little space on your PC board

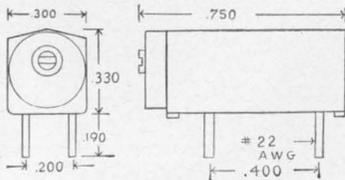

Only 1/2 the physical size of existing units

These miniature tunable inductors are encapsulated with transfer molded epoxy material and incorporate an "O" ring-sealed tuning device for maximum moisture protection. Their small size makes them ideal for compact packaging and weight is just slightly more than an equal value fixed coil.

- Nominal L values available from .10 to 1000 microhenries (RETMA values)
- Tuning range $\pm 15\%$ minimum
- 48 nominal L values to choose from
- Q values approximate 50 on all units thru entire range of tuning
- Tuning torque remains stable with repeated usage
- Testing confirms ability to meet requirements of MIL-C-15305 Grade & Class 4

Off The Shelf/In Stock Now

Delevan Electronics Corp.

Subsidiary of American Precision Industries Inc.
270 Quaker Road, East Aurora, N. Y. 14052

New Microwave

Ditherer changes magnetron frequency

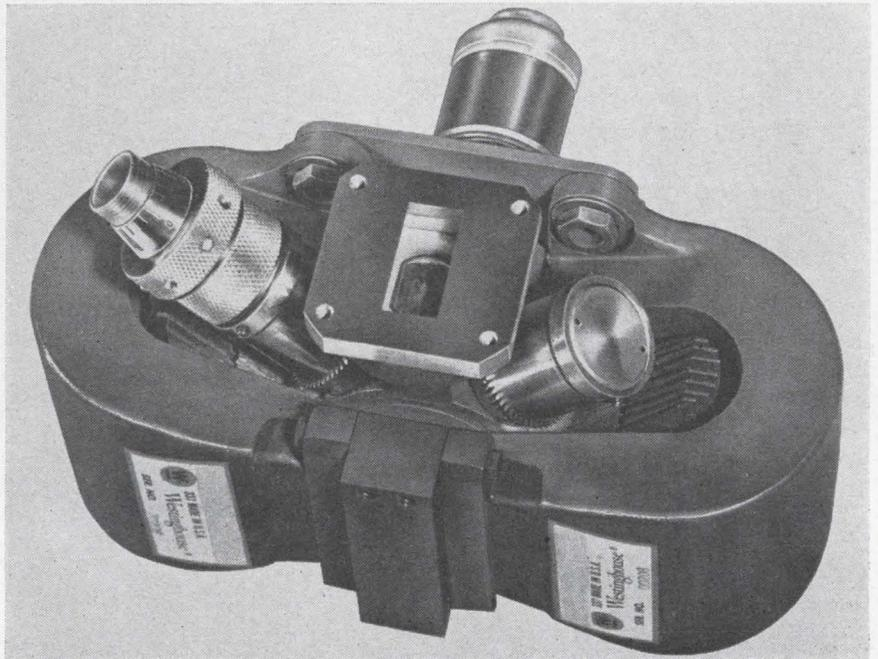

Target fading is a problem common to all radar systems. Often targets fade and are lost during the most critical moments of examination. Rapid changes in the transmitter frequency help reduce fading as well as increase the effective range and power of the radar system. Until now, most systems for frequency changing have been large, unwieldy mechanical structures or bulky electronic systems. A new Westinghouse magnetron provides users with all the advantages of rapid frequency changing with no major increase in size.

The new Westinghouse tube, the WX4742 accomplishes its frequency changing by a technique which Westinghouse calls "dither tuning." It provides narrow-band frequency diversity (tunable from pulse to pulse) at high pulse power without the cost and size of magnetrons using hydraulic or spin tuning.

The ditherer, or frequency shifter, is a vibrating reed which changes the magnetron frequency in steps up to ± 10 Mc, depending on the drive power. It is driven at an audio frequency rate—200 to 1000 cycles preselected by the user—by a stable sine wave generator

(0.1% in frequency, 10% in amplitude) having an output of 1 ampere into a 0.2-ohm load.

The magnetron is mechanically tunable from 8.5 to 9.6 Gc. If the pulse repetition frequency and the dither rate are synchronized at 600 cycles, a single pulse spectrum is transmitted. However, if the pulse repetition rate is increased for 1,200 cycles per second, 2 spectra are transmitted, one at $+\Delta f$ and one at $-\Delta f$ from the center frequency. Increase of the dither rate to 2400 cps would cause 4 spectra to be transmitted.

The WX4742 was first designed for a military airborne application, but its low cost and size make it suitable for many nonmilitary applications. Frequency dither (diversity) is especially effective in improving target definition and enhancing range capability; it reduces sea return and clutter; improves angle measurement; and reduces target scintillation. For example, if a target is scintillating (fading in and out) at one frequency, and the frequency is shifted, the target then fades at a different rate. Rapid frequency changing then enables a maximum number of radar echos to be regis-

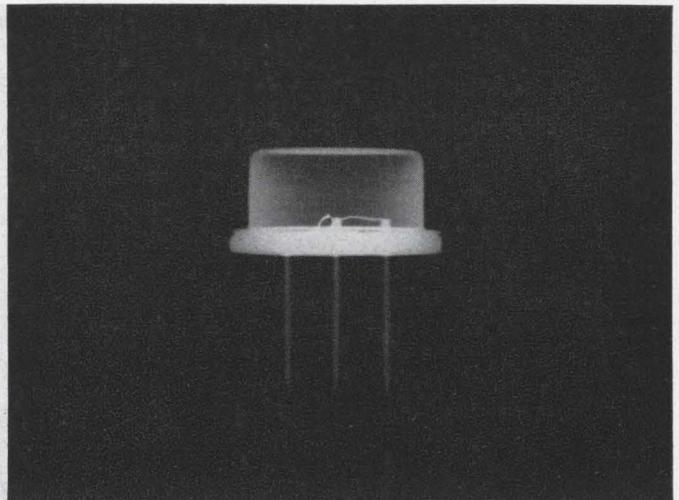
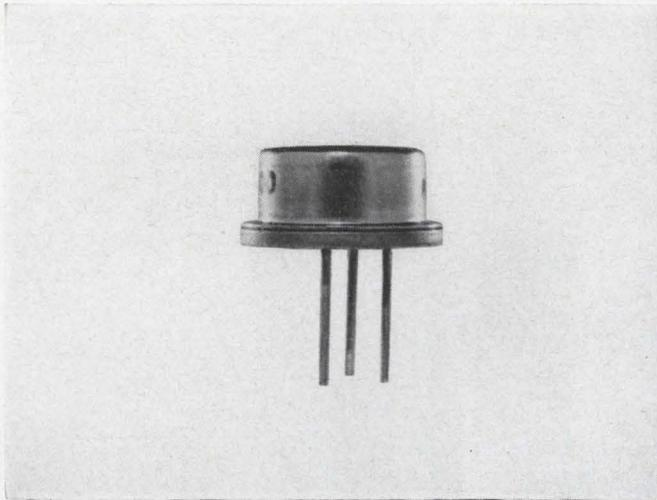

Meeting MIL specs?

***Ansco film lets you
see the reliability***

If you've invested millions in an in-plant reliability program, you should include Superay® 'H-D' Industrial X-ray film. Why? Because it can show up best the tiniest imperfection in your electronic components. This ultra-fine grain Class I film has very high contrast and microscopic definition throughout the entire KvP range. It's designed for high definition radiography and the ultimate in image quality.

For the X-ray "reliability" your components deserve, ask your GAF Representative about Ansco Superay 'H-D' Industrial X-ray films. Or write: X-ray film Dept., Box E531

gaf

GENERAL ANILINE & FILM CORPORATION

140 WEST 51 STREET · NEW YORK 10020

The highest quality Sub-miniature switches



S-2022

SB-2061

MRY-106

SM-1

	MODEL NO.	CIRCUIT	CAPACITY	CIRCUIT ARRANGEMENT
Toggle	S-2012	SP.DT	10A 125V A.C	ON-ON
	S-2013	SP.DT	6A 125V A.C	ON-OFF-ON
	S-2022	DP.DT	10A 125V A.C	ON-ON
	S-2023	DP.DT	6A 125V A.C	ON-OFF-ON
	S-2025	DP.DT	6A 125V A.C	ON-ON(momentary)
Push Button	SB-2011	SP.DT	6A 125V A.C	ON-ON (momentary)
	SB-2061	DP.DT	6A 125V A.C	ON-ON (momentary)
	SB-2085	DP.DT	6A 125V A.C	ON-ON (double action)
Rotary	MRX-110	1 Pole	1A 125V A.C	usable position 1-10
	MRX-205	2 Poles	1A 125V A.C	usable position 1-5
	MRY-106	1 Pole	3A 125V A.C	usable position 1-6
Nikaron	SM-1	SP.DT	3A 125V A.C	ON-ON (momentary)

Line of products:

Toggle switch
Push switch
Rotary switch
Motor timer
Power relay
See-saw switch
Rotary solenoid



Wanted dealers in England, West Germany and Italy

NIHON KAIHEIKI IND. CO., LTD.

3-644, Higashi, Magome, Ota-ku, Tokyo, Japan
Cable Address: "NIKKAI-ELECTRO" TOKYO

Circle 154 on reader service card

SPECIAL OFFER: Reprints of Special Reports from Electronics

Now, for your reference file—a complete set of Special Reports reprinted from the pages of Electronics in 1964. A total of 207 pages of valuable and informative articles combined in an attractive folder. The reports are individually bound. The special discount price for the reports is \$2.50 which includes both handling and shipping costs. Order now, using the coupon below. The following reprints are included in this offer:

Field Effect Transistors 64 pages.
Electronic Telephone Switching 16 pages.
Direct Digital Control in Industry 24 pages.
Transistor Heat Dissipators 32 pages.
Oceanography 15 pages.
Magnetics 24 pages.
Digital Instrumentation 16 pages.
Modern Electronic Packaging 16 pages.

Send your order to: **Electronics Reprint Dept. McGraw-Hill Inc.**
330 W. 42nd Street, New York, N.Y. 10036

Reprint order form

A-2

For reprints of **feature articles** or **special reports** fill in below:

Send me reprints of Key No.(s) at ¢ each.

For prices and listing please see the reader service card.

Send me **complete set(s) of special reports** listed above at \$2.50 per set.

Name

Number of street

City, State, Zip code

New Microwave

tered. The result is target enhancement.

The WX4742 is the first of a family of ditherable magnetrons now in production at Westinghouse's tube division in Elmira, N. Y. It is a mechanical and electronic replacement for the WL7111, a nonditherable tube, which has been in production at Westinghouse for more than 6 years.

Specifications

Frequency	8.5 to 9.6 Gc
Peak power	200 kilowatts
Average power	200 watts minimum
Duty factor	.001
Efficiency	38%
R-f bandwidth	2/pulse width
Pulling figure	15 megacycles maximum
Pushing figure	0.3 Mc per amp
Stability	less than 0.5%
Pulse width	1 microsecond
Pulse repetition	variable 200-4000 cycles per second (dependent on the dither mode)
Peak anode voltage	22 kilovolts
Peak anode current	27.5 amps
Weight	12 lbs.
Cooling	forced air
Life	greater than 400 hours
Operating temperature	-55°C to 70°C
Availability	60 days after receipt of order

Westinghouse Electronic Tube div., Box 284, Elmira, N.Y. [421]

Telemetry transmitter operates at 2.2 to 2.3 Gc

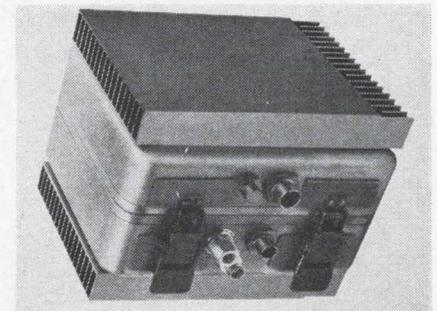

This telemetry transmitter produces 4 w of c-w output power at 2.2 to 2.3 Gc. The EM4575 has a volume of 280 cu in. and weighs 9.5 lbs. All specifications are met in aircraft operational environments, per MIL-T-21200D Class I and MIL-T-5422, including -54°C to +55°C temperature range. Interference controls also meet re-

quirements of MIL-I-6181D. All of the above specifications are met without mounting to a heat sink and in presence of solar radiation. Modulation frequency response of the EM4575 transmitter is flat ± 1 db, 5 cps to 800 kc. Over-all efficiency is 10%. The transmitter operates from a 100-150 v, 350-450 cps, single-phase primary supply. Delivery is quoted in 90 to 120 days.

Eitel-McCullough, Inc., 301 Industrial Way, San Carlos, Calif. [422]

Low-voltage magnetron delivers 100-mw power

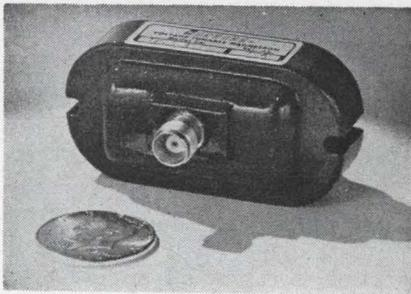

A low-voltage, wide-band voltage tunable magnetron has been announced. The anode voltage required to tune the unit linearly from 500 to 1,000 Mc is 250 to 500 v. The power output is 100 mw minimum and the power variation over the entire range is ± 1 db. The subminiature vtm weighs $\frac{3}{4}$ lb and measures $2\frac{3}{4}$ in. by $1\frac{1}{2}$ in. Price is \$950; delivery, two weeks.

Micron Inc., 265 Osborne Road, Albany, N.Y., 12211. [423]

3.5-pound twt rated at 1 kc

A major reduction in size and weight is claimed for the L-3954 traveling-wave tube. The tube weighs 3.5 lb., yet is rated at a minimum of 1 kw across the frequency range of 8 to 11 Gc. Small signal gain is rated at 33 db or greater, and duty is 0.01. The L-3954 is all metal and ceramic, ppm-focused and capable of operation in many of the more severe military environmental applications.

Litton Industries Electron Tube division, 960 Industrial Rd., San Carlos, Calif. [424]

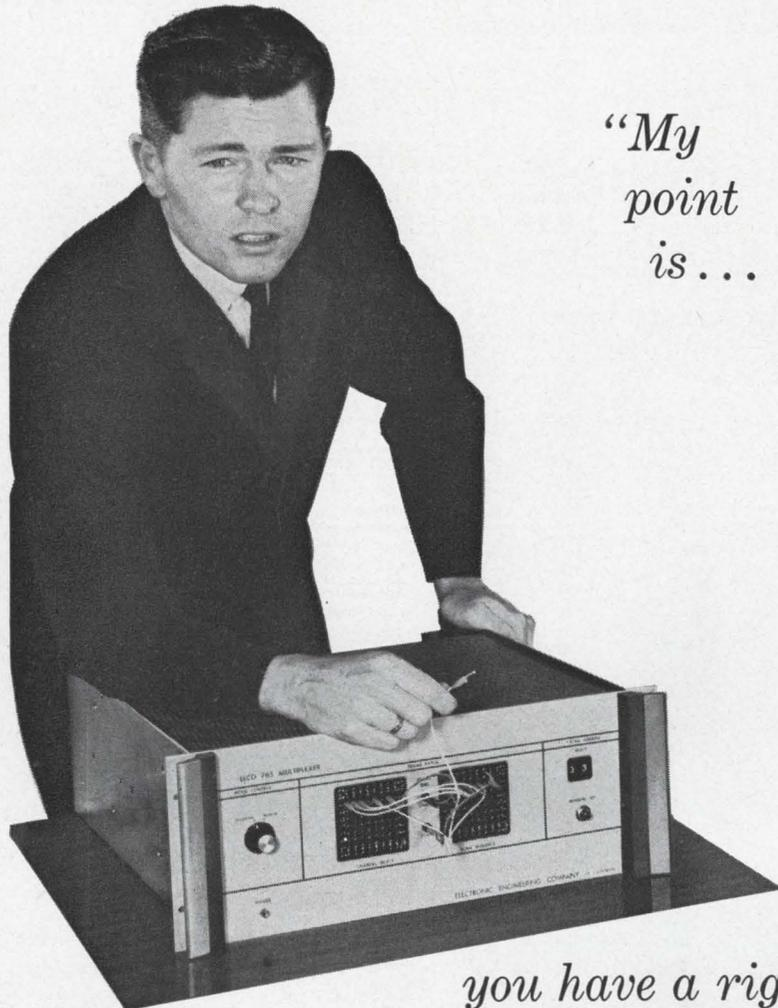

“My point is . . .

you have a right to expect all this in an analog multiplexer . . .”

And the EECO 765 gives it to you without shortcuts in features or construction:

- 50 kc sampling rate
- 0.01% accuracy
- built-in programming ease
- gated display on ADC
- inputs: ± 50 mv to ± 5 v
- high input Z
- 10-100 channel capacity
- minimum crosstalk

It's quality throughout — with Field Effect Transistors used for switching and in the first

stage of the buffer amplifier. For greater usefulness, front-panel patchboards allow you to program any number of inputs (to 100) in any sequence . . . including super-commutation.

A real instrument value, the EECO 765 costs from \$2,200 to \$4,000 depending on options . . .

100 channels at less than \$4,000. Interesting? Write, phone or wire for the full story.



Electronic Engineering Company
of California

1601 E. Chestnut Ave. (Box 58) Santa Ana, Calif. 92702
Phone: KImberly 7-5501 Area Code 714 • TWX: S Ana 5263

Latronics

Seals Terminals Assemblies

Ceramic-to-Metal

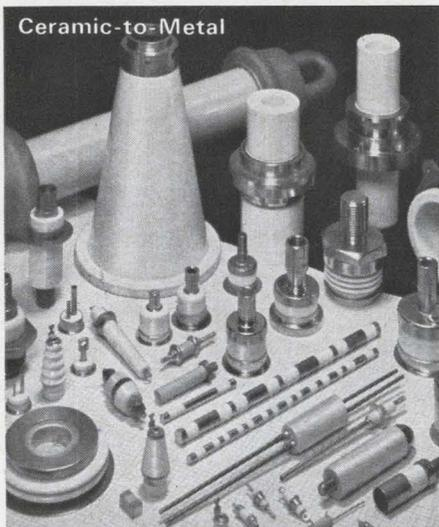

Glass-to-Metal

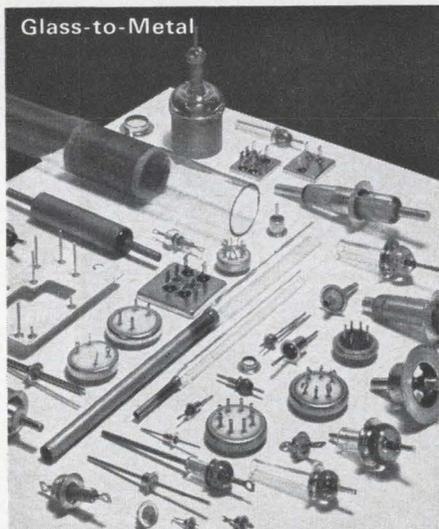

Standard or Custom-Made

You benefit by 25 years' experience in design and manufacturing. Standards from stock. Specials as needed. Mail drawings and specifications for quotation.



995 Lloyd Ave., Latrobe, Pa. 15650,
Phone 412-539-1626 TWX 412-594-7857

New Production Equipment

Hot probe for semiconductors

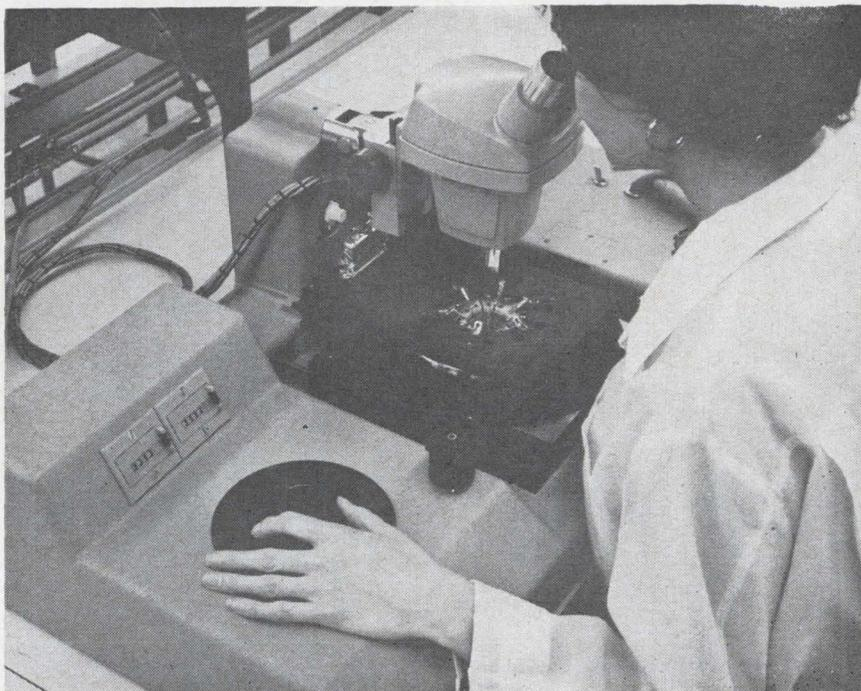

Hot probing, reports Siliconix Inc., raises the percentage of integrated circuits or transistors that are rejected, but lowers the cost of producing them.

This seems like a contradiction, but it isn't. Integrated circuits are cheap at the time they are probed—electrically tested with an array of needle-like contact fingers. Probing is done while the circuits are still part of a silicon slice on which hundreds of circuits are made simultaneously. Most of the cost of the circuits represents the handling, packaging and testing done after probing.

Hot probing raises the reject rate during probing by testing the circuits at elevated temperatures. Conventionally, circuits are probed at room temperature and not tested at elevated temperatures until after packaging. The room-temperature probing may not reveal circuits that must later be rejected because their leakage current or other temperature-sensitive characteristics vary too widely at temperatures of 100°C or higher. For example, a leakage current variation of one nanoampere at room temperature might rise to tens of nanoamperes

at 150°C, and the circuit would be unacceptable for high-temperature use.

To detect such potential failures, Siliconix has developed a hot-probing modification which it is offering to purchasers of the \$3,995 Waferprobe Mark III. A silver hot-plate is built into the vacuum-chuck stage which holds the silicon slice during probing. Temperature is controlled up to 150°C by thermocouples and transistorized feedback circuits which regulate electrical resistance heaters in the insert.

According to the manufacturer, this device makes the Mark III the first commercially available hot prober.

Specifications

Machine rate	60-mil spacing, 1,300 cycles/hour 20-mil spacing, 4,000 cycles/hour
Rotation	360°
Stepping, x axis	10 to 150 mils
Manipulator	30:1 reduction
Vacuum chuck	electrically isolated
Probe points	up to 12
Wafer diameter	up to 1½ inches
Thickness variation	3 mils
Bonding pads	down to 2 mils

Siliconix Inc., 1140 W. Evelyn Ave., Sunnyvale, Calif. [451]

3 FREQUENCY NEEDS 10 SULZER ANSWERS

SULZER FREQUENCY STANDARDS

MODEL	FREQUENCY OUTPUTS	24 HOUR STABILITY
SULZER 2.5.....	2.5 mc/s, 1 mc/s, 100 kc/s.....	$\pm 1 \times 10^{-10}$
SULZER 5A.....	5 mc/s, 1 mc/s, 100 kc/s.....	$\pm 5 \times 10^{-10}$

The SULZER Frequency Standards are rugged, all-silicon solid state devices used in standards laboratories and for timing and communication systems.



Model 2.5 frequency outputs are guaranteed stable to 1×10^{-10} or better over a 24-hour period with moderate ambient temperature and load variations, with power supply variations from 22 to 32 volts. Short term stability is better than 8×10^{-11} over 1 second and 8×10^{-10} over 0.1 second. Output frequency adjustment from front panel is 100×10^{-9} , approximately 5×10^{-11} per division. Internal adjustment approximately 300×10^{-9} .

Model 5A frequency outputs are guaranteed stable to $\pm 5 \times 10^{-10}$ or better over a 24-hour period with temperature variation -10°C to $+60^\circ\text{C}$, with power supply variations from 22 to 32 volts, and for any load condition. Short term stability is better than 8×10^{-11} over 1.0 second and 8×10^{-10} over 0.1 second. Output frequency adjustment from front panel is 100×10^{-9} , approximately 1×10^{-10} per division. Internal adjustment 600×10^{-9} .

SULZER Model 5P Power Supply operates from 105-125 volts, 48-400 cps, and includes sealed nickel-cadmium cells for 10 hour standby operation.

SULZER PORTABLE CRYSTAL CLOCKS

MODEL	FREQUENCY OUTPUTS	TYPICAL 24-HOUR STABILITY
SULZER A5-2.5	5 mc/s, 1 mc/s, 100 kc/s, 10 kc/s	± 2 microseconds
SULZER A5-5	5 mc/s, 1 mc/s, 100 kc/s, 10 kc/s	± 10 microseconds
SULZER 1B	1 mc/s, 100 kc/s, 10 kc/s	± 25 microseconds

SULZER Portable Crystal Clocks generate a highly precise time reference under an extreme, moderate or restricted temperature range. Self powered operation at 25°C for Model A5-2.5 and A5-5 is 15 hours and Model 1B 24 hours. Pulse outputs are provided at various frequencies down to one second.

SULZER CRYSTAL OSCILLATORS

SULZER highly stable quartz crystal oscillators are compact, rugged frequency generators suitable for use as time base generators in equipment and systems requiring high frequency stability. Models 1B, 1J, and 1K are $2\frac{1}{8} \times 2\frac{1}{4} \times 4\frac{1}{4}$ ". Models D 2.5 and D 5 are $4\frac{1}{4} \times 4\frac{1}{4} \times 6\frac{7}{8}$ ".



SULZER CRYSTAL OSCILLATORS

MODEL	OUTPUT FREQUENCIES*	STABILITY	WEIGHT
SULZER 1B	1 mc/s	$\pm 2 \times 10^{-9}$ per 24-hours $\pm 2 \times 10^{-9}$ 15°C to 35°C $\pm 1 \times 10^{-8}$ -5°C to $+55^\circ\text{C}$	1 pound
SULZER 1J	1 mc/s	$\pm 1 \times 10^{-8}$ per 24-hours $\pm 2 \times 10^{-9}$ 15°C to 35°C $\pm 1 \times 10^{-8}$ -5°C to $+55^\circ\text{C}$	10 ounces
SULZER 1K	1 mc/s	$\pm 5 \times 10^{-9}$ per 24-hours $\pm 2 \times 10^{-9}$ 15°C to 35°C $\pm 1 \times 10^{-8}$ -5°C to $+55^\circ\text{C}$	10 ounces
SULZER D 2.5	2.5 mc/s	$\pm 2 \times 10^{-11}$ per 24-hours $\pm 2 \times 10^{-10}$ 15°C to 65°C	3.5 pounds
SULZER D 5	5 mc/s	$\pm 1 \times 10^{-10}$ per 24-hours $\pm 5 \times 10^{-10}$ 7°C to 85°C $\pm 1 \times 10^{-9}$ -29°C to 90°C	3.5 pounds

*1 volt rms into 50 ohm load

For immediate information
telephone 512-476-6601.

For literature on all SULZER products
write TRACOR, Inc.,
1701 Guadalupe Street,
Austin, Texas 78701



SULZER
Precision Oscillators

**SPRAY
COATER
ORGANICALLY
FINISHES
ELECTRONIC
and
ELECTRICAL
COMPONENTS**
having axial leads (such
as capacitors, fuses and
resistors), at rates of up to
**12,000
PER HOUR**

The completely automatic, remote masking C/M Model HD-3 applies a solvent and abrasion-resistant clear coating that protects color coding and labeling, or a light-tight seal for silicon diodes. Coating is confined to desired area while racks, loaded with diodes move continuously through spray station. The diodes, while in the racks, are spun so as to assure an even coating and remain in the racks for both spraying and baking operations.

Also inquire about the C/M Model PR-1 automatic powdered resin coating machine, the C/M Model TL-1 automatic tray loading machine, and the C/M Model ML-1 magazine loader.

SEND FOR LITERATURE

Conforming Matrix
CORPORATION

815 NEW YORK AVENUE
TOLEDO 11, OHIO



In Europe: Conforming Matrix Division
Phoenix Telephones, Ltd.
Grove Park, London N.W. 9, England

New Materials

Polyurethane cures at room temperature

Stycast CPC-16 is a room-temperature curing, polyurethane casting rubber compound. It is supplied as a relatively low viscosity liquid which, when mixed with a liquid catalyst, is converted to a tough flexible solid. The material can be cast to exact contour and can be used for potting electrical circuits and connectors. The resin shows excellent adhesion to a wide variety of materials. To improve adhesion to metal surfaces, Eccoprime PR-1 may be used. Stycast CPC-16 is usable from -70°F to $+300^{\circ}\text{F}$. At 300°F the unpigmented material will discolor but retain its physical characteristics. Typical properties: hardness (Shore A), 75; tensile strength, 3800 psi; elongation,

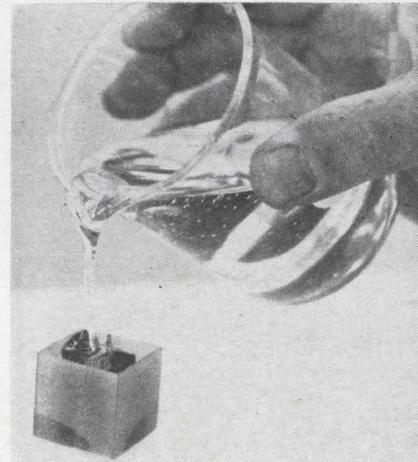

160%; brittle point, below -80°F . Emerson & Cuming, Inc., Canton, Mass. [441]

**High-alumina material
used for substrate**

A high-alumina material is available with a 20-microninch AA as-fired finish. The material, of 99.5% alumina content, is suitable for use as a substrate for microelectronic circuitry and for mechanical seals. The surface is achieved without grinding or polishing, so the cost of the completed seal or substrate can be drastically reduced from previous levels. The specific gravity of this alumina material is 3.9, in contrast to the specific gravity of 3.6 to 3.7 of 85% to 95% alumina materials.

Centralab, The Electronics Division of Globe-Union Inc., P.O. Box 591, Milwaukee, Wisc. 53201. [442]

**Hard dielectric
film coatings**

Durafilm hard dielectric coatings are announced for lasers, rubies, glass rods, filters, dichroics, and mirrors. Designed to resist extreme thermal and mechanical shock, and to withstand high power, high pulsation rate, and fast rise time, Durafilm may be cleaned in water

without thin film degradation or variation in optical performance. Performance loss from scattering and absorption is less than 0.1%, resulting in reflectivity values of 99.9%.

Maser Optics, Inc., 89 Brighton Ave., Boston, Mass., 02134. [443]

**Binary and ternary
high-purity compounds**

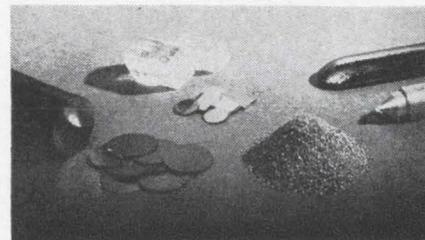

A variety of high purity binary and ternary compounds are now in production. They have application in the manufacture of semiconductors, optics and sophisticated electron tubes. Such compounds as silver arsenic sulfide, copper antimony trisulfide, gadolinium telluride and zinc triantimonide are a few of the 47 types being offered. Many of the materials are available in either crystal, bar, lump or powder form. Allegheny Electronic Chemicals Co., 20 Leon St., Bradford, Pa., 16701. [444]

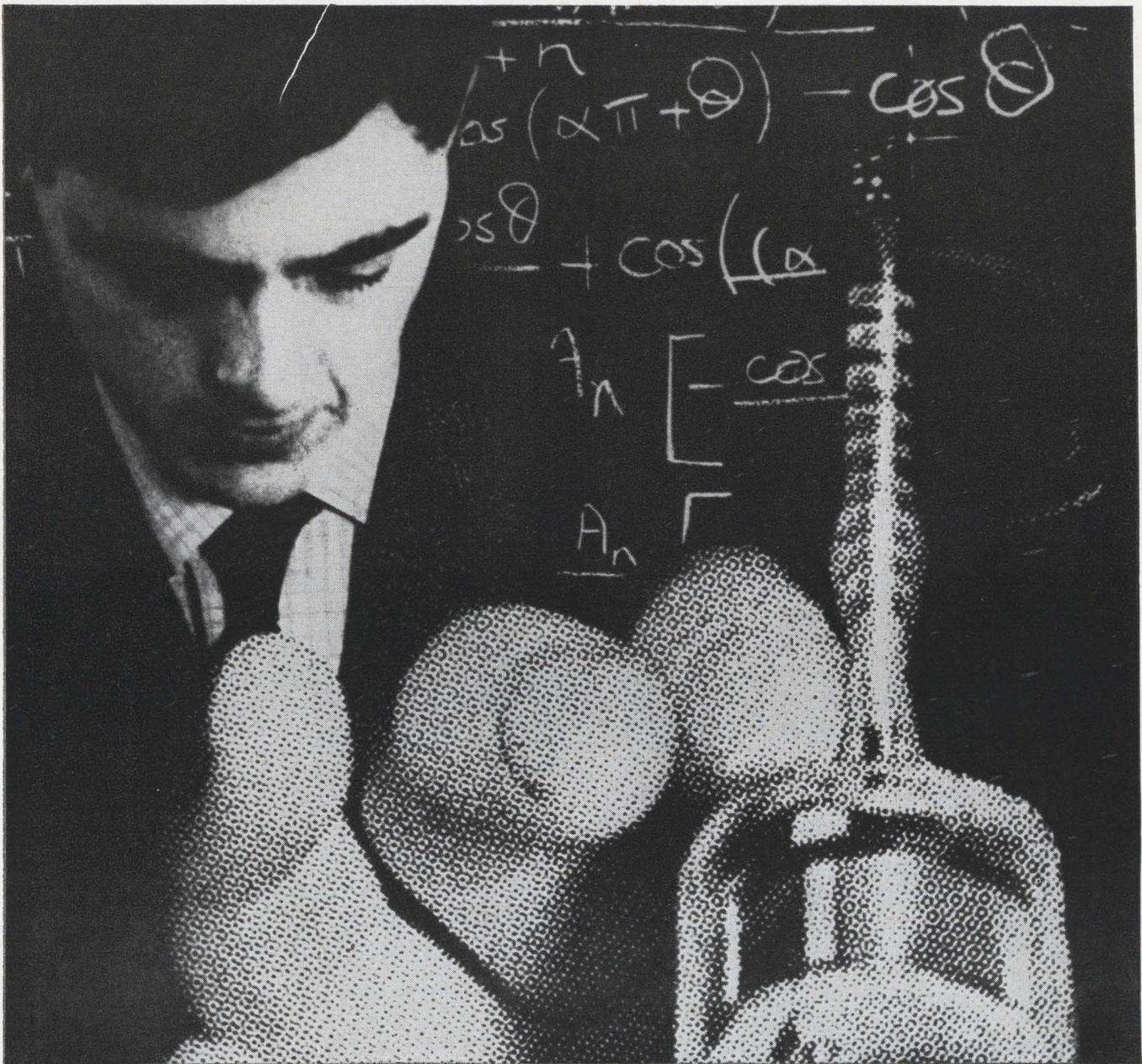

the product is only part of the deal

The ultimate design of the most complex electronic apparatus may well be determined by one special component. It may be a magnetron, a visual display tube or a transistor; but whatever it is the design engineer must choose from many alternatives and equivalents. How does he make his choice? Not by specifications and measurements alone. Equally important are the supplier's research and applications know-how, technical data and assistance and his willingness to share problems before and after the products have been purchased.

This is the kind of support that Mullard gives, and much of it stems from Mullard research.

Scientists at the Mullard Research Laboratories are engaged on fundamental and target investigations in almost every field of electronics. They work in close co-operation with the applications and development engineers at Mullard factories and independently collaborate with universities and government departments.

If we are not serving your Company already, please let us know if we can help you.



Mullard electron tubes · semiconductors
magnetic and other components

MULLARD LIMITED · MULLARD HOUSE · TORRINGTON PLACE · LONDON · W.C.1 · ENGLAND

CAMBION® Catalog 700 Supplement

It's NEW! It's FREE!

Give us a ring
any time for your
own personal copy

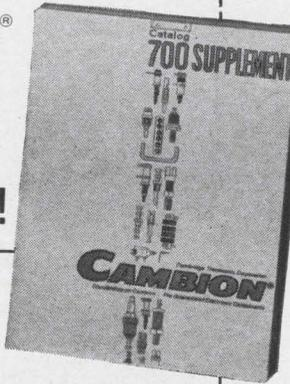

The new supplement to CAMBION'S Catalog 700 gives you all the latest developments and technical advancements in CAMBION'S line of more than 15,000 standard electronic products. Together these two catalogs provide electronic design engineers with the industry's most complete file of technical data on battery holders, panel and chassis hardware, digital modules, solder terminals, swagers, terminal boards, insulated terminals, coil forms, shielded coil forms, coils, RF chokes, capacitors, connectors — plugs and jacks, component clips, handles, kollet knobs, thermoelectric modules, magnetic bearings, etc. all built for guaranteed performance.

If you don't have your free copy of Catalog 700 or the new supplement, call CAMBION right now. Cambridge Thermionic Corporation, 401 Concord Ave., Cambridge, Mass. 02138. Tel: **CAMBION®** (617) 876-2800.

Standardize on CAMBION...The Guaranteed Electronic Components
Circle 220 on reader service card

NEW ELGENCO 3 BAND 20 cps to 5 mc. RANDOM NOISE GENERATOR



MODEL 602A

- Symmetrical wave form
- Non-clipped wave form
- Constant output Z
- All Solid State
- \$290

SPECIFICATIONS: MODEL 602A — GAUSSIAN DISTRIBUTION: Symmetrical non-clipped wave form all ranges. **FREQUENCY RANGES:** 20 cps to 20 kc, 20 cps to 500 kc, and 20 cps to 5 mc. **OUTPUT SPECTRUM:** Uniform from 20 cps to 20 kc within ± 1 db, 20 cps to 500 kc within ± 3 db, 500 kc to 5 mc within ± 8 db. **OUTPUT VOLTAGE:** Maximum open circuit at least 3 volts for 20 kc range, 2 volts 500 kc range, and 1 volt 5 mc range. **TYPICAL SPECTRAL DENSITY** (with 1 volt rms output): 5 mv/√cps for 20 kc range, 1.2 mv/√cps 500 kc range, and 0.4 mv/√cps 5 mc range. **CONTINUOUS AMPLITUDE CONTROL — FIVE POSITION OUTPUT ATTENUATOR:** X1.0, X0.1, X.01, X.001, and X.0001; Accuracy $\pm 3\%$ to 100 kc, $\pm 10\%$ to 5 mc. **OUTPUT IMPEDANCE:** Constant 900 ohms on direct output; 200 ohms on step attenuated output. **OUTPUT VOLTMETER:** 0-5 volt, calibrated to read rms value of Gaussian noise. **Operating Temperature:** 0 to 50 degrees C. **POWER REQUIREMENTS:** 115/230 volts $\pm 10/20$ volts, 50 to 1,000 cps, approx. 5 watts; rechargeable battery option available. **DIMENSIONS:** 5 1/4" high x 8 3/4" wide x 11" deep. Panel height for 19" relay-rack mounting is 5 1/4". **PRICE:** \$290. **DELIVERY:** Stock to 30 days.

OTHER MODELS: 610A 10 cps to 5 mc — \$1175; 603A 20 cps to 5 mc — \$495; 301A - DC to 40 cps — \$1995; 321A DC to 120 cps — \$2095; 311A DC to 40 cps and 10 cps to 20 kc — \$2395; 312A DC to 120 cps and 10 cps to 20 kc — \$2495; 331A 10 cps to 20 kc — \$1295.



ELGENCO INCORPORATED
1550 EUCLID ST. • SANTA MONICA, CALIF. • (213) 451-1635

For more than 10 years Noise Generators have been our major endeavor.

Ω

7

NEW
FROM
IEE

μ

+

W

WORLD'S SMALLEST REAR-
PROJECTION READOUT GIVES
YOU CHARACTERS THIS BIG ▶

A

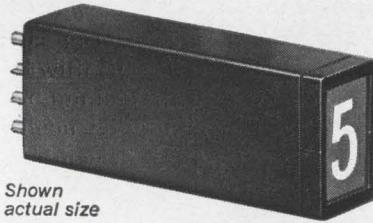

Shown
actual size

+9

The new Series 340 is the smallest rear-projection readout in the world! It's just 3/4" x 1/2" x 2"—yet its 3/8" characters are clear, sharp, and easily read.

4

8

Only IEE's patented rear-projection readouts give you your choice of any type face, symbol, color. Anything you can put on film! Use the single-plane Series 340 anywhere you need maximum clarity in minimum space.

1
VOLT

Send for complete technical information,



GO

INDUSTRIAL ELECTRONIC ENGINEERS, INC.
7720 Lemona Avenue • Van Nuys, California
Phone: (213) 787-0311 • TWX (213) 781-8115

3

Representatives in Principal Cities

Circle 221 on reader service card

Planning to change your address?

Use the form below to indicate a change of address. Because our issues are addressed in advance, please try to allow at least 5 weeks for change of address to become effective. Attach the address label from your most recent issue in the space provided below.

[Please print the following information for proper service]

Title or position

Name

Chief job responsibility

Company and Div.

Product or Service Approx. No. of employees

Address

City Zone State or Prov.

Mail to: Fulfillment Manager, Electronics
P.O. Box 430, Hightstown, N.J. 08520

*Paste present mailing label or address
from wrapper or envelope here.

New Books

Information Theory

Probability and Information Theory
With Applications to Radar
P. M. Woodward
Macmillan Co., 136 pp., \$5

This second edition of a classic monograph is essentially unchanged from the original edition published 12 years ago except for minor corrections, a revised index and a short addition on statistical decision. It is still one of the best expositions of modern techniques of statistical communication such as correlation detection and coding.

While the technical literature dealing with these subjects has grown enormously and advances have been rapid, Woodward's book manages to hold its own because it deals with fundamental principles. In essence, this is what the book presents—a clear exposition of the basic principles of information theories, illustrated with simple, well-chosen numerical examples.

The introductory material on probability and noise is adequate for readers already acquainted with the mathematics of probability. A welcome feature is a short discussion of the concept of entropy prior to the chapter on information theory. Entropy is a measure of the spread of statistical results.

The chapter on information theory gives a clear distinction between information capacity of a channel (number of distinguishable states) and information content of a message (minimum average capacity). The reader is led into the statistical theory of reception, which in the end reduces to calculations of inverse probabilities. The calculations are employed in classical coin-tossing experiments and in detection of signals embedded in gaussian noise, and they are related to the general technique of correlation detection. These ideas, in turn, are applied to developing a theory of radar reception.

The book is well written, and should be useful as a reference for scientists, engineers and students. However, instead of the new chapter on statistical decision—an area

where pertinent information is already available—it would have been more appropriate to include a chapter on the quantum aspects of noise and information theory.

Henri Hodara
National Engineering Science Co
Asadena, Calif.

Materials

Physics of III-V Compounds
Dr. Otfried Madelung
John Wiley & Sons, Inc., 409 pp., \$13.

This book is an excellent comprehensive treatise on the physical properties of III-V semiconductor compounds. It includes a thorough discussion of optical properties, transport properties, impurity levels, metallurgy, junction phenomena, and mechanical properties. The discussed is based on the work that has been reported in the literature. Kane's theory is described in detail and band structure is thoroughly studied.

The book is written in a clear, appealing style with most parameters such as absorption edge and mobility carefully defined. The symbols for physical qualities and mathematical operations are standard and easy to follow. It is assumed, however, that the reader is familiar with solid state theory on a graduate physics level. The major part of the book is devoted to deducing band structure of the III-V semiconductors from the physical data. The introductory discussions of Brillouin zone, and energy ellipsoids are not sufficiently detailed to enable an undergraduate reader to understand the importance of data correlation to band structure.

The book does not discuss III-V semiconductor devices at any great length. The properties of junction devices such as stimulated and spontaneous emission of radiation, tunneling probability, and transistor behavior are mentioned, but not discussed. As the title implies, the book is devoted to materials rather than to device physics.

The theoretical results and physical data are excellently referenced throughout the book.

Picatinny Arsenal
Dover, N.J.

Edgar J. Evans



G.E. WROTE THE BOOK ON SILICONE GREASES

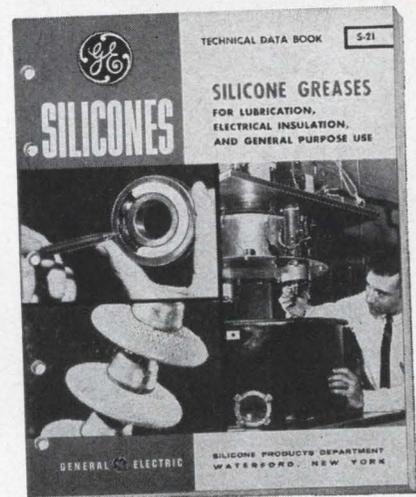

Lubrication . . . Need a good lubricant for bearings, gears, and other mechanisms under rolling or sliding friction conditions, over temperature ranges from -100°F to $+450^{\circ}\text{F}$? G-E Versilube® provides a wide choice of lubricating greases . . . and they won't evaporate, won't bleed and won't washout.

Electrical Insulation . . . Need protection against contamination and environmental extremes for electrical insulating, sealing, and heat transfer applications? G.E. has Insulgrease® and Insulgel® dielectric compounds that are water repellent and guard against solid particle deposits, with a useful temperature range from -65°F to $+300^{\circ}\text{F}$.

General Purpose . . . Need a general purpose compound for any number of water repellent and general sealing applications where you can't afford evaporation or bleeding? G.E. has compounds for use as corrosion inhibitors, non-curing seals, anti-seize compounds, and for specialty release applications.

As a matter of fact, G.E. has so many excellent silicone greases for so many applications, we've written a book about it. It's a 20-page Technical Data Book loaded with information such as physical and electrical properties and applications. And it's yours for the asking.

®Registered Trademarks of General Electric Company

**Send now for your FREE copy of
G-E Silicone Greases Technical
Data Book S-21**

Write to Section N5151, Silicone Products Dept.,
General Electric Co., Waterford, New York.

GENERAL  ELECTRIC

MINIATURE SOCKETS NEED MUSCLES, TOO!

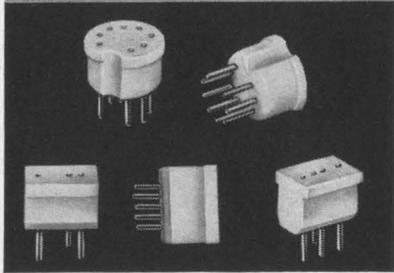

A prevailing problem with miniature sockets has been the ease of pulling the pin from the socket during either the manufacturing process, while servicing, or through general use. Garlock has solved this problem with a newly designed contact which will consistently withstand up to a 7 lb. pull test.

**GARLOCK MANUFACTURES
A WIDE-RANGE OF STAND-
ARD AND CUSTOM SOCKETS
FOR TRANSISTORS, MICRO-
MODULE AND MICRO-LOGIC
ELEMENT APPLICATIONS.**

For complete information, ask
for your copy of Catalog
EP-169.

NEW!

12-PIN TRANSISTOR SOCKET

By utilizing TFE (Fluorocarbon plastic) and silver-plated, gold-flashed Beryllium copper, Garlock has developed a socket that exhibits unusually good electrical qualities with minimum pin-to-pin and pin-to-chassis capacitance. Compression mounted. Ask for details on Part No. 69012-0019.



GARLOCK
ELECTRONIC PRODUCTS
CHERRY HILL, N. J. 08034

Technical Abstracts

Inductive coupling

Clamp-on transformer links
underwater sensors to a sea cable
N.L. Brown
The Bissett-Berman Corp.,
San Diego, Calif.

Oceanographic data gathered by deeply moored buoys or instrumented cables is frequently lost because of failure in the connectors and splices between the cables and the sensor packages. A new method of mounting sensor packages on an undersea cable, the "clamp-on" system, has been developed to eliminate this source of failure. Signals from the sensors are inductively coupled into the cable using a clamp-on transformer, eliminating the need for direct electrical connections or cable splices, and their attendant problems.

The clamp-on technique makes use of the same principles used in the clamp-on ammeter, which has been available for many decades. The electrical signals from the sensors are applied to a split-core transformer clamped around the sea cable. The insulated conductor of the cable, plus the sea water return circuit, form a single-turn secondary for the transformer. It is this secondary circuit that conveys intelligence from the sensor to the surface receivers.

Frequency-modulated telemetry was used in the prototype system developed to demonstrate the feasibility of the clamp-on technique, but digital signals can also be transmitted. The prototype system measured underwater temperature, although other variables such as depth, salinity, sound velocity, or any other data that can be converted to an f-m or digital signal, can be transmitted.

Since there is a power loss of approximately 40 decibels between the cable and the clamp-on transformer, the device had to have a battery-powered amplifier. It was also equipped with a means of being interrogated, to minimize battery drain.

The interrogate receiver requires zero stand-by power. A sensor is turned on by a tone generator, which uses resonant reeds to ob-

tain precise frequencies. The tone is amplified and passed through a low-pass filter to the sea cable and then to the clamp-on transformer; the outputs of the transformer are then applied to a tone-sensitive switching circuit in the sensor.

This circuit consists of an amplifier having zero power drain in the absence of a signal to which a resonant reed relay responds. When the incoming tone does correspond to the resonant frequency of the reed relay, a transistor, acting as a switch between the battery and the output amplifier and the sensor, is turned on. The sensor output is then transmitted up the cable to the monitoring station.

Presented at the National Telemetry
Conference, Houston, Texas, April 13-15.

System synthesis

Time-domain synthesis technique for
distributed-parameter control systems
Donald A. Pierre, Department of
Electrical Engineering, Montana State
College and Thomas J. Higgins,
Department of Electrical Engineering,
University of Wisconsin

A technique is presented for synthesizing linear control systems from distributed-parameter elements characterized by nonrational fraction transfer functions in the Laplace variables. With this synthesis procedure, a linear controller is realized that results in a system with a prescribed response to a specified system input. Rather than synthesize the controller directly, the synthesis is performed on a sampled-data representation of the continuous process. The method of applying the technique is illustrated by synthesizing a controller for a system which is characterized in part by the distributed-lag transfer-function, exponential $[-(sD)^n]$.

This technique is useful because design specifications are often given in the time-domain: time-delay, rise-time, overshoot, settling-time and steady-state error that result from one or more specified input signals. In this paper, the time-domain specifications are satisfied directly with a general method for synthesizing linear distributed-

Breakthrough in performance and price—the facts about a new recorder



A built-in power supply lets you (a) plug it in almost anywhere. AC from 105 to 230 volts, any frequency from 50 to 400 cycles. DC from storage batteries. (b) Uses low-cost 7" reels of 1/4" instrumentation tape. (c) High tape-speed stability with a closed loop drive that incorporates a phase-locked capstan servo. (d) Records up to 8 tracks. (e) Direct on each channel to 100 Kc. (f) FM on each channel to 10 Kc. (g) S/N ratios to 40 db. (h) Accepts input signals from 15 mV to 10 V for full scale deflection. (i) Complete, switchable channel electronics, Direct and FM, record and playback, in a plug-in module. (j) Start with one channel if you wish—add more at any time. (k) Record and playback in either direction. (l) Electronic control logic prevents tape damage by operator error.

(m) Three tape speeds in the ratio of 1 to 10 to 100—use the decimal system in your calculations. (n) Switching recorder speeds automatically switches the electronics. (o) Dynamic braking. (p) In a portable case, or rack mount with a simple adapter.

Also available, options that include a loop adapter, remote control, and built-in calibration.

Some of these features are not available on any other recorder at any price, yet the PI-6100 sells for less than half the price of most other data recorders. Get the detailed story, and complete specifications from Precision Instrument Company, 3170 Porter Drive, Palo Alto, Calif.



PEERLESS IS THE BEST

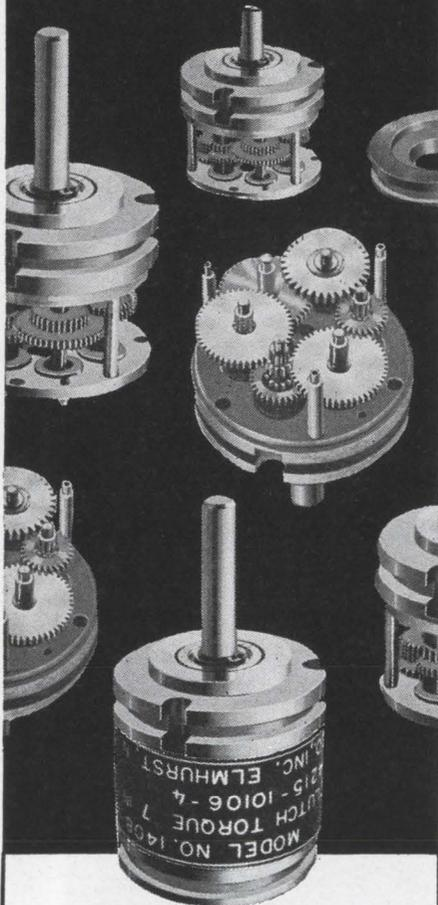

**PRECISION
GEARHEADS
&
SPEED
REDUCERS
•
QUALITY
•
PRECISION
•
RELIABILITY
•
EXPERIENCE**

BACKED BY MORE THAN

25

YEARS OF CONTINUOUS LEADERSHIP
IN THE ELECTRONICS INDUSTRY.

WRITE FOR NEW GEARHEAD CATALOG
& COMPLETE TECHNICAL SPECIFICATIONS.

PEERLESS

PEERLESS INSTRUMENT CO., INC.
90-15 CORONA AVE., ELMHURST, L. I., N. Y.
TELEPHONE 212 HI 6-1100

Technical Abstracts

parameter systems.

To some extent, the method has steps in common with other sampled-data time-domain synthesis techniques. This procedure is different because of the presence of fixed distributed-parameter elements.

Presented at IEEE International Convention, New York, March 22-25.

Latching circulator

A latching ferrite junction circulator for phased-array switching applications P.C. Goodman, The Bendix Corp., Research Laboratories division, Southfield, Mich.

A latching three-port junction circulator, operating at X band, has been designed with wide bandwidth, small size and a switching time of less than one microsecond. It is particularly suitable for use as the switching element in differential time-delay networks and other switching networks required in phased-array antennas.

Switching circulators have been either too slow or too bulky to be suitable for radio-frequency switching. In the new latching junction circulator, high speed and small size are combined by the use of a novel geometry for the ferrite section and the bias coil. The ferrite is designed to provide a closed magnetic path entirely within the material and, therefore, entirely within the waveguide walls. The remanent magnetization of the material provides the necessary magnetic bias in the ferrite.

The sense of magnetization of the material, and therefore the sense of circulation in the device, may be rapidly reversed by passing a current through a bias wire properly located in the junction.

In the experimental device a 15% bandwidth was achieved, centered at 10.5 gigacycles. Isolation was greater than 20 decibels, vswr less than 1.2 to 1, and insertion loss less than a microsecond with 75 microjoules of switching energy. The energy was supplied by a capacitor, which was discharged through the bias coil by a silicon controlled rectifier.

Presented at the 1965 Microwave Theory and Techniques Symposium, Clearwater, Fla., May 5-7.

High-Protean Diet of Optical Devices

Photo-Coupled Transistors:

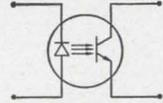

DC, AC, and pulsed signals • True electrical isolation (up to 25 kv in special packaging) • High current output • GaAs light source drives photosensitive multijunction device • Hermetically sealed TO-5 or TO-18 case; 4 leads

Phototransistor:

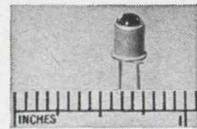

Quantum efficiency of photoconductive sensor >1000 • Spectral response, visible region to near infrared • Low unit cost • Applications for computer systems, industrial controls, optical tracking, optical relays • Standard enclosure, hermetically sealed TO-18 with lens • Special, line arrays and mosaics up to 100×100

Ultra-Low Capacitance Silicon Optical Detector:

Capacitance down to 3 pf/cm² • Peak response at 1.06 microns • Available in singles, arrays, quadrants

High D* Silicon Photovoltaic Sensor:

D* to 10^{13} • Peak at 9000A • Single chip and multiple chip mosaics up to 1000 detectors

Two-Color Detector:

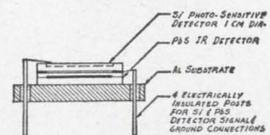

Antireflection-coated Si detects visible and transmits infrared to rear detector (PbS or other). Circular and quadrant assemblies. Special hemispherical Si acts as a 2π front detector and as an IR lens.

GaAs Light Sources:

• High efficiency diodes for DC, AC, and pulsed operation • TO-5, TO-18, Varactor diode mount (0.050 dia. \times 0.125 L) • Peak emission $>10^{-3}$ watts/steradian DC at room temp. (TO-5 lens mount)

For a rich and varied diet of technical data, write or call ENL. You're also invited to ask for special servings in configurations designed to meet the requirements of specific applications.



ELECTRO-NUCLEAR LABORATORIES

2433 Leghorn St., Mountain View, Calif. 94041

ENGINEERS

40,000 PROFESSIONALS CAN'T BE WRONG

ABOUT ROCHESTER, NEW YORK —

FOR CAREERS

AND



FOR LIVING

Rochester has the largest percentage of professional people for a metropolitan region of its size (600,000) in the nation. The large engineering and scientific community, doctors, lawyers, teachers and musicians enjoy an unusual panoply of cultural, residential and recreational advantages.

General Dynamics/Electronics engineers find this many-dimensional living a stimulating background to their careers. Concerts, theater, museums, art galleries, universities and colleges (9 in the area) offer an active intellectual participation usually associated with "big city" living. On the other hand, small town beauty and quietude prevail in Rochester's residential areas with the beautiful homes on tree-shaded streets, churches for all denominations, and in the 2,777 acres of city parks. Four distinct seasons provide year-round sports challenging a variety of tastes. Lake Ontario beaches are nearby. The famous Finger Lakes are only 40 minutes drive away. Besides all water sports, there's ample opportunity to golf, ride, fish, hunt and ski. Buffalo, Niagara Falls and Canada are all roughly 75 miles away.

Just as General Dynamics/Electronics' location on the fringe of greater Rochester offers the engineer living that is rich and varied — so the design of extremely sophisticated electronic equipment fosters extremely challenging and interesting work. Often moving on the outer fringe of present state-of-the-art advances, our engineers work in a quiet environment in separate departmental groups and laboratories in the modern facility situated within greater Rochester.

Assignments at All Experience Levels
Are Presently Open in the Following:

**ASW • HYDROACOUSTICS
HF COMMUNICATIONS • NAVIGATION
RECONNAISSANCE/COUNTERMEASURES
RELIABILITY • MAINTAINABILITY**

To arrange a confidential interview,
send your resume to R. W. Holmes, Dept. 22.

GD

GENERAL DYNAMICS ELECTRONICS

1400 N. Goodman St., Rochester 1, N.Y.

An Equal Opportunity Employer

Electronics | May 31, 1965

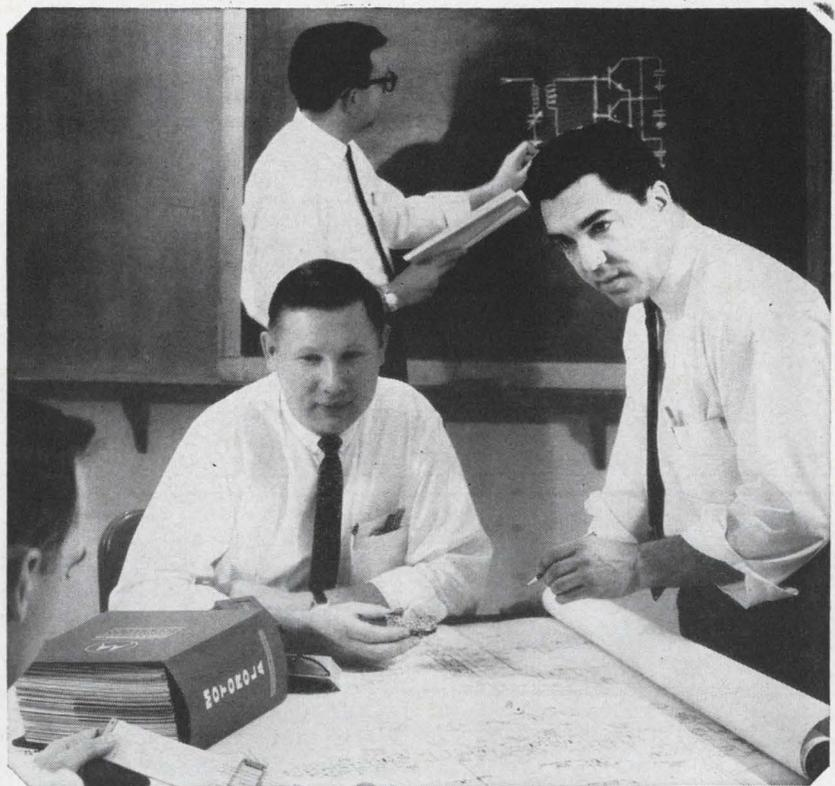

What do they mean by "an engineer's company"?

Some very successful companies are "sales oriented"—others, equally successful, receive their primary impetus from accounting, legal or business-management directions. Probably because of the highly technical nature of its product, Motorola has always been a company wherein engineering has been the moving force. At any management conference at Motorola, you'll find men think like engineers, and talk like engineers, because so many in the management echelon *are* engineers.

At Motorola the engineer achieves full professional status—because he is working in an environment where the state of the art has progressed to the point where only an "engineering oriented" management can direct the flow of achievement.

In this dynamic atmosphere, of course, the challenges are great—but equally rewarding for truly qualified engineers. Would you like to talk to us?

SYSTEMS ENGINEERS advanced R & D in radio communications systems related to Two-way, portable, mobile and radio-telephone equipment.

EQUIPMENT DESIGN high performance solid state receivers, transmitters, and data processing equipment for radar, communications, command and control, tracking and telemetry.

FAMILIARITY WITH STATE-OF-THE-ART statistical communications theory, advanced signal processing techniques, solid state r.f. techniques, ultra-reliability, antenna systems, advanced structural and thermal designs.

SECTION MANAGER direct engineers and support personnel in state-of-the-art communications, including r.f. systems and input-output devices.

CHIEF ENGINEER technical management of R & D group in advanced technology related to solid state r.f. communications.

CIRCUIT DESIGN ENGINEERS advanced R & D in receivers, transmitters, RF, digital, Color TV and automotive electronics.

DEVELOPMENT ENGINEERS advanced communications products in consumer, industrial and military electronics.

Excellent opportunities also available in Phoenix, Ariz.

Mr. W. H. HAUSMANN, Engineering Personnel Mgr., Dept. E 4545 Augusta Blvd., Chicago 51, Illinois

An equal opportunity employer.



MOTOROLA inc.

RADAR ENGINEERS

WITH DATA

PROCESSING EXPERIENCE

... Positions immediately available in Lexington, Massachusetts for Radar Systems Engineers to augment a data processing team.

... Experience in the analysis of radar information is required. Position involves the determination of radar cross-sections, scintillation rates and pulse spectrum densities. BS or MS in EE, Math or Physics is desired.

... Compensation to **\$15,000** with excellent Benefits program.

Send Resume To Department 810-KL

PHILCO TECHREP DIVISION

A Subsidiary of Ford Motor Company

P. O. Box 10 — FORT WASHINGTON, PA. 19034

An Equal Opportunity Employer



E. E.'s
for FEE-PAID Positions
WRITE US FIRST!
Use our confidential application for professional, individualized service . . . a complete national technical employment agency.
ATOMIC PERSONNEL, INC.
Suite 1207L, 1518 Walnut St., Phila. 2, Pa.

POSITION VACANT

Communications Engineer—Excellent opportunity for advancement with large midwestern gas and electric company. B.S.E.E. required. Experience in a Utility Communications Section desirable but not necessary. Must be experienced in system design and operation of mobile radio systems and microwave networks. Should be familiar with carrier systems, utility relay practices, supervisory control and telemetric equipment. Will be responsible for all company communications systems. Salary open but commensurate with qualifications and experience. Send complete resume detailing experience, personal data, and salary requirements to P-6624, Electronics.

SEARCHLIGHT SECTION

- CLASSIFIED ADVERTISING
- BUSINESS OPPORTUNITIES
- USED OR SURPLUS EQUIPMENT

BATTERY CHARGER

1—Gould Type GRF Silicon Controlled Battery Charger. New, never used. Model GRF 24S75 . . . input 110/220 Volts . . . 44/22 amperes . . . single phase 60 cycles . . . Output 25-29 volts D. C. 75 amperes. Complete factory assembly in cabinet 16 1/2" wide, 48" high—16 1/2" deep.

For details call, wire, or write

F. J. BELLUSCIO

Taylor Instrument Companies
Rochester, N. Y.

CIRCLE 951 ON READER SERVICE CARD

FREE...CATALOG BARRY ELECTRONICS

512 BROADWAY 212-Walker 5-7000
NEW YORK 12, N.Y. TWX-571-0484

CIRCLE 954 ON READER SERVICE CARD

free catalog
POTTING APPLICATORS
MANUAL AND DISPOSABLE
6cc 12cc 30cc
FOR POTTING, ENCAPSULATING, AND SEALING OF MINIATURE COMPONENTS
PHILIP FISHMAN COMPANY
7 CAMERON ST., WELLESLEY 81, MASSACHUSETTS

CIRCLE 955 ON READER SERVICE CARD

★ HEWLETT PACKARD ★

80 pieces of laboratory equipment
VTVM's — Oscillators-counters-attenuators
send 25¢ for list and picture.

EASY-UP, INC.

2425 Bradley Road, Rockford, Ill.
or phone 877-5288 area code 815

CIRCLE 956 ON READER SERVICE CARD

RADAR AUTO-TRACK & TELEMETRY ANTENNA PEDESTALS
3 & 10 CM. SCR 584 AUTOTRACK RADARS. M-33 RADAR
TPS-ID SEARCH. APS-45 TPS-100 HT. FINDERS. WX RADARS.
FPN-32GCA. APS-10 APS-15B APS-27 (AMTI) SEARCH. ■ ■
APN-102 DOPPLER. DOZENS MORE. CARCINOTRONS. PFN'S.
.25-5-1-2-3-6 MEGAWATT PULSE MODULATORS. CAVITIES.
PULSE TRANSFORMERS. IF STRIPS. WAVEGUIDE. BENDS
200 MC. 1 KMC. 3 KMC. 6 KMC. 9 KMC. 24 KMC. RF PKGS.

RADIO RESEARCH INSTRUMENT CO.
550 5TH AVE., NEW YORK 36, N.Y. JU 6-4691

CIRCLE 957 ON READER SERVICE CARD

WRITE FOR NEW **KEYSTONE** **free catalog**

We are the leading producers of BATTERY HOLDERS, TERMINALS, TERMINAL BOARDS & ELECTRONIC HARDWARE.

KEYSTONE ELECTRONICS CORP. 49 BLECKER ST. NEW YORK 12, N. Y.

CIRCLE 958 ON READER SERVICE CARD

ROTRON COOLING FAN

Computer pullouts. Like new. "Muffin Fan". Inaudibly cools amplifiers, tuners, power supplies, etc. Lengthens tube and equipment life—improves their performance. 4 1/16" sq. x 1 1/2" deep. 100 cfm. For 110-120 v. 60 cy. AC. 1 1/4 lbs. \$8.50 ea. Quantity discount. Good for 100,000 hrs.

MARS SALES P. O. Box 72832
Los Angeles, Calif. 90016

CIRCLE 959 ON READER SERVICE CARD

PROFESSIONAL SERVICES

GIBBS & HILL, Inc.
Consulting Engineers
Systems Engineering
Operations Research • Development
Field Studies • Design • Procurement
Power • Transportation • Communications
Water Supply • Waste Treatment
393 Seventh Avenue New York 1, N. Y.

Your Inquiries to Advertisers Will Have Special Value . . .

—for you—the advertiser—and the publisher, if you mention this publication. Advertisers value highly this evidence of the publication you read. Satisfied advertisers enable the publisher to secure more advertisers and—more advertisers mean more information on more products or better service—more value—to YOU.

CAPACITORS

MFD	VOLTS	PRICE	MFD	VOLTS	PRICE
.025	50KV	29.00	2	3000V	4.35
*1	25KV	24.00	2	6000V	12.95
*2	50KV	55.00	2	10KV	35.00
.25	15KV	14.95	2	16KV	69.95
.25	50KV	42.50	3	12.5KV	59.50
1	5000V	5.95	4	4000V	9.25
*1	7500V	2.60	4	5000V	14.75
1	15KV	39.50	5	10KV	51.95
1	25KV	49.50	75	6000V	65.00

32 mfd—600V \$3.25
Comprising four 8 mfd sections; 5 solder lug terminals
Dims. 4 3/4 x 3 3/4 x 3/4. Large qua. available.
* Case common.

INQUIRIES SOLICITED

MONMOUTH RADIO LABS

BOX 247—OAKHURST, N. J.
212-222-0121 ART HANKINS, Prop.

CIRCLE 952 ON READER SERVICE CARD

COAXIAL CABLE

RG 213U (former RG 8U)
RG 215U (former RG10U)
RG 219U (former RG18U)

**LARGE QUANTITIES—
BELOW FACTORY COST**

Other types available
Rigid—Flexible—Semi-flex

Call or write for listing

Sierra Western Electric Company

P. O. Box 4668
Oakland, California 94623
Telephone AC 415-832-3527

CIRCLE 953 ON READER SERVICE CARD

New Literature

Tantalum foil capacitors. Tansitor Electronics, Inc., West Road, Bennington, Vt. Bulletin TES-2A includes data on 18 new case sizes of plug-in type tantalum capacitors distinguished by extra-high capacitances up to 14,000 μ f. Circle 461 on reader service card

Log frequency conversion. Houston Omnigraphic Corp., 4950 Terminal Ave., Bellaire, Tex., 77401. A new technique in precision wide frequency bandwidth logarithmic conversion is described in a two-page bulletin. [462]

L-f oscillators. Accutronics, Inc., 12 South Island, Batavia, Ill. A brochure entitled "How to Specify Low Frequency Oscillators" is now available. [463]

Rotating components. Clifton Precision Products, division of Litton Industries, 5050 State Road, Drexel Hill, Pa. A 48-page catalog gives electrical and mechanical characteristics on a wide line of synchros, servo motors, precision computing resolvers, linear transformers, motor rate tachometers and other rotating components. [464]

Precision bridge. Boonton Electronics Corp., Route 287, Parsippany, N.J. A technical bulletin describes the 33A precision bridge for high resolution r-f impedance measurements. [465]

Heat sinks. The Staver Co., Inc., 41-51 North Saxon Ave., Bay Shore, L.I., N.Y., has published a four-page bulletin on a line of heat dissipators for cooling transistors. [466]

Glass-to-metal seals. Uniform Tubes, Inc., Collegeville, Pa., offers a data sheet on seamless metal tubing and tubular components for glass-to-metal seals. [467]

Resin system selection. Isochem Resins Co., Cook St., Lincoln, R.I., offers a resin selection and property chart that shows thirty basic systems. [468]

Lab type power supplies. Dressen-Barnes Electronics Corp., 250 N. Vinedo Ave., Pasadena, Calif. Bulletin E-65 describes a series of regulated and unregulated vacuum-tube, laboratory d-c power supplies. [469]

Connectors. The Deutsch Co., Electronic Components division, Municipal Airport, Banning, Calif. Catalog DBX-65 covers the DBA series, said to be the first connector and contact series to qualify under the National Aerospace Standards Committee qualifications. [470]

P-m motor. Globe Industries, Inc., 2275 Stanley Ave., Dayton, Ohio, 45404. Two-page bulletin A-3600 gives performance and dimensional data on the type GRP permanent-magnet d-c motor rated to 1/10 h-p. [471]

Medium power transistor. Silicon Transistor Corp., East Gate Blvd., Garden City, N.Y., has available a technical bulletin covering its industrial medium power silicon transistor, type 2N3054 in the TO-66 package. [472]

High power terminations. DeMornay-Bonardi, division of Datapulse Inc., 780 South Arroyo Parkway, Pasadena, Calif. Technical bulletin 1-65 describes three series of high power terminations for 2.60 to 90.0 Gc. [473]

Miniature charge amplifier. Gulton Industries, Inc., 212 Durham Ave., Metuchen, N.J. A miniature, 100% humidity-proof airborne charge amplifier for use with long cable is described in bulletin 203a3.14. [474]

Differential amplifiers. Melcor Electronics Corp., 1750 New Highway, Farmingdale, L.I., N.Y., 11735. A new two-page data sheet discusses the application of d-c differential amplifiers. [475]

Attenuators. Daven Division of McGraw-Edison Co., Livingston, N.J., has published a new 32-page comprehensive catalog on its complete line of attenuators and attenuation networks. [476]

Crimp type contacts. Methode Electronics, Inc., 7447 W. Wilson Ave., Chicago, Ill., 60656, offers a data sheet on crimp type contacts in bulk or reel form, for industrial and military use. [477]

Electronic computation. Mathatronics, Inc., 257 Crescent St., Waltham, Mass., 02154, has available an illustrated brochure on the Mathatron, a new concept in efficient, low-cost electronic computation. [478]

Digital-to-analog converters. Scientific Data Systems, 1649 Seventeenth St., Santa Monica, Calif. An eight-page, illustrated brochure describes high-speed, solid state analog-to-digital converters. [479]

Surface measurement equipment. Brush Instruments division of Cleveite Corp., 37th and Perkins, Cleveland 14, Ohio. A 12-page brochure covers a complete line of surface-finish analyzing instruments and systems. [480]

Ceramic substrates. American Lava Corp., Manufacturers Road, Chattanooga, Tenn., 37405, has available bulletin 652 dealing with a line of ceramic substrates of interest to electronics engineers. [481]

Coaxial cable. Uniform Tubes, Inc., MicroDelay division, Collegeville, Pa., offers technical bulletin 202B describing 25 miniature types of semirigid coaxial cable. [482]

Who needs a dual-output, dual-range power supply?

You might—if you want to step up to the most versatile, sophisticated laboratory power supply available today! Consider the advantages.

The new DL40-700 Silicon Dual-Lab supply gives you TWO independent outputs from one half-rack chassis—simultaneously!

Flexibility? Each of these outputs has TWO independently selectable ranges—40V at 350ma, or 20V at 700ma.

Convenience? Each output is controlled by a concentric vernier voltage control and has its own switchable volt/ammeter.

Versatility? Series or parallel the two outputs at will! Consider, too—at only \$249, the DL40-700 costs only slightly more than a single output power supply with comparable features. Who needs it?

If you want a power supply with real versatility and flexibility, two power supplies in one for your dual voltage laboratory needs...

you do!



For all the exciting features, write

TRYGON
POWER SUPPLIES

Roosevelt, New York
TEL (516) 378-2800 • TWX (516) 868-7508

SWEPT FREQUENCY MEASUREMENT, 5Mc TO 12.4Gc

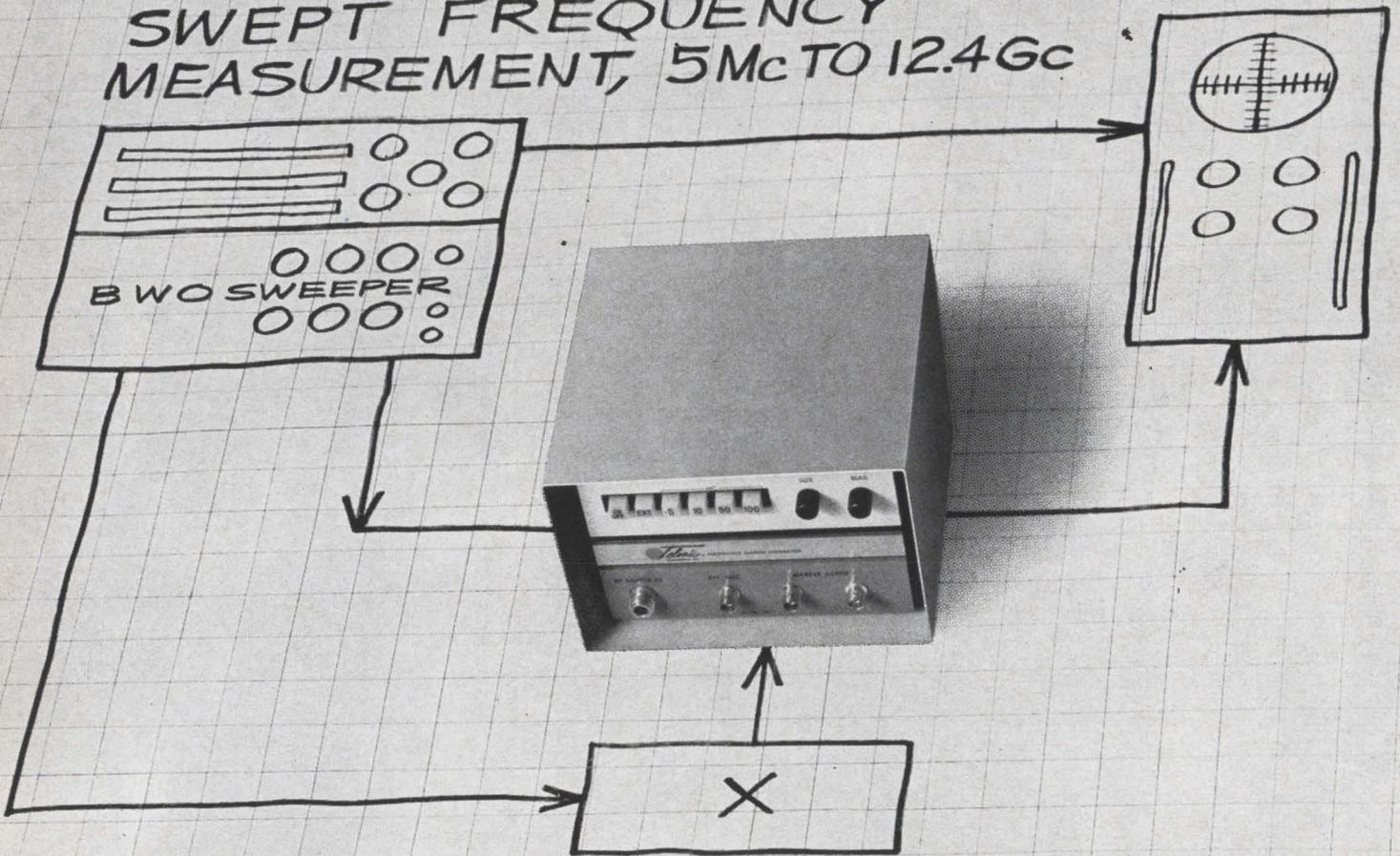

ACCURACY, (.001%) STARTS WITH A SINGLE TMS-1

Telonic's new TMS-1 Microwave Marker Generator makes a .001% system out of any BWO Sweep Generator. That's an improvement in accuracy of about 100X for a frequency range extending from 5 Mc to 12.4 Gc. Test results can be obtained much more quickly and reliably, with a low investment in instrumentation.

Now, you can determine swept frequencies with accuracies approaching that of a frequency counter but at a fraction of the price. What's more, only one TMS-1 Generator is needed to cover this entire band rather than a costly series of .1% wave meters.

The TMS-1 provides sharply defined Birdy-type markers on the 'scope trace (even on steep slopes) every 5, 10, 50, or 100 Mc, selected by convenient push-buttons. Provision is also made for connecting an external oscillator for any frequency from 2 Mc to 200 Mc if other intervals are desired. An extra push button and an RF connector are available for this purpose.

If you would like to see the new TMS-1 in action contact your local Telonic representative for a demonstration, or write direct for complete details and specifications.

GENERAL SPECIFICATIONS

FREQUENCY RANGE	5 Mc to 12.4 Gc
STANDARD MARKER INTERVALS	5, 10, 50, 100 Mc
ACCURACY	.001%
POWER REQUIREMENTS	115V, 60 cycle
CONNECTIONS	Sample In, External Oscillator, Marker Adder In, Marker Adder Out
DIMENSIONS	6" high x 8" wide x 10½" deep
WEIGHT	15 lbs.



ENGINEERING CO.

DIVISION OF TELONIC INDUSTRIES, INC.
480 Mermaid Street, Laguna Beach, California
Phone (714) 494-7581, TWX 714-673-1120

Representatives in all principal cities

International

Counterattack

While some electronics companies only mutter bitterly about foreign competition, the United States' biggest producer of television tuners is carrying the battle to the enemy. In 1961 the Oak Electronics Corp. was a domestic company; today it has subsidiaries in Japan, Hong Kong, Britain, Canada, South Africa and the Netherlands.

Last week Oak established a research and development center in the Netherlands, where 30 scientists and engineers will design tv and radio tuners. Meanwhile, the company has not neglected business at home; it has nine domestic plants today, compared with five in 1961.

Sales have climbed proportionately: from \$17.6 million in 1961 to \$48 million last year, with 14% of its sales coming from abroad. Profit is rising less spectacularly: from \$900,000 in 1962 to \$1,180,000 last year. In the first quarter of 1965, profit rose 15% and sales 16% from the comparable period in 1964.

New boss. Oak's international push began soon after E. A. Carter became president and chairman in 1960. In mid-1962 Oak bought the Hart Manufacturing Co., an American concern with switch-manufacturing subsidiaries in Britain, Canada and South Africa. A few weeks later, Oak entered into a joint venture with Teikoku Tsushin Industries, Ltd., in Japan. The following year, Oak established a subsidiary in Hong Kong, and last April it acquired Messa Electronics, N.V., of the Netherlands.

Carter says the lowering of U. S. tariffs has encouraged foreign competition. "It was imperative," he declares, "that Oak gain positions in all geographic areas" that could

be sources of competition.

Round trip. Carter tries to take advantage of modern manufacturing systems in the U. S. and cheap labor in the Orient. The itinerary of one tuner part illustrates how he does it. The part is manufac-



E.A. Carter, man with a mission abroad

tured at Oak's plant in Crystal Lake, Ill., and shipped to Hong Kong, where it is assembled into a tuner. Then it's shipped back to America, where it will become part of a tv set.

"We've found it's cheaper . . . than to do all the work here," he says. Has this reduced Oak's domestic employment? On the contrary, "it has increased by 33%," Carter replies.

Carter is also interested in Taiwan: far from being discouraged by Communist China's claim to the island, he considers this an advantage. He expects Taiwan to become part of China some day; he also expects trade barriers between the U. S. and China to be lowered. If these things happen, and the vast

Chinese market is opened to American companies, he wants Oak to be among the first electronics concerns on the scene.

Why Hong Kong? "Hong Kong will serve as our base for the Far East," Carter declares. He gives two main reasons: the British colony's status as a free port, and labor costs of 15 to 20 cents an hour, about half as low as in Japan.

Another view of the future, as Carter sees it, has American concerns concentrating on the more profitable color tv, while Japanese companies gain command of the major share of the U. S. market for black-and-white tv sets. Oak wants most of these Japanese exports to the U. S. to contain Oak tuners.

The next expansion could very well be in Argentina, where 250,000 tv tuners are sold each year and the market is expected to expand 10% a year. Carter confirms that Oak is "talking with" a licensee in Buenos Aires.

France

Air show

A roar of jets will herald the opening of the Paris Air Show on June 11. Most of the expected one-million visitors will head for the star attraction: the capsule from which a Soviet cosmonaut took his historic stroll in space. But engineers may find more excitement in 50 to 60 electronics exhibits, because avionics has come a long way since the previous show two years ago.

To facilitate telecommunications stations in space, visitors at the 10-day show will see a low-noise antenna that operates at 4 to 6 gigahertz. Made by the Compagnie Française Thomson Houston, the antenna is 39.3 feet in diameter and

has a gain of 53 decibels.

Thomson Houston also will show thermionic-diode electrical generators that can utilize thermal energy from the sun or from nuclear or hot-gas sources. The TH 5800, used for converting nuclear energy, generates 80 watts with a conversion efficiency of 15%.

There's a lot of advance interest in Secar, the secondary radar system developed jointly by Thomson Houston and the Marconi Co., a subsidiary of the English Electric Co. [Electronics, May 3, p. 156]. The system provides a data link between air-traffic controllers and planes fitted with transponders.

France's biggest. Space communications will take the spotlight at the exhibit of France's biggest electronics company, the Compagnie Générale de Télégraphie Sans Fil (CSF). One system, called Iris, is used by the French government's National Center of Space Studies. It contains remote-control transmitters in the very-high frequency band (148 to 150 megacycles per second), and receivers with phase-locking loops that assure precision measurement of the doppler effect. There are 20 preset channels in the transmission band.

Another exhibit by CSF will show a device for extracting data from the video signals transmitted by the primary and secondary radars of air-traffic control stations. A digital computer processes the data. The system has been ordered for use at Orly Airport in Paris.

The civilian and space versions of CSF's new cesium-vapor magnetometer will be shown. The device can be fitted into the nose of a ballistic missile or towed by a plane or helicopter. It's used for mapping and mineral exploration.

Great Britain

Advances in components

While some segments of British industry feel squeezed in a competitive vise, production of electronic

components, instruments and test equipment continues to soar. Last year's output was \$531 million, up 12% from 1963; exports rose 20% to \$210 million; and the gains are continuing this year. The biggest foreign customer is the United States, which imported \$21 million worth of British components last year, mostly for the hi-fi audio market.

Engineers had a preview of future products at a three-day conference on components and materials that ended May 20. At a concurrent exhibition, that was sponsored by the Radio and Electronic Component Manufacturers' Federation, 300 British companies exhibited more components.

Monolithic vs. multichip. Despite a strong trend in the United States toward monolithic circuits, British manufacturers are still weighing the technique against multichip. To help settle the argument for one application, an experiment was conducted and its results described at the conference by Standard Telecommunications Laboratories. Standard Labs used identical NAND-gate circuits in monolithic and multichip configurations, and declared multichip the winner on the basis of speed of operation and flexibility in manufacture.

American observers noted, however, that European technology in monolithics is about a year behind the U. S. They also pointed out that production in large quantities is far less expensive for monolithics than for multichip.

Standard Labs is the research facility of Standard Telephones and Cables, Ltd., a subsidiary of the International Telephone and Telegraph Corp.

New approach. One result of the Standard tests is a new approach to increasing monolithic circuits' adaptability to more designs. The lab is studying a method of obtaining the horizontal patterns by spark erosion in a three-dimensional shaping technique or by using a two-dimensional cellular structure.

If this approach is successful, all combinations of vertical profiles may be mass-produced as wafers, and stored. Circuit functions could

then be custom-made from these wafers, using computer-programmed machining.

Ubiquitous relays. If any new component can be said to have dominated the show, it was the reed relay, shown by 20 British companies in almost as many forms. Electrothermal Engineering, Ltd., exhibited a series of flat-pack coil assemblies designed for mounting on printed circuit boards, each assembly accommodating up to six reed switches.

Flight Refuelling, Ltd., showed a reed logic system that incorporates diodes and provides logic functions directly equivalent to those of a solid state diode-transistor logic system. Module units are priced at about \$3.

Specialists in millimeter-wave tubes studied a tunable oscillator invented by the government's Royal Radar Establishment. Operating as a line source, it is tunable from 2.1 to 3.9 millimeters, and generates power up to one watt. Second-harmonic operation extends the system to wavelengths of 1.06 to 1.44 millimeters.

Easy to produce. The new tube eliminates the need to produce the small, delicate structures formerly required in millimetric tubes. Instead, radiation is generated by causing free electrons to orbit at the cyclotron frequency in a uniformly high magnetic field inside a cavity. Production methods can be simple because the radiation wavelength, defined by the cyclotronic resonance, is smaller than the tube's characteristic dimensions.

The Radar Establishment also showed a range of submillimeter, far-infrared detectors with time constants of less than one microsecond. These photoconductive detectors cover from 10 micrometers to 2 millimeters.

Trade with the East

To instrument manufacturers in Britain, a trade wind seems to be coming from the East. While one concern conducts private exhibitions in Rumania, Bulgaria and Hungary, 31 members of the

Scientific Instrument Manufacturers Association were opening a Moscow showing of \$1.5 million worth of equipment. The show began May 26.

George Kent, Ltd., is stressing its electronic integrator system for gas chromatographs before prospective buyers in Bucharest, Sofia and Budapest. Kent, the only British maker of process-control instrumentation without ties with United States companies, is also giving prominence to its transistorized electronic controllers and automatic Titrimeters.

The industry association's Moscow exhibition will be its fifth. As usual, the members expect to sell most of the equipment off the stands at the end of the show.

Chemical analysis. The Soviet Union is anxious to get analytical equipment to help in its drive to expand chemical production. The Russians should be interested in a spectrophotometer that uses an air-acetylene flame to determine the magnesium and calcium content of biological fluids. The instrument, made by Hilger and Watts, Ltd., has readout either from a meter or a recorder chart.

U. S.-based companies also are participating. The Perkin-Elmer Corp.'s British subsidiary will show gas chromatographs. The Bell and Howell Co.'s subsidiary will show ultraviolet oscillographs and blood-pressure transducers.

Digital Measurements, Ltd., plans to show a digital voltmeter with a claimed accuracy of one part in 10^5 . The instrument uses tapped transformers to perform the voltage comparison against a standard; most digital voltmeters employ potentiometer chains that are often susceptible to thermal drift and to aging.

Floating relays

A string of communication islands may one day fill in the radio "blind spots" in transatlantic jet travel. The British Ministry of Aviation is spending \$180,000 to study the feasibility of a system of four artificial manned islands floating in the

North Atlantic, linked by underwater cable to each other and to a mainland base.

Transatlantic planes can communicate with land now, but the very-high and ultrahigh frequency bands, which are basically line-of-sight links, become useless about 250 miles out. Pilots must switch to the high-frequency bands between 3 and 30 megacycles, and

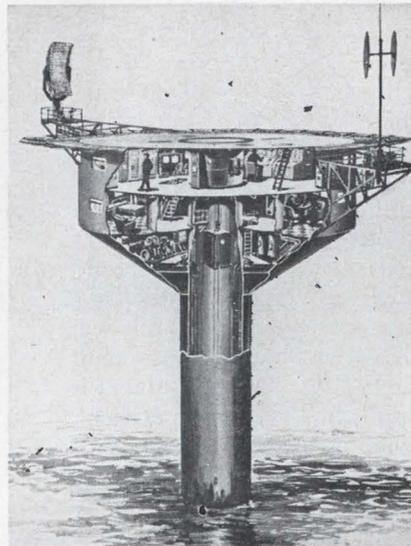

Station at sea would look like this artist's conception.

must contend with noise and fading.

U. S. tries Syncom. Last winter, a Pan American World Airways jet relayed a teletype message from the Formosa Strait to California via Syncom, the communications satellite over the Pacific. It was the first such transmission between a plane and an out-of-sight land station.

But floating islands could carry more traffic than satellites are likely to be able to handle in the near future. The islands could be used in radio, radar and other navigation aids, and for private sky-to-shore conversations.

Floating tube. The British study, which will be completed late this summer, is being conducted for the Aviation Ministry by Seastation, a joint venture of Submarine Cables, Ltd., and Cammell Laird, a shipbuilding company. The sea station would be a platform atop a 400-foot-long submerged tube 16 feet

in diameter. The tube would provide stability to prevent drifting and tilting; it would be linked by three cables to the ocean floor.

The superstructure would contain the antenna systems, a landing platform for helicopters, and living quarters for the crew.

Japan

Fog index

Often shrouded in fog from the sea and smoke from industries on shore, Japan's busy harbors are subject to hazardous traffic snarls if ships aren't warned of poor visibility. The Transportation Ministry, which is charged with the responsibility of issuing such warnings, employs automatic instruments for reporting every relevant aspect of the weather except one: visibility. For this measurement, the ministry hires men to look out over the water and report how far they can see.

This last technical barrier to automatic weather reporting has been overcome with the development of a visibility indicator. The instrument, devised by the Hayakawa Electric Co., operates on the principle of backscatter; the more light returned by particles in the atmosphere, the shorter is visibility.

2 flashes a minute. The light source is a xenon discharge tube whose flash is focused into a beam 1° wide. Equivalent brightness of the one-millisecond flashes from the 60-watt-second tube is about 100 million candles. Flashes are at the rate of one every 30 seconds.

Backscatter from the flashes is picked up by a self-generating silicon photocell, whose mount restricts its field of view to 1° . The signal from the photocell passes through an attenuator for calibration, then through an a-c amplifier. A-c amplification is used to prevent biasing of the signal by a direct-current component resulting from ambient light. After amplification, the signal is fed into an integrator with an infinite time constant. The

SRL VAP

video audio pulse

LABORATORY
FILTER
20 cps. to 4 mcps.



CONTINUOUS CONTROL
IN FOUR MODES

high pass
low pass
band pass
band reject

SKIRT ATTENUATION
Over 40 db/octave

50 μ volt NOISE FLOOR

INSERTION LOSS: 0 db

TRANSIENT OVERSHOOT
less than 1%

BANDWIDTH IN
PASS BAND
20 cps.-7 mcps.

SOLID STATE

DIMENSIONS
7 x 19 x 12 (HWD)

PRICE
\$2250.00

write for complete specs

**SYSTEMS RESEARCH
LABORATORIES, INC.**
500 WOODS DRIVE, DAYTON, OHIO



Electronics Abroad

integrator's output voltage drives the meter that indicates visibility. Seven seconds after each pulse, the integrator is reset to zero.

Calibration. Every eighth flash from the discharge tube is used to calibrate the system rather than to give an indication of visibility. Mechanically actuated vanes block off the backscattered light and simultaneously reflect a small fixed portion of the discharge-tube flash to the silicon photocell. A loop in the unit automatically adjusts the attenuator that calibrates the system. All sensitive circuits are maintained at constant temperature to retain calibration.

Besides visual indication, the detector provides an alarm. A value of integrator voltage is preset to indicate dangerously poor visibility. If this voltage is exceeded four times in succession, a bell rings and a light flashes.

Repetition is required so the alarm won't sound because of stray reflections from birds, airplanes, etc. When the integrator voltage falls below the preset level for three minutes, the alarm stops.

Solid state. The indicator uses solid state circuits except for the xenon discharge tube that provides the light whose backscattering is measured. This tube is automatically exchanged for a spare if it fails in the interval between scheduled maintenance.

Swedish version. Another device operating on the backscatter principle has been developed in Sweden by Sevnska AB Gasaccumulator (AGA), a producer of lighthouse equipment and electronics gear. It uses a perforated rotating disk as a shutter to chop a light beam into 750 flashes a second.

When visibility drops to three nautical miles, a relay is closed and audible warning is given.

the country's government achieves its goal, each of its 55-million residents will have telephone service available by 1970, either at home or nearby.

The latest step in that direction came in mid-May, when a group of British companies won a \$13.2-million contract to supply crossbar-exchange equipment. The biggest affiliates are the Automatic Telephone and Electric Co., a member of the Plessey Group of companies, and British Insulated Callender's Cables, Ltd.

Besides installing long-distance dialing facilities in Lagos, Enugu and Port Harcourt, the British companies will modernize and expand local exchanges. About 25,500 lines will be installed, in addition to telephones and supporting exchange equipment.

Act two. Work is scheduled to be completed next year on this, the second of a four-stage expansion plan. The third stage, for which contracts are expected to be let shortly, will call for a nationwide system of long-distance dialing. The fourth stage, around 1970, will extend improved service into rural areas.

Both Plessey and BICC say they expect the Nigerian project to open up new markets for them in Africa's rapidly expanding telephone systems.

West Germany

Digital dialogue

If all engineers spoke with one voice, computers could be built to respond to that single frequency, volume and dialect. But the enormous variety in speech patterns requires the use of an interpreter—punched cards or tape—between man and computer.

Much effort is being devoted to perfecting the interaction of man and machine, but progress has been meager. Most of the work has been directed at converting sound waves into electronic signals by means of frequency analysis. In West Berlin,

Nigeria

Dial L for Lagos

Nearly one African in five lives in the Federal Republic of Nigeria. If

a new approach has been demonstrated: structural analysis of the amplitude. Telefunken AG showed a recognition device, about the size of a signal generator, that can be connected to a typewriter to write out numbers as they are spoken.

For the demonstration, men and women read out numbers from zero through nine in a wide range of pitch and dialect; only the volume was kept constant. The Telefunken device flashed each number on a digital counter with 93% accuracy.

Phonetics. The Telefunken approach was worked out by Heinz Kusch, a young physicist at Telefunken's Research Institute at Ulm. He began by examining innumerable oscillographs, comparing speech patterns and identifying the characteristic pattern that distinguishes the sound of one digit from every other digit.

The recognition unit employs a simple microphone to transform sound vibrations into electrical oscillations, which are then analyzed. The characteristic curves for the sound of each digit are compared with those of known sounds. A coding matrix channels the results into "sound-group storages." When they are combined with another coding matrix and passed through a display storage, the correct shapes of the numbers are produced and displayed on the digital counter.

China

Electron tracer

An automatic tracer of electron trajectories has been developed in Communist China, according to the New China Press Agency. Used in designing electronic instruments, the system can trace on paper the electron tracks made in various electrostatic fields. In the United States, the usual way to monitor particle tracks is to employ a beam of light that automatically scans tracks in bubble chambers. The light transmits the information to a computer, which can calculate the particles' momentum and position at any instant.

TRYLON ROTATABLE LOG PERIODIC ANTENNA

Single-layer, horizontally polarized, for 6.5 to 32 mc. 65° azimuth beamwidth. 6 db gain/std. dipole. Power to 50 kw PEP.

"One cannot continually disappoint a Continent."
We have designed, constructed, and installed antenna and tower systems in North America, South America, Europe, Asia, Africa, Antarctica. We wish someone from Australia would call us.



Elverson, Pa. 19520 (215) 942-2981 — International Division, 750 Third Ave., New York, N.Y. 10017, U.S.A.

Circle 223 on reader service card

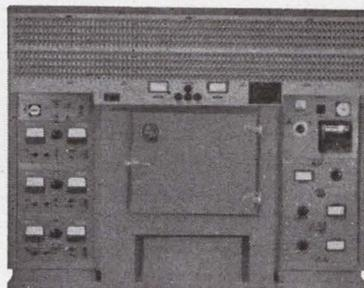

Model 477 Elevated Temperature Life Test System

LIFE TEST/BURN-IN SYSTEMS

for:

TRANSISTORS
 DIODES-RECTIFIERS
 INTEGRATED CIRCUITS
 SCR's, etc.

Ambient, elevated or reduced temperatures using air or controlled liquid systems.

AEROTRONIC ASSOCIATES, INC.
 603-746-3141 Contoocook, N. H.

Circle 173 on reader service card

**HELP YOUR POST OFFICE
 TO SERVE YOU BETTER
 BY
 MAILING EARLY IN THE DAY
 NATIONWIDE IMPROVED MAIL SERVICE
 PROGRAM**

MIAL

polystyrene capacitors outperform micas and other film capacitors ...cut costs, too!

MIAL'S sealed polystyrene capacitors surpass all film capacitors in life span...reliability...freedom from drift...leakage resistance (more than 500,000 megs) and "Q" factor. MIAL offers the widest range of "polys" in production quantities.

Capacitance, 20 pF to 600,000 pF; capacitance tolerance from $\pm 0.3\%$ to $\pm 20\%$; temperature coefficient, N100 and N150 ± 50 PPM/ $^{\circ}\text{C}$; Voltage, 33 VDCW to 1000 VDCW.

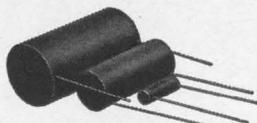

MIAL 602
High Reliability Precision Type



MIAL 603
Printed Circuit Mounting—
High Reliability Precision Type



MIAL 610
Sub-Miniature



MIAL 611
General Purpose N150



MIAL 612
Printed Circuit Board Mounting

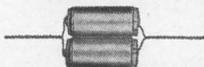

MIAL 613
Axial-Lead Close Tolerance



MIAL 614
Radial Lead Close Tolerance



MIAL 615
End Lead Close Tolerance



MIAL 616
Axial Lead

Polystyrene
Capacitors

MIAL
405C 10m

Write today for new complete catalog. Gives environmental, electrical and mechanical characteristics, charts and dimensions.



MIAL
U. S. A., I N C.

165B FRANKLIN AVENUE, NUTLEY, N.J. 07110 • (201) 667-1600-1601

Reprints Available from Electronics

Special Reprint Offer: For your reference file—a complete set of Special Reports reprinted from the pages of Electronics in 1964. A total of 207 pages of valuable and informative articles combined in an attractive folder. The reports are individually bound. The special discount price for these reprints is \$2.50 which includes both handling and shipping costs. Order now using the coupon at the bottom of this page. The following reprints are included in this offer:

Field Effect Transistors—A report on metal-oxide-semiconductor (MOS) and junction field-effect transistors. 64 pages.

Electronics Telephone Switching—World-wide developments in fast, recorded logic, telephone switching that will replace all existing systems by the year 2,000.

Direct Digital Control In Industry—This report analyzes seven DDC computer systems used in process control by seven major companies.

Transistor Heat Dissipators—A survey of this industry including market data, list of manufacturers, and tips on buying these devices. Included are 7 outstanding technical articles giving the newest applications of these devices and how to make best use of them. 32 pages.

Oceanography—A survey of the growing electronics technology associated with underseas exploration. 15 pages.

Magnetics—A report on what's new in today's magnetic technology. 24 pages.

Digital Instrumentation—A look at some new techniques in instrumentation. 16 pages.

Modern Electronic Packaging—How to locate, connect and afford protection for electronic devices and components. 16 pages.

Remember to refer to this special offer when you order. Price is \$2.50 for the complete set or you may order them individually at 50¢ per copy.

Send your order to:
Electronics Reprint Dept. 330 West 42nd Street
New York, N.Y. 10036

A2

Reprint order form

For reprints of the latest special report:

Experiments On Gemini

Send me reprints of Key no. R-71 at 50¢ each.

For reprints of previous special reports:

Send me reprints of Key no(s)
at ¢ each.

For complete set of special reports (See above offer)

Send me complete set(s) of special reports.

Name

Number & Street

City, State, Zip code

Electronics advertisers

May 31, 1965



■ AMP Incorporated 53 Garceau, Hargrave & McCullough Inc.	Elgenco Incorporated 160	Machlett Laboratories Inc., The 8 Fuller & Smith & Ross Inc.
Adage Incorporated 149 Fuller & Smith & Ross Inc.	Erie Technological Products Co. Inc. 114, 115 Altman-Hall Associates	Mallory & Company, Inc. P.R. 49 The Aitkin-Kynett Company
Aerotron Associates Inc. 173		Markem Machine Company 151 Culver Advertising Inc.
Air Express Div. of REA Express 107 Ketchum, MacLeod & Grove Inc.		Mathatronics Inc. 145 Kalb & Schneider Inc.
Airpax Electronics Inc. 59 Welch, Mirabile & Co. Inc.		Matsuo Electric Co., Ltd. 132 Asahi Advertising Agency & Co.
Air Products & Chemicals Inc. 146 Arthur Falconer Associates Corp.	Fairchild Scientific Instruments, Dumont Laboratories Div. 150 The Roger & Wilbur Co. Inc.	Mial U.S.A., Inc. 174 Keys, Martin Company
Ammon Instruments Inc. 150 Culver Advertising Inc.	Fairchild Semiconductor Corp. 14 Johnson & Lewis Inc.	Motorola Inc., Military Electronics Div. 50, 51 Charles Bowes Advertising Inc.
■ Amphenol-Borg Electronics Corp., Connector Division 98, 99 Marsteller Inc.	Franklin Electronics Inc. 134 James J. Cavella Advertising	■ Mullard Ltd. 159 Stuart Adv. Agency Ltd.
Anaconda American Brass Company 127, 128, 129 Wilson, Haight & Welch Inc.	■ Fujitsu, Limited 141 Fuji Agency	
Astrodata Inc. 11 Bonfield Associates Inc.		
		■ NRC Equipment Company 54 S. Gunnar Myrbeck & Company
Barber-Colman Company 142 Howard H. Monk & Associates Inc.	■ Garlock Inc. 162 Clawges Associates Inc.	Nihon Kaiheiki Ind. Co. Ltd. 154 Eastern Promotions, Inc.
Bausch & Lomb Inc. 39, 148 Wolff Associates, Inc.	Garrett Corporation, Airesearch Mfg. Div. 102 J. Walter Thompson Company	North Atlantic Industries Inc. 117 Murray Heyert Associates
Bell Telephone Laboratories 105 N.W. Ayer & Son Incorporated	General Aniline & Film Corporation 153 Hazard Advertising Company Inc.	
Bishop & Company J. 38 Richardson, Thomas & Bushman Inc.	■ General Electric Company, Lamp Metals & Components Div. 136 Dix & Eaton Incorporated	■ Ohmite Mfg. Company 125 The Fensholt Adv. Agency
Boonton, Div. of Hewlett Packard Company 2 George Homer Martin Associates	■ General Electric Company, Silicone Products Dept. 161 Ross Roy Inc.	
Bramco Controls Div. Ledex Inc. 139 Yeck and Yeck	General Radio Company 7 K.E. Morang Company	
■ Brush Instruments, Div. of Clevite Corp. 3rd Cover Carr Liggett Adv. Inc.	Genisco Technology Corporation 124 Getz and Sandborg Inc.	
■ Bussmann Mfg. Co. Div. of McGraw Edison Co. 122, 123 Henderson Advertising Company	Gudebrod Bros. Silk Co. Inc. 28, 29 Lee Ramsdell & Co. Inc.	Peerless Instrument Co. Inc. 164 Mark Snyder Incorporated
		Pennsalt Chemicals Corporation 104 The Aitkin-Kynett Co.
		■ Philbrick Researches Inc., George A. 58 Culver Advertising Inc.
Cambridge Thermionic Corporation 160 Chirurg & Cairns Inc.	■ Hewlett Packard Company 1 Lennen & Newell Inc.	Potter & Brumfield Div. of American Machine & Foundry Co. 16 Grant, Schwenck & Baker Inc.
Cerro Corporation 27 Feeley Advertising Agency	Hull Corporation 138 The Michener Company	Precision Instruments Company 163 William E. Clayton & Associates
Cherry Electrical Products Corp. 108 Jd culea Advertising Inc.		Princeton Applied Research Corp. 30 Mort Barish Associates
■ Cinch Manufacturing Company 103 Stral Advertising Company Inc.		Printed Motors Inc. Sub. of Photocircuits Corp. 135 Duncan-Brooks Inc.
■ Cinch-Graphik Div. of United Carr 133 Reach, McClinton & Company	■ Imtra Corporation 141 S. Gunnar Myrbeck & Company	
Cominco Products Inc. 144 McKim Productions Limited	Industrial Electronic Engineers Inc. 160 Gumpertz, Bentley & Dolan Advertising	Radio Corporation of America 47, 4th Cover Al Paul Lefton Company
Conforming Matrix Corporation 158 Wendt Advertising Agency	■ International Rectifier Corp. 42 Communication Associates	Raytheon Company, Microwave & Power Tube Div. 106 Fuller & Smith & Ross Inc.
Corning Glass Works 46 The Rumrill Company Inc.	ITT-Cannon Electric Inc. 120 West, Weir & Bartel Inc.	
■ Dale Electronics Inc. 113 Swanson, Sinkey, Ellis Inc. Advertising		
Data Corporation 140 Einhorn-Stern Inc.	Kassoy, I. 140 Harmony Impressions	Shizuki Electrical Mfg. Co. 144 New Asia Trading News Agency Ltd.
Delevan Electronics Corporation 152 Clayton A. Stahika Advertising Company	Keithley Instruments Inc. 137 The Bayless Kerr Company	Sigma Instruments Inc. The 56, 57 Marschalk Company Inc.,The
Dow Corning Corporation 12, 13 Church & Guisewite Adv. Inc.	Krohn-Hite Corporation 37 Stern/Frank Advertising Inc.	■ Sorensen Inc. 143 Fuller & Smith & Ross Inc.
DuPont de Nemours & Co. E.I., Electrochemicals Dept. 109, 110 The Rumrill Company Inc.		Spectra Electronics 144, 150 Stadler/Cowman Advertising
DuPont de Nemours & Co. E.I. 45, 97 Batten, Barton, Durstine & Osborn Inc.	■ Laboratory for Electronics 147 Hepler & Gibney Adv.	Spectral Electronics Corporation 55 Bonfield Associates Inc.
	■ Lambda Electronics Corporation 118, 119 Michel Cather Inc.	Speer Carbon Company 60 Hazard Advertising Company
Electro-Nuclear Laboratories 164 Hal Lawrence Incorporated	Latronics Corporation 156 Downing Industrial Advertising	Sprague Electric Company 5, 6, 10 The Harry P. Bridge Co.
Electronic Engineering Co. of California 155 Barnes Chase Advertising	Ling-Temco-Vought, LTV Electrosystems Inc. Div. 100 Wyatt, Dunagan & Williams Inc.	Stackpole Carbon Company 52 Meek and Thomas Inc.

Executive, editorial, circulation and advertising offices: McGraw-Hill Building, 330 West 42nd Street, New York, N.Y., 10036. Telephone Area Code 212-971-3333. Teletype TWX N.Y. 212-640-4646. Cable: McGrawhill, N.Y. Officers of the Publications Division: Shelton Fisher, President; Vice Presidents: Joseph H. Allen, Operations; Robert F. Boger, Administration; John R. Callahan, Editorial; Ervin E. DeGraff, Circulation; Donald C. McGraw, Jr., Advertising Sales; Angelo R. Venezian, Marketing. Officers of the Corporation: Donald C. McGraw, President; L. Keith Goodrich and Hugh J. Kelly, Executive Vice Presidents; John J. Cooke, Vice President and Secretary; John L. McGraw, Treasurer. Title R registered U.S. Patent Office; © copyright 1965 by McGraw-Hill, Inc. All rights reserved, including the right to reproduce the contents of this publication, in whole or in part.



Great editorial
is something
he takes
home

(What a climate for selling!)

Electronics



A McGraw-Hill Market-Directed Publication
330 West 42nd Street, New York, N.Y. 10036



Sylvania Electric Products Inc. Kudner Agency Inc.	19 to 26
Systems Research Laboratories Robert Frame Adv. Inc.	172
TRW Electronics Corporation Fuller & Smith & Ross Inc.	35
Technical Appliance Corporation Lescarbours Advertising Inc.	36
Tektronix Inc. Hugh Dwight Adv. Inc.	101
■ Telonic Engineering Company Jansen Associates	168
Texas Instruments Incorporated Industrial Products Group Robinson-Gerrard Inc.	130, 131
Texas Instruments Incorporated Semiconductor-Components Division Don L. Baxter Inc.	40, 41
Tracor Inc. David G. Benjamin Inc.	157
Transformer/Electronics	132
■ Trygon Electronics The Wexton Company Inc.	167
■ Trylon Inc. George Moll Adv. Inc.	173
■ Tung-Sol Electric Inc. E.M. Freystadt Associates Inc.	108
■ United Transformer Corporation Philip Stogel Company Inc.	2nd Cover
Westamp Inc. Siegmeister/Grant	141
Westinghouse Semiconductor Division ITSM	9
■ Weston Instruments Incorporated Basford Inc.	48
Classified advertising	
F.J. Eberle, Business Mgr.	
EMPLOYMENT OPPORTUNITIES	165-166
EQUIPMENT (Used or Surplus New) For Sale	166
Classified advertisers index	
Atomic Personnel Inc.	166
■ Barry Electronics	166
Easy-Up, Inc.	166
■ Fishman Co., Philip	166
General Dynamics	165
Keystone Electronics Corp.	166
Mars Sales	166
■ Monmouth Radio Laboratories	166
Motorola Inc.	165
Philco Techrep Div. Subsidiary of Ford Motor Co.	166
■ Radio Research Instrument Co.	166
Sierra Western Electric Co.	166
Taylor Instrument Co.	166

Advertising sales staff

Gordon Jones [212] 971-2210
Advertising sales manager

Atlanta, Ga. 30309: Gus H. Krimsier,
Michael H. Miller, 1375 Peachtree St. N.E.,
[404] TR 5-0523

Boston, Mass. 02116: William S. Hodgkinson
McGraw-Hill Building, Copley Square,
[617] CO 2-1160

Chicago, Ill. 60611: Robert M. Denmead,
J. Bradley MacKimm
645 North Michigan Avenue,
[312] MO 4-5800

Cleveland, Ohio 44113: Paul T. Fegley, 55
Public Square, [216] SU 1-7000

Dallas, Texas 75201: Richard P. Poole, The
Vaughn Building, 1712 Commerce Street,
[214] RI 7-9721

Denver, Colo. 80202: Joseph C. Page, David
M. Watson, Tower Bldg., 1700 Broadway,
[303] AL 5-2981

Houston, Texas 77025: Kenneth George,
2270 Humble Bldg.,
[713] CA 4-8381

Los Angeles, Calif. 90017: Ashley P.
Hartman, John G. Zisch, 1125 W. 6th St.,
[213] HU 2-5450

New York, N. Y. 10036:
Donald R. Furth [212] 971-3615
Frank LeBeau [212] 571-3615
George F. Werner [212] 971-3615
500 Fifth Avenue

Philadelphia, Pa. 19103: William J. Boyle,
Warren H. Gardner, 6 Penn Center Plaza,
[215] LO 8-6161

San Francisco, Calif. 94111:
James T. Hauptli, 255 California Street,
[415] DO 2-4600

London W1: John W. Patten, Edwin S.
Murphy Jr., 34 Dover Street,
Hyde Park 1451

Milan: Ludovico Greco, 1, via
Baracchini Phone: 86-90-617

Frankfurt/Main: Gerd Hinske, 85
Westendstrasse Phone: 77 26 65 and
77 30 59

Genoa: Michael R. Zeynel, Joseph Wuensch,
2 Place du Port 244275

Paris VIII: Denis Jacob, 17 Avenue
Matignon ALMA-0452

Tokyo: Nobuyuki Sato
Shiba, Minato-Ku (502) 0656

Osaka: Kazutaka, Miura, 163, Umegee-cho,
Kilita-ku [362] 8771

Nafioya: International Media Representatives,
Yamagishi Bldg., 13, 2-Chome,
Oike-cho Naka-ku

Hugh J. Quinn: [212] 971-2335
Manager Electronics Buyers' Guide

David M. Tempest: [212] 971-3139
Promotion manager

Milton Drake: [212] 971-3485
Market research manager

Richard J. Tomlinson: [212] 971-3191
Business manager

Theodore R. Geipel: [212] 971-2044
Production manager

■ For more information on complete product
line see advertisement in the latest Elec-
tronics Buyers' Guide

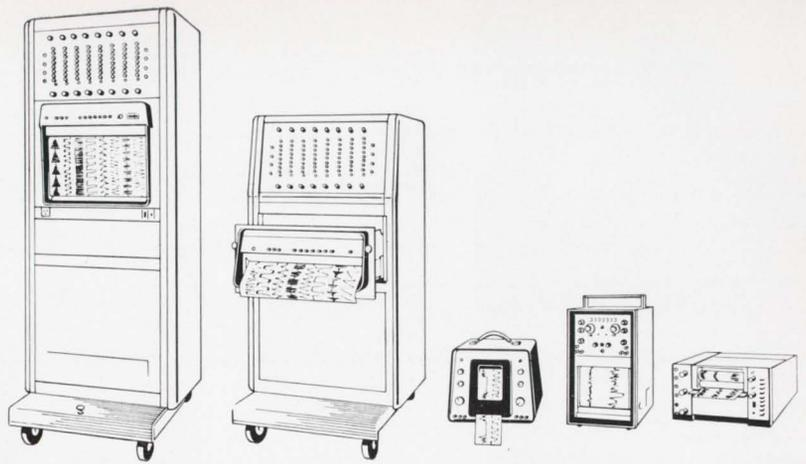

Mark 10
 newest addition to
 the Brush line

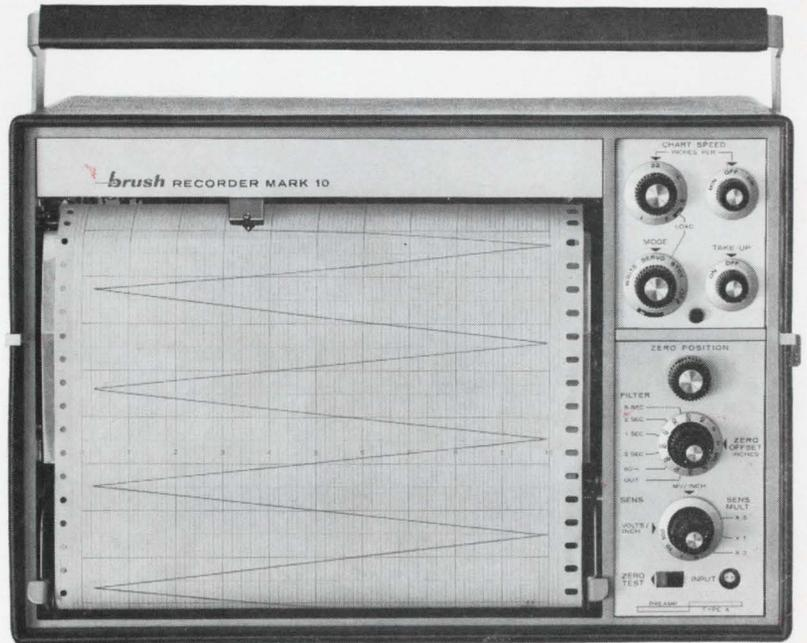

A new strip chart recorder that's all solid state... even the ink!

A solid capsule is the ink supply in this new 10" servo-type recorder. Heated to flow freely from the pen . . . it dries instantly on contact with the paper. Modular electronic and mechanical assemblies simplify operation and maintenance. In addition, you have the complete flexibility of plug-in units. Check out these performance facts . . .

- Full scale span of 5 mv to 200 volts in 15 steps**
- Zero positioned to within 0.1%**
- Zero suppression—up to 10 full scales**
- Selectable input signal filtering**
- Accepts common mode voltages up to 500 volts**
- 140 db common mode rejection**
- 1 megohm input impedance**
- 10 chart speeds**

*Ever see "solid state" ink? Send for free sample today!
 Brush Instruments Division, Clevite Corporation,
 37th & Perkins, Cleveland, Ohio 44114.*

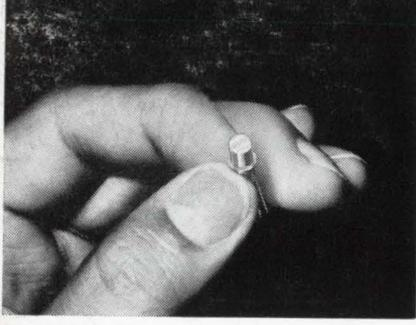

RCA 2N2857 high-frequency, low noise amplifier
 100% tested for gain and noise figure
 Designed for critical aerospace/military applications

Only 4 db NF

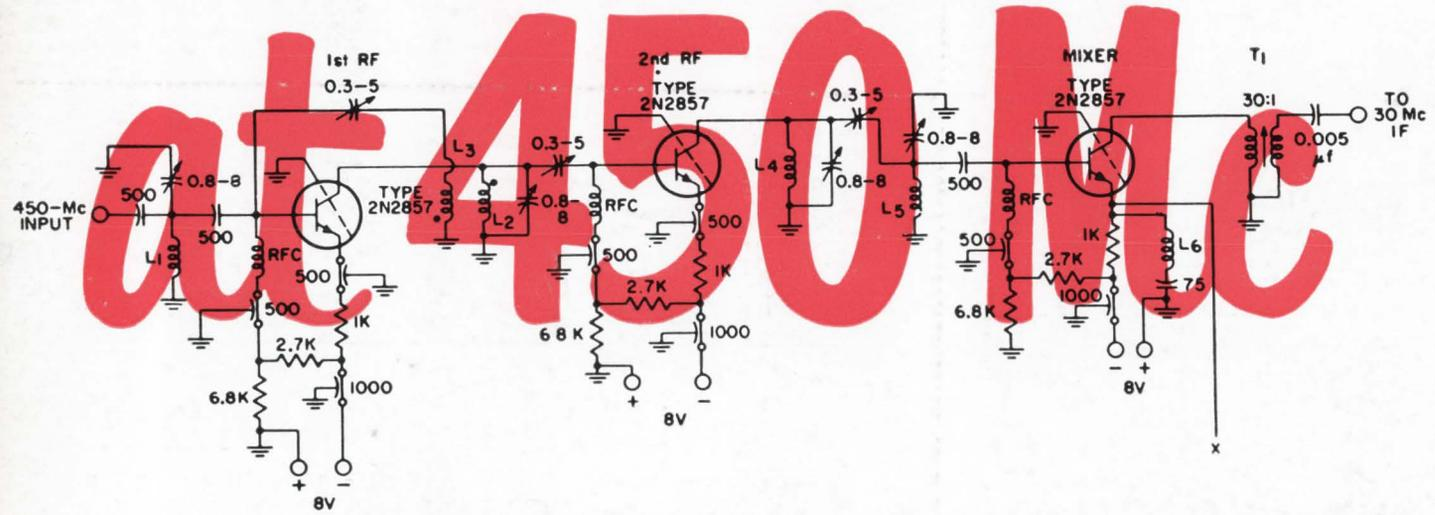

RF amplifier and mixer stages of a 450-Mc UHF communications receiver using the new RCA 2N2857 low-noise transistors

The low-noise RCA 2N2857 uses a unique miniature structure to achieve these outstanding characteristics:

- **Extremely Low Noise Figure (NF)**... 4 db typical in 450 Mc common-emitter RF amplifier
- **High Gain**... 14 db typical at 450 Mc in neutralized 20 Mc bandwidth amplifier
- **Excellent 450-Mc Mixer Performance**... NF = 7.5 db, Gain = 15 db (typical)
- **Excellent UHF Oscillator Performance**... Power Output = 40 mw typical at 500 Mc, 20 mw typical at 1 Gc
- **Maximum Ratings**... $V_{CB0} = 30$ V, $V_{CE0} = 15$ V, $P_T = 200$ mw at 25°C free air

• **Gain-Bandwidth Product** = 1200 Mc Typical
 Every RCA 2N2857 is tested for maximum noise figure and minimum power gain @ 450 Mc as a part of the extensive test procedures developed to assure high reliability. Specified 2N2857 values are based on 1/2-inch leads. With shorter leads, gain can be improved as much as 1.5 db and noise figure as much as 0.25 db.
 RCA also offers new 2N3600 npn silicon planar epitaxial transistors intended specifically for applications to 200 Mc. Here are some of the features:

- 200 Mc Wideband RF Amplifier... 17 db min. gain (neutralized common-emitter)

- NF = 4.5 db max at 200 Mc, $I_C = 1.5$ ma
- NF = 3.0 db typ. at 60 Mc, $I_C = 1$ ma
- **Maximum Ratings**... $V_{CB0} = 30$ V, $V_{CE0} = 15$ V, $V_{EB0} = 3$ V
- **Gain-Bandwidth Product**... 850 Mc min

Also available from RCA: 2N917 and 2N918
 Call your RCA Representative today for complete information on these outstanding RCA transistors. For special versions to meet particular reliability requirements or environmental conditions ask for a quotation. For further technical data, write: RCA Commercial Engineering, Section CN5-5, Harrison, N.J.

AVAILABLE THROUGH YOUR RCA DISTRIBUTOR

RCA Electronic Components and Devices, Harrison, N. J.



The Most Trusted Name in Electronics

Circle 902 on reader service card