

Electronics®

Bright hopes for display systems: page 56

Special report on computer time sharing: page 71

Bigger, better multilayer boards: page 90

November 29, 1965

75 cents

A McGraw-Hill Publication

Below: Persistence varies
in new oscilloscope: page 66

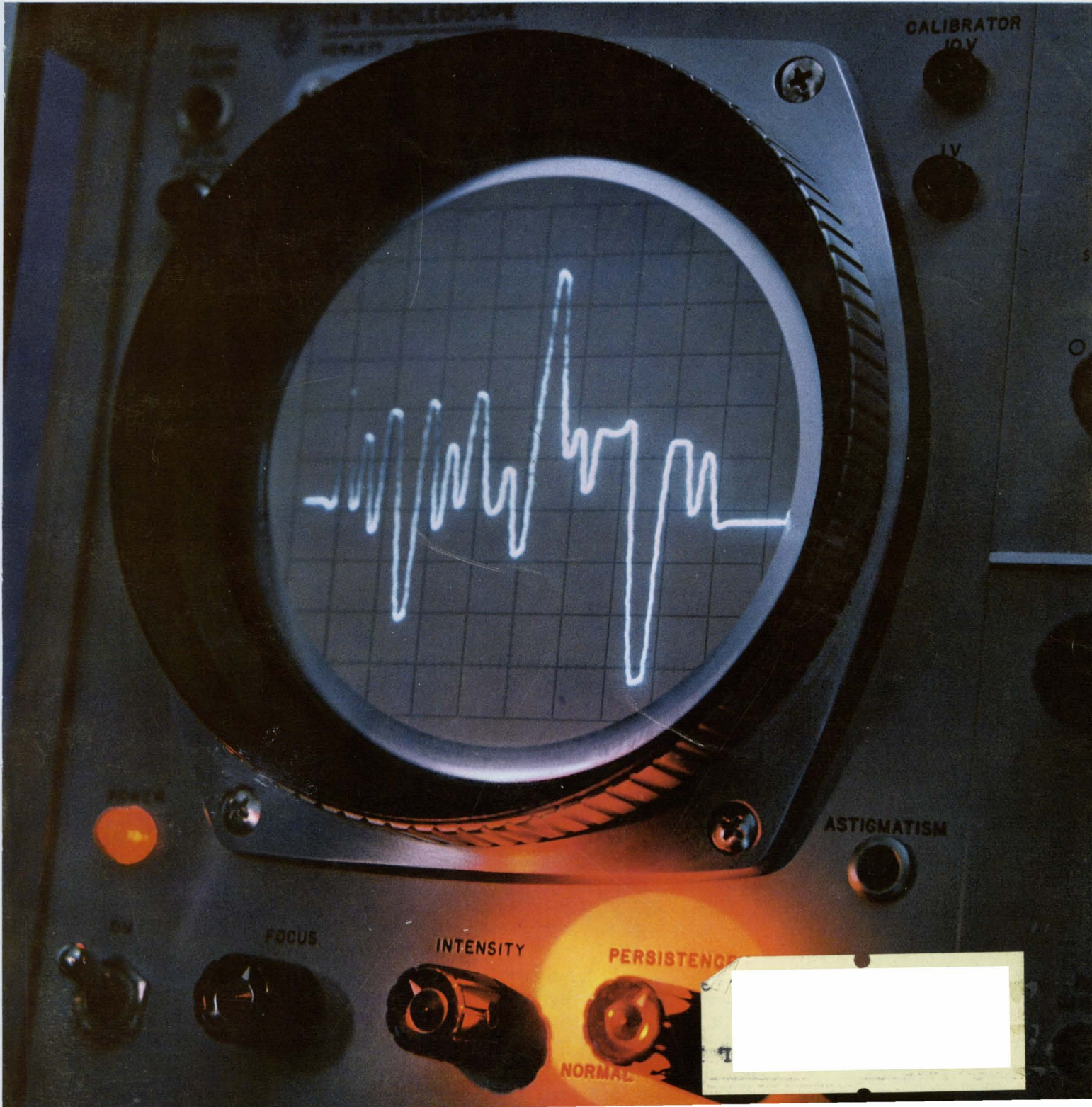



**100-kc, 1-Mc, 12-Mc
SYNTHESIZERS**



**SIXTY
DIFFERENT MODELS**

**WITH UP TO
10-FIGURE
RESOLUTION**

1161 Series

DC to 100 kc/s . . .
continuously adjustable or with steps as small as 0.01, 0.1, 1.0, 10, or 100 c/s, in both manual and programmable models; 20 models available.

1162 Series

DC to 1 Mc/s . . .
continuously adjustable or with steps as small as 0.1, 1.0, 10, 100, or 1000 c/s, in both manual and programmable models; 20 models available.

1163 Series

30 c/s to 12 Mc/s . . .
continuously adjustable or with steps as small as 1, 10, or 100 c/s, 1 or 10 kc/s, in both manual and programmable models; 20 models available. (1-Mc/step decade not programmable)

Three basic frequency ranges plus the add-a-decade feature, which is exclusive with GR Synthesizers, give you unsurpassed flexibility . . . and **ECONOMY**. You can buy only the resolution you need and still have the option of adding more resolution later. GR Synthesizers never go obsolete with a change in application.

You can start with as few as three decades (either manual or manual/programmable) and add decades up to a total of seven as your needs expand. In addition, at any time you can add a Continuously Adjustable Decade for continuous coverage up to 1 Mc/s. The CAD will provide both continuous manual or electronic sweep coverage and can be internally calibrated to provide an additional two or three figures of resolution. Thus, with a "full-house" Synthesizer, consisting of seven decades plus a CAD, ten-figure resolution can be realized. Prices range from \$3200 for a three-decade, 100-kc synthesizer with 100-cycle steps to \$6195 for a 7-decade, 1-Mc model with CAD and full manual/programmable capability; 12-Mc models range from \$3340 to \$6110. Call your GR Sales Engineering Office for full particulars or for a no-obligation "try before you buy."

IN CANADA: Toronto 247-2171, Montreal (Mt. Royal) 737-3673
IN EUROPE: Zurich, Switzerland - London, England



GENERAL RADIO COMPANY

WEST CONCORD, MASSACHUSETTS

BOSTON (W. Concord) 646-0550 NEW YORK, N. Y., 964-2722 (Ridgefield, N. J.) 943-3140 CHICAGO (Oak Park) 848-9400 PHILADELPHIA (Ft. Washington) 646-8030 WASHINGTON, D.C. (Rockville, Md.) 946-1600 SYRACUSE 454-9323 DALLAS ME 7-2240 SAN FRANCISCO (Los Altos) 948-8233 LOS ANGELES 469-6201 ORLANDO, FLA. 425-4671 CLEVELAND 886-0150

Circle 900 on reader service card

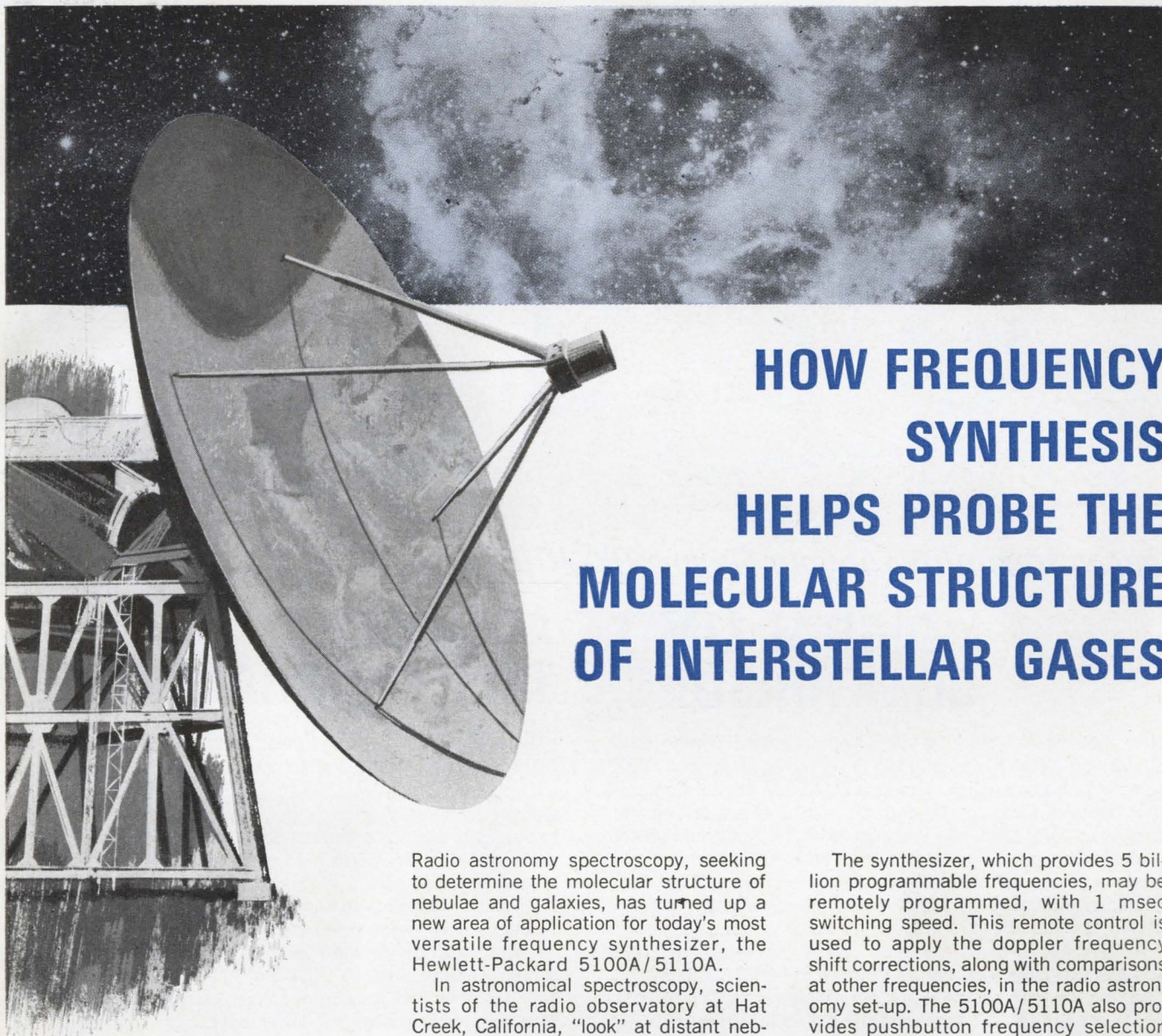

HOW FREQUENCY SYNTHESIS HELPS PROBE THE MOLECULAR STRUCTURE OF INTERSTELLAR GASES

Radio astronomy spectroscopy, seeking to determine the molecular structure of nebulae and galaxies, has turned up a new area of application for today's most versatile frequency synthesizer, the Hewlett-Packard 5100A/5110A.

In astronomical spectroscopy, scientists of the radio observatory at Hat Creek, California, "look" at distant nebulae and galaxies with a narrow-band receiver in order to identify, by narrow-line emission or absorption, atomic and molecular constituents.

In order to accomplish this remarkable feat over so great a distance, the scientists must provide doppler shift frequency corrections periodically to compensate for earth rotation, earth orbital motion, particle motion in the nebula or galaxy and relative motion of the nebula or galaxy with respect to the solar system.

That's where the 5100A/5110A comes in. The corrections are figured in advance, and the Hewlett-Packard frequency synthesizer, operating as part of the variable-frequency local oscillator in the receiver, is used to shift the spectral lines of interest back to the center of the receiver-filter system.

The synthesizer, which provides 5 billion programmable frequencies, may be remotely programmed, with 1 msec switching speed. This remote control is used to apply the doppler frequency shift corrections, along with comparisons at other frequencies, in the radio astronomy set-up. The 5100A/5110A also provides pushbutton frequency selection from 0.01 cps to 50 mc in steps as fine as 0.01 cps.

Output frequencies are derived from a single 1 mc quartz oscillator which has a long-term stability of ± 3 parts in 10^9 per day. Spurious signals are 90 db down. And the high spectral purity of the output signal makes it ideal for this and similar critical applications.

Discuss your application with your hp field engineer to see how this fast-switching, stable and accurate variable frequency source can help you. Or write for data on the 5100A/5110A, \$15,250: Hewlett-Packard, Palo Alto, California 94304, Tel. (415) 326-7000; Europe: 54 Route des Acacias, Geneva.

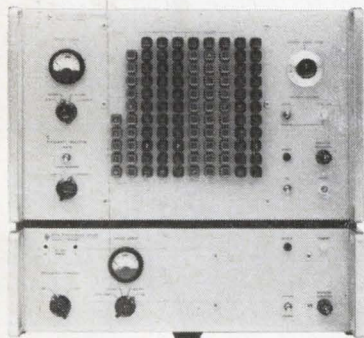

HEWLETT  **PACKARD**
An extra measure of quality

Data subject to change without notice. Price f. o. b. factory.

442R

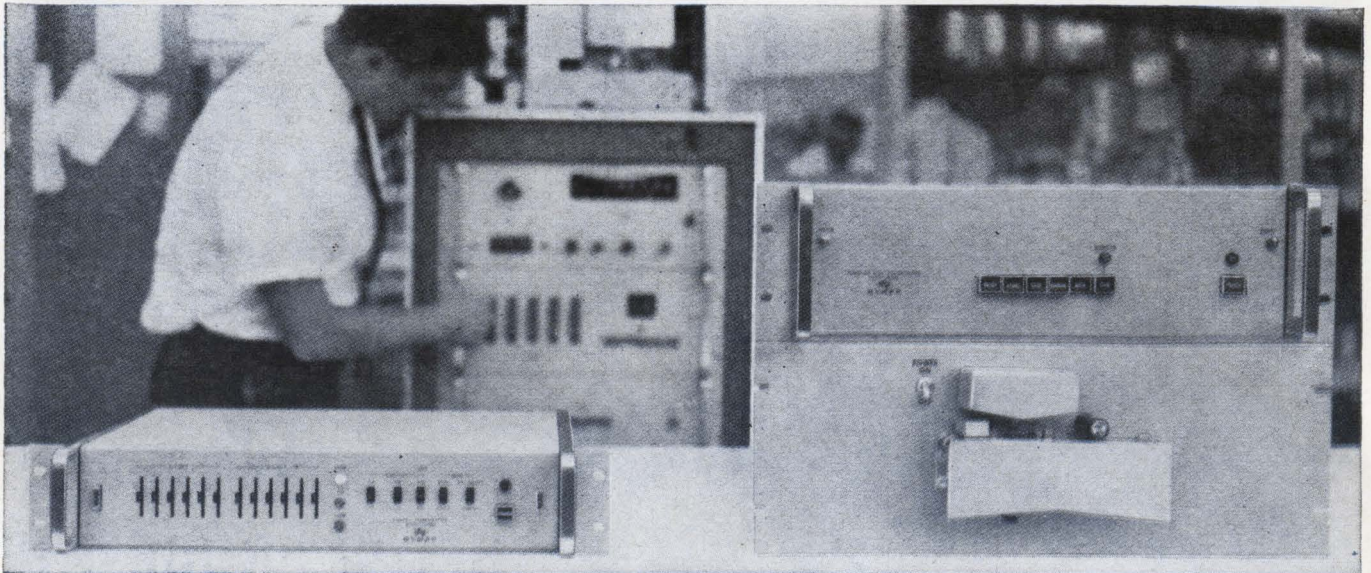

added flexibility for your Dymec DY-2010 Data Acquisition System with

DIGITAL LIMIT COMPARISONS,

AUTOMATIC TAPE PROGRAMMING

New systems flexibility is yours with standard Dymec data acquisition systems, now offering improved accuracy and noise rejecting characteristics. The new DY-2539A Digital Comparator operates with any standard DY-2010 System, letting you compare your digital measurements with single or dual preset limits, obtaining Hi/=/Go or Hi/Go/Lo lamp indications and electrical outputs. The new DY-2560A Punched Tape Programmer automatically programs all measurement functions, including comparison limits, of your 2010 system.

In addition to these new data acquisition capabilities, the DY-2010 systems incorporate the new DY-2401C Integrating Digital Voltmeter as the measuring instrument. The 2401C, which measures ± 0.1 v to ± 1000 v full scale, offers accuracy of 0.01% of reading $\pm 0.005\%$ of full scale ± 1 digit at 25°C. The floating and guarded 2401C virtually eliminates measurement errors due to extraneous noise on the signal, without restriction on grounding of the signal source, recorder or programming device. Signals as small as a few per cent of full scale can be measured accurately even in the presence

Data subject to change without notice. Prices f. o. b. factory.

of noise approaching three times full scale. Standard, too, are 300% overranging and a sixth overrange digit.

Limit comparisons with the DY-2539A take less than 3 msec. Operated manually or by external signals, the comparator handles virtually any combination of limit relative magnitudes and signs. The DY-2560A reads punched tape to program all measurement functions, comparator limit selection and data recording. Changing the entire system operation requires changing only the program tape. The DY-2539A adds \$1850 to the cost of the standard 2010 system; the DY-2560A adds \$3380. Each of eight DY-2010 Data Acquisition Systems is a fully specified and priced data sheet item, not a special. The standard systems give you lower cost, higher reliability and predictable fast delivery.

Brief specs of the standard systems appear in the chart. Call your Dymec field engineer or write for complete specifications to Dymec Division of Hewlett-Packard, 395 Page Mill Rd., Palo Alto, Calif. 94306, Tel. (415) 326-1755; Europe: 54 Route des Acacias, Geneva; Canada: 8270 Mayrand St., Montreal.

	2010A	2010B	2010E	2010H	2010C	2010D	2010F	2010J
Number of input channels	stepping-switch scanner; up to 25 3-wire channels, to 100 channels with slave scanners				guarded crossbar scanner; up to 200 3-wire inputs; also accepts 100 6-wire, 200 3-wire and 600 1-wire inputs			
Programming	self-programming capability permits measurement of mixed types and levels of signals				punched tape or pinboard programmer may be added to handle mixed types and levels of signals and to control system operation			
Measurement speed (max., dc volts meas.)	5 channels per sec.	10 channels per sec.	1 channel per sec.	10 channels per sec.	5 channels per sec.	9 channels per sec.	1 channel per sec.	18 channels per sec.
Output	printed paper tape	perforated paper tape	punched card (IBM 526)	digital magnetic tape	printed paper tape	perforated paper tape	punched card (IBM 526)	digital magnetic tape
Price	\$8310	\$10,225	\$9425	\$15,825	\$10,585	\$12,500	\$11,700	\$18,100
Standard options	Time of day, ac voltage & resistance measurements, 10 mv full scale sensitivity, automatic limit comparison, cabinet.							

**HEWLETT
PACKARD**  **DYMEC
DIVISION**

Electronics

November 29, 1965
Volume 38, Number 24

Page 4	Readers Comment
8	People
14	Meetings
16	Meeting Preview
23	Editorial
25	Electronics Newsletter
43	Washington Newsletter
109	New Products
122	New Books
124	Technical Abstracts
129	New Literature

Electronics Review

Page	29	Laser tv camera	32	Sights on solar flares
	30	IBM in traffic	34	Keeping it clean
	31	Inching down	36	New U-laser
	31	IC's for hearing aids	36	Crack-proof seals
	32	Checking the T pulse	38	Electronics notes

Probing the News

101	When the lights came on again . . .
103	Switchboard in the sky
104	The communications gap
106	The laser: a bright hope in search of an owner

Electronics Abroad

131	Air-traffic control	134	Profit potential
132	Made in Japan . . . and USA	134	Expansion in components
133	The cold eye	134	Around the world

Technical Articles

I. Design

Optoelectronics	56	Bright hopes for display systems New materials, new light sources and new ways to manipulate light give promise of great potential R.A. Soref and D.H. McMahon, Sperry Rand Corp.
Circuit design	63	Designer's casebook <ul style="list-style-type: none">● Bipolar pulse detector with meter display● Low-cost Schmitt trigger reduces hysteresis● 10,000 volt d-c latching relay● Bipolar limiter reduces d-c loss● Zener diode protects backward-wave oscillator

II. Applications

Instrumentation	66	Variable persistence increases oscilloscope's versatility (cover) New scope can handle low-speed waveforms and fast single-shot transients with equal ease Robert H. Kolar, Hewlett-Packard Co.
Computers	71	Special feature: Computer time sharing
	72	One machine serving many masters What it is and what it can't do Wallace B. Riley, computer editor
	79	Flexible addition to IBM's System 360
	83	A computer service for amateurs
	85	Campus computer helps students at Dartmouth
	87	Satellite computers as interpreters

III. Manufacturing

Packaging	90	Multilayer boards: the bigger, the better? Large complex boards supply better interconnection density and improve performance Stephen A. Hays, North American Aviation, Inc.
Manufacturing	96	Finding defects in multilayer boards Infrared thermal profile spots sources of trouble L.M. White and R.W. Jones, North American Aviation

Title R registered
U.S. Patent Office;
© copyright 1965
by McGraw-Hill, Inc.
All rights reserved,
including the right to
reproduce the contents
of this publication,
in whole or in part.

Electronics

Editor: Lewis H. Young

Senior editors

Technical: Samuel Weber

News: Kemp Anderson Jr.

Senior associate editors: John F. Mason, George Sideris

Department editors

Advanced technology: Joan Blum

Avionics: W.J. Evanzia

Circuit design: Michael Elia

Computers: Wallace B. Riley

Consumer electronics: Richard Lipkin

Electronics review: Stanley Zarowin

Instrumentation: Carl Moskowitz

Manufacturing: George Sideris

Military electronics: John F. Mason

New products: William P. O'Brien

Solid state: Jerome Eimbinder

Space electronics: Peter R. Sigmund

Special projects: Richard M. Machol

Regional editors

Boston: Thomas Maguire, editor; Robin Carlson

Los Angeles: William B. Wallace, Walter Barney, editors; June Ranill

San Francisco: Laurence D. Shergalis, Edmond G. Addeo, editors; Mary Jo Jadin

Copy editors

Howard Rausch, Sally Powell

Graphic design

Art director: Saul Sussman

Assistant art director: Donna M. Griffiths

Editorial production: Ann Mella

Production editor: Arthur C. Miller

Editorial secretaries: Claire Benell, Mary D'Angelo, Lynn Emery, Lorraine Fabry, Kay Fontana, Lorraine Longo, Carolyn Michnowicz

McGraw-Hill News Service

Director: John Wilhelm; **Atlanta:** Fran Ridgway; **Chicago:** Bruce Cross, Louis S. Gomolak;

Cleveland: Arthur Zimmerman; **Dallas:** Marvin Reid;

Detroit: N. Hunter; **Los Angeles:** Michael Murphy, Ron Lovell;

San Francisco: Margaret Ralston;

Seattle: Ray Bloomberg; **Washington:** Arthur L. Moore, Charles Gardner,

Herbert W. Cheshire, Seth Payne, Warren Burkett, Warren Kornberg

McGraw-Hill World News Service

Bonn: John Johnsrud, John Gosch; **Brussels:** Arthur Erikson; **London:** John Shinn;

Mexico City: Wesley Perry; **Milan:** Bruce Bendow;

Moscow: Donald Winston; **Paris:** Dan Smith;

Rio de Janeiro: Leslie Warren; **Tokyo:** Marvin Petal, Charles Cohen

Circulation manager: Hugh J. Quinn

Reprints: T.M. Egan

Publisher: C.C. Randolph

Electronics: November 29, 1965, Vol. 38, No. 24

Printed at 99 North Broadway, Albany, N.Y.
Second class postage paid at Albany, N.Y.

Subscriptions are solicited only from those actively engaged in the field of the publication. Position and company connection must be indicated on orders. Subscription prices: United States and Possessions and Canada, \$6.00 one year, \$9.00 two years, \$12.00 three years. All other countries \$20.00 one year. Single copies, United States and Possessions and Canada 75¢. Single copies all other countries \$1.50.

Published every other Monday by McGraw-Hill Inc. 330 West 42nd Street, New York, N.Y. 10036. Founder: James H. McGraw, 1860-1948.

Subscribers: The Publisher, upon written request to our New York office from any subscriber, agrees to refund that part of the subscription price applying to copies not yet mailed. Please send change of address notices, subscription orders or complaints to Fulfillment Manager, Electronics, at the address below. Change of address notices should provide old as well as new address, including postal zone number if any. If possible, attach address label from recent issue. Allow one month for change to become effective.

Postmaster: Please send Form 3579 to Fulfillment Manager, Electronics, P.O. Box 430, Hightstown New Jersey 08520

Readers Comment

Success story—qualified

To the Editor:

I was interested in your editorial "Success story" [Sept. 6, p 23]. I would agree that the silicon controlled rectifier can be extremely useful in providing variable speed electronically, thus eliminating gears in washing machines and driers. But this surely applies only to the use of o-c (or "universal," i.e., series-wound a-c, d-c) motors. You go on to suggest replacing existing machines with induction motors and controlling the speed by variable frequency. Granted that induction motors are the most desirable and that they do need variable frequency supplied for speed control. But has anyone devised suitable variable-frequency inverters at a cost that could make their use in domestic appliances a realistic proposition?

I know that this particular nut has been cracked in the high-power industrial field of induction motors, but I would be interested to hear if anyone has been successful in the low-power domestic field.

The speed control of small d-c and universal motors for domestic appliances is well-established (sewing-machines, drills, etc.) and even of small single-phase induction motors for fans—where the special torque characteristics allow straightforward scr voltage control. But has a cheap variable frequency scr inverter really arrived yet?

J.L. Storr-Best

Chief Applications Engineer

Rectifier division

Standard Telephones & Cables Ltd.

Harlow, England

Oversell on MOS?

To the Editor:

It always puts one on his guard to read of a new electronic device described in such glowing terms that the authors can admit of no drawback in its use. The article "MOS integrated circuits save space and money" [Oct. 4, pp. 84-95] accomplishes just that end for the MOS component. To make matters worse, the authors attempt to strengthen their argument for technical achievement by making ex-

Now from Sprague!

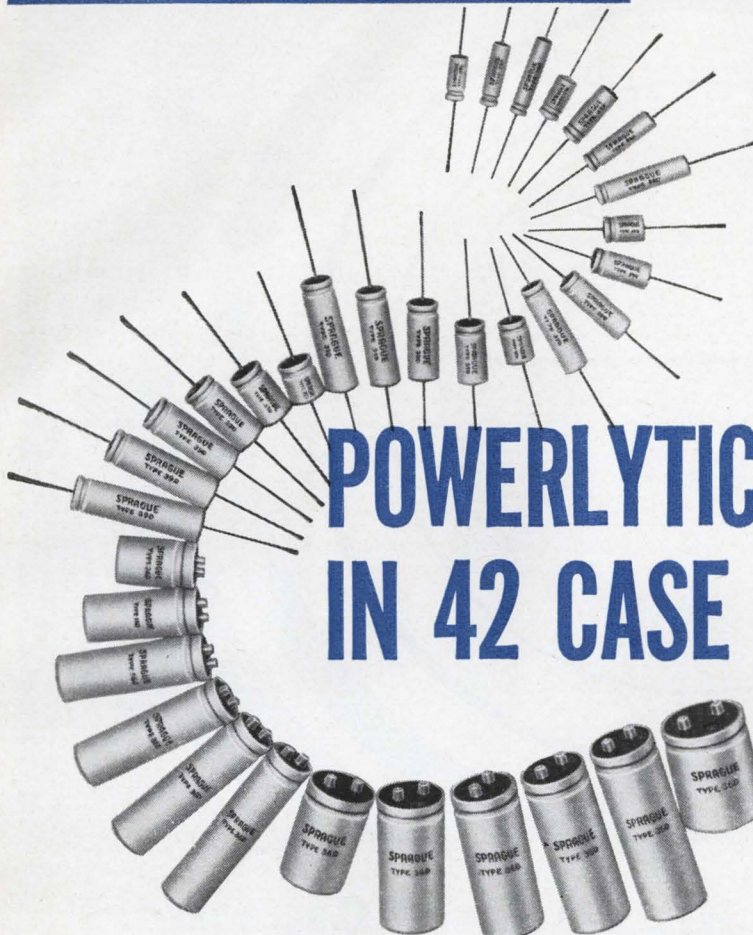

POWERLYTIC® CAPACITORS IN 42 CASE SIZES...

for maximum capacitance in minimum space!



Type 36D Cylindrical Case

Designed specifically for space economy, in applications such as computer power supplies, industrial controls, high gain amplifiers, etc. Case sizes from $1\frac{3}{8}$ " x $2\frac{1}{8}$ " to 3" x $5\frac{5}{8}$ ". Improved temperature capabilities—may now be operated at 85 C. Low equivalent series resistance, low leakage current, excellent shelf life, high ripple current capability. Superior seal employs molded cover with recessed rubber gasket. Reliable safety vents. Solder lug or tapped terminals. Standard ratings from 3 to 450 VDC, capacitance values to 270,000 μ F.

Type 39D Tubular Case

Smaller companion to proven 36D capacitor, possessing same outstanding performance. Case sizes from $\frac{1}{2}$ " x $1\frac{1}{8}$ " to 1" x $3\frac{5}{8}$ ". Designed for operation at temperatures up to 85 C. Unique construction—anode and cathode terminals are welded—no riveted or pressure connections—prevents open circuits, even in microvolt signal range. Improved molded phenolic end seals contribute to unusually long life (expectancy, 10 years or more). Low effective series resistance, low leakage current. Standard ratings include capacitance values to 18,000 μ F, voltages from 3 to 450 VDC.

For complete technical data on Type 36D or Type 39D Powerlytic Capacitors, write for Engineering Bulletins 3431B and 3415, respectively, to Technical Literature Service, Sprague Electric Co., 35 Marshall Street, North Adams, Mass. 01248.

Popular ratings are now available for fast delivery from your Sprague Industrial Distributor.

SPRAGUE COMPONENTS

CAPACITORS
TRANSISTORS
RESISTORS
INTEGRATED CIRCUITS
THIN-FILM MICROCIRCUITS
45C-5131

PULSE TRANSFORMERS
INTERFERENCE FILTERS
PULSE-FORMING NETWORKS
TOROIDAL INDUCTORS
ELECTRIC WAVE FILTERS

CERAMIC-BASE PRINTED NETWORKS
PACKAGED COMPONENT ASSEMBLIES
BOBBIN and TAPE WOUND MAGNETIC CORES
SILICON RECTIFIER GATE CONTROLS
FUNCTIONAL DIGITAL CIRCUITS



*Sprague' and '®' are registered trademarks of the Sprague Electric Co.

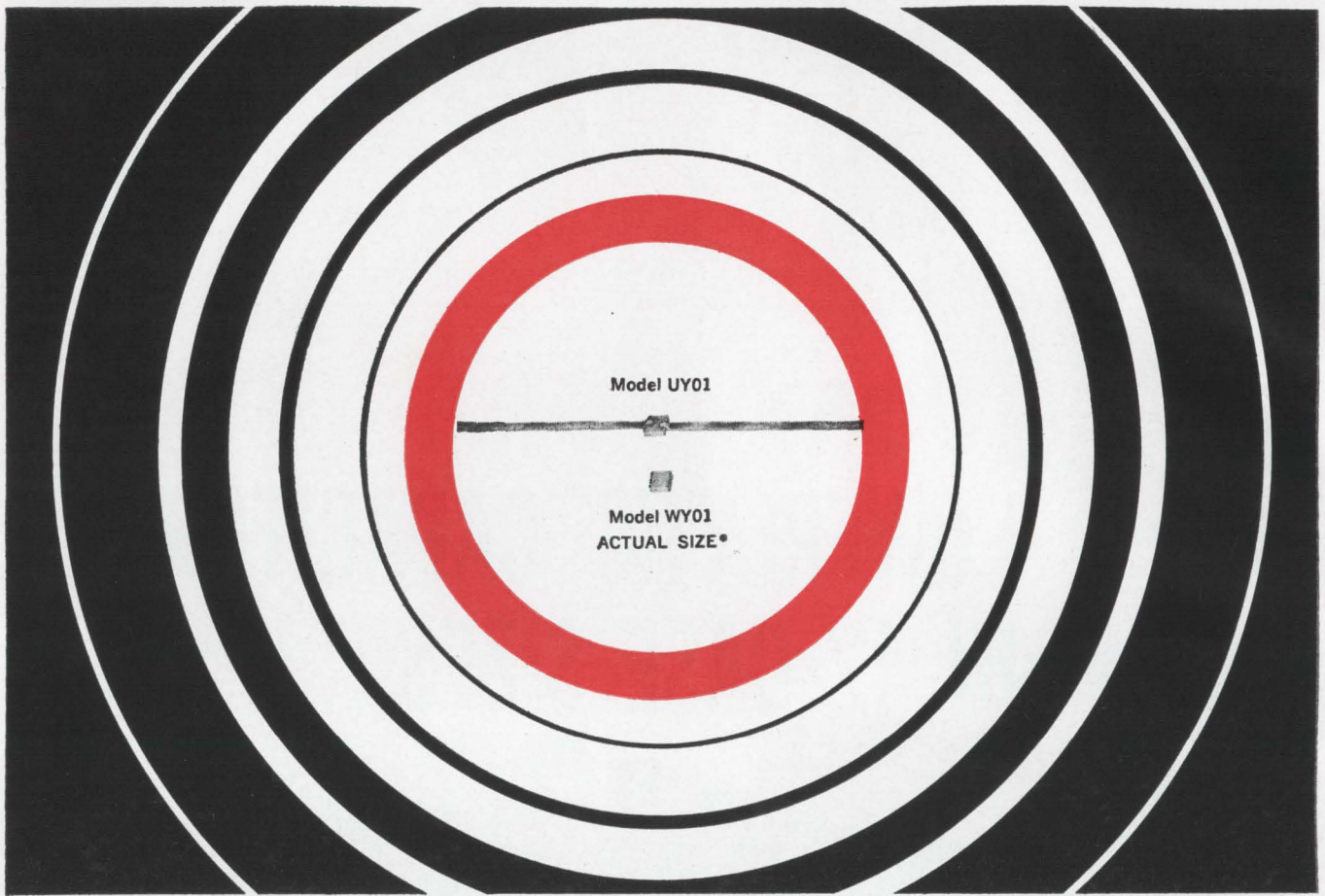

*In this size both are offered in 38 models of various capacitance values from 0.5 to 62 pf.

Now JFD Uniceram® High Q Fixed Capacitors COME TWO WAYS

Uniceram High Q ceramic fixed capacitors offer a unique combination of small size, exceptional stability and a guaranteed minimum Q of 5000 . . . with up to ten times more capacitance per unit volume than competitive units . . . up to .2 mfd/in³.

105 glass encapsulated models, with capacitance values from 0.5 to 3000 pf, provide the ultimate in High Q, reliability and stability. All models meet or exceed requirements of MIL-C-11272B.

Uniceram High Q capacitors are also available as unencapsulated wafers with metalized edges. 88 low-cost units, with capacitance values from 0.5 to 3000 pf, offer the same outstanding electrical properties. These wafers are ideally suited for hybrid integrated circuits, can be soldered directly to printed circuit boards or used as discrete components.

A High K series of Uniceram ceramic fixed capacitors with up to 1 mfd capacitance per unit volume is also available. These glass encapsulated units meet or exceed requirements of MIL-C-11015C. Volumetric efficiency . . . up to 48 mfd/in³.

Some typical Uniceram applications

IF strips • Crystal master oscillators
• Padder capacitors • Critical RC timing networks • Temperature stabilizing devices • Radio frequency filters
• Critical timing delay lines • Fixed tuned resonant circuits • Suitable as cordwood between printed circuit boards • All types of communication circuits

WRITE FOR CATALOG UNM 65-2

JFD-117

JFD ELECTRONICS CORPORATION
THE \neq AMERICA KNOWS BEST!

Components Division
JFD ELECTRONICS CORPORATION, 15th Ave. at 62nd St., Brooklyn, N. Y. 11219
JFD NORTHEASTERN, Ruth Drive, P. O. Box 228, Marlboro, Mass. 07152
JFD NEW YORK-NORTHERN, Damiano Pl., P. O. Box 96, New Hartford, N. Y. 13503
JFD MID-ATLANTIC, P. O. Box 5055, Philadelphia, Pa. 19111
JFD MID-ATLANTIC-MARYLAND, P. O. Box 7676, Baltimore, Md. 21207
JFD MIDWESTERN, 6330 W. Hermione St., Chicago, Ill. 60646
JFD MIDWESTERN-OHIO, P. O. Box 8086, Cincinnati, Ohio 45208
JFD WESTERN, 9 Morlan Place, Arcadia, California 91006
JFD ISRAEL LTD., Industrial Area B, Bldg. 23, Azor, Israel
DUCON CONDENSER PTY., LTD., Christina Road, Villawood, N.S.W., Australia
MURATA MANUFACTURING CO., LTD., Nagaoka Otokuni, Kyoto, Japan
STANDARD TELEPHONE & CABLES LTD., Footscray, Sidcup, Kent, England
JFD ELECTRONICS, EUROPE S A, 7 Rue de Rocroy, Paris, 10, France

Variable Trimmer Piston Capacitors ■ Metalized Inductors ■ LC Tuners ■ Ceramic Fixed and Variable Capacitors ■ Fixed and Variable Distributed and Lumped Constant Delay Lines

travagant claims relative to cost savings incurred through use of this new device.

They state, "At present it appears that systems built with MOS IC's should be able to duplicate the functions of systems built with conventional monolithic IC's (double-diffused, epitaxial IC's) at less than one-tenth their cost."

The most superficial substantiation of that statement appears nowhere in the article. It smacks of pure commercialism rather than an objective engineering judgment. If the comment were true (which is highly doubtful, even under the most favorable conditions), it is necessary and proper to specify the appropriate constraints, where they are applicable. Such a broad assertion implies that the authors are either indifferent or unknowing of all the costs involved in system fabrication or they are simply trying to sell a product. Whatever the reason, such statements do more harm than good for their cause.

Herbert S. Kleiman
Arlington, Va.

The authors reply:

It seems fairly evident that reader Kleiman finds difficulty in imagining a few applications for MOS complex circuits wherein a 60 times reduction in the total number of devices procured, tested and assembled on printed circuit cards and a 44 times reduction in number of cards and interconnections could conceivably result in a 10 times reduction in the cost of the equivalent functions using conventional integrated circuits. It should be evident from the article that the cost of a complex MOS chip equal in size and containing 40 to 50 times the functional complexity of a

conventional double-diffused integrated circuit should be or at least could be cheaper than a single double-diffused JK flip-flop.

The article did not pretend to imply that an IBM system 360 could be made at one-tenth its present cost. It did intend, however, to stimulate some new thinking about where this new tool might produce, if not a 10 times cost reduction, perhaps brand new applications heretofore deemed impractical from a cost and/or space standpoint.

Those of us who have dealt with the cost-of-ownership aspects of electronic hardware might also foresee a significant cost savings for the military customer. One might visualize field equipment that is repairable simply by replacing one printed circuit card which contains all the logic, memory, control and display conversion circuitry; where the card is cheap enough and small enough to carry as a spare and where it is also simple enough (50 packages) to repair at a maintenance depot.

It is true that the appropriate constraints should be specified for any new technology. However, we would prefer that the potential user decide this for himself, based on the brief description of the capabilities of the technology as presented in the article.

We apologize for sounding too presumptuous or commercial and Kleiman is correct if he is demanding close scrutiny by the potential user—good engineers will do this anyhow. And good engineers are making good use of this technology in hardware right now.

Donald E. Farina
Donald Trotter
General Micro-electronics, Inc.
Santa Clara, Calif.

Now from Sprague!

**LOW-COST,
HERMETICALLY-SEALED**

SEPT[®]

**SILICON EPITAXIAL
PLANAR TRANSISTORS**

**A NEW LINE OF NPN
QUALITY TRANSISTORS
IN TO-5 AND TO-18 CASES!**

**SUPERIOR TO
EPOXY-ENCASED TRANSISTORS
IN MOISTURE RESISTANCE
AND POWER CAPABILITY!**

**TN53, TN54—High Voltage Switch,
Amplifier**

**TN55, TN56—Low-level, Low-noise
Application**

**TN59—TN64—High Speed Switch,
Amplifier**

TYPE NO.		CHARACTERISTIC			
TO-5 CASE	TO-18 CASE	V _{CB0}	V _{CE0}	h _{FE}	f _T
TN53	TN54	75V	45V	50 min.	100 Mc
TN55	TN56	40V	30V	60 min.	30 Mc
TN59	TN60	40V	30V	100 min.	100 Mc
TN61	TN62	40V	30V	50 min.	100 Mc
TN63	TN64	20V	20V	25 min.	20 Mc

For complete technical data,
write to Technical Literature Service,
Sprague Electric Co., 35 Marshall St.,
North Adams, Mass. 01248.

455-932



*Sprague and ® are registered trademarks of the Sprague Electric Co.

SUBSCRIPTION SERVICE

Please include an Electronics Magazine address label to insure prompt service whenever you write us about your subscription.

Mail to: Fulfillment Manager
Electronics
P.O. Box 430
Hightstown, N.J. 08520

To subscribe mail this form with your payment and check new subscription renew my present subscription

Subscription rates: in the U.S.: 1 year, \$6; two years, \$9; three years, \$12. Subscription rates for foreign countries available on request

CHANGE OF ADDRESS

ATTACH LABEL HERE

If you are moving, please let us know five weeks before changing your address. Place magazine address label here, print your new address below.

name

address

city

state

zip code

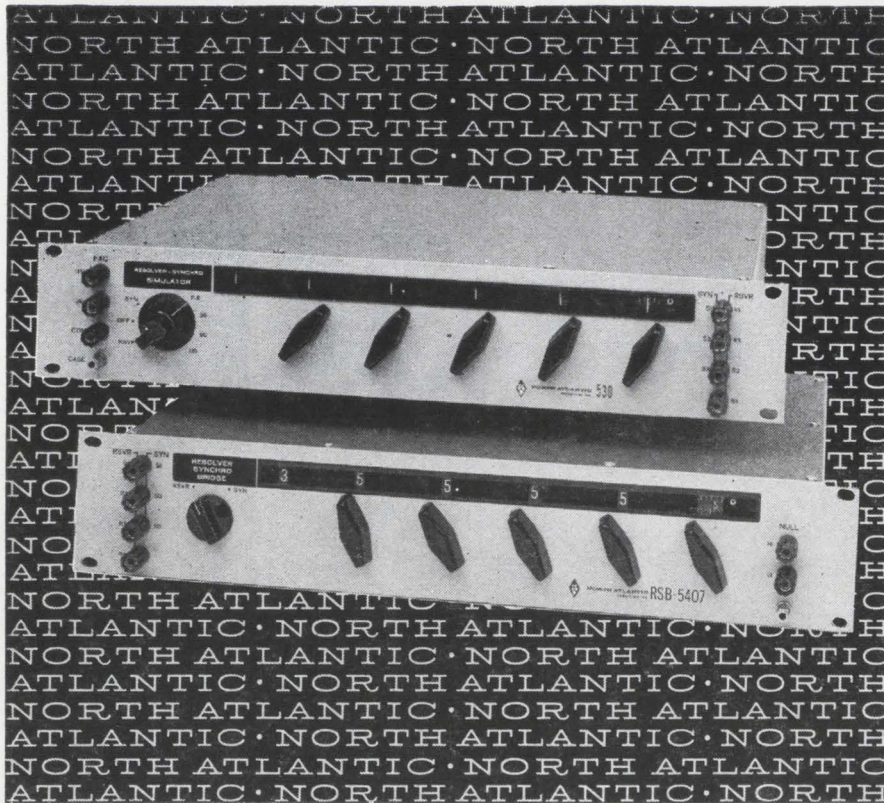

you are looking at the state-of-the-art in resolver/synchro testing

These two instruments provide the widest measurement capability available today for resolver/synchro testing. Each is a dual-mode unit, measuring both resolvers and synchros. Series 530 Simulators are ideal transmitters, and Series 540 Bridges are ideal receivers.

In addition to their dual-mode capability in 3½" of panel space, both series provide in-line decimal readout continuously switched through 360°, 2 second accuracy at any angle, and input/output isolation.

SERIES 530 SIMULATORS FEATURE

- Resolution 0.001°, 1°, or 5°
- Dual 26/115 volt excitation
- Switch selected line-line voltages 11.8, 26, 90, and 115 volts
- Low matched output impedance

SERIES 540 BRIDGES FEATURE

- Resolution 0.0001°, 1°, or 5°
- 500K input impedance
- Constant null-voltage gradient at all line-line voltages
- Unaffected by null detector loading

Prices range from \$1480.00 to \$2680.00

The flexibility of these instruments meets every need for rapid and accurate testing in the engineering laboratory, in production, and in ground support equipment. Used with a Phase Angle Voltmeter, they provide a complete facility for component or system test.

Programmable models with decade or binary input are also available. Your North Atlantic representative will be glad to arrange a demonstration. Call or write him today.



NORTH ATLANTIC industries, inc.
TERMINAL DRIVE, PLAINVIEW, L. I., NEW YORK • OVERbrook 1-8600

People

When the Institute of Electrical and Electronics Engineers holds its annual convention in New York in March, the man presiding over the session will be **William G. Shepherd**. Shepherd was elected president of IEEE earlier this month. He brings experience to the job gained in three roles: researcher, teacher and administrator.



Early in his professional career, Shepherd worked at the Bell Telephone Laboratories on microwave devices for radar. Ten years later he returned to his alma mater, the University of Minnesota—where he had earlier received a doctorate in physics—and became a professor of electrical engineering. In the past few years he has served in several administrative posts at the university, the latest as vice president of academic administration.

The work of the electronics engineer, Shepherd points out, is becoming more and more closely associated with the work of the biologist. And Shepherd hopes the IEEE will help to foster that relationship.

The Vietnam war is creating renewed interest in tactical radars, and will probably speed up the wedding of radar and digital technology, says **Robert N. Maglathlin**. He is the newly appointed manager of the advanced systems and techniques laboratory of Sylvania Electronic Systems division in Waltham, Mass.



Larger systems are already involving more and more digital work, not just for signal processing but in the radar circuits, Maglathlin points out. These changes, he adds, will step up the incorporation of integrated circuits into systems, particularly for such current re-

Two new ways to achieve higher power with Machlett planar triodes

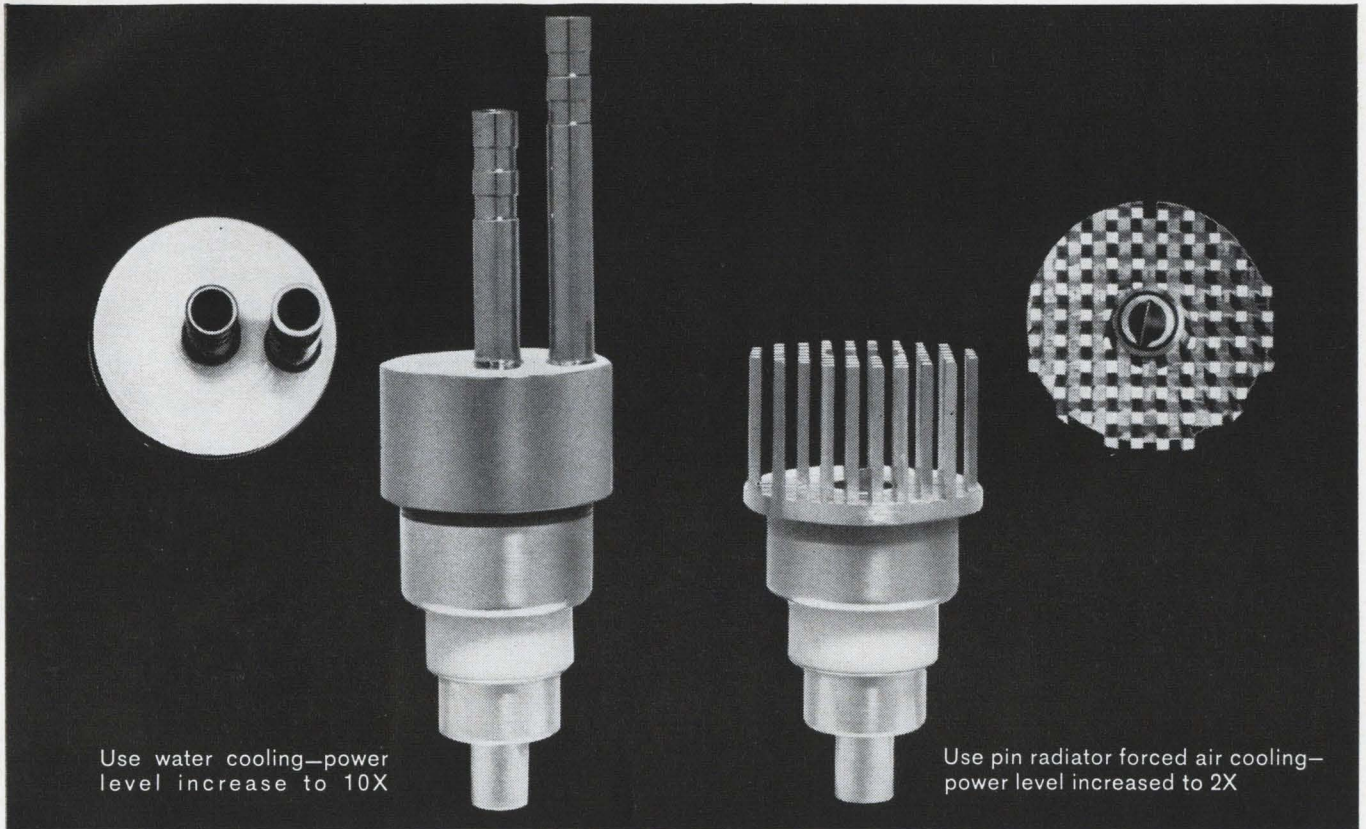

Use water cooling—power level increase to 10X

Use pin radiator forced air cooling—power level increased to 2X

Advanced cooling methods for UHF planar triodes now permit you to make full use of the high power range found in Machlett tubes.

Here are two examples:



ML-7855 with water jacket. Anode dissipation capability: 400 watts. New maximum input: 2.5kV, 300 mA.



ML-7855 with pin radiator. Anode dissipation capability: 150 watts. An optional input: 1.75kV, 150 mA.

For full operating details on Machlett tubes recommended for this new high-service power level, write to The Machlett Laboratories, Inc., Springdale, Conn. 06879. An affiliate of Raytheon Company.



ELECTRON TUBE SPECIALIST

ANTENNA and TOWER INSULATORS by LAPP

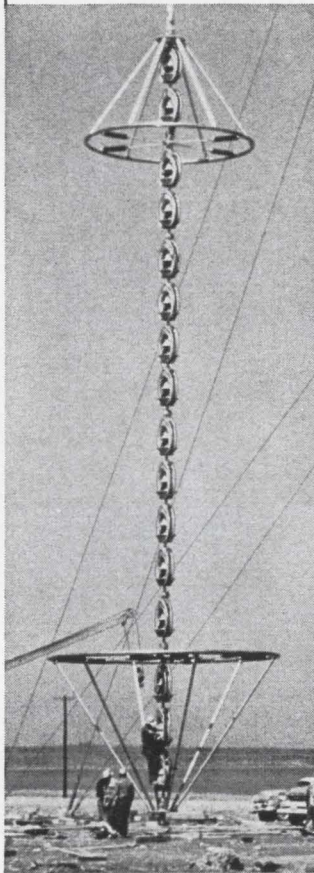
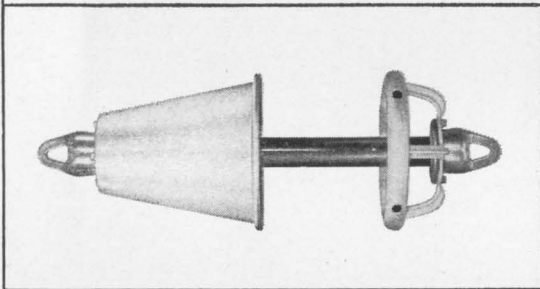
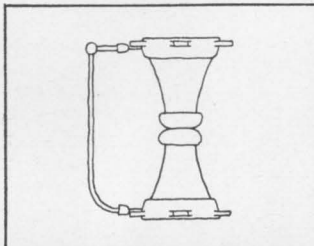
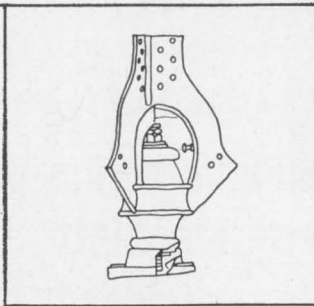

Lapp insulators support most of the world's large radio towers, both self-supporting and guyed masts. Lapp has designed and built base insulators from 80,000 lbs. to 9,000,000 lbs. ultimate strength. Lapp strain insulators have been made from 1200 lbs. to 620,000 lbs. ultimate strength. □ Lapp is also a dependable supplier of entrance, spreader and stand-off insulators for transmission lines. Other Lapp insulators and our gas filled capacitors are used in transmitters and coupling networks. □ Difficult insulating problems are welcome here at Lapp. We've been solving them for almost a half century. Write Lapp Radio Specialties Division, Lapp Insulator Co., Inc., 238 Sumner St., LeRoy, N. Y. 14482.



quirements as three-dimensional radar for limited war needs.

"In the past," Maglathlin notes, "We may have shied away from using a 10-bit word where an analog sample would do the job. But now, with the need for lightweight, less complex and highly reliable radars for the field, digital integrated circuits will be the natural choice in many instances."

Maglathlin, 41, formerly president of a small Massachusetts company, Electronic Systems, Inc., is responsible for technical direction of advanced radar, antenna and data processing systems for the Sylvania division. A part of Sylvania Electronic Products, Inc., the division manages government systems for the parent corporation, the General Telephone & Electronics Corp.

The new manager received bachelor's and master's degrees in electrical engineering from the Massachusetts Institute of Technology.

"There no question but that the computer peripheral-equipment market is going to continue to soar," says **Gordon L. Ness**, 39, newly named executive vice president of Data Technology, Inc., of Palo Alto, Calif. "With more information being put in and stored, and more computers and automated facilities being installed, the market for such equipment will stay on a steep, rising curve."



His chief responsibility will be for long-range planning.

According to Ness, the company plans further expansion in the oceanicographics market (Data Technology now applies 80% of all the underwater data-acquisition equipment used by the Navy). The company will also turn away from custom-made systems and toward modular systems and components technologies, he adds.

Ness was formerly marketing manager of the instrumentation department of the Fairchild Camera & Instrument Co.'s semiconductor division. He was graduated from Stanford University with a bachelor's degree in electric engineering.

Now...a xenon lamp power supply with **NO** spark gaps or relays

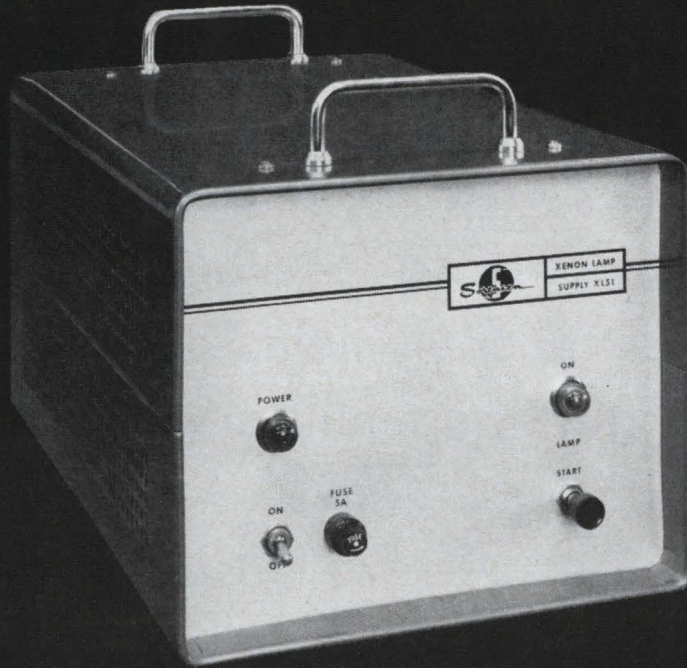

Sorensen pulse ignition circuitry guarantees instant starting...

one push per ignition...every time. Three new Sorensen Xenon Lamp Power Supplies deliver regulated, low ripple, output power with line voltage variations of 100-130 VAC or 200-260 VAC. Uniform impulse energy does not come up to or exceed dangerous level.

Other features include: maximum lamp life due to minimum starting energy; short circuit protection;

input/output physical, electrical isolation; portable, easy to operate.

The precise light stabilization produced by these Sorensen power supplies permits application of the xenon arc lamp in spectrophotometers, spectrometers, precision optical systems, spectroprojection systems, solar simulation, spectrography and general photographic projection systems.

For full information, call your local Sorensen representative or write: Sorensen, A Unit of Raytheon Company, Richards Avenue, South Norwalk, Conn. 06856. Or use reader service card number 200.



A UNIT OF RAYTHEON COMPANY

ELECTRICAL SPECIFICATIONS

MODEL NUMBER	INPUT VOLTAGE*	INPUT FREQUENCY	OUTPUT STARTING VOLTAGE	OPERATING VOLTAGE	OPERATING CURRENT	CURRENT REGULATION	CURRENT RIPPLE	LIST PRICE
XLS-1A (150W)	100-130/200-260 VAC Single Phase	60cps \pm 1%	20 KV (starting energy less than 0.5 Joules)	20 VDC \pm 3V	7.5 ADC nominal	Better than \pm 1.0%** over full input voltage range	less than 5.0% peak to peak less than 1.75% RMS	\$375
XLS-1B (150W)		50cps \pm 1%		20 VDC \pm 3V	7.5 ADC nominal			415
XLS-2A*** (35W)		60cps \pm 1%		12 VDC \pm 2V	3.5 ADC nominal	Better than \pm 0.25%** over full input voltage range		325
XLS-2B*** (35W)		50cps \pm 1%		12 VDC \pm 2V	3.5 ADC nominal	Better than \pm 1.0%** over full input voltage range		360
XLS-3A (450W)		60cps \pm 1%	30KV (starting energy less than 1 joule)	20 VDC \pm 3V	22-28 ADC (adjustable in 1 ampere steps)	Better than \pm 1.0%** over full input voltage range		715
XLS-3B (450W)		50cps \pm 1%		20 VDC \pm 3V				785

* Shipped wired for 100-130 VAC operation



** Available with regulation better than \pm 0.25% at additional cost

*** Also available for constant wattage operation
Circle 11 on reader service card

Fairchild invented Dual in-line packaging for manufacturers of commercial equipment. Dual in-line is a little larger than military-aerospace type packages. 

It is also a lot easier to work with. (Insert it by hand or by machine.) Its leads have

(Dual in-line actual size.)

  dimensional tolerances to fit holes drilled to commercial standards. Use standard circuit boards. Flow solder it. In fact, handle it the way you would any discrete component. 

Dual in-line 

saves you trouble in the field, too: it has an all-ceramic body to prevent accidental shorts. Leads can be probed from the top, where they are visible to the serviceman. And, should you ever

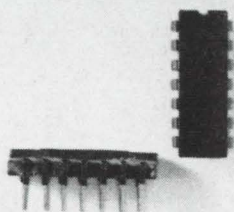

have to replace a circuit, a pair of pliers and a soldering iron are all the equipment you need. We have a complete line of logic functions available in Dual in-line. Your distributor has them in stock. Or, write for brochure.

FAIRCHILD
SEMICONDUCTOR

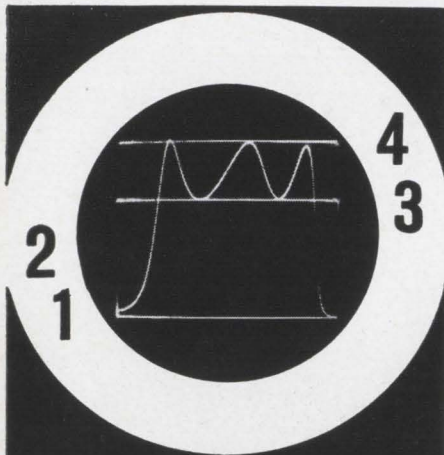

see **4** response traces on single-trace scope

measurement by comparison up to 1,200 mc



NEW

JERROLD SOLID-STATE 3-POSITION COAXIAL SWITCHER

Model TC-3 \$295⁰⁰

Turn any single-trace oscilloscope into a 4-trace scope; insert two reference traces automatically in addition to test trace and baseline. These references have advantage of permanent relative accuracy over scribed or painted lines.

Results are repeatable, as accurate as your reference attenuators. Generator and scope drift do not affect accuracy of measurements. Frequency from dc to 1,200 mc extends usefulness of comparison technique well into the UHF band. The TC-3 Coaxial Switcher can save you thousands of dollars in speed and accuracy. Write for literature.

JERROLD
ELECTRONICS

Industrial Products Division,
Philadelphia, Pa. 19132
In Canada: Jerrold Electronics,
60 Wingold Ave., Toronto 19, Ont.
Export: Rocke International,
13 E. 40th St., New York, N.Y. 10016

SWEEP GENERATORS • AMPLIFIERS
PRECISION ATTENUATORS • COMPARATORS

Meetings

Analytical and Measuring Instruments and Laboratory Apparatus Show, Bureau of International Commerce; U.S. Trade Center, London, Dec. 7-17.

Conference on Welding in Electronics, Long Island Chapter of the Association of Production and Manufacturing Engineers; Island Inn, Westbury, N. Y., Dec. 8-9.

International Conference on Radiological Protection in the Industrial use of Radioisotopes, Societe Francaise de Radioprotection; Centre de Conferences Internationales, Paris 16, Dec. 13-15.

ASSET/Advanced Lifting Re-entry Technology Symposium, Flight Dynamics Lab; Wright-Patterson Air Force Base, Dayton, Dec. 14-16.

Nuclear Magnetic Resonance Workshop, University of Illinois; Chicago, Dec. 15-17.

American Association for the Advancement of Science, AAAS; University of California, Berkeley, Dec. 26-31.*

International Symposium on Differential Equations and Theory of Systems, AFOSR, Brown University and the University of Puerto Rico; University of Puerto Rico, Dec. 27-30.

Astrodynamics Symposium, American Astronautical Society; University of California, Berkeley, Dec. 29.

Solid State Physics Conference, Institute of Physics and The Physical Society; Renold Building, Manchester, England, Jan. 4-7.

Sealab II Symposium, U.S. Navy; Statler Hilton Hotel, Washington, D. C., Jan. 11-12.

Conference on Electronics in Publishing, American University; International Inn, Washington, D.C., Jan. 17-20.

Instrumentation for Process Industries Conference, Texas A&M University; College Station, Tex., Jan. 19-21.

Conference on Symmetry Principles at High Energy, AFOSR, AEC, NASA; Univ. of Miami, Coral Gables, Florida, Jan. 20-22.

Phonon Interaction in Solids Conference, Princeton University; Princeton, N. J., Jan. 20-21.

Helicopter Conference, Helicopter Association of America; Inn of Six Flags, Arlington, Tex., Jan. 23-26.

Aerospace Sciences Conference, Statler-Hilton Hotel, New York, N. Y., Jan. 24-26.

National Electronic Representatives Association Marketing Conference, ERA; Riviera Hotel, Palm Springs, Calif., Jan. 26-30.

International Symposium on Information Theory, AFOSR, IEEE; University of California, Los Angeles, Jan. 31-Feb. 2.

Integrated Circuits Seminar, IEEE, Basic Sciences Committee; Stevens Institute of Technology, Hoboken, N.J., Feb. 2.

Call for papers

International Symposium on Shipboard Automation, Istituto Internazionale Delle Comunicazioni; Genoa, Italy, June 12-15. Dec. 15 is deadline for submission of a summary on automation of shipboard systems to Professor of Engineering, Agostino Capocaccia, Istituto Internazionale Delle Comunicazioni, Viale Brigate Partigiane, 18, Genoa, Italy.

National Operations Research Meeting, ORSA; Miramar Hotel, Santa Monica, Calif., May 18-20. Jan. 1 is deadline for the submission of a 200-word abstract on behavioral sciences, computer systems, space science, transportation and traffic control, to Dr. Paul Brock, General Electric Company, TEMPO, Santa Barbara, Calif.

Southwestern IEEE Conference and Exhibition, IEEE; Memorial Auditorium, Dallas, Apr. 20-22. Jan. 25 is deadline for submission of 200-word abstract on research, design, and system engineering of power generation, communication, computation, and control systems, to Dr. Robert Carrel, Collins Radio Co., Dallas, Tex. 75207.

* Meeting preview on page 16

Introducing Item #6 in the Fluke '65 Pacesetter Line.

It's a tough little "Luigi Meter" or our new solid state 841 Electronic Galvanometer by any other name. Virtually indestructible, the 841 meets mil-spec environmental parameters. Takes million-to-one overload without damage. Sensitivity is 2 na per scale division. Never needs external damping. Recorder output. Works in any position.

Fluke electronic galvanometers are available in the 841 A & B for laboratory use or the 840 A & B for OEM requirements. "A" models have a power sensitivity of 8×10^{-16} watt per division. Input resistance is 180 ohms on three ranges of ± 30 na, ± 300 na, and $\pm 3 \mu\text{a}$. "B" models differ in these respects: current sensitivity, 5×10^{-9} amp/scale division; power sensitivity 4.5×10^{-16} watt/scale division; input resistance 18 ohms on three ranges of ± 100 na, $\pm 1 \mu\text{a}$, and $\pm 10 \mu\text{a}$. The 841 A or B is priced at \$230.00 including case and batteries. The 840 A or B costs \$175.00 plus \$20.00 for the case and \$5.00 for the batteries. A rechargeable battery pack and AC line power pack is available at extra cost for each type of instrument.



FLUKE • Box 7428, Seattle, Washington 98133 • Phone (206) 776-1171 • TWX: (910) 449-2850

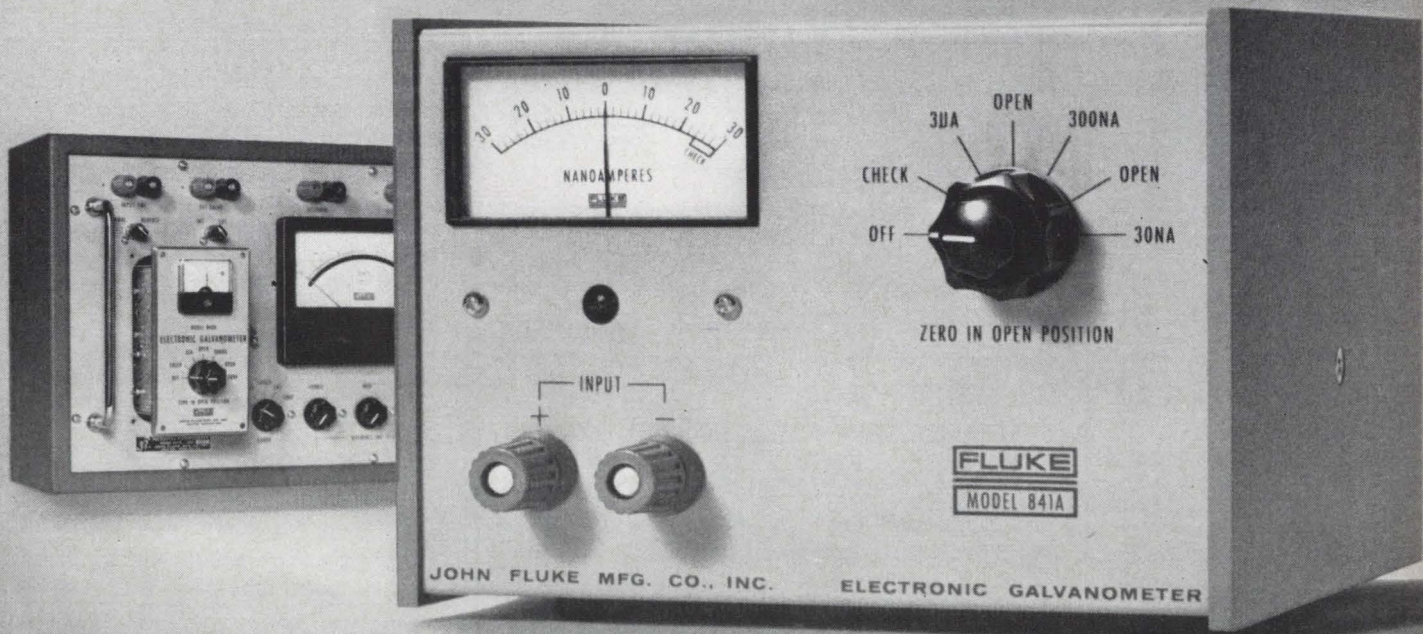

Model 841 in foreground with Model 840 at the rear.

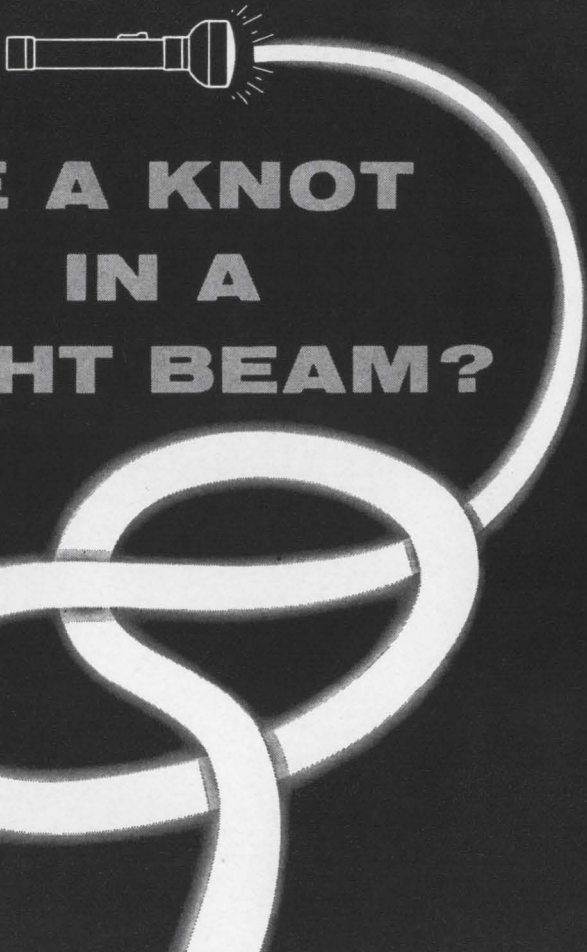

**TIE A KNOT
IN A
LIGHT BEAM?**

**YOU CAN
WITH BAUSCH & LOMB
LIGHT WIRES**

**AND YOU CAN DO MANY OTHER
AMAZINGLY USEFUL THINGS TOO!**

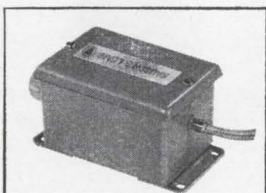

Fiber Optics Light Switch counts objects at a rate of 400/min, measures angular velocity, detects size of objects, acts as a limit switch, can be made sensitive to color with filters, monitors ambient light conditions, and be used in safety and burglar alarm systems. Catalog D-2057 gives the full story.

- Slice the original beam into several beams.
- Pipe the beams under, over and around all kinds of obstacles.
- Pipe the beams into tiny openings.
- Shape the circular beam so that it comes out the other end as a square □, a circle ○, a line — or any shape you can think of }
- Monitor the face of a CRT tube or radar screen.
- Safely pipe light into explosive areas.

**You can mold light to do your bidding
for practically any application**

Write for Catalog 32-2045. It has much information to excite your creativity. Bausch & Lomb, 99723 Bausch Street, Rochester, New York 14602.

BAUSCH & LOMB 

Meeting preview

AAAS in Berkeley

About 6,000 scientists and engineers are expected at the conference, described by its sponsors as the "World Series" of science, to be held on the University of California campus, at Berkeley, December 26 through 31. More than 1,500 papers in all categories of United States science will be delivered at the American Association for the Advancement of Science meeting.

In addition, approximately 20 films will be shown. The "engineering theater," initiated at the 1964 AAAS meeting, was one of the highlights of that conference, and is being repeated this year. Depicting the accomplishments of engineering, the films are directed toward the practicing engineer and scientist, and will be run in an all-day session.

Among the films expected to be of particular interest to engineers are those on high-speed photography in nuclear reactor development, domains and hysteresis in ferromagnetic materials, extravehicular activity in Gemini IV, aerodynamic aspects of Project Mercury, microelectronic reading for the blind, and memory devices.

The wide and varied program will touch on many aspects of engineering. Scheduled are symposia on systems engineering in agriculture, problems of life on Mars, communication with extraterrestrial intelligence, remote sensing of the environment, and recent developments in energy transfer.

Two computer sessions. The Association for Computing Machinery will have two sessions, one on applications of computers to natural language translation, and the second on new developments for the use of computers in scientific computation, with particular emphasis on on-line systems. There will be a demonstration of an on-line system using television. Related work on the computerized university (computers in teaching, library, and research), and the state of the art and the prospects for data gathering, storage, transformation, and retrieval will be described during the industrial science session.

**Been looking at all those OTHER oscillators?
Now—take a long, hard look
at the completely different
SD-104 LINEAR/LOG SWEEP OSCILLATOR**



Tired of the continuous monitoring of output normally necessary when making frequency-response tests? Work in the range of .005 cps to 50 kc? Then here's why—point by point—you will find the SD-104 Linear/Log Sweep Oscillator superior to every other instrument on the market today . . .

- Continuously variable, completely electronic linear and log sweep rates
- Unequalled accuracy in frequency indication and resolution through automatic range switching of the front panel meter
- Exceptionally flat frequency response
- Uninterrupted and automatic sweeps over a full three-decade range
- Eight simultaneous outputs, including extremely accurate DC analog output voltages, permitting DIRECT plotting of data on X-Y recorders without frequency or log converters

Plus

special capabilities and options, including . . .

- Continuously variable phase output, 0-360°
- Fixed-phase outputs of 0°, 90°, 180°, 270°
- Phase locking and frequency tracking
- Combined linear-log sweep
- External programming (analog or digital)
- Stepped-frequency operation

DEMONSTRATIONS? YOU BET! Every one of our Reps—from coast to coast—has a demo unit ready to set up at your convenience. Just call or write.

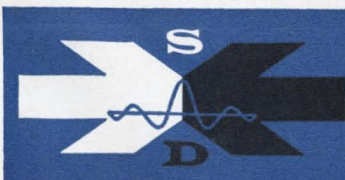

SPECTRAL DYNAMICS CORPORATION OF SAN DIEGO

POST OFFICE BOX 671 SAN DIEGO, CALIFORNIA 92112, TELEPHONE 714-278-2501



New products from improve performance

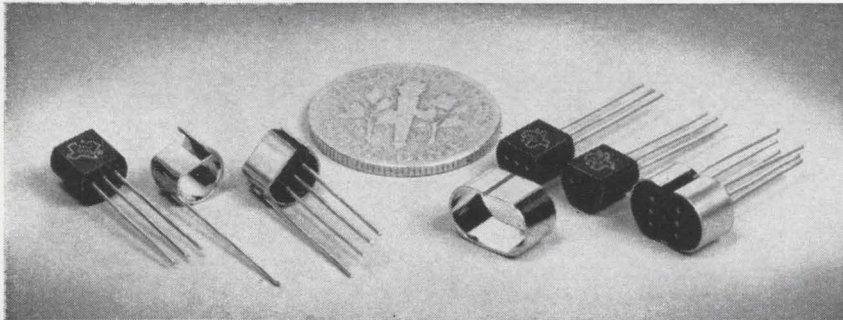

Figure 1: SILECT field-effect transistors are available with low cost snap-on shield for RF service. Matched pairs may be factory-assembled with double clamps for reduced costs

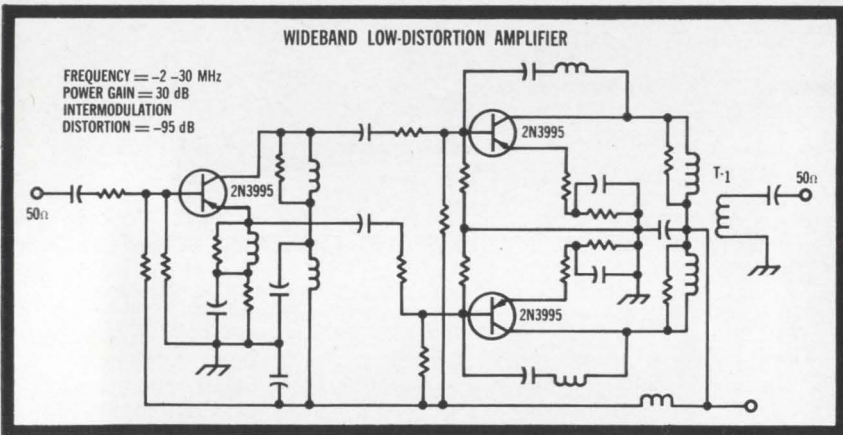

Figure 2: Wideband low-distortion amplifier employs 2N3995 transistors

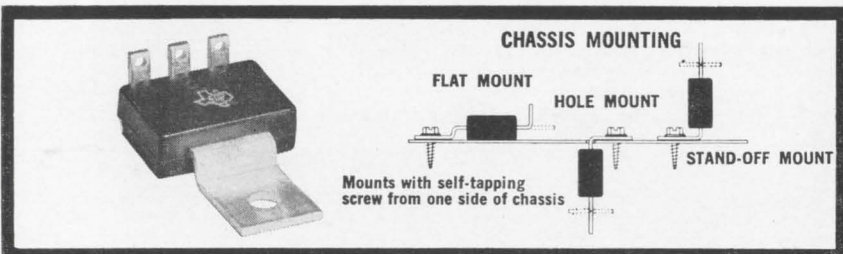

Figure 3: TAB-PAC power transistors feature low cost and easy mounting for cost-critical industrial and consumer applications

Improve performance at low cost with new SILECT* FET's

Now you can improve sensitivity, reduce cross-modulation, reduce noise, and generally improve performance of much consumer and industrial equipment with SILECT field-effect transistors from Texas Instruments.

These new low-cost, plastic-encapsulated, silicon junction units are available as N-channel (2N3819 and TIS34) and P-channel (2N3820) devices. Optional grounded or ungrounded snap-on clamps provide RF shielding and improved dissipation (see Fig. 1).

Applications include AM/FM tuners; mixers; low-, medium- and high-frequency amplifiers; and digital applications. Low-cost matched pairs for FET complementary circuits or differential amplifiers can be obtained by clamping matched units together as shown in Figure 1.

Electrical characteristics include extremely low leakage, high-frequency capability, superior cross-modulation, high transconductance, and low capacitance. N-channel transconductance is 2000-6500 μ mhos at 1 kHz (4000 μ mhos minimum for the TIS34) and 1900 minimum at 100 MHz. P-channel transconductance is 800-5000 μ mhos at 1 kHz and 700 minimum at 10MHz. Capacitance (C_{rss}) is 4pf maximum for both N-channel devices, 16pf maximum for the P-channel. Circle 194 on Reader Service Card for data sheet.

-95 dB intermodulation distortion with new TI germanium transistors

High-performance, low-distortion wideband amplifiers such as the one shown in Figure 2 are now possible with TI's new 2N3995. Extremely low intermodulation distortion (-70 dB maximum) makes this device attractive for many applications formerly restricted to vacuum tubes.

Other advantages include low noise (5 dB maximum at 30 MHz) and guaranteed minimum-maximum gain at dc, 1 kHz, 30 MHz, and 100 MHz. Beta changes less than 2 dB from 5 to 30 mA. Power dissipation is 300 mW at 25°C free air. Circle 195 on Reader Service Card for data sheet.

Reduce costs, simplify assembly with new TI plastic-encapsulated power transistors

You save on both assembly and component costs when you use the new TAB-PAC* silicon power transistor from TI. This new NPN planar device, typed TIP14, is designed especially for cost critical industrial and consumer applications.

The low-profile, double-ended plastic package shown in Figure 3 incorporates a mounting tab for simplified assembly. The transistor can be mounted on chassis or heat sink with a single self-tapping screw as shown. Leads and mounting tab are normally supplied as shown in "Flat Mount" drawing, but may be formed to your specifications on production orders.

Low saturation voltage ($V_{CE(sat)} = 0.1$ volt typical at 200 mA) provides high circuit efficiency with minimum internal losses.

High power dissipation (15 watts at 25°C case) and gain linearity over a wide current range ($h_{FE} = 35$ typical at 50 mA and 30 typical at 1 amp) make the TIP14 ideal for use in amplifier applications. Circle 196 on Reader Service Card for data sheet.

* Trademark of Texas Instruments

TI cannot assume any responsibility for any circuits shown or represent that they are free from patent infringement

TI to help you and reduce costs

Fourteen new transistors extend silicon planar power line to 30 amps

A broad new family of NPN silicon power transistors extends TI's planar-epitaxial product line to meet your power requirements from 50 mA to 30 amps.

Planar construction assures high reliability, and epitaxial design provides uniform gain over wide current ranges (see curves in Figure 4). Very low saturation voltages ensure maximum efficiency with low internal losses and heating.

High voltage capability ($V_{(BR)CEO}$ ranges from 100 to 120 volts) and fast switching characteristics (t_{on} is typically 300 nsec, t_{off} typically 750 nsec) make these devices well suited to both amplifiers and high-speed switching applications. Typical uses include switching and linear power supply regulators, converters, inverters, servo amplifiers, linear power amplifiers, and power switches.

This new fourteen-device family includes two one-amp units (2N4000-01); eight five-amp units (2N3418-21, 2N3996-99); and four 30-amp units (2N4002-05). Package choices include TO-5, standard and insulated 7/16" stud, TO-63 and dime-size Thin-Pac* package. Circle 197 on Reader Service Card for data sheet.

Planar unijunction offers low leakage, high reliability for timing circuits

Now you can build more accurate timing circuits with significantly lower power requirements when you employ TI's new 2N3980 planar silicon unijunction transistors.

You achieve high accuracy because of extremely low leakage—2 nA at 30 volts (several orders of magnitude lower than the best conventional grown unijunction transistors). Greater circuit simplicity is an inherent advantage with unijunction transistors. TI's new planar device allows you to reduce capacitor size as well, because of its exceptionally low leakage characteristics.

These features, combined with planar high reliability and compact TO-18 package, represent an important state-of-the-art advance in unijunction technology. Circle 198 on Reader Service Card for detailed information.

New Schottky-barrier varactor diodes offer 2.3 dB NF at 16.5 GHz, f_T to 500 GHz

Low noise, high tunability and low pump power requirements are characteristics of K_u -band parametric amplifiers that employ TIXV05-07 varactor diodes. This makes possible radar, communications and telemetry equipment that performs better and costs less.

TIXV05-07 varactors are Schottky-barrier, planar-epitaxial, gallium-arsenide units encased in beryllium oxide microwave pill packages.

Low noise permits greatly increased receiver sensitivity, providing increased useful range and/or reduced transmitter power requirements.

High electronic tunability—over 900 MHz in the preamplifier/converter shown in Figure 6—permits simplified design.

Low pump power requirements—as low as 10 mw in the unit shown—permits the use of a low voltage klystron or an all-solid-state pump. Circle 199 on Reader Service Card for data sheet.

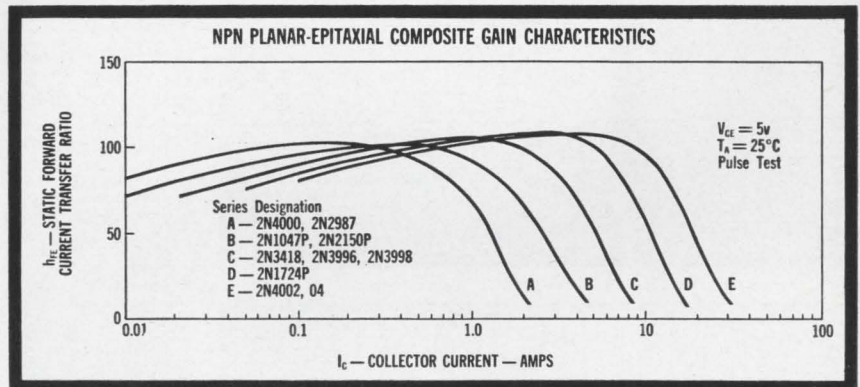

Figure 4: Uniform beta of five families of planar-epitaxial NPN silicon power transistors

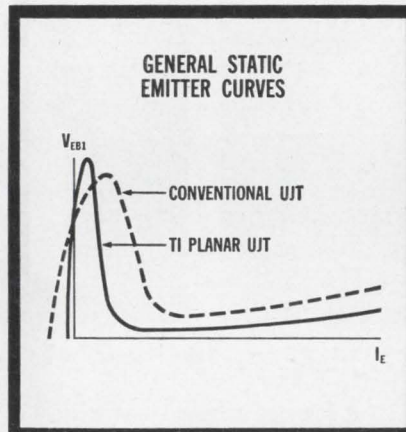

Figure 5: Comparison of curves shows improved leakage, valley current and saturation characteristics of 2N3980 planar unijunction

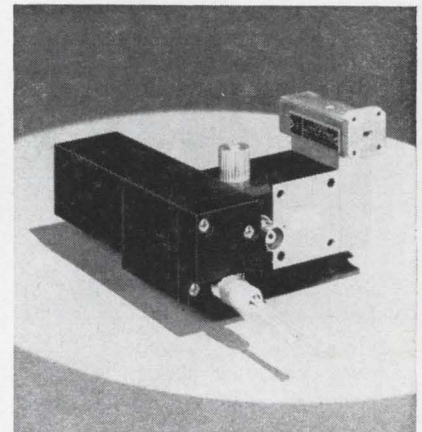

Figure 6: TI K_u -band preamplifier-converter employs TIXV07 varactor diode to achieve 2.5 dB noise figure



TEXAS INSTRUMENTS
INCORPORATED
13500 N. CENTRAL EXPRESSWAY
P. O. BOX 5012 • DALLAS 22, TEXAS

SEMICONDUCTOR PLANTS IN BEDFORD, ENGLAND • NICE, FRANCE • DALLAS, TEXAS



New easy-to-apply RTV-757 silicone rubber foam protects newspaper from 5000°F flame

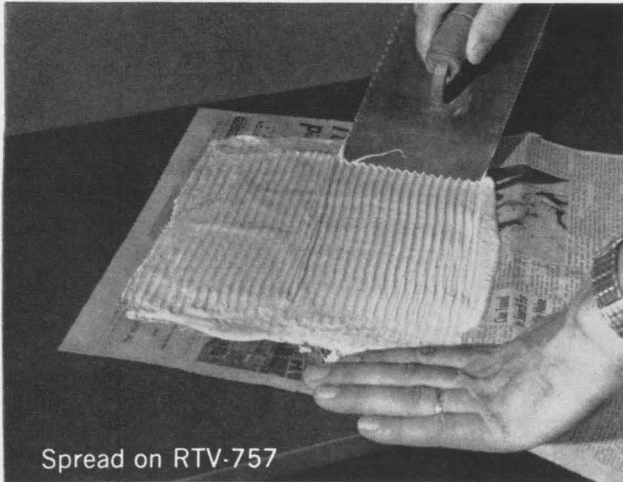

Spread on RTV-757

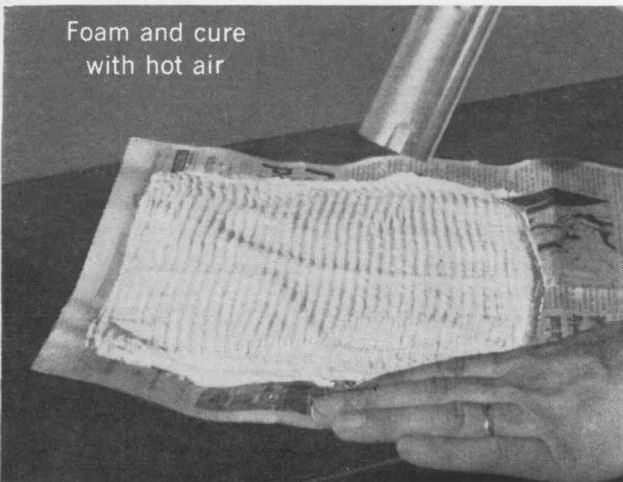

Foam and cure
with hot air

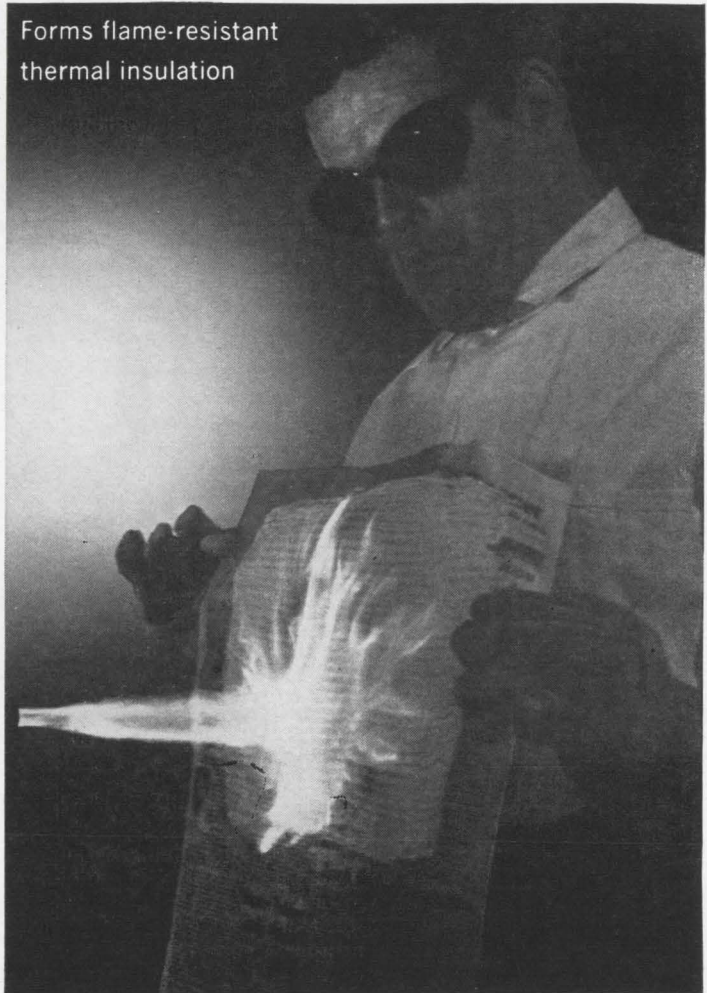

Forms flame-resistant
thermal insulation

General Electric's new RTV-757 foam can protect equipment and materials against heat and direct flame. It even protects an ordinary newspaper, as shown in the demonstration above.

RTV-757 is a thixotropic compound. Just spread it on. Then expose it to hot air. It cures instantly and forms a sponge-like, lightweight, yet tough, blanket with a density of 0.7-0.8.

Along with typical RTV resistance to aging, ozone and weathering, RTV-757 offers these features for firewall and thermal insulation applications.

- cast-in-place application
- one-step cure and foam system
- low density, floats in water
- excellent adhesion throughout temperature extremes
- controlled work life, doesn't foam until heated
- low-temperature flexibility, below —150°F
- high-strength foamed properties, eliminates honeycomb fabrication
- can be modified to pour or spray

Where to use RTV-757

The unsurpassed flame and heat resistance, plus outstanding thermal insulating properties, make RTV-757 uniquely qualified for use as an ablative shield, flame-resistant packaging material, fire-resistant sealant, flame-resistant shield for launch and support equipment, flame-resistant fabric coating, and as a protective barrier for aircraft, tanks, ships and stationary equipment.

7 common properties of all G-E RTV silicone rubbers

- Extreme temperature resistance
- Room temperature cures
- Chemical resistance
- Ozone, weather and age resistance

- Strong bonds
- Excellent dielectric
- Minimum shrinkage

Three more new RTV developments from General Electric

RTV adhesive/sealants now available in handy caulking cartridges



Tight, confined areas of electrical and electronic apparatus are a cinch to seal with General Electric's compact caulking cartridge. Also useful on production lines, they speed up sealing jobs. They provide a strong, flexible bond without priming.

Already mixed, RTV adhesive/sealants need no curing catalyst. Available in white (RTV-102) and translucent (RTV-108). Six and 12 ounce sizes fill standard hand or air-powered caulking guns.

Type I Low Viscosity	RTV-8111 RTV-8112 RTV-8113	Fast Cure Medium Cure Slow Cure
Type II Moderate Viscosity	RTV-8262 RTV-8263	Medium Cure Slow Cure
Type III Thixotropic	RTV-8372 RTV-8373 RTV-8382 RTV-8383	Medium Cure Slow Cure Medium Cure Slow Cure

Nine new RTV's to meet MIL-S-23586 (Wep)

Nine new RTV products have been specially formulated to meet this new military specification which covers the requirements for room temperature vulcanizing silicone rubber compounds most useful in aircraft, electrical and weapons applications. The specification describes the product and performance requirements for such electrical and mechanical applications as potting, encapsulation, sealing and bonding.

The new spec provides a convenient method for specifying RTV compounds for many military and non-military applications.

Tough, new RTV-630 for molding and plastic processing

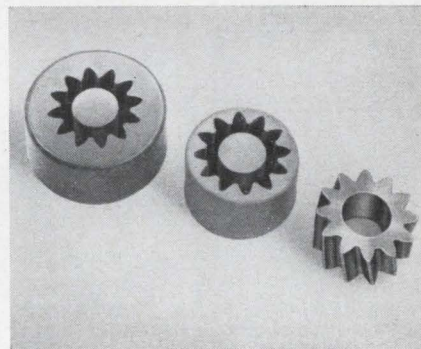

High-strength RTV-630 can be used to fabricate flexible processing tools which assure long runs in thermoforming, matched die, plastics castings and other reinforced plastic molding operations.

It is also an economical flexible mold material for prototype reproduction, since less rubber is required to form a strong durable mold. RTV-630 molds are more flexible, parts are easier to remove and molds last longer. RTV-630 can be cured rapidly in thick sections.

It may also be used in potting, encapsulating, release coatings and other applications requiring maximum strength.

AUTHORIZED DISTRIBUTORS RTV INDUSTRIAL SEALANTS

ALABAMA

Argo & Company
Birmingham

ARIZONA

Electrical Specialty Co.
Phoenix

CALIFORNIA

Electrical Specialty Co.
Los Angeles
Electrical Specialty Co.
South San Francisco
R. V. Weatherford Co.
Glendale

COLORADO

Electrical Specialty Co.
Denver

CONNECTICUT

R. H. Carlson Co., Inc.
Greenwich

D. C.

Read Plastics, Inc.
Washington

FLORIDA

Gulf Semiconductors, Inc.
Coral Gables
Gulf Semiconductors, Inc.
Winter Park

ILLINOIS

Allied Radio Corp.
Chicago
Federal Insulation Corp.
Chicago
J. J. Glenn and Co., Inc.
Chicago

INDIANA

Hyaline Plastics Corp.
Indianapolis

IOWA

Plastic Supply, Inc.
Des Moines

KENTUCKY

General Rubber &
Supply Co.
Louisville

MASSACHUSETTS

Northeast Chemical Co.
Boston

MICHIGAN

F. B. Wright Co., Inc.
Dearborn

MINNESOTA

D. A. Schultz Company
Minneapolis

MISSOURI

D. A. James Company
St. Louis
Regal Plastic Supply Co.
Kansas City

NEBRASKA

Regal Plastic Supply Co.
Omaha

NEW JERSEY

Smooth-on Mfg. Co.
Jersey City

NEW YORK

Punt, Inc.
Floral Park

Queen City Rubber Co.

Buffalo
Adhesive Products Corp.
New York
Chamberlin Rubber Co.
Rochester
Chamberlin Rubber Co.
Syracuse

OHIO

Philpott Rubber Co.
Cleveland
Parkway Products, Inc.
Cincinnati

OREGON

Electrical Specialty Co.
Portland

PENNSYLVANIA

Smith of Philadelphia, Inc.
Philadelphia
Speck-Marshall Co.
McKees Rocks

TEXAS

Lawrence Electronic Co.
Dallas
Houston Industrial
Supply Co., Inc.
Houston

WASHINGTON

Electrical Specialty Co.
Seattle

WISCONSIN

R. J. Wittenburg Co.
Milwaukee

For complete information on one or all of the latest G-E RTV compounds, write to Section N11168, Silicone Products Dept., General Electric, Waterford, New York.

GENERAL  **ELECTRIC**

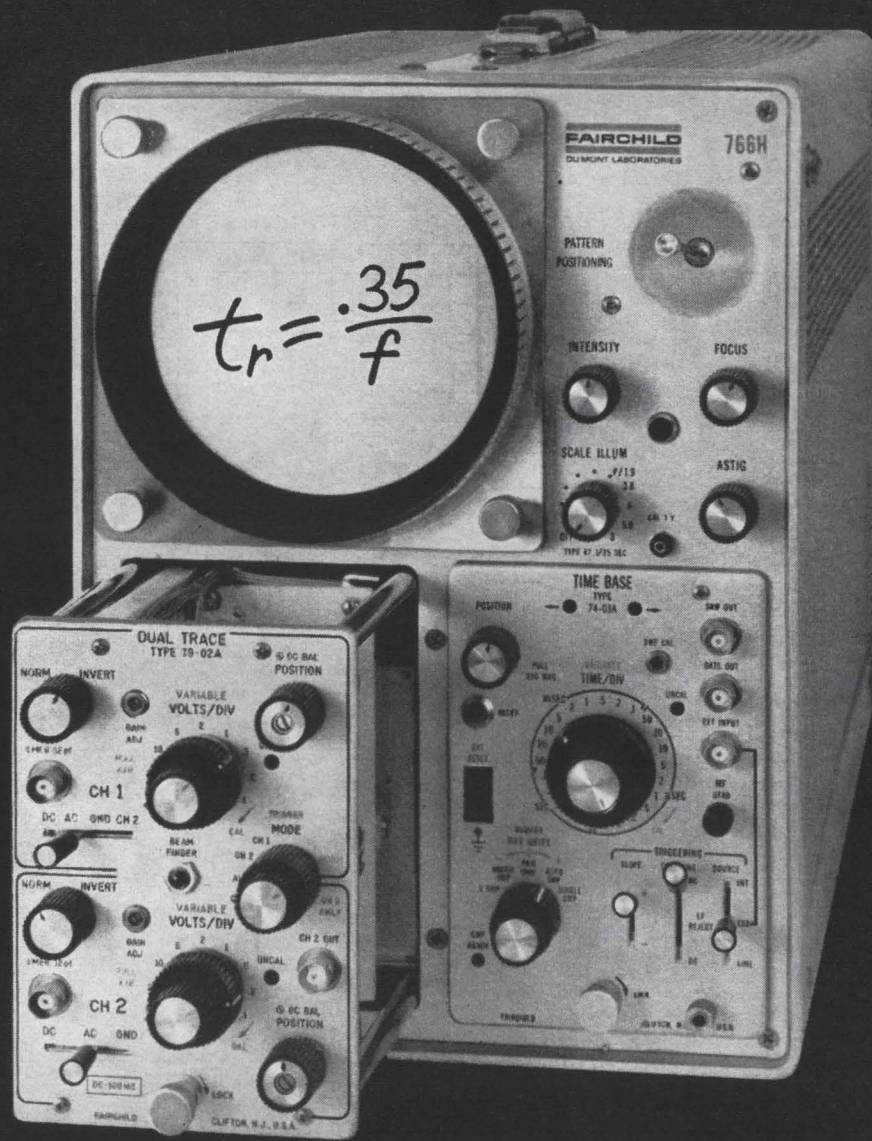

You can get a rise out of a Fairchild scope faster than anybody's

In 3.5 ns, to be precise. That's the risetime of Fairchild's Series 765H scopes fitted with the Type 79-02A plug-in. And if $t_r = 3.5 \text{ ns}$, $f = 100 \text{ mc}$. Thus, whether you look at it in terms of speed or bandwidth, the 765H Series is the highest performance, real-time general purpose scope available.

But compare some other features too: dual trace capability with the 79-02A plug-in... 10 mv/cm sensitivity (or cascade the preamplifiers by flipping a switch and get a 50 mc single trace at 1 mv/cm)... trigger selection from composite signal or Channel 2 only... built-in 230 ns delay line.

Also consider the advantages in reliability and compactness of Fairchild's all solid-state circuitry... of advance design that incorporates all amplifier circuitry in the plug-in. These and other features of the Series 765H with its family of plug-ins give you the precision and versatility demanded in so many applications today.

Price of the dual trace 79-02A plug-in is \$1,200, and the entire 100 mc scope with $5 \mu\text{s/cm}$ sweep is only \$2,265. Call your Fairchild Field Engineer today for a demonstration at your convenience, or for complete specifications write Fairchild Instrumentation, 750 Bloomfield Ave., Clifton, N.J.



*Technological Obsolescence

Circle 22 on reader service card

FAIRCHILD
INSTRUMENTATION
A DIVISION OF FAIRCHILD CAMERA
AND INSTRUMENT CORPORATION

Editorial

Technology and the blackout

In the aftermath of the blackout that paralyzed the northeastern section of the United States earlier this month, technology emerged as the apparent villain. After listening to utility executives' involved and vague explanations of what happened, a common belief was that the power industry had built a technological monster that is too complex to be controlled, that the industry had gone too far technically.

However, closer study leads one to the conclusion that the fiasco may well have been caused not by too much technology but by too little.

Sorting out the technical details of what caused the failure is not easy, and the job is made even more difficult by the utilities' determination to obfuscate the matter as much as possible. Even Joseph Swidler, chairman of the Federal Power Commission, complained that his investigation was not getting enough of the right kind of information from the power companies. Suppliers to these companies have enforced a rigid ban on any discussion of the power failure by their technical employees.

The power companies are embarrassed by more than the failure of their vaunted system. The breakdown stripped away the facade of advanced technology that the companies have erected. Compared with the electronics industry, for example, the utility industry is conservative and something of a laggard. Its research and development is exceedingly thin, and most of it has been done by suppliers, not by the utility companies.

Cutting through the utilities' verbal smog, you come to the conclusion that the upset that triggered the failure—whether it started in a relay at a distribution plant of the Sir Adam Beck station or not—was transmitted through the system so rapidly that the men who control the interconnections had no time to act. At a press conference that concealed rather than disclosed the facts, a dispatcher at the Consolidated Edison Co. complained that electricity moves at the speed of light, and explained that there was no chance for him to cut off the utility from the Canuse interconnection and thus keep Con Ed on line.

The average utility engineer is mystified by transients of the type apparently generated just before the blackout. Too few utilities had automatic controls that would spot such surges and separate the power company from the tie without the intervention of a human operator. Most do not have electronic sensors and oscilloscopes to detect these fast surges. And nobody had an on-line control computer that could consider many variables and decide—in microseconds—that a disaster was imminent.

The big problem is that many utility people, particularly in management, are not yet ready for such sophisticated gear. In fact, a lot of utility engineers are still proud of their independence of electronics. At the IEEE's annual power-group meeting in February, 1964, a program chairman boasted that not a single paper discussed electronics. "It's all electrical," he declared proudly.

If a recurrence of the blackout is to be prevented—and at this writing nobody is willing to bet it couldn't happen again somewhere—someone will have to force the utilities to look at what's available in modern technology—and use it. Automatic shut-down of a power station by computer, for example, might have prevented some of the damage suffered by a few companies. Although this concept has been around since 1958, few utilities have done much about it.

Electronics can contribute much to the prevention of future blackouts. But the initiative will have to come from the utilities, not from electronics companies. While electronics companies have the technology, they do not know enough about the power system to apply it.

More technology—not less—is called for.

Smooth Torquer for Rough Assignments

PIGA torquer in Sabre guidance.
 Custom built by CLIFTON. Life
 18,000,000 revolutions. Gold commutator
 and contact springs. Surface flatness of
 50 millionths of an inch!



Clifton is uniquely qualified to supply you with torquers because:

1. We are an ultra precision house by experience and achievement. Surface flatness of the above PIGA unit is .000050. That's 50 millionths!
2. Our 20 years work in designing and building gyro pick-off synchros and resolvers gives us deep experience with the flat, "hollow" shaft configuration.
3. We have succeeded in lowering current leakage, particularly as a variation with temperature, through the use of better dielectric materials for our magnet wire and slot insulation. Our current leakage is the lowest in the industry.

The variety of torquers shown in the table is only a sample. Try us for your torquer needs. Buy from a firm whose quality you can trust. Call 215 622-1000. Clifton Precision Products, Division of Litton Industries. Clifton Heights, Pa., Colorado Springs, Colo.

TYPICAL CLIFTON TORQUERS

MODEL NO.	O. D. BASIC	I. D. BASIC	MAX. WIDTH	SENSITIVITY (in-oz/amp)	RESISTANCE (ohms)	PEAK TORQUE (in-oz)
D-1938-2	1.938	.587	.586	16	34.5	15
D-1938-4	1.938	.587	.647	23	35	22
D-3187-1	3.187	2.020	.470	38	100	9.6
D-4000-1	4.000	2.562	.300	32	32	
D-3063-1	3.063	1.688	.952	60	21	70
D-3375-1	3.375	1.688	.562	120	100	65
D-6500-1	6.500	4.719	.415	120	100	65
D-4124	4.125	2.188	1.051	180	35	140
D-4562-1	4.562	2.938	.682	220	60	90
D-3375A-1	3.375	2.249	.585	49	32.7	35
D-4000A-1	4.000	2.500	.300	67	26	60
D-5125-1	5.125	3.500	.567	56	9.7	134
D-3030-1	3.029	1.250	.600	45	32	36

RIPPLE TORQUE: Standard—14% of rated torque measured with constant voltage. On special order—as low as 8%.

cppe **CLIFTON** **PRECISION PRODUCTS**
 DIVISION OF LITTON INDUSTRIES



Electronics Newsletter

November 29, 1965

Fast memory built with IC's

A new scratchpad memory system, featuring 36-bit monolithic integrated-circuit memory cells and simplified construction, will be described this week at the Fall Joint Computer Conference in Las Vegas by the semiconductor division of the Fairchild Camera & Instrument Corp. A forerunner of Fairchild's new line of memory systems, the system will be available for sale by mid-1966.

The size of a shoebox, the memory has a capacity of 256 words of 72 bits each and a read or write cycle time of 150 nanoseconds. Readout is nondestructive. Fairchild is also introducing an 8-bit monolithic memory chip that can read or write in 35 nanoseconds.

The new memory system is built entirely on six two-sided printed circuit boards, using a layout method devised by Rex Rice, Fairchild's chief digital systems designer. To avoid multilayer circuit boards, regular wiring patterns and the plug-in circuit packages developed by Fairchild for its complementary transistor Micrologic line were used.

Rice's staff at Fairchild used the method to build a digital systems research model with 1,550 Micrologic circuits—the equivalent of 5,000 NOR gates. This system, which has only 10 two-sided circuit boards and is little bigger than a breadbox, will be displayed at the computer conference.

Doubleheader for Gemini next week

The two Gemini missions scheduled for December will feature:

- The first test of voice communications over a laser beam.
- The first rendezvous between two manned spacecraft.
- And the first simultaneous tracking of two manned spacecraft.

Gemini 7, a 14 day mission, orbits first. About 9 days later, Gemini 6 will lift off and the two space capsules will try to rendezvous soon after.

GE and Time eye school market

The General Electric Co., with its know-how in electronics, and Time, Inc., with its know-how in publishing and education, are forming a joint company to develop and market materials and services that integrate the two specialties.

Products and services for the new unnamed subsidiary will be limited at first for use in elementary and secondary schools. Ultimately, the companies say, programs will be developed for universities, industry, government and for home-study courses.

GE and Time are not alone in this new field. The Xerox Corp. last May acquired Wesleyan University Press, and the International Business Machines Corp. last year bought Science Research Associates, Inc., an educational materials and psychological testing firm. The Radio Corp. of America formed its own electronics-printing subsidiary earlier this year.

FCC will decide whether to hear ABC satellite bid

The Federal Communications Commission will begin deliberations this week on whether to formally consider the American Broadcasting Co.'s proposal to launch a synchronous satellite for domestic communications. The fundamental question before the agency: can a private company own and maintain a satellite network? Should the FCC decide to take up the issue, it might be months before a decision is reached.

The broadcasting company wants to use the network to link its 200 affiliated television stations.

Electronics Newsletter

Radiation, heat affect IC substrate

Engineers at Melpar, Inc., have observed the emission of light from integrated-circuit substrates subjected to gamma radiation at high temperatures. Although the circuits didn't appear to be damaged by the heat and radiation, their output signals showed inconsistencies, indicating that the heat and radiation had affected them, says Charles Feldman, manager of the company's physical electronics research laboratory. The engineers found a direct relationship between the effect of radiation on signal-recovery characteristics and the substrate's photosensitivity.

GT&E plans entry into telephone switching market

Within three years, independent telephone companies will be able to purchase electronic switching equipment similar to gear introduced by the Bell System recently in Succasunna, N.J. The Automatic Electric Co., a subsidiary of the General Telephone and Electronics Corp., has installed a test model of the system, called E-A-X, for electronic automatic exchange, in Portage, Ind. The Bell System equipment, produced by the Western Electric Co., isn't being sold outside the American Telephone & Telegraph Co.'s family of telephone concerns.

GE's scr claims capability record

A solid state switch that can handle 1,200 amperes (root mean square) of continuous current will be introduced next week by the General Electric Co. The device is four inches long, water-cooled and consists of two silicon controlled rectifiers connected in parallel. It has a blocking capability of 1,800 volts and can withstand surges of 7,000 amperes. Applications for the device include plating, battery charging, welding and induction heating control.

Electronic range to test weapons

The Raytheon Co., has been awarded an \$11.4-million Air Force contract to build an electronic testing range for limited-warfare weapons. The program—weapons effectiveness testing (WET)—is designed to provide a realistic environment for testing aircraft, vehicles, missiles, artillery, rockets and other weapons [Electronics, Aug. 24, pp 98-104]. The system records the changing positions of the weapons, with hits and misses. The range, with a 100-mile diameter, will be built at Eglin Air Force Base, Florida, and will test gear up to an altitude of 70,000 feet.

'Hello. The copying machine is calling'

A portable facsimile machine that delivers the message over any distance by telephone has been developed by the Magnavox Co. The machine, the Magnafax 840, needs no special coupling to the telephone. It will be sold by the Xerox Corp., which dominates the copying market.

A few details are available on how the system operates—a document is fed into the Magnafax machine; the paper is electronically scanned and its contents converted into a series of tones that are picked up by the telephone handset. The tones, or signals, are transmitted to the receiving telephone and a Magnafax at the other end of the line. It's claimed that an 8½ x 11 inch letter, on any kind of paper, can be transmitted and received in six minutes.

Addendum

Honeywell, Inc., announced a major price-policy change in a drive to stimulate customers to buy, rather than rent, computers. Now customers will receive a 7½% discount on machines bought outright.

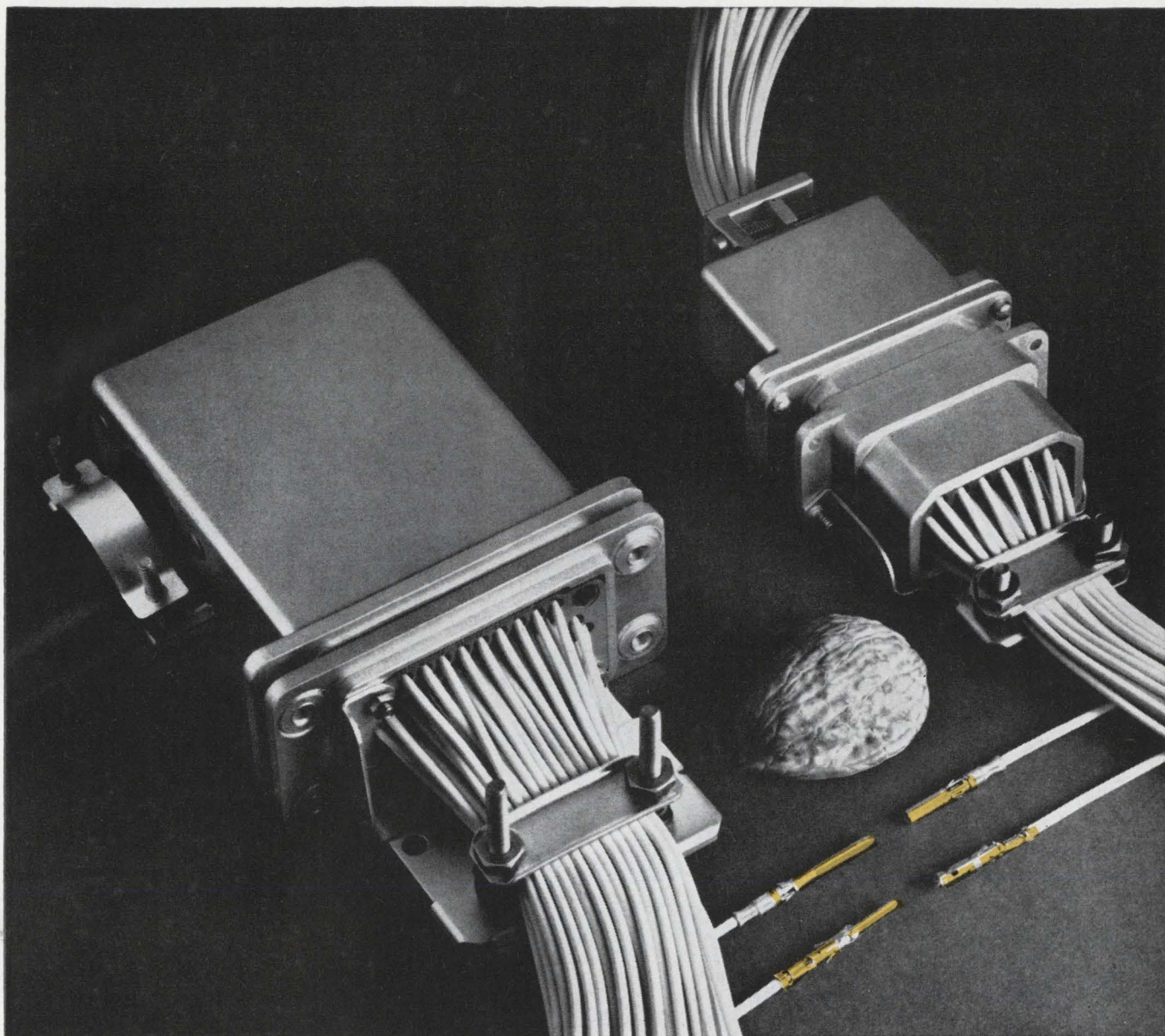

Guess which shell has the coax contacts

The old shell game has nothing on AMP's new subminiature COAXICON★ contacts. They're interchangeable with any A-MP★ pin and socket contact in any Series D or W Connector. No need to stock a dozen or more different housing configurations . . . both contact styles fit the same diameter cavities.

Just select the pin and socket connector with the number of positions you need (from 14 to 156), terminate your leads with AMP's matched hand or automatic crimping tool, and snap either or both types of contact in whatever configuration you want.

Our subminiature COAXICON contacts are designed in only two parts—contact assembly and ferrule—for application with a single controlled crimp. A variety of pin and socket contacts are available in strip form for high-speed automatic machine application. Both types of contacts feature long-life closed-entry design and AMP's exclusive gold-over-nickel plating.

Add to contact versatility the time-proven features of AMP's metal encased pin and socket connectors . . . in a nutshell:

- Meet applicable portions of MIL-C-8384, MIL-N-14, MIL-STD-202
- Ruggedized die-cast aluminum shells in a choice of finishes
- Glass-filled daillyl phthalate plastic inserts per MIL-M-14F, type SDG-F
- Variety of sizes and configurations
- Housings fully enclose contacts with optional hardware for maximum protection

Which shell has the COAX contacts? They all do! You can mix or match contacts in our Series M non-metallic shell connectors, too. Write today for all the facts.

★Trademark of AMP Incorporated



A-MP★ products and engineering assistance available through subsidiary companies in: Australia • Canada • England • France • Holland • Italy • Japan • Mexico • Spain • West Germany

Now available from Philco— industry's most called-for differential amplifier: the high-gain wideband PA 702A

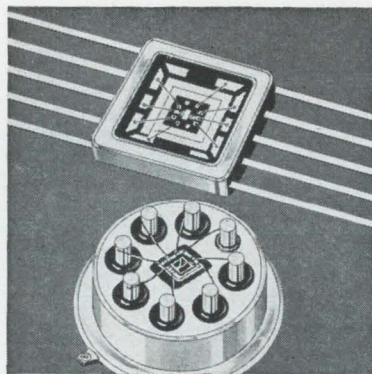

The new Philco PA702A is a linear integrated circuit, fabricated by the silicon planar epitaxial monolithic process*. A glance at the basic specs makes it clear why there is an urgent need for this differential amplifier in such applications as high-speed analog computers, precision instrumentation and general measurement circuitry.

The input offset voltage is low: 2mV. The voltage gain is high: 2800. The frequency range is wide: DC to 30Mc. The operation temperature range is full military: -55°C to 125°C . The power dissipation is moderate. The unit has provisions for external compensation of lead and lag networks. And all Philco PA702A units are tested 100%.

For maximum versatility, the PA702A is available in both Flat Pack and TO-5 packages.

For further information, detailed specifications and design quantities, call your Philco distributor. Now.

*Manufactured by Philco under a cross-license agreement with Fairchild Camera and Instrument Corporation.

The PA702A is available from these Philco distributors:

ALAMOGORDO, N.M.
Kierulff Electronics, Inc.....(505) 437-0370

ALBUQUERQUE, N.M.
Kierulff Electronics, Inc.....(505) 268-3901

BALTIMORE, MD.
Electronic Wholesalers, Inc.....(301) WI 5-3400

CHICAGO, ILL.
Semiconductor Specialists,
Inc.(312) NA 2-8860

DAYTON, OHIO
Semiconductor Specialists, Inc....(513) 277-9784

DEARBORN, MICH.
Semiconductor Specialists, Inc.(313) LU 4-5901

DENVER, COLO.
Kierulff Electronics, Inc.....(303) 825-5347

DISTRICT OF COLUMBIA
Electronic Wholesalers, Inc.....(202) HU 3-5200

HUNTSVILLE, ALA.
Electronic Wholesalers, Inc.....(205) 534-2461

LOS ANGELES, CALIF.
K-Tronics(213) OV 5-5888

MIAMI, FLA.
Gulf Semiconductor, Inc.....(305) 887-6541

MINNEAPOLIS, MINN.
Semiconductor Specialists, Inc....(612) 866-3434

MOUNTAIN VIEW, CALIF.
Kierulff Electronics, Inc.....(415) 968-6292

NEW YORK, N.Y.
Milgray Electronics, Inc.....(212) YU 9-1600

PHILADELPHIA, PA.
Milgray Electronics, Inc.(215) BA 8-2000

PITTSBURGH, PA.
Semiconductor Specialists, Inc....(412) 731-2050

ST. LOUIS, MO.
Semiconductor Specialists, Inc.(314) JA 1-8866

SAN DIEGO, CALIF.
Western Radio & TV
Supply Co.(714) BE 9-0361

SYRACUSE, N.Y.
Eastern Semiconductor
Sales, Inc.(315) 454-9247

WALTHAM, MASS.
Q.P.L. House, Inc.....(617) 899-0870

WINSTON-SALEM, N.C.
Electronic Wholesalers, Inc.....(919) PA 5-8711



MICROELECTRONICS OPERATION

PHILCO®

A SUBSIDIARY OF *Ford Motor Company*

LANSDALE DIVISION • LANSDALE, PA.
In Canada, Don Mills Road, Don Mills, Ontario, Canada

Communications

Laser tv camera

The Perkin-Elmer Corp. has developed an experimental television system in which a rapidly scanning laser beam takes the place of a light source and a multiplier phototube takes the place of a tv camera.

The system produces a tv image as sharp as that of commercial tv, and says the developer, Marvin J. Fenton, with some adjustments of the scan rate, the image can be made even better.

A wide range of applications, including police and military use, is possible because the laser beam is nearly invisible and no auxiliary light is needed for picture-taking. In fact, Fenton adds, were the laser-camera to operate in a brightly lighted studio, adjustments would have to be made in the system.

No danger. The laser's output is only 15 milliwatts, continuous wave—too weak to injure a subject directly in the beam's path, but strong enough to take a picture of a subject standing in a light rain some 30 feet away. With design changes, the camera can photograph a subject up to a mile away, Fenton says.

Basic to the system's operation is a mechanical technique for scan-

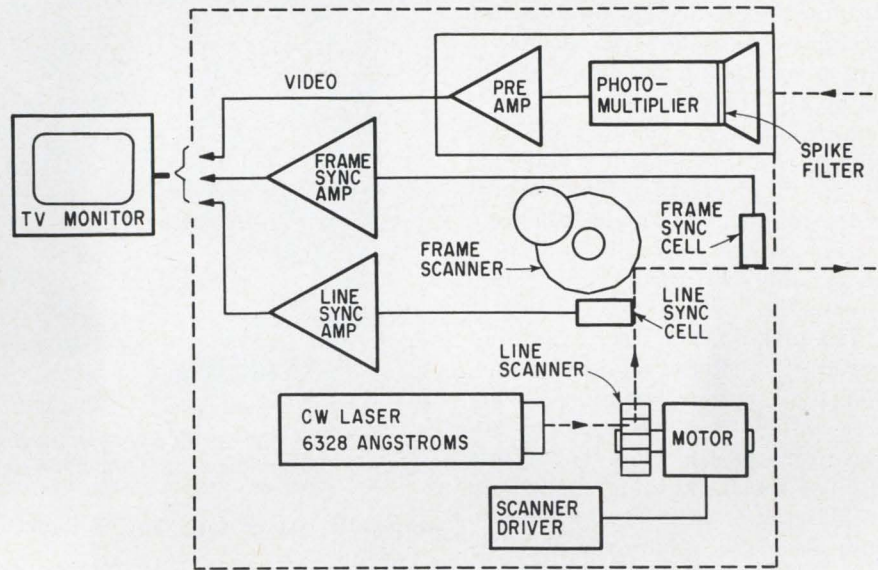

Laser-television system developed by the Perkin-Elmer Corp. uses a multiplier photocell as its tv camera while a laser beam supplies the light.

ning the subject with the thin laser beam. The scanning rate has been designed to be compatible with commercial tv: 15,750 lines per second, 60 frames per second. Commercial tv sets, however, actually operate at only 30 frames, but because the beams are interlaced, the effective frame rate is 60 per second. The monitor used in the Perkin-Elmer system was adjusted to operate at a full 60 frames.

Two steps are used to deflect the c-w laser in two axes. First the beam is aimed at a 16-sided prism

that rotates at 60,000 revolutions per second. During the fraction of a second that the beam is striking one side of the prism, the angle between the beam and the face of the prism is constantly changing, altering the angle of reflection; this produces a scanning motion—about 16,000 scans per second—of the reflected light in the horizontal axis.

The horizontally scanning beam then strikes a frame scanner, a 24-sided mirror that turns at 150 revolutions per minute. Using the same general technique as the line scan-

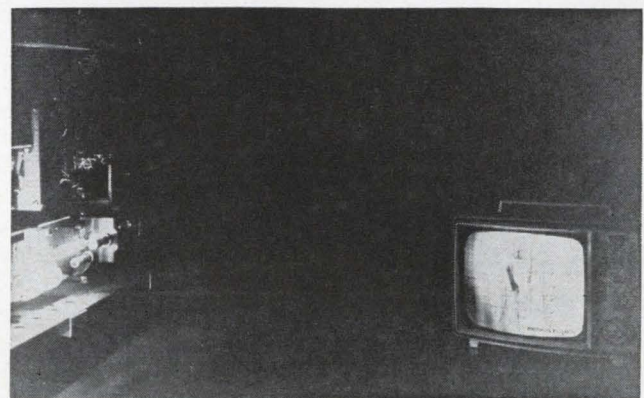

Light on or off, an image of the model appears on the television monitor. Illumination comes from a rapidly scanning laser beam that's virtually invisible to a person in front of the camera.

ner, the frame scanner dips the horizontally scanning beam up and down 60 times per second.

To keep the horizontal and vertical scan rates in step with the tv monitor's deflection circuits, the designers installed photocells in two places along the laser beam's path: at a point after the light is reflected by the line scanner and at a point after the light is reflected by the frame scanner. The outputs of the photocells provide synchronization signals for the monitor's horizontal and vertical deflection circuits.

The pick-up. The laser beam that is reflected off the subject is then picked up by the system's receiving unit, which is made up of a 90-angstrom spectral filter that rejects 99% of the background light, and an 11-stage multiplier phototube with an S-20 photocathode. The signal then is amplified and fed directly into the tv monitor producing an image on the screen.

Although Perkin-Elmer declined to speculate on the possibility, this kind of television system could be used effectively in antisubmarine warfare. If an argon blue-green laser beam, whose frequency is attenuated very slightly by sea water, were used in an underwater laser-tv system, submarines or other underwater targets could be spotted far off. Regular tv cameras can't "see" far under water because ordinary light is attenuated by seawater.

Another military application is seen in aerial reconnaissance; an ultraviolet laser-tv camera could pierce dense jungle camouflage to provide a tv picture of a hidden military installation.

Industrial electronics

IBM in traffic

Every United States city that has a population over 50,000 and traffic snarls is a potential customer for a computerized traffic-control system. And the best advertisement for buying the system is free and is

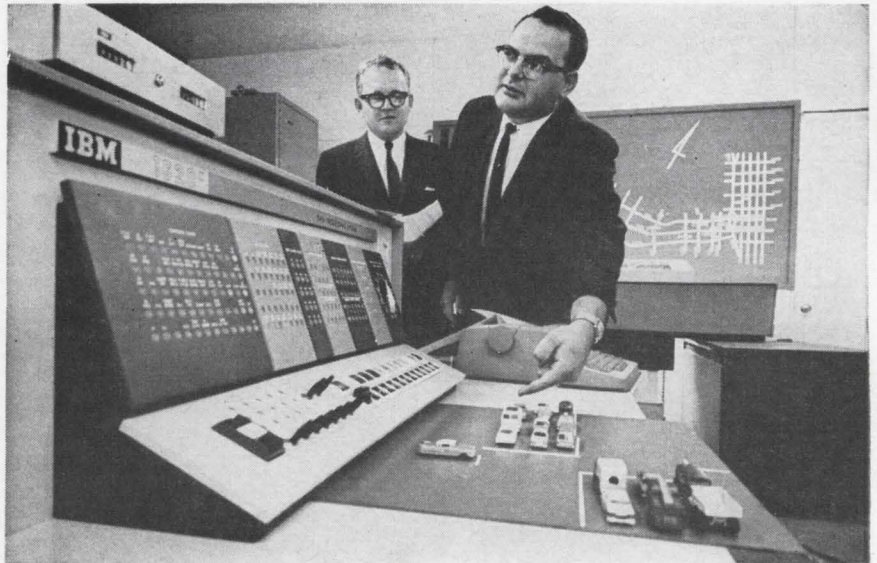

Hoping to put millions of people in the driver's seat, IBM engineers look over their traffic-control computer under test in San Jose, Calif.

repeated twice daily for millions of people.

That's the way the International Business Machines Corp. sizes up the market for computerized traffic systems, a market IBM has now decided to invade after holding back for several years. There are 333 U. S. cities of over 50,000 population.

Joint venture. As a testing ground for traffic-control systems, IBM officials at the company's San Jose, Calif., industrial controls facilities selected the city in which they were headquartered. The officials went around the block to San Jose's city hall and proposed a joint venture: IBM would share the cost of installing the system with the city.

So far, San Jose has spent about \$250,000 to install the roadbed sensors, while IBM has contributed a 1710 computer (a converted 1620 computer) and the technical force. An estimate of the results to date: traffic is moving through the city 15% faster, although the system is far from complete.

Some half-dozen electronics companies in the United States and abroad have been installing computerized traffic systems in major cities for some years. Earlier this year, the Sperry Gyroscope Co. won a \$5.5-million contract from New York City for sections of a traffic-control system. [Electronics, May 17, p. 30]. The company, a

subsidiary of the Sperry Rand Corp., now has the inside track for \$100 million of additional equipment for the city. The first phase of New York's system is scheduled to become operational early in 1966.

Pavement sensors. To collect San Jose's traffic data and to analyze traffic patterns, 400 sensors were installed beneath the pavement at various intersections. They were installed in a downtown sector and along a three-mile highway leading to the sector. There are 35 blocks controlled by 28 traffic signals in the downtown section and 32 signals along the highway, a road used by 35,000 cars daily. The system represents the highest density of sensors of any traffic-control project in the country, says IBM.

About 70 of the sensors are the old pressure-pad type (because they were already installed), but the rest are inductance loops—square coils of wire creating a magnetic field that is broken or interrupted each time something metallic crosses the loop. The six-by-seven-foot sensors are situated from 200 to 600 feet before a traffic light.

The loop, or pressure-pad, is connected to a curbside amplifier with a crystal-controlled 100-kilocycle oscillator. A metallic object crossing the sensor changes the phase of the oscillator. The phase change is then picked up by a detector,

triggering a d-c amplifier relay that produces a contact closure; this brings the input level to ground, thereby sending an impulse of a car's presence to the central computer.

Computer's functions. The central computer makes these basic measurements: over-all traffic volume, speed, lane occupancy, number of cars being sensed at a given moment, whether they are moving or stopped and if stopped, for how long.

The computer contains tables of operations for each intersection in the system. This table tells the computer when to change traffic signal cycles and how to time green lights to keep traffic flowing. The computer goes through its stored tables of operations once every second to determine which signal controllers at which intersections have to be adjusted for changes in traffic patterns. The computer also goes through sub-routines to check its various functions and monitor its own decisions.

The system provides almost instantaneous readout of the traffic situation, and comparison of successive results allows changes to be made to speed traffic flow. The computer revises its tables of operations every minute, so that the computer's reference table is always current with traffic demands.

Avionics

Inching down

By 1970, commercial airlines pilots coming in for landings in near-zero visibility have nothing more to do than look out the window in the last few moments to make sure the runway is there. Everything else will be done by electronic instruments computing the altitude, position on the glide path and wind conditions—and setting the plane down without a hand on the controls.

For U. S. airlines, bad-weather landing capability could mean savings approaching \$60 million a year—the cost of weather-caused delays, diversions and cancellations.

For the electronics industry, it means millions of dollars worth of business and stiff competition.

Step-by-step. Airlines and the Federal Aviation Agency are moving in stages toward blind-landing capability. The pace picked recently as:

- The FAA signed a \$741,500 contract with Lear Siegler, Inc., to design and test an all-weather, fully automatic landing system. The contract calls for installing and flight-testing the system in an FAA Convair 880 by March, 1967. The tests will lay the basis for commercial all-weather cockpit requirements.

- United Air Lines won FAA approval to land passenger planes under conditions of 150-foot ceiling and 1,600-foot visibility along the runway. After a six-month period, United is expected to get a go-ahead for full Category II landings—100-foot ceiling and 1,200 foot runway visibility. The present limit for other airlines is a 200-foot ceiling and a half-mile runway visibility; but three airlines have notified the FAA that they are working on meeting Category II qualifications, and others are buying the necessary equipment.

The FAA certified a new approach system for the Boeing 727 for Category II landings. The Boeing Co. and the Sperry Rand Corp., say the system also is capable of the next step on the way to zero-zero landings—50-foot ceiling and about 700-foot runway visibility. The agency already had certified a Boeing-Bendix system for the Boeing 720 and—under a reciprocity agreement with France—had accepted a Lear Siegler system for use in the French Caravelle.

The newest piece of equipment required by the FAA for Category II landings is a radio altimeter, to give the pilot precise readings as the plane approaches the 100-foot decision level.

The competition. Among companies offering radio altimeters are the Collins Radio Co., the Bendix Corp. and Litton Industries, Inc. Litton uses a klystron transmitter, but all the other companies offer instruments made of solid state components. Generally, companies

are closed-mouthed about prices, but United Air Lines has said it will equip 164 of its planes with the Collins altimeter for a bit more than \$1 million, and Litton's version would be priced in the \$7,000 to \$10,000 range on a single-order basis. Honeywell, Inc., is producing a radar altimeter for use in the F-111's terrain-avoidance and terrain-following system, but it is expected to be priced out of the commercial market.

Other cockpit equipment required by the FAA for Category II includes: instrument landing and glide-slope receivers; flight-control guidance systems; equipment for go-around attitude guidance; glide-slope extension equipment to follow through along the glide slope at altitudes below the present reliability of the instrument landing system and an instrument-failure warning system.

Lear Siegler's package for the FAA test of zero-zero landings will include: two radar altimeters, a flare computer to break the plane's rate of descent and level it off for a soft touchdown; a computer to compensate for wind shear; an auto-throttle computer; two flight mode indicators and devices to test the system before each landing, warn of a failure in the system and test out each component in the air.

The system also will have to be designed to accommodate additional components that will not be required for the FAA tests, mostly to provide backup or visual monitoring of the system's performance.

Consumer electronics

IC's for hearing aids

In the late 1950's, the transistor revolutionized the hearing aid market: production prices dipped, reliability soared and equipment was miniaturized. Now, in 1965, another revolution is in the making: integrated circuits for hearing aids, and production prices are expected to start falling, while reliability rises

and miniaturization continues.

In 1963, the first IC—a monolithic type—was introduced to the hearing aid market by Zenith Hearing Aid Sales Corp., a subsidiary of the Zenith Radio Corp. Zenith, the sales leader in the hearing aid field, has since expanded to use of IC's to 35% of its models.

Eugene M. Kinney, president of Zenith Hearing Aid, says, "By 1970 almost all hearing aids (sold in the United States) will use some form of IC: thick-film, thin-film or monolithic."

Pro and con. Which of the three IC forms is the "right" one is being debated within the industry.

Says Zenith's engineering director, William H. Greenbaum: "Monolithic IC's are 500 times more reliable than any transistorized or hybrid circuits on the market, are competitively priced and are usable in 80% of all applications.

"Not so," contends an executive of the number two producer, Beltone Electronics Corp. Beltone's vice president of engineering, Lawrence M. Possen, argues: "Operating characteristics are not flexible enough and performance is below that of thin-films." In addition, "monolithics are still too high-priced," he says.

Zenith and Beltone together control some 50% of the hearing aid market. Another 20% of the market is held by the Sonotone Corp., which leans toward thick-film in the few IC models it offers.

Beltone may prefer thin-film IC's because it produces its own circuits—the only company in the industry to do this—and has a sizable investment in thin-film production facilities.

Outside buying. Zenith, however, buys its circuits on the open market. Until recently, that meant Zenith bought from Texas Instruments Incorporated exclusively. TI introduced the first hearing-aid IC—developed jointly with Zenith—in 1963. But now there are 11 other companies offering hearing aid IC's and Zenith is buying some IC's from the Westinghouse Electric Co.

The Westinghouse circuit, a monolithic Class B push-pull IC, was developed jointly with Zenith

and costs from \$6 to \$8, the price at which TI's circuit—a monolithic Class A single-ended IC—is being sold to Zenith.

Early next year TI plans to introduce a monolithic Class B push-pull IC, priced from \$15 to \$20. For its Class A amplifiers, prices will be cut 30% in 1966 and probably another 20% in 1967, says a TI marketing manager for liner IC's.

So far, sales volume has generally been limited by the retail price of hearing aids: \$250. It's estimated that there are about two million hearing aids in use today, with some 350,000 sold each year. But the American Hearing Society estimates that there are five million additional people in the United States who need hearing aids.

"Prices could drop by perhaps 25%," says Zenith's Kinney. "This would be due to lower packaging costs and high-volume production," he explains.

The switch to IC's also means size reduction—but this has a limit "and we're near that limit on microphones and earphones right now," says Zenith's Greenbaum. The next step, he adds, will be the development of a technology to reduce the size of those components. Such work is currently under way—using semiconductor materials—at the Bell Telephone Laboratories. "But it will take three to five years before they are commercially available," Greenbaum adds.

Instrumentation

Checking the T pulse

Every sixtieth of a second, television stations transmit a test signal whose duration is so brief that the viewers can't see it. The waveform is a standard that the studio engineer uses to tune his transmitter for high-quality video pictures. But once the tv program is relayed over the vast network of microwave stations, the engineer no longer controls the quality of the picture. And all too often, he isn't satisfied with the way the microwave stations relay the program.

Because of such complaints, the Bell System, the largest owner of microwave relay stations, turned to oscilloscope makers for equipment an order of magnitude more sensitive than that used by the commercial stations.

Bright response. Bell asked the Fairchild Camera & Instrument Corp., Tektronix, Inc., and the Hewlett-Packard Co. for a scope to display signals such as T/2, and T and 2T sine-square test pulses that are as brief as 62.5, 125 and 250 nanoseconds and occur at repetition rates as low as 60 per second, or once per tv field. In addition, Bell wanted the instrument to have at least 1% vertical accuracy, with 1% stability for all operations. And the scope's signals had to be bright enough to be visible in high ambient light.

Fairchild and Tektronix offered Bell modified scopes that met most of these specifications. H-P, on the other hand, which had no off-the-shelf instrument to offer, designed an entirely new scope with the aid of a computer for some of the more complex circuits, and Bell bought it. The instrument is the first tv waveform-monitor made exclusively of solid state components, H-P says.

To achieve high brightness levels when displaying short pulses of low duty cycle at high magnification, the company had to improve the efficiency of the tube's electron gun structure. A boost in the cathode's electron density would have served the same purpose, H-P engineers point out, but the instrument would not have provided high reliability because of greater strain on the electron gun.

Hewlett-Packard now plans to expand its market for the new instruments and expects to offer a commercial version to tv broadcasters early this spring.

Space electronics

Sights on solar flares

High on the list of hazards in space exploration is the danger of long exposure to radiation. The National

HERE'S WHAT THIS 5 WATT ZENER DID FOR ONE COMPANY!

- Reduced weight 93%
- Reduced size 90%
- Reduced cost 73%

IMPRESSIVE? Read on so you can achieve similar savings.

CASE HISTORY

This company has a design engineer--let's call him Bill--who had a problem. Line spikes were causing high base to emitter voltages that were destroying a transistor in the emitter-follower of Bill's solid state amplifier. Transistors with high base to collector voltages were both expensive and difficult to get.

The 24 volts of power for Bill's amplifier came from a high current, low voltage supply that also fed several other sub-assemblies. Bill found that when he inserted sufficient limiting impedance to protect the transistor, the circuit wouldn't operate satisfactorily.

What Bill needed was a line voltage transient clipper that would conduct high current during transient surges while having no steady state power consumption--a 36-volt zener!! Now he had a choice--a bulky 50 watt stud (1N3326), or an equally bulky 50 watt T03 (1N2885).

or

a Unitrode UZ5836, miniature axial leaded zener with a comparable surge rating. He chose the latter and saved in weight, size, and cost.

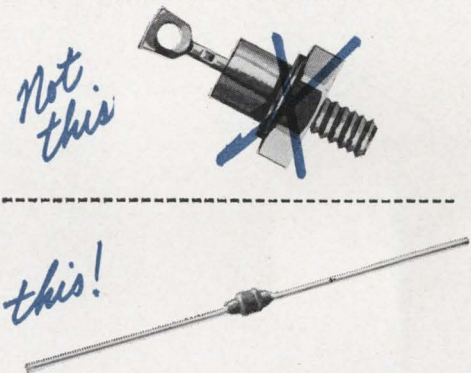
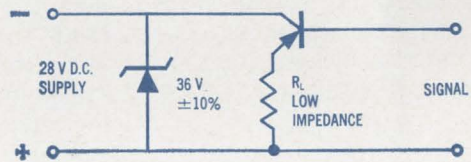

UNITRODE®
"better always/by design"

YOU CAN DO THE SAME. Contact the factory, call your local COMPAR office, or circle the reader service number on the magazine's reply card. All will insure your receiving data sheets and samples of Unitrode Zeners as well as information on other semiconductor devices immediately.

580 Pleasant Street, Watertown,
Mass. 02172 Telephone (617) 926-0404
TWX (710) 327-1296

Aeronautics and Space Administration has already orbited satellites to study solar flares, which spew out lethal high-energy protons, but many questions are still unanswered. NASA hopes to close this information gap sometime in 1969 when its advanced orbiting solar observatory (AOSO) relays data gathered by a new kind of x-ray telescope.

Looking at x-rays. Instead of directly measuring the flow of protons—which travel relatively slowly—the AOSO designers decided to focus on soft x-rays (6 to 60 angstroms), which are also produced by solar eruptions and which travel at the speed of light. The flux of the x-rays, the scientists found, is proportional to the size of the solar flare. To take these precise meas-

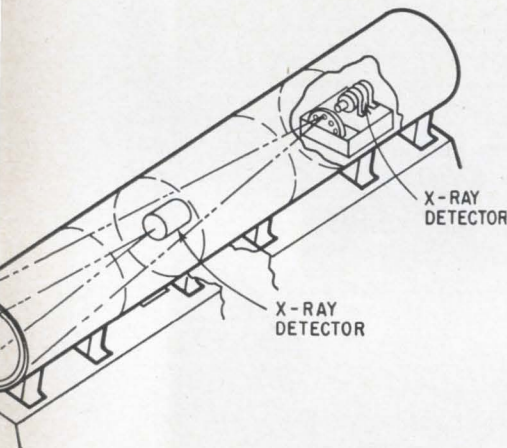

Two-in-one x-ray telescope will gather details on solar flares. Rays entering the slits on the face of the telescope are picked up by detectors and converted into video signals.

urements, the x-ray telescope—actually two telescopes, one inside the other—will convert x-ray beams into television signals. When the video signals reach earth, scientists will view an image of the solar flares.

AOSO is still in the development stage, but much of the basic design of the x-ray telescope has been established. It will consist of a nickel tube, about 27 inches long and about nine inches in diameter. At the face of the instrument, two

pair of curved slits have been cut: one pair is near the edge of the face and the other is near the center (see diagram at left).

X-rays that pass through the outer pair of slits focus on an x-ray detector at the opposite end of the tube, while rays that pass through the center slits are focused on a detector about half way down the tube. Stray rays—those that don't enter the slits in a path perpendicular to the face of the telescope—are deflected by the highly polished inside layer of the tube and eventually are routed to the x-ray detectors.

Video signals. At the x-ray detector, the rays are converted into video signals. The larger telescope produces a picture once every eight minutes and the smaller one, a crude but continuous picture nearly in real time.

The technique for transmitting the video signals back to earth is similar to that used aboard Mariner 4: the analog signals are converted into digital pulses, stored on magnetic tape and transmitted at convenient times back to ground stations on the earth.

The designs differ for the two x-ray video sections. The electronic gear for the larger telescope contains a vidicon tube, which produces a 480-line picture. The shorter scope, on the other hand, contains a scintillator that is electronically scanned once every 10 seconds—the scanning occurs not over the entire face of the scintillator, but only at about 900 points. Because the picture produced by this telescope contains only 30 lines per picture, new images are generated in rapid sequence.

Present plans are to send the 1,250-pound AOSO into a north-south polar orbit, so that it would be able to focus continuously on the sun for at least six months.

The AOSO telescope was designed by Riccardo Giacconi of American Science & Engineering, Inc., and the late John C. Lindsay of NASA's Goddard Space Flight Center. The spacecraft's prime contractor is the Republic Aviation division of the Fairchild Hiller Corp.

Keeping it clean

The National Aeronautics and Space Administration has mounted an intensive campaign to insure that no space capsule landing on Mars will have aboard any hitchhikers — microorganisms which could contaminate the planet. Faced with the prospect of building a sterile capsule, manufacturers have shuddered: for sterility, like pregnancy, is absolute. It means that the capsule must be free of bacteria. Yet this month at NASA's conference on spacecraft sterilization technology, held at the California Institute of Technology in Pasadena, Calif., the manufacturers heard some evidence that the task may not be as difficult or as expensive as they had believed.

Current requirements for sterility dictate that the entire capsule be assembled in a laminar-flow clean room, where there are only 100 particulates in the 4-to-5-micron range per cubic foot of air.

Sterile building. Under such circumstances, building components, systems and capsules is difficult and time-consuming. Now, there is a possibility that this kind of clean room may be required only for the final assembly.

The reason: engineers who had previously insisted that components be heated only once, had some second thoughts about reliability (Heating in dry nitrogen is the only accepted method of sterilization, though chemicals may be used for prior decontamination.) The procedure was for the original raw materials to be heated to destroy interior organisms, before the materials were made into components, and for the entire capsule to be heated for final sterilization. In between, all processes took place in the clean room.

Some reliability engineers now feel that that process is too risky, for it amounts to sending the capsule off untested. They suggest heating the capsule after it is completed, testing it (which introduces recontamination) reheating the capsule, and then flying it.

Given a chance for a second heating, the Jet Propulsion Laboratory at Cal Tech, which is handling the

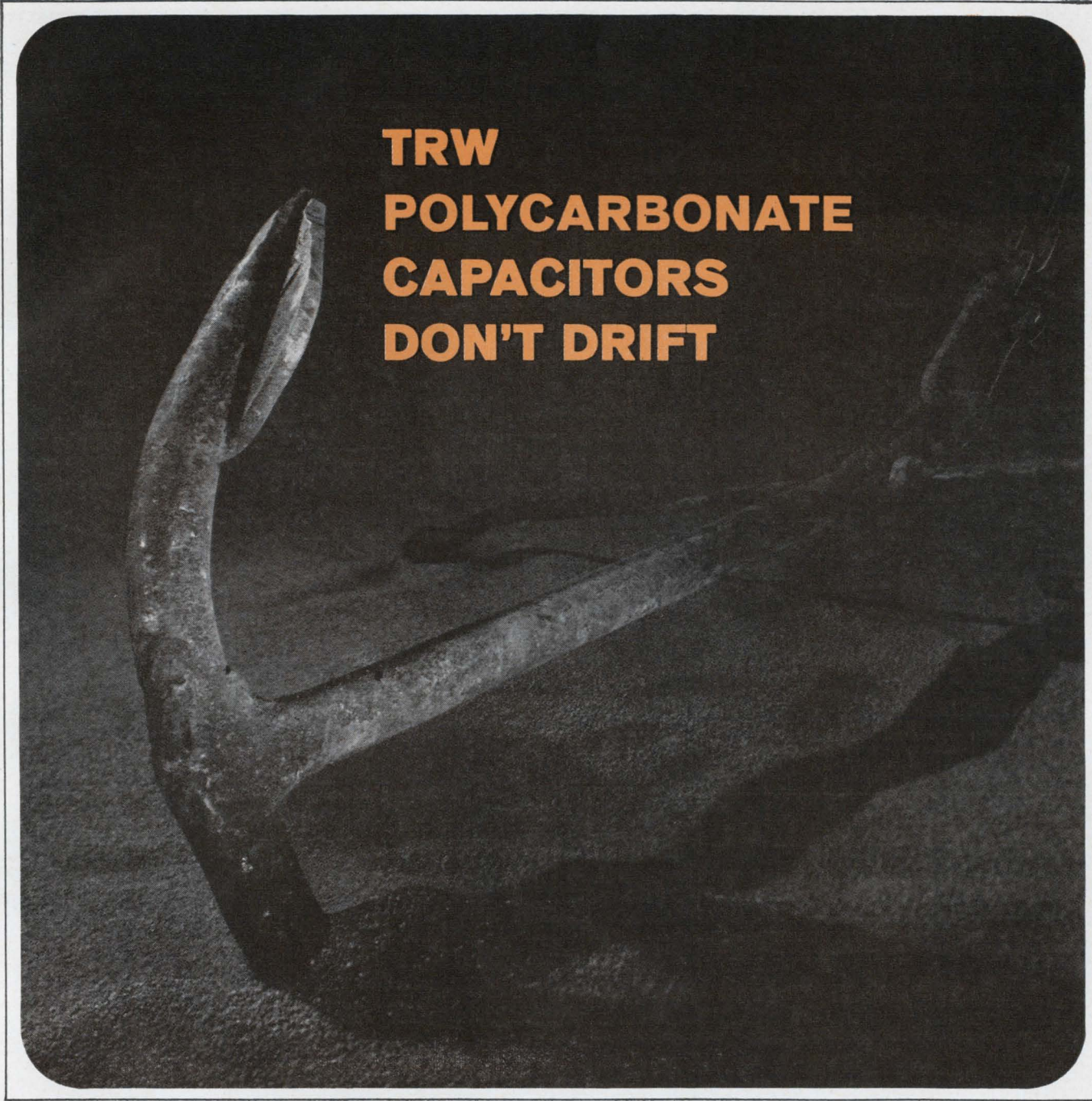

TRW POLYCARBONATE CAPACITORS DON'T DRIFT

Less than .01% T.C. from 0°C to +125°C

TRW—acknowledged leader in film capacitors—continues its leadership with advanced polycarbonate types providing *mica-like stability* through 125°C.

This is a complete new line of low-TC devices designed for no-drift performance at elevated temperatures.

TRW polycarbonates are offered in a variety of styles to meet all design needs for operation from -55°C to 125°C.

- **WIDE-RANGE TEMPERATURE STABILITY**—< 1% capacitance change from 0°C to 125°C (positive or negative TC available).
- **LONG STABLE LIFE**—less than .1% drift after 10,000 hours.
- **CLOSE TOLERANCE**—available in capacity tolerances to ±.5%.
- **SMALL SIZE**—up to 90% less volume than paper dielectrics.
- **QUICK DELIVERY**—widely used styles available from stock.
- **MIL-C-19978 and MIL-C-27287** performance and ruggedness.

For full information phone, wire or write: 112 West First Street, Ogallala, Nebraska. Phone: 308-284-3611. TWX: 308-526-7816.

TRW CAPACITORS

New industrial report stimulates development in Suffolk County, N. Y.

A recently completed industrial development study by the A.D. Little research organization, has sparked new efforts to achieve a dynamic blueprint for economic progress in Suffolk. An analysis of the report, presented to one hundred leaders of government, industry and education, evoked enthusiastic response.

Responding to the efforts of its highly progressive industrial commission, Suffolk's development program points toward expanding opportunities in many diversified fields, including food processing, structural products, printing and publishing, plastics, apparel machinery, instruments and electronics. Expansion also is continuing in the already established aero-space and atomic energy industries.

With still vast areas of attractively zoned and reasonably priced land available, plus a steadily increasing labor pool, Suffolk continues to welcome a growing tide of inquiries about the many advantages this attractive county has to offer.

News of the varied aspects of industrial development in Suffolk County is now available to officers of companies, in a bi-monthly newsletter titled: "News of Tomorrow, from Suffolk County." To receive it regularly, fill out the coupon below.

David J. Kepner, Director
SUFFOLK COUNTY DEPARTMENT OF
COMMERCE AND INDUSTRY
 1136 Walt Whitman Rd., Melville, N. Y.
 Phone: (516) NA 7-2540

Please send me your free bi-monthly newsletter about industrial development in Suffolk County, New York.

Name

Title

Company

Product Service

Address

E

Electronics Review

Voyager Mars probe, came up with a new method. Components and subassemblies could be made by normal techniques and then heated to sterilize the interior of the components; final assembly could be performed in a clean room, followed by testing and terminal sterilization.

No one at Cal Tech or JPL was making firm estimates on savings, but one guess was that the first method would double the cost of a capsule, while the second would add only 15% or 20% to the final cost.

Double trouble. It's still up to NASA to decide how it will proceed. There are still many reliability engineers who feel that any time you heat a component, you damage it, so they will oppose a double heating.

Why sterilize at all? Mainly to preserve the ecology of Mars, so as not to confuse the scientists who study it. Without sterilization, they would have no way of knowing whether an earth type of bacteria actually originated on Mars, or had been transported there by our own spacecraft.

Advanced technology

New U-laser

The Avco-Everett Research Laboratory has developed a U-shaped nitrogen pulsed laser that has achieved a peak power of 200 kilowatts—the highest level yet reached with an ultraviolet laser of any type.

A commercial version of the unit, with a peak output of 50 kilowatts, also believed to be a record, has been sold to the DuPont Co. for studies of fluorescence.

The laser's application extends beyond studies of photochemical reactions, says Edward T. Gerry, who developed the new laser with Donald A. Leonard. The Avco researchers foresee its use in studies of the upper atmosphere, clear air turbulence and investigation into Rayleigh and Raman scattering.

The laser uses commercial-grade

nitrogen and produces pulses that last between 10 and 20 nanoseconds. The repetition rate is variable between 1 to 10 pulses per second, and the output bandwidth is less than one angstrom.

No Q-switching. Q switching isn't needed to produce the pulses; the pulse is self-terminating, and is determined by the lifetime of molecules that are excited into higher energy states. Since the laser lacks a storage mechanism, it requires a special power supply with short pulses.

The electric field that drives the Avco laser is applied across the discharge channel, perpendicular to the stimulated emission. This crossed-field geometry means that high electric fields can be produced over a large volume of gas with reasonable voltages, the developers say. If they had to be applied at one end of the channel, it would require prohibitively high voltages, they add.

A U-shaped aluminum channel two meters long serves both as a structural support and as one electrode of the rugged, table-top laser. The other electrode is also aluminum and runs the length of the discharge channel. The fast-rise current pulse is delivered from a capacitor bank to the laser through 11 transmission lines.

Components

Crack-proof seals

The weakest part of a hermetically sealed component is often the glass-to-metal seal around the conductor pins in the package header. Bend a pin too close to the glass and the seal is likely to crack.

That problem has now been solved, according to the man credited with the invention in 1944 of the kind of glass seals still used in thousands of header and terminal designs. A low-cost way of sealing the pins in ceramic, making the seals almost immune to mechanical and thermal stress, was disclosed by Mannes M. Glickman, president

of Hermetic Seal Corp., at Ceramic '65, a technical ceramics seminar held in New York this month.

Hot and cold. Glickman proved his point by taking a header with pins 0.060 inch in diameter and twisting one of the pins with pliers until it broke. The ceramic did not crack. Back at his plant in Rosemead, Calif., he said, similar headers had been dunked in liquid nitrogen and heated to 800°C five times without damage. It is now practical, he said, to make seals that will withstand operating temperatures higher than 1,000°C as well as the pressures that exist at the bottom of the ocean.

The new way is so much stronger, Glickman says, that the pins can be machined or formed after packaging, to facilitate mounting of components on the header. The package can be sealed by arc welding.

The new advance, he predicted, will "revolutionize" the hermetic sealing industry by making it practical to substitute ceramic for glass seals in headers, crystal holders, sealed housings, meters, transducers and many other kinds of components.

Substitute for glass. Glickman's competitors at the seminar quickly pointed out that ceramic seals have been made for years. True, said Glickman, but they have been too expensive for everyday use, requiring special designs, special tooling and processing, special sealing alloys, and reject rates have been as high as 95%.

The process, he said, results in virtually no rejects. The ceramic "beads" used as the seal part can be made with the same tools used to form glass beads. The seal designs can be exactly like those used for glass.

Metals, such as steel, stainless steel, nickel and probably copper can be used for the pins, instead of Kovar and other sealing alloys which have relatively low conductivity.

Hermetic Seal is now making prototype headers with ceramic seals. These cost 2½ times as much as the same headers with glass seals, but Glickman said he hopes

Ready to Talk High Volume Micro Module Insertion?

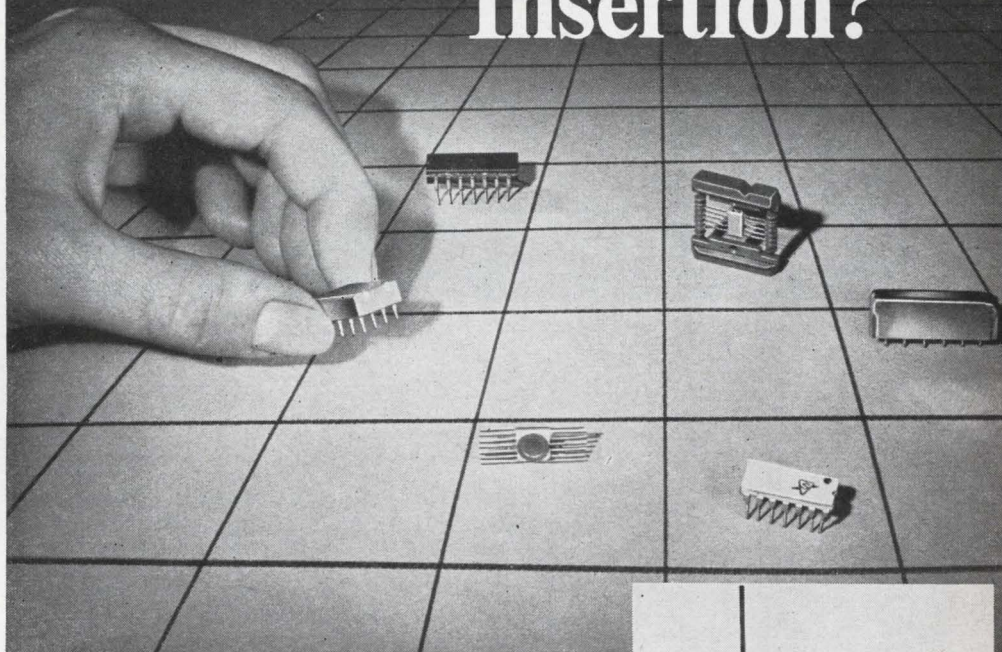

Then your first step should be a head-to-head discussion with our insertion machine specialists. No obligation of course, just a chance to take advantage of our unequaled experience in this new field, including . . .

- Micro module insertion systems both in service and being built . . . with repeat orders from the same customer.
- Micro module packaging studies underway with leading component manufacturers to develop units specially suited for automatic printed circuit board insertion.
- Development projects for high volume micro module users aimed at translating prototypes into efficient, economical and reliable assembly techniques.
- Plus a background of component insertion problem-solving, with over 10 million transistors and axial lead components a day being inserted into PC boards throughout industry using Universal designed and built machines.

Contact us today by letter or phone to see movies of Universal Instruments micro module insertion machines and other component assembly equipment . . . and to find out for yourself how our experience can help solve your micro module insertion problems.



This pantograph operated insertion machine was designed and built by Universal Instruments Corporation for 12-pin SLT modules. It orients them in any of four compass directions and inserts them in PC boards at a rate of 12,000 a shift. The same basic machine configuration can be adapted for Texas Instruments newly announced 16-pin plug-in flat packs.

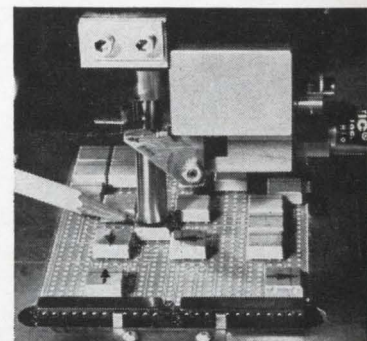

For precise temperature testing from -300°F to $+525^{\circ}\text{F}$

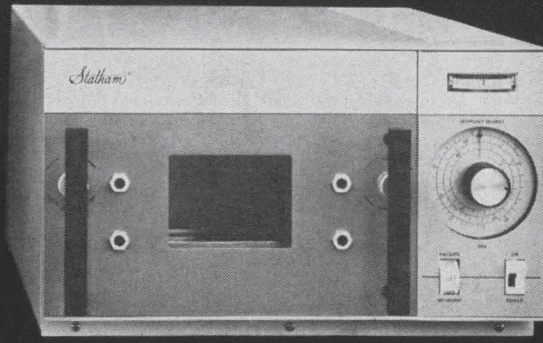

**STATHAM MODELS SD6 AND SD3
ARE 700 CU. IN. CAPACITY CHAMBERS
FEATURING $\pm\frac{1}{4}^{\circ}\text{F}$ CONTROL ACCURACY**

Designed for precise temperature testing of electronic components, Statham Models SD6 and SD3 chambers feature true proportional control of heater power by all solid-state circuitry.

This new generation of test chambers eliminates the conventional heater power relay, prevents cycling about the control point, and substantially *reduces* RFI noise.

The controller maintains a set-point temperature within $.01^{\circ}\text{F}$ per $^{\circ}\text{F}$ ambient. An improved controller design provides excellent temperature uniformity with gradients of $\pm 1.3^{\circ}\text{F}$ at 300°F .

SUPERIOR TEMPERATURE CONTROL

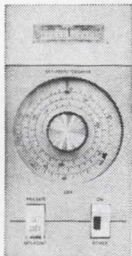

24 Inch Dial Control

Models SD6 and SD3 feature 24 lineal inches of calibrated set-point scale. Temperature readout is obtained by a deviation meter calibrated in one-degree increments. This expanded scale approach provides a level of accuracy and readability not attainable in conventional chambers.

Optional Push-Button Control

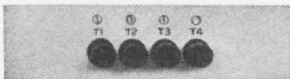

Frequently repeated temperature settings can be made faster and more accurately with Statham's *push-button* temperature selection control. The buttons, which may be set at any desired temperature, provide precise repeatability.

Cycle Time Controller

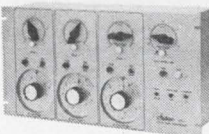

Statham cycle time controllers permit programming the chambers in any required sequence of hot-ambient-cold-ambient, etc.

with mass production to narrow the difference in cost to only about 15%.

The secret, he said, is a ceramic made of alumina powder and undisclosed additives. The composition is pressed with the tools used to press glass powder. When compressed and sintered, the ceramic becomes the same size and has the dimensional accuracy of glass preforms.

Its flexural strength is 40,000 pounds per square inch and its compressive strength 250,000 psi, Glickman said.

Unmatched materials. Glass preforms are melted around pins made of metal with a thermal coefficient of expansion like that of the glass. The ceramic preforms are metalized and the pins are brazed in place. The pins and ceramic don't have to be matched in expansion.

Apparently, Glickman explained the brazing alloy—generally silver or copper—has enough flexibility to absorb the thermal stresses.

He expects to braze up to 55 pins into holes in a ceramic bead $1\frac{1}{2}$ inches in diameter. That could not be done with regular ceramic beads, he said, because of dimensional variations. Pins had to be individually brazed to small ceramic beads, then the beads brazed into a metal header shell.

Electronics notes

▪ **Maser royalty.** The first license agreement under Charles H. Townes's maser patent was granted this month to the Western Electric Co., the manufacturing arm of the American Telephone & Telegraph Co. The nonexclusive license agreement offered by the Research Corp., a nonprofit company that holds the patent, calls for the payment of a 2% royalty, subject to minimum annual payments.

▪ **Video-stereo.** Akai Electric Co. of Japan soon will introduce the first combination video-stereo tape recorder. The machine, which will be marketed in the U. S. next June, can record and play back both stereo and video on conventional magnetic tape.



Statham Instruments, Inc.
Environmental Products Division
2221 Statham Blvd., Oxnard, Calif.
HUnter 6-8386 (Area Code 805)

Write for Statham's new 12-page Temperature Test Chamber Brochure.

COMPONENT COMMENTS *From Speer*

Has our traveling resistor show visited you yet?

We're referring to our new slide film presentation called "How a Speer Resistor Gets Its Stripes."

This lively 20-minute sound and color film follows a typical group of Speer composition resistors as they try to "shape up" to today's tougher MIL-R-39008 specs.

Starting with the first manufacturing steps, you'll see the

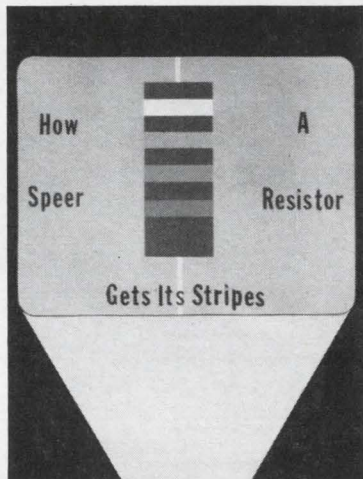

various tests that the raw materials have to pass. You'll see the exhaustive checks that accompany every step of resistor production. You'll see the latest electronic quality control and reliability equipment in action. And you'll see the proud moment when the resistors receive their insignia of uniformity and high quality — five colorful stripes.

If you're concerned with meeting military specifications, you'll want to arrange a free screening of this slide film. To do so, simply contact your nearest Speer representative. If you don't have his name, mail the coupon and we'll let you know where to reach him.

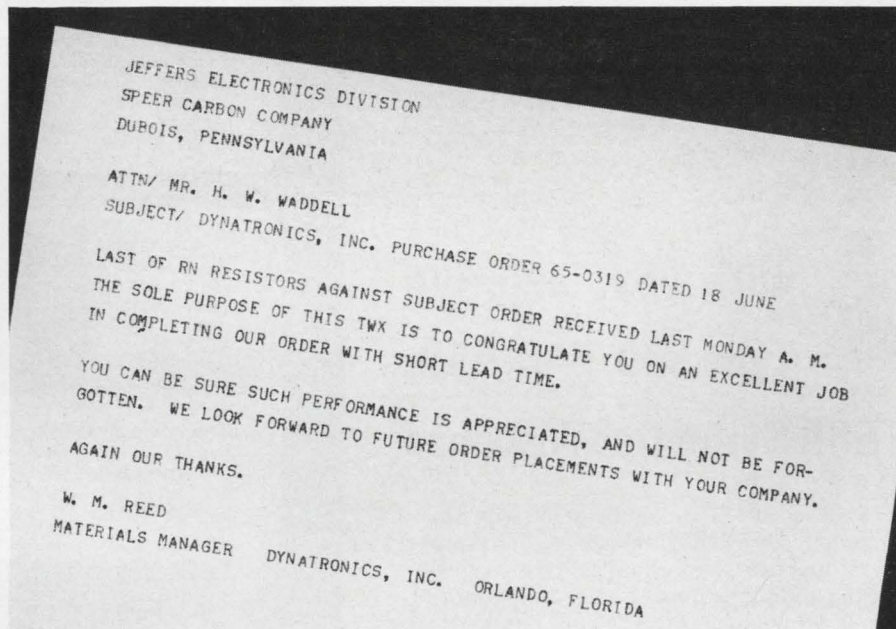

Fan letter. It seems that Dynatronics needed large quantities of .1% tolerance metal film resistors in a week. And only Jeffers Electronics would promise to meet their deadline. As you can see, we also kept that promise. Do we always deliver this fast? No. But even our normal delivery of standard JXP resistors is three times faster than the service you may be getting elsewhere.

If you're looking for the best temperature stability and least cost in a precision resistor, forget about its TC

We're as respectful of traditions as anyone. And we're well aware that the traditional determination of resistance-temperature stability is based upon resistance measured at two specified temperatures. (Otherwise known as "TC".)

We believe, however, that there is a more advantageous way to express resistor temperature stability — one that will prove less costly to you in situations where a high degree of stability is required.

We recommend instead a "design tolerance" or "total resistance deviation limit" expression of the stability of a precision resistor. For example, a resistor with an allowable total resistance deviation limit of 1,000 ppm over a given temperature range will satisfy the same circuit requirement as a resistor that is specified by a ± 5 ppm TC. Yet specifying a 1,000 ppm limit delivers a resistor that would cost only one third as much (and delivers it a lot faster, too).

We might mention our ultra-precise JXP metal film resistor at this point. It is available in tolerances that can meet

your toughest stability requirements.

A detailed discussion of our new stability determination method can be found in our article entitled "Specifying Resistance Temperature Stability." If you'd like a copy, simply mail the coupon.

JEFFERS ELECTRONICS DIVISION,
Speer Carbon Company
DuBois, Pennsylvania

Speer Carbon Co. is a Division of Air Reduction Company, Inc.

- Rush "Specifying Resistance Temperature Stability."
 Rush the name of my nearest Speer representative.

Name _____

Title _____

Company _____

Street _____

City _____

State _____ Zip _____

sampling made simple



with your existing
Type 530, 540, 550,

or 580* Series Oscilloscopes

Here's a new dc-1 GHz sampling unit with operation practically as simple as conventional plug-ins—as you can see by the front panel of the sampling plug-in. You need no pretriggers or external delay lines—the 1S1 unit has internal triggering with a built-in delay line.

Many other features add to the capabilities and operating ease of the Type 1S1, such as: A tunnel-diode trigger circuit that insures stable triggering through 1 GHz • A single control to select the sweep rate and magnify the display up to X100 when desired • Direct readout of the sweep rate even when magnified • A dc-offset control that permits observation of millivolt signals in the presence of up to ± 1 volt input levels • Less than 1 mV noise in the display, with a smoothing control for further reduction • Output signals available at the front panel for driving chart recorders—and for powering an auxiliary time domain reflectometer pulser unit.

BASIC CHARACTERISTICS

RISETIME ≤ 0.35 ns. SENSITIVITY from 2 mV/cm through 200 mV/cm, in 7 steps. DYNAMIC RANGE ± 2 V. Safe overload is ± 5 V. DC OFFSET range is greater than ± 1 V. SWEEP RATES from 100 ps/cm to 50 μ s/cm, with $\pm 3\%$ accuracy normal or magnified. SAMPLES/CM continuously variable. TRIGGERING ac-coupled, \pm internal, \pm external, and free run. DISPLAY MODES are repetitive, single display, manual scan, or external scan. VERTICAL OUTPUT is 200 mV per displayed cm through 10 k. HORIZONTAL OUTPUT is 1 V per displayed cm through 10 k.

Type 1S1 Sampling Plug-In Unit \$1100
Type 281 TDR Pulser Unit \$95

U.S. Sales Prices, f.o.b. Beaverton, Oregon

*used with Type 81 Plug-In Adapter.

For a demonstration,
call your Tektronix field engineer.

Tektronix, Inc.

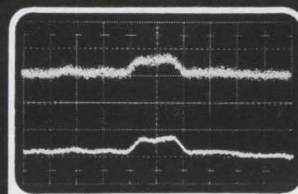

Tangential Noise
Display of a 1 mV, 2 ns wide pulse, externally triggered. Upper waveform is unsmoothed, the lower is smoothed.
2 mV/cm—1 ns/cm

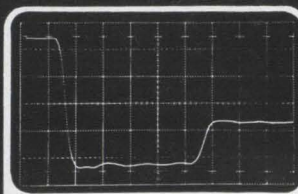

Time Domain Reflectometry (TDR)
Display (with 281 Pulser) of 50 Ω system, with transition to a 25 Ω system. Any portion of the display can be expanded vertically and horizontally for more detailed analysis.
100 mV/cm—5 ns/cm

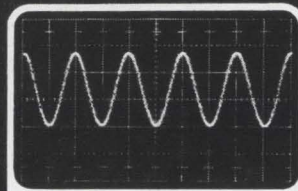

Triggering At 1 GHz
Display of a 1 GHz sine wave internally triggered
100 mV/cm—0.5 ns/cm

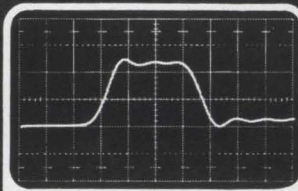

Pulse Triggering
Display of a 50 mV, 2 ns wide pulse, internally triggered.
20 mV/cm—0.5 ns/cm

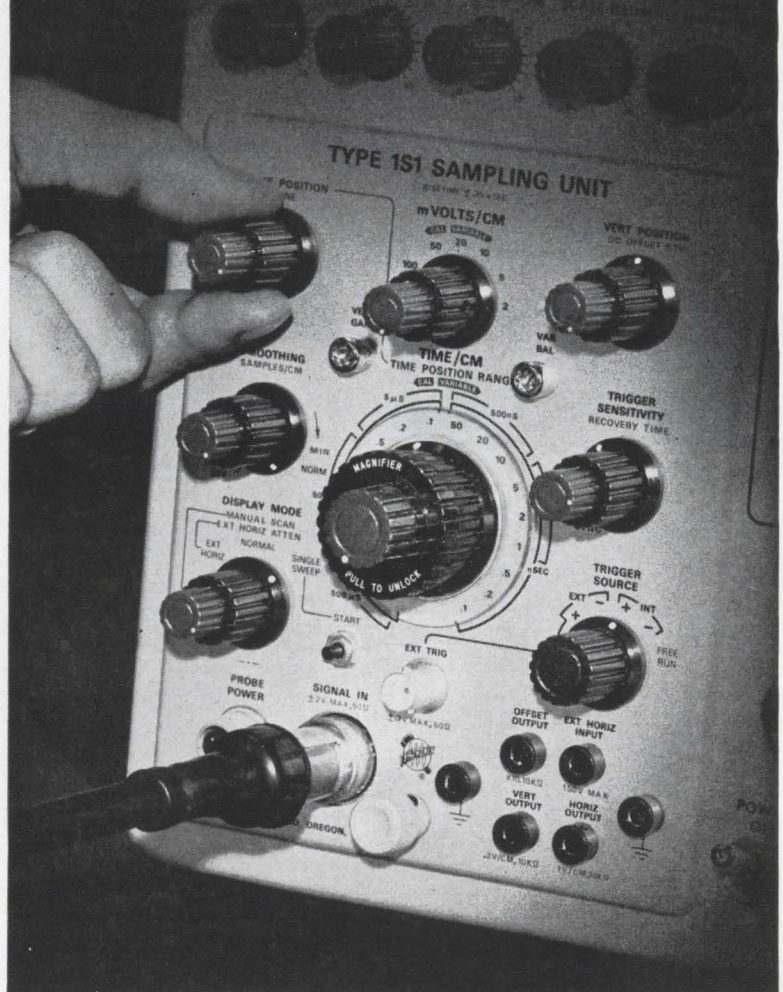

Going strong after 30,000 hours



These RCA-7586 nuvistors have a demonstrated RELIABILITY of 99.901% per 1,000 hours out to 30,000 hours of operation—as revealed in continuing life tests that now exceed 2,000,000 hours.

This exceptional reliability is but one reason why so many circuit designers choose nuvistors for sophisticated applications demanding high-level performance at practical costs. Other reasons include: essentially constant transconductance over a very wide temperature range, dependable performance in the presence of both pulse and steady-state nuclear radiation, low RF and sub-audio noise and 1000 g shock rating.

Be sure to evaluate nuvistors whenever you need an amplifier, oscillator, frequency multiplier, mixer, cathode follower or a general-purpose tube for commercial or military applications. For specifics, call your nearest RCA District Office or write to RCA Commercial Engineering, Harrison, N. J. 07029.

Nuvistor Life Test Conditions	
Heater Volts	6.3
Heater-Cathode Volts	0
Plate-Supply Volts	75
Cathode Resistor—Ohms	100
Grid-Circuit Resistance—Megohm	0.5
Metal-Shell Temperature—°C.	150
Plate Dissipation—Watt	0.75

RCA DISTRICT OFFICES—OEM SALES: EAST, 32 Green St., Newark, N.J. 07102, (201) 485-3900 • MID-ATLANTIC, 605 Marlton Pike, Haddonfield, N.J. 08034, (609) 428-4802 • MID-CENTRAL, 2511 East 46th St., Bldg. Q2, Atkinson Square, Indianapolis, Ind. 46205, (317) 546-4001 • CENTRAL, 446 East Howard Ave., Des Plaines, Ill. 60018, (312) 827-0033 • WEST, 6363 Sunset Boulevard, Hollywood, Calif. 90028, (213) 461-9171 • INTERNATIONAL OPERATIONS, RCA International Division: Central and Terminal Aves., Clark, N.J. 07066, (201) 382-1000 • 118 Rue du Rhone, Geneva, Switzerland, 3575 00.

RCA Electronic Components and Devices, Harrison, N. J.



The Most Trusted Name in Electronics

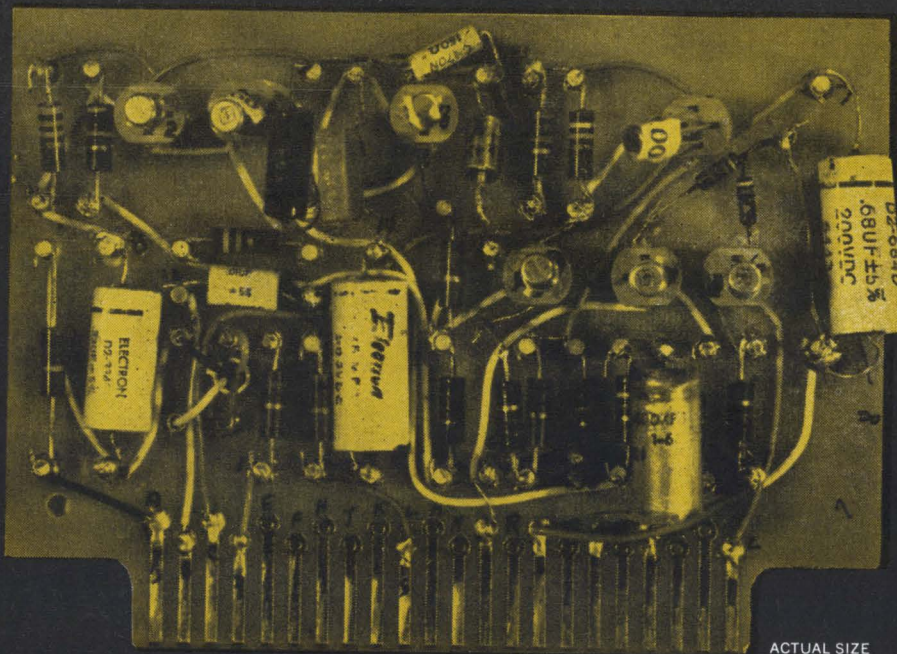

What made this DC amplifier circuit obsolete?



Advanced Microcircuit Packaging

The use of Hamilton Standard microcircuit modules has reduced the size and weight of temperature controls in the Navy's advanced Ling-Temco-Vought A7A light attack aircraft. They function as DC amplifiers in two identical controls for the cabin and pilot's vent suit.

Each module replaces a multi-component 3½ x 4½-inch circuit board,

resulting in a 96% weight and volume reduction. Design, production and testing are greatly simplified. Reliability is improved by electron-beam welding of interconnections within the module, and complete hermetic sealing.

Hamilton Standard's design team is experienced in custom circuit packaging and will assist circuit designers in component selection and circuit layout.

This technology allows flexibility in interconnecting and packaging both uncased integrated circuits and semiconductors for both digital and linear applications.

For more information on the advanced microcircuit packaging technology, write to Marketing Manager, Electronics Department, Hamilton Standard, Broad Brook, Conn. 06016.

Hamilton Standard DIVISION OF UNITED AIRCRAFT CORPORATION

**U
A**

ELECTRONICS • ATTITUDE CONTROLS • STABILIZATION SYSTEMS • ENVIRONMENTAL CONTROLS • FUEL AND AIR INDUCTION CONTROLS
ELECTRON BEAM MACHINES • PROPELLERS • STARTERS • TURBOMACHINERY • GROUND SUPPORT EQUIPMENT • OVERHAUL AND REPAIR

Washington Newsletter

November 29, 1965

Firms may face labor union's united front

If Walter Reuther has his way, large corporations—including electronics firms—will face a gargantuan negotiating job. One company might find itself negotiating with dozens of AFL-CIO industrial locals simultaneously.

Reuther's hope is to get the unions, many of which have fought over jurisdiction in the past, to combine their strength at the bargaining table to win common contract expiration dates at least, and identical contract terms if possible.

Reuther's ultimate goal is national or pattern-setting bargaining, with all unions in a corporation presenting identical demands to force companies to negotiate major economic items on a national level.

More than 60 collective bargaining committees have already been formed, with representation from unions dealing with particular corporations.

The list of target companies reads like a who's who of industrial giants, with electronics represented by such firms as Litton Industries, Inc., the International Telephone & Telegraph Corp., the Minnesota Mining & Manufacturing Co. and Sylvania Electric Products, Inc. The list is still growing.

Pentagon and State to speed exports on strategic goods . . .

The Defense and State Departments are trying to cut the red tape that prevents quick action on export licenses. Both want simpler and faster administration of controls on strategic materials.

The recommendations made by the Defense Industry Advisory Council, a group comprising Pentagon and defense industry officials, have an implicit seal of approval from the State Department.

Among the steps under consideration in both agencies are:

- Creation of an interdepartmental committee to standardize criteria on licensing decisions.

- Clearer delineation of policy guidelines on release of technological data and hardware in such security-sensitive fields as guidance, computers, gyroscopes, space satellite information and supersonic transport planes.

- A Pentagon office to coordinate views of the military services and present a common Defense Department line to the State Department which has final authority on sensitive license issues.

. . . and industry gets some tips

As things are now, industry can help both speed and ease its overseas selling efforts, says the federal government. Engineering and sales personnel, planning overseas contacts that involve disclosure of classified information, are being advised to submit visit requests well in advance. Such requests must be submitted to the Defense Industrial Security Clearance Office (Disco), Columbus, Ohio. Many visits have been disapproved because requests have not been received in time for necessary processing.

Disco suggests lead times of 60 days for visits to France; 21 days for Germany, Canada and Great Britain's Ministry of Defense; 16 days for Britain's Ministry of Aviation; and 7 days for the Netherlands.

Washington Newsletter

Congress may set consultants' scale

A concerted effort is expected in Congress next year to set a scale for per diem rates paid by the federal government to consulting engineers. Congressmen, industry and the Administration agree there should be a set policy.

There is no uniform policy on per diem rates now; the various appropriations subcommittees of Congress establish rates for different departments and agencies of the government. Rates generally range from \$50 to \$150 a day.

The Budget Bureau in 1961 suggested a uniform \$100-a-day limit, and that the President be given authority to set the conditions of employment of engineering consultants when necessary. The recommendation pleased no one, and nothing was done.

Rep. Daniel Flood (D., Pa.) introduced a bill in the waning days of Congress this year that would set the maximum daily rate at \$150, with discretionary power for the President to exceed the maximum whenever absolutely necessary. Flood said his bill "reflects the experience and concern of the National Society of Professional Engineers." NSPE is on record in favor of a government-wide maximum of \$200.

Tv or not tv? Pilots say no to radar display

After years of rejecting suggestions that television and radar be teamed to give small-plane pilots a look at airport radar scopes, the Federal Aviation Agency gave the idea a live test in Boston this month. **Preliminary indications are that it is no feasible substitute for cockpit instrumentation.** Private pilots, usually flying without copilots, have too much to do to make use of the technique.

In the Boston experiment, an educational television station trained a camera on the tower radar and broadcast the image to Sony Corp. five-inch tv receivers in the cockpits of the two test planes. **According to the pilots, an unaided pilot is not able to keep the constant watch needed to identify his own radar blip and avoid other aircraft.**

Congressmen prod Pentagon for more and better planes

The House Armed Services subcommittee that made an on-the-spot investigation of the adequacy of military equipment in South Vietnam is putting pressure on the Defense Department to speed development of the counterinsurgency (COIN) plane. Additionally, subcommittee members want existing tactical aircraft to be equipped with electronic gear that will allow night and bad-weather operations. And they want tactical planes in production or on order, to have similar equipment.

The investigators backed Defense Secretary Robert S. McNamara's contention that **there are no major materiel shortages in Vietnam.**

Military sales show sharp rise

First-quarter figures for the current fiscal year reflect the quickening pace of military procurement as a result of the war in Vietnam. Prime contract awards for the July-to-September quarter rose to \$7.5 billion, nearly \$1 billion above the level of the like period a year ago.

Helicopters, ground vehicles, ammunition, petroleum, food and clothing accounted for most of the increase. Awards for electronics and communications that are not subsystems of weapons systems rose to \$533 million from \$487 million a year ago.

Announcing

a new kind of

miniature Tantalum Capacitor

for microcircuits

...The Mallory TUR

The Mallory TUR is a miniature, unencapsulated, solid electrolyte tantalum capacitor designed for use with integrated circuits, thin films and other microelectronic circuits which will be encapsulated after assembly. It's a square chip, only .225" to .325" on a side, and .04" to .170" thick, depending on rating.

Better packaging efficiency

Through highly efficient use of space, this new configuration provides maximum capacity/volume. The TUR is supplied with an electrically insulated coating on the positive side of the case and can be stacked or placed directly on the circuit chip or board prior to encapsulation.

High C-V product

The type TUR offers extremely high capacity x voltage product and low DCL. When properly pre-dried and encapsulated, it withstands MIL environments. Temperature rating from -55°C to 85°C ; can be derated linearly to $\frac{2}{3}$ voltage at 125°C .

Ten case sizes, ranging from 0.225" x 0.225" x 0.040" to 0.325" x 0.325" x 0.170"; ratings from 120 mfd, 6V to 12 mfd, 50V, and three configurations keyed to lead position are available. Standard units are polarized; non-polarized units on special order. Leads are gold-plated ribbons; can be welded or soldered. For information, write or call Mallory Capacitor Company, a division of P. R. Mallory & Co. Inc., Indianapolis, Indiana 46206.

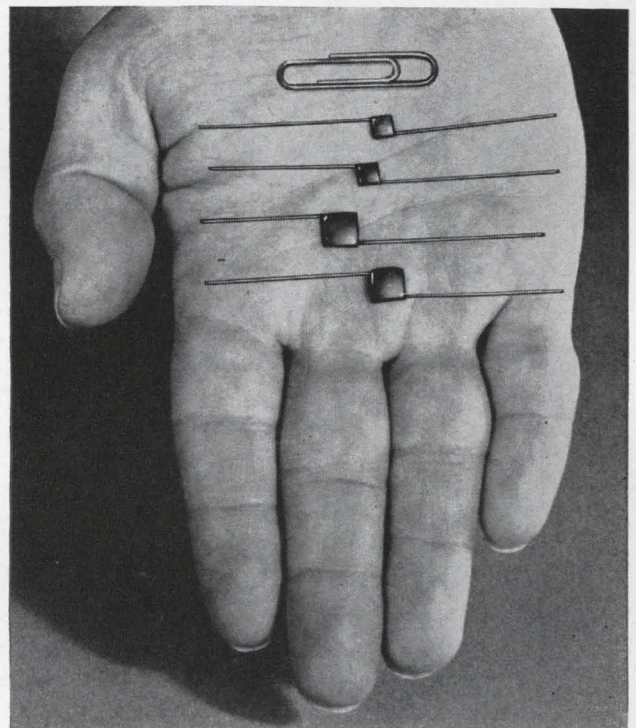

Case Sizes	Dimensions		
	A Max.	B Max.	C Max.
A	.225	.225	.040
B	.225	.225	.050
C	.225	.225	.060
D	.225	.225	.075
E	.225	.225	.110
F	.325	.325	.060
G	.325	.325	.075
H	.325	.325	.110
J	.325	.325	.125
K	.325	.325	.170

MALLORY

GLASS

Now .1 mfd in this case size

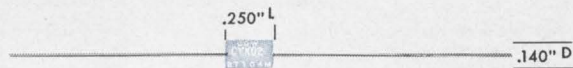

New CORNING® GLASS-K Capacitor with
CORNING® glass capacitor dependability

SS-K

CYK02—100,000 pf in just .250" L x .140" D.

CYK01— 51,000 pf in just .250" L x .100" D.

SMALLER SIZE BY FAR THAN CONVENTIONAL CK CERAMIC TYPES.

Ideal for cordwood packaging and machine insertion applications.

Stability: Remarkable! And predictable. 3 families for optimum stability, capacitance and size.

Voltage Rating: 50 VDC.

Tolerances: 10% and 20%.

Temperature Range: -55°C to +125°C.

Insulation Resistance: 10,000 megohms min.

Power Factor: 2.5% maximum.

Price: Competitive.

Let us tell you more.

Corning Glass Works, Electronics Drive, Raleigh, North Carolina

Please send complete data on the CORNING® GLASS-K Capacitor

Name _____ Title _____

Company _____

Address _____

City _____ State _____ ZIP _____

CORNING
ELECTRONICS

"ROOM AT THE TOP"



Growth opportunities in Communications with **TRW SYSTEMS** in Los Angeles and Houston

There is "room at the top" for your special talents on America's major missile and space programs with TRW Systems' Communication Laboratory in either Los Angeles or Houston. From the beginning of communications via space, this group has played a preeminent role in developing communications systems for the nation's major missile and space programs. Major achievements include the first unified carrier tracking, telemetry and command system and the first PCM telemetry system for space. Now is the time for you to investigate these opportunities with this outstanding professional organization.

MAJOR PROGRAMS . . .

- Apollo spacecraft systems
- Advanced Minuteman systems
- Mars mission and spacecraft studies
- Nuclear Detection (Vela) Satellites
- Pioneer interplanetary spacecraft
- Weather satellite systems
- Standardized tracking, telemetry and command system (SGLS)
- Advanced space probes
- Lunar telemetry systems
- Communication satellite systems

Senior Communication Engineers

For design, analysis and management of communication systems and evaluation of scientific and military applica-

tions of communication techniques for aircraft, spacecraft and underwater craft use. BSEE, MSEE or PhD.

Communication Equipment Design Engineers

Several years' experience in design and analysis in the following fields: RF filters, duplexers, antennas, phased arrays, feeds, solid-state transmitters, receivers, phase-lock loop techniques, cavity techniques, strip line, very wide and very narrow band circuits, circuit engineering, and modulation techniques. BSEE or MSEE.

Communication System Analysis Engineers

Conceptual design, analysis and synthesis of wide variety of digital and analog communication systems, employing coding, modulation, and statistical communication theory. Systems include integrated coherent-carrier systems, phase lock demodulation (restrictive/non-restrictive), communication satellites and deep space probes. MSEE or PhD.

Signal Processing Engineers

Design and development of sophisticated communication systems and components. Signal conditioners, analog and digital encoding and decoding, modulation tracking and carrier track-

ing phase lock loops, and multiphase modulation are involved in tracking, telemetry and command equipment which includes but is not limited to space applications. BSEE or MSEE.

Telemetry Circuit Design Engineers

To design a wide variety of analog and digital signal processing circuits for spacecraft digital telemetry equipment. Experience should relate to the design of analog-to-digital converters, analog and digital multiplexers, logic and data storage. Familiarity with microelectronics desirable. BSEE or MSEE.

Telemetry System Engineers

Experienced in the functional and logical design of analog and digital telemetry systems. Familiarity with design, development, application and evaluation of spacecraft instrumentation systems. Experienced in the design of data systems to interface with a wide variety of data sources including scientific experiments, and engineering measurements.

Please submit resume and salary history in confidence to R. J. Brown, TRW Professional Placement, Dept. E-11, One Space Park, Redondo Beach, California 90278. TRW is an equal opportunity employer.

TRW SYSTEMS

ONE SPACE PARK, REDONDO BEACH, CALIFORNIA
Formerly TRW Space Technology Laboratories - STL

Here's what insulation of MYLAR® meant in: ballast transformers...relays

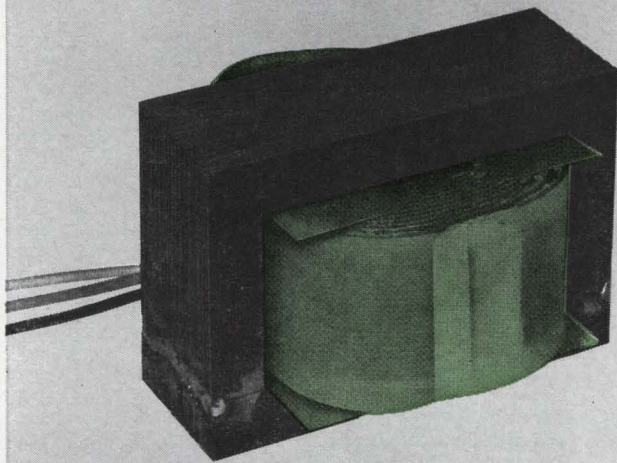

- tripled life of guarantee against failure
- upgraded rating to Class B

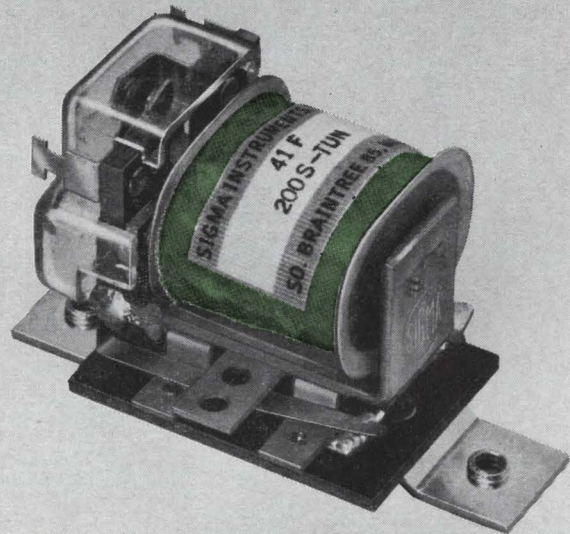

- 50% increase in thermal range
- smaller coil
- longer coil life

Whatever your insulation needs—motors, bus bars, capacitors, relays, transformers, wire and cable—chances are good you can benefit from the ability of MYLAR* to:

- improve insulation performance
- lower costs
- provide greater design capability

This is because MYLAR offers you a unique combination of properties in thin, flexible film form. With MYLAR you can replace heavier, bulkier insulation materials to design smaller, lighter components which have greater insulation resistance.

For the same reason, it's possible to lower insulation costs because often less MYLAR is required for a given insulation value.

Also, the excellent working strength of MYLAR can mean lower reject rates and

faster production speeds for you.

New "Fact File" available!

To get started on your evaluation of MYLAR, send for your copy of the "Fact File". This compact reference piece contains complete technical data, cost comparisons of MYLAR versus other insulation materials, film samples and information on several recent applications. Write Du Pont Co., Room 2796C, Wilmington, Delaware 19898. (In Canada: Du Pont of Canada Ltd., P.O. Box 660, Montreal, Que.)

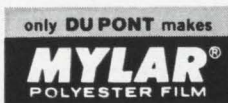
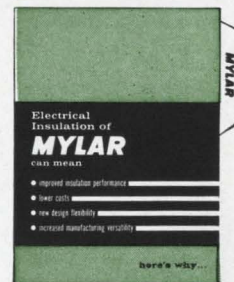

*DU PONT'S REGISTERED TRADEMARK FOR ITS POLYESTER FILM.

RAIN...SNOW...BLAZING SUN

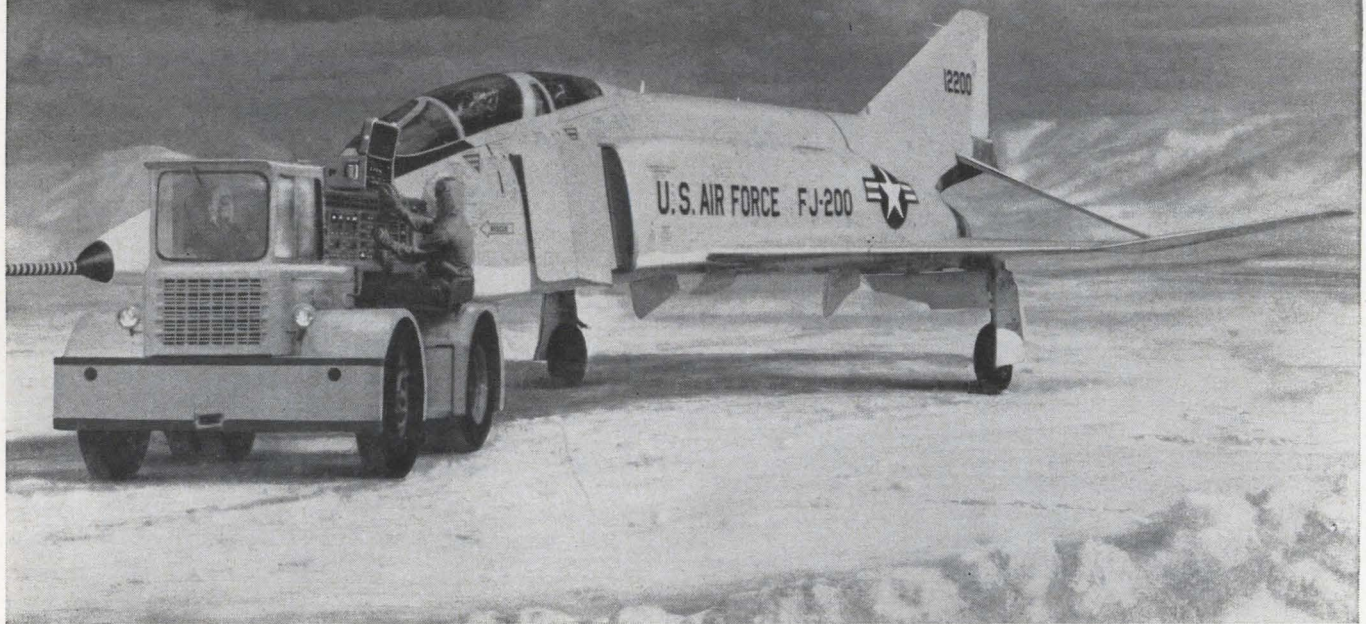

Now! A digital multimeter that meets mil specs... operates in any environment.

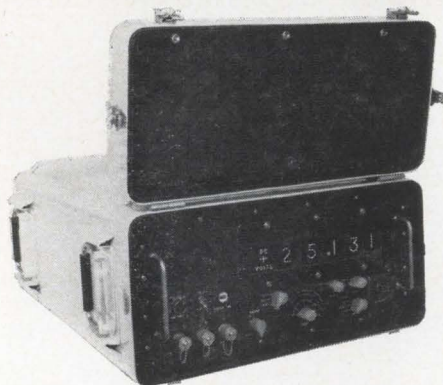

MIL-DMM-250

Cubic's compact, highly durable and reliable digital multimeter is watertight and can withstand prolonged exposure to sunshine and rain at temperatures ranging from -40°C to $+50^{\circ}\text{C}$. It is the only multimeter to conform completely to *rigid military specifications*.

Developed and built for ground support equipment in the U.S. Air Force RF-4C Phantom program, Cubic's MIL-DMM-250 evaluates and displays voltage, resistance and ratio measurement capabilities at flight line and hangar.

Absolute accuracy of $\pm 0.01\%$ of measured DC value, ± 1 digit is provided. AC voltage accuracy is

$\pm 0.5\%$ of measured value, $\pm 0.01\%$ of full scale from 1 kc to 10 kc.

Modular, plug-in accessories in the MIL-DMM-250 include an AC-to-DC converter and an ohms-to-volts converter.

For complete information on this and other digital equipment, write: Cubic Corporation, Industrial Division, Dept. D-235, San Diego, California 92123.



CUBIC
CORPORATION
SAN DIEGO, CALIFORNIA 92123
INDUSTRIAL DIV.



Motorola's New
Complementary Annular
Transistors are in Demand
by BOTH Switching and
Amplifier Designers!
WHY?

"We used them because they were available in complementary pairs."

"Even with high f_t , beta, and voltage . . . they were very reasonably priced!"

"The complete h-parameter specs told us what we needed in our amplifier design."

"We selected them for the switching parameters — t_d , t_r , t_s , and t_f — given in the spec."

"The combination of high voltage and low C_{ob} is just what we needed."



Because these key Motorola transistors (PNP type 2N3250/51 and NPN 2N3946/47) are more completely specified for *both* switching and amplifier performance than any other types!

For example, if you're working with amplifiers, the complete h-parameter specs (h_{fe} , h_{re} , h_{ie} , h_{oe}), the 40-volt (V_{CE0}) breakdown voltage, the 250 MHz (min) frequency response, the noise figure spec, and low capacitance values — would be just the measurements you needed for calculating circuit performance.

Or, if you're working with switching designs, the complete switching time specs (t_r , t_d , t_s , t_f), low saturation voltage ($V_{CE(SAT)} = 0.25$ volts max.), low $r'_b C_c$ value, and low input and output capacitances would be ideal design values to know.

In short, we think you'll find these well-specified Motorola PNP and NPN silicon annular transistors

are the "most usable" complementary devices for general purpose switching and amplifier applications available anywhere!

They are available *now* from your local franchised Motorola semiconductor distributor in quantities to 999 or in production lots from your Motorola field representative. Call your Motorola man. He'll be happy to give you samples for evaluation. For complete technical details on PNP types 2N3250-51 or NPN types 2N3946-47, write the Technical Information Center, Motorola Semiconductor Products Inc., Box 955, Phoenix, Arizona 85001.



MOTOROLA
Semiconductors

Bendix “Pancake” connectors aren’t half of what you can get from the other guy.

Bendix® Pancake connectors are less than half the size of other miniature cylindrical connectors now available. They’ll reduce total connector length up to 50% and cut weight by as much as 60%. Our Double-Density models give you still further advantages by offering up to 128 contacts in a single connector. Whichever type you need, you’ll find crimp or solder terminations available in 9 shell sizes—8 through 24. Over 6

multiple key shell types, too, with over 25 insert patterns, many of which are Pygmy® (Mil-C-26482) insert layouts. In addition, you can select from potted, grommetted and hermetic versions.

Our Pancake connectors are big on performance, also, boasting improved environmental sealing, increased resistance to contact pin bending, greater contact retention and temperature capabilities that range to 392°F. con-

tinuous operation. Even improved electrical characteristics through rigid, glass-filled epoxy inserts, as well as less chance of failure through fewer components and increased materials capability.

So before you decide to get in contact with the other guy, get in touch with us first.

The Bendix Corporation, Scintilla Division, Sidney, New York. Phone 607, 563-9511.

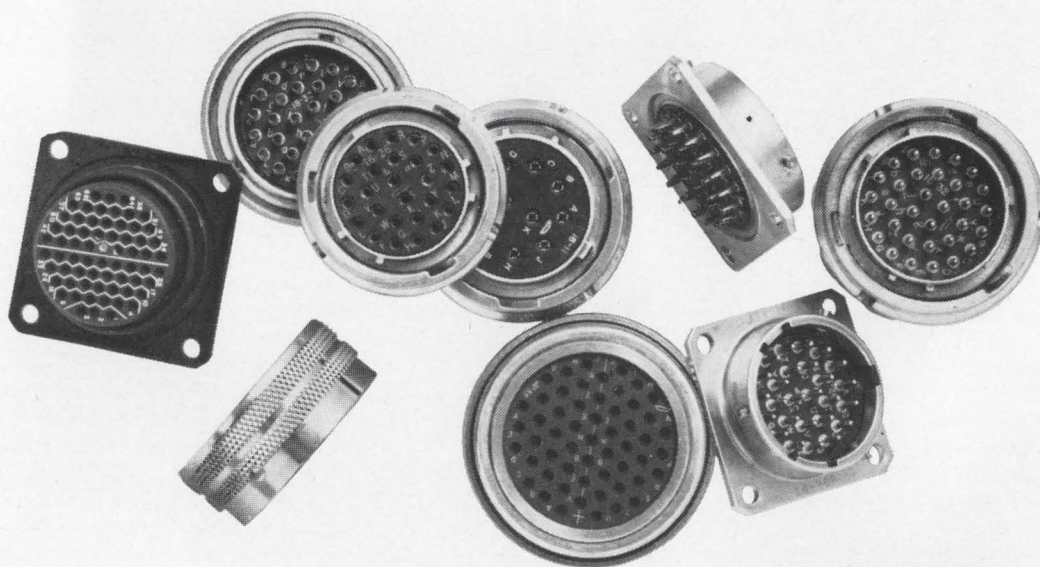

Scintilla Division



Kodak advertises what to do with computer milk

Design engineering is supposed to be a creative activity. Design engineers spend almost all their time searching for data that already exists. This is the activity that looks acceptably industrious and businesslike. The rare moment when the engineer's mind creates something truly new finds him brushing his teeth or staring at a traffic light to make it turn green. Now we are going to brag about saving the government inestimable millions of dollars by converting an estimated 16 million man-hours from searching to creating.

It is accomplished by feeding to computers every available scrap of information—physical and administrative—about every component of every device employed for every known purpose by every agency concerned with the defense of the nation. There are still people around whose minds are incapable of encompassing what we have just said. Let us hope you are not one of them. The computers organize this body of information in numerous ways. They also organize indexes and indexes of indexes, iterated in depth. The problem then arises of how to get the good out of it all.

Perhaps one could try to taste, smell, or hear the results,

but the preferred mode is to see them. Cathode-ray tubes are used quite a bit by computers to communicate with their lessees by drawing pictures. In this case the c-r tube is the only means of unloading the output of documents fast enough from the computer. The c-r tube can only dump it onto fast-running microfilm.

That's our cue. Now we make our contribution. We furnish equipment that takes over all the microfilm. Later, perhaps in some other place, a person will press some buttons on our equipment. In a few seconds a document will appear on the screen. He can also pull a paper copy of the document out of a slot, or he can make it appear down the corridor or around the world by facsimile transmission. It will be the exact document needed to avoid designing, making, or lacking an object that is already available, or to service the object. *Any object.*

Every link in this chain is already in existence, believe it or not. Questions about the use of microfilm the better to milk computers will be answered by Recordak Corporation, 770 Broadway, New York City 10003 (Subsidiary of Eastman Kodak Company).

Kodak advertises another successful marriage from the periodic table

Cadmium telluride now becomes an engineering material.

Some imaginative combinations of elements are sought out for what they will do and others for what they won't do. Cadmium telluride won't interact with photons hardly at all from 2 to 30 μ in wavelength. Much the same can be said of that more familiar compound sodium chloride, but sodium chloride is far less tenacious of the solid state. Incompatible is usefulness in seasoning watermelon and supporting life with usefulness for constructing durable optical parts that pass thermal radiation.

Similarly transparent are several other alkali halides and similarly vulnerable to dew and sweat. One halide, thallium bromide-iodide ("KRS-5"), that has had to do for far-infrared transmission, is less soluble than the others but still plenty soluble by comparison with CdTe and prone to cold flow under mere gravity, an optically disconcerting effect.

We have learned how to put cadmium telluride into a form which is neither an amorphous glass (no cold flow) nor a crystal (hence no cleavage planes for splitting) but an inter-

locked mass of crystals that takes and keeps a beautiful optical polish and looks about as transparent as coal.*

CdTe is the sixth compound to which we have successfully applied our proud art of creating polycrystalline optical materials. It will become known as KODAK IRTRAN 6 Material. By comparison with all the other IRTRAN materials, we'd have to call it soft, but it is not as soft as any of the known alternatives for its wavelength range. For low thermal expansion it trounces them severely.

Special Products Sales, Eastman Kodak Company, Rochester, N. Y. 14650 (phone 716-325-2000, ext. 5166) handles all IRTRAN business.

*At 850m μ the curtain due to absorption by electrons starts to lift, is all the way up by 2 μ , stays all the way up until lattice vibration starts absorbing photons at 28 μ , and doesn't fully cut off the show before 30 μ . About the only loss over that long span is the 2-surface reflection loss of 35%. If this is too much, the high index permits relief by coating. The high index also suggests use of the material for "immersed" detectors, where it contributes to collecting power.

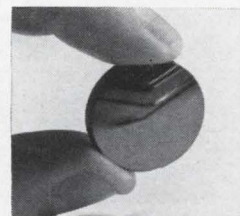

Kodak advertises to haters of chemistry

Two new commercial realities await inquiry to Instrumentation Products, Eastman Kodak Company, Rochester, N. Y. 14650, by engineers who need the sensitivity of photography for data-recording but rarely derive pleasure from the details of photographic chemical technology.

• Certain late-model oscillographs are supposed to make their wiggle traces visible as fast as people can read. This they will actually do if loaded with KODAK LINAGRAPH Direct Print Paper. Records to be kept permanently or duplicated for distribution, however, had had to be treated in special image-preserving chemicals. Now, with the latest improvements in the LINAGRAPH Paper, you put the records to be treated through

the same chemicals for *all* oscillographs, late-model or early-model.

• Data film for recording either real objects or indications from instruments can be processed in a minute at 90°F or half a minute at 105°F if the film happens to be KODAK 2490 RAR Film and the processing is done in KODAK 448 Monobath. This new solution neither requires a tense eye on clock or thermometer nor any interest in the difference between a developer and a fixer, being both. Once it has completed its work, nothing further happens. If you intend to keep the film, wash it later. A quick rinse in warm water several weeks later is adequate.

Why buy a new
Esterline Angus
Servo Recorder
instead of
brand A, B, C or D?

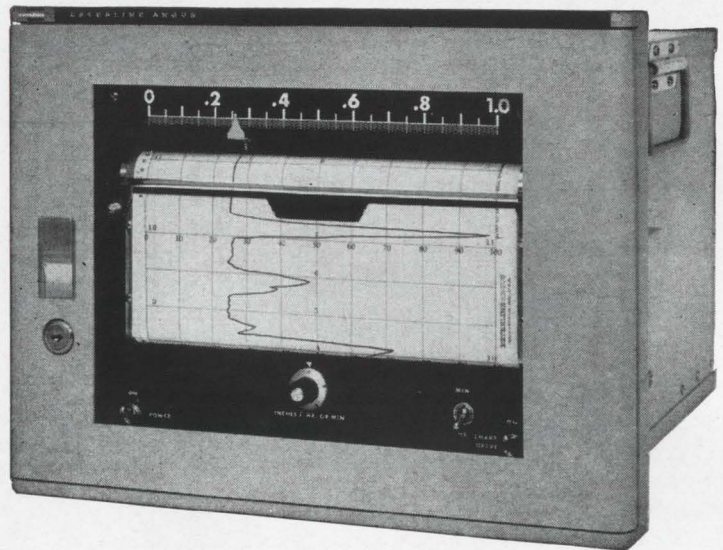

for 12 good reasons*

X's indicate standard features at no extra cost	Esterline Angus	Brands (names available on request)			
		A	B	C	D
List price, \$975 or lower	X			X	
Solid state amplifier	X		X		
50,000 ohm off balance input impedance or better	X				
Response as fast as 1/2 second even at a 1 MV range	X				
Accuracy $\pm 1/4\%$ span or $\pm 3 1/2$ microvolts	X	X	X		
Dead band 0.1% of span or less	X		X		X
Stray rejection: longitudinal 60 cycle AC, 1,000 times span or 120 volts	X		X		
Permanently sealed slidewire requires no cleaning	X				
5 chart speeds	X				
Chart tear off	X		X		
Tilt writing platen	X				
Pen lifter	X				

Discover additional reasons for buying Esterline Angus Single and Two-channel Wide Chart (10") Servo Recorders. Write for Series "E" Catalog.

Esterline Angus Instrument Company, Inc.
Box 24000E • Indianapolis, Indiana 46224

Excellence in
instrumentation for
over 60 years



ESTERLINE ANGUS

Technical Articles

Bright hopes for display systems; flat panels and light reflectors:
page 56

One intriguing prospect in new optoelectronic displays is a wall-type panel made of solid state materials that emit light when activated by an electrically deflected light beam. New materials, new light sources and new ways to manipulate light with electric and magnetic fields have opened some promising ways to produce larger displays with better resolution, brighter presentations and higher data-handling rates. An added advantage is that such displays use less power and cost less.

Variable persistence increases oscilloscope's versatility:
page 66

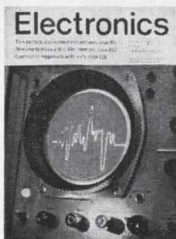

Although the ubiquitous oscilloscope scores high on versatility, no single scope can cope with every measurement problem. It has required a different instrument to handle a low-speed waveform and a fast, single-shot transient. Now a new scope can handle them both because it has variable persistence. A special cathode-ray tube with unique persistence-control circuitry makes the development possible. For the cover, photographer Norton Pearl captured a trace on the new scope's screen while highlighting the knob that controls persistence.

Computer time sharing:
page 71

Although the concept was proposed years ago, time sharing of computers is just becoming practical. In this special feature, the first of two articles, the editors of Electronics survey the field and report on five specific approaches.

1. Time sharing: one machine serving many masters
2. IBM's approach with System 360
3. Project MAC at MIT
4. Helping with homework at Dartmouth
5. Satellite computers as interpreters at the University of Pennsylvania

**Coming
December 13**

▪ **The Japanese assess their own technology**

1. Semiconductors
2. Integrated circuits
3. Solid state microwave
4. Numerical control of machine tools
5. Electronic process control

▪ **Timers with off-the-shelf integrated circuits**

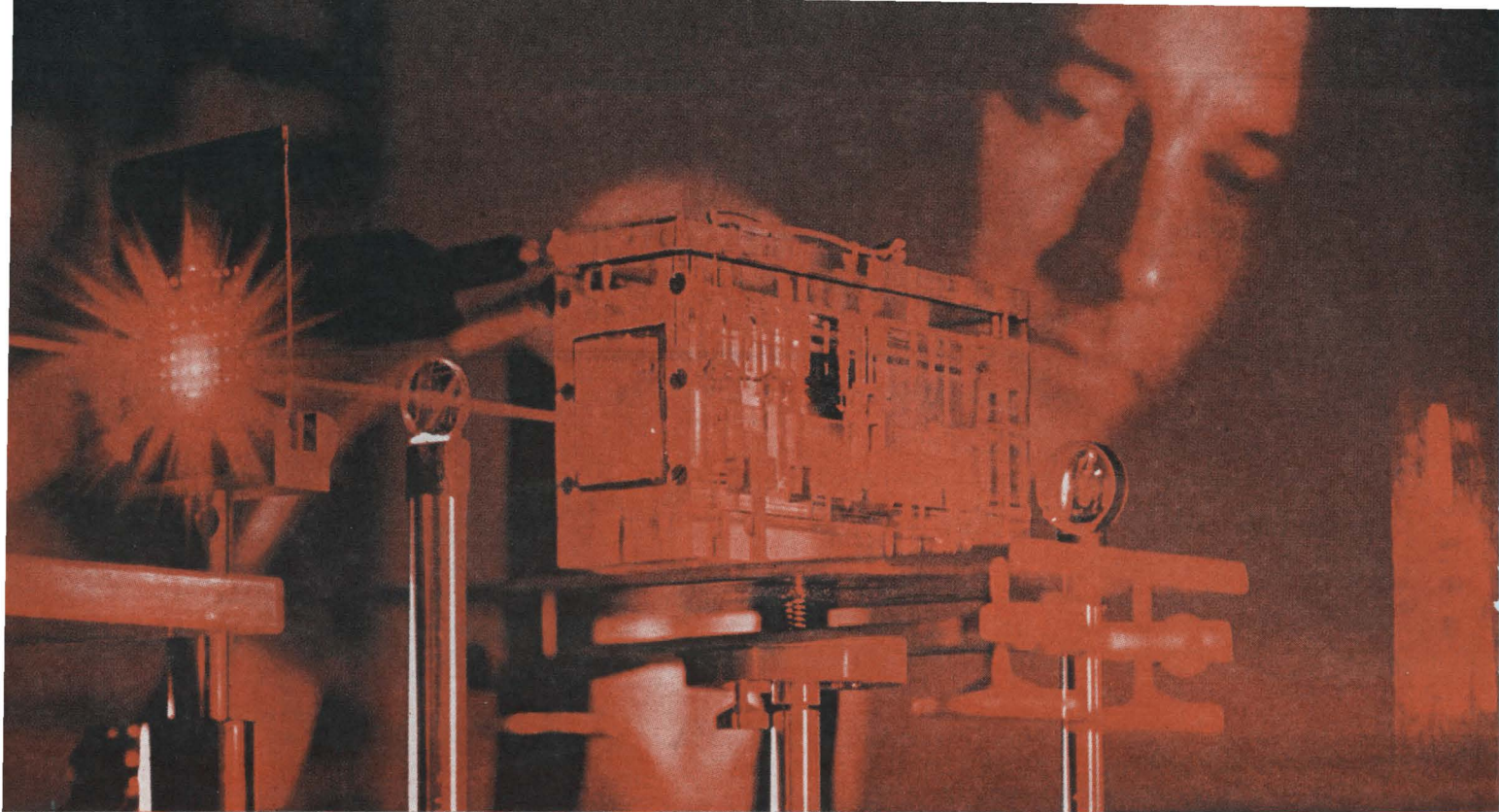

Digital light deflectors offer high-speed precise control of laser beams to produce large, bright displays. This experimental unit, developed at International Business Machines Corp., uses two electro-optic effects—birefringence and Pockels effect—to control the laser beam.

Optoelectronics

Bright hopes for display systems: flat panels and light deflectors

They are made possible by new materials, new sources and new ways to manipulate light. A more distant prospect is a hybrid display that would combine advantages of both approaches

By Richard A. Soref and Donald H. McMahon

Sperry Rand Corp. Research Center, Sudbury, Mass.

Designers of display systems are constantly seeking better resolution, brighter presentations and higher data-handling rates, at the same time increasing the display area and reducing cost and power consumption.

Recent developments in optoelectronics have opened a variety of promising paths to these goals. These developments include new materials, new

light sources and new ways to manipulate light with electric and magnetic fields.

One intriguing prospect is a hybrid display—a wall-type panel made of solid state materials that emit light when activated by a light beam that is deflected electrically. Such a system would combine the advantages of the two principal approaches to optoelectronic display: the higher res-

olution and more modest switching requirements of light-beam "writing," plus the multicolor capability, higher reliability, brighter light and lower power consumption of panel displays.

Four ways to deflect light beams

Light beams can be deflected by mechanical, electromechanical, electroacoustic or electro-optic means. Mechanical deflection, with rotating or vibrating mirrors or prisms, is inherently slow and cannot provide rapid arbitrary positioning of a light beam on a screen. Electromechanical deflection, suitable for a periodic scanning arrangement, is at most capable of producing a television-like scanning pattern, or raster.

In acoustic light deflectors, traveling or standing acoustic waves are set up in the deflection medium, creating patterns of varying refractive index. There are two types of acoustic light deflectors: one in which the light-beam diameter exceeds several acoustic wavelengths, and one in which the beam diameter is much less than a wavelength. The larger-diameter type, called an acoustic grating, has several disadvantages: high microwave power is required for rapid deflection; deflected light is distributed in several grating orders, decreasing its intensity; and the microwave frequency must be swept to accomplish scanning. Deflectors of the shorter-diameter type¹ need a resonant transducer to achieve large deflection angles, and permit only a Lissajous-figure type of presentation.

Electro-optic devices^{2,3} offer the greatest promise as light-beam deflectors. They are capable of high deflection rates, high resolution and large deflection angles; they give immediate access to any display position; and they can be built with rugged solid-state components.

Analog deflectors

The electro-optic prism is the simplest form of analog light deflector. When an electric field is applied to electrodes on the triangular sides of such a prism, its index of refraction changes, as shown in the sketch at the right. Since a light beam's deflection is proportional to the prism's index of refraction, the applied electric field causes the beam to change direction while passing through the prism. Electrooptic materials can be rated according to the magnitude of the change in the index of refraction that results from a given electric field.

In one class of materials, the index changes linearly with the applied voltage. This is called the Pockels or linear electro-optic effect. In other materials, where the change is proportional to the square of the applied voltage, the Kerr or quadratic electro-optic effect is observed. Electro-optic parameters of various materials are listed in the table on page 58.

KTN, a mixed solid solution of potassium tantalate (KTaO_3) and potassium niobate (KNbO_3), has the largest index change at room temperature for a given applied voltage. Dielectric breakdown in

this material limits the number of resolvable positions of the beam to about 500 and the maximum deflection angle to about 1° . This small deflection angle is not a serious limitation, however, because lenses can produce large displays without significant loss of resolution.

A practical display can be built with two electro-optic prisms. Collimated light from a laser source is passed through an intensity modulator, then through the prisms, which provide vertical and horizontal deflection. The width of the light beam is adjusted to cover the maximum aperture of the prism. This allows the smallest possible deflection angle to be resolved. A lens focuses the beam; at the focal point, an image is swept out as a function of time. Then this picture is enlarged and projected onto a display screen.

Digital deflectors

Instead of analog deflection, where the light beam is continuously positioned, many applications require random-access digital deflection, where the beam is positioned at any one of many discrete positions. With digital deflection, the appearance of a continuous display can be achieved by making the number of display points very high.

A digital light deflector has two basic components: an electro-optic half-wave plate and a birefringent crystal element. As shown in the diagram on page 58, vertically polarized light is directed at the half-wave plate which, for simplicity, is assumed to be isotropic. The vertically polarized electric field of the incident light beam has equal components in both the x and y directions of the crystal.

With no externally applied electric field, both components encounter the same index of refraction. Therefore there is no relative phase retardation in the crystal between the two components, and the light beam's polarization remains unchanged as the beam passes through the crystal. However, if an electric field of some critical magnitude is applied in the x direction, the index of refraction in that direction changes enough to retard the x polarization component by 180° with respect to the y component. Because of this retardation, light leaving

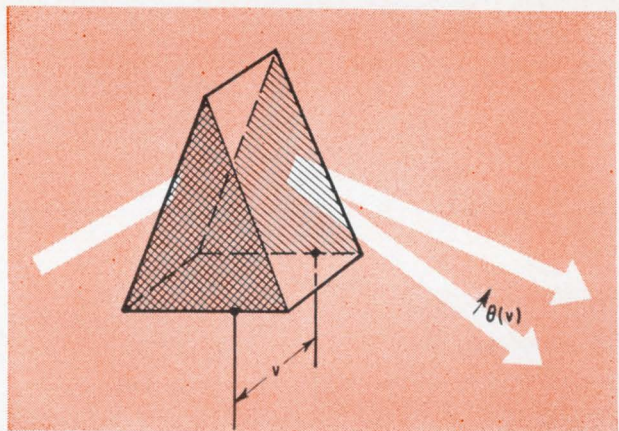

Simplest form of analog light deflector is the electro-optic prism. If Kerr-effect material is used, deviation, $\theta(V)$, of the light beam is proportional to V^2 .

Characteristics of electro-optic materials

Material	Change in index of refraction at 0.546 microns ^{b, c}	Half-wave retardation voltage at 0.546 microns (volts)	Loss tangent at 10 ⁷ cps	Dielectric constant at 10 ⁷ cps	Range of spectral transmission (microns)	Power dissipation (milliwatts) ^d	Reactive power required (watts) ^d	Type of electro-optic effect
KH₂PO₄ (KDP)	9 × 10 ⁻⁶	7500	5.0 × 10 ⁻⁴	20	0.25-1.7	250	500	Pockels
CuCl	1 × 10 ⁻⁵	6200 ^e	1.0 × 10 ⁻³	8.3	0.4-20	140	140	Pockels
ZnS	6 × 10 ⁻⁶	12400 ^e	2.0 × 10 ⁻³	10.3	0.4-14	1400	700	Pockels
KTa_{0.65}Nb_{0.35}O₃ (KTN)^(a)	2 × 10 ⁻³	49 ^e	6.7 × 10 ⁻³	10000	0.4-5	74 ^f	11 ^f	Kerr
SrTiO₃ (at 60°K)	2 × 10 ⁻⁴	517 ^e	1.0 × 10 ⁻⁴	3300	0.4-6	39 ^f	390 ^f	Kerr
BaTiO₃ (at 400°K)^(g)	2 × 10 ⁻³	53 ^e	7.5 × 10 ⁻³	10000	0.5-7	90 ^f	12 ^f	Kerr

^a A crystal which is in the paraelectric phase at room temperature.

^b For an applied electric field of 5000 volts per centimeter.

^c For a 1 × 1 × 1 centimeter sample.

^d For a 1 × 1 × 1 centimeter sample switched between V = 0 and V = V_{λ/2} at a rate of 10⁷ cps.

^e The differential half-wave voltage for an applied bias field of 2000 volts per centimeter.

^f The same condition as (d) except that the differential half-wave voltage is switched.

^g The Curie temperature is about 395°K.

the crystal becomes polarized horizontally. The electro-optic half-wave plate then becomes a switch, capable of selecting either vertical or horizontal polarization.

In the birefringent elements of the deflection unit, the index of refraction depends on the polarization of the light in the crystal. This property can be used to display or deflect a light beam. Displacer and deflector units are shown in the top diagrams on page 59.

A light displacer is a cube-shaped crystal with its optic axis tipped 45° relative to the incident light-beam direction in the xz plane. In the displacer, light polarized parallel to the optic axis (the extraordinary ray) is deviated with respect to the light polarized normal to the optic axis (the ordinary ray). Thus, if two rays having such orthogonal polarizations enter the crystal parallel to one another, they will be parallel upon leaving, but one ray will be displaced in the transverse direction.

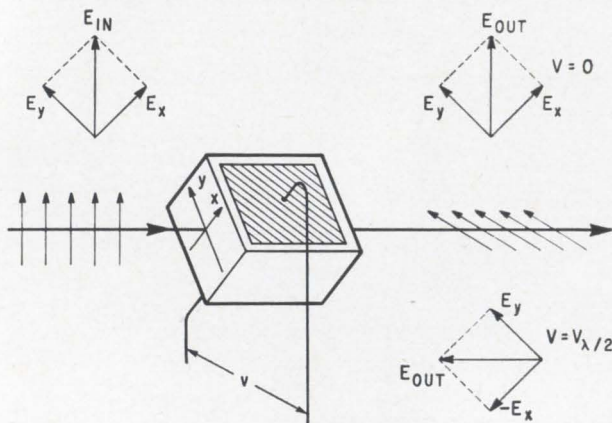

Polarization of a transmitted light beam passing through a half-wave retardation plate remains vertical until an applied voltage, V, reaches sufficient magnitude; then the polarization is rotated 90°.

A deflector unit may be a Wollaston prism, constructed by cementing together two appropriately cut pieces of a birefringent material. This type of prism produces an symmetrical angular deflection of the incident light beam about the beam axis depending on the incident polarization. Wollaston prisms with angular deviations up to ±12° have been made from calcite.

The complete binary light-deflection unit is operated as follows. The electro-optic half-wave plate produces one of two orthogonal polarizations. The birefringent crystal element senses the polarization of the light beam and displaces or deflects the beam to either of two positions.

A sequence of binary displacement or deflection units can be arranged into a digital light beam-deviation bank. If n binary elements, having individual transverse displacements of d, 2d, 4d, . . . , 2ⁿ⁻¹d, are arranged in a series with the same orientation, a one-dimensional array of 2ⁿ equally spaced light-beam positions can be obtained. To generate a two-dimensional array of display points, a second orthogonal beam-deviation bank is introduced. The same principle governs the operation of a deflector bank in a digital display system, except that the beam-displacement distance d is replaced by a beam-deflection angle θ.

The center and bottom diagrams on page 59 show two digital display systems. In the center system, the convergent light passing through the x- and y-displacement banks produces a primary display pattern in the focal plane of L₁. This pattern is magnified and projected by lens L₂ onto a display screen. Convergent light beams must be used in practical systems of this type to obtain a large number of resolvable beam positions; but the convergence must not be too great, or serious image aberrations will result.

In the bottom diagram, a narrow beam of

parallel light changes direction upon passage through the digital deflector banks and, at a distance, produces a display pattern. In both methods, a polarization-correction half-wave plate is inserted between the x and y banks to make the x and y binary positions independent of each other.

Advantages of digital displays

The maximum rate at which data may be displayed in digital systems is governed by the properties of the electro-optic materials used. Since the polarization of the light can be electro-optically switched in nanoseconds, the inherent speed of the electro-optic effect does not limit the rate of data projection. However, in practice the rate is limited by dissipation in the deflection elements and by the stored-energy requirements of the associated circuitry. Therefore the voltage across the half-wave plate and the loss tangent of the dielectric are important parameters.

The table on page 58 lists the electro-optic parameters for some solid state materials being investigated today. Most promising among these is

potassium tantalum niobate (KTN). In this quadratic Kerr-effect material, the voltage necessary to switch the polarization can be considerably reduced by applying a large d-c bias voltage. Thus for a one-cubic-centimeter crystal of KTN the switching voltage, or differential half-wave retardation voltage, is 49 volts with a bias of 2,000 volts. In this material, switching rates of 10^7 bits per second can be achieved with a deflector power dissipation of 0.07 watt and a reactive power—the power stored in the circuit—of 11 watts. On the other hand, in the typical Pockels-effect material, potassium dihydrogen phosphate, a reactive power of 500 watts and a sample dissipation of 0.25 watt are required for the same switching speed. It is still difficult to grow large, optical-quality crystals of KTN, but new techniques are under development at several laboratories, and this material should be available soon.

One of the main advantages of digital light-deflection systems over matrix-type panel displays (discussed on p. 60) is the relatively small number of inputs needed to control the position of the

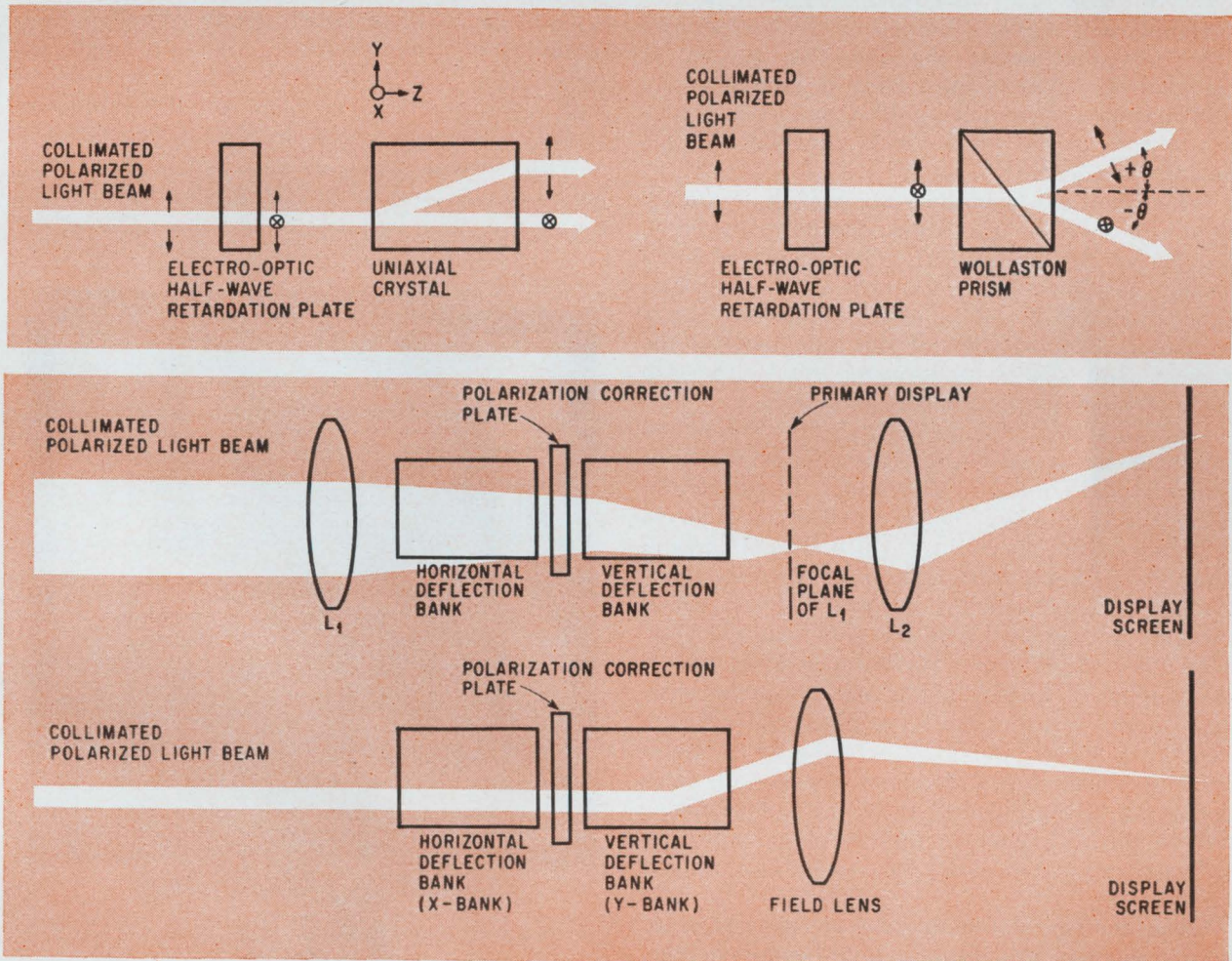

Two types of binary light deflectors. In arrangement at upper left, retardation plate and uniaxial crystal produce linear displacement of light at the output. In Wollaston prism unit at upper right, horizontally and vertically polarized light beams are deflected angularly around the incident beam's axis. Banks of such binary units can be arranged to produce displays controlled by digital inputs. In system at center, using light displacement units, convergent light passing through the x and y banks produces a primary pattern display in the focal plane of lens L_1 which is projected onto a screen. In the light-deflection type of system at bottom, a narrow beam changes direction upon passing through digital deflector banks, thereby producing a primary image directly on a screen.

display point. If there are n stages in the vertical deflection bank and m stages in the horizontal bank, then an array of $2^n \times 2^m$ display points can be produced. To illuminate any point in the display, only $n + m$ input signals are required. In contrast, a panel display having an array of 2^n and 2^m elements must have a total of $2^n + 2^m$ input signals to light up each of its possible positions. For example, suppose that $n = m = 10$, so that the display has over 10^6 distinct points. The digital deflector then requires 20 inputs, while the panel display requires more than 2,000.

Light-deflection systems have some of the limitations of ordinary optical systems. For one thing, the ultimate resolution is limited by diffraction effects. In the light-displacement system shown on page 59, the resolution is limited by diffraction at the aperture of the deflector; in a practical $f/15$ system having a 2-centimeter aperture, more than 1,024 display positions can be resolved in a linear array. To resolve adjacent beam positions in the Wollaston-prism device, the angular deviation of the first stage should exceed the angular divergence of the incident laser beam. The total angular deviation of n stages is limited by the background light generated within the deflection system. If the total deviation of each bank is limited to 5° , a Wollaston system having 10 x and 10 y stages can be constructed which yields a display of 1,024 by 1,024 elements.

When the light beam does not propagate exactly along the axis of the light-deflection system, a fraction of the input light appears at undesired display positions. The amount of this background light which can be tolerated determines the limits both of the convergence of the light used in the displacement system and of the total deflection angle of the Wollaston deflection system.

Light-deflection systems must also be designed to eliminate the usual optical aberrations, such as spherical and chromatic aberrations. In addition to these, the birefringence of the deflection elements introduces other aberrations which are not encountered in isotropic materials. For example, in a Wollaston prism, which is anisotropic, the polarizations are not deviated with the same magnification. This difference creates a nonlinear spacing and an overlapping of display points which can be eliminated only by using more complicated Wollaston structures. A corresponding aberration in the light-beam displacer shown in the system on page 59 is the tilting of the plane of the unmagnified image, due to the difference in optical path lengths of ordinary and extraordinary rays in the birefringent crystal.

Laser sources of illumination are necessary for maximum resolution from a light-beam-deflection display system. Even the intense brightness of a highly collimated laser beam is considerably reduced when the beam is used to illuminate a large area. This reduction has two causes: the reflected laser power is scattered over a solid angle of 2π steradians, and the time-averaged brightness of

the screen is less than the laser brightness by the ratio of the laser spot area to the screen area. For these reasons, continuous-wave laser sources of a few watts are required for large-area displays. Incoherent arc-lamp sources can be substituted for laser sources only if a considerable loss in resolution can be tolerated.

To avoid flicker and to update picture information, each point of the display must be repeated at least every $1/50$ second. Although high-speed repetition is within the capability of light-deflection methods, rapid repetitive presentation is unnecessary if the display screen has good persistence.

Panel displays: pros and cons

Panel displays can be divided into three categories: matrix arrays, in which elements remain in the "on" state only while an input excitation signal is applied; arrays of switchable elements, which are turned on and remain on until switched off; and continuous displays such as scannable piezoelectric panels.

Because matrix arrays are usually limited in resolution, they are most suitable for large, wall-type displays without much detail. Although resolution can be made selectively high over small portions of the display, the cost of forming matrices with a large number of elements and the complexity of the switching required are prohibitive.

With several types of self-luminous devices, panels can be formed of elements that remain "on" during excitation by an external voltage. These de-



Flat panel display developed by the Librascope group of General Precision, Inc., a subsidiary of General Precision Equipment Corp., has variable persistence and erasure capability. Black streaks demonstrate selective erasure by an infrared light source.

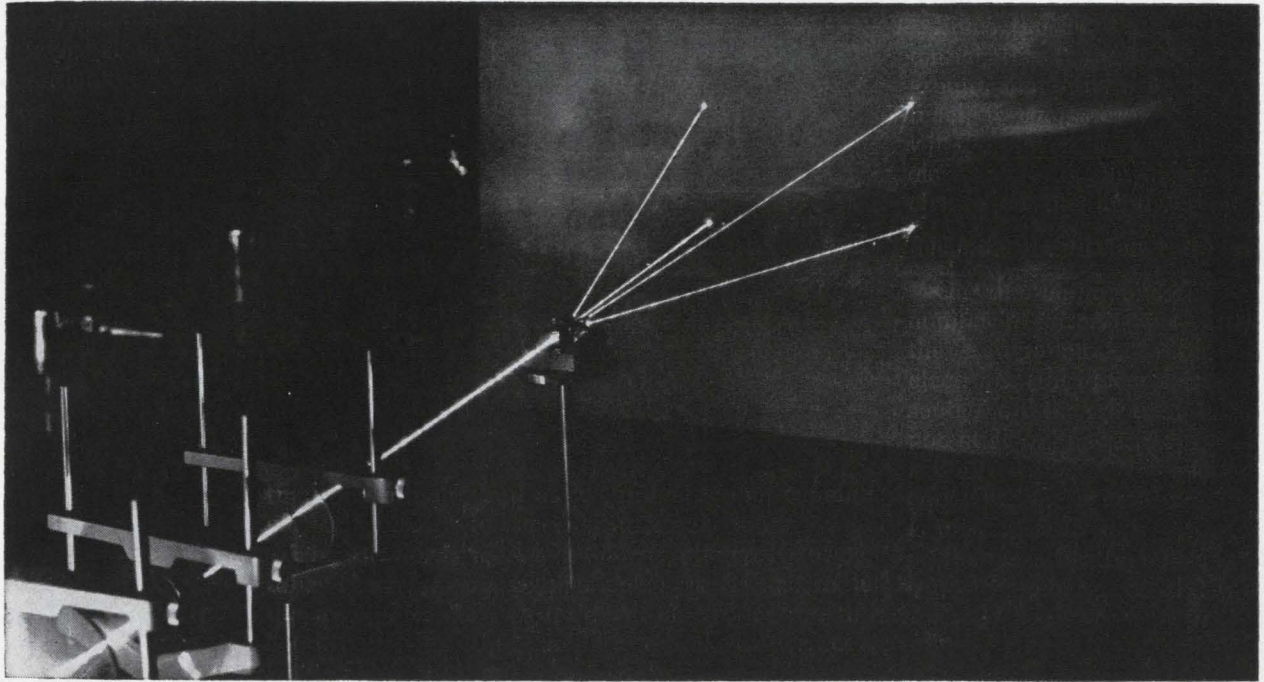

Multiple exposure photograph captures angular laser beam deflection produced by two-stage digital deflector using Wollaston prism. Device was developed by Sperry Rand Corp.

vices include electroluminescent cells, made from layers of electroluminescent and photoconductive materials; gas discharge tubes; injection luminescent diodes; and avalanche-breakdown devices.

This type of display offers intense brightness, multicolor capability, high reliability and low power consumption. But these advantages are accompanied by several drawbacks: undesired illumination along the row or column of a selected element, medium to slow switching speeds, large number of required input signals and, in the case of electroluminescent cells, gradual deterioration.

The matrix-array panel display is normally operated by switching on each element in sequence. Sequential scanning is necessary because attempts to simultaneously excite two elements that are not in the same row or column produce ambiguity. However, it is possible to activate any two elements within a row or column at the same time. Thus a raster can be scanned row by row or column by column.

Instead of using x and y input signals to energize a panel element, the input signal can be made to switch the element on or off to produce a display. This mode of operation is a significant improvement because it gives the panel variable storage capability. With storage, static display patterns do not require repetitive scanning, and the computer driving the display is required only to update the picture information. This method also eliminates the row- and column-leakage luminescence (cross effect) present in simple matrix displays.

This type of display has been produced by a variety of techniques. These techniques include:

- Electromechanical rotatable elements. In one example,⁴ each matrix element consists of a magnetized sphere free to rotate within a magnetic

memory core. One half of the sphere is painted white, the other black. By switching the magnetization of the core, either side of the sphere may be viewed. When the surrounding illumination is great, this display offers good contrast; it is also suitable for alphanumeric display, and can be mass-produced inexpensively. The display exhibits medium speed and low resolution.

- Thin-film magnetic microstructure arrays.⁵ This class of panel display exploits the patterns that occur in certain thin-film colloidal suspensions under the influence of magnetization. The display is side-lighted. When the magnetization of an element is switched, an optical diffraction grating is created on the surface of the element. While the light is on, the grating reflects the side illumination toward the viewer. This type of panel affords brightness, high writing rate and good contrast ratio with low power requirements.

- Magneto-optic reflection displays. These consist of an iron-oxide mosaic reflector⁶ placed near a current-activated xy grid. Currents applied locally to the grid change the magnetization state of the mosaic, thereby changing the polarization of the reflected light. If high-intensity, polarized white light is projected onto the mosaic, a color-contrast display will appear when the mosaic is viewed through a polarizer that is oriented at 90° to the input polarization.

- Electrochemical panels. Several types of electrochemical matrix elements are being studied. One approach uses reversible electroplating techniques⁷ to change the cell's reflectivity; another employs electroflors.⁸ Electroflors are liquids which either exhibit fluorescence or change color when energized by electrical signals. Their biggest limitation is that they require more than one millisecond to

produce a visible change in color.

Large area displays formed from arrays of discrete elements pose two major problems: complexity of the scanning and selection circuitry, and difficulty of fabrication. Both problems can be overcome by continuous panels scanned in an analog fashion along two orthogonal axes.

One such continuous panel, now under development, is the acoustically scanned electroluminescent panel.⁹ This is a sandwich made up of an electroluminescent phosphor layer and a piezoelectric ceramic layer. Elastic waves are launched into the panel by electric pulses applied at the edges of the ceramic plate along the x and y directions.

The elastic waves, in turn, produce an electrical field by the piezoelectric effect in the ceramic layer. At the point of intersection of the x and y pulses, the combined amplitudes of the electric fields produce a light spot in the electroluminescent layer; this spot travels along a path oblique to the x and y axes.

By varying the time relationship between the x and y pulses, the entire panel can be scanned continuously. Brightness is modulated by signals applied at an electrode at the rear of the piezoelectric panel. Construction of large ceramic sheets is difficult because of their fragility. Also, since the velocity of sound is fixed, larger display areas require more time for scanning. At present, the resolution of this type of continuous display is fair and the brightness poor.

Hybrid displays: the best of both types

If panel displays could be combined with light-deflection systems, many of the advantages of both systems could be achieved. Since the panel is controlled by the light beam, only the modest switching requirements of the light deflector are necessary. The active display screen used with a light deflector provides the storage capability offered by some panels but lacking in light deflectors. In addition, active display screens can provide light amplification, a capability that is useful because currently available continuous-wave lasers do not provide enough power to illuminate large display screens adequately.

A continuous, light-activated, electroluminescent panel with variable persistence and erasure capability was recently described.¹⁰ It consists of photoconductive electroluminescent layers sandwiched between two transparent conducting electrodes. When the panel is irradiated with ultraviolet light, the resistance of the photoconductive layer is lowered and the screen lights up at the point of irradiation. Light from the screen provides optical feedback, which keeps the resistance of the photoconductive layer low, maintaining the luminescence of the screen. Infrared light can be used to quench the photoconductivity, thereby erasing the display pattern. Without erasure, the display persists as long as two hours. The display's persistence can be controlled by varying the bias voltage applied to the panel. This solid state panel is simple, rugged

and inexpensive, and has high resolution capability.

Another example is a composite display system that uses a photochromic screen.¹¹ Photochromic materials are organic dyes that become opaque when exposed to ultraviolet light and return to transparency in times ranging from a fraction of a second to 15 minutes, depending on the composition and the temperature. Exposure to infrared light erases the displayed information rapidly.

To produce a display, patterns of varying optical density are written on photochromic film with a deflected ultraviolet light beam. The film so exposed forms the "object" in a projection system. Visible light is projected through the film onto a screen. This display has mechanical simplicity, controllable persistence, and a brightness comparable to conventional film-projection displays.

References

1. R. Lipnick, A. Reich and G.A. Schoen, "Nonmechanical scanning of light in one and two-dimensions," *Proceedings of the IEEE*, vol. 53, 1965, p. 321.
2. T.J. Nelson, "Digital light deflection," *Bell System Technical Journal*, vol. 43, May, 1964, p. 821.
3. W. Kulcke, T.J. Harris, K. Kosanke and E. Max, "A fast digital-indexed light deflector," *IBM Journal*, vol. 8, January, 1964, p. 64.
4. S. Sherr, "Large screen displays," Internal Memorandum, October, 1964, Information and Communication Division, Sperry Rand Corp.
5. H.W. Fuller and R.J. Spain, "A thin magnetic film wall panel display," *Optical and Electro-Optical Information Processing*, MIT Press, 1965.
6. H.B. Bebb, H.E. Heath, R.B. Hilborn and F.S. Maddocks, "Thin film color display device," *Applied Optics*, vol. 3, December, 1964, p. 1416.
7. G. Galli, W.D. Gerber and M.H. White, "Dynamic large screen electrochemical display," Technical Report, Philco Research Laboratories, June, 1964, Document No. AD602-826, Office of Technical Services, U.S. Commerce Dept.
8. C. LaFond and R. Pay, "Special report on advanced displays," *Missiles and Rockets*, vol. 4, October 5, 1965, p. 32.
9. S. Yando, "A solid-state self-scanning display panel," Technical Report, General Telephone & Electronics Laboratories, April, 1964, Document No. AD-608-919, Office of Technical Services, U.S. Commerce Dept.
10. B. Miller, "Electroluminescent display has controlled image storage," *Aviation Week and Space Technology*, vol. 82, April 12, 1965, p. 104.
11. K.J. Stettin, "A real-time photochromic projection display," *Proceedings of the Fourth National Symposium of the Society for Information Display*, Washington, October, 1964.

The authors



Richard A. Soref, holder of a doctorate in electrical engineering, joined Sperry Rand's solid state unit early this year. At MIT's Lincoln Laboratory, he did research on optical effects in semiconductors, and on long-distance photography using laser illumination.



Donald H. McMahon, a research physicist in Sperry Rand's solid state sciences department, is a specialist in nonlinear optics. Until 1963 he was a research assistant at Cornell University, where he earned his doctorate in experimental physics.

Designer's casebook

Designer's casebook is a regular feature in Electronics. Readers are invited to submit novel circuit ideas, packaging schemes, or other unusual solutions to design problems. Descriptions should be short. We'll pay \$50 for each item published.

Bipolar pulse detector features meter display

By C.F. Johnson and J.T. Loisselle

International Business Machines Corp., Lexington, Ky.

The presence of random electrical impulses can be observed by using the circuit at the right. The meter in the collector of Q_1 is deflected for approximately half a second when either a positive or negative pulse appears at the input. A threshold control, represented by R_1 and D_1 allows only pulses of a predetermined minimum amplitude to trigger the circuit. The circuit may be used in other applications as a threshold detector or pulse stretcher. In the experiments for which this circuit was built, the one-volt input pulses were one second apart and lasted 50 milliseconds.

In its stable condition, Q_1 is partially on and Q_2 is almost in saturation. A negative pulse at the input will trigger Q_1 at its base, forcing Q_1 into saturation and turning Q_2 off. The meter will deflect immediately, indicating that a pulse has appeared. Capacitor C_1 charges through R_4 , R_{10} and R_9 and eventually back-biases Q_1 , returning the circuit to its stable state. Diode D_4 allows quick

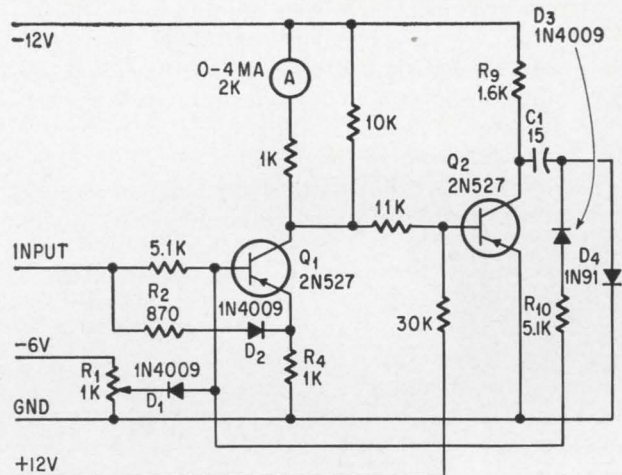

Positive or negative pulses appearing at the input will cause a deflection of the meter in the collector of Q_1 .

recovery by presenting a low resistance, d-c path for charging C_1 in the other direction. A positive pulse at the input results in a similar series of events, except that Q_1 is triggered at its emitter through the low-resistance path offered by R_2 and D_2 .

If the meter indication is not required, any suitable device with an equivalent resistance may be substituted to provide stretched pulses.

Low-cost Schmitt trigger reduces hysteresis

By Allan Pacela

Beckman Instruments Inc., Fullerton, Calif.

The Schmitt-trigger circuit on page 64 allows adjustment of the trigger level, reduces hysteresis, and permits stable operation from 0° to 150°F . The circuit may be used as a zero-crossing detector in addition to its normal use for squaring sinusoidal

waveforms, level detection and restoration of pulse waveforms. Inexpensive transistors allow the circuit to be built at a cost of about \$1.75 if fixed resistors are substituted for the potentiometers.

Except for the addition of hysteresis and trigger-level controls, the circuit is the same as a conventional Schmitt trigger. Hysteresis is defined as the difference between the input voltage level at which the circuit triggers and the input voltage at which the circuit returns to its stable state. Resistors R_1 and R_2 reduce the loop gain during switching, minimize the input negative resistance and thereby reduce the hysteresis. R_2 allows adjustment of the hysteresis to within a few millivolts. However, at low values of hysteresis the circuit will oscillate when the input signal is removed. This means that

the circuit cannot be used for pulse operation at low levels of hysteresis but may be used as a zero-crossing detector for sinusoidal inputs. Resistance R_3 controls the trigger level by controlling the voltage fed back to the base of Q_1 . Since R_3 changes the feedback gain it will also affect the hysteresis.

Component values in the schematic are for a zero-crossing detector that operates at 50 kilocycles per second. The output amplitude is about 8 volts peak to peak. From 0° to 150°F the trigger level and hysteresis are constant within ± 50 millivolts and the output level is constant within ± 0.2 volts. Current drain is 13 milliamperes from each supply.

Good temperature stability is obtained by using low-leakage silicon transistors, low-resistance base return paths, and fairly high operating currents.

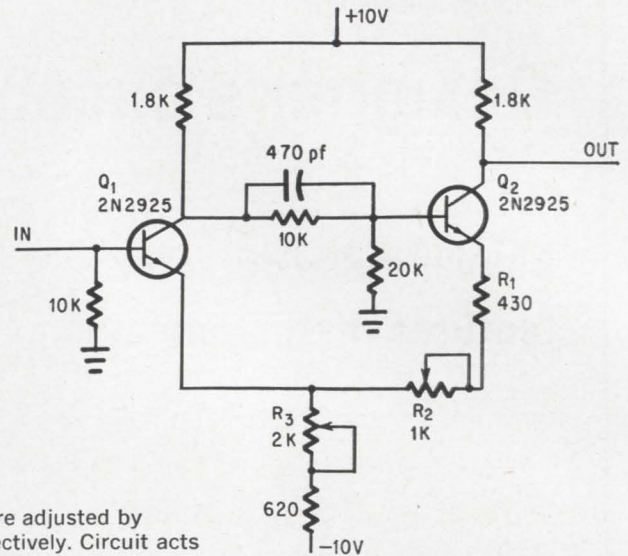

Hysteresis and trigger levels are adjusted by potentiometers R_2 and R_3 respectively. Circuit acts as a zero-crossing detector for a sinusoidal input.

10,000 volt d-c latching relay achieved with reed switch

By J. A. Wisnia

Comstock and Wescott, Inc., Cambridge, Mass.

A polarized latching relay for switching high-voltage, low-current lines can be built with the reed switch, coil, and permanent magnet in the photograph at the right. Positive or negative pulses will switch the relay. It will then remain in either its open or closed position without consuming standby power. Reed switches with breakdown ratings as high as 10,000 volts d-c are available for this application.

The relay is built with a coil designed to hold two reed switches. A normally open reed switch and a magnet are inserted into the coil as in the drawing at the right. The permanent magnet is used to bias the reed switch midway between its pull-in and drop-out ratings. The biasing is adjusted by sliding the magnet parallel to the reed. After the magnet is in the proper position, it is bound to the reed with adhesive. A short-duration magnetic field, developed in the coil by either a positive or negative pulse of current, adds to or subtracts from the biasing field and causes the switch to transfer its state.

The switch is stable in either its closed or open position because the field of the permanent magnet is strong enough to keep the switch closed, but not

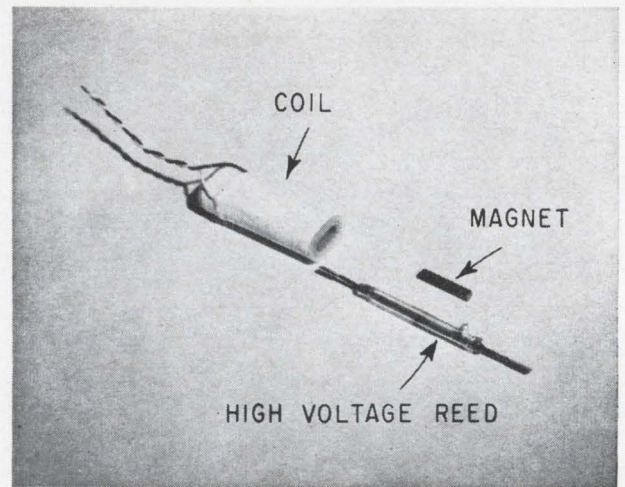

Components for the latching relay include a coil, a high-voltage reed and a small bar magnet. Reed should have a high pull-in to drop-out ratio.

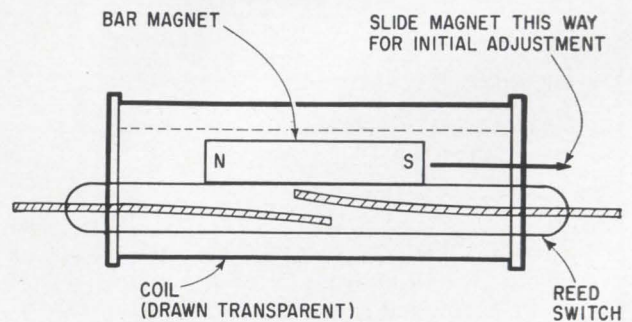

Reed switch is biased by positioning the magnet inside the coil form.

strong enough to close the switch if it is open.

A reed with a pull-in to drop-out ratio of 2-to-1 is required for this relay. This ratio allows the permanent magnet's field strength to vary slightly

without affecting operation. In addition, appropriate coils must be selected to match the desired driving source. Single- or multiple-wound coils are available from several manufacturers.

Bipolar limiter reduces d-c loss

By Stephen B. Gray

Sylvania Electronic Systems, Waltham, Mass.

Limiting positive and negative pulses to levels of three volts can be performed by the circuit at the right. When a positive input pulse, V_{in} , tries to exceed three volts, the 2N404 conducts heavily and passes the excess current to ground. The voltage divider network connected across the positive 20-volt source supplies only enough current to maintain a three-volt reference on the base.

The operation is similar for negative pulses except that the 2N1605 transistor does the limiting. The resistance seen at the emitter when the transistor is conducting is equal to $R/\beta + R_{eb}$, where R is the resistor shown in the schematic, β is the current gain of the transistor, and R_{eb} is the internal emitter-to-base resistance. In this circuit the resistance seen at the emitter is less than 10 ohms for both positive and negative pulses.

The circuit has two features that are difficult

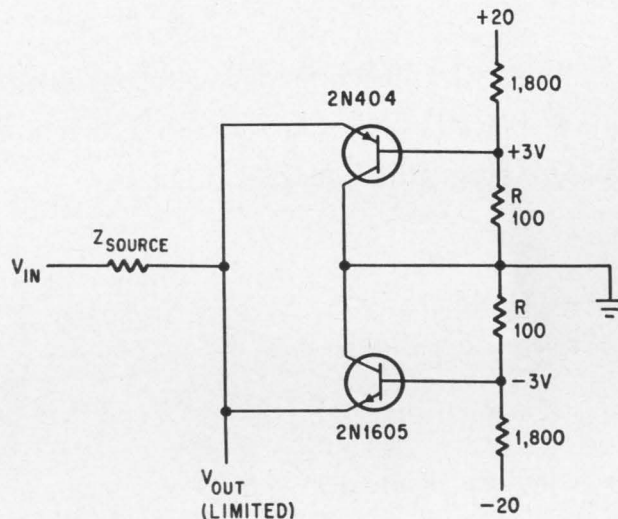

Transistor limiter uses minimal d-c power to establish reference voltages and simulates a diode with small internal d-c resistance.

to achieve in simple diode limiters. It provides its own reference voltage without the necessity for high-current voltage dividers and in the on condition, the circuit presents an internal series resistance of less than 10 rms. This low resistance is difficult to obtain with diodes at low currents.

Zener diode protects backward wave oscillator

Westinghouse Electric Corp., Baltimore

By Louis J. Brocato

One scheme for protecting a type O backward wave oscillator from damage caused by excessive d-c cathode-to-anode voltages is illustrated in the diagram at the right

Zener diode D_1 , rated for the bwo's operating anode-to-cathode voltage, is connected as shown. The zener will hold the voltage at the desired value, and protect the tube from moderate increases in the supply voltage, V_{B1} . The zener current rat-

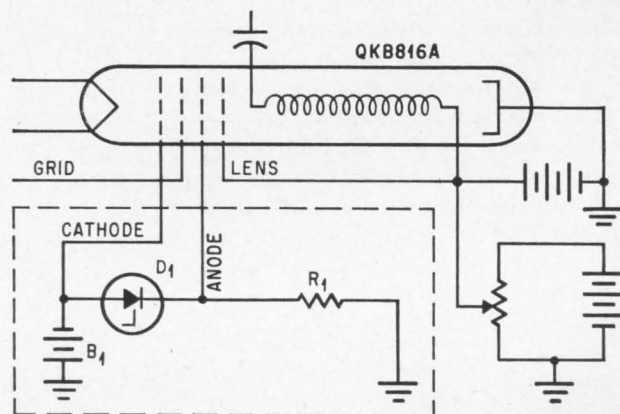

Zener diode circuit in the plate supply prevents excessive anode-to-cathode voltages.

ing should exceed V_{B1}/R to insure that the diode is not damaged by excessive current.

Variable persistence increases oscilloscope's versatility

New cathode-ray tube combined with control circuitry retains displayed waveforms for periods of a minute or more, or stores them for over an hour

By Robert H. Kolar

Colorado Springs division, Hewlett-Packard Co.

Although the ubiquitous oscilloscope scores high on versatility, no single scope can handle every measurement problem. To view low-speed waveforms that change shape, for example, the so-called long-persistence oscilloscope would be best. Capturing fast, single-shot transients, on the other hand, might be a job for the storage-type oscilloscope. A new oscilloscope can now do both these jobs; it features a continuously variable persistence control and combines the best characteristics of the long-persistence screen and the storage tube, without their limitations.

Persistence is defined as the time it takes for the afterglow of an image on a screen to decrease to 10% of its original brightness; a level of light intensity which is still visible. The viewing screens of general-purpose oscilloscopes usually have a persistence of about a quarter of a second. The persistences of the delicate long-persistence phosphors aren't very much longer.

The two most commonly used long-persistence phosphors are known as P2 and P7. P2, composed of zinc sulfide, with silver and copper as activators, gives off a bluish light with a persistence of one second, and is susceptible to burning from

overexposure to the cathode-ray tube's electron beam. P7, a layer of zinc sulfide with a silver activator over a layer of zinc cadmium sulfide with a copper activator, is more versatile; it gives off light in two segments. The initial blue-white glow has practically no persistence, while the yellow afterglow lasts for three seconds. With proper filtering, a scope with P7 can be used as a short- or long-persistence device. But P7 is extremely susceptible to burning, and its persistence is still too short for many applications.

Storage oscilloscopes, too, have limitations. In these scopes, the waveform is retained on the screen at a constant intensity until it is deliberately erased, at which time the entire trace is removed from the screen. Some scopes can be programmed to erase the trace after each sweep, but an annoying flicker is present at medium to slow sweep speeds. At very slow sweep speeds, an inconvenient waiting period occurs while the spot traces out each new picture on the blanked screen. A storage scope does not have the gradual fade property found to a limited extent in long-persistence phosphors. Some storage scopes also suffer from short life, slow writing rate, and poor contrast between trace and background because of background glow.

Variable persistence

These limitations are largely overcome in the new commercial scope in which persistence can be varied. The Hewlett-Packard Model 141A combines a special type of cathode-ray tube with unique persistence-control circuitry, thus permitting its use in three modes: as a normal oscilloscope; as a long-persistence instrument with persistence continuously variable from about 0.1 second to more

The author

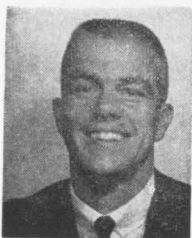

Robert H. Kolar, an applications engineer for Hewlett-Packard, joined the customer service division in 1962 as an oscilloscope service engineer. In 1963 he transferred to the marketing department of the Colorado Springs division, a manufacturer of oscilloscopes and pulse generators.

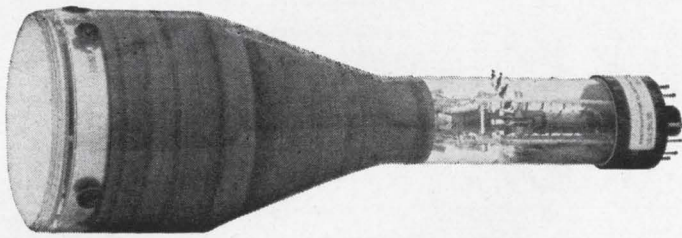

than one minute; and as a storage scope, capable of storing traces for periods up to an hour.

The Hewlett-Packard crt is essentially a storage tube. It has several extra electrodes, as shown in the drawing at the right; these electrodes are the flood guns, flood-gun collimating electrodes, collector mesh, and storage mesh.

Unlike some types of storage tubes, the meshes are separated from the viewing screen, thus allowing the use of any suitable phosphor. P31 was chosen, because it has the appropriate characteristics for general-purpose visual and photographic work, and is extremely resistant to burning.

Separation of the meshes from the viewing screen also allows the use of an internal graticule (grid scale) on the faceplate. The graticule eliminates error often introduced by parallax when observing wave-forms.

Storing the trace

The storage mesh, just behind the phosphor screen, is a conducting mesh covered with a highly resistive coating of magnesium fluoride. The write gun (the same gun that produces a trace in a conventional oscilloscope) etches a positively charged pattern on the storage mesh by knocking electrons loose (secondary emission). Because of the excellent insulating property of the magnesium fluoride, this charged pattern stays put; it does not spread to adjacent areas.

After the trace is stored on the mesh it has to be made visible. The flood guns in the crt spray low-velocity electrons toward the phosphor screen. Some of these electrons are picked up by the collector mesh and never get to the screen; but in the area near the positive charge on the storage mesh, the positive field pulls some of the flood-gun electrons through the storage mesh and they move on to hit the phosphor, producing a visible trace.

Potentials are applied to the various electrodes so that the flood-gun electrons don't wash away the positive charge etched on the storage mesh. The write-gun cathode is always at a large negative potential (-2.3 kilovolts), flood-gun cathodes are always at ground potential, the collector mesh is always at +156 volts, and the phosphor is always at +5kv. The storage mesh potential is variable.

Since the flood-gun cathodes are at ground potential, the storage surface must be placed above ground potential for the flood gun electrons to reach it. Depending on the value of the positive voltage placed on the storage surface, the flood-gun electrons will then either increase or decrease the charge on the insulated storage surface.

Secondary emission ratio

On the curve shown below, the ratio of the number of secondary electrons knocked loose from the storage mesh to the number of bombarding electrons (the secondary-emission ratio) is represented on the vertical axis, and the accelerating potential of the primary electrons is plotted horizontally. Where the secondary emission ratio is equal to one, a crossover point occurs. This point is unstable.

The basis for the curve may be shown by placing a positive charge on the tube's storage surface. If

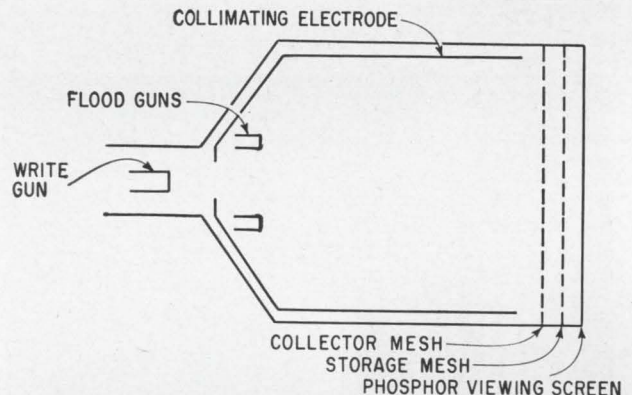

Several electrodes are added to a conventional cathode-ray tube to make a variable persistence crt. The new electrodes are the flood guns, the flood-gun collimating electrode, the collector mesh, and the storage mesh. The write gun and the phosphor viewing screen are part of any standard crt.

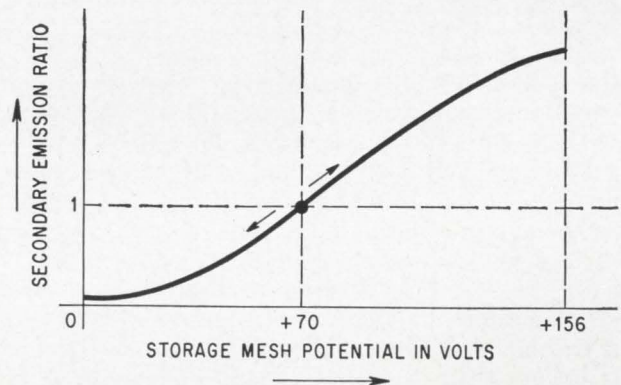

Secondary emission curve for the storage mesh. The crossover point at +70 volts is an unstable point; any spot on the storage mesh below +70 volts will be brought to zero volts by the action of the flood-gun electrons, while any spot above +70 volts will charge positively up to the +156-volt collector mesh potential.

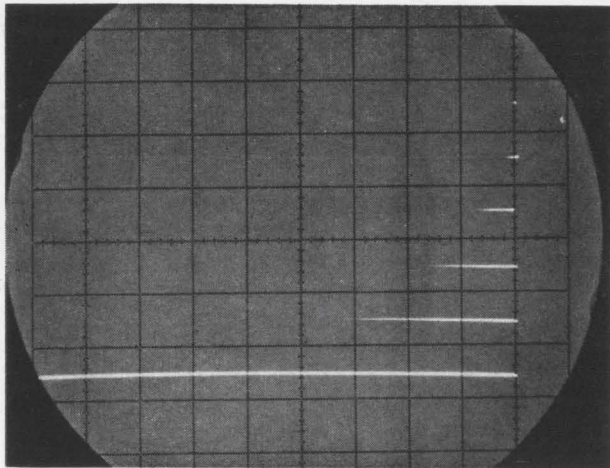

Multiple exposure photograph shows traces with increasingly long persistences at constant sweep speed of one second per centimeter. Camera shutter speed was 1/100 second. Top dot is in conventional crt mode and no persistence is discernible. The second trace has 1/5-second persistence, the third lasts 1 second, the fourth lasts 1.5 seconds, the fifth lasts 3 seconds, and the bottom trace is adjusted for maximum persistence of one minute, with the first nine seconds of the tail showing.

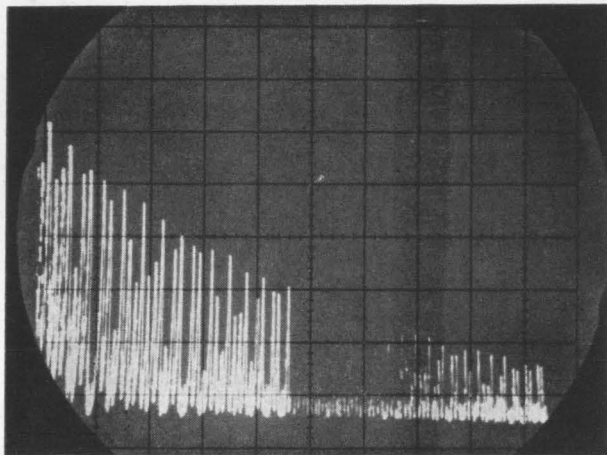

Spectrum analysis of a 1-kilocycle square wave over a range of 35 cycles per second to 100 kc. Note that newly written trace is halfway across screen from left to right, with previous sweep fading away. Shutter speed was 1/100 second.

this voltage is higher than +70 volts, the secondary emission ratio becomes greater than one, more electrons are emitted than are absorbed, and the positive voltage on the storage surface rises even higher. The limit is +156 volts, the value of voltage on the collector mesh. If the voltage on the storage surface tends to go any higher, the collector mesh repels the secondary electrons back to the insulator, keeping the voltage there constant.

On the other hand, if the storage surface voltage is below +70 volts, the secondary emission ratio falls to less than one, fewer electrons are emitted than are absorbed, and the voltage drops. If the voltage on the storage surface tends to go below zero, all flood-gun electrons are repelled and secondary emission stops.

A negative voltage may be also placed on the storage surface through capacitive coupling of a negative voltage applied to the storage mesh. The flood guns will have no effect on the negatively charged storage surface because they are at a more positive potential (ground).

Erasing the screen

To erase the screen and prepare it for viewing, a spring-loaded front panel switch is momentarily set to the erase mode, which applies +156 volts to the storage mesh, charging the storage surface uniformly to this voltage level by capacitive coupling. Releasing the switch then reduces the storage mesh voltage to +12 volts, bringing the charge on the storage surface down at the same time.

At this point, the action of the flood guns reduces the voltage on the storage surface to zero and holds it there. By the action of a diode and an R-C network, the storage mesh voltage is held at +12 volts until the storage surface has time to reach zero volts. Then the mesh voltage is suddenly reduced to +2 volts. This negative excursion is coupled to the insulator surface by capacitance, and results in a final charge on the surface of -10 volts. The surface is now prepared for writing.

Since the writing gun is at -2.3 kv, the electron beam hits the storage surface with very high energy, and immediately charges the point of incidence to zero volts by secondary emission. The point cannot charge to a level any higher than zero due to action of the flood guns. When the writing beam is removed, the spot remains at zero volts because of the insulating qualities of the surface, while the surrounding area stays at -10 volts. The desired charge is now stored on the storage surface. As explained previously, this stored charge pulls flood-gun electrons past the storage mesh. These electrons then go on to hit the viewing screen which is at a positive potential of 5 kilovolts. Most flood-gun electrons are prevented from passing through the storage mesh, because the storage surface not exposed to the write beam remains at -10 volts. The background of the viewing screen is therefore dark, providing good contrast with the illuminated stored trace.

Pulsed erasure

Variable persistence is achieved by varying the time it takes to erase the picture. The erase voltage is applied to the storage mesh in the form of pulses, which are capacitively coupled from the storage mesh itself to the surface of the insulator coating on the mesh. Successive pulses gradually lower the voltage on the storage surface, until erasure takes place at approximately -5 volts. Varying the width of these pulses varies the rate of erasure. In the model 141A, the persistence control is simply the variable width control of the erase pulse generator. This control can adjust the persistence from about a fifth of a second to more than a minute.

Since the storage mesh coating is an insulator,

each point on it is completely isolated from the rest of the mesh as far as erasure is concerned. This means that it is possible to adjust the fading rate so that the part of the trace just written on the screen is at full brightness while an earlier part of the same sweep is fading from view. This effect very closely simulates natural phosphor persistence, as shown in the lower photograph on page 68.

In the variable-persistence write mode a picture will last for a maximum of one minute at full clarity. After this, the picture begins to degrade. The one-minute limit is caused by the presence of positive ions which are created when flood-gun electrons hit residual gas molecules floating about in the crt. The positive ions are attracted to negatively charged areas of the storage surface. The positive collector mesh repels some of the ions, but others manage to strike the storage surface and charge it positively. As the surface charge approaches zero, it permits electrons to pass through to the screen. This appears as background glow which gradually increases in intensity until it masks out the stored image. To store a trace for longer than a minute, it is necessary to reduce the effect of the positive ions. In the store mode this is done by applying flood gun electrons in bursts rather than continuously. Since the flood guns are off part of the time, fewer positive ions are produced and waveforms can be stored for over an hour.

The display is rather dim in the store mode, so a view mode is provided. This brings the trace up to normal brightness by turning the flood guns on all the time. The view mode can be used for a cumulative period of one minute before the background begins to mask out the signal. To prevent additional traces from being written in the store and view modes, the write gun is automatically biased off.

Finally, to use the oscilloscope as a conventional instrument, the storage mesh and the storage surface are placed at -30 volts. Although the write gun tends to make the storage surface more positive by secondary emission, the relatively large negative voltage of -30 volts on the storage mesh causes leakage of electrons to the storage surface. Thus, while the write gun is trying to charge the surface positively, the leakage from the mesh tends to charge it negatively. The influence of leakage is greater and the entire storage surface is kept negative. The write beam simply strikes the viewing screen, and the trace fades at a rate that depends on the natural persistence of the phosphor.

Applications

Since the variable-persistence oscilloscope can be operated as a storage oscilloscope, it is more convenient than a standard oscilloscope used with a camera in many applications. The observation of slow-moving traces or single-shot phenomena, and the comparison of events separated in time are greatly simplified by the use of a storage scope.

The variable-persistence feature also has advantages over the standard storage oscilloscope. There

Glowing example of versatility

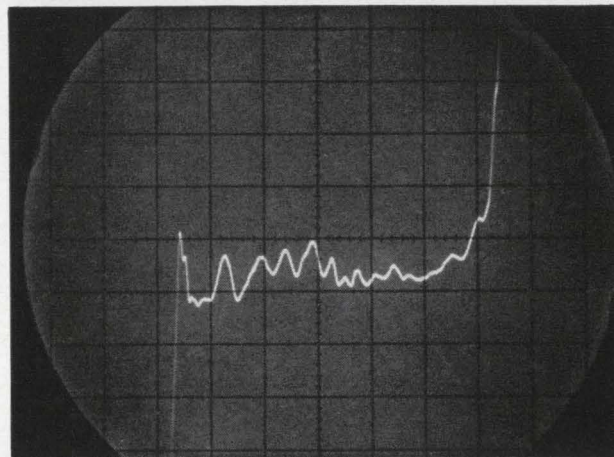

Fast sweep mode

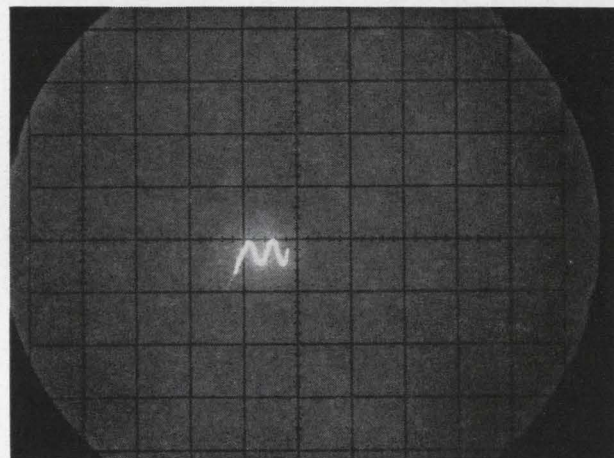

Slower sweep

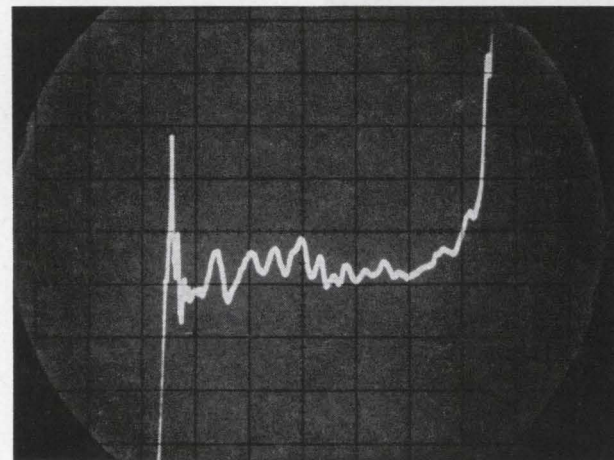

Variable persistence

Time-domain reflectometry measurements of a 240-cm-long, 50-ohm coaxial cable. Camera shutter speed was $1/100$ second in all three pictures. Vertical scale is calibrated in reflection coefficient of $\rho = 0.01/\text{cm}$. The fast sweep mode, shown at the top, produces trace that is easy to look at, but resolution is lost. In the center photo, the sweep is slowed to increase resolution, but it is difficult to see the complete sweep. At the bottom, variable persistence was used to obtain high resolution and steady waveform simultaneously. Note the leading spike, in this case caused by a BNC connector.

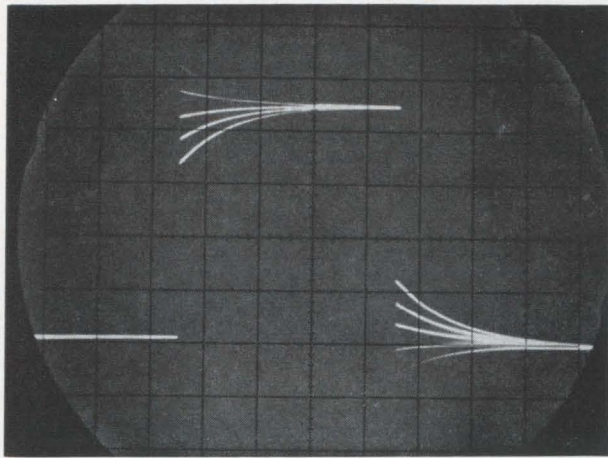

Single exposure photograph shows results of adjustments made to a system being tested with a square wave. Persistence is adjusted here so responses to the last five adjustments are all shown for comparison purposes.

is no annoying flicker from displays slower than a few milliseconds per centimeter; trends in changing waveshapes may be observed by superimposing as many previous sweeps as desired, with each new sweep replacing the oldest sweep on the screen; undesired random deviations on a signal may be automatically and continuously rejected by integration of the repetitive portion, with simultaneous uninterrupted viewing.

Electrocardiograph signals and other biomedical phenomena, for example, produce waveshapes that are slow-moving and constantly changing. With variable persistence, it is possible to find the best compromise between flicker and response to new waveshapes. That is, the trace is made to linger long enough so that its entire shape may be easily seen at all times, yet it fades fast enough so that a new waveshape is not masked or confused by previous shapes.

Another very useful application of the elimination of flicker occurs when measurements must be made at very slow sweep speeds to insure high resolution. Here again, persistence is adjusted so that the entire waveform is present on the screen at all times, yet multiple waveforms do not build up and confuse the picture. One example of this type of

Tube teamwork

The special cathode-ray tube used in the Model 141A oscilloscope was jointly developed by the Hewlett-Packard Co. and the Westinghouse Electric Corp. Westinghouse had experience in making this type of tube, but Hewlett-Packard wanted to incorporate a number of its own parts to make the finished crt compatible with its existing instruments. To make production of the tube efficient, Hewlett-Packard builds the complex writing guns and ships them to Westinghouse where the phosphor, internal graticule and special storage meshes are added. Then, Westinghouse completes the assembly of the cathode-ray tube.

measurement is spectrum analysis, where amplitude is plotted vertically and frequency is plotted horizontally on the crt. If a wide frequency range is shown on the screen, the beam must be swept very slowly to insure that every sudden deviation is captured at its full amplitude. Variable persistence eliminates the dilemma of choosing between high resolution or easy viewing by providing both, as shown in the photograph on page 68.

In microwave swept-frequency measurements, which are really a variety of spectrum analysis, the same advantages apply. A swept-frequency oscillator feeds r-f power into a system under test. Reflections are picked up by directional couplers, detected, and displayed vs a function of frequency on an oscilloscope. Similarly, the insertion loss as a function of frequency of a device may also be monitored. In both cases, it is often desirable to vary the range of test frequencies slowly, for maximum resolution. Once again, the variable persistence oscilloscope is the perfect tool.

In time-domain reflectometry measurements, broadband systems such as cables, connectors, and striplines are tested for flaws by sending a pulse down the line under test and watching the reflections on an oscilloscope. One great advantage of this measurement technique is that discontinuities are spread out in time on the screen and individually resolved. However, when checking long lines, a very slow sweep must be used to resolve closely spaced discontinuities. Variable persistence produces a steady, complete picture, and still allows maximum resolution, as shown in the photographs on page 69.

Several sweeps

In the preceding examples, only one full sweep need be displayed on the screen at a time. The trace can be made to fade fast enough so that the new sweep restores the part of the pattern just vanishing from the screen. In some applications, however, it might be desirable to show several sweeps at once. When making adjustments to electrical or mechanical systems, several successive sweeps showing the response of the system may be displayed, superimposed. This provides a continuous monitor of the system response to each new adjustment. With the H-P scope, responses can be made to fade away automatically after any length of time up to a minute, as shown in the photograph above. Thus, a continuous-monitoring-comparing system can be set up, with no need to touch the oscilloscope.

Superimposed sweeps also permit automatic integration. Repetitive signals can be built up to a visual level after several sweeps, while unwanted random deviations would never occur often enough in the same place to become visible on the screen. A typical example would be the observation of a low duty cycle waveform at a fast sweep speed, with occasional jitter present. While building up the presentation of the desired signal, the scope persistence can be set to eliminate the jitter.

Special report

Time-sharing computers

Although the concept was propounded years ago, time-sharing is just beginning to find practical applications, thanks to new hardware and new techniques. This survey, reviewing the principles and describing some applications, is written for engineers: those who plan equipment, those who design systems and those who simply use computers. A later issue will contain articles on time-sharing in hospitals and for computer maintenance, and the case against the accepted approach to time-sharing.

- p. 72 Time-sharing: one machine serves many masters
- p. 79 IBM's approach
- p. 83 Project MAC at MIT
- p. 85 Campus workhorse at Dartmouth
- p. 87 Penn's satellite computer

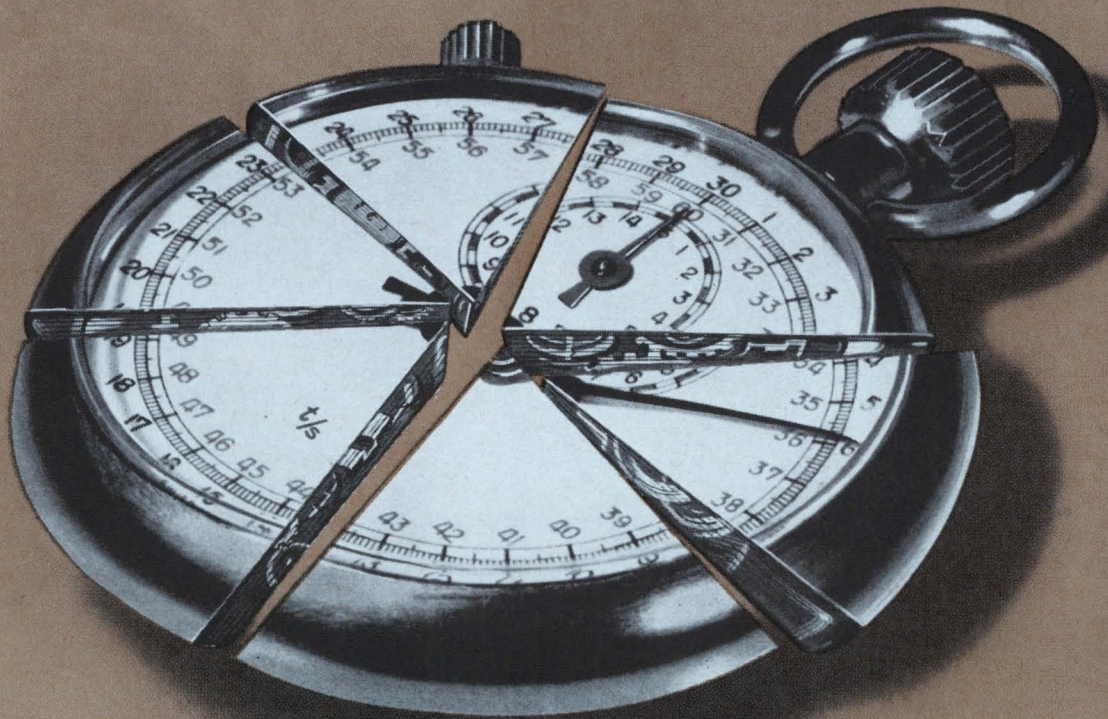

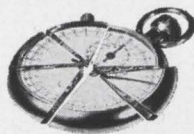

Time-sharing: one machine serving many masters

A technique that permits a 'dialogue' between scientist and computer is now being offered to nontechnical customers as well.

Here's what it does—and what it can't do

By Wallace B. Riley

Computer Editor

Like any expensive machine, a computer justifies its cost only when it is in nearly constant operation. One way to accomplish this is batch processing, the execution of several programs in series—that is, one at a time. A newer, more refined technique is time-sharing, in which programs are handled "in parallel." A supervisory program acts as a traffic cop, flashing "stop" and "go" signals to inputs from many terminals at varying distances from the computer and preventing each user's demands from interfering with the others'.

The trouble with batch processing is that it requires the computer to run a complete program without stopping; programs often must wait in line a long time to get on the computer. Frequently when the wheels stop spinning and the read-out begins, the computer's judgment is: "I can't run your program because you made a mistake at point x; fix it and try again."

Time-sharing permits a "dialogue" between the computer and the user, who may be miles away. If the program contains a mistake, the computer informs the user immediately. If preliminary results indicate that more thought should be given to the problem before further computations are made, that too can be done without further ado. And the dialogue starts right away, without waiting until the computer completes previous programs.

But batch processing will never disappear. For one thing, a time-shared computer will not always be in heavy demand from its remote terminals, and programs run in batch-processing mode give it something to do at these idle intervals—for instance between midnight and 8 a.m. Moreover, batch processing is ideal for certain types of problems that cannot be solved easily from a remote

console. An example is the classic problem for a scientific computer: "Is the number $2^{100000} - 1$ a prime?" The answer, either "yes" or "no," may require a relatively small program, but it may also require many hours of computer time.

One problem with time-sharing is the cost of telephone service between the computer and remote terminals which may be hundreds of miles away. These costs have been known to approach the rental fee for a small computer. The Bell System says it is studying various ways to provide service at less cost.

Any computer will do, but . . .

Any large computer can be time-shared, but for efficient operation a specially designed machine is necessary. The newer systems designed for time-sharing—such as the General Electric Co.'s 635 and the model 67 of the International Business Machines Corp.'s System 360—contain hardware for special tasks such as program relocation and memory protection.

Relocation permits a program to be loaded anywhere in the memory, at the option of the supervisory program: the program may be in a different location every time the computer resumes work on it. For time-sharing, the relocation problem is complicated enough to warrant putting the solution into hardware, rather than software as has been used for many years in standard computer practice. The supervisory program loads a constant—the address of the program's first instruction—into a hardware register and adds this constant to each address reference.

Memory protection is necessary whenever more than one program exists in the memory; it estab-



Time sharing is exemplified by this airline reservation system, American Airlines' Sabre installation in Briarcliff Manor, 30 miles north of New York City. The computer is an IBM 7090; it can reserve a seat on any American Airlines flight almost a year in advance, in less than three seconds—and handle 2,100 such requests every minute.

lishes bounds for instructions and data pertaining to a particular program.

A time-shared computer looks much like a batch-processing type. The most obvious difference is the terminal, or console, that gives the user access to the computer.

The great majority of terminals in present time-sharing systems are either Teletypes or IBM 1052 printer-keyboard units. Two models of Teletypes made by the Teletype Corp., a subsidiary of American Telephone and Telegraph Co., are most common: the 33 and the 35. The model 28 Teletype is also encountered occasionally. Buffered display units are becoming increasingly popular. Each has a cathode-ray tube with a screen that resembles that of a small television set.

To connect the terminals with the computer, the Bell System offers several kinds of links, including: voice-grade telephone line, used with Bell's Dataphone equipment to permit transmission of voice and data over a bandwidth up to 4 kilocycles; and a less expensive service, called TWX, for Teletype service without voice communication. A variation, TWX-prime, is available for use with equipment other than Bell's.

Bell also offers Telpak service, a group of leased lines of voice grade. Wide bandwidth (4 kc for each of as many as 240 lines) permits high-speed transmission from terminals such as buffered display units, or from groups of teleprinters in a small area a long way from the computer.

Large memory needed

A time-shared computer requires a large memory, or storage—both a main memory (rapid-access core memory) and bulk back-up storage (magnetic drum or disk). A typical main memory has a capacity of several hundred thousand characters and an access time of one or two microseconds. The magnetic drum usually has a capacity of about a million characters, and its average access time is in the tens of milliseconds; the magnetic disk memory has a capacity of hundreds of millions of characters; a typical average access time is 200 milliseconds.

The main memory usually contains the supervisory program, some frequently used subroutines, and the present user's program. The demand for large memory areas comes from the compilers and subroutines of the general-purpose system, and even more, from the large requirements of the supervisory program that directs the "traffic" of other programs.

Users' programs are typically carried in a magnetic drum memory. These programs can be swapped into main memory on short notice. Magnetic disk memory is for programs that are not being used at the moment but that are called upon frequently.

A slightly different type of memory arrangement will be used in a service planned by Allen-Babcock Computing, Inc., of Los Angeles. In this arrangement, which is expected to be operating in 1966, a

large and relatively slow bulk core storage will replace part of the memory capacity for drum and disk. Access to the bulk core storage will be substantially slower than to the main memory but still three or four orders of magnitude faster than access to a magnetic drum. The system will be built around an IBM System 360 computer, with the IBM eight-million-character storage unit attached.

One page at a time

Memory paging, or program segmentation, reduces the size of the main memory but increases that of the bulk storage. With this technique, a program is broken up into "pages" of about 1,000 words each. These pages are "turned," or transferred in and out of the memory. In this way, a small portion of a large program can be kept in the main memory for a long time, while the larger inactive part of the program is retained on the drum. Paging permits the computer to retain small pieces of several programs at once; it also permits rapid transfer from one program to another within the computer. A more complete explanation of memory paging will be found in the article beginning on page 79.

Since a program runs only for a prescribed time—a few milliseconds or at most a few seconds—the computer must have a clock that keeps track of this interval. The clock may be driven either by an oscillator operating at a few kilocycles per second, or from the power line's 60 cycles per second.

Who's next?

If a program uses up its allotted time before it is completed, the computer must save the results for completion later, and choose the next program.

The simplest priority is first-come, first-served; when a program's time is up, the program takes its place at the end of the line and the computer turns to the program that has been waiting longest. If a program must be stopped because it is waiting for additional input or some other lengthy delay, it is not allowed back into line until it is ready to run again.

A variation on the first-come, first-served system is called round-robin priority. When a program's time is up, the computer samples all incoming lines in a prescribed order until it finds a request to run.

A more complex priority system has been proposed whereby a computer could whittle away at large problems in its "spare time," when it is not busy with simpler, high-priority services. Several different levels of service could be offered, at different speeds and prices. The slowest and least expensive would be deferred service; next would be quick turn-around; the most costly would be responsive service, where the user would reserve a specified percentage of machine capacity for a specified time. The tasks within each level would be performed on a first-come, first-served basis, but the higher-priority levels would be completed first.

Another priority scheme is based entirely on the

Time-sharing: what it is and what it is not

Time-sharing lets several people use a computer at the same time from a distance. Three terms often used for time-sharing are multiprogramming, multiprocessing and on-line, real-time. But they differ from time-sharing, as the term is used in this report.

Multiprogramming. When several programs are stored in a computer system at once, that system is said to be multiprogrammed, whether the programs are batch-loaded or time-shared. In time-sharing, however, the programs are loaded from remote consoles. But in both systems, only one program can be running at any given instant. The multiprogrammed computer immediately switches to another program after one program is completed or reaches a point where more information is needed.

This moving of programs is called "swapping," and the time lost moving them is called "swap time." Inactive programs are held on a high-speed magnetic drum. The drum is fast enough to move the programs around without excessive delay and large enough to hold several programs at once. A drum typically makes three revolutions during one swap—up to one

revolution to start, at least one to dump the old program from memory to drum, and at least one more to load the new program into memory from the drum. This three-revolution swap can take 100 milliseconds—a lot of computer time. But some systems can perform a complete swap in one revolution by using parallel rather than serial recording on the drum and a buffer arrangement between the drum and core memory. In this system, a word is brought from the drum and placed in a buffer; at the same time, another word kept in another buffer is placed on the drum. Then words are transferred to and from memory between drum transfers.

Multiprocessing. The simultaneous operation of two or more independent computers executing more-or-less independent programs, with access to each other's internal memories, is called multiprocessing. However, a single computer can be time-shared. In some multiprocessing systems, there is communication between computers, making it possible for one computer to control another.

The line between time-sharing and multiprocessing is not clear, so it is difficult to tell just where a

time-sharing system stops and multiprocessing begins. For instance, some remote terminals for multiprocessing have been designed with a degree of computational ability built in; one example of this is the buffered display unit. The buffer can be used for simple local computation as well as data by adding a few instructions. Researchers at the University of Pennsylvania have carried this idea somewhat farther, by having a small computer control a number of local terminals independent of the central processor (see p.).

On-line, real-time. An on-line, real-time system combines two kinds of activity. One, an on-line system receives information about current activity as soon as it occurs. Second, a real-time system is one in which an answer to a continuing problem for a particular set of input values is available while those values are still usable. A time-shared computer is on-line because the computer user interacts directly with the computer, and real-time because the computer gives answers immediately. But on-line, real-time computers are not necessarily time-shared because some may be doing only one program. The one program may be completed so rapidly that time-sharing isn't necessary.

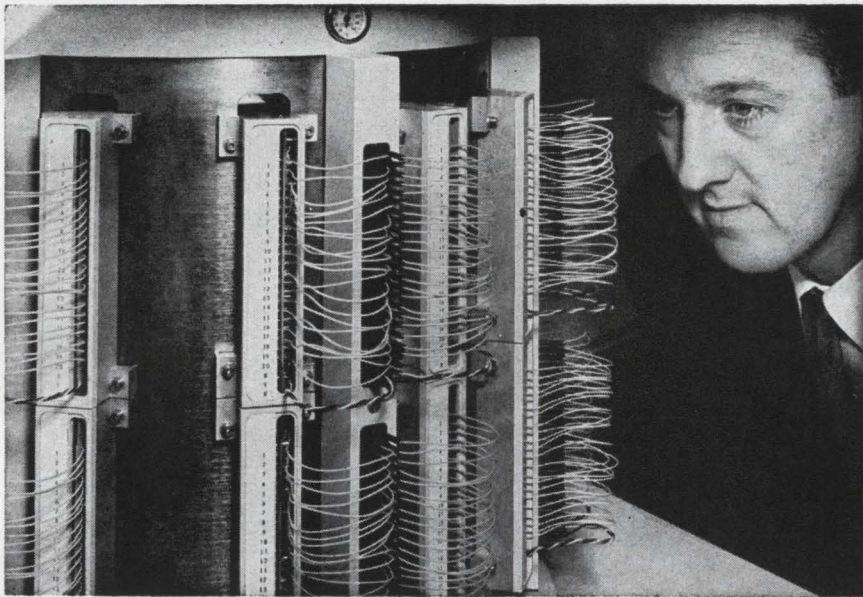

Magnetic drum storage unit, an IBM 2301, typical of those used in time-sharing systems. Up to 1.1 million characters are recorded on the surface of the drum in 200 tracks; read-write heads are mounted on the vertical members near the surface.

program's length: the shortest program gets the highest priority. This approach is based on the Corbato algorithm, which was devised by F. J. Corbato at the computation center of the Massachusetts Institute of Technology. Under this system, any program will run either until it is completed, or its allowed time is used up, or a higher-priority request is received by the computer. No program is interrupted, however, until it has run for a minimum period; also, the algorithm has a built-in protection against the computer's being monopolized by a short program with a disproportionately long run time.

Programing for time-sharing

While the customer keeps his attention on the ultimate goal, the routine computations are controlled by the computer's supervisory program, also called the executive or the monitor. In batch-processing systems, it supervises such recurring tasks as loading of new programs, data recovery after an error, and the mechanics of input and output.

Software often includes a library of subroutines for such recurring processes as calculation of square roots, sorting of lists, and other tasks that are primarily mathematical or clerical. Usually the programmer can specify one of these subroutines with a single instruction, called a macro-instruction, in his program; the supervisory program initiates these subroutines at the proper time.

In time-sharing systems, supervisory programs have additional tasks. These include charge accounting and language choice. Each user of the system must be charged for his time on the machine, even if this occurs only in millisecond increments; the supervisory program keeps track of this and can send out the equivalent of monthly statements. As for language, one of the first inputs from each user of a general-purpose computer is a designation of the language he expects to use. The supervisory program then calls the proper compiler

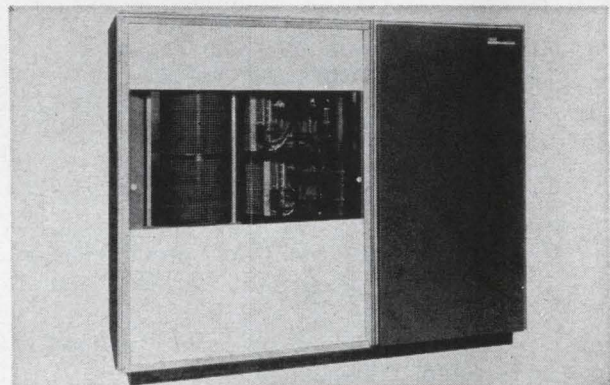

Magnetic disk storage unit, an IBM 1301, typical of those used in time-sharing. As many as 28 million characters may be stored on the surfaces of disks at left; there are two groups of 25 disks each, with separate access mechanisms (center). Magnetic read-write heads are mounted on a comb-like structure that is hydraulically driven to any one of 250 track positions. Cabinet at right houses electronic controls. Several of these units may be used in tandem.

from a library of subroutines and stores it on the drum for quick access whenever a string of instructions is received from that user.

For time-shared systems, the supervisory program must be large because of the complex sequence that must be controlled. But the size of the program increases less rapidly than the size of the computer itself. For example, in a computer with 60,000 words of memory, as much as half of the space can be taken up by the supervisor; but in a two-million-word memory the supervisor might occupy only 10% of the space. Even so, a 200,000-word program, supervisory or otherwise, is by no means small.

Multilingual computers

The ability to use different computer languages



is vital in the design of time-shared systems.

Computers work only with machine language. Computer users almost never do, because machine language requires a vast amount of clerical work—for which the computer itself is ideally suited. So programmers usually give instructions in a symbolic language—each make and model of a computer has its own. Before it goes to work on the program, the computer translates it into machine language by means of an assembly program. Every type of machine requires a specific assembly program for its own symbolic language.

In addition to symbolic languages, there is a large number of problem-oriented languages, each designed for a particular type of problem. It takes much less time to write a good program in a problem-oriented language; also, a single program will work in a large number of computers. Thus Fortran (for formula translation) is designed to get a computer to solve equations, and Cobol (for common business oriented language) helps to set up payrolls, inventories and other commercial applications. Each problem-oriented language works with a computer of any type so long as the computer has a compiler program, written for that type, to translate the program into machine language. Compilers are complex programs that take up a great deal of computer time; sometimes a program's compilation takes longer than its execution.

Recently, computers have been designed that accept typed input in almost every-day English, sometimes in the user's own jargon. The computer types its replies in idiomatic English. This conversational mode requires another program, similar to a compiler. Such a system, being used at the Massachusetts General Hospital, will be described in a later issue of *Electronics*.

Commercial applications

A customer of a commercial time-shared com-

puter has in his office a teletypewriter which he rents by the month for a specified minimum number of hours of computer use; if he requires extra time, he pays an extra fee. From his machine, he feeds programs and data directly to the computer. And answers are received quickly at the same machine.

Theoretically, a single time-shared computer could offer both scientific and commercial services; but none does so at present. The big drawback to a purely commercial service is the fact that non-technical customers require much more training than scientists do in the use of a computer. The advantage, however, is in the vastness of the commercial market. Some specialists believe that any profit in time-sharing will have to come from commercial, rather than purely scientific, applications.

The first service that is entirely commercial has been opened in Cambridge, Mass., by the Keydata Corp. Keydata's commercial system specializes in invoicing and inventory control for liquor wholesalers, although ultimately the company plans to offer more services [*Electronics*, Feb. 22, 1965, p. 17]. From its present capacity of about 24 terminals, Keydata plans to expand to several hundred.

Another kind of time-sharing is Quiktran, offered by the International Business Machines Corp. This service, which helps scientific users solve technical problems, is described in the panel on pages 80 and 81.

Other commercial time-sharing services are the airline reservation systems and the somewhat similar hotel-reservation systems.

For the airline the system produces, on demand, information for reservation agents about flight times and available space on each plane. The system also produces documents for management information and for statistical analysis of the airline's service.

For the future, some specialists have predicted a string of computers, available as a public utility like gas and electricity. Such a utility is described in the article beginning on page 83.

Another proposal is for a "money key," an extension of the credit card. Under this concept, when a customer makes a retail purchase he presents his money key to a clerk, who inserts it into a local terminal and enters on a keyboard the price and other information. The terminal relays all this information to a central computer that has access to account information in the local bank. The computer deducts the amount of the purchase from the customer's account and adds it to the merchant's account. No money has changed hands, and there is no billing, no accounting and no deferred payment. Such a system has been proposed for the Salt Lake City area by Sperry Utah, a division of the Sperry Rand Corp.

Scientific applications

At the frontiers of knowledge, one difficulty is the separation of the heuristic phase—the insight or "aha!" phase—from the algorithmic, or rote, phase of problem-solving. Computers excel at al-

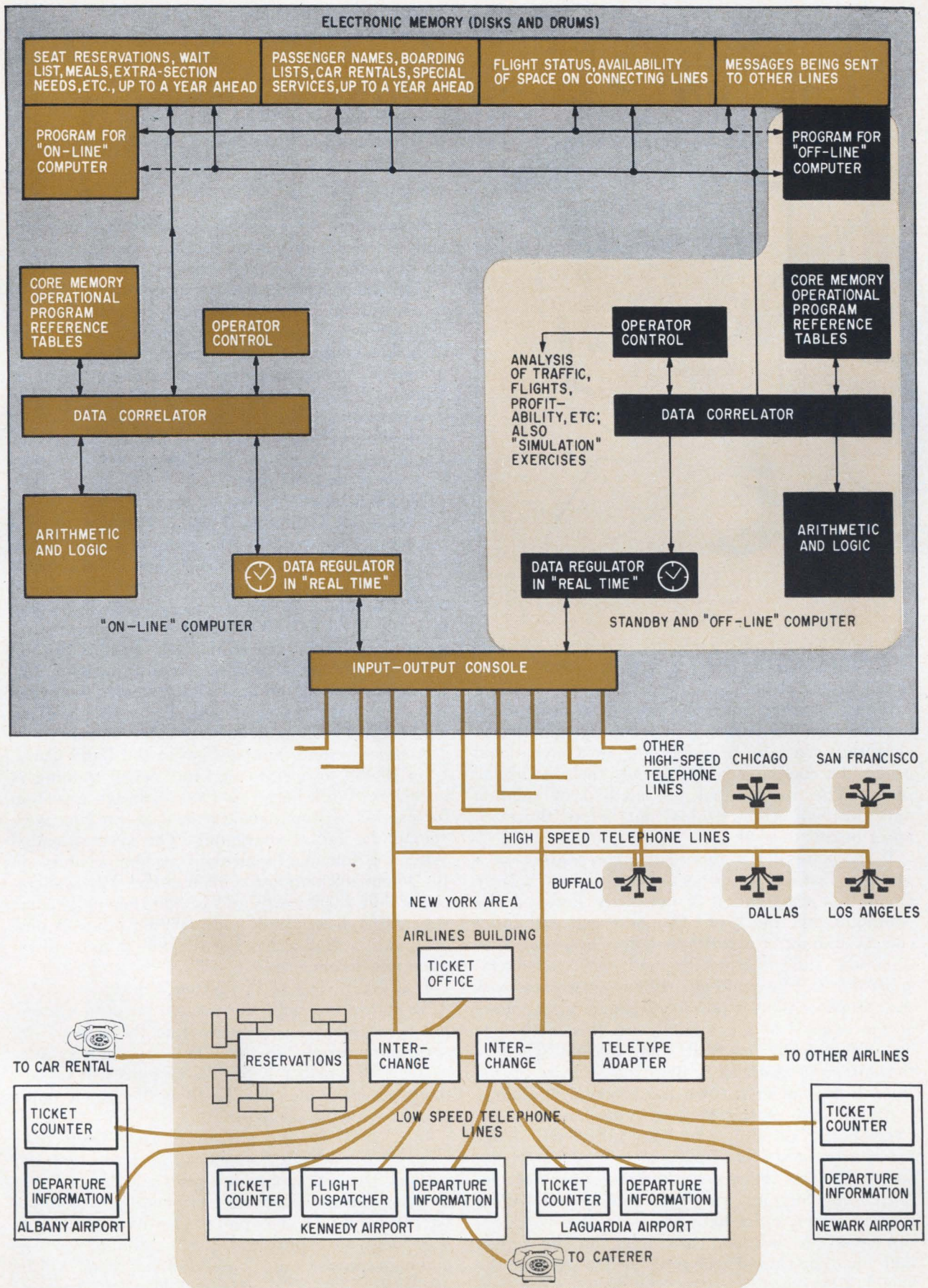

American Airlines' electronic reservation center. Each block in each of the "airport" enclosures represents one or more typewriter-like terminals from which the airline ticket agent communicates with the computer. The input-output console polls all incoming lines at high speed. One of the two IBM 7090 computers is on-line and processes the reservation; the other is standing by, ready to cut in instantly if needed. (Diagram by Fortune magazine.)

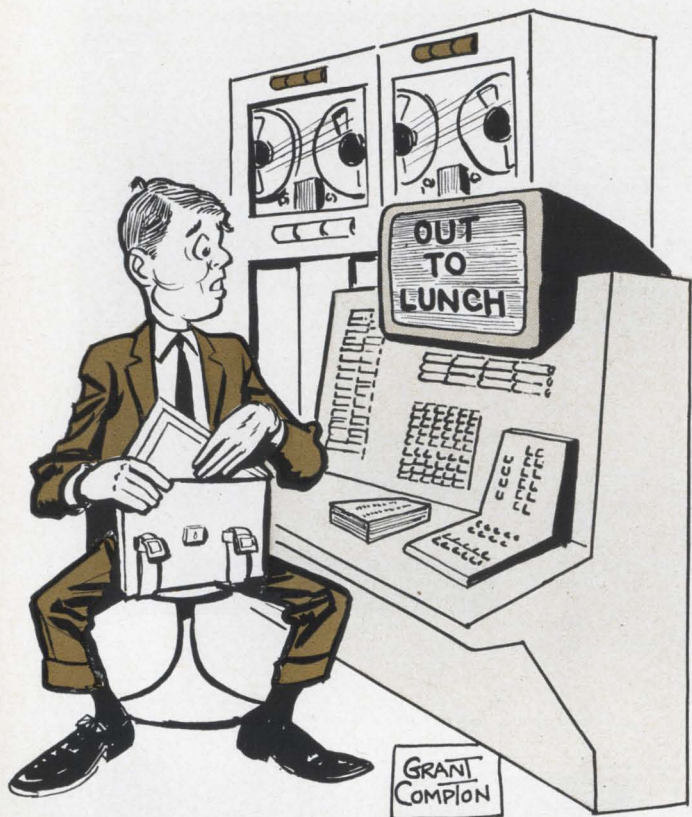

gorithmic operation; people are better at the heuristic. Time-sharing offers a way to combine the best abilities of both.

Every problem must be solved at least once heuristically; thereafter, if it recurs frequently, an algorithm may be worked out. In conventional usage, the computer performs only the algorithmic phase. This means that the method of solution must be completely worked out before the computer begins to work.

If the computer is to assist in the solution of a problem that has never been solved before, a large amount of cooperation is necessary between the computer and the user. The user can call for a certain amount of algorithmic effort in a particular direction, study the results, and come to conclusions that call for more algorithmic assistance from the computer. This is possible if a man works alone at the console of a computer, but this method is not economically practical. Time-sharing, whereby the computer cooperates with many users at the same time, can help solve the economic problem.

An example of this kind of time-sharing is the "Sketchpad," developed by Ivan Sutherland, director of information processing at the Advanced Research Projects Agency in the Department of Defense. This permits a computer equipped with a display screen and a light pen to do the work of a draftsman. A designer can sketch on the screen and the time-shared computer will transform the sketches into neat drawings. The designer can then make changes, deletions or additions, and the computer will assimilate them. When the designer is finished, he can ask the computer to calculate areas,

stresses or other functions of his design.

One disadvantage of time-sharing for heuristic problem-solving is the tendency to substitute trial and error for constructive thinking. Any engineer who has found himself multiplying 3 by 4 on a slide rule will understand this. An article in a later issue of *Electronics* will propose a remedy with an on-line batch-processing technique.

Other applications

In addition to the eight major time-sharing applications described in articles in this and later issues of *Electronics*, several others are also of interest.

The General Electric Co. was one of the first to incorporate memory protection, program relocation and paging, all in hardware, into a commercially available computer. These were in part an outgrowth of experience gained with GE equipment at Dartmouth College (see pages 85-87.) With these developments, GE lured two customers away from IBM—Project MAC at MIT, and the Bell Telephone Laboratories. Since then, IBM has added the Model 67 to its System 360 series.

Two time-sharing projects are under way at the University of California. One, at Berkeley, uses a Scientific Data System 940 computer. The other, being set up at the Lawrence Radiation Laboratory in Livermore, is built around a Control Data Corp. 6600. Eventually the Lawrence system will employ not only the CDC 6600 but also a Digital Equipment Corp. PDP-6, an IBM 7094, an IBM Stretch and a CDC 3600. It will be a multiprocessor, but its many remote terminals—perhaps as many as 200—will make it time-shared. The system will include IBM's trillion-bit photographic memory.

Another system, in operation at the Rand Corp., is so simple to operate that no special training is necessary. Work began in 1960 to design a system for use by persons inexperienced at working with computers, and is continuing. The system, called JOSS for Johnniac open-shop system, centers on the Johnniac computer, a 1950 model with a memory of only 4,096 words and an add time of 50 μ sec; this patriarch was built with vacuum tubes. A new computer, a PDP-6, has been installed and will replace the Johnniac.

J. C. Shaw, one of the system's designers, says: "The future lies with the general-purpose system, but it remains to be seen whether the supervisory programs will absorb the JOSS approach as subsystems, or whether JOSS-like systems will replace the supervisory and thus serve as the user's single contact with the computer."

In its 6000 series, the Control Data Corp. does away with hardware for relocation, protection and paging. These functions are performed by a "non-unified processor"—several peripheral processors in parallel. The CDC computers also have very large core storage—approximately one million words—and high transfer rate. Conversational mode will be available, CDC says. Meanwhile CDC has announced two versions of its 3000 series designed for time-sharing; memory is divided into 2000-word pages in these machines.

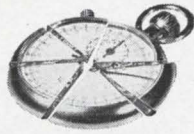

IBM's flexible addition to System 360

This system will enable one big computer to serve hundreds of users via various terminals, from the familiar teletypewriter to cathode-ray tubes with erasable displays

By John Iverson and Frank Yee

International Business Machines Corp., White Plains, N.Y.

Although the principle of time-sharing is two decades old, as is shown in the panel accompanying this article, computers have been tailored to this application only a little more than a year. The latest advance, so new it is only now being built into hardware, is the Model 67, one model of the International Business Machines Corp.'s System 360. It will permit operation by hundreds of customers, working from many different kinds of terminals that range from teletypewriters to cathode-ray-tube displays.

The Model 67 will be controlled by a monitor program, consisting of three major subsystems: control, command and processor.

The control subsystem will allow simultaneous execution of batch and conversational programs; it

will also schedule multiprogrammed tasks, handle interrupts, manage storage, control input-output devices, provide data-management service, manage maintenance and system generation, control start-up and shut-down, provide reconfiguration functions, and provide usage accounting. This segment will include a scheduling algorithm that determines how long each program is allowed to run, and the sequence of programs. This scheduling algorithm can vary with each installation.

The command segment will provide debugging aids for users' programs, modify and catalog data sets, and permit programs that are not time-sharing to be performed in a multiprocessing mode. It will contain routines that allow access to and control of the system by the operator in the computer room—the man or woman who pushes the "on" and "off" button, loads and unloads tape drives, and so on—without stopping the computer. The command segment also will control the operation of graphic devices—input-output units, either local or remote, with which a user "draws pictures," such as plotting graphs, designing structures, or working problems in geometry.

The processor segment is the system's conversational language, which will permit the user to enter statements through the terminal. As each statement is entered, the processes will return diagnostic comments on that statement to the terminal. When the last segment has been completed, the user may request the system to compile the program or to insert it in a library maintained on disk files.

Almost always available

The Model 67 has a high level of availability and a memory that can hold any program a user

The authors



John Iverson is a member of the Industry Marketing Group for Education in IBM's Data Processing division at White Plains, N.Y. He previously worked in the time-sharing marketing group.



Frank Yee works in the industrial development section of the Data Processing division's scientific marketing department. He was previously an IBM systems engineer in San Francisco.

may write. Redundancies increase the system's availability by allowing it to continue running at a somewhat lower level of performance when some part of it is out of order.

A system with enough redundant elements may be divided or partitioned into two or more subsystems. Each element contains a set of switches which may be turned on or off manually or by the program. These switches indicate whether that element is available to the rest of the system. Thus the various elements can operate together as one large system, or independently as small systems (see diagram on p. 82). Then the user's program in each system must be relied upon to refer only to those components that have been assigned for their use. This reliance can be enforced by a supervisory program that controls storage assignment and protection, besides assigning input-output devices. System 360 was designed for operation with such a supervisory program.

Partitioning is indicated internally, with a single wire that carries the availability signal. When the signal is on, the unit is available to the processor; when the signal is off, the unit is not available.

An availability signal will be provided from each storage unit within the multiprocessing system. Partitioning may be established under program

control; absolute partitioning may be established with manual switches to which the lines are connected. One storage array, therefore, may be available to one part of the system and not to another. An invalid address indication will result from any attempt to address an array that is not available.

Partitioning, therefore, will make it possible to operate the processors within the multiple system as single independent units sharing common storage facilities, as a part of a multiprocessing system. Each such configuration is a partition point, and each storage unit can be assigned to any or all processors and channel controllers in any desired configuration.

Paging reduces overhead

By definition, a multiple-access, on-line computing system is one in which a large number of users can request computation at any time and expect a fast response. These requests can be honored only if memory time is allotted to a program that is loaded into the memory.

Traditionally the only way to activate a program is to honor all of its memory demands at once. The total of memory demands of any significant number of users will exceed the physical core memory available. The overflow must be placed on a

Evolution of an idea

Back in World War II the armed services maintained inventories of supplies on punched cards. They also maintained communications networks to link outlying points by means of teleprinters with paper-tape input and output.

To produce the paper-tape input, IBM developed card-to-paper-tape conversion equipment. In 1954, a data transceiver was added to transmit and receive punched-card data over wire or microwave circuits, eliminating the conversion step. The data transceiver was the first of a long line of terminals that could be connected to existing communications circuits for data transmission.

In 1959, IBM announced the 7701 magnetic-tape terminal, which could transmit and receive data at the same time. This was quickly expanded to include card transmission and the ability to move data from one computer's internal core memory directly to another. Transmission speeds for this family of terminals range from 75 to 300 characters per second on a voice-quality line, up to 28,000 characters per second on broadband microwave or coaxial cable services.

In 1963, the 1050 terminal was introduced. This is a typewriter-keyboard terminal to which a card or paper-tape reader can be at-

tached. It can print 148 words per minute, about 50% faster than other keyboard terminals at that time, and operates over standard voice-grade line facilities.

Up to now, communications costs have been the principal limitation on the expansion of remote computing techniques. To help cut these costs, line adapters have been developed that modulate and demodulate signals sent over private or leased communication lines. These adapters make it possible for a line's relatively wide bandwidth to be divided among several terminals of narrow bandwidth. There are different kinds of line adapters, including those designed specifically for lines up to eight miles long, and others that work with any length of line. The design of the adapter and the number of terminals that it can handle depend on the type of terminal—magnetic tape, punched card, etc.—and on the type of line used—regular voice-grade, microwave, coaxial cable or other.

The first big systems

As computers became faster and more complex, highly specialized programmers were needed to prepare problems for computer solution. But users, particularly engineers, wanted to deal with the computers directly, in a language the men could comprehend. IBM's first steps toward such a computer sys-

tem were two projects called Sage and Sabre.

Sage is an acronym for semi-automatic ground environment. The system was developed to protect the United States from surprise air attack, and was the first real-time on-line system. Sage required equipment and programming that put several terminals on-line in direct communication with the computer, and provided a real-time response from the computer.

Sabre was designed by IBM for American Airlines, to handle reservations. Making a reservation requires more than 80 different transactions; the Sabre system's central computer, 30 miles north of New York City, contains more than a million instructions to carry out these transactions. A reservation can be made from any ticket office in the country in less than three seconds with Sabre, and the system can carry out more than 2,000 transactions per minute (see diagram on p. 77).

Commercial time-sharing

Another system for commercial users is called Administrative Terminal System (ATS). ATS is designed for the small-scale 1440 computer, which can service up to 40 terminals and peripheral equipment at virtually the same time. ATS will also be available with System 360. A typical 1440 configuration would include a central

magnetic disk or drum for ready access. If programs are small, several can be loaded into memory simultaneously, and switching between programs can be rapid.

Furthermore, most programmers request more memory than they use. For example, most programs contain elaborate error routines that are rarely used. Programmers seem to use memory the way wives use money; they say, "How much do you have? That's exactly how much I need, and if you get more, I'll need that too."

Thus a multiple-access, on-line computing system is memory-limited. If such a system is to be responsive, it requires a new technique of memory management. Such a technique has been developed for the Model 67; IBM calls it dynamic address translation. It combines program-relocation hardware in a partitioned system with memory paging, which is also in hardware; this frees the user from any ties to physical memory, while permitting active portions of many programs to reside in memory simultaneously.

There are four main characteristics of a system that has dynamic address translation. The total program need not be in memory when any part of it is being executed; those parts that are in memory may be in noncontiguous, nonsequential

pages; the parts may be left in memory after the quantum of time is used up, unless it is necessary to swap pages of another program into their places; and if all of this happens, when the original program is restored for another quantum it may go into a different area of memory the second time around. The supervisory program uses its tables to keep track of the pages in each user program.

At any time, programs tend to concentrate their activity in particular areas. In practice, a given program executes only one instruction at a time; therefore, multiple programs could be activated simply by loading into memory only the active instruction of each program, plus necessary data. The inactive portions of all programs would be kept on a disk or drum. The memory of thousands of programs could thus be honored almost simultaneously.

The overhead time required would make such a procedure impractical. Overhead is the time taken to move single instructions in and out of memory. Some optimum point is needed between the two extremes—one program occupying all of memory, versus one instruction from each of many programs. IBM has determined experimentally that a reasonable, convenient size for a program division is a page of 4,096 bytes. A byte in the System 360 is

processing unit with 16,000 characters of storage, 1311 or 1301 disk files, a 1448 transmission-control unit (a smaller version of the 7740), half-duplex private telephone lines, forty 2741 typewriter-like terminals, and additional input-output equipment as needed.

Here's what ATS permits:

- Editing text—such details as capturing input as it is typed at the terminal, assisting with corrections and rekeying, storing corrected information or an entire document once it has been entered, retrieving a document and handling automatic formatting, justifying left and right margins, numbering pages, and adding heading and

footing information;

- Using the typewriter terminal as a desk calculator;
- Using the terminal as part of the communications network;
- Using the terminal as a standard typewriter when not otherwise used;
- Converting source data into machine-processable form as the data is originated, thus insuring its validity;
- Programming from the terminal for assembly or compilation.

For the engineer

Another IBM system, called Quiktran, offers the technical user

a complete programming language and the ability to program and debug in that language with great flexibility. Some customers can program in Fortran while others work in a discipline-oriented language such as Cogo, a coordinate-geometry language for civil engineers. The systems are open-ended, and languages can be added.

Quiktran's terminal command language allows the user to execute, alter and change values, variables and formulas and to request information selectively.

For constructing programs, a subset of Fortran IV is used; some of the less common Fortran IV language capabilities are not available in Quiktran. But Quiktran offers a valuable option: the customer can construct his program under Quiktran, check it out, then run it on any other computer having a Fortran IV compiler program.

The Quiktran equipment configuration is shown in the diagram at the left. The central processing unit has a memory of 32,768 words. The disk and drum storage units represent bulk memory for large quantities of data and instructions. The card read-punch, the high-speed printer and the magnetic tape units log the system's status from time to time and permit conventional batch operation on the system. There are up to 50 keyboard-printer terminals, each of which can be equipped with card reader and card punch.

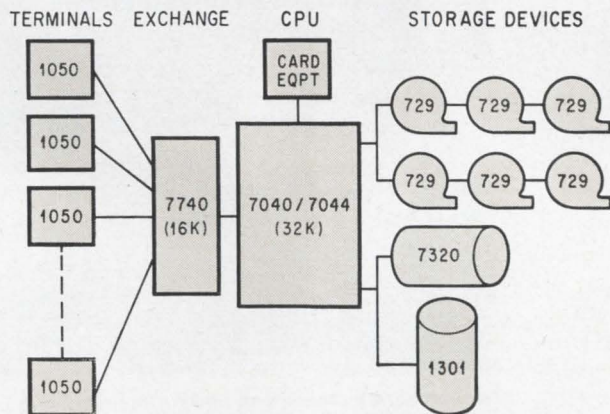

Equipment for remote-computing Quiktran system. Up to 50 remote terminals may be connected. Numbers in the blocks are IBM model numbers.

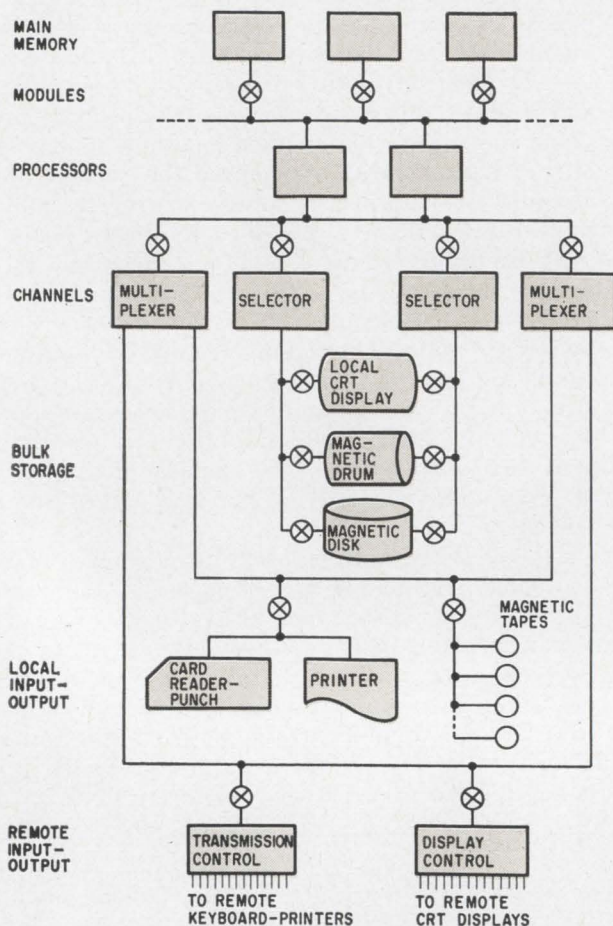

Dual time-sharing system built around two Model 67's. Three memory modules are shown. Note the partitioning switches (circled X's) that allow the system to be reconfigured into smaller subsystems in various ways.

eight bits, corresponding to one alphanumeric character or to two digits. This division permits a reasonable number of programs to be kept available in memory, yet the pages are large enough to hold to a minimum the swapping in and out of memory to and from the drum or disk.

Paging the program

Division into pages is performed with both hardware and software. The time-sharing supervisory program sets up software tables in memory, containing entries that define the starting points of the pages for every task that the program must control. As new tasks are started—that is, as users turn on their consoles and go to work—new entries are established in the table; as tasks are completed, entries are erased and the table shortened. Then, as a user's time on the computer begins, the supervisory program loads a hardware register with an entry from the table; this entry defines the starting point of the currently active page in that user's program. The contents of this register are then added to every address reference made by that program. Thus the program may refer to data as if it were stored in location 0 to 1,000, but if the register contains the number 20,000 then that data

will properly be found between locations 20,000 and 21,000.

During execution of any program, the supervisory program checks to see which program is to be run next and whether its currently active page is already in memory; if not, the supervisory program starts a swapping operation to bring in that page. This and other activities of the supervisory program interfere somewhat with the execution of the user's program—except in a multiprocessing system—and constitute overhead time; but supervisory overhead is much less than the overhead required when only one program can be in memory at once and when swapping is required every time the system starts to work on a different program.

This paging procedure introduces another important concept: virtual memory. If a program is divided arbitrarily by the equipment into pages, and only active pages are loaded into memory in any available location as they are addressed, then the program is completely independent of physical memory. The programmer is limited only by the addressing capabilities of the machine; he has a machine which has as much memory as it can address. In the Model 67, this virtual memory is as large as 2^{24} —more than 16 million—bytes.

Each user has access to the entire virtual memory. Active 4,096-byte pages of many users' programs are contained simultaneously in memory, and control is transferred rapidly between them.

All programs and data are loaded in equal pages. New pages can replace old ones, and the user is completely unaware of the process of translating his logical program, written in a virtual memory, to execution in physical memory. It then becomes apparent that, in addition to having a means of rapid computing as in many on-line user programs, the programmer is completely independent of physical memory.

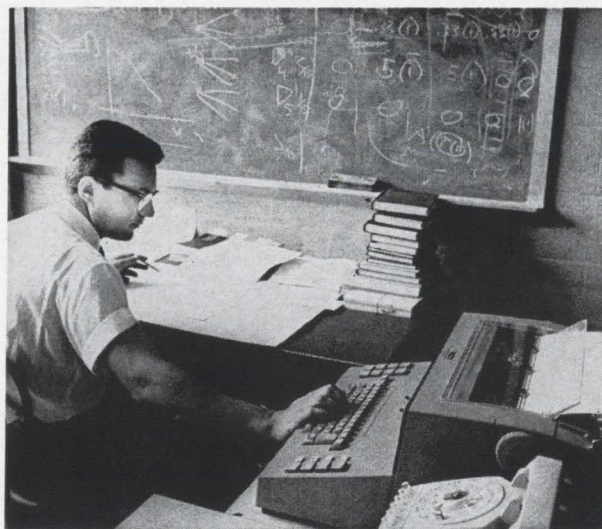

Researcher has the speed and problem-solving power of a large computer whenever he needs it—without leaving his desk. Terminal device at right, behind the telephone is connected to an IBM 7094 computer. He can dial the computer and share it with as many as 30 other users at a time.



A computer approach for people who know nothing about computers

Project MAC studies ways in which a powerful computer might deliver answers, while-you-wait, to distant specialists in various disciplines, who need not even be aware that their helper is a machine

About 300 people from 15 laboratories and departments, at the Massachusetts Institute of Technology, are sharing a big, powerful computer that delivers answers while they wait. They are part of a group called Project MAC; the acronym stands for two concepts—machine-aided cognition and multiple-access computer.

The program is based on the assumption that the typical user of an on-line, multiple-access computer system in the future should need to know little or nothing about programming; he'll merely want the solution to a problem. A long-range goal of Project MAC is to offer any user access to a computer and he can "talk with" a language appropriate to his application.

Such a language must be matched to his field both in syntax and in semantics. It must insulate the user from the mechanical details of the computer and of its programming. Similarly, the terminal equipment must be appropriate: perhaps a teleprinter for a librarian or a cathode-ray-tube display for a structural designer. And the computer must be able to cope with a variety of such languages.

Toward a dream

Computer users have long dreamed of a "computer utility" that would be available to hundreds of computer users in the same way that an electric utility is available to users of electric energy. To turn on the lights, the electric utility customer merely snaps a switch—without a flicker of thought about the system of boilers, turbines, generators, transformers and transmission facilities that permit this simple transaction. The computer utility customer could solve his complex problem almost as easily.

The present Project MAC system is a small step in this direction. The host computer is a modified IBM 7094, which is in operation 24 hours a day, seven days a week. Access to the computer is confined to users who directly contribute to research for Project MAC; for other purposes, another time-

shared 7094 is available at the MIT Computation Center.

About half of the user stations associated with Project MAC are Model 35 Teletypes; the other half are IBM 1050 transmission terminals. Both Teletypes and 1050's are connected to the computer through MIT's private telephone system. Each station can dial either computer or any other station.

At each computer, an IBM 7750 Programed Transmission Control multiplexes the incoming lines and routes data to and from the computer. Approximately 50 lines connect Project MAC's 7750 with MIT's private branch exchange; there are also several direct connections with common-carrier networks of the Bell System and Western Union. The IBM 7750 at Project MAC is also connected by three lines to satellite computers and other remote devices.

Communications, including terminal equipment, represent about 20% of the total cost of the multiple-access system; this proportion is expected to increase as the system becomes more complex.

Project MAC system offers each user the full capability of the 7094, by means of 14 languages ranging from the basic assembly language of the IBM 7094 to some highly specialized, application-oriented languages such as Stress, for the structural-design field.

The next step: a new computer

Project MAC has had to get along with a makeshift arrangement for the two years of its existence. Next year, when a more powerful system is installed that was designed specifically for time-sharing, the program will for the first time have a suitable vehicle for carrying on its work. Here are some of the reasons for this.

The IBM 7094 was not designed to be time-shared; but using the compatible time-sharing system developed at MIT's computation center, it was a system that enabled Project MAC to get

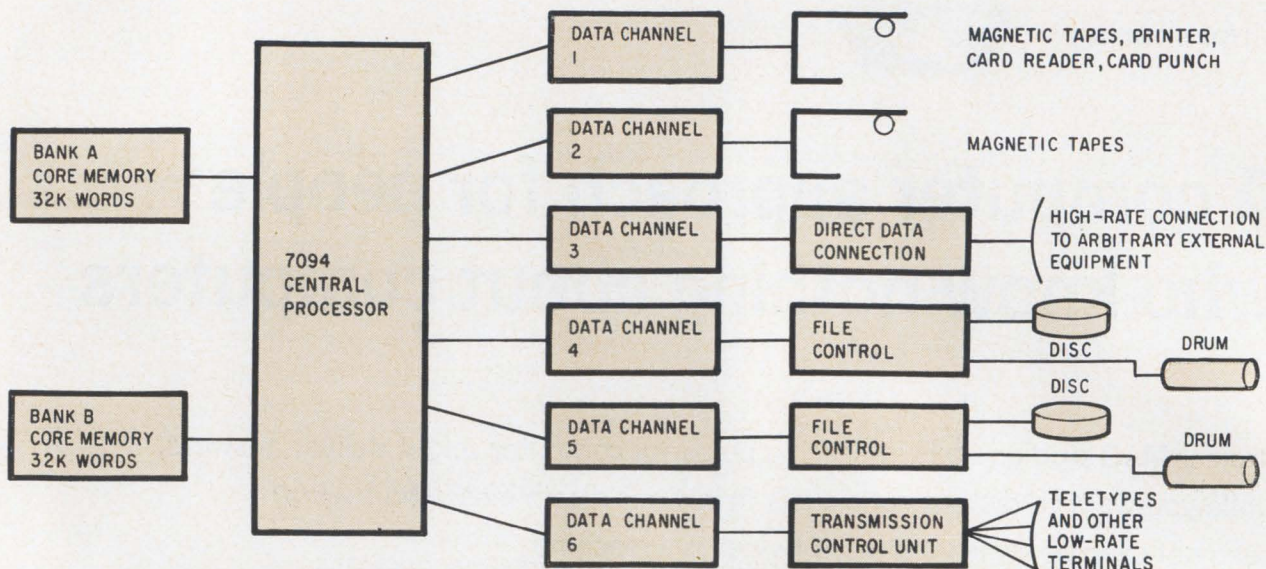

Project MAC's computer system. One bank of core memory contains the supervisory program; the other is available for users at remote terminals.

"on the air" quickly. The new computer will be a GE 645, made by the General Electric Co. It will have larger memories, more flexible organization, and capability for multiprogramming and multiprocessing.

The 7094's limited core memory can contain only a single complete program at a time; as a result, the supervisory system is limited in its ability to assign tasks to the processor. When one user program is completed or suspended for some reason, the entire system must wait while the old program is "swapped" for a new one. If two programs in operable condition could coexist in memory, then when one stopped, the central processor could begin to execute the other immediately, while the input-output controller performed the swapping, avoiding much lost time during swapping. This approach can be extended to any number of operable programs in the core; as the number increases, more core memory is required, and the percentage of processor running time approaches 100. This is multiprogramming.

But such a memory-heavy system would get badly out of balance; at some point, as the memory expanded, it would be more economical to install an additional processor rather than add still more memory. Then programs could be assigned to either processor, and two programs could be running simultaneously. This would be multiprocessing.

A system could become processor-heavy as well as memory-heavy. System balance also must take into account input-output controllers, since these special-purpose processors control both the swapping process and access to the bulk storage. The balance between memory, processor and input-output controllers depends on the costs of the different units, also on the kinds of programs to be run.

Reliability, maintainability, continuity of operation, and system partitioning also must be con-

sidered. The ideal would be a computer that could be reconfigured to varying proportions of these elements to match demand at any given time. The result would be a system that meets a statistical average of the demands imposed by all of the users, instead of merely satisfying the requirements of a single "typical" task. Such a computer would consist of "pools" of the principal elements—memory, processors and input-output—and would be capable of operation in such a way that the number of elements in each pool at any instant would not be important.

To organize a computer that provides the necessary flexibility and modularity for multiprogramming and multiprocessing would require careful planning. In particular, the special requirements of the on-line, multiple-access operation must receive attention from the earliest stages of the design process.

The new Project MAC system, scheduled for full operation in 1966, will be based on the foregoing design considerations.

The GE 645 system will initially contain two processors, two input-output controllers and four memory modules plus bulk storage and peripheral equipment. The supervisory program will eventually permit fully modular operation, implementing the "pool" concept. In principle, the quantities of processors, input-output controllers, or memories in each pool simply constitute data to the supervisory program; each may change during operation. Thus, periodic maintenance operations or unexpected component failure do not shut down the whole system; as an element is added or removed from the system, the supervisory program can take the action necessary to permit continuity of operation, utilizing whatever system elements are present. This form of operation is essential to the public-utility concept. Furthermore, this kind of hardware modularity is necessary to permit balancing the system to handle the composite load

presented by a large number of simultaneous users.

Ultimately, if some part of the system goes down, the user will note—if anything at all—only a slightly longer response time or other degradation of performance. Sometimes a failure—in hardware or software—can be so catastrophic that the user would receive a message, typed out on his terminal: “You are off the air; please stand by.” Or responses might stop altogether. But even when lightning strikes the power company’s main feeder and the lights go out all over town, it takes milliseconds for the computer to “die,” because of the energy stored in the power supply filter capacitors, and during that period there can be provision to save all the programs so that normal operation can resume immediately when the power comes back on. Project MAC’s computer system will evolve toward this kind of operation; but for the first year or two

after the GE 645 goes into operation, the reconfiguration required by a component failure will be done manually.

It is difficult to estimate the number of users that can be served satisfactorily by the new system, but guesses start at 100. As with the IBM 7094, the number of users is not a design parameter but an empirical determination.

The immediate goal of the computer system research part of Project MAC is to implement and prove a design concept and system organization; later the system can be modified to meet specific need. Now that Project MAC has developed at least a “model-shop” version of a powerful new tool, its directors are turning their attention to the setting up of a production model of the large-scale computer as a local, personal tool in a researcher’s daily work.

Time sharing

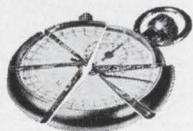

Campus computer helps students do their homework at Dartmouth

Time-shared system serves as many as 40 users at once. Short turn-around time permits it to deliver answers quickly, while student waits at a teleprinter in his classroom

By William M. Zani *

Dartmouth College Computer Center, Hanover, N.H.

Every month, one out of every four students and faculty members at Dartmouth College make use of the liberal-arts school’s time-shared computer from any of 40 remote consoles. Many class assignments can be done easily only on a computer, which is also expected to help with 80% of all faculty studies made in the next three to five years.

In routine computations, the system is able to deliver answers quickly, while the user waits at a teleprinter in the student union building or the classroom; it can also handle many different kinds of problems, and cope with three computer languages.

The 40 remote terminals, operating at 110 bits

per second, take up only 30% of the available time of a Datanet-30 computer made by the General Electric Co. The rest of the computer’s time can be used for character processing or for other tasks.

The computer

This special-purpose, real-time computer has 16,384 eighteen-bit words of memory, a powerful set of logical commands and the ability to communicate with a variety of external devices. Although it is a bit-processing machine, the Datanet-30 has a special instruction coupled with a relatively simple interrupt program that permit it to operate, from the programmer’s point of view, as a character-processing machine. The bit buffers, both incoming and outgoing, are scanned about every

* Now a student at the Graduate School of Business Administration, Harvard University

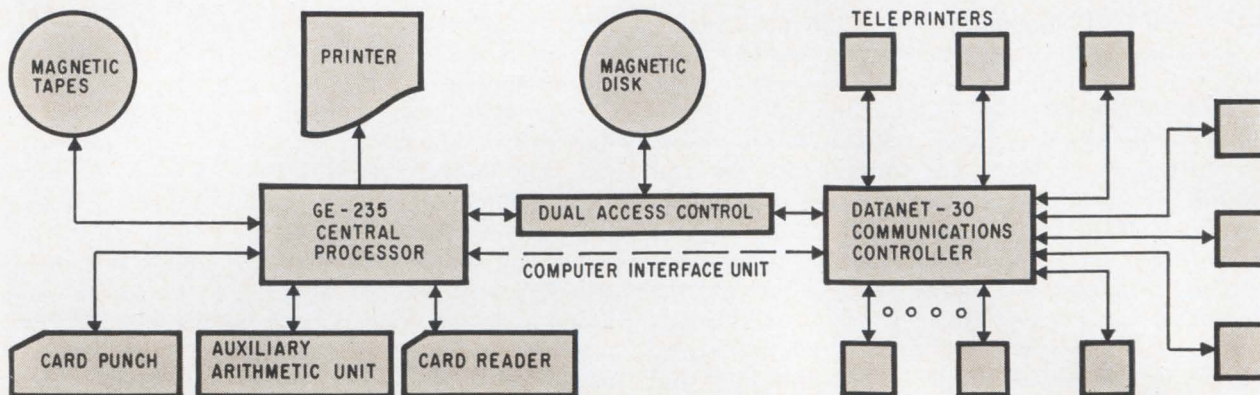

Dartmouth's shared-time computer system serves as many as 40 students and faculty members at a time from teleprinters in dormitories, classrooms and other locations.

eight milliseconds.

The editing, compiling and computation are done by a GE 235. This computer has a central processor with a memory of 16,384 words of 20 bits each, floating point arithmetic, priority interrupt and concurrent input-output and computation. It is limited, as is the Datanet-30, by the short word-length and small memory.

A disk storage unit provides intermediate storage and transfer of data between the Datanet-30 and the 235. The unit has dual access—that is, the GE 235 and Datanet-30 both have access to the disk. The disk has a capacity of six million 20-bit words, with 128 read-write heads, four on each side of 16 separate disks; the average access time is 150 milliseconds. The transfer rate is 256,000 characters per second.

A supplementary communication link, called the computer interface unit (CIU), exists between the 235 and Datanet-30. It transfers only one word at a time and transmits controlling messages between the two computers.

This unit consists of a register in each of the two computers, with two controlling instructions for each register; a set of wires joins the computers for data and control signals. Data to be sent from one computer to the other is put into its register, and a signal is sent to the receiving computer to interrupt it. The receiving computer then accepts the data for processing. When one computer requires data from the other, it sends an interrupt signal and receives a reply, either the requested data or an inquiry signal.

The 40 remote communication devices are model 35 Teletypes. These are standard devices, relatively easy to use; they have a standard character set and

The author



William Zani is in the doctorate program at the Harvard University Graduate School of Business Administration. This article is based on his experience as supervisor of the computation center at Dartmouth College.

can easily be attached to the Datanet-30. Some terminals are connected to the computer by direct line, others through Dataphone sets and the campus telephone network, and still others through the Bell System TWX-prime service. These services are described in the article beginning on page 72. These connections permit access to the Dartmouth system from anywhere in the country; several off-campus users, in various parts of the country, provide professional comment and criticism.

There is also conventional peripheral equipment attached to the 235: eight magnetic tape drives, a 900-line-per-minute printer, a 400-card-per-minute reader and a 100-card-per-minute punch. These are not accessible from remote devices, but can be used with batch-processed programs running concurrently with time-sharing programs in a low-priority background mode.

The Datanet-30 is the master of the time-sharing system; it communicates with all remote devices and schedules programs on the 235, using the 235 as a peripheral unit to edit, compile and compute.

The software

The software in the Datanet-30 is divided into two parts: real time and spare time. The real-time part services the remote devices and analyzes messages. If a message is a command to the time-sharing system, the program sets up a series of spare-time tasks to carry out the command. The spare-time portion of the software carries out tasks that may have been assigned during real time. Scheduling of programs for the 235 and communication with the 235 are real-time tasks, but can be done in spare time if necessary.

An executive program in the 235 consists mainly of routines to carry out commands from the Datanet-30. These routines move data internally, and shift compilers and programs to and from the disk. In addition, the executive program permits simultaneous peripheral operations and keeps track of time to be charged to users.

The rest of the software in the Dartmouth time-sharing system consists of compilers and house-keeping routines such as disk dumps and loaders.

The Dartmouth time-sharing system was de-

signed on the principle that a remote console should be, above all, easy to use, even if this makes access to some parts of the system rather difficult.

When Dartmouth decided to install the system in 1963, the only equipment suitable for time-sharing for less than \$1,000,000 included GE 235 and Datamet-30 computers. With these, Dartmouth set up a simple time-sharing system that could be programmed gradually.

Ten seconds is the longest time allowed for any program at once in the Dartmouth system; few programs require 10 seconds at a single pass. The maximum time allowed on the first pass is 2.5 seconds; only rarely do programs run even this long. There is also provision for an intermediate level of 5 seconds. Programs that require more time have lower priorities, as with the Corbato algorithm (see article on page 72.)

Short wait

A user of the Dartmouth time-sharing system seems to have the central-processor to himself, in spite of the fact that he may be sharing it with 39 other people. The worst-case turn-around time is approximately 100 seconds, but the probability of this worst case happening is extremely low; for this to occur, 40 people must give a command to

execute at exactly the same time, and the programs must all run at least 2.5 seconds. The average turn-around time is approximately 25 seconds because not all users want to compile or execute at the same time.

Additional hardware would make time-sharing at Dartmouth more efficient and hence more economical. The time-shared computer should have a large expandable memory, with memory protection and program selection. Memory should be a peripheral unit accessible to more than one central processor. There should be high-speed drums that are fast enough to act as extensions of memory. There should be large random-access data-storage devices for storing users' programs and data; also "public" files accessible to all users. Also useful would be inexpensive bulk storage devices that can be easily attached to or removed from the system at the user's option. These would store users' large data files conveniently.

All of this hardware is available, but not all from the same manufacturer. Equipment from various sources requires the design of special interface equipment, which adds markedly to the cost. Dartmouth College has no specific plans now to modify the existing hardware or to replace the present system.

Time sharing

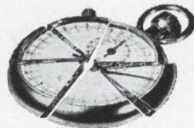

Satellite computers as interpreters

At the University of Pennsylvania, they block meaningless questions and edit the others so thoroughly that a user can 'interview' the central processor. The system also 'learns' with use

By John W. Carr III and Noah S. Prywes

Moore School of Electrical Engineering, University of Pennsylvania, Philadelphia

At the University of Pennsylvania, a satellite computer is acting as interpreter between a central processor and its various users. Before feeding data to the central computer, the satellite edits it so thoroughly that the user can pose his questions in almost conversational language, and carry on a question-and-answer session with the processor until he finds the data he needs.

The system, under study since 1954, has been simulated on four large general-purpose machines

at the university's Moore School of Electrical Engineering. In one of these, the input-output contains high-speed cathode-ray-tube displays operated by a keyboard; a console is shown on p. 89. Two technical developments have enabled this approach to be translated into hardware: a method of multiple shared access, and the development of large random-access memories.

The Pennsylvania system combines the advantages of two other programs: the multiple-access

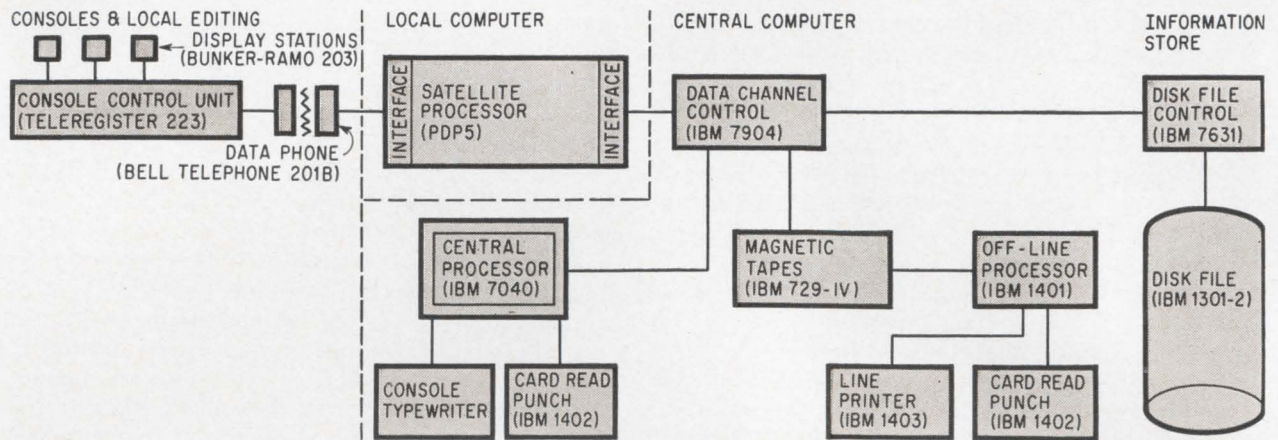

Time-shared computer system at University of Pennsylvania. Inquiries from consoles are edited by the intermediate processor, a PDP-5, before the central processor—an IBM 7040—is interrupted.

approach of project MAC,^{1,2,3} described on page 83, and the use of a time-shared computer by non-programmers, developed by researchers at the Moore School and installed at the Naval Aviation Supply Office. The Pennsylvania approach has the added advantage of screening out questions that may be ambiguous or too general before they can reach the central computer.

In one configuration, shown in the diagram above each remote console has a keyboard, a crt display, and an internal local store or memory with a capacity of 768 characters. These stores hold the data being displayed. Because the display is volatile, it must be continually rewritten, or refreshed, under control of the local store. Once the satellite has transmitted data to the console, the local store retains it for refreshing, so that the connection to the satellite need not be maintained. The consoles can also receive keyboard information, display it, allow the local user to edit it, and transmit it to the satellite computer. The connection of the consoles with the satellite is through a local control unit and the university telephone switchboard.

There is only one satellite in the Moore School system, and four local consoles; the concept envisions more consoles—perhaps several dozen—connected to several satellites. Each satellite would serve several consoles in one geographical area; the satellite might either be near the consoles or near the central computer.

The satellite computer, a Digital Equipment Corp. PDP-5, contains a program for further editing and checking, and for switching from one input format to another. This program is contained in a memory of 4,096 twelve-bit words operating in a 6-microsecond cycle. The PDP-5 is a buffer and message editor between the consoles and the larger IBM 7040, made by the International Business Machines Corp. The PDP-5 may either interrupt the 7040 directly or wait to be polled by the 7040. If it waits for polling, there are fewer interruptions of the central computer, and less expenditure of time for such interruptions; there is also a slight

increase in response time for the user. The IBM 7040 contains the Multilist software system described later in this article; Multilist is a simulation of a larger processor.

Multilist and Multilang

Memory organization is the kernel of the Moore School's problem-solving facility. Part of the system's function is to help the user find out how to solve his problem. With the Multilist technique⁵ information storage and retrieval are incorporated in the executive program and in a man-machine communication language called Multilang.⁷

The complete time-sharing system with its remote consoles, has a memory of more than 56 million characters. Most of this is in a magnetic disk storage unit; the 7040 itself has 32,768 words in its core memory, each having 36 bits. In addition, there are the 4,096 words in the PDP-5 plus the 768 characters in the display consoles.

The system performs several functions. It makes information of all sorts available jointly to many users; expands the system by adding software elements automatically; catalogs it and rearranges the memory structure whenever necessary; retrieves information on the basis of complete or incomplete descriptions; and stores both data and programs in the same memory system, retrievable with a single type of description, as in a general-purpose digital computer.

The Multilist system simulates a storage system that contains an associative memory as a substructure. From such a descriptive memory, a programmer can retrieve stored information by specifying a key—that is, by giving a description of the information desired, rather than its address. A complete description will yield a unique result; an incomplete description will provide a sequence of responses, from which the programmer can make further selections.

Multilang is a problem-oriented language that translates the user's statement of the problem into requests for relevant programs and data in the sys-

tem's memory. The language was designed specifically to assist in problem-solving and, in so doing, to "accumulate knowledge." For example, it may not recognize the term "eligible voter," but it can be told that an eligible voter is a thing that is "human," "age over 21" and either "born in the U. S." or "naturalized." If these terms have been previously defined, the computer can find an answer to the question; additionally, the next time it is asked about eligible voters, it will know what is meant. Thus, the more Multilang is used, the bigger it grows, storing away new terms as they are learned.

A user who is not a programmer doesn't know in advance whether the machine has ever solved his kind of problem before. If it has, it can solve his problem too. If not, inclusion of Multilist and Multilang allows the system to interpret the problems and, by trial and error if necessary, to set up new algorithms for its solution. These new algorithms are then stored for future reference.

Multilang is part of the system for describing commands to be performed. A typical Multilang statement gives an operation and a series of operands, which can be either sets of data or other programs to be executed.

Multilang operations can store new elements in the Multilist file; cause the computer either to branch to other instructions depending on relations between operand and values when these values are completely known, or to sequence through data lists when the values are not completely known; store retrieved information in a local file; and add new keys or data.

Multilang can also form procedures from sequences of other Multilang statements, translate subroutines in the IBM 7040 assembly language into Multilang programs, and define new descriptions from old ones, as with the "eligible voter" example. Multilang is also being expanded to include Algol and Fortran routines in its own language.

A requested element from storage can be retrieved in about 0.1 second from a 56-million-character storage. This is slower than the microsecond operating speeds of core memories, but it is fast for the size of the storage.

Researchers at the Moore School plan to employ Multilist-Multilang in the development of a generalized problem-solving facility, using the joint time-sharing capability to permit men and machines to work together on problems whose solutions are only heuristic—that is, nonformal.

An information-retrieval system called Project Vector is being developed, with which an uninformed person can use an inexpensive terminal to gain access to a vast library of information that would otherwise not be available to him. For instance, a high-school student in a rural school district many miles from a university could consult reference materials in the university's library.

In another application, called Project Cids—for chemical information data system—the computer



Cathode-ray tube display of the type used in the time-shared computer system at the University of Pennsylvania. The keyboard includes function and editing keys for message composition and correction. The unit is a Bunker-Ramo model 203 display station.

will list all chemical compounds that fit the specifications in a user's inquiry, giving formulas, physical and chemical properties, and all known chemical and commercial names. If the inquiry is too general, the satellite computer will indicate this before the search is started.

Other applications include research in the locating of legal precedents and experiments in man-machine interaction in game-playing.

Authors

John W. Carr III is a professor of electrical engineering at the University of Pennsylvania, and head of the computer sciences department there.

Noah S. Prywes is an associate professor of electrical engineering at the University of Pennsylvania.

References

1. John McCarthy, "Time Sharing Computer Systems," Management and the Computer of the Future, MIT Press, 1962.
2. H. M. Teager, "Real-Time, Man-Machine Communication with Graphical Languages," First Congress on Information System Sciences, Session 5, November 1962, pp. 19-28, Mitre Corp., Bedford, Mass.
3. Robert M. Fano, "The MAC System: A Progress Report," in Computer Augmentation of Human Reasoning, M. Sass and Wm. Wilkinson, ed., Spartan Books, N. Y., 1965.
4. John W. Carr, "Better Computers," International Science and Technology, March, 1962, Vol. 1, No. 3, pp. 35-47.
5. "The Multilist System," Technical Report No. 1, Moore School of Electrical Engineering, University of Pennsylvania, Report No. 62-10, Nov. 30, 1961.
6. B. Zimmerman et al., "The Naval Aviation Supply Office Inventory Retrieval System," Management Science, April, 1964, pp. 403-420.
7. "A Problem Solving Facility," Moore School of Electrical Engineering, University of Pennsylvania, Report No. 66-02.

Reprints of this report are available. See the reader service card at the back of this issue.

© copyright 1965 Electronics ® A McGraw-Hill Publication

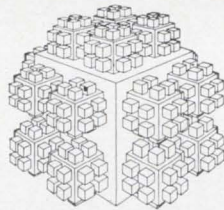

The packaging revolution, part IV: Bigger, better multilayer boards

Many computer designers add variable wiring to simple, standardized boards but one company has obtained higher interconnection density and better system performance from large, complex boards

By Stephen A. Hays

Autonetics Division, North American Aviation, Inc., Anaheim, Calif.

Two forms of multilayer printed circuit boards for the interconnection of integrated circuits have evolved in the past few years. One represents an effort to mate the system packaging to integrated circuits (IC's) in interconnection density. The other represents an effort to retain earlier methods of packaging and wiring by fanning out or extending the wiring structure.

The high-density form of multilayer board (MLB) is typified by those which Autonetics employs in its missile and aerospace computers. These are individually designed and made as large as practical for the application. Some Autonetics' MLB's have an area of less than one-third square foot, carry over 500 IC flatpacks, provide well over 10,000 interconnections, and have 10 or 12 layers.

An alternate form, which has become popular with commercial computer manufacturers and some

military manufacturers, consists of boards prefabricated with standardized internal planes, to which external etched or discrete wiring is added to suit the application.

The high-density MLB's have been criticized as overly complex, difficult to design, modify and fabricate, ill-suited to system maintenance and repair, and hence too expensive. Actually, the reverse is true in the computers made by Autonetics. System performance, reliability and economy would have suffered if the "old faithful" methods of interconnection and modular packaging were used.

Multilayer boards with high density result in systems that are smaller, have far fewer parts to maintain and less mechanical connections to fail. These are critical advantages in total mission costs for airborne computers and in total maintenance costs for land and sea-based computers. The MLB design and fabrication costs are a minor part of total system costs.

At present, the high-density boards are considered too costly for commercial use and unsuited to methods of mass producing and maintaining commercial computers. But commercial mass-production methods generally lag behind advances in military and space systems because commercial producers are wary of rapid advances in technology.

Autonetics is building computers with less than 30 MLB's and only two levels of modular assembly that are comparable in computing capacity with some commercial computers with about 1,000 simpler MLB's and three or four modular levels.

The third dimension

The development of high-density multilayer boards was a part of the system redesign occa-

This article is part of Electronics' continuing report on techniques of interconnecting integrated circuits in computers and other large systems. Part I appeared Oct. 18; parts II and III, Nov. 1. A related article on page 96 of this issue describes a method of detecting and repairing faults in complex multiyear boards.

The author



Stephen A. Hays, a senior technical specialist, is the engineer responsible for interconnection techniques used in Autonetics' Minuteman and Monica computers. He holds several patents for chemical milling and electroless plating and has been developing multilayer techniques since 1962.

sioned by the development of integrated circuits. The redesign led to a reduction of 50% in system weight, cut system size by 75% and increased capability by 150%. MLB's extended into the third dimension the techniques which provide in conventional printed circuit boards a compact and orderly form of wiring for discrete components.

Integrated circuits required roughly a 50:1 improvement in wiring density over the wiring used for discrete components. It became impractical to use many small standardized modules in the packaging design, since each IC package had 14 leads, almost as many as some discrete-component modules. The IC's replaced many of the standardized groups of components previously used.

Rather than enlarge the IC package or extend the IC lead spacing to accommodate existing packaging designs, the packaging design was changed. Improved wiring density was obtained by adding additional layers and internal connections and by decreasing the size and spacing of the conductors.

Multilayer-board development has reached the point where the achievable interconnection density is more than adequate for present needs. With further refinements, MLB's should suffice at least into the late 1960's, as the number of leads on IC packages doubles and triples.

Multilayer board designs

Interconnection density in MLB's depends on circuitry requirements, conductor width and spacing, layout efficiency, board area required for connectors and other hardware, number of layers and the size of the internal connections between layers (these will be called intraconnections, to distinguish them from interconnections between IC's and other components of the MLB module). Constraints include electrical-design ground rules, space allowed for process tolerances and the number of intraconnections between layers that can be superimposed. The latter depends on the board's cross-sectional design and the fabrication method.

Eight variations of prevalent methods are illustrated on page 93. In chronological order, they consist of through-hole, sequential and combination designs. The sequential method (4) gives the highest density. With that exception, the figures are in order of increasing density. The combination method, recently developed by the author, is called the "mature process" at Autonetics because it combines the best design and fabrication advantages of the earlier methods. The table on page 92 lists major fabrication operations (except conductor etching or plating, which is done in all cases) and the number of prohibited intraconnections for the number of layers shown in the figures.

When all holes in the board are through holes fabricated after lamination (1), density is low because each hole can be used for intraconnection only once, yet requires space in all layers. Adding intermediate intraconnections or through holes in subassemblies (2 and 3) improves density by superimposing intraconnections. The intermediate con-



Individual layers of a multilayer board are spread out on a table. Two boards are directly in front of the author; a D37 computer for the Minuteman 2 missile system is at his left.

nections are comparable to the turnaround or crossover connections provided by plated-through holes in two-sided circuit boards.

Sequentially fabricated boards permit the greatest freedom in intraconnection positioning and conductor routing, and give the highest interconnection density. They are made by adding single-sided layers to either side of a two-sided core board. The density of a sequential board (4) is four times as high as a through-hole laminate (1), which is frequently used to make standardized boards. Thus, one sequential board can equal nine parts—four through-hole laminates, four connectors and a master interconnection board.

The sequential layers are made of 1-ounce copper foil over an epoxy-impregnated, glass-fiber insulation. After these are laminated to the core board, the intraconnections are made by chemically etching blind holes and then plating or filling the holes to make the connection to the layer underneath. As each pair of outer layers is added, the laminate becomes the core board for the next pair of layers.

Various other methods can be used. For example, insulation can be coated, cemented or screen-



Master negative for a board layer is prepared automatically with this computer-programmed drafting machine. Standard parts of the pattern, such as pads and line segments, are generated photographically.

printed on the core. The conductors can be foil or plated metal.

The sequential method is best used for three- or four-layer boards, which can be made in a single fabrication cycle. The lengthening of processing time and the greater likelihood of misalignment between layers make a large number of layers inadvisable unless process control is excellent and processing time is shortened by automation.

The mature process

The combination designs (5, 6, 7 and 8) wed the sequential technique to the through-hole and sub-assembly techniques, so that complex, high-density boards with numerous layers can be designed and made efficiently.

The least expensive combination boards are made by laminating two-sided core boards and single-clad outer layers (5). Then the blind holes in the outer layers are chemically etched and the through holes are drilled. All surfaces are etched to ensure adhesion of a plating of electroless copper that is followed by plating of electrolytic copper. Next, the outer layers of circuitry and pads are etched and conduction cooling strips and board hardware are added. Boards are tested with a computer-programmed wiring analyzer and other automated test equipment (see article on p. 96).

A more expensive form of eight-layer combination board is made by adding sequential layers to two core boards and laminating these subassemblies (6). Adding additional sequential layers (7) and core boards (8) increases the number of layers without complicating the basic fabrication techniques.

A typical layer arrangement in an eight-layer board has the ground and major voltage planes in the center, with two signal-wiring layers and a bonding layer (outer layer, to which component leads are joined) on each side.

Pad and hole locations usually correspond to the 50-mil spacing of flatpack leads. Signal wiring lines are 10 mils wide and 10 mils apart. Line resistance is 6 milliohms per inch and feedthrough resistance is less than 10 milliohms. Capacitance between adjacent lines on the same layer is 0.3 picofarads per inch, 3 pf for parallel lines on adjacent layers of circuitry and 7.5 pf for lines on layers next to a power plane.

Signal wiring is generally arranged in parallel lines on each layer. The lines run across one layer at one angle and across an adjoining layer at a different angle. The difference in the angles on adjoining layers should be at least 45°, to reduce noise and capacitance. Line density varies with grid design. The highest density is obtained when the difference angle is 60° and the lines are wavy. This arrangement allows more lines to be run between intraconnection positions on the layers and gives greater freedom in choosing line directions and in routing wiring paths through complex MLB's. The wiring density is twice as high as that of straight lines at the 90° angle favored for stand-

Fabrication operations for multilayer boards

Figure number	1	2	3	4	5	6	7	8	PC†
Number of layers.....	8	8	8	8	8	8	10	12	2
Fabrication operations									
Laminations.....	1	1	3	3	1	3	3	3	0
Drilling.....	1	4-5	7	4	5	5	6	7	1
Plating.....	1	4-5	7	4	4	5	5	6	1
Total operations.....	3	10	17	11	10	13	14	16	2
Fabrication sequences.....	2	2	3	4	2	3	3	3	1
Prohibited intraconnections.....	7	3-4	3	0	2	1	1	2	0

† Two-sided printed circuit board

Multilayer-board fabrication techniques

Eight ways to make multilayer boards. Horizontal lines are conductor layers, rectangles are drilled holes. Color indicates layers and holes made by the sequential process. The lettering code for the holes is: A, intraconnections formed before lamination; B, C and D, intraconnections formed after the first, second and third laminations, respectively; X, layers that cannot be connected as single pairs in the laminate; Y, pair connections prohibited in subassembly laminates. The table on page 92 lists major fabrication steps for each kind of board.

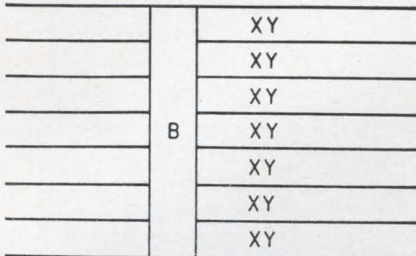

1. Simple through hole board is lowest in interconnection density because each hole requires space in all layers. It is the simplest to design and make, but each hole location can be used for only one intraconnection, such as a top to bottom connection.

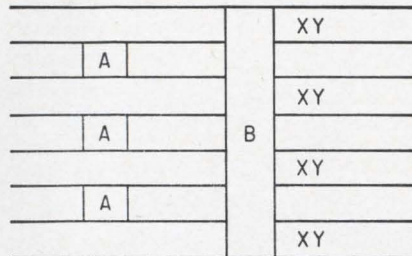

2. Through-hole boards with intermediate connections. Boards with single-sided external layers (left) are preferred when leads are to be joined in the through holes. Such boards are used to interconnect several other boards that are plugged into connectors on the through-hole board. The type with two-sided external layers (left) are preferred when leads are to be joined in the through pads on the board surface because, with efficient layout, the top two layers on either side can be used for as much as 50% of the interconnections.

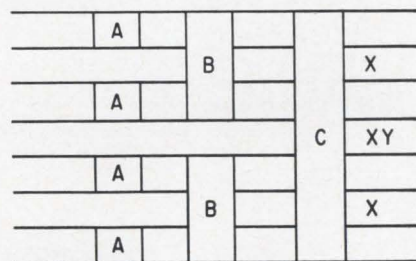
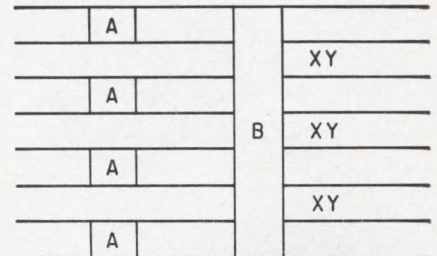

3. Through-hole board made by laminating subassemblies of through-hole boards and then drilling holes through the completed laminate. This allows two connections to the innermost planes in the same amount of space a through hole requires.

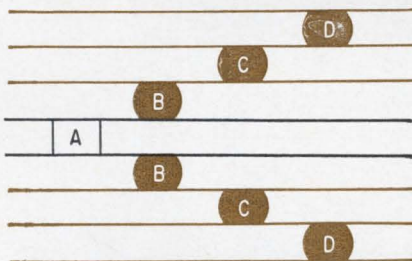

4. Sequential board gives the highest interconnection density and the greatest freedom in hole and conductor positioning. Intraconnections can be superimposed to provide the equivalent of through holes and through-hole subassemblies.

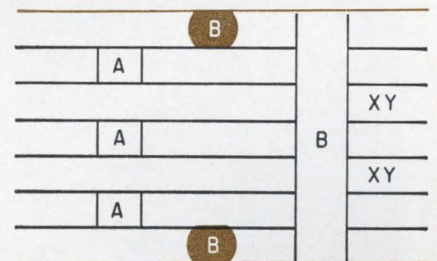

5. Combination board made by the mature process. The three two-sided core boards and the two single-clad outer layers are assembled in a single lamination. After lamination, both the outer connections and the through holes are made and plated.

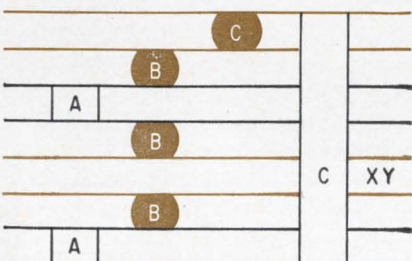
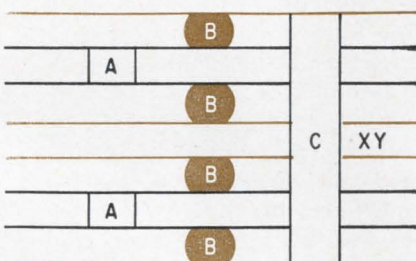

6. Eight-layer combination board is made by preparing two sequential subassemblies, laminating them and then fabricating the through hole. This way of making an eight-layer board is more expensive than the previous design (5) because the fabrication of the subassemblies requires an additional plating step and two additional laminations, one for each sequential subassembly.

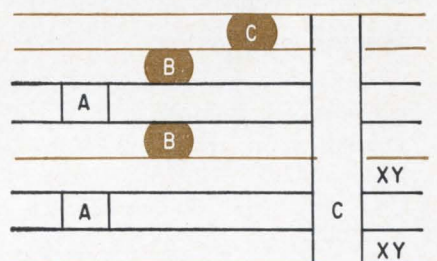

7. Ten-layer combination board is one of many variations of the mature process. The process used to make this design is the same as that used for the single-lamination combination (5) except that two sequential subassemblies are used instead of three two-sided core boards.

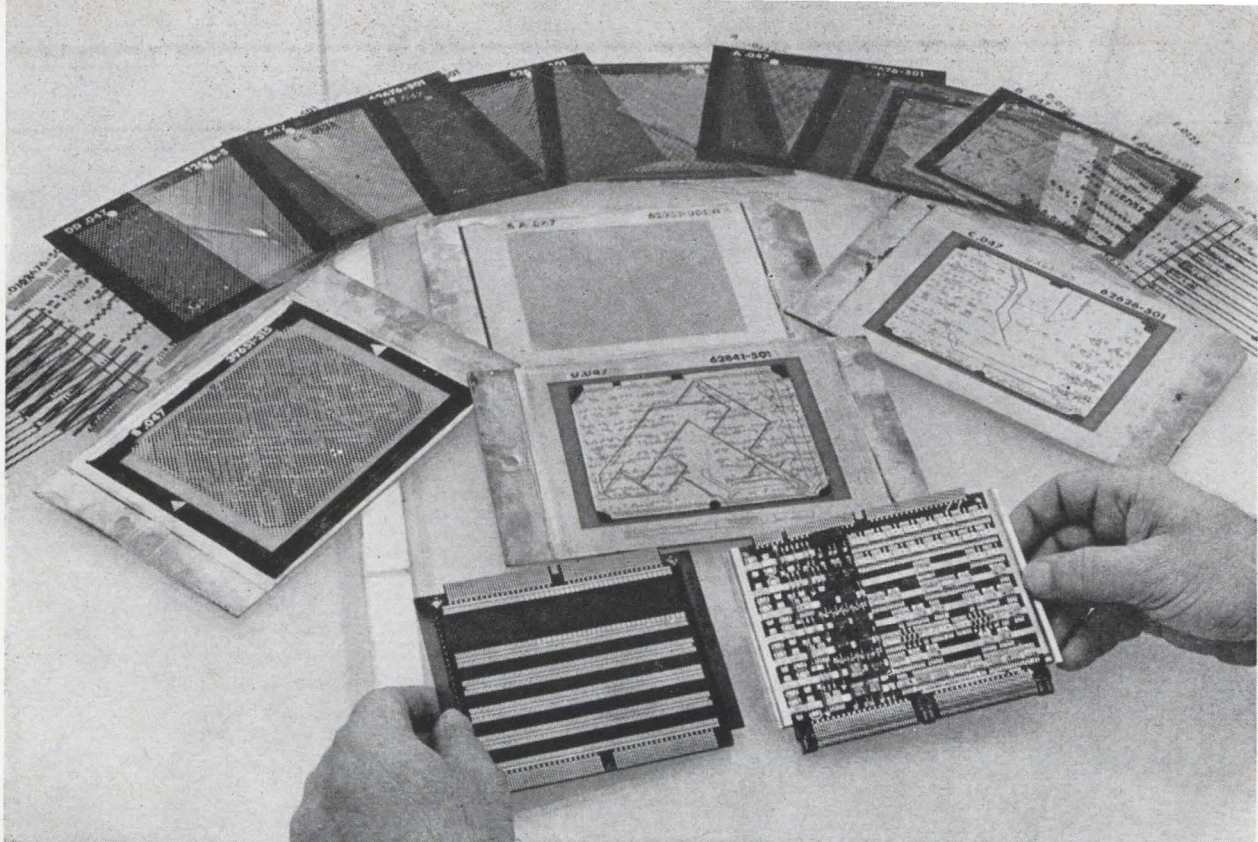

All the tool films for a complete board are spread in a semicircle at the top of the photo. In the center are laminates in various stages of fabrication. The left hand holds a laminated board and the right, a module.

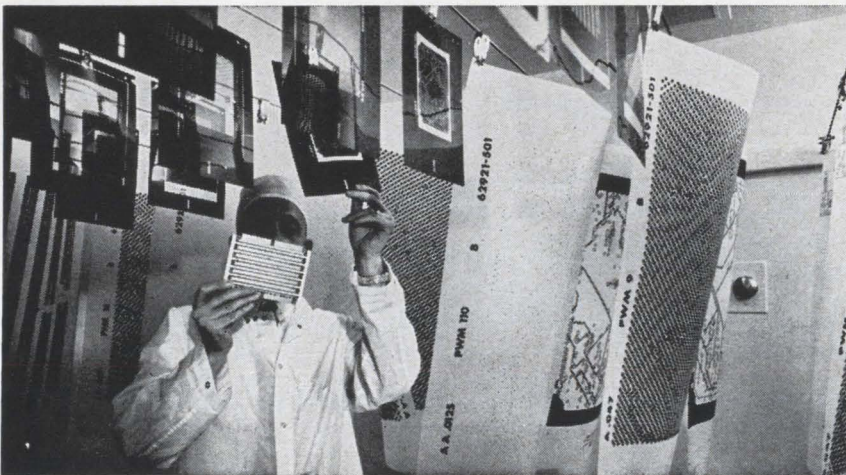

Large negatives, hanging up to dry after photographic processing, are reduced to size of tool film held by lab technician.

ardized forms of multilayer boards.

The wiring density is apparent in the photos above of artwork, films and layers.

Process selection

Autonetics has already used the first five designs on page 93. Companies that lack chemical-milling capability are restricted to the through-hole types (1, 2 and 3). The full range of capabilities also facilitates cost and reliability comparisons. For example, one Autonetics computer was designed (with minor additional layout constraints) so that through-hole (3), sequential (4) or combination (5 or 6) processes could be used to make the boards. This helps eliminate inferior processes and sources of materials and helps promote competition among sources and board vendors.

Multilayer boards cannot be made satisfactorily if there are flaws, moisture or contaminants in the materials, or if process and quality control are inadequate. Accurate alignment of the layers, for

example, requires placing each photoetching mask in a glass jig, aligning the jigs in a master tool and trimming and keying the material for each layer with this tooling before fabrication.

An important improvement in fabrication was insulating the external bonding layers so that conductors could be routed under heat dissipators, on which flatpacks are mounted with a thermally conductive adhesive. The surface insulation allows the outer layers to be used for up to 50% of the interconnections. This can save two internal layers and the equivalent of one feedthrough between layers for almost every component lead. Through-hole connections to each internal power plane are reduced by careful layout from about one per component to an average of less than one-third per component. Autonetics regards eliminated intra-connections as the most reliable kind—they have a failure rate of zero.

Another reason for Autonetics' rejection of standardized MLB's is that standardization results in

less than full use of all lines and pads, or their locations. Consequently, there are decreases in density and reliability and increases per interconnection in fabrication, test, hardware and parts-control costs.

By comparison, the cost of custom design is low because of computer methods of preparing layouts as well as processing and testing data. The processes are similar from board to board. Each board is not necessarily a unique design; some may vary only slightly in wiring design. Basic elements, such as pad and board size and line spacing remain fairly constant. The boards can be modified as readily as other types of MLB's, by cutting lines and adding jumper wires. Such changes are not intentionally included by Autonetics and are incorporated in redesign of the board.

Standardizing internal planes is a negligible factor in reducing board cost, because such planes are simple to design and make. Any cost decrease is more than offset by the fact that unused through-holes and mounting pads waste space. Once variable wiring is added, a board ceases to be standard and the customer gets no standardization benefits.

Instead of tying up a computer and automatic equipment to develop and fabricate the wiring of each board, Autonetics uses a computer to develop the working tools for hundreds of identical boards—the master artwork that controls the chemical processing and lamination alignment, for instance, is made by programed drafting machines.

It also costs less to add a layer to a multilayer board than to add a large quantity of discrete wiring to it, or to spread the components over an additional board. The high-density boards are costlier only when a limited number of boards are required during system development. MLB fabrication costs have shown a "learning curve" of 85% at Autonetics—that is, costs drop 15% for each tenfold multiple of boards produced. Design costs are lower simply because it is easier to route wires through a few MLB's and one master interconnection board than through a pyramid of boards and connectors. Large families of circuits can be mounted on each high-density MLB so that many circuit revisions affect only one board, not several.

Module standardization

One argument on behalf of the pyramid approach is that it enables system subassemblies to be made as small modules composed of standardized groupings of components, as in discrete-component systems.

There are no performance or design advantages in using standardized subassemblies of IC's. The groupings can more readily be accommodated in the MLB interconnection patterns than in additional boards or discrete wiring and additional connectors. The use of small subassemblies has its advantages in the mass production of commercial systems, but even these will diminish as IC's increase in functional content and number of leads.

Rather than seek module standardization, Auto-

netics sought the interconnection design that would be most efficient and reliable. In the D37 and D26 missile and aerospace computers, this required restricting the MLB modules to the number that could be interconnected with one to three master interconnection boards. Each system has about two dozen MLB's. A third level of interconnection is not required.

The MLB's for the D37 computers, made for the Minuteman 2 missile, and for the D26J aerospace computers measure $4 \times 5\frac{1}{2}$ inches, have 160 connector pins and carry about 150 flatpacs. The D26C boards measure $3\frac{1}{2} \times 11\frac{1}{2}$ inches, have 320 pins and interconnect over 500 flatpacs. A discrete-component assembly equivalent to the D26C module would have about 100 two-sided circuit boards, 10 interconnection boards and a master interconnection board.

The larger the functional assembly, and the number of interconnections completed entirely within it, the more efficiently it uses the connectors on the board. The ratio of flatpack leads to connector pins is about 12 leads per pin for the 160-pin boards and about 22 leads per pin for the 320-pin board. By comparison, a 20-pin board would have a ratio of seven leads per pin.

The maintenance and repair problems of large MLB modules have often been cited. Throw-away costs are higher, but a solidly bonded assembly needs less repair than a take-apart assembly—for much the same reasons that a welded auto body requires less repair than a bolted body.

Ideally, a system for a one-shot mission would be completely assembled with metallurgical bonds, such as soldered or welded joints. However, some mechanical connections are convenient for testing and field-storage maintenance.

Large MLB's are as easy to replace and repair as small ones. For replacement, they can be unplugged from the master board. Once the board is unplugged, the circuits on it are as accessible for repair as circuits on a smaller board. The only significant difference in repair costs comes when the MLB is damaged by, for example, burnout due to excessive electrical current.

Interconnection and packaging account for most of the cost, weight, size and performance limitations of IC systems. Reducing the amount of interconnection and packaging in a system will generally make the system more competitive, a conclusion borne out by the long-term trend in electronic system development toward higher capability and smaller size.

Bibliography

- R.C. Platzek and H.C. Goodman, "Digital Computer Aspects of Integrated Circuit Applications," Autonetics publication T-168/33-3, Dec. 13, 1963.
- C.F. O'Donnell, "Digital System Design with Integrated Circuits, Part II, Interconnecting IC's," *Computer Design*, p. 28, Feb., 1965.
- S.A. Hays, "Electrical Interconnections by Multilayer Boards," and D.G. Cummings, "Minuteman Microelectronic Reliability Concepts," Sixth Winter Convention on Military Electronics, Los Angeles, Feb. 3, 1965.
- E.F. Harmon, "Fabrication of MLB's at Autonetics for Minuteman II," MLB Seminar, New York, March 22, 1965.

Infrared fault-finder pinpoints defects in multilayer boards

Even when conventional continuity tests fail, multilayer circuit boards can be repaired because an infrared thermal profile will spot the source of trouble

By L.M. White and R.W. Jones

Autonetics Division, North American Aviation, Inc., Anaheim, Calif.

Small defects in multilayer printed circuit boards can be swiftly and accurately repaired—but first they have to be found. To pinpoint such common faults as short and open circuits, the Autonetics division of North American Aviation, Inc., has developed a computer-controlled, infrared radiometer that scans and analyzes a board's thermal radiation pattern.

Fabrication of the forms of multilayer boards that provide a high density of interconnection requires hundreds of processing steps (see article on p. 90). The possibility of an undetectable fault in a buried layer has caused many packaging designers to think twice about using complex multilayer boards rather than more conventional forms of boards or wiring.

The authors



L.M. White has developed or supervised the analysis and mechanization of a dozen of North American Aviation's navigation computers since 1951. Formerly supervisor of the program engineering unit, he now heads the systems analysis staff unit for system techniques studies.



R.W. Jones, a research specialist, joined North American Aviation in 1956 after 15 years as a radar system instructor and field engineer. After developing test equipment in NAA's Missile division, he joined Autonetics as senior research engineer for etched-circuit modules of automated checkout equipment.

Finding and fixing a fault

An example of a fault that must be pinpointed is a short circuit of a feedthrough at one of the internal plane layers (see illustrations on page 98). That a short exists is easily detected by a wiring-continuity tester, but the tester cannot tell where the short is.

Since nearly every integrated circuit is connected to power and ground, these layers are made as copper sheets, etched only at feedthrough locations. A short circuit between these planes could occur at any of the feedthroughs of either plane, if a sliver of copper were left behind during hole drilling, or if there were a slight misalignment of the layers during board lamination.

The illustration on page 98 shows a small section of a board. The ground plane indicated is connected to every integrated circuit atop the board, but not to the IC's on the bottom of the board, while the reverse is true of the voltage plane. Any one of several feedthroughs could be shorted in the wiring path checked by a continuity tester.

The short can be found by passing current through the wiring path while the radiometer searches the board's surface for a connection pad that is warmer than normal. This will be the pad directly above the short, indicating that the feedthrough has been heated by the short's resistance to current.

To eliminate the short, holes are drilled alongside the post, as shown, to open up the feedthrough. The hole is filled with epoxy. If the feedthrough is damaged by the drilling, it is built up again by plating.

Similarly, other impediments to current flow,

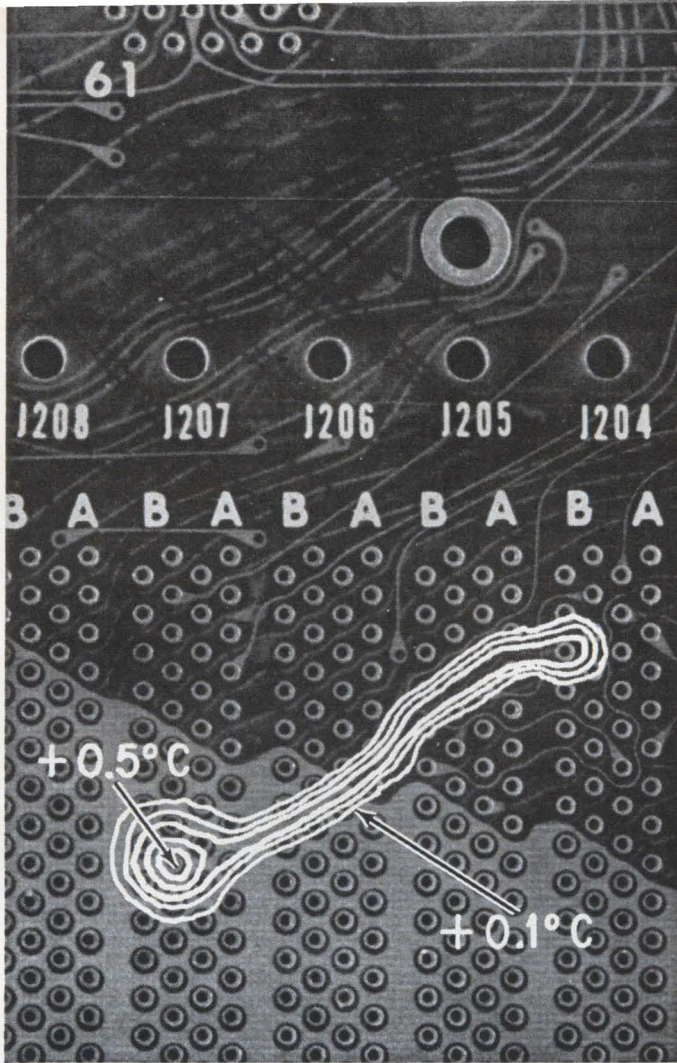

Thermal profile showing hot spot (temperature rise to 0.5°C) is superimposed on photo of a portion of a multilayer board. The system usually prints out hot-spot locations, rather than preparing profiles.

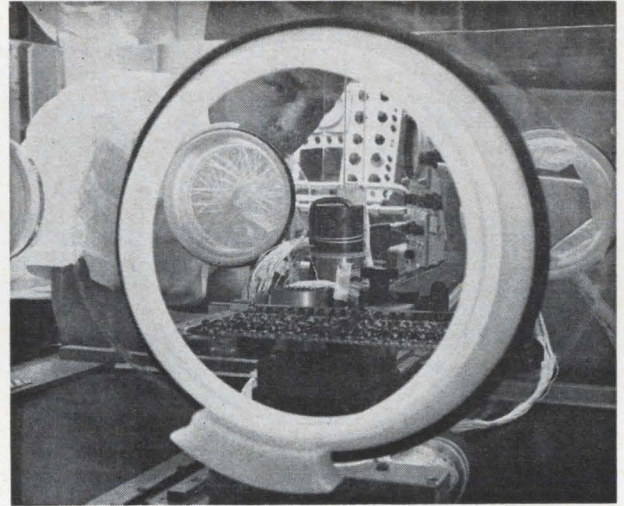
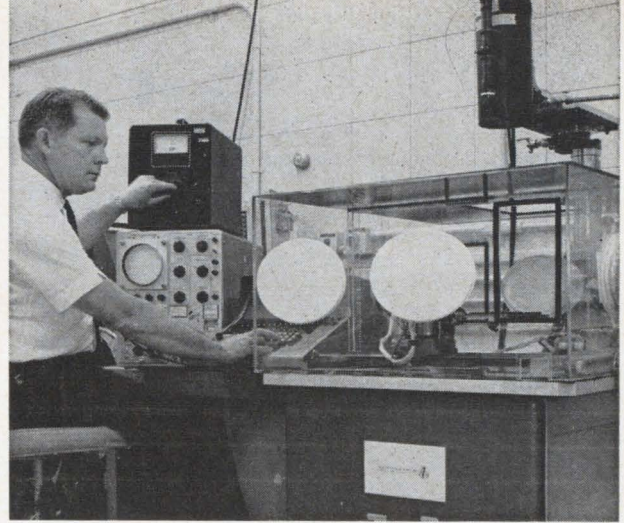

Fault-location system is shown in the photo at the top. The plastic chamber around the board prevents air currents from disturbing the temperature readings. Below, a board assembly is seen through a porthole.

such as a high-resistance joint where a feedthrough is connected to a plane, can be found and repaired.

Stimulating shorts

Short circuits are caused by failures in the insulation between conductors. The resistance of the unwanted conducting path is inversely proportional to the severity of the short. The heating caused by power dissipation in the path is maximum when the resistance of the short equals that of the current source, which in this case is the power-supply impedance plus the resistance of the connection and leads on both sides of the short.

A short circuit between two plane layers of a multilayer board has a resistance of 10 milliohms to several ohms, compared with less than 1 milliohm in the longest path through the conducting planes. Passing current through the short circuit—called stimulating the short—gives a temperature rise proportional to the ratio of the short circuit resistance and the plane resistance.

The relationship of temperature rise to power dissipation is:

$$\Delta T = PR_t$$

The resistance of the short must be measured before it is stimulated so that the power dissipation and temperature rise can be limited to prevent damage to the board. Although the etched wiring of a board can carry 2 amperes of current, the short may carry less. If local heating raises the temperature to about 200°C , the adhesives will soften and the board layers come apart.

The power dissipation of the short should be limited to a few milliwatts. The thermal resistance R_t of a multilayer-board feedthrough has been

Definitions of terms

- C' Contrast (ratio of temperatures)
- C Usable contrast
- I Stimulus current in amperes
- P Power in watts
- R_p Resistance of plane (longest path)
- R_s Resistance of short circuit
- R_t Thermal resistance in degrees centigrade per watt
- ΔT Temperature rise, degrees centigrade
- ΔT_p Temperature rise of plane
- ΔT_s Temperature rise of short circuit

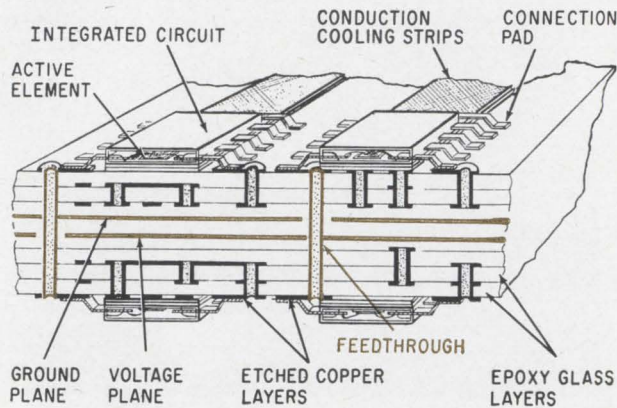

Cross section of a small part of a multilayer board, left, shows locations of feedthroughs and planes (color). Detail drawing of feedthrough, right, indicates where hole would be drilled (color) to relieve short caused by sliver left behind during earlier drilling.

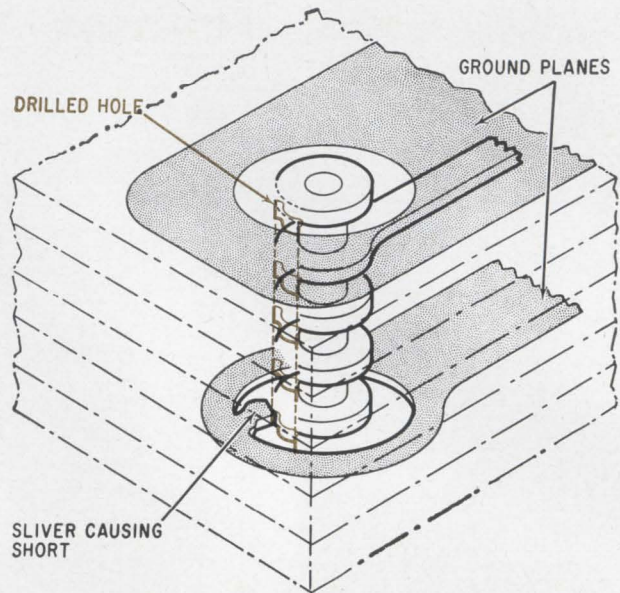

measured at 25° per watt. If a 1-ampere stimulus were applied to an 8-ohm short, the temperature rise would equal 200° C, since:

$$\Delta T = I^2 R R_t$$

In this case, the stimulus current should be reduced.

Temperature contrast

The infrared scanner produces a thermal profile of the board by detecting temperature contrasts. The ratio of temperatures at the point of interest can be expressed as:

$$C' = \Delta T_s / \Delta T_p = I^2 R_s R_t / I^2 R_p R_t = R_s / R_p$$

If a worst-case short (the hardest to detect) of 10 milliohms occurs at a feedthrough, and a 1-ampere stimulus current is used, ΔT_s will be 0.25°C (equal to $I^2 R_s R_t$). Since the resistance of the plane is 1 milliohm ΔT_p will be 0.025° C and the contrast will equal 10.

Analysis has shown that the usable contrast depends on the noise equivalent temperature, NET, of the tester as follows:

$$C = \Delta T_s / \sqrt{\Delta T_p^2 + (\text{NET})^2}$$

Typically, if the minimum resolvable temperature rise ΔT_p is about equal to NET, the contrast for worst-case short circuits is approximately:

$$C = \frac{1}{\sqrt{2}} \cdot \frac{\Delta T_s}{\Delta T_p} = 0.7C'$$

Another way of defining contrast is that it is a measure of the recognizable features of a display of a thermal profile, as illustrated on page 97.

Radiometer plus computer

The infrared tester developed by Autonetics consists of a radiometer, X-Y plotter drive mechanism, Verdant computer (Versatile Digital Analyzer, an early type of airborne digital computer made by Autonetics), display oscilloscope, typewriter, tape

punch and tape reader.

The board to be tested is mounted in a holder on the plotter mechanism, which moves the board under the focal point of the radiometer. The plotter is digitally controlled by the computer and has a full-scale motion of 18 by 20 inches with a resolution of 0.01 inch.

In the radiometer, the incoming radiant energy is chopped as it is detected by a liquid-nitrogen-cooled infrared detector. While the chopper interrupts the energy from the board, the radiant energy from a reference source is reflected on the detector. Thus, the output of the detector alternately represents the temperature of the target and the reference. The output is a d-c voltage, varying at the chopper frequency. The amplitude of the voltage is an analog of the temperature difference between the target and reference. With computer calibration and digital filtering, the radiometer has a temperature resolution better than 0.01°C.

As the computer moves the board in increments which can be set at 0.01 to 20 inches, the radiation measurements are encoded and stored by the computer. Once a complete thermal profile is stored in the computer, it can be processed by any of several techniques and compared with a standard thermal profile. The output of the computer can be used to identify and locate faults such as the shorts discussed, or to display or plot a thermal profile.

The infrared tester also has a number of other uses, including thermal analysis of integrated circuits and assembled modules.¹ It can be used to evaluate conduction cooling materials and cooling paths. Faulty components in electronic circuits can be detected by searching for components which give off excessive amounts of heat.

Reference

1. E.V. Carter, "Implications of Thermal Coupling in Batch-Fabricated Computer Systems," National Symposium on the Impact of Batch Fabrication on Future Computers, IEEE Computer Group, Los Angeles, 1965.



RESISTOR PROVING GROUND: MOISTURE RESISTANCE

For 120 hours Stackpole resistors are drenched in 100% relative humidity at 66°C, in the toughest moisture resistance test the Industry can offer. Still they work perfectly. Such severe testing indicates the care and control that goes into the continual resistor development program. Additional tests are conducted to determine load life and noise

level. Maybe some aspect of our in-depth testing interests you. If so, let our resistor development engineer discuss it with you. Write or call: Don Kirkpatrick, Manager-Engineering, Electronic Components Division, Stackpole Carbon Company, St. Marys, Pennsylvania. Telephone 814 834-1521. TWX 814 826-4808.



INSTRUMENTATION'S
MOST POWERFUL
BABY

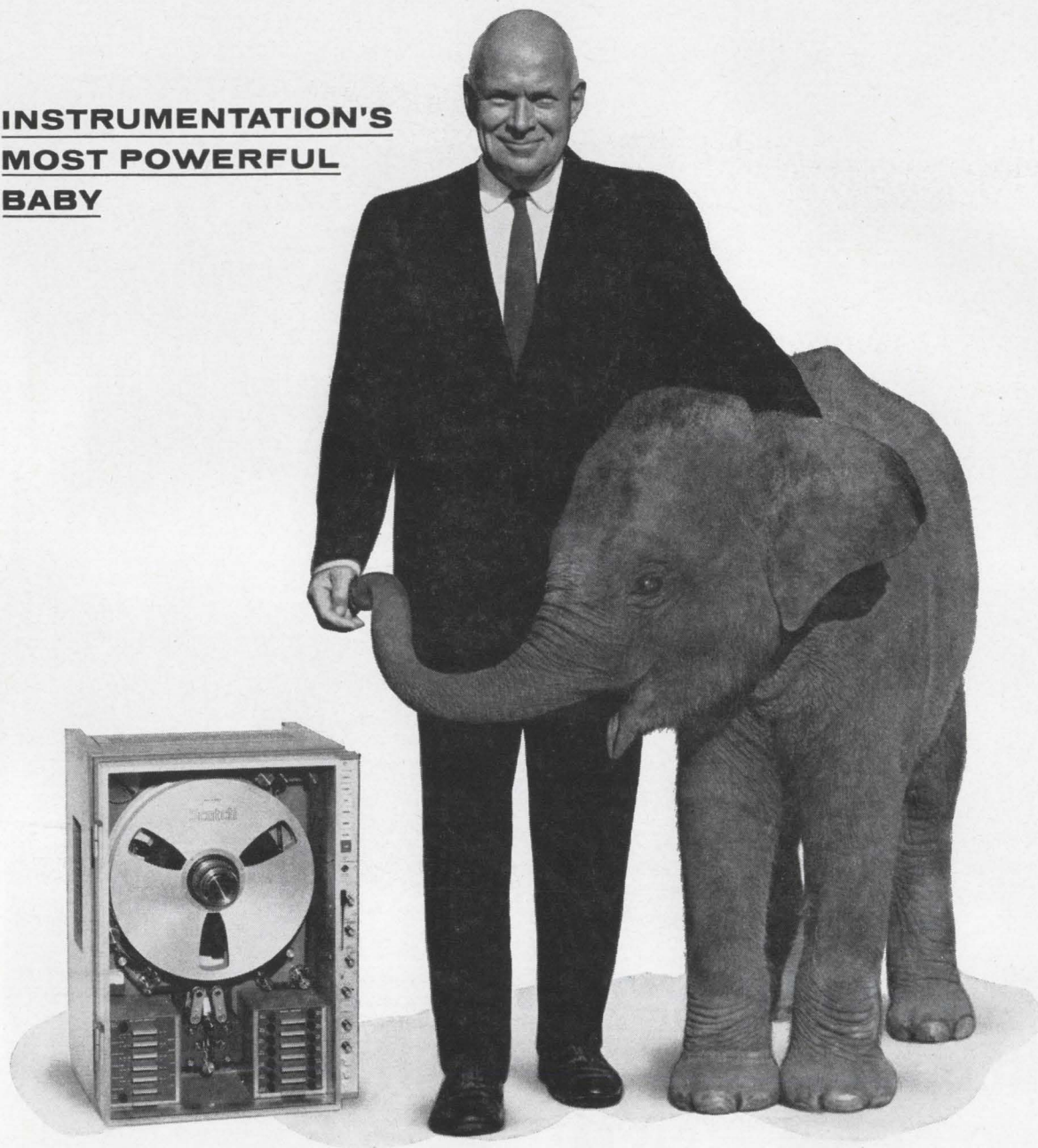

2.0 MEGACYCLES OPTIONAL

FOURTEEN 1.5-mc CHANNELS IN FOUR CUBIC FEET

Our new PC-500 Coax stands alone among compact field recorders, another working proof of Mincom's leadership in wideband instrumentation. Only twenty-four inches tall, this beautifully designed package contains the industry's highest performance per cubic foot — seven or fourteen 1.5-mc record channels, 14-inch reels, seven switchable speeds from $1\frac{7}{8}$ to 120 ips, two selectable reproduce-monitor channels. PC-500 is IRIG-compatible with all standard playback systems, including Mincom's TICOR II. Record on PC-500 with a 200-kc reference signal, on playback take advantage of TICOR II's unequalled $\pm 0.5 \mu\text{sec}$ time base comparison between events. Solve your basic problems in multi-channel wideband field recording by writing for PC-500 specifications.

Revere-Mincom Division **3M**
COMPANY
300 SOUTH LEWIS ROAD • CAMARILLO, CALIFORNIA 93010

Probing the News

The power failure

When the lights came on again . . .

Congress, utilities, and the FPC asked, 'Can it happen again?'

Designers of direct digital controls may have some answers

The great blackout of Nov. 9 is over, but even now the situation is far from bright in Washington, where powerful officials are demanding to know what happened and why, and in electric-company board rooms, where shopping lists are prepared.

Executives at electric power companies, most of whom have been cool to electronic instrumentation and techniques, are likely to be more interested now in equipment such as high-speed instruments and direct digital control.

I. The federal regulators

Joseph C. Swidler, chairman, says the Federal Power Commission may need more authority to require power companies to give his commission details about their operations. Although Swidler has not said so, the next step could be to require companies to provide new safeguards.

The commission's final report on the disaster will undoubtedly change the way public utilities operate, and possibly the quality and amount of electronic equipment they use.

Congress. Chairman Walter Rogers (D, Tex.) of the House Commerce subcommittee on communications and power, has demanded an immediate investigation. He says he will recommend that the entire country be provided with three interconnected grids—a primary and two alternates—to assure power flow and prevent another blackout anywhere.

Before Harris' subcommittee begins its study, the FPC hopes to



Blacked-out NBC studios in New York illuminated news commentator Frank McGee with a white gas lantern and televised him with a portable battery-powered camera.

have results ready from four teams now conducting on-the-spot studies of the big northeast systems.

Whether Harris' recommendations are accepted or not, there will be changes in equipment and procedures.

II. The electronic controls

Utility systems now have computers, monitoring devices, telemetry and communications, but much of this electronic gear will probably be used differently and for more functions as a result of the power failure over 80,000 square miles of the northeastern United States and part of Ontario, Canada.

Some utilities are using process-control computers that scan equipment in the generating station, log

data, monitor performance, trigger alarms when performance is off tolerance, and type out corrective instructions to the human dispatcher. These computers, however, are not closed-loop; they merely tell the operator what to do, and then he does it.

At the Central Hudson Gas and Electric Co., serving an area of upstate New York, an IBM 1710 computer detected the first change in frequency that signaled the failure. The computer informed the operator of this fact and of what he should do.

Most utility companies, like the Consolidated Edison Co. of New York, have no process-control computer at all.

Remedy by computer. A few

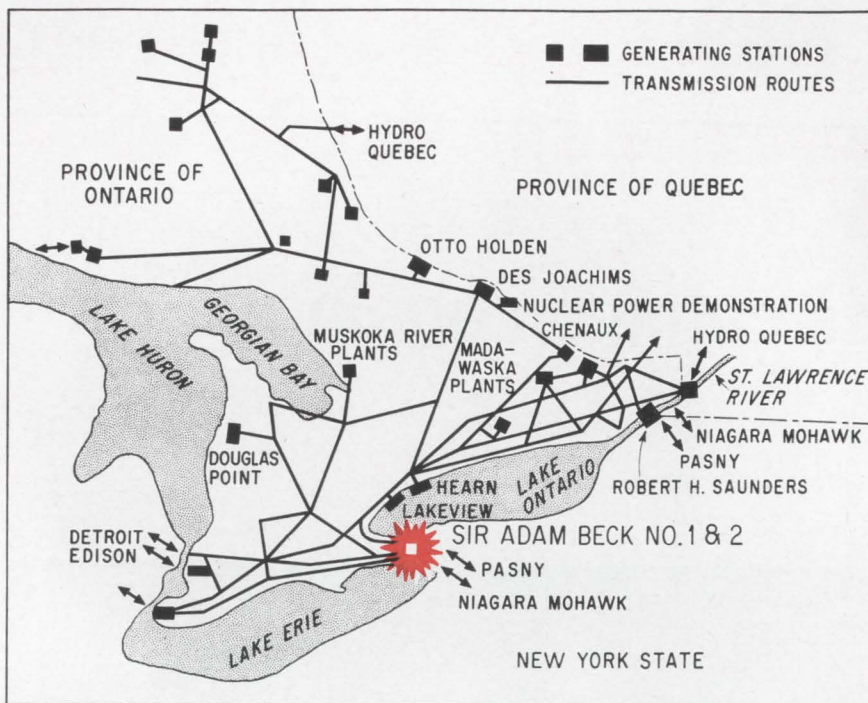

Massive power surges were reflected back into New York State when faulty relay circuits at the Sir Adam Beck plant opened the lines feeding Ontario, Canada.

plants have gone even further than Central Hudson and installed computers that take corrective action instead of telling the operator about it. This is called direct digital control; its development in electric utilities will undoubtedly be accelerated.

Direct digital control of an electric generating plant, or of any industrial process for that matter, is still very much in the developmental stage, although there are some operating installations. One problem is false signals, which cause the computer to take inappropriate action. These signals are produced by calibration errors in the monitoring devices and by noise in the transmission system. The computer could even shut down the system unnecessarily. A parallel problem is that of programming the computer to take the right kind of corrective action for every conceivable set of operating conditions; this kind of program, however, is difficult to prepare.

For these reasons, engineers in the power industry believe that the combination of man and computer working together is still more dependable than a computer working alone.

III. Shopping lists

Number one on everyone's shop-

ping list is generators. Military installations kept operating during the blackout, but civilian airports shut down. Many companies without generators may buy them soon.

"When the lights flicker in Dallas we really start moving," an engineer from Texas Instruments Incorporated said while sitting out the blackout in the lobby of a New York hotel. "If we lose power for more than about 10 seconds, it costs us \$25,000—the value of the silicon crystals in process. We have to throw them out and start over again."

This problem was anticipated by the International Business Machines Corp. when it built its big components plant at East Fishkill, N. Y. When the blackout came, emergency power was ready to keep the silicon diffusion furnaces operating, also the gas supply facilities and the pumps that supply process cooling water.

Byproduct. The blackout also provided another nudge to the New York City Transit Authority to speed up installation of radios in subway tunnels. About 800,000 New Yorkers spent hours in trains during the blackout, and some walked five miles through slush in rat-infested tunnels under the East River.

The radio system, a very high-fre-

quency one, using a twin-lead antenna strung along the walls of the tunnel, is installed in the Lexington Avenue line only—approximately 5% of the 732 miles of subway tunnels in New York City. During the blackout, batteries powered the system for almost five hours, keeping the trapped passengers informed.

Pocket radios. Two weeks after the power failure, the Sony Corp.'s New York sales office said the run on transistor radios was still going on. The most popular models, Sony said, are those smaller than cigarette packages—presumably so they can be carried at all times.

IV. What went right

While broadcasting stations with emergency generators in the blacked-out Northeast transmitted to transistor radios in streets, restaurants, office buildings and at home, the television transmitters were dead. But few receivers had operating power anyway.

Emergency power. Of the three tv networks, only the Columbia Broadcasting Co. has emergency power in its studio; but this was of no avail because its link with the network, supplied by the telephone company, had lost power.

Although the National Broadcasting Co. in New York had no studio power, it got on the network for a few minutes by using a portable, battery-operated camera, with gas lamps and candles for illumination.

Why did the special high-frequency lines lose power while telephone service was maintained? The American Telephone & Telegraph Co.'s Bell System explained that all of the telephone equipment is direct-current, powered through batteries that are recharged by diesel-driven, a-c generators and rectifiers. Of the 1,380 generators which Bell operated that night, it had trouble with one, which happened also to supply the a-c equipment that amplifies the network's video signals.

Telephone service that uses the Early Bird communications satellite was halted almost completely for three minutes, and partially for seven more when the cable between New York City and the antenna at Andover, Maine, became overloaded.

Switchboard in the sky

New satellite may be able to communicate with as many as 600 ground stations simultaneously

A multiple-access technique, enabling widely separated ground stations to communicate simultaneously with satellites, will be tested by the National Aeronautics and Space Administration. The experiment will be tried with the Application Technology Satellites—space laboratories from which NASA will seek information on new space equipment, engineering and techniques—being built by the Hughes Aircraft Co. The first of five ATS flights will be orbited late in 1966. The others will follow at six-month intervals.

All five of the satellites will carry two microwave transponders. Each of the transponders will have dual mode operation capabilities—either in multiple access or frequency translation modes. The multiple access mode will be used to evaluate one technique of interconnecting a number of ground stations in a potential 600-channel, frequency-multiplex system. In effect, the transponder will be serving as a telephone relay system.

Stations sort signals. Single side-band signals from the ground will be converted on the satellite to a single-phase modulated carrier that will be retransmitted to all stations. The stations will then sort out their channels from the carrier. Voice, teletype, and digital data transmission will be tested.

Two satellites to be orbited by the Communications Satellite Corp. next year will use a quasi linear wide band transponder with no processing on the satellite. This system differs from NASA's; users will have their own frequency-modulated carriers instead of demodulating one basic carrier, as in the ATS technique.

The frequency-translation mode, in the ATS test, will be used for wideband (25 megacycle) transmission with one ground station using

a complete channel. The test is designed to meet the delay distortion specifications for color television.

NASA plans to use its 85-foot dish antenna at Rosman, N. C., a 40-foot antenna at Goldstone, Calif., and a 40-foot transportable station to be set up in Australia.

Multiple access to the spacecraft by all of the three ground stations will be evaluated. Theoretically, says ATS project manager, J. R. Burke, the satellite could accommodate as many as 600 ground stations simultaneously if they had the proper antennas, 85-foot dishes with a 50° noise temperature.

The first ATS will also carry a very-high-frequency transponder that will relay voice and teletype communications between aircraft and ground stations. It will be an active frequency-translation repeater receiving in the 149-Mc range and transmitting in the 135-Mc range without a change in modulation. The satellite will be the first with enough effective radiated power (23 dbw) to permit such two-way tests.

Stabilization. The first and third satellites will be spin-stabilized; the other three will be gravity-gradient stabilized; that is, they will use the earth's gravity to keep the axis oriented.

By electronically despinning the antenna, the first ATS will direct its antenna energy towards the ground. A phased array of 16 elements on the antenna will concentrate the antenna beam. In terms of pattern gain, this will increase the effective radiated power of the satellite by about 10 decibels. Previous spin-stabilized satellites like Syncom and Early Bird, radiated their antenna energy in a 360° pattern rather than focusing it continually on earth.

A motor-driven mechanically despin antenna, rotating opposite to

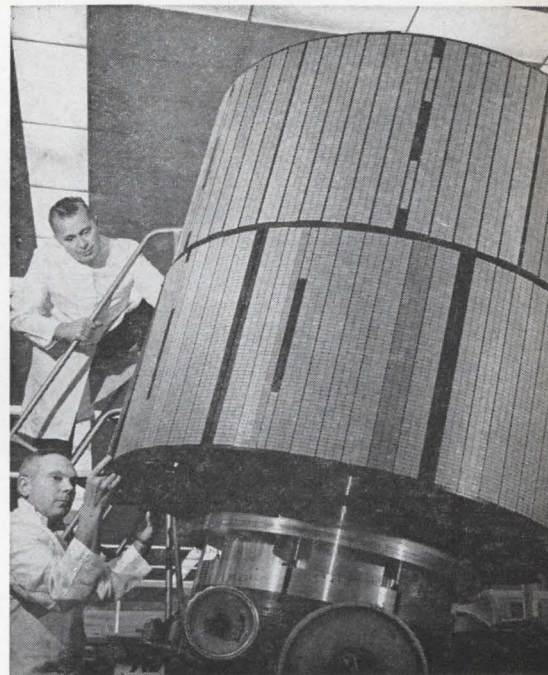

ATS, an orbiting laboratory, will carry 20 experiments for NASA

the satellite spin, is planned for the third satellite; the three gravity-gradient stabilized satellites will work with fixed-beam directive horn antennas.

Tests in space. Scientific experiments on the satellites will include:

- A nutation sensor to evaluate the spacecraft's stability while it spins. Scientists want to know whether spin stabilized craft are stable enough for meteorological applications.

- An ion engine whose performance may determine whether such engines can be used in future synchronous satellites.

- A camera to line-scan the clouds as the satellite spins.

The second satellite will have one of the only purely scientific experiments in the series. It will make detailed measurements of the slot between the inner and outer Van Allen electron belts.

The communications gap

The White House is pushing reforms that it hopes will help government regulations keep pace with advancing technology

By Seth Payne

Washington News Bureau

The White House and Congress, concerned over the government's inability to adequately regulate a rapidly advancing communications technology, have decided to do something about it.

So James D. O'Connell, director of the President's office of telecommunications management since last year, hopes, through several sweeping reforms, to bring some order out of what is now confusion. These reforms could affect the giants of the communications industry, now and in the future. Among O'Connell's proposals:

- A White House move for Congress to create a separate office of telecommunications, much like the Office of Science and Technology.

- Recommendations to revamp the international common carrier structure.

- A study of the government's communications needs for the next 15 years.

- A new technological advisory board for communications, drawing experts from major universities.

I. Cutting red tape

O'Connell will attempt to cut some of the red tape that now prevents the implementation of new communications methods. The Federal Communications Commission is so busy with regulations that it doesn't have time for the basic top-level policy decisions that industry needs from the government. O'Connell intends to provide these policy decisions, and he has the full backing of the White House, and in overall principle, that of Congress. Besides being telecommunications director, O'Connell is also special assistant to the President for telecommunications and assistant director of the Office of Economic



The job of untangling a mushrooming communications snarl is the job of James D. O'Connell, who wants more administrative power to handle the problem.

Planning.

First step. As a first step in reorganization, O'Connell wants Congress to create a separate office of telecommunications. The White House is due to send Congress an executive reorganization plan early next year to accomplish this. The new office would be much like the White House Office of Science and Technology or the President's Bureau of the Budget. They are independent offices working for the President, yet are more accountable to Congress than Presidential assistants.

Common carriers. O'Connell also intends to study the present roles of the United States international communications carriers. As it now stands, only the American Telephone & Telegraph Co. can han-

dle overseas voice traffic. The other major carriers—International Telephone and Telegraph Corp., Press Wireless, Inc., RCA Communications, Inc., and Western Union International—are limited to non-voice traffic. RCA's General David Sarnoff, for one, has pushed hard for a new look at this line-up. The contention is that satellite communications has now made this split in service outmoded.

The Stanford Research Institute (SRI) has been studying the international common carrier structure for the past year, collecting data on the economic, technical and political implications of the proposed revamping. SRI will give its report to O'Connell late this year.

Domestic problem. On the domestic front, there's growing dis-

content about the way the frequency allocations are parceled out. The basic question is whether there isn't a better way of doing things, using modern techniques. The American Broadcasting Co., for example, wants to distribute its tv programs via satellite instead of being limited to land lines.

Future needs. A contract for a study of government communications needs between now and 1980, including recommendations on how these can be met, will be awarded late this year with results due next September. Companies involved in operating or building communications systems are excluded from making the study.

Early next year, O'Connell intends to set up a new telecommunications advisory board on technological matters, drawing members from such organizations as the Massachusetts Institute of Technology and the California Institute of Technology.

The office. President John F. Kennedy created the office of telecommunications management by executive order in 1962, thus making one person responsible for guiding the nation's complex telecommunications role rather than several agencies. For administrative convenience, the director was also made an assistant director of the Office of Emergency Planning. Since then, all of the Presidential responsibilities for communications have been transferred to the director's office.

II. The job

Although the office of telecommunications management is only three years old, it is now being run by its fourth director. O'Connell took over last year. A retired army lieutenant-general, he had been vice president of General Telephone and Electronics Laboratories from 1959 to 1962. When O'Connell became director, he had a staff of six people—four secretaries and two engineers. This year, with separate funding of \$1.3 million, the staff will climb to some 70 people.

Need information. But before the office can do a job, basic information is needed: in its bid to reshape international communications, the office told Stanford Research Institute "to develop factual informa-

tion basic to the review and possible redefinition of national law, policy and objectives with regard to international telecommunications operations."

Specifically, the office wants SRI to help answer these questions:

- What services and facilities are now available for global communications?

- What worldwide capabilities does the U.S. need to meet future requirements?

- What facilities will be required to provide these capabilities, taking into account the outlook for technological change?

- Considering the nature, characteristics, and financial health of existing private companies, to what extent could they—either individually or jointly—provide the required facilities?

- What are the implications for the industry and its users if no organizational changes are made, different organizational structures are adopted or existing industry-government relationships are modified?

Government needs. For the study on government communications needs up to 1980, the office wants answers to policy questions involving the use of satellites for such services as direct tv broadcasting and tv relay, domestic and overseas; conventional fixed relay, including such specialized applications as non-common carrier information retrieval, direct f-m broadcasting and other uses.

Comsat study. The satellite communications system run by the Communications Satellite Corp. (Comsat) will also be studied. O'Connell plans to probe such questions in fiscal 1967 as whether more gateway terminals should be built to serve both government and commercial users from inland points and whether domestic telecommunications satellite service should be used as special purpose tv relay or high-speed data transmissions.

If O'Connell is even partly successful in advancing the government's policies to the level of communications technology, the entire communications industry could be affected. And O'Connell's effort seems to be only the beginning of the government's drive to keep pace.

want big
performance
from a small
portable oscillograph?

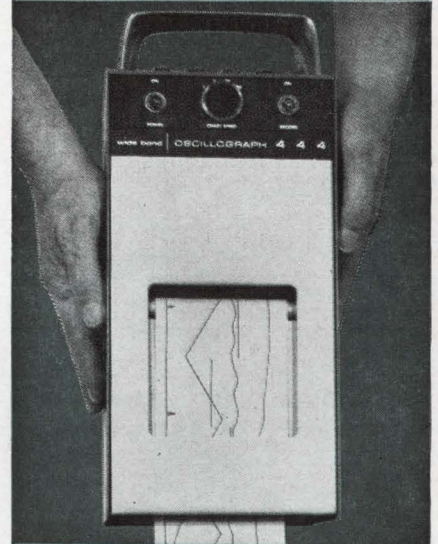

the new
Century 444
has it!

BETTER OPTICS MAKES THE DIFFERENCE: Superior optics by CENTURY means greatest efficiency from the low heat tungsten bulb light source — this means less DC power — smaller power supply — less cost — less weight.

SPECIFY THE CENTURY 444 for the finest in a small*, portable, light weight (15 lbs.), precision six channel wide band oscillograph.

*** (12 1/2" L x 5 5/8" H x 6 1/4" W)**

Send for the
Century 444
brochure
containing
detailed
specifications.



CENTURY
ELECTRONICS & INSTRUMENTS

Subsidiary of Century Geophysical Corp.
6540 E. Apache St., Tulsa, Oklahoma 74115

The laser: a bright hope in search of an owner

A federal court will begin hearings Dec. 8 on a challenge to Townes' basic laser patent

Next week, the tangled laser patent situation will move into federal court. The five judges of the United States Court of Customs and Patent Appeals will hear a classic tale of near-simultaneous discovery and invention as they tackle the job of deciding who first visualized a method for getting laser action.

Although the details are complex, the basic questions before the five-judge panel are: who saw it first? Was it Charles H. Townes and Arthur L. Schawlow, who received a laser patent on March 22, 1960? Or was it Richard Gordon Gould, who says he had the idea notarized in 1957? And did all of the parties exercise adequate diligence in reducing the theory to practice?

The prize is difficult to evaluate. So far, the laser has been lavish with promises but meager with profitable performances. Some people agree with Townes that it will be a billion-dollar a year industry by 1970. Others side with Schawlow, who shares the patent with Townes; Schawlow says the laser's immediate future is in the laboratory, not in the mass market [Electronics, Sept. 20, pp. 137-141].

I. The notarized notebook

Gould's claim to the laser rests largely on a dirty, grey laboratory notebook whose title belied the drama it was to provoke: "Some rough calculations of the feasibility of a laser—light amplification by stimulated emission of radiation." Gould claims that he was the first to visualize the use of the Fabry-Perot cavity, an arrangement of plane-parallel, partially reflecting mirrors, to achieve laser action.

One night in October, 1957, Gould—then 37 years old and a candidate for a doctorate in physics



Charles Townes and Arthur Schawlow received laser patent in 1960



Gordon Gould is contesting patent, contending that he had the idea first

at Columbia University—received a telephone call from one of the professors—Charles H. Townes, who is now provost of the Massachusetts Institute of Technology.

According to Gould, Townes asked for information about the high-intensity thallium lamps that Gould was using in his part-time job as research assistant at the Columbia Radiation Laboratory. Gould supplied the data, and the fact was duly recorded in Townes' own lab notebook.

'Great excitement.' Gould's wife says she remembers that event vividly. "He came in in great excitement," she said in pretrial testimony "to say that Dr. Townes had called . . . and that he was afraid that Dr. Townes might be thinking along the same lines as he was, and therefore he had better get busy and patent what he had so far."

On Nov. 13, Mr. and Mrs. Gould left their apartment in the Bronx, N. Y., and headed for a neighbor-

hood candy store whose owner was a notary public. The storekeeper set his seal upon the first nine pages of Gould's lab notebook.

Townes' notebook. Nearly two months before Gould's trip to the candy store, another notebook was being signed in another place—but on a similar subject. At Townes' request, another graduate student, Joseph Anthony Giordmaine, signed—on Sept. 14, 1957—Townes' notebook describing a light resonator consisting of a glass box with four mirrored sides, with a thallium lamp energizing thallium inside the glass cavity.

Later, comparing the notebook with Townes' patent application, Giordmaine testified that despite a difference of materials used ". . . the principle of the maser action is the same in the two cases."

II. Fabry-Perot cavity

Gould contends that the Fabry-Perot cavity is the type of device

described in the Townes-Schawlow patent, but that it isn't the device described in either Townes or Schawlow's notebooks, and presented testimony on this point. Gould is now employed at TRG, Inc., a division of the Control Data Corp. which has joined him in the suit over the laser patent.

Peter Franken, a physics professor at the University of Michigan, testified that the Townes' notebook did not describe a Fabry-Perot laser, but Bell Telephone Laboratories' lawyers insist that it involves the same principle outlined by Townes. Anthony Giordmaine's testimony supported the Bell contention.

Three steps. Townes and Schawlow, who are brothers-in-law, were busy with the laser in 1958. They took their ideas to the legal department at the Bell Telephone Laboratories, where Schawlow was employed and Townes, a consultant. They wrote a report on their laser-optical maser theories for the Physical Review, which published it in December of that year. And in July they applied for a patent on the laser.

Bell's attorneys charge that Gould revised some of his theoretical calculations after reading Townes' and Schawlow's paper in the Physical Review.

Pretrial testimony also centered on Gould's efforts to reduce his idea to practice. Regardless of who was the first to make the key discovery, the Bell lawyers contend, the patent should go to the man who exercised proper diligence in reducing the theory to practice.

It was not until April, 1959, that Gould and TRG applied for a patent. In granting a patent to Townes and Schawlow and denying Gould's application, the patent examiners stressed the "reasonable diligence" with which Townes and Schawlow had tried to put their idea into practice.

Gould's lawyers maintain that he did the best he could with the resources available to him until TRG supported his efforts. Reasonable diligence, they say, means that the patent should go to "the first to conceive, no matter how limited his resources, if he devotes those resources at his command toward actual reduction to practice of the invention."

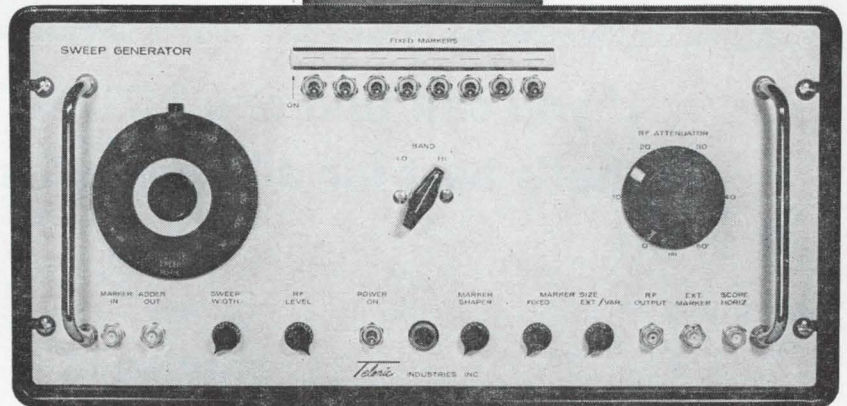

TELONIC HD-1A SWEEP GENERATOR

Here are all the benefits of swept frequency instrumentation at a price under \$1000.00. Telonic's HD-1A Sweep Generator covers a wide range of frequencies, 1 MHz to 900 MHz, with the convenience of a built-in frequency marker system, and performance factors par excellence.

LESS TIME—MORE DATA

The extra wide sweep, covering video to UHF, makes the HD-1A an ideal instrument for frequency response testing of amplifiers, tuners, networks and similar circuits. The use of swept techniques in such applications saves valuable test time and provides a complete response curve. Instead of isolated point by point measurements.

The HD-1A marker system permits the use of up to 8 plug-in markers of specific frequencies or harmonics covering the entire 1 to 900 MHz range. The instrument is fully documented to DOD, Air Force, Signal Corps, and Navy specifications. Federal stock no. is 6625-063-4492.

SPECIFICATIONS	LOW RANGE	HIGH RANGE
Center Frequency	1 - 400 MHz	390 - 900 MHz
Sweep Width	200 KHz - 200 MHz	0.06 - 10%
Output	0.25v r.m.s.	0.50v r.m.s.
Source VSWR	Normally below 1.3:1	
Impedance	50 ohms	
Flatness	± 5%	

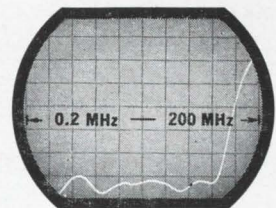

APPLICATIONS

Telonic's Sweep Generator Application file is yours on request. This folder contains a number of application notes covering conventional and unique uses of sweep generators. Your name is also automatically placed on the mailing list to receive copies of new application notes as they are published.

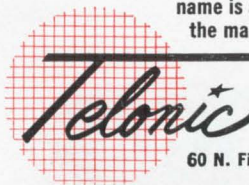

INDUSTRIES INC.

60 N. First Ave., Beech Grove, Ind., Tel: (317) 787-3231, TWX: 810-341-3202
International Leader in Swept Frequency Instrumentation

Representatives in all major U.S. and foreign cities.

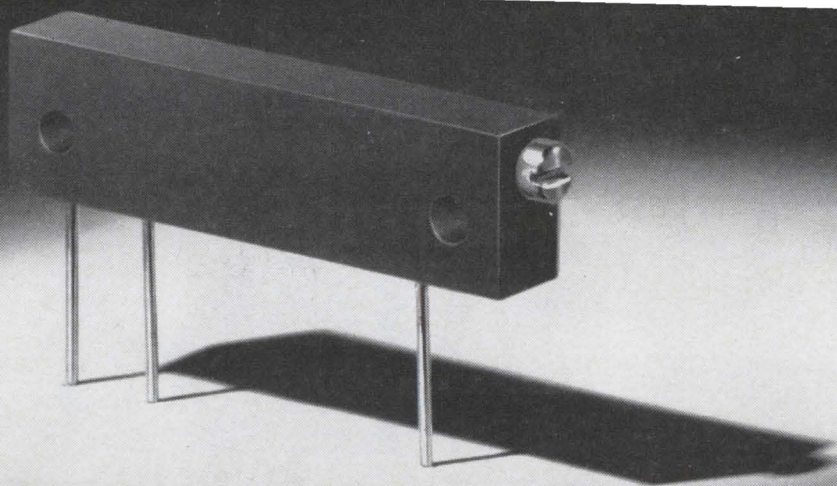







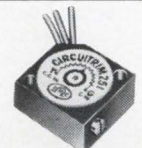
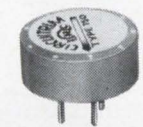

If you can find one **POTENTIOMETER**
that's best for all applications

... choose it

We don't think you will.

Only IRC makes all these different types ... can recommend without bias.

 <p>RECTANGULAR TRIMMER Thick-film Metal Glaze. MIL-R-22097 performance. 1/2-watt, 100 ohms to 1 meg. without gaps.</p>	 <p>1/2" SQUARE TRIMMER Shock resistant. Metal Glaze or wirewound element. 3/4 and 1 watt, 10 ohms to 1 meg. Military and commercial.</p>	 <p>1/2" ROUND TRIMMER Low cost, speedy adjustment. Metal Glaze or wirewound element. 3/4 and 1 watt, 10 ohms to 1 meg.</p>	 <p>3/16" CUBE TRIMMER Ideal for miniaturization. Metal Glaze or wirewound element. 0.3 and 0.6 watt, 50 ohms to 500K.</p>	 <p>METAL CLAD TRIMMER 1/2" dia., 10 times more resolution, 0.1% stability. Shock—moisture resistant. 1.5 watts, 25 ohms to 150K.</p>
 <p>PLASTIC CASE MULTI-TURNS Most popular. Ruggedly built. 7/8" and 1 1/2" dia. 3, 5 and 10 turns. In 3, 4 and 5 watt ratings. 25 ohms to 600K.</p>	 <p>COMMERCIAL MULTI-TURNS Most economical. 3/4" dia., 10 turns. 2 watt rating. 100 ohms to 100K.</p>	 <p>STANDARD PRECISION MULTI-TURNS 1/2", 3/4" and 1" dia. metal case. 5 to 20 turns. 1 to 5 watts, 50 ohms to 600K.</p>	 <p>MOISTURE SEALED MULTI-TURNS 3/4" and 1" dia., 5 and 10 turns. 2, 3, 4 watts, 25 ohms to 500K. O-ring panel seal available.</p>	 <p>HERMETICALLY SEALED MULTI-TURNS 3/4" dia. metal case, dry nitrogen filled. 5 and 10 turns. 2 and 3 watts, 100 ohms to 250K.</p>

Write for complete trimming and precision multi-turn potentiometer catalog.



INTERNATIONAL RESISTANCE COMPANY

Circle 108 on reader service card

PHILADELPHIA, PA. 19108

Easy swept-frequency measurements

Usual limitations are overcome by square-law compensation amplifier that corrects for nonsquare-law performance of detectors

A system designed specifically for critical swept-frequency measurements on microwave or radio-frequency systems replaces most of the test equipment normally required for the task. Designed by Alfred Electronics, it is packaged as an oscilloscope with a sweep-network analyzer plug-in unit. The system overcomes the principal shortcomings of conventional techniques that use the attenuator substitution method. This older method requires calibrating the test setup for each measurement, or off-setting gain or loss by an attenuator adjustment.

The multipurpose readout instrument handles fast swept-frequency measurements and has a wide dynamic range. It can measure two microwave or r-f signal levels in either absolute form or as a ratio with respect to a third reference level. The model 8000 oscilloscope with its associated analyzer plug-in model 7051 eliminates the need for a vswr meter, a power meter, log converters, precision attenuators, calibration reference r-f generators and frequency domain reflectometers to perform these measurements. A suitable sweep oscillator and r-f samplers complete the test set-up.

To overcome the limited dynamic range of conventional measurement systems, the Alfred system uses a square-law compensation amplifier, which corrects for the non-ideal performance of the detector. Transition and linear response ranges of each detector's output curve are corrected independently by separate circuits to permit direct readout up to 100 milliwatts.

Self-balancing, d-c operational amplifiers are used in the detector amplifier and ratio comparator circuits. These feedback-stabilized

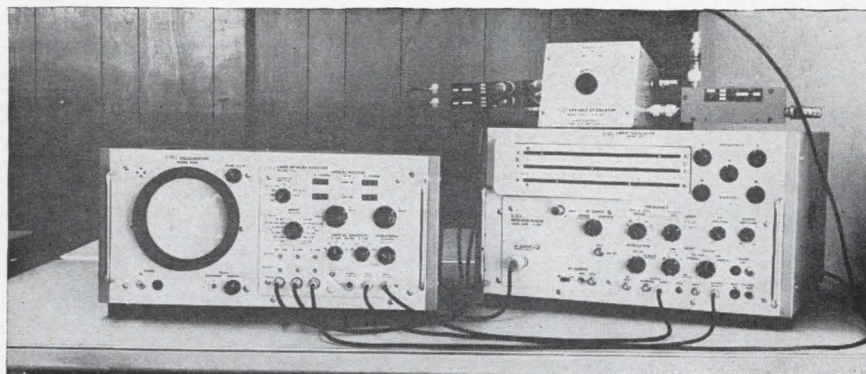

Test setup shows the model 8000 oscilloscope with model 7051 sweep-network analyzer plug-in (left). At right is the signal source, a model 650 sweep oscillator with r-f plug-in unit. Atop that is the device under test, a model E100 series microwave attenuator, and r-f samplers which complete the test loop.

devices permit the measurement of a detected signal at low power levels, thus avoiding the need for audio modulation. Two identical, but independent, signal channels allow simultaneous presentation on a dual-channel oscilloscope of either two absolute or two ratio measurements against a common reference signal over a 60-db range.

To eliminate effects of drift without the use of audio modulation or chopping, the self-balancing technique used takes advantage of the fact that the r-f source is turned off during sweep retrace. The retrace control circuit senses the flyback of the horizontal sweep during retrace, and operates a reed relay that cancels out any drift effects. This contact closure momen-

tarily couples a zero-signal logarithmic amplifier output voltage to a capacitor that controls a field effect transistor.

The FET generates a feedback current for the amplifier input that exactly cancels out the nonzero drift voltage, if any, present at the output. The high impedance of the FET avoids discharging the capacitor, maintaining the proper level of drift correction continuously throughout the next sweep interval. The next time the reed relay samples the no-signal output voltage, the correction level may be revised if necessary. A sampling interval of only 1.5 milliseconds is used to assure that the relay is opened before r-f power is restored at the start of the forward sweep.

Specifications

Frequency range	L-f to over 40 Gc, limited only by availability of suitable crystal detectors and samplers; primary range of usefulness as an improved high-speed, versatile measurement system: 100 Mc and above.
Accuracy	Db ratio measurements: $\pm 2\%$ of direct db reading. Absolute level measurements: $\pm (0.3 \text{ db} + \text{calibrator accuracy at level used})$.
Internal r-f calibrator	Generates 30-Mc signal for detector calibration; accuracy; $\pm 0.3 \text{ dbm}$ at $+20 \text{ dbm}$; $\pm 0.6 \text{ dbm}$ at -40 dbm .
Temperature range:	Specifications apply from 0 to $+50^\circ\text{C}$.
Price:	\$1,250 for the oscilloscope and sweep network analyzer plug-in.

Alfred Electronics, 3176 Porter Drive, Palo Alto, Calif., 94304
Circle 350 on reader service card

Precision capacitor in small package

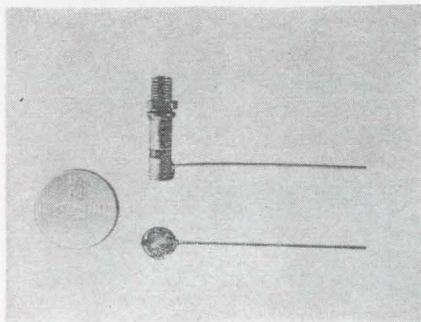

Ideally, capacitors used in ultra-high-frequency circuits must introduce as little a-c resistance and stray inductance as possible. Up to now, it has not been possible to reduce the size of capacitors substantially and still avoid these effects.

Now a piston trimmer capacitor, the MH-11, about the size of an aspirin tablet, introduces no measurable resistance or inductance in ultrahigh-frequency circuits. The precision device has a minimum Q at 250 Mc of 200; its capacitance range is from 0.1 to 1.25 picofarads.

The size of the new device— $\frac{9}{32}$ inch long, with a diameter of 0.075 inch—makes it easy to use in integrated circuits, since it can be as-

sembled in TO-5 transistor cases. The capacitor can be used to terminate the electrical coupling link between uhf cavities or between a cavity and other circuit components, thus providing mechanical as well as electrical stability. It can also serve as a trimmer to tune out the inductance of the coupling link.

The MH-11 is made of a glass dielectric separating solid metal electrode bands. A special fixture is used in production to assure concentricity. The entire unit is assembled without solder. Wires can be soldered directly to the electrode bands. The capacitor is sealed against the possible entry of impurities. Ten turns are required to cover the capacitance range.

Specifications

Capacitance range	0.1 pf minimum to 1.25 pf maximum
Q: at 1 Mc and maximum rated capacity at 250 Mc	500
Working voltage	200 minimum
Temperature coefficient	200 volts d-c
Operating temperature	0 ± 50 ppm/°C
	55°C to 125°C

Roanwell Corp., 180 Varick St., New York, N. Y. 10014 [351]

Push-button switch is small, rugged

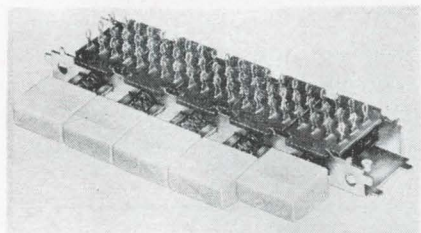

A miniature push-button switch assembly is now available for either printed circuit or hand wiring. Over-all thickness including wiring contacts is under $\frac{5}{8}$ in., and, when the switch is used with a printed circuit board, the height over the board is less than $\frac{1}{32}$ in. Assemblies are available with from 1 to 12

buttons, and each button can be supplied with a maximum of 8 pdt (pictured version is 4 pdt) with hard silver-plated brass contacts.

The rugged device provides several latching functions on one assembly and several mounting possibilities. Individual buttons can be operated in many modes, such as push-to-lock, push-to-release, mutual release and solenoid release of mutually controlled buttons.

Reasonable pricing allows the use of this switch even in home entertainment equipment. Typically, a 5-button assembly including buttons costs \$1.10 each in 1,000 lots.

Seacor, Inc., 598 Broadway, Norwood, N.J. [352]

Other BUCHANAN® cycle- controlled crimping tools

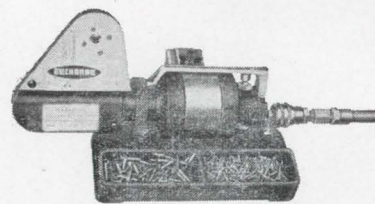

MANUAL FEED PNEUMATIC TOOLS Portable or Bench Mounted.

for moderate volume production. Crimp proprietary and Mil-Spec contacts for wire sizes #8 thru #30. Weighs less than 5 lbs. Bench-mounted model available with foot pedal to permit free use of both hands by operator. Meets performance specs of MIL-T-22520.

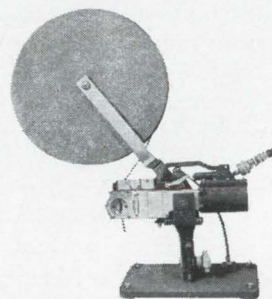

AUTOMATIC FEED PNEUMATIC TOOL Portable or Bench Mounted.

For high volume, it automatically feeds contacts from disposable carriers. For almost any pin and socket contact #12 thru #20. Speed limited only by operator's ability to insert wires. Crimp depth automatically selected by interchangeable snap-in blocks; accommodates foot valve control. In bench-mounted units, carrier reel holds 2,000 or more contacts. For portable applications, carriers in self-positioning "see-thru" magazines hold up to 102 contacts; magazine automatically selects proper crimp depth.

Write today for complete library of crimping data and new catalog on full line.



1077 Floral Avenue • Union, New Jersey
(201) 289-8200 • Telex 1-25471

a subsidiary of Elastic Stop Nut Corporation of America

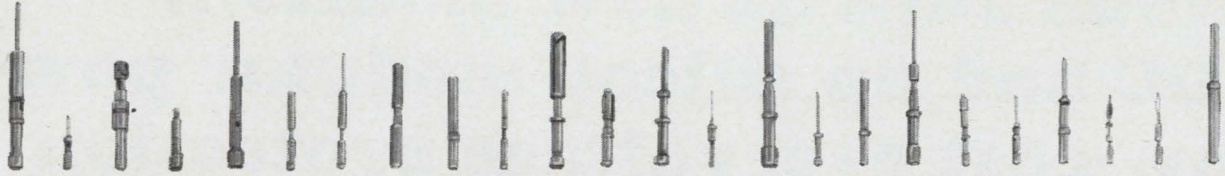

Crimp any of these contacts with no operator adjustment!

MS Hand Tool*
For most contacts
#12 thru #22, MS
and proprietary.



Miniature Tool
For most contacts
#20 and smaller.
Only 6³/₄" long.
10 ounces.



You are looking at two crimping tools that take tool adjustment out of the operator's hands. By simply changing inexpensive positioners, **you** program the tool for proper crimp depth, crimp location and point-of-ratchet release. Once the positioner is in, the tool is set. **The operator cannot make changes, cannot make mistakes.** Rejects are virtually eliminated, productivity goes up, Quality Assurance is satisfied.

That is Buchanan's positioner control principle. Really revolutionary! A giant step forward. For details, write for our new T102 Catalog. Buchanan Electrical Products Corporation, 1076 Floral Avenue, Union, New Jersey, or call (201) 289-8200, Telex 1-25471.

BUCHANAN
ELECTRICAL PRODUCTS CORPORATION

* a subsidiary of Elastic Stop Nut Corporation of America

Lambda adds 42 new models... 2 VDC and up silicon modular power ...low-cost overvoltage protection

New

42 power supplies designed for integrated circuit and other fixed voltage applications—maximum amps per cu. in. . . . maximum amps per dollar

New

Adjustable crowbar type overvoltage protection accessory—\$25

- Designed for continuous operation—no external fuse required
- Temperature coefficient—.05%/°C
- Mounting provisions provided—2-terminal connection

Model	Adj. Volt. Range	Size: H x W x D	Price
LMOV-1	3- 8 v	1¼" x 3¾" x 5/8"	\$25.
LMOV-2	6-20 v	1¼" x 3¾" x 5/8"	\$25.
LMOV-3	18-70 v	1¼" x 3¾" x 5/8"	\$25.

For use with all LM Series power supplies

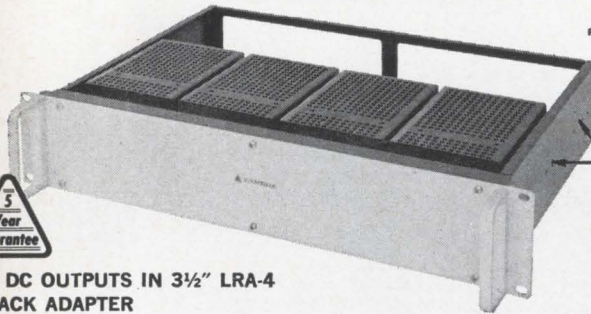

PATENT PENDING

Mounting provisions for use with chassis slides

4 DC OUTPUTS IN 3½" LRA-4 RACK ADAPTER

LM Series . . . Data and Features

A-C Input—105-132 VAC
45-440 CPS

Reg. Line—.05% + 4 MV
Load—.03% + 3 MV

Ripple—1 MV rms—3 MV peak-to-peak

Temp. Coef.—.03%/°C

- Meet Mil. Environment Specs.
RFI—MIL-I-16910
Vibration: MIL-T-4807A
Shock: MIL-E-4907A • Proc 1 & 2
Humidity: MIL-STD-810 • Meth. 507
Temp. Shock: MIL-E-5272C • (ASG) Proc. 1
Altitude: MIL-E-4970A • (ASG) Proc. 1
Marking: MIL-STD-130
Quality: MIL-Q-9858

Multi-Position-Rated™ and Multi-Current-Rated™ for 40°, 50°, 60° and 71°C

Package A		I MAX. AMPS ¹				Price
Model	VDC	40°C	50°C	60°C	71°C	
LM 201	0- 7	0.85	0.75	0.70	0.55	\$ 79
LM 202	0- 7	1.7	1.5	1.4	1.1	99
LM 203	0-14	0.45	0.40	0.38	0.28	79
LM 204	0-14	0.90	0.80	0.75	0.55	99
LM 205	0-32	0.25	0.23	0.20	0.15	79
LM 206	0-32	0.50	0.45	0.40	0.30	99
LM 207	0-60	0.13	0.12	0.11	0.08	89
LM 208	0-60	0.25	0.23	0.21	0.16	109

RACK ADAPTERS

LRA 6—5¼" Hgt. by 14⅞" Depth
[for use with chassis slides]
Price—\$60.00

LRA 3—5¼" Hgt. by 3" Depth
Price—\$35.00

LRA 4—3½" Hgt. by 14⅞" Depth
[for use with chassis slides]
Price—\$55.00

LRA 5—3½" Hgt. by 3" Depth
Price—\$35.00

Package B		I MAX. AMPS ¹				Price
Model	VDC	40°C	50°C	60°C	71°C	
LM 217	8.5-14	2.1	1.9	1.7	1.3	\$119
LM 218	13-23	1.5	1.3	1.2	1.0	119
LM 219	22-32	1.2	1.1	1.0	0.80	119
LM 220	30-60	0.70	0.65	0.60	0.45	129
LM B2	2 ±5%	3.4	3.0	2.3	1.4	119
LM B3	3 ±5%	3.4	3.0	2.3	1.4	119
LM B4	4 ±5%	3.4	3.0	2.3	1.4	119
LM B4P5	4.5±5%	3.3	2.9	2.2	1.4	119
LM B5	5.0±5%	3.3	2.9	2.2	1.4	119
LM B6	6.0±5%	3.2	2.8	2.2	1.3	119
LM B8	8.0±5%	3.0	2.7	2.2	1.3	119
LM B9	9.0±5%	2.7	2.5	2.1	1.3	119
LM B10	10.0±5%	2.6	2.4	2.1	1.3	119
LM B12	12.0±5%	2.4	2.3	2.1	1.3	119
LM B15	15.0±5%	2.1	1.9	1.7	1.2	119
LM B18	18.0±5%	1.8	1.6	1.5	1.2	119

All models in grey are new.

¹ Current rating is from zero to I max.
Current rating applies over entire output voltage range.
Current rating applies for input voltage 105-132 VAC
55-65 cps. For operation at 45-55 cps and 360-440 cps
derate current rating 10%.

Package C		I MAX. AMPS ¹				Price
Model	VDC	40°C	50°C	60°C	71°C	
LM 225	0- 7	4.0	3.6	3.0	2.4	\$139
LM 226	8.5-14	3.3	3.0	2.5	2.0	139
LM 227	13-23	2.3	2.1	1.7	1.4	139
LM 228	22-32	2.0	1.8	1.5	1.2	139
LM 229	30-60	1.1	1.0	0.80	0.60	149
LM C2	2 ±5%	4.9	4.2	3.5	2.4	139
LM C3	3 ±5%	4.9	4.2	3.5	2.4	139
LM C4	4 ±5%	4.9	4.2	3.5	2.4	139
LM C4P5	4.5±5%	4.9	4.2	3.4	2.4	139
LM C5	5 ±5%	4.8	4.1	3.3	2.4	139
LM C6	6 ±5%	4.6	4.0	3.1	2.4	139
LM C8	8 ±5%	4.4	3.8	3.0	2.0	139
LM C9	9 ±5%	4.2	3.6	3.0	2.0	139
LM C10	10 ±5%	4.0	3.5	2.9	2.0	139
LM C12	12 ±5%	3.8	3.3	2.8	2.0	139
LM C15	15 ±5%	3.4	3.2	2.7	1.8	139
LM C18	18 ±5%	3.0	2.8	2.5	1.7	139
LM C20	20 ±5%	2.9	2.7	2.4	1.7	139
LM C24	24 ±5%	2.5	2.4	2.2	1.5	139
LM C28	28 ±5%	2.3	2.1	2.0	1.4	139



LAMBDA ELECTRONICS CORP.
515 BROAD HOLLOW ROAD, MELVILLE, L. I., NEW YORK • 11749

supplies

New

Higher ratings with forced air cooling

Ventilated construction affords substantial increases in rating with small amounts of air flowing over surfaces of power supply.

Example: LM 217 is rated at 2.1 amps at 71°C ambient with 200 linear ft./min.; at 60°C ambient with 100 linear ft./min.

- Convection cooled—no heat sinking or forced air required
- Thermally Protected and Short Circuit Proof—Current Limiting
- Remote Programming
- Mount 3 ways on chassis or in rack
- All Silicon Semiconductors Hermetically Sealed

Ambients



Package D

4 15/16" x 7 3/4" x 9 3/8"

Model	VDC	I MAX. AMPS ¹				Price
		40°C	50°C	60°C	71°C	
LM 234	0-7	8.3	7.3	6.5	5.5	\$199
LM 235	8.5-14	7.7	6.8	6.0	4.8	199
LM 236	13-23	5.8	5.1	4.5	3.6	209
LM 237	22-32	5.0	4.4	3.9	3.1	219
LM 238	30-60	2.6	2.3	2.0	1.6	239
LM D2	2 ±5%	13.1	11.3	9.2	6.2	199
LM D3	3 ±5%	13.1	11.3	9.2	6.2	199
LM D4	4 ±5%	13.1	11.3	9.2	6.2	199
LM D4P5	4.5±5%	13.1	11.3	9.2	6.2	199
LM D5	5 ±5%	12.6	10.8	9.2	6.1	199
LM D6	6 ±5%	12.4	10.6	8.9	6.0	199
LM D8	8 ±5%	12.2	10.3	8.8	5.9	199
LM D9	9 ±5%	11.3	10.0	8.6	5.7	199
LM D10	10 ±5%	10.8	9.7	8.5	5.7	199
LM D12	12 ±5%	10.0	9.2	8.3	5.7	199
LM D15	15 ±5%	9.0	8.4	7.9	5.3	209
LM D18	18 ±5%	7.9	7.4	6.9	5.0	209
LM D20	20 ±5%	7.4	6.9	6.5	4.9	209
LM D24	24 ±5%	6.7	6.3	5.8	4.8	219
LM D28	28 ±5%	6.0	5.6	5.2	4.7	219

 **LAMBDA**
ELECTRONICS CORP.

New Semiconductors

All-diffused scr's have variety of uses

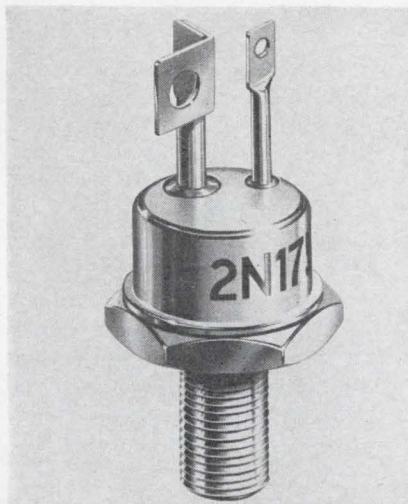

A series of 110-amp silicon controlled rectifiers has been developed for power control and switching applications. Known as series 2N1792 through 2N1800, the scr's are used for voltage regulators, power converters and inverters, dynamic braking, ignition firing and frequency converters. They are also applicable for constant current supplies, pulse width modulators, thyratrons, ignitrons, magnetic amplifiers, power transistors, relays, switches, contactors and circuits.

The all-diffused scr's feature the manufacturer's exclusive rigid post and clip construction for better performance and reliability. They have peak forward blocking voltages of 600 v and forward current capabilities of 70 amps (average) or 110 amps (rms). Peak reverse blocking voltage is from 60 v for 2N1792 to 720 v for 2N1800.

Silicon Transistor Corp., East Gate Blvd., Garden City, N.Y. [371]

Integrated circuit operational amplifier

Model 1812 integrated circuit operational amplifier is constructed on a single monolithic silicon substrate. Compensation may be applied externally to control stability.

The input drift is limited to

$\pm 25 \mu\text{v}/^\circ\text{C}$ over the temperature range of -55° to $+125^\circ\text{C}$. Open loop gain is typically 86 db with a gain bandwidth product in excess of 10 Mc. Input impedance is 500,000 ohms with $4 \mu\text{v}$ rms of noise. Output is 10 v peak-to-peak into 1,000 ohms. Power required is ± 12 v d-c at 5 ma.

The amplifier is enclosed within a TO-5 transistor can with twelve 0.017-in. diameter leads.

Fairlane Electronics, Inc., Box 335, Long Valley, N.J., 07853. [372]

Overlay transistor delivers 2.5 w at 1 Gc

Type 2N4012 overlay transistor is said to be the first single transistor to offer watts of power in the microwave frequency region. The device extends transistor performance into the 1-Gc frequency region with 2.5-w output and 4-db conversion gain (minimum) when operated as a tripler. A single 2N4012 can now replace both the transistor power-amplifier and varactor-diode stages previously required.

The 2N4012 is well suited as the first stage of telemetry transmitters operating on the new 2.2-Gc band, requiring only one varactor-diode doubler stage behind it to produce watts of power in this important new telemetry band.

This epitaxial silicon npn planar transistor with an overlay emitter electrode structure is especially designed to provide high power as a frequency multiplier into the uhf or L-band frequency range for military and industrial communications equipment.

In the overlay structure, there are several individual emitter sites, which are all connected in parallel and used in conjunction with a single base and collector region. When compared with other transistor structures, this arrangement provides a substantial increase in emitter periphery for higher current or power, and a corresponding decrease in emitter and collector areas for lower input and output capacitances.

RCA Electronic Components and Devices, Harrison, N.J. [373]

Military approves new time indicator

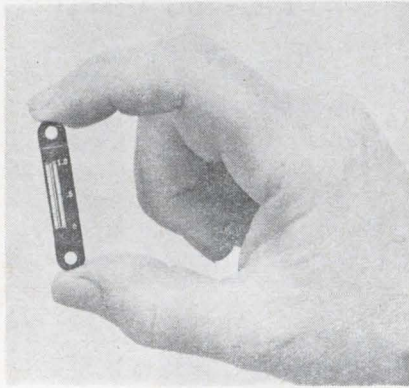

An electrochemical elapsed-time indicator, approved for military applications, has less than one-tenth the weight of conventional meters that are motor-operated. A line of new indicators that consume less than 1/30 the power required by electromechanical elapsed-time indicators has been introduced by Curtis Instruments, Inc. The small size and low power consumption is particularly significant to designers of airborne equipment. Initial applications of the indicators include stable platforms, radar, and other electronic equipment for which operating time must be logged as part of maintenance procedures. The unit meets the requirements of military standard MS 90386 and has been qualified in accordance with MIL-I-81219.

The indicator is a direct-reading microcoulometer that performs integration by electrochemical transfer of mercury. The meter element is in the form of a drawn-glass capillary tube. Filling the capillary bore are two columns of mercury separated by a small, aqueous electrolytic gap. Wire electrodes are inserted into the mercury columns and sealed to the glass with epoxy.

When a small d-c current is passed through the tube, mercury is transferred through the electrolytic gap from anode to cathode. As the gap moves along the length of the tube, its linear displacement is a measure of actual operating hours. The device may be reset by reversing the current.

When ordering it is necessary

to specify whether the indicator is to operate from a 115 volt a-c or 28 volt d-c source and the desired time range. The manufacturer then furnishes the ballast resistor required to establish the full-scale indicator range and a zener-diode circuit to rectify and regulate the a-c.

The new device provides 3% accuracy at approximately one-third the cost of synchronous motor types. The analog readout of the meter can be resolved to within 2%, considered adequate for most requirements.

Specifications

Range	Determined on the basis of 0.0104 ampere-hour required for one inch of gap travel
Temperature range	-20°C to +125°C
Altitude	Tested to 200,000 feet with no seal failures
Weight	0.1 ounce
Power consumption	50 milliwatts maximum
Curtis Instruments, Inc., 351 Lexington Ave., Mount Kisco, N. Y. [381]	

Instrument checks dielectric strength

A dielectric breakdown checker now on the market is called the Insta Test dielectric strength tester. It gives both an audio and a visual response at the breakdown point of windings used in coils, motors, transformers, etc.

A selection scale is graduated in ranges of 750, 1,000, 1,250, 2,000, 2,500 and 3,000 volts a-c. The unit operates on 117 v at 50 or 60 cycles with fused protection. Two high-voltage probes permit a quick check across any winding. At the potential breakdown point a buzzer will sound, and a red leakage lamp will light up if the part or circuit is defective. A check by increasing voltage in steps will show the potential breakdown point of a winding or circuit.

The Insta Test checker sells for less than \$75.

Grand Transformers, Inc., Grand Haven, Mich., 49717. [382]

**AUTHORIZED
ERIE
DISTRIBUTOR**

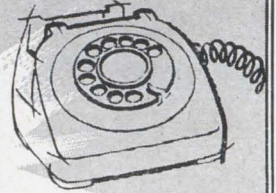

For Erie Components In-Stock Call . . .

- ARIZONA**
Phoenix
Kierrulff Electronics Corp.—273-7331
- CALIFORNIA**
Glendale
R. V. Weatherford Co.—849-3451
- Inglewood
Newark Electronics Corp.—OR4-8441
- Oakland
Elmar Electronics, Inc.—TE4-3311
- Palo Alto
R. V. Weatherford Co.—DA1-5373
- San Diego
R. V. Weatherford Co.—BR8-7400
- South Pasadena—Capacitors, Inc.—MU2-3541
- COLORADO**
Denver
Newark-Denver Elect. Supply—757-3351
- DISTRICT OF COLUMBIA**
Hyattsville, Maryland
Milgray/Washington, Inc.—UN4-6330
- FLORIDA**
Orlando
Crescent Elect. Sales Co.—423-8586
- ILLINOIS**
Chicago
Newark Electronics Corp.—ST2-2944
- INDIANA**
Indianapolis
Graham Elect. Supply, Inc.—ME4-8486
- MARYLAND**
Baltimore
Whise. Radio Pts. Co., Inc.—MU5-2134
- MASSACHUSETTS**
Boston
DeMambo Electronics—783-1200
Cramer Electronics, Inc.—WO9-7700
- MICHIGAN**
Detroit
Newark-Ferguson Elect., Inc.—548-0250
- MINNESOTA**
Minneapolis 1,
Stark Electronics Supply Co.—FE2-1325
- MISSOURI**
St. Louis
Electronic Components for Industry
Kansas City Co.—647-5505
ECI Semiconductor, Inc.—931-0829
- NEW MEXICO**
Alamogordo
Kierrulff Electronics Corp.—437-0370
- Albuquerque
Kierrulff Electronics Corp.—268-3901
- NEW YORK**
New York
Arrow Electronics—MY4-6800
Newark Electronics Center—255-4600
Milgray Electronics, Inc.—YU9-1600
- Rochester
Rochester Radio Supply Co.—454-7800
- NORTH CAROLINA**
Winston-Salem
Electronic Wholesalers, Inc.—PA5-8711
- OHIO**
Cincinnati
Newark-Herrlinger Elect. Corp.—
Columbus 421-5282
Electronics Marketing Corp.—299-4161
- OKLAHOMA**
Tulsa
Texas Instruments Supply Co.—
LU3-8121
- PENNSYLVANIA**
Philadelphia
Radio Elect. Serv. Co. of Pa., Inc.—
Pittsburgh WA5-5840
Cameradio Company—391-4000
- TENNESSEE**
Nashville
Electra Distributing Co.—AL5-8444
- TEXAS**
Dallas
Texas Instruments Supply—FL7-6121
- Houston
Texas Instruments Supply—MO6-2175
- WASHINGTON**
Seattle
Universal Electronics Co.—MA3-2783
- CANADA**
Montreal 12, Quebec
Preico Electronics Ltd.
389-8051
- Toronto, Ontario
Alpha Aracon Radio
Elect. Ltd.—635-6181
- Vancouver 2, B.C.
Western Agencies Ltd.
685-7221



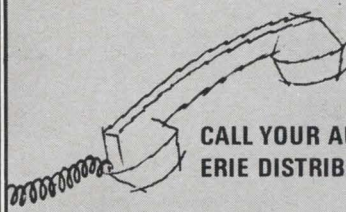

CALL YOUR AUTHORIZED
ERIE DISTRIBUTOR FOR...

“ACTIVE”

SUBMINIATURE

Electronic Components

BY ERIE

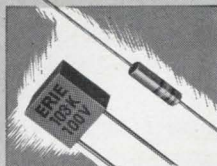

SUBMINIATURE MONOBLOC CERAMIC CAPACITORS

High capacitance to volume ratio.
Hermetically sealed in glass; precision
molded; and phenolic dipped types.



MINIATURE HERMETICALLY SEALED BUTTON MICA CAPACITORS

For -55°C. to $+200^{\circ}\text{C.}$ applications.



SUBMINIATURE BROAD BAND R. F. I. FILTERS

Eliminate RF noise in
10 KC to 10 KMC frequency range.



HIGH RELIABILITY TUBULAR and DISC CERAMIC CAPACITORS

General Purpose; Temperature
Compensating; and High Stability types.



MINIATURE CERAMIC and GLASS TRIMMER CAPACITORS

Precision Trimmers with capacitance
and terminal arrangements to suit need.

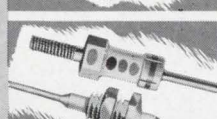

MINIATURE FEED THRU and STAND-OFF CERAMIC CAPACITORS

Threaded bushing, eyelet solder
types; high voltage types.

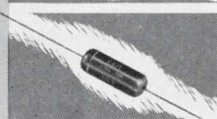

MINIATURE FILM CAPACITORS

Designed for filter, bypass,
coupling and blocking applications.



SUBMINIATURE DIFFUSED SILICON RECTIFIERS

High forward conductance, low-leakage
currents and reliable performance.

FULL WAVE BRIDGES and FULL WAVE DOUBLERS

Rectifier assemblies in modular size for
printed circuit applications.

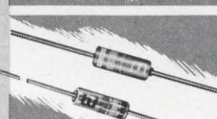

SUBMINIATURE SILICON GLASS DIODES and GERMANIUM DIODES

General purpose, fast-switching,
hermetically sealed types.

ERIE'S Project "ACTIVE" (Advanced Components Through Increased Volumetric Efficiency) now brings to electronics a series of high performance, subminiature components designed for applications where every cubic inch of space and every ounce of weight is critical to successful equipment performance.

These "ACTIVE" Erie components have been and are being designed into the circuitry of such demanding systems as Gemini, Apollo, Minuteman, Nike X, Telesar, Polaris, Honest John... advanced computers, oscilloscopes... and many other applications where size, weight and maximum reliability are vital.

We maintain complete inventories, in a wide range of values, of the Erie subminiature electronic components illustrated at left... and more. Remember, your authorized Erie distributor is *your one-stop source for quality components.*

- Write for your free copy of Erie's 28-page 1966 catalog
- Your nearby Authorized Erie Distributor is listed on the opposite page

ERIE

TECHNOLOGICAL

PRODUCTS, INC.

Formerly
Erie Resistor
Corporation



644 West 12th Street
Erie, Pennsylvania

Advanced Components Through Increased Volumetric Efficiency

NEW

For LEM-MOL-APOLLO-SATURN

BIT ERROR RATE MONITOR

Compares serial data bits, DC to 2 MC
Accumulates, stores, and displays bit errors
Direct 3 or 4 digit display of bit error rate
Internal data delay compensation: 0 to 5 bits
Printer output: 1-2-4-8 BCD
Bit matches selectable in place of bit errors
Wide application as general purpose comparator

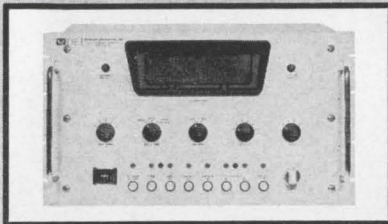

The DEI Bit Error Rate Monitor provides a means of comparing two serial NRZ data bit streams on a bit by bit basis. It accumulates the number of negative or positive comparisons over a bit interval selectable 10^3 to 10^7 bits or on a continuous basis. Provision is made for processing code forms other than NRZ. The number of bit errors (or bit matches) are presented on a visual digital display while simultaneously presented in BCD form as a printer output.

The BA-102 Series can be used in conjunction with PCM serial simulators to measure bit error rate of PCM processing systems. Operation is provided at bit rates from DC to 2 megacycles with data I/O threshold adjustable from +7 to -7 volts.

The power supply is self-contained and input/output connections are provided on both the front and the rear of the unit. A built-in delay to compensate for delay of the processing system under measurement is also provided.

For additional information write for Bulletin BA-102.



DEI
RESEARCH
DEVELOPMENT
MANUFACTURING

Defense Electronics, Inc.

Rockville, Maryland

(301)762-5700

TWX: 710-828-9783

New Subassemblies and Systems

All-IC memory makes debut

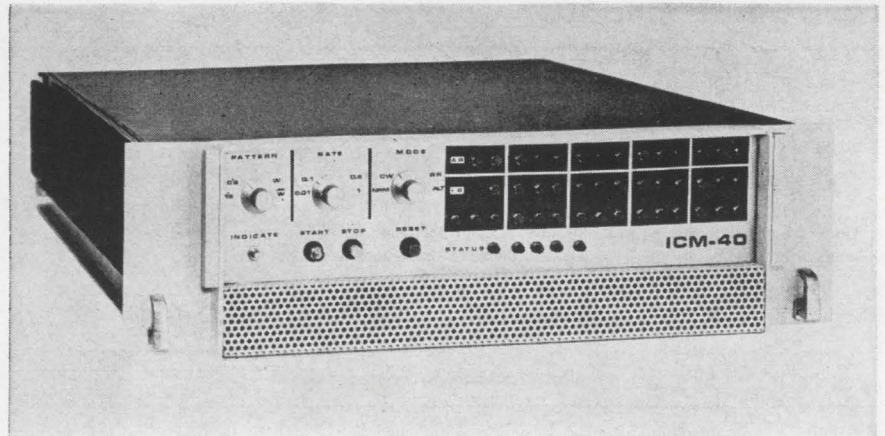

Integrated circuits are being used, for the first time, in a commercially available computer memory. The ICM-40 memory built by the Computer Control Co. is a coincident-current, random-access core memory; it has an address-decoding matrix made with the company's μ -Pac silicon monolithic integrated-circuit digital-logic modules. This matrix addresses one of 16,384 words at the beginning of a cycle.

The memory will operate in any one of three cycles. In a read/restore cycle, data is taken from the addressed location in memory and placed in an information register, from which it can be taken by the processor; this access takes less than 500 nanoseconds. Since the readout from the memory is destructive, this cycle restores the data to memory immediately so it will be available for later access. In a clear/write cycle, the data in the addressed location is cleared, or destroyed, and new data stored in its place. This cycle takes one microsecond. In a read/modify/write cycle, data taken from the memory is held and made available to the processor, and then stored in its original location after modification. Such a modification might be, for example, addition of data to another number, the sum being stored in the original place. The length of time taken for modifying is determined by the processor.

When power is manually shut off, the power supplies are auto-

matically turned off in a prescribed sequence to preserve data stored in the memory. When power is restored, a similar automatic sequencing operation takes place. This sequencing takes only a few milliseconds, and can save data in the memory even in the event of a primary power failure. In this case, or if one of the three d-c power supplies fails, dropping of the voltage level below a prescribed minimum sends a signal to the processor, which is then allowed 10 memory cycles (10 microseconds) to "save its place" and allow restarting of the program in the middle when power is restored. Enough energy is stored in filter capacitors in the power supply for this to take place even when primary power fails suddenly.

Data taken from the memory can be considered as a single word, as two words of half-length, or as four words of quarter-length, at the customer's option. Thus, with a 28-bit word the processor can

Specifications

Capacity and word length	4,096 words of 28 bits or 8,192 words of 28 bits or 16,384 words of 14 bits
Access time	500 nanoseconds
Full cycle time	1 microsecond
Ambient temperature range	0°C to 50°C
Size	5 1/4 inches high. Standard 19-inch rack mounting
Power supply, external	115v 60 cps (domestic) 230v 50 cps (foreign)
Power supply, internal	+ 24v d-c + 6v d-c - 6v d-c

clear/write one seven-bit word and read/restore three other seven-bit words all at once.

The price of the new memory depends on size and options. It is said to be competitive with other 2-microsecond memories, and is about one-third the size of a memory of similar capacity built with discrete components.

Computer Control Co., Inc., Old Connecticut Path, Framingham, Mass. [401]

Sine-wave carrier circuit module

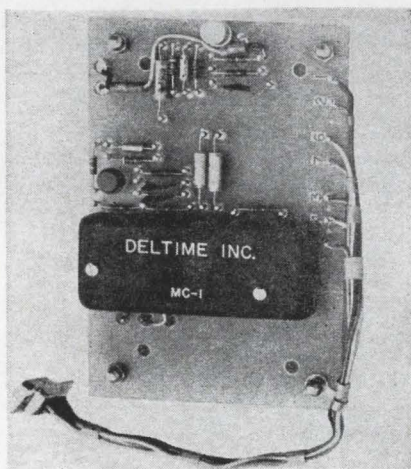

A unity gain sine-wave carrier module has been developed for magnetostrictive delay lines up to 4,000 μsec with 3-db bandwidth of 1 Mc. Delays up to 10,000 μsec are available with reduced bandwidths.

Amplitude-modulated, frequency-modulated and 100% pulse-modulated carrier waveforms can be delayed with an input-output linearity of $\pm 10\%$ or better. The over-all dynamic range of the module, designated model MC-1, is 20 db; output signal-to-noise ratio is 10:1 minimum for 100% pulse modulation. The input level unmodulated is 1 v across 600 ohms. The power supply is 12 v d-c at 50 ma, and -12 v d-c at 55 ma. The operating temperature range is 0°C to +55°C. Over-all dimensions of the MC-1 are $\frac{7}{8}$ x $3\frac{1}{2}$ x $5\frac{5}{16}$ in.

The recommended delay line for up to 1,500 μsec is Delttime model 192C; for 1,500 to 4,000 μsec , Delttime model 197C.

Delttime division, Seallectro Corp., 225 Hoyt St., Mamaroneck, N.Y., 10544, [402]

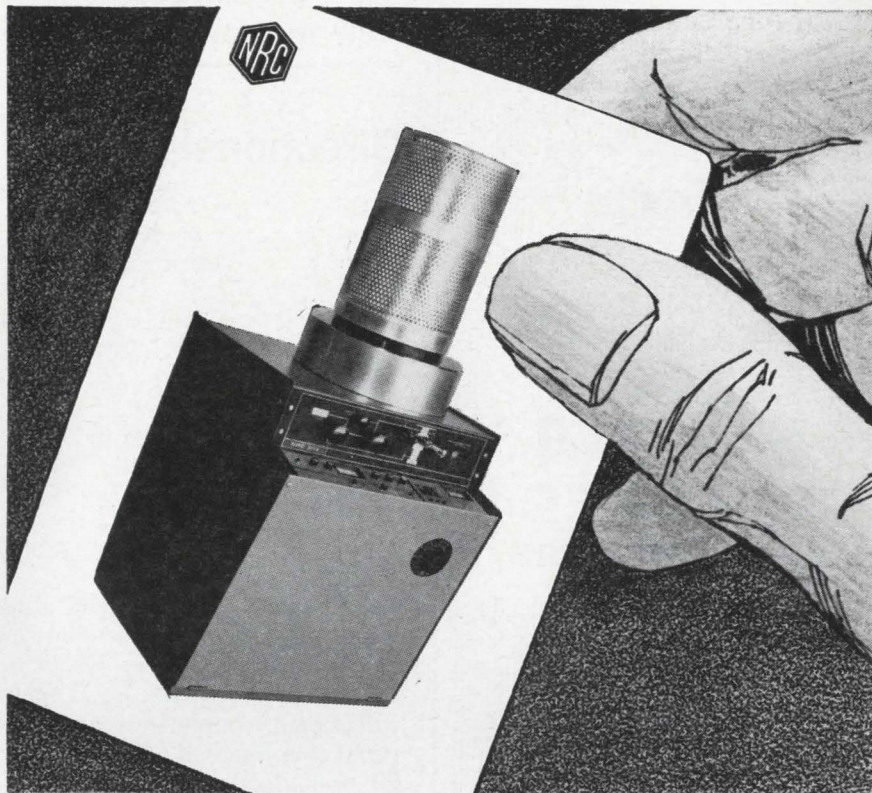

NRC'S *new microcircuit Trump Card will suit your needs!*

If you can't afford to gamble on microcircuit performance and feel that you've been priced out of the **quality** high vacuum coater market, the NRC 3114 economy coater should be welcome news. Designed for general-purpose R & D thin film operations, the NRC 3114 incorporates many of the features of more sophisticated systems, such as the NRC 3176, with the rock-bottom price of a bargain-basement evaporator. The price is about \$3,000. Luxury features include **10⁻⁸ torr range blank-off**, a liquid nitrogen baffle, top-rated NRC 4-inch diffusion pump and the very latest in high vacuum gauge instrumentation — the log and linear-scaled NRC 720 ionization gauge control. Controls are conveniently grouped in an easy-to-read, one-position panel. The compact (31 by 33½") system also features a 5 cfm mechanical pump, an NRC 507 ionization gauge tube, two NRC-521 thermocouple gauge tubes, a raised baseplate with bell jar, guard and gasket. Complete accessibility for routine maintenance is provided through the removable panels on all four sides. For detailed information on our complete line of evaporators and associated equipment for microelectronics, write or call today.

EVAPORATORS • PUMPING STATIONS • POWER SUPPLIES
FEEDTHROUGHS • CRYSTAL PULLERS • TUBULAR FURNACES
ELECTRON BEAM HEAT SOURCES • LEAK DETECTORS



EQUIPMENT DIVISION

NATIONAL RESEARCH CORPORATION

A SUBSIDIARY OF NORTON COMPANY



160 Charlemont Street, Newton, Massachusetts 02161

**NOW! Tone Selective Signaling
to Alert or Activate up to 11,000
Decoder Equipped Units!**

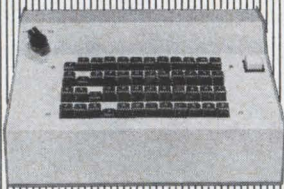

**S&G ELECTRONICS'
ET 12-4
ENCODER
AND DECODERS**

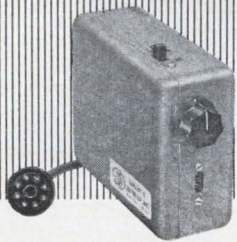

S&G Electronics now offers a complete line of encoding and decoding equipment which *completely eliminates* the necessity of continuous receiver monitoring in two-way communications.

With an S&G ET 12-4 Encoder in the base station and the Decoder (vacuum tube or transistorized) in mobile or subsidiary units, selective paging of any individual unit is possible in almost any communications system—regardless of size!

A "group" or "all" call is also available so that all mobile units can be called simultaneously for emergencies, general information distribution, etc. Better yet, these ET 12-4 units are compatible with almost any similar communications system.

*Why not write
us now for details.*

**ET 12-4
SELECTIVE SIGNALING**

Another fine product
from the leaders in the
resonant reed field.



S&G ELECTRONICS
SARGENT & GREENLEAF, Inc.
ROCHESTER, NEW YORK 14621

New Microwave

Directional couplers made smaller

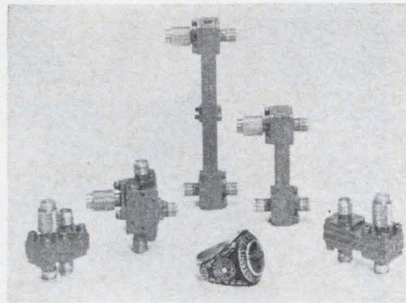

Development of a coaxial directional coupler 25% smaller and lighter than any other is claimed by Sage Laboratories, Inc. The new directional couplers are available with coupling values of 3, 6, 10, 20, or 30 decibels in any of five frequency bands between 0.5 and 12 gigacycles.

The size of the units varies inversely with frequency. For instance, a Sage coupler for the uhf band (0.5 to 1 Gc) has an over-all length of 3.2 inches; its body measures 0.5 by 0.25 inch, and it weighs 1.5 ounces, including an optional internal one-watt load. Comparable dimensions for a C-band coupler (4 to 8 Gc) are 0.86 inch over-all,

0.5 by 0.25 inch and 0.8 ounce. All couplers for a specific frequency band are the same size, regardless of coupling value.

Sage won't say how it made its couplers smaller and lighter, except to indicate that printed circuits are not used. Conventional miniature couplers do use printed-circuit techniques to form the coupling circuit but the company feels this takes more space than necessary.

As an indication of power-handling capacity of the couplers, the S-band coupler can handle 100 watts, continuous wave, at sea level, says Sage. Power handling capability above sea level would be less, but exact data is not available.

The couplers have type-M connectors.

Prices for the couplers start at \$115. Delivery is within 30 days.

Specifications

Voltage standing wave ratio	1.3 maximum
Coupling flatness	± 1/2 db for coupling values to 20 db ± 1 db for the 30-db unit

Sage Laboratories, Inc., 3 Huron Drive, Natick, Mass., 01762 [421]

**Dummy load handles
290-kw peak**

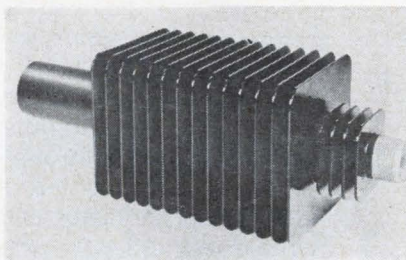

Model DBG-S-385, a high-power dummy load for test of radar systems, is equipped with a special threaded input connector to allow attachment to X-band antennas employing circular waveguides. The load may be attached to the vertex of an antenna in place of the an-

The input connector is 1 in., 24 UNS-2A thread x 5/8 in. long, male. Optional connectors available include type N and EIA 7/8-in. It is also feasible to employ a circular-to-rectangular waveguide transition in adapting the load to a high-power RG-52/U rectangular waveguide system.

Frequency range is 8.2 to 12.4 Gc. Vswr is 1.10 max. Power handling capability is 290 kw peak and 400 w average. Waveguide is circular (0.925 in. i-d).

Dimensions are 8 5/8 in. long x 5 in. square; weight, 2 1/4 lbs.; construction, aluminum. Price is \$195; availability, 30 to 45 days.

DeMornay-Bonardi, division of Data-pulse, Inc., 780 S. Arroyo Parkway, Pasadena, Calif., 91105. [422]

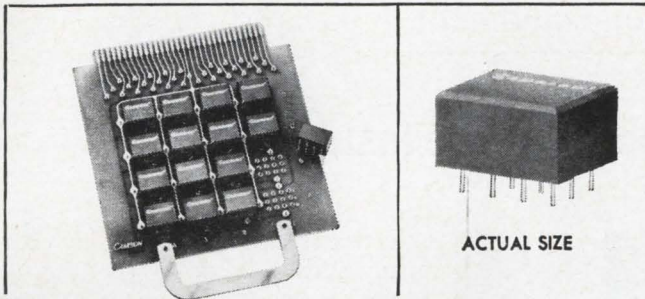

Block out your logic problems

Use CAMBION® Digital Logic Modules. They are available complete with mounting hardware in three new lines: 10 MC and 100 KC germanium plus 2 MC silicon. Featuring standard 12 pin grid configurations and produced with standard pin connections on logic and power points, these building block digital logic modules provide total intercompatibility for simple and mixed logic circuits.

With CAMBION Cambi-Cards, you have the most versatile mounting hardware for any logic circuit. Logic types of all three CAMBION Digital Module lines can be intermixed on each Cambi-Card. To guarantee insertion of proper card into chassis, each card can be key-coded by slotting a specific finger of the connector contact area.

Get valuable assistance in logic circuits from CAMBION. Our application engineers want to help you design CAMBION Digital Modules into efficient, low cost systems for a variety of modern digital logic applications.

FREE! CAMBION Catalog 80 contains circuit diagrams and operating characteristics on 19 CAMBION Module families. Write for your copy today. Cambridge Thermionic Corporation, 401 Concord Avenue, Cambridge, Mass. 02138. (617) 876-2800.

CAMBION®
"DIAL-A-PART" SERVICE

Standardize on CAMBION...The Guaranteed Electronic Components

Circle 148 on reader service card

NEW ELGENCO 3 BAND 20 cps to 5 mc RANDOM NOISE GENERATOR



MODEL 602A

- Symmetrical wave form
- Non-clipped wave form
- Constant output Z
- All Solid State
- \$290

SPECIFICATIONS: MODEL 602A — GAUSSIAN DISTRIBUTION: Symmetrical non-clipped wave form all ranges. **FREQUENCY RANGES:** 20 cps to 20 kc, 20 cps to 500 kc, and 20 cps to 5 mc. **OUTPUT SPECTRUM:** Uniform from 20 cps to 20 kc within ± 1 db, 20 cps to 500 kc within ± 3 db, 500 kc to 5 mc within ± 8 db. **OUTPUT VOLTAGE:** Maximum open circuit at least 3 volts for 20 kc range, 2 volts 500 kc range, and 1 volt 5 mc range. **TYPICAL SPECTRAL DENSITY** (with 1 volt rms output): 5 mv/ $\sqrt{\text{cps}}$ for 20 kc range, 1.2 mv/ $\sqrt{\text{cps}}$ 500 kc range, and 0.4 mv/ $\sqrt{\text{cps}}$ 5 mc range. **CONTINUOUS AMPLITUDE CONTROL — FIVE POSITION OUTPUT ATTENUATOR:** X1.0, X0.1, X.01, X.001, and X.0001; Accuracy $\pm 3\%$ to 100 kc, $\pm 10\%$ to 5 mc. **OUTPUT IMPEDANCE:** Constant 900 ohms on direct output; 200 ohms on step attenuated output. **OUTPUT VOLTMETER:** 0.5 volt, calibrated to read rms value of Gaussian noise. **Operating Temperature:** 0 to 50 degrees C. **POWER REQUIREMENTS:** 115/230 volts $\pm 10/20$ volts, 50 to 1,000 cps, approx. 5 watts; rechargeable battery option available. **DIMENSIONS:** 5 1/4" high x 8 3/8" wide x 11" deep. Panel height for 19" relay-rack mounting is 5 1/4". **PRICE:** \$290. **DELIVERY:** Stock to 30 days.

OTHER MODELS: 610A 10 cps to 5 mc — \$1175; 603A 20 cps to 5 mc — \$495; 301A - DC to 40 cps — \$1995; 321A DC to 120 cps — \$2095; 311A DC to 40 cps and 10 cps to 20 kc — \$2395; 312A DC to 120 cps and 10 cps to 20 kc — \$2495; 331A 10 cps to 20 kc — \$1295.



ELGENCO INCORPORATED
1550 EUCLID ST. • SANTA MONICA, CALIF. • (213) 451-1635

For more than 10 years Noise Generators have been our major endeavor.

Circle 149 on reader service card

Two electrifying reasons for coming home with us to Paris:

1. The Electronic Components Exhibit.
2. Paris.

The first may turn out to be an excuse, although it's the largest exhibition in the world, but that's up to you. Either way, Air France (official carrier for the exhibit) will joyously jet you nonstop to Paris from New York, Los Angeles or Montreal direct from Chicago or Washington, D.C. And we'll start your Paris orientation in the air, from the memorable French cuisine to the matchless comfort and service. We want you to feel at home when you get to Paris. That's why you'll find an Air France Welcome Service desk at the exhibit. We'll be happy to show you around when you arrive: Let us arrange all the details of your stay before you leave. Fares? There are none lower. Cargo Service? None better. For complete information, clip and mail the coupon below.

AIR FRANCE E-11-5
Overseas Trade Show Department
AMN-CG
683 Fifth Avenue
New York, N.Y. 10022

Please send me, free, the detailed technical brochure and admission card for the 9th International Exhibition of Electronic Components

Name _____
Company _____
Address _____
City _____ State _____ Zip Code _____



AIR FRANCE
THE WORLD'S LARGEST AIRLINE
à Votre Service

Circle 119 on reader service card

119

ONLY FROM
TEXAS INSTRUMENTS



NEW EPITAXIAL GALLIUM PHOSPHIDE AND GALLIUM ARSENIDE PHOSPHIDE

New purities . . . new forms . . . new composition control mean broader capabilities for light-emitting diodes, and optoelectronics generally. TI's exclusive epitaxial processes are now supplying for production, as well as R&D requirements, high purity single crystal gallium phosphide (GaP), gallium arsenide-phosphide ($GaAs_x P_{(1-x)}$), and gallium arsenide (GaAs).

Individual epitaxial layers of each material are produced on gallium arsenide substrates in thicknesses from two microns to 0.025 inches. Multiple layers are produced as combinations of GaAs, $GaAs_x P_{(1-x)}$ and GaP, or as separately doped deposits of any desired composition.

Precise material composition is maintained without variation both across the deposits and throughout thick deposits.

Gallium arsenide substrates are P-type, N-type, or semi-insulating, as required.

FOR VISIBLE GREEN LIGHT SOURCES

Gallium phosphide epitaxial slices with (1-1-1) or (1-0-0) orientations, N-type and P-type dopings available. Thick deposits with or without substrates removed.

FOR INFRARED, VISIBLE RED, OR ORANGE LIGHT SOURCES

Gallium arsenide-phosphide slices: Epitaxial material of any composition intermediate between GaAs and GaP. N-type and P-type dopings available. Orientation (1-1-1) or (1-0-0).

FOR INFRARED LIGHT SOURCES

Gallium arsenide epitaxial slices have (1-1-1) or (1-0-0) orientations. N-type and P-type dopings available. Thick deposits with or without substrates removed.



For complete data, write Manager, New Product Development, MCRD

TEXAS INSTRUMENTS
INCORPORATED

MATERIALS & CONTROLS DIVISION
P. O. Box 5303
Dallas, Texas

New Production Equipment

Welder vaporizes wire insulation

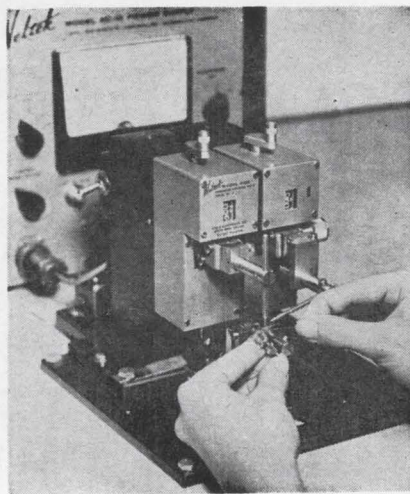

Insulated leads can be welded to component terminals in a fraction of a second—without stripping the wire insulation—by a new three-electrode technique. The electrodes vaporize the insulation before making the weld.

A typical setup is illustrated. Current is first shunted through the top electrode and the electrode at the upper right, which is wedge-shaped to make a line contact with the top electrode. The shunted current generates intense heat, removing the insulation at the spot to be welded. Then welding current is passed from the electrode at the top to the electrode at the bottom right, through the wire and work-piece, thus making the weld in the normal way.

The process takes one-tenth to one-half second, depending on wire size and insulation. Copper wires as thick as 0.01 inch and as thin as 0.0005 inch have been welded. Insulations have included thermoplastic sheathing and Formex or Formvar, according to the developers, the Weltek division of Wells Electronics, Inc.

Weltek says that there is little problem with electrode fouling, because the vaporizing electrodes become very hot. A few swipes with a hand file every 200 or 300 welds keeps them clean. Assemblies with two welds can be made at a rate of 400 an hour for a full day before

electrodes are changed, the company adds.

The process is expected to save considerable time in the production of such components as coils, transformers, miniature motors, relays and memory boards, since the lead wires do not have to be pre-stripped for welding, or prefastened for soldering.

The electrodes are being introduced as an accessory to the AC-10 power supply, which Weltek introduced a few months ago, and the 410-E welding head, introduced last year. These have previously been used for a variety of miniature welding and soldering operations with two electrodes in parallel-gap, series, split-tip, shunt, opposed or pincer configurations.

A standard three-electrode configuration, suitable for many types of welds, is available without extra charge when a power supply and head are purchased. Custom configurations cost about \$25.

Specifications

AC-10 power supply	
Power input	110-120 volts, 60 cycle a-c, single phase
Power output	Variable from 0 to 1 kva, 1.25-milliohm load
Output impedance	1, 4, 8 and 100 milliohms provided by internal impedance-matching transformer
Pulse time	Mode 1: 0.1, 0.2, 0.3, 0.4 and 0.5 second Mode 2: variable from 0.1 to 3 seconds Mode 3: external timer
Price 410 E head	\$650
Welding force	3 ounces to 20 pounds; electronic lockout prevents firing except when electrodes are at preset force
Price	\$725

Weltek, a division of Wells Electronics Inc., 1701 S. Main St., South Bend, Ind., 46623 [451]

Vacuum pencil sucks up solder

A self-contained vacuum pencil, model 123, cleans up excess solder from connections. The Lerloy vacuum pencil can also be used to re-

trieve miniature parts from inaccessible areas without damage. It is easy to use, being held and operated with one hand, and is emptied simply by detaching the Teflon tip. It is lightweight (approximately 1 oz), and may be clipped into a pocket for carrying. There are no bulky parts to obscure the view while the vacuum pencil is in use.

Features of the new device include several tip configurations to meet individual application requirements, low cost (\$9.95 each in single unit quantities, with industrial quantity discounts available) and ease of operation.

Engineering & Electronic Devices Inc., 1024 N. McCadden Place, Los Angeles, Calif., 90038. [452]

Flip chips are bonded ultrasonically

A self-contained instrument has been announced which flips and then ultrasonically welds semiconductor chips directly to substrates. The unit completely eliminates the need for thermal compression wire bonding and does not require heating of the circuits or protective atmospheres. Devices can be welded to alumina or glass substrates metallized with standard interconnect depositions. Mounted devices will pass 25,000 g acceleration without failure.

The unit contains a proprietary optical system which assures accurate orientation of devices on opaque nonreflecting surfaces. A special device reservoir ensures fast die alignment on the circuit pad. A two-stage power supply provides individual power settings for mounting different sized devices alternately.

Electrically, the ultrasonic flip chip die mounter has a line voltage of 115 v at 60 cycles, with a maximum power consumption of 100 v-a. Its frequency output is 60 kc and the power output is from 0 to 20 w. Pulse duration is 0.020 to 1.020 sec and the clamping force is 50 to 450 gm. The optical system has 45 \times magnification. The complete unit is 20 in. long, 14 in. high, and 17 in. wide. Weight is approximately 105 lb.

Hughes Microelectronics Service and Circuits, Hughes Aircraft Co., 500 Superior Ave., Newport Beach, Calif. [453]

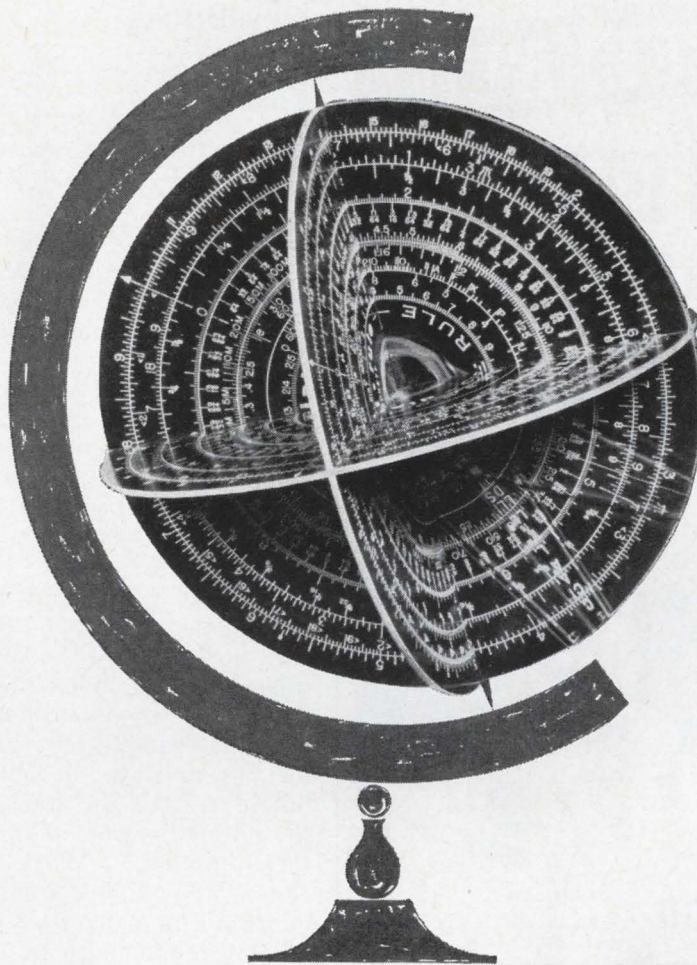

INTERSTATE ELECTRONICS ... where longitudinal experience and latitudinal capability form a world all by themselves.

That's right, Interstate Electronics is long on experience and wide in capability. It took both to develop the sophisticated and highly successful test instrumentation equipment for the FBM weapon system of the Polaris submarine program. As prime contractor for this important equipment, Systems Development Division of IEC relies heavily on its staff of top experts, and excellent facilities. The same applies to the Data Products Division which specializes in the development of real-time permanent paper or film video recorders, phase lock devices, timing systems, data handling systems and analog-to-digital conversion equipment. Lots of savvy. Lots of ability.

And although the seas have been here since time began, Man is only now beginning to read, understand, and use the waters of the world. OceanicS Division, formerly National Marine Consultants Division, for over a decade has used scientific principles to develop unique products and methods for studying everything from piers to pollution, from sand to salinity. It's all done with people... the best in the business.

You see, it's really elementary. People with ability are what make the world go round at IEC.

INTERSTATE ELECTRONICS CORPORATION

707 E. VERMONT AVE., ANAHEIM, CALIFORNIA 92803

Regional Offices: Atlanta, Georgia • Washington, D. C.

Subsidiary of

INTERSTATE ENGINEERING CORPORATION



IEC

FREE! NEW!

NEWARK
1966 INDUSTRIAL
ELECTRONICS
CATALOG
LISTING



silicon
controlled rectifiers

Including the new economy type, 12.5 amp, 2N3668. With 8 amp average forward current, these units are ideal for low voltage power supplies. Companion types, 2N3669 and 2N3670, are for 120V and 240V supplies respectively. All are packaged in standard TO-3 cases with hermetic sealing and direct soldered internal connections to provide high fatigue resistance.

- Immediate Delivery from Stock
- Factory OEM Prices

NEWARK CATALOG 85

- Industry's Most Complete Catalog
- 660 Pages • Over 70,000 items
- Over 600 Standard Brand Lines
- Seven Stocking Warehouses
- Over \$6,000,000 Industrial Electronics Inventory

NEWARK ELECTRONICS CORPORATION

Main office and warehouse • Dept. 000
223 West Madison • Chicago, Ill. 60606

Authorized RCA Warehouses in:

CHICAGO, ILL.
(312) ST 2-2944

CINCINNATI, OHIO
(513) 421-5282

DENVER, COLORADO
(303) 757-3351

DETROIT, MICHIGAN
(313) 548-0250

LOS ANGELES AREA
(213) OR 8-0441

NEW YORK CITY
(212) 255-4600

Other Newark Warehouses in:
GRAND RAPIDS, MICHIGAN
(616) 452-1411

New Books

Bond theory

Chemical Physics of Semiconductors
J.P. Suchet, D. Van Nostrand Co.,
197 pp., \$8.50

A concise book describing semiconductors from a chemist's point of view—from the standpoint of "bond theory" rather than the physicist's "band theory"—would be a valuable tool for the physical or inorganic chemist seeking to produce or understand new semiconductors. J. P. Suchet, in this well-illustrated book, has made the attempt but has fallen short of his goal.

The book is replete with vague, incomplete and often misleading statements which make reading difficult and could lead the unwary reader to serious misunderstandings. For example, referring to non-metallic crystals, the author says "these crystals are transparent in the infrared region, and opaque in the ultraviolet." What can this statement possibly mean? Germanium, silicon, gallium arsenide and indium antimonide are probably the four most important semiconductors technologically and all absorb infrared light. Indium antimonide absorbs into the far infrared region.

This incompleteness is characteristic not only of individual sentences but of entire chapters. The chapter on organic semiconductors is an example. There is currently much interest in organic semiconductor materials by chemists and physicists and a review of recent work in the field would be welcome, but Suchet cites no recent references on this subject; all date before 1960. At one point, Suchet says that "semiconductivity [in organic crystals] must involve the jumping of charged carriers from one molecule to the other." Later, he writes, "the mechanism for semiconductivity can only be intermolecular and can only involve the transfer of charge from molecule to molecule." These statements indicate lack of appreciation of the progress made during the past five years in interpreting semiconduction in organics, based on the band theory. This theory involves "intermolecular jumps" only indirectly.

This newer type of theory also has had a degree of success in interpreting semiconduction quantitatively in particular cases (such as anthracene); the older concepts in general have not yielded more than a qualitative description.

Suchet also apparently does not know that many of the earlier concepts about carrier type and mobility in organics were derived from experimental results now known to have been greatly influenced by contact and surface effects. Similarly (and contrary to Suchet's statements) it is now well established that both electrons and holes can participate in conduction, and the carrier mobilities need not be small. An uninitiated reader is likely to receive a distorted view of the state of organics. Unfortunately this is true, to some extent, of the entire book.

Suchet's own contributions to the field of semiconductors appear to be summarized in the chapter on the crystallochemical model. Here, he attempts to rationalize properties of semiconductors as a "new concept of the ionic-covalent bond." The rationale is extremely difficult to understand—particularly the explanation of the variations of mobilities from one compound semiconductor to another in parameters, such as ionicity and effective charge. This approach would be desirable for a chemist familiar with chemical bonds, not with the band theory.

Suchet extricates the acoustic mobility by considering hypothetical compounds whose atoms have zero effective charge. This is good as an empirical approach. But, as Suchet admits, this doesn't account for the mobilities in germanium and silicon. He proceeds, without obvious physical basis, to define a polar mobility. The defining formula seems to be dimensionally incorrect and unorthodox because it combines different mobilities. From this definition, Suchet calculates polar mobilities for a large series of binary compound semiconductors. For example, for InSb and GaAs, he has 3 cm²/V-sec and 30 cm²/V-sec, respectively. These values don't agree with values accepted by most semiconductor

we are your best bet
for electronic materials

**"What did you say?"
"WE SAID, WE ARE
YOUR BEST BET
FOR ELECTRONIC
MATERIALS!"**

We are a primary fabricator and supplier of high purity metals and alloys, compound semiconductors and thermoelectric cooling materials.

PHONE AREA CODE 509 747-6111
TWX 509-328-1464 Telex 032 610

IMMEDIATE SHIPMENT BY AIR PRE-PAID

COMINCO PRODUCTS, INC.

electronic materials division
818 West Riverside Ave.,
Spokane, Washington 99201

5603

Circle 150 on reader service card

**FREE FREE
ELECTRONICS LETTERS**

A new international monthly... \$7.00 a year
published by the British
INSTITUTION OF ELECTRICAL ENGINEERS
and distributed in the Americas by

BOSTON TECHNICAL PUBLISHERS, Inc.

Please write for a free sample copy plus information on other periodicals and books.
... also

INEXPENSIVE HARD-COVER EDITIONS
of some of the best known books in the electronics world...

PRINCIPLES OF MICROWAVE CIRCUITS

Montgomery, Dicke & Purcell
M.I.T. RAD. LAB. SERIES
Vol. 8
ORIG. PRICE \$10.00
OUR PRICE \$4.50

THEORY OF SERVOMECHANISMS
James, Nichols & Phillips
M.I.T. RAD. LAB. SERIES
Vol. 25
\$9.50 \$4.25

M.I.T. RADIATION LABORATORY SERIES
Complete set of 28 Volumes \$225 \$105*
* prepaid orders only

AIRBORNE RADAR
Povejsil, Raven & Waterman
\$20.00 \$9.75

FOUNDATIONS OF ELECTRO-DYNAMICS
Moon & Spencer
\$9.75 \$5.75

FUNCTIONAL CIRCUITS & OSCILLATORS
Reich
\$12.50 \$7.75

ULTRA HIGH FREQUENCY PROPAGATION
Reed & Russell
REVISED 1964 \$11.00 \$6.75

BOSTON TECHNICAL PUBLISHERS, Inc.

Box 111E, Cent Square, Cambridge, Mass. 02139
Tel. 617-491-0443

FOR FREE CATALOG LISTING
NUMEROUS OTHER PUBLICATIONS
Circle No. 151 on reader service card

Circle 151 on reader service card

physicists from the detailed theoretical work of Ehrenreich and others. This work indicates polar mobilities of about 100,000 cm²/V-sec in the first case and 10,000 cm²/V-sec in the second. Disagreements of this kind may be caused by differing definitions of terms or by varying views on the fundamental mechanism involved. In either case, Suchet owes the reader a careful explanation of what he has done and a statement that there is disagreement with his conclusions.

The book is a translation of a French edition published in 1962. In a field moving as rapidly as semiconductor physics, a three-year gap is unfortunate. All in all, there is very little to recommend in this book for newcomers to the field. But for those already well versed in semiconductors, it may serve as a source of empirical data and interesting empirical relationships.

Joseph Blanc

RCA Laboratories
Princeton, N. J.

Recently published

Automatic and Remote Control, Proceedings of the Second Congress of the International Federation of Automatic Control, Basle, 1963, in English, French and German, Edited by V. Broida, D. H. Barlow, O. Schafer, Butterworth, Inc., 749 pp., Vol. 1, \$60, Vol. 2, \$65

Digital Computer Fundamentals, Prentice-Hall, Inc., 221 pp., \$10

Advanced Quantum Theory, P. Roman, Addison-Wesley Publishing Co., 735 pp., \$17.50

State Variables for Engineers, P. M. DeRusso, R. J. Roy, C. M. Close, John Wiley & Sons, Inc., 608 pp., \$14.95

Electric Networks, Analysis and Synthesis, D. F. Tuttle, Jr., McGraw-Hill Book Co., 327 pp., \$12.50

Batteries 2, Research and Development in Non-Mechanical Electrical Power Sources, Proceedings of the Fourth International Symposium on Batteries, Brighton, 1964, Edited by D. H. Collins, Pergamon Press Ltd., 543 pp., \$25

Transistor Circuit Analysis and Design, J. J. Corning, Prentice-Hall, Inc., 466 pp., \$14

Industrial Electronic Circuits and Applications, R. R. Benedict, N. Weiner, Prentice-Hall, Inc., 527 pp., \$14.60

Graphical Calculators and Their Design, N. H. Crowhurst, Hayden Book Co., 96 pp., \$5.95

Digital Logic Laboratory Workbook, B. W. Stephenson, Digital Equipment Corp., 137 pp., \$5

Industrial Research Laboratories of the United States, 12th Edition, Bowker Associates, Inc., 746 pp., \$25

Mikroelektronik, Proceedings of the Symposium on Microelectronics, Munich, 1964, in German and English, Edited by L. Steipe, R. Oldenbourg Verlag, 304 pp.

Induction Heating's Most Trusted
and Creative Craftsmen Since 1926

Lepel

**INDUCTION HEATING
FOR
EPITAXIAL
GROWTH**

- Minimum contamination since induction coil is outside the decomposition chamber.
- Uniform and controlled growth of the epitaxial layer.
- Design flexibility of gas chamber.
- High production—large number of wafers processed simultaneously.

Arrangement for induction heating within bell jar...

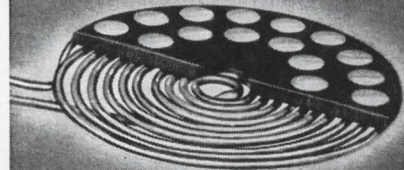

another arrangement using quartz tube...

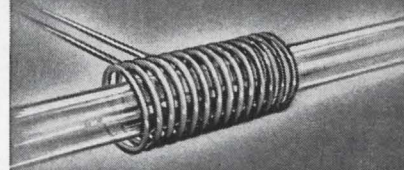

Many solid state devices used in the Electronic, Computer and Aerospace industries depend upon material produced by Epitaxial Growth. Several methods have been developed for decomposition of the carrier gas to form an epitaxial layer on the substrate. Induction heating has been found most effective, particularly when high temperatures are required.

The silicon wafers are heated to decomposition temperature of the silicon tetrachloride by conduction and radiation from the graphite susceptor which is heated by the induction coil, producing the epitaxial layer on the wafers.

WRITE FOR NEW LEPEL CATALOG

Lepel HIGH FREQUENCY LABORATORIES, INC.

Manufacturers of INDUCTION HEATING EQUIPMENT
55th ST. & 37th AVE., WOODSIDE 77, N. Y. C.

Circle 123 on reader service card

123

NEW from McGraw-Hill

VACUUM SCIENCE and ENGINEERING

By C. M. Van Atta
Lawrence Radiation Laboratory
University of California at Berkeley

Here is a coherent and comprehensive presentation of vacuum technology, designed to give you the practical understanding necessary to work with or design modern vacuum systems. The book discusses the nature and flow of gases, describes the behavior of gases absorbed on solid surfaces, and provides detailed explanations of the performance of various types of vacuum pumps, vacuum gauges, and other accessory devices. The important discussion of vacuum system design includes material on both conventional applications and the extreme conditions of ultrahigh vacuum.

457 pages, 328 illus., 6 x 9, \$15.00

Other McGraw-Hill Books

NONLINEAR OSCILLATIONS IN PHYSICAL SYSTEMS by C. Hayashi. An introduction to fundamental concepts and basic techniques. Thoroughly covers forced oscillations and details nonlinear analysis—treating all methods with both theoretical and experimental studies. 377 pp., \$14.50

DIGITAL COMPUTATION AND NUMERICAL METHODS by R. Southworth and S. DeLeeuw. Covers basic principles of computer programming, emphasizing the analysis and solution of engineering problems. Includes flow charting, FORTRAN IV, numerical methods, and more. 512 pp., \$11.75

SEE THESE BOOKS AT YOUR BOOKSTORE
OR MAIL THIS COUPON

McGraw-Hill Book Co., Dept. 23-L-118
330 West 42 Street, New York, N. Y. 10036
Send me book(s) checked below for 10 days on approval. In 10 days, I will pay for book(s) I keep, plus few cents for delivery costs, and return unwanted book(s) postpaid. SAVE MONEY: we pay delivery costs if you remit with coupon; same examination and return privilege.

- Van Atta—Vacuum Science & Engrg., \$15.00
- Hayashi—Nonlinear Oscillations in Physical Sys., \$14.50
- Southworth & DeLeeuw—Digital Computation and Numerical Methods, \$11.75

NAME (print) _____

ADDRESS _____

CITY _____

STATE _____

ZIP _____

For prices outside U.S.
write McGraw-Hill Intl., N.Y.C.

23-L-118

Technical Abstracts

Electron beam recorder

Film scanning and recording by electron beam
Charles F. Spitzer, Ampex Corp.,
Redwood City, Calif.

Because an electron beam subjected to a 15-kilovolt acceleration attains several thousand times the energy of a photon in the visible portion of the spectrum, a substantially shorter exposure of film to electron bombardment will result in the same film density as with photon exposure. Electron-beam recording therefore lends itself to instrumentation recording systems where the high volume of data requires a very fast recording system. High-speed facsimile scanning equipment for the transmission of high-quality images exceeding the capabilities of more conventional systems is another potential application. Other uses are in pattern recognition by computer photo-interpretation and scanning microscopes.

The operation of the Ampex recording system is similar to an oscilloscope with a thin Mylar-base film substituted for the phosphor screen. An electron beam is directed to the film by deflection plates. Very little deflection is necessary in the longitudinal direction since the film motion itself provides most of the Y-scan. The X-deflection plates do most of the work, sweeping the beam across the full width of the film. The information to be recorded modulates the electron beam in the Z-direction so that the rate of electron incidence is directly proportional to the signal to be recorded.

The recording consists of a latent image. The exposed film is processed very much like photographic film. The recorded pictorial image is of very high resolution since the lines are the width of the electron beam, about 1/4 mil. Data recordings may also be made without spatial coherence between adjacent lines. In either case, the recording frequency can be 100 megacycles or higher, with a signal-to-noise ratio of at least 30 decibels.

In preparation for readout, the surface of the fully processed film

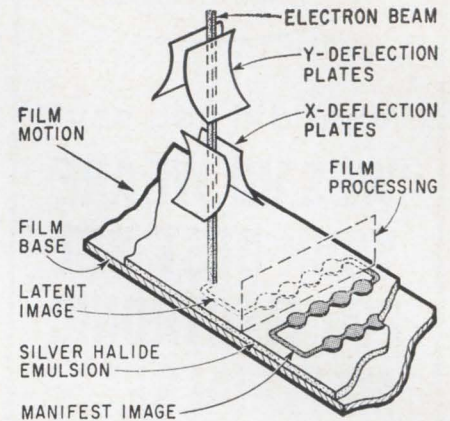

Basic elements of electron beam recorder

is coated with a plastic scintillator, a process that can be combined with formal film processing. In the Ampex readout system, an electron beam is aimed at the film surface where the scintillator acts as a grainless phosphor, emitting light. Since no lens is used, and nearly all the generated light is collected, the system is much more efficient than a conventional flying-spot scanner-photomultiplier system. At a given bandwidth, the available signal-to-noise ratio would be about 34 db higher for the Ampex system.

The scintillator readout method is also applicable to scanning photographic transparencies. Free scan of the electron beam results in the sequential dissection of the image into its resolution elements. With instrumentation recording, however, it is necessary for the readout beam to follow the recorded lines very accurately since departure will cause intermodulation products and spurious signals.

The Ampex system uses light pipes to servo the beam along the recorded track center. If the electron beam is offset, the recorded track will deflect more light to one of the light pipes than the other. Therefore, their respective photomultipliers receive unequal amounts of light. The difference, or error signal, is fed back to the Y-deflection plates, repositioning the electron beam. The sum of the photomultiplier outputs is a measure of the recovered signal.

Presented at 1965 Western Electronics Show and Convention, San Francisco, Aug. 24-27.

Order your copy now,
of the Complete 1964
Electronics Index to
Volume 37

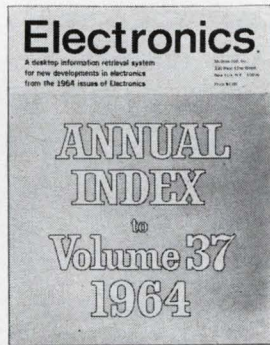

This new, easy to use Index is 40 pages long, and is available for \$1.00.

The Complete Electronics Index for 1964 contains 4 helpful, informative sections:

Subject index—catalogs all articles; technical features, news letter items, Electronics Review, Electronics Abroad and Probing the News stories, also key new product items. They're grouped in more than 250 categories and cross-indexed for easy reference.

Authors index—lists alphabetically all authors of articles which appeared in 1964, so articles may be found when authors are known.

Manufacturers index—This corporate reference gives the page and issue for each mention of an electronics company in the editorial pages of Electronics. It also references government and military organizations.

Advertisers Index: Every advertiser in the 1964 issues of Electronics is listed in this section alphabetically with the issue dates and page numbers of their ads.

This index is a valuable, year round reference tool for your home, office or company library. Use the coupon below to order your copy today. Price is \$1.00

Send your order to:

Electronics Reprint Dept.
330 West 42nd Street
New York, N.Y. 10036

Enclosed is my check for \$1.00.
Please send me a copy of the Complete 1964 Index.

Name

Number & Street

City, State

Zip Code

PRODUCT
NEWS from EPL

**NEW...hi voltage
regulated DC Power Supply
under \$400.**



**ELECTRO
RB-500 \$395.00**

Compare Value

Brand	Volts	Current	Regulation (Combined line & load)	Price
K	0-325	0-200 MA	0.02%	\$495.00
S	0-500	0-200 MA	2.0%	400.00
Electro RB-500	0-500	0-250 MA	0.03%	395.00

Compare Features

High Voltage Output: 0-500 VDC.
Precise Regulation: 0.03% or .015V, whichever is greater, for combined line (105-125V) and load (no-load to full-load) variations.
Ripple: 5MV, RMS maximum.
Bias Output: 0-150 VDC.
Filament Outputs: Two separate 6.3V at 5A outputs for 6.3V at 10A or 12.6V at 5A.
Primary and Secondary Protection.
2% D'Arsonval Meters: Dual scale . . .
0-500V/0-150V. 0-250 MA
Separate AC, DC Switches.
Continuous Output Voltage Adjustment: Regulation maintained well below 3V output setting.
Wherever precisely regulated DC power is a must, the EPL RB-500 fills the bill economically. Engineered and built for heavy-duty production testing; electronic circuitry development and design in industry, laboratories and schools.

Write for Literature & Name of Your Electro Distributor!

5180



Since 1936—Pioneers in Low Voltage DC Power Supplies
• Proximity Switches • Magnetic Pickups • Tachometers
• Pres-Con Controls • Dynamic Micrometers

ELECTRO PRODUCTS LABORATORIES, INC.

6125-F HOWARD, CHICAGO, ILL. 60648 • 312/775-5220

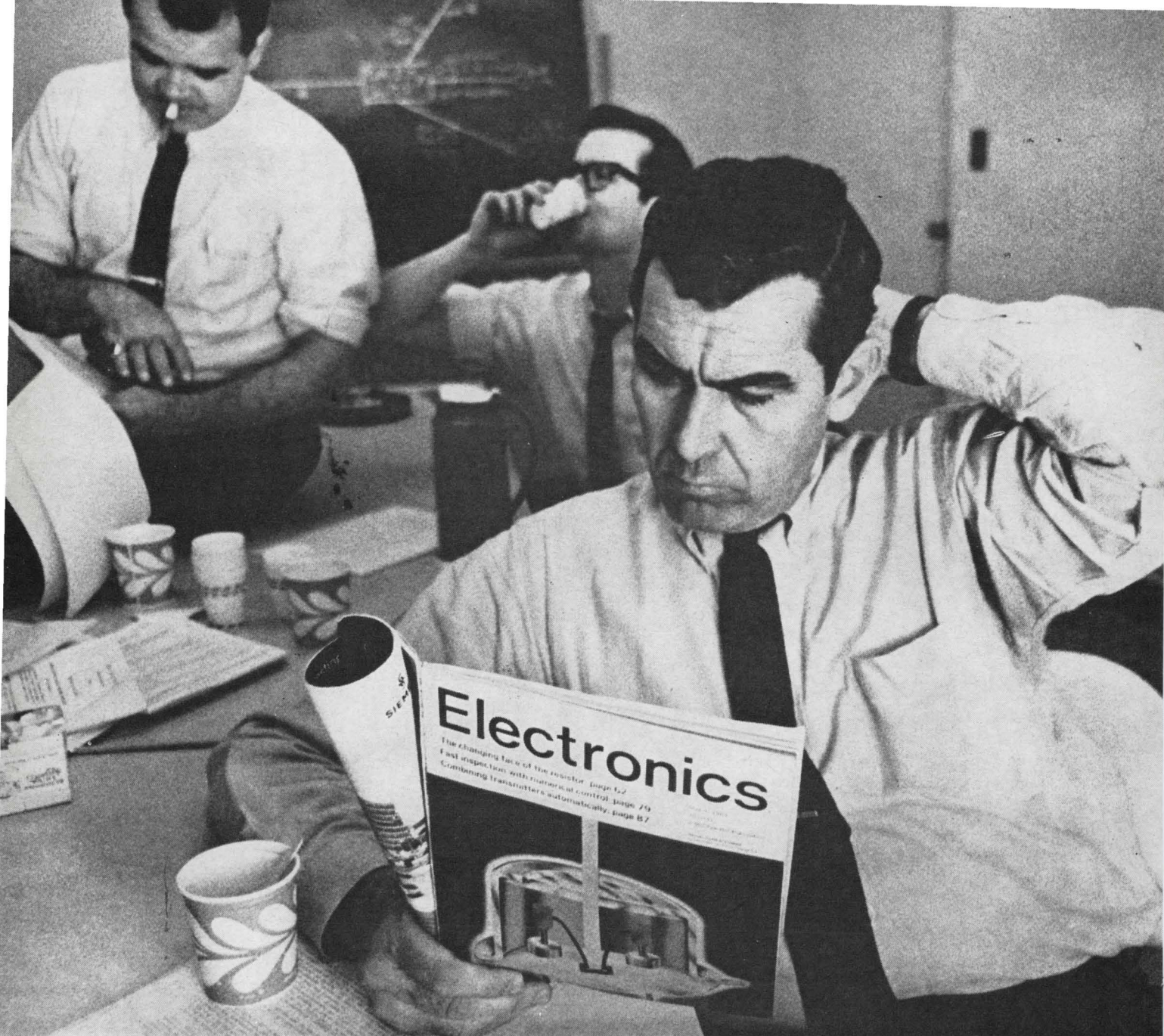

Great editorial is something he takes to a meeting

(What a climate for selling!)

Electronics magazine helps engineers make decisions. It keeps a vital audience of technical men informed on what is new, different and changing in their highly complex world.

These key men are influential in purchasing a wide range of products and services. For example: nearly 80% buy or specify electronic components; nearly 80% buy or specify electronic equipment.

More than 65,000 engineer-subscribers here and abroad depend on the great editorial of Electronics to help them do their jobs effectively. They read Electronics carefully, and pass along their copies to 119,000* additional readers.

You can sell these important customers and prospects when they are most responsive, by advertising in Electronics.

*ELECTRONICS SUBSCRIBER PROFILE

Electronics

A McGraw-Hill Market-Directed Publication
330 West 42nd Street, New York, N.Y. 10036

MEMBER: AUDIT BUREAU OF CIRCULATIONS, AMERICAN BUSINESS PRESS

ELECTRONICS

Qualification Form
for Positions Available

ATTENTION: ENGINEERS, SCIENTISTS, PHYSICISTS

This Qualification Form is designed to help you advance in the electronics industry. It is unique and compact. Designed with the assistance of professional personnel management, it isolates specific experience in electronics and deals only in essential background information. The advertisers listed here are seeking professional experience. Fill in the Qualification Form below. **STRICTLY CONFIDENTIAL:** Your Qualification form will be handled as "Strictly Confidential" by Electronics. Our processing system is such that your form will be forwarded within 24 hours to the proper executives in the companies you select. You will be contacted at your home by the interested companies.

WHAT TO DO. (1.) Review the positions in the advertisements. (2.) Select those for which you qualify. (3.) Notice the key numbers. (4.) Circle the corresponding key number below the Qualification Form. (5.) Fill out the form completely. *Please print clearly.* (6.) Mail to: Classified Advtg. Div., Electronics, Box 12, N. Y. 10036.

COMPANY	PAGE	KEY #
ATOMIC ENERGY OF CANADA LTD. Chalk River, Ontario	223*	1
ATOMIC PERSONNEL INC. Phila. 2, Pa.	128	2
CONTESSA PUBLICITE Paris, France	223*	3
DOUGLAS AIRCRAFT CO., INC. Missiles & Space System Div. Santa Monica, Calif.	215*	4
ELDORADO ELECTRONICS Concord, Calif.		5
KOLLSMAN INSTRUMENT CORP. Elmhurst, New York	222*	6
LOCKHEED MISSILES & SPACE CO. 130 Div. of Lockheed Aircraft Corp. Sunnyvale, Calif.		7
MOTOROLA INC. Chicago, Illinois	221*	8
RCA SERVICE COMPANY Camden, New Jersey	127	9
RIXON ELECTRONICS INC. Silver Springs, Md.	127	10

*These advertisements appeared in the Nov. 15th issue.

PERSONAL BACKGROUND

Name
Home Address
City Zone State
Home Telephone

EDUCATION

Professional Degree(s)
Major(s)
University
Date(s)

FIELDS OF EXPERIENCE (Please Check) 11/29/65

<input type="checkbox"/> Aerospace	<input type="checkbox"/> Medicine
<input type="checkbox"/> Antennas	<input type="checkbox"/> Microwave
<input type="checkbox"/> ASW	<input type="checkbox"/> Navigation
<input type="checkbox"/> Circuits	<input type="checkbox"/> Operations Research
<input type="checkbox"/> Communications	<input type="checkbox"/> Optics
<input type="checkbox"/> Components	<input type="checkbox"/> Packaging
<input type="checkbox"/> Computers	<input type="checkbox"/> Radar
<input type="checkbox"/> ECM	<input type="checkbox"/> Radio-TV
<input type="checkbox"/> Electron Tubes	<input type="checkbox"/> Simulators
<input type="checkbox"/> Engineering Writing	<input type="checkbox"/> Solid State
<input type="checkbox"/> Fire Control	<input type="checkbox"/> Telemetry
<input type="checkbox"/> Human Factors	<input type="checkbox"/> Transformers
<input type="checkbox"/> Infrared	<input type="checkbox"/> Other
<input type="checkbox"/> Instrumentation	

CATEGORY OF SPECIALIZATION

Please indicate number of months
experience on proper lines.

	Technical Experience (Months)	Super- visory Experience (Months)
RESEARCH (pure, fundamental, basic)
RESEARCH (Applied)
SYSTEMS (New Concepts)
DEVELOPMENT (Model)
DESIGN (Product)
MANUFACTURING (Product)
FIELD (Service)
SALES (Proposals & Products)

CIRCLE KEY NUMBERS OF ABOVE COMPANIES'
POSITIONS THAT INTEREST YOU 1 2 3
4 5 6 7 8 9 10

Engineers

Solid State Design—Sonar—Servo

Space Tracking—Radar Receivers

RFI—Computer Systems—Audio Planning

Offensive Systems Analysis—ASW Checkout

Mechanical—CCTV—Engineering Writing

RCA

Challenge—Diversity—Opportunity

Varied Locations U. S. & Overseas

Tuition Refund Plan—Merit Reviews

Retirement Plan—Medical Coverage

Bonus and Per Diem Assignments

Excellent Salaries—Career Development

Send Resumes To:

Mr. J. H. Barnes, Jr., Mgr. of Recruiting

RCA Service Company, Dept. Y-276

Cherry Hill, Camden 8, N. J.



THE MOST TRUSTED NAME IN ELECTRONICS

An Equal Opportunity Employer

ELECTRONIC ENGINEERS

Continuing expansion has created openings for several senior and intermediate engineers. Applicants must have a strong background in solid state circuit design, and experience in system integration of digital devices. Should be interested in acting as project engineer in development of digital handling and data communication devices. BSEE required. Advanced study preferred. These are permanent career positions with a company experiencing steady and rapid growth and with a bright future. These positions offer generous fringe benefits and the many recreational and cultural advantages of the Chesapeake Bay - Washington, D. C. area in Montgomery County, Maryland.

Please submit resume and salary history to PERSONNEL DIRECTOR.

RIXON

RIXON ELECTRONICS, INC
2121 Industrial Parkway, Silver Spring, Md.
An Equal Opportunity Employer

EMPLOYMENT PROBLEM?

When you are in need of specialized men for specialized jobs,
contact them through an employment ad in this publication.

ELECTRONIC ENGINEERS

Challenging career opportunities with a rapidly expanding San Francisco Bay Area counter manufacturer. Present engineering is in direct gigahertz frequency counting and nanosecond measurement. Future work areas include new and advanced state-of-the-art developments and techniques. Senior, project and junior positions available—degree required—salary open. Contact D. Condon, Chief Engineer.

ELDORADO ELECTRONICS

601 Chalmar Road
Concord, Calif. 94520
(415) 686-4200

An Equal Opportunity Employer

ADDRESS BOX NO. REPLIES TO: Box No.
Classified Adv. Div. of this publication.
Send to office nearest you.
NEW YORK, N. Y. 10036: P. O. Box 12
CHICAGO, Ill. 60611: 645 N. Michigan Ave.
SAN FRANCISCO, Cal. 94111: 255 California St.

SELLING OPPORTUNITY AVAILABLE

Well Known Italian Manufacturer of Industrial Electromechanical controls seeks U.S. representations. Would also consider manufacturing under license for distribution in Italy similar electronic controls through well established sales organization. RW-7993, Electronics.



E. E.'s
for FEE-PAID Positions
WRITE US FIRST!
Use our confidential application for professional, individualized service . . . a complete national technical employment agency.
ATOMIC PERSONNEL, INC.
Suite 1207L, 1518 Walnut St., Phila. 2, Pa.

When answering

BOX NUMBERS . . .

to expedite the handling of your correspondence and avoid confusion, please do not address a single reply to more than one individual box number. Be sure to address separate replies for each advertisement.

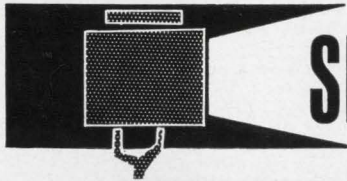

SEARCHLIGHT SECTION

- CLASSIFIED ADVERTISING
- BUSINESS OPPORTUNITIES
- USED OR SURPLUS EQUIPMENT

RADAR AUTO-TRACK & TELEMETRY ANTENNA PEDESTALS
3 & 10 CM. SCR 584 AUTOTRACK RADARS. M-33 RADAR
TPS-1D SEARCH. APS-45 TPS-10D HT. FINDERS. WX RADARS.
FPN-32CA. APS-10 APS-15B APS-27 (AMTI) SEARCH. ■ ■
APN-102 DOPPLER DOZENS MORE CARCINOTRONS PENS.
.25-5-1-2-3-6 MEGAWATT PULSE MODULATORS. CAVITIES.
PULSE TRANSFORMERS. IF STRIPS. WAVEGUIDE. BENDS
200 MC. 1 KMC. 3 KMC. 6 KMC. 9 KMC. 24 KMC. RF PKGS.
RADIO RESEARCH INSTRUMENT CO.
550 5TH AVE., NEW YORK 36, N. Y. JU 6-4691

CIRCLE 951 ON READER SERVICE CARD

New **VACUUM PENCIL**

for picking up miniature parts

PHILIP FISHMAN CO.
7 CAMERON ST., WELLESLEY, MASSACHUSETTS

CIRCLE 953 ON READER SERVICE CARD

AMPEX FR1100

1—Console instrumentation recorder/reproducer. Almost new. 1/4 inch 2 track, 1/2 inch 7 track. Contains power supply, 2 ea. record/reproduce amplifiers. For details wire or write:

FALCON MARINE
305 Valle Viste, Monrovia, Calif.

CIRCLE 955 ON READER SERVICE CARD

Color DIAL TELEPHONES \$10.95 Complete

Factory rebuilt Western Electric in white, beige, ivory, pink, green, or blue. If 4 prong plug is required add \$2.00. Fully guaranteed. Write for free list. All shipments FOB.

SURPLUS SAVING CENTER
Dept. E-11295
Waymart, Pa.

CIRCLE 952 ON READER SERVICE CARD

EQUIPMENT SALE

H-P, TEC.-G.R. ETC. Practically new Decade Boxes, Pulse Gen's, VTVM'S, Audio Osc.—Counter's, etc.

EASY-UP, INC.
2425 Bradley Road, Rockford, Ill.
Ph. 877-5288

CIRCLE 954 ON READER SERVICE CARD

Somebody—Somewhere
needs your idle equipment! Reach that buyer quickly and economically thru the

"SEARCHLIGHT SECTION"

The meeting place of
Used Equipment Buyers and Sellers

SEARCHLIGHT Equipment Locating Service

No Cost or Obligation

This service is designed to help you, the reader of SEARCHLIGHT SECTION, to locate used or rebuilt equipment not currently advertised.

HOW TO USE: Check the ads in this SEARCHLIGHT SECTION to see if what you want is advertised. If not, print clearly the specifications of the equipment and/or components wanted on the coupon below, or on your own letterhead.

THIS IS A SERVICE TO OUR READERS. THIS PUBLICATION DOES NOT BUY, SELL OR STOCK EQUIPMENT OR MATERIALS OF ANY TYPE. Your requirements will be brought promptly to the attention of the used equipment dealers advertising in this section. You will receive replies directly from them.

Obviously, the list of such advertisers is limited by comparison with the over 65,000 subscribers to **electronics**, all directly engaged in the electronics industry. A small 'EQUIPMENT WANTED' advertisement in the SEARCHLIGHT SECTION will bring your needs to the attention of ALL who read **electronics**. The cost is low . . . just \$27.25 per advertising inch—7/8" x 2-3/16"

SEARCHLIGHT EQUIPMENT LOCATING SERVICE

CLASSIFIED ADVERTISING

c/o electronics, P.O. Box 12, New York, N. Y. 10036

Please help us to locate the following used equipment:

.....

.....

NAME..... TITLE..... COMPANY.....

STREET..... CITY..... ZONE..... STATE..... 11/29/65

New Literature

Recording systems. Brush Instruments division, Clevite Corp., 37th and Perkins, Cleveland, Ohio, 44114. A 24-page illustrated brochure (No. 1110) describes the facilities and techniques applied to produce extremely accurate recording and measuring instruments. Circle 461 on reader service card

Power supplies. Kepco, Inc., 131-38 Sanford Ave., Flushing, N.Y., 11352, has available what is said to be the first definitive handbook published in this country dealing exclusively with regulated power supplies. To obtain a copy, write on company letterhead.

Semiconductor metals and alloys. Sigmund Cohn Corp., 121 S. Columbus Ave., Mt. Vernon, N.Y., has announced the fourth edition of its brochure on metals and alloys for use with semiconductor products. [462]

Glass capacitors. Westinghouse Electronic Capacitor Department, Box 130, Irwin, Pa. Catalog B-9157 outlines specifications and gives operating characteristic curves for the company's military and industrial glass-capacitor lines. [463]

Scientific computing system. Electronic Associates, Inc., West Long Branch, N.J. Bulletin AC65028 illustrates and describes the model 8800 scientific computing system's programing versatility, performance reliability, and read-out and display equipment. [464]

Reed relay. Wheelock Signals, Inc., 273 Branchport Ave., Long Branch, N.J., has available a data sheet providing full details on its ultraminiature needle reed relay. [465]

Photo-instrumentation. Adtrol Electronics, Inc., 116 N. 7th St., Philadelphia, Pa., 19106, has released a technical bulletin on the model BCD-5 photo-corder, which makes it possible to record real-time data directly on moving film at the exact instant of the filmed event. [466]

Conformally coated resistors. Ohmite Mfg. Co., 3664 Howard St., Skokie, Ill., 60076. Bulletin 109 describes small, axial-lead resistors recently added to the line of Ohmicone silicone-ceramic, conformally coated power resistors. [467]

Ceramic packages. American Lava Corp., a subsidiary of 3 M Co., Chattanooga, Tenn., 37405. Bulletin 655 covers a line of Al Si Pak high-alumina ceramic packages in the preferred style and custom made. [468]

Axial-lead capacitors. Sprague Electric Co., 35 Marshall St., North Adams, Mass., 01248. Bulletin 3010 C contains a complete list of standard capacitance

ratings, as well as performance characteristics, for the type 31D Transi-lytic, axial-lead electrolytic capacitors. [469]

Dynamic measurement instrumentation. B&K Instruments, Inc., 3044 W. 106th St., Cleveland 11, Ohio, offers a 28-page condensed catalog of its line of dynamic measurement instrumentation, consisting primarily of a-c voltage-measuring devices, vital for measurement, analysis and recording of a-m and f-m signals in many fields. [470]

Switches and drivers. Sanders Associates, Inc., 95 Canal St., Nashua, N.H. Bulletin TG-176 contains complete descriptions of 21 different models of solid-state switches and drivers that offer a complete range of operating characteristics at any frequency from d-c to 11 Gc and in spst, spdt and dpdt configurations. [471]

Printed circuit design. Lockheed Electronics Co., 6201 E. Randolph St., Los Angeles, Calif., 90022, has published a brochure to aid engineers in the design of producible, reliable and economical printed circuit boards. [472]

Potentiometer loading. Markite Corp., 155 Waverly Place, New York, N.Y., 10014. Technical data bulletin TD-113 gives a comprehensive treatment of the effects of loading on several different potentiometer use circuits. [473]

High-megohm resistors. Pyrofilm Resistor Co., 3 Saddle Road, Cedar Knolls, N.J., offers a data sheet describing the HR600 series of miniature, hermetically glass-sealed, high-megohm resistors. [474]

Switches. Licon division, Illinois Tool Works, Inc., 6615 W. Irving Park Road, Chicago, Ill., 60634. The 58-page general catalog G-103 describes a broad line of basic, illuminated, environment-free switches, with illustrations and ordering information. [475]

Laboratory recorder. Scientific and Process Instruments division, Beckman Instruments, Inc., 2500 Harbor Blvd., Fullerton, Calif., 92634. A high-performance, 10-inch laboratory recorder is described in illustrated bulletin 7077. [476]

Radiation-tolerant tv camera. Cohu Electronics, Inc., Box 623, San Diego, Calif., 92112. Specifications, photographs and technical information on a radiation-tolerant tv camera are included in data sheet 6-327. [477]

Operational amplifier characteristics. Analog Devices, Inc., 221 Fifth St., Cambridge, Mass., 02142, has issued a seven-page application note describing how to measure open-loop operational amplifier characteristics. [478]

CONVERTORS OF INSULATED WIRE AND TUBING

YOU USE INSULATED WIRE

Let us Color CODE it

With circumferential color bands—unique, direct reading. Instant identification of circuitry. Enormous savings in hook-up and ring-out time. We can mark to as fine as 32 gauge and with a special set up even smaller. *This unique system fully meets Mil. Std. 681A for aircraft and guided missile wiring.*

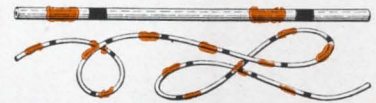

... or PRINT it

Letter and number identification on sizes 26 ga. and larger.

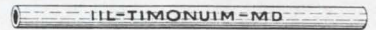

... or SLEEVE it

Marking sleeves, insulating sleeves of all kinds, made precisely to your specs.



... or PREPARE it

We perform all types of wire preparation on extra thin insulation in lengths from 1/2" to 300". *Give us a problem.*



... or provide TAGS

For legible connector terminations.

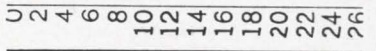

... or you name it!

Send us your wire marking or conversion problems. We'll come up with the money-saving answer.

Ask for samples and brochure!

INTERNATIONAL IDENTIFICATIONS LTD.

1917 Greenspring Drive
Timonium, Maryland

WHERE CAN MAN GO...IN ELECTRONICS?

Electronics is a discipline unlike any other. For whatever name we give to these fast paced times in which we live—the Age of Space, the Age of Mass Communications, the Age of Transportation—electronics plays a vital role. Through advances in this single key technology, advances in all others are brought nearer to reality. And nowhere is this truth more evident than at Lockheed, where to all programs, electronics is essential. Research. Development. Systems. At Lockheed, those knowledgeable in the nuances of

electronics help to
ment upon this planet.
ity to investigative
as Lockheed's Deep



Quest, a two-place re-
search submarine. They permit land vehicles of the
future to achieve reality. And they extend the reach
of mankind heavenward through spacecraft systems
such as Agena. Undersea, on land, and in space en-
vironments, Lockheed electronic systems control and
guide, communicate and compute. Now, generalists
and specialists, experienced and interested in a broad
spectrum of electronics assignments, are invited to
write Mr. K. R. Kiddoo, Professional Placement
Manager, Sunnyvale, California. Lockheed is an
equal opportunity employer.

LOCKHEED
MISSILES & SPACE COMPANY
A GROUP DIVISION OF LOCKHEED AIRCRAFT CORPORATION

Electronics Abroad

International

Air-traffic control

Speedy jet planes are forcing a measure of "togetherness" on civil aviation administrations around the world—and intensifying competition among makers of equipment for automating air-traffic control.

The International Civil Aviation Organization (ICAO), an affiliate of the United Nations, has established uniformity in such things as communications frequencies, instrument-landing systems, and radar-beacon codes for traffic control. There are also regional organizations such as Eurocontrol, which regulates air traffic 25,000 feet or more above Great Britain, Ireland, France, West Germany, Belgium, the Netherlands and Luxemburg.

Within these international guidelines, countries—and companies—are following different routes toward their mutual goals of safety and compatibility in automated air-traffic control (ATC).

Eurocontrol. As might be expected, the closest cooperation exists among the closely bunched countries of Western Europe. During a 70-minute flight from Paris to Copenhagen, a Boeing 707 flies over five countries—France, Belgium, the Netherlands, Germany and Denmark.

Eurocontrol's first automated center is scheduled to go into operation by 1970 in Maastricht, the Netherlands. The next station probably will be built in Luxemburg, covering the Grand Duchy and southern Germany. These two stations will tie in with three national control centers in France and one in Great Britain; each country will continue to control its airplanes below 25,000 feet.

The Maastricht center will receive data from flight plans, also from primary and secondary radar networks. Primary radar detects the presence and location of a plane;

secondary radar determines, via transponders on the plane, the aircraft's identification and altitude.

Hardware for Eurocontrol. Officials have not yet decided whether Eurocontrol should be organized around one big computer or a group of smaller ones. Whatever the decision, the computer or com-

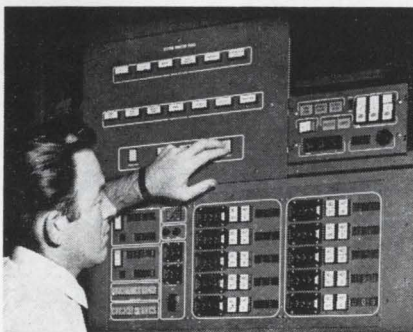

Whittaker control unit consists of monitor panel, top left, master control panel, right, and decoder box at bottom.

puters will be modular, with distinct blocks for flight-plan processing, conflict search, and the like.

Eurocontrol's technical people have decided on automatic tracking by secondary radar. As a backup, the system will provide for manual plotting from primary-radar inputs. Radar information will be digitized at the antenna head and fed into the ATC center over narrow-bandwidth—three-kilocycle—telephone lines.

Great Britain. By 1969, a central data-handling computer system at Britain's main ATC center at West Drayton, near London, will be receiving flight-intention data from airports and flight data from primary and secondary radar installations throughout the country. Various kinds of displays will give an up-to-date picture of any aircraft's progress and intention.

Next May, a computer system will begin operation at West Drayton to automate the monitoring of flight progress. A Hermes digital machine, made by Ferranti, Ltd.,

will correlate flight-plan data with such dynamic factors as take-off direction and wind speed. IBM 731 input-output typewriters will print out, alphanumerically, flight-progress strips containing such information as aircraft identity, destination, and expected time of arrival; all of this data will be inserted on flight-progress boards.

A different display system, with electronic data-display tubes, is being tested at the Royal Radar Establishment's air-transport center in Prestwick, England. The display information is arranged in tabular form along the face of a cathode-ray tube, with horizontal lines corresponding to individual aircraft in the controlled area and vertical columns providing flight data. The display is kept up-to-date by computer outputs or via a manual keyboard.

When a flight controller on the ground touches a spot on the display tube, he unbalances a sensitive bridge circuit because of the capacitance between his finger and a wire on the face of the screen. If he wants information about a particular Trans-World Airlines flight, for example, he touches a button under the TWA designation, and in 20 microseconds the computer sends back the flight numbers of all TWA flights in progress in his control area. Pressing another button, near the flight number, causes the computer to send data about that particular plane.

West Germany. The German Office for Air Safety is shopping for secondary-radar equipment. A leading contender for the contract seems to be the Whittaker Corp. of Los Angeles, which has extensive experience with IFF (identification friend or foe) gear for the United States military. The Bonn government has contracted with Telefunken AG to develop an antenna to go with the Whittaker system.

Whittaker has had trouble selling its analog system in the United

States because the Federal Aviation Agency insists on a digital approach to handle the large, fast-growing traffic. A prototype of the Whittaker system is scheduled to be installed before 1966 at the Frankfurt on Main Airport, and the Bonn government has ordered seven more sets, to be made by Telefunken under a license from Whittaker. The two companies will share the European market, where Whittaker predicts sales of \$10 million outside of Germany in the next few years.

With the Whittaker system, when a controller wants information about a primary radar signal, he places a light gun directly over the signal and pulls the trigger. Since the radar can receive signals from only one plane at any instant, the gun triggers a decoder to display the information. The decoder receives signals from all planes within the radar's 200-mile range.

The decoder's response shows up on the code panel as a digital readout of the plane's code number that the pilot files with his flight plan; it is also seen as one of six pulse-coded modes in which his transponder is operating. In addition, accurately displayed to within 100 feet, is the plane's altitude.

Netherlands. The Dutch have held a position near the forefront of ATC technology for over four

years. Since January, 1961, every plane flying in or out of the Amsterdam airport has been logged on flight-progress strips in a system called Satco, for Signaal automatic air-traffic control. Signaal is the nickname of a Dutch subsidiary of Philips Gloeilampenfabrieken, N.V., of the Netherlands.

Satco is being developed in three phases. The first performs automatic processing of flight-data strips; this phase has been in operation since 1961. The second phase, scheduled to go into operation next February, will process the flight-control boards automatically. The automated boards will provide the controller with the information he needs to set his control patterns to avoid traffic conflicts. The third phase will add a plan-position indicator.

Japan. The Japanese Civil Aviation Bureau claims that an ATC system to be installed late in 1967 is unique in that a simple keypack will buffer the computer from the controller. The keys will control the sequence in which information is fed to the computer. It will also provide a means of clearing up erroneous information easily, and of transferring data to the computer quickly.

The system, being designed by the Nippon Electric Co., is scheduled to begin operation in 1968.

Japan

Made in Japan—and USA

A direct digital control system, designed for use by operators who are more interested in the process than in the computer, has been developed jointly by two companies—one in Japan, the other in the United States.

The system does without a print-out. It provides a complete display of information that is accessible to a control-room operator in a display. The operator can call for any variable; when he presses the button four meters light up, showing the process variable, set point, variable's deviation from the set point, and the output.

Hokushin Electric Works, Ltd., of Japan, and the Fischer & Porter Co. of the United States each spent more than \$1 million developing the DDC system. The Japanese contributed most of the circuit design and the mathematical analysis; the Pennsylvania-based firm's principal contributions were application data and market research.

A typewriter is available as an option, packaged with separate control circuits. Masahiro Kazahaya, general manager of engineering at Hokushin, says elimination of a typewriter from the basic circuitry reduces the number of components and increases the system's reliability.

Accent on reliability. Two central processors can be installed instead of one. One unit controls the plant while the other performs self-checks; if one controller fails, the other automatically takes over.

Unlike some purely digital systems, the Japanese-American method does not operate its two controllers in parallel, one checking the other. Such operation is not feasible because in this system some inputs may be analog, and analog-to-digital conversion always poses the problem of one-bit ambiguity—the possible difference between the outputs of two analog-to-digital converters, due to variations within tolerance.

Each processor contains its own

Flexible data presentation, made by Marconi Co., being tested at Prestwick, Scotland. Display at top shows flight-progress data relating to display at right. Radar display at left shows only digitized data derived from the original radar-video signal.

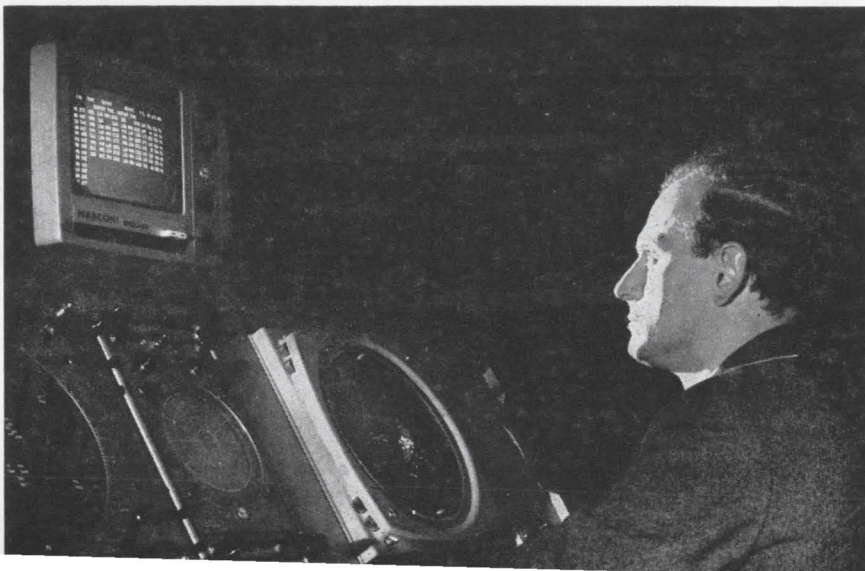

timing circuits for multiplex selection, so there is no need for timing to be programed externally, explained Don Ham, manager of Fischer & Porter's digital processing group.

The basic design concept is to protect the process from adverse effects that might result from failure of the supervisory computer or of any other peripheral equipment. It also prevents major process transients if power should fail and then be restored.

Digital or analog. The system accepts either analog or digital inputs, and delivers either type of output. It scans a maximum of 112 loops twice every second, at about four milliseconds per loops, and provides all conventional controls: proportional reset and rate modes, also rate action with manual reset, cascade control, override control, ratio control, alarm check and even a check of the operation of the control system itself.

Why 112 loops? That is slightly more than enough to control a plant that produces ethylene from naphtha—one of the most complex problems for an industrial computer, according to Masahiro Kazahaya, Hokushin's general manager of engineering.

The point at which DDC becomes more economical than conventional controllers varies with the type of process. But Kazahaya says that in a blending system DDC generally becomes preferable when 20 or more control loops are required.

Two sections. The DDC system comes in two major sections: a display panel, and the central processor. For each control loop, the display panel has one plug-in, which externally resembles a conventional analog controller. An illuminated display on the plug-in shows whenever the process is deviating from predetermined conditions by a preset percentage. A switch on the plug-in permits either manual, automatic or computer control. Each setpoint can be adjusted manually by a potentiometer; for optimization, the potentiometer can also be adjusted by a stepping motor.

Many design innovations are incorporated in the central processor. The central processor's control circuits are fabricated on four large printed-circuit boards, 12 by 18 inches, to reduce interconnections and to increase reliability. There would be no advantage in using smaller boards because they would all be different anyway, Kazahaya says, and a large number would be needed for spares.

The memory. The processor contains a read-only core memory for programing; the memory is non-volatile and completely nondestructive. The working memory is a conventional core type. Both kinds of memory are on boards that contain 32 words of 12 bits each. Total memory capacity—program and working—in a standard system is 1,024 words.

A memory cycle takes 2 microseconds. Addition or subtraction is performed in 7 microseconds; multiplication, 39; and division, 41 microseconds.

IC's. Almost all circuits in the central processor are integrated; the IC's are diode-transistor logic unit, purchased from Motorola, Inc., Texas Instruments Incorporated and other companies. All other components, including silicon transistors which are used as power drivers, are bought from Japanese manufacturers.

The two companies' next joint project, according to Masahiro Shimizu, president of Hokushin, will be to develop an interface supervisory equipment to run many DDC controllers.

Shown in Tokyo. The new system was introduced Nov. 22 in Tokyo at an exhibition sponsored by the Japan Electric Measuring Instruments Manufacturers Association. This week it will be exhibited at the Chemical Industries Show in New York. Later, the two companies plan to try for sales in Western Europe. Both companies will manufacture the equipment.

Cooperation between the Japanese and American companies began two years ago with the signing of a 25-year cross-licensing agreement. Each concern says it could not have created the system alone.

Canada

The cold eye

Surgeons at St. Michael's hospital in Toronto are using a cryogenic probe to weld detached retinas and remove cataracts. Because no large incision is made, the patient can be given a local anesthetic and move his eye as the surgeon directs during the delicate operation.

Since January, when the surgical technique was developed by Drs. Michael Shea and D. H. Dickson, it has been used in more than 100 operations.

The hand-held instrument, about the size of a small electric drill, contains a refrigerator, two boilers where freon gas is evaporated for cooling, and a metal applicator that makes contact with the eyeball, and freezes only the area to which it is applied. It was developed by Frigitechnics, Inc., in Bridgeport, Conn.

Semiconductor cooling. The refrigerator, encased in a small, insulated plastic handle, fits in the surgeon's hand. It consists of a series of p-type and n-type semiconductors, whose cold junctions are arranged in series with the applicator tip. The sides of these thermoelectric modules are placed adjacent to a metal block, one module on each side of the block. The Peltier thermoelectric effect assures a temperature difference of 80°C across the modules, and expanding freon along the modules' warm sides assures that the upper temperature will be low; the applicator's temperature is about -65°C.

Power is supplied by a small a-c to d-c full-wave rectifier; only 2½ volts at 9 amperes is required.

Protecting the eye. To protect healthy parts of the eye from the cold, a heating element is wound around the probe's tip. This masks out the freezing until the tip is in the proper position inside the eye; then the heater is shut off. The thermoelectric refrigerator operates continuously.

The cold-probe technique reduces the healing time to one week from the usual three, and reduces heat damage—a frequent complica-

tion when a laser or electric diathermy is used for hot-welding detached retinas. This complication also can arise with the other usual method, electrocauterization.

Previously, cryosurgery required liquid nitrogen to be circulated and controlled by expensive, complicated refrigerators that were too bulky to be handled easily by a surgeon during a delicate operation.

Eastern Europe

Profit potential

The United States government's first trade mission to Poland and Rumania is advising American companies to consider joint production ventures in the two Communist countries, and suggesting that the U. S. government facilitate such agreements.

After 29 days in the two Iron Curtain countries, the five-man group stressed the advantages of combining U. S. technology with the inexpensive skilled labor in Eastern Europe.

Proposals. Polish and Rumanian officials complained often about the fact that American credit is generally limited to five years while several Western European companies negotiate credit of up to 12 years. Poland receives most-favored-nations treatment from the U. S., but Rumania does not, and officials in Bucharest consider this an "overriding" problem, according to the mission's report. This classification guarantees that country so designated will receive any tariff reduction afforded to any country that lacks the designation.

Thomas P. Collier, a management consultant, stressed coproduction possibilities in electronics, particularly in simple radios, television receivers and tape recorders. Computers constitute another area of "interesting opportunities for joint-venture manufacturing, also for licensing, service and sales for U. S. businessmen," he added.

He noted that Poland has begun the manufacture of tape recorders

with the cooperation of Grundig GmbH of West Germany under an agreement for licensing and manufacturing. "Americans might give some thought to similar arrangements in Poland," Collier added.

Expansion in Poland. Collier expects Poland "to take a strong lead in computer technology" in Eastern Europe, and sees a \$100-million investment in telecommunications there by 1970.

But it was the computer industry that occupied most of Crowell's attention. He said the Zam 41, fourth in a family of digital computers, is scheduled to go into prototype production late this year [Electronics, Oct. 4, p. 216]. Zam 51, a larger, faster data-processing computer, is due in prototype next year.

All ZAM computers will be adapted to the IBM international computer language, Crowell was told in Warsaw.

Rumania. Thomas G. Wyman, a former assistant secretary of commerce and a member of the trade mission, said Rumania's current five-year plan requires increased foreign trade.

Leon Lewis, of the U. S. Commerce Department's bureau of international commerce, reported that Rumania, starting at a low base, has "shown the most rapid industrial growth" in Eastern Europe. Her trade is shifting sharply from the East toward the West, he added, noting that Rumania now does 33% of her foreign business with the West, compared with 21% in 1959. But 42% of her trade is still conducted with the Soviet Union.

Western Europe

Expansion in components

Expansions have been announced by two subsidiaries of SGS-Fairchild, Ltd., of Britain. A components plant, said to be the largest in Scandinavia, is being built in Sweden. Nils Soderberg, chairman of the Swedish subsidiary, says the plant will begin manufacturing discrete planar components in mid-

1966 in Märsta, 25 miles north of Stockholm.

Another new plant is planned by a West German subsidiary. It is expected to begin production next June in Wasserburg, 30 miles from Munich.

The Märsta plant is expected to produce all SGS-Fairchild products sold in Scandinavia. Soderberg says the company also is considering integrated circuits.

Around the world

France. French and Soviet officials are cautiously discussing the possibility of launching a French-built satellite with a Soviet booster. France is reported to be interested in a satellite with an apogee of at least 25,000 miles—much higher than any contemplated under her agreement with the United States' National Aeronautics and Space Administration. The big obstacle is Soviet reluctance to allow westerners near any Soviet launch site.

Britain. Continuous-wave Gunn-effect oscillations at k-band have been achieved at the Royal Radar Establishment in England. Researcher Cyril Hilsum, says epitaxial gallium arsenide was used to generate frequencies at 23 gigacycles per second; the previously known high was 10 Gc. At k-band, microwave oscillators could be useful in weather-radar systems and for determining contour definition. Hilsum forms an extremely thin layer of gallium arsenide by passing hydrogen, containing arsenic trichloride, over a heated substrate of gallium. The reaction on the substrate's surface yields the unusually pure compound.

Japan. The International Business Machines Corp. has arranged to buy technological information on the production of magnetic tape from the Sony Corp. of Japan. IBM now buys tape for computer memory devices from the Minnesota Mining & Manufacturing Co. in the United States; with Sony's technology, IBM should be able to produce its own.

Which vacuum deposition method is best for you?

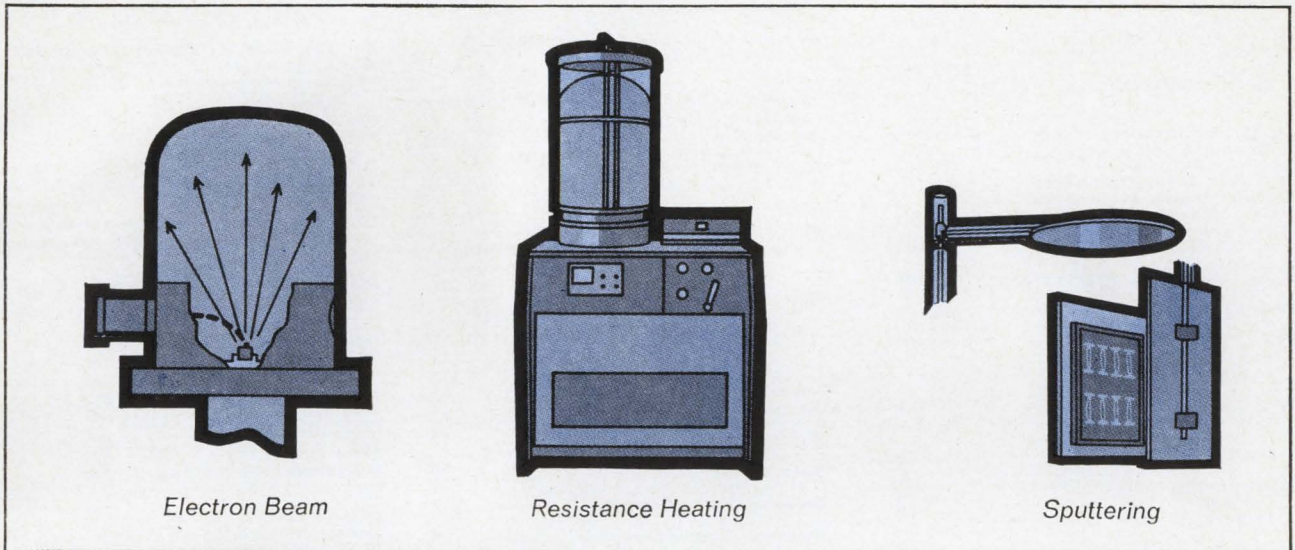

CVC can demonstrate the advantages of each.

Resistance heating, electron beam evaporation, advanced low-energy sputtering—each has its distinct advantages for thin-film applications. CVC has the techniques and the Application Laboratory to help you select the right method. CVC has the equipment to help you do the job.

GUARANTEED PERFORMANCE CV-18 TYPE VACUUM COATERS come completely equipped for resistance heating. Pumpdown to 8×10^{-7} torr in 9 minutes (with standard CV-18) is guaranteed for your laboratory or production line. These vacuum chamber systems are the basis of any vacuum coating operation — electron beam evaporation and sputtering, as well as resistance heating.

ELECTRON BEAM GUN EVAPORATORS with the new CVC deflection system give you high purity films of many metals, insulating materials and ceramics too difficult to handle by resistance heating. The new deflection system permits external mounting of the gun on a baseplate feedthrough ring. The beam enters the chamber and is deflected down to

the evaporant. The advantages of this system are many: easy mounting, greater flexibility in substrate location, longer filament life, greater control over evaporation location, and more working room within the chamber.

PlasmaVac* LOW-ENERGY SPUTTERING. The most versatile thin-film deposition tool ever developed! Triode sputtering deposits a wider range of materials than evaporation techniques — gives precision control of deposition rate and film thickness — works at pressures of 1×10^{-3} torr. PlasmaVac adapts easily to your production line or laboratory set-up. Because it increases quality and yields, PlasmaVac makes thin-film coating a functional tool for many new products and processes — including commercial micro-circuitry.

Please write us with details on what you'd like to do in the thin film field. We'll be glad to make recommendations. Dept. J.

*U. S. Pat. Pending



Consolidated Vacuum Corporation

ROCHESTER, N. Y. 14603 • A SUBSIDIARY OF BELL & HOWELL
International Subsidiaries: Woking, Surrey, England
& Friedberg, West Germany



■ AMP Incorporated	27
Garceau, Hargrave & McCullough Inc.	
Air France	119
Fuller & Smith & Ross Inc.	
■ Bausch & Lomb Inc.	16
Wolff Associates, Inc.	
Bendix Corporation Scintilla Division	52
MacManus, John & Adams Inc.	
Boston Technical Publishers Inc	123
Boston Technical Consultants	
■ Brush Instruments, Div. of	
Clevite Corp.	3rd Cover
Carr Liggett Adv. Inc.	
■ Buchanan Electrical Products Corp.	110, 111
Keyes, Martin Company	
Cambridge Thermionic Corporation	119
Chirurg & Cairns Inc.	
Century Electronics	105
Writing & Advertising Inc.	
■ Clifton Precision Products Co.	
Div. of Litton Industries	24
Ivey Advertising Inc.	
Cominco Products Inc.	123
McKim Productions Limited	
Consolidated Vacuum Corporation	135
Wolff Associates Inc.	
Corning Glass Works	46, 47
The Rumrill Company Inc.	
Cubic Corporation	50
Phillips-Ramsey Inc.	
■ Defense Electronics Inc	116
H. Durand Associates	
■ DuPont de Nemours & Company, Inc. E. I.	49
Batten, Barton, Durstine & Osborn Inc.	
■ Dymec A. Div. of Hewlett Packard Company	2
Lennen & Newell Incorporated	
Eastman Kodak Company	53
The Rumrill Company Inc.	
Electro Products Laboratories Inc.	125
C. M. Gotsch, Advertising	
■ Elgenco Incorporated	119
Wesco Advertising	
Erie Technological Products Co. Inc.	114, 115
Altman-Hall Associates	
Esterline Angus Instrument Company Inc.	54
Caldwell, Larkin & Sidener Van Riper Inc.	
■ Fairchild Instrumentation	22
The Wexton Company Inc.	
■ Fairchild Semiconductor Corp.	12, 13
Faust/Day Inc. Advertising	
Fluke Mfg. Co. Inc., John	15
Bonfield Associates Inc.	
■ General Electric Company, Silicone Products Dept.	20, 21
Ross Roy Inc.	
General Radio Company	2nd Cover
K. E. Morang Company	
Hamilton Standard Div. of United Aircraft Corporation	42
Cunningham & Walsh Inc.	
■ Hewlett Packard Company	1
Lennen & Newell Inc.	
International Identifications	129
Price & Price Inc.	
International Resistance Company	108
Gray & Rogers Inc.	
Interstate Electronics Corporation	121
Hixson & Jorgensen Inc.	
■ J F D Electronics Corporation	6
Michel Cather Inc.	
Jerrold Electronics Corporation	14
Irving Gould Advertising Inc.	
■ Lambda Electronics Corporation	112, 113
Michel Cather Inc.	
■ Lapp Insulator Company Inc.	10
Wolff Associates Inc.	

Lebel High Frequency Laboratories Inc.	123
Apex Graphic Company	
Lockheed Missiles & Space Company	130
McCann-Erickson Inc.	
Machlett Laboratories Inc., The	9
Fuller & Smith & Ross Inc.	
■ Mallory & Company Inc. P. R.	45
The Aitkin-Kynett Company	
McGraw-Hill Book Company Inc.	124
Minnesota Mining & Mfg. Co.	100
Mincom Division	
Reach, McClinton & Co. Inc.	
Motorola Semiconductor Products Inc.	51
Lane & Bird Advertising Inc.	
NRC Equipment Company	117
S. Gunnar Myrbeck & Company	
Newark Electronics Corporation	122
Stral Advertising Company Inc.	
North Atlantic Industries Inc.	8
Murray Heyert Associates	
Philco Corporation Lansdale Division	28
Batten, Barton, Durstine & Osborn Inc.	
Radio Corporation of America	4th Cover, 41
Al Paul Lefton Company	
■ Sargent & Greenleaf Inc.	118
Wolff Associates Inc.	
■ Sorensen Inc.	11
Fuller & Smith & Ross Inc.	
Spectral Dynamics Corporation	17
Teawell Inc.	
Speer Carbon Company	39
Hazard Advertising Company	
Sprague Electric Company	5, 7
The Harry P. Bridge Company	
Stackpole Carbon Company	99
Meek and Thomas Inc.	
Statham Instruments, Inc.	38
Anderson-McConnell Advertising Inc.	
Suffolk County Dept. of Commerce & Industry	36
Snow & Depew Advertising	
TRW Electronics	35, 48
Fuller & Smith & Ross Inc.	
■ Tektronix Inc.	40
Hugh Dwight Adv. Inc.	
■ Telonic Industries Inc.	107
Jansen Associates	
Texas Instruments Incorporated Semiconductor Components Division	18, 19
Don L. Baxter Inc.	
Texas Instruments Incorporated Materials & Controls Division	120
Horton, Church & Goff Inc.	
Unitrode Corporation	33
Electronic Marketing Assistance	
■ Universal Instruments Corporation	37
Caroe Marketing Inc.	

Classified advertising

F. J. Eberle, Business Mgr.	
Employment Opportunities	127-128
Equipment	
(Used or Surplus New)	
For Sale	128

Classified advertisers index

Atomic Personnel	128
Easy-Up Inc.	128
Eldorado Electronics	128
Falcon Marine	128
Fishman Co., Philip	128
RCA Service Co	127
Radio Research Instrument Co.	128
Rixon Electronics Inc.	127
Surplus Saving Center	128

■ For more information on complete product line see advertisement in the latest Electronics Buyers' Guide

Advertising sales staff

Gordon Jones [212] 971-2210

Advertising sales manager

Atlanta, Ga. 30309: Gus H. Krimmier, Michael H. Miller, 1375 Peachtree St. N.E., [404] TR 5-0523

Boston, Mass. 02116: William S. Hodgkinson, McGraw-Hill Building, Copley Square [617] CO 2-1160

Chicago, Ill. 60611: Robert M. Denmead, J. Bradley MacKimm, 645 North Michigan Avenue, [312] MO 4-5800

Cleveland, Ohio 44113: Paul T. Fegley, 55 Public Square, [216] SU 1-7000

Dallas, Texas 75201: Richard P. Poole, The Vaughn Building, 1712 Commerce Street, [214] RI 7-9721

Denver, Colo. 80202: Joseph C. Page, David M. Watson, Tower Bldg., 1700 Broadway, [303] AL 5-2981

Detroit, Michigan 48226: Paul T. Fegley, 856 Penobscot Building [313] 962-1793

Houston, Texas 77002: Kenneth George, 2270 Humble Bldg., [713] CA 4-8381

Los Angeles, Calif. 90017: Ashley P. Hartman, John G. Zisch, 1125 W. 6th St., [213] HU 2-5450

Minneapolis, Minn. 55402: J. Bradley MacKimm, 1104 Northstar Center (612) 332-7425

New York, N. Y. 10036: Donald R. Furth [212] 971-3615, Frank LeBeau [212] 971-3615, George F. Werner [212] 971-3615, 500 Fifth Avenue

Philadelphia, Pa. 19103: William J. Boyle, Warren H. Gardner, 6 Penn Center Plaza, [215] LO 8-6161

Pittsburgh, Pa. 15222: Paul T. Fegley, 4 Gateway Center, (412) 391-1314

Portland, Ore. 97204: James T. Hauptli, Pacific Building, Yamhill Street, (503) CA3-5118

St. Louis, Mo. 63105: Robert M. Denmead, The Clayton Tower, 7751 Carondelet Ave. [314] PA5-7285

San Francisco, Calif. 94111: James T. Hauptli, 255 California Street, [415] DO 2-4600

London W1: John W. Patten, Edwin S. Murphy Jr., 34 Dover Street, Hyde Park 1451

Milan: 1, via Baracchini Phone: 86-90-617

Frankfurt/Main: Gerd Hinske, 85 Westendstrasse Phone: 77 26 65 and 77 30 59

Geneva: Michael R. Zeynel, Joseph Wuensch, 2 Place du Port 244275

Paris VIII: Denis Jacob, 17 Avenue Matignon ALMA-0452

Tokyo: Nobuyuki Sato, 1, Kotohiracho Shiba, Minato-Ku (502) 0656

Osaka: Kazutaka, Miura, 163, Urmegee-cho, Kilita-ku [362] 8771

Nagoya: International Media Representatives, Yamagishi Bldg., 13, 2-Chome, Oike-cho Naka-ku

Hugh J. Quinn: [212] 971-2335, Manager Electronics Buyers' Guide

David M. Tempest: [212] 971-3139, Promotion manager

Milton Drake: [212] 971-3485, Market research manager

Wallace C. Carmichael [212] 971-3191, Business manager

Theodore R. Geipel: [212] 971-2044, Production manager

Executive, editorial, circulation and advertising offices: McGraw-Hill Building, 330 West 42nd Street, New York, N.Y., 10036. Telephone (212) 971-3333. Teletype TWX N.Y. 212 640-4646. Cable: McGrawhill, N.Y. Officers of the Publications Division: Shelton Fisher, President; Vice Presidents: Joseph H. Allen, Operations; Robert F. Boyer, Administration; John R. Callahan, Editorial; Ervin E. DeGraff, Circulation; Donald C. McGraw, Jr., Advertising Sales; Angelo R. Venezian, Marketing. Officers of the Corporation: Donald C. McGraw, President; L. Keith Goodrich, Hugh J. Kelly and Robert E. Slaughter, Executive Vice Presidents; John J. Cooke, Vice President and Secretary; John L. McGraw, Treasurer, Title R registered U.S. Patent Office; © copyright 1965 by McGraw-Hill, Inc. All rights reserved, including the right to reproduce the contents of this publication, in whole or in part.

Another Brush Innovation in Recording

The **Very** versatile
Brush
Mark 842.

For people who never know
what they'll be
recording next!

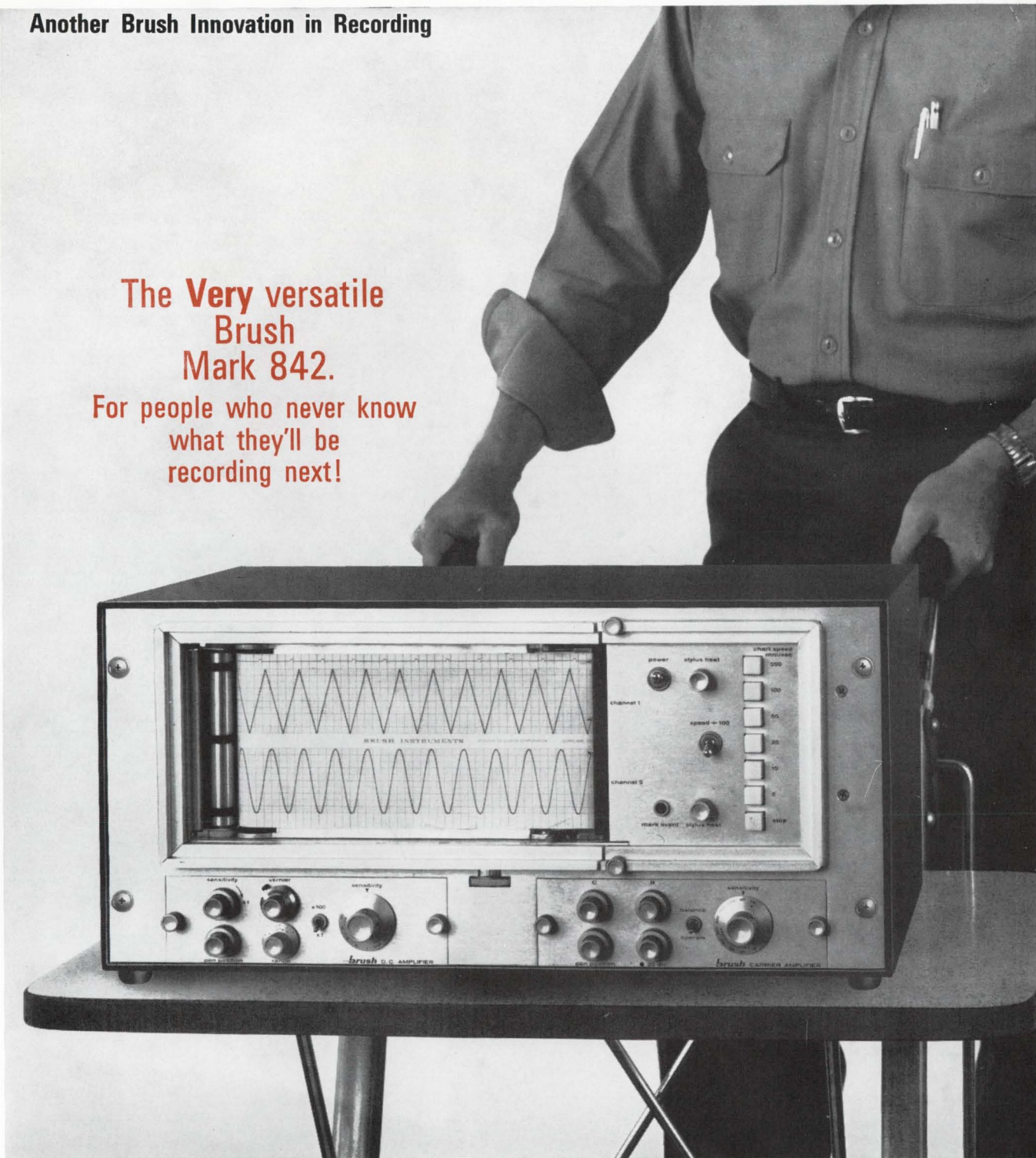

You know what we mean.

Recording requirements change. So it makes sense to buy a recorder you can change with them. Like the Brush Mark 842. See the two pre-amplifiers right below the display and controls? They're the interchangeable plug-in type. Brush gives you a choice of nine. Plus a pick of seven conversion couplers. And any mounting arrangement

you can think of. Lets you match the new Mark 842 to whatever recording job comes along. Great performance, too. Highest usable frequency response of any direct writing recorder . . . 75 cps full scale; flat to 150 cps at reduced amplitude. 1/2% Linearity. All solid state electronics. High torque penmotors. Rugged, crisp-writing styli to assure razor-sharp traces

of unmatched reproducibility. Pushbutton choice of 12 writing speeds. All yours in the clean, neat, easy-to-operate Mark 842. Built by Brush to meet your recording needs for years to come. Ask your local Brush Sales Engineer for a demonstration. A new brochure is yours for the asking. Brush Instruments Division, Clevite Corporation, 37th & Perkins, Cleveland, Ohio 44114.

brush **CLEVITE**
INSTRUMENTS DIVISION

Circle 901 on reader service card

2.5 Watts Output with 4 dB Gain at 1 Gc/s as a Tripler

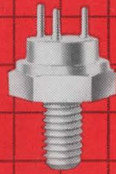

TO-60

RCA-2N4012 "overlay" Transistor
FREQUENCY MULTIPLICATION
WITH POWER GAIN

at UHF and Microwave Frequencies

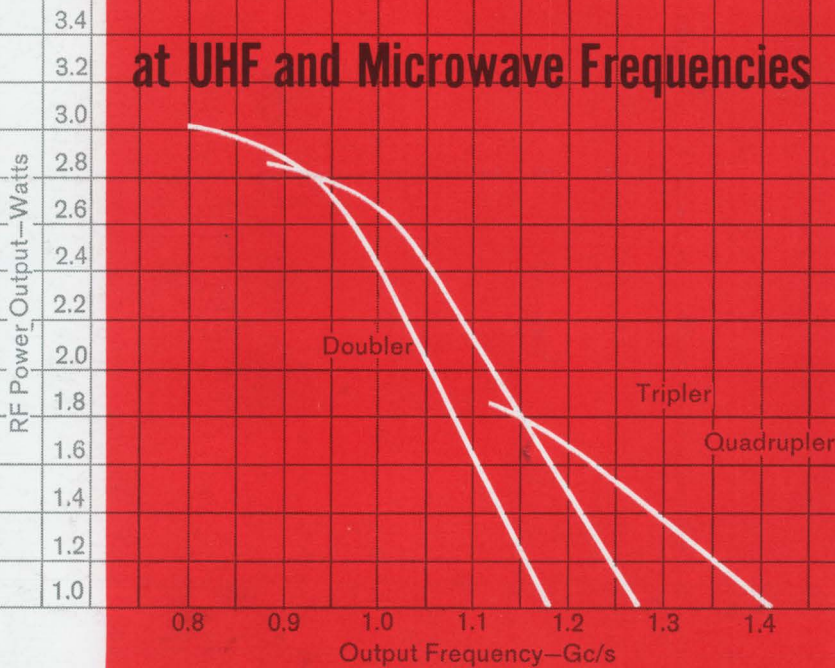

Input Power = 1 Watt

$V_c = 28$ Volts

Case Temp. (T_c) = 25°C

Now for the first time, you can achieve frequency multiplication with power gain at microwave frequencies with a single solid-state device, the new RCA-2N4012 silicon transistor. With this new RCA "overlay" unit, you can greatly simplify circuit design as well as reduce costs. At 1 Gc/s, one single 2N4012 can replace both the transistor power amplifier and varactor diode stages previously required.

Offering frequency multiplication with power gain in the 1 Gc/s region, the RCA-2N4012 as a doubler, tripler, and even as a quadrupler, extends transistor performance into the microwave region with watts of power! When used in a common-emitter configuration, this transistor provides stable operation—power output varies smoothly with changes in power input.

Talk to your RCA representative about how the RCA-2N4012 can help you cut design costs in your space, military, and commercial applications. For technical data, write: RCA Commercial Engineering, Section IN11-5, Harrison, N.J.

	2N4012 DOUBLER	2N4012 TRIPLER	
Output Power	3 (typ)	2.5 (min)	Watts
Output Frequency	800	1002	Mc/s
Input Frequency	400	334	Mc/s
Conversion Gain	4.8 (typ)	4 (min)	dB
MAXIMUM RATINGS	V_{CBO}	65 Volts	
	V_{CEO}	40 Volts	
	V_{CEV}	65 Volts	
	V_{EBO}	4 Volts	
	I_C	1.5 Amperes	

ALSO AVAILABLE THROUGH YOUR RCA DISTRIBUTOR

RCA Electronic Components and Devices



The Most Trusted Name in Electronics

Circle 902 on reader service card