

# Electronics

SEP 6 1966

V 39  
#18  
10/15/71  
hp

- Integrated circuits shrink sense amplifiers: page 89
- Navigating with a high-speed computer: page 105
- Laser hardware for industrial use: page 115

September 5, 1966  
75 cents  
A McGraw-Hill Publication  
Below: Using scattering parameters in design, page 78

LIBRARY  
TENN. MED. UNITS

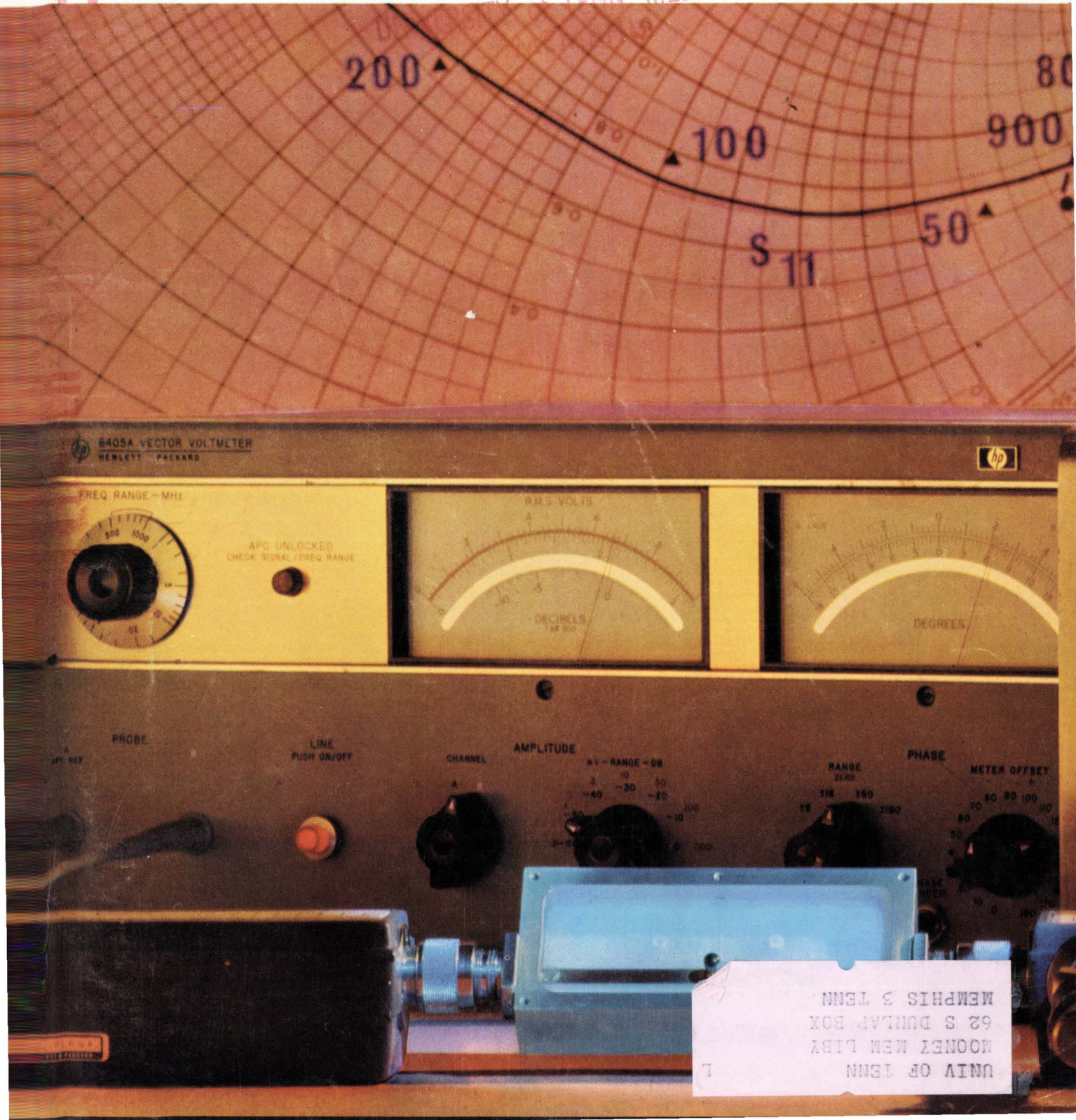



# Why do TEKTRONIX,

# TEXAS INSTRUMENTS

# EG & G and others

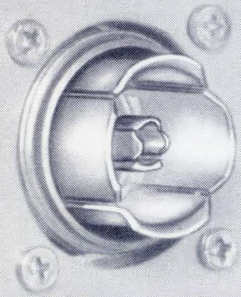

## use GR874 Coaxial Connectors on their products?

### Because GR874 Coaxial Connectors are good for pulses

GR874 Coaxial Connectors are wide-bandwidth, low-reflection devices that are made-to-order for fast-rise-time, high-frequency pulse systems. VSWR is less than 1.02 up to 7 GHz, less than 1.08 to 9 GHz for the rigid air-line locking version, which means that these connectors pass pulses faithfully without ringing or deterioration of rise/fall times.

The GR874 is a versatile coaxial system with a wide variety of elements and components . . . power dividers, air lines, trombones, tees, elbows, pads, terminations, adaptors, etc.

The GR874 offers high performance at low cost . . . price of a basic GR874 Coaxial Connector is \$2.25, and purchases in quantity yield discounts.

The GR874 saves setup time . . . it is both a hermaphroditic (no male or female versions) and quick-connect/ -disconnect connector.

Here is an example of how GR874 Coaxial elements be used to produce bursts of high-rep-rate pulses with low-frequency, fractional-nanosecond pulse generation.

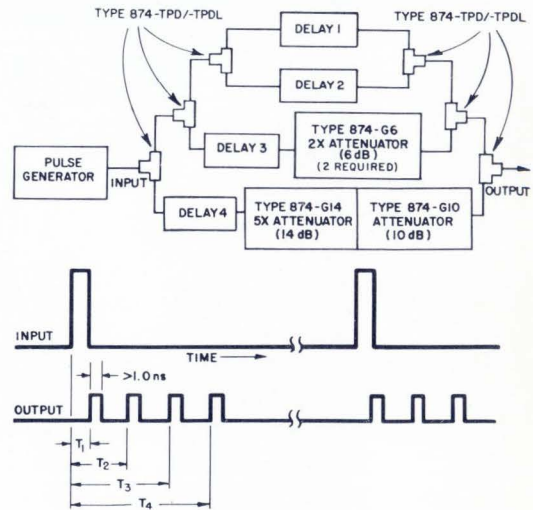

The cascaded GR874-TPD Power Dividers first reproduce the original pulse many times and, later, recombine the individually delayed signals into a higher-rep-rate pulse burst. Rep rates up to several hundred MHz can be obtained by this technique.

GR874 Air Lines can be used to provide small delays (up to 1 ns). GR874 Attenuators can be used when compensatory reductions in amplitude are required (the GR874-TPD Power Divider has a port-to-port insertion loss of 6 dB).

BOSTON • NEW YORK • CHICAGO • PHILADELPHIA • WASHINGTON, D.C.  
SYRACUSE • DALLAS • SAN FRANCISCO • LOS ANGELES • ORLANDO  
CLEVELAND • TORONTO • MONTREAL

BOURNE END, ENGLAND      ZURICH, SWITZERLAND

# GENERAL RADI

WEST CONCORD, MASSACHUSETTS

Circle 900 on reader service card

# Data Acquisition Requirements?

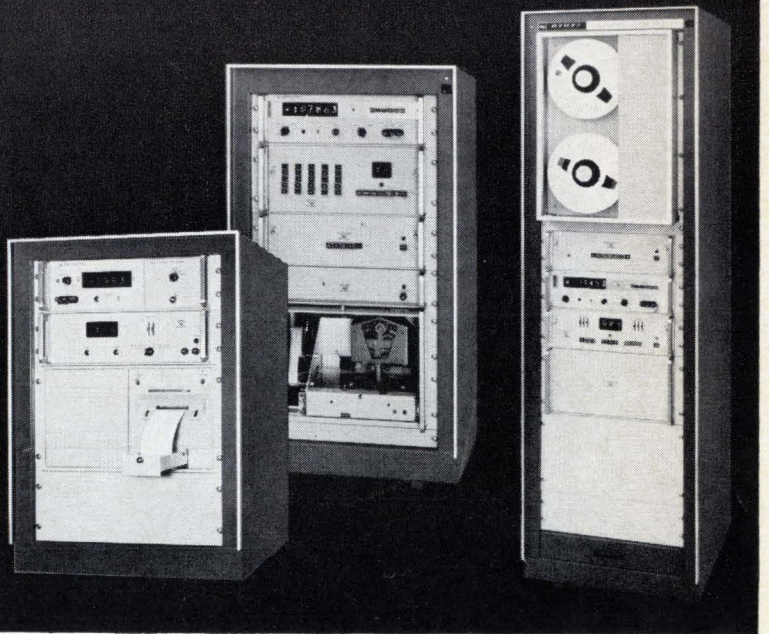

## APPLICATION

Dymec Data Acquisition Systems are designed to measure analog data derived from a number of sources, and to display and record this information in digital form. To present the recorded information in its most useful medium, systems are available with a choice of output recording devices. For direct reading by the operator, readout on paper tape is provided. On the other hand, if the data is to be entered into a computer, it may be recorded on punched paper tape, punched cards, or digital magnetic tape, as appropriate.

...Just turn to an hp Data Sheet!

Feature	2013 Series (economy)	2010 Series (noise rejection)	2015 Series (speed, accuracy)	2017 Series (readout in engr. units)
Number of Input Channels	25 (2-wire) or 50 (1-wire) 2013 A-D	25 (3-wire) expandable to 100 2010A, B, E, H	25 (3-wire) expandable to 100 2015A, B, E, H	25 (3-wire) expandable to 100 2017A, B, E, H
	25 (3-wire) expandable to 100 2013 J-M	200 (3-wire) or 100 (6-wire) 2010C, D, F, J	200 (3-wire) or 100 (6-wire) 2015C, D, F, J	200 (3-wire) or 100 (6-wire) 2017C, D, F, J
Noise Rejection	NMR 30 dB at 60 c/s (filter) ECMR	inf. at 60 c/s (integrating)	inf. at 60 c/s	20 db min. all freq. (integrating)
		At least 105 dB, all frequencies (floating)		
DC Voltage Range	10, 100, 1000 V. fs	0.1, 1, 10, 100, 1000 V. fs	1, 10, 100, 1000 V. fs	0.1, 1, 10, 100, 1000 V. fs
Resolution (mV/digit)	100 $\mu$ V 10 $\mu$ V with amplifier	1 $\mu$ V standard 0.1 $\mu$ V with amplifier	10 $\mu$ V	1 $\mu$ V standard 0.1 $\mu$ V with amplifier
Accuracy (% rdg.)	.05%	.015%	.005%	.015%
Max. Speed, Readings/Sec, DC Volts	1.7 (4 digits)	18 (3 digits) 7 (4 digits) 1 (5 digits)	12 (5 digits)	18 (3 digits) 7 (4 digits) 1 (5 digits)
Optional Measurement Capability	AC voltage, resistance, dc current	AC voltage, resistance (frequency is standard)	AC voltage, resistance	AC voltage, resistance (frequency is standard)
Programming		standard with DY-2901A; add DY-2911C or DY-2560A with DY-2911		
Types of Output Recording	Printed strip, typewriter, punched tape, cards	Printed paper strip, perforated tape, punched card (IBM 526) magnetic tape		
Price Range (Basic System)	\$4495 - \$6000	\$8310 - \$18,550	\$8160 - \$18,400	\$10,960 - \$21,200

Data subject to change without notice. Prices f.o.b. factory.

**HEWLETT  
PACKARD**  **DYMEC  
DIVISION**



## A DC VOLT-OHMMETER WITH NO RANGE SWITCH!

**More time saved**—Put an end to tedious, time-consuming manual range switching with the new Hewlett-Packard 414A Autovoltmeter. Just touch and read... range and polarity change automatically. You read range and polarity on the digital readout above the analog meter.

**More accuracy**—And the analog meter lets you measure  $\pm 5$  mv to  $\pm 1500$  v full scale, 12 ranges, with an accuracy of  $\pm 0.5\%$  of full scale  $\pm 0.5\%$  of reading; 5 ohms to 1.5 megohms, 12 ranges, accuracy 1% of reading  $\pm 0.5\%$  of full scale.

**All this for just \$650!**

**More uses**—The 414A is the world's first "touch-and-read" analog volt-ohmmeter with accuracy anywhere approaching what you require for trouble shooting, tweaking, peaking and nulling, probing a circuit without a schematic. Use it for maintenance testing, on the production line, in the lab.

In the dc voltage function you simply touch the point to be measured and in less than 300 msec read the range and polarity on the digital display and the precise dc measurement on the individually calibrated, mirror-backed taut-band meter. Automatic ranges are selected and displayed for resistance measurements, too.

**More noise rejection**—Ranges also can be selected and held manually, and a Down Range control feature lets you drop to the next lower range merely by pushing a front-panel button.

Input resistance is 10 megohms on the 5 and 15 mv ranges, 100 megohms on 50 mv range and above. The 414A is insensitive to 60 cps signals with peak value less than 7 times the full-scale dc level of range in use in "Hold" position (rejection is 20% of reading when using Auto-ranging).

To get the true significance of this automatic instrument, you need to see it perform on your bench. Call your Hewlett-Packard field engineer for that convincing demonstration. Or write for complete information to Hewlett-Packard, Palo Alto, Calif. 94304, Tel. (415) 326-7000; Europe: 54 Route des Acacias, Geneva.

*Data subject to change without notice. Price f.o.b. factory.*

HEWLETT  PACKARD  
An extra measure of quality

1033

## News Features

### Probing the News

- 129 War on radio-frequency interference
- 135 The best of Tiros and Nimbus
- 139 Turning night into day

## Electronics Review

- 29 **Space electronics:** Lunar traffic jam
- 30 Apollo in November? . . .  
. . . Gemini in September
- 30 **Military electronics:** Ground bugs
- 31 Outdoor advertising
- 32 **Optoelectronics:** Photon finish
- 34 **Computers:** Circuit on display
- 36 **Instrumentation:** Look sharp
- 38 **Manufacturing:** Plastic bandwagon
- 40 **Advanced technology:** Power from plasma
- 41 **Electronic notes**

## Electronics Abroad

- 197 **International:** Pulse-train lullaby;  
Space team
- 198 **Japan:** Characters galore;  
Typhoon chaser
- 199 **Great Britain:** Heads up
- 200 **Red China:** No threat yet
- 200 **Around the world**

## Departments

- 4 Readers Comment
- 8 People
- 14 Meetings
- 16 Meeting Preview
- 23 Editorial
- 25 Electronics Newsletter
- 63 Washington Newsletter
- 147 New Products
- 188 New Books
- 190 Technical Abstracts
- 192 New Literature

## Technical Articles

### I. Design

- Design theory** 78 **Scattering parameters speed design of high-frequency transistor circuits**  
At frequencies where h, y or z parameters fail, this new technique simplifies transistor circuit design  
Fritz Weinert, Hewlett-Packard Co.
- Computers** 89 **Sense amplifier fits any memory**  
General-purpose integrated circuit can be used with most coincident-current memories  
Brant Johnson, Sylvania Electric Products, Inc
- Circuit design** 95 **Designer's casebook**
  - Square-law detector has 40-db dynamic range
  - Transistors replace diodes in milliohm-meter circuit
  - No pulse-forming network in scr trigger generator
  - Scr bridge inverter eliminates transformers

### II. Applications

- Reference sheet** 101 **Graphs reveal reasons for high cost of maintenance**  
Chart pinpoints costly trouble spots in avionics maintenance procedures  
G.W. Corley and H. Faecher, Westinghouse Defense and Space Center
- Computers** 105 **Divic gives answers to complex navigation questions**  
Skillful blending of digital and differential processing avoids need for large memory  
Joseph A. Parini, Lear Siegler, Inc.
- Industrial electronics** 115 **Pumping new life into ruby lasers**  
New pumping system and low-cost flashtube make lasers a practical production tool  
Dieter Roess and Guenter Zeidler, Siemens & Halske AG

# Electronics

**Editor-in-Chief:** Lewis H. Young

**Senior editors**

**Design:** Samuel Weber

**Application:** George Sideris

**News:** Kemp Anderson Jr.

**Assistant to the editor:** Sally Powell

**Senior associate editors:** John F. Mason, Donald Christiansen, Robert Henkel, Joseph Mittleman

**Department editors**

**Avionics:** W.J. Evanzia

**Communications:** Leonard Weller

**Computers:** Wallace B. Riley

**Design theory:** Joseph Mittleman

**Electronics abroad:** Arthur Erikson

**Electronics review:** Stanley Zarowin

**Industrial electronics:** Alfred Rosenblatt

**Instrumentation:** Carl Moskowitz

**Military electronics:** John F. Mason

**New products:** William P. O'Brien

**Special projects:** Don Christiansen

**Staff writers:** Jan Rahm, A. Thomas Thorson

**Regional Bureaus**

**Domestic**

**Boston:** Thomas Maguire, manager; Robin Carlson

**Los Angeles:** William B. Wallace, manager; June Ranill

**San Francisco:** Walter Barney, manager; Mary Jo Jadin

**Washington:** Robert W. Henkel, manager; William D. Hickman, John Rhea, correspondents; Patricia C. Hoehling

**Foreign**

**Bonn:** John Gosch

**Tokyo:** Charles Cohen

**Copy editors**

James J. Moran, David Goller, William Olcott

**Graphic design**

**Art director:** Saul Sussman

**Assistant art directors:** Donna M. Griffiths, Ann Mella

**Production editor:** Arthur C. Miller

**Editorial secretaries:** Claire Benell, Lynn Emery, Lorraine Fabry, Kay Fontana, Lorraine Longo, Carolyn Michnowicz

**McGraw-Hill News Service**

**Director:** John Wilhelm; **Atlanta:** Fran Ridgway; **Chicago:** Reck Johnson;

**Cleveland:** Arthur Zimmerman; **Dallas:** Marvin Reid;

**Detroit:** N. Hunter; **Houston:** Ron Lovell; **Los Angeles:** Michael Murphy, Gerald Parkinson

**San Francisco:** Margaret Drossel

**Seattle:** Ray Bloomberg; **Washington:** Arthur L. Moore, Charles Gardner, Herbert W. Cheshire, Seth Payne, Warren Burkett, Warren Kornberg

**McGraw-Hill World News Service**

**Bonn:** John Johnsrud; **London:** John Shinn;

**Mexico City:** Bruce Cross; **Milan:** Ronald Taggiasco;

**Moscow:** Howard Rausch; **Paris:** Peter Kilborn;

**Rio de Janeiro:** Wes Perry; **Tokyo:** Marvin Petal

**Circulation and Research Manager:** Milton Drake

**Reprints:** Thomas M. Egan

**Publisher:** Gordon Jones

**Electronics:** September 5, 1966, Vol. 39, No. 18

Printed at 99 North Broadway, Albany, N.Y., 12207  
Second class postage paid at Albany, N.Y.

Subscriptions are solicited only from those actively engaged in the field of the publication. Position and company connection must be indicated on orders. Subscription prices: United States and Possessions and Canada, \$6.00 one year, \$9.00 two years, \$12.00 three years. All other countries \$20.00 one year. Single copies, United States and Possessions and Canada 75¢. Single copies all other countries \$1.50.

Published every other Monday by McGraw-Hill Inc. 330 West 42nd Street, New York, N.Y. 10036.  
Founder: James H. McGraw, 1860-1948. Corporate officers: Shelton Fisher, President; John J. Cooke, Secretary; John L. McGraw, Treasurer.

**Subscribers:** The Publisher, upon written request to our New York office from any subscriber, agrees to refund that part of the subscription price applying to copies not yet mailed. Please send change of address notices or complaints to Fulfillment Manager; subscription orders to Circulation Sales Department, Electronics, at the address below. Change of address notices should provide old as well as new address, including postal zip code number. If possible, attach address label from recent issue. Allow one month for change to become effective.

**Postmaster:** Please send Form 3579 to Fulfillment Manager, Electronics, P.O. Box 430, Hightstown, New Jersey 08520

## Readers Comment

### Modern marvel

To the Editor:

F.J. Wilkerson is incorrect in assuming that the size of an object determines its cost or value [May 16, p. 4]. Time was when hearing aids were less expensive than they are at present, and they were a lot bigger then, too—almost as big as the color tv set to which he refers.

Now the hearing aid industry has produced a marvel of electronics, an intricately designed and assembled unit that fills in the tonal gaps of human hearing loss, and consequently, fills in the gaps in human lives where otherwise, great emotional and psychological loss might occur.

A hearing aid is truly a bargain at any cost.

John Kojis

President

Hearing Aid Industry Conference, Inc.

Chicago, Ill.

### An extra ground

To the Editor:

In reading the article "Improving the performance of multipurpose IC's with feedback" [June 27, p. 70], I came upon one circuit that seems to be wrong. On page 73 is a schematic for an exclusive OR gate. With the base of  $Q_3$  at ground potential, the base resistor would not be in the circuit.

Marvin Lee Nolan

U.S. Navy

Charleston, S.C.

▪ Reader Nolan is right; an extra ground symbol crept in.

### Foreign engineer's lament

To the Editor:

It seems evident that the present demand for engineers in the United States exceeds the supply ["Recruiting at IEEE," April 14, p. 46]. One of the few countries in the world with a surplus of engineers is Norway, where a sizeable proportion of graduates have to emigrate to obtain a job. Although a few U.S. firms have tried to recruit engineers from Norway, with some success, the engineers who most

# RESISTORS FOR PERSPICACIOUS DESIGN ENGINEERS

## FILMISTOR® PRECISION METAL-FILM RESISTORS

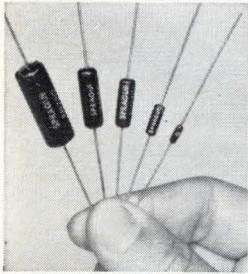

Extended-range Filmistor Resistors now give you dramatic space savings in all wattage ratings — 1/20, 1/10, 1/8, 1/4, 1/2, and 1 watt — with absolutely *no sacrifice in stability!*

Filmistors offer extended resistance values in size reductions previously unobtainable. For example, you can get a 4.5MΩ resistor in the standard 1/4 watt size, which had conventionally been limited to 1 MΩ. Filmistor Metal-Film Resistors are now the ideal selection for "tight-spot" applications in high-impedance circuits, field-effect transistor circuits, etc.

Other key features are ±1% resistance tolerance, low and controlled temperature coefficients, low inherent noise level, negligible coefficient of resistance, and rugged molded case.

Filmistors *surpass* the performance requirements of MIL-R-10509E.

**Write for Engineering Bulletin 7025C**

## ACRASIL® PRECISION/POWER WIREWOUND RESISTORS

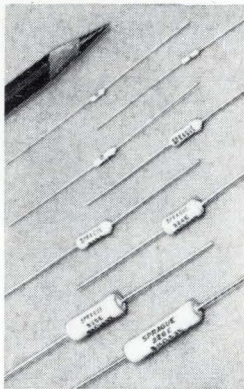

These silicone-encapsulated resistors combine the best features of both precision and power wirewound types, giving them unusual stability and reliability.

Acrasil Resistors are available with tolerances as close as .05%, in power ratings from 1 to 10 watts. Resistance values range from 0.5 ohm to 66,000 ohms.

Their tough silicone coating, with closely matched expansion coefficient, protects against shock, vibration, moisture, and fungus.

Acrasil Resistors meet or exceed the requirements of MIL-R-26C.

**Write for Engineering Bulletin 7450**

## BLUE JACKET® VITREOUS ENAMEL PRECISION/POWER WIREWOUND RESISTORS

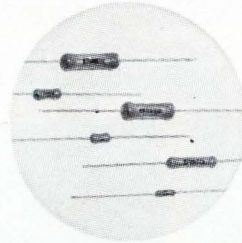

Axial-lead resistors available in ratings from 1 to 11 watts, with resistance tolerances to ±1%. Non-inductive windings available to ±2% tolerance.

All welded end-cap construction securely anchors leads to resistor body. Vitreous coating and ceramic base have closely matched expansion coefficients.

**Write for Engineering Bulletins 7410D, 7411A**



Tab-terminal Blue Jacket Resistors can be had in a wide selection of ratings from 5 to 218 watts, with several terminal styles to meet specific needs.

Tab-terminal as well as axial-lead Blue Jackets can be furnished to meet the requirements of MIL-R-26C.

**Write for Engineering Bulletins 7400B, 7401**

## KOOLOHM® CERAMIC-SHELL POWER WIREWOUND RESISTORS

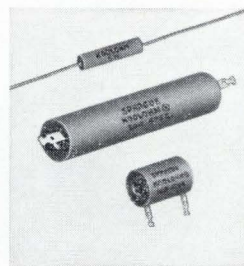

Koolohm Resistors are furnished in axial-lead, axial-tab, and radial-tab styles, in a broad range of ratings from 2 to 120 watts. Both standard and non-inductive windings are available.

Exclusive ceramic-insulated resistance wire permits "short-proof" multilayer windings on a special ceramic center core for higher resistance values. The tough non-porous ceramic shell provides complete moisture protection and electrical insulation. Koolohms can be mounted in direct contact with chassis or "live" components.

Axial-lead Koolohm Resistors to MIL-R-26C are available in MIL styles RW55 and RW56.

**Write for Bulletins 7300, 7305, 7310**

## STACKOHM® POWER WIREWOUND RESISTORS



Sprague Stackohm Resistors are especially designed for equipment which requires power wirewound resistors of minimum height. Their flat silhouette permits stacking of resistor banks in close quarters.

Aluminum thru-bars with integral spacers act as mounting means and also conduct heat from within the resistance element. Resistance windings are welded to end terminations for maximum reliability. An outstanding vitreous coating protects the assembly against mechanical damage and moisture. Ceramic core, end terminations, and vitreous enamel are closely matched for co-efficient of expansion.

Stackohm Resistors are available in both 10-watt and 20-watt ratings, and can be furnished with resistance tolerances as close as ±1%. Resistance values range from 1 ohm to 6000 ohms.

Both 10- and 20-watt types meet the stringent requirements of MIL-R-26C.

**Write for Engineering Bulletin 7430**

*Send your request to Technical Literature Service, Sprague Electric Co., 35 Marshall St., North Adams, Mass. 01247, indicating the engineering bulletins in which you are interested.*

ON READER-SERVICE  
CIRCLE 495

ON READER-SERVICE  
CIRCLE 496

ON READER-SERVICE  
CIRCLE 497

ON READER-SERVICE  
CIRCLE 498

ON READER-SERVICE  
CIRCLE 499

## SPRAGUE COMPONENTS

RESISTORS  
CAPACITORS  
TRANSISTORS  
THIN-FILM MICROCIRCUITS  
INTEGRATED MICROCIRCUITS

PULSE TRANSFORMERS  
INTERFERENCE FILTERS  
PULSE-FORMING NETWORKS  
TOROIDAL INDUCTORS  
ELECTRIC WAVE FILTERS

CERAMIC-BASE PRINTED NETWORKS  
PACKAGED COMPONENT ASSEMBLIES  
BOBBIN and TAPE WOUND MAGNETIC CORES  
SILICON RECTIFIER GATE CONTROLS  
FUNCTIONAL DIGITAL CIRCUITS

**SPRAGUE®**  
THE MARK OF RELIABILITY

\*Sprague\* and ® are registered trademarks of the Sprague Electric Co.

**YOU CAN FIND SOME CIRCUIT PROBLEMS  
THESE LAB KITS WON'T HELP YOU SOLVE...  
...but it'll take a little imagination**

**1.**  
**ZENERS**  
3 Watt  
Low Voltage

**2.**  
**ZENERS**  
3 Watt  
Medium Voltage

**3.**  
**ZENERS**  
3 Watt  
High Voltage

**4.**  
**ZENERS**  
5 Watt  
Low Voltage

**5.**  
**ZENERS**  
5 Watt  
Medium Voltage

**6.**  
**ZENERS**  
5 Watt  
High Voltage

**7.**  
**RECTIFIERS**  
Low Current

**8.**  
**RECTIFIERS**  
High Current

**9.**  
**RECTIFIERS**  
Fast Recovery  
Low Current

**10.**  
**RECTIFIERS**  
Fast Recovery  
High Current

**11.**  
**BRIDGES**  
Single Phase  
To 3600V per leg

**12.**  
**STACKS**  
To 15 KV

## **TAILOR YOUR OWN DIODE LABORATORY KIT FROM UNITRODE'S 12-DRAWER SELECTION**

You'd find it awfully handy to have one of these kits. Unitrode's range of diode types fulfills the requirements of most conceivable applications. Sub-miniature diodes of each family are packed in labeled boxes in each drawer. Every part is standard Unitrode high quality construction, with voidless hermetically-sealed fused-in-glass junctions and controlled avalanche characteristics.

Mix 'n match from 12 different drawers, with any number of duplicates. At \$49.50 each you get prototype requirements at a high quantity price. The rugged 12-drawer metal cabinet is only \$5 and is included free when you buy four or more drawers.

### **TO ORDER YOUR LAB KIT**

contact the factory or call your nearest Compar office. For complete technical data, use the magazine reply card.

**UNITRODE® CORPORATION**

580 PLEASANT STREET • WATERTOWN, MASS. 02172  
TELEPHONE (617) 926-0404 • TWX (710) 327-1296

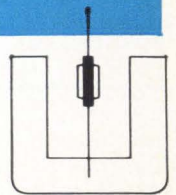



desire to emigrate to the United States have to struggle through too many difficulties to get there.

For example, our salary structure is so low one cannot afford to take a trip across the Atlantic on the odd chance of getting a job. Then, the procedure for obtaining an entry visa to the U.S. is a long and tedious one. Without a sponsor or a job contract, one might not get an entry visa. Thus we have a paradox: it is difficult to get a job without first going to the U.S., but one might not be able to go to the U.S. without first having a job.

I suggest that U.S. firms advertise more in the local newspapers, send their recruiting people to conduct interviews in Europe, for example in Oslo, or invite the candidates to interviews in the U.S. and pay the fares. (It would be fair, I think, to deduct this from the salary if the candidate accepted a job. After all, companies pay fares from coast-to-coast in the U.S.)

And they should assist the candidates with their entry visa applications.

Kjell Haug

Electrical Engineer  
International Telecommunications  
Union  
Baghdad, Iraq.

### Kafka or Koufax?

To the Editor:

Author Wallenstein [June 13, p. 142] is not really offering a solution to the obsolescence problem when he suggests broadening of engineers' perspective. I believe he is making the classical error of assuming that two things which vary together are cause and effect, when in fact they are both functions of some third phenomena.

An engineer with a high degree of intellectual curiosity will dig through quantities of technical material and still have time for Kafka because he enjoys the stimulation of a creative mind. If, as a result, he is technically up-to-date and can command a high consulting fee in his senior years, it is because of this intellectual curiosity, which has enabled him to take advantage of his years rather than submitting to them.

The engineer lacking interest in the arts would be better advised to avoid the museums and concert halls since, lacking this interest, he will not develop into a better designer but simply become bored.

In fact, there has always been in every profession those with varying degrees of motivation. Consequently there have been some who have been current and knowledgeable from the day of graduation through retirement. Any rapidly expanding technology is not going to change this picture but will result in higher degrees of specialization. Those at the top of their profession, in every profession, will have a higher degree of specialization built on a broad foundation. Those at the other end of the scale will be poorly motivated, lacking special skills and having little breadth. The former doesn't need to be told to broaden his outlook because he has been doing it all his life for the sake of the intellectual challenge. The latter is not going to study Taoism because he is too busy watching the ball game, which he enjoys.

A. J. DeBerardis

Manager  
Quality Assurance and Reliability  
Unitrode Corp.  
Watertown, Mass.

## Trygon RS Series:

# 71°C all- silicon power supplies

## for high-reliability systems!

71°C without derating, external heat sinking or forced air—3½" rack height—hermetically-sealed rectifiers—temperature stabilized reference diodes and semiconductors—computer grade filter capacitors—all for extreme reliability! Constant voltage/constant current, with automatic mode crossover. Eight models. Write today for complete specs. Dept. E-30.

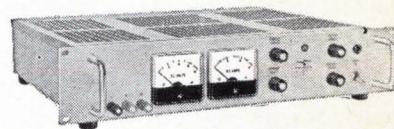

**TRYGON<sup>®</sup>**  
**POWER SUPPLIES**  
Roosevelt, L. I., N. Y. (516) FReeport 8-2800

### SUBSCRIPTION SERVICE

Please include an Electronics Magazine address label to insure prompt service whenever you write us about your subscription.

Mail to: Fulfillment Manager  
Electronics  
P.O. Box 430  
Hightstown, N.J. 08520

To subscribe mail this form with your payment and check  new subscription  renew my present subscription

Subscription rates: in the U.S.: 1 year, \$6; two years, \$9; three years, \$12. Subscription rates for foreign countries available on request

### CHANGE OF ADDRESS

ATTACH  
LABEL  
HERE

If you are moving, please let us know five weeks before changing your address. Place magazine address label here, print your new address below.

name \_\_\_\_\_

address \_\_\_\_\_

city \_\_\_\_\_

state \_\_\_\_\_

zip code \_\_\_\_\_

# What high-performance HF antenna can you airlift to the field and erect in 2 hours?

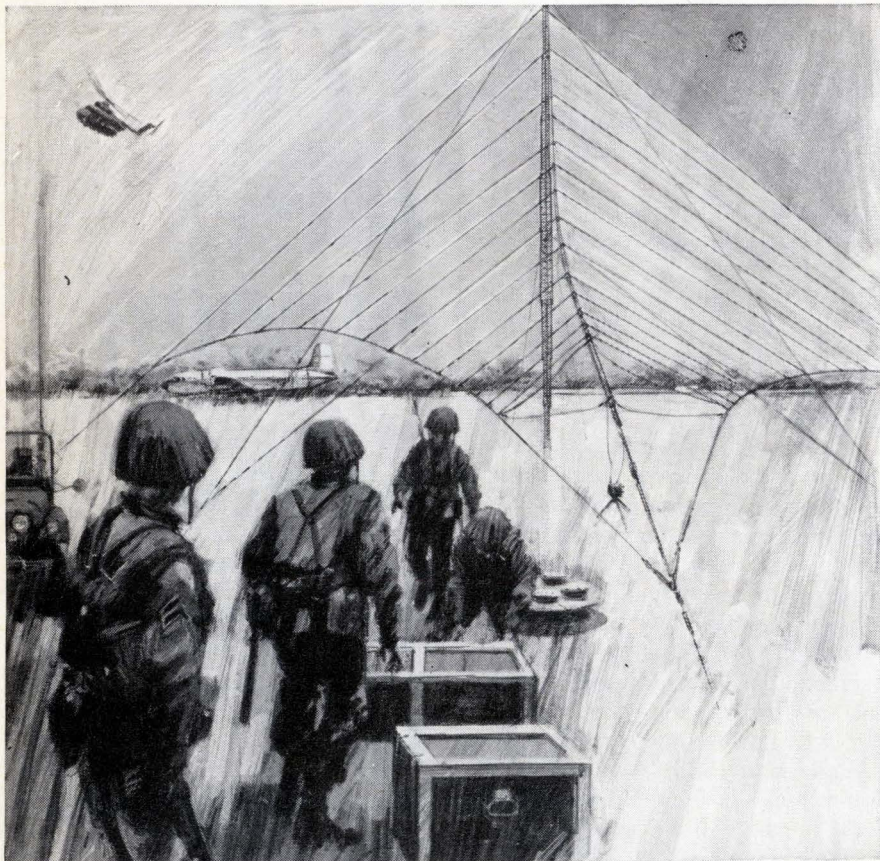

## Granger Associates has the answer

**now**

It's G/A's Model 747CA air-transportable HF antenna — which is only 10 feet long when packed, can be erected by five men in two hours, and stands up in 100-mph winds.

This antenna gets messages through when other transportable antennas don't. It does it by concentrating radiation at the elevation angle most likely to be best for the frequency used and the length of the circuit. Produces a useful gain of 10 to 13 db at any frequency from 4 to 30 Mc, with side lobes 14 db down.

Ordinary transportable antennas — like whips, dipoles and sloping V's — can't approach that kind of performance. The 747CA gives field stations an antenna fully comparable to a well-designed fixed-station antenna.

U.S. forces set up a Model 747CA in the Dominican Republic recently. Operated at only 1kw power, it delivered a better signal than an ordinary transportable antenna operated at 10 kw.

Send for complete technical data on Model 747CA.

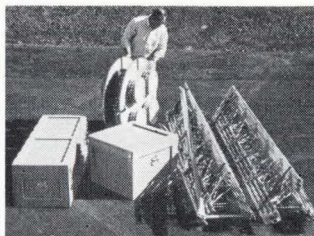

747CA antenna packed for airlift

## People

A hole in a laboratory door at the Raytheon Co.'s research division in Waltham, Mass., serves as a reminder of the gas laser's rapid advance in the last few years from a low-power curiosity to a high-power "weapon." A central figure in that technological leap—and the researcher whose laser accidentally drilled the hole a few years back—will join the National Aeronautics and Space Administration this month. **Roy A. Paananen**, 46, will head a group working on molecular lasers at the space agency's Electronics Research Center.



**New materials.** In the space optics laboratory of the Cambridge, Mass., center, Paananen will explore molecular lasers for deep-space communications. These devices, which stimulate coherent radiation by manipulating the energy levels of molecules instead of atoms, include carbon dioxide systems, the new nitrosyl chloride and the still newer carbonyl sulfide systems.

Recent studies of solar noise background indicate that lasers with outputs in the 2- to 5-micron region are the most promising candidates for interplanetary communications. "There are both atomic and molecular gases that emit in that band," says Paananen, "but the molecular gases give promise of higher efficiency."

Paananen, who moved into laser development from microwave tube work, is a native of Michigan and earned degrees at Michigan State University and the Massachusetts Institute of Technology. He was on the staff of MIT's Research Laboratory of Electronics and of Lincoln Laboratory before joining Raytheon 13 years ago.

**Record holder.** In recent years Paananen has worked with ionized argon lasers. His 53-watt continuous-wave output stands as the highest announced to date for ionized argon [Electronics, June 27, p. 25]. He was also the first to ob-

**Granger Associates**

68

AN EQUAL OPPORTUNITY EMPLOYER

1601 California Ave., Palo Alto, California / Telephone: 321-417 5 / TWX: 910-373-1291  
Granger Associates Ltd., Walton-on-Thames, Surrey, England / Weybridge 44842



## 200 kW power output with .7 kW drive from magnetically beamed MACHLETT triode

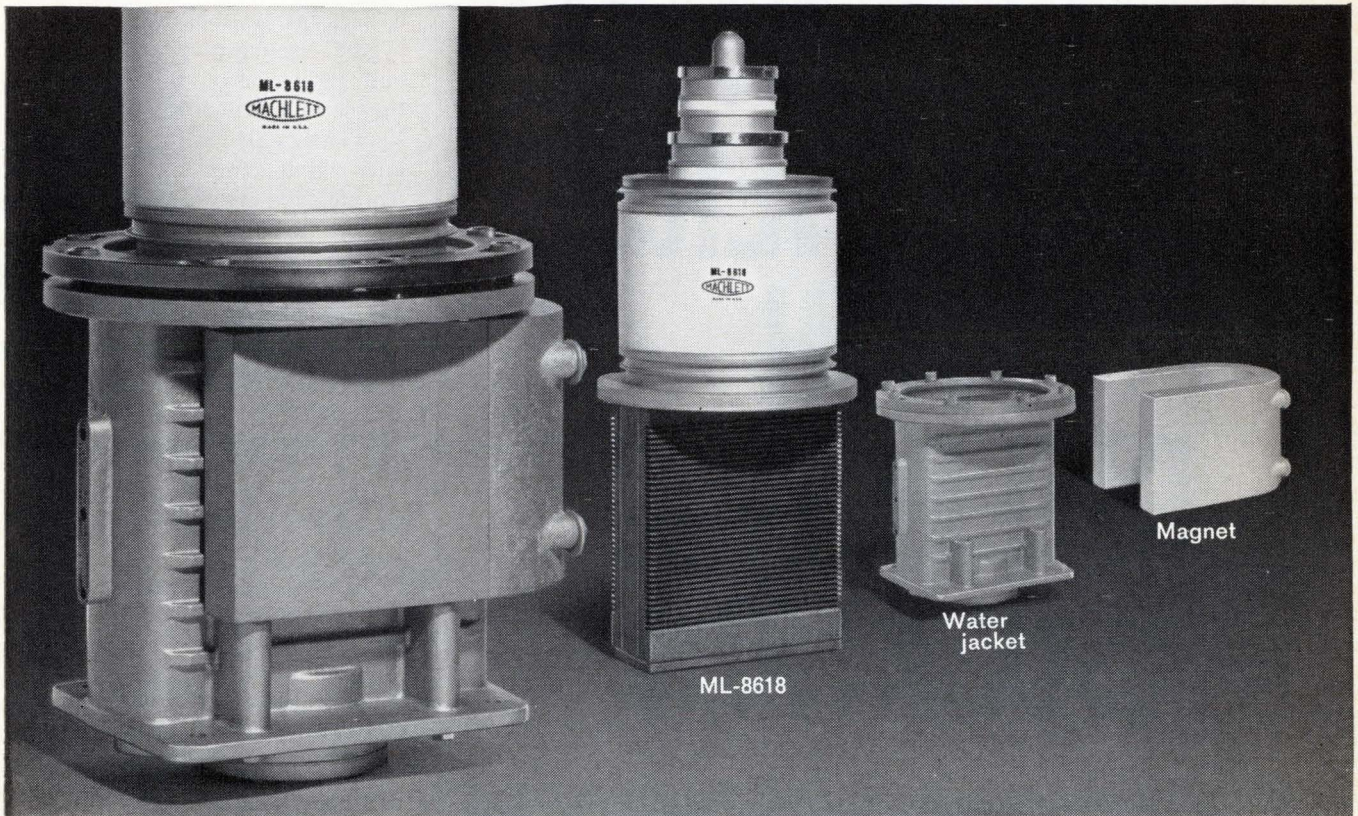

ML-8618, Machlett's new magnetically beamed water-cooled triode, provides high power gain, high plate efficiency and maximum cathode utilization. Electron trajectory from cathode to plate is magnetically controlled to greatly reduce electron interception by the grid . . . and therefore decrease grid current and heating and allow significantly higher performance levels.

**Result:** the ML-8618 delivers a typical 200 kW power output with .7 kW drive as a Class C rf amplifier or oscillator. As a switch tube in pulse modulators, it is capable of a maximum 8 Mw high duty pulse. For full operating details, write to The Machlett Laboratories, Inc., Springdale, Conn. 06879.

**RAYTHEON**

**THE MACHLETT LABORATORIES, INC.**

A SUBSIDIARY OF RAYTHEON COMPANY

**New from Sprague!**

# ISOLAYER<sup>★</sup> DIFFERENTIAL AMPLIFIERS WITH DIELECTRIC ISOLATION



**$V_{BE}$  voltage differential down to 3 mV  
Tight beta matching · Low capacitance**

	UD-2118	UD-2119	UD-2120	UD-2121
$BV_{CEO}$	50V	50V	30V	30V
$h_{FE}$	@ 10 $\mu$ A	80	80	40
	@ 1 mA	150	150	100
$ V_{BE1} - V_{BE2} $	3mV	5mV	3mV	5mV
$\Delta  V_{BE1} - V_{BE2} $	5 $\mu$ V/ $^{\circ}$ C	10 $\mu$ V/ $^{\circ}$ C	5 $\mu$ V/ $^{\circ}$ C	10 $\mu$ V/ $^{\circ}$ C
$C_{ob}$	2pF	2pF	2pF	2pF

**Sprague Electric also makes a broad line of standard differential amplifiers, pairs, quads, and Darlington amplifiers**

\*trademark For complete information, write to Technical Literature Service, Sprague Electric Co., 35 Marshall St., North Adams, Mass. 01247

## SPRAGUE COMPONENTS

TRANSISTORS  
CAPACITORS  
RESISTORS  
INTEGRATED CIRCUITS  
THIN-FILM MICROCIRCUITS  
INTERFERENCE FILTERS  
455-6124R1

PACKAGED COMPONENT ASSEMBLIES  
FUNCTIONAL DIGITAL CIRCUITS  
MAGNETIC COMPONENTS  
PULSE TRANSFORMERS  
CERAMIC-BASE PRINTED NETWORKS  
PULSE-FORMING NETWORKS



†Sprague and ® are registered trademarks of the Sprague Electric Co.

## People

tain an ultraviolet output from an ionized argon c-w laser.

Varian Associates is setting up a new division to cash in on what it sees as a booming market for light-sensing and light-emitting equipment. Varian calculates that the market is currently at \$50 million, but that it will double in five years, passing microwave and power grid tubes in importance. To direct this new activity in Palo Alto, Calif., Varian has lured Vienna-born **Wilfrid F. Niklas** from the Zenith Radio Corp.'s Chicago subsidiary, the Rauland Corp. [Electronics, Aug. 8, p. 109].



"Light sensing and emitting" is Varian's phrase for photodetectors and vidicon and orthicon television camera tubes, cathode-ray tubes, delay storage tubes and image intensifiers. The company had intended to call the activity "light sensing and display" when someone suggested that an "LSD division" might put Varian's image in the wrong light.

**War and peace.** There are rather obvious military advantages in using storage tubes—for information retention of bright displays—and image intensifiers, which convert an optical signal to electricity, amplify it and reconvert the result to light. "Guerrilla warfare has become so widespread in the past 20 years that night surveillance devices for the battlefield are more and more important," says Niklas. There are also applications in plant security and, according to Niklas, even in navigation. He suggests that an image intensification system might make it possible to do away with automobile headlights.

In medicine, where so much activity in electronics is directed today, Niklas wants to do more work with X-rays and nuclear techniques. He predicts great opportunities for light-sensing and emitting equipment.

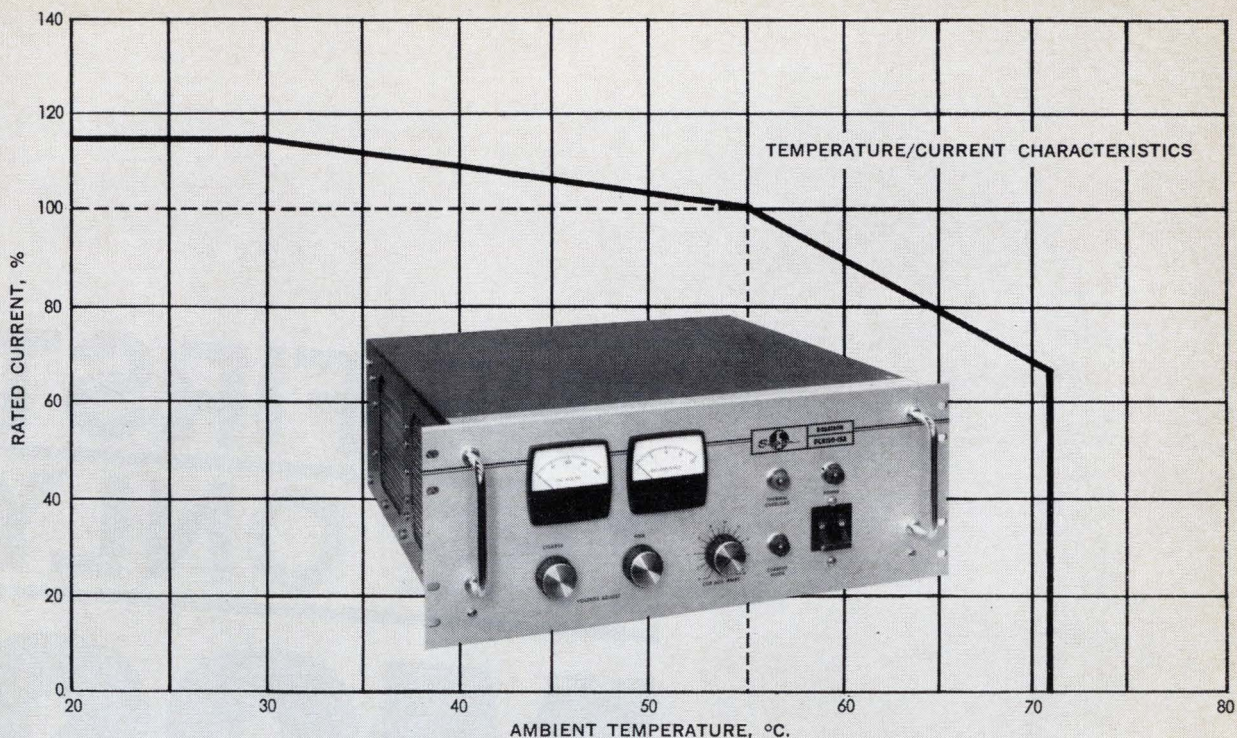

Sorensen DCR Series now with temperature capability to 71°C.

# Sorensen Wide Range Power Supplies to 20 kW.

Sorensen's wide range DCR Series has been up-dated and improved. What's new about the DCR's? They are now 100% silicon; ambient temperature capability is now to 71°C. • Four 3-phase models have been added extending power capability to 20 kW; 24 models are now available with ranges up to 300 volts. • Multiple mode programming—voltage/current/resistance. • Voltage regulation, line and load combined, is  $\pm 0.075\%$  for most models • Constant current range 0 to rated current. • DCR's meet MIL-I-26600 and MIL-I-6181

specifications and conform to proposed NEMA standards. • Front panel indicator for voltage/current crossover. These features of the improved DCR (model numbers will have an "A" suffix) are offered at no increase in price. For DCR details, or for data on other standard/custom power supplies, AC line regulators or frequency changers, call your local Sorensen rep, or write: Raytheon Co., Sorensen Operation, Richards Avenue, Norwalk, Connecticut 06856. Tel: 203-838-6571.

MODEL SELECTION CHART

Voltage	Amps.	Model	Price	Amps.	Model	Price	Amps.	Model	Price	Amps.	Model	Price
0-20	125	DCR 20-125A	\$1055	250	DCR 20-250A	\$1495	—	—	—	—	—	—
0-40	10	DCR 40-10A	325	20	DCR 40-20A	525	35	DCR 40-35A	\$ 710	60	DCR 40-60A	\$925
0-40	125	DCR 40-125A	1350	125	DCR 40-125A	1995	500	DCR 40-500A	2950	—	—	—
0-60	13	DCR 60-13A	525	25	DCR 60-25A	710	40	DCR 60-40A	900	—	—	—
0-80	5	DCR 80-5A	325	10	DCR 80-10A	525	18	DCR 80-18A	710	30	DCR 80-30A	875
0-150	2.5	DCR 150-2.5A	325	5	DCR 150-5A	525	10	DCR 150-10A	710	15	DCR 150-15A	825
0-300	1.25	DCR 300-1.25A	325	2.5	DCR 300-2.5A	525	5	DCR 300-5A	710	8	DCR 300-8A	825

RAYTHEON

**THE FIRST**  
**THE ONLY**  
**MOS**  
**DDA**

( Digital Differential Analyzer Integrator )

The MEM 5021 is a Digital Differential Analyzer Adder Element constructed on a single monolithic chip utilizing MOS P-channel enhancement mode transistors. This element when used in conjunction with a dual shift register forms a complete Digital Differential Analyzer Integrator (DDA) of ternary type. The DDA is designed to be used in parallel operation and performs rectangular integration. The DDA integrator can be used in a variety of control system applications or to solve any differential equation. **FEATURES:**

- Parallel, ternary integrator usable with any length shift register
- Arbitrary scaling
- Initial conditions easily inserted
- Biased or unbiased R remainder
- Adders are separate and can be used independently
- $\Sigma\Delta y$  is possible using additional elements
- Inputs protected against static damage



**FOREMOST**  
in SEMICONDUCTORS

Write for "Application Notes-MOS Integrated Digital Differential Analyzer."

**GENERAL INSTRUMENT CORPORATION**

600 West John Street, Hicksville, L.I., N.Y.

# available now

FROM GENERAL INSTRUMENT

MOS MOS MOS MOS MOS MOS MOS MOS MOS MOS

# ERRORS make us angry!

that's why we  
manufacture  
variable  
attenuators  
with error of less  
than 0.05 db\*

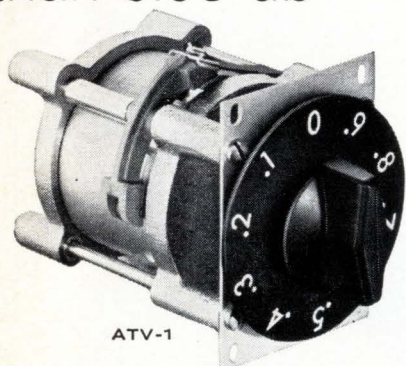

ATV-1

Think attenuators... say the words "Precision Performance"... and you must conclude Jerrold ATV-Series Turret Attenuators. Small, compact, they cost far less than you might expect.

Jerrold attenuators set the pace with intrinsic quality like coin-silver contacts for maximum conductivity, finest-quality deposited carbon disc and rod pad resistors for extreme accuracy, and positive spring-loaded detent mechanism for faultless resolution—in fact all the electrical features of "pull-and-turn" attenuators at one third the cost!

Model ATV-1,\* 0-0.9 db in 0.1 db steps (Fixed Attenuation 3 db), Accuracy  $\pm 0.05$  db at max. attenuation. \$275.00

Model ATV-9, 0-9 db in 1 db steps, Accuracy  $\pm 0.1$  db at max. attenuation. \$250.00

Model ATV-50, 0-50 db in 10 db steps, Accuracy  $\pm 0.5$  db at max. attenuation. \$195.00

Group this with 50 ohm impedance, VSWR of 1.06:1 at 1000 MHz (1.1:1 at 1200 MHz), low insertion loss .1 db maximum, and you come up with THE BEST BUY IN THE INDUSTRY! If you're operating DC to 1200 MHz... send for complete specs today.

**JERROLD**

MEASUREMENT AND  
TEST INSTRUMENTATION

JERROLD ELECTRONICS CORPORATION  
Government and Industrial Division  
Philadelphia, Pa. 19105

## Meetings

**Space Simulation Conference**, American Institute of Aeronautics and Astronautics, Institute of Environmental Sciences; Rice Hotel, Houston, Texas, Sept. 7-9.

**International Conference on the Physics of Semiconductors**, Physical Society of Japan, International Union of Pure & Applied Physics, Science Council of Japan; Kyoto Kaikan, Tokyo, Japan, Sept. 8-13.

**International Nuclear Industries Fair**, Swiss Industries Fair; Basel, Switzerland, Sept. 8-14.

**International Conference on Instrumentation for High Energy Physics**, International Union of Pure & Applied Physics; the Stanford Linear Accelerator Center, Stanford, Calif., Sept. 9-10.

**Eastern Convention on Aerospace and Electronics Systems**, IEEE, Washington Hilton Hotel, Washington, Sept. 12-14.

**Petroleum Industry Conference**, IEEE; Sheraton-Chicago Hotel, Chicago, Ill., Sept. 12-14.

**Electromagnetic Compatibility Conference, Society of Automotive Engineers**; Birmingham Airport Motel, Birmingham, Ala., Sept. 13-14.

**Assembly Meeting**, Radio Technical Commission for Aeronautics; Statler-Hilton Hotel, Washington, Sept. 14-16.

**Institute on Modern Solid-State Design Meeting**, National Aeronautics and Space Administration; University of Santa Clara, Calif., Sept. 15-16.

**Institute on Research Contracting**, the American University, the George Washington University; Twin Bridges Marriott Motor Hotel, Washington, Sept. 19-22.

**Conference on Tube Techniques**, IEEE; United Engineering Center Auditorium, New York, Sept. 20-22.

**Broadcast Symposium**, IEEE; Mayflower Hotel, Washington, Sept. 22-24.

**Communication Symposium**, IEEE; Cedar Rapids, Iowa, Sept. 23-24.

**National Conference on Non-conventional Energy Conversion**, IEEE; International Hotel, Los Angeles, Calif., Sept. 25-28.

**Joint Engineering Management Conference**, IEEE; Statler-Hilton Hotel, Washington, Sept. 26-27.

**Symposium on Gallium Arsenide**, British Institute of Physics, Air Force Avionics Laboratory and the Physical Society of England; Reading University, Berkshire, England, Sept. 26-28.

**Intersociety Energy Conversion Engineering Conference**, IEEE; International Hotel, Los Angeles, Calif., Sept. 26-28.

**Air Force Science and Engineering Symposium**, Air Force Systems Command; Arnold Air Force Base Development Center, Tennessee, Sept. 27-29.

**Instrument Society of America Conference & Exhibit**, Instrument Society of America; New York Coliseum, New York, Oct. 24-27.\*

**Machine Tools Industry Technical Conference**, IEEE; general application group; Sheraton-Schroeder Hotel, Milwaukee, Wis., Oct. 24-26.

**International Congress on Air Technology**, Valley Education and Research Foundation; Hot Springs, Ark., Oct. 26-29.

**Meeting of Metallurgical Society of American Institute of Mining, Metallurgical and Petroleum Engineers**; Sheraton-Chicago, Chicago, Ill., Oct. 30-Nov. 3.

**Technical & Electronic Ceramic Manufacturers Exhibit & Seminar**; New York Trade Show Building, New York City, Nov. 1-3.

## Call for papers

**Technical Meeting and Equipment Exposition**, Institute of Environmental Sciences; Washington, April 10-12. Oct. 1 is deadline for submitting papers to technical program committee, Institute of Environmental Sciences, 940 East Northwest Highway, Mount Prospect, Ill. 60056.

**International Scientific Radio Union Meeting**, U.S. National Committee of the International Scientific Radio Union; Cabana Motor Hotel, Palo Alto, Calif., Dec. 7-9. Oct. 1 is deadline for submission of 200-word abstracts to R.A. Helliwell, Radioscience Laboratory, Stanford University, Stanford, Calif. 94305.

**International Conference on Communications**, IEEE; Minneapolis, Minn., June 12-14. Dec. 1 is deadline for submission of a 50-word abstract and a 300-word summary to Robert J. Collins, technical program chairman, 1967 ComTech Meeting, department of electrical engineering, University of Minnesota, Minneapolis, Minn. 55455.

\* Meeting preview on page 16



AC metrology will never be the same after the Fluke 931A, the first true rms differential voltmeter. Measure the precise rms value of virtually any waveform within 0.05% from 30 Hz to 50 KHz. Overall frequency response is 10 Hz to 1 MHz. Range is 0.01 to 1100 volts. Ten to one crest factor accounts for effects caused by voltage spikes and pulse trains. Comes with or without probe. Both line or combination line/rechargeable battery powered versions are offered. Base price is \$895.

The new Fluke Model 931A True RMS Differential Voltmeter yields accurate rms measurements of any waveform which previously could be made only by ac to dc comparison with a thermal transfer standard. Other features include high input impedance, in-line digital readout (lighted decimal), solid state design, and linear recorder output.

The null meter indicates percent deviation from the dialed voltage.

Ten percent overranging minimizes range changing.

Battery operation gives ideal isolation from ground loops.

Model 931A meets MIL-SPEC shock and vibration requirements.

For complete information, please call your Fluke Sales Engineer or write.





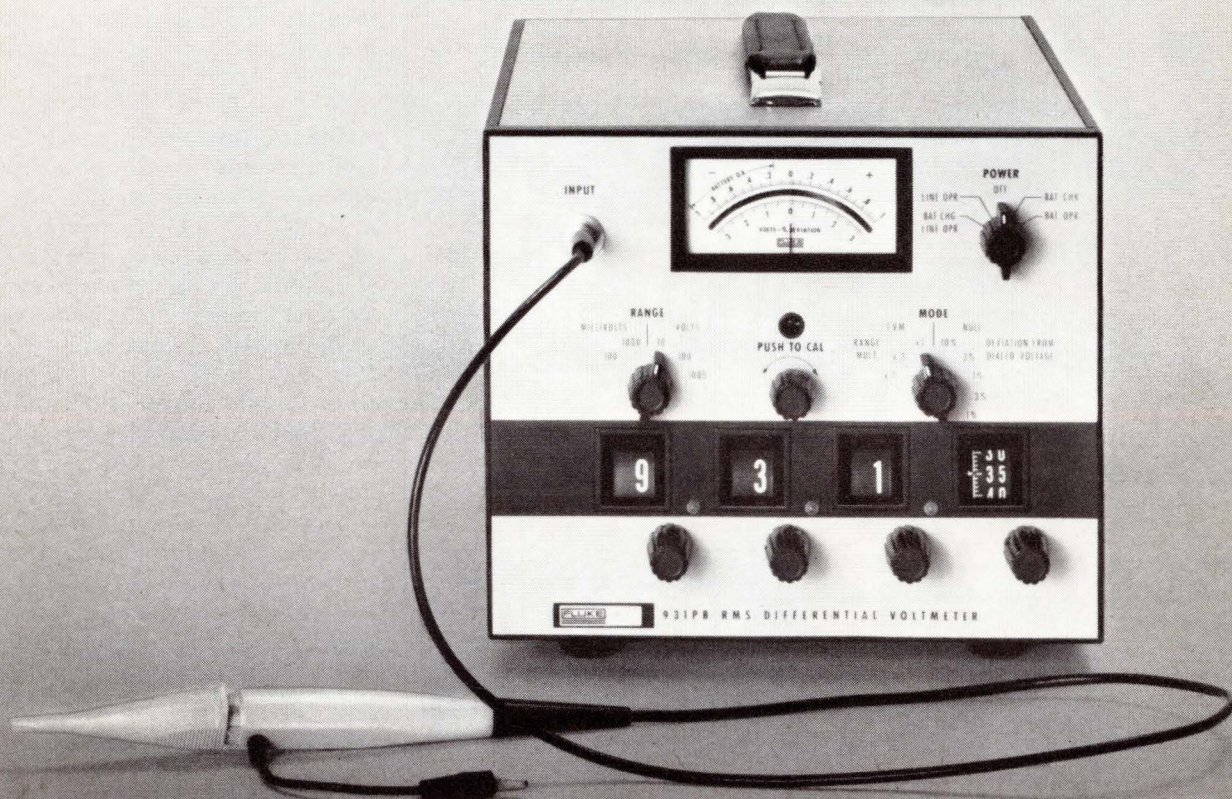









**FLUKE • Box 7428, Seattle, Washington 98133 • Phone: (206) 776-1171 • TWX: (910) 449-2850**



# All from Sprague!

## TWELVE OF OUR MOST POPULAR METALLIZED CAPACITOR TYPES

SPRAGUE TYPE	Case And Configuration	Dielectric	Temperature Range	Military Equivalent	Eng. Bulletin
 680P	hermetically-sealed metal-clad tubular	metallized Metfilm* 'A'	-55 C, +85 C	no specification	2650
 431P	film-wrapped axial-lead tubular	metallized Metfilm* 'E' (polyester film)	-55 C, +85 C	no specification	2445
 155P, 156P	molded phenolic axial-lead tubular	metallized paper	-40 C, +85 C	no specification	2030
 218P	hermetically-sealed metal-clad tubular	metallized Metfilm* 'E' (polyester film)	-55 C, +105 C	CH08, CH09 Characteristic R	2450A
 260P	hermetically-sealed metal-clad tubular	metallized Metfilm* 'K' (polycarbonate film)	-55 C, +105 C	no specification	2705
 121P	hermetically-sealed metal-clad tubular	metallized paper	-55 C, +125 C	no specification	2210C
 118P	hermetically-sealed metal-clad tubular	metallized Difilm® (polyester film and paper)	-55 C, +125 C	CH08, CH09 Characteristic N	2211D
 143P	hermetically-sealed metal-clad "bathtub" case	metallized paper	-55 C, +125 C	no specification	2220A
 144P	hermetically-sealed metal-clad "bathtub" case	metallized Difilm® (polyester film and paper)	-55 C, +125 C	CH53, CH54, CH55 Characteristic N	2221A
 284P	hermetically-sealed metal-clad rectangular case	metallized paper	-55 C, +105 C	no specification	2222
 283P	hermetically-sealed metal-clad rectangular case	metallized Difilm® (polyester film and paper)	-55 C, +125 C	CH72 Characteristic N	2223
 282P (energy storage)	drawn metal case, ceramic pillar terminals	metallized paper	0 C, +40 C	no specification	2148A

\*Trademark

For additional information, write Technical Literature Service, Sprague Electric Company, 35 Marshall St., North Adams, Mass. 01247, indicating the engineering bulletins in which you are interested.

### SPRAGUE COMPONENTS

CAPACITORS  
TRANSISTORS  
RESISTORS  
THIN-FILM MICROCIRCUITS  
INTEGRATED CIRCUITS  
INTERFERENCE FILTERS  
48C-6135

PACKAGED COMPONENT ASSEMBLIES  
FUNCTIONAL DIGITAL CIRCUITS  
MAGNETIC COMPONENTS  
PULSE TRANSFORMERS  
CERAMIC-BASE PRINTED NETWORKS  
PULSE-FORMING NETWORKS



\*Sprague and ® are registered trademarks of the Sprague Electric Co.

## Meeting preview

### Instrumented society

Three talks on the instrumentation needed in traffic control, pollution and biomedicine will highlight the 21st annual international conference and exhibit of the Instrument Society of America. The meeting will be held at the Coliseum in New York City, Oct. 24-27.

These subjects will be pursued in several of the 38 technical sessions scheduled. The rest of the sessions concentrate on instrumentation for specialized industrial problems, control systems, aerospace applications and oceanology.

**Student project.** Electrical engineering students from the University of Michigan will describe a proposal to automate highways. As a class project the students designed a system with magnetic devices buried in the pavement. Under the plan the magnets sense the presence and speed of vehicles and pass the information to small computers; the computers then calculate the proper commands to control the vehicles' acceleration, braking and steering. The students estimate that the system would sharply increase highway capacity by permitting cars to travel safely, five feet apart, at speeds up to 70 miles an hour. Aside from the cost of the automobile control equipment, the highway installation costs are estimated at \$50,000 a mile for intercity highways and about \$1 million a mile for intracity roads.

**Other sessions.** Two symposiums, sponsored by professional groups within the instrument society, will be held concurrently. The plenary session of the measurement standards instrumentation symposium will weigh effects of switching to the metric system in the United States. Allen V. Astin, director of the National Bureau of Standards, will review the problems U.S. business already faces because so many countries use the metric system.

The second symposium, on physical and mechanical measurement instrumentation, will treat the subject of instrumentation for urban problems, such as transportation, water and power supply, air pollution, waste disposal, fire fighting and law enforcement.

# gnitseT

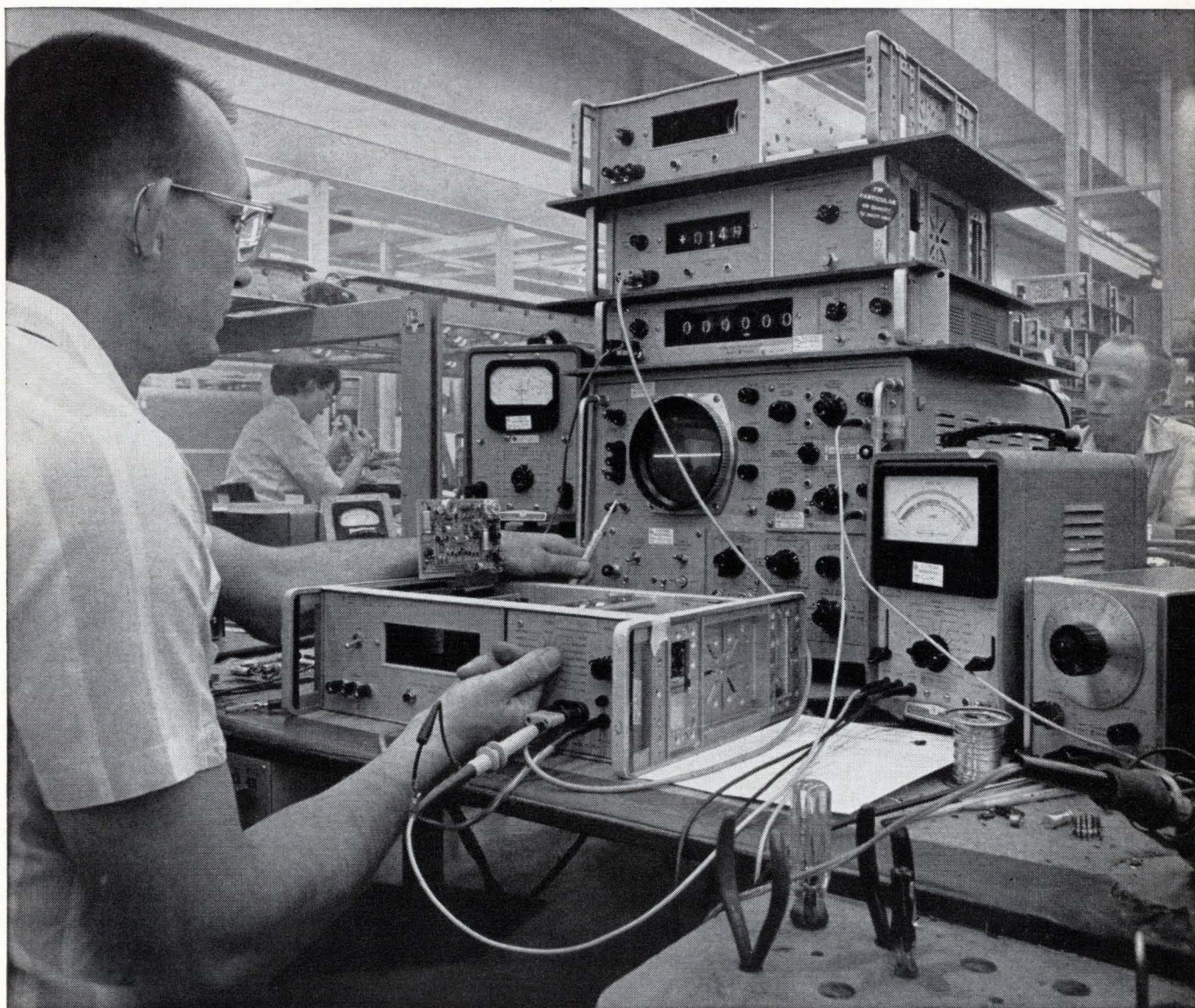

That's "testing" backwards. And that's what we do to every Hewlett-Packard 3439A and 3440A. Test it forwards, backwards, inside and out. ■ Here you see it going through complete testing and calibration after assembly. Every circuit board is checked, and then the entire instrument is calibrated to be sure it meets specifications. ■ But that's just the beginning. From here it goes into a 50°C "oven" for an overnight cycling. On, off, on, off, all night long. Then we recheck it the next day. If any failures show up, they're fixed. And the testing starts all over again. Finished? Not yet. ■ We test it once more at Quality Assurance before it goes into stock. ■ We go through a lot of trouble with your DVM. That's why

you have so little trouble with it. ■ By the time it leaves our plant, we have enough faith in each 3439A and 3440A that we're willing to back it up with a year's guarantee. Ours is a confidence you don't find with other manufacturers. But then, they don't have the 3439A and 3440A either. ■ After testing it forwards and backwards, we're not afraid to get behind it. ■ The 3439A. Solid state. 4-digit readout.

Manual, automatic and remote ranging. Extra-high sensitivity. Ac/dc voltage/current resistance measurements (dc accuracy better than  $\pm 0.05\%$  of reading  $\pm 1$  digit). Price, \$950. The 3440A has BCD output. Price, \$1160. Plug-ins, \$40 to \$575.

*Data subject to change without notice.  
Prices f.o.b. factory.*

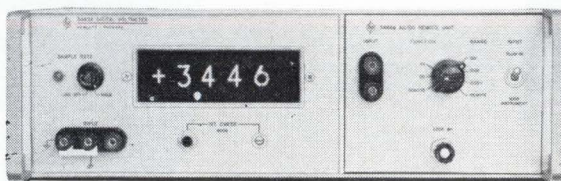

**HEWLETT**  **PACKARD**  
An extra measure of quality

**We couldn't find these  
computer-quality relays on the market.  
So we had to design our own.**

**Here's what they offer you.**

**IBM Wire Contact Relays—200  
million operations at 45¢ per pole**

Solderless connections, multiple coils, compactness and standardized mountings give you lower manufacturing costs, lower initial product costs, lower product servicing costs.

Also high operate speed—as fast as 4 ms; fast release time—under 5 ms; versatile contact arrangements—4, 6 and

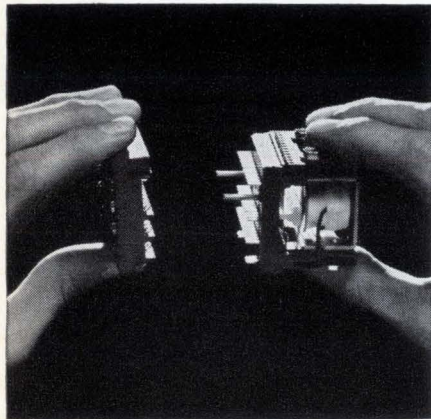

12 PDT, Form C, 4 and 6 PDT latch; maximum reliability—1 error per over 400 million contact closures at 48 VDC is attainable; variable coil voltages—up to 100 VDC.

IBM 12-pole wire contact relays start at \$5.40, 4-poles at \$2.90, latch relays at \$8.45 (even less in quantity).

**Permissive-Make Relays—high  
speed and virtually no bounce**

To design this kind of relay, we turned to a computer for help.

The result was a unique contact spring configuration as a basis for assembly—the “permissive-make”. Its bounce is less than 50 microseconds. Its speed is as fast as 2.0 milliseconds. What's more,

Typical bounce characteristics of the IBM permissive-make relay appear at the right. Time base is 20 microseconds per centimeter—amplitude base is 0.5 volts per centimeter.

this relay has an exceptionally long, *adjustment-free* life—over 400 million operations.

Permissive-make relays are well worth considering for counting, logic switching, switch registers and timing circuits.

The cost: \$6.50 for 4-pole, Form C permissive-make relays; \$7.75 for the 6-poles. Incidentally, IBM permissive-make relays minimize maintenance time and costs. That's because they're

pluggable—just like our wire contact relays.

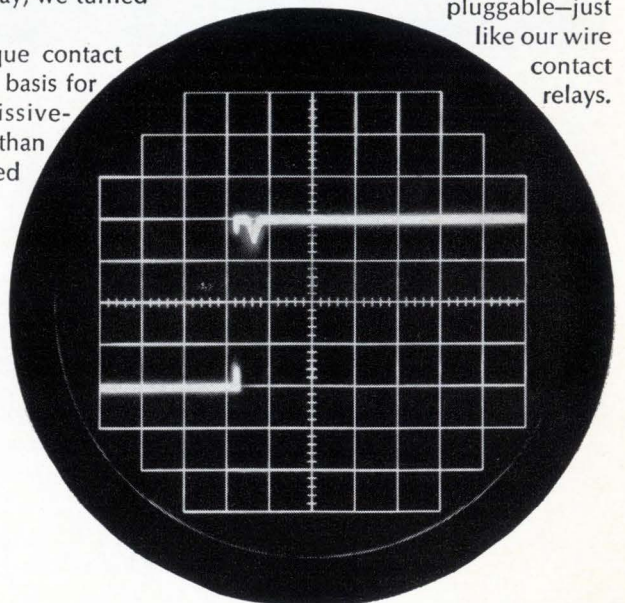

### Reed Relays—miniaturized and pluggable too

Newest of the IBM relays, the reed relays are especially suitable for interfacing relay logic and transistor circuitry.

They have an operate time of 1 ms or less, an operate time variation of 0.5 ms, a release time of 100 microseconds. And, every reed relay is electronically inspected *after* assembly to insure long, trouble-free life.

These miniature relays are available in 1, 2, 4 and 6-pole Form A and B configurations; plus various combinations with either single or double coils. Prices range from \$3.00 to \$8.55 for Form A packages (always lower in quantity).

The IBM miniature dry reed switch serves as the heart of the reed relays, and is now double plated, rhodium over gold, to give you low noise characteristics.

They provide long life (up to 125 million operations—mean time to first

error) and low contact resistance (less than 100 milliohms throughout life).

For highly consistent performance we *dynamically* set the air gap between

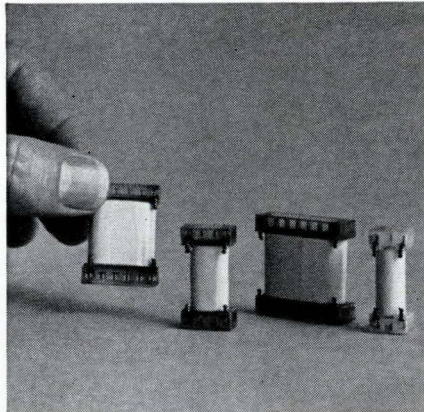

the reeds. This means a stable sensitivity of  $\pm 7$  NI (maximum) in every reed switch.

For illustrated literature on any of these products, write: IBM Industrial Products, 1000 Westchester Avenue, White Plains, New York 10604.



**LOOK TO THE LEADER**  
IN INTEGRATED CIRCUITS

# TEST THE BEST... WITH 50

## *before you buy... try TI's new*

Our proposition is simply this:

We'll give you 50 molded TI integrated circuits with each order of 1000 units or more placed before November 1, 1966.

Do anything you like with these samples . . . hammer them . . . test to destruction . . . wire into your circuits . . . soak in boiling water . . . compare with any others. Prove to yourself that they're best — by test!

**Money-back guarantee**—If you're still not convinced that TI molded integrated circuits do your job better than any competitive types available, just return the unused circuits. We'll give you full credit for them. This offer is good for 60 days from date of any order placed before November 1, 1966.

**Offer includes popular series** — Devices included in this offer are the popular digital circuits from the 930-type DTL and Series 74 TTL families shown below right. Series 74 TTL is first choice of many designers for new equipment. Circuits in this line typically are 48% faster, have 25% higher fan-out and 15% better noise margin than DTL . . . at competitive prices.

Whether your system design calls for DTL or TTL circuits, you'll find a wide selection of single and multiple gates and flip-flops available. With either series, high-speed logic is now available to you at lower prices per function than ever before.

**Rugged design proved by test** — TI molded integrated circuits offer outstanding durability. The rugged, high-density package is molded from the same encapsulant used in millions of SILECT™ transistors and is backed by over 2,000,000 actual hours of test. Resistance to impact, heat and moisture are further borne out by successful testing to the following rigorous schedule: *Thermal Shock* — MIL Std. 750, Method 1056A; *Temperature Cycling* — MIL Std. 750, Method 1051, *Moisture Resistance* — MIL Std. 202C, Method 106B, *Hydropressure* — 3% JOY, 110 PSI for four hours.

**Exclusive features save you money** — You realize big reductions in total manufacturing costs with TI molded integrated circuits because they are specifically designed for use in automatic handling, assembly and test facilities. Exclusive features such as the positive index notch, pretinned leads and side-mounted lead design make it possible. Even the cartridge-type shipping container lends itself to automated production line use.

**Fast delivery** — Deliveries of TI molded integrated circuits are prompt . . . prototype shipments can typically be made within days. And TI's high production rates assure *continued* availability to meet your most critical production schedules.

To obtain your 50 free evaluation samples immediately, just place your order with any TI sales office or authorized TI distributor.

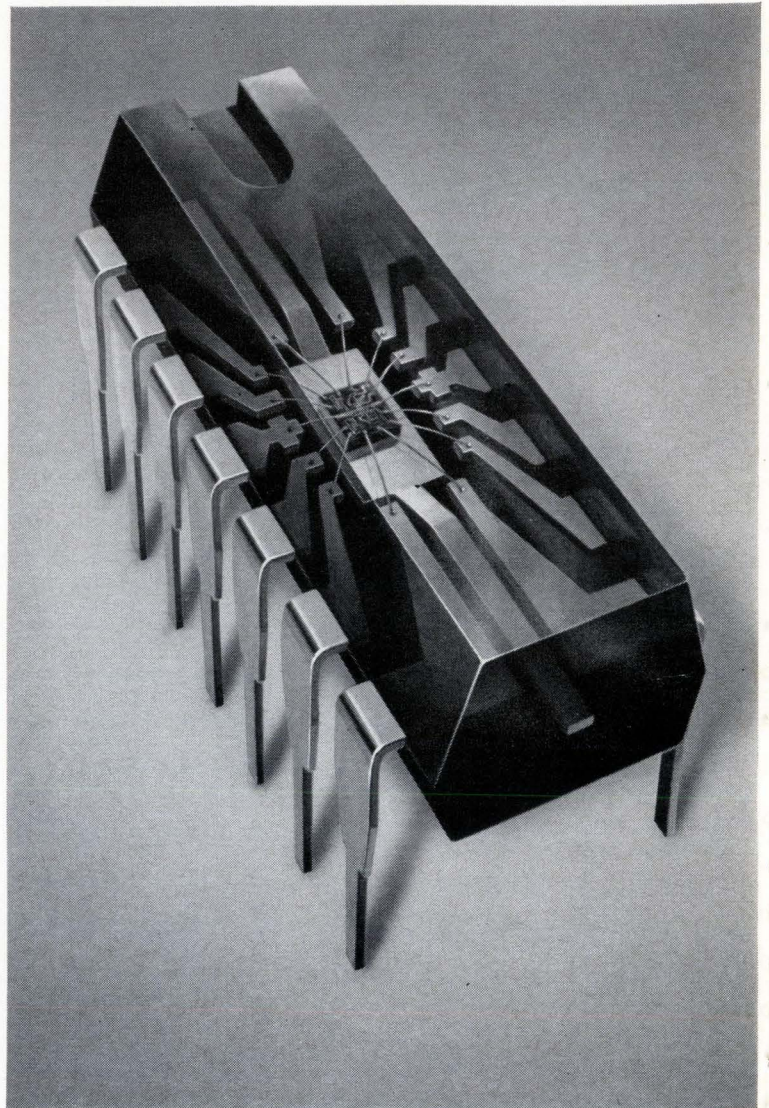

### All these devices are included—

	<b>Series 74 TTL</b>		
	<b>0° to 70°C Operating Temp.</b>		
SN7400N	Quad 2-input NAND Gate	SN7460N	Dual 4-input expander
SN7410N	Triple 3-input NAND Gate	SN7470N	Single-phase Flip-flop
SN7420N	Dual 4-input NAND Gate	SN7472N	Master-slave J-K Flip-flop
SN7430N	3-input NAND Gate		<b>930 Type DTL</b>
SN7440N	Dual 4-input NAND		<b>0° to 70°C</b>
	"power" Gate	SN15830N	Dual 4 Nand Gate
SN7450N	Expandable Dual	SN15831N	RS/JK Flip-flop
	AND-OR-INVERT Gate	SN15832N	Dual 4 Buffer
SN7451N	Dual AND-OR-INVERT Gate	SN15833N	Dual 4 Expander
SN7453N	Expandable 2-input 4-wide	SN15844N	Dual 4 Power Gate
	AND-OR-INVERT Gate	SN15845N	RS/JK Flip-flop
SN7454N	2-input 4-wide	SN15846N	Quad 2 Nand Gate
	AND-OR-INVERT Gate	SN15850N	Pulsed AC Flip-flop
		SN15851N	One Shot
		SN15862N	Triple 2 Nand Gate

# FREE SAMPLES FROM TI

## *molded integrated circuits*

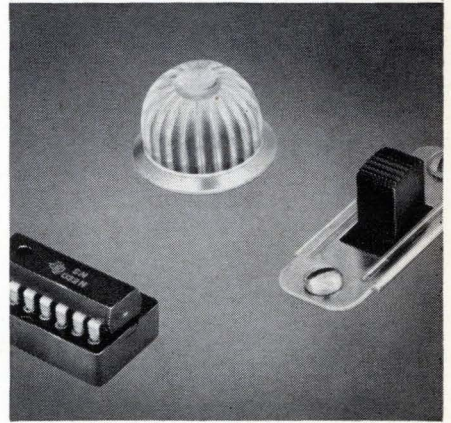
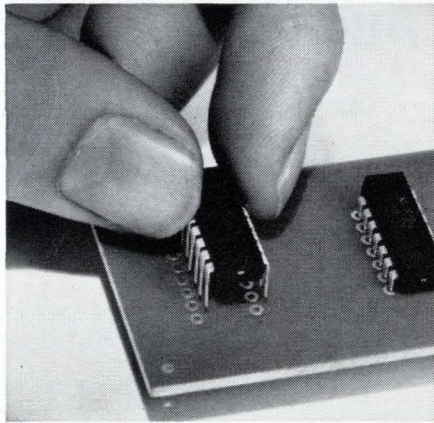
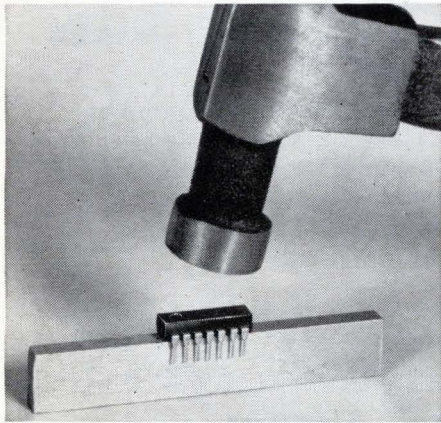
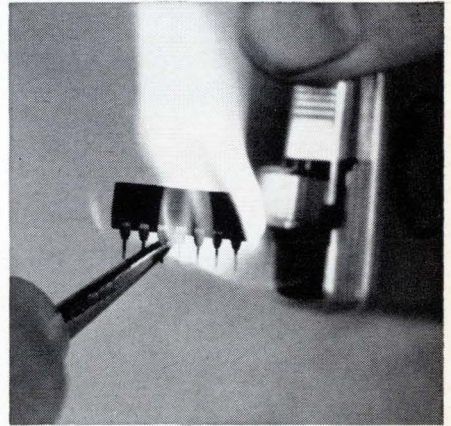
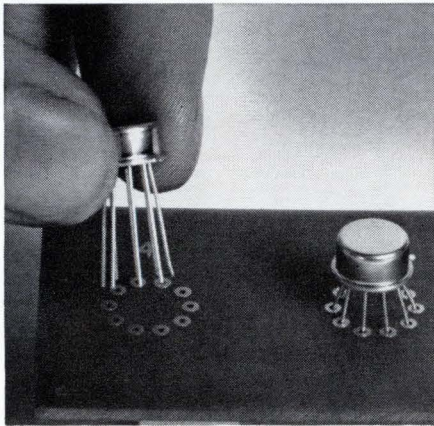
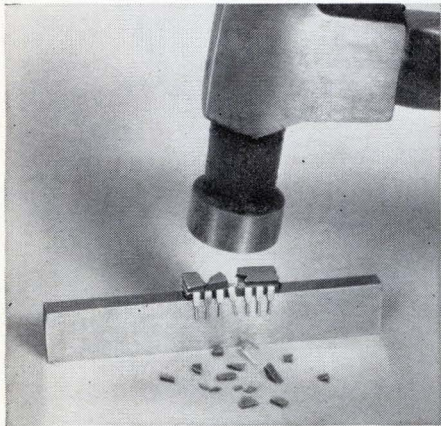

**RESISTS SHOCK...** TI molded integrated circuits resist impacts that would smash metal packages and shatter ceramic packages as shown in top photo. You benefit from fewer failures in handling accidents and greater reliability in service. The solid molded construction gives extreme resistance to acceleration, vibration and shock as proven in actual test (see opposite page).

**EASY TO ASSEMBLE...** TI molded integrated circuits are ideal for mechanized assembly, including automatic insertion and wave soldering. Faster, easier handling cuts total manufacturing costs. You realize big savings because of the in-line rigid lead pattern and convenient indexing notch. These features simplify assembly when compared with transistor-type circular lead packages.

**RESISTS DAMAGE...** You also realize savings from fewer rejects while achieving higher end-product quality because TI molded integrated circuits have outstanding durability. For instance, they'll hold up to heat that would induce failures in many competitive devices. Result: fewer assembly rejects due to high soldering temperatures.

**SEE THESE TESTS FOR YOURSELF! CALL YOUR TI SALES ENGINEER**



**TEXAS INSTRUMENTS**  
**INCORPORATED**  
 13500 N. CENTRAL EXPRESSWAY  
 P. O. BOX 5012 • DALLAS 22, TEXAS

SEMICONDUCTOR PLANTS IN BEDFORD, ENGLAND • NICE, FRANCE • FREISING, GERMANY • DALLAS, TEXAS

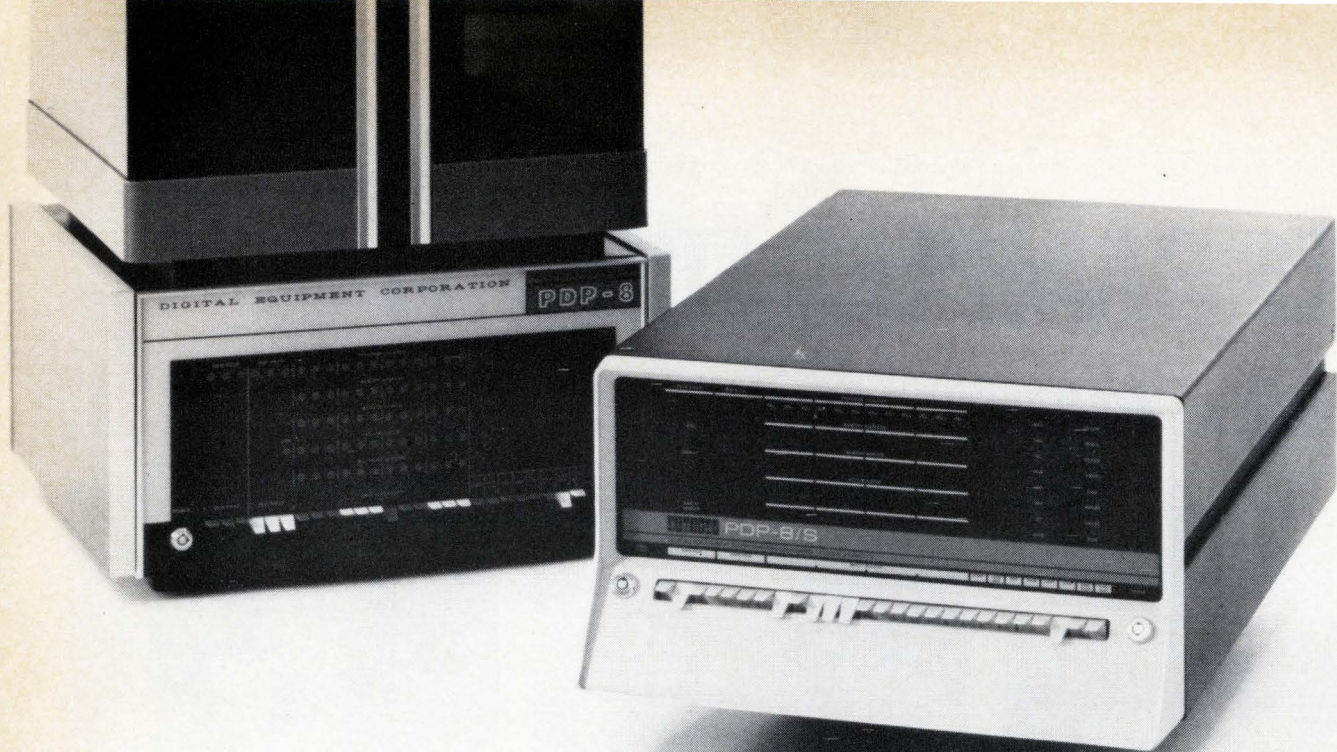

## And Now, the \$10,000 Computer

**PDP-8/S: A new high speed general purpose digital computer. Modular construction for repackaging. Field proven reliability. 4,096 word core memory. Microsecond speeds. Complete software including FORTRAN. Flexible input/output bus. Deliverable 90 days ARO. Teletype included.**

The single unit price for the PDP-8/S is \$10,000, and there are liberal OEM discounts for multiple units.

Designed to be used in instruments or systems, the PDP-8/S can be rack mounted or repackaged.

The new PDP-8/S is a close relation of DIGITAL's PDP-8, the most successful on-line, real time computer in the history of the scientific community. At a base price of \$18,000, more than 500 PDP-8 systems have been sold. Its success results from a design concept that makes it the most flexible, versatile, adaptable digital computer ever made.

The PDP-8/S uses the same programs, the same instructions, the same operations, and the same basic design as the parent PDP-8. It has the same size memory, is equally expandable, and indeed, uses the same line of modules and components.

But the PDP-8/S is a bit slower. It takes 32 microseconds to add. For process control and analysis, you probably won't even notice.

But you'll notice the price.

**digital**  
COMPUTERS • MODULES



---

**Editorial**

---

## Custom IC's; a losing game

**Apparently integrated circuit** makers have everything going their way: boom business with rapidly rising sales and unexpected profits. But in one part of the microcircuit business, makers are "losing their shirt," as Robert Noyce, group vice president of Fairchild Camera & Instrument describes it. Almost every company is racking up giant losses in the custom manufacturing business—that part of the industry in which a semiconductor company designs and tests a special circuit for a particular function of a specific customer.

So many people in other semiconductor companies are echoing Noyce's evaluation that a major upheaval is brewing in the way new circuits are created.

The semiconductor companies are dropping their traditional insistence that they should have all the IC know-how and engineer and build circuits for customers and prospects. Instead, the firms want to transfer the design job at least to their customers' engineering staffs.

What's happened is perfectly clear-cut and painful. A semiconductor firm approaches a potential user and offers to design an IC exclusively for the customer, provided that future volume production is supplied by the designing firm. Once the circuit is designed, the semiconductor firm has a lock on that customer's business. But it rarely works that way. Too often, the semiconductor firm produces an IC that just fails to meet the customer's requirements or costs more than anticipated. So the customer walks away with a sample order of maybe a hundred circuits and the semiconductor firm painfully swallows an engineering bill that can run as high as \$50,000.

Efforts to remedy the situation haven't worked so far. For example, at the Signetics Corp., president James Riley has set some stiff criteria for custom work. "We don't accept a job unless there is the prospect of producing at least 25,000 circuits a month for a minimum of one year," he says. But Riley grudgingly admits some jobs have never gotten to the production stage even though a volume com-

mitment was made when work started. "The chances for success on a customer circuit project are no better than 50-50," according to Steven Levy, manager of operations at Motorola's integrated circuit department.

The solution the semiconductor companies would like to see is the acceptance of standard circuits by users of IC's. But almost everybody in the field admits that far too many customers will never buy such an idea. Too many companies feel as Hewlett-Packard Corp. does: Its proprietary edge comes from having a unique circuit; that is lost if its equipment is built with circuits anybody else can buy. At the Teledyne Corp., a user of IC's, vice president Teck A. Wilson, also casts a dissenting vote: "If you standardize on a circuit everybody can build, you've standardized on what is obsolete."

As large scale integration becomes commercially feasible—the next technological advance in microcircuits—the problem becomes even worse for semiconductor companies. "Chances that any other customer could use a large, array we've designed for a specific job are nil," complained one executive.

Still, the semiconductor companies have about run out of patience with their big losses in the custom circuit business. Some plan to make the customer pay all the design costs, a move that would at least double the fees charged for this service. Another step will be to do more computer-aided design, to reduce the amount of engineering in a circuit.

Fairchild's Noyce believes it will be possible to standardize on a low level of integration and build in proprietary circuits by ingenious wiring devised by a computer.

But the answer that is being offered more and more is to turn the job completely back to the customer. What the semiconductor companies want to do is work from a completed design: prepare the masks and then perform processing and testing.

Thus, the engineers who build equipment that uses IC's will have to know the limitations and capabilities of integrated circuits. The problem is complicated because the design constraints of any one manufacturer's IC processing are different from those of any other.

For the first time a pattern is evolving that plots how the acceptance of integrated circuits will affect the structure of the electronics industry. For a time, many people feared that the semiconductor companies would dominate electronics because the maker of the IC was also the designer. Now it seems clear that the maker of IC's will play the role of just another component supplier, albeit a very sophisticated one.

# CLIFTON

## steps in to the Stepper Motor field

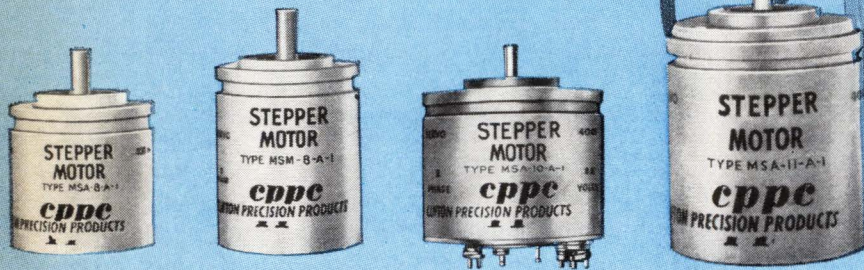
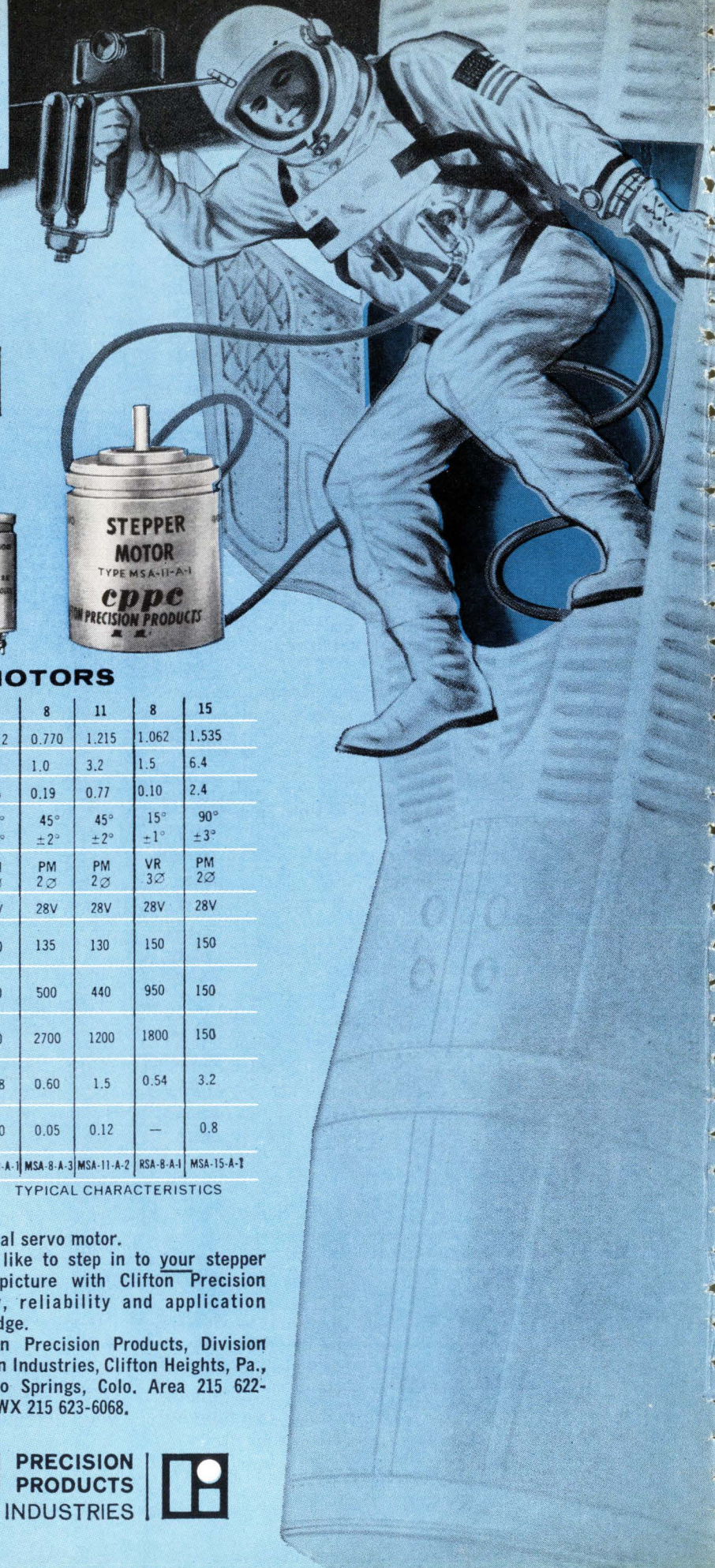

### CLIFTON STEPPER MOTORS

SIZE	8	10	11	11	8	8	8	11	8	15
LENGTH (M.F.)	0.770	0.770	1.215	1.215	1.062	1.112	0.770	1.215	1.062	1.535
WEIGHT (OZ.)	1.0	1.6	3.2	3.2	1.5	1.5	1.0	3.2	1.5	6.4
INERTIA (GM-CM <sup>2</sup> )	0.19	0.19	0.77	0.37	0.18	0.45	0.19	0.77	0.10	2.4
INDEX ANGLE	90° ±3°	90° ±3°	90° ±3°	15° ±1°	90° ±3°	90° ±3°	45° ±2°	45° ±2°	15° ±1°	90° ±3°
TYPE	PM 2∅	PM 2∅	PM 2∅	VR 3∅	PM 2∅	PM 2∅	PM 2∅	PM 2∅	VR 3∅	PM 2∅
RATED D.C. VOLT.	28V	28V	28V	28V	28V	28V	28V	28V	28V	28V
RESISTANCE (OHMS/PHASE)	300	300	300	150	300	300	135	130	150	150
NO LOAD RESPONSE RATE PULSE/SEC	320	350	185	600	360	280	500	440	950	150
NO LOAD SLEW RATE PULSE/SEC	930	700	190	1600	375	650	2700	1200	1800	150
HOLDING TORQUE OZ-IN ONE PHASE	0.35	0.50	1.4	0.60	0.80	0.58	0.60	1.5	0.54	3.2
DETENT, OZ-IN ZERO INPUT	0.05	0.05	0.24	—	0.17	0.10	0.05	0.12	—	0.8
TYPE NUMBER	MSA-8-1	MSA-10-A-1	MSA-11-A-1	RSA-11-A-1	MSM-8-A-1	MSL-8-A-1	MSA-8-A-3	MSA-11-A-2	RSA-8-A-1	MSA-15-A-1

EXCITATION MODE: TWO PHASES PARALLELED ALTERNATELY. TYPICAL CHARACTERISTICS

After careful testing and having already had units in end-use equipment in the field, we are now ready to announce a full line of size 8, 10 & 11 stepper motors and the controllers that go with them.

Steppers are gaining popularity rapidly in digital systems because of their quick response, high resolution, and many other distinct advantages over the con-

ventional servo motor.

We'd like to step in to your stepper motor picture with Clifton Precision quality, reliability and application knowledge.

Clifton Precision Products, Division of Litton Industries, Clifton Heights, Pa., Colorado Springs, Colo. Area 215 622-1000; TWX 215 623-6068.

---

# Electronics Newsletter

---

September 5, 1966

## Los Angeles keeps IBM computer and orders another

Los Angeles has partially resolved its data-processing dilemma: it's decided to keep its International Business Machines Corp. System 360 model 30 even though the computer isn't yet working at expected speeds. The city, however, had no other choice; had it sent the troublesome machine back to IBM, it would have been months before a replacement computer would have been ready. In deciding to keep the model 30, Los Angeles went one step further: **it committed itself to accept, in addition, a model 40, scheduled for delivery by Nov. 1** [Electronics, July 11, p. 129].

Los Angeles continues to charge IBM \$100 a day because software delivery has been delayed. And it has agreed to give the company more time to correct the fault with the data cell drive, which is a bulk-storage unit that can hold up to 400 million characters on strips of magnetic tape, kept in compartments, or cells, each containing 200 strips.

## Comsat's tests of time division complete success

The Communications Satellite Corp. last month successfully completed the first test of time division multiple access with the Early Bird satellite [Electronics, June 27, p. 46]. John Puente, a staff member in Comsat's modulation technique department, said, "Tests were absolutely successful in every category—more successful than we expected."

Voice and data signals were transmitted between terminals at Andover, Maine, and Mills Village, Canada. The voice and data were first combined as pulse-code modulation signals. These signals then modulated carrier frequencies which were time division multiplexed by alternately stopping and starting the transmission in each terminal.

Puente would not reveal the minimum guard time—which prevents signal overlapping—used in the experiment, **but said that it was much less than 1 microsecond and that the test equipment was capable of measuring time intervals of 40 nanoseconds.**

Comsat now plans to test a 600-channel time-division system.

## Navy to bounce signals off moon

Tests leading to the first operational use of the moon as a passive satellite to relay microwave Teletype messages in ship-to-shore communications are scheduled to begin this month. The \$1.3-million shipboard system, built by the Lockheed Electronics Co., Plainfield, N.J., uses state-of-the-art transmission techniques coupled with elaborate aiming equipment to keep the 16-foot dish antenna pointed at the moon while the ship moves. Ground terminals for artificial satellite communications will be employed in the test, but **Lockheed has a contract to build four ground terminals for the moon-bounce system.** Lockheed is a subsidiary of the Lockheed Aircraft Corp.

The Navy and Lockheed decline to say how extensively the system will be used. Several shipboard units are on order, however, **and it is believed that they will be deployed on vessels around the world.** The system is to be operational by 1967. The system can simultaneously transmit and receive wideband carrier, frequency-shift telegraphy of 76 baud over two Teletype channels or one continuous-wave telegraphy channel.

The principal advantage in using the moon as a passive reflector is

---

# Electronics Newsletter

---

that microwave line-of-sight techniques can overcome conditions in the atmosphere and ionosphere that interfere with long-range communication at medium and high frequencies.

## O'Neal getting Pentagon R&D job

Russell D. O'Neal, a 52-year-old physicist, is being nominated as Assistant Secretary of the Army for research and development, succeeding Willis M. Hawkins Jr., who recently resigned to become a vice president of the Lockheed Aircraft Corp. O'Neal was vice president for engineering and research at the Bendix Corp. He is a specialist in microwave radar test equipment, computer design and guided missiles.

## Sylvania East cuts staff

The technical employment picture is not all rosy. Sylvania Electronic Systems East, in Waltham and Needham, Mass., laid off 175 employees this week because of a lack of work. They include engineers and technicians in addition to contracts and production personnel. The employment level there is now at 4,200. Sylvania Electronic Systems has overall responsibility for systems management of major Government projects for the parent company, the General Telephone & Electronics Corp.

While the Eastern operation is cutting back in personnel, the Central operation, in Buffalo, N.Y., and the Western operation, in Mountain View, Calif., are recruiting. A Sylvania spokesman says major contracts are "in the wings." He describes the cutback as a temporary lull.

## New horizons

The Raytheon Co. moves into a new area of commercial diversification with the acquisition of the Seismograph Service Corp. of Tulsa, Okla., whose major business is exploration for oil and other natural resources. Raytheon follows such companies as the Ampex Corp. and Teledyne, Inc., in entering the seismograph business.

## Air Force briefings to forecast needs for next 5 years

A secret briefing for industry, scheduled Oct. 18 to 20 in Boston, will spell out what the Air Force will need in command-and-control equipment two to five years from now.

"Industry doesn't want us to tell it what's coming the next eight months, or a year. We'll try to provide a background for planning beyond the work that is now on their books," says William J. Sen of the advanced planning staff at the Electronic Systems Division, Hanscom Field, Mass. The division and the National Security Industrial Association are cosponsors of the meeting. Reports on advanced technology at Rome Air Development Center, N.Y., and Wright-Patterson Air Force Base, Ohio, also will be included.

The information will be aimed at three kinds of company planners: directors of marketing, systems planning and research and development. It will include strategic and tactical defense systems, sensors, data processing, displays and trends in missile range technology. The sessions will provide more detail than the Defense Department briefings earlier this year. A subcommittee of the Defense Industry Advisory Committee has been set up to provide the Pentagon with feedback on the merits of service briefings of this kind.

Not all the sessions in Boston will be looking ahead. The final one will be a post mortem on existing systems: it too will be secret.

# Announcing the Brush Mark 250, first strip chart recorder for the perfectionists of the world.

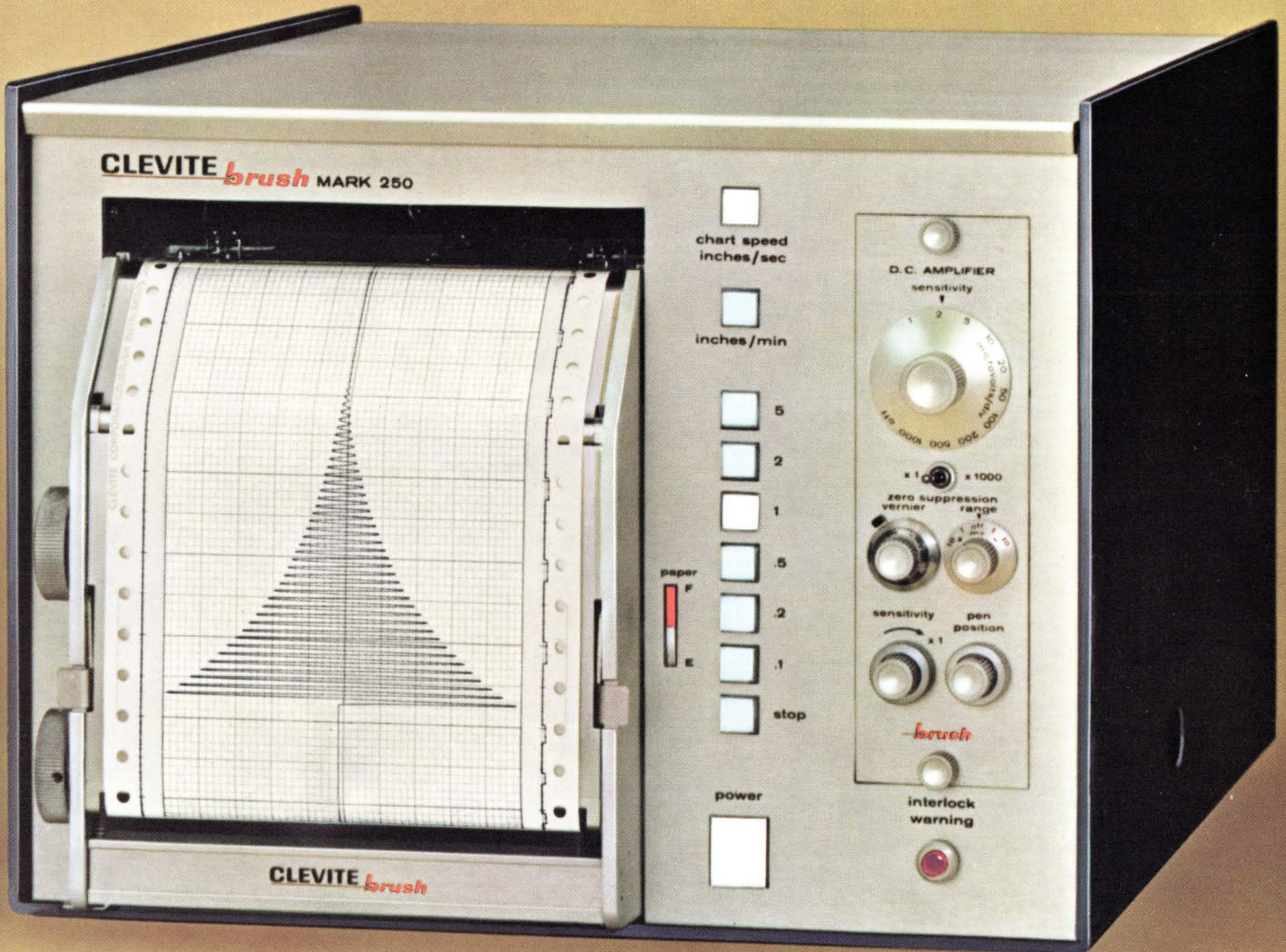

Shown with 1  $\mu$ v preamplifier RD 4215-70;  
event markers optional.

(Turn the page and see what we mean) →

## BUSINESS REPLY MAIL

NO POSTAGE NECESSARY IF MAILED IN THE UNITED STATES

FIRST CLASS  
PERMIT 2472  
CLEVELAND, OHIO,  
U.S.A.

CLEVITE CORPORATION  
BRUSH INSTRUMENTS DIVISION  
3631 PERKINS AVE.  
CLEVELAND, OHIO 44114

**Meet the fastest, most accurate  
strip chart recorder on record:  
The new Brush Mark 250.**

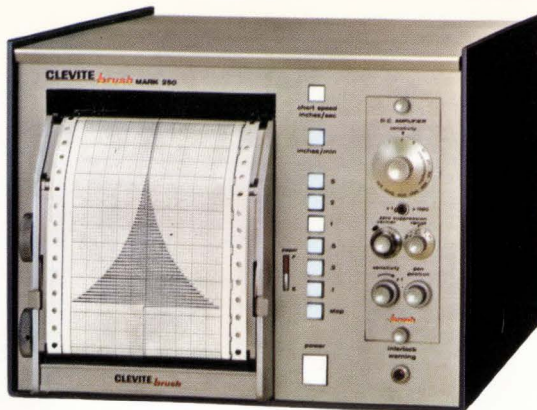

**When you read about all the features  
you'll know why we call it the first  
recorder for the perfectionists of the world!**

**1 Unmatched frequency response.** Flat to 10 cycles on full 4½" span! Useful response to 100 cycles. Nobody has a strip chart recorder in the same league.

**2 Wide selection of signal conditioners.** Choose from 21 interchangeable preamps. Use one today; plug in a different one when your recording requirements change.

**3 Crisp, clean rectilinear writing.** Patented, pressurized inking system puts smudge-proof trace *into* the paper not just on it.

**4 Contactless, non-wearing feed-back system.** Same one used in our multi-channel Mark 200 recorders. (No slide wires!) Accuracy? Better than ½%!

**5 Multiple chart speeds.** Push-button choice of twelve . . . from 5 inches/second to 1/10 of an inch/minute (up to 8 days of continuous recording).

**6 Portable or Rack mounting.** And either way you get the exclusive new dual position writing table.

**7 Removable chart paper magazine.** Great for desk top record reviews. Man-sized manual winding knobs let you roll chart forward and back. Chart reloading is a cinch.



See what we mean? The Mark 250 is for the perfectionists of the world. Ask your Brush Sales Engineer for a demonstration. Or, write for chart sample and specifications. Clevite Corporation, Brush Instruments Division, 37th & Perkins, Cleveland, Ohio 44114.

Yes!

I'd like to know more about your new Mark 250.

Please send chart sample and specifications.

Please have your local Sales Engineer phone.

Name \_\_\_\_\_

Title \_\_\_\_\_

Company \_\_\_\_\_

Address \_\_\_\_\_

City \_\_\_\_\_ State \_\_\_\_\_ Zip \_\_\_\_\_

**Get details fast! Send this card!**

**CLEVITE**  
brush INSTRUMENTS DIVISION

**The Brush Mark 250**  
First recorder for perfectionist

# INNOVATION IS THE PULSE OF PROGRESS



In 1526, Philippus Paracelsus, a German alchemist and physician, defied the traditions of the medieval world by teaching that diseases were specific entities that could be cured by specific remedies. He made such substances as opium, mercury, lead, sulfur, iron, arsenic and copper sulfate a part of the pharmacopoeia. He popularized the use of tinctures and alcoholic extracts and introduced the therapeutic value of mineral baths. Many of these are still in common use. Thus, Paracelsus built the early foundations which led to the treatment of diseases by chemical means.

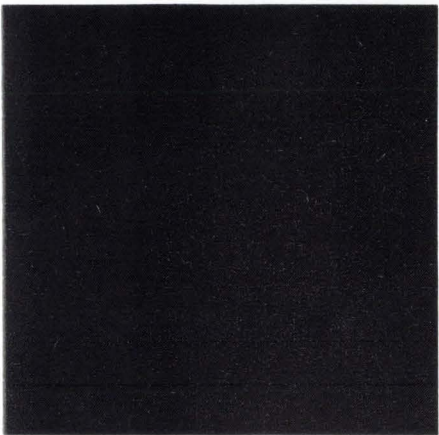
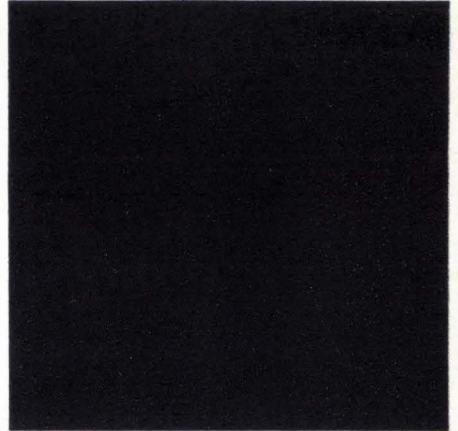

In 1957 Raychem pioneered a series of innovations in the field of radiation chemistry. Among the first was the production of heat-shrinkable plastic tubing for the insulation and protection of connections and terminations. Today this innovation is an accepted device in virtually every industry. Raychem leads the world in the types, properties and technology of heat-shrinkable tubings. Write for Raychem Bulletin 7000 — a comparative summary of types available and their uses.

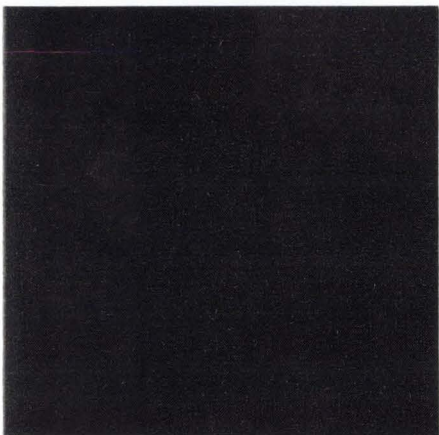
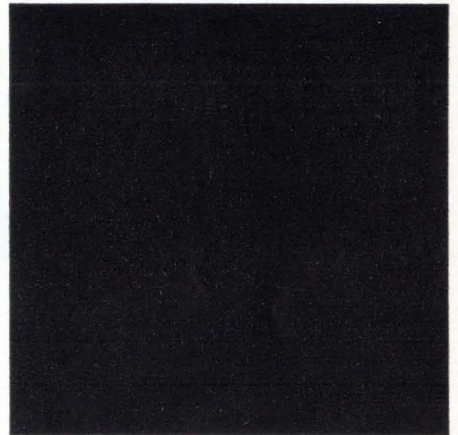

Thermofit Kynar\* is a product of Raychem Corporation's experience in the field of radiation chemistry. It is a heat-shrinkable tubing which is manufactured by exposing specially formulated polyvinylidene fluoride to massive doses of electron beam radiation, thus forming a crosslinked, three-dimensional gel network. The result is a clear, mechanically tough and semirigid tubing, which will not cold flow, does not burn, never melts, will not split, and which possesses a unique "elastic memory." Industry reference specifications are AMS 3632A and UL file E 35586.

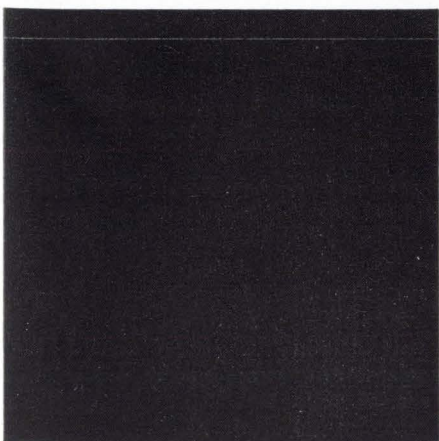

**THERMOFIT®**  
HEAT-SHRINKABLE PRODUCTS

RAYCLAD TUBES INCORPORATED  
A SUBSIDIARY OF  
**RAYCHEM®**  
CORPORATION

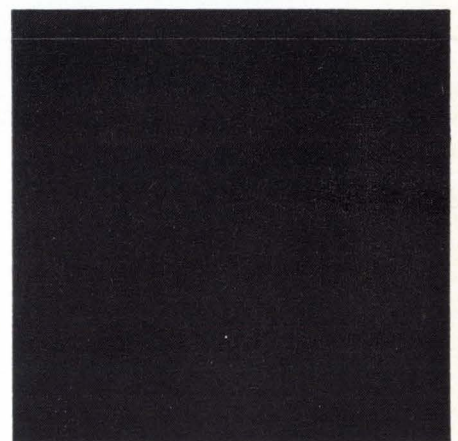

\* T.M. Pennsalt Chemical Corp.

# Reducing a connector's length is one thing. Reducing its weight is another. Bendix Solder and Hermetic-Type "Pancake" connectors do both.

One thing you can say about Bendix® JT Pancake connectors: they reduce connector length by up to 50% and weight up to 60%, making them the smallest, lightest models available.

Equally impressive is the wide range of types we've got on hand, all ready to be delivered in rapid, off-the-shelf fashion. Among them are wall mount,

box mount, jam nut, straight plug and 90° plug; nine different sizes; 34 different insert patterns; 16-, 20-, 22- and 24-contact sizes that will accept a wire range of 16 through 28 gage.

(You'll find most of these types available in our crimp-type JT Pancake connector line, too.)

What about performance? These light-

weights have nine major design improvements. There are provisions for up to 128 contact pins, increased resistance to pin bending, greater contact retention, temperature capabilities to 392°F, and improved electrical characteristics through rigid, glass-filled epoxy inserts, to name a few. For complete information, write us in Sidney, New York.



Scintilla Division





## Space electronics

### Lunar traffic jam

As Lunar Orbiter 1 winds up its photo-taking mission around the moon, officials at the National Aeronautics and Space Administration are preparing its stablemate, Surveyor 2, for its most ambitious mission to date in the double-barrel program to find the best sites for the first American astronauts to step on the moon. The one-eyed Lunar Orbiter, launched Aug. 10, made a major contribution by refining knowledge about the moon's gravity, but failed to take the high-resolution photos needed to verify Apollo landing sites.

The next Surveyor will have a hard act to follow. Surveyor 1 sent back 11,237 high-quality pictures after a perfect launch from Cape Kennedy May 30 and even survived the rigors of lunar night when the temperature fell to  $-250^{\circ}\text{F}$ . The next Surveyor, scheduled for launch around Sept. 20, will duplicate the picture-taking assignment at a site in the middle of the moon but will attempt a far more difficult landing.

**Landing straight.** Benjamin Milwitzky, NASA's Surveyor program manager, explains that Surveyor 1 landed near the so-called vertical impact point on the west side of the moon. At this point, which is based on the complex celestial mechanics of the earth-moon system, a spacecraft launched directly from earth could land vertically. But NASA obviously doesn't want to be restricted to a single landing area when it sends the Apollo astronauts to the moon.

The next Surveyor is due to land farther east, around Sinus Medii (Central Bay) and thus make a sharper turn and still land in an upright position. Instead of approaching the moon

at an angle of about  $6^{\circ}$  from the vertical as was the case with its predecessor, the next Surveyor initially will be  $23^{\circ}$  from vertical. The design limit is  $45^{\circ}$ .

All of this makes the mission far more difficult. Since the radar will not be looking directly down at the moon, it will have to sweep a larger area. This increases the range and weakens the returned signal accordingly. It also introduces more radar "noise" caused by sweeping over rough spots on the moon's surface. The correction maneuvers required of the spacecraft's propulsion systems are also made more complex. The small vernier rockets used to keep the

craft pointed along the axis of its flight will have to expend more fuel.

**Space brake.** The main retro-motor used to slow the craft to a landing speed it can survive also will have to do extra work. Milwitzky explains that as the Surveyor approaches the moon the lunar gravity takes over to make the craft fall straight down. The more the retromotors slow the craft, the greater is the effect of the moon's gravity. This is called a "gravity turn" in space jargon. In the case of Surveyor 2, the gravity turn will be much greater.

Five more Surveyor flights are planned after the next one. All the spacecraft are externally identical, although some may carry scientific instruments to gather more data on the moon. However, Milwitzky sees the program's prime job as calibrating sites for Apollo. He hopes to certify seven sites in the seven-flight program.

The next Lunar Orbiter, meanwhile, will be launched late this fall to do what its predecessor could not do: take photographs of potential Apollo landing sites with a resolution of a few yards. The first spacecraft in the five-flight series sent back medium-resolution photos, including the best pictures to date of the moon's dark side and the first picture of the earth, but the high-resolution camera system apparently was stymied by a spurious signal in the spacecraft that caused the shutter to trip prematurely. To compensate for this condition, officials at NASA's Langley Research Center, Hampton, Va., ordered the spacecraft to lower its orbit in an attempt to get a closer view of the moon.

**Hospitable moon.** The major accomplishment of Lunar Orbiter 1 was the discovery that the moon's gravitational field is not so unevenly distributed that it

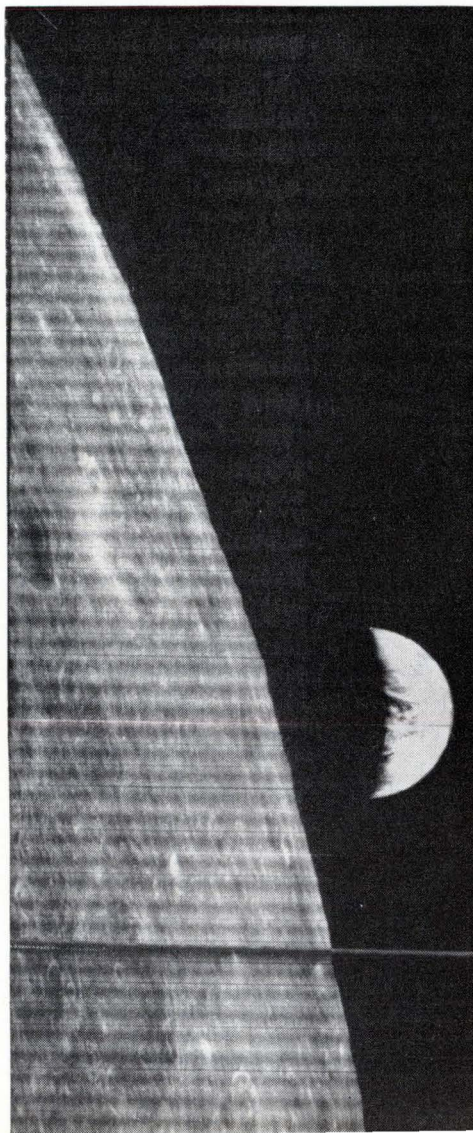

would disturb a spacecraft's orbit. As William H. Michael Jr. of Langley's Space Mechanics Division put it, "We seem to have a hospitable moon." This is vitally important for the Apollo mission since the command module must remain in a stable orbit around the moon with one astronaut aboard while the other two visit the surface.

Michael's calculations showed that the moon seems to bulge at the top and middle and be slightly depressed at the bottom and halfway between the middle and top. The irregularities are quite small: the average radius of 1,100 miles is only a quarter-mile greater at the top and a quarter-mile less at the bottom. The depression in the northern hemisphere is only an eighth of a mile as is the bulge around the lunar equator.

**Russia too.** Based on tracking data so accurate that the effects of the moon's gravity on the spacecraft velocity can be measured to within half an inch per second, Michael predicted the spacecraft would orbit for at least another five months before plunging into the moon. Even then the onboard propulsion system could be used to raise the orbit and keep the spacecraft alive, but this would further add to the traffic jam accumulating around the moon. In addition to the next Lunar Orbiter and Surveyor—both to be launched this year—the Soviet put its Luna 2 up there and may send other spacecraft before long.

Michael cautioned, however, that the data on the moon's gravity will need considerable refinement. The movements of dozens of spacecraft orbiting the earth over the past eight years have been accurately charted and there still exist some questions about the earth's gravity. Although a few days of tracking a single spacecraft can not be considered conclusive, he did say that "immediate prospects for the Apollo are comforting."

### Apollo in November?

The near-perfect Apollo/Saturn 202 flight is setting the stage for the first orbital manned flight of the

moon craft this year. Spacecraft manager Joseph Shea reported as satisfactory the performance of two electronic systems flown for the first time on an Aug. 25 ballistic flight—the S-band tracking system and the guidance system developed by the Massachusetts Institute of Technology.

George E. Mueller, head of the manned program at the National Aeronautics and Space Administration, is sticking to his earlier statements that the first manned Apollo flight is not officially set for this year although it has been widely rumored for around mid-November. He said the final decision will be made in November.

### ... Gemini in September

Also providing information necessary for future space flights will be the three-day Gemini 11 mission scheduled to begin Sept. 9. The astronauts will attempt to rendezvous with the Agena target vehicle on their first trip around the earth. They will also try to achieve the first automatic reentry using the onboard computer and inertial guidance system to feed commands into the attitude control and maneuver electronics system that controls the reentry thrusters. The crew will not touch the controls unless necessary.

---

## Military electronics

---

### Ground bugs

To the chagrin of Congress and the Pentagon, technical problems are plaguing the Army's transportable satellite communications ground terminals, including those needed in Vietnam.

Col. Mitchell Goldenthal, head of the Army's Satellite Communications Agency, told a Congressional group last month that the Hughes Aircraft Co.'s AN/MS-46 terminals are lacking in these areas:

- Cryogenerator systems needed for cooling the parametric amplifier require major maintenance

every 400 hours. Such work cannot be done in the field, so each system must be flown back to Hughes' plant in California for rejuvenation.

- The tracking systems have proved to be "unduly sensitive" and a Government-contractor team is touring the terminal sites to iron out the difficulties and provide additional training to personnel.

- The system's power supply, housed in cargo vans, is troubled by arcing because of high humidity. To solve this, air conditioning must be added.

Goldenthal told the House Military Operations subcommittee that the terminals will be debugged and operating properly by the end of the year. He said some of the technical problems result from the Army's decision not to include an engineering test model in the original contract, which is now nearing \$23.1 million.

**Repair woes.** The colonel credited Hughes with making a "great effort . . . to adjudicate this (cryogenerator) problem." The company, he explained, is bearing the cost of flying the cryogenerators back to the United States for the required maintenance.

In the debugging operation, Hughes-built cryogenerator systems costing \$30,000 are being replaced by a unit supplied by Arthur D. Little, Inc., of Cambridge, Mass., costing only \$12,000. The Arthur D. Little unit can operate for 3,500 to 4,000 hours without major overhauling. But a weight penalty is being paid for the longer-running unit.

The Hughes terminal now weighs 123,000 pounds and includes a 40-foot parabolic antenna housed in an inflatable radome. Three vans are needed to support its operations. Delivery, which started late last year, will continue for some months. Six are in Hawaii, Ethiopia, the Philippines, West Germany, Fort Monmouth, N.J. (a trainer) and somewhere in Southeast Asia. Eight more are on order and will be installed as alternates. After that, no more MS-46 terminals will be built.

**Lighter model.** Another type of ground terminal, developed by

Radiation, Inc., of Melbourne, Fla., the AN/TSC-54, will begin entering the inventory early next year, Goldenthal said. This is a lighter weight terminal for tactical forces with an 18-foot dish antenna.

The Army has ordered 13 of the Radiation systems, including an engineering test model. They will have an antenna not requiring a cryogenic cooling system.

The colonel reported that the tactical terminals are four months behind schedule and about 40% more expensive than anticipated.

He said the scheduling slip was caused in part by technical difficulties that were not further explained. Also, he said, subcontractors have been slow in delivering parts for the system. The first model is due in April, 1967; the original schedule called for delivery by this December. The price of the terminals is now set at \$13.3 million, some \$4 million more than anticipated.

Radiation, Inc., reports it has successfully tested the first model, bouncing signals off orbiting military satellites.

## Outdoor advertising

A chattering Teletype last month printed the first commercial via a military communications satellite. The unlikely location of this event was the infield of Hollywood Park Racetrack in Los Angeles. The X-band message was transmitted from the satellite in its 18,200-nautical-mile orbit to a ground-based antenna only 6 feet in diameter.

Surprisingly enough, the customer—the Navy—and the builder, the Hughes Aircraft Co. in Fullerton, Calif., received last-minute permission from the Defense Communications Agency to interrupt acceptance tests on the new system to send the commercial. They performed this promotional spectacular before thousands of engineers attending the Western Electronic Show and Convention. It was a demonstration of the first model of a second-generation shipboard communications terminal, the AN/SSC-3.

**Navy plug.** There's no doubt that the Navy was anxious to show off its share of the three-service Ini-

tial Defense Communications Satellite Project, since the Air Force and Army have grabbed most of the mentions to date. The Wescon demonstration also helped engineers to learn more about the new shipboard terminal and just how well the military satellites were working, something the Defense Communications Agency has been rather coy about discussing recently.

The 11-line Teletype message was repeated several times with few errors.

Hughes, no slouch in publicizing its technical achievements, had hoped to use the Philco Corp. satellites for voice relay. But for some unexplained reason, the Pentagon's communication agency did not allow voice transmissions in the tests. [For details, see below].

Hughes project engineers say they can track and communicate with all seven of the Philco satellites, which were put into near-synchronous random orbits by a Titan-3C booster on June 16. With the 6-foot dish, the terminal can dig a signal out of the noise with

## Titan 3C: unexpected source of trouble

**The Pentagon's hopes** for a successful launch of another group of communications satellites went up in flames on Aug 25. And so did the satellites. Eighty seconds after the big experimental Titan 3C roared off the pad, a rocket malfunction automatically caused the craft to destroy itself and its satellite package.

The fiery end of the Titan 3C is not without irony. For the past two months Pentagon officials have taken every opportunity to point with pride to their communications satellites, lofted into random orbits on June 16 [See related story on page 31]. All reports claimed an unqualified success—the seven Initial Defense Communications Satellites were flying high and healthy. It appears now these reports were inflated.

Last month, on the eve of the launch of a second series of Initial satellites, Air Force Gen. Ben I. Funk issued a terse announcement which disclosed that something was wrong with either the satellites or the ground stations. For some reason, a Pentagon spokesman explained, signals received from the 18,200-nautical-mile-high satellites were about 30% weaker than had been anticipated. This power loss reportedly was uncovered soon after the satellites were placed in orbit but the information was kept secret.

Because of the problem the Pentagon delayed the

launch of the second series—hopefully until the power loss could be isolated and corrected. The Philco Corp., maker of the seven satellites, announced that its tests indicated that the craft weren't to blame. And the Hughes Aircraft Co., builder of the ground stations, after running some independent calibration tests, also disclaimed any responsibility—despite the rash of trouble that the military has been encountering with Hughes ground stations [See related story on page 30].

**Nothing wrong.** Finally, on Aug. 25, the Pentagon announced that it had a tentative answer: there was nothing wrong with either the satellites or the ground stations. The power loss, explained a Defense Communications Agency spokesman, was attributable to "free space loss"—attenuation that occurs when a signal travels a long distance through space. Apparently, pointed out the embarrassed spokesman, this signal loss wasn't considered when the power specifications were prepared.

Convinced that the problem had been isolated and that no changes were necessary on the satellites, the Pentagon ordered liftoff, a day behind schedule. And then the rocket blew up.

The next series of military satellites is now scheduled for launch early next year. But there's word that the Pentagon may push up the schedule to as early as eight weeks from now because it wants more and better communication links to South Vietnam.

LOS ANGELES, AUG. 22-26, 1966 -- THIS MESSAGE SENT AND RECEIVED AT THE 1966 WESTERN ELECTRONICS SHOW AND CONVENTION, IS AN EXAMPLE OF THE U.S. NAVY'S NEW "SPACE-AGE" VOICE. IT WAS RELAYED THROUGH A MILITARY SATELLITE MORE THAN 18,000 MILES ABOVE THE EARTH'S EQUATOR, USING ONE OF THE NEW SEAGOING SATELLITE COMMUNICATION TERMINALS BUILT FOR THE NAVY BY HUGHES AIRCRAFT COMPANY, FULLERTON, CALIF. THE TERMINALS WILL SUPPLEMENT EXISTING COMMUNICATIONS METHODS AND OFFER RELIABLE LONG-RANGE VOICE AND TELETYPE COMMUNICATIONS UNAFFECTED BY SOLAR AND ATMOSPHERIC DISTURBANCES.  
U.S. NAVY SENDING -----

Teletype message transmitted via the Initial Defense Communications Satellites to a Hughes Aircraft Co. 6-foot antenna at Wescon.

a level as low as  $-140$  dbm (decibels above 1 milliwatt).

**Smaller yet.** The 6-foot parabolic antenna is the largest that can be operated on combat ships without interfering with other ship systems and "is about as small as we can go working with present satellites," says A.W. Ladd, Hughes project manager. However, with satellites currently being designed, which have higher effective radiated powers, shipboard antennas can go down to 3-foot diameters, Ladd explains. With minor modifications, the SSC-3 will also be able to work with the upcoming tactical satellite program, one Navy official notes.

Hughes is building seven of the SSC-3 terminals for the Navy. Two are research-and-development models (XN-1), but all will be installed shortly on ships for command-and-control communications, says Louis Johnson, assistant project manager for satellite communications, Naval Electronics System Command. The first ship will begin operating with one of the terminals in October.

The Navy is trying to get the money to build the terminals for a number of its ships. The SSC-3 is described as the future "workhorse of the Navy." Excluding research and development and installation, Johnson estimates that each SSC-3 will cost about \$700,000.

The Navy became interested in the possibilities of communicating by satellite in 1962—years after the Army and the Air Force. While there were many problems, the first model, used with the Syncom and made basically from off-the-shelf hardware, did prove the feasibility of shipboard satellite terminals.

The SSC-2 used uncooled parametric amplifiers. Total system

noise temperature for the S-band set was  $180^\circ$  K. The SSC-3 took a jump in frequency, to X-band, and used Peltier-cooled (thermoelectric) parametric amplifiers; total system noise temperature is  $240^\circ$  K.

**On the mast.** The SSC-3 will be mounted on a ship's mast. The Cassegrain feed puts out a  $1.5^\circ$  beam and the multimode, four-horn monopulse feed keeps total system losses to 0.1 db or less. First stages in the preamplifiers are three parametric amplifiers: one for error signal plus elevations, one for error signal plus azimuth and the last for sum channel. All have tunnel-diode second stages.

The set has both a frequency-modulation modem and a digital modem. The digital modem can be used with lower signal-to-noise ratios and is 5 db more efficient than the f-m unit. It can receive Teletype messages with the set's transmitter power at only 100 watts. A water-cooled klystron can produce 5 kilowatts, or 43 db of gain, for an output at the antenna feed of  $+67$  dbm minimum.

The three-axis, gyro-stabilized pedestal has a tracking accuracy of  $0.1^\circ$  root-mean-square error and will operate in a 75-knot wind. Once the satellite is acquired, the SSC-3 tracks it automatically. The phase-lock receivers (for which Hughes is seeking patents) will lock on a zero-decibel signal-to-noise ratio signal.

**Enough for now.** Operating with the Initial satellites, the Hughes terminal can handle one duplex voice channel and two Teletype channels or 16 channels, "which is plenty for us," one Navy official says. However, the 6-foot shipboard terminal cannot communicate with a satellite at the same time one of the 40-foot Mark-1B

satellite ground terminals—also made by Hughes—is on the air. Although the SSC-3 is only on one of the four channels, the Mark-1B is so powerful it overrides the shipboard set's signal.

The Navy concedes that it has a number of operational and technical problems to be worked out. It also wants more improvements in the shipboard set: reducing the antenna's weight and size, improving reliability and maintainability and integrating the control console and other equipment inside the ship.

---

## Optoelectronics

---

### Photon finish

As an electronic material, silicon can be classified as a workhorse, performing a remarkable number of jobs reliably and steadily. With careful breeding, scientists at the Hewlett-Packard Co. in Palo Alto, Calif., have now produced a silicon photoconductor that's fast in the stretch, too. And Hewlett-Packard's entry—a photoconductor with a speed of response several orders of magnitude faster than present devices—may cause system designers to again put their money on optoelectronics, once touted as a sure winner.

About a decade ago, optoelectronics—combining solid-state light emitters and detectors in integrated structures to produce electronic functions—looked very promising. Optically coupled circuits and subsystems, it was said, could be produced with a high degree of input-output isolation, combined with ability to handle many signal channels in parallel. And the circuits could do anything conventional electronics could do—amplify, switch, store and perform logic operations.

**Too slow.** But the initial enthusiasm for optoelectronics soon dissipated when designers ran up against what seemed to be a fundamental limitation—lack of speed. The trouble was that the speed with which photodetectors respond to changes in light intensity de-

# Transitron

## THYRISTORS

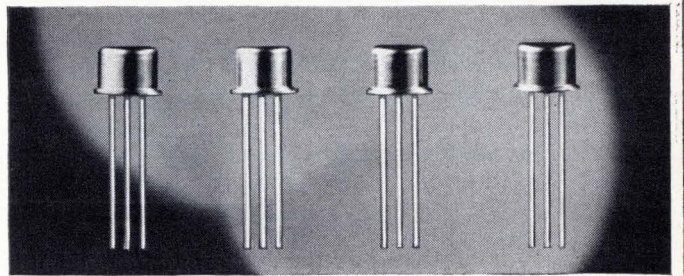

# Now...industry's lowest prices for premium-performance SCR's

Low cost TO-52 packaging provides military quality at commercial prices

### Silicon Triode Thyristors

This Transitron family of premium, high-reliability, planar silicon controlled rectifiers is now available in hermetically-sealed TO-52 packages at the lowest prices in history.

Ideally suited to both commercial and military applications, the 2N4332 family features:

- Blocking Voltages up to 250 volts
- Leakage Currents @ 25°C, less than 20 nano amps
- Leakage Currents @ 125°C, less than 50 micro-amps
- Low Holding Current — 1.0 mA max. @ 25°C.
- Low Gate Triggering Current — 10.0 micro-amps max. @ 25°C

The low trigger current and voltage requirements make the series particularly useful for many high-performance switching applications.

In spite of the miniature package, these devices can effectively handle repetitive, high-peak pulse currents of low duration and duty cycle. They are designed to meet all of the rigid requirements of MIL-S-19500. Extensive temperature cycling, storage and operating life tests, as well as mechanical and hermetic seal tests, are included as a regular part of the manufacturing process to maintain military standards of quality.

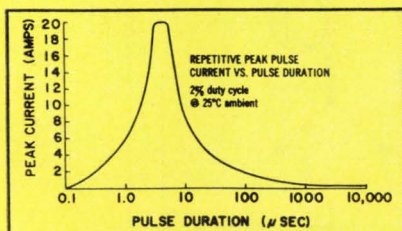

The high pulse current capability of the 2N4332 family makes it ideal for commutating turn-off circuits and other capacitor discharge applications.

Typical applications include: Electroluminescent displays; timing and logic circuits; inverters; and squib firing, servo motor driving and phase control circuits.

#### TYPES AND MAXIMUM RATINGS

TYPE	VDRM/VRRM (@ 125°C)	TYPE	VDRM/VRRM (@ 125°C)
2N4332	30/30V	2N4335	150/150V
2N4333	60/60	2N4336	200/200
2N4334	100/100	2N4337	250/250

### Gate Turn-off Triode Thyristors

Also available in hermetically-sealed TO-52 packages, at extremely low prices, is a new series of silicon planar Transwitches (2N4320/25). These units are ideal for use in industrial and military circuits requiring gate turn-off action.

The series offers anode currents to 250 mA, with a minimum gate turn-off beta of 5. Operating temperature range: —65°C to +125°C.

Reasonable quantities are available for off-the-shelf delivery, with fast action assured on large-quantity orders.

#### TYPES AND MAXIMUM RATINGS

TYPE	VDRM/VRRM (@ 125°C)
2N4320	30/30V
2N4321	60/60
2N4322	100/100
2N4323	150/150
2N4324	200/200
2N4325	250/250

Average Forward Current.....	250 mA @ 75°C
One Cycle Surge (60 CPS).....	5 Amps @ 75°C
Peak Gate Current for 8 msec.....	100 mA @ 75°C
Peak Gate Power for 8 msec.....	200 mW @ 75°C
Average Gate Power.....	20 mW @ 75°C
Storage Temperature Range.....	—65°C to +150°C
Operating Temperature Range.....	—65°C to +125°C

### Light-Activated Triode Thyristors

Transitron's silicon planar Photoswitches are efficient, low-cost, light-sensitive devices for electro-optical applications. Contained in a miniature package (modified TO-18), the Photoswitch has been designed for critical control of electronic switching circuits such as counters, sorters, indexers, logic controls and card or tape readout.

It offers the design engineer the option of gate triggering (50 μa max.) or light activation (150 foot candles) or a combination of the two.

The TPS 20 Photoswitch family features:

- Blocking Voltages up to 200V
- Low Leakage Current — 100 μa max. @ 100°C
- Low Holding Current — 1.0 mA max. @ 25°C

#### TYPES AND MAXIMUM RATINGS

TYPE	VDRM/VRRM (@ 100°C)
TPS 20	25/25V
TPS 50	50/50
TPS 100	100/100
TPS 150	150/150
TPS 200	200/200

Average Forward Current.....	200 mA @ 75°C
One Cycle Surge (60 CPS).....	5 Amp. @ 75°C
Peak Gate Current for 8 msec.....	250 mA @ 25°C
Average Gate Current.....	25 mA @ 25°C
Reverse Gate Voltage.....	5 Volts
Reverse Gate Current.....	3 mA
Storage Temperature Range.....	—65°C to +150°C
Operating Temperature Range.....	—65°C to +125°C

Send for this NEW SCR DATA, just off the press

# Transitron

electronic corporation, Wakefield, Mass. 01881  
Wherever there's electronics... there's Transitron

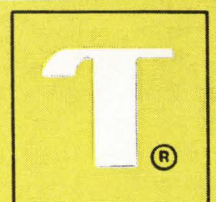

depends on the level of illumination. The best available source of light, electroluminescent zinc sulfide, could only produce modest light levels, about four watts per square meter. As a result, the available photodetectors, cadmium sulfide and cadmium selenide, were too slow to compete with conventional electronic devices as circuit elements.

With the advent of efficient injection electroluminescent diodes, a light source became available that is more than 1,000 times brighter than zinc sulfide, equivalent to 6 kilowatts per square meter. Unfortunately, optoelectronics designers had not been able to take advantage of this high output level because there were no good photoconductors to match the characteristics of gallium arsenide light emitters. They could only choose between junction type photodetectors with limited gain, or high-gain CdS or CdSe, which have limited sensitivity at the wavelength of gallium arsenide emitters.

**Teamwork.** One of the early apostles of optoelectronics, E.E. Loebner of Hewlett-Packard—working with a colleague, T.J. Diesel, and with the help of Stanford University's Richard H. Bube, a photoconductor authority—has now increased the gain and speed of response of single-crystal silicon photoconductors by several orders of magnitude. The development of an efficient and fast silicon photoconductor is significant because the spectral and electrical characteristics of silicon are well matched with those of gallium arsenide injection diodes. Furthermore, silicon devices are compatible with integrated-circuit technology.

One factor that limits the response time of most photoconductors is the lifetime of the majority carriers in a material. A photoconductor is basically a light-sensitive resistor, whose electrical conductivity can be increased when exposed to light radiation. When the photoconductor absorbs light, electron-hole pairs are liberated in the material. These contribute to conductivity until captured by imper-

fections known as "traps," or by recombination. Photodetector responses to changes in light intensity depend greatly on free-carrier lifetime. For example, at low light levels response time in cadmium sulfide is 100 to 1,000 times greater than the lifetime.

**Life expectancy.** Loebner and his co-workers at Hewlett-Packard increased the electron lifetime in silicon by a process they call zinc counterdoping. They made photoconductors by diffusing zinc into n-type silicon single crystals containing arsenic donors. The ratio of arsenic to zinc is about 2 to 1. The result of this combination is highly negatively charged "capture" centers in the material. When incident photons release electron-hole pairs, these centers immediately capture the holes. The centers repel electrons and electron lifetime is increased. Lifetimes up to several hundred microseconds and response times not much greater than 3 or 4 times these have been observed at room temperature.

Photoconductor gain is limited by the onset of space-charge limited current, which occurs when the applied voltage gets too high. At this point, the photoconductor ceases to function. Because silicon has high conductivity, it can operate with higher voltages and there-

fore get high gain before space-charge limiting sets in. Measured gain of the zinc counterdoped photodetectors is greater than  $10^6$ .

According to Loebner, the response speed of the new devices is expected to open up applications thus far closed to optoelectronics. The Hewlett-Packard group has already built some simple storage elements that have worked satisfactorily at excitation levels of  $1\frac{1}{2}$  to  $2\frac{1}{2}$  volts.

The work, sponsored in part by the Army Engineer Research and Development Laboratories, Fort Belvoir, Va., was reported last week at a conference on radiative processes in electronic materials held in Boston.

## Computers

### Circuit on display

Researchers at the University of Illinois are developing some unusual circuit techniques for storing and displaying analog information in a digital system—without a vast computer program, complex circuits or expensive cathode-ray tubes.

The project, under the direction

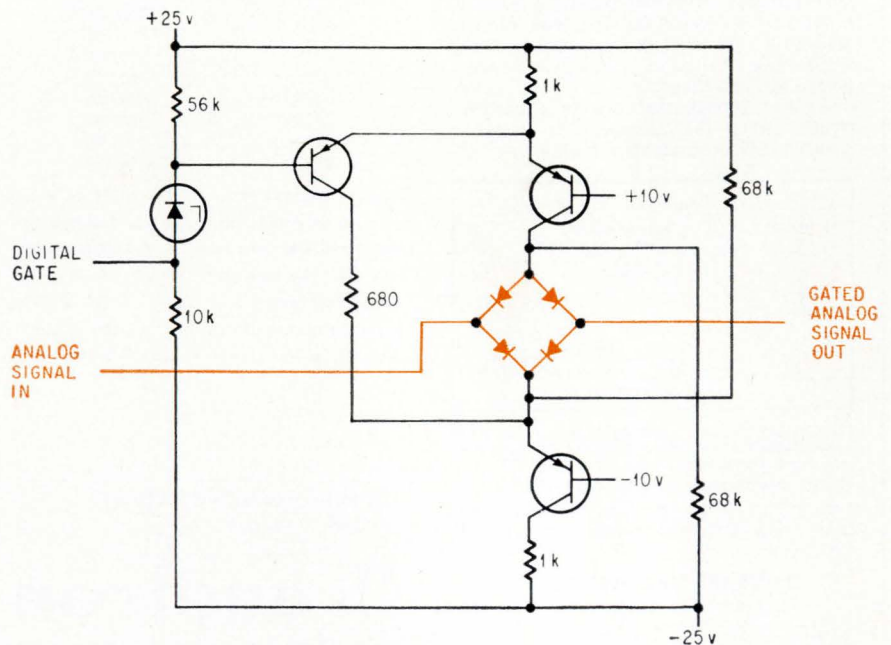

Digital-analog gate (bridge in color) passes an analog signal but is digitally controlled.

# COMPONENT COMMENTS *From Speer*

If our JXP precision resistor is so superb, how come we're reluctant to discuss its reliability?



Because we don't want you to think of the JXP as a "high reliability" resistor.

It is one, of course. But the term in this case is a bit of an understatement (rather like describing the Grand Canyon as a hole in the ground.)

For the same reason, we'd just as soon that you didn't think of the JXP as a "military" resistor, despite its RN classification.

And even the term "metal film" fails to do justice to the JXP. Our Jeffers Electronics Division's metal film resistor has characteristics and performance capabilities that surpass the best of any resistor art, past or present.

How, then, should you think of the JXP? Simply as a "precision" resistor—because it's in this area of precision that our resistor can most clearly be seen to be in a class by itself.

The JXP gives you the highest precision at a reasonable cost, with tolerances down to 0.02% available upon request. But more than that, this extreme precision is arrived at deliberately, rather than by happy accident.

We manufacture the JXP under sophisticated "white room" conditions. We employ a fanatically tight system



of process and material controls. And we limit ourselves to a narrow population of resistor characteristics (25 PPM or less). So it's no wonder that our entire resistor output is identical in precision and stability. (In fact, any pair of JXPs can be matched, time and time again, to within 0.01% !)

We'd be delighted to send you complete information about our JXP precision resistor (including its military and reliability aspects—if you insist). Just mail us the coupon.

## A patent attempt to win your admiration

Even though our various electronic components already offer excellent performance, this never seems to satisfy the restless individuals in our Research Laboratory. They're constantly developing new ways to improve both our products and our manufacturing processes.

During the last six months alone, Speer Carbon Company and Air Reduction Company (our parent) have been awarded a significant variety of patents—including: 3,227,983 (U.S.) for Stacked Resistors; 3,238,151 (U.S.) for Resistor Composition; 3,240,625 (U.S.) for Semiconductor Film Resistors; 727,273 (Canada) for a Method of Capping Film Resistors; 731,781 (Canada) for a Fluorescent Lamp Starter; 648,979 (Belgium) for Resistor Manufacture; 667,242 (Belgium) for Composition Resistors; and 49,129 (Luxembourg) for Composition Resistors.

We have no patent on mere excellence, of course. But when it comes to perfection . . . well, only time will tell.

## We've even been distributing Distributors

In keeping with our basic policy of quicksilver service, we have been setting up a national network of Industrial Electronic Parts Distributors covering every major market area.

These men are hip-deep in both Speer carbon composition resistors and in Jeffers molded chokes. And both inventories, needless to say, offer the latest MIL and commercial specifications.

For the name of your helpful Speer Industrial Distributor, contact your Speer representative—or use the coupon.



JEFFERS ELECTRONICS DIVISION  
SPEER CARBON COMPANY  
DuBois, Pennsylvania 15801

Speer Carbon Co. is a Division of Air Reduction Company, Inc.

- Send *complete* information on your JXP precision resistors.
- Send the name of my helpful Speer Industrial Distributor.

Name \_\_\_\_\_

Title \_\_\_\_\_

Company \_\_\_\_\_

Street \_\_\_\_\_

City \_\_\_\_\_ State \_\_\_\_\_ Zip \_\_\_\_\_

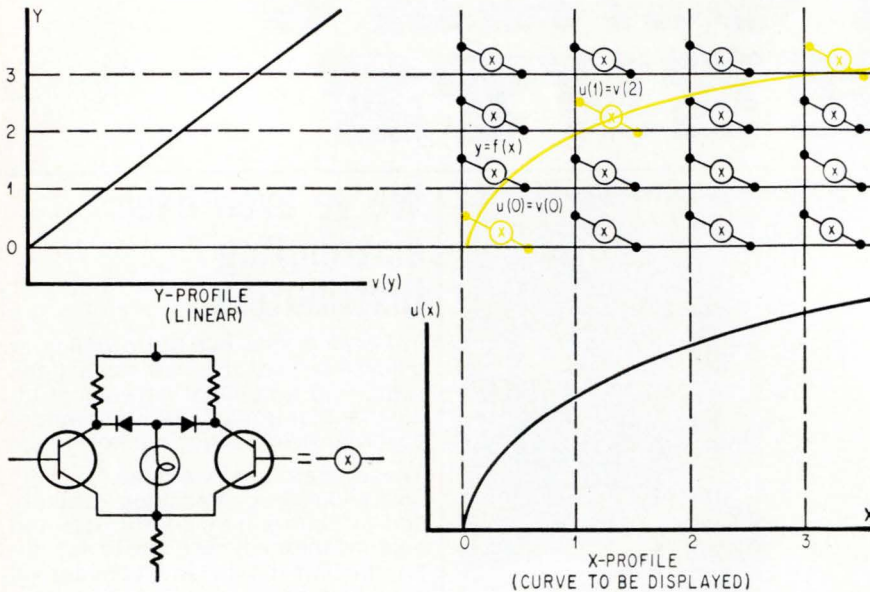

Paramosaic, a prototype of a digitally controlled display for analog quantities.

of W.J. Poppelbaum, professor of electrical engineering, is being conducted at the university's digital computer laboratory.

One technique, still under investigation, is the application of digital-analog circuits to graphical processing and display. For example, circuits such as the one sketched on page 34 can pass an analog signal when the digital gate is open, but when the gate is closed, the output floats.

With these circuits, says Poppelbaum, graphical processing—of bubble chamber data, for instance—can be performed with accuracies of 0.1% or better and at megahertz speeds. The new approach is to do all the graphical processing in analog form, digitizing the data afterward if necessary. The usual procedure requires digitizing the analog data, processing it in a digital computer and then reconvert-ing it to analog form for display. Processing in this context includes moving an image around on a screen or transmitting graphical data through a noisy channel to a remote receiver.

Other circuit examples include comparators—whose digital output indicates the equality of two analog inputs—amplifiers and out-of-range indicators that can inhibit the comparators.

**One at a time.** The circuits are

used in what Poppelbaum calls a paramosaic—one form of which is a matrix of wires with a storage element at each intersection. The matrix is scanned, one storage element at a time, and the digital-analog gating circuit gates analog data to each storage element, such as the coordinates of a point on a curve.

Other digital-analog circuits in the paramosaic can shift the displayed image up, down, sideways, rotate it or change its size.

The lab built one prototype, a 32-by-32 paramosaic in which the storage elements are flip-flop circuits. A small light bulb connected to each storage element displays the stored data. Poppelbaum says a paramosaic made from an electroluminescent panel got much better resolution. It produced a semipermanent display more cheaply than

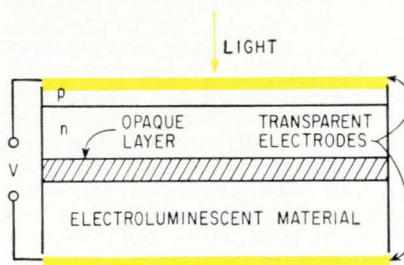

Electroluminescent panel, in cross section, from which a high-resolution paramosaic could be built.

possible with, say, storage cathode-ray tubes.

The paramosaic looks like a sandwich; it's made of two transparent electrodes, an opaque layer, a layer of electroluminescent material and two layers of p and n material. A focused beam of light, controlled by analog-digital circuits, sweeps across the panel, tracing out a curve, for example. The resistance of the light-sensitive p-n junction drops sharply wherever the light strikes it because light generates hole-electron pairs. The resistance remains low because electrons are trapped and slowly released after the light beam passes.

**Turn it off.** Where the junction resistance is low, most of the bias voltage between the transparent electrodes appears across the electroluminescent material causing that spot to glow. The sheet of electroluminescent material, therefore, displays the path followed by the focused beam and retains the display until the bias voltage is removed.

## Instrumentation

### Look sharp

Air Force and space agency officials concede that, too often, satellites designed to observe the earth from afar simply don't "look" in the right direction and the expensive spacecraft spin around the earth without orientation. To provide better aim to these satellites, the military and the National Aeronautics and Space Administration settled on infrared sensing techniques to help orient the craft with the earth's horizon. The search now is for the best infrared spectral band to define the earth's rim.

The program is beginning to pay off. Studies so far indicate that the best band is in the far infrared—specifically the 14- to 16-micron region. Heat in this region is reflected by carbon dioxide. Hence the earth's atmosphere, which includes carbon dioxide, repels heat radiating from the sun. Since there is



# we're not saying conventional shift registers are old hat...

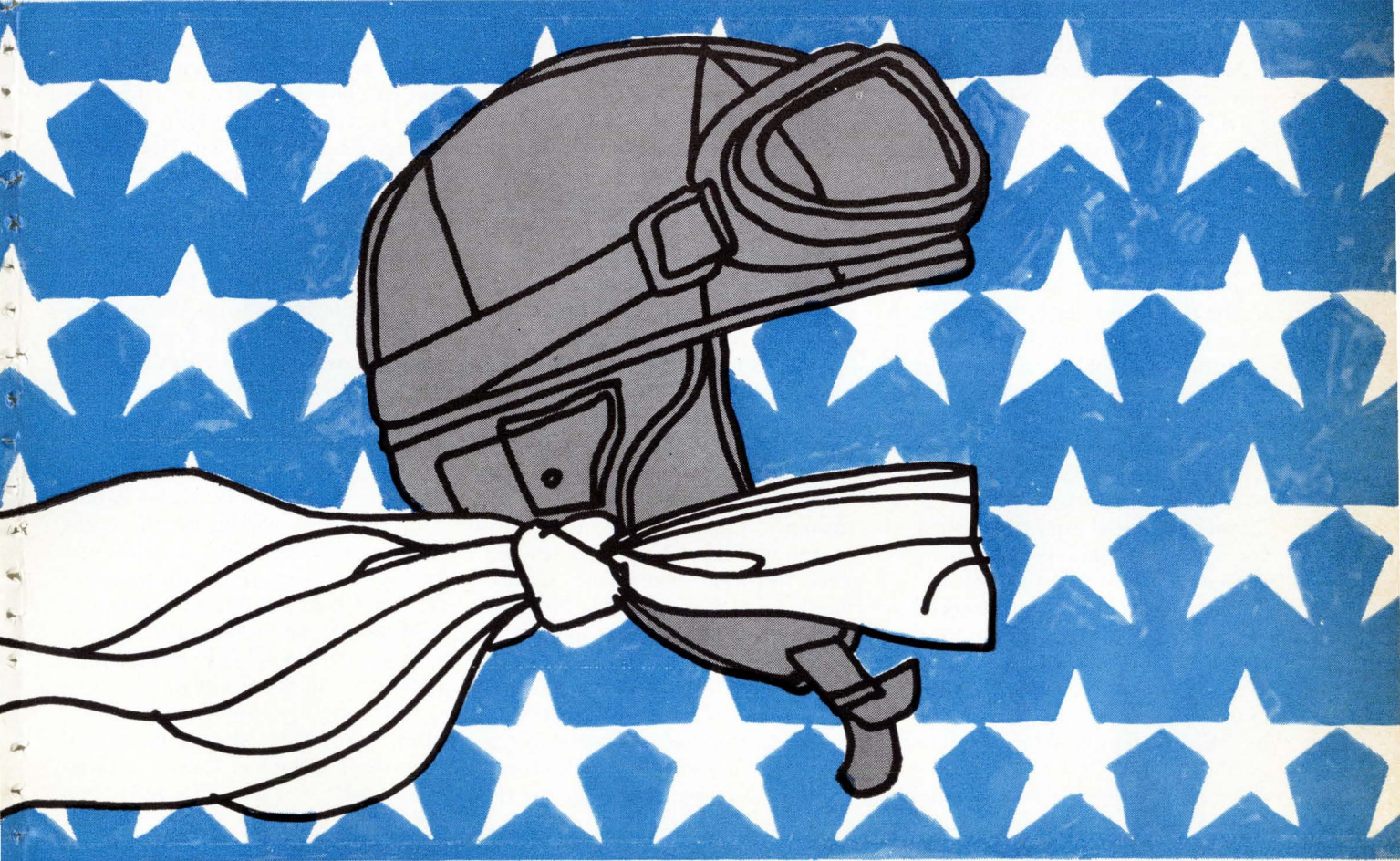

## but, you will!

(AMELCO'S NEW 20-BIT SHIFT REGISTER IN A SINGLE MEMA\* PACKAGE)

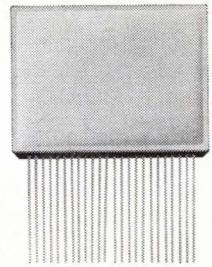

If exceptionally high packaging density, low cost, and high reliability are important considerations to you, consider the many advantages of Amelco's new Shift Register in a MEMA. The MEMA (Micro-Electronic Modular Assembly) is a hermetically sealed package offering the following advantages  275 Monolithic Circuits per cubic inch  Reduced testing and assembly cost both at the component and system level  Improved reliability as a result of reduced interconnection wiring.

The Shift Register itself is assembled using Amelco's

dual TTL Logic elements. It provides  Serial or Parallel Input and Output  1.0 MHz Clock Rate  Low Power Dissipation (190 mW for the 20 bit register).

Two types are now available — 20 bit Shift Register, Type 5551BM — 16 bit Shift Register, Type 5552BM — and the MEMA's great flexibility will be used for additional standard and custom circuits.

So don't take our word that other packages are old hat. Find out for yourself.

## AMELCO SEMICONDUCTOR

DIVISION OF TELEDYNE, INC. • 1300 TERRA BELLA AVENUE • MOUNTAIN VIEW, CALIFORNIA • Mail Address: P. O. Box 1030, Mountain View, California • Phone: (415) 968-9241 / TWX: (415) 969-9112 / Telex: 34-8416 • REGIONAL OFFICES: Southwest — Suite 213, 8621 Bellanca Ave., Los Angeles, California 90045, (213) 678-3146 • Northwest—1300 Terra Bella Ave., Mountain View, California, (415) 968-9241 East—P. O. Box 2091, Paterson, New Jersey 07509, (201) 696-4747; 60 Broad Hollow Rd., Melville L. I. New York, (516) 692-4070; P. O. Box 366, Kimberton, Pennsylvania, (215) 885-1755 • Northeast—805 High Street, Westwood, Massachusetts, (617) 326-6600 • Southeast—711 Magnolia Avenue, Orlando, Florida, (305) 423-5833 • Midwest—650 West Algonquin Road, Des Plaines, Illinois, (312) 439-3250; 3020 Woodlark Lane, St. Paul, Minnesota.

more carbon dioxide near the earth's surface than at high altitudes, an infrared sensor detects more heat when it's pointed at the horizon than far above it.

**Hide the horizon.** The ideal approach would be to look at the earth in the visible spectrum but often clouds make this impossible. Various other spectral bands have been tried—some with disastrous results. The second Orbiting Geophysical Observatory (OGO), for example, tried to find the horizon in the 8- to 20-micron band. When its radiometer found some high-altitude cold clouds—which emit in the 10-micron region—the spacecraft thought it was looking at outer space and went out of control. The third OGO was modified to look at the horizon in the 12- to 22-micron band and that worked for a while. Other problems, however, made that test short-lived.

The research program proceeded on many fronts but some of the best data backing up the CO<sub>2</sub> band came from three sounding rocket experiments—two by the Air Force at White Sands Missile Range, N.M., and the first of NASA's two planned Project Scanner flights from Wallops Island, Va., Aug. 16. NASA plans its second flight at Wallops Island in November, and the Air Force has a program calling for another flight at White Sands and three at Fort Churchill, Canada. Augmenting this program are flights of the X-15 rocket research craft, which is equipped with a far-infrared radiometer.

Still a more ambitious attack on this problem is under study by

NASA and the Scanner's prime contractor, Honeywell, Inc., of Minneapolis. The company received a \$230,000 contract from NASA in March to determine first what additional data is needed and second whether more sophisticated techniques are feasible. The first phase could lead to orbiting experiments as part of the manned Saturn/Apollo applications program of a special-purpose unmanned spacecraft just for that purpose or "piggy-back" experiments on such spacecraft as the Orbiting Astronomical Observatory.

**How sharp?** For the moment, however, NASA's only approved program involves ballistic flights on sounding rockets. Jules Kanter, who runs the program in the electronics and control division of the agency's Office of Advanced Research & Technology, says the biggest question remaining is how good is the resolution. At best, present spacecraft systems give attitude reference to within about 1° of the vertical axis. An infrared radiometer looking through the 14- to 16-micron band detects a sudden drop of radiated heat between 15 and 30 miles. NASA hopes this can be translated into a vertical accuracy of 0.02°.

The November Scanner flight will gather data when the atmosphere in the Northern Hemisphere is coldest. August is the warmest month and if the temperature profiles are the same during both November and August, project officials will have at least a partial answer to the problem.

All the hardware, except the ra-

diometer, for the November flight is at NASA's Langley Research Center, Va., which operates the \$4.5-million project. The radiometer is being tested at the Santa Barbara, Calif., research center of the Hughes Aircraft Co., using infrared sensors supplied by the Barnes Engineering Co. Honeywell will integrate the equipment in addition to furnishing the spacecraft under its \$2.2-million prime contract.

**Water-vapor test.** During the 13.5-minute flight from Wallops Island last month, a Trailblazer-2 vehicle rocketed the Scanner payload to an altitude of 380 miles. Data was telemetered in two wavelength bands: 14 to 16 microns and the 20- to 40-micron band that reflects heat radiated by water vapor. The guidance system on the spinning spacecraft used a telescope with an infrared sensor to measure returned heat energy and control a cold gas jet attitude-control system that kept the payload stabilized to within 2° of the vertical.

Still another flight is possible after November since Honeywell is under contract to deliver a third spacecraft in case the next one doesn't work. This craft could be flown next August to provide more data points on temperature profiles and confirm the findings of last month's shot.

## Manufacturing

### Plastic bandwagon

Plastic packages have been such a success for transistors that integrated circuits are speeding down the same road—even though there seems to be serious doubt as to whether the plastic package will satisfy as many IC customers. The biggest question is reliability; there isn't enough data available. You can also get an argument as to whether plastic will save much money in the long run.

Still, every manufacturer of IC's—including the skeptics—is putting at least part of his line into plastic packages. They reason that the plastic transistor's feat of wiping

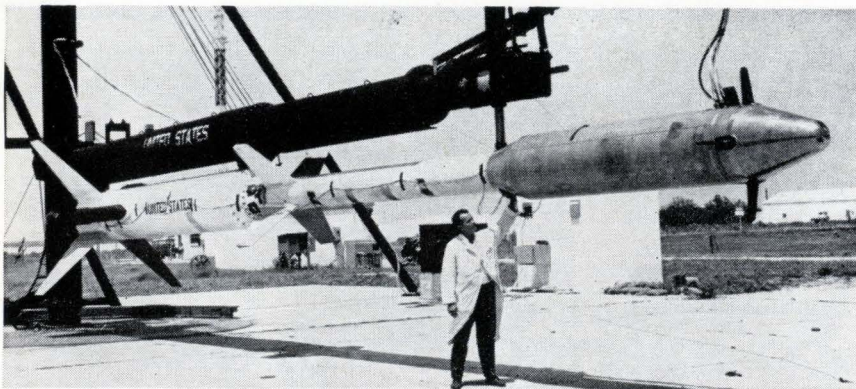

Project Scanner payload designed to gather information on the earth's horizon to orient future satellites more precisely.

## TRW ANNOUNCES NEW MILITARY MYLARS



### Up to 72% smaller than MIL-C-25C paper capacitors!

MIL-C-19978B/2 reduces capacitor size drastically—down to .125" diameter by 1/2" long. At the same time electrical characteristics are upgraded sharply.

MIL-C-19978B/2 hermetically sealed mylar\* capacitors are available now from TRW with immediate delivery in production quantities.

- **REDUCED SIZE**—35% to 72% smaller than MIL-C-25C.
- **VOLTAGE CHOICE**—30V, 50V, 100V, 200V, 600V, 1000V.
- **CAPACITANCE CHOICE**—.001 mfd through 10.0 mfd.
- **TOLERANCE CHOICE**—±10%, ±5%, ±2%, ±1%.

For full information contact: TRW Capacitors, 112 W. First St., Ogallala, Nebraska. Phone: 308-284-3611 • TWX: 910-620-0321

These capacitors—when designated TRW Type 693—are available to high reliability specifications, and in custom capacitances and tolerances beyond the range of MIL-C-19978B/2.

\*Du Pont registered trademark

# TRW CAPACITORS

**“9 years ago  
we had a great  
idea that put us  
in the high-rel  
relay business.**



**It's still a great  
idea, and now  
we've put it  
in a one-inch  
package!”**

**Wedge-action\*** was the great idea. By combining long precious-metal contact wipe with high contact force, it gives Electro-Tec relays the highest dry-circuit confidence level ever reached. (90%, based on a failure rate of only .001% in 10,000 operations.)

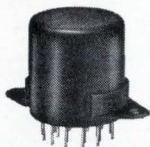

Packing wedge-action into a one-inch envelope wasn't easy. But it was worth it. It gives you maximum reliability in minimum space. And it's available for both 6PDT and 4PDT operations, in relays that exceed all requirements of MIL-R-5757/1 and /7.

The one-inch relay is just one of our family of wedge-action relays, which cover almost every dry-circuit to 2 amp application. When you need a high-rel relay that really works, remember our great idea, and put it to work for you.

\*U.S. Patent No. 2,866,046 and others pending.



**Electro-Tec Corp.**

SLIP RINGS • RELAYS • SWITCHES • OPTICS

P. O. Box 667 • Ormond Beach, Florida  
(904) 677-1771 • TWX 810-857-0305

Manufacturing Facilities:  
Ormond Beach, Fla. • Blacksburg, Va.

## Electronics Review

out the Japanese cost advantage overnight was so spectacular that they have to gamble on a repeat performance with IC's.

Motorola, Inc., Texas Instruments Incorporated and the Signetics Corp., a division of the Corning Glass Works, are betting that plastics will be a big success. The Microelectronics division of the Philco Corp. is also heavily committed to plastic packaging. Philco's Eastern operation, in Lansdale, Pa., will use the transfer method of production. The General Electric Co., which developed one transfer method for transistors, will also use it for IC's; but GE does not seem to be as ready as the other four companies to make such sweeping claims.

On the other hand, the Semiconductor division of the Fairchild Camera & Instrument Corp. and the Radio Corp. of America are sticking to relatively primitive and inexpensive injection techniques.

**Heat and humidity.** The method of encapsulation is a matter of choice. Reliability almost seems to be a matter of opinion; everyone has figures to support his stand, and everyone's figures are different.

"I think you can meet military specifications," says Steve Levy, integrated circuit marketing manager for Motorola. And TI's George Berryman said in a paper presented at Wescon that two million hours of testing on transistors indicates that plastic packages can meet military specifications and are as reliable as their counterparts in metal cans.

Most data on reliability has come from transistor tests. Signetics, however, has deliberately made IC's with cavities in the plastic, then exposed them in a helium atmosphere and found that the leak rate was less than the  $10^{-8}$  centimeters per second accepted as a hermetic standard. It has also tested some devices in a pressure cooker for 30 to 40 days before they broke down.

Says marketing manager George Didinger, "One large military customer has even suggested that we quit using glass." Signetics won't do that just yet, though by next year it expects plastic IC shipments

to outstrip glass, because "not all our military customers feel that way. Most of them just don't believe that plastic is hermetic."

Levy says plastic packages will also dominate Motorola's shipments. The 23 devices, both diode transistor logic and resistor transistor logic, on which Motorola announced price reductions at Wescon, are rated from only 0° to 75° C, however, which is not up to military standards. Philco says it has tested devices at 125° C.

**Skeptics.** Ben Jacoby, IC marketing manager for RCA, says the cost advantages of up to 90% that some manufacturers are claiming may not hold up. RCA will soon introduce an all-ceramic dual in-line package with a welded seal that is at most 25% more expensive than plastic. "There's a real race to be run yet," Jacoby feels. The hermetically sealed ceramic package, he says, has not yet gone through a rigid cost-reduction program.

Fairchild's marketing boss, Don Valentine, says, "We will offer a ceramic, hermetically sealed dual in-line pack with both DTL and RTL for the same or better cost than anybody using molded epoxy." Fairchild expects to eliminate the expensive lead frame and 50% of the ceramic by taking the flip-chip approach. "That way we'll still have hermeticity, and we don't see plastics as being a penny cheaper," adds Valentine.

## Advanced technology

### Power from plasma

One of the problems plaguing spacecraft designers has been the plasma that's created when the craft reenters the atmosphere. A Sandia Corp. researcher now proposes to put the plasma to work by using it to generate current—and without adding weight or complex components. The plan is to separate the forward section of the nose cone from the rear section with an insulator connected to a conductor.

**Hot spot.** When a nose cone re-

## Electronics Review

enters the atmosphere at hypersonic velocities, the heat caused by friction ionizes the atmosphere. Around the front of the craft the cone emits a stream of electrons that flow through the surrounding ionized gases, or plasma, toward the rear of the vehicle. The rear section of the nose cone is cooler and collects some of the free electrons; hence the entire rear of the craft is negatively charged. The potential between the two sections causes a current flow. Current could be stored in either batteries or capacitors.

Continuous current would be generated as long as plasma is being created. The amount of power generated would depend on the nose cone's materials, size and shape, and the speed and temperatures reached during reentry.

The inventor of the generator, Keneel J. Touryan, supervisor of reentry studies at the Sandia laboratory in Albuquerque, N. M., says that a maximum of 2,000 watts could be generated continuously during reentry with a 3-foot-diameter nose cone.

## Electronics notes

▪ **Another IC radio.** The Philco Corp. is the second company to announce a home radio receiver using integrated circuits. Its debut is set for October, about the same time as the General Electric Co.'s clock radio [Electronics, July 11, p. 40]. All the active circuits in Philco's a-m table model will be in two silicon flip chips soldered onto a 1- by 0.6-inch carrier board.

▪ **High field.** A superconducting solenoid generating 103,590 gauss in a two-inch bore is believed to be the highest field attained in a work area of that size. The solenoid was built by Magnion, Inc., of Burlington, Mass. Although it requires a liquid-helium environment, the device operates from a battery—in contrast to conventional magnets which require, for example, 50 kilowatts input and 10 tons of metal to produce 40,000 watts. The Magnion coil, made of niobium tin ribbon, has an outside diameter of 5.2 inches, and an active winding length of only 5.5 inches.



### Field-proven hp 651A Test Oscillator

Accurate test signals, 10 Hz (cps) to 10 MHz (mc)  
Typically 10 ppm short-term stability  
Long-term frequency stability  $\pm 0.02\%$ , amplitude stability  $\pm 0.1\%$   
1% accurate 90 db output attenuator  
50-, 600-ohm output impedances (optional 75 $\Omega$ )

#### Use it for:

Response testing, narrow- or wide-band  
Test signal source with low distortion in presence of shock, vibration or hf radiation  
Measuring filter transmission characteristics, tuned circuit response  
Telephone carrier measurements  
Bridge measurements  
Video amplifier tests  
Voltmeter calibration  
Amplifier loop gain plots  
Receiver alignment  
Network gain/loss measurements

Here's a high-performance solid-state source of low-distortion test signals for a wide variety of uses. Performance-proven in the field. Wide frequency range, continuously variable across six bands. Low hum and noise. Voltmeter output monitor calibrated in v and db, highly accurate output attenuator with output isolation achieved through power amplifier. Price: Only \$590.

Ask your hp field engineer for a demonstration of this basic measuring instrument. Or write for complete information to Hewlett-Packard, Palo Alto, California 94304, Tel. (415) 326-7000; Europe: 54 Route des Acacias, Geneva.

Data subject to change without notice. Price f.o.b. factory.

HEWLETT  PACKARD  
An extra measure of quality

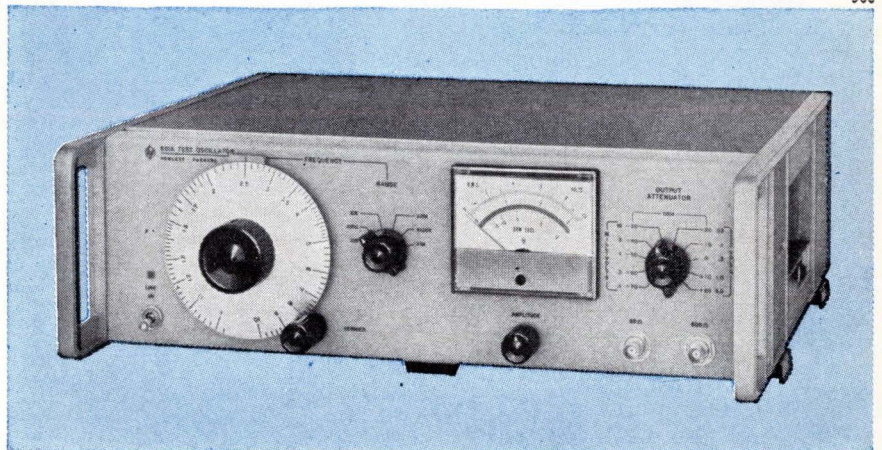

# 3M Brand Inert Fluorochemical Liquids cut component failure rates drastically by removing heat faster.

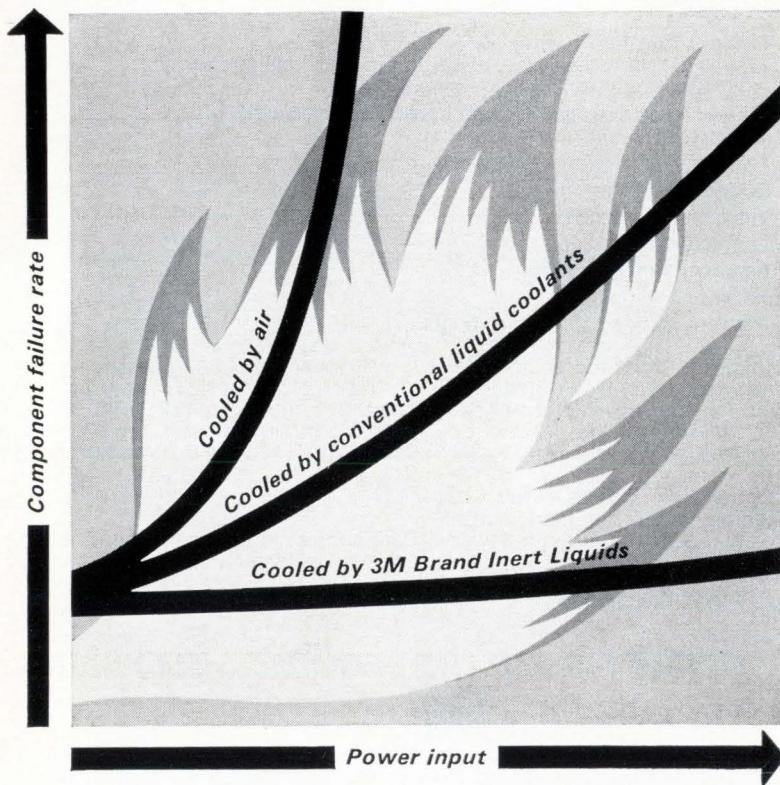

**PRACTICALLY EVERYTHING** we can say about 3M Fluorochemical Inert Liquids adds up to one thing for the designer and engineer: **INCREASED RELIABILITY.** Why? Because component failure rates increase sharply as component temperatures increase. Efficient heat removal lowers the temperature and increases reliability.

3M Inert Liquids are far more efficient at removing heat than air or other conventional dielectric coolants. Results: **LOWER COMPONENT TEMPERATURES, LOWER FAILURE RATES, HIGHER RELIABILITY.**

**FOR THE FULL STORY:** chemical inertness, non-flammability, high temperature stability, compatibility, high electric strength, low dissipation factors, write: 3M Company, Dept. KAX-96, St. Paul, Minn. 55119.

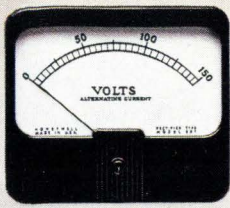

Make sure Honeywell's revolutionary new Auto-Torque mechanism is inside. It's the first substantial improvement in meter technology

in ages — a new kind of band-type meter — first to be machine manufactured. Auto-Torque is more reliable (since there are 50% fewer parts, you can practically wave

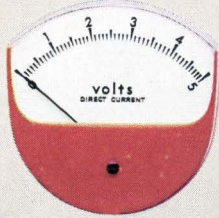

good-bye to service problems). Auto-Torque is more durable (since the moving system is suspended on metal bands under tension, there's no friction and wear). Auto-Torque is more accurate (since the mechanism is self-shielded, it can be mounted on any panel without special calibration — without worrying about "sticks", either).

Auto-Torque is more economical (quantity-order prices for volume buyers are below comparable pivot and

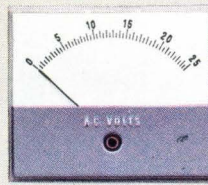

jewel meters). Auto-Torque is under the hood of the world's smartest-looking meters. And there are plenty of styles to choose from. In fact, Auto-Torque meters come to you in the widest selection of band-type meters available today . . .

For more information on Auto-Torque, write to Honeywell Precision Meter Division in Manchester, N. H. 03105.

**Honeywell**  
**Auto-Torque Meters**

**Before you  
pick out a new meter,  
better look under the hood.**

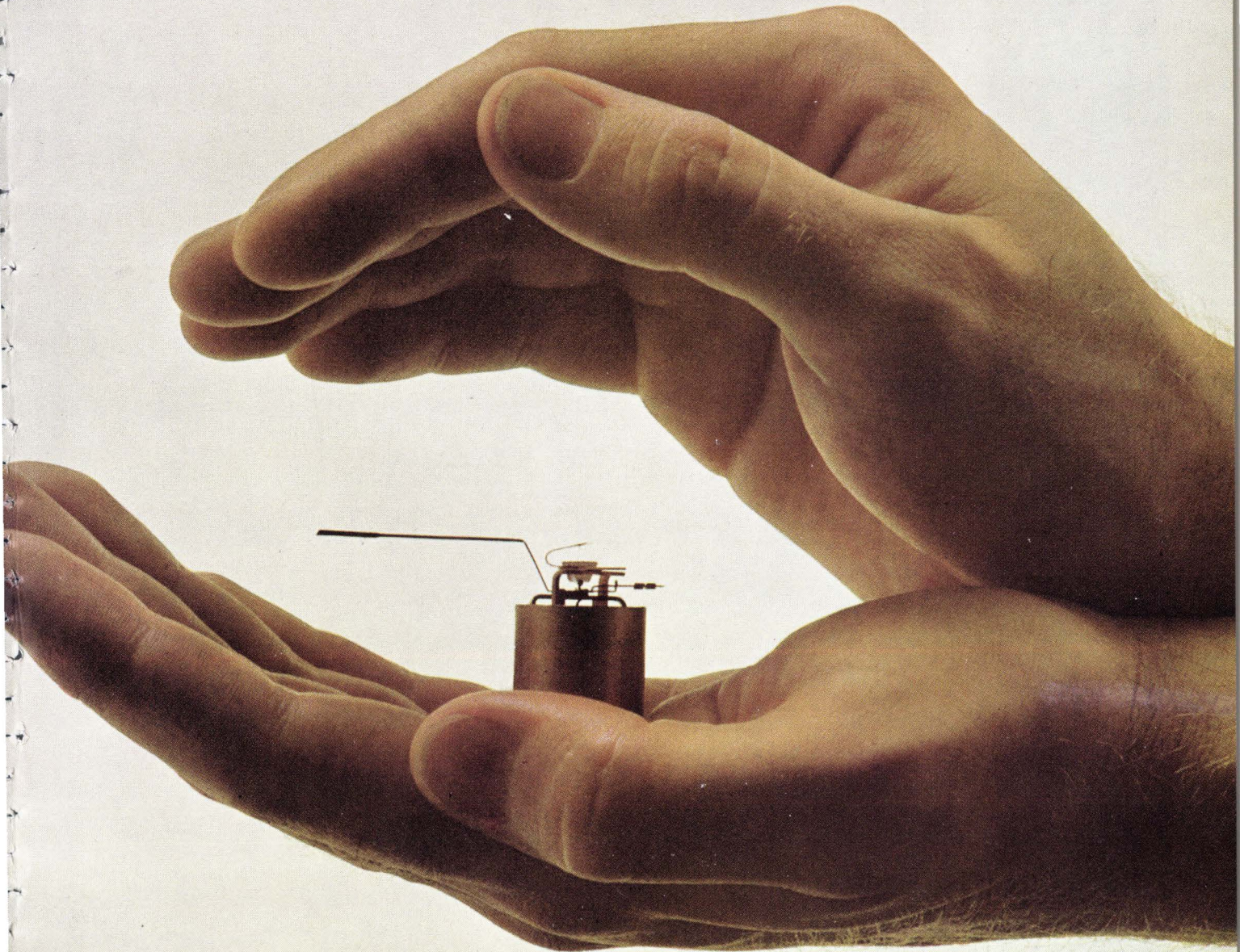

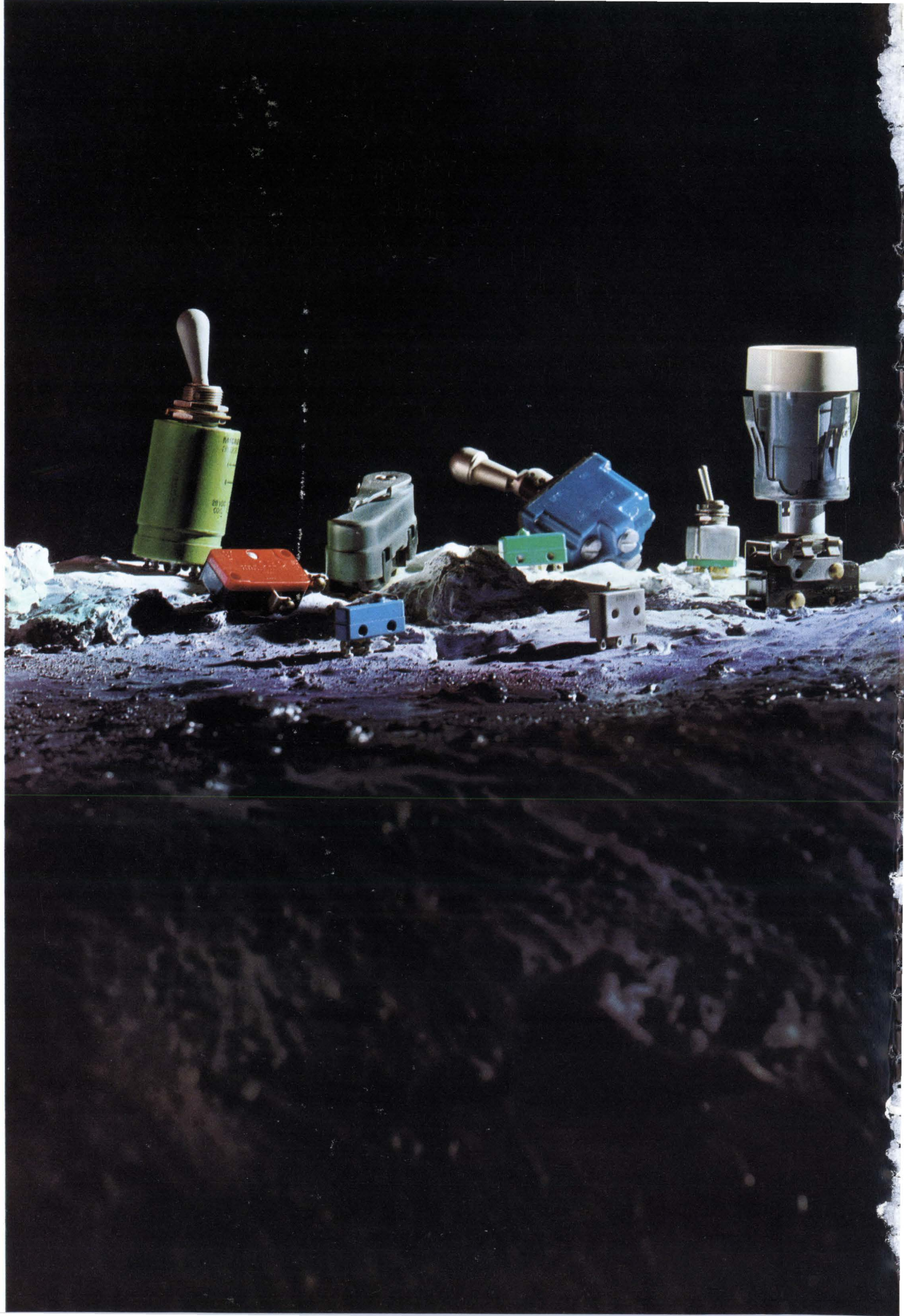



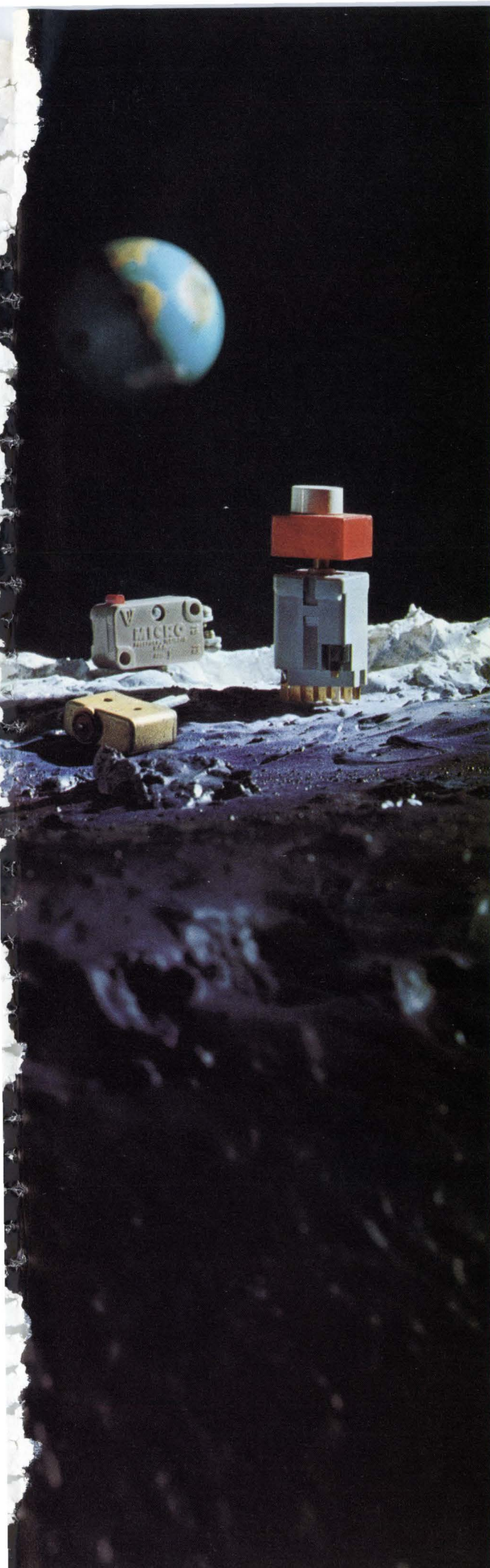

## Pioneering?

# Our switches have already been to the moon, to Mars... and then some

What we have learned about reliability in space age switching—and what we are learning today—should be helpful to you.

We've made important contributions in nearly all of the aerospace projects—Apollo, Mariner, Ranger, Surveyor, to name a few.

And, we've gone beyond. In our laboratories we are solving problems presented by future projects—sophisticated problems involving switch miniaturization, metallurgy, plastics, circuitry, human engineering, and many more.

Our quality assurance procedures and manufacturing experience and facilities are playing important roles in the Zero-Defects program.

Whatever industry you are in, you can benefit from this advanced capability by calling a MICRO SWITCH Field Engineer. He can also show you the largest selection of switches in the universe.

Call a Branch Office (see Yellow Pages, "Switches, Electric") or write us at Freeport.

## **MICRO SWITCH**

FREEPORT, ILLINOIS 61032

A DIVISION OF HONEYWELL

**HONEYWELL INTERNATIONAL** • Sales and service offices in all principal cities of the world.  
Manufacturing in United States, United Kingdom, Canada, Netherlands, Germany, France, Japan.

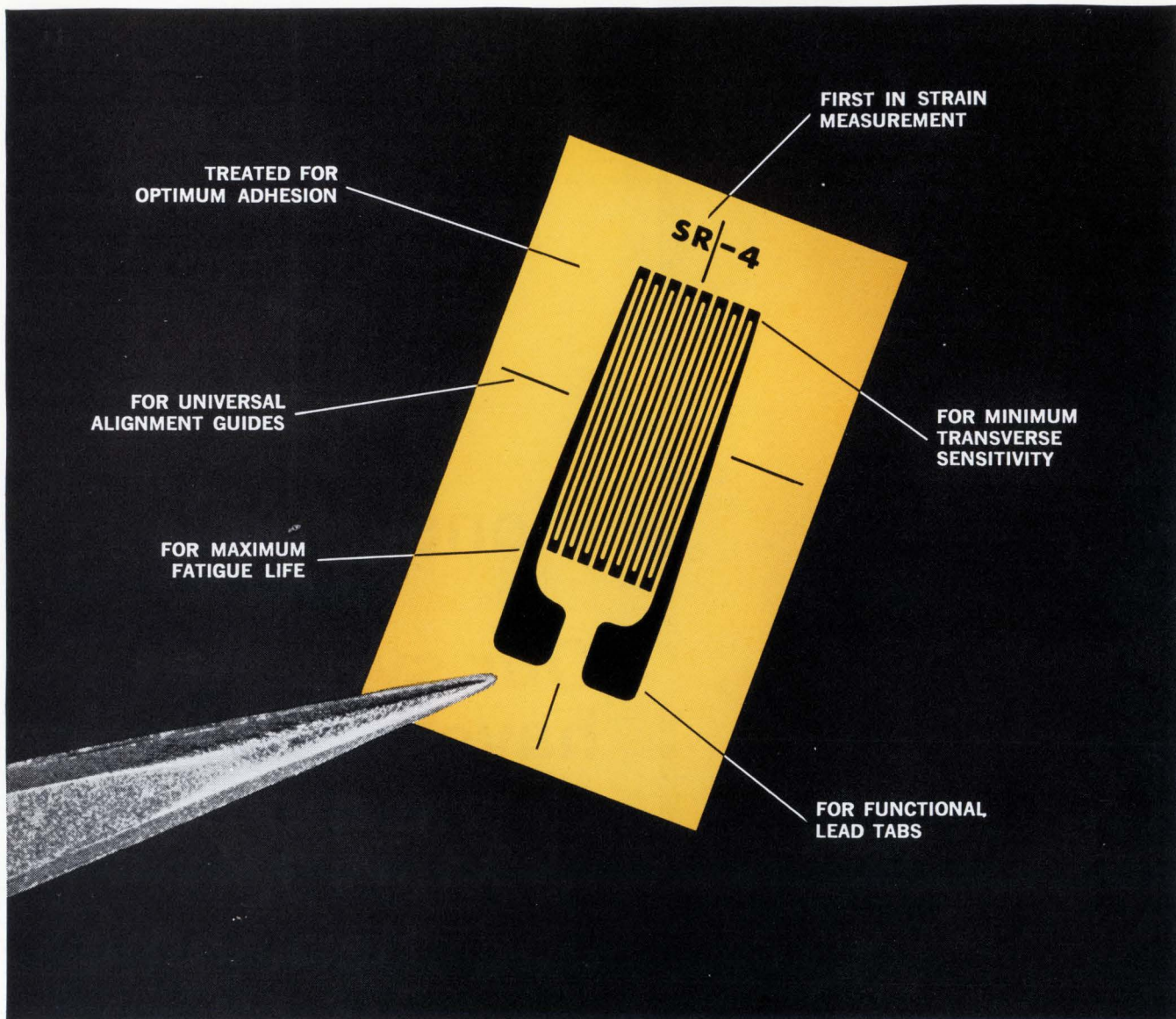

TREATED FOR  
OPTIMUM ADHESION

FIRST IN STRAIN  
MEASUREMENT

FOR UNIVERSAL  
ALIGNMENT GUIDES

FOR MINIMUM  
TRANSVERSE  
SENSITIVITY

FOR MAXIMUM  
FATIGUE LIFE

FOR FUNCTIONAL  
LEAD TABS

## ***Stress Analyzed Design Maximizes Foil Strain Gage Performance***

**Longer Life, Improved Accuracy  
and Ease of Handling head list of  
New SR-4® Foil Gage Advantages**

*BLH Electronics announces a new line of Stress Analyzed Foil Strain Gages. These new gages are the result of demands for precision foil strain gages that stand up under the rigors of dynamic forces such as encountered in rocket testing.*

*Heretofore, the use of foil gages of this quality has been restricted to precision force, pressure and torque*

*measuring transducers. Now, transducer quality foil strain gages are available for all stress measuring applications.*

*The enlarged photograph shows the pertinent design features that separate this gage from its predecessors. No other gages, commercially available for stress analysis, provide all of the advantages shown.*

*Write for complete product and technical information.*

*BLH ELECTRONICS, a division of Baldwin-Lima-Hamilton, Waltham, Mass. Plants in Waltham, Mass., Pasadena, Calif. and Darmstadt, West Germany.*

**BALDWIN · LIMA · HAMILTON**  
A subsidiary of Armour and Company



Strain Gages • Temperature Sensors • Load Cells • Pressure Cells • Torque Pickups • Recorders • Instrumentation • Integrated Systems

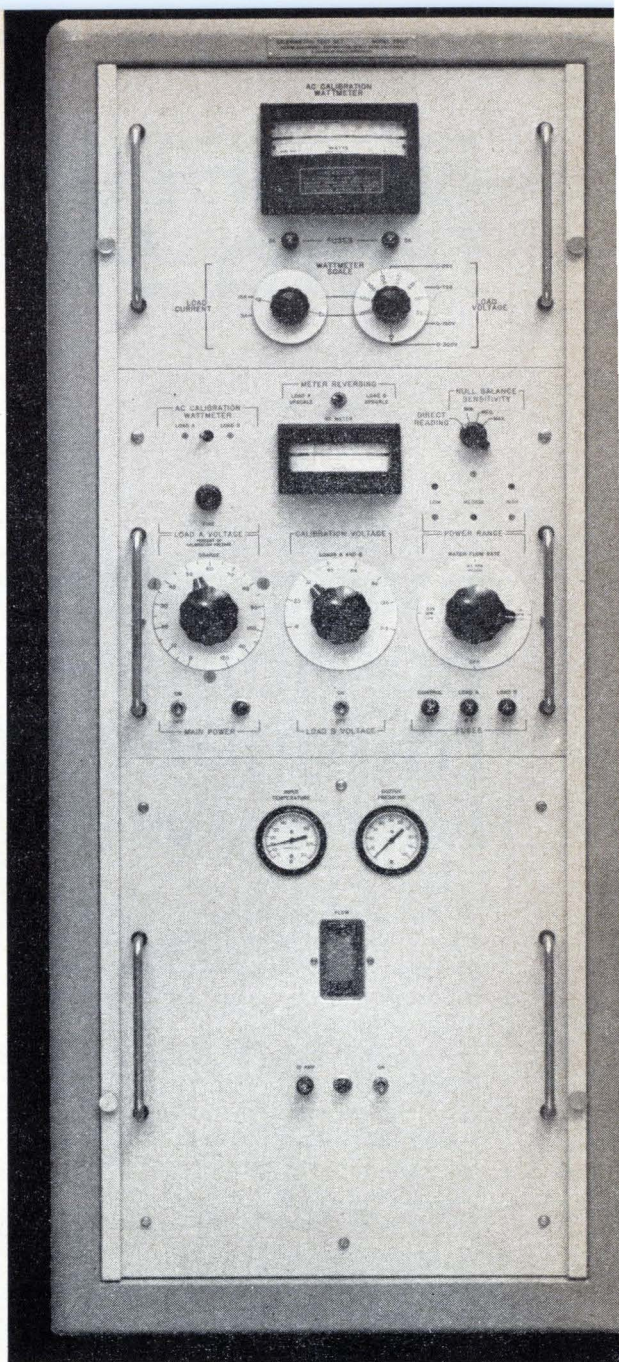
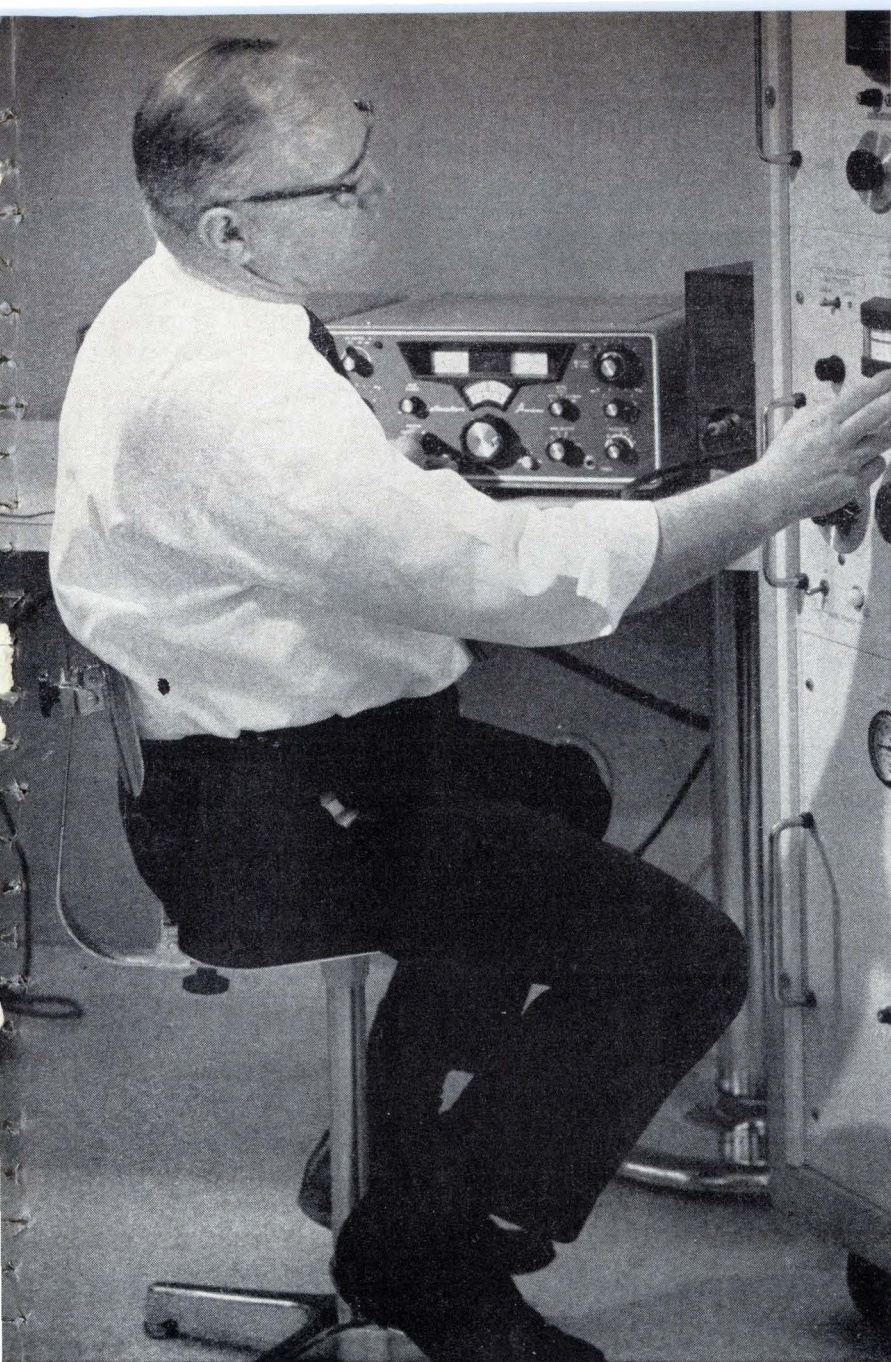

## What takes the guesswork out of Ed Brzana's job?

Hallicrafters takes deserved pride in its blue-ribbon reputation. That's why they class Instrument Calibration and Control Services Lab Manager Ed Brzana as a VIP. In an average week, Ed supervises certification of 460 instruments, making sure they hew to stringent accuracy specifications. On his schedule, he has no time to debate questionable r-f power readings.

To dispense with guesswork, Ed relies on a Sierra Model 290C RF Power Calorimeter. Hallicrafters' ability to measure r-f power from DC to 10 Gc within a 1% limit of error has established the 290C as the company's standard for both military and commercial product lines. In a typical day, QC engineers use the 290C to calibrate r-f wattmeters for working standards, run incoming acceptance tests on Carcinotron tubes, and perform acceptance tests for the military on Hallicrafters-built ALT 13, 15, and 16 jammers.

Many delivered products now receive acceptance checks on a 290C. Maybe some of yours! At today's high cost of r-f generation, you can't afford either to fall short of specs or give away excess power. For further information, write to Sierra/Philco, 3885 Bohannon Drive, Menlo Park, California 94025.

## This r-f power standard from Sierra

SIERRA ELECTRONIC DIV.  
OF  
**PHILCO**  
A SUBSIDIARY OF *Ford Motor Company*

Circle 47 on reader service card

# SURPRISE PACKAGE\* from HONEYWELL

## the greatest price/performance combination in the entire magnetic tape system field— Honeywell 7600 Series!

\*The first tape systems to offer a total modular concept, the brilliantly designed Honeywell 7600 Series is going to change a lot of people's ideas about tape hardware! Incorporated in the versatile new 7600 Series are the following features:

- Choice of Direct Response Electronics: Wideband to 1.6 MHz; Medium Band to 700 KHz
- FM Response to 80 KHz
- Extensive use of Integrated Circuitry
- 7-speed Automatically Switched Electronics
- NRZ Digital to 1000 BPI
- Extremely low Flutter, Skew, and Time Displacement Error
- Choice of Wideband Phase Lock or Velocity Tone Servo Systems
- Balanced Tension

Tape Drive ▪ Seven Speeds from 1 $\frac{1}{2}$  to 120 ips, completely bidirectional

- 10 $\frac{1}{2}$ " or 15" Reel Capability

You can see a Honeywell 7600 Series system now! Call your Honeywell Sales Office for a demonstration of this remarkable new instrument — they've got one, and they'll be glad to put it through its paces for you. Delivery? The 7600 Series is in *full production* and your Honeywell Sales Engineer can give you up-to-the-minute delivery information. Price? Regardless of the 7600 package you specify, we assure you it will be much less than you expect. Don't waste a day — call Honeywell *now!*

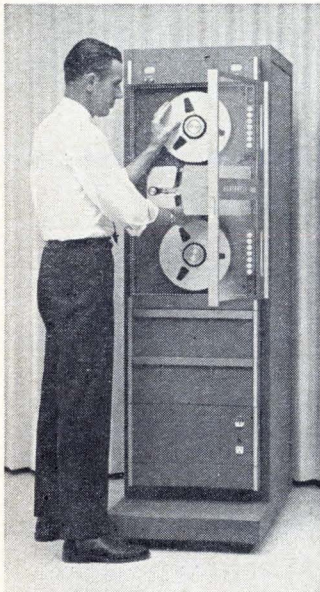

Total modular concept means you can buy the 7600 system you need now; expand it easily with options to meet future requirements.

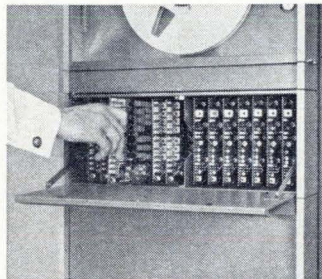

Front-access universal housings assure unmatched flexibility; accept plug-in circuit cards for Digital, FM, or Direct electronics.

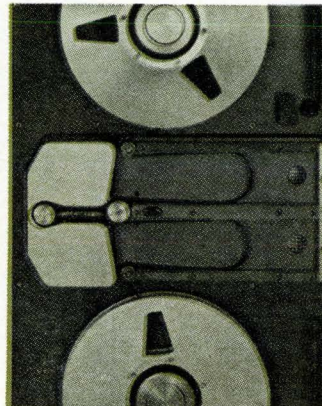

Advanced transport system features balanced tension direct drive. It eliminates belts, pulleys, gears, and pinchrollers and only the tape heads make contact with the oxide side of the tape.

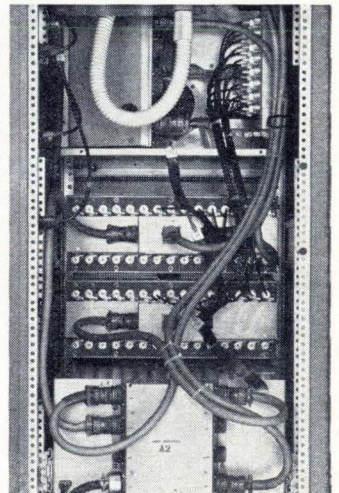

Elimination of fixed rack harnesses means components are completely independent for optimum flexibility.



HONEYWELL 7600

Mail This Coupon Today for Full  
Information on the New 7600!

Bill Wallace  
Mail Station 432  
Honeywell, Test Instruments Div.  
Denver, Colorado 80217

Please rush literature on the new 7600  
Tape System to:

Name \_\_\_\_\_

Company \_\_\_\_\_

Address \_\_\_\_\_

City \_\_\_\_\_

State \_\_\_\_\_ Zip \_\_\_\_\_

DATA HANDLING SYSTEMS

**Honeywell**

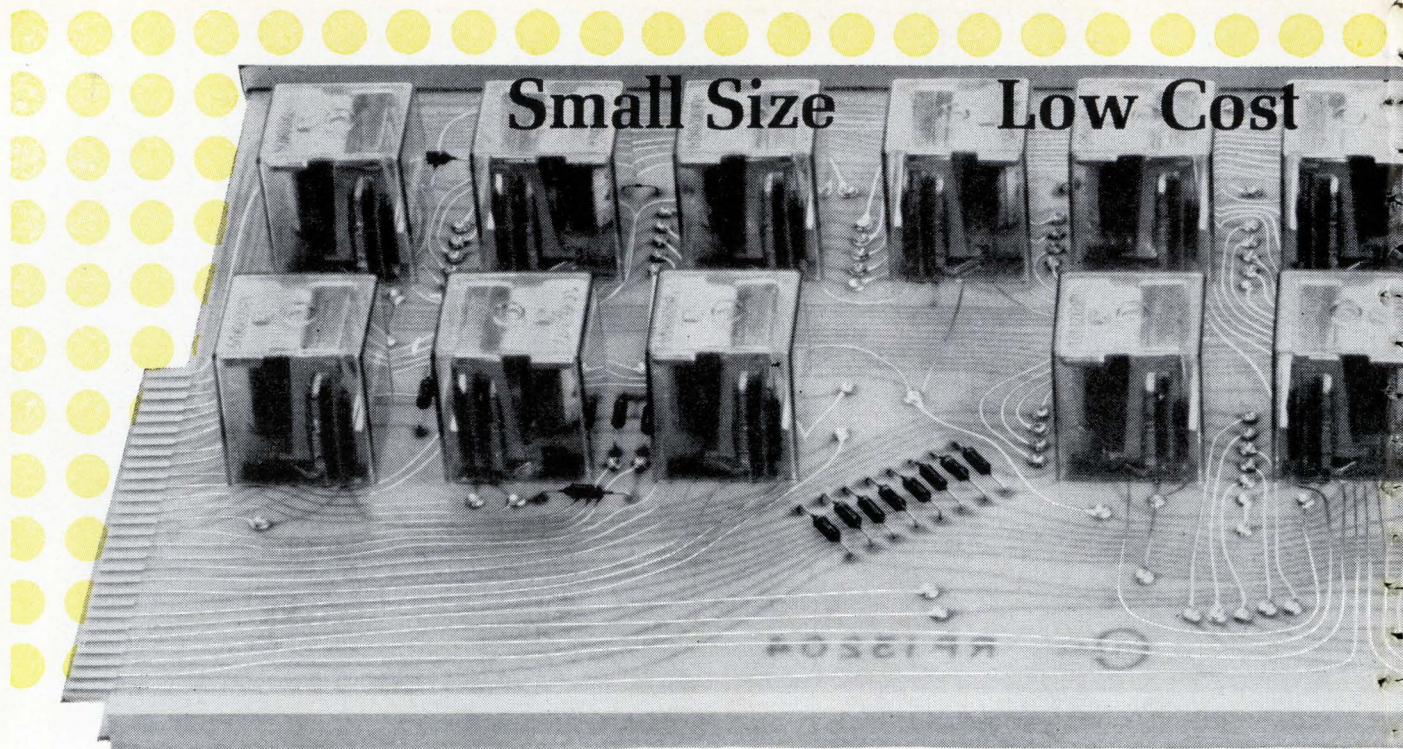

More Switching Capacity at Lower Cost...

for Millions of Operations

# CLARE **LB/LBP RELAYS**

Check these CLARE LB/LBP features against your requirements:

- **6 Form C Contacts**  
(Forms A, B and D also available)
- **Small Size: 1.33 cubic inches**
- **Contact Rating: 2 amperes to low level**
- **Twin contacts for reliability**
- **Direct PCB, or plug-in mounting**
- **Long life operation**

The new Type LB and LBP Relays are million-operation telephone type relays, offering extremely high quality performance at the lowest possible cost. They are ideal components for a variety of military, industrial and commercial applications, where limited space makes small size especially desirable. They provide wide application capability with a 6 form C contact arrangement. Contact forms A, B, and D are available if required. Twin contact construction provides two independent contact surfaces that assure greater contact reliability and performance. Must operate sensitivity for 6 form C is approximately 350 mw. Clear plastic cover with each LB and LBP relay; phenolic bottom plate also supplied with each LB relay.

Typical contact life ratings are: at 1.0 ampere, 28 vdc resistive, 10,000,000 operations; at 10 micro amperes, 10 millivolts, 250,000 operations with maximum contact resistance of 100 ohms.

# Long Life Contact Versatility

## Plug into wired chassis or printed circuit board

## Mount directly on printed circuit

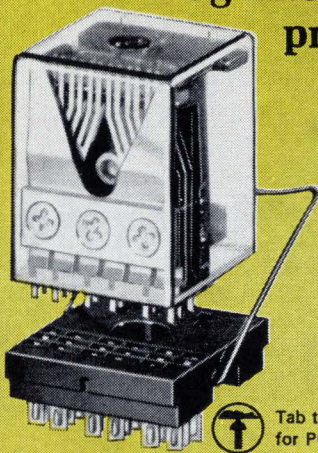

Tab terminals for PCB mounting

Type LBP Relay sockets offer choice of two terminal styles; elongated-hole solder type terminals for wired assemblies (shown in photo) or tab terminals (insert) for PCB mounting. Maximum height for plug-in wired assembly mounting, 1½ inches; for PCB mounting, 1¼ inches. Relay shown actual size.

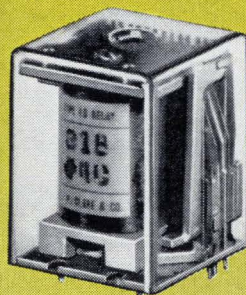

Type LB Relay has tinned nickel silver terminals for direct PCB mounting. Volume: 1.33 cubic inches. Maximum mounted height, 1.24 inches. Relay shown actual size.

**CONTACTS:** Forms A, B, C or D. Up to 6 forms per relay

**CONTACT LIFE: Mech.:** 100,000,000 operations

**Resistive Power Load (at 25°C):**

Current (amperes)	Voltage	Life (operations)	Contact Form
1.0	28 vdc	10,000,000	C
2.0	28 vdc	100,000	C
.25	115 vac, 60 cps	50,000,000	C

**Low Level Load (at 25°C):**

Current	Voltage	Life (operations)	Contact Form
10 µa (closed circuit)	10 mv (open circuit)	250,000	C

(maximum contact resistance—100 ohms)

**COILS**

	Nominal Operating voltage	Resistance ± 10% @ 25°C
Single wound coils	5 to 100 vdc nominal	20 to 6550 ohms
Double wound coils (each coil)	4 to 75 vdc nominal	10/10 to 3275/3275 ohms

**DIELECTRIC STRENGTH**

500 vac rms, 60 cps  
1000 vac as special

**INSULATION RESISTANCE**

500 K Megohms min.

**SHOCK**

OPERATING: 15g's 11 ms ½ sine wave, 10 usec max. contact chatter

**VIBRATION**

OPERATING: 10g's 5-2000 cps, 10 us max. contact chatter

**SENSITIVITY:** Approximately 350 milliwatts—6 Form C or 4C2D contacts.

**TYPICAL OPERATE, RELEASE AND BOUNCE TIME**

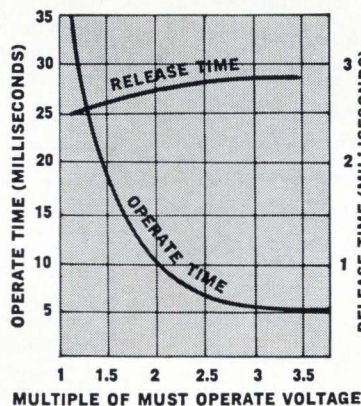

**Contact Bounce**

Normally open at operate  
1.0 ms  
Normally closed at release  
3.0 ms

**Notes**

1. All values are typical
2. Switched battery voltage source
3. Coils not arc suppressed
4. Contact bounce not included in operate and release times.

NOTE—These specifications are condensed. For complete technical data see Data Sheet 552.

Address:  
Group 09N5  
C. P. CLARE & CO.  
3101 Pratt Boulevard  
Chicago, Illinois  
60645



relays and related control components

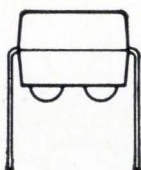
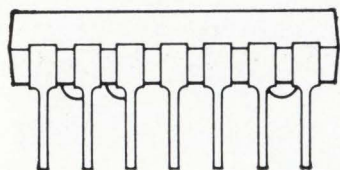
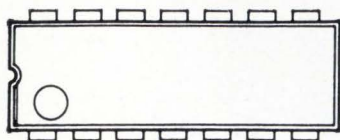

# Now- Motorola 830-Series MDTL Integrated Circuits in PLASTIC!

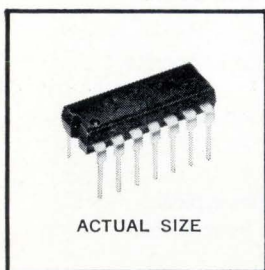

ACTUAL SIZE

Here's the popular 830-series DTL integrated circuit complement in plastic packages at prices from 30 to 60% lower than what you have been paying for metal!

Offering the same wide range of circuit functions as previous metal and flat-packaged types, Motorola's new MC830P series, for operation from 0 to +75°C, provides an unusual opportunity for reducing production costs.

For example, the Motorola-designed Unibloc\* plastic package, with dual in-line pin arrangement, offers great advantage for use in production assembly with automatic insertion equipment.

("Unibloc" is Motorola's trade name for its solid, single-piece pressure-molded package that offers unusual physical strength for internal leads and connections, plus improved heat transfer characteristics.)

Here are the new MDTL\* circuit prices:

Circuit Function	Price† (100-999)
MC830P Dual 4-Input Gate	\$2.70
MC831P Clocked Flip-Flop	3.25
MC832P Dual Buffer	3.00
MC833P Dual Expander	2.40
MC844P Dual Power Gate	3.00
MC845P Clocked Flip-Flop	3.25
MC846P Quad 2-Input Gate	3.25
MC848P Clocked Flip-Flop	3.25
MC862P Triple 3-Input Gate	3.00

†See your Motorola representative for even more substantial savings in larger quantities.

For complete details write to: Motorola Semiconductor Products Inc., Dept. TIC, Box 955, Phoenix, Arizona 85001.

\*Trademark of Motorola Inc.



## MOTOROLA Semiconductors

*- where the priceless ingredient is care!*



All the wishing in the world isn't going to help the performance of a cheap core tester. It is what it is. A cheap core tester. Sometimes it'll work. Sometimes it won't. You never know. And who can afford to take the chance? This kind of hit-and-miss testing has no place in a business where 99.9999% reliability is not nearly good enough. Besides, it's expensive. In lost time. Lost tempers. Lost contracts. If you put your money in CTC systems you get equipment that delivers core driving pulses with unmatched precision and controllability, that detects and measures core responses with the kind of accuracy that spots even the most marginal cores every time. And when you buy CTC test equipment, you only have to pay for it once. That's because it does the job it's designed to do. Over the long run what it saves you in headaches and dollars is a heck of a lot more than wishbone thinking will do.

**COMPUTER TEST CORPORATION**

Cherry Hill, New Jersey



some people  
test cores  
with their  
fingers crossed

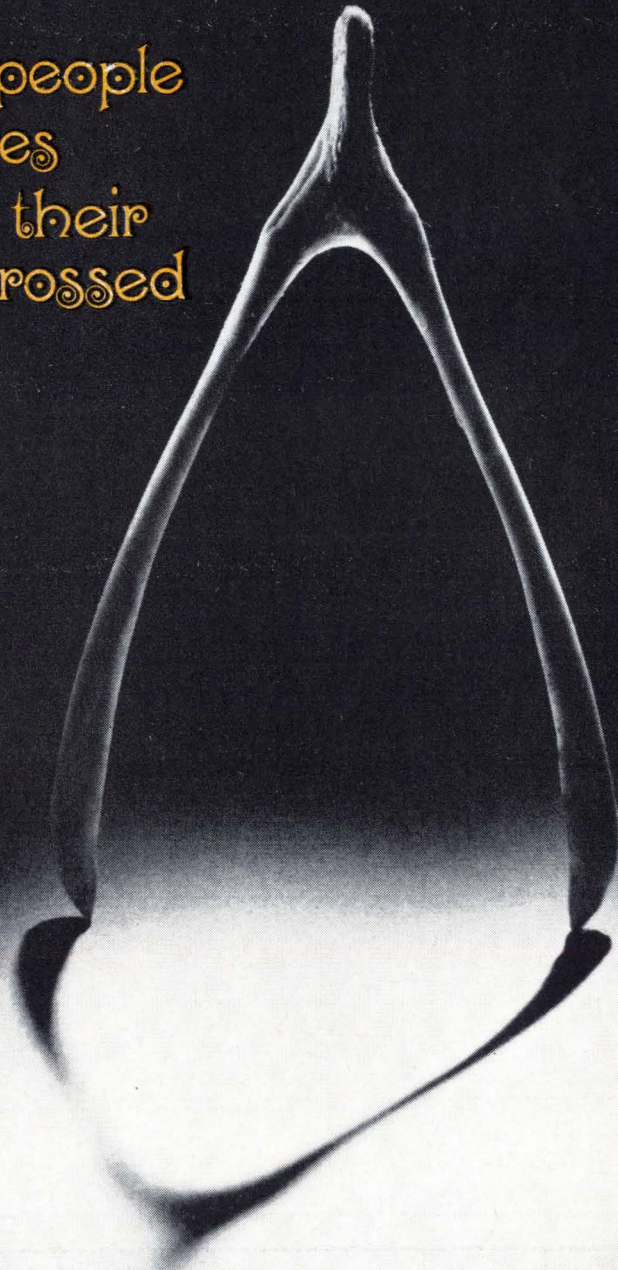

Problem:

Get  
faster,  
more  
efficient  
"read in"  
of data.

Solution from  
American Optical:

Fast,  
quiet,  
reliable  
fiber-optic  
"readers" for  
data processing.

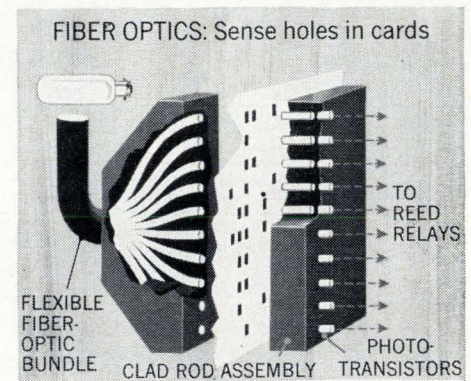
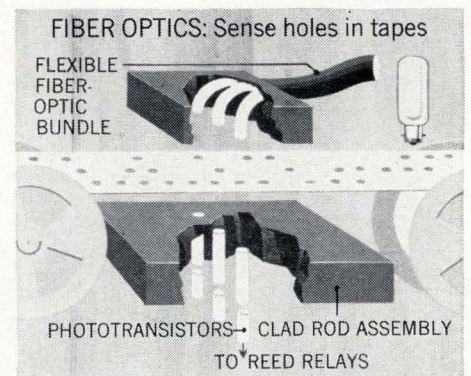
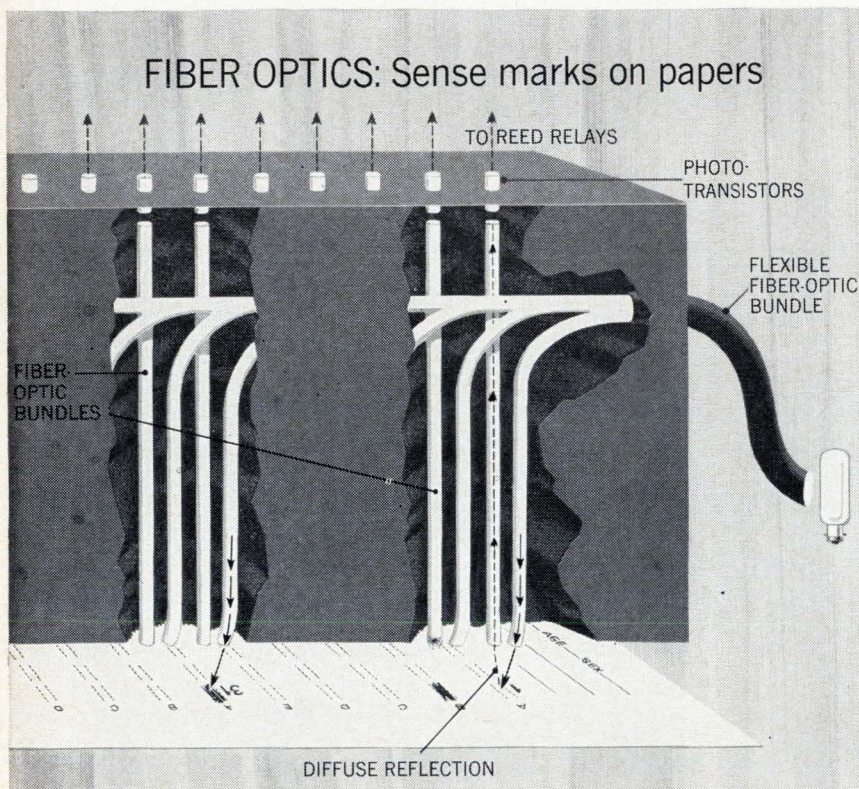

Electro-optical systems incorporating fiber optics are operating at up to four times the speed of electro-mechanical systems. When a combination of fiber optics, phototransistors, and reed relays is used, reading of basic data is not controlled by mechanical limitations. The use of fiber optics allows wide design freedom to increase system operating speed.

In addition, electro-optical devices provide inherently quieter operation. And the need for continual replacement of expensive electromechanical components is eliminated. The use of fiber-optic devices isolates heat and eliminates friction, the major causes of wear and failure. In most applications, both initial cost and use cost can be reduced by design simplicity.

American Optical know-how makes such design simplicity possible. AO pioneered fiber optics and today produces the most widely used sensing devices. This accumulated practical design and application experience, along with research and production capability, is readily available to you.

Contact AO now and lessen the time and expense of getting from exploration to application. Sorters and collators, verifiers and key-punch equipment, printers and readers, teletypes—most any data processing equipment—can benefit from these American Optical fiber-optic devices. Write American Optical Company, Fiber Optics Department, Southbridge, Massachusetts 01550. Or call 617-764-3211.

NEW FROM



**AMERICAN OPTICAL COMPANY**

SPACE-DEFENSE DIVISION—SOUTHBRIDGE, MASSACHUSETTS

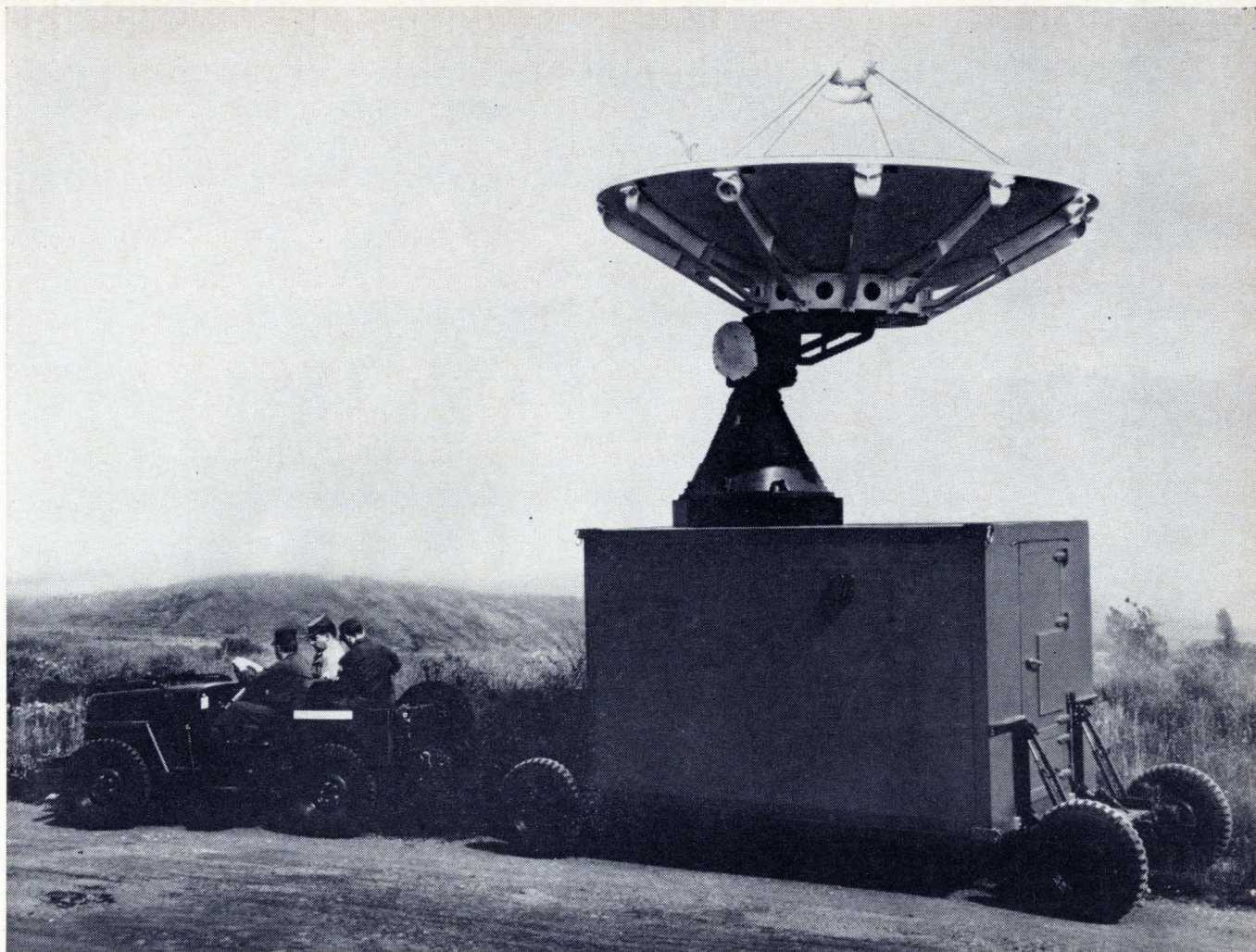

Sylvania's satellite communication terminal is one of the most mobile ground stations ever built. Weighing only two tons, it is readily transported by truck or helicopter. Three men can set it up in less than an hour. When used with Syncom III, this terminal provides one duplex voice channel and 16 simultaneous teletype channels.

#### CUSTOM DESIGNED FOR MOBILITY

The power amplifier for the transmitter in the new Sylvania Comsat Ground Station is the air-cooled VA-881 — a specially designed 6.5 kW Varian klystron. Since the VA-881 operates without a liquid-to-air heat exchanger, it is lightweight and avoids the maintenance problems of leakage, plugged lines, and spillage.

Working hand-in-hand with America's leading satellite ground terminal designers, Varian has developed another new family of CW klystrons. These tubes have now advanced the state-of-the-art to: tuning ranges approaching 10%; bandwidths approaching 1%.

When you need a state-of-the-art klystron, call on

## VARIAN AIR-COOLED KLYSTRON POWERS SYLVANIA'S NEW COMSAT TERMINAL

Varian. Our scientists and engineers have the most thorough knowledge, capability, and technology in the entire microwave tube industry. Why not put this skill to work for you?

Palo Alto Tube Division, 611 Hansen Way, Palo Alto, California 94303. In Europe: Varian A. G., Zug, Switzerland. In Canada: Varian Associates of Canada, Ltd., Georgetown, Ontario.



# WHO SAYS YOU CAN'T AFFORD PTICAL ENCODERS?

If you've suffered the friction, noise and wearout problems of brush encoders because optical encoders were out of your price range, suffer no more! Wayne-George announces a breakthrough in the price of optical encoders applicable to the low and intermediate resolution ranges. These new Wayne-George encoders offer resolution and accuracy to 10 binary digits per input shaft revolution in Natural Binary Code format or to 3 decimal digits per revolution in BCD Code format. The encoders feature self-contained, solid state electronics within a case diameter of 2.5 inches (smaller sizes coming soon). Operating life and MTBF exceed 30,000 hours. Prices? . . . You are in for a surprise! . . . Call or Write:



**WAYNE-GEORGE CORPORATION**

CHRISTINA STREET, NEWTON, MASSACHUSETTS 02161 TEL. (617) 969-7300

TWX 617-332-7637

Our ferrite division can make that many toroids in a month. In sizes as small as 80 mils, with high temperature stability, inductance values within  $\pm 5\%$ , and in a wide range of ferrite materials to meet practically any pulsing speed. For example: for microsecond switching we can offer our Ferramic® 0-5, 0-6, and T-1 ferrites and for nanosecond switching there's our Ferramic H and Q-1 materials.

This materials capability plus our pro-

duction capacity have made us the world's largest supplier of ferrite toroids for pulse transformers. But toroids are only a part of our business. In total we have eleven standard ferrite materials right now and will soon introduce a twelfth one. A brand new flat temperature-coefficient ferrite that will make circuit design news. We are equally big in other ferrites for digital applications such as square-loop (memory core) ferrites,

recording head ferrites, and multiaperture devices.

So whether you want 2 samples, an order of 10 million, or catalogs and technical literature, you can get immediate action by writing Mr. Ken Talbot, Manager of Sales, Indiana General Corporation, Electronics Division/Ferrites, Keasbey, New Jersey.

**INDIANA GENERAL** 

**Ten million pulse transformer cores  
is peanuts to Indiana General.**



# 3

## Tektronix Portable Oscilloscopes

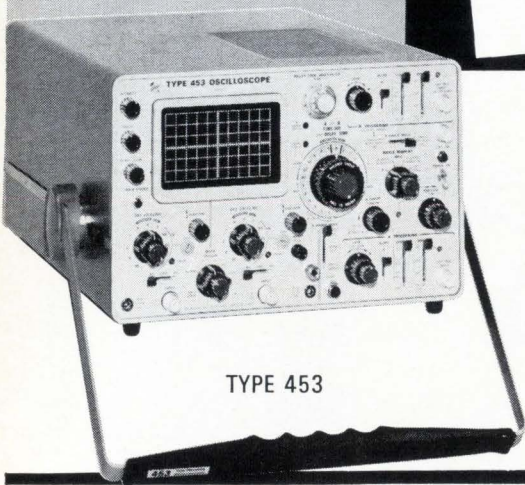

TYPE 453



TYPE 422

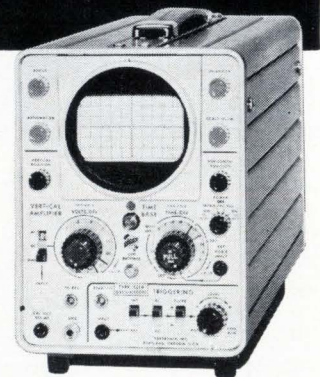

TYPE 321A

CHOOSE ONE  
FOR YOUR OWN MEASUREMENT REQUIREMENTS

TYPE 453

TYPE 422

TYPE 321A

Bandwidth	DC-50 MHz	DC-15 MHz	DC-6 MHz
Deflection Factor	5 mV/div to 10 V/div	10 mV/div to 20 V/div	10 mV/div to 20 V/div
Channels	Dual	Dual	Single
Delay Line	Yes	Yes	No
Sweep Delay	Yes	No	No
Size	Height	7 $\frac{1}{4}$	5 $\frac{3}{4}$
	Width	12 $\frac{1}{2}$	16
	Depth	20 $\frac{1}{2}$	14
Weight (pounds)	28 $\frac{3}{4}$	22	14
Power Requirements	AC: 96-137 V or 192-274 V; 45-440 Hz; approx 100 watts.	AC: 115 V or 230 V $\pm$ 10%; 45-440 Hz; approx. 40 watts. DC: 11.5-35 V; approx. 23 watts; accepts Tektronix 24 V battery pack.	AC: 115 V or 230 V $\pm$ 10%; 45-800 Hz; approx. 20 watts. DC: 11.5-35 V; or 10 size D batteries; approx. 700 mA
Rack Mount Available	Yes (7" Rack Height)	Yes (7" Rack Height)	No
Probes and Accessories Included	Yes	Yes	Yes
Price	\$2050	\$1400 (AC Model) *\$1750 (AC/DC Model)	*\$900

U.S. Sales Prices f.o.b.  
Beaverton, Oregon

\*without batteries

A TEKTRONIX PORTABLE will fit your specific requirements. Your Tektronix field engineer will be happy to demonstrate any of these oscilloscopes at your location. Just call him, or write Tektronix, Inc., P. O. Box 500, Beaverton, Oregon 97005.

**Tektronix, Inc.**

# Our group.

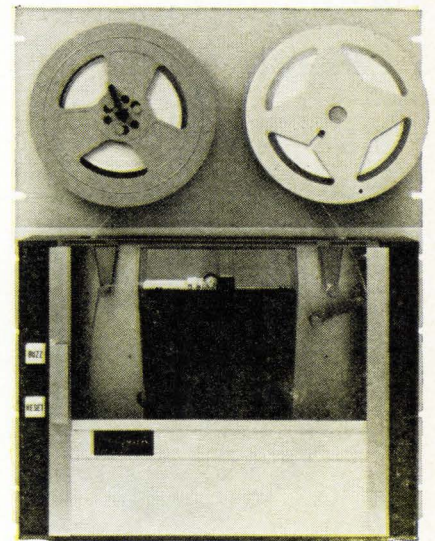
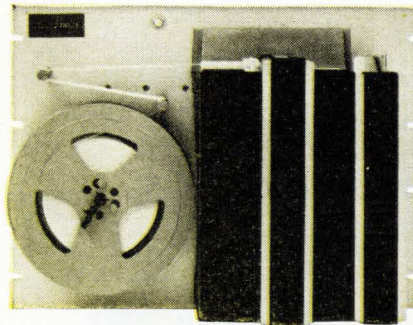
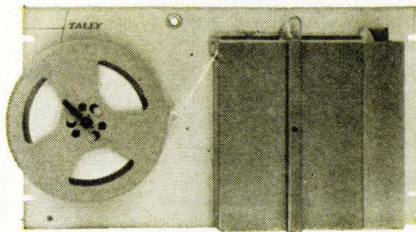

A family of three perforators is just right when it satisfies about 99 percent of the applications. And these Tally perforators do.

Easily the best known perforator on the market today is the wonderfully reliable Tally 420 which operates at 60 characters per second. Some of our customers have operated this perforator up to 500 million cycles without overhaul.

Fastest perforator in the family is the Tally P-150, which, as you might guess, operates at 150 characters per second. Rounding out the line is our popular 120 character per second perforator, the P-120.

The Tally P-120 and P-150 offer a remarkable degree of sophistication. With the parity option they catch their own mistakes while working at maximum speed. Here's how it works. Parity contacts in the perforating mechanism allow

interrogation during a punching cycle and before the tape is advanced to the next character. If an incorrect parity code is sensed, (1) tape advance is inhibited, (2) the code in error is overpunched with an all-hole delete code, (3) tape is advanced and the same character punched again. Clean accurate tapes are a virtual certainty.

All Tally perforators accept paper, plastic, or foil tapes. They feature asynchronous operation so that punch commands can be accepted at any time interval up to maximum speed. Tally perforators handle 5 through 8 channels on any standard tape up to 1 inch without modification. Tally perforators have high quality die blocks and precision honed punch pins individually fitted for long life punching. All models offer integral reeling. All Tally perforators are available in 50/60 Hz, 115/230 vac models.

Options include bit echo verification, remote backup, end of

tape, low tape, tape motion sensors, and teletypesetter configuration.

*Write for more wisdom.* Complete data on each and every member of the Tally group of perforated tape equipment is yours for the asking. For your information please address K. Crawford, Tally Corporation, 1310 Mercer Street, Seattle, Washington 98109. Phone: (206) MA 4-0760. TWX: (910) 444-2039. In the U.K. and Europe, address H. Ulijohn, Tally Europe, Ltd., Radnor House, 1272 London Road, London, S.W. 16, England. Phone POLlards 9199.

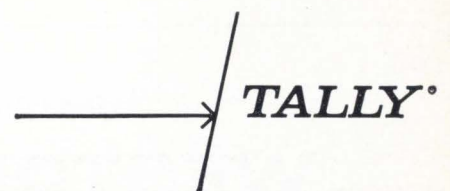

**familiar faces  
from the  
world's broadest  
line of  
indicating  
relays**

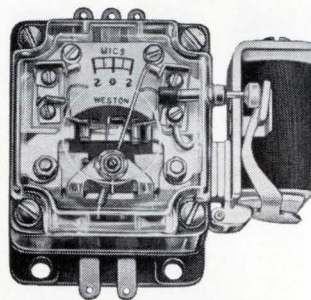

*Model 813 Miniature—compact and lightweight; sensitive and Sensitrol (magnetic) contacts; single or double contact; ranges as low as 2-0-2  $\mu$ a.*

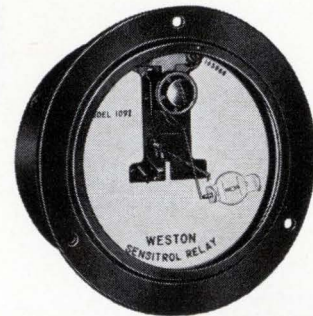

*Model 1092 Sensitrol—low cost; all purpose; magnetically shielded; wide range adjustability; ideal for use in engineering breadboard circuits.*



*Model 705 Sensitrol—highly sensitive; surface or flush mounted; single or double, fixed or adjustable contact; ranges as low as 0.5-0-0.5  $\mu$ a.*

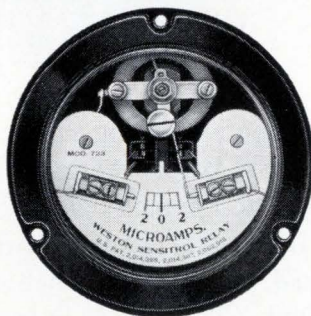

*Model 723 Sensitrol—sealed; shielded; internal reset; solder terminals; single or double magnetic contact; ranges as low as 1-0-1  $\mu$ a.*

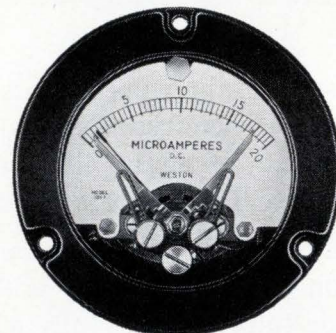

*Model 1097 Ruggedized 3 1/2" Relay—Load Current Contact Aiding type fully meets applicable portions of military ruggedized spec; sealed; long scale; shielded; solder terminals; single or double adjustable contacts.*

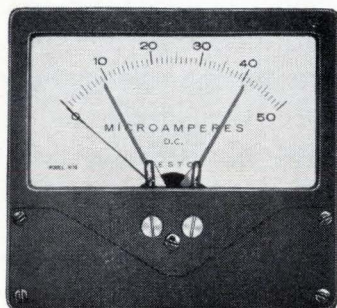

*Model 1075 Photronic—operates without physical contact; single or double adjustable set points; continuous reading beyond set point; taut band frictionless mechanism; solid state switching circuit; ranges from 10  $\mu$ a.*

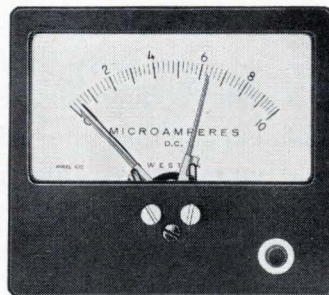

*Model 1073 Mag Track—long scale; shielded; positive contact; combines Load Current Contact Aiding with magnetic attraction; self-contained reset; single or double adjustable contacts, ranges from 10  $\mu$ a.*

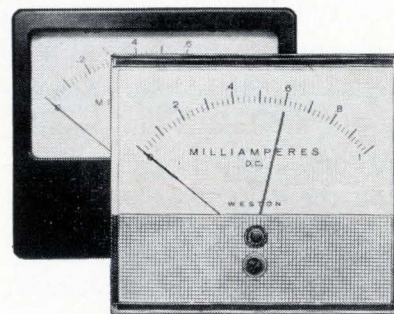

*Model 1930/1940 Photronic—3 1/2" and 4 1/2" in either bakelite or plastic front; low cost; add-on power supply and solid state switching circuit; shielded; non-physical, adjustable contact.*

Weston Instruments, Inc. • Newark Division • Newark, N.J. 07114

**WESTON<sup>®</sup>** prime source for precision... since 1888





# Population Explosion

*Our Innovators in Switch Design have produced more than 200,000 different types. That's a lot of switches.*

200,000 different speciality switches are offered by Arrow-Hart. All quality. All types from electro-mechanical switches to solid state controls. Switches for use on tools, appliances, electronic gear, aerospace devices, ground support equipment, and all electrically-operated equipment.

What does this mean? Simply, that whatever kind of switch you need, Arrow-Hart is the place to get it. Because if it's not on hand, it can be created for you—and produced quickly, efficiently, and economically.

This broad line of quality speciality switches and the specialists who can innovate creatively for you and your products . . . are two of many reasons why you **buy better electrically** at Arrow-Hart. Write today for data. The Arrow-Hart & Hegeman Electric Co., 103 Hawthorn Street, Hartford, Conn.

MOTOR CONTROLS  
WIRING DEVICES  
ENCLOSED SWITCHES  
SPECIALTY SWITCHES



QUALITY SINCE 1890

## ARROW-HART

The Arrow-Hart & Hegeman Electric Company, Hartford 6, Connecticut

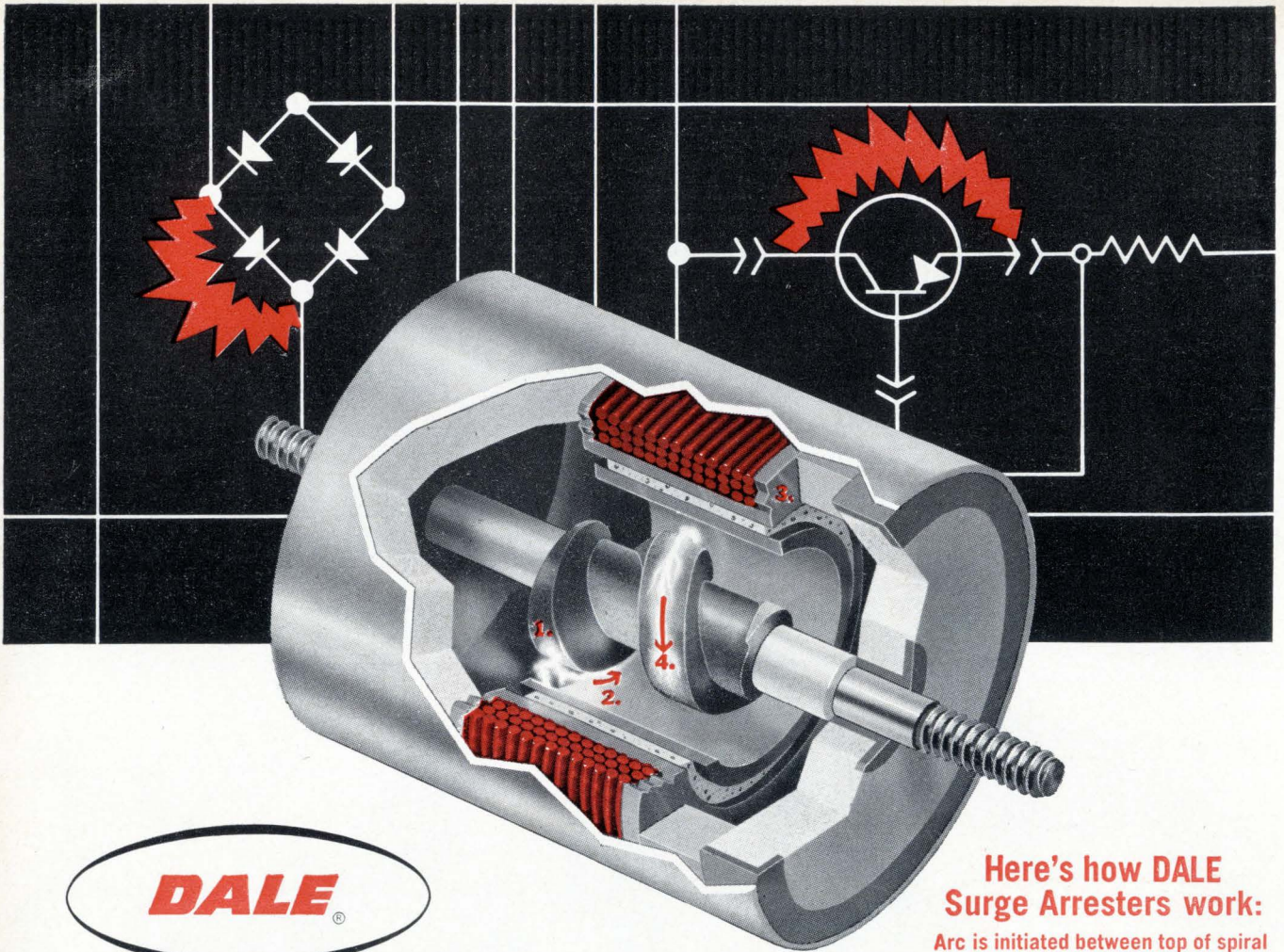

# SURGE ARRESTERS stop damaging transients!

## Here's how DALE Surge Arresters work:

Arc is initiated between top of spiral electrode (1) and cylindrical electrode (2); Coil (3) is energized. Magnetic field produced by the coil causes spark to rotate down tapered spiral electrode, lengthening it to breaking point (4) before excess current is drawn.

Dale Surge Arresters deliver complete 2-way protection against transient over-voltages from any source.

1. Patented\* design bypasses repeated surge voltages without damage to arrester or equipment attached. Pre-ionized atmosphere can be used to establish constant breakdown voltage level.

2. Surge-created arc is extinguished rapidly once normal voltages have been reached. This helps eliminate costly circuit interruptions caused when ordinary spark gaps draw excessive current which blows fuses and opens circuit breakers.

Check the areas where your circuits can utilize this complete transient voltage protection. Dale maintains complete transient voltage laboratory facilities to assist you with application engineering.

\*Covered by U.S. Patent No. 2,916,667

### TWO TYPES AVAILABLE

**LA8** Dustproof case. Will bypass 10 current surges rising to 15,000 amps peak in 5 microseconds and containing total charge of 21 coulombs with no damage to arrester or equipment attached and less than 20% change in original DC breakdown voltage. Spark gap arc-over voltage factory adjustable from 1500 to 4000 VDC  $\pm$  20%.

**LA9** Hermetically sealed with soft solder. Will bypass approximately 100 current surges of 300 amps peak with 2 x 4 millisecond wave shape with no damage to arrester and equipment attached and less than 20% change in original DC breakdown voltage. Factory adjustable from 500 to 5000 VDC  $\pm$  20%. (10% tolerance available). Bypass capability derates below 1500 volts.

Both LA8 and LA9 have insulation resistance in excess of 1000 megohms and will not drop below 10 megohms during or after rated number of current surges.



**For complete information write for new catalog on Surge and Aircraft Lightning Arresters or call DALE: 605-665-7887**



**DALE ELECTRONICS, INC.**  
SIOUX DIVISION  
100 Douglas Avenue, Yankton, South Dakota



---

# Washington Newsletter

---

September 5, 1966

## Ship electronics: new emphasis on reliability

A combination of microelectronics, adaptive switching techniques and redundancy promises more reliability for the electronic equipment used on military ships. The Navy expects to put 85% of shipboard communications gear and 15% of radar equipment in the same category as other vessel subsystems, which have a mean-time-between-failure rate of two years. Planners are hinting at a big purchase of the new equipment within a couple of years for ships; designers of aircraft and tactical ground electronics also are showing interest.

The forecasts are based on work done for the Office of Naval Research by Motorola, Inc., and the Westinghouse Electric Corp., under contracts totaling over \$600,000. Max Yoder, project manager of the study, said the Navy put the companies' transceivers through 7,000 hours of tests before the study was concluded and is extrapolating from these results a mean-time-between-failure rate for other equipment of 18,000 hours.

## Congress cuts funds for Navy F-111B

The budget for the Navy's controversial F-111B interceptor took a drubbing in the final version of the 1967 defense appropriation bill that has cleared a joint Senate-House conference committee. Work on the Navy version of the all-purpose aircraft was reduced to the research-and-development level plus only \$7.8 million for advance parts procurement.

But the bill, which now goes to a vote in both houses, where adoption is probable, preserves electronics R&D on the Navy plane.

Work on the Phoenix missile's fire-control system was given a specific go-ahead. The Hughes Aircraft Co. is prime contractor on the Phoenix; the Control Data Corp. and Univac division of the Sperry Rand Corp. are principal subcontractors.

Last month the House, in its original version of the bill, authorized the Navy to spend \$159 million on its F-111B. The Navy had planned to put about \$88 million of this into R&D and \$71 million into advance parts procurement for an eventual prototype.

But when the bill got to the Senate, Sen. John L. McClellan (D., Ark.) tacked on amendments permitting R&D but prohibiting parts procurement and preventing the Pentagon from spending any of its nearly \$400 million "discretionary funds" for procurement. The conference accepted all but \$7.8 million of the cutback.

## Taylor expected to be named head of ARPA division

Robert Taylor is expected to take over as director of information processing for the Defense Department's Advanced Research Projects Agency (ARPA). The information processing section is the focal point of the Pentagon's decisions on investments in new directions for computer technology. Taylor has been deputy to Ivan E. Sutherland, who left the agency this month for a Harvard University appointment as associate professor of electrical engineering. Sutherland will also continue research work in computer-aided graphics and design. His sketchpad project was one of the first in the field.

It is also reported that Lawrence G. Roberts of the Massachusetts Institute of Technology's Lincoln Laboratory will move to Washington as chief scientist for Taylor.

---

# Washington Newsletter

---

## Can't understand metric system, so Smith votes it down

Lame duck Rep. Howard W. Smith (D., Va.) for the second time in two years has killed a proposed study of United States adoption of the metric system—essentially because, he says, he doesn't understand it. Smith, defeated in the Virginia Democratic primary this year after 35 years in Congress, is chairman of the House Rules Committee, without whose approval bills seldom get to the House floor. Smith first deferred action last Sept. 9 on a study proposed by the chairman of the House Science Committee, George W. Miller (D., Calif.). At that time, Smith said: "I don't understand it, so it can't be very important." Last week after a belated request by Miller, Smith gave it another hearing. But when Miller was unable to translate 10 yards of cheese-cloth at 10 cents a yard into metric units, Smith and the Rules Committee again turned thumbs down.

## Electronics industry welcomes ease in copper squeeze

Pressure of tight copper supplies is easing for electronics and other industrial users. Imports of foreign copper are rising steadily and prices are close to domestic levels. Three factors contributed to the improved situation: a drop in demand by big foreign users, a switch to aluminum and other metals by U.S. users and an increase in supply in world markets. Indications are that defense production set-asides—a quota of excess production capacity—will soon become stabilized. The quota was increased two weeks ago.

## Justice Department opposes copyright charge to CATV

The Justice Department, after some delay, has taken a strong stand against legislation that would subject community antenna television systems to copyright-law payments for programs they pluck off the air-waves and distribute to clients.

For some time the Administration has felt that forcing copyright payments on CATV operators would put most of them out of business. Now the Justice Department has put this feeling into words at hearings before a Senate Judiciary subcommittee. The Johnson family has interests in both CATV and broadcast stations.

Complicating the issue is a ruling in New York by a Federal judge that CATV systems already are subject to copyright payments for programs they pick off the air. That decision is being appealed.

## Project no hole

Project Mohole, the ambitious plan to drill through the ocean bed to sample the earth's mantle, was cancelled indefinitely by a combination of budget cutting, increased Congressional impatience with big, esoteric research projects and an ill-timed political contribution. The Senate last week yielded to House pressure to delete \$19 million from the fiscal 1967 budget for the \$120-million long-term project.

The House opposition had strengthened when it was disclosed that the principal contractor, Brown & Root, Inc., of Houston had contributed \$24,000 to a Presidential political fund. The disclosure coincided approximately with President Johnson's appeal to save the project, providing House opponents of the project with leverage. The National Science Foundation, which manages the project, estimates that it has paid out or has obligated \$36 million for the stable deep-sea drilling platform and elaborate control mechanisms and drilling technology.

# Why specify Mallory wet slug tantalum capacitors?

One reason:

- lowest weight and smallest size per microfarad-volt

Check these characteristics:

	Wet Slug Mallory MTP	Solid Mallory TAS
Mfd-volts/in <sup>3</sup>	178,000	37,200
Wt: grams/mfd-volt	0.00067	0.0024

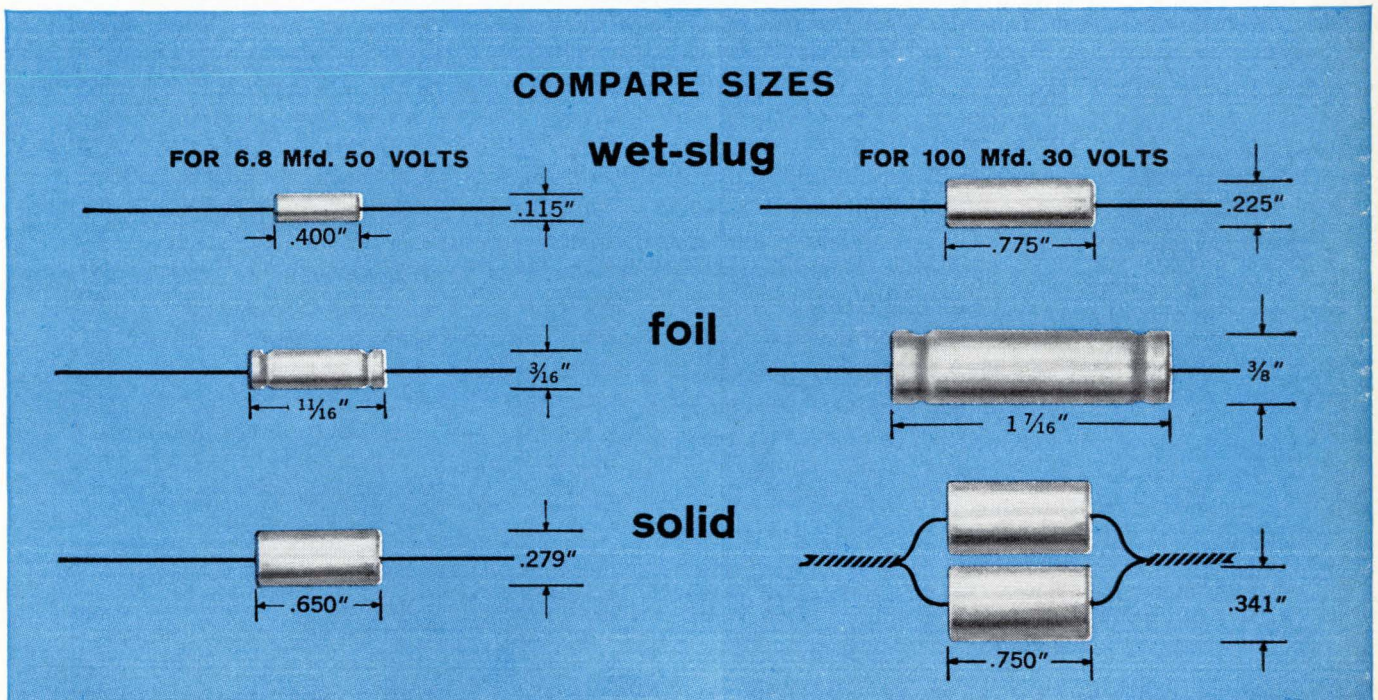

Specify Mallory wet slug tantalum capacitors wherever you need lowest DC leakage, and proven freedom from catastrophic failure. Note: they don't need voltage derating. We'll help you by recommending the best type for your application.

And we'll recommend without bias, because we make a complete line of wet slug, solid and foil types. Write or call Mallory Capacitor Company, a division of P. R. Mallory & Co. Inc., Indianapolis, Indiana 46206.

**50<sup>th</sup>**  
ANNIVERSARY

**MALLORY**

# What's so special about this Thermal Writing Recorder?

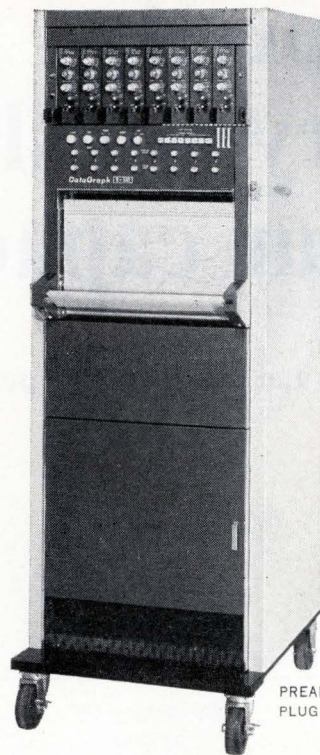

## Just about everything.

**This is CEC's new DG 5510 — the most advanced, versatile and reliable direct-writing instrument yet perfected.**

The basic 5510 recorder is a solid-state, eight-channel, self-contained unit with driver amplifiers and power supply capable of accepting a broad selection of high-level signals.

### *Specific advantages include . . .*

**Electrical Signal Limiting** assures that the stylus motor and writing assembly cannot be damaged by transient or other high-level signals which may occur. Each analog channel is provided with electrical signal limiting built into the driver amplifiers, adjustable to 115% of full-scale deflection.

**Varying ac and dc signals**, having a wide dynamic range, can be precisely conditioned by the proper choice of the Type 1-500 series preamplifiers available: the 1-510 Attenuator, 1-511 Medium Gain, and 1-512 Medium-Low Gain Preamplifiers.

**Solid-state driver amplifiers** provide compensation and damping to the stylus motors throughout the entire operating limits to assure constant instrument accuracy.

**A heated writing stylus** traveling over a "knife edge" produces exceptionally sharp contrast rectilinear traces when used with CEC DataTrace® thermal-sensitive paper.

**Accessibility and ease of maintenance** are significant advantages of the recorder assembly. It comes with 3-position rack slides and mounts into a standard 19" rack.

Applications include the military, aerospace and industry in general.

The complete DG 5510 System consists of the following:

- One Type 5-510 Basic Recorder.
- One Type 1-051 Preamplifier Mounting Case.
- One Type 17-050 Mobile Console Cabinet.
- Eight Type 1-500 Preamplifiers, (specify type desired).

### **Features:**

- Solid-state electronics.
- Designed for operator convenience.
- Immediate readout.
- Interchangeable plug-in preamplifiers.
- Sensitivity — 25 mv to 500 volts full scale.
- Rectilinear recording without ink.
- Frequency response — dc to 150 Hz.
- Calibrated zero suppression  $\pm 100$  volts max.
- Automatically adjusted trace contrast.

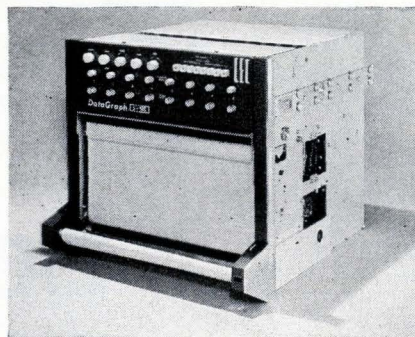

BASIC RECORDER

- Twelve-speed pushbutton chart drive.
- Modular design with built-in driver amplifiers and power supply.
- Timing marker and pushbutton event marker integral to basic recorder.
- Zero adjust integral to the basic recorder provides full-scale position adjustment.

### **Accessories:**

- Remote-control panel.
- Interchannel bipolar event markers (max. of seven available).
- Driver amplifiers for bipolar event markers. (For low-level event signals.)
- Slow-speed conversion kit—provides mm/min. chart speeds in addition to standard mm/sec. chart drive.
- Polarity reversal switching. Factory option.
- Six-channel, 50 mm width per channel. Factory option.
- Paper supply and take-up, 1000-ft. roll. Factory option.
- Power supply for 50 Hz and nonstandard voltages available.

For complete information about the advanced new DG 5510 System, call or write for CEC Bulletin 5510-X13.

# CEC

Data Instruments Division

**CONSOLIDATED ELECTRODYNAMICS**

A SUBSIDIARY OF BELL & HOWELL/PASADENA, CALIF. 91109  
INTERNATIONAL SUBSIDIARIES: WOKING, SURREY, ENGLAND  
AND FRIEDBERG (HESSEN), W. GERMANY

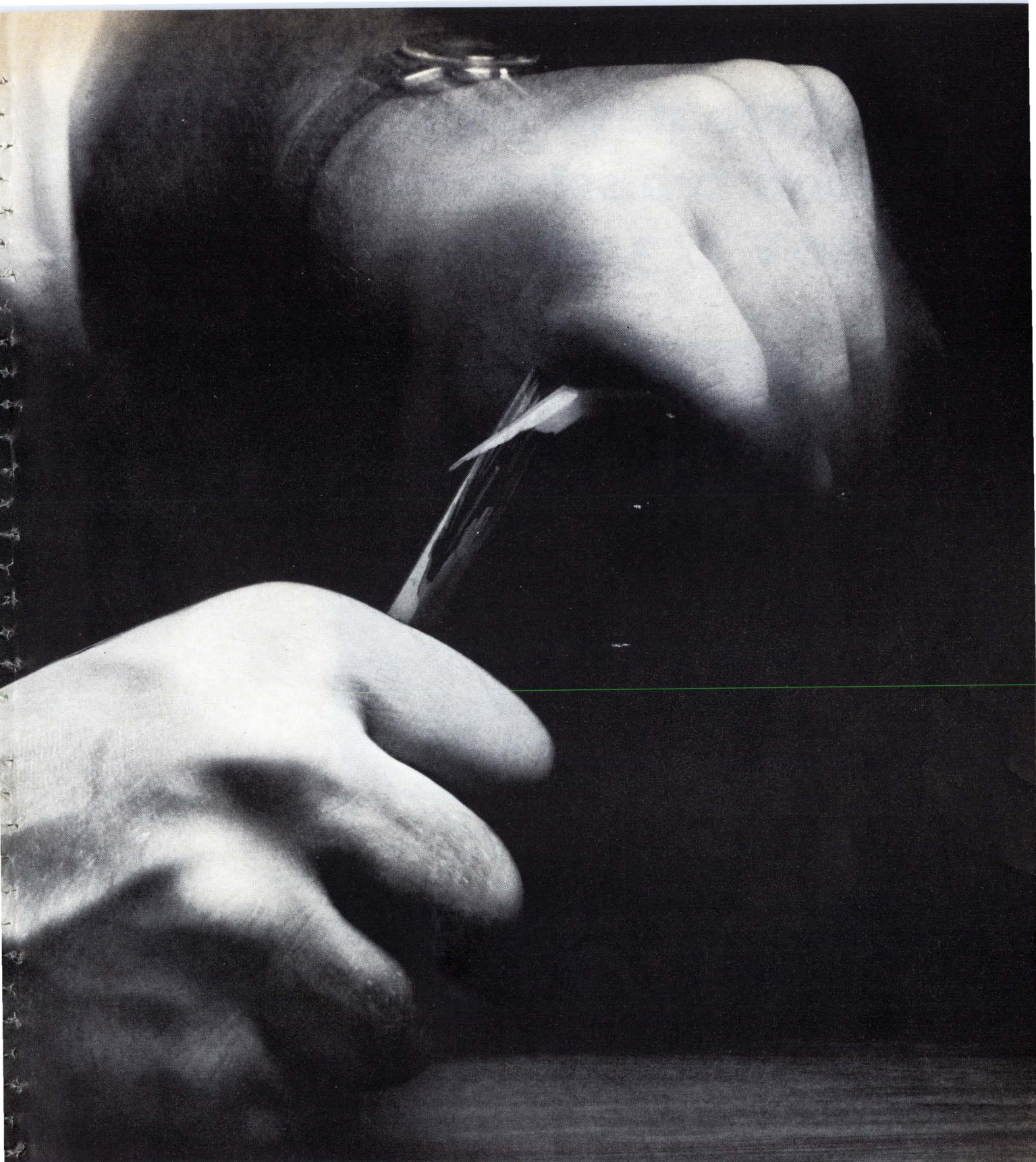

## Relay shipments rescheduled again? Next time call Leach!

One week delivery. That's a promise. At least on standard units. Even our new **SERIES K** for example. Here's a 10 amp 4PDT polarized relay offering maximum capabilities for the most severe aircraft, missile and aerospace applications. And we have built up an inventory to cover your requirements.

The **SERIES K** holds size and weight to an absolute minimum without sacrificing operating characteristics. It will withstand 100g shock, 30g, 70 to 3000 cps vibration, meets Mil-R-6106E and has a temperature

range of  $-70^{\circ}$  to  $+125^{\circ}\text{C}$ . Operate and release time is less than 15 milliseconds including bounce. Yet it measures only 1.000" x 1.015" x 1.015" and weighs less than 2.5 ounces. Need one? A dozen, a hundred? Even a thousand? Then call us today. You'll have them. Right on time.

Leach Corporation, Relay Division, 5915 Avalon Boulevard, Los Angeles, California 90003

Phone (Area code 213) 232-8221

EXPORT: LEACH INTERNATIONAL S.A.

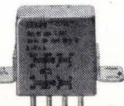

# LEACH

# Two new high power silicon transistors: 200V & 300V, 3.5A, low cost



**\$1.95†**

**\$3.15†**

These new Delco NPN transistors are designed to do a better job in your medium-high voltage inverters, converters, regulators and switching circuits.

Low saturation resistance (typically 0.3 ohm) and built-in protection against high-voltage transients make these two new devices ideal for rugged switching applications.

High punch-through voltage, high frequency response, and low saturation resistance are provided by the silicon element itself, which is fabricated by our unique triple sequential diffusion process. Exceptional resistance to thermal and mechanical shock are a result of ultrasonic bonding of aluminum to aluminum

base and emitter contacts.

Both devices are packaged in solid copper Delco TO-3 packages which give them ruggedness and low thermal resistance (typically 0.75° c/w).

Contact your nearest Delco sales office or distributor for complete data, the low prices and off-the-shelf delivery.

TYPE	V <sub>CEO</sub>	V <sub>CB0</sub>	V <sub>CEO</sub> (sus)	I <sub>C</sub>	I <sub>B</sub>	h <sub>FE</sub> V <sub>CE</sub> = 5V@I <sub>C</sub>	R(sat) typ @ I <sub>C</sub>
DTS 410	200V	200V	200V min	3.5A	2.0A	10 @ 2.5A	0.3 ohm @ 1.0A
DTS 411	300V	300V	300V min	3.5A	2.0A	10 @ 2.5A	0.3 ohm @ 1.0A

†Prices shown are for quantities of 1000 and over.

**FIELD  
SALES  
OFFICES**

UNION, NEW JERSEY\*  
Box 1018 Chestnut Station  
(201) 687-3770  
SYRACUSE, NEW YORK  
1054 James Street  
(315) 472-2668

DETROIT, MICHIGAN  
57 Harper Avenue  
(313) 873-6560  
CHICAGO, ILLINOIS\*  
5151 N. Harlem Avenue  
(312) 775-5411

SANTA MONICA, CALIFORNIA\*  
726 Santa Monica Blvd.  
(213) 870-8807  
General Sales Office:  
700 E. Firmin, Kokomo, Ind.  
(317) 459-2175

\*Office includes field lab and resident engineer for applications assistance

**DELCO RADIO**

Division of General Motors  
Kokomo, Indiana



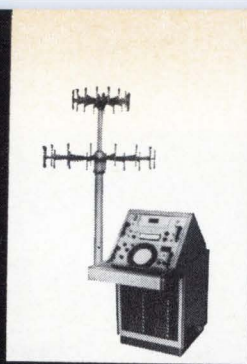

# servo is a safe landing

Air safety recently took a giant step forward. A light plane was lost in the fog over rugged Alaskan terrain miles from Kenai airport. Fuel was running low. The pilot came in for a 3-point landing. How? With ADF. And laurels go to a Servo Corporation VHF-UHF direction finder system. These Doppler-effect units will soon be installed throughout the U.S.

The Servoflight® Model 5000 VHF/UHF Doppler Direction Finder is pictured above. Frequency coverage is 118 to 160 MHz and 225 to 400 MHz. It has

10 preset channels on VHF and 10 on UHF. Servoflight offers a bearing accuracy of  $\pm 1^\circ$ , and a sensitivity of  $10 \mu\text{V}/\text{Meter}$  on VHF and  $20 \mu\text{V}/\text{Meter}$  on UHF.

This is one of the many sophisticated systems produced by Servo's Communications & Navigation Division. Other Servo divisions produce unique products which daily serve safety through science: the Servodynamics Division, the Infrared & Electro-Optics Division, and the Railroad Products Division.

servo corporation of america

# servo

111 new south road  
hicksville, l.i., new york 11802  
516 938-9700

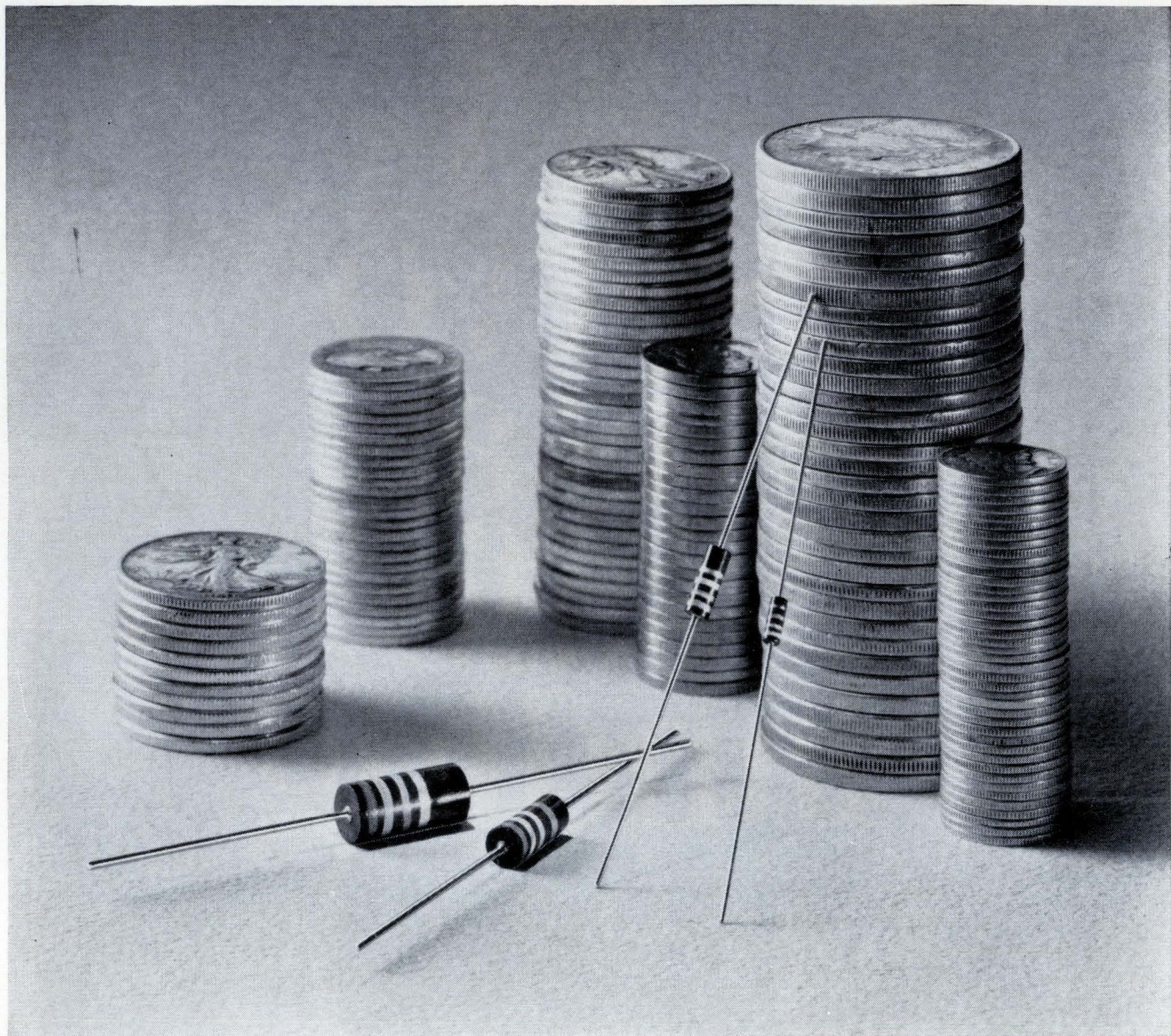

## Quality Need Not Be Expensive

Some people would have you believe that to buy the best, you must pay the most. This is not necessarily true. Price is only a measure of value—never a substitute for it.

At Stackpole, the real value of any resistor is determined by a combination of its performance record and its price. Perhaps this is why so many of our customers continue to specify Stackpole resistors year after year to maintain top performance for established products and for their new ones, too. Such confidence and loyalty cannot be based on price alone.

Uniformity has become the accepted characteristic of Stackpole resistors. Unique production methods, coupled with in-depth experience in manufacturing and testing are your assurance that Stackpole resistors will give you absolute performance. The resistors you order today will be identical in every way to your last order.

Most leading manufacturers of electronic equipment have long recognized Stackpole resistors for reliability.

Whether it be the rugged demands of portable television or the critical tolerances of space age communication and tracking equipment, Stackpole resistors deliver the performance you expect—the kind of dependability that builds a reputation for your products.

Why continue to pay a premium for quality? Let us prove that you get value from Stackpole. Quality resistors, economically priced, are delivered promptly and backed up by our complete corporate facility. Next time, specify Stackpole. There's a family of fine resistors available in sizes of 2, 1,  $\frac{1}{2}$  and  $\frac{1}{4}$  watts. For samples and additional information, write: Stackpole Carbon Company, Electronic Components Division, Kane, Pa. Phone: 814-837-7000 — TWX: 510-695-8404.



**STACKPOLE**  
ELECTRONIC COMPONENTS DIVISION  
"OUR 60th YEAR"

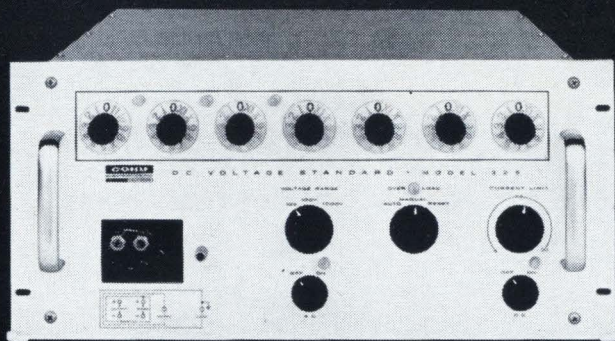

## Meet the DC voltage standard with:

# STABILITY WITHIN 15 PPM

... for 7 days, 25 ppm for 6 months.  
Recorded stability history available.

# 0.003% ACCURACY

... ensured by temperature-controlled precision  
Zener reference.

# IMMEDIATE DELIVERY

... the COHU Model 326 is off-the-shelf ... like the  
entire family of COHU DC voltage standards.

... and voltages from 0 to 1222.2221 in 3 ranges;  
steps as small as 1  $\mu\text{v}$ .

Price: \$2490.00 F.O.B. San Diego,  
additional export charge.



Box 623  
San Diego, Calif. 92112  
Phone 714-277-6700

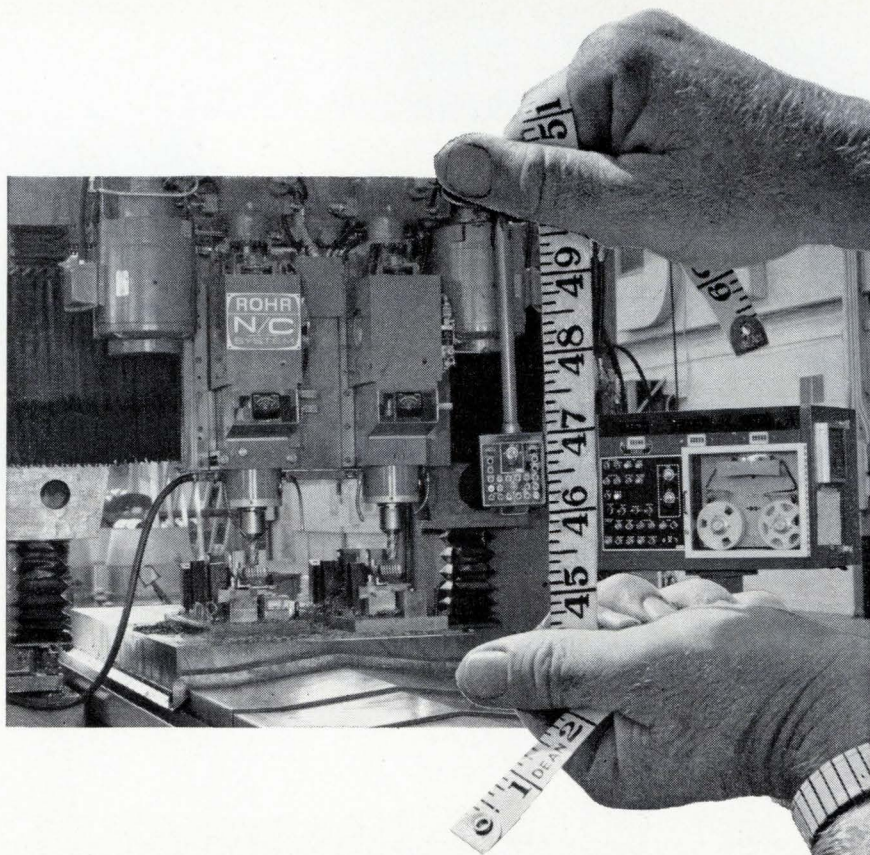

## To expert tailors with an engineering background

Rohr has been famous for years for the capability to tailor a wide variety of special-purpose machines and facilities for the ever changing production requirements here. And, increasingly, this vital equipment design function works in the areas of engineering and fabrication of numerical and automatic control. If your qualifications measure up to our requirements, we invite you to investigate Rohr. It may be a perfect fit.

### **ELECTRONICS ENGINEERS (MACHINE CONTROLS)**

Backgrounds should include an E.E. degree, and hardware-oriented design and development experience in solid state circuits, digital logic techniques, and servo-mechanisms. Senior level assignments are available. Numerical control experience is desirable, but a high degree of interest in the field is even more important.

### **MACHINE DESIGN ENGINEERS**

Background should include engineering in one or more of the following disciplines: Design of machine tools, design of automated handling devices, and the design of servo-drive systems, both electrical and hydraulic.

Call or address resume to Mr. N. DeWitt, Professional Placement Supervisor  
Dept. 89, Rohr Corporation, Chula Vista, California.



MAIN PLANT HEADQUARTERS: CHULA VISTA, CALIF./PLANT: RIVERSIDE, CALIF./ASSEMBLY PLANTS: WINDER, GA.; AUBURN, WASH.

**ROHR**  
CORPORATION

HANDBOOK OF STANDARD CONNECTORS

**WINCHESTER**  
**ELECTRONICS**  
DIVISION OF LITTON INDUSTRIES



TWENTY-FIFTH ANNIVERSARY COMMEMORATIVE ISSUE

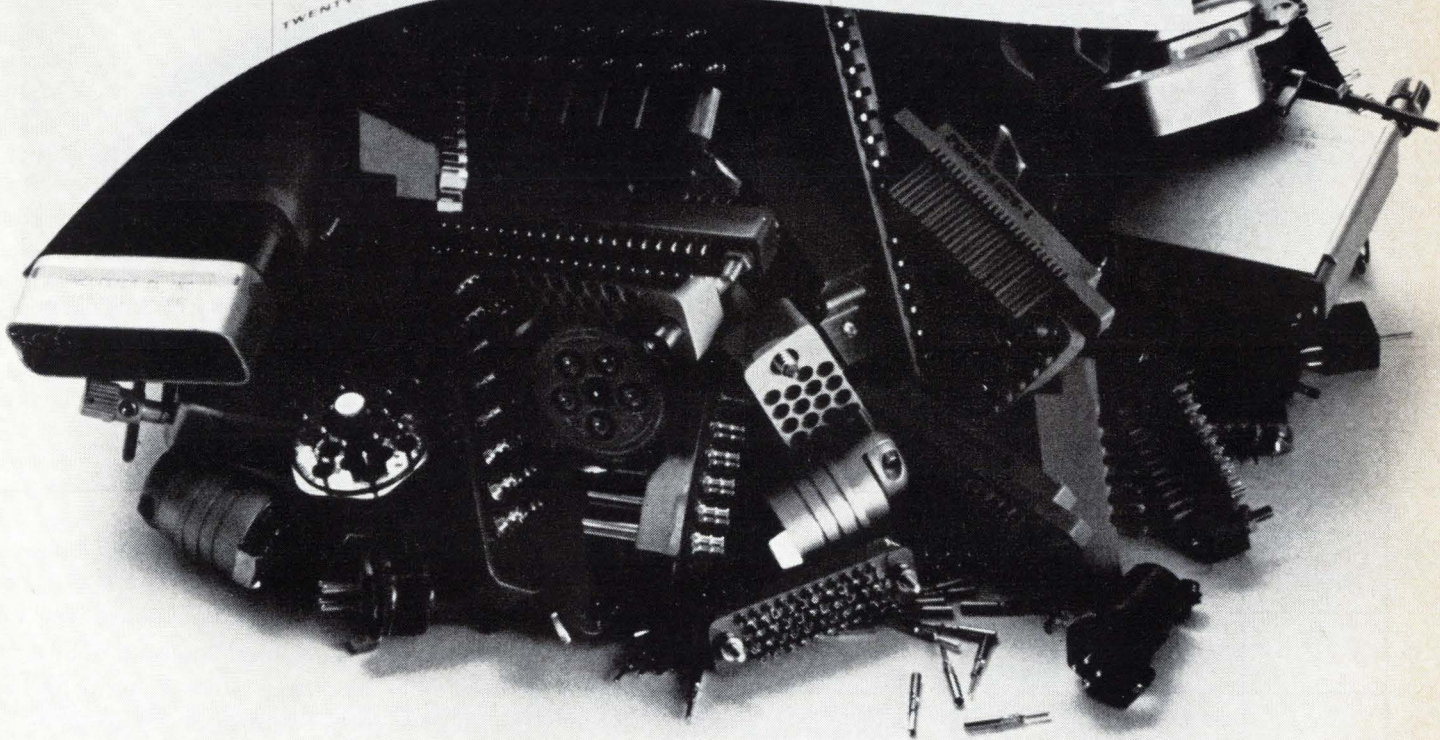

**We've got every connector in the book.**

For your copy, write: Winchester Electronics, Main Street & Hillside Avenue, Oakville, Conn. (203)274-8891.

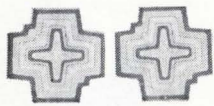

# As comfortable as an old shoe.

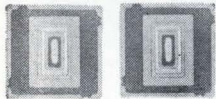
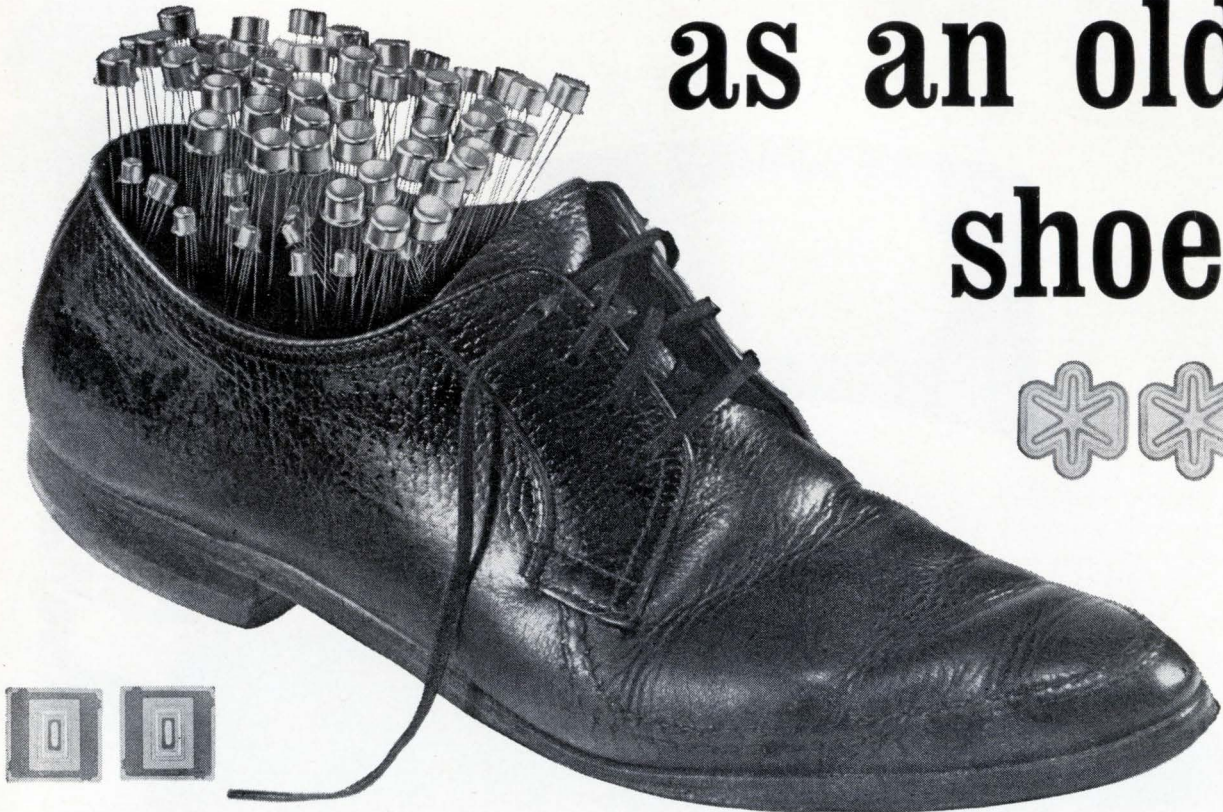
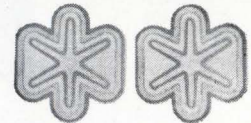

That's the way most engineers feel about using these 28 popular Motorola silicon annular complementary transistors in their designs.

NPN	PNP	APPLICATION
2N2218-18A 2N2219-19A 2N2221-21A 2N2222-22A	2N2904-04A 2N2905-05A 2N2906-06A 2N2907-07A	Complementary high performance STARS* for medium level switch and amplifier applications.
2N3946 2N3947	2N3250-50A 2N3251-51A	Complementary high performance BOX for low level switch and amplifier applications.
2N3252 2N3253	2N3467 2N3468	Complementary high performance SNOWFLAKES for high level switching applications.
2N2369	2N3546	Complementary high performance low level high speed switch applications.

Why ?

Because they are *versatile*. They fit anywhere — do *all* jobs well. If there were such a thing as a “universal” transistor, these would all be top candidates for the title.

Secondly, they're *reliable*. That's what makes it so comfortable for the designer. He knows he can depend on each and every device with patented annular structure that he uses.

He also knows he has a *dependable supply*. Motorola has been making these types by the millions for years.

And the prices? They're comfortable, too. That is the nicest part.

So, why don't you get yourself some old shoes — and *get comfortable!* Your local Motorola semiconductor distributor has them all *in stock* in up to 1000 quantities. Larger requirements can be handled by your nearest Motorola district office. For complete technical data write: Motorola Semiconductor Products Inc., Dept. TIC, Box 955, Phoenix, Arizona 85001.

\*Trademark of Motorola Inc.



## MOTOROLA Semiconductors

*— where the priceless ingredient is care!*

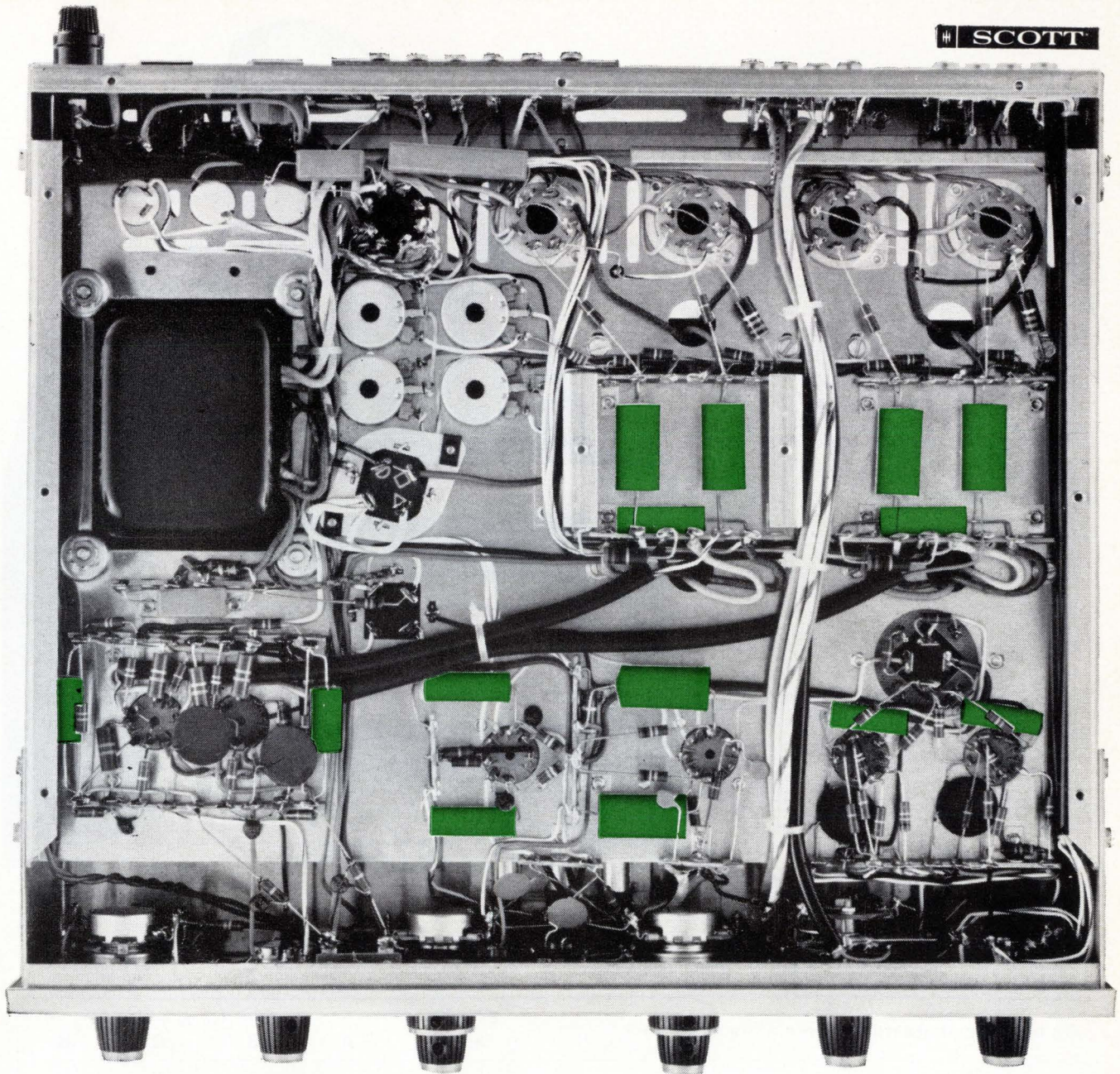

## Capacitor reliability? Take Scott's word for it: MYLAR®

H. H. Scott manufactures some of the world's most widely used stereo amplifiers. They are recommended by many leading independent testing organizations. Because this kind of reputation depends on capacitor reliability, engineers at Scott use capacitors of MYLAR\* exclusively for audio circuits from .047 to .47 microfarads:

"We don't have to worry about performance with capacitors of MYLAR in our components and consoles," says Chief Engineer Dan von Recklinghausen. "We use capacitors of MYLAR because of their low leakage, extremely long life, excellent capacitance stability and ability to withstand the wide temperature and humidity



ranges encountered in high-power hi-fi amplifiers." MYLAR also offers high dielectric strength in thin gauges, so capacitors can be made smaller, leaving space for more circuitry. And, in many cases, capacitors of MYLAR cost less than paper.

Scott components and consoles are known for excellence in quality, performance and reliability. So are capacitors of MYLAR. For complete information write DuPont Co., Room 3370A, Wilmington, Delaware 19898. (In Canada, write Du Pont of Canada Ltd., P.O. Box 660, Montreal 3, Quebec.)



Better Things for Better Living  
through Chemistry



\*DUPONT'S REGISTERED TRADEMARK FOR ITS POLYESTER FILM.

When you buy  
our Multipoint...  
be prepared for  
surprises

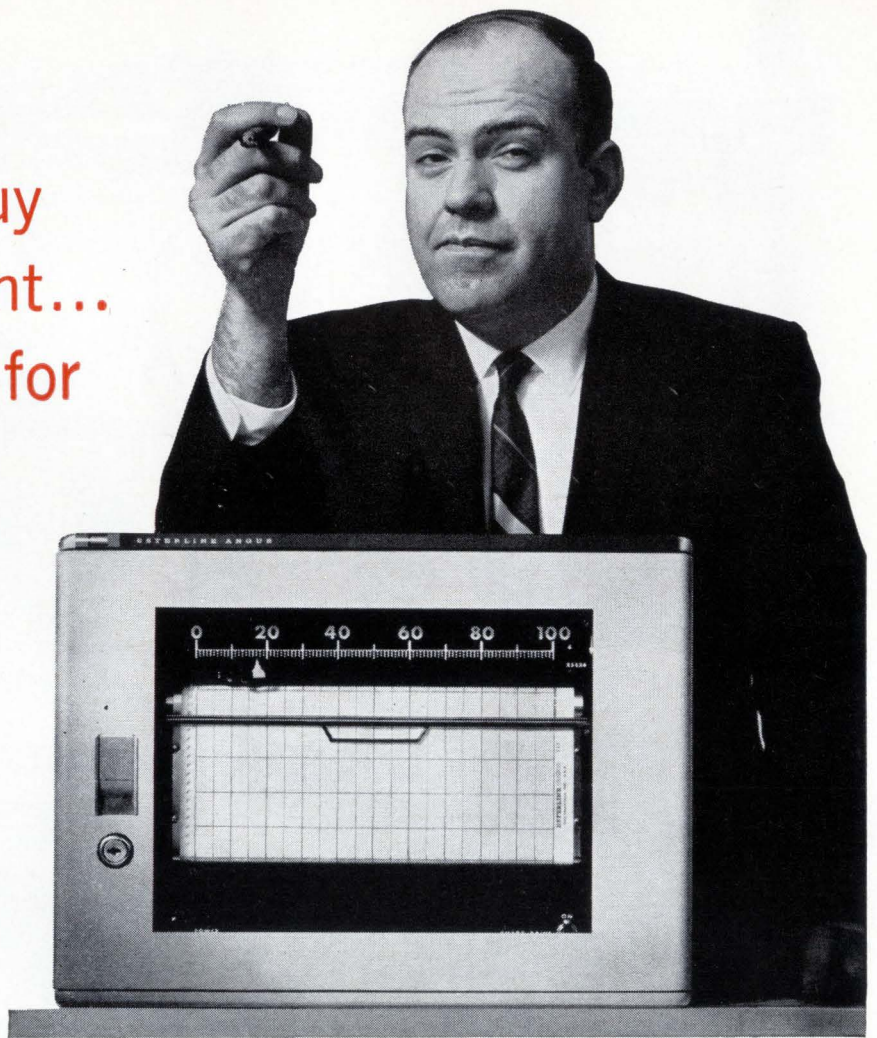

10 at least\*

X's indicate standard features at no extra cost	Esterline Angus	Brands (Names available on request)			
		A	B	C	D
List price \$1535 or lower	X			X	X
Solid state amplifier	X		X		
50,000 ohm off balance input impedance or better	X				
Stray rejection: longitudinal 60 cycles AC, 1,000 times span or 120 volts	X		X		
Accuracy $\pm \frac{1}{4}\%$ span or $\pm 3\frac{1}{2}$ microvolts or better	X		X		
Manual point advance. Dial in any point without disturbing synchronization	X				
Permanently sealed slidewire requires no cleaning	X				
5 chart speeds	X				
Choice of 8 print frequencies from $1\frac{1}{2}$ to 60 seconds per point	X				
Tilt out writing platen and chart tear-off bar	X				

Discover additional surprises, such as optional electrical programmed printing which permits point skipping as fast as  $\frac{1}{4}$  second. Write for Series "E" Catalog.

Esterline Angus Instrument Company, Inc.  
Box 24000E • Indianapolis, Indiana 46224

Excellence in  
instrumentation for  
over 60 years



**ESTERLINE ANGUS**



# Technical Articles

---

**Scattering parameters speed design of h-f transistor circuits**  
page 78

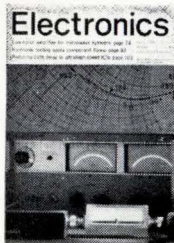

As microwave systems go solid state, engineers have learned they need new design techniques to take advantage of the characteristics of new high-frequency transistors. One such technique involves the measuring of so-called scattering parameters and plotting their values on a Smith chart to synthesize the desired transistor circuit. For the cover, photographer Norton Pearl superimposed on a Smith chart a Hewlett-

Packard vector voltmeter, which is measuring s-parameters of the transistor shown mounted in a special fixture.

**Sense amplifier fits any memory:**  
page 89

Though integrated circuits have won wide acceptance in computer design, mostly they have been used in the logic portion. A new design, however, makes a sense amplifier of microcircuits so it will be compatible with the microelectronics of processors. In addition, this general-purpose design works in any computer with a coincident current memory.

**Divic gives answers to complex navigation questions:**  
page 105

A special algorithm and a unique combination of digital and differential processing techniques have been devised for this small computer, whose size has been shrunk by the use of integrated circuits. The effect is to combine the speed of a digital differential analyzer with the flexibility of a general-purpose machine.

**Pumping new life into ruby lasers:**  
page 115

Two bars to using the ruby laser in industrial applications have been their short life that makes them uneconomic and slow repetition rates. Now, a device with a new resonator design and a low-cost mercury flashtube for pumping promises at last to make the laser a production tool in commercial micromachining processes.

---

**Coming**   ▪ An introduction to computer-aided design  
**September 19**   ▪ Glass as a design material  
                  ▪ Pulse-code modulation for telephone transmission

# Scattering parameters speed design of high-frequency transistor circuits

At frequencies above 100 Mhz scattering parameters are easily measured and provide information difficult to obtain with conventional techniques that use h, y or z parameters

By Fritz Weinert

Hewlett-Packard Co., Palo Alto, Calif.

**Performance of transistors** at high frequencies has so improved that they are now found in all solid-state microwave equipment. But operating transistors at high frequencies has meant design problems:

- Manufacturers' high-frequency performance data is frequently incomplete or not in proper form.
- Values of h, y or z parameters, ordinarily used in circuit design at lower frequencies, can't be measured accurately above 100 megahertz because establishing the required short and open circuit conditions is difficult. Also, a short circuit frequently causes the transistor to oscillate under test.

These problems are yielding to a technique that uses scattering or s parameters to characterize the high-frequency performance of transistors. Scattering parameters can make the designer's job easier.

- They are derived from power ratios, and consequently provide a convenient method for measuring circuit losses.

- They provide a physical basis for understanding what is happening in the transistor, without need for an understanding of device physics.

- They are easy to measure because they are based on reflection characteristics rather than short- or open-circuit parameters.

## The author



Fritz K. Weinert, who joined the technical staff of Hewlett-Packard in 1964, is project leader in the network analysis section of the microwave laboratory. He holds patents and has published papers on pulse circuits, tapered-line transformers, digital-tuned circuits and shielding systems.

Like other methods that use h, y or z parameters, the scattering-parameter technique does not require a suitable equivalent circuit to represent the transistor device. It is based on the assumption that the transistor is a two-port network—and its terminal behavior is defined in terms of four parameters,  $s_{11}$ ,  $s_{12}$ ,  $s_{21}$  and  $s_{22}$ , called s or scattering parameters.

Since four independent parameters completely define any two-port at any one frequency, it is possible to convert from one known set of parameters to another. At frequencies above 100 Mhz, however, it becomes increasingly difficult to measure the h, y or z parameters. At these frequencies it is difficult to obtain well defined short and open circuits and short circuits frequently cause the device to oscillate. However, s parameters may be measured directly up to a frequency of 1 gigahertz. Once obtained, it is easy to convert the s parameters into any of the h, y or z terms by means of tables.

## Suggested measuring systems

To measure scattering parameters, the unknown transistor is terminated at both ports by pure resistances. Several measuring systems of this kind have been proposed. They have these advantages:

- Parasitic oscillations are minimized because of the broadband nature of the transistor terminations.
- Transistor measurements can be taken remotely whenever transmission lines connect the semiconductor to the source and load—especially when the line has the same characteristic impedance as the source and load respectively.

- Swept-frequency measurements are possible instead of point-by-point methods. Theoretical work shows scattering parameters can simplify design.

### Scattering-parameter definitions

To measure and define scattering parameters the two-port device, or transistor, is terminated at both ports by a pure resistance of value  $Z_0$ , called the reference impedance. Then the scattering parameters are defined by  $s_{11}$ ,  $s_{12}$ ,  $s_{21}$  and  $s_{22}$ . Their physical meaning is derived from the two-port network shown in first figure below.

Two sets of parameters,  $(a_1, b_1)$  and  $(a_2, b_2)$ , represent the incident and reflected waves for the two-port network at terminals 1-1' and 2-2' respectively. Equations 1a through 1d define them.

$$a_1 = \frac{1}{2} \left( \frac{V_1}{\sqrt{Z_0}} + \sqrt{Z_0} I_1 \right) \quad (1a)$$

$$b_1 = \frac{1}{2} \left( \frac{V_1}{\sqrt{Z_0}} - \sqrt{Z_0} I_1 \right) \quad (1b)$$

$$a_2 = \frac{1}{2} \left( \frac{V_2}{\sqrt{Z_0}} + \sqrt{Z_0} I_2 \right) \quad (1c)$$

$$b_2 = \frac{1}{2} \left( \frac{V_2}{\sqrt{Z_0}} - \sqrt{Z_0} I_2 \right) \quad (1d)$$

The scattering parameters for the two-port network are given by equation 2.

$$b_1 = s_{11} a_1 + s_{12} a_2$$

$$b_2 = s_{21} a_1 + s_{22} a_2$$

In matrix form the set of equations of 2 becomes

$$\begin{bmatrix} b_1 \\ b_2 \end{bmatrix} = \begin{bmatrix} s_{11} & s_{12} \\ s_{21} & s_{22} \end{bmatrix} \begin{bmatrix} a_1 \\ a_2 \end{bmatrix} \quad (3)$$

where the matrix

$$[s] = \begin{bmatrix} s_{11} & s_{12} \\ s_{21} & s_{22} \end{bmatrix} \quad (4)$$

is called the scattering matrix of the two-port network. Therefore the scattering parameters of the two-port network can be expressed in terms of the incident and reflected parameters as:

$$s_{11} = \left. \frac{b_1}{a_1} \right|_{a_2 = 0} \quad s_{12} = \left. \frac{b_1}{a_2} \right|_{a_1 = 0} \quad (5)$$

$$s_{21} = \left. \frac{b_2}{a_1} \right|_{a_2 = 0} \quad s_{22} = \left. \frac{b_2}{a_2} \right|_{a_1 = 0}$$

In equation 5, the parameter  $s_{11}$  is called the input reflection coefficient;  $s_{21}$  is the forward transmission coefficient;  $s_{12}$  is the reverse transmission coefficient; and  $s_{22}$  is the output reflection coefficient. All four scattering parameters are expressed as ratios of reflected to incident parameters.

### Physical meaning of parameters

- (2) The implications of setting the incident parameters  $a_1$  and  $a_2$  at zero help explain the physical

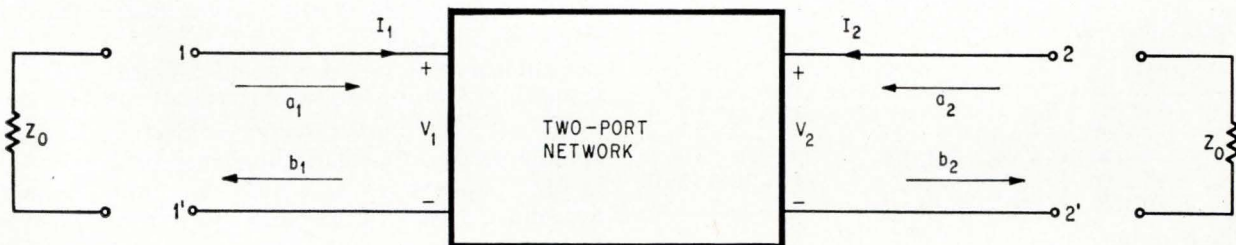

Scattering parameters are defined by this representation of a two-port network. Two sets of incident and reflected parameters  $(a_1, b_1)$  and  $(a_2, b_2)$  appear at terminals 1-1' and 2-2' respectively.

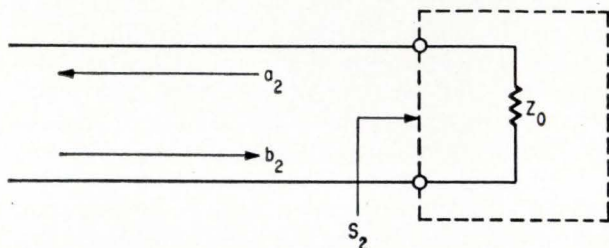
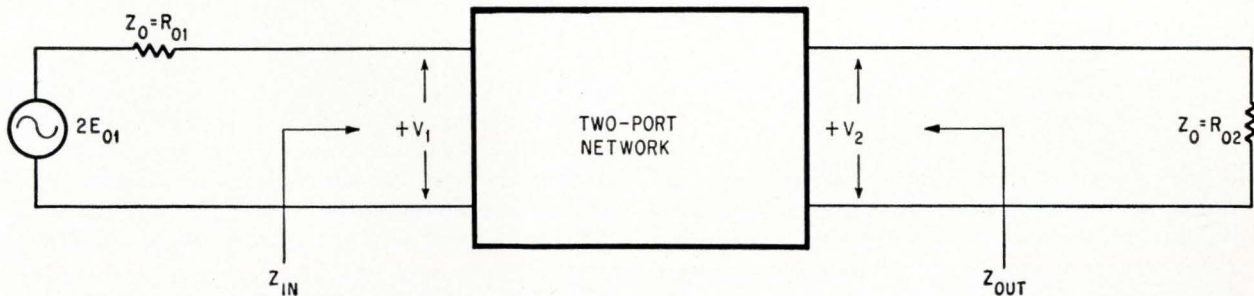

By setting  $a_2$  equal to zero the  $s_{11}$  parameter can be found. The  $Z_0$  resistor is thought of as a one-port network. The condition  $a_2 = 0$  implies that the reference impedance  $R_{02}$  is set equal to the load impedance  $Z_0$ . By connecting a voltage source,  $2E_{01}$ , with the source impedance,  $Z_0$ , parameter  $s_{21}$  can be found using equation 5.

meaning of these scattering parameters.

By setting  $a_2 = 0$ , expressions for  $s_{11}$  and  $s_{22}$  can be found. The terminating section of the two-port network is at bottom of page 79 with the parameters  $a_2$  and  $b_2$  of the 2-2' port. If the load resistor  $Z_0$  is thought of as a one-port network with a scattering parameter

$$s_2 = \frac{Z_0 - R_{02}}{Z_0 + R_{02}} \quad (6)$$

where  $R_{02}$  is the reference impedance of port 2, then  $a_2$  and  $b_2$  are related by

$$a_2 = s_2 b_2 \quad (7)$$

When the reference impedance  $R_{02}$  is set equal to the local impedance  $Z_0$ , then  $s_2$  becomes

$$s_2 = \frac{Z_0 - Z_0}{Z_0 + Z_0} = 0 \quad (8)$$

so that  $a_2 = 0$  under this condition. Similarly, when  $a_1 = 0$ , the reference impedance of port 1 is equal to the terminating impedance; that is,  $R_{01} = Z_0$ . The conditions  $a_1 = 0$  and  $a_2 = 0$  merely imply that the reference impedances  $R_{01}$  and  $R_{02}$  are chosen to be equal to the terminating resistors  $Z_0$ .

In the relationship between the driving-point impedances at ports 1 and 2 and the reflection coefficients  $s_{11}$  and  $s_{22}$ , the driving-point impedances can be denoted by:

$$Z_{in} = \frac{V_1}{I_1}; \quad Z_{out} = \frac{V_2}{I_2} \quad (9)$$

From the relationship

$$s_{11} = \left. \frac{b_1}{a_1} \right|_{a_2 = 0}$$

$$s_{11} = \frac{\frac{1}{2} [(V_1/\sqrt{Z_0}) - \sqrt{Z_0} I_1]}{\frac{1}{2} [(V_1/\sqrt{Z_0}) + \sqrt{Z_0} I_1]} \quad (10)$$

which reduces to

$$s_{11} = \frac{Z_{in} - Z_0}{Z_{in} + Z_0} \quad (11)$$

Similarly,

$$s_{22} = \frac{Z_{out} - Z_0}{Z_{out} + Z_0} \quad (12)$$

These expressions show that if the reference impedance at a given port is chosen to equal the ports driving-point impedance, the reflection coefficient will be zero, provided the other port is terminated in its reference impedance.

In the equation

$$s_{21} = \left. \frac{b_2}{a_1} \right|_{a_2 = 0}$$

the condition  $a_2 = 0$  implies that the reference impedance  $R_{02}$  is set equal to the load impedance  $R_2$ , center figure page 79. If a voltage source 2  $E_{01}$  is connected with a source impedance  $R_{01} = Z_0$ ,  $a_1$

can be expressed as:

$$a_1 = \frac{E_{01}}{\sqrt{Z_0}} \quad (13)$$

Since  $a_2 = 0$ , then

$$a_2 = 0 = \frac{1}{2} \left( \frac{V_2}{\sqrt{Z_0}} + \sqrt{Z_0} I_2 \right)$$

from which

$$\frac{V_2}{\sqrt{Z_0}} = -\sqrt{Z_0} I_2$$

Consequently,

$$b_2 = \frac{1}{2} \left( \frac{V_2}{\sqrt{Z_0}} - \sqrt{Z_0} I_2 \right) = \frac{V_2}{\sqrt{Z_0}}$$

Finally, the forward transmission coefficient is expressed as:

$$s_{21} = \frac{V_2}{E_{01}} \quad (14)$$

Similarly, when port 1 is terminated in  $R_{01} = Z_0$  and when a voltage source 2  $E_{02}$  with source impedance  $Z_0$  is connected to port 2,

$$s_{12} = \frac{V_1}{E_{02}} \quad (15)$$

Both  $s_{12}$  and  $s_{21}$  have the dimensions of a voltage-ratio transfer function. And if  $R_{01} = R_{02}$ , then  $s_{12}$  and  $s_{21}$  are simple voltage ratios. For a passive reciprocal network,  $s_{21} = s_{12}$ .

Scattering parameters  $s_{11}$  and  $s_{22}$  are reflection coefficients. They can be measured directly by means of slotted lines, directional couplers, voltage-standing-wave ratios and impedance bridges. Scattering parameters  $s_{12}$  and  $s_{21}$  are voltage transducer gains. All the parameters are frequency-dependent, dimensionless complex numbers. At any one frequency all four parameters must be known to describe the two-port device completely.

There are several advantages for letting  $R_{01} = R_{02} = Z_0$ .

- The  $s_{11}$  and  $s_{22}$  parameters are power reflection coefficients that are difficult to measure under normal loading. However, if  $R_{01} = R_{02} = Z_0$ , the parameters become equal to voltage reflection coefficients and can be measured directly with available test equipment.

- The  $s_{12}$  and  $s_{21}$  are square roots of the transducer power gain, the ratio of power absorbed in the load over the source power available. But for  $R_{01} = R_{02} = Z_0$ , they become a voltage ratio and can be measured with a vector voltmeter.

- The actual measurement can be taken at a distance from the input or output ports. The measured scattering parameter is the same as the parameter existing at the actual location of the particular port. Measurement is achieved by connecting input and output ports to source and load by means of transmission lines having the same impedance,  $Z_0$ ,

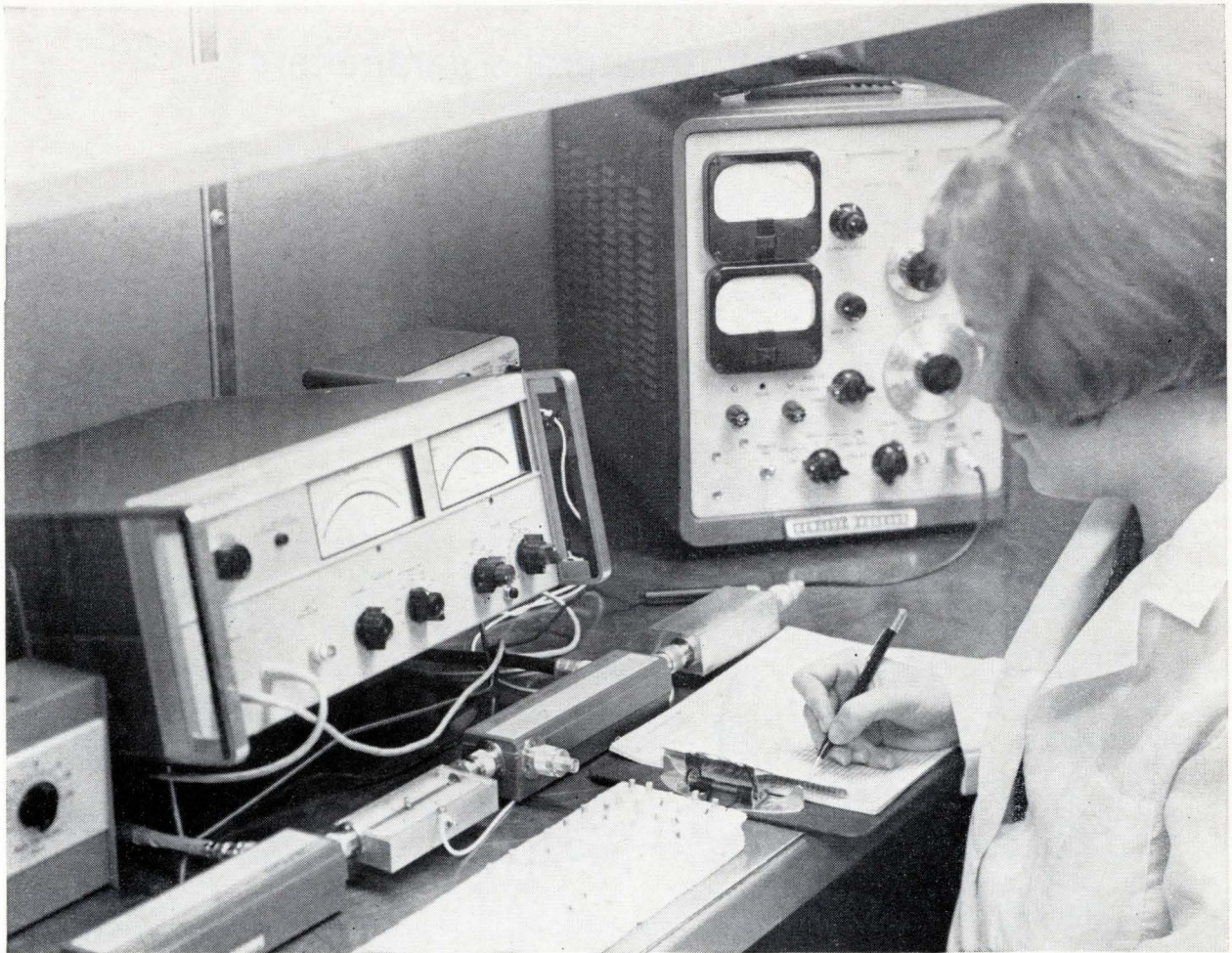

<b>25°C</b>	<b>100 Mhz</b>	<b>300 Mhz</b>	<b>100°C</b>	<b>100 Mhz</b>	<b>300 Mhz</b>
S <sub>11</sub>	0.62 < -44.0°	0.305 < -81.0°	S <sub>11</sub>	0.690 < -40°	0.372 < -71°
S <sub>12</sub>	0.0115 < +75.0°	0.024 < +93.0°	S <sub>12</sub>	0.0125 < +76.0°	0.0254 < +89.5°
S <sub>21</sub>	9.0 < +130°	3.85 < +91.0°	S <sub>21</sub>	8.30 < +133.0°	3.82 < +94.0°
S <sub>22</sub>	0.955 < -6.0°	0.860 < -14.0°	S <sub>22</sub>	0.955 < -6.0°	0.880 < -15.0°
<b>25°C</b>	<b>590 Mhz</b>	<b>1,000 Mhz</b>	<b>100°C</b>	<b>500 Mhz</b>	<b>1,000 Mhz</b>
S <sub>11</sub>	0.238 < -119.0°	0.207 < +175.0°	S <sub>11</sub>	0.260 < -96.0°	0.196 < +175.0°
S <sub>12</sub>	0.0385 < +110.0°	0.178 < +110.0°	S <sub>12</sub>	0.0435 < +100.0°	0.165 < +103.0°
S <sub>21</sub>	2.19 < +66.0°	1.30 < +33.0°	S <sub>21</sub>	2.36 < +69.5°	1.36 < +35.0°
S <sub>22</sub>	0.830 < -26.0°	0.838 < -49.5°	S <sub>22</sub>	0.820 < -28.0°	0.850 < -53.0°

Scattering parameters can be measured directly using the Hewlett-Packard 8405A vector voltmeter. It covers the frequency range of 1 to 1,000 megahertz and determines  $s_{21}$  and  $s_{12}$  by measuring ratios of voltages and phase difference between the input and output ports. Operator at Texas Instruments Incorporated measures s-parameter data for TI's 2N3571 transistor series. Values for  $V_{CE} = 10$  volts;  $I_C = 5$  milliamperes.

as the source and load. In this way compensation can be made for added cable length.

Transistors can be placed in reversible fixtures to measure the reverse parameters  $s_{22}$  and  $s_{12}$  with the equipment used to measure  $s_{11}$  and  $s_{21}$ .

The Hewlett-Packard Co.'s 8405A vector voltmeter measures s parameters. It covers the frequency range of 1 to 1,000 megahertz and determines  $s_{21}$  and  $s_{12}$  by measuring voltage ratios and phase differences between the input and output ports directly on two meters, as shown above. A dual-directional coupler samples incident and reflected voltages to measure the magnitude and phase of the reflection coefficient.

To perform measurements at a distance, the setup

on page 86 is convenient. The generator and the load are the only points accessible for measurement. Any suitable test equipment, such as a vector voltmeter, directional coupler or slotted line can be connected. In measuring the  $s_{21}$  parameter as shown in the schematic, the measured vector quantity  $V_2/E_0$  is the voltage transducer gain or forward gain scattering parameter of the two-port and cables of length  $L_1$  and  $L_2$ . The scattering parameter  $s_{21}$  of the two-port itself is the same vector  $V_2/E_0$  but turned by an angle of  $360^\circ (L_1 + L_2)/\lambda$  in a counterclockwise direction.

Plotting  $s_{11}$  in the complex plane shows the conditions for measuring  $s_{11}$ . Measured vector  $r_1$  is the reflection coefficient of the two-port plus

# Amplifier design with unilateral s parameters

## Step 1

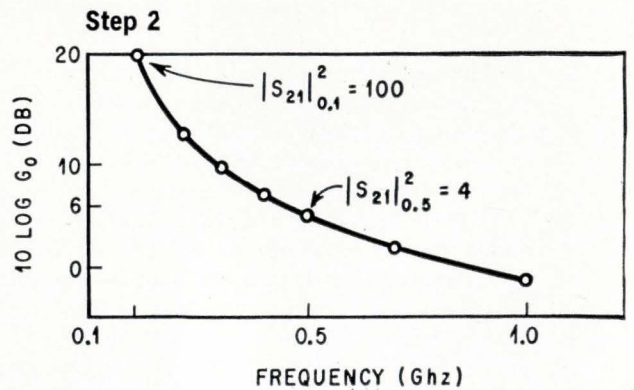
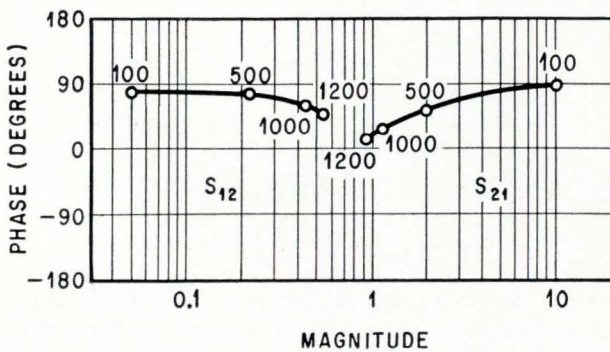
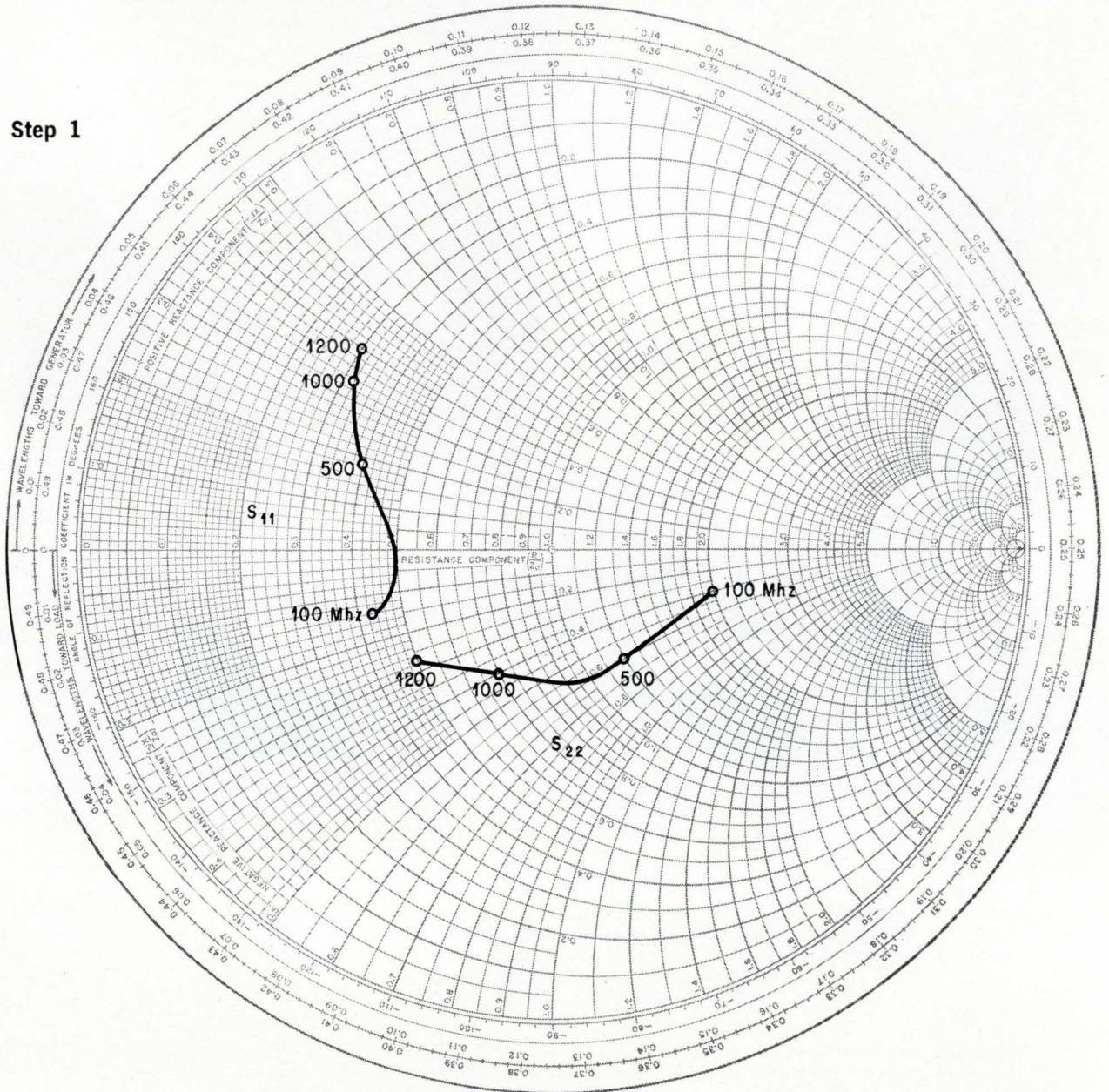

From the measured data transducer power gain is plotted as decibels versus frequency. From the plot an amplifier of constant gain is designed. Smith chart is used to plot the scattering parameters.

**To design** an amplifier stage, a source and load impedance combination must be found that gives the gain desired. Synthesis can be accomplished in three stages.

**Step 1**

The vector voltmeter measures the scattering parameters over the frequency range desired.

**Step 2**

Transducer power gain is plotted versus frequency using

equation 19 and the measured data from step 1. This determines the frequency response of the uncompensated transistor network so that a constant-gain amplifier can be designed.

**Step 3**

Source and load impedances must be selected to provide the proper compensation of a constant power gain from 100 to 500 Mhz. Such a constant-gain amplifier is de-

signed according to the following:

- Plot  $s_{11}^*$  on the Smith chart. The magnitude of  $s_{11}^*$  is the linear distance measured from the center of the Smith chart. Radius from the center of the chart to any point on the locus of  $s_{11}$  represents a reflection coefficient  $r$ . The value of  $r$  can therefore be determined at any frequency by drawing a line from the origin of the chart to a value of  $s_{11}^*$  at the frequency of

**Step 3**

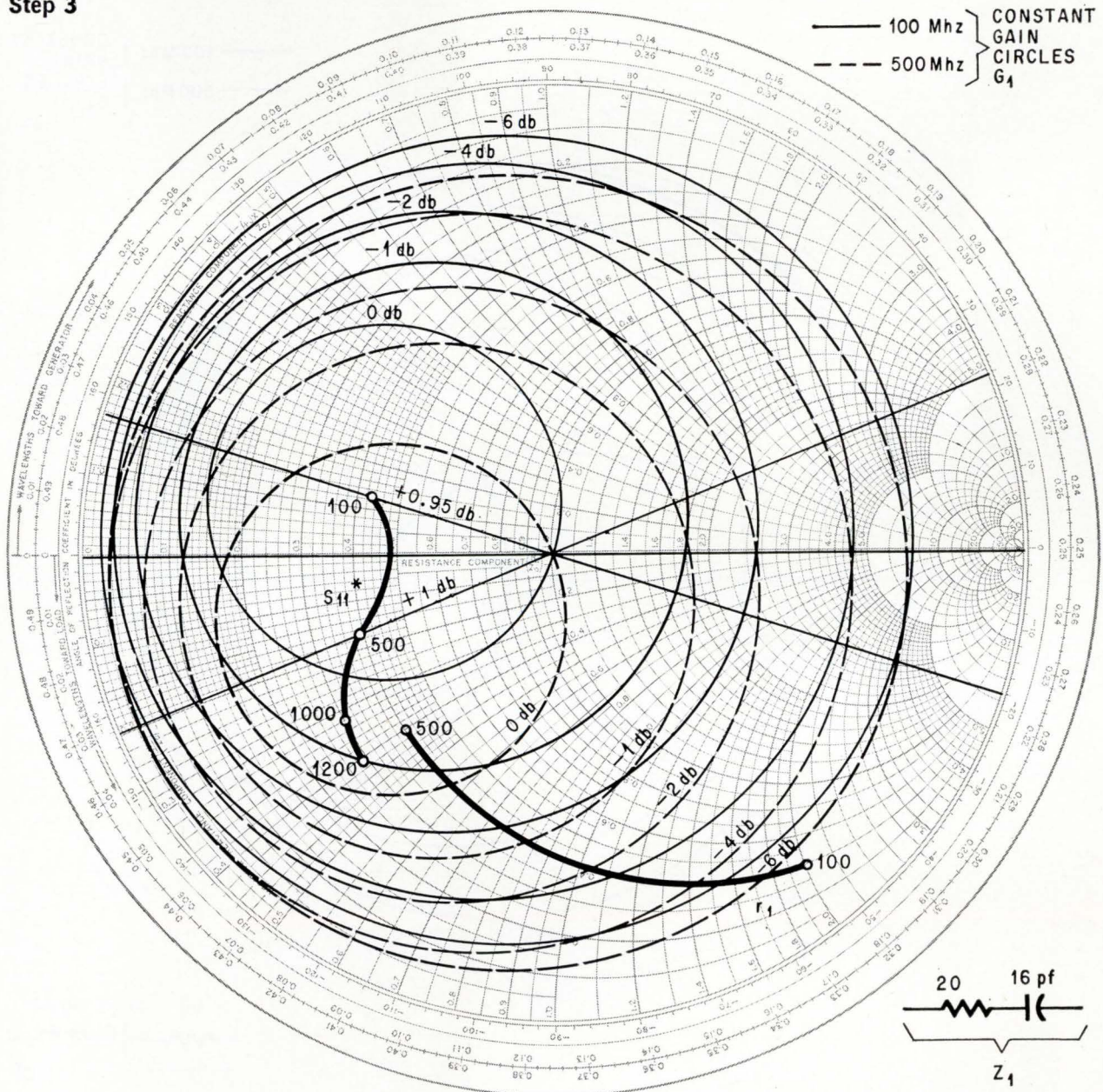

Source impedance is found by inspecting the input plane for realizable source loci that give proper gain. Phase angle is read on the peripheral scale "angle of reflection coefficient in degrees."

interest. The value of  $r$  is scaled proportionately with a maximum value of 1.0 at the periphery of the chart. The phase angle is read on the peripheral scale "angle of reflection coefficient in degrees." Constant-gain circles are plotted using equations 24 and 25 for  $G_1$ . These correspond to values of 0, -1, -2, -4 and -6 decibels for  $s_{11}^\circ$  at 100 and 500 Mhz. Construction procedure is shown on page 83.

▪ Constant-gain circles for  $s_{22}^\circ$  at 100 and 500 Mhz are constructed similarly to that below.

▪ The gain  $G_0$  drops from 20 db at 100 Mhz to 6 db at 500 Mhz, a net reduction of 14 db. It is desirable to find source and load impedances that will flatten this slope over this frequency range. For this case it is accomplished by choosing a value of  $r_1$  and  $r_2$  on the constant-gain circle at 100 Mhz, each corresponding to a loss of -7 db. If this value of  $r_1$  and  $r_2$  falls on circles of 0-db gain at 500 Mhz, the over-all gain will be:

$$\begin{aligned} \text{At 100 Mhz,} \\ G_T(\text{db}) &= G_0 + G_1 + G_2 \\ &= 20 - 7 - 7 = +6 \text{ db} \end{aligned}$$

At 500 Mhz,  
 $G_T(\text{db}) = 6 + 0 + 0 = +6 \text{ db}$   
 ▪ A source impedance of 20 ohms resistance in series with 16 picofarads of capacitance is chosen. Its value is equal to  $50(0.4 - j2)$  ohms at 100 Mhz. This point crosses the  $r_1$  locus at about the -7 db constant-gain circle of  $G_1$  as illustrated on page 83. At 500 Mhz this impedance combination equals  $50(0.4 - j0.4)$  ohms and is located at approximately the +0.5 db constant-gain circle. The selection of source impedance is an iterative process of inspection of

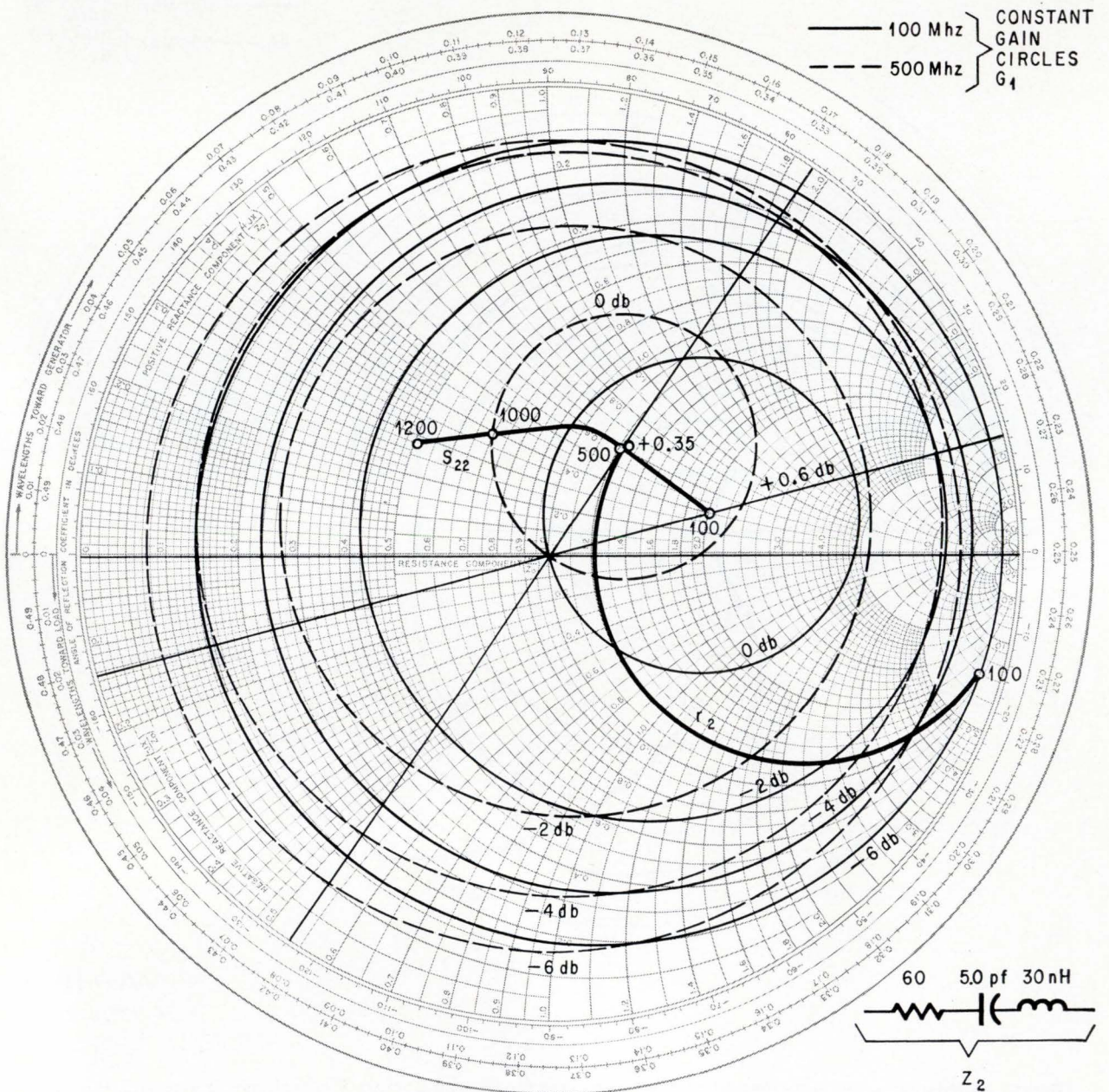

Load impedance is found by inspecting the output plane for loci that give proper gain.



the input  $r_1$  plane on the Smith chart. The impedance values at various frequencies between 100 and 500 Mhz are tried until an impedance that corresponds to an approximate constant—gain circle necessary for constant power gain across the band is found.

- At the output port a  $G_2$  of -6 db at 100 Mhz and +0.35 db at 500 Mhz is obtained by selecting a load impedance of 60 ohms in series with 5 pf and 30 nanohenries.

- The gain is:  
At 100 Mhz,

$$G_T(\text{db}) = G_0 + G_1 + G_2$$

$$= 20 - 7 - 6 = +7 \text{ db}$$

At 500 Mhz,  
 $6 + 0.5 + 0.35 = +6.85 \text{ db}$   
 Thus the 14-db variation from 100 to 500 Mhz is reduced to 0.15 db by selecting the proper source and load impedances.

**Stability criterion.** Important in the design of amplifiers is stability, or resistance to oscillation. Stability is determined for the unilateral case from the measured  $s$  parameters and the synthesized source and load impedances. Oscillations

are only possible if either the input or the output port, or both, have negative resistances. This occurs if  $s_{11}$  or  $s_{22}$  are greater than unity. However, even with negative resistances the amplifier might be stable. The condition for stability is that the locus of the sum of input plus source impedance, or output plus load impedance, does not include zero impedance from frequencies zero to infinity [shown in figure below]. The technique is similar to Nyquist's feedback stability criterion and has been derived directly from it.

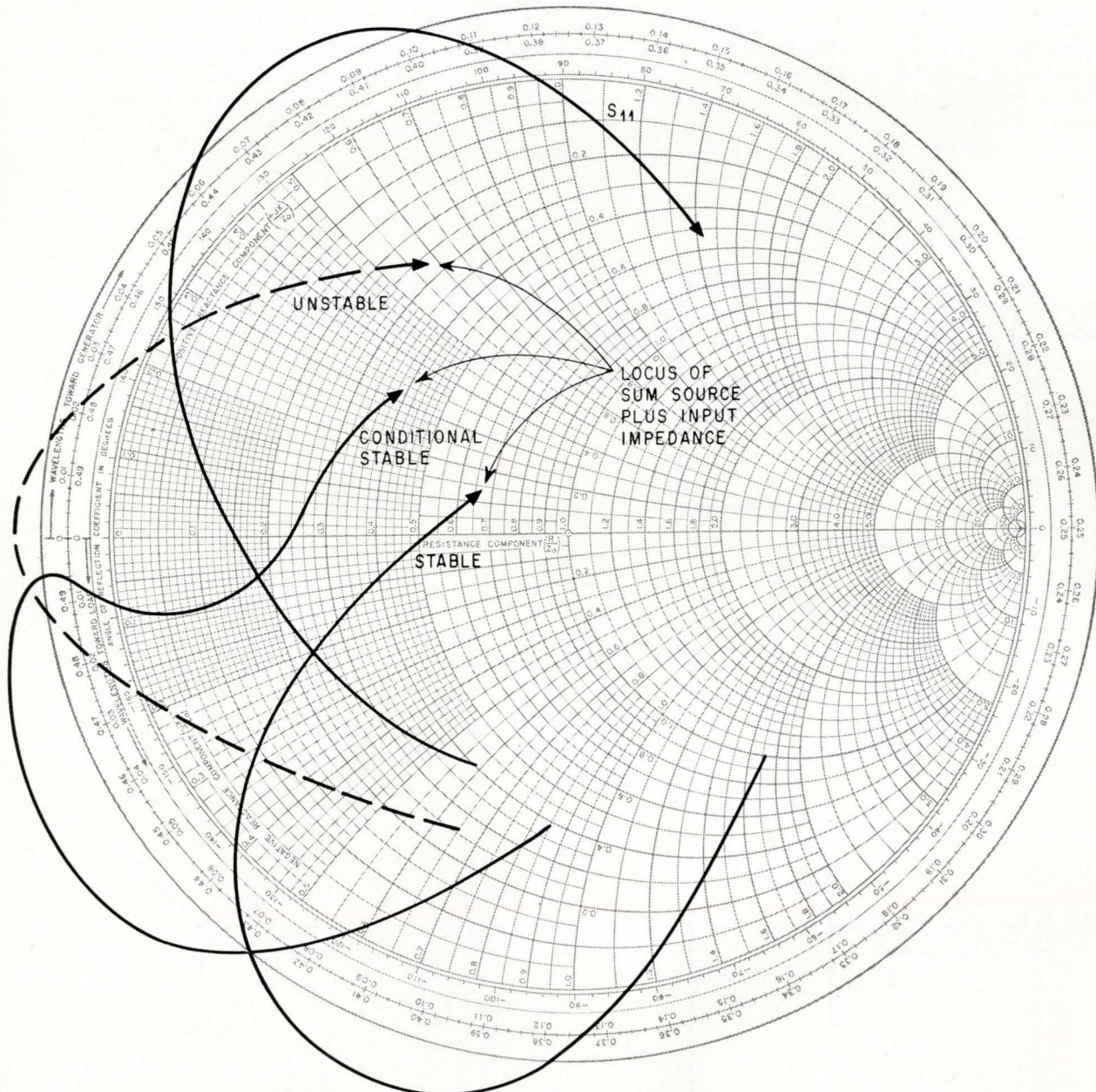

Amplifier stability is determined from scattering parameters and synthesized source and load impedances.

input cable  $L_1$  (the length of the output cable has no influence). The scattering parameter  $s_{11}$  of the two-port is the same vector  $r_1$  but turned at an angle  $720^\circ L_1/\lambda$  in a counterclockwise direction.

### Using the Smith chart

Many circuit designs require that the impedance of the port characterized by  $s_{11}$  or the reflection coefficient  $r$  be known. Since the  $s$  parameters are in units of reflection coefficient, they can be plotted directly on a Smith chart and easily manipulated to establish optimum gain with matching networks. The relationship between reflection coefficient  $r$  and the impedance  $R$  is

$$r = \frac{R - Z_0}{R + Z_0} \quad (16)$$

The Smith chart plots rectangular impedance coordinates in the reflection coefficient plane. When the  $s_{11}$  or  $s_{22}$  parameter is plotted on a Smith chart, the real and imaginary part of the impedance may be read directly.

It is also possible to chart equation 1 on polar

coordinates showing the magnitude and phase of the impedance  $R$  in the complex reflection coefficient plane. Such a plot is termed the Charter chart. Both charts are limited to impedances having positive resistances,  $|r_1| < 1$ . When measuring transistor parameters, impedances with negative resistances are sometimes found. Then, extended charts can be used.

### Using a parameter in amplifier design

Measurement of a device's  $s$  parameters provides data on input and output impedance and forward and reverse gain. In measuring, a device is inserted between known impedances, usually 50 ohms. In practice it may be desirable to achieve higher gain by changing source or load impedances or both.

An amplifier stage may now be designed in two steps. First, source and load impedances must be found that give the desired gain. Then the impedances must be synthesized, usually as matching networks between a fixed impedance source or between the load and the device [see block diagram top of p. 87].

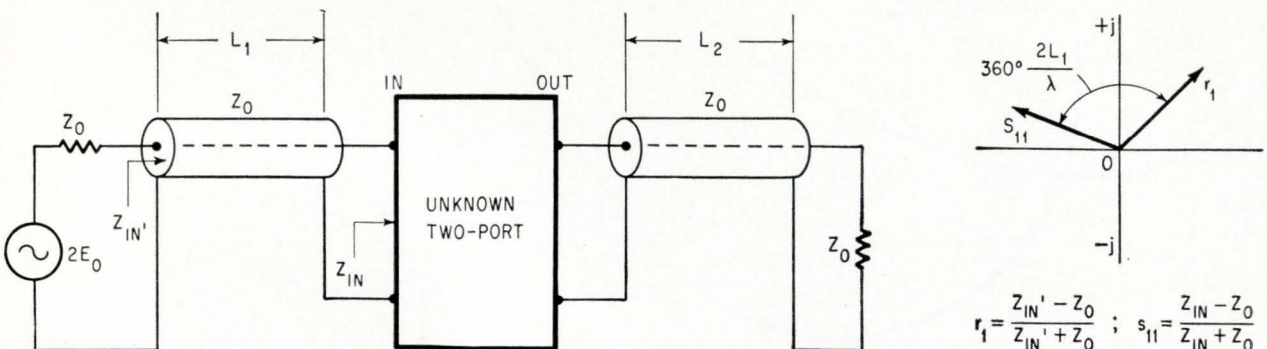
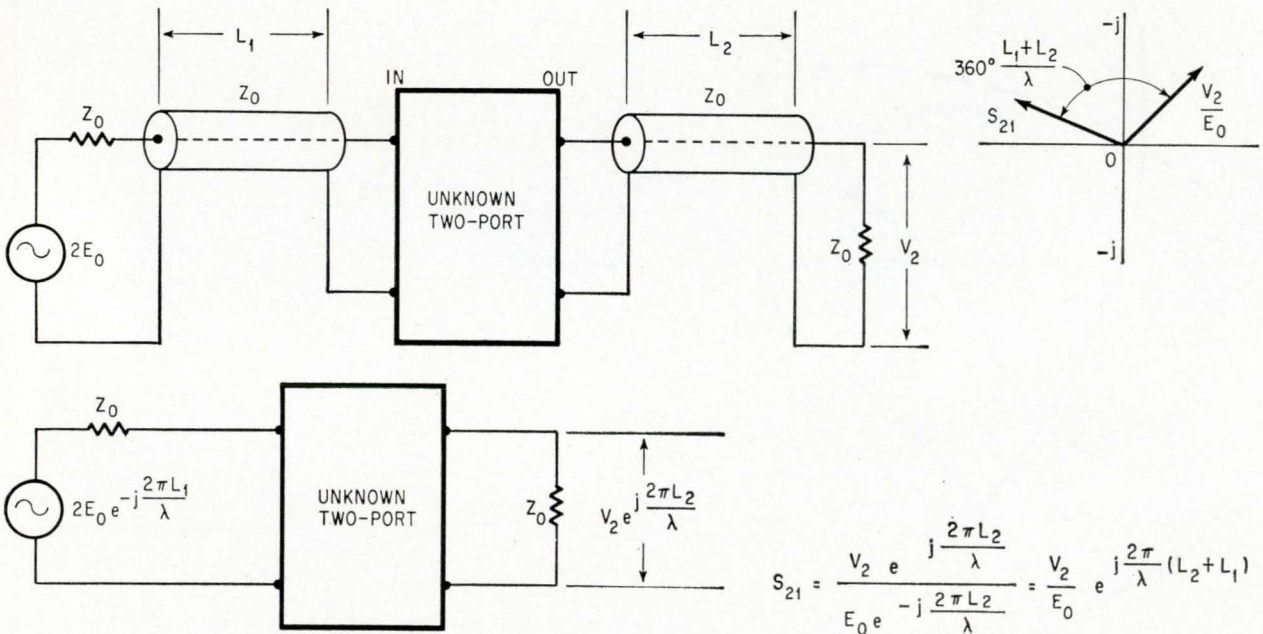

**S parameters can be measured remotely.** Top test setup is for measuring  $s_{21}$ ; bottom, for  $s_{11}$ . Measured vector  $V_2/E_0$  is the voltage transducer gain of the two-port and cables  $L_1$  and  $L_2$ . The measured vector  $r_1$  is the reflection coefficient of the two-port plus input cable  $L_1 + L_2$ . Appropriate vectors for  $r_1$  and  $s$  parameters are plotted.

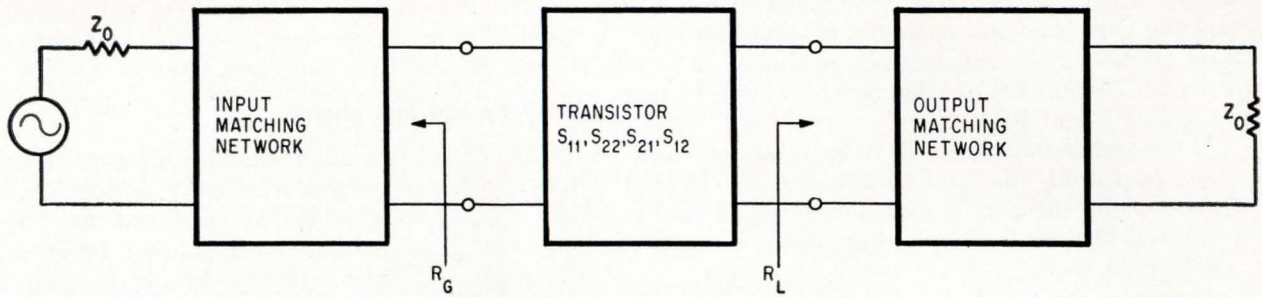

To design an amplifier stage, source and load impedances are found to give the gain desired. Then impedances are synthesized, usually as matching networks between a fixed impedance source or the load and the device. When using  $s$  parameters to design a transistor amplifier, it is advantageous to distinguish between a simplified or unilateral design for times when  $s_{12}$  can be neglected and when it must be used.

When designing a transistor amplifier with the aid of  $s$  parameters, it is advantageous to distinguish between a simplified or unilateral design for instances where the reverse-transmission parameter  $s_{12}$  can be neglected and the more general case in which  $s_{21}$  must be shown. The unilateral design is much simpler and is, for many applications, sufficient.

#### Unilateral-circuit definitions

Transducer power gain is defined as the ratio of amplifier output power to available source power.

$$G_T = \frac{I_2^2 \cdot R_{e2}}{E_0^2} \quad (17)$$

$$4R_{e1}$$

For the unilateral circuit  $G_T$  is expressed in terms of the scattering parameters  $s_{11}$ ,  $s_{21}$  and  $s_{12}$  with  $s_{12} = 0$ .

$$G_T = G_0 \cdot G_1 \cdot G_2 \quad (18)$$

where:

$$G_0 = |s_{21}|^2 = \text{transducer power gain for } R_1 = Z_0 = R_2 \quad (19)$$

$$G_1 = \frac{|1 - |r_1|^2|}{|1 - r_1 s_{11}|^2} \quad (20)$$

= power gain contribution from change of source impedance from  $Z_0$  to  $R_1$

$$r_1 = \frac{R_1 - Z_0}{R_1 + Z_0} \quad (21)$$

= reflection coefficient of source impedance with respect to  $Z_0$

$$G_2 = \frac{|1 - |r_2|^2|}{|1 - r_2 s_{22}|^2} \quad (22)$$

= power gain contribution from change of load impedance from  $Z_0$  to  $R_2$

$$r_2 = \frac{R_2 - Z_0}{R_2 + Z_0} \quad (23)$$

= reflection coefficient of load impedance with respect to  $Z_0$

In designing an amplifier stage the graphical procedure shown at the bottom is helpful. The measured values of parameter  $s_{11}$  and its complex conjugate  $s_{11}^*$  are plotted on the Smith chart together with radius distances. Center of the constant-gain circles located on the line through  $s_{11}^*$  and the origin at a distance

$$r_{01} = \frac{G_1}{G_{1 \max}} \left[ \frac{|s_{11}|}{1 - |s_{11}|^2 (1 - G_1/G_{1 \max})} \right] \quad (24)$$

The radius of circles on which  $G_1$  is constant is

$$\rho_{01} = \frac{\sqrt{1 - G_1/G_{1 \max}} (1 - |s_{11}|^2)}{1 - |s_{11}|^2 (1 - G_1/G_{1 \max})} \quad (25)$$

If the source reflection coefficient  $r_1$  is made equal

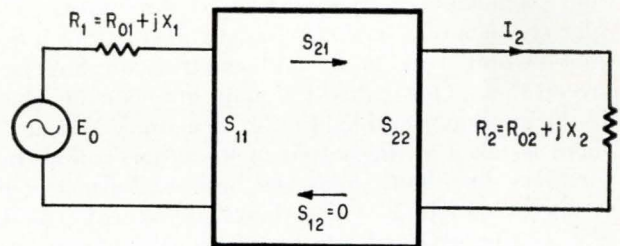

The two-port network is terminated at the ports by impedances containing resistance and reactance. Expressions for the transducer power gain can then be derived in terms of the scattering parameters.

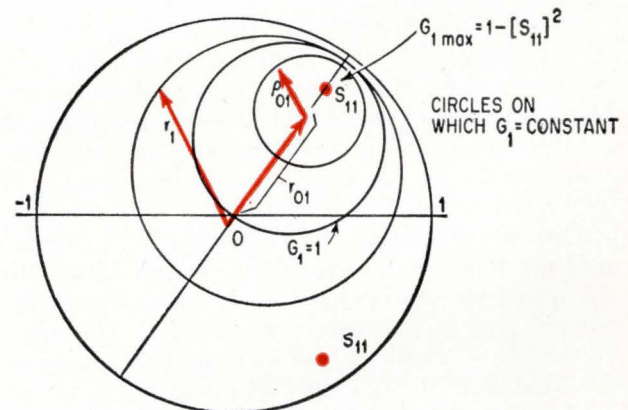

A graphical plot helps in design of an amplifier stage. Here the measured parameters  $s_{11}$  and  $s_{11}^*$  are plotted on a Smith chart. The upper point is  $s_{11}^*$ .

to  $s_{11}^*$ , then the generator is matched to the load and the gain becomes maximum ( $G_{1max}$ ). Constant-gain circles can be constructed, as shown, in 1- or 2-decibel increments or whatever is practical using equations 9 and 10.

If the source impedance  $R_1$  or its reflection coefficient is plotted, the gain contribution  $G_1$  is read directly from the gain circles. The same method is used to determine  $G_2$  by plotting  $s_{22}$ ,  $s_{22}^*$ , constant-gain circles and  $r_2$ .

Examples for the design procedure are given in greater detail in Transistor Parameter Measurements, Hewlett-Packard Application Note 77-1. The procedure is outlined in "Amplifier design with unilateral s parameters," beginning on page 82.

### Measuring s parameters

S-parameter measurements of small-signal transistors require fairly sensitive measuring equipment. The input signal often cannot exceed 10 millivolts root mean square. On the other hand, wide frequency ranges are required as well as fast and easy operation. Recent advantages in measuring equipment have provided a fast and accurate measuring system. It is based on the use of a newly developed instrument, the H-P sampling vector voltmeter 8405A [see photo p. 81], and couplers.

The vector voltmeter covers a frequency range of 1 to 1,000 Mhz, a voltage measurement range of 100 microvolts full scale and a phase range of  $\pm 180^\circ$  with  $0.1^\circ$  resolution. It is tuned automatically by means of a phase-locked loop.

Directional couplers are used to measure reflection coefficients and impedances. A directional coupler consists of a pair of parallel transmission lines that exhibit a magnetic and electric coupling between them. One, called the main line, is connected to the generator and load to be measured. Measurement is taken at the output of the other, called the auxiliary line. Both lines are built to have a well defined characteristic impedance; 50 ohms is usual. The voltage coupled into the auxiliary line consists of components proportional to the voltage and current in the main line. The coupling is arranged so that both components are equal in magnitude when the load impedance equals the characteristic impedance of the line.

Directional couplers using two auxiliary lines in reverse orientation are called dual-directional couplers. A feature of the unit is a movable reference plane; the point where the physical measurement is taken can be moved along the line connecting the coupler with the unknown load. A line stretcher is connected to the output of the first auxiliary line.

The reference plane is set closer to the transistor package than the minimum lead length used with the transistor. Additional lead length is then considered part of the matching networks. The influence of lead length is also measured by changing the location of the reference plane.

Measurement of  $s_{11}$  parameter is made when the instrument is switched to one of two positions. The quotient  $V_B/V_A$  equals the magnitude of  $s_{11}$ . Its

phase is read directly on the 8405A meter. When switched to the alternate position, the  $s_{21}$  parameter is read directly from the same ratio.

### Accuracy and limitations

When measuring small-signal scattering parameters, a-c levels beyond which the device is considered linear must not be exceeded. In a grounded-emitter or grounded-base configuration, input voltage is limited to about 10 millivolts rms maximum (when measuring  $s_{11}$  and  $s_{21}$ ). Much higher voltages can be applied when measuring  $s_{22}$  and  $s_{12}$  parameters. In uncertain cases linearity is checked by taking the same measurements at a sampling of several different levels.

The system shown is inherently broadband. Frequency is not necessarily limited by the published range of the dual directional couplers. The coupling factor  $K$  falls off inversely with frequency below the low-frequency limit of a coupler. The factor  $K$  does not appear in the result as long as it is the same for each auxiliary port. Since construction of couplers guarantees this to a high degree, measurements can be made at lower frequencies than are specified for the coupler.

The system's measurement accuracy depends on the accuracy of the vector voltmeter and the couplers. Although it is possible to short circuit the reference planes of the transistors at each frequency, it is not desirable for fast measurements. Hence, broadband tracking of all auxiliary arms of the couplers and tracking of both channels of the vector voltmeter are important. Tracking errors are within about 0.5 db of magnitude and  $\pm 3^\circ$  of phase over wide frequency bands. Accuracy of measuring impedances expressed by  $s_{11}$  and  $s_{22}$  degrade for resistances and impedances having a high reactive component. This is because  $s_{11}$  or  $s_{22}$  are very close to unity. These cases are usually confined to lower frequencies.

### Bibliography

- Charter, P.S., "Charts for Transmission-Line Measurements and Computations," Radio Corp. of America Review, Vol. III, No. 3, January, 1939, pp. 355-368.
- Smith, P.H., "An Improved Transmission Line Calculator," Electronics, January, 1944, pp. 130-325.
- Alsbet, D.A., "A Precise Sweep-Frequency Method of Vector Impedance Measurement," Proceedings of the IRE, November, 1951, pp. 1393-1400.
- Follingstad, H.G., "Complete Linear Characterization of Transistors from Low through Very High Frequencies," IRE Transactions on Instruments, March, 1957, pp. 49-63.
- General Radio Experimenter, "Type 1607-A Transfer-Function and Impedance Bridge," May, 1959, pp. 3-11.
- General Radio Experimenter, "Mounts for Transistor Measurements with the Transfer-Function Bridge," February-March, 1965, pp. 16-19.
- Mathis, H.F., "Extended Transmission-line Charts," Electronics, Sept. 23, 1960, pp. 76-78.
- Leed, D., and O. Kummer, "A Loss and Phase Set for Measuring Transistor Parameters and Two-Port Networks Between 5 and 250 Mc," Bell System Technical Journal, May, 1961, pp. 841-884.
- Kurokawa, K., "Power Waves and the Scattering Matrix," Institute of Electronic and Electrical Engineers Transactions Microwave Theory and Techniques, March, 1965, pp. 194-202.
- Leed, D., "An Insertion Loss, Phase and Delay Measuring Set for Characterizing Transistors and Two-Port Networks between 0.25 and 4.2 Gc," Bell System Technical Journal, March, 1966, pp. 340-397.
- Hewlett-Packard Journal, "The RF Vector Voltmeter," Vol. 17, No. 9, May, 1966, pp. 2-12.

# Sense amplifier fits any memory

General-purpose amplifier attaches to most coincident-current memories without redesigning; it has adjustable threshold, good noise rejection and it drives any standard logic gate with positive or negative output

By Brant Johnson

Sylvania Electric Products, Inc., Woburn, Mass.

**A new sense amplifier** will simplify the memory designer's job and enable computer makers to produce less costly machines. In the past when a memory was designed, a sense amplifier was designed to go with it. The new general-purpose amplifier can be used in most coincident-current computer memories.

Sylvania Electric Products, Inc., a subsidiary of General Telephone and Electronics Corp., developed the sense amplifier at its Woburn, Mass. laboratories. It attaches to most coincident-current memories without the need for custom design work. It accepts any threshold levels over a wide range of temperatures, rejects noise, drives standard logic gates with either a positive or negative output and works with high- or low-speed memories.

The sense amplifier is an integrated circuit, which makes possible a computer built entirely of integrated circuits. Up to now most sense amplifiers were made of discrete components. The sense amplifier [see photo on page 90] has a bandwidth of 10 megahertz and drifts only 22 microvolts per degree centigrade.

Most sense amplifiers are designed specifically for the particular memory with which they will be used. This is necessary because the threshold level varies from application to application, because of the presence and severity of noise and because the requirements of logic circuits may vary.

## The author



Brant Johnson is a design engineer in the integrated circuits department of Sylvania's semiconductor division. Besides the sense amplifier described here, he has designed a wide-band amplifier that Sylvania produces and has worked with digital IC's and with memories.

The new circuit was designed to be compatible with Sylvania's universal high-level (SUHL) logic family, [Electronics, April 19, 1965, p. 166] for use with Sylvania's MSP-24 microcircuit computer [Electronics, October 18, 1965, p. 72].

## What's a sense amplifier?

When data is taken from a coincident-current ferrite-core memory, it comes out as electrical pulses on a group of wires—one wire for each bit in the word. Ordinarily the presence of a pulse indicates a 1 bit, and the absence of a pulse at the proper time indicates a 0 bit. The sense amplifier accepts these pulses, rejects noise pulses, shapes the signal, amplifies it and drives logic circuits through which data is transferred to the computer's memory data register.

The sense amplifier is a differential amplifier whose two inputs are connected to the two ends of the sense winding [see panel on p. 91]. The input to the amplifier is sometimes positive, sometimes negative and always noisy. The amplifier must therefore accept both positive and negative pulses, but produce a uniform output that is always of the same polarity.

## Two kinds of noise

Common-mode noise and differential noise complicate the task of signal detection. Common-mode noise—that is, noise that appears equally at both amplifier inputs—is caused by inductive coupling from the relatively large currents that write information into the memory, across the closely spaced wires on which the cores are strung. Differential noise arises from fully selected cores that do not switch because they are already in the 0 state and from half-selected cores. The zigzag routing of the sense line partly cancels differential noise; with this routing half the cores are sensed in one direction and half in the other. Nevertheless, the signal-to-

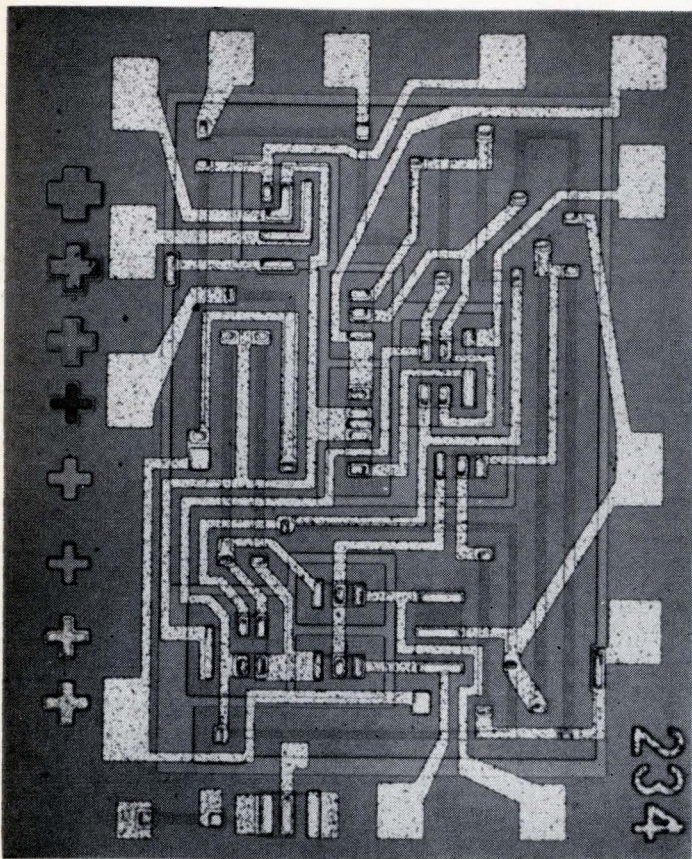

**Sense amplifier** on monolithic silicon chip 40 mils square can be used in most coincident-current memories.

noise ratio on the sense line is low. For example, a 64-by-64 bit memory plane made of 20-mil cores that require an 875-milliamperere write current and produce a 35-millivolt pulse when they switch can generate differential noise greater than 10 millivolts and common-mode noise of 1 volt or more.

A sense amplifier must reject differential signals below a fixed threshold level. Usually the threshold level is optimized for a particular memory; it depends on the size of the core. Such an amplifier may be unreliable in another memory system. If, for example, the signal-to-threshold ratio is too low, a valid 1 bit may be read as a 0. Conversely, a high signal-to-threshold ratio may permit noise to be detected so that a 0 is read as a 1. Therefore, a sense amplifier to be used with a variety of memory systems must have a variable threshold control. The threshold voltage of a sense amplifier must be well defined, because the degree of uncertainty in the threshold limits the accurate setting of the amplifier's threshold level to the minimum output pulse expected from the core. With poor threshold definition, the threshold voltage must be set lower than desired, decreasing the degree of noise protection.

Sense amplifiers must reject common-mode noise several volts in amplitude, yet be sensitive enough to detect small differential voltages of either polarity. Therefore the sense amplifier's input stage normally consists of a differential amplifier fed by a

current source. The supply voltages and bias levels for the input stage must be chosen so that the collector-base junctions of all transistors are strongly reverse biased—enough to keep the transistors in their active region even in the presence of several volts of common-mode noise. The Sylvania circuit rejects up to  $5\frac{1}{2}$  volts of common-mode noise.

Unlike most others, the Sylvania sense amplifier does not include an internal strobe circuit—a circuit that blocks passage of signals through the amplifier except during a short time interval when the proper signal is expected. The strobe usually follows detection and amplification and precedes wave shaping. With the Sylvania amplifier, more precise strobing is possible with an external gate circuit at the output, where the signal is a pulse with well defined amplitude and duration. Strobing at the output is preferable because it avoids loading of the amplifier analog section and improves frequency response.

#### Circuit details

Sylvania's monolithic sense amplifier is a silicon integrated circuit, diagramed on the opposite page. Its input is through pins A and B to transistors  $Q_1$  and  $Q_2$  connected as a differential pair. Transistor  $Q_3$  supplies a constant current to the pair. The two resistors connected to the bases of  $Q_1$  and  $Q_2$  provide a low input impedance, approximately matching the input impedance of the amplifier to the output impedance of the sense winding, and thereby reducing reflections.

The output of the first stage passes through the emitter-follower transistors  $Q_4$  and  $Q_5$ , which isolate the input stage from the rest of the circuit. The isolation helps preserve the gain of the input stage by reducing the loading effect of the following stages. The negative voltage at the emitters of  $Q_4$  and  $Q_5$  is connected to ground (or to an alternative voltage—see below) through the voltage divider network  $R_{10}$ ,  $R_{11}$ ,  $R_{12}$  and  $R_{13}$ , and establishes a less negative voltage at the base of transistor  $Q_8$ . This voltage remains constant regardless of the presence of a signal; therefore  $Q_8$  operates as a grounded-base amplifier, with its base at a fixed negative voltage instead of at ground.

The emitters of  $Q_6$ ,  $Q_7$  and  $Q_8$  are all electrically common and are approximately 0.75 volt more negative than the base of  $Q_8$ . But that base is more positive than the bases of  $Q_6$  and  $Q_7$ , considerably more so than 0.75 volt, because of the voltage divider. Therefore  $Q_6$  and  $Q_7$  are reverse biased and do not conduct.

When the amplifier is quiescent, pins A and B are at the same potential, a few volts below ground. The differential pair  $Q_1$  and  $Q_2$  conduct. A small current passes through  $Q_8$  and  $R_{14}$  to the -12 volt power supply. If a voltage appears between pins A and B, one of the input transistors—say  $Q_1$ —will conduct less and the other will conduct more. The collector of  $Q_1$  becomes more positive, and this level is transmitted through  $Q_4$  to the base of

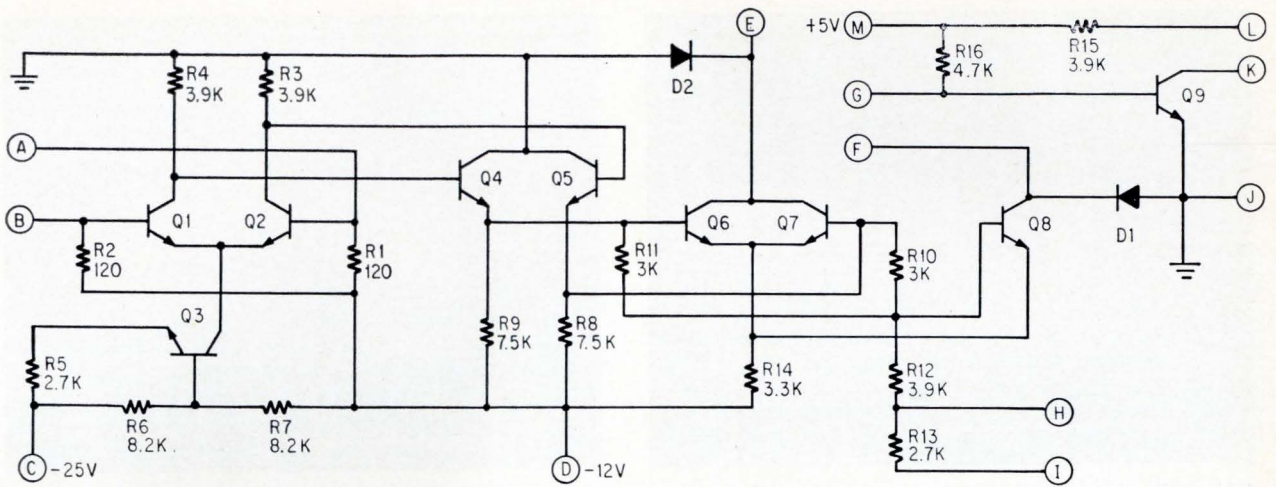

**Adjustable threshold** and choice of positive or negative output pulse are features of this general-purpose sense amplifier. The threshold is established by the connection of pin H or I to ground or to a positive or negative voltage, directly or through a resistance; thus there are three ways to adjust it. For a negative output pulse, pins F and G are connected together; for a positive output pulse, pins E and G are connected.

Q<sub>6</sub>, which turns on (if the input signal is large enough). A signal of reversed polarity between A and B will pass through Q<sub>2</sub> and Q<sub>5</sub>, and will turn on Q<sub>7</sub>. This passes additional current through R<sub>14</sub>, raising the potential at the three common emitters and turning off Q<sub>8</sub>.

#### Positive or negative

If pins F and G are connected together, and E is disconnected, the current through Q<sub>8</sub> passes from

the +5 volt power supply through resistor R<sub>16</sub>. Transistor Q<sub>9</sub> does not conduct. When Q<sub>8</sub> turns off, this current is diverted into the base of Q<sub>9</sub>, which then becomes saturated. Its current flows through a connection between pins L and K; when it turns on, the voltage at K decreases sharply and a negative output signal is generated.

On the other hand, if pins E and G are connected, and F is disconnected, the current through Q<sub>8</sub> comes through the diode D<sub>1</sub>. There is no diversion

#### Memory windings

The diagram at the right identifies the various windings ordinarily used in a coincident-current memory. Half-select currents, too small to switch the magnetization state of the ferrite cores alone, pass through one x and one y winding. The total or full-select current flowing through the two wires is large enough to switch the one core through which both wires pass. The direction of the current forces the core into the 0 state; if it is already in that state, then it does not switch and no output pulse is generated. But if the core was previously in the 1 state, then it switches to 0; the change in magnetization generates a pulse in the sense winding; this winding passes through all cores in the plane.

The inhibit winding controls the writing of new data into the memory. Half-select currents pass through the x and y windings in the opposite direction to that for reading, so that a single core tends to switch into the 1 state. If that core is intended to remain in the 0 state, an opposing current passing through the inhibit winding insures that it does not switch.

Coincident-current memories are made of a stack of planes like the one in the diagram. Typical sizes are from 32-by-32 up to 100-by-100, wired in a pattern similar to the 4-by-4 in the diagram. All the x windings are connected in series and so are all the y windings. A current on one x and one y

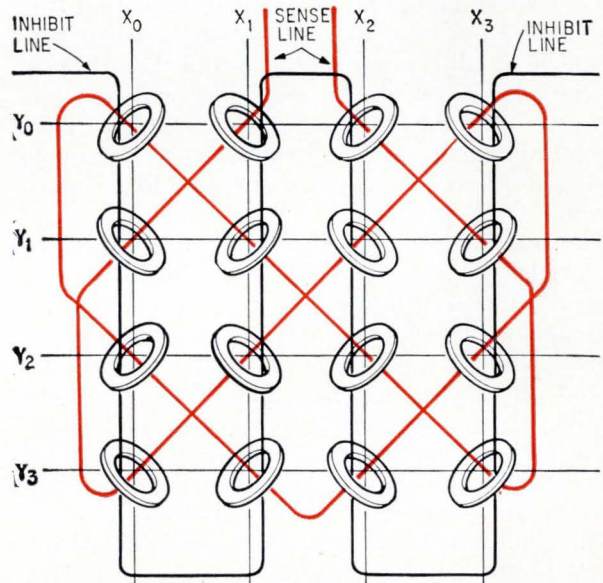

winding therefore selects a single core in each plane; if the planes are horizontal, the selected cores will be in a vertical column through the stack. Each plane corresponds to one bit in a word, and contains one bit of every word in the memory. Each plane has its own individual sense winding and inhibit winding passing through every core in the plane.

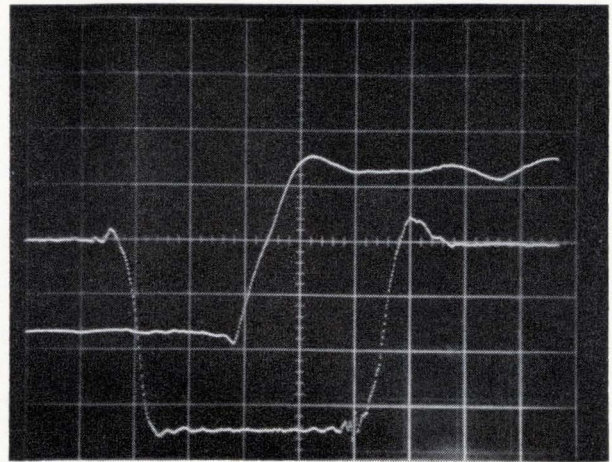
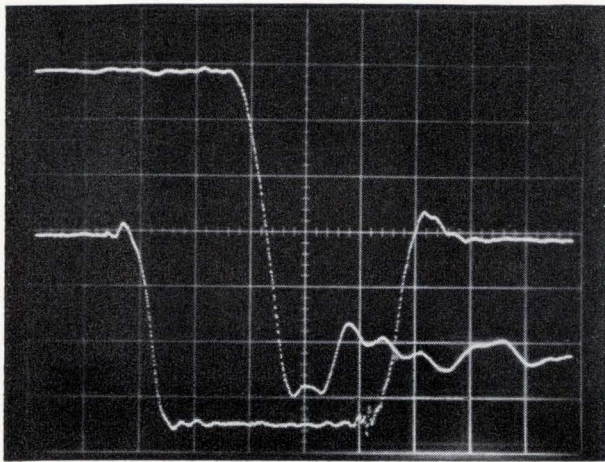

A 17-millivolt input pulse 100 nanoseconds wide (left) produces a negative output pulse less than 60 nanoseconds later. A similar pulse (right) can produce a positive output pulse with a similar propagation delay.

of  $Q_9$ 's base current, so that  $Q_9$  is normally saturated. When a signal turns on either  $Q_6$  or  $Q_7$ , the base current is diverted from transistor  $Q_9$  to the collector of  $Q_6$  or  $Q_7$ ;  $Q_9$  cuts off, the voltage at K increases sharply and a positive output signal is generated.

When the sense amplifier is one of a group operating from a single memory stack, pins L and K are connected on each amplifier. But when several stacks are operated individually, each feeding information into a single processor, the outputs from the various stacks must pass through an OR gate. (One can also visualize other situations where outputs of several sense amplifiers must pass through an OR gate.) The easiest way to combine the outputs of several amplifiers (provided the outputs are negative) is to omit the connection between pins L and K on all but one amplifier and then connect all the pins K on all the amplifiers with the first logic circuit in the data path of the processor. Then when any one transistor  $Q_9$  turns on, the common connection becomes negative and acts like a negative-input OR gate.

The number of amplifiers that can be operated in parallel this way depends on the parallel resistance of all the output transistors in the cutoff state, the capacitance of the interconnecting wires and other system factors. Amplifiers of this design connected for positive outputs cannot be operated in parallel; their output transistors are normally saturated, and cutting off one of them will not cause the common connection to become positive because the remaining transistors will hold it down.

The photographs shown above are oscilloscope traces of the amplifier's performance for positive and negative outputs. Both photos show an input pulse 100 nanoseconds wide and 17 millivolts high. In each case the amplifier reaches its output level in less than 60 nanoseconds. The trailing edge of the output is not shown in the photos; its delay and transition time can be different, depending on the circuit driven by the amplifier and on the distributed capacitance along the wire that connects the amplifier with its driven circuit.

### Adjusting the threshold

The reverse bias on transistors  $Q_6$  and  $Q_7$  controls the threshold voltage of the amplifier. Several different ways to adjust the threshold level are available. The description of circuit operation assumed that pin I was connected to ground. But if either pin H or pin I is connected to ground, or to some positive or negative voltage, directly or through a resistance connected in series or in parallel with  $R_{13}$ , the bias on the two transistors and hence the threshold level will be affected.

Including the effects of a resistor  $R_x$  and a threshold-controlling voltage  $V_x$ , either of which can be zero, the voltages at the emitters of  $Q_6$  and  $Q_7$  are:

$$V_{eQ_6} = (V_{eQ_4} - V_x) \left[ 1 - \frac{\frac{1}{2}R_{11}}{\frac{1}{2}R_{11} + R_{12} + R_{13} + R_x} \right] - V_{beQ_8}$$

$$V_{eQ_7} = (V_{eQ_5} - V_x) \left[ 1 - \frac{\frac{1}{2}R_{10}}{\frac{1}{2}R_{10} + R_{12} + R_{13} + R_x} \right] - V_{beQ_8}$$

The two expressions are identical except for the components involved. The term  $V_{beQ_8}$  is the base-to-emitter voltage drop on the transistor  $Q_8$ ; all other voltages are measured to ground. Since the bases of  $Q_6$  and  $Q_7$  are connected directly to the emitters of  $Q_4$  and  $Q_5$ ,

$$V_{eQ_4} = V_{bQ_6} \quad \text{and} \quad V_{eQ_5} = V_{bQ_7}$$

Then the reverse bias on  $Q_6$  and  $Q_7$  is:

$$V_{bQ_6} - V_{eQ_6} = V_x + \frac{(V_{bQ_6} - V_x) (\frac{1}{2}R_{11})}{(\frac{1}{2}R_{11}) + R_{12} + R_{13} + R_x} + V_{beQ_8}$$

$$V_{bQ_7} - V_{eQ_7} = V_x + \frac{(V_{bQ_7} - V_x) (\frac{1}{2}R_{10})}{\frac{1}{2}R_{10} + R_{12} + R_{13} + R_x} + V_{beQ_8}$$

To forward bias either  $Q_6$  or  $Q_7$ , a positive signal voltage that exceeds the reverse bias by the base-to-emitter voltage or more must be delivered to the base. The three transistors  $Q_6$ ,  $Q_7$  and  $Q_8$  are nominally identical, and therefore have equal base-to-emitter voltage drops. Thus the required signal voltage is the middle term in either of the previous



pair of equations. This voltage divided by the single-ended gain of the input stage (about 50) defines the threshold voltage of the amplifier. The effects of  $R_x$  and  $V_x$  on the threshold voltage are shown in the graphs at the right.

### Symmetric response

The voltage transfer characteristic shown in the photo at the right is the amplifier's output plotted against an input of an a-c voltage with an amplitude of 80 millivolts peak to peak. Pin I was connected directly to ground for this test. The photo shows that the amplifier's 17-millivolt threshold level is highly symmetric—that is, the amplifier responds in the same way to positive and negative signals of equal amplitude. To obtain this symmetry or low offset, the two input transistors should have the same base-to-emitter voltage drop—within  $\frac{1}{2}\%$ —when conducting, and the collector resistors must match within two or three percent. The matching of the resistors is less critical than that of the voltage drops, because their value has less effect on threshold level.

The Sylvania sense amplifier has a threshold whose uncertainty is very low. Less than 1 millivolt increment in the input voltage causes output to change from a logic 1 to a logic 0 or vice versa. This low uncertainty may be attributed to the operation of transistor  $Q_8$  and to the amplifier's high differential gain. The input stage amplifies the input signal by a factor of 50 and applies it to transistor  $Q_6$  or  $Q_7$ . These transistors possess high transconductance so that an increasing voltage as small as 50 millivolts applied to the base generates enough emitter current to raise the collector potential of transistor  $Q_8$  and saturate transistor  $Q_9$ . When pins F and G are connected, the collector potential of  $Q_9$  is limited to a minimum of  $-0.7$  volts by diode  $D_1$  and to a maximum of  $+0.7$  volts by the base-emitter junction of  $Q_9$ . This clamping action keeps  $Q_8$  in its active region so that it is capable of both high-speed operation and voltage gain. When no signal is present, the transistor draws about 2.4 milliamperes. About 1.2 milliamperes of this current comes through diode  $D_1$  and the rest through  $R_{16}$ . The conducting diode establishes the collector potential of  $Q_8$  at  $-0.7$  volts. To raise this collector potential to  $+0.7$  volts, the  $D_1$  diode current must be reduced to zero, and the voltage drop across  $R_{16}$  reduced by 1.4 volts. Therefore the  $Q_8$  collector current must be decreased by  $1.2 + 1.4/R_{16}$ . One and a half milliamperes of current from either  $Q_6$  or  $Q_7$  will effect this reduction and will cause a change in the logic state of the amplifier output.

With this information, an equation may be written that relates input threshold uncertainty to amplifier and transistor characteristics. Calling the threshold uncertainty  $\Delta V_t$ ,

$$\Delta V_t = \frac{1.2 + \frac{1.4}{R_{16}}}{(G)(g_m)}$$

where  $G$  equals 50, the gain of the input stage, and  $g_m$  equals the transconductance of  $Q_6$  or  $Q_7$ , which

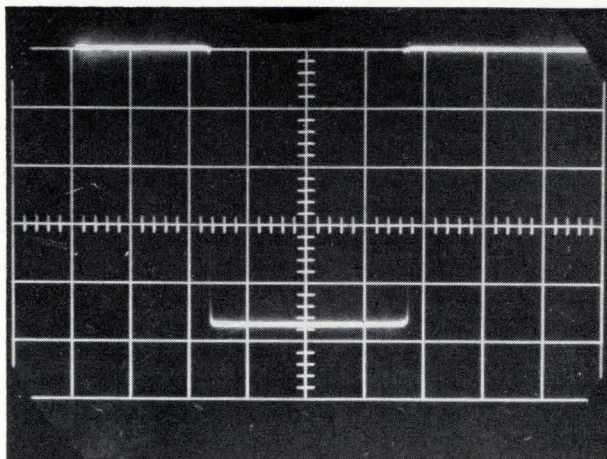

An a-c input signal 80 millivolts peak to peak produces a 5-volt output signal. Less than 1 millivolt incremental voltage causes the output to switch; the positive and negative thresholds are both 17 millivolts, symmetrical with respect to ground.

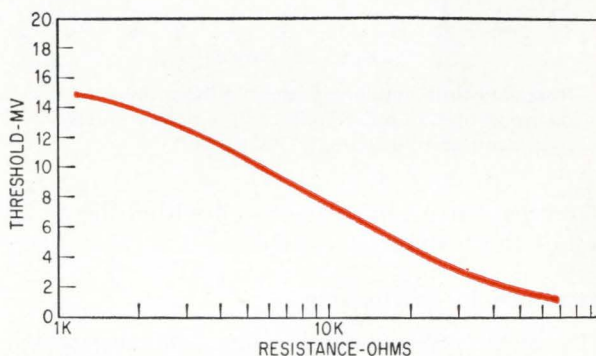

Threshold voltage can be varied by changing the resistance between pin I and ground.

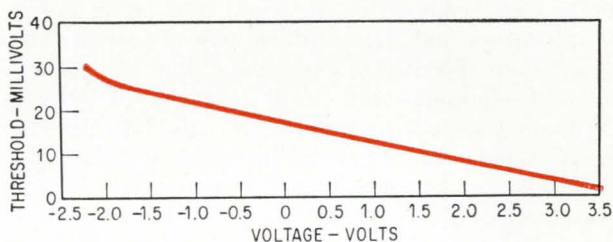

Threshold voltage can also be varied by applying a voltage at pin I.

is equal to  $\alpha/R_e$ ;  $R_e$  is the a-c resistance of a transistor's base-emitter junction, about 26 volts per ampere. (The factor 26 is the approximate value of the quantity  $nkT/q$  at room temperature;  $k$  is Boltzmann's constant,  $T$  is the absolute temperature,  $q$  is the electron charge, and  $n$ , about 1, accounts for second-order effects in the junction.) The  $\alpha$  of the transistor may be considered approximately unity, so that

$$\Delta V_t = \frac{\left(1.2 + \frac{1.4}{R_{16}}\right)(26)}{(50)(1)\left(1.2 + \frac{1.4}{R_{16}}\right)} = \frac{26}{50} = 0.52$$

This approximation was checked against experi-

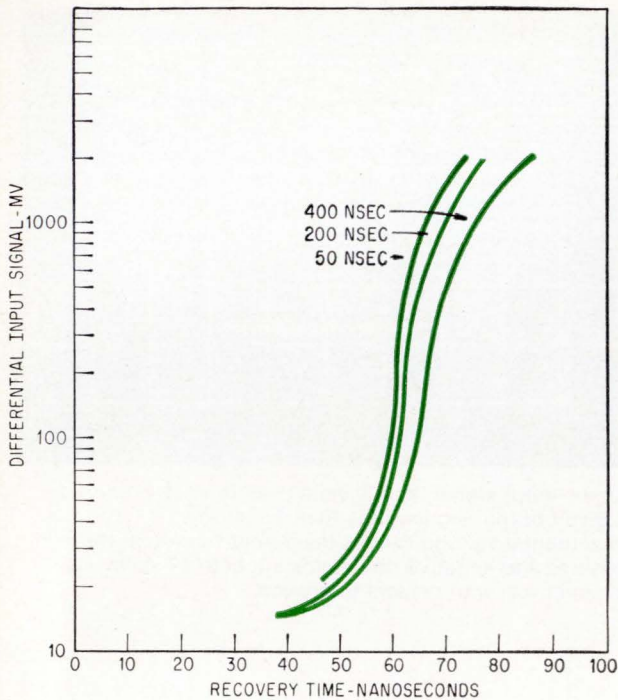

Recovery time depends both on differential overload and on pulse width, but is not seriously high even at inputs greater than a volt.

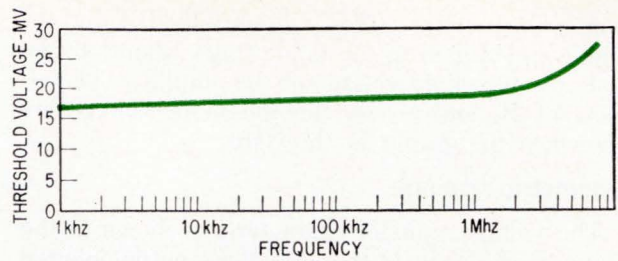

Frequency response of the sense amplifier, in terms of threshold, is flat up to one megahertz or more. Above that frequency the threshold voltage increases, reaching +3 db at 7 Mhz.

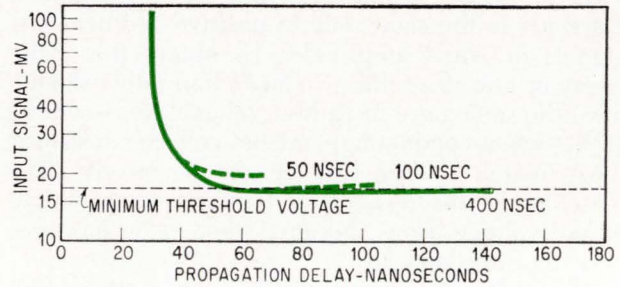

Propagation delay depends on amplitude of input pulse to 60 millivolts and on the width of the input pulse to a smaller extent.

mental evidence, and agreed well within the accuracy of the testing equipment.

### Resistance to overloading

To block common-mode noise voltages, which may reach several volts, the input stage of a sense amplifier must have a large reverse bias across its collector-base junction. Otherwise, a common-mode signal may drive the input into either cutoff or saturation and the amplifier will not work. The input stage of Sylvania's sense amplifier has several volts of common-mode protection provided by a -12 volt power supply that biases the bases of the input transistors to 8 volts below their collectors. The -25 volt supply biases transistor  $Q_3$  which also is strongly reverse biased. With these large reverse biases, the input stage can function normally even in the presence of large common-mode voltages. Common-mode pulses varying from 10 to 100 nanoseconds and up to 2.5 volts have been applied to the amplifier without affecting its output. The amplifier can reject larger common-mode sinusoidal voltages.

Large reverse biases on the input transistors also improve amplifier recovery from differential overloads. When a large differential signal appears at the base of  $Q_1$ , the constant-current source  $Q_3$  limits the collector voltage of  $Q_1$  to -7.8 volts. Since the bases of  $Q_1$  and  $Q_2$  are biased at -12 volts, the transistors will not saturate and recovery delays due to storage time are avoided.

Sense amplifier recovery time, as shown above, is relatively independent of pulse width. Even when differential overdrive exceeds 1 volt, recovery time is less than 75 nanoseconds.

### High-frequency operation

The frequency response of the sense amplifier input stage should be high to avoid degrading the input signal's waveform, which would increase propagation delay in the amplifier.

The frequency at which roll-off begins for the Sylvania sense amplifier is 7 Mhz, as shown above. The graph shows the frequency response in terms of threshold voltage instead of in terms of power output, as is customary in audio and r-f amplifiers; the threshold voltage increases beyond the roll-off frequency in much the same way that power output decreases. The roll-off frequency is called the -3 db point as if power output were being measured. The 7-Mhz level is high enough to satisfy bandwidth requirements of most medium- and high-speed core memories. It reduces propagation delay in the amplifier to about 50 nanoseconds.

The chart above displays propagation delay versus input signal amplitude for various pulse widths. As the pulse width decreases, both threshold voltage and propagation delay increase, because of the finite bandwidth of the input stage. However, the overdrive above the low-frequency threshold voltage required to keep the propagation delay less than 60 nanoseconds increases only slightly as pulse widths are narrowed. For example, a 50-nanosecond pulse requires less than 15% overdrive above the 17-millivolt threshold to keep amplifier propagation delay under 60 nanoseconds. The high-speed operation and the fast recovery time make Sylvania's integrated-circuit sense amplifier useful in high-speed memory systems that have narrow output pulses and cycle times of less than one microsecond.

# Designer's casebook

Designer's casebook is a regular feature in Electronics. Readers are invited to submit novel circuit ideas, packaging schemes, or other unusual solutions to design problems. Descriptions should be short. We'll pay \$50 for each item published

## Square-law detector has 40-db dynamic range

By Robert J. Matheson

Institute for Telecommunication Sciences and Aeronomy, Boulder, Colo.

A diode network and detector circuit provides an output proportional to the square of an input voltage. It has a 40-decibel input range, uses no critical or expensive components and is easily extended to larger dynamic ranges, if required. This circuit replaces such devices as thermal converters, second-harmonic generators and diode-shaping networks in metering circuits.

Splitting its 40-db input range into two 20-db segments avoids limitations such as high-amplitude saturation and low-amplitude drifts and nonlinearities inherent in other diode network schemes [see plot directly below]. Two identical stages operating

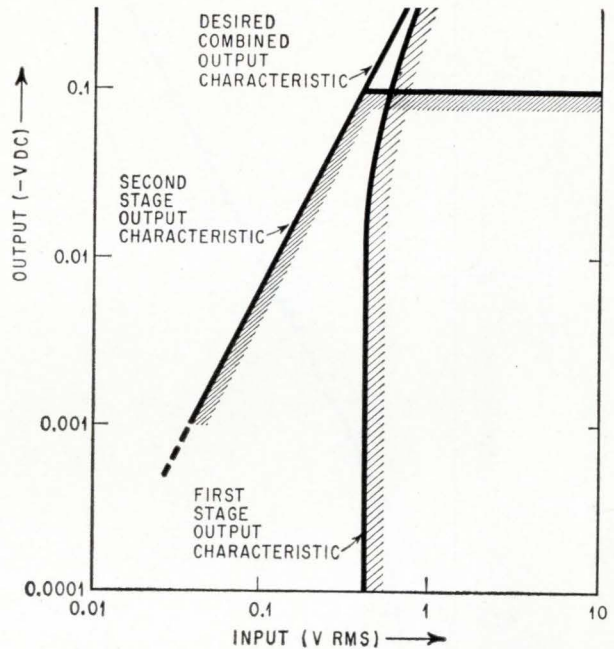

Output characteristics required to give a square-law device with a smooth transition between stages.

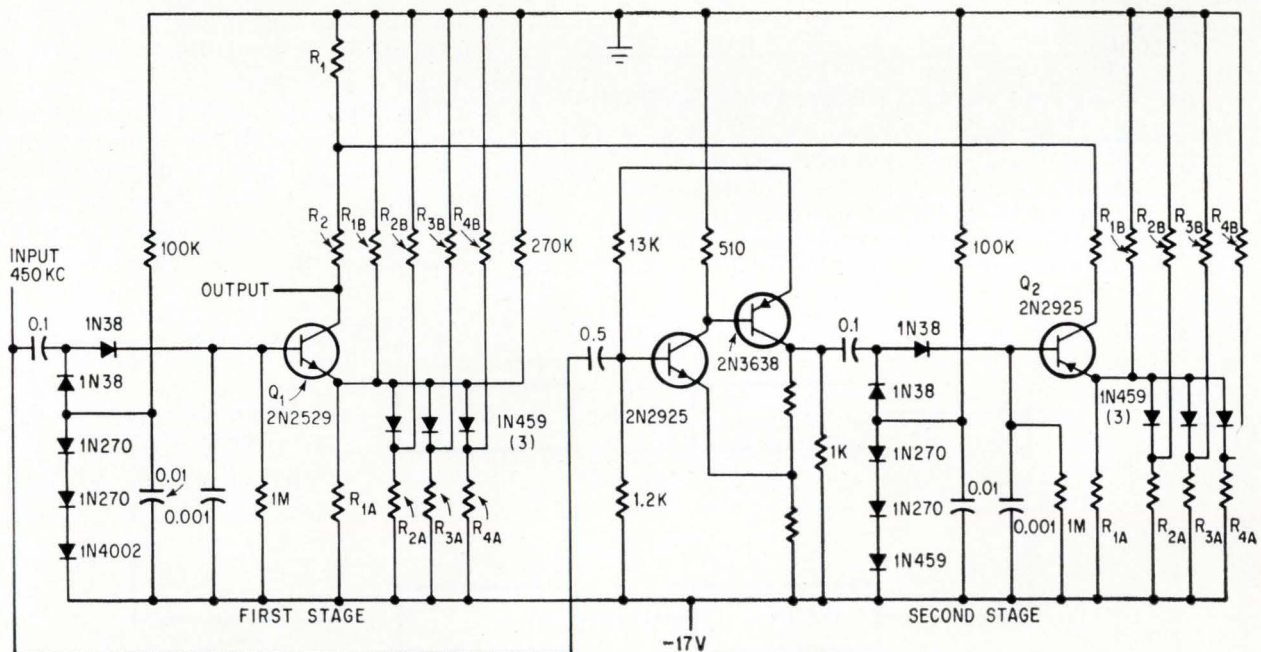

Diode network in series with the emitter lead of transistor  $Q_1$  is the key to circuit operation. It causes the effective emitter resistance to decrease as the emitter voltage increases. Thus  $Q_1$  acts as a current source and produces an output current proportional to the square of the base voltage. Values for resistance are as follows:  $R_{1A}, R_{3A} = 3.18K$ ,  $R_{1B} = 57.9K$ ,  $R_{3B} = 18.75K$ ,  $R_5 = 3K$ ,  $R_7 = 10$ ,  $R_{2A}, R_{4B} = 5.06K$ ,  $R_{4A} = 1.86K$ ,  $R_{2B} = 64.2K$ ,  $R_6 = 300$  and  $R_8, R_9 = 990$ .

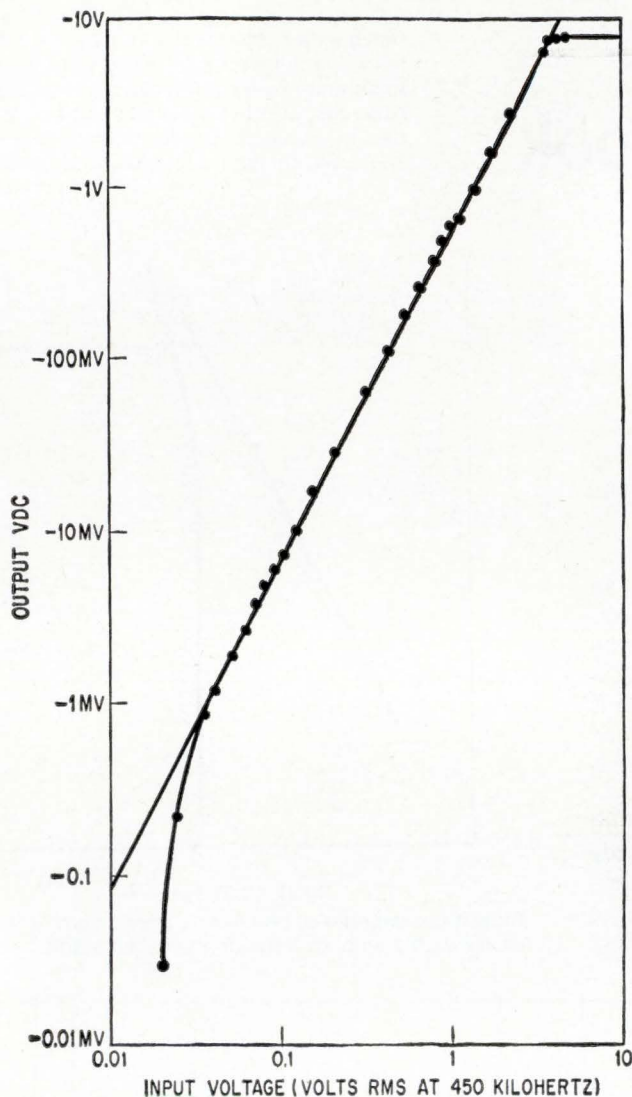

Measured output characteristics of the circuit operating with a 17-volt power supply. Adding stages extends the dynamic range on the low end without seriously affecting total accuracy. Greater accuracy is achieved by increasing the number of segments in each diode network.

at convenient levels produce the two segments. When matched, the stages, shown in the block diagram, give the proper output function by means of input amplifiers and output attenuators.

Operation of each stage is as follows: a signal between 0.4 and 4.0 volts root mean square is detected and applied to the base of transistor  $Q_1$  (see schematic). The diode network, in series with the emitter lead of  $Q_1$ , causes the effective emitter resistance to decrease as the emitter voltage increases. Transistor  $Q_1$  acts as current source to produce an output current  $i_1$  proportional to the square of the base voltage. An output voltage of 0.1 to 10 volts develops across the 1,000-ohm load formed by resistors  $R_1$  and  $R_2$ .

Stage two is essentially identical to stage one. However, because of an additional 20 db of amplification, its operating range of 0.4 to 4.0 volts corresponds to an input signal of 0.04 to 0.4 volts. Similarly, although  $Q_2$  is capable of supplying as much output current  $i_2$  as  $Q_1$ , the output is developed only across  $R_1$ . This results in an output voltage of 0.001 to 0.1 volt.

Each stage saturates and gives a constant output for voltages above its operating range. For voltages below its operating range, the stage is cut off and has zero output. The output characteristic at the low end of the operating region of stage one adds to the saturated output of stage two. In this way the desired square-law characteristic is achieved. Minor differences between the stages are omission of a 270-kilohm resistor and substitution of a different diode in the detector compensation network. These differences extend the second stage square-law characteristic beyond the controlled cutoff required by the first stage.

Thus, detection and squaring is accomplished at voltage levels where diode offset and temperature coefficient are easily made negligible. Moreover, when the outputs of the two stages are combined, only one of the stages contributes significantly to the total output. Either stage one swamps out the

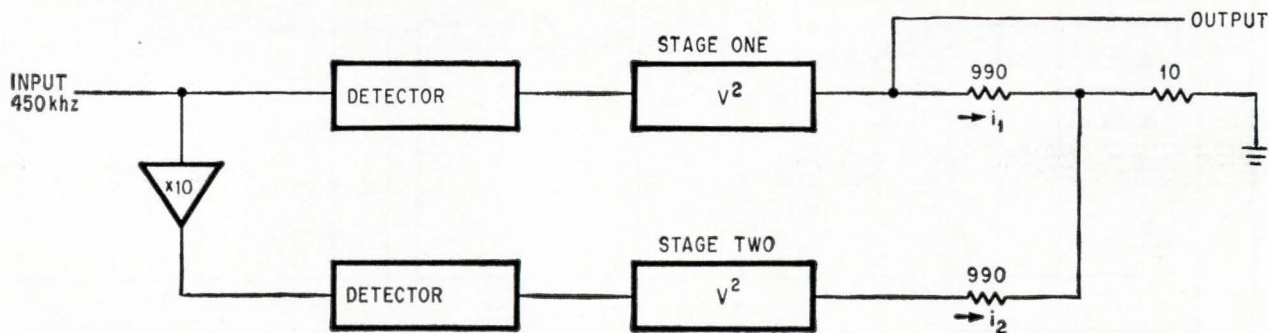

The 40-db input range of the diode detector is split into two 20-db segments, thus avoiding high-frequency saturation, low-frequency drift and nonlinearities inherent in other diode networks. Both stages are identical and operate at levels that produce the two segments. When matched, the stages give the proper output function by means of input amplifiers and output attenuators.

saturated output of stage two, or stage one is cut off and contributes nothing to the output of stage two. It is this feature that gives over-all accuracy comparable to that of an individual stage (see output plot). It also permits additional stages to extend the dynamic range on the low end without seriously

affecting total accuracy.

Preliminary tests using three stages indicate that little difficulty is involved in adding stages to get larger dynamic ranges. Increasing the number of segments in each diode network and careful temperature compensation achieve greater accuracy.

## Transistors replace diodes in milliohmmeter circuit

By Peter Lefferts

TIA Electric Co., Princeton, N.J.,  
subsidiary, Heinemann Electric Co.

**Substitution of transistors** for diodes in the rectifier circuit of an a-c milliohmmeter produces a significant increase in sensitivity and linearity. The cost of the circuit is reduced because a relatively inexpensive milliammeter is used instead of a microammeter, a consequence of the transistors providing gain.

In the circuit on the right the transistor base-emitter junctions are connected in a full-wave circuit to rectify the incoming signal. The amplified collector current deflects the millimeter.

For a given output current, the base to emitter voltage drop of the transistor is smaller than the voltage drop across a conventional diode. The lower voltage drop and the transistor's gain results in at least a 30-to-1 increase in sensitivity.

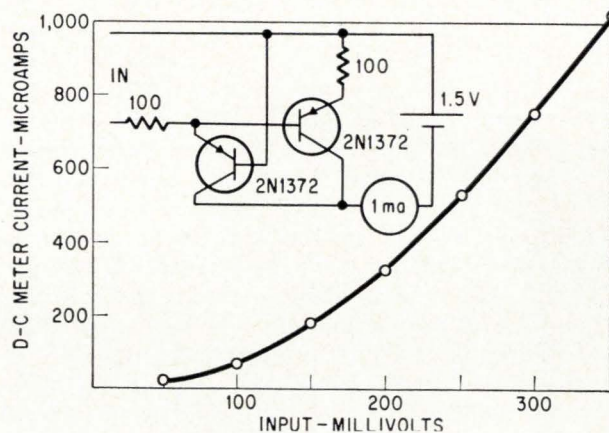

Milliohmmeter uses transistors as rectifiers with gain, permitting measurement of low values of a-c voltage.

As indicated in the graph, negative feedback in the emitter circuit results in linear voltage rectification at lower input voltages than is possible with diodes. However, the input impedance is as low as 100 ohms during the positive portion of the input wave. This is not detrimental, because the circuit is intended to measure voltage drops across low values of resistance.

## No pulse-forming network in scr trigger generator

By James E. Curry,\*

ITT Gilfillan, Inc., Los Angeles

**A modification** of the well-known line-type radar modulator produces a general-purpose triggering circuit that is immune from noise. While trigger generators built with silicon-controlled rectifiers are not new, the circuit on page 96 replaces the expensive pulse-forming network with a capacitor, improving the circuit's performance while reducing

its cost by 25%. Its sharply-peaked output pulses are ideal for applications from triggering modulators in radars to firing flash tubes in strobe units.

Capacitor  $C_1$  in the circuit is charged by the +150-volt supply through the charging choke  $L_1$  and diode  $D_1$ . With  $C_1$  fully charged, an incoming pulse, typically a 4-volt square pulse of 1-microsecond duration, turns on the scr. Provided with a resistive path to ground,  $C_1$  discharges through the primary of the pulse transformer producing a spiked output pulse; in this case the pulse has a 300-volt peak amplitude and its width at the 50%-amplitude level is 5 microseconds. Pulse amplitude can be varied by adjusting the transformer-turns ratio.

During discharge, the ringing of  $C_1$  with the charging choke  $L_1$  drives the voltage across  $C_1$  to -15 volts, back-biasing the scr and shutting it off. Diode  $D_1$  isolates the power supply from the capac-

\* Now with Houston Fearless Corp., Los Angeles

itor's discharging effect [see wave shapes].

An important aspect of the circuit's design is protection against accidental turn-on of the scr during the charging cycle. If low-level noise or reflections from the load were to cause such a turn-on, the entire 150-volt supply would be shorted to ground, blowing a fuse or tripping a circuit breaker in the protection circuitry [not shown].

The scr is conducting during approximately the first 10 microseconds after triggering, so false triggering pulses have no effect. For the next 15  $\mu\text{s}$ ,  $C_1$  and  $L_1$  are ringing and the voltage at  $C_1$  is negative as shown in the waveform; the negative voltage back-biases the scr, preventing a false triggering pulse from turning on the scr. At 25  $\mu\text{s}$  after triggering, when the voltage at  $C_1$  is zero or rising, the scr is vulnerable to false turn-on by low-level noise pulses for a period of 5  $\mu\text{s}$ . However, this time interval occurs long enough after discharge so that most reflective pulses have been dissipated. The circuit's 5- $\mu\text{s}$  interval of vulnerability is much briefer than those of comparable scr triggering circuits and constitutes the circuit's principal advantage.

At 30  $\mu\text{s}$  after discharge, and certainly by 40  $\mu\text{s}$ , there is enough charge on the capacitor to forward bias the scr and a large triggering pulse is again required to turn it on. By 60  $\mu\text{s}$  after discharge  $C_1$

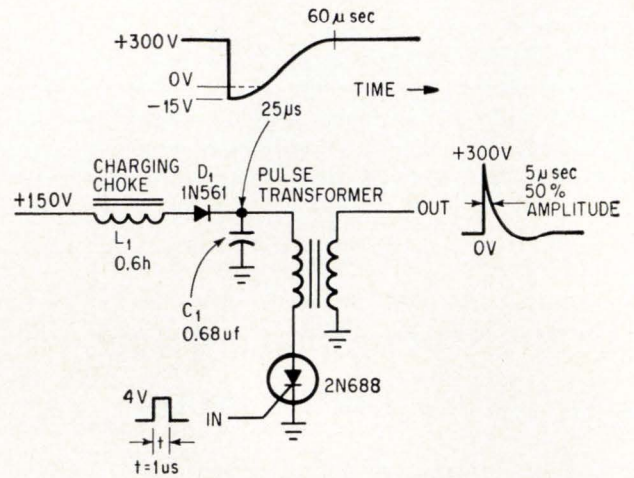

Capacitor  $C_1$  is charged by the supply through charging choke  $L_1$  and diode  $D_1$  to 300 volts. An incoming trigger pulse turns on the scr, discharging  $C_1$  through the primary of the pulse transformer and producing a 300-volt spiked output pulse. The ringing of  $L_1$  and  $C_1$  turns off the scr.

is again charged up to +300 volts and the circuit is ready for the next triggering pulse. The circuit's maximum pulse repetition rate is 12 khz, leaving about 80 microseconds between pulses.

## Scr bridge inverter eliminates transformers

By L.M. Tibbets

Electronic Tube Division,  
Sylvania Electric Products, Inc., Emporium, Pa.

A bridge inverter's cost can be cut in half by slave-triggering two silicon-controlled rectifiers with a capacitive load. Slave-triggering eliminates bulky and expensive gate transformers and enables the entire inverter to be easily mounted on a printed circuit board. The circuit at the right was designed as part of a power supply for an electroluminescent panel serving as a capacitive load.

The bridge circuit is directly coupled to a multivibrator which drives it with staggered square pulses, each 2 volts in amplitude. The input pulses drive  $SCR_3$  and  $SCR_4$  directly while  $SCR_1$  and  $SCR_2$  are slave-driven by the capacitive load  $C_1$ .

Slave triggering is an indirect switching technique, employing two or more switches, in which secondary or slave devices are turned on automatically by the energy released when a primary device, the master trigger, is fired. In this circuit, for example, slave triggering is illustrated by the sequential

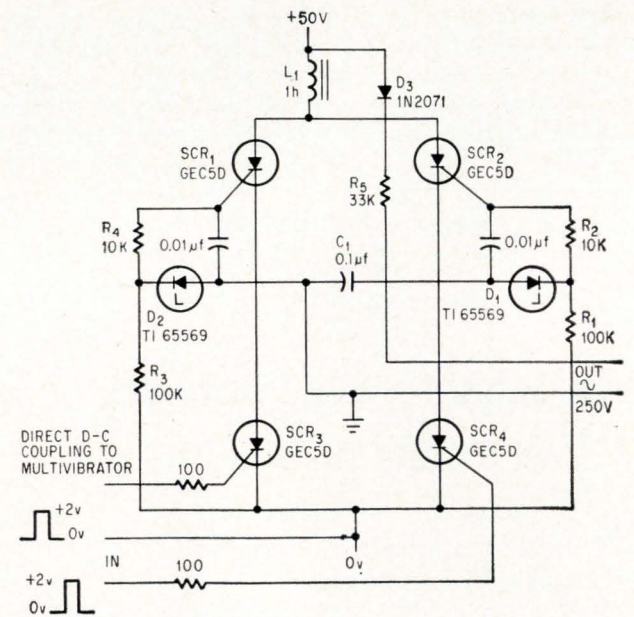

Capacitive load  $C_1$  slave triggers  $SCR_1$  and  $SCR_2$ , eliminating the need for gating transformers.

switching during the second half-cycle of bridge operation. Only the master trigger,  $SCR_3$ , is turned on directly; the firing of  $SCR_3$ , however, switches load  $C_1$  into a position where it turns off  $SCR_4$  and generates a switching signal to turn on  $SCR_2$  (which

then turns off SCR<sub>1</sub>). Thus the other three active elements in the bridge are all turned on or off by the firing of SCR<sub>3</sub>.

An input of 800 pulses per second (both half-cycles of a 400-hertz multivibrator) gives a 400-hz output. Bridge switching inverts the second pulse of each successive pair of pulses while choke L<sub>1</sub> and load capacitance C<sub>1</sub> resonate in series to shape the resulting square wave to a sine wave with a peak amplitude of 350 volts.

An initial positive charge is placed on the right side of load capacitor C<sub>1</sub>, through diode D<sub>3</sub> and resistor R<sub>5</sub> to prepare the circuit for bridge operation. The first half-cycle begins when a pulse turns on SCR<sub>4</sub>; C<sub>1</sub> is then discharged through SCR<sub>4</sub>, R<sub>3</sub>

and D<sub>2</sub>, placing 10 volts across the gate-cathode junction of SCR<sub>1</sub> and turning it on. C<sub>1</sub> now charges rapidly through the path L<sub>1</sub>, SCR<sub>1</sub>, C<sub>1</sub> and SCR<sub>4</sub>, making the left side of C<sub>1</sub> positive.

While this charge on C<sub>1</sub> is still intact, a second pulse turns on SCR<sub>3</sub>, placing the entire C<sub>1</sub> voltage across SCR<sub>4</sub>, reverse biasing it and shutting it off. The C<sub>1</sub> voltage also sets up a current flow through R<sub>1</sub> and D<sub>1</sub>; the resulting 10-volt drop across D<sub>1</sub> turns on SCR<sub>2</sub>. With SCR<sub>2</sub> conducting, the anode of SCR<sub>1</sub> is shorted to the right side of C<sub>1</sub>. This reverse biases SCR<sub>2</sub> and shuts it off. With a second charging path L<sub>1</sub>, SCR<sub>2</sub>, C<sub>1</sub> and SCR<sub>3</sub> established, C<sub>1</sub> charges rapidly in the opposite direction, and the cycle begins over again.

## Feedback improves parallel-T filter

By James Strattan,

High Fidelity Recording, Wichita, Kan.

**A single-transistor feedback circuit** reduces the high attenuation in the pass band that severely limits the conventional T-notch filter.

Without feedback, a 60-hertz filter having the component values shown below for R<sub>1</sub>, R<sub>2</sub>, R<sub>3</sub>, C<sub>1</sub>, C<sub>2</sub> and C<sub>3</sub> will have a Q factor of 0.25. The addition of feedback between the collectors of Q<sub>1</sub> and Q<sub>2</sub> (the feedback transistor) improves the response by a factor of 80. Thus, the filter response is down

1 decibel at 62 hertz. For 120 and 180 hertz, capacitor values C<sub>1</sub>, C<sub>2</sub> and C<sub>3</sub> decrease proportionally from those at 60 hertz.

The emitter-followers, Q<sub>2</sub> and Q<sub>3</sub>, minimize the effects of source and load impedances.

The best results are obtained when preliminary adjustments on the parallel T are made with somewhat less feedback than the 150-ohm resistor, R<sub>4</sub>, provides. To reduce the feedback, R<sub>4</sub> should be increased to approximately 680 ohms. If R<sub>4</sub> is replaced by a potentiometer, the feedback can be varied. Replacing Q<sub>1</sub> with a transistor of higher beta, such as a 2N3390, reduces the loss through the circuit at frequencies below 60 hertz.

A basic application for this circuit is in reproducing stereo tape, where the design salvages signals normally buried far below the noise level of the original tape recording.

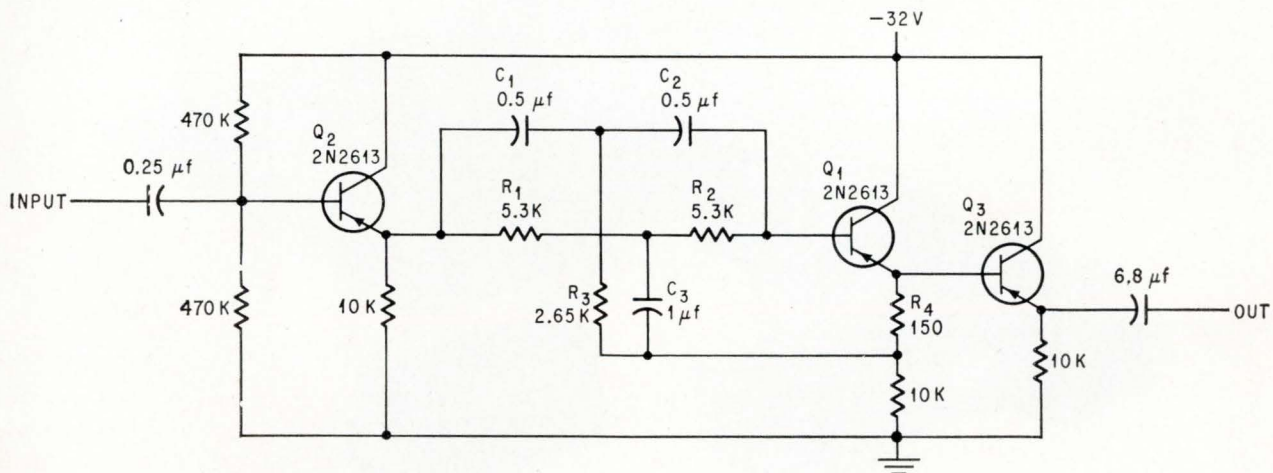

**Transistor Q<sub>2</sub> provides feedback** for the parallel T-notch filter. Values shown for components are designed for 60 hertz. For 120 and 180 hertz decrease capacitor C<sub>1</sub>, C<sub>2</sub> and C<sub>3</sub> values proportionally. Control of the rejection bandwidth is provided if the 150-ohm resistor is made variable to 680 ohms. This is done with a potentiometer.

# The astonishing performance of Secret Agent, Glass Bond.

See how Ferroxcube's Secret Agent, Glass Bond, gets up to five times greater packing density out of a recording head than arch enemy Epoxy Bond. It's done with your existing plating or coating and no increase in electronics by shrinking gap lengths to 50 microns or less.

Thrill to flying heads that dare to fly lower (less than 100 microns) with Glass Bond than with conventional agents. The resulting reduction in space losses means significant improvements in output amplitude and packing density over that possible with higher flying assemblies.

Learn why Ferroxcube's glass-bonded recording heads last at

least ten times longer in contact recording applications than laminated metal types and at least three to four times longer than epoxy-bonded ferrite heads. In comparative life tests, wear on a glass-bonded head was almost imperceptible at the time an epoxy-bonded head reached end-of-life.

The secret of our Secret Agent is the unique combination of Ferroxcube's new ferrite material, called 4R5, a special glass-bonding agent, and an exclusive fabricating process which permits more precise control of recording head

geometry than any other manufacturing technique. 4R5 and our special glass agent are fully compatible with one another providing a mechanically homogeneous structure which is almost impervious to external environmental stress. And there is no sacrifice in electromagnetic properties; 4R5 has excellent permeability, very low residual retentivity and material and gap losses are negligible in most applications over a wide frequency range.

For the latest performance achievements of Secret Agent Glass Bond, write for the book. Don't wait for the movie. Ask for Bulletin 1007B.

**Ferroxcube** 



FERROXCUBE  
CORPORATION  
OF AMERICA  
Saugerties, New York  
914-246-2811

Boston  
617-889-3110

Chicago  
312-261-7880

Dallas  
214-255-0441

Los Angeles  
213-837-1484

Minneapolis  
612-888-4681

New York Area  
201-267-5888

Phoenix  
602-265-1792

Philadelphia  
215-667-4685

Washington, D.C.  
703-893-4900



# Graphs reveal reasons for high cost of maintenance

Nomograph reduces man-hour calculations and provides an easy way to pinpoint maintenance procedure problems

By G.W. Corley and Harold Faecher

Westinghouse Defense and Space Center, Baltimore, Md.

**Maintenance stands out** as one of the major factors in the operational cost of avionics and airborne weapons systems. About one-fourth of the annual Department of Defense budget is spent on it.

To measure this factor the parameter "maintenance man-hours per flight hour" (MMH/FH) was set up. This parameter can be calculated in three ways: by using inputs based on performance predictions, field data on similar equipment and engineering data from pilot production.

The nomograph on page 102 developed from a need to cut down on the number of calculations required. It presents all the factors contributing to maintenance man-hours per flight hour for any system, and permits rapid analysis of the effects of changes in system maintenance procedures. The nomograph is based on the equation

$$\frac{\text{MMH}}{\text{FH}} = \frac{(M_{cto} \times F_c \times P_o + M_{ctf} \times F_c \times P_i) K + (M_{pt} \times F_p \times P_p)}{N}$$

which is an expanded version of the maintainability equation found in Military Standard 471. (Mil-Std 471 will supersede Mil-Maintenance 26512). The equation is general enough to evaluate other systems, including ground transportation systems and complex weapons systems.

The example illustrated on the nomograph is an airborne high-frequency voice communications transceiver in need of repair. It is designed to be removed from the aircraft, replaced at the flight line and repaired at the field shop. For this particular unit, the following factors are determined:

- MTBF (mean time between failures) = 210 hours
- $M_{cto}$  = 0.25 hours
- $M_{ctf}$  = 4 hours
- $M_{pt}$  = 7.5 hours

In this case, the number of preventive maintenance actions in a given time interval,  $N_p$ , is calculated by dividing the total operating time  $N$  of 50,000 hours by the average time between preventive maintenance actions. Thus  $N_p = 50,000/100 = 500$ .

The number of operating hours is 1.5, since for every hour of flight, an additional 0.5 hour is devoted to ground checks, runway holding patterns and other tests.

## Glossary of maintenance terms

- $M_{cto}$  = mean active corrective maintenance time (arithmetic mean) at the organizational level (flight line).
- $M_{ctf}$  = mean active corrective maintenance time (arithmetic mean) at the field shop level.
- $M_{pt}$  = mean active preventive maintenance time (arithmetic mean).
- $F_c$  = number of expected corrective maintenance tasks occurring during the representative operating time period ( $N$ ).
- $F_p$  = number of expected preventive maintenance tasks occurring during the representative operating time period ( $N$ ).
- $P_o$  = average number of personnel required to perform organizational level corrective maintenance.
- $P_f$  = average number of personnel required to perform field shop level corrective maintenance.
- $P_p$  = average number of personnel required to perform preventive maintenance.
- $K$  = average operating hours per flight hour. This is a constant normally greater than one since the equipment is operated on the ground during maintenance checks in addition to being operated in flight.
- $N$  = an arbitrary number of operating hours, usually very large compared to equipment failure rates.

### Examining cost and scheduling problems

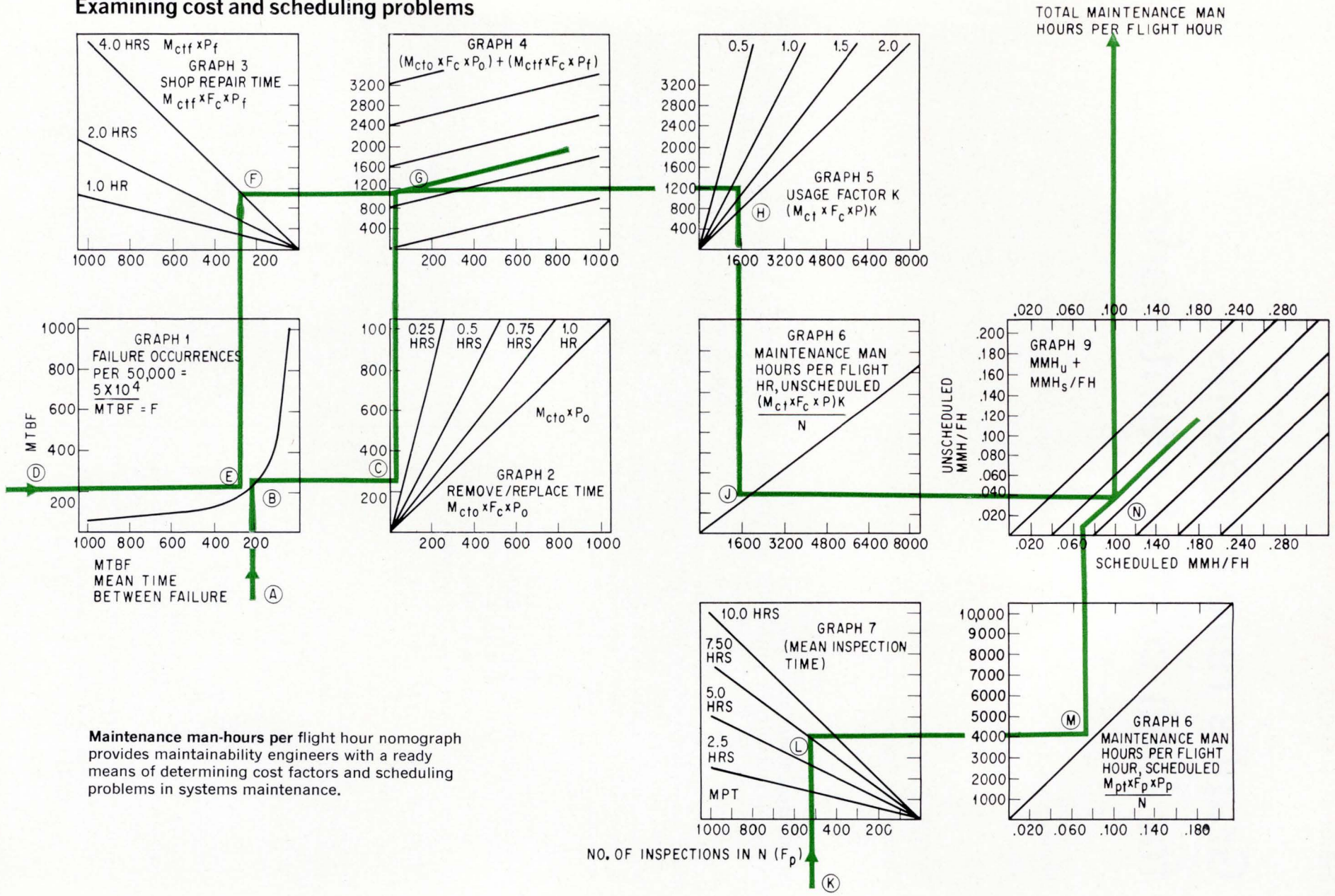

Maintenance man-hours per flight hour nomograph provides maintainability engineers with a ready means of determining cost factors and scheduling problems in systems maintenance.

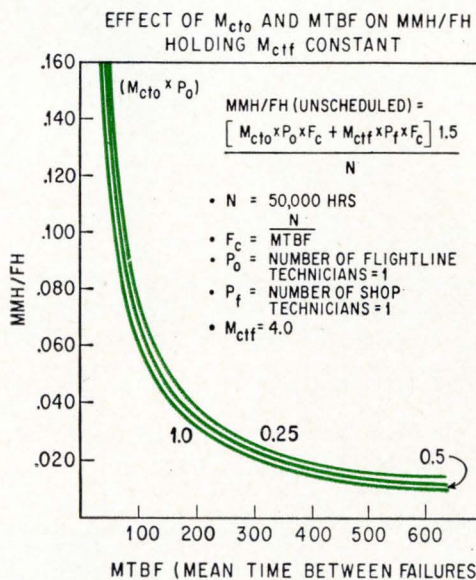
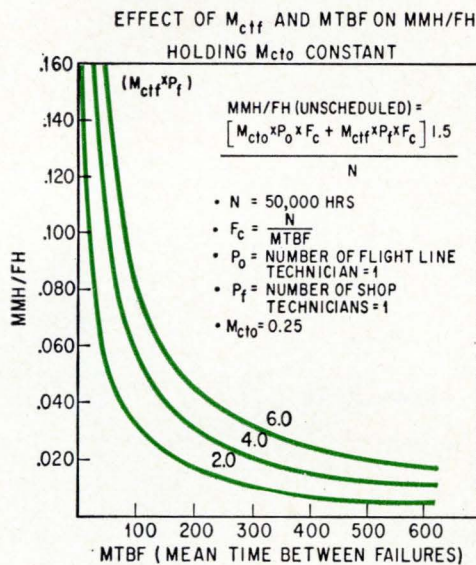
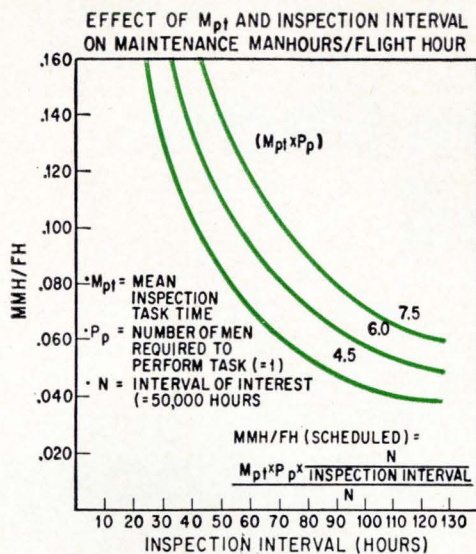

**Sensitivity curves** for use with nomograph. Analysis shows the effect of changes in maintenance procedures.

Additional analysis shows that  $P_o = P_f = P_p = 1$  man.

**Procedure**

The nomograph can now be used to determine the major contributors to the maintenance burden of the airborne receiver.

Enter graph 1 at point A (MTBF = 210 hours) and proceed vertically to point B. Point B represents the number of expected corrective maintenance actions ( $F_c$ ) in a given time interval N (50,000 hours was the time interval used in the preparation of this example).

From point B move horizontally on graph 2 to intersect the line representing 0.25 hours ( $M_{cto} \times P_o$ ) at point C.

Enter graph 1 at point D (MTBF = 210 hours) and proceed horizontally to point E.

From point E move vertically on graph 3 to intersect the line representing 4 hours ( $M_{ctf} \times P_f$ ), at point F.

From points C and F move vertically and horizontally to sum the two quantities on graph 4 at point G.

From the summing point (point G) move horizontally on graph 5 to intersect the line representing the usage factor (K) of 1.5 (operating hours per flight hour) at point H.

From point H move vertically to intersect the line on graph 6 at point J; then move horizontally on graph 9 to determine the unscheduled maintenance man-hours per flight hour (0.029).

Enter graph 7 at point K ( $N_p = 500$ ) and proceed vertically to intersect the line representing 7.5 hours ( $M_{pt} \times P_p$ ) at point L.

From point L move horizontally to point M on graph 8 then vertically to point N in graph 9.

Sum the scheduled and unscheduled maintenance times on graph 9 as shown (0.104 MMH/FH).

For this example, the nomograph clearly shows that the man-hours given to preventive maintenance (periodic inspections) far exceed time spent on corrective maintenance. If the predicted maintenance man-hours per flight hour of 0.104 must be reduced to 0.09 to meet a contractual requirement, a more detailed analysis is required. A study of the nomograph and the sensitivity curves at the left shows that this can be accomplished by any one of the following:

- Increase mean time between failures from 210 to 425.
- Decrease shop repair time ( $M_{ctf}$ ) from 4 hours to 1.85 hours.
- Increase interval between periodic inspections from 100 hours to 125 hours.
- Decrease mean inspection time ( $M_{pt}$ ) from 7.5 hours to 6.1 hours.

Once each approach has been analyzed and its cost factors and schedule impact determined, a trade-off study will show which approach or combination of approaches will eventually be the most economical.

# Any material that can help Western Electric cut down its phone bill must be something.

## Something called Plaskon Epoxy.

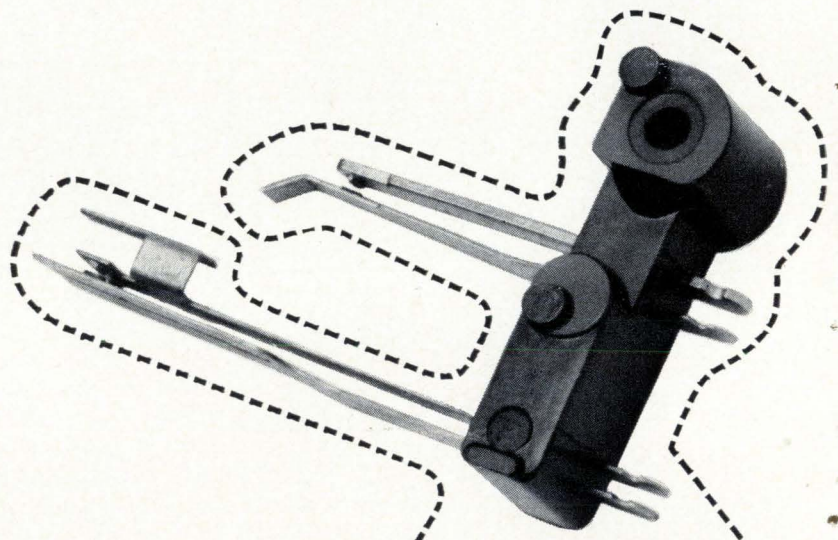

This phone dial relay switch used to be molded of soft-flow phenolic. Now it's made of a stronger, more versatile Plaskon<sup>®</sup> epoxy molding compound. Because of that, Western Electric was able to eliminate an expensive metal flange with no loss of strength. And at a substantial saving, considering the millions of parts that were made.

They were also able to use the existing molding equipment for the job.



Plaskon epoxies have excellent dimensional stability. They cure fast and shrinkage is often less than one percent. And because of great electrical insulation value, applications are numerous.

Allied Chemical has an extensive line of epoxy molding compounds, including DAP, phenolics and alkyds. Whatever your application requires, one of them should work best — and most economically. Call your Plastics Division representative for more information. Or, mail the coupon, and start saving right away.

Gentlemen:

I'd like to know more about the complete line of Plaskon epoxy molding compounds. Please send me your technical brochure.

E-9

Name \_\_\_\_\_

Company \_\_\_\_\_

Address \_\_\_\_\_

City \_\_\_\_\_ State \_\_\_\_\_

**PLASTICS  
DIVISION**  
POST OFFICE BOX 365  
MORRISTOWN, N. J.

**Allied  
Chemical**

# Divic gives answers to complex navigation questions

A special algorithm and a unique combination of digital and differential processing techniques make up a microelectronic computer that solves problems in hyperbolic navigation systems

By Joseph A. Parini

Lear Siegler, Inc., Instrument Division, Grand Rapids, Mich.

**A computer** that combines the speed of a digital differential analyzer with the flexibility and accuracy of a general-purpose machine is being flight-tested for use with a wide variety of air navigation systems. The computer, developed by the Instrument division of Lear Siegler, Inc., can solve problems in spherical trigonometry and computes with an algorithm that permits flexible design and high speed, but doesn't require a large memory.

The computer, called Divic, for digital variable increment computer, was built for the United States Coast Guard and the Federal Aviation Agency. The key to Divic is its ability to be adapted to various navigation systems. Divic is constructed of monolithic integrated circuits and has a stored program in a core-rope memory which can be replaced easily if the application of the computer must be changed. Flight tests will continue through autumn and 20 computers will be built for the Coast Guard for delivery in early 1967. Lear Siegler anticipates orders for a great many more computers, and is considering modifying the design for commercial aircraft.

A prototype version of Divic was flight-tested

in 1964. It was built of thin-film hybrid micro-circuits assembled in standard packages. It followed a parallel processing-serial arithmetic organization and its program was wired into the machine.

Both versions of the Divic are more accurately described as hyperbolic-coordinate converters. An aircraft's location is given in terms of the intersection of two hyperbolas in navigation systems such as loran, Omega, or Decca. However, this information must be translated into latitude and longitude to be intelligible to the pilot, and the translation also can provide range and bearing information [see panel, pp. 106-107]. The hyperbolas are derived from two time differences between pairs of signals broadcast by three synchronized radio transmitters. The navigation systems have different signal formats (pulse or continuous wave), power, frequency and range. For instance, loran C sends out pulses one millisecond apart in each of three phase-coded pulse trains; the airborne receiver, which is capable of some elementary computation, measures the intervals between the received pulses and produces time-difference signals that are processed manually or by a navigation computer.

## Hardware configuration

The improved Divic is a stored-program machine containing two core memories: a core-rope permanent memory, part of which stores the program; and a scratch-pad memory for temporary storage of data. The core rope has a capacity of 2,048 words with 70 bits per word. The scratch-pad memory contains 128 words of 30 bits each. The cores for

## The author



Joseph A. Parini is the manager of the computer systems department at Lear Siegler, Inc.'s Instrument division. He was formerly manager of the navigation systems group, which did much of the early development work on Divic.

the permanent memory are made of molybdenum permalloy tape 1/8 inch wide, and the temporary memory is made of lithium-ferrite cores.

The integrated microcircuits are attached by gap soldering to printed circuit boards that plug into a "mother" board; the latter interconnects the various modules such as the arithmetic unit, input-output registers and memories [see photograph, p. 111]. With this packaging arrangement, a typical navigation computer that can convert hyperbolic coordinates, compute dead reckoning and perform guidance functions will take up only half a standard rack. A program change provided by a change of the core-rope memory would allow a similar computer to process inertial or celestial equations.

Therefore, the basic Divic computer organization can be used with radio, inertial or celestial sensors, either individually or in an integrated system, in approximately the same configuration. Other hardware changes that would be necessary in changing the purpose of the computer are in the input-output interface between the sensors and the computer, controls and displays. These are required because the signal content varies in rate, form and resolution in the different systems. Therefore, with a defined application, a design engineer can esti-

mate in the early phases of the program the size and weight of the necessary Divic to do the job.

### Navigational problem

The time-difference signals that are inputs to the Divic computer may be either analog or digital. For instance, the AN/ARN-78 loran C receiver built by the Sperry Rand Corp. has an optional digital output that produces six binary-coded decimal signals indicating the time difference precise to microseconds. The two time differences are produced alternately. An analog output is produced by International Telephone and Telegraph Corp.'s AN/APN-152 Omega receiver—two lines carrying pulses whose durations are proportional to the time differences measured by the receiver. The Divic computer comes with the proper interface equipment so that it may be used with any kind of autotrack (non-manual) receiver.

Divic must first translate these time differences into hyperbolic coordinates. It then computes the latitude and longitude from these coordinates, using the previously stored position of the transmitters as a reference. The latitude and longitude are displayed on dials for the pilot's reference. With successive values of latitude and longitude,

## Finding yourself with hyperbolas

**Hyperbolic coordinates** were first used during World War II to determine the position of ships at sea. That navigation system was loran, now known as loran A to distinguish it from its successors.

With loran A, a navigator tuned his receiver to pick up pulse signals from three radio stations 200 to 300 miles apart on shore. These signals were carefully synchronized at the transmitters; but in general they were not synchronized when the receiver picked them up, because of propagation delays. The navigator displayed the pulse signals from two stations on an oscilloscope and measured the time difference between them. This time difference told him that he was somewhere along a hyperbola whose foci were the two stations he was listening to at the moment. (A hyperbola is a curve described by the motion of a point whose distances from two fixed points—the foci—maintain a constant difference.)

Then the navigator checked the time difference between one of these two signals and the signal from the third transmitter. The sec-

ond time difference gave him another hyperbola, and the intersection of the hyperbolas was his position at sea. The whole procedure took about three minutes.

If the vessel's navigator found all three signals still in synchronism, just as they were broadcast, then he knew he was at the intersection of the perpendicular bisectors of the straight lines joining the three stations.

Airborne navigators could also take advantage of loran A, except that they had to take a second reading on the first pair of stations and average the two. The reason, of course, was that an aircraft—even of World War II vintage—can travel quite a long distance in three minutes.

Later versions of loran broadcast different frequencies and signal formats, and station spacings were changed to improve range and accuracy. The newer versions also rely on the receiver to generate the time difference directly, so that the navigator or pilot doesn't have to twiddle dials or look at oscilloscopes.

Other hyperbolic-coordinate navigation systems include Decca,

Decca and Omega. Decca and Decca broadcast continuous-wave signals and the receiver measures phase differences instead of time differences. In Decca, two of the stations are relatively close together—about 80 miles—so that the hyperbola determined by these stations is nearly straight. Omega is a very low frequency system intended to provide worldwide coverage with only eight stations.

Despite the improvements in the navigation systems the navigator, knowing that he is at the intersection of two hyperbolas, isn't much smarter than he was before. What he really wants to know is his position in latitude and longitude, or even better, the direction and distance to his destination. In the past, he has had several tools to help him.

One scheme gave him a distorted map on which the hyperbolic coordinates were printed directly. This isn't too bad for ships at sea, where there are no landmarks; but for airplanes, especially one-man airplanes in which the pilot must do his own navigating, it's confusing. When the pilot's map tells him he is flying over a round lake and he looks out the window and sees a kidney-shaped lake, that's when he turns off the radio and flies by the seat

the computer also computes direction and velocity of the aircraft. Finally, the computer works out the range and bearing of the destination and the cross-track error—distance right or left of course—of the aircraft for course correction.

Because the earth is round, latitude, longitude, range and bearing are all expressed as angles. Therefore, spherical trigonometry is required in all these computations. Bearing is the angle measured eastward from north, varying from  $0^\circ$  to  $360^\circ$ ; range is measured in degrees of arc, ordinarily much less than  $180^\circ$ , but displayed in nautical miles. Latitude and longitude, of course, are in degrees of arc, with ranges of  $-90^\circ$  to  $+90^\circ$  and  $-180^\circ$  to  $+180^\circ$  respectively.

### Algorithm for solution

The Divic computer uses the computing algorithm for circular functions that was worked out in 1959 by J.E. Volder.<sup>1</sup> This algorithm provides a method for the rapid evaluation of trigonometric functions and related expressions. The Divic therefore has the accuracy of a general-purpose computer coupled with the speed of a digital differential analyzer—the digital equivalent of an analog resolver.

The equations that relate time differences to latitude, longitude, and other navigational measurements consist of sums and products of sines and cosines [see panel, p. 108]. The Volder algorithm evaluates sines and cosines by an iterative process that is easily implemented in digital circuitry. The same technique can convert rectangular to polar coordinates, and binary to binary-coded decimal numbers, and vice versa, and it can evaluate hyperbolic functions such as  $\sinh u$  and  $\cosh u$ .<sup>2</sup> (These hyperbolic functions are only indirectly related to the hyperbolic coordinates that are inputs to the Divic.) At Lear Siegler, the Volder algorithms have been extended to carry out multiplication, division and square root.<sup>3,4</sup>

All the algorithms require four registers for temporary storage of intermediate results, and relate successive values of results by shift-and-add or shift-and-subtract operations. The algorithms differ principally in the convergent series that they use for various functions.

### Two categories

In general, computational algorithms—Volder's or any other—may be implemented in a digital computer in either of two ways. The computer may

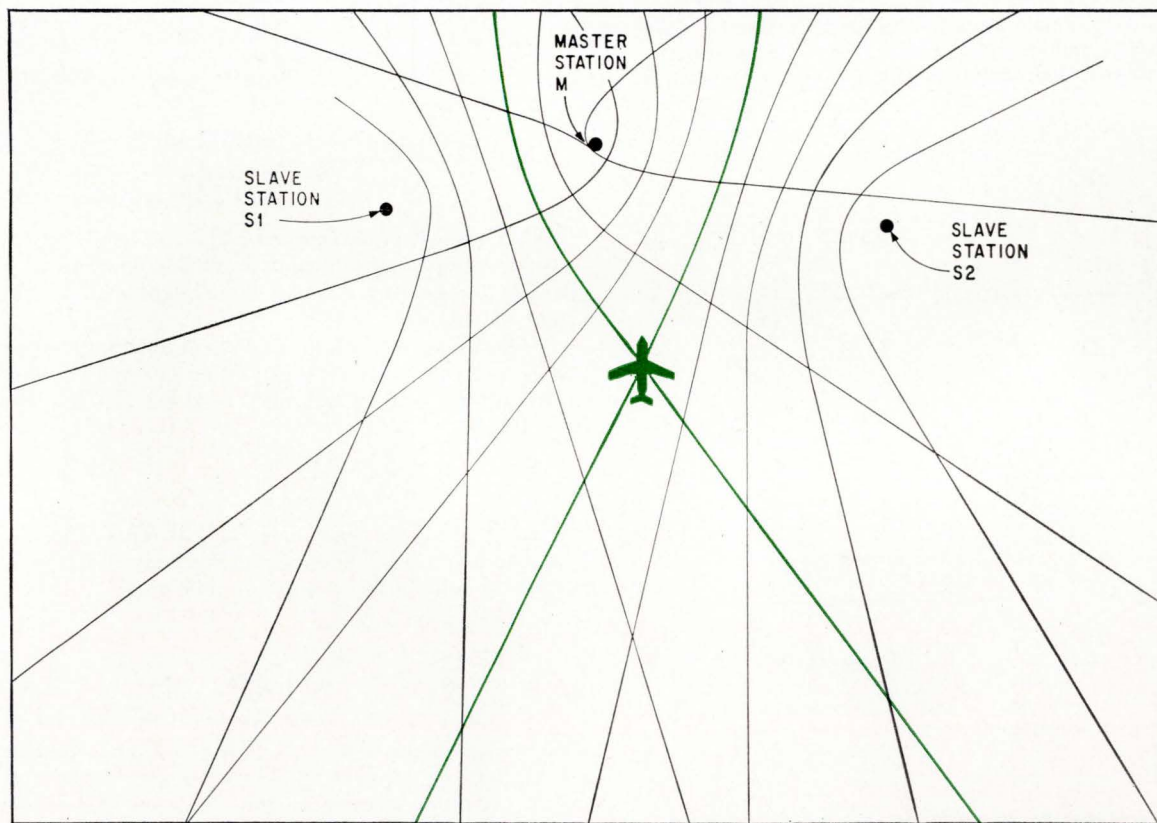

HYPERBOLA DEFINED BY M & S2

HYPERBOLA DEFINED BY M & S1

of his pants.

Another way gave the pilot a standard map with hyperbolic lines of position printed on it. This wasn't quite as confusing, but with so many lines going every which

way on the map, the pilot of a 600-mph jet can easily go 30 or 40 miles while trying to figure out where he is—or where he was.

How convenient it would be to have an "instant navigator" to

make the difficult computations to convert hyperbolic coordinates into latitude and longitude. Divic not only does that but displays the latitude and longitude readings on dials, too.

## Equations of position

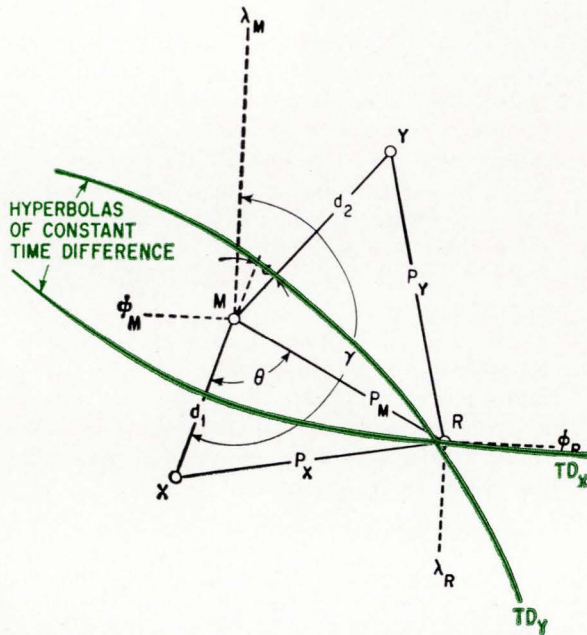

Two spherical triangles must be solved and the results transformed into position and course data in a hyperbolic coordinate system. The symbols  $\phi$  and  $\lambda$  represent latitude and longitude, respectively; the subscripts represent the master station, M, and the receiver, R.

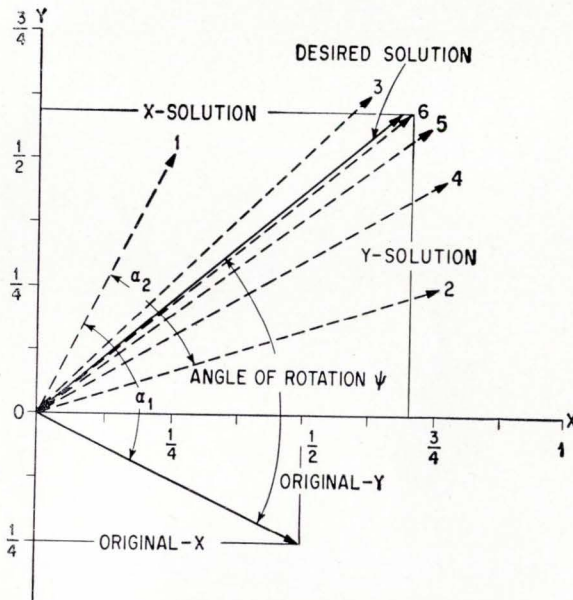

Typical rotation operation is shown plus the steps toward its solution with the Volder algorithm. The angle after the rotation is approached with steadily decreasing steps; the magnitude steadily increases with each step and in general will require correction, the amount of which depends on the computer word length and the number of steps taken.

There are several ways to transform an unprocessed set of time differences into the various outputs required in navigation. One set of equations that gives range and bearing directly in terms of the time differences [see diagram at the left] is:

$$P_m = \tan^{-1} \left[ \frac{(\cos d_2 - \cos \xi_y) + \omega(\cos d_1 - \cos \xi_x)}{\sin \xi_y + \omega \sin \xi_x + \sin d_2 \sin \alpha \sin \theta} \right]$$

$$\theta = \cos^{-1} \left[ \frac{\cos \xi_x - \cos d_1 - \tan P_m \sin \xi_x}{\tan P_m \sin d_1} \right]$$

where

$P_m$  = distance of receiver from master station (range)

$\theta$  = angle between master-receiver line and master-slave base line

$\xi_x = P_x - P_m$  (expressed as time difference)

$\xi_y = P_y - P_m$  (expressed as time difference)

$$\omega = \frac{\sin d_2 \cos \alpha}{\sin d_1}$$

$\alpha$  = supplement of angle between  $d_1$  and  $d_2$

Then the latitude  $\phi_R$  and longitude  $\lambda_R$  of the receiver can be determined with the equations:

$$\phi_R = \tan^{-1} \left[ \frac{\cos (\lambda_m - \lambda_R) [\cos P_m \cos \phi_m + \sin P_m \cos \phi_m \cos (\gamma - \theta)]}{\cos P_m \cos \phi_m - \sin P_m \sin \phi_m \cos (\gamma - \theta)} \right]$$

$$\lambda_R = \lambda_m - \tan^{-1} \left[ \frac{\sin P_m \sin (\gamma - \theta)}{\cos P_m \cos \phi_m - \sin P_m \sin \phi_m \cos (\gamma - \theta)} \right]$$

Other sets of equations may also be used, perhaps to determine latitude and longitude first and then range and bearing; or one could begin with a different set of measurements.

The Volder algorithm consists of an iterative process that can evaluate these equations with a series of shift-and-add operations based on the following relations:

$$x_{i+1} = x_i \pm 2^{-(i-2)} y_i$$

$$y_{i+1} = y_i \pm 2^{-(i-2)} x_i$$

The initial values are  $x_1 = 1$ ,  $y_1 = 0$ . This is equivalent to a series of diminishing rotations. Each increment of rotation is an angle  $\alpha$  such that:

$$\alpha_1 = \tan^{-1} \infty = 90^\circ$$

$$\alpha_2 = \tan^{-1} 1 = 45^\circ$$

$$\alpha_i = \tan^{-1} 2^{-(i-2)} \text{ for } i \geq 2$$

A similar algorithm may be used to evaluate the new coordinates of a vector rotated from a position with a given coordinate. For example, in the rotation operation shown in the diagram at the left, the vector with coordinates  $(\frac{1}{2}, -\frac{1}{4})$  is to be rotated through an angle of  $67.5^\circ$  counterclockwise. The initial coordinates are placed in the machine and the first rotation is  $90^\circ$  counterclockwise. Subsequent rotations are smaller and smaller in accordance with the inverse tangent formula, in directions that make them zero in on the desired angle.



## Comparing computation times

Operation	General-purpose computer			Divic computer		
	Bit Times per Operation	Frequency	Total Bit Times	Bit Times per Operation	Frequency	Total Bit Times
Add	n	1	n	n	0	0
Subtract	n	2	2n	n	1	n
Multiply	n <sup>2</sup>	7	7n <sup>2</sup>	n <sup>2</sup>	1	n <sup>2</sup>
Divide	n <sup>2</sup>	1	n <sup>2</sup>	n <sup>2</sup>	0	0
Sine	5n <sup>2</sup> + 3n	3	15n <sup>2</sup> + 9n	....	....	....
Cosine	5n <sup>2</sup> + 3n	4	20n <sup>2</sup> + 12n	....	....	....
Inverse tangent	8n <sup>2</sup> + 6n	1	8n <sup>2</sup> + 6n	....	....	....
Inverse cosine	8n <sup>2</sup> + 6n	1	8n <sup>2</sup> + 6n	....	....	....
Rotation	....	....	....	n <sup>2</sup>	6	6n <sup>2</sup>
Resolution	....	....	....	n <sup>2</sup>	2	2n <sup>2</sup>
Total!			58n <sup>2</sup> + 36n			9n <sup>2</sup> + n

handle numbers either incrementally or as whole numbers, and the algorithm is implemented accordingly. The digital differential analyzer is an example of an incremental computer; it repeatedly adds a variable  $y$  to an accumulator, which therefore contains the integral of  $y$ . Conventional general-purpose computers are examples of whole number machines.

Since the differential analyzer can handle only increments of numbers, it solves the equations of conversion, range and bearing and position by a proper application of its basic integration algorithm. It arrives at a solution quickly, but it may be subject to a cumulative error.

The general-purpose computer on the other hand has available all standard arithmetic operations; namely, add, subtract, multiply and divide. In addition, hardware or software algorithms based on infinite series for forming trigonometric functions using only arithmetic operations may be available. The equations can be evaluated with great precision using these algorithms, but at the cost of either much hardware or much time.

The Divic is neither an incremental nor a whole-number machine, but something between the two. It solves the equations by using the standard arithmetic operations plus rotation and resolution. The rotation operation rotates a vector  $R$  defined by its  $x$  and  $y$  components  $R_x$  and  $R_y$  through an angle  $\theta$  and computes the new  $x$  and  $y$  components  $R'_x$  and  $R'_y$ . The new components are related to the original ones by:

$$R'_x = R_x \cos \theta - R_y \sin \theta$$

$$R'_y = R_x \sin \theta + R_y \cos \theta$$

Resolution computes the magnitude and direction of the vector from the vector components  $R_x$  and  $R_y$ :

$$R = R_x^2 + R_y^2$$

$$\alpha = \tan^{-1} \frac{R_y}{R_x}$$

The speed of solution of the equations can be estimated by determining the amount of time required for each operation and the relative frequency of use of each.

The frequency of use depends on the programmer's skill; the frequencies in the summary table shown below are typical. This table shows that the Divic can solve the same problem that a general-purpose computer can solve, with less hardware and six times faster.

### Computer organization

Implementation of an algorithm like Volder's in a computer like Divic requires a special arithmetic unit. The design of the arithmetic unit, in turn, depends on the speed required of the machine. The other basic subdivisions of the computer—the control unit, the memory unit, and the input-output interface—are not directly affected by the computational algorithms.

The arithmetic unit may operate serially or in parallel, or in combinations of these two basic methods. Four such designs—serial processing-serial arithmetic, parallel processing-serial arithmetic, serial processing-parallel arithmetic, and parallel processing-parallel arithmetic—are shown on the next page. To implement the rotation algorithm, three steps are required for each iteration: the sum or difference of  $x$  and shifted  $y$  to find the new  $x$ ; the difference or sum of  $y$  and shifted  $x$  to find the new  $y$ ; and the sum or difference of the angle and the angle increment to find the new angle.

These three steps are repeated during  $n-1$  iterations to solve the rotation algorithm, where  $n$  is the word length in bits.

The four configurations have different solution times and require different amounts of hardware:

- For serial processing and serial arithmetic, only a single adder-subtractor is required. It will be time-shared by the four shift registers, which make up the other parts of the arithmetic unit, as

## Four computer organizations

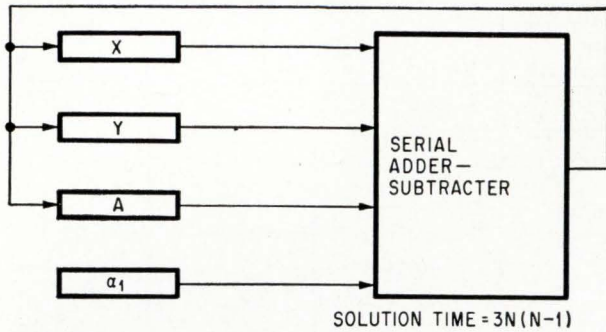

The simplest organization for a Divic computer is when data is processed serially, and arithmetic operations are performed serially.

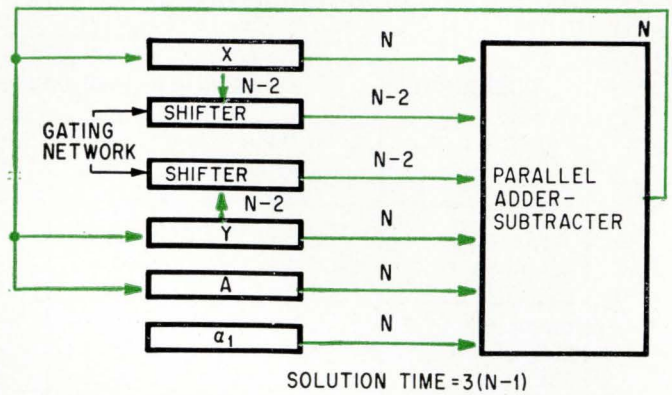

Still faster operation is possible with a parallel arithmetic unit that retains the simple serial shift-registers of the basic organization.

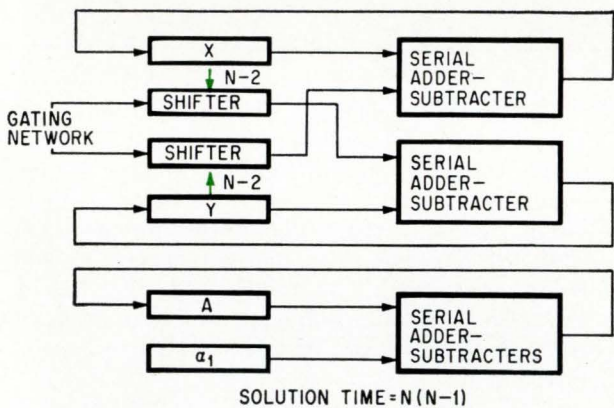

A somewhat faster and more complex organization is parallel processing. It increases the speed and requires additional hardware; serial arithmetic is retained. The arrows in color refer to a number of parallel lines.

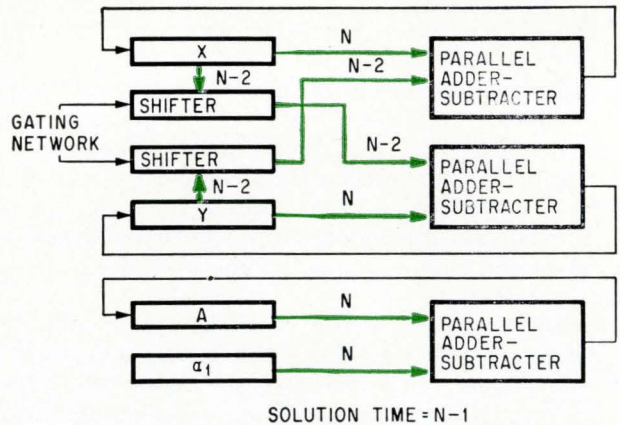

The fastest and most complex layout uses both parallel arithmetic units and parallel processing from all registers. This organization also costs the most.

at the top left above. Each of the four registers are  $n$  bits long. The three steps required for each iteration of the algorithm are computed in series; thus the total solution time becomes  $3n(n-1)$  bit times. The shifted values of  $x$  and  $y$  are obtained by transferring numbers between registers with proper timing.

- In the second design of an arithmetic unit, at the lower left above, computation is made faster by processing many serial arithmetic operations at one time. In this configuration a gating network on the  $x$  and  $y$  registers obtains the shifted values of  $x$  and  $y$ . The arithmetic unit requires three adder-subtractors, four shift registers, and two sequential gating networks. Since all three steps are now processed at one time, the solution time is  $n(n-1)$  bit times for this design.

- An arithmetic unit with serial processing and parallel arithmetic, like the first method, takes three steps to process the information. However, with a parallel adder-subtractor, as in the diagram at the upper right, gating networks route the shifted values of  $x$  and  $y$  from each register into the adder-subtractor. This arithmetic unit now requires four  $n$ -bit storage registers, two gating networks, and

one parallel adder-subtractor. The solution time now becomes the speed of the parallel adder-subtractor divided by the three sets of inputs. If the speed of the parallel adder-subtractor is one bit time, the solution time is  $3(n-1)$  bit times.

- Parallel processing with parallel arithmetic is the fastest method of processing information. In this method, the shifted values of  $x$  and  $y$  are again obtained with gating networks, as in the lower right diagram. By processing the information in parallel, the solution time for this method is reduced to  $n-1$  bit times—the fastest way to solve the algorithms in an arithmetic unit.

### Speed and cost comparisons

The selection of the organization to fit the requirements of a particular application will depend on the solution time required for the problem and the cost. As the speed increases with the introduction of parallel processing, more hardware is required.

The graphs on page 112 compare the different arithmetic unit solution times for various word lengths and the relative hardware complexity of each arithmetic unit in terms of the integrated-cir-

cuit modules needed for the basic arithmetic functions. These numbers do not include any control circuitry.

Therefore, the selection of the optimum computer requires a diligent study of all methods and their trade-offs; the faster the information processing, the more costly the arithmetic unit.

The table shown below illustrates these principles for a typical navigational problem—depicting the bit times for the various algorithms as a function of the computer organization, along with the total bit times and the resulting solution times for a 32-bit word and 1-Mhz clock frequency. A comparison of the cost of each computer organization with a 32-bit word is also shown.

### Flight test proves the system

A prototype Divic computer with a parallel processing, serial arithmetic design was flight-tested two years ago in the East Coast loran-C chain. Time difference signals were obtained from an AN/SPN-30 receiver and fed into the computer. Outputs of the computer were present latitude and longitude, distance to go, bearing angle and steering signal commands.

The tests totaled more than 120 flight hours in various types of aircraft. A typical flight began at Grand Rapids, Mich., and went to Miami, San Juan, Bermuda, Washington and back to Grand Rapids. The computer was tested on both the land and sea sides of the chain of loran stations, both in and out of the area covered by the ground wave. Accuracy was checked against air traffic control radar, Atlantic missile range radar, very high frequency omnirange and visual landmarks. The mean error in all flights under a variety of conditions was about 1 nautical mile (approximately 1.15 statute miles).

The flight tests of the prototype showed, among other things, that the parallel processing-serial arithmetic organization was adequate for the straight forward conversion of hyperbolic coordinates in aircraft. With this in mind, and with plans

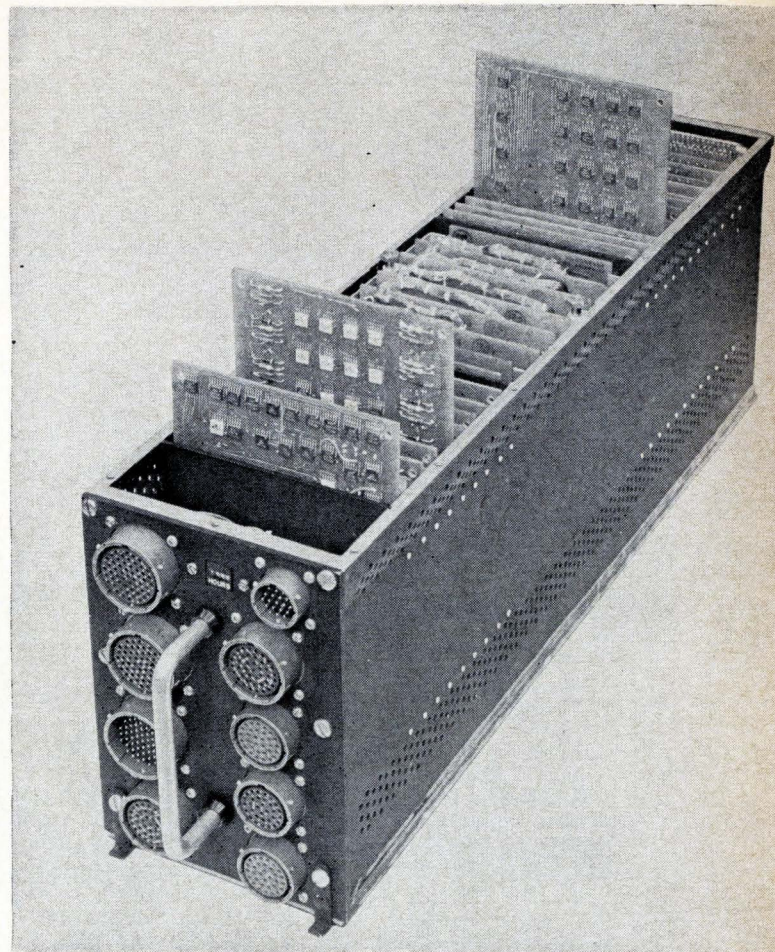

The Divic computer with the top cover removed and some of the circuit cards partly pulled out. The group of cards in the center carry the core-rope memory; portions of the rope are just visible. The ferrite core memory is on the module at the rear; only a few test points are visible.

to alter the packaging and to replace the wired program with a stored program, the design was simulated on an International Business Machines Corp. 1620 computer. The simulation bore out the

### Speed-cost trade-offs

Operation	Computer speed			
	Serial-serial	Parallel-serial	Serial-parallel	Parallel-parallel
Subtraction	$2n^*$	$2n$	2	2
Addition	$n$	$n$	1	1
Multiplication	$6n^2$	$3n^2$	6n	3n
Rotation	$3n^2 - 3n$	$n^2 - n$	$3n - 3$	$n - 1$
Resolution	$3n^2 - 3n$	$n^2 - n$	$3n - 3$	$n - 1$
Total	$12n^2 - 3n$	$5n^2 + n$	$12n - 3$	$5n + 1$
Total for $n = 1$ usec**	12.192 msec	5.152 msec	0.381 msec	0.161 msec
Cost in number of modules	135	172	505	660

\*n=time required to process one bit

\*\*Assumes 1 megahertz clock, 32-bit word

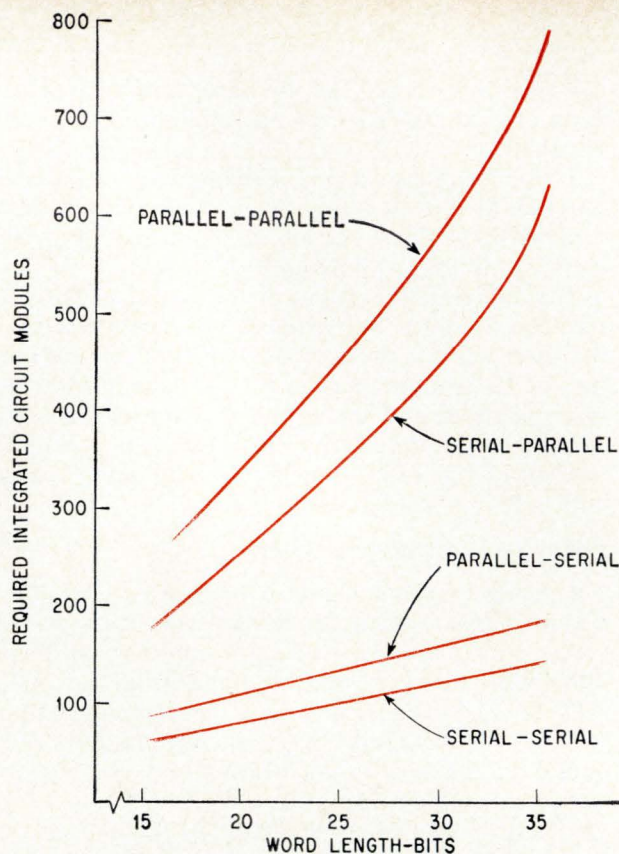
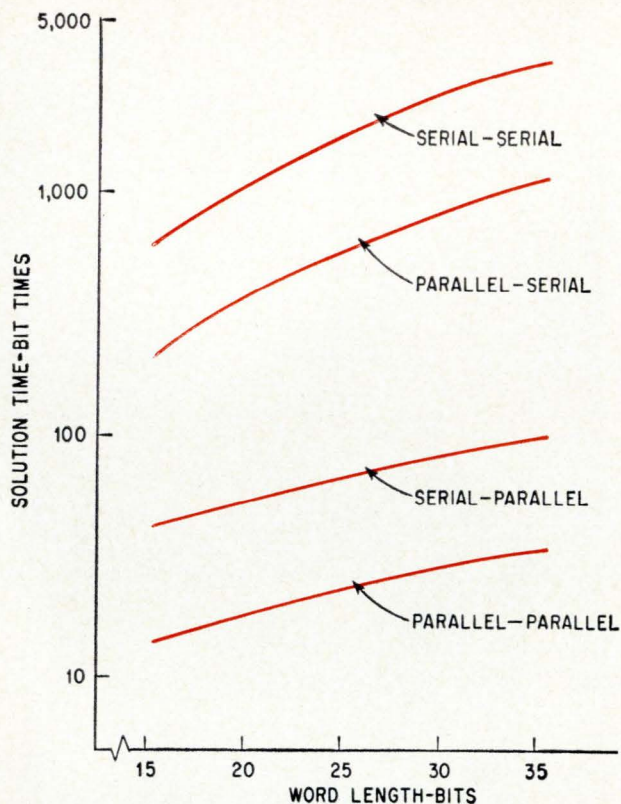

Solution time increases as word length increases. The increase in time is more rapid for the simpler computer organizations. Hardware costs also increase as word length increases but less rapidly for the simple organizations. The designer must use a word length and an organization that will provide the required solution time at a price he can afford to pay.

results of the flight test and gave the accuracy of the algorithm as a function of word length. Therefore the improved design for Divic retained the parallel-serial organization, with a word length of 30 bits as indicated by the simulation.

### Divic has many faces

Any equation using trigonometric functions can be evaluated by a Divic computer as well as by a digital differential analyzer or a general-purpose machine. Most of the applications are in navigation systems of various kinds.

In hyperbolic systems, such as loran C, velocity and direction can be derived. When position, velocity and direction are known, the computer can resolve the guidance for the aircraft in the form of error or command signals and feed these to the autopilot and displays. Bearing, great-circle distance and along-track distance also can be computed and displayed.

In dead-reckoning systems, such as inertial, doppler-gyro or airspeed-heading systems, the sensor inputs usually are in the form of pulses from an accelerometer, a frequency representing velocity from the doppler radar, and synchro d-c or a-c voltages. From these inputs, velocity, direction and position can be computed just as in the hyperbolic system. The differences between the dead-reckoning navigation computer and the hyperbolic computer is the replacement of the coordinate conversion routines with integration routines that in-

volve programing changes in the core rope. Also a faster computer is needed in an inertial system; the system has a higher data rate, so the computer must process more data in less time, even though it executes fewer instructions. The speed can be increased either by increasing the clock rate (if the modules are capable of the higher rate) or by using a parallel computer organization.

Many integrated systems, such as loran-inertial, Omega-inertial, loran-doppler, and so forth, can use the Divic. In the simpler integrated systems the time-independent systems update the time-dependent systems; in others, the systems mutually aid each other. The most advantageous application of the Divic computer in an integrated system is to reduce each navigation subsystem to a common frame of reference and then to operate on the inputs, processing the common data to the mutual advantage of both systems. The resultant system is usually more accurate than either system individually.

### References

1. Jack E. Volder, "The CORDIC trigonometric computing technique," IRE Transactions on Electronic Computers, Sept. 1959, p. 330.
2. D.H. Daggett, "Decimal-binary conversions in CORDIC," IRE Transactions on Electronic Computers, Sept. 1959, p. 335.
3. C.M. Lekven and M. Uno, "A digital electronic hyperbolic coordinate converter," Proceedings of the 11th Annual East Coast Conference on Aerospace and Navigational Electronics, IEEE, 1964, p. 3.2.1-1.
4. Robert A. Racy, "A digital computer for the loran-C navigation system," Proceedings of the 11th Annual East Coast Conference on Aerospace and Navigational Electronics, IEEE, 1964, p. 3.2.2-1.



Four outstanding performers... designed with the care and imagination that has made them the talk of the analog computer world. ★ Ci-265S Resolver... presents a new concept in electronic resolvers, using D-to-A switches and logic circuitry. Outstanding performance has been recorded for rate inputs of from 0.01 radian per second to 1000 radians per second. ★★ Ci-308 DC Amplifier... solid state through-out (including chopper) with an output capabil-

ity of 50 milliamperes over a range of -100 to +100 volts! ★★★ Ci-291 Multiplying Digital/Analog Converter (DAC)... produces the product of two input variables where one is digital and the other analog. ★★★★★ Ci-196 Hybrid Operated Digital Attenuator Device (HODAD)... the first all solid state device to replace servo-set potentiometers in a computer system. Let COMCOR set your stage with these star performers. Call (714) 772-4510 or TWX 714-776-2060.



**COMCOR**  
A SUBSIDIARY OF ASTRODATA, INC.

1335 SOUTH CLAUDINA STREET / ANAHEIM, CALIFORNIA 92803

Career opportunities available now in engineering and marketing.

APPLAUSE...

APPLAUSE...  
APPLAUSE...



Circle 113 on reader service card

**IT'S EASIER, QUICKER, MORE SATISFACTORY . . . AND CHANCES ARE IT WILL COST LESS, TOO!**

**MANUFACTURERS' REPS . . .** You'll save money and reduce overhead by using Honeywell repair and calibration labs on a project basis. You can also eliminate the problems of in-warranty repair. Just let your principals and customers know their equipment can be picked up or serviced right on the spot by our experienced service group.

**TEST EQUIPMENT MANUFACTURERS . . .** Don't take a chance with repair and calibration trainees during peak periods of turn-around. Call on the expert specialists at Honeywell. And if your size doesn't warrant a repair and calibration staff . . . or you don't want to be bothered . . . let us help. *We'll function as your own department, at much less than one would cost.*

**ELECTRONIC EQUIPMENT USERS . . .** Equipment not functioning properly? That doesn't mean that new equipment is a must. Let our specialists analyze your requirements and if repairs are feasible, give you estimates. You can count on them for an impartial, expert opinion.

**OUR ENGINEERS ARE SPECIALISTS IN:**

digital voltmeters • wide-range DC amplifiers • frequency counters and timers • oscilloscopes • needle-moving instruments • data loggers consisting of x-bar type scanning instruments, x-y type recording devices and print-out equipment • medical electronic equipment • electronic process controls

**COUNT ON OUR SERVICE CENTERS FOR:**

Repair & Calibration, modification, assembly, and inspection

tion of precision instruments used for measurement  
Systems Installation services and check-out  
Clean, Touch-Up, Lubricate to like-new condition  
Certification traceable to National Bureau of Standards  
Pickup & Delivery by protected instrument carrier  
Scheduled Preventative Maintenance programs  
Warranty on all work and parts

Complete Repair Reports submitted on each job

**THERE'S A HONEYWELL SERVICE CENTER NEAR YOU:**

Fairborn, Ohio, 600 E. Dayton Dr., Tel. 513-878-2551 / Newport News, Va., 5010 Jefferson Ave., Tel. 703-244-6586 / Silver Spring, Md., 2425 Linden Lane, Tel. 301-587-1154 / Glendale, Cal., 635 W. Colorado St., Tel. 213-245-8551 / Cleveland, Ohio, 20950 Center Ridge Rd., Tel. 216-331-7651 / Montvale, N.J., 305 W. Grand Ave., Tel. 201-391-2306 / Waltham, Mass., 69 Hickory Dr., Tel. 617-894-7229 / Santa Clara, Cal., 3235 Kifer Road, Tel. 408-739-6917 / Orlando, Fla., Orlando Central Pk., 7100 Lake Elernor Dr., Tel. 305-855-2721

Write us or your nearest Service Center for a free copy of our repair and calibration brochure!

**HONEYWELL, Test Instrument Division,  
Annapolis Operation  
Box 391, Annapolis, Maryland 21404  
OR Telephone: 301-263-2661**

Please send me a free copy of your repair and calibration brochure.

Name \_\_\_\_\_ Title \_\_\_\_\_

Firm \_\_\_\_\_

Street \_\_\_\_\_

City \_\_\_\_\_ State \_\_\_\_\_ Zip \_\_\_\_\_

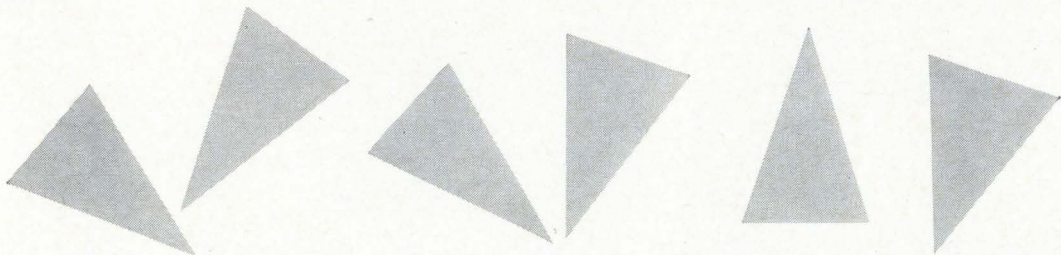

**need repair and calibration service?**

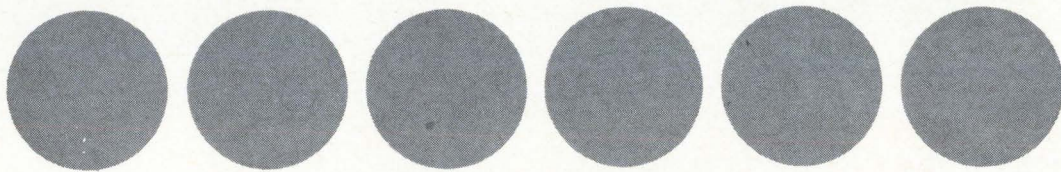

**Let our pros do it!**

**Honeywell**

# Pumping new life into ruby lasers

New pumping system and low-cost mercury flashtubes bring longer life and high repetition rates, promising to change the ruby laser from a laboratory instrument to a production tool

By Dieter Roess and Guenter Zeidler

Central Laboratories, Siemens & Halske AG, Munich, West Germany

A ruby laser has been developed that promises to move the bright red beam from laboratory work to the production line. The new laser achieves the highest pulse repetition rate of any ruby laser and its beam can be focused to an extremely fine point yet it is cheap to operate and has long life. Its secret is a new pumping system and an especially designed mercury vapor flashtube that replaces the conventional xenon lamp of ruby lasers. The new tube has from 100 to 100,000 times the lifetime of a xenon tube at one-tenth the cost per tube.

Developed by Siemens & Halske AG in West Germany, the new laser is particularly suited for commercial micromachining processes such as melting, drilling, cutting and trimming. In the laboratory the laser has corrected the wiring of large-scale arrays of integrated circuits by vaporizing the leads to unwanted or faulty elements and has ac-

curately trimmed thick- and thin-film elements by partially vaporizing their materials.

Until now three serious imperfections have held back the commercial development of ruby lasers:

- First, the characteristics of the output beam have been far from ideal, making it impossible to focus to a sharp enough point. The beam has not been restricted to the zero-order mode, the mode easiest to collimate, giving it divergences 10 to 100 times greater than desired. Also, the beam is not uniform but has maximums and minimums that vary from pulse to pulse.

- Second, the xenon flashtube, which is ordinarily used as a pump light source, can deliver only from 100 to 100,000 pulses—too few at \$100 per tube.

- And finally, typical pulse repetition rates vary from 0.1 to 1 hertz. Higher duty cycle operation is possible with forced cooling but this is still impractical because the flashtube would be quickly destroyed and a very large and costly power supply would be needed.

The Siemens laser goes a long way towards overcoming these defects. It has an output pulse repetition rate ranging around 100 hz and its ellipsoidal pumping system yields greatly improved beam divergence and stability because the laser generates a perfectly circular, uniform beam and can operate largely in the zero-order mode.

The xenon lamp is replaced by a \$10 mercury flashtube having an exceptionally long life of 10 million pulses. The mercury unit also has high efficiency at small arc dimensions.

Absolute output efficiency of the system, which uses a ruby rod only 1-inch long and 80 mils in diameter, is about 0.22% [see table on p. 117].

The pumping system<sup>1</sup> shown on page 116 has the special characteristic that its efficiency does not drop for a small crystal length, as it does in cylindrical units, because no end effects are present. A

## The authors

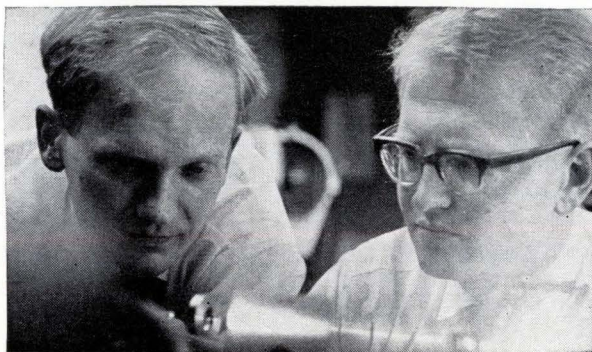

Guenter Zeidler, left, is a research engineer at Siemens & Halske engaged in solving laser problems. He graduated from the Technische Hochschule in Munich in 1964. Physicist Dieter Roess holds a doctorate from the University of Wuerzburg. With Siemens & Halske since 1960, he is manager of the maser and laser research laboratory.

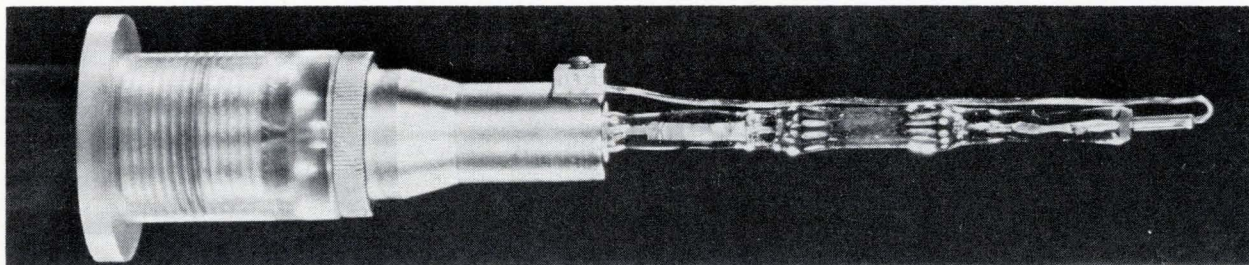
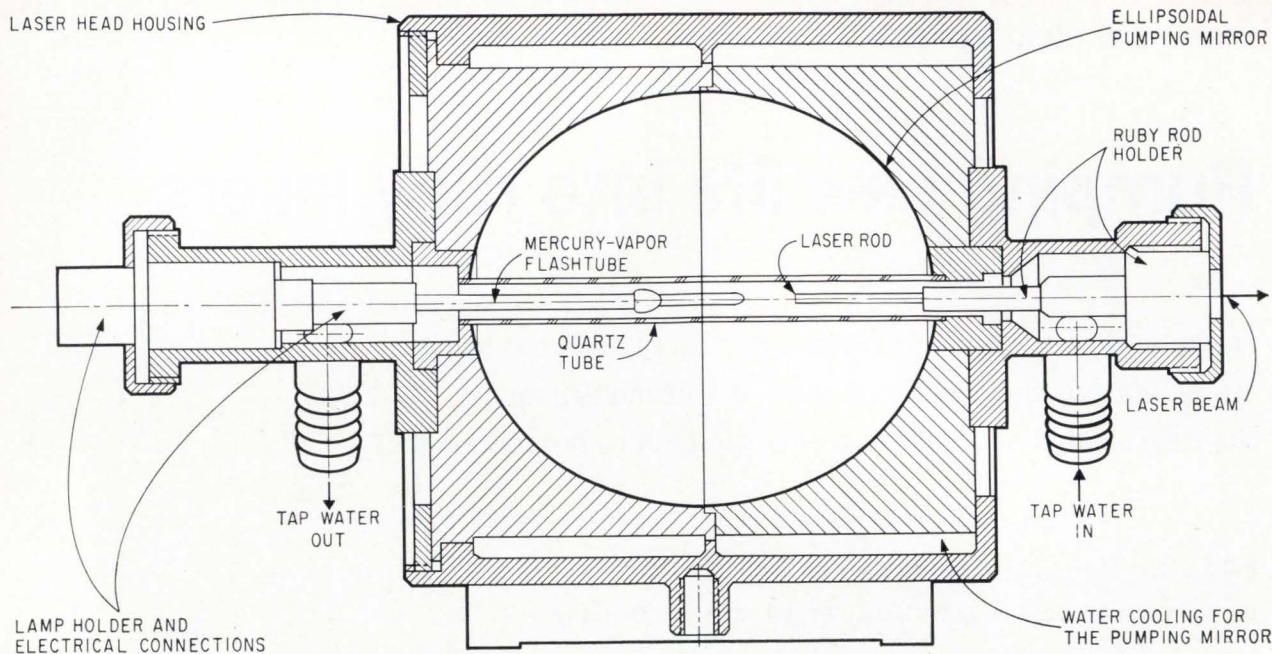

**Ruby laser** with repetition rate of 100 hz uses ellipsoidal pumping mirror, 1-inch-long ruby rod, high-pressure mercury-vapor flashtube. Absolute output efficiency is 0.22%. Flashtube, in photograph has preadjusted, interchangeable holder and electrical plug-in. It can be produced cheaper than xenon units.

similar ellipsoidal system had been used previously for continuous operation of ruby lasers at room temperature.<sup>2</sup>

The light source is placed along the axis of an ellipsoidal mirror between one of the focuses and the neighboring apex, as in the basic optical diagram on page 117. In the corresponding area at the other half of the ellipsoid is the laser rod. Tap water flowing through a concentric quartz tube cools the rod and light source. The pumping mirror is cooled by tap water flowing around the outside of the system.

The pump pulses of the laser are derived from the triggering of a Siemens (STE-6011) thyatron. These triggers can be varied between 50 and 120 hz. Standby current of 100 milliamperes is furnished by a 1,500-volt d-c power supply.

With the present power supply—a commercially available Siemens unit shown in the schematic on page 117—maximum output power is obtained at 70 hz. At this frequency, the average pump power can be varied from 500 to 1,000 watts. The pump pulse duration is 2 milliseconds with the laser output pulses lasting from 1 to 1.5 msec. The threshold energy was measured at 2.5 to 3.5 joules. Measurements were taken indirectly since the laser was

above threshold even with minimum input power.

At a pump power of 900 watts into the lamp, and using a mirrored rod of 10% coupling, the average laser power is 2 watts with 80-watt peaks. This value drops by about 30% after 20 hours of operation at  $10^7$  pulses.

In one experiment a ruby rod was operated with one end antireflection-coated and with an external curved mirror. Maximum average power was 1.5 watts. This laser was also operated in 70-hz giant-pulse mode with a saturable absorber as a Q switch. The amplification in the 1-inch rod was as high as 1.5 per light pass—high enough so that the laser can be operated with several damping elements in the resonator. The amplification of gas lasers, for example, is much lower; a typical value for a helium-neon laser is 1.06.

### Mercury tube advantages

The prime advantage of the mercury flashtube is, of course, its long life. The tube doesn't deteriorate because there is no low-pressure discharge phase, as in low-pressure xenon tubes, during which the electrodes can evaporate. Steady internal pressure of about 100 atmospheres, equal to 1,470 pounds per square inch, is maintained and this sharply re-



duces the evaporation and deterioration.

Another advantage of the mercury lamp is that its efficiency is high at small discharge lengths. With xenon tubes, efficiency decreases when the discharge path is less than 2 inches. High efficiency means there is little heating of the electrodes. The lamp can be very small and can be produced much more cheaply than the xenon units.

Over-all system efficiency is increased still further using the mercury tube because its emission lines match the laser pump band of ruby extremely well, as shown on page 118.

To keep the mercury in a gas state, the laser must run almost continuously above a minimum average power. The present system was designed for a repetition rate between 50 and 120 hz.

With almost continuous operation the laser rod is in thermal equilibrium.<sup>2,3</sup> This is important in generating identical pulses.

### Hot rod

The pumping and lasing processes generate heat in the ruby of the laser. Temperature gradients in the rod cause curvature at the end faces and, because the refractive index is temperature dependent, the light rays in the material also curve. A pumped laser rod, therefore, acts like a lens whose focal length depends upon the temperature distribution in the rod, which, in turn, depends upon the distribution of the pump light.

In high pulse-rate operation curvature by thermal gradients is practically constant. This contrasts with the operation of single-pulse lasers in which the curvature is strongly time-dependent and fluctuates with the thermal history of the laser during the thermal relaxation times.

The thermal curvatures of nominally plane-parallel resonators cause the imperfect beam-divergence characteristics of solid-state lasers. In the new ruby system, however, the thermal spherical curvature of the resonator is corrected optically as on page 118. The end faces are curved negatively in such a way that in the hot rod the curved light rays of the zero-order mode hit the mirror at right angles at any point in its cross section. Hence, only the zero-order mode is excited.

It's interesting to note that the corrected laser rod cannot be run cold in single pulses because the negative curvature of the resonator introduces

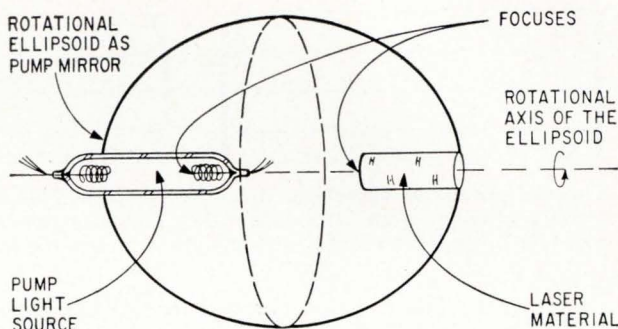

**Light source** is placed between focus and apex of the rotationally symmetric ellipsoidal pumping mirror. Reflection properties of ellipsoid cause light rays from the pump light source to be reflected through the focus-apex area at the opposite side of the ellipsoid where the laser material is located.

high losses that cannot be overcome by laser amplification.

Only when part of the curvature is compensated for by thermal expansion of the rods, and the rest by a bulk lens effect, do the resonator losses drop below the threshold value. Proper correction, it was found, was not very sensitive to the average pump power so that high-mode selection can be achieved for all possible pump powers.

A special advantage of the ellipsoidal pumping system is that the pump light distribution and

### Operating data of ruby laser

Wavelength	0.6943 micron
Laser material	ruby, 25 mm long, 2 mm diameter
Ruby volume	0.08 cm <sup>3</sup>
Pump pulse duration	2 msec
Pulse repetition rate	50 to 120 hz with 70 hz optimum
Pulse threshold energy	2.5 to 3.5 joules
Maximums	
Pump energy	15 joules (4 to 6 times threshold)
Average input power	1,000 watts (120 hz)
Average output power	2 watts (70 hz)
Peak output power	N 80 watts
Output efficiency	
Absolute	0.22% (70 hz)
Differential	0.87% at max. pump power
Lamp lifetime	> 10 <sup>7</sup> pulses ≈ 20 hours at 70 hz

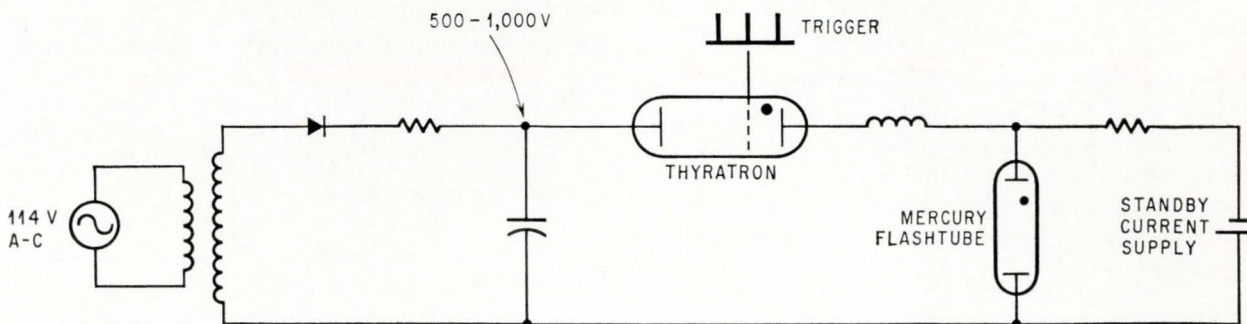

**Trigger pulses** on the thyatron determine the pumping frequency (50 to 120 hz) of the flashtube in this simplified schematic of the commercially available Siemens power supply.

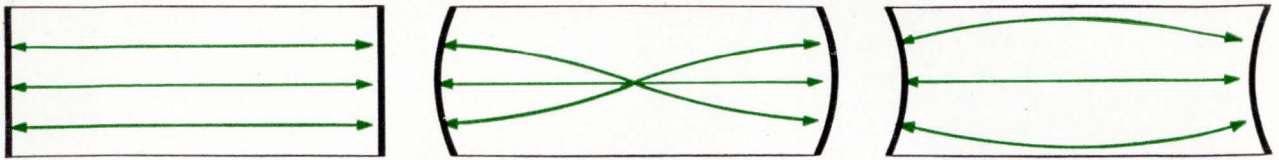

**Thermal resonator curvature.** In nominally plane-parallel resonator, left, zero-order mode exists across the whole cross section. Thermal curvature makes the resonator confocal, center; the zero-order mode exists only near the axis and high-order modes predominate. Curving the surfaces negatively compensates for thermal effects, right.

therefore the thermal curvature are of exact rotational symmetry.

With the lamp and laser rod placed along the rotational axis of the ellipsoidal mirror the pump light hits the cross section of the laser in the same rotationally symmetric way that it leaves the lamp cross section. Consequently, the cross section of the laser beam stays perfectly circular and has no pronounced minimums.

In contrast, the pump light in cylindrical systems strikes the laser cross section with a concentration in preferred planes because of image distortions. The temperature distribution in the rod curves and twists the resonator, leading to a less well-defined laser beam.

### Applications and future developments

With this laser the price per laser flash no longer places an economic limit on its application, but its economy is not its only advantage:

- For machining purposes, the laser's ability to apply a large number of consecutive pulses, each with low energy, allows the operation to be better defined and controlled than if single, high-energy laser flashes were used. Reduction of the peak power increases the life of the optical components.

- For ranging, the laser can be used in fast-measuring and scanning systems having high angular resolution because the beam can be collimated to divergences of seconds of arc. In single-distance measuring systems the input power can be reduced considerably.

Even with the present 1-inch system, in which a volume of ruby less than 0.08 cubic centimeters is operating, several practical applications have been demonstrated.

At 1.5 watts of average power, the focused beam evaporates absorbing materials, such as ferrite or germanium in bulk, with a bright plume. Thin layers of highly reflective metals, such as gold or silver, are easily cut and working diameters of 3 to 5 microns can be achieved.

Living tissue is coagulated at average powers below 0.5 watt in the focused beam. Retinal coagulation was successfully performed in a joint experiment conducted by the authors and Drs. F. Fankhauser and W. Lotmar of the University of Bern, Switzerland. Here, operating with an almost continuous, stable beam of exactly adjustable power and of moderate peak power seemed to be of special advantage.

Because of its good spatial coherence the ruby laser is also a good bright light source for coherent

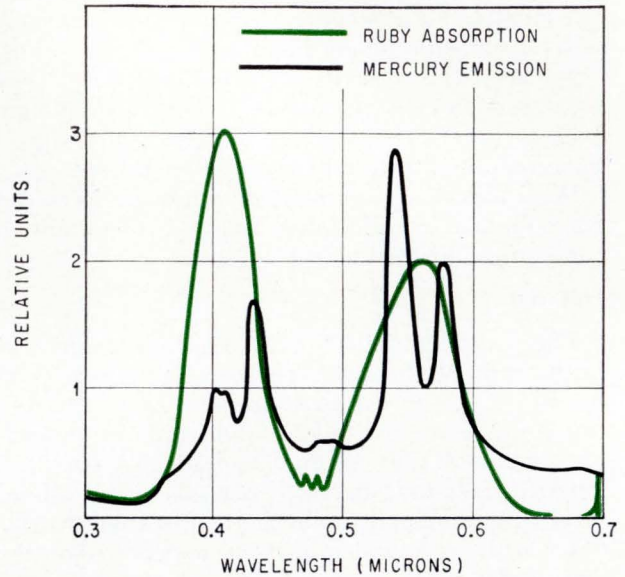

**Absorption bands** of ruby match very favorably the emission lines of the mercury-vapor flashtube. Peaks occur at almost the same wavelengths.

wavefront reconstruction of holograms. And, it is a powerful excitation source for Raman spectroscopy, a method widely used in the chemical industry to determine the structure of organic molecules.

Further applications of the laser are possible with giant-pulse operation. At 70 hz, giant pulses of 30 nanoseconds duration with 10 to 100 kilowatts peak power were obtained in one single-axial and transverse mode. The 100-kw pulses obtained at 70 hz are believed to be a record with a ruby of such small volume. The average power at 100 kw maximum is 100 milliwatts. With single-pulse lasers having ruby crystals 30 to 100 times larger than the experimental laser, powers in the megawatt and gigawatt range have been achieved.

Currently being investigated is the possibility of extending the operation to large crystal volumes. Special flashtubes for this purpose are now being developed. With a 3-inch, 4-millimeter diameter ruby rod an average power of 30 watts at 1% efficiency seems to be a safe goal. Beam welding of bulk materials is one application that will be possible at this power level.

### References

1. D. Roess "Exfocal Pumping of Optical Masers in Elliptical Mirrors," *Applied Optics* Vol. 3, No. 2, 1964, p. 259.
2. *Electronics*, Feb. 8, 1965, p. 17.
3. D. Roess, "Room Temperature CW Ruby Lasers," *Microwaves*, Vol. 4, No. 4, p. 29.

# Besides making the brightest laser in the world...

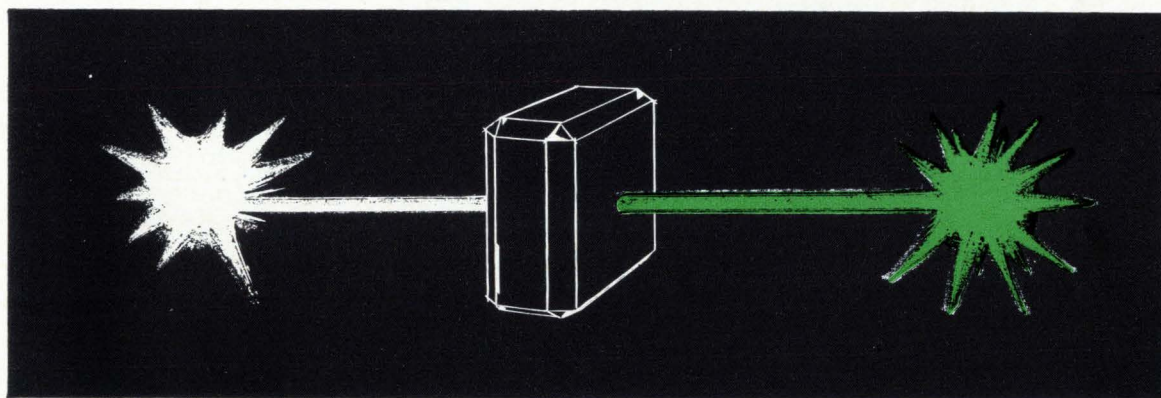

## we make new improved Lithium Niobate crystals.

Our new LINDE Lithium Niobate crystals are synthesized by radically improved methods, from ultra-pure raw materials. Results: a new high in efficiency — as a frequency doubler; as well as excellent performance in modulation, delay line and other electronic applications.

But laser systems and crystals are only two of the many product lines we make. Others include integrated and modular circuits ... solid tantalum and foil-film capacitors ... field effect transistors.

These are all directed at advanced applications in the fast-moving field of modern electronics. They're all backed by the technology of Union Carbide — the corporation that's dedicated to growth through research.

If you'd like specific data on laser systems or crystal products, or if you'd like more information on our electronic activities, please write Dept. E-91, Union Carbide Corporation Electronics Division, 270 Park Ave., New York, N.Y. 10017.



LINDE is a registered trade mark of Union Carbide Corporation.



Are you  
listening?

## Mallory Capacitor Company chooses GAF x-ray film to make sure everyone gets the word

Computers, telemetry, AC/DC converters, navigational gear, radar and other sensitive electronic components used in our space and missile programs rely on tantalum capacitors for long life and dependable communications.

Mallory Capacitor Company, manufacturer of these tantalum capacitors, relies on GAF Industrial 'H-D' x-ray film to detect inclusions, excess bonding material, and check casing element clearances on all electrical connections.

To quote Mr. John E. Beckley, Quality Control Supervisor, "Only Industrial 'H-D' is used to radiograph our capacitors. It's the one x-ray film

producing the definition, sensitivity and contrast that reveals minute detail within tiny components."

Ultra-fine grain and very high contrast characteristics make Industrial 'H-D' film the ultimate for pinpoint radiographic examination. Your distributor of GAF x-ray products can supply you with information on our complete line of films and chemistry.

GAF maintains a nationwide staff of full-time Industrial X-ray Specialists—trained to render expert radiographic counsel, assistance and service. We have one in your area. Don't hesitate to call on him.

E88

**gaf**

GENERAL ANILINE & FILM CORPORATION

140 WEST 51 STREET, NEW YORK, NEW YORK 10020

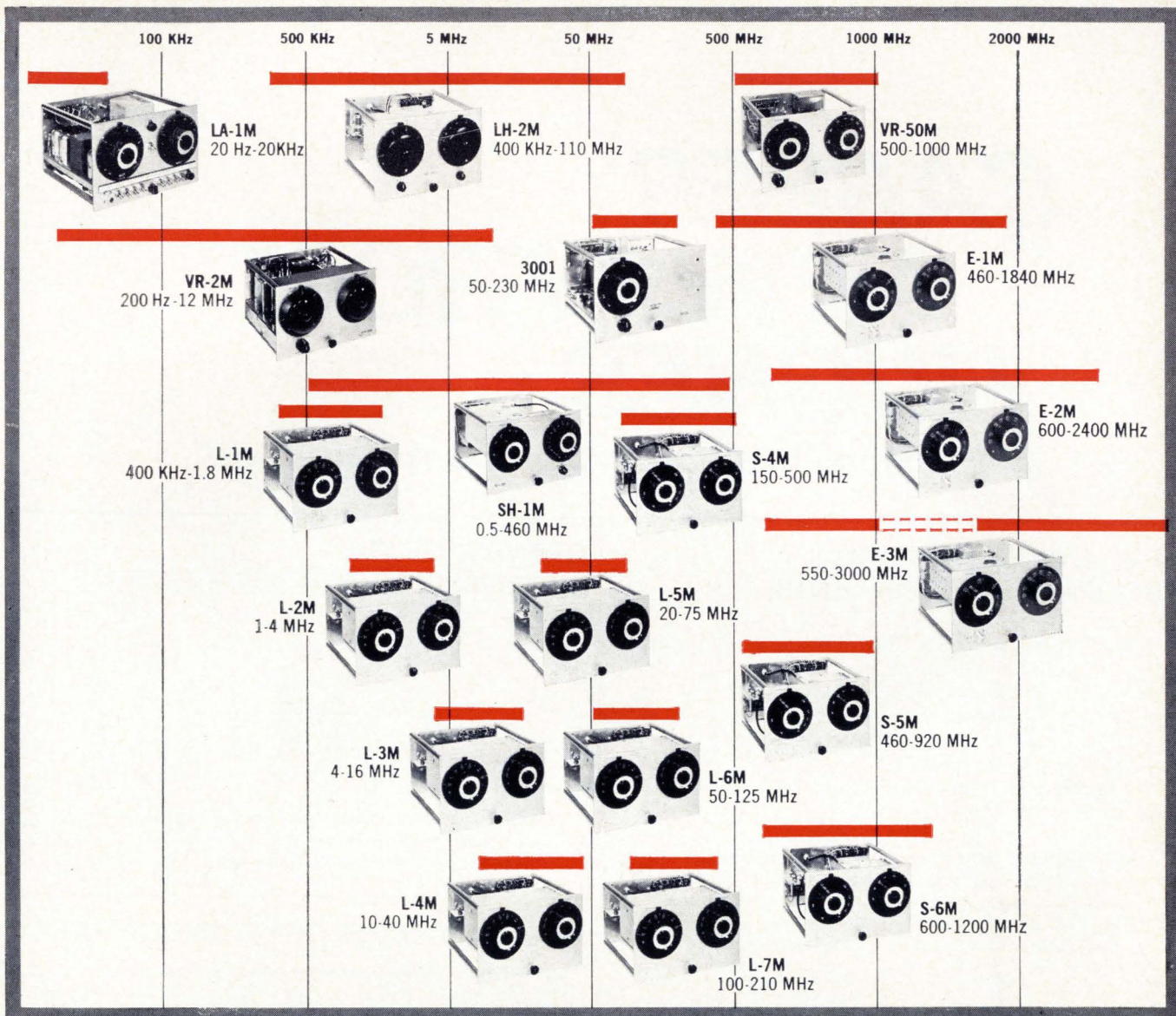

## Frequency—From 19 Points of View

The benefits of swept frequency measurement in terms of quicker testing and more precise answers easily justifies the employment of a Sweep Generator in both lab and production applications.



Now, Telonic's SM-2000 Sweep Generator (left) offers these benefits in a configuration that gives the instrument maximum versatility at a low equipment investment. The SM-2000 accepts the 19 different oscillators, shown above, ranging from the

LA-1M that covers 20 Hz to 20 KHz to the E-3 that goes to 3120 MHz. The entire spectrum from DC to 3 Gc can be viewed with as much detail as needed. In some cases a whole octave may be displayed on the scope at one time.

The SM-2000 Sweep Generator provides the method, the machinery, and the flexibility for a myriad of frequency measurement applications. Your local Telonic representative would be glad to show you how.

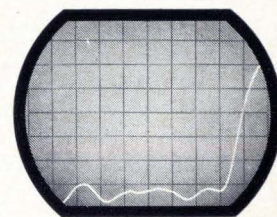

**Telonic INDUSTRIES, INC.**  
 60 North First Avenue, Beech Grove, Indiana 46107  
 Tel.: (317) 787-3231 TWX: 810-341-3202  
 SALES REPRESENTATIVES THROUGHOUT THE WORLD. FACTORY OFFICES IN FRANKFURT, GERMANY AND MAIDENHEAD, ENGLAND.

Does your work involve application or manufacture of Power Supplies, Oscillators, RF Circuits, Audio Amplifiers, UHF Tuners, Communication Networks, Crystal Devices, R.F. Filters or the like? Then find out how you can apply swept frequency methods to make your work easier, and more reliable. Telonic Application Techniques cover all these and more. Yours on request.



# CAREER NEWS FROM HUGHES

*Aerospace Divisions in Southern California*

## NEW AND CONTINUING PROGRAMS AND PROJECTS

PHOENIX Missile & Fire Control System  
SURVEYOR Lunar Landing Spacecraft  
Synchronous Communications Satellites  
TOW Anti-Tank Missile System  
ATS (Applications Technology Satellites)  
AIM-47A/AIM-4E Missiles  
VATE Automatic Checkout Equipment  
CORDS

These examples of Hughes Aerospace activities are representative of more than 230 major product and service capabilities ranging from aerospace vehicles to ASW systems. Diversification such as this promises long-range stability both for the company and its employees.

## NEW MISSILE SYSTEMS DIVISION

More than 900 engineers, scientists and technicians will soon be at work on expanding R & D programs at Hughes new 85-acre Canoga Park complex in the San Fernando Valley. Unexcelled facilities and the professional atmosphere at Hughes encourage creativity and achievement.



**IMPORTANT OPPORTUNITIES**, steady growth, diversification, long-range stability, professional atmosphere, advanced facilities, fine living conditions—these are the advantages which Hughes Aerospace Divisions can offer you at Culver City and Canoga Park.

Requirements include an accredited E.E. or M.E. degree and specialized experience which can be related to the development of aerospace vehicles and electronics. U.S. citizenship is required.

## GROWTH OF THE ENGINEERING STAFF

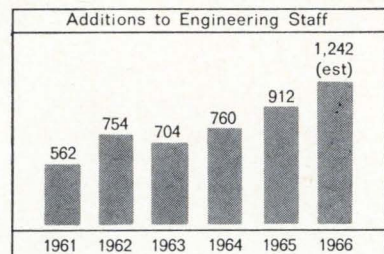

Of the over 11,000 employees of the Aerospace Divisions, almost 4,000 are Members of the Technical Staff. Average experience is 11.7 years. Average age is 37.9 years.

## HUGHES-CULVER CITY/CANOGA PARK

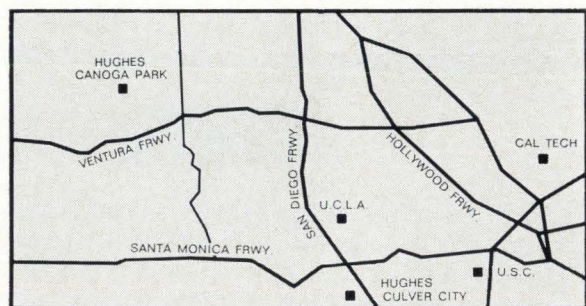

Hughes Aerospace Divisions at Culver City, and Canoga Park offers Engineers and Scientists a unique combination of urban and suburban advantages. Located adjacent to major freeways. Los Angeles Civic Center is about a half-hour distant—beaches, just a short drive. Attractive residential neighborhoods are nearby. U.C.L.A., U.S.C. and Cal Tech offer outstanding educational facilities.

For immediate consideration, please airmail your resume today to:

**MR. ROBERT A. MARTIN**  
Head of Employment  
Hughes Aerospace Divisions  
11940 W. Jefferson Blvd.  
Culver City 32 California

An equal opportunity employer



# Sign waves.

Why?

Well, if recording sine (or any other) wave form is in your bailiwick, we've got news for you.

Du Pont offers a complete line of photorecording products, including chemically-processed and dry-writing papers covering a wide range of test requirements.

We probably have just what you're looking for.

But you'll never know unless you sign the waves in the coupon below.

E. I. du Pont de Nemours & Co. (Inc.)  
Photo Products Department, Room 3899-B  
Wilmington, Delaware 19898

OK, I'm testing . . . or I'm going to be testing something that may involve photorecording. Send me technical information about Du Pont photorecording products.

Name \_\_\_\_\_

Position \_\_\_\_\_

Company \_\_\_\_\_

Address \_\_\_\_\_

City \_\_\_\_\_ State \_\_\_\_\_ Zip Code \_\_\_\_\_

Photo Products Department



Better Things for Better Living  
... through Chemis<sup>tr</sup>

# *Anciently!*

## NIGHT'S COVER IS STRIPPED AWAY

And the enemy becomes nakedly exposed. □ Under the cover of darkness, he had been moving, swiftly, quietly infiltrating, confident the night would provide its accustomed sanctuary. □ Now he is shocked, confused. The light is intense. It doesn't go away. He flees. It's still there—shining down brightly, covering a broad expanse. Unlike a flare which burns out in moments, this light is different. It doesn't go out. It remains, covering him—no matter where he flees. □ Think about it—an airborne battlefield illumination system that virtually turns night into day. Its name is AGIL—and it is becoming increasingly better known every day as a result of its application in Viet Nam, where it is effectively robbing "Charlie" of the sanctuary of night he's enjoyed too long. □ AGIL is a major breakthrough, replacing flares, which are primitive by comparison.

From a distance of 12,000 feet altitude, AGIL casts a cone of light four times brighter than full moonlight over an area two miles in diameter. Illumination is continuous over one area as long as needed. Light intensity increases dramatically at lower altitudes while the illuminated area is only slightly decreased.

□ Conceived and developed by the Greenville Division of LTV ElectroSystems, AGIL (Airborne General Illumination Light Set) has been refined and produced under sponsorship of the Department of Defense Advanced Research Projects Agency (ARPA), under a contract with the Air Force Systems Command Aeronautical Systems Division (ASD). It is available for production in quantity and use anywhere in the world. □ LTV ElectroSystems, Inc. / P. O. Box 1056 / Greenville, Texas / A Subsidiary of Ling-Temco-Vought, Inc.

**LTV ELECTROSYSTEMS, INC.**

GREENVILLE DIVISION





# An Eight-Second Review.

- 8** CDE makes timers and time delay relays.
- 7** With rugged solid state circuitry.
- 6** repeatability of  $\pm 2\%$ .
- 5** 25 millisecond reset time, maximum.
- 4** 200 millisecond to 300 second range.
- 3** high volumetric efficiency.
- 2** design flexibility and
- 1** long, dependable life built right in.
- 0** standard stock ratings available.

If you like the subject, do some research with the CDE field engineer or authorized distributor in your area. He will gladly discuss your application requirements at no obligation.

**CDE** **CORNELL-DUBILIER**

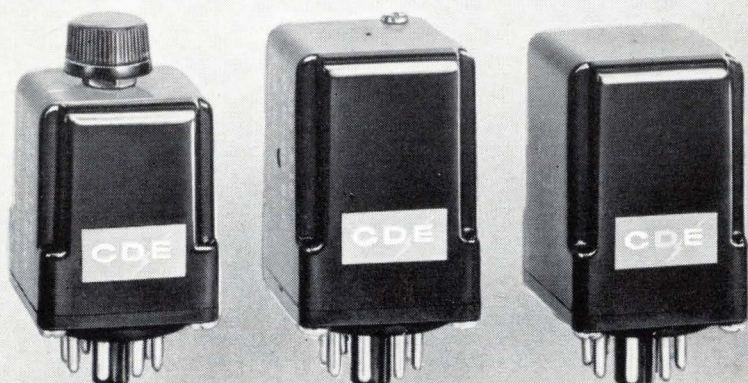



# Electronics

Which digital voltmeter? page 84  
Sensors for celestial guidance: page 94  
Transistors can multiply, divide: page 109

April 4, 1966  
75 cents  
A McGraw-Hill Publication

When Scotch tape makes memory increases  
and other "Opportunity" page 138

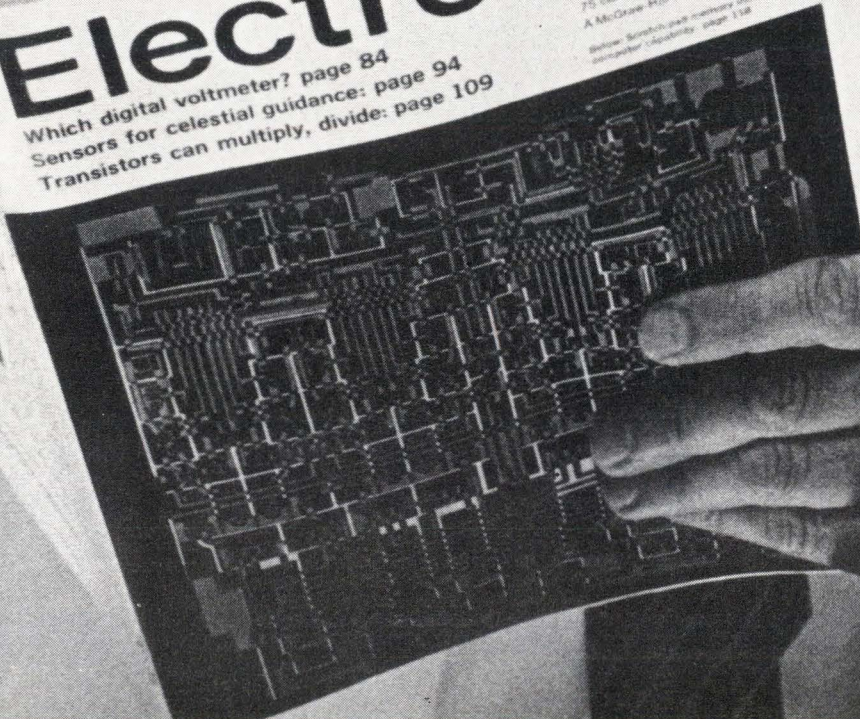

# Great editorial is something he takes to the plant

**What a climate for selling!** The myth of the closeted design engineer, with a world no larger than his breadboard, has been exploded. Today, survival in electronics requires that engineers possess the practical knowledge to see a product through from design to assembly line.

This all-encompassing need to know is best filled by Electronics — the magazine that out-publishes every periodical in its field. Side-by-side with such regular features as “Designer’s Casebook”, more than 70,000 subscribers look to Electronics for meaningful technical articles on testing, packaging, application. Where the busy engineer seeks editorial, he finds ads that keep him abreast of products and services. Be there!

**Electronics** A McGraw-Hill *Market-Directed* Publication,  
330 West 42nd Street, New York 10036

# TT $\mu$ L IS TTL LOGIC YOU CAN GET.

You get fast delivery on Fairchild TT $\mu$ L integrated circuits. We're in full production, backed by the facilities and know-how that helped us deliver over 1/3 of all integrated circuits shipped this year. Get any of our six new high level TT $\mu$ L circuits. Get them in dual in-line packages from Fairchild Distributors. Or get our data sheet.



### Features (0°C to +75°C):

- 8nsec. typical propagation delay per gate function.
- .350V guaranteed minimum noise immunity under worst case operating conditions.
- 1.3V typ. noise immunity for "1" levels.
- 0.85V typ. noise immunity for "0" levels.
- Single 5V power supply required.
- 8TT $\mu$ L fan-out over temperature range and supply voltage.
- High capacitive loading capability.
- Direct physical and electrical replacement for Fairchild DT $\mu$ L 930 series circuits.

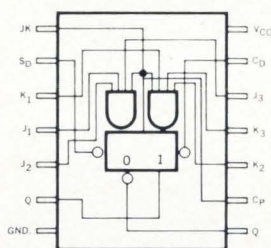

**9000 J-K Flip-Flop:** master-slave (dual rank) flip-flop with 3 J and 3 K inputs, J-K input, internal J-K connection, positive edge trigger, data input inhibit line (clock pulse), and asynchronous direct inputs to set and clear FF.

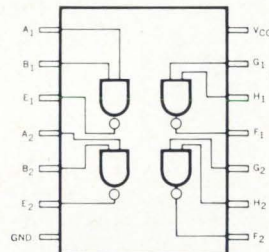

**9002 Quadruple 2-input positive NAND gate.**

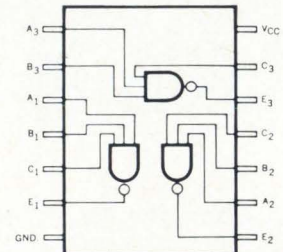

**9003 Triple 3-input positive NAND gate.**

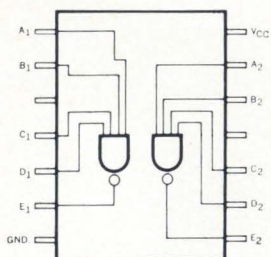

**9004 Dual 4-input positive NAND gate.**

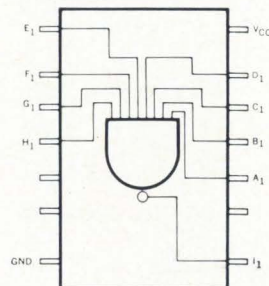

**9007 8-input positive NAND gate.**

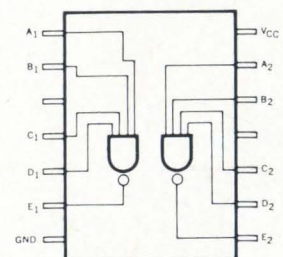

**9009 Dual 4-input positive NAND "Power" gate.**

# Probing the News

Instrumentation

## Government and industry seek to block interference

Radio-frequency interference is becoming more of a problem in communications as use of the electromagnetic spectrum expands

By Carl Moskowitz

Instrumentation Editor

**Soon after Christmas** last year, many of the 900,000 or so radio operators who use the Citizens' band (27 megahertz) were horrified to find their adult business world invaded by a barrage of children's voices claiming to be cops, robbers, Indians and cowboys.

The new transistorized walkie-talkies, operating on the same frequency as radio-equipped trucks and cabs and car telephones had hit the Christmas market, and were being operated by children across the country. Besides disturbing the Citizens'-band operators, the new toys interfered with television sets in some cities.

Last December, when Frank Borman and James Lovell orbited the earth in Gemini 7, the tracking station at Corpus Christi, Texas, lost contact with the astronauts. It was soon discovered that the cause was radio-frequency interference from the motor of a crane in a nearby steelyard. Since the noise blocked most of the useful data from the spacecraft, the National Aeronautics and Space Administration halted the crane's operation until the mission ended.

These cases of rfi are only two of many that take place in the increasingly crowded electromagnetic spectrum. But Citizens'-band operators and astronauts are not the only ones plagued by the problem. Perhaps more involved are the military services, the Federal Communications Commission, industry and research centers. "There are serious

implications to the problem," states Major General Richard J. Meyer, Commanding General of the Army's Strategic Communications Command. "Radio interference can be severe enough to result in the loss of some defense capability."

**New muscle to fight rfi.** While no

nationwide drive can clear up the whole problem, the various groups involved are increasing efforts to prevent transmitting noise as well as receiving it.

To protect home and car radio listeners, Congress is considering an amendment to the Communica-

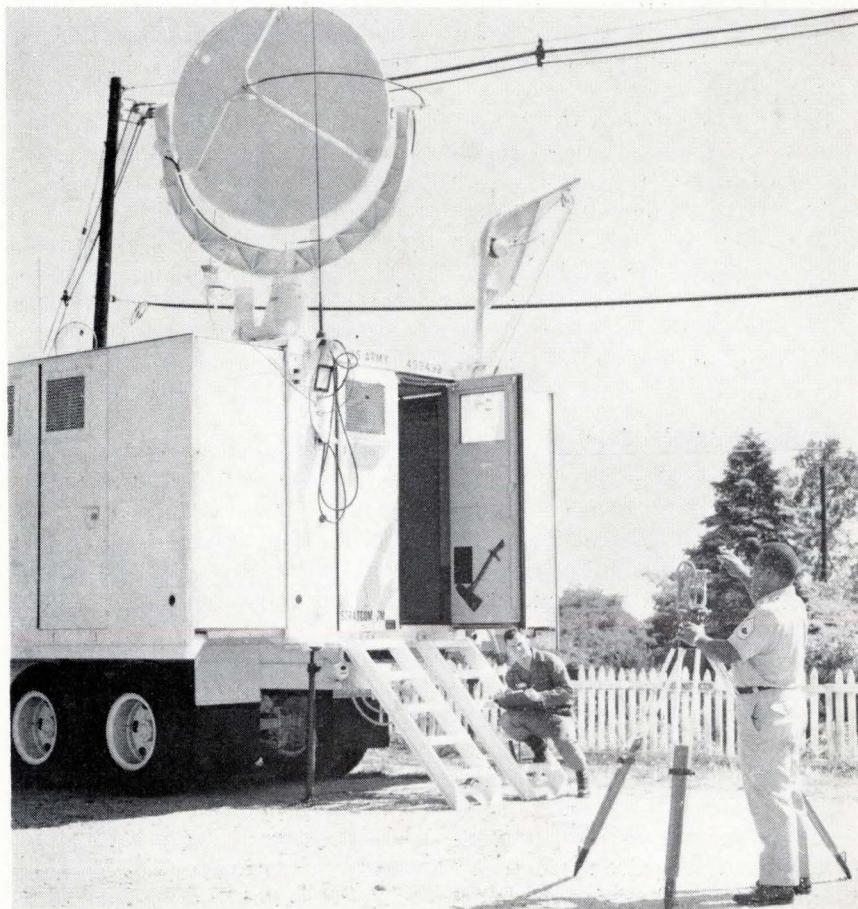

Stratcom's mobile rfi detection system provides the capability for on-site interference measurements. The antenna orientation is checked with a transit.

tions Act of 1934 to give the FCC regulatory powers to suppress radio interference. To try to put some order in the thousands of radiating devices operated by the Defense Department, the Pentagon established a facility to investigate compatibility problems—the Electromagnetic Compatibility Analysis Center (ECAC) [Electronics, May 18, 1964, p. 79].

The Army's Strategic Communications Command (Stratcom) developed an rfi detection system to measure and record the spectral content of rfi in the field. The Army also built an electromagnetic environmental test facility at its Electronic Proving Ground at Fort Huachuca, Ariz., to investigate interference problems within large concentrations of tactical communications. The Air Force and the Navy have similar facilities.

Industrial groups also organized defenses against the problem. The Society of Automotive Engineers' technical committee AE-4 has studied the electromagnetic compatibility problem for more than 10 years. The Institute of Environmental Sciences, formed to study the deleterious effects of such environments as vibration, shock, temperature, humidity and altitude, decided this past May to form a technical committee on rfi. Its program is to create an awareness of the electromagnetic environment within the environmental sciences field, to act as a liaison between electromagnetic compatibility engineers and environmental scientists and to provide a means for exchanging information throughout the electronics industry.

### I. Pentagon hunts static

The Defense Department set up ECAC in 1961 to advise the military services on their plans for installing radiation-emitting and receiving equipment and operating frequencies. According to Lt. Col. James Wishart, ECAC's chief for plans and programs, the need for such a central facility became apparent with the proliferation of communications and other electronic equipment in the services. Expenditures in military communications electronics skyrocketed from \$10 million to almost \$7.5 billion in the past 25 years.

ECAC, at the U.S. Navy Marine

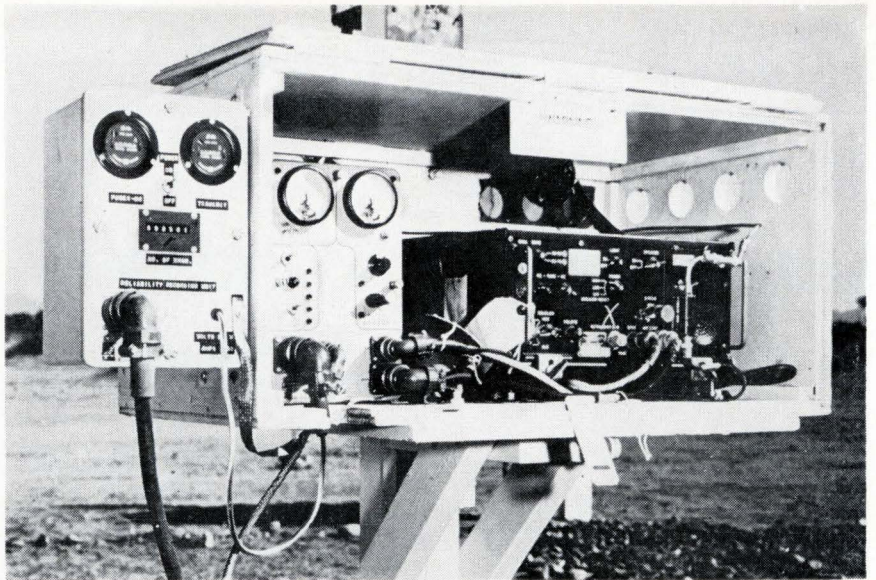

Electromagnetic environmental generator site, shown in photo at the right, used to produce a specified interference situation that could occur within an army corps. The van houses the equipment to monitor and record the electromagnetic content of the environment. The small enclosures scattered around the area, closeup above, contain equipment designed to simulate the electrical characteristics of a normal tactical radio installation.

Engineering Laboratory, Annapolis, Md., now has sufficient data to devote its full energies to predicting interference in operational situations and recommending solutions. To do its job, ECAC continually accumulates this data to enable engineers to predict rfi for specific equipment in a particular environment. The data includes an environmental file, a terrain data file and an equipment characteristic or spectrum signature file.

- The environmental file contains technical information, operating characteristics and site information relating to communications and electronic equipment already deployed. The file has been developed from field surveys as well as data from such agencies as the FCC, the Federal Aviation Agency, the Weather Bureau and the Coast Guard. The data includes geographical location of the equipment, the operating agency, operating frequency, duty cycle, antenna orientation and carrier modulation characteristics.

- The terrain data file permits computation of terrain dependency effects, such as propagation losses at existing and proposed sites. This data consists of a computer-stored matrix of latitude and longitude versus elevation above mean sea level from information supplied by the Army's map service.

- The equipment characteristic file contains general technical performance and the nominal electrical characteristics of specific equipment in both the military and non-military inventory. ECAC compiles the file from technical manuals, technical reports and spectrum signature tests performed in accordance with military specifications. The data includes transmitter power output and modulation, and receiver bandwidth and tuning ranges.

The information is stored in a computer format for use with the center's Univac 1107 computer. For a specific problem the computer calculates rfi levels and eliminates all equipment from the environment which cannot possibly cause interference. "The computer reduces the rfi problem to a size that can be analyzed by the engineer," says Stanley Safferman, one of the ECAC research engineers. Further analysis can determine degradation in system performance. Recommended corrective measures complete the investigation.

### II. The Army way

The purpose of the Army's Stratcom project is similar to ECAC's—studying the effect of rfi on fixed, strategic communications systems in their proposed environments. "But," says Sol Perlman, technical

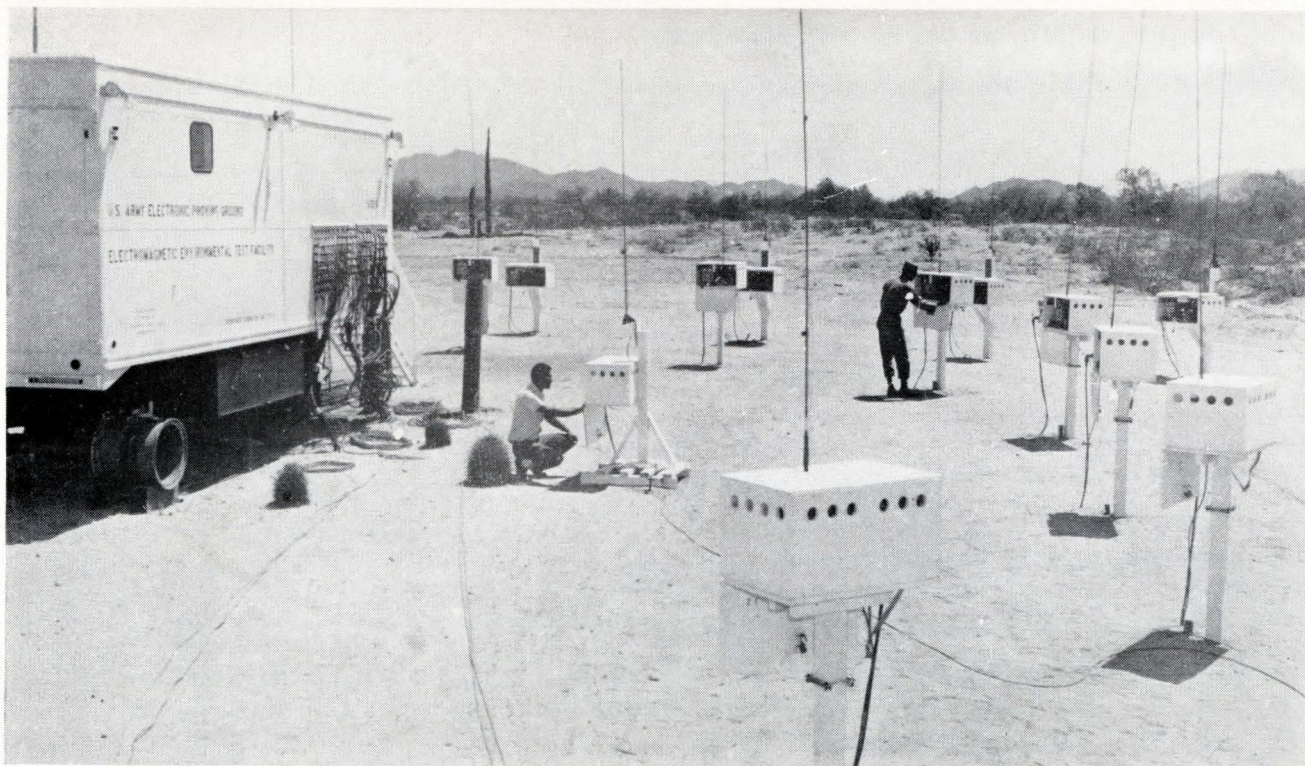

director for Stratcom-Conus' Fort Monmouth, N.J., facility, "our work starts where ECAC leaves off. Its activities are essential as a preliminary for the Army, but the answers we get are sometimes different since ECAC is only a predictive facility based on worst case analysis whereas we make actual measurements."

Stratcom, organized in 1964, is the managing agency for the Army's global communications networks, and is responsible for fixed plant communications equipment estimated at nearly \$1.5 billion.

**In the field.** Stratcom's weapons against rfi are two mobile radio-frequency interference detection systems; each truck tows a trailer that has a 15-kilowatt generator with a second for backup and storage for the three-foot dish receiving antenna and its yoke.

The rfi detection systems measure unwanted signals that interfere with operation of satellite ground stations, troposcatter installations and point-to-point high-frequency installations. Eight enlisted men and one officer run each system. Sometimes a civilian engineer provides technical backup.

Stratcom does not send out the detection team whenever and wherever interference crops up. "The measuring teams are an important instrument for analysis,"

says Perlman, "more important is what we do with the data we get. For example, the measurements enable us to interpret typical problems in terms of environment and yield a useful by-product—guidelines or rules of thumb that military commanders can use to cope with their particular rfi problems."

Stratcom-Conus' location at Fort Monmouth—between New York and Philadelphia—is a fortunate one. The concentration of powerful tv and radio broadcasting stations and military transmitters in this area enable the engineers to simulate almost any communication installation.

### III. Tactical communications

The Army's problem with rfi is not confined to strategic installations. Field units use more electronic gear than ever—radios and devices for battlefield surveillance, jamming enemy communications, fire control, telemetry, drone controls and navigational aids. The Army says a typical field army in World War II, such as Patton's Third Army, had about 12,000 sets; today a comparable unit would have more than 65,000 sets.

What would happen if all these transmitters were operated simultaneously? To answer this question, the Army set up tactical transmitters in a 40- to 60-mile area at

its test facilities near Gila Bend, Ariz. The complexity and density of traffic flow is varied and detailed measurements are made of the interference. Also measured is the interaction as new equipment replaces older models or additional equipment is added to the network. The interference patterns then determine the offending transmitters.

The engineers went a step further and developed what is called an articulation index that shows the intelligibility of a specific piece of equipment in the presence of measured amounts of interference. The index derives from a device that measures the effects of noise and interference on a special test signal representing a voice signal in a radio receiver. The articulation index when compared with actual listening tests produces what is, in effect, a calibration curve for a particular radio receiver.

The engineers also use a computer and a mathematical model of an Army field communications network to predict rfi problems that can't be set up at the test facility.

### IV. NASA

NASA's extremely sensitive receiving equipment makes it particularly vulnerable to interference. The chances, however, of an operator on the same, or very close frequencies, affecting NASA's opera-

## ... tracking down pockets of electromagnetic pollution on campus ...

tions has been reduced because the International Telecommunications Union set aside the 136-to-138, 1,700-to-1,710 and 2,290-to-2,300 Mhz bands exclusively for space purposes. NASA, however, can and does use other frequencies too.

Another source of interference harassing space agency officials arises from ordinary electrical equipment. Even an automobile ignition system or an electric mixer generates electromagnetic radiation. Usually, the effects are relatively harmless, such as blurring the picture of a tv set, but the crane incident showed how serious this type of interference can be.

**Dictator.** The agency combats rfi with a broad program that has generally paid off. NASA almost always builds ground stations in isolated areas, often with mountain barriers to block any possible rfi. (Corpus Christi was an exception; it was used because Government buildings were already there.) NASA also assigned frequency coordinators to each of its centers to choose the best available frequencies with the least potential interference. At the Cape Kennedy Space Center, the coordinator wields a virtual dictatorship over the adjacent area. Two hours before a launching, he orders taxis, ships and nearby ham radio operators off the air. Because of their rfi potential, electric garage door openers are strictly taboo in the Cape Kennedy area.

Cases of interference around the world are reported to an rfi control center at Andrews Air Force Base, Md. The center immediately contacts the responsible military base, or in the case of a foreign country the State Department, to set corrective steps in motion.

The problem is not always as simple as merely eliminating interference at ground receivers. NASA must also worry about stray signals reaching a spacecraft. It does not announce the frequencies used on manned missions for fear that ham operators in the band could contact the craft. Another fear is interference from high-powered radars already suspected of prematurely triggering satellite equipment.

NASA's problem may be simplified somewhat when the agency moves to higher frequencies less subject to interference than the present frequencies. But this changeover is moving slowly. The Defense Department says this is to take place by 1970.

### V. Industry and research

Scientific communities and research centers also have their share of rfi problems. For example, an aerial survey of r-f noise levels reportedly showed that the industrial area around the Massachusetts Institute of Technology in Cambridge, Mass. is the second noisiest r-f location along the East Coast. Only a huge shipyard along the East Coast produces more electromagnetic radiation.

On the MIT campus itself, there are hundreds of r-f radiators such as experimental radars, communication equipment and lasers. The complaints of interference have increased over the last few years.

"The man who screamed the loudest got the job of doing something about it," says one faculty member. As a result, bearded Robert P. Rafuse, an assistant professor of electrical engineering, now heads a faculty committee to solve MIT's rfi problems. The Institute made an initial investment of \$100,000 in the program.

Rafuse's goal is to track down the pockets of "electromagnetic pollution"—as he calls rfi—and prevent new ones from developing within campus boundaries.

**The offenders.** On campus, an rfi officer, Ralph C. Burgess, enforces the rules set by the faculty committee and searches for offending equipment.

Burgess designed and built an rfi wagon instrumented to measure radiation from 20 hz to 22 Ghz. The instrumentation is designed around calibrated receivers whose intermediate frequency outputs can be fed into spectrum analyzers. A 100-Ghz oscilloscope displays waveform characteristics and an x-y plotter measures frequency amplitude.

Because it has its own power source, the rfi wagon can take

measurements free of noise on the commercial power line and can go anywhere on the campus. The self-propelled wagon cruises at four miles per hour, can climb a 20° slope and fits into any elevator at the Institute.

Under the program started at MIT, the interference officer will have a role similar to that of the safety officer. He will have some say about the type of equipment purchased and some control over installation methods. Eventually, the interference officer will map out the campus to pinpoint good and bad locations for r-f transmitters.

**Building blocks.** Even buildings present problems. One new one at MIT is thought to be a quarter-wave resonator to the broadcast signal from a Boston radio station. But measurements have not yet been taken to confirm this.

When a building in the path of a signal measures from base to top about one-quarter the length of the radio wave, the resulting resonance can start high currents flowing at the base of the building. These can be the sources of interference to equipment in the neighborhood. "The building becomes a parasitic antenna," says Burgess. "The diameter of the building makes little difference. The structure acts like a radio tower, which is—after all—a building excited to radiate at a set frequency." The problem is compounded if the building has not been designed with rfi in mind, if it is not grounded as an electrically integrated structure. Then, metal parts that are electrically floating can produce harmonics and intermodulations of the signal and radiate these to the surrounding area.

The rfi faculty committee advises the MIT administration on the design of new buildings. Rafuse considers this one of the most important areas in the crusade against electromagnetic pollution. Rafuse has taken a stand against poured concrete buildings. The reinforcing rods—left floating within the walls—are not electrically grounded and can pass currents along in the presence of strong fields. Also, says Rafuse, iron oxide and other chemicals formed between two adjacent rods can form rectifying contacts and produce harmonics of a signal being reradiated.



# What cable jacket material has the toughness Grumman wants

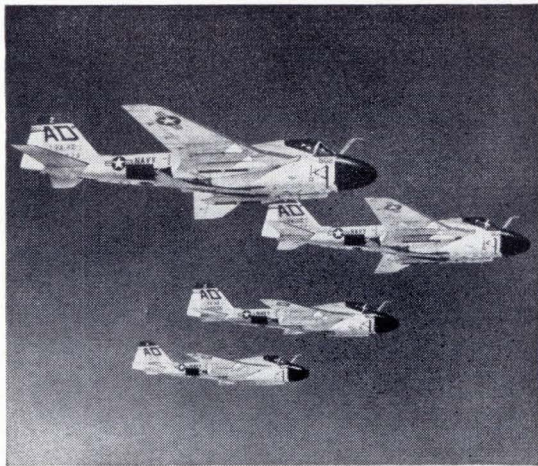

for its  
**A6A Intruder?**

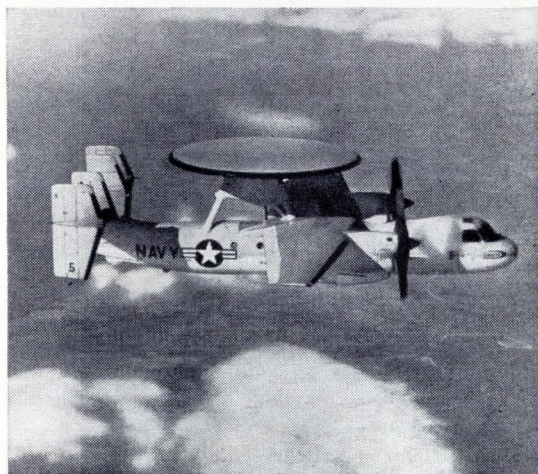

for its  
**E2A Hawkeye?**

## Answer: Kynar\*...the fluoroplastic that's tough!

Grumman Aircraft's own tests showed Kynar to be an ideally tough jacket material for single, double and triple conductor cabling. It has twice the cut-through resistance of any other fluoroplastic insulation. It resists a wide variety of solvents and corrosive fluids. And, it won't degrade with age or severe

environmental conditions.

When your design calls for cable jacket, wire insulation or heat-shrinkable tubing that's tough . . . really tough . . . specify Kynar. Write for a list of suppliers. Plastics Department, Pennsalt Chemicals Corporation, 3 Penn Center, Philadelphia, Pa. 19102.

***Kynar...the fluoroplastic that's tough!***

\*Kynar is a registered trademark of Pennsalt Chemicals Corporation for its vinylidene fluoride resin.



ONLY 3C OFFERS

# 30 DAY DELIVERY ON THE HOTTEST COMPUTER IN THE \$28,500 PRICE RANGE

DDP-116 computers are now operational in over 50 installations including communications, data acquisition, hybrid and other real-time control applications. Specifications include: 16-bit word, 1.7 $\mu$ sec cycle, expandable 4096-word memory and keyboard with paper tape I/O unit.

Software is a proven factor! The compact DDP-116 offers as many as 134 subroutines in its ASA FORTRAN IV library. Also, it is compatible with the DAP assembler and desectorizing loader. A/D and D/A subsystems, a full peripheral line and special purpose systems capability are available to extend the flexibility of the basic DDP-116.

Write for full details, or telephone today to test operate the DDP-116 at a selected 3C regional office nearest you.

## DDP-116

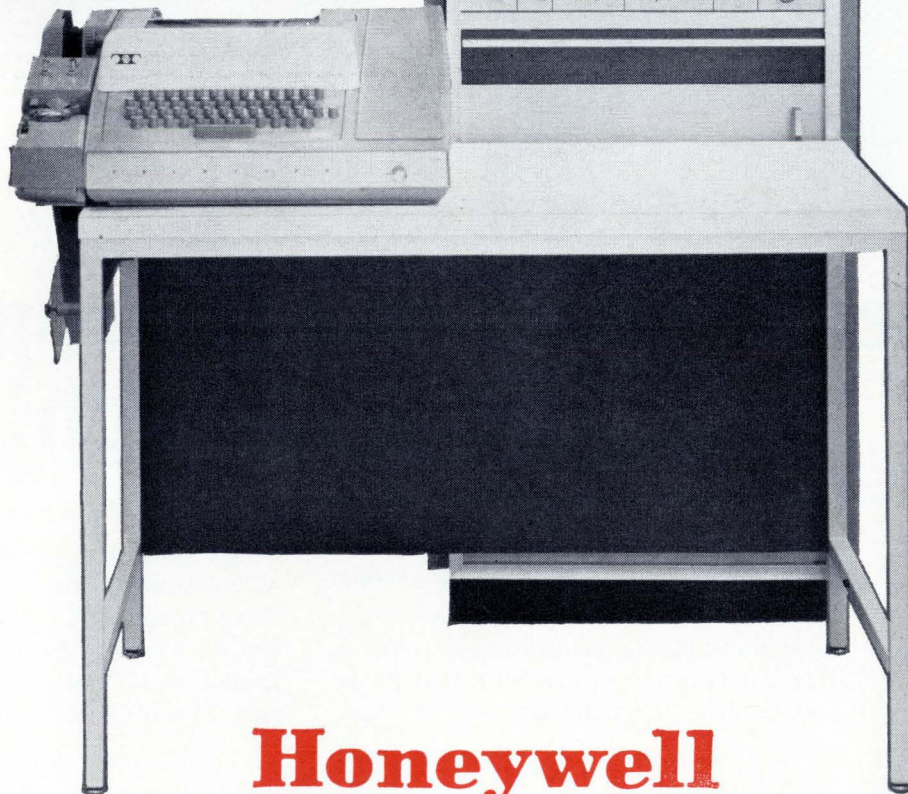

# Honeywell



COMPUTER CONTROL DIVISION

OLD CONNECTICUT PATH, FRAMINGHAM, MASSACHUSETTS

# The best of Tiros and Nimbus

RCA seeks combination of reliability and large size in a weather satellite that will carry a variety of optional sensors

By John Rhea

Electronics Washington Bureau

The nation's meteorological workhorse for the early 1970's promises to be a new satellite that combines some of the best features of the ultrareliable but limited Tiros and the big, sophisticated Nimbus that turned out to be too expensive and not reliable.

Tiros-M, as the satellite will be called, is still conceptual, with nothing more tangible built than a mockup at the Radio Corp. of America's Astro-Electronics division in Princeton, N.J. RCA has a \$932,000-contract with the National Aeronautics and Space Administration to improve Tiros.

## I. Space bus

Unlike the operational Tiros, the new satellite will be a space bus, which means it can carry different experiments and instrumentation on every launch. Tiros-M will be bigger than its predecessors and carry more instrumentation.

This flexibility delights the customer, the Environmental Science Services Administration (ESSA) of the Commerce Department. According to David S. Johnson, director of ESSA's National Environmental Satellite Center, Suitland, Md., Tiros-M for less cost will provide more weather information than before and with fewer satellites. Although the cost of ground support, \$10 million a year, stays the same no matter how many satellites are launched, the bill for launching does not. Tiros stations have a 9- to 12-month life, which means about six have to be launched each year to provide continuous global coverage. With each Tiros costing \$3 million and each launch, \$4 million, it now costs about \$42 million for satellites and launches plus \$10 million for ground support, a total of \$52 million a year.

With only two Tiros-M satellites needed a year, according to director Johnson, at \$5 million a satellite and \$4 million a launch, the total with ground support comes to \$28 million, or \$14 million less than at present.

More important than the savings, Johnson says, is the increased capability. Tiros-M will carry two advanced vidicon camera systems for high-quality weather pictures, two automatic picture transmission camera systems for broadcast to low-cost ground stations and two high-resolution infrared radiometers to collect nighttime cloud-cover data as well as a few environmental sensor experiments. Furthermore, both daylight and in-

frared data can be read out in real time by the small ground stations all over the globe or can be stored for playback at the two ESSA stations at Wallops Island, Va., and Fairbanks, Alaska.

By contrast, the ESSA 1 and 2 satellites launched in February and ESSA 3 scheduled to rise Sept. 21 can carry only two automatic picture transmission systems or two vidicon systems and no infrared sensors. Since ESSA demands constant global coverage on a daily basis the agency must be ready to launch a new satellite as soon as any sensor fails. All ESSA satellites are versions of the Tiros, first launched in 1960.

William Jones, who heads the

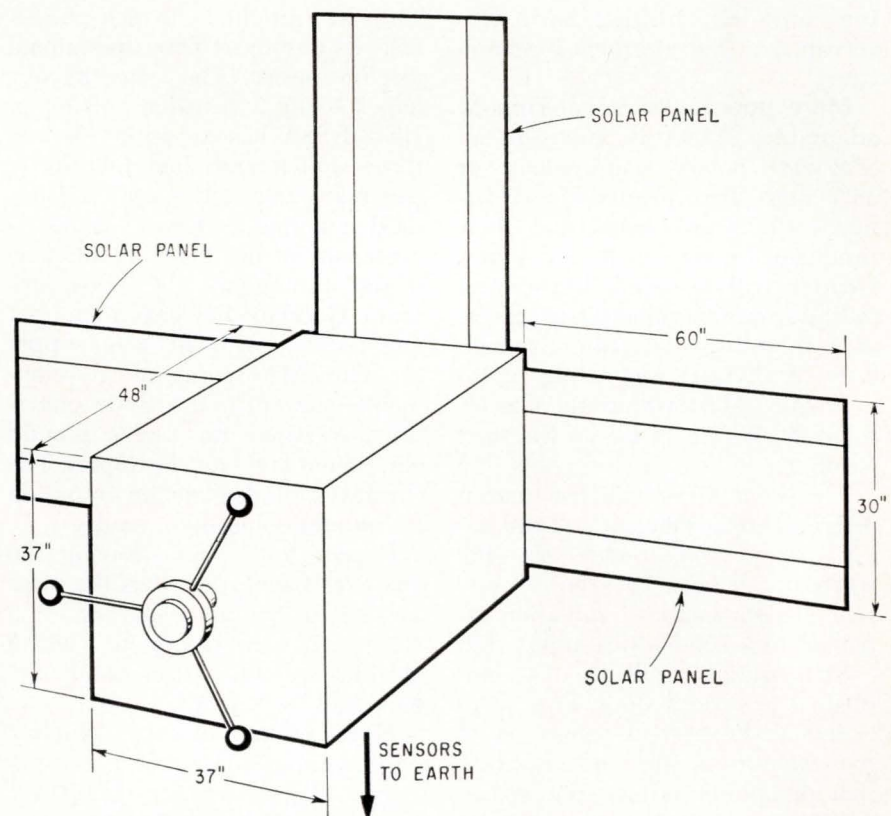

Stabilization system on the front of Tiros-M points sensors toward the earth.

## ... the old Tiros satellites will be around for at least the rest of this decade ...

Tiros-M project at NASA's Goddard Space Flight Center, says the configuration of Tiros-M has undergone many changes since RCA was selected to make the study. Conceived originally as a 500-pound spacecraft shaped like a cylinder, 5 feet tall by 4½ feet in diameter, its weight has since shot up to around 625 pounds and a unique apple-crate shape has emerged. Tiros satellites of today weigh 300 pounds. The experiment section at the bottom of the spacecraft will carry a solar proton sensor being developed by the Applied Physics Laboratory of Johns Hopkins University and a flat plate heat radiation experiment from the University of Wisconsin. Also at the bottom is the S-band antenna, although the exact arrangement is still under study.

The bus concept is something new for RCA, which has traditionally pushed its small, specialized spacecraft such as Tiros and the Space Electric Rocket Test as opposed to the big satellites such as the Orbiting Geophysical Observatory of TRW Systems Group, TRW, Inc., and the Orbiting Solar Observatory of Ball Brothers Research Corp.

**More power.** To make Tiros-M adaptable, NASA is imposing an 86.2-watt power requirement, or 25% more than needed. Jones believes the solar panels that RCA produced for the successful Lunar Orbiter will be used, but that a radioisotope thermoelectric generator might be substituted much later. A 30-watt unit using plutonium-238, Martin-Marietta Corp.'s Snap-19, is due to fly on the next Nimbus.

The solar array will use n-on-p cells with 9% efficiency. Total array output requirement is 186 watts based on a 70% power system efficiency and the radiation expected in a 750-nautical-mile orbit.

Stabilization will be accomplished in several steps. First a so-called Yo-Yo system consisting of two weights on the end of cables will deploy to reduce the spacecraft's spin rate to a few revolutions per minute. Then magnetic

coils will orient the craft along the plane of the earth's magnetic field and further reduce spinning to 1 rpm. Finally, a new device of RCA's known as Stabilite goes into action. It consists of an external flywheel that spins in a direction opposite to the spacecraft's so that all the sensors always face the earth. Tiros-M will be the first space agency satellite to use Stabilite. The design goal of the new satellite is six months of useful life, but the agency and ESSA hope to increase that by using the superior technology that will be available in the 1970's.

### II. Still has a role

For the rest of this decade, ESSA will stick with its present Tiros program. Eight more satellites each with either two advanced vidicon or two automatic picture transmission systems are being built by RCA. Also, two prototypes will be refurbished and flown to bring the total to 10. The goal is to have one of each kind of satellite in orbit and operational at all times.

The next step is to phase in the Tiros-M satellites, which ESSA calls its improved Tiros operational satellite series. The space agency hopes to fly a research version in 1969. ESSA has an option to buy three similar craft and Johnson is eager to exercise this option. Goddard is acting as ESSA's purchasing agent in dealing with RCA as it has throughout the Tiros program. Goddard has begun contract negotiations with RCA to supply the Tiros-M research and development spacecraft, the three operational versions for ESSA, ground equipment and launch support. The contract will also contain an option for an additional flight model.

Except for NASA's buying the spacecraft, ESSA's role is the same as the Communications Satellite Corp.'s: it has complete control of the satellites once they are launched by NASA.

**High price.** Although Nimbus will continue as a research and development platform for testing new instrumentation, it is no longer considered the ultimate operational

weather satellite. Three years ago, the Weather Bureau pointed out that costs in the three-flight Nimbus program had skyrocketed to \$140 million and by the time of the first launch, Aug. 28, 1964, the program was two years behind schedule. The first Nimbus operated for one month, far short of the practical minimum.

The General Accounting Office, Congress's watchdog, added its criticism in January, 1965, charging that poor management at NASA's Goddard Space Flight Center had resulted in an excessively heavy and expensive satellite.

Although ESSA demanded—and got—a refund of some \$20 million from the space agency for its share of the Nimbus program, ESSA continued to be interested in the larger satellite for research purposes. In fact, ESSA is developing a satellite infrared spectrometer to measure atmospheric temperature profiles on the next Nimbus flight scheduled for late 1967. Nimbus 2 is now in orbit carrying research versions of weather instruments.

**Booster.** The launch vehicle for Tiros-M will be the familiar Delta used for all previous Tiros satellites but with some differences. Performance will be improved by using more fuel, adding three solid rocket motors and substituting a more powerful upper stage, perhaps the retrorotor which landed the Surveyor gently on the moon. All future ESSA launches will be from the Air Force's Western Test Range in California. The orbit will carry the satellite over the poles where it will be synchronized with the sun so that about half of each orbit will be in daylight and the other half in darkness. The satellite measures 37 by 37 by 48 inches and the three solar panels are 30 by 60 inches. These fold flat against the spacecraft at launch and the entire package is housed in the protective shroud used for Nimbus satellites. According to Jones, the satellite can be unfolded to install experiments.

### III. Three objectives

From the ESSA point of view, according to Johnson, Tiros-M represents the fulfillment of an important agency objective: uninterrupted global cloud-cover photog-

raphy. Johnson spelled out two more ambitious goals before the Senate Space Committee in March, 1965.

One is constant sampling of such environmental data as wind direction and velocity, temperatures and atmospheric pressure on a global basis. Various schemes have been proposed, such as gathering data from balloons and buoys and relaying the information to satellites for playback later to ground stations. Nimbus will be the major research tool in the sampling program, Johnson believes.

The Applications Technology Satellite, scheduled by NASA for its first launch in December, will meet the other goal: continuous observation of the earth from a synchronous and stationary orbit. In this orbit 22,300 miles above the equator, a satellite's motion is synchronized with the earth's rotation so that it hovers above one spot. From this vantage, where the entire earth's disk is visible, storms could be traced from birth and data could be gathered for hurricane warnings. A special meteorological camera developed by the University of Wisconsin and the Santa Barbara, Calif., Research Center of Hughes Aircraft Co. will be tested for this purpose on the first flight.

**What lies ahead?** ESSA doesn't know what form the weather satellite system of the late 1970's will take, but Johnson doubts that any single satellite can do the job. He foresees a mixture of polar-orbiting, medium altitude (750 to 1,500 nautical miles) satellites and synchronous-orbit satellites ranging around the equator. Two equatorial satellites could provide satisfactory coverage of North America and nearby oceans; four satellites would cover the globe.

Also unanswered is the question of what support other countries and the World Meteorological Agency of the United Nations will provide. The Russians have already announced the launch of their first weather satellite and on Aug. 18 began sending satellite-gathered weather data to the United States through the Moscow-Washington data link. Still, in this area of space technology the United States is clearly the leader and any international system is certain to be built around the American program.

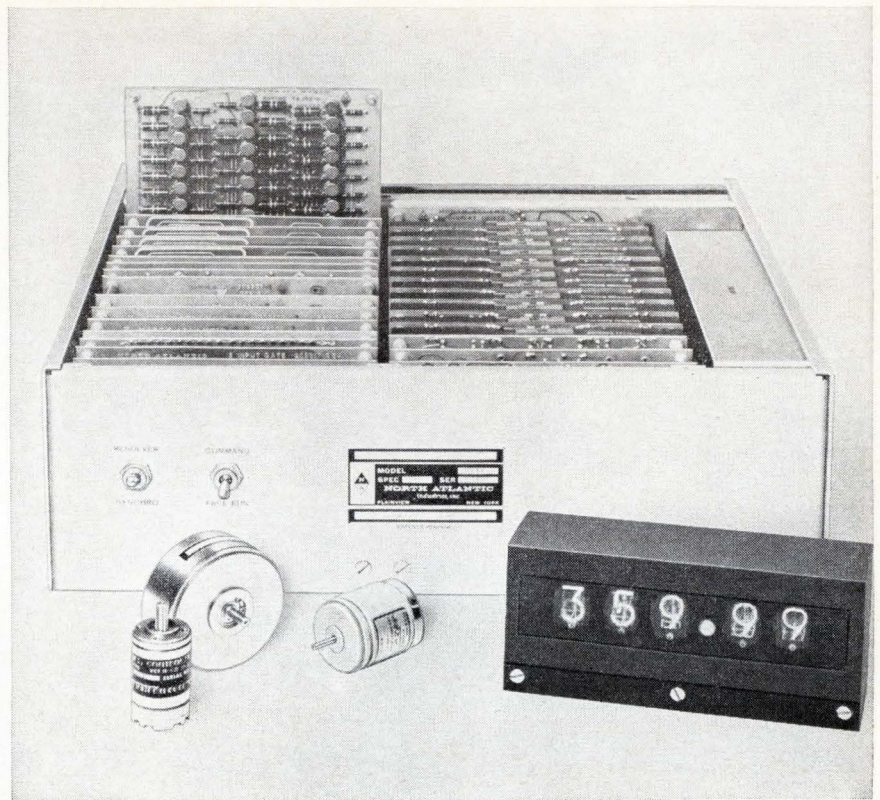

## how to convert resolver and synchro angles to digits (and vice versa)

North Atlantic now brings you a new family of solid-state analog-to-digital and digital-to-analog converters for resolver and synchro data. They offer a major advance in conversion accuracy in modern navigation, simulation, data processing and measurement systems.

Typical of these new instruments is the Model API-5450 shown here. It provides both continuous and command conversion of both resolver and synchro angles, accommodates all line-to-line voltages from 11.8 to 90 volts at 400 cps. Output data is in decimal digits and is presented both as a Nixie-tube display and a five-digit printer output with supplementary print command. Accuracy is  $0.01^\circ$  and update time is less than 1 second.

All instruments in this family are designed to MIL-T-21200 and feature all solid-state circuitry and precision transformers—there are no motors, gears, or relays. Their flexible plug-in modular circuit design permits a wide range of variations to suit your specific requirements. For example:

- 18 bit or 10 second accuracy and resolution
- binary, BCD, or decimal inputs/outputs
- multiplexed channels
- multi-speed inputs/outputs
- high conversion speeds
- other signal frequencies

Your North Atlantic representative has complete application information. He'll be glad to help you solve interface problems in measurement and data conversion. Simply call or write.



**NORTH ATLANTIC industries, inc.**  
TERMINAL DRIVE, PLAINVIEW, L. I., NEW YORK • Overbrook 1-8600

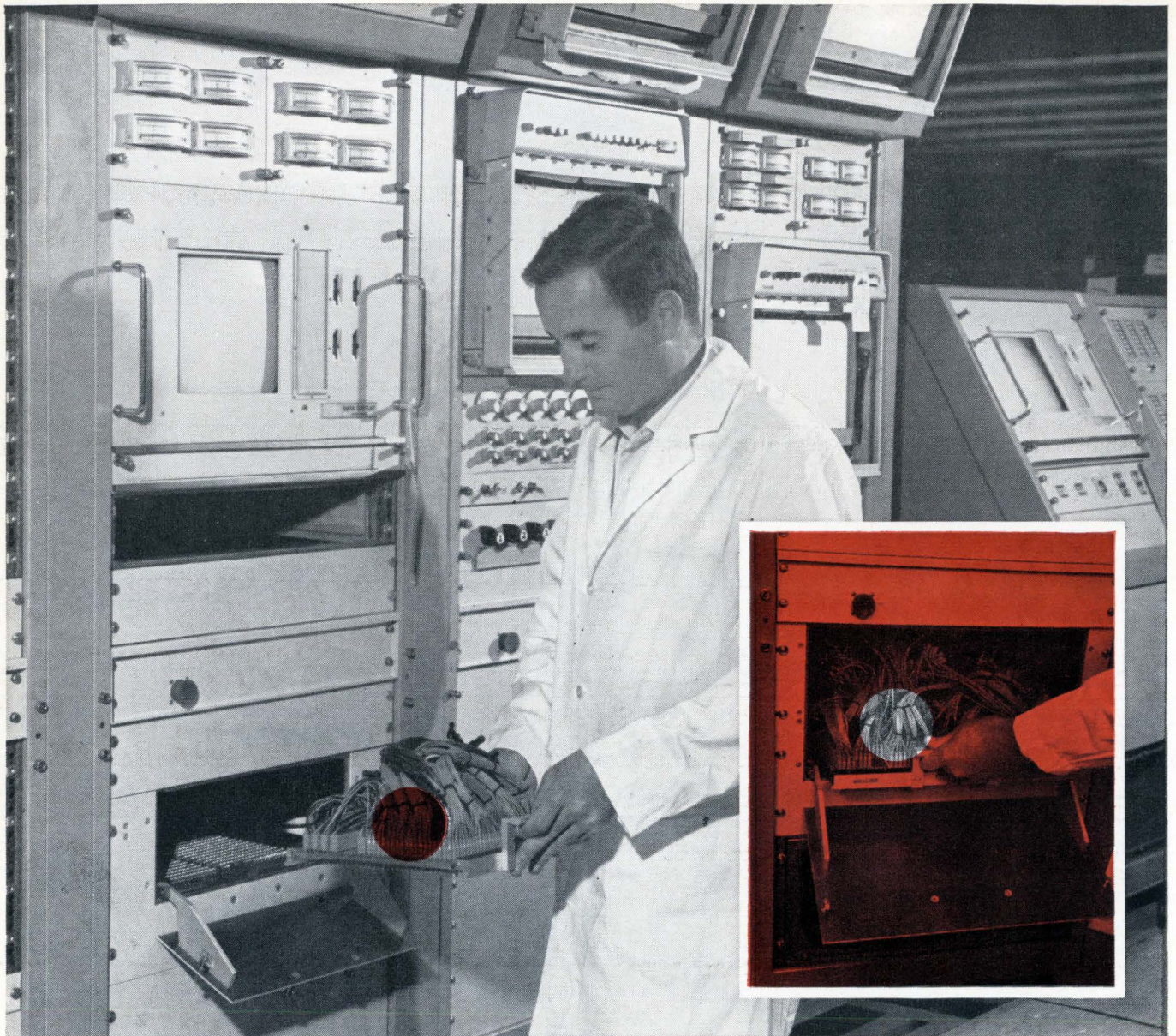

## Project APOLLO . . . Shooting for the moon

With the emergence of Apollo as a full-fledged space program, Acceptance Checkout Equipment is being automated. General Electric Company has the responsibility for building a number of ACE stations, each comprising over a hundred racks used for data computation, recording, and display.

Space saving was second only to component reliability in these systems, particularly in the Control Room, where lead engineers and technicians man 59 different consoles to monitor the various spacecraft functions. For the all-important patchboards required in this facility, GE's Apollo Support Department selected AMP's Patchcord Programming System.

Occupying only 8¾ in. of rack height, our system provided space savings up to 50% over vertical installation. And it embodied all the quality and performance features characteristic of A-MP\* Patchcord Programming Systems—including panel door-actuated front board/rear bay engagement, a range of sizes accommodating as many as 1632

pre-programmed circuits, and AMP's exclusive double-wiping contact action.

A-MP Patchcord Programming Systems will be used in pre-launch checkout equipment for the Apollo spacecraft. The high integrity, compactness, and programming flexibility of these precision-engineered systems are a vital step toward assuring the success of America's moon mission and future space conquests.

AMP makes a complete line of patchcord programming products for both military and commercial applications. Write today for more information.

\*Trademark of AMP INCORPORATED

**AMP**  
INCORPORATED  
Harrisburg, Pennsylvania

A-MP\* products and engineering assistance are available through subsidiary companies in: Australia • Canada • England • France • Holland • Italy • Japan • Mexico • Spain • West Germany

# Turning night into day

The Defense Department is pushing harder for development of low light-level television for spotting the enemy from aircraft

By Marvin Reid

Dallas News Bureau

**The United States forces** in South Vietnam are fighting one of the Vietcong's staunchest allies—the night—with new weapons. Reports from Vietnam tell of Army helicopters equipped with low light-level television cameras that seek out the enemy by moonlight or starlight.

The Pentagon is upset by these reports and is trying to find out how the highly classified project, called Batman, got out.

## I. Batman sees all

According to the New York Times and Washington Star, there are five of the new tv systems in South Vietnam. One of them recently picked up a good picture at 2 a.m. of a couple of enemy trucks and the unloading of a Vietcong sampan. The systems, each of which costs \$1 million, consist of a small tv camera mounted on the nose of the helicopter and two 8-inch tv receivers. One receiver is in front of the copilot and the other is in the rear for use by a photo interpreter. The view can also be videotaped. Although both the Air Force and the Navy are interested, the Batman systems are being flown by the Army.

The reports did not say who built Batman equipment, and the Night Vision Laboratory of the Army Electronics Command at Fort Belvoir, Va., where such work is being done, or contracted for, won't even discuss it.

**Eyeglasses.** One of the more interesting projects, partially sponsored by the Laboratory, is known to be a low light-level tv system being built in Hurst, Tex., by the Bell Helicopter Co., a division of Bell Aerospace Corp. The tv camera, which is installed in a three-



Pilot views on his special lenses what his low light-level tv camera picks up in the dark. He can also look through this display at the normal night scene.

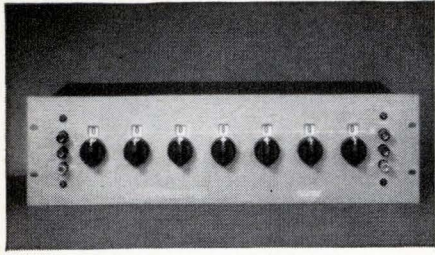

# Kelvin and Varley would be exultant!

**(Their circuit is being used in this ESI Voltage Divider to give you 1 ppm accuracy.)**

The Kelvin-Varley Circuit was invented while the two men were collaborating on the Project Mercury of their day—the laying of the Atlantic Cable.

It is now used to achieve state-of-the-art accuracy in the decade voltage divider above (our model RV-722). This instrument has a terminal linearity of 1 ppm.

At low settings you will be able to do even better than 1 ppm. If, for example, the first three dials are set at zero, the output voltage will be accurate to a fraction of one division of the seventh dial. Each step of that dial is *one part per ten million*.

With each instrument, you get a calibration certificate giving check-out readings accurate to 0.2 ppm. All at a price worthy of Lord Kelvin's Scottish heritage: \$900. ESI, 13900 NW Science Park Drive, Portland, Oregon (97229).

**Model RV 722 DEKAVIDER Decade Voltage Divider**  
**Circuit:** Kelvin Varley Resistive Divider  
**Resolution:** 10,000,000 divisions—0.1 ppm steps  
**Input Resistance:** 100 Kilohms  $\pm 0.005\%$   
**Temperature Coefficient:**  $\pm 0.5$  ppm/ $^{\circ}\text{C}$   
**Power Coefficient:**  $\pm 1$  ppm/watt maximum  
**Maximum Input Power:** Five watts  
**Maximum Input Voltage:** 700 volts rms, 1000 volts peak  
 Input terminals for individual decades are provided for calibration of each decade. Paralleled switch contacts of silver alloy provide improved accuracy at all settings.



axis turret on the nose of a UH-1B helicopter, is aimed by the movement of the pilot's head—up, down, left or right. The pilot's display screen is a special pair of eyeglasses. He can also look through the display on the eyeglasses at the night scene as he would normally see it.

Projecting the display on the eyeglasses eliminates the need to tie up valuable instrument panel space for a conventional display system, and it gives the pilot a natural view of the direction in which he is looking.

**Tiny tubes.** Miniaturized cathode-ray tubes, built for Bell by Thomas Electronics, Inc. of Passaic, N.J., are on either side of the pilot's helmet. Each tube is 1 inch in diameter and projects a 1-mil electron spot beam. With an aspect

ratio of 3:4, image resolution is approximately 450 horizontal tv lines per inch. Glasses and tubes weigh 15 ounces. The optics system, built by the Perkin-Elmer Corp., provides a 40° by 40° field of view.

The image on the face of the crt is reflected by a mirror through a relay lens that re-forms the rays into an aerial image. A second mirror positions the aerial image on the reflecting lens (the inside of the pilot's glasses) which also acts as a collimator. The result is that the tv image is superimposed upon the pilot's normal field of view.

## II. Electro-optical headtracker

The pilot's ability to aim the camera by moving his head is accomplished through an optoelectronic servosystem. It begins with a monitor attached to the top of

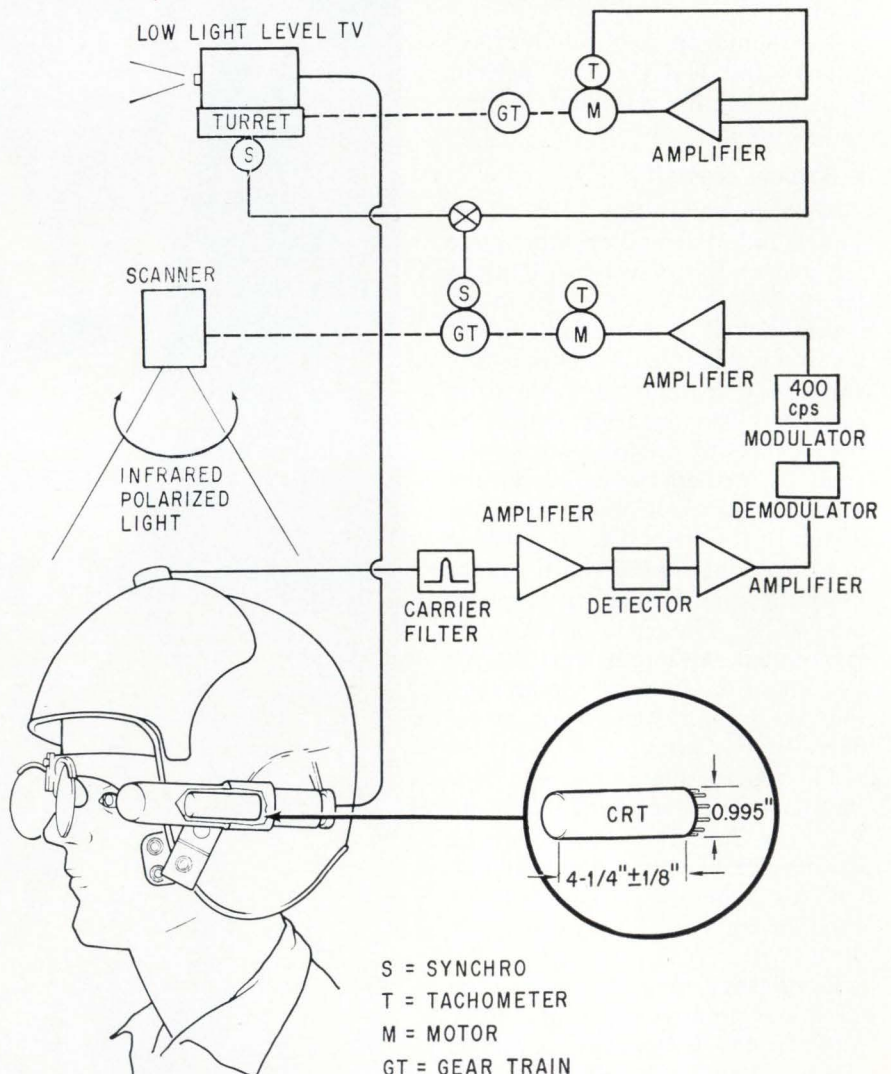

**Optoelectronic servosystem** allows pilot to control television camera in nose of helicopter by movements of his head. Transmitter in scanner emits light in the near-infrared region that is polarized and is scanned to determine its phase and amplitude. The monitored signal is used to drive a servosystem that controls the camera's position.



the cockpit that measures the position of the pilot's head. The transmitter emits a cone-shaped (70°) beam of nonvisible light in the near-infrared region, approximately 0.9 microns. The energy is 50 milliwatts.

The emitter is a gallium-arsenide diode, made by Texas Instruments Incorporated, that is excited at carrier frequencies from 3 to 10 kilohertz. A different carrier frequency is used for each of the three axes—pitch, roll and yaw—to reduce crosstalk. The light passes through a linear polarizer, producing a reference polarizing angle. The polarizer is mounted on a torsional scanner that operates on a frequency of 100 khz and modulates the carrier signal.

A second polarizer is over the electro-optical receiver on the helmet. The receiver's output is also modulated by a 100-hz signal. The amplitude and phase of the modulated signal varies according to the angle and distance between the transmitter and the receiver. Its amplitude is inversely proportional to the square of the distance, and its phase varies according to the angle because of the polarization of the infrared light.

**Filtered signal.** The received carrier signal is filtered to reject spurious signals, for example, when pitch is being measured the carrier frequency for roll and yaw will be rejected. The output's d-c level is detected and is used to develop an automatic gain control signal in the servo loop illustrated in the diagram on page 140, so that the servo loop gain is independent of the distance between the transmitter and the receiver.

Meanwhile, a phase-sensitive demodulator develops an error signal that drives a 400-hz modulator, amplifier and servomotor. The servomotor moves the reference polarizer in the scanner to minimize the intensity of the light, thus nulling the error signal. A synchro control transmitter measures the servo position, which is proportional to head position.

The scanner system was fabricated by the American Time Products Co. at Woodside, New York. The filters were provided by the Polaroid Corp.

The only attachment to the pilot's helmet is a small flexible set



*basic measuring tools from*

**HEWLETT  
PACKARD**

*hp field-proven*  
**412A Multi-Function Meter**

**Basic tool for measuring 1 mv-1000 v dc, 1  $\mu$ a-1 a, 1 ohm-100 Meg  
1% accuracy, floating input, high input impedance  
No zero set**

**Use it for:**

**Broadband measurements  
High-gain amplification—a 60 db amplifier with rear-terminal output  
Lab or production line, where high performance and low cost  
are important**

Ease of use and wide dynamic range are the principal benefits of using the hp 412A—only three controls, no zero set. Measurement accuracy for dc voltage is  $\pm 1\%$  of full scale; dc current is  $\pm 2\%$  of full scale; ohms accuracy is  $\pm 5\%$  of reading. Thirteen voltage and current ranges and nine resistance ranges give you maximum resolution, and an individually calibrated meter assures highest possible accuracy. hp

412A, \$400; 412AR (rack mount), \$405.

Call your Hewlett-Packard field engineer for a demonstration of the popular 412A, or write for full specifications: Hewlett-Packard, Palo Alto, Calif. 94304, Tel. (415) 326-7000; Europe: 54 Route des Acacias, Geneva.

*Data subject to change without notice.  
Prices f.o.b. factory.*



1901

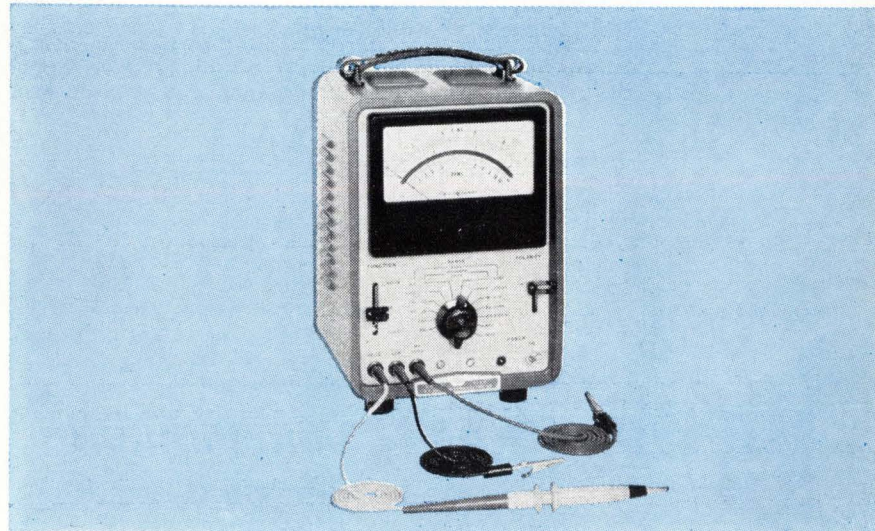

# NEW!

## Push-Button Bridge

### Measures Impedance to 0.1% Accuracy

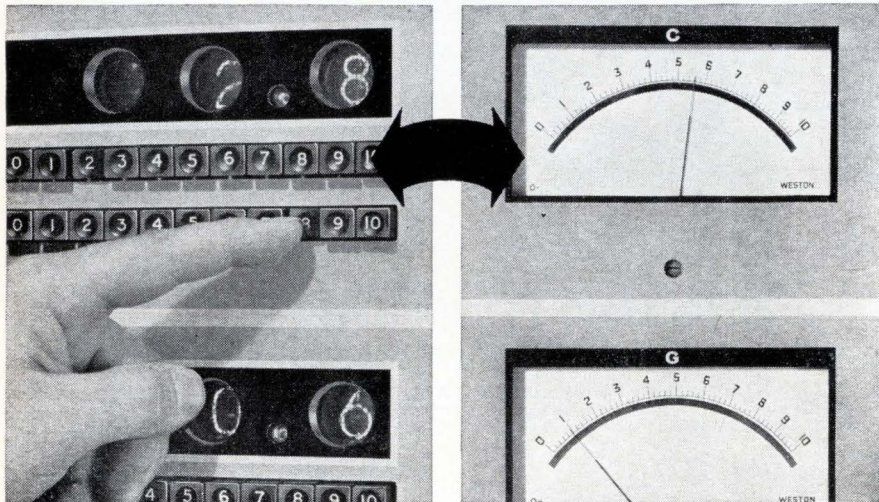

Once the Bridge is trimmed, a series of front-panel range push-buttons are suppressed in sequence until a reading is obtained on the meter. Setting up the first one or two digits of this reading on push-button decade controls gives the final reading.

## No Manual Balancing with New Wayne Kerr B641 Universal Impedance Bridge

Now, batch testing of components or the observation of changing values under laboratory conditions are made simpler and faster by the new Wayne Kerr B641 Universal Impedance Bridge.

Designed for the continuous measurement of any type of impedance or admittance, at audio frequencies, as low as 1 picofarad — to an accuracy of 0.1% — the B641 eliminates manual balancing, makes readout virtually automatic.

Operation is simple: once the Bridge is trimmed, it is necessary only to depress a series of front-panel range push-buttons in sequence until a reading is obtained on the electronically-balanced meters. Setting up the first one or two digits of this reading on push-button decade controls makes the balancing automatic; the meters can read the first, second, third or fourth digits.



The Bridge produces analog voltage proportional to the meter readings and BCD (in a 1248 code), for the nixie readout.

The B641 is based on the transformer-ratio-arm principle, giving stable performance even when components under test form part of a sub-assembly (such as a printed board or an encapsulated unit) or when long measurement leads must be used.

#### SPECIFICATIONS

<b>Overall Ranges:</b> 0.002pF — 50,000 $\mu$ F	<b>Accuracy:</b> 0.1% from 1pF to 10 $\mu$ F
20p $\Omega$ — 500 $\Omega$	10n $\Omega$ to 100m $\Omega$
200nH — 5MH	1mH to 10kH
2n $\Omega$ — 50,000M $\Omega$	10 $\Omega$ to 100M $\Omega$
<b>Discrimination:</b> 0.01% of max. on all ranges	<b>Price:</b> \$1,700 FOB Montclair, New Jersey

For literature and detailed specifications, write:



## Wayne Kerr CORPORATION

18C Frink Street, Montclair, N.J. 07042 • Phone 201 746-2438

INNOVATIONS IN INSTRUMENTATION

of wires leading to the receiver. This connection can be quickly severed in an emergency.

### III. Tested and approved

The forerunner of this electro-optical system was a mechanical headtracker that Bell tested as a possible way to use the pilot's head motions to aim a tv camera. The mechanical system consists of a set of parallelogram linkages and gimbals with associated synchros to measure head position in pitch, roll and azimuth. It was fabricated initially to permit flight testing of the entire system.

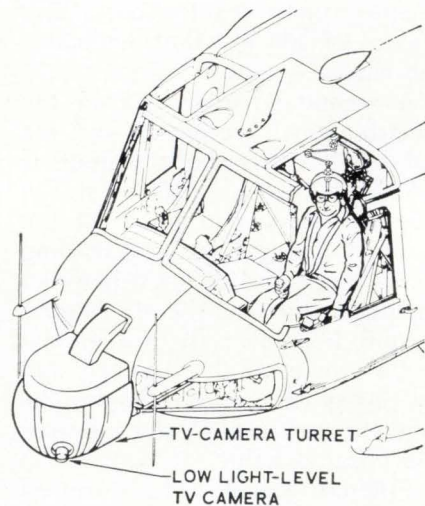

Bell envisions several uses for its tv system: pilots can fly by it, direct armament and use it for surveillance.

All the systems except the low light-level tv camera have been completed and tested in the laboratory. The tests were carried out with a regular tv camera. Flight tests have been conducted using the mechanical headtracker eyeglasses and the daylight camera, and Bell says the system feasibility has been confirmed.

The eyeglass display is being worked on now by Perkin-Elmer to improve the optical resolution. Also, the miniaturized crt's are under further development to improve brightness and resolution. Both the mechanical and the electro-optical headtrackers are being reviewed critically. Future systems will be committed to one or the other headtracker design. Bell leans at this stage to the electro-optical, saying it provides the pilot with more freedom. But, the final decision on which system wins out will have to be made by the customer.

# Because you have to know NOW!

Technical Series IC-40  
Suggested Price \$2.00

RCA linear integrated circuit fundamentals

## RCA linear integrated circuit fundamentals

• design  
• application

 Radio Corporation of America  
Electronic Components and Devices, Harrison, N. J.

RCA announces the first definitive engineering text solely on **linear integrated circuits**. 240 pages of solid information cover important considerations for the engineer who has to be ready to make the transition to **linear integrated circuits** for communications, TV, radio, instrumentation, telemetry, data processing, and control.

RCA LINEAR INTEGRATED CIRCUIT FUNDAMENTALS is your "bridge" from discrete-component concepts to the practical, here-and-now details of linear IC's. It's the professional design man's guide—not a discussion of diffusion techniques, not a hobbyist's manual.

It covers:

general design considerations... differential amplifiers... operational amplifiers... transfer characteristics... feedback considerations... equivalent circuit models... frequency response... phase compensation... circuit applications... design features.

GET STARTED NOW in this important, new design area. Pick up a copy at your RCA Distributor's—or use the coupon to place your order.



Electronic Components and Devices

The Most Trusted Name in Electronics

COMMERCIAL ENGINEERING  
RCA ELECTRONIC COMPONENTS & DEVICES  
HARRISON, N. J. 07029

Attached is my check/money order for \$\_\_\_\_\_,  
covering \_\_\_\_\_ copy/ies of RCA LINEAR  
INTEGRATED CIRCUIT FUNDAMENTALS  
@ \$2.00 each.

NAME \_\_\_\_\_

COMPANY \_\_\_\_\_

ADDRESS \_\_\_\_\_

CITY \_\_\_\_\_ STATE \_\_\_\_\_ ZIP \_\_\_\_\_

# Work at your own speed at Lockheed.

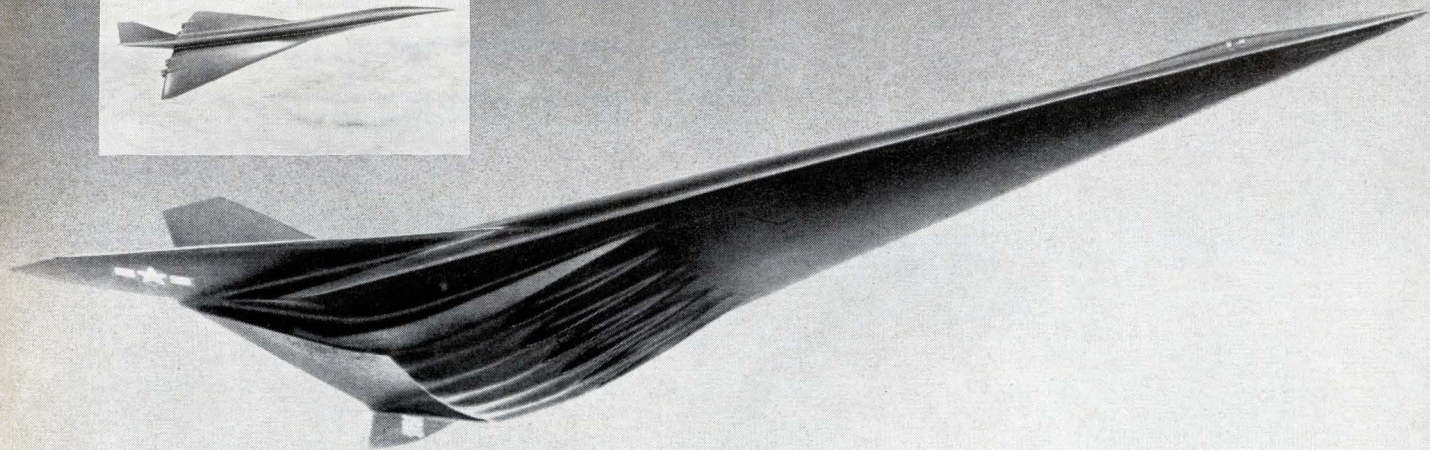
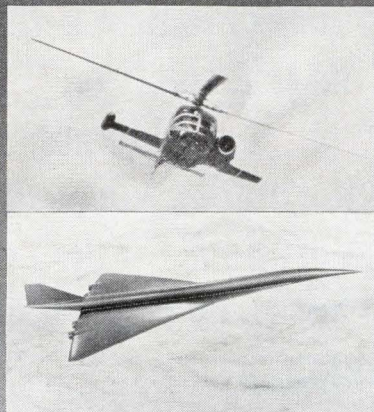

## Subsonic. Supersonic. Hypersonic.

Where do you feel the greatest potential in developmental aviation lies today? Which type of craft, which speed regime, is personally most stimulating to you? Subsonic? Supersonic? Hypersonic? No matter what your answer, you will find a breadth of opportunity at Lockheed that is unmatched in the aerospace industry today.

The Army's Advanced Aerial Fire Support System—AAFSS—is the first major compound helicopter award in history to enter development. It is at Lockheed. Revolutionary composite vehicles able to stop, fold, or start blades in forward flight are another current Lockheed project. From heavy-lift helicopters for large cargo operations to STOL and V/STOL short-haul

passenger transports, Lockheed is active in virtually every aspect of developmental aviation.

Lockheed is also hard at work on a new generation of high performance aircraft in the upper supersonic speed range. At the same time, other remarkable aircraft, for Mach 3 flight, are currently in development at Lockheed. Additional work is continuing on supersonic V/STOL fighters, extremely advanced versions of the famed F-104 Starfighter, and America's fixed-wing SST.

Lockheed is using the SCRAMJET approach in manned hypersonic test and cruise vehicles. Designed to fly many times the speed of sound, they will help man achieve the capability of

landing at earth bases after maneuvers in space. And also, they will lead to high priority passenger and cargo transport at hypersonic speeds.

A large number of significant positions are now open for engineers on sub, super, and hypersonic programs. For information concerning specific opportunities, please write: Mr. E. W. Des Lauriers, Professional Placement Manager, Dept. 1509, 2404 North Hollywood Way, Burbank, California. Lockheed is an equal opportunity employer.

**LOCKHEED-CALIFORNIA CO.**  
A DIVISION OF LOCKHEED AIRCRAFT CORPORATION

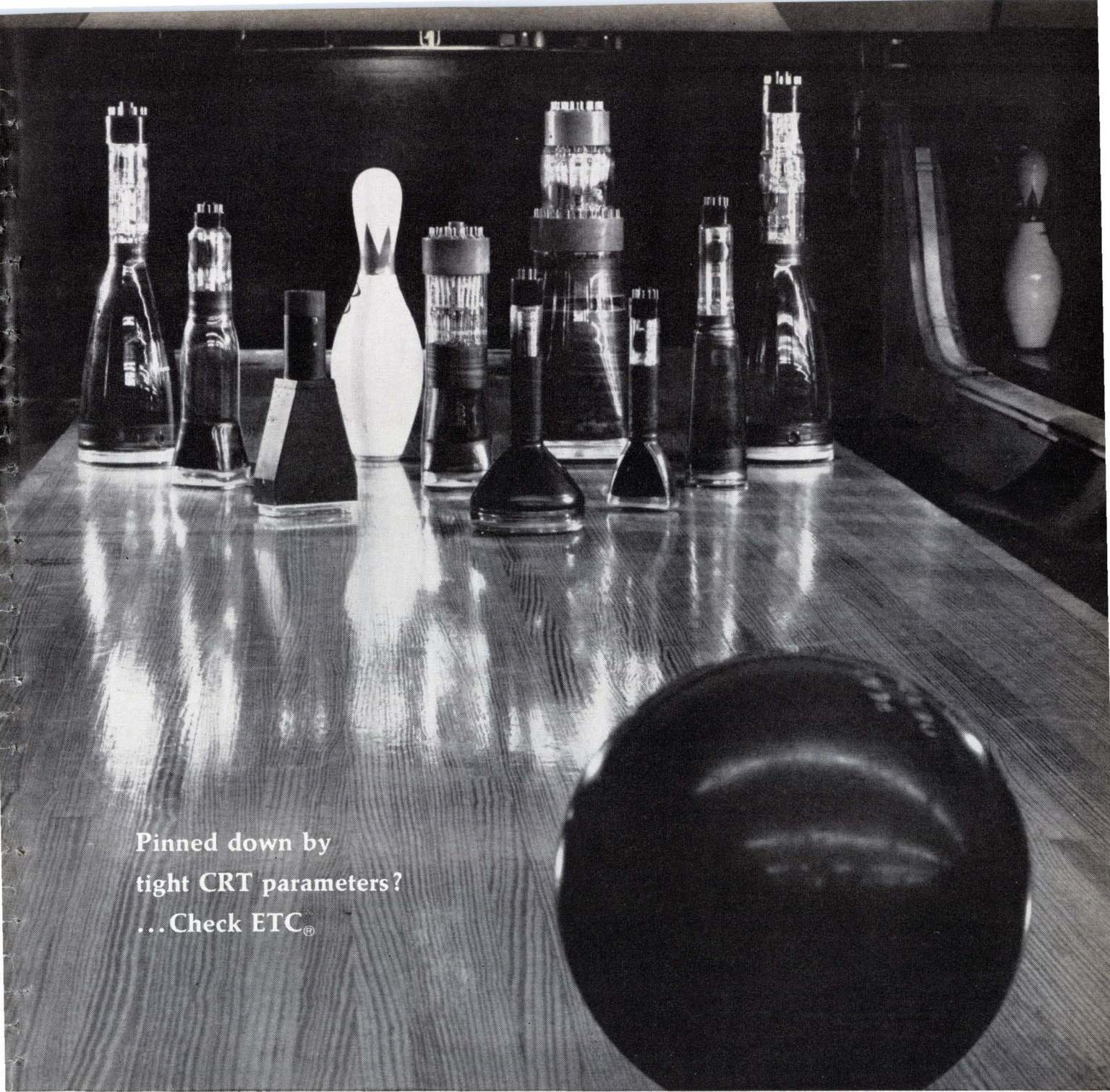

Pinned down by  
tight CRT parameters?  
... Check ETC<sup>®</sup>

## Tube capability is right down our alley

Challenge has been our game for nearly 30 years . . . the challenge of designing, building, and testing special CRT's for special applications. We meet this challenge, continually, through the know-how and creativity of our champion CRT research team, comprising some of the most advanced minds in the technology.

From our modern research and development facilities have come many "firsts" in CRT development. Electrostatic deflection plates, aluminized screens, reticular optics,

and flying spot scanners are some of our pioneering achievements. And our contributions to industry, science and the military have earned us a reputation for solving particularly difficult tube problems.

Today, in addition to virtually unlimited capability in special CRT design, we offer the largest variety of off-the-shelf tubes in the industry. Each has undergone the quality-controlled product engineering and stringent testing required as a custom fabricated item. And each will provide more display per dol-

lar in the application for which it was designed.

Try pinning us down to your individual CRT needs, whether they involve multi-layer phosphors, special shapes, ultra high resolution, or multi-guns. You'll find us "right down your alley" when it comes to meeting your specs. Why not call us today . . . or write for our complete capability story.

**GENERAL  
ATRONICS**  
ELECTRONIC TUBE DIVISION  
PHILADELPHIA • PENNSYLVANIA 19118



# RECTIFIERS

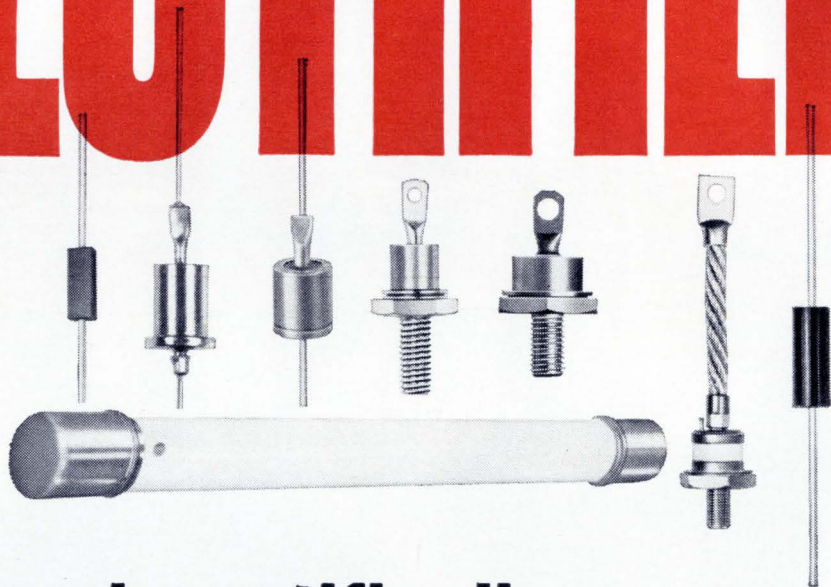

## IRC expands rectifier line

### Wide choice of MIL and industrial devices

Now, IRC is offering an even larger selection of silicon rectifiers. These devices are immediately available from stock to fill the vast majority of your MIL and industrial requirements. Most IRC rectifiers are also available in reverse polarity.

- Ratings from .045 to 250 amps, and 50 volts to 100 Kv
- MIL types meet all performance and environmental requirements of MIL-S-19500
- Subminiature, high-voltage types to 4000 volts

- 100 and 250 amp controlled avalanche units for industrial use
- Fast recovery types—200 nsec—in five package choices

If you specify or buy silicon rectifiers, you should know about the money-saving advantages of IRC's silicon rectifier line. For new semiconductor catalog, prices and samples, write: IRC, Inc., Semiconductor Division (formerly North American Electronics), 71 Linden St., West Lynn, Massachusetts 01905.

 <p><b>ZENER DIODES</b></p> <p>MIL and industrial regulator types, silicon reference diodes, 1-watt DO-7, and solid construction Poly-Sil packaging.</p>	 <p><b>AXIAL LEAD RECTIFIERS</b></p> <p>AR16 thru AR24 replaces 363 JEDEC devices for 50 to 1000 V/.25 to 1A needs. Costs less than stud-mounted types.</p>	 <p><b>SCR's</b></p> <p>MIL and industrial devices, including fast-switching types. Choice of power ratings and package shapes.</p>	 <p><b>SPECIAL ASSEMBLIES</b></p> <p>Rectifier stacks, potted bridges and high voltage assemblies. Available in prototype or production quantities.</p>
--	--	--	--



# Integrated circuits shrink numerical control

First industrial product built completely with microcircuits is 10 times more reliable than former units

The first numerical control systems with all integrated circuit construction are coming down the assembly line at Cimtrol division of The Cincinnati Milling Machine Company. Although Cimtrol chose integrated circuits for reliability, the new design also cut the control unit's size to one-third that of its discrete-component predecessor.

Cimtrol engineers claim that integrated circuits are responsible for a 10 to 1 improvement in the reliability of the control unit, designated Acramatic IV, making it virtually as reliable as the contouring machine it controls. To overcome doubts as to the ability of integrated circuits to stand up under rigors of industrial application, Acramatic IV was tested under actual operating conditions for more than a year without failure. During this period it was operated continuously for 2,000 hours.

Gains in reliability were primarily due to replacement of large numbers of discrete components and solder joints by microcircuits. In some instances a single microelectronic circuit supplants an entire circuit board and three circuit cards take the place of an entire drawer containing 15 larger circuit boards, as shown in the photo. Cimtrol maintains that one logic board now replaces as many as ten boards in a former system.

Improved reliability of the control means that downtime on the controlled machine is reduced substantially. The more reliable control also increases the interval during which the machine can be continuously operated without preventive maintenance.

Since the control contains fewer boards, time required for locating and repairing a defective component is considerably reduced.

Space on the factory floor is precious; thus factory planners will welcome the jukebox-size Acra-

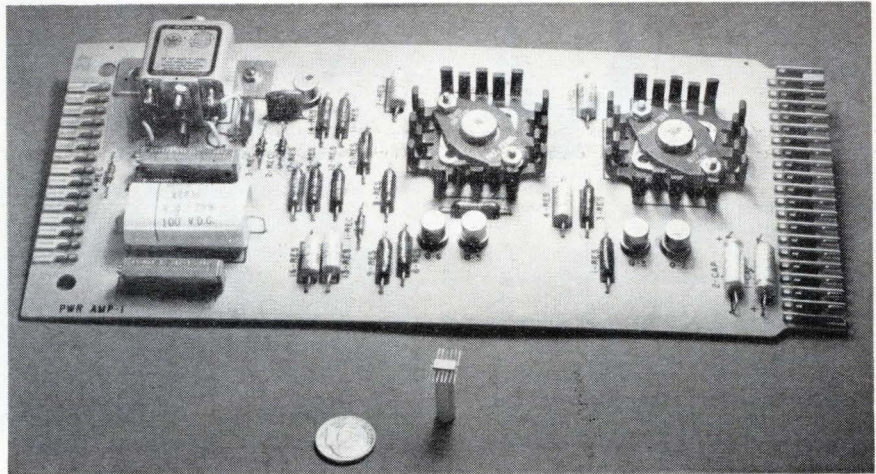

A single integrated circuit flatback replaces an entire circuit board in Cincinnati Milling Machine's numerical control unit.

matic IV which can be placed on the operator's platform of the big contouring machine it controls.

In addition to improved reliability, integrated circuits have also enhanced the performance of Acramatic IV. Previously, numerical control units were limited by cycle time or time to read and act on an

instruction from punched tape. Occasionally the entire machine and control would have to pause and wait for the instruction to be read from the tape. Minimum cycle time on the new control is 100 times shorter than that offered in former systems.

Because the integrated circuits have a lower cost per function than their discrete-component counterparts, Cimtrol can offer contouring capability (as opposed to point-to-point machining) at a price that more users can afford. Although the price for various Acramatic IV models has not been set, the company has indicated that the cost will be comparable to those on discrete-component units with some possibility of a modest reduction.

Integrated circuits in the new control were produced by Texas Instruments Incorporated. Cimtrol engineers designed all command, switching and readout logic with seven of the nine etaintaa in TI's series 73 line of saturated diode transistor logic (DTL).

The Cincinnati Milling Machine Co., Cimtrol division, Cincinnati, Ohio 45209

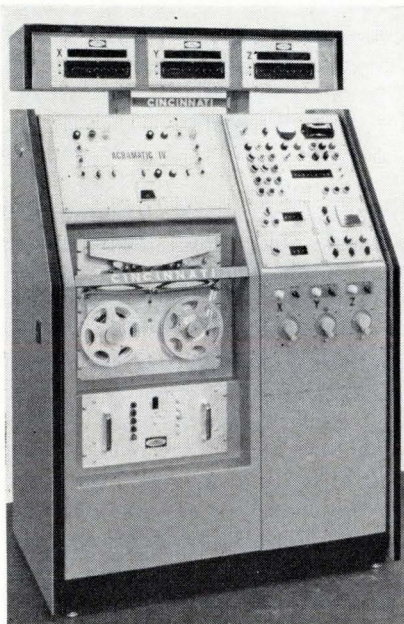

Acramatic IV numerical control is housed in this jukebox sized enclosure.

Circle 350 on reader service card.

# Bulova forks solve low frequency problems

Let the experience behind 300,000 forks per year help you!

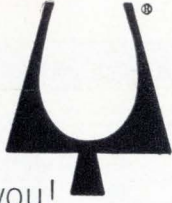

American Time Products forks are now available up to 25 kc, thanks to years of experience plus new design techniques developed by Bulova. (Including the tiny forks for Accutron® electronic timepieces, Bulova made 300,000 last year alone!)

Result: ATP units provide lower cost, smaller size, lighter weight and greater long term stability in such applications as Computers, Navigation Systems, Doppler Radar, Motor Drives, Encoders and Timers. Accuracies of up to 0.001% are available.

Bulova fork oscillators offer the added advantage of simplicity of design and circuitry. Fewer components mean greater reliability. Finally, Bulova fork products are uniquely capable of withstanding severe shock and vibration environments.

No wonder Bulova sold 300,000 last year!

## FS-11 FORK FREQUENCY STANDARD

Standard Frequencies: Up to 10,000 cps

Accuracy: Up to  $\pm 0.001\%$

Input: 28V DC (others on request)

Output: 5 volts p-to-p min. into 10K ohms

Temperature Range: As low as  $-55^{\circ}\text{C}$  to as high as  $+85^{\circ}\text{C}$

Size:  $1\frac{1}{2}$  in. sq. x  $\frac{3}{8}$ "

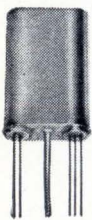

## SUB-MINIATURE TF-500 TUNING FORK

Standard Frequencies: Up to 2400 cps

Accuracy: Up to  $\pm 0.001\%$  at  $25^{\circ}\text{C}$

Input: 28V DC (others on request)

Output: Up to 5V rms into 20K ohms

Temperature Range: As low as  $-55^{\circ}\text{C}$  to as high as  $+85^{\circ}\text{C}$

Size:  $\frac{3}{8}$ " x  $\frac{3}{4}$ " x  $1\frac{1}{2}$ " max.

Write or call for specifications on Bulova's complete line of tuning fork products. Address: Dept. E-16.

# BULOVA

**AMERICAN TIME PRODUCTS**

ELECTRONICS DIVISION OF BULOVA WATCH COMPANY, INC.

61-20 WOODSIDE AVENUE WOODSIDE, N.Y. 11377, (212) DE 5-6000

## New Components and Hardware

### Quick switch possible with modular relays

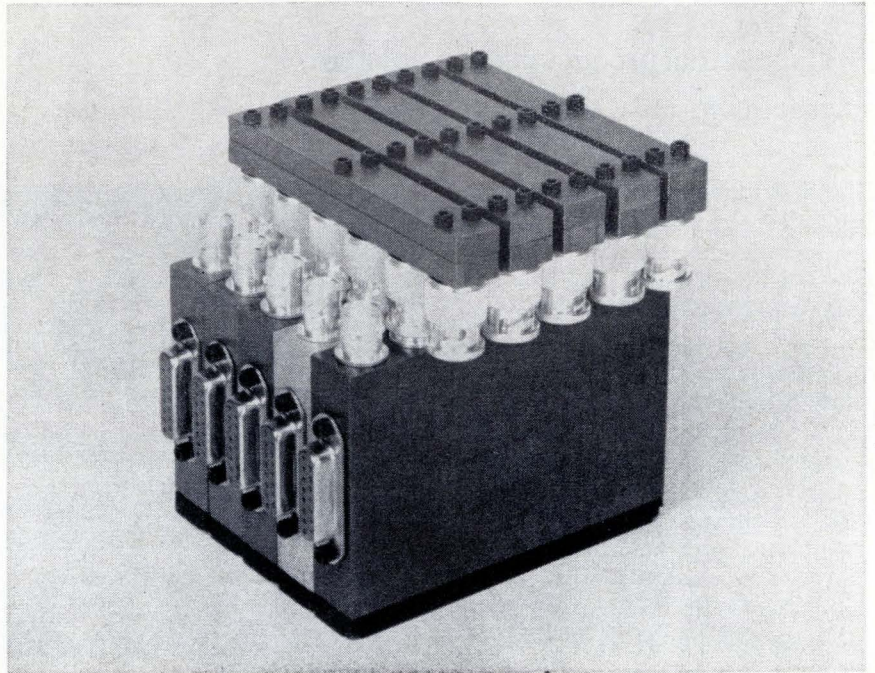

For its debut in switching, the Matrix Co. is introducing a line of modular reed-relay coaxial switches that may be assembled in a variety of configurations. Isolation is good—up to 170 decibels. Depending on the specific frequency, the switches give two to three times better isolation than any other switch, according to Matrix president John D. Williamson.

Matrix claims that its MMS series is the first modular switch that can be repaired in the field. All that is needed is a screwdriver and a soldering iron.

Matrix also has a new concept of modularity. Instead of one basic module, there are 20—ranging from a single-pole, single-throw switch to a single-pole, 20-throw switch. The modules can be assembled to form multipole, multithrow, matrix or hybrid switches. The handy thing, Williamson says, is that the user can change the size and the form of a switch as needed. The control units (the relays that operate the switches) are also modular.

The photograph shows five single-pole, 5-throw switches cross-strapped into a 5-input, 5-output matrix. The BNC connectors shown are standard equipment, but sub-

miniature connectors can also be used. This particular 5- by 5- by 4-inch switch could link an instrumentation recorder and a readout unit or be used for low-level switching as in transducer scanning for aerospace applications.

Williamson reports that the switch is excellent for television, especially if the user doesn't want to miss a single frame (as in satellite transmission). Where unskilled personnel might damage a switch, the field-repairable feature is valuable. Other applications include antenna phasing, military-security transmission, wide-band and low-level instrumentation recording and computer interconnections.

#### Specifications

Frequency range	D-c to 300 Mhz
Load capacity	Up to 50 w
Isolation	Up to 170 db
Switching control voltage	20-40 v range, 28 v, d-c, nominal
Switching speed	Under 1 msec
Life	20 million operations
Switch-point spacing	$\frac{5}{8}$ in. minimum
Impedance	50 to 75 ohms
Closed-contact resistance	Less than 150 milliohms
Insulation resistance	More than 10 megohms
Average switch-point price	\$20
Delivery	30 days

Matrix Co., 18075 Ventura Blvd., Encino, Calif. [351]



# Now you can forget

- ✓ SENSITIVITY CALCULATIONS
- ✓ FRC CURVES
- ✓ TEMPERATURE STABILITY PROBLEMS
- ✓ CABLE NOISE PROBLEMS

A new state-of-the-art has been achieved with CEC Low Impedance Piezoelectric Accelerometers.

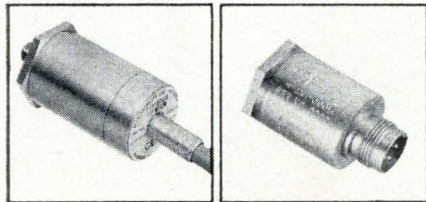

4-280 LOW Z  
ACCELEROMETER

4-281 LOW Z  
ACCELEROMETER

CEC's unique solid-state design and construction (U.S. patent pending), make these low impedance instruments unequalled in performance by any other accelerometers.

The use of piezoelectric accelerometers has been traditionally complicated by special problems which have plagued even the most sophisticated user. However, by combining a source follower with a piezoelectric accelerometer in a single small package, permanently calibrated, with no external pot or other electronics—CEC has perfected instruments which offer all the advantages of the piezoelectric principle without the accompanying headaches of high impedance.

The reasons why low impedance units are superior:

- Fixed Sensitivity. All calculations are done by CEC at the factory—precisely and permanently. Since the source follower is an integral part of

the instrument, there is *no cable* from accelerometer to follower. Therefore, total circuit capacitance remains constant for all applications. Even the FRC effects can be ignored as the initial calculation never varies.

- Low Frequency Response Guaranteed. The field-effect transistors give a low frequency response which is unaffected by, and independent of, the load impedance on the accelerometer output. As a result, room temperature frequency response is within  $\pm 5\%$  from 2 Hz to 10,000 Hz, regardless of load impedance.

- Fixed Temperature Stability. The temperature response curves for conventional accelerometers show a varying slope as the value of load capacitance changes. This *does not occur* in a CEC Low Impedance Accelerometer. A fixed tolerance of  $\pm 5\%$  can be assigned to temperature response over the entire range, regardless of output cable capacitance.

- Low noise—and no cable noise. Broad-band noise level is less than 1 mv p-p over the temperature range. Due to high sensitivities, as high as 36 mv/g, very low G-levels can be measured with excellent signal-to-noise ratios. And since there is no cable noise with a CEC Low Impedance Accelerometer, there can be *no signal deterioration*, and the need for expensive cables is eliminated.

Don't scrap it—convert it.

If you have a high impedance piezoelectric system, it is still possible to



1-304 SOURCE FOLLOWER

obtain state-of-the-art performance. By the simple addition of a CEC 1-304 Source Follower—which is adaptable to all high impedance piezoelectric accelerometers—you may convert an obsolete unit into a low impedance instrument. That way, you can always expand or replace with the new low impedance accelerometers as the need arises.

Who needs CEC Low Impedance Accelerometers?

Everyone who needs a truly precise and reliable piezoelectric accelerometer. Aerospace users would include such obvious groups as NASA, missile sites, environmental test labs and testers of airframes and aircraft engines. Industrial users—all applications where vibration monitoring and noise reduction are critical factors.

When can you expect to receive these instruments?

Whenever you need them. As the leader in data instrumentation, CEC now has 78 Field Engineers throughout the country to serve you—more than all other accelerometer manufacturers combined. Furthermore, CEC will be pleased to prepare a comprehensive analysis of your needs and conversion costs without obligation.

For complete information on the CEC low impedance piezoelectric line, call or write CEC for Bulletin Kit 9069-X3.

PIEZOELECTRIC  
USERS  
HANDBOOK

We will also include a copy of the current "Piezoelectric Users Handbook."

## CEC

Data Instruments Division

CONSOLIDATED ELECTRODYNAMICS

A SUBSIDIARY OF BELL & HOWELL/PASADENA, CALIF. 91109  
INTERNATIONAL SUBSIDIARIES: WOKING, SURREY, ENGLAND  
AND FRIEDBERG (HESSSEN), W. GERMANY

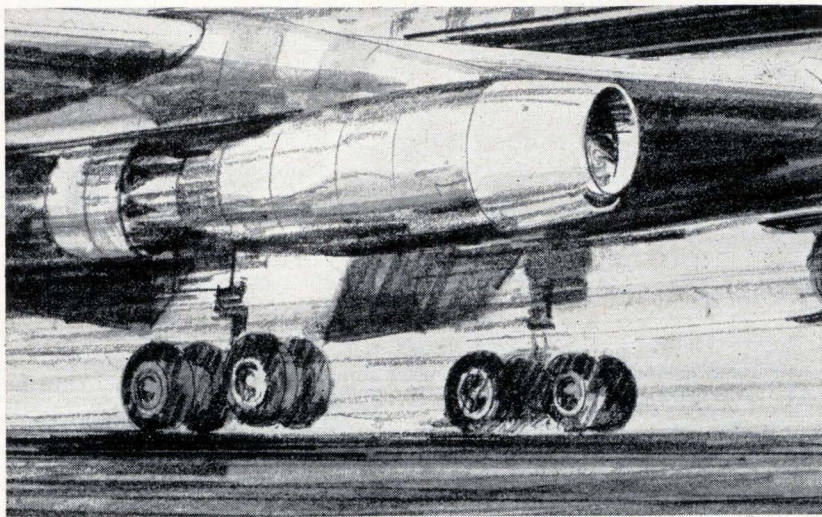

**When everything has to work right**

## specify CTS Knights

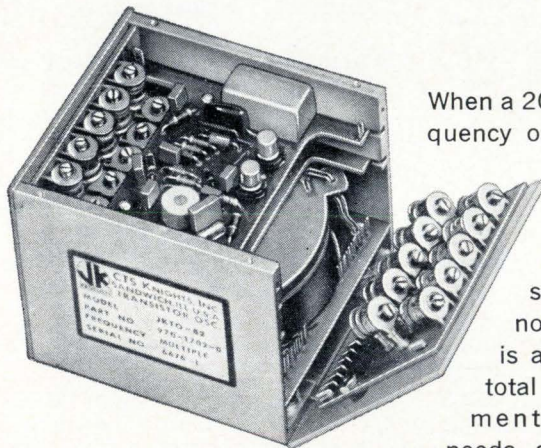

When a 20-selectable high-frequency output oscillator with quick warm-up was needed for military aviation, CTS supplied it. This same advanced technology and assistance is available to you. For total Frequency Management tailored to your needs, specify CTS Knights.

Additional features of Model JKTO-82 (illustrated) are:

- 1) Fast warm-up provisions;
- 2) High ambient operation;
- 3) Shock and vibration resistant; and
- 4) A compact 2.5" x 2.5" x 2.75" anodized, aluminum housing.



**CTS KNIGHTS, INC.**

(Formerly the James Knights Company)

SANDWICH, ILLINOIS

A Subsidiary of CTS Corporation, Elkhart, Indiana



## New Components

### Low-pass filters ideal for IC's

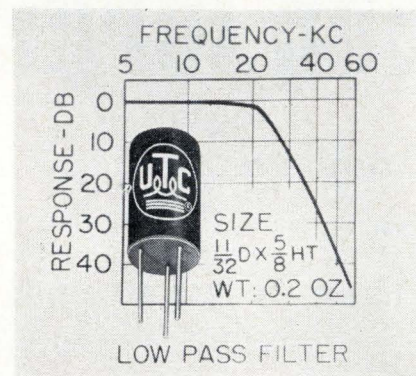

Ultraminiature low-pass filters have the same physical configuration as the DO-T family of audio and power transformers, having a diameter of only  $\frac{11}{32}$  in., height of  $\frac{5}{8}$  in., and weight less than 0.2 oz. Its size makes it ideal for printed-circuit applications. The metal-encased, hermetically sealed filter is designed, manufactured and tested to complete MIL-T-18327B specification.

Source and load are 10,000 ohms. Response from d-c to 22 khz is within 3 db; at 36 khz it is 20 db minimum; at 44 khz it is 30 db and above 48 khz the response is 35 db or more.

United Transformer Corp., 150 Varick St., New York, N.Y., 10013. [352]

### Translational pots handle high power

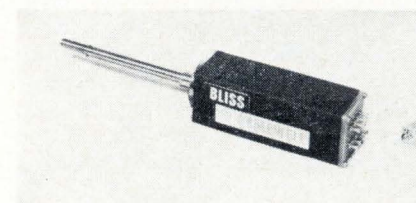

A series of translational precision potentiometers has been announced. The line is designated TS or TD styles.

These compact pots can handle power levels to a maximum of 1 watt per inch of stroke. Standard resistances range from 100 ohms to 40,000 ohms per inch. This re-

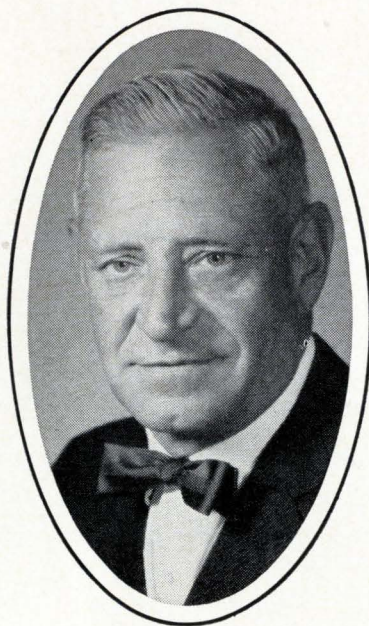

## Our Marriage Broker

Applications of photography are diverse and technical enough so that no one man in the world could possibly answer everyone's every question on the subject. The next best thing is a man who knows where to get the answers. A "marriage broker" between problems and solution. *A man who can connect you with the right specialist.*

We have one such man. His phone number is (716) 325-2000, Ext. 5129.

He has at his fingertips the names and phone numbers of a staff of photographic engineers unique in its wide knowledge of all facets of phototechnology. He can con-

nect you with *the* one who is most fluent in your language and who can either answer your question or evaluate your idea.

Our people may suggest the use or adaptation of a Kodak system. Or help you invent a new one. Or (and it does happen) they may put you in touch with another company—one which specializes in your area. In any case, your problem gets solved, and the way to get started is to call or write **Special Applications, Eastman Kodak Company, Rochester, N.Y. 14650.**

**Kodak**

# nanodelaytol \*

## New Components

sistance is varied as the pot's shaft is slid into or out of the unit's housing. Both linear and nonlinear outputs are available.

Translational pots are designed for both military and commercial applications where highly accurate measurement of linear motion is required, such as in a laboratory set up or for machine tool control or surveillance.

Both single (TS) or dual resistance (TD) elements with separate contact brushes and terminals are produced in a compact housing. Housings are anodized aluminum rigidly constructed to withstand vibration and shock.

The stainless steel shaft can be rotated 360° without affecting the mechanical or electrical operation. Shaft actuation for full stroke requires minimal force.

Special configurations can be provided for specific requirements. Taps are supplied as desired. Stroke lengths from 1/2 in. to 16 in. are standard but nonstandard lengths can be supplied. Contacting elements are precious metal throughout.

Gamewell division, E.W. Bliss Co.,  
1238 Chestnut St., Newton, Mass.  
[353]

\* An out-of-the-blue word to drive home the capability of Phelps Dodge Electronics coaxial cable delay lines to consistently and uniformly meet  $\pm .02$  nanosecond delay tolerances.

But, that's not all. Here is broader band operation, lower attenuation per nanosecond of delay, greater stability at microwave frequencies. And, all conventional packaging techniques are available: containers, shock mounting, standard rack-panel mounting, strapping, potted or encapsulated coils, with mounting brackets and connectors. Delay lines can also be chemically-treated, painted, or enclosed in standard or customized racks or carrying cases. Design parameters' frequencies from 60 CPS to 12 Gc, power from milliwatts to kilowatts, impedances from 50 to 125 ohms, delay line from .3 to 1.0 microseconds.

Want more detail? Write for Bulletin DL, Issue 2.

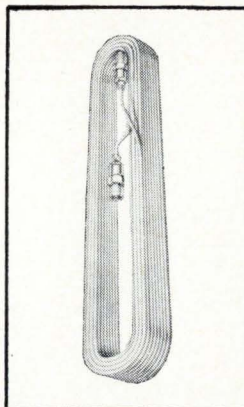

## Synchronous motor for high-volume use

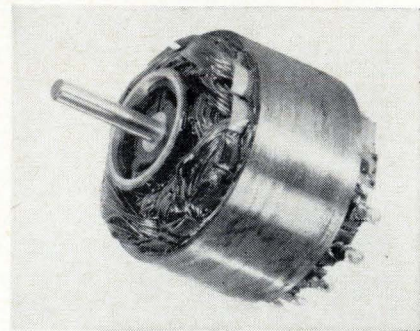

The Type IC motor is available either for low-voltage square-wave transistor drive or as a single phase 115 v a-c, 60 hz unit. Torque output is 1.0 oz in. at 2 or 4 pole speeds. The unit is furnished without case to permit easy insertion in constant-speed requirement

**PHELPS DODGE** ELECTRONIC PRODUCTS  
NORTH HAVEN, CONNECTICUT



# SCIENCE/SCOPE

A "window shade" array of solar cells is being developed by Hughes for the U.S. Air Force as a power source for space. It will be designed to withstand launch requirements for a Titan III type booster in a stowed condition...will unfurl in a manner loosely comparable to unrolling a window shade. Demonstration model will have a 50-square-foot array; modular design allows larger arrays for extra solar power.

"Large array" microcircuits and high density packaging techniques are features of the HCM-205, new microminiature airborne computer designed by Hughes. It has a 4,096 18-bit word memory, expandable to 32,768 words; can perform about 125,000 operations per second; weighs 13.3 lbs. including power supply; occupies 1/5 of a cubic foot. It will be integrated into a multimode radar data processing system for flight test early next year.

A prototype radar system, most powerful ever built by Hughes, is called ADAR (Advanced Design Array Radar). The reduced-size prototype city defense system will be used to demonstrate new long-range phased-array techniques for the U.S. Air Force prior to defining the best type of full-scale system.

The first four Mark 1B satellite ground-link terminals, now on duty for the U.S. Army to communicate with the random-orbit military satellites launched in June, form the world's first global military satellite communications network. Three of the air-transportable terminals are located in Hawaii, the Philippines, and West Germany. The fourth, now being erected in Ethiopia, will soon be ready for test operations.

We have immediate openings for system-oriented engineers in a wide variety of disciplines: advanced aerospace radar, missile guidance and control, space craft electronics, command/control, communication satellites, laser systems, automatic checkout equipment. Please write: Mr. D.A. Bowdoin, Hughes Aircraft Company, Culver City, California. Hughes is an equal opportunity employer.

Surveyor 2 made the first leg of its trip to the moon aboard an out-sized "Super Guppy" aircraft, which carried it from Los Angeles to Cape Kennedy in mid-July. Scheduled to be launched this fall, its mission will be to repeat the tasks of Surveyor 1 and to perform additional experiments at a new location on the lunar surface. It is the second of seven planned lunar landings.

A new joint-venture firm called Satellite Telecommunications Company (Satelco) has been formed by Nippon Electric Company Ltd. and the Hughes Aircraft Company for worldwide marketing of satellite communications ground terminal stations and equipment. The activities will also include systems and applications engineering, site surveys, test installation, maintenance, spares provisioning of terminal stations under contract, and other field service and support functions.

Creating a new world with electronics

**HUGHES**

HUGHES AIRCRAFT COMPANY

Circle 153 on reader service card

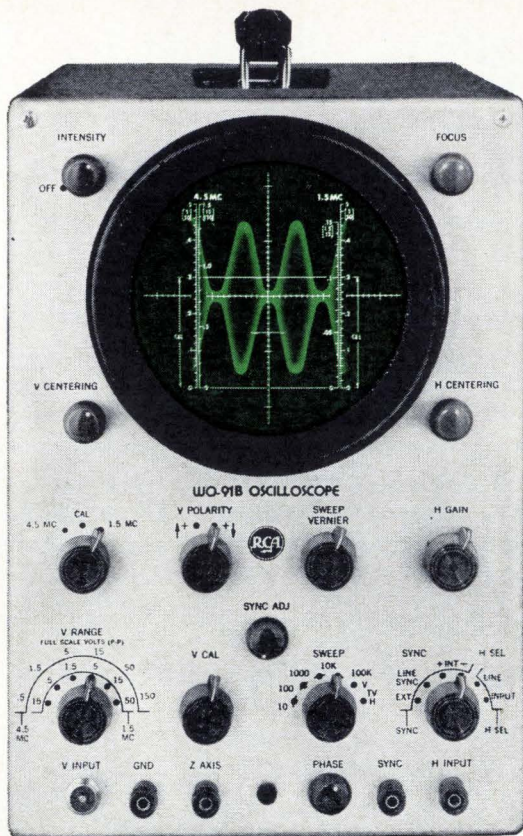

THE  
SCOPE  
WITH THE  
HIGH IQ\*

RCA WO-91B...  
\*INEXPENSIVE QUALITY

## Why pay for Oscilloscope capabilities you don't really need?

There are many situations—production line work, product quality checks, basic laboratory measurements—that require a large number of scopes or employ standard measurements... and where simplicity of operation is essential.

### That's where you need the RCA WO-91B!

Of course the so-called "industrial/laboratory" type scopes will make certain measurements that ours won't. They may feature triggered sweep, horizontal deflection in microseconds, and other costly refinements. Whenever you need these extras... capability for those extremely precise measurements... spend the money and buy an expensive scope.

Actually, for many very precise research, experimental and lab measurements, we don't even recommend ours (we use theirs).

### But if your requirements call for scopes with characteristics such as the following, the RCA WO-91B is probably your best buy:

- Built-in voltage calibration—large 5-inch screen with VTVM-type voltage scales for fast, simultaneous peak-to-peak measurements and waveshape display
- Flat response ( $\pm 1$  dB) from 10 cps to 4.5 Mc
- 0.018 rms volt per inch maximum sensitivity for use at low signal levels
- Continuously adjustable (to 100 kc) sweep oscillator with excellent linearity
- Z-axis input for direct modulation of CRT permitting use of timing and calibration markers on trace
- Provision for connecting signals directly to the vertical deflection plates of the CRT.

The Optional User Price of the RCA WO-91B is \$249.50. It is available locally from your Authorized RCA Test Equipment Distributor. Ask to see it or write for complete specifications to RCA Commercial Engineering, Section 119W-1, Harrison, N.J.

RCA ELECTRONIC COMPONENTS AND DEVICES



The Most Trusted Name in Electronics

## New Components

equipment, such as tape and record players. Size is 1.990 in. diameter x 2.150 in. maximum length with a weight of 10 oz.

The shaft is 0.1875/0.1870 in. diameter stainless steel and supported between two self-aligning sleeve bearings. The motor is designed to meet specific performance over a temperature range of  $-20^{\circ}\text{C}$  to  $+140^{\circ}\text{F}$ . Custom designed units can be made for other voltages, speeds, torques, etc., where production volume will be high.

Globe Industries, Inc., 2275 Stanley Ave., Dayton, Ohio, 45404. [354]

## Hot-molded pot features reduced size

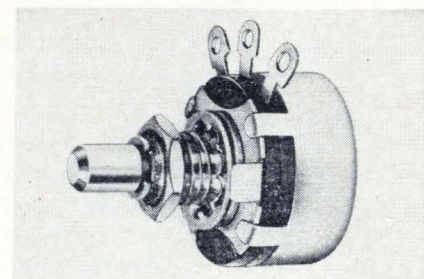

Miniature hot-molded resistive controls feature a size reduction to  $\frac{5}{8}$  in. from the earlier 1 in. as well as lower static noise levels.

Designated series 369, the controls have been designed to meet or exceed MIL-R-94B and have an RV1 envelope size. Built to the same quality specifications as the company's series 53, the units are smaller in size and operate through 50,000 rotational cycles, compared to earlier film types with an upper limit of 10,000 cycles.

The units possess low temperature coefficients and are available with a resistance range of 100 ohms to 5 megohms, with tolerances of  $\pm 10\%$  to 100,000 ohms and  $\pm 20\%$  above 100,000 ohms. Power rating for military units is 1 w at  $70^{\circ}\text{C}$  and 350 v d-c maximum derated to zero watts at  $120^{\circ}\text{C}$ ; for commercial units,  $\frac{3}{4}$  w at  $40^{\circ}\text{C}$  and 500 v d-c maximum. Clarostat Manufacturing Co., Inc., Dover, N.H. [355]

## New Semiconductors

### Small amplifier packs big voltage

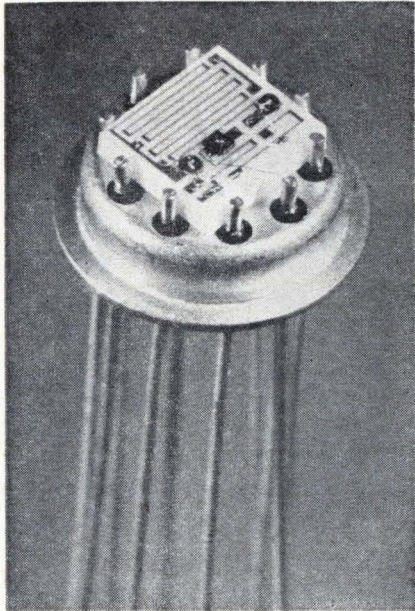

The Hughes Aircraft Co.'s Microelectronics division has developed a d-c amplifier with an output voltage range of  $\pm 36$  volts. The company claims the hybrid integrated circuit amplifier, designated HMC 1148, outperforms any unit its size. Hughes says amplifiers with monolithic circuits usually can deliver only about  $\pm 15$  volts.

Packed in a low-profile TO-5 can, the amplifier gets its performance from a hybrid circuit that has discrete silicon transistors and diode chips attached face up on an alumina substrate with deposited thin-film resistors on it. Wires are bonded to the chips by thermocompression.

The price is attractive—\$28 each in quantities of 25 to 100. Other operational amplifiers with less output, Hughes reports, cost about \$20 to \$40 each. And the future price picture looks even better. In about 60 days, quantities over 10,000 should drop below \$10 each. The key to the low price is that Hughes is planning to replace the three active-device chips with ultrasonically bonded, face-down flip chips, thus cutting assembly time by one-third.

Hughes expects the HMC 1148 to be used where space is limited, such as in missiles. The amplifier is only 0.360 inch in diameter and 0.165 inch high. It is adaptable for

any type of control system, such as computers, servos, filters, oscillators, voltage regulators and modulator-demodulators.

#### Specifications

Input offset voltage	Less than 0.2 v
Input bias current	Less than 2 $\mu$ a
Input impedance	100 x 10 <sup>3</sup> ohms minimum
Input common-mode voltage	$\pm 20$ v
Common-mode rejection ratio	80 db minimum
D-c open loop voltage gain	600 v minimum
Unity gain	10 Mhz minimum
Power dissipation	400 mw typical
Delivery	2 weeks

Microelectronics Div., Hughes Aircraft Co., 500 Superior Ave., Newport Beach, Calif. [360]

### Stud-mount rectifier is small and light

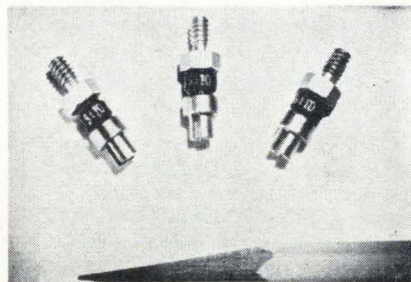

A significant reduction in size and weight of rectifiers with a 12-amp rating is possible with this miniature stud-mount series. Only 0.187 in. in diameter and 0.46 in. long, the unit weighs less than 1.5 grams. A 4-40 stud 0.19 in. long permits mounting to a heat sink. All units feature controlled avalanche characteristics and piv ratings up to 600 v are available.

Units are made by using the manufacturer's voidless, whiskerless construction, with hard glass fused directly to the silicon and terminal pins. The 4-40 stud is brazed to one end and a turret terminal to the other.

Surge ratings are as high as 200 amps for one cycle with this series. Units are available from stock. Prices range from \$5 to \$11. Unitrode Corp., 580 Pleasant St., Watertown, Mass [361]

## NEW LINE

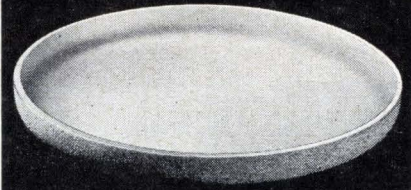

## VITREOSIL<sup>®</sup> PURE FUSED QUARTZ CYLINDRICAL FLAT BOTTOM TRAYS

Thermal American's recently introduced line of cylindrical, pure fused quartz flat bottom trays will find many uses in industrial and laboratory service. For roasting, sintering and igniting operations, high resistance to heat and thermal shock assures users of long, trouble-free service. Cylindrical trays may be introduced cold into a muffle or furnace preheated to operating temperatures.

#### SIZES

Nominal O.D. Inches		Nominal O.D. Inches	
Diameter	Height	Diameter	Height
5-1/4	2-3/4	9-7/16	4-1/4
6-1/8	1-1/2	9-11/16	2-3/4
6-5/8	4	10	2-3/4
7-1/16	3-1/4	10-9/16	3
7-7/16	3-3/4	11-7/16	6-1/4
7-1/2	3-1/2	12-7/8	3
7-7/8	2-3/4	13-7/8	4-1/2
8-7/16	4-1/4	15-1/2	5-1/2
8-11/16	2-3/4	17	6
8-7/8	2-3/4	19-1/4	3-3/4

50



**THERMAL AMERICAN**  
FUSED QUARTZ CO.  
RT. 202 & CHANGE BRIDGE RD.  
MONTVILLE, NEW JERSEY  
ZIP CODE 07045

# 2-32 Mc

# POWER HYBRID

## HHP-50

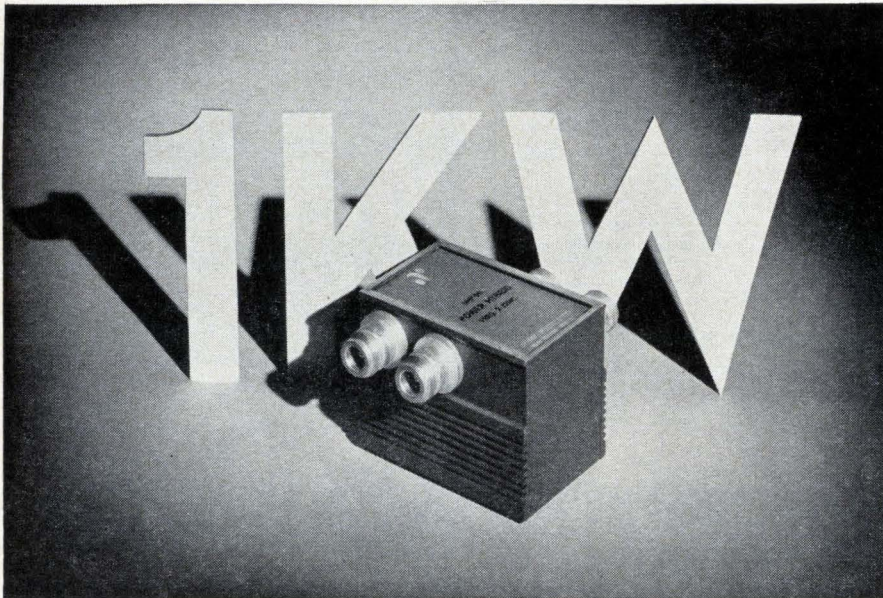

THE SUM AND THE DIFFERENCE of any two signals between 2 and 32 Mc are now available at power levels useful for transmission as well as receiver applications.

The same desirable performance characteristics provided by a proven family of Adams-Russell hybrid devices are incorporated into the HHP-50 Power Hybrid. It handles up to 500 watts CW and 1,500 watts PEP to allow new HF antenna-transmitter applications.

The HHP-50 can divide a signal input into two phase-stable, equal-amplitude outputs or can resolve two independent inputs into their algebraic sum and differences. Shortly, the HHP-50 will offer this same performance from 30 to 76 Mc for mobile communication applications.

HHP-50 power hybrids weigh less than 2 lbs, are compact (3" x 2" x 2<sup>3</sup>/<sub>4</sub>"), and transfer heat through the mounting surface. Standard units are supplied, as shown, with 50 ohm Type N connectors. Try some. They're powerful good!

### HHP-50 SPECIFICATIONS

Power Rating (with heat sink)	500 watts CW 1,500 watts (PEP)
Insertion Loss	0.5 db maximum
Isolation	25 db minimum
VSWR	1.3 maximum
Phase Balance	± 5° maximum
Amplitude Balance	0.2 db maximum



**ADAMS-RUSSELL CO., INC.**

280 Bear Hill Road • Waltham, Massachusetts  
(617) 899-3145 TWX: (710) 324-0618

## New Semiconductors

### Diode quad for high frequency

A balanced-modulator, hot-carrier quad has been introduced for high-frequency applications. Each of the four diodes is closely matched at four points on the forward curve and molded into a plastic package 0.20 x 0.200 x 0.310 in. with four leads.

Similar devices are also available in matched sets that are unmolded and also made to special matching requirements.

The MS396 is priced at \$60 each in quantities of 1 to 99 with delivery from one to three weeks. Solitron Devices, Inc., 256 Oak Tree Road, Tappan, N.Y. [362]

### Integrated circuit operational amplifier

The WC-161 commercial integrated circuit operational amplifier has both single-ended and differential outputs. The unit has a Darlington input stage which permits the use of megohm-range scaling resistors. Applications include general-purpose instrumentation, integration and summation. With feedback, the amplifier can serve as a transducer amplifier, preamplifier, voltage comparator and as a bandpass or buffer amplifier.

Operating parameters include: differential gain, 2,200 v/v; input impedance, 300,000 ohms; output impedance, 40 ohms; drift, 10  $\mu$ v/ $^{\circ}$ C and 1 na/ $^{\circ}$ C.

Testing is stringent. Every unit undergoes a 24-hour bake at 150 $^{\circ}$ C; three cycles of thermal shock (-55 $^{\circ}$  to +150 $^{\circ}$ C); 30,000-g acceleration on the centrifuge; as well as gross and helium hermeticity tests.

Price of the WC-161 is \$39.50 each in quantities of 1 to 49; \$29 each in quantities of 50 to 499. Availability is from distributor stock.

Westinghouse Molecular Electronics division, Westinghouse Electric Corp., Box 7377, Elkridge, Md., 21227. [363]



# Only Varian delivers low-noise TWT amplifiers that have...



lowest noise figure,  
smallest size,  
lightest weight,  
highest saturation power,  
single-reversal  
permanent-magnet focusing,  
integral power supply,  
broad band frequency range,  
narrow band frequency range,  
S-band performance,  
C-band performance,  
X-band performance.

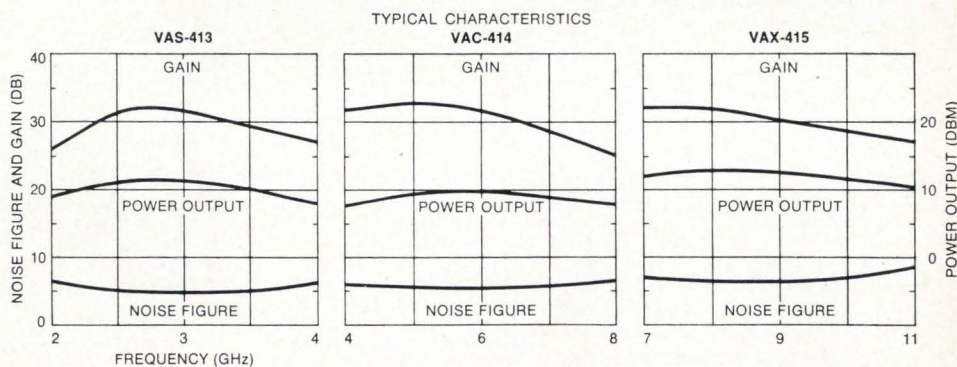

For more information on these 3-inch TWT amplifiers, covering the complete spectrum of applications, write Palo Alto Tube Division, 601 California Avenue, Palo Alto, Calif.

In Europe: Varian A. G., Zug, Switzerland.

In Canada: Varian Associates of Canada, Ltd., Georgetown, Ontario.



# NEW EG&G SILICON DIFFUSED PHOTODIODE

- HIGH QUANTUM EFFICIENCY
- WIDE SPECTRAL RANGE • FAST RESPONSE TIME • LOW NOISE

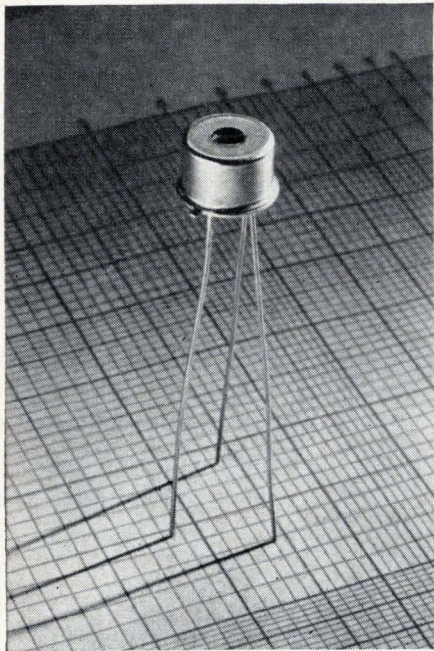

SGD-100 PHOTODIODE

The SGD-100 Photodiode — successor to the popular SD-100 — offers greater sensitivity and lower noise characteristics. Embodying EG&G's improved diffused guard ring design, the SGD-100 has a wide spectral range with an unusually high response in the "blue" region, fast response time and high quantum efficiency. The photodiodes are hermetically sealed in a TO-5 package.

Sensitivity . . . . .  $0.5 \mu\text{A}/\mu\text{W}$  at 0.9 microns  
(70% quantum efficiency)  
Spectral Range . . . . . 0.35 to 1.13 microns  
Capacitance . . . . . 7 picofarads at 90v  
Rise Time . . . . . 4 nanoseconds  
Leakage . . . . .  $0.2 \mu\text{A}$  at 90v  
NEP ( $0.9 \mu$ ,  $10^3$ , 1) . . . . .  $7.9 \times 10^{-19}$  watts  
Linearity of Response . . . . . over 7 decades

Applications include CW, pulsed light and laser detection and measurement, star tracking, optical navigation, communication and guidance, and range-finding systems. The new SGD-100, also available in calibrated versions, is in quantity production for fast delivery at low price.

For information, write: EG&G Inc., 160 Brookline Avenue, Boston, Massachusetts 02215. Telephone: 617-267-9700. TWX: 617-262-9317.



## New Instruments

### Voltage divider operates at 500 khz

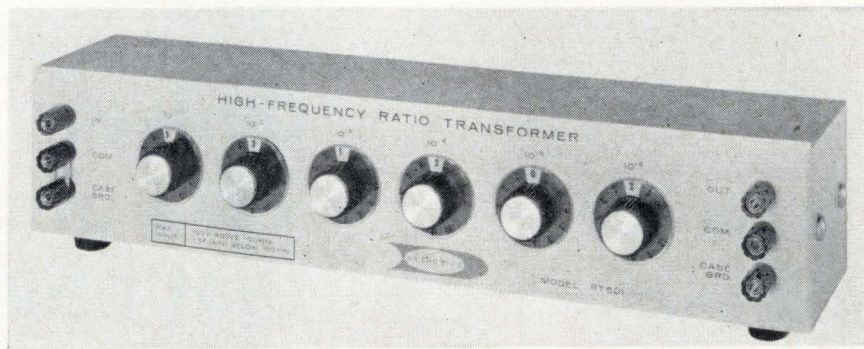

The first commercially available ratio transformer capable of operating to 500 kilohertz is claimed by the Dytronics Co. The model RT-501 inductive voltage divider can resolve an a-c input voltage into more than one million parts. The accuracy of the divider's transformation ratio is within 0.0005% near the lower operating frequency limit of 4 khz and 0.09% at the upper frequency limit of 500 khz.

With the divider, many measurements not normally feasible within the ultrasonic and lower radio-frequency regions are now possible. Included are the measurement of distortion created by inverting amplifiers, calibration of attenuators and calibration and linearity tests of voltmeters; the divider provides precise control of voltage attenuation and impedance transformation with almost no power loss.

Dytronics says the device was made possible by the availability of new magnetic materials and the development of special coil-winding techniques that permitted the company to construct almost ideal toroidal inductors. "Filling the core area of the toroid with a high-permeability material," a company spokesman says, "reduces the leakage flux to a point where the behavior of the inductor is extremely close to that of an ideal toroidal inductor. With no leakage flux, the emf generated in each turn is identical. With the new coil winders, the coils can be wound with no fractional turns. As a result, the voltage ratio between coil elements is a direct function of the turns ratio."

In addition, the model RT-501

has an output impedance which is essentially less than 1 ohm. The low output impedance eliminates almost all the circuit loading effects of conventional dividers.

#### Specifications

Frequency range	4 khz to 500 khz
Ratio range	0.00000 to 1.11111 in 0.000001 steps
Linearity deviation (in ppm) (= output volts/input volts—setting)	$2 + f/2 + (f/20)^2$ (f = frequency in khz)
Max input voltage	1.5f or 150v rms max
Output impedance	equivalent to 0.21 ohms in series with 1.5 $\mu$ h
Resolution	1 ppm below 100 khz, 10 ppm above 100 khz
Price	\$350

Dytronics Company, Inc., 5566 North High St., Columbus, Ohio 43214 [370]

### Portable electrometer covers 73 ranges

Model 601 is a battery-operated electrometer with off-ground operating capability. It offers 73 ranges for d-c measurements: 9 voltage ranges from 1 mv full scale to 10 v; 28 current ranges from  $10^{-14}$  amp full scale to 0.3 amp; 23 resistance ranges from 100 ohms full scale to  $10^{13}$  ohms; 13 coulomb ranges from  $10^{-12}$  coulomb full scale to  $10^{-6}$  coulomb.

Besides these ranges, the model 601 can operate up to  $\pm 1,500$  v off ground. The case and all controls are at ground potential.

Price is \$595; delivery, within 60 days after receipt of order. Keithley Instruments, 12415 Euclid Ave., Cleveland 6, Ohio. [371]

## New Instruments

### Standard oscillators are compact and light

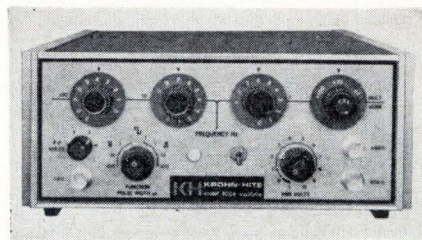

Series 4000 RC oscillators feature transient-free tuning, exact resetting by means of rotary switches, harmonic distortion less than 0.01%, frequency response within  $\pm 0.01$  db, amplitude stability of  $\pm 0.01\%$  per hour, and voltage calibration accuracy of  $\pm 0.25\%$  without a meter. The solid state units cover frequencies from 0.001 hz to 100 khz.

Modular plug-in construction has been used to achieve compactness and light weight, while still keeping all circuits readily accessible for easy servicing. All models provide an additional quadrature ( $90^\circ$ ) sine wave output, and all can be synchronized with an external signal. Options include a simultaneous square wave, and a pulse which is controllable in both polarity and width.

Prices range from \$850 to \$1,300 depending on the choice of options. Krohn-Hite Corp., 580 Massachusetts Ave., Cambridge, Mass., 02139. [372]

### Phase-sensitive vtm offers versatility

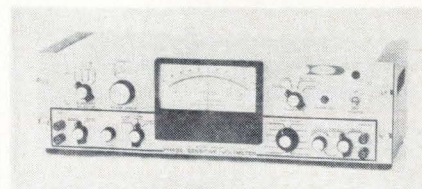

Model 240SP will operate either as a standard vacuum-tube voltmeter or as a phase-sensitive vtm. As a standard vtm, the instrument will measure either the total signal or the fundamental component of the signal. When operated as a phase-sensitive voltmeter, the in-phase

# Ballantine Announces a New Solid State DC Digital Voltmeter



Model 353

## Gives you fast, accurate readings to 0.02% $\pm 0.01\%$ f.s. and at a low cost of just \$490

Ballantine's new Model 353 enables you to speed up dc measurements materially over those made on multi-knob differential voltmeters. And with laboratory accuracy from 0 to 1000 volts dc.

It requires just two steps: (1) Set knob to NORMAL mode and read voltage; (2) dial in the first digit in EXPAND mode and read voltage to four places with over-range to five; and, in addition, interpolate to another digit.

The NORMAL mode error becomes submerged by more than ten to one, and the operation is fast and accurate to 0.02% of reading  $\pm 0.01\%$  f.s. If the input signal is varying, the last digit may be followed visually, thus providing the advantage of analog display.

Note these other interesting features of the new 353: a left-to-right digital readout; an automatic display of "mV" or "V"; proper placement of the decimal point; 10 megohms input resistance; an automatic disabling of the motor during the "expand" dialing; a red light to indicate overrange or wrong polarity; and provision for a foot-operated switch for a "read" or "hold" function.

Write for brochure giving many more details



— Since 1932 —

**BALLANTINE LABORATORIES INC.**  
Boonton, New Jersey

CHECK WITH BALLANTINE FIRST FOR DC AND AC ELECTRONIC VOLTMETERS/AMMETERS/OHM METERS, REGARDLESS OF YOUR REQUIREMENTS. WE HAVE A LARGE LINE, WITH ADDITIONS EACH YEAR. ALSO AC/DC LINEAR CONVERTERS, AC/DC CALIBRATORS, WIDE BAND AMPLIFIERS, DIRECT-READING CAPACITANCE METERS, AND A LINE OF LABORATORY VOLTAGE STANDARDS FOR 0 TO 1,000 MHZ.

Step 1.  
NORMAL  
Mode  
8.342 V



Step 2.  
EXPAND  
Mode  
8.342 V



Example of  
"Overrange"  
presentation  
108.340 V



**A specialty of the house...**

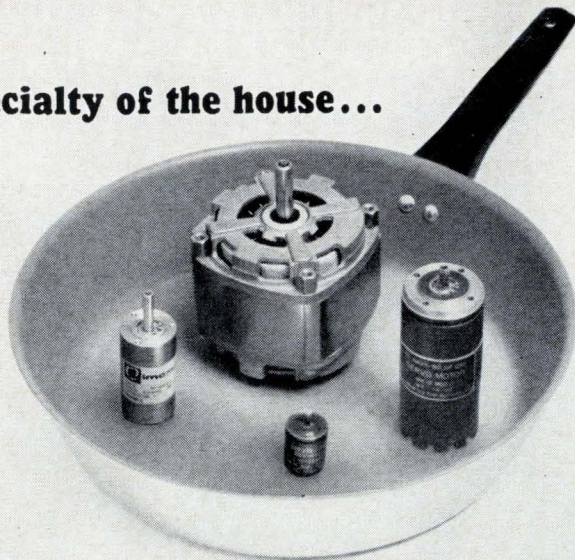

**cooking up new ideas in electric motors.**

Like the GT1612 that runs up to 60,000 rpm on hydrostatic air bearings. Extreme accuracy in locating the beryllium shaft helps make this possible. Other specialties to help you serve up exactly what's needed include induction, hysteresis, torque, synchronous, AC drive, DC drive and servo motors, in the milli- to integral-horsepower range, and without the compromise of run-of-mill

mass-produced motors. For motors for spacecraft, avionics, control, computer peripherals and other systems, contact IMC Magnetics Corp., Eastern Division, 570 Main St., Westbury, N.Y. Phone (516) 334-7070 or TWX 516 333 3319. If you need information for future projects write IMC's Marketing Div., at the same address, or circle the bingo number at the bottom of this ad.

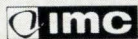

Circle 228 on reader service card

- 4 ways to beat a hot system**
- 1. Centrifugal Blowers**
  - 2. Propeller Fans**
  - 3. Vaneaxial Fans**
  - 4. Tubeaxial Fans**

Learn about them from a 12 page booklet called the "Airmover Selector." It has a technical information section to aid you in your choice of airmovers. On the remaining pages we have plugs for our products which help pay the cost of free booklets. Or a better bargain is our 136 page catalog given free when

you meet with our technical sales reps. For very quick service contact: IMC Magnetics Corp., Eastern Division, 570 Main Street, Westbury, N.Y. 11591. Phone 516 334 7070 or TWX 516 333 3319. For the "Airmover Selector" write: Marketing Division at the same address, or circle the Bingo number below.



**New Instruments**

and quadrature components as well as the phase angle may be measured at a single frequency. Isolation transformers in both signal and reference channels may be switched in or out of the circuits by means of front panel controls. Internal filters reject the influence of noise and harmonics.

Full-scale sensitivity of the model 240SP may be adjusted to any value from 300  $\mu$ v to 300 v. The signal voltage is displayed directly in volts on a large taut-band with a mirrored scale panel meter. The internal calibrated phase shifter covers the full range from 0° to 360° without ambiguity.

Typical applications include the measurement of phase angle; measurement of transformation ratio at the single operating frequency; null indicator for ratiometer and synchro bridge, measurement of power factor and complex impedance and the zeroing of synchros, resolvers, and transducers.

Dytronics Co., Inc., 5566 North High St., Columbus, Ohio, 43214. [373]

**Versatile, broadband sweep generator**

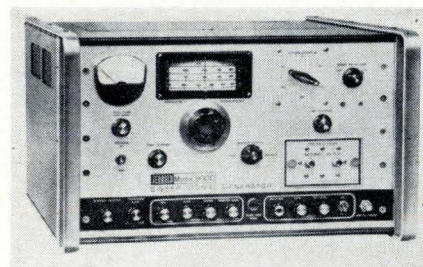

A broadband sweep generator, model 900-C, is designed for sweep frequency analysis of the response of various electronic circuits. The instrument permits observation of the entire frequency response of the unit under test (up to a 400-Mhz bandwidth), or will examine a narrow 10-khz segment. It can be used to make qualitative analysis of the response of a wide range of electronic devices such as receivers, amplifiers, filters, transformers or transmission lines. Built-in features include a plug-

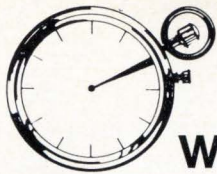

## WHAT IS MOTOROLA OSCILLATOR STABILITY?

*Accurate within a second  
in 300 years. Stabilities to  
1 part in  $10^{-10}$*



## WHAT IS MOTOROLA OSCILLATOR WARM-UP TIME?

*Down to ten minutes.  
The industry's fastest.*



## HOW WELL DO MOTOROLA OSCILLATORS PERFORM?

*Specifications are guaranteed.*



*Get the full story from your  
Motorola Representative. Or write for  
details to: Motorola Communications  
& Electronics Inc., 4900 West Flournoy,  
Chicago, Illinois 60644. A Subsidiary  
of Motorola Inc.*



**MOTOROLA**  
Precision Instrument Products

# 24 STANDARD MODELS...

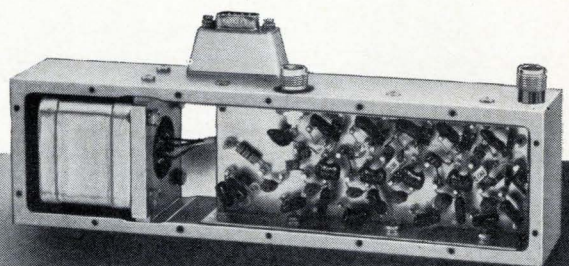

## RHG OCTAVE AMPLIFIERS

### FEATURING

- Noise figures to 2.5 db • Solid State Reliability • Low input and output VSWR
- RFI and Weatherproof housing • Octave coverage to 1000 MHz • With or without power supply

### FOR EXAMPLE

Model B505	
Frequency:	200 - 400 MHz
Gain:	20 db (min.)
Noise Figure:	< 4 db over band
Input and Output Impedance:	50 ohms
Input and Output VSWR:	2:1 typical over band
Price:	\$495

Utilizing RHG's broad background in low noise pre-amplification, an additional 43 CUSTOM DESIGNS have been produced. The solution to your problem may be on file in our library now.

For specials, test our ONE-DAY-QUOTE Service. For standards, see complete listing in EEM Section 3400.

# RHG

**RHG ELECTRONICS LABORATORY, INC.**

94 Milbar Blvd., Farmingdale, L.I., N.Y. 11735 ■ (516) 694-3100

MICROWAVE FM and AM RECEIVERS ■ MICROWAVE MIXER PREAMPS  
LINEAR and LOG IF AMPLIFIERS ■ RF and OCTAVE AMPLIFIERS

# ÷ and conquer



Vanquish your problems as they come, with Mathatron, the \$5,000 digital computer. No need to go to number-systems school or build a FORTRAN empire. Just express yourself in algebra on the Mathatron keyboard — use power-of-10 exponents, parentheses, square roots and decimal points.

Mathatron is a programmable, general purpose, electronic companion that saves hours of a professional man's day. Up to 11 pre-wired programs, expandable memory, optional paper tape reader/punch and page printer.

More than 80% of Mathatron owners have access to a big computer, but they would rather get quick answers than fight that battle. Write for the whole story.

**mathatron:** Program memory (core), 24 to 480 steps • Addressable storage, 4 to 88 registers • 9 significant digits, exponent, and sign • Number range  $\pm 10^{-42}$  to  $10^{+58}$  • Speed 100 accumulations per second • Optional prewired programs for special applications.

## MATHATRONICS

a division of Barry Wright Corporation 

241 Crescent Street, Waltham, Massachusetts 02154, Telephone: 617-893-1630

## New Instruments

in detector, harmonic marker system, scope preamplifier, precision turret attenuator and r-f output meter. With accessory equipment, the unit can measure by comparison methods: gain, attenuation and return loss; or measure the unloaded bandwidth and Q of cavities and resonant circuits.

Range for vhf is 50 khz to 400 Mhz; uhf, 275 Mhz to 1,200 Mhz; response is flat within  $\pm 0.5$  db up to 800 Mhz. Output capability for vhf is 0.25 v rms; uhf, 0.5 v rms. Price is \$2,180.

Jerrold Electronics Corp., 401 Walnut St., Philadelphia, Pa., 19105. [374]

## Impedance bridge has high accuracy

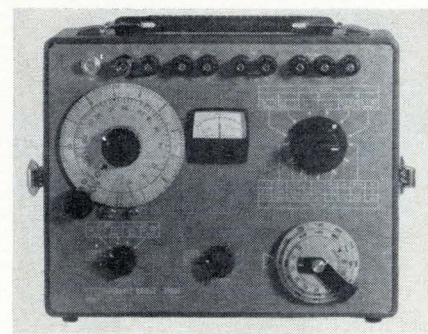

The 250DE impedance bridge, a self-contained instrument can measure resistance, capacitance and inductance on-site with high accuracy, the manufacturer says. Dissipation factor and storage factor can be read out directly on capacitance and inductance measurements.

Accuracy of the 250DE is conservatively rated to within 0.1% for resistance, 0.2% for capacitance and 0.3% for inductance. Comparative measurements can be made with greater precision because the dial resolution is 12,005 divisions.

The a-c/d-c null detector allows full accuracy on all ranges with a sensitivity of better than 20  $\mu$ v on d-c and 10  $\mu$ v on a-c. The single front-panel meter displays both a-c and d-c null balances. Matching a-c generator features transformer output and diode rectifiers

7 of a series

TRANSICOIL SOLVES SERVO PROBLEMS

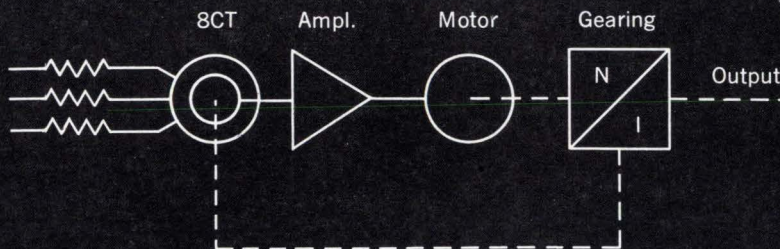

shown without cover

## New Transicoil size 23 servo repeater

Developed specifically as a plug-in replacement for a size 23 synchro torque receiver, this unit uses a closed-loop position servo to provide superior response. Synchro data at 90V, 60 CPS is scaled down by series resistances, then fed into a conventional size 8CT. Amplified synchro error applied to a size 8 motor closes the loop and drives the synchro and output shaft to a null position with improved sensitivity, stiffness and static error. Internal circuitry includes a power supply for the solid-state servo amplifier, making the entire assembly only slightly longer than the synchro it replaces.

**PERFORMANCE** Input: 90V, 60 CPS, 3-wire synchro ■ Output: Shaft position—5 oz. in. at stall ■ Accuracy: Static, 1/2°; Dynamic, 1° at 20 RPM ■ Slewing Speed: 20 RPM ■ Power Required: 115V, 60 CPS ■ Weight: 38 oz. ■ Size: 2 1/4" dia. x 6 5/8" length

Weston Instruments, Inc., Transicoil Division, Worcester, Pa. 19490.

**WESTON®** prime source for precision . . . since 1888

Circle 222 on reader service card

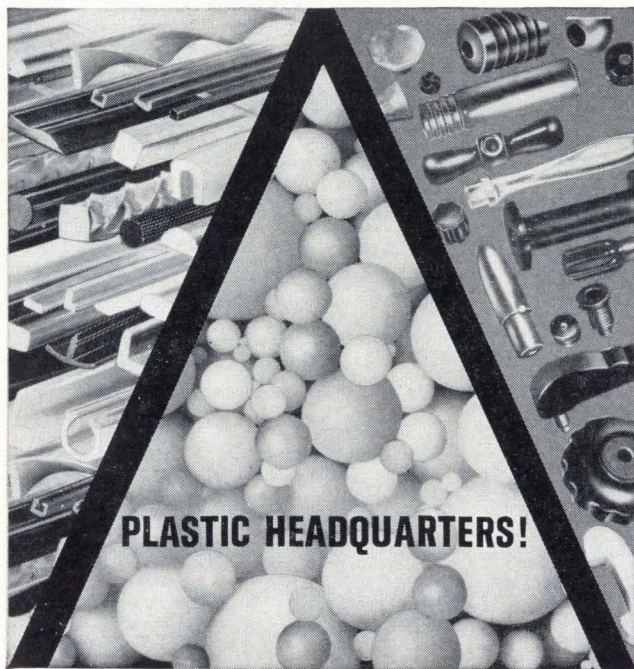

**PLASTIC HEADQUARTERS!**

**Extrusions, balls and parts**

SINCE 1931  
EXTRUDERS  
**A**  
FABRICATORS  
**ACE**

ACE is one of America's leading mass producers of an almost unlimited variety of plastic products. Extrusions, seamless balls, fabricated parts, etc.—in almost any size, quantity, color, tolerance, shape, form or plastic including nylon, teflon\*, acrylic or you name it. Small runs or large runs. In stock or specials. Write, wire or call for samples, price lists and technical bulletins. \*Teflon is DuPont's registered trademark for fluorocarbon resin.

ACE PLASTIC CO., INC. (91-20) VAN WYCK EXPWY., JAMAICA, N.Y. • (212) JA 3-5500

**FREE**  
**NEW 1967**  
**ALLIED**  
**INDUSTRIAL**  
**ELECTRONICS**  
**CATALOG**

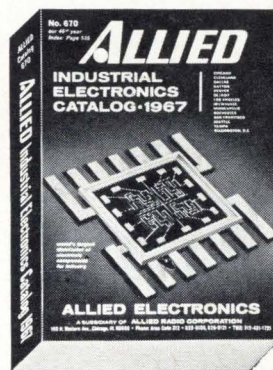

**552 Value-Packed Pages**

Here's the standard of the industry from Allied, the world's largest distributor of electronic components and equipment. 552 pages. 64,000 items, scores of new products. Factory OEM prices. Same-day shipment. Get your personal copy now.

**ALLIED**—WORLD'S LARGEST DISTRIBUTORS OF FAMOUS QUALITY BRANDS, FEATURES

**P&B**  
RELAYS

**WIDEST SELECTION • SAME-DAY SHIPMENT**  
See your Allied Catalog for Potter & Brumfield Relays: General Purpose, Special Purpose, Power, High Performance, Mercury Wetted Contact, Telephone types—all in stock at Allied.

For FREE catalog, check reader service card or write direct to:

**ALLIED ELECTRONICS**  
Our 46th Year

Subsidiary of ALLIED RADIO CORPORATION  
100 N. Western Ave., Dept. 82-J, Chicago, Ill. 60680

# VOLTMETER WITH A MEMORY ...DC TO 20 MEGACYCLES

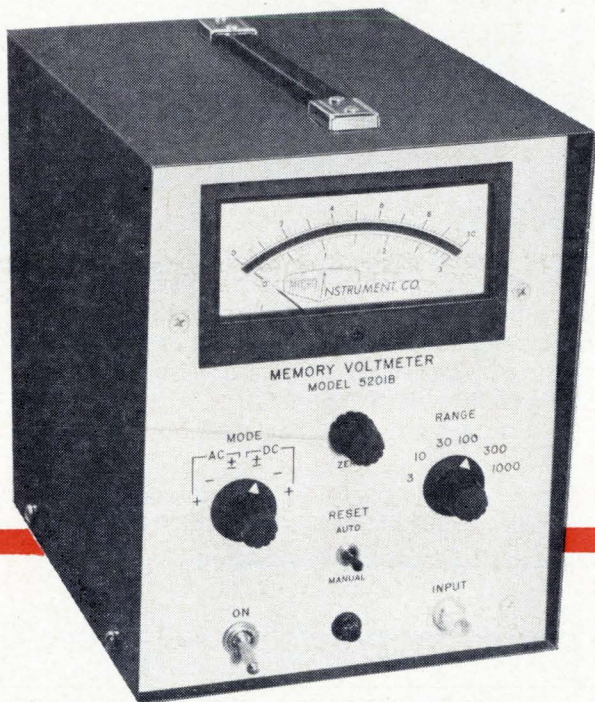

The Model 5201 memory voltmeter is a dc to 20 mc instrument which measures and stores indefinitely the maximum peak voltage applied, including continuous or one shot pulses as short as 50 nanoseconds. A memory reset-switch on the front panel allows the 5201 to monitor peak values of a varying waveform, either positive or negative going.

The solid-state 5201 is also available with a 3-digit in-line Nixie® tube readout. The voltage range may be extended to 30 kv with optional high voltage probes. For complete technical information, contact the Micro Instrument representative near you or write directly to us.

## Specifications

<b>VOLTAGE RANGE</b>	0-3, 10, 30, 100, 300, 1000 volts. Can be operated up to 1000 volts above ground.
<b>INPUT IMPEDANCE</b>	100 k- 10 megohms (depending on range).
<b>PULSE WIDTH</b>	DC to 50 (typically 30) nanoseconds.
<b>OPERATING MODES</b>	+, -, ± (DC or AC coupled).
<b>READOUT</b>	5" mirror-backed 1% meter.
<b>PRICE</b>	\$695.00.



12901 CRENSHAW BLVD., HAWTHORNE, CALIFORNIA 90250  
PHONES: (213) 679-8237 & 772-1275/TWX (213) 647-5133

## New Instruments

for applications requiring d-c.

Both detector and generator are solid state throughout. Added binding posts provide for application of bias voltage to capacitors or use of external generators and detectors. The company says its precision wirewound resistors ensure accuracy and stability, and that the Dekadial coaxial main dial permits easy adjustment and reading. The cover is attached by self-locking clamps but can be detached for unencumbered use. Operation instructions are permanently affixed to the inside of the cover.

Price is \$470; availability, stock to 30 days.

Electro Scientific Industries, Inc.,  
13900 N.W. Science Park Drive, Portland, Ore. [375]

## Video X-Y plotter is useful in 4 modes

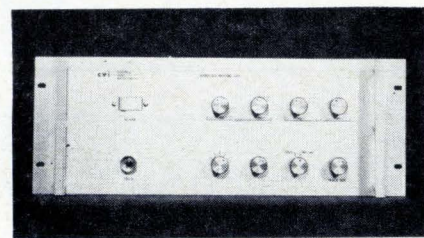

A video plotter has been developed to display graphic information directly on the screens of standard television monitors, with resultant increased flexibility as compared with conventional paper recorders. The traces produced by the model 401 are bright and nonfading, but can be completely erased in a fraction of a second. Signals from the 401 can be intermixed with those from tv cameras, flying spot scanners or other video sources to produce highly complex displays.

Model 401 may be used in four different modes: as an X-Y plotter writing at a rate of 60 points per second; as a low frequency storage oscilloscope by using the internal time base; as a raster display device writing at a rate of 60 lines per second; as a direct-writing device driven from an external video signal.

Of considerable importance in



**Designed  
for  
Advanced  
Data Systems...**

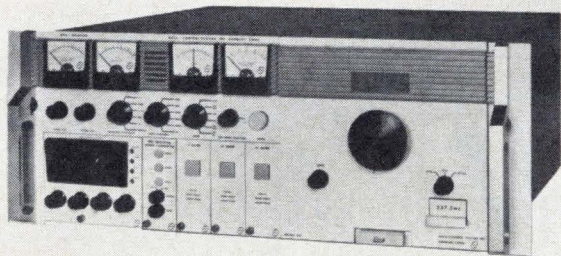

**The  Series 400  
TELCOM Receiver**

**Look at these features...**

- All solid state design
- Superior performance
- Completely modular, plug-in construction
- RF heads for VHF and S-Band telemetry, sweep tuned and wide band heads for surveillance applications
- Plug-in pre-detection recording converter, spectrum display, electrically switchable IF Filters

**Interested?** Get the detailed specifications. Write for your free copy of the DCS Series 400 TELCOM Receiver brochure.

Would you like an appointment to see a TELCOM Receiver for yourself? Just call the DCS office below nearest you...

Dept. E8-6, East Liberty Street, Danbury, Conn. 06813  
Telephone: 203-743-9241 • TWX 744-1990



**DATA-CONTROL SYSTEMS INC.**  
*Instrumentation for Research*

Sales Offices  
Silver Spring, Md., Huntsville, Winter Park, Long Beach, Santa Clara,  
Albuquerque

Copenhagen London Rome Paris Munich Amsterdam

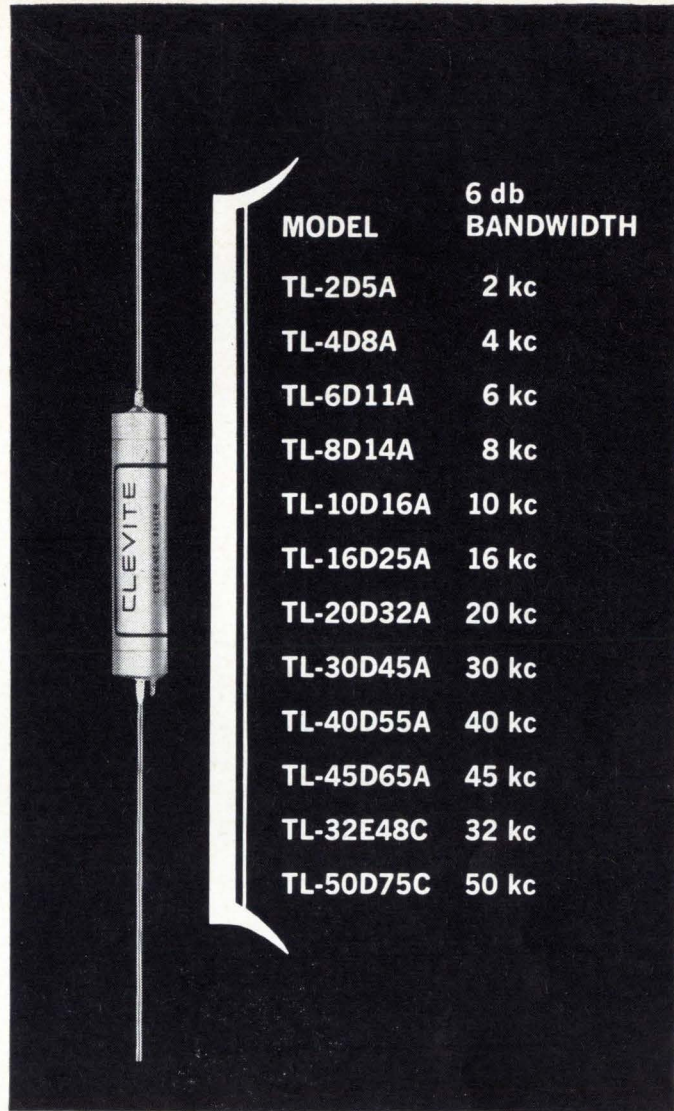

MODEL	6 db BANDWIDTH
TL-2D5A	2 kc
TL-4D8A	4 kc
TL-6D11A	6 kc
TL-8D14A	8 kc
TL-10D16A	10 kc
TL-16D25A	16 kc
TL-20D32A	20 kc
TL-30D45A	30 kc
TL-40D55A	40 kc
TL-45D65A	45 kc
TL-32E48C	32 kc
TL-50D75C	50 kc

**Clevite Ceramic Ladder Filters  
80 db rejection in 0.1 cu. in.**

- 50% lower insertion loss
- Increased skirt selectivity
- Less insertion loss change with temperature

Clevite ceramic ladder filters provide more selectivity for their size than any conventional i-f filter. They are fixed tuned and need no alignment—are non-magnetic and non-microphonic. Leading manufacturers now specify Clevite ladder filters for their modern communications equipment. Improve your newest design with these unique filters. Write now for complete specifications—Bulletin 94017 or request selectivity curves for each stock model. ■ Dimensions: 5-1/6" diameter x 1-1/2" long ■ Selectivity: 60 db/6db shape factor from 1.4:1 to 2.5:1 ■ Center Frequency Stability: within 0.2% for 5 years, and within 0.2% from -40°C to +85°C ■ Impedance: 1200-2500 ohms ■ Designed for military and space environment. ■ Clevite Corp., Piezoelectric Division, 232 Forbes Road, Bedford, Ohio 44014.

**CLEVITE**

# WOW!

\*... DoD will completely vacate 225-260 mcs by Jan. 1, 1970 with no exceptions. Document makes clear plan for 1435-1535 mcs, 2200-2300 mcs ... for the exclusive use of air/space-ground telemetering ..."

## JANUARY 1, 1970

# BAM!

(1435-1535 MHz—2200-2300 MHz)

### ARE YOU EQUIPPED FOR THE NEW TELEMETRY BANDS?

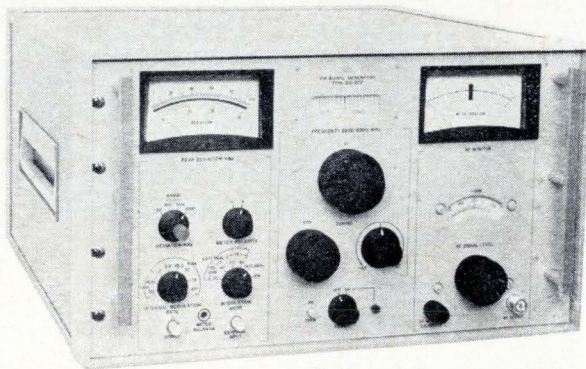

L-BAND SG-305  
S-BAND SG-307

### ACL has precision-engineered L-BAND OR S-BAND FM SIGNAL GENERATORS

Designed and produced by telemetry engineers to meet the telemetry industry requirements.

## NOW AVAILABLE!

Send for complete specifications

**ACL**

**ASTRO COMMUNICATION LABORATORY**  
801 GAITHER ROAD, GAITHERSBURG, MD. 20760  
TELEPHONE (301) 948-5210 TWX 710-828-9706

\*EXCERPT FROM THE TELEMETRY JOURNAL, JUNE/JULY, 1966

### New Instruments

some applications is the fact that the 401 can be Z-axis modulated, and can render better than six shades of gray.

The plotter's versatility is due to its high capacity, wide band, magnetic disk memory that provides indefinite data storage.

Price of the video plotter is \$4,000, and delivery is 90 days after receipt of order.

Colorado Video, Inc., Box 928, Boulder, Colo., 80302. [376]

### Limit bridge tests capacitors

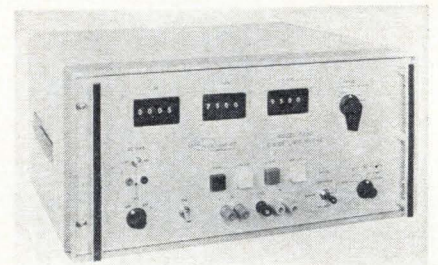

Limit bridge model 5350 provides simultaneous limit decisions for both series capacitance and dissipation factor at 120-hz or 1,000-hz test frequencies, and completely eliminates stray capacitance effects due to bias supplies, capacitance to ground, shielded leads, and other causes. A zero to 300-v bias supply can be used with no effect on either capacitance or dissipation factor measurements. The company claims this is the first bridge to allow this type of measurement.

The bridge operates on a go, no-go principle. It makes a limit decision in 250 msec. Accuracy is to within 0.25% on capacitance and better than 1% on dissipation factor. It provides one accept and three reject categories; additional accept categories are optionally available. Output relay closures permit operation of solenoids, automatic feeders, etc. A two-, three-, four-, or five-terminal measurement allows guarding and sensing for the capacitor under test.

Capacitance ranges are from 0 to 1199.9  $\mu$ f at 120 hz, and from 0 to 11.999  $\mu$ f at 1,000 hz. Capacitance limits are: lower, 0 to 9,999; upper 0 to 11,999. Limits are set in

# HERE'S HOW...

THE ELECTRONIC INDUSTRY IS USING THESE TWO FAMOUS ULANO FILMS IN ULTRAMINIATURE MASK TECHNOLOGY AND COMPLEX PRINTED CIRCUITRY

# Ulano<sup>TM</sup>

## RUBYLITH<sup>TM</sup> • AMBERLITH<sup>TM</sup>

HAND CUT MASKING FILMS FOR THE GRAPHIC ARTS

**ULANO RUBYLITH**... a revolutionary knife cut red film is laminated to a stable transparent plastic backing sheet. The red film is "light safe" so that when contacted to a sensitized emulsion and exposed to a suitable light source, light passes through the cut-out portions only... not through the red film. ■ The polyester backing is absolutely stable... insures perfect register. ■ Special effects such

as crayon tones, paste ups, benday sheets, and opaques are easily combined with versatile ULANO RUBYLITH.

**ULANO AMBERLITH**... a companion to Rubyolith serves as a color separation medium used as the master on camera copy board to secure negatives or positives.

A wide variety of Ulano films—in rolls and sheets—is readily available

# ulano

NEW YORK • CHICAGO • ZURICH

610 DEAN ST., BROOKLYN, N. Y. 11238  
In Europe: ULANO A. G., Untere, Hesiibachstrasse No. 22  
Kusnacht, Zurich, Switzerland

"Ulano"-"Rubyolith"-"Amberlith" are registered trade marks of the Ulano Companies.

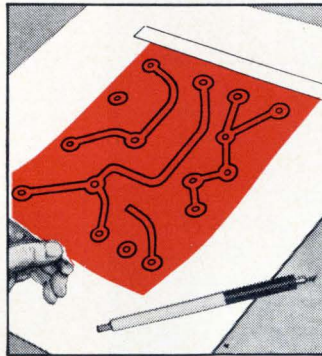

Cut a piece of the desired film large enough to cover area to be masked. Tape it down firmly at the top with dull-side up.



With sharp blade, outline the areas to be masked. Do not cut through the backing sheet. The Ulano Swivel Knife does the job quickly, easily.

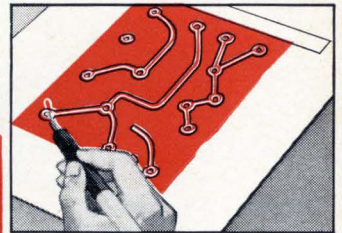

Using the tip of the blade, lift up a corner of the film thus separating it from the backing sheet.

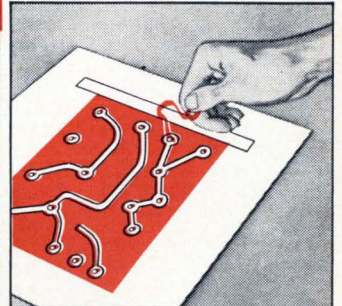

Now carefully peel off the film as outlined leaving a completed mask, positive or negative, that corresponds exactly to the desired pattern.



**WRITE TODAY**

on your letterhead for free special sample kit 1848



## telephone quality components

There is no higher standard for switching components. Specify famous Stromberg-Carlson... known to telephony since 1894.

**RELAYS:** Types A, B, BB, C and E. All standard spring combinations are available. Send for Bulletin T-5000R3.

**KEYS:** Broad selection of push-button, cam and twist types. Send for Bulletin T-5002R2.

**HANDSETS:** High-efficiency instruments; standard or with switch assemblies. Send for Bulletin T-5017R.

Full-line data on request.

## STROMBERG-CARLSON

A Subsidiary of General Dynamics

114 Carlson Road • Rochester, N. Y. 14603

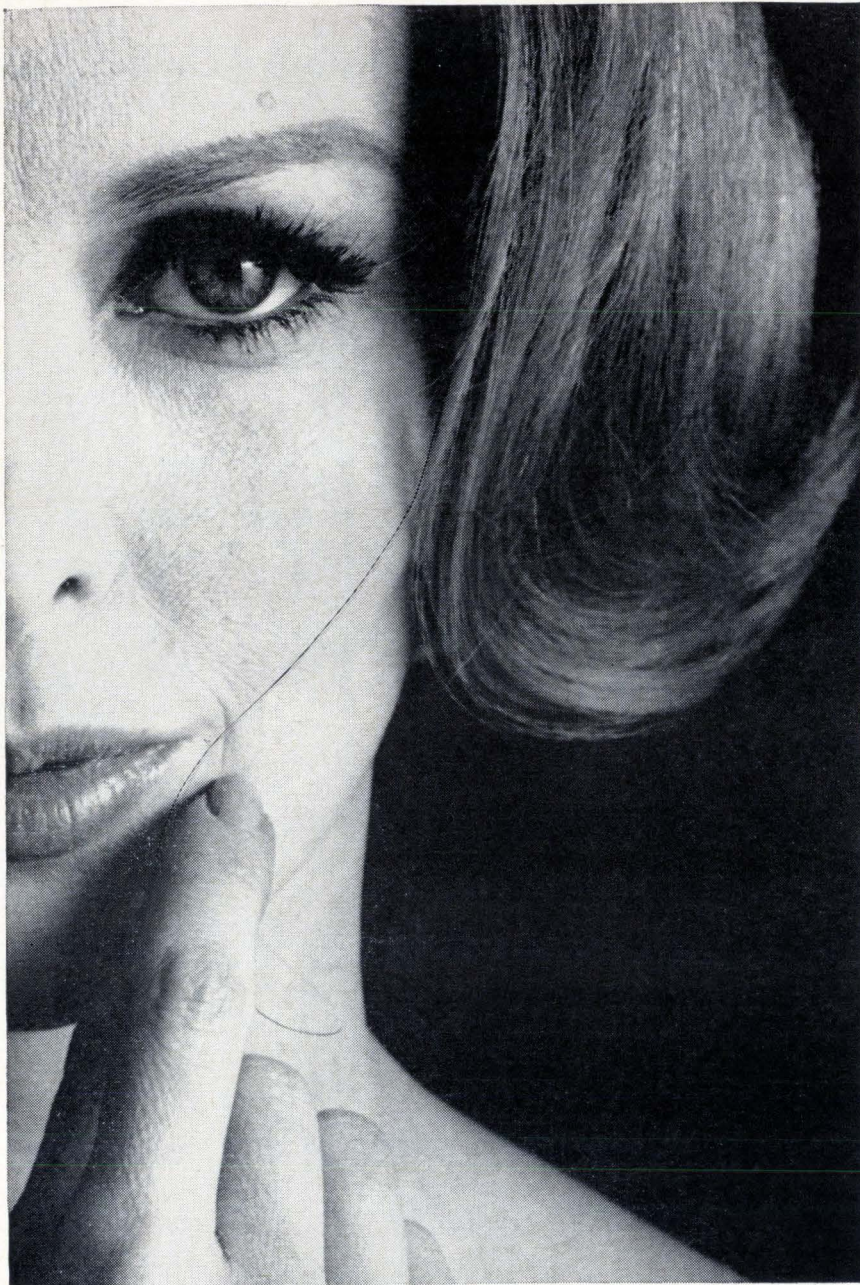

Her fine hair is  
25 times thicker than our foil

Depending on the material, we roll to 0.0001 inch or *thinner*. We do it with your alloys, with Hamilton-developed proprietary alloys, or with off-the-shelf metals. We roll them to *exact* specifications within the closest tolerances with the precise finish you direct. We retain the required metallurgical properties and characteristics. Further, we guarantee the finished product.

We have the capacity and ability to provide the closest-to-perfect precision metals. We have the craftsmen, the knowledge, the experience, and the equipment.

Would you like to know more in greater depth? Write. Teletype. Phone. Ask for our brochure PM-51.

## HAMILTON PRECISION METALS

division of Hamilton Watch Company • Lancaster, Pennsylvania 17604

Phone: 717-394-7161

TWX 717-560-4417

## New Instruments

with 4- and 5-digit in-line thumb-wheel switches. Dissipation factor is from 0 to 0.9999, the upper limit of which is set in with a 4-digit in-line thumbwheel switch.

Model 5350 sells for \$2,000 (less oscillator). Either a 120-hz or a 1,000 hz internal oscillator is available at \$300. Delivery is 8 weeks from receipt of order.

Micro Instrument Co., 12901 Crenshaw Blvd., Hawthorne, Calif., 90250. [377]

## Motor aspirated portable psychrometer

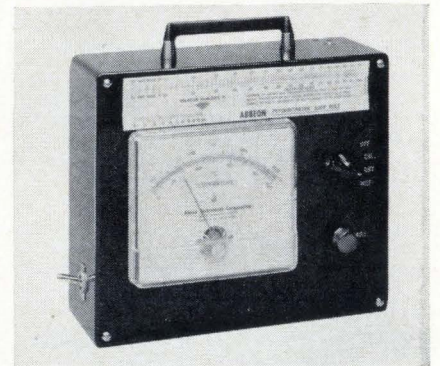

A motor aspirated portable psychrometer, model ABX-667, accurately measures the relative humidity in the air. The thermistor thermometers are carefully matched with an error of less than  $\frac{1}{2}^{\circ}\text{C}$ . A turbine fan in the interior of the instrument delivers the air stream over the sensing elements at the proper speed to insure correct and rapid reading. It covers the range of readings from 2% to 100% relative humidity and is completely portable and easy to use. All the components are built in the rugged carrying case which is equipped with a handle. Elimination of glass thermometers and slings increases the durability of the instrument while lessening potential human errors.

The portable psychrometer is powered by two flashlight batteries and one mercury cell. The unit comes ready for use except for the addition of water at the filling port at the top of the instrument. A four-position switch registers "off" when not in use. The operator then

# Come to MELPAR

Where *PERFORMANCE*  
and *RECOGNITION*  
Come *FIRST!*

At Melpar, our emphasis on individual recognition of accomplishments is not just a printed policy statement nor just a talking matter. It represents the very foundation of our personnel management system.

For more than 20 years, Melpar has enjoyed an enviable reputation as a leader in Space and Defense.

Are you qualified to join us?

*Immediate openings exist in the following areas:*

Adaptive Systems • Antenna Systems • Communications • Countermeasures • Electro-Optical Data Processing • General Purpose Computer Applications • Information Systems • Intelligence Collection • Simulation and Training • Tactical Avionics

Write, in confidence, to:

Clarence Endsley, Professional Placement

## MELPAR INC

A SUBSIDIARY OF WESTINGHOUSE AIR BRAKE COMPANY  
7731 ARLINGTON BOULEVARD, FALLS CHURCH, VIRGINIA  
(10 miles S.W. of Washington, D. C.)

An equal opportunity employer M/F

Circle 225 on reader service card

# NCC to be Sure

## POLYESTER FILM CAPACITORS

### Type MXT

MXT-4.5-47  
4.00V  
.047 MFD

In Plastic Tube.  
Capacitance  
Range : .001 MFD to .22 MFD.  
Voltages : 100v, 200v, 400v, 600v DC.

### Type MFL

dipped Flat Shape.  
Capacitance  
Range : .001 MFD to .47 MFD.  
Voltages : 35v, 50v, 100v, 200v DC.

### Type MFK

dipped Flat Shape.  
Non-Inductive Construction.  
Capacitance  
Range : .01 MFD to .22 MFD.  
Voltages : 100v, 200v, 400v, 600v DC.

## METALLIZED POLYESTER FILM CAPACITORS

### Type FNX-H

FNX-1.5-10  
12V  
10 MFD

Mylar Wrapped Semioval  
With Epoxy End Seal.  
Capacitance  
Range : 1 MFD to 10 MFD.  
Voltages : 50v DC.

## SOLID TANTALUM CAPACITORS

### Type TSL

Sealed with Epoxy Resin.

Capacitance  
Range: 1 MFD to 220 MFD.  
Voltages: 3v, 6v, 10v, 15v, 20v, 25v,  
35v DC.

### Type TAX

MIL-C-26655A Hermetically Sealed.

# MATSUO ELECTRIC CO., LTD.

HEAD OFFICE: 3-chome, Sennari-cho, Toyonaka-shi, Osaka, Japan.  
Cable Address "NCC MATSUO" OSAKA

Circle 226 on reader service card

# Cherry

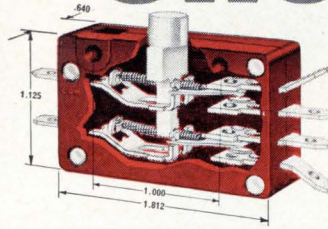

**E19-00A  
DOUBLE POLE**  
15 amp, 125-250 VAC  
¾ H.P. 125 VAC  
1½ H.P. 250 VAC

# LONG-LIFE

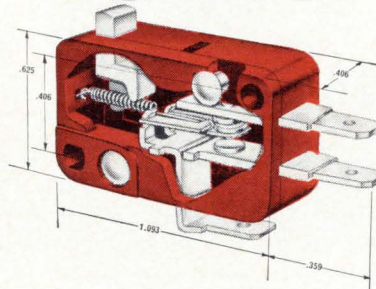

**E34-00A  
MINIATURE**  
15 amp, ½ H.P.  
125-250 VAC

**E13-00E  
GENERAL PURPOSE**  
15 amp, 125-250 VAC  
¾ H.P. 125 VAC  
1½ H.P. 250 VAC

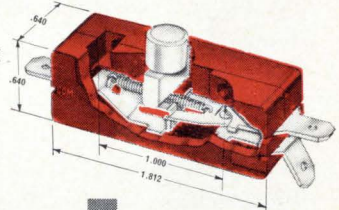

# switches

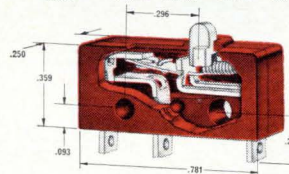

**E62-10A  
SUBMINIATURE**  
10.1 amp, 125-250 VAC  
¼ H.P. 125 VAC

The more than 80,000,000 Cherry precision switches now in use prove every day that their exclusive coil spring construction lasts millions of cycles longer. Prove it to yourself. Tell us what you need in long-life switches and ask for a sample.

**CHERRY**   
**ELECTRICAL  
PRODUCTS CORP.**

1656 Old Deerfield Rd., Highland Park, Ill. 60035

Circle 169 on reader service card

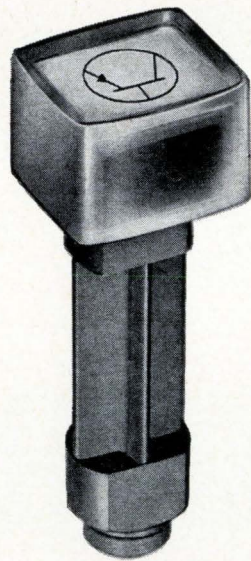

## push-button drafting?

Why not! When you try to improve drafting room production, it soon becomes apparent that yesterday's methods just aren't up to the job. They're time-consuming and costly. Mergenthaler has an answer. We call it The Diagrammer, and it's the first practical step to automated drafting. We can't begin to tell you all about it here. But if you're interested in a fast, simple, sleeves-up approach for producing schematics and diagrams photographically, The Diagrammer is for you. Just a note to us on your letterhead will bring you the full story. You have nothing to lose but the backlog in your drafting room. Mergenthaler Linotype Company, 29 Ryerson Street, Brooklyn, N.Y.

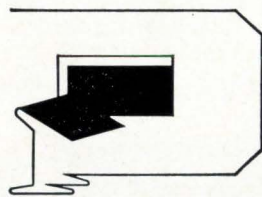

## THE DIAGRAMMER

Circle 170 on reader service card

To order reprints: Fill in, cut out coupon below, insert in envelope and mail to: **Electronics Reprint Dept., 330 W. 42nd Street, New York, N.Y. 10036**

### Reprint order form

For listing of reprints available see the Reader Service Card.

Communications Satellites Part I

Send me ..... reprints of Key no. R-89 at 50¢ each.

For reprints of previous special reports fill in below:

Send me ..... reprints of Key No.(s) ..... @ ..... ¢ each.  
(For prices, see Reader Service Card)

Name .....

Number of street .....

City, State, Zip code .....

## New Instruments

turns the switch to "cal" which checks the calibration of the instrument. If necessary, a small adjustment can be made with the adjusting knob. The operator then turns on the fan, flips his switch to "dry" and reads his dry bulb reading. He then takes his wet bulb reading. A slide rule is built into the instrument, and he puts his wet bulb reading over his dry bulb reading and reads his relative humidity directly as a percentage.

Price of the ABX-667 complete is \$150.

Abrax Instrument Corp., 179-15 Jamaica Ave., Jamaica, N.Y., 11432. [378]

## Audio flutter meter guarantees accuracy

An audio standard flutter meter is designed for production lines and laboratories of tape recorder manufacturers. This solid state instrument requires no operator calibration for full accuracy. The 8100/8100-W guarantees accurate and consistent measurement of tape recorder performance. The meter can measure both U.S. (NAB) and International (DIN) Standards.

The unit provides consistent accuracy in the simultaneous measurement of both speed and flutter. It operates from reproduce electronics output or directly from the play-back head. Options include a tunable wave analyzer (8100-W) to determine frequencies of observed flutter, thus facilitating determination of the cause of flutter.

The instrument features: full scale flutter ranges of 0.01%, 0.03%, 0.1%, 0.3%, 1%, 3% and 10%; full scale drift ranges of  $\pm 0.03\%$ , 0.01%, 0.3%, 1%, 3% and 10%; demodulator output accuracy of  $\pm 2\%$  on all ranges; frequency range of d-c to 200 hz; rms and peak measurements are NAB weighted or unweighted; automatic input level indication and simultaneous indication of drift and flutter.

Micom, 2570 Leghorn St., Mountain View, Calif., 94040 [379]



## ULANO EUROPEAN TECHNICAL CENTER FOR GRAPHIC ARTS

Ulano's technical center in Switzerland is headed by the very capable Mr. Henri Kunz. He is qualified by his many years of experience in the Screen Process and Graphic Arts fields. Demonstrations and technical seminars are held in many languages throughout the year. Complete laboratory facilities have been installed to provide demonstrations of the complete Ulano line. Large stocks of all famous Ulano films are available for immediate delivery to all parts of the world.

You are invited to contact Mr. Henri Kunz at ULANO A.G., Untere, Heslibachstrasse No. 22, Kusnacht 8700, Switzerland, Telephone 905959. It is our pleasure to serve you.



**DO YOU USE  
SCREEN PROCESSING**  
IN THE PRODUCTION OF  
**COMPLEX  
PRINTED  
CIRCUITRY?**

**TWO NEW PRESENSITIZED FILMS TO  
SPEED PRODUCTION — LOWER COSTS**

**Ulano**  
T.M.



**WRITE TODAY**  
on your letterhead  
for free special  
sample kit  
number 5448

### **HI-FI RED**

#### **HEAVY-DUTY INDUSTRY PROVED**

Presensitized photo film used by many leading electronic firms for clean, sharp, tough, durable, almost indestructible screens of unmatched quality. Adheres tightly to wire, silk, nylon and dacron.

### **PREP®**

#### **PRESENSITIZED FOTO FILM**

.002 Polyester support guarantees good register. Does not require a dark room. Very good resolution—suitable for halftones. Excellent adhesion to silk, nylon, dacron and metal mesh. Tough, strong emulsion—good for machine printing and long runs.

### **J. ULANO & COMPANY, INC.**

610 Dean Street, Brooklyn, N. Y. 11238, U.S.A.  
Cable address: "UlanoFilm"  
In Europe: ULANO A. G., Untere, Heslibachstrasse No. 22  
Kusnacht, Zurich, Switzerland

# New reliability in radio and teleprinter communications from Mitsubishi

Mitsubishi Electric presents a recently developed parametric ARQ terminal system designed to increase the reliability of radio telegraph circuits. Designated the TZ-4 ARQ, this equipment reduces error rates in teleprinter traffic, while bringing a level of accuracy in radio traffic that approaches that of the cable circuit.

Model TZ-4 ARQ provides a duplex system (2 x 2 ch.) or a quadruplex system (1 x 4 ch.) in a single cabinet. Eight-extensors and four-subdividers are also included. Model TZ-4 ARQ is designed in accordance with new CCIR recommendation No. 342. For further information, a card bearing your name and address and sent to Mitsubishi Electric, Tokyo, Japan, will bring full particulars.



**MITSUBISHI ELECTRIC CORPORATION**

Head Office: Mitsubishi Denki Bldg., Marunouchi, Tokyo. Cable Address: MELCO TOKYO

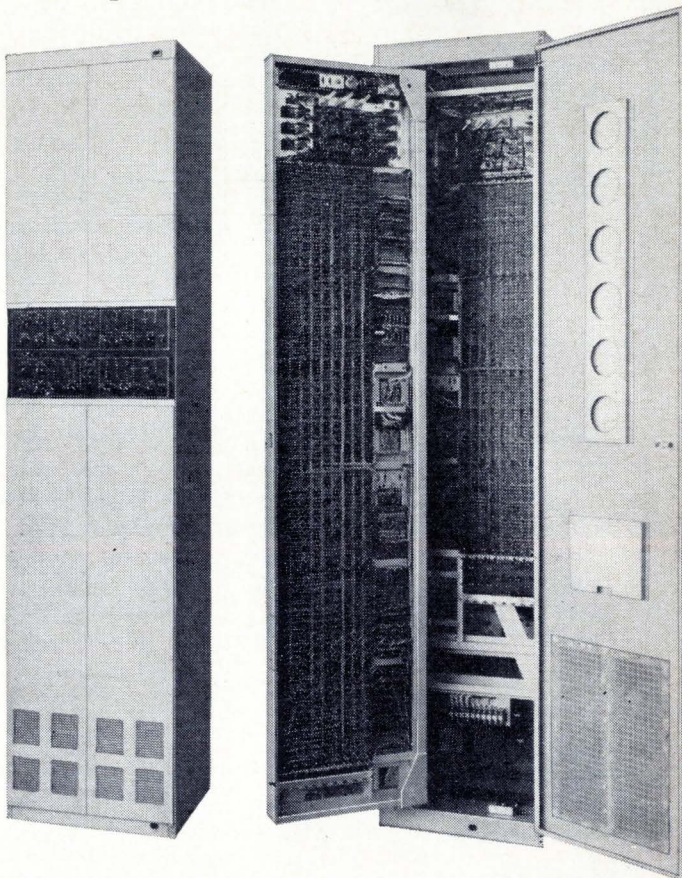

# WHAT DO YOU NEED IN TOGGLE SWITCHES?

**Control Switch has it!**



**World's smallest cylindricals.** Overall lengths as small as  $\frac{27}{32}$ ", diameters as small as  $\frac{11}{32}$ ". Life of 25,000 to 100,000 operations, depending on switch type and load. 1,150 types, 2- and 3-position, maintained and momentary, 1- or 2-poles, rated from  $\frac{1}{4}$  to 10 amp at 28 VDC or 115 VAC.

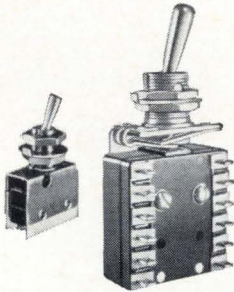

**1 to 6 circuits.** Ratings to 40 amps, single- or simultaneous double-break actions, maintained or momentary contact, 4-way action, holding coils, special toggle shapes. Name it, Control Switch probably has it right now.



**Moistureproof.** A complete line of internally sealed, moistureproof types as small as  $\frac{11}{32}$ " diameter by  $\frac{27}{32}$ " long overall. Momentary or maintained, 2-position, 2-circuit contact arrangements handle loads up to 3 amps at 28 VDC or 115 VAC. There's a moistureproof toggle switch to suit your exact needs—from us or from leading electronic parts distributors throughout the country.



**CONTROLS COMPANY OF AMERICA**  
CONTROL SWITCH DIVISION  
1420 Delmar Drive, Folcroft, Pennsylvania 19032  
A Subsidiary of  
**General Precision Equipment Corp.**

## New Subassemblies and Systems

### Fast multiplier sums logarithms



Engineers at Optical Electronics, Inc., have developed a solid-state analog multiplier which they say is five times faster than any other single-quadrant multiplier. It's priced in the range of conventional multipliers.

The high speed of the Model 519/520 is the result of a new conceptual approach to analog multiplication. In the past signals were multiplied directly in operational amplifier feedback circuits. This multiplier takes the logarithm of both signals, sums them and takes the antilogarithm of their sum to arrive at the product.

Although multiplication is done indirectly, logarithmic amplifiers in the 519/520 can process signals at 10 Mhz. The fastest previously available multiplier is an operational amplifier, with a Hall-effect device, that is limited to a 2-Mhz frequency response, according to the company.

Feedback circuits tend to be unstable, making it difficult to control and process lower-level signals which require subsequent amplification. The 519/520 can handle two input signals of 100-volt amplitude and yields a 20-volt output signal

at full scale. These large signal levels bring the possibility of high-frequency wattmeters within reach.

Faster multiplication will enable real-time processing of video data from radars and video tape recorders; the company says the 10-Mhz upper frequency limit was chosen with this in mind.

The new device also opens the way to higher speeds in analog computers since multipliers are among the slowest of the computer's components. One multiplier has already been sold to an oil company for processing of instrumentation data sampled at high rates.

#### Specifications

Maximum input voltage	100 v
Full-scale output voltage	20 v
Input impedance	10,000 ohms
Output impedance	100 ohms
Polarities (Model 519)	x and y inputs positive
(Model 520)	x and y inputs negative
Nominal transfer equation	$E_0 = kxy$ (where k is an adjustable scale factor)
Price	\$140
Delivery	30 days

Optical Electronics, Inc., Tucson, Arizona, 85706. [381]



**You need**

**1**

**very special switch.**

---

**Control Switch has**

**167,921**

**very special switches.**

---

**How can you beat odds like that?**

---

We'll get even more specific.

These 167,921 very special switches include pushbutton, basic precision, toggle, leaf and lever, interlock and limit, lighted panel, hermetically-sealed and environment-free switches.

Another specific. They're good ones . . . for equipment, systems, products that must reflect the integrity of the maker.

Doesn't it seem like a waste of time to pore through catalogs from umpteen suppliers when you're so sure of getting what you want through one of our distributors, one of our salesmen, or through us?

Send for any or all of the catalogs listed at the right. If you get them all, you'll have a *real* switch reference file!

Here's the list. Check numbers on the Reader Service Card corresponding to those on the left below for the catalogs you want.

- #481 *Condensed Switch Catalog 100*
- #482 *Basic Snap-Action Switch Catalog 110*
- #483 *Toggle Catalog 180*
- #484 *Indicator Light Catalog 120*
- #485 *Hermetic Switch Catalog 130*
- #486 *Switchlite Catalog 220*
- #487 *Pushbutton Catalog 190*



**CONTROL SWITCH DIVISION**  
1420 Delmar Drive, Folcroft, Pennsylvania 19032

A Subsidiary of  
 General Precision Equipment Corp.

*P.S. For an idea of what we have in toggle switches alone, see our ad on the facing page.*

# help!

A **SIGNAFLO**  
wiring system with

● **254 ROUND CONDUCTORS**  
on **.015" CENTERS**

● Excellent Dielectric and  
High Heat-resistant DuPont H  
Film Insulation.

● Cumulative error  
within .002"



Yes, we need your help to tell us where else this system (or something like it, even up to 600 conductors) is needed!

We solved one customer's problem with this unique aci Signaflo system. If you have a high density wiring problem with other unusual requirements, circle reader service No. \_\_\_\_\_

Or call, write or wire:

"Acknowledged leader in flat cable systems."



**aci** DIVISION OF KENT CORPORATION  
206 Industrial Center, Princeton, N. J. 08540  
Telephone 609-924-3800 TWX. 609-921-2077

and here are a few other  
problem-solving aci

**SIGNAFLO**

wiring interconnection  
systems.

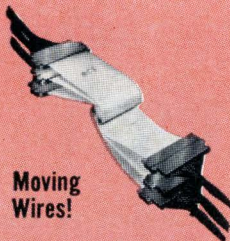

**Moving  
Wires!**

Multi-layered (for high density  
wiring) retractile systems for  
rack and panel cabling. Wires  
won't sag or droop!

Reader service No. \_\_\_\_\_



**Controlled  
Characteristic  
Transmission  
Wiring!**

Control impedance value,  
cross-talk, capacitance,  
propagation velocity with  
shielded or unshielded aci  
Signaflo transmission line  
systems. (Illustration shows  
106 ohm system).

Reader service No. \_\_\_\_\_



**Jumpers**

Strong, flexible, lightweight  
interconnection of circuitry.  
Also ideal as card extenders for  
p.c. board test checking.  
Exclusive aci computer  
controlled manufacturing  
technique for "Spread-Pitch"  
and "Micro-Pitch" make aci  
Signaflo systems adaptable to  
any hardware requirements.

Reader service No. \_\_\_\_\_

## New Subassemblies

**Solid state receiving  
system is versatile**

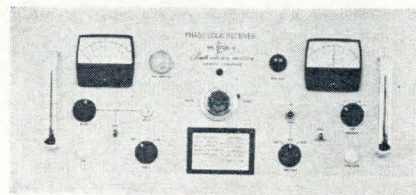

A phase-lock receiving system, the SRA-530, features solid state construction without sacrificing the phase stability and automatic gain-control characteristics normally associated with vacuum tubes. Tetrode field effect transistors are used to provide logarithmic agc over a dynamic range of more than 100 db.

Modular design provides versatility and ease of maintenance. Change of received frequency, i-f bandwidth, or demodulator characteristics is accomplished by replacing plug-in modules or module subassemblies. Special multiple-channel receivers may also be assembled with standard modules.

R-f heads and phase-locked first local oscillators are available for any received frequency from 30 Mhz to 16 Ghz. Standard i-f bandwidths from 500 hz to 30 khz and loop noise bandwidths from 5 hz to 1 khz are available; wider i-f and loop bandwidths by special order. Automatic acquisition is standard, with switch selection of normal acquisition for use with extremely weak signals.

Smyth Research Associates, 3555 Aero Court, San Diego, Calif. 92123. [382]

**Power supply  
adjusts output**

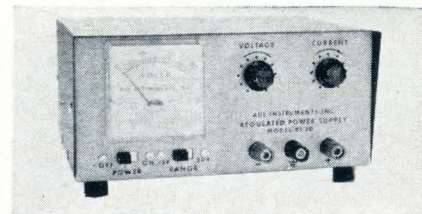

Model RS-30—a regulated, solid state power supply—provides continuously adjustable outputs cover-

ing the range from 1.2 to 30 v at currents from 0 to 500 ma. It has a ripple level below 1 mv rms. Output voltage is monitored by a front panel meter and is isolated so that either terminal may be grounded. Short-circuit protection is provided.

The unit is laid out for easy servicing. All components are accessible for checking and replacement.

The RS-30 measures 3½ in. high, 7½ in. wide and 8 in. deep. It is priced at \$45. Delivery is 30 days from receipt of order.

Aul Instruments, Inc., 24-13 Bridge Plaza North, Long Island City, N.Y., 11101. [383]

## Wideband amplifier for laboratory use

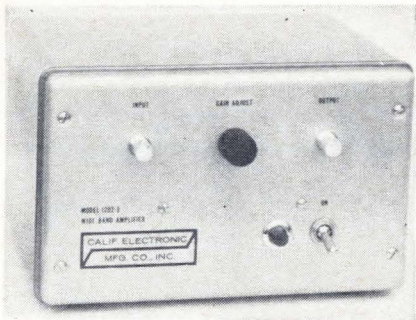

Model 1202-3 wideband amplifier, which is composed of silicon planar devices, uses feedback to achieve fast response and gain stability. Gain is adjustable from 10 to 100. Frequency response is 5 hz to 10 Mhz at 20-db gain and 10 hz to 1 Mhz at 40-db gain.

Other specifications include: output voltage, 6 v peak to peak across 1,000 ohms; pulse rise time, 60 nsec at 20-db gain; input impedance, greater than 100,000 ohms shunted by 25 pf; noise, less than 15 µv rms referred to the input with the input shorted; size, 5.5 in. high x 8.5 in. wide x 7.5 in. deep; weight, 4 lbs; input and output connectors, BNC type

Designed as a general purpose laboratory instrument, the 1202-3 is suited as an oscilloscope preamplifier, tape recorder preamp, pulse amplifier, and a-c transducer amplifier.

Price is \$135; delivery, 3 weeks after receipt of order.

California Electronic Manufacturing Co., Inc., P.O. Box 355, Alamo, Calif., 94507. [384]

The Kodak Instamatic M6 Movie Camera's battery-powered electric eye, with Vactec Cadmium Sulfide photocells, operates through the lens for high exposure accuracy.

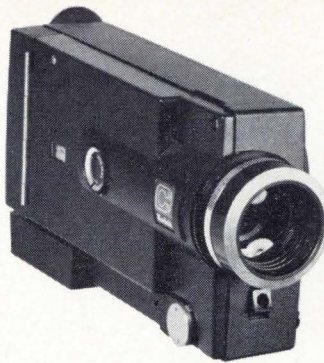

## Part of Kodak's automatic ease

"You aim through here, and press here." That's the simplicity of Instamatic Kodaks. And Vactec furnishes part of the ease—photocells that automatically control exposure settings. Come to think of it, that's controlling quite a lot.

# vactec photocells

Vactec Selenium photocells are among the important components that help the Kodak Instamatic 804 Camera automatically integrate film speed, shutter speed, lens aperture and existing light to compute and set exposures faster than you could yourself.

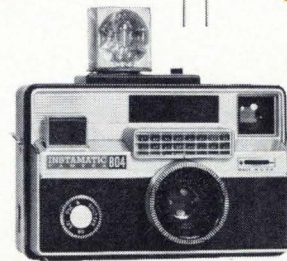

You can always expect the finest in light sensitive devices from Vactec. A complete line of photocells is available for your products. Or, we will custom design units to meet special needs.

Write for Bulletin PCD-3 for Cadmium Sulfide and Selenide types; Bulletin SPV-4 for Selenium photoelectric types.

**VACTEC**

2423 Northline Industrial Blvd.  
Maryland Hts., Mo. 63045  
Area Code 314, HE. 2-4200

**INC.**

Circle 227 on reader service card

## NEW! The only bench type pantograph with 1:1 RATIO

Drills PRINTED CIRCUITS pneumatically  
Engraves up to 100:1

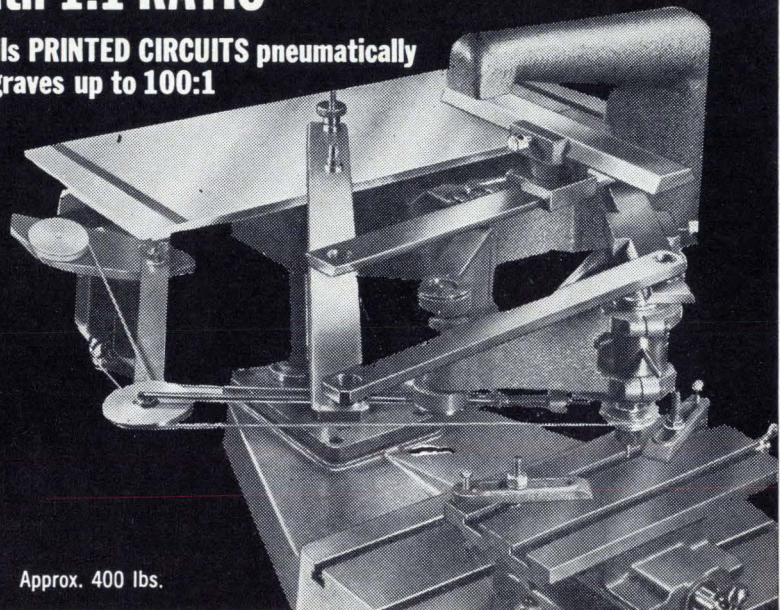

Approx. 400 lbs.

The most versatile machine tool for pantographic production drilling and routing. Reproduces your printed circuit prototype in full scale or in any ratio to 100:1. Ideal for unskilled labor. No changing of tools. One tool for all diameter holes and profiles. Close tolerances. Send for catalog # 139.

*new hermes engraving machine corp.*

154 WEST 14th STREET, NEW YORK 11, N. Y. Chicago, Atlanta, Dallas, Los Angeles, Dayton, Detroit, Mexico City, Montreal

## New Step-Ahead Design Gives Big Scope Features In a Rugged, Lightweight Instrument

You get more total performance, more usability in the new hp 180A Oscilloscope—*more than any other scope on the market!* You get this greater measurement capability in a 30-pound package that goes anywhere—field, laboratory or production line. Designed from the user's viewpoint in, this new high-frequency scope is packed with new ideas and innovations to give you big picture CRT, plug-in versatility, step-ahead electrical performance, minimum weight and rugged design.

With hp's all-new CRT, you get a big picture 8 x 10 cm display in a compact 17-inch tube length to allow portability. Display area is 30% larger than on existing high-frequency scopes—and 100% larger than some portable scopes. This means that you make accurate measurements, easier!

The vertical amplifier drives the CRT vertical deflection plates directly, requiring only 3 v/cm. This allows extended bandwidth capabilities, and means the vertical amplifier is lightweight, requires low power. Solid-state amplifiers with FET input stages provide stable gain and low drift for accurate measurements. Vertical attenuation, which sets vertical deflection factor, is ahead of the amplifier. This prevents trace jumps as you change ranges; bandwidth is maintained on all ranges even when verniers are used.

For easy viewing of the leading edge of a fast pulse, a new lightweight 160 nsec, 140 MHz etched circuit delay line was developed. Wide bandwidth together with good impedance characteristics insure clean display of input signal.

A new type of horizontal amplifier has wide bandwidth with X10 magnification to provide linear 5 nsec/cm sweeps, giving you greater resolution of high frequency signals and fast pulses.

Circuitry in the new 180A is 100% solid state. Only premium quality components were used throughout. This means you have lower power requirements, lighter weight and increased reliability. This results in the utilization of convection cooling—no fans.

Circuit boards in the scope are arranged to provide easy access to all circuitry. Snap-off covers give quick access. The control panel has been "human-engineered"—control knobs and switches are "convenience-grouped" and plainly marked to make them easier to see, easier to operate. Control panel and nomenclature are selective dye anodized for permanence.

Ask your nearest hp field representative for a demonstration of the 180A Oscilloscope, and he will show how you can see *more, do more* with this new big picture, 30-pound scope! Or, write to Hewlett-Packard, Palo Alto, California 94304, Tel (415) 326-7000; Europe: 54 Route des Acacias, Geneva. Price: hp Model 180A Oscilloscope, \$825.00; hp Model 180AR (rack) Oscilloscope, \$900.00; hp Model 1820A Time Base, \$475.00; hp Model 1821A Time Base and Delay Generator, \$800.00; hp Model 1801A Dual Channel Vertical Amplifier, \$650.00, f.o.b. factory.

**HEWLETT**  **PACKARD**  
An extra measure of quality

**SEE MORE!** 

**DO MORE!** 

Tear out actual size photo of hp 180A Oscilloscope. Set it on your bench. See what the big picture display could mean to your work! 

## New Microwave

### Waveguide-coaxial ferrite isolator

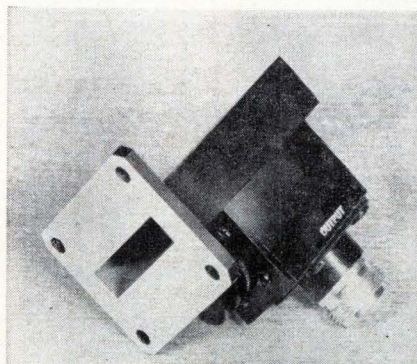

Added packaging flexibility is provided with the incorporation of integral waveguide adaptors on the company's standard coaxial ferrite circulators and isolators. A typical example is the ICC-199 isolator which covers 5.9 to 6.3 Ghz and has a waveguide input and a type N female coaxial output.

Size is approximately 2 x 2 x 2½ in. including connector, termination and waveguide flange. The unit can handle 5 watts of average power and will not be damaged if the output is inadvertently opened or shorted.

The waveguide/coaxial technique can be employed between 1 and 18 Ghz.

Western Microwave Laboratories, 1045 Di Giulio Ave., Santa Clara, Calif. [389]

### Tunable magnetron operates in Ku-band

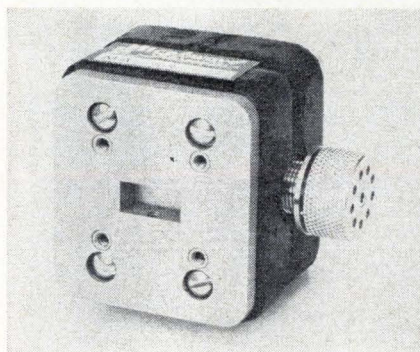

A positive-pulsed, 2.2 kw, Ku-band tunable beacon magnetron is offered. The MA-258 is a compact, rugged unit designed to tune over

the 15.4 to 15.7 Ghz range with a 0.2  $\mu$ sec pulse width and a duty ratio of 0.001. Peak anode voltage is 3,600 v and peak anode current is 3.1 amps.

Input connections are made through flexible leads or solder lugs and the output connector is designed to mate with a UG-541/U choke flange.

The MA-258 beacon magnetron is designed for use in beacon and navigational systems, lightweight radar systems, missile ground support equipment, transponders, and airborne radar.

Microwave Associates, Inc., Burlington, Mass. [390]

### Frequency multiplier works over 6 octaves

A frequency multiplier, model N808, features high efficiency and ultra wide band operation over six octaves for extending the usable frequency range of signal generators and frequency synthesizers with minimum conversion loss. Input power up to 400 mw from 50 Mhz to 4 Ghz produces high harmonic energy in the 100 Mhz to 12 Ghz range at efficiencies approaching the theoretical 200% divided by n, where n stands for the harmonic number.

The N808 is said to be ideal from an economical viewpoint for generating a comb of harmonics from a crystal-controlled 100-Mhz source. A tunable filter, such as a cavity-type frequency meter or an electronically-tuned YIG filter, can be used to select the high-power signal that is suitable for transmitter or local-oscillator service.

The harmonic-generating device is a 100-picosecond step-recovery diode. Its bias circuit is entirely self-contained, and d-c blocking is provided at both ports allowing the maximum flexibility in external circuitry.

Model N808 measures 1.13 x 1.38 x 3.81 in. Weight is 4 oz. Price is \$115; availability, 20 days from receipt of order.

Somerset Radiation Laboratory, Inc., 2060 North 14th St., Arlington, Va., 22216. [391]

## CUSTOM DESIGNED POWER SUPPLIES

TO

Mil-E-16400

Mil-E-5400

Mil-E-4158

Mil-T-21200

Mil-P-11268

NASA-200-2

Mil-I-983

Mil-F-18870

*Detailed data on facilities,  
capabilities and contract  
accomplishments on request.*



90 ROME STREET  
FARMINGDALE, NEW YORK 11735  
Phone 516-694-5484  
TWX 516-694-1505

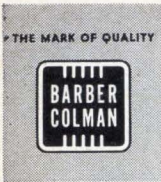

# Ultra-sensitive relays

## HELPFUL DATA FOR YOUR CIRCUITRY IDEA FILE

The circuit drawing below indicates just one of the hundreds of ways many manufacturers utilize Micropositioner® polarized relays to solve complex control problems.

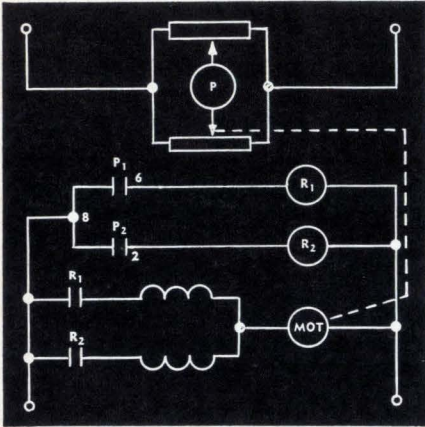

### SERVOMECHANISMS APPLICATIONS

Many remote positioning applications can be solved by utilizing the Barber-Colman Micropositioner ultra-sensitive relay either as a null detector or a differential relay. In the circuit shown above, movement of the transmitting potentiometer introduces an error signal in Micropositioner coil P, which in turn energizes the positioning motor until balance is restored. Secondary relays R<sub>1</sub> and R<sub>2</sub> operated by the Micropositioner handle larger loads. This circuit can also be applied to synchronization . . . or the Micropositioner can be utilized in the output of an electronic servo control.

Among the many applications for this simplified servo control relay are positioning of antenna rotators and tuning condensers . . . aerial camera mounts . . . valves . . . test cell apparatus.

If your projects involve servomechanisms, why not make a test with a Micropositioner designed for circuits similar to that shown above? Write for Engineering Bulletin No. 9.

### BARBER-COLMAN MICROPOSITIONER®

#### POLARIZED D-C RELAYS

Operate on input power as low as 40 microwatts. Available in null-seeking and magnetic-latching "memory" types of adjustment. Also transistorized types with built-in preamplifier. Write for our latest catalog with full information on polarized relays.

**BARBER-COLMAN COMPANY**  
Electro-Mechanical Products Division  
Dept. 1, 1259 Rock Street, Rockford, Illinois

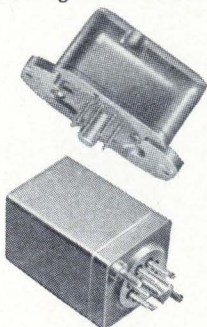

### New Microwave

## X-band source offers low noise

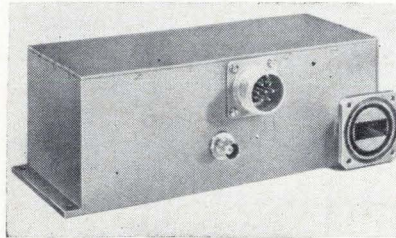

Low noise and high stability characterize this X-band solid state source. The output can be remotely switched between three discrete frequencies all above 10 Ghz in a 150-Mhz bandwidth.

This source is capable of: incidental f-m noise less than 50 hz peak in the bandwidth  $\pm 150$  khz from the carrier (all three channels); a-m noise 120 db below the carrier level (+20 dbm); short term power stability better than 0.1 db; power flatness between channels within 1.0 db.

Microwave Development Laboratories, Inc., 87 Crescent Road, Needham Heights, Mass. [392]

## Matching tuner goes from 0.25 to 2.5 Ghz

A coaxial matching tuner is available with a frequency range from 0.25 to 2.5 Ghz. Type 900-TUB tuner is a short section of coaxial line with three lockable tuning screws, which are used to tune out small reflections in low-voltage standing-wave ratio measuring instruments and devices.

The vswr matching range of the tuner is greater than 1.02 at 0.4 Ghz and greater than 1.05 from 1 to 2.5 Ghz. An important feature is a frequency-independent neutral position, which effectively removes the tuner from the circuit.

Vswr resettability of the tuner is better than  $1.001 \pm 0.0003$  times the frequency in Ghz and connection is repeatable to within a vswr of 1.0005. Price is \$195. General Radio Co., West Concord, Mass., 01781. [393]

# HATHAWAY

# NO. 1 DRIREED

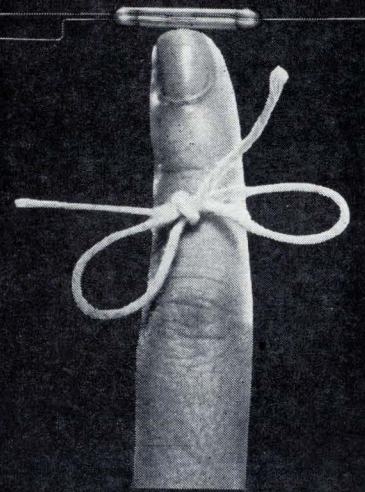

# and don't forget it

...not a scaled down single purpose telephone version  
...but a highly refined electronic switch available in 4 specific application types  
...from DC to 300 MHz and from micro amps to 500 m.a. For detail information call collect or write

**HATHAWAY INSTRUMENTS, INC.**  
5250 EAST EVANS AVENUE  
DENVER, COLORADO 80222  
(303) 756-8301 • TWX 292-2935

## ULTIMATE IN PERFORMANCE

**TOHOKU  
METAL'S**

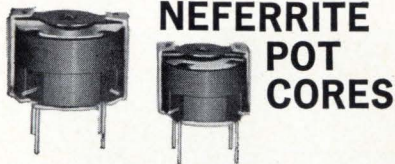

**NEFERRITE  
POT  
CORES**

NEFERRITE—developed by Nippon Electric Co., Ltd., and exclusively produced and sold by Tohoku Metal—a new type magnetic ferrite material which offers higher magnetic permeability and a low core loss coefficient even at high frequency. Highly

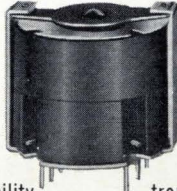

suitable for tele-communications and electronic equipment. NEFERRITE CORE—utilized for coils and transformers over a wide frequency range, it tremendously improves functional characteristics and helps reduce their size and weight.



**1966 Japan Electronics Show**  
September 20 — 29  
Tokyo International Trade Center

Please visit our booth and see NEFERRITE POT CORES at Bldg. No. 1-A71 (Electronic Parts Div.)

### Tohoku Metal Industries, Ltd.

7-4, GINZA-HIGASHI, CHUO-KU, TOKYO, JAPAN  
Tel. Tokyo (542) 6171 Cable Address: "TOHOKUMATAL TOKYO"

Circle 213 on reader service card

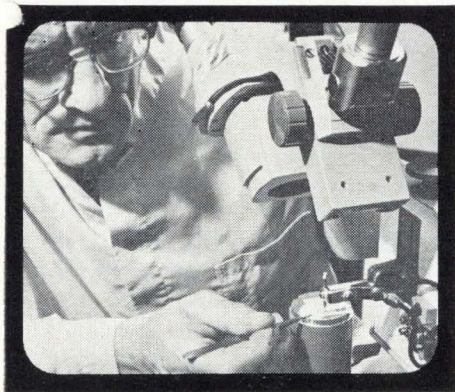

To  
**ELECTRONIC  
ENGINEERS**  
with a sense  
of timing...

## BENDIX IS ON THE MOVE!

(KANSAS CITY DIV.)

This is the opportune moment to investigate your career potential at Bendix, Kansas City Division. As prime contractor for the AEC, we have enjoyed an enviable, orderly 16-year growth. Now we are entering a unique developmental phase, opening new fields of activity in microminiaturization, microwave and logic circuitry. This situation adds up to a ground-floor opportunity in a well-established corporation noted for advanced engineering. Cooperative, professional atmosphere, plus excellent living conditions. Let us hear from you promptly so we may detail more clearly the many advantages we can offer you.

Please mail résumé at once to:

Mr. E. C. McGurren, Tech. Personnel Repr.  
THE BENDIX CORPORATION, Box 303-HH  
Kansas City, Missouri 64141

AN EQUAL OPPORTUNITY EMPLOYER

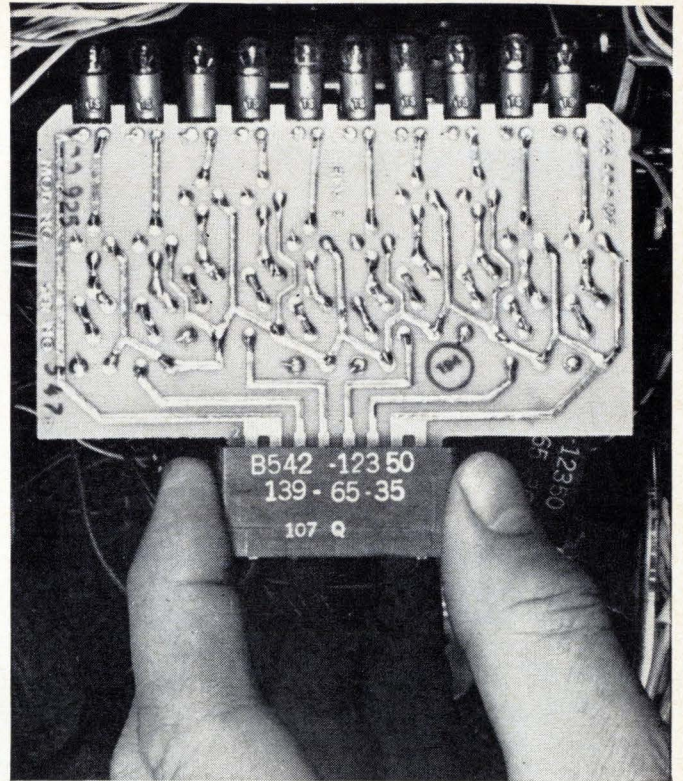

Lamps in this Electronic Associates, Inc., computer circuit board are the Tung-Sol Tu-Pin molded base types.

## Computer-Inspired, Molded Base Subminiature Lamps are Self-Mounting

Requirements of the computer industry for a compact subminiature lamp assembly, led to the development of the Tung-Sol integrally molded base lamp.

A molded nylon encapsulation replaces the conventional cemented-on metal base. This permits direct mounting of the lamp without need for the usual mated socket. Greater reliability is achieved, with obvious simplification of installation procedures.

The molded-base lamp lends itself to automated assembly and molding permits extreme flexibility of base configuration. Bases may be color-coded for accurate identification.

Tung-Sol integrally molded base subminiature lamps are available in Tu-Pin form or with special harnessing to your specifications.

Describe your requirements for more specific information.

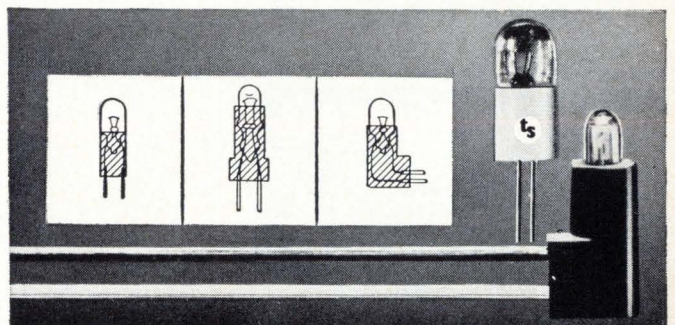

Molding permits extreme flexibility of base configuration.

## TUNG-SOL® MOLDED BASE SUBMINIATURE LAMPS

Tung-Sol Electric Inc., Newark, N. J. 07104

Got a Problem of  
DIMENSIONS?  
**TEMPERATURE?**  
UNUSUAL CYCLING?  
SHOCK RESISTANCE?

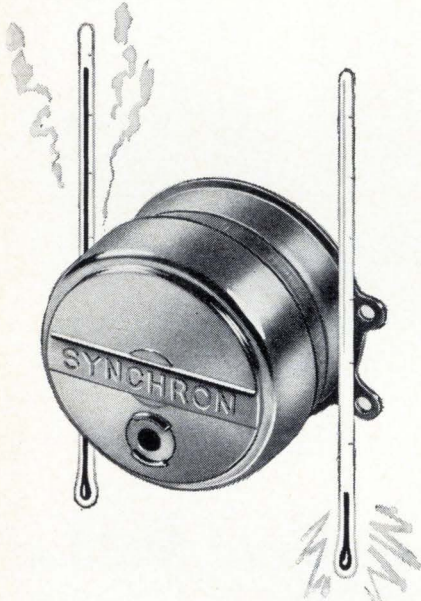

## turn the job over to **SYNCHRON® MOTORS!**

What's the motor problem you face in the design you're working on? One of tricky performance requirements? Difficult environment? Total accuracy? Before you do anything else, see how SYNCHRON Motors can be applied. (Do the same thing even when you have a simple, straightforward application in mind!) Just write us at Hansen Manufacturing Company and tell us what you want a motor to accomplish. You'll get an immediate answer and any help you need for specific problems.

# HANSEN

MANUFACTURING COMPANY, INC.



PRINCETON,  
INDIANA

HANSEN REPRESENTATIVES: CAREY & ASSOCIATES, Houston, Tex., R. S. HOPKINS CO., Sherman Oaks, Calif., MELCHIOR & MACPHERSON, INC., San Carlos, Calif., THE FROMM CO., Elmwood Park, Ill., H. C. JOHNSON AGENCY, INC., Rochester, N. Y., WINSLOW ELECTRIC CO., Essex, Conn., Norberth, Pa., and New York, N. Y. EXPORT DEPARTMENT, 64-14 Woodside Ave., Woodside, N. Y.

## New Production Equipment

### Proximity sensors gauge hot glass



One of the production problems facing manufacturers of precision glass components, like television tubes, is that glass emerges hot from the production line and will crack or explode if touched by something cool. So the component has to sit in a cooling oven for about four hours before inspection. If the glass turns out to be defective, time and money have been wasted. The Phylatron Corp. says that nondestructive testing of glass and other materials can be done with its multichannel proximity detection and sensing system. It can gauge any material, conductive or nonconductive, hot or cold, moving or stationary.

In the photograph the thickness of a glass television tube face is being gauged at nine locations. If the glass in one spot is thinner or thicker than the high and low tolerances, the appropriate light on the middle row goes on. Each sensor is connected to a potentiometer.

Phylatron claims its all solid-state instrument can give direct linear readings to 0.0001 inch.

Each sensor forms a capacitor connected in parallel with a high-q inductance circuit. A change in capacitance caused by the presence of the material sensed by the probe tip shifts the resonant frequency of the circuit. A link coupling to the box converts the change in the resonant frequency to a linear voltage output. The system's output can be fed into a computer for control.

The system, dubbed PM-800, is available with from 1 to 20 sensors. It can be built to provide either parallel or serial output from the sensors. The scan rate can be set between 4 hertz and 10 khz.

#### Specifications

Frequency response	D-c to 1 khz, depending on switching time and No. of channels
Linearity	Within 2% $\pm 0.05$ in.
Power input	100 w
Output	500 ohms $\pm 24$ v, d-c
Drift	Less than 1%
Price	
Basic instrument	\$3,166
Channels 2-10	\$600 each additional
Channels 11-20	\$540 each additional
Delivery time	About 6 weeks

Phylatron Corp., 1183 Chesapeake Ave., Columbus, Ohio 43212 [401]



## Production Equipment

### IR oven coats p-c boards automatically

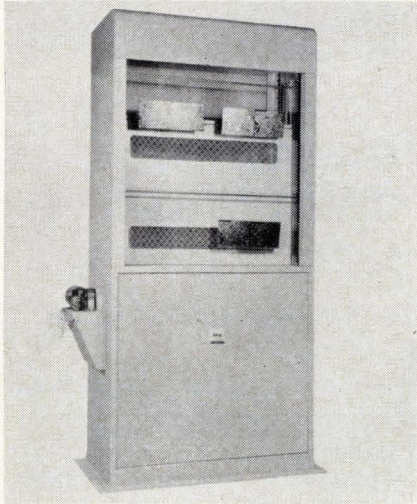

An infrared oven for p-c board coatings and metal flats automatically dips and cures photoresists in one-fifth the time taken by conventional ovens, according to the manufacturer. Besides effecting this reduction in process time and achieving a more precise temperature control with its infrared heaters, the oven offers automatic, controlled withdrawal of the p-c board out of the dip. This feature assures uniform coating and prevents edge buildup. It also eliminates the variations in coating from board to board that can happen when dipping is done manually.

Typical curing time cycles are: photoresist, 60 to 180 seconds; screened etch resist, 30 to 40 seconds; solder resist, 60 to 80 seconds; protective coatings, 30 to 40 seconds. The dip tank is used with photoresists only. Typical output is 200 10 in. x 12 in. boards per hour. Work size can go up to 18 in. x 45 in.

To load, the operator hooks the circuit boards on the chain conveyor cross rods, which takes them down through the dip at the preset speed. As they emerge from the dip at the back of the oven, they pass up between infrared heating modules where the coating is cured at a preset temperature. The conveyor moves them forward and then down to the open front of the oven for unloading. A pressurized, filtered cooling air supply keeps

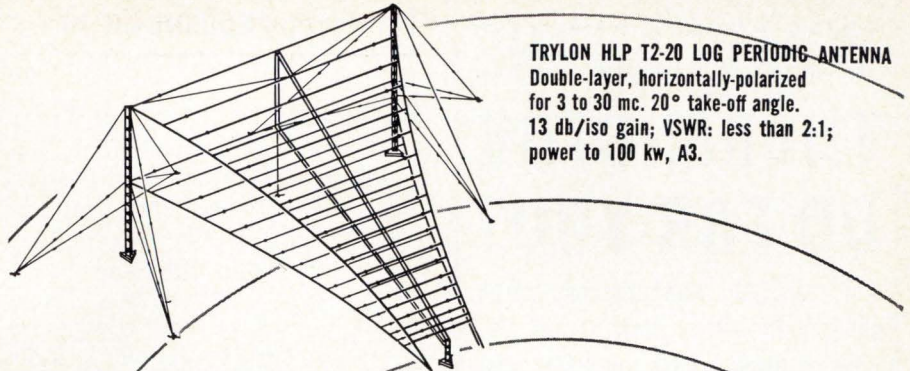

**TRYLON HLP T2-20 LOG PERIODIC ANTENNA**  
Double-layer, horizontally-polarized for 3 to 30 mc. 20° take-off angle. 13 db/iso gain; VSWR: less than 2:1; power to 100 kw, A3.

**Three things make a good antenna system: design competency; fabrication proficiency; and economy—which is the sure result of integrating the electrical and the structural problems as a single responsibility of the TRYLON group.**



ELVERSON, PA. 19520 (215) 942-2981  
Circle 214 on reader service card

## NEW Cold-Weld Crystals withstand 20g vibration at 10-2,000 Hz

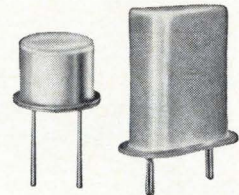

Actual Size

### TYPICAL SPECIFICATIONS

Frequency Range... 300 to 700 KHz Shock..... 100g  
Holder..... HC-6 type Vibration.... 20g at 10-2,000 Hz

After 5,000-hour life test at 65°C,  
 $\frac{\Delta F}{F}$  less than  $2 \times 10^{-8}$  per day.

Reeves-Hoffman's high reliability cold-welded crystals meet all requirements for space programs such as Apollo and Ranger. Cold welding solves problems of damping and corrosion, permits minaturization, provides typical specifications as shown above. We invite your inquiry for complete information.



**REEVES-HOFFMAN**  
DIVISION OF DCA



400 WEST NORTH STREET, CARLISLE, PENNSYLVANIA 17013

# WHAT CAN THE THERMISTOR DO FOR YOU?

This versatile little precision sensor can help the circuit designer, the systems engineer, instrumentation specialist and the control engineer in dozens of different ways.

The FREE literature below tells how

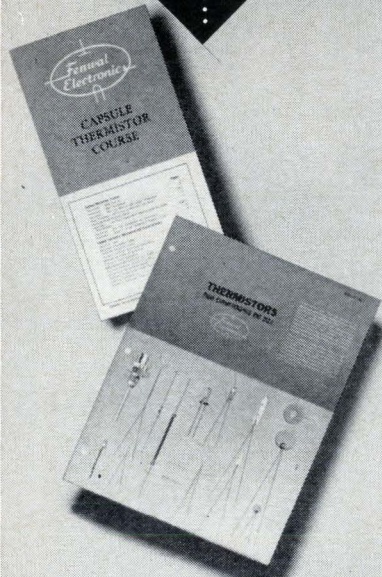

## Capsule thermistor course book

Ten quick, painless lessons on precision thermistors, their characteristics, and how they are used. Illustrates basic thermistor circuits, compares thermistors with other sensors, gives typical circuit design calculations, etc. Ask for F.E.I. Capsule Thermistor Course Book.

## Thermistor fact folder

An illustrated booklet which describes various thermistor types, including F.E.I. ISO-CURVE\* interchangeable thermistors, and how to apply them in measurement and control circuits. Ask for F.E.I. Thermistor Fact Folder.

\*MADE UNDER PAT. 3109227 AND OTHERS. ISO-CURVE IS A TRADEMARK OF F.E.I.

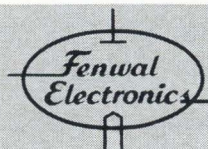

63 FOUNTAIN STREET, FRAMINGHAM, MASS.

## Production Equipment

out lint and dust.

The infrared heaters radiate heat uniformly over their entire working faces, hence they can be mounted close to the work for highest efficiency and short time cycles. They supply instant heat, hence the oven needs no lengthy conveyor travel to warm up the work. Temperature control is  $\pm 5^\circ\text{F}$ . Conveyor speed and infrared heater temperature control are infinitely variable, which allows best setting to be made for each job.

The oven occupies minimum floor space by using height instead of length. Typical oven size is 5 ft wide x 8 ft high x 3 ft deep. It operates on 230 v, 60 hz.

Infra-Red Systems, Inc., Route 23, Riverdale, N.J. [402]

## Machine solders circuit assemblies



Series 4000 dual wave soldering machine has been developed for the high production and efficient soldering of circuit assemblies.

This machine features a dual cavity, dual wave solder wave generator; pyrometric control of the temperature of each solder wave and preheater; illuminated control switches; eight-foot, lift-off type conveyor; potentiometer speed control and tachometer speed indicator; dual feed foam fluxer with air regulators; Radiant-Aire preheater; eye level controls; and hinged exhaust canopy.

The machine performs three important operations in a predetermined time cycle. It fluxes the parts to be soldered, preheats and dries the flux and solders the parts



## Revolutionary electronic calculator

- Unmatched speed, versatility
- Simple to operate
- Single keystrokes provide all these functions

+	-	÷	x	x <sup>2</sup>	$\sqrt{x}$	e <sup>x</sup>	log <sub>e</sub> x
---	---	---	---	----------------	------------	----------------	--------------------

- Two independent accumulators for random data entry and retrieval
  - **LOW PRICE — FROM \$1690 to \$2095**
  - Additional keyboard units from \$450
  - Time sharing units also available
- Write for complete details



Dept. HH-9, 836 North St., Tewksbury, Mass. 01876  
Tel. (617) 851-7311

Circle 215 on reader service card

### Reprint order form

Send to: **Electronics Reprint Dept.**  
330 West 42nd Street  
New York, N. Y. 10036

For listing of reprints available see the reader service card.

To help expedite mailing of your reprints please send cash, check or money order with your order.

For reprints of the latest special report:

### Communications Satellites Part I

Send me . . . . . reprints of key no R-89 at 75¢ each.

For reprints of previous special reports fill in below:

Send me . . . . . reprints of key no.(s) . . . . . at . . . . . ¢ each.

For prices see the reader service card.

Name . . . . .

Number & Street . . . . .

City, State . . . . .

Zip code . . . . .



# Reed Relays

Basic and special REED RELAYS and/or COILS for high reliability and sophisticated switching

Operating Inputs: low as 1mA. and 15mW.  
 Standard Coil Voltages: 6, 12, 24, 32, 48V in stock for immediate delivery.  
 Special Voltage or Resistance, multiple windings for flip flop, memory and crosspoint selection applications — to customer specifications.  
 Relay Contacts in Form A, B, C and latching. Also high vacuum type 5000V Form A.

Write for Bulletin and Prices

# Coto-Coil

COMPANY INC.

61 Pavilion Ave.  
 Providence, R. I. 02905  
 Phone: (401) 941-3355

Circle 216 on reader service card

## Production Equipment

that have already been fluxed.

Dual air input provides a foam stability with controls for air pressure and foam height on the Foam Fluxer, with a drain valve for ease of maintenance. The Radiant-Aire preheater has a cast iron hot plate that assures long life and is practically maintenance free.

Surface temperature is accurately controlled and forced air is utilized to remove gas which forms during the preheating operation. This increases the efficiency of the preheater and accelerates the drying of the flux. The preheater has a direct readout pyrometric control.

The dual/cavity/dual wave generator has individual pumps that generate solder waves up to 2 in. in height. The temperature of each wave is independently controlled by pyrometric controllers with a sensitivity of  $\pm 2^\circ\text{F}$ . Temperature range of the wave generator is  $100^\circ\text{F}$  to  $650^\circ\text{F}$ .

Dee Electric Co., 2501 North Wayne Ave., Chicago, Ill., 60614. [403]

maintenances  
 12 columns  
 16 columns  
 22 columns  
 32 columns  
 for the

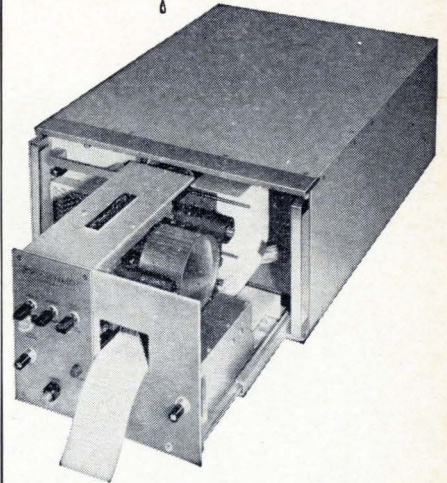

# World's Fastest, Low-Cost Digital Printer

Apply several drops of oil to the drive-motor shaft-ends each year (or every fifty-million lines). Brush out any accumulated dust or lint. Clean the air filter periodically.

That's the extent of maintenance for a Franklin Model 1000 . . . the only digital printer that offers a printing rate of 40 lines per second (or less) at low, low, OEM prices.

REQUEST BULLETIN 2301

**FRANKLIN**  
 electronics, inc.

East Fourth St. • Bridgeport, Pa. 19405  
 A Division of the Anelex Corporation

Circle 185 on reader service card 185

## LOW LOSS CASTING RESINS

Emerson & Cumings, Inc.  
 PRELIMINARY TECHNICAL SPECIFICATIONS  
 STYCAST 35 SERIES  
 Low Loss, Room Temperature Casting Resins

	Stycast 35	Stycast 35D	Stycast 35PE	Stycast 35DG
Material	Polystyrene	Cross-Linked Polystyrene	Cross-Linked Polystyrene- $\text{Al}_2\text{O}_3$	Cross-Linked Low Density
Color	Clear	Clear	Opaque	Opaque
$\rho$ , g/cc	1.05	1.05	1.8	0.7
$\rho$ -10 <sup>10</sup> cps	2.6	2.6	2.5	1.9
tan $\delta$	<0.001	<0.001	<0.001	<0.001
Temp. range, °F	-20 to +170	-20 to +300	-60 to +300	-65 to +300
Thermal stability (Relative)	Fair	Fair	Good	Good
Dielectric constant (Relative)	Fair	Fair	Good	Good
Volume resistivity, $\rho$ (Relative)	Good	Excellent	Excellent	Excellent
Price per lb.	15.000	14.000	11.000	5.000

### FREE CHART

Ten Low Loss systems are offered for both room and elevated temperature cure. Dissipation factors are below 0.001 for minimum effect on circuit operation. Dielectric Constants as low as 1.7. Temperature capability to  $400^\circ\text{F}$ .

This valuable Chart is yours.

Write or Use Reader Service Card

**EMERSON & CUMINGS, INC.**

CANTON, MASS.

604 W. 182nd St.  
 Gardena, Calif.

3450 Commercial Ave.  
 Northbrook, Ill.



Circle 217 on reader service card

## Vibratory feeder aids film coating

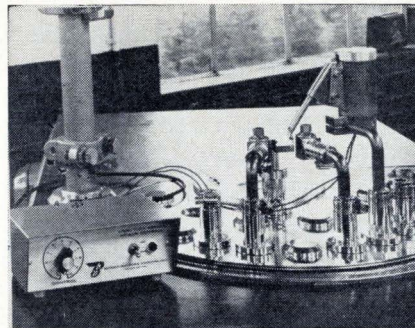

An accessory for thin-film evaporators permits continuous, controlled feeding of coating material to a hot source or an electron beam gun. Known as a vibratory feeder, the accessory makes it possible to obtain uniform, homogeneous film formation even with varying vapor pressures of coating material compositions and alloys.

The vibratory feeder consists of a container for the coating material, the interior wall of which is a conveying helical spiral. By means of vibration, initiated by a mag-

Circle 217 on reader service card

**Sensitive Research\***

**solve your  
problems with**

**1/4%**

**Accuracies**



**IN AC/DC VOLTAGE, CURRENT,  
POWER, AND POWER FACTOR  
PANEL METERS**

- Accuracies to 0.25%
- Multi-range switching
- 5" or 7" scale lengths
- Edgewise or rectangular designs
- NBS traceability
- Reliable, friction-free diamond-tipped pivots

For complete data on the broad selection of *Sensitive Research* precision panel instruments, contact your local Singer Instrumentation representative, or write to: The Singer Company, Metrics Division, 915 Pembroke St., Bridgeport, Conn. 06608.



A Trademark of THE SINGER COMPANY  
**SINGER**  
INSTRUMENTATION

EMPIRE • GERTSCH • PANORAMIC • SENSITIVE RESEARCH

S-66-12

## Production Equipment

netic coil, coating material moves upward through the helical spiral to an exit channel. From the exit channel it falls into a tube positioned to permit the material to drop into the evaporation source. An electronic power control permits stepless variation of the feeding speed.

Bendix-Balzars Vacuum, Inc., 1645 St. Paul St., Rochester, N.Y. [404]

## Machine splices solderless connectors

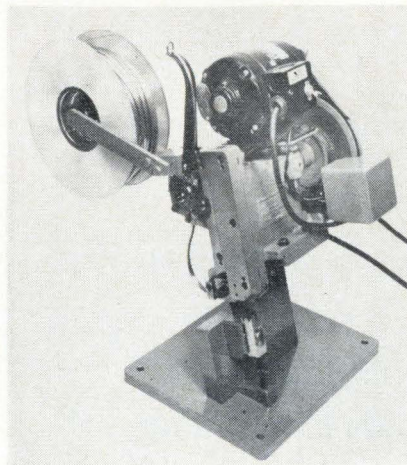

A solderless connector attaching machine has been developed for splicing leads. It utilizes a continuous spool of wire and completely eliminates the need for preformed connector strip. Connectors made from flat wire cost 80 cents per thousand as opposed to \$2.50 per thousand when made from preformed connector strip. This machine can operate with copper, brass, tinned brass, silver and aluminum wire.

An operator inserts two leads, either stranded or single, into a nest on the machine, and then depresses the electric foot switch. The machine feeds a length of wire, cuts and forms the connector, then securely attaches it around the two leads. The machine will operate at speeds up to 300 cycles per minute. A non-repeat clutch is incorporated into the machine to insure operation safety.

General Staple Co., 26-28 E. 22nd St., New York, N.Y., 10010. [405]

**semi-elements  
YOUR  
PRIME  
SOURCE  
FOR**

## SEMI-CONDUCTOR SINGLE CRYSTALS and MATERIALS

- II-VI Compounds  
Cadmium Sulfide, Selenide,  
Telluride  
Zinc Sulfide, Selenide, Telluride  
Custom Compounds II-VIs
- III-V Compounds  
Gallium Arsenide, Antimonide  
Indium Phosphide, Arsenide,  
Antimonide  
Custom Compounds of III-Vs

## SINGLE CRYSTAL FERRITES

- Y I G  
YTTRIUM IRON GARNETS
- Y G I G  
YTTRIUM GALLIUM IRON GARNETS
- E I G  
ERBIUM IRON GARNETS
- N I F  
NICKEL IRON FERRITES
- M I F  
MANGANESE IRON FERRITE
- Li N  
LITHIUM NIOBATE
- Ba T  
BARIUM TITANATE

Literature sent promptly on request



**semi-elements, inc.**  
Saxonburg Blvd., Saxonburg, Pa., 16056  
Phone: 412-352-1548

## New Materials

### Conformal coating for p-c boards

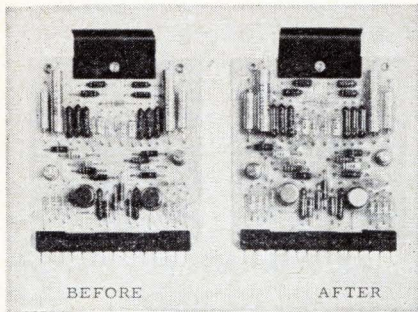

A conformal coating has been added to the company's line of quality resin products. TC-3050 coating was developed to give p-c boards the best environmental protection possible, while giving the applicator a broad selection of application methods and curing schedules.

The material can be applied by dip, brush, flow coating or even sprayed with standard heavy-duty paint spray equipment. The curing schedules range from overnight at room temperature to ½ hour at 300°F.

Electronic Production & Development, Inc., 11965 South Prairie Ave., Hawthorne, Calif., 90250. [406]

### Thin copper-clad epoxy-glass laminate

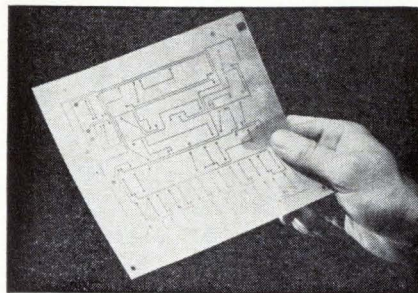

Materials developed for multilayer p-c boards permit maximum design flexibility and consistent, high-quality production. The product package consists of a thin copper-clad epoxy-glass laminate, designated Textolite Grade 11685, designed for use with three new epoxy-resin impregnated glass cloth bonding sheets — Grades

11384, 11385 and 11386.

Grade 11685 copper-clad material permits the fabricating of clean circuits, according to the manufacturer. Base laminate staining, caused by oxide transfer from the copper, has been totally eliminated in the new grade because there is no copper oxide on the foil.

The material is available with 1-oz or 2-oz copper as standard, clad one or two sides, in base (etched) laminate thicknesses from 0.002 in. through 0.015 in. in 0.001-in. increments.

Another feature of Grade 11685 is a textured surface on the unclad side which makes for improved bonding between layers in the multilayer circuitry without additional processing. The textured surface almost doubles bonding area.

Textolite Grade 11685 and bonding sheets are available in packages of five 24-in. x 36-in. sheets. General Electric Co., Laminated Products Dept., Coshocton, Ohio. [407]

### Polyester film of corrugated Mylar

Corrugated Mylar polyester films for wire and cable applications are designated 200 WC 67 and 300 WC 67.

The corrugation of the film traps air much as crepe paper does, providing excellent thermal protection for polyethylene-insulated conductors in the cable core during the hot-melt extrusion of the cable's outer jacket.

When applied to a cable core, the corrugated film interlocks as it overlaps itself, minimizing core-wrap movement and gapping, called "shingling," at the overlap when the cable is bent. In spirally wrapped constructions, the interlocking of the corrugated grooves also increases the inherently high core-to-shield breakdown strength of Mylar polyester film. The excellent cut-through resistance of Mylar is improved by the corrugations, which act as shock absorbers to cushion the conductors in the cable core against mechanical impact.

The 200-gage film will sell at \$1.85 a pound, and the 300-gage film will be \$1.80.

E.I. duPont de Nemours & Co., Wilmington, Del., 19898. [408]

Another Quality Product of  
**SIGMUND COHN CORP.**

**1% Silicon  
Aluminum  
Wire** [specially  
spooled]

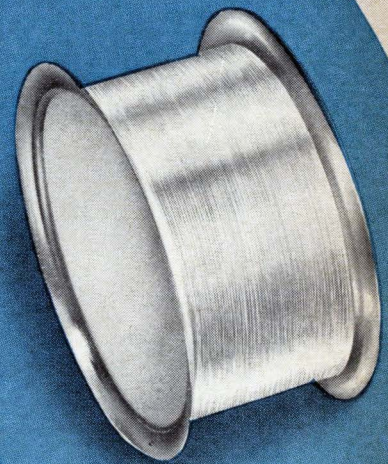

Available in  
a complete  
range of sizes...

Made as small as  
.0007" diameter...

Precision spooled on  
our No. 3 (above) or  
No. 22 Spool; single  
or multiple layer...



Cased in dust-free, plastic container to safeguard wire during shipment.

**SIGMUND COHN CORP.**

121 S. Columbus Ave., Mt. Vernon, N.Y.



# NEW

Low Cost

*tunable*

# COILS

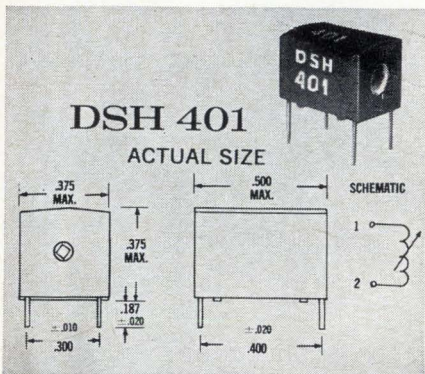
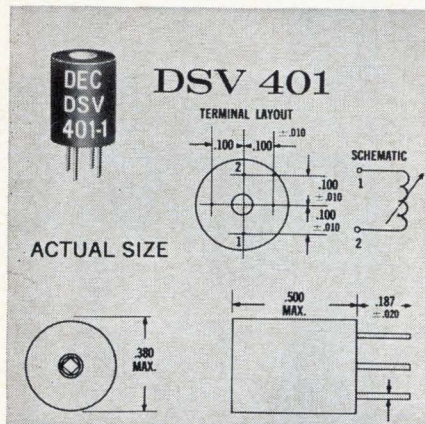

- Electro-static shield available for DSV 401.
- Electromagnetically shielded.
- Tunable from either end.
- Winding sealed in molded epoxy.
- Stable Q — Max 20% drop from nominal thru entire tuning range.
- Inductance range .10 to 10,000 uh.

Meets MIL-C-15305 — Grade and Class 6. Manufactured under Delevan's Quality Proven Processes.

Delevan Electronics Corporation / Division



AMERICAN PRECISION INDUSTRIES INC.

270 QUAKER RD. / EAST AURORA, N. Y. / 14052  
TELEPHONE 716/652-3800 TELEX 091-293

## New Books

### Control systems

Introduction to Variational Methods in Control Engineering  
A.R.M. Noton  
Pergamon Press, 122 pp., \$5

A new approach to control system design has been emerging during the last ten years. The variational method, as modified by Bellman, Pontryagin and others, makes possible the consideration of economic criteria for optimization of the control system structure. Realistic constraints such as saturation are included, and the final design may contain nonlinear elements. While the method itself is not new—the calculus of variations has been used for years to find functions which optimize—its application to control engineering is new and potentially useful.

The evolution of the method has been watched with considerable interest by control engineers who are still using the classical methods of Nyquist or Evans or derivations of these methods, and to whom the subjects of synthesis, optimization, and non-linearities are to be handled (if at all) separately and academically. At the same time, high-speed computing has come into general use by control engineers, and much of the potential for the variational method awaits the establishment of theoretical guideposts for the non-trial-and-error use of computers.

Noton's book comes at a good time. It is an honest attempt to explain the theory and sort out the claims, and it largely succeeds. Noton accepts the central role of high-speed digital computers in applying the theory, and examines critically the problems inherent in application of variational methods—problems often buried beneath a layer of enthusiasm. At the end of the book the author answers the question of the method's utility with a very qualified yes, perhaps too qualified.

The book covers all the major methods systematically, starting with the classical calculus of variations, and introducing its shortcomings. The explanation of dynamic programming is excellent, as is the computer problems to be

met when the method is applied.

In chapter 5, the derivation of the Pontryagin maximum principle by the method of characteristics is difficult to follow; an introduction via dynamic programming might have been better. Also, the method itself is left a little unclear. For example, more could have been said about the  $p$  variables which seem to arise more mysteriously than need be. However, the author's use of examples makes up for most of the obscurity, a lot of which is inherent in the method itself. At the end of the chapter the method is applied, simply and gracefully, to the design of a bang-bang system leaving the reader with a generally good feeling, marred only by the suggestion of the real problem to come.

It comes in the next chapter—the two-point boundary value problem. Because boundary values must be satisfied simultaneously at “both ends” of the solution, serious computational problems arise. The author's treatment of this is good. The choice of methods is adequate, although including some material on invariant imbedding would have been appropriate.

If prospects are grim by the end of Chapter 5, they improve considerably in Chapter 6 where the intriguing possibilities raised by the problem of inaccessible state variables are discussed. Treatment of the problem of process identification could have been included to advantage; the variational approach may lead to difficult (or impractical) computational problems, but it does much to unify control theory.

Throughout the book, real though simple problems are used as examples, and solutions are sought on a large, high-speed digital computer. No special knowledge of computers is assumed or needed. On the other hand, the book shouldn't be undertaken without some mathematical sophistication. Prior exposure to the calculus of variations would be a minimum, although the book might provide motivation for mathematical study to make up deficiencies.

The author sums up by mention-

## GRAPHIC VISUAL CONTROL

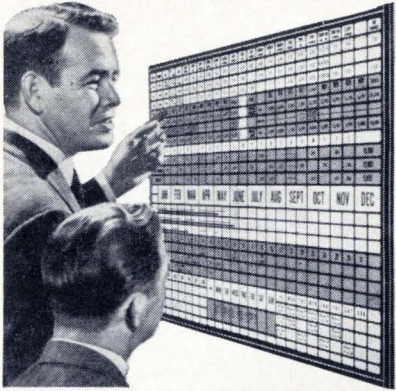

### You SEE How To Get Things Done With The BOARDMASTER System

You see a Graphic Picture of your operations, spotlighted in color. You have facts at Eye Level. Saves time, cuts costs and prevents errors.

Ideal for Production, Maintenance, Scheduling, Inventory, Sales, Traffic, Personnel and many other uses.

Simple and flexible tool. You write or type on cards and post on board. All cards are interchangeable.

Compact and Attractive. Made of Aluminum. Over 1,000,000 in use.

Complete Price \$49<sup>50</sup> Including Cards

**FREE** 24-Page BOOKLET No. C-10 Mailed Without Obligation

Write Today for Your Copy

**GRAPHIC SYSTEMS**  
925 Dánville Road • Yanceyville, N.C.

Circle 219 on reader service card

## RODAN NEON LAMPS

The Best in Durability & Stability!

### ● NEON BRACKET LAMP

- Ultra-Miniature Indicate Light



Actual Size

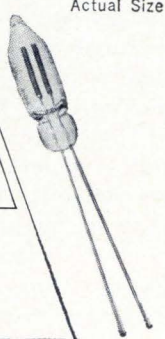

Actual Size

### ● NEON GLOW LAMP

- High Brightness (NE-2H)
- Standard (NE-2)

● For catalog, write to

**OKAYA MUSEN CO., LTD.**

3-8, 1 chome, Shibuya, Tokyo, Japan  
Phone: 400-8511

ing very briefly some possible future applications. The picture he presents is not encouraging, especially since the reader is referred elsewhere for aerospace applications. This is unfortunate, first, because many of the best current examples of the application of variational theory lie in that area; and second, because the reference (G. Leitman's 1962 book, "Optimization Techniques") doesn't cover the subject with anything approaching Noton's brevity and candor.

The book is what it claims to be—a short monograph intended to help the control engineer close the gap in his knowledge of new developments in his field. Control engineers should find it valuable as an introduction to an important design approach and as a reference for further study; students may find it a guide for things to come.

John A. Aseltine

TRW Systems  
Houston, Texas

### Recently published

Atomic Transition Probabilities—Hydrogen through Neon, W.L. Wiese, M.W. Smith and B.M. Glennon, National Bureau of Standards, U.S. Government Printing Office, 153 pp., \$2.50

Basic Matrix Analysis and Synthesis, G. Zelinger, Pergamon Press, 228 pp., \$7.50

Electronic Digital Systems, R.K. Richards, John Wiley & Sons, Inc., 637 pp., \$15.00

Modulation, Resolution and Signal Processing in Radar, Sonar and Related Systems, R. Benjamin, Pergamon Press, 184 pp., \$8.50

Topics in Advanced Mathematics for Electronics Technology, Stephen Paul, John Wiley & Sons, Inc., 420 pp., \$4.95

Semiconductor Circuits: Theory, Design and Experiment, J.R. Abrahams and G.J. Pridham, Pergamon Press, 310 pp., \$4.95

Electronic Properties, Robert M. Rose, Lawrence A. Shepard and John Wulff, John Wiley & Sons, Inc., 306 pp., \$3.50

Audio Systems, Julian L. Bernstein, John Wiley & Sons, Inc., 409 pp., \$4.50

Network Analysis and Synthesis, second edition, Franklin F. Kuo, John Wiley & Sons, Inc., 515 pp., \$11.95

Transform and State Variable Methods in Linear Systems, Someshwar C. Gupta, John Wiley & Sons, Inc., 426 pp., \$12.75

Marketing Guide to U.S. Government Research and Development, Robert Rickles, Noyes Development Corp., 229 pp., \$20

Electronic Troubleshooting: A self-instructional Programed Manual, staff members of the Philco Technical Institute, Prentice-Hall, Inc. 274 pp., \$12.50

Electrical Fundamentals and Circuit Analysis, H. Alex Romanowitz, John Wiley & Sons, Inc., 715 pp., \$8.95

Circle 220 on reader service card

Circle 189 on reader service card→

## how to tame a temperature problem



# HYGRADE

## POLYTUBE 463

CLASS F

## Fiberglass Sleaving

retains its flexibility and electrical properties in continuous operation at temperatures up to 155°C. Even after 1000 hours, it will not crack when bent 180° around a mandrel. Constructed of closely woven fiberglass, it is thoroughly impregnated and uniformly coated with modified acrylics, making it compatible with most wire enamels and encapsulants and resistant to oils, acids, alkalis, jet fluid, lox and water. Good resistance to abrasion and cut-through—non-wicking. Write for samples, data and prices.

# MARKEL

SINCE 1922

## L. FRANK MARKEL & SONS

Norristown, Pennsylvania 19404

INSULATING TUBINGS AND SLEEVINGS



Superior cameras deserve superior lenses. COSMICAR's proven precision performance is the combined result of advanced optical engineering and exquisite workmanship.

Now widely used, COSMICAR LENSES come in 23 models for focal lengths ranging from 12.5 mm to 500 mm, and in 3 zoom models including a remote-control zoom.

Your CCTV camera and COSMICAR LENSES will make an unbeatable team. For technical data and other particulars write to:

**ICHIZUKA OPTICAL CO., LTD.**

568, Shimoochiai, 2-chome, Shinjuku-ku, Tokyo  
CABLE ADDRESS: "MOVIEKINO TOKYO"

## Technical Abstracts

### Planetary processor

On batch processing of evaporated thin-film microelectronics  
Noel W. Scott, Naval Avionics Facility,  
Indianapolis, Ind.

Evaporated thin films are widely used in integrated circuit manufacture to produce passive components and conductive interconnections on circuit substrates. The method usually entails placing substrates in a vacuum chamber and depositing the film selectively in controlled amounts with a series of sequential material depositions and mask changes.

According to the author, many thin-film applications do not require sequential depositions, but lend themselves better to batch processing, in which a large number of substrates are exposed to a "one-shot" deposition. This approach is particularly successful when there is a wide disparity in the required evaporation time for various film materials. In many cases, mask alignment for high-density circuits cannot be accomplished within the required tolerances by automatic techniques used in sequential systems. Furthermore, an in-atmosphere process is sometimes required between depositions.

The author bases his case for batch processing on 10 years of experience at the Naval Avionics Facility laboratory with a planetary coater that permits uniform deposition of thin films over relatively large substrate areas.

In the planetary coater, the substrate wafers and their masks are mounted on one of four disks attached to a wheel that rotates horizontally at 60 times a minute. The four disks rotate one to four times a second depending on the selected gear ratio. The substrate movement describes epicyclical paths during the coating cycle, which assures a high degree of film uniformity.

The system has been used with both 18-in. and 32-in. diameter bell jars. Complex 11- and 13-layer circuits have been successfully fabricated and reproduced in a single planetary coater by batch operations.

One of the chief advantages of the coater's planetary motion is that the vapor stream's deposition angle constantly changes. Consequently, the walls and edges of the many plateaus on the substrate are covered from many angles. Sharp corners with their attendant stresses are reduced.

Presented at the Fifth Annual Microelectronics Symposium, St. Louis, July 18-20.

### Bodily harm

The effects of microwaves on biological systems

Joseph H. Vogelman  
Chromalloy American Corporation  
West Nyack, N.Y.

Since the introduction of high-power radar and communication equipment, there has been a growing fear of potential damage to human biological systems. The major impetus to an investigation of the effects of microwave energy has been provided by the Air Force in an attempt to establish a safe level of exposure for military personnel required to work on radar.

All experimental and statistical results can be grouped in three categories—thermal, peak thermal and nonthermal. Microwave energy that duplicates the radiant effects of infrared energy and the conductive effects of continuous heat exposure are thermal effects and are related to average microwave power. Peak thermal effects are produced by peak microwave power.

Nonthermal effects include all that cannot be explained in terms of thermal or peak thermal effects, such as resonance phenomena that affect the molecular structure of a biological material.

Experiments demonstrated the damaging effects of exposure to continuous microwave radiation. Cataracts were produced in the eyes of rabbits as a result of exposure to 2.45 Ghz of microwave energy. Humans who worked with radar for a long time developed eye opacities. Dogs exposed to radiation suffered nerve irritation identical to that resulting from excessive heat exposure. The animal generally felt uncomfortable and began to pant or chase its tail. The



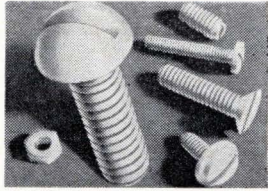

**Widest Selection of MOLDED  
NYLON SCREWS**

- High quality—close tolerances—clean accurate threads.
- Sizes from miniature No. 0 to 1/4"
- Lengths from 1/8" to 1-1/16"
- Standard commercial heads, Slotted or Phillips
- Set screws with plain and standard points.
- Hex nuts from No. 4 to 5/16"
- Screws also available in Delrin

When you need nylon screws you want GRC! Send for: stock list . . . HUNDREDS of sizes . . . samples and specification sheet.

GRC stock plastic parts are available in many sizes and types . . . are precise, uniformly high in quality and economical because they are mass produced by exclusive automatic single cavity techniques. These advantages apply to "specials" and parts to your specs . . . in Nylon, Delrin and other engineering thermoplastics. Send prints for quotation and details on GRC's special methods for molding (and die casting, too). NO SIZE TOO SMALL!

Write, wire, phone TODAY for samples, prices, literature.



**GRIES REPRODUCER CO.**  
Division of Coats & Clark Inc.  
151 Beechwood Ave.,  
New Rochelle, N.Y.  
(914) NEW Rochelle 3-8600

World's Foremost  
Producers of Small  
Die Castings and  
Plastic Moldings

Circle 221 on reader service card

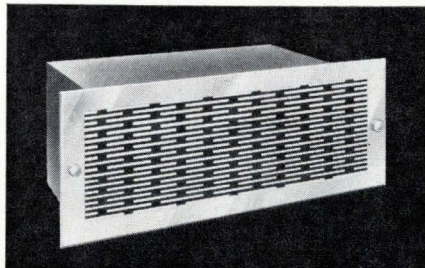

**PACKAGED  
BLOWERS**

**MIL-SPEC • COMMERCIAL  
RFI-SHIELDED  
LONG LIFE • LOW COST**

Quick, easy, low-cost way to cool cabinets, computers, consoles, systems! Ready to install. "Computer-age" styling. Airflows from 150 to 1000 CFM. Wide variety of sizes. Heavy duty extruded aluminum grille. Quiet, reliable.

McLean Engineering Laboratories,  
P. O. Box 228, Princeton, N. J. 08540  
Phone 609-799-0100,  
TWX 609-799-0245, TELEX 083-4345.

Send for 44-Page Catalog

symptoms are dependent on frequency. They are less evident, for example at 1.285 Ghz. The animal's peripheral nerve endings were not excited as much by the longer wavelengths because they penetrate deeper into the body.

In addition to the neurological effects, many investigators found considerable changes in blood chemistry and a significant loss of body water. In animal organ studies exposure produced considerable ovary and testicular damage as well as injury to other internal organs including the heart and liver.

Exposure of living tissue to peak thermal radiation resulted in another series of effects. Pulse energy excites peripheral nerves more markedly than continuous energy at the same wavelength.

Exposing living tissue and organs to microwave radiation of low intensity produced no thermal burden but resulted in important biological effects that cannot be categorized in terms of thermal and peak thermal phenomena.

In France, microwaves reduced the size of cancerous tumors. In Russia, chronic exposure to low-intensity microwaves produced changes in the brain function of dogs, exciting the animal and modifying his inhibition. In the United States, levels of exposure led to chemical changes in dogs' blood. Other exposure experiments caused a drop in the dogs' blood pressure and a significant loss of body water. In other experiments, rats, mice and dogs pretreated with microwaves, exhibited increased resistance to radiation after a long latency period following exposure. During this time the microwaves' thermal burden dissipates.

There is need for more controlled experimentation to define peak thermal more accurately as well as certain nonthermal effects of microwave radiation. The ability to produce stable, single frequencies of polarized microwave energy is important in these investigations.

The power of microwaves to act as a source of thermal energy at certain internal body depths, produces localized internal heating in cold environments. It opens the way for use of the energy as a diagnostic tool in medical therapy.

Presented at the Bio-Medical Engineering Conference, Marquette University, Milwaukee, Wisconsin, June 24-25.

**THIS IS A SPECTRA  
NOISE MEASUREMENT**

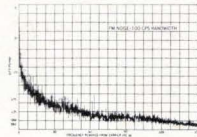

Spectra's exclusive Microwave Noise Measurement Service provides accurate measurements of customers' X-band sources from 8.5 Gc/s to 10.5 Gc/s.

**THIS IS A SPECTRA  
NOISE MEASURER**

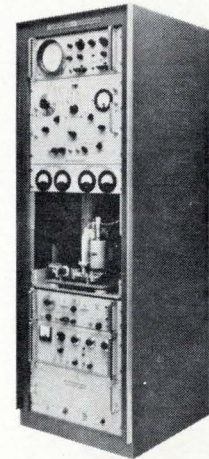

Spectra's SE-200 Series instruments are the only equipments that can give you the FM and AM noise content of conventional and solid state microwave sources — to accuracies of ±1DB.

**THIS IS A SPECTRA  
LEASING CONTRACT!**



Spectra's Microwave Noise Measuring Instruments can now be leased for a monthly amount that's actually less than the salary of a good technician! Ask your Spectra representative to tell you the whole story — or write us today. It's exciting.

SPECTRA  ELECTRONICS

P.O. Box 85  
Los Altos, Calif. 94023 • (415) 948-4998

Rosen & Thal  
**IRIG**

## **WATER COOLED**

(MINIATURIZED)

**&  
AIR COOLED**

**CERAMIC**

## **TRANSMITTER CAPACITORS**

14 kVp—150 A RF 1500 kVAr



15 kVp—24 A RF 50 kVAr

For:

## **COMMUNICATIONS INDUCTION HEATING**

Write for literature to:

**United Mineral  
&  
Chemical Corp.**

129 HUDSON ST.

New York, N. Y. 10013

(212) 966-4330

## **New Literature**

**Multilayer printed wiring.** Wabash Metal Products Co., Inc., 1588 Morris St., Wabash, Ind., 46992, has available sixteen pages of current information on multilayer printed wiring, titled "Symposium In Print". Circle 420 on reader service card.

**Microelectronic interconnections.** ITT Cannon Electric, a division of International Telephone and Telegraph Corp., 3208 Humboldt St., Los Angeles, Calif., 90031. Handbook MMH-1A discusses microelectronic interconnections. [421]

**Education-type meter.** The Triplett Electrical Instrument Co., Bluffton, Ohio, 45817, offers a data sheet on the educational a-c/d-c measuring instrument, model 820-U, which is used with an overhead projector for dynamic classroom display. [422]

**IRIG bandswitching discriminators.** Airpax Electronics Inc., P.O. Box 8488, Fort Lauderdale, Fla., 33310. Bulletin TM-6 describes a line of high accuracy demodulators of frequency-modulated telemetry subcarrier signals having IRIG or similar characteristics. [423]

**Circuit-card mounting.** Scanbe Manufacturing Corp., 1161 Monterey Pass Road, Monterey Park, Calif., 91754. The mounting and packaging of electronic circuit cards is described in comprehensive text-and-photo detail in brochure 205. [424]

**Fluorocarbon solvents.** Olefins division, Union Carbide Corp., 270 Park Ave., New York, N.Y., 10017. A 16-page brochure contains specifications and test methods for Ucon fluorocarbon solvents 113-LR1 and 113-LR2, used in critical cleaning applications, particularly in the aerospace and electronics equipment fields. [425]

**High-vacuum components.** Ultek Corp., Box 10920, Palo Alto, Calif., 94303. Bulletin A-1355 offers condensed specifications and new pricing information on all of the company's high-vacuum components. [426]

**Microwave absorbing materials.** Emerson & Cuming, Inc., Canton, Mass. A quick-reference brochure describes the complete line of Eccosorb microwave absorbers for free space, waveguide and high temperature applications. [427]

**Vibration and shock mountings.** Lord Manufacturing Co., division of Lord Corp., Erie, Pa., 16512. The J-4624 series Flex-Bolt mountings for control of vibration and shock are described in bulletin D-944. [428]

**Dual-slope digital meters.** Fairchild Instrumentation, a division of Fairchild Camera and Instrument Corp., 475 Ellis

St., Mountain View, Calif., offers an eight-page brochure detailing specifications, accessories, dimensions and prices for the series 7100 dual-slope, integrating digital meters for the measurement of voltage, resistance and ratio. [429]

**Microwave energy sources.** Trak Microwave Corp., 4726 Kennedy Road, Tampa, Fla., 33614, has available a 56-page catalog and technical manual on microwave energy sources. [430]

**Frequency counters.** Northeastern Engineering, Inc., 130 Silver St., Manchester, N.H., 03103. An eight-page fold-out catalog describes in detail a complete line of solid state frequency/time interval meters. [431]

**Laminated wire and cable.** Inso Electronic Products Inc., Nutley, N.J., 07110, announces a 20-page booklet describing its line of fused, high temperature, Teflon laminated wire and cable. [432]

**Printed-circuit soldering.** Electrovert Inc., 86 Hartford Ave., Mt. Vernon, N.Y., 10553, offers a four-page brochure on its most recent wave-soldering developments—the 346 and 364—both of which are said to represent a significant advance in the automation of printed-circuit soldering. [433]

**Wire and cable.** Super Temp Wire division, Haveg Industries, Inc., Winooski, Vt., 05404, has available an eight-page brochure explaining the weight and space saving advantages of Spacewrap wire and cable for aircraft, aerospace, and electronic equipment designed to withstand environmental extremes. [434]

**Subcarrier discriminators.** Airpax Electronics Inc., P.O. Box 8488, Fort Lauderdale, Fla., 33310. Bulletin TM-7 describes a low cost, high performance and miniaturized discriminator that yields superior dynamic response and low harmonic distortion. [435]

**Digital-to-synchro converter.** North Atlantic Industries, Inc., Terminal Drive, Plainview, N.Y., has published a two-page data sheet on the series 537 modular digital-to-resolver/synchro converters. [436]

**Electrometer operational amplifier.** Keithley Instruments, Inc., 12415 Euclid Ave., Cleveland 6, Ohio, offers a four-page engineering note covering the model 300 true electrometer operational amplifier. [437]

**Rectifier modules.** Unitrode Corp., 580 Pleasant St., Watertown, Mass., announces bulletin T-118 covering its expanded line of "doorbell" rectifier modules. [438]

## QUALIFICATION FORM FOR POSITIONS AVAILABLE

### ATTENTION: ENGINEERS, SCIENTISTS, PHYSICISTS

This Qualification Form is designed to help you advance in the electronics industry. It is unique and compact. Designed with the assistance of professional personnel management, it isolates specific experience in electronics and deals only in essential background information.

The advertisers listed here are seeking professional experience. Fill in the Qualification Form below.

### STRICTLY CONFIDENTIAL

Your Qualification form will be handled as "Strictly Confidential" by Electronics. Our processing system is such that your form will be forwarded within 24 hours to the proper executives in the companies you select. You will be contacted at your home by the interested companies.

### WHAT TO DO

1. Review the positions in the advertisements.
2. Select those for which you qualify.
3. Notice the key numbers.
4. Circle the corresponding key number below the Qualification Form.
5. Fill out the form completely. Please print clearly.
6. Mail to: Classified Advertising Div., Electronics, Box 12, New York, N. Y. 10036.

COMPANY	PAGE#	KEY#
ATOMIC PERSONNEL INC. Phila., Pa.	194	1
BENDIX CORPORATION Kansas City Div. Kansas City, Missouri 64141	181	2
COMSTOCK & WESCOTT INC. Cambridge, Mass.	194	3
GENERAL DYNAMICS Fort Worth Div. Fort Worth, Texas	175*	4
GENERAL TELEPHONE & ELECTRONICS Sylvania Electronics Systems Waltham, Mass. 02154	164*	5
LAWRENCE RADIATION LABORATORY Livermore, Calif.	194	6
LEAR SIEGLER INC. Instrument Div. Grand Rapids, Michigan 49508	206*	7
LOOKHEED CALIFORNIA COMPANY Burbank, Calif.	144	8
MARIN COMPANY Orlando, Florida	199*	9
PAN AMERICAN WORLD AIRWAYS INC. Guided Missiles Range Div. Cocoa Beach, Florida	207*	10
ROHR CORPORATION Chula Vista, Calif.	72	11
UNION CARBIDE CORPORATION Oak Ridge, Tennessee	194	12

\* These advertisements appeared in the August 22nd issue

(cut here)

## Electronics QUALIFICATION FORM FOR POSITIONS AVAILABLE

(cut here)

(Please type or print clearly. Necessary for reproduction.)

### Personal Background

NAME .....  
HOME ADDRESS .....  
CITY ..... ZONE ..... STATE .....  
HOME TELEPHONE .....

### Education

PROFESSIONAL DEGREE(S) .....  
MAJOR(S) .....  
UNIVERSITY .....  
DATE(S) .....

### FIELDS OF EXPERIENCE (Please Check)

9/5/66

- |  |  |                                       |
|--|--|---------------------------------------|
| <input type="checkbox"/> Aerospace           | <input type="checkbox"/> Fire Control        | <input type="checkbox"/> Radar        |
| <input type="checkbox"/> Antennas            | <input type="checkbox"/> Human Factors       | <input type="checkbox"/> Radio-TV     |
| <input type="checkbox"/> ASW                 | <input type="checkbox"/> Infrared            | <input type="checkbox"/> Simulators   |
| <input type="checkbox"/> Circuits            | <input type="checkbox"/> Instrumentation     | <input type="checkbox"/> Solid State  |
| <input type="checkbox"/> Communications      | <input type="checkbox"/> Medicine            | <input type="checkbox"/> Telemetry    |
| <input type="checkbox"/> Components          | <input type="checkbox"/> Microwave           | <input type="checkbox"/> Transformers |
| <input type="checkbox"/> Computers           | <input type="checkbox"/> Navigation          | <input type="checkbox"/> Other .....  |
| <input type="checkbox"/> ECM                 | <input type="checkbox"/> Operations Research | <input type="checkbox"/> .....        |
| <input type="checkbox"/> Electron Tubes      | <input type="checkbox"/> Optics              | <input type="checkbox"/> .....        |
| <input type="checkbox"/> Engineering Writing | <input type="checkbox"/> Packaging           | <input type="checkbox"/> .....        |

### CATEGORY OF SPECIALIZATION

Please indicate number of months experience on proper lines.

	Technical Experience (Months)	Supervisory Experience (Months)
RESEARCH (pure, fundamental, basic)	.....	.....
RESEARCH (Applied)	.....	.....
SYSTEMS (New Concepts)	.....	.....
DEVELOPMENT (Model)	.....	.....
DESIGN (Product)	.....	.....
MANUFACTURING (Product)	.....	.....
FIELD (Service)	.....	.....
SALES (Proposals & Products)	.....	.....

CIRCLE KEY NUMBERS OF ABOVE COMPANIES' POSITIONS THAT INTEREST YOU

1 2 3 4 5 6 7 8 9 10 11 12

# Lawrence Radiation Laboratory

The continuing emphasis on the development of basic and applied nuclear research programs has provided professional opportunities in responsible assignments at Lawrence.

## Challenging R & D Opportunities for ELECTRONICS ENGINEERS

- Systems Engineering
- Microwave Components
- Digital Computers
- Instrumentation
- Solid State Circuit Design
- Measurement Standards

## APPLIED RESEARCH PROGRAMS

- PLOWSHARE — peaceful applications of nuclear explosives
- BIO-MEDICAL — radiation effects on the biosphere
- SHERWOOD — controlled thermonuclear fusion
- WHITNEY — nuclear weapons for national defense
- SPACE REACTOR — reactors for power in space

You are invited to write in confidence to B. R. Graf, Personnel Department,



**Lawrence  
Radiation  
Laboratory**

UNIVERSITY of CALIFORNIA  
P. O. Box 808 18-96  
Livermore, California 94550

An Equal Opportunity Employer  
U. S. Citizenship Required

# CAN YOU IMAGINE?

If so, imagine working where management is informal to the point of the first-name basis, yet large enough to win substantial contracts and to maintain well equipped, modern facilities. Comstock & Westcott has been using imagination for fifty-four years—solving problems for many of the leading industrial firms in this country. No routine here—always something new to cope with. Physics, chemistry, electronics and mechanics are involved. We manufacture no goods, just help our clients develop more and better things. To work with us, one needs imagination and sound technical ability. A physics major or an electrical or mechanical degree and a leaning toward the physical aspects of things would be a likely starting point. If your imagination makes you feel you would like to join our efforts, call or write us. We would like to tell you more. A. H. Barron, Comstock & Westcott Inc., 765 Concord Ave., Cambridge, Mass. 02138.



**COMSTOCK & WESCOTT, INC.**

## INSTRUMENT TECHNICIANS

### THE OAK RIDGE NATIONAL LABORATORY

Highly skilled instrument technicians to assist in the installation and maintenance of process control instrumentation systems and devices for chemical pilot plants, nuclear reactors and other large experimental installations.

High school education, plus additional training in either the physical sciences, instrumentation, or electronics, and at least 4 years experience in installation and maintenance of complex instrumentation and control systems. Entrance rate \$3.39 per hour; \$3.45 per hour after six months. Reasonable interview and relocation expenses paid by Company.

Excellent Working Conditions  
and

Employee Benefit Plans

An Equal Opportunity Employer

Send detailed resume to:

Central Employment Office  
UNION CARBIDE  
CORPORATION  
Nuclear Division  
P. O. Box M  
Oak Ridge, Tennessee 37830



## E.E.'s

For FEE PAID positions  
throughout U.S.

Send Coupon Today

ATOMIC PERSONNEL, INC.

Suite L, 1518 Walnut St., Phila., Pa.

Experienced Engineers... Working  
"Full Time"... For You!

Send resume today. (If none, send  
coupon for confidential application.)

Name \_\_\_\_\_

Address \_\_\_\_\_

City \_\_\_\_\_ State \_\_\_\_\_

## PROFESSIONAL SERVICES

**GIBBS & HILL, Inc.**

Consulting Engineers

Systems Engineering

Operations Research • Development  
Field Studies • Design • Procurement  
Power • Transportation • Communications  
Water Supply • Waste Treatment

393 Seventh Avenue New York 1, N. Y.

## The Consulting Engineer

*By reason of special training, wide experience and tested ability, coupled with professional integrity, brings to his client detached engineering and economic advice that rises above local limitations and encompasses the availability of all modern developments in the fields where he practices as an expert.*

# YOU'RE H!RED

Do you need electronics engineers or technical management men? Electronics magazine is the way to recruit them. Electronics is designed specifically for the working engineer. 68,000 subscribers and an additional 133,000 pass-along readers turn to it to keep up with their industry. You can find the man that meets your qualifications with an advertisement in the Employment Opportunities Section.

For rates & information write: Electronics, a McGraw-Hill Publication, Classified Advertising Division, Post Office Box 12, New York 10036.

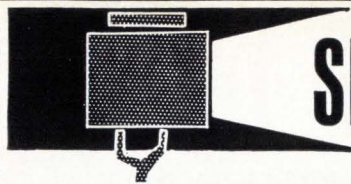

# SEARCHLIGHT SECTION

- CLASSIFIED ADVERTISING
- BUSINESS OPPORTUNITIES
- USED OR SURPLUS EQUIPMENT

## SYNCHROS • GENERATORS INVERTORS • SERVOS

23TR6 Torque Receiver ..... \$32.50  
 23TX6 Torque Transmitter ..... 32.50  
 23CX6 Control Transmitter ..... 32.50  
 1 F Motor 115/90 V. 60 Cy ..... 24.95  
 1 G Generator 115 V. 60 Cy ..... 24.95  
 1 HG Generator 115 V. 60 Cy ..... 39.95  
 1 HDG Differential Generator ..... 39.95  
 5 G Navy Ord. Size 115 V. 60 Cy ..... 24.95  
 5 HG Navy Ord. Size 115 V. 60 Cy ..... 39.95  
 5 F Navy Ord. Size 115 V. 60 Cy ..... 24.95  
 Bendix Type M Size 5 115 V. 60 Cy ..... 24.95  
 Bendix Type A Size 5 115 V. 60 Cy ..... 24.95  
 23RS6 Resolver Size 23 60 Cy ..... 49.95  
 Globe PM Motors 35 VDC 10 RPM ..... 9.95  
 Globe PM Motor 24 VDC 278 RPM ..... 12.50  
 Globe PM Motor 24 VDC 28 RPM ..... 12.50  
 Ampex, Ashland 105/125 V. 58/62 Cy. Hyst. syn. 1800 RPM Tape Recorder Motor ..... 24.95  
 Ampex, G.E. 115 V. 60 Cy. Rewind Motor dual shaft ..... 14.95  
 Ampex, Dale 117 V. 60 Cy. Hyst. Syn. 1800 RPM, Recorder motor ..... 24.95  
 Ampex, Redmond 115 V. 60 Cy. 1800 RPM rev. Tape Recorder Motor ..... 12.50  
 Ampex, IMC 115 V. 60 Cy. 1800 RPM Tape recorder torque motor ..... 19.95  
 Ampex, Bodine 117 V. 60 Cy. Hyst. Syn. 1800 RPM Tape Recorder Motor ..... 24.95  
 Ampex, Ashland 117 V. 50/60 Cy Hyst. Syn. 1800-3600 RPM Tape Recorder Motor ..... 24.95  
 Bendix, Inverter E-1617-1, 24 V. Input, 115 V. 400 Cy. 3 Ph. V.A. output ..... 25.00  
 Jack-Heintz Inverter, 24 V. Input Output 115/230 V. 1/3 Ph. 400 Cy. 2250 V.A. ..... 75.00  
 General Electric E-1823 120/208 V. 400 Cy. Generator 60 KVA ..... 250.00  
 Westinghouse, Generator 120/208 V. 3 Ph. 400 Cy. ..... 75.00

LARGE STOCK OF ROTATING DEVICES  
 All Items F.O.B. Oakland  
 Send for Free Catalog  
 (On Company Letterhead, Please)

**ELECTRO GADGET SUPPLY**  
**DOOLITTLE & LANGLEY STREETS**  
 Oakland Airport Oakland, Calif.  
 Phone 562-6641

CIRCLE 972 ON READER SERVICE CARD

SEND FOR OUR NEW 8 PAGE CATALOG LISTING THE LARGEST INVENTORY OF RADAR AND MICROWAVE EQUIPMENT IN THE WORLD.

## AUTOTRACK ANTENNA MOUNT

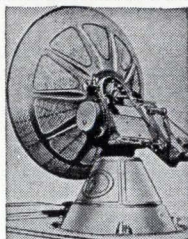

360 degree azimuth, 210 degree elevation sweep with better than 1 mil. accuracy. Missile velocity acceleration and slewing rates. Amplidyne and servo control. Will handle up to 20 ft. dish. Supplied complete with control chassis. In stock—immediate delivery. Used world over by NASA, USAF, MP-61-B, Type SCR-584, Nike Ajax mounts also in stock.

## PULSE MODULATORS

**MIT MODEL 9 PULSER 1 MW—HARD TUBE**  
 Output 25kv 40 amp. Duty cycle .002. pulse lengths .25 to 2 microsec. Also .5 to 5 microsec. and .1 to .5 microsec. Uses 6C21. Input 115v 60 cycle AC. Mfg. GE. Complete with driver and high voltage power supply. Ref: MIT Rad. Lab. Series, Vol. 5, p. 152.

**2 MEGAWATT PULSER**  
 Output 30 kv at 70 amp. Duty cycle .001. Rep rates. 1 microsec 600 pps. 1 or 2 msec 300 pps. Uses 5948 hydrogen thyratron. Input 120/208 VAC 60 cycle. Mfr. GE. Complete with high voltage power supply.

**MIT MODEL 3 PULSER**  
 Output: 144 kw (12 kv at 12 amp.) Duty ratio: .001 max. Pulse duration: .5, 1 and 2 microsec. Input: 115 v 400 to 2000 cps and 24 vdc. \$325 ea. Full desc. Vol. 5, MIT Rad. Lab. series. pg. 140.

**250 KW HARD TUBE PULSER**  
 Output 16 kv 16 amp. Duty cycle .002. Pulses can be coded. Uses 5D21, 715C or 4PR60A. Input 115 v 60 cy. AC \$1200 ea.

**PLAN POSITION INDICATOR CONSOLE**  
 Complete PPI console operating from 115 volt 60 cycle AC. 10" CRT range 4 to 250 miles. Digital height readout. Complete AN/UPA-25.

**SCR 584 AUTOTRACK RADARS**  
 Our 584s in like new condition, ready to go, and in stock for immediate delivery. Ideal for telemetry research and development, missile tracking, satellite tracking. Fully Desc. MIT Rad. Lab. Series, Vol. 1, pps. 207-210, 228, 284-286. Comp. Inst. Bk available \$25.00 each.

## TEST EQUIPMENT

For over 20 years specializing in top brands only. Write for our latest listing. We buy complete inventories.



**ELECTRONIC SALES**  
 1413 Howard Street, Chicago, Illinois 60626  
 Telephone ROgers Park 4-0600

CIRCLE 968 ON READER SERVICE CARD

## ELECTRON TUBES

KLYSTRONS • ATR & TR • MAGNETRONS  
 SUBMINIATURES • C.R.T. • T.W.T. • 5000-6000 SERIES  
 • SEND FOR NEW CATALOG A2 •  
 A & A ELECTRONICS CORP.  
 1063 PERRY ANNEX  
 WHITTIER, CALIF.  
 696-7544

CIRCLE 669 ON READER SERVICE CARD

## SPOT WELDING TWEEZERS



TWI - 36" Lead \$11.65  
 AC and Stored Energy Power Supplies and Welding Heads

**EWALD INSTRUMENTS CORP.**  
 KENT, CONN. 06757

CIRCLE 970 ON READER SERVICE CARD

## ELECTRONIC COMPONENTS

For Production and Research

Write for new catalog

**A. B. INDUSTRIES** 743-5006  
 3133 West Jarrath Ave., Chicago 60645

CIRCLE 971 ON READER SERVICE CARD

## MICROWAVE SYSTEMS

### L BAND RF PKG.

20 KW peak 990 to 1040 MC. Pulse width .7 to 1.2 micro sec. Rep. rate 180 to 420 pps. Input 115 vac. incl. Receiver \$1200.

### 200-225 mc RADAR SYSTEM

1 Megawatt output, 200 nautical mile range for long range detection of medium and high altitude jet aircraft as well as general search. Complete system in stock. Input 120/208 V, 60 cy. Type TPS-28. Mfg. Hazeltine.

### C-BAND RADAR

250 KW output. C-band. PPI indicator. 5C22 thyratron modulator. Antenna hi gain parabolic section. Input 115 volts 60 cycle AC. complete \$2750.00.

### 500 KW L BAND RADAR

500 kw 1220-1359 msc. 160 nautical mile search range P.P.I. and A scopes. MTI. thyratron mod 5J26 magnetron. Complete system.

### 100 KW X BAND RADAR

Complete 100 kw output airborne system with AMTI. 5C22 thyr. mod. 4J52 magnetron. PPI, 360 deg az sweep, 60 deg. elev. sweep, gyro stabilizer, hi-gain revr. Complete with all plugs and cables.

### M-33 AUTO-TRACK RADAR SYSTEM

X band with plotting board. Complete

### AN/GPG-1 SKY-SWEEP TRACKER

3 cm. automatic tracking radar system. Complete package with indicator system. Full target acquisition and automatic tracking. Input 115 volts 60 cycle. New. In stock for immediate delivery. Entire System 6' long, 3' wide, 10' high. Ideal for Infrared Tracker, Drone Tracker, Missile Tracker, R. & D.

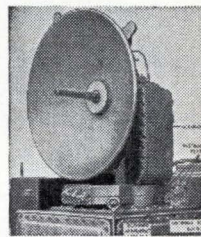

### 500KW S BAND RADAR

G.E. Airport Surveillance System.

RADAR AUTO-TRACK & TELEMETRY ANTENNA PEDESTALS 3 & 10 CM. SCR 584 AUTOTRACK RADARS. M-33 RADAR TPS-1D SEARCH. APS-45 TPS-10D HT. FINDERS. WX RADARS. FPN-32GA. APS-10 APS-15B APS-27 (AMTI) SEARCH. APN-102 DOPPLER. DOZENS MORE. CARCINOTRONS. PFN'S. 25-5-1-2-3-6 MEGAWATT PULSE MODULATORS. CAVITIES. PULSE TRANSFORMERS. IF STRIPS. WAVEGUIDE. BENDS 200 MC. 1 KMC. 3 KMC. 6 KMC. 9 KMC. 24 KMC. RF PKGS.

**RADIO RESEARCH INSTRUMENT CO.**  
 550 5TH AVE., NEW YORK 36, N. Y. JU 6-4691

CIRCLE 966 ON READER SERVICE CARD

## FOR SALE:

## ELECTRIC, GAS, and VACUUM FURNACES

Forming Gas Generators. Nitrogen Generators. Endothermic Generators. Ammonia Dissociators. Induction Heaters. Vacuum Metallizers. Strip Chart Recorders. Temperature Controllers. Programmers. Mass Spectrometers. Spectrophotometers. Refractometers. Gas Purifiers. Electron Tube Manufacturing, Aging, and Testing Equipment.

## INSTRUMENTS & MACHINES INC.

1200 Grove Street Irvington, N.J.  
 201-371-7900

CIRCLE 967 ON READER SERVICE CARD

## BIG CATALOG

World's "BEST BUYS" in GOV'T. SURPLUS Electronic Equipment

FULL OF TOP QUALITY ITEMS—Transmitters, Receivers, Power Supplies, Inverters, Microphones, Filters, Meters, Cable, Keys, Phones, Antennas, Chokes, Dynamotors, Blowers, Switches, Test Equipment, Headsets, Amplifiers, etc., etc. SEND 25¢ (stamps or coin) for CATALOG and receive 50¢ CREDIT on your order. Address Dept. E-6

**FAIR RADIO SALES**  
 P.O. Box 1105 • LIMA, OHIO • 45802

# FOR SALE



When you have used electronics equipment to sell, advertise in Electronics Searchlight Section for fastest results.

For information:  
 Searchlight Section  
 Classified Advertising Division  
 Post Office Box 12  
 New York 10036

# TEN YEARS TOO LATE

Part TEN in a series on THE STATE OF THE CHOPPER ART

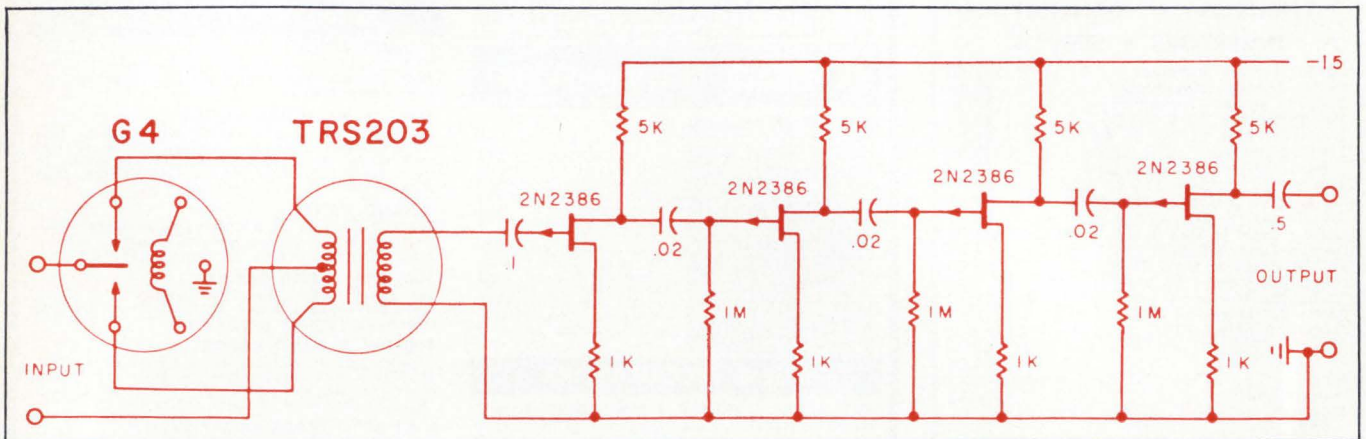

The FET amplifier has remarkable low noise performance. Tubes — and transistor junctions — have at least one thing in common — the noise power increases as the frequency goes down. This means a lot of jitter near DC, making readings at less than 100 nanovolts about impossible, unless the amplifier bandwidth is severely restricted. You can read 10 nanovolts with this circuit with wide band response.

## THE VERY REMARKABLE G4 MECHANICAL CHOPPER — BORN 10 YEARS TOO LATE

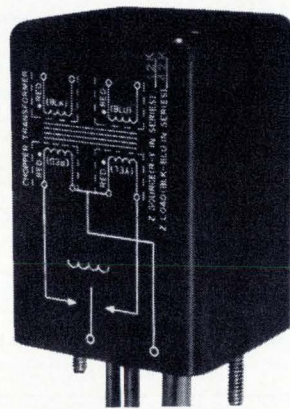
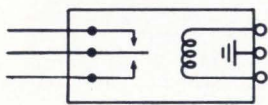
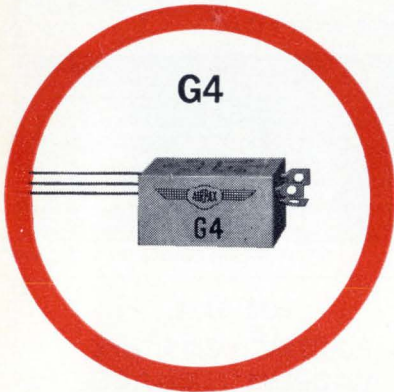

TRANSFORMERS DON'T SEEM TO GET ANY SMALLER

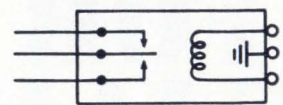
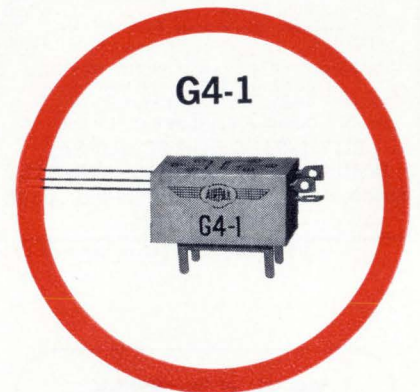

Boy oh boy. If only we had this thing 10 years ago when mechanical choppers were real fashionable. It would have made all those nasty competitors look sick. (Sigh!)

We don't really expect you to care much about a mechanical chopper nowadays. Even if the offset is below 50 nanovolts, even if it buzzes away docilely at most any frequency up to some 1500 cycles. Even when it's almost transistor size. (You can get by without the input transformer — we're just trying to sell you that too. Profit is our motive.)

Could be, of course, you haven't time to horse around — you need something working the first time. Or you'll sacrifice reliability — 25,000 hours life is good enough. You might like the bifurcated contacts isolated completely from contamination. Try one. This G4 chopper is practically perfect.

We maybe ought to ignore the low cost, it not being Solid State. The G4 is a lot smaller and lighter than a solid state chopper. Honest. Just add up the contrivances you need for solid state drive.

It sure would have been nice 10 years ago.

**AIRPAX ELECTRONICS** incorporated Cambridge Division, Cambridge, Maryland

# Electronics Abroad

## International

### Pulse-train lullaby

A white-jacketed therapist straps a padded electrode band around a patient's head, sets a couple of dials and flicks a switch on a small control panel. Soon the patient becomes drowsy, most often he falls asleep.

The scene has become routine in Russian hospitals, where "electrosleep" therapy has been used for several years to treat a variety of illnesses including high blood pressure, insomnia, ulcers, even epilepsy [Electronics, May 24, 1963, p. 20]. Now the technique seems on the verge of catching on around the world. In the United States, Great Britain and in Austria sleep-inducing instruments are either on the market or close to it. And next week, some 300 medical researchers from around the world will turn up at Graz, Austria, to attend the First International Symposium on Electrosleep and Electroanesthesia, which will run from September 12 to 17.

**Questions.** One question sure to keep the doctors awake at Graz is what exactly happens to a patient when he's subjected to the square-wave pulses of an electrosleep instrument. Despite Russian successes with the technique, medical researchers still aren't sure what causes the feeling of well-being, followed by drowsiness and often sleep when the pulses are applied.

One explanation is that the low-level electric currents paralyze a sleep-inhibiting center in the brain. Another explanation is that the effect comes from an electrical potential set up in the casing of the brain. Dr. Sigmund Forster, who heads the physical medicine and rehabilitation service at a Brooklyn, N.Y., hospital, maintains that no one has shown that the pulses actually pass through the brain.

Forster is one of the pioneer

U.S. experimenters in the technique. It was he whom the U.S. government tapped to send to the Soviet Union two years ago to look into the Russian work in electrosleep. Forster was sent because both the Air Force and the National Aeronautics and Space Administration wanted to find out if a few hours of induced sleep could replace eight hours of natural sleep for bomber pilots and astronauts. After Forster's report, government officials decided not to follow through with a special program although the possibility still has not been ruled out.

Forster returned from Russia convinced that the pulse-therapy technique had produced impressive results in treating some ills but that it did not necessarily induce sleep. He currently is directing a clinical experiment aimed at getting an idea of how often auto-suggestion plays a role in the cures or improvements in health credited to pulse-wave therapy. Forster also suspects that what appears to be induced sleep might actually be a hypnotic state brought on by periodic pulsing. Because the action of low-level pulse trains on the brain is not yet fully understood, Forster will plead at next week's meeting at Graz that researchers in the field shy away from the term

"electrosleep" and instead use something like "cranial application of low-level currents."

**Hardware.** The worldwide exchange of information on experiments and clinical trials at Graz should speed the widespread use of pulse-train therapy in countries besides Russia. For medical electronics equipment makers, it could turn into an important new market. The Russians now produce 5,000 electrosleep units a year.

In the United States, the National Patent Development Corp. has readied, under a license arrangement, a transistorized version of the original vacuum-tube Russian equipment. The U.S. unit puts out pulses 1.8 to 2.0 milliseconds long at rates from 27½ to 40 pulses a second. Amplitude is 18 to 24 volts and the current passed is 1.4 milliamperes. National Patent has under way extensive clinical trials of its instrument and expects to have it on the market—for professional use only—early next year. The price will be around \$300. National Patent is keeping the Food and Drug Administration informed of its plans. FDA a few years ago banned a cheap Japanese-made unit that was sold "across the counter" to all comers.

In Great Britain, D.R. Garner & Co. recently put a sleep-inducing

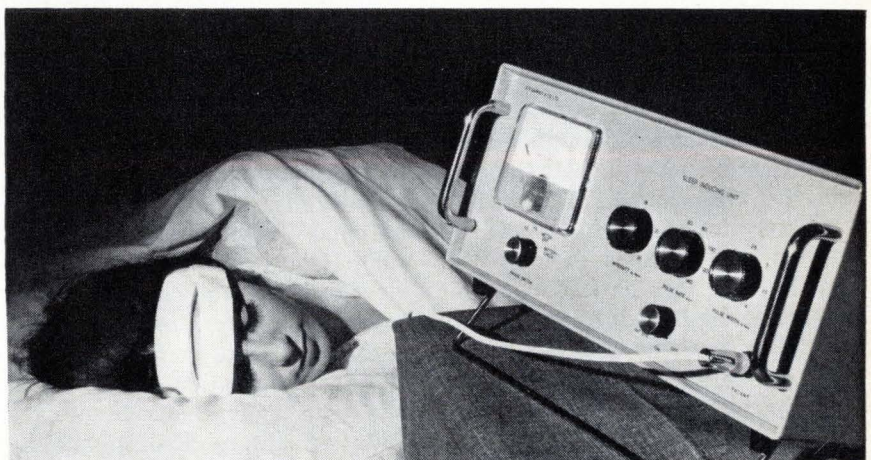

Transistorized sleep-inducing unit recently put on the market in Great Britain is used in a London hospital to treat insomnia and anxiety states.

unit on the market after successful clinical trials in a London hospital. Physicians use it to treat insomnia, anxiety states and other conditions in which sleeplessness occurs.

The patient wears two bands, which apply electrodes to the forehead and the back of the head just above the neck. The square-wave pulses fed to the electrodes are generated by a transistorized astable multivibrator. Frequency can be adjusted from 7 to 140 pulses per second and pulse width from 1 to 4 milliseconds. Maximum amplitude is 27 volts. The Garner unit sells in Britain for \$340.

### Space team

Although United States electronics companies have cornered substantial markets in Western Europe, essentially they've been shut out of the space hardware business there.

Determined not to let America and the Soviet Union wind up with a monopoly in communications satellites, European countries have made it a policy not to use American hardware in their national space programs and in joint efforts. They aim to build a purely European space capability and with it pick up a piece of the lucrative business in communications satellites that's in sight. What's more, the European countries fear their cultural images would be tarnished if the Americans and Russians controlled tv broadcasting by satellite.

**Cashing in.** Up against a hopeless situation in hardware, U.S. companies are tapping the market as best they can by selling know-how to Europe. Many companies have set up advisory arms—a new phenomena—and through them worked out consulting agreements with European companies bidding for hardware contracts.

Thus, the Hughes Aircraft Co. has become an almost constant partner of the British Aircraft Corp. The TRW Systems Group of TRW, Inc., works with Britain's Hawker Siddeley Dynamics Ltd. and with France's Engins Matra. The Ball Brothers Research Corp. has collaborated with Sud-Aviation of

France. The Philco Corp., a subsidiary of the Ford Motor Co., often advises Nord-Aviation, like Sud a French government-controlled aerospace firm. Because of tie-ups like these, Yankee advisors have a key technical say-so for most of the satellite projects of the European Space Research Organization (ESRO).

**Binding.** So far, though, there's been a costly drawback for American companies looking for profits in the space know-how business. A group forms around a U.S. consultant to bid on a satellite and then usually falls apart if a competing group wins the award. When the next project goes up for grabs, the expensive effort to put together a bidding consortium has to start practically from scratch.

To get around this drawback, the General Electric Co. has lined up what it hopes will be a durable consortium, the European Satellite Team. Along with GE's Technical Services Co., a subsidiary set up to handle overseas sales of know-how, the team includes Elliott-Automation Ltd. of Britain, Compagnie Française Thomson Houston-Hotchkiss Brandt, Fabbrica Italiana Apparecchi Radio (FIAR), the Royal Netherlands Aircraft Factories (Fokker), and Allmanna Svenska Elektriska AB (ASEA) of Sweden.

The team already has launched an effort to capture a big chunk of space business. Last month, it bid along with four other competing groups for an \$18-million contract to build a pair of 800-pound scientific satellites for ESRO. If the team gets the job, GE stands to collect a \$1-million fee for consulting and a part of the hardware money as well since it owns 75% of FIAR.

**Togetherness.** The team also has submitted a proposal to the International Telecommunications Satellite Consortium (Intelsat) for a development study on a multipurpose communications satellite. R.C. McBride, who heads Technical Services' operation in Paris, says the team plans to stay together for bids on future ESRO satellites, hardware for European Launcher Development Organization projects

and for the first Intelsat satellite.

Other U.S. companies to date haven't followed GE's lead in knitting together durable space-business consortiums with European hardware producers. Many feel the best way to pick up know-how fees is to form one-shot groups tailored for specific projects. But if the European Satellite Team wins the ESRO contracts for the two 800-pound scientific satellites this fall, the scramble will be on to put together long-lasting consortiums.

---

## Japan

---

### Characters galore

In addition to the same sort of problems their Occidental counterparts run up against, Japanese computer makers face a harrowing situation when it comes to printout—it takes nearly 2,500 different characters to get ordinary Japanese down on paper.

So far, Japanese computer makers have sidestepped the printout problem rather than tackle it head on. They've limited printout to the so-called katakana syllabary, a set of 48 phonetic symbols used in normal Japanese for emphasis and for words taken over from foreign languages. Anyone who can read Japanese can puzzle out the words from the phonetic symbols, so katakana works well enough for computer-prepared inventories, invoices, brief explanations on business forms and the like. But in long prose passages, katakana becomes unintelligible.

Pointing toward the day when widespread use of computers in Japan will make easily readable printouts necessary, Hitachi Ltd. has developed an electrostatic printer that can cope with 1,200 different characters and grind out 40-character lines at 225 lines per minute. The variety of characters is sufficient to turn out texts in normal Japanese prose, a combination of kanji—Chinese characters—and a phonetic syllabary for inflection.

At 150 characters per second,



Hitachi's kanji printer doesn't come close to the speed of the fastest katakana printer, which whirls out nearly 20,000 characters per second [Electronics, Dec. 13, 1965, p. 239]. Still, the Hitachi unit operates 75 times faster than previous kanji printers, the best of which pokes along at two characters per second. What's more, unlike its predecessors the Hitachi printer can be run directly off a computer. First production models will be on the market late this year.

**Kanji store.** The 1,200 characters that the printer can reproduce are stored on a photographic film belt, the equivalent of the row of type wheels in a mechanical line printer. The film belt runs over a bank of 40 optical fiber tubes, each illuminated by a xenon lamp. Control circuits in the printer flash the lamps to match the input from a computer or a paper tape reader.

As the lamps flash, the optical fiber tubes project the 40 characters for each line onto coated paper that can hold an electrostatic charge. The paper first passes a plate that charges it. Then it is discharged line-by-line—except where characters are flashed onto it—as it passes by an exposure plate. Continuing its pass through the printer, the paper picks up a charged toner where light has hit it. The toner is developed to form legible characters by xerographic techniques.

## Typhoon chaser

Getting warnings out to the public well before hurricanes hit is no longer much of a problem for the United States Weather Bureau. It has a battery of weather satellites and far-ranging military patrol planes at its disposal to track hurricanes from Amy to Zelda.

For its typhoon warning system, though, the Japan Meteorological Agency can't afford a panoply of satellites and aircraft. Fuel bills for the planes alone would be more than the agency's entire operating budget. So the agency has put a typhoon-chasing weather-radar ship to sea.

The ship will back up the existing—but sometimes inadequate—

network of weather-radar stations strung out along the Japanese coast, including one atop Mt. Fuji. In recent years, the agency has been caught short several times by typhoons that have veered out to sea beyond the range of the network and then changed course to batter the coast with little warning.

**Defiant.** The Japanese christened their 2,000-ton weather ship the Ryofu Maru, which translates into "wind-defying ship." The ship herself and the 16-foot-diameter radome amidships were designed to withstand winds up to 133 miles an hour. All the same, the agency doesn't plan to send the vessel right into the eye of a typhoon. She can stand off and track storms up to 250 miles away with her radar, which puts out 300 kilowatts of peak power at a frequency of 5,300 megahertz. The resolution in range is better than 600 feet, in azimuth better than 3°.

Circuit design of the Ryofu Maru's radar is similar to that of other high-power radars but the 8.2-foot-diameter dish antenna is far and away the largest yet built in Japan with a stabilized platform. The stabilization system can cope with roll up to 30° on either side and pitch of 10° up or down. Along with the mechanical antenna platform stabilization, there are electronic circuits that keep the radar display oriented "North up."

In addition to the \$180,000 weather-radar system, which was built by Tokyo Shibaura Electric Co. (Toshiba), the Ryofu Maru has been outfitted with an extensive kit of oceanographic gear so she won't be idle between typhoon seasons.

---

## Great Britain

---

### Heads up

Prime Minister Harold Wilson's decision last spring to buy 50 F-111 intercontinental fighter bombers from the United States provoked dismay in the British airframe industry, but electronics manufacturers reckoned the overseas plane buy might turn out to be a good

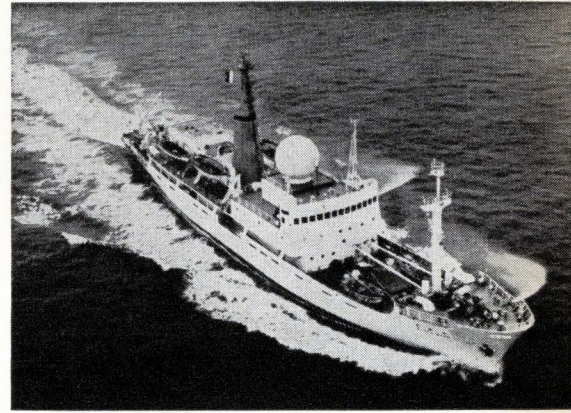

Ryofu Maru's radar can track typhoons up to 250 miles away.

thing for them in the long run.

To clinch the deal, the Pentagon agreed to buy enough British defense gear to offset the cost of the planes—some \$300 million. For this business, the usual 50% "buy American" price differential doesn't apply and British suppliers bid on the same footing as U.S. suppliers. The British electronics industry has long maintained it could compete in the U.S. military market if it weren't for "buy American" protection.

Now it looks as if the British electronics industry had the situation sized up right. Last month, Elliott-Automation Ltd. picked up a \$600,000 initial contract to develop the "head-up" system and a digital computer for the U.S. Navy's Integrated Light Attack Avionics System (Ilaas).

The award came officially from the Sperry Gyroscope division of the Sperry Rand Corp., prime contractor for Ilaas. The Navy has earmarked \$23.9 million to develop and test four Ilaas prototypes for the A-7 Corsair-2 carrier aircraft. Sperry Gyroscope itself was the other main contender for the head-up part of the system, but Elliott got the nod from the Navy. Said Commander H. Pasley-Tyler, who directed Elliott's negotiations with the Navy, "This shows we can compete on equal terms, and we're jolly proud of it."

**In view.** The Ilaas head-up display allows pilots to see both instrument information and the outside world at the same time. The instrument information is projected

from a cathode-ray tube onto a viewer in the pilot's line of sight. All the pilot has to do to stay on course, for example, is keep a dot projected onto the viewer in the center of a circle. One feature of Elliott's display is a ceramic cathode-ray tube, with the electrode structure deposited directly on the ceramic, much as in printed circuits. Elliott head-up displays using the special tube already are standard equipment in some British military attack and transport planes.

Another kingpin element in the Ilaas hardware Elliott will develop is a digital computer that weighs only 90 pounds, including the interface and power supply. The standard model of this computer, which translates flight information so that it can be displayed as a dot on a viewer, has a memory with a capacity of 12,000 words. Elliott will expand the memory for Ilaas.

**More to come?** For Elliott-Automation, the \$600,000 development contract may be just the beginning. If the Navy decides to put Ilaas into production, Elliott almost certainly stands to get a production contract worth several million dollars. And Pasley-Tyler says that Elliott is negotiating with U.S. officials for a contract of "quasi-military" nature, but won't let on exactly what Elliott is trying to sell.

---

### Red China

---

#### No threat yet

For electronics companies eyeing markets in Southeast Asia, one big question is when will the People's Republic of China start looking seriously for customers on the other side of the Great Wall.

The answer, apparently, is not soon. Judging by the Chinese Machinery and Electronics Exhibition mounted a fortnight ago by 14 Hong Kong companies that handle Red Chinese goods, the People's Republic still has little to offer to neighboring countries.

To be sure, the emphasis at the exhibition was on heavy machinery—textile and printing equipment

along with a variety of high-precision machine tools, all rated as well-made by Western observers. But the Reds also showed what electronics gear they have to sell now in export markets.

**Little.** It isn't much—a few measuring instruments and some vacuum-tube radios. The instruments included a signal generator, an oscilloscope, a low-frequency analyzer, a voltmeter, and a pH meter. Few were transistorized and none could handle high frequencies. The electronic computers over which the Red Chinese have made much ado were conspicuously absent.

As for radios, only vacuum-tube sets were shown. Some had as many as five medium- and short-wave bands, but none had frequency modulation. Although it's known the Red Chinese produce transistor sets, apparently they can't spare any now for export markets. With nothing but line-operated sets to sell, they won't stack up as serious competitors in consumer markets for a long time.

Along with instruments and radios, the Hong Kong fair also brought forth a display of components that include variable condensers, fixed capacitors, resistors, ferrite antennas, transformers, loudspeakers and microphones. But there was no miniaturization, a drawback in Asian markets where the transistor radio is king.

**Profile.** It's a reasonably safe bet that the Hong Kong exhibition mirrors the makeup of the Red Chinese electronics industry. The main effort, then, seems directed toward manufacture of instruments for industrial and scientific uses. In consumer electronics, the emphasis is on radios, presumably to keep the population well primed with propaganda. Western observers estimate that in 1965 there were some 6.3-million radio receivers and communal radio relay loudspeakers in use in the People's Republic, but only 100,000 tv receivers.

The Hong Kong show made it clear that Red China still is a sleeping giant as far as electronics exports go. But a long-range threat lurks. Although the range of items was limited, prices quoted at the show were highly competitive.

---

### Around the world

---

**India.** Practically all the instrumentation for India's massive long-range nuclear power program will be produced domestically. By 1970, the Indians plan to be building one nuclear reactor a year and each will require some \$1.3 million worth of electronic monitoring and control gear. To handle the job, the government plans to transform the electronics production division of the Indian Atomic Energy Dept. into a commercial corporation.

**South Korea.** With the labor market in Hong Kong beginning to tighten up, United States semiconductor manufacturers are turning to South Korea. The first U.S. company to go into semiconductor production there will be the Fairchild Camera & Instrument Corp., which recently received government approval to build a plant. Signetics Corp., a subsidiary of the Corning Glass Works, also plans a South Korean semiconductor plant.

**Western Europe.** Two NATO countries are buying low light-level television cameras from the Admiral Corp. in Chicago to install aboard Navy ships to augment radar. The tv will take over the job of tracking low-flying aircraft when clutter from the sea's surface obscures the target on radar.

**Thailand.** The Thai police department is evaluating bids for a \$5-million "hot line" telephone system to link Bangkok with 107 towns in the northeastern provinces where Communist activity is rife. The trunk line will be paralleled by microwave links to keep the system operating should the Communist insurgents cut the cable. Six countries are competing for the contract.

**Japan.** The Nippon Electric Co. has started taking orders for the first small Japanese computer with integrated circuits. NEC calls the computer the NEAC Series 2200 Model 50, says it bridges the gap between the low end of the line of computers it builds under license from Honeywell Inc. and its small parametron computer [Electronics, Sept. 6, 1965, p. 155].

# Electronics advertisers

September 5, 1966



<b>aci Division, Kent Corporation</b>	174	<b>EG&amp;G Incorporated</b>	158
Richard L. Renner Industrial Advertising		Culver Advertising, Inc.	
■ <b>AMP Incorporated</b>	138	<b>Eastman Kodak Company</b>	151
Garceau, Hargrave & McCullough, Inc.		Rumrill-Hoyt, Inc.	
<b>Ace Plastic Company</b>	163	<b>Electro Scientific Industries</b>	140
Krate/Weinberger, Inc.		Nadler & Larimer, Inc.	
<b>Adams-Russell, Inc.</b>	156	<b>Electro Tec Corporation</b>	40
Tech/Reps		McClellan Associates, Inc.	
<b>Airpax Electronics, Inc.</b>	196	<b>Emerson &amp; Cuming, Inc.</b>	185
Welch, Mirabile & Company, Inc.		Edwin F. Hall, Inc.	
<b>Allied Chemical Corporation, Plastics Division</b>	104	<b>Esterline Angus Instrument Co.</b>	76
McCann-Erickson, Inc.		Caldwell, Larkin & Sidener Van Riper	
<b>Allied Radio Corporation</b>	163	■ <b>Fairchild Semiconductor Incorporated</b>	128
Marvin H. Frank Company		Faust/Day Inc.	
<b>Amelco Semiconductor Division, Teledyne Inc.</b>	37	<b>Fenwal Electronics, Inc.</b>	184
Sturges & Associates		Larcon Randall Advertising, Inc.	
<b>American Optical Company</b>	54	<b>Ferroxcube Corporation of America</b>	100
Fuller & Smith & Ross, Inc.		Solow/Weston	
<b>Arrow Hart &amp; Hegeman Electric Company</b>	61	<b>Fluke Mfg. Company, John Bonfield Associates, Inc.</b>	15
Chirug & Cairns, Inc.		<b>Franklin Electronics, Inc.</b>	185
<b>Astro Communication Laboratory Inc.</b>	166	James J. Cavella Advertising	
Admasters Advertising, Inc.		<b>General Aniline &amp; Film Corporation</b>	120
<b>Baldwin Lima Hamilton, Inc.</b>	46	Hazard Advertising Company, Inc.	
Gray & Rogers, Inc.		<b>General Atronics Corporation</b>	145
■ <b>Ballantine Laboratories</b>	159	Garceau, Hargrave & McCullough, Inc.	
Lang-Lawrence Advertising, Inc.		<b>General Instrument Corporation, Semiconductor Products Corporation</b>	12, 13
<b>Barber-Colman Company</b>	180	Norman Allen Associates, Inc.	
Howard H. Monk & Associates		<b>General Radio Company</b>	2nd cover
<b>Bendix Corporation</b>	181	K. E. Morang Company	
Winius-Brandon Corporation		<b>Granger Associates</b>	8
<b>Bendix Corporation, Scintilla-Connectors</b>	28	West Associates	
MacManus, John & Adams, Inc.		<b>Graphic Systems</b>	189
■ <b>Brush Instrument Division of Clevite Corporation</b>	26a, 26b, 126, 127	Caswell Advertising Agency	
Carr Liggett Advertising, Inc.		<b>Gries Reproducer Company</b>	191
<b>Bulova Watch Company, Electronics Division</b>	148	Harold Marshall Advertising Co., Inc.	
Frank Best & Company, Inc.		<b>Hamilton Watch Company</b>	168
<b>CTS Knights, Inc.</b>	150	Beaumont, Heller & Sperling	
Burton Browne Advertising		<b>Hansen Mfg. Company, Inc.</b>	182
<b>Cherry Electrical Products Corporation</b>	169	Keller-Crescent Company	
K & A Inc.		■ <b>Hathaway Instruments, Inc.</b>	180
<b>Clare &amp; Company, C. P.</b>	50, 51	Eby and Everson, Inc.	
Reincke, Meyer & Finn, Inc.		■ <b>Hewlett Packard Colorado Springs Division</b>	176, 177, 178
■ <b>Clevite Corporation, Piezoelectric Division</b>	165	Tallant/Yates Inc.	
Carr Liggett Advertising, Inc.		■ <b>Hewlett Packard Dymec Division</b>	1
<b>Clifton Precision Products, Inc.</b>	24	Lennen & Newell, Inc.	
Ivey Advertising, Inc.		■ <b>Hewlett Packard Loveland Division</b>	2, 17, 41, 141
<b>Cohn Corporation, Sigmund</b>	187	Lennen & Newell, Inc.	
Wm. G. Seidenbaum & Company, Inc.		<b>Honeywell PMD</b>	43
<b>Cohu Electronics</b>	71	Batten, Barton, Durstine & Osborn, Inc.	
Erwin Wasey, Inc.		<b>Honeywell Test Instruments</b>	48, 49
<b>Comcor Incorporated, Sub. of Astrodata, Inc.</b>	113	Campbell Mithun Inc.	
Marketing Directions			
<b>Computer Control Company, Inc.</b>	134		
Franklin P. Folts, Inc.			
<b>Computer Test Corporation</b>	53		
James Lees Advertising			
<b>Consolidated Electrodynamics Corporation</b>	66, 149		
Hixson & Jorgensen, Inc.			
■ <b>Control Switch Division of Control Corp. of America</b>	172, 173		
Harry P. Bridge Company			
<b>Cornell-Dubilier Electronics</b>	125		
Daniel & Charles, Inc.			
<b>Coto Coil Company, Inc.</b>	185		
The Williams Company			
■ <b>Dale Electronics, Inc.</b>	62		
Swanson, Sinkey, Ellis, Inc.			
<b>Data Control Systems</b>	165		
Bodge-Eade Incorporated			
■ <b>Delco Radio Division of General Motors</b>	68		
Campbell-Ewald Company			
<b>Delevan Electronics Corporation</b>	188		
Stahlka, Faller & Klenk			
<b>Digital Equipment Corporation</b>	22		
Kalb & Schneider, Inc.			
<b>DuPont &amp; Company, Mylar Division</b>	75		
Batten, Barton, Durstine & Osborn, Inc.			
<b>DuPont &amp; Company, Photo Products Dept.</b>	123		
N. W. Ayer & Son, Inc.			

## Classified Advertising

F. J. Eberle, Business Mgr.	
<b>EMPLOYMENT OPPORTUNITIES</b>	194
<b>EQUIPMENT</b>	
<b>MERCHANDISE</b>	
(Used or Surplus New)	
For Sale	194

## ADVERTISERS INDEX

<b>A &amp; A Electronics Corp.</b>	195
<b>A B Industries</b>	195
<b>Atomic Personnel Inc.</b>	194
<b>Comstock &amp; Wescott Inc.</b>	194
<b>Electro Gadget &amp; Supply</b>	195
<b>Ewald Instruments Corp.</b>	195
<b>Fair Radio Sales</b>	195
<b>Instruments &amp; Machines Inc.</b>	195
<b>Lawrence Radiation Laboratory</b>	194
<b>Norman Electronic Sales</b>	195
<b>Radio Research Instrument Corp.</b>	195
<b>Union Carbide Corp.</b>	194

■ For more information on complete product line see advertisement in the latest Electronics Buyers' Guide

INFORMATION : CFE EXPOSITIONS - INFORMATION : 40, RUE DU COLISEE 75 - PARIS 80



**PARIS**  
14-21  
APRIL 67



**mesucora**  
International exhibition and congress  
measurement • testing • control • automation

**61<sup>st</sup> physics exhibition**

**67**

PALAIS DE LA DÉFENSE

SEPIC

Over 1300 Exhibitors are expected (400 French and 900 Foreign from more than 10 countries)

Show space will be 430,000 sq ft.

MESUCORA will be the only European Measurement and Automation Exhibition in 1967—featuring:

- probes and measuring instruments
- test and analysis appliances
- measurement data processing
- control, automation and regulation equipment
- applications of automatic control.

# Electronics advertisers

September 5, 1966

<b>Honeywell Test Instrument Division</b> George T. Petsche Advertising	114
■ <b>Hughes Aircraft Company</b> Foote, Cone, Belding, Inc.	122, 153
<b>IBM Corporation</b> Marsteller, Inc.	18, 19
■ <b>IMC Magnetics Corporation</b> Monad Advertising Design	160
<b>IRC, Incorporated</b> Gray & Rogers, Inc.	146
■ <b>Ichizuka Optical Company, Ltd.</b> Matsushita, Inc.	190
<b>Indiana General Corporation</b> Griswold & Eshleman Company	57
<b>ITT Semiconductor</b> Neals & Hickok	3rd cover
<b>Jerrold Electronics Corporation</b> Lescarboura Advertising, Inc.	14
■ <b>Leach Corporation</b> Jay Chiat & Associates	67
<b>Ling-Temco-Vought, Inc.</b> Wyatt, Dunagan & Williams	124
<b>Litton Industries Inc., Winchester Electronics Division</b> West, Weir & Bartel, Inc.	73
<b>Lockheed California Company</b> McCann Erickson Inc.	144
■ <b>McLean Engineering Laboratories</b> Healy Advertising, Inc.	191
<b>Machlett Laboratories Inc. Division of Raytheon Corporation</b> Fuller & Smith & Ross, Inc.	9
■ <b>Mallory Capacitor Company Division of P. R. Mallory &amp; Co., Inc.</b> Aitkin-Kynett Company, Inc.	65
■ <b>Markel &amp; Sons, L. Frank</b> George Moll Advertising, Inc.	189
<b>Mathatronics, Inc.</b> Kalb & Schneider, Inc.	162
■ <b>Matsuo Electric Company, Ltd.</b> Fuji Agency	169
<b>Melpar, Inc.</b> Arthur J. Lamb, Inc.	169
<b>Mergenthaler Linotype Company</b> Merlin Advertising	170
<b>Mesucora</b> Sepic	201
<b>Micro Instrument Company</b> Bonfield Associates, Inc.	164
■ <b>Micro Switch Division of Honeywell Company</b> Batten, Barton, Durstine & Osborn, Inc.	44, 45
<b>Minnesota Mining &amp; Mfg. Company, Chemical Division</b> MacManus, John & Adams, Inc.	42
■ <b>Mitsubishi Electric Corporation</b> Hakuhodo, Inc.	171
<b>Motorola Communications &amp; Electronics, Inc.</b> K & A Inc.	161
<b>Motorola Semiconductor Products, Inc.</b> Lane & Bird Advertising, Inc.	52, 74
<b>New Hermes Engraving Machine Corporation</b> Lester Harrison Advertising, Inc.	175
<b>North Atlantic Industries, Inc.</b> Murray Heyert Associates	137
<b>Okaya Musen Company Ltd.</b> K. K. Kyoei Kokoku Sha Agency	189
■ <b>Pennsalt Chemicals Corporation</b> Aitkin-Kynett Company	133
<b>Phelps Dodge Electronic Products Corp.</b> Smith, Dorian & Burman, Inc.	152
<b>RHG Electronics Laboratories, Inc.</b> S. M. Sachs & Associates	161
<b>Radio Corp. of America</b> Al Paul Lefton Company	4th cover, 143, 154

<b>Rayclad Tubes, Inc.</b> Shafer Associates	27
■ <b>Reeves-Hoffman Division, Dynamics Corp. of America</b> Adams Associates, Inc.	183
<b>Rohr Corporation</b> Lane & Huff	72
<b>SBD Systems Incorporated</b> Murray Heyert Advertising	179
■ <b>Semi-Elements</b> Cavanaugh Morris Advertising	186
■ <b>Servo Corporation of America</b> Basford Incorporated	69
<b>Sierra/Philco</b> Hall Lawrence, Inc.	47
■ <b>Singer Company, Metrics Division</b> Hepler & Gibney Inc.	186
■ <b>Sorensen Operation, Raytheon Company</b> James Advertising, Inc.	11
■ <b>Spectra-Electronics</b> Stadler/Cowman Advertising	191
<b>Speer Carbon Company, Inc.</b> Hazard Advertising Company, Inc.	35
<b>Sprague Electric Company, The</b> Harry P. Bridge Advertising	5, 10, 16
<b>Stackpole Carbon Company</b> Meek & Thomas, Inc.	70
<b>Stromberg-Carlson Corporation</b> Rumrill-Hoyt, Inc.	167
<b>TRW Capacitor Division</b> Fuller & Smith & Ross, Inc.	39
<b>Tally Corporation</b> Bonfield Associates, Inc.	59
■ <b>Tektronix Incorporated</b> Hugh Dwight Advertising, Inc.	58
■ <b>Telonic Industries, Inc.</b> Jansen Associates	121
<b>Texas Instruments, Incorporated Semiconductor/Components Division</b> Don L. Baxter, Inc.	20, 21
<b>Thermal American Fused Quartz, Inc.</b> Kniep Associates	155
<b>Tohoku Metal Industries Ltd.</b> Kokusai Tsushin-Sha KK	181
<b>Transitron Electronic Corporation</b> Larcom Randall Advertising, Inc.	33
<b>Trygon Electronics</b> Solow/Weston	7
■ <b>Trylon Incorporated</b> George Moll Advertising, Inc.	183
■ <b>Tung-Sol Electric, Inc.</b> E. M. Freystadt Associates, Inc.	181
<b>Ulano &amp; Company, John</b> Byrde, Richard & Pound, Inc.	167, 171
<b>Union Carbide Corporation Linde Division</b> J. M. Mathes Incorporated	119
<b>United Mineral &amp; Chemical Corporation</b> Benauf Associates Advertising	192
<b>Unitrode Corporation</b> Electronic Marketing Assistance	6
■ <b>Vactec Incorporated</b> Coleman & Associates	175
<b>Varian Associates, Tube Division</b> Hoefler, Dieterich & Brown, Inc.	55, 157
<b>Wang Laboratories</b> Larcom Randall Advertising, Inc.	184
<b>Wayne George Corporation</b> Studio D Incorporated	56
<b>Wayne Kerr Corporation</b> Josephson, Cuffari Company	142
<b>Weston Instruments, Inc.</b> Newark Division Arndt, Preston, Chapin, Lamb, Keen, Inc.	60
■ <b>Weston Instruments, Inc.</b> Transicoil Division Arndt, Preston, Chapin, Lamb, Keen, Inc.	163

■ For more information on complete product line see advertisement in the latest Electronics Buyers' Guide



## Advertising sales staff

**Frank E. LeBeau [212] 971-6464**  
Advertising sales manager  
**Atlanta, Ga. 30309:** Michael H. Miller, 1375 Peachtree St., N.E., [404] TR 5-0523  
**Boston, Mass. 02116:** William S. Hodgkinson McGraw-Hill Building, Copley Square, [617] CO 2-1160  
**Chicago, Ill. 60611:** Robert M. Denmead, J. Bradley MacKimm, 645 North Michigan Avenue, [312] MO 4-5800  
**Cleveland, Ohio 44113:** William J. Boyle, 55 Public Square, [216] SU 1-7000  
**Dallas, Texas 75201:** Richard P. Poole, 1800 Republic National Bank Tower, [214] RI 7-9721  
**Denver, Colo. 80202:** Joseph C. Page, David M. Watson, Tower Bldg., 1700 Broadway, [303] 255-5484  
**Detroit, Michigan 48226:** J. Bradley MacKimm, 856 Penobscot Building [313] 962-1793  
**Houston, Texas 77002:** Kenneth George, 2270 Humble Bldg., [713] CA 4-8381  
**Los Angeles, Calif. 90017:** Ian C. Hill, John G. Zisch, 1125 W. 6th St., [213] HU 2-5450  
**Minneapolis, Minn. 55402:** J. Bradley MacKimm, 1104 Northstar Center [612] 332-7425  
**New York, N. Y. 10036:** Donald R. Furth [212] 971-3615 James R. Pierce [212] 971-3615 George F. Werner [212] 971-3615 500 Fifth Avenue  
**Philadelphia, Pa. 19103:** William J. Boyle, Warren H. Gardner, Jeffrey M. Preston, 6 Penn Center Plaza, [215] LO 8-6161  
**Pittsburgh, Pa. 15222:** Warren H. Gardner, 4 Gateway Center, [412] 391-1314  
**Portland, Ore. 97204:** James T. Hauptli, Pacific Building, Yamhill Street, [503] CA 3-5118  
**St. Louis, Mo. 63105:** Robert M. Denmead The Clayton Tower, 7751 Carondelet Ave. [314] PA 5-7285  
**San Francisco, Calif. 94111:** James T. Hauptli, 255 California Street, [415] DO 2-4600  
**London W1:** John W. Patten, Edwin S. Murphy Jr., 34 Dover Street, Hyde Park 1451  
**Milan:** 1, via Baracchini Phone: 86-90-617 86-90-656  
**Frankfurt/Main:** Gerd Hinske, Joseph Wuensch, 85 Westendstrasse Phone: 77 26 65 and 77 30 59  
**Geneva:** Michael R. Zeynel, 1, rue du Temple Phone: 31 95 60  
**Paris VIII:** Denis Jacob, 17 Avenue Matignon ALMA-0452  
**Tokyo:** Nobuyuki Sato, 1, Kotohiracho Shiba, Minato-Ku [502] 0656  
**Osaka:** Ryosi Kobayashi, 163, Umegee-cho, Kita-ku [362] 8771  
**Wallace C. Carmichael [212] 971-3191**  
Manager Electronics Buyers' Guide  
**David M. Tempest [212] 971-3139**  
Promotion manager  
**Milton Drake [212] 971-3485**  
Research and circulation manager  
**Wallis Clarke [212] 971-2187**  
Assistant to sales manager  
**Wallace C. Carmichael [212] 971-3191**  
Business manager  
**Stephen R. Weiss [212] 971-2044**  
Production manager  
**Thomas M. Egan [212] 971-3140**  
Production manager Electronics Buyers' Guide

Executive, editorial, circulation and advertising offices: McGraw-Hill Building, 330 West 42nd Street, New York, N.Y., 10036. Telephone (212) 971-3333. Teletype TWX N.Y. 212 640-4646. Cable: McGrawhill, N.Y. Officers of the McGraw-Hill Publications: Joseph H. Allen, President; Bayard E. Sawyer, Executive Vice President; Vice Presidents: J. Elton Tuohig, Operations; John R. Callahan, Editorial; Donald C. McGraw, Jr., Marketing; John M. Holden, Marketing Services; Huber M. Gemmill, Circulation; Angelo R. Venezian, Production; Robert M. Wilhelm, Controller. Officers of the Corporation: Donald C. McGraw, Chairman of the Board; Shelton Fisher, President; L. Keith Goodrich, Hugh J. Kelly and Robert E. Slaughter, Executive Vice Presidents; John J. Cooke, Vice President and Secretary; John L. McGraw, Treasurer. Title R registered U.S. Patent Office; © copyright 1966 by McGraw-Hill, Inc. All rights reserved, including the right to reproduce the contents of this publication, in whole or in part.