

Electronics[®]

Simplified drift compensation: page 90

Switching electroluminescent arrays: page 95

Timers exploit ferroelectric memories: page 98

February 5, 1968

\$1.00

A McGraw-Hill Publication

Below: Generating IC masks automatically, page 78

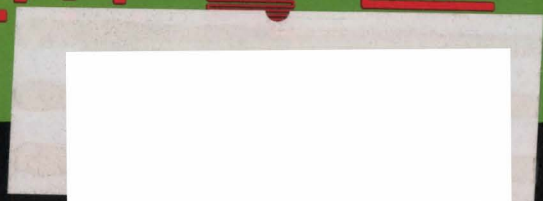
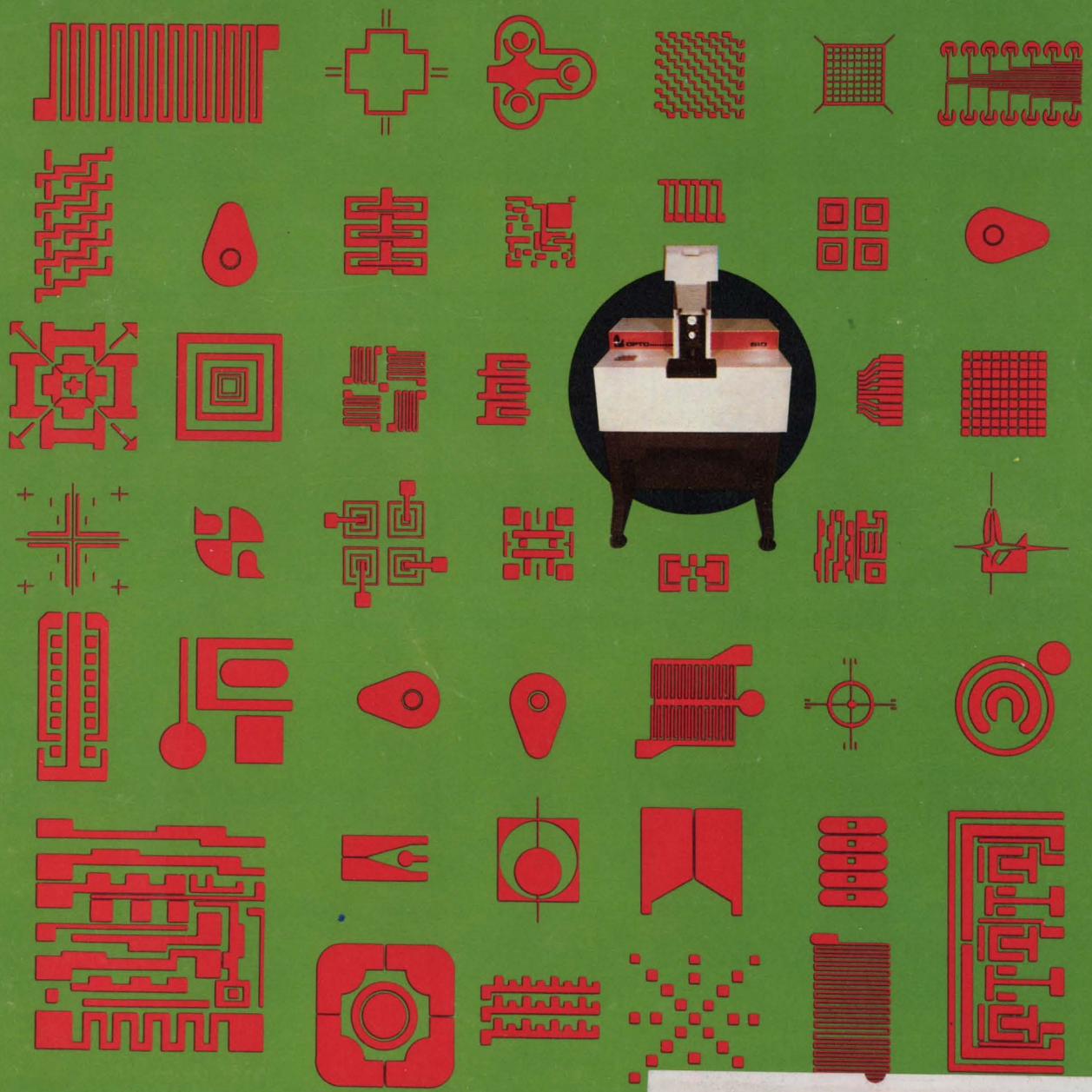



NEW

DO-T200™ SERIES

**ULTRAMINIATURE TRANSISTOR TYPE
AUDIO TRANSFORMERS**

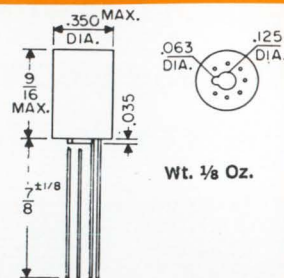

U. S. PAT. NO. 2,949,591; others pending.

This DO-T200 series of transistor transformers and inductors has been newly added to the UTC lines of stock items available for immediate delivery. These transformers provide the unprecedented power handling capabilities and the inherent reliability found only in the basic structural design of the UTC DO-T Family of miniature transformers. This reliability has been dramatically proven in the field.

Leads are 7/8" long, .016 Dumet wire, gold plated, and may be either welded or soldered. They are uninsulated and are spaced on a .1" radius circle, conforming to the termination pattern of the "TO-5" cased semiconductors and micrologic elements.

DO-T200 series of transformers are designed for Class R application. On special order they may be designed to Class S Specifications. No additional life expectancy is gained by using Class S insulation systems at Class R temperatures.

In pulse coupling impedance matching applications, (when measured with a 30 microsecond input pulse voltage wave), typical values for these transformers are: 5% or less droop, zero overshoot, and less than 10% backswing.

Special unit modifications, such as additions and deletions of leads, changed lead lengths, different impedance ratios and incorporation of electrostatic shields, etc., are available in these constructions.

• Manufactured and successfully tested to complete environmental requirements of MIL-T-27B

- Most Ruggedized MIL Structure, Grade 4, Metal Encased
- Immediate Delivery From Stock
- Full Conformance to MIL Mounting Requirements
- Solderable and Weldable Leads
- Hermetically Sealed
- Straight Pin Terminals
- Excellent Response
- High Efficiency
- Low Distortion

Type No.	MIL Type	Pri. Imp.	D. C. ma [‡] in Pri.	Sec. Imp.	Pri. Res.	Mw Level	Application
DO-T255	TF4RX13YY	1K/1.2K CT	3	50/60	115	100	Output or matching
DO-T275	TF4RX13YY	10K/12K CT	1	1.5K/1.8K CT	780	100	Interstage
DO-T277	TF4RX13YY	10K/12K CT	1	2K/2.4K split	560	100	Interstage
DO-T278	TF4RX13YY	10K/12.5K	1	2K/2.5K CT	780	100	Driver
DO-T283	TF4RX13YY	10K/12K CT	1	10K/12K CT	975	100	Isol. or Interstage or Pulse
DO-T288	TF4RX13YY	20K/30K CT	.5	.8K/1.2K CT	830	50	Interstage
DO-T297	TF4RX16YY	200,000 CT	0	1000 CT	8500	25	Input and Chopper
DO-T200SH	Drawn Hipermalloy shield provides 15 to 20 db shielding through side of case						

[‡]DCma shown is for single ended useage. For push pull, DCma can be any balanced value taken by .5W transistors. Where windings are listed as split, 1/4 of the listed impedance is available by paralleling the winding.

THE DO-T FAMILY OF COMPONENTS



DO-T



DI-T



DI-T200



PIL



PIP



DO-T400

All these hermetically sealed, ultraminiature transistor transformers & inductors are to MIL-T-27B, Grade 4, Class R, Life X. Except PIP: to MIL-T-21038B, Grade 6, Class R, Life X.

DO-T Flexible leads. Freq range 300 CPS—10KC & up. Power up to 1/2 W. Size 5/16 dia x 1 1/2" h. Wt approx 1/10 oz.

DI-T Flexible leads. Freq range 400 CPS—10KC & up. Power up to 1/2 W. Size 5/16 dia x 1/4" h. Wt approx 1/15 oz.

DO-T200 Series. See above

DI-T200 Series Straight pin gold plated, Dumet leads. Freq range 400 CPS—100KC. Power up to 500 mw. Size 5/16 d x 3/8" h. Wt approx 1/15 oz.

PIL Inductors range from .025 hy to .8 hy, DC 0 to 10 ma. Transformers from 500 ohms to 10,000 ohms impedance. Freq range 800 cps—250 KC; power up to 100 MW. Size 5/16 dia x 3/16" h. Wt 1/20 oz.

PIP (Pulse) Flexible leads. Wide application pulse transformers, to MIL-T-21038B specifications. Size 5/16 dia x 3/16". Wt 1/20 oz.

DO-T400 (Power) Flexible leads, power transformer. Power output 400 mw @ 400 cycles. Size 5/16 dia x 1 1/2". Wt 1/10 oz.

AND SPECIAL, CUSTOM BUILT COMPONENTS TO YOUR SPECIFICATIONS

Write for catalog of over 1,300 STOCK ITEMS with UTC High Reliability IMMEDIATELY AVAILABLE from YOUR Local Distributor



UNITED TRANSFORMER CO. TRW
DIVISION OF TRW INC. • 150 VARICK STREET, NEW YORK, N. Y. 10013

IN CANADA: A. C. SIMMONDS & SONS LIMITED, AGINCOURT, ONTARIO

Circle 900 on reader service card

Here's how to measure CW, FM or pulsed frequencies from 50MHz to 18GHz -

THE EASY WAY:

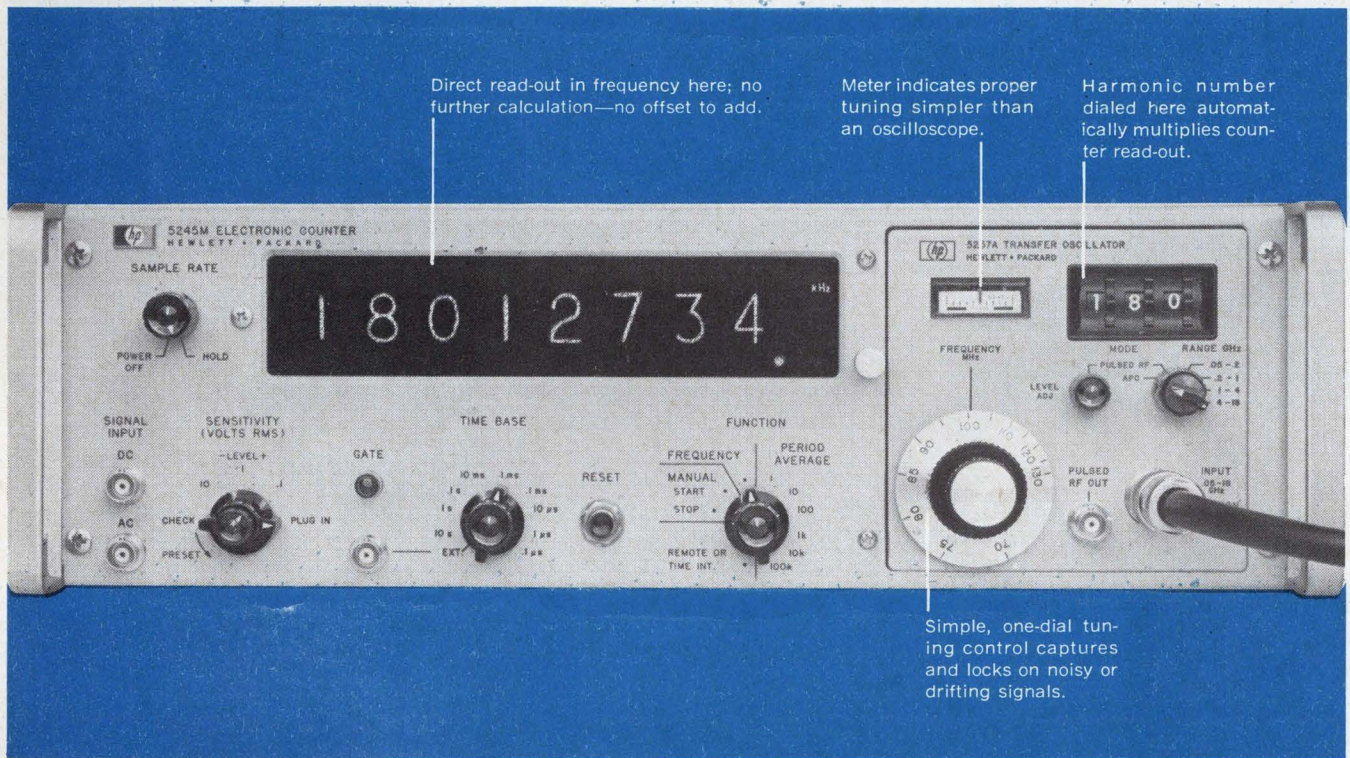

Hewlett-Packard's Model 5257A Transfer Oscillator extends the range of HP high-frequency counters all the way to 18 GHz for pulsed, CW or FM signals. Yet it's the easiest to use of any manual transfer oscillator.

For CW signals, just pick your frequency range, sweep with the tuning dial, set the level control and dial in the proper harmonic number. Then read the unknown frequency directly from the counter without further calculation.

A deflection on the tuning meter tells you when you've captured your signal—a lock-on that's much easier to detect than with complex scope patterns. And lock-on is sure, even on noisy signals or those drifting as much as $\pm 0.2\%$. If the signal drops out, the counter returns to zero; when the signal returns, the count is displayed again without re-tuning. And measurement of pulsed

carrier frequencies is just as easy: in pulsed RF mode, sweep dial till meter peaks, adjust level control and read counter.

A new transfer oscillator technique using a broadband sampler in a phase-locked loop gives the 5257A outstanding input sensitivity—typically -23 dBm at 50 MHz to -8 dBm at 18 GHz (-7 dBm to -4 dBm guaranteed, worst case). It also eliminates bothersome manual tuning of input mixers. Prices: 5257A Transfer Oscillator, \$1850. Electronic Counters: 5245L, \$2450; 5246L, \$1750.

For more details on the 5257A, 11 other plug-ins, and four compatible HP counters, call your local HP field engineer or write Hewlett-Packard, Palo Alto, California 94304; Europe: 54 Route des Acacias, Geneva.

HEWLETT  PACKARD
ELECTRONIC COUNTERS

02729

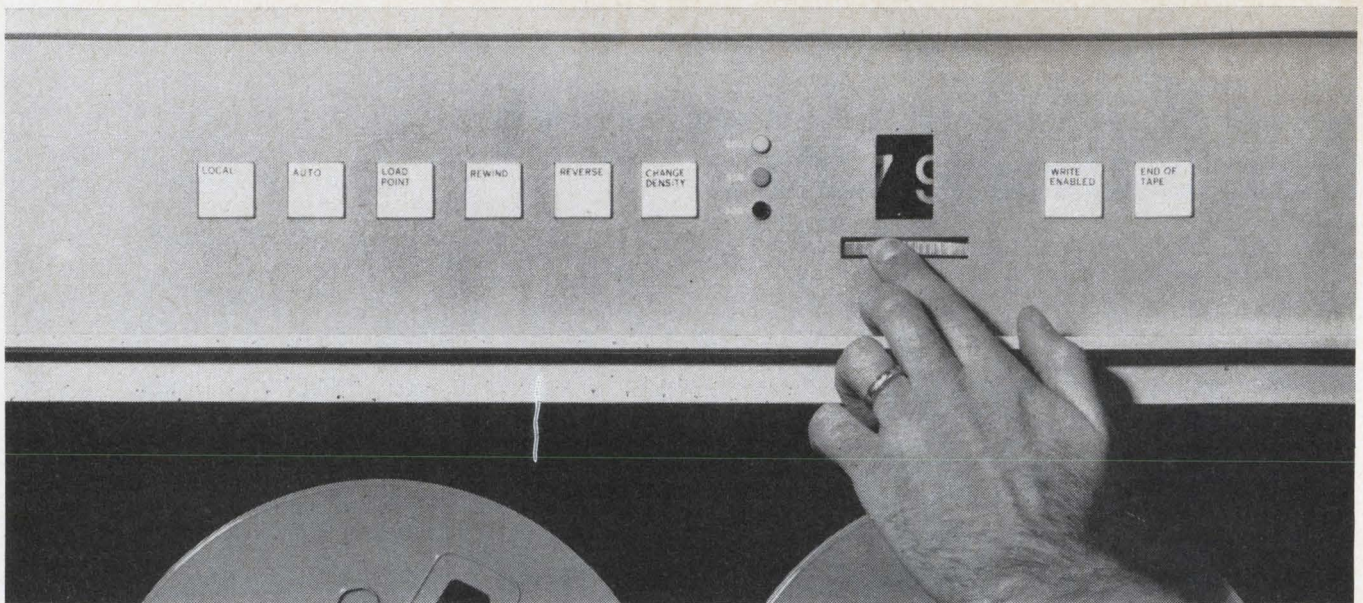

**Reading both
7 and 9 track
digital tapes?**

**Change
tape formats
with one
finger**

A single tape unit that reads both of the industry-standard digital tape recording formats—with format selection at the flip of a switch. You no longer need *two* tape units for those installations processing computer-written tapes; include a Hewlett-Packard READ/READ Tape Unit that will read *both*.

Think of the savings this offers in the design and production of *your* digital system—and the flexibility you'll be able to offer the *user*.

Your choice of tape units for READ/READ operation may be either the 3030 Series with tape speeds to 75 ips, or the 2020 Series offering the optimum in economy of tape speeds below 45 ips.

Other tape units in the 2020 and 3030 Series class offer single-format capabilities for both writing and reading.

Whatever your application, the flexibility of Hewlett-Packard's 2020 or 3030 Series Digital Magnetic Tape Units can provide a tape unit with the optimum configuration to interface to *your* digital system.

For more details, call your local HP field engineer or write Hewlett-Packard, 690 Middlefield Road, Mountain View, California 94040.

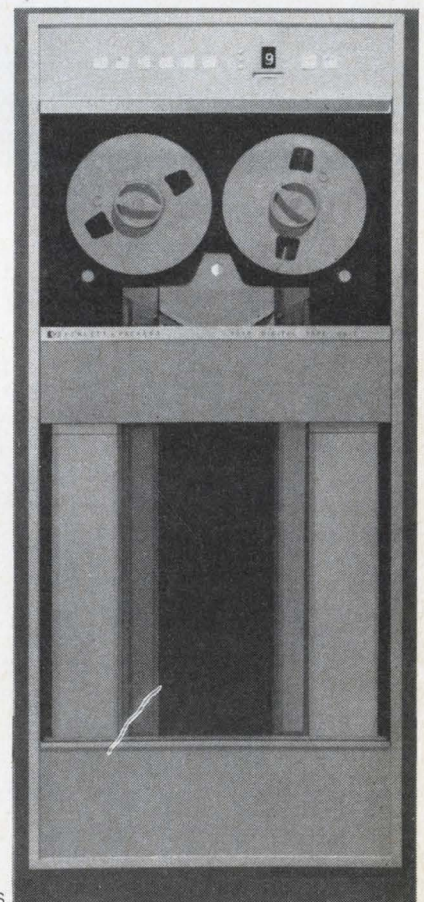

HEWLETT  PACKARD

MAGNETIC RECORDERS

3030 SERIES

42708

News Features

Probing the News

- 121 **Off to the wars—again**
127 **FAA readies new checkout system**

Electronics Review

- 45 **Integrated electronics:** LSI, Fairchild style; Integrating agc; Warming up to germanium
47 **Microwave:** In step
48 **Military electronics:** Taking command
50 **Companies:** H-P vs. GAO, continued
52 **Advanced technology:** Cooling it
52 **Displays:** Drawn to light
54 **Manufacturing:** Window trimming
56 **For the record**

Electronics Abroad

- 209 **Japan:** Watch out; Desaturated; Through channels
211 **West Germany:** Mating game; In a scrape
212 **Great Britain:** Up the Hall
214 **Soviet Union:** Export wares
214 **Around the world**

New Products

- 151 **Navigation converter** talks two languages
154 **New components review**
154 **New components:** Giving IC op amps a powerful boost; Amplifying data without noise
158 **New subassemblies review**
158 **New subassemblies:** A switch for the teletypewriter market; LST arrives at terminal before LSI
165 **New microwave review**
165 **New microwave:** 1968—year of the impatt; Uhf triodes aim to plant tricolor
168 **New instruments review**
168 **New instruments:** Putting the pressure on thin films; Monitoring panels by the numbers
177 **New production equipment review**
177 **New production equipment:** Matched magnets in five seconds; Where rulers cannot go
183 **New semiconductors review**
183 **New semiconductors:** Logic signals pull a discrete switch; Car 54—where are you?; Splendid isolation
189 **New consumer electronics review**
189 **New consumer electronics:** A long, hard life for recording heads; Weakest link gets stronger

Technical Articles

Industrial electronics 78

Improving the mask-maker's image (cover)
Computer-controlled system turns out integrated-circuit masks quickly and cheaply
Roland C.M. Beeh, Optomechanisms Inc.

Circuit design 85

Designer's casebook
▪ FET oscillator helps dolphin understand people
▪ Dual-Quad IC gives flip-flop a fast recovery
▪ Reversed-polarity triode measures insulation
▪ Inexpensive SCR regulator for consumer equipment
▪ Grounded-base amplifier mates npn to pnp

Integrated electronics 90

Linear IC's: part 6
Compensation for drift
Six circuits give bias-current compensation, and an input preamplifier reduces voltage drift
Robert J. Widlar, National Semiconductor Corp.

Advanced technology 95

Through a glass brightly
Carbon-coated glass fibers reduce switching requirements for electroluminescent panels
Franklin G. Reick, ITT Federal Laboratories

Computers 98

Memories shot from guns
Ferroelectric ceramic memories withstand severe environments and hold countdown data for weapons fuzes
Alvin B. Kaufman, Litton Systems Inc.

Special McGraw-Hill report: C-1

Business and the urban crisis*
What business can do in the vital areas of jobs, housing, and education
* not included in overseas issues

Departments

- | | | | |
|----|------------------------|-----|------------------------|
| 4 | Readers Comment | 47 | Index of Activity |
| 8 | People | 59 | Washington Newsletter |
| 14 | Meetings | 192 | New Books |
| 16 | Meeting Preview | 196 | Technical Abstracts |
| 23 | Commentary | 200 | New Literature |
| 25 | Electronics Newsletter | 207 | Newsletter from Abroad |

Electronics

Editor-in-Chief: Donald Christiansen

Associate managing editors

Technical: Stephen E. Scrupski

News: Robert Henkel

Copy: Sally Powell

Senior associate editors

Joseph Mittleman, Harry R. Karp

Department editors

Avionics & Space: Alfred Rosenblatt

Computers: Wallace B. Riley

Communications: William Bucci

Consumer electronics: John D. Drummond

Design theory: Joseph Mittleman

Industrial electronics: Harry R. Karp

Instrumentation: Carl Moskowitz

Military electronics: Richard Gundlach

Solid state: Mark B. Leeds

Section editors

Electronics abroad: Arthur Erikson

Electronics review: Stanley Zarowin

New Products: H. Thomas Maguire,
William P. O'Brien

Probing the news: Eric Aiken

Assistant editors

Stephen Wm. Fields, Peter Schuyten,
James Kirby, Owen Doyle

Regional bureaus

Domestic

Boston: James Brinton, manager; Robin Carlson

Los Angeles: Lawrence Curran, manager

New York: Howard Wolff, manager

San Francisco: Walter Barney, manager

Washington: Robert Skole, manager; William D. Hickman, Paul Dickson

Foreign

Bonn: John Gosch

London: Michael Payne

Tokyo: Charles Cohen

Copy editors

James Chang, Frederick Corey

Graphic design

Art director: Saul Sussman

Assistant art directors: Ann Mella, Valerie Betz

Production editor: Arthur C. Miller

Editorial secretaries: Claire Benell, Lynn Emery, Kay Fontana, Patricia Gardner,
Lorraine Longo, Barbara Razulis, Frances Vacca

McGraw-Hill News Service

Director: Arthur L. Moore; Atlanta: Fran Ridgway; Chicago: Bruce Cross;

Cleveland: Arthur Zimmerman; Dallas: Marvin Reid;

Detroit: James Wargo; Houston: Robert E. Lee; Los Angeles: Michael Murphy

Pittsburgh: Louis Gomolak

San Francisco: William F. Arnold

Seattle: Ray Bloomberg; Washington: Charles Gardner, Daniel B. Moskowitz,

Herbert W. Cheshire, Seth Payne, Warren Burkett, William Small

McGraw-Hill World News Service

Bonn: Robert Dorang; Brussels: George Williamson; Hong Kong: Wes Perry;

London: John Shinn; Mexico City: Gerald Parkinson; Milan: Ronald Taggiasco, Jack Star;

Moscow: Howard Rausch; Paris: Robert E. Farrell, Peter Kilborn;

Rio de Janeiro: Leslie Warren; Tokyo: Marvin Petal

Reprints: Susan Nugent

Circulation: Milton Drake

Publisher: Gordon Jones

Electronics: February 5, 1968, Vol. 41, No. 3

Published every other Monday by McGraw-Hill, Inc. Founder: James H. McGraw 1860-1948.

Printed at 99 North Broadway, Albany, N.Y. 12207; second class postage paid at Albany, N.Y.

Executive, editorial, circulation and advertising addresses: McGraw-Hill Building, 330 W. 42nd Street
New York, N. Y. 10036. Telephone (212) 971-3333. Teletype TWX N.Y. 710-581-4235. Cable address:
MCGRAWHILL N.Y.

Subscriptions solicited only from those professionally engaged in electronics technology. Subscription rates: qualified subscribers in the United States and possessions and Canada, \$8.00 one year, \$12.00 two years, \$16.00 three years; all other countries \$25.00 one year. Non-qualified subscribers in the U.S. and possessions and Canada, \$25.00 one year; all other countries \$50.00. Air freight service to Japan \$50.00 one year. Single copies: United States and possessions and Canada, \$1.00; all other countries, \$1.75.

Officers of McGraw-Hill Publications: Joseph H. Allen, President; Bayard E. Sawyer, Executive Vice-President; J. Elton Tuohig, Senior Vice-President-Operations; Vice Presidents: John R. Callahan, Editorial; John M. Holden, Marketing; Paul F. Cowie, Circulation; Angelo R. Venezian, Production; Jerome D. Luntz, Planning & Development; Robert M. Wilhelm, Controller.

Officers of the Corporation: Donald C. McGraw, Chairman of the Board; Shelton Fisher, President; L. Keith Goodrich, Robert E. Slaughter, Executive Vice Presidents; Donald C. McGraw, Jr., Senior Vice-President; John J. Cooke, Vice-President & Secretary; John L. McGraw, Vice-President & Treasurer.

Title © registered in U.S. Patent Office. © Copyright 1968 by McGraw-Hill, Inc. All rights reserved. The contents of this publication may not be reproduced either in whole or in part without the consent of copyright owner.

Subscribers: The publisher, upon written request to our New York office from any subscriber, agrees to refund that part of the subscription price applying to copies not yet mailed. Please send change of address notices or complaints to Fulfillment Manager; subscription orders to Circulation Manager, Electronics at address below. Change of address notices should provide old as well as new address, including postal zip code number. If possible, attach address label from recent issue. Allow one month for change to become effective.

Postmaster: Please send form 3579 to Fulfillment Manager, Electronics, P.O. Box 430, Hightstown, New Jersey 08520

Readers Comment

On the bridge

To the Editor:

I must take issue with George F. Smayling's article, "Bridge circuit cuts contacts in series-parallel network," [Aug. 21, 1967, pp. 89-90].

Example 1 reduces not to a bridge with a diode but to any of three simple five-contact series-parallel networks:

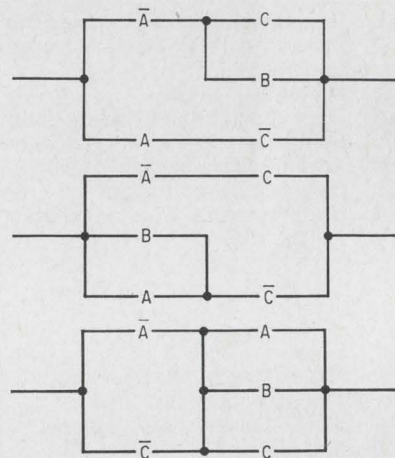

The six-contact solution shown for example 2 is a series-parallel network and not a bridge at all. Furthermore, the network is not a minimum; two four-contact solutions are:

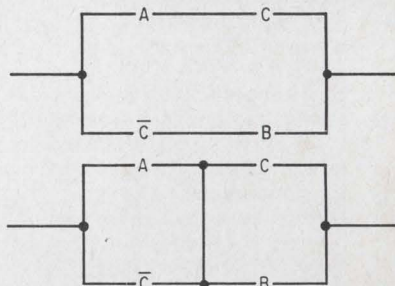

Mitchell P. Marcus
IBM SDD Laboratory
Endicott, N.Y.

Headed for production

To the Editor:

Readers of your story on the new Sprague Type ULX-2111A detector limiter [Nov. 13, 1967, p. 220] received the unfortunate impression that this integrated circuit is still in the research stage. It has long since emerged.

The Type ULX-2111A is presently in one of our pilot plants in

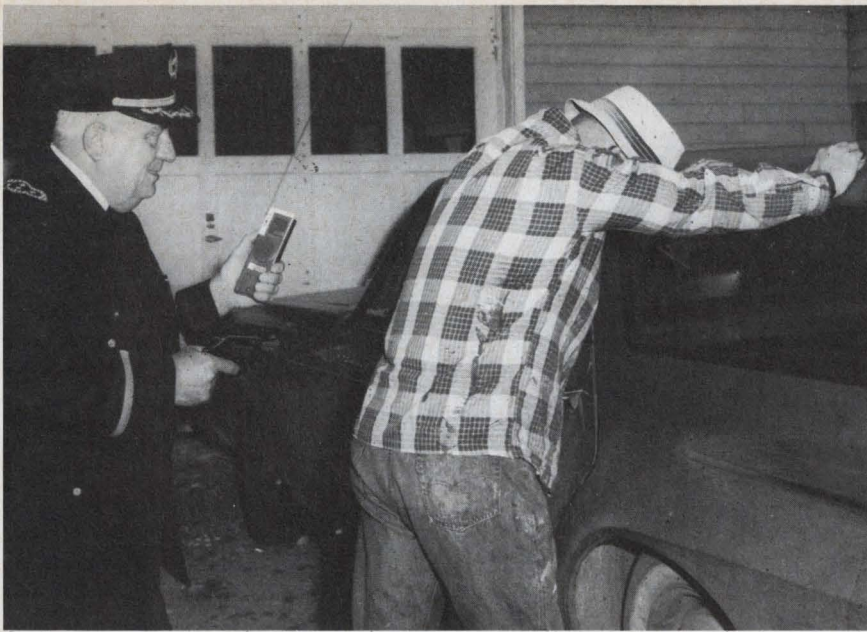

how to save space in subminiature communications gear...

Application: Shirt pocket size 1-watt FM transceiver.

Problem: How to fit a precision two channel, 1-watt FM transceiver into a 7" x 2 $\frac{3}{8}$ " x $\frac{7}{8}$ " package weighing 18 ounces and still not sacrifice performance or reliability.

Solution: Ultra high density packaging utilizing Minitan subminiature solid tantalum capacitors.

The pocket sized transceivers carried by policemen, the beacon-transceivers in aircrew survival packs, and the tape recorders in our latest space shots have at least one thing in common — Minitan subminiature solid tantalum capacitors. Wherever large value capacitors are needed for by-passing, coupling, or filtering, there is really no substitute for electrolytics. And among electrolytics, none offers greater capacitance to volume ratios or greater reliability than Minitan subminiatures.

Minitans are up to 75% smaller than equivalent CS13 styles and up to 90% smaller than "miniature" aluminum electrolytics. They are even smaller than monolithic chip ceramics and miniature Mylars beginning at about .05 mfd. Minitans don't sacrifice performance and reliability for size, however. This is why they are designed into a growing number of portable and miniature communications equipments.

Minitans operate reliably to 125°C, handle 130% voltage surges, withstand Method 106 moisture testing, and have excellent TC's. Standard tolerances are $\pm 20\%$, $\pm 10\%$, and $\pm 5\%$. DC leakage is typically less than .01uA per mfd-volt. Impedance is typically below 10 ohms between 1MHz and 10MHz.

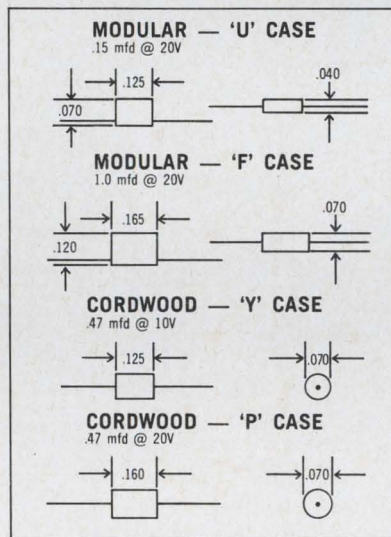

Will equipment give thousands of hours of trouble-free life even after being stored for months or years? We can't guarantee the equipment, but we can the capacitors which never require re-forming, never leak or dry out, and have normal life expectancies measured in the tens of thousands of operational hours.

What about voltage derating for even greater reliability and longer life. Don't try this with capacitors whose dielectric uniforms with less than rated applied voltage. But with Minitan solid tantalums, voltage derating not only substantially reduces leakage values but materially increases reliability and life as well.

Minitans are available in 11 case sizes, working voltages to 35 volts, and capacitance values from .001 to 220 mfd. A full line of non-polar styles is offered for severe reverse DC bias applications.

Both axial and radial leads are available in both tubular and rectangular case styles. For maximum IC compatibility, gold plated ribbon leads are a standard option.

Components, Inc. offers more subminiature case styles and ratings than anyone else. **Our products are designed in, not added on.** So we welcome requests for samples, performance and reliability data, and applications aid. Almost every catalog part can be shipped in prototype quantities within 24 hours.

... with
Minitan[®]
**solid tantalum
capacitors**

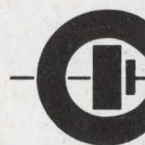

COMPONENTS, INC.

SMITH STREET / BIDDEFORD, MAINE 04005
TEL. 207-284-5956 / TWX-710-229-1559

Circle 5 on reader service card

Little plug-ins make the big difference in 50 MHz counters



When you look only at the main frame, it's hard to find important differences between 50 MHz counters. But when you compare plug-ins, you'll find great differences and decisive advantages. Only Systron-Donner plug-ins can give you:

1. Final-answer frequency readings to 40 GHz.

A single plug-in, our Model 1292 semi-automatic transfer oscillator, boosts the counter's frequency-measuring range to 15 GHz. Measures FM and pulsed RF above 50 MHz. And the complete dc to 15 GHz system (counter with plug-in) costs only \$3250. Our new Model 1298 semi-automatic T.O. now gives you final-answer readings up to 40 GHz—a new record.

Contact Systron-Donner Corporation, 888 Galindo Street, Concord, California. Phone (415) 682-6161.

2. Automatic frequency readings to 18 GHz.

Three Acto[®] plug-ins now produce fully-automatic microwave frequency readings: 50 MHz to 3 GHz (P, L & S band), 3 to 12.4 GHz (S & X band), and 12.4 to 18 GHz (K_u band).



Find more unique measuring capability in this catalog

3. Time readings with 10-nano-second resolution.

Our latest time interval plug-in gives you time readings with 10-nanosecond resolution—greater precision than ever before possible with a standard counter.

All this unique measuring capability can be yours today—or tomorrow—when you buy your basic counter from Systron-Donner. Sixteen different plug-ins have been especially designed to give your Systron-Donner counter more measuring power at less cost than any other system.

SYSTRON  **DONNER**

Circle 6 on reader service card

North Adams, Mass., where we have made more than 10,000 circuits and are continuing to make several thousand more. This allows the new circuit to be fully characterized and adequately sampled.

An orderly transfer to production is thus assured for users who are now designing their 1968-1969 models of tv sets and other equipment. Small quantity prices have been set for this purpose but mass production prices will necessarily depend on the orders to be received.

Sidney L. Chertok
Sprague Electric Co.
North Adams, Mass.

Disclaimer

To the Editor:

Two recent stories [Electronics Newsletter, Jan. 8, p. 25] give an erroneous impression of some of the work going on at Bell Telephone Laboratories.

The first, "Bell Labs weighs a giant Illiac 4," makes an unfortunate comparison between Bell's work and the University of Illinois' project. Bell Labs is studying the design of a highly parallel computer using a global control technique [common control of many processors from a single control unit]. While it is similar to the Illiac 4 in this respect, the Bell Labs machine is intended for quite different purposes, will be applied to widely different problems in different ways, and differs in a number of features.

Our machine is made up of an unstructured ensemble of computing elements of modest capacity. While the machine would be "conceptually capable" of working with as many as 32,000 units at once, no serious consideration has been given

to an ensemble of that size. The Illiac 4 is a network using 256 elements of relatively large capacity in an array configuration.

With regard to the second story, "Fourier transform may ring the phones," no group at Bell Labs is currently studying such an application.

J. L. Gregory
Bell Telephone Laboratories
Murray Hill, N.J.

▪ A Bell Labs source told Electronics that fast Fourier transform has been proposed as a method of distinguishing various dial tones. As the article noted, the "scheme may not be applied to phone equipment for a long time, if ever."

Field training

To the Editor:

I generally agree that many products, civilian, military, and industrial could be a lot easier to service [Dec. 25, p. 103].

I believe that all engineers and designers should spend a year or two in the service field as part of their post graduate training. (Few engineering graduates are more than that, it takes considerable experience to turn an engineering graduate into a graduate engineer.)

I also believe that in many cases the technicians and engineering assistants who have had some service experience, as well as "practical" engineers who worked their way up instead of going to college, could contribute more to serviceable design if allowed to. Their opinions and suggestions should be listened to more often.

Joseph S. Naber
Versa-Tronics
Marengo, Ill.

Have you seen your IR lately?

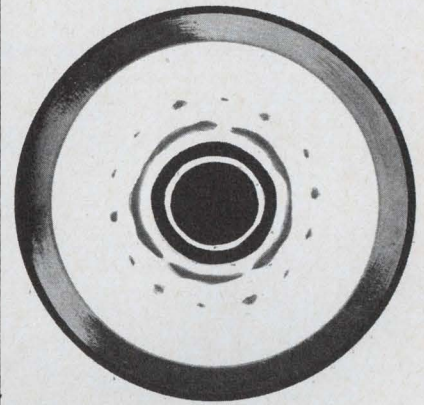

Convert and display infrared or ultraviolet with EOA's new LASERVIEWER*. Observe geometric mode patterns of 1.06, 1.08, 1.15, 3.39, or 10.6 μ lasers.

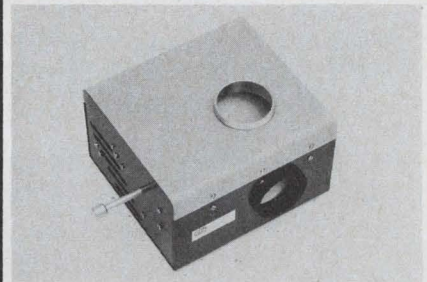

Salient specifications are:

- May be used over entire IR range. Unit has ultraviolet capability.
- Sensitivity better than one milliwatt/mm² on high sensitivity screen.
- Will accept beams up to 2 inches in diameter.
- Maximum intensity 100 watts/cm² on high power screen. LASERVIEWER* will accept up to 100 watts CW.
- Image persistence of approximately one second.

The Model EOA-9032 LASERVIEWER* is available now and is priced at only \$295.00.

* Trademark

Ask ELECTRO OPTICS ASSOCIATES, where the Second Generation of Lasers is available now.

EOA ELECTRO OPTICS ASSOCIATES

981 COMMERCIAL AVENUE, PALO ALTO, CALIFORNIA
(415) 327-6200

SUBSCRIPTION SERVICE

Please include an Electronics Magazine address label to insure prompt service whenever you write us about your subscription.

Mail to: Fulfillment Manager
Electronics
P.O. Box 430
Hightstown, N.J. 08520

To subscribe mail this form with your payment and check new subscription renew my present subscription

Subscription rates: qualified subscribers in the U.S.: 1 year \$8; two years, \$12; three years, \$16. Non-qualified: 1 year \$25. Subscription rates for foreign countries available on request.

CHANGE OF ADDRESS

ATTACH LABEL HERE

If you are moving, please let us know five weeks before changing your address. Place magazine address label here, print your new address below.

name _____

address _____

city _____ state _____ zip code _____

Introducing



The Jack Armstrong adjustable time-delay relay.

Rugged, dependable, versatile, thrifty, accurate, solid (state). Capable of operating under wide line variations and temperature ranges.

It does everything well. The type of relay you'd introduce to your daughter. (If she were a systems engineer.)

We offer two models. A "delay-on-break" SPDT unit with a standard cycle range of 1.0 to 30 seconds. And a "delay-on-make" DPDT unit with an 1.0 to 60 second range. Both have infinite adjustment within the range and an optional range up to 180 seconds.

Repeatability is $\pm 2\%$ at 70°F. And only relays costing twice as much can cut a better figure than that.

Our relay is rugged. Designed to take years of heavy use . . . operating at temperatures from 0° to 150°F. It's unaffected by line variations from 100 to 135 VAC. And DC units have built-in protection against reverse voltage.

Contact capacity is 10 amps, resistive load, 115 volts, 60 Hz AC; 28 volts DC. Standard octal plug-in base and a compact size make for easy installation.

Actually, we call our new relay "the Trans-O-Netic® solid state, adjustable time-delay relay." But all that you have to remember is that it's from Heinemann. With Heinemann's five year "repair-or-replace" guarantee.

Write us for a copy of Bulletin 5302. Heinemann Electric Co., 2600 Brunswick Pike, Trenton, N.J. 08602.



HEINEMANN

3942

People

What can a small outfit like Newell Associates in Sunnyvale, Calif., which has eight patents, a 33,000-square-foot-plant but no production line, offer a division president of Litton Industries Inc. as an inducement for changing jobs?



Vinton D. Carver

Says Vinton D. Carver, who made the switch: an idea and the chance to build. "At the Atherton division of Litton," says Carver, "I learned what it means to be an entrepreneur, but I'm essentially a builder. Now I'm going to build."

Rapid transit. The idea, or the "Newell principle," as Carver calls it, is embodied in a high-speed tape transport with only three moving parts and is capable of handling tape at more than 10 times the speed of conventional transports. The new unit also makes it possible to incorporate up to 100 tracks on 1-inch wide tape [Electronics, May 15, 1966, p. 25].

Paraphrasing Henry J. Kaiser's famous dictum, "Find a need and fill it," Carver says: "At Newell we've found a market. Now we're going to supply it." The market Carver refers to is the tape-recording market.

Busy hands. Under Carver's guiding hand, Newell will try to exploit some of its patents that, until now, have been used under license by such firms as the International Business Machines Corp., the Memorex Corp., and the Borg-Warner Corp. Its first product line will be a home tape system using 2-inch diameter "reelettes" that provide 44 minutes playing time. The device will automatically change up to 15 of the reelettes and is self-threading.

Users of common-carrier data-transmission lines complain that their costs are too high on the one hand, and that transmission is slow and error-filled on the other. The ideal solution to these complaints would be a black box that could



Check these Machlett planar triode advantages for microwave applications.

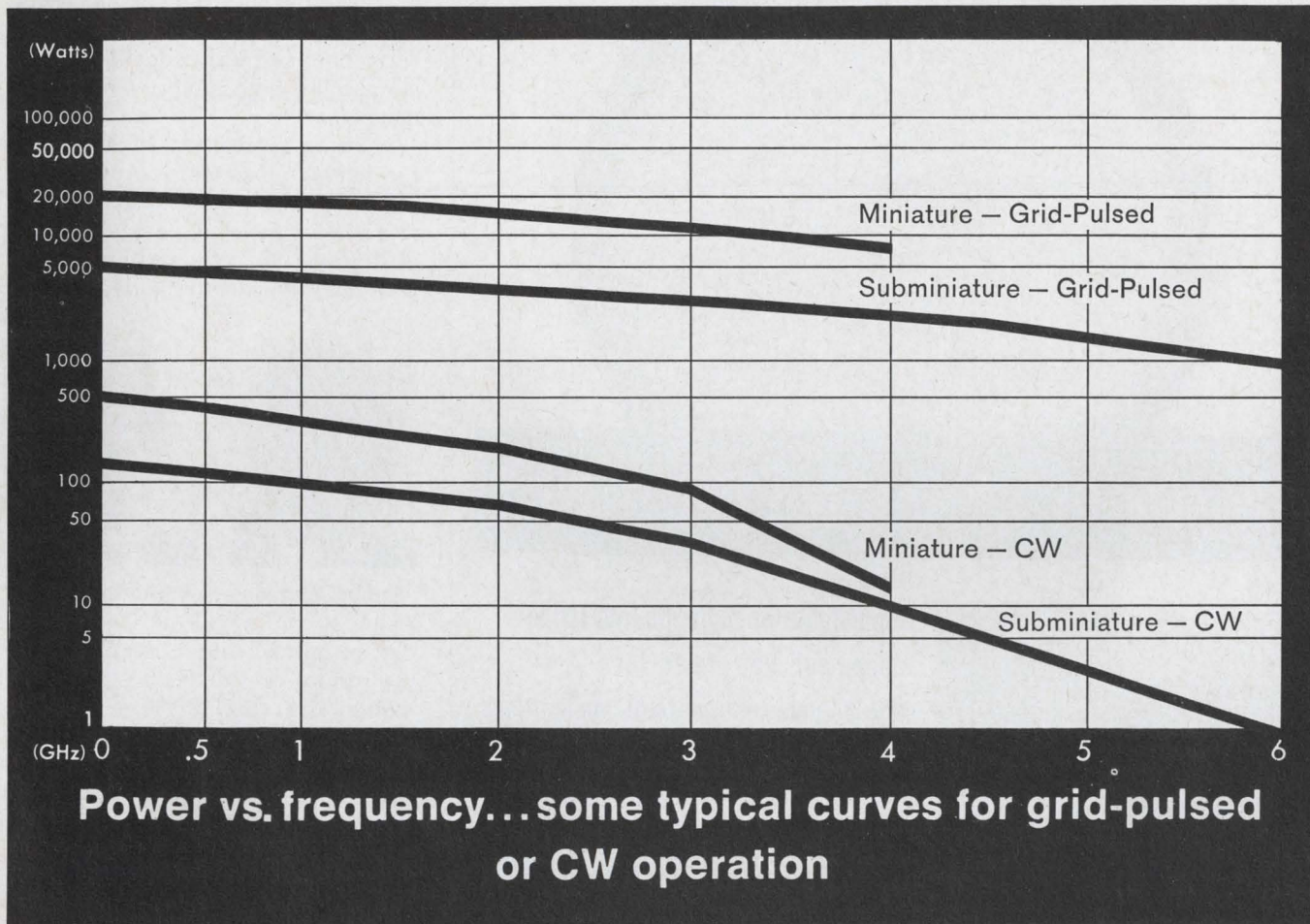

Electrical Advantages

- Superior frequency stability
- Negligible phasing problems
- Comparable or superior efficiency
- Low plate voltage
- Low noise
- Faster warm-up

Mechanical Advantages

- Small size
- Very low weight
- Greater ruggedness

Cost Advantages

- Lower initial cost
- Lower developmental cost
- Lower replacement cost

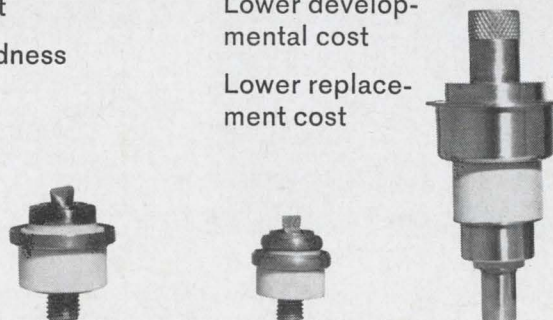

Write us now for application information on Machlett planar triodes: subminiature, miniature and standard. The Machlett Labs., Inc., 1063 Hope St., Stamford, Conn. 06907

The Machlett Laboratories, Inc., welcomes resumes from engineers and scientists.



THE MACHLETT LABORATORIES, INC.

A SUBSIDIARY OF RAYTHEON COMPANY

Trigate® Pulse Transformers...

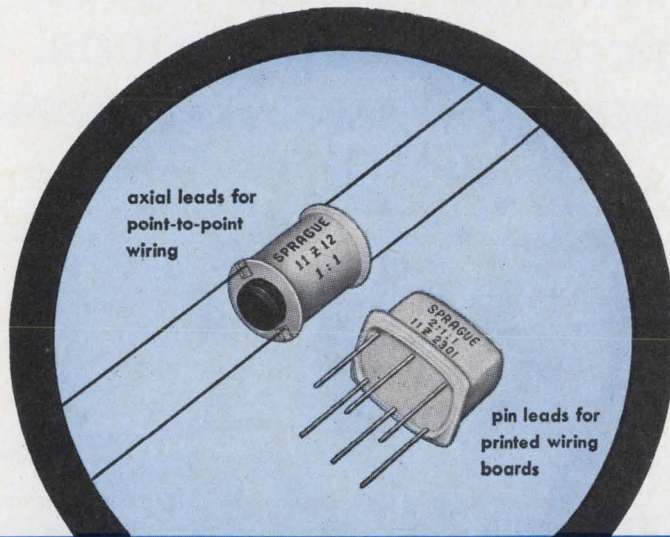

the industry's lowest-cost SCR triggers!

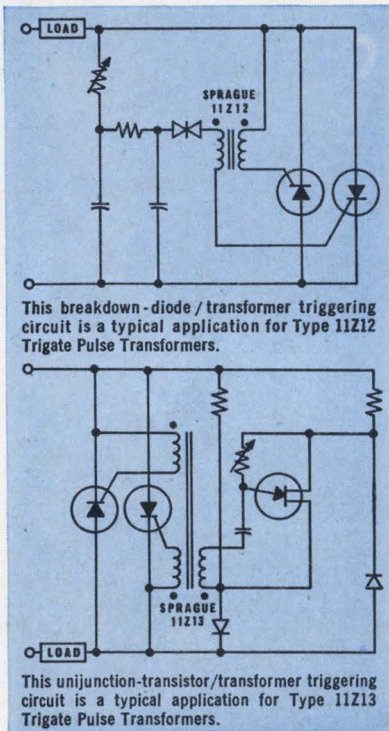

Dependable enough for industrial equipment, yet priced for high-volume commercial applications

Here's good news for designers of appliances; lighting controls; air-conditioning and heating controls; industrial controls. You can actually cut costs while upgrading your present method of SCR triggering!

Type 11Z Trigate* Pulse Transformers offer these unique features:

1. Balanced pulse characteristics and energy transfer from primary to secondary and tertiary windings.
2. Minimum saturation effect to allow operation where increased pulse widths are required.
3. Fast pulse rise time and increased current capability to prevent SCR di/dt failure.
4. Increased energy transfer efficiency.

Temperature operating range, -10 C to $+105\text{ C}$. 2- and 3-winding designs for half- and full-wave applications. Turns ratios, 1:1, 1:1:1, 2:1, 2:1:1, 5:1. Available for use with line voltages up to 240 VAC or 550 VAC. Inductances to 1 mH at 550V, 5 mH at 240V.

For complete information, write for Engineering Bulletin 40,003A to the Technical Literature Service, Sprague Electric Co., 35 Marshall St., North Adams, Mass. 01247

*trademark

SPRAGUE COMPONENTS

PULSE TRANSFORMERS
CAPACITORS
TRANSISTORS
RESISTORS
THIN-FILM MICROCIRCUITS
INTEGRATED CIRCUITS

INTERFERENCE FILTERS
PACKAGED COMPONENT ASSEMBLIES
FUNCTIONAL DIGITAL CIRCUITS
MAGNETIC COMPONENTS
CERAMIC-BASE PRINTED NETWORKS
PULSE-FORMING NETWORKS



*Sprague® and ® are registered trademarks of the Sprague Electric Co.

People

wring every bit per second out of a line while at the same time minimizing error. **Samuel T. Harmon** has invented such a black box, with the added feature of inexpensive relay lines formerly considered unsuitable for high-quality data transmission.

Harmon is president of the newly formed Datamax Corp., Ann Arbor, Mich. He has headed systems analysis and engineering physics groups at the Bendix Corp. and holds several patents, including one for an

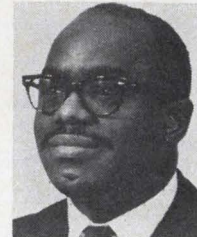

Samuel Harmon



Lawrence Dobrin

electro-optical computer. He is also the former president of Sensor Dynamics Inc.

Cutting errors. Harmon's invention is an error-correcting encoder-decoder. By adding it to an existing system that used high-quality conditioned telephone links, a user can increase his bit-transmission rate by as much as a factor of five. Or he can fall back to cheap voice-grade transmission lines and retain the original bit rate but with a lower error rate.

According to **Lawrence L. Dobrin**, Datamax' vice president, the use of what the Bell System calls unconditioned lines can save a user up to two-thirds of his transmission-line costs. Dobrin joined Datamax after six years as director of commercial and Government marketing for the Conducon Corp.

Datamax officials are understandably vague about the innards of their system, but they do point out that its applications extend to analog-communications. It's claimed that, with the system, facsimile transmission time can be cut by two-thirds without any degradation, and that teletypewriter transmissions can be made to knife through burst noise and garble-causing interference with much-reduced error rates and fewer dropouts.

We'll pay \$200⁰⁰ for your old laser!

(as a trade-in on our new \$750 model)

Trade in your old laser — any brand, regardless of condition — to Spectra-Physics. You'll get a \$200 allowance toward a new Model 130C, priced at only \$750. (Your total purchase order with discount will come to only \$550 for this full-performance laser.) We make this unique offer because we want you to find out how much more performance you get from Spectra-Physics lasers. For example, here are just some of the benefits of owning and using our proven Model 130 Series gas laser:

1. In laser experimentation the 130C lets you change reflectors to get I-R and visible outputs, and shift from single-mode 1.0 milliwatt to multi-mode 2.0 milliwatt operation.
2. The Model 130C has Brewster's Angle windows to generate polarized light for modulation and communications.
3. For alignment work the 130C

gives you portability and convenience, with the laser and exciter in a single, rugged package (with a carrying handle).

4. If you want compact power, for classroom or holographic work the 130C has more "microwatts per inch": It's only 14 inches long and puts out a full milliwatt of laser power.
5. And this laser has an "auto-start" feature with a simple on-off switch.

You won't find this kind of laser value in other instruments at twice the price. Plus, every Spectra-Physics laser is guaranteed under a one-year full warranty, backed by world-wide service facilities.

HOW TO GET YOUR \$200 TRADE-IN ALLOWANCE. To qualify, your old laser must be a bonafide "laser," but it does not have to be in working condition.

Contact our sales engineer, or ship your old laser to us with your purchase order before March 31, 1968, and we'll give you a discount or credit worth \$200 toward a new Model 130C. Act now! Write or call us at Spectra-Physics, Inc., 1255 Terra Bella Avenue, Mountain View, California 94040. (415) 961-2550. In Europe, Spectra-Physics, S.A., 18, rue Saint Pierre, Box 142, 1701 Fribourg, Switzerland.



Model 130C: \$550 plus trade-in. The third generation in our Model 130 Series, proven in use by the more than 1300 units in the field. This newest laser in the series features new full-performance at a new, low price.



Spectra-Physics

Here are the winning totals

To be a Grand Prize Winner you should
have submitted ALL of these figures:

CIRCUIT FAMILY	NUMBER OF CIRCUITS
MDTL* (diode-transistor logic)	13
MECL* (emitter-coupled logic)	18
MHTL* (high-threshold logic)	4
MRTL* (resistor-transistor logic)	9
MTTL* (transistor-transistor logic)	15
I/C Operational Amplifiers	5
I/C Differential & Sense Amplifiers	1
I/C Video, RF & IF Amplifiers	2
Grand Total	67

If you had the correct Grand Total, even though your totals for the individual circuit categories were inaccurate (or if you were among the 100 closest entries), you are still a winner of the Frank Sinatra hit album that features, "It Was A Very Good Year."

Yes! 

It was a very good
year for integrated
circuits... at Motorola

-where the priceless ingredient is care!



In Motorola's "It was a very good year" Integrated Circuits Contest

With 67 new and different linear and digital functional circuit elements added to the line this year alone, there should be little doubt that . . . **MOTOROLA MAKES THEM ALL!** And, there's also little doubt that Motorola offers you the greatest design flexibility in the industry, through its broadest-of-all integrated circuit line. In fact, if we were to count all of the package and temperature-range variations, on just those circuits shown below, we could say that we've introduced 226 new integrated circuits during the past year. So, when you're considering the advantages of integrated circuit design . . . think Motorola — where you can depend on complete freedom of circuit choice!

Here is the complete list of *all* Motorola integrated circuits, introduced during the 12-months preceding the close of the contest — by family group, type number and circuit function.

MRTL

MC774G, MC874G, MC974G J-K Flip-Flop
MC775P, MC875P Dual Half Adder
MC776F/P, MC876F/P, MC976F Dual J-K Flip-Flop (mW)
MC778F/P, MC878F/P, MC978F Dual Type D Flip-Flop (mW)
MC783P, MC883P Dual Half Shift Register
MC784P, MC884P Dual Half Shift Register (w/o Inverters)

MC791P, MC891P Dual J-K Flip-Flop
MC881G, MC981G Dual Buffer
MC882G, MC982G J-K Flip-Flop

MECL

MC1001P, MC1201F Single 6-Input Gate (3 OR/3 NOR with pulldowns)
MC1002P, MC1202F Single 6-Input Gate (3 OR with pulldowns; 3 NOR without pulldowns)
MC1003P, MC1203F Single 6-Input Gate (3 OR/3 NOR without pulldowns)
MC1007P, MC1207F Triple 3-Input Gate (3 NOR with pulldowns)
MC1008P, MC1208F Triple 3-Input Gate (1 NOR with pulldowns; 2 NOR without pulldowns)
MC1009P, MC1209F Triple 3-Input Gate (3 NOR without pulldowns)

MC1014P, MC1214F Dual R-S Flip-Flop (Positive Clock)
MC1015P, MC1215F Dual R-S Flip-Flop (Negative Clock)
MC1016P, MC1216F Dual R-S Flip-Flop (Single Rail)
MC1017P, MC1217F Translator (Sat. Logic to MECL)
MC1018P, MC1218F Translator (MECL to Sat. Logic)
MC1019P, MC1219F Full Adder
MC1020P, MC1220F Quad Line Receiver
MC1021P, MC1221F Full Subtractor
MC1023P Dual 4-Input Clock Driver
MC1024P, MC1224F Dual 2-Input Expandable Gate
MC1025P, MC1225F Dual 4- and 5-Input Expander
MC1027P 120 MHz AC Coupled J-K Flip-Flop

MTTL

MC400F/P, MC450F/P, MC500F, MC550F Dual 4-Input Gate
MC401F/P, MC451F/P, MC501F, MC551F Expandable Quad 2-Input Gate
MC402F/P, MC452F/P, MC502F, MC552F 8-Input Gate
MC403F/P, MC453F/P, MC503F, MC553F Dual 3-Input Gate (w/complement)
MC404F/P, MC454F/P, MC504F, MC554F Expandable Triple 3-Input Gate
MC405F/P, MC455F/P, MC505F, MC555F Expandable Dual 4-Input Gate
MC406F/P, MC456F/P, MC506F, MC556F Expandable 8-Input Gate
MC408F/P, MC458F/P, MC508F, MC558F Quad 2-Input Gate
MC409F/P, MC459F/P, MC509F, MC559F Quad 2-Input Expander
MC410F/P, MC460F/P, MC510F, MC560F Dual 4-Input AND-OR Expander
MC411F/P, MC461F/P, MC511F, MC561F Dual 4-Input AND Expander
MC412F/P, MC462F/P, MC512F, MC562F Triple 3-Input Gate
MC413F/P, MC463F/P, MC513F, MC563F R-S Flip-Flop
MC415F/P, MC465F/P, MC515F, MC565F J-K AND Flip-Flop
MC416F/P, MC466F/P, MC516F, MC566F J-K OR Flip-Flop

MHTL

MC660P Dual 4-Input Gate (Active Pullups)
MC661P Dual 4-Input Gate (Passive Pullups)
MC663P Dual J-K Flip-Flop
MC664P Master Slave R-S Flip-Flop

MDTL

MC834F/P, MC934F Hex Inverter
MC836F/P, MC936F Hex Inverter
MC837F/P, MC937F Hex Inverter
MC838F/P, MC938F Decade Counter
MC839F/P, MC939F Divide-by-16 Counter
MC843G, MC943G 4-Input AND Driver (w/NOR Strobe)
MC849F/G/P, MC949F/G Quad Inverter
MC852F/P, MC952F Dual J-K Flip-Flop
MC853F/P, MC953F Dual J-K Flip-Flop
MC855F/P, MC955F Dual J-K Flip-Flop
MC856F/P, MC956F Dual J-K Flip-Flop
MC861F/G/P, MC961F/G Dual 4-Input Gate
MC863F/G/P, MC963F/G Dual 2-Input Gate

I/C Diff./Sense Amplifiers

MC1710CF/CG/CP/F/G Sense Amplifier

Video, RF & IF Amplifiers

MC1314G TV Sound IF Amplifier & Discriminator
MC1510F/G Video Amplifier

I/C Operational Amplifiers

MC1435F/G/P, MC1535F/G Dual Operational Amplifier
MC1437P Dual Operational Amplifier
MC1520F/G Operational Amplifier
MC1709CF/CG/CP/F/G Operational Amplifier
MC1712CF/CG/F/G Operational Amplifier

Thanks for joining in the fun of Motorola's "It Was A Very Good Year" integrated circuits contest! Prizes are on the way to the winners. For a list of winners, simply send a self-addressed, stamped envelope to P.O. Box 955, Phoenix, Arizona 85001.

*MDTL, MECL, MHTL, MRTL, MTTL are trademarks of Motorola Inc.

MOTOROLA Semiconductors

Here's a little something that will save more time, space and money in circuit design than anything else.

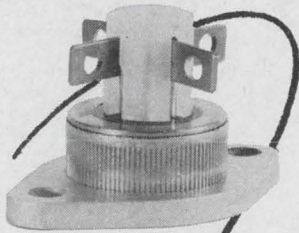

IBR® from Varo.

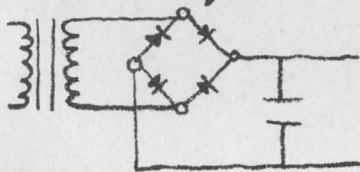

Varo's Integrated Bridge Rectifier requires just one-half to one-twentieth as much space as its competition. Saves design and installation time and reduces error.

Our IBR® is available as a 10-Amp, 10 Amp fast recovery and 25-Amp full-wave bridge rectifier. 200V, 400V and 600V controlled avalanche ratings. Electrically insulated case for direct chassis mounting. Three mounting options: Press mount, TO3 flange, single stud.

**25-Amp IBR® only
\$3.05***

**10-Amp fast-recovery
IBR® only
\$4.75***

**10-Amp IBR® only
\$2.35***

*In 200V rating and quantity of 1,000 (press mount).

Write for complete information on Varo IBR® products. It could solve problems you didn't even know you had. Available now from Allied Electronics.

*Registered trademark of Varo, Inc.



SPECIAL PRODUCTS DIVISION
2203 WALNUT STREET, GARLAND, TEXAS 75040
(214) 272-3561

Meetings

Defense Contract Administration Service Forum, American Society for Quality Control, Jack Tar Hotel, Clearwater, Fla., **Feb. 10.**

Aircraft Design for 1980 Operations Meeting, American Institute of Aeronautics and Astronautics; Mayflower Hotel, Washington, **Feb. 12-14.**

Aerospace and Electronic Systems Convention, IEEE; International Hotel, Los Angeles, **Feb. 13-15.**

International Solid-State Circuits Conference, IEEE; Sheraton Hotel, Philadelphia, **Feb. 14-16.**

National Space Meeting, the Institute of Navigation; Ramada Inn, Cocoa Beach, Fla., **Feb. 19-21.**

Scintillation and Semiconductor Counter Symposium, IEEE; Shoreham Hotel, Washington, **Feb. 28-March 1.**

Technology for Manned Planetary Missions Meeting, American Institute of Aeronautics and Astronautics; New Orleans, **March 4-6.**

Western Regional Technical Session, Electrochemical Society; Hilton Inn, San Francisco, **March 7.**

Conference of the American Society for Nondestructive Testing; Biltmore Hotel, Los Angeles, **March 11-13.**

Physics Exhibition, Institute of Physics and the Physical Society; London, **March 11-14.**

International Convention and Exhibition, IEEE; Coliseum and N.Y. Hilton Hotel, N.Y., **March 18-21.***

International Convention, Aerospace and Electronics Systems of IEEE; Warwick Hotel, New York, **March 19.**

Modulation Transfer Function, Society of Photo-Optical Instrumentation Engineers; Boston, **March 21-22.**

Symposium on Microwave Power, International Microwave Power Institute; Statler Hilton Hotel, Boston, **March 21-23.**

Flight Test Simulation and Support Conference, American Institute of

Aeronautics and Astronautics; Los Angeles, **March 25-27.**

International Aerospace Instrumentation Symposium, College of Aeronautics and Instrument Society of America; Cranfield, England, **March 25-28.**

Quality Control Conference, American Society for Quality Control; University of Rochester, N.Y., **March 26.**

Railroad Conference, IEEE and American Society of Mechanical Engineers; Conrad Hilton Hotel, Chicago, **March 27-28.**

Electrical Engineers Exhibition, American Society of Electrical Engineers; London, **March 27-April 3.**

Short Courses

Computer-aided circuit design, IEEE; New York Hilton Hotel, **March 18-21;** \$60 for members, \$75 for nonmembers.

Computer graphics, Association for Computing Machinery; Warwick Hotel, Philadelphia, **March 29;** \$40 for ACM members, \$45 for nonmembers; and \$15 for ACM student members

Quantum magneto-optics, Stevens Institute of Technology's Department of Electrical Engineers, Hoboken, N.J., **May 1;** no fee.

Call for papers

Aerodynamic Deceleration Systems Conference, American Institute of Aeronautics and Astronautics, El Centro, Calif., Sept. 23-25. **Feb. 12** is deadline for submitting abstracts to William Pepper, Rocket and Recovery Systems, Division 9324, Sandia Laboratory, P.O. Box 5800, Albuquerque, N.M. 87115

Solid State Sensors Symposium, IEEE and Instrument Society of America; Leamington Hotel, Minneapolis, Sept. 12-13. **April 1** is deadline for submission of abstracts to Dr. M. Atalla, program chairman, 1968 Solid State Sensors Symposium, Hewlett-Packard Co., 1501 Page Mill Rd., Palo Alto, Calif. 94304

Symposium on Switching and Automata Theory, IEEE Computer Group; Schenectady, N.Y., Oct. 15-17. **May 17** is deadline for submission of abstracts to Sheldon B. Akers, Electronics Laboratory, General Electric Co., Syracuse, N.Y. 13201

* Meeting preview on page 16.

THE Connector Thing

A periodical periodical designed, quite

frankly, to further the sales of Microdot connectors and cables. Published entirely in the interest of profit.

The "Why Aint You" CONTEST & THE UNABASHED PLEA

We were over at our advertising agency the other day, participating in one of their creative dart games and trying to come up with another great contest idea. Which we did. But found we could get in serious trouble transporting the prize across a state line.

While we may throw a dart or two during coffee breaks, we're usually rather serious people. Especially when it comes to such things as the advantages of our Twist/Con connectors.

Twist/Con is our exclusive method

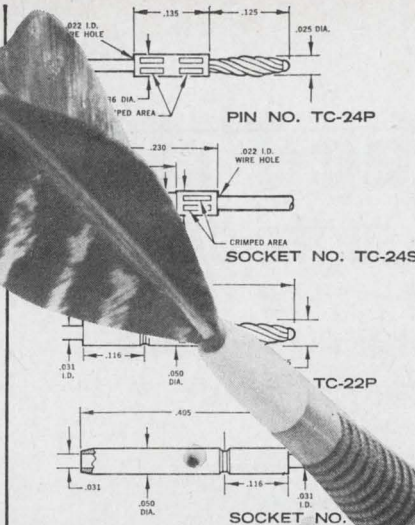

of giving you very high density packing of contacts on .050" centers. (That's up to 420 contacts per square inch.) We've been able to do this by removing the standard contact spring member and replacing it with a breathing helical spring.

Twist/Cons come in 24 and 22 pins and sockets. The 24 is for #24 and smaller wire; the 22 is for #22 wire and smaller. The 22 is a crimp removable contact on .065" centers. Both have grooves in the contact body for real tight retention.

Rack and panel configurations have 9, 15, 25, 37 and 51 contact arrangements. Strip connectors can be ordered in almost any length.

The same Twist/Con principle has been used for recording heads, PC boards, computers, splices, environmental connectors, flat cable connectors and on.

ENOUGH COMMERCIAL BROTHER, HOW ABOUT THAT CONTEST?

Okay. Now that you see the logic, the greatness (and humility) behind this

fantastic concept, WHY AIN'T YOU USING IT (THEM)?

In 25 words or less, answer, "I'm not using Twist/Con because."

Answers may be either truthful or smart aleck, but be factual.

Some smart aleck answers are:

"I ain't allowed to work on anything that calls for all that sofistikation." (AN EASTERN E.E.)

"Your stuff is too good for our cheap outfit"

"Management figures if we use your stuff and reduce failures too much, we deprive people of work which is Un-American."

"Who needs man-rated reliability on war toys?"

Some truthful answers are:

"I ain't allowed to work on anything that calls for all that sophistication." (A WESTERN M.S.E.E.)

"Too many people without any real knowledge of what's going on have the authority to make changes. And you know how that can mess up a good thing."

"I can't convince the project people we really need that extra-priced reliability."

Everybody wins! All entries will be rewarded with a set of unique lapel buttons as shown below. Also with our new Twist/Con catalog. The "RESCUE MISSION" button has nothing to do with the contest. It is yours for the asking if you will fill out the Unabashed Plea in Coupon B. To find out why you should fill out this coupon, read the coupon. Better yet: fill out both coupons. You'll have enough buttons for a suit.



MICRODOT INC.

220 Pasadena Ave.
South Pasadena
California 91030

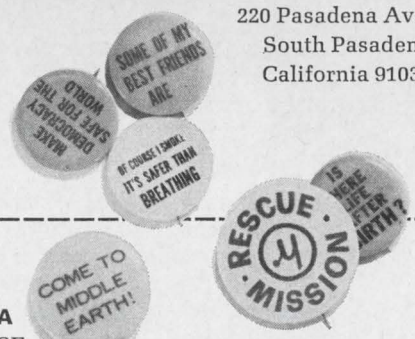

NO SUBSTITUTIONS PLEASE (offer void where law prohibits.)

COLUMN A WHY AIN'T YOU? CONTEST

I'm not using your TWIST/CON because:

Truthful Smart Aleck

Name _____

Company _____

Address _____

City _____ State _____ Zip _____

I use 'em all the time, Clyde. For that I should at least get a White Horse Good Guy button.

Twist/Con is a Registered Trademark of Microdot Inc.

COLUMN B UNABASHED PLEA RESCUE ME PLEASE

I'll be in chilly L'il Ole New York during the IEEE festivities. I'd love to come to your svelt, ostentatious, luxuriously modest penthouse suite at the New York Hilton. I understand this Rescue Mission will be open to properly accredited Microdot "Connector Thing" devotees every day of the IEEE show from 4 p.m. on. I also understand that I will need a special lapel button to get in. So button me.

Name _____

Company _____

Address _____

City _____ State _____ Zip _____

Play "Wee-Fils"®

THE NYTRONICS FILTER GAME

Match your custom filter requirements
to a Nytronics standard filter!

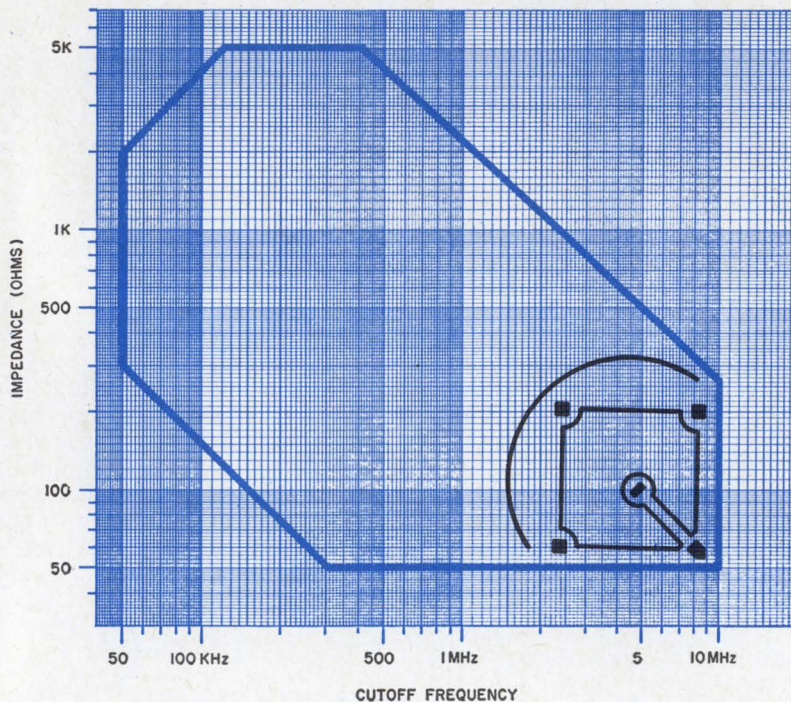

THE FEASIBILITY BALLPARK

Low-pass and high-pass **Wee-Fils** are available with 20, 35 or 50 db attenuation. Order **Wee-Fils** if your frequency-impedance characteristic falls in the feasibility ballpark.

Our in-house supplies of standard variable inductors and molded capacitors enables Nytronics to meet **Wee-Fil** orders with off-the-shelf components. And **Wee-Fils** offer all these features:

- Molded Construction
- Mil-Quality Components
- Specification Flexibility
- Small Size ■ Low Cost
- Rapid Delivery

Play **Wee-Fils** today. It might just be your most rewarding game in filter history.

ARE YOU IN THE BALLPARK?

To play in the **Wee-Fil** league, both input and output terminating impedances must be the same. Write for a set of detailed rules showing each filter and its attenuation—(normalized) frequency characteristic.

ARE YOU OUT OF THE BALLPARK?

Take heart. You may still be a winner. Nytronics offers custom filters too. Consult your nearest representative.

 **NYTRONICS, INC.**
10 Pelham Parkway ■ Pelham Manor, New York 10803
(914) 738-5000 ■ TWX 710-563-0604

Meeting preview

Tutorial sessions

This year's IEEE International Convention, scheduled for March 18 to 21 in New York, will have a new look. The 1968 conference has more than 200 papers—all of them invited—covering a wide range of interdisciplinary topics treated in a tutorial or survey fashion, instead of the usual catch-as-catch-can approach to the technical sessions.

High on the list of state-of-the-art sessions will be discussions of large-scale integration. Both Gordon E. Moore, director of research and development at Fairchild's Semiconductor division, and C.G. Thornton, R&D director at the Philco-Ford Corp.'s Microelectronics division, will deliver papers on LSI technology. P.R. Low, program manager for the advanced logic technology program at the International Business Machines Corp.'s Components division, will cover the application of LSI to small computers, while L.M. Spandorfer, director of technology development for the Sperry Rand Corp., will discuss LSI and large computers.

Far out. Another area to receive coverage will be space communications. One of the sessions, a survey of satellite communications, will be covered in papers by William Watkins, the Federal Communications Commission's deputy chief engineer; Howard Prescott, an engineer for the Communications Satellite Corp.; and Robert J. Darcey, project manager of the Applications Technology Satellite program at NASA's Goddard Space Flight Center. Also, H.W. Evans, head of the satellite systems engineering department at the Bell Telephone Laboratories, will deliver a paper on satellite propagation problems.

Quick fix. A third area to be covered is automated maintenance. Algirdas Avizienis, of the University of California faculty, will chair the session on automated maintenance and present a paper on the application of concurrent diagnosis and replacement in a self-repairing computer.

For further information, contact J.M. Kinn, IEEE, 345 E. 47th St., New York 10017.

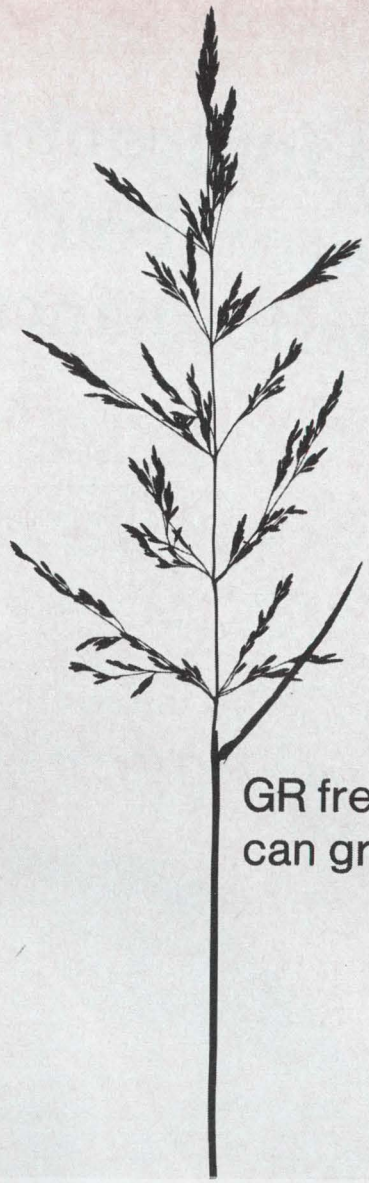

GR frequency synthesizers can grow on you.



Start with the basic package . . . a 3-digit synthesizer . . . in a 70-MHz, 12-MHz, 1-MHz, or 100-kHz model for as little as \$3640 . . .

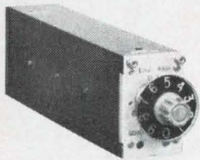

add additional digits (\$455 each) as you need them for up to 7-digit resolution and . . .



at any time add a continuously adjustable decade (\$550) for 2 extra figures of resolution or for continuous, manual control of frequency . . . sweep it electrically with your own external sweep signal or . . .

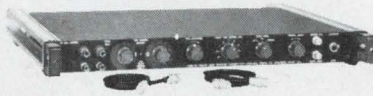

get the sweep, and frequency markers too, by adding our new sweep and marker generator (\$495).

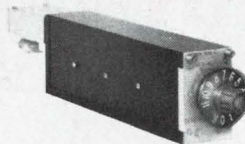

Want to go programmable? . . . use programmable decades (\$545-\$575) . . . new units now provide stepped programming up to 12 MHz . . . programming can be controlled by simple switch closures . . .



or, if you'd rather not flip switches, add our new preset-frequency programmer (20 channels for \$1000; 40 channels for \$1825) with a storage capability of up to 40 preset 7-digit frequencies per tray. Actual storage capability is unlimited if you don't mind switching trays . . .



and, if you need exceptional long-term stability, add an external frequency standard (\$2050) and improve it by three orders of magnitude to better than 1×10^{-10} . . .

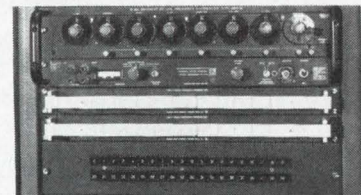

or, if you're bothered by growing pains, why not outline your needs and we'll recommend the right system . . . at off-the-shelf prices. Write General Radio Company, W. Concord, Massachusetts 01781; telephone (617) 369-4400; TWX (710) 347-1051.

GENERAL RADIO

Circle 17 on reader service card

When you're headed for trouble, there's no time to worry about microwave device performance.

That's why MEC created "super components." In most cases, systems troubles are caused not by components, but by the interfaces between them. With the introduction of "super components," MEC has made a major contribution toward minimizing microwave device interface problems.

Basically, "super components" are modular combinations of TWTs, solid-state delay devices, power supplies, limiters, switches and isolation networks. Together, they form complete sub-assemblies for systems application. Now a single specification can be generated for the combination unit . . . with MEC assuming unit responsibility.

Working closely with systems manufacturers, MEC has developed packaged amplifiers, zero loss microwave acoustic signal storage units, and chains of low-to-high power TWTs — many with shaped gain and limiting characteristics — for use in signal repeating, augmentation, microwave memory, direction finding, communications and target simulation systems.

Frequency, power and environment? MEC provides "super components"

covering VHF through 40 GHz. Power levels range from milli-watts to hundreds of watts, cw, and kilo-watts pulsed. All "super components" satisfy the most demanding military or commercial requirements.

True, most of the time there is no system problem to worry about; but, when you're headed for trouble, is most of the time good enough?

For complete information, contact us at 3165 Porter Drive, Palo Alto, Calif. 94304. Phone (415) 321-1770.



MICROWAVE ELECTRONICS
A TELEDYNE COMPANY



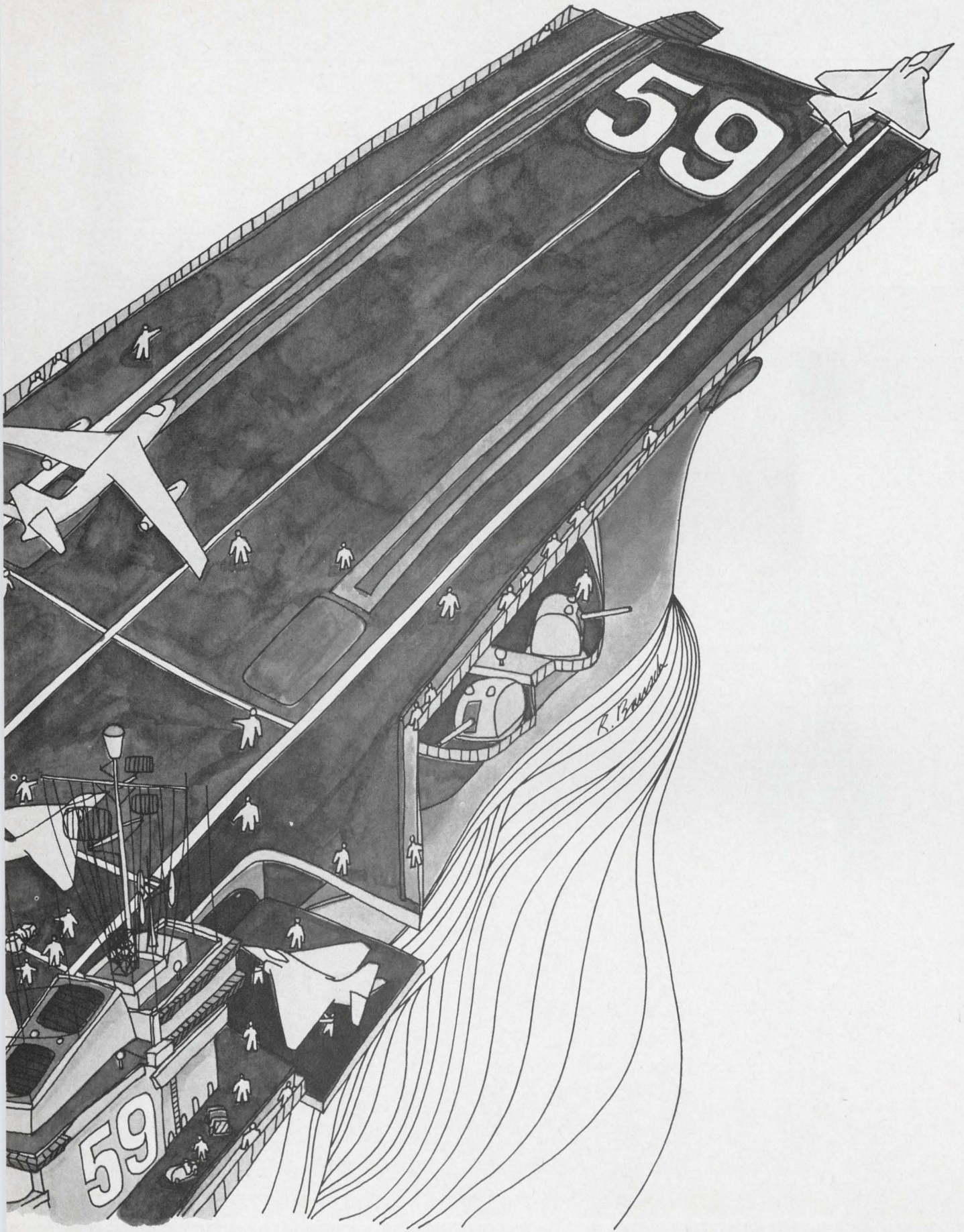

4 breakt new NI



size .530" dia. x 1.5" for IC compatibility - largest numeral height provides best readability.



anode strobing new design permits all like-numerals to be driven in parallel for time sharing operation with improved brightness.



pin spacer simplifies both PC board layout and tube insertion.



price in quantities of 1,000 - only **\$3⁹⁵** each.

Burroughs: XIE[®] tube

This new tube, type B-5750, has been engineered to achieve all these outstanding breakthroughs in a single design. The new slim-line tube not only has two internal decimal points but also has an "in-line" lead arrangement which is compatible with dual in-line IC's. In addition, the numeral aspect ratio has been designed to provide the optimum in readability and viewing distance.

The movable pin spacer-standoff, which is used to align the tube pins for ease of PC layout and insertion, is part of the tube assembly.

The anode-strobing/time-sharing operation permits substantial reduction in driver costs for many multi-digit display applications. For more information on these and other features contact your nearest Burroughs representative or sales engineer, or write: *Burroughs Corporation, Electronic Components Division, P.O. Box 1226, Department N8, Plainfield, New Jersey 07061 TEL: (201) 757-5000.*



Burroughs 

Circle 21 on reader service card

ACTUAL SIZE

No moving parts.

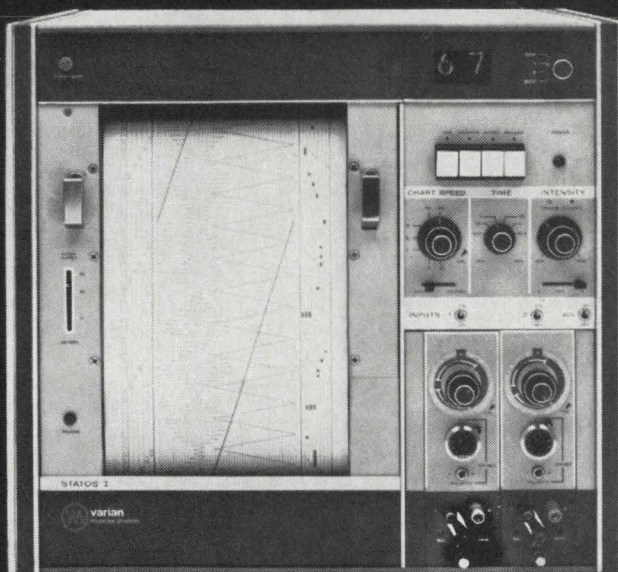

Unparalleled Reliability. This is the keynote of the new Varian Statos™ I Recorder with electrostatic writing. It records with NO MOVING PARTS—no adjustments, no messy ink, no slidewires, galvanometers, or pens.

Direct Computer Interface. Statos I is the first recorder actually designed to interface directly with computers. Not only can one digital signal be recorded simultaneously with two analog signals, but the BCD values of all three signal inputs are available as auxiliary outputs for storage on magnetic tape or punched tape, or for direct computer processing. Other models provide all three inputs for digital BCD.

Accuracy. The accuracy of 1.0% from dc to 1500 Hz at 10 cm full scale is ideal for telemetry recording and numerous aerospace applications.

200 μ sec. Rise Time. Having a rise time of 200 μ sec.—10 cm full scale with no overshoot—Statos I can provide the fast response required in transient and pulse analysis, in medical work, such as EEG and EKG, or other lab applications such as mass spectrometry.

Prints Its Own Charts. Statos I prints its own chart grids and time bars on inexpensive white paper. You'll get fine, sharp traces with no blurred edges, wide variations in thicknesses, or fading with time.

And you see the recorded data immediately as the paper comes out. There's no post fixing or further processing of any kind.

Economy. This recorder will literally pay for itself with the savings in paper, photo supplies, and dark-room facilities.

Chart Speeds to 50 cm/sec. You can have chart speed ranges from 0.2 cm/min. to 20 cm/sec. or from 0.5 cm/sec. to 50 cm/sec. Chart speeds can be varied continuously and controlled externally.

Event Markers. Eight event markers with up to 0.5 msec. timing accuracy are also provided.

Write us for literature and learn all of the advantages of Statos electrostatic recorders, a fresh new approach to graphic recording.

You may be interested in a companion product: Statos II, a 50, 75, or 100-channel event recorder with the same design concepts as Statos I. We'll send you literature on this revolutionary development, too.



varian
recorder division

palo alto/california 94303
zug/switzerland · sydney/australia

Commentary

The other jobs were easy

Business is being urged to take the lead in solving the problems of the cities. But these are not easily defined nor are their solutions immediately evident [See McGraw-Hill special report: Business and the urban crisis, page C1].

Engineers—especially those in electronics, aerospace, and systems-planning companies—may succeed where others have failed. By temperament and training, they are uniquely qualified to change the environment in which too many people live; to plan and build the cities of the future; to improve mass transportation; to provide innovations in the techniques of education, and thus contribute to ending forever the kind of society in which millions of citizens are trained for failure.

Training and education of the unskilled and the unschooled has already been given high priority by many electronics and aerospace companies, whose leaders realize that meaningful jobs give men dignity. Intelligent management knows that dead-end jobs deaden the spirit. Today, many companies—working with the Government under the Manpower Development and Training Act—are taking the “unemployable,” training them for responsible jobs, and encouraging them to aim higher.

Here's what some companies are already doing:

- The Douglas Aircraft Co., a part of the McDonnell Douglas Corp., is the largest single trainer-employer for MDTA programs. Beginning in 1965, Douglas has conducted 53 MDTA programs, providing instruction in 16 skills and training more than 13,000 people. Another 4,000 were trained without assistance during lapses in MDTA contracts. Under one 1967 contract—which will cost the company \$7 million—Douglas is training 2,400 unskilled people. The Government will contribute about \$700,000 to this program.

- The Lockheed Missiles & Space Co. put 111 “hard-core unemployed” through a four-week training course that cost it \$145,000 (\$10,000 was rebated by MDTA). Of the 111, 105 are now working. To understand the significance of these numbers it should be pointed out that to qualify, a trainee had to want to work, yet had to be a school dropout with no marketable skills.

Instructors at Lockheed follow up their “graduates” about once a week, checking with supervisors to discuss problems that arise. If there are work problems, the trainees go back to class. If there are personal problems, the instructors offer their help. “There is always the need for remedial training,” says Stanley Hawkins, who heads the project. “Remember,” he says, “success disqualifies you from this program.”

- Philco-Ford manages a job-preparation program called Team (Training and Experience to Augment Manpower). The company contracted with the U.S. Department of Labor to recruit, give prevocational training, lo-

cate on-job training sites, and finally place in jobs 800 of the hard-core unemployed in greater Philadelphia. Training periods average six weeks. During the day, three one-hour periods cover reading, arithmetic, and basic work-related information (some trainees have never held a job). On-job training is subcontracted by Philco to an employer who will pay the trainee the same wage paid other beginners.

- The Kaiser Aerospace & Electronics Corp. has achieved good results in hiring, training, and upgrading Negro and other minority-group employees. At Kaiser's San Leandro, Calif., plant, Joe Flynn, manager of industrial relations, said, “Almost without exception, people have had excellent records from the standpoint of attitude and just coming to work every day and doing their job.”

- The Whittaker Corp., in one of its service divisions, has an “Instant Hiring” program that waives the usual probationary period. Applicants must be in reasonable health and show an achievement level equivalent to that of a fifth grader. Such applicants must also be unemployed and live in an impoverished area. Instant Hiring administers a battery of medical, psychological, and educational tests to provide insight into each applicant's potential. The training is geared to individual needs and abilities. Trainees work at their own speed and are placed in full-time jobs when they are ready for them. Whittaker estimates that the program probably costs two to three times more than conventional industrial training programs. Robert Scanlon, Whittaker's corporate training director, says Instant Hiring has a 60% success record.

Advice to businessmen who want to start a training program is given by Eugene Cox, who heads the training team for Whittaker's Instant Hiring:

- Accept the program as a commitment and a responsibility, approaching each task with enthusiasm.

- Train for realistic jobs that offer rewards both in dollars and status. Menial jobs will not motivate.

- Set targets that are difficult (but not impossible) to achieve for both trainers and trainees.

- Offer a spectrum of specialties so a trainee can pursue his strongest suit.

Training programs—never a 100% success—are a part, not the whole, of the solution to the crisis of the cities. President Johnson has asked Congress for an additional \$244 million in fiscal 1969 to support industry training programs; this year \$106 million is available. Johnson's target is 100,000 new jobs by June 1969, and 500,000 by June 1971.

A half-million jobs by 1971 is not an impossible goal because the achievements by the few companies we have cited are being matched by others.

But the greater challenges of better housing, public transportation, and education remain. It can be met if electronics, aerospace, and systems-planning firms put their experience and resources, singly and collectively, to work. With companies like the Rand Corp., The System Development Corp., and Schriever Associates already investigating a systems-engineering approach to the problem of the cities, great expectations are justified.

We think we've developed the world's most reliable memory plane.

We worked on it during the day. For days. And days. And after hours. For hours. And hours. Finally, we got what we set out to get: the most reliable memory plane in the world. All the magnetic wire terminals and cores are enclosed within the frame. That means less chance of damage from handling, probing, or soldering. Or from shock and vibration. In any coincident current military or commercial application. It's the Cor-Gard memory plane. We went to the trouble of making it because cores, planes, and stacks are as far as our business goes. We don't make complete systems. We make parts for the system you want. Just tell us what kind of work you're after. We'll stay after work until we get it. Indiana General Corporation, Electronics Division/Memory Products, Keasbey, N.J.

INDIANA GENERAL 

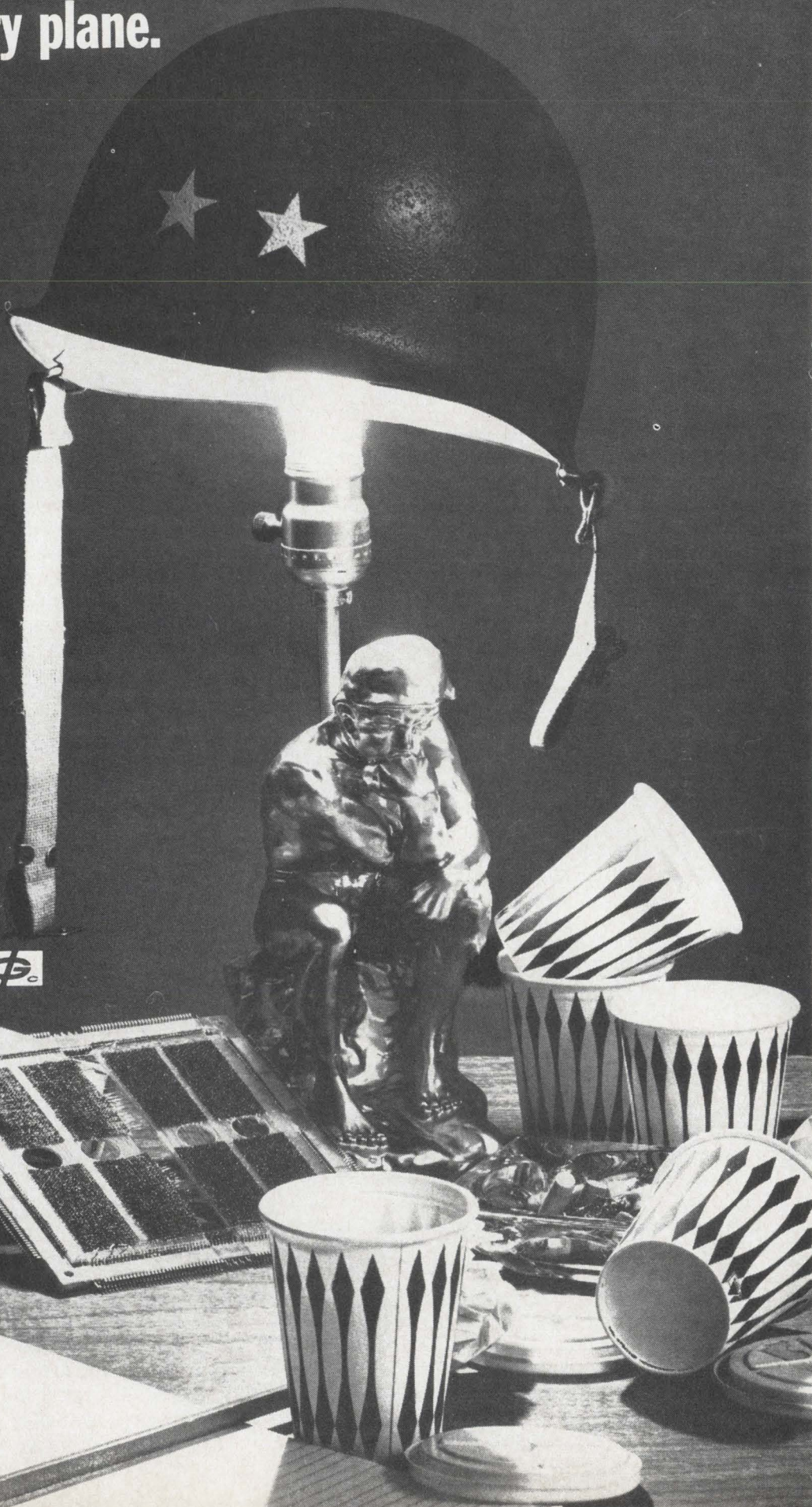

Electronics Newsletter

February 5, 1968

Johnson's budget: more business for electronics

With masterful sleight of hand, the Johnson Administration has put together a Federal budget that on balance is sure to mean more business for the electronics industry. Juggling funds among programs to meet the massive needs of Vietnam, however, will continue to hurt many projects involving electronics firms.

The Pentagon proposes to spend \$77.1 billion in fiscal 1969, up nearly \$3 billion from this year's outlay, and an ax-wielding Congress, for all the cutting and chipping it's likely to do, isn't expected to blunt the impact of this spending on the electronics industry. The Defense Department is asking, and will get, more money for research and development—\$8.03 billion against this year's \$7.42 billion. The increase will cover heavier outlays for such programs as the Minuteman 3 system, the F-106X aircraft, over-the-horizon radar, and nuclear warships.

The military will ask for only a modest supplemental funding this year—\$800 million compared with last year's \$12.3 billion.

As expected, NASA has been forced to ask for less money next year—\$4.37 billion compared with the \$4.59 billion it got this year. But if the space agency is able to get its request through Congress relatively intact, it will be able to lay the groundwork for a significant post-Apollo space exploration program through the 1970's.

Backed in efforts to start such expensive new programs as Voyager—which would have cost at least \$2.4 billion—NASA is now proposing scaled-down projects that could easily be expanded. The agency is planning Mariner launchings to Mars in 1971 and 1973 at an estimated cost of only \$500 million, and an unmanned laboratory that would be launched fully equipped in late 1972 by a Saturn 5.

Bone for watchdog may save its life

Tucked away in the \$186.1 billion Federal budget is a \$3 million item that may be a new lease on life for the Renegotiation Board, the Government's fiscal watchdog for defense and space contracts. The request is almost \$500,000 above this year's level, and the administration has told Congress to expect a further request for \$72,000 in the current fiscal year.

The board will expire June 30 unless Congress votes to extend it [Electronics, Jan. 22, p. 42]. The money request may head off hearings planned by Sen. William Proxmire (D., Wis.) and his economy-in-government subcommittee. Proxmire had planned to take the White House to task if it didn't ask for more funds for the board.

Fairchild readies larger-scale IC

Hard on the heels of Fairchild Semiconductor's 4500 large-scale integrated circuit [see story on p. 45] comes another Fairchild LSI entry, the 3800. Unlike the 4500, which has 32 four-input NAND gates, Fairchild's 3800 is an eight-bit parallel accumulator that has 200 MOS gates and is mounted in a 36-pin, dual in-line package.

The accumulator marks the company's departure from its Micromatrix approach: the user doesn't have to specify the circuit's final connections.

Fairchild is quietly stockpiling the 3800 for immediate availability as soon as it's officially announced—probably sometime in the spring. The company is aiming the accumulator at small, relatively slow machines for process control, data acquisition, and similar applications.

Electronics Newsletter

MOS linear IC's planned by GI

General Instrument, a leading manufacturer of discrete metal oxide semiconductors and digital MOS integrated circuits, **now plans the industry's first commercial linear MOS IC line.** Target date is late 1968. Major impetus is the booming market for linear bipolar IC's and keener competition in the MOS field from semiconductor giants like Texas Instruments, RCA, Motorola, and Fairchild [Electronics, Jan. 8, p. 111].

But GI has hit a few potholes in the road to production. Among them: **putting usable discrete MOS characteristics into IC form for i-f, wide-band, and other linear amplifiers.** There also have been processing difficulties in building high-quality n-channel units and meeting circuit resistance needs on the chip.

Gear on spy ships faces an overhaul

The capture of the spy ship Pueblo by the North Koreans raises knotty questions for military intelligence officials: should next-generation electronic cryptology gear be equipped with faster, more efficient destruct mechanisms or should it be carried on warships?

Reportedly, **high costs plus the dangers inherent in adding explosives or heat-generating chemicals to self-destruct equipment make redesigning impractical.** Washington insiders say the more likely solution is the use of fast, well-armed warships to do the spying.

MAC's offspring: a console firm

A relatively inexpensive computer graphic display terminal developed by the Massachusetts Institute of Technology for its Project MAC (multiple access computer) will become a commercial product. Newly formed Computer Displays Inc. of Cambridge, Mass., plans to have first units available by midsummer. The firm's president, Robert H. Stotz, was assistant leader of the display group in MIT's electronic systems lab.

The standard model will consist of a Tektronix storage display tube [Electronics, Oct. 16, 1967, p. 165], a 94-symbol keyboard, and vector and character generators. Prices range from below \$10,000 each in quantity to \$12,000 to \$14,000 for single consoles.

IBM, Honeywell add to computer lines

Honeywell is bringing out a small computer, seventh in its Series 200 line, plus a machine—new to Honeywell—that writes data on magnetic tape directly from a keyboard. Almost simultaneously, IBM announced a large computer, the Model 85, at the top of its System 360 line—right after announcing its small Model 25 [Electronics, Jan. 22, p. 156].

Honeywell's H-110 will have a 16,000-word, 4-microsecond memory. Its Keytape machine has a keyboard much like a standard keypunch machine; it loads up to 120 characters into a small core buffer, which then dumps the data onto the tape in a few milliseconds.

IBM's Model 85 contains a large, fast buffer memory made of monolithic IC's and is capable of floating-point calculations with twice the precision of those in other 360 models.

Addendum

International Fastener Research's first move after acquiring Fairchild's Oscilloscope division at the turn of the year has been to lay off a large number of production workers. **None of the cutbacks have yet affected the division's research and development section.** One grim note, though: International Fastener, which recently acquired bankrupt Webcor, is now selling off assets of the firm piecemeal.

IDEAS / *Circuit Boards*

"Mother-grandmother" board concept cuts space, weight, assembly time, and eliminates wiring error in complex systems.

Use of multiple printed circuit boards in successively larger sizes—in lieu of hand wiring—provides a means of fast, easy, foolproof assembly and very high packaging density in complex electronic systems.

Sylvania's interconnecting circuit-board technology represents a significant advance in packaging complex electronic systems.

The basic building blocks are from our family of high-speed, low-noise integrated circuit logic cards, each designed to carry two multi-layer circuits. The performance of these boards is enhanced by their integral buried power and ground planes.

These logic modules slip into the

multi-layer mother board, avoiding the need for conventional jumper wires . . . and the problems associated with their use in complex wiring configurations: wiring errors, wire costs, wire weight and volume consumption.

There is no discrete wiring in this part of the system. Total system wiring is limited to that necessary to tie the grandmother board into the peripheral system. By this technology, a complete high-speed computer logic system can be assembled by plugging module into module to reduce costly assembly time.

And with great savings in weight and improvement in packaging density; using the "mother-grandmother" principle, Sylvania recently was able to reduce a 234-pound system to about 34 pounds—a weight reduction

of almost 7 to 1 with a comparable size reduction.

Equally important, performance is always identical from system to system. At very high operating speeds, both the dress and the length of each current path become critical. With wired circuits, dress may vary even when path length remains constant—and at high speeds even this slight difference can affect performance. With "mother-grandmother" assembly, both dress and length of every current path is always identical from system to system, assuring dependably repeatable operation.

Sylvania would like to work with you to determine whether this new and superior means of system assembly can be adapted to your requirements. CIRCLE NUMBER 300

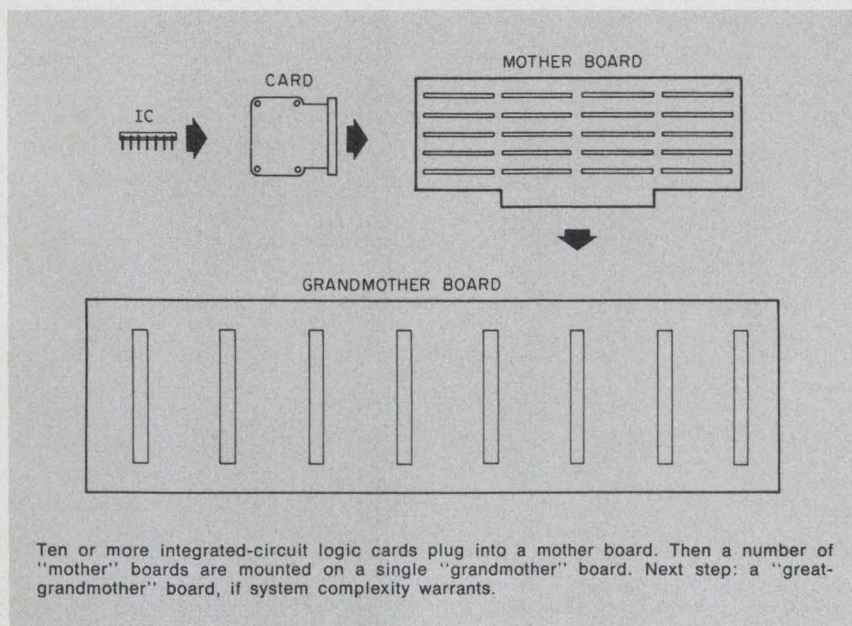

This issue in capsule

Cathode Ray Tubes. You can print over 30,000 characters per second with a new 2" monoscope.

EL Readouts. EL alphanumeric readouts: modern approach to visual information display.

Integrated Circuits. Designing parallel adder subsystems with anticipated or ripple carry.

Diodes. Now, planar 8-diode arrays for high-speed memory core driving.

Receiving Tubes. New high-voltage rectifier with posted filament provides instant TV turn-on and fail-safe operation.

Manager's Corner. Matching components to circuits? Maybe we can help.

Designing parallel adder subsystems with anticipated or ripple carry.

How parallel adder subsystems operate and how Sylvania IC fast adder units enhance their performance. Anticipated-carry subsystems are for high-speed operation; ripple-carry subsystems are not as fast, but are more economical to design and assemble.

Anticipated carry subsystems

Some high speed parallel adder subsystems incorporate the anticipated carry configuration which is designed to perform all summing operations in a given time interval without regard to the number of binary digits being added. In such subsystems, all previous combinations of bits must be monitored simultaneously at each succeeding stage. A "stage" of anticipated carry addition is defined as the summing of one Augend bit and one Addend bit of the same significance, taking into account all previous carry combinations affecting the sum at that stage. Each "stage" must also provide the sum for that stage and the necessary carry-out information to all succeeding stages.

A single anticipated carry adder stage is the overall fast adder logic diagram shown in Figure 1. In the anticipated-carry (SM20, SM30 series) configuration there are three separate outputs, each dependent upon an input logic configuration. The three outputs are the SUM, the Exclusive-OR, and the Carry. The Exclusive-OR output is dependent upon the following combination of the literals A and B being added:

$$\text{Exclusive-OR} = \bar{A}B + A\bar{B} = A \oplus B$$

The symbol " \oplus " means "Exclusively ORed"

The Carry output is dependent only on the AND function of the two literals A & B. Hence, the Carry is:

$$\begin{aligned} \text{Carry-Out} &= AB + AC_P + BC_P \text{ (SM20 Series)} \\ \text{Carry Out} &= A \cdot B \text{ (SM30 Series)} \end{aligned}$$

The SUM output is the result of the following expression:

$$\text{SUM} = A_N B_N C_P + \bar{A}_N \bar{B}_N C_P + A_N \bar{B}_N \bar{C}_P + \bar{A}_N B_N \bar{C}_P \quad (1)$$

Where A_N and B_N are the Nth digit of the Addend and Augend.

Equation (1) may be factored as follows:

$$\text{SUM} = (A_N B_N + \bar{A}_N \bar{B}_N) C_P + (A_N \bar{B}_N + \bar{A}_N B_N) \bar{C}_P$$

Where C_P is a complex Boolean expression and represents the carry-in to the Nth stage from all less significant stages.

C_P is defined as a complex expression since to implement a fast or simultaneous carry adder all possible combinations of previous adder stages must be simultaneously examined to determine if a Carry into the Nth stage will affect the SUM_N .

For a Carry into the Nth stage, the inputs must satisfy the following expression:

$$\begin{aligned} C_P &= A_{N-1} \cdot B_{N-1} + (A_{N-1} \oplus B_{N-1}) \\ &\quad (A_{N-2} \cdot B_{N-2}) + (A_{N-1} \oplus B_{N-1}) \quad (2) \\ &\quad (A_{N-2} \oplus B_{N-2}) (A_{N-3} \cdot B_{N-3}) + \dots \\ &\quad [(A_{N-1} \oplus B_{N-1}) (A_{N-2} \oplus B_{N-2}) \\ &\quad (A_{N-3} \oplus B_{N-3}) \dots (A_2 \oplus B_2) (A_1 \cdot B_1)] \end{aligned}$$

Where $1 \leq N \leq 8$ for an eight stage anticipated carry adder subsystem.

This expression is logically demonstrated by the Carry-In structure shown in Figure 1.

In Figure 1, the crux of the anticipated carry adder stage is enclosed by dashed lines. Examination will show that it is a series of two comparators. Truth tables for the two comparators are shown below:

Comparator 1			Comparator 2		
X	Y	Output W	W	Z	Output V
0	0	1	0	0	1
0	1	0	0	1	0
1	0	0	1	0	0
1	1	1	1	1	1

For Comparator 1, X and Y are the inputs and W is the output. For Comparator 2; W and Z are the inputs and V is the output. The following expressions are derived from the above truth tables:

$$W = XY + \bar{X}\bar{Y}, \bar{W} = \bar{X}Y + X\bar{Y} \quad (3)$$

$$V = WZ + \bar{W}\bar{Z} \quad (4)$$

by substitution:

$$V = (XY + \bar{X}\bar{Y})Z + (\bar{X}Y + X\bar{Y})\bar{Z} \quad (5)$$

Equation (5) is the same as the SUM equation.

Upon examination of the inputs it can be seen that:

$$X = \bar{A}_N, Y = \bar{B}_N, \text{ where } N \text{ represents the digit under consideration, and: } Z = C_{N-1} + C_{N-2} (A_{N-1} \oplus B_{N-1}) + (A_{N-2} \oplus B_{N-2}) (A_{N-1} \oplus B_{N-1}) (C_{N-3}) \quad (6)$$

Since $C_N = A_N \cdot B_N$, it can be seen that Z is the complement of the complex Carry-In structure previously referred to as C_P (see equation 2).

$$\text{Therefore, } Z = \bar{C}_P$$

By substituting the above values in equation (5) one arrives at the following:

$$V = (\bar{A}_N \bar{B}_N + A_N B_N) \bar{C}_P + (A_N \bar{B}_N + \bar{A}_N B_N) C_P \quad (6)$$

By manipulation, it can be shown that equation (6) is the complement of equation (1) the standard SUM equation. Therefore by a simple inversion of equation (6), the correct SUM at S_N is available.

Maximum addition time

Worst case logic conditions (overflow) for anticipated-carry adder subsystems occur when all respective Augend and Addend bits are different except for each least significant bit which in both cases is a binary ONE. For example:

1	1	0	1	1	1	0	1	AUGEND
0	0	1	0	0	0	1	1	ADDEND
0	0	0	0	0	0	0	0	SUM

Expressions for the propagation delay of the SUM of two 8-bit numbers which are multiples of eight may be derived in the following manner:

$$\text{For one 8-stage section: } (6) T_{\text{SUM}} = t_{\oplus} + t_s \quad (7)$$

where t_{\oplus} = propagation delay of the EXCLUSIVE-OR output with respect to the inputs A & B.

t_s = propagation delay of any SUM output with respect to an EXCLUSIVE-OR input.

It should be noted that only the first 8-stage section is dependent on the propagation delay of the EXCLUSIVE-

CARRY IN STRUCTURE (C_z)

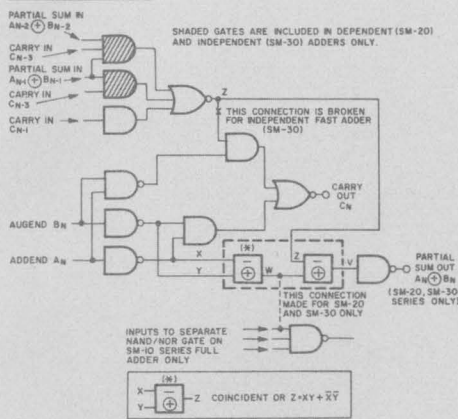

Figure 1. Logic diagram for a single parallel adder stage

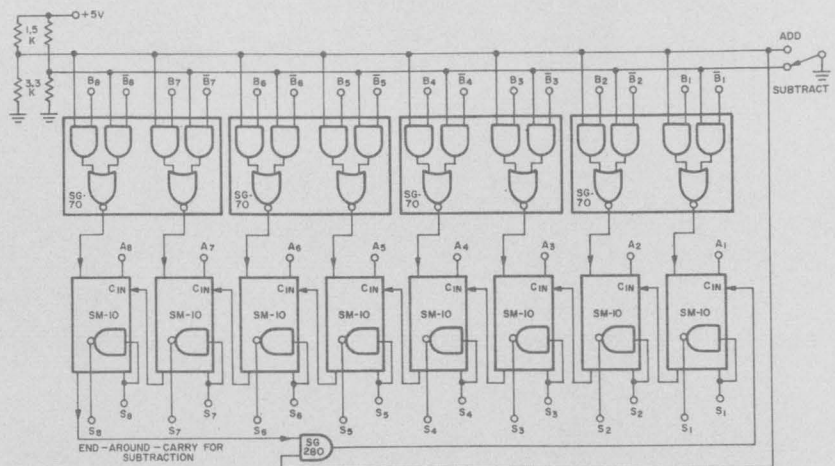

Figure 3. This parallel add/subtract configuration uses ripple carry propagation. This configuration will compute an eight-bit sum in approximately 135 nanosecs, or a difference in approximately 150 nanosecs. The SG280 dual 4-input AND/OR gate is enabled during subtraction to provide end-around-carry. The "B" register is made from only four SG70 Dual 2-Input AND-NOR Gates. Both the SG280 and the SG70 are standard SUHL gates.

Figure 2

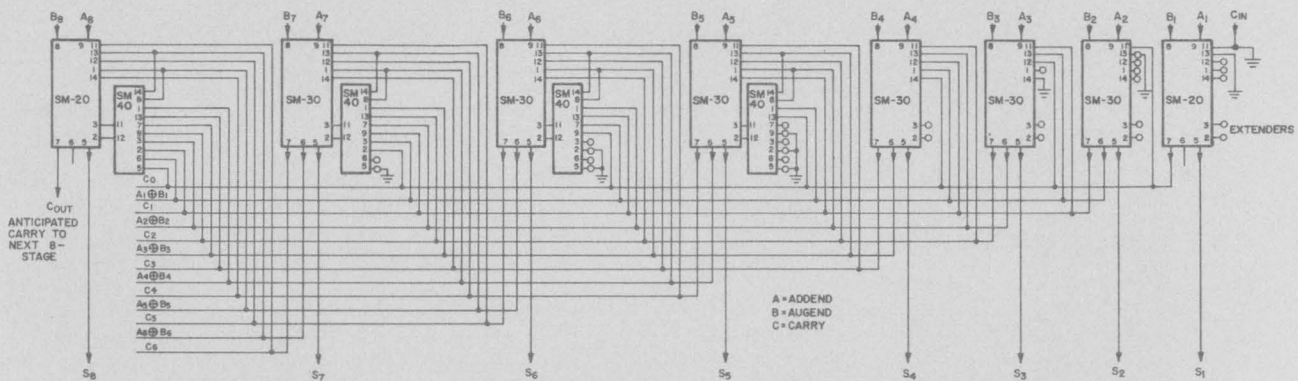

Figure 2. The above diagram shows SM-20, SM-30, and SM-40 series Adder Arrays interconnected to form an eight-stage anticipated-carry parallel adder subsystem.

OR outputs. Succeeding 8-stage sections will be dependent on a function of the Carry-Out signal.

For any number of cascaded 8-stage adder sections, the propagation delay for the SUM with respect to the Augend and Adder may be expressed as follows:

$$T_{SUM} \approx (2N-1)t_{CO} + t_s \quad (8)$$

where N = number of 8-stage sections

t_s = as defined previously

t_{CO} = propagation delay for the Carry-Out of one stage of an adder, where Carry-Out = $A \cdot B$

A careful examination of the 8-stage adder section shown in Figure 2 will show the derivation of equations (7) and (8).

Ripple adder subsystem

Where package count and interconnection economies are prime factors in the design of an adder subsystem, the parallel ripple-carry adder configuration is usually chosen (Fig. 3). This configuration, though logically much simpler than the anticipated-carry approach, is also slower in terms of total add time.

A stage of ripple-carry addition is similar to a stage of

anticipated-carry addition except that carries from previous stages do not simultaneously affect the sum at subsequent stages. Instead the sum at each stage is affected sequentially by the carry from the next less significant stage.

A single stage of ripple-carry addition is shown in Figure 1. In this diagram, the logic structure for this configuration is described by the unshaded gates. The expressions for the sum and carry are as follows:

$$SUM = ABC + \bar{A}\bar{B}C + \bar{A}B\bar{C} + A\bar{B}\bar{C}$$

$$CARRY = AB + AC + BC \text{ (from previous stage and propagated to the next stage)}$$

There are three inputs to each stage: the Addend, the Augend, and the Carry-In. The Carry-In, propagated from the previous stage, represents the result of addition at the previous stage and the ORed result of carries from all previous stages. The Carry-Out from a given stage is the Carry-In to the next subsequent stage. The output is the true sum of two binary digits of the same significance at the specific stage, and including the result of all carries up to that stage.

New high-voltage rectifier with posted filament provides "instant-on" and fail-safe operation.

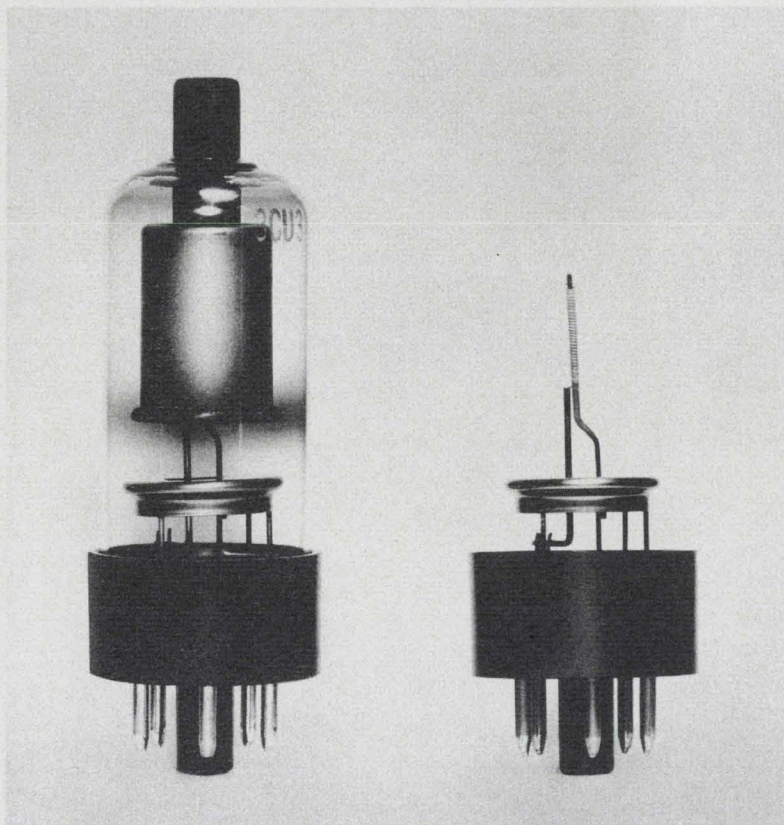

New Sylvania 3CU3, above, contrasted with our 3A3A high-voltage rectifier with cathode-type construction. Note simplicity and ruggedness of posted filament design in 3CU3.

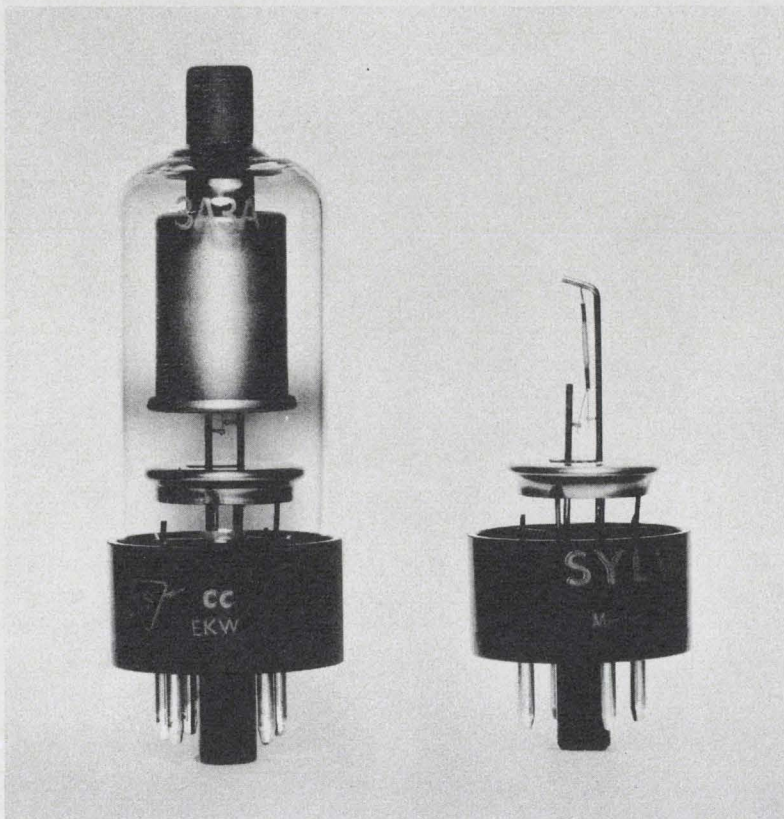

Sylvania has developed a new high-voltage rectifier tube, our 3CU3, with a rugged posted filament that is virtually fail-safe in that it cannot short out and damage other components.

The receiving tube above represents a significant advance in high-voltage rectifier design. The filament is wound onto — but insulated from — a strong central support post. This construction aligns the filament in the exact center of the anode to assure uniform field distribution.

In addition, it makes filament-to-anode shorts virtually impossible *even if the filament should fail*. This affords fail-safe protection for other circuit components that could be damaged by filament-to-anode shorts in the high-voltage rectifier.

The tube was designed to meet the most demanding and critical color-TV circuit requirements, and is particularly useful in sets which are all solid-state except for the CRT and the HVR. The tube takes momentary overloads in stride, where a solid-state HVR may not. And its total warm-up time is less than one second, making it ideal for "instant-on" TV sets.

Posted filament construction assures long life and provides considerable reserve emission capability and excellent emission stability at reduced line or overload voltages. Reliability is increased by the large filament area, by the high filament-power input and the center posted filament suspension. The undesirable shielding effect caused by side mounted supports (see heater cathode type construction of the 3A3A, below) which unavoidably reduces emission capability, is eliminated with the posted filament design.

Electrical Data

Heater Characteristics

Heater Voltage (AC) 3.15±0.5 Volts
 Heater Current 280 mA

Direct Interelectrode Capacitances

Plate to Filament and Internal Shield Without Shield
 1.5 pF..

Ratings (Design Maximum System)

Pulse Rectifier Service

Peak Inverse Plate Voltage
 Total DC & Peak 33,000 Volts
 DC Component 27,500 Volts
 Steady State Peak Plate Current 100 mA
 DC Output Current 2.0 mA

Characteristics

Tube Drop for $I_b=7$ mA 50 Volts

EL alphanumeric readouts: The modern approach to visual information display.

Sylvania EL readouts are today's most advanced solution to numeric or alphabetical information display problems. Each letter or number appears on the same flat surface, for widest possible viewing angle, and with none of the "bloodshot-eye" look characteristic of multiplane incandescent and gas-glow tubes.

There is virtually no information display problem that cannot be solved *better* with Sylvania electroluminescent panels.

For long-range visibility, characters may be as much as 12" high. For pictorial or analog displays, any figure may be presented as a combination of dots as small as 1/10" square on a random-access panel.

All characters are in the same plane; they don't jump back and forth as in incandescent and gas-glow tubes. And there's no "bloodshot-eye" appearance; you don't have to look through nonilluminated characters to see the one that's lit.

If the information can be displayed in numbers or letters, EL panels can do it. Better. Faster. Faster, in fact, than the eye can detect...when you need that kind of speed.

Our "C" Series is designed to operate typically at 250 volts rms, 400 or 800 Hz with a peak voltage rating of 420 volts over the temperature range of -55 to +94°C. This series yields an average initial brightness of 8 footlamberts operating at 250 volts rms, 400 Hz and 12 footlamberts at 250 volts rms, 800 Hz.

Sylvania also has other electroluminescent units, such as our "P"-series, which offer high brightness and all-glass construction. They are available in 115-volt (400 Hz) and 250-volt (400 Hz) versions.

A few possible applications

- | | |
|---------------------------|----------------------------|
| Hospital paging systems | TV channel indicators |
| Elevator floor indicators | Nuclear radiation counters |
| Auto speedometers | Desk calculator readouts |
| Bar-graph indicators | Airline monitor boards |
| Random-access panels | Baggage pickup boards |
| Frequency counters | Stock quotation boards |

CIRCLE NUMBER 303

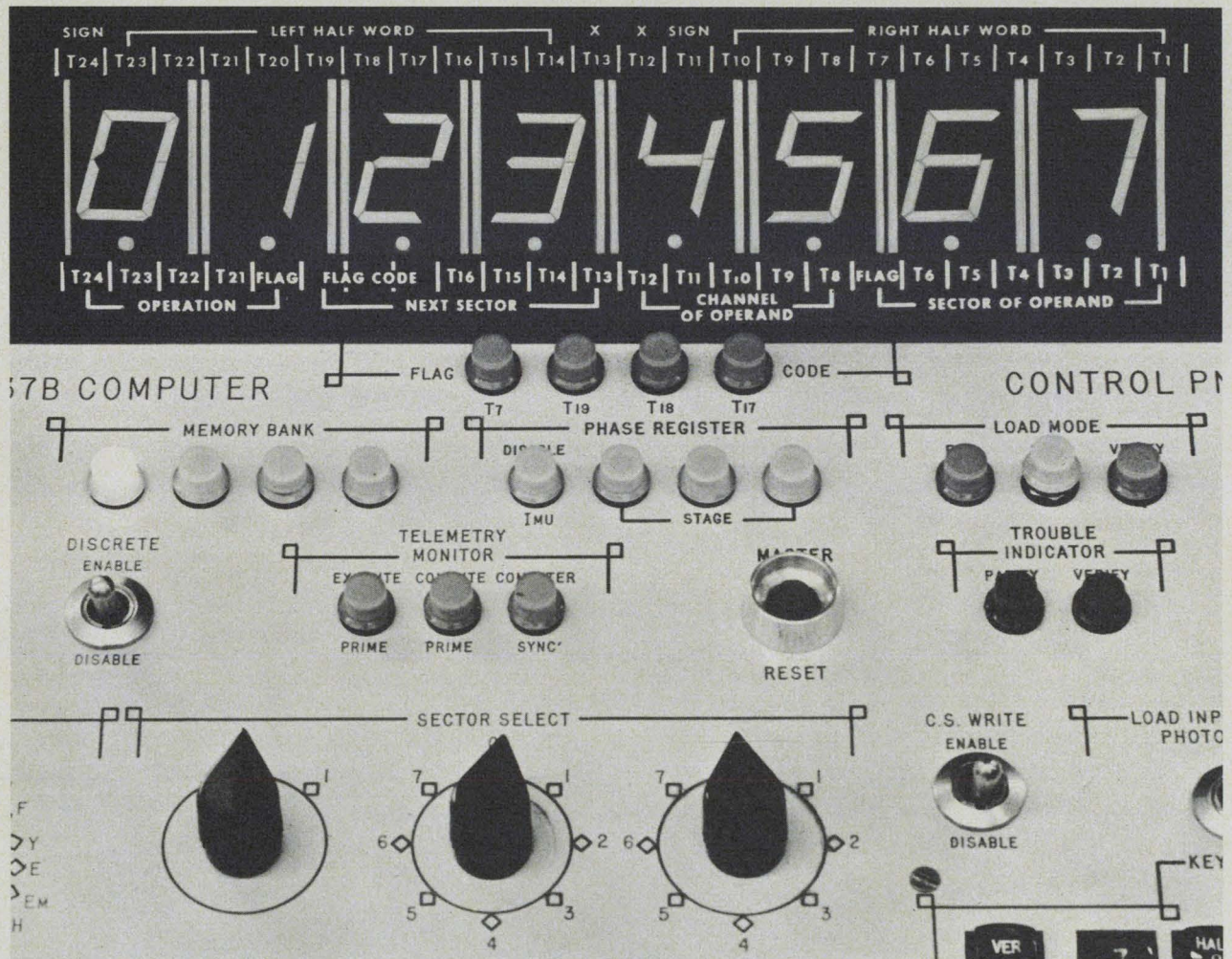

Control panel... part of console used in repair and test of Minuteman II missile electronic equipment. Unit is used to check out the D-37B computer, the central computer for the missile system. The units displayed are 250-volt 400Hz, "C"-series panels. Photo courtesy Autonetics, Division of North American Rockwell Corporation.

Now, planar 8-diode arrays for high-speed memory core driving.

Sylvania planar diode arrays combine such benefits as reduced assembly costs, less external wiring and component handling plus high reliability and packaging density—with ultra-fast switching capability in configurations from 2 to 16 diodes.

The combination of high forward conductance, fast recovery, low capacitance and tight performance tolerances makes Sylvania's new diode arrays well suited for high speed core driver applications.

Typical of these units are the SID8A-2 and SID8B-2, eight diode core drivers with forward current ratings of 300 mA and power ratings of 300 mW per diode. Couple this power drive capability with ultra-fast recovery and designers have diode arrays which meet the demanding requirements for memory drivers in military and aerospace computers as well as commercial computers.

Reverse recovery time of these diodes is a maximum of 50 nsec even

at such extreme switching conditions of a forward current of 300 mA and an I_R of 30 mA. Typical values for the recovery time of I_F and I_R switching from 300 mA to 30 mA is 35 nsec.

Sylvania's SID8A-2 and SID8B-2 are monolithic silicon diode arrays assembled in hermetically sealed flat packs (0.250" x 0.175") or dual-in-line plug-in packages. Available in a common cathode (SID8A-2) or common anode (SID8B-2) configuration, these planar devices feature silicon dioxide passivated construction. They are fabricated on a high resistivity layer which is epitaxially grown on a low resistivity substrate.

The manufacturing process used to produce these arrays results in diodes which have closely matched electrical characteristics over a wide temperature and current range. Passivation insures that performance remains stable over a long operating life. Manufactured to standard MIL quality assurance requirements, these packaged arrays meet MIL-S-19500 standards.

Other core driver arrays available

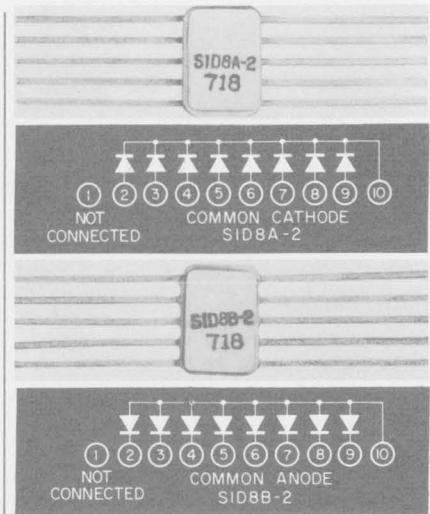

Sylvania Type SID8A-2 and -8B-2 8-diode arrays in common cathode and anode configurations. Either type is also available in 10-lead dual-in-line plug-in packages.

on request from Sylvania include units with two to sixteen diodes connected common cathode or common anode.

CIRCLE NUMBER 304

Maximum Ratings at 25°C (each junction):

Reverse Voltage, V_R	40 volts
Forward Current, I_F	300 mA
Peak Forward Current, I_{FP}	1.0 amp (0.1 μ sec, 25% D.C.)
Average Power Dissipation, P_D	300 mW (500 mW total package)
Junction Temperature, T_J	-65°C to +150°C
Storage Temperature, T_{stg}	-65°C to +300°C

Notes:

1. Pulse test $\leq 300 \mu$ sec, $\leq 2\%$ duty cycle.
2. Forward voltage drop of highest reading diode junction shall be within 200 mV of lowest reading diode.
3. $\theta_{JC} 0.1^\circ\text{C}/\text{mw}$; $\theta_{CA} 0.2^\circ\text{C}/\text{mw}$. Linear-derating of +25°C to +150°C.

Electrical Characteristics at 25°C (each junction):

Conditions	Min	Max	Unit
Forward Voltage Drop, V_F (Note 1.)	—	1.25	V
Forward Voltage Drop, V_F (Note 1.)	—	1.40	V
Forward Voltage Drop, V_F (Note 1.)	—	2.00	V
Reverse Current, I_R	—	0.1	μ A
Peak Inverse Voltage, PIV	40	—	V
Capacitance, C			
SID8A-2		3.0	pf
SID8B-2		6.0	pf
Reverse Recovery, t_{rr}		50	nsec
$I_F = 300 \text{ ma}$			
$I_R = 30 \text{ ma}$			
$I_r = 3 \text{ ma}$			
$R_L = 100 \text{ ohm}$			
$I_F = 500 \text{ ma}$	—	0.2	V
Forward Voltage Match, ΔV_F			
(Notes 1. and 2.)			

TYPICAL CHARACTERISTICS
FORWARD CURRENT vs FORWARD VOLTAGE
(EACH DIODE)

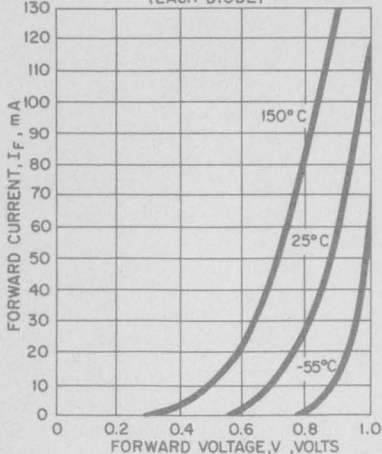

TYPICAL CHARACTERISTICS
CAPACITANCE vs REVERSE VOLTAGE
(EACH DIODE)

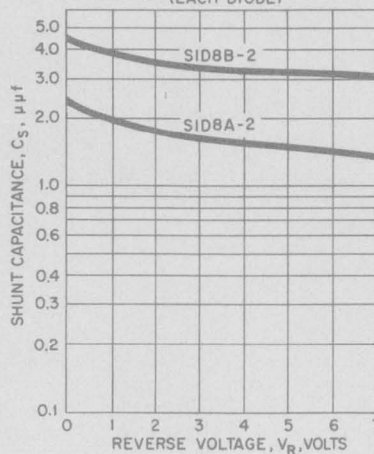

TYPICAL CHARACTERISTICS
REVERSE CURRENT vs TEMPERATURE
(EACH DIODE)

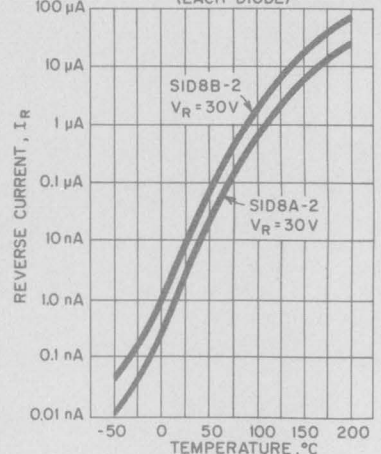

Use this new 2" monoscope and CRT to print over 30,000 characters per second.

Consider a new system for extremely high-speed printout of computer-generated or computer-retrieved data — alphanumeric, special symbol or foreign language.

The new 2"-monoscope (Fig. 1) can generate over 30,000 characters per second from computer tape. And our cathode-ray printing tube (Fig. 2) can print them just that fast by an electrostatic printing technique.

The secret of the monoscope's unique character-generating capability is in the metallic character screen (Fig. 3), electronically opaque except for the open characters. To generate a character, the electron beam scans only one character location, not the entire target. Since a single character occupies less than 1/100 of the full screen, the monoscope generates a character in 1/100 the time required for a full raster scan.

The stencil target screen shown has 64 alphanumeric and mathematical symbols. But it can be made with additional character symbols to meet your individual specifications including other languages, in any given character style.

This monoscope is recommended as a character generator for: computer display, airline status boards, stock quotation boards, teaching machines, address-label printing, command control center displays, racetrack tally boards—anywhere a high-resolution electronic information readout system is required.

CIRCLE NUMBER 305



Fig. 1. Sylvania 2" monoscope Model SC-4648

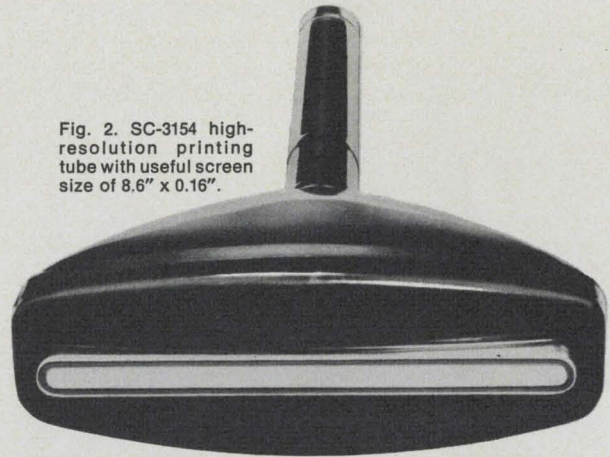

Fig. 2. SC-3154 high-resolution printing tube with useful screen size of 8.6" x 0.16".



Fig. 3. Stencil character screen from 2" monoscope can be custom-designed to your requirements.

SEE OUR SPECIFICATIONS IN
VSMF
MICROFILM CATALOG FILE

Use Sylvania's "Hot Line" inquiry service, especially if you require full particulars on any item in a hurry. It's easy and it's free. Circle the reader service number(s) you're most interested in; then fill in your name, title, company and address. We'll do the rest and see you get further information by return mail.

BUSINESS REPLY MAIL

No Postage Stamp Necessary if Mailed in the United States

FIRST CLASS
Permit No. 2833
Buffalo, N.Y.

POSTAGE WILL BE PAID BY

Sylvania Electric Products Inc.
Sylvania Electronic Components
1100 Main Street
Buffalo, New York 14209

Dept. C 22

Commercial Engineering ... where it's our business to mind yours.

Some time ago an irate customer confronted a Sylvania sales engineer with the accusation: "This high-voltage rectifier you sold us doesn't work!"

"What seems to be the problem?" we asked.

"It has problems on life," the customer said. "It runs all right on the production line, but it burns out too early in the field."

Analysis of quality control measurements and life tests showed excellent conformance to ratings and specifications.

Then we examined the customer's circuit and found that the tube was being run at higher than specified filament voltage. We recommended inexpensive circuit changes necessary to bring filament voltage within proper limits...and the early life failure problem disappeared.

That's often the cause of component failure: not the component itself, but the circuit in which it's used. Where such failures occur, it's our job to find causes and recommend remedies.

In another case, a customer brought in for evaluation a prototype of a new TV set he planned to market. We checked it through, *predicted* trouble on life with the horizontal output tube, and recommended circuit changes to compensate. But the customer, with thousands of subassemblies in stock, did not feel the changes were essential. The predicted trouble did indeed occur in the field, and he wound up changing the circuit as we had suggested.

What else do we do in the Commercial Engineering Department of our receiving tube operation in Emporium, Pa.?

Well, for example, we make independent labora-

tory evaluations of customer-designed prototypes, systems, instruments or subassemblies in which our components are used. Run high-line and dynamic life tests simulating worst-case operating conditions. Provide thorough technical descriptions, specifications, application notes and standards for every component we manufacture. Furnish technical answers to customer questions that cannot be answered fully by our engineering field force.

We recommend component substitution when necessary, so that a given circuit will operate properly without redesign. Recommend changes in test, setup or production procedures to eliminate dependent and interdependent failures. Help assure that every component we sell is operated in the most reliable mode. *Anything to help a customer match components to circuits.*

Because we, in our receiving-tube manufacturing operation, are *component* people while our customers, by and large, are *circuit or systems* people who often need the component-oriented engineering backup we provide. Yet unfortunately, some customers occasionally forget that we offer such services.

And the important thing is, our Commercial Engineering factory service is *nearby and immediate*; similar service from foreign manufacturers—if available at all—is far, far away and takes a long, long time. As you probably well know.



H. C. Pleak
Manager, Commercial Engineering
Receiving Tubes

This information in Sylvania Ideas is furnished without assuming any obligations.

SYLVANIA

A SUBSIDIARY OF
GENERAL TELEPHONE & ELECTRONICS

NEW CAPABILITIES IN: ELECTRONIC TUBES • SEMICONDUCTORS • MICROWAVE DEVICES • SPECIAL COMPONENTS • DISPLAY DEVICES

C 2

NAME _____

TITLE _____

COMPANY _____

ADDRESS _____

CITY _____ STATE _____ ZIP _____

Circle Numbers Corresponding to Product Item

300 301 302 303 304
305

Please have a Sales Engineer call



HOT LINE INQUIRY SERVICE

Need information in a hurry? Clip the card and mail it. Be sure to fill in all information requested. We'll rush you full particulars on any item indicated.

You can also get information using the publication's card elsewhere in this issue. Use of the card shown here will simplify handling and save time.

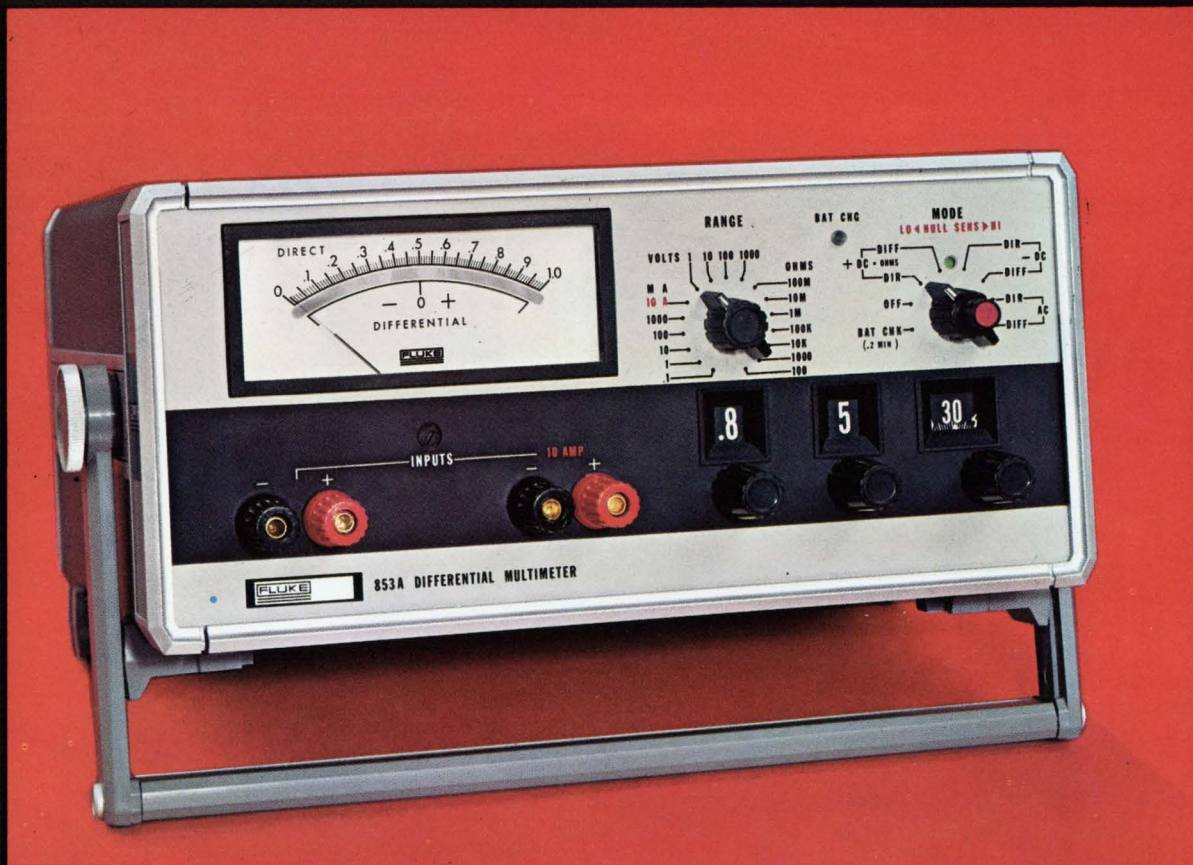

The new Fluke 853A: The only complete multimeter.

Accuracy, measurement capability, and low cost have been a long time coming in the multimeter field. Now, they're here with the introduction of the new Fluke 853A. □ These specs are guaranteed for one year without recalibration. DC volts, 0.2%. AC volts, 0.5%. Range, 0 to 1.1 kv. DC amps, 0.2%. AC amps, 0.5%. Range, 0 to 11 amps. Ohms, 0.2%. Range, 0 to 110 megohms. All this plus complete overload protection. Price, \$445. □ Does this data bit give you just a hint why we also call the Fluke 853A, "the only complete multimeter"? Write or call for complete information.

Fluke, Box 7428, Seattle, Washington
98133. Phone: (206) 774-2211.
TWX: (910) 449-2850.

See us at IEEE, Booths 2C02-2C04.

FLUKE

In Europe, address Fluke International Corporation, P. O. Box 5053, Ledeborstraat 27, Tilburg, Holland. Telex: 844-50237. In U. K., address Fluke International Corporation, P. O. Box 102, Watford Herts, England.

Circle 35 on reader service card



PHILBRICK/NEXUS: BEST SOURCE FOR YOUR ANALOG NEEDS

Philbrick and Nexus, world leaders in electronic analog computing equipment, combine to offer you the best in modern technology and the highest product integrity in the industry. Philbrick/Nexus Research, a recently-formed Teledyne Company, brings to the analog instrumentation field unequalled capabilities in design, development and production of analog components, modules, instruments and systems. Philbrick/Nexus also exhibits unusual all-around abilities in the area of electronic circuitry and hardware.

Philbrick/Nexus can fill your needs for anything analog from the industry's broadest range of analog products — ranging from simple operational amplifiers to the most sophisticated analog systems. Philbrick/Nexus' 26 years of combined experience offer you the advanced-technology of the pioneer and the vitality of a customer-oriented organization dedicated to producing the answers to any of your unsolved problems. For prompt, competent applications, engineering assistance or advice, call your local Philbrick/Nexus field-engineering representative or write, Philbrick/Nexus Research, Allied Drive at Route 128, Dedham, Massachusetts 02026.

DISCRETE-COMPONENT OPERATIONAL AMPLIFIERS

High-gain, low-gain, low-drift amplifiers for stable feedback loops. Provide precise, predictable operations on one or more input signals. Available in a wide variety of economy or premium grades (FET's, universal, wideband, high-voltage, general purpose) in plug-in or wire-in modules in every packaging style.

IC OPERATIONAL AMPLIFIERS

Micro-Hybrids combine linear monolithic chip and discrete microminiature component technologies to offer immunity to overloads, shorts and supply voltage stresses. Other types available include monolithic thin-film in TO-5 and dual in-line packages and hybrid thick-film operational amplifiers.

LOW-ERROR OPERATIONAL AMPLIFIERS

Ideal where drift and offset must be held over long operating periods through wide ambient temperature fluctuations. A wide variety of chopper-stabilized and parametrics types are available.

DC POWER SUPPLIES, REGULATORS AND BOOSTER AMPLIFIERS

Compound-regulated, stable, noise-free power supplies designed to meet the needs of high-performance, low-level analog systems. Rack, cabinet, modular, plug-in or built-in models available. Voltage regulators and high powered booster amplifiers are also available.

NON-LINEAR FUNCTION MODULES

Analog systems components for linearizing or performing non-linear functions. Available in natural continuous function or straight-line approximation types. Non-linear function modules include networks that accurately exhibit logarithmic, trigonometric and quadratic behavior.

Q3 MODULAR SYSTEMS

Modular components for implementing both analog and hybrid computers, simulators and analyzers include: arbitrary function fitters, universal linear operators, multiplier-dividers and manifolds. Modular front panels, chassis, adaptors and accessories combine all modules into compact units.

OPERATIONAL MANIFOLDS

All-in-one self-powered analog instruments that virtually eliminate wiring problems. They simplify experimentation, simulation and instruction in the practical application of feedback techniques.

TECHNICAL SUPPORT SERVICES

Philbrick/Nexus Research welcomes opportunities to help you apply analog techniques and products in such areas as industrial and scientific instrumentation, process and quality control systems and in-line analog data processing. Customer services of Philbrick/Nexus include: applications engineering, technical bulletins, applications manuals, the "Lightning Empiricist", and factory or on-site applications seminars.

PHILBRICK/NEXUS REPRESENTATIVES:

Instrument Dynamics, Inc., Wakefield, Mass. (617) 245-5100 • West Hartford, Conn. (203) 233-5503

Crane & Egert Corp., Elmont, L.I., N.Y. (516) 448-2100 • Conshohocken, Pa. (215) 277-0559

K.L.M. Associates, Whitesboro, N.Y. (315) 736-2450 • Palmyra, N.Y. (315) 597-9776 • North Syracuse, N.Y. (315) 458-6214

S. Sterling Company, Southfield, Mich. (313) 357-3700 • Cleveland, Ohio (216) 442-8080 • Dayton, Ohio (513) 298-7573 • Pittsburgh, Pa. (412) 884-5515

Torkelson Associates, Northfield, Ill. (312) 446-8450 • Minneapolis, Minn. (612) 920-1046 • Indianapolis, Ind. (317) 241-0725

Applied Science Associates, Dallas, Texas. (214) 526-8316 • Houston, Texas (713) 781-1441 • Tulsa, Okla. (918) 627-6199

W.A. Brown & Associates, Inc., Alexandria, Va. (703) 836-1800 • Fort Lauderdale, Fla. (305) 564-8000 • Orlando, Fla. (305) 425-5505 • Fort Walton Beach, Fla. (904) 243-6424 • Huntsville, Ala. (205) 536-8393 (205) 539-6884 • Tucker, Ga. (404) 939-1674 • Winston-Salem, N.C. (919) 725-5384 • Newport News, Va. (703) 245-8272 • Baltimore, Md. (301) 727-1999

Palatine Engineering Sales Inc., St. Louis, Mo. (314) 426-7055 • Mission, Kansas (913) 262-5643

Hytronic Measurements, Inc., Denver, Colo. (303) 388-4081 • Salt Lake City, Utah (801) 466-4924 • Albuquerque, N. Mex. (505) 268-3941 • Phoenix, Ariz. (603) 253-6104

ARVA, Inc., Seattle, Wash. (206) 622-0177 • Portland, Ore. (503) 292-8762 • Anchorage, Alaska (907) 272-5231

Ward/Davis Associates, Pasadena, Calif. (213) 684-2840 • San Diego, Calif. (714) 297-4619 • Palo Alto, Calif. (415) 968-7116



PHILBRICK/NEXUS RESEARCH

A TELEDYNE COMPANY

TYPE YH

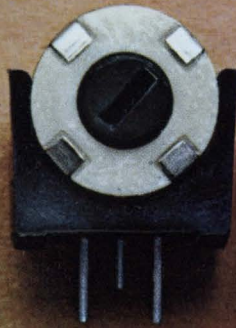

TYPE YS

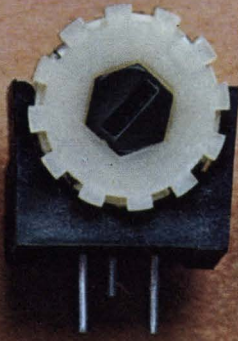

TYPE YR

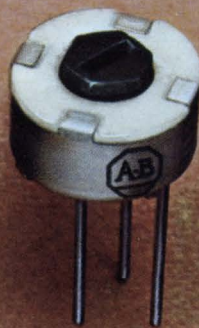

TYPE YC

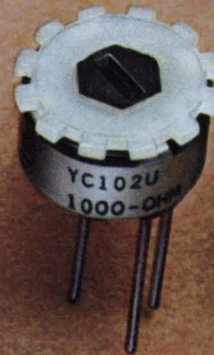

TYPE YN



best in "set" ability...best in "hold" ability

This family of Allen-Bradley trimmers features a solid resistance track made by A-B's exclusive hot-molding technique. This solid resistance element assures smooth adjustment at all times. It approaches infinite resolution—there are never any of the abrupt changes in resistance which introduce transients as is characteristic of wirewound controls.

When Allen-Bradley hot-molded trimmers are once set, they will remain stable during severe

mechanical shock and vibration. In addition, A-B trimmers have low distributed capacitance and are essentially noninductive, permitting their use at high frequencies where wirewound units are totally useless.

For complete specifications on these high performance trimmers, please write: Allen-Bradley Co., 110 W. Greenfield Ave., Milwaukee, Wis. 53204. In Canada: Allen-Bradley Canada Ltd. Export Office: 630 Third Ave., N.Y., N.Y., U.S.A. 10017.

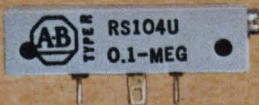

Type R trimmers are ruggedly built to maintain their settings under severe shock and vibration. Continuous resistance change is provided over 25 turns of the adjustment screw. Enclosures are dust-tight and watertight. Long operational life—accelerated tests produce less than 5% resistance change after 500 complete cycles (25,000 turns of the actuator). Rated $\frac{1}{4}$ watt at 70°C, and can be applied in temperatures from -55°C to $+125^{\circ}\text{C}$. Available in resistance values from 100 ohms to 2.5 megohms. Write for Technical Bulletin B5205.

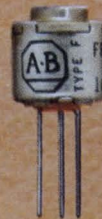

Type F trimmers are single turn controls built to withstand severe environmental condition. They are $\frac{1}{2}$ " in diameter and are rated $\frac{1}{4}$ watt at 70°C. Can be used from -55°C to $+120^{\circ}\text{C}$. Enclosure is nonmagnetic, corrosion-resistant, and watertight. Available in resistance values from 100 ohms to 5.0 megohms. Various tapers can be furnished. Send for Technical Bulletin B5201.



Type N trimmers are similar to the Type R units, and provide substantial economies where environmental conditions are not excessively severe. The 25-turn adjustment screw permits precise settings. The operational life is the same as the Type R. The enclosure is dust-tight and immersion-proof. The rating is $\frac{1}{3}$ watt at 50°C and can operate in ambient temperatures from -55°C to $+100^{\circ}\text{C}$. Available in resistance values from 100 ohms to 2.5 megohms. Please write for Technical Bulletin B5206.

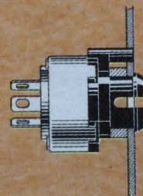

Type Y trimmers are economical single-turn units designed for use where environmental conditions are not particularly severe. The low profile construction allows them to fit easily within the commonly used $\frac{3}{8}$ " stacking. Options for the Type Y include thumb wheel and mount for horizontal installation. Type Y is also made with snap-in mount for panel mounting, as shown in drawing. Rated $\frac{1}{4}$ watt at 70°C. Resistances from 100 ohms to 5.0 megohms. Please write for technical literature.



ALLEN-BRADLEY
QUALITY ELECTRONIC COMPONENTS

<1% distortion sine, <250 ns square,
<1% linear triangular waveform outputs.

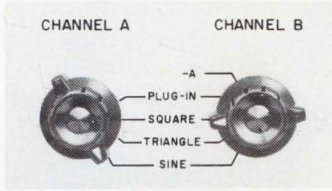

**COVER THE SIGNAL
SPECTRUM TO 100kHz
WITH HP MODEL 3300A
FUNCTION GENERATOR
AND HP MODEL 3302A
TRIGGER/PHASE
LOCK PLUG-IN!**

hp 3302A TRIGGER/PH

Multiple or Single bursts,
controlled by external signal with 360°
variable Start/Stop Phase.

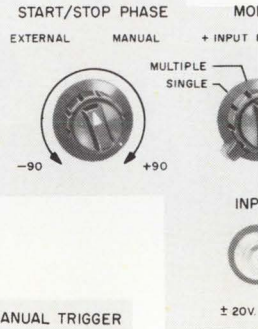

Manually select single or multiple
cycles by the push of a button. Frequency is
controlled by Frequency dial.

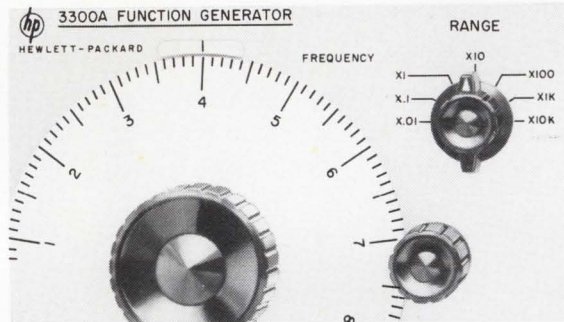

Frequency range
0.01 Hz to 100 kHz through
seven decade ranges.

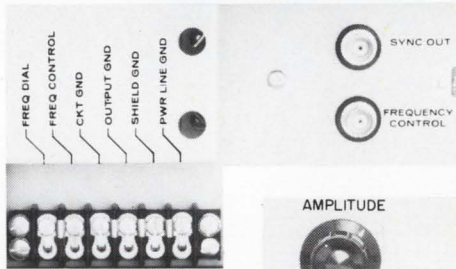

External frequency programming
greater than 1 decade can be achieved
with 0 to -10 V input.

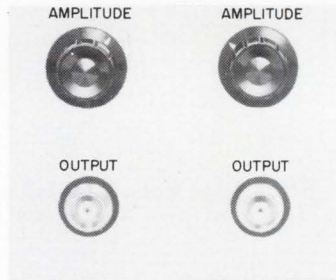

Two independently amplified fully floating
outputs with separate controls for 35 V p-p.

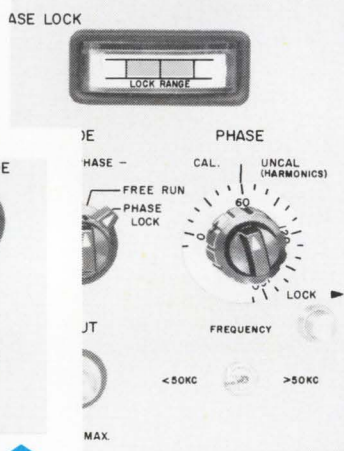

Any two functions
(sine, square or triangle) can
be phase locked to any external
periodic signal. Phase can be
controlled 360° ± 10°.

Price: hp 3300A Function Generator Mainframe,
\$625.00; hp 3301A Auxiliary Plug-In, \$20.00; or hp
3302A Trigger/Phase Lock Plug-In, \$190.00. For full
specifications, contact your nearest hp field engineer.
Or, write Hewlett-Packard, Palo Alto, California 94304.
Europe: 54 Route des Acacias, Geneva.

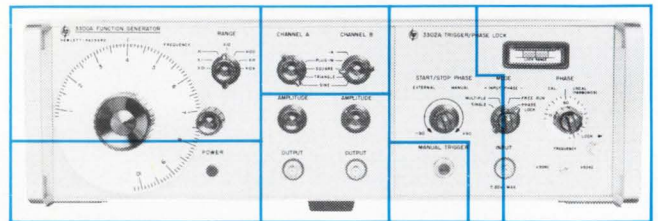

097/12

HEWLETT  **PACKARD**
An extra measure of quality

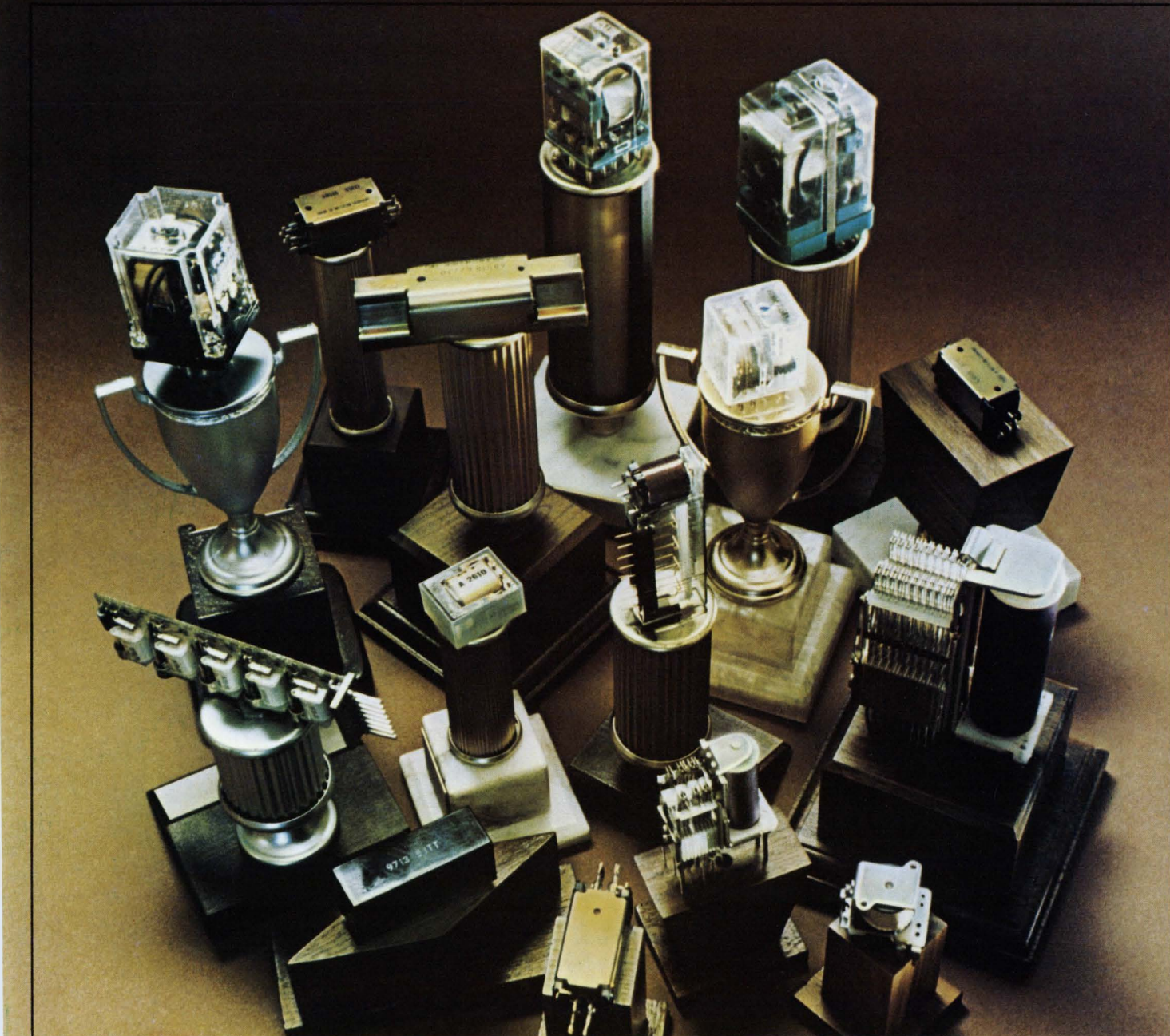

Introducing the Relay All-Stars.

The broadest, most select relay team ever assembled.

The team is new. But the individual performers are proven pros. We scouted the world-wide manufacturing facilities of ITT. Then we tested. And tested some more.

Finally, we selected the best performers from 14 ITT companies. That's

how we're able to enter the market with the most comprehensive line of quality-tested, electro-mechanical relays available.

We call them The All-Stars.

Production quantities of dry reed, mercury wetted, clapper, polarized, latching and telephone type relays are available now . . . off-the-shelf delivery.

Get your complete summary catalog. Write now to ITT Jennings, a division of International Telephone and Telegraph Corporation, 275 Meridian Road, Salinas, California 93901. Telephone: (408) 663-2501.

JENNINGS **ITT**

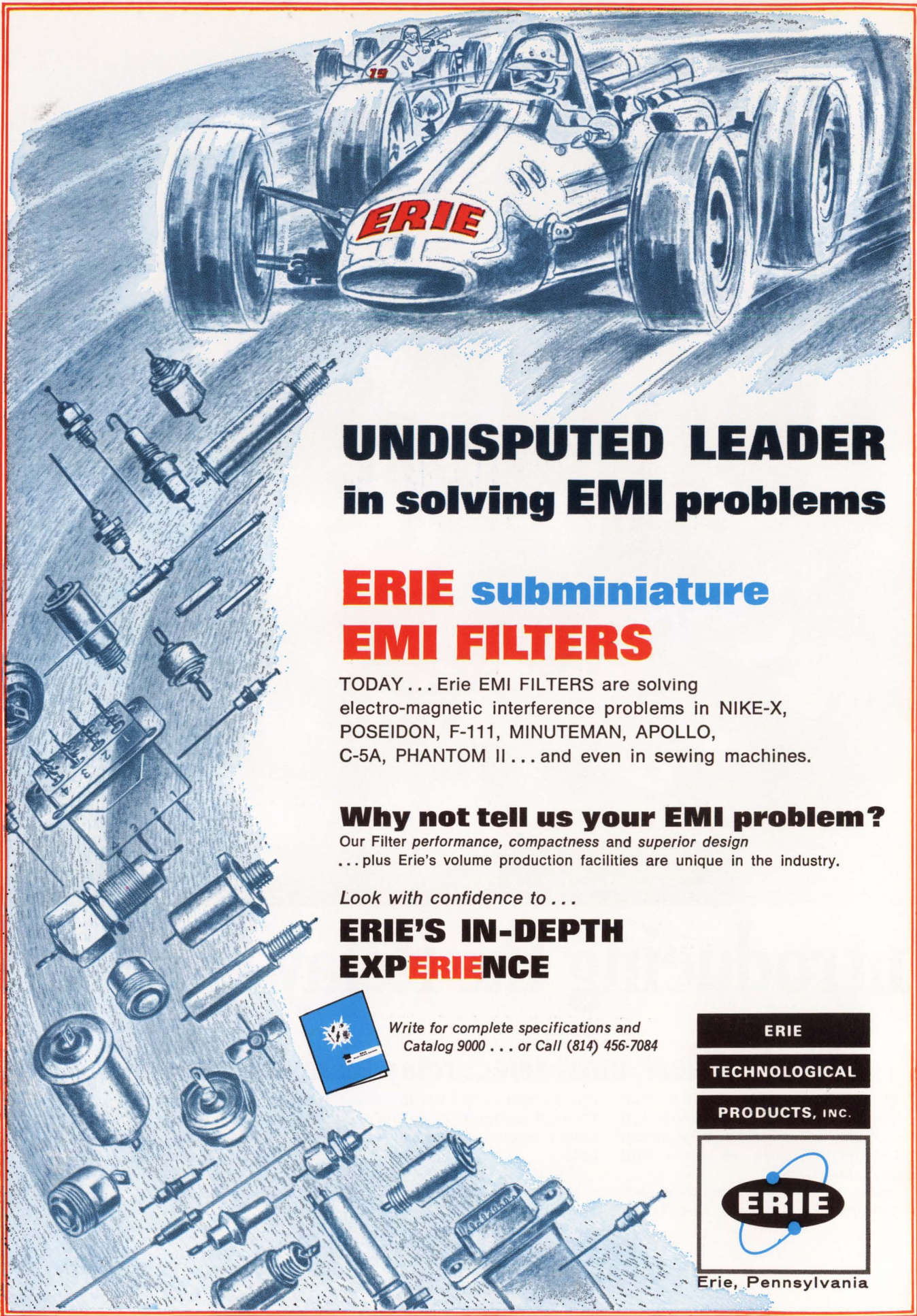

UNDISPUTED LEADER in solving EMI problems

ERIE subminiature EMI FILTERS

TODAY... Erie EMI FILTERS are solving electro-magnetic interference problems in NIKE-X, POSEIDON, F-111, MINUTEMAN, APOLLO, C-5A, PHANTOM II... and even in sewing machines.

Why not tell us your EMI problem?

Our Filter performance, compactness and superior design... plus Erie's volume production facilities are unique in the industry.

Look with confidence to...

ERIE'S IN-DEPTH EXPERIENCE

Write for complete specifications and Catalog 9000... or Call (814) 456-7084



ERIE
TECHNOLOGICAL
PRODUCTS, INC.



Erie, Pennsylvania

**Now — A Wideband
I/C op amp
With Differential
“Inputs” And “Outputs”**

Here's a new integrated circuit operational amplifier that adds a new level of flexibility to the designers' tools. The differential input gives the MC1520 extremely good common-mode rejection ratio of 90 dB (typ) — making it an excellent choice for use in instrumentation, communications and computer equipment.

The MC1520 also offers high differential gain of 70 dB (max) — numerically 3,000 — giving it wide applications potential as a general purpose operational amplifier. (Other comparable circuits offer a gain of less than 1000.) It's particularly useful in wideband applications that require large output voltage swings at high frequencies — especially those requiring differential outputs.

- Wide closed-loop bandwidth — 10 MHz.
- High input impedance — 2 Megohms.
- Low output impedance — 50 Ohms.
- Full output voltage swing to greater than 2 MHz.
@ $V_e = 100$

**Versatility of MC1520
Discussed
in New Note**

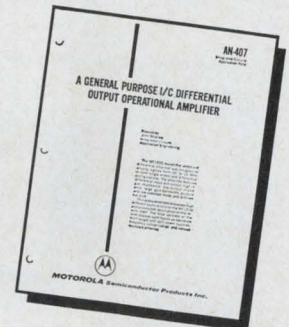

Motorola Application Note AN-407 familiarizes the designer with the electrical characteristics, operation and the unusual versatility of the MC-1520 amplifier and describes stage-by-stage operation of the device. Applications discussed include: wideband non-inverting operational amplifiers, wideband inverting operational amplifiers and differential amplifiers (with both differential inputs and differential outputs).

The MC1520 is available *now* from distributor stock, in both the TO-99 metal package and the TO-91 ceramic flat pack. For complete specifications and a copy of AN-407, write P.O. Box 955, Phoenix, Arizona 85001.

—where the priceless ingredient is care!



MOTOROLA Semiconductors

MOTOROLA SEMICONDUCTOR PRODUCTS INC. / P.O. BOX 955 / PHOENIX, ARIZONA 85001 / (602) 273-6900 / TWX 910-951-1334

Investigate Random or Periodic Processes with Correlation Function Computers

Correlation functions occupy a cardinal position in modern information theory and are basic to the analysis of random or periodic processes and the complex signals they produce. In many application areas, autocorrelation analysis allows noisy periodic or random signals to be defined, whereas crosscorrelation can determine the degree of conformity between two different noisy signals as a function of their mutual delay.

PARTM Models 100 or 101 Correlation Function Computers simultaneously compute 100 points of the auto- or crosscorrelation function in real time over delay spans from 100 microseconds to 10 seconds. The Model 101 includes the capability for insertion of fixed delay increments ahead of the 100 computed points of the function, thereby providing greater resolution. The correlation function readout which may be obtained continuously as it is computed, is available at various rates consistent with the speed of the external readout device, e.g. oscilloscope or X-Y recorder.

Vibration analysis, radio astronomy, laser research, geophysics, radar, plasma physics, aero- and hydrodynamics, and biophysics are only a few of the fields where correlation techniques are useful.

Price of the Model 100 is \$8,500. The Model 101 is priced at \$9,500 to \$12,900. Export prices are approximately 5% higher (except Canada).

For additional information, write Princeton Applied Research Corporation, Department D, P.O. Box 565, Princeton, New Jersey 08540 or call 609-924-6835.

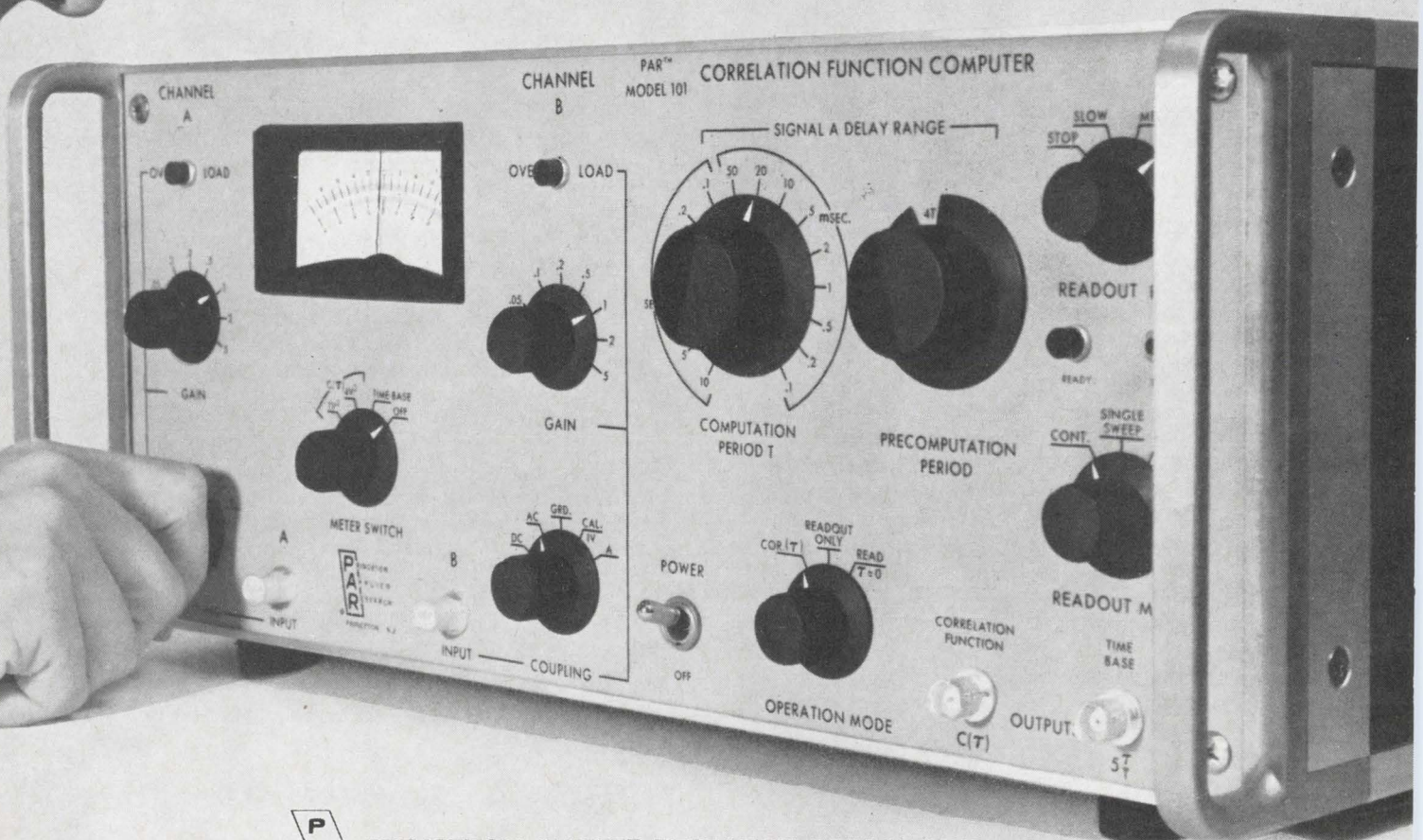

PRINCETON APPLIED RESEARCH CORPORATION

Integrated electronics

LSI, Fairchild style

Right on schedule, Fairchild Semiconductor introduced what is probably the most advanced bipolar monolithic integrated-circuit array ever offered off the shelf. So complex is the circuit that the company feels the unit is clearly the industry's first bipolar large-scale-integrated catalog product.

The chip measures 80 by 100 mils and contains a two-by-four array of cells, each of which is subdivided into quarter cells that are four-input diode-transistor-logic NAND gates. There are 32 gates in all.

LSI or not. Functionally, the IC, designated the 4500, fits the LSI definition: it's capable of performing a wide variety of subsystem logic functions. However, in complexity, the number of components within the chip falls short of the

... meanwhile, back in Dallas

Even as production lines at Fairchild were cranking out its version of a large-scale integrated circuit, Texas Instruments Incorporated was gearing up to mass-produce its entry in the field. The TI product is a 32-bit shift register that contains 76 gates, configured into four cells, and made with two layers of metalization interconnect. The circuit was designed with computer-aided design techniques. TI calls its device an IEC, for integrated electronic component. The device was developed, in part, for undisclosed computer interests, but will soon be offered to the electronics industry at large.

Unlike the Fairchild device, TI's is a complete unit. All interconnections have been made, whereas Fairchild's requires that the user make the final interconnections. TI says its circuit will also be offered without the interconnect pattern, so that users can reconfigure the circuit into something other than a 32-bit shift register.

widely used definition of LSI. And, the 4500 isn't quite a finished product; the user still has to specify the final interconnections.

An informal agreement among IC makers and users defines LSI complexity as a minimum of 100 gates per chip. Most producers continue to subscribe to this definition—

but not Fairchild Semiconductor.

Several months ago, the company came up with its own definition: two or more layers of metalization for interconnections laid out by computer-aided design [Electronics, Nov. 27, 1967, p. 50]. At that time, Fairchild also said it would deliver an LSI circuit by early 1968.

Customizing. In designing the 4500, the company turned to Micro-matrix, a two-layer version of the master-slice technique that standardizes design families of cellular arrays up to the point of metalization interconnection [Electronics, Feb. 20, 1967, p. 157]. The buyer customizes the circuit to his particular needs by indicating the interconnection pattern.

Fairchild believes this approach bridges the gap between inexpensive, high-volume, standard, small- and medium-scale integrated circuits, and the growing need for complex IC designs. The latter are typically costly and often require long turn-around time.

Fit a need. Large quantities of the 4500 wafer are being stockpiled by Fairchild. As buyers specify their building-block requirements, the company merely puts down the particular cell interconnections. Only three masking operations are

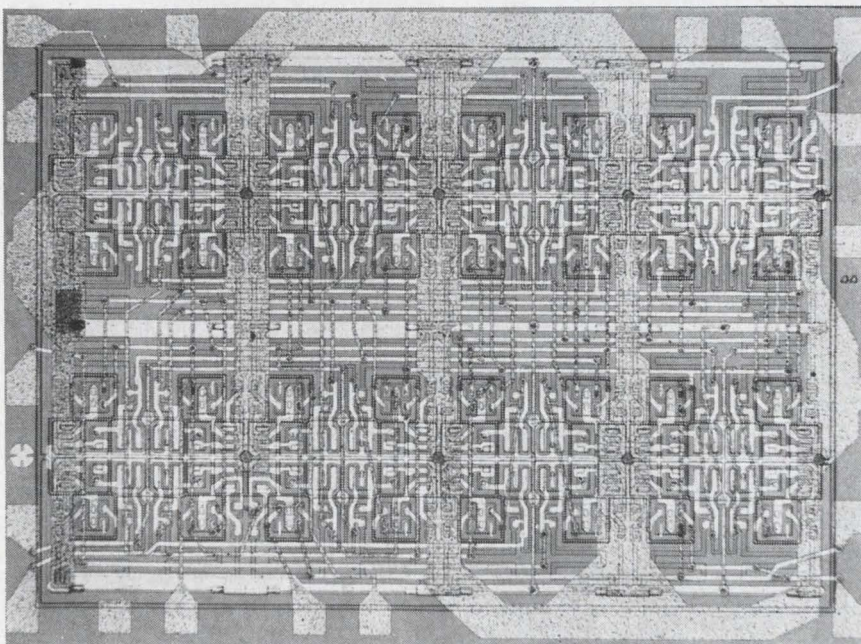

Off the shelf. Fairchild is stockpiling what it claims is the first and most advanced off-the-shelf large-scale integrated circuit.

required: first-layer metalization, dielectric insulations for interlayer connect, and second-layer metalization.

Examples of customized complex subsystems built around the 4500 are a four-bit ripple carry counter, a general-purpose four-bit shift register, and even a 32-gate array. Fairchild will deliver 4500's with extended logic option points, permitting the user to breadboard functions and verify the logic design himself. Fully connected 4500 devices, some designed by CAD techniques, are expected to be marketed later this year.

Dollars and sense. Jerome D. Larkin, LSI products manager, sees big savings once automated design is incorporated. Engineering costs alone, he says, should drop from the present \$25,000 level to \$15,000 and lead times, as well, should be

drastically reduced.

Adds Larkin: "We expect some people to quibble with our definition of LSI, but I don't care. The essence of this breakthrough is one of economics, not labels, or even technology. It's a capability we have and will build on, and the internal design freedom we are giving users will throw the challenge of design back into the logic designer's lap. He can now economically tailor a subsystem to his needs, instead of contenting himself with a number of standard IC's put together on a printed-circuit board."

Flexibility. Each quarter cell in the 4500 has three options: input AND expansion, internal OR expansion, and output open collector. The array itself will be packaged in 24-, 36-, and 50-lead flatpacks and dual in-line packages. Since gaps in the metalization make each gate a

group of four independent elements, gates from one section may be linked to gates in others.

Fairchild also plans to introduce metal oxide semiconductor arrays and products with higher gate content during the year. On the drawing boards are complementary arrangements that will combine diode-transistor and transistor-transistor logic families.

Integrating agc

The design of a solid state intermediate-frequency amplifier with good automatic gain control has always been a problem—even to skilled circuit designers. For, although agc can be achieved by merely shifting the operating current or voltage of a transistor, this method of gain reduction almost invariably alters the input and output impedances of the gain-controlled stages, producing undesirable shifts in the bandpass characteristics of the amplifier when large agc voltages are applied.

A better way to achieve gain control is to employ diode attenuators between amplifier stages. Even though this approach minimizes impedance shifts, no one has succeeded in developing an integrated circuit using this technique.

Turnaround. Motorola has found a way to integrate the agc function on an IC. Working on an improved version of a differential mode agc, Motorola's linear circuits engineers, under research chief James E. Solomon, have succeeded in developing a new IC i-f amplifier circuit that has a greater agc range than any previous i-f amplifier chip, is less susceptible to distortion in the presence of large agc voltages, and can be produced as an integrated circuit. Motorola plans to introduce the new circuit this spring.

Intended primarily for use as a video i-f amplifier in television receivers, the circuit, designated MC-1351, has an agc range of 60 decibels, and a power gain of 51 db; it is twice the gain and agc capability of Motorola's MC1550 i-f amplifier, which is currently on the market.

Electronics Index of Activity

February 5, 1968

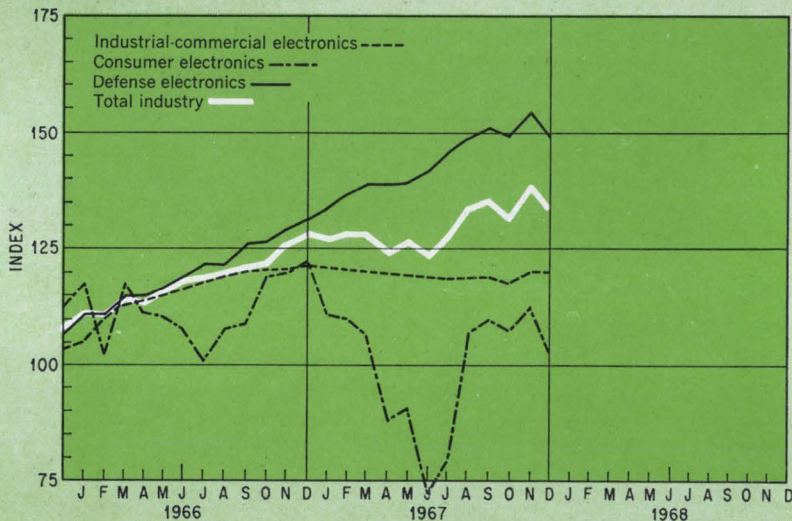

Segment of Industry	Dec. 1967	Nov. 1967*	Dec. 1966
Consumer electronics	103.1	112.9	123.8
Defense electronics	149.6	154.2	130.8
Industrial-commercial electronics	121.1	120.7	123.1
Total Industry	133.2	137.3	127.3

Electronics production declined 4.1 index points in December from the record November level. Consumer volume fell 9.8 points, halting a five-month recovery from the June low of 72.3. Defense electronics output slipped 4.6 points in the month, indicating that the rapid rise in this area since early 1966 may be over. The Federal Reserve Board has changed its method for computing raw production data, and past data for the Electronics Index of Activity has been revised to reflect this change.

Indexes chart pace of production volume for total industry and each segment. The base period, equal to 100, is the average of 1965 monthly output for each of the three parts of the industry. Index numbers are expressed as a percentage of the base period. Data is seasonally adjusted.
* Revised.

The MC1351 can be used in a tv receiver with a single-transistor output stage to provide a gain of 75 db—more than enough for the video i-f stage.

Over the range. In the schematic, at the right, gain reduction is achieved by increasing the control voltage, V_{agc} , which gradually bypasses Q_1 's and Q_2 's collector current to ground. The main feature of this gain reduction technique is that it exhibits excellent linearity over a wide agc range.

In a typical television video i-f amplifier application, the MC1351 does not require external bypass capacitors. Previously bypassed nodes are virtual grounds. And, because the operating point of the input transistor does not change with agc, the input impedance is essentially independent of agc voltage variations, greatly simplifying power supply decoupling circuitry. Moreover, the design enables a second stage to be directly coupled to it, since output voltage shift with the agc is essentially a common mode signal that can be rejected. Under conditions of equal cross-modulation, it has an improved voltage-handling capability over a single-ended input stage.

Details of the circuit will be described by Solomon and W. Richard Davis at the International Solid State Conference in Philadelphia, beginning Feb. 14.

A company spokesman said a low-cost plastic packaged version will be offered at a price that is competitive with discretetes.

Warming up to germanium

Solid state researchers have known it all along: integrated circuits made of germanium are theoretically faster than silicon. But since silicon withstands heat better than germanium—and that's where the demand was—germanium has been left out in the cold.

Engineers at the International Business Machines Corp., however, are warming up to germanium, at least for applications where circuits will be used in low-tem-

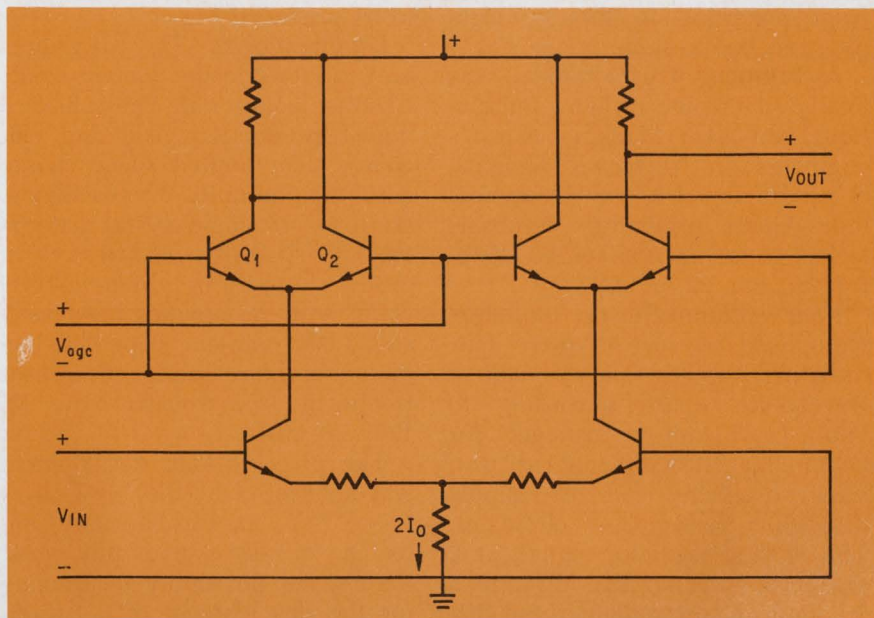

Controlling agc. Motorola's new device, the MC1351, integrates the agc function of a tv set on a single chip.

perature environments.

Researchers at the Yorktown Heights, N.Y., laboratories, have developed monolithic logic devices made from germanium that operate between 25°C (room temperature) and 77°K (liquid nitrogen), and are nearly four times faster than comparable silicon devices. Propagation delays of just a few hundred picoseconds have already been clocked.

More than speed. It's not only speed that attracts these engineers. They've found that germanium ic's, which are nonsaturating, emitter-coupled-logic types, have transistor elements with higher transconductances than comparable silicon units. Moreover, the ic stages feature smaller voltage swings, eliminating the need for level-translating diodes within the chip.

An IBM research engineer reports "small but significant savings in power dissipation, immunity to noise, and improved reliability." He linked these advantages to the use of germanium and the low-temperature operation, and to the simplified, circuit arrangement of the transistor elements.

Germanium ic's are clearly still in the research-and-development stage, and practical applications have yet to be pinned down. But some applications are already in-

triguing the IBM research team: cryogenic or near-cryogenic computers, and signal-processing equipment in such cold, hostile environments as space, under the sea, and the Arctic.

E.S. Schlig of the Yorktown Heights group will present a paper on the subject at the Feb. 14 to 16 meeting of the International Solid State Circuits Conference in Philadelphia.

Microwave

In step

The attractive thing about solid state phased-array radars is that each radiating element—and there can be thousands in a single radar—can be a small, self-contained microwave-power generating and radiating unit. Gunn-effect oscillators, if they can be made to operate in phase, would be ideal sources for such a system: they are small, potentially cheap devices that have radiated as much as a watt of peak power. They operate in the low-gigahertz to 20-gigahertz range. However, Gunn devices have been plagued with an independent streak that has kept them

from operating in groups, in a phase-locked system.

A solution. This problem was finally overcome when International Business Machines Corp.'s engineers in Yorktown Heights, N.Y., developed a way to operate four Gunn oscillators in-phase, locked to an external source [Electronics, Jan. 22, p. 25].

Four gallium-arsenide oscillators were used by IBM to drive four radiating dipoles, placed half a wavelength apart, according to Paul L. Fleming, manager for Gunn-effect development at IBM. Each oscillator fed its dipole through a three-port Y circulator. The locking-oscillator signal, at 2 gigahertz, was applied through a 4:1 lossless power divider and distributed through coaxial lines to each of the circulators.

"This is really the first time more than one Gunn device has been locked to an external source," says Fleming. "The hard part about doing it was not really in the microwave plumbing, though. It was in IBM's development of materials that would allow identical devices

to be produced."

Unidirectional. The oscillators are operating in the domain mode, Fleming points out. These have a higher production yield and efficiency than limited space charge accumulation units. The oscillators are made of single-crystal material that is specially heat-treated to produce uniform high-mobility GaAs with resistivities between 1 and 1,000 ohm-cm, depending on the temperature and length of heat treatment [Electronics, Nov. 13, 1967, p. 110].

The phase-locking development was sponsored by the Air Force's Rome, N.Y., Air Development Center. As a follow-on to this work, there's the possibility of funding for the development of a two-dimensional array having 25 or 36 elements.

Not only have the oscillators been locked together through coax, but Fleming has also successfully locked the linear array through the mutual coupling of the antennas. Locking signals are applied to the two end antennas and propagate to the remaining two dipoles. This

approach tends to save on the number of components, but in a longer array there would be a longer locking transient after the pulse is turned on.

Assessing the future of Gunn devices as solid state microwave power sources, Fleming looks to still higher powers. Average power outputs at IBM of 100 to 165 milliwatts are being attained, with one unit having reached 250 milliwatts, Fleming says. Potentially, the Gunn devices can reach higher than 1 watt, making them excellent competitors for transistors and varactor multiplier chains for producing high powers at gigahertz frequencies.

Taking command

The Pentagon's management, contracting, and research and development policies will change little as Clark M. Clifford takes over command of the Defense Department from Robert S. McNamara [Electronics, Nov. 13, 1967, p. 69]. But

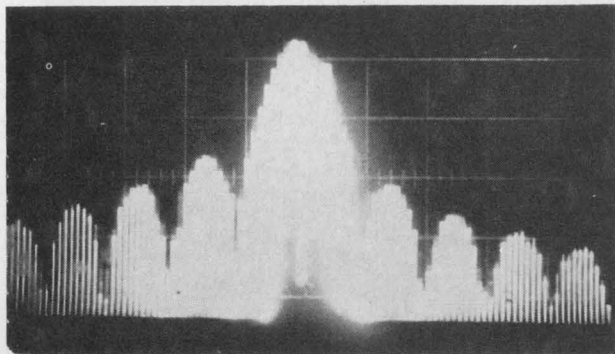

Output of phased-locked antenna array . . .

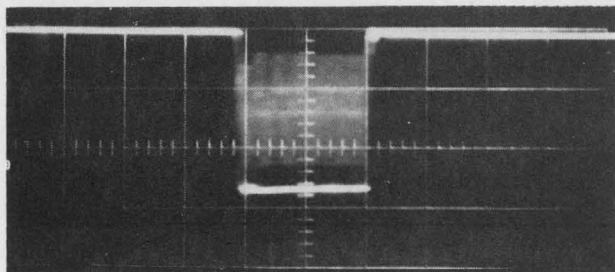

. . . provides square detector response

Four dipoles are fed by phased-locked Gunn-effect oscillators. Locking signal is distributed by coax lines to three-port circulators.

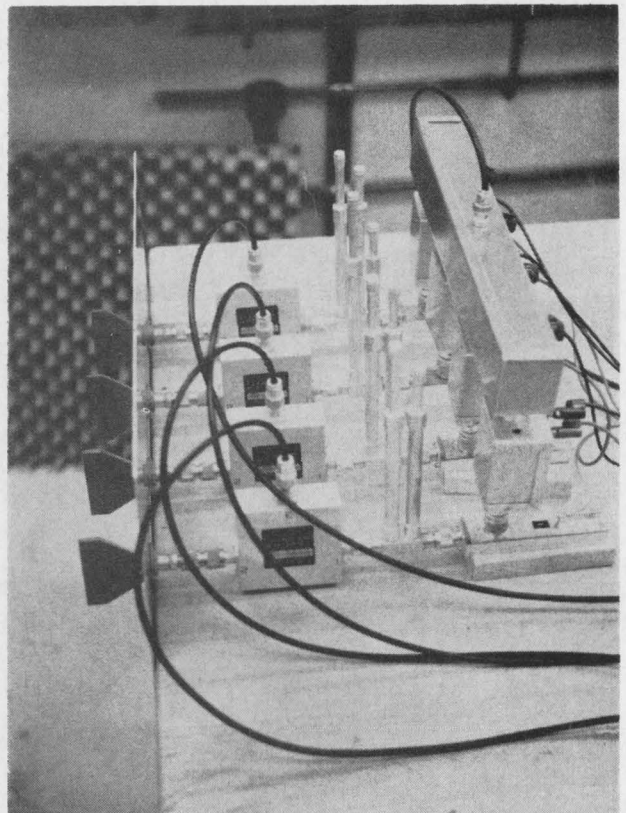

TRW Metallized Capacitors



...stand tall

Type X601PE Metallized Mylars typify TRW's stature in advanced metallized dielectrics.

They're smaller and lighter... *metallized!* Tough and rugged...

epoxy sealed! Ideal for printed circuits...*save space!*

TRW offers many additional styles and dielectrics for demanding Military and Industrial needs.

Product information is available from TRW Capacitor Division, TRW INC., Box 1000, Ogallala, Nebraska. Phone (308) 284-3611. TWX: 910-620-0321.

TRW

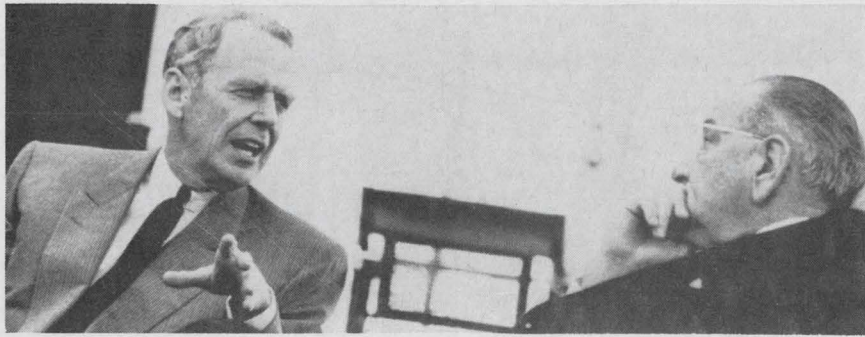

In the hot seat. Clark Clifford will soon take command as Secretary of Defense, replacing Robert S. McNamara.

there will be one big difference.

Clifford, an adviser of presidents, will try harder than McNamara to placate a Congress that has shown increasing restlessness over defense matters. And as a peace offering, Clifford may just cancel the overweight, trouble-plagued Navy version of the General Dynamics F-111—a move McNamara resolutely refused to take.

Going to the Hill. Clifford's biggest and most immediate task will be to get the operating budget, revised for the current fiscal year by McNamara, and the new one laid down for fiscal 1969, also by McNamara, through Congress.

And one of the first problems Clifford will have to face will be getting Congressional permission to carry out a massive reshuffling of funds so that the Defense Department won't have to ask for a supplementary appropriation for the current fiscal year. Increased costs, largely the result of Vietnam spending, will require another \$6 billion in obligational authority.

To achieve this without raising the \$74.3-billion spending level projected for the current year, the Pentagon plans to cut a like amount from non-Vietnam programs—a move that will affect various electronics projects.

Missile woes. For instance, the new Minuteman 3 missile, which has developed technical problems, will be held in a development stage for an extra 10 or 11 months.

Similarly, the SQ-23 sonar and a new tactical air control system are to be stretched out because of technical difficulties.

The Pentagon plans to spend \$77.2 billion in fiscal 1969, only \$2.9 billion from the level projected for this year, the smallest such rise since the Vietnam buildup began. Year-to-year increases over the past three fiscal years have been \$8 billion, \$13 billion, and \$6 billion.

Companies

H-P vs. GAO, continued

Refusing to strike the flag, the Hewlett-Packard Co. has decided to carry to the Supreme Court its fight to keep secret its cost data on off-the-shelf instruments. Last November, a U.S. Circuit Court of Appeals ruled that the government has the right to the information, even though it concerns catalog items purchased under a fixed-price contract [Electronics, Dec. 25, 1967, p. 107].

A Federal case. As a first step, the company will file a petition for a writ of certiorari—a writ calling for consideration of the records of a lower court—hoping that the court will feel that the appellate court had decided an important question of federal law that merits higher attention. A source close to the H-P legal staff points out that the appellate court's decision was the first ever given on the appropriate section of the Renegotiation Act of 1951.

H-P hopes that the Supreme Court's interest will be aroused by one or more of three questions:

- Whether the government, after entering a fixed-price contract that did not call for cost data, is still entitled to that data.
- Whether a contractor can be compelled to give it up.
- Whether the appellate court erred in its definition of the word "contract."

That court ruled that "contract" had a broad meaning, embracing not only the specific terms and conditions of the agreement, but the general subject matter, and that, since the subject matter was procurement of property, the cost data relating to the property were pertinent.

Although the chances for certiorari—and eventual full consideration by the high court—appear slim, H-P's counsel feels it's worth attempting a review because the court has a history of reviewing cases concerning the construction of language in standard government contracts.

H-P's reason for seeking review, according to board chairman David Packard, is that the case has "grave and far-reaching implications in the business community."

Free marketplace. "At issue in this case are two fundamental principles," Packard continued. "One is the preservation of a free marketplace with prices based on competitive influences rather than government formula. The other is the protection of the private affairs of business from the unwarranted intrusion of government agencies."

Packard didn't say so, but at issue also is the power of the General Accounting Office, which inspired the request for cost data. H-P and dozens of other electronics companies fear that such cost data on off-the-shelf equipment would find its way into competitors' hands.

The petition for certiorari will be filed sometime before Feb. 15, the statutory deadline. The government then has one month to file a reply and the Supreme Court is expected to accept or reject the case within a month after that. If it refuses, H-P's five-year battle will be over and it will have to yield the information.

150 MHz, 2.4 ns

New performance from probe tip to CRT!

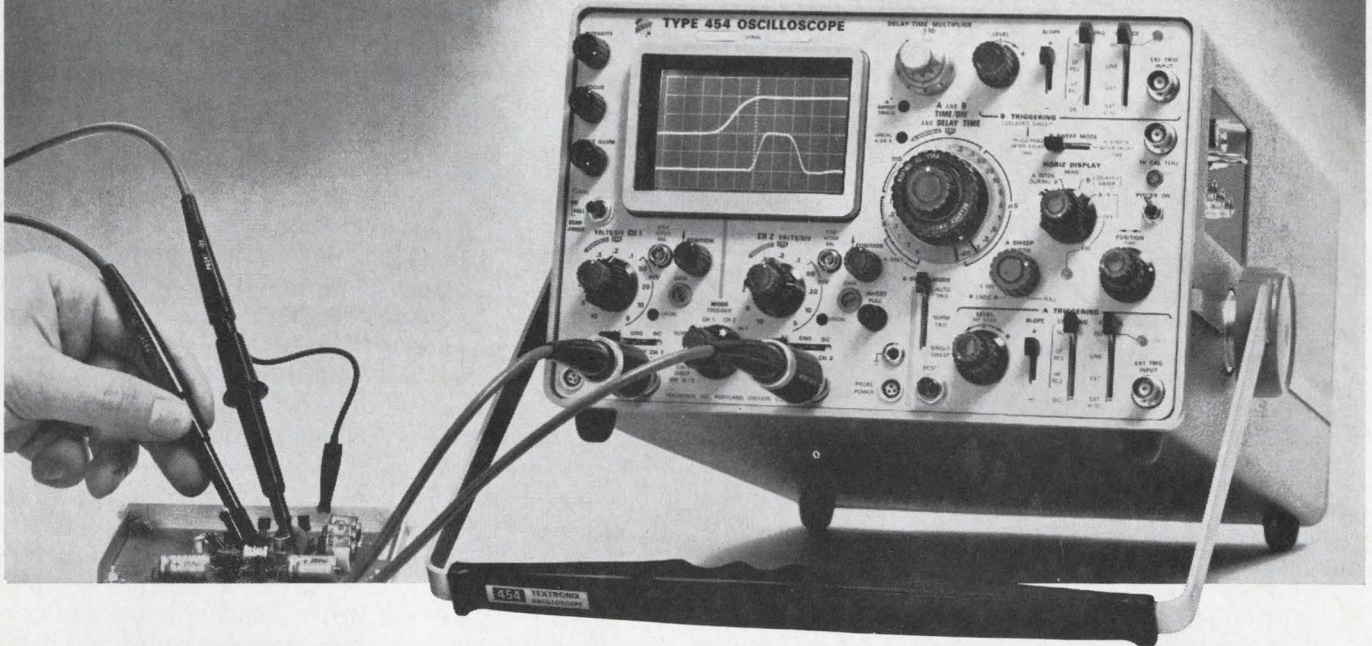

The Tektronix Type 454 is an advanced new portable oscilloscope with DC-to-150 MHz bandwidth and 2.4-ns risetime performance specified at the probe tip. The new P6047 10X Attenuator Probes and the optional FET and current probes are designed to solve your measurement problems.

The Type 454 has a dual-trace vertical, high-performance triggering, 5-ns/div delayed sweep and solid state design. You also can make 1 mV/div single-trace measurements and 5 mV/div X-Y measurements.

The dual-trace amplifiers provide the following capabilities with or without the P6047 probes:

Deflection Factor*	Risetime	Bandwidth
20 mV to 10 V/div	2.4 ns	DC to 150 MHz
10 mV/div	3.5 ns	DC to 100 MHz
5 mV/div	5.9 ns	DC to 60 MHz

*Front panel reading. With P6047 deflection factor is 10X panel reading.

The Type 454 can trigger to above 150 MHz internally, and provides 5 ns/div sweep speed in either normal or delayed sweep operation. The calibrated sweep range is from 50 ns/div to 5 s/div, extending to 5 ns/div with the X10 magnifier. Calibrated delay range is from 1 μ s to 50 seconds.

For a demonstration, contact your nearby Tektronix field engineer, or write: Tektronix, Inc., P. O. Box 500, Beaverton, Oregon 97005.

Two P6047 Miniature 10X Attenuator Probes are included with the Type 454. They have a 10 M Ω input resistance and 10.3 pF input capacitance and provide DC-to-150 MHz bandwidth with 2.4-ns risetime performance when used with the Type 454.

The Optional P6045 FET Probe features unity gain with 10-M Ω input resistance and 4-pF input capacitance. With the Type 454 it provides a system risetime of 2.7 ns and a bandwidth of DC to 130 MHz from 20 mV/div to 10 V/div without signal attenuation. Probe power is obtained from a jack on the front panel of the Type 454.

The Optional P6020 Current Probe is easy to use with its clip-on feature and it provides up to 2.4-ns risetime and 150-MHz bandwidth when used with the Type 454.

Type 454/P6020 Characteristics (454 at 20 mV/div)

P6020	Deflection Factor	Risetime	Bandwidth
1 mA/mV	20 mA/div	3 ns	8.5 kHz to 120 MHz
10 mA/mV	200 mA/div	2.4 ns	935 Hz to 150 MHz

- Type 454 (complete with 2-P6047 and accessories) \$2600
 - Rackmount Type R454 (complete with 2-P6047 and accessories) . . . \$2685
 - Type P6045 FET Probe (010-0204-00) \$ 275
 - Type P6020 with Passive Termination (015-0066-00) \$ 135
- U. S. Sales Prices FOB Beaverton, Oregon



Research and development



... part of the Tektronix commitment
to progress in the measurement sciences

Advanced technology

Cooling it

The Gunn effect and limited space-charge accumulation hold lots of promise as methods of generating microwave power. But a couple of factors keep devices employing them from reaching high power outputs: the difficulty of dissipating the heat generated during operation, and the quality of the gallium arsenide from which such bulk oscillators are made.

T.B. Ramachandran, a research scientist at Microwave Associates Inc., Burlington, Mass., may have a solution to the heat problem in a new flat oscillator configuration. While the usual Gunn device is cubic and has contacts on top and bottom, the tile-shaped Microwave Associates device is only about 100 microns thick and has both contacts on top.

Growing GaAs. Ramachandran grows his own epitaxial GaAs, working upward from a silicon substrate that forms most of the thickness of the device. Atop this is grown a 3-to-9-micron-thick layer of 1-ohm/centimeter n-type GaAs. With photolithographic techniques like those used in integrated-circuit construction, rectangular contact areas are etched out of the n-type material and filled with n-plus GaAs through liquid regrowth. Electrical contacts are bonded to the n-plus material and the oscillator is ready to be packaged.

In the new configuration, heat is carried downward into the silicon, cooling the active GaAs portion of the device. As an added benefit, the contact strips can be made longer or shorter, raising or lowering output for a given current density. Thus, a sheet device should be able to boost output without heating up as much in the first place.

But it hasn't been that easy. Although Ramachandran has achieved 3.5 watts of continuous power at 1.5 gigahertz—a new Gunn-effect record—efficiency has yet to top 0.5%. The scientist feels the problem reflects either uneven doping

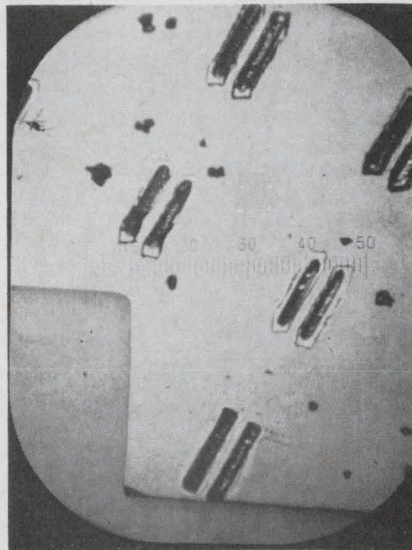

A sheet of Gunn devices. Higher microwave power is possible with better heat sinking.

of the GaAs or the failure of the test jig to couple out the device's total power. He is currently reworking both coaxial mount and GaAs production system. Hopefully, one of these will make possible operation in the limited space-charge accumulation mode, something Ramachandran has yet to achieve with a flat device.

Next step. Future experiments will include construction of devices with smaller spaces between the contact strips. On the one hand, narrower separations will make possible higher frequency output. On the other, the circuits will be harder to build, since the n-plus contact material tends to grow together and short out. Ramachandran figures that exchanging liquid regrowth for epitaxial vapor deposition of the contacts ought to solve this.

Ramachandran also wants to build devices with two contact strips of different lengths. When such devices are pulsed, as in a radar application, the shape of the output-pulse envelope depends on the relative length of the strips. For example, an oscillator with one very long and one very short contact could generate a sawtooth-shaped pulse, and make a radar pulse-forming network unnecessary.

Displays

Drawn to light

Although millions have been spent to develop a better computer display, engineers still fall back on the cathode-ray tube and mechanical printers. Both, however, have built-in disadvantages: the inherent slow speed and unreliability of the printer, the high cost and need to continuously refresh the crt display, among others.

Engineers at the General Electric Co. in Syracuse, N.Y., seeking to avoid these disadvantages, have taken an unusual approach, using magnetic domains in thin films to diffract a light beam shining on it. A pattern of long, narrow magnetic domains, called stripe domains, are set up in a film of nickel-iron alloy similar to Permalloy. These domains are made visible through a colloidal suspension of ferromagnetic particles on top of the alloy film; the particles settle on the domain walls. Because the domains are stripe-shaped, the rows of precipitated particles set up a diffraction grating.

Directed light. Ordinary white light is aimed at the film at a 45° angle; the incident and reflected rays define a plane that is perpendicular to the plane of the film. If the plane of the rays is parallel to the diffraction grating, no diffraction will occur and the light will be reflected in the ordinary way. But if the plane of the rays is perpendicular to the grating, the light will be diffracted, or reradiated in several different directions besides the direction of ordinary reflection producing an image.

A pattern of stripe domains with varying orientations sets up a visible display as incident light is reflected from some parts of the display and diffracted from others. The display can be letters and numbers, or graphic information. Because different wavelengths of light are diffracted at different angles, the display changes color (from red through the spectrum to violet) as the viewing angle changes over a range of 30° on

Now from Sprague!

QUALITY
STABILITY
RELIABILITY
SMALL SIZE



All the advantages of tantalum in one **LOW COST** capacitor!

EPOXY-DIPPED TANTALEX[®] CAPACITORS...

For industrial, commercial, and entertainment electronic applications where tantalum capacitors were previously too expensive!

⊣ Type 196D Solid-electrolyte Tantalum Capacitors have special epoxy-dip coating which keeps costs down without sacrifice in dependability. Positively seals capacitor section while providing excellent electrical insulation. Protects against mechanical damage in handling.

⊣ Radial lead design for plug-in mounting on printed wiring boards. The .250" lead spacing will fit standard .125" grids.



⊣ High stability—very little capacitance change, even at outer limits of operating temperature range.

⊣ Low dissipation factor of these capacitors permits higher ripple currents.

⊣ Meet environmental test conditions of Military Specification MIL-C-26655B.

⊣ Prime capacitance and voltage ratings. Based on rating popularity of other types of solid tantalum capacitors.

⊣ Designed for continuous operation at temperatures from -55 C to +85 C.

For complete technical data, write for Engineering Bulletin 3545 to Technical Literature Service, Sprague Electric Company, 35 Marshall Street, North Adams, Massachusetts 01247.

Now available for fast delivery from your Sprague Industrial Distributor

SPRAGUE COMPONENTS

CAPACITORS
TRANSISTORS
RESISTORS

INTEGRATED CIRCUITS
THIN-FILM MICROCIRCUITS
45C-4138R1

PULSE TRANSFORMERS
INTERFERENCE FILTERS
PULSE-FORMING NETWORKS
TOROIDAL INDUCTORS
ELECTRIC WAVE FILTERS

CERAMIC-BASE PRINTED NETWORKS
PACKAGED COMPONENT ASSEMBLIES
BOBBIN and TAPE WOUND MAGNETIC CORES
SILICON RECTIFIER GATE CONTROLS
FUNCTIONAL DIGITAL CIRCUITS



'Sprague' and '®' are registered trademarks of the Sprague Electric Co.

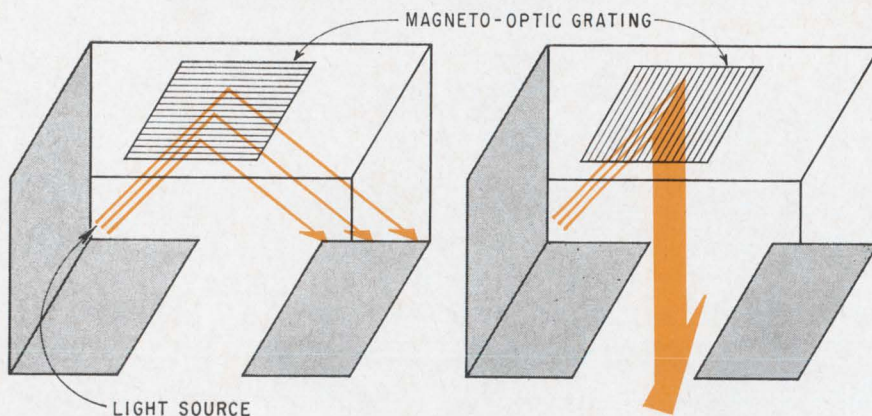

Eye-catcher. Simple display panel uses magnetic domains and a beam of light to generate alphanumeric characters on a screen.

either side of the perpendicular plane.

A coincident-current technique writes and erases the display. Underneath the nickel-iron film, on the same substrate, are two insulated layers of thin-film conductors, forming an x-y matrix, 16 mils wide and spaced 4 mils apart, so that there are 50 conductors per inch in each direction. A current through one conductor in each of the two sets isolates a single incremental area in the display and permits the direction of the stripe domains in that area to be changed.

In the models that have been built so far, a right-angle rotation of the stripes is possible in about 10 microseconds, limited by characteristics of the driving circuits; 1-microsecond writing would not be difficult to attain.

Erase, write. Thus, at a conductor density of 50 per inch, the display density is 2,500 points per square inch. At a writing rate of 10 microseconds per point, a display six inches square can be completely wiped out and replaced in about one second.

The actual writing process requires a d-c current on one of the two conductors that locate the point and an a-c current on the other. In the experimental models, the a-c frequency is 10 megahertz; a higher frequency could write faster.

The first few models have been delivered to the Army at Fort Monmouth, N.J., for experiments in military display applications. The

designers, L.E. Somers, R.E. Glusick, and J.E. Eide, will describe the details of the process at the International Solid State Circuits Conference in Philadelphia, Feb. 14 to 16.

Manufacturing

Window trimming

Most reliability engineers are familiar with the frustration of having integrated-circuit resistor elements drift out of tolerance when it's too late to do anything about it—after the device has been packaged. Drift can be triggered by the packaging process itself, or by whatever burn-in may be required for the device.

Engineers at the microelectronics laboratory of the TRW Systems group, Redondo Beach, Calif., believe they've found a way to adjust ic resistors after packaging. They're using an argon ion laser to "zap" resistor elements, beaming the light through a glass lid developed at the lab. The technique is still experimental and has been applied only to thin-film cermet resistors in linear ic's, but TRW engineers expect to be using it in production work within six months.

After the fact. Typical of the circuits to which the process has been applied is a precision instrumentation amplifier in which the feedback resistors are included in

the ic itself. Close resistor control is needed to achieve a gain of $1,000 \pm 0.5\%$, input temperature drift of 0.1 microvolt per degree centigrade, and a common-mode rejection of 100 decibels. "You've got to have post-fabrication resistor adjustment to realize these characteristics simultaneously," says David Breuer, a project engineer at the lab.

The idea of using lasers to trim resistors isn't new in itself, but C.P. Johnson, applications manager at the lab, believes his group is the first to employ the method to make adjustments after packaging. Breuer explains that with the shorting-bar adjustment technique previously used in the lab, "it's very costly and time-consuming to put probes down on the circuit, and you never know if the resistor is good because you've shorted it. Besides, the package has to be open because shorting-bar adjustment requires temperature cycling, leaving the circuit susceptible to moisture or other kinds of contamination."

In contrast, by waiting until the flatpack is sealed with a lid of Corning 7052 glass, circuit testing can be completed before the resistors are adjusted, eliminating contamination. Also, the circuit can be powered and monitored while the resistor adjustment is made. The TRW researchers have been working mainly with linear ic amplifiers, and Breuer points out that the technique allows the direct monitoring of a characteristic such as gain. "You simply pulse the laser until the amplifier gain is where you want it."

Up or down. Johnson notes that resistance values can be increased or decreased when the laser is used; the shorting-bar technique restricts the user to increasing resistance. "By controlling laser power or spot size, we can achieve almost any accuracy we want," Breuer says. "We know we've gone down to 0.01%." Johnson observes, however, that his group is shooting for consistent accuracies of 0.1%, and that he is more interested in decreasing resistance than increasing it.

Choice is the name of the game with Bendix blue chips



15 plastic power transistors, including 5 new 60-volt units

V _{CEO} @ I _C =.2A		hFE @ .5A	Max Pt @ TC =100° C
B-5000	35V	30-250	25W
B-5020	35V	30-75	25W
B-5030	35V	60-120	25W
B-5040	35V	100-175	25W
B-5050	35V	150-250	25W
B-5001	35V	30-250	14.3W
B-5021	35V	30-75	14.3W
B-5031	35V	60-120	14.3W
B-5041	35V	100-175	14.3W
B-5051	35V	150-250	14.3W
B-5002	60V	30-250	14.3W
B-5022	60V	30-75	14.3W
B-5032	60V	60-120	14.3W
B-5042	60V	100-175	14.3W
B-5052	60V	150-250	14.3W

STATIC PARAMETERS (all types)

PARAMETER	CONDITIONS	LIMIT	
		MAX.	MIN.
hFE	I _C =1A, V _{CE} =14V		20
I _{CBO}	V _{CB0} =14V, T _C =150°C	1.5mA	
I _{CEO}	V _{CEO} =25V	10mA	
V _{BE}	I _C =0.5A, V _{CE} =14V	1.2V	
V _{CE} (sat)	I _C =1A, I _B =50mA	1.2V	
I _C (Max.)		3.0A	
I _B (Max.)		1.0A	

Now you've got three families of Bendix plastic silicon power mesas to choose from. Our 35-volt V_{CEO} B-5000 series, that has pioneered the whole field of plastic encapsulated power transistors, provides you with 25 watts of dissipation at 100° C case temperature. Our B-5001 series featuring TO-66 mounting compatibility (electrical isolation *without* insulating washers, sockets or extra hardware) with V_{CEO}=35 volts. And the latest newcomer to our growing plastic line—the B-5002 series, also with the same great TO-66 compatibility, but rated at 60 volts V_{CEO}.

We call them our blue-chip line. They're blue in color, and combine high performance with competitive pricing. All of which adds up to a series of 35- and 60-volt powerhouses ideally suited for audio amplifier, voltage regulator and diversified switching applications.

That's our blue-chip line—15 quality transistors that you never have to gamble with. Why not deal yourself in today? Just contact our nearest sales office or write Semiconductor Division, The Bendix Corporation, Holmdel, New Jersey 07733.

Bendix **Electronics**

Chicago—(312) 637-6929; Dallas—(214) 357-1972; Detroit—(313) 548-2120; Greenwich, Conn.—(203) 869-7797; Holmdel, N.J.—(201) 946-9400; Lexington, Mass.—(617) 861-8350; Los Angeles—(213) 776-4100; Minneapolis—(612) 926-4633; Rochester, N.Y.—(716) 266-5550; Runnemede, N.J.—(609) 933-2550; Seattle—Ray Johnston Co., Inc. (206) LA 4-5170; Export—Cable: "Bendixint," 605 Third Avenue, New York, (212) 973-2121; Ottawa, Ont.—Computing Devices of Canada, P.O. Box 508—(613) 829-1800.

Wedge-Action*

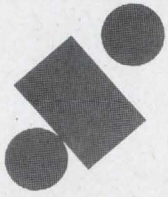

Relays

Hermetically-sealed, electromagnetic relays that provide high performance and reliability under the most difficult operating conditions in dry-circuit to 2 amp applications.

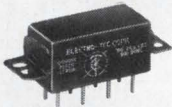

2 PDT
MARK II, SERIES 500
MIL-R-5757/9



2 PDT
MARK II, SERIES 400
(1.35" high)
SERIES 410 (1" high)
MIL-R-5757/8



6 PDT 4 PDT
(1" x 1")
MARK II, SERIES 300
(6 PDT).
SERIES 350 (4 PDT).
MIL-R-5757/1 and
MIL-R-5757/7



6 PDT
MARK II, SERIES 085
(-55°C to +85°C)
SERIES 100
(-65°C to +125°C),
SERIES 200
(-65°C to +200°C).
MIL-R-5757/1.

*Wedge-Action



The moving contacts are mounted between two stationary contacts. On actuation, they drive into the stationary contacts, creating high pressures and low

contact resistance at all current levels. In addition, wedge-action contact wipe provides self-cleaning of the precious-metal contacts.

*Patent No. 2,866,046 and others pending.

For complete data write Relay Sales and Engineering Office, P. O. Box 667, Ormond Beach, Fla. 32074, Phone 904-677-1771, TWX 810-857-0305.

Electro-Tec Corp.

SLIP RINGS • RELAYS • SWITCHES

Electronics Review

"During ordinary processing," Johnson says, "cermet resistors are stabilized by temperature cycling. The laser heats them the same way, but because it's closely localized you actually get annealing of the cermet, which brings the resistance down." The amount of annealing is governed by the spot size of the laser beam and its duration. By applying higher power, some of the cermet material can be removed, increasing resistance. "But we still don't know enough about how this affects the circuit—whether it degrades it or not," Johnson adds.

Another advantage of the laser adjustment method cited by TRW engineers is that it isn't limited to discrete increments of 5 or 10 ohms as the shorting-bar technique is.

Breuer says he doesn't have enough data yet to compare the cost of laser resistor adjustment with that of the shorting-bar process, but notes that eliminating the need for shorting bars simplifies circuit layout and frees more chip space for active devices.

Jim Buie, head of the lab's semiconductor technology section, observes that the transparent glass lid allows engineers to inspect circuits for gross failures, and though conceding that it is a little more expensive than a metal lid, he admits that sealing with the glass is harder than sealing with a metal lid.

For the record

Check out. Although a number of banks have experimented with computerized purchasing, the Hempstead Bank, Hempstead, N.Y., is going to be the first to install such a system on a permanent basis. The bank has ordered 100 terminals—50 for its teller windows and the rest for retail outlets—from the Electrospace Corp., Glen Cove, N.Y., plus a Burroughs B-2500 computer. The computer will be linked by telephone lines to the terminals, which will have card-dialed phones. As purchases are made, the sales clerk will enter at the terminal both the store's and the purchaser's iden-

tification, along with the amount of the purchase. The computer will then transfer that amount from one account to the other and print a record of the transaction.

School work. An experimental computer-assisted instruction system that has conventional tv sets and pushbutton telephones instead of costly input-output terminals is being tested by IBM at Catholic schools in Brooklyn, N.Y. Two new pieces of hardware have been developed for the system: a voice-response subsystem in the computer to store words digitally on a rotating magnetic disk, and a buffer unit to store slides at the tv set and hold them on the screen. Instead of pulse-code modulation, which requires complicated converters, delta modulation is used to store voice information. Presently, the buffer unit records the tv signals on a disk, but IBM is also working with continuous-loop tapes and delay lines.

New deal. In a continuing effort to divest itself of troublesome operations, the Fairchild Camera & Instrument Corp. announced plans to sell its memory-products group to the Data Products Corp., Culver City, Calif., a maker of high-speed line printers, memory systems, and other computer-oriented products.

Got his number. John B. Gunn, an IBM researcher, has been granted a U.S. patent on his development of a solid state device capable of generating microwaves.

Plant plans. The Raytheon Co.'s Equipment division will build a 400,000-square-foot plant in Hudson, Mass., to produce hardware for Sentinel missile-site radar, and possibly domestic air traffic control radar and microwave communications gear.

Looking good. The Control Data Corp. has announced that its sales in the six months ended Dec. 31 amounted to \$163,938,959, up a whopping 48% from the year-earlier period.

Hands up. The Los Angeles Police Department has awarded a three-year, \$375,000 contract to the Litcom division of Litton Industries Inc. to develop and install a facsimile identification network that will enable arresting officers to run fast identification checks.

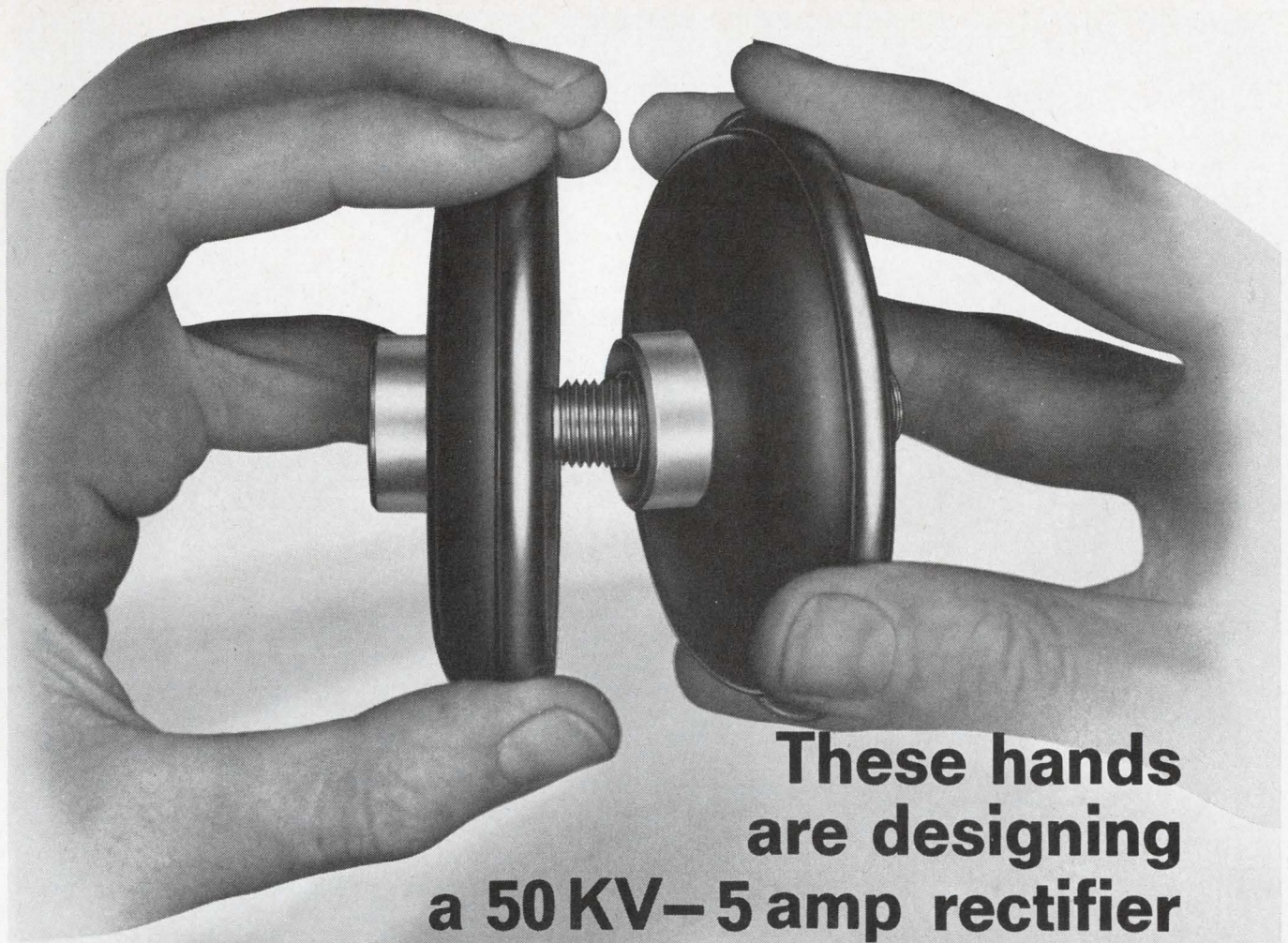

These hands are designing a 50 KV–5 amp rectifier that is virtually fail-proof.

It's no oversimplification. They do work, they don't fail, and you can screw together almost any assembly you need up to 600 KV from the 14 stackable modules we have on the shelf. PIV's from 2.5 KV to 15 KV and currents to 10 amps. The men who designed these modules were high-voltage engineers. They knew the high-voltage engineering had to be done in the module before you started stacking. That's why they built in protection against transient surges. That's why they built in things like an anti-corona ring, shunt capacitance and controlled gradients. And that's why we haven't seen a legitimate failure of one of these devices in 3 years. Look . . .

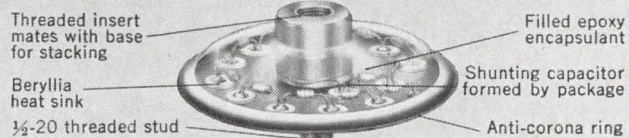

THE DOORBELL RECTIFIER MODULE BY
UNITRODE

580 Pleasant St., Watertown, Mass. 02172, (617) 926-0404



Get yourself a complete set of specs that give you all kinds of information too detailed to put in this ad. Circle the reply card number now.

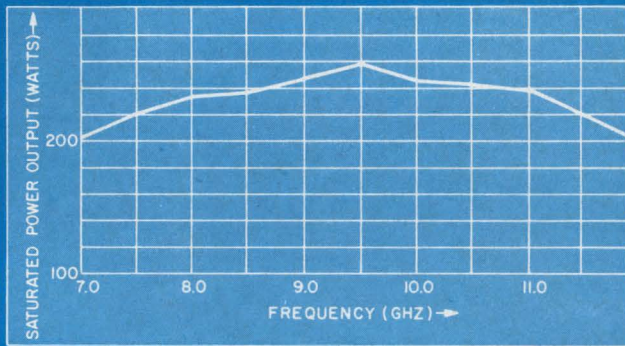
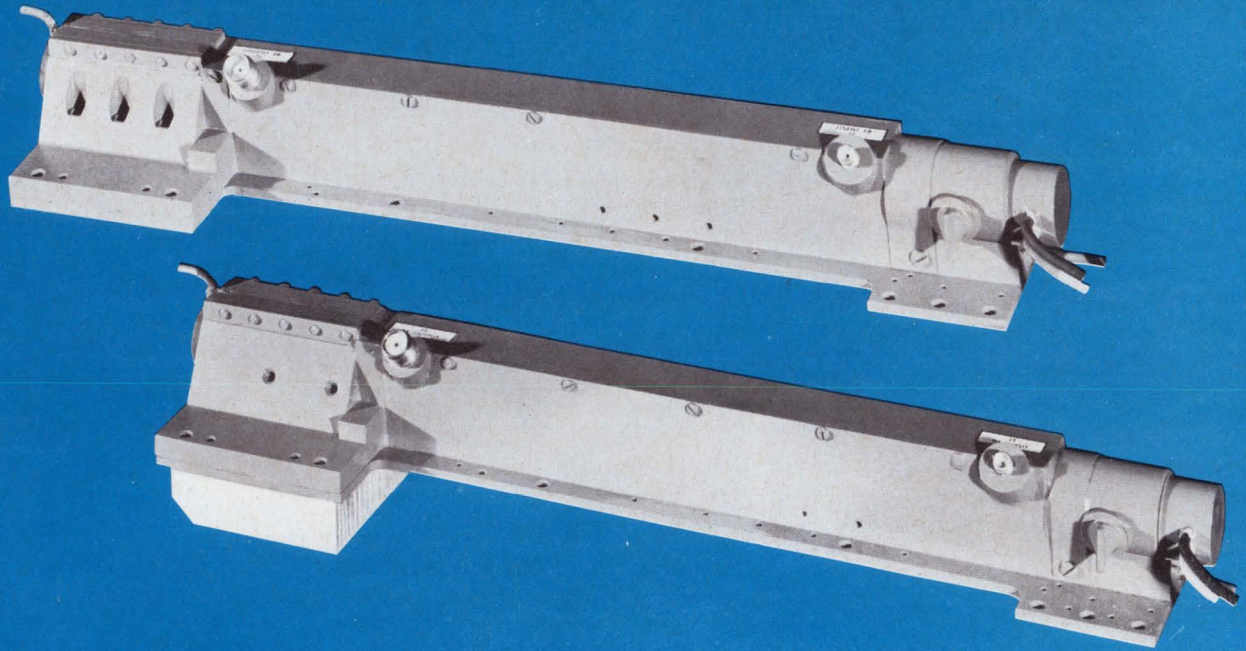

TYPICAL SATURATED OUTPUT POWER VS FREQUENCY, STX-5220

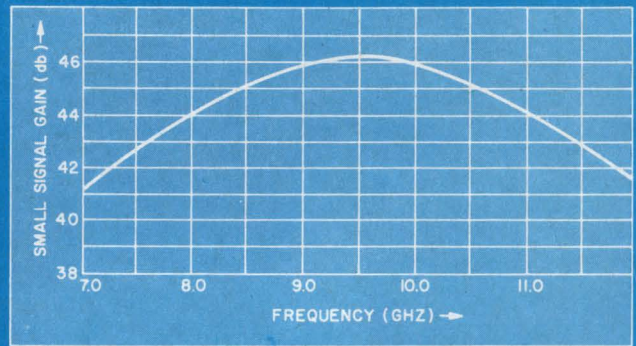

TYPICAL SMALL SIGNAL GAIN VS FREQUENCY, STX-5220

SPERRY OFFERS WIDE BAND, 200 WATT, CW TWTS AT C AND X BANDS

Sperry has news for system designers who need high power broadband performance in commercial or military communication satellite ground terminals, airborne radars, augmentors or ECM applications. In X band, it's the STX-5220, a PPM focused tube that delivers a minimum 200 watts of power from 7 to 11 GHz. Typical small signal gain is 40 db.

The STX-5220 is also available with a matched power supply and a wide selection of input voltages. The tube can be provided for either forced air or conduction cooling. This compact, rugged, high power device is only 15 $\frac{1}{8}$ " long and weighs 6 pounds.

Sperry also offers a C band (4 to 7 GHz) version of the 200 watt CW tube, designated the STC-5210. This tube offers the same advantages as its X band counterpart. Contact Cain and Co., or write Sperry Electronic Tube Division, Gainesville, Fla., for full details on either model.

SPERRY ELECTRONIC TUBE DIVISION, GAINESVILLE, FLORIDA

Washington Newsletter

February 5, 1968

Firms meet to plan action to aid cities

An eight-company consortium that hopes to apply systems analysis to major urban problems is now meeting on the West Coast to study specific situations it may tackle. The group, being organized by Gen. Bernard Shriever and his new consulting firm [Electronics, Jan. 22, p. 23], is negotiating with several other firms and would like to recruit still more. The total might reach 14.

If the companies can agree, **the consortium may make a major proposal to a city or state government in about three or four months.** The group, recognizing that no one company can lay out the money it will take to get large programs rolling, is ready to invest millions of dollars. The pay-off on such work could take as long as five years to realize.

Present aerospace and electronics members include Raytheon, Control Data, Emerson Electric, Lockheed, Northrup, and Aerojet-General. Others in the group are the American Cement Co. and the Ralph M. Parsons Co.

Navy eyes Cheyenne as river-war copter

The Navy may buy the Army's AH-56A Cheyenne for its own use. The compound helicopter, which barely scraped by the Pentagon's cost-versus-value tests to get into production, is now being looked at by the Navy as a gun platform in its recently organized river warfare program. The Army, which has been fighting rising costs on the helicopter, is delighted with the Navy's interest, since a longer production run would trim the cost per craft.

The office of Naval Inshore Warfare seems to be leaning toward a Cheyenne carrying the same weaponry and avionics the Army is buying from Lockheed [Electronics, Jan. 22, p. 51].

Linotron is success at Printing Office

The Government Printing Office is so pleased with the first three months' experience with its new high-speed, crt-driven phototypesetting equipment that it has asked **no design modifications in a second unit scheduled for delivery this summer.** Called Linotron, the equipment is the result of a joint project of the Mergenthaler Linotype Corp. and CBS Laboratories [Electronics, April 3, 1967, p. 113].

While there have been no problems with the equipment, **programing remains a major hangup.** "We're breaking new ground and have to program each job," a source at the agency explains. "This is a tremendous task, but it will diminish when we get a library of programs."

NASA gets boost for ERTS project

NASA's Earth Resources Technology Satellite (ERTS) project will move along at a faster clip than the \$12 million earmarked for it in the fiscal 1969 budget would indicate. **The space agency is counting on additional funds for sensor development from the Agriculture and Interior Departments.** Both have shown great interest in ERTS and are asking for more R&D funds.

The space agency is considering modifying an existing satellite design—possibly Nimbus or Tiros-M—for ERTS. **This would mean that the \$2 million NASA is seeking for development of an ERTS satellite could go a long way.**

Washington Newsletter

Doubt fast action on radiation bill

Despite President Johnson's call for "protection against hazardous radiation from tv sets and other electronic equipment" in his State of the Union message, don't look for speedy passage of a radiation-protection bill during this session of Congress. Sen. E. L. Bartlett (D., Alaska), who introduced the bill in the Senate, had hoped to hold hearings this month. But he is still recovering from a heart attack. Rather than introduce a separate Administration bill, the White House is expected to go along with the bill submitted by Bartlett, and Rep. Paul Rogers (D., Fla.) in the House.

FCC rulings blunt computer probe

Two recent FCC actions have muddled the agency's coming investigation of computers in communications. Companies and trade groups scheduled to file comment are surprised by the FCC's decisions to allow Western Union to start a computer-based service providing brokers in 15 cities with market data, and also to permit RCA to continue with its computerized airline information and reservation system without an FCC-regulated price scale.

Manufacturers of the display and control equipment used by brokers are asking the FCC to suspend Western Union's service and investigate its rates. The firms claim they're at a disadvantage because they can't compete with common carriers. In the RCA case, the FCC refused requests to make an interim decision on the ground it might prejudice the computer inquiry. However, notes the agency, "it may finally be determined that computerized switching services, whether offered by common carriers or others, are subject to rate regulations."

Broadcasters gird for spectrum fight

Television broadcasters are readying a war chest to finance their battle against allocating tv spectrum to land mobile radio users. The National Association of Broadcasters and the National Association of Educational Broadcasters are planning to pay for studies supporting their stand.

NAB, in a sharply worded letter to FCC chairman Rosel Hyde, criticized the agency's report that urged additional spectrum for land mobile radio [Electronics, Dec. 11, 1967, p. 68]. The association—whose member radio and tv stations are land mobile users themselves—also complained about not being included on the FCC-appointed panel.

Navy may cut F-111 but retain missile

Though it now seems certain the Navy will get Pentagon approval to dump the trouble-plagued F-111B before it becomes operational, work will continue on the plane's avionics and missile systems. The airborne missile control system and the Phoenix missile, both being developed by Hughes Aircraft, would go on a lighter, less costly fighter.

The Navy already has quietly solicited proposals from four plane makers: Grumman, LTV Aerospace, McDonnell Douglas, and North American Rockwell. Grumman, the builder of the F-111B, is said to have reservations about the aircraft's suitability for carrier operations.

Watkins to become FCC chief engineer

William Watkins, deputy chief engineer of the FCC, is expected to succeed Ralph J. Renton as chief engineer. Renton, who held the post for almost two years, retired last week after 36 years with the agency. Watkins, an advocate of greater FCC involvement in research and technical planning, has been with the agency since World War II. He holds both a law and an engineering degree.

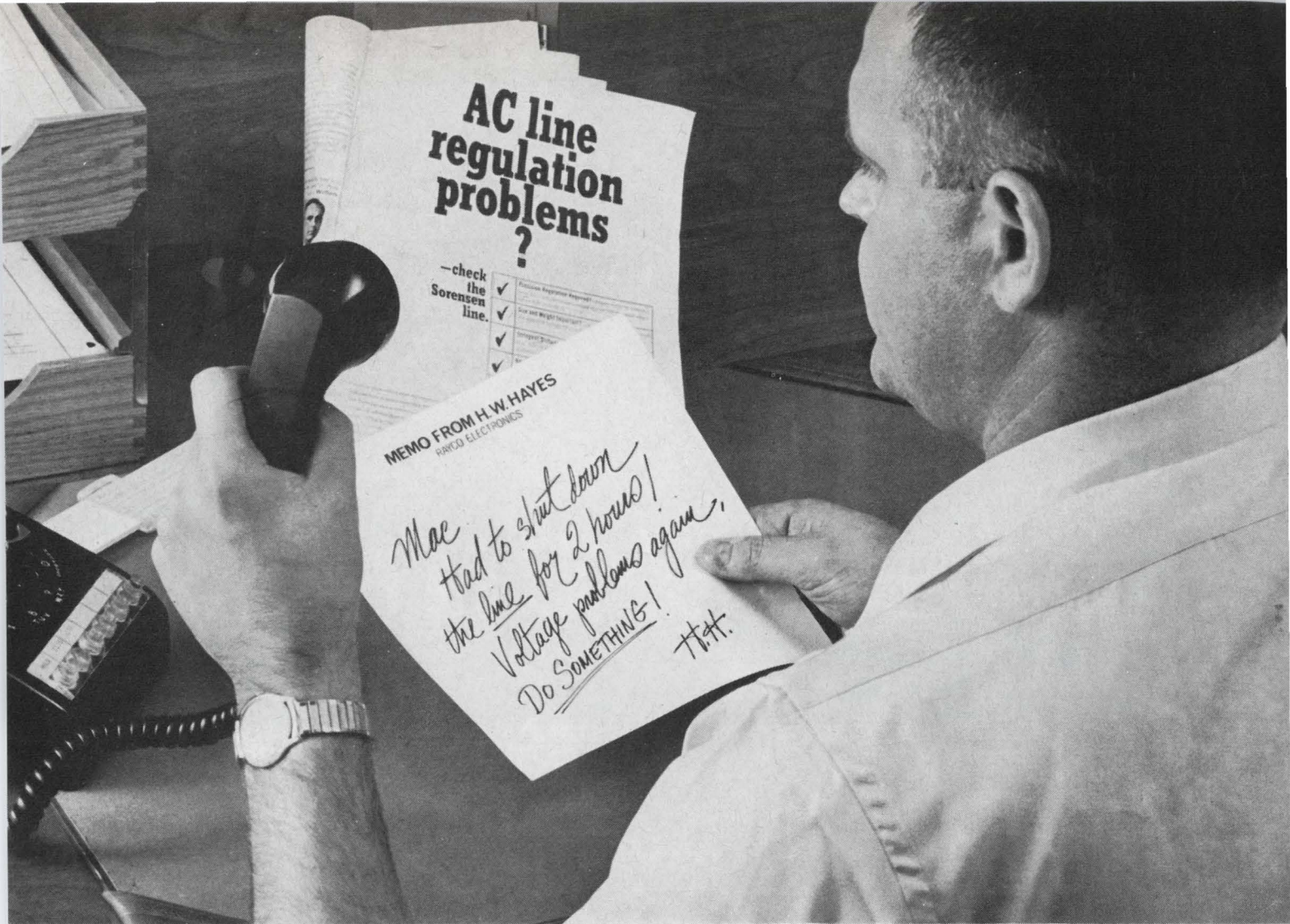

Call Sorensen

203-838-6571

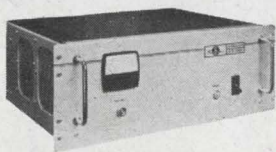

... for the solution to your voltage problems! As you know, AC line regulation is the single, most effective preventive maintenance measure you, or any other engineer can specify. Regulation reduces costly production line down-time, and insures precision laboratory instrument performance. Whether your problem is on the production line or in the laboratory, there are Sorensen regulators, available from 150 VA to 45 KVA, that will more than satisfy those "DO SOMETHING" demands.

The Sorensen ACR Series combines SCR regulation, printed circuit maintainability, with up to 60% size and weight reduction over conventional units. The 0.01 Series provides $\pm 0.01\%$ precision regulation for problems de-

manding the strictest accuracy and stability. Where fast response and high accuracy is important, models of the FR Series respond to line and load changes within 50 μsec —considerably less than one cycle. Where size is not a factor, Sorensen's magnetic-amplifier S Series offers most effective, low-cost regulation. Each of Sorensen's 27 models have been expertly designed to solve specific voltage problems. We've been experts at solving regulation problems for over a quarter of a century.

For details on AC Line Regulators or DC Power Supplies, call or contact your local representative, or: Raytheon Company, Sorensen Operation, Richards Avenue, Norwalk, Connecticut 06856. Telephone: 203-838-6571; TWX 710-468-2940.

RAYTHEON

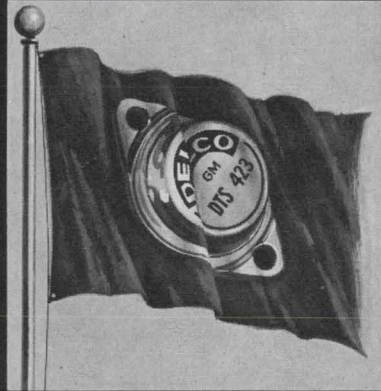

The Kokomoans

When it comes to high voltage semi-conductors, come to us. Power is our specialty.

We were the first supplier, for example, to mass produce power transistors.

The first to develop high energy silicon power transistors with voltage capabilities of up to 700 volts, current to 10 amps.

The first to build silicon transistors suitable for large-screen color and black-and-white TV deflection.

The first to develop practical micro-circuitry for the automotive IC voltage regulator.

And we mass produce diodes for use in

automotive generators.

Such achievements were no accident, of course. We're in the industrial control, entertainment, communications and automotive fields. Our products include stereotape systems for cars, car radios, digital systems and portable military communications equipment. So we know what the end-use requirements are. We know how to meet those requirements. And we know how to meet them in volume (our daily production of semiconductors, for instance, would make a line five miles long).

To meet today's requirements, we make rectifiers. High voltage silicon transistors. High power germanium alloy transistors. High and medium power germanium diffused base transistors. For use in such applications as DC and switching regulators, high power con-

SEMICONDUCTOR DISTRIBUTORS: EAST—BALTIMORE, MD. 21201, Radio Electric Service Co., 5 North Howard Street, (301)-539-3835 BINGHAMTON, N.Y. 13902, Federal Electronics, Inc., P. O. Box 1208, (607)-748-8211 CLIFTON, N.J. 07015, Eastern Radio Corporation, 312 Clifton Avenue, (201)-471-6600 NEWTON, MASS. 02195, The Greene Shaw Co., Inc., 341-347 Watertown St., (617)-969-8900 NEW YORK, NEW YORK 10036, Harvey Radio Co., Inc., 2 West 45th St., (212)-582-2590 PHILADELPHIA, PENN. 19123, Almo Industrial Electronics, Inc., 412 North 6th Street, (215)-922-5918 PITTSBURGH, PENN. 15206, Radio Parts Company, Inc., 6401 Penn Ave., (412)-361-4600 WOODBURY, L. I., N.Y. 11797, Harvey Radio Company, Inc., 60 Crossways Park West, (516)-921-8700 **SOUTH**—BIRMINGHAM, ALA. 35233, Forbes Distributing Company, Inc., 1416 Fourth Ave., South, (205)-251-4104 MIAMI, FLORIDA 33142, Mountain Electronics, Division of Mountain National Co., 3730 Northwest 36th St., (305)-634-4556 RICHMOND, VA. 23220, Meridian Electronics, Inc., 1001 West Broad Street, (703)-353-6648 WEST PALM BEACH, FLA. 33402, Mountain Electronics, Division of Mountain National Co., 1000 N. Dixie Highway, (305)-833-5701 **MIDWEST**—CINCINNATI, OHIO 45237, United Radio, Inc., 7713 Reinhold Drive, (513)-761-4030 CLEVELAND, OHIO 44125, The W. M. Pattison Supply Co., Industrial Electronics Division, 4550 Willow Parkway, (216)-441-3000 INDIANAPOLIS, IND. 46225, Graham Electronics Supply, Inc., 122 South Senate Avenue, (317)-634-8486 KALAMAZOO, MICH. 49005, Electronic Supply Corp., P. O. Box 831, (616)-381-4626 KANSAS CITY, MO. 64111, Walters Radio Supply, Inc., 3635 Main

are in power.

verters, ultrasonic power supplies, computer hammer drivers, VLF class C amplifiers, off-line class A audio output and CRT deflection—just about *any* power switching or amplification job.

And we make them on time. At competitive prices. With uniform, high-quality reliability.

For more information on Delco power semiconductors, contact your local Delco distributor or Delco sales office. Take advantage of the powers that be—*from the Kokomoans.*

FIELD SALES OFFICES

Union, New Jersey* 07083
Box 1018 Chestnut Station
(201) 687-3770

Chicago, Illinois* 60656
5151 N. Harlem Avenue
(312) 775-5411

Syracuse, New York 13203
1054 James Street
(315) 472-2668

Santa Monica, Calif.* 90401
726 Santa Monica Blvd.
(213) 870-8807

Detroit, Michigan 48202
57 Harper Avenue
(313) 873-6560

Kokomo, Ind. 46901
700 E. Firmin
(317) 459-2175 Home Office

*Office includes field lab and resident engineer for application assistance.



MARK OF EXCELLENCE

DELCO RADIO
DIVISION OF GENERAL MOTORS
KOKOMO, INDIANA

Street, (816)-531-7015 MINNEAPOLIS, MINNESOTA 55401, Stark Electronics Supply Co., 112 3rd Ave., North, (612)-332-1325 SKOKIE, ILL. 60076, Merquip Electronics, Inc., 7701 N. Austin Ave., (312)-282-5400 ST. LOUIS, MO. 63144, Electronic Components for Industry Co., 2605 South Hanley Road, (314)-647-5505 WEST—ALBUQUERQUE, N. M. 87103, Sterling Electronics, Inc., 1712 Lomas Blvd., N. E., (505)-247-2486 DALLAS, TEXAS 75201, Adleta Electronics Company, 1907 McKinney Ave., (214)-742-8257 DENVER, COLO. 80219, L. B. Walker Radio Company, 300 Bryant Street, (303)-935-2406 HOUSTON, TEXAS 77001, Harrison Equipment Co., Inc., 1422 San Jacinto Street, (713) 224-9131 LOS ANGELES, CAL. 90015, Radio Products Sales, Inc., 1501 South Hill Street, (213)-748-1271 LOS ANGELES, CAL. 90022, Kierulff Electronics, Inc., 2585 Commerce Way, (213)-685-5511 OKLAHOMA CITY, OKLAHOMA 73102, Radio, Inc., 903 North Hudson, (405)-235-1551 PALO ALTO, CAL. 94303, Kierulff Electronics, Inc., 3969 East Bayshore Road, (415)-968-6292 PHOENIX, ARIZ. 85005, Sterling Electronics, Inc., 1930 North 22nd Ave., (602)-258-4531 SAN DIEGO, CAL. 92101, Milo of California, Inc., 2060 India Street, Box 2710, (714)-232-8951 SEATTLE, WASH. 98108, Kierulff Electronics, Inc., 5940 6th Ave., South, (206)-763-1550 TACOMA, WASH. 98402, C & G Electronics Company, 2502 Jefferson Ave., (206)-272-3181 TULSA, OKLAHOMA 74119, Radio, Inc., 1000 South Main Street, (918)-587-9124 CANADA—SCARBOROUGH, ONTARIO, Lake Engineering Co., Ltd., 123 Manville Rd., (416)-751-5980

Circle 63 on reader service card

Circle 65 on reader service card—>

Breakthrough: strip and terminate

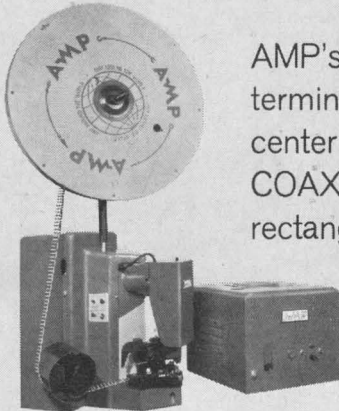

AMP's new exclusive automatic tooling strips cable, assembles ferrule, and terminates strip-form contacts. One stroke crimps ferrule, braid and center conductor. Uniformly reliable terminations. No solder. No heat. COAXICON[★] contacts fit all RG/U subminiature cable sizes. Use them with rectangular M Series connectors, rack-and-panel D, DD, W, or WW Series connectors, modular G Series or subminiature circular connectors. Mix power signal or coax in the same connector. Low VSWR, 500-volt dielectric, uniform gold plating. Axiomatic coax.

*Trademark of AMP Incorporated

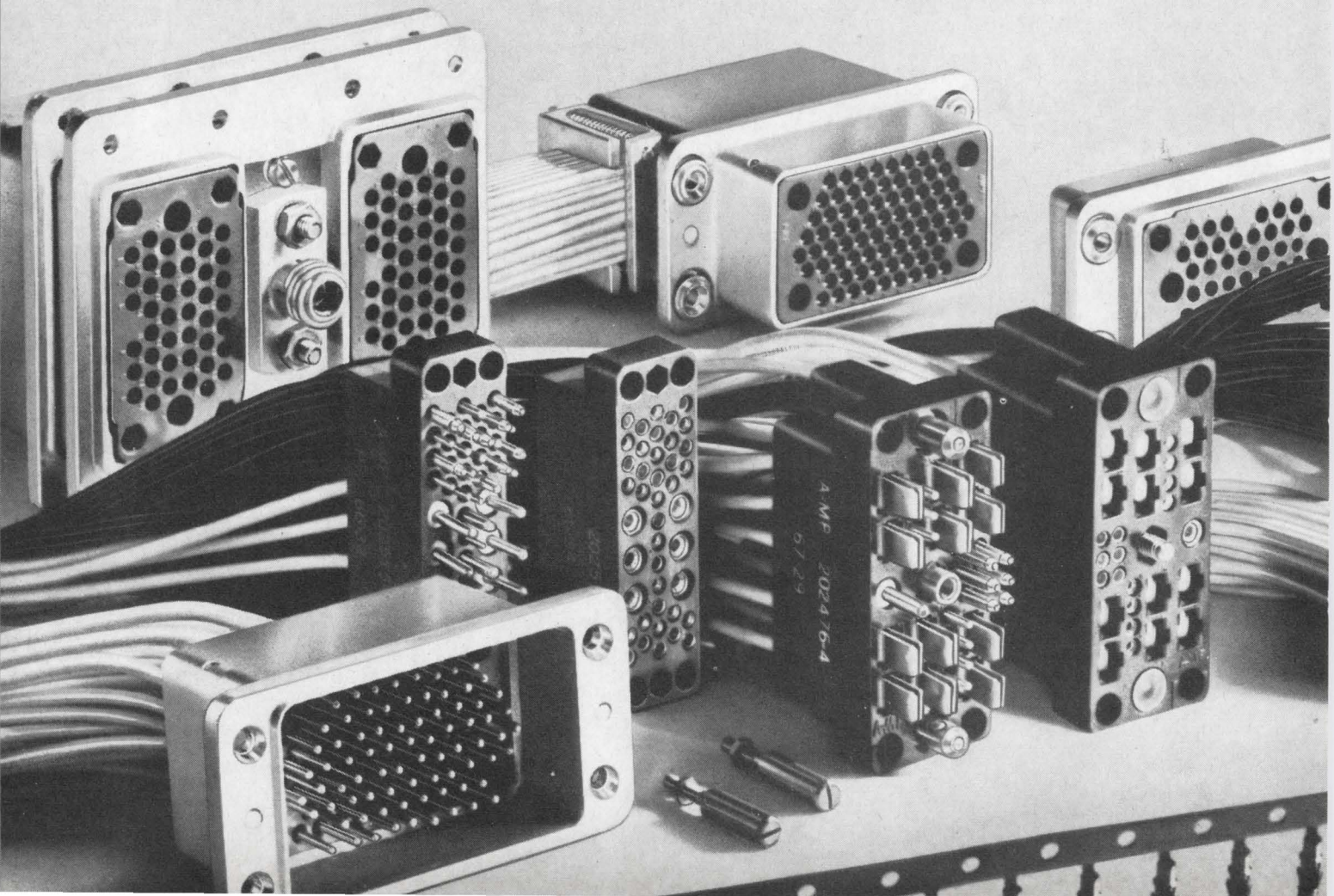

coax in 20 seconds

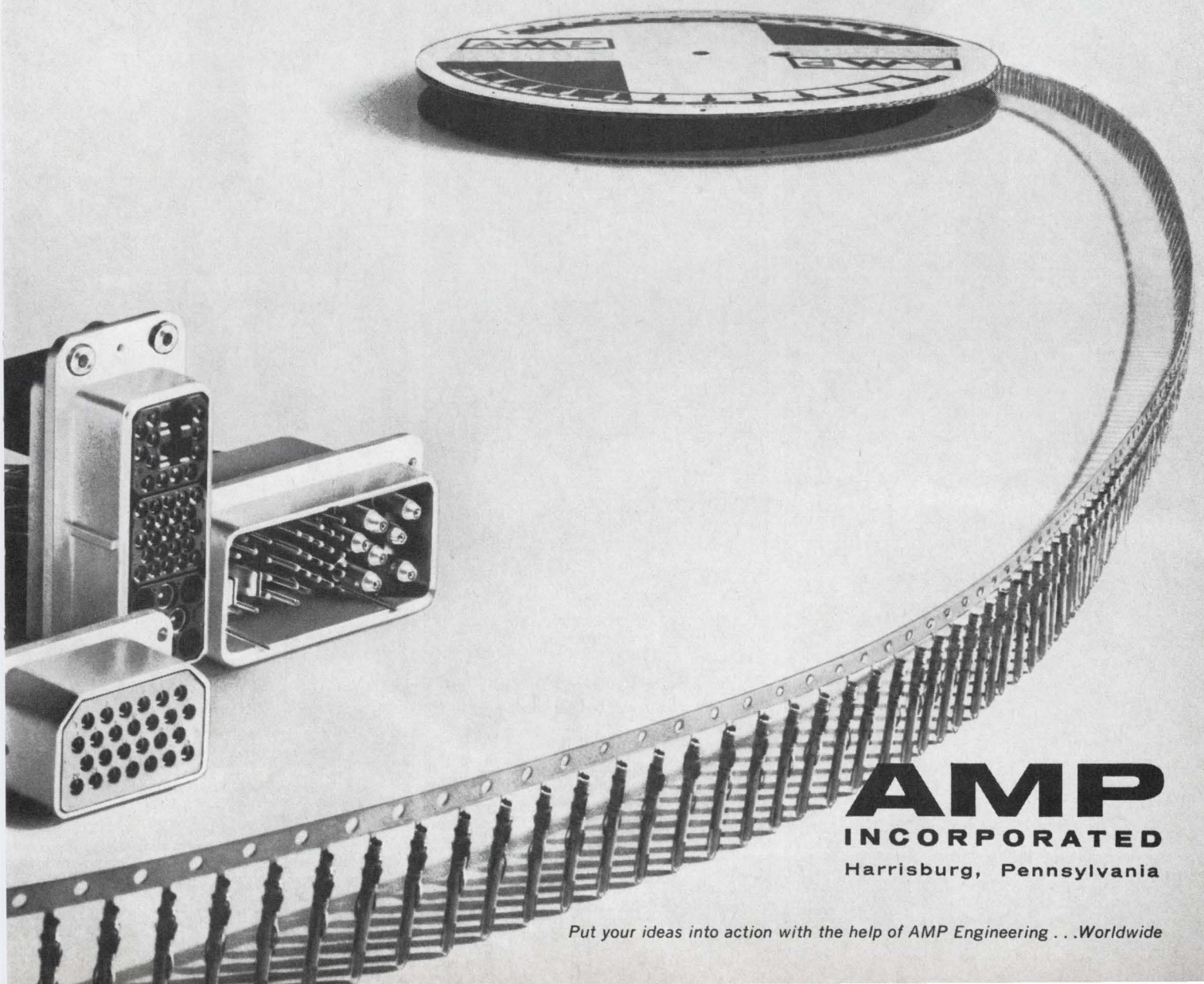

AMP
INCORPORATED
Harrisburg, Pennsylvania

Put your ideas into action with the help of AMP Engineering . . . Worldwide

IRC Precision

Precision trimmers in all 4 popular styles

RECTANGULAR

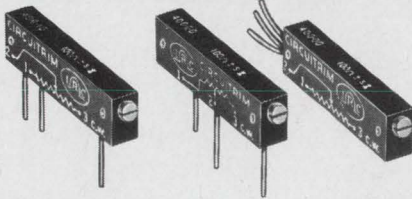

Series 400. Wirewound RT-12 case size with one extra model having staggered RT-11 P.C. pin placement for direct, space savings substitution.

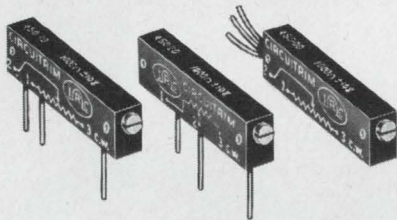

Series 450. Metal Glaze element provides essentially infinite resolution output. RJ-12 size to MIL-R-22097 requirements. Resistance values from 50Ω to 1 Meg. Standard tolerance is ±10% with 20% available for cost-saving applications.

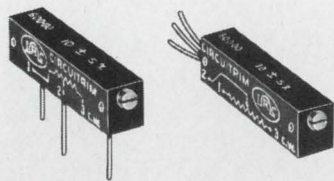

Series 600. RT-11 case size. Wirewound stability and military quality at industrial prices. Well-sealed lightweight diallyl phthalate case.

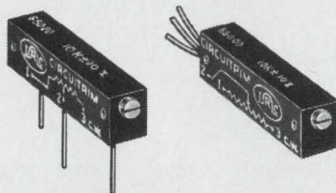

NEW Series 650. Metal Glaze resistive element built to MIL-R-22097, Characteristic C capability. ±250ppm/°C over range of 100Ω to 10K. Std. tol. ±5%.

½-INCH SQUARE

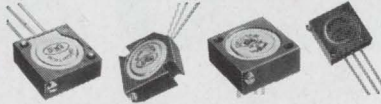

Series 205. Standard wirewound units for high-quality industrial needs in all four RT-22 styles. Built, tested and marked to MIL-R-27208 specifications.



Series 251. RJ-22 styles. Metal Glaze infinite resolution from 100Ω to 1 Meg. Offered in ±5, 10 and 20% tolerances to provide exact performance requirements.

½-INCH ROUND



Series 100. Largest ½" round selection in the industry. Well-sealed for critical industrial or military use. Single turn, positive stops. Long (0.9") winding provides superior resolution and closer settings.



Series 150. Metal Glaze companion to wirewound model 100 above. Available in same configurations. 100Ω to 1 Meg. with choice of ±5, 10 and 20% tolerances.

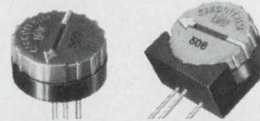

NEW Series 500. Most economical for commercial and industrial use. Two most popular adjustment and mounting configurations. Best wirewound resolution at lowest price.

MINIATURE 5/16" CUBE



Series 300 wirewound and 350 Metal Glaze provide space savings in all P. C. board applications. Panel mount also available.

PANEL MOUNTING

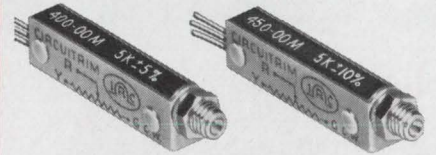

For wirewound Series 400 and Metal Glaze Series 450

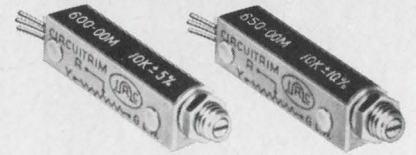

For wirewound Series 600 and Metal Glaze Series 650



For ½" square series

For ½" round series

For 5/16" cube series

SINGLE TURN ROTARY

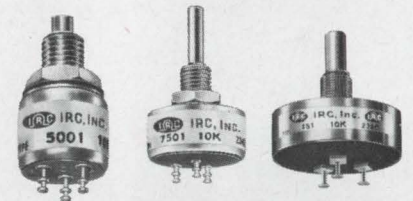

Sturdy metal-cased units for severe environmental conditions. Wirewound stability and ±5% resistance tolerance. Excellent linearity for close setting of comparison and control instrumentation.

Mod.	Case Diam.	Res. Range (Ω)	Power @40°C	Linearity
5001	½"	10 to 50K	2 W	±5%
7501	¾"	50 to 50K	2½ W	±1%
151	1½"	100 to 100K	3½ W	±0.5%

MOUNTING VARIATIONS

IRC offers hundreds of different terminals, terminations, mounting variations and adjustments. Unique in the industry, they provide economy and unequalled design flexibility.

Potentiometers

Precision multi-turns for all applications

LOW-COST COMMERCIAL/INDUSTRIAL

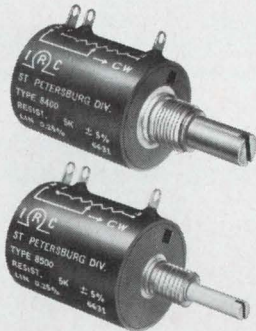

High performance and long life at lowest cost. 10 turns, $\frac{1}{8}$ " diameter with only $\frac{1}{8}$ " behind the panel. 2 watts @ 25°C., derates to zero @ 105°C. 100Ω to 100K, with all popular intermediate values. $\pm 5\%$ tolerance and $\pm 0.25\%$ linearity. Side terminals accept to #14 wire. Model 8400 has $\frac{3}{8}$ "-32 bushing, $\frac{1}{4}$ " shaft. Model 8500 has $\frac{1}{4}$ "-32 bushing, $\frac{1}{8}$ " shaft.



Model 7300 has 100 oz.-in. patented stop system and space-saving rear terminals. 10 turns, 2 watts @ 40°C., derates to zero @ 85°C. 100Ω to 100K. $\pm 5\%$ tolerance, $\pm 0.25\%$ linearity.

MINIATURE HIGH PERFORMANCE



Industry's only $\frac{1}{2}$ " metal-cased multi-turn trimmer with 100 oz.-in. stop system and $\frac{1}{4}$ " diameter shaft. Maintains settings to $\pm 0.1\%$ under severe shock and vibration. Rear terminals for closest packaging. Many shaft and bushing variations.

Model 5000: 10 turns, 1.5 watts, 25Ω to 100K. $\pm 5\%$ tolerance

Model 5005: 5 turns, 1.0 watt, 15Ω to 50K. $\pm 5\%$ tolerance

METAL-CASED STANDARD PRECISION

IRC's exclusive line of metal-cased multi-turn potentiometers offer rugged protection and superior shielding. Field tested and approved in every phase of the electronics industry, their case sizes and power handling capabilities are based on widely accepted standards for good design and packaging. Hermetically sealed, panel sealed and moisture sealed versions are also available.



Model	Case Dia.	Turns	Resistance Range (Ω)	Linearity Std. (±)	Power @ 40°C
7500	$\frac{3}{4}$ "	10	50 to 250K	0.5%	3 W
7505	$\frac{3}{4}$ "	5	25 to 125K	0.5%	2 W
1000	1"	10	500 to 250K	0.5%	3 W
1005	1"	5	250 to 125K	0.5%	2 W
1215	1"	15	500 to 450K	0.1%	4 W
1220	1"	20	750 to 600K	0.1%	5 W

Standard tolerance: $\pm 5\%$. Temperature range: -55°C to 125°C. Closer tolerances and linearity available.

RUGGED STOP MECHANISM

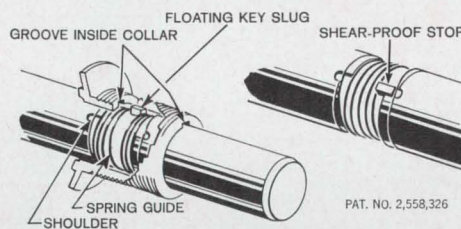

Electrical and mechanical functions of IRC metal-cased multi-turns are separate. Positive 100 oz.-in. patented stop mechanism in the shaft and bushing prevents damage to internal parts and catastrophic failure. The wiper contact assembly is relieved of stopping action. This assures setting accuracy, stability and long rotational life.

REVODEx DIALS ELIMINATE READING ERRORS

IRC has a full line of turns counting dials for use with 3, 5, 10 and 15 turn potentiometers. Only 1 inch in diameter, they fit $\frac{1}{4}$ -inch and $\frac{1}{8}$ -inch diameter shafts. Choice of black or clear anodized aluminum finish.

- Easy reading—angular surface gives maximum numeral size. Primary and secondary scale.

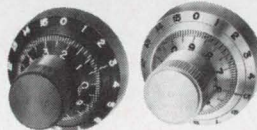

- Full range—000 to 999 to indicate up to 10 full turns (to 1499 for 15 turns).
- Accurate reading—reproducible to one part in a thousand. Can estimate to a fraction of a thousandth.
- Easy mounting—set-screwed directly to potentiometer shaft, there is no backlash and no need for extra panel holes.
- Long life—tested to 250,000 cycles with no appreciable wear.

WRITE FOR NEW PRECISION POTENTIOMETER CATALOG



IRC, Inc., 401 N. Broad St., Phila., Pa. 19108

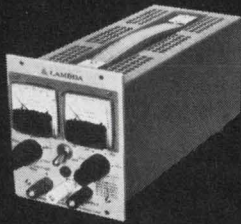

5 1/4" LP Series
Metered

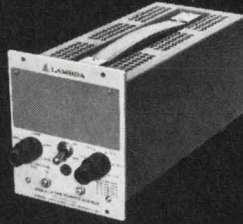

5 1/4" LP Series
Non-Metered



5 1/4" LH Series 1/4 Rack
Metered



5 1/4" LH Series
1/4 Rack Non-Metered



5 1/4" LH and LK Series 1/2 Rack
Metered

All from Lambda. Broadest line of all-silicon lab

NEW advanced design dual output lab supplies give you twice the power plus output ranges never before available... plus...

5 Models with two independent DC outputs offer widest choice—Up to ± 250 VDC, up to 1.7 amps. Either output may be + or -, or both outputs may be + or -.

Series/Parallel operation of both outputs yields two times the voltage or two times the current—up to 500 volts or up to 3.4 amps.

Auto Series/Auto Parallel (master slave) permits tracking to a common reference.

4 Meters provide simultaneous monitoring of both voltage and current.

Most power in a half-rack package.

Overvoltage Protection as an accessory.

Compatible with LP, LH and LK Series rack adapters and other accessories.

Multi-Current-Rated—Only dual power supplies on market with this advanced design feature.

Regulation— $.01\% + 1\text{mV}$.

Ripple— $500\mu\text{V RMS}$ (1.5mVp-p).

Size: $5\frac{3}{16}" \times 8\frac{3}{8}" \times 10\frac{5}{8}"$

Model(2)	Voltage Range Per output/ Outputs in series	I MAX AMPS AT AMBIENT OF: (1) Per output/Outputs in parallel				Price(2) US and Canada
		30°C	40°C	50°C	60°C	
*LPD-421-FM	0- ± 20 /0-40	1.7A/3.4A	1.5A/3.0A	1.3A/2.6A	0.9A/1.8A	\$325
*LPD-422-FM	0- ± 40 /0-80	1.0A/2.0A	0.85A/1.7A	0.7A/1.4A	0.55A/1.1A	260
*LPD-423-FM	0- ± 60 /0-120	0.7A/1.4A	0.6A/1.2A	0.5A/1.0A	0.4A/0.8A	325
LPD-424-FM	0- ± 120 /0-240	0.38A/0.76A	0.32A/0.64A	0.26A/0.52A	0.20A/0.40A	325
LPD-425-FM	0- ± 250 /0-500	0.13A/0.26A	0.12A/0.24A	0.11A/0.22A	0.10A/0.20A	350

* Overvoltage Protection available as an accessory. Each output requires separate OV accessory—add \$35.00 for each output.

(1) Current rating applies over entire voltage range. Ratings based on 57-63 Hz operation.

(2) Prices are for metered models. LPD Series models are not available without meters.

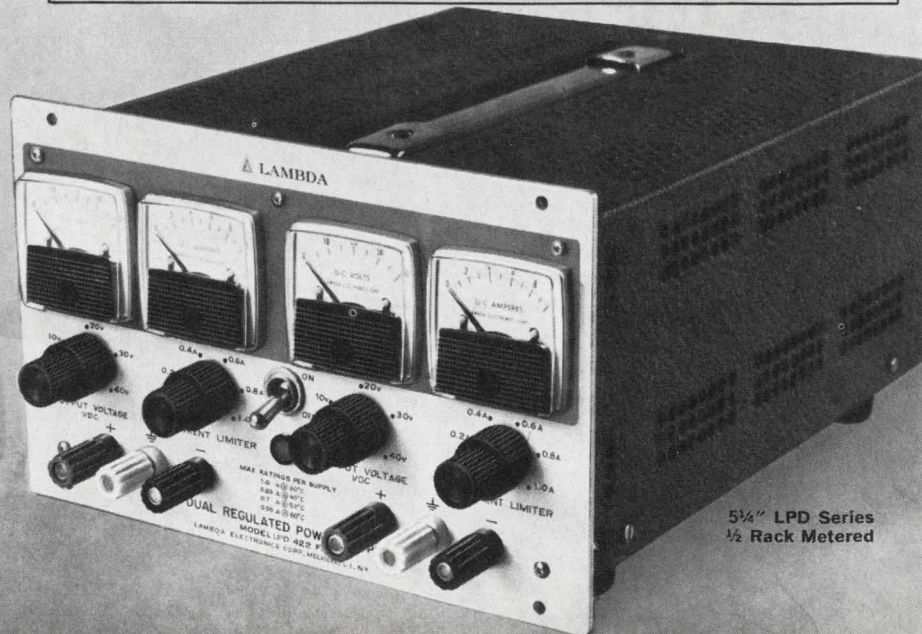

5 1/4" LPD Series
1/2 Rack Metered



5 1/4" LH and LK Series
1/2 Rack Non-Metered

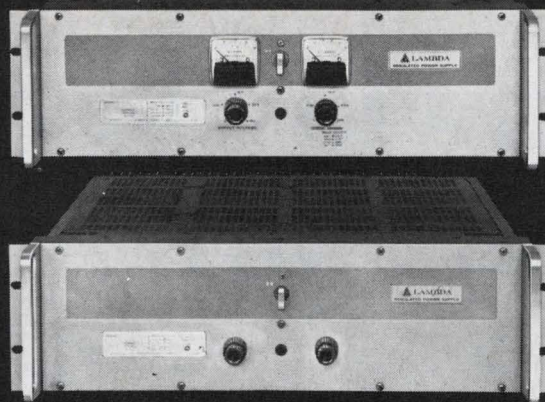

5 1/4" LK Series Full-Rack Non-Metered

5 1/4" LK Series
Full-Rack Metered

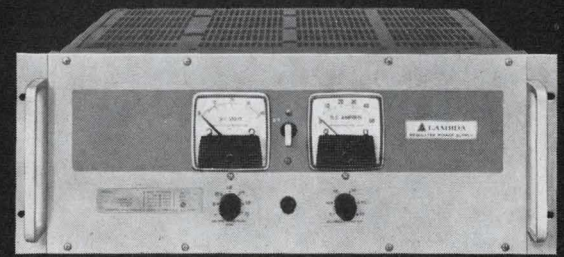

7" LK Series Full-Rack Metered

or systems power supplies... bench or rack

or choose from these 1/4, 1/2 and full-rack Lambda supplies

Size 5 1/8" x 4 3/8" x 10"

Model ²	Voltage Range	CURRENT RANGE AT AMBIENT OF: ¹				Price ²
		30°C	40°C	50°C	60°C	
LP 410	0-10 VDC*	0-2A	0-1.8A	0-1.6A	0-1.4A	\$129
LP 411	0-20 VDC*	0-1.2A	0-1.1A	0-1.0A	0-0.8A	119
LP 412	0-40 VDC*	0-0.70A	0-0.65A	0-0.60A	0-0.50A	114
LP 413	0-60 VDC*	0-0.45A	0-0.41A	0-0.37A	0-0.33A	129
LP 414	0-120 VDC	0-0.20A	0-0.18A	0-0.16A	0-0.12A	149
LP 415	0-250 VDC	0-80mA	0-72mA	0-65mA	0-60mA	164

Size 5 1/4" x 19" x 16 1/2"

Model ²	Voltage Range	CURRENT RANGE AT AMBIENT OF: ¹				Price ²
		40°C	50°C	60°C	71°C	
LK 350	0-20VDC	0-35A	0-31A	0-26A	0-20A	\$675
LK 351	0-36VDC	0-25A	0-23A	0-20A	0-15A	640
LK 352	0-60VDC	0-15A	0-14A	0-12.5A	0-10A	650

Size 5 1/8" x 4 3/8" x 15 1/2"

Model ²	Voltage Range	CURRENT RANGE AT AMBIENT OF: ¹				Price ²
		30°C	50°C	60°C	71°C	
LH 118-A	0-10VDC	0-4.0A	0-3.5A	0-2.9A	0-2.3A	\$180
LH 121-A	0-20VDC	0-2.4A	0-2.2A	0-1.8A	0-1.5A	170
LH 124-A	0-40VDC	0-1.3A	0-1.1A	0-0.9A	0-0.7A	170
LH 127-A	0-60VDC	0-0.9A	0-0.7A	0-0.6A	0-0.5A	185
LH 130-A	0-120VDC	0-0.50A	0-0.40A	0-0.35A	0-0.25A	240

Size 7" x 19" x 18 1/2"

Model ²	Voltage Range	CURRENT RANGE AT AMBIENT OF: ¹				Price ²
		40°C	50°C	60°C	71°C	
LK 360 FM	0-20VDC	0-66A	0-59A	0-50A	0-40A	\$995
LK 361 FM	0-36VDC	0-48A	0-43A	0-36A	0-30A	950
LK 362 FM	0-60VDC	0-25A	0-24A	0-22A	0-19A	995

Size 5 1/8" x 8 3/8" x 15 1/4"

Model ²	Voltage Range	CURRENT RANGE AT AMBIENT OF: ¹				Price ²
		30°C	50°C	60°C	71°C	
LH 119-A	0-10VDC	0- 9.0A	0- 8.0A	0- 6.9A	0-5.8A	\$289
LH 122-A	0-20VDC	0- 5.7A	0- 4.7A	0- 4.0A	0-3.3A	260
LH 125-A	0-40VDC	0- 3.0A	0- 2.7A	0- 2.3A	0-1.9A	269
LH 128-A	0-60VDC	0- 2.4A	0- 2.1A	0- 1.8A	0-1.5A	315
LH 131-A	0-120VDC	0- 1.2A	0- 0.9A	0- 0.8A	0-0.6A	320

Model ²	Voltage Range	CURRENT RANGE AT AMBIENT OF: ¹				Price ²
		40°C	50°C	60°C	71°C	
LK 340-A	0-20VDC	0- 8.0A	0- 7.0A	0- 6.1A	0-4.9A	\$330
LK 341-A	0-20VDC	0-13.5A	0-11.0A	0-10.0A	0-7.7A	385
LK 342-A	0-36VDC	0- 5.2A	0- 5.0A	0- 4.5A	0-3.7A	335
LK 343-A	0-36VDC	0- 9.0A	0- 8.5A	0- 7.6A	0-6.1A	395
LK 344-A	0-60VDC	0- 4.0A	0- 3.5A	0- 3.0A	0-2.5A	340
LK 345-A	0-60VDC	0- 6.0A	0- 5.2A	0- 4.5A	0-4.0A	395

LP NOTES

*Overvoltage Protection available as an accessory—\$35.00 each.

1 Current rating applies over entire voltage range. Ratings based on 57-63 Hz operation.

2 Prices are for non-metered models. For metered models, add suffix (FM) and add \$10.00 to price.

LK-LH NOTES:

1 Current rating applies over entire voltage range.

2 Prices effective Feb. 1, 1968. Prices are for non-metered models (except for models LK360FM, LK361FM, and LK362FM which are metered models not available without meters). For metered models, add suffix (FM) and add \$30.00 to price.

3 Overvoltage Protection up to 70 VDC is available as a bolt-on accessory for models with suffix (-A). To order, add suffix (OV) and add \$35.00 to the price. For full-rack models, overvoltage protection up to 70 VDC is available as a built-in option. To order add suffix (OV) and add \$90.00 to price of models LK350-352; add \$120.00 for models LK360FM-362FM.

4 Chassis Slides for full rack models: Add suffix (CS) to model number and add \$60.00 to the price except for models LK360FM-362FM, for which add \$100.00.



LAMBDA
ELECTRONICS CORP.

TERMINAL DRIVE, PLAINVIEW, L. I., N. Y. 11803 • TEL. 516-681-8300

A VEECO SUBSIDIARY

VEECO HIGH VACUUM EQUIPMENT/LAMBDA POWER SUPPLIES

Of the following 14 MOS devices, some are merely equal, a few are slightly superior, a couple are almost unbelievable, and one is plainly incredible.

– 55°C to + 125°C

0°C to + 70°C

	100-999		100-999	
Merely Equal: DUAL 3-INPUT NOR GATE DUAL EXCLUSIVE OR GATE	MM 480	\$12.00	MM 580	\$ 8.00
	MM 481	18.00	MM 581	12.00
Slightly Superior: DUAL 25-BIT DYNAMIC SHIFT REGISTER <i>Low power with 1MHz guaranteed.</i> DUAL DIGITAL MULTIPLEX SWITCH <i>Ideal for routing information in dynamic register memory.</i>	MM 400	25.00	MM 500	9.85
	MM 482	12.00	MM 582	8.00
Almost Unbelievable: DUAL 50-BIT DYNAMIC SHIFT REGISTER <i>14.8¢/bit.</i> DUAL 16-BIT STATIC SHIFT REGISTER <i>Single clock, 1MHz operation up to 125°C.</i>	MM 402	40.00	MM 502	14.80
	MM 404	30.00	MM 504	12.00
Plainly Incredible: DUAL 100-BIT DYNAMIC SHIFT REGISTER <i>200 register bit in a single package.</i>	MM 406	60.00	MM 506	30.00

Amazingly, they're all available now. For a list of stocking distributors and additional information, write: National Semiconductor Corporation, 2975 San Ysidro Way, Santa Clara, California 95051. (408) 245-4320.

National Semiconductor

We build uncommon recorders

SMALL, CARTRIDGE-LOADED UNIT FOR COMPUTER PROGRAMMING, TEST INSTRUMENTATION, ECM—SERIES MTR 8000. Records and reproduces voice, analog, FM, and digital data with a variety of combinations for a wide range of applications. Eliminates tape threading and assures fast tape change. Performs with high reliability in 0 to 130°F temperature, 100% humidity, 150,000 feet altitude. Tape storage: 1/4" x 260'. Tape speed: up to 60 ips. Size: 7" x 4.5" x 4.5". Weight: 5 lbs. Power consumption: 20 watts.

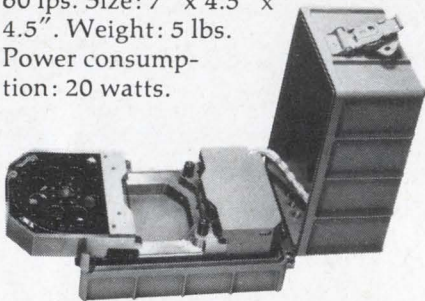

RANDOM BIN LOOP RECORDER FOR AIRCRAFT, SATELLITES, MISSILES—SERIES MTR 6000. Provides record of last 30 minutes of digital and voice information, three tracks digital and four tracks voice. Contains dual speed transport drive of

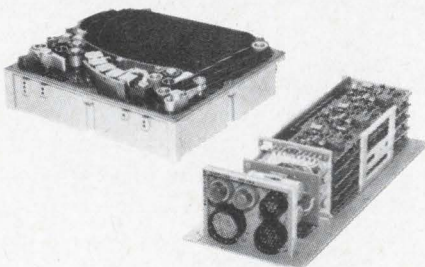

15/16 ips and 6 times speed. Tape storage: 150' x 1/2". Dimensions: 8" x 9" x 2.75". Weight: 5.5 lbs. Power dissipation: 10 watts max.

PORTABLE RECORDER/REPRODUCER FOR GENERAL PURPOSE INSTRUMENTATION TEST—SERIES MTR 3000. Provides up to 14 channels analog and FM or 16 digital

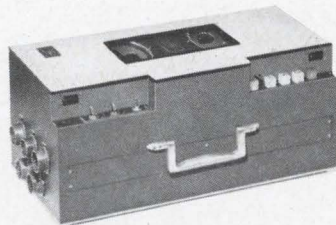

channels which can be used in any combination. Plug-in modular electronic construction makes possible numerous record/reproduce options. Seven IRIG standard tape speeds available. Shock: 25 g—8 ms 1/2 sine—5% p/p flutter. Vibration: 10 g rms random operating—6% p/p flutter. Weight: 50 lbs. maximum. Size: 8.625" x 9.5" x 20".

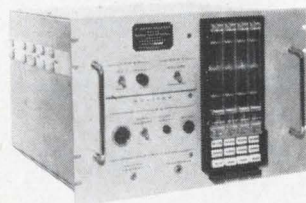

LOW COST, LONG TIME SYSTEM FOR AUDIO MONITORING—SERIES MTR 5000. Four cartridge unit each recording 5 separate channels for

24-hour surveillance. Automatically replaces and rewinds each reel, prepares it for playback in portable reproducer. Permits recording of 20 channels (all reels) at one time. Contains alarm system for malfunction warning. Twelve cartridge military unit available. Tape: 1/4" x 1800' at 15/16 ips. Size: 19" rack mount.

LIGHT WEIGHT, LOW POWERED, LONG LIVED SYSTEM FOR SATELLITE APPLICATIONS—SERIES 2000. Backed by over 150,000 hours of successful operation in space. Offers custom flexibility in data programming. Accommodates PAM/FM, Multiplex

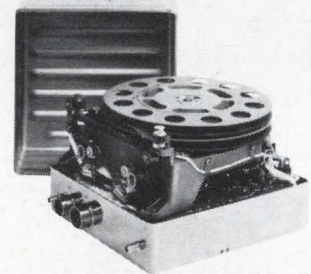

FM, direct, single carrier FM, PDM and digital data. Releases in burst the data collected in orbit. Tape: 1/4" x 1200', 1900' and 3000'. Speeds: 0.1 to 100 ips. Size: 290 cubic inches. Weight: 10-15 lbs. Power consumption: 5-25 watts.

Write Dept. K for details on our uncommon recorders for your unusual requirements. Leach Corporation, Controls Division; 717 North Coney Avenue, Azusa, California 91702; Telephone: (213) 334-8211.

LEACH

20 AMP

PNP SILICON POWER TRANSISTORS



TO-61 ISOLATED

from **Solitron**

Type Number TO-61 Isolated	MAXIMUM RATINGS			PRIMARY ELECTRICAL CHARACTERISTICS (T _C = 25°C)					
	V _{CEX} Volts	V _{CEO} Volts	V _{EBO} Volts	h _{FE}		V _{CE(sat)} Volts	V _{BE(sat)} Volts	I _{CEX} μA	f _T MHz
				I _C = 20A V _{CE} = -5V	I _C = 10A V _{CE} = -5V	I _C = 10A I _B = 1.0A	I _C = 10A I _B = 1.0A	V _{CE} = Rated V _{CEX}	I _C = 1.0A V _{CE} = -10V
				Min.	Range	Max.	Max.	Max.	Min.
SDT 3101	-40	-40	-6	5	30-90	-1.75	-2.5	10	30
SDT 3102	-60	-60	-6	5	30-90	-1.75	-2.5	10	30
SDT 3103	-80	-80	-6	5	30-90	-1.75	-2.5	10	30
SDT 3104	-100	-100	-6	5	30-90	-1.75	-2.5	10	30

Solitron has now assumed the leadership of PNP Silicon Power Transistors with the introduction of 20-Amp devices. These transistors are the highest current units of their type presently available in the industry. Identified as the SDT3101-4 family, they were developed with the same HIGH RELIABILITY standards of quality and performance associated with Solitron. Packaged in the popular Isolated TO-61 case, they have a voltage breakdown range of 40 to 100 Volts. A few of their many applications include power supplies, audio amplifiers, inverters, converters, relay drivers and series regulators.

Dial 1-800-327-3243 for a "No Charge" telephone call and further information

When you think of semiconductors...

think Solitron!

Solitron DEVICES, INC.

1177 BLUE HERON BLVD. / RIVIERA BEACH, FLORIDA / (305) 848-4311 / TWX: (510) 952-6676

**Save your old
pressure
transducers.**

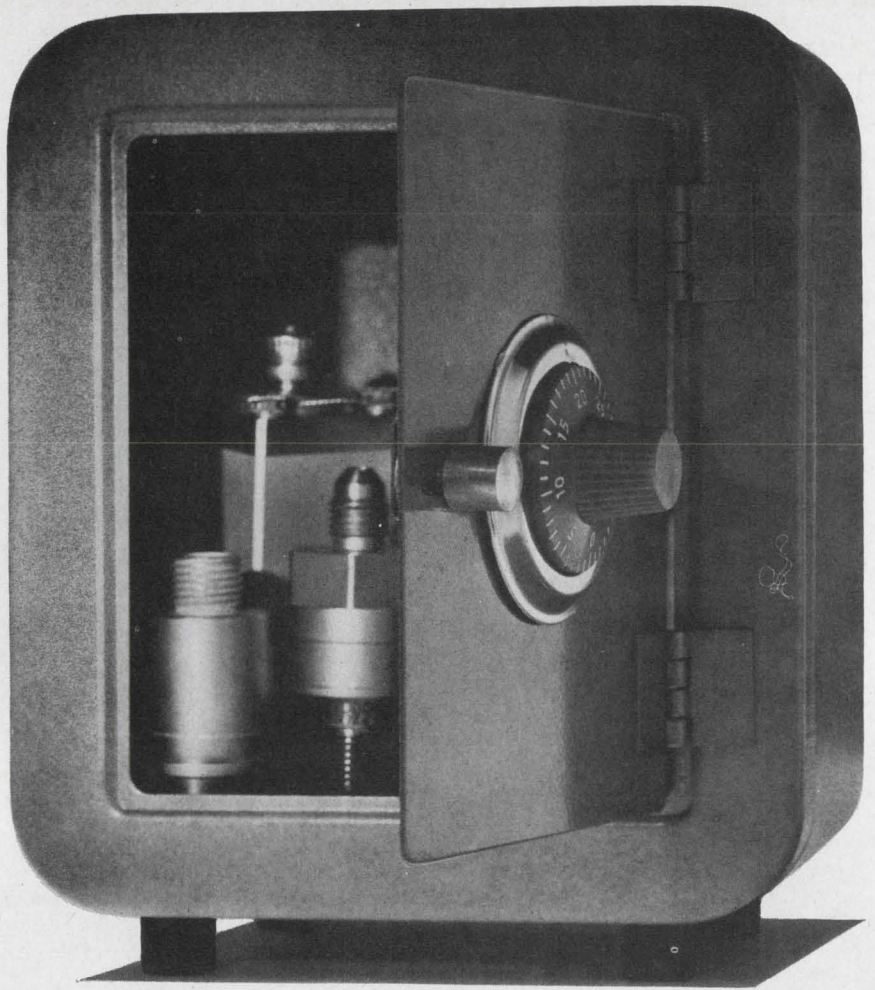

**The new 4-356
may make them collectors' items.**

CEC's little 4-356 is the most ambitious pressure transducer ever to make the scene. For it's a triple-threat instrument that's demonstrably superior in the three areas most concerned with pressure measurement.

- 1. Accuracy.** It consistently achieves a combined linearity and hysteresis of $\pm 0.25\%$.
- 2. Durability.** It not only senses the truth and reports it when the pressure is on, but continues to do so in even the most hostile environments. Thanks to its all-welded, heat-treated, annealed case of 17-4 PH stainless steel, the 4-356 is at home in temperature ranges of -320°F to $+300^{\circ}\text{F}$ and it thrives in corrosive media.
- 3. Size and Weight.** The 4-356 is only $1\frac{3}{8}$ " high and weighs a mere $2\frac{1}{2}$ oz. This has resulted in a unit that

will fit into present or foreseeable pressure measurement applications. Particularly since its cavity volume is small enough to *not* affect the accurate measurement of the fluid under pressure in the system.

Why not call your nearest CEC Transducer Specialist for the complete story? Or write Consolidated Electro-dynamics, Pasadena, California 91109. A subsidiary of Bell & Howell. Ask for Bulletin 4356-X4.

CEC/TRANSDUCER PRODUCTS

 **BELL & HOWELL**



A word to the do-it-yourself module builder:

Don't.

Buy our J Series modules instead.

The J Series is our new family of general purpose, all integrated circuit logic modules. Their performance almost matches that of our famous T Series modules, but they cost about 25% less. They're made to the same dimensions as the T Series, with the same 52 pin connectors, so they're physically interchangeable. We make them for our own seismic recorder systems, so they're rugged and reliable. Now, as of January, you can buy them (com-

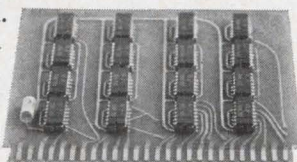

These will cost you less.

plete with mounting hardware, racks and power supplies, if you wish) in any of 25 different functions.

And save yourself the time and cost of making your own: designing, assembling, testing, new procedures, new equipment, new personnel, additional training, to say nothing of the added paper work.

If you're building systems, you must have better things to do than go into the module assembly business. Such as reading our J Series catalog. It's free.

SDS
Scientific Data Systems,
Santa Monica, California

**WE
AT
COOK
ELECTRIC
ARE
OUT
TO
CHANGE
YOUR
OUTLOOK...**

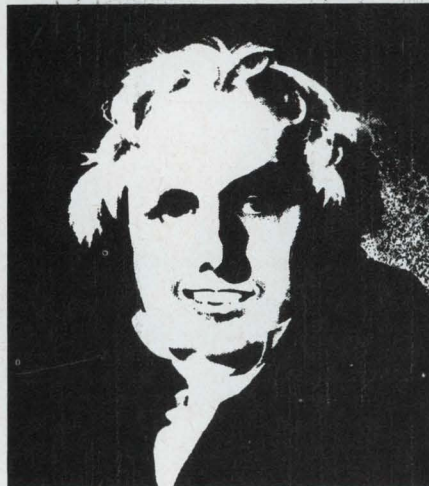
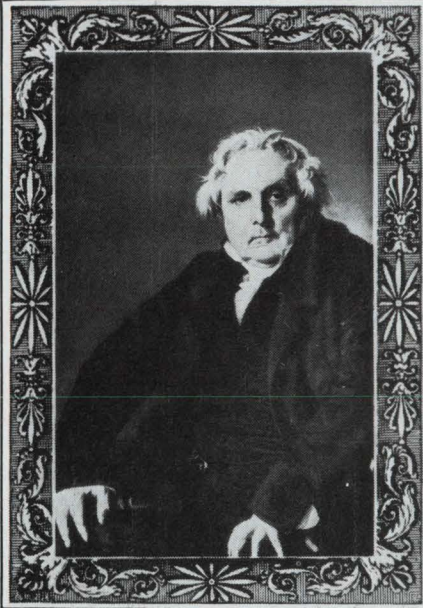

About sales and sales people. About service and delivery deadlines. About quality you can depend on. About new products to meet new requirements before the need becomes an emergency. For example, our relays and pressure switches have been solving industrial problems for 20 years...ranging from small manufacturing operations to the national space program.

Whether you need a component replacement today, or a specially-designed unit to meet a future need, count on us. We specialize in having solutions on hand before problems arise.

And if you're tired of promises unkept and delivery dates unmet, we invite you to investigate the production and service facilities of Cook Electric. You'll find it's good business. With us, performance comes before promise.



**COOK
ELECTRIC**

AUTOMATIC CONTROLS DIVISION

200 E. DANIELS ROAD • PALATINE, ILLINOIS 60067 • 312-359-2100

Technical Articles

**Improving
the mask-maker's
image
page 78**



Making masks for complex integrated circuits manually becomes a difficult if not impossible chore. They take too long to make, are difficult to alter, and are often inaccurate. A new mask maker that's computer-controlled is linked to an artwork generator to speed up the process, while permitting submicron accuracy and repeatability. The cover design was gener-

ated by the author, Roland Beeh, to show a variety of element geometries; the automatic mask maker is inset.

**Linear IC's: part 6
Compensating for drift
page 90**

Most users of monolithic integrated circuit amplifiers are accustomed to applying frequency compensation to improve stability, but not all are aware of the need for input bias compensation to reduce drift-caused output errors. In practice, a half-dozen bias-current compensation arrangements satisfy most linear IC applications. Input preamplifiers can reduce voltage drift to levels comparable to those of expensive chopper-stabilized, discrete component amplifiers.

**Through a glass brightly
page 95**

All-electronic dynamic displays may be just around the corner. The multi-element electroluminescent array is a prime candidate, but usually each element needs a high series resistance during turnoff. An alternate technique is to use a high resistance built into the electroluminescent panel, in parallel with each element. The built-in resistance means that less series resistance is needed, and permits the use of inexpensive glassy switches that can be batch fabricated.

**Memories shot from guns
page 98**

Timing is all-important in fuzes for artillery shells and guided missiles. The memory that stores the time delay must be small, rugged, and inexpensive. Ferroelectric ceramic memories are able to withstand extreme temperature, spin, and shock, and at the same time can store data indefinitely without using power. Furthermore, they are easily alterable to accommodate changes in the system.

**Special McGraw-Hill report:
Business and the
urban crisis
page C 1**

The problems of our cities are overwhelming, and solutions hazy or lacking altogether. Business now faces its most urgent challenge: to successfully bring its resources to bear on the urban crisis—particularly in helping educate and train the underprivileged to assume a useful role in business and the community. In some areas, business has made a commendable start. But in others, efforts have been mediocre. This report focuses on what must be done in the three most critical areas: jobs, housing, and education.

**Coming
February 19**

**▪ Special report: The transistor—two decades
of progress**

Improving the mask-maker's image

Computer, artwork generator, and masking camera combine forces to cut mask-making process from nine steps to five

By Roland C.M. Beeh

Optomechanisms Inc., Plainview, N.Y.

It's no secret that manually scribed master masks just won't do for large-scale integration. They take too long to make, are difficult to alter, and, more importantly, aren't accurate enough. Eventually, some form of computer-controlled mask-maker wedded to artwork generators probably will be the answer—for all LSI manufacturers.

One such system in operation now, built by Optomechanisms Inc., not only speeds up the mask-making process, but is also capable of the submicron tolerances and repeatability required for LSI. Such properties permit storing circuit component geometries on a master slide to generate from punched or magnetic tape the initial artwork for LSI masks. The circuit library concept, with its standard component patterns, avoids the conventional drafting procedures currently used in mask fabrication processes.

Automated artwork generators and a recently developed step-and-repeat camera make it possible to attain minimum line widths of one micron with positioning accuracies within ± 0.25 micron. The minimum line width determines, in part, the component-packing density on a wafer. At present, most IC's are designed around line widths of 2.5 microns, about 0.0001 inch. Minimum spacing between lines or device geometries usually equals the line width plus the positioning tolerance, which in

conventional systems is ± 1 micron. Consequently, the minimum center-to-center distance between lines 2.5-microns wide is equal to the sum of one line width plus the line spacing and over-all tolerance, or $2.5 \mu + 2.5 \mu + 2\mu$, or 7μ .

But submicron line capabilities permit a minimum center-to-center distance between lines equal to $1 \mu + 1 \mu + 0.5 \mu$ —a total of 2.5μ —and increases the linear component packing density by a factor of 2.8

More for the money

Increased density directly effects savings. For example, 5,600 components can be fabricated on a wafer where only 2,000 could be placed before. Assuming that the basic cost of the wafer and the diffusion and metalization steps remain constant, the previous cost of a wafer element, which may have been 10 cents, now costs 3.5 cents. This basic cost reduction enables the designer to increase the complexity of circuits to perform more functions per device.

Furthermore, automating the process increases production yields by reducing the number of steps needed to make IC masks. Besides the improved yield, the basic cost reduction achieved in manufacturing decreases over-all costs by a factor of another 1.8 to a total of about 4.6. Moreover, the labor force required can be cut by an average factor of 15, making the total cost reduction ratio on the order of 20. In other words, the new machine can get masking patterns on the wafer at 1/20th the cost involved in the manual process.

In the language of the computer manufacturer, a single bit of information that in the past may have cost 10 cents now could cost 0.5 cent.

There are other advantages. The smaller photographic plates required for automatic processing are more convenient to handle and less apt to be contaminated. Drafting procedures are circum-

The author



Roland C.M. Beeh has been with Optomechanisms Inc. since 1965. As director of research, he investigates technologies associated with semiconductor devices and materials. He holds a Ph.D. in physics from the Faculty of Sciences of Marseilles, France.

Manual mask-making gives way . . .

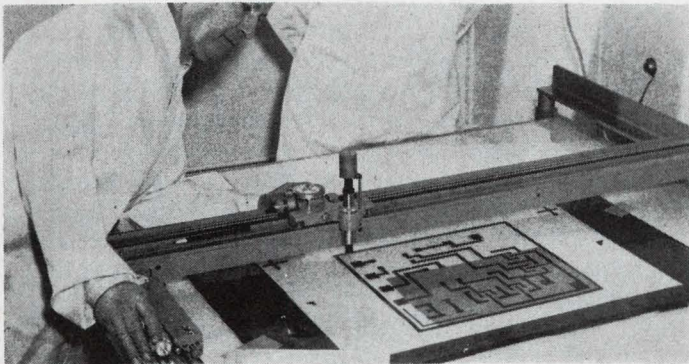

Large-scale drawing cut from rubylith . . .

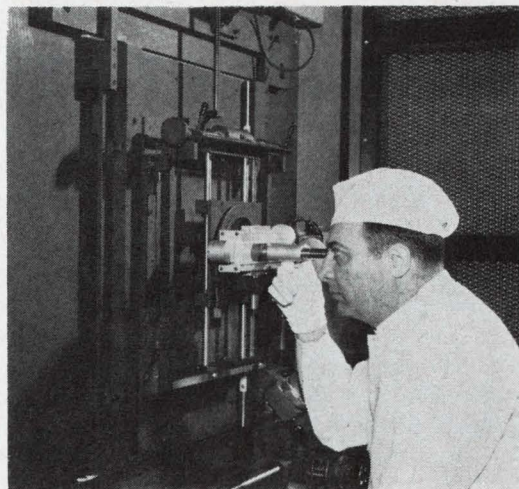

. . . reduced with photoreducing camera.

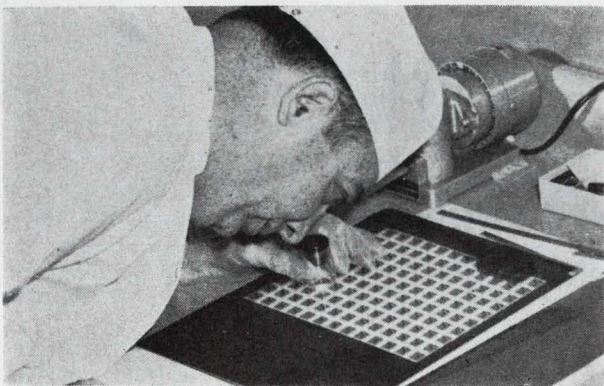

Finished masks are inspected visually.

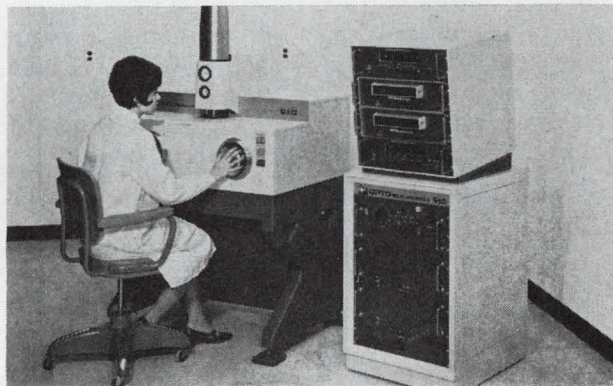

Reduced artwork is master for step-and-repeat camera.

Manual mask fabrication is a nine-step process involving a number of machines. Each step lengthens the time it takes to make an IC mask once a circuit concept has been developed. There is little margin for error since alterations are difficult and costly to make.

. . . to an automatic process

Combining the masking process in one automated machine reduces to five the number of fabricating steps. The initial artwork is generated by the computer from circuit library cards. Accuracies are increased since entire fabrication process is done with one machine.

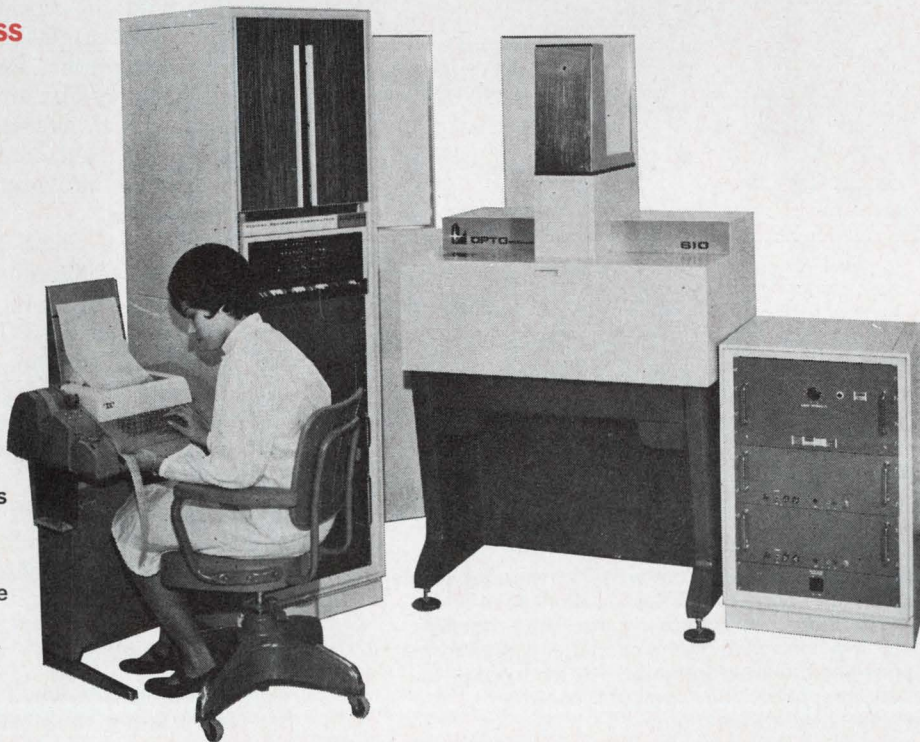

vented. The finished designs need only include information on punched tape about the component and its position on the mask for the computer to lay out the circuit and make the mask. This narrows the gap between the designer and his circuit. It enables him to think in terms of the three-dimensional process used with IC masks. Consequently, he is better equipped to fabricate on single chips complete systems, complete memories, thousand-bit decoders, and nearly complete machines.

Generating IC mask artwork from programs on tape also makes it possible to realize other significant savings. Tape programs are impervious to dust and can be stored easily. On the other hand, photographic plates must be protected. And, since few LSI circuits will have the general-purpose usage now enjoyed by many IC's, the number of LSI types, and consequently, the number of artwork sets, will increase.

Storing tapes instead of rubylith masters is much easier. Since punched-paper or magnetic tapes are dimensionally stable, there shouldn't be problems when more units are called for a few years hence. The xy coordinate entries on tape also minimize the problems of aligning one mask to the next.

One machine, two jobs

The Optomechanisms Inc. artwork generator is based on an automated step-and-repeat camera

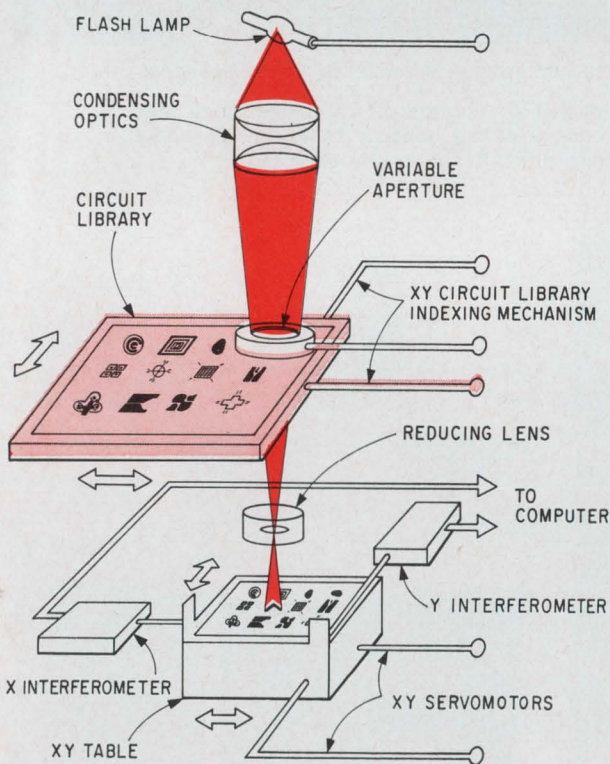

Mask-maker. Computerized artwork generator selects from circuit library the pattern to be flashed on high-resolution photographic plate. The xy table's position is controlled by the computer from information supplied by the interferometer. The xy drive for the circuit library moves by computer control to any of 49 discrete locations.

(panel on page 82) introduced about a year ago. To the basic machine, however, has been added a small, commercial general-purpose computer. The computer enables the machine to be used both as a conventional step-and-repeat camera and to generate IC patterns in a completely automated mode. Lines or segments from circular or square apertures, as well as entire circuit geometries, may be flashed onto a photographic plate. The plate rests on an xy coordinate table set in motion by motors that receive commands from an interferometric measurement system and input programs from the computer.

The computer also enables the camera to be part of a closed-loop mask-making system with circuit design capabilities. In a computer-aided circuit design, for example, the initial design can be made with a computer, visual display, and light pen. The computerized artwork generator extends this concept.

Once the computer has compared the display's output with design parameters stored within its memory, it can generate two programs: one to command the artwork generator, the other to operate the step-and-repeat camera. Furthermore, digital data from the camera interferometers can generate on the display console an actual representation of the circuit design being made. The designer, therefore, can correct the design with the light pen while the circuit mask is being fabricated.

Manual method tedious

Analyzing the two basic methods—manual and automated—for making photomasks reveals how many of the advantages are achieved.

Currently the fabrication process is manual or, at best, semi-automated. This method requires making a large-scale drawing followed by cutting rubylith with an automated or manual drafting machine. The original could also be transferred onto a photographic emulsion with a light-beam tracing machine. The image then is reduced a number of times with intermediate contact prints. Then it can be projected onto a step-and-repeat master and inspected individually before being used to produce wafers.

Fabricating a single photomask in this manner requires nine different steps. Since each circuit may require 12 or more photomasks, the operation is tedious and costly. While this process is suitable for making conventional IC's, it is almost totally unacceptable for making LSI masks because of contamination of the masters and alignment and distortion problems. The circuit designer working with submicron geometries can't tolerate masks with micron-size pinholes or inclusions. Moreover, the alignment and distortion ratio of the images must be kept constant throughout the nine-step operation.

Nine-to-five job

Automating the mask-making process reduces to five the number of fabrication steps required and

increases the production yield by a factor of 9/5, or 1.8. All steps are automated except for processing the photographic plates, loading and unloading the cameras, and inspecting the masks.

Since each IC or LSI circuit comprises N photomasks and an imaging surface equal to a^2 on each, the number of masks and their area directly affect the error population of the mask fabrication process.

Each plate may contain an imperfection area, x , caused by a dust particle, a pinhole, distorted image, misplaced image, or a blank space located anywhere on the imaging surface.

The error density, or imperfection probability, is x_n . The surface a^2 can be considered the finite probability space of the photomask; for a set of N plates, the total probability space for a set of masks is defined as Na^2 . The total error population, therefore, is

$$E = \sum_{n=1}^N x_n Na^2$$

In conventional systems, the over-all production yield over a single wafer may be as low as 20%. While this may be acceptable for IC's where the wafers are divided into active chips, it cannot be tolerated in the case of LSI, where maximum utilization of the wafer must be reached. Because fewer photographic plates of smaller surface area are used in automated mask fabrication, the process reduces significantly the error factor E.

The general-purpose computer prepares three basic programs: an artwork generator program, a step-and-repeat program, and an inspection program. In the circuit, the positions of the active and passive elements are constant as each mask is placed in position. For instance, the base of a typical transistor in the first photomask must correspond with the location of the emitter and collector in subsequent photomasks.

The computer program also includes three other functions; one for the artwork generator, another for the step-and-repeat camera, and the third for the automated inspection machine. Consequently, an element of a circuit has an equation that is the function of the location coordinates and the three machines.

The circuit library

From the basic computer-controlled masking concept, it is but a short step to a circuit library concept where such circuit geometries as mask and wafer reference indexes, resistor patterns, and base, emitter, and collector contacts are stored on a master reticle, or library plate. These images, selected and indexed by a special mechanism controlled by the computer, are projected through a minification objective to generate a circuit on a photographic plate. A variable aperture that accommodates the different size circuit library elements also is computer-controlled.

The photographic plate then is inserted in place of the library plate and the system used as a step-

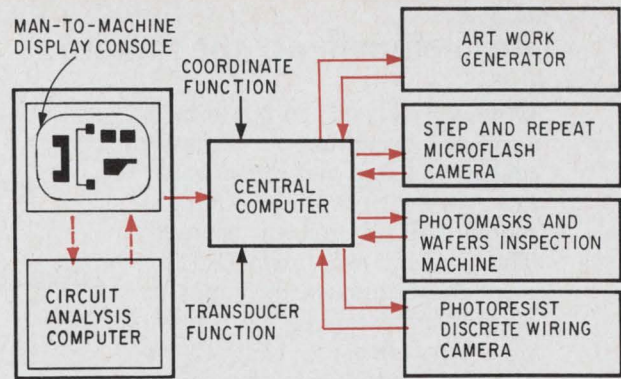

Closed-loop mask maker. A computer can be combined with a series of machines to take circuit concept to the actual printing of geometries on IC wafer. The machines can be commanded from a central computer or central programing functional system.

and-repeat camera to expose the IC wafer. The final image dimension will be either 0.004- or 0.01-inch square, depending on whether the minification combination from the artwork generator to the final wafer contact is 100X or 40X.

The circuit library technique permits considerable flexibility in artwork generation. In LSI, the technique permits reducing photomask production time by two to five orders of magnitude, compared with conventional artwork generating schemes. The actual time saved depends on the complexity of the circuit being fabricated. Not only does this technique save programing, photography, and design time, but it also increases accuracy and registration, since the mechanical accuracies of the system exceed the alignment requirements by a factor of 10 with the 40X minification system.

Use of the circuit library technique also makes possible the fabrication of lines of various widths by means of stored square or circular apertures. For example, with the 100X minification system, a 0.0001-inch-wide line is made with a 0.01-inch dot or elongated segment 0.01-inch wide. It also enables the rapid projection of repetitive geometries belonging to specific components in an LSI circuit.

Take, for example, a digital decoder built with several thousand diodes or transistors having identical electrical characteristics and, consequently, identical geometries. The transistor bases, emitters, and contacts, stored on a library circuit plate, are flashed sequentially onto the photographic plate for the decoder circuit. The imaginary axis of the image-selector mechanism of the circuit library can serve as the absolute axis of the decoder components. Once a photographic image of a circuit element, such as the transistor's emitter, has been selected by the computer commands, it can be flashed across the LSI photomask at rates to 10 per second.

The original image to be flashed onto high-resolution photographic plates is stored on 4x5-inch glass photographic plate. This plate is divided into 49 projection regions located at the intersection of

(continued on page 84)

Key component: the camera

Optomechanisms' computerized artwork generator, IC mask-maker, and step-and-repeat camera evolved from the company's model 610 Microflash camera. The camera was designed to meet the requirements imposed on photorepeaters by more complex, high-density IC's. It is equipped with an interferometric measurement system that achieves positioning accuracies within ± 0.25 micron (± 10 millionths of an inch). The interferometric system provides the digital outputs used by the computer to control the masking process.

The Microflash camera comprises three basic elements: an xy table, the interferometric system, and an optical system.

The xy table—consisting of two individual tables—allows positioning over an area 4 inches square. The two x and y tables have hardened steel surfaces. They are mounted on a base table of granite. The x and y tables slide on a set of ball bearings guided in V ways on one side, and on the other side, are supported by flat ways. No lubrication is used. This gives the xy table stability in the Z axis, or focusing dimension. It is an

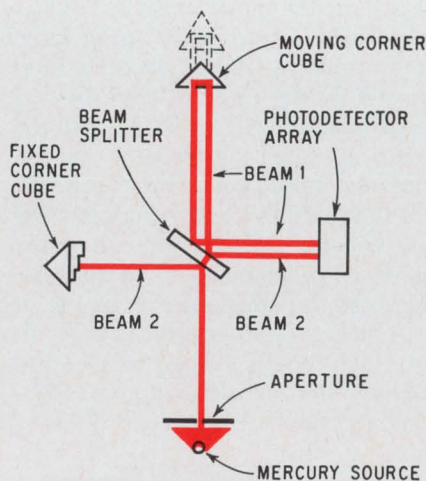

Out of step. Sensitivity of 0.068 micron per count is achieved by shifting phase of light beam plus and minus 90° by a stepped surface on fixed corner cube.

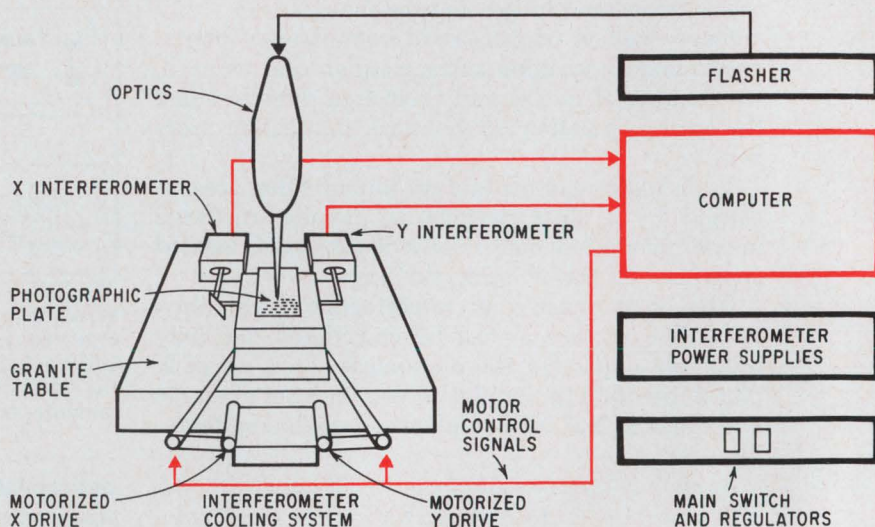

Fringe effect. Interferometer outputs provide computer with data to control entire masking process. Computer supplies motor-drive commands, controls flashing schedule, and selects proper circuit pattern, all from punched-tape input command.

important criteria, since a vertical displacement of only about 0.0001 inch will distort a sub-micron line.

The tables are moved by two d-c motors. Electrically operated brakes lock one axis while the other moves. This reduces migration of one axis with respect to the other while flashing is taking place.

Fringe benefit. Two Michelson interferometers measure displacements of the x and y tables. The interferometers use mercury light sources—5,460.782 angstroms—that are accurate to within one part in 10^7 .

The emitted light is directed through a small aperture to a beam splitter. One beam is aimed at a fixed trihedral prism, or corner cube; the other is directed to another, movable corner cube at a right angle to the first corner cube.

A photodetector array perpendicular to the primary beam counts the interference fringes as the table moves. The distance traveled equals $n \lambda/2$, where n is the number of counts and λ is the wavelength of the light source. This digital data is fed to the computer to control the xy table and the cam-

era's flash schedule.

The accuracy of the interferometric system exceeds the ± 0.25 micron accuracy needed by LSI manufacturers. At its maximum sensitivity range, $\lambda/8$, the interferometer reads in increments of 0.068 micron—2.7 millionths of an inch. Consequently, a photographic plate that has an imaging area of 100 millimeters square is made of a large number of finite increments. The total number of such increments is:

$$N = (10^2 \text{ mm} \times 10^3 \mu \times \frac{1}{0.068 \mu})^2 = 196 \times 10^{10}$$

Since the error in a digital system is \pm one count, the total error is ± 0.068 micron, 3.6 times smaller than the 0.25-micron-radius uncertainty sphere.

Achieving the high sensitivity of 0.068-micron increments required departing from traditional interferometric fringe-counting techniques. The fixed corner cube in the system has a stepped surface that shifts the phase of the incident light beam plus and minus 90° . The photodetector array is then able to sense positive or negative shifts

in phase around a zero reference. The photodetector array incorporates a peak detector with two selective levels to discriminate between phase shifts by sensing transitions from the maximum to the minimum light levels of the interference fringes.

Usually an interferometer system achieves a maximum sensitive range of $\lambda/8$ by inserting a one-quarter wavelength thick glass in front of the fixed corner cube. However, this technique is extremely temperature-dependent, since the thickness of the glass changes with minute temperature changes.

Optics. The optical system is made up of a flash lamp, the flash-lamp power supply, triggering module, and optical column.

Objectives in the system have been designed for operation to match the mercury light source. A narrow bandpass filter in the condensing system rejects the ultraviolet and infrared portions of the lamp's spectrum. There are two objectives available, a 28-mm f:1.8 and 55-mm f:2 for

10X and 4X minification respectively. Resolution is 600 lines per millimeter.

A focus control holds the lenses in a plane perpendicular to the flashing plane to within ± 0.0005 inch. Displays in the system indicate both focus adjustment and minification ratios. Nominal minification can be adjusted within 0.0001 inch across the field.

The Microflash camera system is controlled entirely by Digital Equipment Corp.'s PDP-8 computer. Input to the computer is through magnetic or punched paper tape. Not only does the computer position the xy table, but it also fires the light source at the correct time, selects the appropriate flash duration and intensity, and selects the proper aperture for the size image being flashed onto the photographic plate. The close control of the system by the computer enables flashing to be done while the table is moving in either direction, resulting in substantial time savings.

Proof positive. The machine's operation can best be understood by examining the technique used to fabricate a series of submicron lines.

Submicron lines are made through a series of step-and-repeat segment generation and intermediate contact printing steps, shown below. A line 1.6 inches long and 0.4 inch wide is reduced with a 4X objective, and stepped and repeated by moving the x axis of the high-resolution photographic plate parallel to the segment located at the projection plane. The result is a line 1.6 inches long by 0.025 inch wide.

A contact print of this line is made and replaces the original line. The reduction and step-and-repeat process is repeated—this time with a 10X objective—and a line 1.6 inches long by 0.0025 inch wide results. The line-producing operation is repeated twice more until a line 0.000025 inch wide—approximately 0.8 micron—results.

The final lines are made of 4,000 segments butted end-to-end to achieve the 1.6-inch length. Angular misplacement, overlapping, or gaps in the line are not present. This indicates that the alignment procedure and stepping accuracy exceed the line width.

One problem is to measure accurately these line widths approaching submicron geometries. To do this, a special technique is used to approximate the widths of the lines generated. First, the y-axis interferometer fabricates a series of lines with decreasing spacing. Then the large line spacings are measured optically to check the interferometer's digital readout. This data is used to deduce the line widths by comparing these known spacings with the thickness of the reproduced lines.

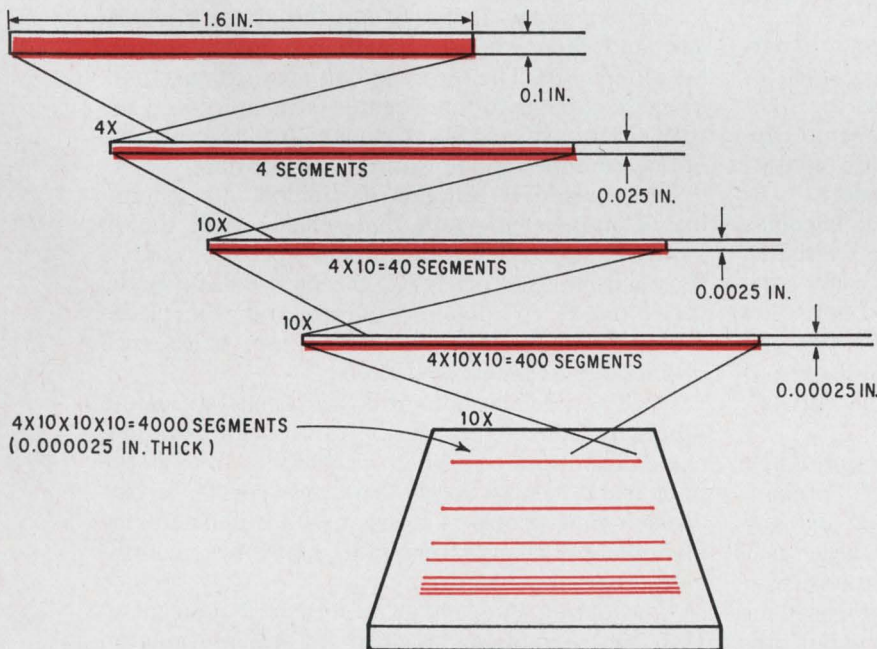

Down to size. Submicron lines are generated by reducing oversize line. Final line is made of 4,000 segments butted end-to-end to form line 0.000025 inch wide by 1.6 inches long. Lines reproduced in this way have no noticeable angular displacement, segment overlap, or line interruption. Overlapping of segments would cause over-exposed areas that would enlarge during processing of the plates. Submicron lines are measured by comparing thickness to known spacings between lines.

Bibliography

R.C.M. Beeh, "A high accuracy automated microflash camera," *Semiconductor Products and Solid State Technology*, July 1967, p. 43.

lines one-half inch apart. The circuit library, therefore, may contain as many as 49 images that do not exceed approximately 0.4 inch square.

The repeatability and accuracy of the final image is held within ± 0.25 micron by the Microflash step-and-repeat camera. Therefore, the registration accuracies of the images in the artwork generator should be ± 25 microns for 100X minification or ± 10 microns for 40X minification. Such prealignment accuracies are well within the capabilities of good mechanical systems. In this system, the circuit library also is prepared with the ± 0.25 micron Microflash camera. Therefore, a registration is achieved of ± 1 micron—exceeding the system requirements.

Cyclic production

This mask-making approach makes it possible to take a circuit concept all the way to the actual printing of geometries on a wafer by using a series of machines under the control of a central computer. Through a display console, an operator performs the decision-making and intelligence entry. The console permits alterations to be made with a light pen and interrogation through the central computer of any of the peripheral equipment.

Combined with a peripheral circuit-analysis computer, the display console helps in designing extremely complex circuits. Three-dimensional thinking becomes a reality, since the central computer provides spatial and vectorial data related to component densities, besides being used to select one image in preference to another.

The computer can operate the artwork generator sequentially by retrieving selected geometries from the circuit library. It also commands the step-and-repeat camera and an inspection machine capable of comparing idealized geometries against those produced on the photomasks or wafers.

Once the LSI wafer has been made, it becomes necessary to interconnect the individual circuits. The artwork generator can lay out on wafers the discrete wiring for LSI. All that is needed is for the operator to enter into the display the defective and usable portions of a specific wafer. Then a personalized mask is designed with either the artwork generator or a photoresist camera.

Most LSI manufacturers may have access to large computing systems that may be used to prepare programs for photomask fabrication. But just any computer won't do. Programming these large machines is costly and lengthy tapes are expensive to generate. Consequently, it is essential to consider fabricating photomasks automatically by input programs fed into small, in-line computers operating with several transducers.

The transducers include an artwork generator camera, a step-and-repeat camera, wafer or photomask inspection machine, a photoresist discrete wiring wafer camera, a circuit-analysis peripheral computer, and a visual input console.

It is clear that photomask manufacturers should develop programs and software concepts applicable to a species of photomasks that are compatible with the transducers.

For example, consider a shift register made of several thousand transistors that are to be grown within a single crystal and interconnected to perform input-output functions. Each transistor is located at a specific spot on the wafer that can be defined to within a ± 0.25 -micron radius uncertainty sphere. For this example it is assumed that the entire wafer is active and has no imperfections. The main axis of this transistor on the circuit can be defined by an equation that is a function of the location coordinates of transistor.

A transistor would have the following equation:
 $T_n = f(X_n, Y_n) f(F_A, F_S, F_I, F_P, F_C, F_D)$.

Although the functions F_A, \dots, F_D pertain to specific transducers, the coordinate function X_n, Y_n pertains to all the masks and inspection stations associated with a particular LSI circuit.

Accordingly, a computer program can be written for the function X_n, Y_n that is common with each of the peripheral transducers. Such is not the case for the machine functions since they differ according to the transducer. The function X_n, Y_n would then address the machine function. In most instances, the function X_n, Y_n is a large number, partially because of the high density of elements that constitute an LSI circuit. Each element is subdivided into a number of bits that correspond to the probability of location and the type of coordinate measuring technique used.

The coordinate function program is generated by a large computer. It is fed into the artwork generator and then compared with the interferometer measurements. The program also causes a small, in-line computer to interrogate its memory and extract the transducer function, which is fed into the in-line computer prior to mask fabrication.

The transducer function is divided into a number of output commands that select one of the 49 stored images, choose the proper aperture, control the flash intensity, select an a-c or d-c flash mode, verify the xy coordinate program, and control the servomotors' direction of travel, stop, start, end-of-line, and scanning schedule.

Once a specific photomask has been fabricated, a new transducer function is inserted into the machine. The same coordinate program is used if the photomask belongs to the same LSI specie. In the event a new specie is desired, the circuit library photoplate is changed manually and a new coordinate program inserted.

Considering the savings in cost and time along with the advantages created by the submicron capability, it is almost a foregone conclusion that manufacturers will seek out automated mask-making equipment. Large-scale IC manufacturers will benefit from the ability to produce identical photo masks every time. Small-volume IC makers will have the capability for custom designing IC circuits at a low cost.

Designer's casebook

Designer's casebook is a regular feature in Electronics. Readers are invited to submit novel circuit ideas, packaging schemes, or other unusual solutions to design problems. Descriptions should be short. We'll pay \$50 for each item published.

FET oscillator helps dolphins understand people

By Stephen L. Moshier

Listening Inc., Arlington, Mass.

Human communication with dolphins—necessary in studies of the animal's sonar—requires a conversion of the amplitude-modulated human word into a frequency-modulated word that the dolphin understands. The converted human word is similar to the dolphin's whistle signal and can thus be used to control the animal's movement.

A practical two-step method that converts words into f-m signals, first changes the a-m speech into a varying d-c level. Conversion of the human speech into a varying d-c level is accomplished by a complex voice recognition circuit. In the second step the varying d-c level is used to modulate the

output of an audio generator. Modulating the frequency of an audio generator with a voltage, however, requires redesign of the generator's signal source—the Wien-bridge oscillator.

Because of its stability over a wide frequency range the Wien-bridge oscillator is the usual signal source in an audio generator. Its frequency of oscillation is related to the components in the reactive arms of the bridge by

$$f = \frac{1}{2\pi\sqrt{R_1C_1R_2C_2}}$$

where R_1 and C_1 are parallel components in one arm and R_2 and C_2 are series components in another arm.

When $R_1C_1 = R_2C_2$ the relationship becomes

$$f = \frac{1}{2\pi RC}$$

where $R = \sqrt{R_1R_2}$
 $C = \sqrt{C_1C_2}$

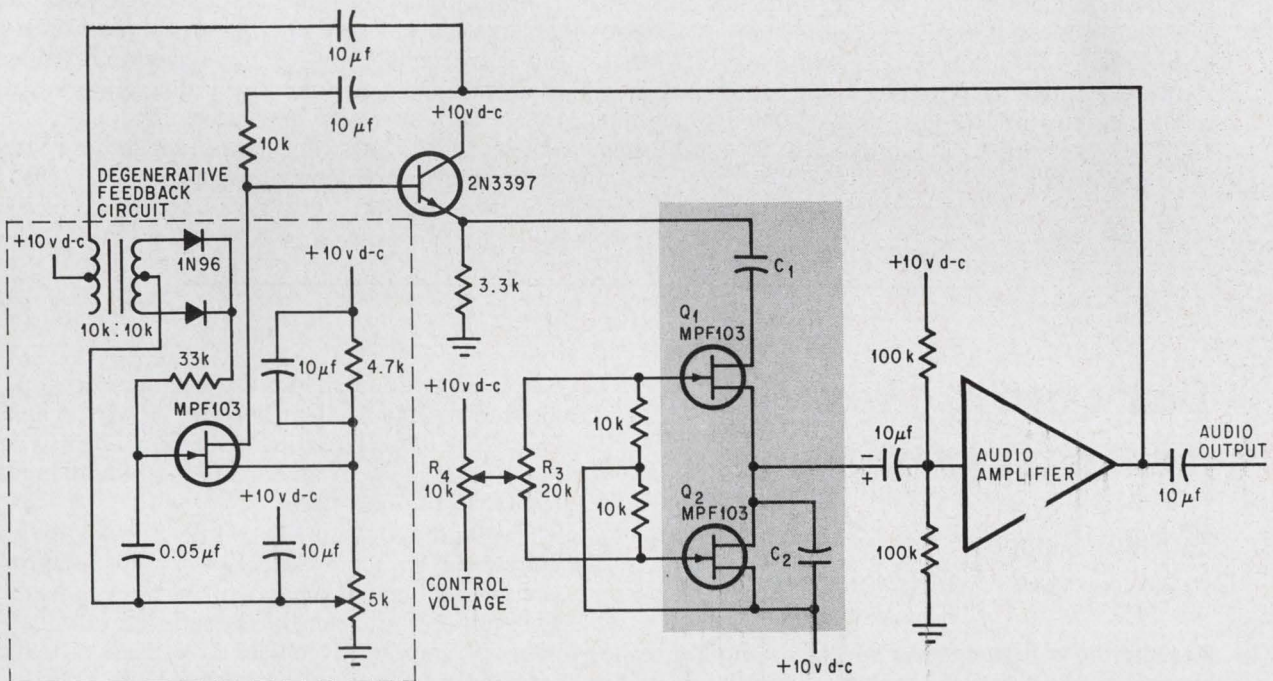

Frequency-modulated oscillator. Phase shift of feedback signal by components in shaded area allows only one frequency in oscillator to be regenerative. Capacitors C_1 and C_2 are fixed. Drain-to-source resistance of field effect transistors Q_1 and Q_2 , are changed by the variations in the control voltage. Control voltage thus determines oscillator frequency. Degenerative feedback circuit keeps output amplitude constant over a wide frequency range.

The resistors in the reactive arms of the bridge are replaced by field effect transistors Q_1 and Q_2 . This makes the frequency of oscillation dependent on the drain-to-source resistance of the FET's. Since the drain-to-source resistance, R_{DS} , of the FET is related to the gate voltage of the FET by the following equation:

$$\frac{1}{R_{DS}} = \left(\frac{1}{R_o} - \frac{1}{VR_o} \right) V_g$$

where V_g = gate-to-source voltage
 V = pinch-off voltage
 R_o = drain resistance when $V_g = 0$,

The frequency of oscillation in this generator is related to V_g by

$$f = \frac{1}{2\pi C} (M) (V_g)$$

$$\text{where } M = \left(\frac{1}{R_o} - \frac{1}{VR_o} \right)$$

The voltage that modulates the audio generator is injected at the point designated control voltage, and is divided by potentiometer R_3 and R_4 . It then becomes the gate voltage of the field effect transistors.

Adjusting R_3 overcomes dissimilarities in the pinch-off characteristics of the FETs and insures that the ratio of $\Delta \text{kHz} / \Delta V_g$ is constant. Variation of less than 1% in the kHz / V_g curve over a 10 to 1 frequency range is possible if the drain-to-source resistance R_{V_1} of the FETs are matched to within 10% of each other. Potentiometer R_4 establishes the ratio of kHz / V_g .

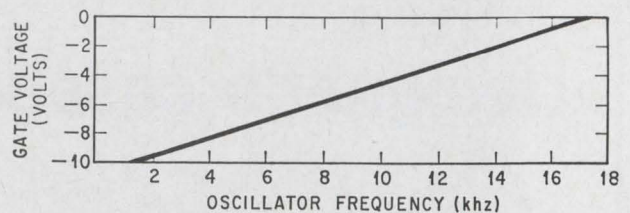

Frequency control. The gate voltage on field effect transistors in the oscillator sets the frequency of the audio generator's output signal. Careful adjustment of potentiometers in the gate circuit keeps the variation in the output less than 0.1 db over a 2 to 20 kHz frequency variation.

The value of the fixed capacitors C_1 and C_2 are determined by

$$C_1 = C_2 = \frac{0.5}{\text{maximum desired frequency}}$$

where capacitance is in microfarads, frequency is in kilohertz.

To obtain low-distortion operation, the signal voltage between source and drain of each FET is limited to 50 mv peak to peak. Therefore, resistive arms in the conventional Wien bridge are not used for degenerative feedback because of the noise they would inject. An automatic-gain-control circuit that detects and amplifies the feedback signal is used in their place.

Applications of the voltage-modulated audio generator developed for this technique are numerous. For example, by placing a sawtooth voltage at the control voltage point, the audio generator can be made into a sweep generator. The entire audio spectrum can be swept across an audio system to determine its frequency response.

Dual-Quad IC gives flip-flop a fast recovery

By Ralph Glasgal

Siemens AG, Munich, West Germany

Assembling a high-speed triggerable flip-flop from the gates of a single integrated circuit offers an inexpensive and convenient method of obtaining a common logic circuit not yet readily available in completely integrated form.

Positive logic NAND gates A and B are cross-

coupled to form a simple d-c bistable flip-flop. The flip-flop changes state when the input to capacitor C_1 goes to zero. To switch it back, a negative input must be applied to gate B with the first input returned to the one state.

Capacitors C_1 and C_2 couple the negative triggers to the inputs of the flip-flop and block the d-c and low frequency components of the trigger signal. The value of C_1 and C_2 is made large enough to permit triggering by pulses or even sine waves of any desired slope or frequency. With a 0.1- μf capacitor, the circuit triggers on sine waves down to a frequency of about 50 hz and generates exceptionally clean and symmetrical square waves from a push-pull input signal.

The network D_1 , R_1 , D_2 , R_2 and C_3 limits the positive voltage on the flip-flop side of C_1 and C_2 to a value just above the switching threshold of the gate, reducing the voltage requirements on the trigger. If there is enough trigger voltage available, these components may be omitted, provided the input voltage does not exceed the maximum for which the gate is designed.

Gates C and D, with diodes D_3 and D_4 , form a fast-recovery circuit that recharges C_1 or C_2 positively to a value above the threshold level in less than 100 nsec after the capacitors have been driven negative by the trigger signal. Even faster recovery times are possible if a smaller value of C_1 and C_2 is used. The output impedance of the gate, here 150, and the source impedance of the trigger generator are factors that affect the recovery time.

The extra inputs on gates C and D, when grounded, inhibit their respective triggers without affecting the state of the flip-flop.

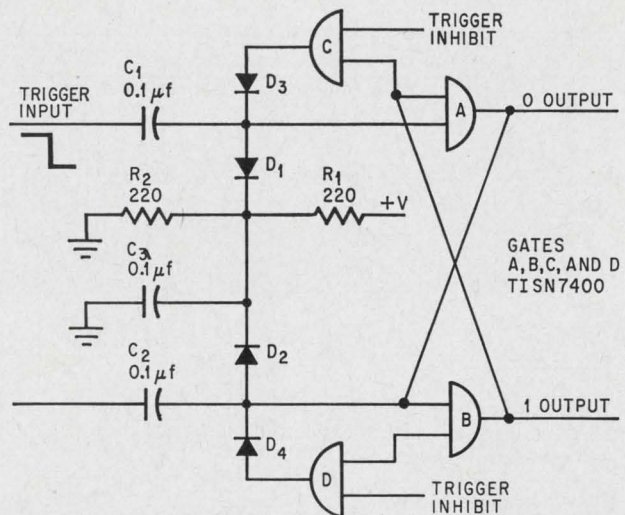

Logic. Triggerable set-reset flip-flop has fast recovery time and no capacitive loading on its outputs.

Reversed-polarity triode measures insulation

By Richard A. Parks

Westinghouse Electric Corp., Leesburg, Va.

Insulation of high-voltage conductors is accurately measured by a simple vacuum-tube circuit whose plate voltage is made negative with respect to its cathode. Because the circuit consists solely of the tube, two resistors and a transistorized Schmitt trigger, it can be contained in a package the size

of a flashlight, minus its power supply. In this application—testing cable insulation strung through airframes and shipboard superstructures—a compact package was necessary to enable the electricians to crawl into small places where sharp bends, oil leaks or acid spills may have damaged cables.

An inverted vacuum tube, V_1 , determines the insulation resistance by measuring the voltage that the insulation can sustain.

When the probe touches a leak in the cable, the measured voltage will be lower than the supply value. Thus, the voltage drop across the limiting resistor R_1 increases, which lowers the negative plate voltage. This decreases the density of the electric field in the tube and causes the grid current, i_g ,

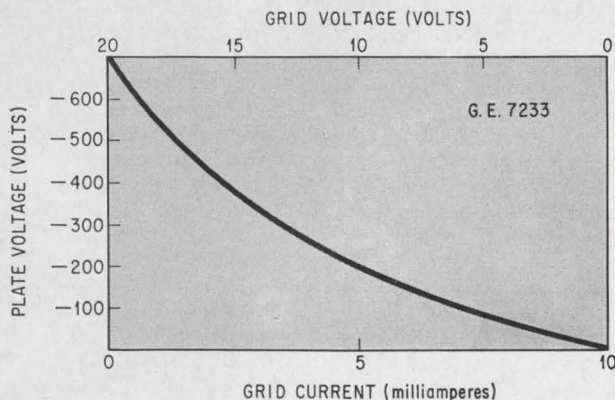

Reverse operation. Defective cable insulation causes the negative plate voltage on a triode to drop. The drop in plate voltage causes the grid current, i_g , to increase and the grid voltage, e_g , to decrease. The change in grid voltage is used to trigger automatic readouts.

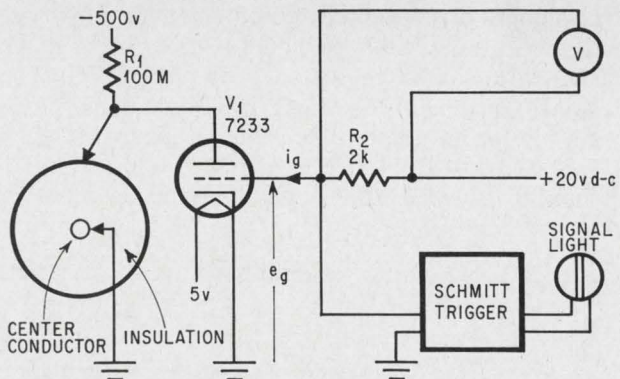

Infinite-impedance voltmeter. A strong negative electric field exists in the vacuum tube when the insulation meets specifications. Leaks in the insulation cause the plate voltage to drop, which weakens the electric field and its resistance to grid-cathode current flow.

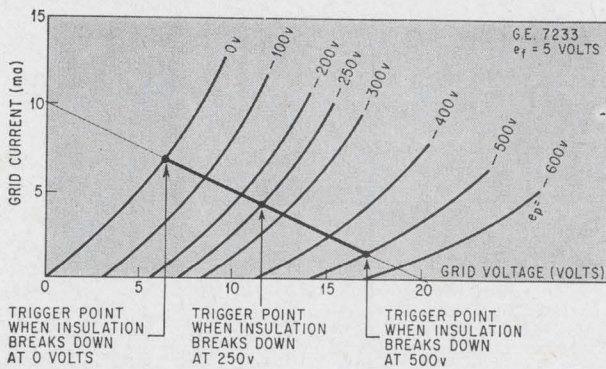

Trigger-point determination. The grid voltage that triggers the level detector is found using this grid voltage—grid current plot.

to increase. The increase in the grid current causes the grid voltage to drop to a point where the Schmitt trigger, used as a level detector, is turned on. Triggering the level detector causes the signal light to turn on.

The trigger point on the level detector is set once the minimum acceptable voltage for the cable's insulation is known. For example, cable that handles 200 volts should with some safety margin be

able to sustain at least 250 volts.

To determine the grid voltage for a plate voltage of 250, the i_g-e_g curve, which relates plate voltage to grid voltage and grid current, is used. A load line whose slope is equal to the reciprocal of the grid resistance is drawn, for this case 1/2,000 ohms. It connects a point on the vertical axis where grid current is a maximum—10 ma—with a point on the horizontal axis where the grid voltage is maximum—20 volts.

Where the plate voltage, —250 v, crosses the resistance line, the grid voltage is 11 and the grid current is 4.5 milliamperes. Thus the level detector is adjusted to turn on when the grid voltage reaches 11.

The tube characteristic curve is not conventional; the plate voltage is negative and the grid current is a variable.

If an engineer wishes to design a circuit for voltages higher than 600, a tube other than the 7233 must be used. Since handbooks do not show the tube characteristics when the plate voltage is negative, the engineer will have to draw his own curve. Conventional ammeters and voltmeters can be used to determine the relationship between negative plate voltage, grid voltage, and grid current.

Inexpensive SCR regulator for consumer equipment

By Peter Volkov

Zagreb, Yugoslavia

Designers of consumer equipment tolerate varying d-c voltages in their products because it is expensive to include a regulated power supply. In consumer equipment that must have a regulated power supply for its proper operation, an inexpensive silicon controlled rectifier regulator can be used. Although its regulation is not as good as more ex-

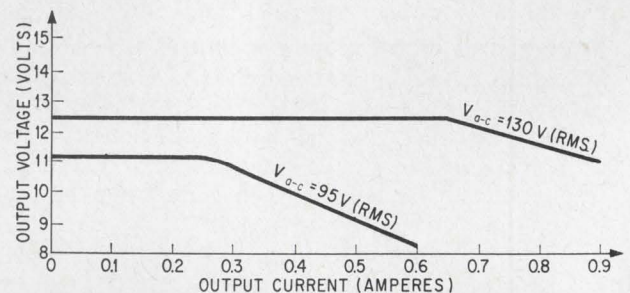

Limits in parameter changes. Output voltage versus current is plotted by the upper curve when the supply voltage is 130 v rms. When the line voltage is 95 v rms, the lower curve shows the output voltage. Loss of regulation at high currents results from saturation in the transformer.

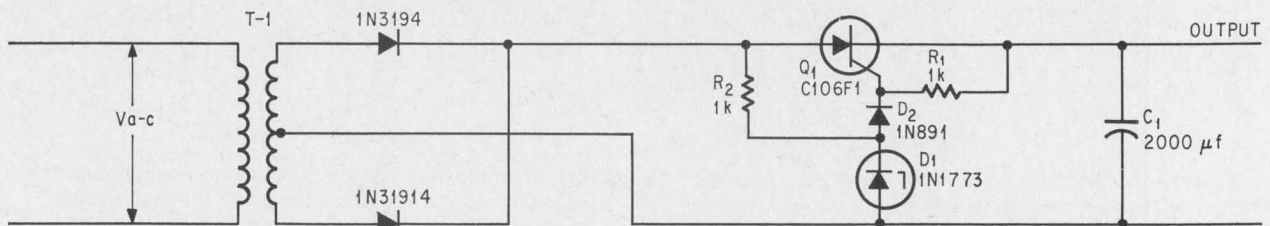

Controlled power supply filter. Silicon controlled rectifier Q_1 allows current to flow into the capacitor when current is drawn by the load.

pensive transistor regulators, it is adequate for overcoming load and line voltage variations that usually occur in consumer equipment.

Zener diode, D_1 , places a reference voltage—in this case 12 volts—at the gate of the silicon controlled rectifier Q_1 . When the voltage on capacitor C_1 falls to less than 12 volts, the SCR is gated into conduction by the potential drop between the gate and cathode. Current flow through the SCR replenishes the charge on C_1 , keeping the output voltage at 12 volts with the load present.

With the SCR not conducting, carriers are bled from the gate cathode junction by resistor R_1 . This keeps the carriers from being swept out by the high inverse voltage, and destroying the SCR.

Diode, D_2 isolates the zener diode's current-limiting resistor, R_2 from R_1 when the SCR is not conducting. Thus R_1 and R_2 are prevented from becoming a voltage divider that would turn Q_1 on with a voltage drop developed across R_1 .

The total cost of this regulator for most consumer equipment is less than \$3.00.

Grounded-base amplifier mates npn to pnp

By G.D. Morant

Fairchild Instrumentation, Palo Alto, Calif.

An effective and economical method of coupling two logic systems—one built with npn integrated circuits and the other with pnp discrete transistors—is sandwiching a single pnp transistor between them. The single transistor achieves proper polarity matching for the two logic systems.

Transistor Q_1 , a germanium 2N1303, is connected between the two systems as a grounded base stage so that the current from the ic flows into the emitter of the pnp device causing it to saturate. The collector voltage levels that result are directly compatible with those required for pnp logic.

Three ic transistors comprise a Fairchild μL 903, a three-input NAND/NOR gate. A positive voltage on any input terminal causes the gate to conduct. The

gate ground is returned through the emitter-base junction of Q_1 , and the current is limited by the value of the ic resistor, R_1 , and flows directly through R_2 to $-V_{cc}$. The minimum value of resistor R_2 provides maximum fanout at the collector of Q_2 , also a 2N1303. However Q_1 's collector current must be less than its emitter current if saturation is to occur. Thus

$$R_2 \geq \frac{-V_{cc}R_1}{+V_{ce}}$$

Since Q_1 's V_{be} is 0.35 v and its V_{ce} is 0.1 v, a positive pulse at the ic causes the collector of Q_1 to rise above ground by the difference of these two voltages, 0.25 v.

Transistor Q_2 , which forms a typical pnp discrete component gate, is turned off by this voltage and forms the output pulse.

Before the pulse appears, the voltage at the collector of Q_1 is approximately 4.0 v, determined by $V_{cc} R_2 / (R_2 + R_3)$.

Diode D_1 compensates for the V_{be} of Q_1 and preserves the output characteristics of the μL 903. Adding Q_1 to the circuit improves the input noise rejection capability of the μL 903.

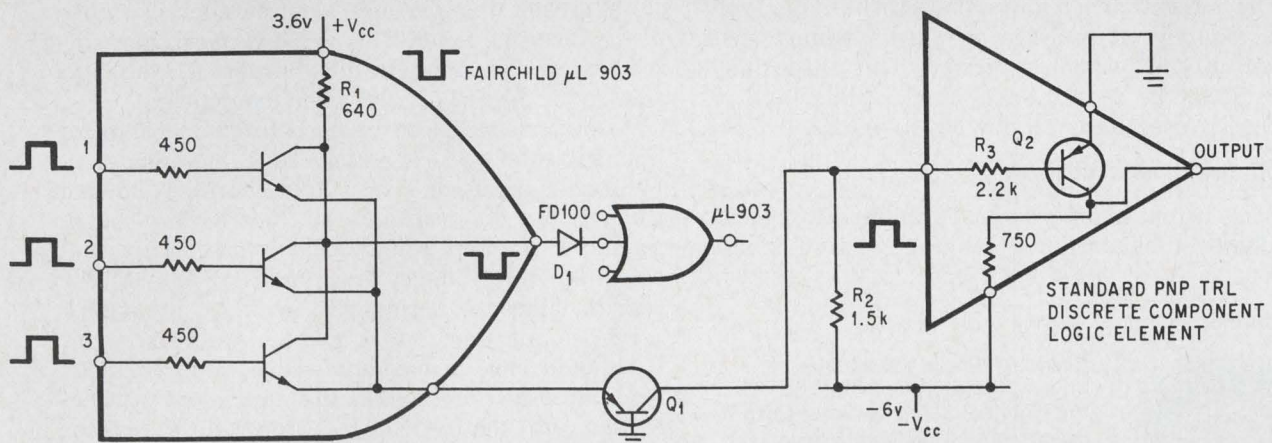

Conversion amplifier. Emitter current in the integrated circuit, μL 903 at the left, pulses transistor Q_1 when gated on. The saturated Q_1 's collector current biases Q_2 off and causes a negative pulse to appear at the output. Diode, D_1 , compensates for the $V_{be(sat)}$ of Q_1 by adding its forward drop to the next integrated circuit.

Linear IC's: part 6

Compensating for drift

Tailored to particular operating modes and impedance levels, corrective network can be easily adjusted at room temperature

By Robert J. Widlar

National Semiconductor Corp., Santa Clara, Calif.

Many users of monolithic linear amplifiers don't realize that by adding external circuitry, they can improve the amplifier's drift performance. In many cases, the extra circuitry enables the substitution of a low-cost amplifier for a high-priced chopper-stabilized amplifier. Depending on both the circuit and the application, drift caused by bias current and offset voltage can be compensated.

Six methods of bias-current compensation are available to reduce drift when the operational amplifier is driven from high-source resistances—about 10 kilohms or greater. Offset-voltage compensation reduces drift when low-source resistances, such as thermocouples, are encountered. A preamplifier can be used with an operational amplifier to reduce the drift to that of a chopper-stabilized circuit. Compensations are comparatively easy, necessitating an adjustment at room temperature to null out the offsets.

The integrated circuit's inherent d-c offset voltage and current produce an output voltage even when no input signal is present. This output voltage limits the resolution of the amplifier and reduces its usefulness for low-level signals.

Help an adjustment away

Bias-current compensation is tailored to specific feedback configurations, ranging from a simple

variable resistor to circuitry having three discrete transistors and four resistors. These circuits cover both single-ended and differential input modes for high-impedance situations.

The simplest and most effective way of compensating for bias currents in a summing amplifier is achieved by using a single potentiometer. The offset voltage produced by the bias current on the inverting input is canceled by the voltage developed across the variable resistor placed from the noninverting input to ground. The main advantage of this scheme, besides its simplicity, is that the bias currents of the two input transistors tend to track well as the temperature changes so that low drift is also achieved.

To assure a sufficient adjustment range to compensate for the input-current variation of most IC operational amplifiers, maximum value of the variable resistor should be approximately three times greater than the equivalent parallel resistance of the inverting input. This value is more than adequate since the input currents of most IC amplifiers track to within 10 or 20% over temperature.

A similar circuit can be used to compensate for bias currents when a noninverting amplifier configuration is used. The input current flowing through the d-c resistance of the driving source produces an offset voltage that is essentially canceled by the voltage drop across the variable resistor, placed in series with inverting input. For a proper adjustment range, the variable resistor, R_1 , should have a maximum value of three times the source resistance, and the equivalent parallel resistance of the feedback resistor and the resistor that is placed from R_1 to ground should be less than one-third the input source resistance.

For long-interval integrators, sample-and-hold circuits, switched-gain amplifiers, and the like in which the source impedance isn't well defined,

The author



Robert Widlar is the director of advanced circuit development at the National Semiconductor Corp. Before joining the company in 1966, he was with Fairchild Semiconductor, where he designed the μ A 702, 709, 710, 711, and 726.

Six bias-current compensation techniques

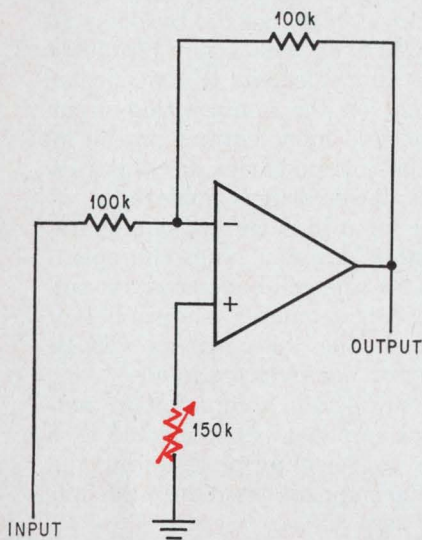

■ A variable resistor, in color, provides compensation for a summing amplifier that has a fixed source impedance. The resistor's value should be three times the equivalent parallel resistance of the inverting input. Unaffected by power supply variations, this circuit has the best temperature characteristics but only works for fixed values of feedback resistors.

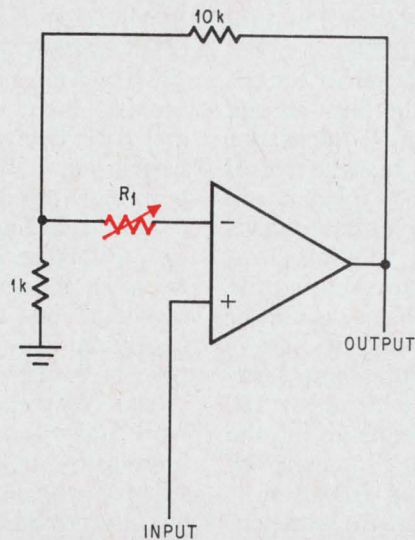

■ A variable resistor, in color, provides compensation for a noninverting amplifier that has a fixed source impedance. The value of this resistor should be three times the source impedance. This circuit covers a wide range of temperature and is unaffected by common mode or power supply variations. If the source impedance changes, a readjustment is necessary.

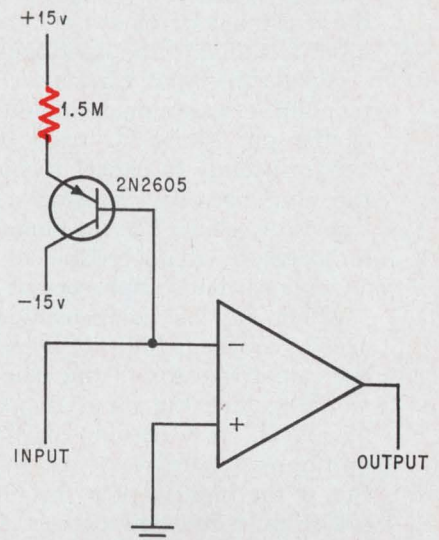

■ A selected resistor, in color, and a pnp transistor make up the compensation network for a summing amplifier that is independent of source impedance. This circuit is effective only over a narrow range of positive supply voltages and the amplifier's temperature drift depends on how closely the betas of the integrated and external pnp transistors track.

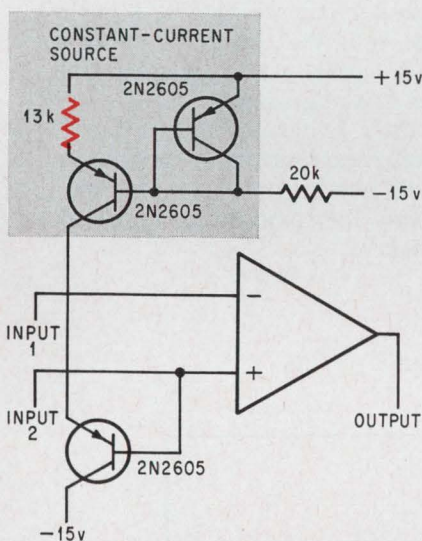

■ Three pnp transistors and a selected resistor, in color, provide the compensation network for a noninverting amplifier requiring large common mode ranges. This circuit provides tighter drift control over a limited range of temperatures. Variations in power supply have little effect. Since the inverting input isn't compensated, feedback resistance must be kept low.

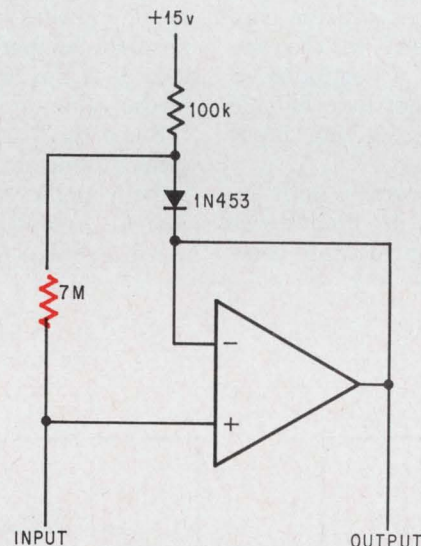

■ A germanium diode and a selected resistor, in color, provide compensation for a voltage-follower configuration. Bootstrapping the diode to the amplifier output provides a high input impedance. This circuit is relatively insensitive to power supply variations. Since the diode voltage doesn't track the input current accurately, larger temperature drift results.

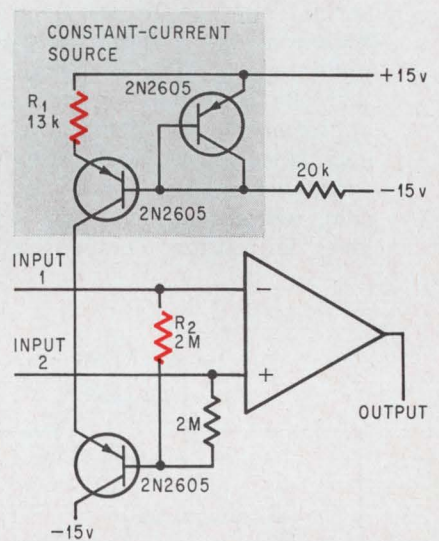

■ Two selected resistors, in color, and three pnp transistors take on the compensation chores for differential input that is independent of source impedance. This circuit compensates both inputs over the entire common mode range, and further drift reduction is obtained if the source resistors are equal. This general scheme works well for all configurations.

other compensation schemes are necessary.

In such schemes, a resistor is connected in series with the emitter of a discrete pnp transistor. Thus, the resistor determines the current injected into the input terminal of the operational amplifier.

Since npn input transistors are used in today's monolithic operational amplifiers, the base current of the pnp transistor used in the compensation network tends to cancel the input bias-current of the amplifier. By choosing a silicon planar pnp transistor, which has the same current-gain versus temperature characteristic as the ic transistors, an engineer finds improvement in temperature drift.

Although this compensation scheme could be used as a voltage follower by connecting the base of the pnp transistor to the noninverting input, this would reduce the input impedance to about 150 megohms. The reason: current supplied by the pnp transistor will vary with the input voltage level. But if the emitter of a discrete pnp transistor is fed from a constant current source, the compensating current won't vary with the input voltage.

The design of the current source should be such that it gives about the same temperature characteristics as those of the input stage of the monolithic amplifier to compensate for changes in temperature and power supply voltage.

Another compensation scheme for a voltage-follower configuration, using a diode, is simpler but not as good. Although the voltage across the diode does decrease with increasing temperature, this decrease isn't fast enough to completely compensate for the current-gain change of the input transistor. The current to compensate the noninverting input is obtained through a resistor connected across a diode bootstrapped to the amplifier output. The diode acts as a regulator so that the compensating current does not change appreciably with signal level, thus giving input impedances above 1,000 megohms.

Another scheme is possible in which both inputs, not necessarily at the same d-c impedance level, are current compensated for the full com-

mon-mode range as well as for power supply and temperature variations. With discrete pnp transistors, the circuit performs much like that for the noninverting amplifier, except that the bias-current compensation is applied to both input terminals. Two resistor values are selected. R_1 is selected for zero input current on the noninverting input, and R_2 is chosen for zero input current on the inverting input. If the d-c impedances are equal for both input terminals, lower drift is achieved.

After selecting an input-bias current compensation technique, a circuit designer plugs the operational amplifier and the selected compensation network into one of two test circuits, shown below, depending only on whether the amplifier will be used in the inverting or noninverting mode.

The complete circuit—both compensation network and operational amplifier—is connected as a unity-gain amplifier. By selecting or adjusting the value of resistance, the engineer can reduce the output offset voltage to zero.

Offset-voltage compensation

The predictable behavior of the base-to-emitter voltage of a transistor is the basis for an offset-voltage drift-compensation technique using a discrete differential transistor amplifier. The offset drift of a transistor pair can be reduced by about an order of magnitude by unbalancing the collector currents so that the initial offset voltage is zero. This follows from the equation expressing the base-emitter voltage differential V_{BE} of two transistors in terms of temperature and current.

The change in V_{BE} is $(kT/q) (\ln I_{S2}/I_{S1} - \ln I_{C2}/I_{C1})$ where k is Boltzmann's constant, T is the absolute temperature, q is the charge of an electron, I_C is the collector current, and I_S is a constant whose value depends on the geometry.

Since the base-emitter voltage is a function of collector current—not emitter current—the balance initially achieved will not be upset by the base current, except possibly for some interaction with the d-c source resistance.

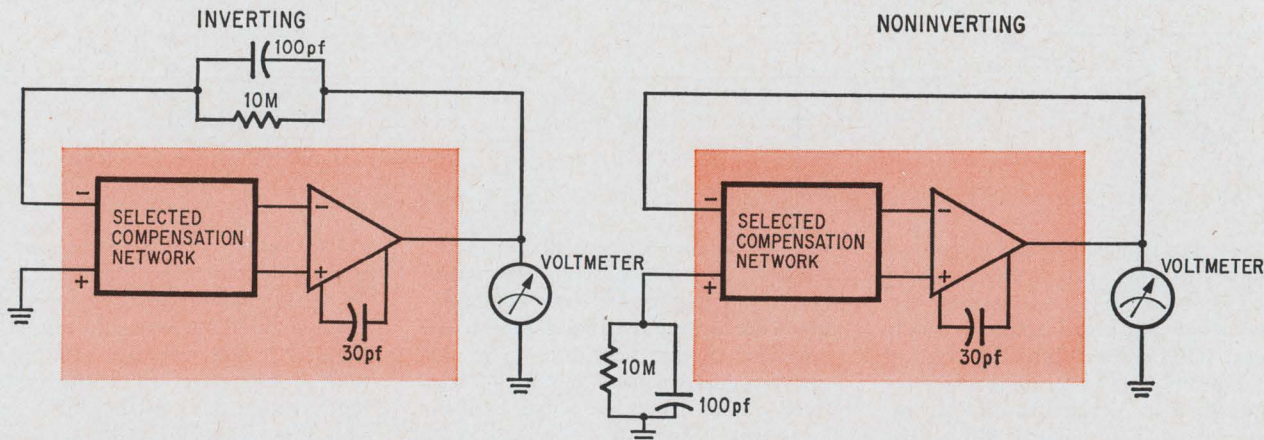

User's choice. Two test circuits permit the engineer to minimize the input current drift. Users simply connect the combination of compensation network and operational amplifier to the external test circuitry and then adjust the bias compensation resistors for zero output.

The first term of the equation, $(kT/q)(\ln I_{S2}/I_{S1})$, represents the offset voltage of the differential transistor pair for identical collector currents.

The second term, $(kT/q)(\ln I_{C2}/I_{C1})$, reflects the change of offset voltage that would arise from operating the transistors at unequal collector currents. For any fixed ratio of collector currents, the second term is also proportional to the absolute temperature. If the collector currents are properly unbalanced to compensate for this difference in transistor currents, the base-emitter voltage differential, as well as the temperature drift, will be zero.

To obtain very low drifts, it is almost always necessary to use an external monolithic transistor pair as a preamplifier for a conventional operational amplifier since a temperature differential of only 0.05°C will give a 100-microvolt drift.

With a monolithic pair, the proximity of the two transistors and the high thermal conductivity of silicon holds the offset voltage differential to a minimum. Thermal drifts of less than $100\ \mu\text{V}$, over the temperature range of -55°C to $+125^\circ\text{C}$, have been realized.

No substantial improvement in performance would be realized by operating this amplifier in a temperature controlled oven. The reason: any improvement would be masked by the various thermoelectric effects not directly associated with the amplifier, unless care was taken in the choice of input lead material, the method of making connections, and the balancing of all thermal paths.

The preamplifier transistors must operate from a low-source resistance—approximately several hundred ohms—so that the voltage drop across the source resistance due to the base current (or base current differential in the case of equal source resistance) is insignificant.

The transistors must operate at a low enough collector current so that the emitter-contact and base-spreading resistances are negligible, since the equation expressing the change in V_{BE} assumes that they are zero. The preamplifier gain must be sufficient so that the drift of the operational amplifier doesn't degrade the over-all circuit performance.

The input drift of the preamplifier can be made to approach that of chopper-stabilized amplifiers. By making the output offset voltage zero, the engineer finds the offset drift is also zero.

Best of all worlds

A complete amplifier based on these principles, at the right, has a monolithic transistor pair as the preamplifier. A null potentiometer unbalances the collector-load resistors of the transistor pair so that zero output is obtained when the input is zero. This circuit is relatively unaffected by power supply voltage variations—a 1-volt change in either supply will cause an offset voltage change of only about $10\ \mu\text{V}$. The reason for this insensitivity to power-supply voltage variations is that neither term in the equation relating the change in V_{BE} and transistor current is affected by the magnitude of the collector currents.

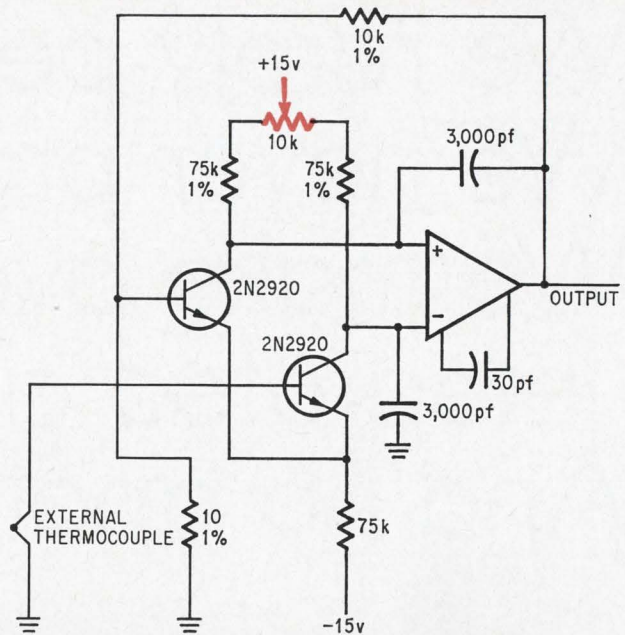

One good turn. A simple adjustment with a potentiometer (shown in color) reduces the offset-voltage drift of a differential transistor pair by about an order of magnitude. The potentiometer unbalances the collector currents so that the initial offset voltage is zero.

To minimize drift, the engineer must take certain precautions. The preamplifier-load resistors must be well matched because as little as 0.1% imbalance due to thermal or other mismatches will produce a $25\text{-}\mu\text{V}$ shift in offset. The potentiometer introduces an error that will depend on how far it is set off midpoint if it has a different temperature coefficient than the load resistors.

Drifts of $0.05\ \mu\text{V}/^\circ\text{C}$ over a 0 to 50°C temperature range were achieved by A.H. Hoffait and R.D. Thornton using matched discrete transistors in a single package. Using the relatively simple circuit above, drifts of 0.5 to $1\ \mu\text{V}/^\circ\text{C}$ over a temperature range of -55°C to $+125^\circ\text{C}$ were realized.

This low drift compares favorably with the drift figures of the more expensive and complex chopper-stabilized amplifiers: $0.4\ \mu\text{V}/^\circ\text{C}$ for mechanical choppers, $0.5\ \mu\text{V}/^\circ\text{C}$ for photoelectric choppers over a 0 to $+55^\circ\text{C}$ temperature range, and $2\ \mu\text{V}/^\circ\text{C}$ for field-effect-transistor choppers over a temperature range of -55°C to $+125^\circ\text{C}$.

Bibliography

- C.T. Sah, "Effect of Surface Recombination and Channel on PN Junction and Transistor Characteristics," IRE Trans. on Electron Devices, January 1962, pp. 94-108.
- A. Tuszynski, "Correlation Between the Base-Emitter Voltage and Its Temperature Coefficient," Solid State Design, July 1962, pp. 32-35.
- J.E. Iwersen, A.R. Bray, and J.J. Kleimack, "Low-Current Alpha in Silicon Transistors," IRE Trans. on Electron Devices, November 1962, pp. 474-478.
- A.H. Hoffait and R.D. Thornton, "Limitations of Transistor D-C Amplifiers," Proceedings of the IEEE, February 1964, pp. 179-184.
- R.J. Widlar, "Some Circuit Design Techniques for Linear Integrated Circuits," IEEE Trans. on Circuit Theory, December 1965, pp. 586-590.

"We rarely perform miracles.
We never promise them.
We make over a million
integrated circuits a month.
And no apologies."

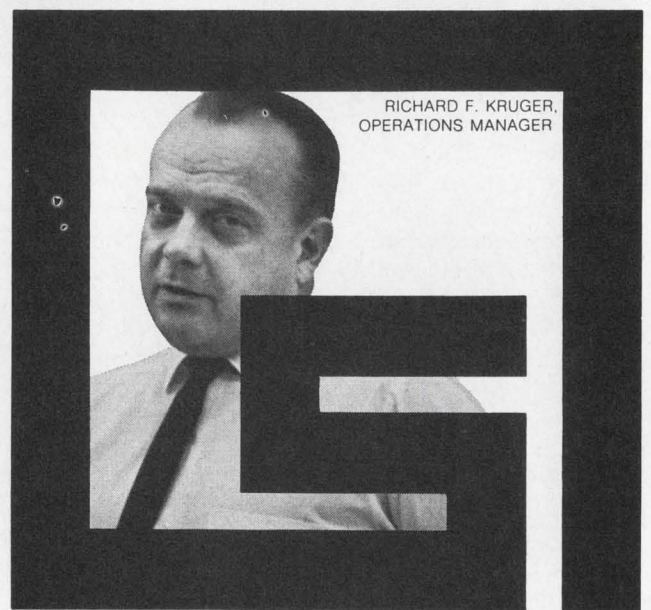

RICHARD F. KRUGER,
OPERATIONS MANAGER

SIGNETICS INTEGRATED CIRCUITS

SIGNETICS CORPORATION
THE RESPONSE/ABILITY COMPANY

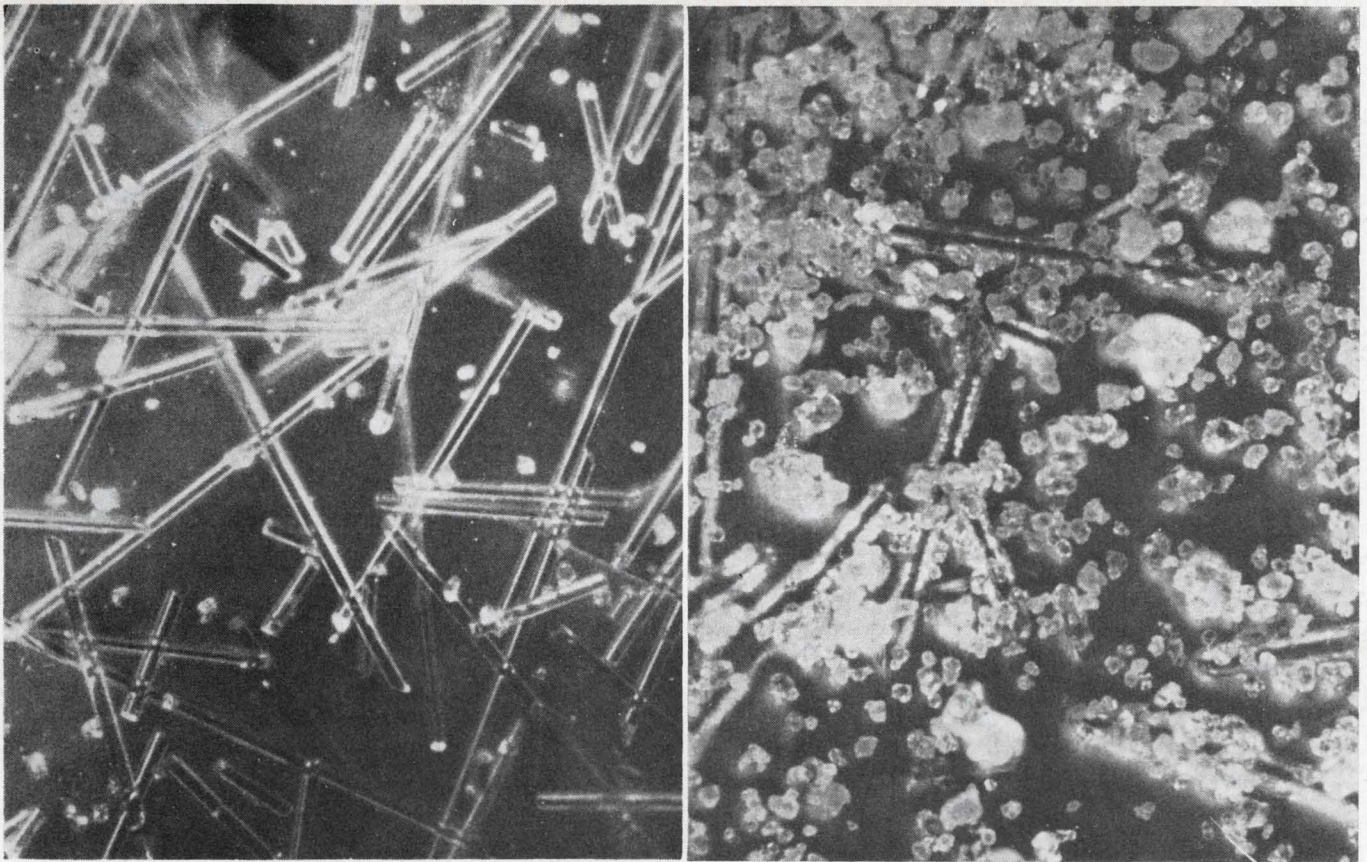

Glass fibers. Uncoated, left; carbon-coated and sealed in electroluminescent layer, right.

Advanced technology

Through a glass brightly

Switching requirements of multi-element electroluminescent displays can be eased by adding coated lossy fibers to the dielectric material

By Franklin G. Reick

ITT Federal Laboratories, Nutley, N.J.

Only a glimmer of an idea just a few years ago, all-electronic real-time dynamic displays are on the verge of becoming a reality. One big reason: electroluminescent elements can be modified so that they can be controlled easily by glass semiconductor switches. The result is a multi-element electroluminescent array that can be of almost any size, from a small readout to a wall-size display.

Mating an array to glassy switches is simple. But because electroluminescent devices have a high impedance, they require a minimum current level to hold them on and a high series resistance to turn them off. By changing the internal impedance, the devices can be controlled by the glassy switches.

The modification can be achieved by incorpo-

Tailoring fibers to fit display

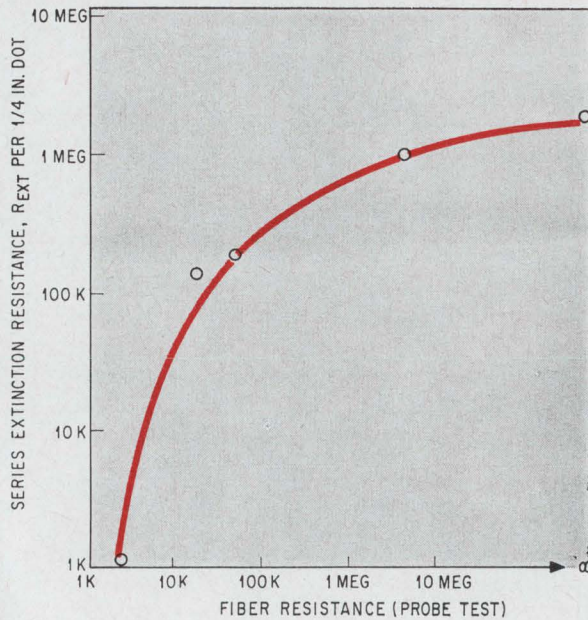

Constant change. The fiber resistance has a strong effect on the series extinction resistance.

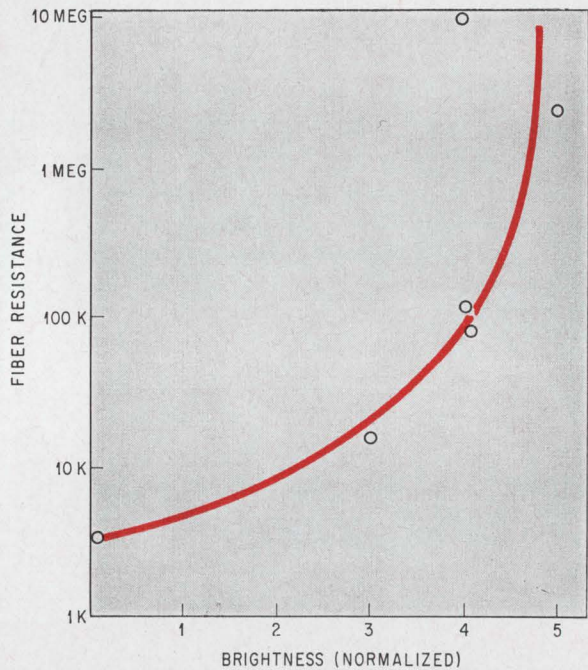

Sharp change. The brightness isn't seriously affected until the fiber resistance is reduced to 100 kilohms.

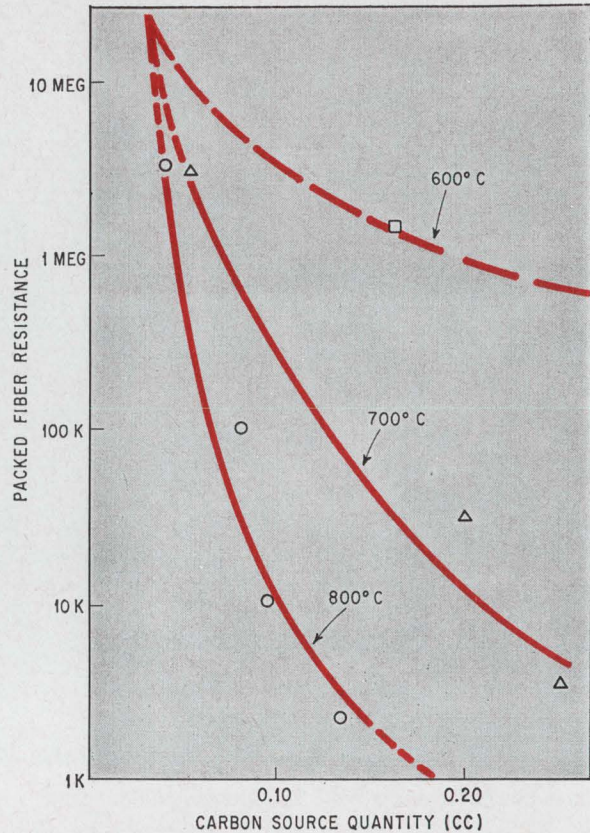

Controlling resistance. Fiber resistance is determined by the amount of vapor and the temperature of firing.

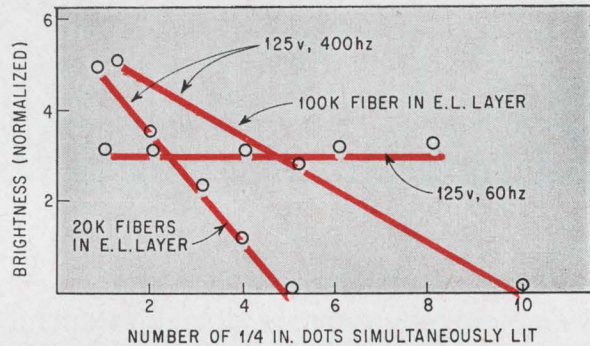

Dimming. Fiber resistance, number of dots, and the frequency of the supply all effect the brightness.

Pick and choose. By using the right fiber resistance in conjunction with the characteristics of a particular electroluminescent panel, a display can be made to work with glass semiconductor switches. This approach minimizes both cost and complexity.

rating a high resistance in the electroluminescent sandwich. This resistance, in parallel with each element, lowers the needed series extinction resistance. Glassy switches have a high off-state resistance, and a-c capability, making it a natural for controlling electroluminescent arrays.

The mating of glassy switches to the light-emitting array is desirable because of cost; both

lend themselves to batch fabrication [Electronics, July 24, 1967, p. 74]. However, in mating the two, the extinction resistance and the holding current requirements must be taken into account.

The high extinction resistance requirements of the panel can be met by the glassy switches, but as the off-state resistance increases, so does the on-state resistance. Thus, the panel wouldn't draw

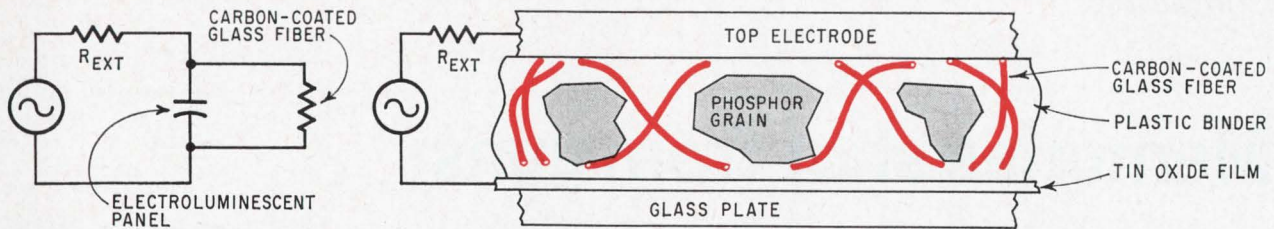

Placement. Electrically, an electroluminescent panel acts like a capacitor. To increase panel's impedance, carbon-coated glass fibers are placed in the dielectric, making contact with both plates.

sufficient current to remain on, causing flicker.

If the glassy switch is constructed so that its on-state resistance is low enough to draw sufficient current, then its off-state resistance isn't high enough to turn the panel off. To overcome this problem, a lossy dielectric is inserted in the panel. This dielectric also causes the panel to draw more current to prevent flicker.

Although the electroluminescent circuit could be made to draw more current and thus have a lower extinction resistance by shunting it with an external resistor, this would mean a loss in efficiency. More important, this also means each element in the array would require a resistor. The wiring would be too complex to be practical.

However, if an internal leakage resistance were used, the same results can be achieved without resorting to external wiring. Short carbon-coated glass fibers are included in the dielectric-phosphor layer, and set up a leakage resistance between 500 kilohms and 1 megohm. The fibers make contact to each electrode, but their spacing should be great enough so as not to block the emitted light or to affect the electrostatic field around the phosphor crystals.

At low light levels, the added internal resistance dims the panel's brightness. But at high light levels, the fiber resistance has a diminishing affect. For example, in one test the brightness didn't change appreciably after the fiber resistance was raised above 700 kilohms, while the needed series extinction resistance didn't increase much above 1 megohm after the fiber resistance was raised to about 3 megohms.

Carbon coat

A number of techniques for coating inorganic surfaces with carbon have been developed for use in manufacturing discrete film resistors. They usually require that the surfaces to be coated be exposed to hydrocarbon vapors such as methane at temperatures of 800°C and up so that the gas decomposes, forming a layer of hexagonal carbon crystallites on the surface. But boro-silicate glass, used in the manufacture of the fiber, starts to soften at 650°C and loses its identity as fiber at 800°C. Another method, using phenolic resins, is preferable.

Phenolic resins are excellent sources of carbon, and their starting reactants, phenol and formaldehyde, evaporate at reasonably low temperatures. It is possible to condense their vapors on surfaces,

forming resins that can be carbonized without any serious loss of adhesion to the surface on which they are formed. Fibers are exposed to the vapors and react with them to form a polymer. This layer can then be carbonized to give the desired resistance values.

With this technique, carbonization temperatures can be higher than the melting point of the glass because the resin-carbon film protects the fibers from melting. The resistance of the fiber can be controlled by the quantity of the reactant vapors, the temperature of firing, and the length of time the fiber is exposed. The peak firing temperature is a key variable because a significant change of resistance occurs between 600° and 800°C.

The higher the process temperature, the lower the resistance of the fibers. This is expected because more carbon is condensed from the vapor phase on to the fibers, and more carbon means less resistance. The effect of the vapor is greatest at concentrations between 0.05 and 0.15 cubic centimeters.

One of the disadvantages of using a lossy dielectric is that more power is needed to drive the electroluminescent panel. For a standard 400-hertz supply, the number of ¼-inch elements dim the brightness of the total display drastically by loading down the supply. A simple solution is to use a 110-volt, 60-hz supply because high currents are readily available. Because electroluminescent devices are frequency dependent, there is a loss in brightness at the lower frequency. A 400-hz power supply, with an increased current capability, would be used for a production-model display.

Another problem, heat that's produced by the increased impedance of the panel, is also easily solved. Alumina, or some other heat-conductive substrate, can be used. However, it would be necessary to provide adequate air flow to cool the panel.

The author



Now a senior technical specialist at ITT Federal Laboratories, Franklin G. Reick once headed Diversified Technology Inc., a small research firm involved in plastics and electrochemical etching. Before that, he was a development engineer at GE, where he worked on phosphors.

Memories shot from guns

Able to stand up to the extreme of heat, cold, spin, and shock that go with the job, ferroelectric ceramic units store digital data that controls the timing of fuzes in artillery shells and guided missiles

By Alvin B. Kaufman

Guidance and Control Systems Division, Litton Systems Inc., Woodland Hills, Calif.

Back in the days of bombs filled with black powder, the essentials for an effective explosion were dry weather, a match, a long fuze, and a good sense of timing. None of these figure in today's ordnance specifications—except the need for timing. The memory that stores the time delay for a fuze in a missile or artillery shell must retain its data in any environment, yet be small, simple, and inexpensive.

Ferroelectric ceramic memories fill the bill. They can be used in any digital control system, military or industrial, that must store data for a long time without using power, and can accommodate changes in the data for testing or altering the system. Their low cost stems partly from a configuration that permits readout by a single pulse, or step, rather than by a resonant oscillation.

In ordnance applications, the memories must work at any temperature in the range -55° to $+75^{\circ}\text{C}$ while spinning at up to 35,000 revolutions per minute after having been subjected to shocks equivalent to 30,000 times the force of gravity imposed in a few milliseconds—that is to say, after having been shot from guns.

Countdown

For ordnance fuzing, digital timers have proven far more reliable than analog types, which depend,

The author

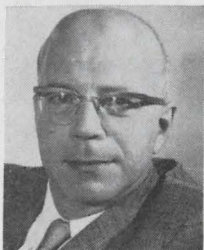

Alvin B. Kaufman manages the instrumentation and nuclear studies section at the Applied Research Laboratory of Litton Industries. His previous experience includes calibrating and checking out Snark missile instrumentation and systems at Northrop Aircraft. He has also written approximately 200 technical papers and articles.

for example, on small clock motors or discharging capacitors. In a digital timer, a precise clock drives a counter preset to a number representing the required time delay. The counter counts backward to zero before generating a signal that detonates the explosive.

The counters are ordinarily composed of a series of transistor flip-flop circuits. But such circuits cannot store the preset number before countdown without the continuous application of power; if power is interrupted, the number stored in the counter is lost.

What's needed, therefore, is a separate memory that can store the number indefinitely without power, can accept a new number at any time, and can transfer its contents into the flip-flop counter just before counting begins. Such memories could be made from a magnetic alloy in the form of a ribbon wound on a bobbin. But these bobbins, with the windings, cost about \$2.50 apiece, far too much when a dozen or more are needed for each artillery shell—and artillery shells are turned out by the millions.

A pure ferrite-core memory similar to a computer memory produces only millivolt signals, which would have to be amplified to drive the flip-flop circuits. Cores can produce larger signals if the sense wires are wound many times around the core, or if the drive currents are large, but multiturn windings are hard to make and large currents tend to produce noise that has to be screened out by strobing or other complex methods. Also, data stored in cores is destroyed when it's read out; further use requires regeneration.

However, a disk of ferroelectric material half an inch across costs about a dollar and can store a dozen or more bits. And the output of a ferroelectric ceramic memory is measured in volts, not millivolts, so that the unamplified signal can drive logic cir-

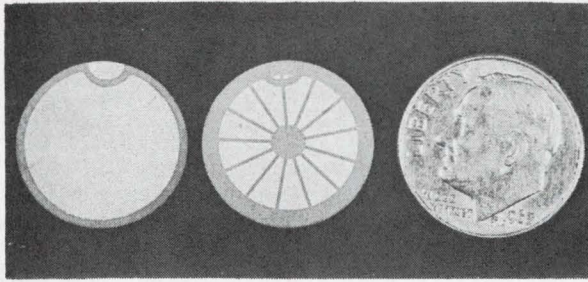

Ferroelectric pie. Costing only about a dollar, this little wafer can store a number and transfer it directly into an electronic counter. A voltage applied to the bottom layer bends it; the upper layer bends too, generating voltage pulses at the pie-shaped electrodes. Pulse polarity depends on previous polarization of the ceramic.

cuits directly. The 13 bits in the photo directly above can store a number as large as 8,192, corresponding to a time delay greater than 1½ minutes if the counter is driven at 100 counts per second. Finally, the readout is nondestructive.

The memory is a disk, made of a polycrystalline ceramic such as lead zirconate titanate, upon which electrodes have been vacuum-deposited. A single solid grounding electrode covers most of one side of the disk, while several pie-shaped sector electrodes cover the other.

A negative remanent polarization in the ferroelectric material under all the sector electrodes corresponds to the reset, or all-zeros, state of the memory. A binary number is stored by applying a pulse of several hundred volts for a millisecond or so to the sector electrodes corresponding to the 1's in the number, reversing the polarization in the material under those electrodes. The polarization stays reversed, because of hysteresis, after the write-in voltage is removed.

The readout process utilizes the piezoelectric property of ferroelectric material. Applying a voltage to a piezoelectric material creates a small physical deformation; conversely, deforming the material generates a small but significant voltage. The readout signal, a 15-volt, 100-microsecond pulse applied to the round electrode in the center of the disk, deforms the entire ceramic and causes voltages at each of the sector electrodes.

With resonant ceramic memories, the interrogate signal's frequency has to match the resonant frequency of the crystal. The cost of a ceramic memory's peripheral circuits are considerably reduced if this resonant drive requirement is eliminated and a single pulse or voltage step is used as the interrogate signal. A nonresonant memory doesn't need a clock with a frequency that's stable over a wide temperature range. And with its freedom from this constraint, the unit can handle more applications than the resonant type.

The nonresonant ferroelectric memory is based on a "bender" element—for which a patent is pending—made from two pieces of ceramic bonded on opposite sides of a thin brass or invar vane, as above at right. The piezoelectric property of the ceramic combines with the bonding to the vane to make the

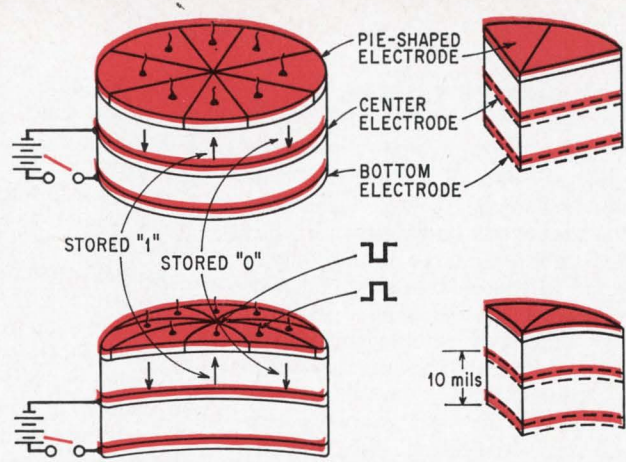

device bend or curl when a voltage is applied, just as a bimetallic strip bends when it's heated. A round bender thus becomes cupped when a voltage is applied.

If both ceramic chips are polarized in the same direction, the piezoelectric action is quite marked; in this mode, as a generator, the device can be used as a ceramic phonograph cartridge.

Chain reaction

In memory applications, one ceramic disk acts as the "motor" that drives the device and the other stores the data. When a voltage bends the motor disk, the change in configuration is transmitted through the vane to the other disk, and a positive or negative voltage pulse appears at each pie-

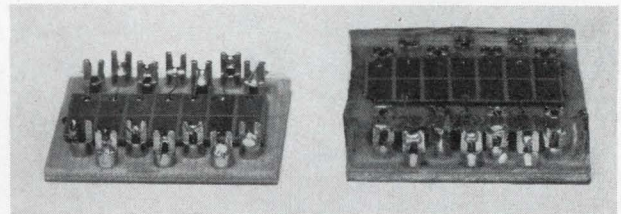

Specialization. Performance of this memory is improved because the motor layer has been chosen for superior electrostrictive characteristics and the storage layer for low coercive force and easy write-in.

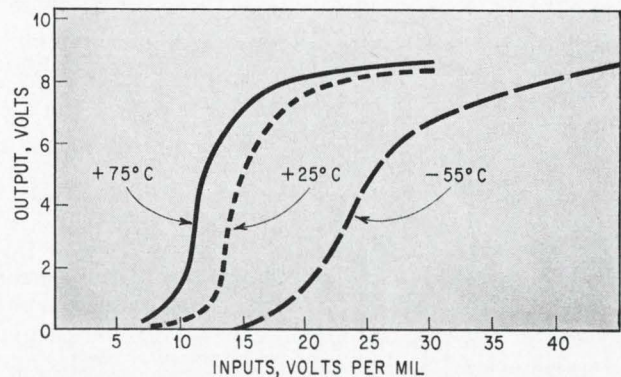

Frigid storage. Although the ceramic's performance isn't seriously affected by wide temperature variations, a higher write-in voltage is required at lower temperatures to achieve a satisfactory output pulse.

For bigger pulses

A ferroelectric memory's output can be increased if the drive voltage is boosted. Unless transformers are used, however, most circuits are limited to an output voltage equal to the voltage supplied. But a scheme of capacitor charging can effectively double the pulsed drive voltage to the memory without transformers.

The circuit that employs this scheme in the ferroelectric memory was designed at NASA to handle resistive loads. The capacitive-load version comes in two forms, one using a transistor as the switching element to create the output pulse, the other using a four-layer diode.

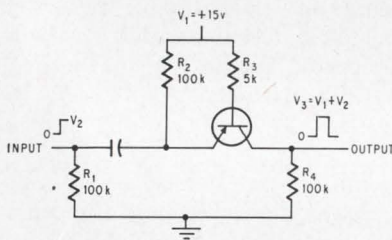

In the voltage doubler, capacitor C_1 is charged through resistor R_2 to the supply voltage, V_1 . With no input pulse, both the emitter and base of the transistor, Q_1 , are at the same potential and the collector is cut off. With an input pulse of height V_2 , the positive potential of the emitter of Q_1 with respect to ground is increased by V_2 , the emitter becomes more positive than the base, and the transistor is switched on. This results in an output pulse, V_3 , equal to

$V_1 + V_2$ minus negligible losses in C_1 and the collector-to-emitter voltage of the saturated transistor. Q_1 turns off after the capacitor has discharged through it, and the output continues to fall as the memory capacitance discharges.

Earlier version. The original circuit designed for a resistive load had a capacitor connected between the base of Q_1 and ground. When the input pulse caused Q_1 to turn on, some of the charge on C_1 "spilled over" onto the base capacitor to the extent that $V_1 + V_2$ exceeded 15 volts. After C_1 had completely discharged through the transistor, the charge on the base capacitor kept the transistor on for a short time, widening the output pulse. This widening, though, occurred at the expense of the output pulse amplitude because of the loss of charge to the base capacitor.

With a capacitive load, the output pulse is widened somewhat as the load discharges through R_4 , so that the base capacitor is unnecessary. And because the extra capacitor decreases the amplitude of the output, it becomes a positive liability.

A simplified variation of the voltage doubler circuit, shown below,

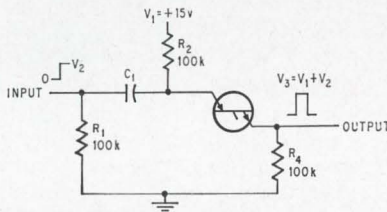

uses a pnpn four-layer diode. After breakdown, the diode continues to conduct as little as 125 microamperes with a voltage drop of about 1 volt.

The charge time of C_1 isn't affected by resistor R_1 if the input line is normally at ground, as in this instance, because both ends of R_1 are at the same potential.

Bigger the better. The higher the value of R_2 , the slower $V_1 + V_2$ decays toward V_1 . The value of C_1 doesn't regulate the peak output pulse voltage, but it does determine the discharge time constant, $C_1 R_4$, and therefore the squareness of the output, which ideally should be the same type as the input but of shorter duration.

The performance of the voltage doubler with a capacitive load and unit step function drive is shown below. Output with a 15-volt drive

With a transistor

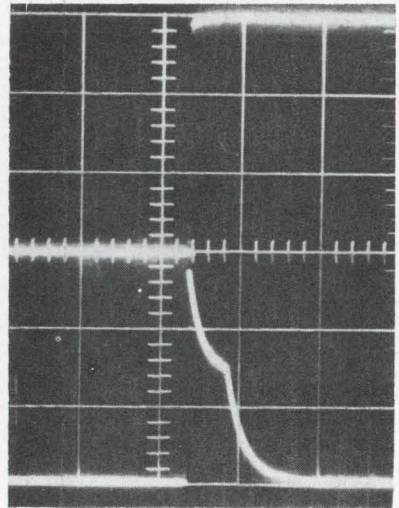

shaped electrode—depending on which way the material under the electrode is polarized.

Though the bender is used in a nonresonant mode, its resonant frequency is important. This frequency is high enough—several hundred kilohertz—to prevent the bender from picking up stray vibrations from its environment.

The output signal's shape is similar to that of the input signal. Although the memory's output impedance is higher than that of the resonant ferroelectric memory, its output signal is still large enough to drive logic circuits made of junction field effect transistors, metal oxide semiconductor devices, or low-power bipolar transistors. The output impedance is easily controlled because it depends on the electrode area and on the ceramic's dielectric constant.

The bender memory requires rather high input-signal levels to strain the ceramic sufficiently to

cause the generation of an adequate output signal. A typical 15-volt input signal produces a 2-volt output in a bender. In a resonant memory, the two levels would be more nearly equal. The additional energy in the bender causes its output to ring as shown on page 102.

The relation between a high signal level and ringing in the bender is somewhat analogous to that between a hammer blow on a bell with no clapper and the resulting sound. The bell doesn't strike very far, particularly if the hammer doesn't strike at its swinging resonance. But after the bell has been started swinging, its motion can be maintained by relatively small pushes without enough energy to cause ringing.

Encapsulating the ferroelectric memory can reduce the ringing, which basically represents noise. The ratio of the output signal's amplitude to the amplitude of the ringing is a signal-to-noise ratio.

is indicated by the trace at the left. The signal V_3 peaks at about 28 volts; its waveshape and duration are a function of the capacitance value selected for C_1 . The initial drop in the V_3 pulse is caused by C_1 discharging through R_4 and into the capacitance load. Q_1 cuts off at the breakpoint, and the subsequent decay reflects the discharge of the memory capacitance through R_4 .

Performance of the four-layer diode circuit is shown in the photograph below. The switch turns on with modest forward-gate current and remains on until the drain-source current falls below 3.5 milliamperes. With the switch on, C_1 and the memory capacitance across R_4 are effectively in parallel. The output amplitude is similar to that obtained with the transistor switch except that the V_3 rise time isn't

With four-layer diode

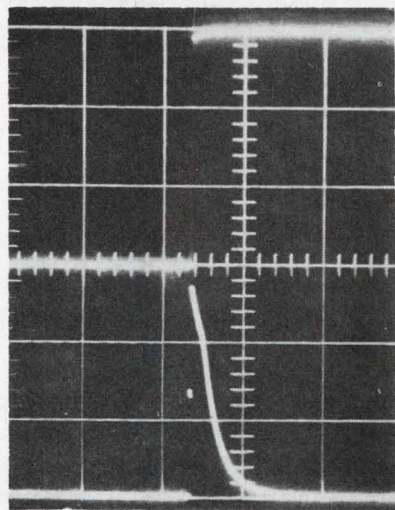

With 0.1 microfarad capacitor

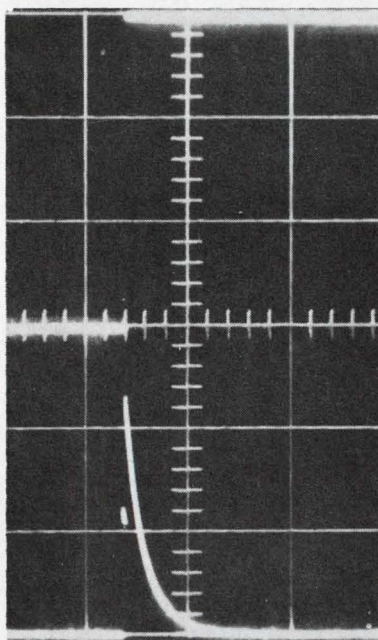

With 0.33 microfarad capacitor

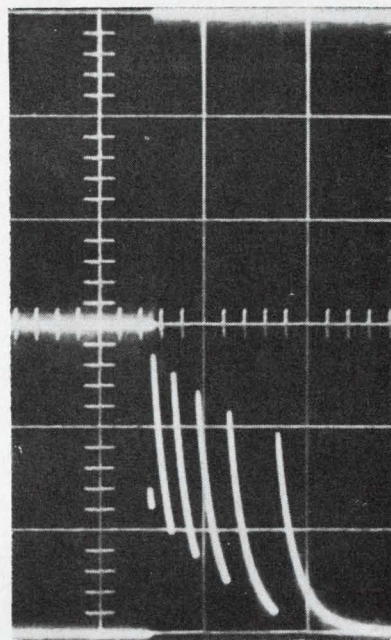

quite as fast—probably because the rectifier's turn-on time is longer.

The V_2 signal's rise must be fast for satisfactory performance, as it determines the amplitude of the voltage-doubler pulse, V_3 . If V_2 rises too slowly, the capacitor charge begins to dissipate while V_2 is coming up, reducing the output amplitude.

Sawteeth. Where C_1 is below a critical value in the circuit with the diode switch, a single interrogation pulse is developed from a single input. For larger values of C_1 , the circuit produces a series of sawtooth pulses, as shown above. The current through the diode falls below the holding point

after initial turn-on partly because of circuit impedance and the drop of C_1 's potential. At this point, Q_1 turns off and the potential on the unloaded capacitor increases rapidly until Q_1 again fires. RC decay then occurs and Q_1 shuts off, and this process continues until the stored charge in C_1 is depleted.

A phenomenon called rate effect undoubtedly contributes to the generation of sawtooth pulses. In its off condition, the four-layer diode passes a capacitive current in response to a sharply rising voltage wave. If this voltage rises quickly—say 10 to 100 volts per μsec —switching takes place below the d-c switching voltage.

If the ringing is very great, the output signal may appear momentarily to have reversed polarity; a 1 may look like a 0, or vice versa. This sort of error could throw off the timing of a fuse and cause a premature explosion.

A special drive circuit that doubles the amplitude of the interrogate pulse, and thereby nearly doubles the output amplitude as well, also incidentally reduces the amount of ringing [see "For bigger pulses," above]. But the circuit's particular benefit is that it improves performance without requiring higher supply voltages or transformers.

Variations

The circular 13-bit memory shown on page 99 represents only one of several possible forms. The electrodes can be deposited in several patterns, the device itself can take several shapes, and different materials can be used.

All these factors affect performance, though. For example, a rectangular bender is cheaper to make than a round one, but it has a lower coupling coefficient between its two parts, and its output is thus smaller in proportion to its interrogate signal amplitude.

The round memory in the photo has one electrode folded over its edge for connection to the center vane between the layers of ceramic. The connection is needed because both input and output voltages are referenced to the center vane. In some benders, however, access to the center vane is made through a hole in one of the ceramic layers.

The pie-shaped electrodes in the round memory don't extend to the edge of the disk. As the edge doesn't curl very much under applied voltage, it contributes very little to the output. It also tends to absorb some of the piezoelectric potential developed by the more highly strained part of the

From oven to deep freeze

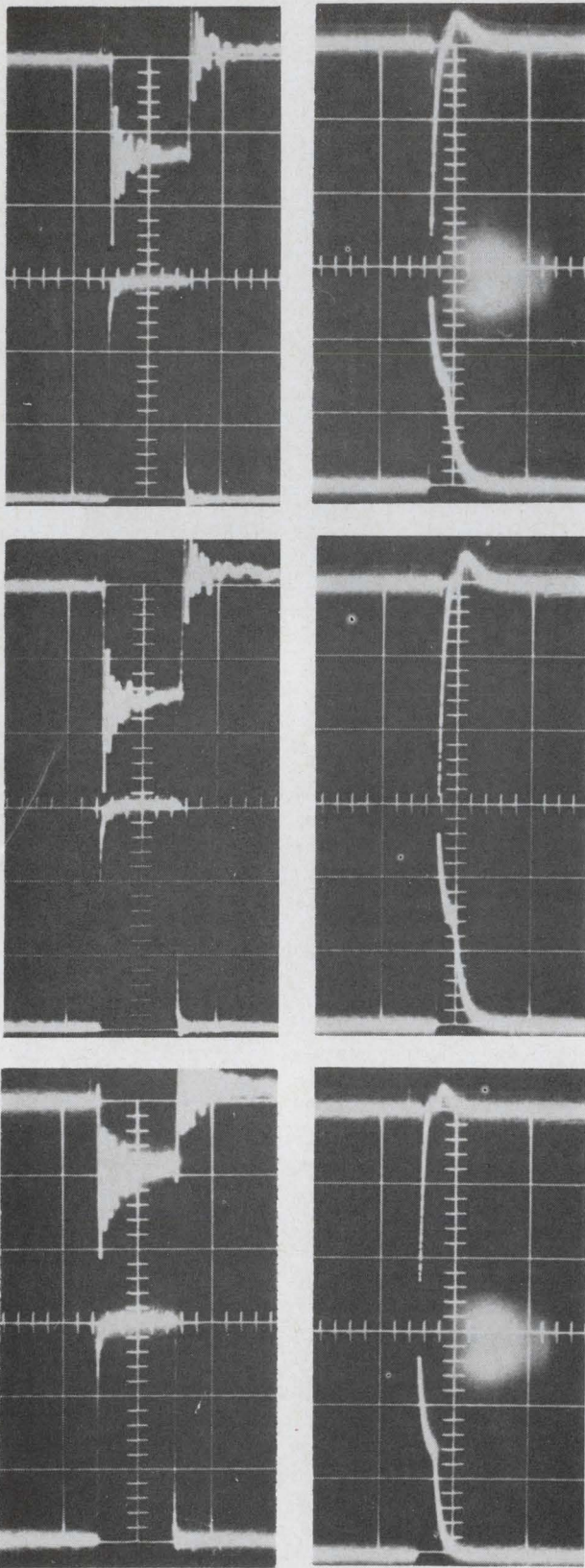

Hot and cold. Temperature extremes have hardly noticeable effect on ferroelectric memory's performance, as shown by these oscilloscope traces, made at +75°, +25°, and -55°C, respectively (top to bottom). Ringing of unencapsulated memory (traces at left) is reduced by use of voltage doubler circuit as source of input pulse.

disk near the center.

A ferroelectric material with a lower coercive force can be impressed with the desired binary data more easily—that is, with a smaller, narrower input pulse. However, such a material is less satisfactory as a motor because its electrostrictive response to an input pulse is smaller. But a bender made of different kinds of ceramic on either side of the central vane—one kind with a low coercive force to load data easily, and the other with superior electrostrictive characteristics—is more nearly ideal.

The rectangular memory on page 99 is made of two different mixtures of the same lead zirconate titanate materials. It measures 19 by 500 by 860 mils, and can store two rows of seven bits each. On its special storage element of low-coercive ceramic, data can be set by a pulse of 130 volts—considerably smaller than that required in the round memory of high-coercive material. The shape of the memory is incidental; it has nothing to do with the coercive force or the amplitude of the write pulse.

Driving in the cold

Although the memory can be made to work satisfactorily at any temperature from -55°C to +75°C, a higher writing voltage is necessary at the lower temperatures. The curves representing output signal levels for various inputs and temperatures, on page 99, have been plotted for the rectangular bender made with two kinds of ceramic, but their shape is characteristic of all ferroelectric memories.

Output voltage remains at about 8 volts for increases in write-in voltage beyond a threshold of about 15 volts at 75°C. At lower temperatures, the threshold is less sharp. At -55°C, in fact, increases in write-in voltage from 15 to 25 volts result in output curves smoothly sloping from 0 to about 6 volts and rising more slowly thereafter.

The success of ferroelectric ceramic memories in ordnance fuzes suggests the application of similar techniques to matrix memories of several thousand bits—again where low cost and high output are important and where extreme environmental conditions must be overcome. One obvious field for these techniques is missile and aerospace guidance computers, but commercial applications shouldn't be ruled out either.

Bibliography

Alvin B. Kaufman, "Obtaining nondestructive readout with ferroelectric memories," *Electronics*, Aug. 25, 1961, p. 47.

Alvin B. Kaufman and Harry Newhoff, "Ceramic memory for ordnance fuzing," Harry Diamond Laboratories, Reports TR-250(D)-1, Feb. 25, 1966; TR-250(D)-2, April 20, 1967; TR-250(D)-3, Sept. 25, 1967.

Alvin B. Kaufman, "Ceramic memory for ordnance fuzing," *Proceedings, Timers for Ordnance Symposium*, Harry Diamond Laboratories, November 1966, vol. 3, p. 27.

Alvin B. Kaufman, "Ceramic memory; design and use in programmable timers," *Electromechanical Design*, April 1967, p. 34.
"One-transistor circuit ups pulse amplitude," *National Aeronautics and Space Administration tech brief*, *Electronic Design*, April 1, 1967, p. 100.

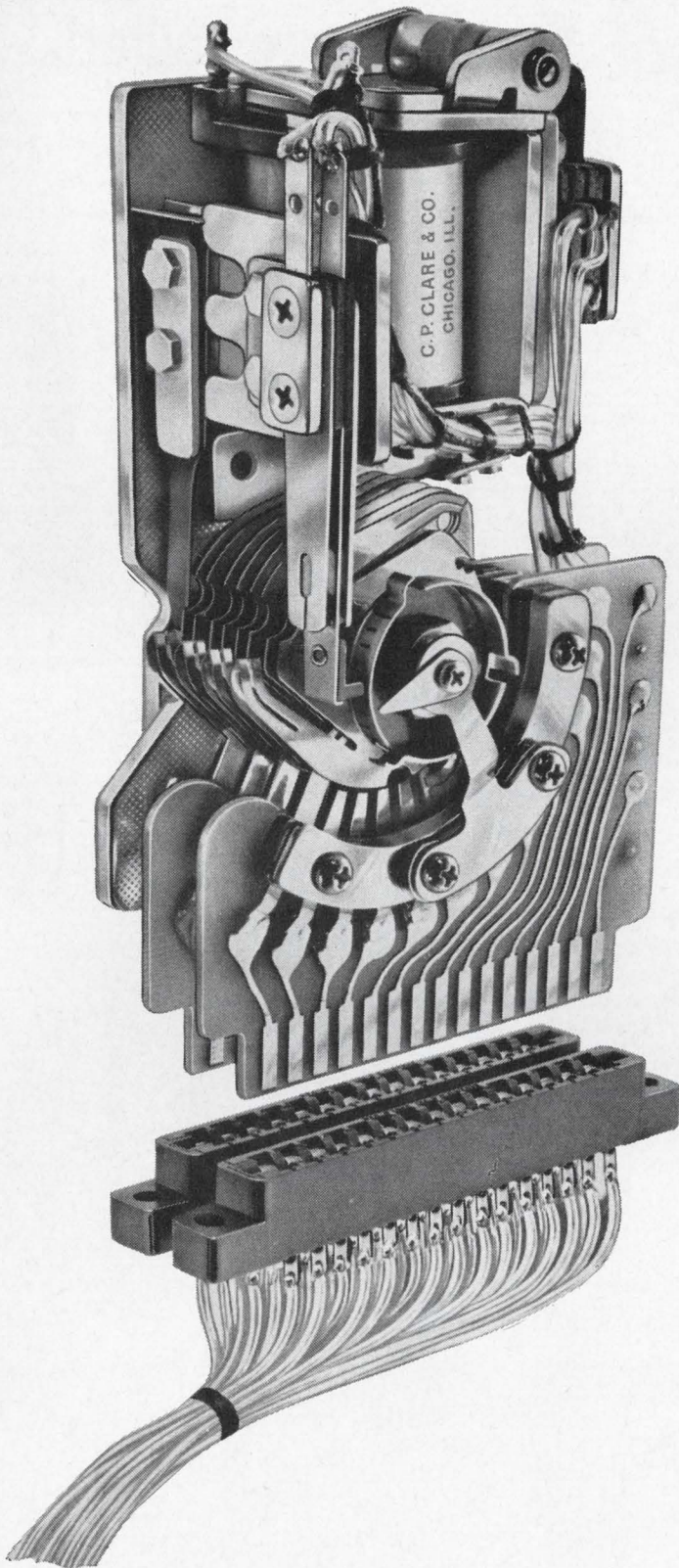

quick-mount

adds new *plug-in* simplicity to the mass sequential switching advantages of Clare Stepping Switches.

The exclusive Clare Quick-Mount brings the speed and ease of plug-in connectors to stepping switch application... makes mass sequential switching more economical... easier to use. Fast unit-for-unit replacement assures continuous service where minimum downtime is required. Clare Quick-Mount is available with all Clare spring-driven switches, using standard 15, 22 or 28-pair connectors.

For complete information, circle reader service number—or ask Clare for Bulletin 651-3... Write Group 2N6

C. P. Clare & Co., Chicago, Ill. 60645



a GENERAL INSTRUMENT company

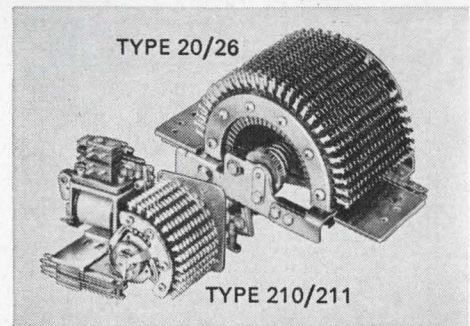

- Low cost scanning and counting
- Maximum switching density
- Long service life
- Special purpose shorting switches—"All But One", "Progressive", "Alternate" operations
- Special high voltage switches are available

CLARE QUICK-MOUNT STEPPING SWITCHES

for mass sequential switching, counting, totalizing,
scanning, sequence control, circuit monitoring

EIMAC

has a rugged 500 watt tetrode that is ready to talk before you are.

We knew you weren't satisfied with ordinary push-to-talk mobile and airborne UHF/VHF communications systems. Why? They took up to 60 seconds to warm-up. You needed more power and you needed it with "instant talk" speed.

The EIMAC metal ceramic X2099B is the only tetrode combining 500 watts of plate dissipation with instant warm-up. The quick-heat cathode in the X2099B takes only 250 milliseconds to warm up to half power or 70% of peak current. You can drive the X2099B with low level solid state, and you can air cool it.

The X2099B is available only at EIMAC. We're ready to talk whenever you are. (415) 592-1221.

Contact your nearest distributor or Varian Field Office for further information. Offices are located in 16 major cities. Ask information for Varian Electron Tube and Device Group.

TYPICAL OPERATING CHARACTERISTICS Class AB₁ Radio Frequency Linear Power Amplifier

	DC Plate Voltage		V
	1600	2600	
DC Screen Voltage	200	250	V
DC Grid Voltage	-24	-34	V
Zero-Signal Plate Current	250	225	mA
Max Signal DC Plate Current	455	370	mA
PEP or CW Plate Output Power	400	500	W
Third Order Intermodulation Distortion	-36	-38	dB
Fifth Order Intermodulation Distortion	-54	-46	dB
Filament Voltage	2.5	2.5	V
Filament Current	10.0	10.0	A
Warm-up Time (to half power)	250	-	ms

EIMAC

Division of Varian
San Carlos, California 94070

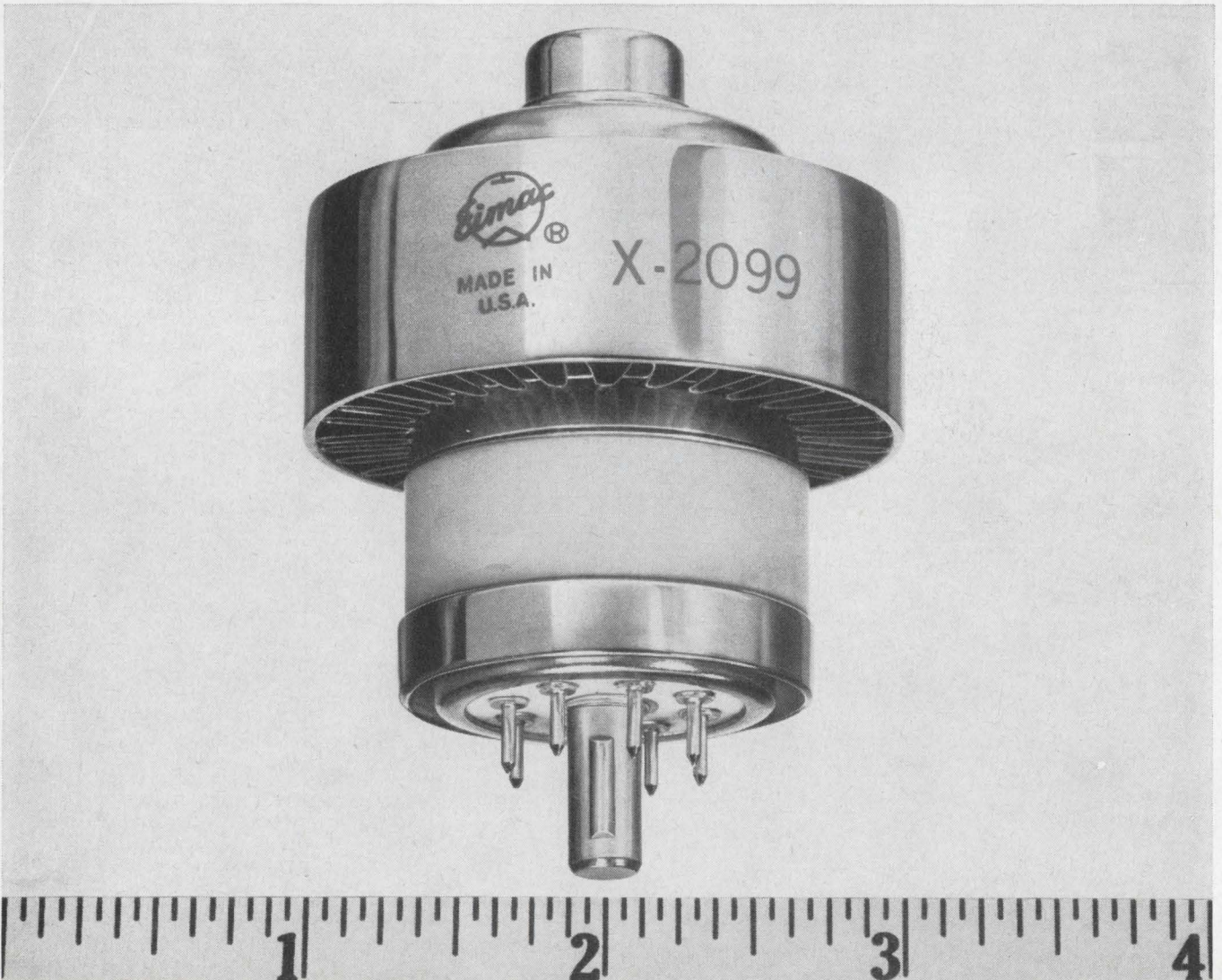

Business and the urban crisis

"Absolutely terrifying. No wonder people riot."

So said William Day, president of Michigan Bell Telephone, looking over the ghettos in Detroit after last summer's riots.

Bill Day said it well. The urban ghettos are terrifying—in Detroit and in dozens of other cities. And until positive steps are taken to solve the ghetto problem, this country of ours faces social and economic chaos.

And unless business takes the lead—now—the problem will not be solved.

Yet what business can do is neither easy nor immediately clear. The problem of the cities is complex, of long duration, and made up of issues that range from lack of jobs to bad housing, from faulty education to inadequate police protection.

In some areas of the problem, business has already made a fine start. In others, there still are only glimmers of what can be done.

This special report, distributed through McGraw-Hill publications to their millions of business and professional readers, focuses on what must be done in the three most critical areas: jobs, housing, and education. It was written by a task force of McGraw-Hill editors, drawing upon the editorial resources of our 44 business publications and 19 U.S. news bureaus.

We believe we are especially qualified to gather, edit, and disseminate vital information on this subject—what companies and industries have done, are doing, plan to do. Hence this report. We hope to convey some of our own feelings about the terrible urgency for action, and thus to stimulate and encourage other business organizations to do what each is best qualified to do.

We would like to hear of action your company has taken or plans to take. We shall continue our reporting on this subject, and we offer the editorial pages of all our publications as a forum for the exchange of constructive thinking on this massive problem we share.

We all face this urban crisis together; together we must solve it.

Sincerely,

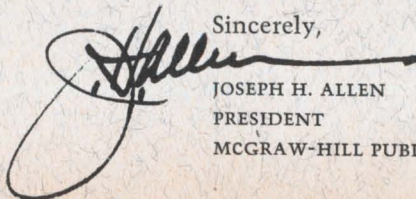

JOSEPH H. ALLEN
PRESIDENT
MCGRAW-HILL PUBLICATIONS



The problem

In the wake of riots that focus attention on the angry frustrations of America's slum dwellers, business faces a choice: Let the anger take its course, or act now to relieve it. For rational men, that's no choice at all

"If you cats can't do it, it's never going to get done."

The speaker: Frank Ditto, a Black militant leader in Detroit.

The cats: a group of Detroit businessmen who visited Ditto's Voice of Independence headquarters after last summer's riots.

"The government can't lick this problem," Ditto added. "So business has to."

Of course, business *has* to do nothing of the sort. What's more, no one—business included—can expect to come up with a swift cure for the ills that plague the cities.

But, if only for intelligently selfish reasons, businessmen can't afford to ignore the urban crisis. Here's why:

If you ignore the crisis, no one else may be able to cool the anger that boils up in riots. So far at least, no one else has gotten more than token results—not the government, not the labor unions, not the churches, and not the civic organizations.

Make no mistake—the riots are not yet revolutionary, nor do they involve more than a tiny fraction of the Negro population. They are significant only as a headline-grabbing symbol that focuses attention on the resentment felt by Negroes, now 11% of the nation's population. The real problem is not the riots but the frustration that generates them.

That frustration often explodes in rioting just when conditions are improving. Reason: Deprived people feel most frustrated when their hopes and expectations have been raised but not completely satisfied.

Detroit was a case in point. Its poverty programs were held up as models. Its mayor and police chief were sympathetic to Negroes. Detroit, in short, seemed well on its way to avoiding racial outbreaks. Yet Detroit was wracked by 1967's worst riot.

If you ignore the crisis, slums could siphon off more and more of your profits. Slums are a luxury few cities can afford, and much of what they cost is paid by taxes on business. Deterioration of the cities speeds up the flight of middle- and upper-income families (and some industries) to the suburbs. Result: Tax bases are reduced, retail trade slumps, and an increasing share of the tax burden falls on business.

New York City's annual slum bill, for example, is \$3.2 billion. Welfare alone costs \$1.5 billion—\$1 billion in federal and state funds, plus \$500 million raised by the city. To that, add a \$1.7-billion subsidy in the taxes the slums don't pay, the extra fire and police protection they require, and the social and health problems they create.

But even that huge outlay isn't doing the job. Right now, according to the New York Regional Planning Assn., the city needs another \$1.1 billion—\$300 million for educating slum children, plus \$800 million for a host of poverty services.

Is New York an isolated example? Not really. It is simply an advanced case of what many other cities could experience in less than a decade.

If you ignore the crisis, you may be overlooking a big potential market. The city has always been a social and economic necessity for businessmen. Markets thrive in healthy cities, waste away in sick ones.

If today's sick cities can be cured—if ghetto dwellers can be better housed, better educated, and, above all, better employed—new and profitable markets will open up for business.

Even the very process of saving the cities creates opportunities for some industries—construction, for example. Between now and the year 2000, the city ghettos will need some 10 million new dwelling units. No matter who builds these units—private operators or public authorities—they will add up to \$200 billion in today's dollars in new business for developers, contractors, and building-product manufacturers.

What's needed to open up this huge market, to begin cutting the high cost of slums, and to cool the anger that boils up in riots is to break down the barriers that trap Negroes in the ghettos.

Slums, of course, have always been a fact of U.S. life. The rural and immigrant poor moved in, found jobs (especially in unskilled and semi-skilled fields), and then moved up the economic ladder. Not so today. Now the poor (mostly non-whites) still move in, but that's as far as they can go.

Why? What traps the Negro in the ghetto? One barrier—both a cause and a result of the problem—stands out:

The income gap between this country's whites and non-whites is wide and getting wider. Today, in the midst of general prosperity, over 30 million Americans live in poverty (family incomes under \$3,130), and almost 30 million more live in deprivation (incomes from \$3,130 to \$5,000). Roughly half of each group is clustered in the city slums.

To be sure, slum dwellers' incomes are rising—but not at the same pace as the incomes of everyone else. And in the worst slums, incomes are actually falling. In New York's central Harlem, for instance, the average dropped from \$3,997 in 1960 to \$3,907 in 1966. Meanwhile, consumer prices in the New York metropolitan area rose 12%.

Just how badly off is the typical Harlem family? A Bureau of Labor Statistics study, released last fall, shed some light on that one. Said BLS: A year's moderate living for a family of four in New York City costs \$10,195—or almost three times the average income in Harlem.

The gap between white and non-white buying power is largely the result of a paradox: Advancing technology, a boon to most Americans, has made it steadily more difficult for the hard-core poor to find work. Mechanized farming has sped the migration of Southern Negroes to Northern cities. And in the cities, automation has wiped out the very jobs that untrained, rural-bred Negroes can handle. In 1950 one out of six Negro migrants failed to find jobs in Northern cities; by 1960 the figure had doubled to two out of six.

But the income gap is just one of the barriers that trap non-whites in the city ghettos. Here are four others:

1. Zoning bars low-income families from the suburbs—first, by stipulating lot sizes (and thus house prices) that are beyond their reach; second, by keeping out blue-collar industry that could provide jobs for people now living in the city.

2. Welfare often hinders more than it helps. First of all, the welfare burden (annual cost: \$7 billion) falls heavily on the Northern cities and lightly on the areas where the bulk of the poor came from. Second, even states and cities with liberal benefits fail to meet federally defined minimum-income levels. Finally—and this is the crux of the matter—welfare practices kill the slum dweller's incentive to find a job and hold his family together. If the father of a family on welfare gets a job, whatever he earns is deducted from his family's welfare payments. In effect, he is taxed 100% on his earnings. So he may face a hard choice: Quit the job or abandon his family.

3. A new legislative coalition has little sympathy for the sick cities. In state legislatures and Congress, there has always been an understandable rivalry between representatives of the cities and the rural areas. Now—and for equally understandable reasons—the rural spokesmen have a potent new ally: representatives of the burgeoning suburbs. This new coalition reinforces suburban zoning and limits the ability of urban-based legislators to put across programs aimed at solving the cities' problems.

4. Cities lack the financial base to do the job that must be done—to tackle adequate housing programs, for instance. The basic problem: Property taxation—source of most municipal revenue—is inequitable; it puts the biggest burden on business, the smallest on slum-housing owners. So, not surprisingly, many companies flee the city—which only loads a bigger burden on those who stay, puts the city in a worse financial bind than ever, and makes it less and less likely that slum problems will be solved with local money.

In theory at least, removing all those barriers is every American's problem. But this report is about what businessmen can do—if they get involved. And since this report stresses the purely practical reasons for business action, it goes without saying that getting involved invites economic risks.

When the president of Detroit's largest department store led a state open-housing fight last November, more than 10,000 customers closed out their accounts in 10 days. Every time Henry Ford II has made a pronouncement in behalf of Negro rights, Ford Motor Co. sales have tumbled in the South.

But Henry Ford still maintains: "People who don't face up to this issue are stupid. It's a great opportunity for business. It's shortsighted not to step in and do something to solve the problem."

What, then, can business do to ease the frustration of the ghetto dwellers?

Business can turn the staggering need for low-rent city housing into a big and profitable market—if some of the government-imposed rules that now regulate housing construction are changed (*see p. C10*).

Business can also put its influence and special skills behind sorely needed changes in the city school systems (*see p. C14*).

And business alone holds one key to breaking the vicious slum cycle of unemployment, poverty, poor housing, poor education, and low productivity. That key is jobs.

Jobs

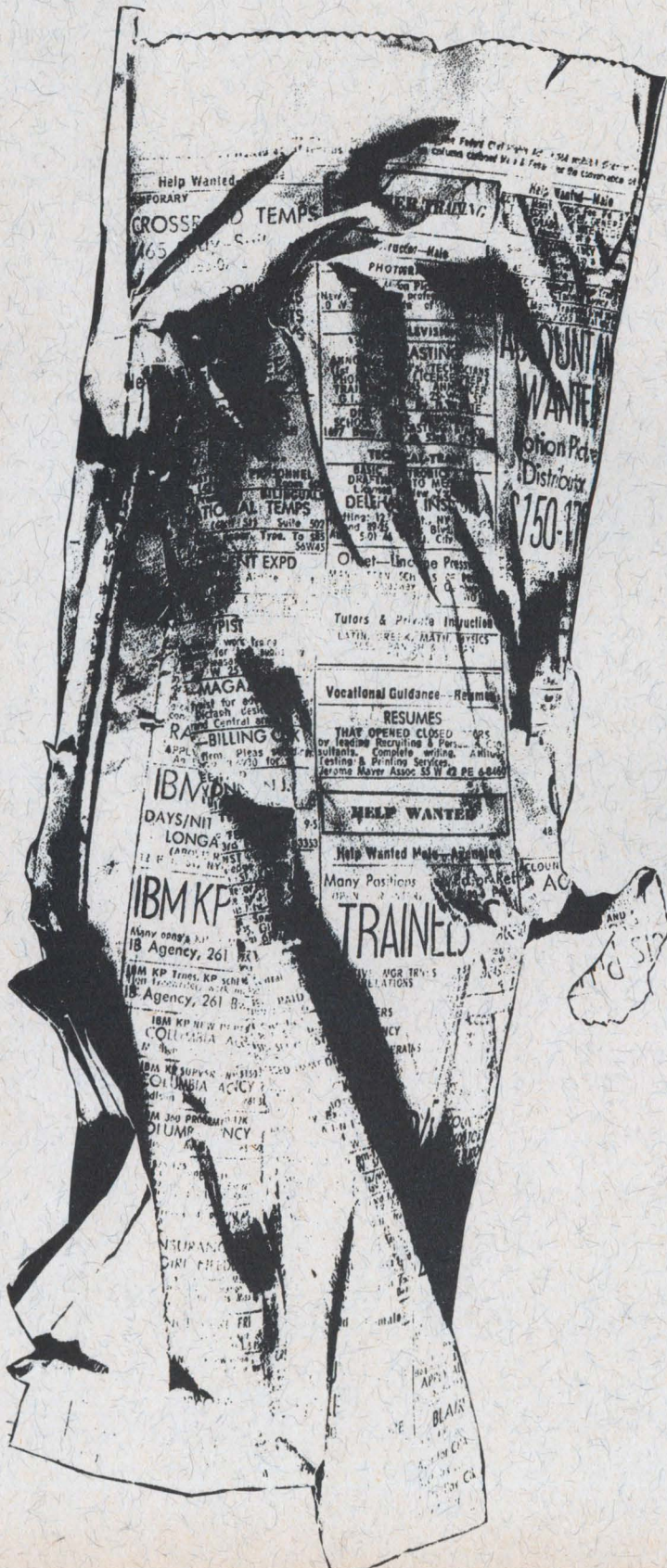

"Jobs are the live ammunition in the war on poverty," says Labor Secretary Willard Wirtz. And, he adds, it's up to business and industry to pass the ammunition

How many jobs are needed? Secretary Wirtz estimates a half-million for 100 city slums, another half-million for the rest of the country.

In a growing economy that produces a million and a half new jobs a year, the need to place half a million slum dwellers—or even a million—does not sound all that tough.

But it is. Business has found that hiring and training the people at the bottom of the ghetto barrel—"making the transition from the street corner to a job," as a Los Angeles training executive puts it—is tougher than it sounds.

Yet business must face up to it. President Johnson, for one, has issued a direct challenge: "... Help me find jobs for these people or we are going to have to offer every one of them a job in government."

Members of the Urban Coalition, which includes the nation's top industrialists, recently pledged a million jobs. And many businessmen cite practical reasons for action.

Says Chester Brown, Allied Chemical's chairman: "Business can broaden its markets by increasing people's purchasing power. One way to do this is to lift the economic status of poverty-stricken slum dwellers."

Says H. C. (Chad) McClellan, who heads the Los Angeles-based Management Council for Merit Employment: "Shall we go on paying \$400 million a year in Los Angeles welfare costs, or shall we go down and take a realistic look at the potential workers in the slums?"

Just who are these potential workers? Mostly they are the hard-core unemployed—unschooled, unskilled, and unmotivated. To turn them into productive workers, business must help them overcome handicaps that bar them from good jobs: culturally impoverished lives, grossly deficient education, poor health, fear of failure, the exodus of jobs to the suburbs, and finally society's discrimination against them.

There is no clear-cut answer. Businessmen, in fact, are simply learning by doing. Here are some of the things they have learned:

No program to hire the hard-core poor will succeed unless top management is totally committed.

"Any company that gets into this kind of project without the backing of the top man will fall flat on its face," says Richard Knapp, personnel manager at Warner & Swasey, Cleveland. Kodak Chairman William Vaughn says bluntly: "Unless top management lays it on the line, lower-echelon people won't do it. Even then, they may not do it without follow-up."

Follow-up by top management is vital if a project is not to drift. Humble Oil's recruitment coordinator, Harry G. Taylor, says: "We recently shook up a lot of our people when we called them together and told them they weren't doing as well as they should. Now those who have been taking it easy know management is serious."

A firm stand also heads off possible resistance from other employees.

"You find some resistance among plant employees," admits Walter Maynor, industrial relations director at Sherwin-Williams. "But we let them know in no uncertain terms that this policy had been set by our top people and that they intend to enforce it."

Martin Stone, president of Los Angeles' Monogram Industries, lost one foreman who wouldn't go along with his program. "You've got to sell the shop supervisors," Stone warns. "If you don't, the job will never get done—and you'll never be able to pinpoint why."

They won't come knocking at your door—recruiting may call for special efforts. You can't just hang out a sign and expect a flood of grateful, job-hungry applicants.

"If we had waited for them to come to us," says Harry Taylor, recruitment coordinator at Humble Oil in Houston, "we might still be waiting." Humble even finds it difficult to convince college people that it really wants to hire Negroes.

"Pessimism pervades the entire minority," says Charles Rutledge, assistant to the president at Lockheed Missiles & Space. "They feel they've got as much chance getting to the moon as getting a job at Lockheed."

When Kaiser Industries started looking for "qualified" minority employees in Oakland, "most of the unemployed didn't even bother to apply," says Vice-President Norman Nicholson. Now Kaiser has a program for "qualifiable" people and cultivates contacts with Negro groups.

Candor is the best antidote to diffidence and distrust, Nicholson finds. "We're late in doing this, and it was under pressure," he tells Negroes. "But don't cry about past history. The door is open now."

To reach across the barriers of suspicion, companies can call on dozens of job-development groups in the Negro-employment field. The Urban League, for one, has had long experience.

Another notable Negro-led effort, the Opportunities Industrialization Centers, stresses enlisting business to help Negroes help themselves. Started in Philadelphia by the Rev. Leon H. Sullivan, OICs have spread to 65 cities.

The Twin Cities OIC in Minneapolis is typical. Launched a year ago with 75 trainees, it raised \$80,000 from business, now has 1,100 trainees and 300 already on jobs. Like other OICs, it devotes about half its training program to skills, office and shop work, and service trades—the other half to grooming, work habits, attitudes, and basic reading and arithmetic.

Other sources of help are community-wide groups that seek to reconcile disparate civic and racial organizations, moderate and militant alike, and to bring the jobless into contact with jobs.

Some of these groups—Cleveland's AIM-JOBS, St. Louis' Work Opportunities Unlimited, Los Angeles' Management Council—provide pre-job training, on-the-job counseling, and other aids. And they are getting results.

AIM has helped find jobs for some 600 applicants; WOU for 6,500; the Boston Community Development Corp. for 5,000; the Management Council for 18,000. And the new Detroit Committee, working with the Detroit Board of Trade, has spurred 20 companies into hiring 15,000 unskilled Negroes.

Such results call for special recruiting efforts. A few examples:

After the Watts riots in Los Angeles, some 50 companies sent recruiters directly into the district, and the Management Council induced the California Employment Commission to open a branch there.

In Rochester, N.Y., Kodak and other companies hold interviews at Negro neighborhood centers and take job referrals from 17 social agencies.

United Airlines sends Negro pilots, stewardesses, and ticket agents into the ghettos to talk with people. Says Daniel E. Kain, personnel director for field services: "These people have to taste it, feel it, see it. Otherwise it's a bunch of hot air."

You may have to relax your hiring standards and change your hiring practices. Most companies find they have to drop their hiring bars a bit or, if they are taking admittedly unqualified people, a lot. Intensive training projects like Whittaker Corp.'s "Instant Hiring" in Los Angeles ask for little except a will to work.

Warner & Swasey eliminated the usual hiring yardsticks, including testing. Pacific Telephone & Telegraph, along with other companies, has hired people with police records. Ohio Bell Telephone went back over its list of rejected applicants just to hire some who had been considered unqualified. And Lockheed Missiles went looking for high school dropouts—people with no marketable skills—for its VIP (Vocation Improvement Program). Of the first 100 applicants referred to the company by social agencies, only 11 were rejected.

Not everyone agrees, however, that lower hiring standards are a prerequisite. For instance, Chad McClellan of the Los Angeles Management Council tells companies: "Don't hire anyone who doesn't meet your standards. Don't lower your standards—raise theirs."

And while hiring requirements may be less stringent, there's no compromise on work performance. A Pacific Telephone & Telegraph executive speaks for most companies: "We would rather train than perpetuate the problems of unskilled labor."

You may also have to restructure some of your jobs to make them easier to master. Some companies have solved the work performance problem by redefining or restructuring jobs to bring them closer to the reach of unskilled people. Lockheed compares this to measures used to train wartime workers.

Buxton-Skinner in St. Louis established a category of "electrician's helper" one step below "electrical maintenance assistant" to provide niches for poorly skilled workers. To implement its nurse training project, the Kaiser Foundation in San Francisco created the job of "clinic assistant" to relieve nurses of such routine though important chores as weighing patients and taking temperatures.

But this approach may not appeal to every company. "McDonnell-Douglas in Los Angeles has never changed production procedures to fit trainees," says a company official. "We fit the trainees to our procedures."

McDonnell-Douglas doesn't think much of the war-period analogy, either. "The days of Rosie the Riveter are gone forever," its spokesman says. "The one-step assembly worker has given way to workers handling a series of operations on the line."

The key to success—and the toughest part of the whole problem—is the right kind of training. "The first question an executive must ask himself is: 'Are we ready to spend the extra time to prepare

these employees?' Unless the answer is a flat yes, the program won't go."

This advice from an Emerson Electric executive in St. Louis is based on hard experience in training workers from scratch. It's more than a matter of teaching specific job skills. At the very least, companies must orient their trainees to a totally unfamiliar environment of shop or office. At the most, they must somehow plug up wide gaps in basic education. And they must grapple all along the line with problems of instilling motivation and a proper attitude.

It can be done. Business is already deep in the effort. Some 1,600 companies have contracts to offer training under the Manpower Training & Development Act, which turned out 140,000 trainees in the past fiscal year.

Westinghouse Electric is one large company that is training hard-core unemployed under a new Concentrated Employment Program. Raytheon is launching a special project at its Waltham (Mass.) plant for 100 hard-core people. Government is offering new lures to employers who will tackle the training of unskilled people. About \$350 million in federal funds is available this fiscal year.

New training techniques are often needed. Emerson Electric, for example, uses closed-circuit TV to show clerical trainees their job operations in slow motion. Hoffmann-La Roche also uses audio-visual aids to train clerks in its Newark (N.J.) offices.

The results of a balanced program can be impressive. Of 111 in a Lockheed VIP training group, only four were fired—mostly for poor attendance—and 105 are working today. Lockheed bore down hard on teaching both skills and attitudes. "We overtrain," says Charles Rutledge, assistant to the president, "so the worker will be able to perform all his duties and get an immediate feeling of success."

The key to effective training is a job at the end of the training cycle. That's what community programs, however well-intentioned, cannot promise. Much of what passes for training in store-front settings has little relation to employers' needs. And trainees themselves sense this. "Training to be unemployed" is how one New York Negro put it.

Only business can provide both training and a job. What's more, most company training programs pay the trainee while he's learning.

Eugene Cox, who runs Whittaker Corp.'s "Instant Hiring" project, declares: "Nobody but business—not welfare, not the government, not charities—can offer green-power motivation."

Mayor Alfonso J. Cervantes of St. Louis notes that "private industry's training of the disadvantaged on the job is much more efficient than training by any public agency." And only industry, he adds, can give purpose to the training by providing a job at the end of the line.

But the mere existence of beginners' jobs is not enough. Trainees must also be able to see some chance to advance. Business, too, must count on an upgrading process. Unless trainees can advance, a Kodak executive points out, the bottom jobs will soon be clogged with unpromotable people.

Effective training isn't always limited to job skills—you may even have to teach the three Rs. Lee Gassler, industrial relations director at Kodak Park, points out: "The under-educated worker is often unable to get over even the first hurdle in getting a job. A simple application form holds terror for him if he can neither read the questions nor write the answers."

Gassler speaks from experience. In 1964 Kodak began an experimental project to hire unskilled people and bring them up to the entry level for skilled apprenticeship training. Even though classes were small—no more than 15 each—the company found that classroom instruction was not enough. So the instructors—skilled men pulled off regular jobs—wound up giving almost individual tutoring.

The basic problem: Trainees were seriously deficient in reading, writing, and arithmetic. "We were surprised at how retarded they were," says a training executive. Even prior schooling was no guarantee. One trainee who had attended three years at a Rochester high school was told to drill a series of holes a foot apart. "What's a foot?" he asked. Another was given a job requiring measurement with a ruler. When the instructor found the job undone, the embarrassed trainee admitted he didn't know how to use a ruler.

Kodak's experience is hardly unique: A Los Angeles bus company recruiting in a ghetto area found few people who could make change for a dollar.

Kodak took steps to solve the problem in 1966. In the midst of a bruising battle with a militant Rochester group called Fight, the company reorganized its training. It now limits instruction by Kodak personnel to on-the-job programs and brings in outside experts—the Board for Fundamental Education of Indianapolis—to teach reading, writing, and numbers. The unskilled are put in a job class and, if they need it, in a BFE class. One BFE section raises basic education to the fifth-grade level, another from fifth to eighth.

Effective training may also immerse you in the personal problems of your trainees. Sometimes, in fact, the line between training and therapy gets very thin indeed. Fear of failure, for example, is widespread.

"These kids are oriented to failure," says an Inland Steel vice-president, William G. Caples. For that reason, Kodak's BFE classes aim as much at instilling confidence as at teaching facts. Says an instructor: "Most of these people have failed everywhere—in school, at home, in jobs. So we try to put them in situations where they'll succeed."

Since they fear failure, many trainees resist responsibility—at least at the start.

"We start them off where they make no decisions," says Training Dept. Manager R. H. Hudson of Lockheed-Georgia. "Then we slowly let them take on responsibility."

First-line supervisors get involved in mundane problems. Stanley W. Hawkins, training coordinator at Lockheed Missiles, points out: "We help with problems, on shift and off—getting people into hospitals and out of jail, getting gas and electricity turned back on, towing cars off the freeway, fighting off finance companies, arguing with car dealers."

How do you cope with problems like these? One way is to put qualified Negroes into supervisory and managerial jobs.

"You can use some white guys, but there's a real need for the worker to identify with the top guys, the upper echelon," says Leon Woods, the 24-year-old Negro general manager of Watts Mfg. Co. in Los Angeles. This is the highly publicized company that Aerojet-General started in the riot-torn Watts area to provide jobs for Negroes in their own neighborhood. One of Aerojet's aims was to eliminate a prime cause of absenteeism—long trips between slums and plants, often without public transportation.

Sometimes the waters are murky—you may have trouble communicating with your trainees. "Most jobs are lost by attitudes, not inability to do the work," says the Rev. Leon Sullivan of the Opportunities Industrialization Centers. A Kodak executive agrees. But, he adds, "It's often hard to know what their attitude is."

Many workers are reluctant to admit they don't understand. Verbal confusions crop up. A newly hired Negro clerk at a St. Louis company wanted to quit because she was "bored." A bit miffed, her supervisor was ready to let her go until he found she really meant she was perplexed.

At Lockheed Missiles, one instructor tries to anticipate poor understanding. Every day he re-

views his material for "suspect words," then writes these on the blackboard and defines them whether anybody asks or not.

Clear communication is particularly important in the crucial process of motivating new workers. Training personnel tend to agree with Eugene Cox of Whittaker Corp. that motivation starts with showing people how they can get tangible rewards. "The best way to change attitudes about their future," he says, "is to show them what they can get if they apply themselves."

Frank Libby, vocational training supervisor at Kodak Park, puts it simply: "I try to get them addicted to the paycheck." And Frank S. Jabes, an employee relations executive at TRW in Cleveland, adds: "If you want to see some really motivated people, take a look at a guy who is having his first chance to make a living wage. You couldn't have a better employee."

This is no one-way street—you have to strike a balance between sympathy and firmness. Companies that hire hard-core unemployed minority people can expect them to behave differently from the corporate rank and file. Turnover is high—holding more than 50% of trainees is pretty good. Absenteeism, tardiness, a general lack of responsibility are common failings.

"Mondayitis is almost epidemic," says one supervisor.

"They have a tremendous number of grandmothers and grandfathers who keep dying month after month," another supervisor complains.

It doesn't help to be over-sympathetic, companies have found. In fact, a firm hand on the reins seems to work best.

A Kodak instructor, Frank Palmisano, explains why his company decided to take a firmer attitude toward absenteeism and tardiness in training classes: "We checked on former trainees and found that those with poor attendance records in training did no better on the job. So now we deal with absenteeism in training—ask the problem cases what's wrong and how we can help them. If they still goof up in spite of our efforts, we let them go."

Jack B. McCowan, vice-president of Firemen's Fund American Insurance in San Francisco, lets supervisors "spoonfeed" trainees for a while in work matters. But he makes it clear that he expects standards to be met on attendance and behavior.

A practical question: What will all this extra time and effort cost? It depends on what you have to start with—the background of your trainees—and on the level of skills you need from them. Experi-

ence indicates that the cost per trainee can range from a few hundred dollars to several thousands.

On the more modest level, IRC, Inc., a Philadelphia electronics company, spends between \$300 and \$400 per person; McDonnell Aircraft in St. Louis, \$450. Leon Sullivan's OICs report an average \$900 per trainee.

For harder cases and higher skills, the tab gets bigger. Lockheed-Georgia spends \$700 of its own money plus \$400 of government funds for each trainee. Humble Oil spends \$1,200 per man. It cost Kaiser Engineering a total of \$12,000 to train six draftsmen.

When you deal with badly underskilled people, you run into big money. Just how big is open to argument. And it's an argument that often involves the federal government, which pays part of the cost of these hard-case training programs.

Robert Scanlon, corporate training director at Whittaker Corp., says "Instant Hiring" costs two or three times as much as conventional industrial training.

Avco Corp. estimates it will cost \$5,000 per man to train 230 hard-core unemployed, including ex-convicts, reformed drug addicts, and former alcoholics. The government will pick up two-thirds of the cost.

In the last analysis, are the extra training costs worth it? Most businessmen who have tackled the job problem think so. And Norman Nicholson of Kaiser Industries speaks for many of them when he says, "The costs of training are high. But riots and jails are also expensive."

Businessmen point out, however, that they are thinking primarily of long-range values rather than immediate pay-off. Kodak's Lee Gassler, for example, says his training program helps the company, the trainee, and the community, "but at the moment the trainee and the community are benefiting most."

More specifically, there are signs of real progress.

Says an auto company executive: "Some of the inner-city people we hired are working out better than the walk-ins."

Says Industrial Relations Manager Joe Flynn of Kaiser Aerospace & Electronics: "We've already upgraded 21 minority employees at our San Leandro plant. Our experience has been excellent."

Says the manager of a Philadelphia store that employs eight Philco-Ford trainees: "In the past we hired Negroes because we felt we had to. Now we feel these girls deserve to be hired on their own merits."

And that, of course, is the aim of every hiring and training program.

Housing

To government, the enormous need for city housing is a staggering problem. To business, that need represents a huge market—but only if some way can be found to make it profitable

The problem of supplying housing in the cores of cities is not a problem of logistics or construction technology. It is purely a problem of economics.

Under present taxation and finance practices, no one can supply the volume of housing needed. But if the rules that force these practices are changed—if some new form of government subsidy is accepted and if red tape is trimmed from federal housing programs—a staggering need can be turned into a profitable market.

Business' stake in changing the rules is pretty simple and direct. Just replacing the substandard housing in cities would involve more new construction than the total volume of housing starts over the past five years.

The 1960 housing census uncovered more than 4 million urban dwelling units that were completely dilapidated, some 3 million more that were badly deteriorated, and another 2 million with serious code violations or serious overcrowding. If that is not a bad enough problem—or a big enough market—recent Census studies indicate the 1960 figures may have underestimated the number of dilapidated units by as much as one-third.

What's more, revitalizing the cities would encourage the return of hundreds of thousands of families who have fled to the suburbs—and thus would generate new demand for middle- and upper-income housing.

So sitting right there in the city slums is a market for well over 7 million new and rehabilitated housing units and all the building products that go into them—everything from flooring and dry-wall to lighting and plumbing fixtures. And, points out Raymond H. Lapin, president of HUD's Federal National Mortgage Assn.: "The profit earned on a sheet of gypsum board is the same whether the board is used in a low-rent apartment or a \$50,000 house."



Key problem: the gap between what housing costs and what low-income families can pay. New housing in multi-family buildings—the kind needed in most city slums—costs from \$17,000 to \$22,000 a unit, even with an urban renewal land write-down. Rehabilitated housing, in any volume and in the densities desirable, costs at least as much, and sometimes more.

This means the monthly rent for a \$20,000 unit with one bedroom would be roughly \$150. That figure would include (1) maintenance, (2) operating costs, (3) amortization and interest on a subsidized loan with interest a few points below market yields and a term up to 40 years, (4) partial realty-tax abatement (about 50%), and (5) a two-thirds write-down of the land cost.

Yet half the low-income families in the slums can afford to pay only \$65 to \$110 a month for rent. And the other half cannot afford more than \$35 to \$60 a month.

Government programs to fill the gap have been too small, under-financed, and over-complicated.

Congress has created one program after another—FHA's Section 221d3 and public housing and urban renewal, for example—with enough visibility to persuade voters that something is being done. But most of these programs are too poorly funded to have any impact on urban problems. Many of them overlap and even conflict with earlier programs. So each new program adds chaos to the already chaotic machinery of federal, state, and local governments. In retrospect, it is easy to see why the programs tried so far have not worked:

- Until fairly recent years, the public housing idea was unacceptable to most Americans—"Why should I pay part of somebody else's rent?" Congressional authorizations for low-rent public housing have permitted only a fraction of what is needed. And, with some notable exceptions, the quality of public housing has been bad: monolithic, prison-like structures, stripped of such "frills" as doors on the closets. In short, super-slums.

- Urban renewal has not solved the problem. Most localities have used renewal programs to broaden their tax base with new commercial development or upper-middle-income housing rather than to provide low- and middle-income housing.

- FHA's 221d3 program, greeted in 1961 as the answer to low-income housing, has virtually ground to a halt because of too-low mortgage limits (\$17,500 in high-cost areas) and the fantastic red tape involved in getting projects through local FHA offices.

The 221d3 program was designed to provide new and old rehabilitated rental and co-op housing for low- and moderate-income families. In some cases it permits a below-the-market interest rate of only 3% on mortgages. But as Jason Nathan, head of New York City's Housing & Development Administration, pointed out last fall: "Six years after the program was started, it had provided only 4,350 rehabilitated apartments—and 1,500 of them are in New York City."

Most other FHA programs were never intended to provide low-income housing. In fact, the agency's original purpose in the 1930s was to get money moving again. Built into its legislative history is the requirement that mortgage insurance be placed only on economically sound properties. Since it is hard to argue that a slum area is economically sound, slum properties were automatically ruled out.

"FHA is the easy and popular target for all our frustrations," says New York City's Nathan. "But to blame FHA alone is not the whole truth. Their reluctance is not simply a matter of inertia. It also arises out of a schizophrenic Congress. One segment of Congress blasts FHA for failure to provide socially motivated housing. Another segment almost gleefully seeks out a few cases of mortgage defaults and scorches FHA for its radicalism and lack of sober conservatism."

But, Nathan adds, "Even if existing programs were adequately financed and enthusiastically administered, there would be enormous problems."

The myth that new technology can cut costs continues to confuse the issue. It is unrealistic to count on some magical breakthrough in technology to solve the cost problem.

It is unlikely that research will find new materials cheaper than wood and brick and cement and gypsum. It is equally unlikely that labor practices can be changed in any effective way. Yet industry leaders and government officials from HUD Secretary Robert Weaver on down keep calling for the breakthrough—thus delaying a commitment to solve the problem with the building tools already at hand.

For years one innovator after another—often aided by federal grants—has tried to put housing on the assembly line. And for years these attempts have failed to cut costs.

Reason: Most innovators have concentrated on the shell of the building—the bare walls, floor, and roof. And the shell is the cheapest part—if the walls were simply eliminated, the total price would be cut by less than 5%. The bulk of the cost is in land, financing, overhead, profit, interior finishes, and mechanical equipment.

Rehabilitation of slum housing is a highly publicized solution—but hardly a cure-all. It does indeed improve housing in what is usually a rather limited rehabilitation area. But, so far at least, it has fallen short on other counts.

Rehab has not added to the supply of housing units. Except in a few neighborhood-wide ventures, it has not performed the social function of rehabilitating a community. And, despite such rarities as New York City's 48-hour "Instant Rehab" (new units were dropped into the shells of gutted tenements), it has not solved the problem of relocating slum families while the job is being done.

In slum areas, where tenements brought up to a "safe and sanitary" standard are at best a minimum goal, rehab does buy time while better plans are made. But a big question remains: Is rehab housing really cheaper than new housing? Many experts do not feel it is—especially when the high costs of planning and managing a rehabilitation job are counted in.

What's more, there is still no evidence that rehab can be profitable. A number of major corporations—including Alcoa, Armstrong Cork, Rockwell Mfg., Reynolds, U.S. Steel, and Smith, Kline & French—have made small experimental forays into rehabilitation. On a larger scale, several companies in Pittsburgh—Westinghouse, National Gypsum, Pittsburgh Plate Glass, and others—have teamed up to form a limited-profit rehab corporation.

The best-known effort is U.S. Gypsum's rebuilding of several hundred units in New York City's Harlem and its plans for similar work in Chicago and Cleveland. But USG has yet to say how its venture is faring financially.

Whether a businessman sets out to fix up old apartments or build new ones, he faces two harsh realities:

Harsh reality No. 1: a shortage of money to finance low-rent city housing. There is no magic way to finance housing. Housing must draw on the same capital pool that business, industry, and the consumer draw on. Any investment in housing must match the market yield of other segments of the capital pool.

Ray Lapin of the Federal National Mortgage Assn. puts it this way: "Let's admit at the outset that there are no new sources of mortgage funds. There is no money tree—not the Federal Reserve, not the U.S. Treasury, not FNMA, and certainly not the treasuries of the nation's corporations."

Lapin points out that the traditional sources of mortgage money—life insurance companies, mutual savings banks, savings and loan associations,

and, more recently, the commercial banks—have invested about as much as they can afford.

"From now on," he says, "the volume of mortgage lending by these institutions will be limited to the future course of savings—and to the choice between mortgages and other investments."

Harsh reality No. 2: the red tape that strangles government housing programs. Government-assistance programs won't work unless some way can be found to eliminate the time-consuming rules and procedures that confront—and frustrate—every prospective builder or developer.

In New York City it takes at least two years to process the average FHA 221d3 project—and by that time, costs have risen 10%. Furthermore, builders often run into delays before their proposals even reach FHA. A case in point: Late last year a 1,450-unit project, proposed by HRH Construction Co. in 1961, was still awaiting approval by the New York City Board of Estimate.

But, notes HRH Vice-President Richard Ravitch, there are signs that federal administrators are finally bending their rules and speeding up their procedures. Last fall, for example, HUD Assistant Secretary Philip N. Brownstein told his district directors: "Slash through red tape, indecision, and pussyfooting. . . . Set rigid time goals and see that they are met. . . . Be prudent as well as urgent, but be prepared to take the risks necessary to get the job done."

Brownstein's conclusion was most direct: "You should work at this task as though your job depended on it—because it may!"

Several ways to provide more mortgage money have been proposed. Three recent ones:

- FNMA's Lapin has suggested a government-backed mortgage market. He hopes such a market would offer the investor a competitive yield and give the mortgage borrower access to all parts of the savings pool—not just the "compartmented, specialized part of the capital market" now available.

- A group of 348 life insurance companies has pledged to invest \$1 billion in new and rehabilitated slum housing within the next year. It should be noted, however, that these mortgages will carry the peak FHA rate of 6%. And to insure them, FHA must substitute a policy of social benefit for its traditional policy of economic soundness.

- A task force of the National League of Insured Savings & Loan Assns. has recommended that the S&Ls put \$5 billion a year for the next 12 years into renewing the city slums. Bart Lytton, the task force chairman, says this can be done if the gov-

ernment permits a combination of federal loan guarantees, tax-free interest on investments in risky "improvement districts," and terms of up to 60 years to reduce monthly mortgage payments.

New federal programs may provide more money and loosen the stifling rules. Perhaps the most important—if it is adequately funded—is the Model Cities program. In the first round, it provides \$11 million for planning and \$300 million for construction (by paying 80% of what, under normal urban-renewal procedures, is the one-third local contribution to a project's cost).

Another program, launched in 1966 and now beginning to accelerate, is the so-called "Turnkey." Designed to involve private enterprise to a degree rare in government-sponsored work, this program gives a developer an almost-free hand to proceed as he would with a private project. It simplifies the approval process and permits the developer to build low-rent public housing on his own land, to his own plans and specifications, and then to sell the project to a local housing authority. Early experience leads government officials to believe that public housing built this way can be completed in two or three years' less time and at cost savings ranging from 10% to 15%.

In the wings is legislation that may involve business much more deeply in urban housing. Best known are the Percy and Kennedy proposals.

Sen. Charles Percy would set up a quasi-public agency capitalized with up to \$2 billion in government-guaranteed debentures at market interest rates. The agency would offer 30-year mortgages to non-profit housing corporations at subsidized interest rates.

Sen. Robert Kennedy's proposal calls for a tax credit of up to 30% accelerated depreciation on a sliding scale (from 20 years down to 7 years) and an insurance fund to protect capital investment. For 100% equity in a project, an owner would get a 22% tax credit and 10-year depreciation.

Early this year President Johnson was expected to propose an omnibus housing bill, including requests to continue urban renewal, public housing, and other major programs through 1973. The Administration bill will probably overlap one proposed by Sen. John Sparkman and his housing subcommittee. The most significant change urged by the Sparkman committee is to raise the 6% statutory ceiling on interest rates for FHA and VA mortgages. This would stimulate the flow of money into construction, but, politically, it is a hot potato.

Do all the difficulties faced so far rule out adequate housing for slum families? Not if one idea

—admittedly distasteful to some businessmen—is accepted:

Any solution to city housing problems must involve some form of government subsidy. Subsidies now look like the one way to span the gap between what low-income families can pay for housing and what private enterprise can supply at a reasonable profit.

The subsidy idea is hardly new. It was the aim, if not the result, of many existing federal housing programs. It is also the basic tool of the Kennedy and Percy proposals. What's more, many businesses—from farming and oil to autos and aerospace—benefit from subsidies, open or hidden. One example: The U.S. government finances irrigation projects for agriculture to the tune of \$1 billion a year on 50-year, zero-interest loans.

Some of the required housing subsidy can continue in the form of below-the-market interest rates and long-term mortgages. But this alone is not enough. Bolder forms of subsidy will also be needed. The most obvious possibilities: total land write-down (in essence, state or municipal ownership of the land) and total tax abatement on dwelling units for at least as long as they are occupied by low-income families.

Yet no major city could afford to write down land entirely and lose all taxes on the property. This suggests the oft-mentioned possibility that the federal government relieve the cities of all welfare, health, and education costs, on the ground that these services are a national concern.

Whatever form the expanded subsidies take, the government must be prepared to provide them without insisting on over-complicated procedures. The government has a right to regulate what it subsidizes, but rules that keep every conceivable wrong-doer out of a program make it almost impossible for right-doers to get in.

Finally, as business and government work together on new rules to make the needed housing possible—by making it possible for private enterprise to earn a profit building it—one often-overlooked principle must be kept in mind:

While the most urgent need is to replace the slums, the cities also need the kind of housing that will attract and hold a middle class. It makes no sense simply to reinforce the ghettos, to freeze the trend that populates the cities only with the very rich and the very poor. Socially, politically, and economically, cities need a broader base of people.

This country is a long way from President Johnson's dream of "cities of spacious beauty." But if business and government face some hard facts, at least a start can be made.

Education

Traditionally, businessmen have left public education to the educators. But the professional educator is in trouble today in the city, and businessmen could help him find a way out

At the U.S. Office of Education, Commissioner Harold Howe II spells out the problem:

"There is a vast psychological gap between the clientele of today's city schools (students and parents) and the suppliers of education (teachers, administrators, and school board members)."

This gap is steadily widened by the spreading Negro ghettos, the flight of white families to the suburbs, and the mushrooming non-white population of city schools.

An example that scares everybody is Washington, D.C., where 93% of public-school pupils are Negroes and the percentage is still rising. Elsewhere, worried school administrators watch the trend and see their systems as "Washington minus five years" or "Washington minus three years." In Detroit, non-whites represent 57% of the school population; in Chicago, 54%; in Cleveland, 53%; in St. Louis, 62%.

When the Negro school population reaches such high levels, the quality of education suffers. Negro pupils begin to feel segregated and lose their motivation to learn. Teachers have to spend more time keeping order than teaching. So, not surprisingly, the most-experienced teachers tend to shun the very schools that most need them.

Total solution of the educational problem may not be possible. But ghetto schools can be vastly improved—if there are major changes in attitude and action not only among educators but also among businessmen.

Educators must become more flexible and more responsive to the pupils' needs. Critics claim that an entrenched bureaucracy, unmoving and unresponsive, has fought bitterly against changes in some cities.

"Our urban public school systems seem mulebound with tradition," says Dr. Kenneth B. Clarke, a Negro sociologist and president of the Metropolitan Applied Research Center. "They seem to represent the most rigid forms of bureaucracies, which are paradoxically most resilient in their ability to resist demands for change."

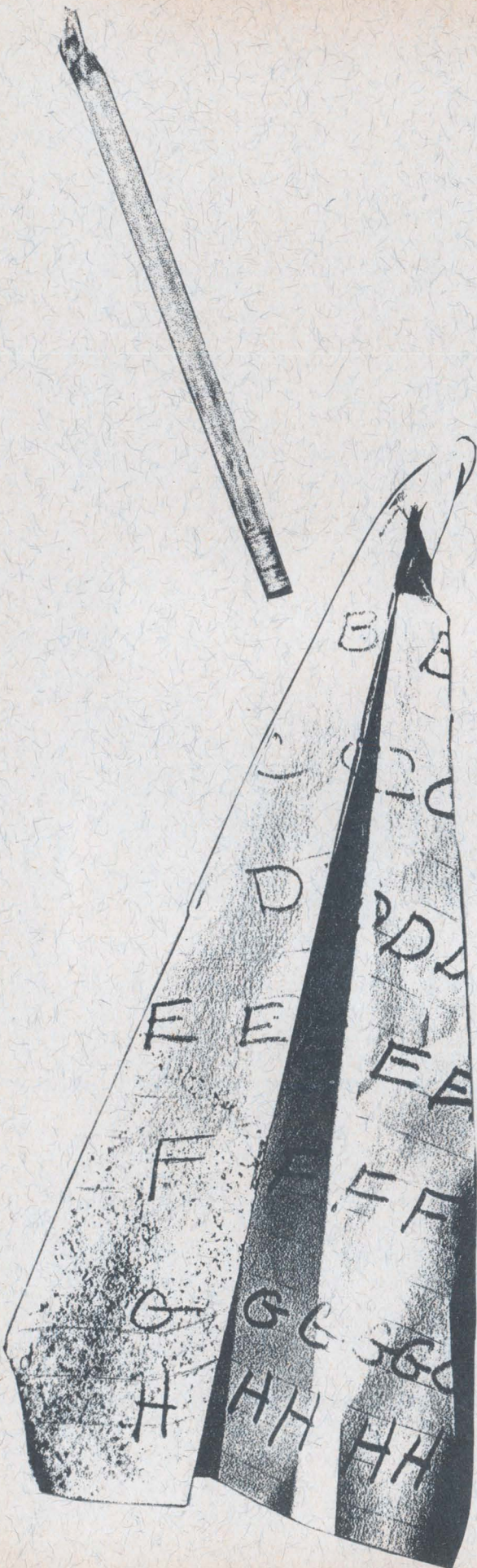

Bureaucracy strait-jackets not only some school systems but also many government officials. So businessmen emerge as one force that can bring about change.

Businessmen must understand education, support it, and even get directly involved. Specifically:

- Businessmen will have to alter their traditional opposition to more spending for schools, and face up to higher taxes. Almost every suggestion to improve the ghetto schools takes enormous sums of money. One federal act alone, authorized \$6.1 billion for fiscal 1967 and 1968 to help elementary and secondary education; and the figure is over \$9 billion for 1969 and 1970.

Some businessmen have already changed their stance on school spending. In Detroit last year the usually conservative Board of Trade raised \$60,000 to campaign for higher school taxes that would bring in an additional \$25 million a year.

- Businessmen will have to speak out on school improvements, many of which are controversial. In Pittsburgh, for example, businessmen have allied themselves with educators and civic and religious groups to support a revamped educational system that includes replacing all the city's high schools with five super high schools—a move to aid integration.

- Businessmen will have to work more with professional educators. When the Hartford (Conn.) Board of Education and Common Council reached an impasse on what should be done about the city's schools, the Chamber of Commerce persuaded both parties to bring in an outside consultant to recommend action. The New Detroit Committee, formed mainly of businessmen after last summer's rioting, is pressing Detroit's school system to adopt consultants' recommendations that had been ignored by the city's educators.

- More businessmen should also turn to education for a career. In Philadelphia, for example, an enlightened school administration has gone to business rather than traditional educational circles for two new associate superintendents. One, a former partner in a large accounting firm, is in charge of finance; the other a professional planner, heads the school system's planning.

- Finally, businessmen need to make one other contribution to education: Using skills perfected for business—such as marketing, engineering, and management—they can help frame creative proposals for new educational programs.

If educators and businessmen are to work together to upgrade the city schools, what changes and improvements should they seek? Here are five suggestions by men who have already been deeply involved in the problem:

1. Change the ghetto schools to gear them more closely to the right culture. Harold B. Gores, president of Educational Facilities Laboratories Inc., a nonprofit corporation established by the Ford Foundation, blames a lot of the schools' troubles on the existence of two cultures in the cities. And, he says, many schools are geared to the wrong one.

"That culture," Gores explains, "is white, middle-class, Anglo-Saxon, Protestant. The children attuned to it are success-oriented and have strong family ties. In contrast, the Negro child in a ghetto doesn't know or appreciate the standards, values, or morals of the middle-class family. He may have no father. His only close relative, his mother, may raise him to live for the pleasure of the moment. For such a child, there is no tomorrow to worry about or plan for."

Kenneth Mines, a Negro lawyer in Detroit, describes an added handicap: "Every Negro child realizes he is different, that there is something wrong with him. This builds an inferiority complex. Some children react negatively; some react violently; some just drift down and become inferior."

So the ghetto school has to be both school and family for many Negro pupils. That is the reasoning behind some of the compensatory programs that have been started.

The Preschool Project in Ypsilanti, Mich.—a program that included home visits, psychological consulting, medical services and a special task-oriented curriculum—produced a consistent jump in intellectual ability among disadvantaged Negro children—but at a cost of \$1,500 per pupil.

Frustratingly, high cost doesn't guarantee success. Three years after New York City started the More Effective Schools program that raised instructional costs from \$434 to \$994 per pupil, The Center for Urban Education concluded: "The MES program has not had any significant... effect on children's performance in arithmetic... [nor has it] stopped the increasing retardation of children who began it in grades two or three."

The same charge of ineffectiveness has been leveled at Headstart, the Office of Economic Opportunity's \$1.5-billion-a-year program for preschool children. Although it is still too early for a complete evaluation, critics maintain that the children lose their headstart soon after leaving the program. Apparently, the government sees some truth in the charge, because it is now adding a "Follow Through" program to continue up through the third grade.

2. Change the school curriculums to make them more realistic than they are now. Even if a young

Negro now makes it through early grades, he's likely to fall afoul of a curriculum that bears little resemblance to real life around him.

No part of the curriculum is held in lower regard by the average ghetto dweller than vocational training, which is supposed to turn out graduates ready to step into jobs in industry. Negroes claim that many vocational programs teach trades oriented to the '30s and '40s rather than the '60s. Negro students now want to learn telephone installing, business-machine repair, computer programming, and television maintenance instead of traditional woodworking, metal working and automobile repair.

Ghetto leaders hope that business, prompted by its need for better employees, will force a change to more useful training. In fact, only business can make vocational training more realistic, according to Robert Potts, of the Virginia Park Rehabilitation Citizens Committee, which is trying to rebuild the area where Detroit's 1967 riots started.

"Private industry will have to contribute people and equipment and help plan the curriculum," says Potts. "School administrators don't know what kinds of jobs industry has today."

Exactly what can industry do? Here is one example: Michigan Bell Telephone Co. adopted a heavily Negro Detroit high school whose students went on strike last year to oust the principal. The company sends its personnel people to the school to teach weekly classes on how to get a job—what to wear, how to act and what the interviewer is looking for.

"Only eight students showed up for the first class," says Michigan Bell President William Day, "but when the others heard via the grapevine that it was for real, more started to attend. Now the classes are jammed."

3. Consider a whole new approach to the design of school buildings. Too many city school buildings are old and outmoded. In Boston, for example, a third of the schools were built more than 100 years ago. Even worse in the minds of architects, most of today's school design still stems from a 120-year-old idea first applied at Boston's Quincy school, which is still in use. It treats a school as an egg crate that seals the pupils into compartments, each with a teacher.

"Today's schoolhouse is monastic, antiseptic, and unattractive," says Harold Gores of the Educational Facilities Laboratories. "Its only benefit is that it is nearly indestructible." More to Gores' liking are wide-open spaces, now starting to show up in suburban schools, that allow team teaching and greater flexibility.

4. Bring more Negro teachers and administrators into the city school systems. "Negro pupils would be more motivated to learn," says Ernest Brown, a personnel executive with the Michigan Consolidated Gas Co., "if they had models to look up to. Since the first person of stature a Negro child meets may well be his teacher, there should be more Negro teachers in ghetto classrooms."

That's easier said than done, according to many school officials. Not enough Negroes are qualified, and business often snaps up those who are.

True enough—but only to a degree. It's also true that some school systems have not been sympathetic to hiring Negroes, and others have simply not thought about it. In Detroit's system, for example, where enrollment is more than 50% Negro, there is not a single Negro athletic director.

5. Take a new look at the thorny question of integration. With the fast-rising Negro population in so many cities and the equally fast white exodus, the integrated school's ideal racial mix—70% white and 30% Negro—is no longer physically possible in more and more schools. Result: Some of the first integration efforts—busing, educational parks, and metropolitan schools—don't look so effective anymore.

Now the most promising efforts seem to be aimed at upgrading the city schools enough to lure whites back. That means adding a lot of educational services once considered frills: extensive counseling, extracurricular remedial programs, smaller classes, and higher salaries for teachers.

But integration is no longer the chief concern of militant Black leaders like James Del Rio, a Michigan state legislator.

"We don't want integration," he says bluntly. "We want to improve the education in our Black schools." Del Rio's goal is also the goal of some more-moderate Negroes and whites—at least as a realistic first step toward solving the problem.

For the long pull, however, the best solution still seems to be the old Horace Mann concept of a common school where the banker's daughter and the blacksmith's son attend classes together. In a well-publicized study (the so-called Coleman report), two Johns Hopkins professors found that mixing students of all classes and races was a more effective way to improve education in ghetto schools.

Reprints of this report are available at publisher's cost: Less than 100, 25¢ each; 100 or more 20¢ each; 1000 or more, 15¢ each. Address all requests to McGraw-Hill, P.O. Box 756, Times Square Station, New York, New York 10036.

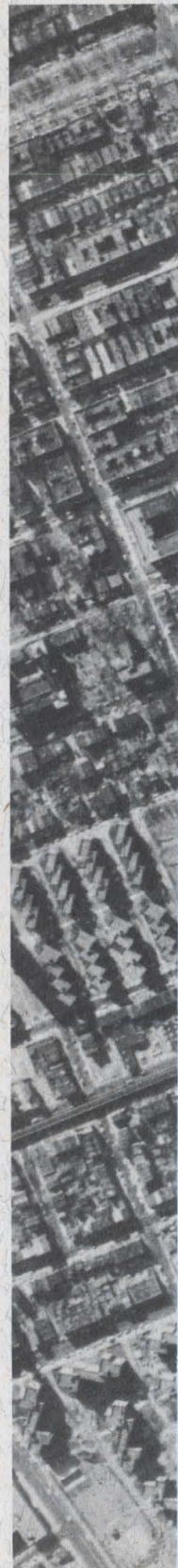



Proven... better, faster, more economical scribing

THE TEMPRESS AUTOMATIC SCRIBING MACHINE HAS FULFILLED THE PROMISE MADE WHEN INTRODUCED . . . NEW EFFICIENCY FOR SEMICONDUCTOR MANUFACTURE. To restate the advantages: one microscope . . . one group of positioned sequence controls . . . one streamlined package, as small as an office typewriter. A look inside discloses all electronic circuitry on easy-access circuit boards and life-lubricated mechanical components. The price has made it practical for an entire industry to adopt it as the standard scribing device. New refine-

ments include high reliability electronic components, high contrast illumination system, provision for triangular scribing, and a new system for clamping and adjusting scribing tools. The Automatic Scribing Machine is a product of the Tempress Standard of Excellence . . . a proud member of the growing family of Tempress miniature assembly tools and production machines.



TEMPRESS

Tempress Research Co., 566 San Xavier Ave., Sunnyvale, California

Circle 105 on reader service card

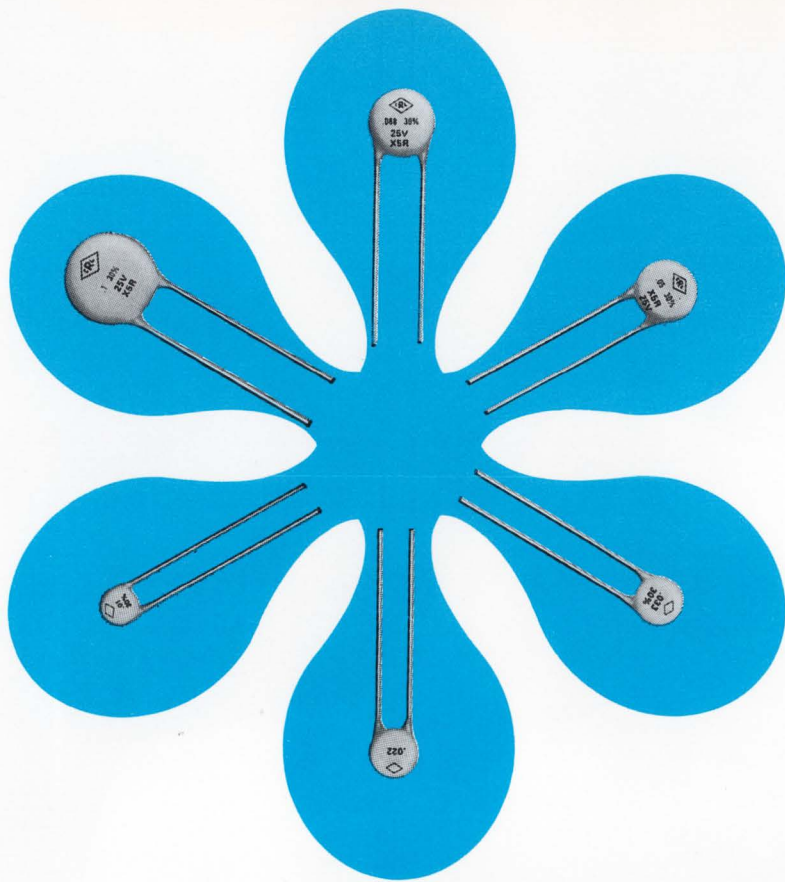

Centralab's "Ultra" Ultra-Kaps[®] put new capacity in shrinking design space

Smaller Size...Outperforms Other Capacitors...Costs Less, Too!

"Inner space" continues to shrink in this trend to transistorization... but not the capacitance values you need in your design applications.

Centralab's answer: an improved 25V Ultra-Kap Disc Capacitor... smaller in size but not in performance.

This "ultra" Ultra-Kap goes one-up on previous Ultra-Kaps (which feature 100 times the capacitance of conventional ceramic dielectrics). Now you can use the Ultra-Kap instead of monolithic ceramic capacitors or mylar capacitors. It even replaces many 50V disc capacitors! Features improved temperature compensation characteristics, too—X5R (−55° to +85°C ±15% from 25°C).

All this at lower cost than with other capacitors, adding an extra touch of economy to your design applications... whether for consumer entertainment, communications, the military—or for medical, instrumentation and computer markets.

Get full details about the "ultra" Ultra-Kap... and the complete Ultra-Kap line of ceramic disc capacitors... from your Centralab representative or drop us a line...



CENTRALAB

Electronics Division
GLOBE-UNION INC.

5757 NORTH GREEN BAY AVENUE
MILWAUKEE, WISCONSIN 53201



Here's why they're "Ultra" Ultra-Kaps!

RANGE CHART					Minimum Insulation Resistance At Rated Voltage
Maximum Dissipation Factor 5% @ 1 kHz					
Nominal Lead Spacing	Capacitance MFD	Maximum Diameter*	Tolerance		
.250	.01	.290	IMPROVED ULTRA-KAPS	10 MEGS	
.250	.022	.405	16 Volt 25 Volt	10 MEGS	
.250	.033	.405	+80-20% (Z) ±30%	10 MEGS	
.250	.05	.515	or	10 MEGS	
.375	.068	.590	±20% (M)	10 MEGS	
.375	.1	.760		10 MEGS	

*All Ultra-Kaps have a maximum thickness of .156 inches.

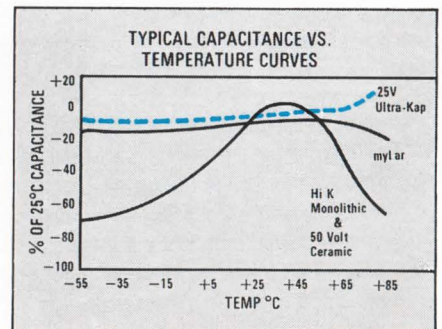



a new perspective

It seems as if the City-By-The-Bay was created to give new life, new energy, new stimulus. A new perspective in doing what you enjoy doing well far better.

SECURITY SYSTEMS ORGANIZATION

System, Equipment & Product Engineering

Conceive, develop, design and produce systems using electromagnetic, infrared, acoustic, seismic, optical, magnetic and other technologies to provide detection of perimeter or volume intrusions for military, government and industrial installations.

Detection and reporting movement or location of men or equipment in combat situations. Security devices and techniques to assume acoustical or visual security for rooms or buildings.

All levels of engineers are needed, BSEE required with MSEE preferred. Prefer two or more years applicable experience.

The Golden Gate Bridge could have been just a bridge. But look what the world got instead. Let us show you what you can expect from Sylvania instead of just a job. It is all in black and white in our "Trans-Sylvania" kit. Only the pictures are in full color. Your qualified resume can be exchanged for this new perspective. Address it to: C. M. Davis, P. O. Box 188, 2L, Mountain View, California. Sylvania is an equal opportunity employer.

SYLVANIA
A SUBSIDIARY OF
GENERAL TELEPHONE & ELECTRONICS

We have a complete line of photodevices — from a 50-cent epoxy transistor to a \$4,000 custom photo array. Light-emitting and light-sensing devices for everything from computers to electric organs. They can translate keyboard signals, read punched cards and tape, measure height and volume, perform character recognition, read motion picture sound track. You name it. Write for complete information and we'll throw in a glossary of the latest photometric and radiometric terms.

FAIRCHILD
SEMICONDUCTOR

FAIRCHILD SEMICONDUCTOR / A Division of Fairchild Camera and Instrument Corporation ■ 313 Fairchild Drive, Mountain View, California 94040, (415) 962-5011 ■ TWX: 910-379-6435

***What this country
needs is a good
50¢ phototransistor.***



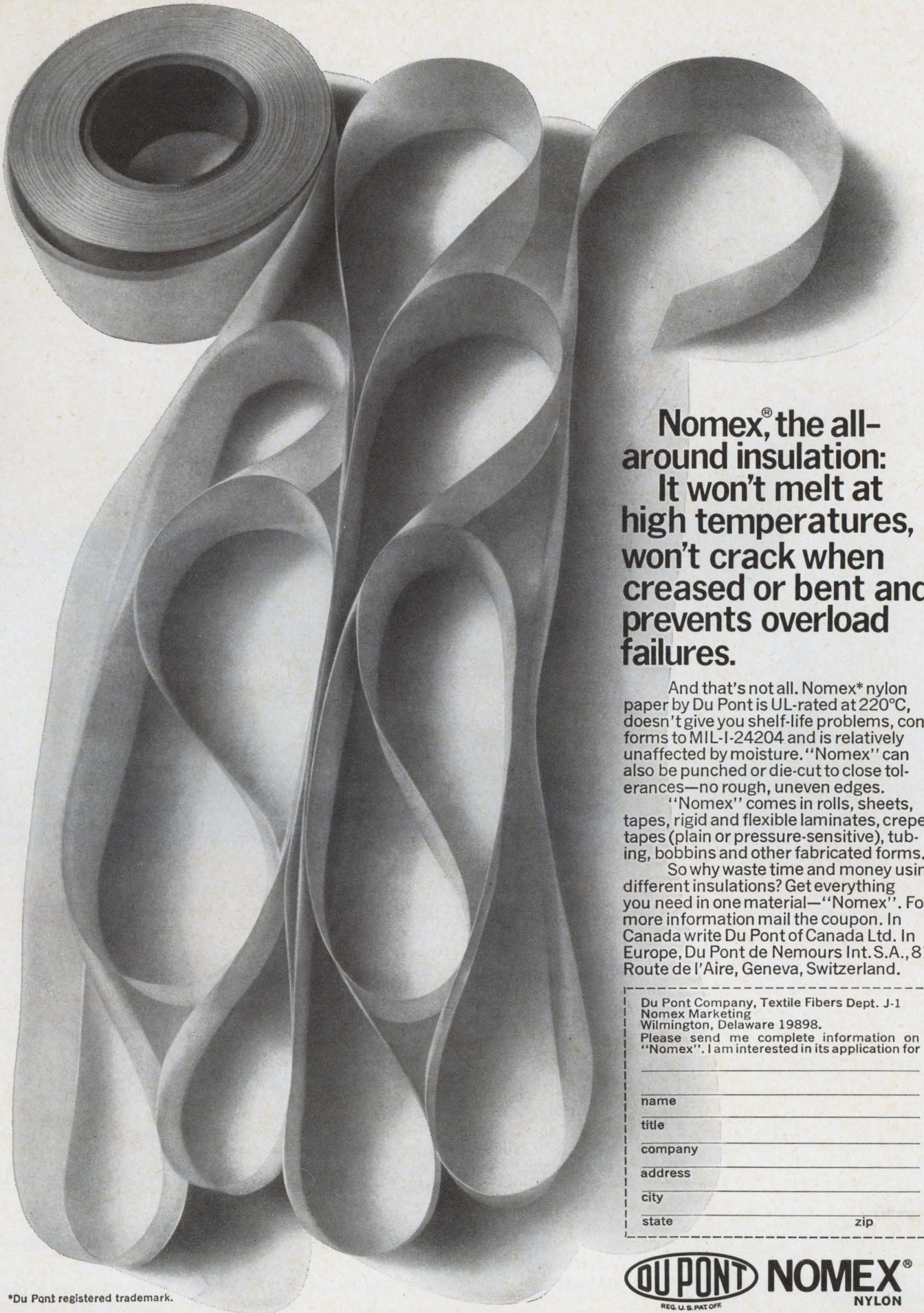

**Nomex[®], the all-around insulation:
It won't melt at high temperatures, won't crack when creased or bent and prevents overload failures.**

And that's not all. Nomex* nylon paper by Du Pont is UL-rated at 220°C, doesn't give you shelf-life problems, conforms to MIL-I-24204 and is relatively unaffected by moisture. "Nomex" can also be punched or die-cut to close tolerances—no rough, uneven edges.

"Nomex" comes in rolls, sheets, tapes, rigid and flexible laminates, creped tapes (plain or pressure-sensitive), tubing, bobbins and other fabricated forms.

So why waste time and money using different insulations? Get everything you need in one material—"Nomex". For more information mail the coupon. In Canada write Du Pont of Canada Ltd. In Europe, Du Pont de Nemours Int. S.A., 81, Route de l'Aire, Geneva, Switzerland.

Du Pont Company, Textile Fibers Dept. J-1
Nomex Marketing
Wilmington, Delaware 19898.

Please send me complete information on "Nomex". I am interested in its application for

name

title

company

address

city

state

zip



NOMEX[®]
NYLON

*Du Pont registered trademark.

Air variables from JFD solve your high Q high frequency problems

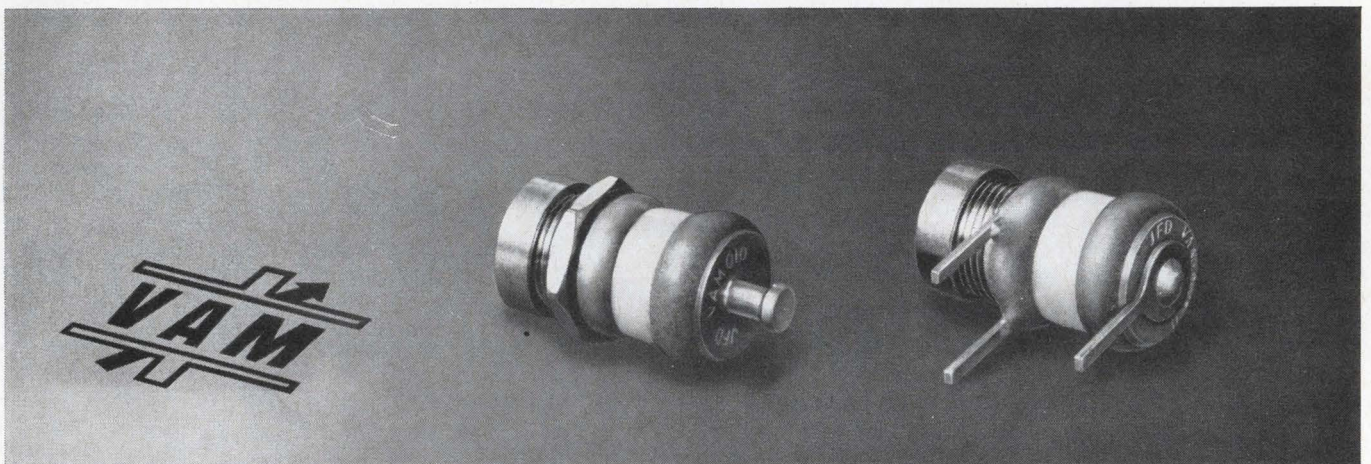

Capacitors shown enlarged 120%

The JFD air variable miniature capacitor series—VAM—is specifically designed for high frequency applications that demand extreme stability, small size and high Q (greater than 2,000 measured at 10 pf and 100 MHz) VAM's have rugged construction, measure approx. ½" in length and are completely interchangeable with competitive devices.

ELECTRICAL DATA — ALL VAM MODELS

Cap. Range at 1 MHz ... 0.8 to 10.0 pf

Q at 10 pf & 100 MHz ... >2,000

Insulation Res. at 25°C ... 10⁶ megs.
at 500 VDC

Temp. Coeff. of Cap. (-55°C to
+125°C) ... 0 ±20 PPM/°C

WVDC ... 250 VDC

Test Voltage ... 500 VDC

ACTUAL SIZES

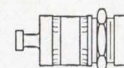

VAM 010*
Panel Mount w/Turret Terminal

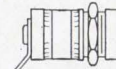

VAM 010M
Panel Mount w/Lug Terminal

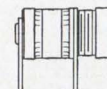

VAM 010W
Printed Circuit

*VAM 010 also available as VAM 010H with 4-40 threaded stud replacing turret terminal.

Write for catalog VAM-67-B

"TODAY'S COMPONENTS BUILT FOR TOMORROW'S CHALLENGES"



JFD ELECTRONICS CO. / COMPONENTS DIVISION / 15th Avenue at 62nd Street / Brooklyn, New York 11219 / Phone 212-331-1000
Offices and subsidiaries in principal cities, world-wide.

an invitation from 5,200 Manufacturers:

"look into VSMF"



5,200 manufacturers invite your judgment of their products in Visual Search Microfilm Files.

VSMF . . . 1,500,000 catalog pages, 5,200 manufacturers, millions of components and materials, indexed by product for side-by-side comparison. The VSMF Defense Design File, alone, contains over 250,000 pages from defense manufacturers. And, there's a file for OEM, too. In all, Information Handling Services produces 6 different VSMF files for industry and government.

We know that when you design a product you want to use the best components and materials. And, to do this, you need to compare all that is available. VSMF can help you in this comparison because VSMF supplies the data on **all** products. You supply the judgment.

Manufacturers who place their data in VSMF know this and invite comparison. The constantly changing "state of the art" is reflected in the pages of VSMF.

If you have VSMF in your company, look into it. If you don't, you might look into that, too. Write for "Looking into VSMF."

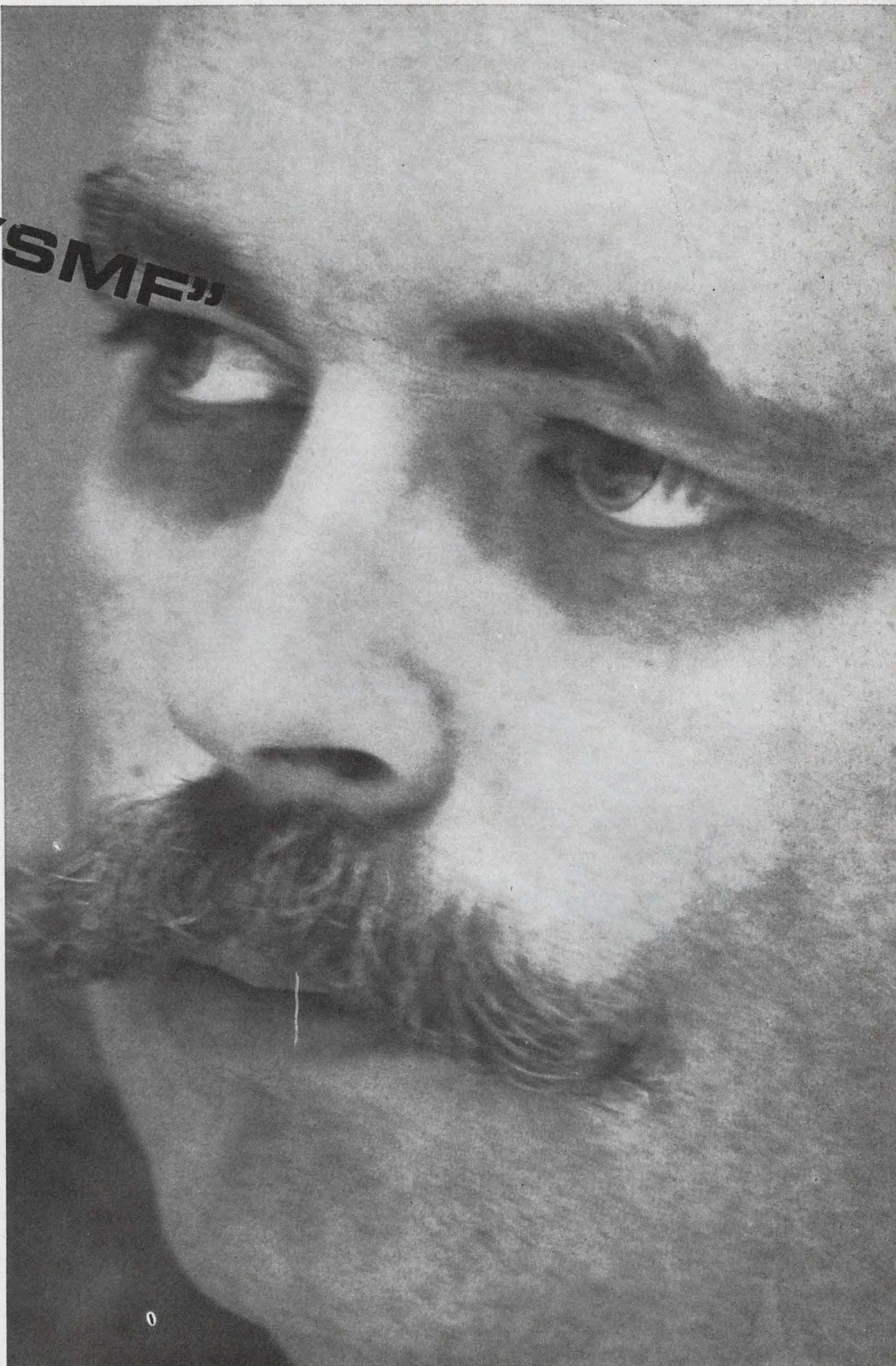

William H. B. Combs, Manager, Engineering Services, Relay Division, Leach Corporation, Los Angeles, uses the VSMF Defense Design File.



Information

HANDLING SERVICES, INC.
Dept. E-25

Denver Technological Center
Englewood, Colo. 80110

Circle 111 on reader service card

Ever need plug-in power supplies in a hurry?

Send for our catalog.

It lists 62,000 different types.

The one you need will be shipped in 3 days.

(We've never failed to make good on this promise)

DUAL OUTPUT SOLID STATE REGULATED POWER SUPPLIES (400 MA MAX.)
 Ambient temperature rating 0 to 55°C.

Acopian

DUAL OUTPUT SOLID STATE REGULATED POWER SUPPLIES (400 MA MAX.)
 Ambient temperature rating 0 to 55°C.

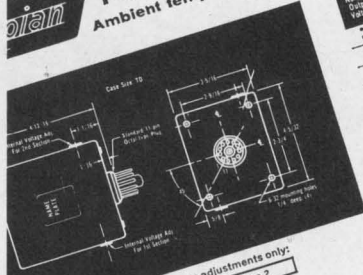

Pin connections with internal voltage adjustments only:
 Section 1 Input: Pins 1 & 2
 Section 2 OUTPUT 3(+)-4(-)
 10(+)-9(-)

Pin connections for models with provisions for both internal and remote output adjustment, identical with prefix "E", see optional feature, Remote output adjustment:
 Section 1 Input: Pins 1 & 2
 Section 2 OUTPUT 3(+)-4(-)
 10(+)-9(-)
 For Internal Pot. 4 & 5
 Short out pins
 For Remote Pot. 4 & 6
 Use pins

SPECIFICATIONS
 INPUT VOLTAGE: 105-125V, AC, 50 to 400 cycle single phase.
 OUTPUT VOLTAGE: SEE SPECIFIC SECTIONS
 OUTPUT CURRENT: SEE SPECIFIC SECTIONS
 REGULATION: SEE SPECIFIC SECTIONS
 RIPPLE: SEE SPECIFIC SECTIONS
 OUTPUT VOLTAGE ADJUSTMENT: ±1 volt adjustment provided for each section.
 POLARITY: Outputs are floating. Each individual section may be connected as a separate power supply. Either negative or positive side of one section may be grounded irrespective of the other section.
 IMPEDANCE: Approximately 2 ohm at 10Kc.
 INSTALLATION: Plugs into standard 11-pin octal-type socket. Mounting holes 9-32 provided at each corner for installation in any position.
FEATURES
 Identical or different sections may be selected. Short circuit protection. No additional heat sinking required. May be used in series.
HOW TO ORDER
 Select two sections desired. The Model Number is the combination of the two sections selected. Example: Section 6B10D and section 12A0D is Model 6B10D-12A0D. Always assign the lower voltage section first.
 For pricing purposes, add the cost of the individual sections selected. Example: Model 6B10D-6B10D—Price: \$120.00.

OPTIONAL FEATURES
REMOTE OUTPUT ADJUSTMENT—All standard dual power supplies are provided with accessible internal voltage adjustments. For remote adjustment, Example: 6B80D-12B20D. "E" model number and add \$2.00 to price. Example: 6B80E-12B20D. "E" power supplies will have provisions for both internal and remote adjustments in both sections.
REMOTE SENSING—provision for remote sensing of the output voltage so as to compensate for drops in the load lines can be furnished at an additional charge of \$20.00 per model. Add prefix "R" to model number when ordering. "R" power supplies will also have provisions for both internal and remote output adjustment.
230 VOLT INPUT—All standard units can be furnished to accept input of 210 to 250V. Add suffix "-230" to model number. Additional cost \$10.00.

Model No.	Nominal Output Voltage	Output Current (mA)	REGULATION Lead %	Ripple mV RMS	Price per Section	Section (Max. to Order)
1	1.5	400	1.0	0.05	64	1B80D
2	1.5	200	1.0	0.05	64	2B80D
3	1.5	100	1.0	0.05	64	3B80D
4	1.5	50	1.0	0.05	64	4B80D
5	1.5	25	1.0	0.05	64	5B80D
6	1.5	12.5	1.0	0.05	64	6B80D
7	1.5	6.25	1.0	0.05	64	7B80D
8	1.5	3.125	1.0	0.05	64	8B80D
9	1.5	1.5625	1.0	0.05	64	9B80D
10	1.5	0.78125	1.0	0.05	64	10B80D
11	1.5	0.390625	1.0	0.05	64	11B80D
12	1.5	0.1953125	1.0	0.05	64	12B80D
13	1.5	0.09765625	1.0	0.05	64	13B80D
14	1.5	0.048828125	1.0	0.05	64	14B80D
15	1.5	0.0244140625	1.0	0.05	64	15B80D
16	1.5	0.01220703125	1.0	0.05	64	16B80D
17	1.5	0.006103515625	1.0	0.05	64	17B80D
18	1.5	0.0030517578125	1.0	0.05	64	18B80D
19	1.5	0.00152587890625	1.0	0.05	64	19B80D
20	1.5	0.000762939453125	1.0	0.05	64	20B80D
21	1.5	0.0003814697265625	1.0	0.05	64	21B80D
22	1.5	0.00019073486328125	1.0	0.05	64	22B80D
23	1.5	0.000095367431640625	1.0	0.05	64	23B80D
24	1.5	0.0000476837158203125	1.0	0.05	64	24B80D
25	1.5	0.00002384185791015625	1.0	0.05	64	25B80D
26	1.5	0.000011920928955078125	1.0	0.05	64	26B80D
27	1.5	0.0000059604644775390625	1.0	0.05	64	27B80D
28	1.5	0.00000298023223876953125	1.0	0.05	64	28B80D
29	1.5	0.000001490116119384765625	1.0	0.05	64	29B80D
30	1.5	0.0000007450580596923828125	1.0	0.05	64	30B80D
31	1.5	0.00000037252902984619140625	1.0	0.05	64	31B80D
32	1.5	0.000000186264514923095703125	1.0	0.05	64	32B80D
33	1.5	0.00000009313225746151546875	1.0	0.05	64	33B80D
34	1.5	0.000000046566128730757734375	1.0	0.05	64	34B80D
35	1.5	0.0000000232830643653788671875	1.0	0.05	64	35B80D
36	1.5	0.000000011641532182689434375	1.0	0.05	64	36B80D
37	1.5	0.0000000058207660913447171875	1.0	0.05	64	37B80D
38	1.5	0.00000000291038304567235859375	1.0	0.05	64	38B80D
39	1.5	0.000000001455191522836179296875	1.0	0.05	64	39B80D
40	1.5	0.0000000007275957614180896484375	1.0	0.05	64	40B80D
41	1.5	0.00000000036379788070904482421875	1.0	0.05	64	41B80D
42	1.5	0.000000000181898940354522412109375	1.0	0.05	64	42B80D
43	1.5	0.0000000000909494701772612060546875	1.0	0.05	64	43B80D
44	1.5	0.0000000000454747350886306030303125	1.0	0.05	64	44B80D
45	1.5	0.00000000002273736754431530151515625	1.0	0.05	64	45B80D
46	1.5	0.000000000011368683772157650757578125	1.0	0.05	64	46B80D
47	1.5	0.00000000000568434188607877537889375	1.0	0.05	64	47B80D
48	1.5	0.000000000002842170943039387689446875	1.0	0.05	64	48B80D
49	1.5	0.0000000000014210854715219438447234375	1.0	0.05	64	49B80D
50	1.5	0.00000000000071054273576097192236171875	1.0	0.05	64	50B80D
51	1.5	0.00000000000035527136788048596118089375	1.0	0.05	64	51B80D
52	1.5	0.000000000000177635683940242980590446875	1.0	0.05	64	52B80D
53	1.5	0.0000000000000888178419701214902952234375	1.0	0.05	64	53B80D
54	1.5	0.0000000000000444089209850607451476171875	1.0	0.05	64	54B80D
55	1.5	0.0000000000000222044604925303725738089375	1.0	0.05	64	55B80D
56	1.5	0.0000000000000111022302462651862869446875	1.0	0.05	64	56B80D
57	1.5	0.00000000000000555111512313259314347234375	1.0	0.05	64	57B80D
58	1.5	0.0000000000000027755575615662817171171875	1.0	0.05	64	58B80D
59	1.5	0.000000000000001387778780783140858589375	1.0	0.05	64	59B80D
60	1.5	0.0000000000000006938893903915704292946875	1.0	0.05	64	60B80D
61	1.5	0.000000000000000346944695195785214647234375	1.0	0.05	64	61B80D
62	1.5	0.0000000000000001734723475978926073236171875	1.0	0.05	64	62B80D
63	1.5	0.0000000000000000867361737989463036618089375	1.0	0.05	64	63B80D
64	1.5	0.0000000000000000433680868994731518309446875	1.0	0.05	64	64B80D
65	1.5	0.00000000000000002168404344973657591518089375	1.0	0.05	64	65B80D
66	1.5	0.000000000000000010842021724868287957590446875	1.0	0.05	64	66B80D
67	1.5	0.0000000000000000054210108624341439787952234375	1.0	0.05	64	67B80D
68	1.5	0.0000000000000000027105054312170719893946875	1.0	0.05	64	68B80D
69	1.5	0.000000000000000001355252715608539947234375	1.0	0.05	64	69B80D
70	1.5	0.0000000000000000006776263578042699736171875	1.0	0.05	64	70B80D
71	1.5	0.0000000000000000003388131789021349893946875	1.0	0.05	64	71B80D
72	1.5	0.0000000000000000001694065894510674947234375	1.0	0.05	64	72B80D
73	1.5	0.00000000000000000008470329472553374718089375	1.0	0.05	64	73B80D
74	1.5	0.00000000000000000004235164736276837359446875	1.0	0.05	64	74B80D
75	1.5	0.0000000000000000000211758236813918697234375	1.0	0.05	64	75B80D
76	1.5	0.0000000000000000000105879118406954348618089375	1.0	0.05	64	76B80D
77	1.5	0.0000000000000000000052939559203477174309446875	1.0	0.05	64	77B80D
78	1.5	0.000000000000000000002646977960173888718089375	1.0	0.05	64	78B80D
79	1.5	0.00000000000000000000132348898008694439446875	1.0	0.05	64	79B80D
80	1.5	0.00000000000000000000066174449004347234375	1.0	0.05	64	80B80D
81	1.5	0.00000000000000000000033087224502173618089375	1.0	0.05	64	81B80D
82	1.5	0.00000000000000000000016543612251068309446875	1.0	0.05	64	82B80D
83	1.5	0.00000000000000000000008271806125253418089375	1.0	0.05	64	83B80D
84	1.5	0.00000000000000000000004135903062626709446875	1.0	0.05	64	84B80D
85	1.5	0.0000000000000000000000206795153131347234375	1.0	0.05	64	85B80D
86	1.5	0.0000000000000000000000103397576565673618089375	1.0	0.05	64	86B80D
87	1.5	0.000000000000000000000005169878828283689446875	1.0	0.05	64	87B80D
88	1.5	0.0000000000000000000000025849394141418089375	1.0	0.05	64	88B80D
89	1.5	0.0000000000000000000000012924697070709446875	1.0	0.05	64	89B80D
90	1.5	0.00000000000000000000000064623485353547234375	1.0	0.05	64	90B80D

*.5 volt adjustment from nominal.

Acopian

Acopian Corp., Easton, Pennsylvania (215) 258-5441

Because of new ideas from Sanders . . .

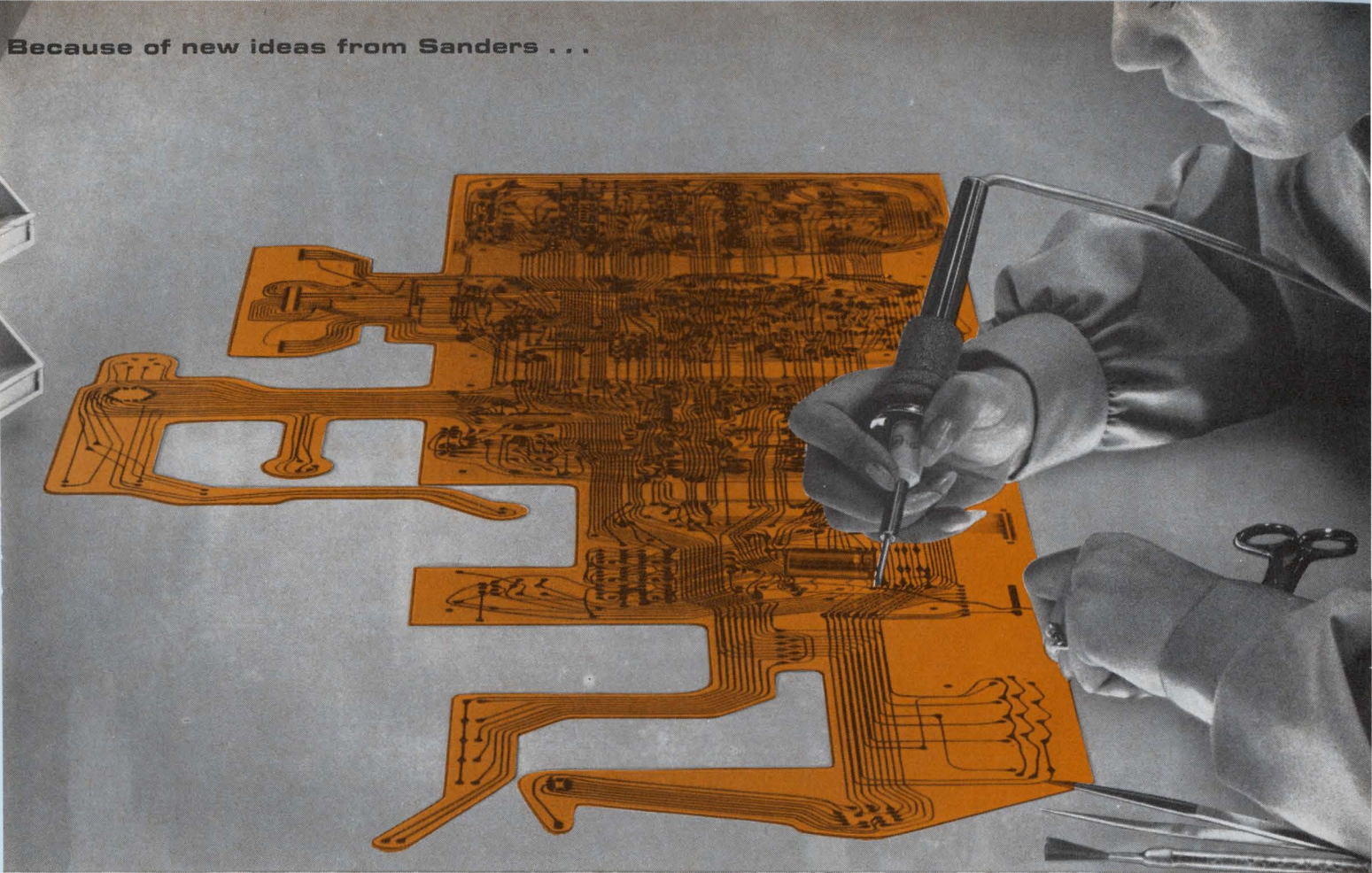

New FLEXMAX* Circuitry permits assembly of components flat out for reliability

FLEXMAX—the new direction in Sanders FLEXPRINT Circuitry. It's a multilayer flexible circuit with interlayer connections by a proven plated-throughhole technique.

Just lay the FLEXMAX Circuit flat, mount components where you want them, solder and test. Then fold up the completed circuit for easy, sure-fit into the equipment.

And by using FLEXMAX Circuits, you increase reliability by mounting components directly on a flexible substrate (something you could never do before) and at the same time eliminate hardboard, connectors and wiring.

Start your design with the FLEXPRINT concept of interconnection and your packaging problem will be solved. Sanders has the capability to show you how. Find out for sure by looking into FLEXPRINT Circuitry. Call or write Sanders Associates, Inc., FLEXPRINT Division, Grenier Field, Manchester, New Hampshire 03103. Phone: (603) 669-4615.

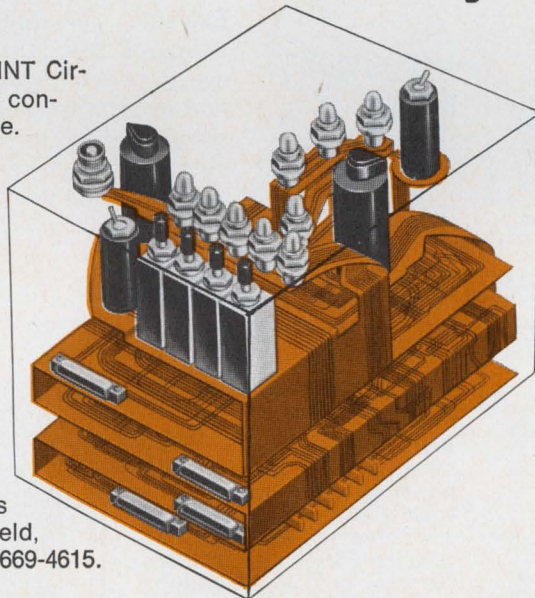

This new two-layer FLEXMAX circuit is made from high-temperature material, providing excellent inherent dimensional stability. This insures constant electrical and mechanical characteristics over a wide environmental range.

This typical example of a FLEXMAX circuit fits in a package 8" x 10" x 4" high. In the flat form, its dimensions are 40" long x 17" wide. Approximately 200 components can be mounted on the circuit.

Creating
New Directions
In Electronics

Circle 113 on reader service card

SA  **SANDERS
ASSOCIATES, INC.**
FLEXPRINT DIVISION
GRENIER FIELD, MANCHESTER, NEW HAMPSHIRE



PRECISION SWITCHES

for accurately controlled switching in electrical circuits...

Unlimited applications—C.D.I. thumbwheel and rotary switches offer fast, sure settings and quick read-out for computer, automated machine control consoles, check-out equipment, test equipment, programming applications, etc.

Quick Serviceability—In five seconds, any wafer of a C.D.I. rotary switch can be removed. No soldering, disassembling or wiring required. The entire module on thumbwheel switches is removable for equally fast maintenance or replacement.

Extreme versatility—Regardless of size or shape, C.D.I. is well prepared to meet your every switch requirement. Our comprehensive line of thumbwheel and rotary switches is supplemented by an engineering capacity that will custom design any switch to your precise specifications.

COMPLETE PROTECTION AGAINST HOSTILE ENVIRONMENTS

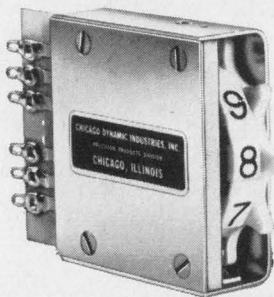

New Completely Sealed Switch Modules.

Both Panel and Switching Elements are *separately sealed* providing complete protection against all types of hostile environments. Clean room assembled. For R.F.I. applications. Decimal or coded versions. Series PS tab type Thumbwheel Switch retrofits CDI Series TTS. Switch life exceeds 100,000 operations.

NO SCREWS VISIBLE

New Aluminum Bezel

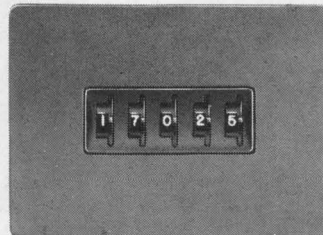

Permits rear mounting of miniature and standard type switches with no screws visible. Accommodates to 20 switch modules. Miniature model fits CDI Series MTTD and MTTB miniature tab type switches. Standard model fits CDI Series TTD and TTB standard tab type switches. Available in colors to match any instrument panel.



CHICAGO DYNAMIC INDUSTRIES, INC.

PRECISION PRODUCTS DIVISION 1725 Diversey Blvd., Chicago, Illinois 60614 Phone: WEllington 5-4600

Here's One Way to Automate Coffee-Pots With ^{Some} Servo Pots...

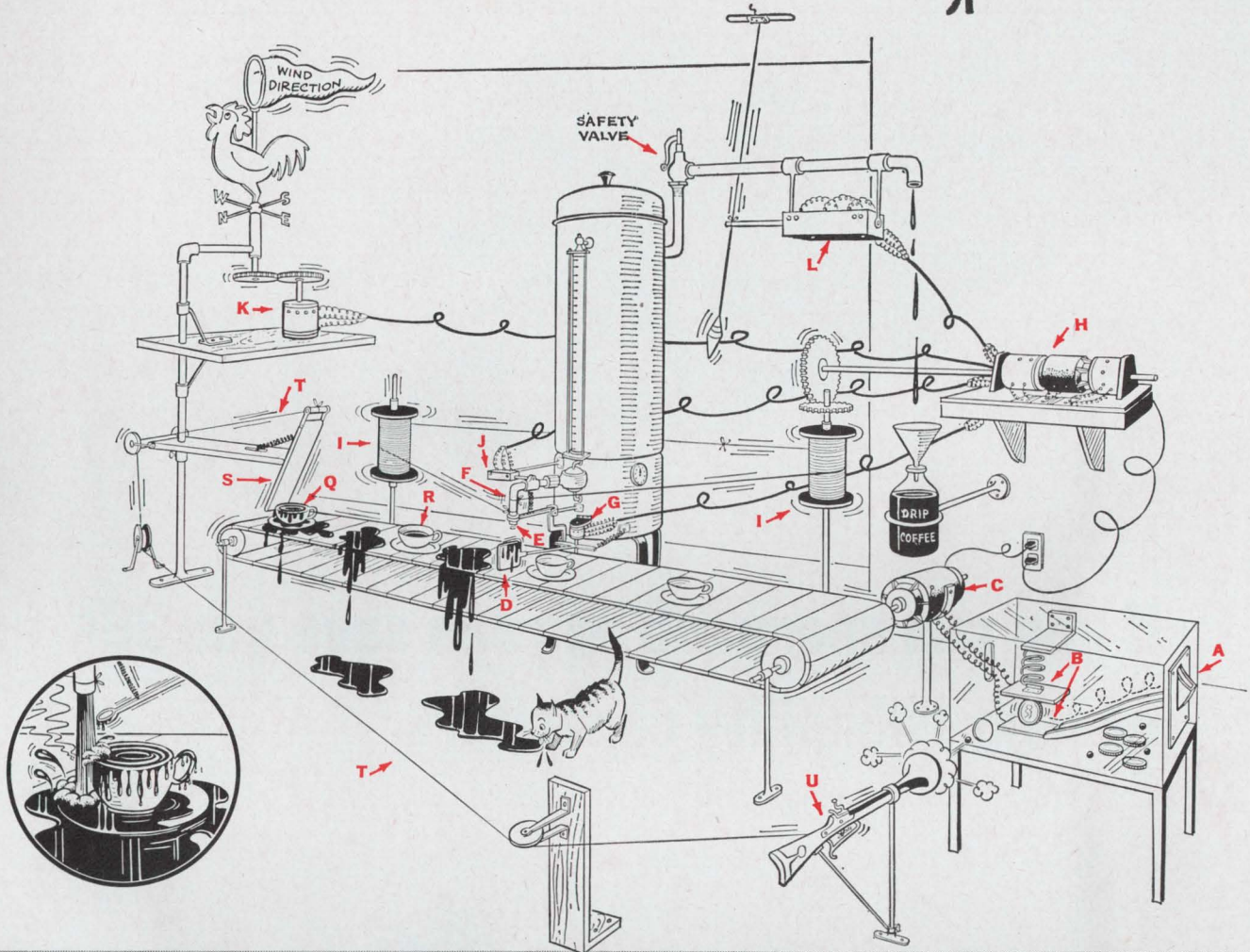

Place dime into coin slot (A). Coin rolls down ramp into position between spring-loaded metal contacts (B). Contact starts motor (C) and coffee-conveyor-belt proceeds to carry cup into position below spout. As coffee cup pushes actuator blade (D), plug (E) is lowered from spout (F) and coffee starts flowing. Wire-wound pot (G), indicating cup position, sends signal to high gain servo-amplifier (H) and precision drive system (I), causing spout to move toward cup. Wire-wound spout-indicator-pot (J) feeds signal back to amplifier in effort to follow movement of cup. In order to compensate for wind direction and angle of building, wire-wound windage-pot (K) and vertical-sensor-pot (L) send additional aiming signals to servo-motor amplifier. Due to poor linearity, high noise, poor resolution and high starting torque —

typical of wire-wound pots — servo-system is unstable and inaccurate. Coffee misses cup, spills over belt onto floor, where coffee-loving pussy cat (Cafe au lait colored, of course) attempts to keep floor clean. Note that cup (Q) is overflowing, while cup (R) is only half-full. As cup (Q) reaches end of belt, paddle (S) is pushed forward causing string (T) to pull trigger of early 18th century solid-propellant missile launcher (U). Missile dislodges coin, thereby stopping entire system. (Which isn't a bad idea, considering the price of coffee!)

Men who know coffee and servo-systems best* all agree that the above system works perfectly, everytime, by replacing wire-wound with C. I. C. film potentiometers.

*Every major aircraft and missile manufacturer uses C. I. C. precision film potentiometers.

BUT THE BEST WAY YET



Whether aiming missiles or coffee, use C. I. C. Precision Film Potentiometers . . . only C. I. C. film pots have infinite resolution, linearity to .01%, low starting torque and microvolt operational noise.

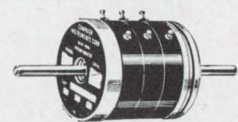

C I C "first in film pots"

COMPUTER INSTRUMENTS CORPORATION

76 MADISON AVENUE • HEMPSTEAD, L. I., NEW YORK



If you can spare 5/8" we can save you 36¢ on high-reliability capacitors

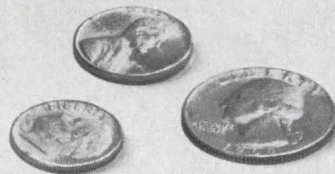

The secret's simple. Just switch from solid tantalum, MIL C and D case sizes to our TPG-VPG series aluminum electrolytics. They're our "miniature computer grade." Life, reliability, MTBF are comparable to tantalum. And they cost about 50¢ in production lots. No premium for 75 and 100 volt ratings.

If you've got the room, we've got the capacitor. In both axial lead and vertical mount styles. Get complete data by writing to Mallory Capacitor Company, a division of P. R. Mallory & Co. Inc., Indianapolis, Indiana 46206.

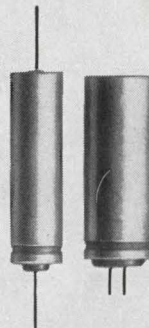

MALLORY

MALLORY CAPACITOR COMPANY

a division of P. R. MALLORY & CO. INC.
3029 E. Washington St., Indianapolis, Indiana 46206

Put it all together and it spells coax environmental sealing.

These Bantam miniature round connectors are designed and built to keep out dust, moisture or anything liable to interfere with the electrical performance, in accordance with the requirements of MIL-C-26482.

Crimp removable contacts are standard in Smooth Bantam. But the coaxial contacts and connectors of the Bantam environmentally sealed type are now available for a wide range of coaxial and shielded wire. The contacts are of MS 3192 and MS 3193 geometry. The wide range is provided by the design of two basic contacts. A #12 size, interchangeable with the standard #12 MS contact, allows any combination of coaxial, single conductor or twisted pairs to be used in the same connector. A #8 size contact, available in matched impedance, completes the cable range.

Like every Burndy Bantam, and every Burndy connector for that matter, the new coax Bantam is the result of design and engineering skill in connectors, contacts and installation tooling. Whether hand or automatic tooling is called for, crimp removable contacts and installation tooling, meeting the requirements of MIL-T-22520, lowers installed costs and increases connector dependability. We've built a reputation on it.



 **BURNDY**
Norwalk, Connecticut

INTERNATIONAL SALES HEADQUARTERS AND MANUFACTURING FACILITIES:
CANADA: Scarborough, Ontario / ENGLAND: St. Helens, Lancs.
BELGIUM: Mechelen / MEXICO: Naucalpan de Juarez / BRAZIL: Sao Paulo
JAPAN: Tokyo / Sales Offices in Other Major Cities

Circle 117 on reader service card

3 ways you can use the Raysistor[®] to improve your product, cut costs

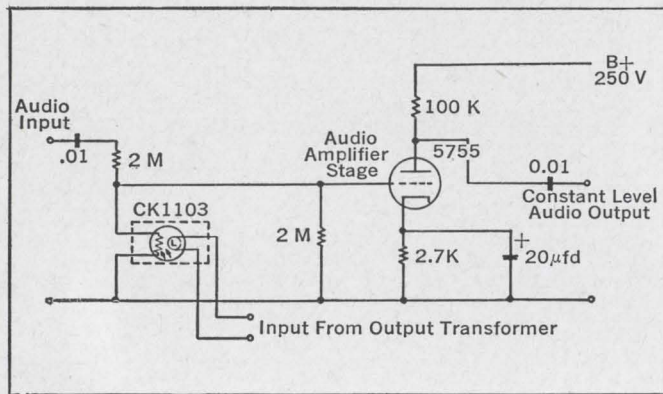

1. Use the Raysistor[®] as a simple remote or automatic volume control in SSB suppressed carrier receivers. Feeding part of the audio output into the control light source varies the resistance of the Raysistor's photocell, making it usable in place of a normal volume control.

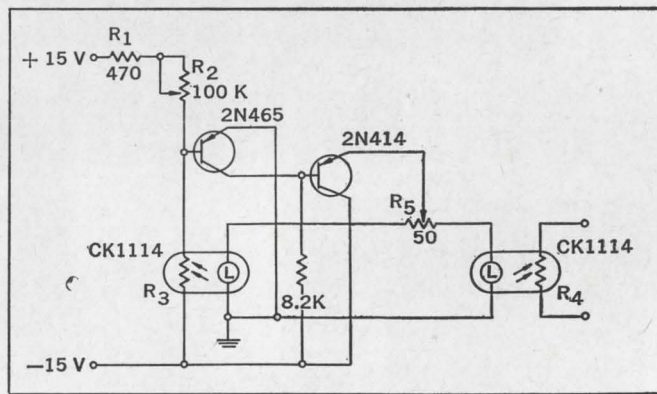

2. As a remotely controlled linear potentiometer. The Raysistor can be used as a remotely controlled linear potentiometer when used in the circuit shown above. Here the Raysistor forms a voltage divider between the positive and negative voltages.

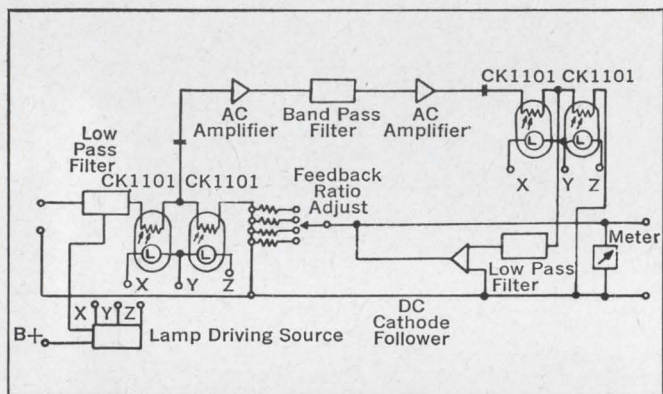

3. As a photochopper stabilized D-C microvoltmeter. Raysistors, used as photochoppers in both modulator and demodulator circuits, enable d-c levels to be measured to a fraction of a microvolt. They facilitate synchronous detection and demodulation with simple electrical coupling, have less noise than transistor choppers, while avoiding maintenance problems of mechanical choppers. Other photochopper applications: photochopper relay, series or shunt chopper, modulator circuit, and as a stabilizer to reduce long-term drift.

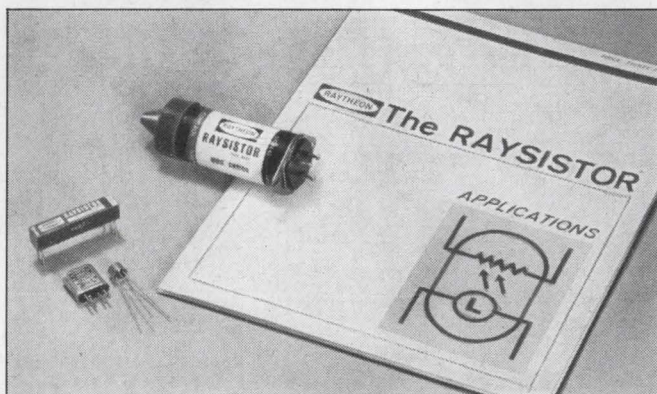

Many more ways you can use the Raysistor. Send for *The Raysistor Applications Manual* which describes ways you can use this unique optoelectronic component as a photochopper, variable resistor, solid-state switch, relay, voltage or signal isolator, nonlinear potentiometer, etc. For complete specifications and prices, call your Raytheon distributor or regional sales office. For a copy of this 28-page manual, circle the reader service card or write directly to *Raytheon Company, Components Division, Quincy, Massachusetts 02169.*



Industrial Components Operation—A single source for Circuit Modules/Control Knobs/Display Devices/Filters/Hybrid Thick-Film Circuits/Industrial Tubes/Optoelectronic Devices/Panel Hardware

Now you can put long-term reliability into precision resistor applications.

Because Corning made a production of precision.

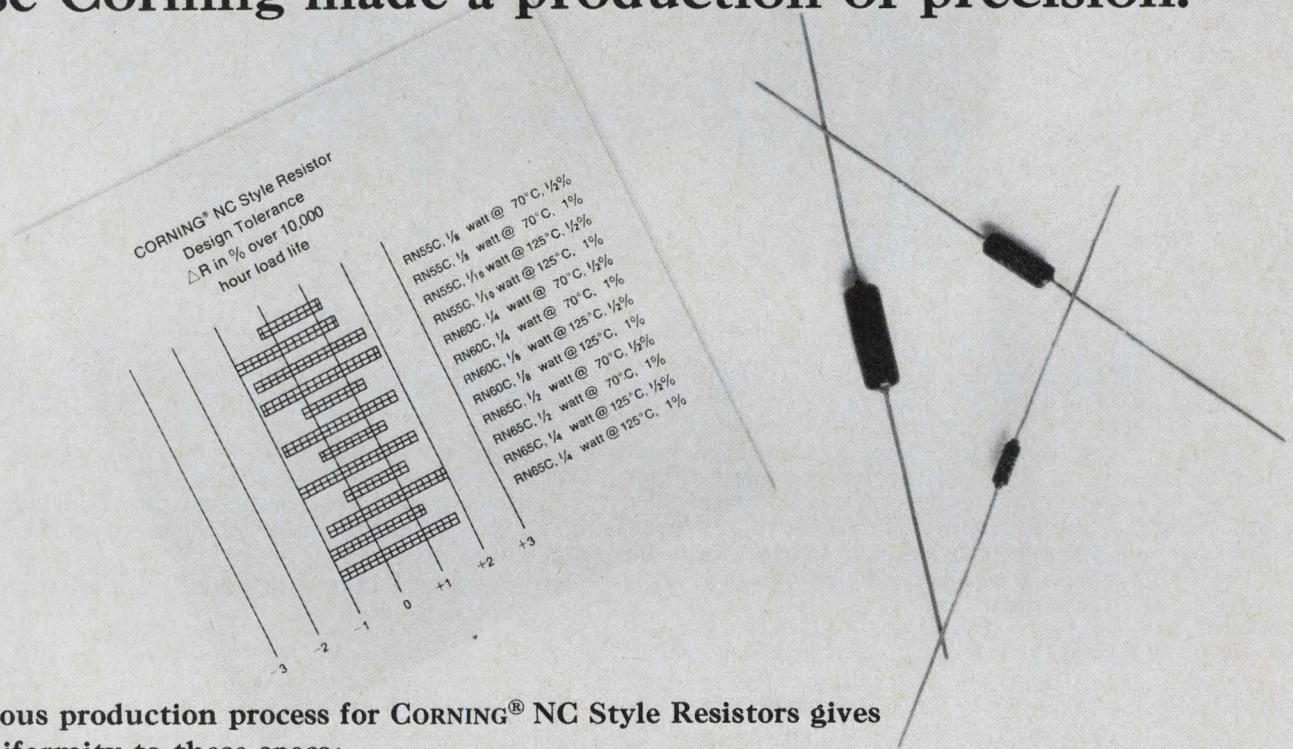

The continuous production process for CORNING® NC Style Resistors gives you total uniformity to these specs:

- Predictable end-of-life design tolerances from +1.8% to -1.0%.
- Molecular bonding of metal oxide film and glass substrate.
- Matching TC's of film and glass.
- <math><1/2\%</math> load life ΔR .
- Overall TC of ± 50 ppm.
- Mil-R-10509E, Char. C conformance.

Get this precision again and again. Specify CORNING NC Style Resistors.

In three sizes, with these ratings at 125°C.: 1/10 watt in 49.9 ohms to 301K, 1/8 watt in 49.9 ohms to 1 meg, and 1/4 watt in 49.9 ohms to 2 meg.

Precise data is yours for the asking from your Corning distributor, or by writing to: Corning Glass Works, Electronic Products Division, Corning, N. Y. 14830.

CORNING
ELECTRONICS

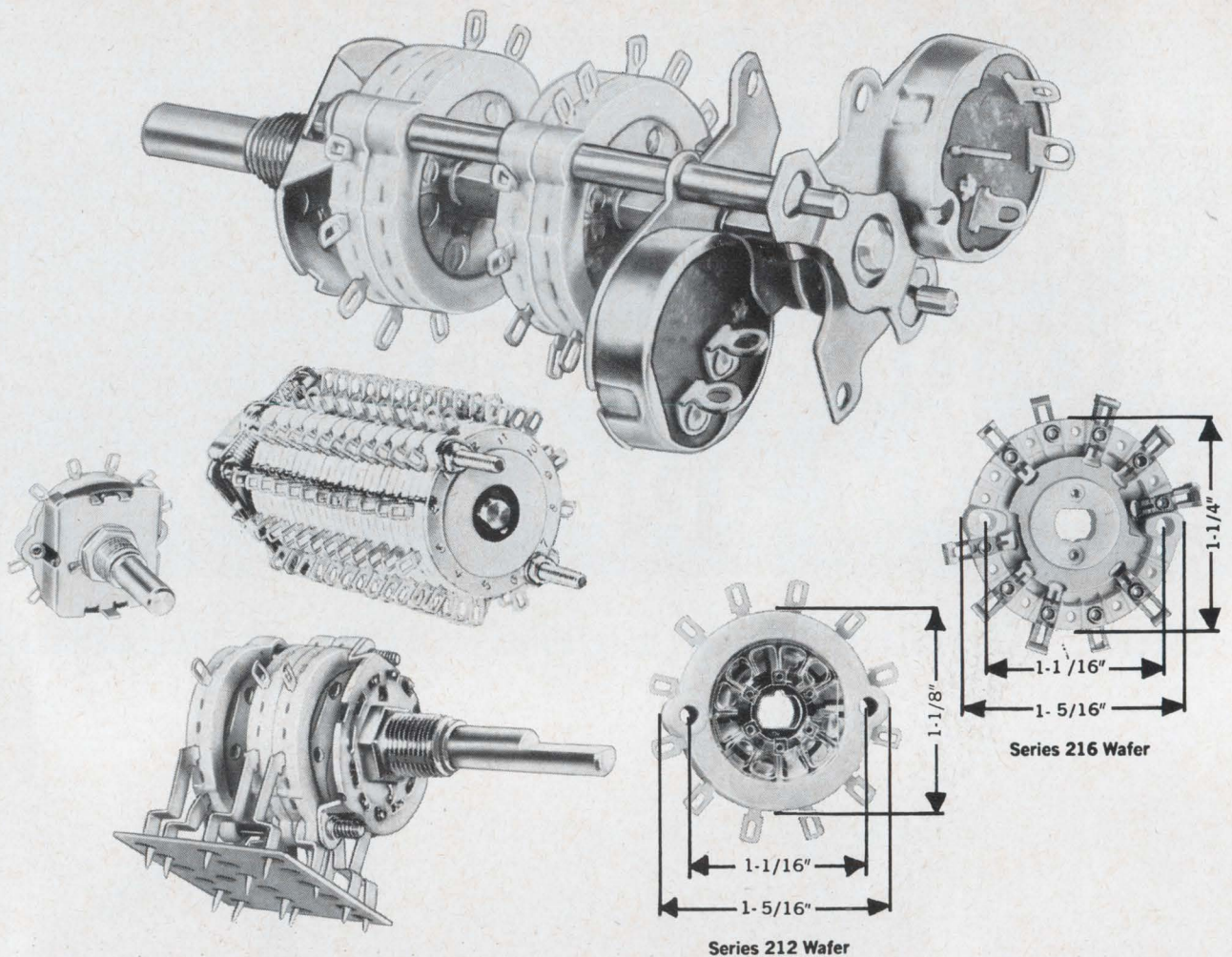

These are the facts that make CTS Switches the engineer's choice

NO BREAKAGE•They don't break on production lines or on finished equipment if dropped or jarred...CTS glass alkyd wafers are not brittle like phenolic... easy to handle.

NO SHIFTING•Precision molded construction eliminates mechanical shifting of stator circuitry and terminals.

MORE COMPACT•No spacers needed when stacking wafers... Maximum switching capability with minimum depth... Smaller diameter—only 1 1/8" (Series 212 wafers)

VERSATILITY OF CIRCUITS•Many circuit variations available due to varied rotor contact configurations.

External jumpers eliminated by CTS internal connectors between adjacent positions.

AVAILABILITY OF POWER SWITCHES•Available with 4 types of power switches and/or numerous potentiometers.

SUPERIOR INSULATION•Glass alkyd is superior to phenolic insulation.

- Soldering heat can't loosen terminals.
- Meet MIL-S-3786 A&B, Style SR03 (Series 211, 212 and 215)
- Balanced contact spring.
- Natural solder barrier provided by glass alkyd insulation.

Which Detent best fits your requirement?

Detent	Application	Cycle Life	Switching Torque
Type 211—Star Wheel Detent	Highest quality applications	250,000	10-50" oz.
Type 215—Double Ball Detent	Quality instrument applications	100,000	6-35" oz.
Type 212—Hill and Valley Detent	Home entertainment and low cost instrument applications	25,000	20-48" oz.
Type 212 ND—Die Cast Detent	Lowest cost applications	20,000	18-40" oz.



4-6 WEEKS DELIVERY

CTS CORPORATION
ELKHART, INDIANA 46514

® Phone: 219, 523-0210. TWX: 810-294-2256

Western Source
CTS Electronics, Inc.
(formerly Chicago Telephone of California, Inc.)
1010 Sycamore Avenue
S. Pasadena, California 91031
Phone: 213, 254-9141
TWX: 910-321-4060

Canadian Source
CTS of Canada, Ltd.
Streetsville, Ontario
Phone: 416, TA 6-1141

Probing the News

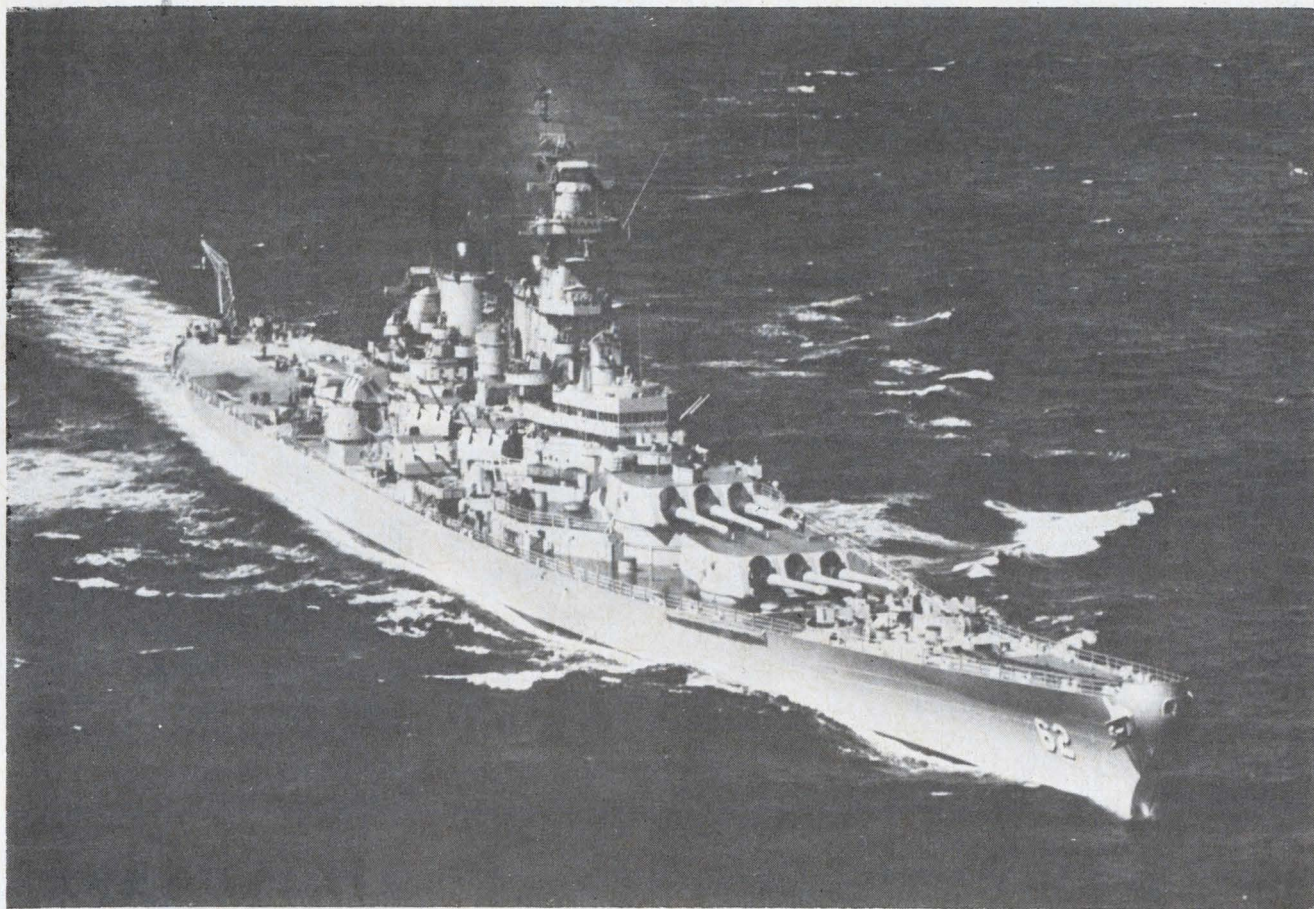

Military electronics

Off to the wars—again

Soon to be the only battleship on the high seas, the USS New Jersey will rely largely on electronic equipment of Korean war vintage

By Howard Wolff

New York bureau manager

Two thousand workmen at the Philadelphia Naval Shipyard are fitting out an anachronism. They're removing the mothballs from the battleship New Jersey—a giant built to duel other giants in another era—and getting her 16-inch guns ready to go to Vietnam.

They're also turning back the clock on electronics. With few exceptions, the radar, loran, and communications equipment aboard the

New Jersey will be the same gear she carried at the time of the Korean conflict 15 years ago.

The reason is money. Our war planners are looking for a bargain, weighing the \$25 million being spent to turn the New Jersey into the only battleship afloat against the mounting cost of tactical air warfare. A single aircraft can cost up to \$4 million, and we've lost more than 1,000 in Vietnam so far.

But the New Jersey can stand offshore and hurl 2,700-pound shells up to 23 miles with deadly accuracy—and she can do it round the clock in any kind of weather.

I. Damn the torpedoes

The lack of up-to-the-minute electronic aids doesn't particularly disturb Navy brass. One high-ranking officer puts it this way:

"We're getting the New Jersey



Hunt. Workman checks out Jersey's old receiver patch panel.

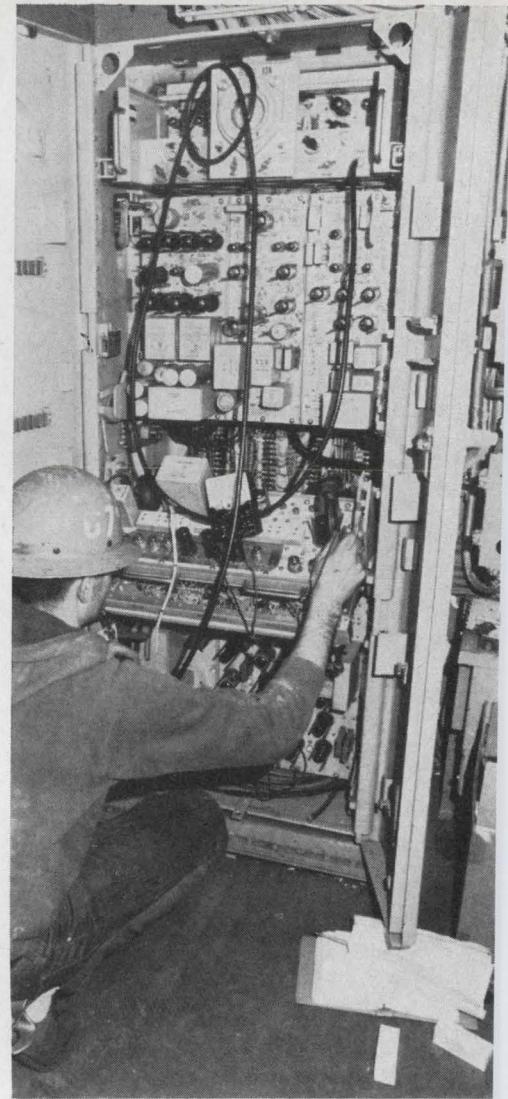

Optic nerve. Mark 25 secondary battery radar shapes up.

ready to provide the artillery punch in Vietnam that only a battleship packs, and it doesn't take any fancy piloting or plotting to get those 16-inchers out there. There was a big thing after World War II about electronic navigation and piloting aids; before long everyone was below looking at radar screens and no one was on the bridge. Now the pendulum has swung the other way with the realization that it takes men to run ships.

"Enemy planes? We'll have air cover, so we don't need those 40-millimeter guns that were fine against propeller-driven aircraft. Small surface boats? We'll have destroyers with us, and the Jersey's 5-inchers will be manned. Submarines? Again, there are the destroy-

ers and air cover.

"We don't want a showboat. We just want to spend enough money to get those guns to Vietnam."

Underlining the emphasis on economy, a shipyard foreman who believes a battleship's beauty is skin deep says ruefully: "The Navy might not even be able to afford paint for her insides."

What's new? However, the New Jersey won't quite be a throwback to Teddy Roosevelt's Great White Fleet. For example, there's an empty compartment high above the

bridge that will soon be filled with the latest in secret electronic countermeasure equipment. Also slated for the refurbished battlewagon is the Naval Tactical Data System (NTDS). Officers won't discuss how the New Jersey's present equipment will be modified to accommodate NTDS, but they boast that, as with similarly equipped vessels, she'll be able to maintain a real-time record of all ships, aircraft, and submarines within range [Electronics, Feb. 20, 1967, p. 211]. This will come in handy for the New Jersey's secondary mission in Vietnam: to serve as a refueling stop-over for helicopters.

At the heart of the NTDS are as many as four computers supplied by the Univac division of the Sperry Rand Corp. Designated AN/USQ-20, the computers are general-purpose, stored-program digital machines with a 4-microsecond cycle time

Back to work

Upon recommission, which the Navy optimistically expects sometime in May, the New Jersey will be the only battleship sailing the seas.

During World War II and the Korean conflict she carried a crew of 112 officers and 2,450 enlisted men. For Vietnam, her third combat foray, the New Jersey will carry a bare-bones crew of 70 officers and 1,400 sailors, volunteers all.

The 45,000-ton vessel is 887 feet long, has a beam of 108 feet, and draws 38 feet of water. Her armor plating is, in some places, 19 inches thick and has yet to be penetrated by an enemy shell.

All nine of her 16-inch guns and all 20 5-inch guns will be operational, but she has been stripped of her 80 40-millimeter antiaircraft guns.

The New Jersey's geared turbine engines generate 212,000 horsepower. She can carry 8,800 tons of oil and is pushed through the water by her four propellers at a maximum speed of 33 knots.

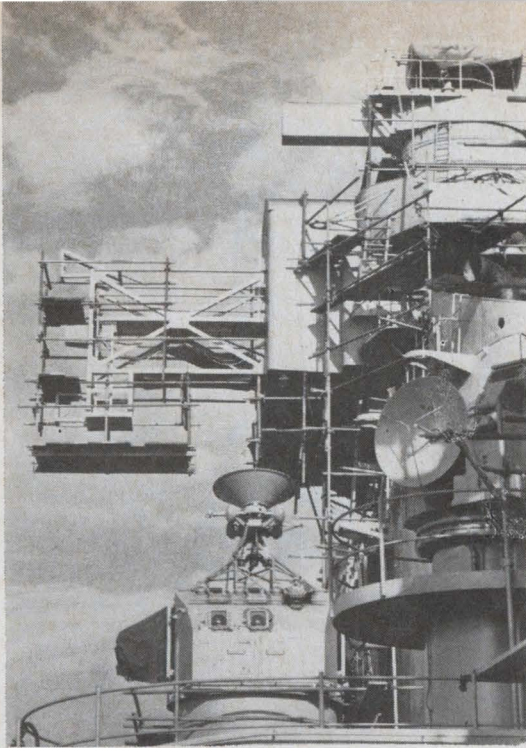

New. Electronic countermeasure gear goes in compartment, antenna on platform.

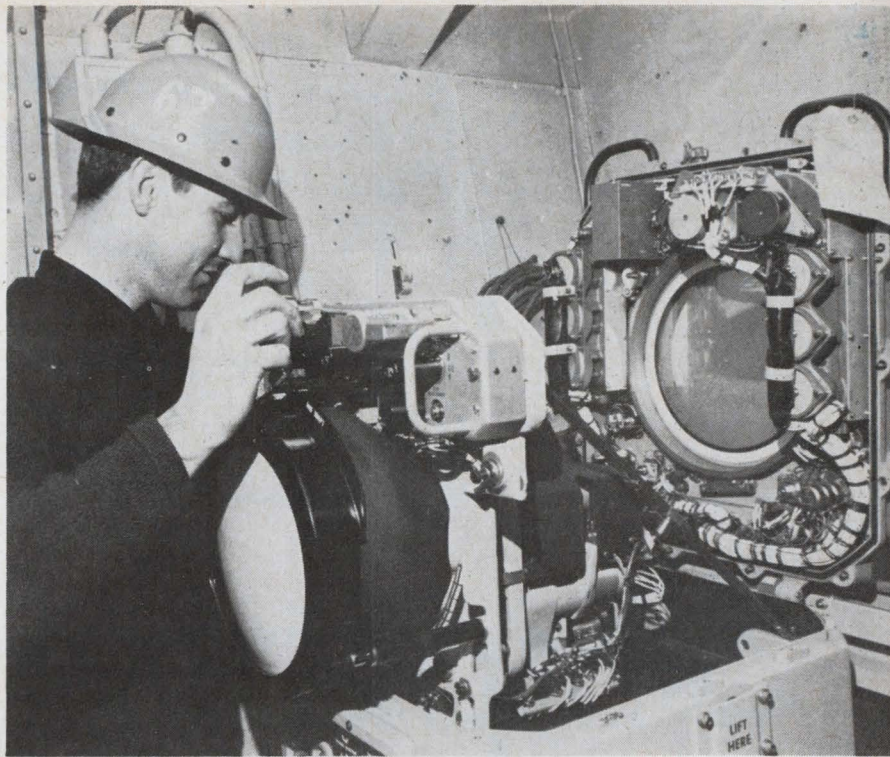

Eyes right. AN/SPA-4F range and azimuth indicator for the New Jersey's radars is prepared for installation.

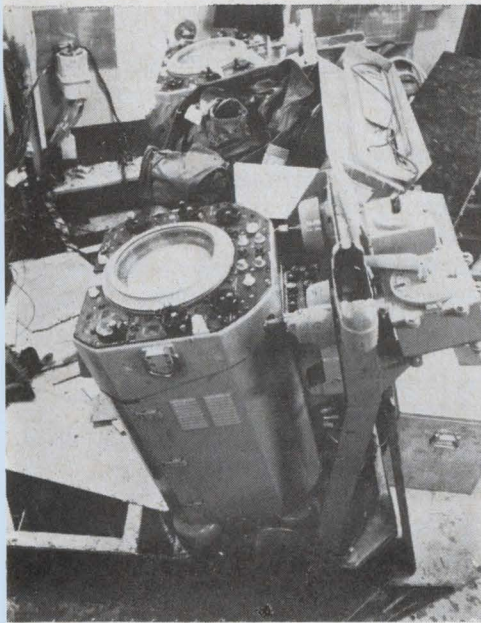

Bifocals. Twin displays, for air and surface search radars, in Combat Information Center.

and 32,000-word memory. Occupying about 54 cubic feet of space and weighing 2,100 pounds apiece, they will store information on aircraft and weapon status and serve as a way station for data supplied from surveillance gear.

Track information from such sources as height-finding and navigation radar and sonar is presented on the 12-inch radarscopes of data-input consoles. An aircraft carrier might have as many as 10 such

consoles watching the world.

Patchwork. Lt.(jg) J.D. Turner, the New Jersey's electronics officer, admits that "very little of the equipment being retrofitted is state of the art." Nowhere is this more evident than in radio central, the ship's communications nerve center. Now a jungle of loose cables, empty crates, and discarded coffee containers, the compartment appears to have become a temporary home for a dozen or so relaxed workmen unhurriedly reworking 10-year-old patch panels and mechanical locking gear.

Pointing to a 6-by-12-foot wall covered from floor to ceiling with electrical switching equipment, Lt. Turner smiles and says: "The Navy knows that there are black boxes available to do the work of all this gear. But this stuff is here, it works, and we're going to go to Vietnam with it. It'll be cleaned, overhauled, and tested at Philadelphia. Then, if we have to modify it at sea, we'll do that."

Loose ends. Mention of modification brings up a major problem for the electronics officer, the holder of an electrical engineering degree from North Carolina State and a veteran of 10 years' Navy service. "When we started work on the Jer-

sey," he explains, "we had a set of the original blueprints. But it turns out that major communications modifications were made in 1943 and on three subsequent layovers here in Philadelphia, not to mention what was improvised at sea, so nothing is where it's supposed to be. The workmen have to spend a lot of time finding and tracing cables for testing."

The story may be apocryphal, but one member of the work gang insists that a fellow worker opened a cable housing and found that the insulation had turned to a fine powder.

II. Now hear this

The radio shack looks more like an abandoned urban renewal project than a nerve center. Most of the equipment that will fill it has been taken out and sent to one of the many shops at the shipyard for inspection and overhaul. On the blueprints for the shack are an assortment of transceivers dating back to the Korean conflict, plus something new: the AN/WRT-2 single sideband transceiver. The older devices range from an AN/VRC-46 radio set to an AN/GRC-27 ultrahigh-frequency transceiver, and include an AN/WRT-21 low-frequency trans-



Just \$3500

Simplicity:

New RF Attenuation Calibrator from AIL

Now there's a simpler, faster way to measure attenuation at RF. Thanks to AIL's new Type 137 solid-state Attenuation Calibrator.

This new instrument, designed around the series substitution principle, reduces operator controls to four—greatly simplifying and speeding calibration procedures. A unique noise-injection system extends the instrument's range to greater than 100 db in a single step. Accuracies range as high as .007 db, error never exceeds ± 0.4 db for a 100 db measurement.

Through a new design concept, the self-contained AFC system provides an exceptionally large frequency capture range and eliminates the need for frequency control of the external local oscillator. An indicator positively confirms AFC operation, and an exclusive "prohibit" circuit prevents false measurements.

Plug-in mixers provide continuous coverage from 100 MHz to 40 GHz. The reference attenuator is of the wave-guide-below-cutoff type, and is easily removed for NBS calibration.

See your nearby AIL Sales Representative for complete information.

TYPE 137—SPECIFICATIONS

RF Attenuation Range (db)	Receiver Accuracy	Attenuator Accuracy	Measurement Accuracy	Scale Resolution	Normal 0.2 db/div Expanded 0.01 db/div
10	± 0.01	± 0.05	± 0.06	Automatic Frequency Control (Internal AFC)	500 to 1 reduction of signal frequency drift
20	± 0.01	± 0.10	± 0.11	Indicator Light	Indicates when AFC is locked properly
40	± 0.01	± 0.15	± 0.16	Measurement Frequency Range	100 MHz to 40 GHz
80	± 0.05	± 0.20	± 0.25	Power Required	115/230 volts AC, 50 to 400 Hz, 30 watts
90	± 0.07	± 0.25	± 0.32	Dimensions	19 ¹³ / ₁₆ w by 9 ⁷ / ₈ h by 12 ¹ / ₂ d
100	± 0.10	± 0.30	± 0.40	Weight	40 pounds

Note: These errors are not cumulative. The error for a 100-db single step is ± 0.4 db. The measurement accuracy of the system can be improved by calibration of the attenuator at NBS.



AIL
DIVISION

AIRBORNE INSTRUMENTS LABORATORY
DEER PARK, LONG ISLAND, NEW YORK

ceiver and AN/SCR-220 and SCR-221 ship-to-aircraft uhf transceivers.

In an adjoining compartment designed to house secure Teletypes—now standard in the Navy—that send and receive Teletype signals with covering cryptographic signals, space is provided for the AN/SGC-1 signal-to-tone converter and AN/UCC-1 tone-termination equipment. The latter gear contains integrated circuits.

Lt. Turner points out that this equipment is adequate because the New Jersey won't have to keep in touch with a huge fleet of support vessels spread over a wide area of the ocean.

Battle-tested battlewagon

Exactly one year to the day after Pearl Harbor, the battleship New Jersey slid down the ways at the Philadelphia Naval Shipyard. Now a veteran of two wars, the warship has earned 13 battle stars, nine during World War II and four in Korea. Following her refitting, sometime in May, she will be commissioned for the third time and sent to Vietnam.

During World War II the New Jersey took part in the Battle of the Philippine Sea and saw action around the Marshall Islands, the Marianas, Leyte Gulf, Luzon, Iwo Jima, and finally Okinawa. She served as Adm. Halsey's flagship. In 1948 she was decommissioned and mothballed with the reserve fleet near Bayonne, N.J.

In 1950, the New Jersey was recommissioned and sent to Korean waters for a tour of duty with Task Force 77. Her primary missions were gun strikes along the North Korean coast and support around the 38th parallel "bombline." The New Jersey has the distinction of being the last battleship to fire 16-inch guns in combat.

In 1957, the vessel was retired once more to the mothball fleet at Bayonne.

A further historical note: the New Jersey is the second warship to bear the name. The first, also a battleship, was launched in 1904 and sunk in 1922 by an aerial bomb dropped during a demonstration by Gen. Billy Mitchell. The second New Jersey will be out to prove that the demise of the battleship foreshadowed by that demonstration was a bit premature.

See-worthy. The battleship will be loaded with radars. And except for the countermeasure devices, they will all be of Korean war vintage. Air search will be taken care of by the AN/SPS-6C, surface search by the AN/SPS-10 and 253A. Loran equipment includes an AN/SPN-40 radar for navigation. The Combat Information Center, located in the battleship approximately where New Brunswick would be in the state of New Jersey—dead center—will have AN/SPA-8 and SPA-4F radar repeaters. In all, there will be a dozen repeaters scattered about the ship.

Target-determination radar, with its high resolution requirement, uses a wide bandwidth and narrow pulses. Here again, the Navy feels

that devices developed more than a decade ago fill the bill. The ship's main battery—nine 16-inch guns—will be directed by a Mark 13 system, the secondary battery—20 5-inch guns in 10 mounts—by a Mark 37. A Mark 48 computer, an old analog machine that operates mechanically, is the main battery's fire-control computer.

Will the New Jersey mount missiles? Ask Navy brass and the reaction ranges from prompt denial to blank stares, even though there has been some speculation in Washington that missiles are a natural for the ship's long-range bombardment mission. However, this may

be another area the \$25 million won't be able to cover.

Where and when. Estimates vary as to just when the New Jersey will position herself off the Vietnam coast and start lobbing shells. The schedule calls for recommissioning April 6, departure for San Diego for shakedown May 15, and arrival in the South China Sea in September. Lt. Turner says the work on the electronics is more or less on schedule; another officer maintains that the rest of the work to be done in Philadelphia can't possibly be completed by May 15. "The civilian crews at the yard are working on other ships at the same time they're refitting the New Jersey," he says. "You just have to wait your turn sometimes."

Trygon's New EAL Series Laboratory Power Supply

■ This is Trygon's new EAL wide-range laboratory power supply—four models in the most commonly used laboratory voltage ranges. At \$99, it's a giant.

■ And it's a clean giant. Clean output, with ripple less than .5mv rms, plus rock-steady .01% regulation, .05% stability.

■ Clean, compact all-metal case, too, that doesn't waste an inch of bench space. The switchable volt/ammeter, concentric coarse and fine voltage controls, pilot light and output terminals (fully floating output) are all on the front panel.

Meet Trygon's Jolly Clean Giant



Trygon

TRYGON ELECTRONICS, Inc.
111 Pleasant Ave., Roosevelt, L.I., N.Y. 11575*

I need the following EAL unit(s).

Qty.	Model	Rating
....	EAL 10-1	0-10 VDC @ 1.0 Amp
....	EAL 20-500	0-20-VDC @ 500 ma
....	EAL 32-300	0-32 VDC @ 300 ma
....	EAL 50-250	0-50 VDC @ 250 ma

Name _____ Title _____

Firm _____

Address _____

City _____ State _____ Zip _____

- Purchase Order Attached.
 Contact us for Purchase Order.
 Please send Trygon Power Supply Handbook.

*PRICES SLIGHTLY HIGHER IN EUROPE.
TRYGON GMBH, 8 MUNCHEN 60, HAIDELWEG 20, GERMANY.

CRAFTSMANSHIP...a New England Tradition



A TRADITION AT CLAROSTAT TOO is craftsmanship in the design and manufacture of potentiometers, resistors and switches. For more than 40 years, Clarostat has been the leading source of components designed and manufactured to the highest standards of craftsmanship at down-to-earth prices. The name Clarostat on a potentiometer, resistor or switch is your assurance of superior quality and honest value. Another respected tradition at Clarostat is quick service and fast, off-the-shelf delivery. When you add up all the reasons for specifying Clarostat, you see why so many have skipped the rest and continue to buy the best...

CLAROSTAT

CLAROSTAT MFG. CO., INC., DOVER, NEW HAMPSHIRE 03820

FAA readies new checkout system

Lack of inertial gear won't prevent Signal Evaluation Airborne Laboratory from carrying out its mission of monitoring ground-based navigational aids

By Alfred Rosenblatt

Avionics and space editor

Lack of funds is forcing the Federal Aviation Administration to shortchange an airborne system it is developing to check on its network of ground-based navigation aids. The price to be paid: less performance, utility, and operating speed than the agency was after.

Because of the clampdown on Federal spending brought on by the rising costs of the Vietnam war, the agency eliminated the inertial-navigation gear from the Signal Evaluation Airborne Laboratory (Seal) project. Without this equipment, FAA inspectors will have to fix their positions much like the pilots of puddle jumpers—by looking out of the cockpit to spot such checkpoints as railroad tracks and church spires.

Even so, Seal is far from a wash-out. The system still retains its key features, diagnostic and check-out capabilities.

At stake is the flying public's safety, which depends a great deal on the performance of the navigation aids. These aids are periodically checked by the agency's flight-inspection aircraft—DC-3's, Convairs, and an instrumented KC-135.

Seal is designed to make low-altitude checks on the quality of the signals radiated by very-high-frequency omnirange (VOR), tactical air navigation (Tacan), and vhf omnidirectional range Tacan (Vortac) facilities as well as instrument landing systems (ILS). The job is presently being done with a fleet of 50 DC-3's, flying at altitudes up to 5,000 feet. However, the equipment aboard the Seal craft—a turboprop Convair—will differ markedly from that aboard the DC-3's [Electronics, Nov. 27, 1967, p. 95].



New home. Turboprop Convairs, outfitted with the Seal system, will eventually replace the FAA's fleet of DC-3's in making low-altitude checks of ground-based navigation aids like VOR, Tacan, and Vortac.

"Instead of making our [Seal] Convair a typical checkout plane, we designed it as a measurement laboratory," says W.H. Faux, chief of the flight inspection section at the agency's navigation development division.

I. The heights of inspection

The DC-3's are flown in radial patterns with respect to the ground stations as well as in clockwise and counterclockwise patterns at different altitudes and ranges. Low-altitude checks are made when a ground station is being set up, before it is commissioned, and following an accident in that area.

The airborne inspectors check the accuracy of the range and bearing information obtained from the signals transmitted by the ground stations by comparing the readings on their receiving equipment with the "known" position of the plane. This position is determined by visual checks of landmarks.

Checking out ILS is far more complex, requiring operators on the

runway with optical equipment to track the plane as it lands. These operations are restricted to daylight hours during clear weather.

Midway. Checks are made at altitudes around 18,000 feet with the Semiautomatic Flight Inspection (SAFI) system developed six years ago by Cutler-Hammer Inc.'s Airborne Instruments Laboratory division. This job is done with five Convairs flying grid patterns around the country, tuning in on a large number of VOR and Tacan facilities at the same time. The SAFI was the first airborne-checkout system to record information digitally for processing on the ground.

Higher altitude checks are made by the KC-135 flying at 40,000 feet. The FAA is considering whether checks should be made at the 70,000-foot altitudes at which supersonic transports will fly.

II. Fault finder

The operator in the Seal aircraft will get more data than the oper-



Power Supply Users

HOW WOULD YOU:

- ... Evaluate the effects of environmental change on a regulated current?
- ... Program a voltage inversely?
- ... Control very small currents?
- ... Measure dynamic output impedance?
- ... Provide variable voltage limiting?
- ... Connect a feedback signal to a power supply from a temperature sensor? ... From a photo electric cell?
- ... Determine programming speed?
- ... Calculate the effect of duty cycle loading?
- ... Convert a source to a sink?
- ... Make a voltage corrector?
- ... Determine the effect of offset voltage and offset current on a power supply's output?
- ... Write the operational equation that controls feedback power supply behavior?

These are the kinds of questions answered by the 160 page *Power Supply Handbook* published by Kepco, Inc.

This book, now in its fourth printing, takes a close look at the complexities of regulated power supplies and describes their behavior and characteristics in clear, consistent terms using readily understood, simple mathematics and profuse illustrations.

Of course, if you have a power supply project in mind, we'll be glad to discuss it with you personally.

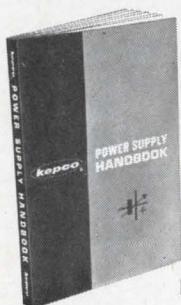

For your personal copy of this handy Handbook, write on your company letterhead to:



Dept. J-14
G.P.O. BOX 67
FLUSHING, N.Y. 11352

... Seal can diagnose troubles as well as check out systems ...

ator in any other plane operated by the agency, says Donald L. Fehr, project engineer at the FAA's National Aviation Facilities Experimental Center (Nafec) in Atlantic City, N.J. It will be possible to tell not only when there is an error but also its cause. The reason: Seal monitors many more ground-station signal parameters than previous equipment, thus giving the system a diagnostic capability.

For the first time, all measurements will be made digitally. This will make real-time computation and real-time error readout possible. Presently, inputs are recorded in analog form and then processed on the ground. The receivers for the Seal plane have been designed to minimize receiver error, says Fehr. Thus, what is seen by the operator represents a true picture of what the ground stations are doing. Presently, receiver error must be accounted for in the computations.

Seal's basic measuring equipment includes:

- A VOR receiver built by AIL, Deer Park, N.Y. The set's naviga-

tion section has been redesigned to process the received bearing signals by digital, rather than analog, techniques.

- A Tacan receiver from the International Telephone & Telegraph Corp.'s Federal Laboratories division, Nutley, N.J. The set is the company's model 100B that has been modified to give it greater stability in the front end, and to allow digital rather than analog processing of bearing and range signals.

- A glide slope receiver from the Wilcox Electric Co., Kansas City, Mo. The company's model 800D has been modified for greater stability; the set's analog outputs are converted to digital form before they are recorded.

- A localizer built by the Collins Radio Co. The unit, a 51X-4, has been modified by AIL, the system contractor for the Seal project.

Best yet. Seal is far better than equipment used in the DC-3's. The bearing resolution of Seal's vor receiver can be read out in 0.01° , while that of present equipment is only within $\pm 0.25^\circ$; Tacan accuracy over a 200-mile range is

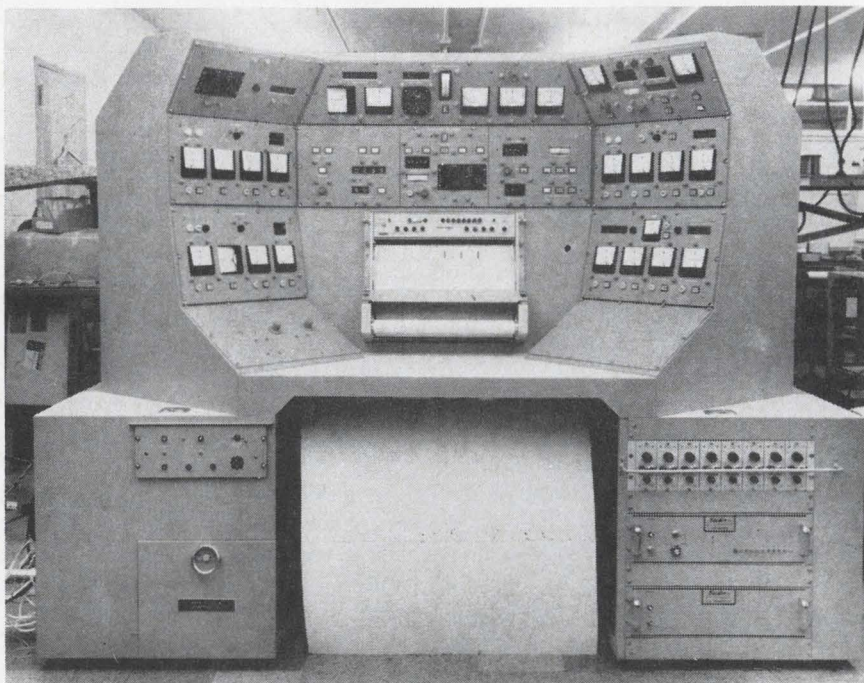

One of a kind. Seal system will check FAA's navigation aids. Equipment has diagnostic and checkout capabilities, but lacks inertial system that would have greatly enhanced its utility.

pegged at 0.03 nautical miles, as against 0.10 nautical miles; bearing accuracy is $\pm 0.1^\circ$ compared with $\pm 0.5^\circ$.

In addition to checking the accuracy of bearing, range, course alignment of the localizer, glide-path alignment, horizontal and vertical polarization for the localizer and the VOR, Seal will measure radio-frequency signal levels, low-frequency modulation levels, deviations in modulation frequencies, and percentage modulation of the r-f carriers.

These measurements will be recorded on magnetic tape for an IBM 7090 computer. Provisions are made for recording selected parameters on an eight-channel analog strip-chart instrument.

III. Homestretch

A prototype system has already been put through what the FAA calls a research and development flight-test period at Nafec where instrumentation radars and precise optical theodolites were used. Actual field tests are expected to get under way early next month.

Wait and see. Whether Seal will eventually get the inertial-navigation system is uncertain. Development work on the system stopped abruptly last August at the Massachusetts Institute of Technology's Instrumentation Laboratory in Cambridge when money for this part of the project ran out. The agency will say only that the equipment is resting on a lab bench in the prototype stage, waiting to be tested.

Rather than buy a conventional inertial system, the agency wanted to develop its own for two reasons. First, FAA engineers wanted a unit that would give them vertical position data for the ILS tests; commercial units provide only horizontal position information. For another, they wanted a drift rate they felt couldn't be obtained commercially despite, as one FAA man put it, "what the inertial system manufacturers say." Wanted is at least an order of magnitude better, says this source. The major part of the inertial system was taken from a classified inertial-measurement system originally developed by MIT for the Air Force. New accelerometers and an 8,000-word digital computer were to be added

"Miss Foster... why are you filing Price Electric and Hi-Spec industrial relays under C?"

Miss Foster knows her relays . . . CONELCO . . . is the new name for the complete line of Price Electric and Hi-Spec military and industrial relays . . . A completely new selection of commercial/industrial relays to fit your applications from low level to 10 amp 28VDC/115VAC res.

SZC

SPDT Low Level

Coil: 100 MW 690 ohms
High speed, 2 coil, polarized, bi-stable or mono-stable relay with 50 million operation contact life.

31

SP 3AMP 28VDC/115VAC res.

Coil: 176 MW Typical: 12VDC 440 ohms
Stabilized Memory Relay—every other pulse to relay coil closes the contact. Open or completely dust covered with 8 pin octal plug.

220

DPDT 2AMP 28VDC/115VAC res.
Coil: 572 MW Typical: 12VDC 110 ohms
Completely dust covered, for direct PC mount.

228

SPDT 2AMP 28VDC/115VAC res.
Coil: 50 MW Typical: 12VDC 1760 ohms
Completely dust covered, for direct PC mount.

230

DPDT/SPNO 5AMP 28VDC/115VAC res.

Coil: 290 MW Typical: 12VDC 220 ohms
Completely dust covered, for direct PC mount.

1000

SPDT 3AMP 28VDC/115VAC res.
Coil: 44 MW Typical: 12VDC 1760 ohms
Dust cover for contact area, solder or PC terminals.

1010

SPDT 10AMP 28VDC/115VAC res.
Coil: 176 MW Typical: 12VDC 440 ohms
Solder or PC terminals.

L

Up to 4PDT 5 or 10AMP 28VDC/115VAC res.
Coil: Typical: 12VDC 120 ohms 115VAC 2250 ohms
Open or completely dust covered with 8/11 pin octal plug.

Send for complete specs. If you are in a hurry, call 301/663-5141, Price Electric Corporation, Frederick, Maryland 21701, TWX: 710/862-0901

PRICE ELECTRIC CORPORATION

CONELCO
SWITCHING DEVICES

HI-SPEC ELECTRONICS CORP.

Some Q's & A's on BENRUS CRT DISPLAYS

Q. Why 3½" high?

A. Vertical dimensions on standard racks are always multiples of 1¾".

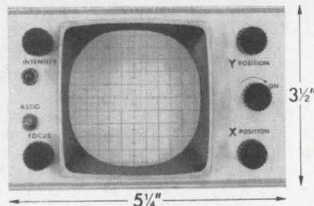

Q. Then why 5¼" wide?

A. So you can turn it 90° and mount 5 in a 19" rack.

Q. What if I want a bigger screen?

A. Our 5" series is 5¼" high and 7" wide — turn 90° and mount 3 in a 19" rack.

Any more questions?

Chances are you'll find the answers in our Catalog #704 which describes 310 standard modules.

Write or phone for your copy.

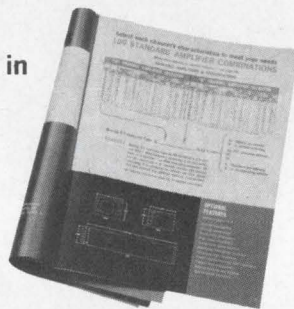

BENRUS

TECHNICAL PRODUCTS DIVISION

BENRUS Watch Company, Inc.

Ridgefield, Connecticut 06877

Telephone: (203) 438-0333

FOR LEADERSHIP IN CRT DISPLAY WATCH BENRUS

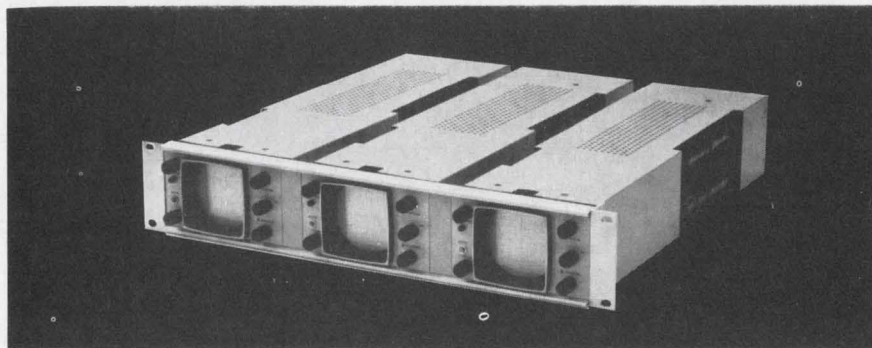

Array of Benrus CRT Displays ready to insert in rack.

On a clear day . . .

Flying a private airplane from one part of the country to another in fair weather is easy. With the aid of relatively simple and inexpensive receiving equipment, a general-aviation pilot can get a fix from one of the more than 900 ground-based navigation stations maintained by the Federal Aviation Administration. By simply tuning his automatic direction-finding equipment to a station near his destination, he can fly right to any area. When operating under visual flight rules, pilots frequently use such checkpoints as highway crossings, church steeples, and reservoirs to supplement their afd data.

Commercial airline pilots, of course, have a tougher time of it. Most of the time they are forced to rely on instruments for information on their position and heading. In addition, their approaches and, frequently, landings are handled by instrument. As a result, there is a premium on the reliable performance of the FAA's network of ground-based navigation aids.

for the version the FAA was hoping to use with Seal.

IV. Settling

Instead of the inertial system, the FAA is installing a Westinghouse Electric Co. Flight Inspection Positioning System (FIPS) for tracking the Seal Convair during ILS approaches. This system will be able to locate the plane precisely as it comes in for a landing, but men and equipment will have to be stationed on the ground. This puts the FAA's goal of a single-approach, 15-minute ILS check out of reach. Hours and several landing approaches will still be necessary.

Meanwhile, the agency is considering other ways of determining the position of the craft when it's flying VOR radial patterns. Two methods being considered are multiple distance-measuring equipment readings and an adaptation of an airborne doppler radar. Faux isn't optimistic about the latter technique. He doubts it can provide the required accuracy.

Seal is still at least two years away from becoming operational, Faux says. By then, he says hopefully, the inertial system could be

Giant Killers

Third in the series



Summer, 1956 . . . the eyes of the world were focused on Melbourne, Australia, as Murray Rose swam his way to immortality. At 17 he became the youngest triple gold medalist in modern Olympic Game history, later setting world records in every freestyle swimming event from 200 meters to one mile—a true giant killer of sports.

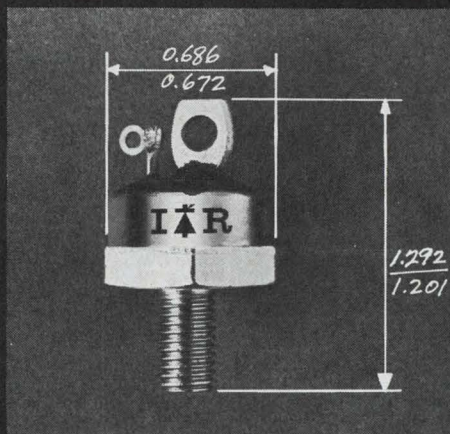

In the low cost, medium current SCR race, the industry giants used to pick up all the medals. But no more.

Now we have a 40-ampere encapsulated SCR, Type 40RCS, with size, price and power advantages over anything the big boys offer. About all you used to get were de-rated 70-amp monsters or smaller units rated up from 16 ampere devices. But the 40RCS is a product designed for its intended application. Mounted, it's only about $\frac{3}{4}$ -inch high; it weighs one ounce, yet sports a large diameter junction. Plastic encapsulation provides moisture resistance, yet allows operation from -40°C to 105°C . Quantity prices range from less than \$20 to about \$8 each, for ratings from 600 to 50 volts.

The 40RCS is available now, for economical compact power control. Check with the giant killer—IR, developers of the 200 ampere power logic triac—for product bulletin and complete specs.



INTERNATIONAL RECTIFIER

YOKE SPECIFYING PROBLEM?

**ASK AN
EXPERT...**

**A SYNTRONIC
DEFLECTION
YOKE SPECIALIST**



Since we make more types of yokes than anyone else, it's natural enough for our team of experts to know more about yoke design, application engineering, and quality control.

Specifying can be a challenging problem, and with this in mind, we put our experience at your disposal. Don't hesitate to call or write us when you're puzzled as to the right deflection yoke for your display.

syntronic

INSTRUMENTS, INC.

100 Industrial Road, Addison, Illinois
Phone: Area 312, 543-6444

Circle 219 on reader service card

*Now...the
most enjoyable,
most rewarding
electronic
kit project
of your life*



**a Schober
Electronic Organ!**

The Schober Organ Corporation
43 West 61st Street, New York, N. Y. 10023

HAD YOUR FILL of amplifier kits, receiver kits, meter kits, all the conventional kits? Then go to work on the biggest, most fascinating kit of them all—and end up with a finer musical instrument than you could buy for twice the price. The Schober Theatre Organ at left, for example, plus Schober's self-teaching music courses, lets you *participate* in music, not just listen to it. This is one electronic project the wife and kids will encourage—because it's for them, too! It contains the best components available—thousands of them—plus the kind of unmistakable, step-by-step instructions you've dreamed of and Schober is famous for.

The Theatre Organ (*left*) costs just \$1550 if you use your own amplifier and speaker system, and you can pay as you build to spread out the cost. There are three other Schober Organ models, too, starting at \$645. Each one includes every bit and piece you need, including a magnificent walnut console—unless you want to build your own woodwork and save even more. And each model has the kind of pipelike tonal variety you don't often find in electronic organs. The free Schober color catalog has lots of pictures and data; and for 25¢ we'll send you 72 pages of schematics and tech specs so you can see just what you're buying.

FREE INFORMATION AND DEMONSTRATION RECORDING
Send today for your free copy of Schober's 16-page, full color booklet, plus 7" free recording.

The Schober Organ Corp., Dept. EL-10
43 West 61st Street, New York, N. Y. 10023

- Please send me Schober Organ Catalog and free 7-inch "sample" record.
- Enclosed please find \$1.00 for 12-inch L.P. record of Schober Organ music.
- Enclosed is 25¢ for schematics and tech specs.

NAME
ADDRESS
CITY..... STATE..... ZIP NO.....

... the FAA would like to
make high-altitude checks ...

ready for installation.

With the inertial navigation system included in Seal, ground stations could be checked under instrument rather than visual flight rules. And 12 Convairs could manage the job now done by the 50 DC-3's. Other factors also come into play, Faux points out: Seal equipment will be easier to maintain; there will be better repeatability of measurements; and a Convair flies faster than a DC-3.

Three years ago, AIL speculated that Seal-type planes could take over the periodic inspections at the higher altitudes. However, with the coming of the supersonic transport, the FAA is interested in learning whether the navigation signals are adequate at even higher altitudes. It's believed that they will be, but the agency wants to get an instrumented aircraft up there—at about 70,000 feet—and make certain.

To this end, the FAA is negotiating with the Air Force in hopes of getting a military aircraft to carry out these tests this summer. Last spring, plans to check the Vortac network came to naught. The agency had hoped to fly KC-135's at altitudes around 40,000 feet and reconnaissance aircraft like U-2's at 70,000 feet. Both sets of planes were to carry equipment to record ground-station signals for analysis in the computer laboratories of the FAA.

The money squeeze stemming from the Vietnam situation forced a postponement, but the agency hopes to get a bobtailed version of the project off the ground in the near future. Current plans call for the use of FAA aircraft and off-the-shelf measuring equipment.

Low priority. High-altitude checks of ground stations are not considered critical by FAA planners since, in theory at least, there should be no difference in the quality of signals received at low and medium altitudes. "But we'd like the insurance," says one official. In addition, SST aircraft will be less dependent than commercial airliners and general-aviation planes on ground-based navigation aids. Each SST will have three inertial navigation systems.

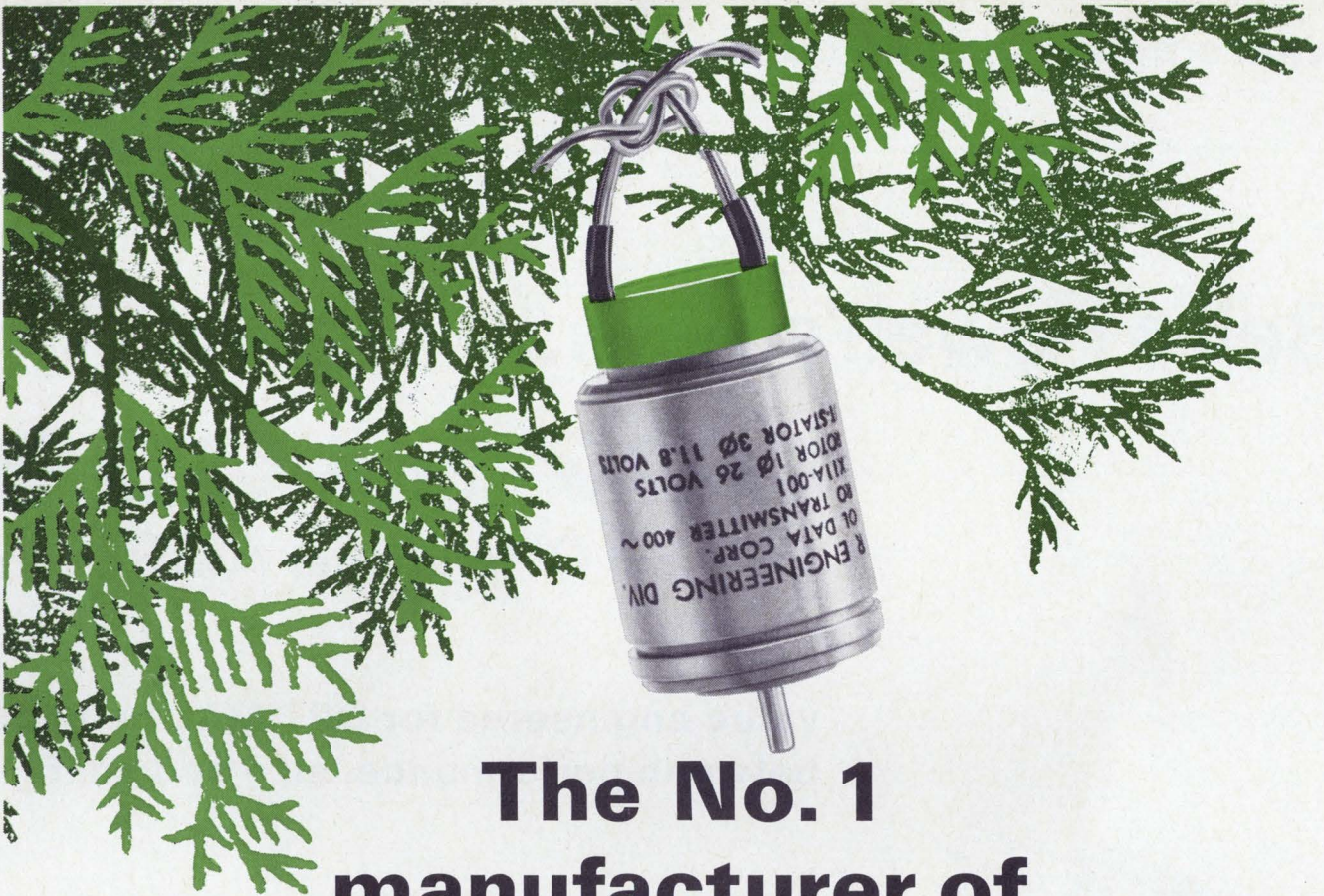

The No. 1 manufacturer of servo motors is branching out into **SYNCHROS**

■ Cedar has long been a leader in the manufacture of precision servomotors, motor-tachometers and stepper motors. Through the years, Cedar has built a reputation for quality and economy.

Now Cedar brings its experience to bear on the manufacture of synchros. The first entry into this field is a Size 11 synchro transmitter available in a variety of winding and shaft configurations. Other types and sizes are soon to be announced.

Cedar's first synchro has been carefully developed and tested to assure conformance to strict specifications. It has already been qualified and government certified.

When you need synchros, write or give us a call. When it's made by Cedar, you know it's a quality product.

CEDAR **CONTROL DATA**
ENGINEERING DIVISION CORPORATION

5806 West 36th Street, Minneapolis, Minn. 55416 • Phone (612) 929-1681

what's better than an op amp?

Bell & Howell's new...

007 and 008 OPTimal OPERational AMPlifiers

value engineered for OPTIMAL balance
between performance, size and cost.

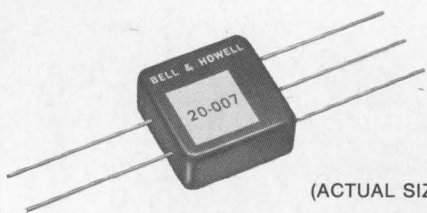

(ACTUAL SIZE)
TYPE 20-007 general purpose Optimal op amp

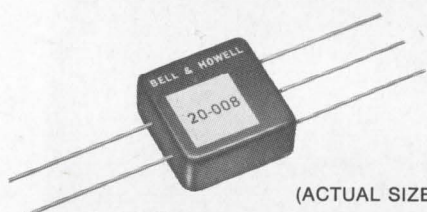

(ACTUAL SIZE)
TYPE 20-008 FET input Optimal op amp

With this matchless pair you can satisfy the requirements of most op amp applications, and real meaning has now been given to the term "universal op amp." Note these major features:

- choice of bipolar or FET input
- hybrid microcircuit construction
- frequency compensated
- input and output fully protected
- offset trimmed (where else can you find this?)
- small, compact size (0.6" x 0.6" x 0.25")

Compare the typical characteristics of Bell & Howell Optimal Op Amps with ordinary op amps and see what value engineering does for you:

CONTROL PRODUCTS DIVISION

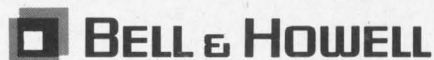

Opt for 007 and 008 by writing or telephoning for complete technical information. Ask for a Bell & Howell sales engineer to call on you to discuss your particular application. Control Products Division, Consolidated Electrodynamics Corp., a Bell & Howell Company, 706 Bostwick Avenue, Bridgeport, Connecticut 06605. Telephone: (203) 368-6751. Ask for Mr. Isdale.

	20-007	20-008
Voltage offset	200 μ V	200 μ V
Input bias current	150 na	25 pa
Common mode rejection	100 db	100 db
Gain band width (at 10 kHz)	20,000,000	10,000,000
Output current	5 ma	5 ma
Price (in quantities of 100, any mix)	\$16.50	\$26

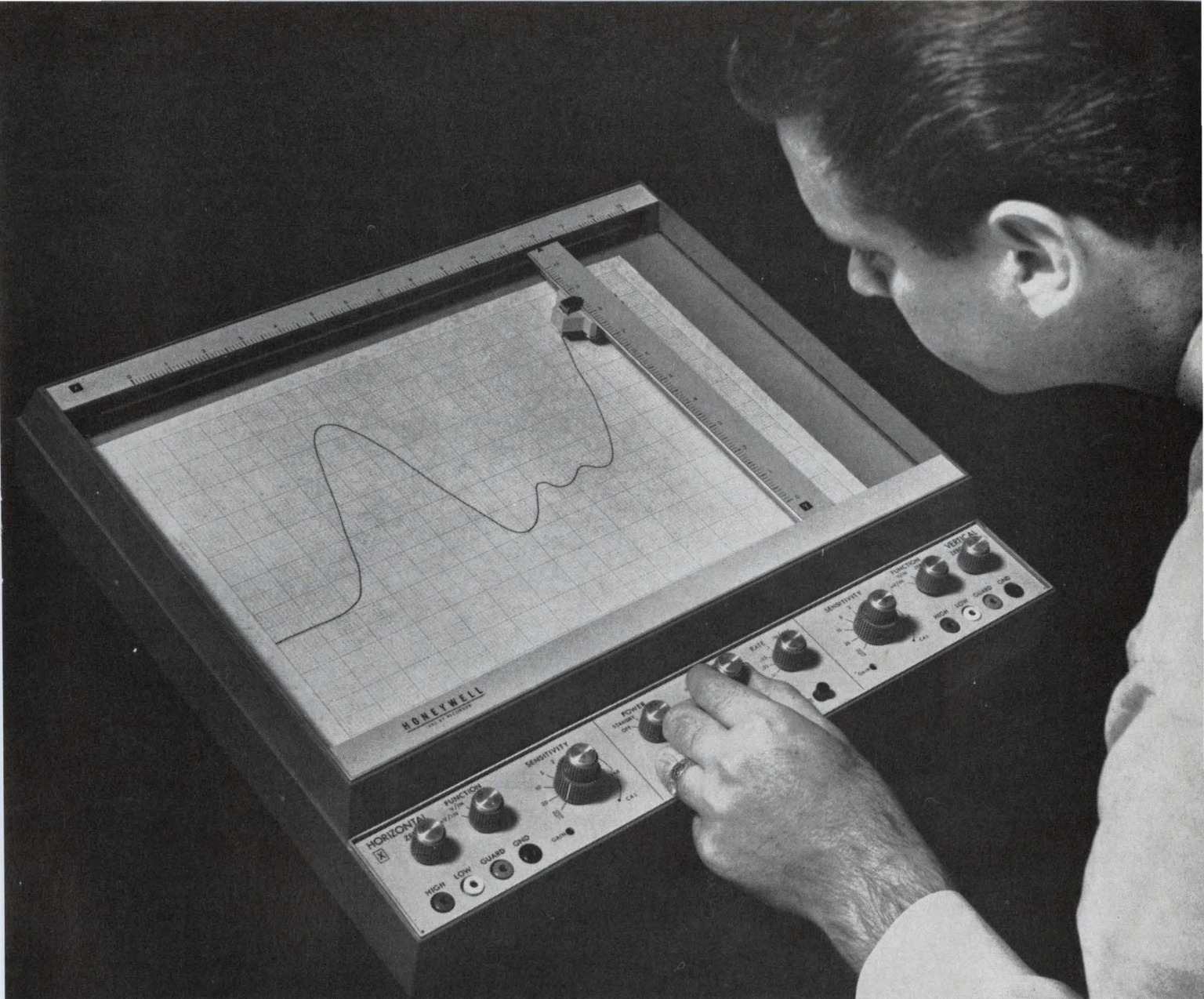

Self-supported at a 30° angle, the new Honeywell 550 offers convenient bench operation — converts to rack mounting easily.

It's rugged, portable, and it works when other X-Y recorders fail. Meet our new Model 550!

We've used X-Y differential recorders around our plant for years. Most have been mechanical dropouts, balking or clogging when we really needed a record. So we decided to build one ourselves. One that worked.

The result is the new Honeywell 550—a slim, crisply designed instrument that overcomes the mechanical problems that plague other X-Y's. Its built-in reliability is protected by a tough, molded base that seals working parts from dust and dirt, even when the 550 is rack-mounted. You get smooth, quiet operation, and you get it for a long, long time.

With true differential input, high sensitivity to 100 $\mu\text{V}/\text{in.}$, and accuracy of 0.15%, the dependable 550 takes a back seat to no one in the performance department. And, it's convenient to use — there's a standby position for quick, easy paper loading, a zero check position, and rear inputs and remote capability built in.

Other 550 features include: a stainless steel pen with non-clogging polished sapphire tip; sealed potentiometers for maximum field reliability; snap-on ink cartridges; a handy zero check, and a built-in event marker. There's lots more, yet the 550 is moderately priced!

If you've been bugged by your current X-Y recorder, look into the new 550. It's another example of how Honeywell's broad line, backed by local sales and service, can provide the *precise* solution to your instrumentation problems. For full details on the 550, call your local Honeywell Sales Engineer, or write: Honeywell, Test Instruments Division, 4800 East Dry Creek Road, Denver, Colorado 80217.

Honeywell

Honeywell engineers sell solutions

Circle 135 on reader service card

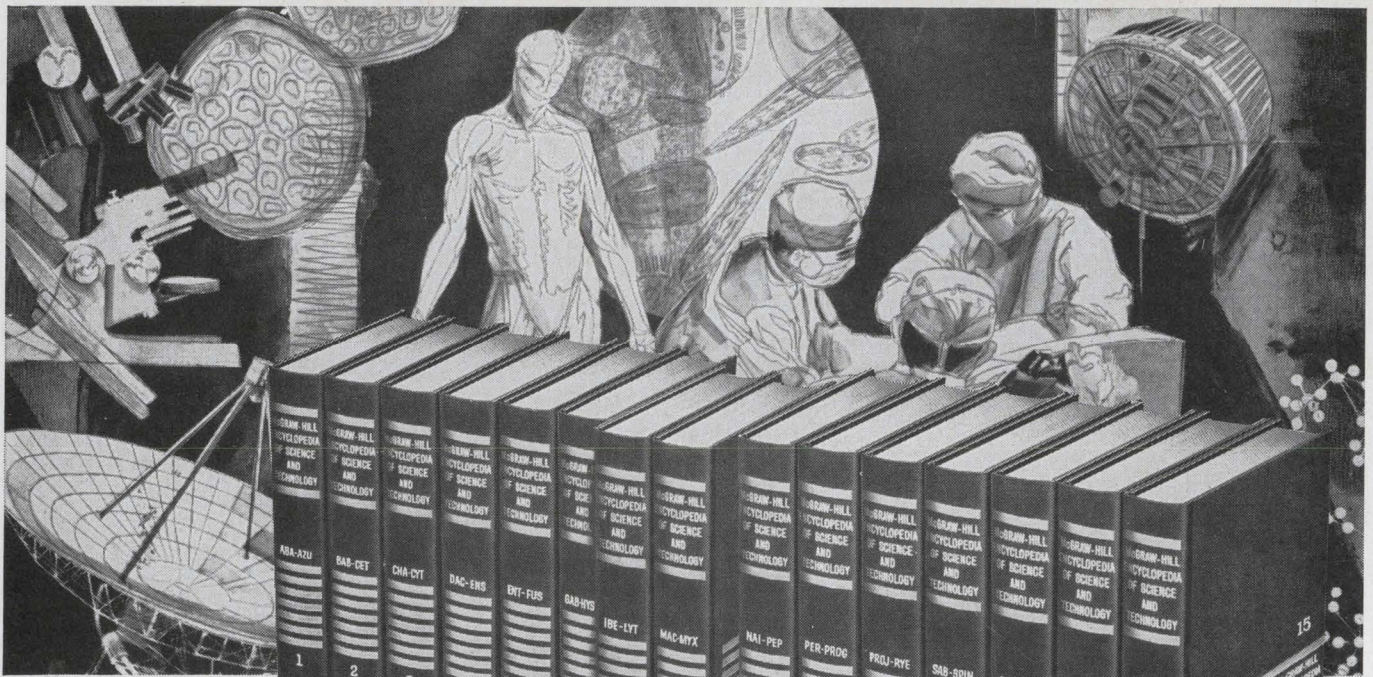

McGraw-Hill
Encyclopedia of

science and technology

A unique Information Center
encompassing the entire range of today's scientific and engineering
knowledge in 15 volumes — 7,400 articles — 9,500 illustrations

THE REVISED EDITION of the famed McGraw-Hill Encyclopedia of Science and Technology is available. This extraordinary set of books is the most respected, most widely-used reference for accurate, up-to-date information in any area of the physical, life, and earth sciences, and in all fields of engineering.

Here, you will find every theory, concept, term . . . every significant new discovery and technological advance . . . every important problem currently under study . . . gathered from the frontiers of scientific exploration around the globe. To obtain equivalent information, you would have to consult thousands of journals, textbooks, monographs, papers, proceedings of meetings. Now, in this unified science *Information Center*, it is as accessible as the nearest bookshelf.

For quick reference, systematic study, or leisurely browsing. This unique set of books is the first place to look for authoritative answers to questions on any scientific or engineering subject . . . whether you are concerned with theoretical aspects or practical applications . . . whether you require information on basic principles or advanced technology. It is invaluable for reviewing concepts, procedures, terms . . . or as a reliable research tool.

Prepared by more than 2,000 leaders of the scientific community. All articles are written by specialists of international reputation — in many cases, by the very person who made the actual discovery, proposed the original concept, or carried the research forward. Over 9,500 photographs, maps, drawings, and diagrams enhance and clarify the text. The multiple Index volume of over 100,000 entries and the cross-reference system of 40,000 citations make it easy to find the information you need quickly.

This authoritative reference library, with its timely yearbooks, helps you stay abreast of the whole spectrum of today's rapidly expanding technology. For the engineer, the scientist, the teacher, and the student, the *Encyclopedia of Science and Technology* has become *the one indispensable reference*.

Available direct from publisher. Simply mail the coupon to receive this incomparable 15-volume Encyclopedia for two weeks' examination, without obligation. Then, if you wish, you may purchase the set *direct from the publisher* on a convenient budget plan. Consult the coupon for full details, and send it today. McGraw-Hill Book Company, 330 West 42 Street, New York, N. Y. 10036.

HIGH PRAISE FOR REVISED EDITION
"Excellent . . . the star in its field."
—*Scientific American*
"It is the best fundamental science and technology reference work . . . Highly recommended."
—*Science Books*

Two new optional reference books also available . . .
Now two highly useful new reference volumes are available in matching bindings. Their price is \$12.50 each to purchasers of the Encyclopedia. The comprehensive *McGraw-Hill Basic Bibliography of Science and Technology* lists and describes the outstanding current books in every scientific and technical field. The *McGraw-Hill Modern Men of Science* presents informative biographical and autobiographical articles on 426 leading contemporary scientists.

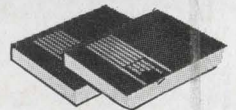

Examine the set without obligation
Mail this coupon today

McGraw-Hill Encyclopedia of science and technology

McGraw-Hill Book Company
330 West 42 Street, New York, N. Y. 10036

Please send me for *two weeks' trial examination*, the revised edition of the famous *McGraw-Hill Encyclopedia of Science and Technology*.

I enclose my check or money order for \$10 as deposit, which will be considered my first payment. I will remit the balance in eighteen monthly payments of \$16.50 and a final payment of \$6.75 until the total price of \$313.75 is paid. I understand, however, that if I am not delighted with the set I may return it within two weeks for a refund of my deposit, and I will be under no further obligation.

Name.....

Address.....

City.....

State.....Zip.....

BN-103

Here is a brief sampling of the many fields covered:

Acoustics — Aeronautical Engineering — Agriculture and Soils — Analytical Chemistry — Animal Anatomy — Astronomy — Atomic, Molecular, Nuclear Physics — Biochemistry — Biophysics — Chemical Engineering — Civil Engineering — Classical Mechanics — Communications — Computers — Conservation — Cytology — Electrical Engineering — Electricity and Electromagnetism — Fluid Mechanics — Food Engineering — Forestry — Genetics and Evolution — Geology — Geophysics — Heat — Industrial Engineering — Inorganic Chemistry — Low-Temperature Physics — Machine Design — Mathematics — Mechanical Power Engineering — Medical Microbiology — Metallurgy — Meteorology — Mineralogy and Petrology — Mining Engineering — Naval Architecture — Nuclear Engineering — Oceanography — Optics — Organic Chemistry — Paleobotany and Paleontology — Petroleum Engineering — Physical Chemistry — Physiological and Experimental Psychology — Solid State Physics — Space Technology — Theoretical Physics — Zoology — plus thousands of other subjects in every scientific and engineering discipline.

No need! Nearly twenty years of flight time on aircraft from the B-29 to the C-5A have proven the dependability of wiring insulated with TEFLON fluorocarbon resins. Lab tests are O.K.; we've got hundreds on record, but nothing tops the proof of use . . . and TEFLON has the proof

of millions of flying hours in scores of aircraft.

Ask for our brochure explaining in detail why there are no test flights for TEFLON. It may help you eliminate one unnecessary variable from *your* next test flight. Write Du Pont Company, Room 5617C, Wilmington, Delaware 19898.

*Reg. U.S. Pat. Off. for Du Pont fluorocarbon resins and films.

There are no test flights for Teflon*



Better things for better living
...through chemistry

TEFLON... the proven performer

pnp equals npn at DEECO

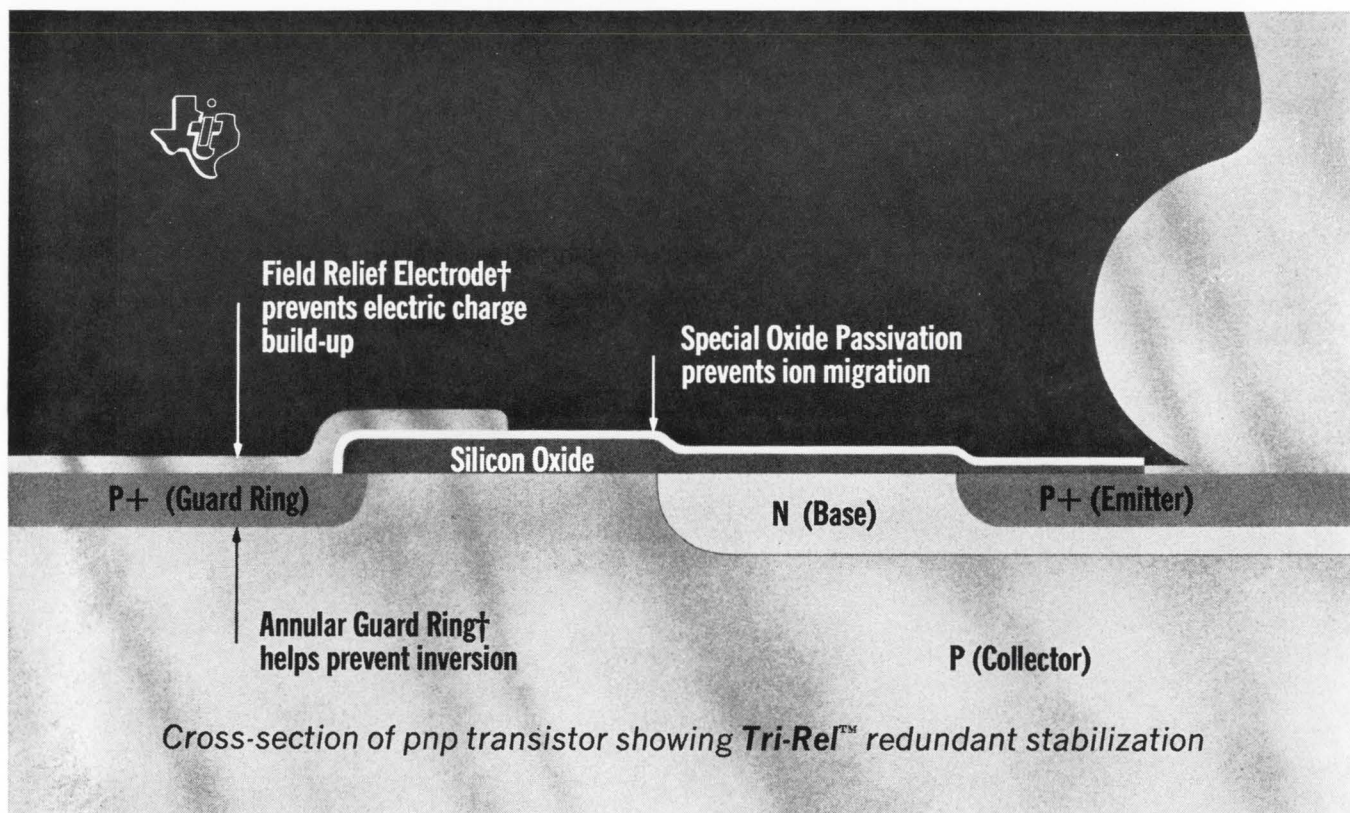

That's right...the Texas Instruments pnp silicon transistors you get from us are every bit as stable and reliable as npn devices. That's because of the exclusive *Tri-Rel* redundant stabilization shown above.

Tri-Rel employs three different techniques to guard against ion migration and electric charge buildup. This gives greater stability than one or two stabilization processes

† Patent Pending

which improve reliability...but not enough.

As a result, pnp transistors from TI meet the most demanding military and space reliability requirements.

In comparative tests, for example, only 20% of the conventional unstabilized pnp transistors drifted less than 0.5 nA during a 500-hr. test, while 97% of the units with

Tri-Rel drifted less than 0.5 nA and all units held within 1.0 nA.

All pnp silicon transistors from TI feature *Tri-Rel*...and that goes for duals and complementary transistors too.

You can get 'em quick from us! We carry in-depth stocks of all types of semiconductors from Texas Instruments. Call us for fast delivery.

DEECO  **Inc.**

**AUTHORIZED
DISTRIBUTOR** 

DISTRIBUTORS — SERVING INDUSTRIALS EXCLUSIVELY

618 FIRST STREET N. W. • CEDAR RAPIDS, IOWA • PHONE 319 365-7751

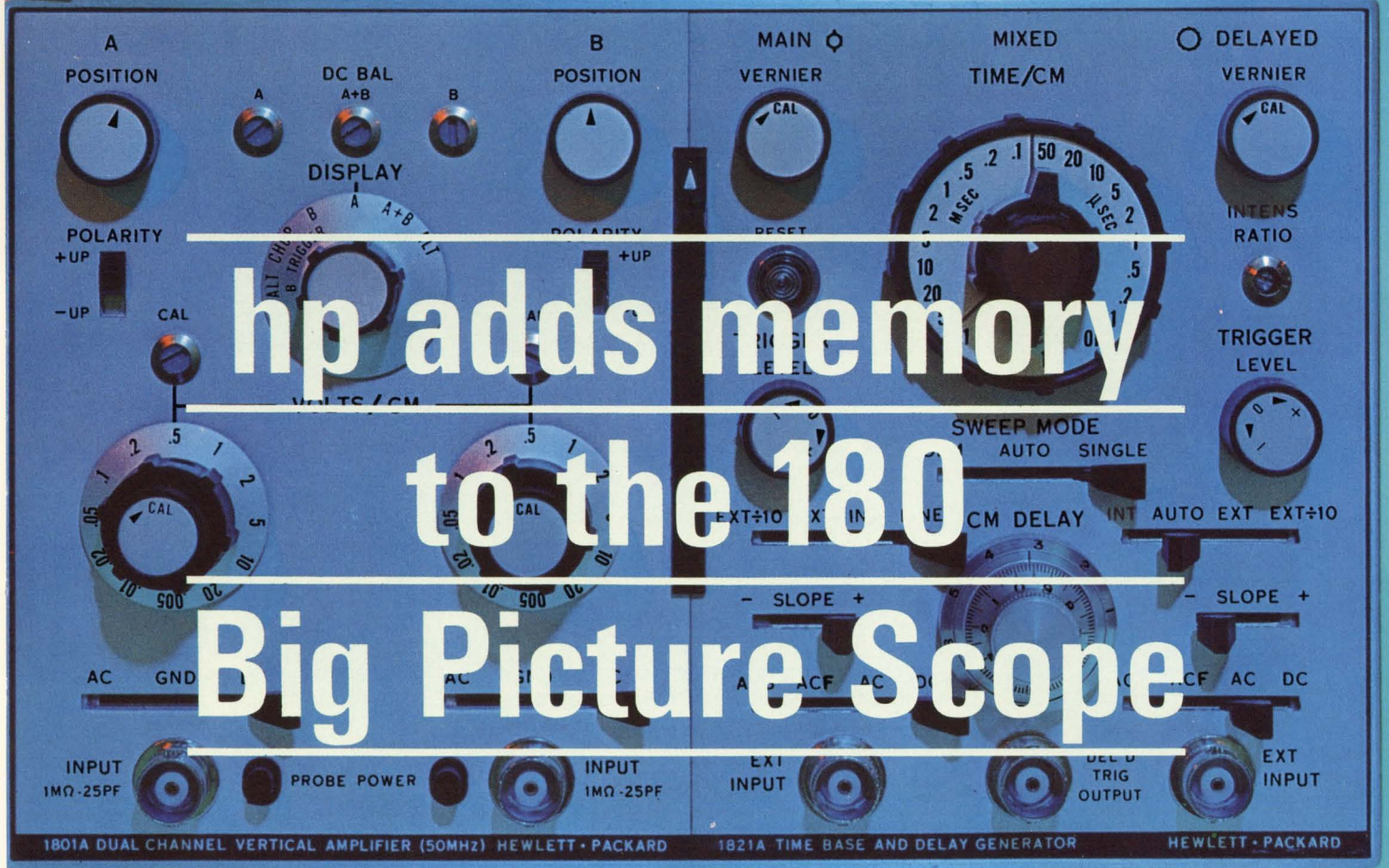
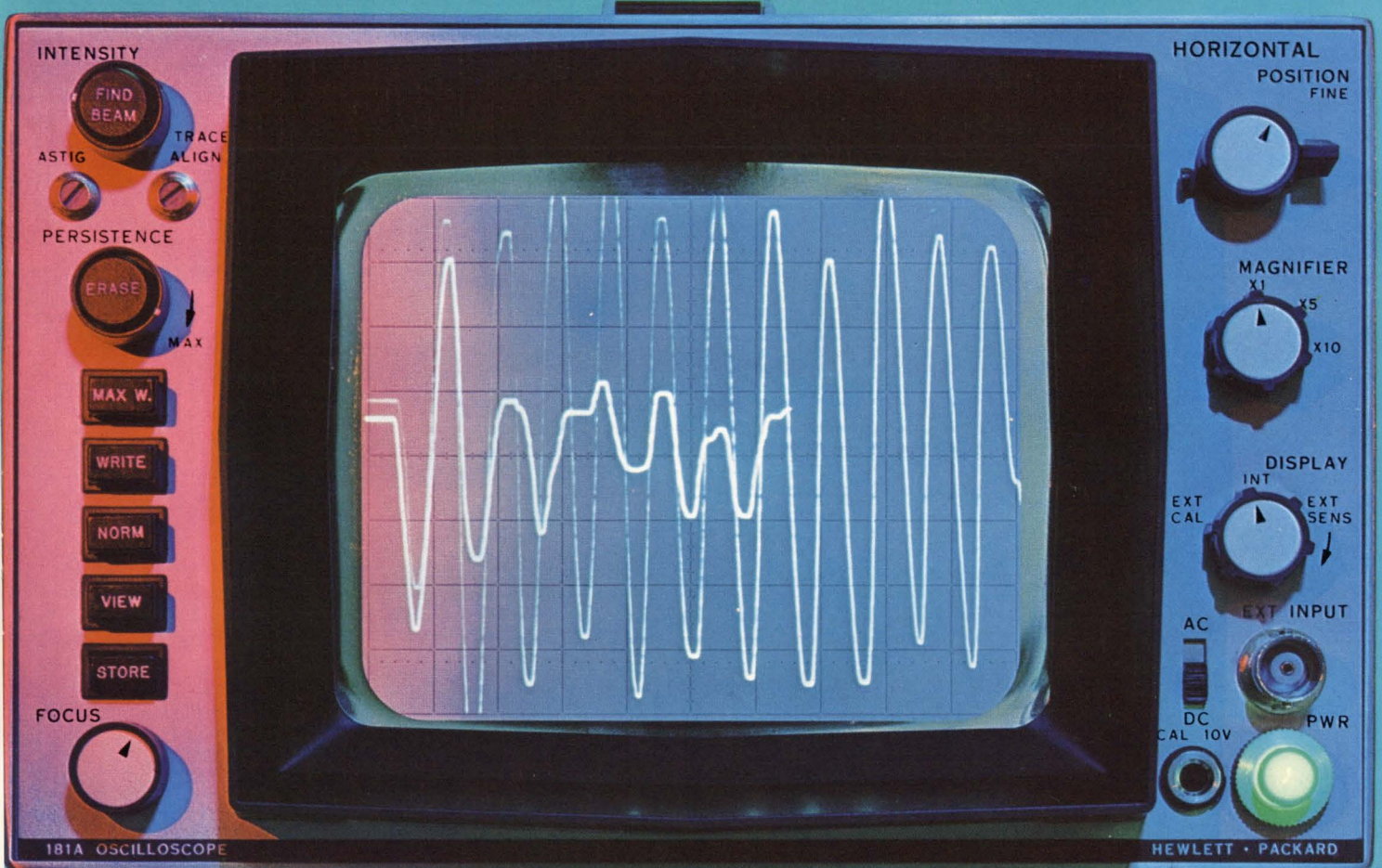

hp adds memory
to the 180
Big Picture Scope

1801A DUAL CHANNEL VERTICAL AMPLIFIER (50MHZ) HEWLETT • PACKARD 1821A TIME BASE AND DELAY GENERATOR HEWLETT • PACKARD

ACTUAL SIZE

PERSISTENCE



MAX



YOU
CONTROL CRT
PERSISTENCE!

STOP • STORE

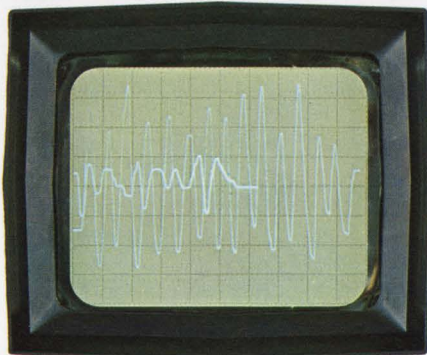

VARIABLE PERSISTENCE

See more with the new 181A's variable persistence—made possible by the special rectangular CRT using hp's exclusive mesh storage design! At the twist of a knob you can adjust the memory span from 0.2 second to more than a minute.

See clear, flicker-free displays of fast 7 ns rise time, low rep rate pulses. See signal trends while making circuit adjustments by simply adjusting persistence so several traces appear on the screen simultaneously. See slow traces such as transducer or biomedical waveforms by adjusting persistence so the old trace fades as the new one is being written.

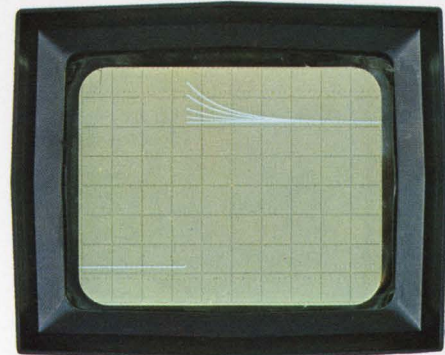

STORAGE

Do more with the new 181A's storage capabilities! Catch and store single-shot transients with the 181A's fast writing rate of 1 cm/ μ sec. Store traces side by side for later comparison. Hold traces intact for later viewing for more than an hour. With the trace stored and the scope turned off, store as much as a full minute of information for days—or even weeks! Use this feature to get a graphic display of critical parameters prior to system failure, the activation of a safety device, or excursion beyond some predetermined limit.



New hp 181A Oscilloscope with Variable Persistence and Storage . . .

For the first time you get the added dimension of variable persistence and storage in a high frequency scope—50 MHz bandwidth at 5 mV sensitivity now, and mainframe capabilities for 100 MHz.

With the 181A, you also have big picture displays, plug-in versatility, 100% solid-state circuitry, 30-pound portability, and superior performance for field, laboratory and production applications.

Get the complete story on the new hp 181A from your nearest hp field engineer. Or, write to Hewlett-Packard, Palo Alto, California 94304. Europe: 54 Route des Acacias, Geneva. Price: \$1,850.00 plus plug-ins.

VARY DISPLAY TIME!

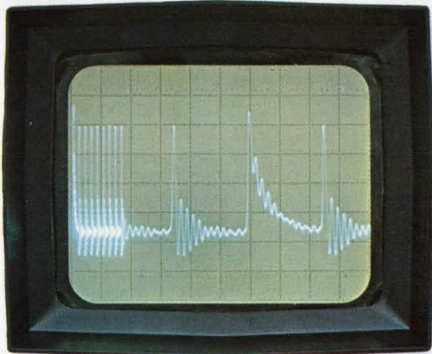

CONVENTIONAL USE

Use the new 181A as a conventional scope. You get the same high-frequency and high-sensitivity performance found in the other scopes in the hp 180 Series—50 MHz bandwidth at 5 mV sensitivity now, and mainframe capability for 100 MHz. All the hp 180 Series plug-ins give full performance in the 181A mainframe.

Use it anywhere. All-solid-state circuitry and aircraft frame construction give maximum ruggedness with minimum weight. Scope with plug-ins operates in temperatures from -28 to $+65^{\circ}\text{C}$ —and at altitudes up to 15,000 feet. It operates in a steaming 95% relative humidity up to 40°C !

It's rugged enough to take rough treatment in field, laboratory or production area without affecting electrical performance!

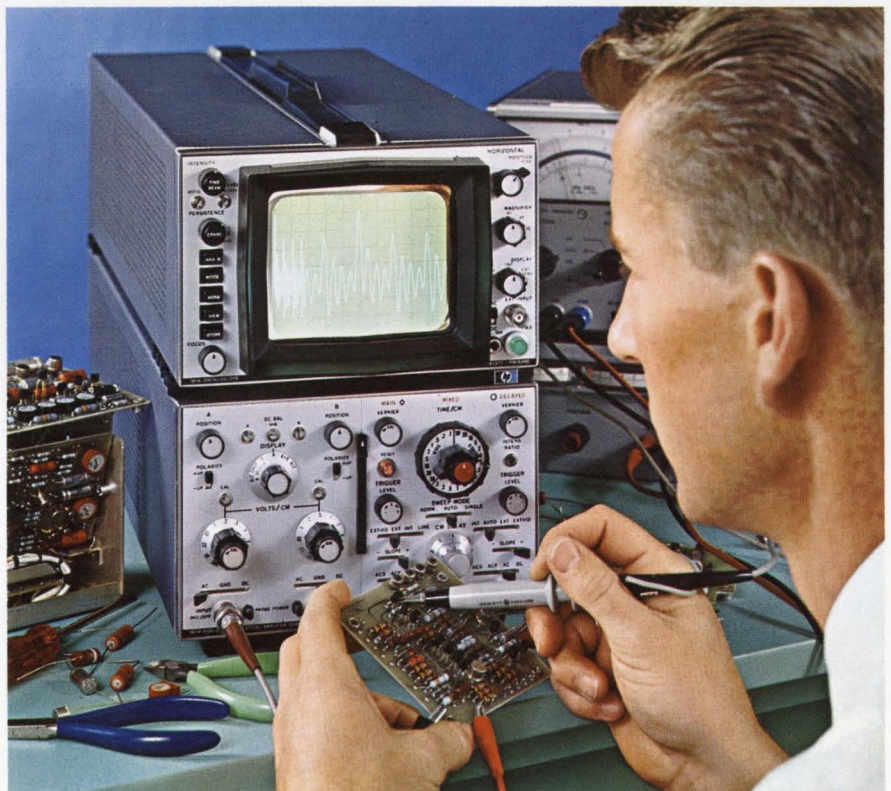

HEWLETT  PACKARD

OSCILLOSCOPE SYSTEMS

SEE MORE... DO MORE!

with a scope from the growing, versatile hp 180 system.

The hp 180 plug-in scope system has set the trend—for today and years to come. With an hp 180 scope, you get versatility previously possible only with a benchful of special purpose scopes. Hewlett-Packard now offers three mainframes—the 180A, 180E and the new 181A—plus three versatile plug-

ins with more to come, soon! You buy a scope to see with, so get the hp 180 mainframe with *the big picture* that meets your present requirements. It will continue to meet your growing requirements with new, fully compatible plug-ins in the future!

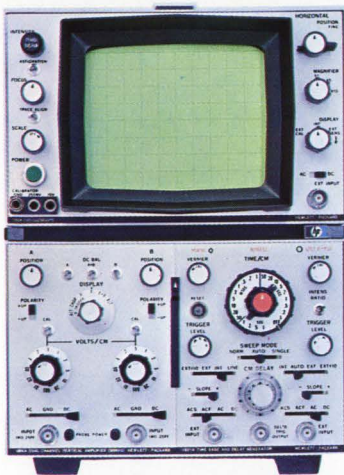

Lab/Field 180A Oscilloscope—First in the hp 180 Scope System, this scope has capability beyond 100 MHz, has horizontal amplifier sensitivity of 0.1 V/cm. X1, X5, X10 magnified sweep, accuracy $\pm 5\%$. Beam finder brings trace on CRT regardless of setting of horizontal, vertical or intensity controls. Power supplies and large 8 x 10 cm CRT are capable of handling existing and future plug-ins. Price: hp 180A, \$825; hp 180AR (rack mount), \$900.

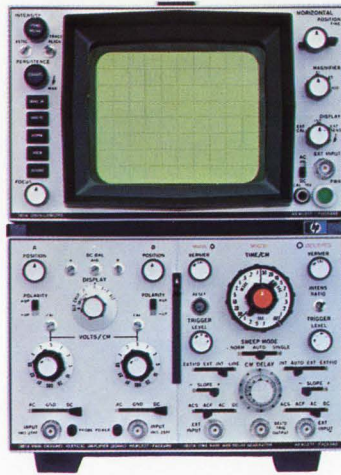

Variable Persistence and Storage 181A Oscilloscope—The new all-solid-state 181A scope expands the versatility of the 180 Scope System. The 181A operates as a conventional scope, or as a variable persistence scope, or as a storage scope. Persistence variable from 0.2 sec to more than a minute. Single shot writing rate is 1 cm/ μ sec. Standard 180 System plug-ins give full electrical performance in the 181A mainframe. Price: hp 181A, \$1850.

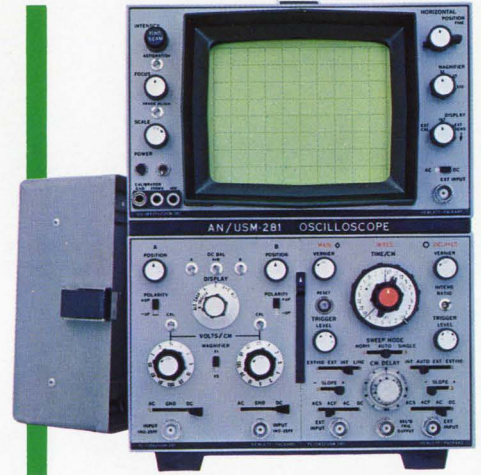

Military Version 180E Oscilloscope—Ruggedized version of hp 180A scope meets military requirements. Has same electrical performance specifications as 180A under such extreme environmental conditions as 95% humidity at 65°C. Passes MIL-S-910C for shock. Only 30 pounds including plug-ins for easy portability. Has proven MTBF of 5000 hours in accordance with MIL Hdbk. 217. Price: hp 180E, \$1215; hp 180ER (rackmount), \$1205.

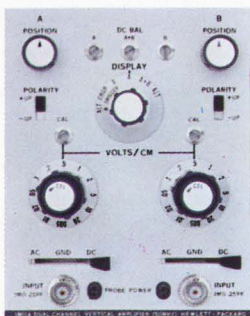

1801A Dual Channel Vertical Amplifier—Has dc to 50 MHz bandwidth (all ranges), 7 ns rise time, 5 mV/cm sensitivity, A + B and A - B operation, internal trigger on Channel B in ALT and CHOP modes. Price: hp 1801A, \$650; ruggedized hp 1801E with X5 amplifier for use with the 180E, \$800.

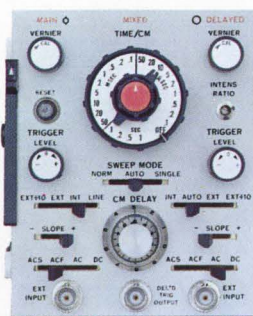

1821A Time Base and Delay Generator—Triggers to beyond 100 MHz, sweeps from 1 sec/cm to 10 ns/cm. Mixed sweep is provided for slow/fast sweep display. Delayed sweep is easy to use. Price: hp 1821A, \$800; ruggedized hp 1821E with added 2 sec/cm sweep to be used with the 180E, \$920.

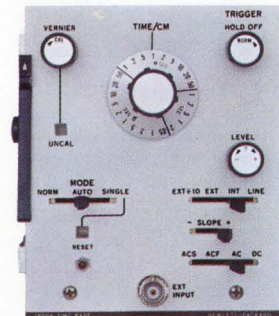

1820A Time Base—Triggers to beyond 100 MHz, sweeps from 2 sec/cm to 5 ns/cm. Variable holdoff locks-in complex waveforms. Has bright line automatic triggering. Gives you economy without sacrificing performance. Price: hp 1820A, \$475; ruggedized hp 1820E for use with the 180E, \$570.

HEWLETT  PACKARD
OSCILLOSCOPE SYSTEMS

Your "ELECTRONICS TROUBLESHOOTER"

—help him meet the challenges of today's expensive...

INSTRUMENTATION CONTROLS
NUMERICAL CONTROL SYSTEMS
INDUSTRIAL COMMUNICATIONS SYSTEMS
ELECTRONIC INDUSTRIAL CONTROLS

WHATEVER HIS TITLE in your particular operation, the "Electronics Troubleshooter" is on the payroll to protect you against costly electronic equipment failure. But he can't guard your investment if his skills and know-how aren't every bit as up-to-date as your equipment.

Now there's a practical way you can "train up" your troubleshooters to meet the challenges of today's—and tomorrow's—complex equipment. It's the "Grow Your Own" Program developed by the Cleveland Institute of Electronics.

With this program, training materials and methods are "tailored" to the needs of your operation... and the capabilities of your employees. Training space and time are flexible. And "Grow Your Own" training can save you money and administrative time.

Want complete details? Just send the coupon below. Or, if you prefer, telephone collect—(216) 781-9400 and ask for Kenneth Ede, Vice President, Industrial Programs Division.

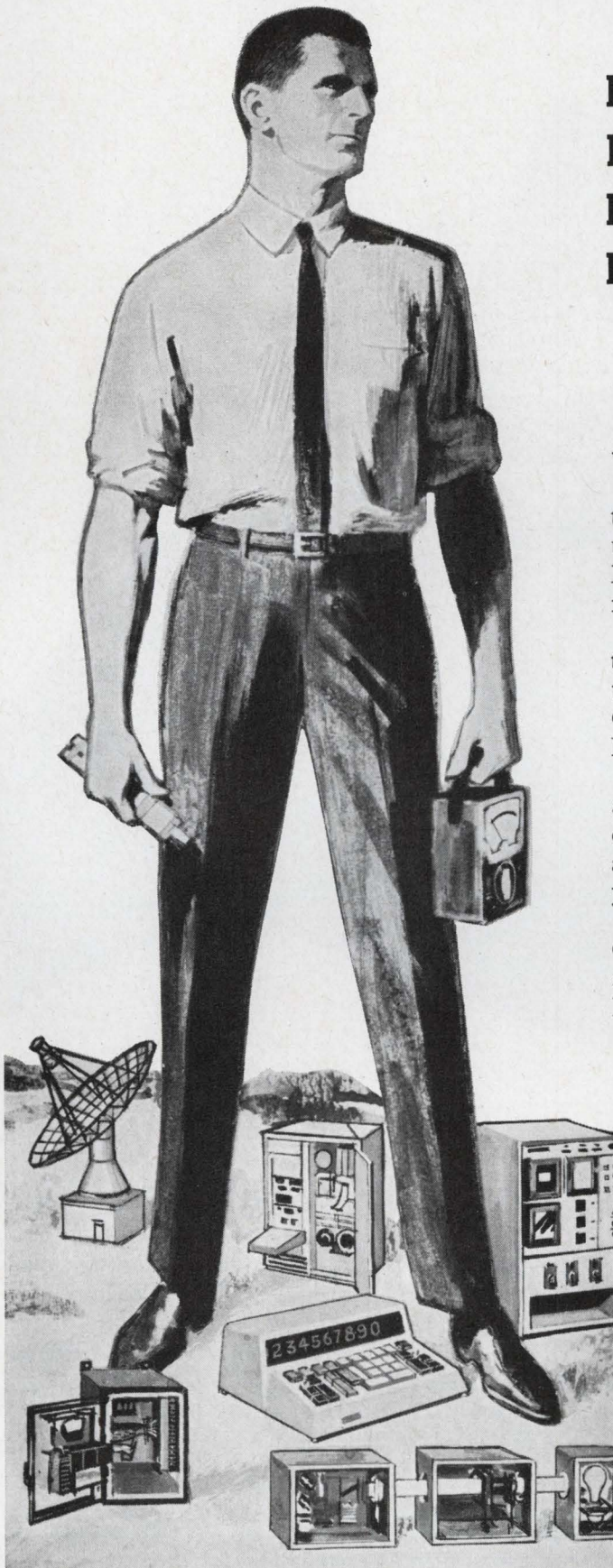

CIE **Cleveland Institute of Electronics**
1776 E. 17th St., Cleveland, Ohio 44114

**Attention: Kenneth Ede, Vice President,
Industrial Programs Division**

Please send me complete information on CIE's "Grow Your Own" training programs for Electronics Troubleshooters.

Name _____
Title _____
Firm _____
Address _____
City _____
State _____ Zip _____

E-33

new digital readout

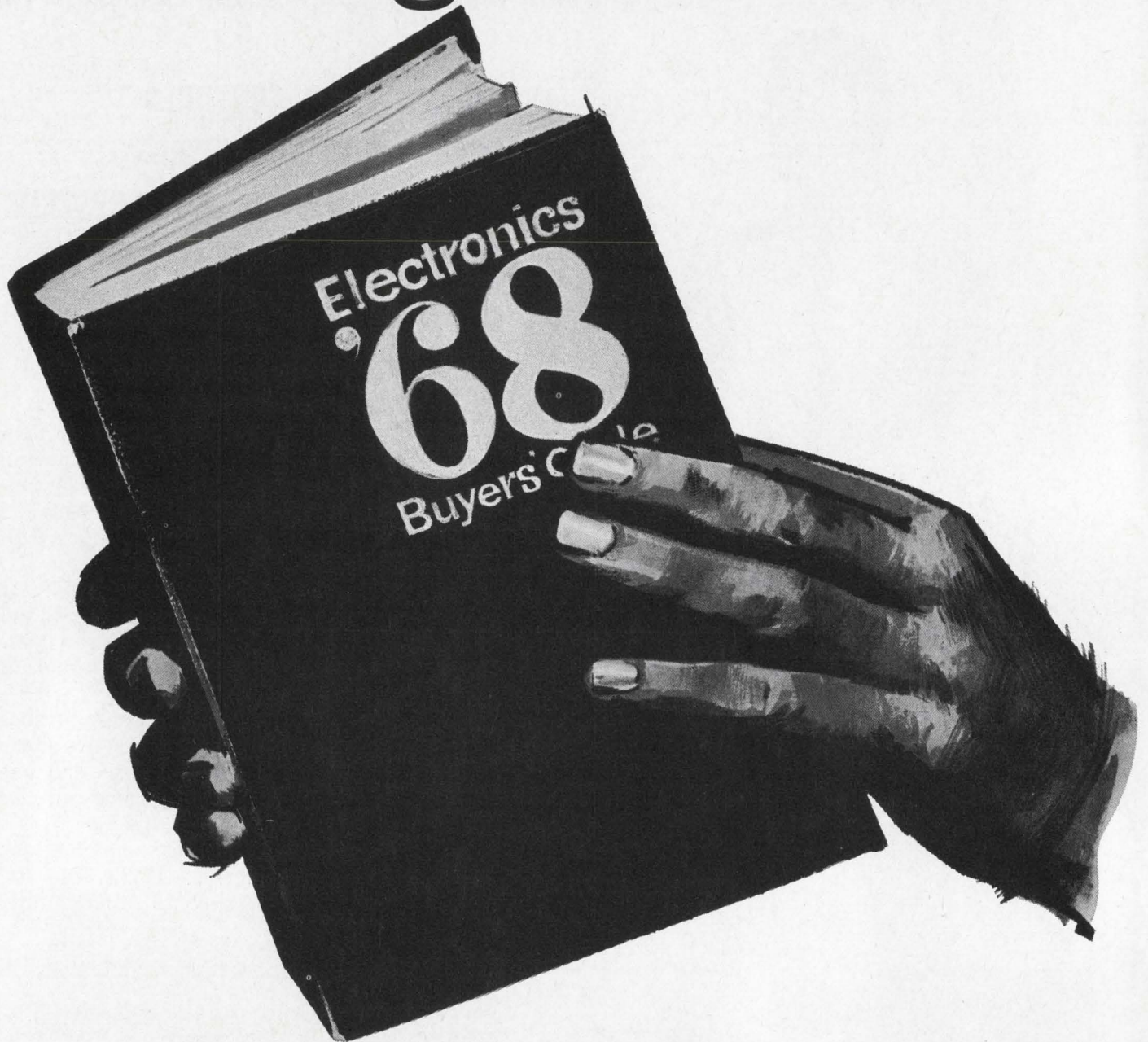

-lets your fingers flip through the entire electronics industry.

The '68 EBG gives you almost instantaneous desk top retrieval of 4 million bits of information that constitute the electronics industry.

If the answer to a problem involves finding a product or the people to supply it, this year the Electronics Buyers' Guide can help you find it faster than ever.

The '68 EBG yellow pages integrate editorial product

listings and advertiser's specifications in one continuous alphabetical section that is 4,000 categories long.

The green section tells you who's nearest, with the product you want, by listing local telephone numbers and addresses for more than 6,000 manufacturers.

Use the '68 EBG. And whenever you find an answer to your problem, tell them who sent you.

Electronics Buyers' Guide

A McGraw-Hill Market Directed Publication, 330 West 42nd Street, New York, N.Y. 10036

We're selling more Muffin Fans than ever before. Is it because the Muffin is still the best low cost, high performance, low noise solution to your cooling problems?

YOU BET IT IS !!!!!



muffin[®] fan

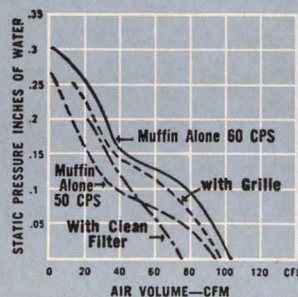
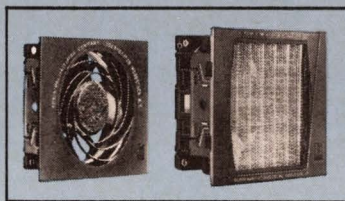

CALL YOUR ROTRON

4-WARD
DISTRIBUTOR

WEST

R. V. WEATHERFORD CO.
GLENDALE, CALIF.
213-849-3451

MIDWEST

ALLIED ELECTRONICS
CHICAGO, ILL.
312-829-9121

SOUTH

HALL-MARK ELECTRONICS CORP.
DALLAS, TEXAS
214-231-6111
ORLANDO, FLORIDA
305-855-4020

EAST

SCHLEY ELECTRONICS CORP.
WATERTOWN, MASS.
617-926-0235
RUTHERFORD, N. J.
201-935-2120



ROTRON MANUFACTURING COMPANY, INC.

WOODSTOCK, NEW YORK • 914-679-2401

West Coast: Rotron/Pacific, Burbank, Calif.
Canada: Aerovox Canada Ltd., Hamilton, Ont.
Rotron Europa N.V. Breda, The Netherlands

Roll Your Own I/C's

Your company has resolved the "make-or-buy" I/C's question with a "make" answer. Your next problem is how? First hire experienced troops at about 15K each. You'll need a manufacturing guy, a mask-making guy, a diffusion guy, and a circuit design guy. Only in an industry that produced 460 megabucks worth of I/C's last year, you can't find them. We can help. Put your men in our Fabrication Course. They get five weeks of intensive laboratory training covering every topic of the technology. Design of I/C's; Wafer Processing; Thin/Thick Film Processing; Assembly Techniques; Management of I/C Operations. The whole caboodle. While they're with us, have them build the prototypes of the first devices you need. Write or call us for detailed information. The Fabrication Course. Only from ICE.

**I/C Fabrication Course
Given at ICE's Phoenix Laboratories**

**March 18 - April 19, 1968
September 16 - October 18, 1968**

ICE

**ICE Corporation 4900 E. Indian School Road Phoenix, Arizona 85018
Telephone 602 959 4760 TWX 910 950 1285 Cable ICE PHOENIX**

Coors Strate-Breaks™

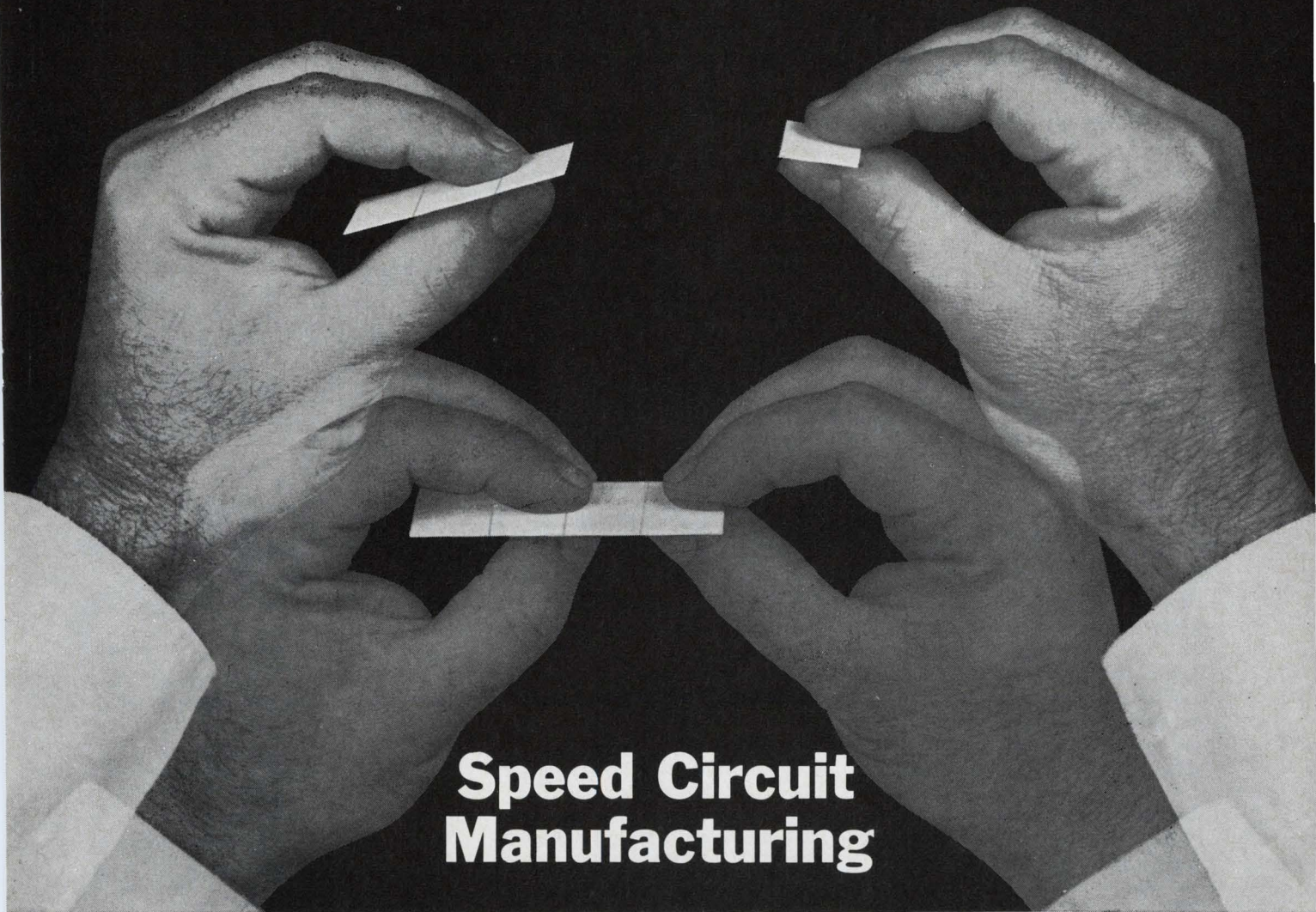

Speed Circuit Manufacturing

High quantity production of integrated circuits with uniform quality, increased precision tolerances, greater economy in the production of micro-ceramic components—all these are yours by gang printing your circuits on Coors *Strate-Breaks*. No cutting apart, no multiple handling before assembly. Just SNAP! . . . and there are your individual components with a straight, smooth, precision edge.

Coors *Strate-Breaks* are made to your specifications in sizes from $\frac{1}{2}$ " x $\frac{1}{2}$ " to 4" x 4". They are available unglazed for thick-film circuits, and glazed or unglazed for thin-film circuits. Get on-the-spot answers. Dial Coors—303/279-6565, Ext. 361. For complete design criteria, write for Coors Alumina and Beryllia Properties Handbook No. 952.

Patent Pending

*consider
Coors
ceramics*

Coors

CERAMICS

ALUMINAS • BERYLLIAS • MAGNESIAS • SPECIAL OXIDES

Coors Porcelain Co., Golden, Colo.

Circle 147 on reader service card

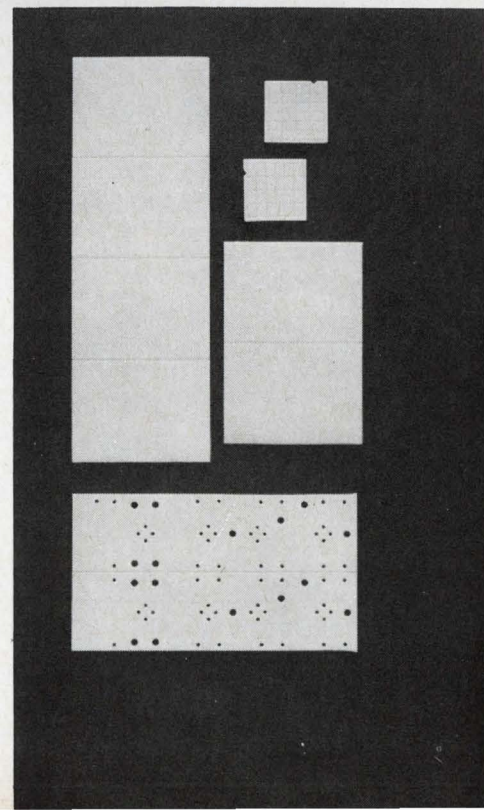

Don't sit there
wishing your
 support people
 knew more
 electronics...

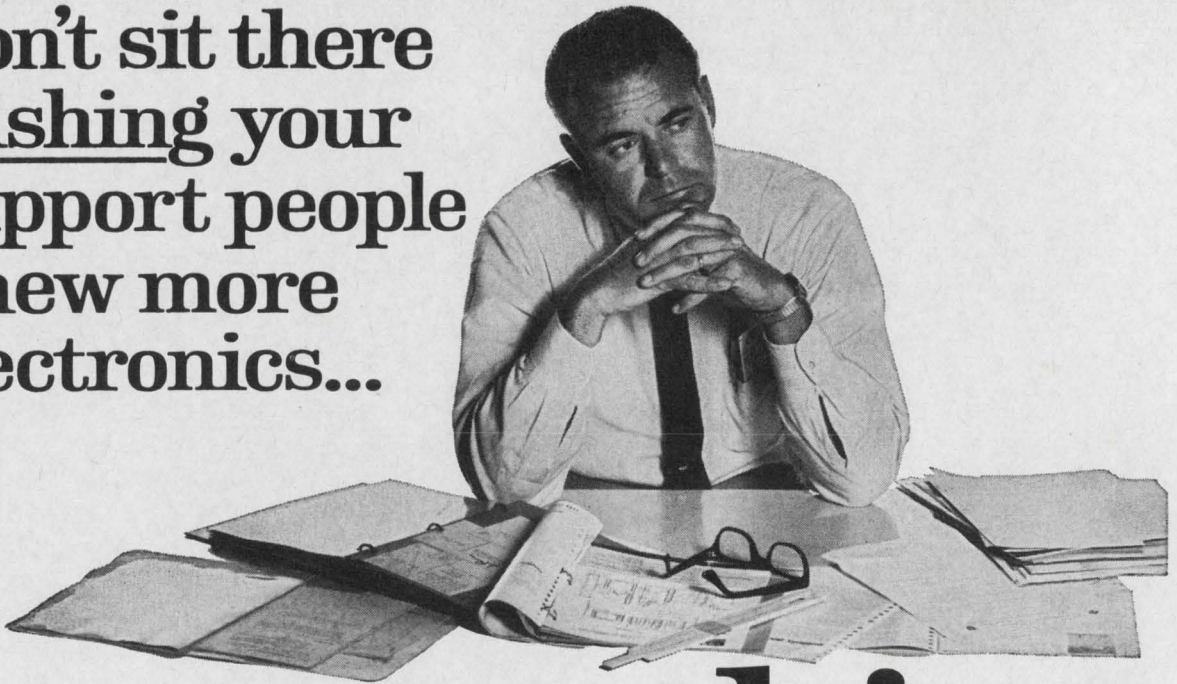

do something

Look over your men. Pick out a few who are intelligent enough to profit from more education in electronics, ambitious enough to work hard to get it. Send us their names and addresses. We'll send them complete information about CREI Home Study Programs in Electronics, tell them how these programs have helped thousands of young men increase their value to their employers. We'll explain how they can study at home, at their own pace, on their own schedule

without traveling to classes. We'll give them the names of the more than 80 leading scientists and engineers who help us develop and update programs related directly to the needs of industry.

Yes, we'll do all that. If you're lucky some of your men may enroll. Why not give it a try? Fill out the coupon and get it in the mail today.



CREI Programs cover these specialized areas of advanced electronics:

- Communications Engineering •
- Aeronautical and Navigational Engineering •
- Television Engineering •
- Computers • Nuclear Instrumentation and Control •
- Automatic Control Engineering •
- Missile and Spacecraft Guidance •
- Radar and Sonar Engineering •
- Nuclear Engineering Technology •
- Industrial Electronics for Automation •
- Computer Systems Technology.

CREI
THE CAPITOL RADIO ENGINEERING INSTITUTE

A Division of McGraw-Hill, Inc.
 Dept. 1806-G, 3224 Sixteenth Street, N.W.
 Washington, D.C. 20010

Gentlemen: The men listed at right are high school graduates working in some phase of electronics. Please send them your FREE book, "How to Prepare Today for Tomorrow's Jobs" and complete information about CREI Home Study Programs.

And please send me the free brochure which tells how we can use CREI Home Study Programs to supplement our educational program for electronics personnel.

Name _____
 Title _____
 Company _____
 Address _____
 City _____ State _____ Zip Code _____

Name _____
 Address _____
 City _____ State _____ Zip Code _____

Name _____
 Address _____
 City _____ State _____ Zip Code _____

Name _____
 Address _____
 City _____ State _____ Zip Code _____

Name _____
 Address _____
 City _____ State _____ Zip Code _____

Name _____
 Address _____
 City _____ State _____ Zip Code _____

(Not enough room? Attach sheet of paper with additional names and addresses)

Don't buy a DVM— buy a measuring system. It's cheaper that way.

Because we designed our new DVM as part of an expandable measuring system, you get a complete digital voltmeter at a price of only \$580. But you also get much more . . .

The only system that will accept two function modules at a time.

The digital display unit is the focus. Plug in one module, and you've got a DVM for measuring DC. Add another, and you can measure AC. Substitute others and you can measure frequency, period, time intervals and other parameters.

Our new Model 6200 DVM doesn't cost much more than a multimeter. But it's 10 to 30 times more

accurate. It's linear over the entire range. You change voltage ranges just by pressing buttons. You read off the voltage value as a number. You don't have to work at interpreting scales.

And the plug-in concept is the topper. Buy a plug-in for whatever function you need at a fraction of the cost of a single-purpose instrument.

For a demonstration, call (201) 229-4400. Or write for a complete technical description.

EAI[®] ELECTRONIC ASSOCIATES, INC.
West Long Branch, New Jersey

MODEL 6200 DISPLAY UNIT with long-life Nixie tube readout accepts two modules simultaneously. Gives you 4-place digital readout and "mix-or-match" of modules for flexibility. Compact: half rack width. Solid-state silicon and I.C. circuitry.

MODEL 6201 DVM MODULE. Measures DC voltages in 5 ranges from 100.0 mv to 1000 volts. Accuracy is $\pm 0.1\% \pm 1$ digit. Features: Push-button ranging. Automatic polarity selection. Integrating function for high accuracy even with a background of hum and noise. 40% overrange on 4 most sensitive ranges.

MODEL 6203 AC CONVERTER MODULE. Measures AC voltages accurately over a wide frequency range. Four pushbutton ranges to 300 volts rms. Frequencies from 20 Hz to 100 KHz. Used in conjunction with DVM Module.

MODEL 6202 COUNTER MODULE. Measures frequencies to 10 MHz with $\pm 0.005\% \pm 1$ count accuracy. Measures period or time intervals from 1 microsecond to 1000 seconds with 1 microsecond ± 1 count resolution.



JUST ADDED: MODEL 6240 RACK MOUNTED DVM. Self-contained DC DVM with optional BCD output and Model 6241 expansion chassis for plug-in modules.

GLASS-TO-METAL SEALS

by
AIRPAX

Exacting customer specifications are met by the quality, glass insulated terminals manufactured by Airpax.

A wide variety of terminal designs are producible and glass can be color coded for identification. (We like blue, one reason is that blue is supposed to be difficult.)

Leads can be kovar, or sleeved solid copper, or tubular. A large choice of standardized pins and lugs permits quick delivery to your specific needs. A 90 page catalog giving technical details is yours for the asking.

AIRPAX ELECTRONICS

CAMBRIDGE DIVISION, CAMBRIDGE, MARYLAND 21613

Phone 301-228-4600

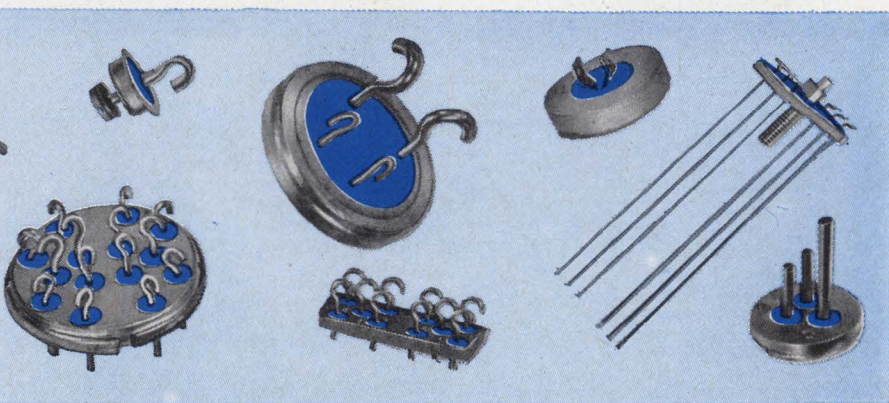
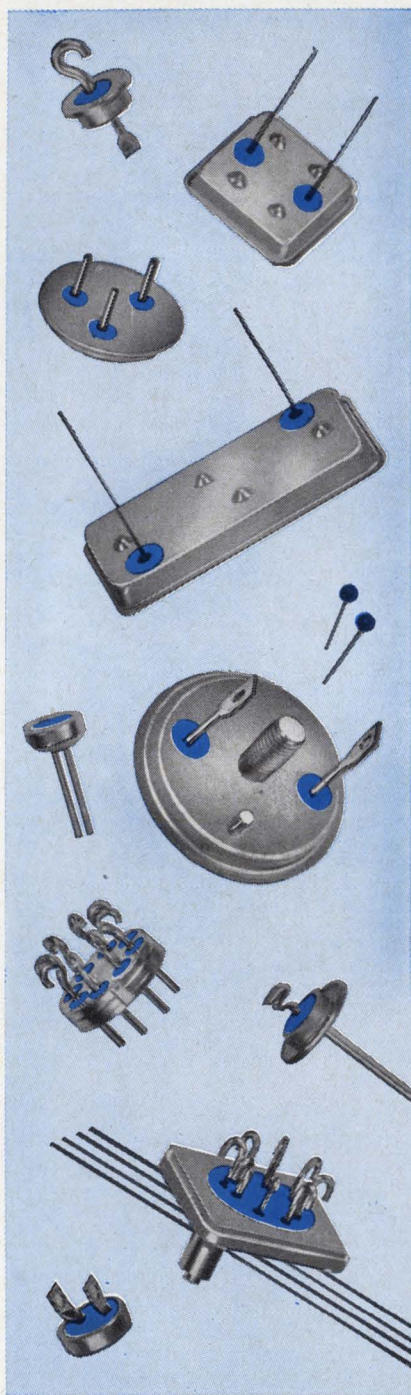

New Products

New subassemblies

Navigation converter talks two languages

Computer device for aircraft, submarine, space applications swaps data with synchros, resolvers, other analog components of guidance systems

Most navigation problems require solving trigonometric equations, so guidance equipment manufacturers have to develop suitable trigonometric computing devices. Rarely, however, are they versatile enough to be marketable. An exception is a trigonometric converting and computing technique developed by the Kearfott Products division of General Precision Systems Inc.

The technique, dubbed Trigac, employs demodulators, integrators, inverters, and zero-crossing detectors that can be adapted for synchro-to-digital, digital-to-synchro, and coordinate conversion, as well as function as a trigonometric computer.

Devices incorporating the technique can be used for heads-up display systems in aircraft cockpits or to convert roll, pitch and yaw information for cathode-ray tube displays in submarines. In a star-tracking missile or space system, they can convert spherical into planar coordinates.

I. Direct link with sensors

As a coordinate converter or trigonometric computer, Trigac has the unique property of being able to connect directly with synchros and resolvers, the key transducers in most automatic navigational systems. Its ability to directly link to analog components makes this type of instrument less complex

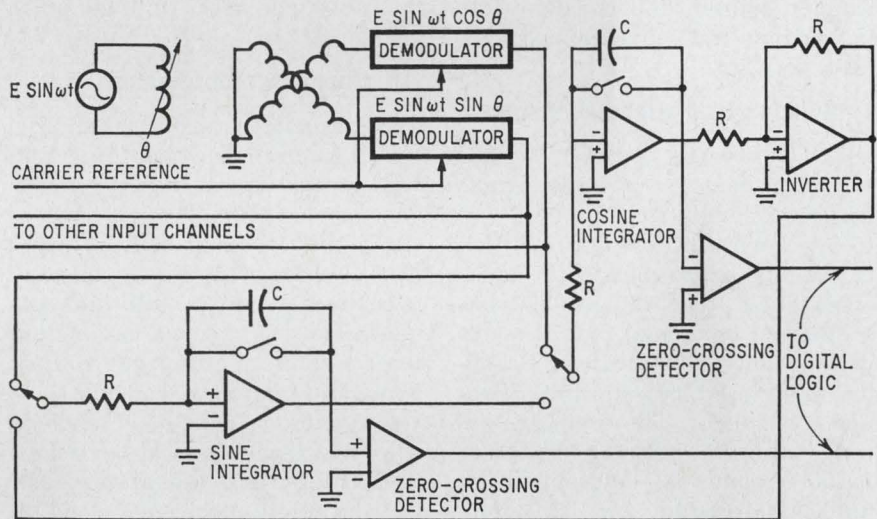

Translator. Trigac converts resolver signals to digital output by first demodulating sine and cosine components of resolver waveform and then charging up d-c integrators. Inverter forms with integrators a two-phase oscillator to produce clock pulses. These are counted until either component of input crosses zero to produce least significant bits for digital output.

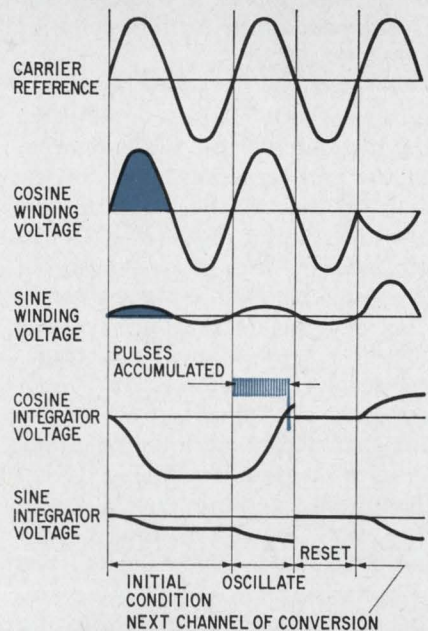

and expensive than conventional coordinate converters and trigonometric computers.

One Trigac converter application is flat-screen display projection of three-dimensional objects. In an aircraft heads-up display, for a landing-field representation to appear in perspective as the aircraft translates or rotates, the Trigac converter develops vertical and horizontal deflection voltages for each landing-field vertex. Vector stroke-writing circuits connect the vertices.

Trigac units feature solid state modular construction, are cost-competitive with servoed shaft encoders, and can multiplex numerous input and digital/synchro output channels. They have a digital angle output format, and are insensitive to such carrier signal characteristics as frequency, amplitude, and harmonic content. They're also smaller, lighter, and consume less power than the conventional methods.

II. Synchro-to-digital conversion

For converting synchro signals to digital data, a-c resolver signals first are demodulated to charge up to two d-c integrators in proportion to the sine and cosine of the input shaft angle. The integrators subsequently are connected in series with a unity-gain inverting amplifier in a closed loop to form a two-phase oscillator. The oscillator period, typically between 1/100 or 1/200 second, is determined by precision resistors and capacitors in the operational integrators, and is independent of carrier excitation frequency.

To provide the least significant bits, a stable clock counts from the beginning of the oscillation until the zero crossing of either the sine or cosine voltages. The two most significant digital output bits are derived from the polarity of the initial sine and cosine voltages.

In the typical waveforms on page 151, the second and third traces are resolver waveforms for a first-quadrant shaft-angle, say 10° . The crosshatched areas are integrated, as in the bottom two traces, during the initial condition mode. Oscillate mode lasts for exactly one-fourth of the oscillator period. The zero-crossing of either integrator during this interval is certain, and

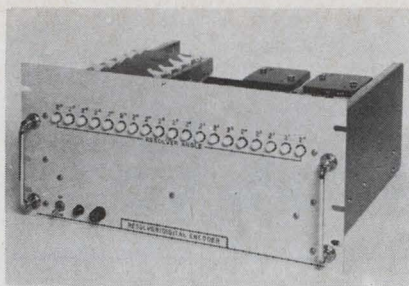

Digitizer. Converter generates a digital equivalent of analog signals from resolvers and synchros.

the pulses accumulated until zero crossing yield complements of the input shaft-angle, in this case 80° .

Capacitors are then reset (shorted) until the next initial condition mode, which is determined by the carrier reference's positive-slope zero-crossing. A change in carrier frequency changes only integrated signal amplitudes at the beginning of the oscillate mode, but not their ratio or total pulse accumulation.

III. Changing coordinates

Coordinate transformation between a reference frame fixed to a vehicle and some external reference frame is a major part of navigation and weapons-delivery problems. Vehicular attitude is generally measured by pitch, roll, and azimuth synchro signals originating from a stable platform (or vertical gyro) and compass system.

Conventional methods include using electromechanical devices or a general-purpose digital computer. But the electromechanical solution requires three servos to follow up platform resolvers, along with accurately buffered computing resolvers. If a digital computer is programmed to perform these computations, it becomes necessary for some applications to provide three resolver-to-digital conversion channels and two digital-to-resolver channels.

The Trigac coordinate converter provides a low-cost alternative. It has the advantage of being able to handle synchro or resolver inputs for roll, pitch and azimuth, as well as vector components in earth's coordinate system. It provides inputs in the form of digital numbers, d-c voltages, or control transmitter signals, eliminates the need for electromechanical servos, and reduces costs as compared

with analog-to-digital converter-computer combinations. It also eliminates the need for a computer and remains totally insensitive to synchro/resolver harmonics and other disturbances.

The Trigac coordinate converter accuracy is comparable to that of high-quality servoed resolver chains: the computed rotated vector angle is within about 6 minutes of the true angle. A tradeoff in accuracy and resolution versus computation rate shows that a combined resolver-to-digital conversion and coordinate rotation of 13-bit resolution and 12-bit accuracy requires 20 milliseconds. Solution rate can be doubled or quadrupled at somewhat lower accuracy.

A significant characteristic of the Trigac converter is that integrating capacitor stability is not very critical. If the oscillator frequency decreases, the resolver angle encoding is smaller than the true angle. However, subsequent vector rotation is correspondingly larger than the encoded quantity. There is a very small residual error due to differential capacitance variation. Thus, if one capacitor increases by 1% and the other remains fixed, there will be a worst-case vector rotation error of only 6 minutes.

Other applications for a Trigac coordinate converter are laser or radar-range-finder pointing, gun-aiming from mobile platforms such as tanks and boats, and any moving-vehicle instrument orientation application currently done with electromechanical servos.

IV. Simple computer

Trigac's versatility is also demonstrated by the variety of applications possible as a computational instrument performing navigational functions aboard aircraft, spacecraft, or other moving vehicles.

Though highly versatile for certain computations, Trigac is not an alternative to stored-program general-purpose computers. Its significant advantages in those applications in which it functions most effectively lie in its conversion hardware combination, and the ease of its input/output interfacing.

Kearfott Products Division, General Precision Systems, Inc., 1225 McBride Ave., Little Falls, N.J. [338]

New miniature PC Correeds

Here's the pee wee edition of our famous dry-reed switches. Same efficient magnetic shielding as their big brothers. Same soggy-proof bobins—made of glass-reinforced nylon.

All this with a low, low silhouette (just 0.350 inch above mounting surface).

MPC Correeds measure as small as $1\frac{1}{32}$ by 1.350 inch. We located the terminals on 0.050 inch centers to match your board grids. You can stack them tightly in your racks—without magnetic interaction.



These space-saving little switches are perfect for high-speed applications. They're readily driven from transistors (their self-inductance is lower than their profiles). They give you an ideal interface between electronic and electromechanical circuitry.

Want some helpful new technical information? Just write to the Director, Electronic Control Equipment Sales, Automatic Electric, Northlake, Illinois 60164.

AUTOMATIC ELECTRIC

SUBSIDIARY OF GENERAL TELEPHONE & ELECTRONICS

New Components Review

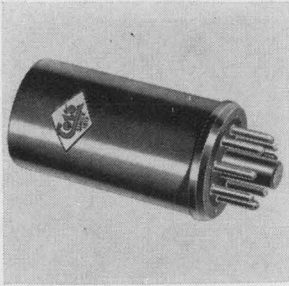

An a-c reed relay, for replacing more costly a-c/d-c circuits, operates on 60-hz input, with 50- to 400-hz voltages also available. Rating is from 1/10 to 3 amps, and up to 5,000 v d-c. Contacts are in forms A, B or C, with single or multiple contacts. The unit is available in steel or plastic octal base housings. Coto-Coil Co., 62 Pavilion Ave., Providence, R.I. 02905. [341]

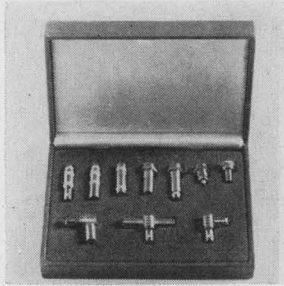

Kits are available that include ten 50-ohm miniature (1/2-in. diameter) coaxial connectors for use with cable such as RG-195A/U. The connectors have a max. vswr of 1.12:1 at 10 Ghz and a test voltage rating of 2.2 kv d-c at 2 amps operating current. The kit has a total value of \$62.48 and is offered for \$25 plus tax. Lemosca Inc., 465 California St., San Francisco 94104. [342]

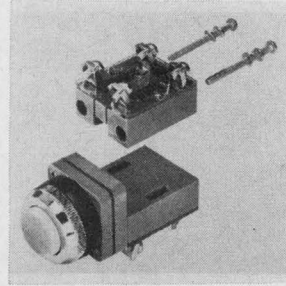

Oil-tight push button switches, rated to carry 6 amps at 230 v a-c, can control circuits independently or with optional contactors or starters. They feature double-break solid silver contacts for positive make or break. Units mount in a 1-in. hole. They are supplied with a versatile (normally open-normally closed) block. Alco Electronic Products Inc., Lawrence, Mass. 01843 [343]

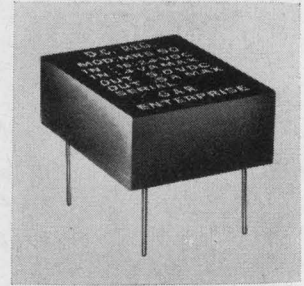

A voltage regulator for powering IC's in systems using digital logic measures 1 9/16 x 1 1/4 x 1/2 in. high. With an output power of 2.5 w, output voltage is 4.5, 5.0, or 5.5 v d-c from a nominal input voltage of 20 v. Efficiency at full load is greater than 65%. Units offer line and load regulation of $\pm 0.5\%$. GAR Enterprises Inc., 2029 N. Lincoln Ave., Pasadena, Calif. 91103. [344]

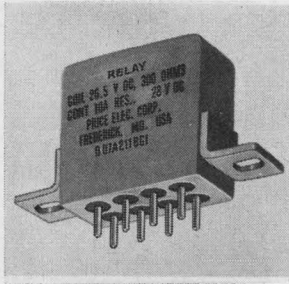

Double-pole double-throw relay style 7B is a 10-amp crystal can unit designed for avionic systems. It is actuated by one coil balanced armature motor, with 100,000 minimum operations at -70° to $+125^\circ\text{C}$. Sensitivity is rated at 565 mw, with 10 milliohms max. contact resistance and 10 msec max. operating and release time. Price Electric Corp., Frederick, Md. 21701. [345]

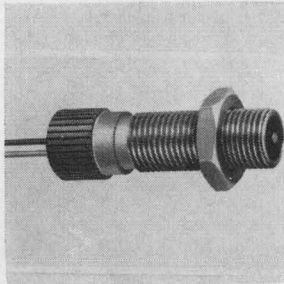

Subminiature magnetic pickup 340-0006 converts mechanical motion to an a-c voltage without physical contact or external power. Applications include tachometry, counting, positioning, timing, vibration measurement, motion study and computer equipments. The unit measures 1 x 0.25 in. and weighs 0.12 oz. Airpax Electronics, P.O. Box 8488, Fort Lauderdale, Fla. 33310. [346]

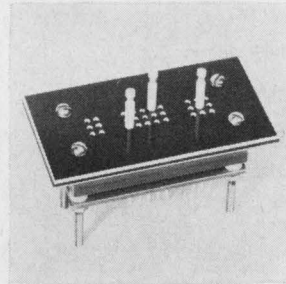

A miniature program board is designed for tight space requirements. It features holes on 0.100-in. centers and separate electrical groups of 3 x 2, 3 x 3, and 3 x 5. Unit measures 1 1/8 x 1 3/4 in. and has extended studs for rear mounting. It takes the place of many separate toggle switches and features shorting pins as shown. Sealectro Corp., 225 Hoyt St., Mamaroneck, N.Y. 10543. [347]

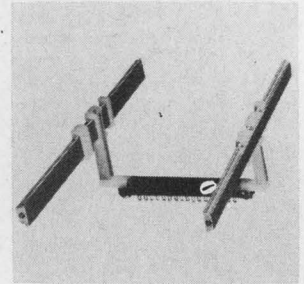

Circuit card guides series M are for cards from 1 in. to 2.75 in. long. With a 3/8-in. minimum card spacing, the series can accommodate over 500 IC card configurations. Incorporating only 1 T-or H-shaped mounting bar, they provide a small guide profile that permits high density packaging and good cooling. Scanbe Mfg. Corp., 1161 Monterey Pass Rd., Monterey Park, Calif. [348]

New components

Giving IC op amps a powerful boost

Thick-film hybrid device that's short-circuit proof can increase an amplifier's output as much as 40 times

Integrated-circuit operational amplifiers can deliver large gains at low offset voltages, but their power output is inherently low—typically about 0.064 watt for op amps in the Fairchild 709 category. Engineers at Beckman Instruments Inc.'s Helipot division now have a linear

power amplifier which, when used in combination with an IC op amp, delivers outputs of 2.56 watts.

Designated model 821, the device is a hybrid cermet thick-film power amplifier that can drive 100-ohm loads to within 4 volts of a supply voltage from d-c to 10 megahertz.

Besides boosting power outputs, says Beckman, the device has another big plus. Because an output-current-sensing resistor and a voltage sensing divider are built in, the amplifier is short-circuit proof, says John Ypma, the division's microcircuits application engineering supervisor. "The outputs of these two elements are combined to drive a transistor that can bypass the output-power stages when an overload exists," he points out.

Power up, size down. George Smith, senior engineer at the micro-circuit operation, says the idea of the amplifier stems from an analysis

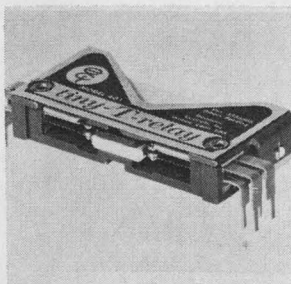

Flatpack relay series 401 Tiny-T is suited for computer interface, automatic test, or communications switching. The units allow p-c boards to be mounted on 1/2-in. centers. The Tiny-T uses an electromagnetic arrangement that allows it to transfer 3 amps at 28 v d-c or interrupt up to 1,000v a-c at 100 ma. Electronic Controls Inc., 141 Danbury Rd., Wilton, Conn. 06897. [349]

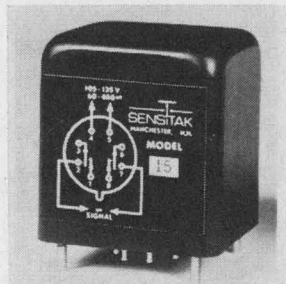

Servo differential relay 15B has application in temperature control, phase detection, etc. Input sensitivity for reed pull-in is 5 mv, with 3 mv average production sensitivity. Direct overvoltage capability of 10 v allows the unit to be used over a wide dynamic range producing differential resolution of 0.001%. Sensitak Instrument Corp., 531 Front St., Manchester, N.H. 03102. [350]

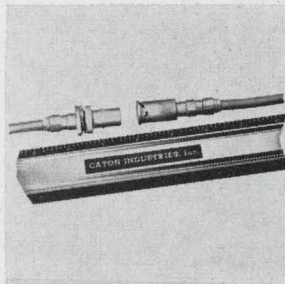

Shielded, corona free connectors UG616/u and UG617/u are suited for application in high-voltage, milliamperage-type power supplies, such as found in infrared units, airborne radar and high electron acceleration needs of bright display on crt devices. High-potential test capability of mated units exceeds 15 kv d-c. Caton Industries Inc., 5241 Secor Rd., Toledo, Ohio 43623. [351]

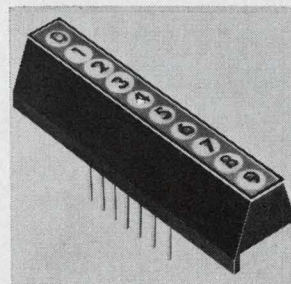

The Decalite concept provides a 14-pin dual-in-line readout compatible with most IC logic types. The readout offers 5-v operation with 30 ma current. Long-life lamps of typically 100,000-hr life are used. The unit, useful in testing counters, measures 12 x 12 x 43 mm. Price is \$11.95 each in lots of 1 to 10. Rotorcraft S.A., 5 rue de l'Universite, Geneva, Switzerland. [352]

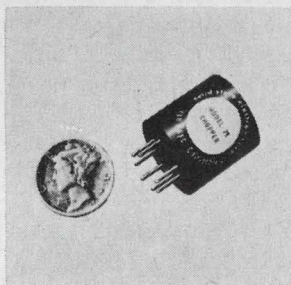

Plug-in transistor chopper model 75 uses a transformer-coupled isolating drive network so that it can be driven from a 400-hz power line or from a drive source common to the d-c voltage being chopped. Units withstand shock of 500 g for 11 msec, 30 g vibration from 0 to 2,000 hz, and acceleration to 700 g. Solid State Electronics Corp., 15321 Rayen St., Sepulveda, Calif. 91343. [353]

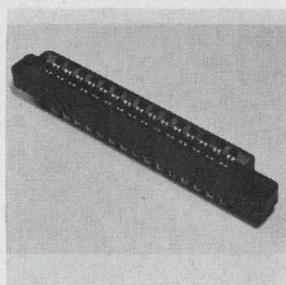

P-c board receptacles series 061 have bifurcated cantilever contacts and coined dual wipers with 0.156-in. spacing. Designed for commercial, industrial and military use, these edgeboard connectors accommodate 1/16-in. p-c cards, double or single sided. Engagement-separation forces are 2 oz minimum, 16 oz max. Transiron Electronic Corp., 168 Albion St., Wakefield, Mass. 01881. [354]

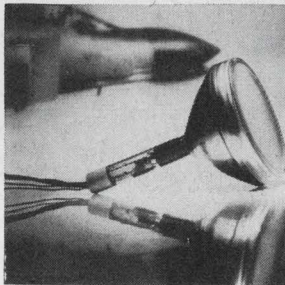

Compact crt WX-30582 for radar or monitor display features 70° magnetic deflection and a 0.004-in. line width. The 5-in.-diameter, aluminized faceplate allows 90% light transmission. The electrostatically focused crt weighs 1 lb, is less than 8 in. long, and has a 0.87-in.-diameter neck. It mounts in any position. Westinghouse Electronic Tube Division, Elmira, N.Y. 14902. [355]

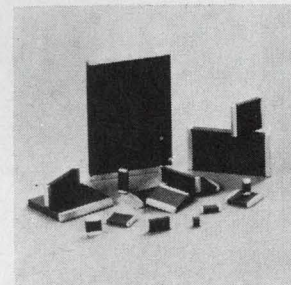

Miniature Ceramolithic chip capacitors in the K1200 line can be used in thick or thin film hybrid circuits for filtering, buffering, bypass, coupling, timing, and tuning. They are available in a capacitance range of 120 pf to 3.3 μf with voltage ratings of 50, 100 and 200 vdc. Standard tolerance is ±10%. U. S. Capacitor Corp., 2151 N. Lincoln St., Burbank, Calif. 91504. [356]

of what could be done with the division's thick-film hybrid-circuit capability. "We thought we could sell higher speed and power than is available in monolithic ic's" he says. "And because the linear ic market is growing so fast, we wanted a companion device for linear ic's. We had experience with wideband power amplifiers, so we continued applying the things we know best. We wanted to give the user of linear ic's a device to boost the output 20 to 40 times."

Usually, Smith points out, discretely are used to get power out of op amps. But, he quickly adds, this approach requires six to eight times

the space of the Beckman device, which uses a half-inch square of board space. Only 0.170 in. high, the power amplifier is about the same size as the op amp with which it is used.

According to Smith, a discrete booster that would be comparable with the model 821 would sell for about \$100. Beckman's amplifier, on the other hand, is priced at \$35 in quantities of one to nine. And if the op-amp user wanted to develop his own associated power amplifier that's comparable, Ypma and Smith say, he would find it a costly process.

Pre-engineering. "The features

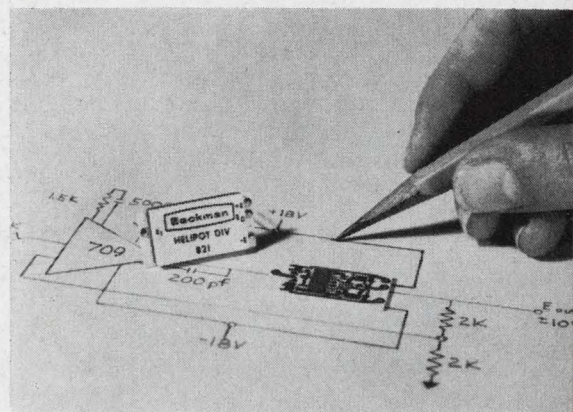

Hybrid muscle. Op amp power booster has short-circuit protection.

SPUTTERING ELECTRODES

■ METALS

zone refined for the ultimate in purity

■ ALLOYS

magnetic and custom alloys — precisely controlled compositions

■ NON-METALLICS

nitrides, oxides, silicides

Any shape . . . any size!
Many available from stock for immediate delivery.

MRC is the world's largest supplier of hi-purity sputtering and vapor deposition materials. Equipment for sputtering is also available.

Send for literature and prices on MRC's Electronic Materials.



**MATERIALS
RESEARCH
CORPORATION**

Orangeburg, New York 10962

(914) 359-4200

"Cable MATRESCO"

88c

we're building into the model 821 —power boost, absolute short-circuit protection, wide bandwidth, wide voltage swing, and elimination of overloads reflected back into the IC—pose design problems the user would rather not have to solve himself," Ypma maintains. "He wants a pre-engineered device he can drop into the feedback stage and have no problems."

Beckman buys only the active elements—diode and transistor chips—for its hybrid. The company makes its own passive elements—alumina substrate, conductors, crossovers, resistors, and capacitors—which are screened and fired onto the substrate. "After they're fired," says Ypma, "these elements either work together or fail together." In terms of reliability, he says, the passive network can almost be considered a monolithic device.

Once the diode and transistor chips are added, the four-pin package (input, output, and plus and minus power terminals), is sealed with an alumina lid. An inert helium atmosphere is inside the package. According to the amplifier's developers, both the lid and the substrate have high enough thermal conductivity to eliminate the need for extra heat sinks.

Same power source. The model 821 runs off the same power used to drive the linear IC with which it is associated. As long as the power is between 10 and 20 volts, Smith says, the amplifier's specifications needn't be changed.

Beckman officials look for their device to make operational amplifiers more attractive for military applications because of the space and weight advantages it offers over discrete power boosters. They're also looking for new applications in process control—driving relays, galvanometers, and terminated lines.

Specifications

Power output	2.5 w
Voltage swing	±16 v
Gain bandwidth	—3 db at 30 Mhz
Rise time	10 to 90% from 0 to ±10 v, 60 msec max.
Temperature range	—55° to +125°C
Delivery	30 days

Helipot Division, Beckman Instruments Inc., 8475 Artesia Ave., Buena Park, Calif. [357]

New components

Amplifying data without noise

Encapsulated module with variable gain mounts to p-c boards

For the engineer who needs a data amplifier designed to handle low level signals developed by strain gages, thermocouples, bridges, and other transducers used in research and industry, size and cost has always been a problem. Now, an encapsulated device is available for printed-circuit board mounting that sells for \$220, less than half the price of conventional units with comparable specifications.

Analog Devices' model 601 wide-band differential d-c amplifier measures approximately 2½ by 1 by 3½ inches compared to conventional rack-mounted units of 6 by 1 by 18 inches.

Essentially a subsystem, rather than a universal building block like an operational amplifier, the model 601 comes with closed-loop control of gain that enables the user to set signal amplification anywhere from 20 to 2,000. It features high common-mode rejection, good d-c stability, high input impedance, and wide bandwidth, all of which are simultaneously needed in data-amplifier applications.

Special blocks. The data amplifier is a special-purpose subsystem, whereas the op amp is a general-purpose building block. Data amplifiers are used almost exclusively to increase the amplitude of millivolt range signals (from microvolts to millivolts), and usually in the presence of ground-loop and common-mode noise. By contrast, the operational amplifier may be used as the basic building block for oscillators, active filters, comparators, integrators, and current sources, none of which is an amplifier circuit in the usual sense.

For example, it would be possible to base a circuit capable of amplifying microvolt signals on Analog's model 201 chopper-stabilized operational amplifier. This

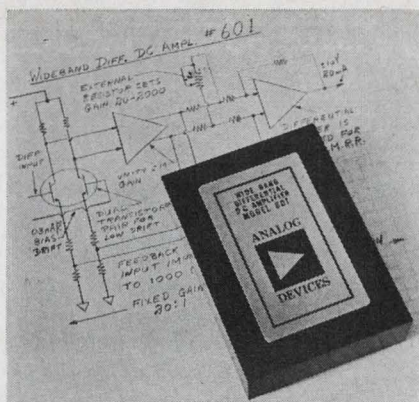

Reduced size. Modular data amplifier, 2½ by 1 by 3½ inches, replaces rack-mounted units in most low-level applications.

unit has tenfold better voltage stability than the 601 data amplifier. However, the chopper amplifier's low-input impedance and single-ended operation would prevent its use in the majority of data-acquisition applications.

Although it would be possible to use two such amplifiers in a good data-handling circuit, cost and size would become excessive and the end result would offer no great advantage over existing data amplifiers.

Similarly, the model 147 FET amplifier has the impedance and d-c stability capabilities of a data amplifier, but its 300,000:1 common-mode rejection ratio, although high for a FET op amp, would be inadequate for high accuracy measurements in the presence of ground loops and common-mode noise.

Adjustable gain. Key specifications for the model 601 include 2 $\mu\text{V}/^\circ\text{C}$ maximum input voltage drift, 300 $\text{pa}/^\circ\text{C}$ maximum bias current drift, and 100 $\text{pa}/^\circ\text{C}$ maximum off-set current drift, over the working temperature range of -25° to $+75^\circ\text{C}$. Input impedance is 1,000 and 10 megohms, respectively, for the common-mode and differential values, while common-mode rejection ratio is 10^6 (120 decibels) for the 2,000:1 gain setting and for as much as 1,000 ohms source-impedance unbalance and 60 hertz operating frequency. The gain is adjustable by adding an external resistor.

Output rating is ± 10 volt at 20 milliamps and full power output is developed to 20 khz.

Analog Devices, Inc., 221 Fifth Street, Cambridge, Mass. 02142 [358]

How To Solve Your Power Supply Problem—

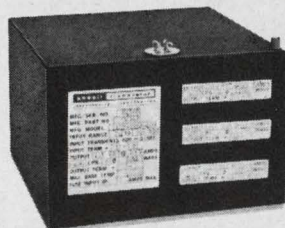

28 VDC to 400 A 3 ϕ
Model Q10D-115A-400Y
Size 6" x 6" x 4" — Wt. 8.3 lbs.
Output 100 volt amps

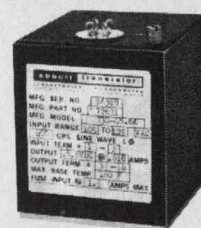

400 A to DC (Reg)
Model T3D-48.6A
Size 2¾" x 3" x 3¼" — Wt. 2.3 lbs.
Output 48 VDC at 618 ma

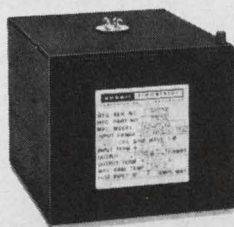

60 A to DC (Reg)
Model V6D-27.6A
Size 4½" x 6" x 4" — Wt. 10.3 lbs
Output 28 VDC at 2.1 amps

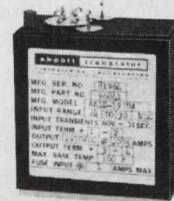

28 VDC to DC (Reg)
Model AK1D-1970A
Size 1½" x 2¾" x 3" — Wt. 1 lb.
Output 2000 VDC at 5 ma

NEW! Mil-Spec Quality Power Supply Modules for All Types of Power Conversion

Abbott has a new line of power supply modules. They are built to meet military environment-MIL-E-5272C. All types are available with any output voltage you need from 5 volts to 10,000 volts DC—and DC to 400 A inverters with either 1 ϕ or 3 ϕ outputs.

DC to 400 A , 3 ϕ —This new inverter changes 28 VDC battery voltage to three phase power with outputs of 33, 66, and 100 volt amps, 400 cycles or 800 cycles, as well as output voltages of 115 VAC or 27 VAC. All three phases are independently regulated at 1%. Also, 1 ϕ output units are available with powers of 30, 60, 120 and 180 volt amps, 400 cycles or 800 cycles, at 115 VAC or 27 VAC. All of these solid state inverters are completely described on Pages 13, 26 and 27 of our new catalog.

60 A to DC—These modules are the smallest, lightest weight 60 A to DC power supplies we have seen. They are well regulated for line and load changes. Hermetically sealed for military environment they will operate to 160°F heat sink temperatures. They are available in any output voltage you need—5 volts to 10,000 volts,

with power outputs of 5, 10, 20, 30, 60, 120, and 240 watt sizes as standard catalog listings. You will find them completely described with prices on Pages 2, 3, and 4 of our new catalog.

400 A to DC (Reg)—Designed especially for 400 A input power, this line of converters is available with any output voltage you want—5 volts to 10,000 volts DC. Power outputs of 5, 10, 20, 30, 60, 120, and 240 watt sizes are standard. Well-regulated and hermetically sealed, these units are described on Pages 5, 6, and 7 of our new catalog.

DC to DC (Reg)—Some of these DC to DC converters are as small as a package of cigarettes and weigh less than a pound. Output voltages from 5 volts to 10,000 volts are all listed as standard models in our new catalog. Power outputs come in standard sizes from 5 to 240 watts. These converter modules feature close regulation, short circuit protection and hermetic sealing for rugged applications found in military environment. They are listed in order of increasing output voltage on Pages 8, 9, and 10 of our new catalog.

If you need a power supply module in a hurry please check Pages 1665 to 1678 in your EEM (1967 ELECTRONICS ENGINEERS MASTER Directory). Most of the above units are listed there. Or, for a complete list of our power supply line please send for your FREE 36-page catalog.

abbott transistor

LABORATORIES, INCORPORATED
5200 W. Jefferson Blvd. • Los Angeles 90016
Area Code 213 • WEBster 6-8185

TO: Abbott Transistor Labs, Inc., Dept. 41
5200 W. Jefferson Blvd.
Los Angeles, California 90016

Sir:
Please send me your latest catalog on power supply modules:

NAME _____ DEPT. _____

COMPANY _____

ADDRESS _____

CITY & STATE _____

New Subassemblies Review

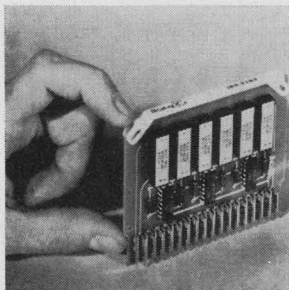

Reed relay IC logic card IRR-2293 is for low-level switching, multiplexing and other switching uses. It provides 6 normally-open spst contact relays each controlled with a 3-input driver. The reed contact is closed when all 3 inputs to each driver are positive, and open when any one of the 3 is negative. Engineered Electronics Co., 1441 E. Chestnut Ave., Santa Ana, Calif. 92702. [381]

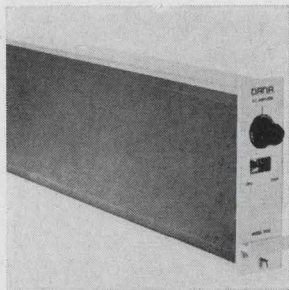

Direct-coupled 2820 is an active guard differential amplifier designed for research instrumentation and data acquisition. No common mode return path is required to achieve a common-mode rejection of 120db, d-c to 60 hz. Noise referred to the input at a gain of 1,000 is less than 4 μ v rms at full bandwidth. Dana Laboratories Inc., 2401 Campus Dr., Irvine, Calif. 92664. [382]

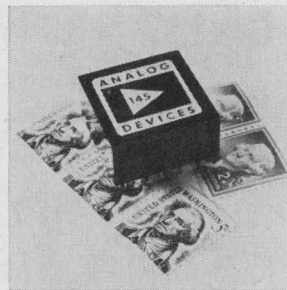

Differential FET operational amplifier model 145 features 40-v output swing at 2.5 ma. Specifications include 50,000 d-c gain, 1.5 Mhz bandwidth, 10 khz full power response, 30 μ v/ $^{\circ}$ C drift, 100 pa initial bias current at 25 $^{\circ}$ C, 10¹¹ ohms common mode and differential input impedance. Price is \$75 each. Analog Devices Inc., 221 Fifth St., Cambridge, Mass. 02142. [383]

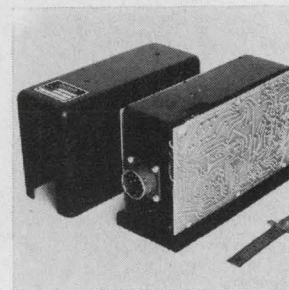

Servo amplifier GA453 is a linear unit designed to drive d-c motors and torques to 400 w of power. Its inherent drift stability eliminates need for balance adjustments. The device provides a bidirectional two-wire output that is d-c isolated from the input signals. It operates from a 28-v d-c power supply. Glentek Inc., 1557 7th St., Santa Monica, Calif. 90401. [384]

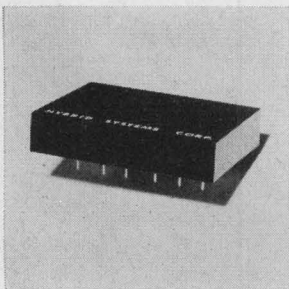

Upon command, the SH-100 samples input analog voltage and holds its value for an indefinite period, or until commanded to sample again. Hybrid analog/digital techniques result in zero decay (no droop) of stored analog voltage. Acquisition time is 200 μ sec max. and accuracy is \pm 0.5% max. Hybrid Systems Corp., 127 Alewife Brook Parkway, Cambridge, Mass. 02140. [385]

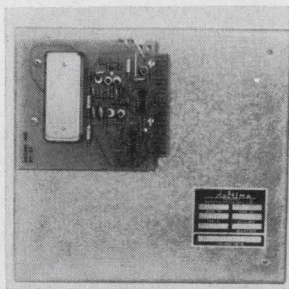

Memory module model 214A/RZ-90 features direct interface for IC's and a storage capacity of 10,000 bits. It uses a magnetostrictive delay line in the RZ mode, and requires only gating signals, clock and a power supply to operate. Unit is rated to operate between 0 $^{\circ}$ and +50 $^{\circ}$ C. It has a prf of 1 Mhz max. at 10 msec. Seaelectro Corp., 225 Hoyt St., Mamaroneck, N.Y. [386]

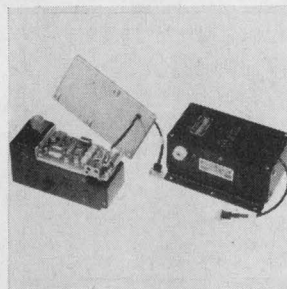

Miniature h-v power supplies HVU6 & 7 take d-c and a-c inputs respectively. Designed for avionic use, the HVU6 can provide a continuously variable output of 10 to 15 kv d-c with a max. continuous load current of 250 μ a. Combined line, load, and temperature regulation is better than 1%. Computing Devices of Canada Ltd., Box 508, Ottawa 4, Canada. [387]

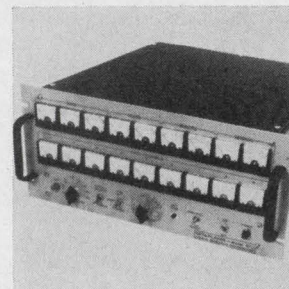

Dataplexer 6711 incorporates a time-code generator/reader, utilizing time division techniques to offer flexible multichannel analog recording on the single track of a magnetic tape recorder. It provides 9 channels of analog data plus 9 channels of time information. The unit is adaptable to a standard rack mounting. Kratzenberg Inc., 298 Main St., Buffalo, N.Y. 14202. [388]

New subassemblies

A switch for the teletypewriter market

Programed system can store and forward messages for 40 circuits having 40 teletypewriter stations each

Prohibitive pricing—upwards of \$200,000—has limited the market for teletypewriter switching systems. Rather than buy, many brokerage firms, advertising agencies, and news-gathering services rent such systems and time-share computers. Others simply “switch”

messages by tearing off paper tape from one machine and hand-carrying it to another.

Texas Instruments Incorporated, however, reasoned a lower-priced system could turn a good part of this rental market into a buying market. The company is going af-

ter this market with a programed switching system capable of handling from two to 40 teletypewriter circuits. Priced at \$80,000, the new system—called the 861 EMS (Electronic Message Switch)—stores messages in a disk memory and forwards them to their destinations whenever lines are available.

The 861 uses only integrated circuits and, because of the system's modular construction, it is easily expandable. Programed for six circuits, the system requires a set of interface cards and some additional programing for each circuit that is added. For a charge, ranging from \$30 to \$50 an hour, TI will

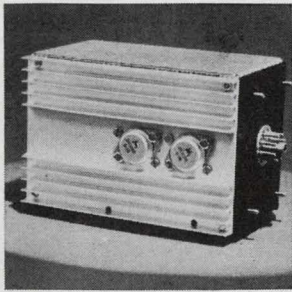

Dual supply SEI-15/15-C is for powering operational amplifier circuits. It provides 1 amp of continuous power on each of the outputs, is short circuit proof, and allows independent adjustment of each output over a range of ± 0.5 v. Input voltage is 110-130 v a-c, 60 hz; regulation, line and load, 0.02%. Sallent Electronics Inc., Blue Barns Rd., Rexford, N.Y. 12148. [389]

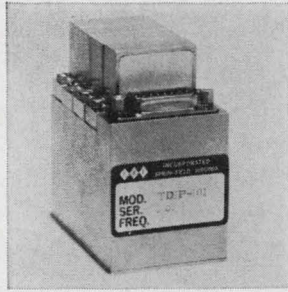

Plug-in telemetry decoders in the BAB series permit rapid changes of tone channels. Standard IRIG and non-standard tone channel frequencies are available. Each module contains a 2-section tone decoder filter, amplifier and relay. Standby power is 0.5 ma per channel. Relay capacity is 2 amps at 20 to 32 v. TRF Inc., 6627 Backlick Rd., Springfield, Va. 22150. [390]

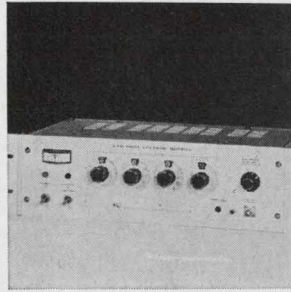

Regulated d-c biasing supply 246 has an output capability of 0 to 3,100 v and a stability of 0.01%. It is suited for use with photo-multiplier tubes, ion gauges, photocells, and other current detectors. The unit features line regulation of 10 ppm, load regulation of 20 ppm. Price is \$450. Keithley Instruments Inc., 28775 Aurora Rd., Cleveland, Ohio 44139. [391]

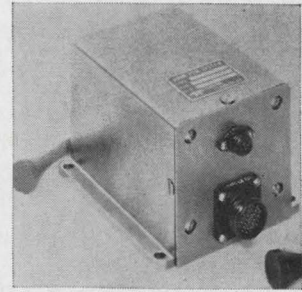

Microminiature pcm system CT-100 is comprised of a 32-channel time division multiplexer, sample-and-hold, 8-bit analog-to-digital converter, system clock, power supply, and serial non-return-to-zero output logic. High density IC packaging is used throughout except for the power supply. Prices start at \$10,000. Teledyne Telemetry Co., 9320 Lincoln Blvd., Los Angeles 90045. [392]

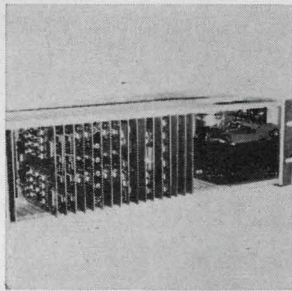

Magnetic core memory model DC-31 is a compact 2D unit featuring random access operation with full cycle time of less than 900 nsec. Memory access time is less than 450 nsec. Maximum capacity of the unit is 1024 x 12 in one-bit-per-word increments. Prices start at \$1,210, and delivery can be made in 30 days. Datacraft Corp., 776 N.E. 40th Court, Ft. Lauderdale, Fla. 33307. [393]

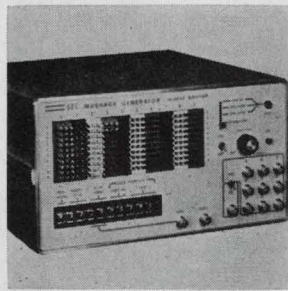

Fully programable digital data simulator model 900-SP provides either parallel or serial outputs at clock rates to 10 Mhz. Heart of the unit is a tiny plastic programming pin that makes it possible to program 900 bits on a pin board that measures 7 x 13 in. Price is \$3,227; delivery, 30 to 60 days. SRC Division, Moxon Electronics, 2309 Pontius Ave., Los Angeles 90064. [394]

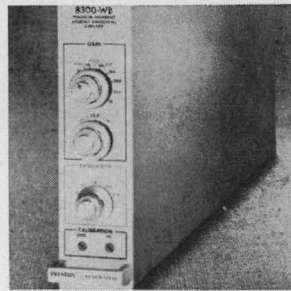

Floating differential amplifier 8300-WB operates over a bandwidth of 50,000 hz with 10 calibrated switch-selectable gains from 1 to 1,000. Input noise at full bandwidth is less than 7 μ v rms at input impedance not greater than 1,000 ohms. Low drift, 0.2 μ v/ $^{\circ}$ C, is achieved without mechanical choppers. Preston Scientific Inc., 805 E. Cerritos Ave., Anaheim, Calif. [395]

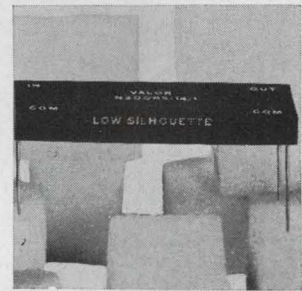

Standard nanosecond delay lines come in 2 package configurations: low silhouette (typically less than 0.225 in. high) and slim line (typically 0.385 in. and 0.265 in. max. width). Units have delays ranging from 2.5 to 100 nsec in the 125-Mhz cut-off range; 5 to 200 nsec in the 65-Mhz cut-off range. Valor Electronics Inc., 13214 Crenshaw Blvd., Gardena, Calif. 90249. [396]

provide a programmer to make the changes. The memory has a capacity of 14 circuits. If more are required, a larger memory must be used.

As many as 40 teletypewriter stations—the maximum allowed by telephone-company regulations—can be tied into each circuit. Once the number of stations has been decided, changing it requires changing the program. Two hours of a programmer's time are necessary when adding a single station to the circuit. However, no additional hardware is required.

Self-help. The 861 handles either 75 or 100 words-per-minute signals

and operates with various input and output devices, including paper tape, magnetic tape, and teletypewriter. Messages are assigned one of two priority levels, with those having the higher priority forwarded first. Other features include a circuit-failure alarm, attempted self-restoration if failure occurs, and message-storage for the defective circuit. The system also keeps a running record of all messages sent and received.

Power supply, computer, memory, and related electronics are in a 70-by-48-by-24-inch cabinet.

Texas Instruments Incorporated, Dallas [397]

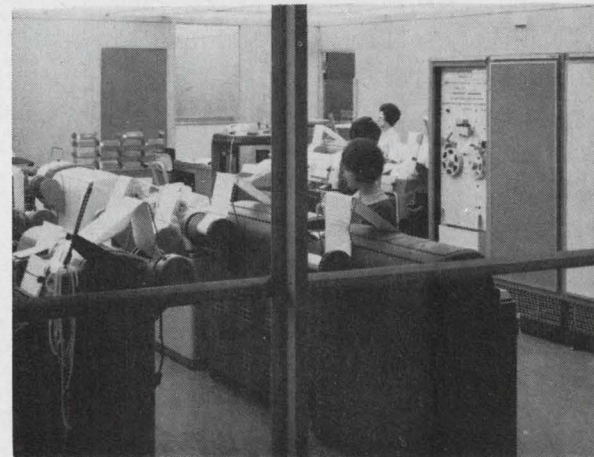

Keeping track. Switching system, right, controls traffic on multicircuit teletypewriter network.

CONSIDER COLORADO / INDUSTRIAL COLORADO

... where you have your choice of weather. For business or pleasure. For golfing or skiing. For living or traveling. On the plains or in the mountains. All year-round.

Consider Colorado's climate variety. Variety that makes Colorado "Ski Country, U.S.A." only in the mountains. Commercial centers on the State's eastern and western plains and plateaus with less snow and warmer winter weather than most northeastern and midwestern cities. Towering Rockies that lift and cool moisture-laden prevailing winds from the Pacific, producing precipitation in the high country. Air that is warm and dry when it reaches the lower elevations.

Consider the effect of Colorado's climate on business and recreation. Good visibility and favorable weather conditions keep people and products moving on schedule. Stapleton International Airport open for operations 99.86% of the year (closed less than 13 hours annually). The vast majority of Colorado highways open every day of the year. Absenteeism due to adverse weather conditions almost nil. Power outages due to climate conditions nearly nonexistent. Ski season from December to May in the high country. Golfing 300 days a year in most Colorado cities. Businessmen and shoppers on Colorado streets without topcoats in mid-winter. Summers with low relative humidity and cool, pleasant evenings that are comfortable even without air conditioning.

If a climate favorable to industry and pleasant living can be advantageous to your business, consider Industrial Colorado for your expansion or relocation.

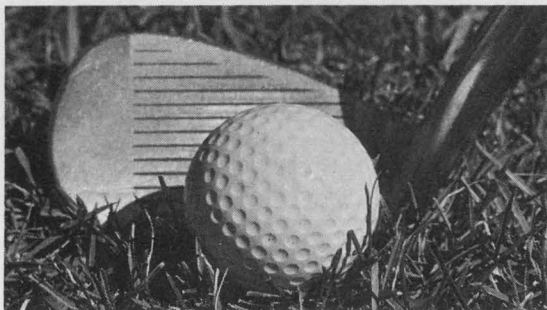
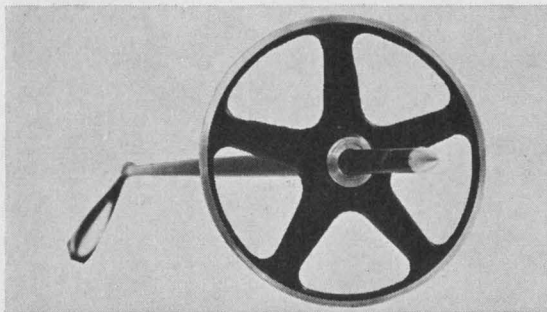
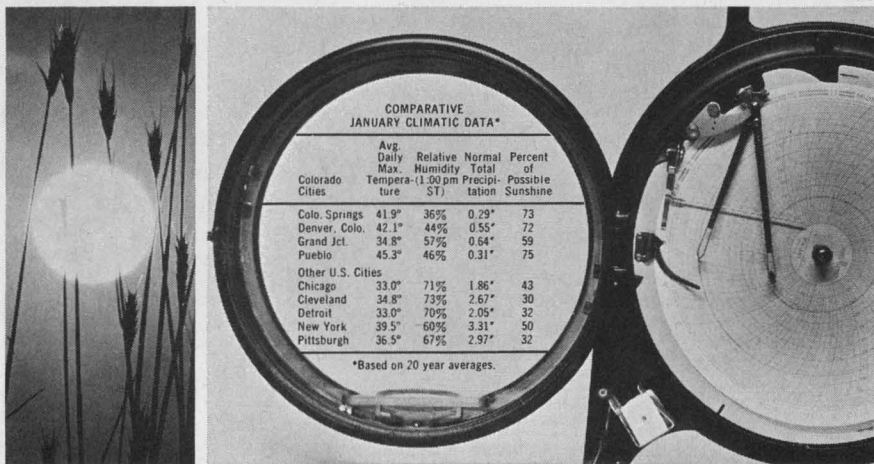

To paraphrase a familiar song "The snow in Colorado stays mainly in the mountains." It accumulates on the ski slopes and watersheds, but it melts quickly at lower elevations and business activities are carried on unhampered by weather. Write for a complimentary copy of *Industrial Colorado*, a revised-to-the-minute, factual, spiral-bound portfolio. It covers important considerations pertinent to plant expansion or relocation in any part of the State. Address inquiries to Ronald D. Lemon, Director, Industrial Research & Development, Division of Commerce and Development, 67 State Services Building, Denver, Colorado 80203.

New subassemblies

LST arrives at terminal before LSI

Large-scale tester can probe 3,000 spots on boards, circuits, chips

When Marvin Paller first demonstrated his firm's Scat-28 (Sequential Circuit Automatic Tester) to a friend, the friend went home, assessed what he had seen, then called Paller to say he didn't believe the machine was doing what it appeared to be doing. Paller, manager of Continental Device Corp.'s Apparatus division, says the Scat-28 can probe 20 terminals on an integrated circuit, and can be expanded to handle 200 terminals.

Now Continental has come up with the Scat-30; it can probe up to 3,000 terminals at a time, whether they are circuit boards, packaged ic's or large-scale integrated chips, Paller says.

Paller's friend would be even more skeptical about the performance that Continental is claiming for the newer machine. Another industry source shares this skepticism, saying the unit would be almost worthless for LSI testing because in its present form it can do only d-c testing. But Paller insists that the machine can be adapted to do testing up to 100 kilohertz or to 1 megahertz. "It's presently a d-c machine because our policy is to build the simplest machine for the application," he says. The Scat-30's first use will be in testing printed circuit boards.

New frame design. Development of the machine began about six months ago after a customer asked for a machine that could test circuit boards with up to 3,000 terminals. For that many terminals a completely new hardware frame design was required. Paller maintains that most competitive ic testers can probe from 14 to 40 terminals. Among those he lists are Fairchild's 4,000 and 5,000 series machines, and Texas Instruments' 600

series. The Fairchild and TI machines sell for between \$70,000 and about \$130,000, says Paller; the Scat-30 will carry a price tag between \$100,000 and \$200,000, depending on the application.

The principal variables influencing price, according to Paller, will be the kind of interconnection to the circuit or set of circuits being tested, the type of programing for the application, the kinds and speeds of output information, and the level of accuracy of the measurement circuits in the machine. He claims that the Scat-30 can be accurate to 0.1%, but adds that such tight accuracy isn't required by the two customers who have ordered the tester; 2% is adequate for them.

Paller stoutly defends his contention that the Scat-30 "is a natural" for preproduction or custom IC and LSI testing and design. "The machine can't tell the difference between circuits on a board and those on a chip," he says. He adds that now that new interconnection techniques between the machine and the device to be tested have been developed, it's a fairly straightforward mechanical engineering task to design a fixture to hold 3,000 press-type probes for an LSI chip. The fixture for testing circuit boards holds up to 3,000 spring-like probes that are brought down in drill press fashion to make contact with the boards to be tested.

Forecast good. Paller's enthusiasm for the Scat-30 isn't dimmed by protestations that few chip designers are far enough into LSI to test 3,000 terminals on a chip. He forecasts a market of 20 to 50 of the machines in the next three years for chip-testing alone, and says another 100 will be sold for circuit-board testing in the same period.

The Scat-30, says Paller, can be linked to any digital computer on the market. Examples he cites are models in the IBM 360, Scientific Data Systems' Sigma, and Digital Equipment Corp.'s PDP series. In computer controlled testing the program is initiated, and the computer takes the Scat-30 test results to generate new mask images or data listings. New masks for the circuits being tested can then be drawn by other means, avoiding interconnections to bad devices. The tester is programed with a high-speed optical reader and can output data to a

Amplitude modulation without incidental FM

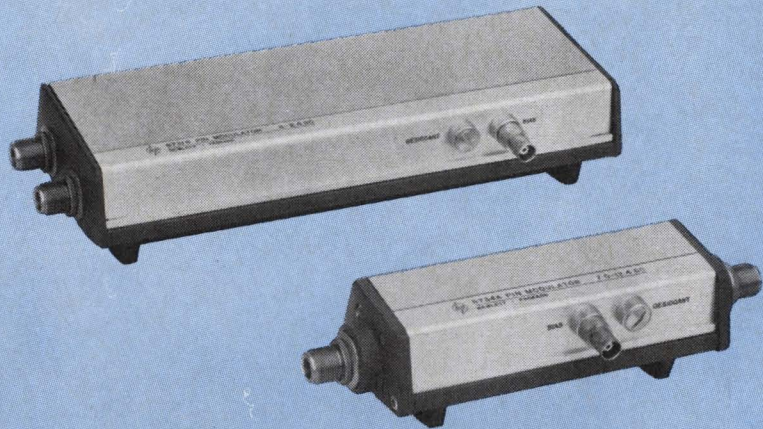

Using HP PIN Modulators

Hewlett-Packard microwave modulators (employing PIN diode arrays) provide coverage from 0.8 to 12.4 GHz in four wideband coax ranges, plus X-band waveguide (8.2-12.4 GHz). For each frequency band, there's a modulator with 35 dB dynamic range for general usage and one with 80 dB dynamic range for high "on-off ratio" pulse modulation.

These modulators absorb RF power and minimize incidental FM by presenting a nearly constant match to both source and load. You can pulse modulate, perform switching functions, level the output of microwave generators or amplitude modulate with sinusoidal and complex waveforms—all without frequency pulling.

All HP PIN modulators have fast rise times, typically less than 30 nanoseconds. And each modulator can handle one watt (average and peak) of applied RF.

HP MODEL NUMBER	FREQUENCY RANGE (GHz)	DYNAMIC RANGE (dB)	SWR		PRICE
			@ Min. atten.	@ Max. atten.	
8731A	0.8-2.4	35	1.5	1.8	\$300
8731B	0.8-2.4	80	1.6	2.0	525
8732A	1.8-4.5	35	1.5	1.8	300
8732B	1.8-4.5	80	2.0	2.0	525
8733A	3.7-8.3	35	1.8	2.0	325
8733B	3.7-8.3	80	2.0	2.2	550
8734A	7.0-12.4	35	1.8	2.0	350
8734B	7.0-12.4	80	2.0	2.2	575
8735A	8.2-12.4*	35	1.7	2.0	350
8735B	8.2-12.4*	80	2.0	2.2	575

*X-band waveguide (WR-90)

For more information about these exceptionally flexible microwave modulators call your local HP field engineer or write Hewlett-Packard, Palo Alto, California 94304; Europe: 54 Route des Acacias, Geneva. Ask also about the HP 8403A modulator, a versatile pulse generator designed to drive HP PIN modulators (8403A, \$800).

HEWLETT  PACKARD

MICROWAVE TEST EQUIPMENT

04717

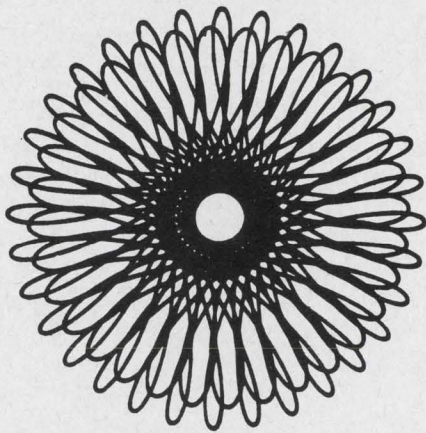

CYCLIC A/D CONVERTER

For more than a decade, engineers have attempted to design a workable CYCLIC A/D converter. Bunker-Ramo has engineered and manufactured the first practical Cyclic A/D converter, the B-R 850.

- **CYCLIC!** Within the B-R 850, the signal is synthesized rather than successively approximated. Input data conversion is continuous, eliminating requirement for sample and hold. Output can be sampled continuously or on command.
- **FAST!** Worst-case conversion time: 1 μ sec. for 8-bit word. 1-bit changes as short as 60-nsec. When following a multiplexer, conversion time will add less than 1 μ sec.
- **ECONOMICAL!** \$1,348 (single unit price); POWER: max 7½ watts; SIZE: 3¾" x 4¾" x 7½"; WEIGHT: less than 2-lbs.

For more information on the BR-850 and on our upcoming line of components, (i.e.: 12-bit, 300 KHz; 8-bit, 3 MHz converter; 16-channel multiplexer and others) please contact Mr. W. G. Garner. Phone (213) 346-6000 or write:

"SEE YOU AT THE IEEE SHOW—Booth 4E39-41"



THE BUNKER-RAMO CORPORATION
DEFENSE SYSTEMS DIVISION
8433 FALLBROOK AVENUE • CANOGA PARK CALIFORNIA 91304



Prober. Machine is designed to test as many as 3000 terminals at a time.

heavy duty teletypewriter system or to a computer printout.

Paller says the Scat-30 can handle all high-current Kelvin measurements and most high-impedance, low-current measurements. The machine consists of three main parts—a testing system similar to that of the Scat-28 but with considerably more lines (each with a current line and sensing line), and two interconnection units. The two units are housed in a console separate from the main tester. One holds 60 circuit boards on which are mounted specially developed reed relays; the other forms the part of the machine that makes contact with the parts to be tested. The reed-relay unit performs switching and multiplexing functions.

The machine incorporates diode-transistor logic, except for some transistorized drive functions for which higher powers are needed. Operational amplifier techniques are used for high-speed metering purposes, notes Paller. He says the machine can random access any two terminals out of the 3,000—or any combination of terminals. Devices are fed to the tester according to their configuration. "If the part is the size of a wafer mounted on some other substrate, it can be automatically fed using a belt-type drive system. The same technique can be used for circuit boards," says Paller.

Outputs from the Scat-30 could include limit information—go, no-go or go, low, high—or three-, four-, or five-decimal digital data on each measurement.

Continental Device Corp., 12515 Chadron St., Hawthorne, Calif. 90250 [398]

The Six MSD's

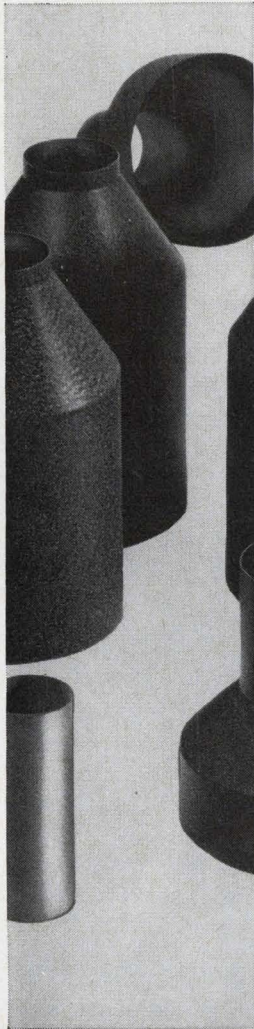

1 FABRICATION

MSD's Netic and Co-Netic Magnetic Shields can be fabricated in any size, shape and quantity, from a miniature tube to a shielded room.

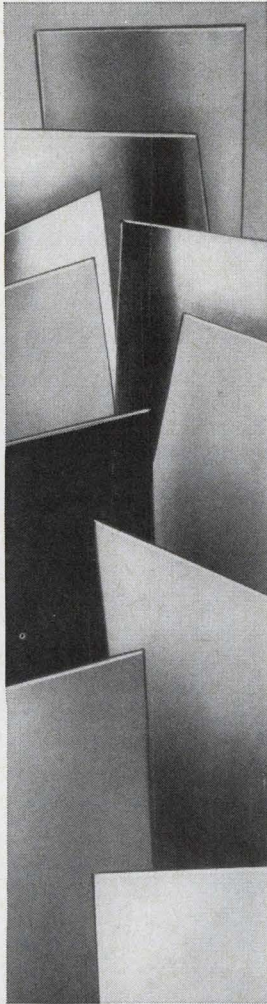

2 SHEET STOCK

For fabrication in your plant or ours. Low cost shielding solutions are provided by fully hydrogen annealed Perfection Annealed stock which normally requires no further heat treatment.

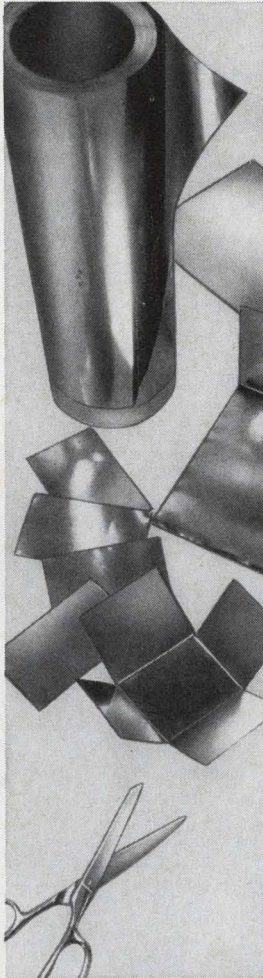

3 FOIL

MSD Netic and Co-Netic Foils are ideal for prototype evaluation and production applications. Available in both plain and adhesive backing, they can be easily shaped in minutes to fit your needs.



4 TAPE PRESERVER CONTAINERS

Used world-wide to protect against loss of valuable tape data. Round and rectangular portable units include the new, smartly designed "Executive." Stacked, sectionalized units for permanent storage are also available.

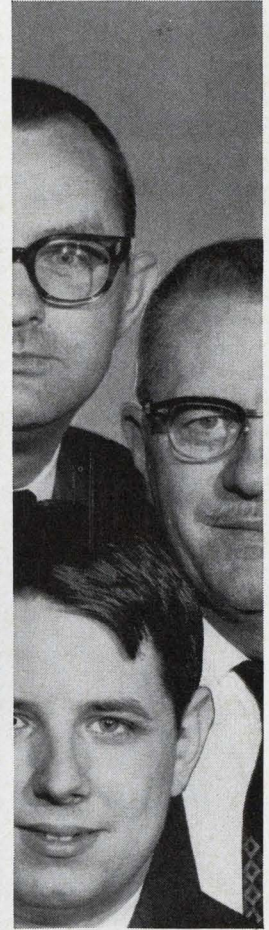

5 TECHNICAL ASSISTANCE

The concentration of design experience and engineering knowledge that has provided over 80% of the magnetic shield designs now in use is yours to assist you in solving an engineering, R&D or production problem. Phone 312, EV 4-2122.



Netic and Co-Netic are not affected by ordinary shock, have minimal retentivity and do not require periodic annealing

MAGNETIC SHIELD DIVISION PERFECTION MICA COMPANY

1322 N. Elston Ave., Chicago, Illinois 60622. TWX 910 221-0105

6 FAST, CONVENIENT DELIVERY is the SIXTH MSD.

Some items from stock. Fabricated items 3-4 weeks.



Thank you friend, whoever you are.

Out there among all you engineers, we have a friend. And we have a statistic to prove it!

About a year ago one of those magazine polls asked whom you would think of when buying relays and timing devices. You guys wrote down the names of all those giants.

Except our friend. He remembered us.



And he wrote down our name just as plain as can be, "MIDTEX/AEMCO."

That may not sound like much to you, but we sure did appreciate it. It's one thing to get only one mention, but to be shut out completely would have been terrible.

In fact, we so appreciate it that if we could find our faithful friend, we'd invite

him right down here to Mankato. We'd set aside our relays and timers and our new mercury wetted relays, and go out and kick up our heels a little bit. He'd enjoy it too, because our customers like RCA, General Dynamics and Westinghouse tell us Mankato really is Fun City U.S.A.

Come to think of it, we'll make the same offer to you. Next time somebody says, "Who can solve our relay problems," just blurt out "MIDTEX/AEMCO," and you're on your way to Mankato.

Fun fun fun.

But remember, when somebody says "relays" or "timers" you have to shout "MIDTEX/AEMCO!" just as quick as a wink.

Start training yourself now and we'll get ready for you here in Mankato.

By the way, if you plan to come down on the weekend, we'd appreciate hearing from you ahead of time. The movie show gets pretty crowded on a Saturday night you know!



AEMCO DIVISION
10 STATE STREET
MANKATO, MINNESOTA 56001

PROGRAMMERS/TIME DELAY RELAYS/MINIATURE COAXIAL RELAYS/INDUSTRIAL RELAYS/MERCURY-WETTED CONTACT RELAYS

New Microwave Review

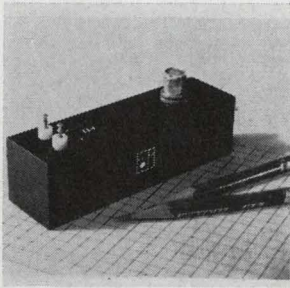

Solid state fundamental oscillators called Quietrons provide high harmonic rejection and low f-m noise. Model PM-7000 is mechanically tunable over any 10% bandwidth between 1 and 2 Ghz. Output power is 200 mw minimum into a 50-ohm load; input power, 2.5 w. Frequency stability is $\pm 0.050\%$. Alpha Industries Inc., 381 Elliot St., Newton Upper Falls, Mass. 02164. [401]



Double balanced mixer ASM-15 accepts r-f and local oscillator signals over a 0.2-1,000 Mhz range, and provides i-f output from d-c to 500 Mhz. Typical l-o/r-f isolation is above 35 db and conversion loss is less than 8.5 db. Maximum input power is 400 mw. Price is \$110; availability, stock to 4 weeks. A-R-Anzac Electronics Co., 121 Water St., Norwalk, Conn. 06854. [402]

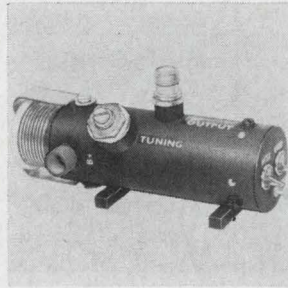
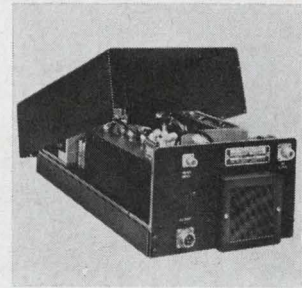
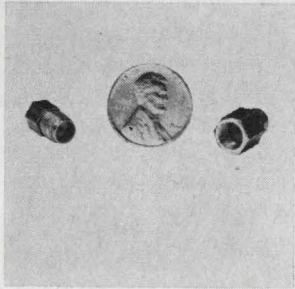

Plate pulsed oscillator model 8207 is a 20-oz, 6-kw peak output unit that operates in the 940-to 980-Mhz range, has a pulse width of 1 μ sec and a duty cycle of 0.001. Maximum output vswr is 1.2:1. Output impedance is 50 ohms. Frequency drift is less than 1 Mhz per 15-minute operation. Microwave Cavity Laboratories Inc., 10 N. Beach Ave., LaGrange, Ill. 60525. [403]



Air-to-ground f-m/tv relay links operate in C band with 20-w output and 10-Mhz baseband. Known as the MSRA series, the systems are available from 4 to 8 Ghz. Applications are in surveillance, communications and reconnaissance. Features include high density packaging and elimination of heat sinks. RHG Electronics Laboratory Inc., 94 Milbar Blvd., Farmingdale, N.Y. [404]



Coaxial terminations cover d-c to 18 Ghz, with a maximum vswr of 1.15, and can handle average power levels of up to $\frac{1}{2}$ w. Model TA-C80 uses a male type MFM connector, is 0.5 in. long and weighs 0.1 oz; the TA-C81 has a female type MFM connector, is 0.465 in. long and weighs 0.07 oz. Microlab/FXR, 10 Microlab Rd., Livingston, N.J. 07039. [405]

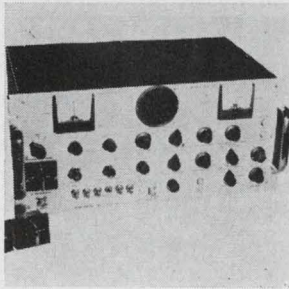

Self-contained microwave radiometer VHF-6R, with appropriate mixers, covers from 10 Mhz to 140 Ghz. Input frequency is 10 to 190 Mhz, noise figure is 3 db. Bandwidth is adjustable to 180 Mhz, 10 Mhz and 2 Mhz with plug-in filters. A bandwidth of 800 Mhz with 2-db noise figure is optional. Price is \$4,800. Space-Kom Inc., Box 235, Goleta, Calif. 93017. [406]

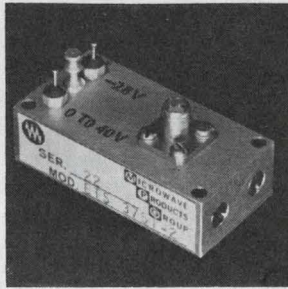

Fundamental oscillator ETS3751-2 provides in excess of 150 mw of output power over its 500-to 1,000-Mhz tuning range. It is voltage tunable with a control voltage of 0 to 28 v. The unit measures $\frac{5}{8} \times 1 \times 2$ in. Linearity deviation is less than 5%. Price is \$250; availability, from stock. Consolidated Airborne Systems Inc., 115 Old Country Road, Carle Place, N.Y. 11514. [407]

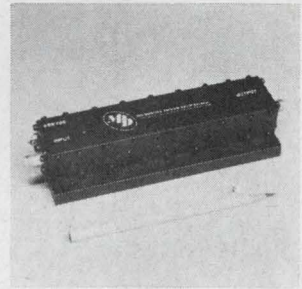

Transistor amplifiers, capable of generating up to 25 w at 250 Mhz and 10 w at 1,000 Mhz, employ a combination of lumped-strip line techniques. They can drive load vswr's of 2.5:1, at any phase, with negligible detuning and/or change in input vswr. Input vswr is 1.5:1 typical. Impedance is 50 ohms. Microwave Power Devices Inc., 114 Old Country Rd., Mineola, N.Y. [408]

New microwave

1968—year of the impatt

Two companies offer 100-milliwatt sources at X band; local oscillator, paramp, test-signal applications seen

"We hope to be selling impatt oscillators in thousand lots by the end of 1968," says one microwave marketing executive. He may succeed. Although impatt—impact avalanche transit time—oscillators aren't in mass production yet, there are signs that they may come

into their own this year.

One such sign is the large number of systems firms evaluating these microwave semiconductors for application to local oscillator, parametric amplifier pump, or test-signal source use. Among the companies are Hughes, Raytheon,

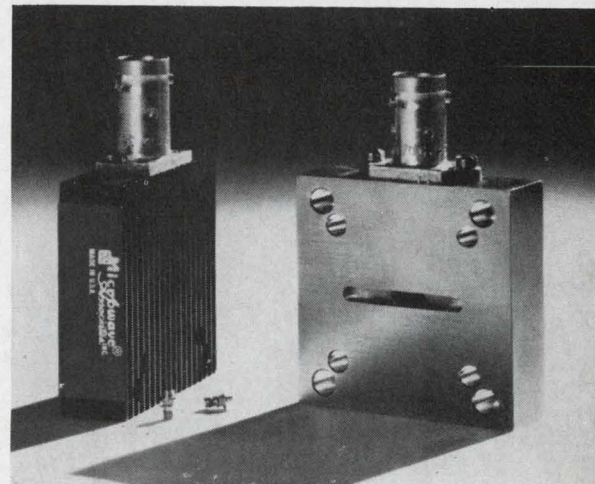

Out of lab. Impatt oscillators are moving into system designs.

WANG electronic calculators



perform all basic
arithmetic functions



instantly, silently, accurately.
Optional keys produce:

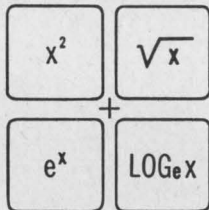

by single keystrokes.

There are models to fit every need. Wang calculators can be used to figure everything from monthly mortgage payments to rocket engine thrust coefficient. You can add fractions, do chain multiplication, produce reciprocals, store and recall sums of products, multipliers and/or entries as well as intermediate answers. You can have such options as: four additional random-access storage registers, 80 step plug-in card programmer and/or built-in programs for single keystroke calculations of $\sin \theta$, $\cos \theta$, $\arcsin x$, $\arctan x$. And that's just the beginning. Add-on compatibility enables you to build to a powerful computing system that will branch, loop, do sub-routines, make decisions and manipulate arrays. There is nothing comparable, anywhere.

For complete information, write:



WANG
LABORATORIES, INC.

Dept. 2-H, 836 North St., Tewksbury, Mass. 01876
Tel.: (617) 851-7311

In Major Cities, Tel.:

(201) 241-0250	(313) 278-4744	(514) 482-0737
(203) 666-9433	(314) 727-0256	(518) 463-8877
(205) 245-6057	(317) 631-0909	(601) 234-7631
(206) 622-2466	(319) 365-2966	(612) 881-5324
(212) 682-5921	(402) 341-6463	(614) 488-9753
(213) 278-3232	(404) 457-6441	(617) 851-7311
(214) 361-4351	(405) 842-7882	(702) 322-4692
(215) 642-4321	(412) 366-1906	(702) 735-5802
(216) 333-6611	(415) 454-4140	(713) 668-0275
(301) 588-3711	(416) 364-0327	(714) 234-5651
(301) 821-8212	(504) 729-6858	(716) 381-5440
(303) 364-7361	(505) 255-9042	(717) 397-3212
(305) 841-3691	(512) 454-4324	(816) 421-0890
(312) 456-1542	(513) 531-2729	(817) 834-1433
		(919) 288-1695

... improved materials technology, heat-sinking
help to boost power levels of new devices ...

Sperry, Westinghouse, and the Radio Corp. of America.

Another sign is the advent of higher-powered impatt oscillators. Both the Bomac division of Varian Associates, Beverly, Mass., and Microwave Associates Inc., Burlington, Mass., have just developed oscillator diodes which attain 100 milliwatts or more of X-band (8-12 gigahertz) power.

Microwave Associates' MA 4985 supplies a minimum of 100 mw continuously at frequencies between 9 and 12.4 Ghz with typical efficiency of 3 to 4%. Bias voltage is 70 to 100 volts d-c at about 50 milliamps. M-A's other new oscillator, the MA4984, puts out 50 mw at 2-to-3% efficiency. Bias is the same but current is about 40 ma. The complete MA4984 oscillator in a waveguide mount will be priced at about \$300.

Diode refill. Impatts are moving toward the applications stage and away from the laboratory. Microwave Associates' two new oscillators can be replaced in the field. The diode is removed with a single screw and a new one is dropped in to replace it. Minimal tuning of associated circuitry is said to bring power and efficiency up to rated levels.

The company also plans to sell individual impatt diodes as well. The MA4986 and -87 diodes cover 8.2 to 12.4 Ghz with 50 and 100 mw minimum outputs respectively. The MA4987 can attain peak output between 200 and 300 mw. Three other units reach into K-band; the MA4988 and -89 operate at 12.4 to 18.0 Ghz with 10 mw and 50 mw minimum outputs respectively; the MA4992 reaches 18 to 26 Ghz with a 10 mw minimum output. Each diode is supplied with basic instructions for constructing a mount—valuable information since the mount can play a large part in overall efficiency.

Power choice. Bomac's new impatts are the VA0012A, -012B, and -012C diodes. The most powerful of these new diodes, the -012C, produces 100 mw minimum. Typical power reaches 150 to 200 mw and individual units have gone well

beyond 200 mw. Minimum efficiency is 2.5%, measured at the rated minimum power of 100 mw. Direct current bias voltage is 60 to 80 volts at about 50 to 55 ma. Unit price for the VA0012C is about \$125.

For lower power applications, the VA0012A supplies a minimum of 25 mw. Efficiency is 0.75% minimum, 1.2 to 1.3% typical. The VA0012B delivers 50 mw with 1.25% minimum efficiency and 2% typical.

Bomac's line features a choice of pronged pill packages, one designed for minimum parasitic inductance, the other for minimum parasitic capacitance. Also, a number of mounts are offered: a high Q mount for low noise, a lower Q mount for phase-locked applications, and an Invar mount for tight control of output frequency with changes in temperature.

Bomac has succeeded in reaching thermal impedances of 15° to 20° C per watt on the -012C, and 25° to 30°C per watt on the lower-powered -012A.

Amplitude modulation noise for diodes on both Bomac and M-A is about 120 decibels below the fundamental output when measured 1 Mhz away from the carrier frequency.

Heat-sinking. Bomac and Microwave Associates reach the 100- to 200-mw level through improved heat-sinking and improved material technology. Part of the trick is the thermal bond that allows heat generated in the semiconductor to pass easily into the package and be dissipated.

Bomac's bonding technique has received a lot of the firm's R&D attention and is proprietary. So is Microwave Associates'. Another aspect of improved heat dissipation is the surface treatment the diode undergoes. Cleaning, passivation, and sealing of the surface must be carefully done to assure that the heat-transfer characteristics are not degraded.

Bomac Division, Varian Associates, Salem Road, Beverly, Mass. [409]
Microwave Associates, Inc., Northwest Industrial Park, Burlington, Mass. 01803 [410]

New microwave

Uhf triodes aim to plant tricolor

French tubes amplify tv signals for relay to isolated regions

France's Compagnie Francaise Thomson Houston-Hotchkiss Brandt, a major supplier of equipment to European ultrahigh frequency stations, is now counting heavily on U.S. sales.

The company's latest marketing entries in the U.S. are two power triodes—the TH302 and the TH328—designed for uhf translators. Heart of a translator is the amplifying device. The problem with triodes as amplifiers has been distortion at high gain. The company claims this problem has been solved in the TH302 and the TH328.

Linear. Both tubes are designed to operate in a frequency range from 470 to 960 megahertz. Each has a -52 decibel cross-modulation level and a 20 db gain.

In a class A amplifier, the TH328 uses 700 watts, delivers 100 watts output, and requires 2,000 volts at the anode. The TH302 uses 250 watts, delivers 25 watts to the antenna, and requires 1,500 anode volts.

Thomson Electric Co., Inc., 50 Rockefeller Plaza, Room 916, New York, N.Y. 10020 [411]

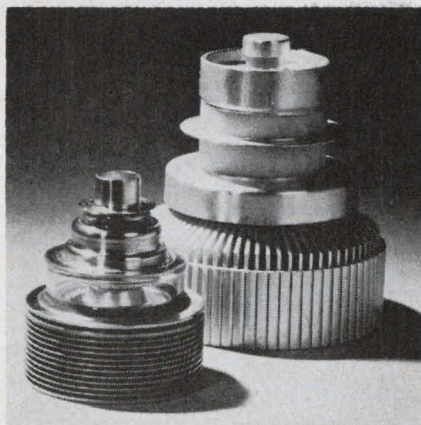

Passing it on. TH302, right, and TH328 amplify uhf signals at translator stations before retransmission.

this man has your printed circuit problems well in hand

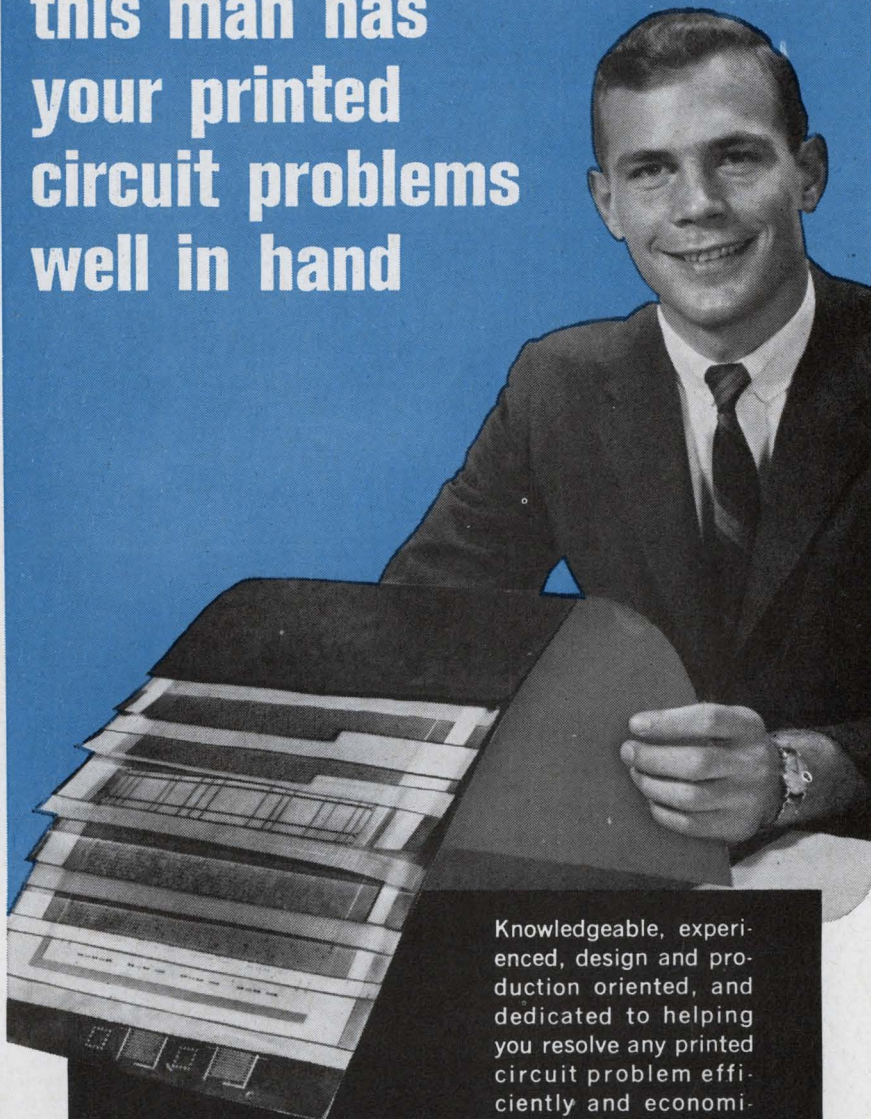

Knowledgeable, experienced, design and production oriented, and dedicated to helping you resolve any printed circuit problem efficiently and economically.

Methode is staffed, equipped, and experienced to provide you with a practically limitless printed circuit production capability from sub-miniature to king size, single to multi-layer boards with as many as 20 layers—with an established reputation for performance and reliability to meet the demands of any product, military or commercial.

If the space-age is pushing you into multi-layer integrated circuit designs, METHODE can show you how to keep the number of layers to a minimum. Your production costs will be reduced; reliability increased.

We are confident these capabilities can prove beneficial to you.

We invite your inquiry.



Printed Circuit Division

Methode Electronics, Inc.

General Offices:

7447 W. Wilson Ave., Chicago, Illinois 60656 • 312 867-9600

New Instruments Review

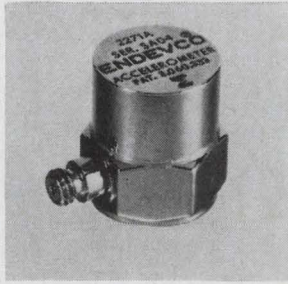

Accelerometer 2271A, weighing 1 oz., is for shock and vibration measurements. Features include flat charge sensitivity over a temperature range of -300° to $+500^{\circ}$ F, shock to 10,000 g in any direction, vibration to $\pm 1,000$ g sinusoidal in any direction, with frequency response $\pm 5\%$ from 2 to 5,500 hz. Price is \$225. Endeveco, 801 S. Arroyo Parkway, Pasadena, Calif. 91109. [361]

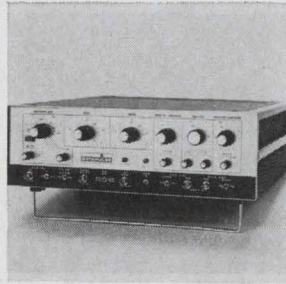

Pulse generator 110B features variable rise time from 4 nsec, and repetition rates to 50 Mhz. D-c baseline offset is variable over a 12-v range and is held constant by a closed-loop system. Positive and negative outputs are available simultaneously from less than 10 mv to more than 10 v into 50 ohms. Datapulse Inc., 10150 W. Jefferson Blvd., Culver City, Calif. 90230. [362]

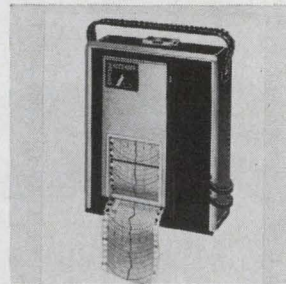

Miniature strip chart recorder LDV-8600 is a 3-range d-c voltmeter (0-150, 0-300 and 0-600 v d-c; all ranges 20,000 ohms/v). It is suited for monitoring input to electronic equipment as well as a broad range of industrial applications. The unit comes in portable or flush mount versions. Amprobe Instrument Div., Soss Mfg. Co., 630 Merrick Rd., Lynbrook, N.Y. 11563. [363]

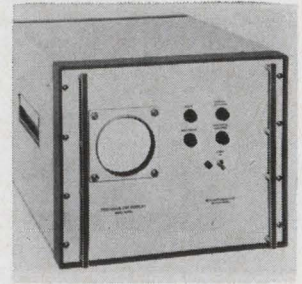

X-Y crt display PD900 is for use in film and hard copy recording, and film reading. It resolves more than 1,700 elements/diameter, and is capable of random access X-Y deflection from d-c to a slewing speed of 7 μ sec for the full diameter. Small signal bandwidth is greater than 1 Mhz. Price is \$6,200. Beta Instrument Corp., 377 Elliot St., Newton Upper Falls, Mass. 02164. [364]



Programmer ESC-125A uses digital-logic circuitry and controls the EMC-10 interference analyzer for the range of 20 hz to 14 khz, and the 15 octave bands of the EMC-25R from 14 khz to 1,000 Mhz. It automatically steps the rfi receiver-analyzer to the proper band and scans the band at a predetermined rate. Fairchild Electro-Metrics Corp., 88 Church St., Amsterdam, N.Y. 12011. [365]

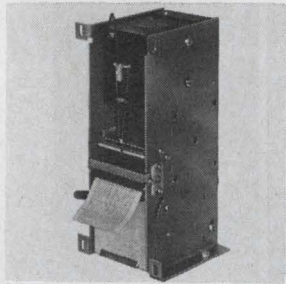

Rectilinear strip chart recorder Cygnus 220 has a response of d-c to 125 hz. Standard chart speeds are 25 and 50 mm/sec. Pressure thermal marking is used on the unit which accepts easily-loaded, heat-sensitive chart paper. The 220 operates efficiently in both the vertical and horizontal positions. Justus & Justus Corp., 1841 National Ave., Hayward, Calif. 94545. [366]



Rada-Pulser 5071B serves as a c-w generator as well as a video pulse generator. It provides a stable c-w signal from 10 Mhz to 250 Mhz continuously variable in 5 overlapping bands. Dial accuracy is $\pm 1\%$. Pulse repetition rates are continuously variable from 50 to 5,000 pps. Pulse width is 100 nsec to 100 μ sec. Kay Electric Co., Maple Ave., Pine Brook, N.J. 07058. [367]

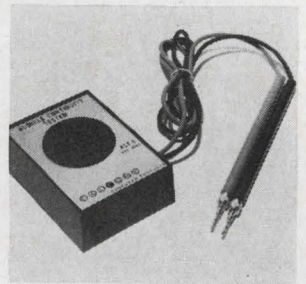

An audible continuity tester checks electronic circuits without danger to components, and replaces expensive ohmmeters. It also replaces buzzer and bells with their higher voltage drain. Continuity is indicated by clear tone and pitch changed with resistance (0 to 50 ohms). Price is \$9.95. CalComp Consumer Products, 626 W. Brookhurst St., Anaheim, Calif. 92801. [368]

New instruments

Putting the pressure on thin films

Transducer combined with signal-processing electronics; integrated package eliminates cables, cuts size and space

When engineers at Statham Instruments Inc. decided to design a new line of pressure transducers, they set as a goal a complete transducer-electronics package close to the size and weight of existing transducers alone. This approach, it was felt, would lead to better perform-

ance and eliminate interconnecting cables between the transducer and its signal-conditioning electronics.

The goal was achieved by using integrated-circuit manufacturing techniques to make both the transducer and the electronics. The two elements are combined in a

single, welded package. Thin-film construction, besides achieving substantial savings in size and weight, leads to good accuracy and reliability under extreme temperatures and shock.

Statham's AmpliBridge pressure transducer features a 0-5 volt d-c output signal compatible with most telemetry requirements.

The thin-film transducers are manufactured by vacuum deposition. A metal substrate provides the desired mechanical properties and a ceramic film is deposited onto the metal as insulation. Four strain gages, deposited onto the insulator, are electrically connected to a

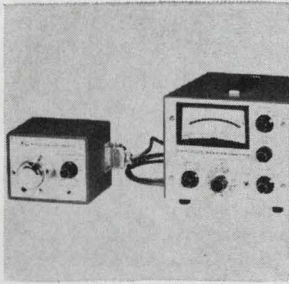

Vibrating capacitor electrometer model 640 measures voltage, current, and charge. It measures potentials as low as 1 μv . Input impedance is greater than 10^{10} ohms. Current sensitivity is to 10^{-17} amp (to 10^{-15} amp full scale). The unit offers less than 20 μv drift per day and per $^{\circ}\text{C}$. Price is \$1,875. Keithley Instruments Inc., 28775 Aurora Rd., Cleveland, Ohio 44139. [369]



Oscillator model 3305, for the 2003 sweep/signal generator system, permits coverage of 5 to 1,500 Mhz in a single sweep. Its wide range is made possible by a patented circuit that automatically sequences 3 voltage-controlled oscillators each covering a segment of the total range. Absolute linearity is 1.2. Telonic Instruments, 60 N. 1st Ave., Beech Grove, Ind. 46107. [370]

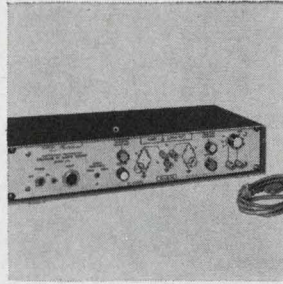

Precision r-f power bridge 445 allows measurement of absolute power with 0.15% accuracy with automatic temperature compensation. It is suited for r-f and microwave laboratory use, as well as for production calibration. It can be used as a lab standard against which other power measuring devices can be calibrated. Price is \$975. Narda Microwave Corp., Plainview, N.Y. 11803. [371]

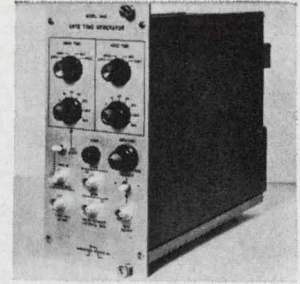

Gate time generator model 2410 is a precise and versatile square wave and dual pulse generator developed primarily for fast counter gating in high energy physics labs. A variable duty-cycle square wave is digitally generated, so that the period of each half-cycle can be separately controlled. Price is \$825. Nanosecond Systems Inc., 176 Linwood Ave., Fairfield, Conn. 06430. [372]

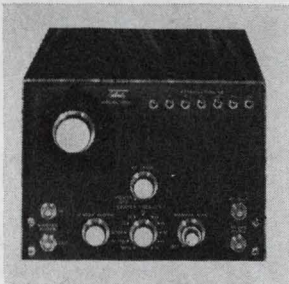

Sweep generator 1011 automatically tracks variations of the test frequency, suiting it for production testing and aligning vhf tv tuners and receivers. It supplies 0.5 v rms into 75 ohms with linearity of 1:1.5. Sweep width is continuously variable from 5 to 30 Mhz over the entire 5- to 250-Mhz tuning range. Telonic Instruments, 60 N. 1st Ave., Beech Grove, Ind. 46107. [373]

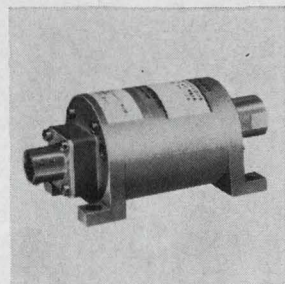

Reluctance pressure transducer 2304 combines high accuracy, fast response and continuous resolution plus high reliability with high level d-c output. Ranges from 0-15 to 0-5,000 psi, either absolute or gauge, are available in compact configurations. Static error band is $\pm 0.8\%$; acceleration and shock, 50 g. Bourns Inc., 6135 Magnolia Ave., Riverside, Calif. 92506. [374]



Bipolar integrator 922 integrates both positive and negative input signals to 100 mv with output in the form of an electrical analog of the integral. It offers infinite memory, permanently storing the last recorded integral until reset. Accuracy is $\pm 2\%$. Dimensions are 5.7 x 7 x 10 in. Price is \$395. Curtis Instruments Inc., 200 Kisco Ave., Mount Kisco, N.Y. 10549. [375]

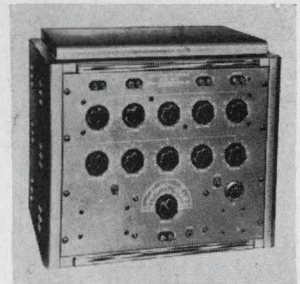

Direct readings of inductance and conductance of iron ore component at audio frequencies, with or without superimposed d-c, are featured in 3 new inductance bridges. Current ranges are 2, 15 and 30 amps superimposed d-c. Inductance readings are within $\pm 0.5\%$ to 5 khz with $\pm 3\%$ to 10 khz. Range is 20 hz to 10 khz. Freed Transformer Co., Weirfield St., Bklyn, N.Y. 11227. [376]

bridge circuit through vacuum-deposited interconnecting leads. These multiple evaporations are performed during a single pump-down. Lead wire is attached to the film by microwelding.

Temperature-stable. The thin-film sensor operates over wide temperature limits. Techniques developed in the manufacture of the thin-film transducers provide an intrinsically temperature-compensated transducing bridge. These techniques assure consistent performance even under changing temperatures.

Since the deposited strain-gage material is only a few millionths

of an inch thick, it exhibits excellent stability and gage factor, combined with high resistance to vibration. Because of the minute size of the sensing element, it is possible to package these transducers with Statham's Amplibridge electronics.

The Amplibridge is a direct-coupled differential amplifier. Comprised of a strain-gage transducer and a transistorized servoamplifier, it differs from most 5-v transducers in that all the transistors and the strain-gage pick-off are contained within a single feedback loop. The transduction element is a resistive, balanced, fully active, four-leg Wheatstone bridge. Typically, an

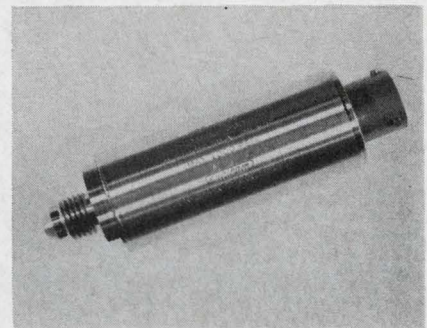

Single unit. Thin-film technology enables transducer and associated electronics to be packaged as a single small unit.

It's in the cards



Printed circuits can be your strong suit if you pick Cinch-Graphik for a partner. Quality is the name of the game. No wild cards. No fast shuffles. Just the finest circuit cards to make sure you have a winning hand. It's your deal... our bid. We're not bluffing, go ahead and call us.

CINCH-GRAPHIK

DIVISION OF UNITED-CARR



200 South Turnbull Canyon Road, City of Industry (Los Angeles), Calif. 91744 • Phone (213) ED 3-1201. Sales offices in 33 principal cities throughout the United States, Great Britain, Canada, Australia and West Germany.

CONSISTING OF CINCH MANUFACTURING COMPANY, CINCH-GRAPHIK, CINCH-MONADNOCK, CINCH-NULINE, UGINITE (ELECTRONICS) AND PLAXIAL CABLE DEPT.

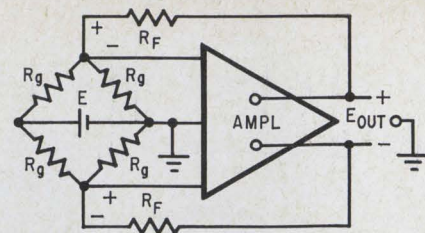

Pressure offset. Changes in pressure are reflected as changes in the resistance legs of the Wheatstone bridge. The amplifier generates an output voltage that nulls out the bridge offset voltage and is also a measure of the parameter change.

Amplibridge is constructed from a variable voltage source, a resistance and a null detector connected to the transduction element, or bridge.

Nulling technique. The transducer converts the parameter to be measured to a change in resistance of each of the bridge legs. The variable source is adjusted to a value that nulls the voltage between them. A differential amplifier connected to the transduction element, shown above, automates this manual adjustment to establish the null condition. If the amplifier's open-loop gain is high, the gain doesn't affect the voltage output and the output is only a function of the input parameter and various constants that can be reliably controlled.

The circuitry constitutes an unisolated system with balanced output. Some Amplibridges, however, are required to be completely isolated. Either output terminal may be connected to either input terminal without affecting circuit operation. Such voltage isolation may be accomplished with a conventional d-c-to-d-c converter comprised of two switching transistors, a saturated-core transformer, a rectifier, a filter, and an electronic voltage regulator. The converter will operate within a power-input range of 24 to 32 v. Most Amplibridges for aerospace applications are of this isolated configuration.

For some applications, a single-ended output is sufficient. The lower output terminal is the 28-v common or negative terminal. To obtain single-ended output, two complementary emitter-followers are connected.

Statham Instruments Inc., 12401 W. Olympic Blvd., Los Angeles, Calif. 90064 [377]

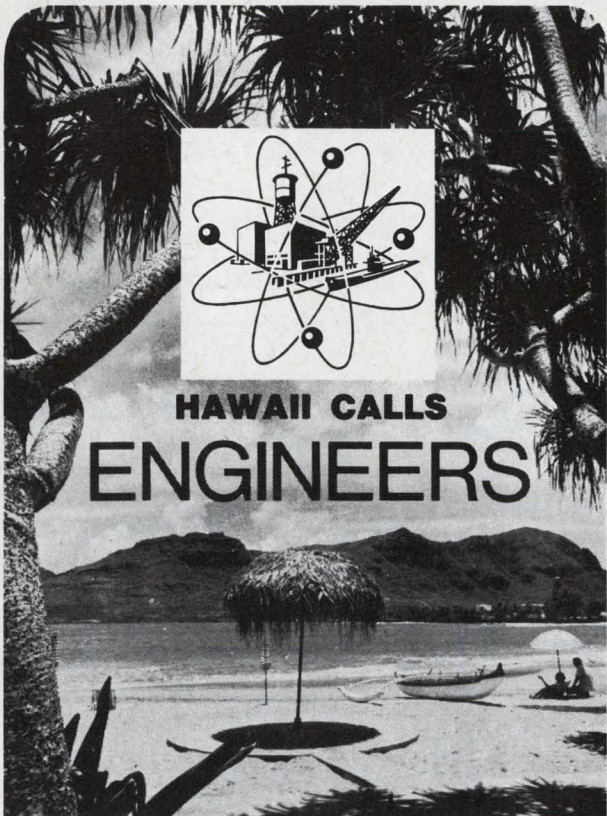

**HAWAII CALLS
ENGINEERS**

**PEARL HARBOR NAVAL SHIPYARD
needs
Electronic, Electrical, Marine,
Mechanical, General, Nuclear Power
Engineers and Naval Architects**

STARTING SALARIES: \$8,325 to \$13,619
depending on experience

Salaries include 15% cost-of-living allowance,
which is subject to change.

- Opportunities for professional growth, advancement.
- Pleasant living for you and your family.
- Pearl Harbor Naval Shipyard, the largest industrial organization in the Pacific, plays a vital role in today's nuclear Navy. The activities of the Yard create a broad range of assignments for engineers and naval architects.

Transportation to Hawaii and back provided for employees and their dependents. Household effects will be shipped at government expense. Transportation for home leave provided if employment agreement is renewed after three years.

These are career Civil Service positions with regular salary increases, generous benefits, liberal retirement plan, and will be filled on an Equal Opportunity basis. Send resume of professional experience or Standard Form 57 to:

PEARL HARBOR NAVAL SHIPYARD
(CODE 170)
BOX 400, FPO SAN FRANCISCO 96610

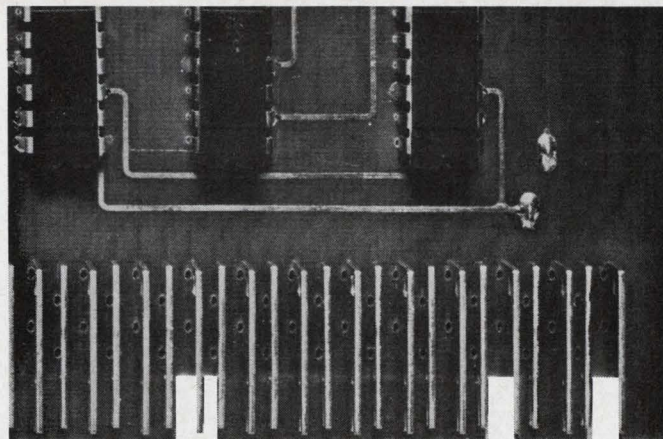

MicroVersaLOGIC

Designed for the toughest applications.

Priced for the easiest.

MicroVersaLOGIC is the complete line of IC logic modules designed for the toughest applications, yet priced lower than other cards.

Built into MicroVersaLOGIC are small size, high reliability, and high performance. They give you assured performance at 5 megaHertz, leakproof ceramic DTL chips, and a filter capacitor on each card.

The complete MicroVersaLOGIC line gives you all the ready-made building blocks you need for anything from a register to an entire digital system, including plug-in power supplies and a broad line of system assemblies and accessories.

Our 40-page catalog can give you all the facts and possibilities of the MicroVersaLOGIC line, and our price list will prove to you how economically it can be yours. Just write.

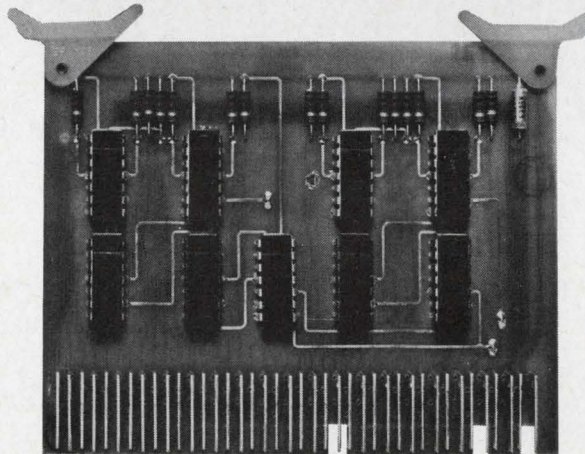

 **varian data machines**
a varian subsidiary

Formerly Decision Control, Inc.
1590 Monrovia Ave., Newport Beach, Calif.
TEL. (714) 646-9371 TWX (910) 596-1358



HOW TO FORM STRONGER BOXES FAST!

1

Shear up to 160 blanks per minute with lowest cost, high speed, precision shear on the market! Di-Acro Power Shear No. 36 — only \$1,350 complete!

2

Notch blanks on a Di-Acro Power Tab Notcher. Extra strong tabbed corners are self-aligning. And easier to fasten.

3

No wasted motion. Form box on a Di-Acro Hand or Power Press Brake or Di-Acro Leaf Type Brake. Read the full story in Di-Acro's newest catalog. See your distributor or write us.



New instruments

Monitoring panels by the numbers

Digital replacement for analog meter feeds data directly to computer

When marketing director Thomas Bakey suggested that the Data Technology Corp. try to develop a digital voltmeter that would be a direct replacement for an analog panel meter, he recalls, "they almost threw me out of the plant." A precision analog meter can be bought for about \$100. While it has been suggested that integrated circuit technology permits design of dvm's costing less than \$100 [Electronics, Nov. 28, 1966, p. 88], that day has not yet arrived.

Data Technology did not, in fact, succeed in matching the price of an analog meter. But the model DT 340 dvm that it will introduce at the Institute of Electrical and Electronics Engineers' show next month is the smallest, lightest, and least expensive on the market.

Panel meters are found in clusters in large industrial plants. In an oil-cracking plant, for example, they provide information that is periodically read by an attendant; the tabulated data is later used to make valve adjustments, etc. In order to display the information digitally, the DT 340 first converts it to binary-coded decimal form. This offers the additional advantage that the BCD data can easily be buffered and fed directly to a computer for constant monitoring and even direct feedback control.

Bakey says he expects the instrument to capture a healthy portion of the panel meter market, estimated by Electronics this year at \$41.8 million, despite the relatively high price tag of \$295 for a single instrument.

Data Technology did not meet its price goal of "under \$200," but Bakey indicates it might for a customer with a significantly large order. The DT 340's nearest competitor, the Weston Instruments Inc. model 1270, sells for about

\$17 more than Data Technology's device. But, unlike Weston's fixed-range meters, the Data Technology unit accommodates any input from 200 millivolts to 1,000 volts.

The DT 340 weighs 20 ounces, measures 2.4 inches high, 5.2 inches wide and 7.5 inches deep, and provides display storage and front-panel calibration. Since it is built on a single printed-circuit board, it can be slid out of its housing in seconds.

In the 100-millivolt range, accuracy is within $\pm 0.1\%$ of reading, $\pm 0.3\%$ full-scale. This is comparable to the accuracy of precision analog panel meters.

Simple idea. The DT 340 was designed by Cameron Reid, a 28-year-old engineer formerly with the instrumentation division of the Fairchild Camera and Instrument Corp., who had some ideas about how to simplify Fairchild's model 7050 digital multimeter.

Reid attacked the cost and bulk problem by synchronizing the display to the 60-hertz line frequency and designing a unique input amplifier. Previous ic dvm's have used one ic for counting, one for storage, and one for driving the Nixies. Reid used one chip to count and one to decode and drive.

The Nixies turn on and off 60 times a second, displaying whatever count is present at those times. Thus no storage is necessary, because the eye of the observer integrates the brief—4 millisecond—Nixie flash just as it does the 60-field-per-second television raster scan.

A neon bulb that fires only on the zero crossing of the power supply voltage gates the measure-

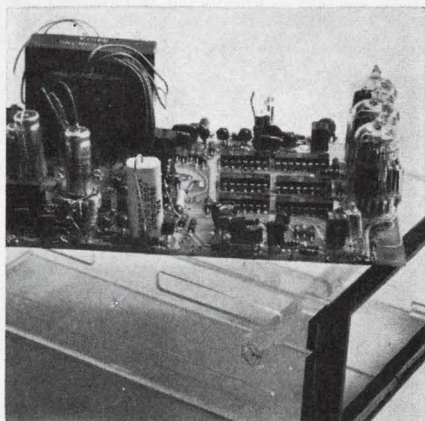

Integrated. Entire meter is on one circuit board. Three readout tubes are at right.

Ballantine low-cost DVM's are small, easy-to-use... permit fast, highly accurate measurements in production with unskilled personnel... are ideal, too, for the lab and quality control. Compare their many useful features.



BALLANTINE DC DVM

Model 353

Designed to replace multi-knob manual vm's for speed and accuracy ■ 0 to 1100 V ■ High accuracy $\pm 0.02\%$ of reading $\pm 0.01\%$ f.s. ■ 4 digit with overranging to 5, plus interpolation of last digit ■ Resolution 0.002% ■ Reading retention or continuous observation of varying signals ■ All solid state ■ 10 megohms input resistance ■ Isolated signal ground with high common mode rejection ■ Small size ($\frac{1}{2}$ rack module) and low weight (7.7 lbs.) ■ Power requirement 115/230 V, 50 to 60 Hz ■ Price: \$510

BALLANTINE AC-DC DVM

Model 355

Designed to increase accuracy and speed up readings compared to those made with analog instruments ■ 0 to 1000 V ac, 30 Hz to 250 kHz ■ 0 to 1000 V dc ■ Accuracy 0.25% f.s. ■ Full scale sensitivity of 10 mV on ac; 100 mV on dc ■ 3 digits with overranging to 4, plus interpolation of last digit ■ Single economical package ■ Small size ($\frac{1}{2}$ rack module) ■ Reading retention, or continuous observation of varying signals ■ Isolated signal ground, with high common mode rejection ■ DC output for connection to recorder ■ Amplifier output, 60 dB gain ■ Zener reference ■ Power requirement 115/230 V, 50 to 60 Hz ■ Price: \$640

Write for brochures giving complete details



BALLANTINE LABORATORIES INC.
Boonton, New Jersey

CHECK WITH BALLANTINE FIRST FOR DC AND AC ELECTRONIC VOLTMETERS/AMMETERS/OHM METERS, REGARDLESS OF YOUR REQUIREMENTS. WE HAVE A LARGE LINE, WITH ADDITIONS EACH YEAR. ALSO AC/DC LINEAR CONVERTERS, AC/DC CALIBRATORS, WIDE BAND AMPLIFIERS, DIRECT-READING CAPACITANCE METERS, AND A LINE OF LABORATORY VOLTAGE STANDARDS FOR 0 TO 1,000 MHZ.

SOLID CARBIDE CIRCUIT BOARD DRILLS

... for every circuit board
drilling need

Precision to maintain location and hole size tolerances to close limits. Permits ultra high speed drilling at feeds up to 15 feet per minute. Design features include four facet point configuration and very fine flute finish. Drill point concentric to drill diameter within .0005".

STANDARD CIRCUIT BOARD DRILLS... Standard design with flute and shank same diameter. For use on any type production drilling from single board to high volume, stacked drilling tape controlled set-ups.

SERIES 125—1/8" SHANK DRILLS . . . Eliminate need for drill bushings when used with precision spindles and collets. Drill diameter to shank concentricity is within .0003". Common 1/8" shank for all drill sizes ends need for collet inventory for each size.

For complete information write for Catalog D67



THE METAL REMOVAL COMPANY

1859 West Columbia Avenue • Chicago, Illinois 60626
Manufacturing Plants Located in CHICAGO/LOS ANGELES/SAN JUAN

MASTER TOOL AND WHEEL MAKERS FOR THE WORLD
END MILLS / DRILLS / REAMERS / BURS / SPECIAL TOOLING



Circle 174 on reader service card

Our little black book has over 100,000 phone numbers.

You never had a black book like it. Over 1,500 pages. And those phone numbers! More than 100,000 telling you who to call/where to go, for the over 4,000 different product categories listed and advertised in the yellow pages of the Electronics Buyers' Guide.

It's the industry's one-stop shopping center that lets you find the products and services you need quickly. You can depend on EBG.

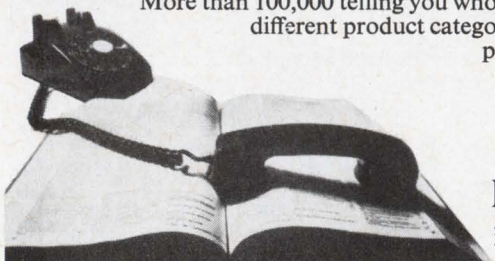

Electronics Buyers' Guide

A McGraw-Hill Market Directed Publication,
330 West 42nd Street, New York, N.Y. 10036

... amplifier controls
sampling interval . . .

ments into an r-s flip-flop for counting. The flip-flop output goes to a decoder-driver that does not change state unless there is a change in the counter.

On demand. The input amplifier is a gated amplifier, which is inoperable until it is time to take a measurement. It consists of a field-effect transistor switch and an LM 201 operational amplifier, made by the National Semiconductor Corp. The design, Reid says, saved him about 40 components—or half the number in the entire instrument—and permitted the 180-volt power supply to be simplified to a winding and a zener diode. There were considerable savings in bulk here.

The gated amplifier also eliminated the need for a crystal oscillator for analog-to-digital conversion. Reid uses a two-transistor multivibrator, with a dual-slope zero detection method so that the oscillator can drift as much as 50% without affecting accuracy.

Display is on three Nixie tubes with one overrange digit. There are five ranges: lowest is zero to 199.9 millivolts, with the decimal point moving successively to the right up to 1,999 volts. Resolution is ± 1 digit, or 0.1%. The best analog meters can be read to a resolution of about 0.5%.

The meter was designed to operate in an industrial environment, and Baley says it has been tested next to a noisy power drill with no degradation of performance. The line synchronization makes line noise unimportant.

Specifications

Accuracy	(23°C, 7 hrs.)
D-c volts	
2, 20, 200 v	$\pm 0.1\%$ reading, $\pm 0.05\%$ full-scale
200 mv	$\pm 0.1\%$ reading, $\pm 0.15\%$ full-scale
1,000 v	$\pm 0.1\%$ reading, $\pm 0.1\%$ full-scale
D-c current	$\pm 0.25\%$ full-scale
Input configuration	single-ended, single polarity
Readout	three-digit with one overrange digit; decimal point indicators and display storage
Sample rate	10 msec max.
Reading rate	10 readings/sec continuous
Input power	105 to 125 v, 50 to 60 hz, less than 10 watts

Data Technology Corp., Palo Alto, Calif.
[378]



**COSTA
MESA**



**PUERTO
RICO**



DICEON IS DOUBLE ENDED

For across-the-board service and quality, look to one of the country's leading printed-wiring specialists... Dicon Electronics, Inc. Dicon circuit boards are available from two facilities: the Dicon headquarters plant at Costa Mesa, California and a new, fully equipped facility in Puerto Rico. The result: Dicon quality, value, and on-schedule delivery... anywhere in the country.

Write for free facilities brochure.

DICEON ELECTRONICS INC. ... Volume Production of High-Quality Printed Circuit Boards

WEST COAST SALES OFFICE: 644 Terminal Way, Costa Mesa, Cal. 92627 (714) 642-7100

EAST COAST SALES OFFICE: 1268 Main St., Waltham, Mass. 02154 (617) 899-3048

Circle 222 on reader service card

Measure impedances directly in polar form

From pure resistance, capacitance or inductance,
to complex impedances...

Acton's 310-B Z-Angle Meter
measures any RLC combination,
with only one balancing step.

Impedance range from 0.5 to 100,000 ohms
frequency range from 30 cps to 40 kc
with magnitude accuracy of $\pm 1\%$
and $\pm 2^\circ$ for angle at 20 kc
The 310-B is both
compact and portable



ACTON LABORATORIES · INC.

Subsidiary of Bowmar Instrument Corporation
531 Main Street, Acton, Mass. 01720
Tel: (617) 263-7756 (Boston) 542-0284

where's Icon in stepping motors?

way out front!

Out front with the highest performance stepping motors
in existence. Out front in stepping motor
applications... with the right drive circuit,
logic module or control unit you need.

Out front with the technical savvy to automate
your plant or products practically, simply,
and at low cost. Get ahead. Call Icon now!

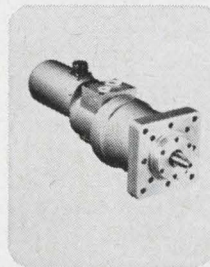

**ELECTROHYDRAULIC
PULSE MOTORS**

Speed: To 8,000 steps/
sec
Power: To 6 HP
Resolution: 200 or 240
steps/rev.

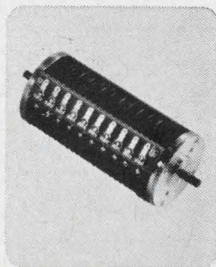

**ELECTRIC PULSE
MOTORS**

Speed: To 10,000
steps/sec
Power: To 1 HP
Resolution: 160 or 240
steps/rev.



LEADERS IN DIGITAL MOTION
156 Sixth St., Cambridge, Mass. 02142
617/868-5400

Circle 223 on reader service card

Circle 175 on reader service card

175

Laundromat for E.E.'s.

(Barnstead's Micro-Cleaners and transistor washers lower rejects with rinses of hot, high-purity water.)

Barnstead's microelectronic cleaning systems make micro-circuits and other highly critical electronic parts come clean with cascades of hot, distilled water. And they do it at minimum cost.

The water not only measures 15 to 18 megohms/cm but is also free from the particles, organic, gaseous and biological impurities that often cause circuit failure. Because it is far purer than water that is only demineralized, it makes the ideal rinsing medium. Continuous repurification and recirculation makes several gallons do the work of



thousands, saving on water and heat.

Whether you want a cabinetized, dust-free station, like the one shown here, or a hoodless built-in for your own clean room . . . we can engineer it to your needs. Chemical baths, ultrasonic cleaners or solvent rinses may be incorporated too, if you wish.

We also make a complete line of stills and demineralizers for the electronics industry. For full information on any of these products write Barnstead Still and Sterilizer Co., 225 Rivermoor Street, Boston, Massachusetts 02132.

Barnstead

Ritter Pfaudler Corporation

New Production Equipment Review

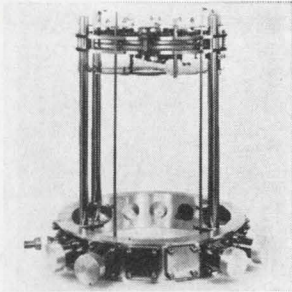

IC mask-to-substrate registration accuracy to within 0.0005 in. is possible with the Pos-Align, a positive alignment mask changer. It is ready for direct installation in any standard 18-in.-diameter by 30-in. bell jar system and handles 6 substrates up to 2 1/4 in. square and 6 conventional masks. Allen-Jones/Vacuum Technology, 17171 So. Western Ave., Gardena, Calif. 90247. [421]

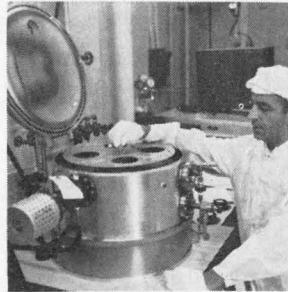

The Plasma-Vac 501 batch sputtering system deposits thin films in pilot production quantities for the integrated electronics field. It will handle up to 64 1 1/4-in.-diameter wafers per run with thickness variations of 2% from substrate to substrate in any given production runs. Consolidated Vacuum Corp., a subsidiary of Bell & Howell, 1775 Mt. Read Blvd., Rochester, N.Y. 14603. [422]



Air/oil actuated head model VFH is for automated welding, soldering, brazing, or insulated wire welding set-up. The standard unit has a force range of 8 oz to 15 lbs and a 1-in. stroke. Since it is designed for boom mounting, there is no throat depth limitation. Over-all head size is 2 3/4 x 3 x 9 1/8 in. Wells Electronics Inc., 1701 S. Main St., South Bend, Ind. 46623. [423]

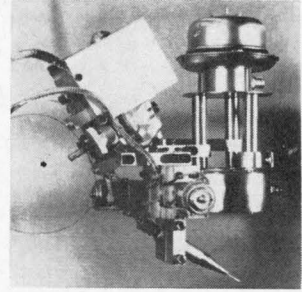

Wire feeder 2309-137 is adapted for use in vacuum chambers. Two small motors provide precise positioning of the nozzle for feeding of metal. The photo shows the feeder attached to an electron gun. An scr controlled, variable-speed reversible motor runs the wire drive. Price is \$975; availability, stock. Brad Thompson Industries Inc., P.O. Box CCCC, Indio, Calif. 92201. [424]

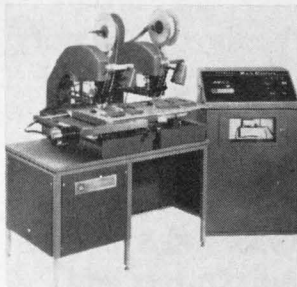

Numerically controlled machine model 6022 automatically inserts axial lead components into 2 p-c boards simultaneously. It feeds and inserts reel-packaged components, which can be all the same part, or unlimited programmed sequences of components of varying size. It is for high volume assembly use. Universal Instruments Corp., E. Frederick St., Binghamton, N.Y. 13902. [425]

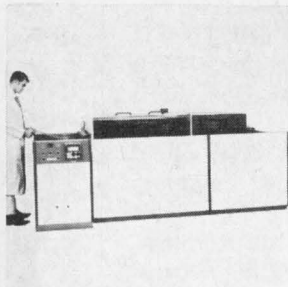

P-c production etcher Vector 30 provides double-sided etching of material up to 30 in. wide and of continuous length. The workpiece is loaded on a conveyor at the front end and then automatically conveyed through etching and rinse chambers on O-rings stretched between drive shafts. Moving spray nozzles give complete coverage. Pemco, 4930 W. 35th St., Minneapolis. [426]

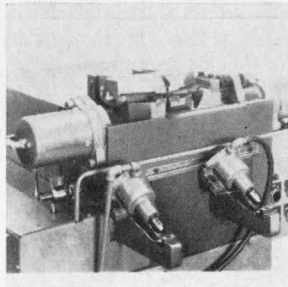

Butt welders series BA are for wire drawing operations. They adapt to either ferrous or non-ferrous welding applications. Welding is accomplished with a dual force upsetting system. The machine employs individual rolling diaphragms for forge and bucking forces to eliminate all possible friction. Thomson Electric Welder Co., 161 Pleasant St., Lynn, Mass. 01901. [427]

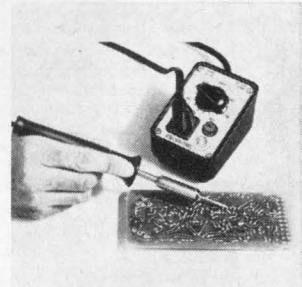

Close control of a soldering iron tip temperature or that of solder in a soldering pot is offered by the EC-6 Esicontrol wattage controller. The unit will handle any 120-v heater load up to 840 w. Close control is provided for up to 80% of full wattage of the heating element and allows operation without control at 100% of full wattage. Electric Soldering Iron Co., Deep River, Conn. [428]

New production equipment

Matched magnets in five seconds

Magnetizer for makers of meters, traveling-wave tubes has high repeatability, requires minimum skill

Push a button and make a magnet. That's easy. Making another magnet with the same properties as the first just by pushing the button again—that's another story.

Engineers at F. W. Bell Inc. have developed a push-button magnetizer with excellent repeatability.

For a given instrument setting, they say, the magnetic strength of each processed unit will be within 0.1% of the strength of any other.

The Magnetic Processing System, model 460, makes the hard permanent magnets used in meters, traveling-wave tubes, and motors.

The 460 has three subsystems: a magnetic charger, model CS-6040, a gaussmeter, model 620 or 640, and magnet stabilizer, model MS-6000. External control circuits that connect the subsystems are solid state. Magnetizing and demagnetizing coils are in a fixture attached to the 460.

Keep pushing. An operator needs little skill to use the 460. He sets the desired magnetic strength with a dial and puts the sample to be magnetized in the fixture. Then he presses a button, removes the sample, puts in another, and so on. One sample can be magnetized each five seconds and the magnetic



NEW/ FROM NORTRONICS

EXTENDED POLE PIECE TAPE HEADS FOR READING SOUND FROM FILM

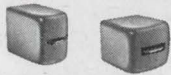

Nortronics extended pole piece record/play heads read sound from 8 mm or 16 mm film without touching the film's optical or sprocket areas. This avoids scratching of the optical surfaces and eliminates possible picture bounce or sound flutter from sprocket hole-to-head contact. The extended tip on these heads is available with Alfenol laminations for long wear or Mu-metal laminations for maximum sensitivity.

These heads are also appropriate for a variety of other applications requiring a projecting track, such as card readers, drums and discs. As small as a 1/4 inch cube, the heads can be supplied with track widths from .006" to .070", with a choice of sizes and case styles. Complete technical data is available upon request.

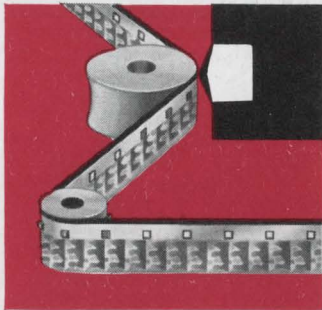

Like all Nortronics tape heads, the extended pole piece type has a fine laminated, precision lapped core structure for low loss, a deposited quartz gap for optimum high frequency resolution, and superb shielding for protection from external magnetic fields. The world's largest manufacturer of tape heads and pace-setter for the industry, Nortronics offers a complete line of heads, including many for replacement and prototype applications off-the-shelf from your local distributor.

Nortronics
COMPANY, INC.

8101 Tenth Avenue North
Minneapolis, Minnesota 55427

. . . a-c field reduces magnetic strength . . .

strength of each will be within 0.5% of the dial setting.

The 460 also has an automatic mode that triggers the magnetizer at set intervals.

Up, then back. When the 460 is activated, the field strength of the sample is raised to the saturation level. The sample is then demagnetized to the desired level.

The magnetic charger contains charged capacitors that release sufficient energy into the magnetizing coil to cause saturation. When not discharging, the capacitors are kept at a proper voltage by a comparator circuit. Another circuit prevents the charger from firing unless the capacitors are at this proper voltage level.

The magnetic stabilizer applies a demagnetizing a-c field to the saturated magnet. The field level is controlled so that magnetic strength is gradually reduced to the desired level.

The gaussmeter uses a Hall-effect probe to measure the magnetic strength of the sample. The meter is the control link in the stabilization process. It shuts off the demagnetization field at the proper level of sample field strength.

Since the meter has a suppression circuit, only the strength of the sample's field is measured and not the strength of the alternating field of the stabilizer coil.

The model 460, complete with one fixture, is priced at \$7,500. Different jobs may require the use of different fixtures and prices for these range between \$500 and \$700.

The complete system is usually packaged in a rack cabinet, 19 inches wide and 48 inches high. Bell engineers can package the 460 for specific industrial requirements. And subsystems can be purchased separately.

Delivery time is 60 days.

Specifications

Charging energy	450 watt seconds 900 ws (special order)
Maximum charging current	3,000 amps
Flux-density measurement range	1 to 30,000 gauss
Stabilization range	to within 35% of saturated value
Input voltage	117 v
Input current	20 amps

F.W. Bell Inc., 1356 Norton Ave., Columbus, Ohio 43212 [429]

Fast acting.

The Electronics Buyers' Guide can get you on the right frequency in a hurry. For example, there are 14 different kinds of oscillators listed. Everything from AF oscillators to voltage controlled crystal oscillators. There are three sections in your EBG, devoted to products, manufacturers and trade names. So see your fast-acting EBG.

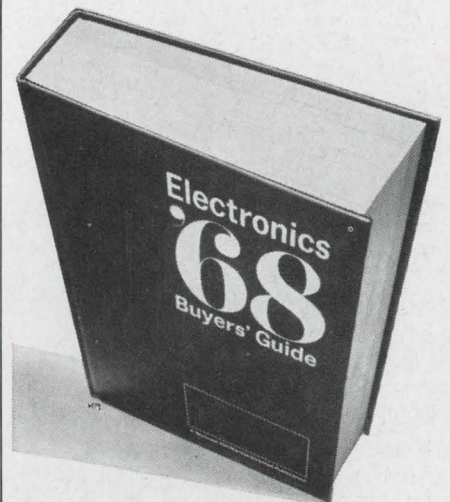

Electronics Buyers' Guide
A McGraw-Hill Market Directed Publication,
330 West 42nd Street, New York, N.Y. 10036

New production equipment

Where rulers cannot go

Portable ultrasonic probe measures thickness of walls of any shape

"Measure wall thickness," they tell you, and, right away, you reach for a ruler. But suppose they're talking about the wall of a pipeline or a chemical storage tank.

To measure thickness where one surface is not accessible, engineers at Sonatest Ltd. have developed an ultrasonic thickness meter called the TE/10.

The device, which is battery-powered, measures thickness up to three inches with an accuracy of $\pm 1.0\%$. Designed for portability, the TE/10 weighs 6½ pounds and comes in a carrying case. It relates thickness to the measured transmission time of a reflected pulse of ultrasonic energy in the wall.

Before using the unit, the operator calibrates it with a known thickness of wall material. To measure, he places the TE/10's probe on the wall surface. A pulse of ultrasonic energy is transmitted by the probe into the wall. The pulse travels through the wall and bounces off the opposite surface. The return signal is detected by the probe.

Another rebound. Only a portion of the return signal passes through the wall to the probe, however. Part of the signal is reflected and makes another round trip. This causes a secondary echo,

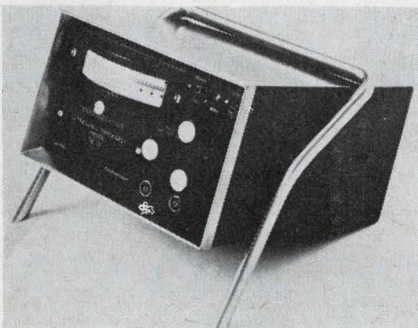

Inside look. Unit will automatically adjust for corrosion and wall shape.



introducing a new versatile phase angle voltmeter for production test

North Atlantic now brings you a new group of solid-state Phase Angle Voltmeters for precision phase-sensitive nulling applications in production test and ground support equipment.

Designed for versatility, they feature measurement of the vector components (including phase) of complex AC signals at 4 discrete frequencies from 30Hz to 20KHz. Operating frequencies can be rapidly changed without calibration by direct plug-in replacement of frequency modules and harmonic rejection filters. Full operating performance is maintained over a bandwidth of $\pm 5\%$ and with 10X signal input overload.

The unit illustrated is the Model 214A. Also available are the Model 214B with reference isolation, and Model 214C with both signal and reference isolation.

North Atlantic's sales representative in your area (see EEM) can tell you all about these units as well as other Phase Angle Voltmeters and Phase Sensitive Converters.



NORTH ATLANTIC industries, inc.
TERMINAL DRIVE, PLAINVIEW, NEW YORK 11803 • 516-681-8600

GLASS ENCLOSED Thermostatic DELAY RELAYS

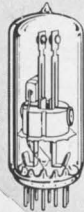

by **AMPERITE**

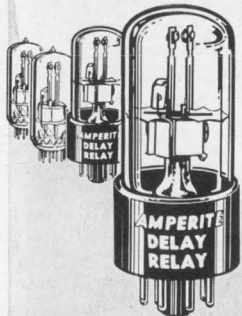

Offer true hermetic sealing — assure maximum stability and life!

Delays: 2 to 180 seconds

Actuated by a heater, they operate on A.C., D.C., or Pulsating Current . . . Being hermetically sealed, they are not affected by altitude, moisture, or climate changes . . . SPST only — normally open or normally closed . . . Compensated for ambient temperature changes from -55° to $+80^{\circ}$ C . . . Heaters consume approximately 2 W. and may be operated continuously. The units are rugged, explosion-proof, long-lived, and inexpensive!
TYPES: Standard Radio Octal and 9-Pin Miniature. . . . List Price, \$4.00
PROBLEM? Send for Bulletin No. TR-81.

AMPERITE

BALLAST REGULATORS

Hermetically sealed, they are not affected by changes in altitude, ambient temperature (-50° to $+70^{\circ}$ C.), or humidity . . . Rugged, light, compact, most inexpensive.

List Price, \$3.00

Write for 4-page Technical Bulletin No. AB-51

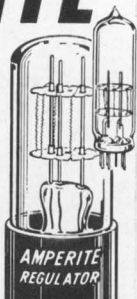
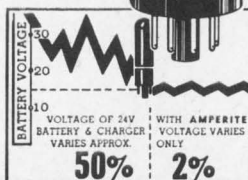

AMPERITE

600 PALISADE AVE., UNION CITY, N.J. 07087

Telephone: 201 UNION 4-9503

In Canada: Atlas Radio Corp., Ltd.,
50 Wingold Ave., Toronto 10

which can also be detected.

If there are no surface imperfections to distort the pulse, there is a predictable relationship between the energy levels of the primary and secondary echoes. Monolithic logic circuits in the TE/10 compare the energy of the two echoes to determine whether distortion is taking place. If distortion is detected, the TE/10 uses only the transmission time of the primary echo. If there is no distortion, the two transmission times are averaged to determine thickness.

This feature, says Sonatest, increases accuracy, especially where there is deterioration of the wall.

Good shape. The intensity of return signals depends partly on the shape of the wall surface. Other things being equal, increasing the radius of curvature decreases the energy the probe receives. The TE/10 automatically compensates for changing wall shapes. As the contact area between the flat-headed probe and the wall changes, the instrument's gain changes to keep energy levels constant.

The instrument also automatically adjusts its bandwidth, which enables it to have the same accuracy, regardless of wall thickness. Monolithic circuits widen the bandwidth as thickness increases.

If a narrow bandwidth is used for a thick wall, there is too much signal attenuation. If a wide bandwidth is used for a thin wall, there is excessive distortion of some harmonics.

Who needs it. The TE/10 can accurately measure the thickness of any metal section. But it is intended for walls that are subject to corrosion, erosion and other surface deterioration.

Sonatest thinks the TE/10 will be particularly useful any place where tanks and pipes are under pressure and have to be regularly checked as a safety precaution, such as refineries and chemical plants.

Automobile makers can use the instrument to check the thickness of cylinder heads and block castings. Sea captains can use it to check the thickness of plates on a ship's bottom.

The price is \$1,750.

Sonatest, Beacon House, 113 Kingsway, London W.C.2 [430]

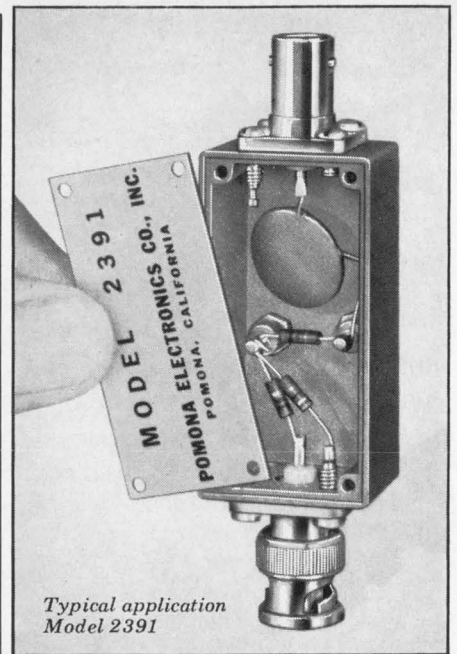

Typical application
Model 2391

SHIELDED

BLACK BOXES

To package,
protect and

SHIELD

custom test circuits

(voltage dividers, attenuators, isolation and impedance, networks, etc.). Rugged die-cast aluminum box with aluminum cover, available in 16 different connector combinations. Write for free catalog.

2390

2392

2411

2413

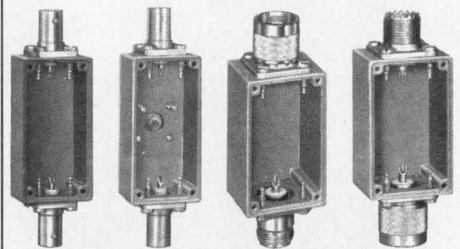

POMONA

ELECTRONICS CO., INC.

1500 E. Ninth Street, Pomona, Calif. 91766

Total Shielded Capability from 2.0 to 40.0 GHz in BACKWARD-WAVE OSCILLATORS

Ranged here are four of the latest magnetically- and RFI-shielded voltage-tunable BWOs available exclusively at W-J. Designed and produced mainly for the commercial market, these reliable tubes utilize either a single (WJ-2022 and WJ-2041) or bifilar (WJ-2018 and WJ-2019) helix and a permanent-magnet focusing system. Unsaturated magnetic shielding reduces the magnetic field strength to less than 10 gauss one-half inch from any point of the housing. This immunity to external ac or dc magnetic fields makes these BWOs eminently desirable for use as the oscillator in sweep frequency generators, as a local oscillator in radar receivers, as master oscillators in frequency diversity transmitters and in ECM equipment. What's more, they deliver smooth power output over their bands with low operating cathode current. Ask us about the rest!

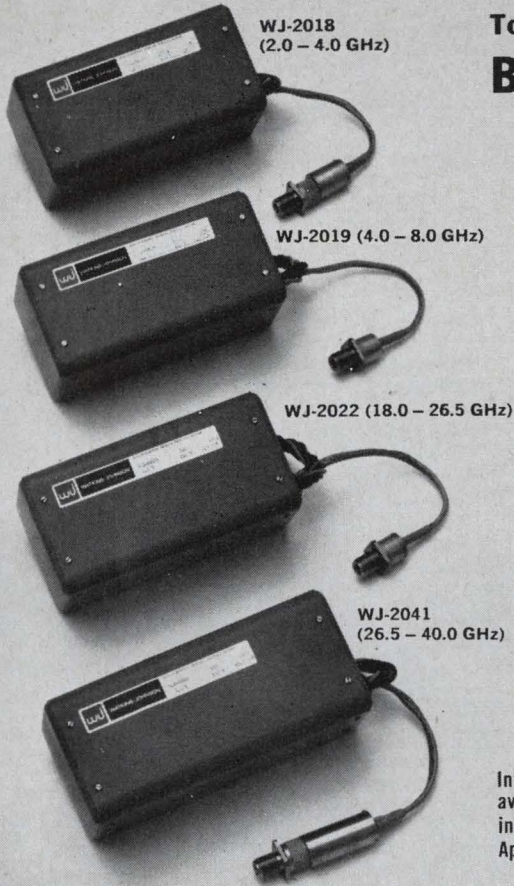

Information in more detail
available from representative
in your area, or from
Applications Engineering ...

WATKINS JOHNSON

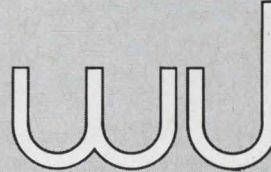

3333 HILLVIEW AVENUE
STANFORD INDUSTRIAL PARK
PALO ALTO, CALIFORNIA 94304

Circle 220 on reader service card

Cramped for panel space?

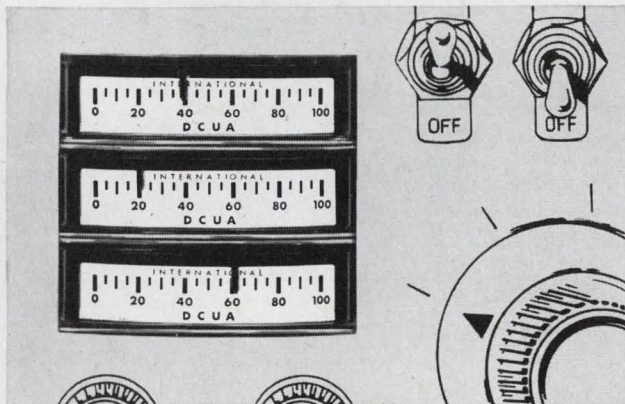

STACK YOUR METERS IN EDGEWISE.

You get the full scale reading of a conventional meter in one-third the panel area, when you use an edgewise meter.

And you get the widest selection in the field, when you choose International Instruments edgewise meters. Sizes from 1½" to 6". Horizontal or vertical models. Military or commercial types. Completely shielded—you can stack as many as you like with no fear of magnetic interaction. Optional internal illumination.

Get the full story on edgewise meters. Write for Bulletin 391.

 **international instruments inc.**
8703 Marsh Hill Road Orange, Conn. 06477

3753

Circle 225 on reader service card



NEW from Cramer



ADJUST-A-LOK STOOLS

Adjust to every worker like fine tools!

Cramer Adjust-A-Lok is immediately adjustable to any worker's height. Just release the safety stop, and lift or lower. It can be done just that quick. Since fatigue is a critical factor in efficiency of seated workers, it's just good economics to provide tools that minimize fatigue. With Adjust-A-Lok every worker can find his own most comfortable and efficient level. 6 seat styles and 5 base types provide 30 available models. For more information: write V. P. Sales, Cramer Industries, Inc., 625 Adams, Kansas City, Kansas 66105.

Industrial supplier
inquiries invited



CRAMER INDUSTRIES INC.

A Subsidiary of USM Oil Co.
Cramer—The leader in style and quality

Circle 181 on reader service card

181

Think twice about your switch requirements.



Think Unimax.

Break the Brand M habit—think twice about your switch supplier. The Unimax line is complete from miniature sub-miniature to big, rugged, explosion-proof metal-cased switches. And we bow to no one in the quality, price or delivery of our products.

If your switch requirement decisions have become automatic Brand M selections, you may not have considered Unimax's 20 years of experience in snap-acting switch design and manufacture. Or the thousands of specials we have developed for individual applications.

Why not—this time—think twice before you act? The coupon at right offers you, free, your personal "Think Twice" button and any or all of our detailed, full specification catalogues.

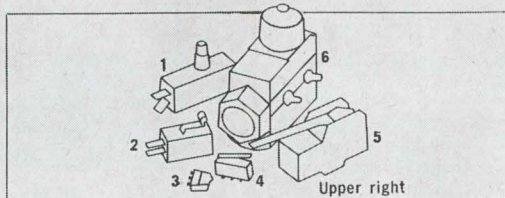

Typical switches from each category of the complete Unimax line.

1. **General Purpose.** Complete line of actuator styles, single and double pole. Ratings up to 25 amps at 250 V. AC.
2. **Miniature.** Extra long life. Complete range of forces and motions in all actuator styles. Rated to 15 amps and 1/2 H.P., 125/250 V. AC.
3. **Miniature Subminiature.** Differential motion as low as .0005" max. Leaf and leaf-roller integral actuators available.

4. **Subminiature.** Designed to meet the requirements of applicable Military specifications. Close control and high repeatability on sealed and unsealed units.
5. **Basic Precision.** Standard line rated at 20 amps 125/250/480V. AC. Other ratings to 25 amps; 1 H.P. 125 V. AC; 2 H.P. 250 V. AC.
6. **Metal-Cased.** Compact, Heavy-duty, Splash-proof and Explosion-proof models, with all types of actuators.



Unimax Switch Dept. E-82
Division Maxson Electronics Corporation
Wallingford, Connecticut 06492

Yes, I've thought twice about it and I would like to receive, in addition to my free, personal "Think Twice" button, the following catalogues:

- General Purpose. Cat. 40-2.
- Miniature, Subminiature. Cat. 20-2.
- Basic Precision. Cat. 10-2.
- Metal-Cased. Cat. 30-2.
- I can't wait for the mail. Please have your local representative contact me immediately to discuss a particular need.

Name _____

Company _____

Address _____

City _____ State _____ Zip _____



Unimax Switch

DIVISION MAXSON ELECTRONICS CORPORATION / WALLINGFORD, CONNECTICUT 06492

Circle 182 on reader service card

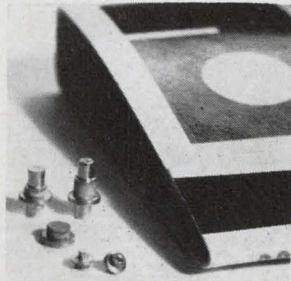

Parametric amplifier varactor diodes made of silicon are designed to meet severe environmental conditions and incorporate an all-welded construction and thermal-bonded contacts. Four case styles are offered: L, M, P and S. Case capacitance ranges from 0.20 to 0.30 pf; lead inductance, from 0.20 to 0.40 nh. Alpha Industries Inc., 381 Elliot St., Newton Upper Falls, Mass. 02164. [436]

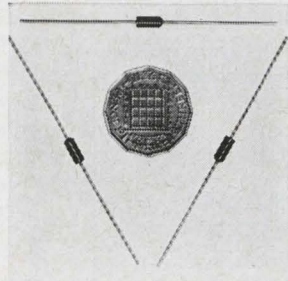

Voltage regulated (zener) diodes type BZX61 are encapsulated in a thermosetting epoxy resin to give complete environmental protection. They have a rating of 400 mw and a voltage range of 33 to 75 v. With a junction temperature of 25° C, the devices have a surge rating of 50 w for 0.1 msec. Outline is similar to the DO-7. Mullard Ltd., Torrington Place, London, England. [437]

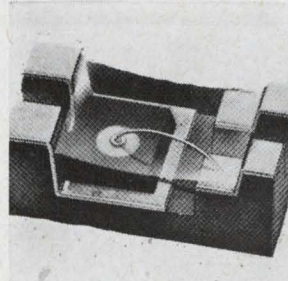

Lid diodes for voltage variable capacitor applications are offered in ranges from 6.8 to 47 pf at voltages from 30 to 100 v. Tuning ratios vary from 3:1 at 30 v to 5:1 at 110 v reverse voltage. Q's range up to 800 measured at 50 Mhz and 4 v reverse voltage. Price (1 to 99) is \$2.75 to \$10 depending on capacitance and Q. MSI Electronics Inc., 34-32 57th St., Woodside, N.Y. [438]

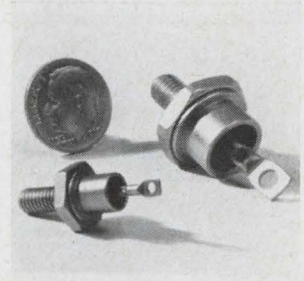

Silicon rectifier diodes (1N1199A-1N1206A, 1N1341A - 1N1348A, 1N3879-1N3883, 1N3889-1N3893) cover up to 12 amps, half-wave max. per diode up to 1,000 v prv. They are double diffused to provide minimum power dissipation through controlled forward and reverse characteristics. Units meet MIL-S-19500 specs. Solitron Devices Inc., 256 Oak Tree Rd., Tappan, N.Y. [439]

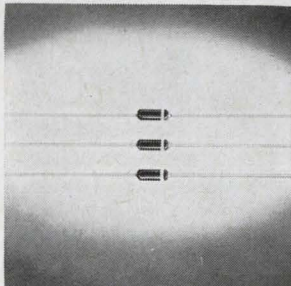

Silicon rectifiers series 1G1-1G5 and 5G1-5G5, rated 1,000 to 5,000 piv, are in sealed glass cases 0.1 x 0.3 in. Rated for 10 ma and 50 ma d-c, they have a forward drop of 4 v d-c at rated piv and a reverse current of 1 μ a at 25° C. Price of the 1G3 (3,000 piv) is \$1.10 each for 100. Electronic Devices Inc., 21 Gray Oaks Ave., Yonkers, N.Y. 10710. [440]

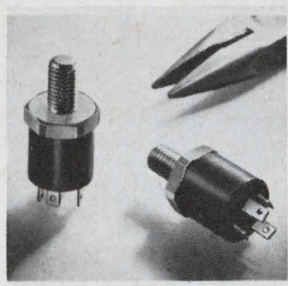

Full wave bridge silicon rectifiers S-6240 are 12-amp units with piv ratings from 100 to 1,000 with rms voltage ratings of 140 to 700. They are used in power supplies for communications equipment, and control systems. Prices are \$2.25 to \$7.20 for maximum, and \$3.76 to \$12 for minimum quantities. Sarks Tarzian Inc., 415 N. College Ave., Bloomington, Ind. [441]

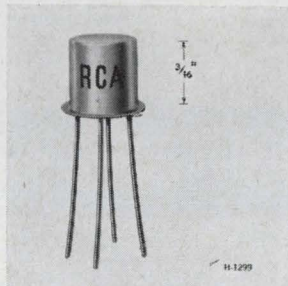

Silicon, insulated-gate MOS FET 3N153 is intended for chopper and multiplex service. Its low "on" resistance of 200 ohms typical, high "off" resistance of 10¹⁰ ohms typical and low feedback capacitance of 0.34 pf typical suit the device for many high-performance circuits. Price is 96 cents each in lots of 1,000. RCA Electronic Components and Devices, Harrison, N.J. [442]

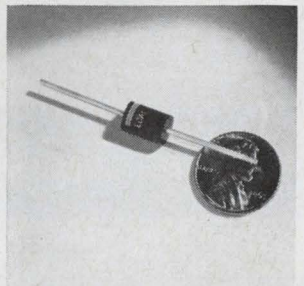

Silicon rectifiers series M meet moisture resistance of MIL Standard 202A, Method 16 without the costly insulation required by glass-to-metal seal types. The units use a passivated, double-diffused junction technique. Standard and bulk avalanche types are rated from 50 to 1,000 v piv, and from 1.5 to 3 amps. Edal Industries Inc., 4 Short Beach Rd., East Haven, Conn. 06512. [443]

New semiconductors

Logic signals pull a discrete switch

Hybrid gates with low R_{on} , high reliability can couple digital and analog circuits

"They can't be built with monolithic circuits. If they could, that's the way we'd build them." Joel Cohen, chief engineer at Crystalonics, is talking about two hybrid analog gates just introduced by his company.

Analog gates, usually built with

monolithic integrated circuits, can be made smaller and cost less than gates made with hybrid ic's.

But Crystalonics feels that in some high performance applications monolithic ic's can't match the performance of hybrids. To meet this need for high performance

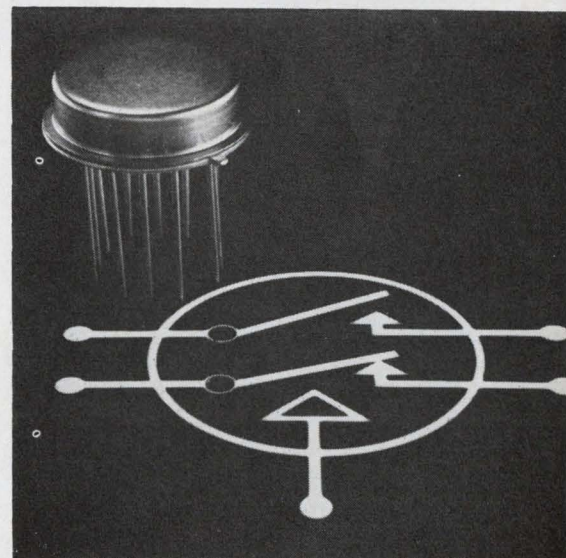

PROGRESS IN AN EXPLODING TECHNOLOGY
 PROGRESS IN AN EXPLODING TECHNOLOGY
 PROGRESS IN AN EXPLODING TECHNOLOGY
 PROGRESS IN AN EXPLODING TECHNOLOGY
 PROGRESS IN AN EXPLODING TECHNOLOGY
 PROGRESS IN AN EXPLODING TECHNOLOGY

EXHIBITS
 NEW YORK COLISEUM

TECHNICAL SESSIONS
 NEW YORK HILTON

Monday through Thursday

- 48 GENERAL SESSIONS at the New York Hilton. Hours: 10:00-12:30; 2:00-4:30.
- FOUR FLOORS OF EXHIBITS at the N. Y. Coliseum including over 750 firms. Hours: 10 a.m.-8 p.m. 4 Days.
- GALA ANNUAL BANQUET—Wednesday 7:15 p.m. N. Y. Hilton Grand Ballroom—\$16.00.
- FREE SHUTTLE BUSES between the Hilton and the Coliseum—every few minutes.

- REGISTRATION—Good all days—General Sessions and exhibits. In and out privileges.—IEEE Members \$3.00. Non-members \$6.00. Ladies \$1.00. High School Students \$3.00 if accompanied by an adult—One student per adult; Thursday only—limit of 3 students per adult.
- REG-IDENT CARD speeds request for exhibitors' literature. Ask for one when registering.
- ESCALATORS/EXPRESS ELEVATORS to the Fourth Floor.



IEEE Exhibition MARCH 18-21, 1968

Circle 226 on reader service card

SUBJECT: *Toroidal Cores—Data Sheets*

USE: *RF Coils, Chokes, Filters, Transformers*

FREQ: *To 200 MC.*

SOURCE: *Micrometals*

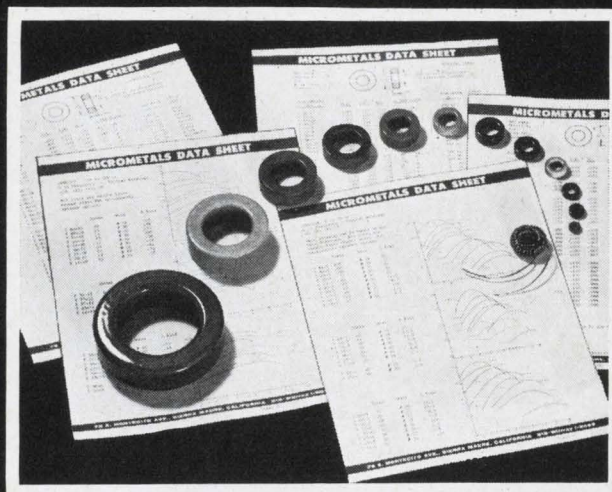

MICROMETALS

72 E. MONTECITO AVE., SIERRA MADRE, CALIF. 91024
 213-MURRAY 1-9025

switches, Crystalonics makes a family of hybrid analog gates with field effect transistors that have very low drain-to-source resistance. "FET's with low R_{on} are our specialty," says Cohen.

The gates. The CAG 7 is an FET analog gate which acts as either a single-pole, double-throw or a double-pole, single-throw switch. The switch resistance, R_{on} , is 6 ohms which is one-fiftieth the value of R_{on} for a typical monolithic gate. Switching time is 1.5 microseconds.

The CAG 6, the other new FET analog gate, is a single-pole, double throw switch. It has the same R_{on} as the CAG 7 but its switching time is only 0.7 microsecond.

The input to the CAG 7 is digital logic signals and the output is analog signals. The CAG 6 cannot be used with digital logic unless some external circuits are used.

"The CAG 7 is a complete circuit," says Cohen. "In the CAG 6 we've just assembled the semiconductors for the designer."

Steady hand. Crystalonics built the two gates for applications requiring very precise control. The company expects CAG 6's and CAG 7's to be used in multiplexers, digital-to-analog converters, and store-and-hold devices.

Both units draw a minimum of 100 milliamps when they are switched on, and can be used to light lamps or activate relays. "This is kind of a hack job for these switches," says Cohen. "But they can do it."

The test. Crystalonics is stressing the reliability of its hybrid gates. Transistors and capacitors are tested at their maximum rated voltages at maximum current before they are mounted in a circuit.

Each complete circuit is then tested at its maximum rated conditions.

"These circuits are just as reliable as if they had been built with discrete components," says Cohen. "This is not always the case when all the testing is done after the circuit has been assembled."

Both gates are stock items at Crystalonics. The CAG 7 costs \$59.40. For quantities over 100 the unit price is \$39.70. The comparable prices of the CAG 6 are \$33.00 and \$22.00.

Crystalonics, 147 Sherman St., Cambridge, Mass. 02140 [444]

At ECI in St. Petersburg, Florida...
RF Communications Opportunities

For a special breed of engineer

If you're one of that special breed of communication engineers who finds a challenge in projects beginning with applied research and advanced development and continuing through prototype and product design, you may well be the kind of person we're looking for.

Check this partial list of RF engineering activities at ECI. If you'd like to help push the state-of-the-art in any of these or other areas in communications, send us your resume. You'll design systems and equipment for satellite communications, multiplexing, electronic switching, command and control and advanced radio communications for some of the nation's major defense and space programs.

RF Communication Engineering Activities:

- Modulation and Demodulation
- Frequency Synthesis
- Solid State Power Amplification
- Hi Power Amplification
- Power Supply Technology
- Receiver Front End Design
- Packaging and Cooling
- Microelectronic Applications
- Reliability Techniques

CHALLENGE, GROWTH . . . and LOCATION TOO!

At ECI your job will be challenging. At ECI you'll find real opportunity for growth instead of just another confining groove — two-thirds of all advanced development is done in regular engineering development areas. And, at ECI you'll like where you're living just as much as you'll like your job. We'll match subtropical, sunny St. Petersburg against any location in the U. S. for stimulating, comfortable living.

SEND YOUR RESUME TODAY — in confidence — to K. E. Nipper, Supervisor of Professional Placement, Electronic Communications, Inc., P. O. Box 12248, St. Petersburg, Florida 33733.
(An equal opportunity employer, M & F.)



ELECTRONIC COMMUNICATIONS, INC.
ST. PETERSBURG DIVISION

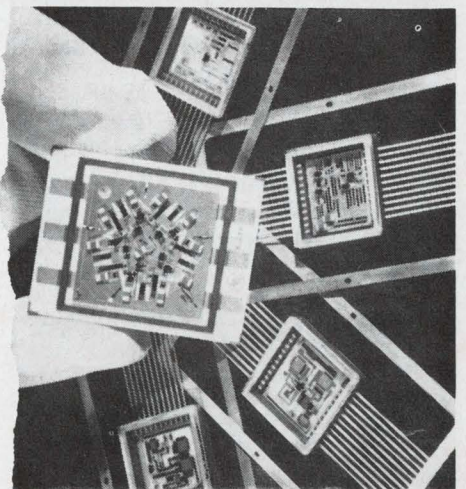

A-to-D Converters

... up to 12 bits
... loaded with options



4½" x 2⅝" x ¼"

- High-frequency FET input amplifier.
- Bipolar or unipolar input signals of varying ranges.
- Parallel and serial outputs of binary or BCD codes.
- TTL logic for high speed and fanout drive capability.
- Resolution up to one part in 4096 (12 bits)
- Extended temperature capability.

Get any of these options easily in the Pastoriza Model ADC-12_{ic} analog-to-digital converter — without the usual delays and extra cost that "specials" always involve.

The 12-bit Model ADC-12_{ic} is a single-card, general purpose, integrated circuit A-to-D converter that accepts input voltages on command and converts them to a 12-digit binary code in 25 microseconds. The single card contains an input amplifier, precision reference supply, logic, weighing network, switching, comparison, and internal clock. Only external DC power is needed.

The Model ADC-12_{ic} 12-bit converter is just one of Pastoriza's many competitively priced A-to-D and D-to-A converters. All are available with a variety of different input options, resolutions, and output codes.

Write or call for more information
on ADC TTL Series.

 **PASTORIZA**
ELECTRONICS, INC.
385 Elliot St., Newton, Mass. 02164 • 617-332-2131

New semiconductors

Car 54— Where are you?

Mobile radio power
transistor operates
even after overload

Microwave transistor manufacturers have been concentrating on the military rather than the commercial aspects of solid state power devices. Not so with the semiconductor division of the Fairchild Camera & Instrument Corp. Fairchild has announced a 25-watt, 400-megahertz device with built-in protection needed in mobile radios by commercial users.

Designated the S24275, the transistor achieves increased reliability by means of feedback resistors integrated into hundreds of tiny discrete emitter sites. These stabilizing resistors, deposits of thin-film nickel and chromium, prevent the buildup of current concentrations that would normally upset the uniformity of temperature load throughout the device.

If the current should increase beyond bounds, the individual resistors act as fuses under an overload condition and open up. According to Fairchild, the increase in gain caused by the resistors opening up is so minute as to be insignificant. To determine the exact value, the associated circuitry and operating conditions would first have to be known.

The feedback protection is in contrast to that afforded by diffused resistors employed by other manufacturers that short rather than open, rendering the device useless. This would be disastrous in police and ambulance equipment. Other applications include wideband class A power amplifiers and class B single-sideband amplifiers.

The operating range of the S24275 is 200 to 400 Mhz, with a guaranteed gain of 7 decibels at 400 Mhz. It's priced at \$75 in a specially designed 4-lead strip line case with an isolated stud.

Fairchild Semiconductor Division,
Mountain View, Calif. [445]

Microelectronics Applications Engineers

Interesting and rewarding growth assignments await qualified Microelectronics Applications Engineers at HUGHES Aerospace Divisions in Southern California.

These positions involve providing assistance to circuit engineers in the utilization of microelectronics in breadboard and prototype circuits and conducting liaison between circuit engineers and the HUGHES Microcircuit Facility. Successful applicants will follow fabrication of circuits through the Facility and assist in electrical testing and troubleshooting. They will learn microcircuit fabrication techniques to assure accurate estimation of price and delivery schedules.

These assignments require an accredited B.S.E.E. degree and a minimum of five years of applicable experience.

U.S. citizenship is required.

For immediate consideration, please airmail your resume to:

MR. ROBERT A. MARTIN
Head of Employment
Hughes Aerospace Divisions
Dept. 12
11940 W. Jefferson Blvd.
Culver City, Calif. 90230



An equal opportunity employer—M&F

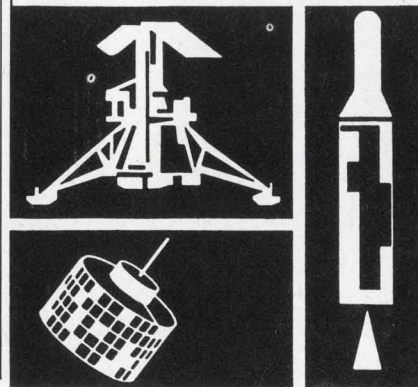

Splendid isolation

Dielectric approach yields premium, competitive op amp

The success story of monolithic linear integrated circuits has generally been marked by changes in circuit design rather than in fundamental approach. But in the latest chapter, Radiation Inc.'s Microelectronics division has gone to dielectric isolation in developing an IC op amp that has across-the-board electrical advantages over rival IC's but is priced in the same range [Electronics, Jan. 22, p. 44].

The circuit, called the RA-909, is also a pin-for-pin replacement for the standard 709 op amp. Its fabrication with dielectric isolation has lowered parasitics and yielded true npn-pnp complements. It has 13 npn's and 6 pnp's, and contains built-in frequency compensation and separate terminals for bias, offset, and bandwidth control.

Unity-gain bandwidth is 7 Mhz, voltage gain 45,000, and dissipation 52 mw. Input offset current and voltage are 50 na and 2 mv respectively, output swing ± 13 volts into a 1-kilohm load and transient response 40 nsec. Slew rate is 5 v/ μ sec and input noise 5 μ volts.

Suited for operation between -55 and 125°C the 909 in 100-lots is priced at \$37.50 (flatpack) and \$32 (can).

Radiation Inc., P.O. Box 37, Melbourne, Fla. 32901 [501]

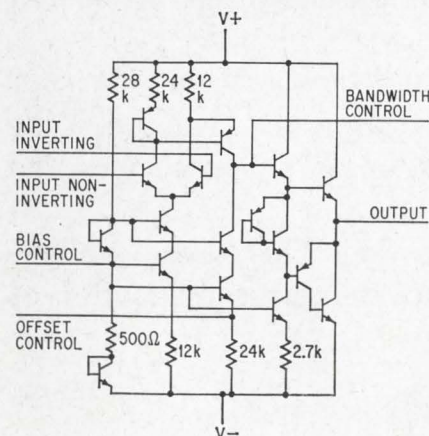

Inside job. Op amp circuit has internal frequency compensation.

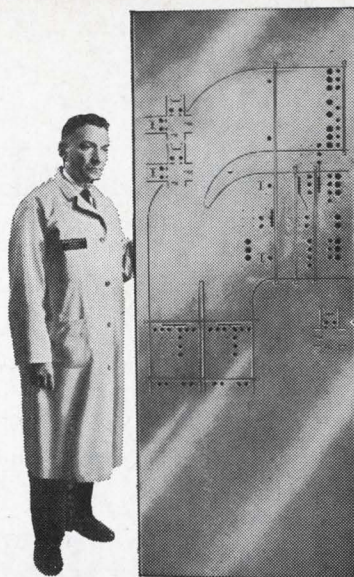

think BIG

(also small)

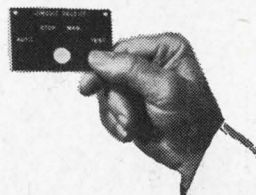

Now engrave anything from 6 ft. panels to tiny nameplates

Engravograph tackles them all. Right in your own shop, effortlessly, speedily — ideal for unskilled workers. Adjustable ratio engraves 21 different sizes.

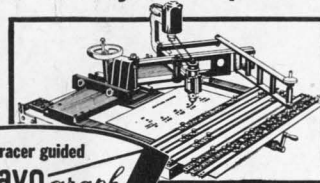

Write for illustrated catalog # 114



new hermes engraving machine corp.

20 Cooper Square, New York, N. Y. 10003. Chicago, Atlanta, Dallas, Los Angeles, Montreal

Write Directly to Manufacturer

Circle 228 on reader service card

For Production Efficiency

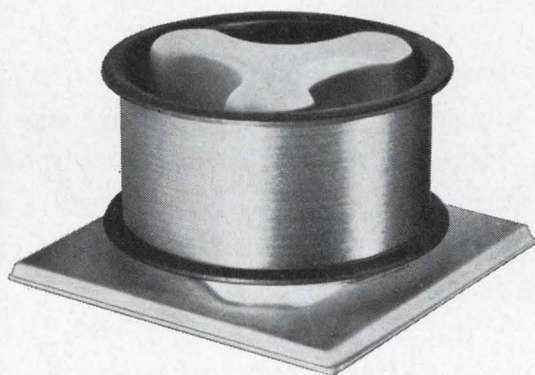

CRM FINE WIRE

for **ULTRASONIC BONDING — ALUMINUM & ALUMINUM ALLOYS**

featuring
Cleanliness • Strength • Uniformity

Contact CRM engineers for recommendations for your application.

Write for latest catalog.

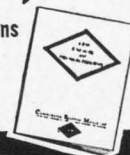

CONSOLIDATED REACTIVE METALS, inc.

115 Hoyt Avenue — Mamaroneck, N. Y. — OWens 8-2300 — TWX 914-835-3380



You know who's 2nd in rental cars...

**Bet you don't know
who's the 2nd largest supplier
of snap action switches**

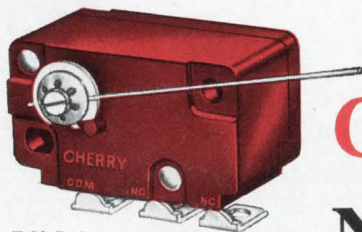

*E-51 Series
Low Torque Coin Switch*

CHERRY

Now you know...surprised?

Frankly, it surprised us, too. We've been quietly shipping switches in ever-growing numbers—until today there are over 80,000,000 Cherry switches in use.

How come? Well, most importantly, demanding design engineers in leading companies have specified Cherry switches—watched their performance and reliability in application after application—and decided that Cherry delivers what they promised, time after time.

What next? As "No. 2" we'll be working harder than ever to produce soundly designed switches that give you the long mechanical life, the precision operation that you need for an ever-growing number of applications.

As a matter of fact, it's a good bet that the switch you'll be specifying for your next application has already been through the tough field testing you demand. Like the Cherry Low Torque Coin Switch shown here. (It's "No. 1" in photocopy and vending machines right now.)

Drop us a note for a free sample of this switch for testing. There is no obligation...but then you'll know why Cherry has become the 2nd largest supplier of precision snap action switches.



CHERRY ELECTRICAL PRODUCTS CORP. • 1656 Old Deerfield Road • Highland Park, Illinois 60035

New Consumer Electronics Review



Solid state, modular stereo system CS-1W features 35 w of peak power. It contains a Garrard record changer in the master section which also houses the amplifier, bass, treble, loudness, and balance controls. Frequency response is 50-25,000 hz. Harmonic distortion is less than 1% for 2.5 w each channel. Price is \$99.95. Sylvania Electric Products Inc., 730 Third Ave., N.Y. [491]

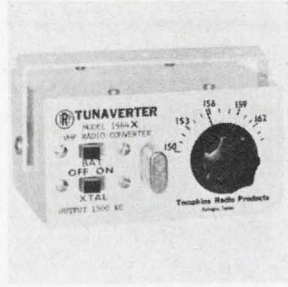

Designed for mobile operation, the Tunaverter model 1564X covers the 150- to 164-Mhz band with both crystal controlled and tunable provisions selectable with a switch. It is possible to monitor any number of crystal controlled channels by plugging in the correct crystal in the Tunaverter front. Price is \$32.95, less crystal. Herbert Salch & Co., Woodsboro, Tex. 78393. [492]

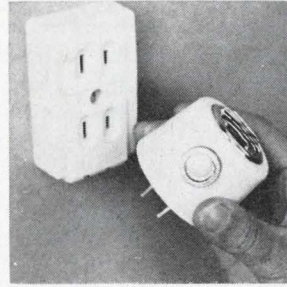

A compact fire alarm is designed for homes, offices, hotels, schools, warehouses, etc. It has 3 essential parts: buzzer, fire alarm sensor, and plug. The fire alarm sensor activates the buzzer when room temperature reaches 135°F. Specs include: voltage, 110-120 v a-c; dimensions, 1 3/4 x 1 3/4 in.; weight, 0.15 lb. Majima Co., 561, 2-Chome, Kugayama, Sugunami-Ku, Tokyo, Japan. [493]

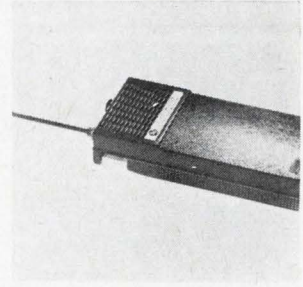

Hand-held uhf 2-way radio for personal use, the Compact, with 2 controls and a fully retractable 6-in. antenna, is for use by those who make frequent contact with a central office. The transmitter has an r-f output of 150 mw and the receiver an audio output of 100 mw into a 2-in. loudspeaker. Pye Communications Inc., 100 U.S. Highway 46, Mountain Lakes, N.J. 07046. [494]

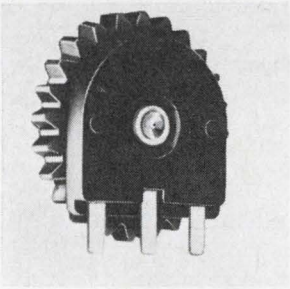

Applications for the improved series M-250, 9/32-in. diameter, 1/10-w composition variable resistor are in miniature transistor hearing aids and telephone equipment. Features include even starting torque, consistent smooth turning torque throughout the control's life, and minimized corrosion effects. Price is \$3 each in 1,000 lots. CTS of Asheville Inc., Skyland, N.C. 23776. [495]

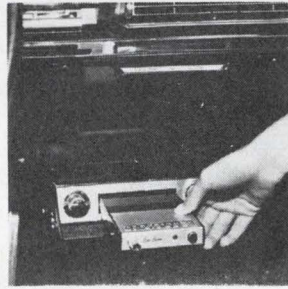

The AutoTuner, designed for automobile and home stereo, is an a-m/f-m cartridge tuner that will fit any 4 or 8 track cartridge playback unit. It slips in and out of the tape deck like any regular 4 or 8 track cartridge. The solid state unit includes afc and is built to EIA specs. Price is under \$50. GW Electronics Inc., 9465 Wilshire Blvd., Los Angeles 90000, Calif. [496]



Solid state TC-155 is a 4-track stereo playback-only tape deck that provides stereo facility for those who do not wish to record their own tapes as well as duplicating facility for those interested in dubbing prerecorded tapes. It operates at 7 1/2, 3 3/4 and 1 7/8 ips, and has a vibration-free motor. Price is \$99.50. Superscope Inc., 8150 Vineland Ave., Sun Valley, Calif. 91352. [497]



Solid state f-m 2-way radios, designed for cars and trucks, are available in 25 to 50 Mhz and 132 to 174 Mhz. Fifty-watt models are offered for low band and 35-w units for high band. They include a circuit that uses sensing and control principles to protect against destruction when on the air too long or under unusual stress. General Electric Co., Lynchburg, Va. 24501. [498]

New consumer electronics

A long, hard life for recording heads

Coating extends life span of tape duplicating heads from 500-1,000 hours to as long as 20,000

Three years ago, Kingston Ganske of Arvin Industries Inc. came up with an idea for a color-video tape recorder. His idea set off a chain of far-reaching events.

Because the requirements for the tape head were so stringent that they were considered impossible

to be met by Arvin's outside suppliers, Robert Nau, the firm's vice president and general manager, decided to set up a separate division to develop the vtr recording head. Now that Arvin had a new company, Arvin Magnetics, someone was needed to head research.

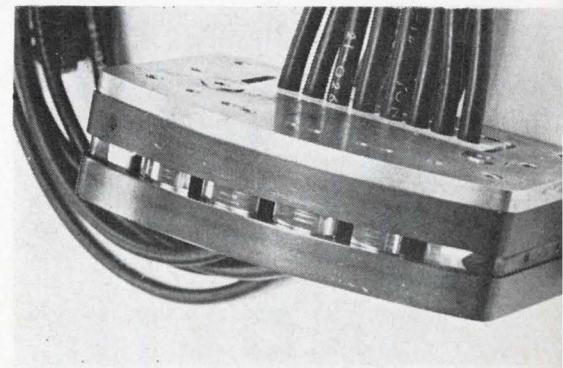

Hard head. Professional unit for production of eight-track tape has hard coating for longer wear.

Monolithic capacitors

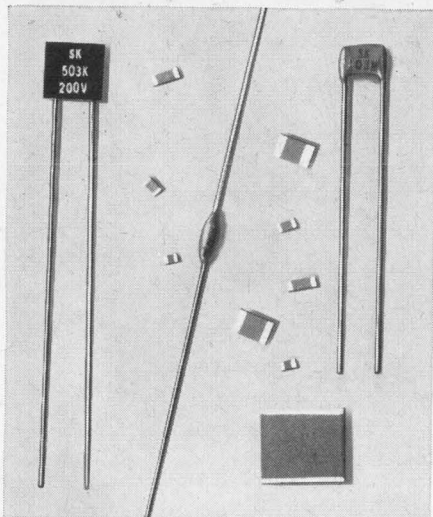

components and chips shown actual size

If you need microminiature size and the ultimate in reliability—you need SKottie monolithic capacitors.

SKottie monolithics provide the highest capacitance per unit volume available. And monolithic construction makes these capacitors practically immune to their environment. They offer the double protection of fused ceramic plus epoxy or phenolic encapsulation.

Both capacitors and chips are available in values ranging from 1.0 pf to 1.0 Mfd and higher in three dielectric materials. The chips are ideally suited for hybrid integrated circuits and can be soldered directly to the substrate. They can be supplied either tinned or untinned and also in special terminations other than silver. SKottie monolithic capacitors are available molded, dipped, or unencapsulated in both axial and radial lead configurations.

Write on your company letterhead for test samples. Ask for bulletin 6801 for more detailed information.

SKOTTIE
ELECTRONICS, INC.
Subsidiary of Renwell Industries, Inc.
Line St., Archbald, Penna. 18403
Ph: 717-876-1686 TWX: 510-656-2979

To fill the post, Nau reached out to RCA Laboratories in Camden, N.J., to tap Francis Oliver, an acknowledged leader in magnetic recording.

With a new product, a new company, and a new executive, Arvin needed yet another ingredient: a definition of the market. After surveying prospective commercial and industrial customers, the company decided to concentrate on producing heads for tape duplication, character recognition, computer systems, and video and audio recordings. Realizing the relatively short useful life of existing magnetic heads—500 to 1,000 hours—Arvin set out to make a better one. (In the duplication of four- and eight-track tapes, virgin tape is passed over the mastering head at speeds ranging from 30 to 60 inches per second or more, causing extreme head wear.)

Innovation. Today, resulting from a year's development, Arvin Magnetics has a hardening process that extends the life of professional mastering heads from 1,000 hours to a minimum of 10,000 hours and as much as 20,000 hours—possibly longer.

"Since none of our heads has even approached the limits of its life expectancy in actual use," says Oliver, "we can only make an estimate based on laboratory tests. In applications other than tape duplication—computer, instrumentation, and audio and video recording, and playback—where the same tape is passed over and over across the head, with lower abrasion each time, the useful head life will easily exceed 20,000 hours."

To achieve long wear, a coating of an alloy that the company says is almost as hard as diamond, is applied to the head. The alloy adheres to the head's surface to become a part of it. The coated head is then lapped and finished with a diamond wheel.

Cost advantages. Although head wear is extended by a factor of from 10 to 20, Arvin's duplicating and mastering heads are priced only about twice as much as conventional heads. Arvin Magnetics is offering a mastering head—the A808-OLH—for eight-track stereo tapes priced at from \$700 to \$800 each, depending on quantity. A mastering head for a four-track stereo is also available, priced be-

tween \$450 and \$550.

As Oliver points out, "The benefits of longer head life also includes savings in down time of the tape duplicating equipment. Readjustments that are normally made every two or three days can now be made at intervals of from 20 to 40 days."

Although most duplicating heads have a gap depth of from 0.02 to 0.03 inch, the Arvin heads utilize gap depths of only 0.003 to 0.005 inch, resulting in better recording sensitivity. This improved sensitivity not only enhances the dynamic performance of the head, but also cuts down the driving power required for recording by as much as 50%.

Specifications (A808-OLH)

Inductance (nominal at 1 khz)	2.2 mh
D-c resistance (nominal)	4.25 ohms
Resonant frequency	2 Mhz
Bias frequency	240 khz
Bias current (nominal at 3.2 khz, 30 ips, 10 db current ratio at 80 khz)	1.5 ma

Arvin Magnetics, Thirteenth Street, Columbus, Ind. 47201 [499]

New consumer electronics

Weakest link gets stronger

Plastic replaces paper in new speaker shape that lowers cost

As audio buffs know, the weakest link in a sound-reproducing system is the speaker. For the past 40 years speakers have generally been designed with the same basic components: a cone, a coil, and a magnet. Changes in the materials used in the cone and magnet have improved frequency characteristics, but the general configuration has remained unchanged.

The only exception here is the electrostatic speaker, which employs a flat panel to radiate sound and is driven by charged plates. But they cost about \$1,500.

Engineers at ERA Acoustics Corp. decided to combine the best features of the electrostatic speaker with low-cost plastic manufactur-

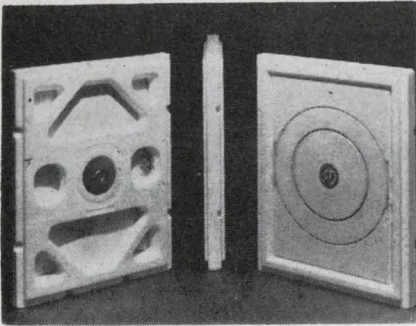

Skinny. Thin speakers perform like their big brothers at lower cost.

ing techniques. The result is the Poly-Planar, a speaker costing \$14.95 and measuring $1\frac{3}{4}$ by $14\frac{3}{4}$ by only $1\frac{7}{16}$ inches. An even smaller version, $4\frac{1}{2}$ by $8\frac{1}{2}$ by $\frac{3}{4}$ inches is available for \$8.50.

The Poly-Planar contains a magnetic structure that produces a radial field within a closely spaced gap. Audio signals applied to a voice coil inserted in the gap produce motor action with resulting acoustical output.

Rigid panel. In place of the conventional paper cone however, is a flat plastic panel which is only a fraction of the depth of the equivalent cone structure. The material used for the diaphragm is expanded polystyrene beads in a compacted head structure. Since the beads are largely air, the mass is extremely low. For example, the weight of a typical $\frac{1}{8}$ inch acoustic panel is less than 0.2 gram per cubic inch.

With the flat rectangular panel, a larger piston area is also available. As a result, the length and width dimensions can be made smaller than the cone speaker. Superior low frequencies can be reproduced by using an area equivalent to that of a cone speaker.

Because of the unit's mechanical stability, more accurate coil centering is feasible, permitting a shorter magnetic gap. This, together with the smaller acoustical panel mass, allows the use of a lower magnet weight for a power output equal to that of the cone speaker. For a given design, it is possible to reproduce the same sound power output with a smaller amount of piston displacement and the magnet thickness can be made thinner without introducing appreciable distortion.

ERA Acoustics Corp., 311 East Park St., Moonachie, N.J. [500]

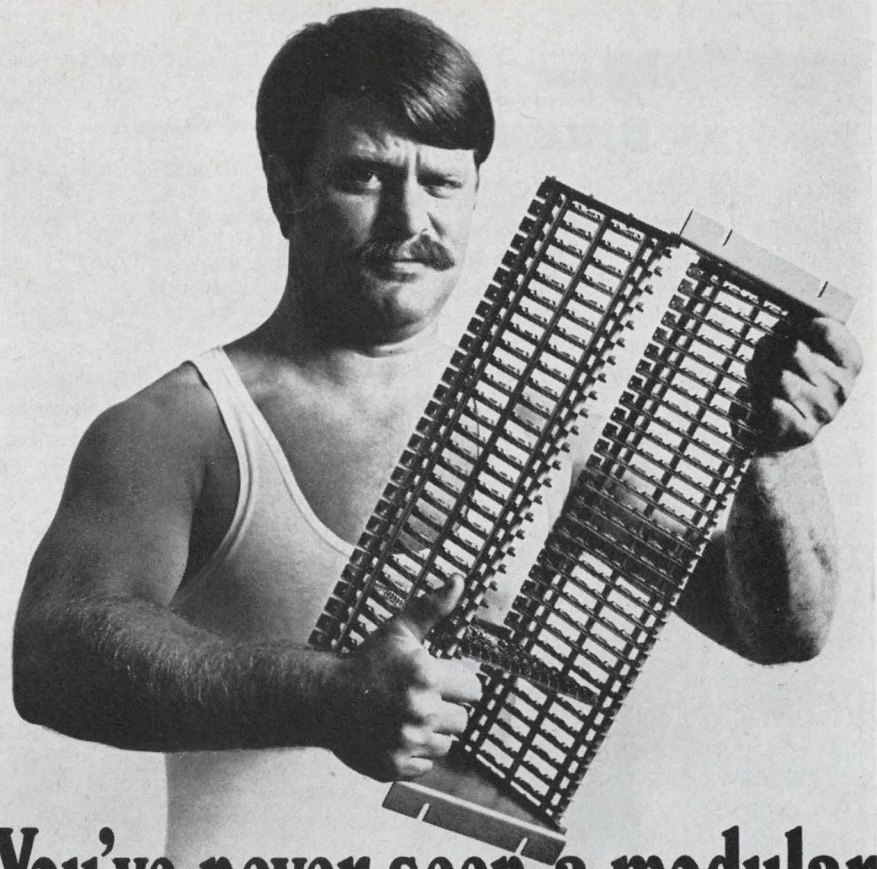

You've never seen a modular PCB rack this rugged. Before.

The card guides are stainless steel, and have multiple spring fingers for positive retention; all structural members are cold rolled steel, the support rods $\frac{3}{16}$ " in diameter, with additional $\frac{1}{4}$ " stiffener rods available to reinforce extremely long or heavy assemblies. ■ This is the Birtcher 56 Series rack—emphasizing high-density packaging (your choice of card spacings down to $\frac{3}{8}$ ") and low profile (card height plus just $\frac{11}{16}$ "). It handles $\frac{1}{16}$ " and $\frac{3}{32}$ " boards, with retainers from 2" to 10" long, in 1" increments. The rack itself can be 2" to 25" long, and board spacers are available to any length, with .002" accuracy. Unusual thinness of the card guides promotes maximum air flow between cards, and their firm grip and stainless steel construction provide excellent retention and reliable electrical contact for grounding. Available in component form or fully assembled to your specifications.

EXTRA STRONG CARD RETENTION—These new stainless steel guides hold cards firmly with a series of spring-type grippers along the length of the guide. Design also provides smooth travel on insertion and withdrawal.

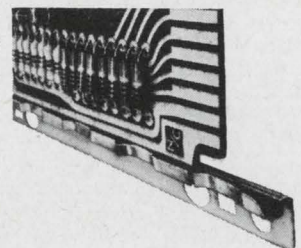

Write for data sheets on the 56 Series PCB Rack.

the BIRTCHER CORPORATION
INDUSTRIAL DIVISION

745 Monterey Pass Road • Monterey Park, California 91754 • (213) 268-8584

To put it in writing...

look first to **BRUSH®**

No matter what your direct writing recording requirements, look first to Brush for the optimum answer. There's the famous Mark 200 series of modular systems plus a complete line of portable and general purpose recorders:

Mark 200—8 Channel Recorder

New generation Series 1707 system combines all solid state electronics with modular construction for tailoring to specific requirements. Choice of channel widths and input preamplifiers. Range of chart speeds 0.05 to 200 mm/sec. Patented pressurized-ink writing system.



Mark 220 Portable Recorder

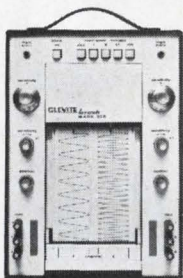

High performance two analog channel unit weighs only 25 pounds, writes in any position. Has the Mark 200 writing system. Chart speeds from 1 to 125 mm/sec. One millivolt sensitivity. Portable.

Mark 250 Strip Chart Recorder

Fastest, most versatile 5" strip chart recorder anywhere. Contactless servo. Detachable chart magazine. Has the Mark 200 writing system. Chart speeds from 0.2 sec/div. to 5 min/div., sprocketed drive. Portable.

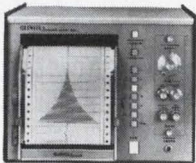

Mark 280 Dual 80mm Recorder

Feedback penmotor unit has two "double width" analog channels. Has the Mark 200 writing system. Chart speeds from .05 to 200 mm/sec. Portable.

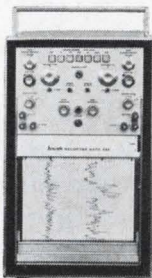

Brush Lightbeam Oscillographs

Choice of three high performance models with up to 25 channels, frequency response to above 5000 Hz, variety of chart speeds .002 ips to 120 ips. Writing speeds to 60,000 ips.

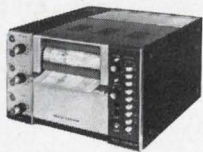

To put it in writing, write for complete catalog. Clevite Corporation, Brush Instruments Division, 37th and Perkins, Cleveland, Ohio 44114.

CLEVITE BRUSH

New Books

The effect of change

Technology—Economic Growth and Public Policy
Richard R. Nelson, Merton J. Peck and Edward D. Kalchek
A Rand Corp. study
Publications division,
Brookings Institution
238 pp., \$6.00

Engineers are far more concerned with introducing new technologies than contemplating the problems such innovations may create. They are, in the main, too involved with advancing the state of the art to consider how their efforts might affect the state of the nation.

That important issue has now been examined by three members of the Rand Corp. Their study, well documented and eminently readable, offers some answers to the questions of what happens to an economy when new technology is introduced; its effect on employment, production, and education.

Their work will aid the innovators—engineers, scientists, technologists—to present their case in clear terms to economists and policy makers. Management, too, can profit from reading this study because it illustrates the need for long-range planning and an understanding of the political and economic changes that are made by changes in technology.

The authors discuss the relationship of productivity growth to research and development spending, the allocation of resources to advance technology, the various sectors of the economy, and the factors influencing the rate at which new technology is absorbed into the economy. They define the operational concepts of technology itself, and explore such vital side issues as the expansion and updating of capital stock, educational needs, and the inner workings of industry.

This is followed by an examination of the role played by the labor market, natural resources, supply and demand, and the social framework.

The study offers some suggestions which would allow society to reap the full benefit of technological progress with minimum adjust-

ment pains. And it shows how technological advance should keep step with the strengths and the weaknesses of the economy.

The concluding section of the book is devoted to the establishment of policy. It describes effective methods of judging the need for change and obtaining private, public and institutional funding of research and development. The authors suggest areas where government effort may be most effective and provide a general strategy for policy-making on technology.

Groping in the dark

Introduction to Automata
R.J. Nelson
John Wiley & Sons Inc.
400 pp., \$12.95

Automation is a technology everyone's talking about but few seem to understand. One of the latest works on the subject, R. J. Nelson's "Introduction to Automata," does little to change this situation. In fact, the book is so enmeshed in jargon and symbology that it may well require a primer—an introduction to "Introduction."

Nelson refutes the old argument that mathematics is a science in which easy terms are used to comprehend difficult ideas. True, he introduces and defines his terms and symbols in the opening chapter. But to little avail. In succeeding chapters he plunges into difficult and complex ideas using this terminology, forcing the reader to constantly refer to the definitions in hopes of understanding what the author is saying.

Typical of the comprehension barriers found in the book is: "A Godel function is a one-one function on a subset of A^* into the integers." Another, "Assume that ϕ is a homomorphism of a monoid M onto M' and that M/R is the quotient monoid modulo R ." Not that the book is completely incomprehensible.

Every now and then Nelson writes in language understandable to most engineers, thus throwing some light on the subject. For example: "The study of formal systems, and therefore of automata, is

The 7-year-old miracle.

The Mark 200 came on the market back in 1961. And ever since, the competition's been playing catch-up. Take the traces it gives you. A patented, pressurized inking system puts them into the paper . . . not just on it. They're incredibly crisp. You won't smudge them. You can reproduce them. And talk about accuracy! We promise you 99½% (mostly because of a pen position feedback system that other manufacturers are *still* trying to figure out!) ■ There's more. Lots more. ■ You have a choice of 32 different preamplifiers and an almost unlimited number of penmotor combinations. Then too, you can select either Z-fold or roll type chart paper take-up and a vertical or horizontal or pull-out oscillograph. In short, you tell us what kind of recording you want to do and we'll put together the Mark 200 system to

do it. ■ But here's the real kicker: Specify a Mark 200 and you specify a *proven* system. Right this minute there are more than 27,000 channels purring away throughout the world. We can *talk* all day about "reliability" but acceptance and experience like this says it in seconds. ■ We still haven't done the Mark 200 justice. To *really* understand what we're talking about, you have to see one in action. Ask your Brush representative to arrange a demonstration. After all, how often do you get to see a miracle? Clevite Corporation, Brush Instruments Division, 37th & Perkins, Cleveland, Ohio 44114.

CLEVITE BRUSH

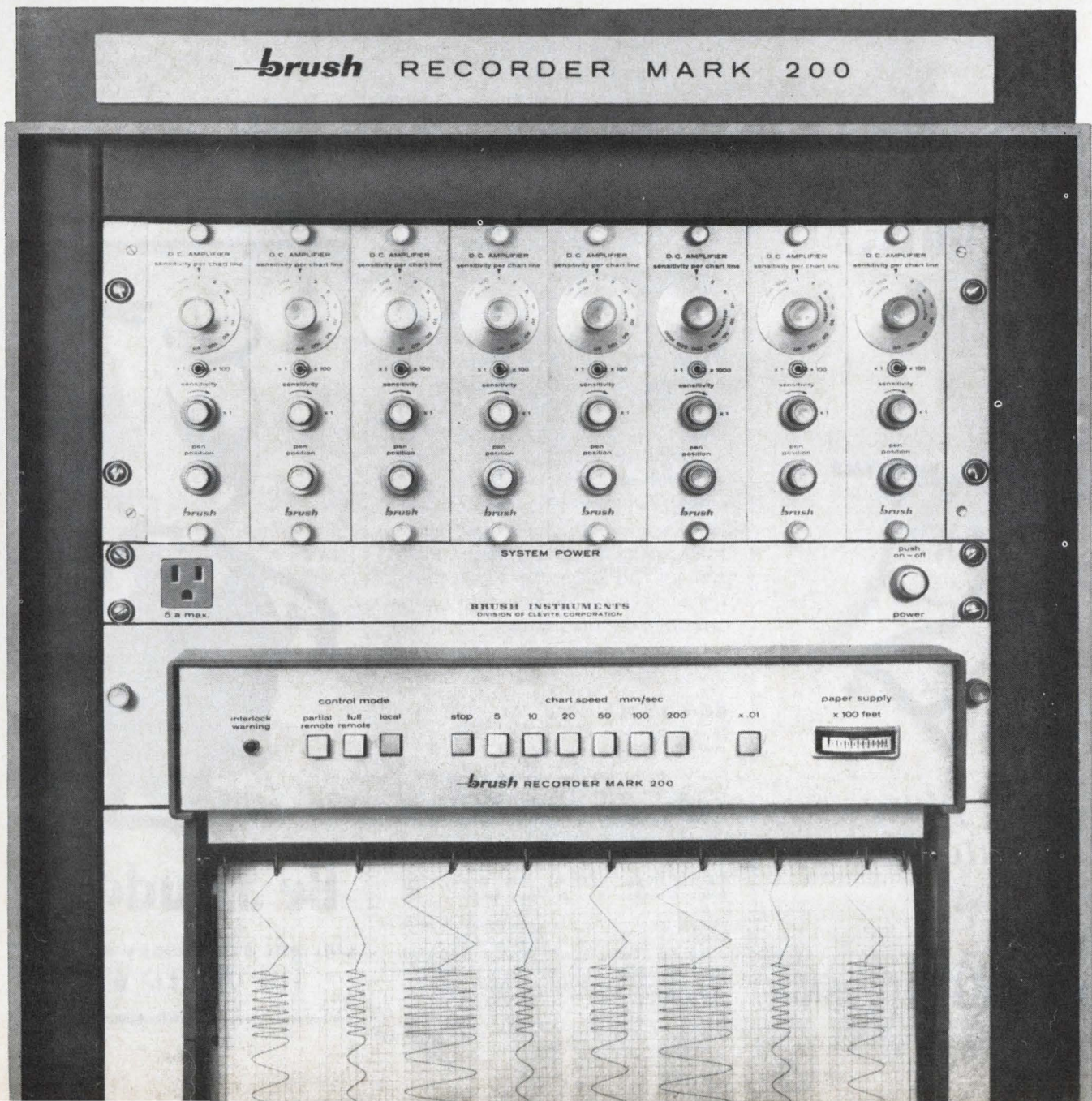
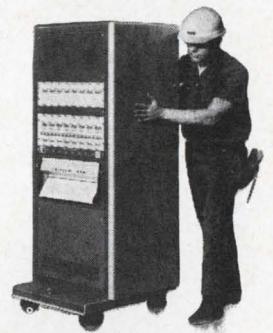

From deForest to Shockley to Packard to Varian; from the 5 Nobel Laureates at Stanford to the 3,500 PhDs at work in this area — this is where innovators gravitate.

Locate your business in an area where the synergistic rub-off between industry and education converts ideas into enterprise, and turns innovation into profit. People of accomplishment come here because they like it: the climate, the environment, and the pace of the Western electronic market now pegged at \$6 billion. If you are starting or expanding a business, send for your copy of "Executive Checklist for Site Selection". It may help you determine that you're our kind of company, and that we're your kind of profit center. Write Ed Beaty, Chamber of Commerce, 499 S. Murphy Ave., Sunnyvale, California 94086.



this is
**ENTREPRENEUR
TERRITORY...**

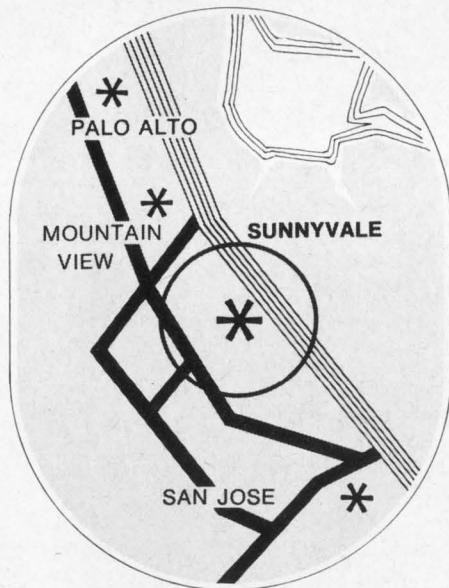

*a good place
to locate your
business*

SUNNYVALE CALIFORNIA

194 Circle 194 on reader service card

New Books

a part of mathematics and is related to the broader field of computer science in much the same way as analysis is to well-established empirical sciences such as physics or chemistry. It is the mathematical part of the study of finite-state complex systems, in the engineers' jargon." A computer is given as an example of a finite-state complex system, but so is a mechanical desk calculator and the mechanism that extends and retracts the point of a ball-point pen.

But when light appears, darkness quickly follows. For example: "Suppose we want to construct an ordinary pulse divider [that] ejects a 1 at time t iff [the word "iff" is mathematical shorthand for "if and only if"] the number of inputs up until t is even but not zero. The alphabet is 0, 1, #, q_0 , q_1 , and we have one axiom scheme where w is a variable ranging over the elements. . . ." After about a page and a half of this, the author presents a logic diagram that is essentially what an engineer would have constructed quite easily had he read no further than the very first sentence of the particular topic.

Nelson makes some good points, but they are few and far between. These include dissertations on the concepts of an inductive process and a formal system, a Turing machine that is an idealized model of a computer with an infinite memory, various aspects of sequential machines and circuits, and languages and algebraic linguistics as branches of the theory of automata. But by and large, the subject matter remains undecipherable to the uninitiated. The book's value to most engineers is questionable.

Recently published

Introduction to Automata, R.J. Nelson, John Wiley and Sons, 400 pp., \$12.95

Introduction to the main mathematical theory underlying digital computer circuits, programming, language translation, and nerve networks. By using one central, formal model, the author affords a broad understanding of the whole field of automata.

Electric Power Systems, B.M. Weedy, John Wiley & Sons, Inc., 307 pp., \$8.50

Covers both theory and application of power system operation and analysis. Topics include electromagnetism, network theory, energy conversion, and control systems; also fault analysis, thermal limitations, stability, and load flow.

**400W 28VDC
Servo Amplifier**

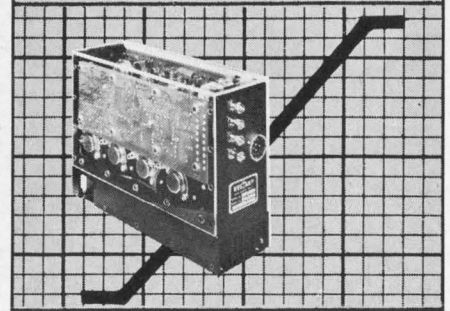

for torquers and
printed circuit motors

Westamp Model A499 is a linear DC servo amplifier which operates directly from 28VDC or 40VDC. It has 3 summing inputs, each independently adjustable in gain from 0 to 500V/V with voltage feedback, or 0 to 50A/V with current feedback. Model A499, an AC carrier type amplifier with built-in frequency generator, provides stability which eliminates a need for balance adjustments. For further data, just send for our catalog.

HIGH POWER SERVO AMPLIFIERS

WESTAMP 1542 15TH STREET
SANTA MONICA, CALIF. 90404
PHONE: (213) 393-0401

Circle 229 on reader service card

Cartoon by Whitney Darrow, Jr.

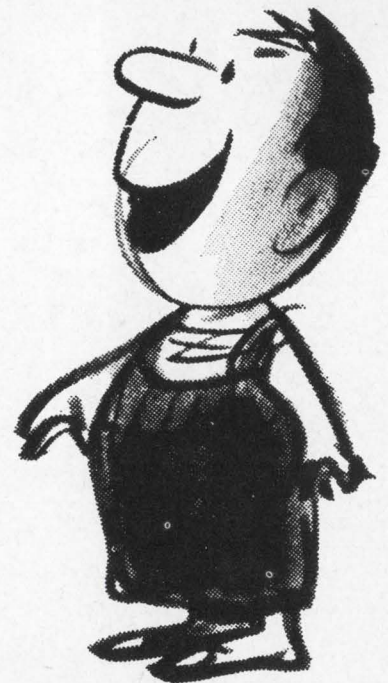

Be a buddy!

One gift works many wonders
THE UNITED WAY

mighty
minitokins

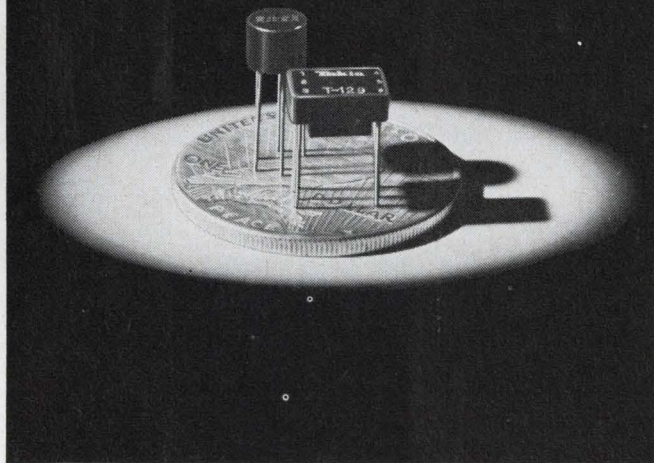

On Tokin miniature pulse transformers, everything's been minimized but power. There are none smaller-sized, lighter-weight, nor lower-priced. Even under extreme conditions of humidity or temperature, effects on Tokin mini-transformers are next to nil. Yet these tiny Tokins have tremendous transmitting power. Power to drive a memory matrix.

The power-source is Tokin itself. Tokin takes its advanced techniques, rigid quality controls and long experience in making complete memory systems, and applies them to the manufacture of Tokin miniature pulse-transformers: real reliability from the largest manufacturer of memory cores, planes, stacks, and everything to do with magnetic materials, in Japan.

Whether it's minitokins or matrix that you're after, remember: Tokin memory systems are, start-to-finish, totally Tokin.



Tohoku Metal Industries, Ltd.
4, 7-chome, Ginza-Higashi, Chuo-ku, Tokyo, Japan
Tel: Tokyo 542-6171 Cable Address: TOHOKUMETAL TOKYO

Best Value Meters Come From Heath!

Heathkit IM-25 Solid-State Volt- Ohm-Milliammeter



Kit
\$80
Wired
\$115

• 9 DC and AC volts ranges — 150 millivolts full scale to 1500 volts • 7 Resistance ranges measure from one ohm to 1000 megohms • 11 Current ranges — 15 uA full scale to 1.5 A. • Response to 100 kHz • 11 megohm DC input impedance, 10 megohm on AC • Battery or AC power

Heathkit IM-16 Solid-State Volt-Ohm-Meter

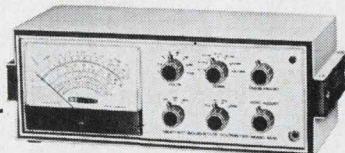

Kit
\$44.95
Wired
\$64.95

• 8 DC & AC volts ranges — 500 millivolts full scale to 1500 volts • 7 Resistance ranges measure from one ohm to 1000 megohms • 11 megohm DC input impedance, 1 megohm on AC • Battery or AC power

Heathkit IM-13 Bench Type VTVM

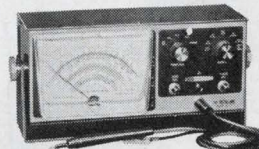

Kit
\$34.95
Wired
\$52.95

• 7 DC & AC volts ranges — 1.5 volts full scale to 1500 volts • 7 Resistance ranges measure from one ohm to 1000 megohms • Response 25 Hz to 1 MHz • 11 megohm DC input impedance, 1 megohm on AC • AC powered



Kit
\$26.95
Wired
\$44.95

Heathkit IM-11 Standard VTVM

• 7 DC & AC volts ranges from 1.5 volts full scale to 1500 volts • 7 Resistance ranges measure from one ohm to 1000 megohms • Response 25 Hz to 1 MHz • 11 megohm DC input impedance, 1 megohm on AC • AC powered



Kit
\$37.50
Wired
\$52.95

Heathkit IM-21 Lab AC VTVM

• 10 AC volt ranges measure from 0.01 to 300 volts RMS full scale • Decibel range —52 to +52 total in ten ranges • Response 10 Hz to 1 MHz • 10 megohm input impedance • AC powered



Kit
\$29.95

Heathkit MM-1 Portable Volt-Ohm Milliammeter

• 7 DC & AC volts ranges from 1.5 volts full scale to 5000 volts • 5 Direct current ranges from 150 uA full scale to 15 A. • 3 Resistance ranges measure from 0.2 ohm to 20 megohms • 20,000 ohms per volt sensitivity



Kit
\$19.95

Heathkit IM-17 Solid-State Volt-Ohm-Meter

• 4 AC & DC volts ranges from one volt full scale to 1000 volts • 4 Resistance ranges measure from 0.1 ohm to 1000 megohms • 11 megohm DC input impedance, 1 megohm AC • Response 10 Hz to 1 MHz • Battery powered • Includes all probes and portable case

HEATH COMPANY, Dept. 520-28
Benton Harbor, Mich. 49022
In Canada, Daystrom Ltd.

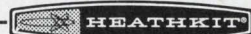

Please send my FREE 1968 Heathkit Catalog.

Enclosed is \$ _____, plus postage.

Please send model(s) _____

Name _____

Address _____

City _____

State _____

Zip _____

Prices & Specifications subject to change without notice.

TE-173

Catch 1 μ s
voltage peaks.

Why?

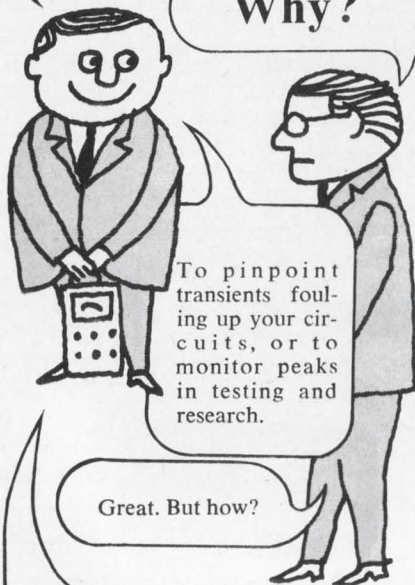

To pinpoint transients fouling up your circuits, or to monitor peaks in testing and research.

Great. But how?

With PEAK LOK. It measures positive, negative or bipolar peaks with 1% full scale accuracy, holds its reading in an analog state until it's reset. Use it to measure physical parameters in environmental tests, record surges in power lines and supplies, detect overload transients in electronic and electrical systems . . . everywhere precise determination of voltage peaks can help solve a problem. It has an output for data logging, can be remotely reset, has nine ranges from 0.1 to 1000v full scale, and can go up to 30 kv with a high voltage probe. When you're not catching transients, use PEAK LOK as a sensitive DC voltmeter, to measure that hard to get to voltage with a quick touch of the probe.



For complete specifications

write to PEAK LOK Sales, Dept. 243, Analog-Digital Systems Division, Control Data Corporation, 4455 Eastgate Mall, La Jolla, California 92037. Or phone 714/453-2500.

CONTROL DATA

CORPORATION

4455 Eastgate Mall, La Jolla, Calif.

Technical Abstracts

In Bounds

An algorithm for computing frequency response bounds for systems with variable parameters
D.L. Chenowith, C.L. Phillips, and R.K. Cavin III
Department of Electrical Engineering
Auburn University, Auburn, Ala.

Components and parameters in control and other electronic systems seldom remain at their nominal or design values. For economical manufacturing, the system must be designed with components having suitably wide tolerances. For operational reasons, such as a large increase in ambient temperature, components change values. Either kind of variation can effect the system's frequency response characteristics.

To determine the extent of these dynamic changes, the system's transfer function is separated into real and imaginary parts, the tolerance values added to each parameter, and the extreme values of each part are determined at selected frequency intervals.

Combining the real and imaginary responses, at high-tolerance conditions, establishes the upper bound of the dynamic characteristics. A similar bound is found for low-tolerance values. The upper and lower bounds are the envelope of expected dynamic performance.

Presented at ASME Winter Meeting, Pittsburgh, Nov. 12-17.

Extending spacecraft life

A coulometer-controlled battery charge regulator optimized to a solar array source
John Paulkovich
Goddard Space Flight Center
Greenbelt, Md.

How long a spacecraft remains operational depends largely on its nickel cadmium batteries. These batteries, charged by solar cells, supply surge power when demand exceeds solar-cell capacity during 'light' conditions, and total power during 'dark' periods.

Present battery systems rarely extract more than 50% of the available solar power, are relatively slow charging, and are easily shorted by overcharging and opened by overvoltage. Also, their

sensitivity to temperature makes for poor regulation.

These problems can be avoided with a new system that uses a coulometer to sense the state of the batteries' charge. The coulometer, which is similar to a NiCd cell except that both its plates are cadmium, maintains a low and predetermined voltage drop when passing current.

An input voltage control circuit transforms preselected operating voltages from the solar-cell array into output power for the cells. And the output voltage and current limiting enhance over-all charge regulation via a feedback path to the input, duty-cycle, and reset elements.

With the coulometer, charging rate is pushed to half the rated ampere-hour capacity of the cells, while built-in limiting action prevents overcharging. An internal feedback circuit reduces the charge to trickle rates just before full charge is reached; extraction efficiency is 90%.

Voltage limiting is based on a series arrangement under which the shorting of one or more cells can't interfere with the functioning of the remaining cells or of the charging circuit. Another voltage-limiting circuit, brought into play if one cell opens, prevents over-voltage buildup.

If overvoltage were allowed, the amount of oxygen generated within the charging circuit could reach the point where the resulting oxides would break down the cell separators. Also, the internal heat generated would shorten battery life.

Presented at 1967 IEEE Eastcon Meeting, Washington, D.C., Oct. 16-18

Weather watcher

A single-ended device for the remote determination of atmospheric transmittance over horizontal and slant paths
Richard T. Brown Jr.
Sperry Rand Research Center,
Sudbury, Mass.

Despite advanced electronic all-weather landing aids, no device is now in routine use for measuring visual conditions along the aircraft glide path. However, the laser

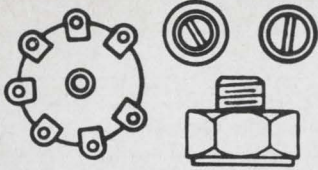

CHICOPEE MANUFACTURING CO. RESEARCH DIVISION MILLTOWN, NEW JERSEY	
TITLE:	
DRAWN BY:	DATE:
CHECKED BY:	SCALE:
APPROVED BY:	DWG NO.:
PROJECT NO.:	

The second time you draw these (or any other repetitive element) you're wasting creative time!

Use STANPAT repetitive symbols for any diagram, spec, detail, title block . . . or any other detail you draw. It's like adding another draftsman to your staff. STANPAT will preprint your own symbol. You'll always have it ready for application to your drawings and tracings on any medium. It will be accurate, permanent, reproducible, and . . . most important . . . you will gain creative time!

STANPAT reproduces the drawing you need on top-quality tri-acetate sheets. You simply apply the STANPAT to your tracings whenever you need to, as often as you need to. Adherence is instant. Reproductions are crisp and clean, even when microfilming. There's never ghosting . . . no matter what tracing medium you use!

Send for literature and samples today.
faithfully serving the engineer and architect for a quarter of a century

STANPAT PRODUCTS INC.



Covert and Main Street, Dept. J-2
Port Washington, N.Y. 11050
Telephone: 516 883-8400



Circle 231 on reader service card

*"Do you have problems
in getting extra fine
etching work done?"*

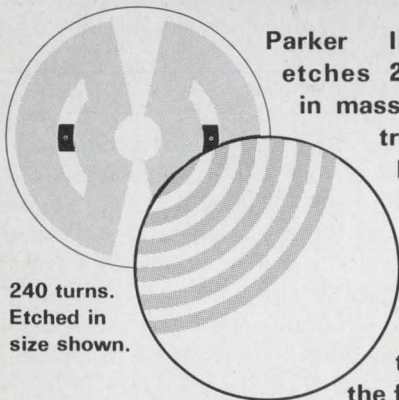

Parker Instrument Corp.
etches 2 mil wide lines
in mass production. Illustrated is a Parker Electrical Instrument Rotor Containing 240 etched turns.

240 turns.
Etched in
size shown.

Our increased production facilities permit us, for the first time, to accept

custom orders for etching. We can help you with your fine line etching problems!

WRITE OR CALL

PARKER
INSTRUMENT CORPORATION

200 Harvard Ave. • Stamford, Conn. 06904 • (203) 325-4361

Circle 232 on reader service card

TURN TO **DELEVAN** AS THE INDUSTRY LEADER FOR . . . **COILS and TRANSFORMERS**

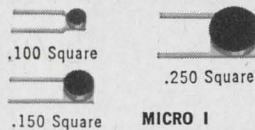

MICRO I

Micro I inductors are physically compatible with integrated and hybrid circuit packaging.

Magnetically shielded—low coupling
No core saturation problems
L & Q stability excellent
Epoxy encapsulated for environmental protection

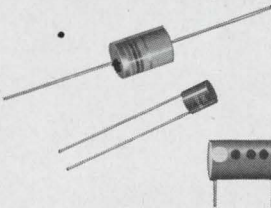

MOLDED FIXED

Miniature sizes down to .095 inches dia. x .250 inches length
Available in 10 standard series
Inductances from .15 microhenries to 220 millihenries

Excellent Q values for all circuit applications

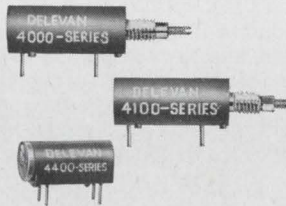

MOLDED TUNABLE

MOLDED TUNABLE

A remarkable break-thru for design engineers

Reliable high-quality molded tunable coil

Maximum Q values
Guaranteed L values .18 uh to 70,000 uh

Tuning ranges as high as three to one
Chassis or printed circuit applications

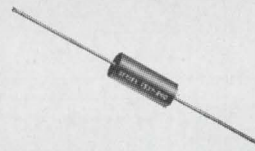

FIXED SHIELDED

FIXED SHIELDED

Finest industry advancement in molded shielded coils

Size .157 inches dia. x .375 inches length

Inductance range from .10 microhenries thru 100 millihenries

Epoxy molded for reliability

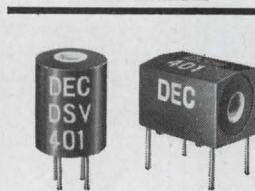

SHIELDED TUNABLE COILS

SHIELDED TUNABLE COILS

Model DSV-401 (vertical mount) and DSH-401 (horizontal mount) units for printed circuit boards.

Size .375 x .500
Range .10 to 10,000 uh
Stable Q

Electromagnetic Shielding
Transfer Molded Epoxy Encapsulation
Top and Bottom Tuning

From Delevan's inception, its product philosophy called for an extremely high degree of precision manufacturing to meet exacting performance levels required by all quality-minded manufacturers of electronic systems.

This led to the creation of Delevan's in-plant certified test laboratory . . . with great consideration given to the design and processing techniques which resulted in the products' repeated reliability under extensive environmental testing.

In addition to Delevan's standard line of coil and transformer products, a specialized group of engineers are available for the sole purpose of designing custom coils of any variation to your specifications.

CUSTOM COILS & TRANSFORMERS TO YOUR SPECIFICATIONS

Delevan Electronics Corporation / Division



**AMERICAN
PRECISION
INDUSTRIES INC.**

270 QUAKER RD. / EAST AURORA, N. Y. 14052
TELEPHONE 716/652-8600 TELEEX 091-293

OTHER DIVISIONS OF AMERICAN PRECISION INDUSTRIES INC.:
BASCO INC. • ELECTRO-MECHANICAL PRODUCTS DIVISION

Circle 197 on reader service card

197

VECO THERMISTORS

BEADS • DISKS • WASHERS • RODS
 BULBS • GLASS PROBES • SENSOR ASSEMBLIES
 CRYOGENIC • MILITARY GRADE • THINISTORS®



Thermistors provide precision measurement, compensation and control of temperatures, liquid levels, the flow of liquids and gases . . . WITH INSTANT RESPONSE. VECO Thermistors are available in a wide range of sizes, shapes, resistance values and temperature coefficients. VECO's staff of experienced engineers is available to assist you in product application and circuit design. Write for Condensed Catalog MGP681.

THERMISTORS • VARISTORS / VECO First in Progress • First in Service



VICTORY ENGINEERING CORP.

136 Springfield Ave., Springfield, N.J. 07081 Tel: 201-379-5900 TWX: 710-983-4430

J-8975

Circle 233 on reader service card

NORTON Magnetic Tape Heads

4514 1" Tape

4507 1/2" Tape

4504 1/4" Tape

SERIES 4500

Crosstalk—50 DB
 +75°C Temperature Operation

Send now for complete technical literature.

NORTON

ASSOCIATES, INC.

10 Di Tomas Court, Copiague, N.Y. 11726
 Phone: 516 598-1600

ECONOMICAL Thin Film!

If you want to be a leader, keep up with developments in SUSUMU's unique and original line of thin film products.

World's newest!

- Plate-ohm: evaporated metal film resistor
- Pla-con: organic thin film capacitor produced by plasma reaction
- Pla-module

Visit us at IEEE booth 4J23

Specialists in thin film technology

SUSUMU INDUSTRIAL CO., LTD.

Export Department:
 Minami Bldg., 1-12 Ebisuminami,
 Shibuya-ku, Tokyo, Japan
 TEL. Tokyo (03) 712-5990
 TELEX NO. 246-6270

Circle 234 on reader service card

Technical Abstracts

backscatter signature concept may provide a practical means for measuring cloud ceiling, range to a fog bank, and visual range over a horizontal or slant path.

The backscatter technique uses unique energy patterns obtained by bouncing a high energy pulse of light from a Q-switched ruby laser off the particles—fog or haze—that restrict visibility. The light backscattered from the obscuring medium is picked up in a photomultiplier receiver and displayed on a fast rise-time oscilloscope. This technique gives more representative and reliable measures of visibility because it can be used with a single-ended system—transmitter and receiver at the same location—rather than a double-ended system.

The backscatter signature concept is based on the decrease, with range, of the backscattered light from a laser beam as it passes through the fog or haze. Because of the overlapping cones of vision of the transmitter and receiver, the received backscattered light at first increases for short ranges, then decreases with range as the attenuation of the medium becomes significant. The shape of the curve relating received light to range then can be used as a measure of the transmittance of the scattering medium, and thus of the visibility conditions.

A double-ended system measures the attenuation of a calibrated light source for a known length of atmosphere—usually 500 ft. Since the path length is fixed, only a small sample of atmosphere, at one point along a 500-ft. runway, can be measured, and the sample is assumed to represent the average runway conditions.

A single-ended system, using the scattering medium as a means of folding the transmission path, has the following advantages: it is easily transportable, it can probe the atmosphere at a distance from the instrument, and it can be directed along an aircraft approach area without imposing any hazards to air traffic.

Presented at Eastcon, Washington, D.C. Oct. 16-18.



It's never too early to start saving their hearts

Help your children form good health habits now to reduce risk of heart attack later:

- Encourage normal weight; obesity in youth may persist throughout life;
- Build body health through regular physical activity;
- Serve them foods low in saturated fats;
- Teach them that cigarette smoking is hazardous to health;
- Make medical check-ups a family routine.

Set a good example. Follow the rules yourself and guard *your* heart, too.

GIVE...
so more will live
HEART FUND



Contributed by the Publisher

TUNG-SOL FLAT PACKS

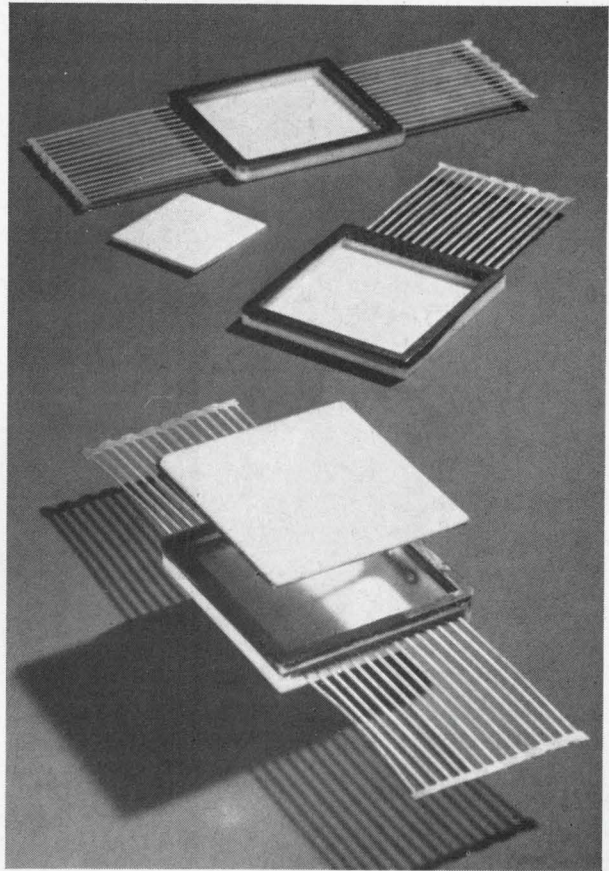

High mechanical strength, excellent thermal dissipation and precise dimensional accuracy, provide microcircuit packaging that assures maximum performance and utmost reliability with widest latitude of design freedom.

TYPICAL CONFIGURATIONS

Available in closed and "see-through" types.

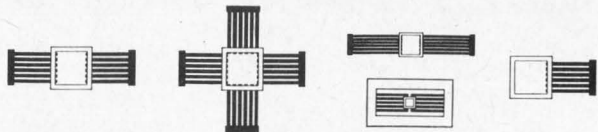

WRITE FOR "MICROCIRCUIT PACKAGES"



This brochure is eight pages of detailed information about Tung-Sol Flat Packs. No charge.

TUNG-SOL DIVISION
Wagner Electric Corporation

One Summer Avenue, Newark, N. J. 07104

Sophisticated Gaussmeter



Model 220

Budget Price!

\$540* buys this completely self-contained RFL Hall-effect gaussmeter (*plus probe). Measures flux density from 0.2 gauss to 20,000 gauss; permanent magnet, DC and AC fields up to 50 kHz, allowing measurement of sinewave and pulsed magnetic fields with a time base down to the microsecond region. Better than $\pm 3\%$ accuracy with self-calibrating feature which requires no reference magnets. Accuracy capabilities to $\pm 1\%$. Wide application in production, engineering, research and QC.



For detailed data and free Magnetic Application Booklet, write or call Herb Brumbach.

RFL Industries, Inc.
FORMERLY RADIO FREQUENCY LABORATORIES, INC.

Instrumentation Div. • Boonton, N. J. 07005
Tel: 201-334-3100 / TWX: 910-987-8352 / CABLE: RADAIRCO, N. J.

New Literature

Transient analyzer. White Electromagnetics Inc., 670 Lofstrand Lane, Rockville, Md. 20853, has published a bulletin on the model 200A transient analyzer used in recording of broadband, short-duration, and one-shot interference.

Circle 446 on reader service card.

H-f antenna systems. Keltec Industries, 5901 Edsall Rd., Alexandria, Va. 22314. A product catalog covers h-f antennas for radar, direction finding, communications, radio-propagation research, and electronic warfare. [447]

Piezoelectric ceramics. Gulton Industries Inc., 212 Durham Ave., Metuchen, N.J. 08841. A 25-page handbook, brochure H-500, describes nine piezoelectric materials, including barium titanates, lead-zirconate titanates, and lead metaniobates. [448]

Switches and relays. Electronic Controls Inc., 141 Danbury Rd., Wilton, Conn. 06897. A 24-page catalog describes high-density switches and relays capable of switching from four to 144 circuits simultaneously in computers, automatic testers, and process controls. [449]

E-element crystals. Reeves-Hoffman Division, Dynamics Corp. of America, 400 W. North St., Carlisle, Pa. 17013. A one-page leaflet gives specifications of E-element crystals in the 90- to 300-khz range. [450]

Piston trimmers. JFD Electronics Co., 15th Ave. at 62nd St., Brooklyn, N.Y. 11219. A 24-page catalog covers a broad variety of precision piston trimmer and tuning capacitors. [451]

Tip jacks. Raytheon Co., Fourth Ave., Burlington, Mass. 01803. Data sheet MC125 describes a line of tip jacks that meet the requirements of MS16108 revision F. [452]

Molding powder. Hysol Corp., 211 Franklin St., Olean, N.Y. 14760. A stable, epoxy molding powder for use in component encapsulation is described in bulletin E7-709. [453]

Molded tube sockets. Connector Corp., 6025 N. Keystone Ave., Chicago 60646. Dimensional drawings of 24 types of 7-pin molded tube sockets for chassis or p-c mounting are shown in technical publication 43A. [454]

Digital servo indicator. Gilmore Industries Inc., 3355 Richmond Rd., Cleveland 44122. A set of bulletins details applications for the model 710 high-speed digital servo indicator. [455]

Shielded enclosures. Technical Wire Products Inc., 129 Dermody St., Cran-

ford, N.J. 07016. Four-page data sheet covers 72 standard emi/rfi shielded enclosures to conform to MIL-STD-189, NASA KSC-153-F, RETMA SE-102 and EIA standard design. [456]

High-temperature adhesive. Aremco Products Inc., Box 145, Briarcliff Manor, N.Y. 10510. A two-page data sheet describes Aremco-Bond 515, a plastic adhesive for bonding ceramics, glass, metals, or plastics. [457]

Computing system. Electronic Associates Inc., West Long Branch, N.J. 07764. Bulletin 240-702 discusses the model 580 desk-top analog/hybrid computing system and its applications. [458]

Precision attenuators. Kay Electric Co., Maple Ave., Pine Brook, N.J. 07058. Precision in-line attenuators are listed and described in an eight-page catalog. [459]

Potentiometers. Samarius Inc., 300 Seymour Ave., Derby, Conn. 96418. Precision potentiometers from micro-miniature ($\frac{1}{2}$ in.) through 5-in. models are described in a 24-page catalog. [460]

Conductive-plastic pots. Helipot Division, Beckman Instruments Inc., 2500 Harbor Blvd., Fullerton, Calif. 92634. Data sheet 671520 covers two new ultrathin, conductive-plastic precision potentiometers. [461]

Scanner. Sigma Instruments Inc., 170 Pearl St., Braintree, Mass. 02185. Bulletin 1169 describes scanner 9231, which monitors up to 20 measuring points. [462]

Palladium plating solutions. Technic Inc., Box 965, Providence, R.I. 02901. Brochure describes two palladium solutions for electroplating electronic components that must function in high-temperature environments. [463]

Pulse generators. Solid State Electronics Corp., 15321 Rayen St., Sepulveda, Calif. 91343. A single-sheet bulletin details models PG-111 and PG-1112 solid state pulse generators that operate between 2 khz and 20 Mhz. [464]

Miniature ceramic capacitors. U.S. Capacitor Corp., 2151 N. Lincoln St., Burbank, Calif. 91504, offers a two-color, six-page catalog of miniature ceramic capacitors for military and industrial applications. [465]

Phase-angle measurement. Dytronics Co., 4800 Evanswood Drive, Columbus, Ohio 43224. A 10-page booklet describes a new primary phase-angle technique and outlines the merits and shortcomings of the various methods of phase-angle measurement. [466]

Simulation with stimulation.

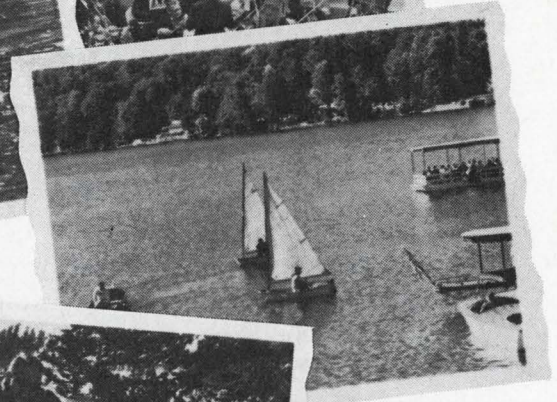
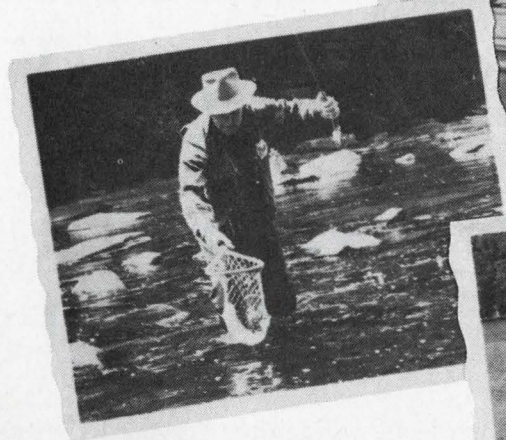

Here in Binghamton in the beautiful southern tier of New York, living the good life is part of the Link career package.

For practically outside your door is a year-round vacationland people travel thousands of miles to get to.

Winter transforms the area into a wonderland. The slopes at Innsbruck, U.S.A., just 15 minutes from downtown Binghamton, are among the best in the state. (As are those of five other ski resorts, all within an hour's drive.) By the way—it's great for the children too!

Summer sports abound with: great fishing, camping, horseback riding and all kinds of water sports. Over a dozen top golf courses too. There's plenty of bird and deer hunting in the most exhilarating countryside you've ever seen.

In Binghamton, Roberson Center for the Arts and Sciences provides a well-rounded schedule of lectures, performances, workshops, seminars and classes.

Performances by the nationally-acclaimed Tri-Cities Opera Workshop draw enthusiastic audiences. Area universities not only provide opportunity for continuing education but a full schedule of cultural events. Top flight public and parochial schools will offer your children the finest education available.

Inside Link, the climate is exhilarating, too. We employ the most sophisticated skills to make products for the space age. Such as the design and manufacture of aircraft and space simulators for training pilots and astronauts. Link has carried simulation to the point of a science.

But that's not all. Work and technologies run the gamut from visual display systems, photogrammetry, analog and digital computers to data processing, storage and retrieval systems.

These advanced arts challenge your best. If you've specialized in the field of engineering or science

—you can have a long and stimulating career with us. Here are some of the disciplines required now:

- AERODYNAMICISTS
- AEROSPACE SYSTEM ENGINEERS
- AIRCRAFT SYSTEM ENGINEERS
- TACTICS ENGINEERS
- MATH MODELERS
- SCIENTIFIC PROGRAMMERS
- HYDRAULIC SYSTEMS ENGINEERS
- MECHANICAL DESIGNERS
- ELECTRONIC RELIABILITY ENGINEERS
- PROPOSAL ENGINEERS
- CIRCUIT DEVELOPMENT ENGINEERS
- CLOSED CIRCUIT TV ENGINEERS
- OPTICAL ENGINEERS
- HUMAN FACTORS ENGINEERS
- INDUSTRIAL ENGINEERS
- SALES ENGINEERS

Send your résumé to: Mr. J. J. Robilotto, Employment Manager, General Precision Systems, Inc., Binghamton, New York 13902.

**GENERAL
PRECISION
SYSTEMS INC.**

LINK GROUP

A SUBSIDIARY OF GENERAL PRECISION EQUIPMENT CORPORATION
Binghamton, New York

An equal opportunity employer. A plans for progress company.

PROJECT LEADERS

(present & future):

Look at your capabilities.

Then look at ours. As a catalyst.

A catalyst in terms of significant projects, with important contributions yet to be made. A catalyst in terms of environment, with solid technological competence in a wide variety of areas, both to draw upon and to grow into. And, equally important, a catalyst in terms of your future development with an in-writing 'people development' plan that charges each supervisor with developing his own replacement before he moves up the ladder.

Anti-Submarine Warfare Laboratory

ASW activities are concentrated in three separate departments: Hydroacoustics, Electroacoustics, and Special Development—each with its own technical facilities and staff. Among the newest and most intriguing programs you might work on are the advanced marker/launcher system for USW; an advanced integrated sonar system for surface ships, and the use of special hydroacoustics sources for deep submergence sonar. Special facilities support these projects in design and testing: a fully instrumented, 48-ft. diameter sonar tank; a nearby lake—600-ft. deep and ice-free; and a completely instrumented, 165-ft. self-propelled barge capable of testing transducers weighing up to 35 tons.

Data Communications Laboratory

Data Communications is currently designing at the state-of-the-art in hardware and systems for digital communications equipment. Two strong areas of current R&D interest are (1) the application of modulation and coding theory to data communications for transmission via many different media (2) development of frequency-differential signaling for high-speed data transmission in the high frequency band, studies of propagation and polarization phenomena at high frequency, and frequency measurement in the microwave band. The subscriber terminal equipment for AUTODIN, a world-wide digital communication network, is just one of the current programs in the data lab.

Communications & Avionics Laboratory

The RF Group is involved in ground and air communications hardware and systems. Their interest involves all frequencies ranging from HF through UHF. Included are secure communications pack sets, receiver design utilizing micro min techniques, and advance communication systems integrating black box design and techniques into mobile or shelter installations. Currently avionics design work is being concentrated on the micro min of the F106

TACAN. This involves complex design utilizing the state-of-the-art in integrated circuits and solid state devices.

Aerospace Ground Equipment Laboratory

The F-111 places heavy demands on an AGE engineer. This most complex and advanced combat aircraft in the U.S. arsenal must be tested with even more complex simulation equipment in order to test the diversified types of the F-111 for its various missions and their respective avionics. The magnitude of the systems and design problems to be encountered are illustrated by the following intricacies of this ground support equipment: It's a highly automated test and fault-location system which includes a video station, radar receiver/transmitter modulation station, indicator/controls station, central air data computer station, radar servo and indicator station, UHF—HF and TACAN stations, HF flightline tester, IR digital station—each sophisticated enough to test the state-of-the-art. And to create responsible positions in engineering and management within this laboratory.

Microelectronics Application Laboratory

This technical service laboratory is now in its embryo stages of development. Its purpose will be to provide the above product labs with the most advanced designs in micro min techniques for the development of their individual needs. This task involves a close partnership with the product development laboratory, aiding in the design of circuits and utilizing thin and thick film techniques. At present positions are available at both Junior and Senior salary levels for those who have experience in circuit design using integrated circuits and/or the actual design of ICS and micro-miniaturization techniques.

Your Opportunities:

If you have background/interest in one or more of the above areas, we'd like to tell you more about the year-round creative climate we offer. Send a resume to Mr. J. P. O'Reilly, Dept. 153.

GENERAL DYNAMICS

Electronics Division

1400 N. Goodman St., Rochester, N.Y. 14601 *An Equal Opportunity Employer (M&F)*

Have you traded in your career for a job?

Remember the promises you made to yourself only a few years ago—the achievements you knew were just around the corner?

Those promises can be kept alive; those achievements can be realized. In the right environment.

Aerojet-General's Electronics Division is one of the most exciting scientific environments in the Western World. Here the projects, the people, the vital sense of self-achievement—all are top level.

We need engineers and scientists—such as electronic circuit design and project engineers, optical engineers,

infrared specialists—for work on some of the nation's most advanced programs. In fields like sophisticated space surveillance, satellite payloads, infrared and star sensing devices, data processing.

And many more.

If you have the capability but not the challenge, possibly you belong with us. Let's get together and talk. Soon.

Maybe you can get your career back.

Just send your resume to Director of Personnel, Aerojet-General Corporation, Box 303F, Azusa, California 91702.

We are an equal opportunity employer.



Just because you work
with hardware like this...

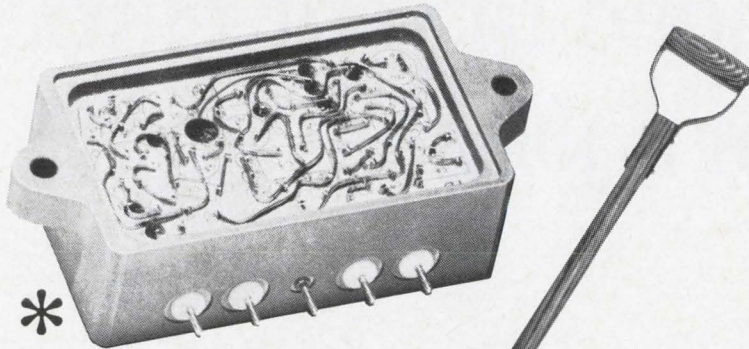

doesn't mean you have to
work with hardware like this!

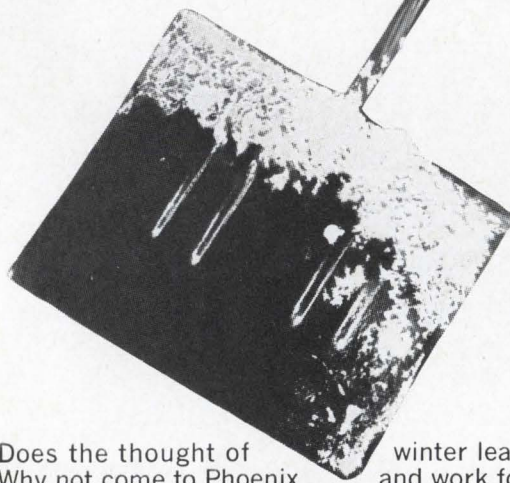

Does the thought of winter leave you cold? It does us. Why not come to Phoenix and work for Motorola's Aerospace Center? The work is important, the assignments are rewarding, the freedom is refreshing, the state-of-the-art is challenged, and, lest you forget, the weather's great. If you can qualify, send us a resume. You'll never feel snowbound again.

*Motorola VCO shown actual size

Specific Opportunities:

Space Communications ■ Radar Systems ■ Tracking & Telemetry ■ Fuzing ■ Digital Data Transmission ■ Guidance & Navigation ■ ECM & Elint ■ Checkout Systems ■ Coherent Transponders ■ Radar Transponders ■ Integrated Electronics ■ Antennas & Propagation ■ Reliability & Components ■ Advanced RF & Microwave Techniques

in PHOENIX



MOTOROLA

Government Electronics Division · Aerospace Center

Write: Paul Ahler, Recruitment Mgr., Dept. 65 Box 1417, Scottsdale, Arizona

MOTOROLA ALSO OFFERS OPPORTUNITIES AT CHICAGO, ILLINOIS — AN EQUAL OPPORTUNITY EMPLOYER

**In electronics
it's Electronics
magazine
to sell used
equipment!**

Your advertisement will produce Results in Electronics. Engineers turn to Electronics magazine for the latest technical developments — and for the latest buying information. You can reach them inexpensively in Electronics Searchlight Section.

For information:
Searchlight Section
Classified Advertising Division
Post Office Box 12
New York 10036



CIRCUIT DESIGNERS

for advanced microelectronic circuit synthesis. Managerial, engineering & research candidates wanted for novel thin-film circuit development. New business opportunity offers growth potential for Electronic Circuit Engineers. Send resume to Rm. 62-F, General Electric Co., Box 112, Main Post Office, Schenectady, N. Y. 12301

(An equal opportunity employer)

CIRCLE 955 ON READER SERVICE CARD

EMPLOYMENT SERVICES

Across The Spectrum In the Electronics Industry—Engrg—Mgmt—Sales. Gardner Assoc. MU 7-6616 545 5th Ave., N.Y., N.Y. 10017.

"Don't forget the
Box
Number
when answering
replies"

ELECTRON TUBES

KLYSTRONS • ATR & TR • MAGNETRONS
SUBMINIATURES • C.R.T. • T.W.T. • 5000-
6000 SERIES
• SEND FOR NEW CATALOG A2 •
A & A ELECTRONICS CORP.
1063 PERRY ANNEX
WHITTIER, CALIF.
696-7544

CIRCLE 956 ON READER SERVICE CARD

GET IT from GOODHEART!

EVERYTHING UNCONDITIONALLY GUARANTEED!

MARCONI FM DEVIATION METER TF-934, regularly \$890. Reads dev. w/ranges 5, 25, 75 kc. Has audio monitor. Made for MIL, 2 $\frac{1}{2}$ -100 mc, easily reaches 1000 mc on harmonics; we include all instructions. Check out, really OK. . . . \$249.50

TEKTRONIX #531 15 mc scope w/dual-trace plug-in, w/NBS-traceable Certif. books, probes. . . . \$775.00
Other Tkt., Hewl-Pack, DuMont scopes. . . . ASK!

COUNT FREQ. DIGITALLY 10 cy to 220 mc with crystal accuracy, at the lowest price available anywhere; and each set has been completely checked and comes with a dated CERTIFICATE OF CALIBRATION (and stickers) traceable to the National Bureau of Standards. You get Hewl-Pack #524B with #525A & 525 B plug-ins, and complete set of books. . . . \$275.00

Brand New VFH revrs look like BC-453 Command but are 9-tube 108-135 mc, 2 xiv sens; 2 m's, 3 1P's; noise lmt; avc W/schem. Instruct, spline knob, & graph to set freq. by counting turns. A.R.C. Type 13B, 28v htr wiring; 7# shpg wt. . . . \$22.50
R32 is same but w/squelch; 14v htr wiring. . . . \$27.50

R-23/ARC-5 Command revr 190-550 kc. . . . \$14.95
A.R.C. 12 #22 Command revr 540-1600 kc. . . . \$17.95

LM-14 freq. meter, .01% 125 ko-20 mc. . . . \$7.50
TS-323/UR freq. meter 20-180 mc, .001%. . . . \$169.50
BC-221's OK. . . . \$67.50 TS-175 OK. . . . \$27.50

CLOSING OUT Radio Receivers 38-4000 mc at CRAZY LOW PRICES! Ask for APR-44/CV-253 sheet.

ALL-BAND SSB RCVR BARGAIN: Hallcrafters R-45/ARR-7, 550 kc to 43 mc continuous. Voice, CW, MCW, aligned, grtd, w/book; 2-RF, 2-IF's S-meter; noise lmt; 3 xtl, 3 non-xtl selectivity choices. Less pwr sply. . . . \$149.50
60 cy pwr sply; \$30. SSB product detector. . . . \$20

SP-600-JX Revr .54-54 mc, Exc. Cond., w/book. \$25.00
Super. EMT 6220Y 3ph 20 kva Line V Regulator 450.00
Sorens. 10000S 10 kva Line V Regulator. . . . \$95.00

And others from 250 VA up. Ask for Regulator List, Automotron Cesium-Beam Freq. Standard. . . . ASK!

Regulated Power Supplies, Meter Calibrators. . . . ASK!
All kinds of AUDIO Test Equipment. . . . ASK!
Standard Signal Generators CW/AM/FM/Sweep ASK!
Bridges, Potentiometers, other Lab Standards. ASK!
Electronic & Rotary Frequency Converters. . . . ASK!
Noise & Field Strength Meters. . . . ASK!

TIME PAY PLAN: Any purchase totalling \$160.00 or more, down payment. . . . 10%

Above is a small sampling of our terrific inventory. WE ALSO BUY! We want Tektronix scopes, Hewlett-Packard equip., Aeronaut, radio-shop equip., etc. . . . AND Military Communications of all kinds.

DO NOT ASK FOR CATALOG! ASK FOR SPECIFIC ITEMS OR KINDS OF ITEMS YOU NEED!

R. E. GOODHEART CO. INC.
Box 1220-E, Beverly Hills, Calif. 90213
Phones: Area 213, office 272-5707, messages 275-5342

CIRCLE 957 ON READER SERVICE CARD

Electronics Field Engineers

This Is a Discriminatory Ad!

Major N. Y. metropolitan area aerospace manufacturer is seeking the services of top-flight electronics field engineers to work on and master extremely complex airborne electronic equipment. The men accepted for these positions must have exceptional competence, be of a high order of intelligence, with a mental attitude of not being fazed by the unexpected. Possessed of good health and drive, these men will have the attributes of a "team captain." Indeed, many will be just that. . . . able to get the most out of electronics equipment and the men who keep it working.

Applicants must be experienced in one or more of the following areas: search and track radars, digital computers, inertial guidance systems, transistorized equipment. BS degree in Electronics or Physics, is desirable, but candidates demonstrating the equivalency will be considered. In-plant training will be given to the applicants chosen.

These are unique career opportunities for qualified
Weapons or ECM Systems Engineers.

SALARIES TO \$18,000

commensurate with background and experience

Arrange interview by sending comprehensive resume in strictest confidence to:

Box P-4277, Electronics

Class. Adv. Div., P. O. Box 12, New York, N. Y. 10036

An Equal Opportunity Employer (M/F)

CIRCLE 958 ON READER SERVICE CARD

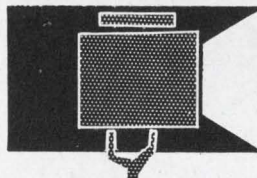

SEARCHLIGHT SECTION

• CLASSIFIED ADVERTISING • BUSINESS OPPORTUNITIES
• USED OR SURPLUS EQUIPMENT

AUTOTRACK ANTENNA MOUNT

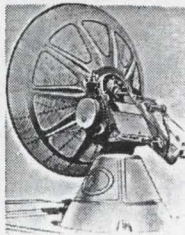

360 degree azimuth, 210 degree elevation sweep with better than 1 mil. accuracy. Missile velocity acceleration and slewing rates. Amplidyne and servo control. Will handle up to 20 ft. dish. Supplied complete with control chassis. In stock—immediate delivery. Used world over by NASA. USAF, MP-61-B. Type SCR-584. Nike Ajax mounts also in stock.

PULSE MODULATORS

MIT MODEL 9 PULSER 1 MW—HARD TUBE

Output 25kv 40 amp. Duty cycle .002, pulse lengths 25 to 2 microsec. Also 5 to 5 microsec. and 1 to .5 microsec. Uses 6C21. Input 115v 60 cycle AC. Mfg. GE. Complete with driver and high voltage power supply. Ref: MIT Rad Lab. Series, Vol. 5, p. 152

2 MEGAWATT PULSER

Output 30 kv at 70 amp. Duty cycle .001. Rep rates. 1 microsec 600 pps. 1 or 2 msec 300 pps. Uses 5948 hydrogen thyratron. Input 120/208 VAC 60 cycle. Mfr. GE. Complete with high voltage power supply

250 KW HARD TUBE PULSER

Output 16 kv 16 amp. Duty cycle .002. Pulses can be coded. Uses 5D2P, 715C or 4PR60A. Input 115 v 60 cy. AC \$1200 ea.

18 MEGAWATT PULSER

Output 150KV at 120 amps. Rep rate: 50-500 PPS. Pulse length: 5 msec. 15KV 120 amp. Into pulse transformer. Rise time 1.5 msec. Filament supply 5V 80 amp. incl. 17.5KV 1.5 amp DC power supply. Input: 220V 60 cy AC.

VARIAN KLYSTRONS

V-45: 15W output CW 9 to 10 KMC
VA-800: 10 KW output CW 1.7 to 2.4 KMC
VA-806H: 1KW output CW 7.5 to 8.5 KMC

IBM 704 IBM 650

These computers in stock for immediate delivery

SCR 584 AUTOTRACK RADARS

Our 584s in like new condition, ready to go, and in stock for immediate delivery. Ideal for telemetry research and development, missile tracking, satellite tracking Fully Desc. MIT Rad. Lab. Series, Vol. 1, pgs 207 210, 228, 284-286. Comp. Inst. Bk available \$25.00 each.

MICROWAVE SYSTEMS

L BAND RF PKG.

20 KW peak 990 to 1040 MC. Pulse width .7 to 1.2 micro sec. Rep. rate 180 to 420 pps. Input 115. vac incl. Receiver \$1200

200-225 mc RADAR SYSTEM

1 Megawatt output, 200 nautical mile range for long range detection of medium and high altitude jet aircraft as well as general search. AN/TPS-28.

10 KW CW S-BAND

Complete 1700-2400 MCS RF system using VA-800 klystron. New.

SURVEILLANCE DRONE RADAR SYSTEM

X-Band tracking system with plotting boards. Type AN/MPQ-29. Drone also in stock.

5 MEGAWATT C-BAND

Klystron RF package delivering nominal 5 megawatt pulse RF. Complete with pulser and power supply.

500 KW L BAND RADAR

500 kw 1220-1359 msc. 160 nautical mile search range P.P.I. and A scopes. MTI. thyratron mod 5J26 magnetron. Complete system.

100 KW X BAND RADAR

Complete 100 kw output airborne system with AMTI. 5C22 thyr. mod. 4J52 magnetron. PPI. 360 deg as sweep, 60 deg. elev. sweep, gyro stabilizer, hi-gain recf. Complete with all plugs and cables.

AN/GPG-1 SKY-SWEEP TRACKER

3 cm. automatic tracking radar system. Complete package with indicator system. Full target acquisition and automatic tracking. Input 115 volts 60 cycle New. In stock for immediate delivery. Entire System 6' long, 3' wide, 10" high. Ideal for Infrared Tracker, Drone Tracker, Missile Tracker, R. & D.

500KW X BAND RADAR

250 miles search 115V 60 cy AC. Mfg. G.E.

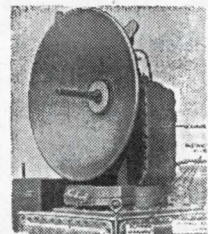

RADAR SYSTEMS GROUND AND AIRBORNE. AUTOMATIC TRACKING ANTENNA SYSTEMS. NIKE AJAX. NIKE HERCULES. M-33. MSQ-1A. MPS-19. MPS-9. SCR 584. TPS-1D. TPS-28. FAA-ASR-2. AIRBORNE SYSTEMS. APN-84. APN-102. APS-20. APS-27. APS-45. DPN-19. DIGITAL COMPUTERS. IBM 650. IBM 704.

LARGEST INVENTORY OF RADAR AND MICROWAVE EQUIPMENT IN THE WORLD.

RADIO RESEARCH INSTRUMENT CO.

45 WEST 45TH ST. N. Y. 10036 212-JU 6-4691

CIRCLE 959 ON READER SERVICE CARD

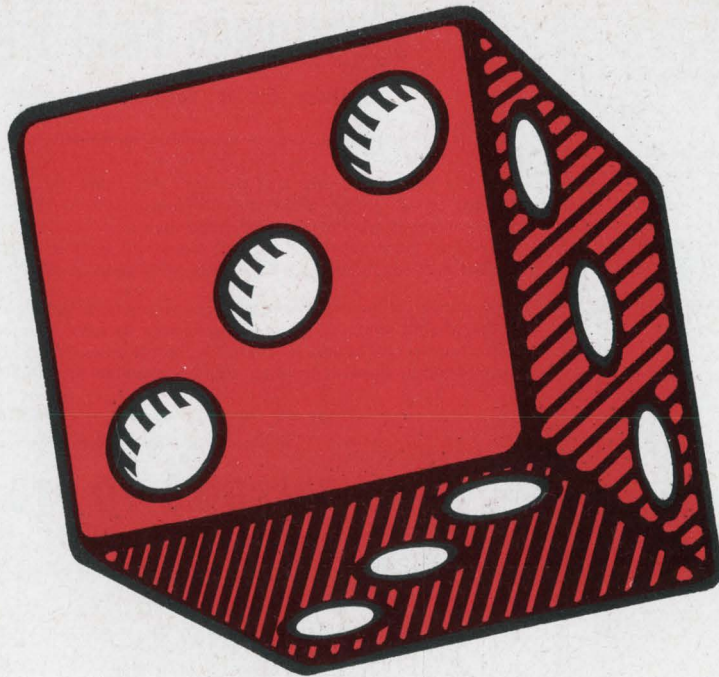

LIKE A SURE THING?

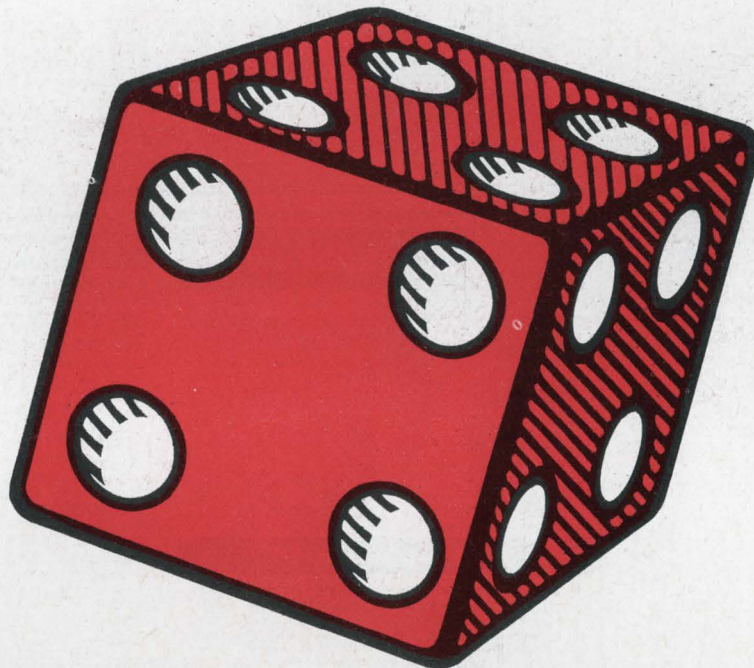

THE ODDS ARE 36,000 TO ONE COHU HAS THE RIGHT TV SYSTEM FOR YOU! A pioneer in TV, Cohu today is the largest producer of standard, off-the-shelf TV systems in the industry. Take the standard lenses, camera controls, pick-up tubes (both vidicons and Plumbicons®) and video monitors—put these together with Cohu's various camera housings, remote controls and lens drives and you have over 36,000 possible TV system combinations. And this does not include Cohu's wide variety of quality TV accessories and switching systems.

ONE IS RIGHT FOR YOU! Whether your needs be industrial, educational or military, one of Cohu's TV combinations is right for you. Let Cohu engineering know-how design for you a custom TV system from standard, off-the-shelf components.

For details on the industry's most complete TV line, contact your nearest Cohu representative or call Bob Boulio direct at 714-277-6700 in San Diego. The odds are in your favor.

® Reg. TM N. V. Philips Co. Holland
Box 623, San Diego, California 92112. TWX 910-335-1244.



Newsletter from Abroad

February 5, 1968

Japanese firms ponder profits in Sony-TI deal

Japanese companies with integrated-circuit hardware in their product pipelines have begun to size up overseas markets in earnest.

Exports were held in abeyance during a four-year dispute about patents with Texas Instruments. They have for practical purposes been unleashed by an agreement by the Sony Corp. and TI to set up a joint venture in Japan to manufacture IC's. Under the deal, Japanese semiconductor producers will get licenses for the basic IC patents TI holds [Electronics, Dec. 25, 1967, p. 157].

Sony and TI still have many details to settle. A key one is the royalty rate TI will get from Japanese producers. Currently, they pay 4.5% to Fairchild Camera & Instrument Corp. for rights to Fairchild's patent on the planar process used to produce transistors and IC's. Another 2% is levied by Western Electric for its transistor patents. Some Japanese companies pay an additional 2% to RCA. Insiders think TI's royalty will run about 3.5%.

The rush into export markets won't begin until midyear at the earliest, after royalty rates have been settled. Meanwhile, the Hayakawa Electric Co. has quietly started exporting IC calculators to the U.S. and has started selling them in Switzerland and Canada. And a delegation of Japanese IC experts—representing the country's electronics industry—is in the U.S. studying market trends.

Plessey may join computer group

The merged computer company planned in Britain could be stronger than first thought. Insiders say the Plessey Co. may now join International Computers & Tabulators and English Electric, which are on the verge of grouping their business and scientific-computer operations [Electronics, Dec. 11, 1967, p. 247].

Plessey's line is currently oriented to process-control machines. But the firm ranks as the country's leading supplier of memories and would bolster the components potential of the merged company.

France may sell jets to Iraq and Israel

President de Gaulle may demonstrate his "neutral" stance toward the Middle East by selling Mirage fighters to both Israel and Iraq.

A deal for a small number of the jets could be part of a trade package de Gaulle and Iraqi president Abdel Rahman Arif will discuss in Paris this week.

To offset the sale to Iraq, insiders say, de Gaulle would unfreeze 50 Mirage jets that Israel had ordered—and partly paid for—before de Gaulle slapped his embargo on arms sales to the Mideast last summer. The double sale would also help still complaints from French electronics and aerospace companies that de Gaulle's foreign policy is hurting their sales in badly needed export markets.

ICT brass plans Russian sales trip

Britain's International Computers & Tabulators hopes to get into the Russian market in a big way. So far, the company has sold only one computer to the Russians, and that five years ago.

A quartet of top ICT executives will go to Moscow next April—at Soviet invitation—to discuss a deal with the State Committee on Science

Newsletter from Abroad

and Technology. ICT chairman Terence Maxwell says the trip could lead to "good business."

ICT officials won't give details, but it's a good bet the deal will call for them to sell production know-how as well as computers. That would almost certainly touch off a countermove by the U.S., which is trying to block two deals involving sales of computer technology to Czechoslovakia.

Pulse-averaging i-f amp on way

ITT-Europe's semiconductor division expects to have a new breed of tv sound i-f amplifiers in pilot production in a few months.

The amplifier, packed on a monolithic integrated circuit, demodulates the f-m sound signal by pulse averaging. Therefore the circuit needs no coils and avoids the major drawback of conventional monolithic i-f amplifiers. Two ITT subsidiaries in West Germany—Standard Elektrik Lorenz and Intermetall—worked on the development.

Tv rental firms to merge in U.K.

Britain's two biggest television rental companies plan to merge.

Under a deal worked out by directors but not yet approved by stockholders, Thorn Electrical Industries would acquire Radio Rentals Ltd. for stock valued at \$370 million.

Thorn is Britain's biggest producer of tv sets and owns the second largest rental company, Domestic Equipment Rentals. Radio Rentals leads its field and also owns Baird Television, a receiver producer. Together, the two rental organizations have 2.5 million subscribers.

U.S. may end ban on arms to Greece

Arms shipments to Greece, halted last April after a military junta seized the country, apparently will be quietly resumed soon. The Pentagon now wants a go-ahead to ship 24 supersonic F-5 fighters there, along with jet trainers, M48 tanks, and other sophisticated weapons. Greece had been scheduled to get \$65 million in military aid this fiscal year, but only essential spares have been shipped so far.

Junkers to build capsules for ELDO

The seven-nation European Launcher Development Organization has picked Junkers Flugzeug und Motorenwerke as prime contractor for the biggest space payload yet developed in Western Europe.

The German firm will build a quartet of 890-pound capsules for ELDO under the \$1.4 million deal. ELDO wants the capsules to space-test the Italian-built apogee engines that will lift communications satellites, launched by European-built rockets, into stationary orbits.

First tests of the capsules are scheduled for the fall of 1969, with the launchings by Diamant-B rockets taking place at the French test range in French Guiana. Much of the capsules' electronics will come from French companies, whose \$475,000 in subcontracts is mainly for telemetering systems and transponders.

Rumania highballs freight computer

Rumania is going full speed ahead with plan to computerize freight-handling on the state-owned railroads. A Siemens model 4004/45 machine—an offshoot of RCA's third-generation Spectra 70—will be the heart of a data-processing center scheduled to handle freight-movement plans for the entire rail network. The plans, made four weeks in advance, will be checked daily and changed immediately if necessary.

Japan

Watch out

Time may have run out for Swiss watchmakers, who've been wrangling over how and when to put their industry-developed electronic wristwatch into production.

The Swiss long have counted on getting onto the market first with a "fantastically accurate" electronic timepiece built with integrated circuits and controlled by a tiny quartz crystal [Electronics, March 6, 1967, p. 357]. Now it looks as if they could be beat second-hands down by Suwa Seikosha, a subsidiary of the Japanese horological heavyweight K. Hattori and Co.

Like the Swiss, Seikosha has produced a prototype. But while the Swiss debate, Seikosha has started to size up the potential market for a wristwatch that will carry a ticket of several hundred dollars, perhaps \$500. No date has been set, but the company's engineers are confident they'll be first to get into production with a quartz-controlled IC wristwatch.

Countdown. Neither Seikosha nor the Swiss, understandably, will tell all about their new timepieces. But what's known about the two movements indicates they're fairly similar.

Both, for example, use an 8,192-hertz crystal oscillator as the basic timekeeping element. That means a quartz crystal too large for a woman's watch but small enough for a man's.

Both count down the output of the crystal to 1 hz by IC binary dividers. And both presumably have the same error—about 1 second per month.

By comparison, tuning-fork wristwatches like the Bulova Watch Co.'s Accutron stray about 2 seconds a day and the very best

conventional wristwatches err as much as 4 or 5 seconds a day.

In the Japanese timepiece, the crystal is a "matchstick" quartz element that oscillates in the bending mode. The crystal is tucked into a hermetically sealed metal tube about 5/32-inch in diameter by 29/32-inch long. To correct for temperature variations without using electrical power, there's a bimetallic element that varies the capacitance of the circuit.

One, two, three. For the prototype, Seikosha chose three IC packages, all hybrids. One makes up the oscillator circuit; the second has the 13 binary dividers that bring the crystal output down to 1 hz; and the third contains the driving circuit for the transducer—a cross between a micromotor and an escapement—that drives the hands and their gearing.

Together, the three IC's in the prototype total some 60 transistors, 80 resistors, and 50 capacitors. Production versions, the company says, will pack these components on just one or two substrates. Seikosha buys its transistor chips from a semiconductor producer, but from then on the IC's for the wristwatch are an in-house affair.

Unwound. The battery is a 160-milliamper-hour mercury cell that lasts more than a year. The power needed to drive the hands and the

associated gear trains amounts to only 1 or 2 microwatts. Bulk of the power drain comes from the frequency-divider circuits and the transducer that converts the electrical output to a mechanical one.

Desaturated

Computer designers generally figure that any time they step up the speed of their logic circuits they'll have to pay for it in added power consumption.

Not necessarily so, say four researchers at the Japanese government's highly regarded Electro-technical Laboratory. They've developed an integrated circuit that works fast, like nonsaturating logic, but extracts no penalty in power dissipation. Multiply the propagation delay by the power consumed for their circuit, the Japanese maintain, and the product is about half that of other types of fast logic schemes. The lower the better, of course.

Barrier. The kingpin element in the new logic circuit is a Schottky diode, working in what otherwise would be a conventional transistor-transistor-logic circuit. The diode applies nonlinear negative feedback to the inverter transistor and thus keeps it from saturating. More than any other factor, the time required for the inverter transistor to re-

IC time. Crystal-controlled IC oscillator and binary frequency-dividers keep prototype wristwatch movement—shown here actual size—accurate to within 1 second a month. Production versions will be laid out to fit standard man's wristwatch case.

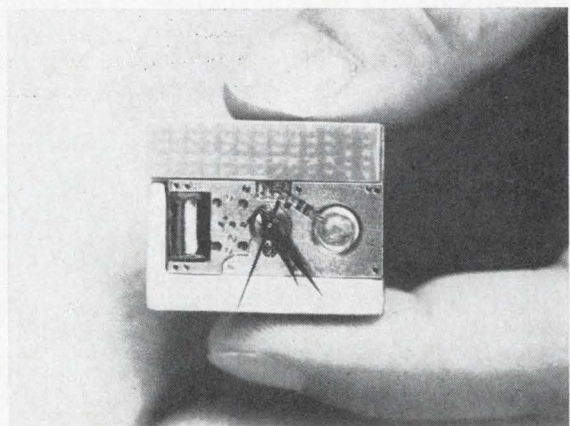

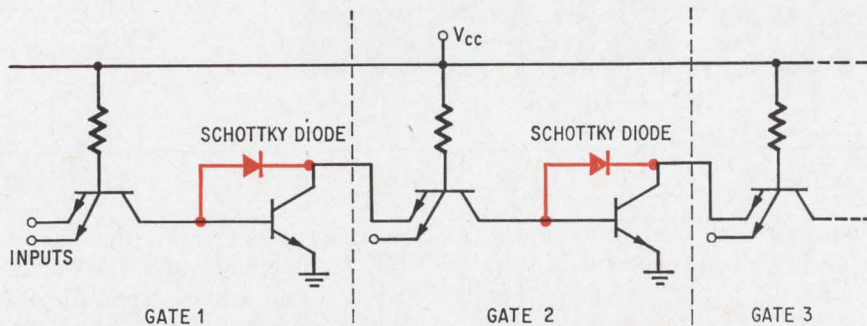

Double-duty diode. Schottky diode in transistor-transistor logic circuit keeps inverter transistor from saturating. This speeds up circuit and holds down power consumption.

cover from saturation accounts for the relatively long propagation delay of TTL.

Actually, the tack of speeding up transistor switching time by warding off saturation was proposed more than a decade ago by Richard H. Baker of the Massachusetts Institute of Technology. Baker's clamp circuit, though, was designed for germanium transistors and germanium diodes, so it couldn't be realized directly in silicon monolithic IC's.

Nor could a silicon junction diode be used on the IC to turn the trick. So far, no one has devised a way to precisely preselect the voltage drop across a junction diode laid down on a volume-produced IC substrate. For the clamp circuit to work right, the threshold voltage of the diode must be about 0.3 volt lower than that of the inverter transistor's base-collector junction.

Double proof. The Japanese researchers—Yasuo Tarui, Yutaka Hayashi, Toshihiro Sekigawa, and Hiroh Teshima—first tried out their circuit with discrete components to prove it was inherently faster than straight TTL. Then, the group fabricated a simple TTL monolithic circuit to demonstrate that Schottky diodes can be laid down on silicon substrates without great difficulty.

Since the IC production equipment at the laboratory is less sophisticated than that found at the most modern IC production facilities, Tarui and company wound up with a 15-nanosecond propagation delay for their conventional TTL circuits. This, of course, is far slower than the best saturating TTL circuits now on the market. With

Schottky diodes, though, the delay was slashed to 5 nsecs and that does compare favorably.

The Electrotechnical Lab group will describe their circuit in detail next week at the International Solid State Circuits Conference at Philadelphia.

Through channels

With 22 new ultrahigh-frequency television stations scheduled to start broadcasting this year, a burgeoning market for uhf adapters is in the offing for Japan. And the Matsushita Electric Industrial Co. is rising to the occasion.

Matsushita has readied a uhf tuner that selects channels like a conventional very-high-frequency tuner. Every other set maker uses

continuous tuning for uhf. Matsushita's recipe: substitute varactor diodes for the usual variable capacitors.

The company already has a vhf set with varactor tuning on the market and, presumably, will offer an all-channel set when it feels the time is ripe. Meanwhile, Matsushita will soon start selling its new tuner that adapts a vhf-only set to uhf. The tuner is priced at \$28.

Lucky number. In the Japanese frequency allocation, there are 49 uhf channels. Matsushita, however, doubts that many viewers will be within range of more than seven stations. As a result, the company limited the tuner to seven channels.

The viewer tunes the set simply by pushing a small lever, which advances a seven-position rotary switch. The switch has two sets of contacts: one selects the voltage fed to the varactor diodes and the other lights the channel indicator. Seven variable resistors at the rear of the tuner are preset to match the varactor voltages to the channels that can be tuned in.

Sharp. In the tuner, Matsushita uses double-diffused diodes with hyperabrupt junctions. The diodes' capacitance varies inversely with the two-thirds power of the voltage applied to them. Typical values for the diodes: 12 picofarads at a reverse bias of 2 volts and 2.5 pf at



Step by step. Varactor diodes in Matsushita's uhf tv tuner provide key to channel selection as in vhf band. Other uhf tuners have variable capacitors and, therefore, continuous tuning.

a bias of 30 volts.

Three varactor diodes in coaxial-line cavities replace the usual three-gang condenser found in conventional uhf tuners. To cover the band—590 to 770 megahertz in Japan—the diodes are operated over a range of 4 to 20 volts. To prevent detuning by variations in line voltage, the adapter has a stabilized power supply.

West Germany

Mating game

The economic climate in West Germany has taken a turn toward the balmy in recent months and the mating season for corporations once again is at hand.

Late last year the Gillette Co. won the hand of Braun AG, a major German producer of household appliances and consumer electronics. Now Saba GmbH, a radio and television producer based in the Black Forest, is casting about for a partner. AEG-Telefunken, Germany's second-ranking electronics producer, has its eye on a group of telecommunications companies called Telefonbau und Normalzeit.

These are just a few of the better-known firms that have gone into the marriage market in the past two months. And they apparently are the harbingers of a new wave of takeovers, mergers, cooperative deals, and other arrangements for corporate togetherness.

Hans W. Langner, who heads one of the country's biggest industrial brokerage firms, says the number of inquiries from companies looking for partners should run about 60% to 70% higher this year than it did in 1966.

Ups and downs. For mergers, 1966 was a vintage year in West Germany. During last year's recession, though, merger activity slumped. "Many purchase-minded companies held back, waiting for better times," Langner says. "But around September of last year, things began to perk up and we have now already surpassed the 1966 level," he goes on.

Although sheer bigness is still a major stimulant, diversification has become the prime mover toward merger. "Nowadays, it isn't so much the desire to expand production capacities that brings firms together," says Langner. "Rather, what's behind merger moves today is a drive to improve company positions by getting into new areas."

A case in point is the recent takeover of Alfred Teves GmbH by the International Standard Electric Corp., a subsidiary of the International Telephone and Telegraph Corp. Teves, a 6,500-employee firm with annual sales of more than \$75 million, is a leading European maker of disk brakes. But insiders suggest that IRT wasn't primarily interested in the brake business. Instead, they speculate, IRT maneuvered for a foothold in the upcoming market for automotive electronics by picking up a sales network that knows how to sell to the auto industry.

On call. And bigness isn't the main reason behind Telefunken's wooing of Telefonbau und Normalzeit despite the latter's 16,000 employees and almost \$120 million annual sales. It's no secret that Telefunken wants to get more involved in telephone work and a full 85% of Telefonbau's capacity is for exchange equipment.

As for Saba, it seems to be much in the same position as Braun was before Gillette came to the rescue and bought an 85% holding in the family-owned firm. Although a whopping success by anybody's standards—the company's sales soared from \$4.5 million in 1952 to nearly \$70 million in 1966—Braun's owners felt they couldn't hold their strong market position without a stronger financial base to carry their research and development effort.

Saba's owners, it's believed, aren't looking for someone to buy them out. Rather, they're looking for a tie that will strengthen them in technology. The firm is tight-lipped about possible partners but Grundig Werke GmbH, Siemens AG, Philips' Gloeilampenfabrieken, and the General Telephone and Electronics Corp. are rumored to be among the favorites.

In a scrape

Nuclear research institutes and atomic power plants are studded with about every imaginable safety device. Nonetheless, accidents could happen and after a mishap someone would have to go in and cart radioactive debris to a safe place away from it all.

If the unthinkable ever happens at West Germany's Karlsruhe research facility, there'll be no need for cleanup-crew volunteers. The center has a radio-controlled scoop loader built under contract by Schopf Maschinenbau GmbH, a Stuttgart manufacturer of earth-moving equipment.

Keep your distance. Designed as it was for remote control, the loader has no steering wheel in the cab



On its own. Scoop loader's 28 different functions are controlled from remote transmitter.

and none of the pedals and levers that bristle in man-run machines. The operator can guide the machine as long as he keeps it within 1,000 yards of the control transmitter. A somewhat greater range can be had by carrying the transmitter aloft in a helicopter.

But Schopf points out that there's no need to see the loader to make it work. When it is working out of direct sight, a television camera in the cab can transmit the scene in front of the loader and the movements of its scoop back to a monitor near the remote-control transmitter.

Although the loader was de-

signed specifically for carting off radioactive debris, the vehicle also could be used for fire fighting, demolition, and like jobs—anywhere the operator's life would be risked were he in the cab.

Simple but sure. The electronics in the \$10,000 control system are straightforward. A total of 28 loader functions—from starting its engines to honking its horn—can be controlled by punching pushbuttons on the transmitter panel.

An audio frequency between 300 and 1,000 hertz is assigned to each loader function. When a button is pushed on the panel, a tuning-fork resonator generates the corresponding audio frequency, which modulates a high-frequency carrier. The transmitter has 3-watt output power and broadcasts over 28 channels in the 467-megahertz band. Logic circuits in the transmitter make sure there's no interaction among channels.

On the loader, a receiver demodulates the signals and applies them to tuning-fork resonators. Their outputs are amplified and rectified to drive relays that control the various movements of the loader.

To simplify the control setup, the loader has two engines rather than the usual one. A 125-hp engine maneuvers the machine and a 70-hp engine powers the scoop. The twin-engine arrangement eliminates the need to cut a power takeoff for the scoop in and out.

The loader can be run with the operator in the cab, so he can get the "feel" of the machine. For this training, the transmitter is mounted in the cab and the control panel outputs are connected directly to the control relays by wires.

Great Britain

Up the Hall

Many a researcher has realized that a Hall-effect transducer would make a marvelous readout head for tape. For one thing, the Hall heads could be much smaller than conventional ferrite ones. For another, a Hall head could produce

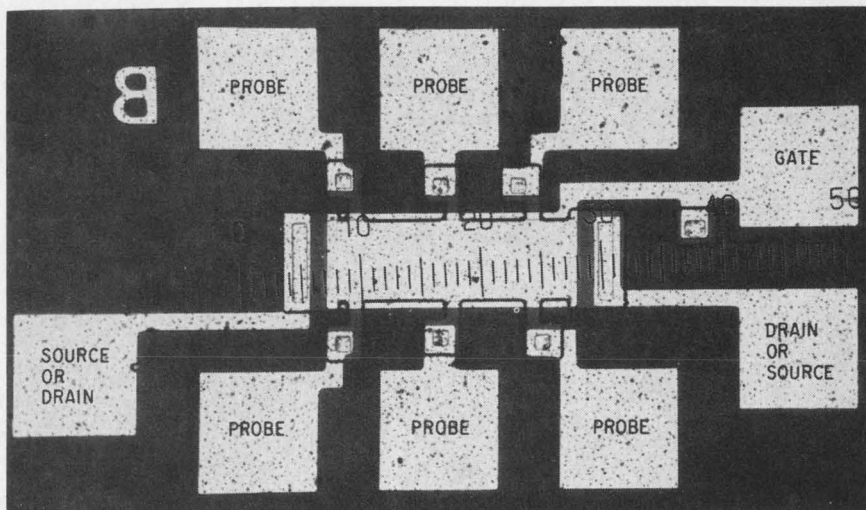

Dandy drain. Plessey researchers found that using a pair of probes at one end of the gate as a dual drain makes this MOS transistor a very small and highly sensitive Hall transducer.

an output from a stalled tape, something a ferrite head can't do because it needs a change in magnetic flux to develop a signal voltage.

So far, though, no one has come up with a really satisfactory Hall transducer. For a worthwhile output, it's necessary to use such high-mobility semiconductors as indium arsenide and indium antimonide, but neither material does very well when the heat's on. And even at room temperature, the indium devices don't develop much of an output. A typical InAs Hall plate puts out about 170 millivolts per kilogauss with a device current of 300 milliamperes, dissipating 1 watt.

The most. It's occurred to a number of people that the wedge-shaped inversion layer under the gate of a metal oxide semiconductor transistor should make an excellent Hall plate. But with normal MOST geometry, the output turns out to be much the same as with InAs or InSb.

Two researchers at the Plessey Co., Peter Fry and Steven Hoey, wondered why this was so. They built themselves a special mos slice to find out, but instead of one pair of probes alongside the gate, they put on three. They then plotted the Hall voltage along the length of the inversion layer under the gate. To their surprise, they found that voltage dropped off sharply where theoretically it should have been

highest—at the point where the wedge tapers off to nothing.

Split. The British pair couldn't explain this voltage drop to their complete satisfaction, but figured it was somehow connected with the fact that the drain of the MOST extended over the entire width of its gate.

Going on this assumption, they connected one set of probes into the circuit as a dual drain separated by the width of the gate. With this connection, the output voltage shot up to about 250 mv per kilogauss at a device current of 200 microamps, for a dissipation of a mere 3 milliwatts. A further—but slight—rise in output voltage can be obtained by adding a third drain along the end of the gate and between the first two, Fry and Hoey have found.

Fry, who will report on the work at the International Solid-State Circuits Conference in Philadelphia next week, concedes that the MOST transducer has a high output impedance but doesn't see this as a serious drawback. He notes that compatible amplifiers could be incorporated on the same silicon chip as the MOST.

The Plessey transducer measures about 0.005 inch square, and Fry and Hoey say a large number of them could be mounted side by side to read computer-tape tracks.

Fry also concedes that the operating speed of present MOST devices

THE MOST COMPLETE RANGE
IN THE WORLD
OF U.H.F. CERAMIC-METAL
TETRODES

In operation for more than
5 YEARS
on more than
500

low and high power U.H.F.
television transmitters
and translators



HIGH GAIN U.H.F. TETRODES UP TO 1000 Mcs

THOMSON THHB HOUSTON

... a trusted name

OUTSTANDING PERFORMANCES
IN SSB COMMUNICATIONS — TROPOSPHERIC SCATTER LINKS — RADARS



COMPACTNESS



RUGGEDNESS



THE MOST ADVANCED TECHNOLOGY * — THE LOWEST OPERATION COST

HIGH LINEARITY



LONG LIFE

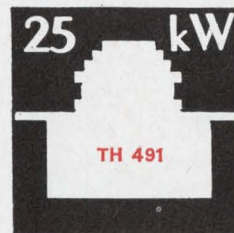

HIGH RELIABILITY

VAPOR COOLED

* Special grids patented

ASK FOR SPECIFIC DATA SHEETS

THOMSON HOUSTON - HOTCHKISS BRANDT

ELECTRON TUBE DIVISION 8, RUE CHASSELOUP-LAUBAT - PARIS XV^e - FRANCE - TÉL. : 566.70.04
THOMSON ELECTRIC Co INC. 50 ROCKEFELLER PLAZA · ROOM 916 NEW-YORK, 10020 N.Y. U.S.A. · Phone : (212)245.3900

Now in
publication!

A Fully Documented Analysis of International Electronics

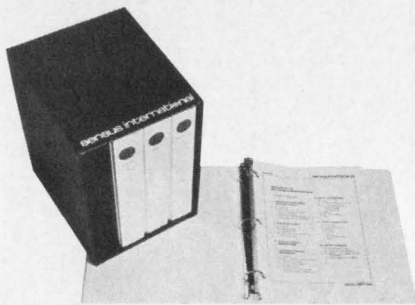

Four volumes of incisive data — by country — basic elements in planning and maintaining a position of marketing strength in the international electronics markets.

Updated regularly, information is gathered on the spot and covers all aspects of doing business in electronics in every major electronics market of the world. Tariffs, government policies, exchange controls, credit, trade unions, even the impact of smuggling are covered in these in-depth reports.

Send for complete, free information

sensus international

Please send me your free,
descriptive literature.

Name _____

Title _____

Company _____

Street _____

City _____

State _____ Zip _____

SENSUS INTERNATIONAL

712 Montgomery Street,
San Francisco, Calif. 94111

If you can't wait,
call (415) 989-6973

Electronics Abroad

is limited, but thinks Hall transducers based on gallium arsenide can be developed for high-speed applications.

Soviet Union

Export wares

Scant information about computers comes out of the Soviet Union. But some news gleaned recently has convinced most Western watchers of Soviet technology that the Russians are making great improvements in their data-processing equipment.

The latest word on computers indicates the Russians have completed the shift from vacuum tubes to transistors. Up to now, Russian computer exports—to Eastern Europe and some developing countries—have been special machines, nearly all of them with vacuum tubes. This year, the Soviets say, they'll start exporting transistorized general-purpose machines.

Trio. The Russians have pinned their export hopes on a three-machine series called the Ural family. All have refinements like modular construction, an interrupt system, multiprogramming capability, and a standardized interface channel that makes it possible to add the peripherals necessary to suit the computer package to its intended job.

The smallest machine, the Ural 11, has an add time of 20 microseconds and a minimum internal memory of 4,096 words of 24 bits. The memory can be expanded to a maximum of 16,384 words. Fixed-point operation is the usual, but floating-point operation can be had through subprograms or by adding equipment.

Onward and upward. Next comes the Ural 14. It has the same add time as its smaller brother but multiplies and divides much faster. And its basic internal store is 8,192 words of 24 bits, which can be expanded up to eight times. The central processor can handle up to 24 input-output terminals. All this puts the Ural

14 in about the same class as the GE 425. Its add time is 17 μ s and its basic memory capacity is 8,000 words of 24 bits.

Largest of the machines the Soviets will peddle abroad is the Ural 16, which boasts an add time of 10 microseconds. It has a working memory up to 524,288 words of 24 bits and can handle either fixed-point or floating-point calculations. Like the Ural 14, the Ural 16 can work with as many as seven programs simultaneously.

Stay-at-homes. In addition to the three Urals, the Soviets say they have three other new transistorized computers. One is the M220, the solid-state version of the M20, the vacuum-tube machine that has been the workhorse of Soviet data-processing for nearly a decade. The transistorized machine has an add time of 40 microseconds and a memory capacity up to 16,384 words of 45 bits.

The others are the MN 18, an analog computer that can solve equations as high as the 25th order, and the Minsk 23.

Around the world

Curacao. Texas Instruments will build a semiconductor production plant at Willemstad here, about 40 miles north of the Venezuelan coast. The firm settled on Curaçao for its Caribbean facility partly because the island is Dutch territory and therefore associated with the European Common Market.

Luxembourg. The Grand Duchy will soon have one of the most powerful medium-frequency broadcast stations in Europe. Two AEG-Telefunken transmitters—one rated at 600 kilowatts, the other at 350 kw—will be added, along with paralleling networks, to Radio Luxembourg's existing 300-kw transmitter to boost total power to above 1,200 kw.

Turkey. Television will be introduced here within three months. A Siemens transmitter with 600-watt video power and 150-watt audio power will be installed near Ankara.

Abbott Transistor Labs, Inc. Technical Adv. Agcy.	157	Cook Electric Co., Automatic Controls Div. Grant/Jacoby, Inc.	76	Hewlett Packard, Microwave Div. Lennen & Newell, Inc.	161
Acopian Corporation Mort Barish Associates	112	Coors Porcelain Co. Tallant/Yates Adv., Inc.	147	Hewlett Packard, Mt. View Lennen & Newell, Inc.	2
Acton Laboratories, Inc. Impact Advertising, Inc.	175	Corning Glass Works Electronics Products Div. Rumrill Hoyt Co., Inc.	119	Honeywell, Test Instruments Div. Campbell Mithun, Inc.	135
Airborne Instruments Laboratory Campbell-Mithun, Inc.	124	Cramer Industries, Inc. Bryan/Donald Adv., Inc.	181	Hughes Aircraft Co. Foote, Cone & Belding	186
Airpax Electronics, Inc. Welch, Mirabile & Co., Inc.	150	C. S. F. S P I Agency	OAS 10	Icon Corporation Van Christo Assoc., Inc.	175
Allen-Bradley Co. Fensholt Adv. Agcy.	38, 39	CTS Corporation Burton Browne Advertising	120	IEEE (Institute of Electrical & Electronic Engineers) Alpaugh Advertising	184
AMP, Inc. Garceau, Hallahan & McCullough, Inc.	64, 65	Cutler-Hammer, International Campbell Mithun, Inc.	OAS 5	Indiana General Corp., Electronics Div./Memory Products The Griswold & Eshleman Co.	24
Amperite Co. H.J. Gold Co.	180	Dale Electronics, Inc., Sub. of Lionel Corp. Swanson, Sinkey, Ellis, Inc.	3rd Cover	Information Handling Service Martz & Associates	111
Automatic Electric Co., Sub. of General Telephone & Electronics Corp. Marsteller, Inc.	153	Delco Radio Division of General Motors Corp. Campbell-Ewal Co.	62, 63	Integrated Circuit Engineering Corp. Gordon L. Ness Associates	146
Ballantine Laboratories Lang-Lawrence Adv., Inc.	173	Delevan Electronics Corp. Stahlka, Faller & Klerna	197	International Instruments, Inc. Thomas R. Sundheim, Inc.	181
Barnstead Subsidiary of Ritter Pfaudler Corp. Creamer, Trowbridge, Case & Basford, Inc.	176	Di-Acro Corp., Div. of Houdaille Industries, Inc. Charles E. Brown Adv., Agcy.	172	International Rectifier Corp. Botsford, Constantine & McCarty, Inc.	131
Beckman Instruments International, S.A. Hixson & Jorgensen, Inc.	OAS 1	Diceon Electronics, Inc. Bostelman Burkhart, Inc.	175	I R C, Inc. Gray & Rogers, Inc.	66, 67
Bendix Corp., Semiconductor Products Div. MacManus, John & Adams, Inc.	55	DuPont de Nemours Co., Industrial Fibers Nomex Batten, Barton, Durstine & Osborn, Inc.	109	ITT Jennings Mfg. Co. West, Weir & Bartel, Inc.	41
Benrus Watch Co., Technical Products Div. S & S Creative Services	130	DuPont de Nemours Co., Teflon Div. Batten, Barton, Durstine & Osborn, Inc.	137	J F D Electronics Co., Components Div. Delphi Adv., Inc.	110
Bircher Corporation, The Guerin, Johnstone, Gage, Inc.	191	Eimac Division of Varian Associates Hoefler Dieterich & Brown, Inc.	104	Kepeco, Inc. Weiss Advertising	128
Brush Instruments Div. of Clevite Corp. Carr Liggett Adv., Inc.	192, 193	Electro Optics Associates Jerome G. Steimle	7	Lambda Electronics Corp. Michel Cather, Inc.	68, 69
Bunker-Ramo Co. Diener & Dorskind, Inc.	162	Electro Tec Corp. Wilson, Haight & Welch, Inc.	56	Leach Corp. Jay Chiat & Associates	72
Burndy Corp. Don Kemper Co., Inc.	117	Electronic Associates, Inc. Ross Roy of New York, Inc.	149	LTT Promotion Vente Publicite	OAS 8
Burroughs Corp., Electronic Components Div. Conti Adv. Agcy., Inc.	20, 21	Electronics Buyers' Guide Plansboard Adv., Inc.	178	McGraw-Hill Encyclopedia and Subscription Book Div. David Altman Advertising	136
Capitol Radio Engineering Institute Henry J. Kaufman & Associates	148	Electronic Communications, Inc. Neals & Hickok, Inc.	185	Machlett Laboratories, Div. of Raytheon Co. Fuller & Smith & Ross, Inc.	9
Cedar Engineering Div., Control Data Corp. Colle & McVoy Adv. Agcy., Inc.	133	English Electric Valve Co., Ltd. Allardyce Palmer Ltd.	OAS 9	Magnetic Shield Division, Perfection Mica Co. Burton Browne Advertising	163
Centralab Div. of Globe-Union, Inc. The Brady Company	106	Erie Technological Products Co., Inc. Altman-Hall Associates	42	Mallory & Co., P.R., Mfg. Division Aitkin-Kynett Co.	116
Cherry Electrical Products Corp. K & A, Incorporated	188	Fairchild Semiconductor, Inc. Faust/Day, Inc.	108	Marconi Co., Ltd. Line Communications Hampshire House, Ltd.	OAS 4
Chicago Dynamic Industries, Inc. Burton Browne Advertising	114	Fluke Manufacturing Co., John Bonfield Associates	35	Marconi, Ltd., Space Communications Hampshire House, Ltd.	OAS 12
Cinch Graphik, Div. of United Carr Fastener Co. Reach McClinton & Co.	170	General Radio Co. Horton, Church & Goff, Inc.	17	Materials Research Corp. MRC Corporation Sub. Keyes, Martin & Co.	156
Clare & Company, C.P. Reincke, Meyer & Finn Adv., Inc.	103	Heath Co., Sub. of Schlumberger, Ltd. Advance Advertising Service	195	Metal Removal Co., The Advertising Producers Associates	174
Clarostat Manufacturing Co. Lescarboura Adv., Inc.	126	Heinemann Electric Co. Thomas R. Sundheim, Inc.	8	Methode Electronics, Inc. Sander Rodkin Adv. Agcy., Ltd.	167
Cleveland Institute of Electronics Foote, Cone & Belding, Rapp & Collins Div.	143	Hewlett Packard, Colorado Springs Div. Tallant/Yates Advertising, Inc.	139 to 142	Microdot, Inc. Gumpertz, Bentley & Dolan Advertising	15
Cohu Electronics, Inc. Erwin Wasey, Inc.	206	Hewlett Packard, Frequency & Time Div. Lennen & Newell, Inc.	1	Micrometals Printing Advertising Promotion	184
Colorado State of Industrial Development Div. Buchen Adv., Inc.	160	Hewlett Packard, Loveland Div. Tallant/Yates Advertising, Inc.	40	Microwave Electronics Corp., Sub. of Teledyne Bonfield Associates	18, 19
Components, Inc. Creative Advertising Agency	5				
Computer Instruments Corp. Dickerman Adv., Inc.	115				
Consolidated Electrodynamics Corp., Sub. of Bell & Howell Hixson & Jorgensen, Inc.	74				
Consolidated Reactive Metals, Inc. Charles V. Corbin Assoc., Inc.	187				
Control Data Corp., Analog Digital Systems Div. Barnes-Champ Advertising	196				
Control Products Division Consolidated Electrodynamics Corp., a Bell & Howell Co. Watson-Manning, Inc.	134				



Midtex/Aemco	164
Chuck Ruhr Assoc. Adv.	
Motorola Semiconductor Products, Inc.	12, 13, 43
Lane & Bird Adv., Inc.	
National Semiconductor Corp.	70, 71
Jay Chiat & Associates	
New Hermes Engraving Machine Corp.	187
Lester Harrison Adv., Inc.	
■ Norton Associates, Inc.	198
J.J. Coppo Co.	
■ North Atlantic Industries, Inc.	179
Murray Heyert Associates	
■ Nortronic Co., Inc. OEM Div.	178
Stral Adv. Co., Inc.	
Nytronics, Inc.	16
S.M. Sachs & Associates, Inc.	
■ Parker Instrument Corp.	197
HPM Advertising	
Pastoriza Electronics Co.	186
L.K. Frank Co., Inc.	
■ Philbrick/Nexus Research	36, 37
Culver Adv., Inc.	
Pomona Electronics Co.	180
Buxton Advertising Agency	
■ Price Electric Corp.	129
H.W. Buddemeier Co., Inc.	
Princeton Applied Research Corp.	44
Mort Barish Assoc., Inc.	
Radio Corporation of America	4th Cover
Al Paul Lefton Co.	
■ Raytheon Co., Components Div.	118
Fuller & Smith & Ross, Inc.	
RFL Industries, Inc., Instrumentation Div.	200
Josephson, Cuffari & Co.	
Rotron Manufacturing Co.	145
Lescarboua Adv., Inc.	
Sanders Assoc., Inc., Flexprint Products Div.	113
Chirurg & Cairns, Inc.	
□ Schlumberger, Ltd.	OAS 7
Sodipa Contact	
Schober Organ Corp.	132
Harry C. Waterston, Inc.	
Scientific Data Systems	75
Doyle, Dane, Bernbach, Inc.	
Sensus International	214
John W. Hall	
Signetics Corp. Sub. Corning Glass Works	94
Cunningham & Walsh, Inc.	
Skottie Electronics	190
Patrick J. Lahey, Inc.	
□ Solartron Electronic Group, Ltd.	OAS 2, OAS 3
Southern Advertising, Ltd.	
Soliton Devices, Inc., Transistor Div.	73
Haselmire Pearson Adv., Inc.	
■ Sorensen Operation, Raytheon Co.	61
James Advertising, Inc.	
Spectra-Physics, Inc.	11
Hal Lawrence, Inc.	
□ S.P. Elettronica	OAS 6
Publicitas SPA	
Sperry Rand Corp., Sperry Electronic Tube Div.	58
Neals & Hickok, Inc.	
Sprague Electric Co., The	10, 53
Harry P. Bridge Co.	
Stanpat Products, Inc.	197
Morton Advertising, Inc.	
Sunnyvale, Chamber of Commerce, Industrial Development Div.	194
Giulie, Smith & Beal, Inc.	
■ Susumu Industry Co., Ltd.	198
Dentsu Advertising	

Sylvania Electric Products, Inc., Electronic Components Group	27 to 34
Doyle, Dane, Bernbach, Inc.	
Sylvania Electronic Systems, Div. of Sylvania Electric Products, Inc.	107
Hal Lawrence, Inc.	
■ Syntronic Instruments, Inc.	132
Burton Browne Advertising	
Systron-Donner Corp.	6
Bonfield Associates, Inc.	
■ Tektronix, Inc.	51
Hugh Dwight Adv., Inc.	
Tempress Research Co., Inc.	105
Hal Lawrence, Inc.	
Texas Instruments Incorporated Components Group	138
Don L. Baxter, Div. of Albert Frank-Guenther Law, Inc.	
Thomson Electric Co., Inc.	213
■ Tohoku Metal Industries, Ltd.	195
Hakuhodo, Inc.	
TRW Electronics, Capacitors Div.	49
Fuller & Smith & Ross, Inc.	
■ Trygon Electronics, Inc.	125
Kameny Associates, Inc.	
■ Tung Sol Div., Wagner Electric Corp.	199
Feeley Adv. Agcy., Inc.	
Unimax Switch	182
Mohr & Co., Inc.	
■ United Transformer Co., Div. of TRW, Inc.	2nd Cover
Philip Stogel Co.	
■ Unirode Corp.	57
Silton Brothers, Inc.	
U.S. Naval Ship Missile Systems	171
Henry J. Kaufman Associates	
Varian Associates, Recorder Div.	22
Botsford, Constantine & McCarty, Inc.	
Varian Data Machine	171
Durel Advertising	
Varo, Inc.	14
Tracy-Locke Co., Inc.	
■ Victory Engineering Corp.	198
Black-Russell-Morris	
■ Wang Laboratories	166
Impact Advertising, Inc.	
Watkins-Johnson Co.	181
William C. Estler Pub. Rel.	
Westamp, Inc.	194
Siegmeister-Grant	

Classified Advertising	
F.J. Eberle, Manager	
EMPLOYMENT OPPORTUNITIES	201-205
EQUIPMENT	
(Used or Surplus New)	
For Sale	205
ADVERTISERS INDEX	
A & A Electronics Corp.	205
Aerojet General Corp.	203
General Dynamics-Electronics Div.	202
General Electric Co., Capacitor Dept.	205
General Precision Inc.	201
Goodheart Co., Inc., R.E.	205
Motorola	204
Radio Research Instrument Co.	205

■ For more information on complete product line see advertisement in the latest Electronics Buyer's Guide

□ Advertisers in Overseas Advertising Section following Newsletter from Abroad

Advertising sales staff

Frank E. LeBeau [212] 971-6464
Advertising sales manager

Wallis Clarke [212] 971-2187
Assistant to sales manager

Donald J. Austermann [212] 971-3139
Promotion Manager

Atlanta, Ga. 30309: Michael H. Miller, 1375 Peachtree St., N.E. [404] 892-2868

Boston, Mass. 02116: William S. Hodgkinson McGraw-Hill Building, Copley Square [617] CO 2-1160

Chicago, Ill. 60611: Robert M. Denmead, J. Bradley MacKimm, Ralph Hanning, 645 North Michigan Avenue, [312] MO 4-5800

Cleveland, Ohio 44113: William J. Boyle, 55 Public Square, [216] SU 1-7000

Dallas, Texas 75201: Richard P. Poole, 1800 Republic National Bank Tower, [214] RI 7-9721

Denver, Colo. 80202: Joseph C. Page, David M. Watson, Tower Bldg., 1700 Broadway, [303] 255-5484

Detroit, Michigan 48226: Ralph Hanning 856 Penobscot Building [313] 962-1793

Houston, Texas 77002: Kenneth George, 2270 Humble Bldg., [713] CA 4-8381

Los Angeles, Calif. 90017: Ian C. Hill, John G. Zisch, 1125 W. 6th St., [213] HU 2-5450

Minneapolis, Minn. 55402: J. Bradley MacKimm, 1104 Northstar Center [612] 332-7425

New York, N.Y. 10036
500 Fifth Avenue
Donald R. Furth [212] 971-3615
James R. Pierce [212] 971-3616
John A. Garland [212] 971-3617

Philadelphia, Pa. 19103:

Jeffrey M. Preston
Warren H. Gardner
6 Penn Center Plaza,
[215] LO 8-6161

Pittsburgh, Pa. 15222: Warren H. Gardner, 4 Gateway Center, [412] 391-1314

Portland, Ore. 97204: James T. Hauptli, 218 Mohawk Building, 222 S.W. Morrison Street, Phone [503] 223-5118

Rochester, N.Y. 14534: William J. Boyle, 9 Greylock Ridge, Pittsford, N.Y. [716] 586-5040

St. Louis, Mo. 63105: Robert M. Denmead The Clayton Tower, 7751 Carondelet Ave. [314] PA 5-7285

San Francisco, Calif. 94111: James T. Hauptli, 255 California Street, [415] DO 2-4600

London W1: Edwin S. Murphy Jr., 34 Dover Street, Hyde Park 1451

Paris: Pierre Braude, European Director 88-90 Avenue Des Champs-Elysees, Paris 8. Phone: 225 85 88

Milan: Robert Saidel 1 via Baracchini Phone: 86-90-656

Frankfurt/Main: Hans Haller Elsa Brandstroem Str. 2 Phone: 72 01 81

Geneva: Mike Zeynel 1, rue du Temple Phone: 31 95 60

Tokyo: Nobuyuki Sato, 1, Kotohiracho Shiba, Minato-Ku [502] 0656

Osaka: Ryoji Kobayashi 163, Umegae-cho Kita-ku [362] 8771

Business Department

Wallace C. Carmichael, Manager [212] 971-3191

Stephen R. Weiss, Production Manager [212] 971-2044

Thomas M. Egan, Assistant Production Manager [212] 971-3140
Dorothy Carmesin, Contracts and Billings [212] 971-2908

Frances Vallone, Reader Service Manager [212] 971-2865

Circulation and Research

Milton Drake, Manager [212] 971-3485
Isaaca Siegel, Assistant Circulation Manager [212] 971 6057

David Strassler, Assistant Research Manager [212] 971-6058

Chloe D. Glover, Research Associate [212] 971-6057

Electronics Buyers' Guide

George F. Werner, General Manager [212] 971 2310

Ray Smyth, Eastern Regional Manager [212] 971 6538

Regina Hera, Directory Manager [212] 971 2544

Thomas M. Egan, Production Manager [212] 971-3140

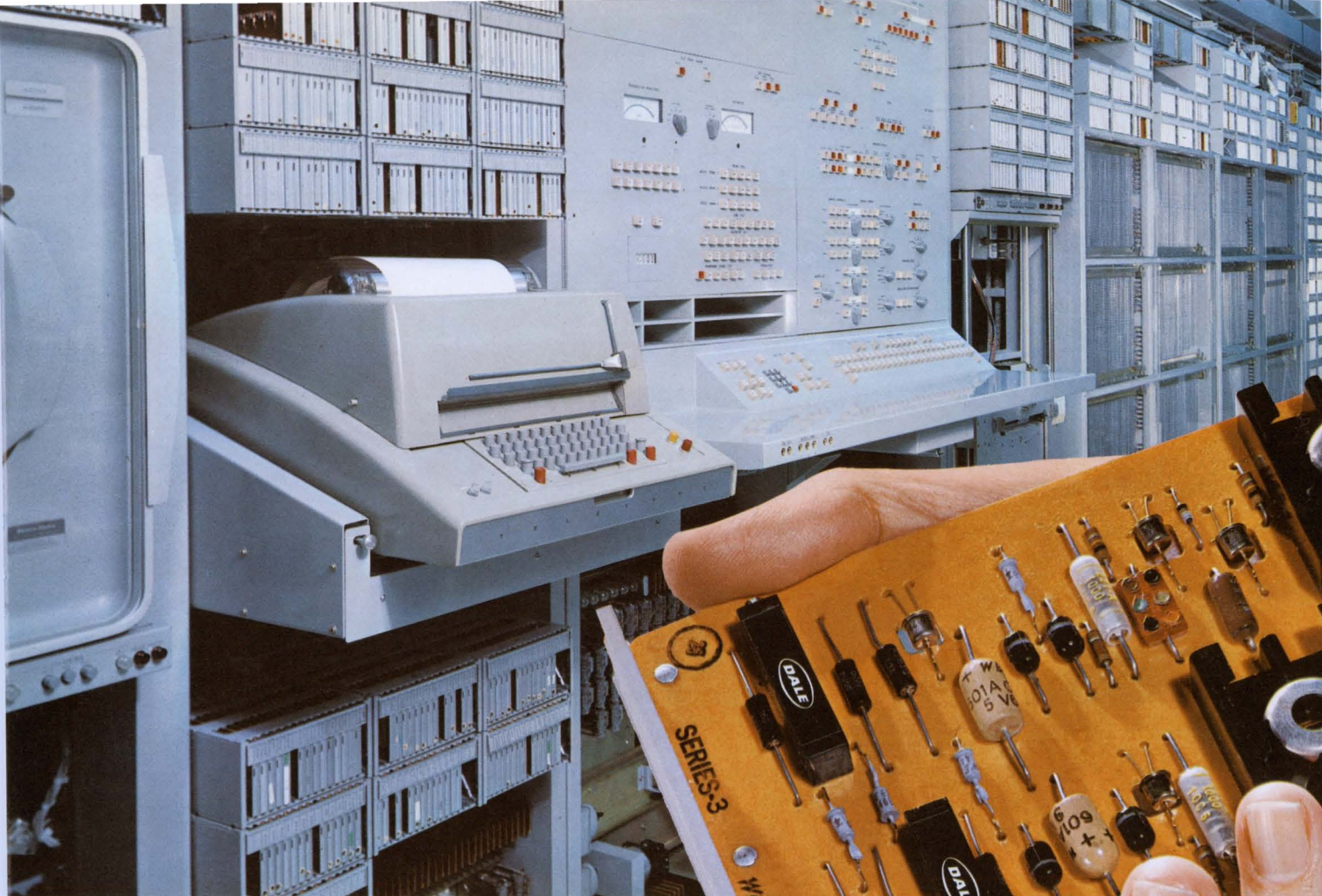

Here's where to find a good industrial trimmer!

Western Electric makes wide use of Dale's 2100 Trimmer in circuit packs for Electronic Switching Systems

Western Electric's complex ESS #1 uses Dale 2100 Series Wirewound Trimmers in various circuit packs. Each of these circuit designs requires a trimmer with good stability, fine resolution and stable temperature characteristics—items which the 2100 can deliver easily at industrial price levels. By using one simple, highly reliable design throughout its trimmer line, Dale has earned the confidence of industry leaders. This concept makes

performance no problem at any price level—and it means that value analysis techniques really pay off when you apply them to the Dale trimmer line.

For example, the 2100 Series—offering 1 watt at 70°C—is the commercial counterpart of RT-11, MIL-R-27208A. For pennies more it becomes a low-priced humidity-proof model equal to the mil spec everywhere but temperature. Similar values are available throughout the Dale trimmer line. For help in finding them, call 402-564-3131 today.



Circle No. 201 for Catalog B

for optimum value in trimmer potentiometers

DALE ELECTRONICS, INC., 1300 28th Ave., Columbus, Nebraska 68601
In Canada: Dale Electronics Canada, Ltd.



**At RCA our new
corporate symbol
is really a minor change
compared with
the innovations
it will signify
in decades to come.**

RCA