

Electronics[®]

Improved unijunctions are 'integrated': page 56

Radiation resistance of thyristors: page 65

Comparing VTR scanning methods: page 80

April 1, 1968

\$1.00

A McGraw-Hill Publication

Below: Intelsat 3's high-gain
despun antenna, page 71

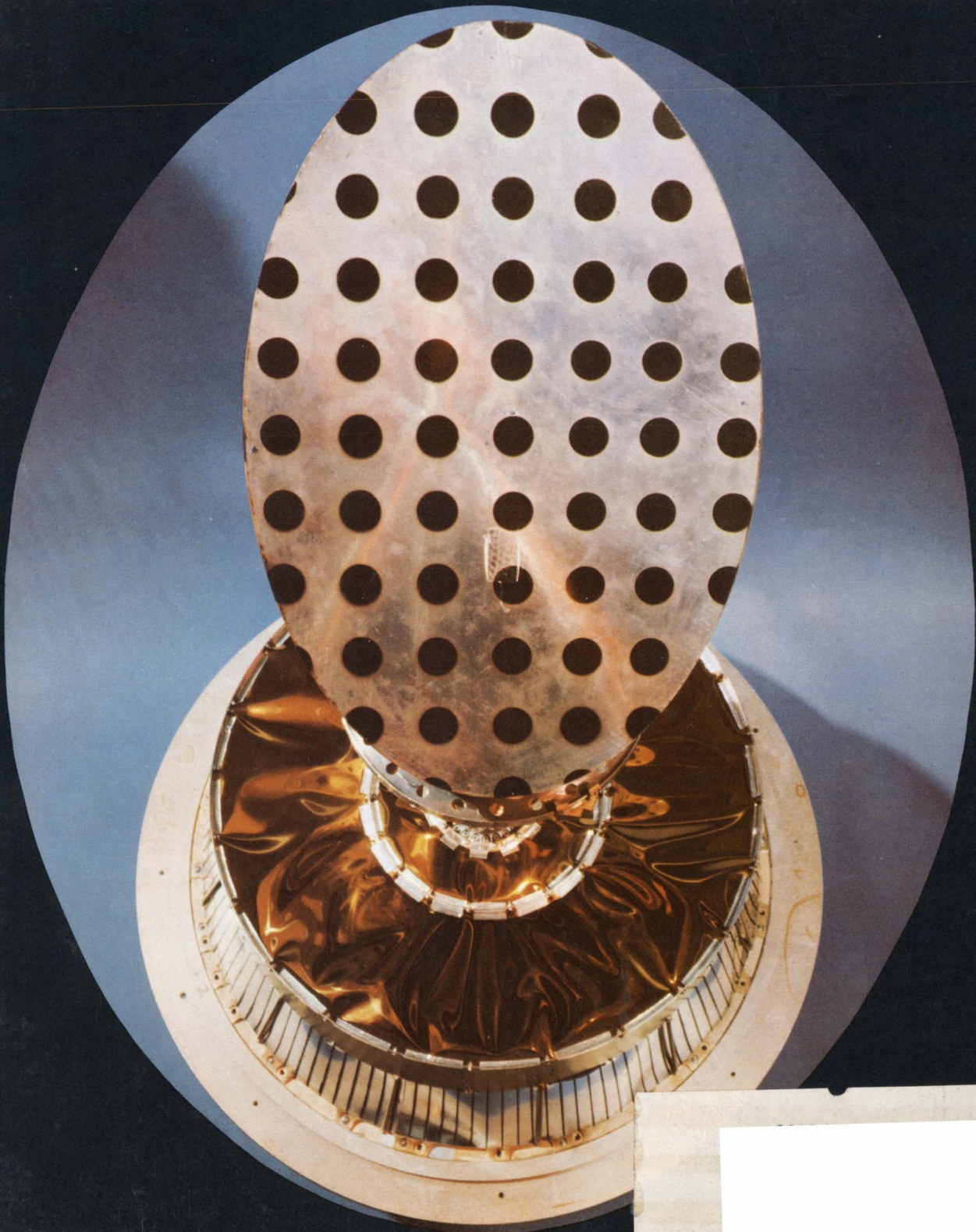



NEW BIT-250™ LINE

SMALLEST METAL-ENCASED TRANSFORMERS AVAILABLE!

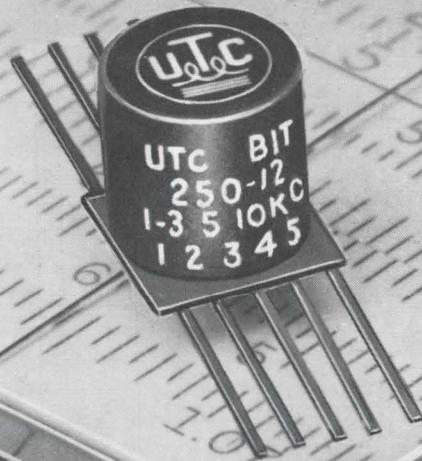

BIT-250's achieve outstanding reliability, in a profile compatible with Flat Packs and IC's, while maintaining response and power levels found only in larger units. MIL-T-27B, Grade 4, completely ruggedized. Seventeen items immediately available from stock, plus specials to your requirements. Dimensions: .025" high x .025" diameter. Power to 80 mw. Patent applied for.

Write for descriptive brochure depicting ranges and capabilities.

UNITED TRANSFORMER CO. TRW
DIVISION OF TRW INC. • 150 VARICK STREET, NEW YORK, N. Y. 10013

TOTAL ANALOG SYSTEM CAPABILITY...

Analog tape systems from Hewlett-Packard offer you a broad line of hardware to satisfy your most stringent recording requirements. HP tape systems give you high performance at competitive prices, assuring you of best equipment values. Fully IRIG-compatible, with the highest signal-to-noise ratio in the industry, HP analog tape systems minimize costly downtime because design simplicity affords simple and fast maintenance.

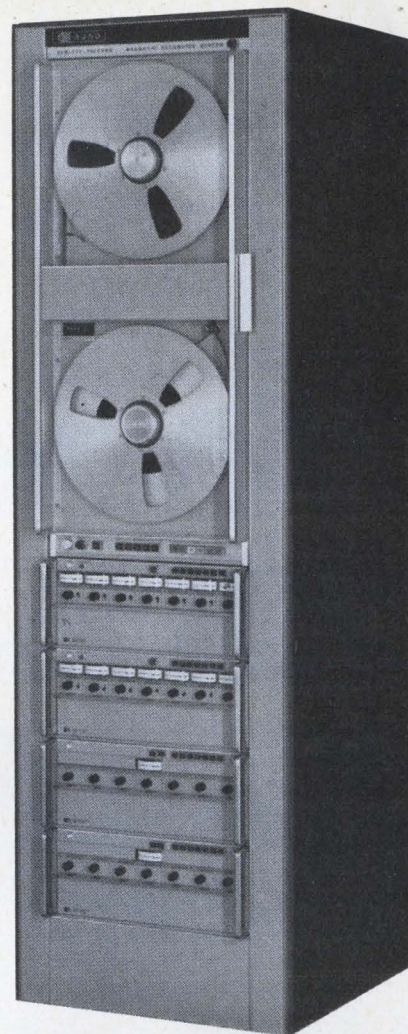

...WITH OUR COMPLEMENTS!

A complete line of complementary equipment gives you the system back-up needed to operate your system at top efficiency. Representative of HP's specially designed support line are these latest additions:

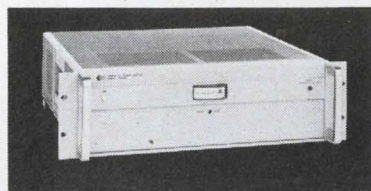

3680A AC Power Supply: Now you can drive synchronous capstan motors with crystal-controlled drive speed accuracy (60 Hz), eliminating minor tape

speed changes resulting from abnormal frequency variations in an AC power line. Works as an amplifier with up to 40 dB gain, 30 to 1500 Hz bandwidth. The all solid-state 3680A delivers 100 Watts at over 115 V. No more exasperating need to put up with variations in main power sources. Can also be used with our 3681A IRIG-compatible tape servo system.

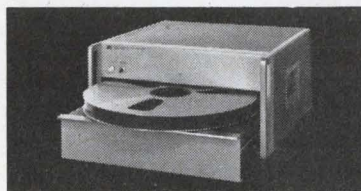

The 3603A Degausser: Now you can erase analog or digital magnetic tape completely in 40 seconds with this remarkably simple device. Fully automatic,

independent of operator skill or technique—and with no need for cooling between uses, the 3603A can be used continuously. It accepts tape reels from 3" to 15", 1/2" to 1" wide tapes and accommodates EIA or NAB type reels with 5/16" or 3" hubs. Erases to at least 90 dB below recorded level. Use with system or separate.



3605A Crystal-Controlled Frequency Source: Here's a convenient way to get stable, accurate CW frequencies for alignment of FM reproduce electronics, without having to tie it to your system. The 3605A is

completely portable and provides all IRIG frequencies with pushbutton ease. Absolute frequency accuracy of $\pm 0.05\%$ for all frequencies, and excellent stability also make it useful for flutter testing in low and intermediate bands. Use with system or separate.

For more information, call your local HP field engineer or write Hewlett-Packard, 690 Middlefield Road, Mountain View, California 94040; Europe: 54 Route des Acacias, Geneva.

HEWLETT  PACKARD

MAGNETIC RECORDERS

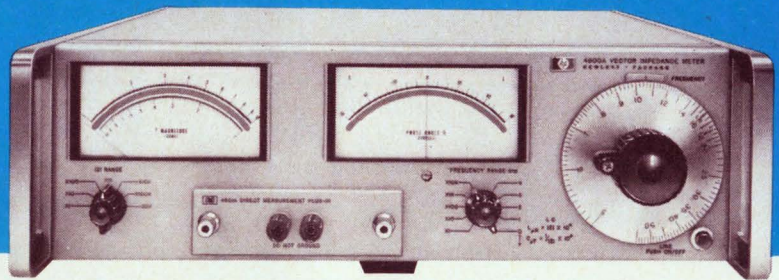
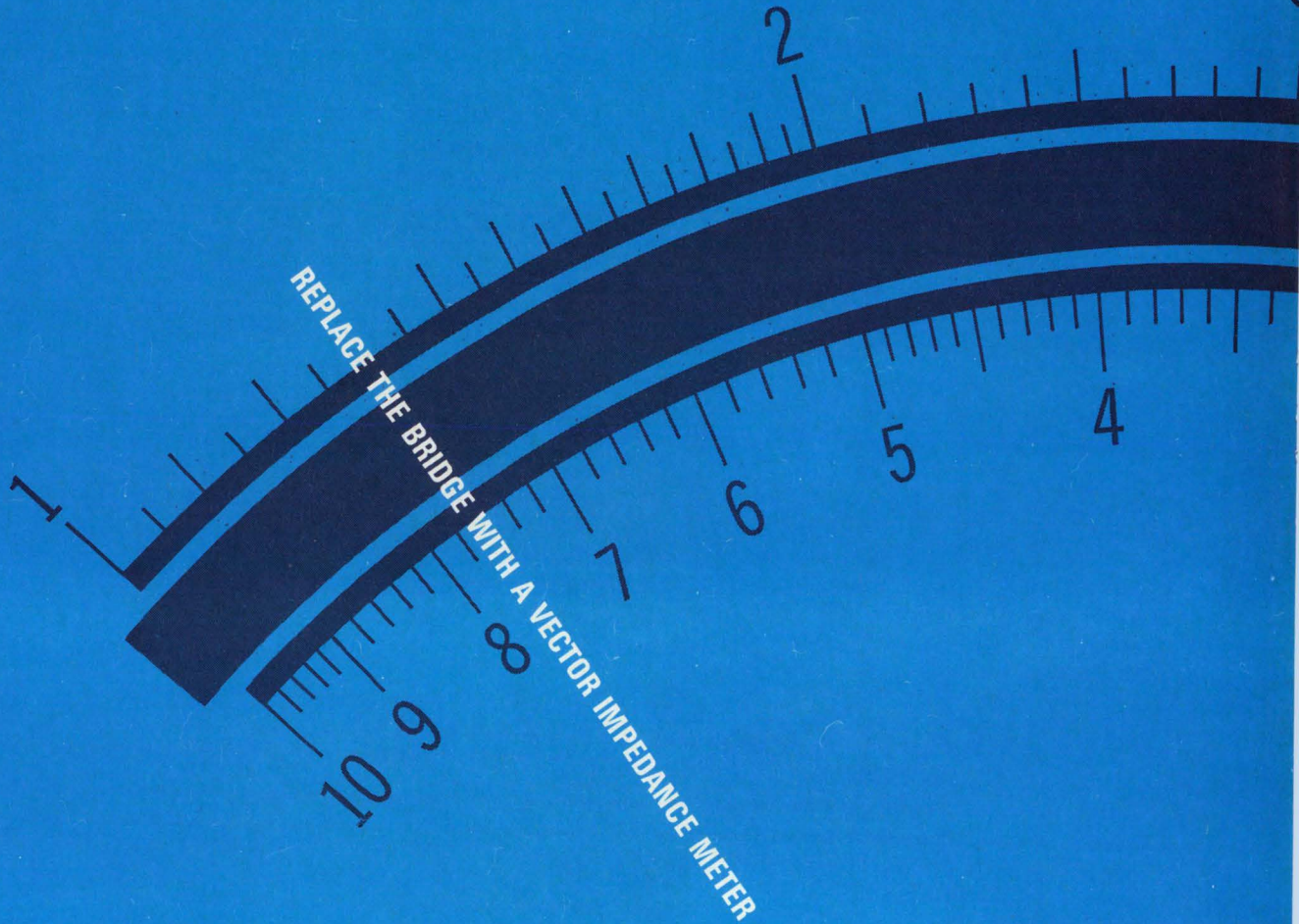

Vector Impedance Meter makes measurements in seconds

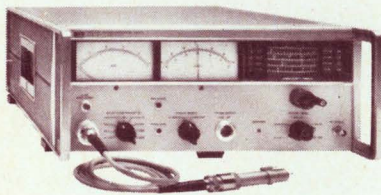

MODEL 4815A OFFERS DIRECT READOUT OF HIGH FREQUENCIES IN OPERATING CIRCUITS

The 4815A offers direct readout of impedance and phase angle measurements from 500 kHz to 108 MHz with continuous tuning. Probe on five-foot cable simplifies in-circuit measurements. Price: \$2,650.00. Complete specifications are yours on request.

Now there's no excuse for not making all the impedance measurements that previously have been too bothersome to make. The Hewlett-Packard 4800A Impedance Meter eliminates bridge balancing and nulling. It does for AC measurement what the ohmmeter does for DC testing. Just plug it in and read it. The 4800A may be mechanically swept to produce measurements over its full frequency range. You get direct readings of impedance and phase angle from 5 Hz to 500 kHz. Analog outputs of frequency, impedance and phase are provided for X-Y recording. Low-level signal strength prevents overloading of the test component. Price: \$1,650.00.

Application Note 86 discusses many applications of the Vector Impedance Meters. For your copy of this note and complete specifications, please contact your local Hewlett-Packard field engineer or write: Hewlett-Packard, Green Pond Road, Rockaway, N. J. 07866.

HEWLETT  PACKARD
IMPEDANCE INSTRUMENTS

News Features

Probing the News

- 95 Mexico nears finish line in first Olympic event
101 JPL up in the air over space role

Electronics Review

- 31 **Computers:** Univac finds way to cut thin-film memory costs
32 **Components:** Magnetic amplifier designed without an external demodulator
33 **Patents:** Service offers details on patents pending
34 **Manufacturing:** Inexpensive way to make printed-circuit boards
34 **Integrated electronics:** National Semiconductor's new IC's
36 **Space electronics:** Coding technique cuts telemetry errors
38 **Displays:** Materials that change color with temperature
38 **Communications:** Phoning in a weather map
40 **For the Record**

Electronics Abroad

- 145 **Great Britain:** Government's harsh budget will hurt; IC delay networks "steer" antenna; Merger gives U.K. largest computer company outside U.S.
147 **East Germany:** Zeiss makes low-cost planetarium
147 **France:** Paris components show
148 **Sweden:** Automatic tester checks Viggen electronics
149 **Japan:** Fujitsu producing large computer; Noise level controls traffic signals

New Products

- 105 **Design-it-yourself LSI's**
109 **Components review**
109 Nonlinear resistor regulates voltage
113 **Instruments review**
113 Packing 33 channels on 1/4-inch tape
117 **Subassemblies review**
117 Data system for thin purses
121 **Production equipment review**
121 Adding classifications to testers
125 **Semiconductors review**
125 Hybrid IC has no substrate
131 **Consumer electronics review**
131 Video tape recorder travels light

Title R registered U.S. Patent Office; © copyright 1968 by McGraw-Hill Inc. All rights reserved, including the right to reproduce the contents of this publication, in whole or in part.

Technical Articles

I. Design

Solid state 56

Unlocking the gates for UJT's

Integrated-circuit techniques give unijunction transistors a boost in stability and frequency
Walter R. Spofford Jr.,
General Electric Co.

Circuit design 61

Designer's casebook

- Measuring impedance with insertion loss
- Voltage sensor limits discharge in batteries
- A pulse every millisecond is Rx for hysteresis ills
- RC-biased Schmitt trigger times pulse accurately

Military 65

Here's a good switch: radiation-resistant thyristors

Data shows that thyristors are better than transistors for switching under high radiation conditions
Jacob J. Aghassi, Arie Najman and Edward Simon, Solid State Products Co.

II. Application

Space electronics 71

Motor gives reverse twist to the Intelsat 3 antenna

Mechanically despun antenna gives higher gain than all-electronic systems
Francis E. Donnelly Jr., Reynold P. Graunas, and John D. Killian,
Sylvania Electronic Systems

Consumer 80

Video tape recorders: Longitudinal or helical scan?

Helical-scan, rotating-head recorders are more complicated, but offer many advantages
Delmar Johnson and Barrett Guisinger,
Ampex Corp.

Departments

- | | | | |
|----|------------------------|-----|------------------------|
| 4 | Readers Comment | 32 | Index of activity |
| 8 | People | 45 | Washington Newsletter |
| 14 | Meetings | 134 | New Books |
| 16 | Meeting Preview | 136 | Technical Abstracts |
| 23 | Editorial Comment | 138 | New Literature |
| 25 | Electronics Newsletter | 143 | Newsletter from Abroad |

Electronics

Editor-in-Chief: Donald Christiansen

Associate managing editors

Technical: Stephen E. Scrupski
News: Robert Henkel
Copy: Sally Powell

Senior associate editors

Joseph Mittleman, Harry R. Karp

Department editors

Avionics & Space: Alfred Rosenblatt
Computers: Wallace B. Riley
Communications: William Bucci
Consumer electronics: John D. Drummond
Design theory: Joseph Mittleman
Industrial electronics: Harry R. Karp
Instrumentation: Carl Moskowitz
Military electronics: Richard Gundlach
Solid state: Mark B. Leeds

Regional bureaus

Domestic

Boston: James Brinton, manager; Robin Carlson
Los Angeles: Lawrence Curran, manager; Burton Bell
New York: Howard Wolff, manager
San Francisco: Walter Barney, manager; Peter Vogel
Washington: Robert Skole, manager; William D. Hickman, Paul Dickson

Foreign

Bonn: John Gosch
London: Michael Payne
Tokyo: Charles Cohen

Copy editors

James Chang, Frederick Corey, James Darby

Graphic design

Art director: Saul Sussman
Assistant art directors: Ann Mella, Valerie Betz
Production editor: Arthur C. Miller

Editorial secretaries: Claire Benell, Lynn Emery, Kay Fontana, Patricia Gardner, Lorraine Longo, Barbara Razulis, Frances Vacca

McGraw-Hill News Service

Director: Arthur L. Moore; **Atlanta:** Fran Ridgway; **Chicago:** Bruce Cross;
Cleveland: Arthur Zimmerman; **Dallas:** Marvin Reid;
Detroit: James Wargo; **Houston:** Robert E. Lee; **Los Angeles:** Michael Murphy
Pittsburgh: Louis Gomolak
San Francisco: William F. Arnold
Seattle: Ray Bloomberg; **Washington:** Charles Gardner, Daniel B. Moskowitz, Herbert W. Cheshire, Seth Payne, Warren Burkett, William Small

McGraw-Hill World News Service

Bonn: Robert Dorang; **Brussels:** George Williamson; **Hong Kong:** Wes Perry;
London: John Shinn; **Mexico City:** Gerald Parkinson; **Milan:** Ronald Taggiasco, Jack Star;
Moscow: Howard Rausch; **Paris:** Robert E. Farrell, Peter Kilborn;
Rio de Janeiro: Leslie Warren; **Tokyo:** Marvin Petal

Reprints: Susan Nugent

Circulation: Milton Drake

Publisher: Gordon Jones

Electronics: April 1, 1968, Vol. 41, No. 7

Published every other Monday by McGraw-Hill, Inc. Founder: James H. McGraw 1860-1948.

Printed at 99 North Broadway, Albany, N.Y. 12207; second class postage paid at Albany, N.Y.

Executive, editorial, circulation and advertising addresses: McGraw-Hill Building, 330 W. 42nd Street New York, N.Y. 10036. Telephone (212) 971-3333. Teletype TWX N.Y. 710-581-4235. Cable address: MCGRAWHILL N.Y.

Subscriptions solicited only from those professionally engaged in electronics technology. Subscription rates: qualified subscribers in the United States and possessions and Canada, \$8.00 one year, \$12.00 two years, \$16.00 three years; all other countries \$25.00 one year. Non-qualified subscribers in the U.S. and possessions and Canada, \$25.00 one year; all other countries \$50.00. Air freight service to Japan \$50.00 one year. Single copies: United States and possessions and Canada, \$1.00; all other countries, \$1.75.

Officers of McGraw-Hill Publications: Joseph H. Allen, President; Bayard E. Sawyer, Executive Vice-President; J. Elton Tuohig, Senior Vice-President-Operations; Vice Presidents: John R. Callahan, Editorial; John M. Holden, Marketing; Paul F. Cowie, Circulation; Angelo R. Venezian, Production; Jerome D. Luntz, Planning & Development; Robert M. Wilhelmy, Controller.

Officers of the Corporation: Shelton Fisher, President and Chief Executive Officer; John L. McGraw, Chairman; L. K. Goodrich, Executive Vice President; R. E. Slaughter, Donald C. McGraw, Jr., Senior Vice Presidents; Daniel F. Crowley, Senior Vice President and Treasurer; John J. Cooke, Vice President and Secretary.

Title © registered in U.S. Patent Office; © Copyright 1968 by McGraw-Hill, Inc. All rights reserved. The contents of this publication may not be reproduced either in whole or in part without the consent of copyright owner.

Subscribers: The publisher, upon written request to our New York office from any subscriber, agrees to refund that part of the subscription price applying to copies not yet mailed. Please send change of address notices or complaints to Fulfillment Manager; subscription orders to Circulation Manager, Electronics at address below. Change of address notices should provide old as well as new address, including postal zip code number. If possible, attach address label from recent issue. Allow one month for change to become effective.

Postmaster: Please send form 3579 to Fulfillment Manager, Electronics, P.O. Box 430, Hightstown, New Jersey 08520

Readers Comment

Clam digging

To the Editor:

My congratulations on the story, "Why foreign exhibitors come to IEEE," [March 4, p. 82]. The defeatist attitude with which most Europeans view the U.S. market comes through loud and clear. It is especially noteworthy that even the most energetic European firms that have gone to the difficulty of exhibiting in the U.S. have a pronounced phobia about the U.S. Most have defeated themselves before they start and are miraculously unaware of their attitude.

It was good reporting on attitudes, but if your reporters had dug a little deeper your readers would now know much more about what is available from Europe. In comparison to American effusiveness, it must seem like digging for clams in Rockefeller Center to get European publicity men to tell what's new.

Bernard Fudim

Calvert Electronics
International Inc.
New York

Lowering the cost

To the Editor:

I disagree with some of the statements made by Donald E. Lancaster in his article, "For low cost, count on RTL," [Jan. 22, p. 74]. Diode-transistor and transistor-transistor logic elements are available at the same prices as are currently charged for RTL. This has been made possible by engineers who are forever dissatisfied with their circuits and want to improve performance of their designs. These engineers seek advance information on new integrated circuits, concerning their performance and price. They use this information to design a timely and competitive product.

Author Lancaster's circuit can be implemented at a lower cost by using DTL circuits and a further decrease in cost will result from using power supplies with less stringent regulation requirements. Additionally, with DTL implementation, the input trigger signal does not require any special shaping—a simple

Here's a new digital IC from Sprague. The 54/74107A.

It's a single-chip
replacement for the
5473/7473 dual JK
m-s flip-flop.

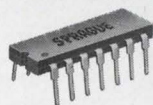
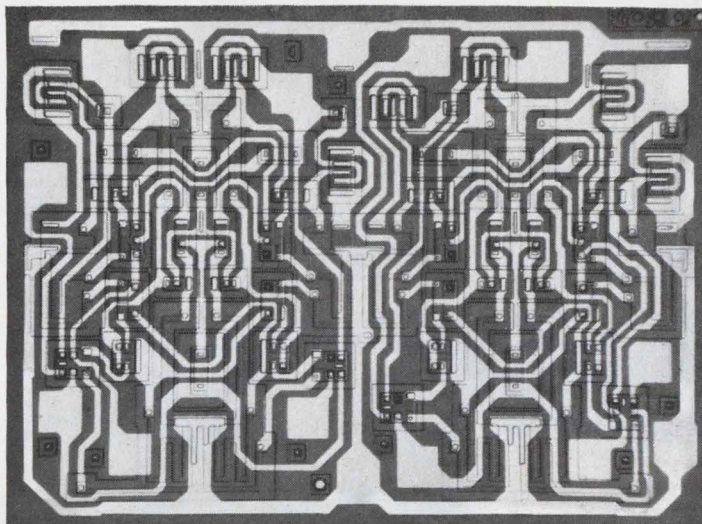

In DIP it has pin 7 GND,
just like the rest of the Series 54/74 family.

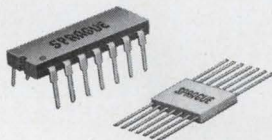

For existing designs,
it's also offered in the "old"
pinning in either DIP or flat pack.

SPECIFICATIONS Dual JK m-s Flip-Flop

Choose 0 to +70 or -55 to +125 C
temperature range. Choose "old"
or new compatible pinning.
Choose Sprague for all Series 54/74.

	DIP PIN 7 GND	DIP PIN 11 GND	TO-88 PIN 11 GND
0 to +70 C	USN-74107A	USN-7473A	USN-7473J
-55 to +125 C	USS-54107A	USS-5473A	USS-5473J
Clock freq.	15 MHz	15 MHz	15 MHz
P _{diss}	50 mW/ff	50 mW/ff	50 mW/ff
Fan Out	10	10	10

To request samples, call your Sprague representative.
For further information, write to Technical Literature
Service, 35 Marshall St., North Adams, Mass. 01247.



SPRAGUE WORCESTER . . . the world's finest microcircuit facility.

Little plug-ins make the big difference in 50 MHz counters

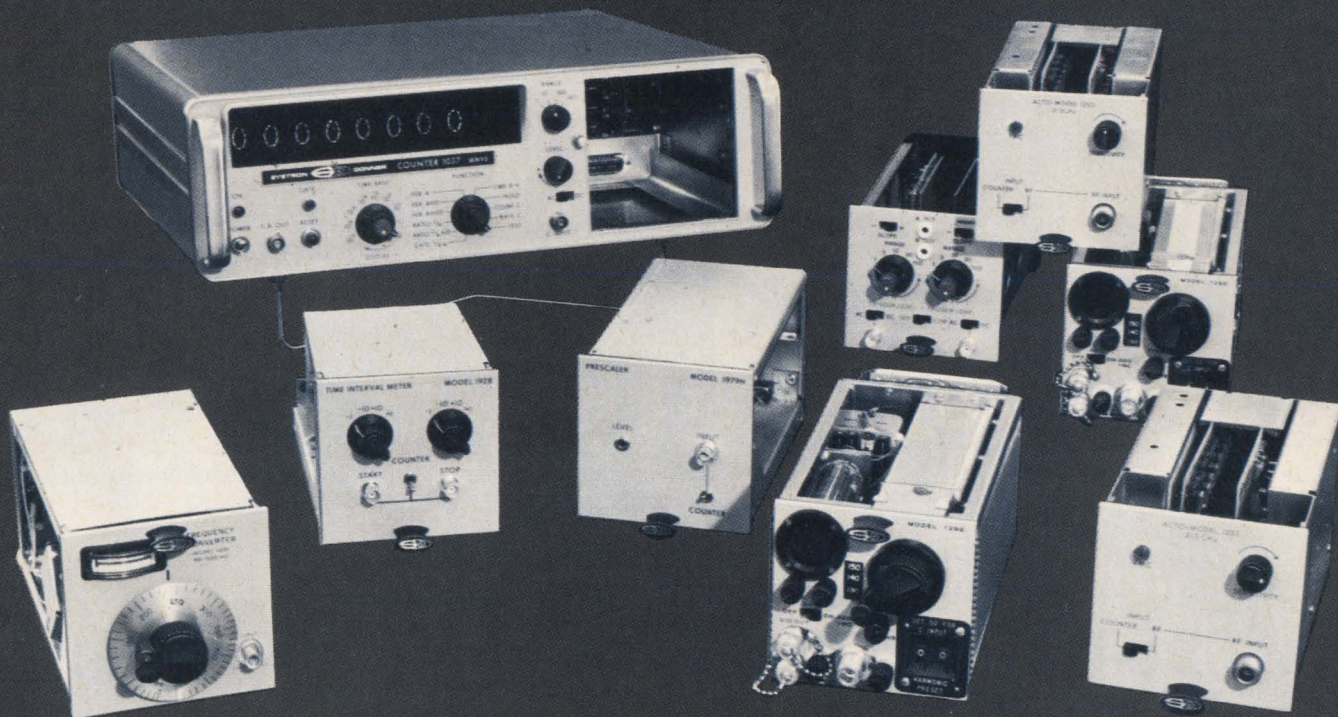

When you look only at the main frame, it's hard to find important differences between 50 MHz counters. But when you compare plug-ins, you'll find great differences and decisive advantages. Only Systron-Donner plug-ins can give you:

1. Final-answer frequency readings to 40 GHz.

A single plug-in, our Model 1292 semi-automatic transfer oscillator, boosts the counter's frequency-measuring range to 15 GHz. Measures FM and pulsed RF above 50 MHz. And the complete dc to 15 GHz system (counter with plug-in) costs only \$5250. Our new Model 1298 semi-automatic T.O. now gives you final-answer readings up to 40 GHz—a new record.

Contact Systron-Donner Corporation, 888 Galindo Street, Concord, California. Phone (415) 682-6161.

2. Automatic frequency readings to 18 GHz.

Three Acto[®] plug-ins now produce fully-automatic microwave frequency readings: 50 MHz to 3 GHz (P, L & S band), 3 to 12.4 GHz (S & X band), and 12.4 to 18 GHz (K_U band).



Find more unique measuring capability in this catalog

3. Time readings with 10-nano-second resolution.

Our latest time interval plug-in gives you time readings with 10-nanosecond resolution—greater precision than ever before possible with a standard counter.

All this unique measuring capability can be yours today—or tomorrow—when you buy your basic counter from Systron-Donner. Sixteen different plug-ins have been especially designed to give your Systron-Donner counter more measuring power at less cost than any other system.

SYSTRON  DONNER

Circle 6 on reader service card

6-cent diode will do the trick nicely by eliminating the negative portion of a sine wave. All electronic counters do not require an abrupt fall time. Improved noise margin of the circuit will make the design of associated circuitry less complex and, therefore, less expensive.

Ivars P. Breikss

Senior Engineer
Honeywell Inc.
Denver, Colo.

Drop in the bucket

To the Editor:

In my testimony before the House Small Business subcommittee I did state that some allocations to the maritime services are "wasted" in Colorado [March 4, p. 52] but I emphasized that these allocations are so small in relationship to the needs of the mobile services that they would not begin to solve the problem of congestion for the mobile services. I stressed that they would be just a drop in the bucket.

William L. Detwiler

President
Radio Specialists Co.
Denver

Dolphin algebra

To the Editor:

In "FET oscillator helps dolphins understand people" [Feb. 5, p. 85], a serious typographical error occurred in the algebra. The correct approximate expression for the FET drain-to-source resistance is

$$R_{DS} = \frac{R_o}{1 - \frac{V_g}{V}}$$

in which

R_o = resistance when $V_g = 0$,
 V_g = source-to-gate voltage
 V = pinchoff voltage

The frequency of oscillation is

$$f = \frac{1 - \frac{V_g}{V}}{2\pi R_o C}$$

in which C is the capacitance of the Weinbridge reactive arms.

Stephen L. Moshier

Listening Inc.
Arlington, Mass.

Heave, ho

To the Editor:

While reading the lead article in "Electronics Abroad" [Jan. 22, p. 193], I was pleased and gratified to see that your editor believes in adding a bit of Gallic flavor to his writing by not attempting to clove too closely to English grammar, while at the same time attempting to wove in an occasional unfamiliar word or term.

L.R. Baerst

Space Division
North American Rockwell Corp.
Downey, Calif.

▪ Reader Baerst is poking fun at a phrase that read, "... count on President Charles de Gaulle to hoave into view." We now defend the use of the archaic form of the verb "to heave" on the grounds that it produced this amusing letter.

Readers' letters should be addressed:
To the Editor,
Electronics,
330 West 42nd Street, New York,
N.Y. 10036

new diagnostic technique TAKE YOUR OWN X-RAYS



MADE EASY
with
AUTOMATIC
exposure
control

FAXITRON® 805

New research design tool
for workbench or lab . . .

X-ray inspection where and
when you want it - - - \$2380

Anyone can operate the new 805—your technician, your secretary—because it has new convenience features which take the guesswork out of exposures.

Built-in shielding reduces external radiation to levels specified by NBS Handbook 93 for exempt installations.

The image may be recorded on Polaroid film with 10-second on-the-spot processing without a darkroom. Wet films may also be used in sizes up to 14 x 17".

High resolution is provided by a small X-ray source (0.5 mm). Good contrast for a useful range of specimen thickness and densities is provided by a wide voltage range (10 to 110 kVp). Current of approximately 3 mA continuous gives usefully short exposure times.

Send for Free "Do-it-yourself" Application Kit—technical information on typical on-the-spot X-rays of potted electronic components, multi-layer PC boards, integrated circuits, die cast parts, plastics, biological specimens—other research, design, production and quality assurance applications. Ask for a free radiograph sample of a product or object of your choosing.



Field Emission Corporation
McMinnville, Oregon 97128/A C 503, 472-5101

SUBSCRIPTION SERVICE

Please include an Electronics Magazine address label to insure prompt service whenever you write us about your subscription.

Mail to: Fulfillment Manager
Electronics
P.O. Box 430
Hightstown, N.J. 08520

To subscribe mail this form with your payment and check new subscription renew my present subscription

Subscription rates: qualified subscribers in the U.S.: 1 year \$8; two years, \$12; three years, \$16. Non-qualified: 1 year \$25. Subscription rates for foreign countries available on request.

CHANGE OF ADDRESS

ATTACH
LABEL
HERE

If you are moving, please let us know five weeks before changing your address. Place magazine address label here, print your new address below.

name

address

city

state

zip code

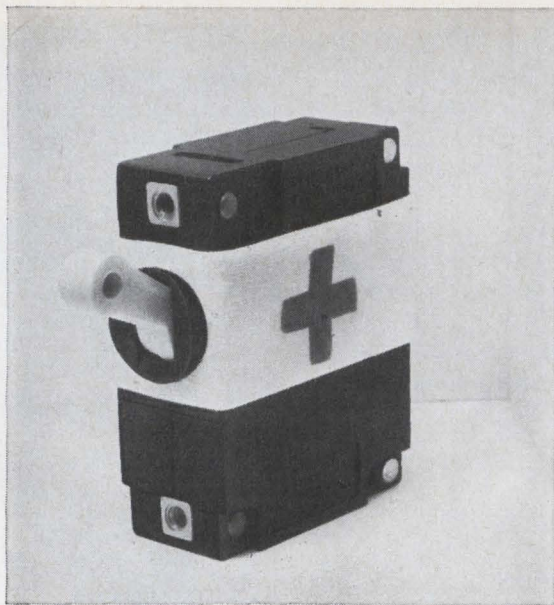

Nurse's aide?

Sure. And medical technician's. And doctor's, too, for that matter.

Anybody who has to operate medical instrumentation sooner or later will appreciate the advantages of our circuit breakers over the usual fuse arrangement.

You don't have to keep replacements on hand. Or worry about having the right size. Or remember where you put the spares in an emergency.

(It may sound melodramatic to say so, but under certain circumstances, a breaker could save a life.)

As a designer, you naturally have to worry about cost. But, with OEM discounts, our Series JA breaker is quite reasonable. Particularly when you consider

the kind of premium protection it provides:

- ultra-precise current ratings, from 0.020 to 30 amp
- response characteristics job-matched to the specific needs of your equipment
- special-function internal circuits: (like relay-trip, for example) that can greatly simplify equipment circuitry
- color-codability for instant recognition
- five year warranty

Our Bulletin 3350 will provide you with all the details you'll need to prescribe the right JA breaker for your next medical instrument. It's yours for the asking. Heinemann Electric Co., 2600 Brunswick Pike, Trenton, N.J. 08602.



HEINEMANN

4032

People

Though it will be gradual, there is a change in the offing for NASA's Langley Research Center under its new director, Edgar M. Cortright, 44. Langley has been mainly a center for aeronautical research and will continue this work, concentrating on SSR technology and v/STOL research. But it will now get more involved in astronautics.

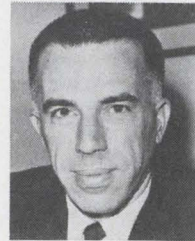

E.M. Cortright

Cortright notes that NASA plans to assign the managership of the proposed Mariner Mars 1973 missions to Langley. And he predicts Langley will be doing much of the work on advanced space stations for the 1970's. [For more on this subject, see page 101.]

Well versed in space technology, he is suited to bringing more astronautics to the center. Cortright was a charter NASA official, first as chief of advanced technology programs. He directed and formulated NASA's meteorological satellite program and the automated lunar and planetary programs. He headed the Office of Space Science and Applications and most recently has been deputy associate administrator for manned space flight—in effect, he was general manager of that effort.

"I'm going to get in there and scrap for the program," says Harold T. Luskin, 50, the newly appointed director of the Apollo Applications Program. "There is no overwhelming technical problem in getting the program moving. The problems for Apollo applications are such things as balance of payments, Vietnam, and the gold flow."



H.T. Luskin

Luskin says that without a strong Apollo applications program space efforts by the U.S. will come to a

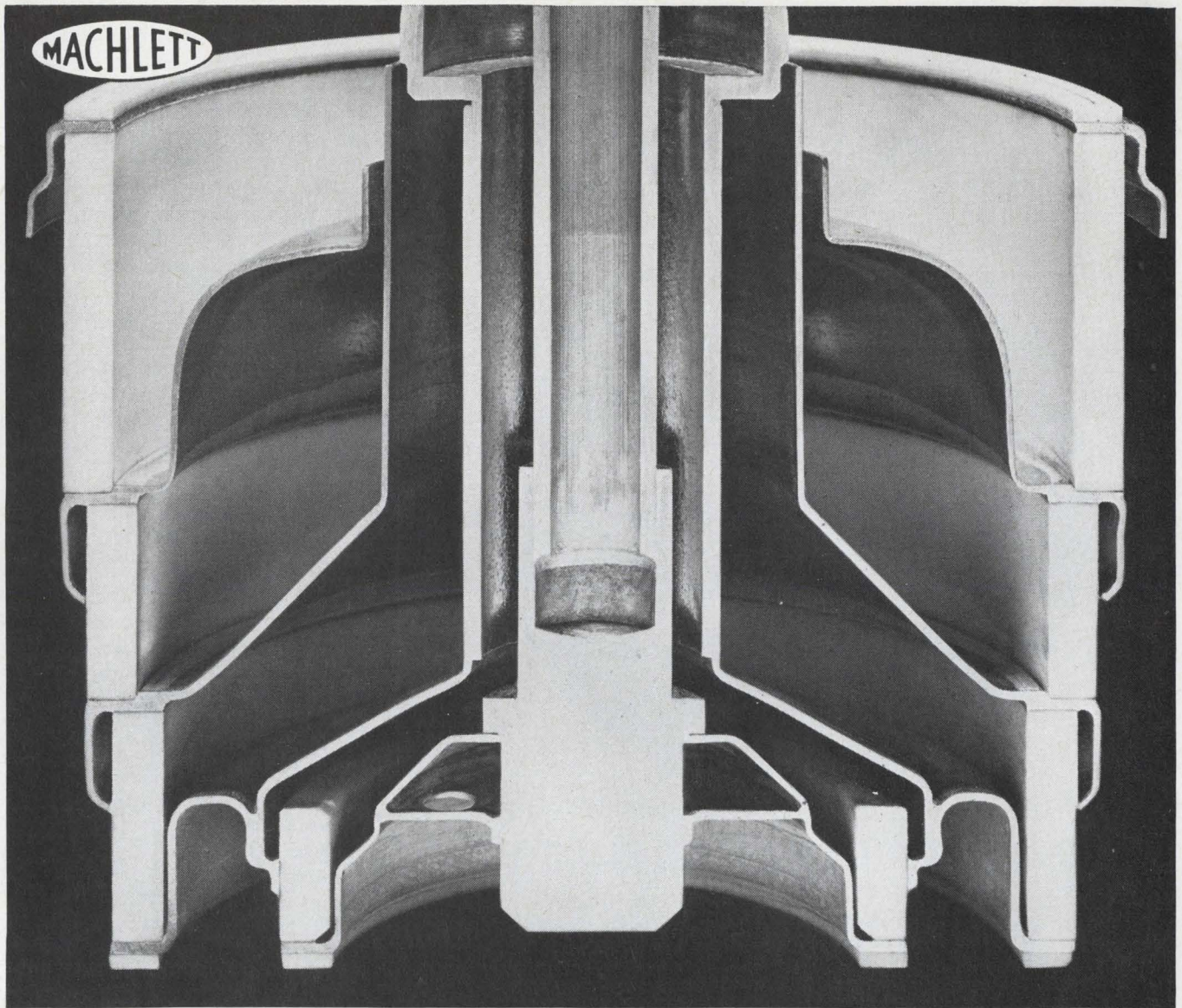

Continuous cone electrode geometry: designed into all these tetrodes only by Machlett

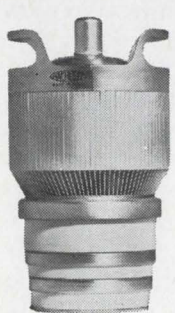

ML-8170/
4CX5000A

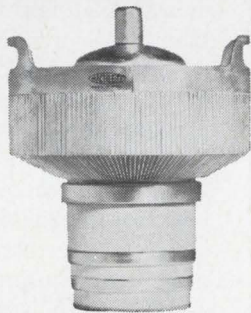

ML-8171/
4CX10000D

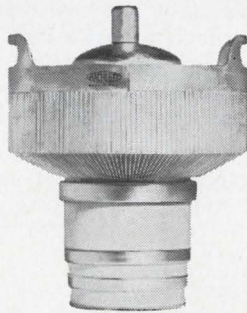

ML-8281/
4CX15000A

The result: uniform internal r.f. energy distribution and high performance stability.

Write for complete details:
The Machlett Laboratories, Inc.,
Springdale (Stamford), Conn. 06879.

Engineers' resumes invited

RAYTHEON

THE MACHLETT LABORATORIES, INC.

A SUBSIDIARY OF RAYTHEON COMPANY

New from Sprague!

**5 Times the Resistance of
a Conventional Metal-Film Resistor
of Equal Size!**

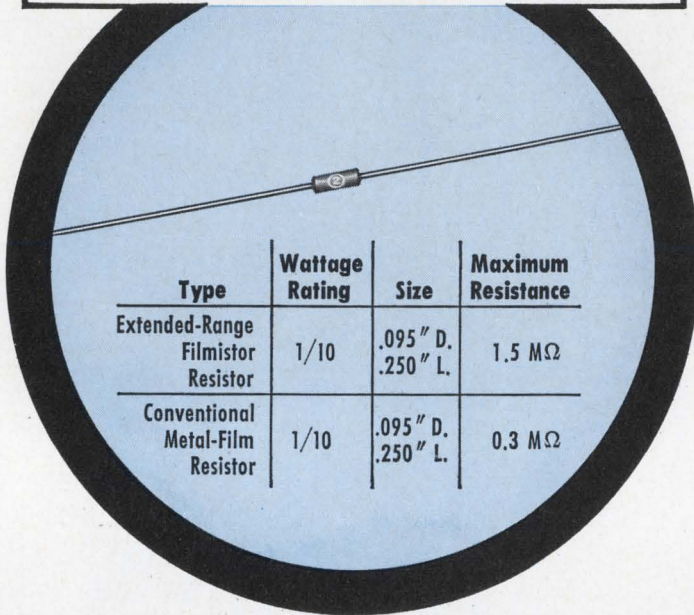

EXTENDED-RANGE FILMISTOR[®] METAL-FILM RESISTORS

**Substantial saving of space in all wattage ratings—
1/20, 1/10, 1/8, 1/4 1/2, and 1 watt—with
absolutely NO SACRIFICE IN STABILITY!**

Extended-Range Filmistor Resistors now offer, in addition to accuracy . . . stability . . . reliability . . . resistance values in size reductions which were previously unobtainable. Size and weight advantages of Filmistor Resistors now make them ideal for applications in high-impedance circuits, field-effect transistor circuits, etc. Many designs which previously had to settle for the higher temperature coefficients of carbon-film resistors in order to obtain required resistance values can now utilize the low and controlled temperature coefficients of Filmistor Metal-Film Resistors.

Other key features are $\pm 1\%$ standard resistance tolerance, low inherent noise level, negligible voltage coefficient of resistance, and tough molded case for protection against mechanical damage and humidity.

For complete technical data, write for Engineering Bulletin 7025D to Technical Literature Service, Sprague Electric Co., 35 Marshall Street, North Adams, Massachusetts 01247.

SPRAGUE COMPONENTS

RESISTORS
CAPACITORS
TRANSISTORS
INTEGRATED CIRCUITS
THIN-FILM MICROCIRCUITS
INTERFERENCE FILTERS

PACKAGED COMPONENT ASSEMBLIES
FUNCTIONAL DIGITAL CIRCUITS
MAGNETIC COMPONENTS
PULSE TRANSFORMERS
CERAMIC-BASE PRINTED NETWORKS
PULSE-FORMING NETWORKS



'Sprague' and '®' are registered trademarks of the Sprague Electric Co.

People

standstill after the first moon landing—just short of practical application of that knowledge.

The articulate, soft-spoken Luskin joins NASA from private industry. He leaves a job as chief advanced design engineer at Lockheed-California Co. in Burbank, Calif. At Lockheed, he was manager of the Agena space vehicle program and headed work on the Manned Orbiting Laboratory and Apollo applications. He was last year's president of the American Institute of Aeronautics and Astronautics.

New technologies come and go, but tape and core memories for computers are here at least for the next decade. So says G. Harry Ashbridge, newly named manager of long-range planning of the Ampex Corp.'s computer products division.



As holder of **Harry Ashbridge** one of the original patents on modular computer construction, Ashbridge has heard the death knell sounded more than once for conventional memories only to see cores and tapes continue to be preferred over such substitutes as thin-film and microelectronics.

"We're embarking on a 10-year growth plan and we intend to plow back 10% of our total dollar into research," Ashbridge says. He plans to acquire computer-service companies with expanding technologies. Noting that the computer industry's growth rate increased to 61% last year from a 1956-66 average of 47%, he says, "the market for computer peripheral equipment is increasing even faster. This is the market we're after."

He doesn't think new kinds of computer memories will sharply limit sales of Ampex's dominant line of cores and tapes. He thinks tape transports, tapes, and cores can be improved faster than the substitutes.

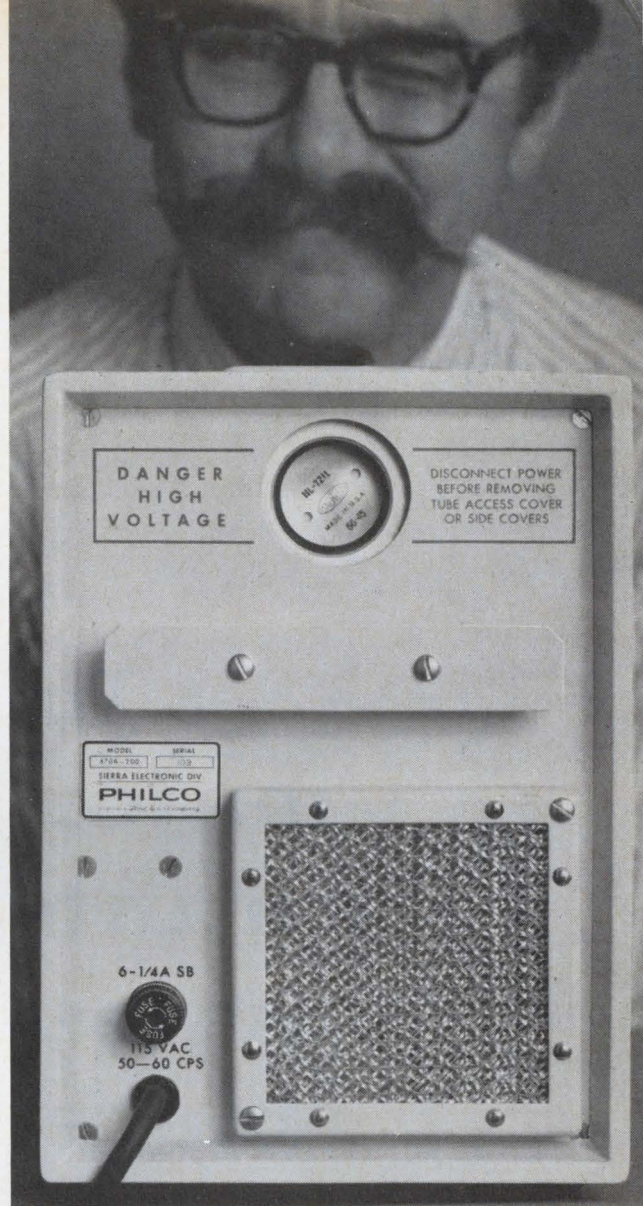

Just by looking at Sierra's new 50-200 MHz High-Power Signal Generator

On the front panel above, for example, a two-range wattmeter that keeps you posted on r-f power output. Right next to it, a meter that monitors grid and cathode current. Above right, see where Sierra has placed the final output tube. You can change it in 30 seconds. In some other high-power signal generators, that tube's out-of-sight and takes hours to change.

Sierra's new Model 470A-200 delivers 50 mw to more than 50 W in a continuously tunable 50-200 MHz range, more than enough power to comply with field-strength requirements of currently effective EMI specifications. It incorporates automatic no-load, underload circuitry. It's capable of CW, square wave (internal or external), or pulse-modulated outputs. A monitor output jack provides power samples 35 dB down from the main output, corresponding to frequency counter input requirements. All-solid-state (save for the final output tube), it measures only 10" x 6 $\frac{3}{4}$ " x 18 $\frac{1}{2}$ ", weighs but 45 lbs.

Model 470A-200's the newest in Sierra's five-instrument line of r-f signal generators, spanning a spectrum of 50 to 2500 MHz. Now, train your eyes on the product brochure, available from Sierra/Philco-Ford, 3885 Bohannon Drive, Menlo Park, California 94025.

...you can see
the advantages!



PHILCO-FORD CORPORATION
Sierra Electronic Operation
Menlo Park, California • 94025

Circle 11 on reader service card

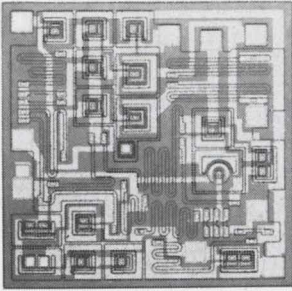

**In 1967, one
major supplier had
an integrated circuit
sales growth rate
more than double
anyone else.**

**Any
semiconductor firm
can tell you who.**

MOTOROLA SEMICONDUCTOR PRODUCTS INC.

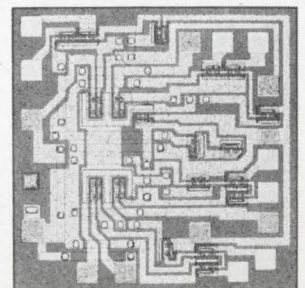

Trygon's New EAL Series Laboratory Power Supply

■ This is Trygon's new EAL wide-range laboratory power supply—four models in the most commonly used laboratory voltage ranges. At \$99, it's a giant.

■ And it's a clean giant. Clean output, with ripple less than .5mv rms, plus rock-steady .01% regulation, .05% stability.

■ Clean, compact all-metal case, too, that doesn't waste an inch of bench space. The switchable volt/ammeter, concentric coarse and fine voltage controls, pilot light and output terminals (fully floating output) are all on the front panel.

Meet Trygon's Jolly Clean Giant



TRYGON ELECTRONICS, Inc.
111 Pleasant Ave., Roosevelt, L.I., N.Y. 11575*

I need the following EAL unit(s).

Qty.	Model	Rating
....	EAL 10-1	0-10 VDC @ 1.0 Amp
....	EAL 20-500	0-20-VDC @ 500 ma
....	EAL 32-300	0-32 VDC @ 300 ma
....	EAL 50-250	0-50 VDC @ 250 ma

Name _____ Title _____

Firm _____

Address _____

City _____ State _____ Zip _____

- Purchase Order Attached.
 Contact us for Purchase Order.
 Please send Trygon Power Supply Handbook.

* PRICES SLIGHTLY HIGHER IN EUROPE.
 TRYGON GMBH, 8 MUNCHEN 60, HAIDELWEG 20, GERMANY.

Meetings

Business Aircraft Meeting and Engineering Display, Society of Automotive Engineers; Broadview Hotel, Wichita, Kan., April 3-5.

International Magnetics Conference, IEEE; Sheraton Park Hotel, Washington, April 3-5.

Meeting and Technical Conference of the Numerical Control Society; Marriott Motor Hotel, Philadelphia, April 3-5.

Symposium on Engineering Aspects of Magneto hydrodynamics, American Institute of Aeronautics and Astronautics; University of Tennessee, Tullahoma, April 3-5.

Conference on Thick Film Technology; Institution of Electronic and Radio Engineers; London, April 8-9.

Aerodynamic Testing Conference, American Institute of Aeronautics and Astronautics; Sir Frances Drake Hotel, San Francisco, April 8-10.

Communications Satellite Systems Conference, American Institute of Aeronautics and Astronautics; St. Frances Hotel, San Francisco, April 8-10.

International Pulse Symposium, International Federation of Automatic Control; Budapest, Hungary, April 8-11.

Telemetry Conference, IEEE; Shamrock Hilton Hotel, Houston, April 9-11.

International Vacuum Congress, British Committee for Vacuum Science and Technology; Manchester, England, April 16-19.

Symposium on Law Enforcement Science and Technology; Manchester, Institute; Chicago, April 16-18.

Symposium on Remote Sensing of Environment, Air Force Cambridge Research Laboratories, Department of Agriculture, Army Engineer Topographic Laboratories, and Geological Survey; University of Michigan, Ann Arbor, Mich., April 16-18.

Cleveland Electronics Conference, IEEE; Instrument Society of America; Cleveland Physics Society; Case-Western Reserve University, and

Cleveland State University; Cleveland Engineering Center, Cleveland, April 16-18.

Instrument Society of America Conference; White House Inn, Charlotte, N.C., April 16-18.

Southwestern Conference and Exhibition, IEEE; Sheraton Lincoln Hotel, Houston, April 17-19.

Symposium on Automation Techniques in Industry, Institution of Electronics and Radio Engineers; Paisley, Scotland, April 17-19.

Aerospace Electronics Conference, IEEE; Sheraton-Dayton Hotel, Dayton, Ohio, May 6-8.*

Short Courses

Applying research and development to existing products, University of Wisconsin, Madison, Wis., May 14-15; \$50.

Distributed system modeling and control, Purdue University's Schools of Engineering and Laboratory for Applied Industrial Control, Lafayette, Ind., June 3-14; \$250.

Preparatory course in electromagnetic propagation, University of Colorado's Department of Electrical Engineering, Boulder, Colo., June 3-14; \$200.

Call for papers

Electronics and Aerospace Systems Convention, IEEE; Sheraton Park Hotel, Washington, Sept. 9-11. May 1 is deadline for submission of abstracts to Burton I. Edelson, Communications Satellite Corp., Department TRDA, 1835 K St., N.W., Washington D.C. 20036

National Electronics Conference, IEEE; Conrad Hilton Hotel, Chicago, Dec. 9-11. May 4 is deadline for abstracts and summaries to Edwin C. Jones, Electrical Engineering Department, Iowa State University, Ames, Iowa 50010.

Northeast Electronics Research and Engineering Meeting, IEEE; Sheraton Boston Hotel and the War Memorial Auditorium, Boston, Nov. 6-8. July 1 is deadline for submission of abstracts to Arthur Uhlir, program chairman, IEEE Nerem-68, 31 Channing St., Newton, Mass. 02158.

* Meeting preview on page 16.

The Connector thing

A periodical periodical designed, quite frankly, to further the sales of Microdot connectors and cables. Published entirely in the interest of profit.

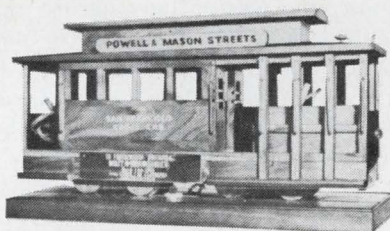

THE SUPER CABLE contest

FIND OUT MORE ABOUT THIS.

We were salivating over a couple of particularly comely, full color gate-folds not long ago, when the product manager, the manufacturing manager and the applications manager of the cable division came in foaming at the parameters.

"Remember that mild mannered little microminiature cable?" they intoned. "We now have proof positive it is, in reality **SUPER CABLE**, on our side to wage war against the forces of high attenuation." We shoved them out and swiped a data sheet. They were right. Super Cable is just that. And it's Microdot's alone.

It's all done secretly and patently with foamed FEP and gives people who have low capacitance requirements, a capacitance that's the lowest. Just the ticket for smallest possible packages for microelectronics. The high strength cellular composition has a dielectric constant of about 1.4 and a specific gravity of close to 1.0.

GIVE 'EM THE ADVANTAGES, CHARLIE

You can start out with a micromin cable, beef up the center conductor, keep the same capacitance and impedance, but lower the attenuation without changing the O.D.

Larger center conductors make for miniature coax cables with a greatly

increased breaking strength.

Your present connector can be retained if you want to replace a standard weak conductor coaxial cable with **SUPER CABLE**

OTHER NEAT THINGS

Most conductors tend to get a little nervous working over 80°C. Our foamed FEP conductor will function continuously even at 200°C.

It's also a fantastic buy where solderability is a problem. It'll solder, not disappear.

Off the shelf you can get it in 93, 70 and 50 (VERY SMALL) ohm impedances. Custom, you can order various types of jacketing, and with centers from .003 to .025.

Of course one of the big questions is, is Super Cable really necessary? Will foamed FEP really triumph? It will wherever low capacitance, low impedance and even lower attenuation in micro-miniature cables is a requirement.

ENOUGH PITCH. WHERE DO WE COME IN?

You are going to tell us where you think a SUPER CABLE like that could and should be used.

GROSS HINT

A Redwood City, Calif. tape recorder manufacturer wanted a sub low capa-

citance cable with an extremely low DC resistance for their 3000 video tape recorder. The only cable that met their requirements was **SUPER CABLE**. Now, the contest is to tell us what to do with it. (And that, sir, doesn't win a thing.) We've got some applications, but we're looking for more. The most interesting one you send us will WIN a genuine, good sized, authentic, replica of a San Francisco cable car, measuring 12" x 6" x 8" and made of wood.

ALL ENTRIES WIN a super picture of the Polaroid proof of SUPER CABLE stripped of her mild mannered funky garb suitable for sticking on the wall.

Contest closes with a thud, Midnight May 30, 1968. Void where prohibited by the constabulary.

TELL IT TO US LIKE IT COULD BE

In 25 words or less, on your brave company's letterhead, write, "You can use SUPER CABLES as follows..."

Include your name, address and what-not and send to us at:



MICRODOT INC.
220 Pasadena Ave., South Pasadena, Calif. 91030



115V
NL

100V
NL

100V
FL

130V
FL

130V
NL

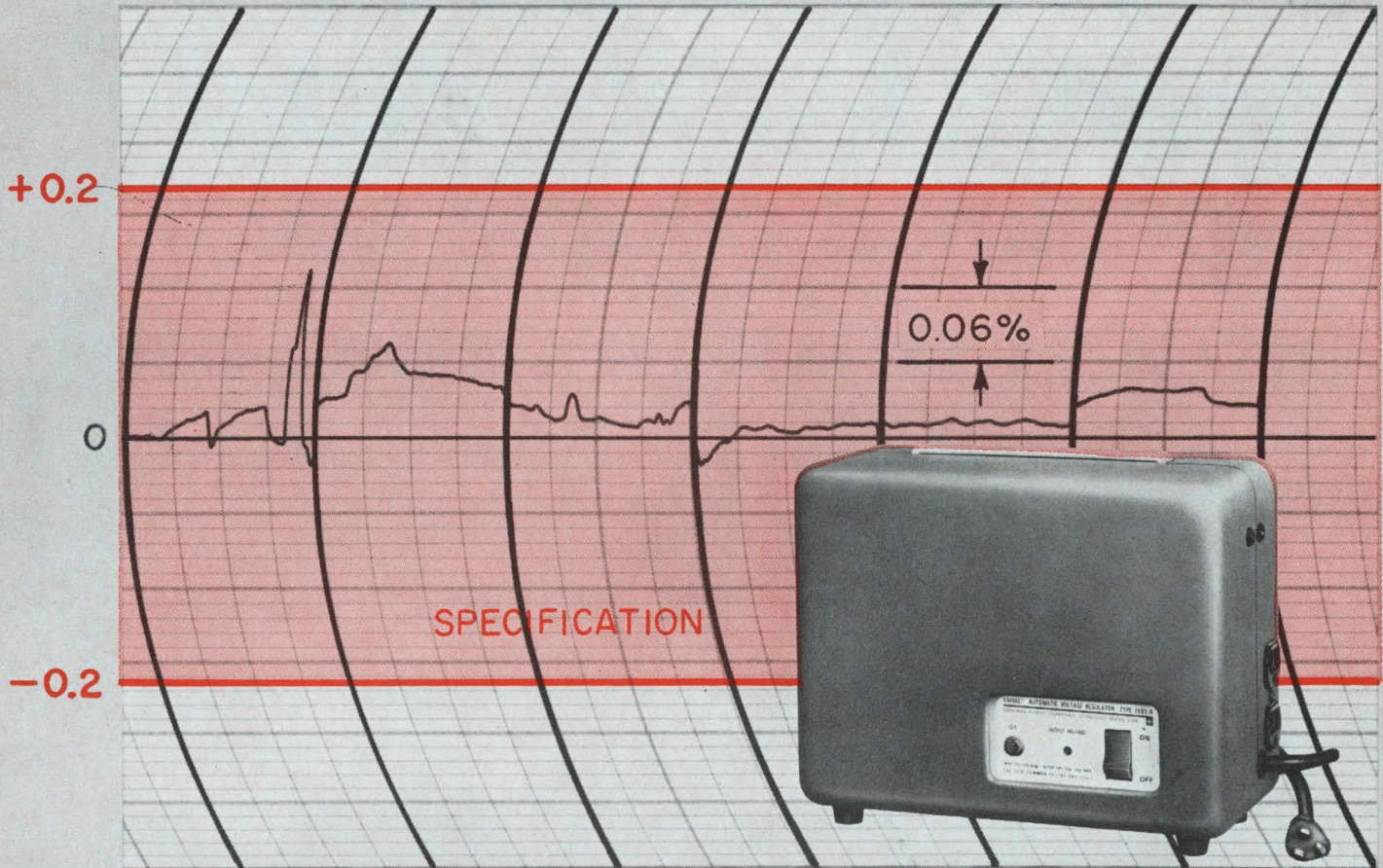

1591 Variac® Automatic Voltage Regulator, \$295 in U.S.A. (115 V)

NOW... a low-cost line-voltage regulator for every bench ... for every rack

High performance, proven reliability, small size, and low cost are the key words that identify GR's new 1-kVA line-voltage regulator.

By performance we mean that this regulator will maintain a 115-volt output (adjustable from 105 to 125 volts) within ± 0.2 percent for *simultaneous variations* of: input-line voltage from 100 to 130 volts, load from no load to full load, power factor from 1.0 to 0 leading or lagging, and line frequency over a range of $\pm 10\%$.

By reliability we mean continued high performance even under conditions far worse than those any regulator is likely to encounter in actual use. The tests indicated on the above chart were performed on a randomly selected unit that had already been subjected to a one-year, round-the-clock life test plus an accelerated life test in which the input signal was modulated at a 3.5-hertz rate. At the time this recording was made, the motor-gear train, Variac® autotransformer, and control circuitry had been subjected to 10 million oscillations

while operating at nearly full-load rating. No lubrication or adjustments were required.

By small size we mean $12\frac{3}{4} \times 9\frac{1}{2} \times 5\frac{3}{8}$ inches and a weight of 17 pounds for the portable model.

By low cost we mean a price of \$295 for a single portable model; rack and 230-volt models are slightly higher. Quantity discounts are available for all models.

Because there is no distortion added to the input waveform, average and peak voltage values are held as constant as the rms value. Response time is 6 cycles ± 1.5 cycles per volt under worst conditions for the 115-volt model.

For complete information, write General Radio Company, W. Concord, Mass. 01781; telephone (617) 369-4400; TWX (710) 347-1051.



Rack model, \$325 in U.S.A. (115 V)

GENERAL RADIO

Circle 17 on reader service card

Of the following 14 MOS devices, some are merely equal, a few are slightly superior, a couple are almost unbelievable, and one is plainly incredible.

– 55°C to + 125°C

0°C to + 70°C

100-999

100-999

Merely Equal: DUAL 3-INPUT NOR GATE DUAL EXCLUSIVE OR GATE	MM 480	\$12.00	MM 580	\$ 8.00
	MM 481	18.00	MM 581	12.00
Slightly Superior: DUAL 25-BIT DYNAMIC SHIFT REGISTER <i>Low power with 1MHz guaranteed.</i> DUAL DIGITAL MULTIPLEX SWITCH <i>Ideal for routing information in dynamic register memory.</i>	MM 400	25.00	MM 500	9.85
	MM 482	12.00	MM 582	8.00
Almost Unbelievable: DUAL 50-BIT DYNAMIC SHIFT REGISTER <i>14.8¢/bit.</i> DUAL 16-BIT STATIC SHIFT REGISTER <i>Single clock, 1MHz operation up to 125°C.</i>	MM 402	40.00	MM 502	14.80
	MM 404	30.00	MM 504	12.00
Plainly Incredible: DUAL 100-BIT DYNAMIC SHIFT REGISTER <i>200 register bit in a single package.</i>	MM 406	60.00	MM 506	30.00

Amazingly, they're all available now. For a list of stocking distributors and additional information, write: National Semiconductor Corporation, 2975 San Ysidro Way, Santa Clara, California 95051. (408) 245-4320.

National Semiconductor

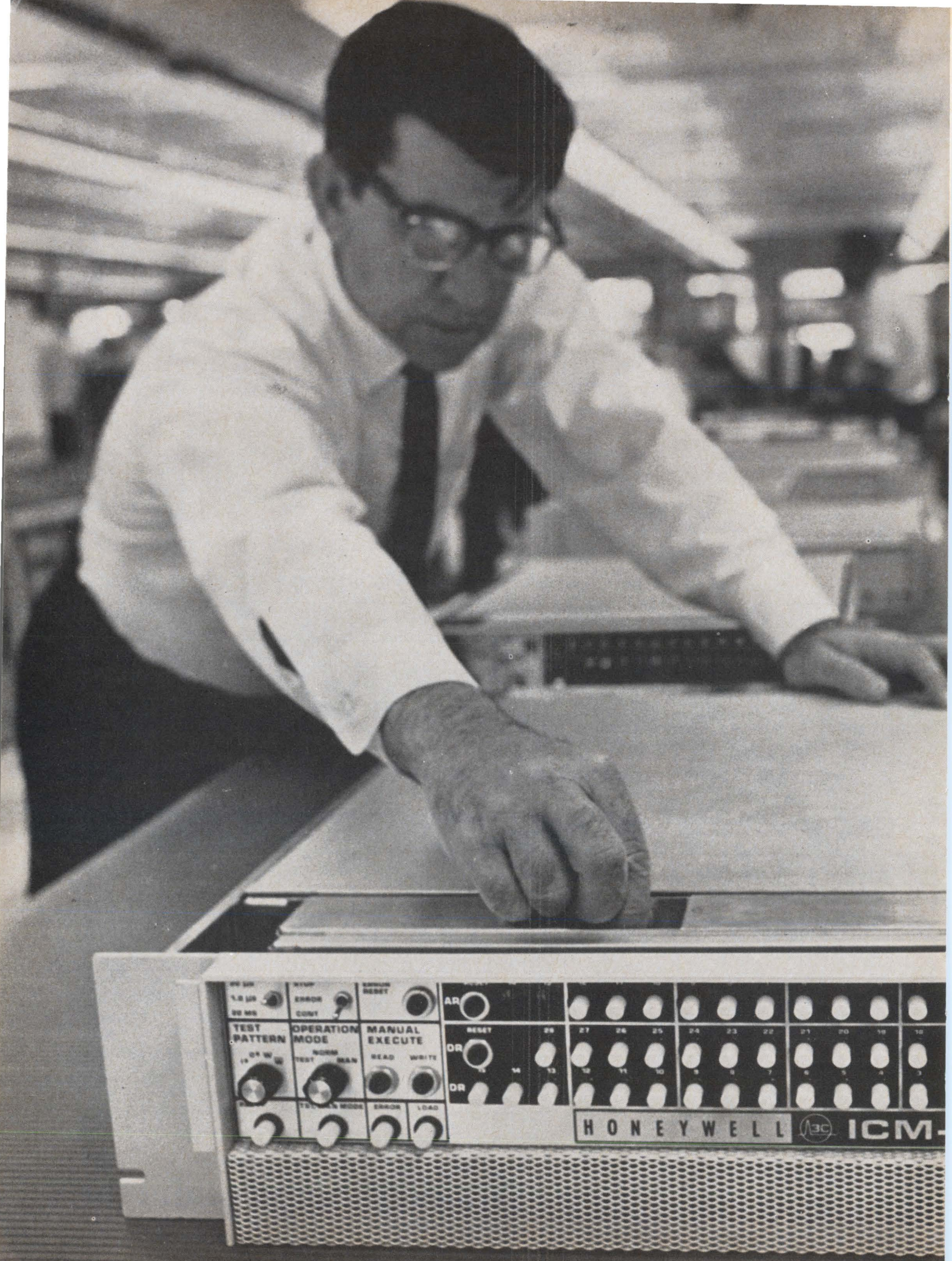

1.8 MS
20 MS
STOP
ERROR
COST
EMULS
RESET
TEST PATTERN
OPERATION MODE
MANUAL EXECUTE
TEST
READ
WRITE
TEST
MODE
ERROR
LOAD

AR
RESET
DR
DR
29
27
26
25
24
23
22
21
20
19
18
17
16
15
14
13
12
11
10
9
8
7
6
5
4
3

HONEYWELL  ICM-3C



3-week delivery...

**on the standard 1 μ -sec
I/C memory system
that packs 1/2 million
bits in a single
5 1/4" high unit.**

That's the ICM-40. A fast, highly reliable core memory system that's ready to meet your system requirement.

And when you say so, we'll give you 3-week CFS (Certified Fast Shipment) under our accelerated shipment plan.

What's more, the ICM-40 is a standard product... a proven performer with over 5,000 hours of life test without failure. Plus, some 400 actual installations; same success rate. What you'd expect from the most experienced memory maker.

I/C Construction — The ICM-40 is a 1 microsecond, full-cycle, magnetic core memory designed for operation as a high-speed random-access store. It is a basic system module that takes maximum advantage of the high reliability and low power consumption of integrated circuitry.

Packaging — Compactness and a high degree of maintainability are achieved in the ICM-40 design by packaging all of the circuitry on readily accessible, removable circuit modules.

Capacity — The ICM-40 packs nearly 1/2 million bits in a single 5 1/4" high module. The basic unit can be specified for up to 16K words, 4-26 bits per word. It's big brother, the ICM-40E with capacities of 32K words, 4-78 bits per word is available with 60-day CFS.

If you've drawn a block marked "core memory" recently, why not find out more about the ICM-40/40E. You'll be pleased by their versatility. And the standard-product pricing. And our Certified Fast Shipment commitment.

Now, don't you think it's about time you called us? Or, write Honeywell, Computer Control Division, Old Connecticut Path, Framingham, Massachusetts 01701.

Honeywell

 **COMPUTER CONTROL**
DIVISION

Circle 21 on reader service card

Space heater, oven, furnace control problems? Try these 15A Triacs.

RCA, the Triac leader, keeps the ball rolling with two more product advances! Now the industry's largest line-up of Triacs has been expanded to include two 15A devices. What really sets these Triacs apart from those now on the market is RCA's use of the inexpensive, practical TO-66 package. After all, why pay for the costly press-fit package when it doesn't buy you anything extra in electrical performance? Just compare the spec's on our devices. You get a full-rated 15A I_T (rms) at 70°C... surge current protection up to 100A... and thermal resistance of 1.3°C/W.

Actually, you shouldn't expect anything less from RCA... we're the Triac leader!

Switching problems for ultrasonic generators, power supplies, and switching control circuits? Try these fast turn-off SCR's.

Hold on world! RCA is extending its thyristor leadership ability into the marketplace of fast turn-off SCR's. We're proud to announce three 5A devices that are just right for a host of fast-switching circuits for which only higher current devices had been available. Again it's that old story of why pay for something you don't need. Prices on these types start at \$1.98*, in case you hadn't noticed. And at that price, you get turn-off times of 6 μ s Max,

dv/dt of 100 V/ μ s, and di/dt of 200 A/ μ s. Further, we have a unit rated up to 600 V, and there are not too many devices available with this combination of high voltage and fast switching speed.

For more technical data on specific types, including Application Notes, see your RCA Field Representative, or write RCA Electronic Components, Commercial Engineering Department, Harrison, N.J. 07029. Check your RCA Distributor for his price and delivery.

**Price for 1000 units*

RCA

5 more Thyristors from RCA help solve your control problems

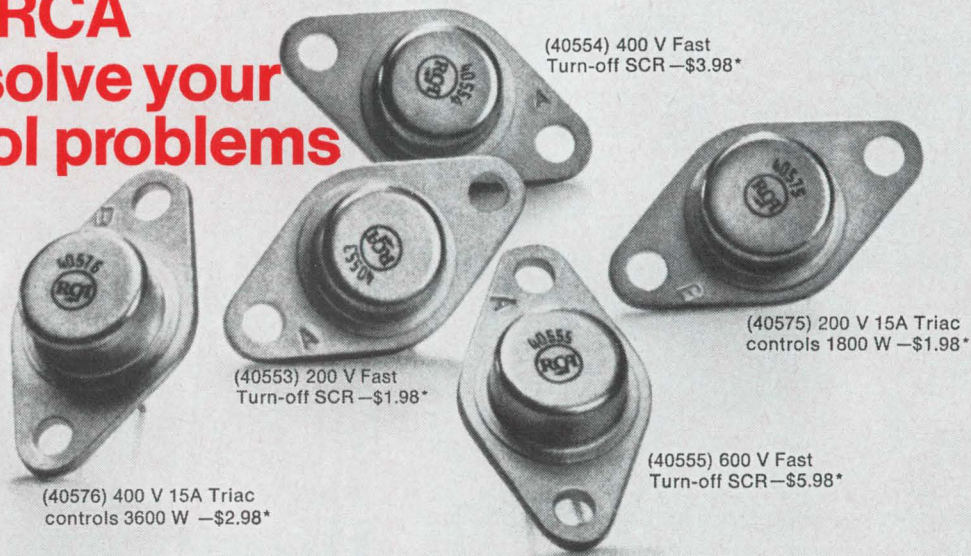

Editorial comment

The earth: a neglected spacecraft

The mood at the National Aeronautics and Space Administration is one of caution and concern—caution about how it spends its current funds, sharply curtailed by the war in Vietnam, and concern for its future.

The agency's proposed budget for fiscal year 1969 was \$4.4 billion. A \$153 million slice has already been lopped from that by the House Science and Astronautics committee, and another \$200 million could be pared before the budget gets approval from the full House.

Among the projects already scratched from NASA's '69 budget are four satellites—Explorers C and D and two 21-day mission biosatellites. Nerva, the project to develop a nuclear-powered rocket, was cut to less than one fifth of its proposed budget—from \$60 million to \$11.7 million. In the manned space program, 10% was cut from the \$439 million requested for Apollo applications, and the advanced missions studies request of \$5 million was cut in half.

In the face of budget cuts and program stretch-outs, NASA managers are hard pressed to keep all programs alive while emphasizing those of high priority. There's a trend to encourage those projects that are likely to pay off quickly.

Before the cuts, NASA had ambitious plans—in a variety of areas—that are now stalled. At its Electronics Research Center in Cambridge, an engineer and two technicians rattle around in a laboratory impressively equipped to fabricate semiconductor devices. The intention was to produce a variety of types of devices under carefully controlled conditions, then study the effects of measured disturbances on the fabrication processes. But with the "billet freeze" now in effect, the NASA laboratory has been able to turn out only simple n-channel MOS units—and very few of those. Even if the laboratory gets an okay to add two or three men in fiscal 1969, they will hardly be enough to speed it toward its next goal—the fabrication of complementary n- and p-channel units.

An obvious hazard of the austerity program is the dissolution of teams of key engineers and technicians recruited by NASA to pursue specific projects. NASA's von Braun emphasizes that most of the agency's budget goes for salaries and administrative support, not hardware. He decries the "scattering to the winds" of important NASA teams. Such

teams have taken time and money to find and train, and reconstituting them at a later date would be at least as time consuming and expensive.

Adding to the blurred employment picture for NASA are complications arising from the agency's attempt to cut its personnel by 5% in fiscal 1968. Part of its job-shuffling involved the wider use of contractor personnel at NASA field centers. The AFL-CIO union representing many NASA employees insists that NASA should not lay off workers while keeping contractor personnel in similar jobs.

Amidst the uncertainty, a trend is apparent within NASA to push programs that have earth-bound implications. An executive at the Cambridge center observes that some of its efforts are being redirected to projects "closer to the ground."

That aerospace technology can help solve "earth-oriented" problems has been the conclusion of several study groups, including a review committee that recently reported to the National Academy of Sciences and the National Research Council. For example, surveillance of the earth can provide great objectivity—"complete and real-time coverage of the entire earth." More specifically, the benefits from earth-circling satellites are expected to be in longer-range weather forecasting that could aid agriculture, forestry, transportation and communications. Also, quantitative chlorophyll surveys of the oceans' water might aid fishermen. Foresters could benefit through accurate identifications of vegetation, and geologists could be aided in finding new mineral resources. NASA had taken a conservative approach to its earth resources programs—proposing that detailed cost effectiveness studies be carried out over a protracted period of time. Rep. Joseph Karth (D., Minn.), chairman of the House subcommittee on space sciences and applications, asserted that such studies are unnecessary; he believes that the programs have a potential for immediate economic payoff.

The House Science and Astronautics committee reacted to NASA's proposed budget for the Earth Resources Technology Satellite by more than doubling it. The House committee also added \$1 million to the Office of Advanced Research and Technology's request, covering studies in areas like air safety and jet noise abatement.

In view of the trend at NASA to involve itself with down-to-earth problems, one is led to wonder just how far the trend could proceed. If the agency can help solve problems like air traffic control, can it help solve those involving ground traffic control? Or rapid transit, air and water pollution, and urban renewal?

If NASA tackled such problems, it could forestall the creation of another superagency to do jobs for which the space agency is equipped. Robert C. Seamans provided the rationale when he reminded the National Space Club last month that the earth itself is a spacecraft—a neglected one, we might add.

Engineers who have learned to live with the flutter problem in hysteresis synchronous motors will find that living comes easier now. Especially in voice/data recording applications.

Indiana General's unique inverted stator design provides up to six times the rotor inertia of conventional designs. Flutter characteristics are so low as to be practically negligible.

And the price is not so high that it

restricts the use of our inverted stator motor solely to recording devices. It is so economical to manufacture that it's priced competitively with induction type motors, making the Indiana General hysteresis motor economically practical for units like fans and blowers. And, the inverted stator design significantly reduces start-up input power-surge and combines very high operating efficiency with low slip characteristics.

Indiana General inverted stator motors are smaller and lighter than conventional synchronous motors and are available in a wide range of sizes, mountings, power ratings and torques. You can get full details by writing Mr. R. D. Wright, Manager of Sales, Indiana General Corporation, Electro-Mechanical Division, Oglesby, Illinois.

INDIANA GENERAL 

New inverted hysteresis motor design drives the flutter out of recording equipment.



Electronics Newsletter

April 1, 1968

Semiconductor gains spur makers' efforts

The semiconductor market's recovery from last year's slowdown now appears widespread. Returns for this year's first quarter are nearly complete, and, together with the sales spurts posted in the final months of 1967, they point to higher sales and profits this year. The industry leaders—Texas Instruments, Fairchild Semiconductor, and Motorola Semiconductor Products—as well as such smaller producers as ITT Semiconductors and Radiation Inc.'s Microelectronics division, all report gains. And, National Semiconductor, active only one year as an IC producer, is already in the black.

This market firming is reflected in the industry's R&D and production plans. TI intends to speed up its efforts in the fields of metal oxide semiconductor and large-scale integrated circuits. Fairchild is doing the same, plus beefing up its linear IC lines. The company is pushing development of hybrid microwave integrated circuits and moving to improve its IC production and testing techniques. Motorola plans to put more emphasis on MOS IC's.

ITT is expanding activities in the areas of medium-scale integration, transistor-transistor logic, and r-f power transistors. And Radiation Inc., whose IC operation is also profitable, plans to supplement its successful dielectric-isolation product lines with circuits isolated by other means, advanced linear circuits, and industrial IC's. National will place more research emphasis on its linear IC and MOS programs.

Instrument sales short of mark...

So far this year, sales of analytical instruments have fallen short of the 20% growth rate predicted for 1968. Besides a general leveling off of sales, there has been less R&D money from the Government. Money for such programs as those funded by the National Institutes of Health has been diverted to war-related projects.

... and other woes lead to austerity at H-P

One of the companies clearly suffering from this squeeze, Hewlett-Packard, also has problems in other instrument markets. One result: reduced profit margins. This has apparently led H-P to accelerate its austerity plans and strengthen operations at its two weakest divisions, Avondale (Pa.) and Rockaway (N.J.). The Rockaway division is in the more serious trouble; R&D has been curtailed, and all engineering operations will be moved to other divisions. Rockaway will continue to make its own products and will start making items of other divisions. At Avondale, H-P's efforts are directed toward bringing the division out of the red through a management realignment that may mean laying off as many as 25 engineering or administrative employees.

CBS sharpens color picture...

A new circuit to increase the sharpness of color-tv signals will be detailed by CBS next week at the National Association of Broadcasters show. The image-enhancement circuit, used at a station's transmitter to provide a crisper picture on home receivers, is just coming into use.

The circuit automatically samples three successive horizontal lines of the picture, notes the differences between the middle and top lines and the middle and bottom lines, and then adds these differences to

Electronics Newsletter

reinforce the middle line. Simultaneously, it examines coded color signals and adjusts the vertical and horizontal picture details to eliminate color softness. **CBS says the circuit also reduces noise that would otherwise appear as snow on the home receiver.** The circuit was developed at CBS Laboratories by Renville H. McMann Jr., vice president and director of engineering, in cooperation with the CBS network.

... and may turn new eye on political scene

CBS may make some news of its own at this summer's political conventions with a digitally controlled, portable color tv camera system. The network is expected to unveil what's believed to be **the first camera of this type that can work directly with a video tape recorder and monitor to produce standard color pictures.** The over-all system weighs 38 pounds and includes three 1-inch Plumbicon color tubes plus a 3-inch viewfinder and associated waveform monitor. **The camera itself weighs 18 pounds and can be operated up to 100 feet away from its companion back pack.** All functions—beam, focusing, centering, gain, and encoder phase—can be controlled from a console at a base station a mile away via a 160-megahertz audio link.

New timer getting Army examination

A simple electromechanical device developed by North American Rockwell for the Army may **replace the complex, miniature timing circuitry used in artillery fuzes.**

The secret of the device—details are proprietary—is a **high-ion-conducting electrolyte developed by the firm's Atomics International division.**

Essentially, **the device is a small storage battery with a dry electrolyte.** The cell consists of a cathode and an anode separated by the electrolyte. When current passes through the device it transfers a coating from one terminal to the other, triggering the fuze.

Since the transfer process is reversible, the device could be used as a miniature power supply. North American also sees a number of civilian applications for its electrolyte, including use in tiny batteries to power camera flashes and electric watches.

Unpackaged chips in Motorola's future

Motorola may be the first major semiconductor manufacturer to introduce a line of standard **unpackaged chips.** Although it isn't saying what kinds of devices will be included, the firm is readying the line for its debut soon—an indication that the **traditional reluctance among semiconductor houses to sell unpackaged chips is beginning to crumble.**

Addenda

Comsat has asked the Philco-Ford Corp. to build a demonstration model of an **r-f rotary joint that could handle four signal channels** between a spinning spacecraft and a mechanically despun antenna. . . . **TRW Inc. is sure to get the contract to build two Intelsat 3.5 satellites;** it was the only firm to bid on it. TRW's bid: \$15 million plus another \$3 million in potential incentive awards. . . . After six years of litigation, the case of whether the General Accounting Office has the right to look into Government contractor's books has ended in a **GAO victory with two words from the Supreme Court: petition denied.** The case involved the Hewlett-Packard Co.'s refusal to give cost records to the GAO [Electronics, Dec. 25, 1967, p. 107]. The High Court, by refusing to review the case, upheld a lower court ruling that Hewlett-Packard must show its records.



Shock and
Vibration
Resistant

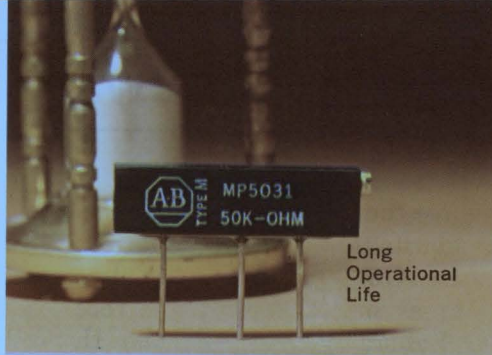

Long
Operational
Life

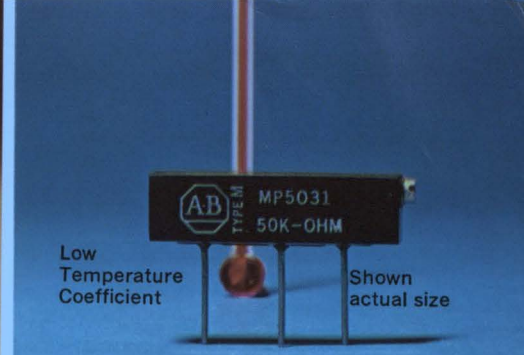

Low
Temperature
Coefficient

Shown
actual size

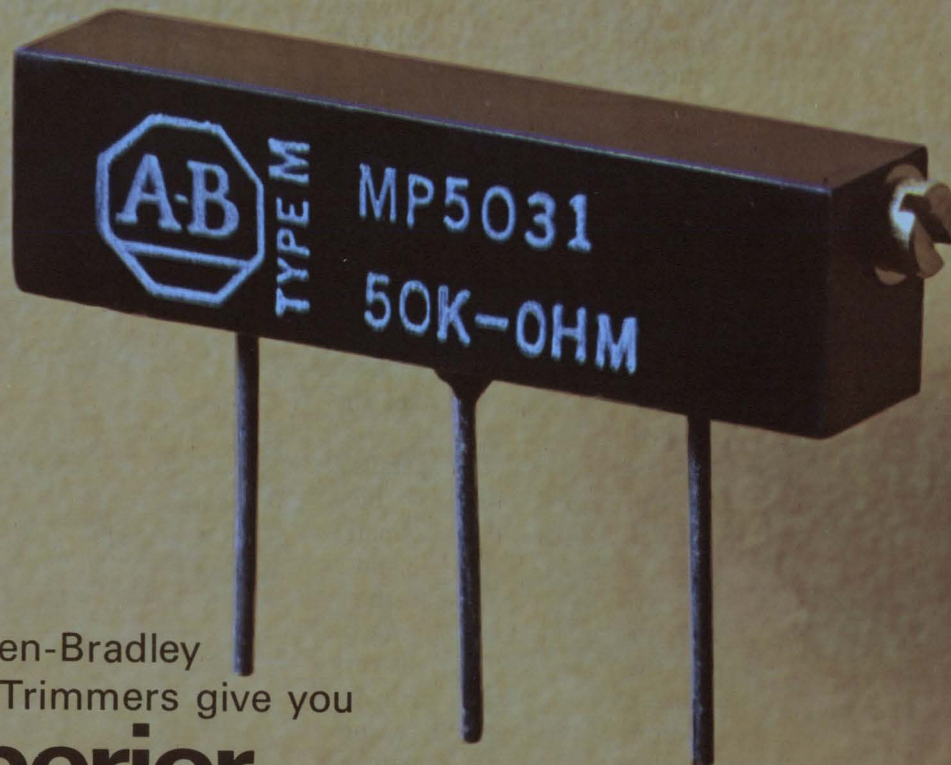

New Allen-Bradley
Cermet Trimmers give you

superior "all-round" performance

Allen-Bradley's new Type M Cermet trimmer provides very fine multi-turn adjustability in a rugged package for severe environmental conditions.

This latest addition to the line of trimmers features the same high performance cermet resistive material—developed by A-B—which has enabled the Type S trimmer to gain such widespread popularity.

Sturdy structural design resists impact—a unique rotor design ensures smooth adjustment and stable setting. Resolution is essentially infinite. Leads are permanently anchored and bonded. Attachment exceeds lead strength—opens cannot occur.

The Type M trimmer is dust-tight and watertight. The entire unit is immersion-proof and can be potted. The enclosure has mounting pads to prevent moisture migration and also to prevent post-solder washout.

For more details on the Type M cermet trimmer, please write Henry G. Rosenkranz, Allen-Bradley Co., 222 West Greenfield Avenue, Milwaukee, Wisconsin 53204. In Canada: Allen-Bradley Canada Ltd. Export Office: 630 Third Ave., New York, N. Y., U.S.A. 10017.

Type M Specifications

Rating: 1 watt @ 85°C

Temperature Range: -55°C to +150°C

Resistances: 50 ohms thru 1 megohm. Lower resistances available.

Load Life: Less than 3% total resistance change after 1000 hours, 1 watt at 85°C.

Tolerances: ±10% standard, ±5% available.

Temp. Coef.: Less than ±250 PPM/°C for all resistance values and over complete temperature range.

Rotational Life: Less than 2% total resistance change after 200 complete cycles.

CE681



ALLEN-BRADLEY
QUALITY ELECTRONIC COMPONENTS

with your reputation at stake, which resistor line would you specify?

take a close look—there'll be no question

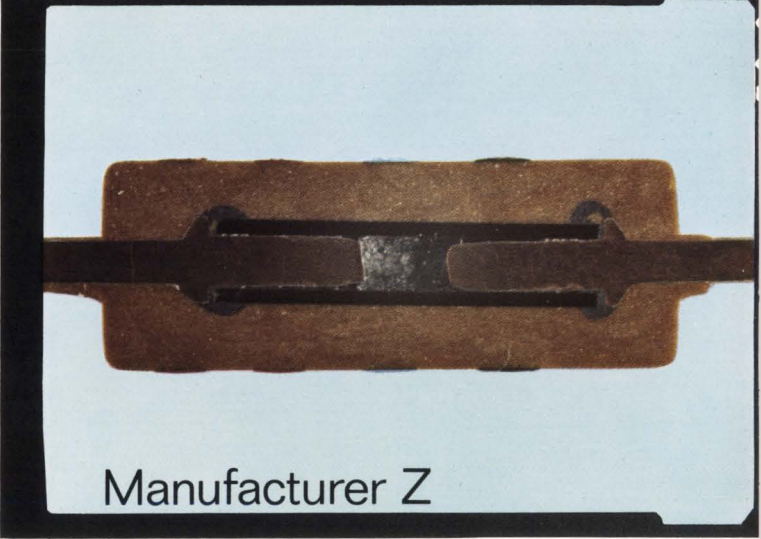
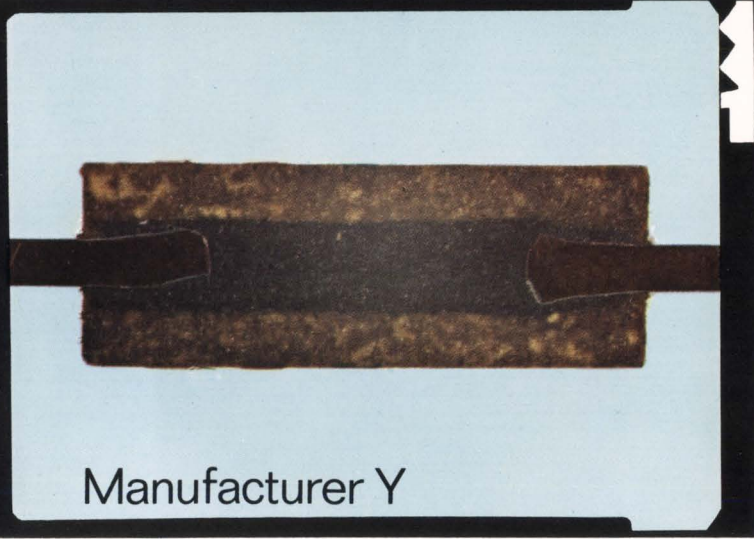
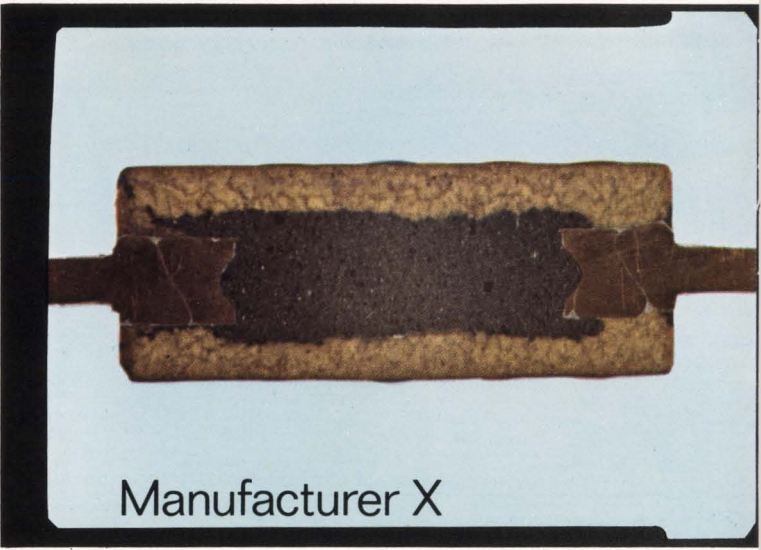
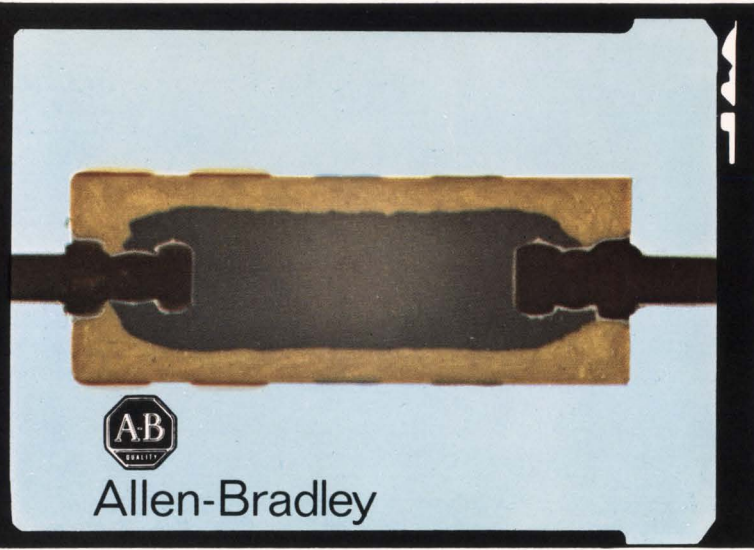

The above illustrations are from unretouched photomicrographs taken of four $\frac{1}{2}$ -watt fixed resistors. Compare the anchoring of the leads, the seal provided by the insulating jacket at the ends, the homogeneity of the resistance material, the sharp color code bands—and decide for yourself.

For more details on Allen-Bradley hot-molded resistors, please write for Technical Bulletin 5000: Allen-Bradley Co., 222 W. Greenfield Ave., Milwaukee, Wis. 53204. In Canada: Allen-Bradley Canada Ltd., Export Office: 630 Third Avenue, New York, N. Y., U.S.A. 10017.

A-B hot-molded fixed resistors are available in all standard resistance values and tolerances, plus values above and below standard limits. **A-B hot-molded resistors meet or exceed all applicable military specifications including the new Established Reliability Specification.** Shown actual size.



1067E-4

QUALITY ELECTRONIC COMPONENTS



ALLEN - BRADLEY

THIS APPLICATIONS LIBRARY TELLS YOU HOW TO USE MOTOROLA LINEAR I/C's

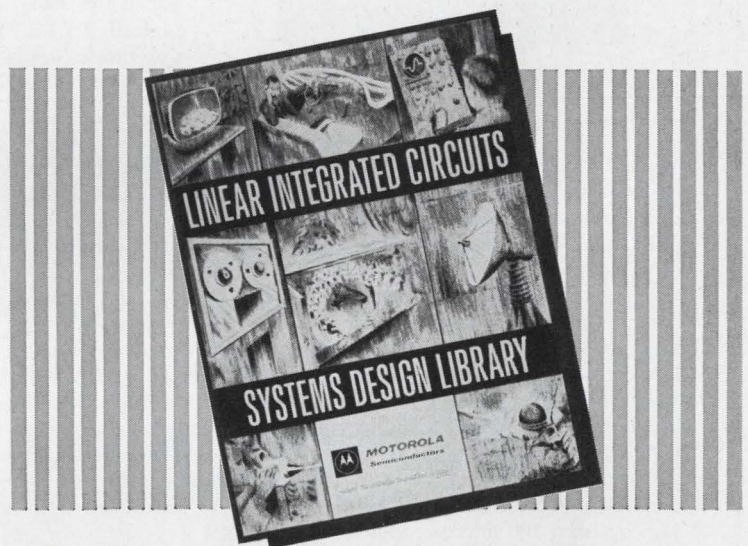

The Circuits Speak for Themselves!

This Linear Systems Design Library is a compilation of valuable "How To" information about a wide spectrum of designs using linear integrated circuits. It includes the very latest ideas and information for designing-in the new dual operational amplifiers. And, it also examines, in depth, design ideas for the use of linear I/C's in single power supply, instrumentation, communication, data processing systems, analog computation and comparator applications, radar and PCM pulse applications, and, much, much, more!

Also included is practical information, such as "do-it-yourself" instructions for building an inexpensive integrated circuit operational amplifier tester; and, pertinent pointers on how to get the most information from an op amp data sheet. Finally, key parameters are specified for Motorola's broadest of all lines of commercially-usable linear I/C's.

For your copy, write us on your company letterhead at: P.O. Box 955, Phoenix, Arizona 85001.

-where the priceless ingredient is care!



MOTOROLA
Semiconductors

When information buried in noise is periodic, transient, or random, there is a **PAR^{T.M.}** instrument to recover it

PAR manufactures a complete line of signal processing equipment to measure signals of various types buried in noise. The choice of the most appropriate instrument depends upon the characteristics of the signals. The equipment falls into three general classes:

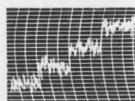

LOCK-IN AMPLIFIERS

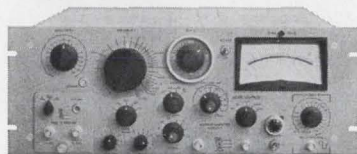

Lock-In Amplifiers have application where the signal of interest is or can be made to appear at a single frequency and where a reference voltage related in frequency and phase to the signal can be obtained. These instruments employ phase-sensitive detection and narrow-band filtering techniques to provide a DC output signal proportional to the amplitude of the fundamental component of the signal being measured. The Lock-In Amplifier can be described as a tuned voltmeter, the response of which is "locked" to that particular frequency and phase at which the signal information has been made to appear. They operate typically in the frequency range of 1.5 Hz to 150 kHz with full scale sensitivities down to 10^{-9} volts.

Waveform Averagers are useful when, after processing, the actual waveform of the signal of interest must be maintained and the signals are repetitive waveforms or transients whose onset can be related to a trigger pulse. The application of a synchronized, repetitive waveform will result in an output that corresponds to the average value at each of the segments of the waveform being studied, whereas any non-repetitive (or un-synchronized) signals such as noise will be suppressed since their average after many occurrences will approach zero. PAR makes two instruments that perform this function; the Boxcar Integrator and the Waveform Eductor.^{T.M.} The Boxcar Integrator is a single point averager in which a single slice, as narrow as 1 microsecond, of the input waveform is averaged while the position of the slice is slowly scanned through the waveform. The Waveform Eductor simultaneously averages one hundred points of the waveform which can be distributed over periods varying from 100 microseconds to 10 seconds.

WAVEFORM AVERAGERS

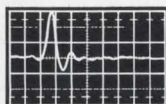
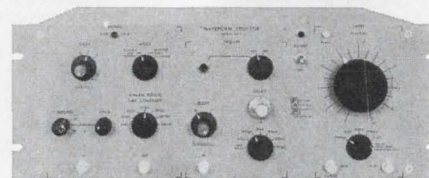
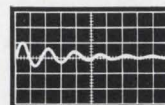

CORRELATION FUNCTION COMPUTERS

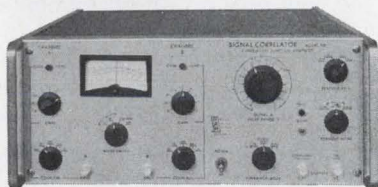

Correlation Function Computers are the most general form of signal processing equipment that can be constructed (Lock-In Amplifiers and Waveform Averagers are actually special cases of correlation equipment). Whereas a reference or synchronization signal is required in the other equipment discussed, autocorrelation analysis allows periodic and random signals to be defined without this restriction. An even more powerful technique is crosscorrelation which has the ability to describe the degree of conformity between two different signals as a function of their mutual delay. The PAR Signal Correlator simultaneously computes in real time 100 points of either the auto- or crosscorrelation function over total delay spans of 100 microseconds to 10 seconds.

A variety of instruments and associated peripheral equipment is available from PAR in each general class. Instrument prices range from \$765 to \$9500. Since PAR has wide experience in applying these systems to many situations in all fields of science and engineering (e.g.: aero- and hydrodynamics, spectroscopy, medical physics, geophysics, etc.), we welcome the opportunity to discuss your specific application. For additional information, or to arrange for a demonstration at your facility, contact Princeton Applied Research Corporation, Dept. D, P.O. Box 565, Princeton, New Jersey 08540. Telephone: (609) 924-6835.



PRINCETON APPLIED RESEARCH CORP.

Computers

Low-budget films

Cost is the single factor that has barred the wide use of planar magnetic thin films as high-speed computer memories. But a technique promising to put the film units in the price range of core memories has been developed at the Univac division of the Sperry Rand Corp. The process strings discrete word wires through holes in the substrate upon which the thin-film array has been deposited.

Univac is already using this method in a pilot production operation, and it expects to put the thin-film memories in some military computers soon.

Thin films have always been faster than ferrite cores. Even at high speed, the time required to switch the magnetic state of a thin-film element is negligible; the memory's speed is limited primarily by the electronic drive circuits. Ferrite cores, on the other hand, have several thousand times the volume of the thin films, and therefore take a much longer time to change states; this time can be shaved to a certain extent only by driving heavier currents through the core windings.

Touch. Besides their speed advantage, thin films are less sensitive to temperature changes than are ferrite cores, and they can tolerate wider variations in drive currents. "We are now delivering 200-nano-second thin-film memories built with the conventional technique, but without controls for adjusting the current," says William M. Overn, a Univac group manager for memory design and development. "All core memories have such controls."

The high cost of conventional planar thin films arises from the

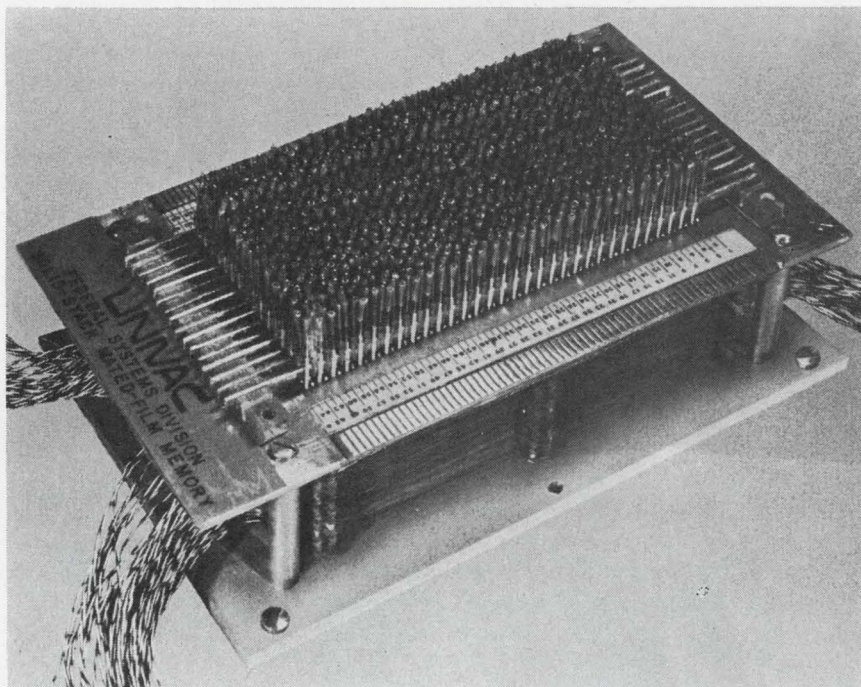

New shape. Univac's design for low-cost, thin-film memories takes the form of a magnetic sandwich (right), with the bit line between two layers of film. Magnetic flux encircling the bit line stores binary data. Readout flux is generated by current in the U-shaped word wire passing through the two holes in the element. A complete memory stack is above.

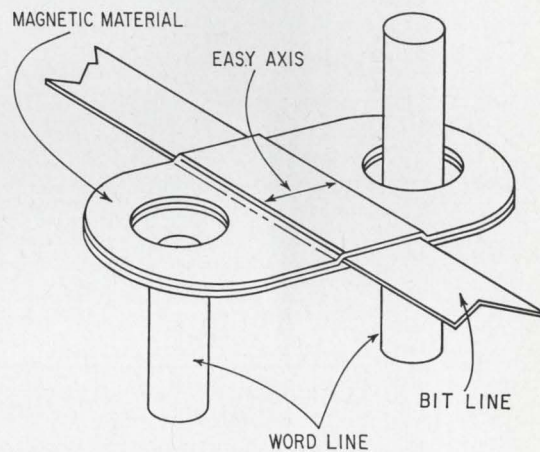

fabrication process applied. In this approach, a glass substrate carries the magnetic film and a thin Mylar overlay carries word and digit lines at right angles to one another. The overlay must then be registered on the film with great accuracy—a difficult and expensive job, particularly since Mylar is sensitive to temperature and humidity.

In the new approach, the glass substrate carries both the magnetic film and the bit lines. The bit lines, a few microns thick, lie between two magnetic film layers and connect adjacent memory elements in a row. Each film layer is several thousand angstroms thick. A stack of substrates are strung together

with word wires through holes. Registering the three deposited layers is relatively easy, and stringing wires all but removes the registration problem at that step.

Easy path. The memory elements are, like most thin films, anisotropic—more easily magnetized in one direction than at right angles to that direction. In this case, the easily magnetized axis is parallel to the line between the centers of the

holes. The data is stored in the two-layer film around the bit line along this axis, in one direction for a binary 1 and the other for a 0, just as in ferrite cores. The two word wires on page 31, which are 10 mils in diameter and fit through 17-mil holes, are connected at the bottom of the stack. A current down through one wire and up through the other creates a magnetic flux pattern parallel to the bit line. This flux in combination with the flux already in the film generates a pulse in the bit line.

The word flux, in general, destroys the stored data. It can be regenerated, or new data can be written in its place, by applying a current in one direction or the other through the bit line just as the word current pulse turns off. The current

remagnetizes the film in the proper direction around the bit line. As with thin films generally, nondestructive readout is possible. It has been tried with the new Univac units, but the memory operation hasn't been satisfactory, presumably because the output pulses are necessarily small.

Hookups. One end of the U-shaped word wires carries two selection diodes, while the other is connected to a common bus that is part of a conventional selection matrix. When this matrix generates a current pulse through a single word wire, the resulting bits are taken from the bit lines in parallel.

Univac engineers have built several different models with the new assembly technique. One of these contains 80 substrates in a stack

about 2 inches thick. The word lines, including the selection diodes, are about 3 inches long—short enough to string easily and not long enough to add significant inductance or capacitance to the circuits. The 80 bits read out by a single selection constitutes four 20-bit words. The complete array contains 1,024 word lines for a total capacity of 4,096 words.

Overn will outline the new approach at the International Conference on Magnetics in Washington on April 3.

Components

Stripped for action

The magnetic amplifiers widely used to boost d-c inputs from control sensors are relatively bulky and expensive components. Until now, they've required complex and costly external demodulators.

But now a scientist at Sola Basic Industries has developed a second-harmonic-type magnetic amplifier that uses a zener diode in place of the demodulator, eliminating not only this external unit but any need for frequency doubling and phase locking.

The device, designed by Bodo M. Wolfram, executive scientist at Sola Electric division, Elk Grove, Ill., is said to have the sensitivity and stability needed for such jobs as precise temperature control. It takes d-c microwatt inputs and boosts them to the milliwatt range.

No sale. Sola at present doesn't plan to offer the amplifier except as a component of its industrial equipment. But Wolfram estimates that the device could be produced as a separate item for about \$25, compared with \$300 for a conventional magnetic amplifier with an external modulator and \$70 for an integrated-circuit amplifier.

As Wolfram explains it, the application of a d-c input to the amplifier's control winding causes two positive peaks at the output winding during each cycle. The zener diode, which is in the d-c

Electronics Index of Activity

April 1, 1968

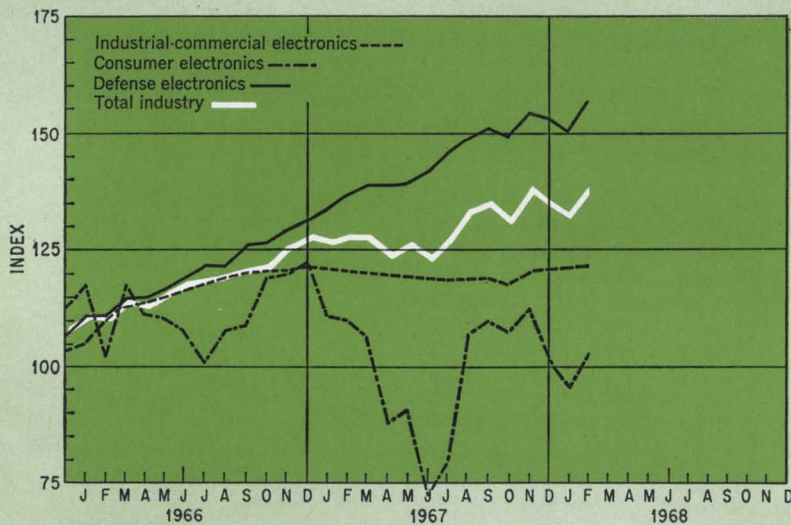

Segment of Industry	Feb. 1968	Jan. 1968*	Feb. 1967
Consumer electronics	103.8	96.2	109.8
Defense electronics	156.8	150.3	136.6
Industrial-commercial electronics	122.0	121.6	121.9
Total Industry	137.6	132.6	127.7

Electronics production sputtered 5 index points in February to a record 137.6, up 0.3 point from last November's level—the former high—and nearly 10 points ahead of the February 1966 figure. Both consumer and defense output gained substantially in the month, rising 7.6 points and 6.5 points, respectively. The smallest advance was posted in the industrial-commercial area, where production edged up 0.4 point from January and only 0.1 point from a year earlier.

Indexes chart pace of production volume for total industry and each segment. The base period, equal to 100, is the average of 1965 monthly output for each of the three parts of the industry. Index numbers are expressed as a percentage of the base period. Data is seasonally adjusted.
* Revised.

leg of a rectifier bridge, passes only those pulses whose amplitudes are greater than its breakdown voltage. These pulses charge a capacitor paralleled with the load, producing square waves whose net d-c offset is proportional to the d-c input signal. Unlike most other magnetic

Africa consider a patent "public" as soon as it's applied for. And an American firm seeking a patent in these countries must submit a certified copy of the application it filed in the U.S.

R&D of sorts. Few people knew of this loophole until William W.

Press employs people in France and Holland to search through patent applications as they're published there—usually about six months after they've been filed in the Netherlands and a year after in France. Under international patent conventions, an inventor has one year from the date of his original application to file in other countries. Thus, American inventors usually file in France or the Netherlands exactly one year after applying in the U.S.

"Those patents applied for abroad are usually the most valuable," says Buchanan. "Those in our collection show not only who is doing what kind of work, but what directions companies are taking."

No language barrier. Right now, Buchanan collects only patents filed in the English language. However, he says that if there is a demand, he will collect Japanese patents in the same way. These would require translation; applications filed in Holland and France are published in their original language.

Buchanan says he has received no complaints from the companies whose patents he has disclosed. He figures their patent attorneys had already informed them of the loophole and of the risk they would be running if they filed applications overseas.

He says small companies will probably benefit most from his service. They can't afford to do the checking in France and Holland themselves, he explains, and they can afford even less to waste any of their resources on work that duplicates earlier developments.

Lamp lights. The Lamp collection covers a broad range of designs, including a laser communications system of the International Standard Electric Corp., a bidimensional beam-scanning device from the United Aircraft Co., a hologram system from the American Optical Co., and an optical scanner from the International Business Machines Corp.

A couple of years ago, Buchanan edited the 1966—and only—edition of a publication listing the titles of pending patents and the names of those applying for them. The U.S.

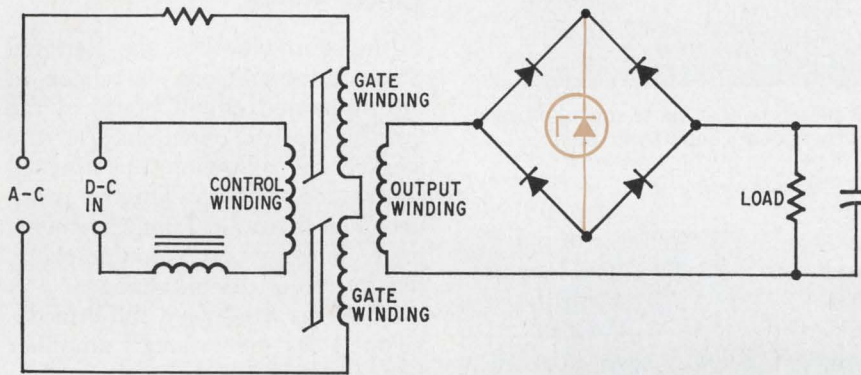

Circuit saver. One zener diode separates d-c control signal from a-c carrier in this magnetic amplifier that needs no external demodulator.

amplifiers, this device produces no output for a zero input.

Filter. Most applications require that the d-c component be separated from the larger square waves. However, if the output goes to a moving coil meter, the meter will do its own filtering.

Wolfframm will discuss the development this week at the Intermag Conference in Washington.

Buchanan, a former Central Intelligence Agency officer, turned it into a business. Now the president of Carrollton Press Inc. of Washington, Buchanan has gone through all U.S. and British patent applications filed in France and the Netherlands for laser and maser designs since 1960. There are about 120 of these, and he has collected photostatic copies of them into a 2,000-page loose-leaf book.

This first collection, called Lamp for laser and maser patents, is on sale for \$540, and Buchanan is offering an annual updating of the report for \$175 a year.

Art collector. Buchanan notes that some patents in his collection were applied for in the U.S. back in 1959 and still haven't been granted. Lasers and masers were selected for the first collection, he says, because "it's a new art—the technology is still somewhat hidden under the patent blanket."

Buchanan plans to apply his unique methods to other fields. He doesn't think the next collection will involve electronics, though, unless he can channel the demands of potential customers into specific areas of interest; he cites integrated circuits as a possible subject for another collection.

Continental agents. Carrollton

Patents

Peddling your papers

You could have knocked them over with that proverbial feather when the engineers at the Sperry Gyroscope Co. opened their mail one day last month. For there on the cover of a sales letter from a Washington publishing company—for all to see—were their supposedly secret drawings of a ring laser gyro for which U.S. patents are pending.

There was no leak to plug, no skulduggery to uncover. It's all quite legal and Sperry isn't the only victim. For while patent applications are kept secret in the U.S. and most other industrialized nations, France, the Netherlands, and South

Patent Office subsequently decreed this information secret.

Unsquashed himself, Buchanan this month announced publication of the Laser Contracts Directory, 1963-1967, a book containing descriptions of more than 1,200 Government research, development, and procurement contracts for lasers.

Manufacturing

Stamping the boards

Makers of printed-circuit boards generally use either a silk-screen process to lay down conductor paths, or photoetch the artwork onto the board. Patterns can also be stamped on the boards with metal dies, but the tooling costs involved in this process can run as high as \$10,000 for complex circuits, and only a handful of firms—most notably the Rogers Corp. of Rogers, Conn., and Dytronics of Leesburg, Ind.—have applied it successfully.

For small production runs, however, a new dry technique developed by the Boeing Co. makes die stamping not only economically feasible but desirable. The brain-child of Walter Weglin, a former Boeing engineer, the process can turn out 30 p-c boards a minute at a cost as low as 75 cents apiece. Weglin is now president of Stampede Inc. of Edmonds, Wash., and is employing the process under a Boeing license.

A fine line. Imprecision was a problem in the early stages of development, but Weglin says the system can now consistently hold tolerances of $\frac{1}{32}$ of an inch between adjacent conductors. He adds that lines have been held between paths as tight as 5 mils, but not on a mass-production basis.

Stampede chemically mills the circuit's artwork onto the die. Mounted in a press, the die casts the pattern on an adhesive-backed copper or aluminum foil and imprints it on a substrate. The foil-imprinted boards are then heat-cured and holed out. Stampede's

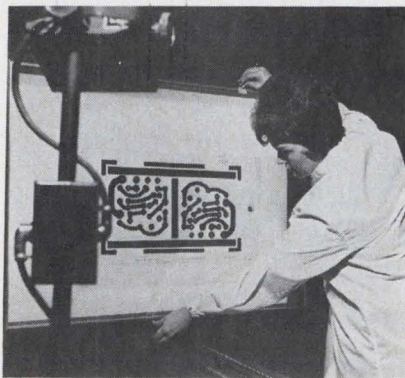

Scaled. Low-cost die stamping process for p-c boards begins with offset reduction of circuit's artwork.

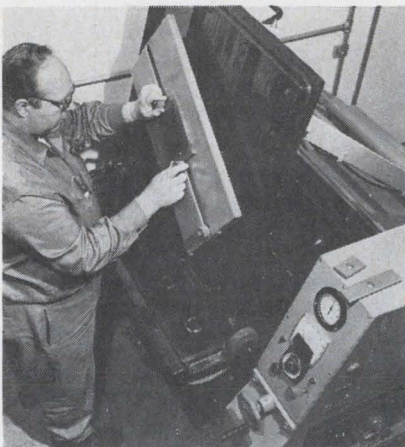

Bathed. Once the artwork is prepared, the steel die is placed in a chemical solution for milling.



Aligned. Finally, the die is put in a punch press to stamp a circuit on a substrate from a sheet of foil.

press can handle boards as large as 12 by 18 inches, and Weglin feels that producible circuit dimensions are limited only by the size of the press.

Chemical milling, Weglin claims, makes for sharply defined die edges and reduces tooling costs

to between \$50 and \$200, depending upon the complexity of the artwork.

Integrated electronics

Clever move

In the short time that the National Semiconductor Corp. has been in the integrated circuit business, the firm has carved out a share of the market by following an unusual course: it's come up with new products not by radical improvements in technology or manufacturing, but by clever design changes.

That was true when the firm developed its operational amplifier line last year—its first product—and it's true with its new pair of ic's: a dual line receiver and a dual line driver. The circuits—linear types for a digital job—are earmarked for the emerging computer periphery market. Both circuits contain innovations.

Among them:

- The ic's operate from a single, standard-level supply, instead of two power supplies or a high-level source.

- Compatibility with transistor-transistor logic, digital-transistor logic and resistor-transistor logic, avoiding the usual interface problems.

The designer is Robert J. Widlar, National's director of advanced circuit development. He invented many first-generation linear ic's while at Fairchild Semiconductor.

Compared with currently available ic's, the new National devices are less susceptible to environmental noise. They permit independent channel strobing, accommodate ± 15 -volt input signals, contain short-circuit protection, and have general-purpose characteristics that fit a number of data-processing applications.

National achieved these improvements primarily by advanced design—common-base input stages instead of common-emitter, simulated current sources that don't require pnp transistor elements, termination resistors for improved filtering,



TRW
Metallized
Mylar Capacitors

are different

The little things set them apart.

Things like superior electrical properties. Better environmental properties, too.

Things like variety. Tape-wrap, epoxy or hermetically sealed. Axial or radial leads. Voltages from 50 volts to 600 volts. Values from .001 mfd. to 10.0 mfd. And

tolerances to 1%.

And not so little things like unequalled experience in metallized mylar*. And the technical know-how to meet special requirements. They all add up to a big difference!

Contact any TRW distributor, or TRW Capacitors, Box 1000

Ogallala, Nebraska. Phone (308) 284-3611. TWX 910-620-0321. *TRW Capacitors is a Division of TRW INC.* *DU PONT REGISTERED TRADEMARK

TRW[®]

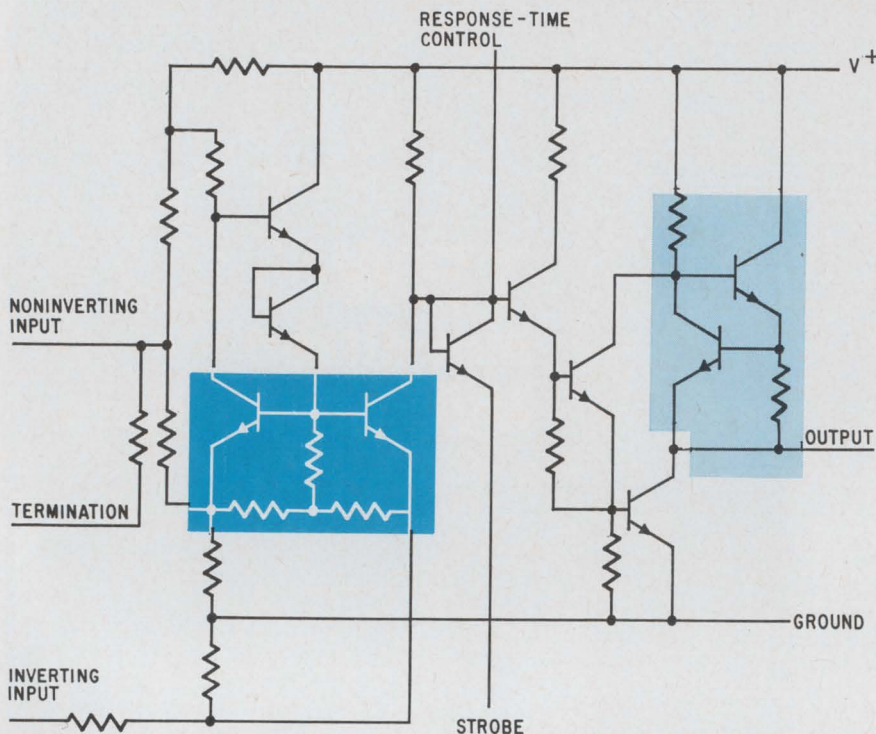

Better half. Common-base input stage and non-pnp-element, simulated output-stage current source help provide superior electrical performance in National's new dual line receiver. Only one side of the linear IC is shown.

clamp diodes, and wired-OR output options.

The line receiver, the DM7820, and the driver, the DM7830, are priced competitively with existing IC's—\$24 and \$16, respectively, in lots of 100 for military-specification versions. Both the DM7820 and the DM7830 will be made available this month.

Industrial versions, with less-stringent temperature specs, and priced at \$10 and \$8, will also be offered.

Space electronics

Down with errors

Communications engineers working on NASA's Pioneer space program will use a data coding technique on Pioneer D this fall that they say will extend the effective range of the spacecraft's data link by 40% and just about eliminate bit errors. The technique, known as convolutional coding, is similar to a code previously advanced by International Business Machines Corp. en-

gineers for ground-to-ground data transmission [Electronics, Jan. 22, p. 77].

Pioneer spacecraft transmit a single channel of data at a fixed power output; the signal received at earth stations has a power of 0.5×10^{-18} watts. With such a weak signal, spurious noise causes many errors. Pioneer engineers, unable to increase the power of the output signal or to boost input direction power by using a directive antenna, reduce the data rate as the signal becomes less intelligible. From a maximum rate of 512 bits per second (bps), the data flow is reduced to 8 bps at distances of more than 56 million miles. The reduced data rate makes for more power per transmitted bit.

With reduced bps rates, Pioneer engineers have used a simple parity error-detection code capable of detecting and correcting only one error in each six data bits. This gave an error rate of 1 in 1,000.

Far out. Following a thesis advanced 12 years ago, Ames Research Center in California has used convolutional coding to achieve an equivalent gain 3 decibels more than achieved in present signal

transmission. For the Pioneer D spacecraft, to be launched from Cape Kennedy this fall, convolutional coding will allow data to be transmitted from distances 40% greater and at much higher bit rates for intermediate distances.

The simple parity error detection used in present Pioneer operations transmits one parity check bit for each six data bits; the seven bits form one telemetry word. The parity bit is a 0 or a 1, whichever is needed to make the sum of the bits odd. Convolutional coding uses data bits in an extremely sophisticated manner to generate parity bits. Although each data bit is transmitted immediately, it affects subsequent parity bits for the next 25 events after initial transmission. One parity bit is transmitted for each data bit.

Since this coding increases the number of bits transmitted, the available power per transmitted bit is halved, causing a much higher bit-error rate, but the error rate after decoding is less than 1 in 10^5 .

Aboard the Pioneer D, a 25-bit shift register will receive binary data from the spacecraft's demodulator and generate a parity bit for each data bit it receives. Each parity bit is derived from 15 taps on the shift register. The definable relationship between the parity bit and the previous 24 information bits permits detection and correction of all errors if the ground station can read the data with a high degree of reliability.

25 chances. On the ground, reliability depends on probability; the most probable transmission is deduced from the parity bits. As each data bit slides through the register, first appearing and then disappearing as the bit is tapped or not, it effectively has a total of 25 chances to affect the reception of its transmission.

Encoded telemetric data consists of 7-bit words divided into 32-bit word frames. The data bits are received in positive-negative voltages corresponding to 1 or 0; the decoding process is essentially an attempt to differentiate between voltage polarity, which may be affected or reversed by spurious r-f noise. The more closely the received signal ap-

Pulse Fidelity

This double-exposure photograph shows the same 12-ns-wide pulse displayed by the Tektronix Type 454 (upper trace) and by a 7-ns, 50-MHz oscilloscope (lower trace). Note the difference in detail of the pulse characteristics displayed by the Type 454 with its 2.4-ns risetime performance.

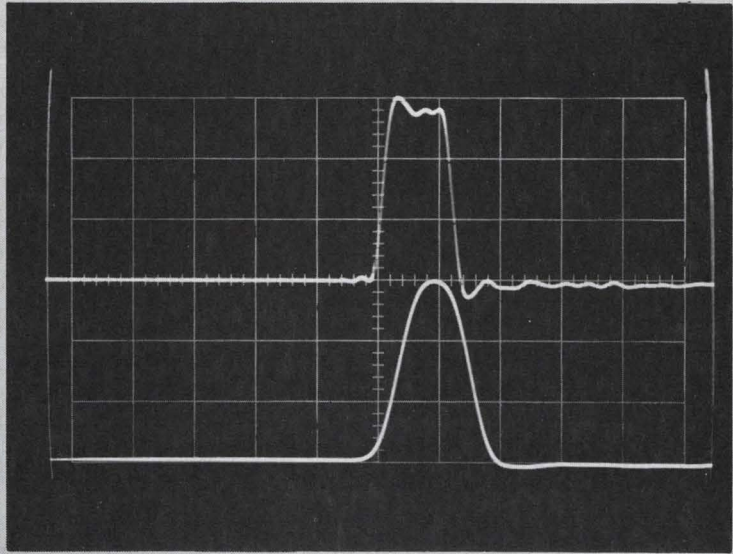

10 ns/div

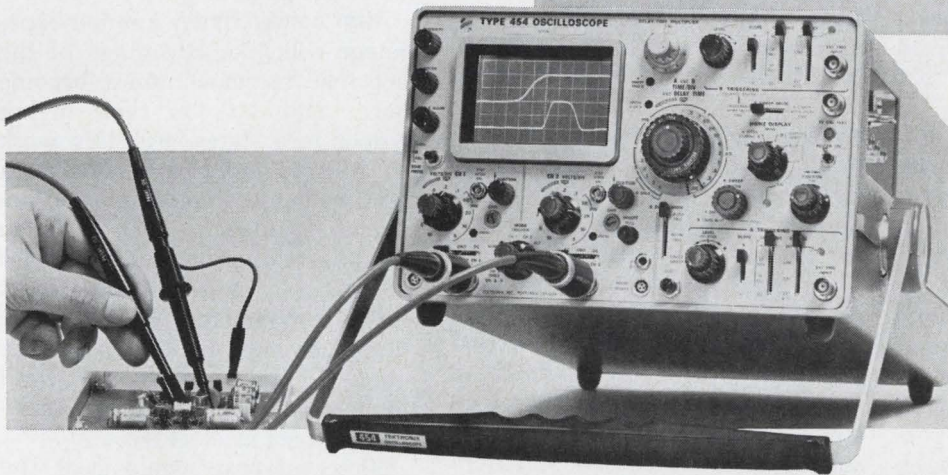

**150 MHz,
2.4 ns
with or
without
probes**

The Tektronix Type 454 is an advanced portable oscilloscope with DC-to-150 MHz bandwidth and 2.4-ns risetime performance where you use it—at the probe tip. It is designed to solve your measurement needs with a dual-trace vertical, high performance triggering, 5-ns/div delayed sweep and solid state design. You also can make 1 mV/div single-trace measurements and 5 mV/div X-Y measurements.

The vertical system provides the following dual-trace performance, either with or without the miniature P6047 10X Attenuator Probes:

Deflection Factor*	Risetime	Bandwidth
20 mV/div to 10V/div	2.4 ns	DC to 150 MHz
10 mV/div	3.5 ns	DC to 100 MHz
5 mV/div	5.9 ns	DC to 60 MHz

*Front panel reading. With P6047 deflection factor is 10X panel reading.

The Type 454 can trigger internally to above 150 MHz. Its calibrated sweep range is from 50 ns/div to 5 s/div, extending to 5 ns/div with the X10 magnifier on both the normal and delayed sweeps. The delayed sweep has a calibrated delay range from 1 μ s to 50 seconds.

Type 454 (complete with 2 P6047 and accessories).....	\$2600
Rackmount Type R454 (complete with 2 P6047 and accessories)	\$2685
Type 200-1 Scope-Mobile® Cart	\$ 75

U.S. Sales Prices FOB Beaverton, Oregon

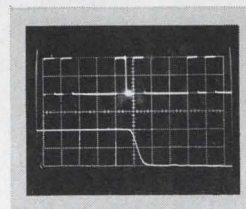

Double Exposure

5 ns/div delayed sweep

The delayed sweep is used to measure individual pulses in digital pulse trains. The Type 454 with its 1 μ s-to-50 s calibrated delay time, 5-ns/div sweep speed and 2.4-ns risetime permits high resolution measurements to be made. Upper trace is 1 μ s/div; lower trace is 5 ns/div.

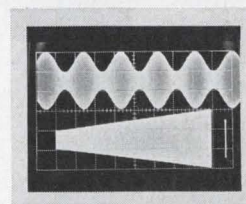

150 MHz AM

X-Y

The upper display is a 150-MHz signal that is 50% modulated by a 2 kHz signal. The lower display is an X-Y trapezoidal modulation pattern showing the 150-MHz AM signal vertically (Y) and the 2 kHz modulation signal horizontally (X). Straight vertical line is the unmodulated carrier. Multiple exposure.

For a demonstration, contact your nearby Tektronix field engineer, or write: Tektronix, Inc., P. O. Box 500, Beaverton, Oregon 97005.



*Coordinated research,
design and manufacturing*



*... part of the Tektronix commitment
to progress in the measurement sciences*

proaches the maximum ± 3 volts, the more certain the decoding computer can be that polarity hasn't been reversed by spurious noise. The more closely the signal approaches the cross-over point between positive and negative polarity, the greater the probability that the signal has been reversed. In decoding, the computer assesses polarity and assigns one of four values to each bit according to how closely it approaches ± 3 volts. A perfect $+3$ volts would be 1^4 , a perfect -3 volts would be 0^4 .

At the ground decoding stations, a computer-driven duplicate encoder generates two pairs of "trial" information-parity bits, one based on the assumption that the received information bit is 1, the other that it is 0.

Matching the numbers. The duplicate encoder's information parity pairs are derived from the previous 24 bits of transmitted information. The computer knows what the parity bit should be for a 1, and what it should be for an 0, so that one of the trial pairs will be correct, the other wrong. The decision is made by comparing the trial pairs with the received information-parity pair to see which one matches most closely.

For each information-parity pair transmitted from the spacecraft, there are four possible combinations: 0,0; 0,1; 1,0; 1,1. Assigning degrees of polarity to each combination of information-parity pairs establishes 256 probability "categories." By reference to the computer-assigned polarity values, the computer then looks at probability tables that indicate the likelihood of a correct interpretation of the sequel.

The computer has matched a trial pair with the most probable transmitted pair. If a mistake is made, the subsequent calculations will indicate the incorrect choice by a decreasing match (less probability) between the duplicate encoder and the actual received pair. The decoder then detects the situation, reverses itself and attempts a different assumption until the generated data matches the received data with the highest degree of probability.

Displays

Cool view

NASA is investigating an unusual way to display information using materials called thermochromics, which change color when their temperatures change.

The space agency is funding work in this area at the Aerospace group of General Precision Inc. in Little Falls, N.J., and at the Research division of the Martin-Marietta Corp. in Orlando, Fla.

General Precision is locating thermochromic materials and cataloging their characteristics. It is also working on their application to cathode-ray and electroluminescent displays.

Martin-Marietta is building a fluidic decoder and display device that would probe the feasibility of thermochromic displays in combination with spacecraft computers.

No good for space. So far General Precision has investigated more than 30 compounds and found about 10 useful thermochromics. Metallic iodides seem prevalent, and a good example is silver mercuric iodide, which switches from yellow to red at 50.5°C and back again when cooled. Other materials, such as the salts of tellurium, cadmium, and selenium, hold promise, too, and cadmium indium sulfide looks especially good for high-vacuum applications.

With some good materials on hand, General Precision is moving toward possible applications and experimenting with various substrates. The resolution and speed of color change fluctuate with the thermal conductivity of the substrate. So far metal foil has proven fastest and clearest while glass, such as that in crt's, hasn't worked well.

However, with a modified cathode-ray tube, the General Precision scientists have achieved color changes without heat, using electron beams at 10 kilovolts. Also, according to Daniel Grafstein, manager of materials research, some thermochromics don't "poison" crt phosphors when mixed with them. "This could make possible a con-

stant-contrast crt," he says, "one that could retain its visibility regardless of ambient light variations."

Grafstein predicts an experimental crt that uses a mixture of P-14 phosphor and silver mercuric iodide. In dim light, the viewer would see the phosphor emissions. As ambient light increased, the phosphor display would fade and the thermochromic display would come into view.

This mix would probably be used merely to prove the principle, because the phosphor emits yellow light and the thermochromic turns red when excited.

Alter conductivity. Another experiment will take advantage of the fact that thermochromics become more conductive in their higher temperature states. For this work CPL scientists will try to operate a hybrid electroluminescent thermochromic sandwich. The sandwich will have a thin layer of phosphor on one side of a platinum sheet and a 1-millimeter thick layer of thermochromic material on the other. Conductive glass will form the top and bottom of the sandwich and act as electrodes.

Direct current would heat the thermochromic to the point at which it would conduct enough alternating current to allow the phosphor to emit. Potentially, this is a cheap way of switching electroluminescent displays which now most often use either relays or scr's.

Communications

Weather watch

The bandwidth of the communications channel between Washington and the command post in Vietnam is effectively limited to that of the shortest link—the phone line between the field and a local headquarters. Such lines can't be used for fast facsimile transmission of such things as weather maps. The military is now investigating an instrument developed for high-speed

ANNOUNCING . . .

The *WORLD'S* most compact *QUALITY*

CERAMIC TRIMMER CAPACITOR

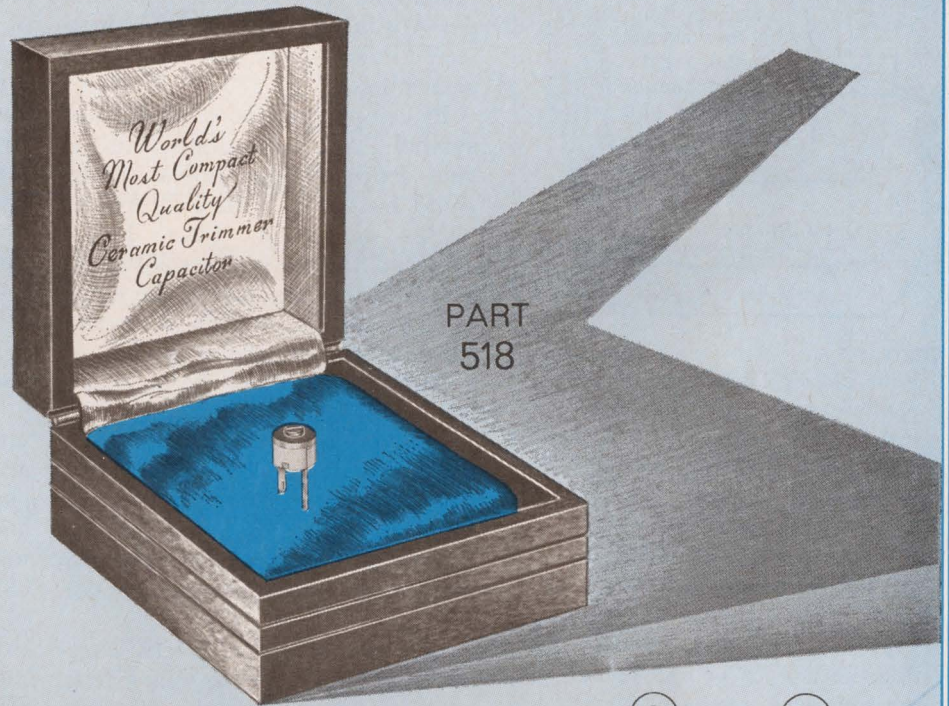

AMAZING 1.0 to 25 pF. CAPACITANCE RANGE IN LESS THAN .007 CUBIC INCH

- Two mounting arrangements.
- Occupies less than .007 cubic inches.
- Has the ruggedness and range of much larger Trimmers.
- Unique design insures rigid mounting stability.
- Sealed-in-ceramic rotor electrode guarantees environmental stability.
- Precision lapped bearing surfaces insure smooth linear tuning.

GENERAL SPECIFICATIONS

Capacitance Ranges.....	1.0pF - 3pF 2.5pF - 9pF 3.5pF - 20pF 5.0pF - 25pF
Operating Temperature Range.....	-55°C to +125°C
Working Voltage.....	100 WVdc to 85°C 50 WVdc to 125°C
Dielectric Strength.....	.200 Vdc 1 - 5 sec.

ERIE OFFERS THE MOST COMPLETE SUBMINIATURE TRIMMER
CAPACITOR LINE IN THE INDUSTRY . . .



Another Series of Components in Erie's Project "ACTIVE"
Advanced Components Through Increased Volumetric Efficiency

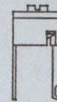

VERTICAL
TUNING

HORIZONTAL
TUNING

ERIE

TECHNOLOGICAL

PRODUCTS, INC.



Erie, Pennsylvania

Catch 1 μ s voltage peaks.

Why?

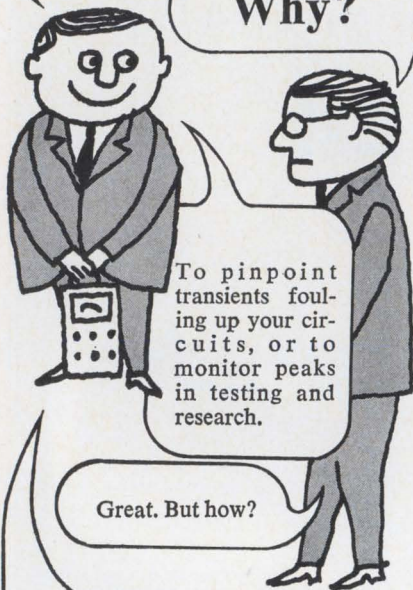

To pinpoint transients fouling up your circuits, or to monitor peaks in testing and research.

Great. But how?

With PEAK LOK. It measures positive, negative or bipolar peaks with 1% full scale accuracy, holds its reading in an analog state until it's reset. Use it to measure physical parameters in environmental tests, record surges in power lines and supplies, detect overload transients in electronic and electrical systems . . . everywhere precise determination of voltage peaks can help solve a problem. It has an output for data logging, can be remotely reset, has nine ranges from 0.1 to 1000v full scale, and can go up to 30 kv with a high voltage probe. When you're not catching transients, use PEAK LOK as a sensitive DC voltmeter, to measure that hard to get to voltage with a quick touch of the probe.



For complete specifications

write to PEAK LOK Sales, Dept. 252, Analog-Digital Systems Division, Control Data Corporation, 4455 Eastgate Mall, La Jolla, California 92037 Or phone 714/453-2500.

CONTROL DATA

CORPORATION

4455 Eastgate Mall, La Jolla, Calif.

transmission of weather maps over ordinary telephone lines for possible use in sending position maps from the battleground to the war room.

The instrument is an isographic plotter built by the Western Development Laboratories of the Philco-Ford Corp. for the West German defense ministry, which runs the German weather service. The Germans asked for resolution of 3,000 by 4,000 elements; at the European phone-line rate of about 1,200 bits per second, a single weather map would take nearly three hours to transmit.

By compacting codes for weather symbols, and by storing sine/cosine codes so that isobar curves could be drawn with 1.4° arcs of circles of various sizes, Philco achieved the desired resolution in a system that reproduces the maps in less than 90 seconds from data transmission to hard copy.

Now to the mask. The maps are drawn by an electron beam on photosensitive paper. Philco believes its beam-steering system could be adapted to any chart or graphical drawing; it has already begun work on using the system for direct production of semiconductor masks.

The plotter is not directly competitive with facsimile, since it is not useful for picture transmission, says Herbert C. Hendrickson, director of advanced development for the laboratories. But for mapmaking, the system offers considerable savings on line charges over facsimile or the Xerox Corp.'s LDX system. The price of the machine is under \$50,000.

The Philco system uses an Ampex Corp. core memory of 4,096 words of 18 bits each to store symbols and sine/cosine data. About 2,500 to 3,000 words are needed for these functions; the rest of the memory is available for the program, which gives position data, draws lines and arc segments, and addresses the symbols. Symbol and sine/cosine data are transmitted as vector data to a digital vector generator, which provides analog x, analog y, and blanking signals to the deflection circuitry of a crt.

The pattern traced by the crt is

reflected and magnified through a system of ordinary mirrors and lenses onto a sheet of paper 18 by 24 inches. This paper is automatically run through a developing solution before emerging from the machine.

Eye U.S. market. The U.S. Weather Bureau now transmits maps once daily by facsimile. Philco claims its plotter would fit beautifully into a system of continuous updates of weather data—such as are provided for tornadoes or hurricanes. But Hendrickson admits that integrating the machine into the current system would be a long task. Probably, he says, areas like Alaska and Hawaii, where phone line charges from Washington are high, would be the first prospects. In the meantime, he sees the military as a much earlier customer.

The mask-making application would be confined to the so-called tooling plates, which are made, by a step-and-repeat process, into master plates for a whole silicon slice. The tooling plates are for one chip only; the system's resolution and repeatability (0.025%) are within required tolerances for the chip.

The process would eliminate the drawing of huge tooling plate masks and then reducing them to chip size, and it would lend itself to direct processing of computer-designed masks.

For the record

Gunslinger. A four-color cathode-ray-tube display system with a single electron gun has been developed by Sylvania Electric Products Inc. Red and green phosphors are separated by a barrier on the face of the screen and are activated by the electron gun—a low-voltage beam for the red and a high-voltage beam for the green. The other two colors, yellow and orange, are obtained by intermediary voltages, and all four colors can be produced simultaneously by switching voltages rapidly. Sylvania is looking for

You have probably replaced your High Voltage Rectifier Tubes for the last time.

New Silicon "Doorbell" Rectifier Modules just plug in, last almost forever, save you lots of money, and let your equipment keep its cool.

- Modules with current ratings from 0.67 amps to 6.6 amps, and PIV's from 2.5 KV to 15 KV just screw together to permanently replace over 50 different types of tubes. Ratings to over 100 KV.
- Reduce cabinet temperatures by 60°F to 100°F — prolong the life of your other components.
- Reduce power consumption by eliminating filament.
- Designed by high-voltage engineers who built in tremendous capacity to handle overload surges.
- Only void-free, whiskerless, controlled avalanche, individually fused-in-glass Unitrode diodes are used.

For fast action, call Fred Swymer COLLECT at (617) 926-0404



Send for Bulletin N-130A. It's 16 pages of really complete specs, diagrams, pictures, cutaway drawings, application dope, case histories, and direct replacement data. CHECK 315 ON INQUIRY CARD.

UNITRODE®

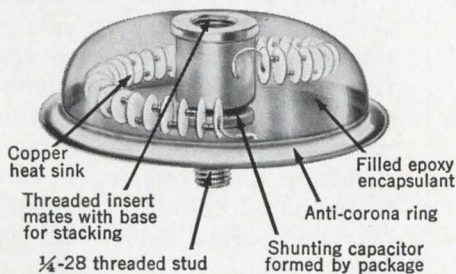
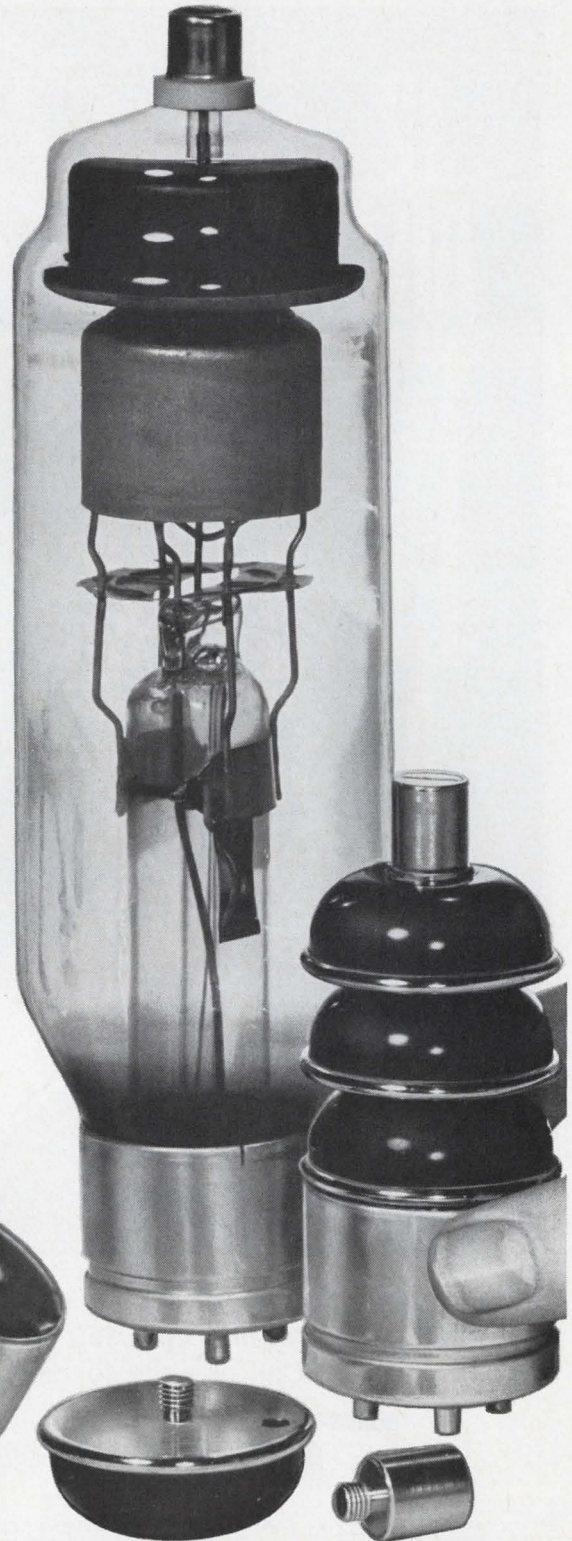

UNITRODE CORPORATION • 580 Pleasant St., Watertown, Mass. 02172 • Telephone (617) 926-0404 • TWX (710) 327-1296

this receiving system covers

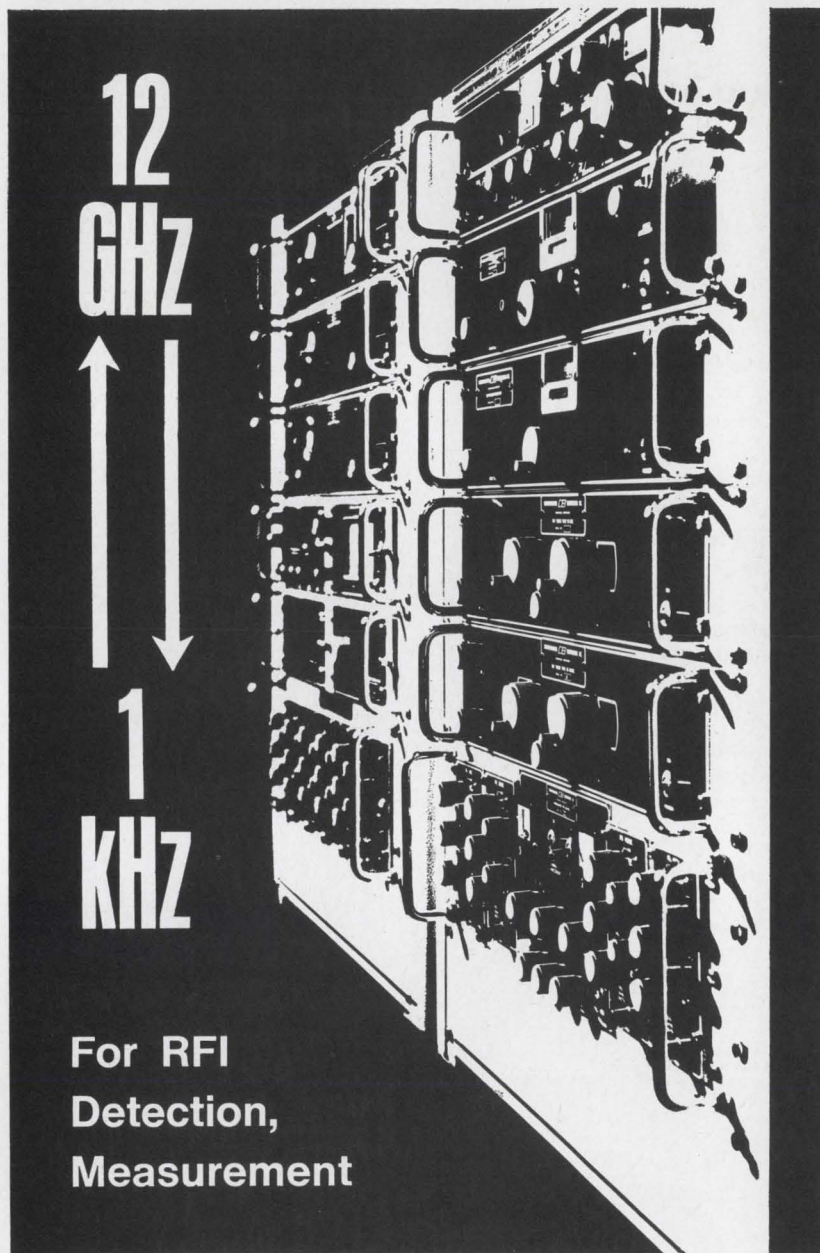

Eleven bands . . . receiver and seven tuners . . . IF demodulation bandwidths from 150 Hz to 8 MHz . . . signal monitoring. . . Call or write for specifications.



SUBSIDIARY OF WATKINS JOHNSON
WU

COMMUNICATION ELECTRONICS

6006 Executive Boulevard, Rockville, Md. 20852 • 301/881-3300 • TWX: 710-824-9603

customers among the military and the FAA, but won't set a price until the unit has been designed into a larger system specifically tailored to a customer's needs.

Air transport. The first magnetic-tape transport to fully meet military specifications for airborne recorders—including stringent shock-resistance standards—has been built by Honeywell Inc.'s Test Instruments division. The transport, developed for the Navy's P3C anti-submarine system, has a single bi-directional tape speed of 75 inches per second (the bidirectional feature permits real-time data retrieval); selectable packing densities of 220, 556, and 800 bits per inch; and a vacuum column that maintains constant tape tension and allows the instrument to reach top speed or stop in a maximum of 6 milliseconds and a distance of 0.03 inch.

Changing chairs. In what some observers see as an attempt to appease disgruntled stockholders, Laboratory for Electronics Inc. has elected Herbert Roth Jr. president and chief executive officer. Henry W. Harding, former LFE president, moved to the post of chairman. The company, which was in the red in fiscal 1968, has been showing signs of a turnaround lately.

Distant teacher. An instruction system RCA installed in New York City to serve 6,000 children in 15 schools is now hooked into a Spectra 70-45 computer in Palo Alto, Calif. But the system, which is being financed under a three-year, \$2.5 million Federal grant, will soon get its own local Spectra to go with its 200 terminals.

Plastic seal. A new technique to seal IC's hermetically may influence the military to use plastic-encapsulated IC's. The process, dubbed Goldilox by its developer, Westinghouse Electric, uses titanium-gold bonding, glass-over interconnections, and silicon-nitride passivation over the thermal oxide. The company intends to incorporate the Goldilox technique in all of its major IC product lines.

EECOSWITCH® style and binary capability...

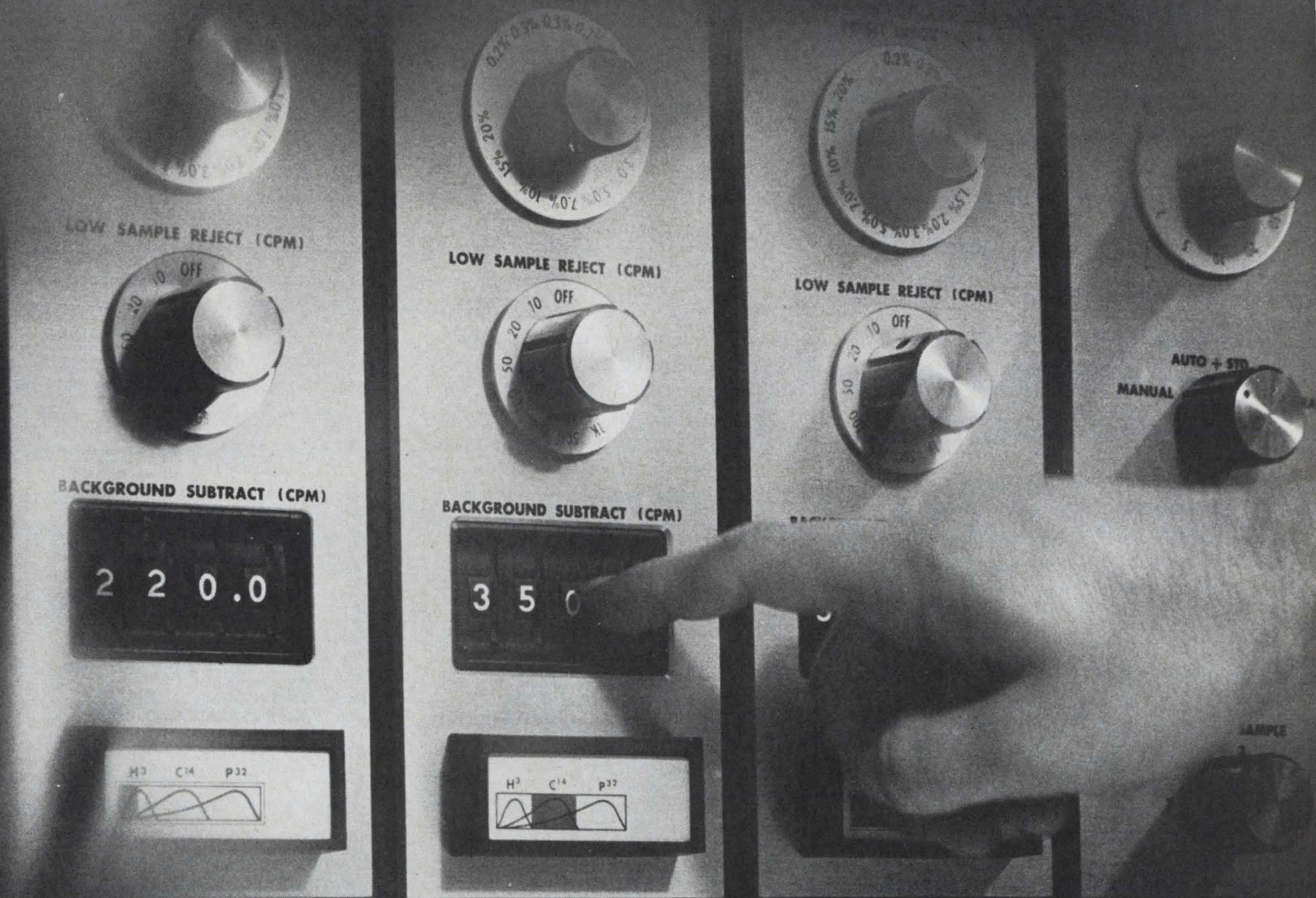

PHOTOGRAPH COURTESY OF BECKMAN INSTRUMENTS, INC.

give your products a selling advantage

When you use EECOSWITCH Rotary Thumbwheel Switches in your front panels, you're designing a truly user-oriented instrument. Attractive, functional EECOSWITCH assemblies often reduce product cost, too. There are 7 broad lines, with dozens of binary coded outputs — in stock — to fit almost any application... all backed by EECO's exclusive 2 year warranty. How can you use a versatile space-saving EECOSWITCH in your panel? The new EECOSWITCH catalog describes our complete lines, and includes 15 pages of useful application data to help you. Send for your personal copy.

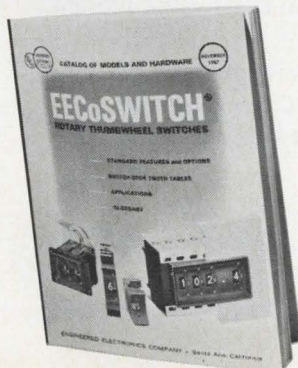

COMPONENTS DIVISION

ELECTRONIC ENGINEERING COMPANY OF CALIFORNIA

1441 EAST CHESTNUT AVENUE • SANTA ANA, CALIFORNIA 92701 • (714) 547-5651

Circle 43 on reader service card

MICROWAVE IC PROGRESS REPORT #1

Sperry PACT program carries avalanche transit time oscillator past 5,000 hours of life testing

Sperry's PACT (Progress in Advanced Component Technology) Program now offers more than 5000 hours of life test data on an X band Avalanche Transit Time Oscillator. With a test history dating from July 6, 1967, the device has not yet shown a measurable change in characteristics.

A direct result of PACT, Sperry's intensified effort to accelerate the development of microwave integrated circuits, the ATTO is believed to be the smallest device of this type available anywhere for the direct conversion of DC to a microwave signal. Its outline dimensions are identical with that of a DO-5 diode package.

In developing the device, PACT engineers attacked the following requirements:

- Relatively high power output in microwave IC size packages.
- Electronic tunability over 5 to 50% bandwidths.
- Frequency modulation capability without excessive spurious amplitude modulation.
- Minimum AM and FM noise characteristics.

Success of the project depended largely on Sperry's in-house capability for development and production

of avalanching diodes. This capability met the challenge, and ATTO's are now produced entirely within Sperry's Clearwater, Fla., facility.

As soon as PACT had demonstrated its ability to deliver the diodes required, the other technical problems came under staff scrutiny. One of the first developments was an "upside-down" diode mounting technique which puts the heat dissipating region of the silicon mesa chip as close as possible to the heat sink. Resulting reduction of thermal resistance between junction and heat sink enabled

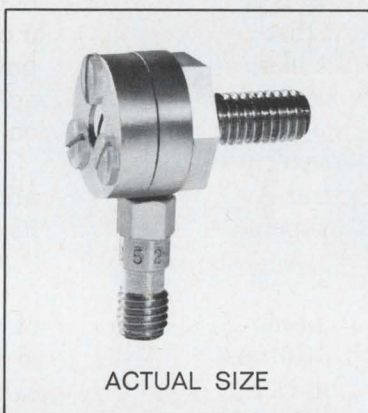

PACT engineers to handle current densities as high as 850 amps/cm². Power outputs have reached 380 mW CW.

Both frequency and phase locking techniques have been demonstrated.

Tuning requirements were met by utilizing mechanical, varactor or YIG techniques. Magnetic tuning across a 40% bandwidth is a reasonable expectation, and Sperry's experience in stalo design has permitted FM noise reduction by a factor of 30.

In summary, PACT has now demonstrated the feasibility of ATTO power output from 20 to 350 mW at specified frequencies between 5 and 10 GHz; inputs would vary from 80 to 110 VDC at 30 - 50 mA. These forerunners of true microwave IC's will deliver conversion efficiency as high as 5%, and

SPURIOUS AMPLITUDE MODULATION

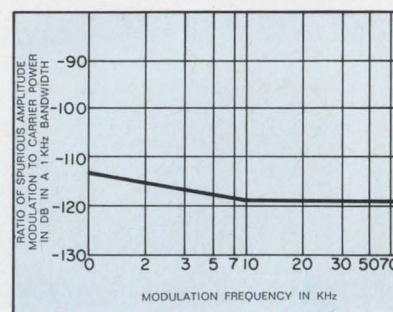

frequency stability of 4.5 ppm/°C between -10 and +50/°C.

In its ATTO effort, the PACT program has already proved its ability to provide direct DC to microwave conversion for the most demanding of custom specifications. Chances are that the technology required for your application is already in existence. And, PACT's achievements in ATTO development foreshadow a quickening pace in the refinement of microwave integrated circuits.

To learn more about an ATTO for your application or the coming impact of PACT, contact your Cain & Co. representative or write Sperry Microwave Electronics Division, Sperry Rand Corporation, Clearwater, Florida.

*For faster microwave progress,
make a PACT with people
who know microwaves.*

SPERRY

MICROWAVE ELECTRONICS DIVISION
CLEARWATER, FLORIDA

Washington Newsletter

April 1, 1968

Firms to hear NASA peeves about parts

Top NASA officials, increasingly concerned over the quality of parts suppliers' quality control, are arranging a meeting with industry representatives to discuss the problem. The symposium is expected to be announced shortly.

Among the items on the agenda will be: multilayer printed-circuit boards of inconsistent quality; soldered connections that break under vibration testing; faulty connectors and circuit breakers turned up by bench testing and launch-pad checkouts; and the multiplicity of "preferred parts" lists—company lists of high-performance parts. Notes one source: "Just about everybody has his own list and the result is turmoil."

An in-house memo is said to have directed NASA staffers to call the symposium as soon as possible and to dispense with the customary convention trimmings because of the urgency of the situation.

Air Force to sic doppler on CAT

The Air Force plans to test doppler radar for clear air turbulence (CAT) detection. Its Cambridge Research Laboratories will try to find if CAT severity can be determined from the characteristics of the doppler spectrum. The test is an extension of work done at Wallops Island, Va., where it was found that ground-based radar operating at the uhf, S and X bands could detect clear air turbulence, but only at a distance of 20 miles—much too short a range to be practical. The Air Force is hoping to get longer range and a better resolution with the doppler approach. Frequencies haven't yet been decided.

The Federal Aviation Administration is taking a different approach and using temperature gradients in its attempt to find a detection system.

FAA finally sets Tracon-C meeting

After an eight-month delay, the FAA will finally hold a bidders' conference April 9-10 on a semiautomated terminal air traffic control system called Tracon-C. Requests for proposals were sent out last week. The FAA still has no definite idea on how many of the 20 terminals initially planned will be covered by the \$14.5 million earmarked for the project in fiscal 1968 [Electronics, Feb. 19, p. 155]. It does know that each unit will be a "turnkey" job, with equipment of modular design to suit the needs of different size airports. The bidders conference is being held at Atlantic City, N. J., so that participants can view alphanumeric displays and test hardware at the FAA's experimental-facilities center there.

ERTS budget rise gives studies a push

Pleasantly surprised by the action of a House committee in doubling fiscal 1969 funds for the Earth Resources Technology Satellite, NASA is accelerating the pace of the program. It expects to sign contracts for two or three sets of parallel studies aimed at identifying the system's integration problems and pinpointing the economic benefits of collecting earth resources data by satellite. And the agency may bypass any solicitation of bids on these studies and go directly to contractors who've worked on ERTS projects. The studies will be awarded in two to three months.

The House Science and Astronautics Committee boosted the original request of \$2.2 million to \$5 million [Electronics, March 18, p. 58]. Funds to begin developing the system may be sought for fiscal 1970.

Washington Newsletter

Air Force to buy portable Tacan

The Air Force is readying a rush order for a better portable Tacan ground beacon, the AN/TRN-26. The contractor will have to provide a station that can be carried by a C-47 and erected by four airmen in an hour. It will be used in areas of heavy air traffic, obviously including Vietnam, and will supply bearing, distance and station identification simultaneously to at least 50 planes within its 100-mile range.

A contract for 40 sets is expected to be signed this spring, with delivery of prototype models due 13 months later. To make the deadline, the Air Force is limiting competition to firms that have already done this type of work. **Only two companies now qualify: ITT-Avionics and Memcor Electronics.**

Goddard study to evaluate satellite relay

The space agency is starting the ball rolling on an experimental satellite program that would test a relay technique to allow continuous real-time communications between low-orbit observation satellites and a ground station. **Though far from being approved as a line item, the program will be investigated by Goddard Space Flight Center which is accepting study bids this month.**

The test craft, which would orbit at an altitude similar to that of weather satellites, would transmit data to a communications satellite in stationary orbit for relay to a ground station. **If the technique works, it could be incorporated in future satellites observing earth resources and weather conditions.** Weather satellites must now store data in orbit and "dump" it as they pass over a ground station. The relay, via the stationary satellite, would also reduce congestion at a ground station.

Doubt Holifield can win backing on procurement study

California's Rep. Chet Holifield is still trying to free his procurement-study bill from the House Rules Committee, where it has been pigeon-holed because of a jurisdictional dispute. But his chances are slim.

The bill has been gathering dust since Holifield's fellow Democrat, South Carolina's L. Mendel Rivers, came out strongly against it. Rivers, chairman of the powerful House Armed Services Committee, said his committee should handle any study of Government procurement policies. Holifield is a member of the Government Operations Committee.

Backed by the defense industry, the bill calls for the creation of a panel made up of experts outside of Government to look at every aspect of Federal procurement—including the issue of "adequate" profits.

Addenda

A pre-bidding briefing on a contract to flight-test and evaluate a collision-avoidance system for the Air Transport Association attracted 25 potential bidders. **The list of firms that will submit hardware proposals for the system has grown to four: a Wilcox Electric-Sierra team has joined Collins Radio, Bendix, and McDonnell Douglas . . . The Senate Commerce Committee will begin hearings about May 1 on the radiation control bill passed by the House March 27.** Also to be considered is the tougher Administration bill providing for factory inspection of radiation-emitting products and the recall of faulty equipment—items not included in the House measure. **Slowing things down will be the fact that the Labor Committee will get also a crack at the Senate's version of the bill—an unusual procedure . . .** The FAA will spell out the research it's doing and the directions it's taking in its second annual report to industry, June 11 in Washington.

3,000,000 VOLTS/SEC.



The scope photo illustrates the QRD40-.75's high-speed response to 10KHz square, sine and triangular waves. Amplitudes are 20V peak-to-peak.

New Sorensen QRD:

- A High-Speed Programmable Power Supply with a "Slewing Rate" Greater than 3,000,000 volts/second.**
- A Versatile Laboratory Supply Featuring $\pm 0.005\%$ Regulation.**

This new precision power supply leads two lives! In the high-speed programming mode, its performance is unmatched—only 10 microseconds programming time from E_{max} to 0 Volts. Capable of being programmed by resistance, voltage, or current to 100KHz. The oscilloscope photo vividly illustrates the QRD's high-speed capability which makes the QRD unequaled in digital, microcircuit testing, and servo system applications. The QRD also serves as a precision general-purpose instrument featuring $\pm 0.005\%$ voltage regulation, $200\mu V$ r.m.s. (3mV p-p) ripple, automatic crossover between constant volt-

age and constant current operation, and overload/short circuit protection.

Sorensen QRD's are available in seven off-the-shelf models ranging from 0-15v @ 2.0 Amps. (QRD15-2) to 0-60v @ 1.5 Amps. (QRD60-1.5). Prices start at \$178.00.

Contact your local Sorensen representative or: Raytheon Company, Sorensen Operation, Richards Avenue, Norwalk, Connecticut 06856 TWX 710-468-2940.

RAYTHEON

for more data on this versatile instrument . . . **Call Sorensen: 203-838-6571**

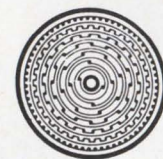

V-Scan Binary.

Memorandum

To: Systems engineers who keep their files of the world's finest encoders up to date.

From: Norden.

Re: Our latest list of versatile encoders for all your systems — magnetic, optical or contacting.

	Total Count	Revolutions for Full Count	Diameter"	Model Number
External Logic V-Scan Binary Encoders	128 or 256	1	1.750	ADC-7/8-BNRY-XB
	8,192 or 16,384	64	1.750	ADC-13/14-BNRY-XB
	524,288 or 1,048,576	4,096	1.750	ADC-19/20-BNRY-XB
High Reliability, Long-Life, Self-Contained Logic Binary Encoders	128	1	1.750	ADC-ST7-BNRY-E
	8,192	64	1.750	ADC-13-BNRY-E
	524,288	4,096	1.750	ADC-19-BNRY-E
Single Turn Gray Code Encoders	256	1	1.066	ADC/11/8/GRAY
	256	1	1.750	ADC-ST8-GRAY
	512	1	2.250	ADC-ST9-GRAY
	1,024	1	3.062	ADC-ST10-GRAY
Multiturn Gray Code Encoders	1,024	4	1.062	ADC-11/10GRAY256
	1,024	16	1.062	ADC-11/10GRAY 64
The above encoders are available with various levels of RFI suppression.				
Binary-Decimal Code Encoders Self-Contained Logic	100	1	2.250	ADC-ST2-BCD
	1,000	10	2.250	ADC-3-BCD
	10,000	100	2.250	ADC-4-BCD
	100,000	1,000	2.250	ADC-5-BCD
	1,000,000	10,000	2.250	ADC-6-BCD
	8-4-2-1 Code			
Binary-Decimal Encoders Self-Contained Logic	100	1	2.250	ADC-ST2-BBCD
	1,000	10	2.250	ADC-3-BBCD
	10,000	100	2.250	ADC-4-BBCD
	100,000	1,000	2.250	ADC-5-BBCD
	1,000,000	10,000	2.250	ADC-6-BBCD
	4-2-2-1 Code			
Degree Counting Binary-Decimal Encoders Self-Contained Logic	360	1	2.250	ADC-3-36BCD-E-360L
	3,600	10	2.250	ADC-4-36BCD-E-360L
	360	1	3.250	ADC-ST3-36-BCD
	3,600	36	2.250	ADC-4-36-BCD
	36,000	360	2.250	ADC-5-36BCD
	360,000	3,600	2.250	ADC-6-36BCD
Latitude-Longitude Binary-Decimal Encoders, Self-Contained Logic	3,600	36	2.250	ADC-4-36BBCD
	36,000	360	2.250	ADC-5-36BBCD
	360,000	3,600	2.250	ADC-6-36BBCD
Beacon Altitude Reporting Encoders	8-4-2-1 Code			
	36,000	3,600	2.250	ADC-4-LAT-BCD
	36,000	3,600	2.250	ADC-5-LNG-BCD
Beacon Altitude Reporting Encoders	560	7	1.062	ADC-ALT-11-560
	720	9	1.062	ADC-ALT-11-720
	1,280	16	1.062	ADC-ALT-11-1280
The above encoders are available with various levels of RFI suppression.				
Binary-Decimal Encoders with Extended Environmental Capability	100	1	2.250	ADC-ST2-BCD-A
	10,000	100	2.250	ADC-4-BCD-A
	360,000	3,600	2.250	ADC-6-36BCD-A
Optical Incremental Encoders	500	1	2.250	OADC-23/500/INC
	512	1	2.250	OADC-23/512/INC
	1,000	1	2.250	OADC-23/1000/INC
	1,024	1	2.250	OADC-23/1024/INC
	2,000	1	2.250	OADC-23/2000/INC
	2,048	1	2.250	OADC-23/2048/INC
All optical incremental encoders are available with index marker, quadrature outputs and internal squaring circuit options. Other counts available on special order.				
Low-Cost Magnetic Noncontacting Encoders	Incremental	128	1	1.750
	Gray	16	1	1.750
	Gray	256	1	1.750
	Binary	128(V scan)	1	1.750
	Binary	8,192(V scan)	64	1.750
	Binary	524,288(V scan)	4,096	1.750
All magnetic encoders are normally furnished with sleeved leads. Terminal header or Cannon connector options are available for all units. Non-standard counts within the capabilities of the encoder are available on special order.				

For more information and detailed specs on Norden encoders, write Components Department, Norden Division, United Aircraft Corp., 1475 Barnum Ave., Bridgeport, Conn. 06610. Or phone (203) 366-4531. TWX: 710/453/1855.

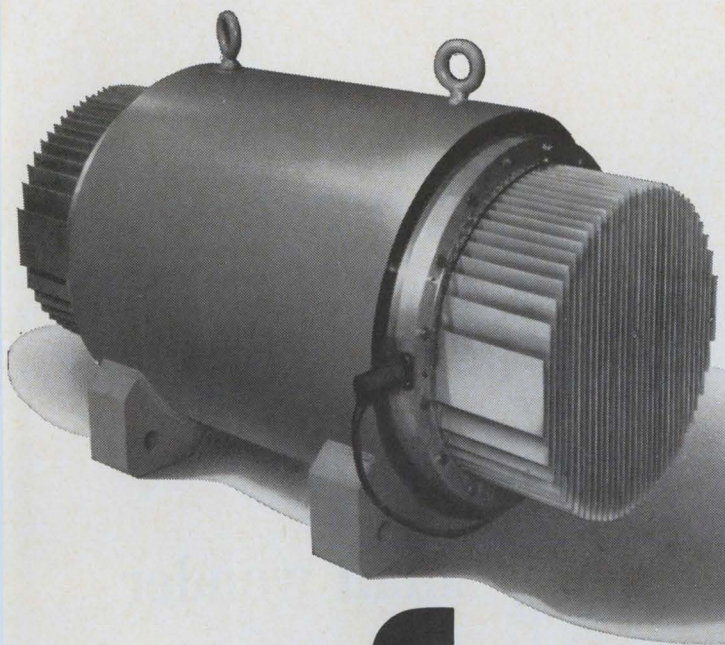

Don't refuel it until 1973.

You can place an order right now for a portable nuclear generator that produces 50 watts of electric power non-stop for five years, guaranteed.

It works anywhere, even thousands of feet down in the ocean.

And it needs absolutely no refueling or maintenance.

You can put a Martin Marietta nuclear generator on a mountain peak, in deep jungle, or hundreds of fathoms under the sea. In fact, anywhere that it's too expensive—or downright impossible—to use conventional power.

Models offered produce 3, 25, or 50 watts non-stop for five years without refueling. The 50 watt generator will produce more than 2-million watt hours on a single fuel capsule. Per-

formance is guaranteed.

Systems can be designed to store power on a cyclical basis, so that system output can be stepped up to several kilowatts.

The generators have no moving parts, so they can't wear out, and need absolutely no maintenance. They are unaffected by heat, cold, dust, gases.

Martin Marietta nuclear generators are at work supplying power to a weather station in the Arctic, to navigation beacons in the Atlantic, and to oil well control and warning systems in the Gulf of Mexico.

They can be used in monitoring and control systems, and in lighting, marking, communications and navigation.

Generators can prove especially valuable in solving remote power prob-

lems for the oil industry, in exploration, production and pipeline transportation.

One powers an undersea wellhead control system which requires *no hydraulic or electrical connections to the surface*. The nuclear generator sits on the wellhead itself, right on the ocean floor. It is activated by acoustical commands from the surface. We have also developed a nuclear-powered blowout preventer (BOP) control system.

If you have a remote power problem anywhere, ask us how a nuclear generator might help. Write John Morrison, Box 1100-L2, Nuclear Division, Martin Marietta Corporation, Baltimore, Maryland 21203.

MARTIN MARIETTA

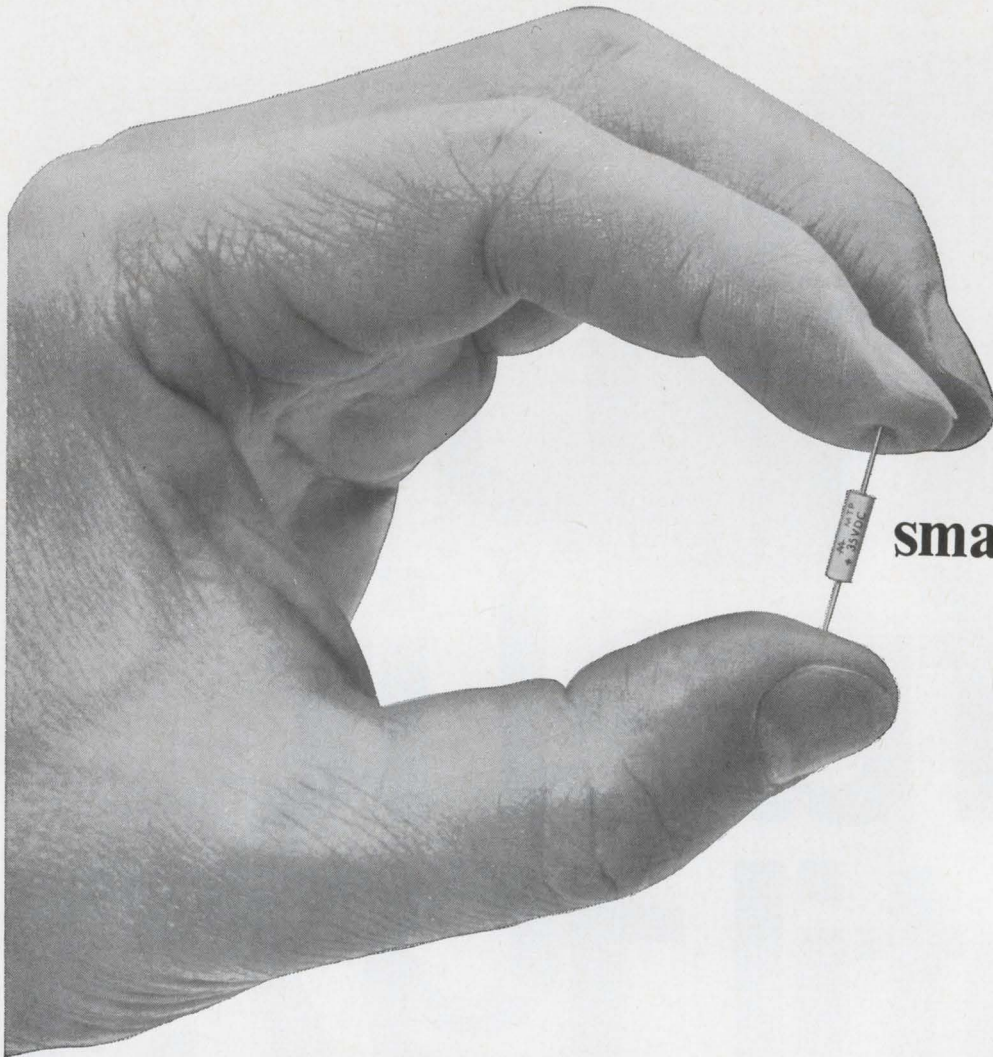

small wonder

No wonder Mallory MTP miniature wet tantalum capacitors are the delight of designers who are squeezed for space in computers and miniaturized electronic equipment. These commercial grade midgets pack up to 178,000 microfarad-volts per cubic inch . . . 5 times what you can get with solid tantalum.

The military version, MTPH, had only one catastrophic failure in 6,200,000 test hours, which calculates to a failure rate of .032% /1000 hours, MTBF of 3×10^6 hours, at 60% confidence level. Write for specs and consultation.

MALLORY

MALLORY CAPACITOR COMPANY

a division of P. R. MALLORY & CO. INC.
3029 E. Washington St., Indianapolis, Indiana 46206

Do the Pavlovian Giants give you the Freudian slip?



Pavlov, you know, was the guy who handed his hound the same old baloney day after day. Nothing extra. Nothing special. Just the same old baloney.

He got by with it because he was the pup's only source of supply. So sure of himself was this giant-like man that soon even his Freudian slip began to show . . . the baloney began to miss delivery dates! Finally, all the faithful friend got anymore was promises, promises and more promises from that stupid bell.

If you're tired of the standard Pavlovian

kind of baloney you get from some of the giants, think about little Midtex/AEMCO. For a long time people like Collins Radio, Bruning and Xerox have been getting what they want, when they want it . . . on a silver platter. If

there is a relay or timer problem to solve, we

dive in head first and don't come up until we have an answer. We kinda feel that our customers like that attitude instead of some of the usual phoney baloney.

When you're a little company in Mankato, Minnesota, doing battle with the giants in the industry, you just have to think smarter, move quicker, and care a lot more.

We do. And we'd love to show you.

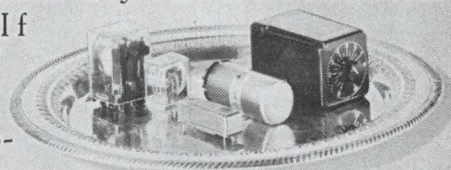

MIDTEX 
INCORPORATED

AEMCO DIVISION

10 STATE STREET

MANKATO, MINNESOTA 56001

PROGRAMMERS/TIME DELAY RELAYS/MINIATURE COAXIAL RELAYS/INDUSTRIAL RELAYS/MERCURY-WETTED CONTACT RELAYS

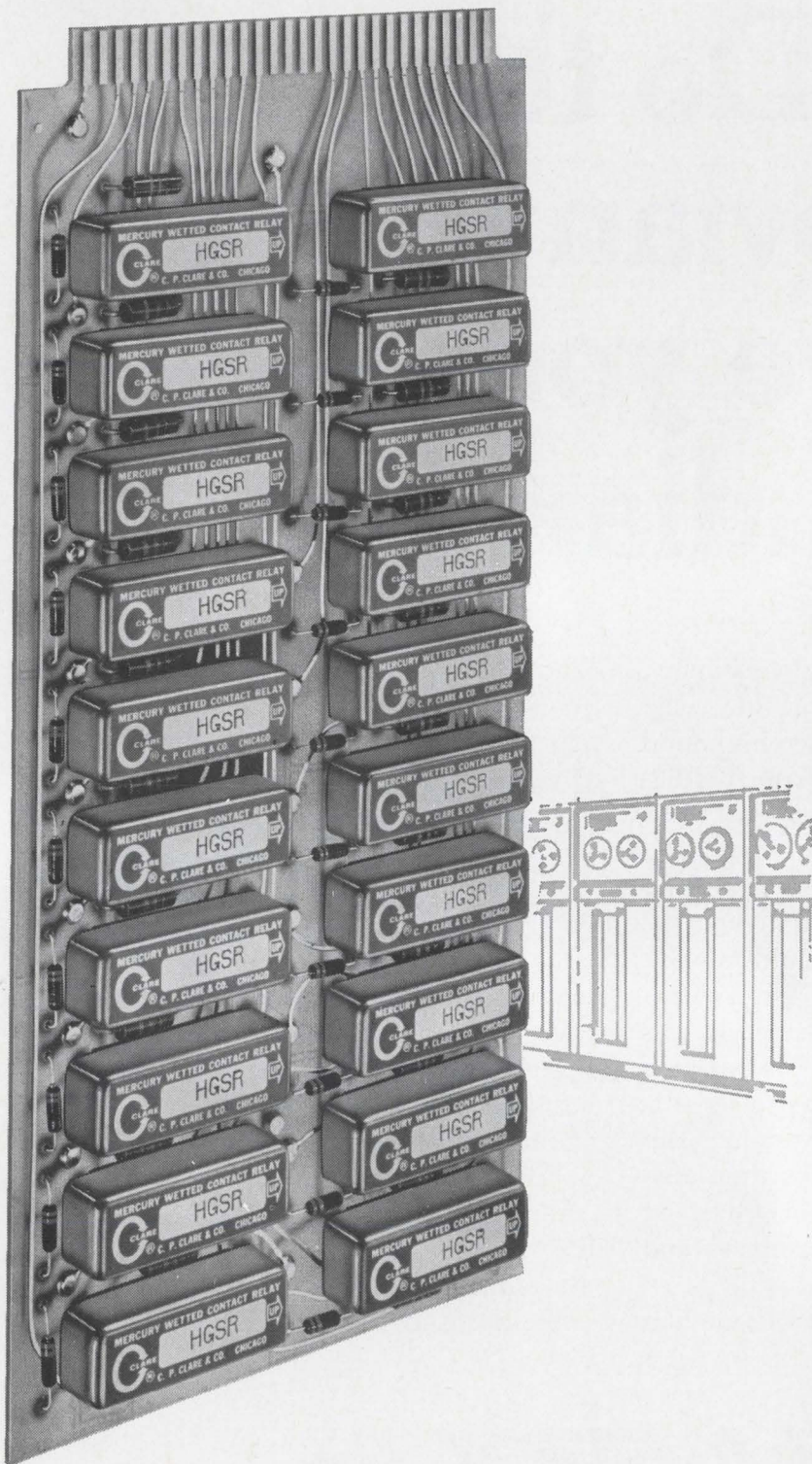

lowest profile— only .4" high,

the Clare HGSR (.33 cu. in. over-all) puts more switching capacity on a board than ever before possible with long life mercury-wetted contacts.

It's fast and tough—serves most process control operations . . . provides over 22 billion operations without fail or falsing. And like the widely recognized Clare HGM and half-size HGSM, it provides a combination of high speed and low contact noise generation . . . the elimination of contact bounce and chatter and resulting false signalling. Advanced circuits can be designed with power gain up to 5000 . . . sensitivities as low as 20 mw. For solid state buffering, you get built-in input/output isolation . . . for measurement circuitry, minimal contact resistance, constant over billions of operations.

For complete information, circle reader service number—ask Clare for Data Sheet 855C . . . Write Group 4N8.

C. P. Clare & Co., Chicago, Illinois 60645 . . . and worldwide.



a GENERAL INSTRUMENT company

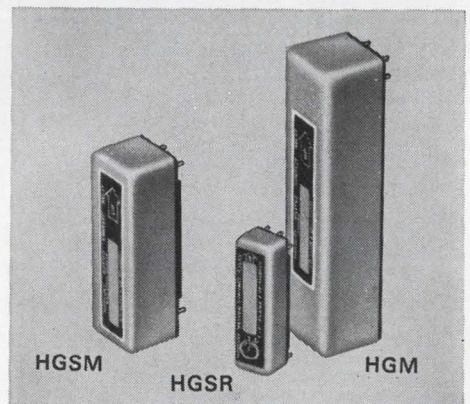

- Life: 22 x 10⁹ operations—with no maintenance
- Low, constant contact resistance—no mechanical wear or electrical erosion
- No contact bounce
- Switching speeds to 1 ms
- Versatile contact load capabilities—low level to 250 va
- High power gain—to 5000 with no noise sensitivity
- Sensitivities as low as 20 mw

CLARE MERCURY-WETTED CONTACT RELAYS

for input analog switching, output power conversion switching,
solid state input and output buffering

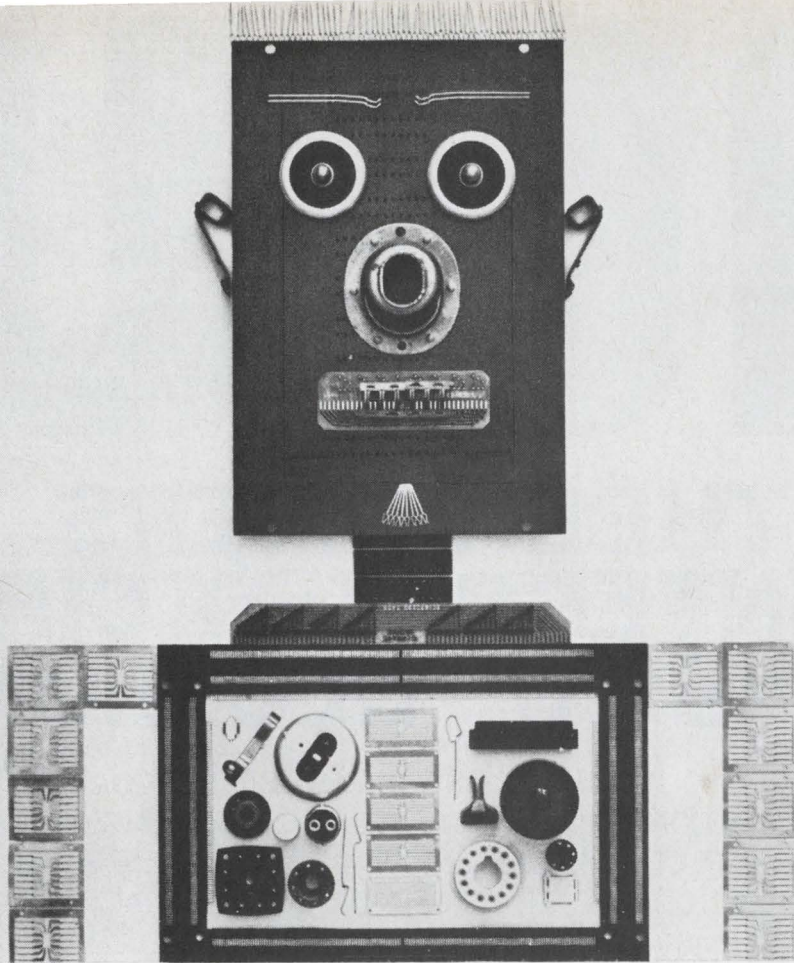

Sylvanians do as they're told.

Our living depends on it.

We turn out 50 million custom-fabricated parts a day. To exact specifications.

Including precision stamping of high-tolerance, miniature metal shapes.

Precision molding of intricate plastics parts.

Precision forming of wire for critical electronics.

Combining metals, plastics and wire into precision-built assemblies.

We live by our accuracy. After all, if we don't do what we're told, you

may not tell us anymore.

We've been doing it for over 17 years. On transistor leads, computer memory core frames, connectors, pen caps, aerosol spray tips, razor blade dispensers, integrated circuit frames. You name it.

We've got nine plants, the most advanced equipment, and the best engineers and die makers around to do it.

And we'll even help you design the part. Then we'll build the dies, produce the parts, and do the assembly. Exactly as we're told.

That means you get the parts you want, the way you want them, when you want them—probably at less cost than you could do it for yourself.

So the next time you need a custom fabricated part, call a Sylvanian and tell him what to do.

Sylvania Metals & Chemicals, Parts Division, Warren, Pa. 16365.

CUSTOM PARTS BY

SYLVANIA
A SUBSIDIARY OF
GENERAL TELEPHONE & ELECTRONICS

new

NIXIE® TUBE DRIVERS WITH INTEGRATED CIRCUITS MAKE "BUY" DECISIONS

- PRICED AS LOW AS \$26.00 INCLUDING THE NIXIE TUBE (100 QUANTITY) ■ SMALLEST, MOST CONVENIENT PACKAGES ■ COMPATIBLE WITH TTL, DTL, & RTL ■ DECODER/DRIVERS WITH OR WITHOUT MEMORY ■ COMPLETE ASSEMBLIES AVAILABLE OFF-THE-SHELF FROM BURROUGHS AND DISTRIBUTORS ■ 0.6" CHARACTER HEIGHT OR 0.3" CHARACTER HEIGHT NIXIE TUBES ■ MINIMAL NOISE PROBLEMS — DRIVERS ARE MOUNTED AS CLOSE TO TUBES AS POSSIBLE.

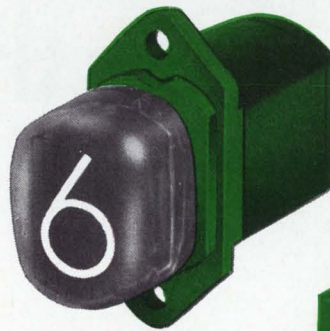

ACTUAL SIZE (even with memory).

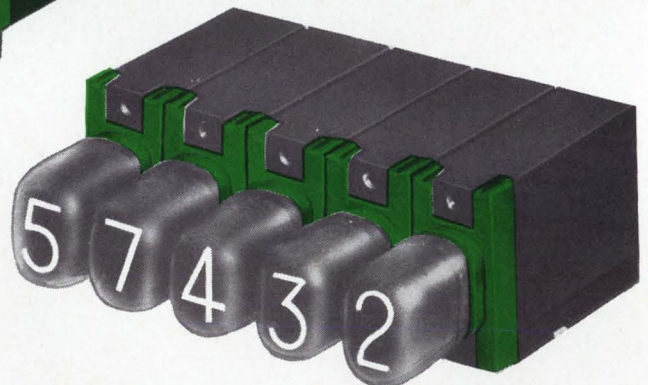

ACTUAL SIZE miniature drivers.*

SPECIFICATIONS OF IC NIXIE TUBE DRIVERS

Part Number	Tube Type	Character Height	Max. Overall Length (with tube)	Max. Height	Max. Width	Has Memory	Input Code	Price 100 quantity (includes NIXIE tube)
BIP-8806	Standard B-5991	0.6"	2.506"	1.583"	0.750"	Yes	4 line 8-4-2-1 BCD	30.00
BIP-8804	Standard B-5991	0.6"	2.506"	1.583"	0.750"	No	4 line 8-4-2-1 BCD	26.00
BIP-9801	Miniature B-4998	0.3"	2.648"*	0.960"	0.480"	No	4 line 8-4-2-1 BCD	42.00

*Note new shorter overall length.

For additional information contact, Burroughs Corporation
 P.O. Box 1226, Department D2, Plainfield, N.J.
 Circle 54 on reader service card

 **Burroughs Corporation**

Technical Articles

Complementary unijunctions excel
page 56

The vastly superior stability and frequency capabilities of the complementary unijunction transistor, compared with the conventional UJT, is attributed to the use of integrated-circuit techniques in its fabrication. Two transistor elements and two diffused resistors are fabricated at the same time in a monolithic block. The result is a device that's useful in precision tv sweep circuits, oscillators, and high-accuracy, low-cost clocks.

Thyristors are radiation tolerant
page 65

Engineers have been dubious about using thyristors and other four-layer semiconductor devices in radiation environments. Their rule of thumb was that radiation resistance decreases as the number of junctions increases. This rule has been disproved; thyristors perform better under radiation than bipolar transistors.

Earth-directed beam for Intelsat 3
page 71



Communications satellites must point their high-gain antennas directly toward the earth. As a result, the antenna itself has to be "despun" with respect to the spinning satellite. Surprisingly, a mechanical method has some important advantages over an all-electronic despinning technique. For Intelsat 3, scheduled for launch later this year, a mechanical unit is expected to provide a

higher gain over the solid angle subtended by the earth when the satellite is in synchronous orbit at an altitude of 22,238 miles. The antenna (cover) has a conical horn and flat reflector plate inclined at a 45° angle.

Comparing vtr scanning methods
page 80

When designing video tape recorders for the consumer market, engineers must decide whether they'll use the fixed-head or the rotating-head technique. A strong case is made, in this comparison of the two approaches, for the helical-scan rotating-head design because it offers better picture quality and easily covers the full bandwidth of 4.2 megahertz needed for color reproduction.

Coming April 15 ▪ Fast Fourier transforms
 ▪ Low-cost data link

Unlocking the gates for UJT's

IC-fabrication approach is key to better stability and higher cutoff frequencies of complementary unijunctions for oscillator, timer, thyristor-gating circuits

By Walter R. Spofford Jr.

General Electric Co., Syracuse, N.Y.

Take the traits of a discrete semiconductor, use integrated-circuit fabrication techniques to improve them and the result is still a discrete device—but one that has the advantages of an IC. This is what led to the complementary unijunction transistor, a threshold-switching device having 10 times the stability and twice the cutoff frequency capabilities of the standard UJT.

Unlike the standard device, whose 50-kilohertz frequency and $\pm 5\%$ stability limit its application, the complementary UJT is particularly attractive for television sweep circuits, oscillators, highly accurate but low-cost clocks and time delays, and synchronized thyristor phase-control banks. It does the same job as the standard type—only better.

Fabricated with the same planar techniques used for monolithic IC's, the complementary UJT can best be described as an integrated device. It contains two active transistor elements and two diffused resistors that are simultaneously fabricated in a monolithic-type structure. This results in the device having temperature-tracking and resistance-ratio characteristics equal to those of a monolithic IC, and superior to those of the standard UJT. Also, device behavior is more predictable, and parameter values from unit to unit are more uniform. And, the operating levels of the complementary unijunction transistor are compatible with those of standard integrated circuits, easing the design interface problem.

The author



Walter R. Spofford Jr., an applications engineer at GE's semiconductor products department, is completing studies toward a master's degree at Syracuse University. A specialist in timing and control, Spofford was previously employed at Crouse-Himes as a design engineer.

Alike, yet different

Like the standard device, the complementary UJT is a natural relaxation oscillator. But the complementary unit is a p-type device whose emitter voltage-current (V-I) characteristic is the inversion of the standard n-type UJT's. Moreover, the complementary device's charging circuit and two base resistors are reversed; it uses the opposite polarity bias supply and its output is negative-going instead of positive-going. And the switching actions of the two devices differ.

Switching in the UJT is based on bulk conductivity modulation. But in the complementary device, the switching action is similar to that of the pnp silicon controlled switch.

In the complementary device's equivalent circuit, a positive feedback npn-pnp complementary pair is shunted by a resistor divider, which is the functional equivalent of the standard UJT's interbase resistors. The threshold voltage is the product of the standoff ratio, η , and the base-to-base, or interbase, bias supply, V_{BB} . When the emitter voltage is negative relative to the threshold, the device switches into full conduction. Regenerative action is provided by the npn-pnp pair, and the circuit exhibits a V-I characteristic having a negative-resistance region—the basis of oscillatory behavior.

The complementary UJT is fabricated on an n-type substrate to avoid the channeling effects associated with p-type substrates [see "Avoiding the leakage problem," p. 59]. Although IC devices on n-type substrates typically exhibit higher peak-point currents than those on p-type substrates—because of low gain in the lateral pnp elements—the complementary device, with its high npn gain, produces the same peak-point currents as standard UJT's.

In the complementary UJT circuit, a capacitor charges from a positive voltage towards ground instead of from zero to a positive peak point. However, since the designer is often primarily interested

in the output pulse at the end of each oscillation period, he cares little whether the intermediate sawtooth waveform used to generate these pulses is positive or negative.

Compared with standard UJT's, complementary devices exhibit less parameter variation. For example, variations in the intrinsic standoff ratio are kept within $\pm 3\%$ in the General Electric Co.'s complementary D5K1 device. This is far better than the $\pm 15\%$ figure of standard 2N494C and 2N2647 UJT's. Moreover, the D5K1's base-to-base resistance variation is only 1.25:1, against the standard devices' 2:1.

In a given production lot of complementary UJT's, standoff ratios typically fall within $\pm 1\%$ of the median, base-to-base resistances fall within a few hundred ohms of the 7-kilohm median, and voltage and current parameters are consistently close from device to device.

The complementary device, however, has one disadvantage. Where standard UJT's have typical breakdown voltages of 30 volts, the complementary

device's emitter breakdown is in the neighborhood of 8 or 9 volts. The difference: the standard device has an alloy junction and the complementary unit an npn element base-emitter junction.

But with an external diode in series with its emitter, the complementary device is capable of handling base-to-base bias levels of 30 volts. The diode, a type exhibiting low leakage—about 50 picoamps—is only needed for supply levels in excess of 15 volts.

Stabilizing performance

Parameter variation with temperature change is exceptionally small in complementary devices, about a third that of UJT's. For example, temperature coefficients of a typical complementary unit are base-to-base resistance $\pm 0.25\%/^{\circ}\text{C}$, valley voltage -1.6 millivolts/ $^{\circ}\text{C}$, and internal diode drop $-1.8\text{mv}/^{\circ}\text{C}$. Corresponding coefficients of a standard UJT are $\pm 0.8\%$, -3mv , and -2.5mv .

In fact, the valley voltage, V_v , temperature characteristic of standard UJT's is inconsistent and users

Conventional unijunction transistor . . .

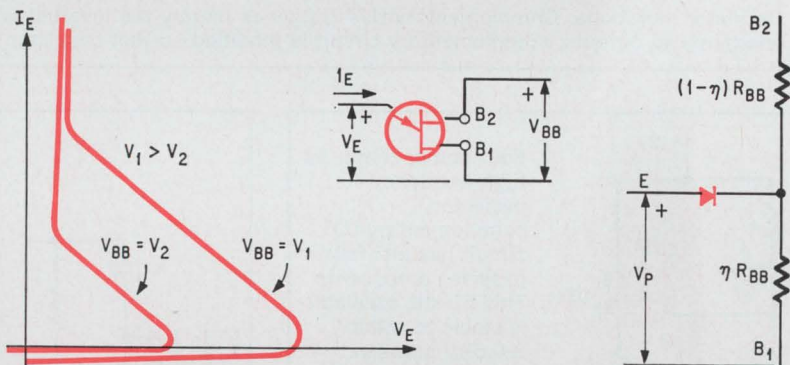
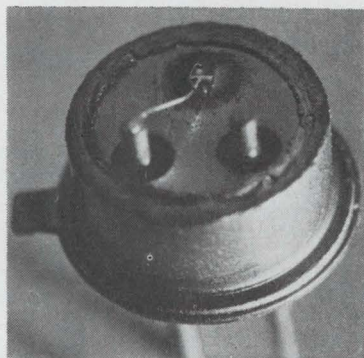

. . . vs. complementary UJT

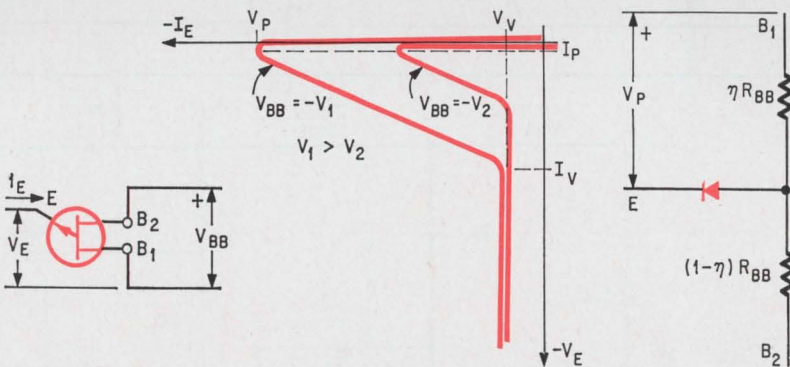
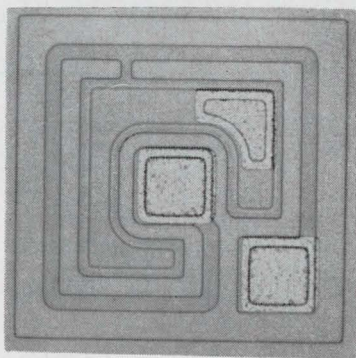

Match up. Comparison of standard UJT, above, and complementary UJT points up their inverse matching. And a contrast of chip construction shows the integrated device's greater element uniformity. Unlike the standard double-base device, where emitter current is supplied to the transistor, the complementary unit switches to a negative-resistance state when current is drawn from its emitter. Switching modes are indicated in plots of emitter voltage, V_E , vs. emitter current, I_E . V_{BB} is bias voltage, V_v is valley-point voltage and V_p is peak-point voltage that establish the breakpoint. Equivalent circuits at right exhibit unijunction threshold action. When the diode conducts, pulse outputs are established by the interbase resistors, ηR_{BB} and $(1-\eta)R_{BB}$, which form the voltage divider.

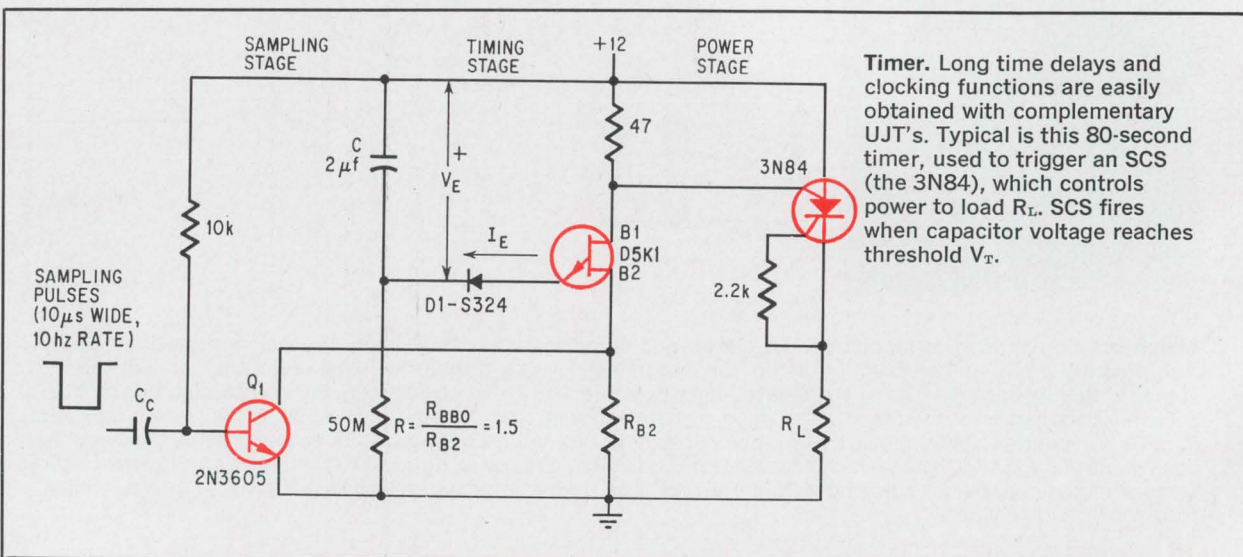
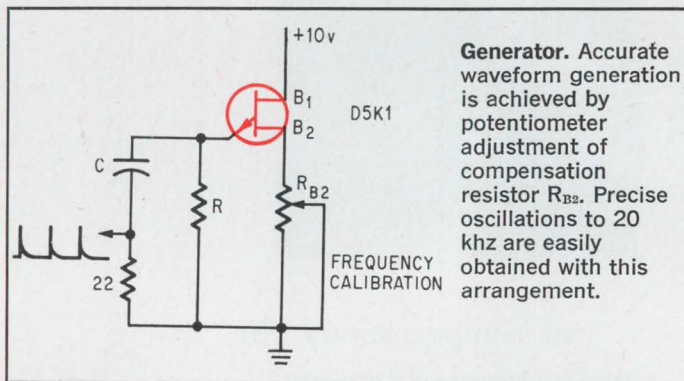
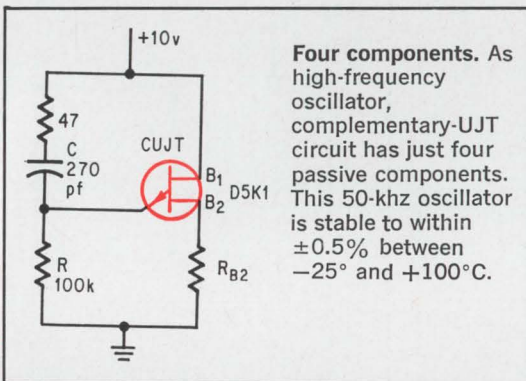
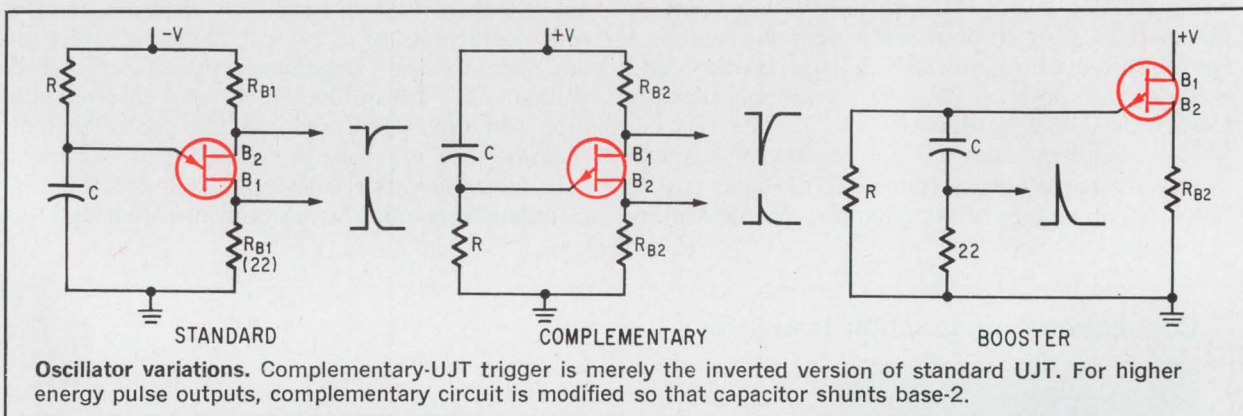
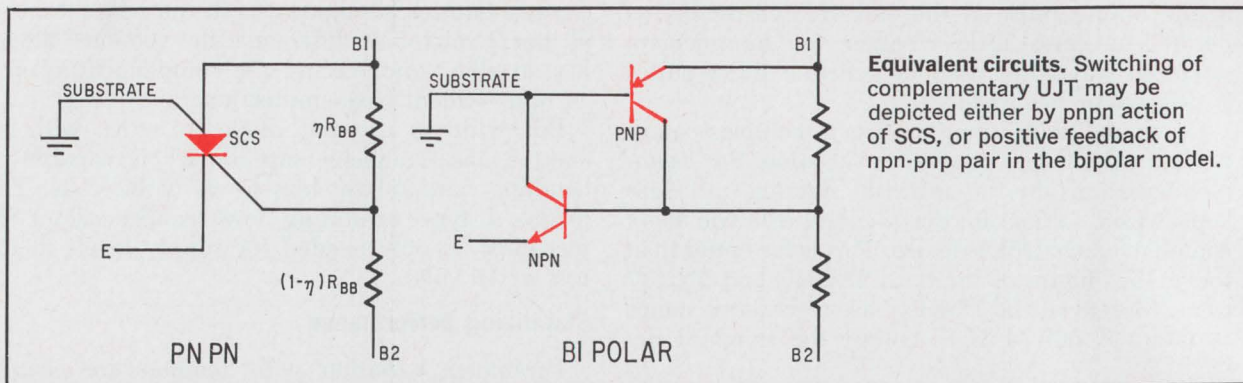

UJT parameter comparisons

Parameter	Bar 2N494C		Cube 2N2647		Complementary D5K1	
	Min	Max	Min	Max	Min	Max
Intrinsic standoff ratio, η	.62	.75	.68	.82	.58	.62
Peak-point current, I_p (μa)	2	2	5
Interbase resistance, R_{BB0} (K Ω)	6.2	9.1	4.7	9.1	5.5	8.2
Leakage current, I_{EBO} (nA)	20	200	10
Breakdown voltage, V_{EBO} (volts)	60	30	8
Emitter saturation, $V_{E(SAT)}$ (volts)	4.6	2	1.5
Oscillator stability, -55°C to $+150^\circ\text{C}$	5-8%		10%		1% or better	

are forced to determine the variation experimentally. With the complementary device, the V_v temperature behavior is predictable, and can be expressed by the empirical equation $V_v = 0.7 - (0.0016)T + (0.018)V$, where T is ambient temperature and V the interbase bias supply voltage.

In timers, oscillators, and trigger networks, the complementary device's operation follows the common logarithmic relationship. With a general relaxation circuit model containing the device, an RC charging path, and the bias supply, the circuit period, τ , is expressed as $\tau = RC \ln (V - V_v / V - V_p)$, where V_p is the peak-point voltage. Temperature variation effects on τ can be made small because of built-in offsets.

Although the base-to-base resistance, R_{BB} , has a positive temperature coefficient, it is insufficient to offset V_p 's stronger negative coefficient. This would cause τ to vary if not for an added fixed resistor in series with base-2, which together with R_{BB} , nullifies V_p 's effects. Because of the IC-fabrication the ensuing close tracking reduces drift.

Easy compensation

Determining the value of the fixed resistor, R_{B2} , is easier with the complementary than with the standard UJT. With the relationship $R_{B2} = 0.7R_{BB0}/\eta V$ —where R_{BB0} is the room-temperature value of interbase resistance—compensation in the standard UJT is difficult; large variations in η and R_{BB0} from device to device make for different R_{B2} values for each UJT.

With the complementary UJT, specification sheets indicate proper R_{B2} values. These are in the form of selection curves, and suffice for most applications. When optimum R_{B2} values are sought, additional curves, based upon the ratio of R_{BB0} to R_{B2} , are used. With a compensated complementary UJT, device stability is maintained at $\pm 0.5\%$ or better in all oscillator applications below 30 khz.

At frequencies above 30 khz, however, the device's turnoff time becomes a limiting factor, and the thermal stability degrades to about $\pm 1\%$ at the 100-khz extreme. Turnoff time, a temperature-dependent quantity, is a function of the stored charge in the pnp element and varies from device to device. Since turnoff time may reach 3 microseconds, it becomes appreciable in the higher-frequency circuits. Also, overshoots in the emitter dis-

charge loop introduce additional errors.

Therefore, a resistor is added to minimize the effect of these variations. Placed between base-1 and the bias supply, the resistor acts as a current limiter for the capacitor discharge, and also swamps the turnoff time effects. A 20-ohm resistor does the job for most complementary UJT applications.

Energy boost

Because the complementary device provides high pulse outputs, it is a likely candidate for high-energy thyristor triggering applications. For such applications, a designer can choose from a standard UJT network, a complementary device circuit, or a flipped version of the complementary unit. Each of these circuits contains an RC charging network that establishes the basic timing action. Except for the interchanged RC components, the standard and complementary UJT's are identical. The flipped circuit, however, contains a shunt RC timing network between the emitter and base-2 [see page 58].

Unlike the standard UJT, in which a high-energy positive pulse is obtained at base-1, the complementary device has a high-energy negative pulse available at base-1 and a low-energy positive pulse at base-2.

But in the flipped arrangement, the capacitor—returned through a small resistor to the ground

Avoiding the leakage problem

Channeling, particularly troublesome with p-type silicon substrates, is a prime cause of excessive current leakage.

Silicon dioxide, which covers the surface of planar pellets, has a positive charge at the SiO_2 -Si interface. Since the p-type silicon has a predominance of holes—positive charges—throughout, the SiO_2 's plus charge tends to repel the holes near the semiconductor surface and draw electrons up to it. The result: an n-type inversion layer at the surface of the p-type substrate.

This inversion layer becomes a conduction path between two otherwise isolated diffused n regions and shorts them out, leading to high leakage currents across junctions. Since low leakage is essential for timing functions, designers of UJT's avoid the problem by using n-type substrates.

Compensating for temperature variation

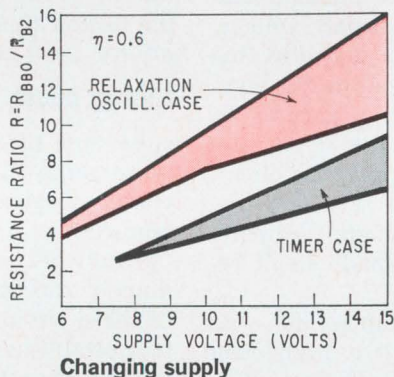
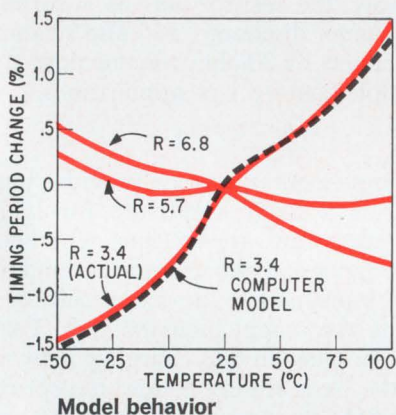
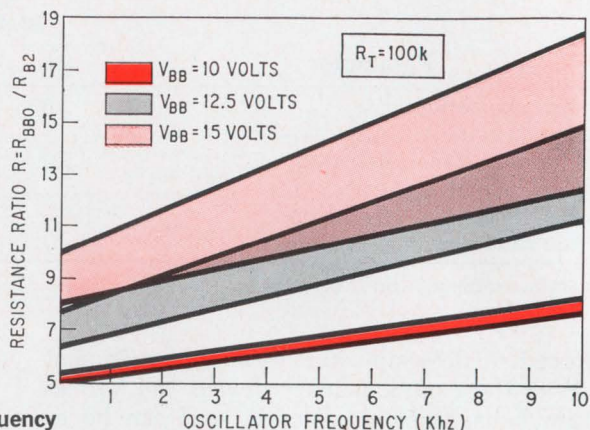
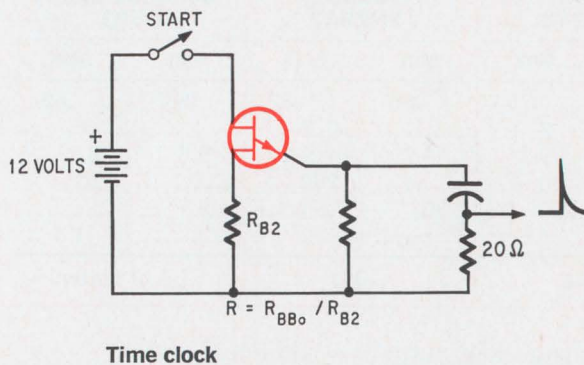

Precision. Temperature variations in timer circuit are minimized by compensating resistor R_{B2} . Ratio of interbase resistance, R_{BB0} , to R_{B2} , plotted as a function of temperature indicates required value of R_{B2} . Curves for three typical values of R ratio are displayed; dashed curve, representing computer model for $R=3.4$, closely matches actual characteristic. Curves of resistance ratio as a function of oscillator frequency, and as a function of supply voltage, show R values needed to maintain $\pm 0.5\%$ stability.

side of the supply voltage—rapidly charges up to a positive voltage when the unijunction fires, and the device develops a sharp, high-energy, positive pulse at the output terminal. The capacitor discharges during the cycle's timing portion.

Fewer losses

Both the complementary device and its flipped version are much less lossy than standard UJT's, and they develop high-energy trigger pulses at much lower supply voltages. The D5K1, for example, develops 4.5 volts across 20 ohms when C is 0.2 microfarad and the supply voltage is 12 volts. For the same values, a standard UJT would develop only about 2.5 volts.

As a high-frequency oscillator, a 50-kHz complementary device maintains a $\pm 1\%$ thermal stability across the temperature range -25° and $+100^{\circ}C$.

In selecting R_{B2} , designers may use a potentiometer to obtain a precisely calibrated, temperature-compensated oscillator. By choosing an RC combination having close tolerance, the designer need merely adjust the R_{B2} potentiometer for the desired frequency (or period in the case of a timer). In effect, this means he can easily and automatically select the right compensation resistor value, because the R_{BB0}/R_{B2} ratio fixes V_p , which in turn is reflected by the fixed frequency. With standard UJT's, determining the proper compensa-

tion resistors for precise timers and oscillators has been a tedious task.

With a three-stage circuit consisting of a bipolar-transistor sampling switch, a complementary UJT timer, and a silicon controlled switch output stage, an extremely stable, long-interval timer—such as the one shown on page 58—is easily achieved.

With a bipolar transistor shorting out the compensation resistor, R_{B2} , 10-hertz sampling pulses are applied to the bipolar's base. This turns off the bipolar transistor for 10-microsecond intervals, during which time voltage at base-2 goes from zero to a positive level determined by the $R_{B2} = R_{BB}$ divider. Thus, V_p varies from ηV to V_T . When the capacitor has reached the peak-point voltage, the complementary UJT fires on the next sampling pulse. This, in turn, applies a negative pulse to the scs anode gate, thereby applying power to load R_L .

When the capacitor voltage is just below the V_p value, the sampling pulse causes the capacitor to discharge at a rate of 50 microvolts per pulse. Between sampling pulses, the capacitor gains approximately 5 millivolts because of the timing resistor circuit. Drawing 50 μV from a 2 μF capacitor is equivalent to 100 picocoulombs of charge. Since the complementary device requires only about 50 picocoulombs to cause regeneration, reliable firing is assured.

Designer's casebook

Designer's casebook is a regular feature in Electronics. Readers are invited to submit novel circuit ideas, packaging schemes, or other unusual solutions to design problems. Descriptions should be short. We'll pay \$50 for each item published.

Measuring impedance with insertion loss

By K.G. Byers Jr. and H.W. Denny
Georgia Institute of Technology, Atlanta

Complex impedances can be determined rapidly and accurately with a sweep-frequency technique based on insertion-loss measurements. This approach is ideal for applications such as measuring ground and bond impedances and, hence, the effectiveness of the electromagnetic isolation of electronic equipment.

Conventional impedance-measuring methods are inadequate because some only provide data at discrete frequencies; others must be balanced at each test frequency, are restricted to measuring impedances above 1 ohm, or are limited to operating at relatively low frequencies. In addition to overcoming these limitations, the insertion-loss technique is insensitive to minute variations from the connection impedance between the unknown and the measurement system.

The sweep-frequency technique visually displays impedances ranging from 30 milliohms to 1,000 ohms over frequencies from d-c to approximately

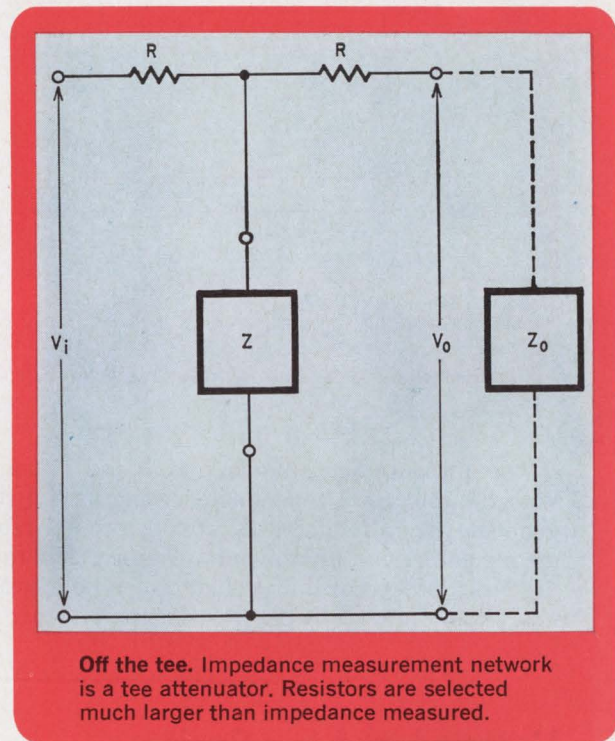

Off the tee. Impedance measurement network is a tee attenuator. Resistors are selected much larger than impedance measured.

400 megahertz. With the exception of a measurement network, all equipment needed to implement the test circuit is commercially available and can be assembled in the field as well as a laboratory.

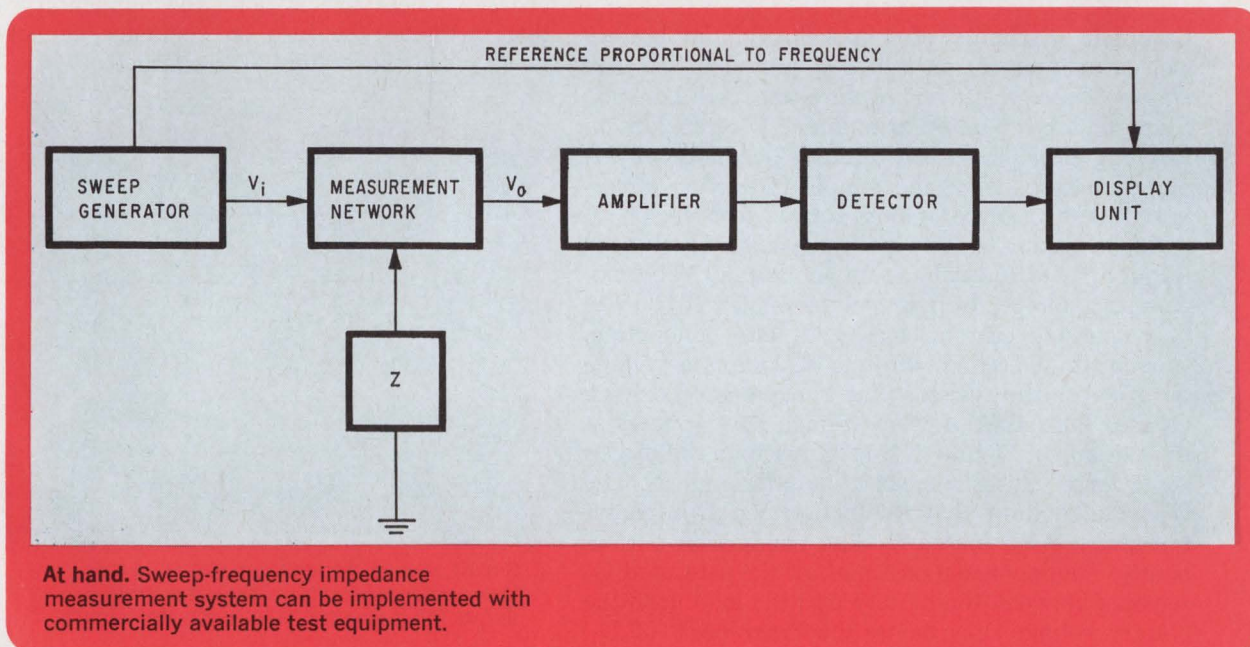

At hand. Sweep-frequency impedance measurement system can be implemented with commercially available test equipment.

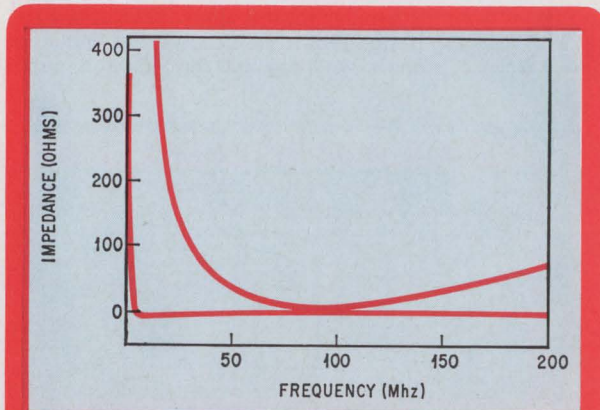

Showing up unknowns. The capacitor with its inductive leads resonates at about 90 Mhz. The inductive slope is due to the leads.

The measurement network is a tee attenuator with the unknown impedance serving as the shunt element. An attenuator is connected between a source and a load of known impedance. The resulting insertion loss of the attenuator can be measured and simply related to the unknown impedance.

This technique works if the unknown shunt impedance Z is small compared to the series resistors R . Under this condition, the insertion loss of the network is directly proportional to the magnitude Z . Thus,

$$\left| Z \right| = \frac{R(R + Z_o)}{Z_o} \left| \frac{V_o}{V_i} \right|, \quad Z \ll R$$

where Z_o is the load impedance (a display device) and V_o and V_i are the output and input voltages, respectively.

The upper limit of the impedance that can be measured is determined by the value of R ; the lower limit by the amount of insertion loss that can be measured accurately—a low value of Z corresponds to a high insertion loss.

Typical display units that may be used for the measurement system are an oscilloscope or X-Y recorder. The system is calibrated either by measuring the impedance of resistors of known values, or by replacing the measurement network with a precision attenuator and relating the magnitude of impedance to insertion loss with the equation.

Voltage sensor limits discharge in batteries

By D.L. Haskard

Royal Adelaide Hospital, Adelaide, Australia

Complete discharge of a nickel-cadmium battery causes an increase in cell gas pressure that can shorten battery life or rupture the cell housing. Since battery-operated equipment is often left on for long periods, either through necessity or accident, a responsive and simple protection circuit is required to guard against total discharge.

At the closing of the switch, capacitor C_1 charges through R_1 to the voltage on the battery. The momentary voltage drop in potentiometer R_1 due to C_1 's charging current, biases Q_1 into conduction. Current drawn by Q_1 through R_2 causes a voltage drop across the resistor that is capable of driving Q_2 into saturation. Battery voltage now appears at the cathode of D_1 and, if it is higher than the diodes zener level, causes current to flow through R_1 . The d-c voltage drop that exists between R_1 's center tap and ground biases Q_1 into conduction permanently. The low-resistance path of the saturated Q_2 remains between the battery and the load until the battery voltage falls below the zener point of D_1 .

When the battery voltage drops below that level, current flow through R_1 stops. This causes an instantaneous removal of Q_1 's bias, which ultimately turns off Q_2 and opens the line between the battery and the load.

It is necessary to open the switch after the circuit has been turned off so that capacitor C_1 can discharge. Unless this is done the momentary surge that instigates the turn on sequence cannot take place when the battery is recharged.

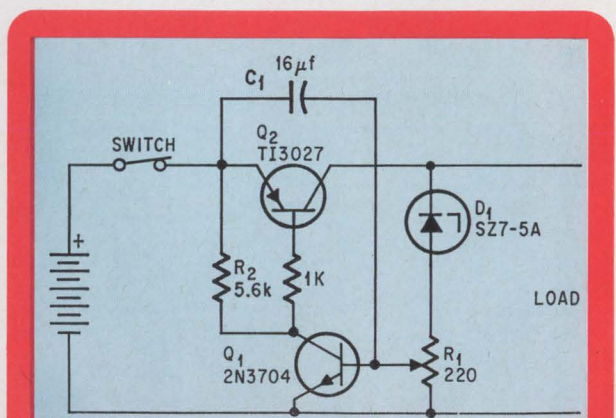

Circuit breaker. Series-transistor Q_2 is a low-resistance path for high battery voltage. Before full discharge, feedback opens circuit.

A pulse every millisecond is Rx for hysteresis ills

By D.A. Juett

Addenbrooke's Hospital, Cambridge, England

Feedback voltage sharpens the sensitivity of a precise voltage-level detector, but it is also the cause of hysteresis—the detector turning on at one voltage and off at another. Called backlash in Britain, hysteresis can be minimized by adding a pulse generator to the detector circuit.

Unlike the conventional circuit in which the input level is continuously compared with the reference level, the modified circuit's reference voltage is biased out. The pulser regularly returns the reference voltage to a differential amplifier, which senses changes in the input level.

The reference voltage, ranging between 0.05 and 5 volts, is established by adjusting the variable contact on potentiometer R_4 . The reference voltage's

presence at the base of Q_2 when there is no input voltage biases that transistor into conduction. Current through R_2 causes a voltage drop between the base and emitter of Q_3 , driving the transistor into saturation. A voltage equal to the difference between Q_3 's emitter supply and saturation voltages appears at the transistor's collector. The low input impedance of the Q_4 - Q_5 buffer stage enables the collector voltage to drive such high current devices as meters and relays.

When the input voltage becomes greater than the reference voltage, Q_1 turns on. Since Q_2 's emitter is at the same voltage as its base, the transistor turns off. Consequently, current flow through R_2 stops and Q_3 turns off.

Every millisecond a pulse from the unijunction transistor forward biases the voltage at the base of Q_3 . Collector current flow through Q_3 raises the voltage on R_4 's variable contact from 0 to the previously established reference voltage. Unless the input voltage is lower, Q_2 will not turn on and feed back through Q_3 .

During pulsing, the waveform at the common-emitter point is a train of pulses that, when filtered by R_3 and C_1 , produces a d-c voltage much lower than the 5.5 volts generated at a low input.

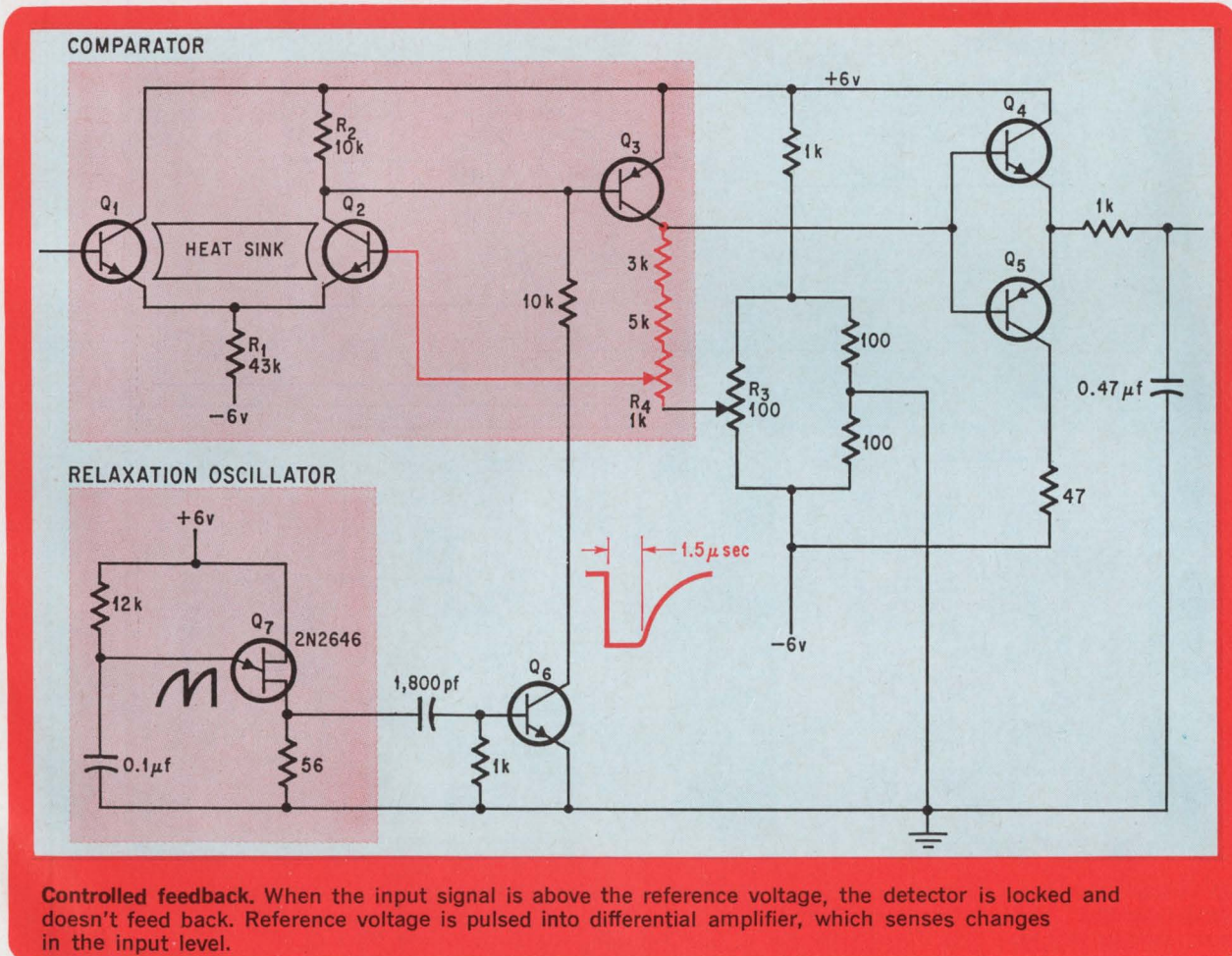

RC-biased Schmitt trigger times pulses accurately

By P.F. Howden

University of Sydney, Australia

Time intervals between the pulses that fire gas discharge lasers in ionization experiments must be accurate to within 1%. Blocking oscillators, multivibrators, and phantastrons are affected by temperature and voltage and won't do for basic plasma research. But the stable and linear charging of a capacitor through a resistor can be combined with the sharp turn-on of a Schmitt trigger to provide an accurate delay.

A pulse greater than 2 volts make zener diode D_1 conduct, driving transistor Q_1 into saturation.

This moves the base voltage of Q_2 to ground and causes this transistor to conduct. The collector-to-emitter path of the forward-biased carries the charge for capacitor C_3 and the discharge from C_1 . The almost immediate discharge of capacitor C_1 through the primary of T_1 generates a pulse on the secondary that establishes the circuit time, t_0 .

While C_3 is charging through R_5 toward the supply voltage, transistor Q_4 is held in conduction by the potential drop across R_3 . After a time determined by the adjusted values of C_3 and R_5 , the voltage on C_3 reaches a value that biases Q_3 on.

An increase in collector current raises the voltage drop across R_1 , making the collector of Q_3 more negative. This voltage change causes a discharge in C_4 , which biases Q_5 into conduction. Conduction in Q_5 then turns Q_6 on, thereby providing a discharge path for C_5 . This C_5 discharge induces the delayed pulse in T_2 's secondary. When C_5 is completely discharged Q_5 and Q_6 turn off.

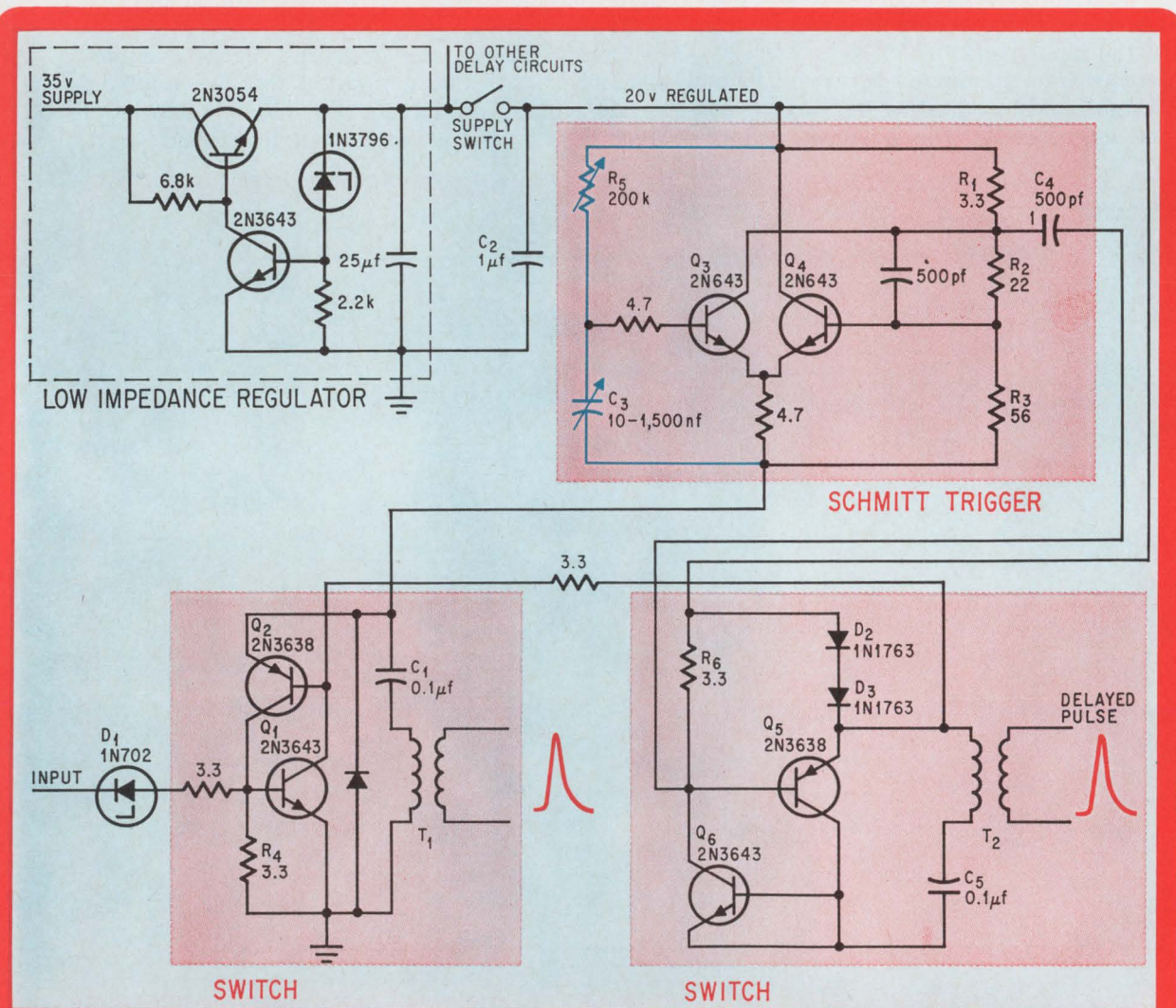

Delayed switch. Input pulse causes immediate conduction in transistors Q_1 and Q_2 , but has no effect on Q_5 and Q_6 until C_3 charges to a voltage that triggers Q_3 . The timer is reset when the switch is opened, stopping current flow through Q_2 and R_1 and removing the forward bias from Q_1 .

Here's a good switch: radiation-resistant thyristors

Comparison of performance data shows that thyristors and other four-layer devices are less vulnerable to permanent damage than bipolar transistors

By Jacob J. Aghassi, Arie Najman and Edward Simon

Solid State Products Co., Salem, Mass.

A false assumption has kept many engineers from using thyristors and other four-layer devices in a radiation environment. They believed that a device's tolerance to radiation decreased as the number of junctions increased. Now, experiments demonstrate conclusively that thyristors perform better under radiation than bipolar transistors.

Both were subjected to radiation and the comparison of measured data showed the superiority of the thyristor. The data also gives an engineer some design guidelines for holding transient effects to a minimum and increasing the device's resistance to permanent damage.

Radiation can cause temporary undesired effects in a semiconductor or it can inflict permanent damage. Transient effects are caused by short bursts of radiation that ionize the material, creating carrier pairs that change the device's characteristics. Because this is a reversible process, similar to that which photons might produce, the device will recover after the transient-generated carriers recombine. This recovery time depends on the width and intensity of the radiation pulse and either the minority carrier lifetime or the device transit time, whichever is shorter.

A device suffers permanent damage when one of its characteristics is irreversibly altered.

Think small

The ionizing effect of radiation increases carrier density at the semiconductor junctions. These excess carriers diffuse to and are collected by the nearby junctions and contribute to the normal junction current. The carrier density is proportional to several factors and can be expressed as

$$\Delta n = \Delta p = \frac{CF\tau}{q}$$

where q = charge of an electron

τ = minority carrier lifetime

Δn = excess electron density

Δp = excess hole density

F = radiation flux density

C = conversion factor that depends on the type and energy distribution of the radiation.

Reducing the effective collecting volume is the biggest consideration in reducing transient effects. That is accomplished by keeping the collecting-junction area as small as possible, the junction separations as narrow as possible and the carrier lifetimes as short as possible. The final precaution will minimize diffusion lengths.

The effective volume can be obtained by multiplying the junction area, A , and the sum of two lengths, L_1 and L_2 . L_1 is the diffusion length or the junction separation, whichever is shortest, on one side of the collecting junction, L_2 the shortest on the other.

The transient diffusion current, I_J , caused by the excess carriers is directly related to the effective collecting volume. The current reaching a junction if all the other junctions were shorted is given by

$$I_J = CFA(L_1 + L_2)$$

The total device current, I_A , depends on the inter-junction current transfer ratios and consists of the ionization-induced junction currents and normal junction currents. For a four-layer device, such as a thyristor biased in the forward direction, the current distribution is shown on page 66. The thy-

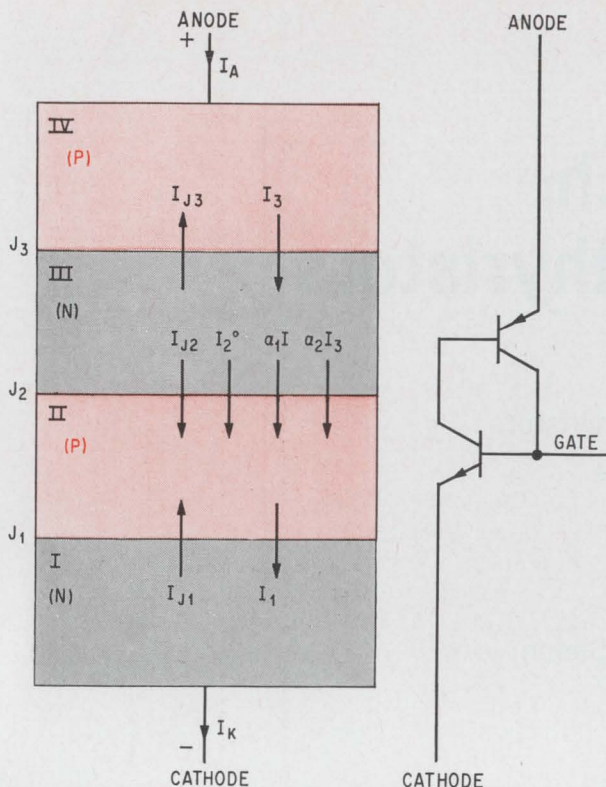

Current trends. Normal and radiation-induced junction currents for a forward-biased thyristor; p-type regions are tinted red, n-type are grey. A two-transistor—pnp and npn—equivalent circuit of a thyristor is at the right.

thyristor's anode current is approximately

$$I_A = \frac{\alpha_1(I_G + I_{J1}) + I_{J2} + I_2^0 + \alpha_2 I_{J3}}{1 - \alpha_1 - \alpha_2}$$

where α_1 = current transfer ratio of the npn transistor; region I is the emitter, II the base, and III the collector.

α_2 = current transfer ratio of the pnp transistor; region IV is the emitter, III the base, and II the collector.

I_{J1}, I_{J2} = ionization-induced junction currents of junctions 1, 2 and 3.

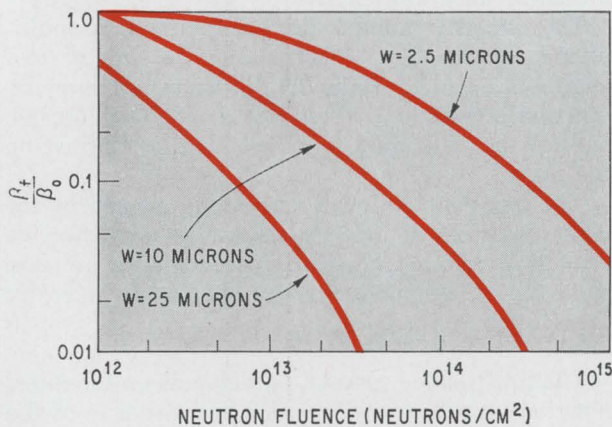

Keep it narrow. The ratio of a transistor's gain after exposure to radiation, β_r , to the gain before irradiation, β_0 , is plotted for three base widths as a function of neutron fluence.

I_G = gate signal current

I_2^0 = leakage current of reversed bias junction 2.

I_1, I_3 = currents across junctions 1 and 3 due to forward bias.

When the sum of the small-signal current-transfer ratios is unity, I_A reaches the anode-trigger level, I_{AT} and the thyristor switches on. However, for short radiation bursts, the anode-firing current is higher because of the time delay that results from regenerative action of the thyristor. This current is approximately

$$I_{AT(PULSE)} = I_{AT(DC)} \left[1 - \exp\left(-\frac{t_b}{t_r}\right) \right]^{-1}$$

where $I_{AT(PULSE)}$ = anode-trigger current required to switch on the thyristor for the pulse condition

$I_{AT(DC)}$ = normal anode-trigger current

t_b = time duration of the burst

t_r = approximate device turn-on time (delay plus rise time) for the condition of $I_{AT(DC)}$

High-energy neutrons can permanently damage semiconductors by displacing atoms from their regular lattice positions. This produces vacancies and interstitials. Interstitials are atoms displaced outside their regular lattice position. They introduce energy levels between the valence and conduction band that act as carrier recombination or trap centers. Recombination centers reduce the minority-carrier lifetimes and trap centers reduce majority carrier concentration.

The extent of the change in carrier lifetime depends on the type and energy distribution, total radiation dosage and the carrier lifetime before irradiation. The carrier lifetime, τ , is related to the total recombination center density by¹

$$\tau = \frac{K}{N_0 + \Delta N}$$

where K = constant—function of semiconductor material and the nature of the radiation

N_0 = density of recombination centers prior to irradiation

ΔN = added recombination center density due to irradiation

Designing becomes a tradeoff

In addition to juggling base widths, junction areas, and minority-carrier lifetimes, the designer must also consider conductivity effects.

Minority-carrier lifetimes of thyristors or bipolar devices can be shortened by introducing a sufficient density of recombination centers during processing—either by gold diffusion or high-energy-particle bombardments. Thus, by increasing the initial density, the effects produced by additional recombination under radiation will be masked until that density approaches the pre-irradiation level. When the recombination center density is increased, a

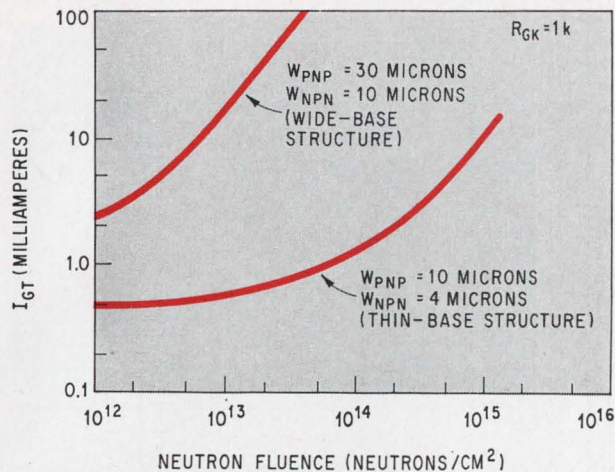

Turning it on. The amount of gate-trigger current required to turn on a thyristor depends on base width and the amount of neutron fluence it receives.

larger amount of gate current is needed to turn on the thyristor—the circuit must be designed to supply this extra current.

For maximum gain and frequency response—which also depend on the transport of minority carriers from the injecting to the collecting junction—the base width as well as the ratio of the base width, W , to diffusion length, L , must be kept small.

The diffusion length is a function of the diffusion constant, D , and the minority-carrier lifetime. It can be expressed as

$$L = \sqrt{D\tau}$$

Reducing the lifetime also decreases the diffusion length. Consequently since L is small, to keep the W/L ratio low, the base width must be very narrow; this creates additional problems.

To increase the gain requires extremely narrow base widths; but the narrower the base, the greater the possibility of punch-through and the smaller the device's blocking voltage capability. The compromise will depend on the ultimate use of the device.

Thyristors versus transistors

Most design guidelines used to manufacture radiation-tolerant devices are the same as those for high-frequency semiconductors. Until recently, these guidelines were applied only to transistor and diode structures, but when they were applied to thyristors the resulting devices showed approximately an order of magnitude improvement in radiation tolerance over a similar structured bipolar.²

When using bipolars, the minimum switching gain is important because the bipolar's gain degrades rapidly when the device is irradiated. If the small-signal current gain of a bipolar is less than 10, it loses its value as a switch. But a thyristor remains operative as a latch as long as the product of the forward current gain of the npn and pnp regions, at the required current, is greater than unity. This can be achieved even if the gain of the one region is less than unity. For example, if β of the

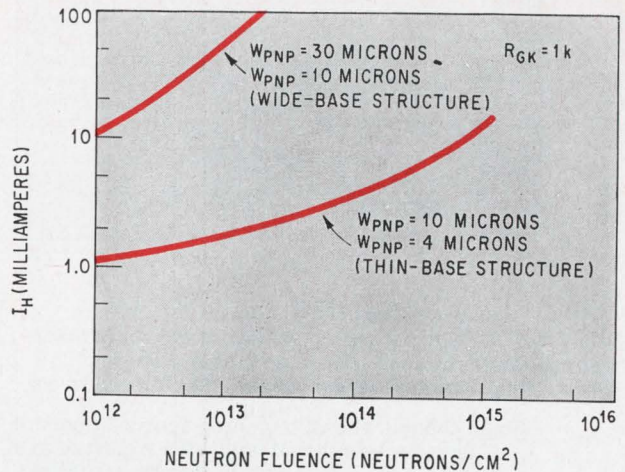

Holding out. Neutron fluence increases the anode-holding current of all thyristors; less for those with small base widths.

pnp region is 0.5, simply making β of the npn region greater than 2 will produce the required gain.

Another factor that must be considered is the voltage breakdown, which is directly proportional to the base width. However, gain is inversely proportional to the base width.

Because the thyristor's pnp section takes most of the voltage, its base width can be increased to achieve a large voltage breakdown capability at the expense of gain. In compensation, the base width of the npn section—where breakdown voltage presents no problem—can be narrowed to increase the over-all thyristor gain. But even if the npn sector gain is increased, it still is much less than the gain required to efficiently switch a discrete bipolar. And since the lower the initial gain before radiation results in less gain reduction after radiation, the lower-gain thyristor is much less sensitive to radiation effects.

The thyristor is also able to handle higher current densities than a bipolar. The thyristor's current is evenly distributed across the cathode-junction area, but because of a transverse field in the base region of the bipolar its current is crowded along the emitter periphery. Unlike the thyristor, which requires only a short gate pulse to latch on, the bipolar requires continuous base drive to remain on. It is this continuous base current that creates the transverse field in the bipolar.

The voltage capability of a common-emitter bipolar is limited by high gain and avalanche multiplication effects to approximately $V_{CBO}/2$. This is shown by the following relationship

$$I_C = \frac{\alpha I_B + I_{CO}}{1 - \alpha \left(\frac{V_C}{V_{CBO}} \right)^n}$$

where I_C = collector current
 α = current transfer ratio
 I_{CO} = leakage current
 I_B = base current
 V_C = collector voltage

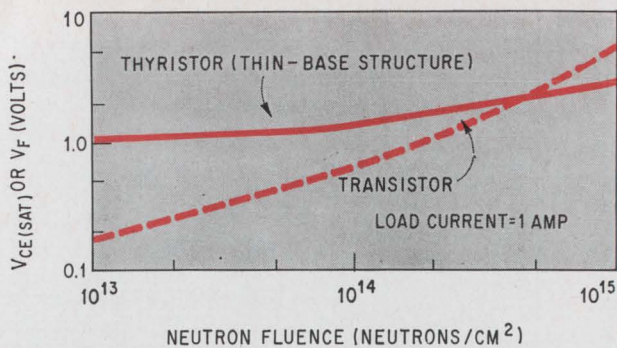

Dissipated. Though saturation voltage of bipolar is lower than thyristor's forward voltage drop at low neutron fluence, this situation is reversed at higher fluence levels.

Small change. The voltage drop across a thyristor increases less than 4 volts after exposure to a neutron fluence of 10^{15} nvt.

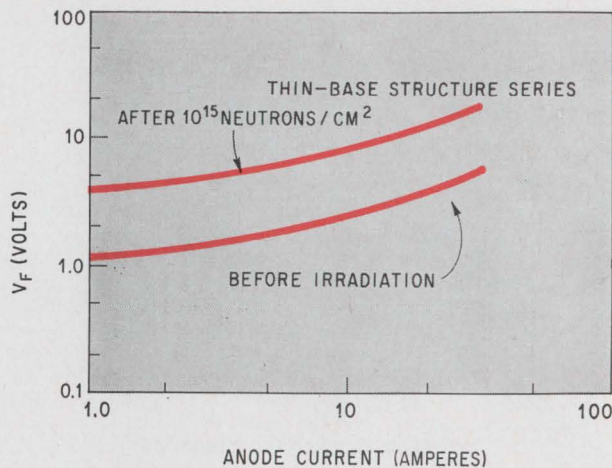

V_{CBO} = collector-base breakdown voltage with the emitter open

n = constant—depends on the collector junction characteristics

When V_C reaches the value of V_{VCEO} —given by $V_{CBO}(1-\alpha)^{1/n}$ —the denominator vanishes and I_C would approach infinity if not limited by external circuitry. For example, take a typical silicon bipolar with a current gain of 50 to 100. Using a value of 6 for n , V_{VCEO} is approximately equal to $V_{CBO}/2$.

The thyristor, is also limited by these same failure mechanisms, but because its sector gains can be made lower than a single bipolar and still achieve satisfactory performance, the equivalent breakdown voltage is almost equal to V_{CBO} . Thus, for equivalent doping levels, the thyristor can switch a higher voltage than can a bipolar before breakdown; for an equivalent current level, the thyristor has a greater power-switching capability.

The injection of radiation-induced minority carriers into a low conductivity region produces conductivity modulation.³ (Conductivity modulation produces a change in the conductivity similar to the way an increase in emitter current produces a decrease in emitter resistance.)

The impedance of a thyristor's low conductivity region—region III of the structure on page 66—is reduced by the conductivity modulation resulting from carrier injection into both sides of the region.

Electrons are majority carriers in the low conductivity n-type region, and since this region in a thyristor floats—not connected to an external circuit—a drift field is sustained. This drift field in a thyristor further improves its gain and lowers its forward voltage drop.

But in a bipolar, the increase in conductivity is less because carriers are injected into the low-conductivity collector region from only one side. And there is no aiding drift field for minority carriers because there are no injected carriers from the collector contact. Both these factors lead to higher saturation voltages and lower gains after the bipolar is irradiated. In addition, this lower gain produces even less device saturation for the same base drive and this further increases saturation voltage.

A thyristor can take more irradiation—about an order of magnitude greater—than a bipolar with the same npn base spacing, current and voltage parameters, and still function.

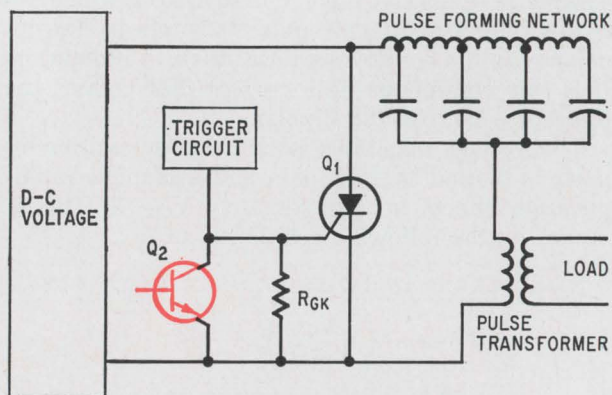

An ounce of prevention. Add one transistor—that quickly saturates when irradiated across the gate and cathode of a thyristor—to a pulse-forming network, a pulse transformer and a circuit that turns the thyristor switch on. The result: a modulator circuit that will return to normal if triggered on by radiation.

The proof of the pudding

The measured radiation effects on critical parameters for both the bipolars and thyristors show the thyristor's advantages.

For a bipolar, the gain reduction for a given radiation dosage is proportional to $1/W^2$. The smaller the base width is made, the less the device gain will degrade under radiation. A plot of the gain degradation factor, β_r/β_0 —the ratio of the gain before radiation to the gain after radiation—of a common emitter transistor is shown in the graph on page 66.

Two important thyristor parameters most affected by radiation are the gate-trigger current, I_{GT} , and the anode-holding current, I_H .

The amount of gate drive required under radiation depends on the width of the base regions. If the neutron fluence increase 10 times, a wide base-width thyristor—pnp base width of 30 microns, npn

base width of 10 microns—now requires 10 times as much gate current. But the neutron fluence would have to increase about 600-fold before 10 times more gate current is needed for a thin base-width thyristor—pnp base width of 10 microns, npn base width of 4 microns. A plot of I_{GT} as a function of neutron fluence is shown on page 67.

After exposure to a radiation dose of 10^{15} nvt, the necessary gate drive to turn on the thyristor, although increased, still remains in the milliamperere range to switch 1 ampere of load current; but a bipolar, depending on how much its current gain is degraded, might require a base current only slightly less than the collector current it must switch.

The amount a thyristor's anode-holding current changes under radiation also depends on the width of the base regions. The anode holding current of the wide base-width thyristor increases 10 times if exposed to an equal increase in neutron fluence. However, if the thin base-width thyristor is used, the neutron fluence would have to increase 1,000 times before the anode holding current would increase tenfold. The change in anode holding current as a function of neutron fluence for two thyristors having different base widths is shown in the graph on page 67.

Radiation exposure also affects other parameters. The forward-on voltage, V_F , of a thyristor and the saturation voltage, $V_{CE(SAT)}$, increases as the radiation dosage increases.

Prior to radiation, the bipolar's saturation voltage is less than the forward-on voltage of the thyristor; therefore, if switching the same amount of current, the power dissipated in the bipolar will be less than in the thyristor. However, after exposure to a neutron fluence of 10^{15} nvt, this changes. Since $V_{CE(SAT)}$ increases much faster than V_F , the thyristor now exhibits lower power dissipation than the bipolar. A comparison between a high-speed power transistor and a thin base-width type of thyristor under radiation is shown on page 68.

Plan ahead

No matter how radiation-tolerant a device may be, the circuit should be designed to prevent false firing, or if it does occur, to provide quick recovery by the device. The circuit shown on page 68 is a simplified version of a modulator circuit designed for this purpose.

A d-c voltage charges a pulse-forming network that remains charged until the thyristor, Q_1 , is turned on by the trigger circuit, and then the energy stored in the pulse-forming network is transferred to the load through the pulse transformer. The pulse transformer is designed so that the transformed load impedance is low. This insures a high Q circuit and when the pulse-forming network discharges, ringing—underdamped oscillations—will occur. It is the negative excursion of this underdamped voltage that turns the thyristor off.

A radiation-intolerant transistor, Q_2 , is placed across the cathode-gate of Q_1 . When the circuit is irradiated this transistor saturates and after radia-

tion, recovers more slowly than the thyristor.

When the modulator circuit is exposed to ionizing radiation, the excess carriers generated in Q_2 quickly drive it into saturation, thus providing a low-resistance path for the radiation-induced carriers of Q_1 . This allows any carriers of Q_1 to leak from its gate through Q_2 to ground, effectively clamping the cathode-gate of Q_1 to a voltage below the trigger voltage, V_{GT} , required to turn it on. The thyristor is now prevented from latching on during radiation; the circuit will return to normal after the transient radiation decreases, the carriers in Q_1 leak off and Q_2 comes out of saturation.

References

1. Journal of Applied Physics, August 1959, pp. 1117-1316.
2. D.K. Wilson and H.S. Lee, IEEE Transactions on Nuclear Science, October 1967, p. 15.
3. A.B. Phillips, Transistor Engineering, McGraw-Hill Co., N.Y. 1962.

Bibliography

- A. Corneretto, Electronic Design, June 8, 1964, p. 35.
 P. Lauritzen and D. Fitzgerald, IEEE Transactions on Nuclear Science, November 1964, p. 39.
 F.E. Gentry, et al., Semiconductor Controlled Rectifiers, Prentice-Hall, Englewood, N.J. 1964.
 H. Oleson, "Designing against space radiation," Electronics, Jan. 11, 1964, p. 70.
 F. Leith and J. Blair, IEEE Transactions on Nuclear Science, December 1965, p. 64.
 G.D. Smith, IEEE Transactions on Nuclear-Science, December 1966, p. 341.

Acknowledgment

Part of the work described in this article was supported by the Bell Telephone Laboratories, Whippany, N.J., The Naval Ordnance Laboratories, Silver Spring, Md., and the Sandia Corp., Albuquerque, N.M.

The authors



Jacob J. Aghassi was a founder of Solid State Products Co. in 1958. He has since worked extensively in materials processing and device design. For the last four years, he has been engaged in evaluating radiation effects on silicon devices.



Arie Najman joined the company in 1967 as a project engineer for special devices. He is now chief of the product engineering section.



Edward Simon is also a founder of the company. He heads the engineering effort as a vice president.

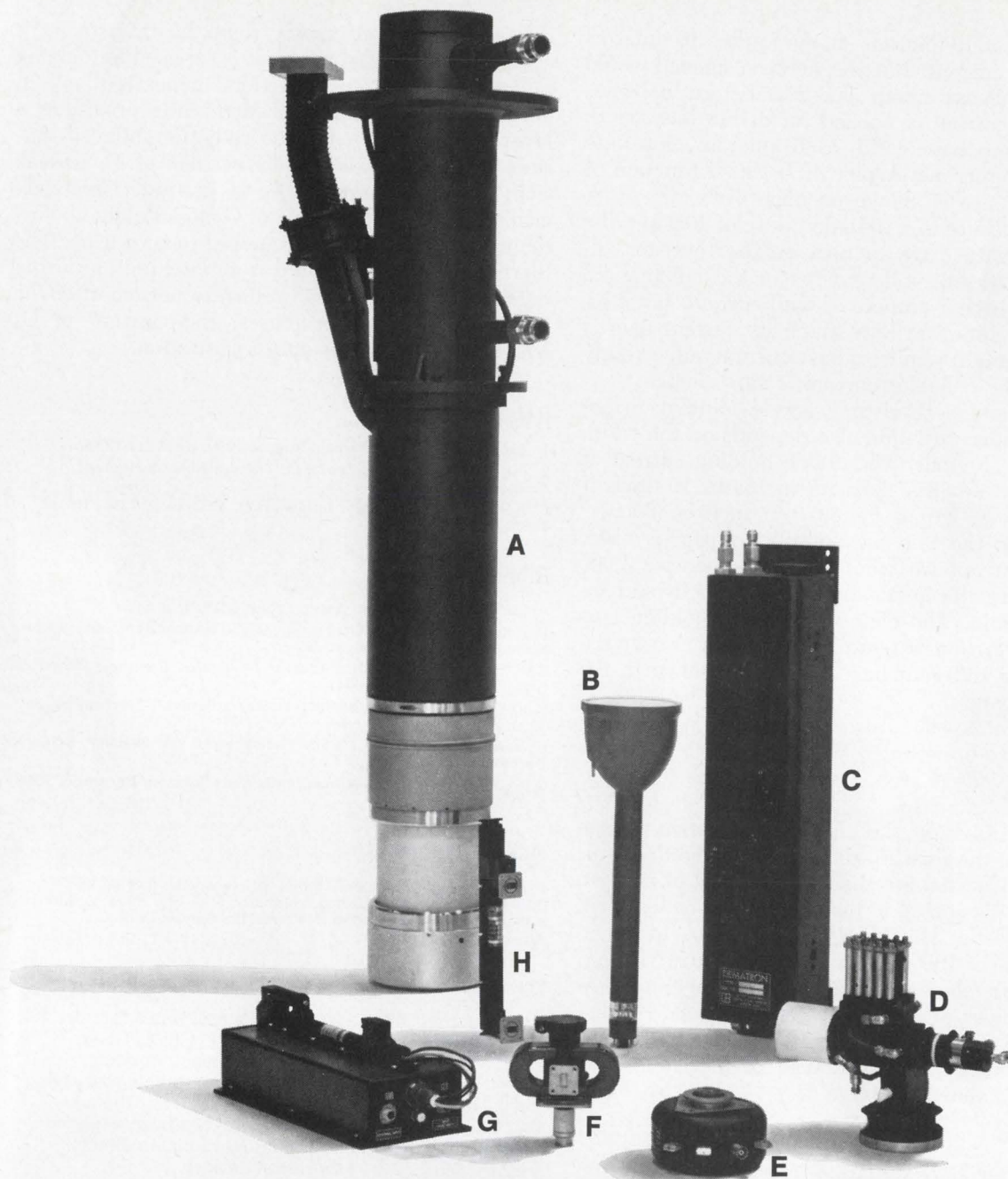

Litton Electron Tubes

MAGNETRONS for radar, navigation and guidance, fire control, countermeasures, beacons, missile fuzes, transponders, and microwave heating and cooking. From one watt CW to 300 kilowatts pulse; 350 to 34,900 MHz. Frequency agility and dither modes. Vane and strap and coaxial types.

M-TYPE BACKWARD WAVE OSCILLATORS for electronic countermeasures power sources, high power sweep oscillators, and FM or AM transmitters. From 500 to 11,000 MHz; 100 to 500 watts. CW and Pulse modes. Standard and miniature families.

CROSSED FIELD FORWARD WAVE AMPLIFIERS including the self-modulated DEMATRON crossed field amplifier. For electronic countermeasures, CW and Pulse multi-mode radar, phased array radar, and multi-channel wide-band communications.

AMPLIFIER KLYSTRONS for long-range search radar, missile and satellite tracking, particle accelerators, phased array radar and

radar astronomy. From 400 to 11,000 MHz. 20 KW to greater than 30 Mw, pulsed; 5 W to 50kW, CW.

TRAVELING WAVE TUBES as drivers for high power microwave transmitters, missile guidance and control, electronic countermeasures, space communications, telemetry and phased array radar. From L-band through Ku-band; 10 mW CW to 5 kW pulse. Small signal gains from 33 to 70 db. Low noise TWT's.

CATHODE RAY TUBES for airborne radar display, flying spot scanning, infra-red recording and photographic encoding. High resolution and high brightness tubes. Electrostatic printing tubes, fiber optic CRT's and CRT operational accessories.

INTEGRATED SUB-SYSTEMS AND TUBE-RELATED EQUIPMENT to complement our tube line in many of the above applications. Microwave power sources, transitions, sockets, solid state TWT power supplies and flying spot scanners.

ADVANCED DEVICES. Electrostatically focused klystrons, BIMATRON® injected beam crossed field amplifiers, low noise research, acoustic delay lines, pulse compression filters, low light level camera tubes, etc.

INFORMATION. For information on the entire Electron Tube product line, send for the comprehensive 48-page brochure and catalog. Contact Electron Tube Division, 960 Industrial Road, San Carlos, California 94070.

Products illustrated: (A) L-3989 Particle Accelerator Klystron; (B) L-4238 Ultra-High Resolution CRT; (C) L-5111 DEMATRON Crossed Field Amplifier; (D) L-5182 Electrostatically Focused Klystron; (E) Miniature M-BWO; (F) L-5049 Coaxial Pulse Magnetron; (G) Model 484 Power Supply; (H) L-5117 TWT.

LITTON INDUSTRIES
ELECTRON TUBE DIVISION

Motor gives reverse twist to the Intelsat 3 antenna

Instead of an all-electronic setup, the communications satellite will use a mechanical despinning system to keep its antenna stationary in relation to the earth; the prime benefit is a higher-gain directional beam

By Francis E. Donnelly Jr., Reynold P. Graunas, and John D. Killian

Eastern Division, Sylvania Electronic Systems, Waltham, Mass.

To remain pointed directly at earth, antennas on spin-stabilized communications satellites must be rotated, either electronically or mechanically, in a direction opposite to that of the craft. One would expect the electronic despinning technique to be favored by an aerospace community that usually shuns moving parts, but a good case can be made for the sturdy and reliable motor-control system.

For one thing, the mechanical units provide a higher gain than all-electronic systems can achieve over the solid angle subtended by the earth at the synchronous altitude of 22,238 miles. Electronically despun antennas are prone to signal-power losses in their phase-shifting and beam-steering circuitry—elements not present in mechanically despun systems.

Easy choice

Sylvania Electronic Products Inc., a subsidiary of the General Telephone & Electronics Corp. has designed a mechanically despun antenna and control system for the Intelsat 3 communications satellite scheduled for launch later this year. Under contract to TRW Systems, Redondo Beach, Calif., Sylvania Electronic Systems, an operating group of the company, is developing seven antenna systems.

The choice of a mechanically despun antenna was dictated by the fact that Comsat had specified a minimum transmit gain at the edges of the earth of 13 decibels over the operating beamwidth—a level 1 or 2 db higher than has been obtained with electronic systems.

The first mechanically despun antenna in space was the system—also developed by Sylvania—aboard the Advanced Technology Satellite 3 launched last November. More are on the way, though; besides the Intelsat 3 design, Comsat has



Around the horn. Mechanically despun antenna has an elliptical reflector plate supported by a fiberglass shell resting on a conical horn. The motor is out of sight beneath the protective support structure.

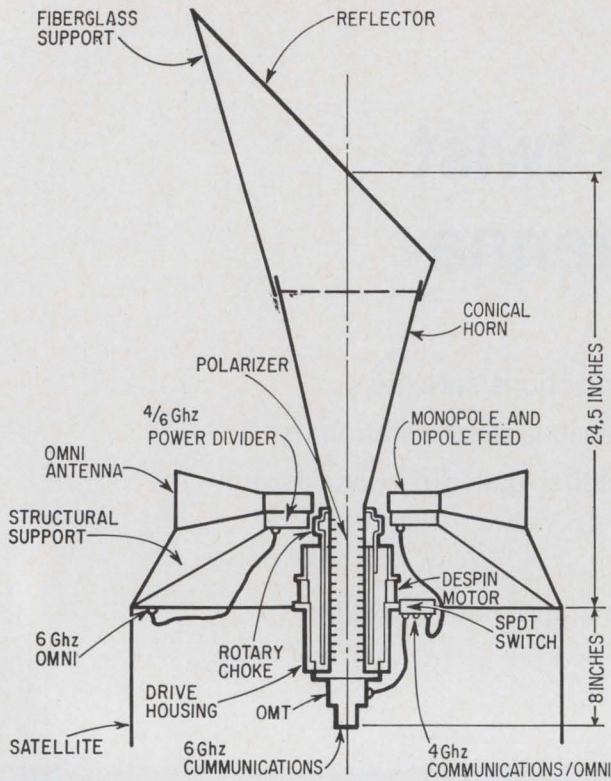

Cross section. Despin motor is housed in support structure beneath the conical-horn communications antenna. Rotary choke joint isolates the antenna from the body of the satellite. Linear-to-circular polarizer is built into the circular waveguide feeding the unit.

specified a mechanically despun antenna for the Intelsat 3.5 slated for a mid-1969 launch [see panel on page 73.]

Deflection shot

The communications antenna for the 1,200-channel Intelsat 3 consists of a conical horn antenna with a flat reflector plate positioned over its aperture, shown on the preceding page and above. The reflector is inclined 45° toward the axis of the horn so that the beam from the horn is deflected through an angle of 90° .

Once the satellite is at its synchronous position and spinning at its stabilizing speed, a stepper motor will counterrotate the directive antenna at a rate equal to the satellite's spin. The motor will also move the antenna 0.7° per satellite revolution until the beam is oriented directly toward the earth. Directional signals for this process will come from two infrared sensors on the satellite, sensors that generate pulses each time they spin past the earth. In effect, these pulses indicate the pace of the satellite's spin.

The key to the operation of the Intelsat 3 antenna is, of course, the stepper motor; it must rotate the antenna at a rate of about 100 revolutions per minute to offset the satellite's spin, and must be able to perform this task, without interruption, for five years [see panel, page 75].

The two-phase, salient-pole unit makes a complete revolution in 128 steps. A stepper rather than

continuous motor is used because it can be driven by pulses or square waves generated in a digital control system. However, in the satellite spin range of 65 to 117 rpm, the motor is slewing so fast that no discrete stepping is discernable, and it operates, in effect, like a continuous, synchronous motor. Its output torque is 30 ounce-inches and its outside diameter is 5.375 inches.

The demands of continuous operation make bearings lubrication a prime consideration. The job is done in this motor by a Ball Bros. Co. process employing both a solid lubricant and a low-vapor-pressure fluid. Reservoirs in the motor housing contain enough lubricant to last for 50 years in space.

The motor's control circuitry, page 77, is in four separate sections:

- A phase-lock loop that synchronizes the spins of the antenna and the satellite.
- A digital positioning circuit that adds or subtracts pulses to the pulse train driving the motor to adjust the antenna's position.
- Circuits that start and damp the motor, plus control logic.

- A magnetic shaft encoder on the motor to provide two separate pulse trains as the antenna spins. One train of 512, or 2^9 , pulses per revolution is used in the starting and damping circuits. The second consists of a single, 2^0 , reference pulse for each satellite revolution.

Except for the motor and the encoder, all of the system's elements are redundant. The complete package, including antenna and motor, weighs only 32 pounds and consumes less than 6 watts at the nominal 100-rpm antenna-rotation pace. The electronics, in four aluminum chassis, weigh less than 9 pounds.

Breakdown

Other major parts of the antenna system itself are an orthomode transducer (OMT) to permit simultaneous reception and transmission of signals, a specially designed wideband linear-to-circular polarizer, and an omnidirectional telemetry antenna. The rotary choke joint in the throat of the horn allows the antenna to rotate while energy is coupled in and out.

The communications antenna operates over two bands: 3.7 to 4.2 gigahertz for transmit and 5.925 to 6.425 GHz for receive. The OMT provides an isolation of greater than 40 db between the two terminals throughout the bands. Isolation between the directional and omni antennas is also greater than 40 db.

Alternative designs Sylvania considered were a cornucopia, an offset parabolic reflector, and a conventional horn mounted above the spacecraft. The cornucopia appeared promising because of its high radiation efficiency. But it has a beam offset that's dependent on the polarization. Since the transmit channel for Intelsat 3 is right-hand circularly polarized and the receive channel is left-hand, the two beams, with the offset, would be 5° apart and couldn't point directly at earth at the same time.

One up, two on the way

A mechanically despun antenna has been carried into space by only one satellite—the experimental Advanced Technology Satellite 3 launched last November by NASA and now in synchronous orbit over Brazil. Both this antenna and the unit slated for the Intelsat 3 were designed by Sylvania.

A third is on the way. Comsat has specified a mechanically despun antenna for its Intelsat 3.5, for which proposals were submitted last month. The firm is further specifying that this antenna have the capability to aim narrow beams at eastern North America and Western Europe.

The ATS 3 antenna now aloft consists of two parabolic cylindrical reflectors—the upper for transmitting, the lower for receiving. Signals are linearly polarized. Line sources that are fed by coaxial cable can be used as drivers here because the system operates over a comparatively narrow bandwidth—95 Mhz in transmit, 115 Mhz in receive. And because the coax is smaller than the waveguide on the Intelsat 3, the driving motor is smaller.

Line feeds can't be used on the Intelsat 3, however, with its 500-Mhz bandwidth. The direction of the antenna beam would change with frequency because of a frequency-scanning effect characteristic of these feeds.

Another reason for not using the parabolic design for Intelsat 3 is that the new system requires circularly polarized signals, and conversion of the linearly polarized signals would require the addition of a polarization grid to intercept the signals from the line source feeds. This would increase system losses and reduce gain.

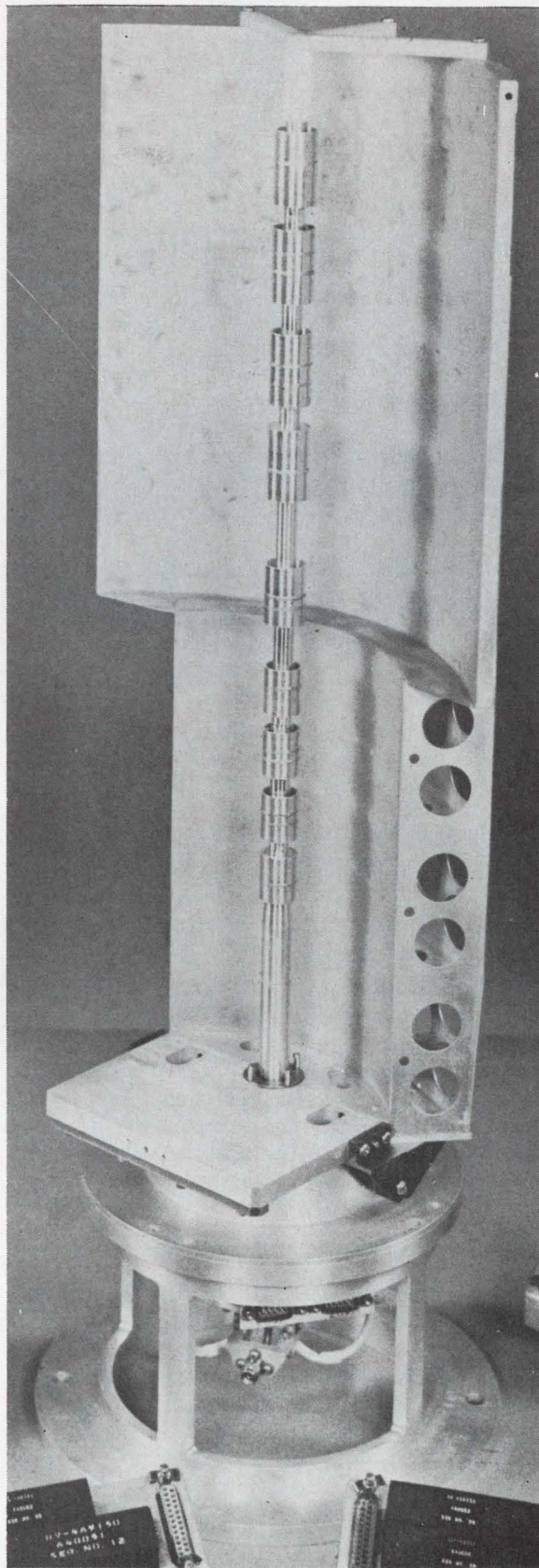

First try. Antenna for ATS-3 satellite has line drivers feeding separate cylindrical reflectors for transmit and receive.

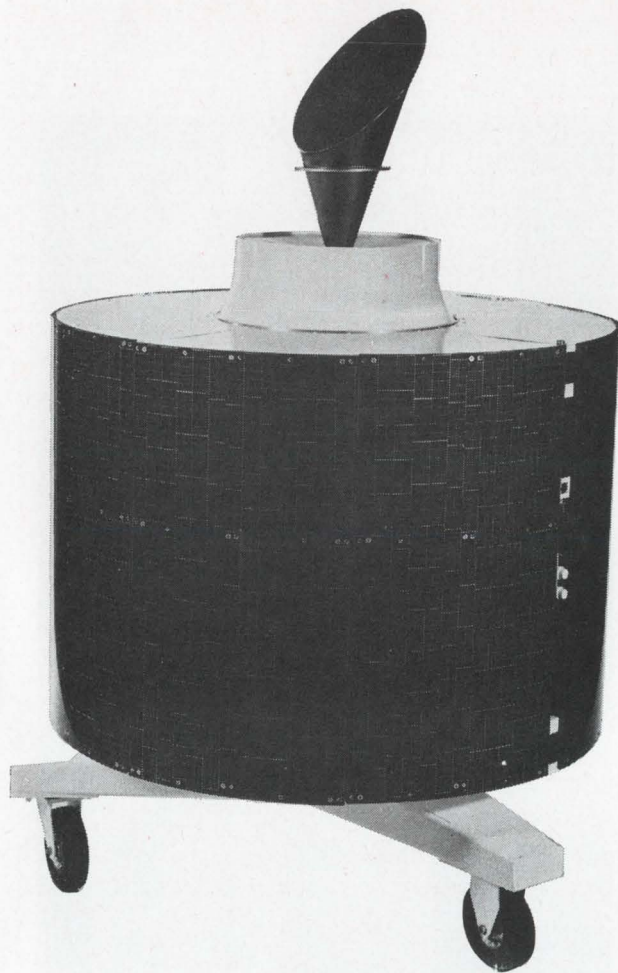

In-line. Mechanically despun antenna shown in mock-up, is mounted atop the Intelsat 3 communications satellite so that they both spin about the same axis.

Similar difficulties were encountered with the offset parabolic reflector.

The idea of placing a horn antenna above the spacecraft was rejected because it would require the use of dual-channel coaxial rotary joints to connect the antenna to the transponder within the satellite, and the reliability of such joints over a five-year operating life was considered doubtful. The conical horn and reflecting plate arrangement finally chosen has none of these problems.

The size and location of the reflecting plate was determined empirically to preserve the gain characteristics of the horn. The plate is elliptical and is supported by a thin fiberglass shell. By deflecting the radiated energy by 90° , the reflector causes the long axis of the horn antenna and the linear-to-circular polarizer to coincide with the spin axis of the satellite, as shown in the photo on this page. This spin axis is perpendicular to the equatorial plane of the earth.

Without the reflector, the axis of the horn antenna would have to be at a right angle to the spin axis of the satellite, an extremely difficult design to implement. The dual-channel rotary joint that would have to be fitted in a small coaxial line would be much more fragile than the joint placed in waveguide, and could easily be fractured by the shaking and rattling during the launch.

Tough joint

As it is, the rotary choke joint is built right into the circular waveguide horn input, which is 2.125 inches in diameter for this frequency range. Because this structure is in line with the spin axis of the satellite, the radio-frequency input and output can be placed close to the transponder that takes received signals and amplifies and translates them to the transmit frequency; this proximity reduces transmission line losses aboard the satellite.

The major element added by the mechanical despinning technique to the signal path—the choke joint—presents no problem. It is of a conventional noncontacting design and consists of two cascaded quarter-wavelength sections designed about a 6-GHz center frequency. The choke's voltage standing-wave ratio is negligible and its insertion loss is less than 0.05 db in both transmit and receive modes.

The conical horn of the communications antenna has an aperture diameter of 8 inches and a cone angle of 28° —dimensions chosen to maximize transmit gain over the operating beamwidth of 19.3° . At the same time, the variation between the peak and edge-of-earth gains does not exceed 6 db in the receive mode, a variation so small that the strength of the signals beamed from earth will not depend too much on the location of the transmitters.

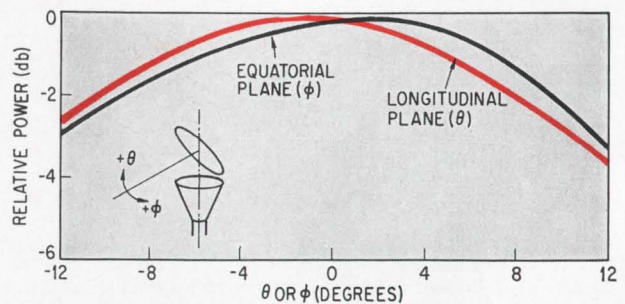
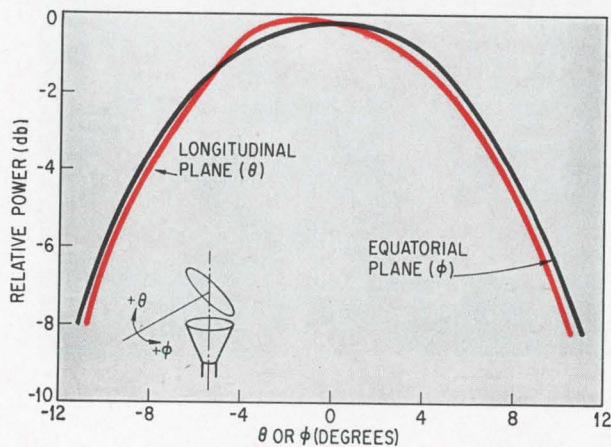

Planes in proximity. Antenna's radiation patterns for longitudinal and equatorial planes are within 0.3 db. Measurement frequencies are 3.7 GHz in transmit mode, left, and 6.425 GHz in receive, above.

Process of elimination

A number of different motors—both d-c and synchronous—were considered for the task of despinning the Intelsat 3 antenna.

Of the d-c motors, brush types with permanent magnets have been operated in space, but they were rejected for this application because of the long-term (five years) reliability required. Brushless d-c motors have a higher reliability, but they would need a complex, low-efficiency analog driving circuit to achieve the required beam-pointing accuracy.

A synchronous motor is ideally suited to the application. It can be controlled with digital circuitry and readily synchronized to the satellite's spin speed. Any change in the speed of the satellite's spin will cause a corresponding change in the synchronous motor's rate.

Poles apart. With the choice narrowed to synchronous motors, the need became apparent for a unit in this category—whether hysteresis, reluctance, or stepper—with more than two poles.

The equation for drive frequency is

$$f = \frac{PN}{60} = \frac{100}{60} = 1.667 \text{ Hz}$$

The dimensions also provide similar E- and H-plane patterns which enable low polarization axial ratios to be maintained over the operating beamwidth.

The height of the aperture above the spacecraft—24.5 inches—was established by the dimensions of the horn and the interface between the antenna and the gear inside the satellite. It's high enough so that the satellite won't interfere with the antenna's radiation pattern.

The polarizer, also built in 2.125-inch circular waveguide, is loaded periodically by 16 pairs of thin, rectangular metal irises perpendicular to the waveguide axis, as shown on page 72. These provide near-constant differential phase shift between the orthogonally applied fields over the 3.7-to-6.425-GHz range, along with a cosine input coefficient reflection taper.

Cosine taper

This cosine taper, set by the varying heights of the irises, results in an input reflection coefficient whose form is analogous to the far-field amplitude pattern of an array with a similar taper. By spacing the irises 0.45 inches apart, the input reflection coefficient can be adjusted to the region analogous to an array's low sidelobe level area.

This approach yields a particularly low vswr across the entire bandwidth—1.09:1 for transmit and 1.07:1 for receive. With irises of equal height the vswr would be high.

The maximum polarization axial ratio is 1.9 db in transmit and 1.0 db in receive, a difference that compensates for changes in the beamwidth of the antenna's E and H planes with increasing fre-

quency. The aim is to maintain a constant antenna polarization axial ratio independent of frequency.

Inputs for the orthomode transducer are coaxial, while the outputs are linearly polarized orthogonal TE₁₁ modes into the circular waveguide. The receive terminal, which comes in along the longitudinal axis of the circular waveguide, consists of a coaxial-to-rectangular-waveguide transition followed by a two-step rectangular-waveguide transformer coupled to the circular guide.

The transmit coaxial terminal enters directly into the circular waveguide and is orthogonal to the transmit field in the waveguide.

The field orthogonality of the two signals and the cutoff properties of the rectangular guide section provide the transmit-receive isolation.

where P is number of pole pairs and N is the speed. When P is 1 and N is 100 revolutions per minute, the starter requires a great many turns, and this results in high copper losses and general inefficiency.

The antenna-spinning motor obviously should have as many poles as possible. And since the drive signal is a binary pulse train, it is desirable that the number of poles be a binary number such as 64 (2⁶) and 128 (2⁷). But though hysteresis and reluctance synchronous types can be designed with 64 or 128 poles, the result is a motor with a large diameter. The stepping motor, on the other hand, can carry 128 poles and still be fairly small.

In its stepping mode, the stepper motor runs from a fast periodic source, but in the slow mode, it behaves like a synchronous machine.

The unit used in the Intelsat 3 is of the permanent-magnet type. It's a brushless, two-phase vernier unit with windings on the stator and the permanent magnet on the rotor. The stepper is driven directly by a binary train of 128 (2⁷) square waves via transistor switches that control the power applied to the motor windings. The inertia of the antenna and rotor smooth the steps and, thus, the spin.

quency. The aim is to maintain a constant antenna polarization axial ratio independent of frequency.

The field orthogonality of the two signals and the cutoff properties of the rectangular guide section provide the transmit-receive isolation.

The field orthogonality of the two signals and the cutoff properties of the rectangular guide section provide the transmit-receive isolation.

The field orthogonality of the two signals and the cutoff properties of the rectangular guide section provide the transmit-receive isolation.

Short course

The Intelsat 3 antenna was evaluated on a comparatively short—17 feet—antenna range in order to ease the job of aligning the r-f beams relative to the satellite. Radiation patterns were measured about what would be the spin axis of the satellite, and far-field corrections were applied to both the radiation patterns and gain measurements to account for the fact that the phase center and the axis of rotation don't coincide.

Normally, the phase center of the antenna—the point from which energy appears to emanate—would be that of the conical horn as imaged by the reflecting plate.

But because of its comparatively small size, the plate modifies the phase center of the antenna to the point that the energy distribution differs from the level predicted by the imaging theory.

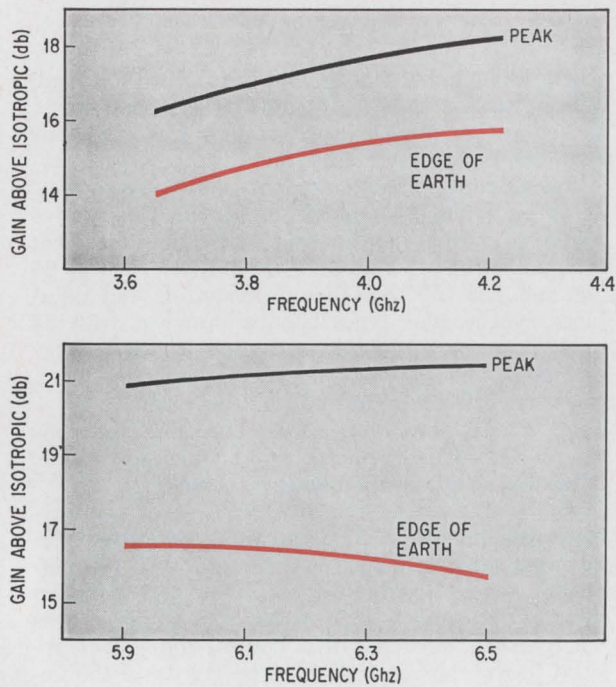

Big gain. Minimum edge-of-earth gain of 14.2 db across both transmit, top, and receive bands is well above the 13 db specified for the Intelsat 3.

The phase centers of the antenna were found to be 10 inches from the spin axis in the transmit mode and 12 inches in the receive. This is 25% greater than expected.

Typical radiation patterns, bottom, page 74, indicate that equatorial and longitudinal plane patterns are identical to within 0.3 db. The beam centers vary only very slightly with frequency over the entire transmit and receive bandwidth.

Antenna gain, page 76, was measured at the orthomode transducer in receive and at the switch input to the antenna in transmit. At 3.7 GHz, the edge-of-earth gain was found to be 14.2 db, well above the 13 db specified.

Further, the Intelsat 3 design provides the required gain over an operating beamwidth of 19.3°, although at synchronous altitude the earth subtends an angle of only 17.3°. This leeway insures adequate gain at the edges of the earth over the five-year life of the satellite. Edge-of-earth gain tends to decrease as time passes because of small pointing errors introduced into the system by deterioration of the satellite's stabilization.

Ripples

The radiation patterns were not measured with the antenna rotating at its despin speed. Out in space, the actual patterns will vary slightly from the measured values, principally because of changes in the polarization axial ratio of the antenna as it rotates. The polarization ellipse of the polarizer turns once per despin revolution and combines with the ellipse of the aperture. The aperture ellipse is stationary, and maximum and minimum polarization axial ratio occurs twice per

antenna revolution. Since a change in axial ratio is equivalent to a change in gain, a gain ripple occurs at twice the despin rate. Maximum ripple is 0.4 db peak-to-peak.

Thus, the amplitude modulation caused by the despinning depends on the satellite's spin rate; the frequency ripple is 3.33 hertz at a spin of 100 rpm, for instance. This modulation is only significant in terms of its effect on gain; frequency is well out of the communications passband.

The omnidirectional antenna provides telemetry at 3.95 GHz, command capability at 6.175 GHz via radiation coverage over a 20° sector centered about the equatorial plane. A bicone with a 3.3-inch aperture and a 20° flare angle, it is fed by a parallel-plate waveguide. A ring of 16 dipoles and 16 monopoles are used in the parallel plate section to excite the guide independently at 6.175 and 3.95 GHz.

The bicone surrounds the large waveguide at the base of the horn and is placed close to the main body of the satellite, an arrangement that doesn't necessitate additional rotary joints and helps to maintain spacecraft stability.

Polarization is parallel to the equatorial plane at the 6.175-GHz command frequency and parallel to the longitudinal plane at 3.95 GHz. Bandwidth about each of these center frequencies is 34 Mhz.

The antenna rings are fed from separate, strip-transmission-line reactive power dividers composed of multiple layers of irradiated polyethylene boards immediately beneath the parallel-plate region. The 6.175-GHz input is hard-wired into the transponder while the 3.95-GHz input is selected through a single-pole, double-throw switch.

Out in space

Once the satellite is spinning in position over the earth, and power to the motor-control electronics is turned on, the phase-lock loop will begin synchronizing its output pulses to the satellite's rotation rate while the starting circuitry brings the motor up to its operating speed.

Because of its synchronous design, the motor has to be started at a pace much below the spin rate of the satellite. It's pulsed by a voltage-controlled oscillator (vco) in the motor-starting circuit, an oscillator whose output frequency is preprogrammed to increase gradually.

At the same time, the phase-lock loop, which initially produces a pulse train corresponding to a motor speed of about 80 rpm, begins bringing its output up to correspond to the nominal operating speed of 100 rpm by locking onto the reference pulses generated by the infrared earth sensors. These pulses drive a vco in the loop that feeds a binary counter.

The times the sensor pulses arrive are compared with the occurrence of the 2⁰ output of the counter, and a proportional error voltage is developed. Depending on the sense and magnitude of this error, the vco is adjusted up or down in frequency until the two signals coincide within a predetermined error. At coincidence, the phase-lock loop is gen-

Controllers. Phase-lock loop takes control of the synchronous stepper motor once the starting circuit has set the unit spinning. Digital positioning of the antenna is done with a 2^9 pulse train, but pulses come to the motor at a rate of 2^7 per revolution. All the circuitry is redundant.

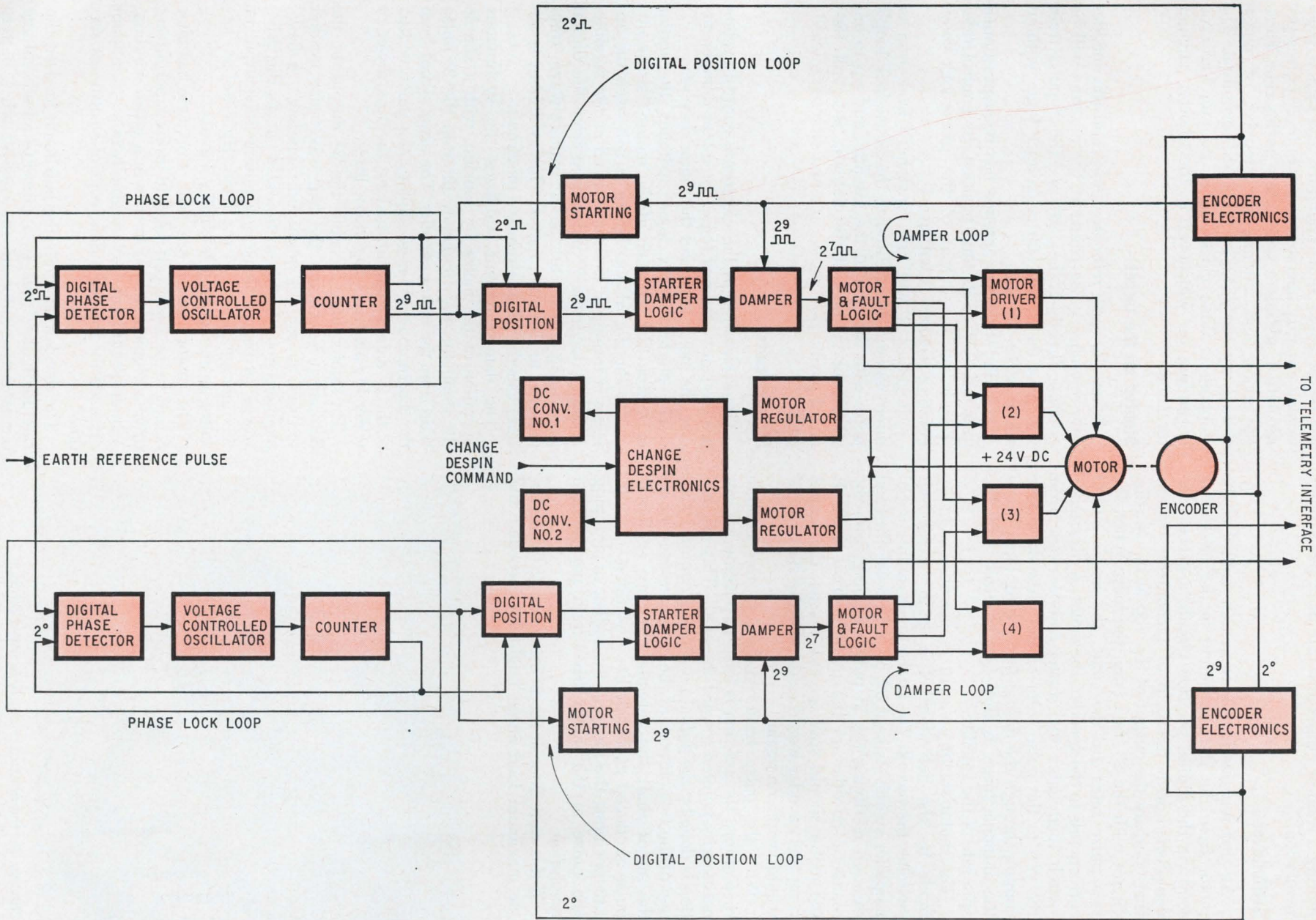

erating a train of pulses at a rate of 2^9 per satellite revolution.

Switchover

All that remains now is to switch control of the motor from the starting circuit to the phase-lock loop via the digital position circuit, a process accomplished with the help of tachometer circuits that compare the output of the vco in the starting circuit with the 2^9 train from the loop. When the two pulse rates are the same, the loop's output corresponds to the speed of the motor. A differential switch then gates the starter-damper logic from the vco to the pulse train of the phase-lock loop coming through the digital positioning circuit, and the antenna speed is thus synchronized with the spin rate of the satellite.

The motor-starting circuit is put in a standby mode by the activation of a latch circuit that switches the vco off. The latch circuit—a differential amplifier switch—is kept off by a d-c level obtained through rectifying the 2^9 pulses coming from the magnetic encoder on the motor's drive shaft. If the motor should stall for any reason, the output from this encoder would cease and the start circuit would switch on again.

With the pulse train synched to the satellite revolutions, the antenna is fixed in position but not necessarily pointed toward the earth. This orientation is done by the digital positioning circuit. Using one of the two outputs of the magnetic encoder on the motor shaft the antenna reference or the 2^9 pulse produced each satellite revolution—this circuit positions the antenna by adding or dropping one pulse in the motor-drive train per satellite revolution.

If this were done at the 2^7 drive rate of the motor, the maximum load angle might be exceeded and

the motor could stall. Therefore, the digital positioning circuitry operates at a rate of 2^9 pulses per revolution, adding or subtracting at this rate. Thus, the motor and antenna are stepped, or phase shifted, by $360^\circ/512$, or 0.7° , per revolution. The stepping is done clockwise or counterclockwise, depending on whichever is the shorter angular direction.

Sighted on the target

When the earth reference pulse and the encoder zero reference pulse coincide, the antenna will be pointing directly at the earth and the 2^9 pulse train will pass on to the starter-damper logic without additions or deletions.

Actually, when the antenna has been positioned to within 0.7° of its final position, its control rides directly on the output of the phase-lock loop. Pointing accuracy is within 0.1° .

Altogether it will take anywhere from one to three minutes to synchronize the phase-lock loop's pulse with the spin of the satellite, and up to another four minutes—if the antenna is a full 180° out of position—to get the antenna directed towards earth.

More circuits

Other elements in the electronic control system are the starter-damper logic, the motor-damper circuit, the motor logic and the motor drivers.

The starter-damper logic switches the motor drive from the vco train of the motor-starting circuit to the digital positioning circuit once the antenna is turning at the same speed as the satellite. It also reduces the 2^9 pulse train from the digital positioning circuit to the 2^7 square-wave train required to drive the motor. This switching is accomplished with an exclusive OR circuit.

The damper circuit stabilizes the synchronous operation of the motor by sensing, with a simple discriminator, the frequency jitter in the 2^9 pulse train from the motor encoder. The error signal from the discriminator then modulates the pulse widths of the 2^7 damper output, making them narrower or wider to counteract the motor jitter.

The motor logic accepts the 2^7 output of the damper and generates the four wavetrains needed to drive the motor's quadrature windings. A fault-monitor circuit in this section also checks the drive waves for proper shape and timing; the output of this monitor is sent to the telemetry interface circuitry as an outgoing telemetry signal.

The motor drivers are transistor switches that complete the motor coil paths to ground, permitting drive excitation current to flow in a given winding. A single set of four—each internally quad-redundant—is used for the redundant control-electronics section.

The device that limits the maximum load on the satellite battery bus is a current-limited voltage regulator that automatically cuts off when battery voltage drops below 21 volts. Normal bus input runs from 21 to 31 volts d-c, for which the regulator

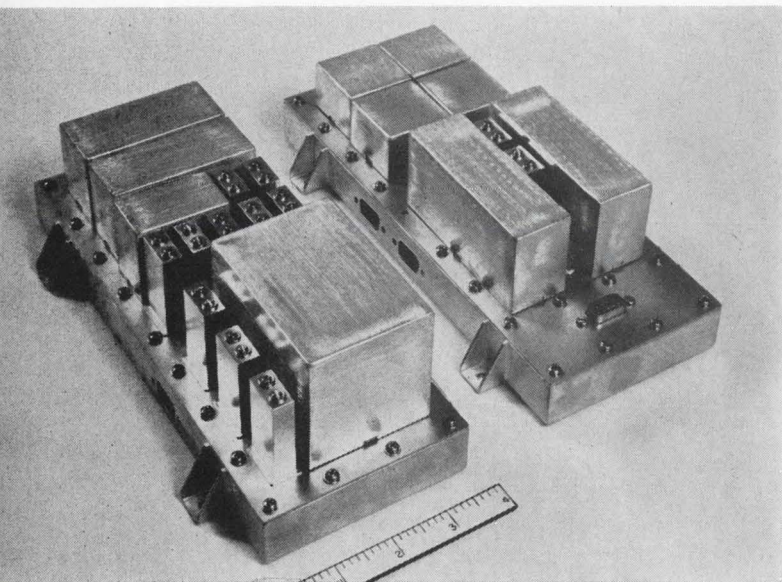

Chassis. All the control circuitry is fitted on four 4.6-by-9-inch aluminum chassis, two of which are shown here. Assemblies are first encapsulated in epoxy and then copper plated and given a gold flash.

Flatpacs. Integrated circuits used in the system are placed between epoxy printed-circuit boards and potted in special aluminum cans.

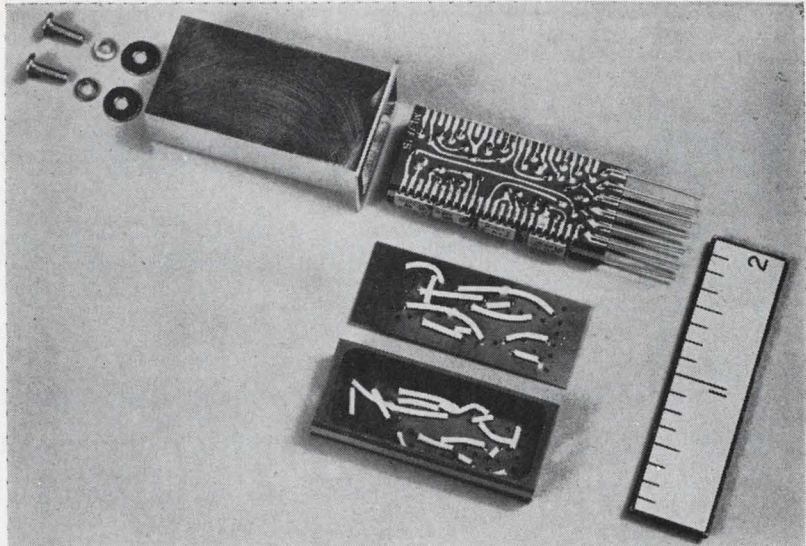

maintains a nominal output voltage of 20 volts d-c. Current limiting is provided at 325 milliamperes.

And there's a change despin circuit that, upon command from an earth station, will switch control from one set of redundant circuits to the other. Two latching relays are switched simultaneously to make the changeover.

Packaging

All the control electronics for the antenna fit onto four aluminum chassis, shown on page 78, each 4.6 by 9 by 4 inches. These are bolted to the inside of the satellite and linked to each other and to the antenna. Most of the circuitry uses discrete components fabricated in cordwood modules.

Each assembly is encapsulated with Stycast 1090, copper plated, and given a gold flash to protect against radio-frequency interference and to enhance heat transfer.

Silicon monolithic integrated-circuit flatpacs—with resistor-transistor logic—are used in the phase-lock loop, the digital positioning circuit, and the motor fault logic section. The IC's are attached to a pair of printed circuit cards and potted in aluminum housings, shown above.

The radiating cone of the mechanically despun antenna consists of 20-mil-thick aluminum machined from solid stock. A cone of epoxy fiberglass, also 20 mils thick, extends from the radiating cone to support the reflector plate—a quarter-inch-thick sandwich of aluminum honeycomb and aluminum sheets.

Hot stuff

A mix of heat-conducting and radiating coatings inside and outside of the assembly controls temperature by radiating heat into space. The object is to keep the motor drive shaft from getting hotter than the housing, whose temperature will range from 30° to 100°F. Among the heat sources to be considered are the sun, the satellite's attitude-control jets, and the antenna control system itself.

The fiberglass reflector support is covered with

Silastic. This coat is painted white and covered, in turn, with an orange sheet of Kapton to protect the paint from the ultraviolet rays of the sun. A thermal blanket composed of layers of heat-conducting aluminized Mylar and Kapton is wrapped around the antenna cone and the omnidirectional antenna.

Black epoxy paint covers all of the inside surfaces, and there are circles of black paint on vacuum-deposited aluminum on the outside of the reflector plate.

A computer calculated the essential thermal balances on the basis of an analytical heat-transfer model of the antenna, and helped determine the necessary temperature-controlling measures.

The authors



With Sylvania since 1958, Francis E. Donnelly Jr. is supervisor of the control electronics section in the satellite antenna department. Earlier, he was responsible for the design and construction of the computer-operated phase- and amplitude-monitoring system for the MAR receiver and transmitter.



Reynold P. Graunas is head of the mechanical engineering section of the satellite antenna department. Joining Sylvania in 1951, he has since worked on several antenna systems, including those used at the mechanical engineering section of satellite communications ground stations in Paumalu, Hawaii and Brewster Flat, Wash.



John D. Killian supervises the antenna section of the satellite antenna department at Sylvania, where he has worked since 1956. He has designed a number of antennas, including broad-band flush-mounted aircraft units, log periodic types, and multifrequency feeds for satellite communications ground terminals.

Video tape recorders: Longitudinal or helical scan?

In a comparison of both techniques, a strong case is presented for the helical approach, which offers better picture quality and covers the full bandwidth required for color reproduction

By Delmar Johnson and Barrett Guisinger

Consumer and Educational Products Division, Ampex Corp., Elk Grove Village, Ill.

Engineers are limited to two approaches to video tape recorders for the consumer market—fixed-head and rotating-head designs. At first glance, the fixed-head or longitudinal-scan design looks good. But a closer examination of this approach shows that it suffers from limited bandwidth and high tape consumption that add up to poor performance. Rotating-head designs, on the other hand, can record the full bandwidth needed for color reproduction.

Although longitudinal recorders have the advantage of simplicity—just a straightforward tape-threading path but no scanner servo or tape-tension controls for playback synchronization—their best response thus far has been 2 megahertz. This is a far cry from the National Television Standards Committee's 4.2-Mhz bandpass, which is easily achieved by rotating-head vtr's. Moreover, the high tape speeds of fixed-head vtr's, from 120 to 160 inches per second, make large tape reels necessary for uninterrupted recording. Helical-scan video recorders, however, have tape speeds of only 3.75 to 9.6 ips.

In the helical-scan recorder, the tape is wound in a helix around the head drum so that the recording appears on the tape as a series of diagonal lines. Although this type of system can be used by broadcasters, it is most commonly found in home and industrial applications. In another rotating-head type, the transverse-scan recorder, the head assembly rotates about an axis parallel to the edges of the tape, producing a series of tracks almost perpendicular to the edges of the tape. The transverse-scan system yields the highest quality recording and is the type favored by television broadcasters.

Helical-scan recorders have their drawbacks,

too. Unless precise control is provided, variations in the tape path around the scanners will rule out tape interchange among similar machines, and uneven tape tension will result in phase error in the horizontal sync pulses of the composite video—from the end of one scan to the beginning of the next. This would reduce picture stability. Since the heads move, they are prone to damage; constant replacement of heads can be costly. And, a complex tape-threading path is required.

But the over-all advantages of the helical-scan vtr far outweigh its disadvantages. There is minimum effect from longitudinal tape flutter because the head velocity provides most of the head-to-tape speed. And since audio and video are recorded on separate tracks, they can be erased at will to permit editing and dubbing; picture resolution is at least as good as that of a standard tv receiver.

Performance objectives

A fair comparison of helical-scan and longitudinal-scan techniques depends a great deal on the desired video response, the advantages of recording audio, video, and control signals on separate tracks, and tape consumption or maximum uninterrupted record and playback time. The video bandwidth, and hence the horizontal picture resolution, depends to a great extent on the recorder's writing speed as well as on whether the recording is direct, amplitude modulated, or frequency modulated.

A video tape recorder with limited bandwidth capability will be a liability, since it will be incapable of reproducing the full NTSC monochrome or color signal. This rules out processing color programs on such a machine. The video recorder should have sufficient time base stability to produce a

Three types of video scanners

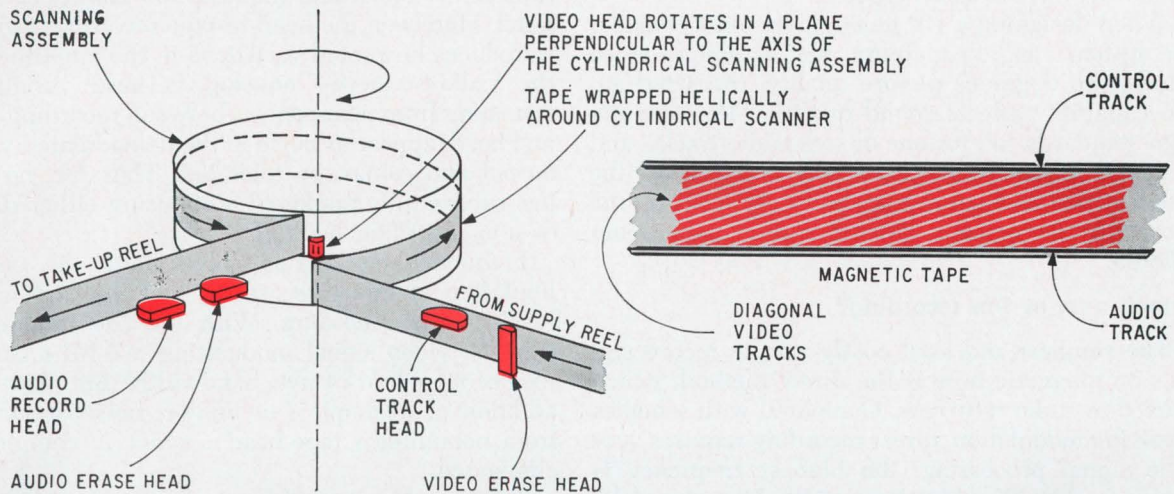

Helical format. Helical wrap of the tape around the periphery of the scanning assembly allows video information to be recorded on the tape as a series of parallel diagonal lines.

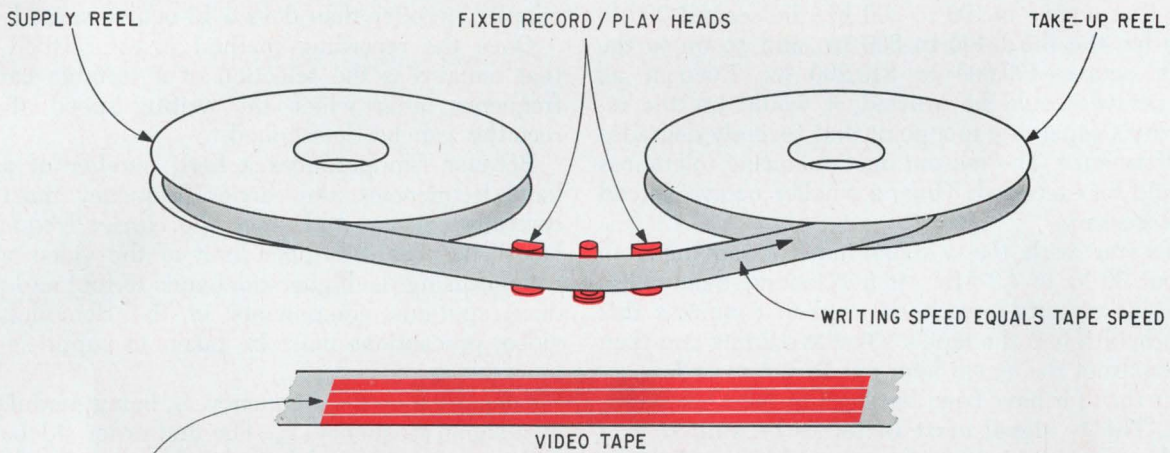

LONGITUDINAL TRACKS

Longitudinal format. Because of fixed-head recorder's high writing and tape speed—120 to 160 inches per second, large tape reels are necessary. Several longitudinal tracks are usually recorded on the tape, requiring track stepping and direction changing at the end of recorded reel.

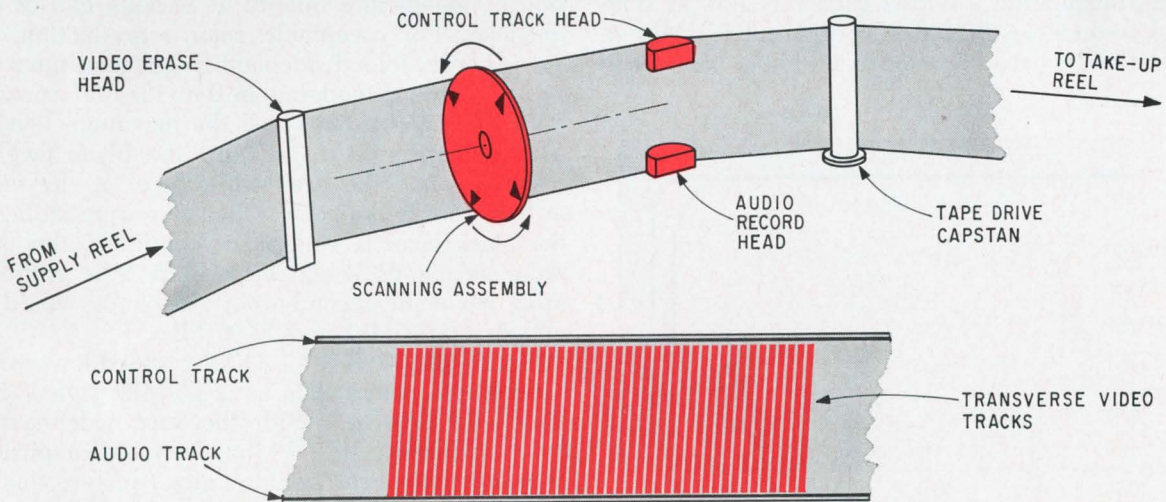

Transverse format. A four-headed rotating scanner assembly spins perpendicularly to the tape surface producing nearly parallel lines to record video information. Fixed heads record control and audio tracks longitudinally along the edges of the tape.

stable picture with conventional monitors, as well as a tape format that permits tape interchange with other vtr's of the same type.

When designing a vtr, an engineer must consider the system's audio capability. Just as limited video bandwidth degrades picture quality, restricted audio capability affects sound quality. Minimum design standards call for one or two audio tracks, and a means of recording them independently of the video. Once the audio capability is decided, the recording method and writing speed can be considered.

Direct, a-m, or f-m recording?

The simplest and least costly way to record signals on magnetic tape is the direct method, which is used in audio recorders. Compared with schemes involving modulation, direct recording requires very little signal processing; the highest frequency is determined by the video bandwidth. Unfortunately, the practical bandwidth limit of magnetic-tape recording is 13 octaves. For a frequency of 100 hertz, the first octave is 100 to 200 hz, the second 200 to 400 hz, the third 400 to 800 hz, and so on to the 13th octave—409,600 to 819,200 hz. Even if all 13 octaves could be utilized, it would tax the recorder's capability to a point that severely degrades performance. The reason: manufacturing tolerances would be exceeded. Thus, a smaller octave spread is necessary.

To start with, the tv signal itself—extending from about 30 hz to 4.2 Mhz—is a 17-octave bandwidth. Various circuits have been used to compress this bandwidth into the tape's 13-octave limits and then reconstruct the signal later on. Direct-recording results thus far have been far short of the NTSC standard. The tv signal must therefore be shifted to a higher frequency spectrum to achieve minimum octave spread. Since this can't be done with the direct-recording method, the choice is narrowed down to either a-m or f-m.

With amplitude modulation, a 4.2-Mhz video signal modulating a 5-Mhz carrier results in sideband frequencies of 800 kilohertz and 9.2 Mhz—a spread of less than four octaves—but a bandwidth

of 8.4 Mhz. However, the price paid for minimizing the octave spread is a much greater writing speed than direct recording, required for the upper sideband. Moreover, the head-to-tape recording process introduces unwanted variations in the amplitude of the radio-frequency envelope. These variations, stemming from poor contact between recording tape and head, appear as noise in the demodulated video output and cannot be tolerated. Thus far, no one has successfully marketed a vtr using either direct or a-m recording method.

Frequency modulation solves both the octave limitation of direct recording, and the high noise level of a-m recording. With the f-m method, a 4.2-Mhz video signal modulating a 5-Mhz carrier results in a four-octave bandwidth. But with the addition of a simple f-m limiter, noise stemming from nonuniform tape-head contact is completely eliminated.

Another advantage of f-m is that playback equalization can be achieved easily. Amplitude and phase equalization over a four-octave spread requires far simpler circuitry than does a 13-octave spread.

Once the recording method is established, all that remains is the selection of a suitable carrier frequency, after which the writing speed of the recorder can be determined.

Because f-m produces a high number of sideband frequencies, the carrier frequency must be carefully chosen. And since the carrier frequency has to be near the upper limit of the video spectrum, causing the higher sidebands to fold and produce spurious components in the demodulated video, precautions must be taken to suppress the interference.

Consider a carrier frequency, f_c , being modulated by a signal frequency, f_m . The first-order sidebands will be at $f_c + f_m$ and $f_c - f_m$; the second order at $f_c + 2f_m$, and $f_c - 2f_m$, and so on to the n th order. To record color signals, the integrity of the color subcarrier, located 3.579545 Mhz above the picture carrier, must be preserved. This requires close scrutiny of the picture quality at various carrier frequencies. For acceptable color reproduction, the second-order folded sideband frequencies must not be allowed to demodulate in the video information.

Or, take a case in which the maximum level of the sync pulse is at 5.5 Mhz, the black level at 5.83 Mhz, and the peak white level of the video at 6.6 Mhz. If the color subcarrier were riding at the black level, a worst-case condition, the first-order sidebands would be at 2.25 Mhz and 9.41 Mhz, while the second-order sidebands would be folded at 1.33 Mhz and 12.99 Mhz.

During playback, the 1.33-Mhz folded lower sideband would demodulate as a 4.5-Mhz signal (5.83 Mhz - 1.33 Mhz). With the NTSC video-system bandwidth limited to 4.2 Mhz, the 4.5-Mhz spurious or moiré component wouldn't affect picture quality because it would be filtered out. This would not be true, however, for the third-order 4.91-Mhz folded sideband. This would demodulate as a 920-khz signal (5.83 Mhz - 4.91 Mhz), creating the in-

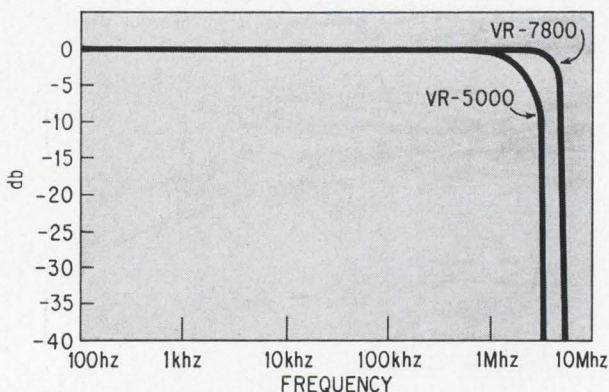

Video response. Variations in the response curves of two Ampex recorders, the VR-5000 and the VR-7800, show high-frequency rolloff of the lower cost VR-5000.

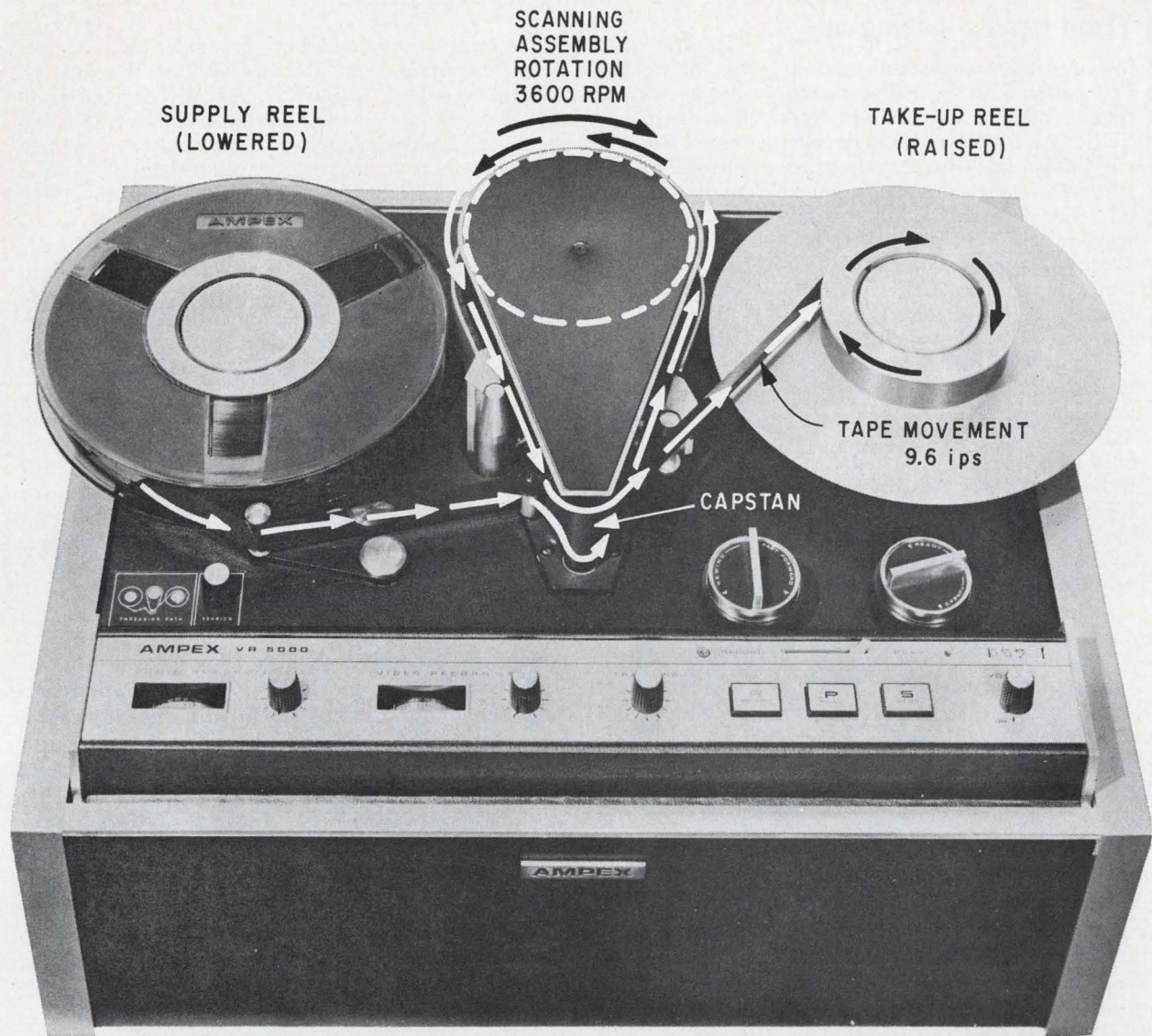

Tape threading. Tape path of Ampex' VR-5000 vtr is typical of those found in helical-scan recorders. Tape moves from the supply reel, around the capstan drive, then around the scanning assembly back to the capstan, and on to the take-up reel. The VR-5000's reels, 9³/₄ inches in diameter, store approximately 3,000 feet of 1-inch wide tape.

terference problem. But since this component is much smaller than the second-order folded sideband, it can be tolerated.

Thus it is essential to have the carrier frequency high enough so that the third-order sideband doesn't demodulate within the 4.2-Mhz bandwidth. This is achieved in the high-band color broadcast recorders. But the cost of the added circuitry required to handle the increase in tape-head speed required for the higher performance cannot be justified in the educational-industrial market. Therefore, the 5.5- and 6.6-Mhz carriers have been chosen as the best over-all compromise.

Determining writing speed

After the carrier frequency is chosen, the optimum writing speed can be determined. Since only the first-order upper and lower sidebands need be reproduced for good color reproduction, the highest frequency to be recorded is 10.8 Mhz—the sum of

the highest modulating frequency, 4.2 Mhz, and the highest carrier frequency, 6.6 Mhz.

The relationship between the writing speed and the recorded wavelength is expressed by

$$\lambda = \frac{\text{tape-head speed (inches per second)}}{\text{video frequency}}$$

For a given speed, the wavelength becomes progressively shorter as the video frequency is increased. Conversely, the wavelength for any given frequency increases proportionately as the tape speed is increased.

The upper frequency limit of the recording head is determined essentially by the head gap—the space between the poles of the U-shaped head. The voltage induced in the coil core is proportional to the rate of change of the net magnetic flux at the head gap. When the tape wavelength equals the width of the gap, there is no change in flux and, therefore, no voltage is induced in the head. Thus, frequencies

Fixed head's looking up

When Ampex came out with its first helical-scan vtr five years ago, several other manufacturers were quick to announce plans to develop and market low-cost, fixed-head recorders. Among those who climbed on the longitudinal-scan bandwagon were Britain's Telcan Co., West Germany's Grundig Werke GmbH, and the U.S.' Fairchild Camera & Instrument Corp. and Par Ltd. The Illinois Institute of Technology also said it was about to launch a research project on fixed-head vtr's.

But despite their efforts, few fixed-head machines reached dealer showrooms.

It wasn't until this year that the first fixed-head color vtr having an acceptable picture quality made its bow [Electronics, Feb. 19, p.

47]. The maker: Arvin Industries Inc. of Columbus, Ind. The Arvin machine, a self-threading recorder that can be used as a color-tv receiver, will be priced under \$1,500. Thanks to Arvin's success in reproducing relatively good color quality with a tape speed of 160 ips, other firms are now taking a new look at the fixed-head approach.

Fairchild's Winston Research division is another firm that has spent considerable effort on longitudinal-scan development. Fairchild says the effort is now beginning to pay off and that the firm expects to market a fixed-head color vtr in the near future. The Fairchild recorder will have a 200-hz-to-2.5-Mhz bandwidth. Thus, it now appears that the fixed-head approach isn't as dead as some

engineers thought just a few months ago. In fact, Newell Associates is presently negotiating licensing arrangements for its track-stepping tape-transport system that was developed for fixed-head vtr's [Electronics, May 15, 1967, p. 25].

Despite the continuing hassle between helical-scan and longitudinal-scan advocates, neither side has made much headway in developing uniform tape-transport standards that would lead to tape interchangeability. Unlike audio tape recorders that merely require the same record and playback speeds, video recorders have different tape formats and speeds for different models that vary from manufacturer to manufacturer. Transverse-scan tapes for broadcast studios are interchangeable.

above this cutoff cannot be reproduced dependably. At frequencies just below cutoff, the gap and eddy current losses of the head are excessive, thus yielding a poor signal-to-noise ratio. To overcome this limitation, it is customary to maintain the gap length at half the shortest wavelength to be recorded.

Although recording heads have been built with gap lengths as small as 20 microinches, most have gaps of about 50 microinches. With a 50-microinch gap and a 100-microinch wavelength, the needed writing speed is $(10.8 \times 10^6) (2 \times 50 \times 10^{-6}) = 1,080$ ips. In practice, the numbers would be rounded out and the parameters would be: writing speed, 1,000 ips; gap length, 50 microinches; and maximum frequency, 11 Mhz.

In helical scanning, one or two heads rotate about the vertical axis of the cylindrical scanning assembly as longitudinal motion is imparted to the helically wrapped tape, and a series of parallel slant tracks are recorded on the tape. The writing speed is essentially equal to the algebraic sum of head peripheral velocity and the tape longitudinal velocity.

In a single-headed helical recorder, a 360° wrap of tape around the scanner is necessary for continuous recording; when two heads are used, only a 180° wrap is required. The development of an air-lubricated scanner has eliminated the tape-to-scanner friction problems usually associated with 360° wrap. Thus, the single-headed helical recorder has become practical. Usually, helical vtr's record one tv field per scan.

Since one field of a tv picture occurs every 1/60th of a second, the scanner rotation must match it. Thus, for a single-headed recorder, a 3,600 revolutions-per-minute drum speed is required. The drum circumference can be calculated for a 1,000 ips writing speed by dividing 60 into 1,000. The di-

ameter becomes 16.6 divided by π .

To synchronize the motion of the rotating head with the longitudinal motion of the tape so that the recorded signals can be tracked by the head upon playback, a servosystem is used to control the rotation of either the scanner or the capstan. The command signal for this servo is provided by a control track that is recorded longitudinally on the tape by a fixed head. In practice, the rotation of the scanner is synchronized with the incoming signal. The reason: since the tape consists of a series of discrete tracks, the track-to-track switching must be timed to the incoming signal. The sync pulses of the incoming video signal is processed and used as the command for the servo.

In helical recording the audio tracks are recorded longitudinally along the edges of the tape, and the simple direct-recording technique is employed.

The authors



Delmar Johnson is manager (mechanical) of video engineering at Ampex Corp.'s Consumer and Educational Products Division. He has worked on helical recorders since their development in 1962.



Barrett Guisinger, manager (electrical) of video engineering at Ampex' consumer division, has done considerable work on transverse-scan, helical-scan, and longitudinal-scan recorders.

"Some people think integrated circuit reliability programs are part of the game 'How to Lie With Statistics.' More than 11% of our people work exclusively on such programs. We wouldn't spend money like that just to play a game."

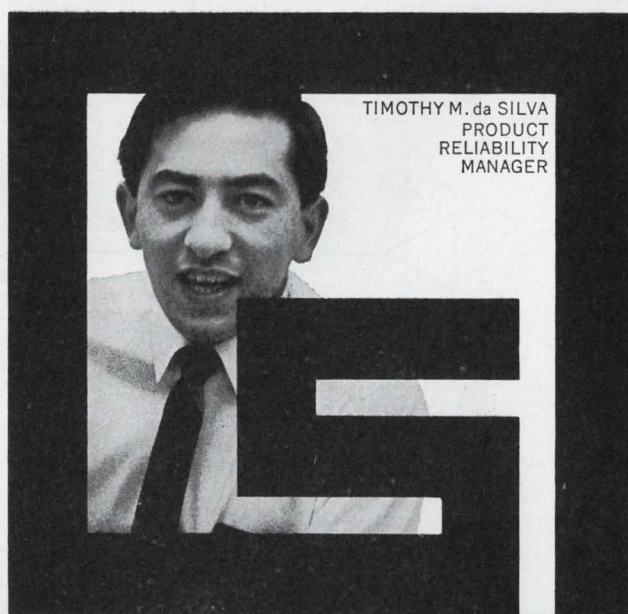

SIGNETICS INTEGRATED CIRCUITS

SIGNETICS CORPORATION
THE RESPONSE/ABILITY COMPANY

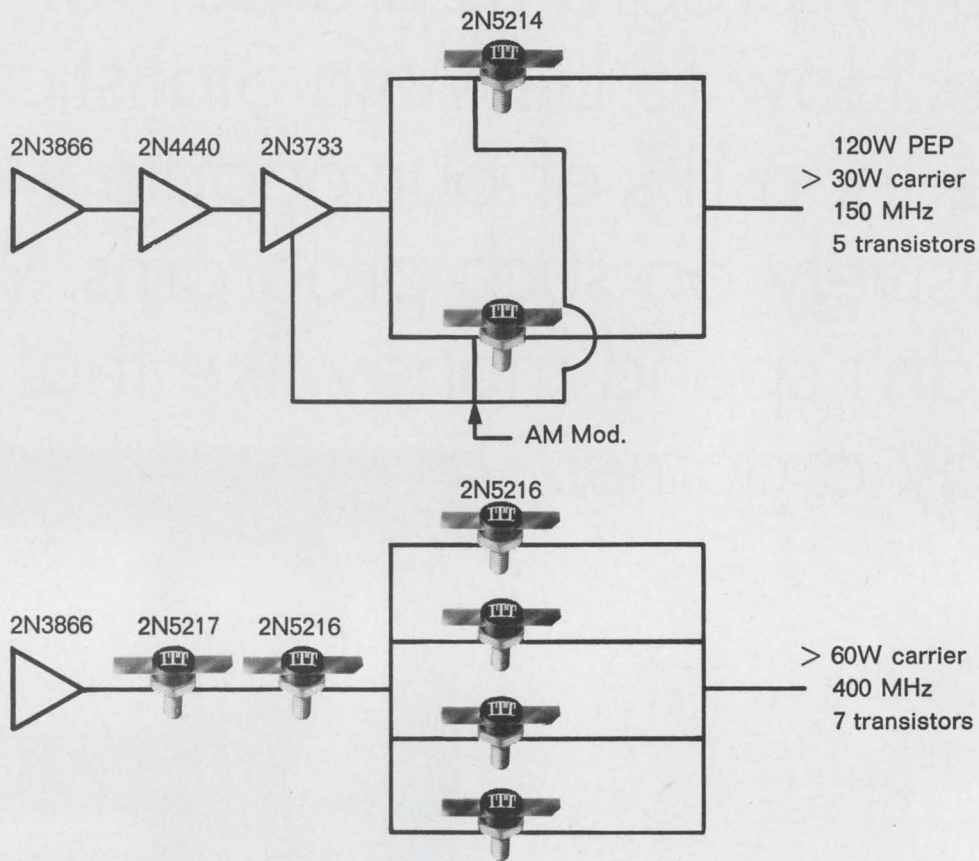

Only ITT delivers so much broadband RF power with so few transistors

Another reason to buy from "The Predictables"

Is your goal circuit simplification through higher power? Would you like to increase reliability and cut cost by reducing the total number of components in your equipment? Then ITT's strip line RF power transistors are for you.

Two application examples are

shown above, but the possibilities are almost endless. Here's why:

Strip line packaging gives you lower inductance, higher power output, broader bandwidth and greatly improved stability. The high BV_{CEO} ratings of the 2N5214 and 2N5216 give you better up modulation capabilities and reduce the danger of damage from transients. Resistor stabilization provides increased safe operating area and built-in bias stability

for class A and AB amplifiers.

Want more information? Write for a free copy of "VHF/UHF Transistor Power Amplifier Design". Want immediate delivery of strip line transistors? Contact any ITT distributor or your ITT factory representative. ITT Semiconductors is a Division of International Telephone and Telegraph Corporation, 3301 Electronics Way, West Palm Beach, Florida.

semiconductors **ITT**

FACTORIES IN FLORIDA • CALIFORNIA • MASSACHUSETTS • ENGLAND • FRANCE • GERMANY • PORTUGAL • AUSTRALIA



**TAKING
GRAVITY'S MEASURE**
precisely...at high speed
...from planes or ships



Bell's new BGM-2 Gravity Meters make precision gravity mapping of water areas possible. Map makers can now determine the earth's exact shape... and prepare more accurate nautical charts. For oil men, they offer a more practical method of detecting offshore oil deposits. BGM-2 is compact, self-contained and light weight. The heart of the unit is Bell's Model VIIIB accelerometer. 3,500 Bell accelerometers have been produced in various sizes for missile, spacecraft and aircraft guidance systems. In sea trials co-sponsored by the Naval Oceanographic Office and the Environmental Science Services Administration, the Bell Gravity Meter proved accurate to 0.5 milligal during sea state 4 conditions. It was also successfully tested in a Navy P3A aircraft. Bell Gravity Meters are currently being delivered for use by the U.S. Army Mapping Service, the Navy's Oceanographic Office, and the Gulf, Shell and Mobil Oil Companies.

Typical Gravity Map

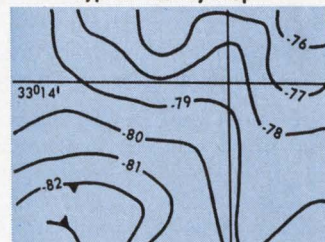

BELL AEROSYSTEMS
A **Textron** Company/ Buffalo, N. Y.
Systems for Aerospace • Defense •
Transportation and Communications

If your LSI performs like LSD...check for H₂O!

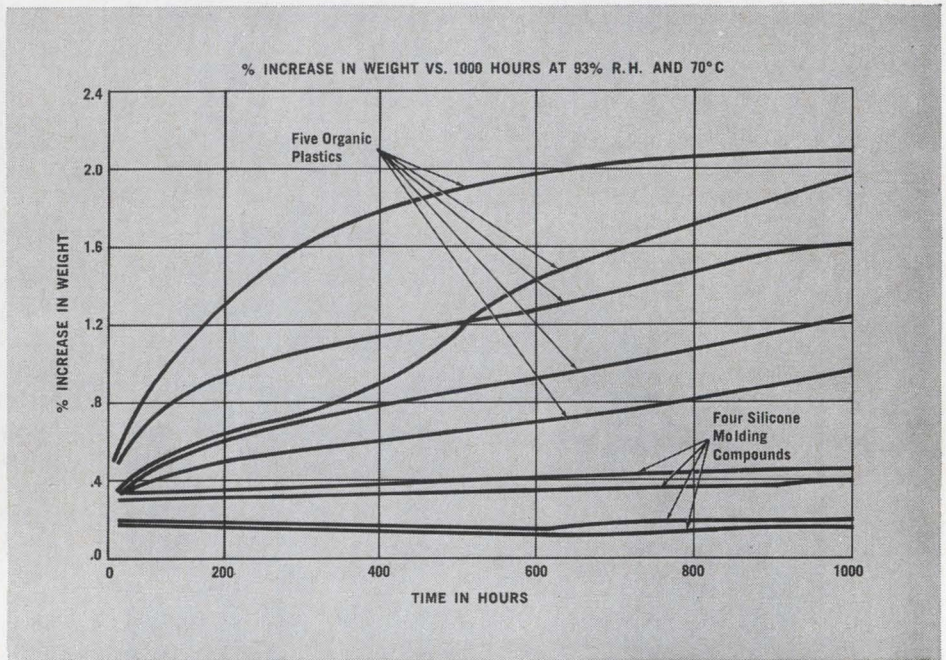
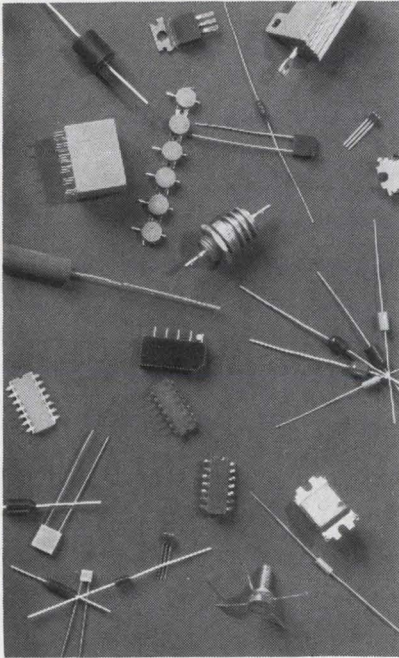

Moisture absorption of most plastics can lead to critical conditions in devices — whether LSI or simple diodes.

But, devices packaged in silicone molding compound are physically and electrically stable after long term exposure to both high humidity and operating temperatures—as shown by the graph above. This stability means more reliable operation at full rated device power without failure due to moisture absorption . . . less need to provide other circuit embedment or encapsulation.

This is just one of the many reasons why more and more equipment manufacturers are turning to devices packaged in Dow Corning® silicone molding compound — whether those devices are simple diodes, power rectifiers or integrated circuits. Some of the other reasons—

No derating necessary. Devices and components packaged in silicone molding compounds can be operated at their full power potential. This permits designs with higher density of devices and components. One manufacturer of glass packaged power diodes reduced his part's volume to 1/30th by using silicone molding compound. Compared to other plastics, size is from 1/5th to 1/3rd smaller since derating due to package material instability is not required with silicone molding compounds.

No cracking. Dow Corning silicone molding compounds—unlike other thermal setting plastics—are virtually unaffected by heat aging and thermal shock. For example, a power resistor molded in Dow Corning® 307 molding compound was sub-

jected to repeated cycling from —65 to 350 C without damage to the packaging material or the component. Subjected to 1000 hours at 300 C (572 F) Dow Corning brand molding compounds show no significant change in physical and electrical properties.

Will not burn. Silicone molding compounds are inherently nonburning. Thus, components packaged in silicone molding compound will not constitute a fire hazard. No flame snuffers are needed . . . a source of ionic contamination for devices packaged in organic plastics. With silicone molding compound there are no ionic or polar constituents to affect junction performance when properly used.

Competitive price. Dow Corning silicone molding compounds cost only a fraction of a cent per device. Thus, they enjoy a substantial price advantage over metal cans and glass packages.

Manufacturing economies. Transfer molding enables devices and components to be packaged with a minimum of manual labor and supervision. Good mold release and minimum flash assure high production rates . . . reduced deflashing costs. These manufacturing advantages make silicone molding compounds totally competitive with organic plastics.

So, why chance a device failure because of a cheap plastic package? Put silicone molding compound protected devices and components into your electronic equipment. For technical data, write to: Dept. A-8467, Dow Corning Corporation, Midland, Michigan 48640.

DOW CORNING

DOW CORNING



**Happiness is an Acopian power supply . . .
because it's shipped in only 3 days.**

Whether your application is op amps, ICs, logic circuits, relays, lamps or electronic measuring equipment, look to Acopian to meet your needs for AC to DC plug-in power supplies. Acopian's new catalog lists over 62,000 different supplies . . . all available for shipment within 3 days. Get your 16 pages of happiness by writing or calling Acopian Corp., Easton, Pennsylvania (215) 258-5441.



Circle 89 on reader service card

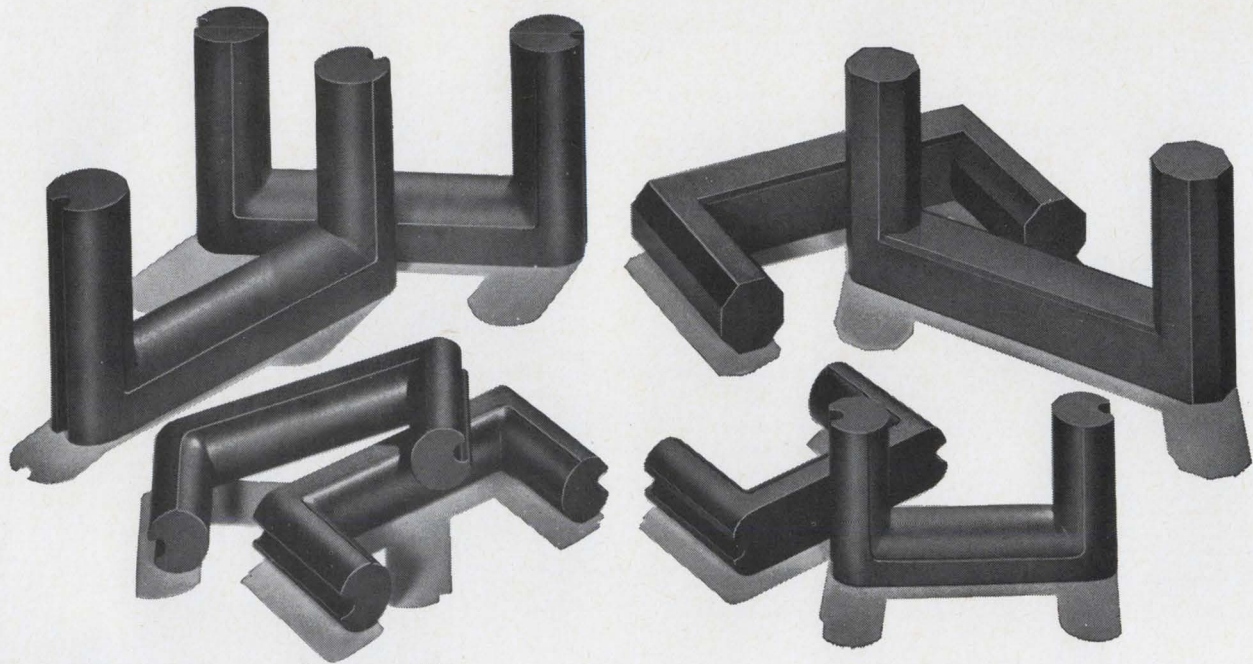

From Stackpole: A New H.O.T. Ferrite Material That Doesn't Lose Its Cool

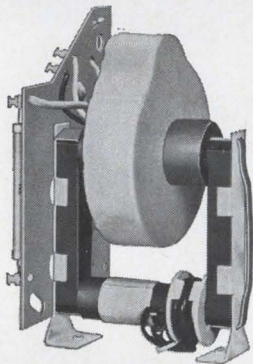

Ceramag[®] 24C was developed by Stackpole engineers especially for Horizontal Output Transformer applications. Because this new material offers an unequalled combination of high power permeability and low power loss under flyback circuitry operating conditions, it provides improved efficiency and cooler operating temperatures.

Excellent electrical and mechanical properties are combined to provide fabricated parts that easily meet standard industry strength and warpage requirements.

The Stackpole Ceramag[®] family of power ferrite materials has been the accepted standard of the television industry for over twenty years. Ceramag[®] 24C is no exception. It features a power permeability of 6200 @ 1800 gauss (typical operating condition), compared to Grade 24B with a permeability of 4200 @ 1800 gauss.

Equally important, the power losses of 24C at operating frequencies and temperatures are 15% lower than those of the widely recognized Ceramag[®] 24A, an industry workhorse.

Stackpole engineering pioneered the first Ceramag[®] horizontal output transformer cores as far back as 1947. Since then, continuous developments have made Stackpole a leading contributor to the growth of black and white, and now color, television technology.

For additional information and

samples of Ceramag[®] 24C, write or call: Stackpole Carbon Company, Electronic Components Division, St. Marys, Pa. 15857. Phone: 814-781-8521. TWX: 510-693-4511.

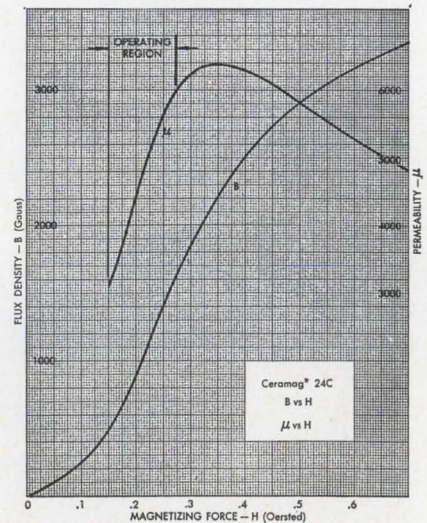

STACKPOLE
ELECTRONIC COMPONENTS DIVISION

ALSO A LEADER IN THE MANUFACTURE OF QUALITY FIXED COMPOSITION RESISTORS

GOOD

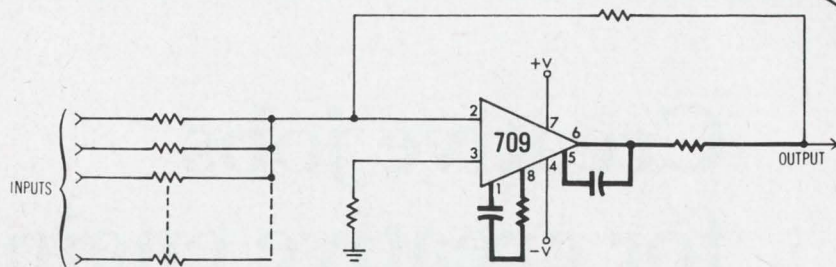

When you have a good adder . . .

BETTER

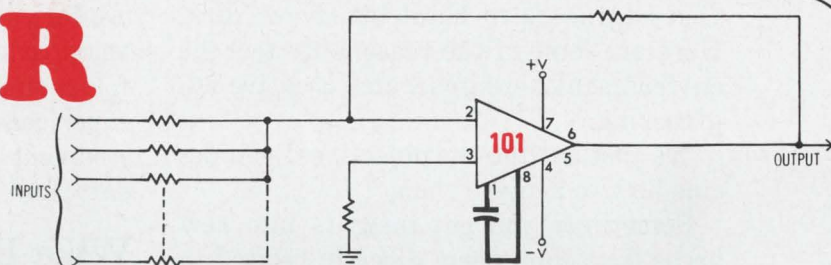

. . . why just improve it . . .

BEST

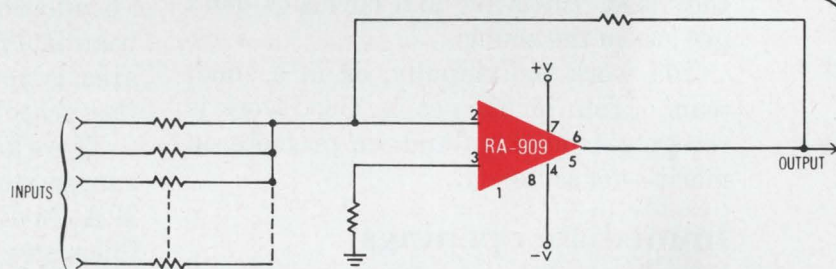

. . . if you can optimize it!

The NEW compensationless RA-909 lets you optimize all 709 circuits.

The RA-909 replaces earlier 709 versions pin-for-pin and exceeds the latest versions spec-for-spec.

Adders . . . regulators . . . buffers . . . gates . . . filters . . . you name it. Any 709 circuit can be optimized by using the RA-909. You eliminate unnecessary compensating components and get better performance in almost every other area. And for a comparable price, too.

Where else can you get a slew rate of 5 volts per microsecond? Or a maximum equivalent input noise of 5 microvolts rms? And the RA-909 offers a transient response of 40 nanoseconds (10 to 90% points) with a 200 millivolt output into a 2K Ω , 100pF load in

the worst-case unity gain configuration. It only dissipates 52 milliwatts, too

An eight-pin TO-5 configuration and TO-86 flatpack, both having blank pins where the 709 and 101 require compensation, allows you to design it in or use it as a direct replacement. Existing compensation networks cannot degrade the performance of the RA-909 or affect the circuit's operation even if a failure occurs in a network. For optimum results, contact your nearest Radiation sales office. Specifications are available.



RADIATION
INCORPORATED

SUBSIDIARY OF HARRIS-INTERTYPE CORPORATION
MICROELECTRONICS DIVISION

Sales Offices: 600 Old Country Road, Garden City, N.Y. 11530, (516) 747-3730 — 2600 Virginia Avenue, N.W., Washington, D.C. 20037, (202) 337-4914 — 6151 W. Century Boulevard, Los Angeles, Calif. 90245, (213) 670-5432 — P.O. Box 37, Melbourne, Florida 32901, (305) 727-5430 — International Sales: Marketing Department, P.O. Box 37, Melbourne, Florida 32901, (305) 727-5412

Creative jobs for creative engineers

IBM has immediate openings for qualified engineers in Endicott, New York. Here are some of the reasons we feel the environment here generates creative engineering.

We just outline the objectives; you decide how to achieve them.

Sometimes you get insights into new areas that don't seem directly related to what you're working on. You get the chance to follow them up and see where they lead. Initiative and curiosity don't get lost in the shuffle.

You work individually, or in a small team of four or five people. Good work is recognized quickly. And we promote on merit—not seniority.

Immediate openings

IBM needs some creative engineering done right now, in the following areas:

Design engineering—These jobs offer an opportunity for creative, innovative work with electron beams, solid-state circuitry and electronic systems in general. The problem is to develop new test technologies and circuit packages.

Quality engineering—We need people to establish quality-control programs for the manufacture of printed circuit assemblies and subassemblies. This is quality *assurance*, not typical quality control.

Test engineering—This involves liaison and support assignments with engineers from many other areas of specialization. For engineers capable of handling complicated electronic system testing, this job offers an overview of the entire EDP field.

Systems engineering—If you're interested

in a future in this area, IBM may be able to offer you one. We need people to plan, develop, code and install computer programs for manufacturing control application, experiment design, product testing, instrument monitoring, numerical control data, and simulation.

What Endicott offers you

These positions are at IBM Endicott in upstate New York. Endicott/Binghamton (population 200,000) is surrounded by beautiful farmland and small woods. The area is noted for its recreational facilities, schools, and cultural activities.

There are educational facilities for advanced study. You can get your M.S. or M.A. in Engineering, Physics, Math or Chemistry through IBM's tuition-refund program. A liberal benefits plan is also paid for by the company.

Interdisciplinary environment

For simplification, we've listed these jobs in categories. But people don't fit into categories, and neither does their work. At IBM, we try to do as little categorization as possible; the more overlap and inter-involvement there is among our engineers and scientists, the better we like it. If that idea interests you, send a brief outline of your educational background and experience to: Jerry Hinkley, Personnel Department, Dept. BD 1020, IBM Corp., 1701 North Street, Endicott, N. Y. 13760.

IBM®

An Equal Opportunity Employer

you get a choice,

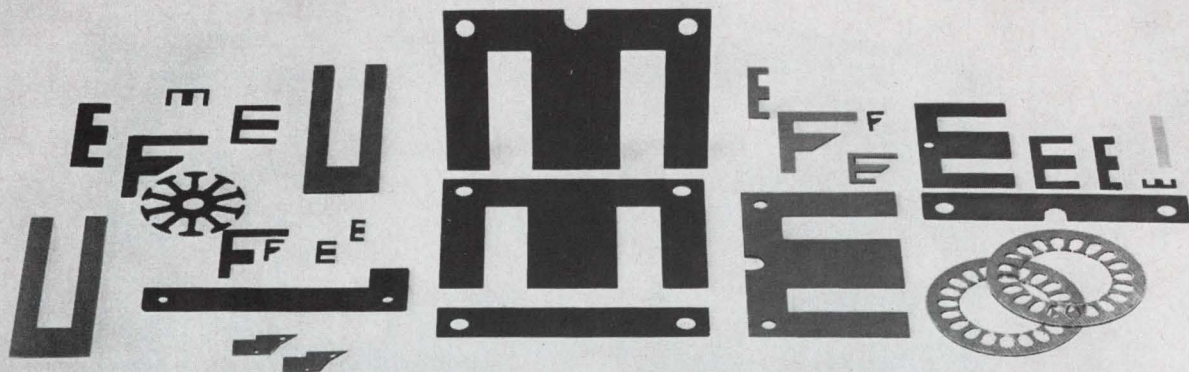

not a challenge

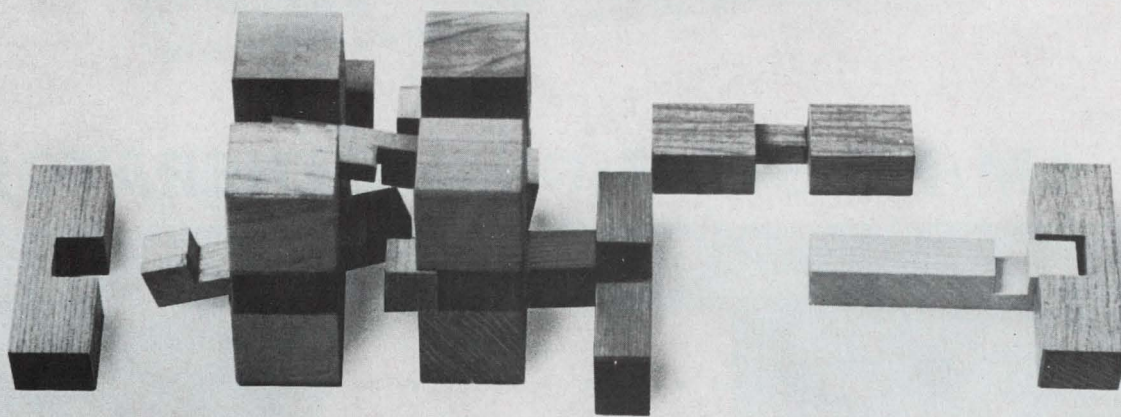

51 standard shapes of laminations simplify solid-state circuit design

Magnetics maximizes your chances of finding laminations that dovetail precisely into your designs for transformers, chokes, reactors and transistor circuits. We offer 51 standard shapes in Permalloy 80, Alloy 48 and Orthonol®. Thicknesses of 0.004", 0.006", and 0.014" are available, with sizes ranging from DU-87 and EI-12 down to the

solid-state circuitry sizes—EI-093, EE-30-31, DU-63 and F-094.

All Magnetics' laminations are hydrogen-annealed and manufactured to guaranteed minimum permeability limits. In addition to the catalog shapes and sizes, we have the capability to make special shapes to fit specific needs, including rotors, stators and recording head laminations. Our photo-etch process is ideal for making

prototype-run laminations and small intricate configurations.

Furnishing a broad spectrum of shapes, sizes and materials is Magnetics' way of saving you valuable design time—we believe in giving our customers a choice, not a challenge. Complete information on Magnetics' laminations can be had by writing today for our Catalog ML-303-R, Magnetics Inc., Butler, Pennsylvania 16001

MAGNETICS inc.
®

1.39 - 510 MHz

Vital Tool for Advanced RF, VHF, UHF Communications Equipment

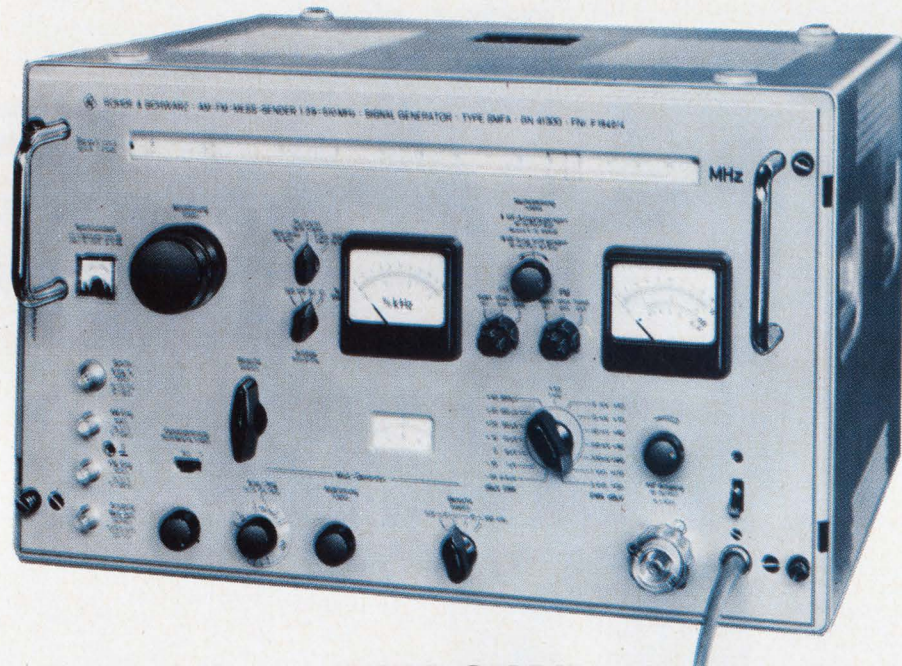

TYPE SMFA

AM/FM STD SIGNAL GENERATOR

FEATURES:

- Frequency Range: 1.39-510 MHz in 12 ranges using 12 inch scales
- Frequency Stability: 30 ppm over 15 min.
- Synchronizable over entire range to at least 7 digits using ND30M frequency synthesizer
- Built-in Electronic Fine Tuning (metered): Offsets to ± 300 kHz with resolution of ± 100 Hz
- Output Voltage: $0.03\mu V$ - 2 V behind 50Ω (To 1 V with AM) with automatic leveling to 0.5 dB
- Modulation: AM, FM, FM Stereo, Simultaneous AM & FM; internal or external
 AM: Modulation accurately set and metered from 0.1%-95%; S/N >70 dB
 FM/FM Stereo: Accurately set & metered from 100 Hz - 300 kHz; crosstalk with stereo <1%; envelope distortion <1%
- Built-in Modulation Generator: 10 Hz - 100 kHz; 0-6 V

APPLICATIONS

- AM, FM, FM Stereo Receiver Testing
- Telemetry Receiver Testing
- Overload and Sensitivity Tests
- Selectivity Testing
- Cross-Modulation Testing
- Study of Detector Discriminator Performance
- Measurement of Drift

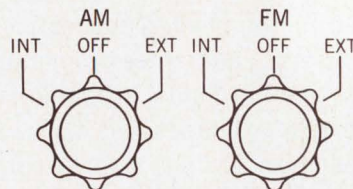

MODULATION MODE

Complete flexibility provided with AM and FM modulation.

Covering the entire RF, VHF, and part of the UHF range (1.39-510 MHz), Type SMFA is a Standard Signal Generator of unmatched specifications. Extremely high resolution is provided using 144 inches of scale with an anti-parallax indicator. Accuracy of $\pm 0.5\%$ can be further improved to $1 (10^{-9})$ by synchronizing with our ND30M+Q4 Frequency Synthesizer. Critical selectivity measurements can be made with the electronic incremental tuning feature. No external battery required; it's all built-in and metered. Output voltage continuously variable from $0.03\mu V$ -2V; leveled, of course.

Exceptional modulation capabilities are included; AM, FM, FM Stereo (use our Type MSC for stereo coding). Simultaneous AM/FM modulation permits vitally important studies of detector and discriminator performance. Measurements at very low, accurate levels possible. Why limit internal modulation to 1 kHz; Type SMFA incorporates a modulation generator continuously variable from 10 Hz - 100 kHz.

With all of these features, the price of the Type SMFA AM/FM Signal Generator is competitive with the most sophisticated AM generator on the market.

Get The Extra Capability,
Greater Reliability, and
Longer Useful Life Of . . .



ROHDE & SCHWARZ

111 LEXINGTON AVENUE, PASSAIC, N. J. 07055 • 201-773-8010

Inquiries outside the U.S.A. should be made to: Rohde & Schwarz, Muehlendorfstrasse 15, Munchen 8, West Germany.

Probing the News

Communications

Mexico nears finish line in the first Olympic event

Most advanced communications network in Latin America will be unveiled before the Games open; the big winner will be the country's electronics industry

By Gerald Parkinson

Mexico City news bureau

Early in August, Mexico will flip the switch on the most advanced communications network in Latin America. By meeting the summer deadline, authorities will have plenty of time to check out the system before it's used to carry accounts of the Olympic Games from Mexico City in October.

The Olympiad isn't the only reason for the installation of an integrated nationwide communications network and microwave links with North and South America. But the Games have advanced the completion of the microwave portion by about 12 months.

Timetable. The five-year, \$560 million project is run by Mexico's Ministry of Communications and Transport. Studies began in 1965, construction a year later. An estimated 90% of the network will be completed by August; the finishing touches are scheduled for yearend 1970. By then, the system will include:

- A 17-story central communications building at the ministry's facilities in Mexico City.
- A ground station with a 105-foot-diameter Cassegrain antenna for satellite communications near the town of Tulancingo, about 80 miles from Mexico City.
- A nationwide microwave network encompassing more than 8,000 miles of trunk lines and more than 200 relay stations.
- New telephone, Telex, and tele-



After the fall. By autumn, Mexico will have an integrated communications hookup linking its principal cities to one another and to the outside world.

graph facilities, as well as the means to extend and improve radio navigation and communications services for air and maritime traffic.

Value added. "The microwave network will give the country a unified communications system for the first time," says Jorge Suárez Díaz, general director of telecommunications at the Ministry of Communications and Transport. At the moment, the nation's only microwave links are those connecting Mexico City with Guadalajara, Acapulco, Veracruz, Puebla, Poza Rica, and San Antonio, Texas.

Suárez also notes that the new system will give Mexico first-class, direct communications by every means—including telephone, radio, television, and telephoto—with the entire North American continent, South America, and Europe. "For example, we can call Buenos Aires by radiotelephone at the present time, but the circuit is not of the best quality," he says. "The alternative is by cable through New York. There is no connection for television."

As director of telecommunications, Suárez has over-all responsi-

... the microwave system will carry most of the Olympics broadcasts ...

bility for the entire program. The electronics portion of the project is the province of two engineers who report to him: Clemente Pérez Correa, who is in charge of all Olympics installations, including the central communications building, and José Luis Almázan, who is responsible for the microwave system.

I. Olympian goals

The Olympics will be beamed to the world via the Tulancingo ground station and a satellite—probably an Intelsat 3—that will be launched in July or August. To handle these transmissions, the ministry is providing more than 40 video channels and hundreds of radio channels. No one yet knows how many radio channels will be needed, but Suárez says broadcasters can easily be accommodated later.

The microwave system will be

used for most of the Olympic broadcasts; the others will be sent over coaxial cable to the communications center. In addition, some 8,500 telephone lines in Mexico City will be used for audio, Telex, and telegraph communications involving the Olympics. About 20% of these will be spares owned by the telephone company, Telefonos de Mexico S.A., but the rest will be new lines.

Olympics construction is being coordinated by the Installations Control Directorate, which answers to the Olympic Games Organizing Committee. The work is being handled by the communications and transport agency, the phone company, and the Ministry of Public Works, which is doing the actual building.

No contest. Radio and tv coverage of the Games involves a number of pooling arrangements. The American Broadcasting Co. has the

U.S. rights for both radio and tv. The European Broadcasting Union will do the job for Western Europe, Britain, and the Commonwealth countries, while the International Organization of Radio and Television, will serve nations in the Eastern bloc. Japanese coverage will be handled by Nihon Hoso Kyokai. These organizations, in turn, will join with Telesistema Mexicana S.A., Mexico's tv network, to coordinate coverage of the various events.

Although work directed towards the Olympics has priority at the moment, the project's principal purpose is to give Mexico a unified domestic and international communications network. Authorities note that the news lines being laid in Mexico City for the Olympics will serve the future communications needs of the city.

II. Fallout

Although only one of the 20 or so companies now working on the network is Mexican, the program is expected to give a tremendous boost to the country's electronics industry.

For one thing, many of the foreign firms working on the system have expressed intentions to set up production facilities in Mexico. For example, Siemens AG of Germany has already started producing teleprinters in Mexico City.

And though equipment and technical direction come from outsiders, almost all the engineers and technicians working on the project are Mexican. The foreign firms are systematically training Mexicans to operate and maintain the equipment once the network is set up. The system will be run by the Ministry of Communications and Transport, which has a monopoly on Mexican communications and either rents out channels or grants concessions to communications companies.

Finally, the network should spur sales of electronic equipment. In the consumer sector, for instance, sales of tv sets will benefit from the expansion of service into remote areas and the improvement of signal reception in more developed ones.

Roster. The companies working on the program include: the Nippon Electric Co. (radio and multiplex equipment for the ground station

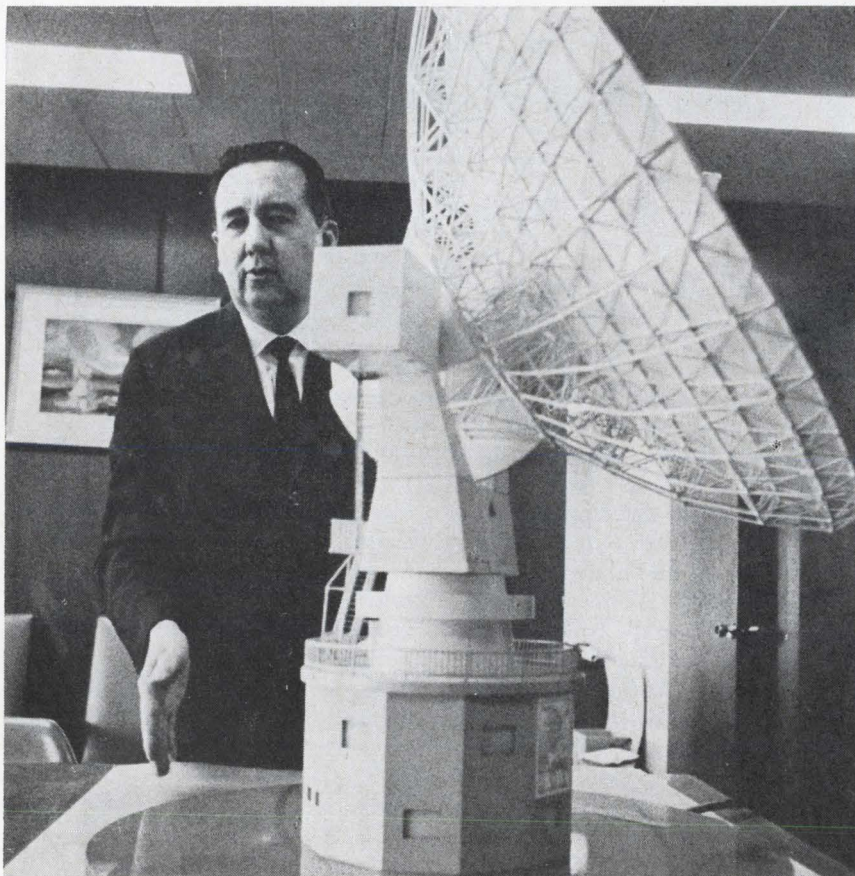

Honcho. Jorge Suarez Diaz, a Communications Ministry official, has over-all responsibility for installation of Mexico's new telecommunications network.

Tomorrow's market—maybe

While a communications revolution is an unlikely prospect for most Latin American countries during the next decade, there's a chance that some South and Central American nations will have at least adequate systems by the mid-1970's.

At the moment, the situation is grim. Because of inadequate facilities message backlogs are tremendous. For example, the average wait to complete a telephone call from Buenos Aires to New York is seven hours. Geographical barriers like the Andes compound the problem, and there are vast interior areas such as the Amazonian jungle without communications of any sort.

Follow the leader? Furthermore, the volatility of Latin American politics restrains long-range planning. An official of the Communications Satellite Corp., mulling the possibility of a satellite earth station in Ecuador, says: "It's really hard to predict what will happen there since we are talking about a provisional government with a provisional telecommunications policy."

Inflation, interest rates as high as 30%, technological backwardness, and political corruption are among the reasons cited for the communications lag. One official of a U. S. firm with Latin American interests figures about 30% of a project's total cost must be paid under the table to insure completion. And a large part of the problem lies in the fact that in almost every nation south of the border, communications are controlled by the government or by government-owned companies.

Some relief in the form of satellite communications is on the way. Besides Mexico, Panama and Chile will have ground stations operating before the Olympic Games. Brazil, Peru, and Argentina have ground stations scheduled to go on line early 1969, and Venezuela plans to set up one soon after. Peru, however, is an "iffy" situation in light of its contract squabble with Hughes [Electronics, March 4, p. 307]. Colombia and Ecuador can be described as "mañana" situations; preliminary studies are complete, but nothing definite is on tap.

Partial answers. The satellite-tracking stations will help unclog the communications traffic jams between major Latin American cities and will have an immediate impact on South America's communications with the rest of the world. However, they will satisfy only part of the need.

A study completed by the Inter-American Bank says that 10 years and \$2.7 billion will be needed to raise telecommunications standards in South America. Of that \$2.7 billion, \$2.2 billion would go toward upgrading local phone service and improving long-distance capabilities. Ground station needs over the decade were estimated at only \$50 million, suggesting that satellite communications can solve only a fraction of the total problem.

and hardware for the microwave links in the communications center); a joint venture of TRW Inc. and the Matsushita Electrical Industrial Co. (ground station antenna); the Hewlett-Packard Co. (instrumentation); the Tokyo Shibaura Electric Co.; Siemens; Standard Elektrik Lorenz, an affiliate of the International Telephone & Telegraph Corp; the Collins Radio Co.; RCA; Compagnie Française Thomson Houston-Hotchkiss Brandt; Compagnie Générale de Télégraphie sans Fil; Tel-ettra S.p.A.; NV Philips Gloeilampenfabrieken; Hasler AG; and Mexico's Comercial Electrica S.A.

Mexico is financing the program with the help of the companies working on it. Payments, which start two years after the equipment

is installed and checked out, will be spread over a period of 15 years at a maximum annual interest rate of 6%.

III. Keystone

The six main microwave links will converge on the telecommunications center in Mexico City from Matamoros; Lajas, Cordoba, and Veracruz; Acapulco; Cerro, Culiacan, Laredo, and Juarez; Tapachula; and the ground-station link. In all, 38 channels will be handled at the center—19 transmitting and 19 receiving.

On the center's top floor will be seven microwave antennas—five parabolic and two horn units. The parabolic antennas are about 13 feet in diameter and the horns are

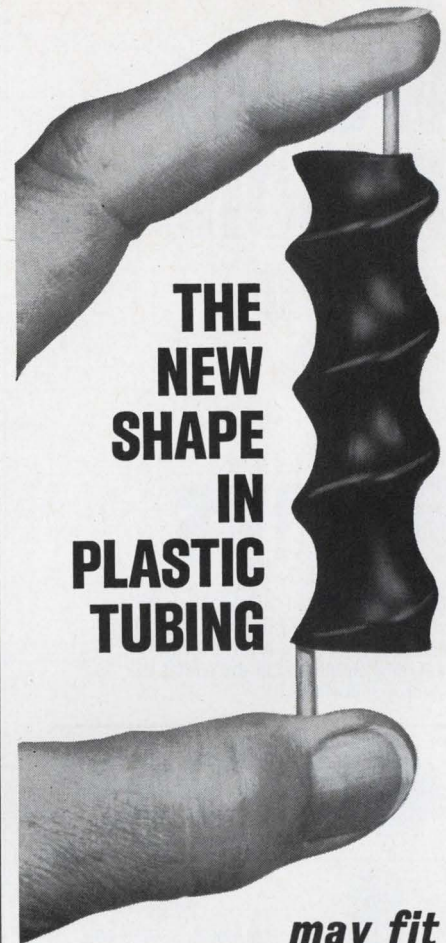

**THE
NEW
SHAPE
IN
PLASTIC
TUBING**

*may fit
your problem
exactly*

FLEXITE *Shrinkdown* Plastic Tubing shrinks 50% in diameter upon application of moderate heat to form a tight-fitting sheath around objects of irregular shape. It's being used to solve many different problems . . . like insulating electrical connections; protecting delicate components; strengthening assemblies; binding things together; resisting corrosion, heat or moisture; preventing wear, vibration and noise. What problems do you have that a tight sheath of tough plastic might solve? Markel offers Shrinkdown in three distinct types to meet a broad range of needs. Your call or letterhead request will bring samples and data.



L. FRANK MARKEL & SONS, INC.
Norristown, Pa. 19404 • Phone: 215/272-8960
INSULATING TUBINGS AND SLEEVINGS
HIGH TEMPERATURE WIRE AND CABLE

Wedge-Action*

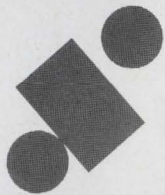

Relays

Hermetically-sealed, electromagnetic relays that provide high performance and reliability under the most difficult operating conditions in dry-circuit to 2 amp applications.



2 PDT
MARK II, SERIES 500
MIL-R-5757/9



2 PDT
MARK II, SERIES 400
(1.35" high)
SERIES 410 (1" high)
MIL-R-5757/8



6 PDT 4 PDT
(1" x 1")
MARK II, SERIES 300
(6 PDT).
SERIES 350 (4 PDT).
MIL-R-5757/1 and
MIL-R-5757/7



6 PDT
MARK II, SERIES 085
(-55°C to +85°C)
SERIES 100
(-65°C to +125°C),
SERIES 200
(-65°C to +200°C).
MIL-R-5757/1.

*Wedge-Action



The moving contacts are mounted between two stationary contacts. On actuation, they drive into the stationary contacts, creating high pressures and low

contact resistance at all current levels. In addition, wedge-action contact wipe provides self-cleaning of the precious-metal contacts.

*Patent No. 2,866,046 and others pending.

For complete data write Relay Sales and Engineering Office, P. O. Box 667, Ormond Beach, Fla. 32074, Phone 904-677-1771, TWX 810-857-0305.

Electro-Tec Corp.

SLIP RINGS • RELAYS • SWITCHES

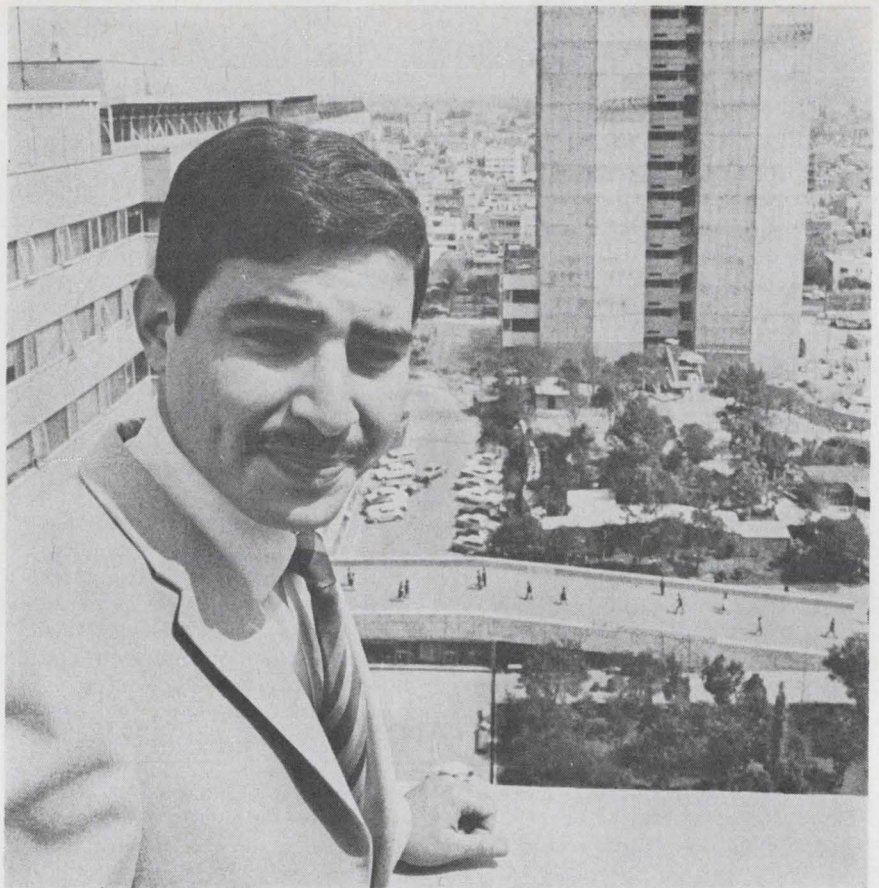

Overview. Jose Luis Almazan directs installation of Mexico's microwave network. In the background is the system's central communications tower.

about 20 feet high.

Another antenna may be added next year for telephone communications with Cerro Gordo, a radar station about 15 miles northeast of Mexico City that's used for air traffic control. Later, Cerro Gordo may be wired into the microwave system for retransmission of tv and telephone communications.

For the duration. Besides the permanent antennas for the microwave network, 14 small antennas (about 4 feet in diameter) will be temporarily installed to receive transmissions from the Olympic sites.

The antennas will be completely enclosed by nonconducting plastic walls to protect them from the elements without attenuating signals.

The lower floors of the building will hold a variety of telecommunications equipment, including gear for international tv, radio, telephone, and Telex services; a data switching and distribution system for the capital; and units to process signals for transmission through the microwave system.

Monitoring and correction equipment will be applied to data (in-

cluding black-and-white and color tv) at various points in the network.

Looking up. Though most of the equipment at the communications tower and the ground station will be standard, the station's 105-foot-diameter antenna will be the world's largest in commercial use.

It has to be big because the angle between Mexico and the satellite will be very small—only about 5°. Noise is therefore a major problem, and a large antenna is needed to provide sufficient gain to capture the signal. The antenna, which will use a horn reflector feed assembly, will have a gain of about 62.2 to 62.5 db.

The traveling-wave tube to be used at the station is being supplied by the Hughes Aircraft Co. and will have a transmitting power of 6 to 8 kilowatts.

Firm underpinnings. The ground station is being built at Tulancingo largely because the town is away from the microwave routes; the antenna and the trunks will work at similar frequencies—5,925 to 6,425 megahertz transmitting and 3,700 to 4,200 Mhz receiving. Also, the

site has firm subsoil with a minimum of seismic movement, whereas the Valley of Mexico, where Mexico City is located, has soft subsoil and is subject to earthquakes. There is also little rain or wind at Tulancingo and it's easy to reach from the capital.

Close to \$200 million is being spent on the microwave system. The main routes will have a minimum of two lines—one each for telephone communications and tv—and some will have as many as three or four of each type. And the number of telephone channels on a line may be 600, 960, 1,200 or 1,800, depending on the location.

Each tv channel will be able to accommodate one video and four audio signals, although at first only three audio signals will be transmitted. Audio transmission is provided for at 7, 7.3, 7.7, and 8.3 Mhz.

The reason for multiplicity of signals, explains Almázan, the microwave chief, is that two or more tv companies may join forces to film a certain event while using their own commentators to describe the action. They can do this by putting the four audio signals into a multiplexer, where four modulators will match the sound to the video signals. The combination will then be converted to intermediate-frequency signals and passed on to the microwave transmitter.

IV. Off the beaten track

Most of the relay stations will be unattended facilities in out-of-the-way spots around the mountainous countryside. Each will be all solid state and will include standby equipment. If the set in use fails, the standby will take over automatically and a signal indicating a breakdown will be transmitted to the next city or manned station to summon a repair crew.

The only exceptions to the all-solid state rule are some widely spaced stations that will use twt's with 5 to 10 watts of power to strengthen the signals. Average power for the network is 250 milliwatts.

Some of the relay stations will be equipped with two parabolic antennas since reception quality varies with the seasons. If reception falls below a minimum level on a receiving antenna, the system will automatically switch over to the other.

integrated circuit telemetry receiver ... another first from DEI



You shouldn't be surprised that Defense Electronics, Inc., producers of DEI and NEMS-CLARKE equipment, has pioneered another first* . . . a telemetry receiver using ALL linear monolithic integrated circuits. The Model ICR-10 is the first in a new series from DEI. It's a double conversion AM, FM or PM superheterodyne receiver (RF input of 130-140 MHz) featuring ultra linear AGC. The unit is lightweight, portable and measures 2" x 13" x 10". And, of course, it has the benefits inherent in IC design: long life and high reliability. Now DEI plans to continue applying our unparalleled experience and background in receiver design, engineering and manufacturing techniques to develop general purpose IC telemetry receivers to meet the future needs of our customers. For information and specifications contact the DEI sales office nearest you.

*Other Firsts / Pre-D Recording Equipment / Modular Receiver Design / Solid State Receivers.

Defense Electronics, Inc.

PRODUCERS OF
DEI AND NEMS-CLARKE
EQUIPMENT



DEI
RESEARCH
DEVELOPMENT
MANUFACTURING

ROCKVILLE, MARYLAND (301) 762-5700; TWX: 710-828-9783; TELEX: 089602 • LOS ANGELES, CALIFORNIA (213) 670-4815 • INTERNATIONAL: ROCKVILLE, MARYLAND • CABLE: DEIUSA; INTELEX: 64102 • Sales Representatives: Rome, Italy • London, England • Madrid, Spain • Tel Aviv, Israel • Bromma, Sweden • Rijswijk, Holland • Koln, Germany • Paris, France • Zurich, Switzerland • Oslo, Norway

Keep critical temperatures* in hand

...with EG&G Thermoelectric Modules

EG&G's Thermoelectric Modules are solid-state heat pumps, based on the Peltier effect, which absorb or inject heat at an electrically excited p-n junction. They offer a high ΔT capability in a volume as small as a $\frac{1}{4}$ " cube. Single stage modules can produce a ΔT of 68°C. and three stage cascades, a ΔT of 120°C. Reversing the DC current reverses the heat flow. Current rating is 3 to 9 amps at 0.1 to 8 volts DC per module. They're the most compact, reliable, and efficient devices for cooling, heating, and stabilization of critical temperatures.

EG&G Thermoelectric Modules and high stability controllers have been incorporated into a wide variety of systems for both military and industrial applications to meet rigid thermal, electrical, and mechanical specifications.

The new EG&G Photomultiplier Tube Cooling Chamber provides the most efficient and most convenient method for minimizing thermionic dark current in the PMT. Maintains temperatures of -20, -30, or -40°C. depending on the model selected.

*Critical temperatures in:

- Airborne Electronics
- Infrared and nuclear detectors
- Photomultiplier and image intensifier tubes
- Medical and laboratory testing equipment
- Electronic components
- Biological samples
- Environmental Instrumentation

The new EG&G Thermo-tip is a complete, self-contained probe-shaped spot heater/cooler for integrated circuit and small component testing covering a range of -60 to +180°C. It replaces cumbersome equipment and time consuming set-up work associated with environmental chambers.

If you'd like more information on EG&G Thermoelectric Modules, or for that matter on any of our products, such as thyratrons, krytrons, spark gaps, flash tubes, transformers, chokes, trigger modules, photodiodes, picoammeters, flash and strobe equipment, or light instrumentation, write: EG&G, Inc., 166 Brookline Avenue, Boston, Mass. 02215. Telephone: 617-267-9700. TWX: 617-262-9317.

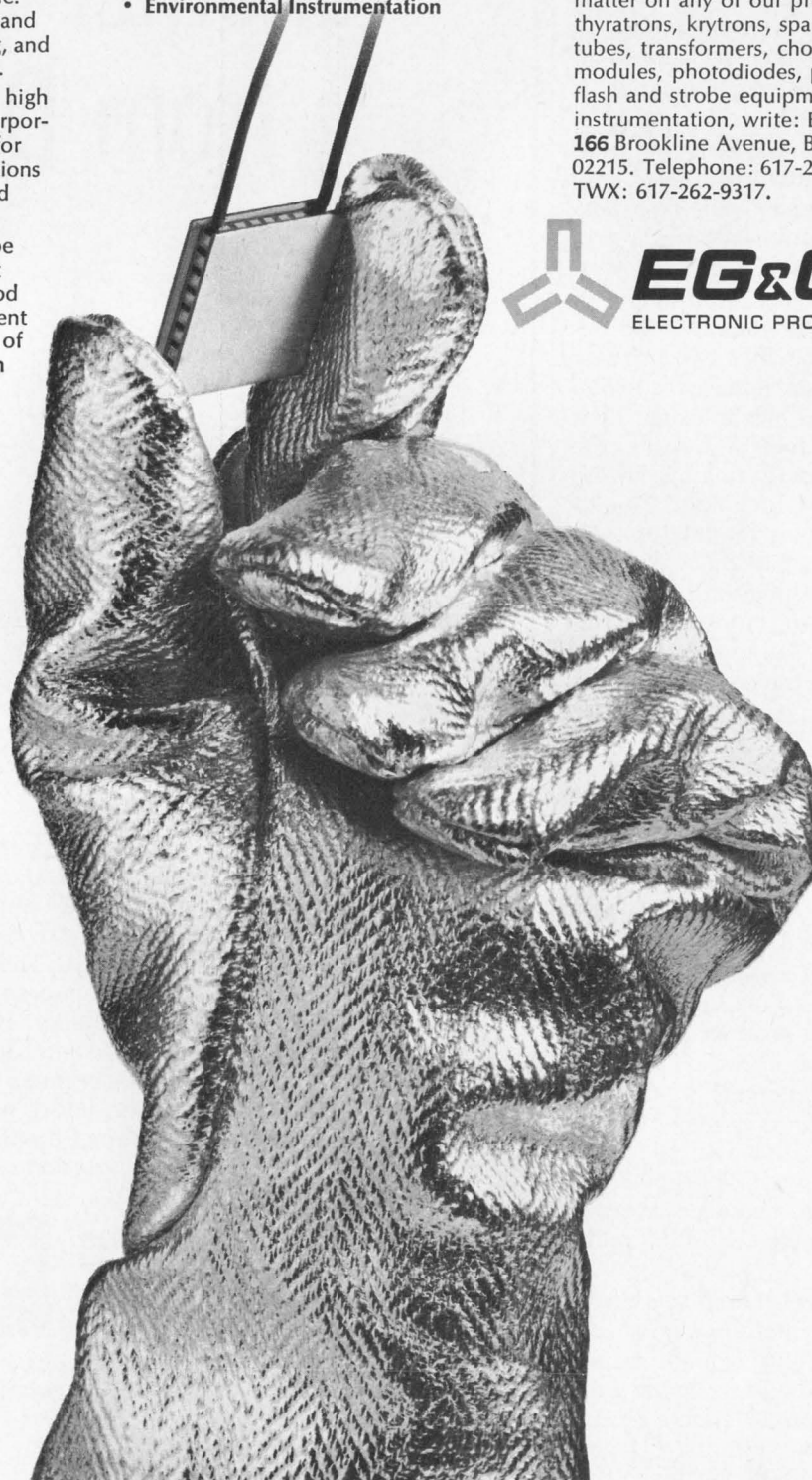

 **EG&G**
ELECTRONIC PRODUCTS DIVISION

JPL up in the air over space role

Fate in hands of Congress; budget cuts could peril aerospace lab's projects and may lead to an exodus of highly skilled, key personnel

Attempts to match yesteryear's glories can prove agonizing, and perhaps no one appreciates this better than William Pickering, director of the Jet Propulsion Laboratory in Pasadena, Calif.

Under Pickering's stewardship, which dates back to 1954, the lab compiled a generally brilliant record in its pioneering work on early Army missile projects and in final stages of Ranger as well as lately in the Mariner and Surveyor programs. But now the unmanned planetary and lunar exploration effort of the National Aeronautics and Space Administration that has been run by JPL is but a shadow of what it once was. And with only about \$72 million earmarked for JPL's activities in NASA's scaled-down budget request for fiscal 1969, additional paring is possible as the space agency runs the Congressional gauntlet.

For one thing, the war in Vietnam has reshaped national priorities, siphoning off space funds. For another, the failures that inevitably attend efforts to extend the state of the art have left the laboratory vulnerable to sniping from industry and other space agency units. Increasingly, the larger contractors are asking whether JPL is really needed—at least in its present capacity. And NASA field centers that swing more weight than JPL at space-agency headquarters are maneuvering for contract dollars that might go to JPL or industry in less parlous times.

Pickering and his colleagues regard an \$18 million request to start work on putting a Mariner spacecraft into orbit around Mars in 1971 as particularly crucial if JPL is to stabilize its staff at 4,150—600 below the peak employment level reached last June. The employment rollback was triggered last September when Congress killed the 1973 Voyager soft-landing mission to Mars and

thumbed down a request for a Mariner mission to Mars in 1971. Some NASA officials indicate, however, that the fate of the Mariner '71 and Titan/Mars '73 missions may not be sealed. Pointing out that Voyager was still alive nine months after the original request was submitted in January, they feel the word could be handed down late in the appropriations cycle.

I. Short rations

Voyager was a pivotal program for JPL. Originally assigned sole management responsibility, the lab eventually ended up with only the surface laboratory, tracking duties, and mission operations. The space agency's Marshall Space Flight Center was put in charge of the spacecraft and the Saturn 5 launch vehicle, while the Langley Research Center was given the task of developing the capsule that was to be ejected from the mother craft to the Martian surface. This capsule

was to have carried the JPL-developed surface laboratory.

"As we got closer to Voyager and realized the magnitude of the mission, we realized it made sense to bring more NASA resources to bear," says Pickering. But at least one official at a long-time JPL subcontractor believes the lab is losing business it might otherwise get "because it doesn't have the political clout other centers do."

Pickering views the personnel cutback as distressing but not catastrophic. "A 10% drop is not serious," he says. "We had one more serious than this a few years ago. The new staffing level would be adequate to handle the new programs if they're funded." Lab officials estimate that by June 30—the deadline for cutting back to the 4,150 level—slightly less than half the 500 staffers who must be cut will be lopped off the payroll; the balance will be accounted for by voluntary terminations.

In addition to the \$38 million sought for planetary projects, NASA wants \$34 million to begin construction of two more 210-ft.-diameter antennas that will supplement the Goldstone, Calif., installation as part of a worldwide deep-space network [Electronics, Feb. 19, p. 145], administered by JPL.

Wishful thinking. Pickering considers both programs reasonable. "Our planning is based on the assumption they will be approved. If they aren't, we have a problem."

Specifically at issue is the difficulty of holding onto the engineering talent that has been assembled at JPL. If the proposed Mars missions run into budget trouble, the lab is left with only two Mariner missions next year. Robert Parks, assistant director for flight projects, says about 600 people are working on the Mariner '69 missions, for which JPL acts as prime contractor. That role rankles many in industry

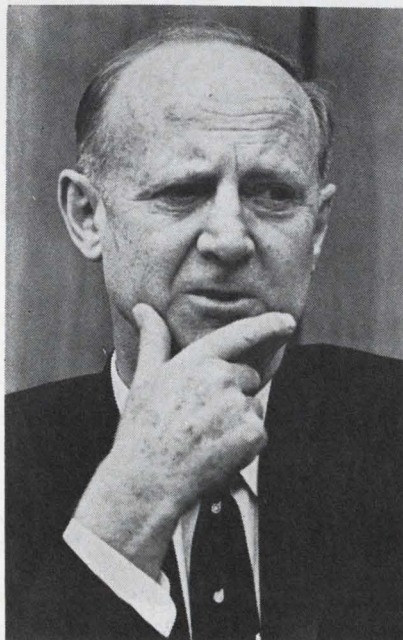

Quandary. William Pickering, who heads JPL, is sweating out budget cuts that could curtail the lab's prospects.

... mission cancellations may have already taken a talent toll at JPL ...

who believe their firms could do as well or better than JPL in running a major planetary program.

Flagging spirits. Lab officials concede they would have serious morale problems if they have to cut the work force to below the 4,150 level. And Parks fears the Voyager and earlier Mariner '71 mission cancellations may have already taken their toll. "These moves left our people wondering if the nation was still going to support a planetary program beyond the dual-Mariner '69 effort," says Parks. "I think we've had a significantly higher number of voluntary terminations as a result. And the ones you lose this way are usually the ones you

want to hang onto."

Neither the Mars missions nor the antenna funds were touched when the House Committee on Science and Astronautics lopped \$153 million from the space agency's request [Electronics, March 18, p. 58]. But the budget has a long way to go before any money is appropriated. One high-ranking aide at NASA headquarters says, "We're whistling in the dark on the two Mars missions. Just getting half the Mars request approved would be fortunate." This official also feels there would be no great unhappiness should the 1973 mission be lost along the way since NASA's heart is not really in the rough-lander con-

cept. Most high officials are still hoping for a more sophisticated Mars lander—possibly a resurrection of Voyager, which could be requested in fiscal 1970 if the 1973 project is scrubbed. However, the impact of such a development upon JPL would be severe.

II. Ambivalence

Industry's reaction to the squeeze on JPL runs true to form. Smaller outfits that have been getting a healthy share of subcontracting money from the lab or its prime contractors are unhappy. But larger companies that feel they've been shut out as a result of JPL's being its own prime contractor on major projects like Mariner are shedding few tears.

Says one aerospace executive: "They've been a customer and could continue to be. But JPL competes with us for business from Langley and other research centers. When we look at our own capabilities, we have to ask 'What can they do that we can't?'"

Says an official of another big firm that has worked closely with JPL: "The lab has had an opportunity to go farther than necessary at the expense of industry. It would be healthier if they had to go out and bid competitively for programs like Mariner." But, he adds, if he were a NASA administrator he would be hesitant about cutting the lab out of the Mariner program. The reason: "Using JPL talent is the cheapest way to get the job done. No new facilities are required." However, he says, for projects that have to be started from scratch, industry can handle the job as well as JPL or any NASA center.

Saving graces. Subcontractors, particularly electronics firms, are almost as concerned over JPL's sagging fortunes as JPL is. Marvin Lekstrum, telemetry product manager at the Astrodata Corp., a long-time supplier, echoes Pickering's calling the JPL's engineering team a national asset. "Much of the work that is now universal and on which companies were founded was pioneered at JPL," he says. "They've been brilliantly inventive in such developments as phase-coherent receivers and phase-lock discriminators for communications at Mars distances."

Herbert Bridge, associate director of the Massachusetts Institute of

A capsule history

The Jet Propulsion Laboratory, operated for the National Aeronautics and Space Administration by the California Institute of Technology, traces its origins to 1936, when a group of scientists and students started development work on jet-assisted takeoff engines for the Army Air Corps. Later, their efforts were channeled into long-range guided missiles, including what were to become the Corporal and Sergeant tactical-weapons systems.

In 1954, JPL took its first step toward space when it was asked to participate with the Army Ballistic Missile agency and the office of Naval Research in Project Orbiter, a scheme to put a man-made satellite into earth orbit. The lab suggested major modifications be made on the Army's Redstone booster. These were adopted, but the Navy's Vanguard was chosen to launch a scientific satellite during the International Geophysical Year. When Vanguard failed, Jupiter C, an offspring of the marriage of Redstone and Sergeant technologies, put the first U.S. satellite—Explorer 1—into orbit Jan. 31, 1958.

New home. With the creation of the space agency in 1958, JPL was transferred from Army to NASA jurisdiction. Subsequently, the lab was assigned to manage the Ranger lunar exploration vehicles.

Nine spacecraft were launched from 1961 through 1965 in this series, the last three of which were to take high-resolution television photos of the moon's surface before crashing. Rangers 7, 8 and 9 were successful, but the first six failed because of malfunctions in the launch vehicles.

Stepping up. The lab managed the Mariner program and has built the spacecraft for all five missions to date; two more launches to Mars are scheduled for next year. The first spacecraft was launched July 22, 1962, but had to be destroyed when the vehicle strayed off course. Mariner 2 passed Venus Dec. 14, 1962, sending back valuable scientific data about the planet. But Mariner 3, launched Nov. 5, 1964, failed. Mariner 4, launched Nov. 28, 1964, sent back tv pictures of Mars. Mariner 5, which went up June 14, 1967, sent back pictures of Venus.

Surveyors 2 and 4, among the first of seven lunar soft-lander surface-photographing units, failed. But the rest—after a spate of criticism from many quarters—were very successful. The most recent landed on the moon last Jan. 9. All seven spacecraft were built for JPL by Hughes.

The Voyager program first achieved project status at JPL in February 1965; it ended last September when Congress failed to vote funds for the project in NASA's fiscal 1968 budget. Meanwhile, primary responsibility for the spacecraft had been transferred from JPL to the Marshall Space Flight Center.



Talent drain. JPL's Robert Parks says voluntary terminations are up because of Voyager and Mariner cancellations.

Technology's space research center, says, "These cutbacks have a definite effect on technology. It's not easy to build a team like JPL's, which has done a very fine job with rather limited resources. A team like that can't be rebuilt overnight. If we don't keep a minimum program alive, what will happen in the future? The faster we start again from a low point, the more inordinate will be the amounts of money involved."

III. Vested interest

Fred Felberg, JPL's assistant director of plans and programs, agrees: "The most expensive thing a nation can ever do is to be undecided about such a program. We have established a technology base here, and it would be a shame to throw away a 10-year investment."

Pickering considers the engineers and scientists he directs a first-class group that could tackle a variety of complex tasks. "If some new priority emerges that is more important than the space program, we stand ready to support that mission," he says. Oceanography and urban problems are among the possible areas cited by observers.

"But damn it all, this space program isn't a luxury, and it would be unthinkable to abandon our mission in the face of other problems, however pressing," says Pickering.

Contributions to this report were made by Walter Barney in San Francisco, Bill Bell and Lawrence Curran in Los Angeles, Paul Dickson in Washington, and Robin Carlson in Boston. It was written by Lawrence Curran in Los Angeles.

Have you been given a snow job about Buffalo?

Sure, there are 13 ski resorts within 100 miles. But within 30 miles are some of the most productive orchards and vineyards in the country (and peaches don't grow in the Arctic). There are many good reasons why 1.4 million happy, sensible people have made metro-Buffalo the nation's 16th largest — and one of the fastest growing in the East. Reasons like power, pure water, productivity and low-cost transportation. And, a great climate for people as well as business.

Ask your secretary to send for a copy of our new booklet and be among those who know why the Niagara Frontier is such a great place to grow a bigger business.



Mr. Edward A. Rath, Erie County Executive
Erie County Hall, Buffalo, N. Y. 14202

Maybe I have been given a snow job about Buffalo. Send me the facts.

Name _____

Title _____

Company _____

Address _____

City _____ State _____ Zip _____

Check if you want convention information.

E18



APG SERIES MAGNETIC PROTECTORS

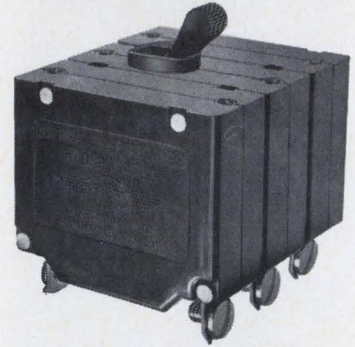
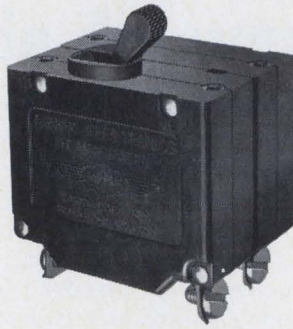
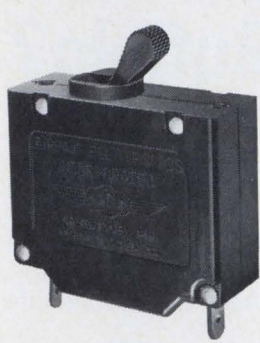

SERIES APG, low cost electromagnetic circuit protectors, are designed for industrial applications and ground support military equipment. The compact size, together with a wide range of current ratings and delays, make it an invaluable component where positive protection is a requisite.

FEATURES

- Low cost
- Compact size
- 1, 2 or 3 poles
- Single toggle
- Choice of delays
- 50V DC; 120/240V 60 and 400 Hz
- Ratings from 50 ma to 30 amperes
- Quick connect or screw terminals
- -40°C to $+95^{\circ}\text{C}$ operating range
- Special contacts quench arc rapidly
- Positive latching
- High rupture current
- Trip free
- Magnetic operation
- Low series R or Z

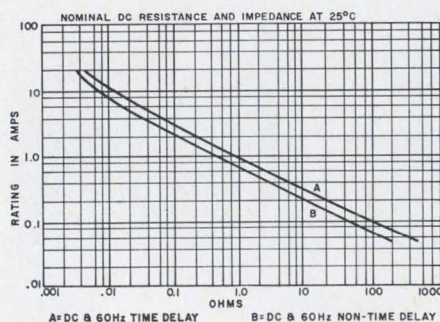
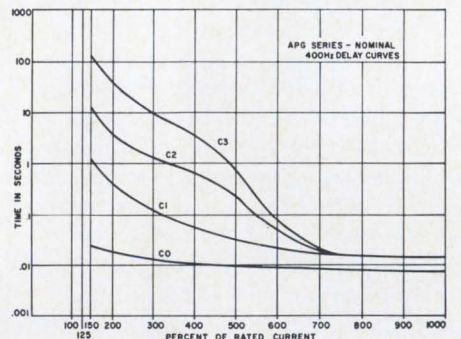
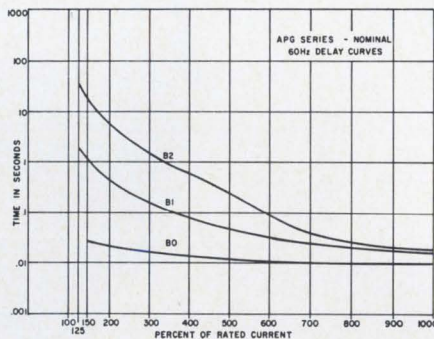
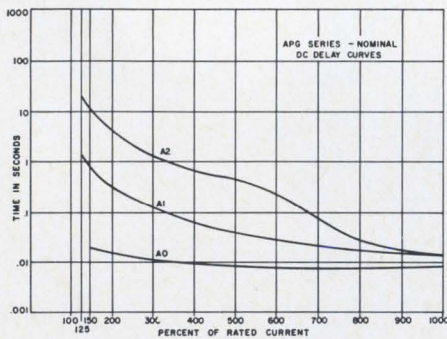
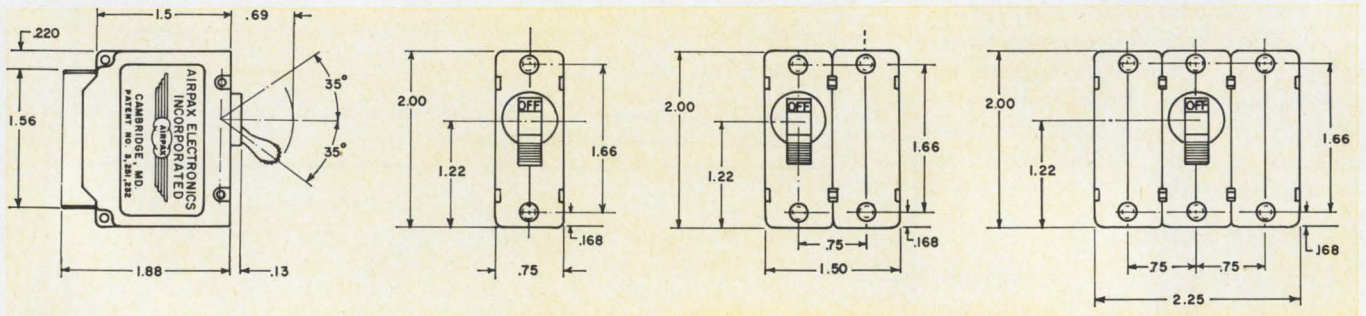

AIRPAX ELECTRONICS

CAMBRIDGE DIVISION, CAMBRIDGE, MARYLAND

Phone (301) 228-4600

TWX 710 865-9655

TELEX 8-7715

New Products

New semiconductors

Design-it-yourself trend invades LSI technology

User specifies the final interconnection pattern in a 2-layer, 12-gate array; shorter set-up time expected to lower production cost of monolithic IC

By Lawrence Curran

Los Angeles bureau manager

Large-scale integration isn't here yet, but three firms are pushing hard toward the goal—and by pretty much the same route. The intermediate units offered by Fairchild, Texas Instruments, and now, Motorola, have two layers of metalization.

Motorola, like Fairchild, will leave the final interconnections to the customer so he can design his own circuits.

The three devices offered have another feature in common: None qualifies as an LSI device if the yardstick of a minimum 100-gates-per-chip density is applied. Fairchild's recently introduced 4500 has 32 diode-transistor logic NAND gates, and TI is developing a 32-bit shift register with 76 gates that will go into production soon. Fairchild classifies its product as an LSI device, but TI doesn't. Fairchild defines LSI devices as circuits with two or more layers of metalization, designed with computer aid (CAD).

Applying the Fairchild definition, Motorola's XC-157 qualifies as LSI even though the chip contains only 12 DTL gates. The device has two layers of metalization and CAD is employed in its production. But Motorola characterizes the device as a form of custom medium-scale

integration and a prelude to LSI.

As with Fairchild Semiconductor's 4500, the users of Motorola's XC-157 will design second-layer metalization interconnections. Motorola designs first-layer metalization, doing the intraconnection of resistors and transistors required to form the 12 gates. However, this layer also contains uncommitted input logic diodes and output load resistors, giving design flexibility to the customer. Motorola furnishes design rules by which the customer works in laying out the second layer; the customer simply tells Motorola what direct-current and operational test procedures he wants followed in checking out the ultimate device.

By properly completing the diode and output-load resistor intraconnections and subsequent gate-to-gate interconnections, the customer can come up with such complex monolithic circuits as a four-bit compare circuit, a quad-exclusive OR, a four-channel clocked latch, or a dual-D flip-flop. Roger Helmick, Motorola's product planner for IC marketing, says that although the division is initially marketing the single-chip, 12-gate version, two or four adjacent arrays can be interconnected to form monolithic chips of 24 or 48 gates. The largest

of these can be accommodated in the same 32-pin flatpack used for the 12-gate chip, which is 60 mils square.

I. Ways to go

Helmick adds that if the customer uses the 48-gate version, he can design eight D-type flip-flops, decade counters, complex ripple counters, and some add functions—"at least a single adder and maybe even a dual adder." Helmick calls the Motorola device roughly equivalent to Fairchild's 4500 in capability. Fairchild is estimating that the customer will have to pay about \$15,000 for engineering the custom por-

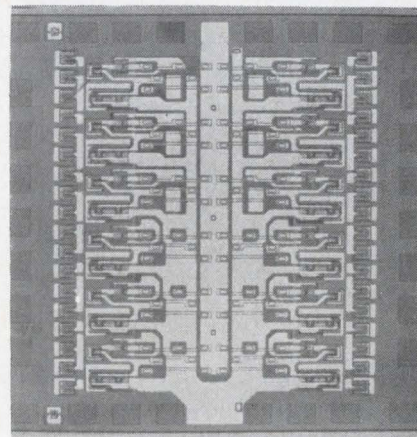

Chip. 12-gate array may be made into many different functions.

**Size 8 Resolver
State-of-the-Art
is off the
shelf at AEI**



Series 8RP Compensated Computing Resolvers are designed for a variety of Aerospace, Military and Aircraft applications where size, weight and accuracy are critical parameters. Exceptional output accuracy has been achieved by unique design of compensator coils to null out effects of temperature and other operating variables.

TYPICAL SPECIFICATION

Computing Applications

- Functional accuracy $\pm 0.1\%$
- Perpendicularity of axis $\pm 5'$
- Transformation ratio balance $\pm 0.1\%$
- Total null voltage 1MV/V

Data Transmission Applications

- Angular accuracy $\pm 3'$
- Total null voltage 1MV/V

Complete literature is available by writing Instruments Group, American Electronics, Inc., 1600 East Valencia Drive, Fullerton, Calif. 92634, (714) 871-3020, TWX 910-592-1256

**Instruments Group AEI
AMERICAN ELECTRONICS INC.**

Please rush checked item(s)

- 22-Page Resolver Design Manual
- New 4-Page Resolver Technical Catalog

NAME _____

TITLE _____

COMPANY _____

ADDRESS _____

CITY _____ STATE _____ ZIP _____

**... array is designed for medium-speed computers
with propagation delays of 20 to 30 nanoseconds ...**

tion of the circuit. "Custom circuit designs now cost anywhere from \$10,000 to \$50,000," Helmick notes. "Cost of the XC-157 will range from \$25 to \$40 per unit function, with a \$2,000 to \$5,000 first-lot charge for masking and test setup, depending on the complexity and type of requirements."

Like most semiconductor manufacturers, Motorola has been doing custom circuit designs for some time, but the XC-157 is the first device that will be carried as a stock item for application in custom designs. Helmick believes its most notable features are its custom nature for a comparatively low development outlay, availability that will encourage a closer customer-supplier relationship and lead to more complex MSI and LSI systems, and the fact that it incorporates a two-layer metalization scheme—a must in advancing to large-scale integration.

Breaking in. The Motorola array is designed for medium-speed computer applications with propagation delays of 20 to 30 nanoseconds per gate. Helmick doesn't think the arrays will sell in large lots during 1968. "It takes about a year to get users to design new devices into their systems," he says. "This year, a lot of people will buy small quantities to evaluate the two-layer metal concept, but in a year or so, it will be going in volume." And when it does gather momentum, Motorola then will expect to make a significant price reduction. The price of \$25 to \$40 per unit function works out to a price-per-gate range of about \$2 to \$4. Helmick thinks cost per gate could dip as low as 40 cents in production quantities. The Fairchild 4500 costs \$20 to \$40, which works out to a cost per gate of about 60 cents to \$1.20.

Nine masking steps are required for the XC-157. The first seven, including a buried layer mask, "take you up to the pre-ohmic level that opens the oxide to the first layer metalization," Helmick says. Only a second-layer mask and a passivation mask are required after Motorola gets the second-layer metalization design from the customer.

Motorola is quoting eight to 10 weeks delivery time after getting the user's logic design. Helmick says this is a conservative estimate. Fairchild is quoting six to eight weeks delivery, and officials there say this will drop as CAD and test-generation techniques become more sophisticated.

II. Road maps

To simplify design for the customer, the data sheet for the XC-157 gate array includes a complete schematic, a mode diagram and the design rules. The schematic lets the

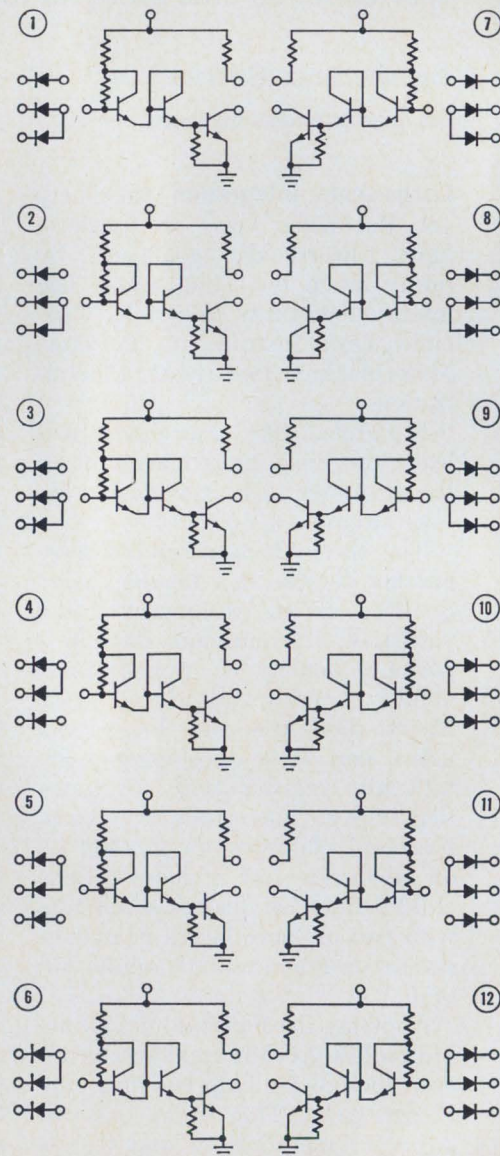

Combining. Component layout is supplied to customer who specifies the final interconnection pattern.

designer convert individual gates into a complete subsystem array. The necessary connections are then transferred onto the node diagram, which provides a rough drawing of the final metalization pattern.

Electrical capabilities of the individual gates are furnished with the design rules. For example, the number of inputs to any individual gate may be expanded to a maximum of 10, and fan-out to gates outside the package is allowed up to five. In other words, a fan-out of 10 is allowable for any individual gate if five fan-outs are internal and on the driver side of the chip. For example, gate 1 must not drive gate 7 through 12, otherwise each internal fan-out must be subtracted from the allowable external fan-out of five. Each load resistor used represents a fan-out of one.

Helmick says the XC-157 technology is unusual because most IC's on the market use only one layer of metalization. "There are three- and four-layer metalization IC's in laboratories, but because of low yields, they're not in production."

A layer of thermally grown glass is used as insulation between the two metal layers of the new device. Helmick, while not divulging the exact process, says the technique has cut pinholes to "three or four per wafer. CAD has contributed significantly to lower custom engineering costs. This technique is used right up through first-layer metal. The second-layer mask can also be done on a computer-aided masking machine."

Number one. "This is only the first of a series of standard-type arrays," Helmick says. "Later, there could be transistor-transistor-logic or emitter-coupled-logic devices. Besides, this device will be compatible with TTL circuitry. Eventually, some of the characteristics of DTL and TTL may be combined on the same chip."

Motorola officials say the gates in the XC-157 array will be described much like the stock MC930 DTL IC's. The characteristics will be based on a 5-volt supply. The one level of the device will yield 2.6 volts minimum and the zero level will be 0.45 volt with a load current of 15 milliamperes.

Motorola Semiconductor Products, Inc., P.O. Box 13408, Phoenix, Ariz. 85002 [338]

The keys to Log & Exponential power

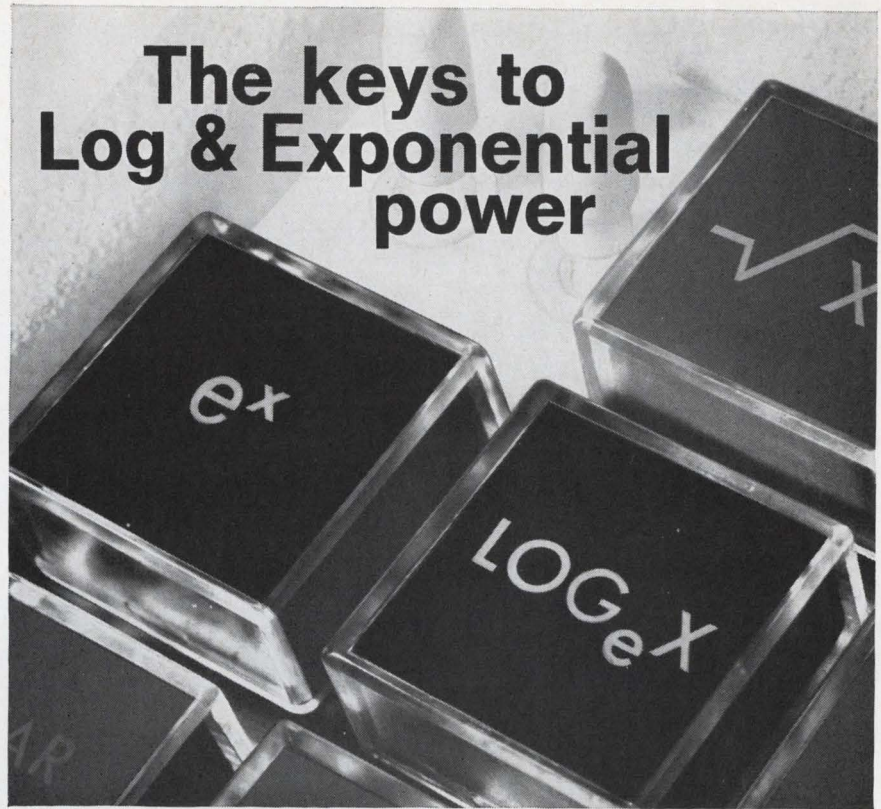

...exclusively on **WANG** electronic calculators



Wang's unique approach to data manipulation (a revolutionary electronic circuit which digitally generates the natural logarithm of any number entered) reduces complex calculations to simple, logical keystrokes and eliminates from 67 to 93 per cent of calculation time.

On keyboard displays, about the size of a telephone, all basic arithmetic functions (+, -, \times , \div , $\frac{1}{x}$) are performed silently, in milliseconds. Optional keys produce X^2 , \sqrt{x} , $\text{Log}e^x$, e^x by a single keystroke. (For unmatched economy, up to 4 keyboards can operate simultaneously from a briefcase-

size electronics package located up to 200 feet away.)

Other options include: 4 additional random-access storage registers (two are standard), 80 step, plug-in card programmer and/or built-in programs for single keystroke calculations of $\sin \theta$, $\cos \theta$, $\arcsin x$, $\arctan x$.

Add-on compatibility makes it possible to expand into a powerful computing system that will branch, loop, do sub-routines, make decisions and manipulate arrays. *There is nothing comparable, anywhere.* For complete information, write or call:

WANG
LABORATORIES, INC.

Dept. 4H, 836 North St., Tewksbury, Massachusetts 01876 • Tel. 617 851-7311

In Major Cities, Tel:

(201) 241-0250	(215) 642-4321	(313) 278-4744	(412) 366-1906	(514) 482-0737	(702) 735-5802
(203) 666-9433	(216) 333-6611	(314) 727-0256	(415) 454-4140	(518) 463-8877	(713) 668-0275
(205) 245-6057	(301) 588-3711	(317) 631-0909	(416) 364-0327	(601) 234-7631	(714) 234-5651
(206) 622-2466	(301) 821-8212	(319) 365-2966	(504) 729-6858	(612) 881-5324	(716) 381-5440
(212) 682-5921	(303) 364-7361	(402) 341-6463	(505) 255-9042	(614) 488-9753	(717) 397-3212
(213) 278-3232	(305) 841-3691	(404) 457-6441	(512) 454-4324	(617) 851-7311	(816) 421-0890
(214) 361-4351	(312) 456-1542	(405) 842-7882	(513) 531-2729	(702) 322-4692	(817) 834-1433
				(919) 288-1695	

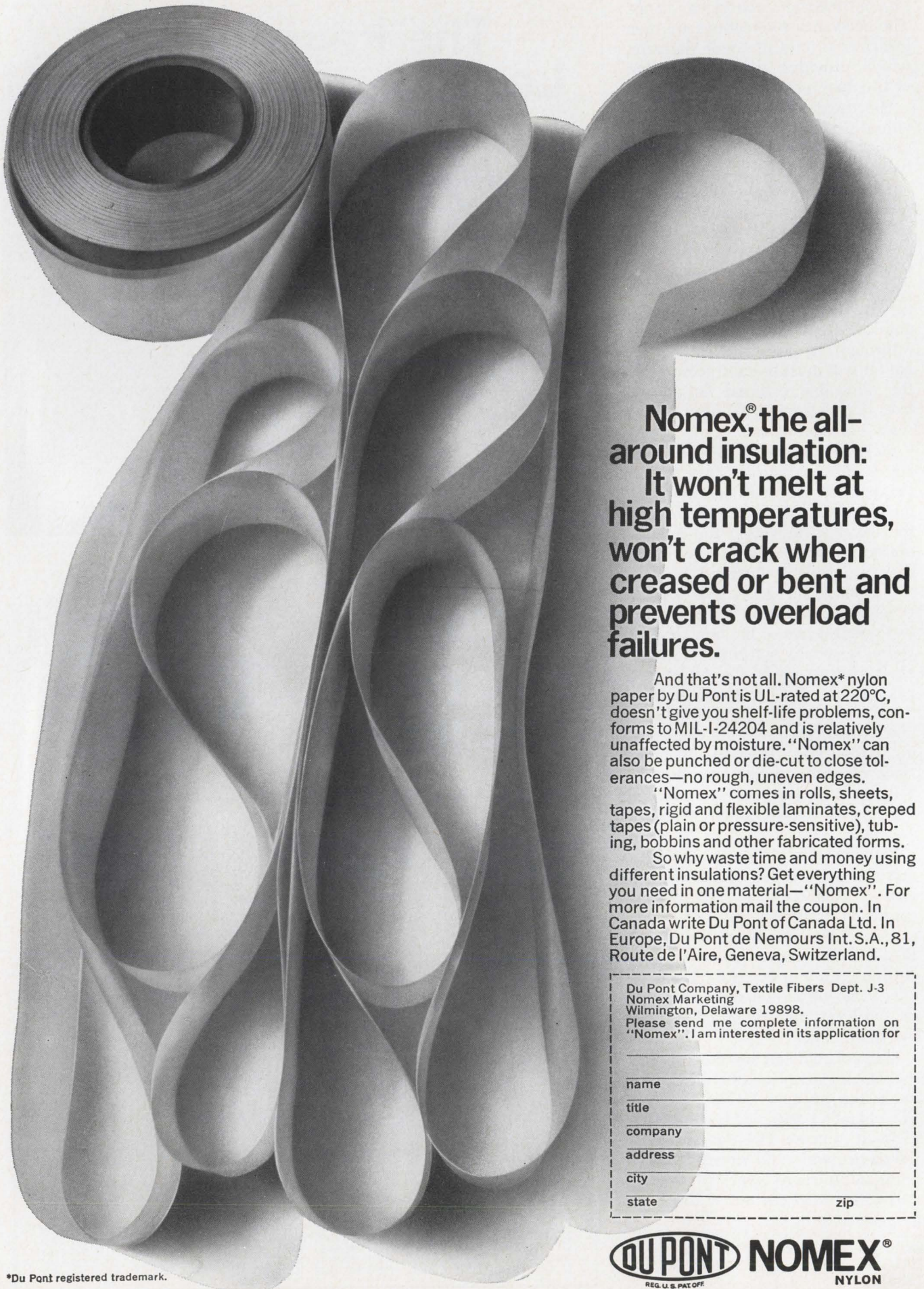

**Nomex[®], the all-around insulation:
It won't melt at high temperatures, won't crack when creased or bent and prevents overload failures.**

And that's not all. Nomex* nylon paper by Du Pont is UL-rated at 220°C, doesn't give you shelf-life problems, conforms to MIL-I-24204 and is relatively unaffected by moisture. "Nomex" can also be punched or die-cut to close tolerances—no rough, uneven edges.

"Nomex" comes in rolls, sheets, tapes, rigid and flexible laminates, creped tapes (plain or pressure-sensitive), tubing, bobbins and other fabricated forms.

So why waste time and money using different insulations? Get everything you need in one material—"Nomex". For more information mail the coupon. In Canada write Du Pont of Canada Ltd. In Europe, Du Pont de Nemours Int. S.A., 81, Route de l'Aire, Geneva, Switzerland.

Du Pont Company, Textile Fibers Dept. J-3
Nomex Marketing
Wilmington, Delaware 19898.
Please send me complete information on
"Nomex". I am interested in its application for

name

title

company

address

city

state

zip

*Du Pont registered trademark.

DU PONT **NOMEX[®]**
REG. U. S. PAT. OFF. **NYLON**

New Components Review

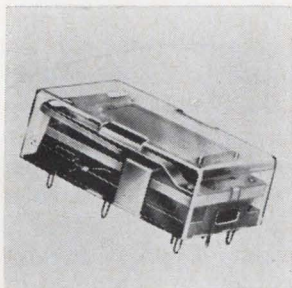

Low-profile dpdt relay PC-6D is 0.405 x 0.78 x 1.17 in., and its terminals fit a 0.1-in. p-c grid pattern. Contacts are rated at 1 amp, 24 v a-c or d-c. Minimum life expectancy exceeds 10 million operations at 12 w loads, 1 million at full load. It is designed for "must operate" at less than 200 mw, with 400-mw coil power. Allied Control Co., 2 East End Ave., New York 10021. [341]

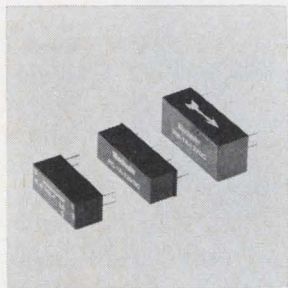

P-c reed relays measure 0.44 x 0.44 x 1.12 in. Dry reed form A contacts offer resistance of 100 milliohms max., rated 1/2 amp or 200 v to 10 w d-c; form C's, 150 milliohms max., 1/4 amp or 28 v to 3 w d-c. Mercury wetted types have resistance of 50 milliohms max., rated 1 amp or 100 v to 28 w d-c. Electronic Instrument & Specialty Corp., Box 24, Winchester, Mass. 01890. [342]

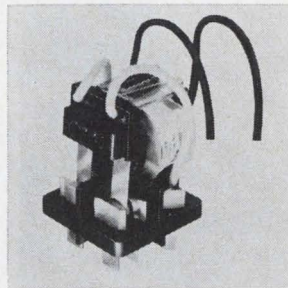

Power relay type 40 is for high current switching, with a trouble-free, long life operation. It has contact ratings up to 25 amps at 115 v a-c, and coil voltages of 6 through 110 v d-c and 6 through 250 v a-c. Operating time is 20 msec, release time 15 msec. Mechanical life is over 10 million operations. Cornell-Dubilier Electronics, 50 Paris St., Newark, N.J. 07101. [343]

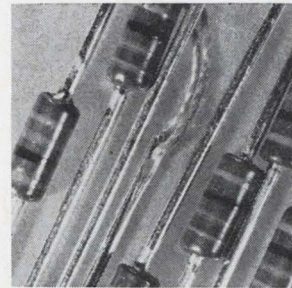

Miniature RN50 tin oxide resistor model C-3 offers purchase tolerances of 1, 2, 5, and 10%, temperature coefficients of either 100 or 200 ppm, and power ratings up to 1/8 w. Resistance range is 10 ohms to 150 kilohms. Maximum length is 0.150 in., max. diameter, 0.065 in., lead diameter, 0.020 in. Delivery is within 5 weeks. Corning Glass Works, Corning, N.Y. 14830. [344]

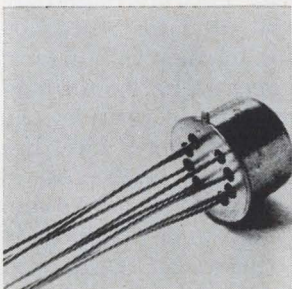

Transistor-sized relays series T come in a dpdt version and in 5 standard coil voltage ratings of 6, 9, 12, 18, and 26.5 v. With a rated contact load of 1 amp at 28 v d-c, the units are rated at 100,000 operations. Each is shock tested at 80 g's for 11 msec, and passes acceleration tests at 100 g's. Deutsch-Filtors Relay Division, 65 Daly Rd., East Northport, N.Y. [345]

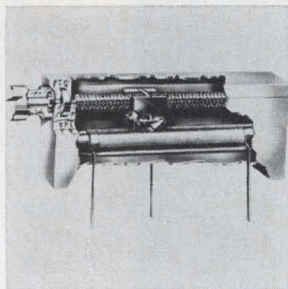

Humidity-proof 3/4-in. rectangular, wirewound trimmer 3810 performs to the requirements of MIL-STD 202B. A silicon "O" ring seal permanently shuts out dust and humidity, and the lid and case are permanently welded. Resistance values are from 10 to 20 kilohms. Power rating is 1 w at 40° C. Amphenol Corp., 120 S. Main St., Janesville, Wis. 53545 [346]

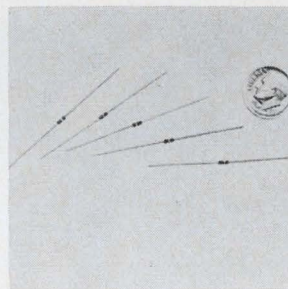

Monolithic capacitor type MA is a molded, axial lead unit measuring 0.130 x 0.045 in. The leads, 0.016 x 1 in., can be tinned copper or gold-flashed domet. Ranges are to 820 pf at 50 v d-c and to 470 pf in the 100-v d-c rating. Tolerances are ± 5 , ± 10 , and $\pm 20\%$. Price, 39 cents to \$2.88. American Components Inc., Eighth Ave. at Harry St., Conshohocken, Pa. [347]

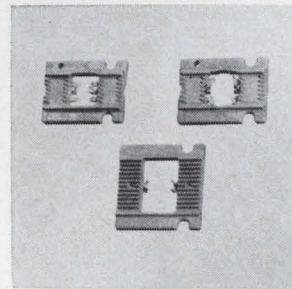

Flatpack IC and hybrid carriers feature one-piece construction and withstand temperatures to $+150^{\circ}$ C. Flexible "fingerlocks" on the Polysulfone carriers securely lock a device in place to protect up to 24 leads during production, quality control and reliability tests. Packages from 1/8 x 1/4 to 1/4 x 5/8 in. can be accepted. Textool Products Inc., 1410 Pioneer Dr., Irving, Texas 75060. [348]

New components

Nonlinear resistor regulates voltage

Breakdown ratings up to 300 volts are possible with capacitor-like zinc-oxide control device

To most circuit designers, voltage regulation means diodes or varistors. These engineers now have another option. The Matsushita Electric Industrial Co. has developed a nonlinear zinc-oxide resistor, called the ZNR, that is bipolar and has a sharp break on its current-voltage

curve at a specified voltage.

Breakdown voltages from 0.6 to 300 volts are possible. For a given input change, the ZNR output voltage varies by less than 10% of the input change.

Twins. The ZNR looks like a ceramic disk capacitor. Its body is a

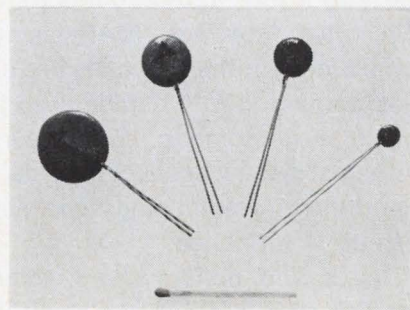

Protector. Zinc-oxide resistor can be used to control and regulate voltage. It's less expensive than most zeners.



Modine technician prepares test core for wind-tunnel test. VIDAR Digital Data Acquisition System speeds testing of automotive and industrial radiators, oil coolers, and other related products.

How Modine saves test dollars...

Automatic measurement — 60 times faster than previous manual methods—and more accurate—allows one man to do the work of three in testing automobile and industrial heat exchangers (radiators and oil coolers). An enormous amount of data is generated by three wind tunnels and two oil-cooler testers.

Modine's Automotive and Industrial Test Supervisor says, "A year ago it took 120 readings to make one valid test run . . . in 20 minutes. Now, our VIDAR system does the job *in one minute*. Transducers in the test cells are scanned and their output voltages converted into numbers on the paper tape — and it's all completely automatic. Water-flow measurements are made at the same instant heat-transfer data is recorded . . . particularly important in determining how much fin surface is needed for correct performance."

Time saved, dollars saved, accuracy increased . . . this is the "magic" of VIDAR. Let us show it to you. VIDAR Corporation, 77 Ortega Avenue, Mountain View, Calif. 94040. (415) 961-1000.

VIDAR

... made the same way as disk capacitors . . .

zinc-oxide wafer, air-fired at 1,000°C. An n-type material is deposited in the oxide by sintering. The amount of dopant in the resistor and the wafer thickness determine the breakdown voltage, which can be controlled to within 10% of a desired value. Units with more precise tolerances are obtained by selection.

ZNR's can be made with the same equipment used to fabricate ceramic capacitors. Both devices are air-fired, and the paste used for electrodes, the method of soldering leads to the electrodes, and the encapsulation technique are the same for both the ZNR's and ceramic capacitors.

The choice. Forward-biased diodes are now used for regulation of voltages up to one volt, and most zeners can operate between 5 and 35 v. Silicon carbide varistors can regulate 30 v or more, but they don't have a sharp enough break in their characteristics for precise control. The range and precision of these three devices can be extended by using special circuitry, but cost is often prohibitive.

ZNR's may bring the price of regulation down. Matsushita says its resistor will cost much less than zener diodes. For example, at Japanese prices, a 2¢ ZNR will be able to replace a 20¢ zener.

The precise voltage control of high quality zeners is not possible with ZNR's, but the company says, this resistor will make constant-voltage power supplies economically possible in many consumer and industrial applications. The added protection of voltage regulation will mean increased reliability and, in some cases, lower costs because of the use of transistors with lower voltage ratings.

In systems that require precise regulation, ZNR's can be used as preregulators that add protection from transients and surges, and allow the use of cheaper zeners in the main regulator.

Sample quantities are ready now, and units will be available from stock late this summer.

Matsushita Electric Industrial Co., Kadoma Osaka, Japan [349]

Standards:

MIL-C-26482

MIL-T-22520

MIL-C-23216

Problem:

Cutting Installed Costs

Solution:

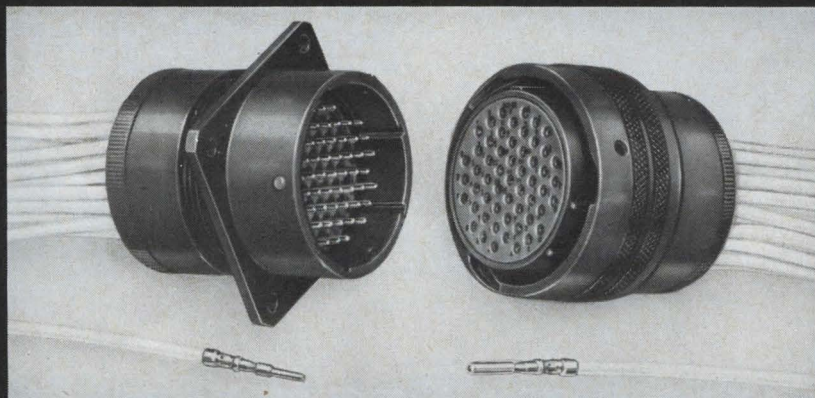

Smooth Bantam and
automatic tooling

MIL-C-26482, MIL-T-22520 and MIL-C-23216 set the standards for miniature round connectors. But they don't say you have to spend a fortune to install them. The key to savings is lower installed costs through crimp connections. And the leader in crimp connections is our Smooth Bantam®

The math is simple. Fast operators with a soldering gun can produce about 200 connections an hour. But give them a Burndy M-10S hand tool and they can crimp more than 700 perfect connections an hour. That's quite a saving. And, if even faster

connections are needed, our Bandomatic™ gives you over 2000 an hour. That's how installed costs go down while quality stays up.

The quality is maintained because our matched installation tooling insures perfect connections every time. Every connection is uniform, reliable and durable. They're the favorite with quality control personnel—and with the controller's office.

If you'd like to know more about our Smooth Bantam and how to cut installed costs without cutting quality, write for our Catalog SCB-67.



INTERNATIONAL SALES HEADQUARTERS AND MANUFACTURING FACILITIES:
CANADA: Scarborough, Ontario / ENGLAND: St. Helens, Lancs.
BELGIUM: Mechelen / MEXICO: Naucalpan de Juarez / BRAZIL: Sao Paulo
JAPAN: Tokyo / Sales Offices in Other Major Cities

 **BURNDY**
Norwalk, Connecticut

Circle 111 on reader service card

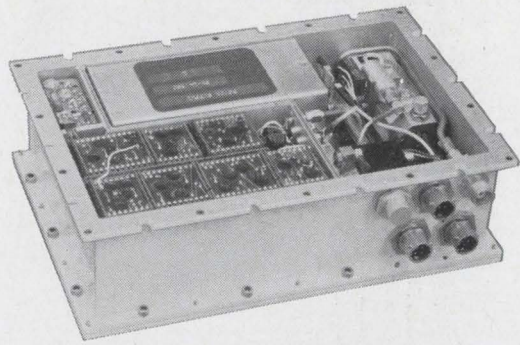

Here Is Where

You Find

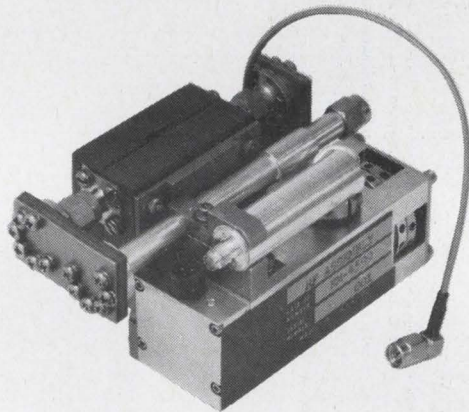
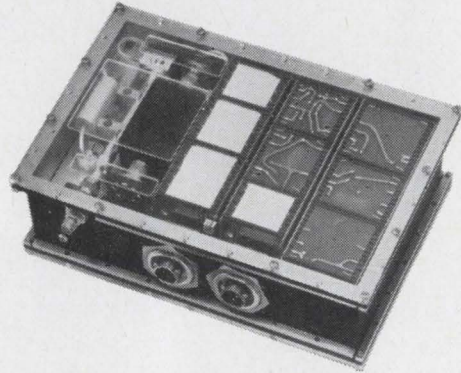

Ultra-High-Frequency

Hybrid

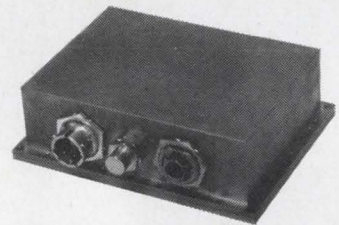

Telemetry Transmitters

Now, with its acquisition of the Eimac hybrid telemetry transmitter and cavity line, W-J has a wider selection of reliable microwave equipment to complement an established line of telemetry and satellite amplifiers for space communications. Designed originally in 1962 for missile flight testing, these L- and S-band transmitters have found wide acceptance in a variety of aircraft and spacecraft applications. Ask around and then ask W-J!

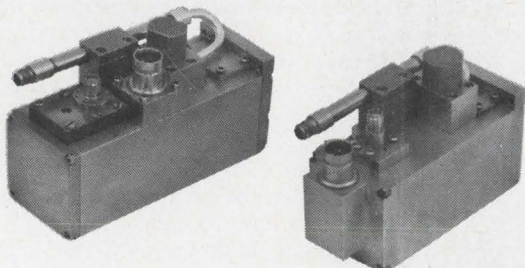

WATKINS JOHNSON



3333 HILLVIEW AVENUE
STANFORD INDUSTRIAL PARK
PALO ALTO, CALIFORNIA 94304

In the East, Contact W-J's Subsidiary
COMMUNICATION ELECTRONICS, INC., 6006 Executive Boulevard, Rockville, Md. 20852

New Instruments Review

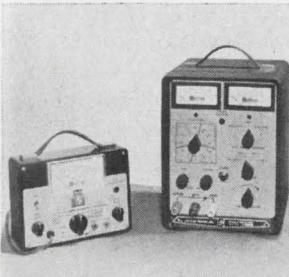

SCR testers are offered in 3 models. The S.100 is a battery-powered unit suitable for field testing; the S.101, an a-c powered, 50-60 hz go-no-go device valuable for quick check in-plant inspections; and the S.120, a solid state lab instrument that gives accurate readings over a wide range of scr characteristics. Solitron Devices Inc., 256 Oak Tree Road, Tappan, N.Y. 10983. [361]

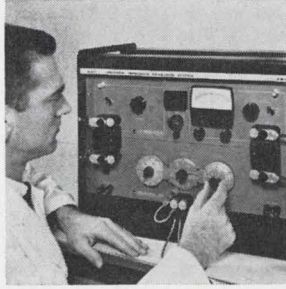

Universal impedance measuring system 293 features solid state design. Consisting of a precision impedance bridge and combined a-c/d-c generator-detector, it permits measurement accuracies of $\pm 0.05\%$ for resistance and conductance, $\pm 0.1\%$ for inductance and capacitance. Price is \$1,100. Electro Scientific Industries Inc., N.W. Science Park Dr., Portland, Ore. 97229. [362]

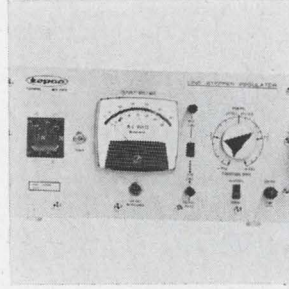

Spike-free programmable line regulator model LSR-6 offers precision ($\pm 0.3\%$) voltage control at 115 v a-c $\pm 10\%$ or 230 v a-c $\pm 10\%$, with an output capability of 5,750 v-a. Correction for a change in line voltage is 30 v/sec at 115 v a-c, or 60 v/sec at 230 v a-c. Price is \$975; availability, 60 days. Kepco Inc., 131-38 Sanford Ave., Flushing, N.Y. 11352. [363]

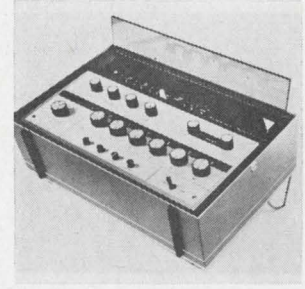

Reference standard potentiometer model 1000 is a high-precision laboratory, production or field tool offering a true direct readout system. Three ppm accuracy is achieved using internal self-calibration circuitry. Seven-digit, 6-dial in-line readout provides resolution of 1 μV , 0.1 μV and 0.01 μV . Price is \$1,700. RFL Industries Inc., Boonton, N.J. 07005. [364]

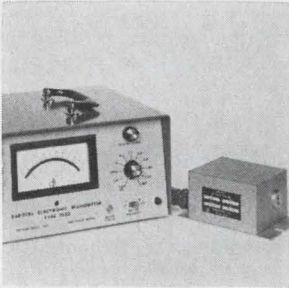

Electronic manometer type 1023 fills the need for low cost, high accuracy (2% as read on meter) vacuum gaging of gases from 10^{-5} torr to 5,000 torr which is independent of gas composition. It is also useful for wide range differential pressure measurements and transduction from 100 psi to 10^{-7} psi. Cost is approximately \$1,200. Datametrix Inc., Waltham, Mass. [365]

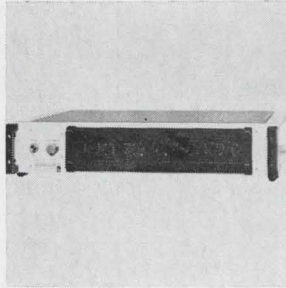

Parallel-storage unit 1125 for time comparisons will accept on command up to 11 digits of time-of-day information in 2 μsec , store and display the information, and transfer it to such slow-speed devices as card and tape punches or printers. It can also serve in systems with a jam-transfer requirement. Price is \$2,600. General Radio Co., West Concord, Mass. 01781 [366]

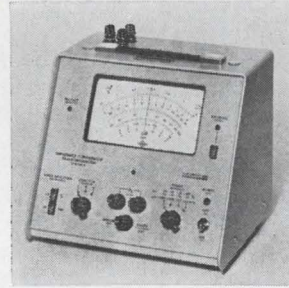

Component comparator TRB11 gives fast, accurate measurements of the magnitude and phase angle of components or networks as compared to basic or production standards. Accuracies to 0.05% of standard value for resistance, 10 ohms to 1 megohm; capacitance, 200 pf to 20 μf ; inductance, 1 mh to 10 henrys at 1 khz. London Co., 811 Sharon Dr., Cleveland, Ohio. [367]

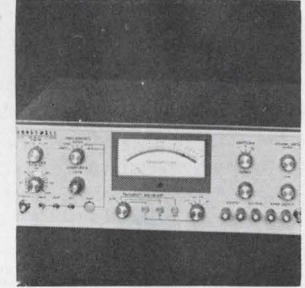

Auto-range oscillator model 95-50A provides million-to-one logarithmic sweep capability spanning 6 decades of frequency, and linear sweep over a 2-decade frequency span. It permits a linear voltage-to-frequency relationship over the 0.01-hz to 100-khz range to within 1% of reading. Test Instruments Division, Honeywell Inc., P.O. Box 5227, Denver, Colo. 80217. [368]

New instruments

Packing 33 channels on 1/4-inch tape

Instrumentation recorder costs are kept low by adding time-sharing to a consumer-type tape transport

Designing a light, portable, instrumentation tape recorder capable of recording multichannels of data on four tracks but not astronomically priced was the project assigned John Kauke when he became manager of the industrial products department of the Ampex Corp.

He took the standard recording shell of a commercial Ampex stereo tape recorder, stuck sophisticated electronic hardware inside the box, used sensitive recording heads, and presto—a 35-pound portable instrumentation recorder capable of handling up to 33 channels of data on

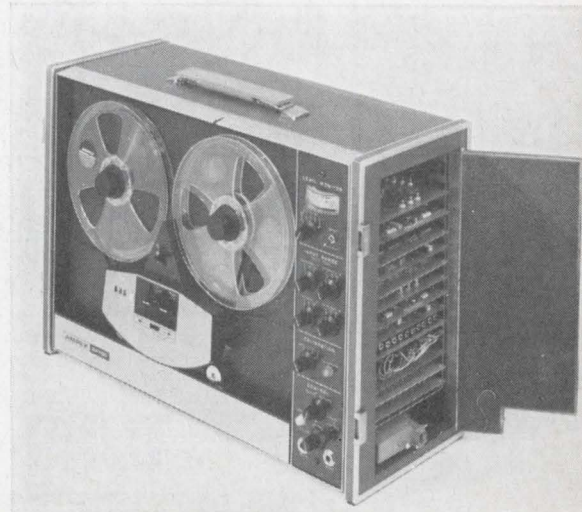

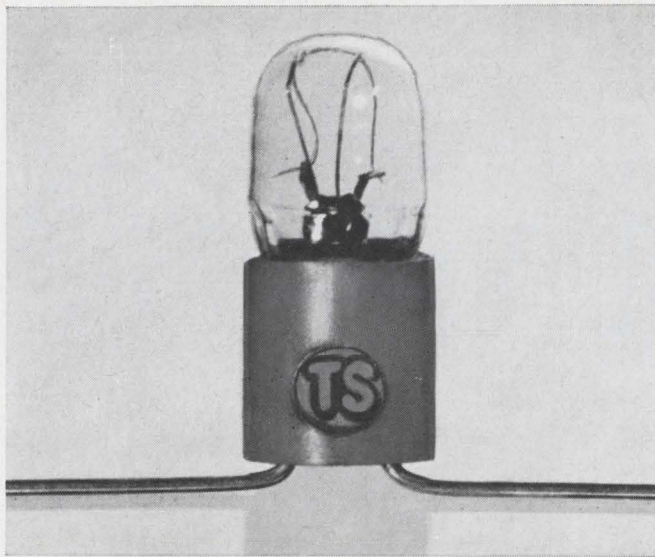

Mounting Flexibility

Tung-Sol Molded Base Subminiature Lamps provide mounting flexibility not possible with the usual cemented-on base and socket installation. Lead wires can be bent sharply at the base without harm to the assembly. Because they are self-mounting, any computer type circuit board provides a fully adequate mount. No more installation is required than with transistors. And like transistors, Tung-Sol Molded Base Lamps may be installed with automated equipment.

The popular Tu-Pin lamp has wide application for instrumentation lighting. For special requirements, the molded nylon base can be formed in a wide variety of configurations. Also, special harnessing can be supplied to customers' specifications. Write for more information about how the flexibility of Tung-Sol Molded Base Lamps can effect economies in the assembly of your equipment. Tung-Sol Division, Wagner Electric Corporation, One Summer Ave., Newark, N.J. 07104.

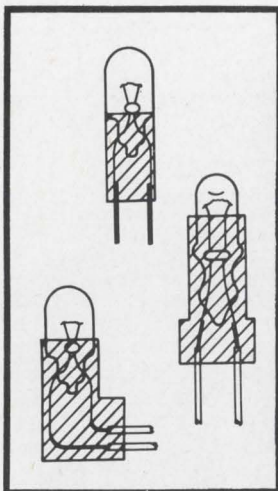

Molded bases can be designed to meet customers' specifications.

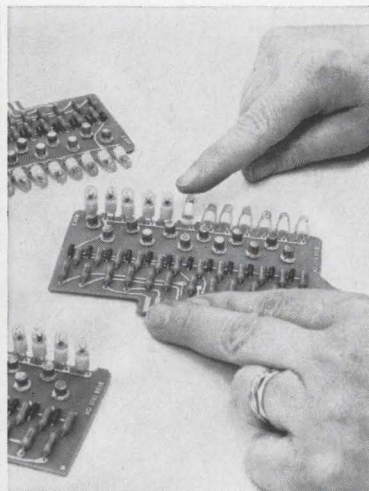

Computer circuit board assembly demonstrates mounting flexibility of Tung-Sol Tu-Pin lamps.

TUNG-SOL®

MOLDED BASE SUBMINIATURE LAMPS

... time multiplexing for more channels ...

standard, quarter-inch tape.

Kauke says there is a growing demand from industrial users for lower-cost instrumentation tape recorders, and the Ampex machine is designed to meet this demand. The SP 700 far exceeds capabilities of conventional, quarter-inch tape machines, Kauke says.

Sony, for example, will introduce a recorder with a capacity of 4 channels that will sell for about \$2,900. The Sony machine, however, is designed for portability in that it operates on line power or 12 volts d-c.

Combine and pack. By eliminating separate external commutators, logic functions and decommutators normally associated with the devices and placing this hardware within the unit, Ampex has been able to price the machine at \$4,800—well below competitive models. And users do not have to worry about making their black boxes compatible with the machine itself because the traditional external electronic components are inside the recorder.

The SP 700 can record and reproduce 30 time-shared channels of frequencies from 0 to 5 hertz and three channels of up to 2,500 hz of frequency-modulated data or voice. Kauke claims this is at least twice the capacity of currently-used non-tape methods—strip charts, pen and ink, hot stylus—at a cost significantly lower per channel (roughly, \$140).

Time-multiplexing techniques are the key to recording so many channels on four standard tracks, Kauke says. Multiplexing, in this instance, means that 30 channels of incoming data can share recording time (or space) on one track of magnetic tape. Each channel's "turn to record" comes every 1/30 of a second. The time-sharing sequence is so rapid that the 30 channels of data can be provided at extremely high accuracy, he adds.

The designer praises the recorder's high signal to noise ratio (43 to 45 decibels depending on tape speed) and low data error in the time-sharing mode of less than 1% at full scale. Frequency response characteristics for the

SP 700 are from zero to 625 hz at 1 7/8 inches per second, 1,250 hz at 3 3/4 ips, and 2,500 hz at 7 1/2 ips.

The SP 700 uses 13 4 1/2 inch-square circuit cards. Circuitry is divided between discrete and integrated components, and Kauke says tradeoffs between the two keep cost below \$5,000. The relays used in the recorder's center frequency-speed switch are the same as those used in the IBM series 360 computer, he notes. The electronic switching commutator uses metal oxide semiconductor field-effect transistors and the drive logic employs IC's. The SP 700 can record on commercially-available thin-coat tape, with a maximum of 3,600 feet on a 7-inch reel.

Other features include built-in calibration, built-in transducer power to eliminate a separate power source, and a peak-reading monitoring meter that can sample and hold a peak parameter every 1.5 seconds. From this, the user is able to determine if the incoming signal is out of the machine's range and can then make adjustments to ensure that the data is picked up. Conceivably, 360 channels of data could be packed into a custom recorder using the integral time-division multiplex concept.

Applications for the SP 700 range from temperature or pressure measurement in a petrochemical refinery to recording electroencephalogram and electrocardiogram rates in a physician's office. The unit is compatible with strip-chart recorders or oscilloscopes enabling it to provide a visual display.

Petroleum refinery operators have expressed interest in the recorder because of its potential in periodic monitoring of engine pumping. Westinghouse Electric Corp. is planning to use the SP 700 to record steam turbine vibrations.

Ampex Corp., Culver City, Calif. [369]

Specifications

Tape	1/4-in. audio
Channels	33
Frequency range	30 channels—0 to 5 hz 3 channels—0 to 2,500 hz
Frequency response	0 to 625 hz at 1 7/8 ips 0 to 1,250 hz at 3 3/4 ips 0 to 2,500 hz at 7 1/2 ips
Input signal	f-m data or voice
Signal-to-noise ratio	43 to 45 db depending on tape speed
Sample rate	1.5 sec
Size	20 x 13 1/2 x 8 in.
Weight	35 lbs
Power requirement	110-v a-c
Price	\$4,800



introducing a new versatile phase angle voltmeter for production test

North Atlantic now brings you a new group of solid-state Phase Angle Voltmeters for precision phase-sensitive nulling applications in production test and ground support equipment.

Designed for versatility, they feature measurement of the vector components (including phase) of complex AC signals at 4 discrete frequencies from 30Hz to 20KHz. Operating frequencies can be rapidly changed without calibration by direct plug-in replacement of frequency modules and harmonic rejection filters. Full operating performance is maintained over a bandwidth of $\pm 5\%$ and with 10X signal input overload.

The unit illustrated is the Model 214A. Also available are the Model 214B with reference isolation, and Model 214C with both signal and reference isolation.

North Atlantic's sales representative in your area (see EEM) can tell you all about these units as well as other Phase Angle Voltmeters and Phase Sensitive Converters.



NORTH ATLANTIC industries, inc.
TERMINAL DRIVE, PLAINVIEW, NEW YORK 11803 • 516-681-8600

I want to know all about the JAK type relays and how they fit into the All-Star Relay Team fielded by ITT Jennings.

My name is _____

My firm is _____

My address is _____

Street

City

State

Zip Code

My position is _____

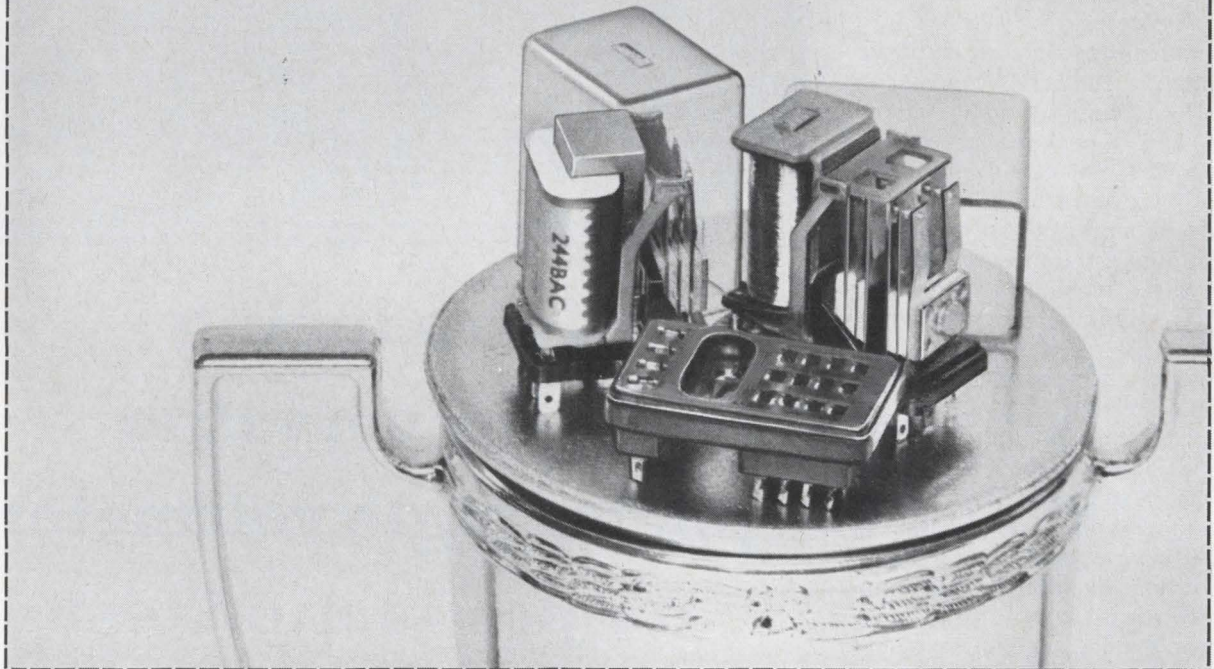

If you're not going to use it, burn it.

Why burn it?

You don't want the guy next door to learn all about the new JAK type relays from ITT Jennings before you do. That could give him a real edge.

For instance JAK type relays with either six or twelve contact springs have sintered steel cores. This means precise shape and size for exact magnetic properties.

Automatically wound and terminated coils on all ITT Jennings JAK type relays mean uniform high quality and close operating characteristics. Contacts may be silver, gold alloy or palladium.

One piece molded bobbins on all JAK type relays eliminate failure due to unreliable assembly of multiple piece bobbins.

Naturally, our JAK type relays are priced competitively.

Information like that (only more detailed) is what you or the guy next to you could get just by mailing the coupon on this page. So give yourself a break. Send the coupon to ITT Jennings, a division of International Telephone and Telegraph Corporation, 275 Meredian Rd., Salinas Calif. 93901. Ph. (408) 663-2501.

JENNINGS **ITT**

New Subassemblies Review

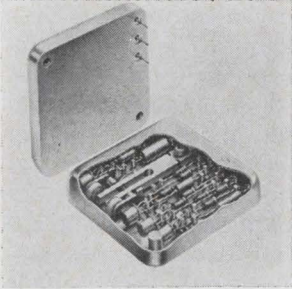

Tuning-fork oscillator LCG3 features a 50-nsec nominal rise and fall "current sink" logic output designed to drive most conventional IC's. It is available for any discrete frequency between 400 and 8,000 hz and has a specified operating temperature range of -55° to $+85^{\circ}\text{C}$. Waveshape is essentially square. Philamon Laboratories Inc., 90 Hopper St., Westbury, N.Y. 11590. [381]

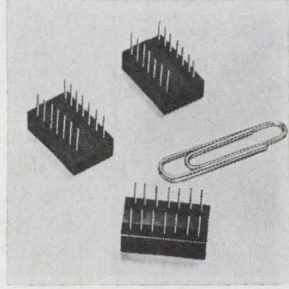

A series of miniature dual-in-line delay lines compatible with integrated circuit designs is now being produced. They offer more than 100 fixed delay values, from 5 to 1,000 nsec, at impedance values of 50, 75, 100, 200, 500, or 1,000 ohms. Each delay line can have 7 to 11 taps, if required. Bel Fuse Inc., 198 Van Vorst St., Jersey City, N.J. 07302. [382]

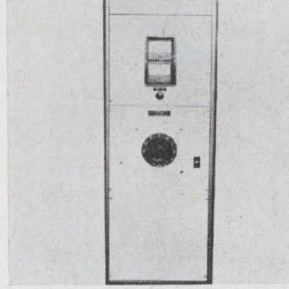

Power supply IT1315, with features required for vacuum sputtering, provides 0 to 11 kv adjustable output at a maximum power level of 4 kw. Use of a 3-phase input and special transformer features limits ripple to 5% of output voltage, a 10-fold improvement over single-phase systems. Price is \$3,925. ITI Electronics Inc., 369 Lexington Ave., Clifton, N.J. 07015. [383]

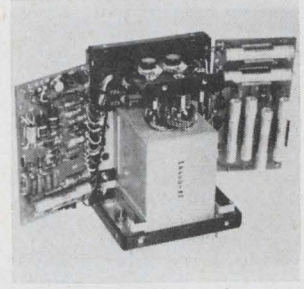

Mil-Spec d-c power modules type MS07 provide an output adjustable over 0-7 v d-c and come in ratings of 500 ma, 1, 2, 4, 6 and 8 amps. Input is 103.5 to 126.5 and 50 to 440 hz. Ripple is less than 800 μv rms. Line regulation is under 0.01% and load regulation under 0.05% during line variations at full load. Electronic Research Associates Inc., Cedar Grove, N.J. [384]



Delay line memory type 505E-2060 provides storage of 21,000 bits. Typical uses are for refreshing raster scan or high density discrete character crt displays, as well as desk calculator main memories, or flexible scratch pad memories. The memory has an access time of 8.3 msec and an internal data rate of 2.5 Mhz. Digital Devices Inc., 200 Michael Dr., Syosset, N.Y. 11791. [385]

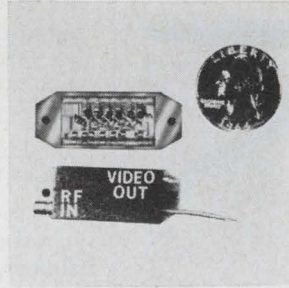

High gain i-f amplifier is $1 \times \frac{1}{2}$ x $\frac{1}{8}$ in. and weighs 15 grams. At a center frequency of 70 Mhz, typical bandwidth is 20 Mhz at the 3-db point with gain of 75 db ± 1 db. Noise figure is 4.5 db and impedance 200 ohm input/50 ohm output. Modifications can be made, such as internal or external agc, or bandwidth. Scientific Research Corp., Kennedy Rd., Tampa, Fla. 33614. [386]

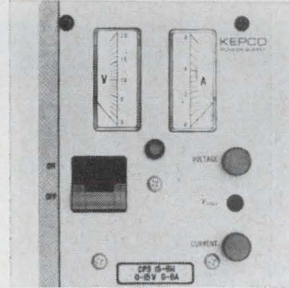

Computer power supplies series CPS suit IC technology. The 0-6 v model offers current ratings of 6, 12, 25 and 50 amps. Sizes include $\frac{1}{4}$, $\frac{1}{2}$ and full-rack widths in a standard $5\frac{1}{4}$ -in. panel height. Integral, redundant, over-voltage protection is included with the protector's trigger level adjustable from the front. Kepco Inc., 131-38 Sanford Ave., Flushing, N.Y. 11352. [387]



Static inverter model S1D converts 28 v d-c to 400 hz sine wave voltages of either 115 or 26 v a-c. With continuous full-load operation at 212°F , it supplies an output power of 10 v-a. Package measures $7\frac{7}{8} \times 2\frac{3}{4} \times 3\frac{1}{2}$ in. Output frequencies of 800, 1,200 and 1,600 hz are also available. Abbott Transistor Laboratories Inc., 5200 W. Jefferson Blvd., Los Angeles 90016. [388]

New subassemblies

Data system for thin purses

Building-block approach lets customers pick only what's needed; provisions for additions add to flexibility

For the first time small laboratories and universities can acquire data that a computer can analyze with a reliable and economical digital system. According to Ronald Porter, marketing manager of Beckman Instruments' Fullerton group, the series 3700 is the result of "put-

ting systems people onto the problem of filling the most important needs of systems customers, then tossing in many goodies as options."

The system employs three modules: an analog scanner termed Anscan that converts signals to digi-

tal data, a universal output coupler that translates the scanner's output into the format required by the recorder, and any one of six models of data acquisition recorders ranging in maximum speeds from 5 to 5,000 samples per second.

Anscan and its universal output coupler are subsystems that operate with any of the recorders offered by Beckman in its 3700 series. The two modules are flexible enough to be used with a wide variety of special-purpose recording devices.

The options include an input capacity that can be increased from 10 to 100 channels by adding multiplexer cards. Porter estimates about

Just your phone

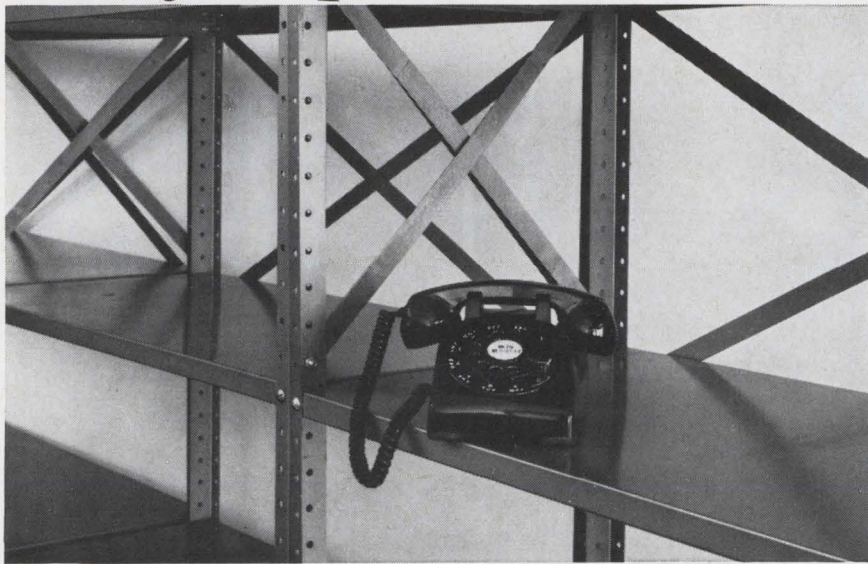

and a Triad catalog



and you have over 1700 transformers in stock.

A TRIAD catalog and your phone gives you instant access to the largest stock of standard transformers. TRIAD distributors are practically everywhere, offering you over 1700 off-the-shelf transformers for immediate delivery. And at factory prices! Your TRIAD distributor will also give you ready technical assistance and application help. The secret is in getting a TRIAD catalog. If your requirements can be met with a standard component, your phone and a TRIAD catalog are two things you shouldn't be without. Triad Distributor Division, 305 North Briant St., Huntington, Indiana.

T Triad Distributor Division
of Litton Industries 

... basic system operates
with different recorders ...

60% of the market requires less than 100 channels. The analog scanner can accept up to 100 signals. A high-speed analog-to-digital converter is used instead of a slower digital voltmeter. Amplifier gain at the analog-to-digital converter input is automatically adjusted to the best level for accurate measurement. And the gain decision is made in microseconds. Because an optimum range is selected and measurement is on a channel-by-channel basis, there is no need for external range programming, thereby simplifying the operation.

Thanks to field-effect transistor switching and integrated circuit control, the Anscan can be used as either a random-access data-gathering device or as a sequential scanner. Sequential-mode is controlled by internal-counting circuits; random-access mode by external-address signals. An option Beckman considers outstanding is an amplifier-zero feature that automatically samples for any amplifier offset signal and then feeds back the amplifier offset as an error correction signal to compensate for the drift that is associated with temperature variations.

Porter believes the most promising recorder is model 3740 with a sampling speed of 1,000 per second, which is designed to connect with larger computer systems. A separate Teletypewriter for direct address to the computer is part of this model. The primary unit is a 10-channel Anscan and a data processor. In this lone instance, no universal output coupler is used. Cost: \$22,500.

Two low-speed models are the 3720, which achieves five samples per second with a punched-paper tape, and the 3710, which uses adding-machine tape and has a speed of 20 samples per second. Besides the two-piece model 3740, in the medium-speed category are the incremental magnetic tape model 3730 with speeds up to 100 samples per second and model 3725 with a speed of 20 samples per second on punched paper tape.

Electronic Instrument div., Beckman Instruments Inc., 2500 Harbor Blvd., Fullerton, Calif. 92632 [389]

The new Mann Type 1600 Pattern Generator produces circuit patterns, directly, at 10X final size...automatically

David W. Mann Company, long a recognized leader in the development of photomask systems, has added a new concept in automation and precision to high-volume photomask production... the Type 1600 Pattern Generator.

The Mann Type 1600 Pattern Generator is a fully automatic, computer-directed, highly accurate, and reliable system. It generates circuit patterns directly, at 10X final image size, without intermediate artwork generation and reduction. Turnaround time is greatly reduced, repeatability and reliability are assured, and the process is carried out in far less time than conventional methods. The circuit patterns produced by the 1600 are further photoreduced and repeated in a rectangular array to form a

photomask using a Mann Type 1480 Series Photorepeater.

The Type 1600 Pattern Generator features:

Input data on punched tape in either decimal or binary format.

Stage positional precision of ± 0.00001 inch over a 2 inch by 2 inch square area.

Stage positioning accuracy of ± 0.00005 inch over a 2 inch by 2 inch square area.

A maximum aperture size of 120 mils square per exposure for composing circuit pattern, a minimum of 0.5 mils.

High resolution... 650 lines/mm over the entire circuit pattern area.

A digital computer controls all automatic functions of the 1600 from punched tape input data. (Optional punched card or magnetic tape input is available.) Input data on the 8-channel punched tape includes: X and Y coordinates of the center of exposure, height and width dimensions of the rectangular exposure, and the angle of aperture rotation (an option) up to 89°. Height and width of the area exposed in a single flash on the 10X pattern may be varied in 240 discrete steps from 0.5 mils to 120 mils... a total of 57,600 sizes. The Mann Microset Scale for both the scanning and stepover axes assures positional precision of ± 0.00001 inch.

We'd like to show you how the Mann Type 1600 Pattern Generator fits your requirements.

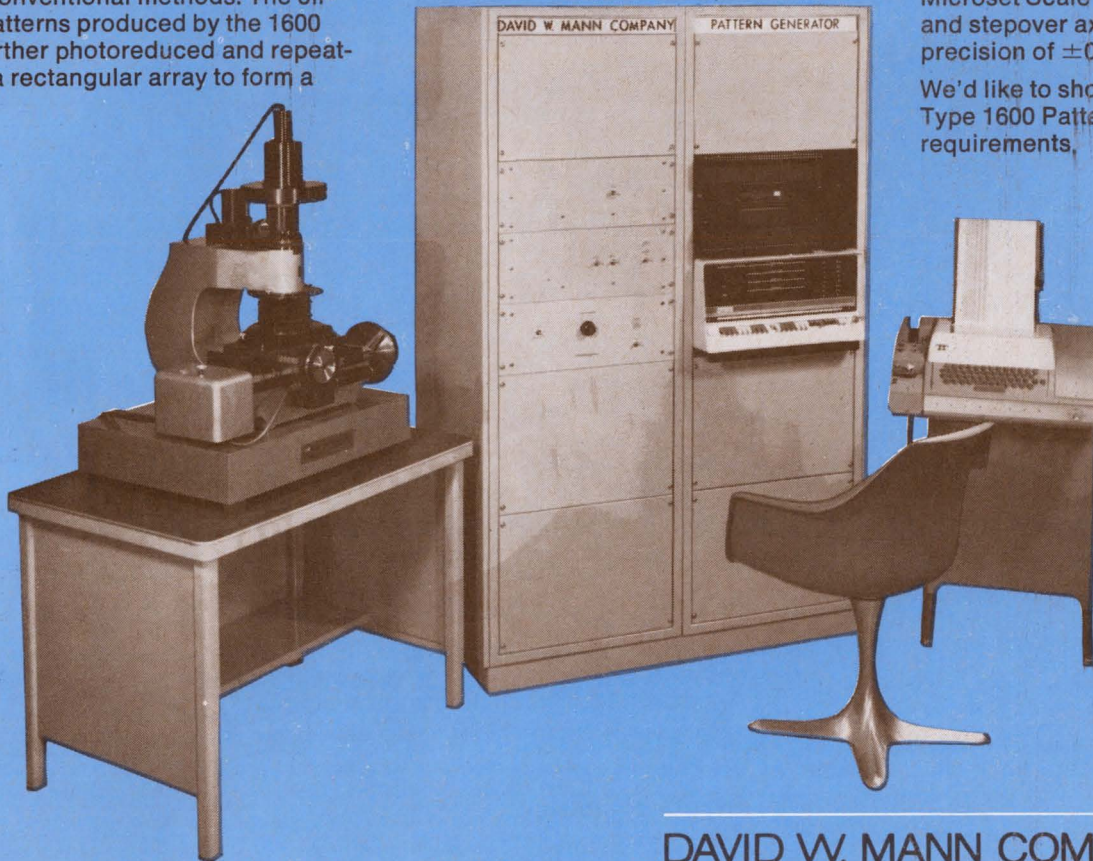

DAVID W. MANN COMPANY

184 Middlesex Tpke., Burlington, Mass. 01803, Tel: 617-272-5600

DIVISION OF
GCA
CORPORATION

Now...fast, highly accurate, reliable, and fully automatic generation of IC patterns.

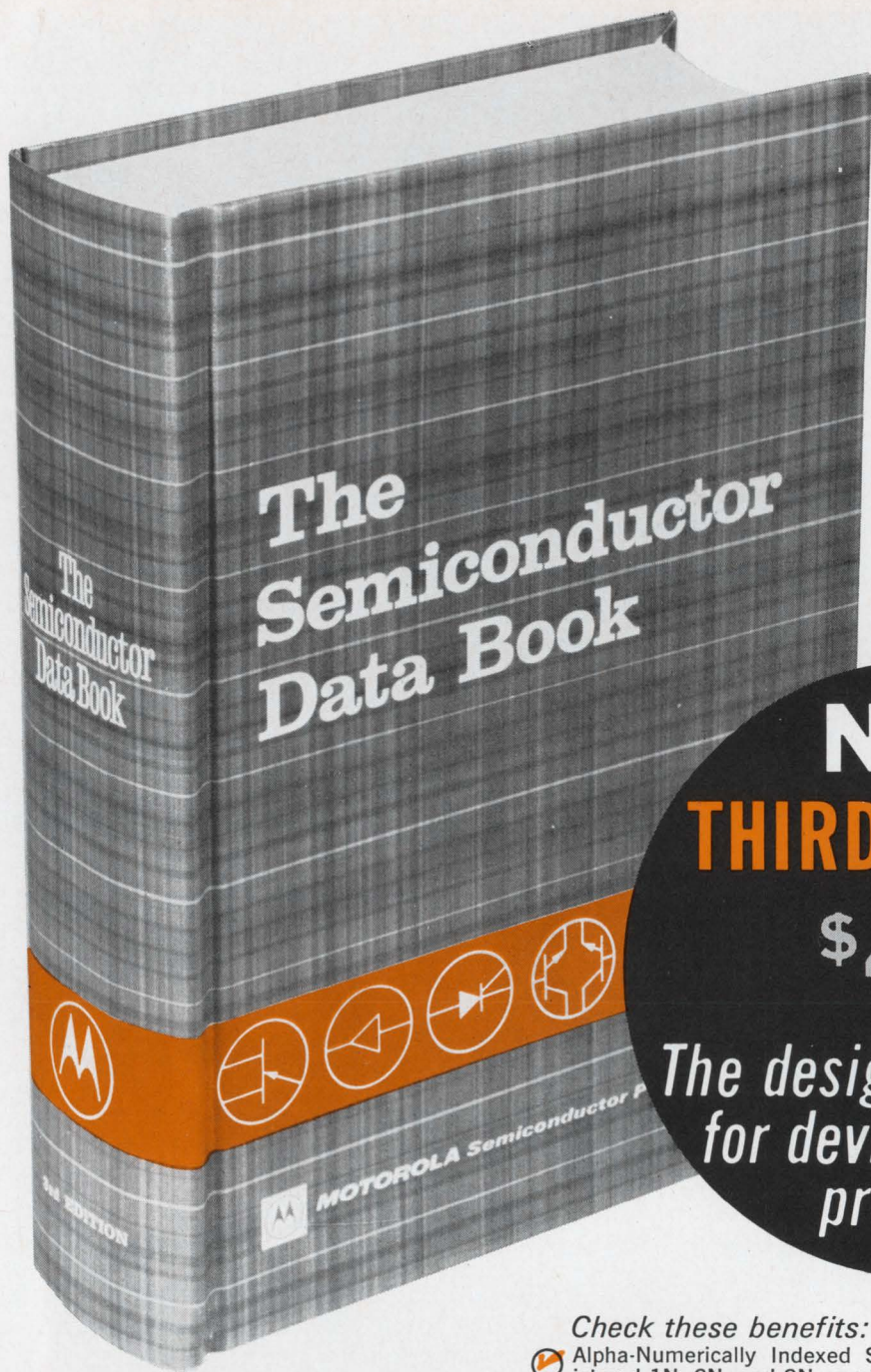

NEW
THIRD EDITION
\$4.95
PER COPY
*The designers' solution
 for device selection
 problems*

Please send my copy of Motorola's new Semiconductor Data Book, Third Edition.

Name _____

Address _____

City _____

State _____ Zip _____

My check or money order for \$4.95 (payable to Motorola Inc.) is enclosed.

Check these benefits:

- Alpha-Numerically Indexed Short-Form Specifications for all* EIA registered 1N, 2N, and 3N numbered devices
- Complete Data for all Motorola devices including house-number types
- Special Index sections with short-form specs for Tunnel Diodes, Varactor Diodes, 4-Layer Diodes, Thyristors, FET's, Reference Amplifiers, Unijunction Transistors
- Twelve separate, logically grouped discrete device data sheet sections
- Separate digital and linear integrated circuit data sections
- Edge-Referenced Quick Selection Guide with each regular product section
- Sixteen valuable "How To" Application Notes
- 1750 pages of data and general information — big enough for easy readability — compact enough to go anywhere.

And For The First Time

- Data Book Updating Service—subscription blank in book—Receive all supplements automatically

*as of close date for publication

-where the priceless ingredient is care!



MOTOROLA
Semiconductor Products Inc.
 P. O. BOX 955, PHOENIX, ARIZONA 85001

New Production Equipment Review

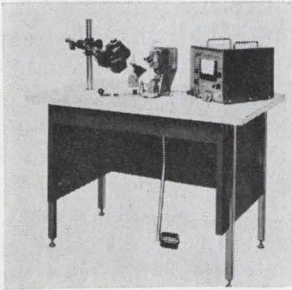

Beam lead devices can easily be joined to their metallic substrates or carriers using model 825 thermocompression bonding console. The bonder can also join small gold wires or ribbons to thin or thick film circuits and to other solid state devices by means of a pulse-heated tip. List price is \$3,975. Wells Electronics Inc., 1701 S. Main St., South Bend, Ind. 46623. [421]

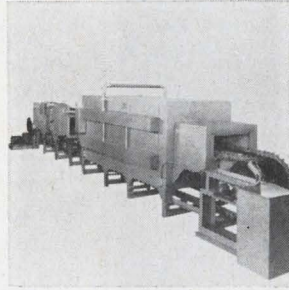

Conveyor enameling furnace, with operating temperature range of 1,200° to 1,850° F, is for firing enamel coatings on wirewound resistors. A cast alloy chain carries the support rods through the heating zone, cooling zone and returns the rods to the charge end where they are unloaded by the same operator that charges the unit. K. H. Huppert Co., South Holland, Ill. 60473. [422]

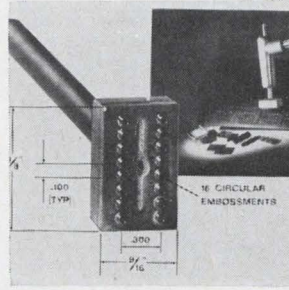

Multi-tip desolderers make possible the removal of dual in-line components without burning the circuit board. Its 16 separate embossments, 1 for each component lead, come in contact only with the individual land and solder fillets. Heat is transmitted into the solder joint only. The shank fits standard soldering irons. Air-Vac Engineering Co., Box 522, Milford, Conn. 06460. [423]



Rotary horizontal/vertical conveyors series RHV are for automatic soldering. The rotary dip conveyor has 8 stations for fixing parts. There is a fluxing station and a solder machine. Soldering or insulation stripping requirements determine the length of dwell in the solder which is set between 1 and 15 sec. Price is \$1,175. Hollis Engineering Inc., Nashua, N.H. 03060. [424]

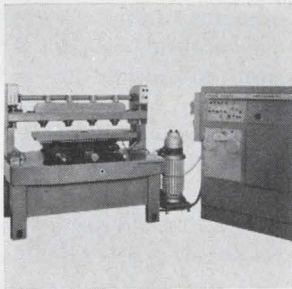

P-c board drilling machine series 8000 is a multiple spindle, numerically controlled unit. The drill is completely hydraulic for increased reliability, has a 0- to 300-in. per minute feed rate, drilled hole accuracies greater than ± 0.001 in., and a production rate greater than 96,000 holes per hour. Digital Systems Inc., 1078 E. Edna Place, Covina, Calif. 91722. [425]

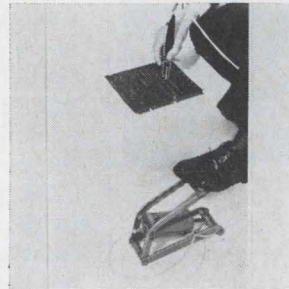

A desoldering kit is offered containing a foot-pump with molded cylinder and a synthetic cup washer. Lubrication and condensation problems are eliminated, weight is 3 lbs, and high pressure is obtained immediately on starting the stroke. Model ESS desoldering tool is obtainable for 12, 24, 50, 110, 220 or 240 v. Antex Ltd., Grosvenor House, Croydon, Surrey, England. [426]



Fully instrumented table model precision chemical etcher Dynamil VRP70 is for lab and experimental etching of printed circuits, fabricating production quantities of thick film masks, and chemical milling of test and preproduction parts and materials. Unit measures 24 x 20 x 20 3/4 in. List price is \$2,995. Western Technology Inc., 220 W. Central Ave., Santa Ana, Calif. 92707. [427]

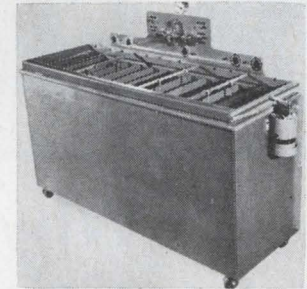

Electroless copper plating equipment consists of 12 tanks constructed into a unit to provide steps to clean, rinse, and apply catalyst, accelerator and copper deposition. It metalizes the walls of drilled holes in p-c boards. It handles up to five 12 x 16 in. panels per rack, and produces 3 racks per hr. Epec Industries Inc., Industrial Park, New Bedford, Mass. 02745. [428]

New production equipment

Stepping up performance classifications

Designed for use with test equipment, transistor sorter has 24-bin capacity and handles 4,000 units an hour

Classifying transistors takes teamwork. Test signals are generated and an evaluation is made by a transistor tester. Brawn is supplied by a sorter that plugs the transistor into the test socket, and then deposits it into a specific bin, designated by the tester.

As testing procedures become more selective, transistor makers need sorters with more and more bins. Some makers build large capacity units for their own use. Now, the Daymarc Corp. has developed a sorter that, the company says, has the highest bin capacity

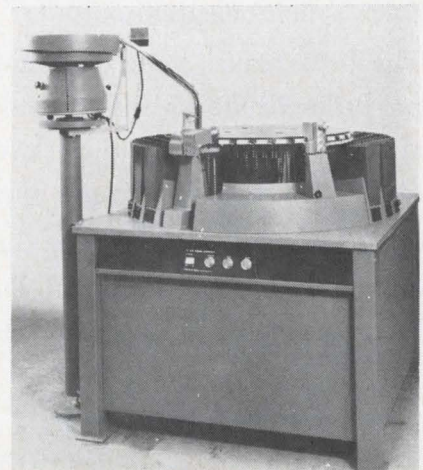

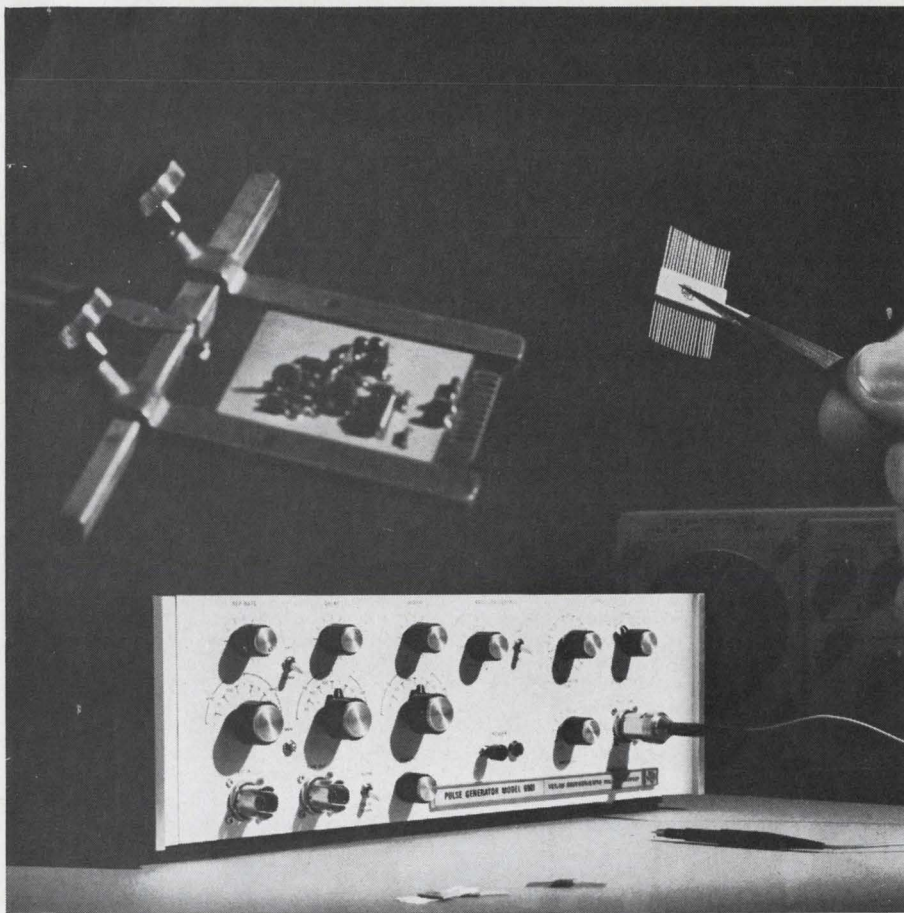

Why You Need a Special Pulse Generator for State of the Art Circuit Design

With high speeds and critical design parameters, you need the best test instruments to be sure your designs will be optimum. The TI Model 6901 Pulse Generator gives outputs from 1 KHz to 0.1 GHz; independent amplitude and baseline controls; jitter less than 0.1% of period + 50 psec; and count-down synchronization output.

The 6901 makes your designing simpler, too. Because the pulse amplitude of the generator can be changed without affecting DC offset, you can use the offset instead of an external bias supply for your circuit.

For additional information, contact your TI Field Office, or the Industrial Products Division, Texas Instruments Incorporated, P. O. Box 66027, Houston, Texas 77006.

TEXAS INSTRUMENTS
INCORPORATED

... mechanical memory determines the bin ...

for a commercially available unit.

Called the 3230, the Daymarc sorter has 24 bins and handles 4,000 transistors an hour. It can be connected to any tester having a switch-closure output, including those made by Fairchild, Texas Instruments, and Teradyne. Daymarc's basic unit sorts long- or short-lead TO-18's, but can be modified for such other types as the TO-5.

Kelvin connectors are used for the probes. Six separate terminals make contact with the three transistor leads. The base-to-collector capacitance is below 2 picofarads and the contact resistance is less than 0.05 ohms.

Drop in. Transistors are fed automatically to the 3230's circular, rotating indexing table, which holds 32 units around its rim. As each transistor is brought to the probing station the device is connected to the tester by cable. After the probe, the tester signals to the 3230 into which bin the device is to be placed. As the table turns, the transistor passes over several bins until it reaches the desired one, at which time the device is automatically released.

A mechanical memory drum rotates with the table and determines when to drop the transistor. A rod, attached to the drum, is under each of the 32 transistor slots on the table's rim; each rod has 24 aligned Y-shaped "operators"—one for each bin—having magnetic slugs in the arms.

The probe station has a column of 24 actuators, one for each bin. After a transistor is tested, a command from the tester discharges a capacitor in one of the actuators, causing a magnetic pulse that rotates an operator. When the table reaches the bin, the unaligned operator triggers the slot's drop mechanism.

A camming surface at the probing station realigns the operator before the next test.

The 3230 sells for \$24,700 and delivery takes 12 weeks. Equipment is available to extend the bin capacity to 29.

Daymarc Corp., 40 Bear Hill Rd., Waltham, Mass. 02154 [429]

announcing

... JFD

compactuner

compactuner

compactuner



JFD is pleased to announce a new line of miniaturized Long Life Modular Tuners, for both straight line capacitance and straight line frequency applications.

JFD has always featured a line of specially designed and built tuners to meet custom applications. Now available is a standardized tuner designed with all the versatility of the custom built units. This is made possible by two new mechanical packages that allow up to eight independent capacitor elements to be tuned simultaneously. This standardization results in a high quality, precision tuner at moderate cost.

Two basic models are available both featuring ten full turns of adjustment for precise tuning and excellent resolution. One model will accommodate up to four cylinders; the other from five to eight cylinders. These cylinders are available in a wide choice of dielectric materials and metalized patterns allowing almost unlimited design freedom. They can all be made as straight line capacitance, straight line frequency, special function, split stator, differentials, etc. or any combination can be specified on a single tuner.

The use of solid dielectrics with their inherent stability and high voltage ratings allow tuners to be built in smaller sizes than have even been achieved before. Wide capacitance ranges or frequency ratios can be achieved in packages that will withstand the severe environmental conditions that today's equipment requires.

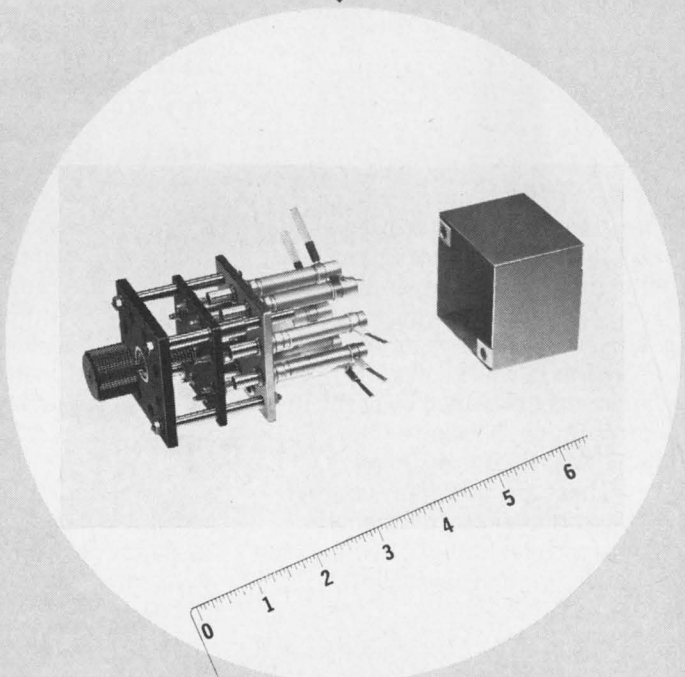

For additional information, write for catalog LLT-68.

"TODAY'S COMPONENTS BUILT FOR TOMORROW'S CHALLENGES"

JFD

JFD ELECTRONICS CO. / COMPONENTS DIVISION / 15th Avenue at 62nd Street / Brooklyn, New York 11219 / Phone 212-331-1000
Offices and subsidiaries in principal cities, world-wide.

"SEE US AT HANOVER FAIR, HANOVER, GERMANY—April 27th-May 5th"

Circle 123 on reader service card

123

evening classes won't fit your schedule?

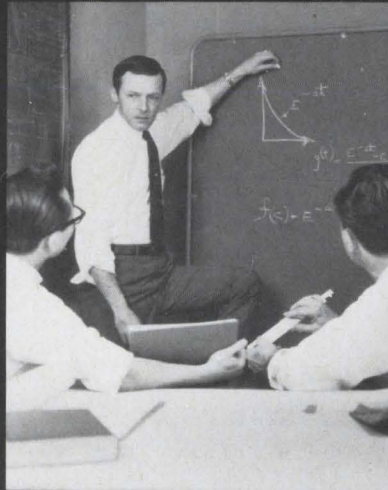

here's a practical way to keep up with new developments

Are irregular hours, travel and family obligations keeping you from attending classes—even though you worry about becoming technically obsolescent? Check into the Special Programs in Electronics for Engineers developed by CREI, the Home Study Division of the McGraw-Hill Book Company.

These are not simply courses, but comprehensive programs in advanced electronics offering major electives in such fields as:

Communications Engineering, Aeronautical and Navigational, Television Engineering, Automatic Control Engineering, Missile and Spacecraft Guidance, Radar and Sonar Engineering, Nuclear Instrumentation and Control, Computers.

Industry-recognized CREI Programs make it possible for you to catch up on new developments in electronics through study in your own home, at your own pace,

your own schedule. Free book gives complete information and details of technical material covered. For your copy, mail coupon below or write: CREI, Home Study Division, McGraw-Hill Book Company, Dept. 1814-G, 3224 Sixteenth St., N.W., Washington, D.C. 20010.

Founded 1927



Accredited Member of the National Home Study Council



CREI, Home Study Division, McGraw-Hill Book Company
Dept. 1814-G, 3224 Sixteenth St., N.W.
Washington, D.C. 20010

Send me free brochure describing CREI Programs in Electronics for Engineers.

NAME _____ AGE _____

ADDRESS _____

CITY _____ STATE _____ ZIP CODE _____

COMPANY _____

TITLE _____

New Semiconductors Review

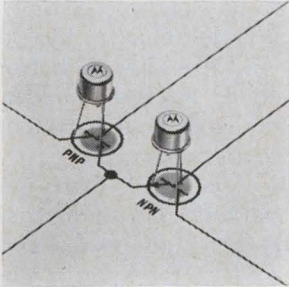

Silicon pnp, large signal vhf/uhf transistor 2N5160 comes in the TO-39 package. Minimum power gain of 8 db with no emitter tuning and a 1-w minimum power output, both measured at 400 Mhz, suit it for use in Class A, B, or C output, driver, or oscillator applications at frequencies up to 800 Mhz. Motorola Semiconductor Products Inc., Box 13408, Phoenix, Ariz. 85002. [436]

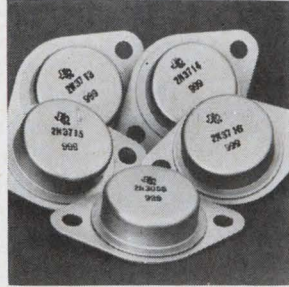

Single-diffused silicon power transistors—JEDEC types 2N3055, 2N3713, 2N3714, 2N3715, and 2N3716—are rated at 10 amps with power dissipations up to 150 w. Breakdown voltage ranges from 60 to 80 v with beta ranges at 1 amp of 25-75 and 50-150. Saturation voltage is typically 1 v or less at 5 amps collector current. Texas Instruments Inc., P.O. Box 5621, Dallas 75222. [437]

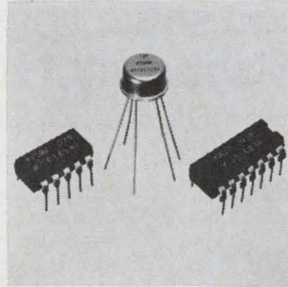

Silicon monolithic linear IC's are designed for entertainment products. Preamplifier MIC0101, dual preamp MIC0103, and driver amplifier MIC0201 have applications in automobile tape players and radios, and stereo sound systems. Price is 80 cents each for single, and \$1.20 for dual preamps, in quantity. P.R. Mallory & Co., 3029 E. Washington St., Indianapolis. [438].

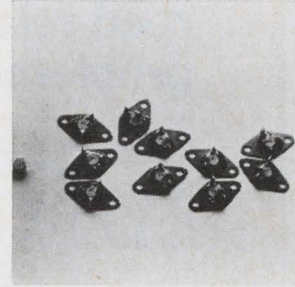

Series B-5002 is a line of 3-amp silicon npn transistors. Power dissipation is 14.3 w at collector current of 100°C, beta from 30 to 250 at 500 ma. The TO-66 mounting compatibility and isolated connector without use of extra hardware, sockets or insulating washers is of benefit to the OEM manufacturer. Bendix Corp., South St., Holmdel, N.J. 07733. [439]

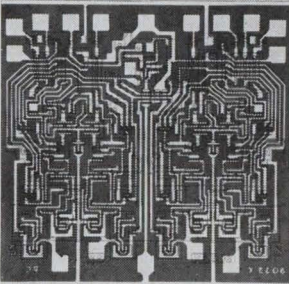

Dual TTL flip-flop 9022 can function as a standard JK or type D circuit. It performs at 35 Mhz and is for use in storage, shifting and counting registers where high speeds are necessary. Prices for military usage (-55° to +125°C) are \$20 each; for industrial usage (0° to +70°C) \$10 each. Fairchild Semiconductor, 313 Fairchild Dr., Mtn. View, Calif. 94041. [440]

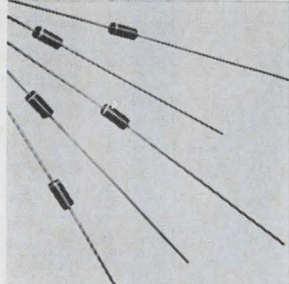

Hybrid diode 5082-2800 combines the advantages of hot-carrier diodes with those of p-n junction diodes. Breakdown voltage is 70 v min. at reverse current of 10 μ a. Forward (threshold) voltage is 410 mv max. at forward current of 1 ma. Minority-carrier lifetime is less than 100 psec. Price is 99 cents. Hewlett-Packard Co., 1501 Page Mill Rd., Palo Alto, Calif. 94304. [441]

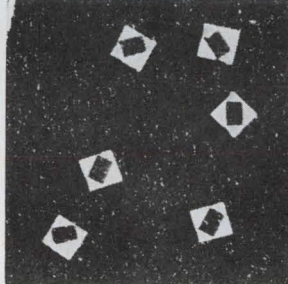

Thick film resistor GC-50 Tiny Chip is for use in the production of IC's and hybrids, where it can be used to replace silicon chip resistors. Size is 0.050 x 0.050 x 0.010 in., with resistance range from 50 ohms to 100 kilohms. Wattage rating is 0.050 w at 125°C. Temperature coefficient is 200 ppm/°C, from -65° to +150°C. Mepeco Inc., Columbia Rd., Morristown, N.J. [442]

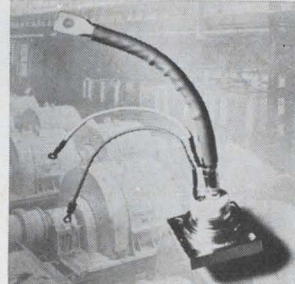

Thyristor SCR type 2248, with a 5,000-amp surge current rating, is designed for cycling loads, making it suitable for applications such as motor control starters, primary controlled power systems, and inverters where high inrush currents are encountered. It passes a forward current of 475 amps rms at up to 1,500 v. Westinghouse Semiconductor Division, Youngwood, Pa. 15697. [443]

New semiconductors

Mini-dip aims mighty high

Fairchild hopes its 10-lead hybrid IC will score well in drive for computer and industrial markets

Like a Volkswagen, Fairchild Semiconductor's new hybrid integrated circuit package, called the Mini-Dip, looks so modest something seems to be missing. The little dual in-line plastic-packaged IC, which has only 10 leads, is like a kid brother to the normal dip.

But the junior-sized Mini-Dip is the spearhead of Fairchild's campaign to expand its hybrid operations into the industrial market. Last year, during which its hybrid sales quadrupled, Fairchild sold almost entirely to space and defense customers. Those are the only peo-

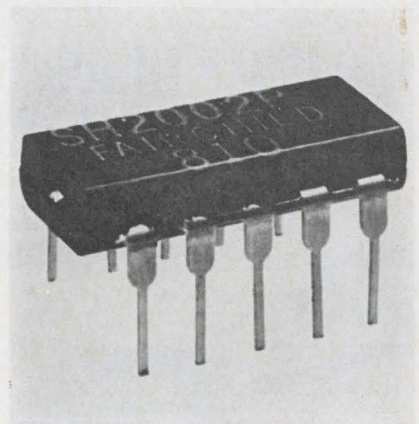

Junior size. Ten-lead hybrid is Fairchild's first plastic IC.

We designed these special reed relays to solve specific problems. Maybe yours.

We think these specials demonstrate our versatility in designing for unique requirements.

Our line also includes standard and miniature varieties of dry reed, mercury-wetted, latching and high power reed relays — available in molded, cased or tubular construction.

Whether you're interested in specials or standards, chances are we can deliver the reed relays you need — fast. Our complete engineering and design facilities are at your service.

For a copy of our latest Doranic® Reed Relay catalog, write to: Douglas Randall, Inc., 6 Pawcatuck Ave., Westerly, Rhode Island 02891.

ULTRA-LOW CONTACT RESISTANCE
Guaranteed maximum: 5 milliohms.

HIGH VOLTAGE
Will break 15,000 volts peak RF and 70 amps for 1 μ sec pulse.

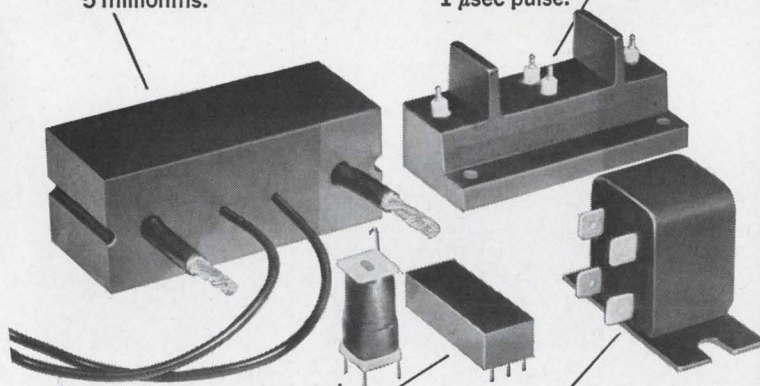

VERTICAL MOUNT AND LOW PROFILE
For use where available space is limited. Low profile relay shown is .315" high. Vertical mount relay fits into .4" square.

SPECIAL MOUNTING
An example of one configuration designed to meet special mounting and terminal requirements.

DOUGLAS RANDALL, INC.
Division of Walter Kidde & Company, Inc. 

Circle 126 on reader service card

Our little black book has over 100,000 phone numbers.

You never had a black book like it. Over 1,500 pages. And those phone numbers! More than 100,000 telling you who to call/where to go, for the over 4,000 different product categories listed and advertised in the yellow pages of the Electronics Buyers' Guide.

It's the industry's one-stop shopping center that lets you find the products and services you need quickly. You can depend on EBG.

Electronics Buyers' Guide

A McGraw-Hill Market Directed Publication,
330 West 42nd Street, New York, N.Y. 10036

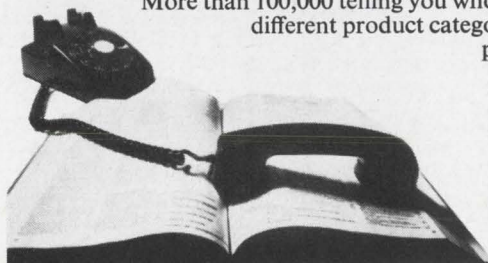

... first plastic package for a Fairchild IC ...

ple making thousand-piece buys, says Geoff Winkler, chief of hybrid operations. And it is that caliber of sales that chiefly interest Winkler, who has revitalized the department during his year's tenure.

Time and place. Still, there are computer markets and industrial requirements for high power and high voltage where the hybrids can match discretes in performance, beat discretes in size and price, and outperform the fully monolithic circuit. It's here that Winkler sees an opportunity to cull as much as 20% of his sales dollar.

The Mini-Dip is Fairchild's first plastic package for an IC, and it is the first production hybrid without a base-plate substrate.

Inside the first Mini-Dip will be a Fairchild 932 diode-transistor logic circuit and a power transistor combined in a high-power driver useful with core memories, go-no-go lamps, and latching relays. The circuit, already in Fairchild's line as the SH2002, will switch up to 150 milliamperes at up to 40 volts. Specifications of the SH2002P ("P" for plastic) are identical to those of the flatpack and TO-100 industrial versions, according to Dan Hauer, hybrid IC marketing manager.

The formula. The plastic package, of course, does not offer hermeticity: it has been this fact that has determined Fairchild's approach to price reduction. The company's position has been that it can match plastic's low cost with flip-chips in a hermetic ceramic package.

Nevertheless, the Fairpak, the company's flip-chip package, has been around over a year and its use is still confined to Fairchild's limited monolithic transistor-transistor logic production.

Two factors led to the adoption of the plastic package. One was the development, in Fairchild's research and development laboratory, of a new silicone resin for coating the semiconductor chips before injection molding. The other was application of the fact that moisture resistance, which is the state that a hermeticity figure is supposed to measure, is less important at the

industrial temperature range (0° to 70°C) than at the high military temperatures. Fairchild does have a ceramic dip planned for its hybrid line.

Bottomless. Elimination of the ceramic substrate was necessary for batch processing, because with a substrate each circuit would have to be made separately. Putting the chips right on the lead frame, which itself serves as a conductive path, had other advantages, Hauer says, and introduces only a few real drawbacks.

The cost of the substrate is eliminated but the lead frame is more expensive because it must be tailored to each individual circuit. In addition, special jigs were needed for eutectically bonding the chip to the frame.

But getting rid of the substrate paved the way to high-voltage operation because it got rid of the resistance between the bond and the substrate, and between the lead and the outside world. The lead frame, by contrast, is a low-resistance, low-inductance mass. Further, thermal conductivity was improved because without the substrate there is no lead-substrate thermal resistance.

The substrate does act as an electrical insulator, but with only a few devices in the circuit (two, in the case of the SH2002P), the insulation is not a very important factor.

Better buy. At current prices, Hauer says, a customer could not put together his own SH2002P as cheaply as he can buy it. The 932 costs \$2, the power transistor \$2.50; the hybrid will cost \$3.95 in lots of 100, and the price will be \$2.50 to \$3 for volume orders.

The packaging process that reduced the price can be adapted to other circuits, Hauer adds. Since it is performed at low temperatures, it is applicable to metal oxide semiconductor and linear devices, he says.

Specifications

V _{cc}	+8 v
V _{cc} (pulsed 1 second or less)	+12 v
Input reverse current	1.0 ma
Uncommitted collector voltage	+40 v
Current capability	150 ma
Storage temperature	-65° to +150°C
Operating temperature	0 to +70°C
Price (100-999)	\$3.95

Fairchild Semiconductor, 313 Fairchild Drive, Mountain View, Calif. [444]



Temp-R-Tape® T

One of a series of self-adhering tapes of skived Teflon* TFE. High elongation provides excellent conformability for tight wraps around irregular surfaces.

Temp-R-Tape HM-350

Made of skived Teflon TFE. A unique CHR manufacturing process imparts lower elongation and higher breaking strength. Good conformability.

Temp-R-Tape C

Extruded Teflon FEP film has extremely high electric strength, highest of all Temp-R-Tapes. Transparent for easy read-through. Excellent conformability.

Temp-R-Tape Kapton*

Made from a polyimide film. Has outstanding thermal endurance. Retains physical and electrical properties at elevated temperatures. *T.M. OF DUPONT

Temp-R-Tape GV

Closely woven glass cloth. Good conformability and flexibility. Strong. Puncture and tear resistant. Excellent abrasion resistance and thermal stability.

Temp-R-Glas®

Glass fabric coated with Teflon TFE. Four thicknesses. Resists Teflon cold flow. Strong. Puncture and tear resistant. Also available without adhesive.

WE MAKE SIX DIFFERENT TYPES OF WIDE TEMPERATURE RANGE ELECTRICAL TAPES.

THAT WAY WE'LL HAVE ONE THAT'S JUST RIGHT FOR YOUR APPLICATION.

Temp-R-Tape is operational from -100 F to +500 F, has excellent electrical and physical characteristics. Pressure sensitive silicone polymer adhesive. Stocked by a national network of distributors capable of technical assistance and fast delivery. Look under CHR in industrial directories or micro-film catalogs. Or write for details and sample. The Connecticut Hard Rubber Company, New Haven, Connecticut 06509.

CHR

Subsidiary of U.S. Polymeric, Inc.

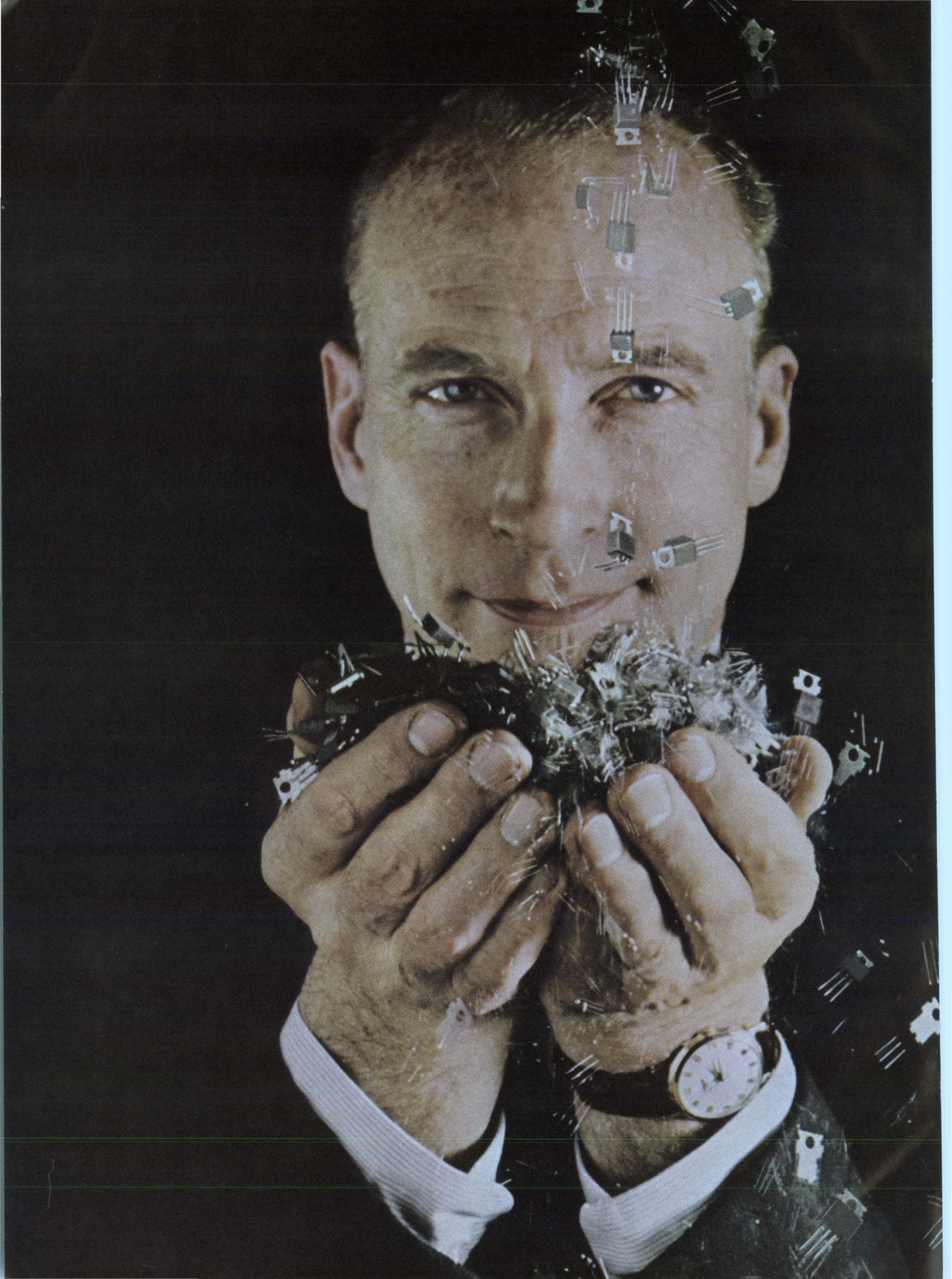

Guess how many new RCA plastic power transistors \$550 will buy

An even 1,000—if it's RCA-2N5294. That boils down to 55 cents* each. And at that price it's one of the better power transistor buys around! Here are the facts:

- *55 cents buys* a plastic transistor having a brute power-dissipation capability of 36 watts—second only to RCA's already announced 83-watt family, the industry's highest power plastic devices.

- *55 cents buys* a plastic transistor that makes mounting a breeze—you choose from a straight-lead design for PC-board mounting or a formed-lead design that can be plugged into any "TO-66" socket.

- *55 cents buys* a plastic transistor with more than two years of field testing in commercial and industrial applications. In fact, we think that its reliability is so good when compared with that of hermetic devices, we called the 2N5294 family the "non-plastic" plastic transistors!

- *55 cents buys* a plastic transistor with outstanding electrical performance—an I_c max of 4A, excellent beta of 30-120 at 1A, V_{CBO} up to 80 volts, and thermal characteristics better than that of many hermetic units. An added plus is RCA's Hometaxial-Base construction, the industry's best answer for freedom from second breakdown. And, unlike many other plastic devices, you get completely spec'd curves for safe area operation!

In all, RCA has 6 new types in its 36-watt family. And, there are no delivery "hang-ups"—*all devices are available right now in production quantities*. Call your RCA representative today for information on pricing and delivery for large quantities, or for help on your special product requirements. For technical data on specific types, write: Commercial Engineering, RCA Electronic Components, Harrison, New Jersey 07029. See your RCA Distributor for his prices and delivery.

*Price for 1000 units.

RCA

Circle 129 on reader service card

DEECO dispatches TI's family of TTL ICs on the double

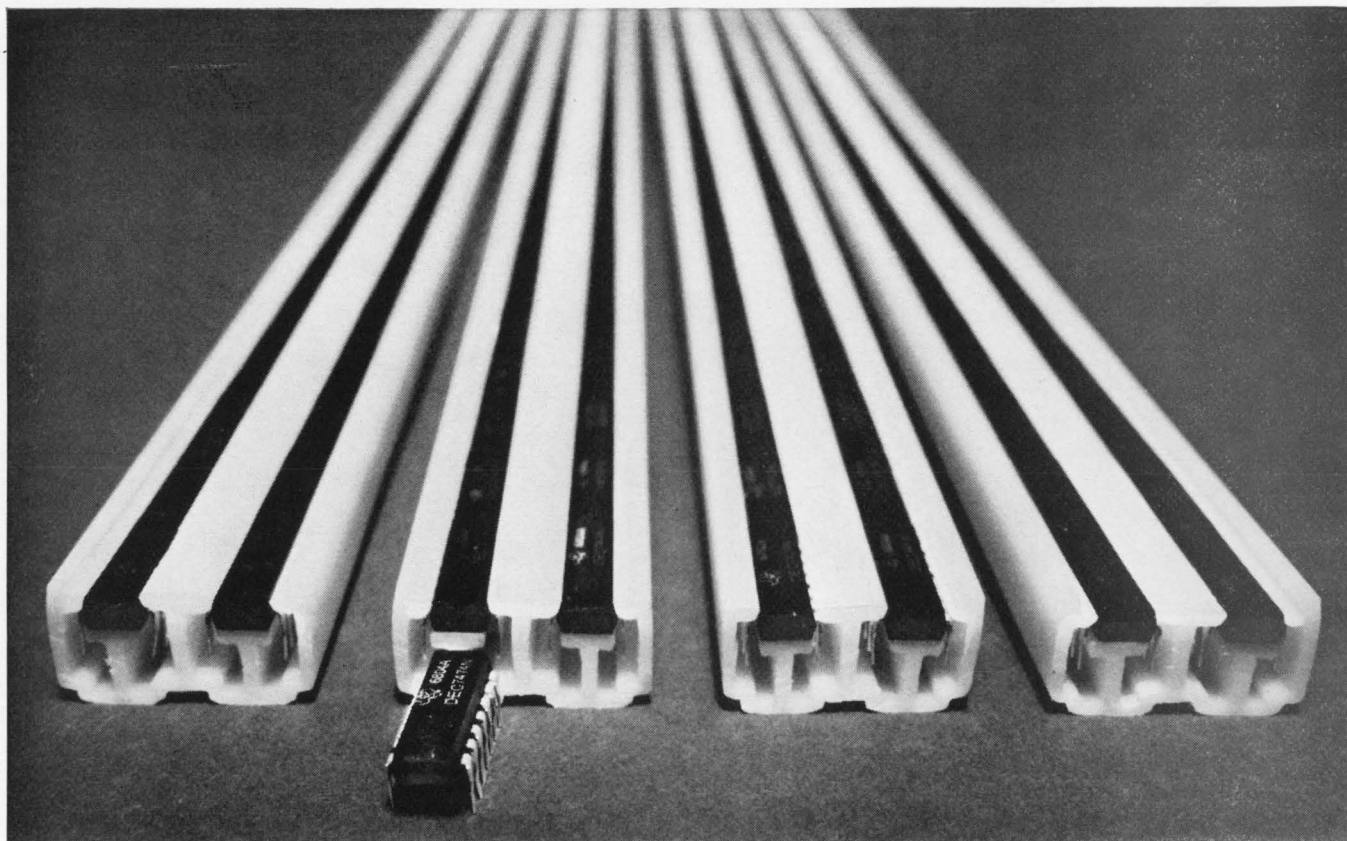

Holding a double row of ICs, this new TI shipping carrier proves a real convenience on your assembly line. Simplifies handling whether assembly is by machine or by hand. Nips seconds off assembly time. TI's Series 54/74 TTL standard and high-speed ICs are available in this handy carrier — and from us!

Our pipeline to Texas Instruments keeps our stocks up to snuff on this

most versatile and complete line of TTL ICs going. You get your best combination of speed, power dissipation, performance and cost-per-function.

We deliver what you want, in the quantity you want on the double. Same with the entire TI line of economy semiconductors.

Check it out for yourself. Circle number 299 on reader service card for a

free copy of this new brochure describing *all* TI economy plastic semiconductors: digital and linear ICs, SILECT™ transistors, FETs, SCRs, unijunctions and silicon rectifiers. Do it today — and depend on delivery *on the double*.



DEECO  **Inc.**

DISTRIBUTORS — SERVING INDUSTRIALS EXCLUSIVELY

618 FIRST STREET N. W. • CEDAR RAPIDS, IOWA • PHONE 319 365-7751

AUTHORIZED
DISTRIBUTOR 

New Consumer Electronics Review



APECO video tape recorder has a 7-in. reel and a 7.5-ips tape speed. Resolution is 300 lines. Frequency range is 60 to 10,000 hz; signal-to-noise ratio, 40 db or more. Power consumption is 9.5 w. The unit measures $18\frac{3}{8} \times 10\frac{3}{8} \times 15\frac{1}{8}$ in. and weighs 52.8 lbs. Three different monitors are available. American Photocopy Equipment Co., 2100 W. Dempster St., Evanston, Ill. [401]

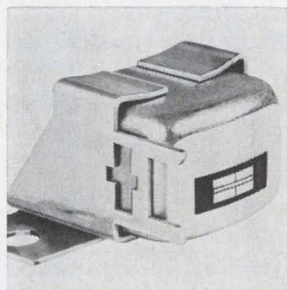

Stereo record/play cassette head designated model 09CR2PX44 features laminated pole pieces for extended frequency response, premium shielding for maximum cross-talk rejections, and the exclusive series 300 glass-filled epoxy housing for unusual extended wear characteristics. Price is between \$3 and \$4 depending on quantity. Michigan Magnetics, Vermontville, Mich. 49096. [402]

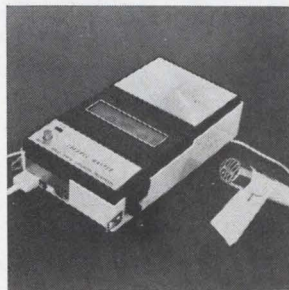

Cassette recorder 6303 weighs 2 lbs 10 oz with batteries installed and will operate on either 4 "C" size cells or on a-c power with an optional adaptor charger. Equipment supplied with the recorder includes a remote control pencil-type mike and stand, accessory case, and a prerecorded demonstration tape cassette. Price is \$54.95. Channel Master Corp., Ellenville, N.Y. [403]



Home stereo cartridge player 3202 accepts all 8-track and $\frac{1}{2}$ -hr 4-track tape cartridges. The unit features pre-amp outputs, which make it easy to tie in to existing home hi-fi systems. It plays up to 80 minutes with 8-track twin packs. Tape speed is $3\frac{3}{4}$ ips. Frequency response is 50 to 10,000 hz. Price is \$99.95. Craig Panorama Inc., 2302 E. 15th St., Los Angeles. [404]

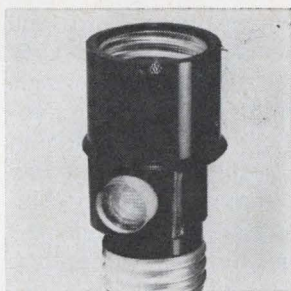

Reliable and automatic dusk-to-dawn lighting is provided by the LGM-10-13 Vigilite, a light control adaptor that screws into any lamp socket between socket and bulb. The photocontrol's one-piece construction leaves no cracks for water to enter making it extremely weatherproof. It is fully guaranteed for 1 year. LGM Electronics Inc., 4304 LaBranch St., Houston 77004. [405]

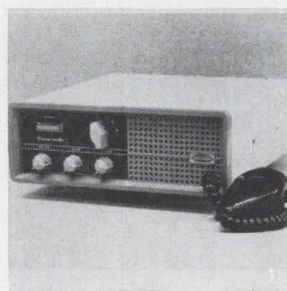

Marine radiotelephone Cruise/Aider has 5 crystal controlled channels to make it effective for either ship-to-shore or ship-to-ship use. It has 60 w of power. Measuring approximately $12\frac{1}{2}$ in. sq. x 4 in. thick, it comes with a trunnion mounting bracket for attachment to shelves, over-heads, or bulkheads. Price is \$255. Raytheon Co., 213 E. Grand Ave., S. San Francisco. [406]

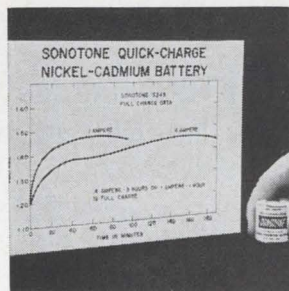

Quick-charge nickel-cadmium battery can be fully charged in 1 hour or charged to a sufficient capacity, in a matter of minutes, to operate a cordless device. The unit is self-sustaining, needing no auxiliary electrode or diode protection devices. The quick charge is built into the battery cell. The device can also accept overcharge. Sonotone Corp., Elmsford, N.Y. 10523. [407]

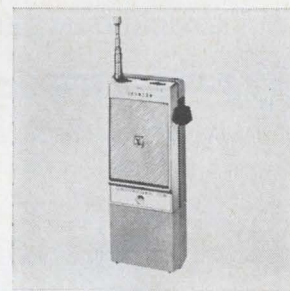

CB transceiver Messenger 109, for hand-held communications, features 3 w of power and offers 2-channel selection. It utilizes 14 transistors, 9 diodes and a thermistor. Unit measures $8\frac{1}{2} \times 3\frac{1}{8} \times 1\frac{1}{8}$ in. and weighs 30 oz. Sensitivity is 0.5 μ v for a 10 db signal-to-noise ratio. It uses a rechargeable nickel-cadmium battery pack. E.F. Johnson Co., Waseca, Minn. 56093. [408]

New consumer electronics

Vtr travels for on-the-spot recording

GE's battery-powered unit weighs 15 pounds, will replace servicing manuals for complex equipment

Manufacturers invading the market for home video tape recorders are faced with two barriers: they must price beyond the reach of most people, and vtr's, being line powered, require rooms with outlets.

Now General Electric has leaped the second barrier. It has made a

vtr that is battery-powered and light. Called Porta-Pack, the unit carries a \$1,295 price tag including battery and battery charger, but not including a playback set. An instant playback unit with an 11-inch diagonal screen costs \$950. A 22-inch screen is also available.

The camera weighs 5 pounds and the over-the-shoulder recorder 10.

GE also has come up with a novel marketing bait for the Porta-Pack. It's offering the unit as a replacement for service and maintenance manuals for industrial and aircraft equipment. The idea is to record on-the-spot servicing or assembly of complex equipment, then ship the tape with the equipment to provide quick and simple instructions for maintenance personnel. The company says its new vtr can also become a valuable aid to lawyers, sports coaches, investigators, and educators.

Up front. The tv camera is com-

10,000% overload capacity

PARKER PANEL METERS

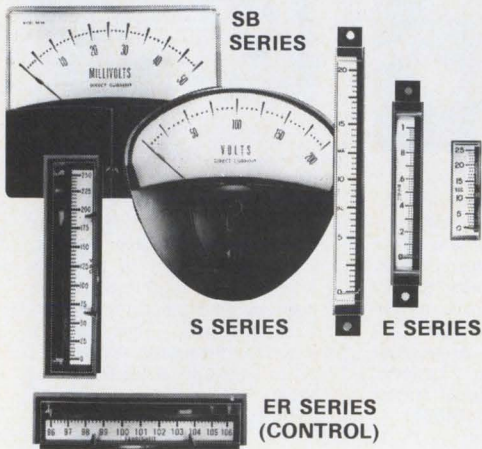

Parker offers a complete line of panel, edgewise and control meters. All feature the unique, rugged Parker movement with 10,000% overload capability and high shock resistance, Panel types surface mounting, Control types solid state. For complete details see catalogs M-2, M-9, M-10.

STOCKED IN DEPTH BY LEADING DISTRIBUTORS

PARKER INSTRUMENT CORPORATION
200 HARVARD AVE. • STAMFORD, CONN. 06904 • TWX 710-474-2277 • PHONE (203) 325-4361

Circle 155 on reader service card

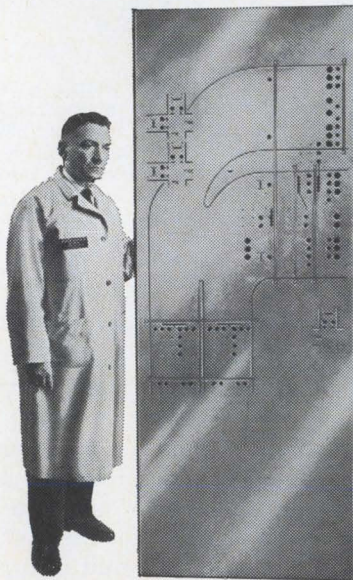

think BIG

(also small)

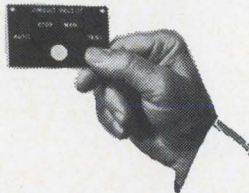

Now engrave anything from 6 ft. panels to tiny nameplates

Engravograph tackles them all. Right in your own shop, effortlessly, speedily — ideal for unskilled workers. Adjustable ratio engraves 21 different sizes.

Write for illustrated catalog # 114

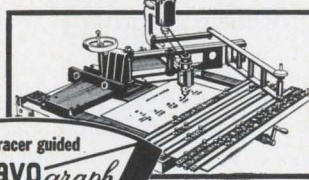

the tracer guided
Engravograph

new hermes engraving machine corp.

20 Cooper Square, New York, N. Y. 10003. Chicago, Atlanta, Dallas, Los Angeles, Montreal
Write Directly to Manufacturer
SEE US AT BOOTH 150 AT THE CHICAGO SHOW

132 Circle 132 on reader service card



New look. Porta-Pack records equipment assembly. Tape is then shipped to buyer as replacement for service and maintenance manual.

pletely solid state except for the one-inch viewfinder and the vidicon tube. The viewfinder, which is a tiny tv monitor, gives the cameraman a clear picture of the action. A pickup microphone used for background sounds is mounted in a holder atop the camera. It can be removed for remote positioning. The camera is equipped with an f2 16-64 millimeter zoom lens.

The recorder is about the size of a large handbag, and is linked to the camera and microphone by a single cable. It has a video frequency response of 100 hertz to 2 megahertz, and a resolution of 200 lines. It uses helical scan with a video writing speed of 1,000 inches per second and a tape speed of 7½ ips, and provides 20 minutes of recording with a 750-foot, 5-inch spool of half-inch tape that GE sells for \$15.10.

Battery pack. The battery pack consists of two 6-volt rechargeable lead-acid batteries that provide about one hour of recording between charges.

Specifications

Video response	100 hz to 2 Mhz
Audio response	100 hz to 10 KHz
Tape	half-inch-wide polyester base video tape
Tape speed	7.5 ips
Power requirements	12 volts d-c
Video signal to noise	better than 40 db
Audio signal to noise	better than 40 db

General Electric Co., Closed Circuit Television Business Section, Syracuse, N.Y. [409]

The \$12.00 C.P. pot.

Helipot's new Model 3351
conductive plastic potentiometer

is your twelve-dollar solution to applications requiring high precision and long, trouble-free life at minimum cost.

Here are just a few of the specs:

- Resistance range: 1K to 75K ohms
- Linearity: $\pm 0.5\%$
- Power rating: 0.75 watts at 70°C
- Bushing mounted

If you like the specs and the price, get in touch with any

Helipot Sales Rep. He'll give you the complete non-wire-wound pot story — about both cermet and conductive plastic models.

Beckman®

INSTRUMENTS, INC.
HELIPOT DIVISION
FULLERTON, CALIFORNIA • 92634

INTERNATIONAL SUBSIDIARIES: GENEVA, MUNICH, GLENROTHES, SCOTLAND; TOKYO, PARIS, CAPE TOWN; LONDON; MEXICO CITY

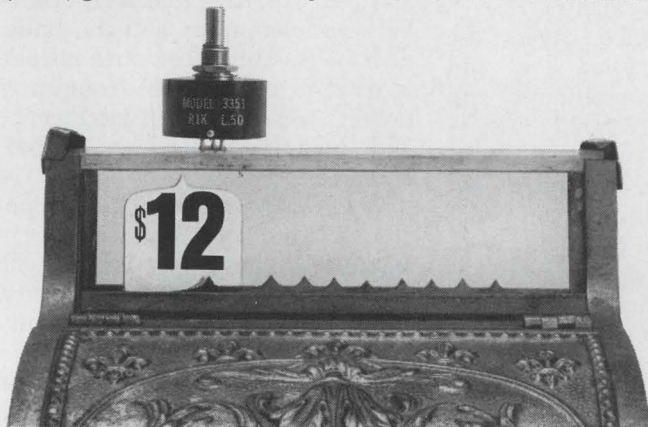

Circle 156 on reader service card

who has the head start in stepping motors?

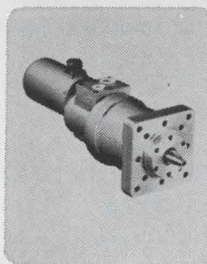

ELECTROHYDRAULIC PULSE MOTORS
Speed: To 8,000 steps/sec
Power: To 6 HP
Resolution: 200 or 240 steps/rev.

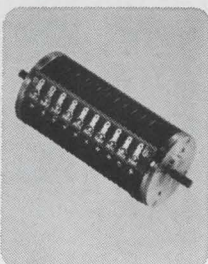

ELECTRIC PULSE MOTORS
Speed: To 10,000 steps/sec
Power: To 1 HP
Resolution: 160 or 240 steps/rev.

icon!

Icon is the leader in stepping motors. Can offer you the highest performance motors available. Can help you apply them practically, economically and simply to automate your plant or products. Call Icon now.

icon
CORPORATION

LEADERS IN DIGITAL MOTION
156 Sixth St., Cambridge, Mass. 02142
617/868-5400

Circle 157 on reader service card

the last time you used a 'scope,
did you really need more performance
than these Heathkit® models provide?



Heathkit IO-17
... new 5 MHz
3" 'scope ... only
\$79.95

IO-17 SPECIFICATIONS — VERTICAL CHANNEL: Input impedance: 1 megohm shunted by 25 pF; x 50 attenuator position 1 megohm shunted by 15 pF. Sensitivity: 30mV P-P/div. (uncalibrated). Frequency response: 5Hz to 5MHz ± 3 dB. **HORIZONTAL CHANNEL:** Input impedance: 10 megohm shunted by 15 pF. Sensitivity: 300 mV P-P/div. Frequency response: 2Hz to 300 kHz ± 3 dB. **HORIZONTAL SWEEP GENERATOR:** Sweep generator: Recurrent type. Frequency: 20Hz to 200 kHz in four overlapping ranges. Retrace: Blanked by a pulse from blanking amplifier. Synchronization: Automatic type. **GENERAL:** Tube complement: (1) 3RP1 cathode ray tube, medium persistence, green trace; (3) 12AU7; (1) 12AX7; (1) 6GH8; (1) 6BH6; (1) 6BQ7. Power requirements: 105-125 volts 50/60 Hz or 210-250 volts 50/60 Hz. Power consumption: 60 watts. Overall dimensions: $9\frac{1}{2}$ " H x $5\frac{1}{2}$ " W x $14\frac{1}{2}$ " L. (Dimensions include handle, knobs, etc.). Net weight: 12 lbs.



Heathkit IO-14
... DC to 8 MHz
5" 'scope ...
triggered sweep
... 0.25 usec
delay line input ...
assembled
\$399.00
kit
\$259.00

IO-14 SPECIFICATIONS — (VERTICAL) Sensitivity: 0.05 V/cm AC or DC. Frequency Response: DC to 5 MHz — 1 dB or less; DC to 8 MHz — 3 dB or less. Rise time: 40 nsec (0.04 microseconds) or less. Input impedance: 1 megohm shunted by 15 pF. Signal delay: 0.25 microsecond. Attenuator: 9-position, compensated, calibrated in 1, 2, 5 sequence from 0.05 V/cm to 20 V/cm. Accuracy: $\pm 3\%$ on each step with continuously variable control (uncalibrated) between each step. Maximum input voltage: 600 volts peak-to-peak; 120 volts provides full 6 cm pattern in least sensitive position. **(HORIZONTAL)** Time base: Triggered with 18 calibrated rates in 1, 2, 5 sequences from 0.5 sec/cm to 1 microsecond/cm with $\pm 3\%$ accuracy or continuously variable control position (uncalibrated). Sweep magnifier: X5, so that fastest sweep rate becomes 0.2 microsecond/cm with magnifier on. (Overall time-base accuracy $\pm 5\%$ when magnifier is on.) Triggering capability: Internal, external, or line signals may be switch selected. Switch selection of + or — slope. Variable control on slope level. Either AC or DC coupling. "Auto" position. Triggering requirements: Internal; 0.5 cm to 6 cm display. External; 0.5 volts to 120 volts peak-to-peak. Triggering frequency response: DC to 2.5 MHz approx. Horizontal input: 1.0 v/cm sensitivity (uncalibrated) continuous gain control. Bandwidth: DC to 200 kHz ± 3 dB. Power requirements: 285 watts. 115 or 230 VAC 50-60 Hz. Cabinet dimensions: 15" H x $10\frac{1}{2}$ " W x 22" D includes clearance for handle and knobs. Net weight: 40 lbs.



FREE 1968 CATALOG

Describes these and over 300 kits for stereo/hi-fi, color TV, amateur radio, shortwave, test, CB, marine, educational, home and hobby. Save up to 50% by doing the easy assembly yourself. Mail coupon or write Heath Company, Benton Harbor, Michigan 49022.

HEATH COMPANY, Dept. 520-28
Benton Harbor, Michigan 49022

- Enclosed is \$ _____, plus shipping
- Please send model (s) _____
- Please send FREE Heathkit Catalog.
- Please send Credit Application.

Name _____ (Please Print)

Address _____

City _____ State _____ Zip _____

Prices & specifications subject to change without notice. TE-178

Circle 133 on reader service card

Astrosystems Inc.

Advanced Instrumentation

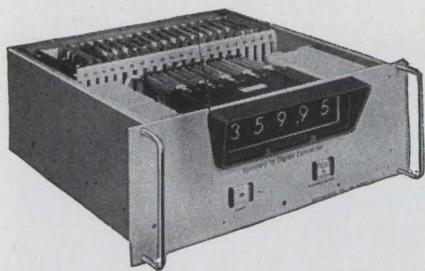

Synchro-to-Digital Converters

A simple, reliable, accurate method of high resolution conversion with **resolution and accuracy to 18 bits**. Available with straight binary code or BCD code outputs. Ideally suited for use as an interface between analog pickoffs and digital computers or off-line equipment.

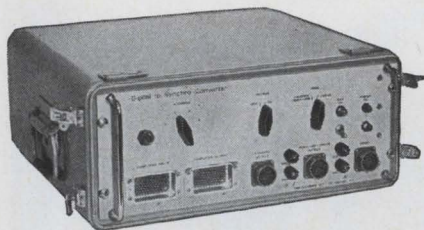

Digital-to-Synchro Converters Digital-to-AC Analog Converters

ASI Converters accept and register digital angles in binary or BCD code and convert these inputs to the equivalent synchro or resolver voltages. Digital-to-Analog AC models convert digital input information to linear AC output signals.

Single-speed resolution and accuracies are available up to **18 bits**.

Miniature Solid-State Airborne Units

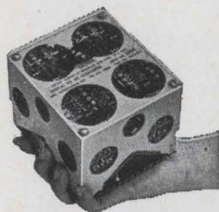

All solid-state converters featuring high density packaging and ultra-reliability. Available as:
Digital-to-Synchro

Converters; Synchro-to-Digital Converters; Digital-to-AC Analog Converters; AC Analog-to-Digital Converters.

Astrosystems Inc.

Advanced Instrumentation

6 Nevada Drive, New Hyde Park,
New York 11040 • (516) 328-1600

New Books

1,001 transistors

Electrical Characteristics of Transistors
R.L. Pritchard
McGraw-Hill Book Co.
715 pp., \$19.50

The outputs of more than a thousand transistors are collected in this reference volume on their theoretical and measured behavior. Its digest of papers also offers a variety of equations and circuits models, and information on how to analyze transistor circuits.

Pritchard's volume covers d-c (static) characteristics, low and high frequency immittance and gain properties, switching behavior, and thermal and noise effects. The author made as little use of internal physics as was consistent with clarity. This gives the work a handbook-like appearance, i.e., many of its conclusions appear without explanation or relation to other pertinent phenomena. But the detailed bibliography helps to close this gap. Since this book is not a substitute for knowledge of the internal physics of semiconductors, its chief use is not as a textbook but as a working manual.

Additional recommendations by the author at the close of several sections relate the theoretical information to specific limitations and/or optimum values for practical circuit applications; these are extremely helpful to the designer. "Electrical Characteristics of Transistors" succeeds admirably in being the book the author intended.

R.C. Levine

Associate Professor
Stevens Institute of Technology

The big wheel

Mechanical Man: The Physical Basis of Intelligent Life
Dean E. Wooldridge
McGraw-Hill Book Co.
212 pp., \$8.95

Wooldridge's theme in this provocative book is that man is only a complex machine and that biology is a branch of physical—not natural—science.

The author explores intelligence and consciousness, and covers man's physical and behavioral

properties. He draws heavily on recent discoveries in computer science, electrophysiology, biophysics, biochemistry, and neurophysiology. And he concludes that all human properties, as well as the origin of life, are entirely the consequence of the laws of physics operating in inanimate chemical matter.

Wooldridge believes man created machines in his own image and he explores the relationship between computers and the brain. This cause-and-effect phenomenon is used to explain why computers possess some degree of intelligence and sometimes display "lifelike" characteristics.

Wooldridge is aware his propositions would profoundly change traditional concepts of free will, religion, morality, and personality. And he makes a case for the unity of all science as the fabric of life.

The portions on the physical properties of organisms include the chemistry of life, the origin of living cells, multicellular organisms and how to differentiate between the human cell and those of other living things.

Consciousness is considered a passive characteristic, easily transferred from metaphysics to physics. Its physical source, and its determinants, are used to explain sensation, memory, emotion and thought.

The text's reliance on physics, and its heavy use of electronics-type analogies and concepts alone would interest the working engineer. But clearly, its main attraction is its message: all is physics. Heresy or no, Wooldridge's theory is at least stirring.

J.B. Steuer

Reimers Electro-Steam Inc.

Recently published

Display Systems Engineering, H.R. Luxenberg and Rudolph L. Kuehn, McGraw-Hill Book Co., 444 pp., \$16.50

A teaching approach to modern display systems and latest developments in information science. Includes image analysis, recording, cathode-ray-tube devices, projection systems, light valves, lasers, and solid state components. Optics, photometry, and colorimetry are also covered.

Measure impedances directly in polar form

From pure resistance, capacitance or inductance, to complex impedances . . . Acton's 310-B Z-Angle Meter measures any RLC combination, with only one balancing step.

Impedance range from 0.5 to 100,000 ohms
frequency range from 30 cps to 40 kc
with magnitude accuracy of $\pm 1\%$
and $\pm 2^\circ$ for angle at 20 kc
The 310-B is both compact and portable



ACTON

LABORATORIES · INC.

Subsidiary of Bowmar Instrument Corporation
531 Main Street, Acton, Mass. 01720
Tel: (617) 263-7756 (Boston) 542-0284

Circle 158 on reader service card



YOU'RE
WHISTLING
IN THE
DARK . . .

. . . if you think that heart disease and stroke hit only the other fellow's family. No one is immune. Protect the hearts you love. For authoritative information, ask your Heart Association. For medical advice see your doctor. To safeguard your family . . .

GIVE...
so more will live
**HEART
FUND**



Contributed by the Publisher

Electronics | April 1, 1968

DIODE CURVE TRACER MODEL

587A

**INTERNAL TEST
VOLTAGE SUPPLY
(RECTIFIED SINE WAVE)**

RANGE 1: FULL WAVE
0~20V PEAK 10A MAX
RANGE 2: FULL WAVE
0~200V PEAK 1A MAX
RANGE 3: HALF WAVE 0~
2000V PEAK 0.1A MAX

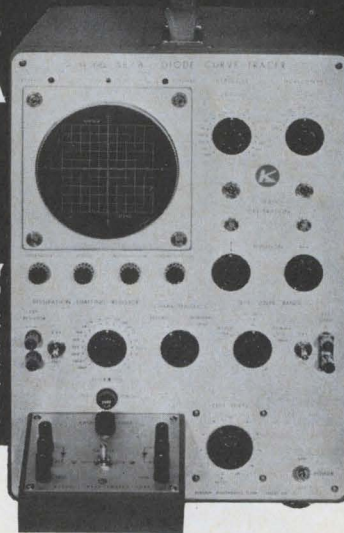

Over-current Cutoff Relay: Sensitivity is proportional to sensitivity of current axis (vertical axis) amplifier. To be operated (mA/div) \times (12~13 div).
Dissipation Limiting Resistors 19 ranges: 0/1/2/5/10...200~500K Ω
Voltage Axis (Horizontal Axis) 11 ranges: 0.1/0.2/...100/200V/div Accuracy: $\pm 3\%$
Current Axis (Vertical Axis) 19 ranges: 0.001/0.002~200/500 & 1,000mA/div.
CRT: SUPIF Dimensions and Net Weight: 315W \times 445H \times 578Dmm, 30Kg approx.



kikusui

KIKUSUI ELECTRONICS CORP.
3-1175, SHINMARUKO-HIGASHI, KAWASAKI-CITY,
KANAGAWA-PREF., JAPAN
CABLE ADDRESS: "KIKUSUIDE" KAWASAKI

Circle 135 on reader service card

135

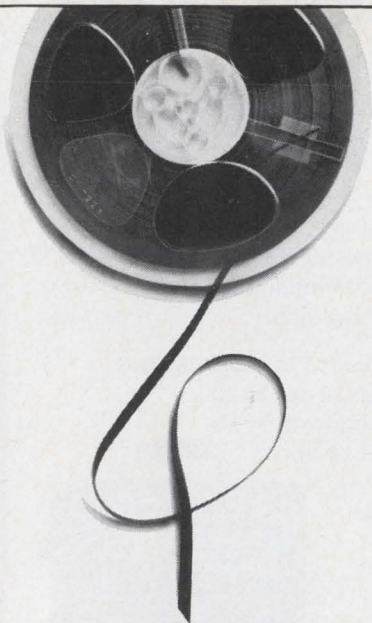

GREATER TAPE SENSITIVITY

with Pfizer
magnetic iron oxides

Whenever there's a need for a more versatile magnetic tape with a high output, chances are Pfizer has the magnetic oxide for you to produce it. Significant advances in magnetic tape technology have coincided with Pfizer's continuing development of high quality oxides. Available are IRN® magnetic oxides of high density which facilitate more magnetic action in a given volume, providing greater sensitivity in a wide variety of uses:

- Audio, video, computer and instrumentation tapes;
- Memory drums and discs;
- Cinema film stripings;
- Magnetic inks;
- Transfer tapes;
- Ribbons.

FYI*

Pfizer is also pleased to announce the availability of Ultralap—a new emulsion-coated, bonded abrasive on a polyester back—available with many different materials and grit sizes—providing amazing effectiveness and durability. For complete technical data, please write.

*For Your Information

Pioneering in Physical Chemicals

MINERALS PIGMENTS & METALS DIVISION

Dept. 75, 235 East 42nd Street
New York, New York 10017

Technical Abstracts

Search and destroy

Stabilizing a Cobra from conception to strike

M.R. Murphy
Bell Helicopter Co.
Fort Worth, Texas

Making a helicopter easy to handle and steady to shoot from is the aim of the Stability and Control Augmentation System for the Huey-Cobra helicopter. The Cobra is the first armed helicopter specifically designed for combat.

SCAS provides stability in all three axes—pitch, roll, and yaw—and has electrical inputs for the pilot to use that supplement the conventional mechanical control. This combination responds to the pilot but not to such disturbances as wind or gun recoil. In short, SCAS improves the helicopter's aerodynamic characteristics.

Each axis can be regarded as having three loops, one for the airframe, one for control, and the third for the pilot's input. The airframe loop includes the rate gyro feedback control loop to provide attitude rate stabilization. This mechanical loop provides proportional control so that the actuator displaces the control surfaces a prescribed number of degrees per unit of input. The airframe thus forms an outer loop and the control an inner loop, the resulting feedback configuration giving the required stability.

The supplementary feed-forward loop differentiates between external disturbances and inputs from the pilot, and hence can be designed to follow the pilot's commands.

The feedback and feed-forward loops can be regarded as independent functions operating in parallel on the actuator.

First, the stability transfer function was found to describe the dynamics and reveal what's needed for controller (feedback) characteristics. Airframe transfer functions were found for hovering at zero knots and flying at 100 knots, and a controller was designed that would satisfy stability requirements over this range.

Next, the pilot's electrical loop was designed to provide an atti-

tude rate steering type system for the airframe. The characteristics of a dynamic network inserted in this loop can be tailored for mission requirements, pilot comfort, and reduction of fatigue in the physical control system. For the Cobra's yaw axis, for example, the transfer function for pilot control acts like an integrator over the frequency spectrum of 0.08 to 8.0 radians per second, and has a time constant of 0.125 seconds and an acceleration gain of about 0.64 radians per second per radian of input.

Presented at the Aviation-Electronics Advanced Planning, Briefing, and Technical Symposium, U.S. Army Electronics Command, Ft. Monmouth, N.J., March 5-7.

Talking through your hat

Voice communication in high-noise environment

W.R. Stover
HRB-Singer Inc.
State College, Pa.

The noise of whirling rotors often drowns out voice messages to or from helicopters. On tactical missions, the problem is not only frustrating but downright dangerous.

The main task is to improve the speech signal-to-noise ratio at the speaking end of the link. And the answer here might be a new microphone that fits into the speaker's ear, a device that has been shown to outperform conventional pressure gradient (lip) and contact (throat) microphones. Lip mikes have a good signal-to-noise ratio and provide a fairly high level of intelligibility, but when they become saturated by background noise, even shouting doesn't help. Because of their location, throat mikes lose the sounds formed at the front of the mouth; output is large but intelligibility is poor.

The ear microphone combines a speech-sensing transducer and a protective plug that attenuates both radiated and tissue-conducted noise. The plug is molded to give a firm but comfortable fit over long periods of time. Speech vibrations are sensed by a probe tube extending to the surface of the ear mold inside the ear canal. The transducer

is reciprocal; the same element can function both as a microphone and an earphone. And with its positioning, this ear-plug transducer improves reception as well as speech signal-to-noise ratios.

Initial laboratory tests ranked the ear mike between the lip and throat types so far as signal-to-noise ratio and intelligibility. But when tested in an actual helicopter hovering at 20 feet to simulate an air-sea rescue operation, the ear device bested its rivals. In conjunction with a helmet, it yielded a signal-to-noise ratio of 15 decibels, 3 to 5 db better than the other types. And this was boosted an additional 5 db by an increase in the acoustic isolation of the helmet ear cups.

Presented at the Aviation-Electronics Advanced Planning, Briefing, and Technical Symposium, U.S. Army Electronics Command, Ft. Monmouth, N.J., March 5-7.

Weather or not

Outlining radar weather clutter in digital processing systems
Howard L. McFann
Federal Aviation Administration
Atlantic City, N.J.

Weather clutter on a radar scope impedes aircraft tracking but provides a picture of flying conditions within the radar's range. Eliminating clutter provides clear see-through tracking but removes a necessary air safety factor—weather data. The trick is to include digitally processed weather data on the scope without detracting from target tracking.

This is accomplished with a weather outline generator, which simply presents the clutter as symbols. Linked by telephone lines to a radar information digitizer, the generator transmits outlines of weather clutter without interfering with the radar's target data.

The weather outline generator displays outer contours for the perimeter of the storms and the inner contours for strong storm centers inside the perimeters. The value of the inner contours isn't fully known, but project meteorologists feel they can be used to indicate the severity of the over-all weather pattern and to serve as a warning for aircraft to avoid the storm area.

Presented at the Aviation-Electronics Advanced Planning, Briefing, and Technical Symposium, U.S. Army Electronics Command, Ft. Monmouth, N.J., March 5-7.

FUNCTIONAL PERFECTION

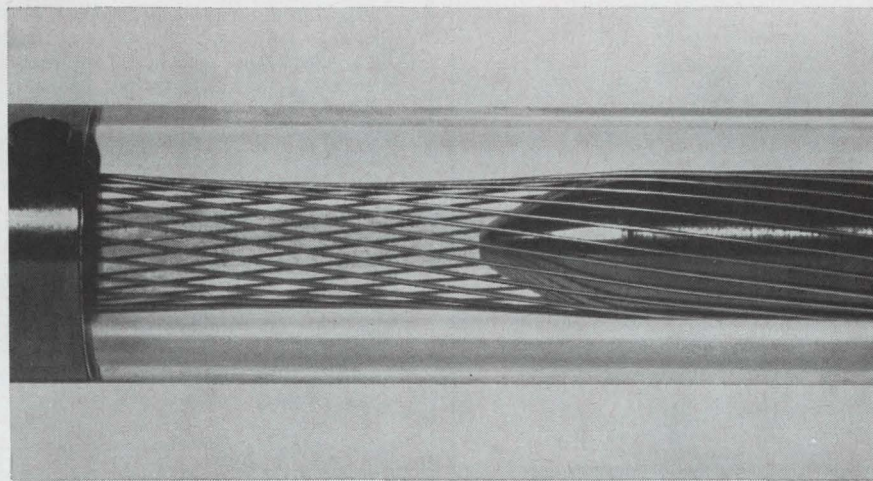

HYPERTAC—a new concept in contact design that assures complete interconnection reliability. It is achieved by a set of fine wires, strung in a tube at an angle, which "hug" the inserted pin and provide a number of lines of contact. This patented "wire trap" design offers many performance advantages: Very low contact resistance, low insertion/extraction forces, Closed entry, Pre-assembly plating, Consistently high results with long life and low rate of wear. There is no noticeable deterioration in operation after over 100,000 operating cycles—surpassing anything in today's state-of-the-art. Contacts withstand high shock and vibration without noise or discontinuity. High density, multiple pin connectors can be easily mated and unmated by hand, often eliminating special jacking hardware.

Rack and panel, edgeboard plug and receptacle or cylindrical connectors can be fabricated with the HYPERTAC design to meet your requirements for insertion force, contact resistance and durability. If you're in the market for connectors, particularly for high performance applications, industrial or military, you owe it to yourself to check our specs. Get the complete facts from your local IEH sales representative or contact:

IEH

INDUSTRIAL ELECTRONIC HARDWARE CORPORATION
109 Prince Street, New York, N. Y. 10012, (212) 677-1881

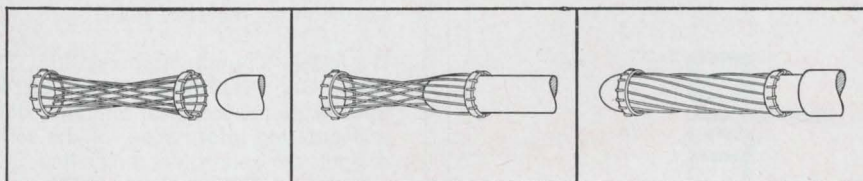

in connector contact design

Evaluate these
new Babcock Relays
in your system.
You'll find them
"ON THE SHELF"
at these
distributors!

AVNET ELECTRONICS CORPORATION
10916 Washington Boulevard
Culver City, California
Phone: (213) 870-0111, (213) 870-6141
TLX 674-354

344 Middlefield Road
Mountain View, California 94041
Phone: (415) 961-7700; TLX 34-8441

First National Bank Building, East
5301 Central Avenue N.E., Suite 1400E
Albuquerque, New Mexico 87108
Phone: (505) 265-7926; TLX 74-6459

2318 6th Avenue
Seattle, Washington 98121
Phone: (206) 623-8824; TLX 32-249

1729 North 28th Avenue
Phoenix, Arizona 85009
Phone: (602) 272-6821; TLX 66-750

1020 W. Ellsworth Avenue
Denver, Colorado 80223
Phone: (303) 623-6255; TLX 45-687

207 Cambridge Street
Burlington, Massachusetts 02103
Phone: (617) 272-3060

3901 Pace Court
Schiller Park, Illinois 60176
Phone: (312) 678-6310; TWX 312-678-2522

70 State Street
Westbury, L.I., New York 11590
Phone: (516) 333-8650; TLX 12-5928

4940 Viking Drive, Suite 208
Minneapolis, Minnesota 55435
Phone: (612) 920-5866; TWX 910-576-2784,
TLX 029-5250

87 Wingold Avenue
Toronto 19, Ontario, Canada
Phone: (416) 789-1838; TLX 02-29195

1505 Louvain Street West
Montreal 11, Quebec, Canada
Phone: (514) 0381-9127; TLX 01-20678

P. D. Q. ELECTRONICS CORPORATION
9559 Irontdale Avenue
Chatsworth, California 91311
Phone: (213) 882-0500; TWX 910-494-1235

POWELL ELECTRONICS, INC.
S. Island Road, P. O. Box 18765
Philadelphia, Pennsylvania 19101
Phone: (215) 724-1900; TWX 710-670-0465

10728 Hanna Street
Beltsville, Maryland 20705
Phone: (301) 474-1030; TWX 710-828-9710

P. O. Box 488
Fayetteville, Tennessee 37334
Phone: (615) 433-5737; TWX 810-380-3890

2049 W. Central Boulevard
Orlando, Florida 32805
Phone: (305) 423-8586; TWX 810-850-0155

Foreign Representation:

SWEDISH ELEKTROLINK AB
Stora Nygatan 39
Stockholm C, Sweden
Phone 114595; Cable Telelink

A.E.M.G.P.
115 Avenue J. B. Clement
Boulogne s/Seine, France
Phone 825-96-20; Telex 842-27985

BODAMER GmbH
8022 Grunwald Bei Munchen
Keltenstr. 2a, West Germany
Phone 471862

For price, delivery and application
data call Babcock collect.
Be sure to ask for Ext. 1000 when
placing your call.



BABCOCK RELAYS

New Literature

Operational amplifiers. Analog Devices, 221 Fifth St., Cambridge, Mass. 02142. A 36-page handbook gives application guidance, tips for amplifier selection, and comprehensive specifications and curves for more than 60 op amps. Circle **446** on reader service card.

LSI circuits. General Instrument Corp., 600 W. John St., Hicksville, N.Y. 11802. An eight-page technical article details the reasons why digital systems designers should be interested in custom-designed large-scale integrated circuits. **[447]**

Vacuum instrumentation. Norton Co., 160 Charlemont St., Newton, Mass. 02161, has available an eight-page, fully illustrated brochure on vacuum measuring instrumentation. **[448]**

Connectors. Methode Electronics Inc., 7447 W. Wilson Ave., Chicago 60656, offers information bulletins on its connectors and connector assemblies of recent issue. **[449]**

Multipoint recorder. West Instrument Corp., 3860 North River Rd., Schiller Park, Ill. 60176. A four-page bulletin describes a solid state potentiometric recorder that can record up to 24 points. **[450]**

Heat sinks. Accel Electronic Products Co., 3040 N. San Gabriel Blvd., South San Gabriel, Calif. 91777. A four-page catalog includes dissipation data, dimensions, and weight of 24 different low-cost semiconductor heat sinks. **[451]**

Injection-molded encapsulations. Capsonic Group Inc., 1000 Bluff City Blvd., Elgin, Ill. 60120, has issued a brochure discussing its standard and custom injection-molded encapsulations. **[452]**

X-ray inspection system. Torr X-ray Corp., 2233 Barry Ave., Los Angeles 90064, offers a four-page color brochure describing the Radifluor 360 X-ray inspection system for quality analysis of electronic components and manufactured parts, and for other technical applications. **[453]**

Analog telemetering receiver. Quindar Electronics Inc., 60 Fadem Rd., Springfield, N.J. 07081. Bulletin 142 gives specifications, features, and ordering information on the QATR-10-12 analog telemetering receiver. **[454]**

D-c relays. Sigma Instruments Inc., 170 Pearl St., Braintree, Mass. 02185. Specifications, technical reference data, and ordering information for the series 4 spdt d-c relays are presented in a four-page catalog bulletin. **[455]**

Dielectric glazes. Electro-Science Laboratories Inc., 1133 Arch St., Philadel-

phia 19107. New dielectric glazes for crossover and multilayer screened circuitry are described in a 12-page brochure. **[456]**

Lead wires. General Electric Co., 21800 Tungsten Rd., Cleveland 44117, offers a product data sheet describing etched molybdenum foil lead wires for use in many types of hard glass or quartz encapsulated devices for high-temperature applications. **[457]**

IC logic. Cambridge Thermionic Corp., 445 Concord Ave., Cambridge, Mass. 02138, has released a 160-page manual featuring a 16-page section on digital logic design information to help both the novice and the experienced design engineer develop systems using IC logic assemblies. **[458]**

Digital-to-synchro converter. Astrosystems Inc., 6 Nevada Drive, New Hyde Park, N.Y. 11040, has available a four-page brochure listing specifications and applications for its high-accuracy digital-to-synchro converter line. **[459]**

Transistor sockets. Connector Corp., 6025 N. Keystone Ave., Chicago 60646. Two new series of transistor sockets are described in detail and illustrated in seven dimensional drawings in technical publication 47A. **[460]**

Microwave absorbers. Electronautics Division, Dielectric Products Engineering Co., Littleton, Mass. 01460, has available a 20-page catalog describing a wide variety of microwave absorbers. **[461]**

Potentiometers and resistors. Clarostat Mfg. Co., Dover, N.H. 03820, has released a 32-page illustrated catalog of potentiometers, field-assembled controls, power rheostats, and resistors. **[462]**

Vacuum instrumentation. Vacuum Equipment Division, Norton Co., 160 Charlemont St., Newton, Mass. 02161, has issued an eight-page, fully illustrated brochure on vacuum measuring instruments. **[463]**

Null detectors. Keithley Instruments Inc., 28775 Aurora Rd., Cleveland 44139, offers a 64-page booklet discussing the use of its null detectors with high-resolution potentiometers and bridges. **[464]**

Fast ramp generator. Signalite Inc., 1933 Heck Ave., Neptune, N.J. 07753. A two-page bulletin discusses the type TS-211 fast ramp generator. **[465]**

Ferrite materials. Krystinel Corp., Fox Island Road, Port Chester, N.Y. 10573. A 16-page magnetic characteristics manual provides design and performance data on ferrite materials. **[466]**

**Four
New
Babcock
Relays**

BR42

- Welded Crystal Can
- 2 Amp.—DPDT
- Single-Coil
- Universal Contacts
- To MIL-R-5757

BR30

- One-Inch Cube
- 4 PDT—10 Amp.
- Single-Coil
- All-Welded
- To MIL-R-6106

BR24

- Welded, Low-Profile
- 10 Amp.—DPDT
- Single Coil
- Universal Contacts
- To MIL-R-5757

BR26

- Welded Half-Size
- 2 Amp.—DPDT
- Single-Coil
- Universal Contacts
- To MIL-R-5757



BABCOCK RELAYS
Babcock Electronics Corp.
3501 Harbor Blvd.
Costa Mesa, Calif. 92626
Telephone: (714) 540-1234

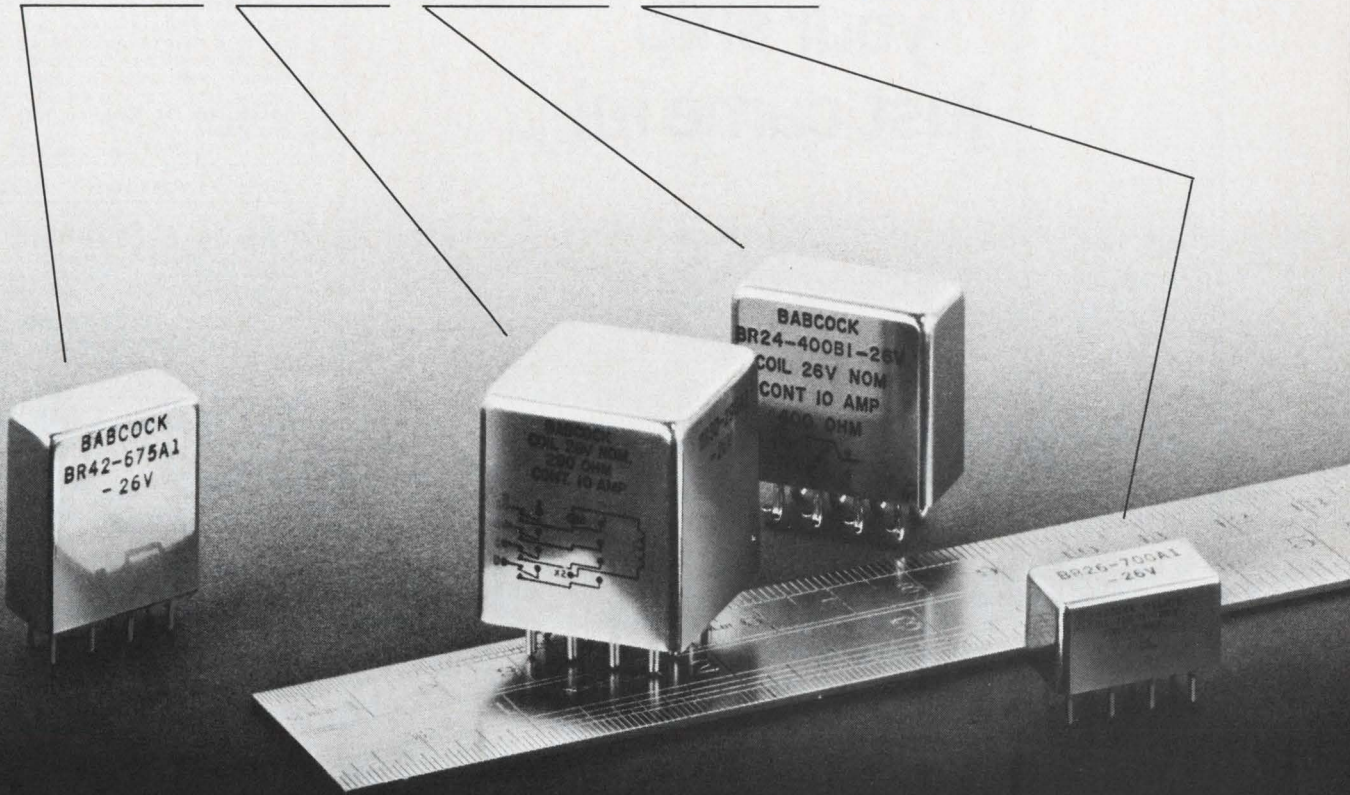

New: At significantly lower prices!

Still the same: Babcock quality

Where: At your Babcock distributor When: Now!

engineers, your ship just came in!

Another nuclear aircraft carrier, boosting our contract backlog to \$500 million, creates added engineering career openings in all these disciplines:

- | | |
|----------------------|-------------------------|
| Mechanical Engineers | Civil Engineers |
| Electrical Engineers | Metallurgical Engineers |
| Marine Engineers | Data Programmers |
| Industrial Engineers | Systems Analysts |
| Naval Architects | Chemists |
| Nuclear Engineers | Laboratory Analysts |

If your training and experience are in or close to these fields, get details on immediate opportunities and long-range career security with the world's largest, most advanced shipbuilding company. Write our employment manager, John J. Gaughan. You'll get fast action.



Newport News
SHIPBUILDING AND DRY DOCK COMPANY, NEWPORT NEWS, VIRGINIA

An Equal Opportunity Employer

CIRCLE 951 ON READER SERVICE CARD

EMPLOYMENT OPPORTUNITIES

Electronic Circuit Engineers for advanced micro-electronic circuit synthesis. Managerial, engineering & research candidates wanted for novel thin-film circuit development. New business opportunity offers growth potential for Circuit Designers. Send resume to Rm. 62-P, General Electric Co., Box 112, Main Post Office, Schenectady, N. Y. 12301.

(An equal opportunity employer)

SEARCHLIGHT SECTION

Wanted
NS 34 ELECTRONIC TUBES
Varian VA-225A (FSN 5960-14-001-0242)

The material must be checked out and guaranteed to work according original specifications. Offers to be sent to:

TELERADAR
LUNGOTEVERE MELLINI 7,00193
Rome, Italy

CIRCLE 956 ON READER SERVICE CARD

GET IT from GOODHEART!

WHAT'S NEW:

BECKMAN #6126 & #607: COUNT DC to 1000 mc. Solid state, only 5 1/4" high, 1 3/4" wd. 8 Electroluminescent digits in basic 25 mc Universal Counter, w/basic plugin, rack-handle adapters, 2PC extender boards, books, & Feb. 1968 NBS-traceable Certificate of Calib. 5 parts/100 million, long term 5 parts/billion. Plus #607 plugin 25-1000 mc; has tuning meter, easy to use, eliminates all ambiguity. Today's price is \$245.00! From us, like brand new, with books and Certificates of Calib. \$195.00

OTHER COUNTERS: 0.1, 1.2, 220 & 510 mc. ASK!

HIGH-FREQ. DUAL-TRACE OSCILLOSCOPES:

Hewlett-Packard said: "... is the scope to use anywhere from DC to 1000 mc. It offers the same simplicity of operation, the same big bright steady trace as conventional low-freq. scopes, yet ... is swift and easy to use all the way to 1000 mc." The scopes sold for \$2000.00. The plugins were \$1000.00 extra. The #120 msec Delay Line was \$200.00 extra. Now see our prices: All with the Delay Line, with the dual-trace plugin, 2 probes for the plugin, books, and NBS-traceable Certif. of Calib. **SLEEPERS!**

#185A accepts triggers 50 cy to 50 mc. With #187A plugin which is useful to greater than 500 mc

#185A with #187B plugin which is useful to 1000 mc \$850.00

H01-184A Synchronizing Trigger Unit is a countdown to view up to 800 mc with the 185A; generates sq-waves locked to input freq. reg. \$215.00 \$150.00

#187B plugin in #185B scope: The #185B accepts triggers 50 cy to 1000 mc so doesn't need external trigger countdown \$1050.00

OTHER SCOPES ASK!

STODDARD NM-20B Noise & Field Strength Meter 150 kb to 25 mc. \$550.00

OTHER STADDARTS 14 kb to 1000 mc. ASK!

POLARAD TSAW Spect. Analyz 10-1000 mc. \$750.00

OTHER heads to 44,000 mc. ASK!

Hewl-Pack., Boonton, Meas. Corp., General Radio, & other **SIGNAL GENERATORS** ASK!

Brush, Est-Ang, Sanborn & other

RECORDERS ASK!

Aer. Radioshop, Amplifiers, Attenuators, Audio Test, Bridges, Potentiometers, Galvos, Voltage Dividers, Decade Boxes, Communications, Freq. Meters, Freq. Standards, Calibrators, DVM's, Meggers, Mod. Meters, Phase Meters, Precision Meters, VTVM's Power Supplies, Freq. Converters, Pulse Generators, Line Voltage Regulators, Etc. Etc. **NAME IT BY CATEGORY & ASK!**

SP-600 RECEIVERS WANTED! Phone person-to-person George Lichterman 213-272-5707 and make a deal! Phone collect if you prefer.

DO NOT ASK FOR CATALOG! ASK FOR SPECIFIC ITEMS OR KINDS OF ITEMS YOU NEED!

R. E. GOODHEART CO. INC.

Box 1220-E, Beverly Hills, Calif. 90213

Phones: Area 213, office 272-5707, messages 275-5342

CIRCLE 953 ON READER SERVICE CARD

VACUUM PENCIL

for picking up miniature parts

\$7.50 ea.

Selected Distributorships available.

PHILIP FISHERMAN COMPANY

7 CAMERON ST., WELLESLEY, MASSACHUSETTS

CIRCLE 954 ON READER SERVICE CARD

ELECTRON TUBES

KLYSTRONS • ATR & TR • MAGNETRONS

SUBMINIATURES • CRT • T.W.T. • 5000-

6000 SERIES

SEND FOR NEW CATALOG A2 •

A & A ELECTRONICS CORP.

1063 PERRY ANNEX

WHITTIER, CALIF.

696-7544

CIRCLE 955 ON READER SERVICE CARD

AUTOTRACK ANTENNA MOUNT

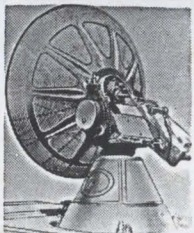

360 degree azimuth, 210 degree elevation sweep with better than 1 mil. accuracy. Missile velocity acceleration and slewing rates. Amplidyne and servo control. Will handle up to 20 ft. dish. Supplied complete with control chassis. In stock—immediate delivery. Used world over by NASA, USAF, MP-61-B. Type SCR-584. Nike Ajax mounts also in stock.

PULSE MODULATORS

MIT MODEL 9 PULSER 1 MW—HARD TUBE

Output 25kv 40 amp. Duty cycle .002, pulse lengths .25 to 2 microsec. Also .5 to 5 microsec. and .1 to .5 microsec. Uses 6C21. Input 115v 60 cycle AC. Mfg. GE. Complete with driver and high voltage power supply. Ref: MIT Rad. Lab. Series, Vol. 5, p. 152.

2 MEGAWATT PULSER

Output 30 kv at 70 amp. Duty cycle .001. Rep rates. 1 microsec 600 pps. 1 or 2 msec 300 pps. Uses 5948 hydrogen thyratron. Input 120/208 VAC 60 cycle. Mfr. GE. Complete with high voltage power supply.

250 KW HARD TUBE PULSER

Output 16 kv 16 amp. Duty cycle .002. Pulses can be coded. Uses 5D21, 715C or 4PR60A. Input 115 v 60 cy. AC \$1200 ea.

18 MEGAWATT PULSER

Output 150KV at 120 amps. Rep rate: 50-500 PPS. Pulse length: 5 msec. 15KV 120 amp. into pulse transformer. Rise time 1.5 msec. Filament supply 5V 80 amp. incl. 17.5KV 1.5 amp DC power supply. Input: 220V 60 cy AC.

INDICATOR CONSOLES

AN/SPA-4A, PPI 10" to 300 mi.

AN/UPA-25, PPI 10" to 250 mi.

VL-1 RHI 12" to 200 mi. 60K ft.

IBM 704 IBM 650

These computers in stock for immediate delivery

SCR 584 AUTOTRACK RADARS

Our 584s in like new condition, ready to go, and in stock for immediate delivery. Ideal for telemetry research and development, missile tracking, satellite tracking. Fully Desc. MIT Rad. Lab. Series, Vol. 1, pps. 207-210, 228, 284-286. Comp. Inst. Bk available \$25.00 each.

SONAR SYSTEMS IN STOCK

AN/FQS-1A, AN/UQS-1B, QHBA scanning sonars. Rochelle salt hydrophones 6 ft. \$150 ea.

MICROWAVE SYSTEMS

L BAND RF PKG.

20 KW peak 990 to 1040 MC. Pulse width .7 to 1.2 micro sec. Rep rate 180 to 420 pps. Input 115 vac incl. Receiver \$1200

200-225 mc RADAR SYSTEM

1 Megawatt output. 200 nautical mile range for long range detection of medium and high altitude jet aircraft as well as general search. AN/TPS-28.

SURVEILLANCE DRONE RADAR SYSTEM

X-Band tracking system with plotting boards. Type AN/MPQ-29. Drone also in stock.

5 MEGAWATT C-BAND

Klystron RF package delivering nominal 5 megawatt pulse RF. Complete with pulser and power supply.

500 KW L BAND RADAR

500 kw 1220-1359 msc. 160 nautical mile search range P.P.I. and A scopes. MTI. thyratron mod 5J26 magnetron. Complete system.

100 KW X BAND RADAR

Complete 100 kw output airborne system with AMTI. 5C22 thyr. mod. 4J52 magnetron. PPI, 360 deg as sweep, 60 deg. elev. sweep, gyro stabilizer, hi-gain revr. Complete with all plugs and cables.

AN/GPG-1 SKY-SWEEP TRACKER

3 cm. automatic tracking radar system. Complete package with indicator system. Full target acquisition and automatic tracking. Input 115 volts 60 cycle New. In stock for immediate delivery. Entire System 6' long, 3' wide, 10' high. Ideal for Infrared Tracker, Drone Tracker, Missile Tracker, R. & D.

500KW S BAND RADAR

250 miles search 115V 60 cy AC. Mfg. G.E.

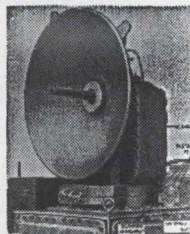

RADAR SYSTEMS GROUND AND AIRBORNE AUTOMATIC TRACKING ANTENNA SYSTEMS, NIKE AJAX, NIKE HERCULES M-33 MSO-1A, MPS-19, MPS-9, SCR 584, TPS-12, TPS-28, FAA-ASR-2 AIRBORNE SYSTEMS, APN-84, APN-102, APS-23, APS-27, APS-45, DPN-19, DIGITAL COMPUTERS, IBM 650, IBM 704

LARGEST INVENTORY OF RADAR AND MICROWAVE EQUIPMENT IN THE WORLD.

RADIO RESEARCH INSTRUMENT CO.

45 WEST 45TH ST. N. Y. 10036 212-JU 6-4691

CIRCLE 952 ON READER SERVICE CARD



The day the coffee break produced the breakthrough in communications

Maybe it was the way the napkin came folded. Or how Norm Taylor crumbled his coffee container. Whatever it was, the breakthrough came at 10:47 A.M.

"Norm, I've got it," said Jack Jones. "We know high-power semiconductors have poor linearity at high output levels and destroy themselves when a mismatch occurs. That's been our problem. Why don't we go the low-power route? We'll couple enough low-power transistors to get high output and good VSWR. And I know how to do it."

So Jack had the answer to the problem Norm and he had been stewing over for more than two months. How to design a viable solid-state broadband amplifier

with high output and good match over the full 2-30 MHz range.

"We can use a special transformer to isolate the low-power transistors."

It proved out theoretically. Designing the special transformer came next. When nobody around could build it, they built their own. All in all it took two years from insight to final operation.

That's the way we do things in Communications. Involving engineers in high-grade problems. And giving them the opportunity — and all the support they need — to come up with elegant solutions.

Like the continuously-tuned receiver for 2-30 MHz operation: as stable as a digitally-synthesized receiver's...yet with full VFO versatility. Or our antenna range: a 135'-diameter wire mesh ground plane used in the 90-1500 MHz range—level to $\pm 1/4''$ over its entire surface and with a 65-foot constant-radius arch that makes vertical angle measurements possible. (Azimuthal ones are facilitated by means

of a 20'-diameter turntable.) It's what you'd expect from a communications laboratory that does the bulk of its own R&D.

However, if you find other electronic fields more fertile, we have them, too. ASW, navigation aids, data equipment, tracking, countermeasures and AGE. The opportunities are as broad as your abilities.

To see what we mean, direct your resume, in confidence, to Mr. J. P. O'Reilly, Dept.164.

GENERAL DYNAMICS

Electronics Division

1400 N. Goodman Street, Rochester,
New York 14601

— We are an equal opportunity employer in deed, not only an equal opportunity employer in words.

SCIENCE/SCOPE

The extraordinary longevity of Hughes-built synchronous communications satellites is causing a continuing downward revision of cost estimates for operating satellite networks. Syncom II, originally designed for one year of service, is still at work five years later. The Hughes satellites, including two Syncoms, three Intelsats (Early Bird, Lani Bird, Canary Bird), and two Applications Technology Satellites, now have a combined service life of over 18 years. Every satellite in synchronous orbit around Earth was built by Hughes.

A daily bunching pattern of the high-energy electrons that orbit Earth in the outer Van Allen belt was revealed recently by the energetic-particle detectors aboard the Hughes-built ATS-1 satellite. The electrons move to lower altitudes on the night side of Earth, higher on the day side. Changing pattern seems to be caused by distortion of Earth's magnetic field due to sharp variations in the solar wind.

The Air Force Avionics Laboratory recently used ATS-1 for a successful demonstration of satellite-relayed voice communications for helicopter/ground and helicopter/aircraft links, using a small helicopter-mounted antenna. Tests also showed that the rotating blades weakened the signal on the helicopter/satellite link; in future tests, antennas will be placed above the main and tail rotors.

Communications via satellite with a jet airliner flying scheduled routes between North and South American points was demonstrated successfully for the first time in a new series of experiments with ATS-3 (in synchronous orbit over Brazil).

Twelve Mark 1B satellite communications ground terminals, positioned around the globe, are providing fast, reliable voice and teletype communications via DOD's satellite network. Hughes has built a total of 14 for the Army Satellite Communications (SATCOM) Agency, to be used by the Army, Navy, and Air Force.

Programmers needed for Europe and California: Hughes has immediate openings for programmers, systems analysts, management information system specialists, and software/hardware interface specialists, to work on large-scale operational command-and-control systems. Please send your resume to: Mr. J.C. Cox, Hughes Aircraft Company, Culver City, California. Hughes is an equal opportunity employer.

The new shipboard systems, a cooperative effort between the two navies, will be built by SEMS (a joint-venture company formed by Hughes and Thomson Houston-Hotchkiss Brandt of France) under license from Hughes.

The 16,000 channels on the Manpack radio Hughes is now delivering to the armed services make the compact, solid-state combat radio virtually jamproof. It uses ground waves to penetrate dense jungle and hurdle rough terrain at close range; at ranges of 25 to several hundred miles it bounces high-frequency signals off the ionosphere. Manpack weighs 29 lbs., operates on dry or wet cells.

Creating a new world with electronics



Newsletter from Abroad

April 1, 1968

Plan Calcul lineup lists U.S. computer

An Anglo-Saxon tinge is in store for the Plan Calcul set up by the de Gaulle government 20 months ago to give France an independent computer industry.

Compagnie Internationale pour l'Informatique (CII) plans to slip the Scientific Data Systems Sigma 7 computer it builds under license into its four-model lineup. CII was formed in 1966 by a merger of the two main French-owned central-processor producers.

Under the original scheme, the government had earmarked some \$80 million in outright subsidies and long-term loans to finance the development of an all-French family of four third-generation computers. But CII's parent companies, which will pour \$100 million of their own money into the program, convinced computer czar Robert Galley that there wasn't enough backing to develop all four machines. Rather than commit more government money, Galley agreed to the arrangement that will leave an American computer in the lineup.

A prototype of the first all-French Plan Calcul computer—designed to compete with the IBM 360/40—should be ready in time for showing at the annual Office Equipment Salon in Paris next October.

Mullard to market IC microwave mixer

Mullard Ltd. may be the first to market hybrid microwave integrated circuits built on sapphire substrates.

The company, a British subsidiary of Philips' Gloeilampenfabrieken, expects to have an IC Schottky diode balanced mixer available before the end of the year. The mixer, made up of a branch arm coupler circuit and microstrip transmission lines, is mounted on a sapphire substrate 0.6-inch square. Associated Semiconductor Manufacturers Ltd., Mullard's semiconductor research and production company, developed the mixer and claims it matches the performance of discrete-component units.

Next year, Mullard plans to offer a complete X-band receiver front end using the mixer. It would include a gallium arsenide Gunn-effect local oscillator—also on a sapphire substrate—with electronic tuning by varactor diode. The receiver would be paired with Mullard's Gunn-effect transmitter.

Algerians buy German tv sets

Grundig Werke GmbH has gone into the Algerian television market in a big way. The West German firm has an order from the government-run Algerian network for 10,000 black-and-white sets. The network will pay Grundig \$110 a set and sell them for \$205.

Grundig beat out some 30 other bidders for the order. Three French companies, however, have the contract to convert the network from the 819-line French standard to the 625-line European standard of the Grundig sets.

U.S. won't oppose Bull-GE Czech deal

The Johnson Administration has stopped trying to block a deal that would give the Czechs access to sophisticated computer production knowhow [Electronics, Jan. 22, p. 192]. The signing could come this month.

State Department officials now hint that the U. S. won't act when Bull-

Newsletter from Abroad

GE, a French affiliate of General Electric, sells a license for the Gamma 140 computer to Telsa, the state-run Czech electronics company. The deal also includes outright purchase by Telsa of some computer parts and peripherals. Negotiations started before last month's change of government in Czechoslovakia, but fit in well with the new government's plans to accelerate growth of key industries like electronics.

Bull-GE officials are convinced that the shift in U.S. position on the Czech deal will clear the way for marketing efforts elsewhere in Eastern Europe.

Plan big computer at Nippon Electric

Now that Fujitsu has taken the wraps off its Facom 230-60 computer—the largest commercial computer yet built by a Japanese company [see story p. 149]—watch for the announcement of an even larger machine by Nippon Electric.

Although they won't say when they'll start offering it for sale, Nippon Electric officials admit the company is well along with the Neac Series 2200 Model 700, a step up in size from Fujitsu's latest. The Model 700, for example, will have an instruction-execution time of 0.6 microsecond compared to 1.6 μ s for the 230-60. Nippon Electric's machine will also have a much larger memory than Fujitsu's but a faster access time nonetheless.

The memory units and the machine's integrated circuit packages are based on the ones Nippon Electric is developing for a large-scale computer (it will eclipse the Model 700 when it is completed in the early 1970's) backed by the government.

Israelis and French may end arms deals

Israel's "punishment raid" into Jordan most likely means a final break between Israel and France over arms contracts.

Just prior to the raid, Israeli officials in Paris told the French that Israel would buy no more military hardware from them unless President de Gaulle lifted his embargo on 50 Mirage-5 fighters by April 15. The Israelis ordered the jets in late 1966 and have partly paid for them.

The recent raid makes it practically impossible for de Gaulle to lift the embargo, which he said would be lifted only when the Middle East had settled down. As a result, France stands to lose the \$100 million yearly Israel has been spending there for jets, helicopters, missiles, and military electronics. Israeli officials in Paris are already talking about throwing their business to the U.K. and the U.S.

Addenda

Researchers at Philips' Gloeilampenfabrieken have developed a computer memory array that can be mass produced by weaving wiring and then depositing magnetic material at the interstices. Philips' T.H. Holtwijk will report on the development at this week's Intermag Conference in Washington. . . . Swedes will get color television starting in April, 1970. The country's state-owned but autonomous tv network will start with six hours a week of color programming and step it up to 20 hours over a three-year period. Viewers with color sets will pay a \$20 annual supplement to the regular black-and-white tv license fee of \$35. . . . Tokyo Shibaura Electric Co. will shift to integrated circuits for its Tosbac 3400 general-purpose computers starting in June. The IC machines will have processing times twice as fast as their discrete-component predecessors.

Great Britain

The taxman cometh

In a fortnight, Britain will mark a new fiscal year. The event has never been celebrated by dancing in the streets, but this year's mood is more than usually somber.

To hardly anyone's surprise, the budget unveiled by Chancellor of the Exchequer Roy Jenkins last month is the harshest Britons have seen since Depression days. There'll be a \$2.2 billion rise in taxes in the next fiscal year, pushing the total to \$30.9 billion.

About half this rise will come from additional levies on consumer spending and the rest from new taxes on dividend income and an increase in corporate taxes. Radio and television-set makers had braced themselves for higher sales taxes and stiffer terms for rentals and sales on credit [Electronics, March 18, p. 243]. But when Jenkins outlined the budget in Parliament, the consumer electronics industry found that the government hadn't been as rough on it as some had expected.

Poor prospects. Terms for rentals and sales on credit weren't changed even though they had been eased somewhat last autumn. The boost in sales taxes was slight, working out to about \$6 more at retail for the average \$170 black-and-white set. For color sets, which sell in Britain for \$700 or so, the price will go up by about \$30—"not enough to put off many potential buyers," as a spokesman for the Philips group put it.

All the same, it could turn out a grim year for tv producers. Everyone is sure there'll be a "post-budget" drop in sales, and the question is how long it will be before an upturn sets in. Manufacturers' costs can only edge up as a result of the new taxes—direct and indirect.

And set makers will be forced to hold the line on prices because demand is sure to fall off as the budget's repercussions send living costs to higher levels at the same time a lid is held on wage increases.

Manufacturers of tape recorders face even more difficult problems. They've been hit with a new 33% sales tax, which, if passed along to customers, would raise retail prices some 20%. But price rises seem out of the question because the market has been static for some years. Chances are, therefore, that tape-recorder makers will have to absorb most of the new sales tax themselves, to the detriment of their profit margins.

Dulled edge. Other areas of the electronics industry won't be hit as directly as the consumer sector, but the outlook over-all is bleak. An official at the Marconi Co., one of the firms in the English Electric group, summed up the prevailing attitude: "Initial increases in costs as a direct result of the budget will be small, but eventually we are

bound to be faced with substantial increases in the cost of materials and services bought outside because of the effect of the budget on others."

Nonconsumer electronics producers will be hard put to hold their price lines and may lose some of the competitive edge last year's devaluation was supposed to give them in export markets.

Good steer

So far, when antenna designers have wanted to steer aerials electronically rather than rotate them mechanically, they have stuck largely to phased arrays. With the technique—varying the phase relationships of the signals picked up by different elements of the array—the antenna can be "pointed," but only at one signal frequency.

Wideband steerable arrays, however, are on the way. Keith Galpin, a researcher at Associated Electrical Industries Ltd. (AEI), showed an experimental version last month at the Physics Exhibition in London. AEI is currently being merged with the British General Electric Co.

Instead of phase variations, Galpin's array is steered by thin-film, time-delay networks. The networks, built around metal oxide semiconductor transistor integrated circuits, delay signals passing through them from 1 microsecond on up to 70 μ s, depending on the clock frequency of a ring counter.

Samples. Actually, Galpin's basic delay circuit is a refinement on a wideband—but fixed—delay scheme reported by L. E. Franks and I. W. Sandberg of Bell Telephone Labs in 1960. The circuit samples, in turn, the charge on capacitors in a bank linked to a network of operational amplifiers.

But where Franks and Sandberg used a constant sampling speed, and thus obtained a fixed delay, Galpin



Medicine man. Exchequerman Roy Jenkins has ladled out a stiff dose of austerity to Britons to cure their country's economic ills.

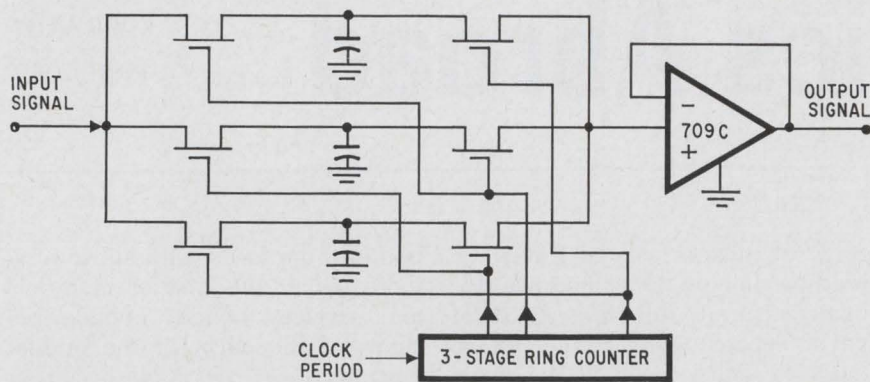

Delay in store. Metal oxide semiconductor transistors switch capacitors, in turn, onto input and operational amplifier under control of ring counter. Except for ring counter, all components are on the same substrate.

uses a varying sampling speed. His capacitor bank is made up of three 1,000-picofarad tantalum thin-film capacitors and his sampling setup consists of a Plessey ML 157 six-transistor MOS monolithic IC, two switching transistors for each capacitor. One switch connects the capacitor to the input signal; the other connects it to a high-impedance readout amplifier—a Fairchild μ L 709C op amp—common to all three capacitors.

The transistors are gated on in pairs under control of a three-stage ring counter, feeding a sampling signal into one capacitor while reading out the stored charge on another. It's the ring counter's speed that sets the maximum delay—two sampling periods. The minimum delay depends on the switching speed of the MOS transistors. Galpin's three-capacitor circuit, with everything but the ring counter laid down on a substrate 1-inch square, operates at frequencies up to 6 kilohertz and can handle signal levels from 6 microvolts to 2 volts.

The lineup. For the electronically steerable antenna, intended eventually for use on sonar sets, Galpin paired a dozen of his thin-film delay networks with a dozen antenna elements. A signal coming toward the antenna at an angle, then, hits the first element slightly before the second and so on down the line. Thus, if the time delay set into the networks matches the delay between the signal's arriving at adjacent antenna elements, the signal increments will all appear at the

output simultaneously as a strong pulse regardless of the frequency. If the delays don't match, the pulse will be weak.

The direction at which the antenna is "pointed" is set simply by adjusting the speed of the ring counter. This is done by means of a potentiometer linked to a voltage-controlled timing generator. The potentiometer, which gives a direct readout of the antenna "position," also controls MOS switches that reverse the sequence of delay-line connections. This is necessary to handle steering in two quadrants; after the sweep passes through the plane perpendicular to the array, the "near" end of the array becomes the "far" end.

Galpin's delays also point to low-cost transversal filters, which are increasingly being used in high-speed data transmission systems where waveforms must be transmitted with little distortion. Conventional transversal filters are made up of delay-line segments with fixed inductance and capacitance. With fixed elements, a filter is tailored for a specific application; one made up of adjustable thin-film networks would be versatile.

Computer combine

About three years after the Wilson government started pressing hard for it, Britain has a strong computer company that consolidates producers of business-scientific machines.

The new company, International Computers Ltd., should be in business by mid-July. It will start with sales and leasing revenue of about \$210 million a year, making it by far the largest non-U.S. computer maker and putting it in the same financial class as the Control Data Corp., whose revenue last year was \$245 million. But like everyone else in the computer business, the merged British company is dwarfed by the International Business Machines Corp., whose 1967 revenue topped \$5 billion.

Well-fixed. International Computers, however, will have the edge over IBM in the British market. The company's majority stockholder, International Computers & Tabulators Ltd., was running neck-and-neck with IBM before its merger agreement last month with the English Electric Co., the Plessey Co., and the government. Added to ICT's share of about 40%, English Electric's computer business will give the merged company more than half of the British market.

ICT has a 53.5% holding in International Computers and at first it will probably account for 80% of the new firm's revenue. English Electric, just getting into volume production of its Series 4 machines, will hand over the assets of its business-computer subsidiary in return for an 18% share. Plessey, too, has 18% of the equity, for which it will pay cash. The prime mover in the merger—the government—will buy a 10.5% holding with cash.

New line. The new company will have assets of about \$240 million and the plus of a \$32 million grant from the government to develop a new generation of computers by the mid-70's. Until then, International Computers will handle both ICT's 1900 and English Electric's Series 4 lines.

Plessey, which entered the merger negotiations late, makes no business or scientific computers although it does produce memories. But Plessey figures the coming thing is a marriage of computers and its main business, communications. International Computers and Plessey, in fact, will form another company to do advanced research involving both fields.

East Germany

New stage for stars

A new planetarium projector promises to take the neck-twisting out of star-gazing.

The unit, which is smaller, less costly, and more versatile than existing types, has been developed by VEB Carl Zeiss Jena, an East German maker of optical equipment. The company figures medium-size cities that haven't been able to afford planetariums should provide a sizable market for the new device.

Electronics helps make it cheaper to put the stars on stage, partly by doing away with the need for operator-lecturers. Digital techniques control the movement of the instrument and its component projectors; a taped lecture is synchronized with punched-tape equipment.

View from space. The device, demonstrated at this year's Leipzig spring fair in East Germany, can also show the skies as seen by a man in space, a feature that points to use in the training of space pilots and future moon travelers. Space flight at any orbital inclination can be simulated.

The projector is about half the size of the equipment at New York's Hayden or Chicago's Adler planetariums. It's priced at \$150,000; the big ones cost about \$240,000. It's designed to be installed in theaters with domes of 30 to 48 feet in diameter, compared with the usual range of 40 to 75 feet.

The instrument can make neck-twisting unnecessary by moving interesting celestial scenes in front of the audience. It can show solar and lunar eclipses; Zeiss Jena's earlier models require an auxiliary projector to do this. It's also possible to project man-made satellites and to show their speed and position.

Moving around. The punched tape contains number-coded commands for moving the instrument about its axes and switching on projectors and motors. Each incremental movement corresponds to a certain number combination. The control accuracy is 0.1°.

The punched-tape reader controls a rotary selector store unit that forms a rotary switch matrix for projector and motor control and preselects instrument movement control.

Since the planets, stars, and other celestial bodies change position from day to day, the program on the tape must be continually corrected. To make the program valid for as long as a month, position correction factors are fed to an aux-

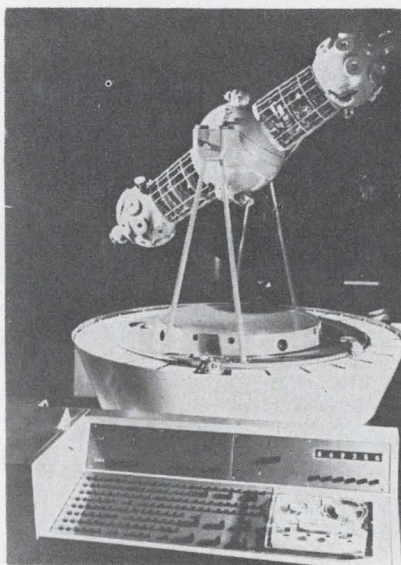

Cut-rate sky. New planetarium uses electronics to reduce costs and ensure accuracy of show.

iliary store unit by hand from the control desk. The momentary position of that store and of the electronic counters can be read at the control desk on cold-cathode indicator tubes.

France

Show time

French components makers were showing signs of confidence as they prepared for the April 1 opening of the 11th Salon International des Composants Electroniques in Paris. The mood was in sharp contrast to the gloom of last year, when the Gallic hosts were clamoring for a halt to U.S. inroads.

Although they didn't get what

they wanted from the de Gaulle government—a crackdown on U.S. plant investments in France—the rush has slowed just the same. One reason: most of the major U.S. electronics firms have already moved into the European Economic Community, if not into France itself. Adding to the French attitude is the feeling among executives that U.S. technology doesn't pose the same threat as it did before.

Says Henri Lerognon, head of the components division at CSF-Compagnie Générale de Télégraphie sans Fil: "There was a time when year after year you found new things. I don't think we will this year. There has been a stabilization of technology. Large-scale integration is the only important new innovation, and that's only a refinement of a technology available to all of us."

Catching up. Like many other executives in the French components industry, Lerognon figures this year's show will find U.S. companies having at best a small lead in technology over their European competitors. All the big French semiconductor firms, he claims, can make enough integrated circuits to satisfy the European market. Lerognon admits, though, that the French firms still lag far behind U.S. companies in production capacity.

Large-scale integration, he feels, is just around the corner in France. Compagnie Générale de Semiconducteurs (Cosem), a CSF subsidiary, will start pilot runs of circuits having from 200 to 500 elements on each chip—medium-scale integration—late this year, and then move up to LSI.

Bolstered. More or less reassured by the fast-narrowing technology gap, French companies are getting a new feeling of security from the rash of mergers in the components industry over the past year.

These have brought together the industry's heavyweights. The largely autonomous French components subsidiary of Philips' Gloeilampenfabrieken, RTC-La Radio-technique-Coprim, has joined forces with Compelec, the components producing subsidiary of

LOOKING AHEAD

The Papers of

DAVID SARNOFF

313 pages, 7 x 10,
52 illustrations.

\$9.95 at all
bookstores



© Karsh, Ottawa

A History of Modern Electronics Communications by one of its Greatest Pioneers

This engrossing chronicle is told by the man who is responsible for much of its tremendous growth and its impact on our lives—David Sarnoff. It is an outstanding collection of his writings, predictions, and personal experiences described in his own words. This firsthand account tells how Sarnoff turned visionary concepts into technical realities, beginning with the idea of bringing music by radio into the American home . . . through the establishment of the first national broadcasting network . . . to the development of color television and new uses for communications in the Space Age.

In **LOOKING AHEAD** you will see Sarnoff both as a history-making innovator and a far-sighted executive.

McGraw-Hill Book Co., Dept. 23-L-41
330 West 42nd St., New York, N.Y. 10036

Please send me **LOOKING AHEAD**, the papers of **DAVID SARNOFF** for 10 days free examination. In 10 days I will remit \$9.95 plus a few cents for delivery costs and local tax, if any, or return book postpaid.

Name (print) _____

Address _____

City _____ State _____ Zip Code _____

23-L-41

Electronics Abroad

Compagnie Générale d'Electricité—the country's largest electrical-electronics combine.

And Cosem shortly will absorb the Société Européenne des Semi-conducteurs (Sesco). The merger will be just one of the many in the offing when the parent companies of Cosem and Sesco, csf and Compagnie Française Thomson Houston-Hotchkiss Brandt, stitch together their operations [Electronics, Dec. 25, 1967, p. 77].

Also bolstering the confidence of French components makers are the government programs to develop independent computer and semiconductor industries. Lerognon says it is government support under the "Plan Calcul"—the computer plan—that has made it possible for Cosem to develop ic packages for the third-generation computer the French hope to have ready this year.

Sweden

Flight physicals

One of the most sophisticated computerized test sets ever built for a military plane will be put through its paces this spring with a prototype of the Saab 37 Viggen. The double-delta combat aircraft for Sweden's air force is now on the production line.

The test set can automatically run through 1,500 performance

checks of the Viggen's integrated electronics in a few hours; manual tests would take several days.

For the autopilot alone, Saab AB engineers say, a full manual checkout would take three to five days. Saab believes it will be able to program the computer that controls the automatic tester to run through about 500 key checks in less than an hour. Checkouts on the Viggen's predecessor took so long that the air force decided the new plane would need integrated electronics systems and the computerized test set.

Reporting on the tester last week at an aerospace instrumentation symposium in England, Per Hellman of Saab's flight-line test office said the checkout sequence program had been almost entirely verified on a test rig of the Viggen electronics systems.

Double duty. Saab's systems men decided to put the Viggen's airborne computer to work in the checkout. The computer, whose program has 7,000 words of 28 bits, controls all the electronics systems in the aircraft and supervises the flight-line checkout as well.

For the comprehensive testing at first-echelon level, the checkout equipment's computer works with the one on the plane. The ground computer, developed by Telefonaktiebolaget L. M. Ericsson, is an asynchronous serial machine with a memory cycle time of 6 microseconds and a core memory of 4,096 words of 17 bits.

Ericsson also supplies the equip-

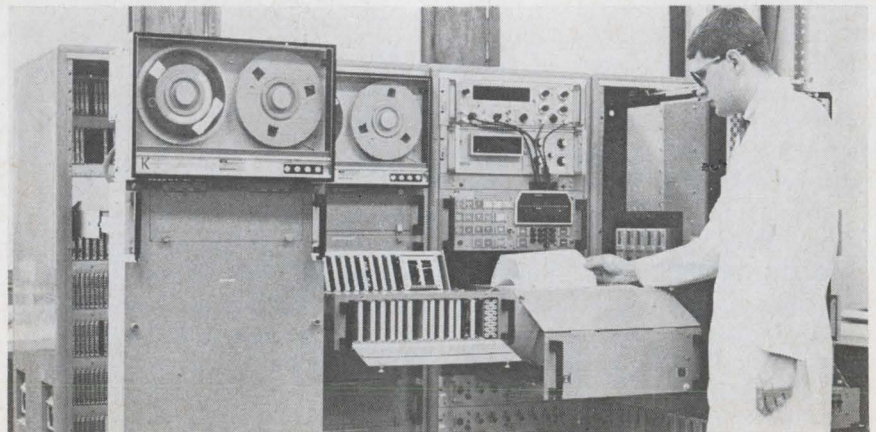

Master module. Automatic test equipment for Saab 37 Viggen is built about this computer developed by L.M. Ericsson.

ment that generates widely used electrical test signals. Special signals, such as radar target simulators, come from adapter units developed to Saab specifications by the suppliers of the systems they're applied to.

Fault finder. The test sequence, on magnetic tape, advances automatically, shifting to a troubleshooting mode whenever a test-point check shows there's something awry. Two operators are needed, one in the test truck and one in the cockpit, largely to feed in readings from the head-up display. The operators get involved in only 10% of the tests, but these checks take up about half the total time involved.

Japan

Back to back

Fujitsu Ltd. has promoted Japan to the big leagues of data processing.

The company last month completed its first Facom 230-60 model, the largest commercial computer yet built by a Japanese firm and the only one designed in the country so far for multiprocessing with two main central processors back-to-back.

The new computer, whose price ranges from \$1.25 million to \$5.5 million, is in much the same class as IBM's 360/67, also a multiprocessing machine. Add time of the Facom 230-60 (Facom is an acronym for Fujitsu automatic computer) central processor is 1.26 microseconds for fixed-point calculations, compared to 1.3 μ s for the 360/67. The 230-60 has a memory cycle time of 0.92 μ s; the figure for the 360/67 is 0.75 μ s. As many as 18 main data channels can operate simultaneously.

Ready to roll. Fujitsu used computer-aided design techniques extensively when it developed the huge machine and the company's engineers say that largely for that reason the computer was debugged in less than a week. The computer uses something like 20,000 transistor-transistor logic circuits pro-



KROHN-HITE

0.001 Hz to 100 kHz

1966
\$850

Model 4000



0.01 Hz to 1 MHz

1967
\$550

Model 4100

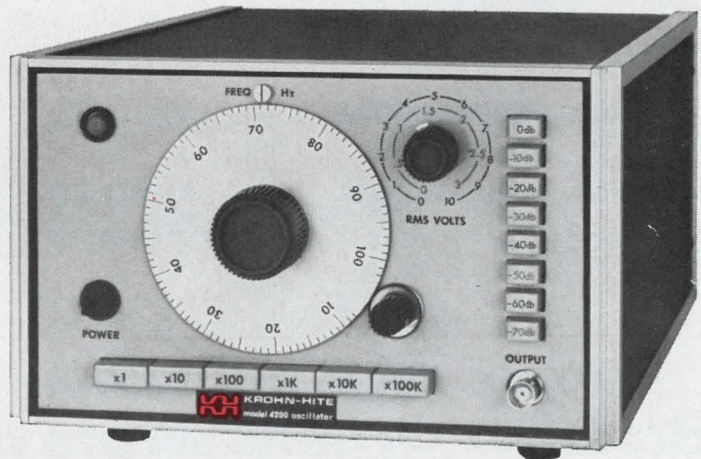

10 Hz to 10 MHz

1968
\$350

Model 4200: The newest addition to the family of K-H Quality Oscillators.

The 10 Hz to 10 MHz Model 4200, the newest (and lowest cost) member of the new family of Krohn-Hite all solid-state oscillators, performs as well as or better than competitive units costing as much as \$250 more! This proves that Krohn-Hite quality instruments do not necessarily have a high price tag.

Here's a general purpose oscillator that spans 10 Hz to 10 MHz with a frequency response so flat that a panel meter isn't necessary. Add to that — the half-watt output is available all the way to 10 MHz! That's not all — the amplitude stability is better than 0.1%/20 hours, the distortion is less than 0.1%, and the frequency response is within 0.025 db.

Pushbuttons provide 10-db attenuation steps for rapid, easily resettable control of output level. A vernier is provided for levels within the 10-db steps.

Write for Model 4200 data.



580 Massachusetts Ave., Cambridge, Mass. 02139, U.S.A.
Phone: (617) 491-3211 TWX: 710-320-6583

Oscillators / Filters / AC Power Sources / DC Power Supplies / Amplifiers

YOUR NO.1 SOURCE FOR ALL MAGNETIC MATERIALS

PERMAG

Complete magnetic material inventory . . . permanent magnets, high permeability, shielding and core materials and ferrites. Full fabrication facilities. Skilled engineering staff. 24-hour delivery.

PERMAG PACIFIC CORP.

5441 WEST 104th ST., LOS ANGELES, CALIFORNIA 90045
Telephone Area Code (213) 776-5656 TWX [910] 328-6547

PERMAG CENTRAL CORP.

5301-D OTTO AVE., ROSEMONT, ILL. 60018
Telephone Area Code (312) 678-1120

PERMAG MAGNETICS CORP.

formerly EMPIRE MAGNETICS
3130 SOUTH AVENUE, TOLEDO, OHIO 43609
Telephone Area Code (419) 385-4621

PERMAG NORTHEAST CORP.

50 THAYER ROAD, WALTHAM, MASSACHUSETTS 02154
Telephone Area Code (617) 484-0550

PERMAG CORP.

88-06 VAN WYCK EXPRESSWAY, JAMAICA, N.Y. 11418
Telephone Area Code (212) 657-1818 TWX [710] 582-2952

Circle 160 on reader service card

During 1967

296

new manufacturing plants
opened in Texas!

370

Texas plants expanded!

*Do they know
something you don't?*

Perhaps! The new electronic firms have learned that a Texas location means lower taxes, higher income, and a steady supply of stable, trainable labor efficiently filling contracts and meeting the demands of a booming population. To the expanded firms, a Texas location simply means business. Big business! Write or phone for the new Texas Fact Book and find out what it could mean to you.

Turn to
TEXAS

Contact
: TEXAS
: INDUSTRIAL
: COMMISSION
: Phone (512) 475-4331
: Box JJ-E, Capitol Station
: Austin, Texas 78711

Circle 161 on reader service card

Electronics Abroad

duced by Fujitsu but very similar to the Series 74 IC's of Texas Instruments.

And Fujitsu has laid out an ambitious production schedule—two per month—for the machines. The company already has logged orders for six systems involving 11 central processors. Negotiations are in progress for another 10 systems.

Ear to the ground

There's relief in sight for city fathers with big traffic problems but budgets too small for computer-controlled lights. Japanese engineers have found a way to make the roar of traffic set the timing for the sequence of light changes from red to amber to green. And they say it's just a little more expensive—about \$140 per controller—than units that vary their timing according to the hour of day.

Noise count. With its noise sensor Matsushita has paired a control unit with three separate cycles for the run through red, amber, and green lights. When the sensor detects a drop in traffic volume, it triggers a shorter cycle to speed light changes. An increase in traffic noise switches the system to a longer cycle.

In Matsushita's new method, called noise-time rate, the action of the controller is based on the percentage of time the noise level rises above a preset threshold during a sampling period. Curves recorded during simultaneous checks by the noise sensor and a loop sensor at an intersection in Tokyo's Ginza coincided over most of the test period.

Triggered. The noise-time rate makes for simple electronics. The noise sensor is simply a dynamic speaker mounted in a trumpet horn aimed at the center of an intersection. Output of this speaker-in-reverse is fed to a transistor amplifier that is stabilized by high feedback. A Schmitt trigger flip-flops whenever the amplifier output reaches the preset threshold. Comparison circuits then determine whether the percentage of time the trigger stays on corresponds to level one, two, or three of the controller's program.

People who built their own Schober Organs wrote this ad

Here's what they say about the pleasure of assembling the Schober Electronic Organ from kits . . . and enjoying the magnificent sound of an instrument they've created in their spare time.

Building was fun

"Building it was at least as much fun as playing it!"

Mr. Lester F. Schwartz,
Somerset, N. J.

So proud I could pop

"I've done over 90 per cent of the work on this organ myself—and I'm so proud I could about pop!"

Mrs. V. P. Allbert,
Topeka, Kansas

Nothing as fine under \$5,000

"... I could not find any organ that sounded as fine as the Schober under \$5,000."

Mr. Jerome J. Fraenkel,
Franklin Square, N. Y.

Proud to own

"I am proud to own such a valuable instrument."

Mr. Jean J. Juteau,
Montreal, Canada



The NEW Schober THEATRE ORGAN—
one of four models available

Most cherished possession

"My spinet has become the most cherished possession in our home—fabulous, indeed."

Mr. Frank J. Marlon,
North Bergen, N. J.

Tremendous sound

"The sound is conservatively, tremendous."

Mr. Paul DeForest Wren,
Westbrook, Conn.

Unbelievably easy to build

"When we ran out of instruction, the organ was finished . . . To me it was unbelievable!"

Mr. Ted Sowinski,
Chicago, Illinois

Thousands of music lovers in every walk of life—from teen-agers to grandmothers, from people who are "all thumbs" to electronic engineers—have enjoyed the pleasure of assembling, playing and hearing the magnificent sound of the Schober organ. Whether you favor Bach or Bop, there is a Schober organ that gives you full range of expressional and tonal quality—so like a fine pipe organ that many listeners can't tell the difference. You can build a Schober organ for as little as \$645. And—even if you've never played a note before—Schober's self-teaching courses give you immediate musical results.

Over 50% of Schober Organ owners never handled an electronic job before and didn't play a note, yet assembled some of the best organs ever designed and get a daily thrill from making their own music. Isn't it time for you to take this cost-saving road to greater musical

pleasure—and enjoy the satisfaction of doing it yourself?

Free Information and Demonstration Recording

Send today for your free copy of Schober's 16-page, full color booklet, plus 7" free recording.

The Schober Organ Corp., Dept. EL-11
43 West 61st Street, New York, N. Y. 10023

Please send me Schober Organ Catalog and free 7-inch "sample" record.

Enclosed please find \$1.00 for 12-inch L.P. record of Schober Organ music.

NAME _____

ADDRESS _____

CITY _____ STATE _____ ZIP _____



■ Acopian Corp. Mort Barish Associates	89	■ Indiana General Corp., Electro Mechanical Div. Griswold & Eshleman Co.	24	■ Stackpole Carbon Co., Electronic Components Div. Meek & Thomas, Inc.	90
■ Acton Laboratories, Inc. Impact Adv., Inc.	135	Industrial Electronic Hardware A. D. Adams Adv., Inc.	137	Sylvania Electric Products, Inc., Parts Div. Doyle, Dane, Bernbach, Inc.	53
Airpax Electronics, Inc. Welch, Mirabile & Co., Inc.	104	■ ITT Jennings Mfg. Co. West, Weir & Bartel, Inc.	116	Syston-Donner Corp. Bonfield Assoc., Inc.	6
Allen-Bradley Co. Fensholt Adv. Agcy.	27, 28	ITT Semiconductors Div. Neals & Hickok Inc.	86	■ Tektronix, Inc. Hugh Dwight Adv., Inc.	37
American Electronics, Inc. Alden Adv. of California, Inc.	106	■ J F D Electronics Co., Components Div. Delphi Adv., Inc.	123	Texas Industrial Commission The Pitluk Group	150
■ Astrosystems, Inc. Don Alt and Assoc., Inc.	134	Kikusui Electronics Corp. Kyodo Adv. Co., Ltd.	135	Texas Instruments Incorporated Components Group Don L. Baxter, Div. of Albert Frank-Guenther Law, Inc.	130
Babcock Relays, Div. of Babcock Electronics Corp. Jansen Assoc., Inc.	138, 139	Krohn-Hite Corp. L. K. Frank Co., Inc.	149	■ Texas Instruments Incorporated Industrial Products Group Robinson-Gerrard	122
■ Beckman Instruments, Inc., Helipot Div.	133	Litton Industries, Inc., Electron Tube Div. West, Weir & Bartel, Inc.	70	TRW Electronics, Capacitors Div. Fuller & Smith & Ross, Inc.	35
Bell Aerosystems Co. Comstock Adv., Inc.	87	Litton Industries, Inc., Triad Distributor West, Weir & Bartel, Inc.	118	■ Trygon Electronics, Inc. Kameny Assoc., Inc.	14
Buffalo Erie County N.Y. Barber & Drullard, Inc.	103	McGraw-Hill Industrial & Business Book Division	148	■ Tung-Sol Division, Wagner Electric Corp. Feeley & Wheeler, Inc.	114
■ Burndy Corp. Don Kemper Co., Inc.	111	■ Machlett Laboratories, Raytheon Co. Div Fuller & Smith & Ross, Inc.	9	■ United Transformer Co., Div. of TRW, Inc. Philip Stogel Co.	2nd Cover
■ Burroughs Corp., Electronic Components Div. Conti Adv. Agcy., Inc.	54	■ Magnetics, Inc. Lando Adv. Agcy., Inc.	93	■ Unirode Corp. Siltan Brothers, Inc.	41
Capitol Radio Engineering Institute Henry J. Kaufman & Associates	124	■ Mallory & Co., P.R., Mfg. Div. Aitkin-Kynett Co.	50	■ Victory Engineering Corp. Black-Russell-Morris	152
Clare & Company, C.P. Reincke, Meyer & Finn Adv., Inc.	52	Mann, David W., Division of GCA Corp. Culver Advertising, Inc.	119	Vidar Corp. Hal Lawrence, Inc.	110
Communication Electronics, Inc. William C. Estler	42	Markel & Sons, L. Frank George Moll Adv., Inc.	97	■ Wang Laboratories Impact Adv., Inc.	107
Connecticut Hard Rubber Co. Chirurg & Cairns, Inc.	127	Martin Marietta Corp. Redmond Marcus & Shure, Inc.	49	Watkins-Johnson Co. William C. Estler Pub. Rel.	112
Control Data Corp., Analog Digital Systems Div. Barnes-Champ Advertising	40	Metal Removal Co., The Advertising Producers Associates	16		
■ Dale Electronics, Inc., Sub. of Lionel Corp. Swanson, Sinkey, Ellis, Inc.	3rd Cover	Microdot, Inc. Gumpertz, Bentley & Dolan Advertising	15		
Defense Electronics, Inc. Harry I. Clarkson Associates	99	Midtex/Aemco Chuck Ruhr Assoc. Adv.	51		
Douglas Randall, Inc. West, Weir & Bartel, Inc.	126	Motorola Semiconductor Products, Inc.	12, 13, 29, 120		
Dow Corning Corp., Engineering Products Div. Church & Guisewite Advertising	88	National Semiconductor Corp. Jay Chiat & Associates	18, 19		
DuPont de Nemours Co., Industrial Fibers Nomex Batten, Barton, Durstine & Osborn Inc.	108	New Hermes Engraving Machine Corp. Lester Harrison Adv., Inc.	132		
E G & G, Inc. Culver Adv., Inc.	100	■ Norden Division of United Aircraft Corp. Cunningham & Walsh, Inc.	48		
Electronic Engineering Co. of California Jansen Associates	43	■ North Atlantic Industries, Inc. Murray Heyert Associates	115		
Electro Tec Corp. Wilson, Haight & Welch, Inc.	98	■ Parker Instrument Corp. HPM Advertising	132		
Erie Technological Products Co., Inc. Altman-Hall Associates	39	■ Permag Corp. Schneider, Allen, Walsh, Inc.	150		
■ Field Emission Corp. Morton and Stanton	7	■ Pfizer & Co., Chas., MPM Div. Newmark, Posner & Mitchell, Inc.	136		
General Dynamics Corp., Electronics Div. Knoth and Meads Co.	152	Philco Ford Corp. Sierra Electronics Operation Hal Lawrence, Inc.	11		
General Radio Co. Horton, Church & Goff, Inc.	17	Princeton Applied Research Corp. Mort Barish Assoc., Inc.	30		
■ Heath Co., Sub. of Schlumberger, Ltd. Advance Advertising Service	133	Radiation, Inc. W. M. Zemp & Assoc., Inc.	91		
Heinemann Electric Co. Thomas R. Sundheim, Inc.	8	Radio Corporation of America Al Paul Lefton Co.	4th Cover, 22, 128, 129		
■ Hewlett Packard, Mt. View Div. Lennen & Newell, Inc.	1	Rohde & Schwarz Walker & Gessell, Inc.	94		
■ Hewlett Packard, Rockaway Div. Culver Adv., Inc.	2	Schober Organ Corp. Harry C. Waterston, Inc.	150		
Honeywell, Computer Control Div. Franklin P. Folts, Inc.	20, 21	Signetics Corp., Sub. of Corning Glass Works Cunningham & Walsh, Inc.	85		
Hughes Aircraft Co. Foote, Cone & Belding	142	■ Sorensen Operation, Raytheon Co. James Adv., Inc.	47		
■ IBM Corp. Ogilvy & Mather, Inc. Adv.	92	Sperry Rand Corp., Sperry Microwave Electronics Div. Neals & Hickok, Inc.	44		
Icon Corp. Van Christo Assoc., Inc.	133	Sprague Electric Co., The Harry P. Bridge Co.	5, 10		

Classified Advertising

F.J. Eberle, Manager

EMPLOYMENT OPPORTUNITIES	92, 140-141, 152
General Dynamics/Electronics Division	141
General Electric Capacitor	140
Newport News Shipbuilding & Drydock	140
EQUIPMENT	
(Used or Surplus New)	
For Sale	140
A & A Electronics Corp.	140
Fishman Co., Philip	140
Goodheart Co., Inc., R.E.	140
Radio Research Instrument Co.	140
Telerader	140

■ For more information on complete product line see advertisement in the latest Electronics Buyer's Guide

Electronics Buyers' Guide

George F. Werner, General Manager
[212] 971-2310
Ray Smyth, Eastern Regional Manager
[212] 971-6538
Regina Hera, Directory Manager
[212] 971-2544
Thomas M. Egan, Production Manager
[212] 971-3140

Circulation and Research

Milton Drake, Manager [212] 971-3485
Isaaca Siegel, Assistant Circulation Manager
[212] 971-6057
David Strassler, Assistant Research Manager
[212] 971-6058
Chloe D. Glover, Research Associate
[212] 971-6057

FREE!

VECO HANDBOOK OF THERMISTORS



- Applications
- Characteristics
- Circuitry

The practical range of applications of the temperature sensitive resistor — the Thermistor — is limited only by the creativity of the circuit designer. The VECO HANDBOOK of Thermistor Applications, Characteristics and Circuitry . . . written for Electronic Engineers, Scientists and Physicists . . . can be a valuable addition to your reference library, just as the VECO Thermistor can be a valuable addition to your personal bag of circuit design tools. Regularly priced at \$2.00, the HANDBOOK is available to you **Free of Charge** for a limited time only.

THERMISTORS • VARISTORS

VECO First in Progress • First in Service

VECO VICTORY ENGINEERING CORP.
36 Springfield Ave., Springfield, N.J. 07801
Tel: 201 • 379-5900 TWX: 710-983-4430

Advertising Sales Staff

Frank E. LeBeau [212] 971-6464
Advertising Sales Manager

Wallis Clarke [212] 971-2187
Assistant to sales manager

Donald J. Austermann [212] 971-3139
Promotion Manager

Warren H. Gardner [215] LO 8-6161
Eastern Advertising Sales Manager

Atlanta, Ga. 30309: Michael H. Miller, 1375
Peachtree St., N.E.
[404] 892-2868

Boston, Mass. 02116: William S. Hodgkinson
McGraw-Hill Building, Copley Square
[617] CO 2-1160

Cleveland, Ohio 44113: William J. Boyle, 55
Public Square, [216] SU 1-7000

New York, N.Y. 10036
500 Fifth Avenue
Donald R. Furth [212] 971-3615
James R. Pierce [212] 971-3616
John A. Garland [212] 971-3617

Philadelphia, Pa. 19103:

Jeffrey M. Preston
Warren H. Gardner,
6 Penn Center Plaza,
[215] LO 8-6161

Pittsburgh, Pa. 15222: Warren H. Gardner,
4 Gateway Center, [412] 391-1314

Rochester, N.Y. 14534: William J. Boyle,
9 Greylock Ridge, Pittsford, N.Y.
[716] 586-5040

J. Bradley MacKimm [312] MO 4-5800
Midwest Advertising Sales Manager

Chicago, Ill. 60611: Robert M. Denmead,
J. Bradley MacKimm, Ralph Hanning,
645 North Michigan Avenue,
[312] MO 4-5800

Dallas, Texas 75201: Richard P. Poole, 1800
Republic National Bank Tower,
[214] RI 7-9721

Houston, Texas 77002: Kenneth George,
2270 Humble Bldg., [713] CA 4-8381

Detroit, Michigan 48226: Ralph Hanning
856 Penobscot Building
[313] 962-1793

Minneapolis, Minn. 55402: J. Bradley
MacKimm, 1104 Northstar Center
[612] 332-7425

St. Louis, Mo. 63105: Robert M. Denmead
The Clayton Tower, 7751 Carondelet Ave.
[314] PA 5-7285

James T. Hauptli [415] DO 2-4600
Western Advertising Sales Manager

Denver, Colo. 80202: Joseph C. Page, David
M. Watson, Tower Bldg., 1700 Broadway
[303] 255-5484

Los Angeles, Calif. 90017: Ian C. Hill,
John G. Zisch, 1125 W. 6th St.,
[213] HU 2-5450

Portland, Ore. 97204: James T. Hauptli,
218 Mohawk Building, 222 S.W. Morrison
Street, Phone [503] 223-5118

San Francisco, Calif. 94111:
James T. Hauptli, 255 California Street,
[415] DO 2-4600

Pierre Braude Tel: 225 85 88

European Director
88-90 Avenue Des Champs-Elysees, Paris 8

Brian Bowes Tel. Hyde Park 1451

United Kingdom and Scandinavia
34 Dover Street,
London W1

Milan: Robert Saidel
1 via Baracchini Phone: 86-90-656

Frankfurt/Main: Hans Haller
Elsa-Brandstroem Str. 2
Phone: 72 01 81

Geneva: 1, rue du Temple Phone: 31 95 60

Tokyo: George E. Olcott, 1, Kotohiracho
Shiba, Minato-Ku [502] 0656
Osaka: Ryoji Kobayashi 163, Umegae-cho
Kita-ku [362] 8771

Business Department

Wallace C. Carmichael, Manager
[212] 971-3191

Stephen R. Weiss, Production Manager
[212] 971-2044

Thomas M. Egan,
Assistant Production Manager [212] 971-3140

Dorothy Carmesin, Contracts and Billings
[212] 971-2908

Frances Vallone, Reader Service Manager
[212] 971-2865

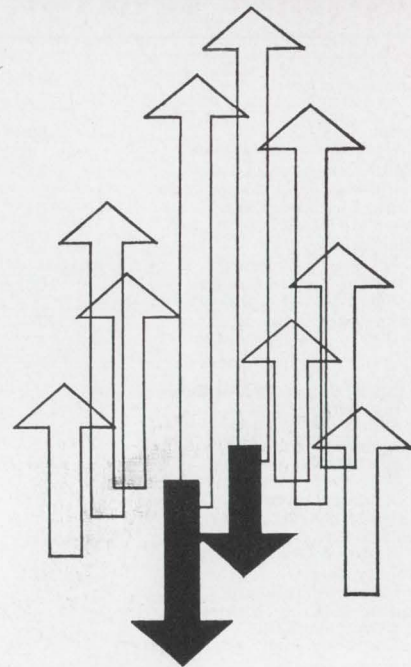

2 Wrongs do make a Write

If you selected the **WRONG** company, and If your career is headed in the **WRONG** direction, then **WRITE** right now for information about the interesting and challenging work at the Electronics division of General Dynamics in San Diego, with real advancement opportunity in the fields of:

Pulse Radar

CW Satellite Tracking

Solid State Circuit Design

Electronic Packaging Design

Send for our free, short-outline, benefits booklet describing graphically and succinctly who we are and what we do. You'll be glad you did. All inquiries will be held in strict confidence.

Mail inquiries to:

Mr. V. D. Finley

Professional Placement

Electronics division of

General Dynamics

San Diego Operations

Post Office Box 127

San Diego, California 92112

GENERAL DYNAMICS

Electronics Division

San Diego Operations

An Equal Opportunity Employer



DALE[®]

G resistors need less space in outer space.

(and in down-to-earth circuits, too)

Dale G resistors give you precision power in the smallest packages available. Test them with equivalent size wirewounds and you get 1.4 to 4 times more power. Run them at mil power levels and you get stability that can't be challenged. Dale's silicone-coated G Series combines the superior conductivity of beryllium oxide cores with the exclusive wire and wire-winding techniques perfected in the Minuteman High Reliability Development Program. When you need more precision power in less space, or more stability without increasing size—call Dale. Only the G Series gives you this freedom of choice.

SURVEYOR RELIABILITY demands are met by AGS wirewounds—the established reliability version of Dale's G Series. Supplied to Hughes Aircraft Company, builder of the Surveyor, AGS resistors have a proven failure rate of .000113% per thousand hours (60% confidence level, 50% rated power at 25° C ambient). They are the world's most reliable wirewounds. GARD TESTING is available to meet Established Reliability requirements at significant timelcost savings over typical 100 hr. burn in. Write for Test Report #19590.

G SERIES SPECIFICATIONS

DALE TYPE	MIL-R 26D TYPE	DALE RATING		RESISTANCE RANGES (OHMS)	
		U	V	.05%, .1%, .25%	.5%, 1%, 3%
G-1	RW-81	1.0 W	—	10 to 950	1 to 3.4K
G-2	—	1.5 W	—	10 to 1.3K	1 to 4.9K
G-3	RW-80	2.25 W	—	1 to 2.7K	.1 to 10.4K
G-5	—	4.0 W	5 W	1 to 6.5K	.1 to 24.5K
G-5A	—	4.5 W	6.5 W	1 to 11.4K	.1 to 42.1K
G-5C	—	5 W	7 W	1 to 8.6K	.1 to 32.3K
G-6	—	6 W	8 W	1 to 12.7K	.1 to 47.1K
G-10	—	7 W	10 W	.5 to 25.7K	.1 to 95.2K
G-12	—	10 W	12 W	.5 to 41.4K	.1 to 154K
G-15	—	15 W	18 W	.5 to 73.4K	.1 to 273K

MIL SPEC: G Series resistors meet the requirements of MIL-R-26D as well as the older MIL-R-26C and MIL-R-23379 specifications.

STABILITY: G Series resistance shift is less than 50% than that of conventional wirewounds of equivalent size (Dale RS) operated at the same ratings.

STANDARD VARIATIONS: G Series resistors are available with radial leads (Type GL) and with non-inductive (Aryton-Perry) winding (Types GN and GNL).

COMPARATIVE SIZE:



Dale G-5C resistance element (left) rated at 5 watts compared with conventional RS-5 watt wirewound element.

For action, call Dale: 402-564-3131. For information, circle 181 for Catalog A.



DALE ELECTRONICS, INC.

1300 28th Ave., Columbus, Nebraska 68601
In Canada: Dale Electronics Canada, Ltd.



DALE[®]

Printed in U.S.A.

This 50-volt silicon switch turns on an ampere in 30ns for only 98¢*

RCA's 2N5262 for high current switching features:

$V_{(BR)CE0} = 50V$; $t_{on} = 30ns$ max @ $I_C = 1A$; $t_{off} = 60ns$ max
@ $I_C = 1A$; plus freedom from second breakdown.

Controlled for safe operation without second breakdown under both forward-bias and reverse-bias conditions when operated within specified maximum ratings...very short turn-on and turn-off times... low saturation voltages... designed to meet the requirements of MIL-S-19500 ... hermetically sealed in a low profile TO-39 metal package to allow for high-density packaging ... and yet the RCA 2N5262 sells for only 98¢ in 1,000-unit quantities!

Intended for use as a driver for "2½D" coincident-current and word-organized magnetic memory systems, the 2N5262 is also ideally suited for other critical industrial applications requiring switching of large currents in inductive loads.

For complete information, including price and delivery, check with your RCA Field Representative. For Data, including Application Note AN-3608 "Operation of Memory-Core Driver Transistors in the Primary-Voltage Breakdown Region," write RCA Electronic Components, Commercial Engineering, Sect. CN4-1, Harrison, N.J. 07029. See your RCA Distributor for his price and delivery.

*1000-unit quantities

RCA

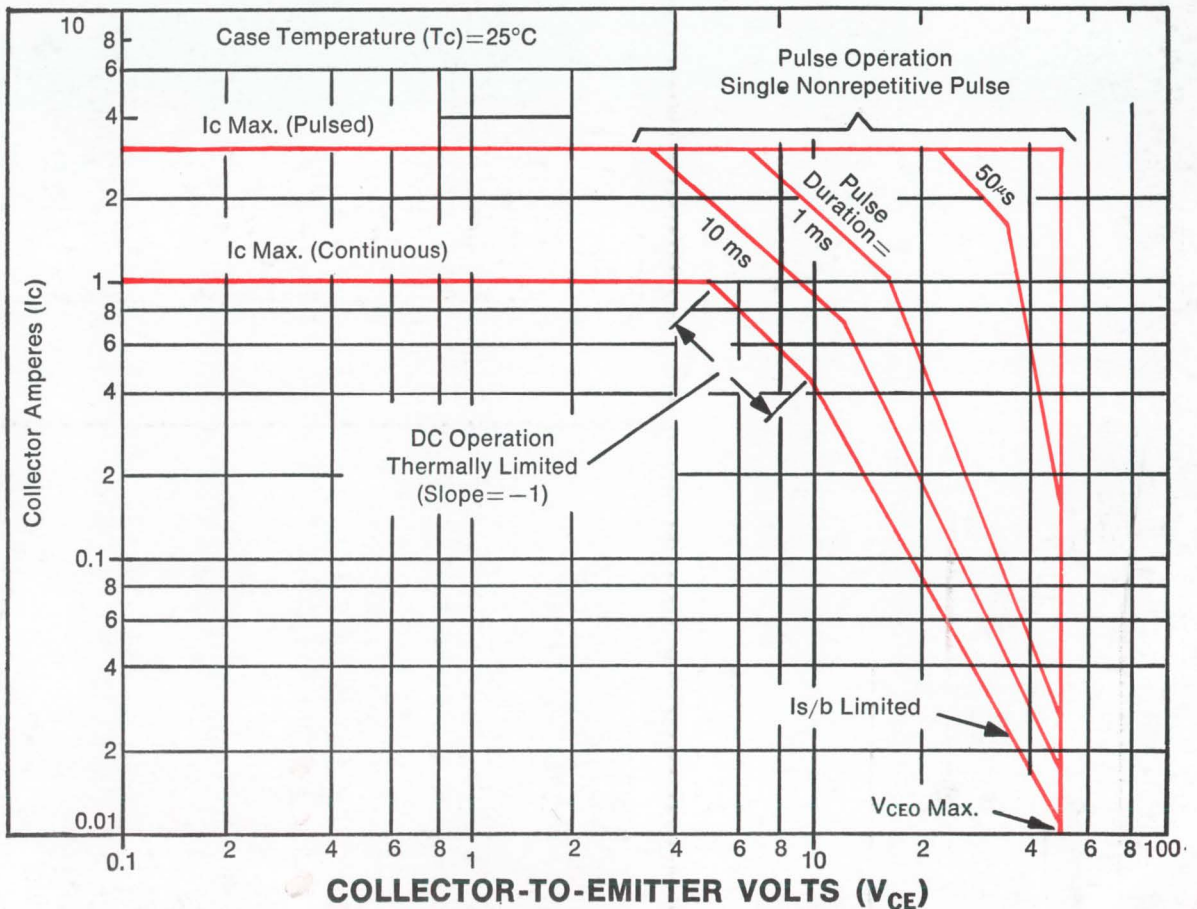

Circle 902 on reader service card