

Electronics

Pitfalls in IC system design: page 110

Dynamic testing for op amps: page 118

Wescon technical program: page 137

August 5, 1968

\$1.00

A McGraw-Hill Publication

Below: Multicolor display systems gather remote data, page 92





DMM (Digital Multimeter)

GR's new 1820 Digital Voltmeter is far more than just another DVM . . . it's really a new breed of digital multimeter. Why? Because with it you can measure:

ac volts, 200 mV to 200 V, up to 1.5 GHz
ac volts, 10 μ V to 200 V, up to 2 MHz
dc volts, 5 μ V to 1000 V
dc current to picoamperes
ac current to nanoamperes
resistance, milliohms to 50 M Ω

Only two plug-ins are required to make all these measurements, but you certainly don't need both to have a very useful multifunction instrument. Which plug-in you select depends basically upon whether your need is for ultra sensitivity (1 μ V) or ultrahigh frequency (1.5 GHz). Compare this broad capability with that of an ordinary DVM.

There's much more. Voltage measurements can be read out directly in either volts or dB. Do you know of any other DVM that does this? High input impedance on all ranges, at least 100,000 megohms or 1000 megohms depending on plug-in, virtually eliminates voltmeter loading errors and ensures a true 0.1% measurement because there's no input attenuator to get in the way. The high input impedance also permits direct-reading resistance measurements to 50 M Ω . Since the ranges and polarity are automatically selected and no external

preamp is needed, a wide variety of voltage measurements can be made rapidly without manual switching or any fussing. This autoranging feature combined with BCD output also permits rapid printout of data that's always measured on the most appropriate range. The 1820-P2 plug-in provides six ranges each for voltage and current, and its picoampere resolution allows the measurement of leakage current in capacitors and semiconductors.

DC Multimeter/UHF Voltmeter (1820 with 1820-P1 Plug-in)

DC Voltage

± 220.0 mV full scale to ± 220.0 V full scale;
 ± 1000 V with attenuator. Measures to 0.1 mV on last digit.

AC Voltage

2.200 V full scale to 220.0 V full scale; 1000 V with attenuator; above 200 MHz, max voltage varies inversely with frequency. Resolution is 1 mV on last digit. Operates as peak voltmeter calibrated to read rms value of sine wave or 0.707 of peak value of a complex wave. Frequency response down 3 dB at 10 Hz and 1.5 GHz.

Log Voltage Function

AC: 6 to 62 dB (re 100 mV).

Resistance

0.220 k Ω full scale to 50 M Ω full scale
(8 overlapping ranges).

AC/DC Millivoltmeter (1820 with 1820-P2 Plug-in)

AC/DC Voltage

2.200 mV full scale to 220.0 V full scale;

1000 V with attenuator. Resolution is 1 μ V on last digit.

Log Voltage Function

60 to 122 dB (re 100 μ V).

Current

DC: 2.200 nA full scale to 220.0 μ A full scale; resolution is to 1 pA on last digit (with 1-M Ω internal shunt); 2.200 μ A full scale to 2.200 mA full scale (with 1-k Ω internal shunt). AC current can be measured with Tektronix clip-on current probe.

Resistance

2.200 Ω full scale to 22 M Ω full scale
(10 overlapping ranges).

Prices in U.S.A.

1820-A only, \$1985; 1820-P1 Plug-in, \$525;
1820-P2 Plug-in, \$550.

Also available . . . 1820-P3 Differential Adaptor (\$90) can be added to either plug-in to convert the 1820 to a fully-balanced differential voltmeter with better than 100-dB common-mode rejection.

For complete information, write General Radio Company, West Concord, Massachusetts 01781; telephone (617) 369-4400. In Europe: Postfach 124, CH 8034 Zurich 34, Switzerland.

GENERAL RADIO

See this instrument at WESCON,
Booth No. 1613-1616.

Circle 900 on reader service card

Trading off ACCURACY FOR SPEED?

Get both in your system

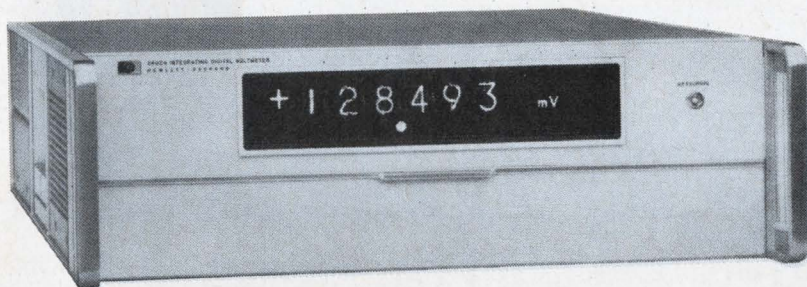

with Hewlett-Packard's 2402A Integrating Digital Voltmeter

It doesn't make sense to keep using one of those DVMs that forces you to sacrifice speed or accuracy, does it? Why slow down your system to measure signals buried in noise? And why tolerate preamp errors and delays when measuring low-level signals?

Hewlett-Packard's 2402A Integrating DVM offers an unequalled combination of speed, accuracy, and noise immunity in a single instrument. No trade-offs necessary. It makes 5-digit measurements 43 times per second, resolving answers down to a microvolt with 0.01% accuracy at full speed. You get *lab* accuracy at *system* speed, even in noise that would slow active-filter DVM's to a virtual halt.

Full programming and BCD output are standard and make the 2402A ideal for use with digital computers and automatic measuring systems. Plug-in options

measure AC, frequency, and resistance with equal ease, and a fast autoranger covers all five ranges from 100 mV to 1000 volts. Price: \$4800.

Isn't it time to take the trade-offs out of your system? Start by calling your local HP field engineer for more information. Or write Hewlett-Packard, Palo Alto, California 94304; Europe: 54 Route des Acacias, Geneva.

06817

HEWLETT  **PACKARD**
DIGITAL VOLTMETERS

Split personality

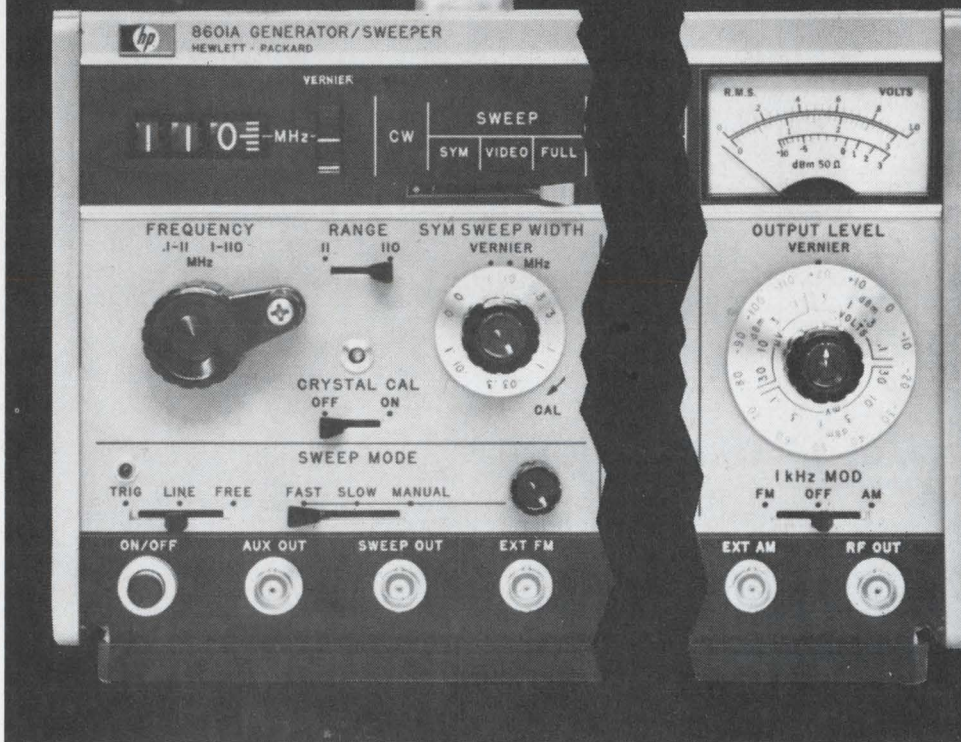

This new Hewlett-Packard instrument can't decide if it's a wideband RF sweeper or a versatile signal generator. No wonder—it's both.

Covering 100 kHz to 110 MHz, the HP 8601A Generator/Sweeper combines the high linearity and flatness of a precision sweeper with a signal generator's frequency accuracy and wide range of calibrated power levels. Though it's small and lightweight, it does the work of two instruments easily and conveniently.

As a sweeper, its 0.5% linearity and 1% frequency accuracy give you calibrated displays without having to use markers. Output flatness is ± 0.25 dB over the full range. Three sweep functions—full, video and symmetrical—let you shift from broad to narrow sweep with the flick of a switch. You can vary the sweep speed, fast enough for flicker-free display, slow enough

for high-resolution recording. And set the trigger for manual, line sync or free run.

As a signal generator, the 8601A output is accurate to ± 1 dB from +13 dBm to -110 dBm. The digital frequency dial is accurate to 1% of frequency; higher accuracy is achieved with 0.01% crystal checkpoints at 5 MHz intervals. Internal modulation is 1 kHz, AM or FM, or you can modulate externally.

The HP 8601A offers many more features that satisfy a wide range of lab and production requirements. Price: \$1975.

No sense developing a split personality yourself, struggling with several instruments. Let your HP field engineer give you complete details on how the HP 8601A alone can fill your RF sweeper *and* generator needs. Or write to Hewlett-Packard, Palo Alto, Calif. 94304; Europe: 54 Route des Acacias, Geneva.

HEWLETT  PACKARD

SWEEP SIGNAL GENERATORS

News Features

Probing the News

- 157 **Avionics:** Airbus makers go two ways on avionics
163 **Computers:** CAI edges slowly into the classroom
170 **Consumer electronics:** Industry nips at consumers' watchdog

Electronics Review

- 51 **Patents:** Decision on the CO₂ laser
51 **Commercial electronics:** Crt's for the reservation desk
52 **Advanced technology:** LSI with germanium
53 **Integrated electronics:** Computer takes it from design to module
54 **Medical electronics:** Reinvention
56 **Communications:** Search for space
58 **Computers:** Adapting a typewriter for a computer; Low-cost design machine
61 **For the record**

Electronics Abroad

- 269 **Japan:** Hitachi skirts planar patents
269 **Italy:** Simulator shows response of nationwide gas network
270 **West Germany:** Munich tv antenna pattern banishes ghosts
271 **France:** Addresser puts proper head on telegraph messages
271 **Great Britain:** Hybrid computer simulates atom power plant; Mullard unveils image intensifier; Manchester University team describes associative memory

New Products

- 191 **Wescon product preview**
191 Fast IC testing without frills
192 Tester takes to any op amp
193 Checking IC against a standard
194 Other key products at show
212 **Components review**
212 Photoresistor switches in 1 msec
216 Tiny transformers made for tv's
221 **Production equipment review**
221 Fast i-r camera scans wide field
228 **Instruments review**
228 Tightly packed signals analyzed
230 Vibrations measured accurately
235 **Microwave review**
235 Log amp ignores temperature
238 **Subassemblies review**
238 Synchro converter is small, quick
246 Servo seeks job in industry
253 **Semiconductor review**
253 Static register stores 200 bits

Technical Articles

- Displays** 92 **Keeping track of the action**
A wallful of color-coded information keeps industry managers or military commanders on target
J.H. Noily, J.G. Ferguson and H. Greenberger
Northrop Nortronics
- Circuit design** 105 **Designer's casebook**
▪ Transistor speeds up charging circuit
▪ Ohmmeter and diode measure dwell angle
▪ IC gate controls triac with audio transformer
▪ Modulating current supplied by op amp
▪ Op amp boosts pick-up voltage
- Computers** 110 **Avoiding IC system-design pitfalls**
Conventional design methods are outmoded when it comes to designing digital systems using integrated circuits
Howard Cohen, Nanodyne Corp.
- Instrumentation** 118 **Dynamic tests for op amps use synchronous demodulation**
A new technique performs dynamic tests of low-frequency parameters and provides direct meter readout
Robert Calkins, Philbrick/Nexus Research
- Consumer electronics** 124 **Lots of radio on just one IC**
A complete receiver circuit—except for the tuning stage—is squeezed onto a 60-mil square chip
M.J. Gay, J.A. Skingley, and M.C. Sucker
Plessey Co.
- Circuit design** 130 **Arc-lamp ballast goes solid state**
Transistors replace thyristors to cut flicker and reduce control circuitry
Peter Schiff, RCA Electronics Components
- Wescon** 137 **Technical program at Wescon '68**
Few surprises are foreseen; plastic IC debate continues

Departments

- | | | | |
|----|--------------------------|-----|------------------------|
| 4 | Readers Comment | 52 | Index of Activity |
| 8 | Who's who in this issue | 73 | Washington Newsletter |
| 14 | Who's who in electronics | 257 | New Books |
| 22 | Meetings | 258 | Technical Abstracts |
| 31 | Editorial Comment | 260 | New Literature |
| 33 | Electronics Newsletter | 267 | Newsletter from Abroad |

Electronics

Editor-in-Chief: Donald Christiansen

Associate managing editors

Technical: Stephen E. Scrupski
News: Robert Henkel
Copy: Sally Powell

Senior associate editors

Joseph Mittleman, Harry R. Karp

Department editors

Avionics & Space: Alfred Rosenblatt
Computers: Wallace B. Riley
Communications: William Buccì
Components: George Watson
Consumer electronics: John D. Drummond
Design theory: Joseph Mittleman
Industrial electronics: Harry R. Karp
Military electronics: Richard Gundlach

Domestic bureaus

Boston: James Brinton, manager
Chicago: Frederick Corey, manager
Los Angeles: Lawrence Curran, manager; Burton Bell
New York: Howard Wolff, manager
San Francisco: Walter Barney, manager; Peter Vogel
Washington: Robert Skole, manager; Paul Dickson, William F. Arnold

Foreign bureaus

Bonn: John Gosch
London: Michael Payne
Tokyo: Charles Cohen

Copy editors

James Chang, Larry Miller

Graphic design

Art director: Gerald Ferguson
Assistant art directors: Valerie Betz, Susan Hurlburt
Production editor: Arthur C. Miller

Editorial research: Kay Fontana

Editorial secretaries: Lorraine Longo, Claire Benell,
Patricia Gardner, Barbara Razulis, Stina Colombo

McGraw-Hill News Service

Director: Arthur L. Moore; Atlanta: Fran Ridgway; Chicago: Robert E. Lee
Cleveland: Arthur Zimmerman; Dallas: Marvin Reid;
Detroit: James Wargo; Los Angeles: Michael Murphy
Pittsburgh: Louis Gomolak

San Francisco: Margaret Drossel

Seattle: Ray Bloomberg; Washington: Charles Gardner, Daniel B. Moskowitz,
Herbert W. Cheshire, Seth Payne, Warren Burkett, William Small, William D. Hickman

McGraw-Hill World News Service

Bonn: Robert Dorang; Brussels: James Smith; Hong Kong: Wes Perry;
London: John Shinn; Mexico City: Gerald Parkinson; Milan: Ronald Taggiasco, Jack Star;
Moscow: Jack Winkler; Paris: Robert E. Farrell, Peter Kilborn;
Rio de Janeiro: Leslie Warren; Tokyo: Marvin Petal

Reprints: Susan Nugent

Circulation: Isaaca Siegel

Publisher: Gordon Jones

Electronics: August 5, 1968, Vol. 41, No. 16

Published every other Monday by McGraw-Hill, Inc. Founder: James H. McGraw 1860-1948.

Publication office 99 North Broadway, Albany, N.Y. 12202: second class postage paid at Albany, N.Y.

Executive, editorial, circulation and advertising addresses: McGraw-Hill Building, 330 W. 42nd Street
New York, N.Y. 10036. Telephone (212) 971-3333. Teletype TWX N.Y. 710-581-4235. Cable address:
MCGRAWHILL N.Y.

Subscriptions solicited only from those professionally engaged in electronics technology. Subscription rates:
qualified subscribers in the United States and possessions and Canada, \$8.00 one year, \$12.00 two years,
\$16.00 three years; all other countries \$25.00 one year. Non-qualified subscribers in the U.S. and
possessions and Canada, \$25.00 one year; all other countries \$50.00. Air freight service to Japan \$50.00
one year. Single copies: United States and possessions and Canada, \$1.00; all other countries, \$1.75.

Officers of McGraw-Hill Publications: Joseph H. Allen, President; J. Elton Tuohig, Executive Vice President;
David J. McGrath, Senior Vice President-Operations; Vice Presidents: John R. Callahan, Editorial; Paul F. Cowie,
Circulation; John R. Emery, Administration; John M. Holden, Marketing; David G. Jensen, Manufacturing;
Jerome D. Luntz, Planning & Development; Robert M. Wilhelm, Controller.

Officers of the Corporation: Shelton Fisher, President and Chief Executive Officer; John L. McGraw, Chairman;
Robert E. Slaughter, Executive Vice President; Daniel F. Crowley, Donald C. McGraw, Jr., Bayard E. Sawyer, Senior
Vice Presidents; John J. Cooke, Vice President & Secretary; Gordon W. McKinley, Vice President & Treasurer.

Title © registered in U.S. Patent Office; © Copyright 1968 by McGraw-Hill, Inc. All rights reserved. The contents
of this publication may not be reproduced either in whole or in part without the consent of copyright owner.

Subscribers: The publisher, upon written request to our New York office from any subscriber, agrees to refund that part of the subscription price applying to copies not yet mailed. Please send change of address notices or complaints to Fulfillment Manager; subscription orders to Circulation Manager, Electronics at address below. Change of address notices should provide old as well as new address, including postal zip code number. If possible, attach address label from recent issue. Allow one month for change to become effective.

Postmaster: Please send form 3579 to Fulfillment Manager, Electronics, P.O. Box 430, Hightstown, New Jersey 08520

Readers Comment

Blameless mixers

To the Editor:

In a recent story about one company's problems with hi-fi sets there was an implication that Schottky barrier diode mixers were in some way responsible [June 24, p. 58]. This is not the case. The diode mixer, notably the ring modulator, is capable of extremely low noise figure and very large dynamic range as a receiver front end. Although it is not generally realized, a mixer of this type (that is, a switching mixer) is intrinsically a lossless system.

Whatever problems the company is encountering, they are not related to the Schottky barrier diode mixer. Mixers of this type show a lower noise figure than FET front ends common in the industry. To my knowledge very few in the hi-fi industry have considered them "over the years" as you suggest.

Mitchell A. Cotter

Cotter & Associates
Riverdale, N.Y.

Clarification

To the Editor:

Hewlett-Packard would like to clarify its position concerning pricing of its new light-emitting diode numeric indicators [Electronics, July 22, p. 95]. The HP integrated logic and display packages will sell at first, in small quantities, for about \$50 each.

Among the many combinations of alternates that one might select from competitive readout devices, cost could run from perhaps \$39 to \$144.50, for the combination of one or another competitive readout and one or another competitive logic, in comparably small quantities. In quantities above 1,000 the lowest figure, again for both readout and logic, might at present be \$25 or so. The cost of these alternates, in the future, might drop to \$20 or so, thanks to new IC logic, possibly from Fairchild or Signetics.

As for itself, HP by no means expects larger IC suppliers to help reduce HP's costs. Indeed, HP expects that its own in-house monolithic IC

Add Sprague Series 7400A to your prints for Series 74N TTL circuits. They're pin-for-pin identical.

SERIES 74N	FUNCTION	SPRAGUE PART NO.
SN7400N	Quad 2-Input NAND	USN-7400A
SN7401N	Quad 2-Input NAND (No Collector Load)	USN-7401A
SN7402N	Quad 2-Input NOR	USN-7402A
SN7410N	Triple 3-Input NAND	USN-7410A
SN7420N	Dual 4-Input NAND	USN-7420A
SN7430N	Single 8-Input NAND	USN-7430A
SN7440N	Dual 4-Input NAND Buffer	USN-7440A
SN7450N	2-Wide 2-Input Expandable AND-OR-INVERT	USN-7450A
SN7451N	2-Wide 2-Input AND-OR-INVERT	USN-7451A
SN7453N	4-Wide 2-Input Expandable AND-OR-INVERT	USN-7453A
SN7454N	4-Wide 2-Input AND-OR-INVERT	USN-7454A
SN7460N	Dual 4-Input Expander	USN-7460A
SN7470N	D-C Clocked J-K Flip Flop	USN-7470A
SN7472N	J-K Master Slave Flip Flop	USN-7472A
	Dual J-K Master Slave Flip Flop:	
SN7473N	Single chip, pin 11 GND	USN-7473A
—	Single chip, pin 7 GND	USN-74107A
SN7474N	Dual D-Type Edge-Triggered Flip Flop	USN-7474A
—	Dual AC Clocked J-K Flip Flop	USN-7479A

Series 5400, full-temperature-range equivalents in 14 pin flat-packs, are also available for rapid delivery from Sprague.

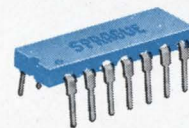

And coming soon: Series 54/74 Complex-Function circuits.

For complete technical data on Series 5400 and 7400A circuits, write to Technical Literature Service, Sprague Electric Co., 35 Marshall St., North Adams, Mass. 01247

SPRAGUE WORCESTER...the world's finest microcircuit facility



'Sprague' and '®' are registered trademarks of the Sprague Electric Co.

Have you talked to an analyst about your identification problem?

The problems of marking and identifying electrical and electronic components can drive a production engineer right up the old wall. "How can you print several color bands on a miniature diode?" "Is there an ink that'll dry on contact and meet Mil specs?" "How can you get fast, smudge-proof marks on things like ceramics, plastics and chrome?" "How can you simultaneously mark the tops and sides of transistors at high rates of speed?"

A Markem analyst thrives on problems like these. He can help you solve them by supplying the best machines, specialty inks, printing elements and other supplies. He can help by being there whenever you need service, whenever an operator needs training. And he can help by showing you how to get better identification for less money. For example, we recently introduced an Instant Type Former which lets *you* make metal type in-plant, as needed. No waiting for delivery . . . You can form new type inserts in less than a minute by simply "dialing" the legend.

Have a Markem analyst visit your plant to look into your marking operation. His ideas could save you a lot of grief. And a lot of money. Call your local Markem Sales office or Bernie Toomey at 603-352-1130. Write for our new "Problem Solver" booklet. Markem Corporation, 305 Congress St., Keene, N.H. 03431.

MARKEM[®]

See us at WESCON, Booth 2405



Readers Comment

facility will yield substantial competitive advantages, both in cost and performance, over others.

Dan Scheel

Marketing manager
HP Associates Division
Hewlett-Packard Co.
Palo Alto, Calif.

First to be second

To the Editor:

In your articles "TTL bandwagon" [April 15, p. 25] and "TTL makers switch their sales pitch" [July 8, p. 147] you failed to mention that Sprague Electric Co. was the original second source for Texas Instruments' 5400/7400 series of transistor-transistor-logic circuits. We announced these at the Wescon show last August.

Sidney L. Chertok
Sprague Electric Co.
North Adams, Mass.

Correct usage

To the Editor:

The circuit in "Voltage comparator is made with op amps and logic gates" [July 8, p. 91] was not used for a voltmeter's automatic ranging circuit in the way described in the article. Two of the comparators combined with additional logic circuitry were used for the automatic ranging circuits.

The circuit as shown can be used in analog computers, testing transistors, testing integrated circuits, testing printed circuit boards, etc. When used with converters (re-

sistance-to-voltage converters, capacitance-to-voltage converters, etc.) it can check the tolerance limits of passive components.

"AND-OR gate I_1 " in the first line of paragraph seven should be "inverter I_1 ." Wherever the article refers to a zero output voltage of the operational amplifiers, this voltage is actually equal to the forward voltage drop across the zener diode, about +0.8 volt.

Walter Ellermeyer

U.S. Navy
Electronics Laboratory
San Diego, Calif.

First-rate technology

To the Editor:

I was a little concerned with the title "Accelerometer has cut-rate price" that you used for your story on our QA-123 accelerometer [June 10, p. 185]. Our instruments, the Q-Flex accelerometers, are the finest accelerometers available. These instruments in performance, in reliability and in every aspect of engineering and manufacturing are, we feel, outstanding units.

It is true that the technology we have applied in producing this unusual instrument has allowed us to set new price performance guidelines for the industry. However, we do not wish to imply that our prices are cut-rate or that we offer less than a first-rate unit.

Earl D. Jacobs
Vice president, Manager
Endevco Corp.
Santa Ana
Calif.



The Alameda County Sheriff's Department

uses Farinon microwave and multiplex for reliable long-distance communications.

So do the Michigan State Police, 16 US government agencies, 33 independent telephone companies, 12 Bell telephone companies and 11 public power and light utilities ... among 223 others.

These people serving the US public know all about Farinon performance, reliability and economy, and so can you.

Write for our catalog of microwave, radio and multiplex equipment, accessories and services.

Farinon

Farinon Electric, 935 Washington St., San Carlos, Cal. 94070

SUBSCRIPTION SERVICE

Please include an Electronics Magazine address label to insure prompt service whenever you write us about your subscription.

Mail to: Fulfillment Manager
Electronics
P.O. Box 430
Hightstown, N.J. 08520

To subscribe mail this form with your payment and check new subscription renew my present subscription

Subscription rates: qualified subscribers in the U.S.: 1 year \$8; two years, \$12; three years, \$16. Non-qualified: 1 year \$25. Subscription rates for foreign countries available on request.

CHANGE OF ADDRESS

ATTACH LABEL HERE

If you are moving, please let us know five weeks before changing your address. Place magazine address label here, print your new address below.

name

address

city

state

zip code

BOOTH 576A

Hollywood Park; WESCON 68

See the new DIGILOG "differatio" trimmers

20-TURN electrical and mechanical travel, with clutch and stops. Metal film element with 30 ppm/°C temp. coefficient of resistance.

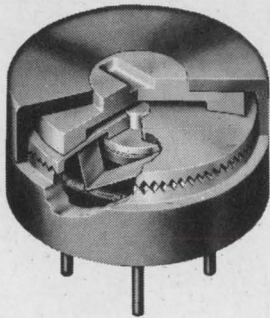

VACUUM DEPOSITION of metal films on ceramic substrates is an exact and continuing operation at Digilog. Well-tooled facilities permit efficient production to close specifications even in relatively short runs.

Stop in and discuss your needs for custom precision pots



APPLICATION-ENGINEERED special potentiometer designs give the customer needed performance at minimum cost by providing all the required special features, but avoiding over-specification.

PRECISE CONTROL of winding, linear or non-linear, is a Digilog specialty. Resistance elements are microscopically monitored during winding. A wide range of alloys, diameters and lengths can be handled.

INSPECTION of metal film resistance elements is carried out to meticulous standards and on 100% of units prior to assembly. Performance characteristics are uniform for sample lots or entire production runs.

—and don't miss Digilog's rotary switch and disc resistor!

Send for full descriptive literature on all Digilog products.

Digilog electronics corporation

701 Third Ave. No., Seattle, Wash. 98109
Phone (206) 284-6811; TWX 910-444-1665

Who's Who in this issue



Noily

Ferguson

Greenberger

Building command and control display systems is more than integrating the right kind of equipment. The prime requisite is assembling a group of men with special background and talents. Each of the authors of the article on large-screen displays on page 92 contributed his own specialty. Josh H. Noily, an engineer turned manager, started working on command and control display systems in 1959 for the North American Air Defense (NORAD) project and joined Northrop Nortronics in 1962. He now supervises the company's display system design and development activities. James G. Ferguson has worked on the design and integration of digital computers for the past 15 years. When he joined Northrop in 1961, he assumed a key role in applying prelaunch and ballistic computers for the Skybolt guidance system. More recently, he designed the English-language compilers for the software package that optimizes the display system's man-machine interface. Henry Greenberger is a senior systems engineer at Nortronics. Although his specialties are circuit, logic, and system design he also does systems studies.

The president of the Nanodyne Corp., Howard Cohen, runs a consulting and model-shop business. Cohen was manager of the general-purpose computer department at Sylvania Electric Products, where he was responsible for the design of the computer described on page 110. Since leaving Sylvania, he has acted as a consultant, specializing in controlling impedance in networks that use integrated circuits. He is developing several products, including a general-purpose multilayer board with guaranteed impedance levels that a designer can use as a breadboard for IC networks; and a wideband amplifier in which the circuit inductance and capacitance are in the etched conductors of the board.

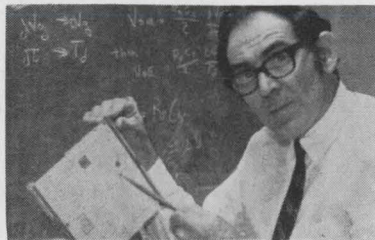

Cohen

These, and other products, will be built in small quantities in his basement workshop. When business warrants, he'll set up a more elaborate factory.

After he received his engineering degree from Northeastern University, Robert Calkins joined the engineering staff of Philbrick/Nexus Research. Since then he has spent most of his time developing the new integrated circuit op amp tester that uses a synchronous demodulation method, page 118. While he was still at college, Calkins worked for the Receiver division of General Electronics Laboratories where he was involved in the design and development of i-f video amplifiers and phase lock loop systems.



Calkins

Anyone wondering about the merits of on-the-job schooling for electronics engineers should turn to page 124 and read the article about a very special integrated-circuit car radio.

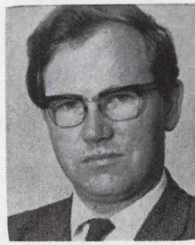

Gay

All three authors started their careers as student apprentices in Britain. Michael Gay did his training stint at the research laboratories of Mullard Radio Valve Co. and some nine years later joined The Plessey Co.'s Allen Clark Research Centre. He's since moved up to Chief Circuit Engineer for consumer and communications equipment at Plessey Microelectronics. John A. Skingley served his apprenticeship at the Cambridge Instrument Co. after graduating from Hendon Technical College. He signed on at Allen Clark in 1966 and this February shifted to Plessey Microelectronics, where he's a senior engineer in the radio and audio section.



Skingley

Michael C. Sucker joined Plessey as an apprentice in 1962 and is now assigned to the company's special equipment development group at Ilford.

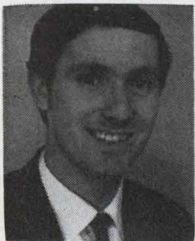

Sucker

Applications engineering is the field that Peter Schiff has been working in for the past five years at RCA in Somerville, N.J. His primary job has been to develop new uses for power transistors. "This isn't R&D," says Schiff, "but rather applying power transistor technology to other fields such as the ballast circuit," described on page 130. Schiff was born in Berlin in 1943, and has completed about 85% of the credits needed for a degree in electrical engineering at Drexel Institute.



Schiff

Sprague delivers Tape Cores



Our Tape Cores come in thirty sizes from $\frac{5}{8}$ to 6 inch O.D., offer a choice of core materials, and have standard phenolic or hermetically-sealed epoxy-coated aluminum cases. Most are available for off-the-shelf delivery. Shouldn't you wind up with Sprague?

For complete technical data, write for Bulletin Series 51000 to Technical Literature Service, Sprague Electric Company, 35 Marshall Street, North Adams, Massachusetts 01247

SPRAGUE COMPONENTS

MAGNETIC COMPONENTS
CAPACITORS
TRANSISTORS
RESISTORS
THIN-FILM MICROCIRCUITS
INTEGRATED CIRCUITS

INTERFERENCE FILTERS
PACKAGED COMPONENT ASSEMBLIES
FUNCTIONAL DIGITAL CIRCUITS
PULSE TRANSFORMERS
CERAMIC-BASE PRINTED NETWORKS
PULSE-FORMING NETWORKS

485C-7130



Sprague and 'S' are registered trademarks of the Sprague Electric Co.

5 things you should know

3. More than a switch:

Most double-diffused power transistors can only be used for switching applications. But, Fairchild power transistors have extremely high power dissipation. That means they can also be used as amplifiers. (Servo-amps, power amps, class B push-pull amps, etc.) They also make good switches.

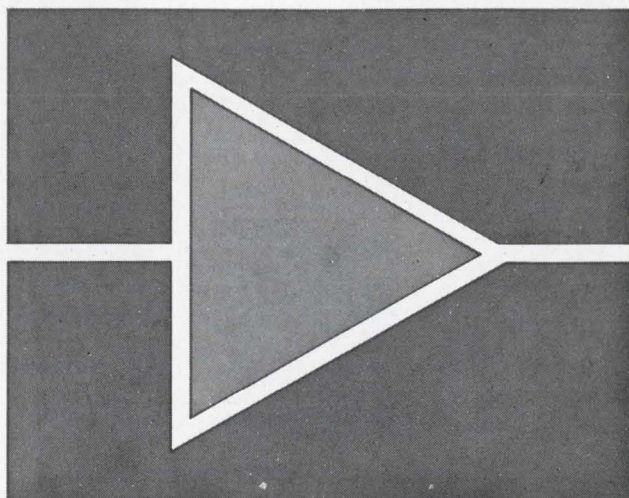

1. The discrete emitter:

Fairchild has improved beta linearity characteristics of power transistors. We chopped the emitter into many small discrete emitters connected in parallel by buss bar metalization. As a result, the increased emitter-base peripheral area raises emitter injection efficiency.

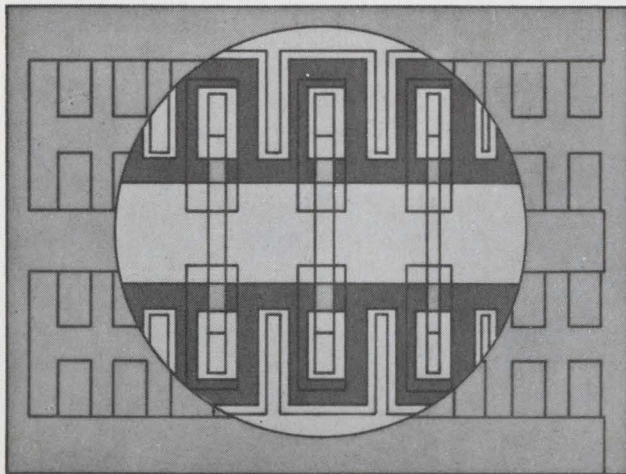

2. Integrated feedback resistors:

We also increased the safe area of operation. With a built-in safety fuse. Each discrete emitter is connected to the buss bar through a deposited thin film nickel-chromium resistor. That keeps the current flow under control and increases the device's second breakdown capability. If any emitter overheats, its resistor will open. Fairchild power transistors will perform without detectable degradation with up to 10% of the emitter sites opened.

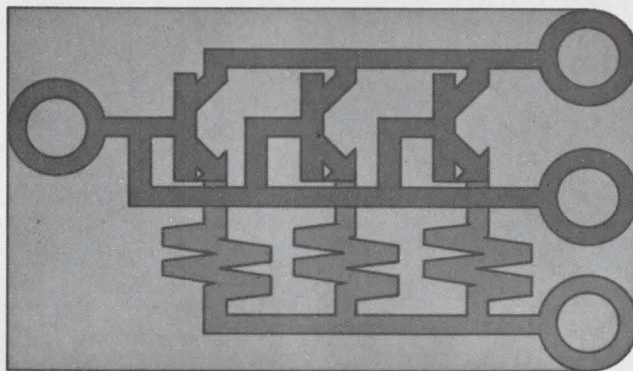

about silicon power transistors:

4. Planar II:

Several manufacturers use the Planar* process to make power transistors. But, not the way we do. (That's why other power transistors are limited to switching functions.) So, if you're a circuit designer, you don't have to put up with the low reliability and poor frequency response of Mesa designs. Fairchild offers reliable, 100%-tested epitaxial Planar power transistors with high frequency response. And, with all the advantages Fairchild power transistors offer, they cost only a little more than Mesa.

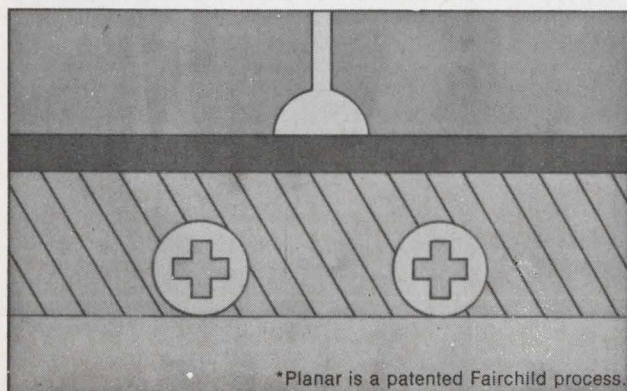

*Planar is a patented Fairchild process.

5. Power source:

You can get power transistors from your local Fairchild distributor. He's got NPNs and PNPs. Amplifiers and switches. Simply circle the Reader Service Number below for complete specifications and applications information.

Fairchild Semiconductor, A Division of Fairchild Camera and Instrument Corporation, 313 Fairchild Drive, Mountain View, California 94040
(415) 962-5011 TWX: 910-379-6435

FAIRCHILD
SEMICONDUCTOR

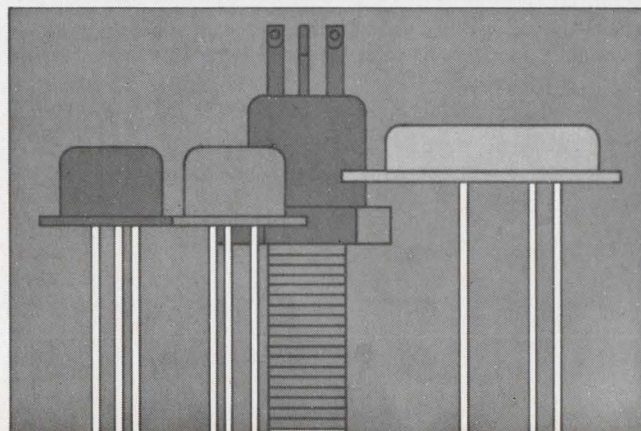

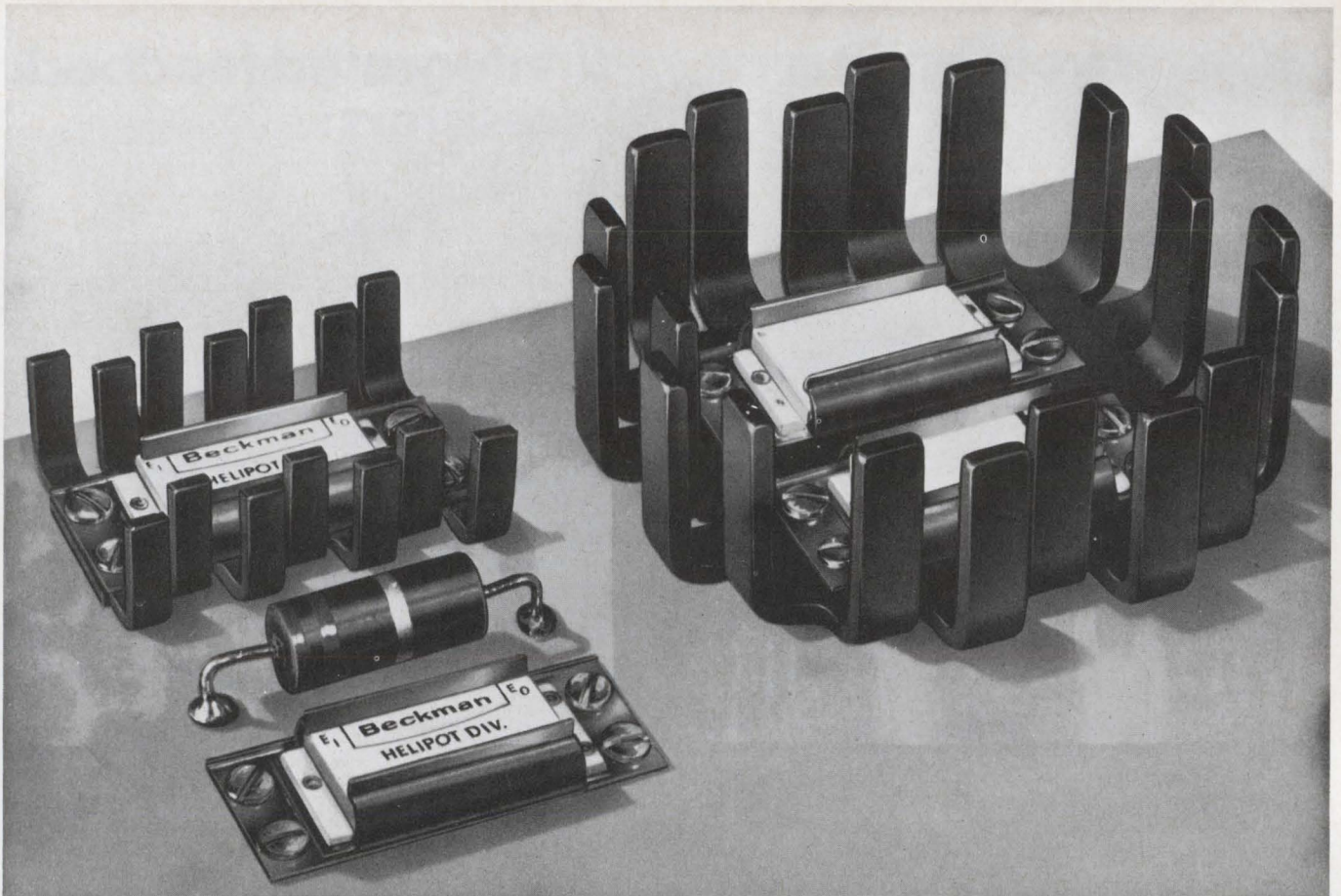

Cool off microcircuit devices with a choice of four new dissipator/retainers. Example: with natural convection, a typical microcircuit device dissipates 1.8 watts with case temperature rise of 103°C.

Add IERC's model LBOC2-61B and you dissipate 5 watts with the same case temperature rise. Retainer-clip may also be used alone to mount package to conduction plane.

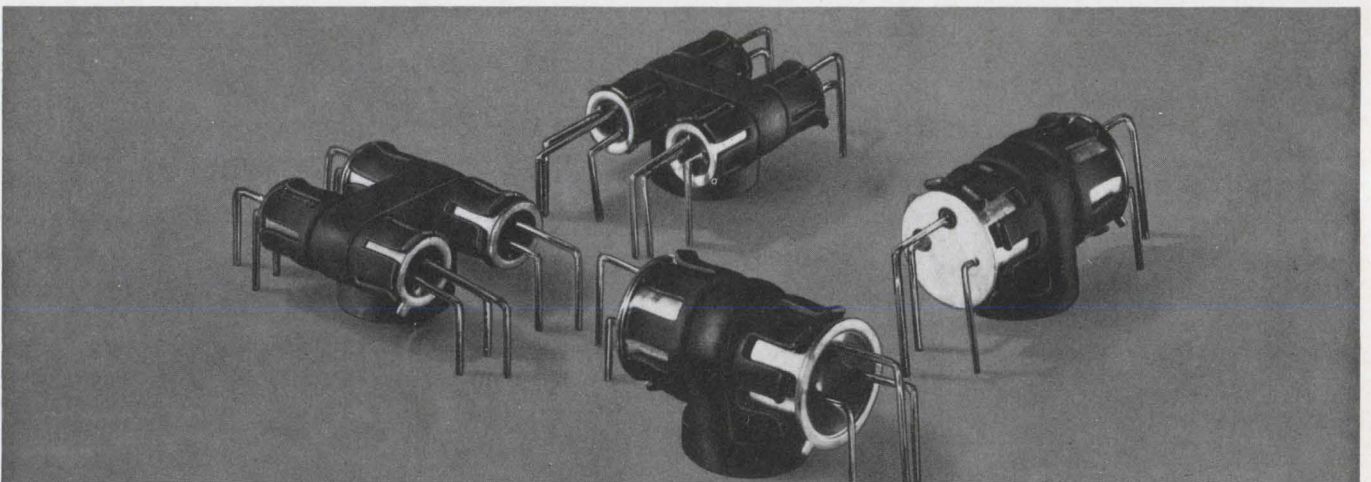

These special dual and quad Thermo-Link dissipators permit thermal mating of matched transistors. Thermo-Link retainers do exactly as their name says: They provide a thermal link between transistors and the chassis or heat sinks. They are also available with

.060" beryllium oxide washers which have the excellent thermal conductivity of aluminum, are electrically insulative and reduce normal mounting capacitance by $\frac{1}{2}$ to $\frac{1}{3}$. The washer is brazed to a brass slug or hex stud for mounting.

Need a non-hygroscopic finish with excellent dielectric properties, 50 K megohms insulation resistance and high heat emissivity? Use Insulube 448. It also protects against salt spray and fungus and other adverse environments.

Tips on cooling off hot semiconductors and microcircuits

Read on. Find out how circuit designers use IERC heat dissipators to protect and improve circuit performance of semiconductors and microcircuits.

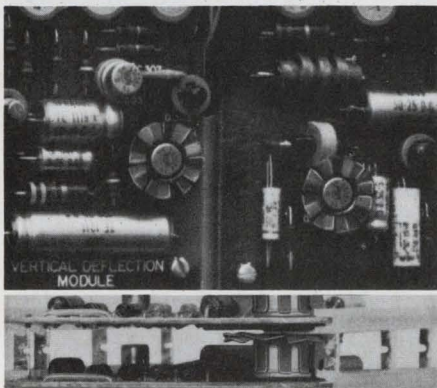

Fan Top Dissipators for TO-5 and TO-18 cases add almost nothing to board height. Don't need much room *on* the board either. Available for both metal and plastic cases. Spring fingers make installation simple. And Fan Tops cost just pennies.

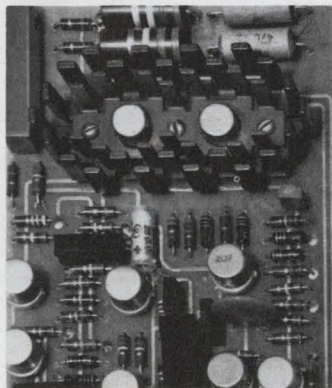

Help low-to-medium power transistors keep their cool with IERC's stagger-fingered LP's. Available in single or dual mounting for thermal mating of matched transistors. They fit both TO-5 and TO-18 cases.

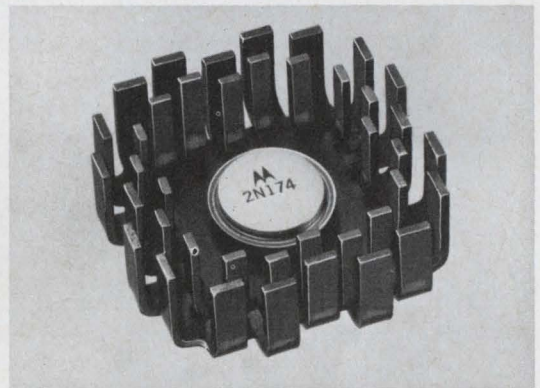

Cool power transistors and diodes with lightweight **HP Series** devices. High heat transfer rate. HP3 displaces only 9 cu.in. and weighs just 1.5 oz. Yet it dissipates as much heat as many finned extrusions requiring 13.5 cu.in. Two sizes for nesting or back-to-back use.

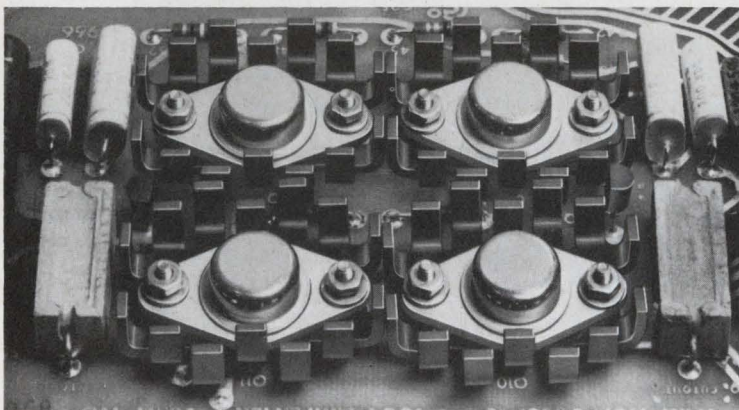

Keep **TO-66** transistors cool with any of four IERC dissipators. The application shown is a 100-volt amplifier with four LB66B2B's dissipating 8 watts per transistor. Exclusive staggered-finger design. Choice of finish: black anodize or Insulube® 448 for positive insulation to 500 watts.

Got a tough one? Our engineers welcome your inquiry for more specific information. Write us on your company letterhead, please.

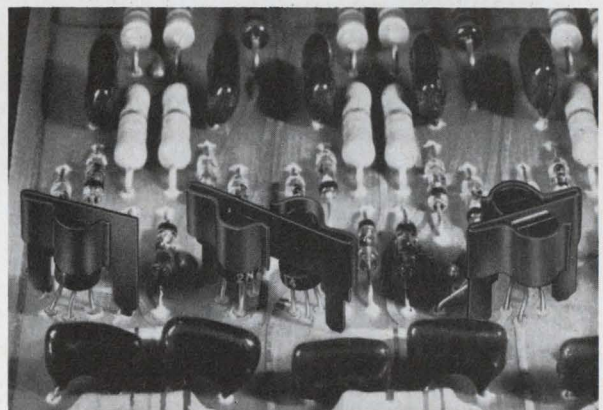

New "Universal" **Spade Series** for plastic transistors fits all D-case sizes. Spring clip allows for variation in case diameters. Excellent dissipation lets you boost operating power 33%. Both single and dual models as shown.

ierc
SEMICONDUCTOR
HEAT DISSIPATORS

INTERNATIONAL ELECTRONIC RESEARCH CORPORATION  A corporate division of Dynamics Corporation of America • 135 West Magnolia Blvd. • Burbank, Calif. 91502

Who's who in electronics

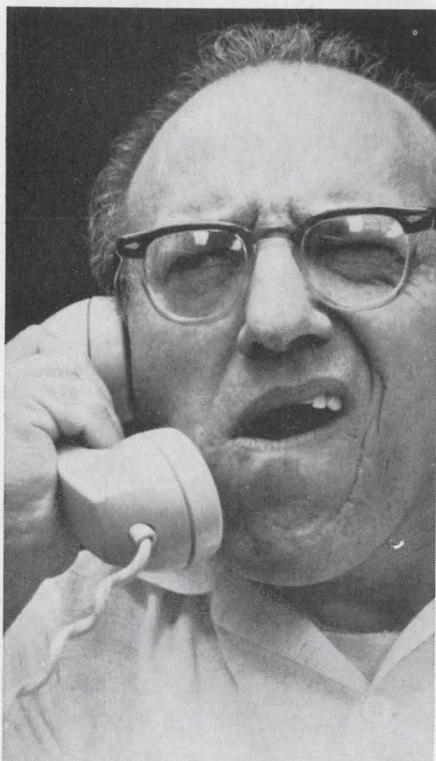

"Four to six weeks for power supply delivery?

Forget it!

Acopian will ship any of their 62,000 different AC to DC plug-in power supplies in just 3 days!"

This catalog lists 62,000 models of AC to DC plug-in power supplies available for shipment in just three days. Choose the exact outputs you need. Singles or duals, regulated or unregulated. Write or phone for your free copy.

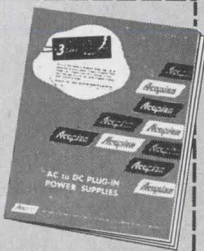

Name _____

Title _____

Company _____

City _____

State _____

Zip _____



Acopian Corp., Easton, Penna. 18042
Phone: (215) 258-5441



Gonzalez

Defense procurement policies allow war profiteering and Defense Secretary Clark Clifford not only refuses to do anything about it but is trying to disguise the fact from the public, charges Rep. Henry B. Gonzalez (D., Texas).

The peppery Congressman notes that the Pentagon spends more than \$45 billion a year in prime negotiated (noncompetitive) contracts with little scrutiny of companies' true costs. No more than 18 men in Government oversee the \$5 billion annually spent on computers and related EDP equipment, he says, "in which two corporations (he won't name names) almost monopolize the whole field."

Pushes probe. As a result, Gonzalez urges a Congressional probe through a new House committee on war profiteering. Gonzalez maintains that companies can hide their true profits through inflated cost figures.

To squelch such criticism Clifford acknowledged that the average profit in negotiated contracts between companies and the Pentagon has increased by 22% to nearly 10% of sales since 1964. But he maintains that companies' actual profits are lower because the Pentagon is issuing more fixed-price contracts.

Calling the report "flimsy," Gonzalez told Congress that Clifford had ignored several other studies, including the Pentagon's own profit review system, which contradicted the study. Gonzalez cited several examples of excess profits,

as well as a private study which showed that large corporations with defense contracts make more money than equally large companies without defense work.

Armchair safety. "If the American soldier in Vietnam does not dwell upon the inequity of putting his life on the line for his country while profiteers get wealthy in armchair safety, I can understand he has other things to concern him," says Gonzalez. "But I have a right to expect more from the Secretary of Defense. He has prime responsibility in the area."

The important thing, Gonzalez says, is to begin a war profits probe now before the situation becomes explosive. "It's not a question of finding crooks," he says, "It's just a question of responsible government. We need a responsible and accurate assessment of the situation."

In its 3½-year existence, the National Academy of Engineering has hardly gained a position of eminence as a trusted adviser to governmental agencies. Not only is it a youthful organization, measured in terms of slow-moving Washington bureaucracy, but its executive secretary, Harold K. Work, was viewed as representing the "old school" of engineering thinking. This thinking, broadly speaking, favored technology for economic and business efficiency, rather than as a tool to help solve society's problems.

Work will retire in September to



Guide to Machlett Electron Tubes

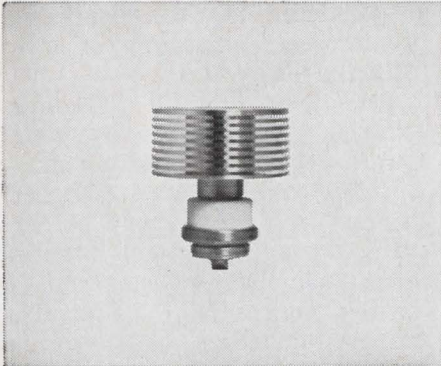

Planar Triodes.

Grid pulsed to 1 kw at 6 Gc. To 35 kw in pulse modulator service. For communications, radar beacons and navigation.

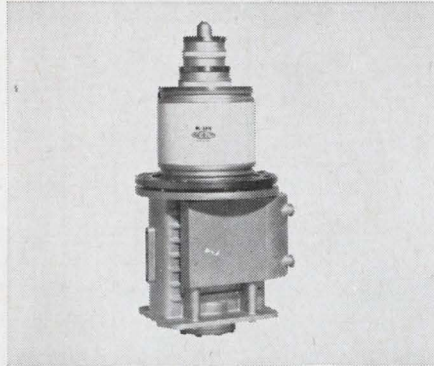

Magnetic Beam Triodes.

Pulsed ratings to 6 Mw with only 2.5 kw drive. CW ratings to 200 kW with only 0.7 kW drive.

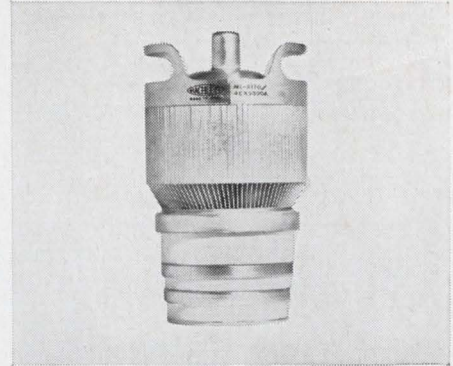

Heavy Duty Tetrodes.

Forced air cooled, water cooled and vapor cooled for broadcasting and communications.

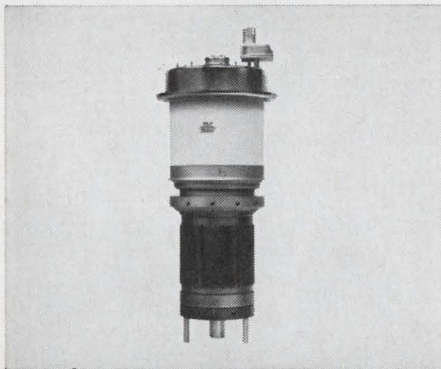

Pulse Modulators.

Shield grid triodes (oxide cathode) to 4.5 Mw, 80 kv peak. High voltage triodes (thoriated tungsten cathode) to 20 Mw with plate voltages to 200 kv peak.

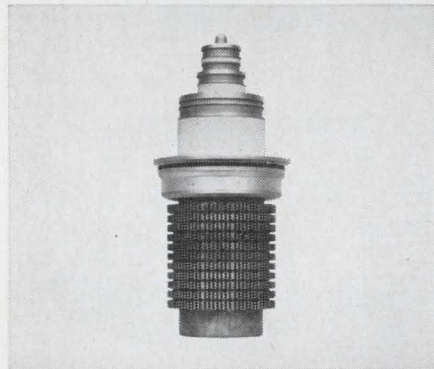

Heavy Duty Triodes.

Includes vapor cooled triodes, to 440 kW CW.



Vacuum Capacitors, Variable.

RMS amperes to 75A; voltage to 15 kv peak. Capacities from 5-750 pF to 50-2,300 pF.

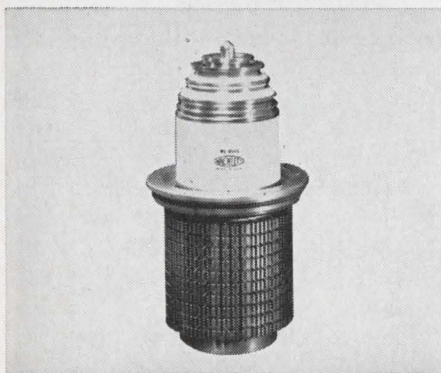

High Power Tetrodes.

Vapor cooled tetrodes to 350 kw CW for communications.

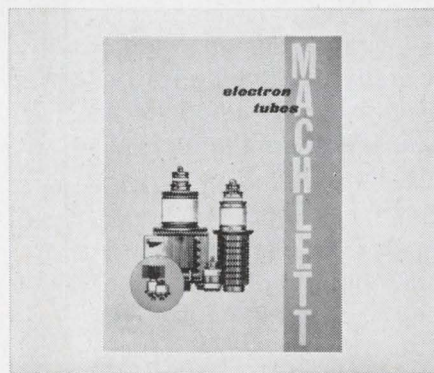

Send for latest condensed catalog

covering the entire line of Machlett electron tubes.

Write: The Machlett Laboratories, Inc., 1063 Hope Street, Stamford, Conn. 06907



THE MACHLETT LABORATORIES, INC.

A SUBSIDIARY OF RAYTHEON COMPANY

Take these
signals:

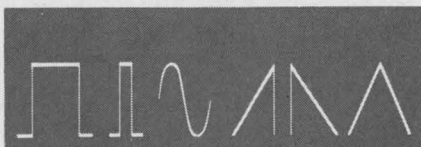

push-pull
them:

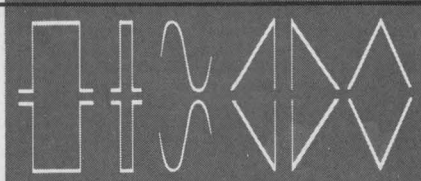

single-shot
or gate them:

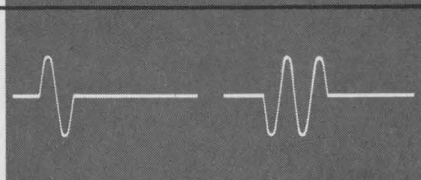

add VCF
at 50:1

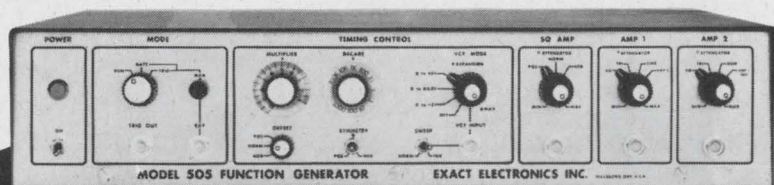
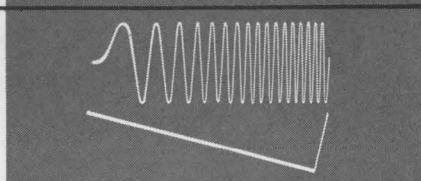

You can have all this . . .
for only \$595⁰⁰

Pulse — square — sine — triangle — ramp — reverse ramp waveforms — you can have them all with Exact's new Model 505 Function Generator. Three separate amplifiers give you three dissimilar or identical signals; or two may be operated push-pull while the third provides a different waveform. All outputs are individually adjustable from zero to approximately 25 Volts p-p, into a 600 ohm load.

The Model 505 operates at frequencies from 0.0001 Hz to 1.0 MHz, or turn a switch and double the output to 2.0 MHz. The VCF lets you sweep up, down, or up and down from center frequency with a 50:1 VCF ratio. There are other 500 Series generators available, with slightly different capabilities, priced as low as \$350. Call or write us today for details.

See us at Wescon — Booth #1425

EXACT electronics, inc.
Box 160, Hillsboro, Oregon 97123
Telephone (503) 648-6661

Who's who in electronics

become technical adviser to the Government of Iran. He is being succeeded by James H. Mulligan Jr., 47, chairman of the department of electrical engineering of New York University.

Get it going. From all indications, Mulligan will take some firm steps toward getting the academy moving. The academy was established by the National Academy of Sciences to promote research into significant national problems and to advise Congress and the Executive Branch "on matters of national import pertinent to engineering."



Mulligan

Action. One of the problems of serving as a "consultant" group to the Government is the fact that unless recommendations are made by prestigious names, with top support and trust in Washington, the reports simply are filed away and there are no shortage of reports and recommendations in Washington. It's expected that Mulligan will be able to pull together those people who can give academy recommendations the luster needed for action.

Because he's new on the job, Mulligan does not predict where the academy will expand its activities. But he does say there is need for greater activity. "We want to see that contributions of the engineering community are optimized," he says. "Mere technical knowledge does not by itself benefit society—there is a process of converting it to action."



At .0001", there must be total involvement

PRECISION ENGINEERING, PRECISION DESIGN, AND PRECISION MANUFACTURE, WITH MATERIALS SUCH AS DIAMOND, TUNGSTEN CARBIDE, AND SAPPHIRE AT TEN THOUSANDTHS TOLERANCES, REQUIRE ALL NEW APPROACHES TO BUSINESS AND TO MANAGEMENT . . . and very special people. Tempress has adopted the Standard of Excellence as its uncompromising pursuit. This is why Tempress people at every supervisory level must be professional managers as well as

expert technicians. Tempress describes its management policies as a form of total involvement. And this has produced a unique array of products . . . the standard of the Semiconductor Industry for miniature assembly tools and production machines. The benefits of total involvement can be extended directly to your production activities.













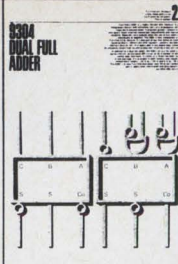
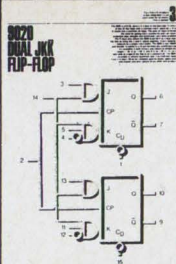
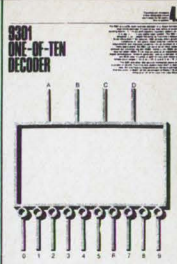

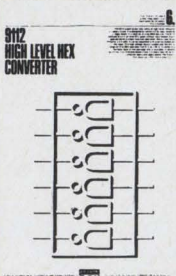
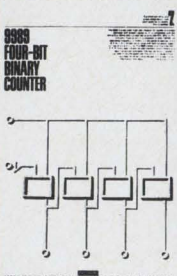
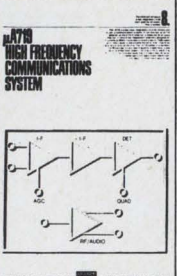
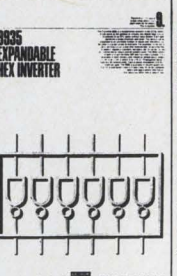
TEMPRESS

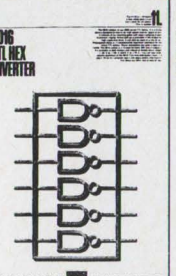
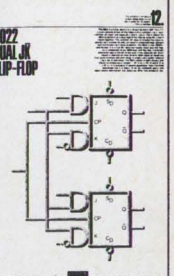
Tempress Research Co., 566 San Xavier Ave., Sunnyvale, Calif. 94086

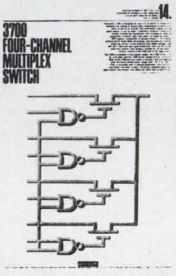
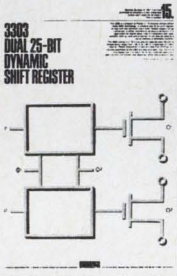
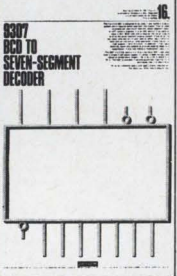
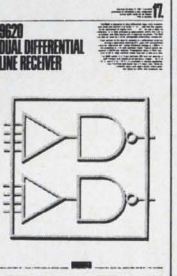
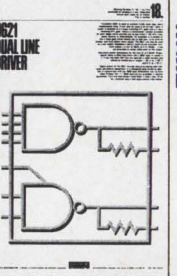
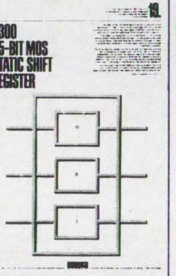
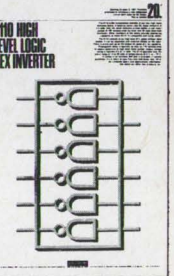
Circle 17 on reader service card

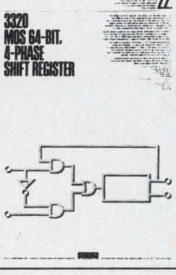
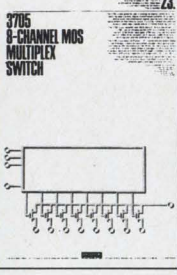
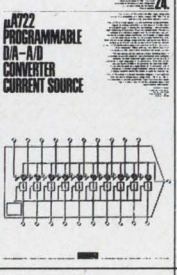
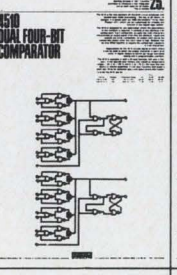
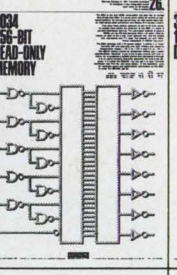
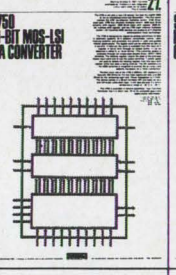
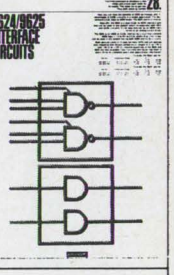
Fairchild has introduced 44 new products in the last 44 weeks.

Our goal is fifty-two new integrated circuits in fifty-two weeks. To obtain the Reader Service number for any product announcement ad, simply add 100 to the new product number. For example, New Product No. 3 is Reader Service No. 103.

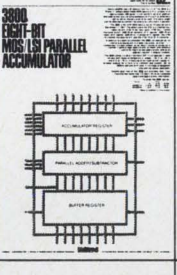
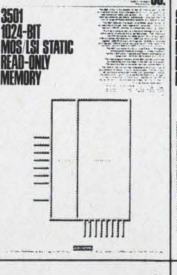
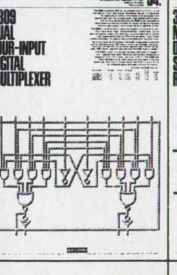
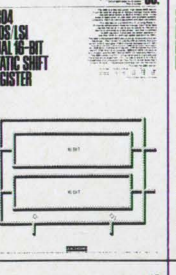
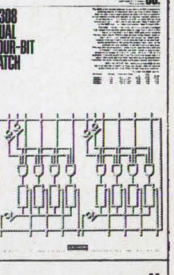
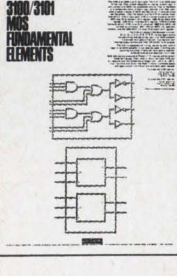
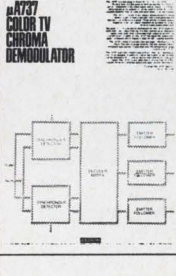
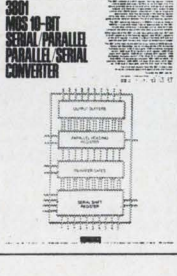
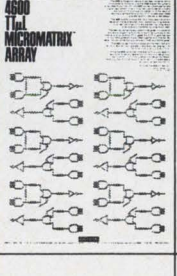
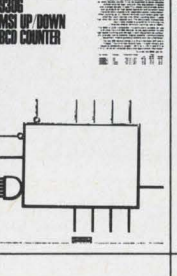
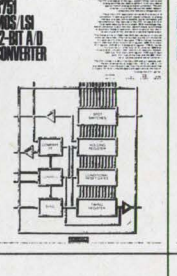
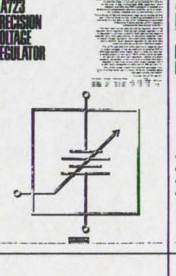
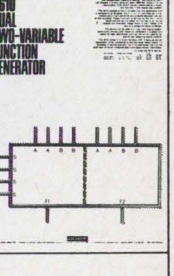
<p>9300 FOUR-BIT UNIVERSAL REGISTER</p> 	<p>9304 DUAL FULL ADDER</p> 	<p>9320 DUAL JK FLIP-FLOP</p> 	<p>9301 ONE-OF-TEN DECODER</p> 
<p>9109 HIGH LEVEL HEX CONVERTER</p> 	<p>9112 HIGH LEVEL HEX CONVERTER</p> 	<p>9989 FOUR-BIT BINARY COUNTER</p> 	<p>μA790 HIGH FREQUENCY COMMUNICATIONS SYSTEM</p> 
<p>9305 EXPANDABLE HEX INVERTER</p> 	<p>3701 SIX-CHANNEL MULTIPLEX SWITCH</p> 	<p>9016 TTL HEX INVERTER</p> 	<p>9027 DUAL JK FLIP-FLOP</p> 
<p>3102 MOS THREE-INPUT GATE</p> 	<p>3700 FOUR-CHANNEL MULTIPLEX SWITCH</p> 	<p>3303 DUAL 25-BIT DYNAMIC SHIFT REGISTER</p> 	<p>9307 RCD TO SEVEN-SEGMENT DECODER</p> 
<p>9620 DIFFERENTIAL LINE RECEIVER</p> 	<p>9621 DUAL LINE DRIVER</p> 	<p>3300 25-BIT MOS STATIC SHIFT REGISTER</p> 	<p>9110 HIGH LEVEL LOGIC HEX INVERTER</p> 
<p>4500 BIPOLAR MICROMATRIX ARRAY</p> 	<p>3320 MOS 64-BIT, 4-PHASE SHIFT REGISTER</p> 	<p>3705 8-CHANNEL MOS MULTIPLEX SWITCH</p> 	<p>μA722 PROGRAMMABLE D/A-A/D CONVERTER CURRENT SOURCE</p> 
<p>4510 DUAL FOUR-BIT COMPARATOR</p> 	<p>9034 256-BIT READ-ONLY MEMORY</p> 	<p>3750 10-BIT MOS-LSI DA CONVERTER</p> 	<p>9624/9625 INTERFACE CIRCUITS</p> 
<p>μA777 TEMPERATURE-CONTROLLED DIFFERENTIAL PREAMP</p> 	<p>9601 TRIGGERABLE MONOSTABLE MULTIVIBRATOR</p> 	<p>μA791 FREQUENCY COMPENSATED OPERATIONAL AMPLIFIER</p> 	<p>3800 EIGHT-BIT MOS-LSI PARALLEL ACCUMULATOR</p> 
<p>3501 1024-BIT MOS-LSI STATIC READ-ONLY MEMORY</p> 	<p>9309 DUAL FOUR-INPUT DIGITAL MULTIPLEXER</p> 	<p>3304 MOS-LSI DUAL 16-BIT STATIC SHIFT REGISTER</p> 	<p>9308 DUAL FOUR-BIT LATCH</p> 
<p>3100/3101 MOS FUNDAMENTAL ELEMENTS</p> 	<p>μA737 COLOR TV CHROMA DEMODULATOR</p> 	<p>3801 MOS 10-BIT SERIAL/PARALLEL SERIAL CONVERTER</p> 	<p>4500 TTL MICROMATRIX ARRAY</p> 
<p>9306 MSI UP/DOWN BCD COUNTER</p> 	<p>3751 MOS-LSI 12-BIT A/D CONVERTER</p> 	<p>μA723 PRECISION VOLTAGE REGULATOR</p> 	<p>4610 DUAL TWO-VARIABLE FUNCTION GENERATOR</p> 
<p>August 12, 1968</p>	<p>August 19, 1968</p>	<p>August 26, 1968</p>	<p>September 2, 1968</p>
<p>September 9, 1968</p>	<p>September 16, 1968</p>	<p>September 23, 1968</p>	<p>September 30, 1968</p>

More about:

Fairchild part number
9304 FA1 and FA2

2

9304 DUAL FULL ADDER

Fairchild's 9304 is a highly versatile MSIC. It contains two full adders in a single package. Each adder is capable of adding two 1-bit numbers and producing a 2-bit sum and a carry-out. The 9304 is fully compatible with Fairchild's 9309, a 4-input digital multiplexer. The 9304 is available in both 16-pin DIP and 16-pin hermetic DIP packages. For more information on this device, contact your Fairchild distributor or write to Fairchild Semiconductor, P.O. Box 9080, Mountain View, CA 94038.

Fairchild part number
9020

3

9020 DUAL JJK FLIP-FLOP

The 9020 is a JJK flip-flop in a dual in-line package. It contains two JJK flip-flops in a single package. Each flip-flop is capable of storing one bit of data and is controlled by J, K, and clock inputs. The 9020 is fully compatible with Fairchild's 9304 and 9309. The 9020 is available in both 16-pin DIP and 16-pin hermetic DIP packages. For more information on this device, contact your Fairchild distributor or write to Fairchild Semiconductor, P.O. Box 9080, Mountain View, CA 94038.

Fairchild part number
9309

34

9309 DUAL FOUR-INPUT DIGITAL MULTIPLEXER

The 9309 is another MSIC building block from Fairchild. It contains two four-input digital multiplexers in a single package. Each multiplexer is capable of routing one of four data inputs to one of two outputs. The 9309 is fully compatible with Fairchild's 9304 and 9020. The 9309 is available in both 16-pin DIP and 16-pin hermetic DIP packages. For more information on this device, contact your Fairchild distributor or write to Fairchild Semiconductor, P.O. Box 9080, Mountain View, CA 94038.

General purpose accumulator

Three new Fairchild ICs will give you two stages of a general purpose accumulator that can shift left, shift right, add, complement and clear.

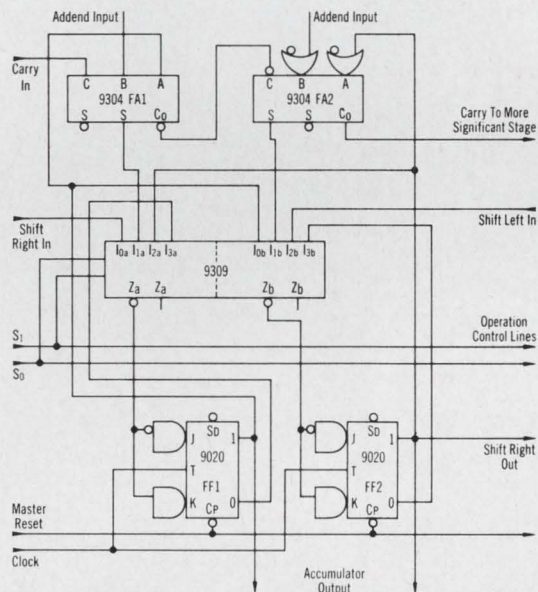

TWO STAGES OF A GENERAL PURPOSE ACCUMULATOR*

Two of the new devices are highly versatile MSIs: The 9304 Dual Full Adder and the 9309 Dual Four-Input Digital Multiplexer. They provide the same gating functions as seven or more discrete components. This low device count is the result of Fairchild's systems approach to designing complex circuitry. Our MSIs (and LSIs) are specifically designed to work together without interface circuitry. And, each device is highly versatile. For exam-

ple, the 9304 used in this application can be used in other systems as an adder, parity checker, exclusive OR circuit, or for a half-dozen other useful logic functions. You get the benefits of lower costs for design and devices, and higher reliability because of fewer connections. The third new device is our 9020 Dual JJK Flip-Flop. Like the 9304 and 9309, it is a dual device with the flexibility of two functional elements per package.

OPERATION CODE LIST		
S ₀	S ₁	INSTRUCTION
0	0	Shift Left
1	0	Add
0	1	Shift Right
1	1	Complement

The key device in this application is the dual four-input multiplexer. It provides logical implementation of a two-pole four-position switch that routes data to the commoned J and K inputs of the dual JJK flip-flop. (Note that in this application we have taken advantage of the inherent symmetry of the 9020; the J and K inputs have been reassigned so the faster negation output of the 9309 can be used.) Depending upon the condition of the S₀ and S₁ inputs of the multiplexer, the data provided to the flip-flops cause a left shift, right shift, addition of an externally supplied number, or the complementing of the register. A common direct clear sets the register to the all-zero condition.

The 9304, 9309 and 9020 come in 16-pin hermetic DIPs. They're available from your Fairchild distributor in both military and industrial temperature ranges. For complete specs and other applications information, circle Reader Service numbers 102, 103 and 134.

*Additional stages can be produced by repeating the same functional design.

FAIRCHILD
SEMICONDUCTOR

Fairchild Semiconductor A Division of Fairchild Camera and Instrument Corporation 313 Fairchild Drive, Mountain View, California 94040 (415) 962-5011 TWX: 910-379-6435



LLOYD

How the state of the art changed the state of the union.

America's broadcast industry started in 1920 and grew fast. By 1928 there were 677 radio stations. By 1934 over half the nation had sets, and new radio amateurs were starting up all over.

That was the year two young hams, Bill Eitel and Jack McCullough, made some higher power, shorter wavelength transmission tubes that were snapped up by other hams and later helped revolutionize the mushrooming broadcast industry. And Eimac — now one of our largest divisions — was in business.

Before that time newspapers had supplied facts, often days after the fact, and people frequently cared little about any but local matters. But radio's real-time reporting began telling them what was going on before it was too late to care.

Today Americans are informed citizens of the world, largely due to the opinion-shaping potential of radio and TV. And Varian's still vitally involved. Our Eimac power grid tubes, our klystrons and other microwave tubes are depended upon throughout the industry. Just as you can depend on our resident expert, the Varian Marketing Engineer, to tackle any broadcast problem, with the backup of the entire group if necessary. Talk to him. He'll deliver what you need.

Major products: microwave tubes;
power and special purpose tubes;
gas tubes; solid state devices;
microwave components; light
sensing and emitting devices;
industrial heating applications.



varian
electron tube and
device group

U.S. field offices in: Albuquerque;
Atlanta; Boston; Chicago; Dallas; Dayton;
Long Island; Los Angeles; New York; Philadelphia;
Phoenix; San Francisco; Syracuse; Tampa;
Washington, D.C.

International offices in: Amsterdam; London;
Melbourne; Paris; Sao Paulo; Stockholm;
Stuttgart; Sydney; Tokyo; Turin; Georgetown,
Ontario and Zug, Switzerland.

twt division
bomac division
national electronics, inc.
S•F•D laboratories, inc.
varian associates of canada, ltd.
solid state microwave operation
light sensing and emitting division
semicon associates, inc.
industrial microwave operation
palo alto tube division
LEL division
eimac division

Bulova ovens are the smallest going

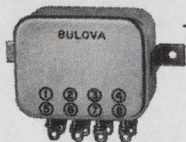

—but
they do
a
big job!

Simply stated, the Bulova BDX series is the smallest and most versatile in the miniature oven field!

Now, for the details. External dimensions are just 1.5" x 1.19" x .46" (or up to .9375", for larger models). Yet, the BDX can hold 1 to 6 tubular devices such as diodes, capacitors or resistors, up to .25" in diameter and length.

Controller is an RFI-filtered snap-action thermostat, meeting MIL-I-6181B. You get the BDX with your components installed and encapsulated in fluoro-carbon blown polyurethane foam insulation and hermetically-sealed. Result: a unit with minimal thermal leak that will withstand the most severe shock and vibration specifications.

The BDX is available with stud mounting, printed circuit board mounting, flange mounting or captive nut. Temperature settings from 50°C to 100°C are available, with a range of operating voltages from 6.3 to 117 VAC or DC. Temperature stabilities are as fine as .5°C over a -55°C to 90°C with a power drain as low as 5 watts.

This is just one of a complete line of Bulova ovens, including bi-metal thermostat, transistat, solid state switched mercury, and AC or DC proportional controls. For more information, write today to Dept. E-28.

Try Bulova First!

FREQUENCY CONTROL PRODUCTS
ELECTRONICS DIVISION
OF BULOVA WATCH COMPANY, INC.

61-20 WOODSIDE AVENUE
WOODSIDE, N.Y. 11377, (212) DE 5-6000

Meetings

G-AP and URSI

Topics of interest to engineers and theoreticians are slated for the joint meeting of the IEEE Group on Antennas and Propagation (G-AP) and the Union Radio Scientifique Internationale (URSI). The meeting will be held in Boston, Sept. 9 to 12.

The organizations will meet separately, with URSI holding sessions at the Hotel Somerset, and G-AP at Northeastern University. A shuttle bus will link the two.

Filling in G-AP. As at most G-AP meetings of recent years, the phased array antenna is much in evidence, as are plasmas and antenna behavior in ionized sheaths. But this year, there seems to be less emphasis on military work.

The two sessions on arrays illustrate this. A typical paper is "Cavity-Fed Concentric Ring Phased Array of Helixes," by K.R. Carver of the University of Kentucky and J.D. Kraus of Ohio State.

The authors have built an antenna which looks like a thick, flat disc with bedsprings arrayed on one side. The bedsprings are helical antennas, fed by concentric electric fields within the disk. By changing the amount of power fed to various quarters of the disc, the beam has been steered 18° off axis. The helical elements propagate and receive a circularly polarized beam—best for transmission through the loss-causing ionosphere, and thus good for radio astronomy.

In the same session, Charles F. Winter of Raytheon will report on a new approach to Cassegrain antenna design and discusses it in "a symmetrical limited scan antenna." Instead of the usual Cassegrain subreflector in front of a larger main dish, Winter substitutes an array of phase shift elements, and uses it to scan the beam without moving the main reflector.

Other G-AP sessions will treat propagation effects, scattering, and other areas. On Sept. 10, G-AP will hold a joint session with URSI, designed to bridge the gap between the theory- and hardware-oriented attendees.

Invited papers will cover "Electromagnetic Waves as a Tool for Sensing and Exploration." Among them will be University of Kansas' Richard K. Moore's discussion of radar as a geophysical tool and Northeastern University's Dr. Samuel Fine's treatment of laser light in medicine and biology.

This year, URSI's preoccupations are with propagation, the ionosphere, scattering, and plasmas.

Update. Recent developments in the Initial Defense Communications Satellite program will be described by Stephen Zolnay of Ohio State—who has much to say about the methods used to determine the satellites' performance, but little data about the performance itself, which is classified.

Mario D. Grossi of Raytheon, will report successful communication between satellites on opposite sides of the earth. Grossi and his coworkers used both h-f and vhf radio, establishing contact via ionospheric ducts.

G. E. Pollon of General Dynamics plans to describe a scheme that overcomes the pulse length and repetition rate dependence of typical radar systems and thereby resolves targets spaced so closely that ordinary systems couldn't separate them.

Throughout both G-AP and URSI's schedules, there's attention paid to h-f and vhf propagation, resolution of returns from oblique angles, improvement of directional accuracy of relatively low-frequency radar systems. A safe conclusion may be that the G-AP/URSI technical programs contain some basic research in over-the-horizon radar.

On example is B.D. Steinberg and Mark S. Zimmerman's paper "On Extending the Azimuthal Resolution of H-F Radar Arrays." The authors, from General Atronics, use a filter technique to remove potentially degrading signal components.

For more information, write Harold Raemer, 1968 International IEEE/G-AP Symposium and Fall USNC/URSI Meeting, 114 Hayden Bldg., Northeastern University, Boston, Mass., 02115.

(Continued on p. 24)

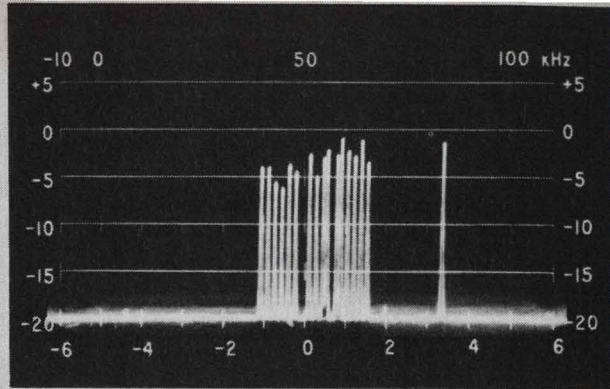

Three 4-kHz channels of L3 carrier multiplex system. Center channel has teletype subcarriers. Model 360A is in 12-kHz sweep width mode, sweeping from 6.780 to 6.792 MHz.

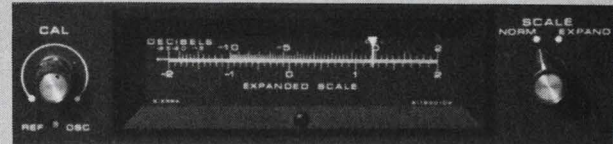

Switch-selected meter modes, normal or expanded scale, provide level measurement resolution of 0.05 dB. Signal generator level increments as fine as 0.01 dB can be readily resolved.

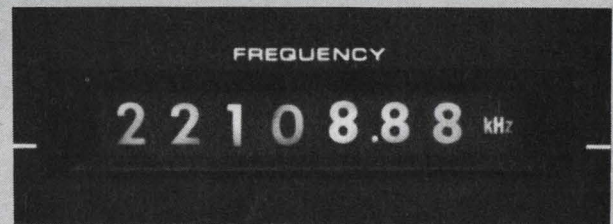

Frequency resolution to nearest 10 Hz in phase-locked tuning mode is displayed on flat-plane, high-brightness readouts. Alternative continuous tuning mode presents frequency resolved to nearest 100 kHz.

A Communications System Test Set (VLF to HF)...

From Sierra comes the most thoroughly human-engineered instrument for HF-radio and telephone-carrier applications in today's knob-and-meter-ridden world: The Model 305/360 Communications System Test Set.

Model 305/360 gives you ultra-bright, unambiguous electronic digital readouts of frequency. Built-in counter automatically totals outputs of both the coarse and fine tuning oscillators, reads out tuned frequency with 10-Hz resolution. Attenuator levels appear in three-digit displays, with unique logic and switching circuits combining the levels of the 10-dB and 1-dB per step attenuators. Rear-projection meters with luminous pointers permit parallax-free viewing from any angle with easy resolution of fine-level increments.

Performance features include phase-locked tuning circuits, a single continuous tuning range covering voice frequencies through 32 MHz, and selective bandwidths of 250 and 3100 Hz. You can resolve signals separated by as little as 35-Hz.

Model 305/360 does everything humanly possible to keep foibles from fouling your readings. For the brochure, write Sierra, 3885 Bohannon Drive, Menlo Park, California 94025.

°Average to Very Bright

engineered for humans (A to VB*)



PHILCO-FORD CORPORATION
Sierra Electronic Operation
Menlo Park, California • 94025

Circle 23 on reader service card



EXTRA DRY

In a martini, it's a matter of taste — in a K-Grip Jr. RF connector in wet, humid climate, it's essential. That's why our new series of plugs and jacks is moisture-proof.

The dry is extra. All the rest is K-Grip Jr. — the lowest cost, high-reliability RF connector installed. Almost 50% smaller, 50% lighter, it's a crimp type version of our standard RF connector reduced to its simplest form. Assembly is foolproof — in seconds.

With K-Grip Jr. RF connectors it's a matter of savings. We save you time, weight, space and, in our new series of plugs and jacks, we save you from weather-worry. Write for details.

KINGS

ELECTRONICS CO., INC.
40 Marbledale Road/Tuckahoe, N.Y. 10707
(914) SW 3-5000 / TWX 914-793-5879

Meetings

(Continued from p. 22)

Calendar

United Nations Conference on the Exploration and Peaceful Uses of Outer Space, United Nations General Assembly; Vienna, Aug. 14-27.

Conference on Radar Meteorology, American Meteorological Society; Montreal, Aug. 19-23.

Association for Computing Machinery Conference and Exposition; Las Vegas, Nev., Aug. 27-29.

International Symposium on Nuclear Electronics, Societe Francaise des Electroniciens et des Radioelectriciens; Versailles, France, Sept. 10-13.

Meeting of the Union Radio Scientific International; Northeastern University, Boston, Sept. 10-12.

Symposium on Computer Control of Natural Resources and Public Utilities, International Federation of Automatic Control; Haifa, Israel, Sept. 11-14.

Solid State Sensors and Transducers Symposium, IEEE and Instrument Society of America; Leamington Hotel, Minneapolis, Sept. 12-13.

Joint Power Generation Conference, IEEE and American Society of Mechanical Engineers; Jack Tar Hotel, San Francisco, Sept. 15-19.

Space Simulation Conference, American Institute of Aeronautics and Astronautics; Seattle, Sept. 16-18.

International Symposium on Analog and Hybrid Computation Applied to Nuclear Energy; Versailles, France, Sept. 16-18.

International Conference on Microwave and Optical Generation and Amplification, IEEE and the University of Hamburg; University of Hamburg, West Germany, Sept. 16-20.

Conference on Measurement Technology, Scientific Apparatus Makers Association and the National Bureau of Standards; National Bureau of Standards Laboratories, Gaithersburg, Md., Sept. 17-18.

Conference on Tube Techniques, IEEE; United Engineering Center Auditorium, New York, Sept. 17-19.

Technical Association of Pulp and Paper Industry Engineering Conference; Regency-Hyatt House, Atlanta, Sept. 18-21.

(Continued on p. 26)

More innovation from the real power in power:

More-advanced power hybrid IC's.

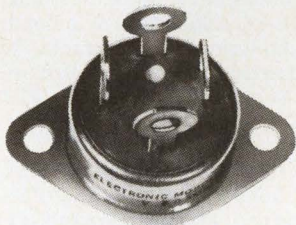

Actual Size

power semiconductor know-how?

It's obvious what this means in power hybrid IC's. Greater flexibility to build more into a circuit to start with. Plus quality from raw materials to finished power function, all under one roof. Immediate off-the-shelf delivery. And attractive prices.

Take our new, thick-film, 10-amp, integrated bridge rectifier for power supplies, AC/DC converters and motor controls. Customers tell us it's the most advanced power hybrid of its type on the market. Because it combines Bendix hybrid fabrication techniques with plastic encap-

It figures.

Who is better equipped than Bendix to make the most advanced power hybrid integrated circuits? Who has spent more time working with your kind of power circuit requirements? And who has more "in-house" access to

sulation in a standard TO-3 package. Because it matches functional specs to your needs: 10-amp average DC output current at 65°C; up to 600 volts Peak Reverse Voltage per leg; and 70- to 420-volt RMS voltage range. And because it gives the design engineer a universal circuit at a low price.

Yet, this unit is just a taste of things to come in Bendix power hybrid integrated circuits: Power audio amplifiers. Power darlington. Power-driver modules. Voltage regulators. And more. Much more.

Looking for the most advanced power hybrid IC's? Look up the real power in power—Bendix. Contact your nearest sales office or write the Power Specialists: Semiconductor Division, The Bendix Corporation, Holmdel, New Jersey 07733.

Bendix **Electronics**

Chicago—(312) 637-6929; Dallas—(214) 357-1972; Detroit—(313) 548-2120; East Northport, N.Y.—Harry Friedman Co. (516) 692-2839; Great Neck, N.Y.—H. V. Sales Co. (516) HU 7-1142; Greenwich, Conn.—(203) 869-7797; Holmdel, N.J.—(201) 946-9400; Lexington, Mass.—(617) 861-8350; Los Angeles—(213) 776-4100; Minneapolis—(612) 926-4633; Orlando, Fla.—(304) 241-6559; Rochester, N.Y.—(716) 266-5550; Runnemeade, N.J.—(609) 933-2550; Seattle—Ray Johnston Co., Inc. (206) LA 4-5170; Export—Cable: "Bendixint," 605 Third Avenue, New York, (212) 973-2121; Ottawa, Ont.—Computing Devices of Canada, P.O. Box 508 (613) 829-1800; San Juan, Puerto Rico—Southern International Sales Co. 723-3879.



Temp-R-Tape® T

One of a series of self-adhering tapes of skived Teflon* TFE. High elongation provides excellent conformability for tight wraps around irregular surfaces.

Temp-R-Tape HM-350

Made of skived Teflon TFE. A unique CHR manufacturing process imparts lower elongation and higher breaking strength. Good conformability.

Temp-R-Tape C

Extruded Teflon FEP film has extremely high electric strength, highest of all Temp-R-Tapes. Transparent for easy read-through. Excellent conformability.

Temp-R-Tape Kapton*

Made from a polyimide film. Has outstanding thermal endurance. Retains physical and electrical properties at elevated temperatures. *T.M. OF DUPONT

Temp-R-Tape GV

Closely woven glass cloth. Good conformability and flexibility. Strong. Puncture and tear resistant. Excellent abrasion resistance and thermal stability.

Temp-R-Glas®

Glass fabric coated with Teflon TFE. Four thicknesses. Resists Teflon cold flow. Strong. Puncture and tear resistant. Also available without adhesive.

WE MAKE SIX DIFFERENT TYPES OF WIDE TEMPERATURE RANGE ELECTRICAL TAPES.

THAT WAY WE'LL HAVE ONE THAT'S JUST RIGHT FOR YOUR APPLICATION.

Temp-R-Tape is operational from -100 F to +500 F, has excellent electrical and physical characteristics. Pressure sensitive silicone polymer adhesive. Stocked by a national network of distributors capable of technical assistance and fast delivery. Look under CHR in industrial directories or micro-film catalogs. Or write for details and sample. The Connecticut Hard Rubber Company, New Haven, Connecticut 06509.



Subsidiary of U.S. Polymeric, Inc.

Meetings

(Continued from page 24)

Broadcast Symposium, IEEE; Mayflower Hotel, Washington, **Sept. 19-21.**

Aerodynamic Deceleration Systems Conference, American Institute of Aeronautics and Astronautics; El Centro, Calif., **Sept. 23-25.**

Electronics Design Conference, IEEE; University of Cambridge, England, **Sept. 23-27.**

International Congress of Cybernetic Medicine; Naples, Italy, **Sept. 23-27.**

Symposium on Physics and Nondestructive Testing, Gordon & Breach Science Publishers Inc.; O'Hare International Inn, Sciller Park, Ill., **Sept. 24-26.**

Ultrasonics Symposium, IEEE; Statler Hilton Hotel, New York, **Sept. 25-27.**

Joint Engineering Management Conference, IEEE; Marriott Motor Hotel, Philadelphia, **Sept. 30-Oct. 1.**

Government Microcircuit Applications Conference, Department of Army; Washington, **Oct. 1-3.**

Allerton Conference on Circuit and System Theory, IEEE; Allerton House, Monticello, Ill., **Oct. 2-4.**

Call for papers

Region Six Conference, IEEE; Phoenix, Ariz., April 16-18, 1969. **Dec. 9** is deadline for submission of abstracts to Sloan D. Robertson, program chairman, 1969 IEEE Region 6 Conference, 722 West Frier Dr., Phoenix, Ariz. 85021

Electrical Insulation Conference, IEEE and the National Electrical Manufacturers Association; Sheraton-Boston Hotel, Boston, Sept. 8-11, 1969. **Sept. 15** is deadline for submission of titles and brief descriptions of proposed papers to H. P. Walker, Naval Ship Engineering Center, Washington, D.C. 20360

Short Courses

Fundamental project management matrix, Tustin Institute of Technology, Santa Barbara, Calif., **Aug. 19-21;** \$275 fee.

Automation in electronic testing equipment, New York University, New York, **Aug. 26-30;** \$245 fee.

Nonlinear optics, University of Rhode Island, Kimble Union Academy, Meriden, N. H., **Aug. 26-30;** \$120 fee.

**Is there an AC digital
voltmeter anywhere
that can measure this
waveform accurately?**

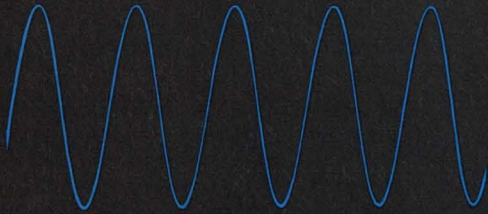

.....And this one too?

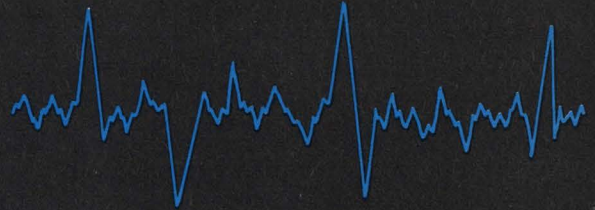

**There is now! The new Fluke 9500A
true rms automatic digital voltmeter reads these
complex waveforms to an accuracy of $\pm 0.05\%$.
And if you know your AC's, that's progress.**

Another DVM on the market? Usually that's good for a ho-hum. But as we've said above, if you know your ac's, that's not the case with the new Fluke 9500A. It's the first automatic ac voltmeter capable of reading and digitally presenting the true rms value of any input—regardless of waveform—to 0.05% absolute accuracy (50 Hz to 10 KHz).

Frequency response is broad, 20 Hz to 700 KHz. The Model 9500A accepts voltage from .001 to 1100 volts rms in five ranges, each with 20% overranging. Range selection is automatic or manual. Crest factor of 10 virtually eliminates effects from voltage spikes or pulse trains.

See us at WESCON Booths #2301, 2302, 2303

Low capacitance, high resistance input minimizes loading effects.

Self-calibration is automatic whenever the instrument is turned on. On-line self-calibration is either automatic or manual, selectable by front panel switching. All controls and indicators, conveniently located on the front panel, are easy to use and understand. Complete control of the 9500A is possible from a remote facility if desired.

Price of the Model 9500A, including rack adapter, is \$2,485. Extra cost options include a probe input (\$75), rear panel BNC input (\$50), and 1-2-4-8 or 1-2-2-4 BCD digital outputs (\$195). For

complete information, please call your full service Fluke sales engineer (see EEM), or write directly to us here at the factory.

Fluke, Box 7428, Seattle, Washington 98133. Phone: (206) 774-2211. TWX: 910-449-2850. In Europe, address Fluke International Corp., P.O. Box 5053, Tilburg, Holland. Telex: 844-50237. In the U.K., address Fluke International Corp., P.O. Box 102, Watford Herts, England.



Circle 27 on reader service card

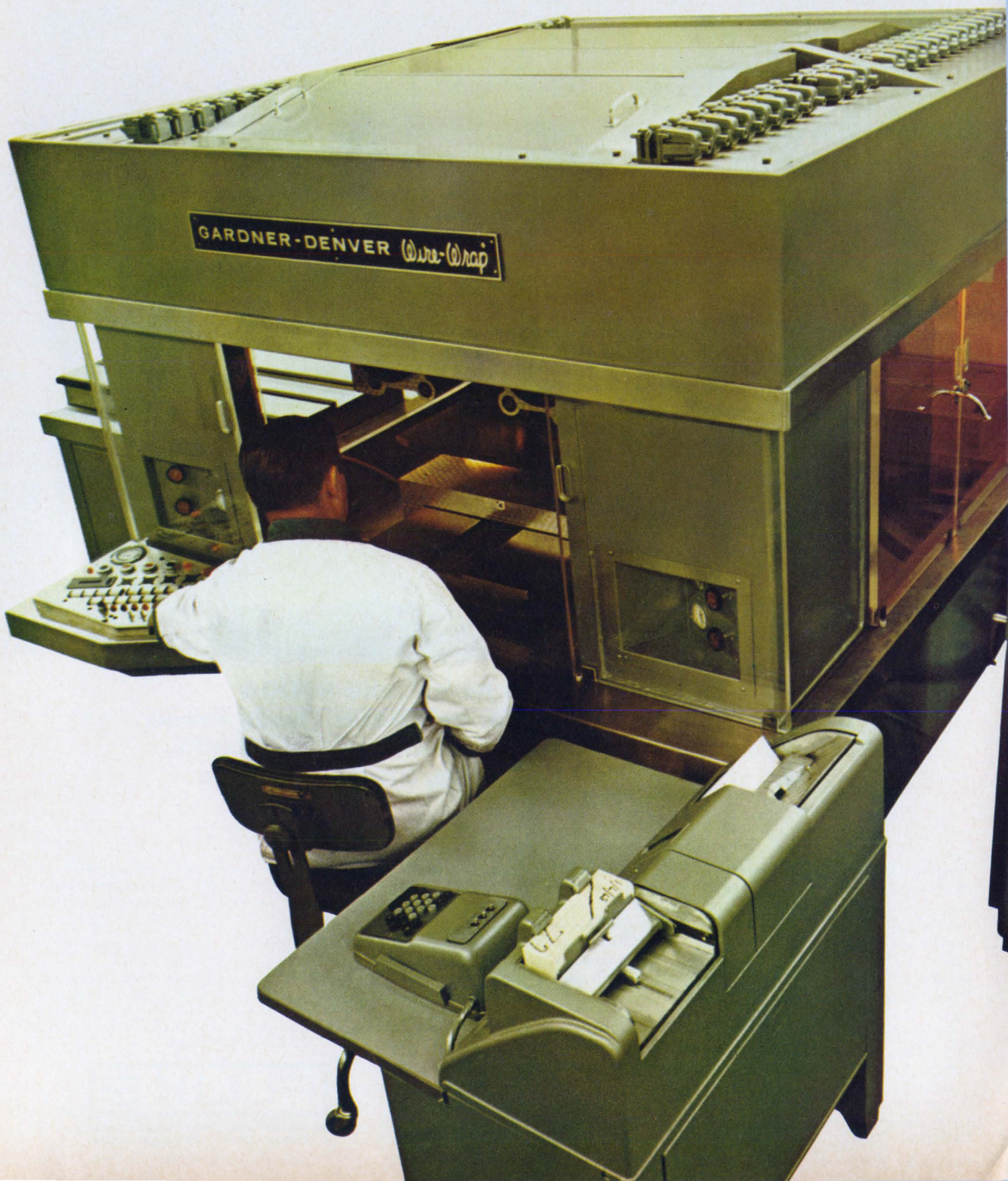

automate

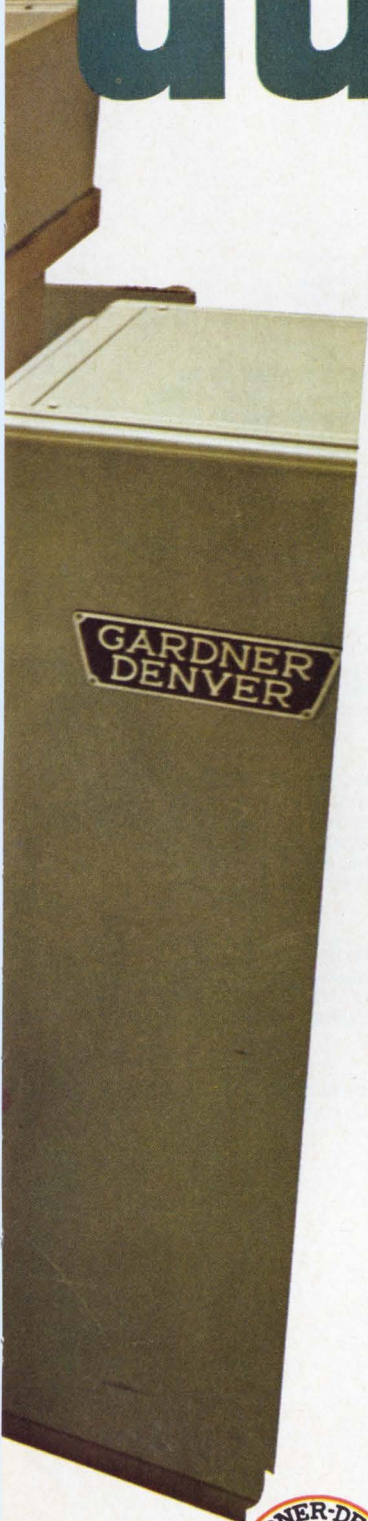

Unique Gardner-Denver Wire-Wrap[®] machines wire back panels at the rate of 1,600 connections an hour... without error

What happens when you try to wire panels where the pin matrices have 0.100-inch centers? You create a rat's nest, that's what, unless—

Unless you use a Gardner-Denver Wire-Wrap machine. Wire-Wrap machines, assisted by computers and instructed by punched cards, automatically position the back panels, cut the wire, strip the insulation from it, and wrap the wire around the desired terminals—at a speed 25 times faster than hand-soldering. Complete computer back panels may be wired in 2 hours.

Cost-savings, needless to say, are spectacular, can range as high as 50 to 1 over hand-soldering.

And the connections are reliable, remain airtight even when exposed to extreme changes of temperature and humidity. Not a single reported electrical failure in billions of connections. There's minimum crosstalk between wires. The wirepath consistency is nearly equal to that of printed circuits.

So sensitive to error is the Wire-Wrap machine that it will stop if it detects an error in card sequence or card punching. Wiring defects stop the machine immediately so the operator can correct them.

Wire-Wrap machines today are widely used in fabricating telephone exchanges, computers, communications equipment, guidance systems.

Call today for complete information—or write for Bulletin 14-121.



GARDNER-DENVER

Gardner-Denver Company, Quincy, Illinois 62301

Which IC Test System does all these things?

DIAGNOSTIC COMPUTER PROGRAMS automatically check out system operation.

FAST TESTING. 1.5 msec per test. If crosspoint is changed, 5 msec. 10 msec on the lowest current scales.

DATALOG A FORCING FUNCTION, such as the input threshold level of a flip-flop needed to produce a specified output.

AUTOMATIC SELF-CHECKING assures accurate data transfer between operator, teletypewriter, computer and test instrument.

TEN-YEAR GUARANTEE for all instrument plug-in circuitry (it's almost all plug-in).

TYPED SUMMARY SHEETS. Whenever desired. No interruption in testing. Give total units tested per test station, test yields and bin yields.

VERY COMPLEX TEST SEQUENCES can be programmed, yet preparation of simple tests can be learned in two hours.

GROWING LIBRARY of improved software packages to insure against obsolescence.

NO ADJUSTMENT OR CALIBRATION POINTS. (Eternal vigilance is the price you pay for a single adjustment.)

DIRECT ENGLISH data logging type-out, showing job name, serial number, test number, decimal point and units.

OPEN AND SHORTED CONNECTIONS and **OSCILLATIONS** are automatically detected. System stops when a selected consecutive number of these occur.

ABSOLUTE SOURCE CONTROL. Sources can be turned **ON** or **OFF** and changed in value in any sequence with variable delays from 100 μ sec. to as long as you please.

COMPLETE FRONT PANEL DISPLAY at any desired step, simultaneously indicating all crosspoint connections, forced values, measured limits, binning decisions—everything about each test.

DATALOG at any test station—without slowing down classification tests at any other station.

MINIMIZED REPETITIVE INSTRUCTIONS for the operator through data libraries, variable word length programming, and autopinping.

MULTIPLEXING. Several jobs simultaneously. Any assigned, at any time, to any test station.

PROGRAMMABLE CURRENT LIMITS for each source at each test.

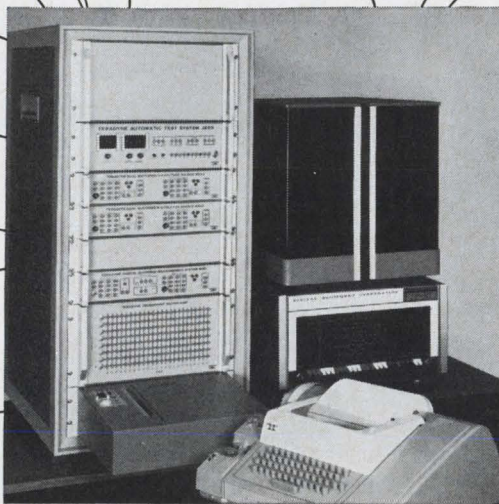

This one.

(complete for only \$65,000)

This is our J259 computer-operated Automatic Circuit Test System. It includes a general-purpose digital computer, teletypewriter, test instrument (comprising modular elements: 24 x 8 crosspoint matrix, four volt-

age sources, measurement system, and test deck), complete software package, and courses in IC testing, system operation, and maintenance. TERADYNE, 183 Essex St., Boston, Mass. 02111 Phone (617) 426-6560.

TERADYNE

"See Us at WESCON, Booth 2306"

Editorial comment

Graphics may return control to the engineer

The unequivocal acceptance of the computer as an aid in designing circuits and systems may be retarded unless the designer has the option of interrupting his program while it is running. Too often batch processing makes him feel the computer is in control. He must be able to interact with the program—to view partial results and modify his actions to suit.

Time sharing and computer graphics together may give him what he needs. Yet neither has fulfilled its press notices. Time-sharing systems are subject to limited subscriber capacity and bandwidth limitations, and graphics has been oversold.

Even so, at the Spring Joint Computer Conference the most crowded exhibits were those displaying equipment for talking with computers via light pen and scope. At the recent Design Automation Workshop in Washington, D.C., engineers and programmers met in clusters during coffee breaks to discuss graphics. With all the attention, there is an underlying concern that graphics will be too costly and not versatile enough for some time to come. Behind that pessimism is a recognition of the high cost of software needed to support graphics.

Yet hope looms that standardizing efforts will help reduce the cost of graphics and extend its use. A basic set of subroutines ought to be able to handle most of the graphic manipulations—like drawing lines, erasing, rotating images, and zooming in on them.

Chiefly to encourage standardization of graphics, IBM has undertaken a cooperative project with several of its customers. Called Project Demand, its goal is to provide a common environment for users of graphics. The project is managed by a committee of representatives from IBM and participating companies. Separate teams are considering geometries and data bases as well as how graphics can be used in different applications. IBM hopes that Project Demand will encourage industry standards and that the military will endorse its recommendations. IBM's efforts are commendable, yet one can sympathize with other computer makers who fear the standards may be compatible only with IBM equipment.

Behind the graphics must be a program to solve the engineer's practical problems. Experts suggest that a single well-designed general-purpose program could handle up to 90% of today's design problems. Indeed, it is the programmer's dream to develop a program so versatile it can handle with equal ease problems involving circuit design, thermal analysis or mechanics.

In theory, it is possible to design a program to solve any problem that can be defined mathematically. The danger lies in the expectation that designers will accept compromises in input/output capabilities, resulting from the versatility of such a program. They won't. Unless the user feels an affinity for the program and can talk to it comfortably in his own language, the best program will stay on the shelf.

Systems engineering for the airlines

It is puzzling why the airlines have dragged their feet in automating check-in and loading of passengers. Could it be that speeding up the system at that point would accentuate the delays on the taxiways and in landing stack-ups? Delays caused by heavy traffic at New York's metropolitan airports range from one-half hour (normal) to more than six hours.

When, "in the interests of safety", air traffic controllers began operating by the rules our first inclination was to cheer. But they should not be applauded for belatedly doing their job.

The groundwork for botched operations at U.S. airports was laid when the FAA failed to press for increased airport capacity in time to meet the obvious need. Furthermore, the agency

has hired no new air controllers since 1963, while at the same time it has been unable to convince Congress of the urgent need for studies of advanced navigation equipment.

The airlines themselves (represented by the Air Transport Association) have not exploited electronics in controlling traffic safely and efficiently. The airlines' imagination seems fired only by dreams of bigger payloads and routes to the South Pacific, not by the safety and comfort of their passengers.

Finally, the electronics industry itself must assume its share of the blame for failing to sell available techniques and technology to the government and the airlines. A good systems engineering approach to the problem is long overdue.



THE NEW IDEAS COME FROM GENERAL ELECTRIC

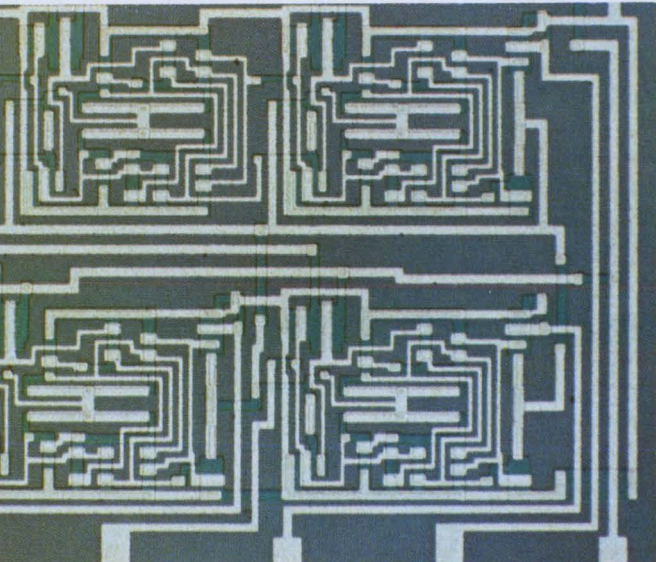
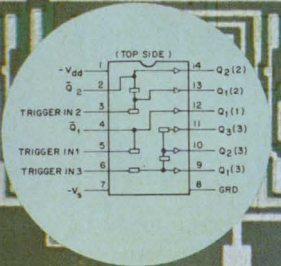
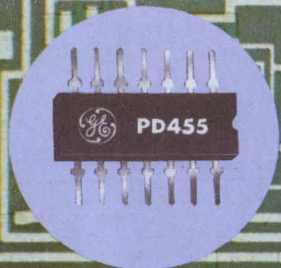

IN SEMICONDUCTORS. A 6-stage MOS-FET bi-stable frequency divider, PD455, is now available for consumer and industrial applications. The PD455 utilizes p-channel enhancement mode technology. It features stages internally connected in groups of 1-2-3 for design flexibility, short circuit protection, zener protected inputs and 0 to 1mHz toggle frequency. Typical applications include: musical instruments, long-term timing circuits and low frequency oscillators. Rely on General Electric for advanced MOS-FET circuits. Circle No. 90.

IN CAPACITORS. GE wet slugs offer lowest leakage current, smallest size per volt-mfd of any electrolytic capacitor. In applications with high volt-mfd requirements, GE wet slugs can often replace physically larger solid tantalums—without increasing cost! Circle No. 91.



IN TUBES. We've built thousands of separate planar tube designs for industrial and military applications. Each offers effective operation in oscillators to x-band (9.6gc) in extremely adverse environments such as artillery and missile fusing and other critical requirements. You expect such high performance and application flexibility from GE—world leader and innovator in planar tubes. And, you'll find similar extra values in every GE tube and allied product, including power tubes, compactrons, pressurized reed switches, photo cells, and display devices. Circle No. 92.



IN RECHARGEABLE BATTERIES. Top reliability of GE nickel-cadmium cells permits use for aircraft emergency lighting. High current discharge, vibration resistance are other features. GE sealed cells offer extra values in rechargeable portable power. Circle No. 93.

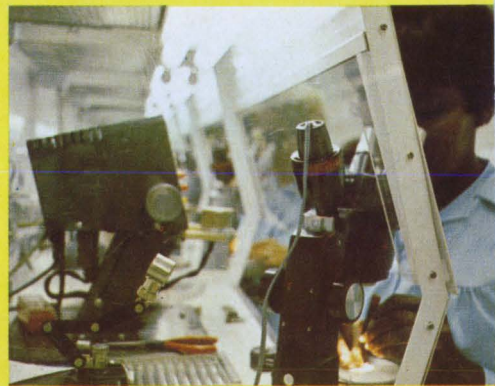

IN SEALED RELAYS. At GE, quality begins in research and continues through final assembly. Clean-room manufacturing, all-welded construction, test after test on parts and finished product—they're just part of our total effort to give you relays to rely on. Circle No. 94.

For the new ideas in electronics, look to General Electric—your best single source for electronic components 285-39

ELECTRONIC COMPONENTS SALES OPERATION

GENERAL  ELECTRIC

Electronics Newsletter

August 5, 1968

Lincoln Lab combines flip-chip, beam-lead technique

An integrated-circuit assembly technique that combines the advantages of beam-leading and flip-chip approaches has been developed by Lincoln Laboratory's IC research group. In the technique the beam leads are simply put on the substrate—not the chip—and bonded to ordinary monolithic IC's. The IC's fit into cavities etched in the substrate so that the IC connection pads meet the beam leads that extend over the edge of the hole. Simple ball bonds or thermocompression assure electrical contact.

Lincoln Lab has already used the technique to build a complex array of TTL functions. Assistant group leader Robert McMahon says that the method overcomes the geometrical constraints forced on board designers by flatpacks and avoids the bonding uncertainties of flip-chip techniques and the uncertain availability of beam-lead IC's.

Philco-Ford has already asked the lab for all available information on the process and is speeding to get the new technique to the marketplace. There are also reports that at least one other large semiconductor firm has found out about the lab's work and is trying a similar approach.

MSI may fly in the Cheyenne

Medium-scale integration, now being applied in only a handful of experimental projects, may get a full-time workout in the Air Force's Cheyenne helicopter. General Electric's Avionic Controls department is negotiating with Fairchild Semiconductor to acquire MSI circuits for the electronic controls of the helicopter's swiveling gunner's station. GE is building the stations for the Cheyenne under a \$50 million subcontract from Lockheed.

Carterphone decision stayed by FCC

The stay granted late last month by the FCC in the controversial Carterphone decision will pave the way for a tariff and rules spelling out the conditions under which private telephone attachments can be accommodated [See earlier story, p. 73].

The stay was granted by the FCC to allow the Bell System time to petition for certain limitations on the use of this equipment.

A spokesman for the newly formed Electronic Industries Association's ad hoc engineering committee on attachments says, "We felt there was a possibility of a stay in the offing all along and it also gives us time to get the technical answers to support or attack the carriers' recommendations."

Welty returns to Motorola

After seven months as general manager of Philco-Ford's Microelectronics division in Santa Clara, Calif., John Welty is returning to the Semiconductor Products division of Motorola as a corporate vice president and director of product and operating groups—the same titles he held when he left Motorola. The Philco-Ford product groups under Welty were germanium transistors, plus all diode and rectifier efforts. Welty stresses, however, that although his new responsibilities will be similar to his former duties in Phoenix, he has no specific description of what activities will be reporting to him.

He says he is leaving Philco-Ford rather than move to Pennsylvania, where the Santa Clara operations are being transferred; ironically, he

Electronics Newsletter

recommended that the operations be moved. Welty maintains that he has no quarrel with Philco-Ford officials and that his main reason for leaving Motorola had been his desire to live in the San Francisco area.

TRW goes back into IC business

TRW has quietly gone back into the integrated-circuit business with the establishment of a division in the electronics group—TRW Microelectronics. The move had been rumored for some time [Electronics, May 15, 1967, p. 26] and was made in April. Q.T. Wiles, a corporate vice president who also serves as manager of TRW Semiconductors, is manager of the new division, which is parallel in the organization with TRW Semiconductors. W.D. Rasdal, assistant division manager, says TRW Microelectronics will make hybrid, monolithic, and large-scale integrated devices, with initial emphasis on hybrids. The devices will be aimed at the microwave and communications systems markets. Rasdal says the division is working on digital-to-analog converters and active filters, and he expects early development of microwave devices with frequencies in the 6 gigahertz region.

TRW dropped out of the IC business about four years ago after doing early development in transistor-transistor logic. Since then, the firm's only microelectronics activity has been centered in the systems group's microelectronics laboratory, which isn't expected to be affected by establishment of the microelectronics division.

Lockheed stays in the running for Intelsat 4

Officials of Comsat and Intelsat's interim committee this week will be examining a revised proposal for the Intelsat 4 satellite submitted by Lockheed Missiles and Space. Last month the consortium's interim committee approved Hughes Aircraft's final draft proposal but also told Lockheed it could stay in the running for the award by revising its original proposal [Electronics, July 22, p. 33]. Lockheed has now rewritten the financial and managerial portions of its plan, "tailoring it to meet the criticisms of Intelsat," as one company official puts it.

While Hughes is still considered the favorite for the contract, Comsat officials are quick to point out that Lockheed is still being considered. The final decision will be made by the interim committee at its next meeting, beginning Sept. 23, in Washington.

Also expected at the meeting: an official and final rejection of the proposal to build an interim communications satellite dubbed the Intelsat 3.5.

Addenda

Flight tests of collision-avoidance equipment for the Air Transport Association will be handled by Martin-Marietta. The tests, slated for June to November next year, will be conducted with five aircraft equipped with hardware from Bendix, Collins, McDonnell Douglas, and Sierra Research and Wilcox Electric jointly. Results will be available by the end of 1969. . . . The doppler radar sensor for the doppler-inertial-loran (DIL) navigation system being developed for the Air Force by Litton's Guidance and Control Systems division will be furnished by General Precision Laboratories. The multisensor system [Electronics, June 24, p. 25] will be considered for new tactical aircraft to improve both navigation and weapons delivery accuracy. General Precision beat Ryan Aeronautical and Canadian Marconi in the competition.

LOOKING FOR LOW-COST AUTOMATION?

EAGLE'S "MT" SEQUENCE PROGRAMMER makes it as simple as A-B-C

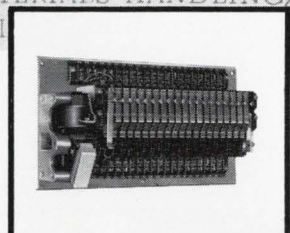

THIS SIMPLE, YET VERSATILE PROGRAMMER

... combines all your sequential functions using 10 amp. contacts to directly control load circuits. Everything is out in the open and unbelievably easy to understand.

SYSTEM OPERATION	CONTROL DEVICE TO ADVANCE TO NEXT STEP	LOADS		
		1	2	3
Off	Push Button	1	0	0
Solenoid Valve No. 1 Energized	Limit Switch No. 1	2	X	0
Hydraulic Ram Hits End of Movement	Timer No. 1	3	X	X
Solenoid Valve No. 1 Energized	Timer No. 1	4	X	X
Timer Holds Ram in Position for Adjustable Time	Timer No. 2	5	X	0
Solenoid Valve No. 1 Energized	Timer No. 2	6	X	0
Pump and Timer No. 2 Starts	Limit Switch No. 2	7	X	0
Solenoid Valve No. 2 Energized	Limit Switch No. 2	8	X	0
Solenoid Valve No. 2 Energized	Limit Switch No. 2	9	X	0
End Ram Hits Limit Switch 2	Limit Switch No. 2	10	X	0

SIMPLE AS A-B-C TO APPLY

A Use This Circuit Design Chart. Develop your electrical circuit by simply listing the input devices and the loads in the operational sequence desired on the helpful chart shown at the left. Copy of this chart will be forwarded when you ask for "MT" data. Additional copies available.

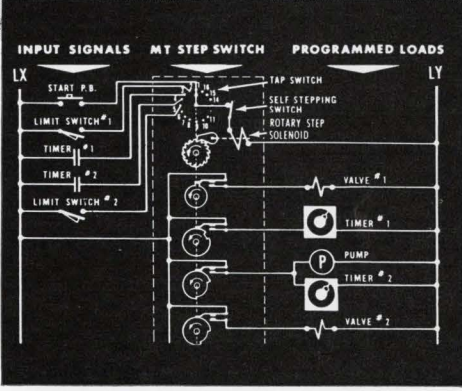

THIS IS A TYPICAL APPLICATION

Years of direct and positive control at low cost are assured.

COMPLETE FREE INFORMATION

The basic and nearly inexhaustible versatility of the Eagle "MT" sequence programmer can solve scores of automation problems for you. Complete "how-to-do-it" literature will be forwarded when you use reader service number below, or write:

Eagle Signal Division
E. W. Bliss Company
736 Federal Street
Davenport, Iowa 52808

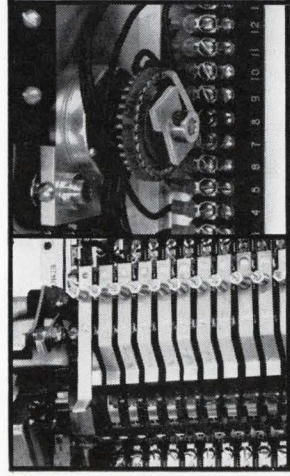
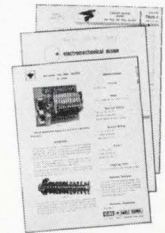

B Connects All Input Devices to the Rotary Switch. Positive interlock always insures correct sequence.

C Connect All Load Devices to the 10 Amp. Cam Switches. The cam shaft operates the load switching exactly as listed on the chart. Switch closures are made in an instant—just "snap out" one or more scored cam sections with pliers.

In Canada: Eagle Signal Division,
E. W. Bliss Company
of Canada, Ltd.,
Georgetown, Ontario



A DIVISION OF THE E. W. BLISS COMPANY

Some companies are in the wire business.



**General Cable is in the magnet wire, lead wire, cordset,
coaxial cable, harness, hook-up wire,
Teflon* resin-coated wire, Teflon resin-coated fabric,
and audio and electronics wire business.**



For information on how General Cable's complete line of OEM products can help you, write:
General Cable Corporation, Section 700-01, 730 Third Avenue, New York, New York 10017.

GCC
GENERAL CABLE CORPORATION

*Teflon is DuPont's trademark for its fluorocarbon resins.

MEET MIDTEX



Midtex
Slayer of
giant problems



Midtex
Faithful
friend

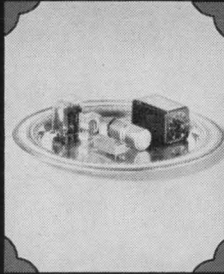

Midtex
The "service on a
silver tray" people



Midtex
The "we'll tackle
anything" people



Midtex
Cracker of
tough nuts

INDUSTRIAL RELAYS	TYPE 155	TYPE 156	TYPE 157	TYPE 48 <i>Single Coil Latching Action</i>
CONTACTS	U/L Recognized 1, 2, & 3 PDT 5 & 10 amp	U/L Recognized 1, 2, 3 & 4 PDT Low Level to 3 amp	1, 2, & 3 PDT 5 & 10 amp	1 & 2 PDT 10 amp
COILS	6 to 240 VAC 5 to 110 VDC	6 to 240 VAC 6 to 110 VDC	6 to 240 VAC 6 to 110 VDC	6 to 240 VAC 6 to 110 VDC
ENCLOSURES	Open and Dust Cover	Dust Cover and Hermetically Sealed	Open and Dust Cover	Open
TERMINALS	Solder, Plug-in, Wire-wrap, 3/16" Quick Connect	Solder/Plug-in, Printed Circuit, #78 Taper Tab	Solder/Plug-in/ 3/16" Quick Connect	Solder, 3/16" Quick Connect

MERCURY-WETTED CONTACT RELAYS	TYPE 159	TYPE 160	TYPE 161	TYPE 168
CONTACTS	1PDT	Mercury-Wetted, 2 amp max, 500 V max, 100 VA max 1PDT		2PDT
SENSITIVITY —Bistable Single-Side-Stable	20 mw 40 mw	20 mw 40 mw	30 mw 60 mw	2 mw 5 mw
TERMINALS	PCB pins	PCB pins	PCB pins	Octal plug



TYPE 153

COAXIAL CRYSTAL CAN

CHARACTERISTIC IMPEDANCES 50 and 75 ohms
RF CHARACTERISTICS:

Frequency	VSWR	Crosstalk
50 MHz	1.05/1	-62 DB
200 MHz	1.06/1	-50 DB
1000 MHz	1.15/1	-35 DB

CONTACTS 2C coaxial or 1C coaxial and 1C auxiliary, 100 watts RF, 2 amp 28 VDC

COILS 6 to 48 VDC

ENCLOSURE Hermetically sealed

TERMINALS RG188/AU Cable or ultra-miniature connectors, Solder hook for auxiliary

MOUNTING Standard varieties of crystal can relay stud, brackets, etc.

ENVIRONMENTAL Mil-R-5757



TYPE 615

ELECTRONIC TIME DELAY

DELAY TYPES Delay on operate Delay on release

DELAY RANGES

0.1 to 1 sec.	1 to 300 sec.
1 to 10 sec.	1 to 60 sec.
1 to 100 sec.	1 to 180 sec.

RESET TIME 25 MS max

REPEATABILITY ±2% at nominal voltage and +77°F

TOTAL TIMING VARIATION ±10% over voltage and temperature range

VOLTAGES AC 120 VAC (105 to 125 VAC) DC 12, 24, 48 VDC ±25%

TEMPERATURE RANGE -40°F to +150°F

CONTACTS 2PDT, 10 amp, 120/240 VAC or 24 VDC

TERMINALS Octal style plug-in, solder, screw

Midtex/AEMCO also designs and manufactures a wide variety of programmers, both standardized and to handle special customer requirements.

Midtex—The broad range relay and timer supplier

MIDTEX

INCORPORATED
AEMCO DIVISION

10 STATE STREET MANKATO, MINNESOTA 56001
PHONE 507-388-6286
TWX 910-565-2244

Small wonder:



Our new "4th-generation" 12.5 MHz universal counter/timer. Wonderful versatility in a wonderfully small package — at an even more wonderfully small price.

With the new Model 100A you can measure average frequency, frequency ratio, single period or time interval, or count total events. It has a crystal-controlled clock, Monsanto integrated circuit construction, and built-in compatibility with a rapidly growing assemblage of accessory modules.

With its \$575* price tag (accessory modules are pegged at comparably modest rates) you can have big-league counter/timer performance at

costs never before possible. Small wonder we are selling (and delivering) Model 100A's just as fast as we can build them.

Call your local Monsanto field engineering representative for full technical details, or contact us directly at: Monsanto Electronics Technical Ctr., 620 Passaic Avenue, West Caldwell, New Jersey 07006. Phone (201) 228-3800; TWX 710-734-4334.

*U.S. Price, FOB West Caldwell, New Jersey.

Monsanto
ELECTRONICS

Hard-nosed soft-ware

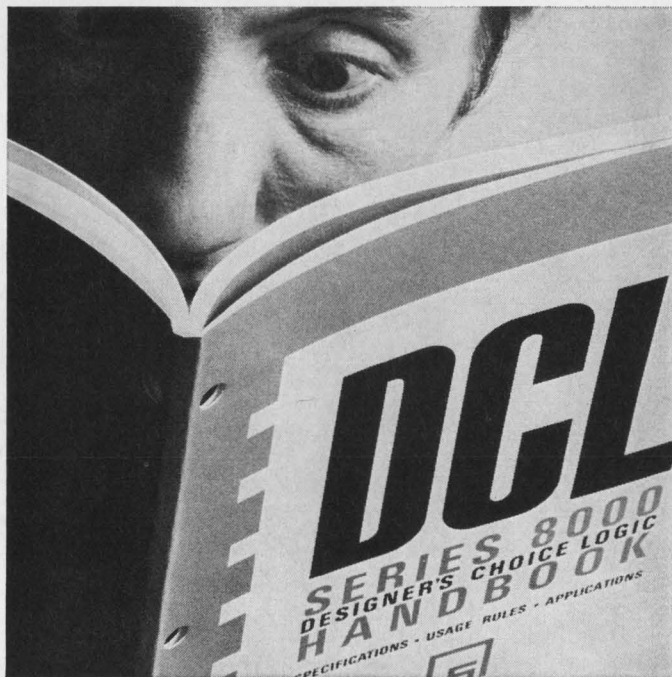

(and it's yours free)

The 120-page DCL Handbook is the most complete and unequivocal reference source ever put together for a digital integrated circuit family.

The DCL Handbook contains a section on design considerations, with all the information necessary to design a reliable, working system; a section on electrical characteristics, detailing test limit and test condition information for simplified device evaluation and incoming inspection; and a section on AC Testing. A section on applications is a

complete guide to trouble-free design, and contains several time-saving device applications to help minimize system design time and cost. The Handbook also provides complete procurement specifications, saving procurement cycle time and cost.

Designer's Choice Logic is a compatibly specified family of DTL and TTL logic circuits, interface elements and monolithic subsystems covering the needs of over 90% of all known digital IC applications. With 24 new DCL elements, the growing family mem-

bership is up to 54. With more to come. For your copy of the DCL Handbook, write Signetics, 811 East Arques Avenue, Sunnyvale, California 94086.

**SIGNETICS
INTEGRATED
CIRCUITS** 
A SUBSIDIARY OF CORNING GLASS WORKS

SIGNETICS SALES OFFICES: Fort Lee, New Jersey (201) 947-9870; Syracuse, New York (315) 469-1072; Richardson, Texas (214) 231-6344; Beverly Hills, California (213) 272-9421; Garden Grove, California (714) 636-4260; Wakefield, Massachusetts (617) 245-8200; Silver Springs, Maryland (301) 946-6030; Collingswood, New Jersey (609) 858-2864; Clearwater, Florida (813) 726-3734; Rolling Meadows, Illinois (312) 259-8300; Northwestern Delaware Valley (215) 228-2000; Universal Electronics Inc. (713) 781-0421.

DISTRIBUTORS: Compar at all locations listed below, Semiconductor Specialists, Inc. (312) 279-1000; Terminal Hudson Electronics (212) 243-5200; Wesco Electronics (213) 684-0880; Wesco Electronics (405) 968-3475; Hammond Electronics (305) 241-6601; Avnet Electronics Corp. of Massachusetts (617) 272-3060; Pioneer Standard Electronics Inc. (301) 427-3300; Kieruluff Electronics (206) RO 3-5510; G. S. Marshall (213) 684-1530; Milgray Delaware Valley (215) 228-2000; Universal Electronics Inc. (713) 781-0421.

DOMESTIC REPRESENTATIVES: Jack Pyle Company (415) 349-1266; Ozark Electronic Marketing, Inc. (314) 423-7200. A Compar Corporation at the following locations: Alabama (205) 539-8476; Arizona (602) 947-4336; California (213) 245-1172; California (415) 697-6244; Colorado (303) 781-0912; Connecticut (203) 288-9276; Florida (305) 855-3964; Illinois (312) 692-4125; Maryland (301) 484-5400; Massachusetts (617) 969-7140; Michigan (313) 357-5369; Minnesota (612) 922-7011; Missouri (314) 542-3399; New Jersey (609) 429-1526; New Mexico (505) 265-1020; New York (518) 436-8536; New York (607) 723-8743; New York (516) 921-9393; North Carolina (919) 724-0750; Ohio (216) 333-4120; Ohio (513) 878-2631; Texas (214) EM 3-1526; Texas (713) 667-3420; Washington (206) 763-1711.

INTERNATIONAL SALES: France, Germany, Italy, Belgium, Holland, Luxemburg, Spain—Sovcor Electronique, 11, Chemin de Ronde, Le Vesinet, (S.-&O.) France. United Kingdom, Ireland, Sweden, Denmark, Norway, Switzerland, Austria, Portugal—Electrosil Ltd., Lakeside Estate, Cohnbrook-By-Pass Slough, Buckinghamshire, Great Britain. Australia—Corning, 1202 Plaza Building, Australia Square, Sydney, N.S.W. 27-4318. Canada—Corning Glass Works of Canada, Ltd., Leaside Plant, Ontario, Canada (416) 421-1500. Israel—Optronix, P.O. Box 195, Ramat-Gan, Israel 724-437. Japan—ASAHI Glass Co., Ltd., Corning Products Sales Dept. No. 2, 3-Chome Marunouchi, Chiyoda-ku, Tokyo, Japan.

See you at WESCON, Island H, Hollywood Park

Circle 40 on reader service card

Monsanto light emitting diodes to be demonstrated at WESCON

The Monsanto exhibit at WESCON, Booths 1312-17 at the Sports Arena, will feature operating displays of new optoelectronic products. These will include coherent and incoherent devices in both the visible and infrared spectra.

Monsanto will demonstrate a new gallium arsenide phosphide laser on a beryllium oxide block which is designed for operation at room temperatures and delivers 2.5 watts at 40 amperes.

One of our new infrared diodes is a medium current planar passivated unit, 10 mw (min.) at 1 amp. Monsanto's smallest infrared diode is a planar passivated unit delivering 0.5 mw (min.) at 50 ma. It is in a 0.1" diameter coaxial package.

Monsanto's visible diodes are used in applications such as in photo-choppers, film annotation units, and as indicator lights. The infrared diodes are used in card readers, optical keyboards, and as emitters in auto-collimators.

Monsanto shows new additions to "4th generation" instrument line at WESCON.

A number of significant additions to the Monsanto line of "4th generation" instruments will be unveiled at WESCON. Basically, they fall into three general areas:

- Standard units, including three additions to the 1500 Series of plug-in counter/timers and frequency counters plus an important new universal counter/timer, all shown for the first time on the West Coast.
- New plug-ins to extend the capabilities of the uniquely versatile 1500 Series.
- A number of new additions to the popular Monsanto half-rack, "system compatible" units including new members of the 100 Series counters as well as strikingly different new ancillary equipment.

Before you settle for less, visit Monsanto's "knob-tweakers" paradise and see what "4th generation" instruments can do for you.

NEW VISIBLE LIGHT EMITTING DIODE with a brightness of 450 footlamberts

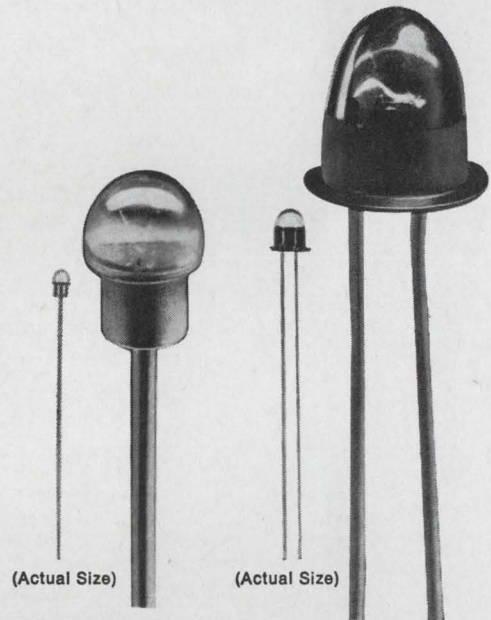

Model MV10A

Model MV10B

Forward bias ($I_f=50\text{ma}$)	1.65 volts	1.65 volts
On-off cycle time	10 nsec	10 nsec
Wavelength range	6500-7000Å	6500-7000Å
Brightness ($I_f=50\text{ma}$)	115-300 ftL	115-450 ftL
Price (in lots of 1000)	\$4.00 to \$18.00	

From film annotation to panel indicators, Monsanto's visible LEDs deliver solid state reliability, miniature size, low power consumption. And they're available off the shelf.

Other Monsanto Optoelectronic Devices

Infrared LED	MI20B—200 microwatts radiated power MI20C—1.5 milliwatts radiated power
Lasers	ML30C—0.5 watts peak power output
Arrays	MA10A—alpha-numeric visible array

Monsanto

ELECTRONIC SPECIAL PRODUCTS

800 N. Lindbergh Blvd., St. Louis, Missouri 63166 / (314) 694-4639 or 4642

Interested in career opportunities? Send resumé to Manager Professional Recruiting. An equal opportunity employer.

BUSS

THE COMPLETE LINE OF SIGNAL-INDICATING, ALARM-ACTIVATING FUSES AND FUSEHOLDERS

FOR USE ON COMPUTERS, MICROWAVE UNITS, COMMUNICATION EQUIPMENT, ALL ELECTRONIC CIRCUITRY



BUSS GBA- $\frac{1}{4}$ x 1 $\frac{1}{4}$ in. Visual-Indicating.

BUSS GLD- $\frac{1}{4}$ x 1 $\frac{1}{4}$ in. Visual-Indicating, Alarm-Activating.



BUSS ACH Aircraft Limiter, Visual-Indicating



HKA panel mounted holder, lamp indicating-signal activating, for $\frac{1}{4}$ x 1 $\frac{1}{4}$ in. BUSS GLD fuse.

$\frac{3}{4}$ to 5 amp.



BUSS MIC-13/32 x 1 $\frac{1}{2}$ in. Visual-Indicating, Alarm-Activating.

BUSS MIN-13/32 x 1 $\frac{1}{2}$ in. Visual-Indicating.



HLD panel mounted holder, visual-indicating, for $\frac{1}{4}$ x 1 $\frac{1}{4}$ in. BUSS GBA fuses (or GLD fuses)

$\frac{3}{4}$ to 5 amp.



HPC-C panel mounted holder, visual-indicating, for 13/32 x 1 $\frac{1}{2}$ in. fuses.

FNA FUSETRON Fuse 13/32 x 1 $\frac{1}{2}$ in. slow-blowing, Visual-Indicating, Alarm-Activating. (Also useful for protection of small motors, solenoids, transformers in machine tool industry.)

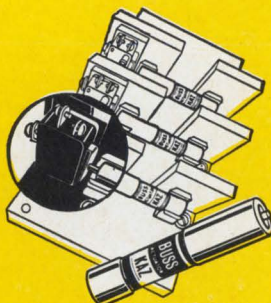

BUSS KAZ Actuator 13/32 x 2 in. Signal-Indicating, Alarm-Activating Device. Use to call attention to the opening of a fuse of 50 amp or larger. Can be mounted "piggy-back" on large fuse or in special block with micro-switch. Ask for Bulletin KAFS.

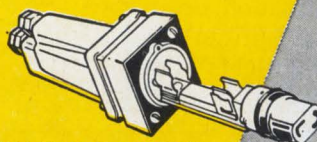

HGB-C panel mounted holder lamp indicating Military type FHL11U Single pole for $\frac{1}{4}$ x 1 $\frac{1}{4}$ in. fuses.

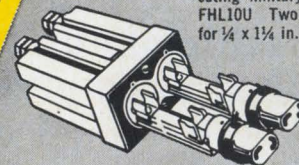

HGA-C panel mounted holder lamp indicating Military type FHL10U Two pole for $\frac{1}{4}$ x 1 $\frac{1}{4}$ in. fuses.

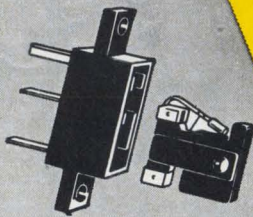

BUSS GMT and HLT holder, Visual-Indicating, Alarm-Activating.

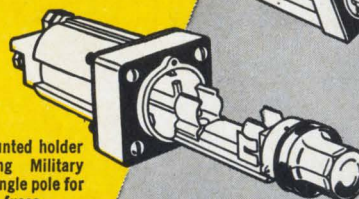

HGC panel mounted holder lamp indicating Military type FHL12U Single pole for 13/32 x 1 $\frac{1}{2}$ in. fuses.

BUSS Grasshopper Fuse, Visual-Indicating, Alarm-Activating.

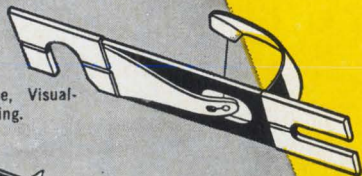

BUSS Series 70. Visual-Indicating, Alarm-Activating. (Used in telephone and similar applications.)

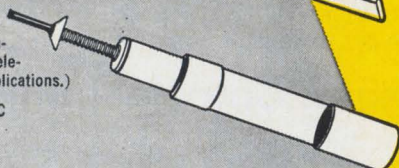

Ask for Bulletin 70S-C



HKL panel mounted holder, lamp indicating, for $\frac{1}{4}$ x 1 $\frac{1}{4}$ in. fuses.

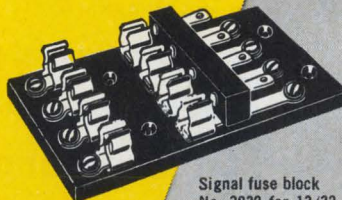

Signal fuse block No. 3839 for 13/32 x 1 $\frac{1}{2}$ in. indicating fuse.

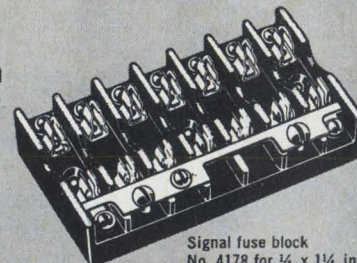

Signal fuse block No. 4178 for $\frac{1}{4}$ x 1 $\frac{1}{4}$ in. indicating fuse.

Write for
BUSS
Form
SFB

BUSSMANN MFG. DIVISION, McGraw-Edison Co., St. Louis, Mo. 63107

SUPPLIED THE ECONOMICAL WAY . . .
THRU DISTRIBUTORS

BUSS QUALITY

FUSES

"See Us At Wescon Show—Booth #355, Hollywood Park"



These Crossflo[®] blowers

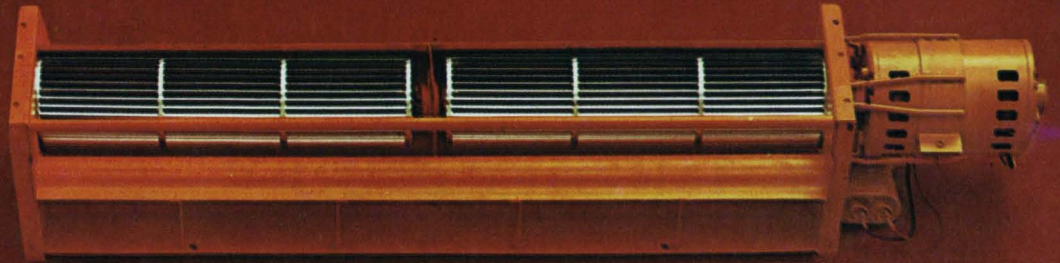

are creating quite a stir

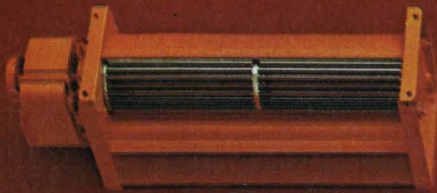

little

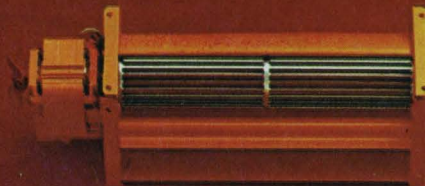

in some tight



circles.



For one thing, Torrington offers the greatest variety of transverse flow blowers available in the U.S. The five Crossflos shown above are merely indicative of Torrington's capabilities in the field. Hardly surprising. When you're the nation's most experienced producer of transverse flow blowers it's no great trick to come up with the broadest line.

Also . . . Torrington Crossflo blowers produce some rather extraordinary effects in limited areas. By drawing air straight through a small diameter impeller Crossflo blowers can move a broader band of evenly distributed air over a wider area—and do it better than any other design of blower.

Got an application requiring a broad band of air? No problem. Just talk it over with the air-moving specialists at Torrington. If they don't have the Crossflo blower you need, they'll design it for you and produce it in whatever quantity you require.

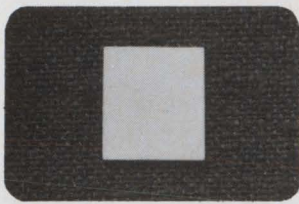

Substrates

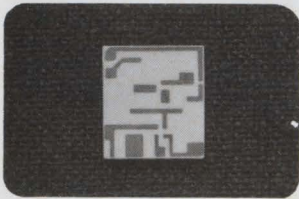

Metallized Substrates

ACTION IN MICROCIRCUITRY



there's
no end to
Centralab's



Microcircuit
with resistors

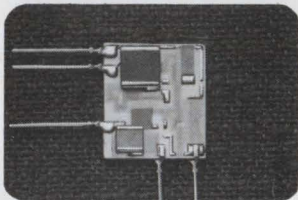

Microcircuit with
resistors and capacitors

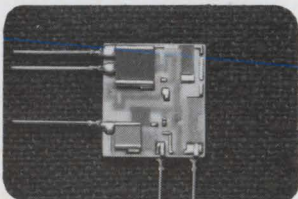

Microcircuit with
resistors, capacitors and
semiconductor devices

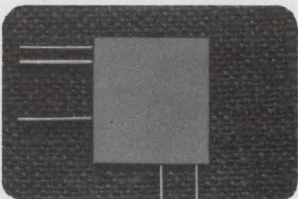

Microcircuit with
resistors, capacitors and
semiconductor devices,
sealed



(No matter how you cut it)

When you AIM with Centralab, you'll soon discover there's no end to the thick film microcircuits we can produce for you. Our experience and craftsmanship have contributed to the manufacture of more than 459,700,000 microcircuits, which is more than any other manufacturer has made. Our skilled designers have produced more than 5,000 different designs. They can tailor a special substrate, ceramic package, or a microcircuit to your requirements, deliver a sample in two weeks and ship production quantities 6-10 weeks later, depending on complexity of the unit. Centralab is an established leader in the microcircuit field, from substrates to complete packages. We're actually one-sided (like a Möbius strip) where microcircuitry is concerned — point us in the right direction and we'll zero-in on the product you require. For immediate design assistance, write Centralab Application Engineering Department today.

AIM with Centralab

CENTRALAB PRODUCTS ARE MARKETED THROUGH CENTRALAB INDUSTRIAL DISTRIBUTORS
AND INTERNATIONALLY THROUGH GLOBE-UNION INC. — INTERNATIONAL DIVISION.



CENTRALAB

Electronics Division

GLOBE-UNION INC.

5757 NORTH GREEN BAY AVENUE
MILWAUKEE, WISCONSIN 53201

No other manufacturer offers as large a selection: hundreds of standard types of control knobs, more than 2,000 "specials". Almost every type, style and color combination is promptly available to you from local distributors and large factory stocks.

Turn to color with the new PANELRAMA knobs shown below...mix or match caps and body colors in almost any combination...to harmonize or contrast with every panel decor.

Or, you can choose elegantly-

styled Designer Series knobs with spun-aluminum caps on body colors of black; light, medium, or dark grays; and off-white. When you need a solid color, select from the nine decorative colors in our 400 series.

For military applications, specify Standard Series control knobs—thousands of quality knobs that meet MS91528. Or, specify the new self-locking push-to-turn knobs and Microverniers...for accurate, precision control settings. And when you need custom-

made knobs, call Raytheon first...to get the advantages of Raytheon quality and fast delivery.

For a catalog, call your distributor or nearest Raytheon regional sales office. Or send the reader service card. *Raytheon Company, Industrial Components Operation, Quincy, Massachusetts 02169.*



Here's why Raytheon knobs control more settings than any other brand.



400 SERIES

MICROVERNIER AND SELF-LOCKING KNOBS

STANDARD SERIES

PANELRAMA

DESIGNER SERIES

CUSTOM KNOBS

announcing a new standard in motor design...



the **Honey Bee**

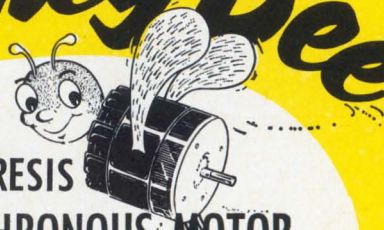

**HYSTERESIS
SYNCHRONOUS MOTOR**

LESS THAN
\$40⁰⁰ IN QUANTITY
INCLUDING
CAPACITOR

1/50 HP



MODEL HB
HONEY BEE

40°C
HEAT RISE
FULL LOAD

**IMMEDIATE
DELIVERY ON STANDARD
MOTORS — SPECIALS
4 TO 6 WEEKS!**

**Video Recording
Instrumentation
Data Handling
Tape Recording
Telemetry
Turntables**

Write
for
literature!



INVERTED ROTOR DESIGN FOR REDUCED FLUTTER
TEMPERATURE RISE 40°C UNDER FULL LOAD
1800 RPM STARTING TORQUE 12 IN. OZ.
PULL IN: 11 IN. OZ.

DYNAMICALLY BALANCED ROTOR
REVERSIBLE, 115VAC, 60Hz
BALL BEARINGS, LIFETIME LUBRICATION
STAINLESS STEEL SHAFT 5/16", 1" LENGTH

(Other shafts available on special order)

ALSO AVAILABLE AT 900 RPM. Write for specifications.

hurst MFG. CORP., PRINCETON, INDIANA 47570

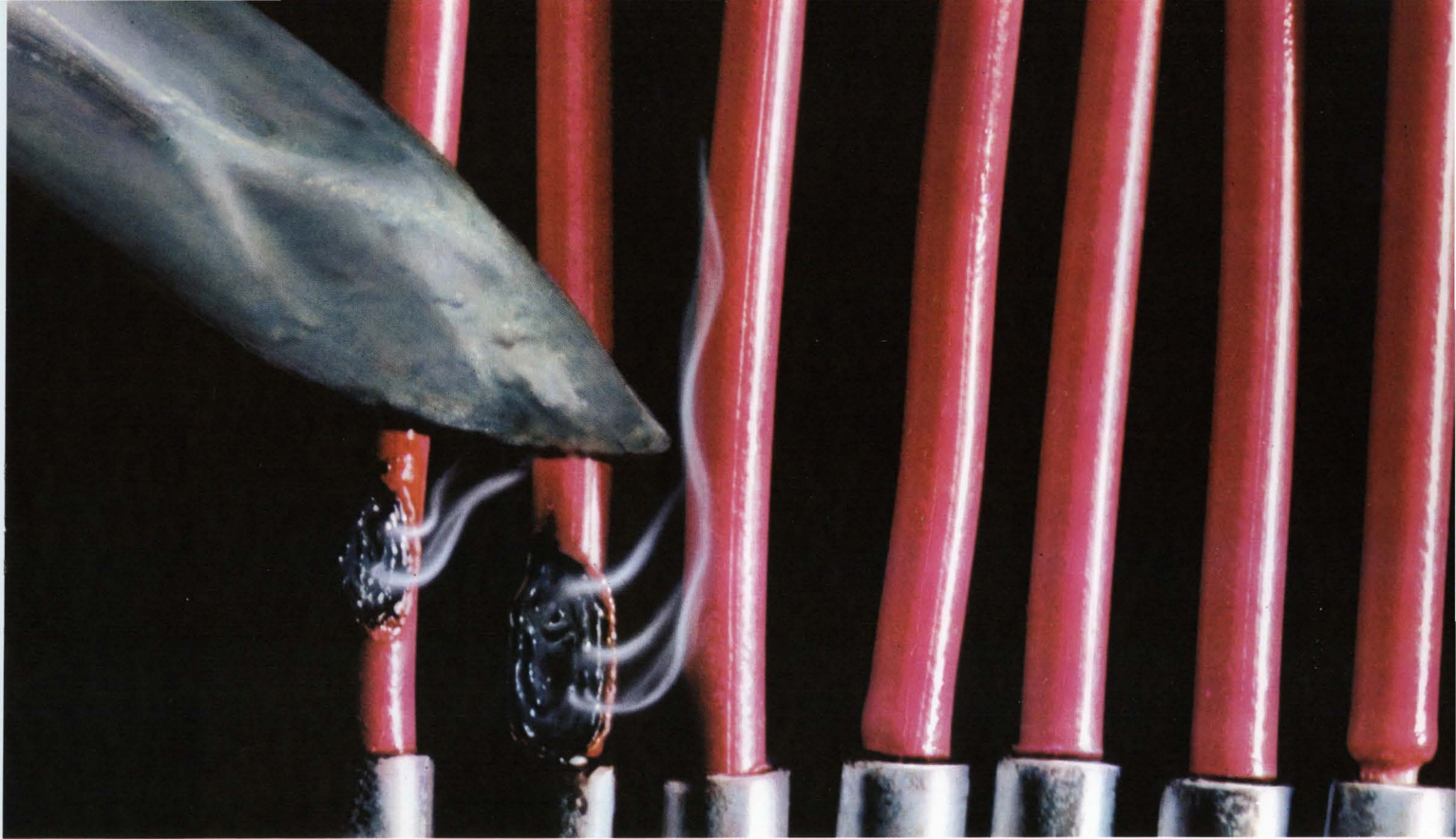

Don't risk it!

Momentary contact with an iron caused this damage to ordinary insulation. Soldering damage is often a hazard on the production line. And even an insulation that isn't burned can be embrittled, leading to failure later on.

This won't happen with wire insulation of Du Pont TEFLON* TFE. TEFLON will not char, smoke or embrittle—even at solder-iron temperatures up to 750°F. And it allows dip soldering without shrinkback.

This is only one of the reasons we call TEFLON the sure one. Among others: TEFLON is nonflammable. It's rated for continuous use from -100°F to +500°F (TFE). It resists heat aging. It is inert to virtually all chemicals and corrosives. It provides space and weight savings without sacrificing performance or long-term reliability.

In short, when you specify insulation of TEFLON, you minimize risk.

For detailed performance data on the resistance of TEFLON to high temperatures and solder-iron damage, write Du Pont Company, Room 5984-E, Wilmington, Delaware 19898.

*Reg. U. S. Pat. Off. for Du Pont fluorocarbon resins and film.

TEFLON®..the sure one



Better things for better living
...through chemistry

Specify TI 709 op amps in low-cost plastic packages now..from CESCO

It's easy to see why our big stocks of TI 709 IC operational amplifiers are your *best choice* to fill the booming demand. Why? Because only TI gives you complete package versatility, economy and performance. TI features a dual in-line plastic package priced lower than ever before...along with standard flat-pack and TO-5 type configurations. This opens up hundreds of new applications in both industrial and military equipment markets.

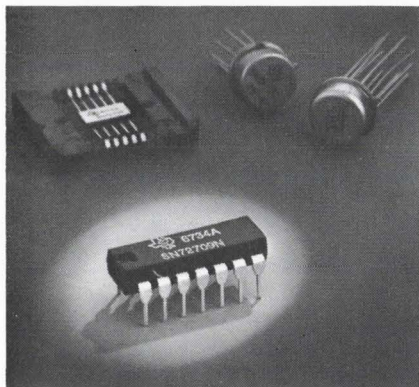

Want performance? Our TI 709s provide high gain, high common mode rejection, high output voltage swing, and low offset. You'll find these devices perfect for instrumentation, process control, computation, and communications.

Want variety? Then consider our TI 702s (high-gain, wide band), 710s (differential inputs and low output impedance) or 711s. Op amps, you know, are the closest thing yet to truly universal circuits.

Check the convenient Linear IC Interchangeability Chart below. You'll find TI circuits are spec-for-spec and pin-for-pin replacements of competitive types. And...we have exclusive low-cost package advantages in many areas!

Make it easy on yourself. Include TI 709 op amps on the requisition you use to order TTL ICs.

Starting with TI's leadership line of TTL integrated circuits, we offer prompt shipment from complete stocks to fill all your IC needs. So call *today*...or circle Reader Service Number 290 and we'll send you a data sheet for the device type you're interested in. This will help you fill the empty spaces in your procurement schedules—fast.

LINEAR IC INTERCHANGEABILITY CHART					
OPERATIONAL AMPLIFIERS					
Texas Instruments	Package	Temp. Range	FSC †	Motorola †	Raytheon †
SN52 702AL SN52 702AF SN52 702AN SN52 702L SN52 702F SN52 702N SN52 702BL SN52 702BF SN52 702BN SN72 702L SN72 702F SN72 702N	T0-99 Flat Pack Plastic Dip* T0-99 Flat Pack Plastic Dip T0-99 Flat Pack Plastic Dip T0-99 Flat Pack Plastic Dip T0-99 Flat Pack Plastic Dip	-55°C to 125°C -55°C to 125°C ↓ 0°C to 70°C ↓ -55°C to 125°C ↓ 0°C to 70°C ↓	U5B770231X U3H770231X U3H7702313 U5B771239X U3H771239X U5B7709311 U3T7709311 U3T7709313 U5B770939X U3T770939X U6E7709393	MC1712G MC1712F MC1712CG MC1712CF MC1712CP MC1709G MC1709F MC1709CG MC1709CF MC1709CP	RM 702 RC 709 RM 709 RC 709
COMPARATORS					
SN52 710L SN52 710F SN52 710N SN52 710BL SN52 710BF SN52 710BN SN72 710L SN72 710F SN72 710N	T0-99 Flat Pack Plastic Dip T0-99 Flat Pack Plastic Dip T0-99 Flat Pack Plastic Dip	-55°C to 125°C ↓ 0°C to 70°C ↓	U5B771031X U3H771031X U3H7710313 U5B771039X U3H771039X U6E7710393	MC1710G MC1710F MC1710CG MC1710CF MC1710CP	RM 710 RC 710
DUAL COMPARATORS					
SN52 711L SN52 711F SN52 711N SN72 711L SN72 711F SN72 711N	T0-100 Flat Pack Plastic Dip T0-100 Flat Pack Plastic Dip	-55°C to 125°C ↓ 0°C to 70°C ↓	U5F771131X U3T771131X U5F771139X U3T771139X	MC1711G	RM 711

†Based on latest available public information

*Dual-In-Line

CESCO ELECTRONICS LTD

MONTREAL
4050 JEAN TALON ST., W.
735-5511

QUEBEC
128 RUE ST. VALIER, O.
524-3518

OTTAWA
1300 CARLING AVE.
PA. 9-5118

DOWNSVIEW
24 MARTIN ROSS AVE.
638-5250





Don't box us in as just a great DVM maker

Frankly, we're proud of Cimron's reputation for excellence in digital instruments you understand — but we now operate in three broad areas. Cimron's box includes five series of 4- and 5-digit voltmeter/multimeter instruments, plus such computer peripheral products as A/D converters, multiplexers and comparators. Cimron also makes complex data systems, custom-designed for your tough systems problems. Then there's Cimron's

line of industrial products used for the manufacture of printed circuit boards. Like the famed Hydro-Squeegee solder leveler, eyelet insertion machines and production drills. Cimron's philosophy of **customer concern** backs every product. And behind Cimron is the international reputation of the parent company, Lear Siegler, Inc. For details on Cimron® products, write Cimron, Dept. B-120, 1152 Morena, San Diego, California 92110.

LEAR SIEGLER, INC.



CIMRON DIVISION

See the Cimron line at WESCON
booth Nos. 1926-27 (Sports Arena)



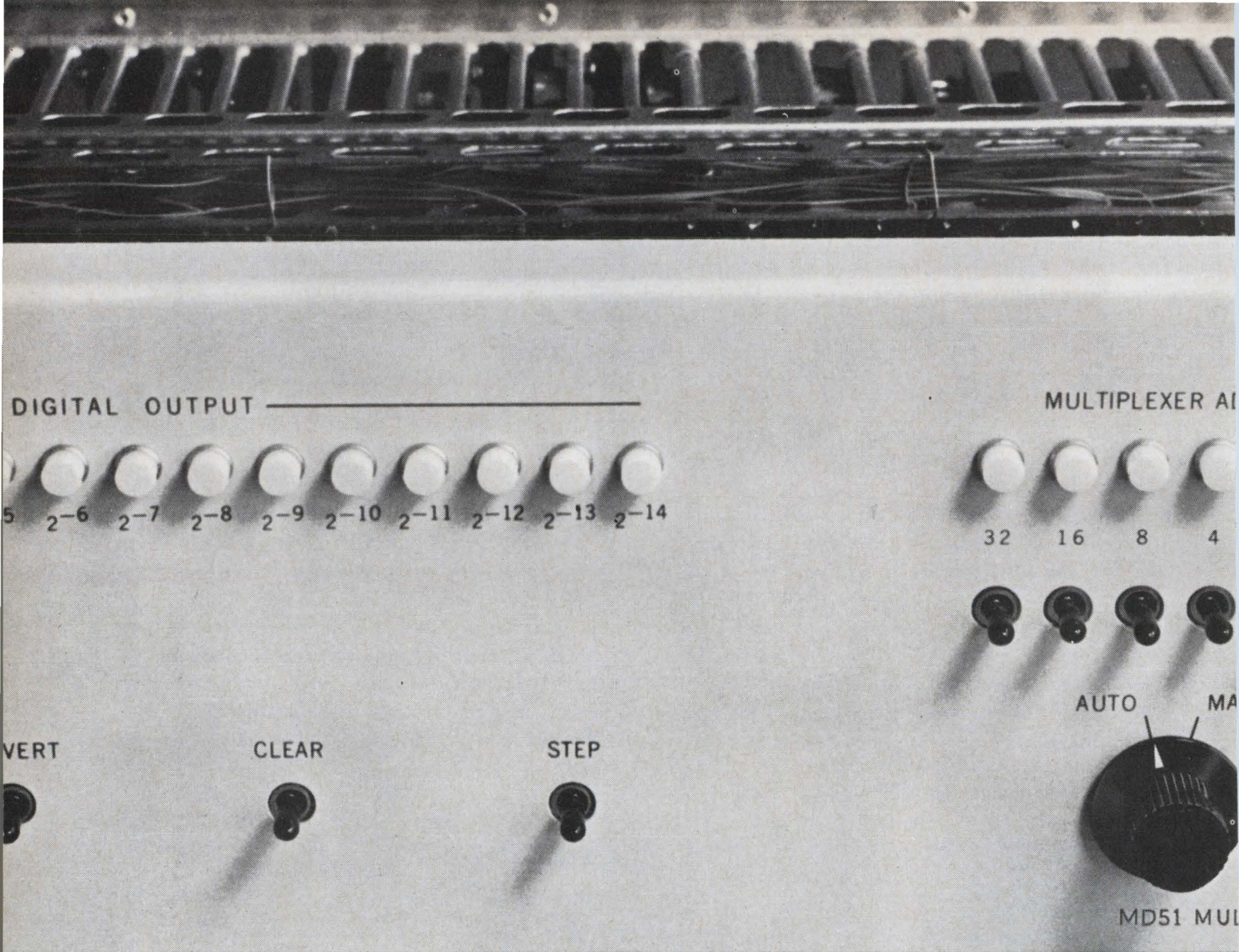

It's the fastest. It's the most accurate.

The MD51 is a high-level 64 channel multiplexer, a sample and hold amplifier and a 15-bit A to D converter, all in a single chassis. It has a total sample and conversion time of 10 microsec-

onds max. and an accuracy of 0.01%. And it sells for under \$10,000. If that doesn't say it all, write for the rest.

SDS
Scientific Data Systems,
Santa Monica, California

Circle 50 on reader service card

Patents

Focus on CO₂

On Dec. 11, 1962, a lawyer for a small Pennsylvania research firm, Semi-Elements, filed an application for a patent on a carbon-dioxide-noble-gas laser that the inventor claimed generated an ultraviolet beam. On March 15, 1963, a lawyer for the giant Bell Telephone Laboratories, unaware of the other claim because nothing on the work had been published in the professional journals, filed an application on a similar laser that generated a coherent beam in the near infrared region. Late last month, after years of legal squabbling, the Patent Office awarded the patent to Semi-Elements—based on the fact that the company filed first.

The five-year legal fight involved more than the feelings of two scientists—both of whom obviously want to be known as the inventor of the CO₂ laser. Considering the fact that the CO₂ design appears to be the brightest prospect on the laser horizon (because of its high power, stability, and relative ease in modulating) the financial potential of the patent may be enormous.

The man credited with the lion's share of the development at Semi-Elements is Ronald Vickery, a British-born chemist who left the company years ago.

The Bell Labs patent was filed under the name of C. Kumar N. Patel, a physicist who continues active research on CO₂ lasers.

When word of the patent award became public within the industry many scientists and engineers expressed surprise that Patel lost the bid because he is well-known in the field; based on what they have read in the professional journals, many researchers consider him to

be the inventor of the CO₂. On the other hand, Vickery and Semi-Elements are relatively unknown.

A famous CO₂ laser scientist, not associated with Bell, expressed dismay over the award: "Patel worked for years on this, and he's probably responsible for bringing the art to

matter. Its main business is supplying single crystals and high-purity chemicals to research firms.

One patent lawyer close to the dispute doubts that the case is over. Even though Bell Labs let pass the deadline for an appeal on the award, many other routes are

July 16, 1968

R. C. VICKERY ET AL
CARBON DIOXIDE LASER SYSTEMS FOR THE EMISSION
OF COHERENT RADIATION
Filed Oct. 26, 1967

3,393,372

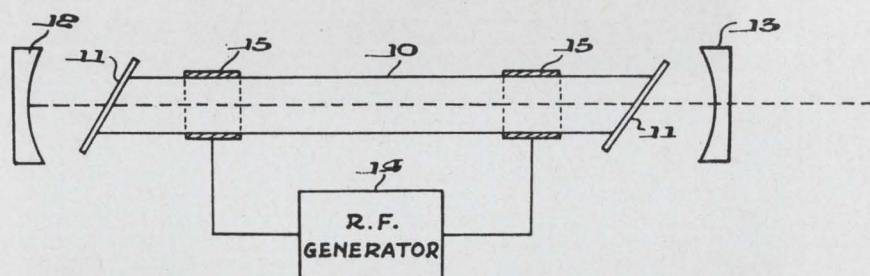

Awarded. Patent Office drawing of Vickery's CO₂ laser.

its present level. But there are many injustices in the patent system—and this one is a gross injustice."

Representatives for Semi-Elements and Bell Labs, however, made it clear that there are no hard feelings between the firms.

The legal dispute is reminiscent of the battle Gordon Gould waged over the basic laser patent. He lost that fight in 1966 to Charles H. Townes and his brother-in-law Arthur Schawlow [Electronics, Aug. 22, 1966, p. 36] after a bitter court battle. Ironically, Schawlow was a researcher at Bell Labs at the time and Townes was a Bell consultant and a teacher at Columbia University; Gould was a student of Townes.

Business. Semi-Elements, which subsequently was acquired by Riker Video Industries of New York, is no longer involved in CO₂ lasers—or in gas lasers for that

open—such as trying to block royalties payments.

Robert Dressler, president of Riker Video is optimistic. "We haven't decided yet how we'll exploit the patent award, but probably we'll make no attempt to produce the lasers ourselves." He notes that the next step is to wait—wait until somebody makes an offer.

What about possible financial benefits to Vickery?

"He'll get nothing," says Dressler, "the company owns the patent."

Commercial electronics

Real-time reservation

If Pan Am does indeed make the going great, then little Stromberg

Datagraphics Inc., a General Dynamics subsidiary, has made a good start on its way to challenging the leaders in the market for the computer-generated cathode-ray-tube displays.

With a \$1.3 million contract from Pan American World Airways, Stromberg is making its bid for a piece of the market now dominated by such giants as International Business Machines and Raytheon. The contract, which marks the first time an airline has installed crt displays for use in ticket sales and passenger information, calls for Stromberg to supply Pan Am with 57 desk-top displays, dubbed SD 1110's, and the associated control units.

The system, which is being integrated into Panamac, Pan Am's

computerized reservation system, is based on Stromberg's Charactron shaped-beam crt. Hooked into a computer, the display is capable of generating up to 300 characters per second; Panamac now uses electric typewriter printouts which can generate only 14 characters per second.

Advanced technology

Germanium for LSI

Because of processing problems and poor temperature characteristics, germanium has been generally abandoned as a material for integrated circuits. But for the past

year a group of engineers at Westinghouse Electric's Aerospace division in Baltimore have been working on germanium and they've come up with a monolithic large-scale array far more ambitious than an IC; they've fabricated a monster array of 12,800 pnp transistors. The 100-by-128 element array measures 1/2 inch square.

The reason. But why use germanium when silicon is so well developed?

James C. Word, one of the engineers on the project, explains that silicon is unable to detect in the 0.8-to-1.5 micron i-r range and that germanium, despite its problems, has a spectral response that the Air Force is interested in.

Epitaxy for the array was accomplished through the hydrogen reduction of germanium tetrachloride. The dopants were diborane and arsine. The structure of the array is dictated by the readout technique involved. On the sensor, emitters for each line of transistors are connected while the strip collectors are connected in series at right angles to the emitter lines. Access to an element is obtained by applying a voltage to the collector strip and commutating the metalized emitter row.

Word says that particular parameters are important in fabricating germanium which are vastly different than those of silicon because of the differences in the physical and chemical properties of the two materials. Word cites substrate and substrate preparation, growing epitaxial layers, thermal conversion, masking of n-type diffusants and diffusion of dopants as the most important parameters in the development of the array.

Growing the epitaxial layers and contending with thermal conversion were acute problems for the Westinghouse group. Word notes that the growth process was highly sensitive to very slight leaks in the epitaxial apparatus and it was only with the elimination of such leaks that the layers could be properly grown. Problems of thermal conversion were traced to the appearance of copper in the germanium, and potassium cyanide was used unsuccessfully to remove the un-

Electronics Index of Activity

Aug. 5, 1968

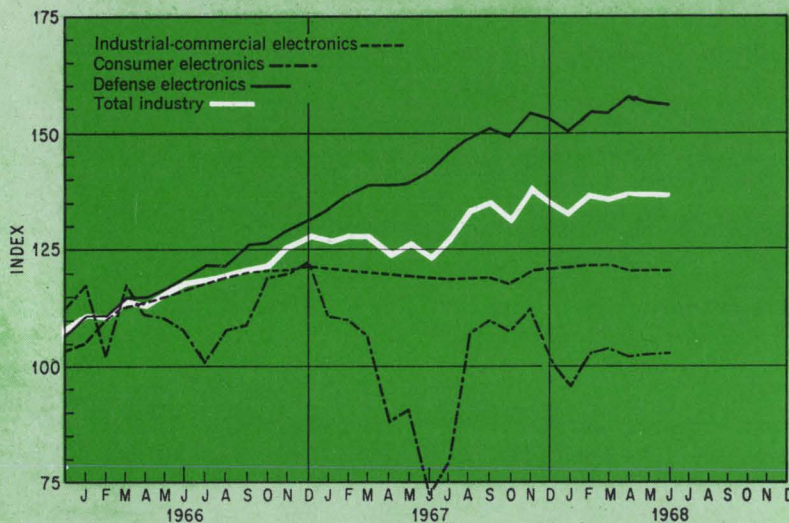

Segment Of Industry	June 1968	May 1968*	June 1967
Consumer electronics	102.4	102.2	72.1
Defense electronics	156.1	156.5	142.0
Industrial-commercial electronics	120.6	120.7	119.1
Total industry	136.6	136.8	123.2

Electronics production slipped 0.2 index point in June from May; however, the index climbed to a level 13.4 points above a year earlier. Consumer output inched up 0.2 point in the month and rose 30.3 points from 1967. Other segments of the index fell in the month: Defense dipped 0.4 point and industrial-commercial production eased 0.1 point. For the 12-month period, however, defense rose 14.1 points and industrial-commercial climbed 1.5 point.

Indexes chart pace of production volume for total industry and each segment. The base period, equal to 100, is the average of 1966 monthly output for each of the three parts of the industry. Index numbers are expressed as a percentage of the base period. Data is seasonally adjusted.
* Revised

wanted copper from the surface of the wafers.

Next step. Work on the germanium technique and the development of the array was sponsored by the Air Force Avionics Laboratory. The team delivered its final report on the germanium array to the Air Force last week. According to Westinghouse project manager E. L. Irwin, his group is hoping for an Air Force follow-on contract to continue the work.

Says Irwin, "We would like to perfect the technique and in particular clean up the leakage which is our number one problem." Irwin says that the array does suffer from near element leakage, which leaves something to be achieved in getting even better resolution. He also feels that the packing density of the array can be increased to 400 to 500 elements on each side of the square. He points that the array already produced will be used by the Air Force for remote sensing application and it has a resolution of 10 lines per millimeter.

Irwin is convinced that germanium LSI technology can move quickly. Reflecting on the Westinghouse development in the last year, he says, "Hell, a year ago we didn't even know how to polish germanium."

Integrated electronics

Not quite LSI

For the design engineer looking for some of the advantages of large-scale integration and design automation, yet can't afford to go all the way with LSI, a company in Mountain View, Calif., has the answer.

Data Technology Corp. is selling a service which will automate the process between the engineers' initial logic design and checkout of the finished logic module.

"All the engineers need do," says marketing vice president Peter Dietz, "is provide us with a rough logic diagram."

Many engineers, he continues, are very clever with logic design,

but are utterly hopeless in the more mundane functions of building the system they have designed. There's no sense quibbling about the universal man, says Dietz; a design engineer should not have to generate wire lists if a computer can do it.

Data Tech's new service is called Total Logic solution (TLS). According to Dietz, TLS will obsolete many of the standard logic card approaches and provide small-volume manufacturers with an economic and sensible alternative to large-scale integration.

One of Data Tech's vertical module racks can accommodate as many as 800 IC's; an alternative horizontal drawer can accommodate 400 IC's, 300 IC's and a power

The program, says Dietz, will result in a 30% saving in design cost and 50% savings in development time. Furthermore, Data Tech will guarantee that finished logic modules will have an error frequency of less than 1 per 10,000 wires.

The heart of the system is an IBM 360/20 computer which has stored in its memory the characteristics of all the major DTL circuits, the 7,400 TTL circuits and five or six other multifunctional chips. The memory also entirely describes the circuits from a drafting standpoint and can be programed to specify necessary components.

The engineer's initial logic design is translated into a line diagram. That form is fed into the

View. Monolithic germanium array, composed of 12,800 pnp transistors, was developed by Westinghouse as an infrared sensor. Scientists chose germanium over silicon, which is unable to detect in the 0.8-to-1.5-micron range. Work was supported by the Air Force.

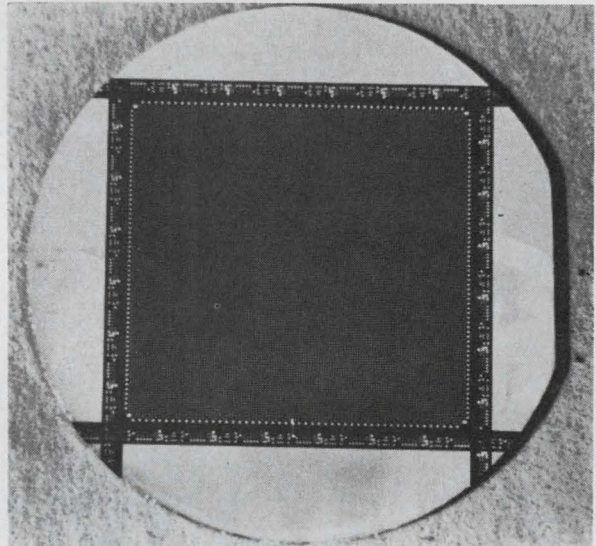

supply or 200 IC's and a variety of discrete components for analog functions.

Frame up. The basic modular building block is the panel which contains 101 mixed 14- and 16-pin dual-in-line sockets or eight large discrete component functional blocks or 30 to 100 small component mounting modules or varying sizes or a combination of the three. Two sizes of die-cast aluminum frames are available for panel mounting. One holds four panels and the other holds one. Both were designed for use with automatic wiring machines and the four-panel unit is aligned so that interconnect can be made automatically between panels.

computer which generates a load check to check for simple errors: no load, excess load, duplicate signal assignment, no source or incorrect circuit assignment. Errors which are noted on a printed read-out can be corrected in less than two minutes. The computer then generates a master term list which specifies where signals originate, where they go, what their function is, the generator source, location, and optimum type of IC to be used.

Additionally, the computer generates a punched paper tape which will guide a numerically controlled wiring machine in wiring up the interconnections. From the master term list, a systems engineer decides whether a horizontal or ver-

tical chassis will be used for the completed module.

Pick an IC. According to the dictates of the master term list, the selected IC's are manually plugged into the chassis and the automatic wiring process begins after power drivers, inverters, or any discrete components demanded by the master term list are mounted on the chassis in plug-in circuit board form.

Logic modules delivered to the Los Alamos Scientific Laboratories have already demonstrated the efficiency of TLS, says Dietz; development time was cut in half and debugging has been cut by 75% because the number of errors on these boards is less, by several orders of magnitude, than those made by the present conventional method of direct conversion from paper design to fixed IC logic cards. Another contract with Litton Industries for ground checkout equipment is proceeding equally well; initial design costs incurred by Litton have been halved.

Medical electronics

Mother of invention

In 1965 at an international hospital conference in Stockholm, a Swedish company demonstrated its newly developed computer system for recording and displaying radiologists' X-ray analysis.

The system, named Medela, was designed to save labor and at the same time speed X-ray analysis from the radiologists to physicians and surgeons [Electronics, July 12, 1965, p. 183]. It's already in operation by technicians at three Swedish hospitals.

Now, three years later, a similar system has been developed in the United States, and at a cost to taxpayers of at least \$100,000. The American effort was begun after the Swedish project was completed.

Earlier work. The American system was developed as an experiment at Johns Hopkins University

in Baltimore under a contract from the Public Health Service. The announcement of the "successful testing" of the system was made by the Public Health Service's National Center for Radiological Health without mentioning the Swedish efforts. Told about this, the embarrassed center rushed out a correction, saying that although there are systems "similar," the new one "represents an advance in application."

Actually, the Johns Hopkins system is far more complicated to operate than the Swedish system. The results, however, are the same—immediate printout and computer storage of X-ray diagnostic data.

The problem that led to the development of the system is common to the United States and Sweden and most other developed countries. Ordinarily, a radiologist reads an X-ray and makes his notes about it on paper or a tape recorder. The notes are typed out, proofread by the doctor, signed, and then sent out to surgeons or physicians who use them for treatment.

The Swedes, faced with serious labor shortages in hospitals, wanted to get the information directly from the radiologist to the physicians. Working on a partly government-financed grant, Saab, the Swedish aircraft, automobile, and electronics firm, came up with Medela. The system makes use of a "dictionary" of radiological and medical terms, which are flashed on a viewing screen. Each term is plainly number-coded. As the radiologist punches the numbers of the term he wants to record, the term is printed out on remote terminals, stored in the computer's memory, and a new "page" in the dictionary is presented on the screen.

Marketing problem. Saab has produced five Medela systems, and three of them are in operation. They are priced at between \$6,000 to \$8,000, exclusive of the computer; they can work with any computer. Saab made some perfunctory efforts to market the system in the United States and had discussions with the Veterans Administration. But—as is the case of many foreign firms—Saab does not have the mar-

July 12, 1965

Electronics Abroad

Volume 38
Number 14

Sweden

Hospital automation

Long a leader in medical research, Sweden is now making big strides in hospital automation. The effort is understandable: under the country's 10-year-old system of medical insurance, hospital care is free and hospitals are severely understaffed.

Visitors to the 14th International Hospital Congress in Stockholm last month paid particular attention to two computer-controlled systems. One innovation, called Autochemist, is an automatic laboratory technician that can perform up to 6,000 analyses an hour of blood, urine and other body fluids, transfer the results to a computer and print them out at distant stations. The other is an electronic library that can deliver diagnoses and other information anywhere in the hospital almost instantaneously.

Autochemist. The first Autochemist is being installed at the Hospital for Infectious Diseases in Stockholm. Details of its operation are being kept secret until patent rights are obtained, but the system shown in Stockholm used a computer to regulate the testing of fluid samples, sort the analyses, and

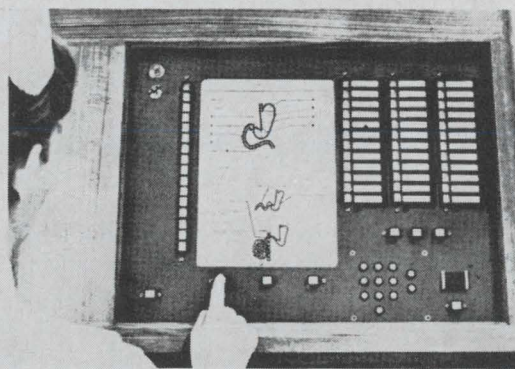

Medela shows patient's x-rays on demand.

Forty tests per tube. The analyzer was invented three years ago by two brothers, Gunnar and Ingemar Jungner, who are physicians. An improved version, made by Svenska AB Gasaccumulator (ACA), performs as many as 40 analyses on one sample—one of the most thorough automatic testing devices known. The system costs about \$300,000, including the computer.

In the United States, several

was provided by a national hospital committee.

The system, called Medela, processes information ranging from commercial data to complex computations for research. Ultimately, Saab envisions a Medela system for every hospital, with a unit in every department where information is exchanged—wards, administration offices, laboratories, kitchens. A central computer would control the network; at the Stock-

Better late than . . . Johns Hopkins University developed a computer-operated X-ray diagnostic system—three years after a similar unit was completed in Sweden.

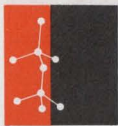

ALLOYS UNLIMITED

The added value group . . .

Alloys Unlimited, Incorporated

Melville, New York

Brazing and doping pre-forms; solder rings and spheres; casting facility for high purity alloys; conductive pastes; plating shop for nickel, gold and tin plating; highly refined indium metal.

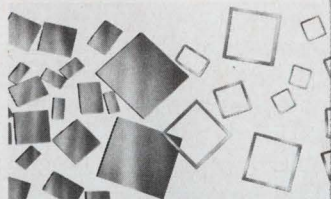

Circle 511 on Reader Service Card.

Contacts, Incorporated

Wethersfield, Connecticut

Electrical contacts of silver, gold, platinum, palladium and their alloys; simple rivets to complicated leaf spring assemblies; Uni-Clad, reduces the silver content in rivet-type contacts.



Circle 512 on Reader Service Card.

Frenchtown/CFI, Incorporated

Frenchtown, New Jersey

High alumina and beryllia ceramics; ceramic-to-metal seals; integrated circuit substrats; ceramic "windows" and spacers for high voltage tubes; aircraft and personnel armor plate.

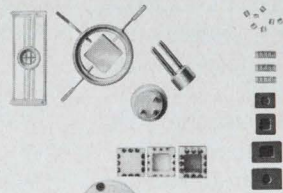

Circle 513 on Reader Service Card.

Micro Science Associates, Inc.

Mountain View, California

Precision photo-etching; complex, close tolerance prototypes and production runs; lead frames; magnetic recording laminations and cores; high-reliability custom "flat packs"; metal parts.

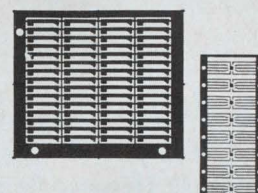

Circle 514 on Reader Service Card.

Montvale Customtool Co., Inc.

Montvale, New Jersey

Precision custom stampings; lead frames, headers eyelets, cans and modules; beryllium copper contacts and contact sockets; special stampings for computers and related equipment.

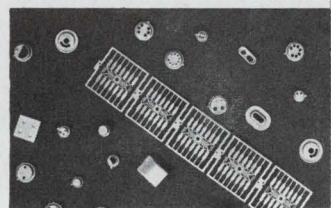

Circle 515 on Reader Service Card.

Northern Metal Products Company

Franklin Park, Illinois

Aperture mask assemblies and internal shields for color television tubes; other metal parts and assemblies for home entertainment and electrical appliance fields; heavy precision stampings.

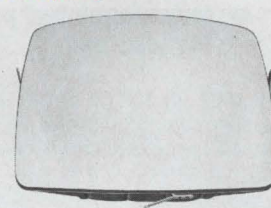

Circle 516 on Reader Service Card.

Veriton West, Incorporated

Chatsworth, California

Glass-to-metal, ceramic-to-metal packaging for integrated circuits; power transistor bases and lenses for photo-components; relay headers; terminal headers; glass-to-metal connectors.

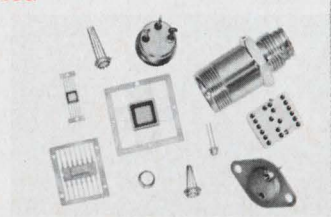

Circle 517 on Reader Service Card.

Our other subsidiaries:

- Automatic Metal Products Corporation
Brooklyn, New York
- Buchman Spark Wheel Corporation
Commack, New York
- Burton Electrochemical Industries, Inc.
Culver City, California
- Chem-Fab, Incorporated
Hot Springs, Arkansas
- Chemical Materials, Incorporated
Hot Springs, Arkansas
- Chemical Energy of California
San Diego, California
- Universal Titanium Corporation
Los Angeles, California and Linden, New Jersey
- U. S. Plastic Molding Corporation
Wallingford, Connecticut

See our displays and discuss your requirements at our suite in the International Hotel during WESCON.

Alloys Unlimited; Corporate Headquarters, 320 Long Island Expressway South, Melville, New York 11746
A.U. Sales Corporation, 16661 Ventura Boulevard, Encino, California 91316

TRYGON HAS THE POWER

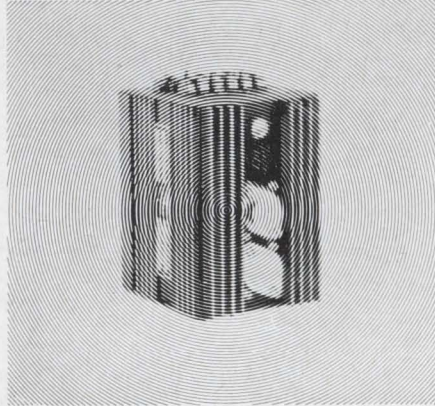

**to deliver systems
power modules
with all these features:**

- All silicon circuitry
- 71°C rating/no derating
- Independent of external heat sinks
- More regulated power for less money

Trygon's all silicon power supply modules: more regulated power for less money. Designed for unattended operation in military, industrial or commercial systems, they feature automatic reset short-circuit and optional overvoltage protection.

Choose from dual output tracking models, fixed voltage units and full-range programmable modules to provide versatile combinations for your multiple output system requirements.

Highest quality components: generously derated and aged power transistors—hermetically sealed rectifiers—temperature stabilized zener diodes—computer grade capacitors.

0.01% line regulation; temperature range from 0° to +71° C; remote programming; remote sensing; and more.

Compact 3¼" modules with ratings from 0 to 210 V, 0 to 1 amp, from as little as \$94. Ratings to 160 V in 4½" size (0 to 2 amps, from \$162); 5" size (0 to 5 amps, from \$177).



TRYGON POWER SUPPLIES

111 Pleasant Avenue, Roosevelt, L.I., N.Y. 11575
Trygon GmbH 8 Munchen 60, Haidelweg 20, Germany;
Write for Trygon 1968 Power Supply Handbook.

Electronics Review

keting and production capabilities enabling it to enter the big American market.

The system developed at Johns Hopkins has no dictionary display. It basically consists of an IBM 360-40 computer tied into IBM series 1050 terminal equipment—a 10-by-10 matrix keyboard, punch-card readers, printers, and card punches. The computer has a dictionary of pathological and anatomical terms programed into it.

The patient's name, address, and other data are recorded onto a punch card by a clerk when the X rays are taken. The films and the card then go to the radiologist. He inserts the card into a reader to record the basic patient data. And then he punches standard code numbers that refer to the medical terms he wants to record about the X rays. As soon as the numbers are punched, the information is printed out at remote terminals as well as being stored in the computer. Of course, unless the radiologist has the code numbers memorized, he must look them up in the standard lexicon.

A price hasn't yet been determined. The National Center for Radiological Health says the next step would be to have the lexicon pages presented visually—as Saab did with Medela three years ago.

Communications

Elbow room

Recommendations about what to do to relieve the crowded frequency spectrum are suddenly getting as numerous as people wanting air space.

Only days apart late last month, recommendations were offered by both the Joint Technical Advisory Committee (JTAC) and the Federal Communications Commission. The JTAC report—four years in the making—was released, by coincidence, shortly before the recommendations of the President's task force on telecommunications, due this month or next. But the timing

of the FCC proposals was a puzzle. One belief is that the FCC wanted to jump the gun on the task force, and to have this action under its belt in case it came in for criticism in the report.

JTAC was formed four years ago by the Electronic Industries Association and the IEEE at the request of Jerome B. Weisner, acting special assistant to the President for telecommunications. Some 200 engineers took part in it.

The 1,200-page report, entitled "Spectrum engineering—the key to progress," urged that spectrum allocation procedures be "markedly changed through the adoption of a spectrum engineering philosophy and system design concept." One effect of this would be to revise the "block allocation" system of allocating space, in which spectrum is reserved for a specific use nationwide, whether it is actually used for the purpose or not.

To find out precisely who is using what space, the report recommended a pilot project be established in one crowded region. Other recommendations:

- Improve spectrum monitoring;
- Improve the data base by standardizing terms and data collection activities;
- Improve standards for receiver susceptibility and unintended radiation;
- Increase funding for research into man-made radio noise;
- Establish a central body for data on biological and physical side effects of radio activity.

The report recommended that the pilot project be carried out in an area having several urban centers. Richard P. Gifford, chairman of JTAC, said that between \$3 million and \$4 million would be needed to launch the pilot project, and about \$10 million would be necessary to finance the project during its peak year.

In on the act. Not to be outdone by JTAC or the upcoming President's task force, the FCC without any fanfare issued two proposals that could have significance for spectrum usage. They were:

- Sharing the use of the lower uhf-tv channels (14 through 20) with land mobile radio where they

What's new in Linear Monolithic ICs?

This is new...

A 1-WATT AUDIO OUTPUT I. C. WITH 10mV. SENSITIVITY THAT OPERATES WITH ANY BATTERY SUPPLY FROM 4.5 TO 10.5 VOLTS.

The TAA 300 requires no external impedance matching resistors and no output transformers. Its better than 10mV. sensitivity is far better than that of any comparable power I.C. Its thermally compensated class "B" output stage gives it the best efficiency, lowest internal dissipation, and lowest current drain of any 1-watt power I.C. available today. In 10-lead, TO-5 envelope.

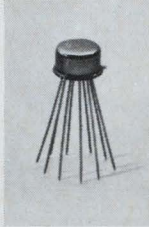

This is new...

AN AUDIO AMPLIFIER THAT ADAPTS CARBON MICROPHONES TO CERAMIC OR DYNAMIC TRANSDUCERS.

The TAA 500 is a unique audio amplifier circuit with a common output and D.C. supply line. With an external load of 100 ohms, it allows the use of ceramic piezoelectric transducers in circuits designed for carbon microphones. Can be used with dynamic microphones. Applications include mobile transmitters, aircraft communications, and telephone circuits. In 4-lead, TO-5 envelope.



This is new...

AN 80 DB GAIN I. F. AMPLIFIER FOR FM SIGNALS.

The TAA 350 is a 4-stage differential amplifier with current driven long-tailed pairs. It gives greater than 50 db AM rejection when operated in conjunction with a very simple slope detector. The input can be driven with either balanced or single ended signals. It is ideal for TV, FM and mobile radio I.F. applications. In 10-lead, TO-5 envelope.

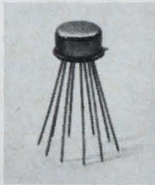

This is new...

A RING MODULATOR/DEMODULATOR WITH ONLY 3 NANOWATT CARRIER LEAKAGE POWER.

The TAB 101 ring modulator consists of four matched transistors isolated and balanced for telephone communications and modulator/demodulator applications. Provides better balance and lower carrier leakage than any conventional telephone carrier ring modulator. In 10-lead, TO-5 envelope.

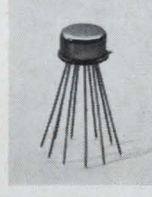

This is new...

AN I. F. SOUND AMPLIFIER WITH GREATER THAN 40 DB AM REJECTION PLUS RATIO DETECTOR AND AUDIO AMPLIFICATION.

The TAA 450 is an IF Sound Amplifier for frequencies up to 10.7 MHz. The circuit includes a ratio detector and a low distortion, controllable audio amplifier delivering up to 2V audio output. In 10-lead, TO-5 envelope.



This is not new, but...

IT'S THE ORIGINAL AND STILL THE BEST BI-FET.

The TAA 320 introduced the concept of an MOS FET and a bi-polar transistor combined on a single chip. Available in large quantities at prices as low as 38¢, it is ideal for high impedance applications in strain gages, radiation counters, crystal transducers and in measuring and timing circuits. In 3-lead, TO-18 envelope.



For data and applications information write, or phone:
Amperex Electronic Corporation, Semiconductor and Microcircuits Division,
Slatersville, Rhode Island 02876, Telephone: 401-762-9000.

... or call the Amperex Monolithic IC Specialist closest to you:
East Coast: Hicksville, N. Y., Phone: 516-931-6200
Midwest: Northlake, Ill., Phone: 312-261-7878
West Coast: Palo Alto, Calif., Phone: 415-327-0461

Amperex®

TOMORROW'S THINKING IN TODAY'S PRODUCTS

Circle 57 on reader service card

Analyze optical systems

Check optical transmission, efficiency, resolution or spectral characteristics easily, precisely, with greater flexibility . . . use a Gamma Scientific light analysis system.

Versatile. All our systems measure in either photometric or spectroradiometric units. All have a full line of plug-in heads and accessories; scanning microscope heads to profile small areas . . . miniature probes to reach restricted locations . . . grating monochromators for spectral analyses. Switch from one to another in moments.

Accurate, reliable. Gamma Scientific's fully transistorized systems are assembled, tested, calibrated . . . guaranteed from input to output. Add our calibrated source for measurements traceable to NBS.

Economical. You'll save time and money by meeting your total instrumentation needs with a single Gamma Scientific system.

Application assistance. We'll help you analyze optical systems, light sources, photo detectors or the optical properties of materials.

More information. Get all the details and our latest catalogue by writing to Systems Manager, Dept. 217, Gamma Scientific, Incorporated, 2165 Kurtz Street, San Diego, Calif. 92110.

Immediate problems? Call collect 714/291-2230.



GAMMA
SCIENTIFIC
Incorporated

Electronics Review

are not used for television.

▪ Allocating an additional total of 115 megahertz, lying between the 806-to-960-Mhz bands, for land mobile use. Some 75 Mhz would be used for a high-capacity common carrier system and 40 Mhz for private systems that are in top urban areas.

In proposing the rule to allow land mobile to use uhf-tv space, the commission majority said this "offers the best prospect for immediate relief of land mobile users." The commission said that existing equipment designs could be modified to permit use of the lowest channels within about six months and new or redesigned equipment could be expected for the remaining channels "within about one or two years." Comments on the proposal must be filed before Dec. 2. Commissioner Robert E. Lee, a staunch supporter of uhf-tv, was the lone dissenter to the proposal.

The recommendation of 115 Mhz of additional space to land mobile would almost triple the space now allocated for this purpose: 42 Mhz. The 115 Mhz would include 26 Mhz

Forest of objections.

The problem of reallocating frequency spectrum was illustrated recently when the Washington, D.C., police, which needs extra space, asked for some unused bands reserved for forestry-conservation use.

Although the only forests in the capital are forests of red tape and bureaucrats, the police proposal got strong objections from the Commonwealth of Virginia, the Virginia Division of Forestry, the New Jersey Bureau of Forestry, the Maryland State Department of Forests and Parks, the West Virginia Department of Natural Resources, and the Pennsylvania Department of Forests and Waters.

These agencies stressed that their present demands are so great they don't have enough spectrum as it is—no less give some away. The FCC, however, went along with the police—but gave assurances that the foresters would have first crack at this spectrum if they needed it sometime in the future in the capital.

formerly reserved for Government use and recently made available to the FCC by the Director of Telecommunications Management. This was in the 890-to-942 Mhz band. The other space lies between 806 and 942 Mhz. This space includes 40 Mhz allocated to tv translator stations, which generally do not use it in metropolitan areas; plus space allocated now for industrial and scientific equipment, and for common carrier mobile and base stations.

The FCC's proposal to allocate 75 Mhz for a common carrier system was good news to the American Telephone & Telegraph Co., which has been plugging for many years for such space. AT&T has said that with 50-khz spacing between channels, high-quality service could be provided to as many as 8,000 customers in an area. AT&T has told the FCC it would consider developing equipment to be used around the 900-Mhz range. The FCC noted it would require "several years" of development to establish "viable service."

In its proposal, the FCC raised a number of questions on which it asked comments by Dec 2.

Among them: will a 75-Mhz allocation for common carriers accommodate aircraft and maritime as well as land mobile units?

To what degree can multiplexing of base stations using single-sideband techniques be employed?

To what degree would uhf-tv receiver manufacturers need to change the image-rejection capabilities of their product to cope with problems of heavy land-mobile usage in the range of 806 to 947 Mhz?

Should portions of the 806-to-890-Mhz band be reserved for broadcasting from satellites, or should channels below this be reserved for such use?

Computers

Different type

Remote computer terminals, as banks and insurance companies

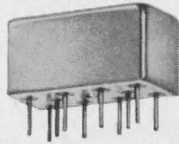

2 Amps.
All Welded

NEW

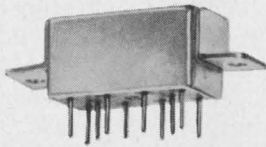

LATCHING RELAY

DPDT

0.37 oz.

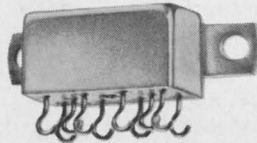

The new KL Series combines the proven performance of Hi-G 1/2 size crystal can relays with a unique new latching design. These relays meet all the applicable requirements of MIL-R-5757 and are available for fast delivery in all standard configurations and header styles.

Write or call Hi-G for Bulletin #103. If you need applications engineering assistance, an experienced Hi-G representative awaits your call. Telephone: 203-623-2481.



SPRING STREET & ROUTE 75 / WINDSOR LOCKS, CONNECTICUT 06096

The new SERIES KL Relays are available at the following DISTRIBUTORS

Angus, Incorporated, Pleasant Valley Avenue, Moorestown, N.J. 08057 TEL: 609-235-1900

Federal Electronics, P.O. Box 1208, Vestel Parkway E., Binghamton, New York 13903 TEL: 607-748-8211

Harvey Radio Company, Inc., 60 Crossways Park West, Woodbury, New York 11797 TEL: 516-921-8700

Lelectronix, Incorporated, 214 North 2nd Street, P.O. Box 188, St. Charles, Missouri 63301 TEL: 314-723-1122

Moulton Electronics Distributors, Inc., 1058 Terminal Way, San Carlos, California 97078 TEL: 415-591-8292

Moulton Electronics, c/o Banks Sales Corp., 2785 N. Speer Blvd., Denver, Colorado 80211 TEL: 303-433-5455

Tomelco/Moulton, 531 N. Brown Avenue, Scottsdale, Arizona 85251 TEL: 602-945-5030

Tomelco/Moulton, 15846 Pacific Highway South, Seattle, Washington 98188 TEL: 206-246-1727

Radio Products Sales, Inc., 1501 South Hill Street, Los Angeles, California 90015 TEL: 213-748-1271

R & D Electronics, Inc., 71 Pearl Street, Cambridge, Mass. 02139 TEL: 617-864-0400 and 8401; ENTERprise 7135 in Major Cities

Solid State Electronics Co. of Texas, 2643 Manana, P.O. Box 20299, Dallas, Texas 75220 TEL: 214-352-2601

Westates Electronics Corp., 20151 Bahama Street, Chatsworth, California 91311 TEL: 213-341-4411

BELL HALL EFFECT GAUSSMETERS



Model 640 A high performance incremental gaussmeter with precalibrated and interchangeable probes. Center zero meter for direct readout for small incremental variations in both \pm direction. 1.0% accuracy to 30 kG (0.5% to 10 kG). One volt FS calibrated output.

- $\pm .005\%$ / $^{\circ}$ C Temperature Stability
- Precalibrated Probes
- 0.5% Accuracy to 10 kG
- Interchangeable Probes
- 1000x Scale Expansion —
— (Model 640 only)

PLUS
other extras
at even
lower cost
for better
measurement of
**Magnetic
Fields**



Model 620 is a budget-priced precision gaussmeter that offers the full advantages of recently developed high linearity Hall elements and solid state circuitry. Precalibrated interchangeable probes. 1.0% accuracy to 30 kG. Direct ac and dc field readout. 0.3% built-in cal accuracy.

Leaders in Hall Effect Components,
Instruments and Systems



SEE US AT WESCON—BOOTH #1704

60 Circle 60 on reader service card

Electronics Review

have discovered, entail considerable expense for equipment ranging from special typewriters to custom desks. So it follows that a terminal using conventional office equipment—already paid for—would find a ready market.

That's what Navigation Computer Corp. of Valley Forge, Pa., hopes will happen with its "overlay" keyboard system. The device, a typewriter keyboard that locks atop any standard electric typewriter, gives key-to-key alignment. A typist can use it to send data to a central computer via an acoustic phone coupler, teletypewriter line, or direct line, while simultaneously producing hard copy.

And it comes out here. When a key is depressed a signal is generated; the signal is then converted to a code. A circuit changes the code from parallel to serial form and sends it to the central computer or another remote terminal. To receive, the solid state overlay is simply switched to the receive mode and accepts data via the same circuit.

William Ogeltree, Navigation Computer's president, says a typical installation—overlay, storage, and coupler—will sell for about \$3,000.

Like some other remote terminals—notably those made by the Community Corp. and IBM—the overlay system can use punched or magnetic tape for storage. But, Ogeltree points out, his device has the advantage of interfacing with a standard typewriter.

Office machine

Designers who have looked longingly at computers as a tool have usually been forced to turn back to their drawing boards and slide rules after glancing at the price tag. Computer-assisted design has required, up until now, large computers—and consequently only large organizations were able to take advantage of them.

Now, an experimental system at International Business Machines Corp.'s Systems Development Division in Kingston, N.Y., aims to put computers economically into

small design shops. In addition, the system can allow satellite design workshops to be set up by large firms that already have third-generation computers assigned to design projects.

Called Glean, for graphic layout and engineering aid method, the system consists of an IBM 1130 computer, IBM 2250 display unit, a plotter drafting machine, and a precision controller. According to W.H. Sass, a staff engineer who has been working on Glean, the system will cost about as much as "one to two engineers on a 40-hour-a-week basis." Sass believes the system would be feasible for small engineering firms currently employing three or four engineers. He explains that the system has been used at IBM to design, analyze and generate art work for circuit cards, boards, special circuits, and computer components.

In line. Key to the program and its economy is that it uses a low-cost computer and several "independent" machines which become specialized processors for elements of the design process. In other words, several tasks can be performed concurrently. While a relatively slow process such as graphic plotting is being conducted, other design work can be in progress in other faster parts of the system. Sass says, "In Glean we are queueing tasks for devices rather than queueing users for the system."

The ability to queue tasks, he says, improves user access and allows the system to maintain a reasonably constant work load. Sass compares the system's ability to handle different tasks at once to time-sharing, but on a miniature scale.

Satellites. The Glean system now used by IBM is linked to a 360 computer by telephone lines, and thus taps the power or data bank of the larger processor for bigger jobs. Sass believes that a single third-generation computer could act as the center for a system of "satellite" 1130 systems.

He says; "In IBM's case, the so-called supermarket laboratories could employ 1130's to handle smaller design tasks and when a

WE SAW A BETTER WAY TO SERVE YOU...

so we took it.

The way led to McKeesport, Pa. and Advanced Metals Corporation, a specialist in the exciting science of *powder metallurgy*. We bought the company. Not because we like to spend money . . . but because this allows us to offer additional products and services . . . *semi-conductor components, filters, structural parts and EDM electrodes* as well as *electrical contacts*. Now, in our own plant, we are producing powder metals and parts in tungsten, copper-tungsten, silver-tungsten, silver-molybdenum, molybdenum, silver, silver-graphite, silver-cadmium oxide, copper, stainless steel, high density iron, etc. Deringer manufactures electrical contacts in a tremendous variety of sizes and configurations. Two recent exclusive developments, the Deringer Duell Head Process and the Economet® Contact are saving up to 70 and 75% in certain contact applications while maintaining or improving electrical performance and contact life. Want to review your applications with an eye on greater cost savings? These new facilities, developments and products could do it for you . . . and we'll be happy to help. Just contact:

DERINGER

METALLURGICAL CORPORATION

1250 Town Line Road (Rt. 60) Mundelein, Illinois 60060

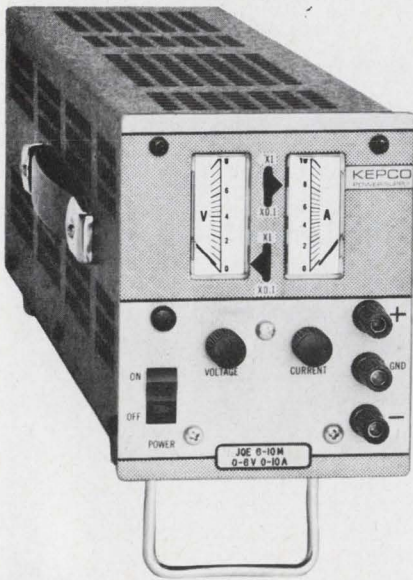

MORE POWER TO YOU from KEPCO

Our new JQE quarter racks pack more power (up to 100 watts) into a fully enclosed, self-cooled power supply that's rated from -20°C to $+71^{\circ}\text{C}$ WITHOUT DERATING!

MODEL	DC OUTPUT RANGE		PRICE
	VOLTS	AMPS	
JQE 6-10M	0-6	0-10	\$275.00
JQE 15-6M	0-15	0-6	275.00
JQE 25-4M	0-25	0-4	275.00
JQE 36-3M	0-36	0-3	275.00
JQE 55-2M	0-55	0-2	285.00
JQE 75-1.5M	0-75	0-1.5	285.00
JQE 100-1M	0-100	0-1	285.00

A special linear IC Regulator provides 0.01% regulation with less than 200 μV ripple and noise. A 10-turn control insures high resolution which, together with dual-scale volt and ammeters, make operation a cinch. Rack mountable, of course, four abreast in a RA-24 Adapter.

For some high powered spec sheets, write Dept. AJ-14



131-38 SANFORD AVE. • FLUSHING, N.Y. 11352
(212) 461-7000 • TWX # 710-582-2631

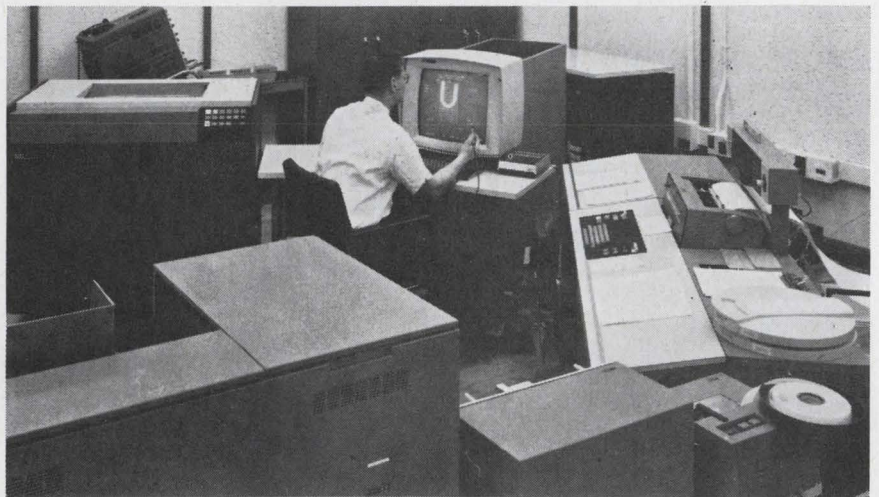

Custom design. Gleam is a low cost IBM system for computer-assisted design. It uses an IBM 1130 computer, a 2250 display unit, plotter drafting machine, and a precision controller.

larger job has to be done it could connect with the central 360 computers."

Sass predicts that low-cost systems will create hundreds of computer-aided design workshops as opposed to the handful now. He concedes that IBM's competition is working on such low-cost systems.

He says these systems are feasible for a host of users—ranging from architects and surveyors to electronics designers. IBM has used the system to successfully design a computer-character generator. IBM would not say when the system will be marketed.

For the record

Laser safety. In three months, the Army and Navy expects to publish safety guidelines for servicemen who will operate laser range finders, target illumination, and station-keeping systems now under development.

The men will be cautioned not to look into a laser, to wear goggles, not to fire down range when other troops are about, and to look out for ricochets. Laser devices are to be adequately shielded. The guidelines will also prescribe eye checkups for men who are about to enter laser work. There will be periodic checkups, probably every six months.

Men believed to have been accidentally exposed to a laser beam will also be given exams. The services are chiefly concerned with the threat of permanent eye damage because the eye is a million times more susceptible to laser burns than the skin, and there is no specific treatment for such eye damage.

The two services are working to put out the joint guidelines within three months. They will follow the Air Force, which published its first safety regulation in January 1967 prescribing mandatory annual eye checkups. In April this year the Air Force put out threshold values and is preparing a new set of standards on such things as what color laboratory walls should be painted.

The Army recently experimented with a tank laser range finder but recalled the experiment when it discovered that a beer can laying in a field could bounce a laser beam back and blind the operator.

Back on the road. Sperry Rand is warming up for another try at traffic control. Last January, after a three-year effort, Sperry gave up on a \$5.9 million contract to develop a computer directed traffic control system for New York City.

This time Sperry Systems Management division has been awarded a \$320,000 contract by the Federal Highway Administration's Urban Traffic Control System to put together the hardware specifications



**YOU'LL JUMP
FOR JOY...**

**when you see the complete specs
and prices on our new**

**"PIXIEPOT"
POTENTIOMETER!**

Never before in the history of the pot industry have you been able to get a TEN-TURN, WIRE-WOUND PRECISION potentiometer at prices like these. The Duncan Model 3253 "PIXIEPOT" is yours for as low as **\$3.97** each in production quantities and only **\$5.95** each for 1-24 units.

Match the following "PIXIEPOT" features with any other similar pot on the market.

- Length: **ONLY 3/4"**
- Diameter: **ONLY 7/8"**
- Linearity: **±0.25%**
- Resistance Range: **100 ohms to 100K ohms**
- Power Rating: **2 watts @ +20°C**
- Temperature Range: **-25°C to +85°C**
- Resolution: **Better than ANY wirewound pot TWICE its size!**
- Slotted Stainless Steel Shaft

A Duncan "PIXIEPOT" can save you dollars on your instrument and system requirements. If you want to know just how many, call or write us today. The full story on the "PIXIEPOT" will be in the mail to you within 24 hours. And when it arrives, be prepared to jump for joy!



DUNCAN electronics, inc.

A DIVISION OF SYSTRON-DONNER CORPORATION

2865 FAIRVIEW ROAD, COSTA MESA, CALIFORNIA 92626



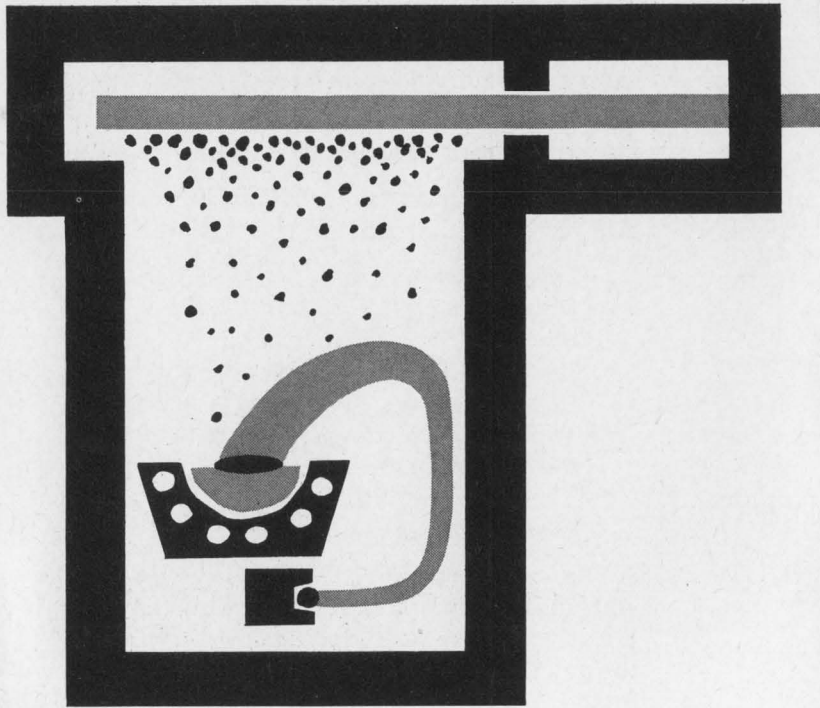

We mechanized thin-film coating

when we perfected our Fast-Cycle Coater

Even unskilled operators can produce consistently uniform, high-quality products at high production rates with automated Airco Temescal Fast-Cycle Coaters. This is because every step in the cycle is preset, every step is automatically controlled, and the cycle can continue only after each programmed step is completed. Rejects are practically eliminated. Check these features:

- The automated cycle is reproducible.
- The coating chamber, sources, and feed material are under continuous vacuum at all times.
- Elimination of repeated pump-downs results in fewer contaminants, purer coatings.
- Evaporant may be replenished without interrupting operation.
- Efficient rate-monitoring system can be used for precise control over film thickness.
- The rotating substrate holder assures piece-to-piece uniformity.
- Substrates may be heated to exact specified temperatures for more effective coating.
- Coated substrates can be cooled in vacuum and/or in inert gas.
- Thoroughly proved electron-beam heat sources can evaporate elements, alloys, refractory metals and dielectrics.

The Airco Temescal Fast-Cycle Coater, Model FC-1100, replaces eight bell jars and seven operators. Why settle for less? Write for details.

AIRCO Temescal

A DIVISION OF AIR REDUCTION COMPANY, INCORPORATED
2850 Seventh Street, Berkeley, California 94710 Telephone 415 841-5720

Electronics Review

for a highway traffic control research site in Washington, D. C. Also included in the program were TRW Systems, which for \$210,000 will do the same thing but for software, and Cornell University's Operations Research department, which is getting \$75,000 for related studies.

If all goes well, Sperry could wind up with follow-on contracts for the system's hardware, once the one-year first phase is over.

Compleat. Hughes Aircraft Co.'s Newport Beach, Calif., division has rounded out its semiconductor operation by introducing a complete family of bipolar monolithic integrated circuits. Confirming an earlier report [Electronics, May 27, p. 25], division manager Jack Hirshon says the new line consists of 27 different transistor-transistor-logic circuits, 50 diode-transistor-logic circuits, and 8 linear amplifiers. All devices will be available in both standard TO-5 and flatpack dual-in-line packages.

Flight control. The Aircraft Equipment division of General Electric and Sperry Rand's Flight Systems division, have been awarded \$300,000 contracts by Boeing to produce studies of advanced flight control electronic systems for the SST.

Wait and hurry up. More than five years since its Versatile Avionics Shop Test (Vast) system was introduced, the Navy has ordered a \$1.15 million study to determine the equipment and personnel required to service all aircraft now in the fleet or due to join it in the next decade. The study is being made by the Grumman Aircraft Engineering Corp.; subcontractors are Autonetics, Bendix, Collins Radio, B-K Dynamics, and Computer Science. The Navy, now in a hurry to get the project under way, wants the study delivered next February. Early indications are that a system of computer-driven buildings blocks will be recommended. And a high degree of hardware commonality would make the most of precious below-deck space in aircraft carriers.

Not all latching relays this small are reliable.

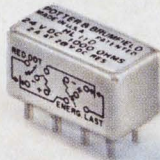

HL Latching Relay

This one is. Here's why.

First, the design. No other half crystal case latching relay, according to major users, can match its magnetic structure and its ability to meet the most stringent specifications.

Second, the meticulous production procedures we follow (our Intensified Control and Reliability Program) exceed industry standards. All assembly, adjusting and hermetic sealing are confined to our spacious clean room, replete with sophisticated air conditioning, laminar air flow work stations, ultrasonic cleaners, a Royco particle counter and a double air lock entrance.

Third, realistic verification of performance—including random vibration testing—is without duplication in the relay industry. For complete information, talk with your local P&B representative or call Potter & Brumfield Division of American Machine & Foundry Company, Princeton, Indiana.

HL SERIES ENGINEERING DATA

Description: Dual coil, polarized, magnetic latching (Single coil, polarized relays available on special order)
Contact Arrangement: DPDT (bifurcated, gold-plated silver-alloy)
Contact Rating: Dry circuit to 2 amperes @ 28V DC, resistive
Contact Resistance: 50 milliohms before life; 100 milliohms max. after 100,000 operations at maximum rated load
Expected life: 100,000 operations minimum at rated load
Pick-up: Dual coil—150 milliwatts (approx.)
Shock and vibration immunity:
Shock: 150g for 11 milliseconds
Vibration: .195" D.A. from 10 to 55 Hz.
 30g, 55 to 3,000 Hz.
Random Vibration: In excess of .4g²/Hz.
 20 to 2000 Hz.

No contact opening in either armature position



Partial view of clean room where HL relays are assembled, adjusted and sealed.



TIG (Tungsten inert gas) welding process is used to seal headers to cases.



Sealing in controlled atmosphere follows evacuation in vacuum ovens.



Hermetic seals of HL relays are verified with radio-active krypton 85.

Military and aerospace equipment demands proven reliability. That's why Dytronics specifies capacitors of MYLAR[®]

Dytronics Co., Inc., of Columbus, Ohio, makes Primary Phase Angle Standards that are used all over the world in all temperature extremes. Each precision unit uses 70 capacitors of MYLAR* polyester film. Why MYLAR? Here's what Paul Ryan, President, had to say: "Military and major aerospace facilities cannot afford equipment failure, and we must be sure of the

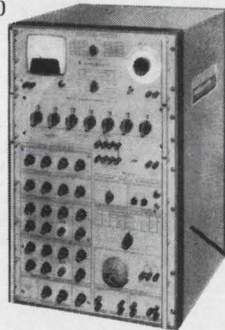

components we select. Hundreds of our Primary Phase Angle Standards are in military usage, and we are not aware of a single failure of capacitors of MYLAR...we feel that this is evidence of both the reliability and performance of MYLAR and we find that capacitors of MYLAR cost about the same as those made of paper."

MYLAR offers thermal stability from -70° to $+150^{\circ}$ C., plus excellent resistance to most chemicals and moisture.

MYLAR has high tensile and dielectric strength. Its unexcelled thinness has enabled manufacturers to reduce size and weight in capacitors.

Isn't that reason enough for you to consider capacitors of MYLAR in your designs? For additional information write to Du Pont, which offers the thinnest, most versatile range of capacitor dielectric materials available. Address: Du Pont Co., Room 5852B, Wilmington, Delaware 19898.

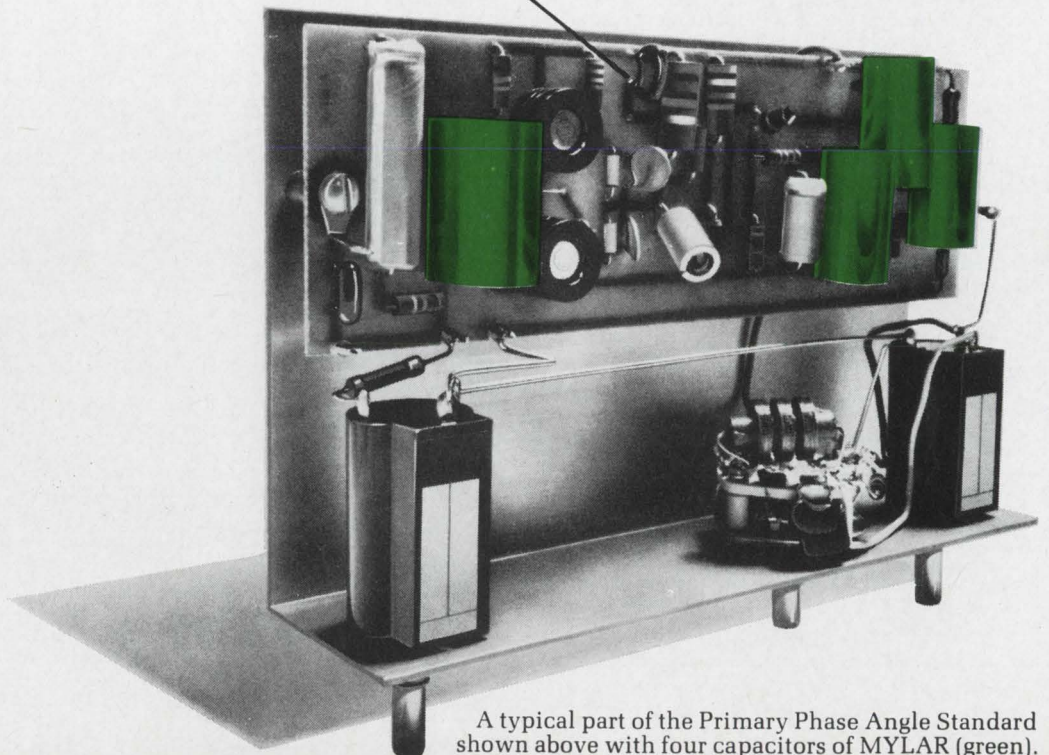

A typical part of the Primary Phase Angle Standard shown above with four capacitors of MYLAR (green).



The Allen-Bradley distributor in your area carries your control center in stock

An AB Modular Control Center can consist of one or more sections, accepting starter ratings from Size 0 to Size 5.

Telephone your local A-B distributor and he will deliver to you—from his stock—all the components necessary for the control center which you require.

The sectionalized mounting frames are complete with all necessary hardware. They can be erected—at the site—in a matter of minutes, and will then be ready to accept A-B combination starters in ratings from Size 0 to Size 5. The enclosures for these starters have been designed so that they will fit as “building blocks” on the mounting frames.

The AB Modular Control Center can be tailored to your particular job with non-reversing, reversing, and multi-speed starters. When the required starters do not completely fill the mounting frame, blank panels can be furnished at a nominal price to cover up the empty spaces. Special enclosures are available, arranged for mounting contactors, timers, relays, and similar control

devices. Additional frames can easily be added to the original installation whenever this becomes necessary. Allen-Bradley NEMA Type 1 or Type 12 combination starters can be used in the one standard frame assembly.

Have your local Allen-Bradley distributor demonstrate this new AB Modular Control Center—you will immediately recognize its money saving value. Furthermore, with all items in the A-B distributor's stock—including the required starters—a modular control center consisting of many sections can be installed and in use in a matter of two or three weeks. For an equivalent, completely assembled control center, a shipment promise of 16 to 20 weeks is common—and before it is installed and ready to be connected to power, many additional weeks will have passed. Allen-Bradley Co., 1201 South Second St., Milwaukee, Wis. 53204. Export Office: 630 Third Avenue, New York, N. Y., U.S.A. 10017.



ALLEN-BRADLEY

Member of NEMA

QUALITY MOTOR CONTROL

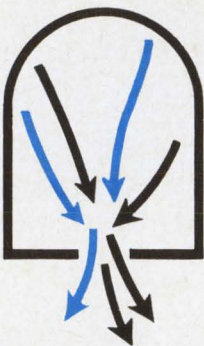

MEET THE DECISION MAKERS...

Four CVC High Vacuum Systems with AutoMate™ Control!

Just touch the start button, AutoMate does the rest. The AutoMate Control on your CVC system controls pumping cycles automatically—as fast and accurate as your best technician. The cycling decision is

made and carried out in response to pressure in the system—you get the same results in your pumpdown every time. For full details, write Consolidated Vacuum Corporation, Rochester, New York 14603.

	CV-144	CV-164	CV-18	CV-1104
APPLICATIONS	Electronic and Optical Thin-Film Deposition, Environmental Studies	Electronic and Optical Thin-Film Deposition, Environmental Studies	Electronic and Optical Thin-Film Deposition, Environmental Studies	Electronic and Optical Thin-Film Deposition, Environmental Studies
CHAMBER	14" Pyrex Bell Jar	18" Pyrex Bell Jar	18" Pyrex Bell Jar	24" or 30" Stainless Steel Bell Jar
DIFFUSION PUMP	4" BlueLine	6" BlueLine	6" BlueLine	10" BlueLine
BAFFLE	Choice of multi-coolant or liquid nitrogen	Choice of multi-coolant or liquid nitrogen	Choice of multi-coolant or liquid nitrogen	Choice of multi-coolant or liquid nitrogen
EVAPORATION POWER SUPPLY RATING (Continuous Duty/20% duty)	2 KVA/3.9 KVA	2 KVA/3.9 KVA	2 KVA/3.5 KVA	4 KVA/8 KVA

New CV-1104 System With AutoMate™ Control

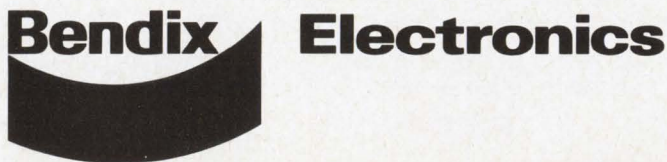

Visit TAC at WESCON booths 2002 & 2003 where we can supply priceless demonstrations of the 1200 Wafer Prober which is the first to handle 3" diameter wafers

The IC 400 DTF which automatically feeds, contacts and classifies carrier mounted TO-5, DIP and flat pack type IC's without track changes at rates of 6,000 parts per hour with 300 ms test time. . . .

The ICT 500 D which final tests naked DIP's at temperatures of -65°C or $+150^{\circ}\text{C}$ at rates up to 3600 pieces per hour with a 3 minute soak and 600 ms test time allowed. . . .

The IC 200 DTF which handles carrier mounted IC's. Manual input, 2 bin output. Standard track for all three packages.

See these and more at WESCON.

***If a picture's
worth
1,000 words
what's a
demonstration
worth***



A TELEDYNE COMPANY

TRANSISTOR AUTOMATION
10 FORBES ROAD
WOBURN, MASSACHUSETTS 01801
(617) 935-5400 U.S.A.

TAC

TWO ENGINEERS WITH THE SAME PROGRAMMING PROBLEM

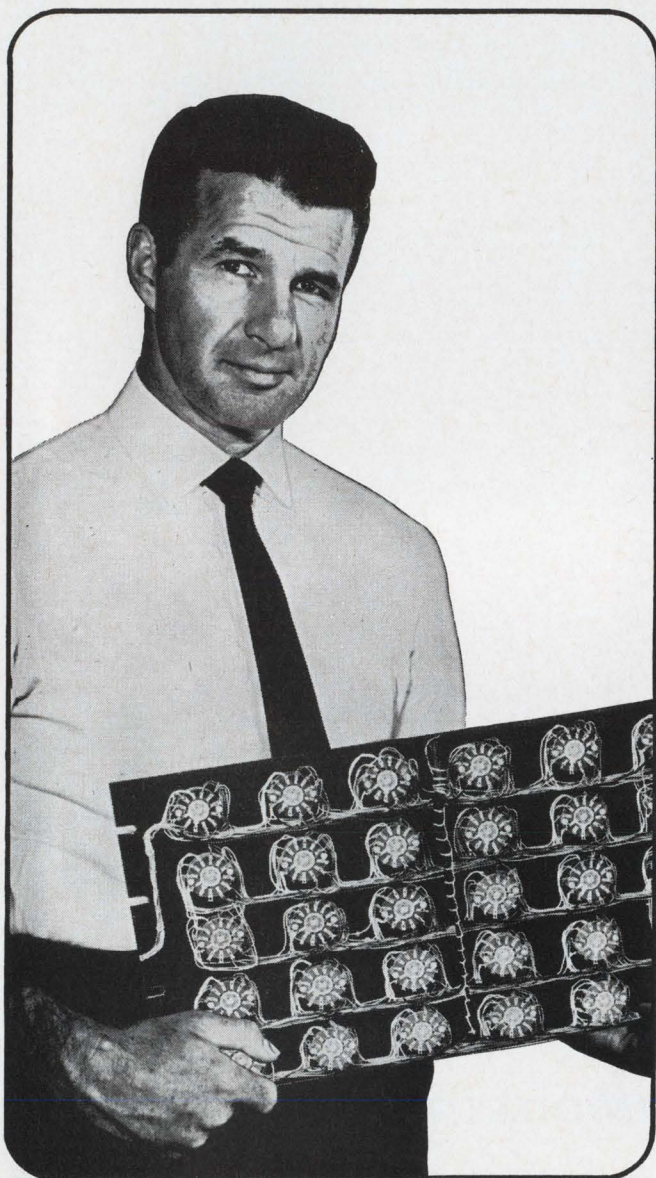

USING ROTARY SWITCHES requires 330 soldered joints . . . over 8 hours of labor . . . occupies 293 square inches of panel space . . . costs \$88.00 installed.
(That's \$0.29 per switching point.)

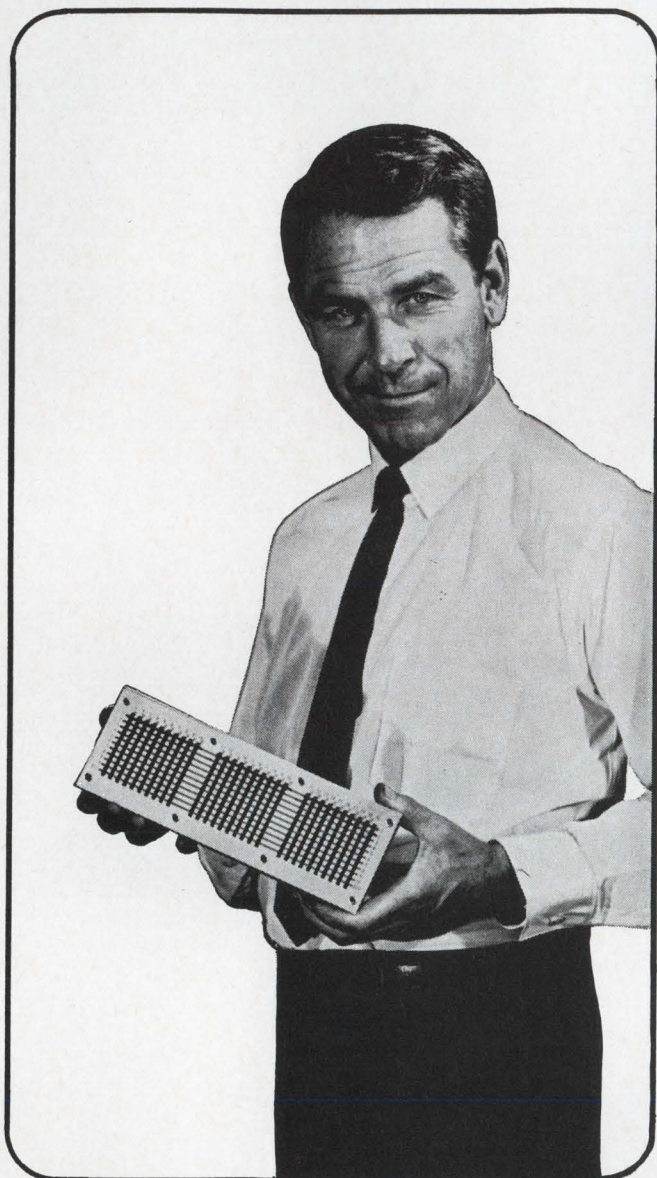

USING CHERRY SELECTOR SWITCH requires no soldering . . . less than 5 minutes of labor . . . occupies 41 square inches of panel space . . . costs \$32.95 installed.
(That's \$0.11 per switching point.)

WHICH ONE WOULD YOU LIKE TO CHECK FOR A MISTAKE IN WIRING?

WRITE TODAY for full details on the totally new Cherry Selector Switch. It may change all your old ideas about programming devices.

CHERRY 

CHERRY ELECTRICAL PRODUCTS CORP. • 1656 Old Deerfield Road • Highland Park, Illinois 60035

More and more electronic and communication components are turning up in LEXAN[®]

POLYCARBONATE RESIN

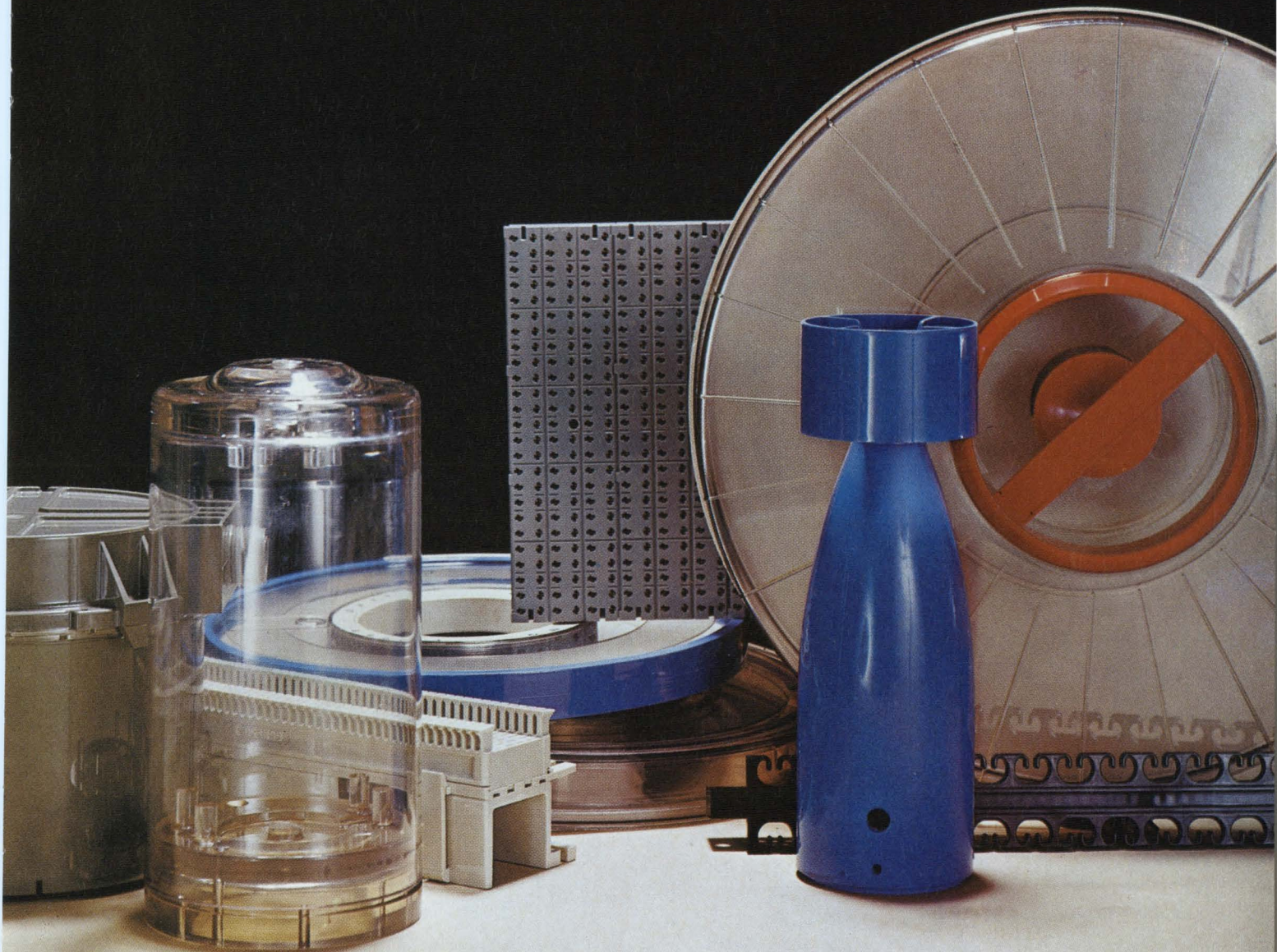

Sanders underwater electronics container and sound signal tailpiece, Memorex disc pack, Motorola housing, Western Electric 3-piece connector, GE tape reel case, Elco diode connector, Data Packaging tape reel and wrap—all molded of LEXAN polycarbonate resin.

The polycarbonate combination of toughness, electrical properties, and flame resistance accounts for its use in so many electronic and communication components.

LEXAN 2014 resin is the only polycarbonate to meet the flame resistant standards of self-extinguishing, Class 1, UL Bulletin 94. Excellent electrical insulating properties and thin section strength up to 250°F add to the value.

LEXAN polycarbonate properties such as dimensional stability, rigidity, creep resistance and impact strength allow parts made of LEXAN to be slammed, banged, shocked and vibrated many thousands of times beyond performance requirements.

These are the reasons why LEXAN resin is repeatedly replacing metals and ther-

mosetting materials. You get the high performance needed, while reaping the low cost processing advantages of a thermoplastic. In fact, the Sanders tailpiece represents a 60% cost reduction over aluminum!

For more information, write Section 145, Chemical Materials Department, General Electric Company, One Plastics Ave., Pittsfield, Mass. 01201.

Leader in Engineering Plastics

LEXAN[®] • NORYL[®] • PPO[®] • PHENOLICS

GENERAL  ELECTRIC

Circle 71 on reader service card



microwave problem? talk to Andrew...the antenna systems specialist

Andrew microwave antenna systems are hard at work all over the world. Fixed, portable, and mobile installations, designed by Andrew, can be found wherever communications engineers demand the utmost in performance and reliability. ■ This new transportable 7 GHz system is a good case in point: used in a quick reaction microwave link, the unit packs broadband communications capability into a compact package. A 100 ft. aluminum telescoping mast pneumatically raises the 6 foot antenna, guy wires, and dual axis positioner in

less than 60 minutes. The flexible HELIAX® elliptical waveguide feeder goes up simultaneously, and the jacket includes control cables for the positioner. An automatic dehydrator-compressor, 1½ ton trailer, and AC power supply complete the package—all from Andrew. One source—one responsibility. ■ **Have a microwave antenna system problem?** Bring it to Andrew, most people do! Andrew Corporation, 10500 W. 153rd St., Orland Park, Ill. 60462.

3-67



Washington Newsletter

August 5, 1968

Johnson won't act on communications task force report

President Johnson will neither submit legislation to implement any recommendations his task force on telecommunications will make, nor will he order any administrative changes based on the panel's report. This means that his successor will face the difficult job of acting on the recommendations, which are bound to be controversial.

The President won't sit on the report, however. He's insisting that the task force complete its work this summer. It now appears certain that the group will miss its mid-August deadline [Electronics, June 10, p. 80]—though not by as much as predicted previously. **If the report is submitted by the end of this month, Johnson would have time to get as much political mileage as possible out of it.** White House insiders point to Labor Day as a likely public release date for the report.

Intelsat 3 delivery is again set back

Another slated delivery date for the first Intelsat 3 satellite will be missed. TRW Systems, the prime contractor, said as late as two months ago that the craft would be delivered no later than the first week in August [Electronics, June 24, p. 141], but the latest word is that it will be turned over to Comsat late this month or in early September.

Comsat still officially holds that the satellite will be launched in time to relay television reports of the Mexico City Olympics, which begin Oct. 14. **However, time is growing short.** Once the satellite is accepted by Comsat, it will be shipped to Cape Kennedy for tests. A communications satellite normally goes through from two to three weeks of hangar testing at the Cape, and five to 10 days of checkout on a launch pad.

One of the major problem areas remaining is reportedly the communications subsystem being built by ITT. On the plus side, the mechanically despun antenna built by Sylvania is now working well. The three flight models delivered to TRW so far yield more gain than Comsat specified. The beam is more narrow vertically than Comsat had wanted, but this loss of a few tenths of a decibel near the edge of the beam is more than offset by the increased over-all gain.

Airport traffic jam spurs call for probe

The FAA may have to answer some embarrassing questions from Congressmen before the year is out. The recent slowdown in airliner takeoffs and landings dictated by air traffic controllers at major airports has spurred Rep. Richard Ottinger (D., N.Y.) to call for a Congressional inquiry. Ottinger, who's pushing for hearings as soon as Congress reconvenes after the political conventions, says he wants to know **"precisely what liberties were taken with safety regulations before the 'by-the-book' campaign went into effect."**

EIA wants word on phone standards

The Electronic Industries Association is moving fast to prevent any unilateral action by the Bell System in setting standards for **"foreign attachments"** on phone company lines. It has formed an ad hoc engineering committee to consider what standards should be set. It wants to do its homework by the time Bell is ready to make its recommendations to the FCC. If the June ruling by the FCC in the Carterphone case is upheld, as expected, in the courts, Bell may seek to establish tough

Washington Newsletter

standards. And the EIA, aware of the huge business potential, wants to get into the act.

First committee hearing will be in early September and the EIA hopes to get Bell's cooperation. A spokesman for the telephone company says that although it has received no official announcement of the EIA committee, they are "awaiting a request to cooperate in the formation of standards with interest."

Fingerprint readers are still on FBI's 'most wanted' list

Two organizations developing automated fingerprint-reading equipment for the FBI have run into design problems that put them a year behind schedule. No one will say what the problems are, but the FBI has extended the two development contracts into 1969. No additional money is involved.

Cornell Aeronautical Laboratory and Autonetics originally were to deliver prototypes this summer [Electronics, July 10, 1967, p. 50]. The FBI now expects to get final designs by November and prototype gear by mid-1969.

Cornell's approach involves a flying spot scanner that reads prints from opaque forms; the Autonetics reader employs holographic techniques. Both systems would automatically read, classify, and sort fingerprints based on the minute differences among them. One of the two systems is expected to serve as the basis for an FBI fingerprint processing center.

Firms oppose tryout of simpler Air Force contract standard

There is growing industry opposition to the Air Force's plan to try out in one or two new contracts an approach to its 375-5 systems engineering management procedure [Electronics, July 22, p. 53] that would involve less paperwork than did the original version. Defense contractors fear that such a trial period might cause the Pentagon to postpone the formulating and implementing of a tri-service systems engineering management standard. Industry has been pushing for such a standard and would prefer that the Air Force adopt the alternate to the 375-5 immediately.

A tri-service standard has been agreed to in principle by the three services but no formal documentation has been started. "There are at least a thousand systems engineering management documents in the Pentagon now," says one industry spokesman. "What we want is some uniformity." Despite the opposition, however, odds are that the Air Force will go ahead with its tryout of the simpler approach.

Comsat charter change may lead to broad shakeup

A proposed reconstitution of Comsat's board of directors could lead to wholesale revisions in the company's charter. The proposal, which would limit common carriers' representation on the board to the proportion of Comsat stock they hold, has support in the Senate Commerce committee and should have little trouble getting to the Senate floor. However, it would be the first amendment to the original Communications Satellite Act of 1962, and it might open the door to a full discussion of the firm's charter and generate further amendments and riders. The company's role in the aeronautical, broadcast, and ground-station fields might be broadened—or contracted.

The common carriers currently hold 42.5% of Comsat's outstanding shares but are represented by six of the firm's 12 directors. Under the proposed formula, they would rate only five directors.

Sorensen modular power supplies

$3\frac{5}{16}$ " x $3\frac{7}{8}$ " x 7", $\pm 0.005\%$ regulation

\$89⁰⁰

any questions?

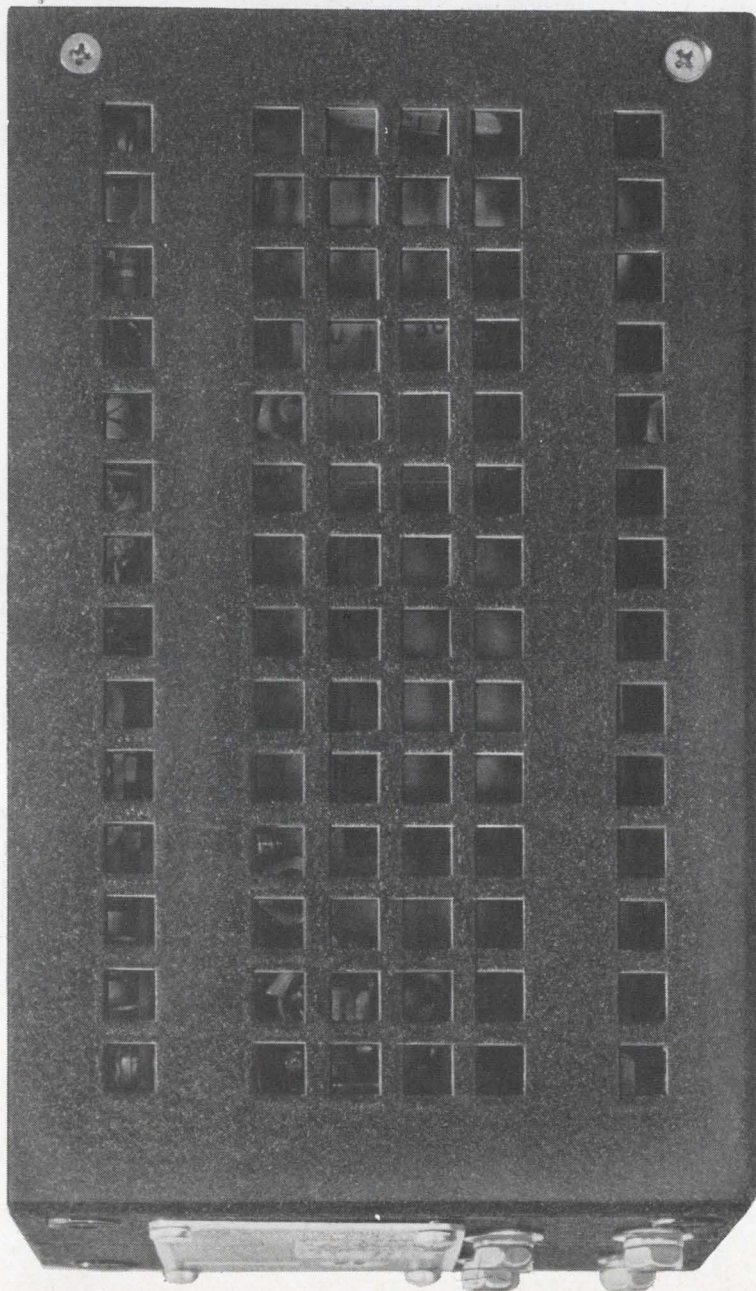

- Model QSA48-.4 Power Supply, shown actual size, illustrates the compactness of the Sorensen QSA Series. New off-the-shelf models cover the range to 150 volts.
- All silicon transistor design—convection cooled—operating temperatures up to 71°C.
- Requires no external heat sink—mount in any position.
- Lowest ripple of any modular supplies—300 μ V rms.
- Best voltage regulation— $\pm 0.005\%$ line and load combined.
- Lowest prices—\$89 to \$149.
- Overload and short circuit protection.
- 20 μ s response time—no turn-on/turn-off overshoots.
- Three sizes in each voltage range depending on power level—all are rack mountable with optional 3½" rack adapter.
- Remote sensing and remote programming—capable of series/parallel operation.
- Any further questions? For QSA details or for other standard/custom DC power supplies, AC line regulators or frequency changers contact your local Sorensen representative or: Raytheon Company, Sorensen Operation, Richards Avenue, Norwalk, Connecticut 06856. Tel: 203-838-6571



Will Scotchpar[®] win the Ester award for the best film of the year?

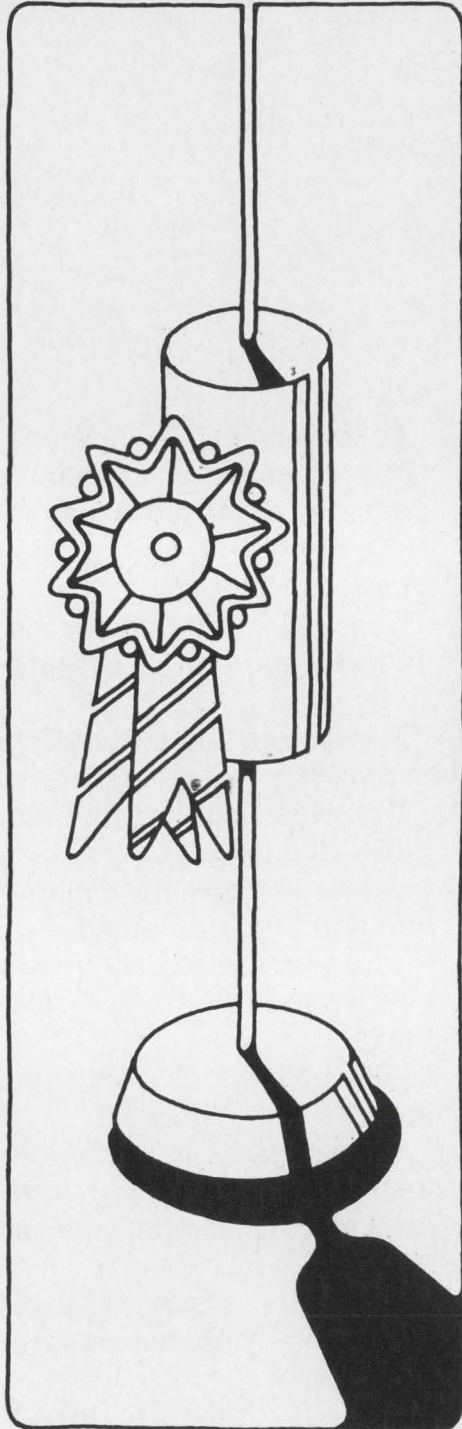

Based on the quality of polyester films, 3M's SCOTCHPAR should win at least as many votes among electrical manufacturers as the "big name" film.

There's nothing better than SCOTCHPAR film for capacitors.

And there's nothing better than SCOTCHPAR film as insulation for transformers, motors, wire and cable.

We have it in thin films and thick films.

SCOTCHPAR film has high dielectric strength, great temperature stability, resistance to moisture and solvents. It's thin, tough, flexible and durable.

If you're going to use polyester film instead of a conventional insulation—and you should, to cut costs, save space, and improve product performance—vote for SCOTCHPAR. If you want the heat sealable version, the name is SCOTCHPAK[®] film.

A vote for SCOTCHPAR polyester film is a vote for quality and adaptability.

3M Company, Film & Allied Products Division, 3M Center, St. Paul, Minnesota 55101.

Scotchpar[®] 3M
BRAND POLYESTER FILM

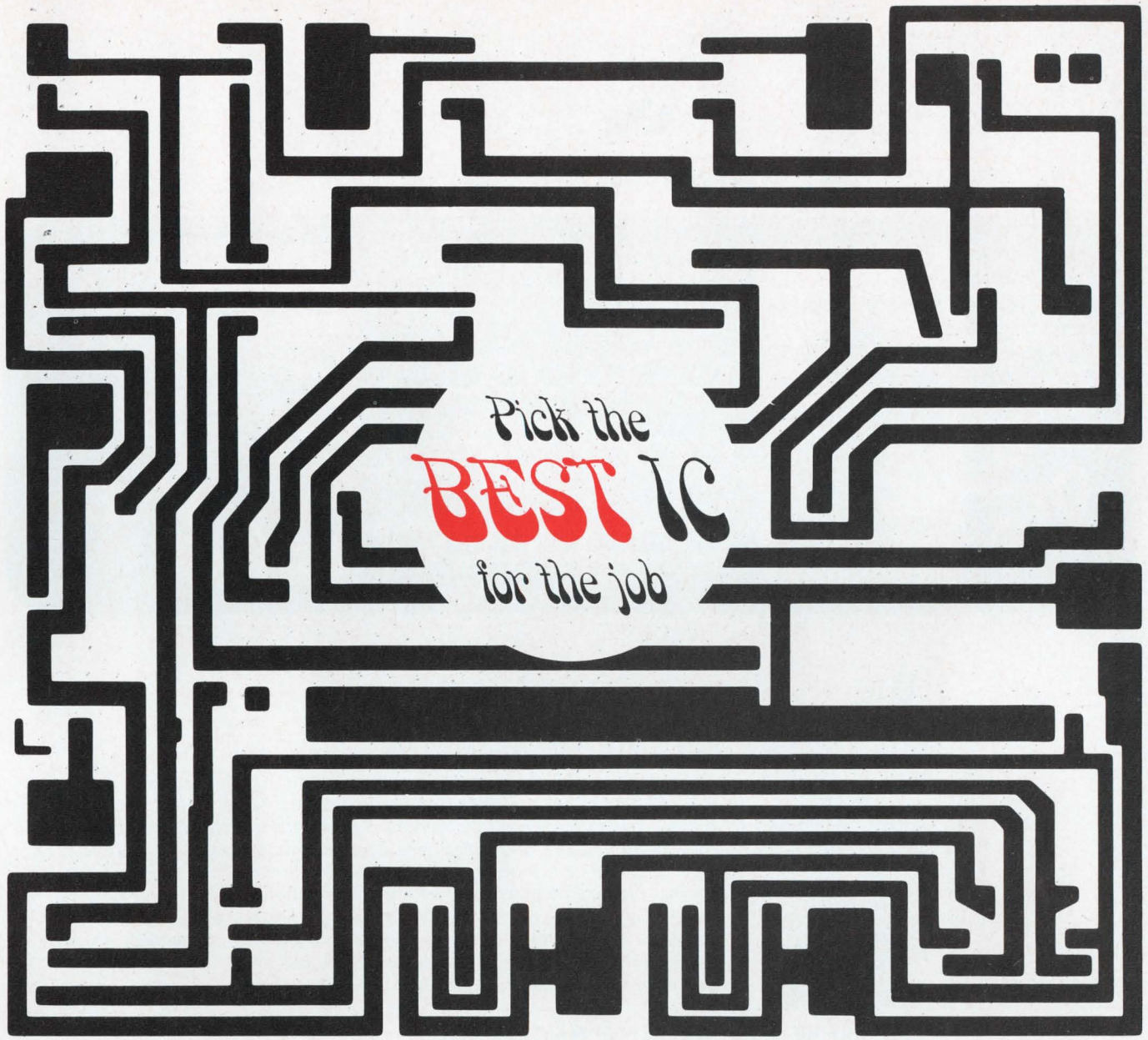

Pick the
BEST IC
for the job

Pick the new RA-245 line transmitter. Pick the new RA-246 line receiver. Pick the new RA-244 buffer amplifier. Pick the new RA-909A. Pick Radiation's Custom MSI capability.

We don't make IC's for *every* job... yet! But *every* Radiation IC is designed to provide the best possible solution to a particular IC application. (It takes time to develop quality integrated circuits. So we're selective. We pick areas where nobody else seems quite able to make the Best IC for the job... and then we sock it to them!)

We believe our success depends on making your life as a Design Engineer a little bit easier... and that means making the Best IC's for the job. (There are five new Radiation IC's announced today... and more to come!)

WE MAKE THE **BEST** IC FOR THE JOB



Visit us at
WESCON '68
Booth 147-148

Pick the
BEST IC
for the job

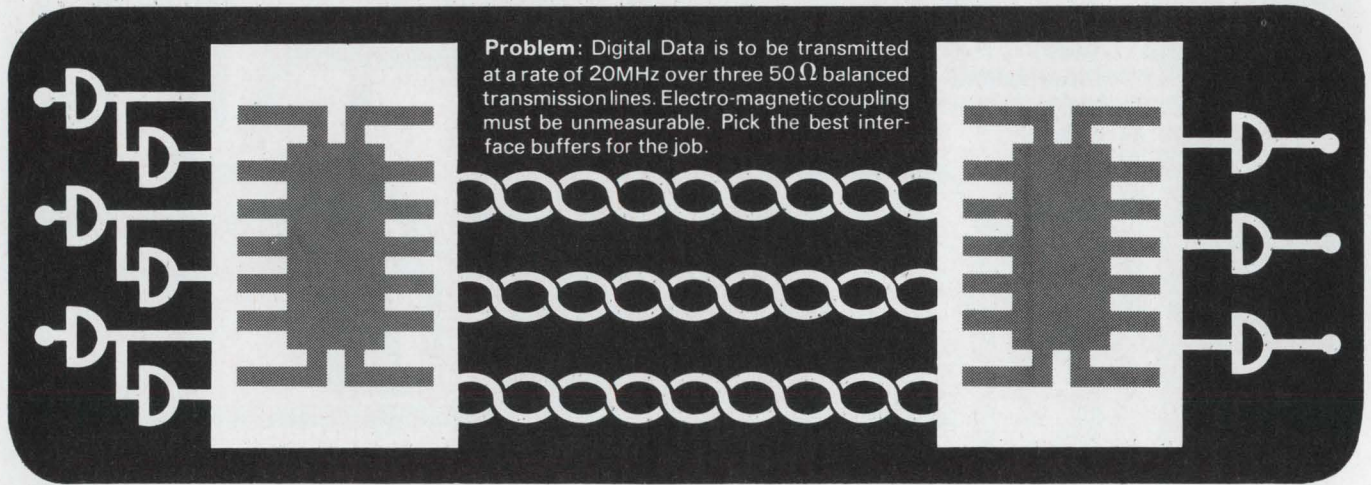

Problem: Digital Data is to be transmitted at a rate of 20MHz over three 50Ω balanced transmission lines. Electro-magnetic coupling must be unmeasurable. Pick the best interface buffers for the job.

the **BEST** Solution:

THE NEW RA-245 LINE TRANSMITTER

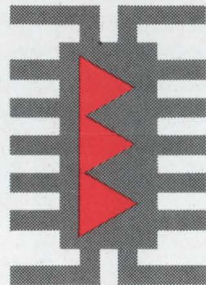

The best IC to use at the sending end is Radiation's dielectrically isolated RA-245. This line transmitter converts digital voltage pulses to current pulses. The high speed CML circuits assure data transfer rates in excess of 30MHz. Power dissipation is a constant, independent of data rate. The balanced system virtually eliminates the adverse effects of line capacity. Electro-magnetic coupling and susceptibility is greatly reduced. RA-245 is available in both the TO-84 flatpack and the ceramic dual in line package. Three voltage-to-current converters are in each package. Power dissipation is negligible when converters are not being used. So use only one or all three. RA-245 is the Best IC for the job.

THE NEW RA-246 LINE RECEIVER

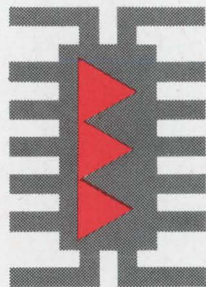

For best results, use Radiation's dielectrically isolated RA-246 at the receiving end. This 3-element buffer faithfully restores the current pulses to digital voltage pulses. The RA-246 current-to-voltage converter has built-in input terminations for balanced 50Ω lines. Outputs from each element are suitable to drive all standard saturated logic circuits (such as DTL, TTL, etc.).

Like the RA-245, the RA-246 is available in both the TO-84 flatpack and the ceramic dual in line package. And you can use any or all of the converters. The Best IC for the job.

Contact your nearest Radiation sales office for further information. Ask how the RA-245 can be used as a level shifter. And how to use the RA-246 as a threshold detector. We will help you pick the Best IC for the job.

WE MAKE THE **BEST** IC FOR THE JOB



RADIATION
INCORPORATED
SUBSIDIARY OF HARRIS-INTERTYPE CORPORATION
MICROELECTRONICS DIVISION

RADIATION SALES OFFICES: P.O. Box 476, Lexington, Mass. 02173, (617) 682-1055 • 600 Old Country Road, Garden City, N.Y. 11530, (516) 747-3730 • 2600 Virginia Avenue N.W., Washington, D.C. 20037, (202) 337-4914 • 6151 W. Century Boulevard, Los Angeles, California 90045, (213) 670-5432 • P.O. Box 37, Melbourne, Florida 32901, (305) 727-5430 • International Sales: Marketing Department, P.O. Box 37, Melbourne, Florida 32901, (305) 727-5412

Pick the
BEST IC
for the job

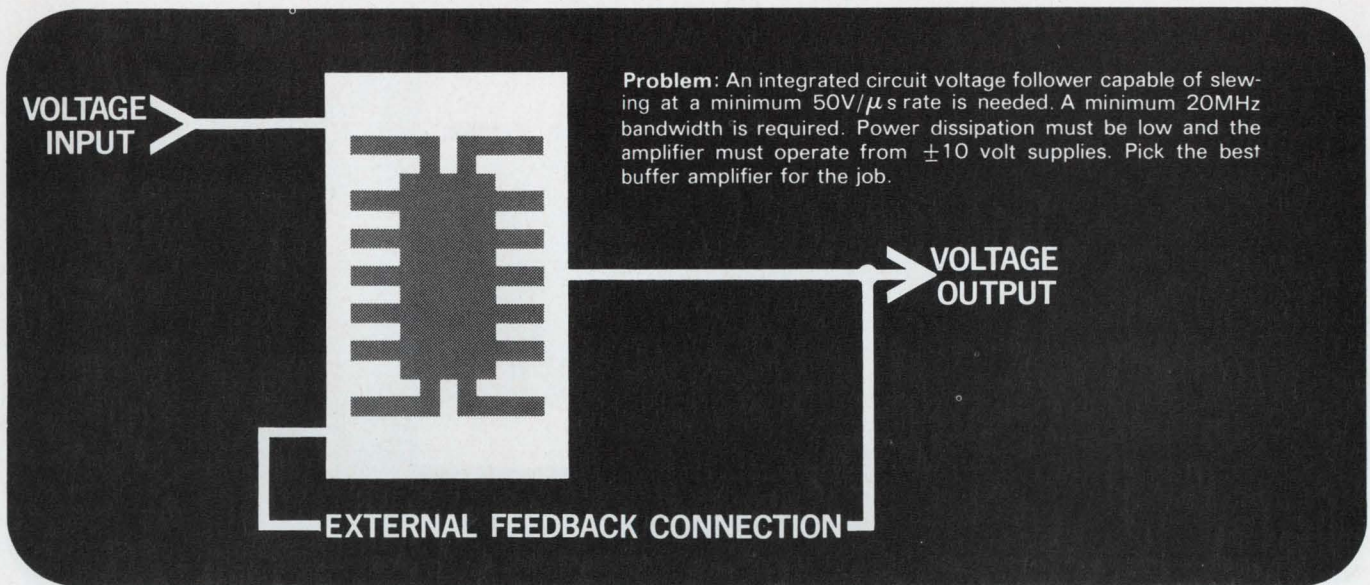

the **BEST** Solution:

THE NEW RA-244 COMPENSATIONLESS BUFFER AMPLIFIER

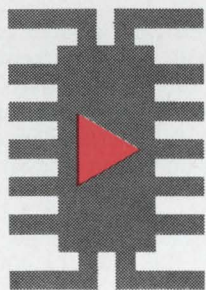

Solve the problem with Radiation's dielectrically isolated RA-244 buffer amplifier. Operating in Mode #2 of its dual-mode capability, a guaranteed minimum slew rate of $50V/\mu s$ is yours! And the bandwidth is 20MHz. Maximum power dissipation is only 170mW. Low enough for the most demanding design criteria. Another plus... like Radiation's RA-909 operational amplifier, no compensation networks are needed. Obviously, the Best IC for the job.

Switch to the $15V/\mu s$ (guaranteed minimum) Mode #1 simply by using externally available resistor trim points. And, also, the feedback loop is accessible, making the RA-244 extremely versatile. Use it as a voltage follower, wideband video amplifier, or general purpose operational amplifier.

Contact your nearest Radiation sales office for further information. We'll help you pick the Best IC for the job.

WE MAKE THE **BEST IC** FOR THE JOB

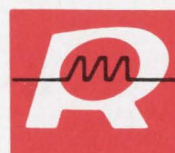

RADIATION
INCORPORATED
SUBSIDIARY OF HARRIS-INTERTYPE CORPORATION
MICROELECTRONICS DIVISION

RADIATION SALES OFFICES: P.O. Box 476, Lexington, Mass. 02173, (617) 682-1055 • 600 Old Country Road, Garden City, N.Y. 11530, (516) 747-3730 • 2600 Virginia Avenue N.W., Washington, D.C. 20037, (202) 337-4914 • 6151 W. Century Boulevard, Los Angeles, California 90045, (213) 670-5432 • P.O. Box 37, Melbourne, Florida 32901, (305) 727-5430 • International Sales: Marketing Department, P.O. Box 37, Melbourne, Florida 32901, (305) 727-5412

Pick the
BEST IC
for the job

Problem: Four DC to 30 kHz signals from high impedance sources must be summed into a $2k\Omega$, 100 pF load. The output is to be a guaranteed minimum ± 12 volts over the full frequency and military temperature range. The logical choice would be a Radiation RA-909. But amplifier offset current drift must not exceed $2 \text{ nA}/^\circ\text{C}$. Pick the Best IC for the job.

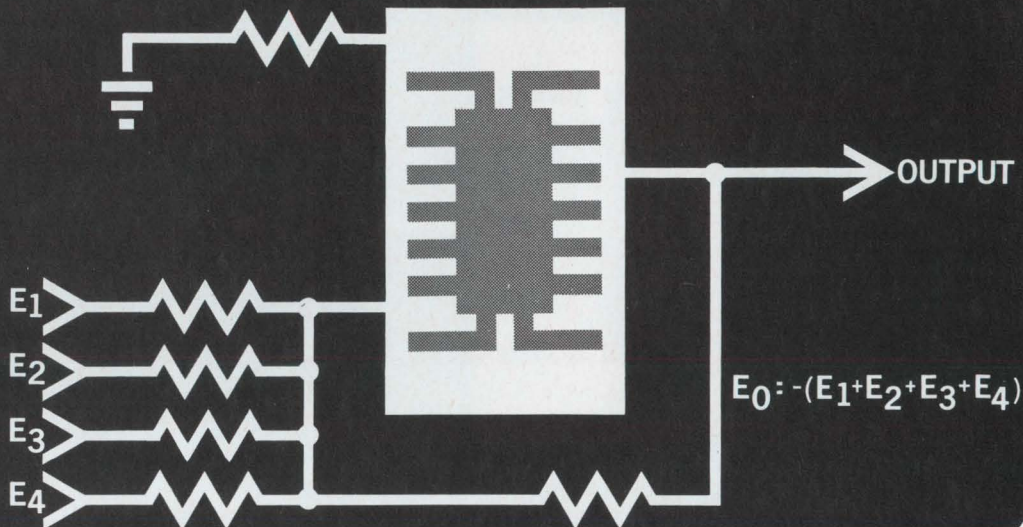

the **BEST** Solution:

THE NEW RA-909A COMPENSATIONLESS OPERATIONAL AMPLIFIER

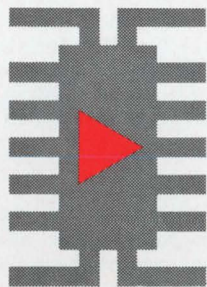

Drift error is very low in the new dielectrically isolated compensationless RA-909A. Between -55°C and $+25^\circ\text{C}$ offset current drift is a low $2 \text{ nA}/^\circ\text{C}$. From $+25^\circ\text{C}$ to $+125^\circ\text{C}$...an even lower $0.5 \text{ nA}/^\circ\text{C}$! And Radiation guarantees less than $15 \mu\text{V}/^\circ\text{C}$ offset voltage drift over the military temperature range. Compare this performance with any 709 type op amp over this extremely wide operating frequency range. You'll pick the Best op amp for the job. The RA-909A.

Like the RA-909, no external compensation is needed. Dielectric isolation and good circuit design eliminates the need for compensation. The RA-909A is in both a TO-99 package and a TO-86 flatpack configuration. A direct replacement for 709 type op amps.

Contact your nearest Radiation sales office. Let us help you pick the Best IC for the job.

WE MAKE THE **BEST** IC FOR THE JOB



RADIATION
INCORPORATED
SUBSIDIARY OF HARRIS-INTERTYPE CORPORATION
MICROELECTRONICS DIVISION

RADIATION SALES OFFICES: P.O. Box 476, Lexington, Mass. 02173, (617) 682-1055 • 600 Old Country Road, Garden City, N.Y. 11530, (516) 747-3730 • 2600 Virginia Avenue N.W., Washington, D.C. 20037, (202) 337-4914 • 6151 W. Century Boulevard, Los Angeles, California 90045, (213) 670-5432 • P.O. Box 37, Melbourne, Florida 32901, (305) 727-5430 • International Sales: Marketing Department, P.O. Box 37, Melbourne, Florida 32901, (305) 727-5412

Pick the
BEST IC
for the job

Problem: 80 milliamps minimum per bar is required to drive a 15 volt seven segment display. One integrated circuit package is to be used. Input to the package is BCD. Pick the best Custom IC capability for the job.

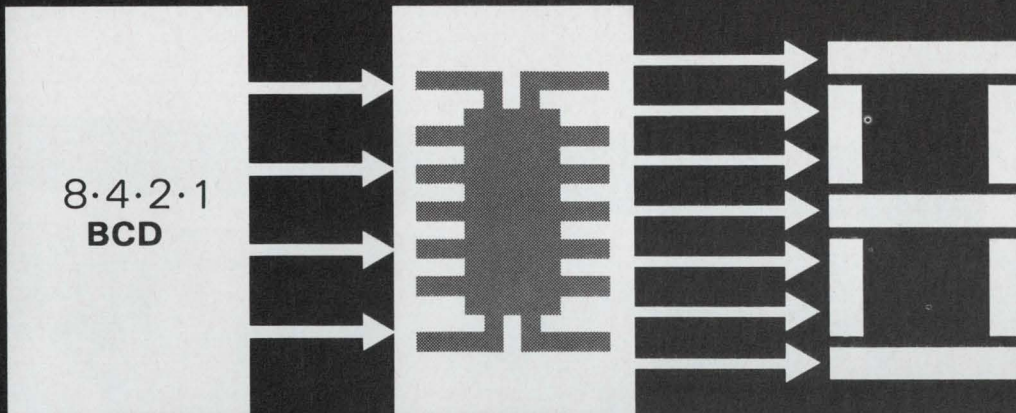

the **BEST** Solution:

THE CUSTOM MSI SEVEN SEGMENT DECODER/DRIVER

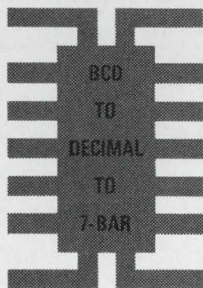

One of our customers had the exact problem stated above. Radiation solved the problem reliably and economically with dielectric isolation and medium scale integration. BCD to decimal to seven-bar with built-in drivers...three hundred elements on a single chip! And an 80 MA per bar minimum drive current. The best IC solution for the job.

Radiation has mastered dielectrically isolated MSI. We would like to work with you on your particular application. Medium scale integration is the best solution to the packaging density problem. Dielectric isolation is the best approach.

Contact your nearest Radiation sales office. State your problem. Let us help you pick the Best IC for the job.

WE MAKE THE **BEST** IC FOR THE JOB

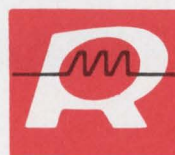

RADIATION
INCORPORATED
SUBSIDIARY OF HARRIS-INTERTYPE CORPORATION
MICROELECTRONICS DIVISION

RADIATION SALES OFFICES: P.O. Box 476, Lexington, Mass. 02173, (617) 682-1055 • 600 Old Country Road, Garden City, N.Y. 11530, (516) 747-3730 • 2600 Virginia Avenue N.W., Washington, D.C. 20037, (202) 337-4914 • 6151 W. Century Boulevard, Los Angeles, California 90045, (213) 670-5432 • P.O. Box 37, Melbourne, Florida 32901, (305) 727-5430 • International Sales: Marketing Department, P.O. Box 37, Melbourne, Florida 32901, (305) 727-5412

for versatile research, development, and training

NEW HEATH MODULAR

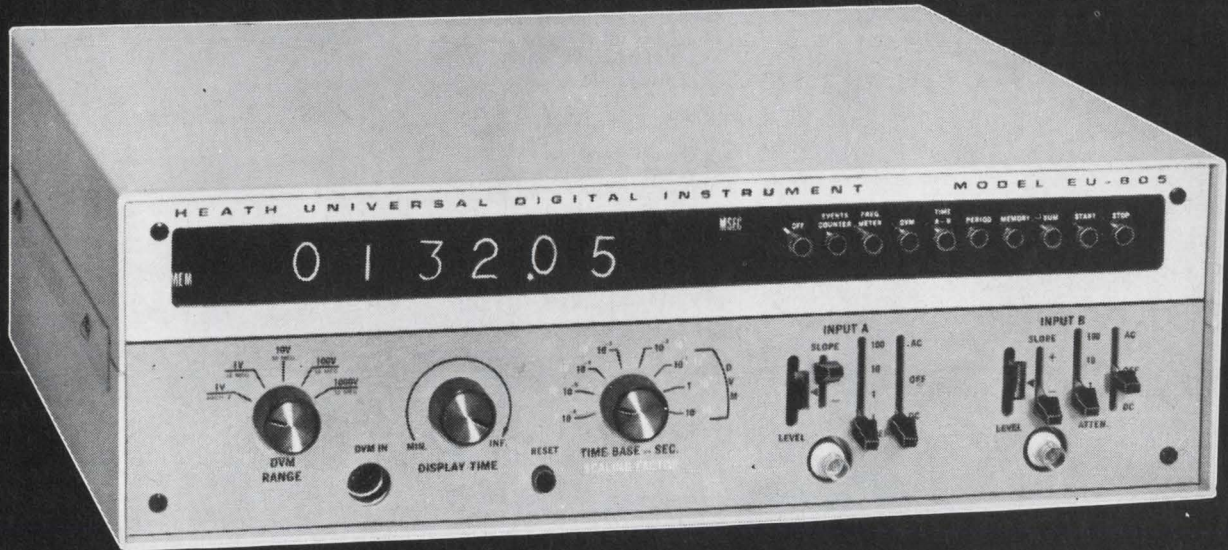

delivery begins in September for any requirement—

Heath "805" Series Digital Instruments begin at \$940

The First Truly Universal Digital Instruments. The 805 Series Perform All These Functions:

- Frequency Meter, 12.5 MHz guaranteed
- Events Counter
- Integrating Digital Voltmeter (optional feature: EU-805A includes all functions; EU-805D does not have DVM function)
- Ratio Meter
- Time Interval Meter
- Period Meter
- Voltage Integrator

The 805 Features:

- 6 digit readout plus over-range
- 0.05% Accuracy As DVM
- Accuracy of ± 1 Count in all frequency, time interval, and period modes
- Count mode has electronic start & stop as well as manual
- Time Base Stability better than one part in 10^6 (15° to 55°C .)
- TTL Integrated Circuitry
- Compatibility with Heath 801 Digital System Modules for education and instrument development
- Versatile circuit cards can be used to make many instruments

Input Comparator Features:

- Two Independent Input Comparators
- Automatic Mode Triggering
- Rear Panel Comparator Outputs
- Switch Selection for AC or DC Coupling or Signal Disconnect

- Four Levels of Input Attenuation
- Includes Provisions for Independent use of Input Comparator B
- Input Comparator B may be controlled at rear panel to provide Main Time Base Input

Readout Features:

- Front Panel Display Memory Switch
- Front Panel Accumulate Switch
- Extended-Range Variable Display Time
- Rear Panel Input for External Time Standard
- Rear Panel Access to Clock/Scaler provides Standard Time Intervals in Decades from 1 microsecond to 10 Seconds, or Continuous 1 microsecond
- Voltage to Frequency Output available at Rear Panel when operating in any mode

Events Counter Features:

- Either Manual or Electronic Gating for Start & Stop
- Events may be scaled in Decade Steps to 10^7 ... 6 digit display permits count to 10^{13} without over ranging
- Input Pulse Resolution better than 50 Nanoseconds.

Frequency Meter Features:

- Frequency Measuring Capability better than 12.5 MHz
- Two-Channel Input for Frequency Comparison or A/B Ratio Measurements
- Resolution at Max. Gate Time 0.1 Hz ± 1 Count
- Time Bases, 1, 10, 100 microseconds; 1, 10, 100 milliseconds; 1 & 10 seconds

Digital Voltmeter Features:

- High Accuracy Integrating Type
- 5 gigohms (5×10^9) Input Impedance on separate 1 v. Range (10 microvolt resolution)
- 1, 10, 100 & 1000 Volt Ranges — 10 megohm input impedance
- Selectable Gating/Integrating Times ... 0.1, 1, 10 Seconds
- Automatic Polarity Indication
- 10% Over Range Capability

Time Interval Meter

- Either Manual or Electronic Gating for Start and Stop
- Switch Selection for minimum. Time Resolution; 1, 10, 100 microseconds; 1, 10, 100 milliseconds; 1 & 10 seconds
- Resolution ± 1 Count

Period Meter Features:

- Either Manual or Electronic Gating for Start & Stop
- Switch Selection for minimum Period Resolution: 1, 10, 100 microseconds; 1, 10, 100 milliseconds; 1 & 10 seconds
- Resolution ± 1 Count
- Two-Channel Input for Period Comparisons or A/B Ratio Measurements

Ready For September Delivery:

- **Assembled EU-805D**, as above less DVM function, (EU-805-12 may be added later if desired at \$340)..... **\$940**
- **Assembled EU-805A**, Universal Digital Instrument with DVM..... **\$1250**

HEATH COMPANY, Dept. 580-04
Benton Harbor, Michigan 49022



- Please Send Free EU-805 series Spec. Sheet
- Please Send Free EU-801 System Modules Spec. Sheet
- Please Send Free Circuit Card Spec. Sheet

Name _____

Company _____

Address _____

City _____ State _____ Zip _____

(prices & specifications subject to change without notice) EK-250

FREE SPECIFICATION SHEETS

EU-805A/D UDI Spec. Sheet contains complete details, photos, prices and explanations of all functions and controls.

EU-801A MDS Spec. Sheet contains complete details of each module, explanations of all circuit cards and prices.

Circuit Card Spec. Sheet contains complete details and specs. on each circuit plus card prices.

another Heath/Malmstadt-Enke design

DIGITAL & ANALOG SYSTEMS

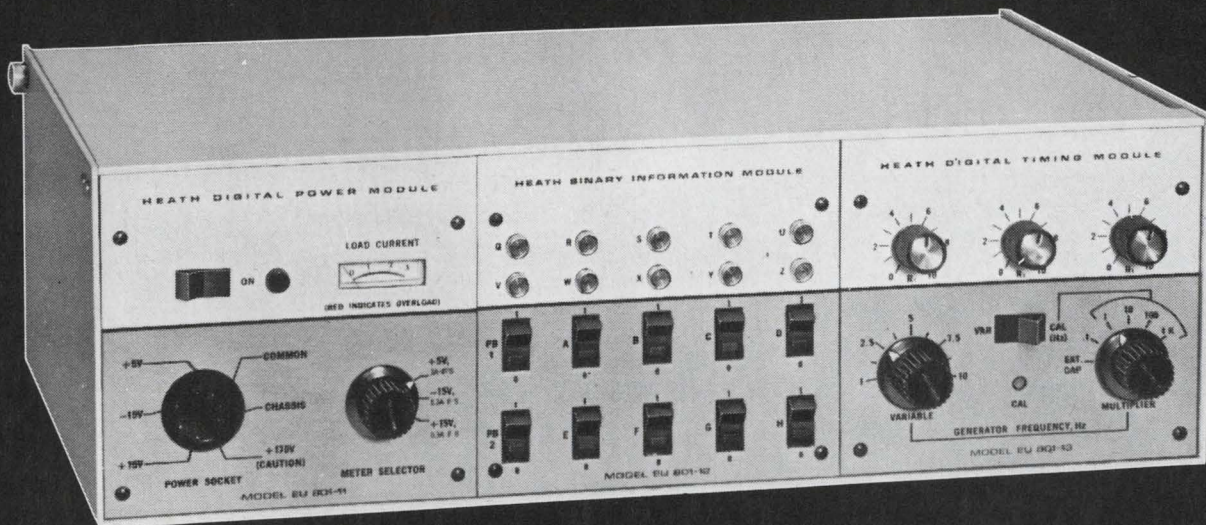

Systems, Instruments, Modules, or Circuit Cards

Heath "801" Series Digital Analog System Modules at \$435

A Unique Design-It-Yourself Approach To Digital/Analog Instrumentation, The 801 Has Everything You Need To Investigate Digital Circuitry, Design Your Own New Circuits, Or "Customize" For Specific Functions As A Discrete Digital Instrument

General Features:

- Factory Assembled Digital Power Module, Binary Information Module, Digital Timing Module, and Plug-In Circuit Cards — each available separately if desired
- Unique System of Circuit "Breadboarding" for experimentation . . . fast, easy solderless connections
- Integrated Circuits
- TTL Integrated Circuit Logic
- Integral Time Base
- Binary Readout (optional digital readout available later)
- Integral Power Supplies
- Accepts Circuit Cards from Heath 805 Universal Digital Instrument

Now You Can Investigate:

- Counter Circuits
- Scaling Circuits
- Gating Circuits
- DVM Circuits
- Adders & Subtracters

- Integrators
- Digital-Analog Interface
- Special Circuits of your own design

Custom-Design Your Own:

- Counters
- Frequency Meters
- Digital Volt Meters
- Precision Timers
- Frequency Standards
- Operational Amplifier Systems
- Digital-Analog Interfaces
- And Hundreds of other Digital & Analog Instruments

Recommended System (EU-801A as illustrated) Includes:

EU-801-11 Digital Power Module

Supplies all voltages necessary to operate the system, distributed by 6-pin connector. (+5, ±15, +170 v.) Power also available on front panel at octal socket, at top of circuit cards, and at banana plugs. \$75.

EU-801-12 Binary Information Module

10 neon lamps and driver circuits; lamps light with application of logic 1. 8 SPDT switches and 2 SPDT spring return switches for binary information inputs. Connections for switches and lamps available at top of circuit cards. \$50.

EU-801-13 Digital Timing Module

Contains function generator and three controls for use with monostable and comparator circuits. Generator range, 0.1 Hz to 10 kHz, variable in 5 decade steps. External capacitor position for other frequencies to 100 kHz. Outputs: complementary square wave, complementary pulse, and ramp. \$60.

EU-801A Circuit Cards

Included are four NAND gate cards, two dual J-K flip flops, one dual monostable multivibrator, one relay card (contains 7 relays), one comparator/voltage to frequency converter card, one dual inline IC patch card, two multiple connector/blank PC cards, one operational amplifier card with 1200 megohm input. Individual cards available, prices range from \$10 to \$40. (Note: many cards from the EU-805A U.D.I. can be used.)

EU-800-RC Three-Module Cabinet

Holds any three modules; has elevating support to allow unit to be tilted back for access to front panel controls or forward when "patching" circuit cards. \$20.

Ready For September Delivery:

Assembled EU-801A System (as described above) **\$435**
(prices of individual modules total \$468 if purchased separately).

Unique, flexible, extendable. This new Heath/Malmstadt-Enke Modular System provides the first instrumentation package with the means to achieve virtually everything you wish in digital & analog circuitry. To investigate existing digital circuitry, just plug in the components required . . . to design your own special digital circuitry, just plug in the components required . . . if you wish to design your own digital or analog-digital instrument, again it's just a matter of plugging in the components . . . it's all here in this new system. Factory assembled circuit cards plug into the chassis. Each card has a special connector board on top which features solderless connectors to accept ordinary hookup wire and component leads for fast assembly of special circuits (several hundred patch wires are included). Integrated circuits using TTL logic provide state-of-the-art electronics. This system is also open-ended . . . other modules and circuit cards will be available as technology changes so the system can be expanded to more and more applications. Information — Application Manual is included.

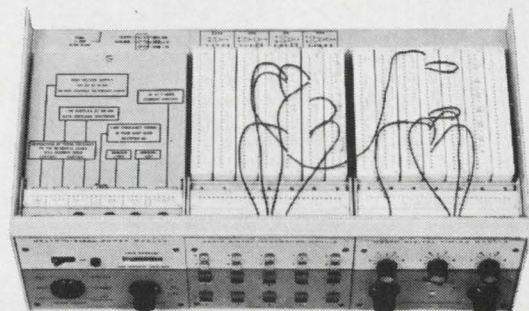

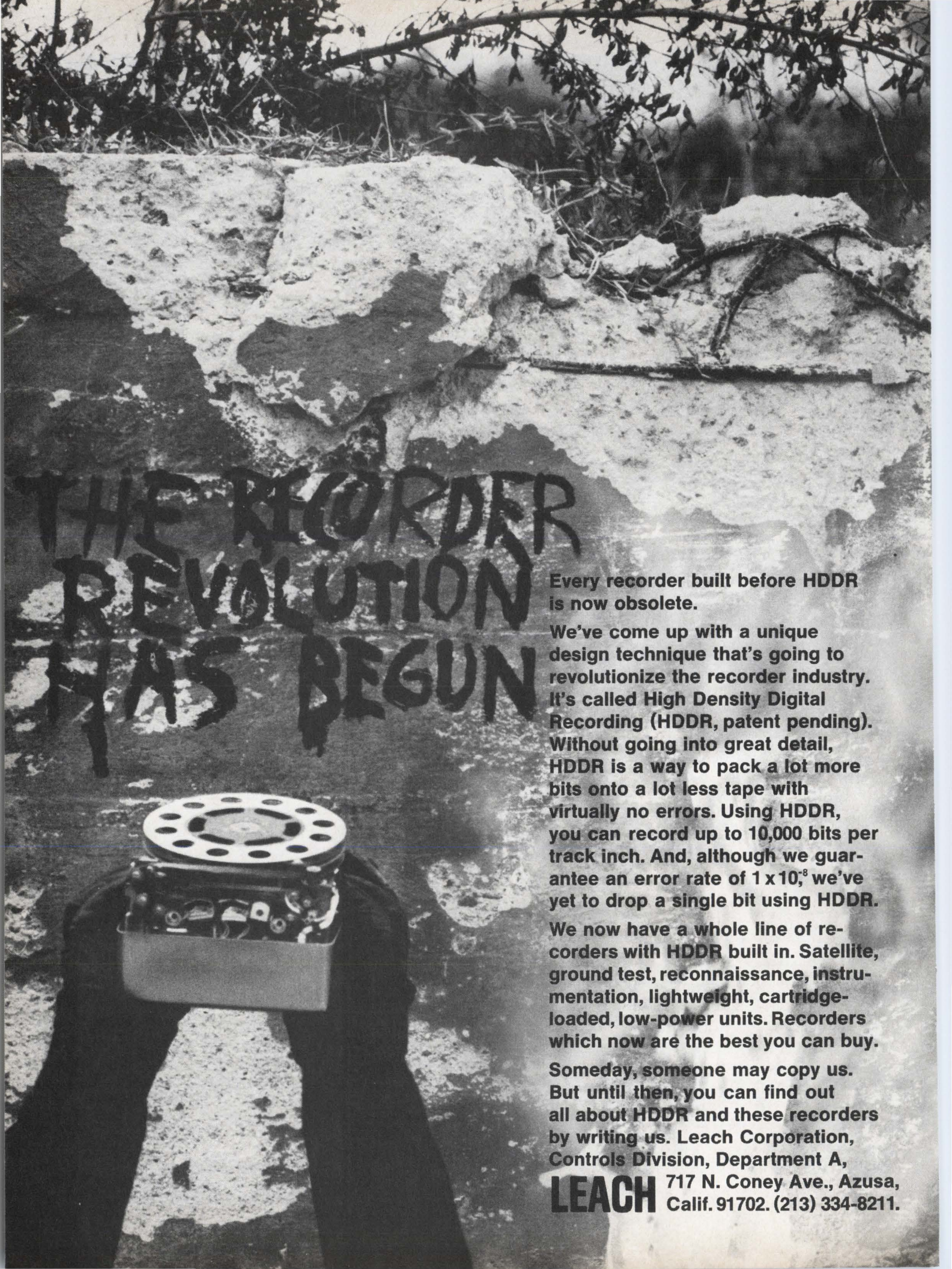

THE RECORDER REVOLUTION HAS BEGUN

Every recorder built before HDDR is now obsolete.

We've come up with a unique design technique that's going to revolutionize the recorder industry. It's called High Density Digital Recording (HDDR, patent pending). Without going into great detail, HDDR is a way to pack a lot more bits onto a lot less tape with virtually no errors. Using HDDR, you can record up to 10,000 bits per track inch. And, although we guarantee an error rate of 1×10^{-8} , we've yet to drop a single bit using HDDR.

We now have a whole line of recorders with HDDR built in. Satellite, ground test, reconnaissance, instrumentation, lightweight, cartridge-loaded, low-power units. Recorders which now are the best you can buy.

Someday, someone may copy us. But until then, you can find out all about HDDR and these recorders by writing us. Leach Corporation, Controls Division, Department A,

LEACH 717 N. Coney Ave., Azusa, Calif. 91702. (213) 334-8211.



You're the last person we

Come as a surprise? Not that our design people aren't painfully aware of your requirements. They are. You know that because a lot of you order the things again and again.

But we're really building our stuff for your customer. Why him? Well, you get to assemble your product the easy way. In your plant. A black box at a time. But your customer has to put all those things together in a very small space, with just a squinch of a place for the fingers. And field servicing is something else. It's done under less than optimum conditions most of the time. We know it. And we design for it. Very small, but very, very practical.



FIVE MOST INTERESTING FOR INSTANCES

First, a first. 3-piece, solderless, all crimp family of 50-ohm coaxial connectors that can operate at 200°C. All of them mate with standard 10-32 coupling nut 50-ohm connectors. They're much shorter. And they weigh only a scant

1.693 grams. Instead of the commonplace, hard-to-manage 5 to 7 pieces, the MARC 131 simply has a contact assembly, an inner crimp sleeve and a housing. Period. Needless to say the law of less parts, greater reliability applies here.

It's available in two plug types, jack and bulkhead jack, bulkhead and printed circuit receptacle, right angle plug and p.c. receptacle.

FLAT CONDUCTOR CABLE CONNECTORS

Yes. How about that? And our second offering is also a first. The first connector—flat conductor cable—developed for 50-mil centers. It's called the MARC 220.

Although applications for flat conductor cables aren't exactly overwhelming now, it's projected that a good 85% of aircraft and missile requirements could call for flat conductor cables (and of course connectors) in a mere ten years. Less demanding versions will also be available for commercial/industrial markets.

The 220 uses the vastly superior twist

pin concept. The pin has an O.D. of 0.0315" and the socket has an I.D. of 0.028". All this makes for a much better electrical connection as the wide pin twists and lengthens going into the socket. (A little design improvement over screw machine type pins.)

Pins and sockets are joined to flat conductor cable in a diallyl phthalate insulator module which shows up with more than admirable temperature characteristics and phenomenal compressive strength. The 220 comes in sizes from 1" to 3", in 1/2" increments, and accommodates from 1 to 3 stacked cables.

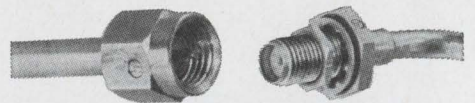

MILITARY AND INDUSTRY WANTED A HI REL. ULTRA LOW VSWR, RF CONNECTOR

We countered with the MARC 151; a new family of tiny connectors designed for use with a 0.141" semi-rigid 50-ohm cable. The max VSWR is 1.05:1 at 12.4 GHz and can be used up to 26 GHz.

design connectors for.

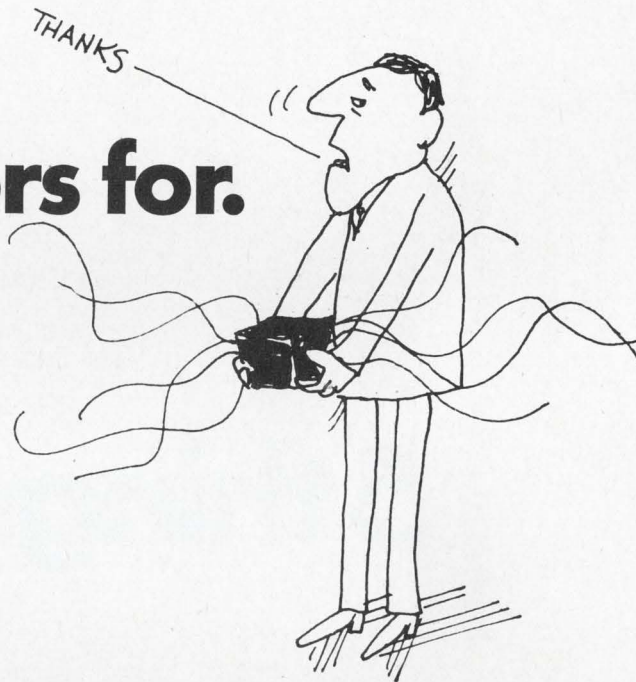

They'll work at 70,000 feet with no problem and will take 250 V RMS applied, without corona. We haven't been filled in on all the applications yet, but the word from the customers is one of smug satisfaction.



ULTRAMINIATURE COAX CONNECTOR

This "help-everything's-getting-smaller" design takes the smallest available coax, the $\frac{1}{8}$ " O.D. Lepra/Con, and combines it with a sure contact, slide-on connection device. This bonus means you don't have to design in knuckle space, and is an answer to various commercial, industrial and military people who were really cramped for room in many aerospace projects, desk top computers, modular packages and other size and space limiting requirements. Slide-on Lepra/Cons are all-crimp, rated for continuous use at 300°F (with short periods to 450°F). They'll take a shot of 450 V RMS dielectric voltage at sea level and have a contact resistance that goes from 4 milliohms

min to 8 milliohms max at 3 amps.

Like the regular Lepra/Con, the slide-on versions come in the same styles.

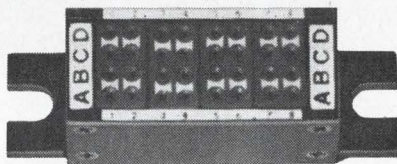

HIGH DENSITY TERMINAL JUNCTION BLOCKS

This is an integrated wire termination system of Junction, Feed-through and Programming blocks, environmentally and non-environmentally sealed. Besides being space and weight savers, they end the klugey, hap-hazard screw on operations of old style terminal blocks.

The basic module is $5/16$ " x $5/8$ " x $5/8$ " (a hair longer in feed-through and environmentally sealed types). With easy to assemble end and side plates, you can make any size block you need. The contact retention system is the most reliable in the business. So secure, it passes the shock test of 50 G's. Spe-

cial sealing glands in the module give every contact a positive seal. Connections are made with an easy to use, non-conductive insertion and removal tool. And every unit checks out as a much more reliable method than those using open connections.

These promise to be snapped up for more and more applications by the aircraft and aerospace industries.

Briefly, that's our new stuff. The finer points are belabored in data sheets available by writing.

Or, drop by our booth at WESCON—(No. 1417—18 & 19) Sports Arena. We'll have a full line-up of the previously discussed items. Plus a full display of our other microminiature cables and connectors.

Let's see. We got a thirty foot booth. And the average engineer takes up nineteen point two inches across. So that's eighteen point five guys at a time. And the new product pitch takes about seven minutes. So that means we can handle about...

Hey. Better get there early.

MICRODOT INC. 
220 Pasadena Ave., South Pasadena, Calif. 91030

5 things you should

3. Applications:

Fairchild MOS FETs are excellent amplifiers. They're also the closest thing to an ideal switch. They've got high input impedance, zero offset voltage, wide dynamic range, low cross modulation, and good noise figure. They're perfect for analog and digital switches, high speed solid-state choppers and amplifiers from DC through UHF frequencies.

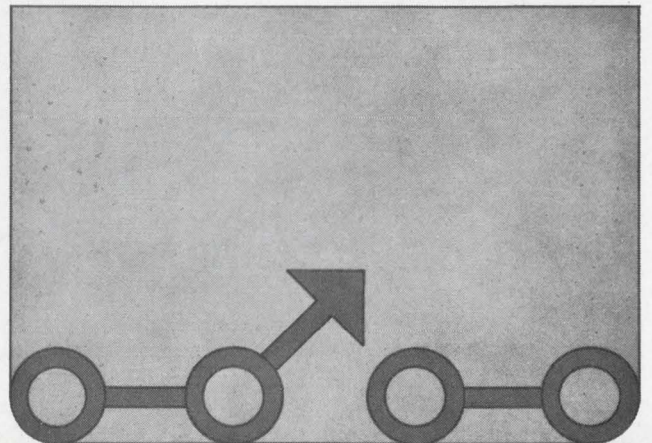

1. Gate protection:

MOS FETs used to be so sensitive, they'd burn out in your hand. Fairchild has solved the problem with Gate Protection. It's provided by our unique integrated diffused resistor Zener diode. The resistor, in series with the gate capacitance, provides an RC time constant. Any transient static charge applied to the gate is delayed until Zener breakdown. The charge is then shunted through the Zener to ground.

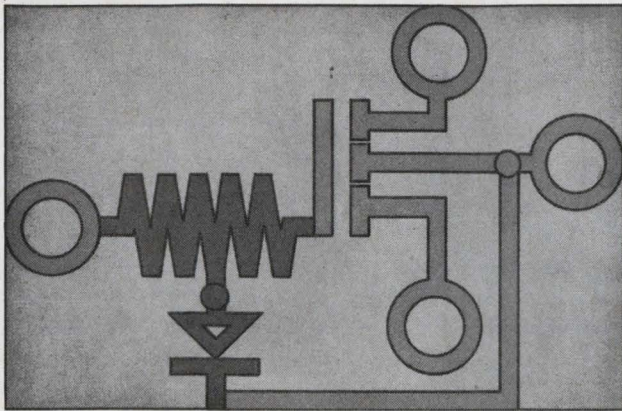

2. Stability:

Some MOS devices have unstable thresholds. That usually means there are many free positive ions in the oxide. Fairchild's patented Planar II* process reduces the number of ions and keeps them under control. Under worst case bias conditions, the average Fairchild MOS FET will experience less than a six percent threshold change over 1000 hours of operation. That's better stability than any bipolar device made. Even ours.

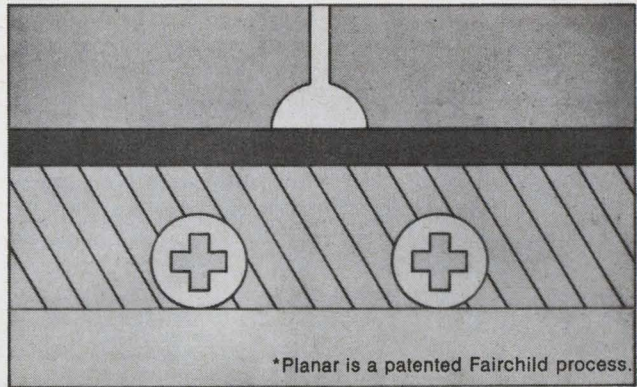

know about mos fets:

4. The price:

When MOS FETs first came out, they cost about five times as much as bipolars. Now, they don't. In fact, you can't afford *not* to use them.

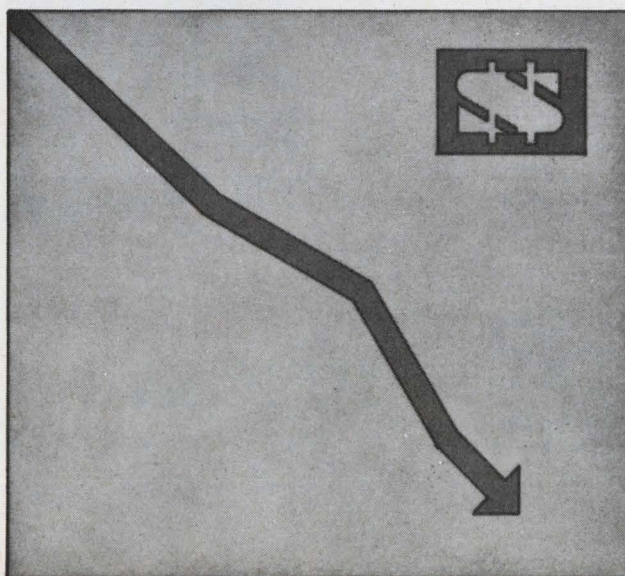

5. The kit:

To prove our specs are in the right place, we've prepared a sample kit to help you get involved with MOS FETs. It's worth \$160.10. You can buy it from any Fairchild distributor for \$39.95. You can also get a bundle of applications information. Free. Just circle the Reader Service Number below.

Fairchild Semiconductor A Division of Fairchild Camera and Instrument Corporation, 313 Fairchild Drive, Mountain View, California 94040
FAIRCHILD
 SEMICONDUCTOR
 (415) 962-5011 TWX: 910-379-6435

QUANTITY	DEVICE	APPLICATION	DOLLAR VALUE
2	FT701	Dual Differential Amplifier	\$ 20.00
2	3N147	Series/Shunt Chopper	18.00
2	3N148	Dual Analog Switch	30.00
2	FT703	High Gain Amplifier	18.00
2	3N149	Low On-Impedance Switch	12.00
2	3N150	Large Signal Switch	24.00
4	FT704	Small Signal Amplifier	18.00
2	3N145	Low Capacity Switch	8.10
2	3N146	Small Signal Switch	12.00
			\$160.10

The Compatibles

NEW Helipot Model 841 Miniature 4-bit Ladder Switches feature:

- unipolar or direct bipolar operation
- 350 nanosecond rise and fall time
- 0 to 2 millivolt switch offsets (at 25°C)
- 5 (± 3) ohms "on" resistance
- 0 to 5 milliamps output current
- small size (1" x 1" x 0.170" high)
- cermet thick film construction
- list price, \$100.00
- available from stock

Helipot Series 811 Precision, High Speed Binary Ladder Networks feature:

- up to $\frac{1}{2}$ bit accuracy in 12 bits from -55° to $+125^\circ\text{C}$ or from -20° to $+80^\circ\text{C}$
- 50 nanosecond settling time
- 1 ppm/ $^\circ\text{C}$ tracking
- small size (1" x 1" x 0.1" high)
- cermet thick film construction (assuring ultrastability and minimum change in performance with time)
- list prices from \$27.00
- available from stock

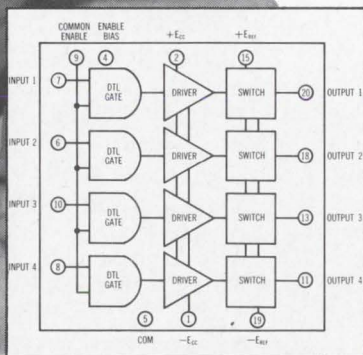
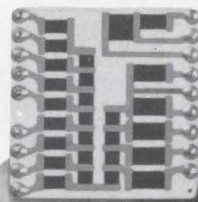
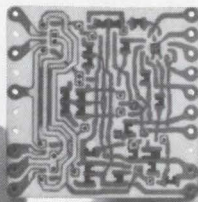

Model 841 Ladder Switch Block Diagram

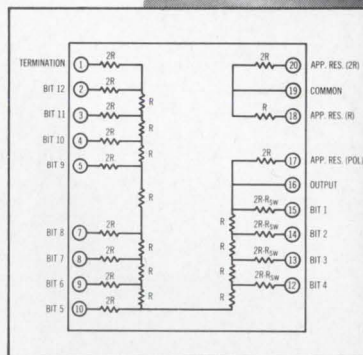

Series 811 Ladder Network Schematic

The Helipot Compatibles are designed to give you—pre-engineered and pre-packaged—a ladder system with the combination of economy, sophistication, small size, and flexibility you can't get anywhere else. ■ Check out The Compatibles from Helipot—for complete specifications, ask your local Helipot sales representative or circle the reader service number.

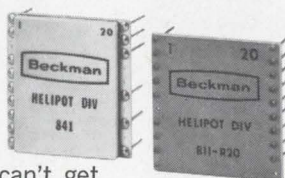

Beckman

INSTRUMENTS, INC.

HELIPOT DIVISION

FULLERTON, CALIFORNIA • 92634

INTERNATIONAL SUBSIDIARIES: GENEVA; MUNICH; GLENROTHES, SCOTLAND; TOKYO; PARIS; CAPETOWN; LONDON; MEXICO CITY

Technical Articles

**Multicolor displays
follow the action**
page 92



Military commanders or industry managers can look up at a wallful of color-coded data to get information—almost in real time—on the status of their operations. Under the direction of a small digital computer the system receives, collects, and processes data before converting it for colorful presentation on large-screen displays. The cover shows a strategic military map. Operation is simple. Push a button and the information appears. Push another and it's erased.

**New thinking
needed in IC
system design**
page 110

Engineers and managers alike must abandon old design methods when they switch to IC's. They must consider the IC as a functional entity, properly specify machine design parameters, get across to an IC manufacturer what the design requires, and insist that everybody involved in the project, from the top management to shipping clerks, gets a lucid explanation of what IC's are, and some understanding of their importance to the company.

**Dynamic tests
for op amps**
page 118

The popularity of IC operational amplifiers has produced a need for better, faster dynamic tests. A method of synchronous demodulation is now available to perform dynamic tests of low-frequency parameters. Moreover, the user gets direct meter readout. An additional benefit: the technique can provide static tests, should they be desired.

**From Britain:
a compact IC radio**
page 124

Squeezing most of an auto radio's circuitry onto a single IC chip can help lower its cost. But the number of external connections becomes unmanageable. An unconventional design reduced the total number of connections by eliminating the usual r-f stage and modifying the i-f stage. The result, a complete circuit—except for the tuning stage—on a 60-mil-square chip.

**Arc-lamp ballast
goes solid state**
page 130

One of the new applications opening up to power transistors is in a ballast circuit for mercury-arc lamps. The advantages of using a transistor instead of a thyristor are that the lamp operates at a frequency higher than the 60-hertz line—eliminating flicker—and the amount of control circuitry is reduced.

Coming

**At the
conventions**

First details on the digital remote control system that will help a backpack color-television camera put the big political conventions in focus.



Surveyor support. Display system at Jet Propulsion Laboratory can monitor four space missions simultaneously. In January, the system backed up the Surveyor 7 mission by providing real-time displays.

When that Chinese sage issued his famous pronouncement about the relative worth of pictures and words he made good sense, but he was probably thinking only about fixed black-and-white images. Pictures and words work better in combination, it's been found, and even more so when they can be displayed in many colors and can change in real time to give dynamic presentations.

Such multicolor displays now handle the almost overwhelming demands of military commanders for clear and timely information—and can do the same for industrial managers. These systems receive information automatically or by manual entry, collect and process the data, and display the results to the executive. A software package, using a language made up of statements realistically related to the application, lets people operate the system in a simple and straightforward manner.

With a large-screen multicolor display system linked to information from the operational site, the commander and his staff—or, for that matter, any senior business manager and his staff—can find out what's happening. They can singly or jointly interact with the system, asking for general or specific information, trying out new schemes, and imple-

menting those that seem best. Display systems thus aid the decision making process.

Where's Task Force 35?

How does a commander use a display system? What can he find out? Consider this realistic but hypothetical situation. A naval commander needs to know about military and maritime conditions in the area around Europe. An operator, having been briefed about the commander's interest, has had the symbols and locations of ships in the area placed on the display in response to his queries to a database computer that receives ship-position information from many sources. Projection equipment scribes the positions of ships on thin-metal-coated slides and displays each in a prescribed color.

Thus, when the commander asks for the map of Europe, and the status of all forces, he sees the display at the top of the next page. However, if he wished to see only his own forces with respect to hostile ones, he would ask the operator to shut off the merchant and friendly ships. Entering just a few words on the Teletype, the operator turns off the yellow and white projectors, leaving the display as shown at the bottom of the next page.

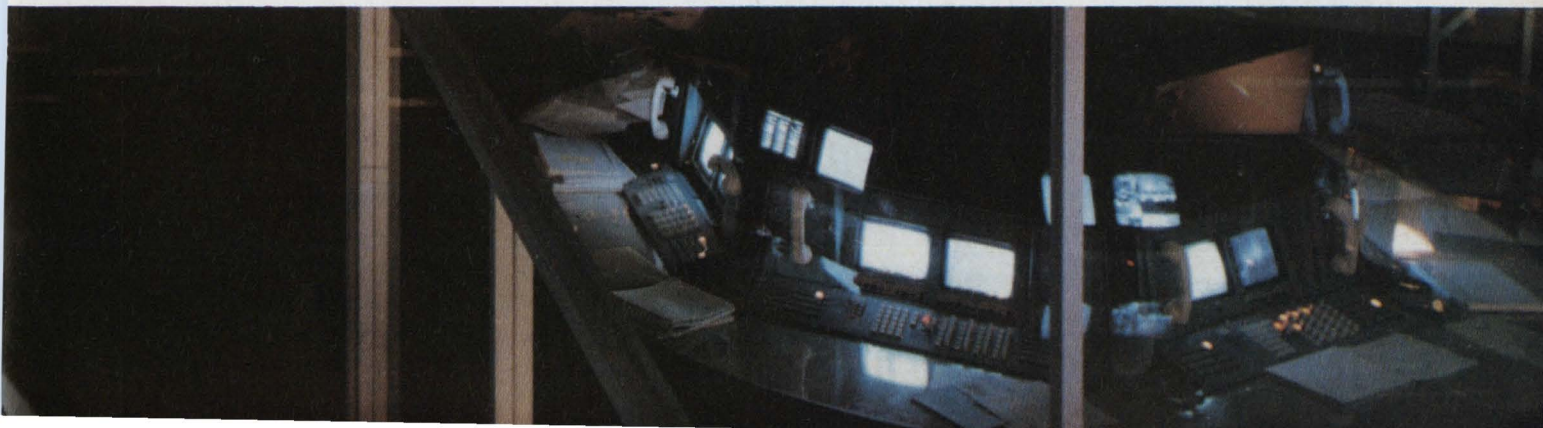

GET MAP EUROPE;
GET STATUS ALL FORCES



**TARGET
CLASSIFICATION**

- Hostile
- Own
- Friendly
- Merchant shipping

IDENTIFICATION

- Trawler
- Carrier
- Destroyer
- Medium freighter
- Cruiser
- Sub
- Nuclear sub
- Heavy freighter
- Supply ship
- Communication ship

PUT MERCHANT AND FRIENDLY OFF



Now the commander has a clearer view of hostile Task Force 35 in the North Sea. But he may want to see even more detail, so he asks the operator to zero in on TF35 and plot activity within a 120-mile radius of the force. With just a few more words typed into the system, the display shown at the upper right appears. Here, there is no land mass for reference, so latitude and longitude are plotted instead. Finally, the commander wants to know what a hostile submarine identified as PIM 893 has been up to since the last time it refueled. All the operator does is type PLOT PIM 893 LAST REFUEL and the commander gets the sub's previous route, as shown at the bottom of the opposite page.

Learn and remember

Any integrated command display system brings together transmission, display, and man-machine interface equipment and concepts. To

CURSOR TO TASK FORCE 35; READ CURSOR; PLOT 120 MILES RADIUS

keep data-transmission costs at a reasonable level, the display system must accept blocks of data from a remote computer at relatively slow transmission speeds and then expand this data into commands to activate the display-generating equipment. The system must be able to include or eliminate any of a wide range of display-generating techniques and equipment to provide the exact display complement required in any display center. Further, it must be able to correctly interpret commands from its human operators, and these commands must be so straightforward that the operator can learn them quickly and remember them easily. Finally, the integrated command display system must present the executive or commander with the maximum information he desires in a clear and comprehensible form.

Over 30 projector-type, large-screen, multicolor display systems have been sold by several companies, primarily to military and other government agencies for operational and training missions. Additional command systems will be bought not only through Federal funding but by industry, for management information systems and by such agencies as metropolitan police forces. There is still more work to be done. Because applications for integrated command displays vary and because technological innovations will have an impact on the efficiency and flexibility of these systems, the Northrop division of the Northrop Corp. constructed its own command center at its research facilities in Palos Verdes, California. At this test and evaluation center, new command-system concepts are tried out, specific systems configurations are demonstrated to users, and equipment and software are kept in continual development.

The test and evaluation control center contains all equipment that might be found in an operational command center. A large-screen display occupies one wall. On the opposite side, a raised, glass-windowed enclosure simulates the

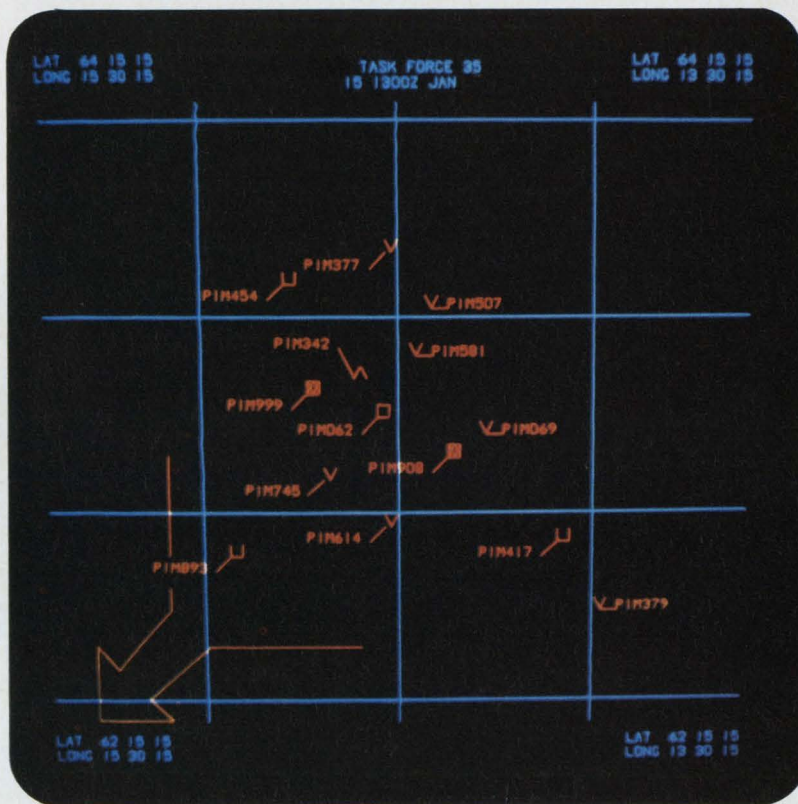

PLOT PIM 893 LAST REFUEL

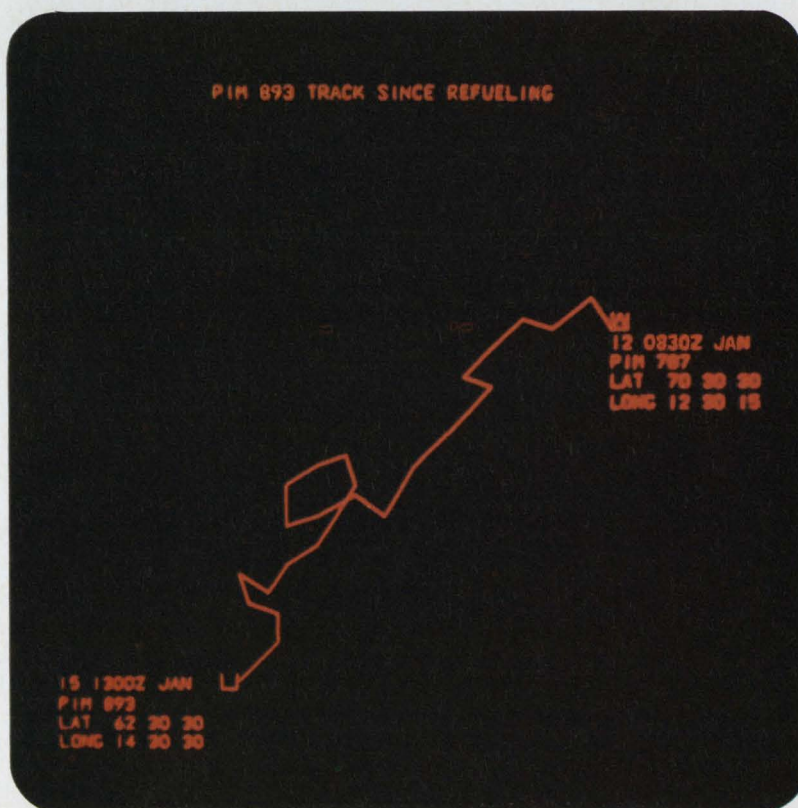

Tryout. Hardware, similar to equipment used in operational systems, is connected in a variety of configurations at the Nortronics command and control center to test out new systems. Experiments with software are also conducted at the center.

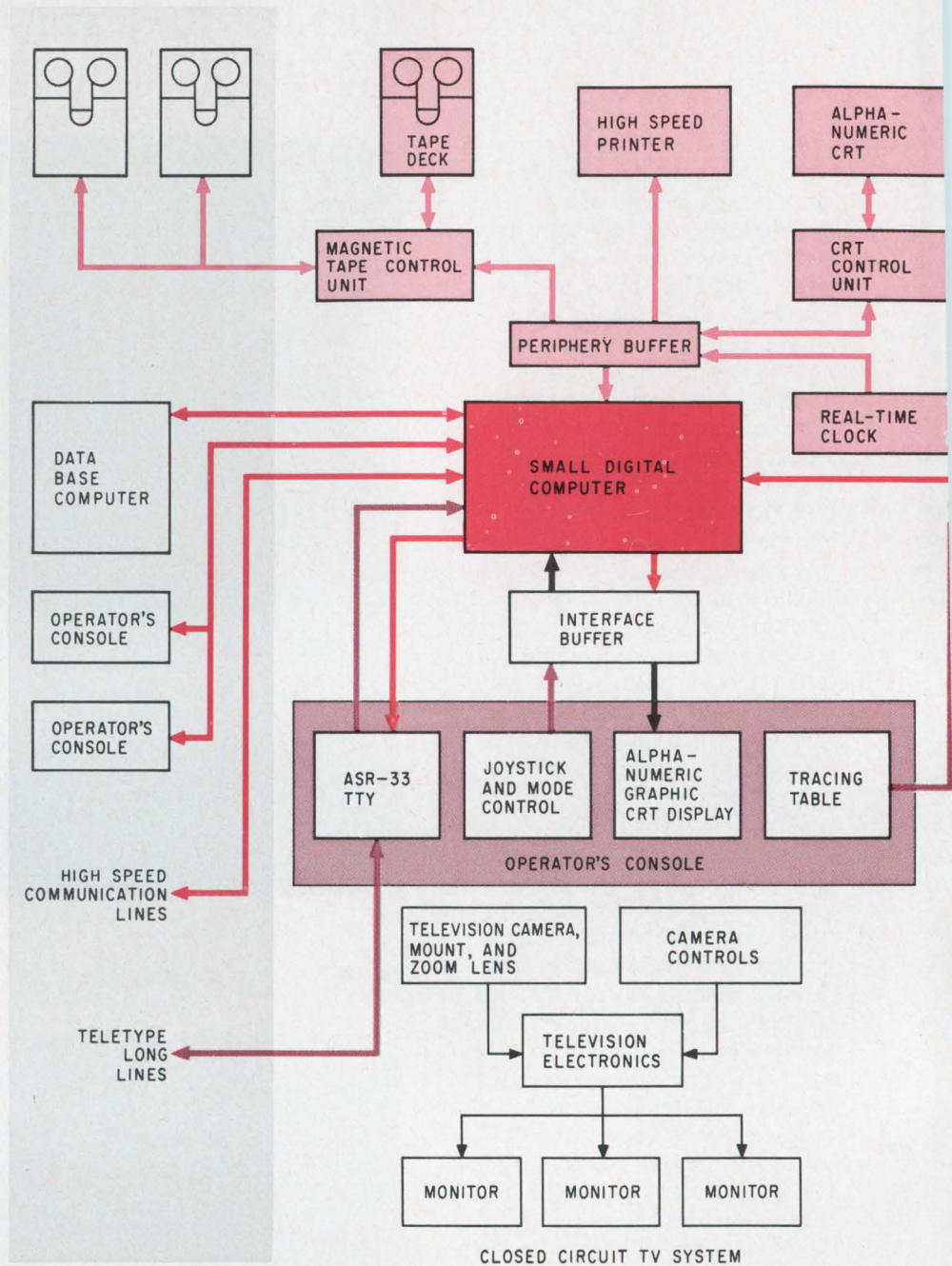

command room of an actual control center.

A cathode-ray tube alphanumeric display, a crt graphics display, a high-speed line printer, and controls for the closed-circuit television and the system intercom are located on the operator's desk in the control room. An ASR/33 Teletype and a tracing table for manual input of graphic data are also in the control center. The display-generating and projection equipment is in a room behind the large screen. The display system's computer, the interface buffers, the magnetic tape deck, and the real-time clock are in an adjacent room.

The display computer is the central element of the entire system. It has a 16-bit word length, divided into two 8-bit characters. All devices com-

municate with each other through the computer, except the tracing table which connects directly to the input and output routing logic portion of the buffer of the large-screen projection system. Programs stored in the computer core memory generate displays such as a military commander or business manager might see if the system were operating in an actual situation.

The computer also responds to commands and requests entered by the operator via the ASR/33 keyboard. Programs and sequential instructions can also be stored on punched paper tape so that the computer will read them in just as it would if connected via a teletypewriter line to a remote data-base computer.

VIGICON BUFFER

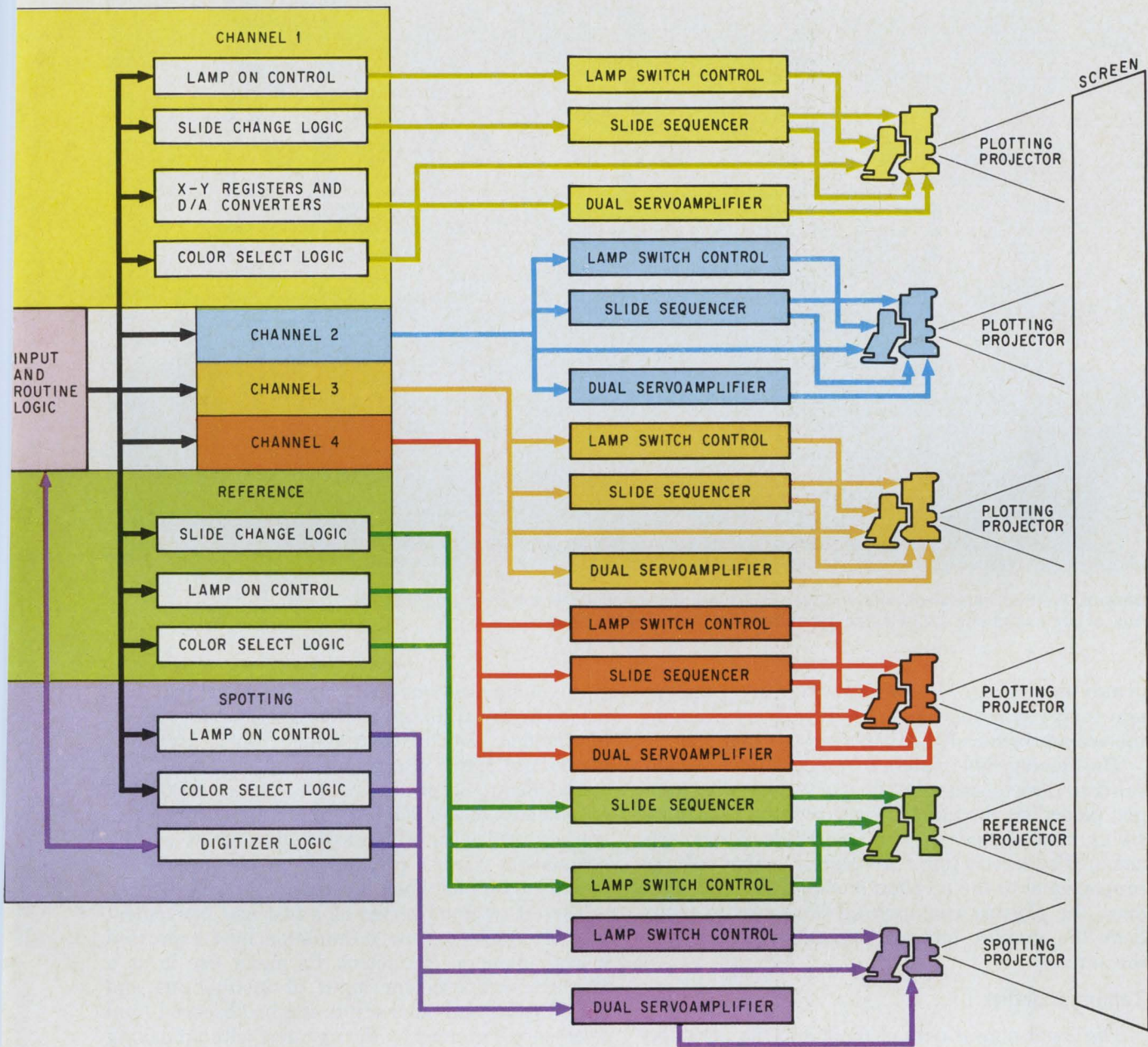

LARGE-SCREEN DISPLAY SYSTEM

The projection equipment—called Vigicon—generates the large-screen multicolored display, virtually in real time. The computer forms the instructions for the display and forwards them to the projector buffer, which converts the digital instructions to analog voltages and to relay and indicator voltages required by the projectors.

Show-off

The display system includes three types of precisely mounted projectors—reference, plotting, and spotting—whose images overlay perfectly on a screen that can be as large as 20 by 20 feet. The reference projectors show background data—maps and charts—prepared in advance. The plotting pro-

jectors, each of a different color, generate dynamic displays based on instructions from the computer. That is, while a metallic-coated slide is in the projector, a computer-driven stylus scribes the coating to form line segments between specified points to produce lines, symbols, and alphanumeric characters for display.

The operator can position the spotting symbol using the joy-stick control, an x-y analog input link, on his console. He can point to a specific location on the display, and he can extract for the computer the x-y coordinates of the spot by pressing a switch on the joy-stick. The buffer logic digitizes the stick's analog voltages, and the digital numbers enter the computer. Then appropriate com-

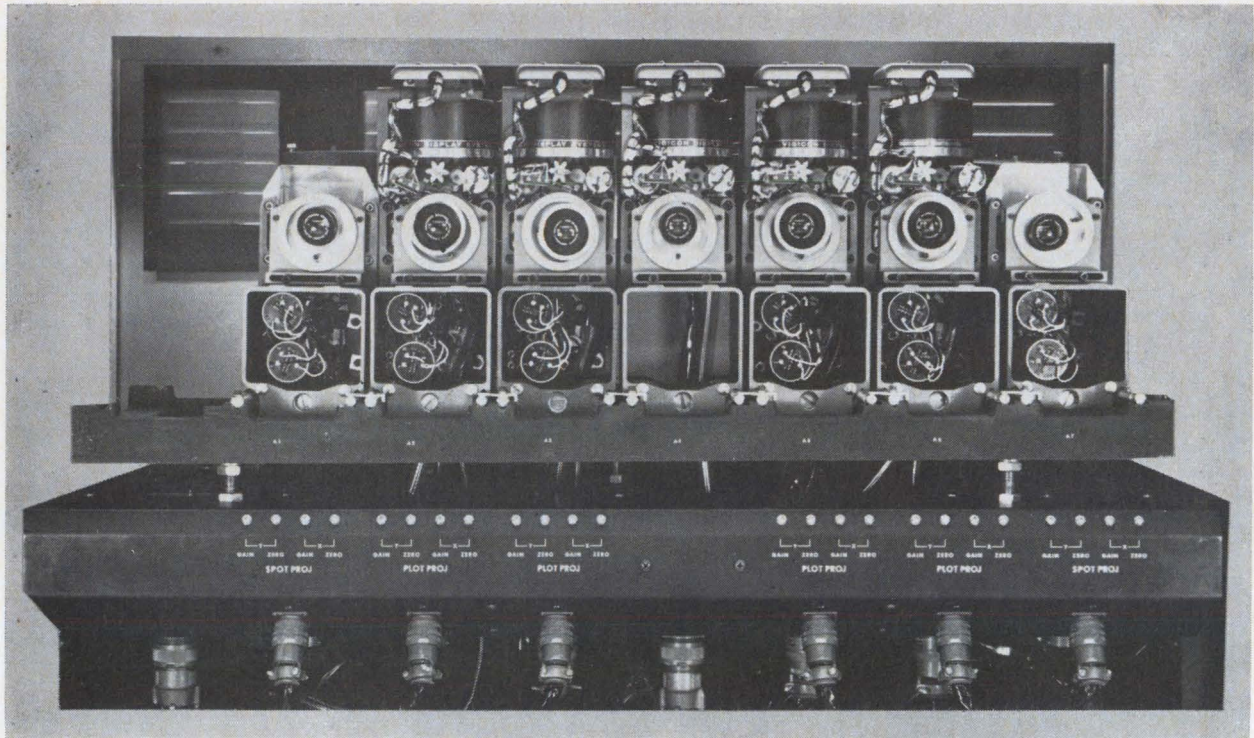

Blowup. Plotting, reference, and spotting projectors display variable and fixed information. Any of six colors can be selected by commands from the computer.

mands entered into the ASR/33 will instruct the system to perform some operation, such as changing the scaling factor of the display about that spot.

The tracing table enters manually-drawn graphical data directly onto the display. A map, for example, placed on the table is traced with a suspended stylus that drives an x-y coordinate servomechanism. The servo's input is a pair of analog voltages proportional to the position of the stylus tip. These drive the plotting and spotting projectors to reproduce the graphic information and project it onto the screen.

Talking together

The input-output data channel and the periphery buffers permit the computer to converse with all of the input-output devices except the Vigicon display. The magnetic-tape transport, the alphanumeric crt display, the line printer, and the ASR/33 use the American Standard Code for Information Interchange (ASCH) 8-bit character code. Information is transferred between these devices and the computer in both directions through a two-character (one-computer-word) buffer. The polling of all devices and all information interchanges is initiated by the computer. The real-time clock, with its output permanently available to the computer, is read as needed.

The ASR/33 is the principal input-output device; its keyboard provides manual means of inserting data and instructions; its printer produces hard copy, and its punch and reader process tapes at a faster data rate than can be done on the keyboard and printer. The ASR/33 is, of course, compatible

with communications lines, and in an actual command display system the teletypewriter can receive information directly from remote data-base computers and active operations.

The electronic printer, a Motorola TP 4000, produces hard copy at 300 lines a minute. Displays can be preserved—or used immediately, such as when a commander wants a printout of military-unit status to carry with him when he steps close to a display.

The crt terminal serves as a fast and convenient way of displaying any information best expressed in alphanumeric characters. Its major use is as a message composer for input of instructions and data. Typing and other errors can be observed—and selectively corrected by the operator without having to print out the entire message—before the data is sent to the computer.

The 4,000 words of core memory in the computer are adequate for all programs controlling the peripheral devices and generating display presentations for an operations command system. However, at the test and evaluation center, more capacity and flexibility are needed to try new programs and to demonstrate display systems to potential users. Thus, more memory is needed, and this is obtained with a magnetic-tape unit. All programs, including simulated data as might be obtained from a database computer or from an operational situation, are stored on the tape. This data is read into the computer's core memory as needed.

Formating simplified

The operator's console contains a crt that displays situations in graphic form. These situation

displays are created on the graphic crt using the same computer programming developed for the projectors. Pictorial data can be edited on this device in much the same way as text is edited on the alphanumeric crt display. The operator calls for a presentation, then rearranges or reorganizes the presentation until it appears in desired format. He can then instruct the computer to transfer the single-color display on the crt to its multicolor equivalent on the large screen.

The entire integrated command display system concept assumes that a large data-base computer will be operating in the total command establishment and connected to the display system computer. The connection may be a direct computer-to-computer link if the two computers are close to each other. Otherwise, they can be connected by teletypewriter or telephone-data lines. Thus, reports from field commanders would be communicated to the distant display system to present a higher-echelon commander with a big picture of the immediate tactical situation.

Natural language

The collection of hardware in the integrated command display system (ICDS) performs many information and display tasks: satellite tracking, missile launch simulation, air defense, and military ground situation displays are a few examples. The basic hardware configuration doesn't change from application to application; the unique solution to each of these problems is provided by software written in English-language statements.

Primarily, man has communicated with computers by cards and tape and by insertion of coded words from a console. Because these methods alone are totally impractical for real-time problem solutions, the ICDS hardware and software package presents information in a direct and natural form: graphics for pictorial and positional data, alphanumeric characters for quantitative data, and simple English statements for expression of explicit and abstract concepts.

Just what constitutes the most natural form for a given piece of information is, of course, somewhat subjective. No matter how well conceived, a command and control system is of questionable value if it forces its users to learn a new set of arbitrary nomenclature and symbology to replace a set with which they are already comfortable. Thus established usage often will prove more acceptable than contrived representation. For example, it would be foolish to invent a method of displaying Army units—artillery, infantry, brigade, battalion—when Field Manual 21-30 already defines a widely used and accepted symbology.

The operator of a real-time command and control system cannot afford to pay the penalty for universal software and should be permitted to work with a language specifically tailored to his problems. The basic element in the creation of a natural query language is identifying the common denominator of the problem.

Straightforward software

In the ICDS, the commonality is the ability of the hardware—under control of software—to draw pictures and print words. Using a small number of discrete hardware functions, any given display consists of some arrangement of symbols as determined by the reading and interpreting of groups of characters.

All words in the ICDS language are chosen to be as concise and unambiguous as possible. Words with more than one meaning, or which may be more than one part of speech, are avoided. Abbreviation may be permitted where no ambiguity results. Every command in the ICDS language is initiated by an imperative verb. Some verbs have very specific meanings, such as the command LAUNCH to ini-

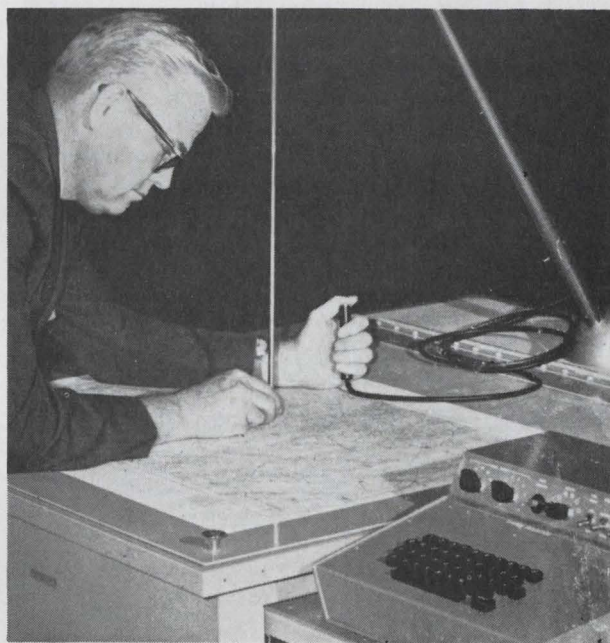

Tracing table. When graphic information isn't available on a slide the operator can trace the picture; the system automatically makes a slide.

tiate a missile simulation. The more basic verbs—PUT, GET, TERMINATE, REPLOT, WRITE, PRINT—initiate a class of command.

All commands may be entered on any of the system's keyboards. The verb PUT is generally used to impart information to the system or impose control on it. The command PUT 2BN 123ABN XD4063 enters into the data base the fact that the second battalion of the 123rd airborne division is located at the indicated coordinate. The command PUT LINE 1234 can be used to annotate the slide (screen) with graphic information needed on an impromptu basis.

Maps and overlays

The verb GET is generally employed to retrieve information from the system. The command GET MAP DA NANG would call up the specified map as

a reference background and, from the data base, create all the symbology suitable to the area displayed. The command GET WEATHER would call up a weather overlay coincident with the area covered by the currently displayed map. The words GET STATUS will initiate a detailed query of the data base.

The verb TERMINATE is used to expunge specified data from memory, REPLOT to reconstruct a situation that is in error or has become cluttered, and WRITE to annotate a display alphanumericly without modifying the data base. The verb PRINT is used to obtain hard copy from the printer.

Detailed data retrieval—about jet fuel, for example—is accomplished by structuring the query to the file being searched. Consider a file named POL—meaning petroleum, oil, and lubricants. It contains several records—each composed of five fields, A, B, C, D, and E. The operator wishes to view a listing of all records in which field B contains a seven and field E contains either a two or three. He would command

GET STATUS POL /7///2,3

The slashes separate the fields, including those not specified. If he now wants a hard copy of this listing, he would command PRINT and receive the same list from the printer. Had he anticipated this desire, he could have substituted the verb PRINT

for GET in the original command.

Twenty questions

Occasionally, detailed data-retrieval queries may require specification of so many parameters that the format becomes unwieldy. Since any system that requires operators to memorize complex formats or to refer to a manual can scarcely be considered optimum, a powerful optional technique has the computer organize the format and display the alternatives possible at each level.

As anyone who has ever played the game “Twenty Questions” is aware, any object in the world can be isolated by a remarkably small number of well-directed yes-no answers. When the questioning process permits multiple choice, rather than yes-no selection, the method becomes more powerful. Consider the previous example. The process would now go something like this

The crt initially displays the six verbs, each now coded with a number, which simplifies communicating with the system.

- 1 PUT
- 2 GET
- 3 TERMINATE
- 4 REPLOT
- 5 WRITE
- 6 PRINT

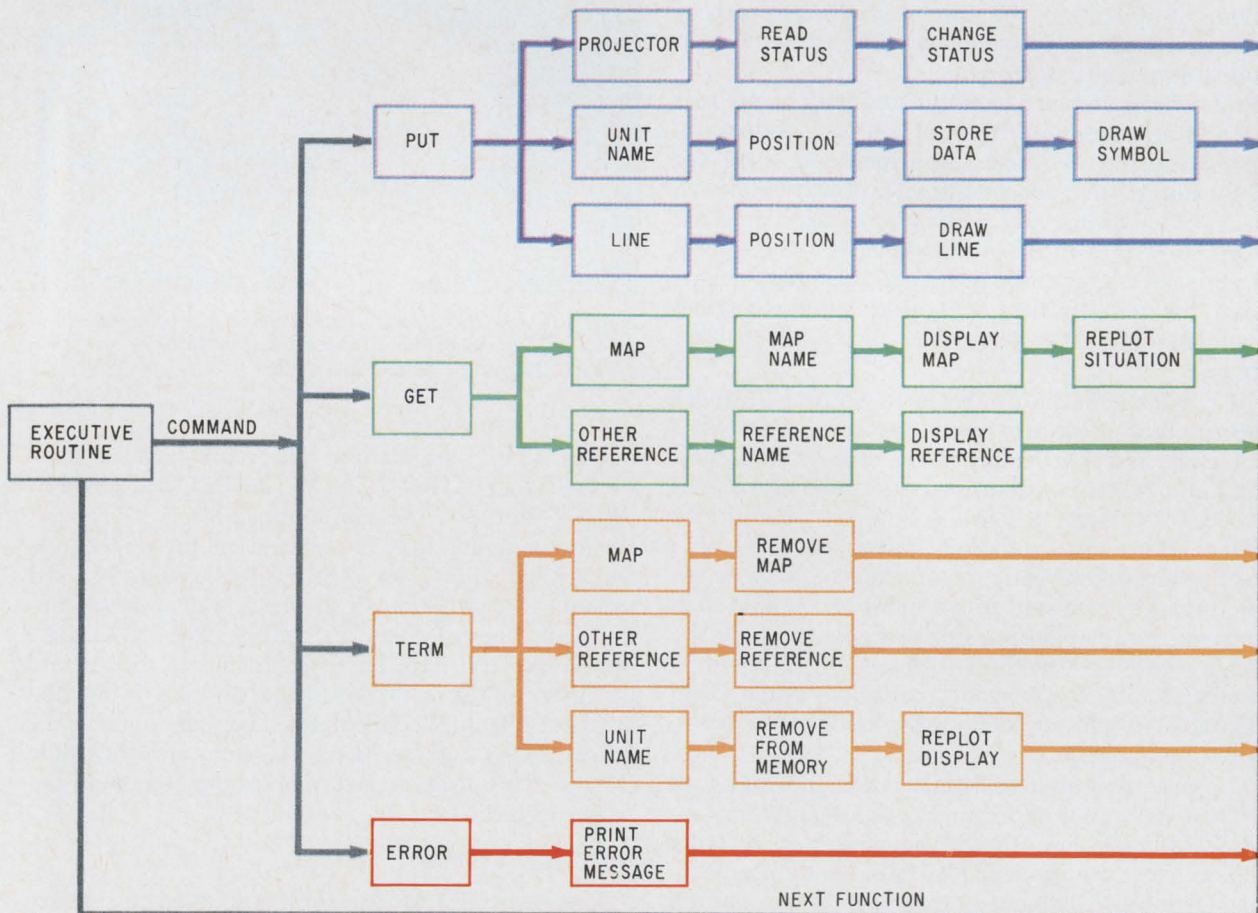

Software. English-language commands and queries, structured to the application, are entered by an operator. Then the computer executes them, rejecting errors and inadmissible requests.

The operator pushes 2 (GET) on his keyboard and is greeted by the choice

- 1 MAP
- 2 OTHER REFERENCE
- 3 STATUS

The operator pushes 3 and is given a list of files

- 1 RATIONS
- 2 POL
- 3 MUNITIONS

The operator pushes 2 and is presented with the format

A B C D E

The field selector (cursor) starts at A and since he does not wish to specify A, the operator lists a space and the cursor advances to B. Now the operator enters 7. He spaces twice more (C and D), and enters 2,3 at E. In a very short time the operator has retrieved and displayed the status of jet fuel supplies within the command.

Links and modules

The ICDS software is based on a building-block concept in which functional subroutines are linked to perform specific tasks. The broad generic power required of these functional modules is achieved largely through the extensive use of tables. Many of the subroutines operate on tables of variables that completely specify or control the action taken. The efficiency and flexibility of this heavily subrouted, table-directed software system has been dramatically demonstrated by the results obtained in more than 15 operational display systems.

The software is written in macroassembly language that permits natural English-language specification of subroutine calls and table parameters. Most of the functions may relate to more than one piece of hardware, separately or simultaneously, under control of a register that directs the subroutine to the selected device.

Match, please

The READ routine, the key to the organization of any program, reads and interprets one word entered from a keyboard or stored on tape. A word consists of any group of ASCII characters terminated by a space, comma, slash, or period. Interpretation is implemented by comparing the received word with a table of words permissible at that point in the program. A match with any word in the table or failure to match will each result in transfer of program control to an address specified by the table. All major branch points in a program are thus efficiently controlled from a keyboard, and a means is provided to link other building blocks into any conceivable configuration.

The programs thus produced take the form of a multiple branching tree as shown at the left, the functional block diagram for a simple ground-situation display. A typical program will process the initial imperative verb with the instruction

READ VERB

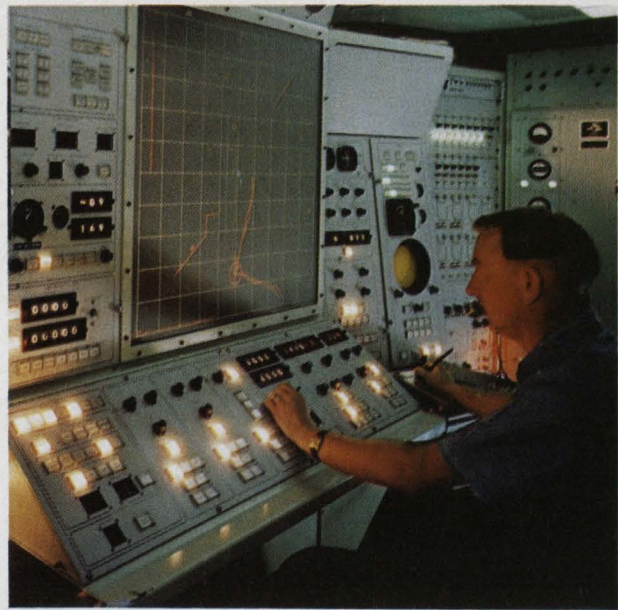

Warfare trainer. Display system helps train helicopter crews in antisubmarine warfare by plotting up to five separate sonar targets. It also displays simulated flights and actual ASW exercises. System is mounted in van.

This instruction will cause the READ subroutine to process the VERB table, which might appear as

```
VERB GO TO PUT IF P,U,T  
GO TO GET IF G,E,T  
GO TO TERMINATE IF T,E,R,M  
GO TO ERROR IF NONE OF THESE
```

This table controls a branch to any of three subprograms or to an ERROR routine if the specified branch conditions are not met. The word TERMINATE could be spelled out in its entirety or the entry could have been abbreviated simply as

```
GO TO TERMINATE IF T
```

The command language for any problem may thus be completely specified in easily interpreted table form with one table linking each program branch point to the corresponding word in the command language format.

Building up

The hierarchy of graphic-generation routines permits the development of extremely complex displays from a small number of basic elements. The DRAW routine creates a graphic symbol by processing a packed table of line-segment end points that define the symbol in an x-y grid system. For example, using a 5-by-7 character matrix (four segments wide and six segments high) the letter F might be formed by the instruction

```
DRAW F
```

which would process a table defined as

```
F PLOT 00,03,33,03,06,46
```

The library of symbols so defined includes the entire 64-character ASCII set; the basic elements of the military symbol set defined in Field Manual 21-30; the North American Air Defense (Norad) air-track symbol set; elements of the Naval Tactical Data Systems (NTDS) set, and an assortment of

arbitrarily selected miscellaneous symbols, including a pair of pseudo-symbols that permit line drawing. These symbols are formed at a size and screen location previously defined and are controlled by registers that store this information. A special form of the DRAW routine permits rotations of a symbol to, for example, affix a directional arrowhead to an air track.

Structured symbols

A composite symbol is defined by a coded word that identifies its individual elements according to a prearranged plan. The representation of an airborne battalion, for instance, consists of a flag, an infantry cross, an airborne gull wing, a battalion symbol and the number of the battalion and of the units to which it is subordinated—all arranged according to established convention. Given the convention, the symbol can be reproduced by a routine that recognizes and draws these elements. The nomenclature of a military unit bears a direct relationship to its graphic representation and can be readily translated to form the appropriate code. These coded words are stored in tables along with positional coordinates to record an entire display. The information contained can be manipulated at will and the entire display recreated at any time by a routine that processes the table.

Sometimes it is desirable to generate symbols that are rounder or smoother than can conveniently be specified by end points—a perfect circle, for example. For this purpose, continuous-function-generation routines have been developed that are similar to the analog devices normally employed to form target circles and cross hairs.

Slaved slides

The calling of a reference slide constitutes a somewhat different form of graphic output. Reference materials may be considered to be primary or secondary. A primary reference slide, such as a map or grid, dictates the scaling of all dynamic information projected against it. The routine that calls map backgrounds, therefore, must extract from a table the scale factor and true position of the map selected for use as multiplier and offset for all symbology superimposed on it. A secondary reference slide, such as a weather overlay, must be slaved to the primary reference being displayed. A command such as GET WEATHER would then select the weather overlay corresponding to the currently displayed map background.

The alphanumeric output routines generate alphanumeric display information on any device. For the teletypewriter and the printer, this routine simply consists of transmitting the appropriate ASCII codes. For the graphic devices, such as Vigicon and the computer graphics terminal, the ASCII code, in turn, specifies the symbol to be created graphically by the DRAW routine. Messages are generated by unpacking the table of ASCII codes specified, for example, as

TYPE FORMAT ERROR

This instruction would cause the teletypewriter to print the indicated error message.

The data-time routine translates the output of the real-time clock into an alphanumeric message to the addressed device.

The status routines control the Vigicon projectors and the magnetic tape unit. The projector-status routine controls color, slide number, and lamp condition. The magnetic-tape status routine controls tape movement, direction, rewind and read-write status.

The position routines allow the operator to specify the location of some entity in either alphanumeric or graphic form. Position, specified in any coordinate system, will be converted to screen coordinates by applying the multiplier and offset appropriate to the coordinate system used and the reference background in current use. Or position may be graphically inserted by moving a cursor on the computer graphics terminal to the desired x-y location and pushing the INSERT button.

Searching the records

The data retrieval system is independent of the content or structure of the files searched. Each file—stored on magnetic tape—consists of a number of data records preceded by a fixed-length record that identifies the file and specifies the number and structure of the records to follow. The retrieval routine locates a selected file on tape and extracts the description of the fields that compose each record for subsequent use as a dictionary.

The file-search routine is the heart of the data retrieval system. It reads one record from the selected file and accepts it for, or exempts it from, further processing based on predetermined search criteria. The search will be performed on one or more of the fields defined by the dictionary. Corresponding to each field in the record is a stored parameter indicating which of four search criteria—inclusive, exclusive, identity, OR—to apply to that field.

The inclusive search accepts any value in a field. The exclusive search rejects any nonzero value, accepting only a blank field. The identity search accepts only a value equal to the search parameter itself. The OR search accepts a value equal to any of two or more search parameters. Rejection of any field results in rejection of the record. The search parameters are established, before calling the routine, by the interpretation of the query in accordance with the constraints of the specific problem. This routine makes it possible to perform complex multiple-field searches on any file simply by assembling the appropriate table of parameters.

The structure of the ICDS software package suits it for driving almost any kind of display, including not only the direct plotting projector and crt projection systems. It's hoped that the software will apply to other means of large-screen display now under development, including the electroluminescent panel, the laser scanner, and the bistable solid state matrix panel.

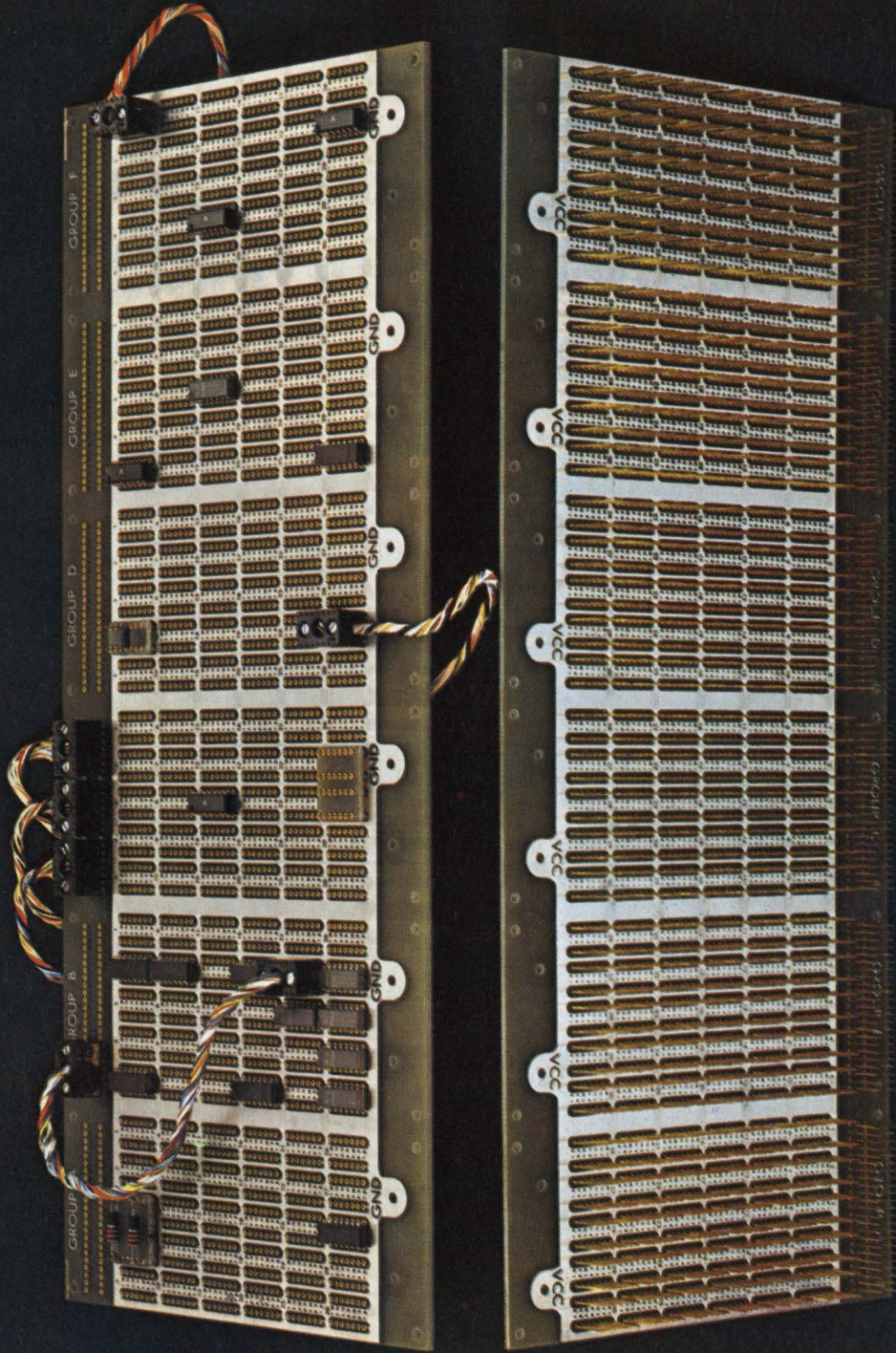

Take the 2-dimensional approach:

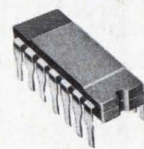

Let Augat in-depth design save up to 60% in total IC Packaging costs

That's what our customers tell us about our unique two dimensional approach in IC packaging panels. They simplify design and production operations — no need for functional logic cards. Our high density chassis, with three-level wire-wrap socket pins, is ready for interconnecting any desired logic or function at design, prototyping or production stage. Modular construction of panels permits user to specify any multiple of 30 up to 180 patterns. Available as standard catalog items or built to exact specifications.

Save time making circuit design changes. Simply disconnect one level of wiring on back of panel; plug in new logic and interconnect on other levels of wire-wrap pins — no waiting for design and fabrication

of logic cards. Boards can be automatically, semi-automatically or manually wrapped.

Save space. Boards may be mounted vertically or horizontally. Interconnecting is point to point with components. Also logistics problems minimized. No cards, connectors or back panels.

Eliminate many hidden costs such as designing and producing individual logic cards and maintaining spares.

Let Augat show you how to reduce your IC packaging cost — and give you greater flexibility in prototyping, production and field service.

Tel: 617/222-2202 or write: Augat Inc., 30 Perry Ave., Attleboro, Mass. 02703. **AUGAT** INC.

Economy is one reason we're sticklers for quality. Your economy and ours.



When you order switches from MICRO SWITCH, you expect high reliability, long service life, precision operation—all the features that have come to be associated with this famous name. At the same time, you expect to benefit from whatever economies the largest and most modern facilities in the industry can pass on to you. Well, you won't be disappointed in either respect.

Take the all-important area of quality, for instance. Because of its size, MICRO SWITCH is in a posi-

tion to maximize the optimum quality that each design requires and attain it economically, thanks to a total company effort. "Make it right the first time" is a standing rule that permeates the entire organization—from design and purchasing on through production. The emphasis is on prevention of defects, rather than simply their detection. This not only adds up to good business sense—it adds up to good dollars and cents—for both you and us.

No matter the size of the order or

the price of the switch, this standardized quality assurance program makes sure that each product will do the job expected of it. This is an important reason why you can depend on MICRO SWITCH—for both the reliability you need and the economy you want.

To find out for yourself the extensiveness of the MICRO SWITCH Quality Assurance program, write for our booklet "Quality Assurance for our Customers." No obligation.

MICRO SWITCH

FREEPORT, ILLINOIS 61032

A DIVISION OF HONEYWELL

HONEYWELL INTERNATIONAL • Sales and service offices in all principal cities of the world. Manufacturing in United States, United Kingdom, Canada, Netherlands, Germany, France, Japan.

Designer's casebook

Transistor speeds up charging circuit

By James J. Klinikowski

Davidson and Hemmendinger Inc., Easton, Pa.

Hefty mechanical impulses—required to raise antennae and close shutters on earth satellites—are produced when solenoids are driven by a capacitor discharge. To allow the silicon controlled rectifier which closed the solenoid-capacitor circuit to turn off a series resistor is used to keep charging current at a low level. The resistor, however, raises the charging time and limits the cycling rate of the solenoid. A series transistor that holds the charging current in the capacitor to a low level allows the SCR to turn off and reduces the recycle time of the solenoid.

Gating SCR₁ with a control signal from the ground station causes C₁ to discharge through the solenoid coil. The plunger is pulled into the solenoid and remains there until the voltage on C₁ drops. When coil current stops flowing the plunger moves to its original position and the SCR turns off if no holding current is flowing.

Current flow through R₃ and the base emitter junction of Q₂ causes the transistor to conduct. This allows a small amount of collector current to

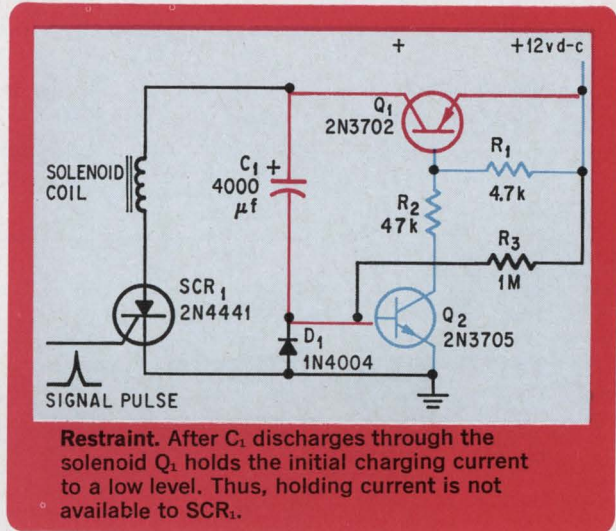

flow and consequently Q₁ is turned on. The current flowing through Q₁ charges C₁ and increases the forward bias to Q₂. Eventually Q₂ is biased into saturation and Q₁ is conducting at a constant collector current. The constant current is at a higher level than the charge current in a resistor-capacitor circuit thus C₁ charges quickly. When current through Q₁ stops flowing—after C₁ is charged to 12 volts—Q₂ turns off. This in turn stops conduction in Q₁.

Diode D₁ completes the discharge path of C₁ but doesn't interfere with Q₂'s operation.

Ohmmeter and diode measure dwell angle

By E.W. Horrigan

University of Toronto

Isolating an ohmmeter with a diode is an inexpensive way to measure breaker-point dwell angle—that portion of a distributor's rotation when the points are closed. The ohmmeter, protected by the diode, pulls current through the points and then measures the effect of point spacing on the current.

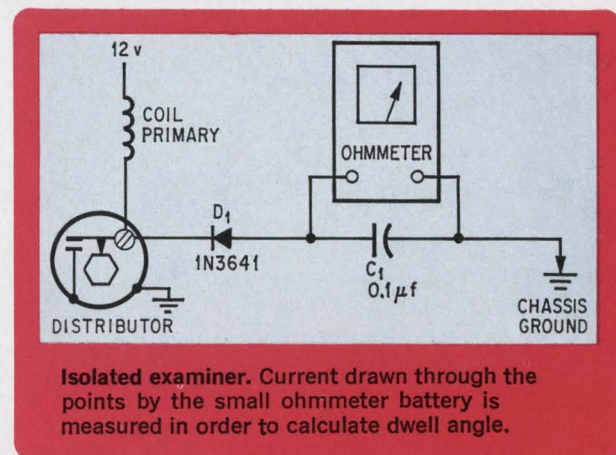

After the meter is connected into the circuit the distributor is rotated until the points close. The needle will lie on the zero resistance mark and the meter is thus calibrated.

When the engine is turned on the needle moves to the left by a distance related to the amount of time the points are closed. The resistance the ohmmeter is reading is actually an average of the infinite resistance when the points are open and the zero resistance when they're closed. If the needle moves a third of the distance to the left, the points are closed a third of the time. Each spark in a six-cylinder engine is generated by opening and closing the points in a 60° angle of distributor

rotation. Since the meter indicates that the points are closed a third of the 60° rotation time, the dwell angle is 20°.

When tuning an eight-cylinder car one should remember that every 45° of distributor rotation is needed for the closed-open breaker sequence. Four-cylinder engines are designed so that 90° of rotation forms a spark.

Capacitor C_1 bypasses to ground any voltage spikes generated during switching.

When using an ohmmeter it is convenient to add a scale to the meter face for ease of measurement. When a multimeter is used the voltage scales can be used to make the closed-open ratio measurement.

IC gate controls triac with audio transformer

By G. V. Wintress

Norfolk, Va.

Pulse outputs from an integrated circuit can be used to turn on a-c control devices such as triacs when an audio transformer is used as an intermediate stage. Easily available and far less expensive than the driver amplifiers presently in use, the transformer is completely and precisely controlled by the integrated AND gate.

In the absence of three simultaneous gating in-

puts to the integrated circuit, the IC's output is held above ground by the collector-emitter resistance of the internal transistors. Gating the IC on causes the output to drop to ground thus completing the primary circuit. The rectified voltage at the anode of D_1 causes primary current to flow, thereby inducing in the secondary the same half-wave rectified voltage. This voltage triggers the triac into conduction every half cycle, allowing the 117 volt supply to deliver current to the load. Any inductive spikes generated by breaking the primary circuit are shunted past the AND gate by D_2 .

Diode D_1 isolates the filtered d-c on the 20-uf capacitor from the primary of T_1 . Primary resistance in T_1 —the transformer is connected for step-down operation—is high enough to keep collector current in the gate at a safe level.

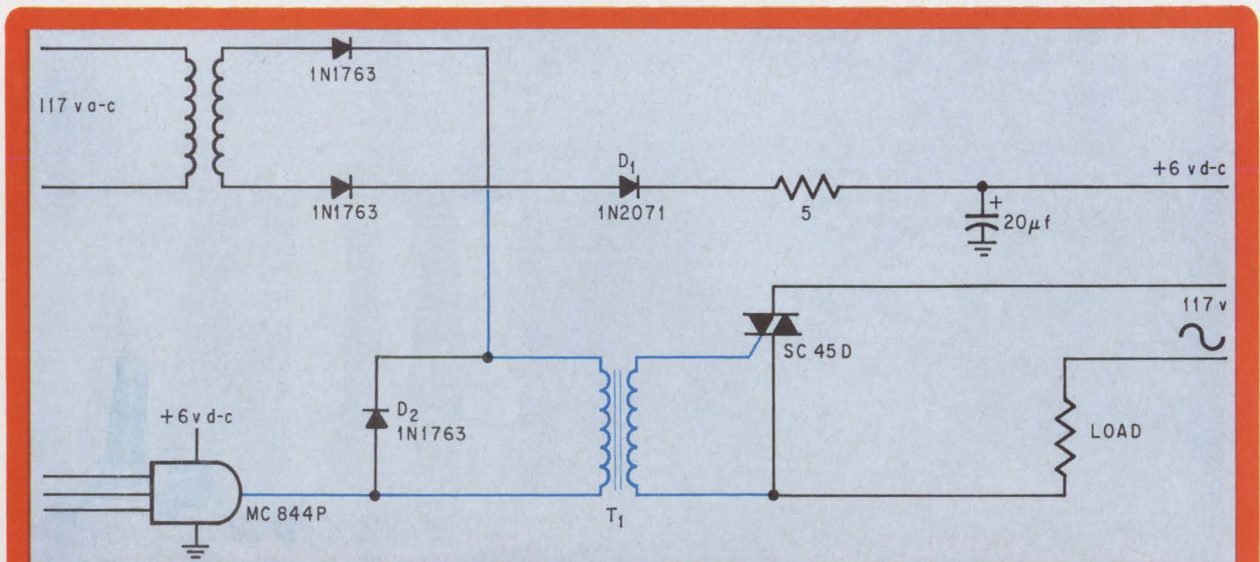

Synchronized switching. When gated on, the integrated circuit allows primary current to flow in the transformer. The rectified voltage induced in the secondary turns on the triac every half cycle so that the a-c voltage available at the line is coupled into the load. Diode D_1 keeps a rectified a-c from the 6 volt supply.

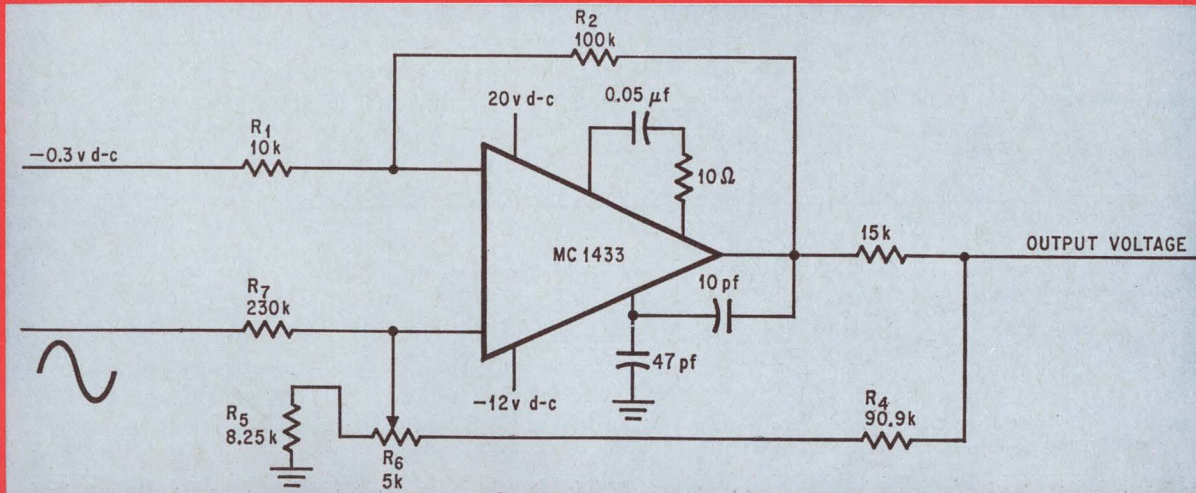

Constant current generator. The d-c input voltage—it is introduced at the point designated by 0.3v—changes level along with a-c signal at the non-inverting input. Consequently a varying d-c voltage is present at the output. The output voltage is used to modulate a double balance mixer.

Modulating current supplied by op amp

By Keith Hanneman

Collins Radio, Richardson, Texas

Double balanced mixers capable of operating over a wide frequency range are excellent suppressed carrier modulators when they are driven by an a-c control current. If a d-c offset is present in the control current then it is possible to have amplitude modulation without carrier suppression. To supply the modulating current an operational amplifier whose output current varies around a d-c level was used.

At the non-inverting input—the point common to R_7 and the wiper of R_6 —a voltage is developed that is related to the output voltage by

$$V_f = \left(\frac{R_5}{R_4 + R_5} \right) V_o$$

where V_f = voltage at junction of R_7 and wiper of R_6
 V_o = output voltage

The resistance in R_6 is disregarded because it doesn't affect the voltage division. Voltage V_1 at the junction of R_1 and R_2 changes in magnitude until its value is the same as V_f .

Since the voltage V_1 is a composite of the input voltage and the voltage fed back from the junction of R_2 and R_3 it can be expressed as

$$V_s = V_a + V_a - V_i \left(\frac{R_1}{R_1 + R_2} \right)$$

where V_s = voltage at the d-c input—designated 0.3v
 V_a = voltage at junction of R_2 and R_3

Combining this equation with the first equation results in

$$V_s = V_a + V_a - V_i \left(\frac{R_1}{R_1 + R_2} \right) = V_o \left(\frac{R_5}{R_4 + R_5} \right)$$

Since the dividers $R_1/R_1 + R_2$ and $R_5/R_4 + R_5$ are equal during normal circuit operation both of them can be set equal to k and make the above equation read $V_i = V_f = V_s + (V_a - V_i) k = kV_o$.

Solving for V_a and V_o and then dividing by R_3 the output current equation results

$$I = \frac{V_s (k - 1)}{kR_3}$$

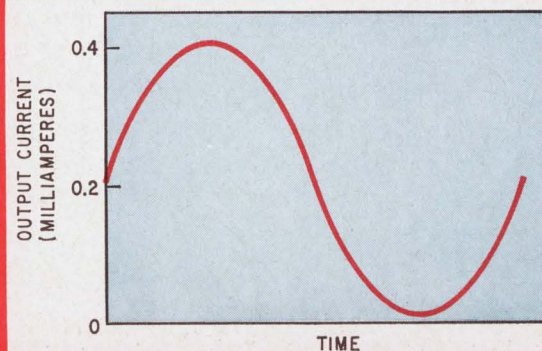

The necessary offset. Output of the generator is a varying d-c level which is an exact replica of the a-c voltage supplied to the op amp.

where I = current through the load

From the last equation it can be seen that current through R_3 is directly proportional to V_s and inversely proportional to V_o .

The potentiometer R_6 is added in order to compensate for the small amount of current drawn

from the output by the R_4 , R_5 and R_6 divider feedback loop. This insures constant current through the load despite wide variations in the load impedance — with the values shown a load current of 0.2 milliamperes varies only 0.4% as the output impedance moves from 1 to 70 kilohms.

Op amp Boosts pick-up voltage

By G.D. Morant

Fairchild Instrumentation Division, Palo Alto, Calif.

Tachometers that use an inductive pickup to sense the field of a rotating magnet must have high gain amplifiers in their front end. The voltage induced in the pickup at low shaft speeds is small, as can be seen by the relation

$$e_p \propto N \frac{d\phi}{dt}$$

where e_p = voltage induced in the pickup

N = number of turns on the coil

$\frac{d\phi}{dt}$ = flux change with respect to time

The pickup coil is made by inserting an alnico magnet into a relay coil. After shielded leads are connected to the coil terminals, the pickup is wrapped in two layers of conetic foil that are wired to a lead shield connected to the circuit's ground point. This arrangement prevents any inductive

coupling between line voltage and the sensitive amplifier circuitry.

One power supply can deliver the negative and positive voltages needed by the operational amplifier. Zener D_1 maintains the proper voltage at the amplifier's 14-volt input, and avalanche breakdown in D_2 keeps the ground terminal of the amplifier 7 volts above the -7 volt terminal. The amplifier, connected for a gain of 1,000, delivers a pulse capable of driving Q_1 into saturation.

The 7-volt d-c level placed at the output of the op amp by the zener configuration is removed by RC filtering. A pulse developed in the pickup coil eventually appears after amplification across resistor R_1 . The emitter follower, Q_1 , takes this voltage and places it across R_1 where it drives Q_2 into saturation.

Transistor Q_2 is connected in what is commonly known as a TRL configuration. When it is biased on, its collector falls from 30 volts to 0.2 volt, thus forming the negative output pulse.

To obtain distinct pulses, the magnet on the rotating wheel is cut so as to have a triangular cross-section. Flux buildup is slow as the magnet approaches the pickup, but it drops sharply after the pickup is passed. The coil output voltage is therefore small on the approach and high on departure.

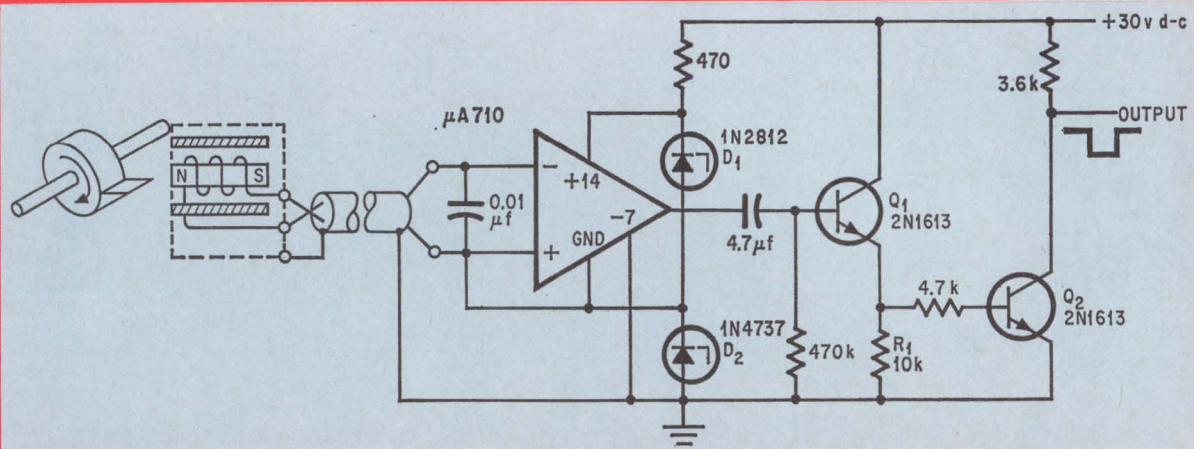

Helping the weak. Small voltages, induced in the magnetic pickup when the shaft is rotating slowly, are amplified by the integrated operational amplifier. Lifted to a higher voltage the pulses are able to drive the emitter follower Q_2 and the TRL gate Q_1 . Ultimately the pulses will drive the tachometer's indicators.

Motorola has introduced 58 new integrated circuits in the first six months of 1968, or an average of about 2.2 new circuits each week.

**And, every one of them
is available.**

But, we don't feel that is the beginning and the end of it all.

To Motorola, such a track record is merely an outgrowth of the normal new product development activities we undertake to make sure we are building and supplying the integrated circuit functions you need to do the

best possible system design job. You'll find, for example, that the new circuits provide you the widest possible selection of functions covering all the major logic lines now used in modern computers, as well as a broad selection of linear circuits to do a wide variety of jobs.

It's part of an overall plan we have to give you state-of-the-art circuits you need, in a logical pattern, to help

DEVICE TYPE NO.	DESCRIPTION
MTTL I	
MC507	Dual 4-Input Line Driver
MC520	Expandable Dual 2-Wide 2-Input AND-OR-INVERT Gate
MTTL II	
MC2100	Expandable 2-Wide 4-Input AND-OR-INVERT Gate
MC2101	Quad 2-Input NAND Gate
MC2102	4-Wide 2-2-2-3 Input Expander for AND-OR-INVERT Gate
MC2103	Dual 4-Input NAND Gate
MC2104	Expandable 4-Wide 2-2-2-3 Input AND-OR-INVERT Gate
MC2105	Single 8-Input NAND Gate
MC2106	Dual 4-Input Expander for AND-OR-INVERT Gate
MC2107	Triple 3-Input NAND Gate
MC2109	AND J-K Flip-Flop
MC2110	OR J-K Flip-Flop
MC2113	Expandable Dual 2-Wide 2-Input AND-OR-INVERT Gate
MTTL III	
MC3000	Quad 2-Input NAND Gate
MC3001	Quad 2-Input AND Gate
MC3002	Quad 2-Input NOR Gate
MC3003	Quad 2-Input OR Gate
MC3005	Triple 3-Input NAND Gate
MC3010	Dual 4-Input NAND Gate
MC3015	Single 8-Input NAND Gate
MC3020	Expandable Dual 2-Wide 2-Input AND-OR-INVERT Gate
MC3025	Dual 4-Input NAND Power Gate
MC3026	Dual 4-Input AND Power Gate
MC3028	Dual 3-Input 3-Output AND Series Terminated Line Driver
MC3029	Dual 3-Input 3-Output NAND Series Terminated Line Driver
MC3030	Dual 4-Input Expander
MC3050	Single J-K Flip-Flop With Positive Edge Clock
MC3052	Single Master Slave J-K Flip-Flop
MC3060	Dual Type "D" Flip-Flop With Positive Edge Clock
MC3061	Common Clock, Common Reset Dual J-K Flip-Flop With Negative Edge Clock
MC3062	Separate Clock, No Reset Dual J-K Flip-Flop With Negative Edge Clock
MRTL	
MC996	Dual Full Adder
MC997	Dual Full Subtractor
MC971	Quad Exclusive "OR" Gate
MDTL	
MC935	Hex Inverter
MC940	Hex Inverter
MC941	Hex Inverter
MC957	Quad Buffer
MC958	Quad Power Gate
MHTL	
MC662	Dual 4-Input Line Driver
MC668	Quad 2-Input Gate (passive)
MC669	Gate Expander
MC670	Triple 3-Input Gate (passive)
MC671	Triple 3-Input Gate (active)
MC672	Quad 2-Input Gate (active)
MECL II	
MC1029	2 x 3 Data Distributor
MC1030	Quad Exclusive OR Gate
MC1031	Quad Exclusive NOR Gate
MC1033	Dual R-S Flip-Flop
MC1022	Type D Flip-Flop
MC1036	16-Bit Coincident Memory
MC1037	16-Bit Coincident Memory (w/φ pull-downs)
MSI	
XC157	12-Gate Array
LINEAR	
MC1711	Dual Differential Comparator
MC1303	Dual Stereo Preamplifier
MC1539	Operational Amplifier
MC1541	Dual Sense Amplifier

you implement the logic design or linear equipment you want with the minimum possible compromises.

We think that's integrated circuit leadership.



MOTOROLA Semiconductor Products Inc.

P.O. BOX 20912 • PHOENIX, ARIZONA 85036

- where the priceless ingredient is care!

Avoiding IC system design pitfalls

Both engineers and managers should review some of the basic concepts to prevent miscalculations that can be all too easy to make

By Howard I. Cohen

Nanodyne Corp., Sudbury, Mass.

Pitfalls in integrated-circuit system design can trap the unwary engineer. And the art of IC systems management is also presenting new challenges.

The engineering difficulties may turn out to be quite embarrassing, either to the design engineer or to his associates. For example, self-inductance, capacitive coupling and their relation to crosstalk—a major concern in the design of high-speed IC systems are problems that the engineer studied in depth in college, but may have put aside with his mortarboard hat. The difficulties may also arise from improper communication with a semiconductor manufacturer, and they may cause large sums of money to be wasted because available skills weren't fully used.

Management must become highly involved. Managers are justified in expecting their risks to be minimized and their long-term planning honored. But the manager must not expect things to be done the way he is used to seeing them done, for two simple and compelling reasons: he is not working with component specifications, but rather with functional parameters, and unless he knows how to work with these parameters, the design may result in breadboards or prototypes or preproduction models that simply do not work.

Even when laboratory personnel are familiar with the use of IC's, the subtleties must be communicated to all corners of the organization, and examined there with an enlightened eye. Establishing this communication is the task of management. All persons must recognize that IC's are new, novel, and versatile, and that canned and stereotyped procedures are useless. Managers must create a sense of openmindedness and adaptability as the objective of their planning. They should look to their design personnel who have been exposed to IC's to show these groups what an IC is in terms of their jobs, what its problems are, and what the IC means to the future of electronic equipment.

None of these problems is new. In large-scale integration they are simply extensions of problems that exist already with ordinary IC's. The author's own experience with the MSP-24, an early IC computer designed under his supervision at Sylvania Electric Products Inc., a subsidiary of the General Telephone & Electronics Corp., will help to illustrate them.

Machine specification

IC's have clearly had a major impact on the design of digital computers. They are faster and smaller, and consequently offer "more bang for the buck," than discrete components. This fact permits features previously executed in software to be embodied in hardware with no significant increase in the cost of structures, cables, power supplies, or other "overhead" hardware.

For example, in the MSP-24, bit and byte manipulation hardware was found to be economical. With this feature the programmer can directly modify a single bit, or a small group of bits within a word, with a single instruction and without specifying masks or other clumsy forms of data. Many critics viewed this and other features as programable frills, but close examination of the critics' basis for judgment showed that they had virtually no idea of how much additional IC hardware would cost. They were making judgments based on their own, generally obsolete, design experience.

The functional-hardware organization must be examined carefully, recognizing the IC's impact on logic-design procedures, packaging methods, problems of equipment debugging, and programmed diagnostic procedures. In the MSP-24, this gave rise to a new packaging scheme, extensive use of state counters, and three bussing systems. And a new IC type, the SG160¹ series, was developed as a direct result of these studies; these are now available as part of Sylvania's universal high level (SUHL) logic line.

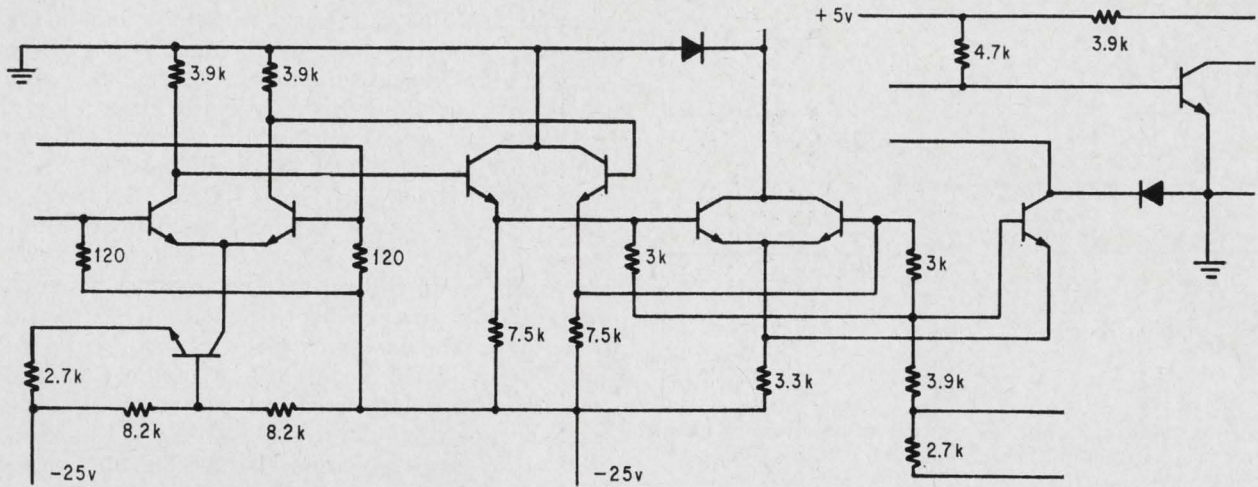

Sense amplifier. This circuit is an example of good integrated-circuit design that meets the specifications and offers no unusual problems to the semiconductor manufacturer.

Thus a new functional circuit designed for a special application became available off-the-shelf for general use.

Establishing a relationship between circuit design and hardware packaging is always difficult. With IC's, in general, the components' switching speeds are high enough to require a ground plane to reduce lead inductance. Concentrating on a ground-plane packaging scheme is much broader an effort than might be first supposed, because it dictates a set of logical ground rules that consider wire length, enhance the large-package concept, and require a vast amount of detailed design and process development to build an economical multilayer board.

The presence of the ground plane may require some engineers to go back to their textbooks to review transmission-line theory and the behavior of the basic circuit elements, inductance, and capacitance. These parameters cause bandwidth limitations or pulse deterioration in any interconnection system. Inductance and capacitance must be considered in the design of the signal lines as well as in the power distribution system. This is to insure proper decoupling of the power supply from the signal lines. Resistivity and conductance are important with regard to copper clad laminates, because in a strip-line system, these are the bandwidth limiting parameters.

Vendor liaison

Specifying and purchasing IC's is not like specifying and purchasing other components, because an IC is really not a component but a functional entity. Purchasing agents think of an IC like a resistor—after all, it's about the same size and weight. But the designer can't afford to make such a mistake. He must learn how the manufacturer of the IC views his device and how to recognize what the manufacturer can and cannot do toward meeting a specification. He also must recognize how to compromise between what he wants and what the manufacturer can build.

The IC manufacturer knows what he can make, what his yields are, what his distributions are; any severe departure from that is either very expensive or totally frustrating. Too many users have tried to tell the IC manufacturer what to build without understanding the constraints. The results have been costly and time-consuming for both parties. The MSP-24 sense amplifier, at top of page, is an excellent example of what a classical circuit designer could do when he realized the constraints and freedoms in the monolithic world.

The sense amplifier circuit² includes a balanced differential amplifier fed by an active constant-current source, a pair of emitter followers, a common-emitter pair, and a three-resistor network, together with an output amplifier stage.³ The resistors that determine the magnitude of the constant current cannot be expected to have a close tolerance, but they can be expected to vary from their nominal values in nearly identical fashion. Any departure from the nominal current level, and thus from the nominal output of the differential-amplifier stage, carries through the entire circuit and cancels itself at the base of the output amplifier, whose base-emitter potential is constant.

The sense amplifier design takes advantage of the fact that realizing nearly identical values of two components is much easier than realizing specified absolute values. Careful mask design using component proximity helps ensure equal component parameter values, and a symmetrical layout ensures equivalent tracking with temperature changes.

Areas that have a functional interface with an IC also require close examination. In the MSP-24, the core memories were a prime example of this. Everything evolved around one concept—a pnp-npn driver circuit, which was used for the read-write drivers, the read-write switches, and the inhibit drivers for the memory. It thus was the universal answer to the need for an efficient logical and electrical interface between an IC on one end and a highly versatile and electrically efficient power driver on the

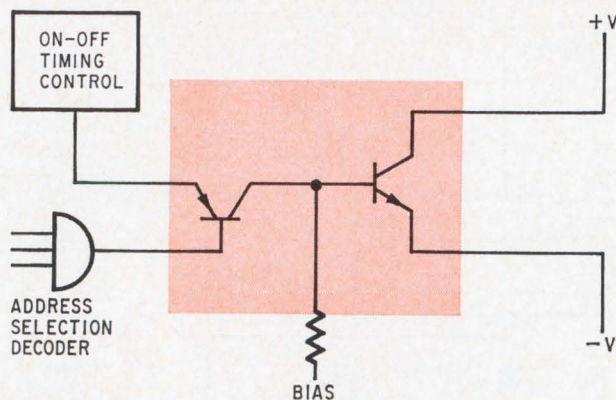

Memory driver. Here is an example of an interface circuit that connects to an IC at its input and provides high power efficiency at its output. Furthermore, it is easily packaged in large numbers on one substrate.

other. The circuit, top of page, conducts no current in either stage when it is not active. But when the decode selection is activated, the pnp section functions like a classical constant-current amplifier that drives the npn section into conduction.

When production demands justify it, this circuit could be very nicely implemented as a hybrid chip form, including the interfacing IC. In the conventional matrixed memory driver, power dissipation is no problem, because only one driver can be on at a time. Many such drivers could be packaged on a common substrate. The larger the substrate, the greater the number of circuits, and the greater the total dissipation which for a memory driver is independent of the number of circuits. This is an example of a well-thought-out electronic interfacing procedure.

Power supply problems

Another unique interfacing problem exists in the power supply design. Above and beyond the problem of physical compactness of the supply are the subsystem interface problems it offers. Two factors predominate—control protection and power distribution.

The IC is electrically fragile. All too often, many IC's have burned out and had to be replaced because overvoltage protection was absent. Protection can be provided in several ways. Local protection with zener diodes or silicon controlled rectifiers on each convenient subassembly offers a statistical hedge over the "crowbar" technique at the central supply, which shuts down the whole system when a minor fault occurs. Series-parallel redundant pass regulators offer protection from both open-and short-circuit failures inside the power supply regulator section. But the particular approach is not as important as the recognition of the need.

Overcurrent protection is just as important as overvoltage protection. Overcurrent in the distribution system or at the load is always caused by a short circuit. Two relatively economical techniques are available to implement overcurrent protection—

electronic sensing at the power supply, and fusing wherever wire size changes. An examination of the thermal time constants of narrow etched conductors should be made, and fusing specified accordingly.

Against the advice of several persons afflicted with traditional thinking, the fuses on the MSP-24 were included on each large board. Soldered-in fuses were used because if such a fuse were to blow, it would indicate the existence of a potentially serious fault. Finding that fault was generally much more difficult than unsoldering the blown fuse and soldering a new one in its place. Short circuits inevitably developed, sometimes in a faulty IC and sometimes caused by careless use of an oscilloscope or meter probe. When these occurred, the traditionalists were invariably relieved that the only damaged component was a fuse.

The power distribution problem has two facets. One is d-c voltage drop, curable only by using sufficient copper, and the other is a-c effects. Whenever a transistor turns on or off, it tends to cause a spike in most power buses. If the impedance of the bus doesn't match that of the load, these spikes can be reflected hither, thither, and yon, wreaking great havoc wherever they go. Planar distribution buses, instead of wires, permit the required a-c impedance to be specified and the corresponding load attached.

Just about any impedance can be realized. The characteristic impedance of a lossless power distribution line is $Z_0 = (L/C)^{1/2}$. For two parallel conductors (p. 113 at bottom) the inductance L per unit length is directly proportional to the distance between the surfaces and inversely proportional to the width of the conductors. The capacitance C per unit length is proportional to the total surface area and inversely proportional to the separation. All three parameters—width, separation, and dielectric constant—can be adjusted to achieve the desired impedance.

Some power-bus manufacturers⁴ have recognized both the problem and the solution, and specify their products in terms of these a-c parameters. The critical factor is to recognize the problem. After that, the solution is usually classical.

Trimming the spike

The need for good high-frequency decoupling is extremely critical, because it is the most effective cure for one of the classical criticisms of transistor-transistor logic circuits. These devices are alleged to cause current spikes on the power lines, as a result of the very sudden increase in current that can occur when the driving IC switches to its more positive output. At that time the power supply must dump a very large capacitive current into the load, shown in diagram on page 115.

The initial current is surprisingly high, limited only by the a-c path as seen from the output looking up into the top transistor. This path has a dynamic impedance of about 50 ohms; if the power supply is 5 volts, therefore, the momentary current can be as much as 100 milliamperes. This momentary energy can come from either of two places: the power

supply bus where a drop in voltage would occur—source of the critics' complaint—or the bypass capacitor at the transistor's collector.

The next question is how large the bypass capacitor should be. The wrong answer is "as large as possible." It need be no larger than the load capacitance C_L . The predominant load capacitance is in the etched wiring of the multilayer board. Therefore, if the entire area of the card is a good dielectric capacitor, that area exceeds the wired area by the amount of surface from which the copper has been etched away. This gave rise to a simple rule, which became known at Sylvania as "Cohen's rule:" "Make the bypass capacitor out of the entire card, and just to make certain, let its dielectric thickness be less than that of the etch." This rule ensures that the total bypass capacitance is at least as great as the total load capacitance on the card, without being unreasonably large, and thus eliminates the voltage drop on the power bus.

Natural laws and crosstalk

The designer need not be an expert in the strip-line techniques or transmission-line theory to identify the crosstalk problems that he will encounter in the use of very-high-performance circuitry. He must only review textbook material at the early undergraduate level in physics or engineering to appreciate the kinds of problems he must face.

Once these problems are recognized the aggressive engineer will turn to the more advanced treatments to seek solutions. The same approach, incidentally, could and should be taken by engineering management in its supervision of the "new technology," which involves no new concepts, but requires old concepts to be exhumed, examined and applied.

To demonstrate these remarks, let us hypothesize a hardware configuration like the MSP-24 and predict, from the most fundamental textbook relations, what might result if the ground plane-transmission line approach were not used.

The one parameter probably most obscure and not understood, or at least underrated, is inductance. Self-inductance is the induced electromotive force in a single circuit per unit rate of change of current. Sometimes it is stated as the induced emf per unit rate of change of flux lines linking a circuit. Mutual inductance is similarly defined, except that the induced emf is in one circuit and the changing current is in another. An often overlooked fact is that the linkage is not on a piece of wire, but through an area, the loop or closed circuit bounded by the conductors involved. For most situations, where ferromagnetic or similar material is not present, the flux density is independent of the size of the loop. Therefore, the smaller the area of the loop, the fewer the lines of flux that pass through it.

This fact often becomes obscured, probably because one can calculate the self-inductance of a piece of isolated wire. However, this calculation assumes that the wire is carrying a unit current in a loop of which that segment of interest is only one part. The unit current is imposed only to simplify

the formulation and eventually drops out of the equations. This demonstrates that self-inductance—and for that matter, mutual inductance—is a function of the circuit geometry only. (High-frequency currents produce second-order changes in inductance because of skin effects, but these generally are small when the relative permeability μ is 1, as in free space or near most nonmagnetic materials.)

The general procedure for finding the self-inductance of a piece of wire in free space assumes that its return path is an infinite distance away. The procedure has two steps. The inductance inside the wire is calculated as a function of its diameter, then the self-inductance from the surface out to the return path is added. Both of these calculations depend on the flux density B , which numerically equals H , the magnetizing force when $\mu = 1$.

Consider a printed-circuit card with a loop in it, shown on page 114, plugged vertically into a chassis. Assume that the loop comprises a device in position A and an etched path from A to B, to C, to D, where current is returned to ground. Let the chassis be a perfect ground plane. The total inductance of this loop is the sum of the self-inductances of each leg of the loop and the mutual inductances of each leg on every other leg. However, one segment can be used to measure the unit inductance.

If the segment BC is four inches off the chassis, its self-inductance is about 30 nanohenrys per inch. This seems innocent enough until one calculates $e = L(di/dt)$.

Assume $di/dt = 10^7$ amperes per second. This is equivalent to switching 40 ma in 4 nanoseconds, which is quite possible with the modern IC. The induced noise turns out to be 0.3 volt per inch.

The same procedure for calculating inductance per unit length can produce an expression in the form of

$$L/i = A \log(4h/d)$$

where A is a constant, h is the height off ground, and d is the effective wire diameter. Normally, the logarithm is a "lazy" function—that is, to double its value, the argument must be changed tenfold. But in this case, h is on the one hand several inches

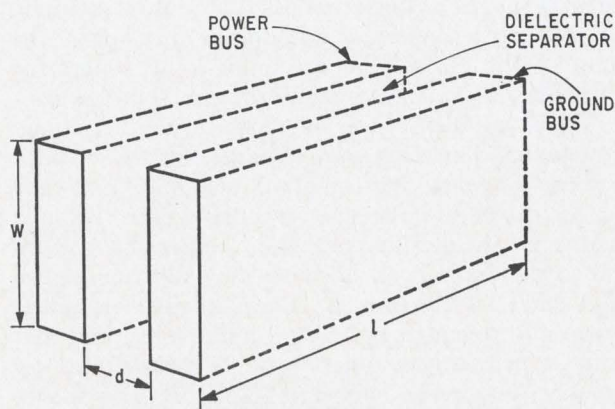

Adjustable impedance. Two parallel conductors serving as a power distribution line can be designed to have any desired characteristic impedance.

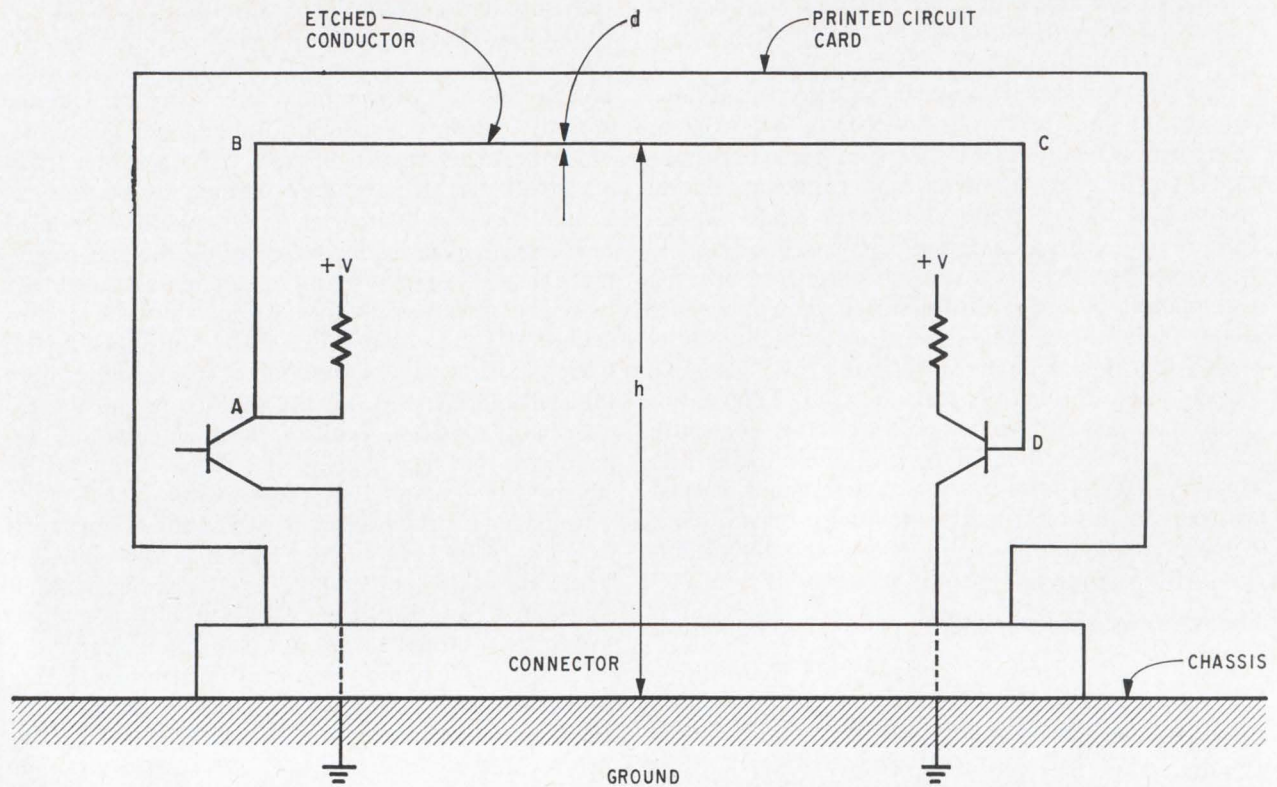

Inductance example. This innocent configuration can generate a surprising amount of noise all by itself.

above conventional chassis ground, and on the other hand a few thousandths of an inch above a multi-layer-type ground plane. Furthermore, as the argument of the logarithm approaches unity—that is, as $4h/d$ approaches 1—the function is no longer “lazy,” but rapidly approaches zero. Thus, the application of the most basic lessons of physics shows vividly what will happen without a ground plane.

Another common error that many an engineer makes, in spite of what he is taught, arises from a misconception about mutual inductance. It is often pictured as a coupling phenomenon between two wires. This has led many an equipment designer to separate wires diligently and to feel that he has solved his problem by putting distance between them. What he overlooked was that mutual coupling is, like self-induction, a function of the area of the loop of the circuits being coupled. By separating the wires he may have made the problem worse.

These problems are not just academic. Many companies and government agencies have been forced to spend great amounts of money and time to get rid of radio-frequency interference. In such instances the design engineers should have been called on the carpet, because they did not realize that such interference is generated by self-inductance and detected by mutual inductance, and that each is primarily a function of its own wiring geometry. The same engineers probably also forgot that self-inductance is mutual inductance, both conceptually and mathematically. It is merely the mutual coupling effect of one element of the loop on

another element of the same loop. Thus one circuit can both affect a second and be affected by it, at the same time, depending on the loop area of each.

Watch the specs

Designers should keep a jaundiced eye on the IC manufacturer's specifications—they may differ slightly from the conditions under which the IC's are to be used, and the difference can make the IC capable of driving a significantly different load than the manufacturer's specifications indicate. Sometimes the manufacturer can be induced to change his specs, and sometimes not.

For example, in the MSP-24, while maximum typical propagation delay with a 100-picofarad load—half the sum of turn-on and turn-off delays—was accepted as 20 nanoseconds, it was recognized that the two delays might not be equal. If one has had a value of 39 nsec and the other 1 nsec, the device would have met this specification, but would have been unusable in the system. Eventually the manufacturer agreed to the limits of an 18-nsec turn-on and a 22-nsec turnoff, which the logic designers found acceptable.

An example of the manufacturer's refusal to vary his specification occurred when the user groups recognized that input “on” current was specified with the input grounded. Actually, no input ever goes below the saturation voltage of the stage driving it. This difference was found to have a marked effect on input current, as shown in diagram, p. 116.

In the grounded circuit, the output current is

$(V_{cc} - V_{be})/R$, but in the other circuit, it is $(V_{cc} - V_{be} - V_{sat})/R$. If $V_{cc} = 5$ volts, $V_{be} = 0.7$ volt, and $R = 2.7$ kilohms—4 kilohms less 33% worst-case tolerance—the current is 1.6 milliamperes grounded and 1.44 ma when $V_{sat} = 0.4$ volt is considered. This 10% saving permits a driver to carry an additional load. The manufacturer would guarantee an output current of 1.6 ma because that was how he tested them; he felt the user could take any desired liberty.

What liberties could we take? If we were careful with signal transmission, we could design with a saturation voltage of as much as 0.9 volt, for which the current is only 1.25 ma. Furthermore, letting the driving transistor run with a V_{sat} of 0.9 volt lets it draw about 30 ma, if its internal impedance is 50 ohms. Such an output could drive $30/1.25 = 24$ loads. While this was a tempting liberty, the manufacturer's figures for allowable fanout were followed, in the design of the engineering model. Sylvania's position on this design parameter was reassessed for its production systems; the company's position is viewed as proprietary.

In general, the manufacturer would accept what he could control and test, and the user, recognizing this, compromised his own desires as much as he felt he could. The compromise was successful, for 5,000 IC's delivered within this specification and the computer worked.

Conclusions for Management

One of the basic factors that motivated Sylvania management to initiate the MSP-24 project was the exploration of the many problems in designing high-performance digital equipment with monolithic IC's. From the explorations, Sylvania learned much about the art of managing IC systems development.

Managers must recognize that the IC is unconventional and that conventional discrete-component thinking must therefore be abandoned. This has an impact on virtually every facet of digital engineering. The cost-per-function tradeoff parameters take on new meaning since entirely new coefficients for them exist. Every conceivable factor, including reliability, maintenance, logistics, manufacturing factors, test methods, and others, requires re-examination. The thinking of the systems engineer is affected, and so is that of the logic designer, the circuit designer, packaging engineer, power-system specialist, thermal analyst, structures expert and radio-frequency interference expert.

If management initiates a major effort with essentially successful laboratory-level results, what does it do next? The answer must focus on two groups: men who can teach others, and men who can generate new ideas from their experience.

Men as teachers

Men who have successfully completed a design using IC's should be called upon to instruct others about the technology and procedures they have evolved. Their students should include personnel in manufacturing, field service, marketing, purchas-

ing, and every other facet of the operating organization, because all these workers inevitably feel the impact of the IC. All other design groups should be deliberately exposed to what has been learned and asked to exploit it.

Designers of IC systems should establish a close relationship with purchasing agents at the very beginning. This new friendship will permit performance specifications to be established along with unit costs of each part—a prerequisite to long-range procurement planning. Many procurements have started out with a dollar figure around which project costs were established, only to find that what the IC manufacturer would deliver for that price was not what the design groups could use.

When an IC manufacturer offers to sell a million IC's over a period of years with prices stabilizing at a quoted level in a specified future year, just what is he selling? Try to get him to guarantee both minimum and maximum values on some of the parameters for that price. He just won't do it.

Big money in little boxes

The receiving room presents a very different problem. Suppose a research team orders a small quantity of custom-built large-scale IC's. The delivered item arrives in a box slightly bigger than a package of cigarettes. Many of these small cardboard cartons fall on the floor, or in the wastebasket of a crowded, often messy receiving room because an overworked, unenlightened receiving clerk never knew that thousands of dollars worth of hardware could arrive in such a small package. Worse yet, his boss does not know, either.

In the incoming inspection department is a dedicated group that will check everything on the spec sheet, down to such trivial items as the thickness

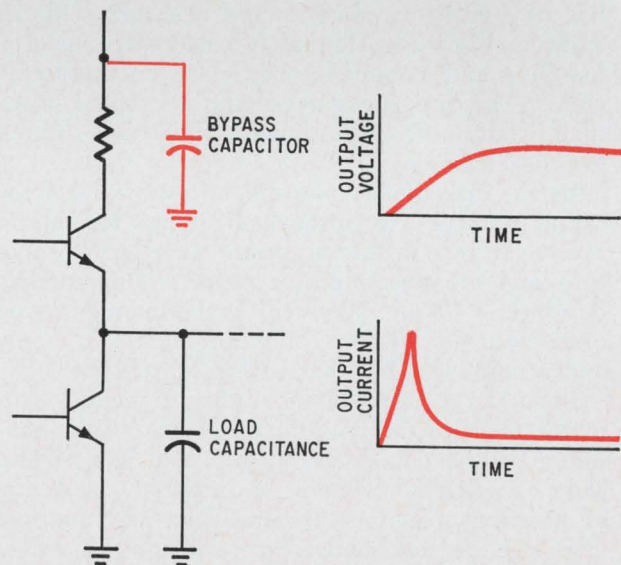

Spike suppressor. The output circuit of a TTL logic block can generate large noise pulses on the power supply line when switching from negative to positive level if it isn't properly bypassed with a capacitor between the supply line and ground.

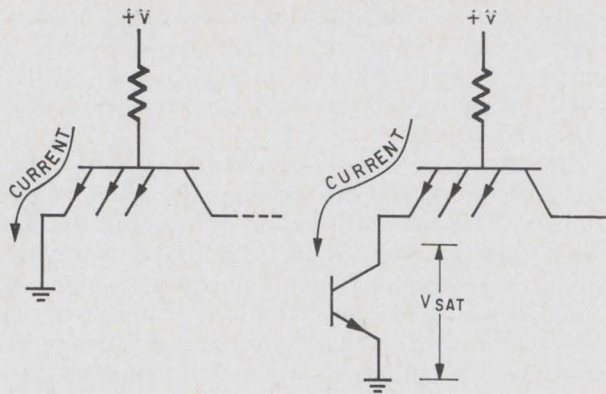

"Grounded" input. A circuit's performance may be substantially different from that guaranteed by the manufacturer if its application differs only slightly from his test configuration.

of every lead on an IC. This group is capable of almost anything, good and bad, and therefore should be made an active participant in the IC world. If 100% inspection is called for on a shipment of IC's, the design and inspection personnel should work together to establish the required test procedures. Inspectors must recognize not only that an IC is functional but also that it is part of a batch with a spread of parameter values.

Incoming inspection is an excellent place to grade key parameters, such as fanout versus saturation voltage, or propagation delay versus capacitive load. Combined grading and inspection opens up another area of freedom in equipment design, which can be worth money.

Similar thinking can be applied to production control, production operations, and production testing. In one known instance, a production estimator was told that an IC was equivalent to some number of transistors, diodes, and resistors with an additional 14 leads. He therefore estimated material handling and assembly costs based on the equivalents. The design engineer, who attempted to explain what an IC was through a phone call, did not get the idea across.

By the time the estimates were reviewed and the rather comical error discovered, it was too late to revise the bid. In the meantime, an otherwise mature and creative engineer went around snidely deriding an "idiot estimator" in the manufacturing organization, while the estimator explained simply and accurately, "But that's what he told me!"

Even if the explanation to the production estimator is more meaningful, have component handling, component insertion, bonding, and testing been completely explored? An impressive selection of handling machinery is available, and multiple lead welders and bonders are available. Can they be used economically, flexibly, and with quality assured? The in-line package was developed for production ease, but is it all it was cracked up to be? Is it cost-effective to get bigger boards and larger structures to use in line, or can flatpacks be

packaged on smaller, less costly boards at the same or a slightly higher mounting cost?

One manufacturer is using in-line IC's with plug-in sockets, because this eases maintenance-replacement problems. Using flatpacks might have permitted smaller, denser assemblies, in fewer racks and cabinets and less interconnecting hardware, and unsoldering a flatpack is simple. Another manufacturer welded flatpacks on nickel-clad cards. To replace a flatpack one simply cuts the defective IC out, inside the weld, and welds the replacement right over the old flatpack leads.

Men with ideas

The second burden of management involves the design environment explicitly. Management has seen a handful of men become experts. It has directed some of their energies to document test procedures and design rules, to conduct seminars, and to travel with marketing men to describe the new capabilities and the newly developed products. But these same men should be put back into the laboratory as soon as possible and their design talents exploited. They should continue their work on techniques and applications and have the critical voice on what to explore next.

Furthermore, and most important, management must recognize that the working of a group, with its own local leadership, makes an effort successful. If such a group exists, it should be kept together and given the mission of exploring the next step in the technology.

This group can concentrate on any of a great many areas. For example, it can study ways to combine hybrid-ceramic printed-circuit techniques with monolithic IC's. The designer who has contributed to a large-card functional packaging scheme knows best how to establish a configuration of interconnected IC chips. The logic designer who implemented the prototype hardware knows best what repetitive patterns of logic nets best lend themselves to large-scale monolithic structures. Any IC manufacturer would be responsive to organized and documented inputs from an engineer who has "been down the road." These examples are intended only to suggest new areas for the best use of design personnel once they know how to use the modern IC.

Management's worst trap is the fear that these efforts will not pay off. Considering the investment by the semiconductor industry in IC research, development, production, and marketing, the failure to pay off lies in the failure to use the men and their skills.

References

1. Sylvania integrated-circuit specification, "Triple two-input bus driver SG160 series," Semiconductor division, Sylvania Electric Products Inc., Woburn, Mass., Nov. 1, 1966.
2. U.S. Patent 3,309,538, "Sensitive sense amplifier circuit," March 14, 1967. Issued to M. Abbott and A. Ashley, Sylvania Electronic Systems div.
3. Brant Johnson, "Sense amplifier fits any memory," *Electronics*, Sept. 5, 1966, p. 89.
4. Technical bulletin B-2, Eldre Components Inc., Rochester, N.Y.

More MSI from Transitron

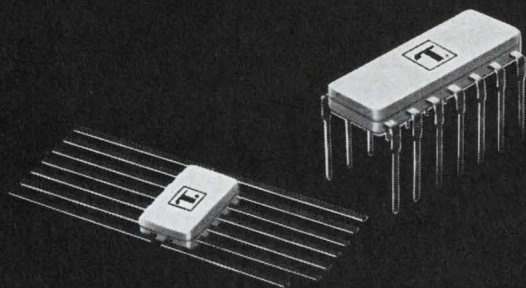

Now available for immediate shipment — 2 new complex circuits with industry's best performance

BCD-to-Decimal DECODER-DRIVER

- High breakdown voltage — 70V min.
- High sinking current capability — simplifies power supply filtering requirements
- No background glow, no oscillation
- Low power consumption — typically 10mA @ 5V
- Compatible with TTL and DTL levels
- Only decoder-driver available in 16-pin hermetically-sealed ceramic dual in-line package
- Also available in 22-lead ceramic flat pack and 16-pin epoxy dual in-line package

SEE WHAT'S NEW AT WESCON (Booth 352-4, Hollywood Park)

IN... Off-The-Shelf
MSI

IN... Linear & Digital
IC's

IN... Thyristors, Transistors, Diodes, Connectors & Displays

High-Speed (45 MHz) 4-BIT RIPPLE COUNTER

- High speed — typically 45MHz
- Low power consumption — typically 180mW @ 5V
- High output current drive — typically 20mA
- Master-slave flip-flops provide application versatility
- Internal buffers provide low input current loading
- Buffered outputs prevent false output signals
- Full TTL compatibility (easily interfaces with other logic)
- Available for industrial or military temperature range operation
- Available in 14-lead flat package (suffix G) or 14-lead dual in-line package, ceramic (suffix P) and plastic for 0-75°C (suffix E)
- Both binary and BCD versions available in two pin configurations:
 - 4/10 { TRC 2511-14, Binary Ripple Counter
TRC 2515-18, BCD Ripple Counter
 - 7/14 { TRC 2521-24, Binary Ripple Counter
TRC 2525-28, BCD Ripple Counter

Send for complete data on these and other Transitron MSI functions. Available without charge.

Transitron
electronic corporation
168 Albion Street Wakefield, Massachusetts 01880

Dynamic tests for op amps use synchronous demodulation

General-purpose technique is accurate, easy to use, gives direct meter readout and handles wide variety of tests

By Robert Calkins

Philbrick/Nexus Research, Dedham, Mass.

Static tests for operational amplifiers are readily available in low-cost testers but dynamic tests—particularly for linear integrated-circuit op amps are more difficult, and suitable testers are hard to come by. The instrument must give accurate results for tests of open-loop gain, common-mode range and rejection, output swing, and power supply rejection. The user wants a unit that's easy to operate and, further, he'd like a direct readout. His requirements can be satisfied with an operational amplifier tester that uses low-frequency square waves and synchronous demodulation.

In the new synchronous detection method, the amplifier operates in a stable, closed-loop mode and thus is assured of operation in its linear region.

In most test methods, the output depends on the gain and when large signals are applied, there is a chance that the amplifier will be operating out of its linear region.

Three test methods

The advantages of the synchronous detection method are best demonstrated by first considering the drawbacks, of three other test schemes.

One is specified in the new military standard, MIL Std 883, as method 4004, section 1. In this method, an auxiliary amplifier is used to keep the amplifier under test zeroed for offset. To accomplish the zeroing the circuit, on top page 119, has two resistors, R_f and R_s . The source resistor, R_g , is made large in comparison with R_s to assure that only a small signal is applied to the circuit under test. Feedback capacitor, C_1 , around the auxiliary amplifier, essentially opens the loop at the input signal frequency, which is typically in the range of 10 to 30 hertz. The output voltage and gain of the

amplifier under test for this circuit are:

$$e_o = e_{in} \frac{R_s}{R_g + R_s} \cdot \frac{R_2}{R_1 + R_2} \cdot A_o$$

where

$$A_o = \frac{e_o}{e_{in}} \cdot \frac{1}{S}$$

$$S = \frac{R_s}{R_s + R_g} \cdot \frac{R_2}{R_1 + R_2}$$

If the input and output voltages of the amplifier under test are displayed as a Lissajous pattern the slope of the line, when properly scaled, represents the open-loop gain.

The two diodes clip the output of the amplifier so that no input offset voltage results because of an unsymmetrical output swing if the amplifier is overdriven. Such a condition can be observed on the oscilloscope and the linearity of the amplifier under test can be evaluated.

This method thus has the advantage of displaying gain, output swing and linearity simultaneously, with the additional benefit that all signals are high level, which eliminates any noise problems. However, it has some serious disadvantages.

First, the output level is directly dependent on the open-loop gain, which makes programing of output test conditions extremely difficult.

With the high gain, internally damped IC amplifiers now available, capacitor C_1 must have an extremely large value to open the loop adequately at the signal frequency.

The R_g - R_s attenuator must be very accurate and variable if IC amplifiers with wide variations in

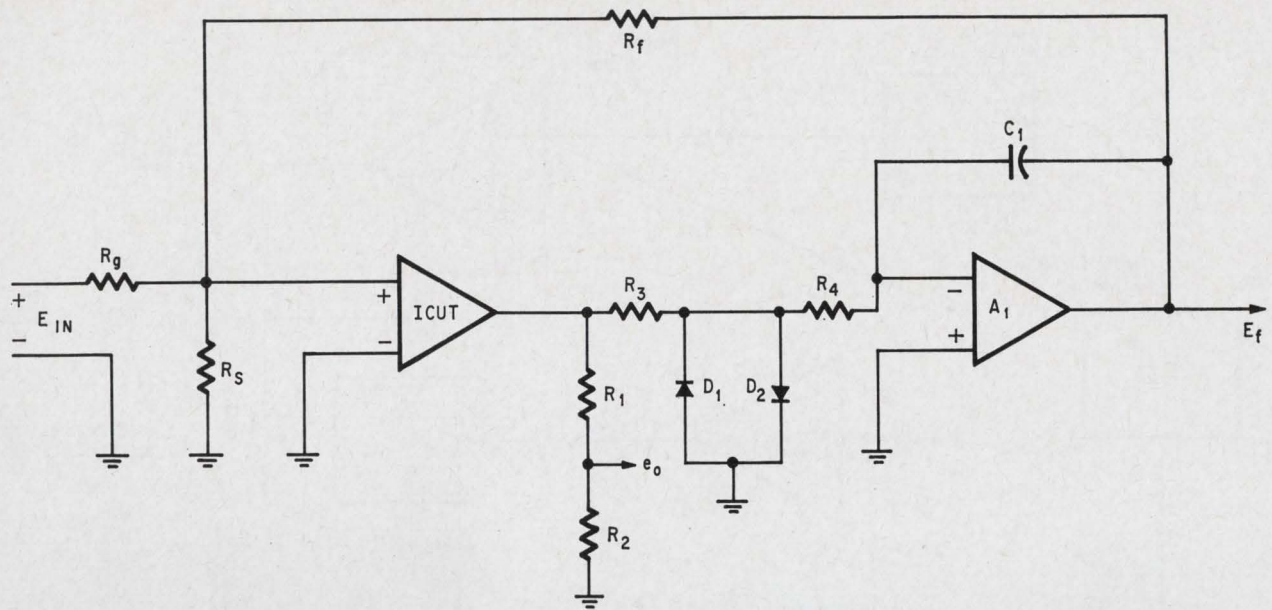

Gain measurement. To determine the open-loop voltage gain for an integrated circuit op amp, A_1 must keep the IC under test (ICUT) zeroed for offset via resistors R_f and R_s . However, because C_1 's value must be extremely large, the circuit is impractical.

parameters are to be tested. Hand programming is mandatory.

Finally, the readout device—the oscilloscope—is not easily adaptable to a direct reading meter.

The second method, below left, is far simpler than the first but has all its drawbacks. It consists of a simple feedback circuit with an attenuated input applied to the amplifier under test. For an a-c signal, the gain will be

$$A_o = \frac{R_g + R_s}{R_s} \cdot \frac{e_o}{e_{in}}$$

This circuit does not allow the amplifier under test to be overdriven as the square wave output tends to rebias the IC, changing its response.

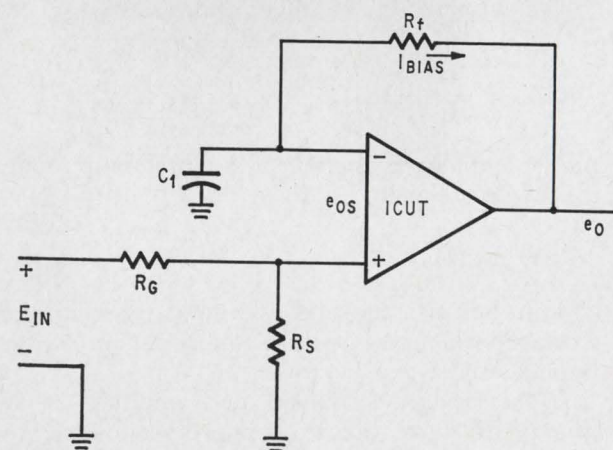

Voltage gain. Output e_o at d-c is equal to the input offset voltage plus the drop across the feedback resistor, $I_{bias}R_f$. Circuit cannot be overdriven because the output tends to rebias the IC, thus changing its open-loop response.

The third method, given in the new military standard, is also simple, see below right. The signal is applied to the amplifier under test through a voltage divider, coupling capacitor, and feedback resistor, R_1 , with a shunted resistor from one terminal of the amplifier to ground. Under the condition that

$$\frac{(A_o + 1)(R_3 \parallel R_4 - jX_{C_1})}{R_1} < 0.1$$

the open-loop gain is

$$A_o = \frac{e_o}{e_s} \cdot \frac{R_3 + R_4}{R_4}$$

$$R_3 \gg R_4$$

The imposed condition requires that the closed-

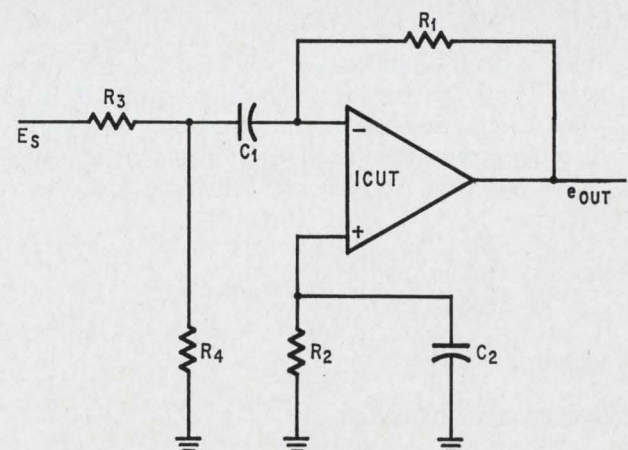

Voltage divider method. Closed-loop gain must approximate the open-loop gain by 90% for this test setup to be effective. However, this means that the circuit will be unstable, and therefore, is not a practical measurement scheme.

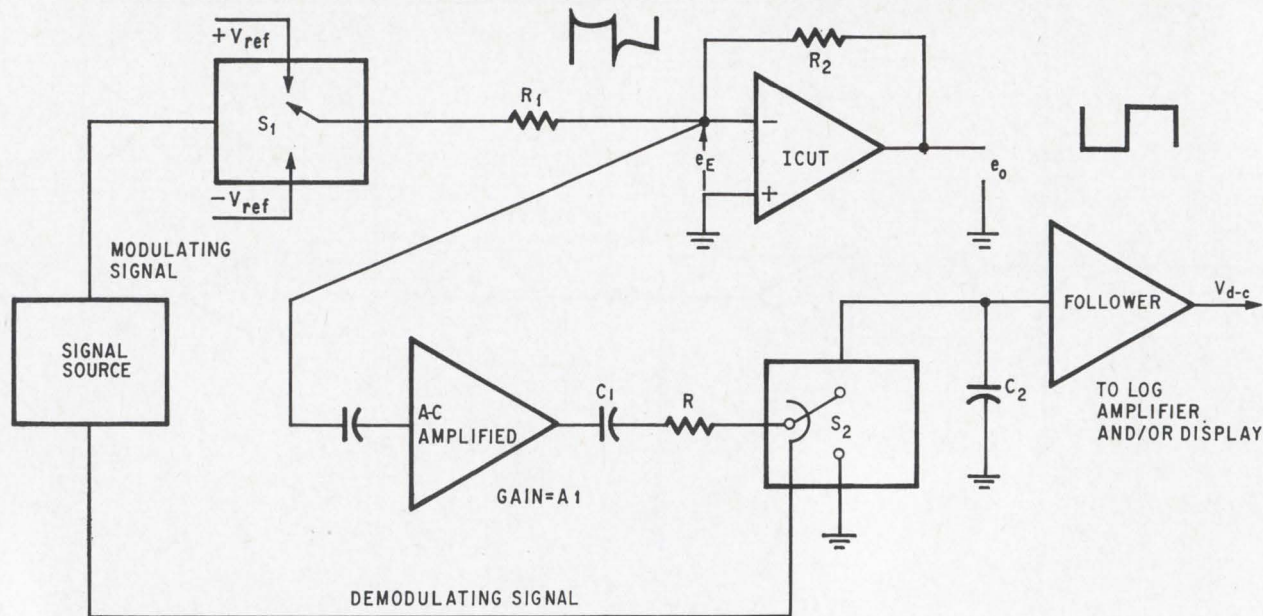

Synchronous detections system. Error voltage, e_E , developed at input of integrated circuit under test is amplified and demodulated by switching circuit S_2 . Both S_1 and S_2 are synchronized, causing C_1 to charge to V_{ref} .

loop gain approaches the open-loop gain within 90%. Thus the stabilizing effect of the feedback has been lost, making the output signal gain depend on the gain again.

The method is thus an impractical way of characterizing the open-loop response of an amplifier. For example, suppose that the amplifier has an open-loop gain, A_{vo} of 100,000 volts/volt, a unity gain-bandwidth product, f_t , of 1 megahertz, and a feedback resistor, R_1 of 10 kilohms. For conditional equation to hold,

$$R_3 \parallel R_4 - j X_{c1} \leq 0.01$$

Suppose R_3 is much greater than R_4 so that the parallel combination is approximately equal to R_4

and that $X_{c1} \leq 0.1 R_4$

then $R_4 \leq 0.01 \text{ ohm}$

and $X_{c1} \leq 0.001 \text{ ohm}$

With a 6 decibels/octave roll-off, the first open-loop break occurs at a frequency of 10 hertz. Thus to get an accurate determination of the gain, the measurement must be performed at or below this frequency. At 10 hertz, the value of C_1 must be

$$C_1 = \frac{1}{2\pi \cdot 10 \cdot 0.001} = 16 \text{ farads}$$

which is hard to come by.

Synchronous detection

In the synchronous detection method, the input to the test circuits is a square wave produced by switching between two stable d-c references. This allows a-c coupling in the system. The voltage signal from the unit under test is amplified further

with precision, and then band-limited to reject d-c drift, very low frequency noise (flicker), and high frequency noises.

The amplified signal is demodulated or converted back to a d-c signal with a peak-to-peak detector switching in synchronism with the input signal. Because synchronous demodulators inherently provide improved signal-to-noise ratios, low level signals on the order of microvolts can easily be detected.

The operation of a synchronous detection system is detailed above. The magnitude of the d-c reference voltages should be at least as great as the largest voltage encountered when testing the unit for the amplifier to operate with a small closed-loop gain or in a common-mode configuration, requiring a large signal to swing the amplifier over its full range.

The output of the amplifier under test is

$$e_{o,p-p} = \frac{R_2}{R_1} \cdot 2|V_{ref}|$$

As the amplifier is running in a closed-loop mode, a gain-error signal (e_E)

$$e_E = -e_o/A_o$$

appears between the negative input terminal and common, where A_o is the open-loop gain of the amplifier under test.

This error is a-c coupled, and amplified to an appropriate level before being demodulated by switching circuit S_2 , since the signal source drives S_2 in synchronism with S_1 . Capacitor C_1 charges to V_{ref} in a negative direction with respect to ground on one half cycle. On the next half cycle, C_2 charges in a positive direction.

After a few cycles, a d-c signal appears across C_2 equal to the peak-to-peak value of the gain error signal multiplied by the appropriate a-c gain. This d-c signal is

$$V_{d-c} = e_E \cdot A_1$$

Where A_1 = gain of the a-c amplifier.

Thus

$$A_o = A_1 \cdot \frac{R_2}{R_1} \cdot \frac{2|V_{ref}|}{V_{d-c}}$$

This d-c signal could be used to drive a logarithmic amplifier for direct readout in decibels with a DVM, go-no-go discriminator, or analog-to-digital converter, however, this basic circuit requires some precautions.

The switching signal must be of low enough frequency that the transient spikes on the detected signal introduce minimal error. The maximum repetition rate will be determined by the low-frequency open-loop characteristics of the amplifier under test. Some form of protection is needed for the input terminals of the amplifier under test.

The a-c amplifier must be able to pass the low frequency square waves encountered and its output

impedance must be relatively low to allow C_1 and C_2 to charge quickly. Finally, the d-c follower must have a very high impedance input (preferably a field-effect transistor type) so not to discharge C_2 on alternate half cycles.

The system can be improved and some of the above problems overcome by modifying the circuit to include a clock signal and sequential logic as shown below. The input signal operates a flip-flop whose output drives an electronic switch. The electronic switch output drives the modulator which in turn feeds the square-wave signal to the test circuit. The electronic switch allows the modulating signal to be put into or out of phase with the original switching signal in order that the output may be of the desired polarity. The clock signal also drives a monostable whose output is gated with the flip-flop outputs.

The flip-flop causes the modulating frequency to be one-half the clock frequency. The flip-flop is designed to trigger on the negative slope and the monostable on the positive slope of the clock output. This causes gates G_1 and G_2 to function only on the latter half of each switching period, by which time, nearly all transients on the error signal (to be demodulated) have damped out.

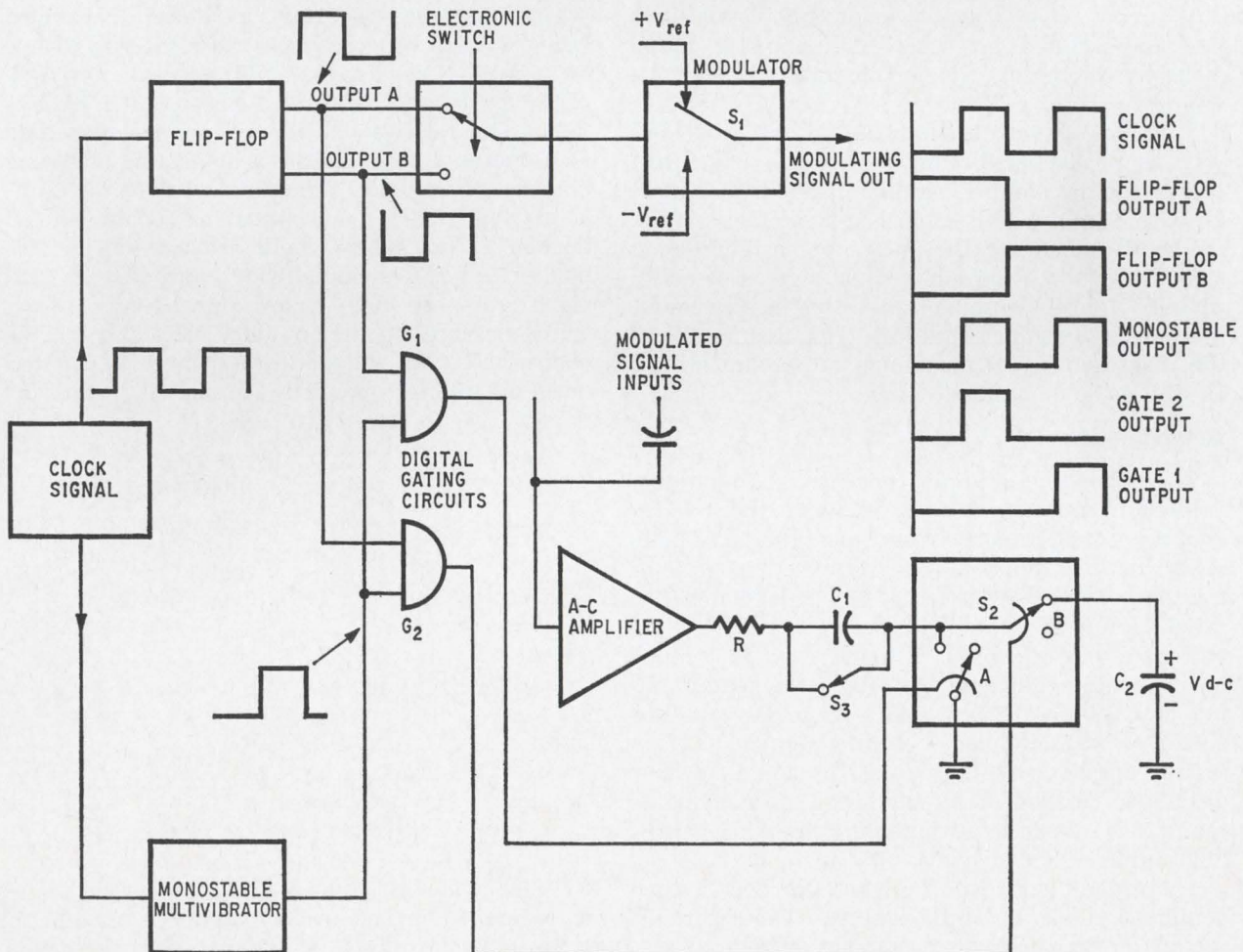

Modified synchronous system. Adding a clock signal and sequential logic to the basic synchronous system eliminates the need for a low output impedance for the a-c amplifier and a high input impedance for the d-c follower.

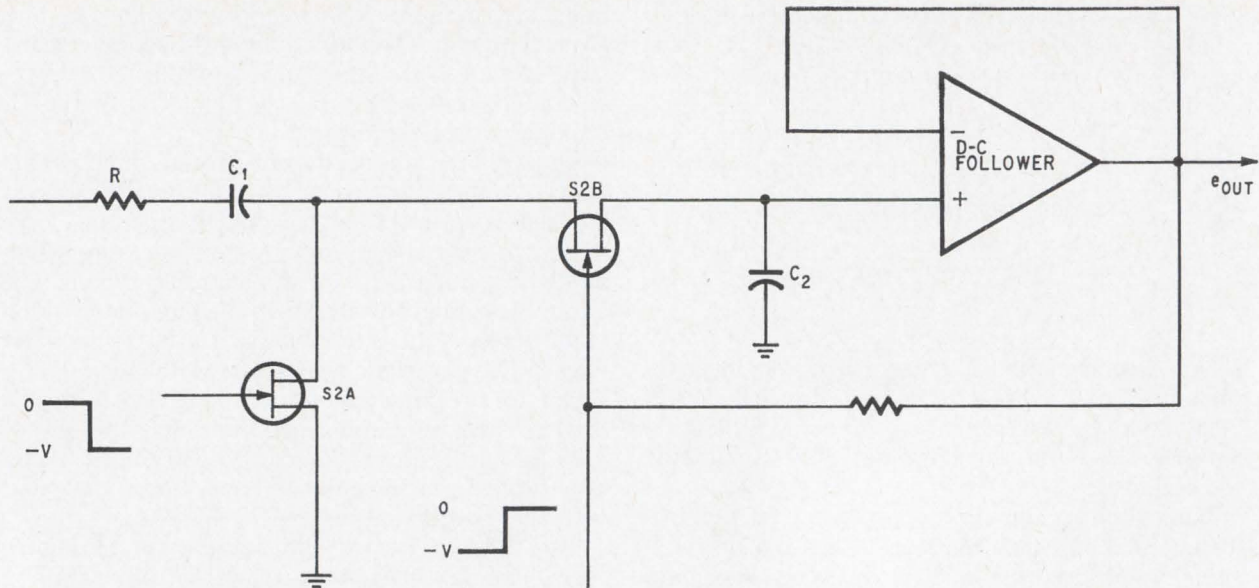

Synchronous demodulation. Because of its wide dynamic range, this demodulator is used to drive a logarithmic amplifier and display. Charging period of each capacitor is controlled independently of the detected signal, and sampling occurs only when a signal is present.

When gate G_1 is turned on, C_1 is grounded by S_{2A} . At the same instant, G_2 is off, opening switch S_{2B} .

We now have a synchronous sample-and-hold peak-to-peak detector, where the sampling period is set by the timing cycle of the monostable multivibrator.

To allow direct measurement of d-c levels, as well as peak-to-peak amplitudes, one may direct couple the a-c amplifier and short-circuit capacitor C_1 with S_3 . Now the system is a synchronous peak reader. By changing the phase of the modulating signal with the electronic switch, signals of either polarity from the amplifier under test can be measured under dynamic conditions. This feature allows the measurement of maximum output under load as well as common-mode range.

Demodulation

The demodulator circuit consists of two junction field-effect transistors operated in a shunt-series chopper configuration, is shown above. The gate signal for the shunt FET is referenced to ground; the gate signal for the series FET is referenced to the d-c follower output. This assures that the FET's will be either on or off. Using a good FET input operational amplifier for the follower, signals ranging in level from a few millivolts to 10 volts are accurately demodulated. The only significant error of this circuit is that produced by the follower's offset and drift. This circuit has a wide dynamic range that is used to advantage to drive a logarithmic amplifier and display.

The circuit has several advantages over a conventional diode voltage doubler. The charging period of each capacitor can be controlled independently of the magnitude of the signal being detected. This permits sampling only when a signal

is known to be present—the circuit ignores transients. Second, the reaction or settling time at slow sampling rates is much faster than with diodes for several reasons:—charging is better controlled because small capacitors can be used due to low FET leakage during the hold interval; and discharging is better controlled because the path is through the relatively low impedance of a turned-on FET, and not through the exponentially varying impedance of a diode. Third, a large dynamic range is possible. This is in contrast to a conventional doubler circuit where diode leakage during the hold period causes ripple, which introduces significant errors, especially at low signal levels.

To measure open-loop gain, the ratio of the change in output voltage to the change in input, a more suitable test circuit is the one at the top left of page 123. The output voltage is

$$e_{out} = - \frac{R_f}{R_g + R_s} \cdot \frac{1}{1 + \frac{1}{A_o B}} \cdot V_{ref}$$

where

$$B = \frac{1}{\left(1 + \frac{R_1}{R_2}\right) \left(1 + \frac{R_f}{R_f + R_g} + \frac{R_f}{R_1 + R_2}\right)}$$

and

$$e_s = - \left(1 + \frac{R_1}{R_2}\right) \cdot \frac{e_{out}}{A_o}$$

A_o = open-loop gain = $\Delta e_{out} / \Delta e_E$

R_s = source impedance of synchronous modulator

By a careful choice of values, one can make $1/A_o B$ small, less than 0.01, resulting in less than 1% error for the following approximation:

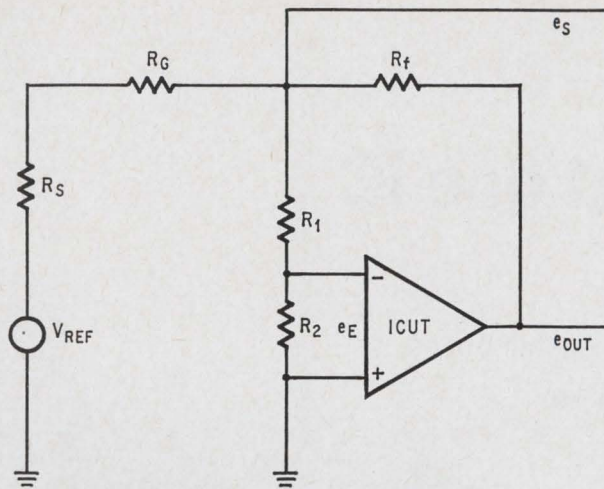

Gain circuit. Because the output signal, e_{out} , is predictably set and measured by the synchronous demodulator, the gain is easily computed logarithmically and can be displayed on a read-out device.

$$e_{out\ p-p} = 2|V_{ref}| \frac{R_f}{R_s + R_g}$$

Keeping this in mind, one can easily program the output level of the amplifier under test with a single precisely-calibrated resistor (R_g) on a program card. This will allow the same basic circuit to measure gain of different devices having different swing capabilities.

The gain equation is:

$$A_o = \frac{e_{out\ p-p}}{e_s\ p-p} \left(1 + \frac{R_1}{R_2} \right)$$

Because e_{out} is predictably set and e_s is measured by the synchronous demodulator, the gain can be easily computed logarithmically and displayed in db on a read-out device. The purpose of voltage divider R_1 and R_2 is to increase the measured error signal and eliminate the need for additional a-c gain. Also, by attenuating any applied inputs, it limits the signal that can appear differentially across the IC's inputs, thus affording a degree of protection. These resistor values are restricted somewhat by the maximum bias and offset voltage of the device under test as well as the gain-error criteria stated in the gain-error equation.

Common-mode rejections ratio (CMRR) is defined as the ratio of the peak-to-peak input common-mode voltage to the peak-to-peak change in input offset voltage that it produces. The test circuit is at the above right. In the circuit,

$$e_{cm} = \frac{R_2}{R_1 + R_2} e_{in}$$

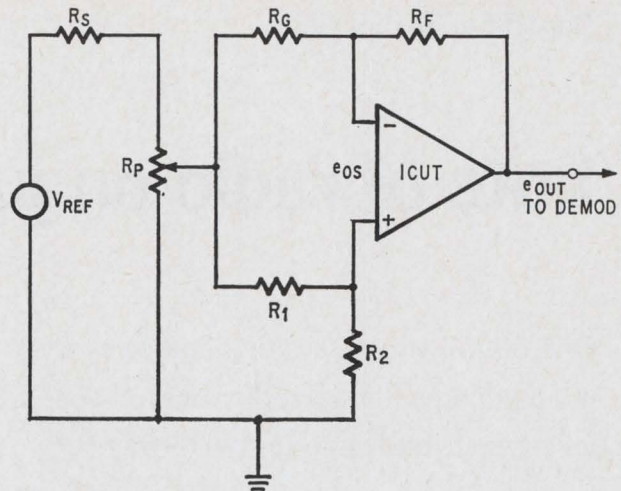

CMRR tester. Common-mode rejection ratio, CMRR is dependent on the input common-mode voltage and the change in offset voltage that results from a common-mode swing.

The common-mode input offset voltage, (e_{os}) resulting from a common-mode swing is now defined as that voltage needed between input terminals to drive the amplifier output to zero when the inputs are swinging together.

The common-mode rejection is

$$CMRR = \frac{e_{cm}}{\Delta e_{os}} = \frac{e_{in}}{e_{out}} \cdot \frac{R_f}{R_g}$$

where e_{cm} is the actual common-mode voltage, and e_{in} is the driving function. This last expression for CMRR is valid provided the following condition is satisfied:

$$\frac{R_2}{R_1} = \frac{R_f}{R_g}$$

For imbalances in the resistor ratio, the actual expression for e_{out} vs E_{in} becomes

$$\frac{e_{out}}{e_{in}} = \frac{R_f}{R_g} \left[\frac{1 + \frac{R_g}{R_f}}{1 + \frac{R_1}{R_2}} \cdot CMRR + \frac{\frac{R_g}{R_f} - \frac{R_1}{R_2}}{1 + \frac{R_1}{R_2}} \right]$$

From this equation, one is able to determine how closely the resistor ratios must be matched for the first equation to be valid with any given CMRR and allowable error. Ways to achieve the required balance are to use precision resistors and to make R_2 adjustable by inserting a variable resistor in series.

The voltage divider R_p allows programing the common-mode voltage desired. The driving signal again comes from the synchronous modulator, and the output of the test circuit is detected by the synchronous demodulator circuit.

Lots of radio on just one IC

One 60-mil-square circuit handles everything but the tuning in an unconventional radio receiver that promises lower costs and superior performance

By Michael J. Gay and John A. Skingley

Plessey Microelectronics, Swinton, England

and Michael C. Sucker

Plessey Co., Ilford, England

Designing a car radio receiver so that it could be fabricated on a small silicon monolithic chip was a task to challenge any design engineer's problem-solving ability. It meant, basically, that the number of external connections had to be kept to a minimum to reduce bonding costs and package size. That goal could only be reached by making some unconventional design decisions. For example, the usual radio-frequency stage had to be eliminated and the intermediate-frequency circuitry redesigned.

But that was only the beginning. Eliminating the r-f stage meant that the mixer had to handle extremely high input signals without introducing undue audio distortion. Moreover, the receiver circuit had to be skillfully laid out to avoid excessive temperature differences between the high-heat-dissipating audio output transistors and the temperature-sensitive mixer, i-f amplifier and automatic gain control circuits. Interaction of these stages can result in serious distortion, or even in instability.

The unconventional approach paid off. All circuits, except the i-f filter and r-f tuning section, were integrated on a 60-mil-square chip. The chip operates with an external i-f filter and can't work with the usual transformer tuned circuit. The r-f tuning section uses external variable inductance tuning—though variable capacitance tuning could also be used—to maintain constant sensitivity over the tuning range when operated with the standard capacitive antenna.

Design and layout

The circuit, which dissipates up to 3 watts, is enclosed in a dual-in-line package that has a metal

bracket to serve as a heat sink. The chip is bonded directly to the metal bracket and can be attached to a chassis or separate heat sink.

The maximum number of connections to the chip is limited by the size of the package; it can be determined simply by allowing a pin spacing of 0.1 inch. A standard receiver circuit would take about 40 connections, but this would produce too large a package at prohibitive costs. The circuit design used on the receiver chip cut this number to 20 pins, as shown on opposite page.

By eliminating the usual r-f stage, about five connections were dropped from the chip. The redesign of the mixer along nonconventional lines saves at least another connection. The i-f filter, used in place of tuned i-f transformers, cuts the pin count by another six. The other eight pins were saved in the remainder of the circuit.

Mixer and agc system

The mixer, agc and i-f stages are examples of the unconventional circuit design. Because there is no r-f amplifier ahead of it, occasionally the mixer must operate under unusually strong signal conditions. For low-level signals, it also provides much higher gain than conventional mixers through the use of a cascode configuration, Q_5 and Q_1 , on opposite page. This affords the IC designer the flexibility of using a high value of i-f load. Conversion gain—i-f output voltage/r-f output voltage—is approximately 41 decibels, including filter losses. The circuit also is self-oscillating, again reducing the pin count.

A low-distortion current source, Q_1 , is used as the input to the system. Though normally it operates at 2 ma, it can handle peak signals of up to

100 mv. In operation, its amplified output is applied to emitter-coupled pair Q_2, Q_3 which make up the oscillator. The r-f signal at the collector of Q_1 is alternately switched between Q_2 and Q_3 at the oscillator frequency. The square wave produced by the oscillator switching action is thus multiplied by the r-f signal at Q_1 's collector to produce the modulated output which is applied to emitter coupled Q_4, Q_5 pair. The output at Q_5 's collector is fed to the i-f filter which selects the difference frequency in the conventional manner. Output signal amplitude is controlled by the agc signal at the base of Q_5 .

The agc system achieves effective control over the entire dynamic range of the receiver, which is in the order of 90 db. Transistors Q_4 and Q_5 maintain good exponential characteristics to operate as a low distortion variable attenuator for agc. The attenuator response to agc signals is in the order of 330 db/volt.

When the receiver is operated close to the transmitter, it could pick up a signal greater than 100 millivolts. If this happens current source transistor Q_1 saturates and clips the incoming signal. Such clipping, however, does not seriously degrade the low-distortion performance of the mixer or agc circuits, which are designed to operate with input signals as high as 500 mv with a modulation of 30%. This signal level at the mixer corresponds to an antenna signal of about 1 volt rms, and is considered average for automobile radio designs except for adjacent station signals.

Noise performance

The receiver's noise figure is about 3.5 db with an 800-ohm source. The precise noise figure is determined from a standard network used to represent the source noise component, e_s , and current noise component, i_n , filtered by the input tuned circuit at all frequencies except the signal frequency. The total signal applied to the circuit is multiplied by the modulating function representing the square wave generated by Q_2 and Q_3 , and can be determined from

$$1/2 (1 + \sin \omega_0 t + 1/5 \sin 3 \omega_0 t + 1/5 \sin 5 \omega_0 t)$$

where ω_0 is the local oscillator frequency.

The signal and noise components, filtered by the input tuned circuit, produce i-f components by multiplication with the first harmonic term, $\omega_0 t$. The noise voltage generator, e_n , produces a wide band noise signal which also produces i-f components by multiplication, with every component in the modulating function.

The value of the over-all noise signal is obtained by summing all rms noise voltages. The net effect of noise voltage, which is unfiltered, is to cause an increase in the source resistance and noise figure above optimum levels. The relationship between optimum and actual values of resistance and noise figure are expressed by

$$R_{opt} = 2.205 \times R_0$$

and

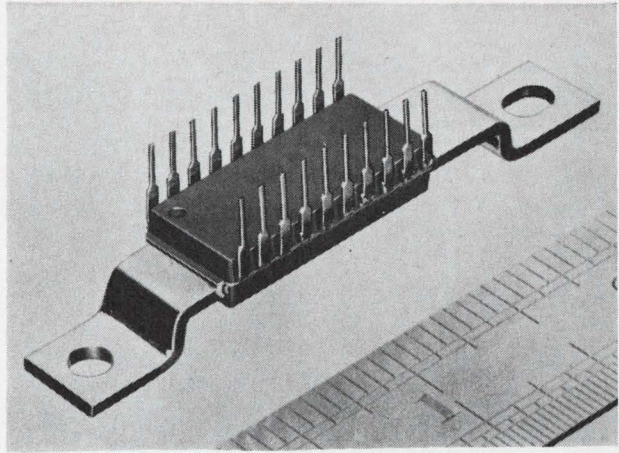

Dual-in-line package. The IC chip is bonded directly to the metal bracket for maximum dissipation. The bracket can be mounted to a chassis or a separate heat sink.

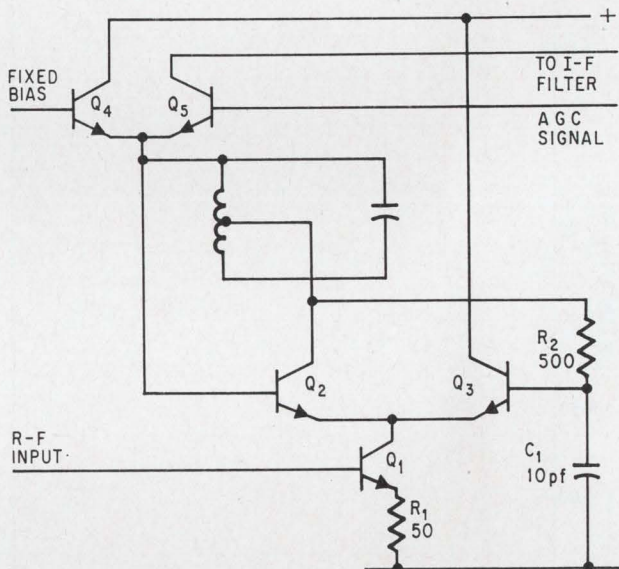

Self-oscillating mixer with agc. Designed for high conversion gain with low distortion, the mixer and agc unit can handle peak signals of over 100 millivolts.

Specifications for IC car radio

Sensitivity (1 Mhz)	10 μ v rms, 30% a-m input for 3 watts output 20 μ v rms, 30% a-m input for 20 db S/N
Maximum r-f input	250 mv rms
Distortion	3% at 2.5 watts 8% at 3 watts
Agc	<10 db output variation for 90 db input variations
I-f selectivity	± 3 khz for -3 db ± 30 khz for -60 db
Supply voltage	11-18 v, 13.5 v nominal
Quiescent current	50 ma at 13.5 v
Temperature range	-10°C to $+70^\circ\text{C}$

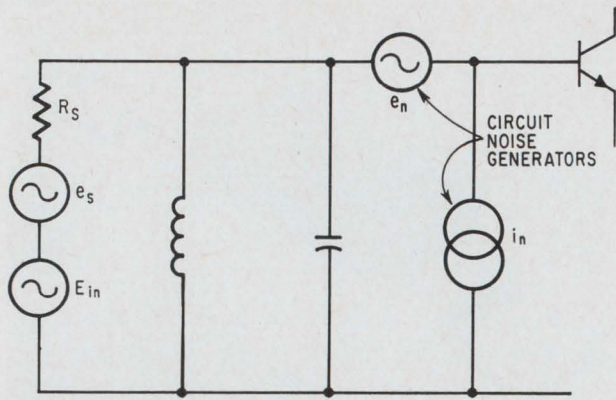

Noise measurement network. Input circuit with noise generators used to determine noise performance.

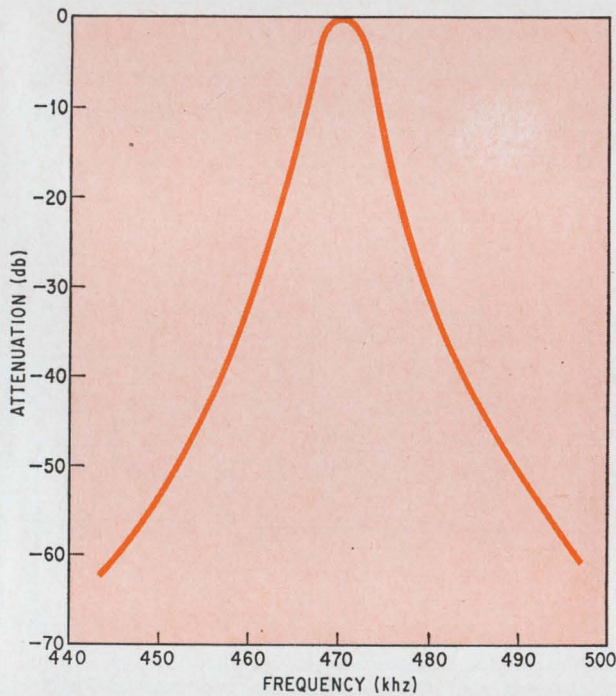

Selectivity curve. I-f filter selectivity curve has 1 db attenuation at ± 1.6 kHz and 3 db attenuation at ± 2.5 kHz.

$$F_{opt} + 1 + 2.205 (F_o - 1)$$

where R_o and F_o represent, respectively, the source resistance and noise figure of a similar i-f stage used as a straight amplifier. However, the actual conversion gain of the mixer is largely determined by the loading of the filter. The gain is limited by the magnitude of the oscillator signal appearing across the i-f filter when the receiver is tuned to its lowest frequency—150 kHz (the low-frequency broadcast band in Europe). At this tuning range, the oscillator operates at 620 kHz, the sum of the i-f and r-f frequencies.

Designing the i-f filter

There are at least two important reasons why the i-f filter was chosen over a conventional tuned transformer coupled i-f amplifier: the use of a filter reduces terminal connections from an average of nine to only three, simplifying the package and resulting in a considerable cost savings; and, because IC's impose minimal loading, the filters can operate at virtually their undamped Q, requiring a minimum number of sections.

The filter is made from three identical inductively coupled, 10-millimeter ferrite pot core coil sections with undamped Q of about 150. The selectivity curve for the three-stage i-f filter has a 1 db attenuation at ± 1.6 kHz, and 3 db attenuation at ± 2.5 kHz.

I-f amplifier and detector

With the mixer unit already providing a gain in excess of 40 db, and all of the required agc range, the i-f amplifier can be made relatively simple since it is only required to provide a gain of 40 db, and no agc at all. The detector is directly coupled to the i-f stage and the operating currents of the transistors are adjusted to provide a voltage drop of about 25 mv across R_6 , the detector linearizing resistor. The detector's transfer characteristic is plotted in the graph on the opposite page.

The response curve shows that the detector operates linearly at signal levels above 100 mv rms.

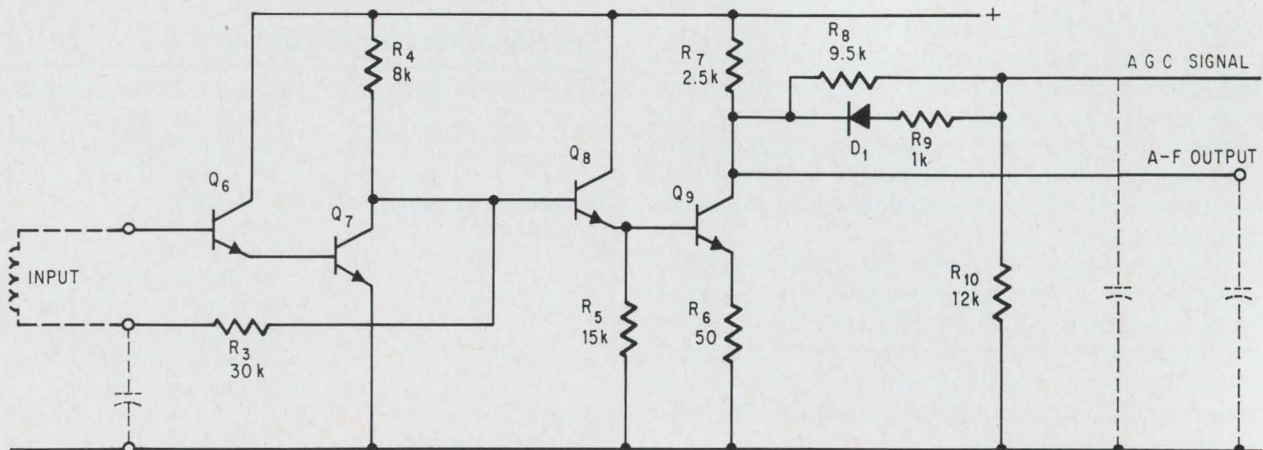

I-f amplifier and detector. Since most of the receiver's gain and all of the agc range are centered around stages preceding the i-f amplifier, the amplifier has been made simple to drive the low-level detector.

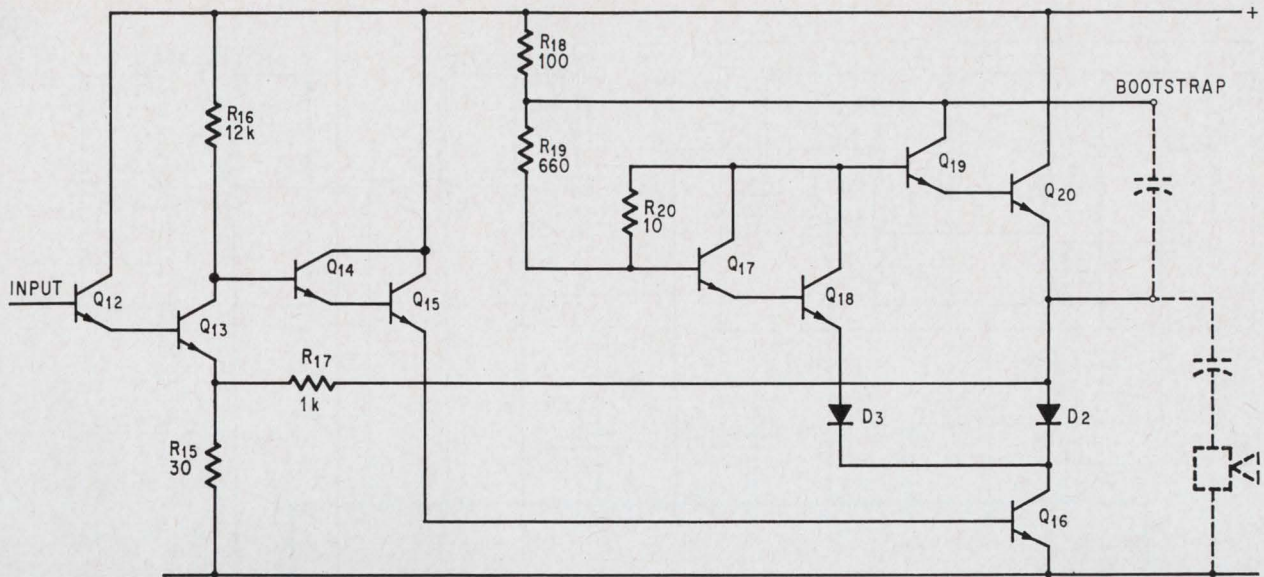

Complete audio amplifier. An offshoot of a wideband video amplifier, the circuit features four Darlington pairs in the driver and output stages for high power. Input bias is from i-f amplifier, eliminating special bias circuitry.

In the actual receiver, it usually operates with input levels of about 200 mv rms. The bandwidth is partly restricted by the feedback through Q_7 's collector-base capacitance. If high-gain transistors with betas of about 200 are produced by the IC process, the bandpass will be somewhat narrower and the gain will be reduced by about 2 db. Lower-gain devices with betas in the order of 40, also produce a gain reduction of 2 db, due to loading of the i-f filter.

The amplifier is relatively immune to variations of supply voltage and temperature. The agc signal is picked off the collector of Q_9 and filtered by a decoupling network consisting of R_8 , R_9 and D_1 . The resistor and diode across R_8 provide a fast recovery for the agc system.

Audio amplifier

The audio amplifier is an offshoot of an existing high-efficiency npn stage, developed earlier by another member of the Plessey Co. for use as a video

amplifier. It can handle currents greater than the 1.5 amperes required to produce the 3-watt output.

Shown in simplified form, below, the amplifier requires large negative feedback for good linearity, but it also provides negligible crossover distortion. The amplifier operation is similar to that of a push-pull circuit, but without the customary phase splitter and output transformer.

With Q_a and Q_b normally biased at some nominal quiescent current level, diodes D_a , D_b and D_c conduct, causing the quiescent current of Q_a to flow to Q_b through the diodes. On negative current swings Q_b conducts further and draws more current from the diode loop, bringing down the voltage applied to the load and Q_b base. On positive swings the current flowing in Q_a is reduced below its quiescent value, also reducing the current flow through the diode loop. This allows the voltage applied to the load, as well as that at the base of Q_b , to rise.

Current distribution among the three diodes and two transistors can be determined at any instant by

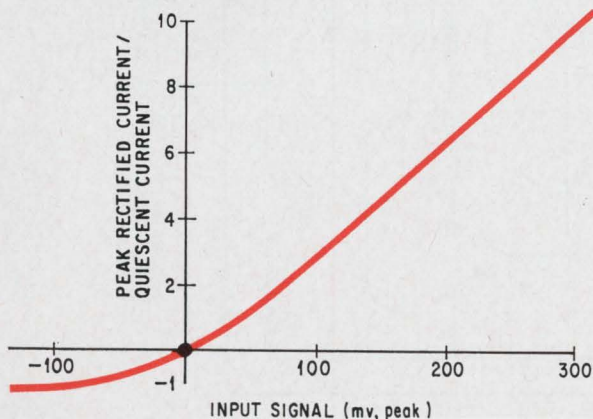

Detector characteristic. Transfer characteristic curve showing linear operation at signal levels above 100 mv.

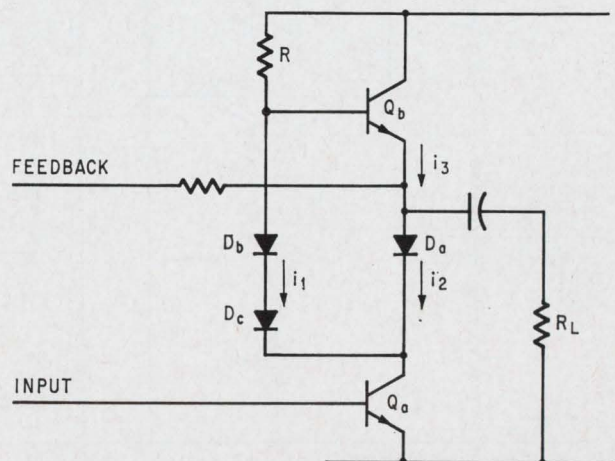

Basic audio amplifier. Output stage uses npn transistors and large negative feedback for good linearity.

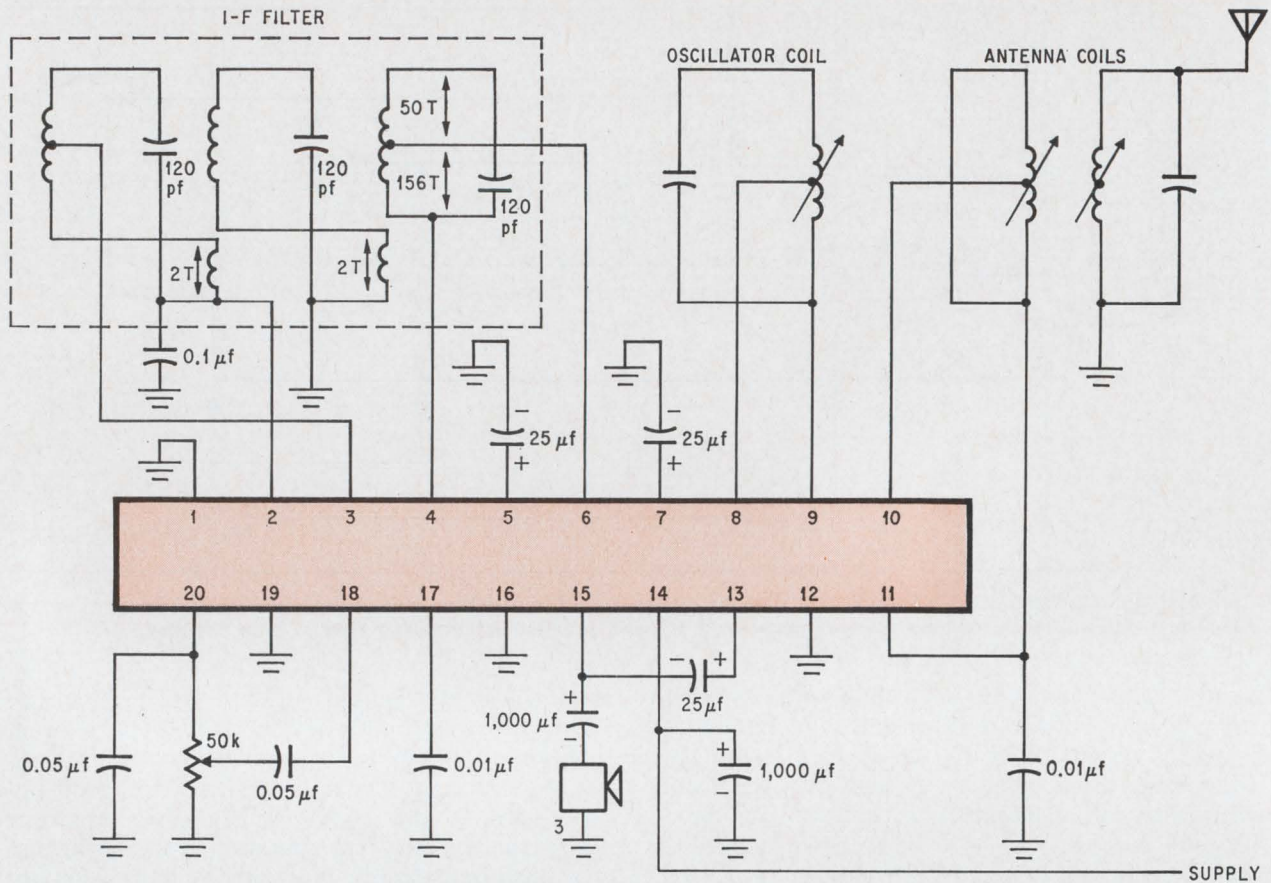

Circuit hookup. External connections to complete the car radio circuit are made through a 20-pin dual-in-line package.

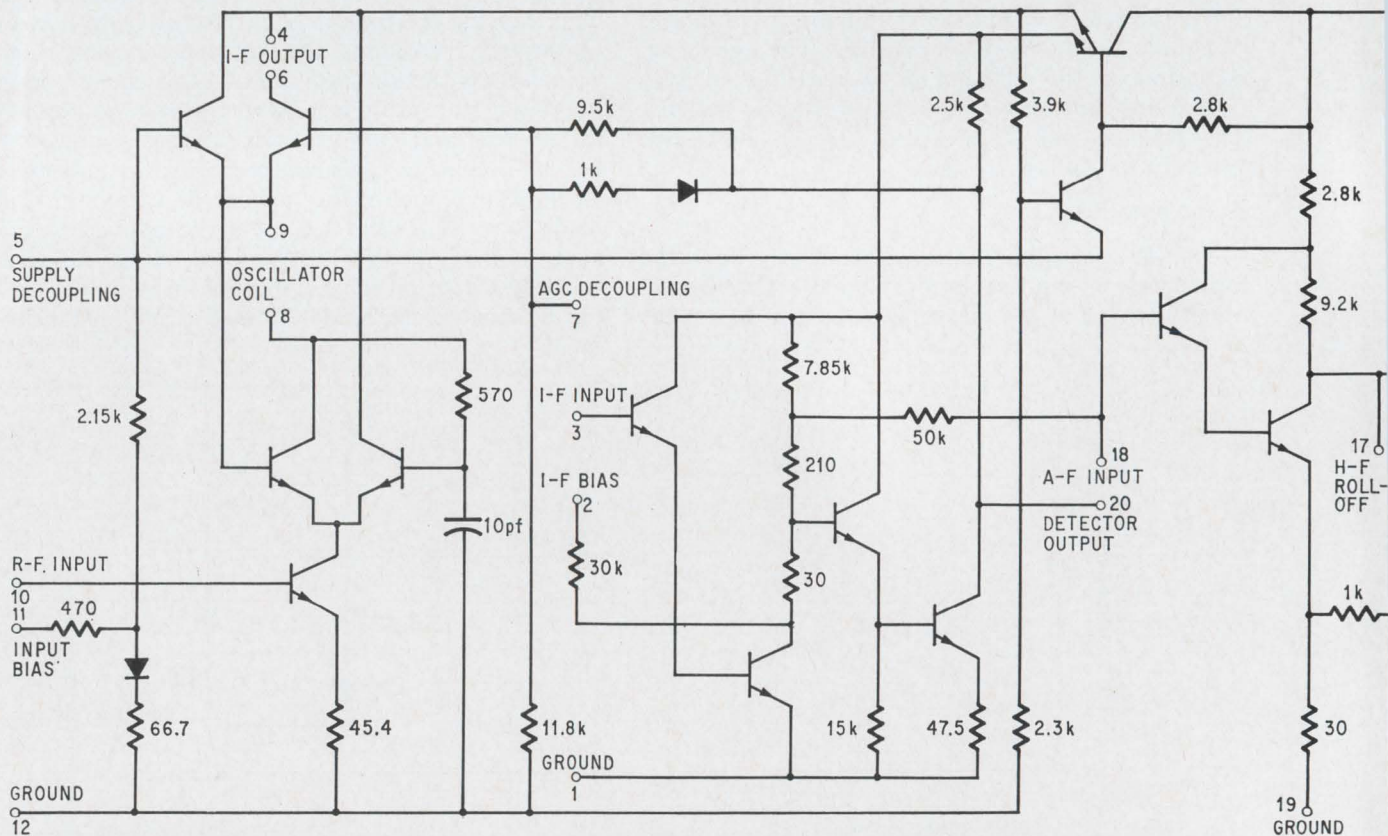

Complete SL420 IC schematic. Over-all circuit uses separate ground leads to ensure operating stability. The leads are arranged on the circuit board with precautions taken to avoid common impedance coupling.

equating the voltage drop across D_b and D_c with that across D_a and D_b , and then substituting for voltage in terms of current, using the exponential characteristic of the device. Thus, i_1^2 -constant i_2 i_3 .

Since the series resistor, R , limits i_1 to a low value, currents i_2 and i_3 cannot have the same value simultaneously. During negative excursions when i_2 is large, Q_b 's collector current is small; during positive current swings, i_3 increases while the collector current of Q_a decreases.

In the actual circuit, on page 127, Q_b is replaced by a Darlington pair, requiring that D_b be also replaced with a similar circuit to preserve matching. To maintain suitable quiescent circuit conditions without materially increasing the sizes of the devices, a fixed voltage is applied in series with the diode chain to modify the i_1 , i_2 , and i_3 constant. The bias resistor, R , is bootstrapped to the output to achieve the largest signal swing possible. In the over-all circuit, the input bias voltage is obtained from the i-f amplifier to eliminate the need for a separate bias chain.

Output transistors are inherently more difficult to design than their low-power counterparts, and present a number of problems. For example, during periods of high conduction, a transistor conducts only along the emitter periphery, which must, therefore, be made large. This in turn, frequently leads to the use of emitter stripes. Because stripe length must be restricted to reduce the voltage drop

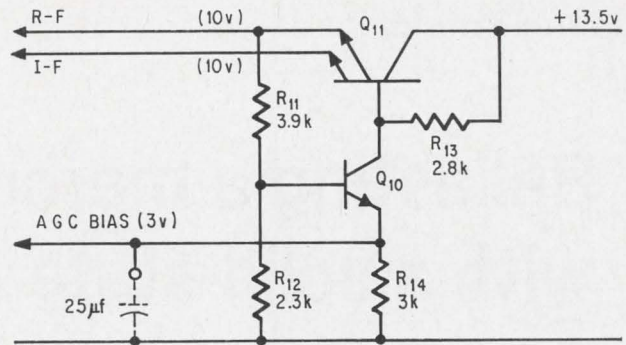

Supply decoupling. Extra decoupling between r-f and i-f is achieved by double-emitter transistor Q_{11} .

along the emitter, due to the infinite resistance of the evaporated metal contacts, it becomes necessary to use multistripe geometries with interwoven base and emitter strips.

Furthermore, because the collector contact must be made on the same surface as base and emitter, it's necessary to sandwich the collector contacts between the emitters to avoid excessive collector series resistance in the buried $n+$ layer. But the three sets of leads can't be put on one plane, so a cross-over must be provided for the base leads and this creates an additional design problem. The solution lies in the use of a separate buried $n+$ layer for crossover. To ensure equal current-sharing between the transistors' emitters, small resistors formed in the aluminum interconnection pattern can be put in series with each emitter.

Decoupling the supply voltage

The supply voltage must be decoupled at some point between the i-f circuit and r-f input to neutralize the potential i-f feedback loop. A similar a-f feedback loop also exists between the i-f and audio stages, and must also be neutralized. But the most critical requirement for decoupling is that of the fixed bias level at the agc emitter-coupled pair. This circuit is extremely sensitive—330 db/volt—and the presence of minute ripple voltages can cause instability, audio distortion, or even noise, depending on the ripple source.

The decoupling circuit, shown above, can be used to minimize the number of separate connections required. By using a dual emitter transistor, Q_{11} , an extra measure of decoupling can be achieved between i-f and r-f sections. The critical bias voltage is taken from the emitter of Q_{10} , and decoupled by the 25 μ f capacitor.

The circuit is laid out to isolate the high dissipation output transistors and keep induction of temperature variations from affecting the heat-sensitive i-f amplifier and detector circuits. Four separate ground leads are provided to minimize the possibility of circuit instability, and these are arranged to avoid common impedance coupling.

In the connection diagram, at the left, pin terminals for external wiring are chosen to minimize cross couplings.

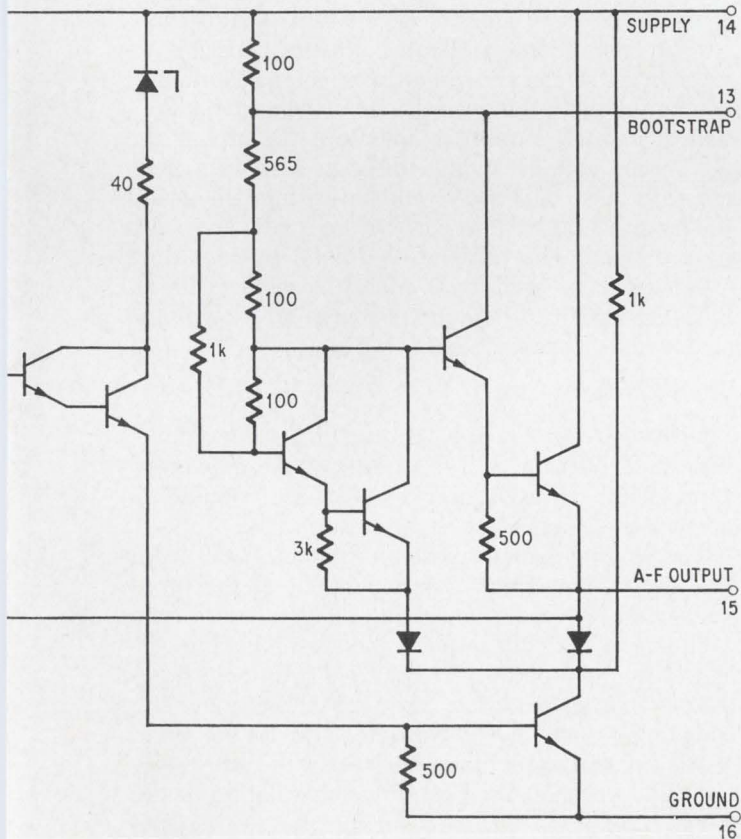

Ballasting a mercury-arc lamp with a solid-state circuit

Versatility is increased and size is reduced by replacing a 60-hertz inductor with a high-frequency unit and a power transistor

By Peter Schiff

RCA Electronic Components Division, Somerville, N.J.

Recent advances in the voltage and current handling capabilities of power transistors, combined with means of mass producing the devices, have contributed to the development of a low-cost, solid state, power-switching circuit. Not only does this ballast circuit for mercury arc lamps offer the customary transistor-circuit benefits of reduced weight and bulk, but it also provides unmatched power regulation of line voltage.

In essence, the ballast circuit must control the arc-discharge lamp during starting, warm-up and steady-state operation; it must have a power transistor that can withstand the high voltage and current transients common to 110- and 240-volt a-c lines.

Thyristors—SCR's and triacs—could be used instead of transistors but it's difficult to make an argument for them. First of all, the circuit would be more complex and that would mean higher costs. The complexity stems from the commutation problems inherent in thyristors—they don't turn off easily. Moreover, transistors outperform thyristors in the temperature area. Most silicon power transistors can operate at temperatures up to 200°C; the upper limit for thyristors is about 125°C.

The simple magnetic ballast, shown on page 131, is cheaper than the solid-state ballast but it has limitations. Moreover, it can supply only a-c to the bulb. If this a-c is high frequency, radio-frequency-interference problems can result.

A dimmer on the basic solid-state ballast circuit permits the circuit to be adapted for use with lamps of various power ratings over a range of 50% to 150% of the power rating specified for the ballast design. Because the transistor ballast has none of the annoying strobe effects associated with conventional ballasting devices, long-life, efficient mer-

cury-arc lamps can be used in photo studios and other critical lighting areas.

The solid-state ballast may be operated from either an a-c or d-c voltage source. A-c input voltages are rectified and the d-c voltage is converted by an inductive component to the level needed to drive the mercury-arc lamp. Converting voltages from one level to another presents a design problem. A conventional 60-hertz ballasting inductor increases the size of the circuit. And a small inductor, compatible with the over-all size of the circuit, can't deliver enough current to maintain the arc as the a-c source voltage swings through zero in a mercury-arc bulb. The arc would be extinguished and the lamp would have to cool before a new arc could be produced. The problem is solved by including a capacitor for additional energy storage. This allows the circuit to be operated from an a-c voltage source and doesn't increase its size.

The best choice

Of the three types of electronic ballasting circuits illustrated on page 132—a ringing-choke converter, a push-pull inverter, and a switching regulator—the switching regulator is the best choice.

The ringing-choke inverter offers the advantage of a d-c output which is independent of the input voltage. However, its operating efficiency is low in comparison with the other types of ballasting circuits. The push-pull inverter suffers from poor regulation, and, in addition, requires three magnetic components, which substantially add to the bulk.

The switching-regulator circuit is the most efficient and provides the best power regulation of the three. It imposes the least stringent requirements on the solid-state power-switching element, the most critical component of any electronic ballast.

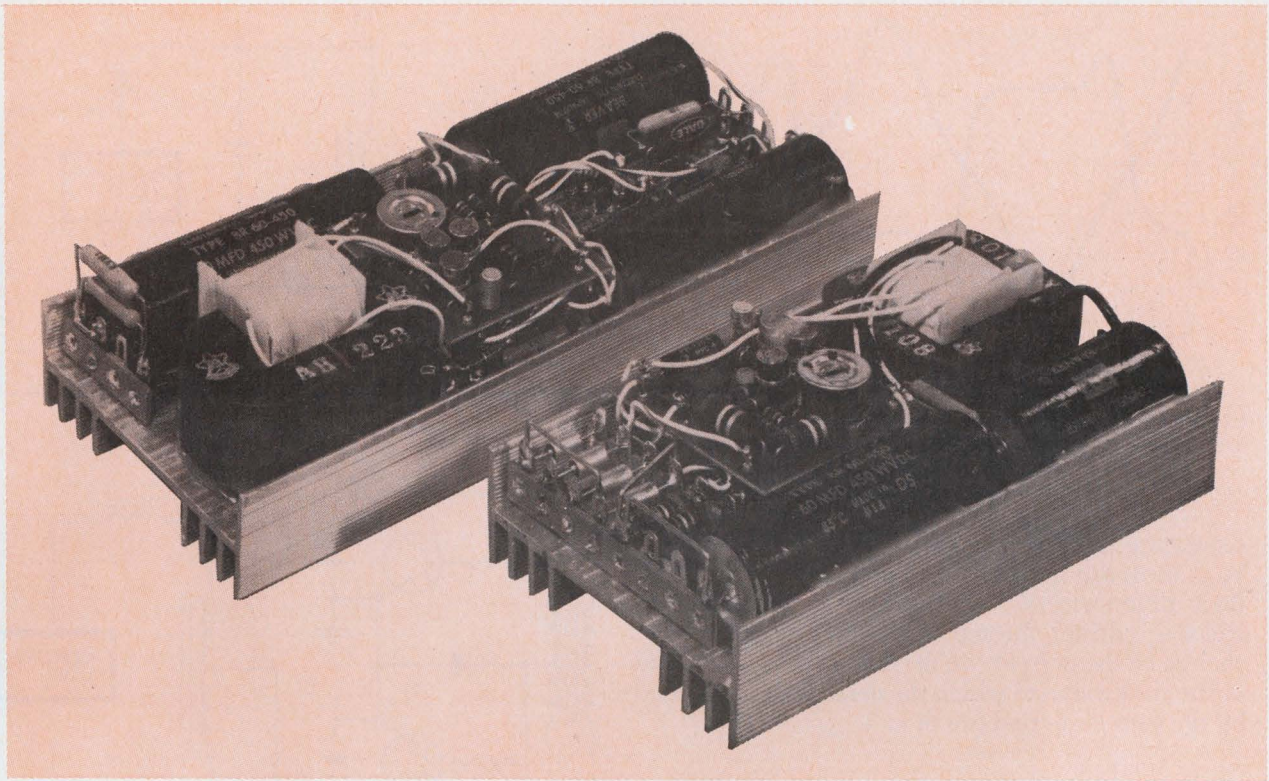

Compact design. Solid-state ballasts for 175-watt (front) and 400-watt (back) mercury arc lamps are constructed on the underside of a heat sink. Both circuits are for 240-volt operation.

It is thus the most economical choice. Another advantage is that it requires only one magnetic component and integrated-circuit construction techniques can be readily applied to achieve the small sizes desired for the ballasting elements. It does have one disadvantage, though: the output voltage is always less than the input voltage.

Positive feedback

For operation in 120-volt line applications, the basic switching-regulator circuit is modified, as shown on page 133, so that the solid-state switching element—transistor Q_1 —is operated in the positive feedback mode to reduce bulb warm-up time. The

rectified 120-volt a-c output appears as a d-c voltage across the V_{IN} terminals of the circuit and drives transistor Q_1 into saturation. The collector current of Q_1 rises linearly through the primary (L_1) winding of transformer T_1 until the voltage drop across the current-sensing resistor R_2 , increases above a predetermined threshold level. At this point, Q_3 is turned off, and its collector current through R_5 , in turn, drives Q_2 into conduction to create a virtual short between the base and emitter of Q_1 . In this way, the drive input to Q_1 is effectively removed.

The inductive kick from the L_1 primary winding of transformer T_1 that results from the decrease in the collector current of Q_1 is clamped by the commutating diode, D_3 , so that the current decays linearly through the winding. Positive feedback coupled from the secondary (L_2) winding of transformer T_1 holds the switching transistor, Q_1 , in the off state until the current through the transformer primary winding decreases to zero. The cycle is then repeated.

The turn-on (t_{on}) and turn-off (t_{off}) times and the switching frequency (f) of the switching-regulator ballasting circuit can be calculated from equations based on the relationship for induced voltage:

$$E_L = L \frac{di}{dt}$$

During turn on, the voltage across the regulator inductor is essentially the algebraic difference be-

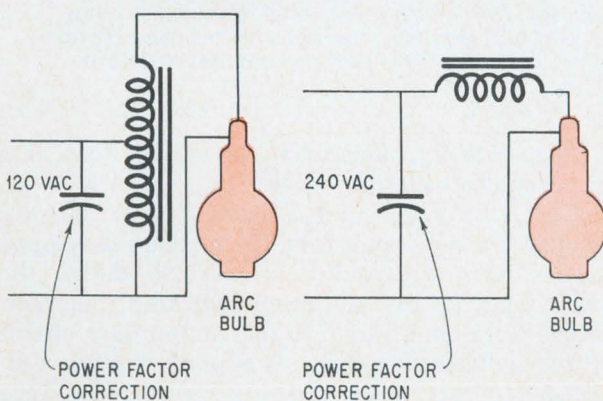

The old way. Conventional ballast consists of a large inductor and a power-factor correction capacitor.

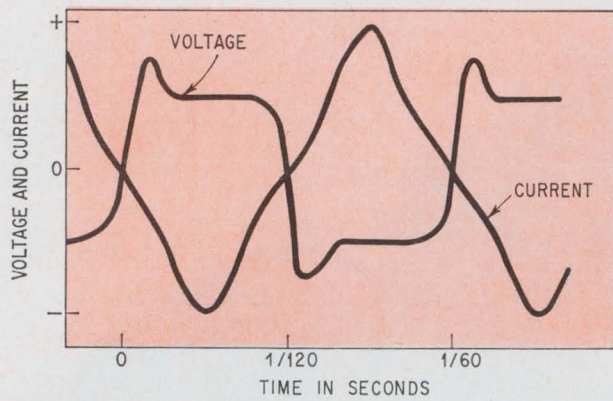

Design criteria. Voltage and current characteristics are selected to reduce the warm-up time of the bulb.

tween the input and output voltages ($E_L = V_{in} - V_{out}$). Because both of these voltages are constant, their difference, E_L , corresponds to a linearly increasing current through inductor L_1 . The rate of change of the current (di/dt) then can be calculated as the peak value to which the current rises, divided by the turn-on period ($di/dt = I_{peak}/t_{on}$). Thus:

$$t_{on} = \frac{L_1 I_{peak}}{V_{in} - V_{out}}$$

The equation for the turn-off time can be similarly derived. During this period, however, the voltage across inductor L_1 is essentially equal to the output voltage. The current decays linearly through the inductor so that the rate of change of current is constant over the turn-off period. When these conditions are imposed on the basic inductor equation, the following equation for the turn-off time can be derived:

$$t_{off} = \frac{L_1 (I_{peak})}{V_{out}}$$

$$f = \frac{1}{t_{on} + t_{off}} = \frac{V_{out} (V_{in} - V_{out})}{L_1 (I_{peak}) (V_{in})}$$

The equations for t_{on} and t_{off} can be combined to give the switching frequency of the switching-regulator ballast in terms of the inductor L_1 , the peak current, and the input and output voltages.

The peak current and associated output voltage of the switching-regulator circuit can be varied with potentiometer R_6 . For any given setting of the potentiometer, however, these quantities are constant and are independent of the input voltage. Another factor that is apparent from the frequency equation is that the switching frequency goes up when V_{in} goes up or I_{peak} goes down. (V_{in} or I_{peak}) results in an inverse change in switching frequency.

At 120 volts

A practical 100-watt switching-regulator ballasting circuit designed for 120-volt-line applications has both the output voltage and current sampled to reduce bulb warmup time. This circuit has a

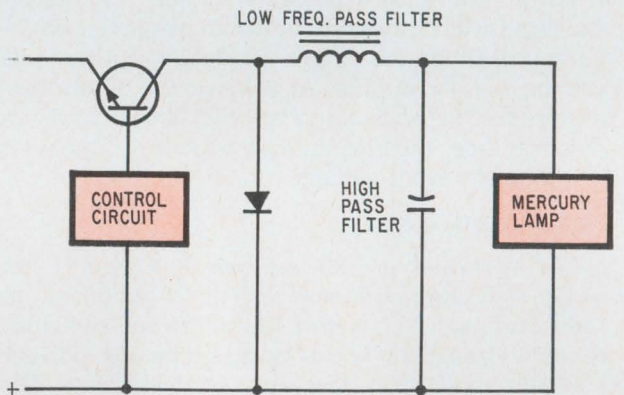
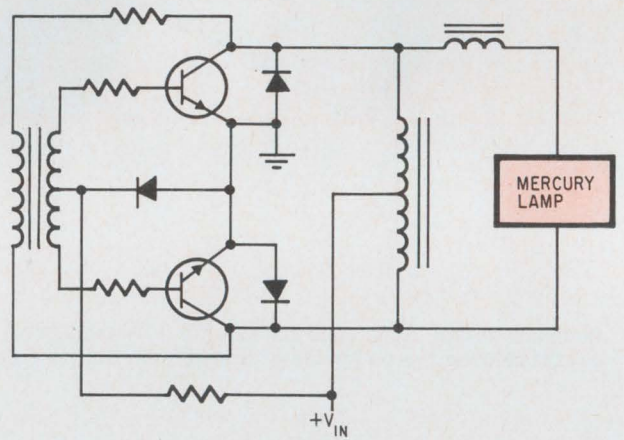
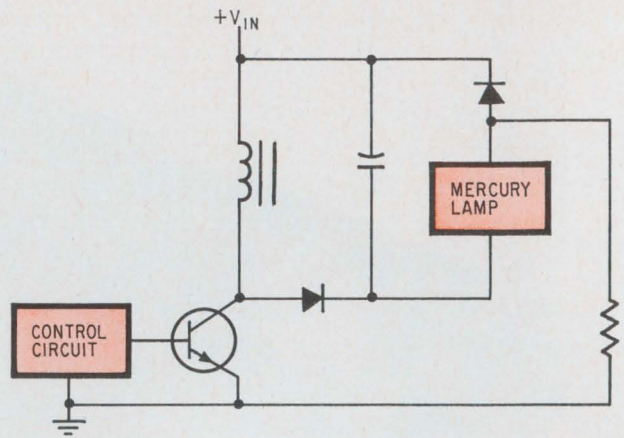

The choice. Of the three types of circuits that could be used, (ringing choke converter, push-pull inverter, or switching regulator) the switching regulator (bottom) offers the highest efficiency and the best regulation.

voltage-current characteristic similar to that of a conventional ballasting reactor.

The 120-volt a-c input is rectified by a full-wave bridge. The a-c output from the rectifier, developed across filter a capacitor is used to derive the drive input for the saturating switching transistor. Because the input drive to the emitter-base circuit of the switching transistor is applied through a resistance network, the relatively high drive voltage can lead to serious I^2R losses unless the drive current is maintained at a very small value. This con-

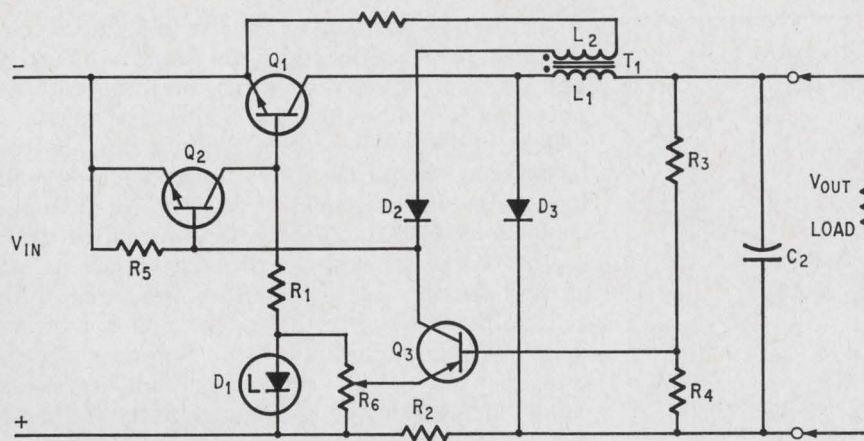

How it's done. The 120-volt switching regulator circuit monitors both current (through R_2) and voltage (through L_2) to keep the output at a constant level.

dition is made possible by use of two transistors connected in a Darlington configuration to provide current gain that will increase the drive current to the level required to saturate the switching transistor.

Because the switching regulator is a down converter with limited filtering and operates from relatively low line voltages, a special low-voltage—100-volt rather than the more common 135-volt—mercury-arc lamp is used with the 100-watt, 120-volt ballasting circuit. The low-voltage arc tube contains slightly less mercury than the higher-voltage type. High starting potentials are obtained by use of a half-wave voltage doubler, connected to a separate starting electrode with a current limiting resistor.

Performance data of the 100-watt switching regulator is shown on page 134. The over-all efficiency of the circuit, including the rectifier bridge and filter capacitor, is 87% for a 120-volt a-c input. The output is adjustable from 15 to 150 watts for operation into a 100-ohm load impedance. The excellent regulating characteristics are achieved, in part, by the action of resistor R_5 , which offsets a rise of output voltage with a corresponding rise in input voltage.

The 120-volt ballast circuit has a relatively small conduction angle, because of a necessarily large filter capacitor. The associated surge currents make the use of bulbs in excess of 200 watts impractical. The ballast has two 1-ohm surge-current-limiting resistors. One resistor limits a-c line transients, and the other limits bulb current during ionization.

At higher voltages

For industrial and highway lighting installations, 240-volt single-phase, 277-volt single-phase, and 208-volt three-phase a-c power sources are readily available. For these voltages, there's enough differential between the arc and tube voltage and input voltage to permit the transistor switching element to be driven from a secondary winding on the inductor of a low-pass filter. Relatively high drive current can then be obtained without high power losses.

Shown on page 135 is the basic configuration for a

switching regulator designed to operate from a-c source voltages between 200 and 300 volts. The equations given for the 120-volt switching-regulator ballasts, are also applicable to higher-voltage ballasts. A unique feature of the higher-voltage circuits is that only the high-current switching transistor Q_1 has to have a breakdown-voltage capability sufficient to withstand the full value of the d-c input voltage including transients applied across the V_{IN} terminals. All the transistors in the control circuit are low-voltage, low-dissipation types. The design for the higher-voltage ballast also features built-in short-circuit protection.

In the switching-regulator circuit the a-c voltage applied to the V_{IN} terminals drives Q_1 slightly forward-biased by a small current (approximately 3 milliamperes), through base-circuit resistor R_8 . Q_1 is immediately driven into saturation by the positive feedback from its collector circuit supplied by the L_2 secondary winding of transformer T_1 . The L_2 secondary winding also supplies the drive power to the control circuit. The collector current of Q_1 rises linearly through L_1 until the voltage across current-sensing resistor R_2 triggers the control circuit in shunt with the base-emitter junction of Q_1 . The transistor is then held cut off by the feedback voltage from the secondary winding of the transformer until the current through the primary winding decays to zero. The inductive kickback that results from the decrease in current through L_1 is clamped by commutating diode D_1 and, therefore, is the same as the output voltage on C_2 . The L_3 winding of transformer T_1 then charges capacitor C_3 to a voltage proportional to the output voltage. During the next cycle, the control circuit samples a combination of the voltage across C_3 and the current through R_2 . In this way, an output characteristic similar to that of a conventional ballast, shown on page 132, is obtained.

Design decisions

The design of solid-state switching-regulator ballasts for mercury-arc lamps involves three preliminary steps: selection of the mercury-arc lamp and the peak starting current; selection of the reactor

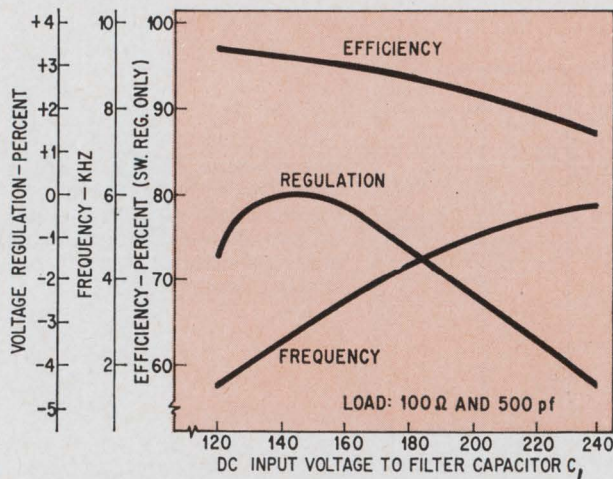

Measuring performance. The efficiency of the circuit remains above 85%, over a wide input voltage range.

element; and selection of the switching transistor and other circuit components.

The types of a mercury-arc lamp used and the peak starting current it must get from the ballast circuit are dictated by the value of the a-c source voltage, the amount of lamp power (P_L) required, and the warm-up time of the lamp. For operation from a 120-volt a-c line at lamp power levels up to 200 watts, the special low-voltage (90-to-100-volt) type of mercury-arc lamp should be used. The peak starting current is then determined from the following relationship:

$$I_{\text{peak}} = 4 \left(\frac{P_L}{100} \right)$$

For operation from a-c source voltages in the range of 200 to 300 volts, the more conventional 135-volt type of mercury-arc lamp is used. The peak starting current, for a specified lamp power rating P_L , is then determined as follows:

$$I_{\text{peak}} = 4 \frac{(P_L)}{135}$$

Switching-regulator reactor element

The series inductor selected for the switching-regulator ballasting circuit should have a maximum core cross-sectional area and minimum air gap, consistent with the required inductance value, so that the minimum physical size is obtained. The circuit shown on page 135 permits simple di/dt measurements that eliminate the need for repetitive calculations to determine the required inductances. In this test circuit, the inductor is connected in series with a switching transistor and a d-c voltage. The switching transistor is maintained in the on state until the inductor saturates. The following equation then becomes the basis for the determination of the inductor parameters.

$$V_{\text{in}} = L_1 \left(\frac{I_{\text{sat}}}{t_{\text{on}}} \right)$$

The desired flux density for the inductor is some fraction of that produced by the saturation current. The air gap, number of turns, and the core are selected as required to obtain the desired value.

If an iron core is used for the inductor, the core laminations should be 4-mils thick. The negligible increase in efficiency doesn't warrant use of thinner laminations. For stabilized operation and to avoid overheating of the inductor, the switching frequency of the ballasting circuit should be less than 5 kHz and the flux density in the inductor should be less than 6 kilogauss. For an inductor that uses a ferrite core, the flux density (determined for worst-case conditions) is usually 3 kilogauss, and the frequency is limited by only the transistor switching losses.

Switching transistor and components

The transistor used as the switching element in a switching-regulator ballast must have a collector-to-emitter voltage breakdown capability $V_{\text{CER(SUB)}}$ high enough so that the device can withstand the total input d-c voltage together with the maximum transient input voltage that may be developed in the circuit. In all the ballasting circuits described herein, the transistor used as the high current switching element is the RCA developmental No. TA7420.

The Darlington transistor circuit in shunt with the emitter-base junction must drive the switching transistor well into the saturation region for the particular I_{peak} .

For the 120-volt ballast-circuit design,

$$I_{\text{B(max)}} < 10 \text{ ma}$$

For the 200-to-300-volt ballast-circuit design,

$$I_{\text{B(max)}} < 300 \text{ ma}$$

The power dissipated by the transistor used as the switching element should not exceed 10% of the power rating (P_L) of the mercury-arc bulb. The transistor power dissipation (P_D) is calculated for a hot, stabilized bulb ($I_{\text{Cmax}} = I_{\text{STAB}} = 2I_{\text{avg}}$) as follows:

$$P_D = \text{saturation loss} + \text{turn-off loss}$$

$$P_D = \frac{t_{\text{on}}}{t_{\text{on}} + t_{\text{off}}} \int_0^{I_{\text{STAB}}} i R_{(\text{sat})} di +$$

$$\frac{f_{(\text{STAB})} V_{\text{in}} t_f}{2}$$

$$P_D = \frac{(I_{\text{STAB}})^2}{2} [t_{\text{on}} (I_{\text{STAB}}) (R_{\text{sat}}) + V_{\text{in}} t_f]$$

In this equation, $R_{(\text{sat})}$ is the saturation resistance of the switching transistor, and t_f is its turn-off time for the particular circuit conditions. [It should be noted that the turn-off time is not directly related

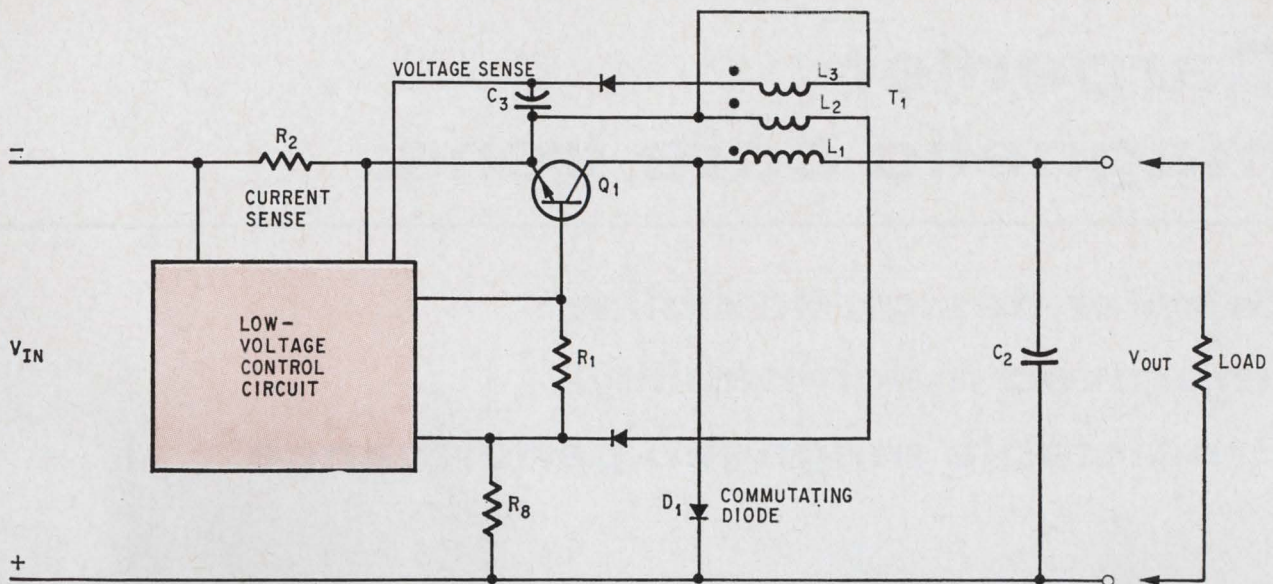

High-power. The 240-volt ballast circuit, like the 120-volt circuit, needs only one high-voltage element.

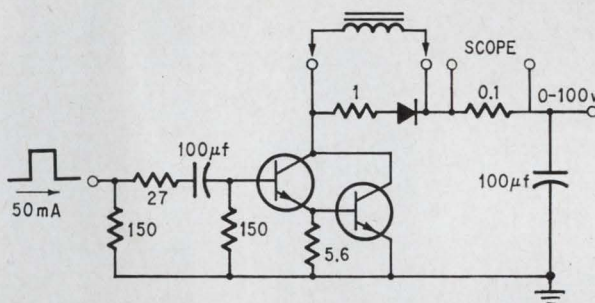

Tester. Simple di/dt measurements can be made with this, eliminating repetitive calculations.

to the gain-bandwidth product (f_T .)]

The total base drive resistance of the switching-regulator ballasting circuits can be estimated on the basis of the current and voltage relationships for peak-current conditions.

For the 120-volt design, the voltage drop across the total of the resistors in the base drive circuit is the d-c input voltage less the voltage (8.2 volts) across the 1N756 zener diode. The maximum value for the drive-circuit resistance for I_{peak} , therefore, can be calculated with:

$$R_{\text{in}} = \frac{V_{\text{in (min)}} - 8.2}{I_{\text{B (max)}}} = \frac{100}{I_{\text{B (max)}}}$$

This equation indicates that the drive-circuit resistance for the 120-volt ballast design must be greater than 9,000 ohms for a permissible $I_{\text{B(max)}}$ of 10 milliamperes.

For the 200-to-300-volt design, the total drive-circuit resistance is estimated as follows:

$$R_{\text{in}} = \frac{[V_{\text{in (min.)}} - V_{\text{out (min.)}}] \frac{L_2}{L_1} - 2}{I_{\text{B (max.)}}}$$

In this case, the drive-circuit resistance must be greater than 60 ohms for the 300 milliamperes of maximum permissible drive in the circuits presented.

The bridge-rectifier diodes and the commutation diode are selected on the basis of the maximum voltage and current requirements of the ballasting circuit.

The value of resistor R_3 , in the diagram on page 133, is determined from the desired voltage current slope of the ballast circuit.

$$VI_{(\text{slope})} = \frac{I_{\text{bulb (hot)}}}{V_{\text{bulb (hot)}}}$$

An increase in the warm-up time for a given bulb and ballasting circuit arrangement can be achieved by the use of a larger resistor R_3 in both the 120-volt and 200-to-300-volt designs. This larger resistor would produce a smaller voltage-current slope, and the collector current during starting (I_{peak}) would then be reduced.

The value of R_5 is selected to provide the best voltage regulation.

Carpenter magnetic core irons:

Greater design flexibility

Improved machinability

Predictable magnetic performance

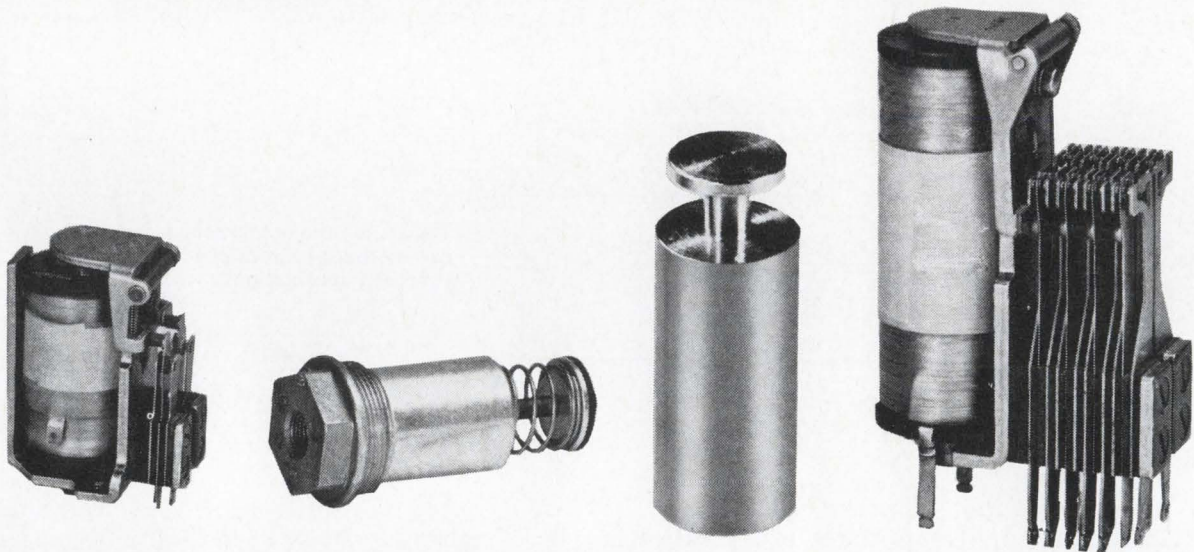

Now get up to 40% improved machinability in producing products like these.

Carpenter now offers you three distinct free-machining grades which combine predictable magnetic behavior with profitable production.

Carpenter Silicon Core Iron "A-FM", for solid cores that demand economical machining in volume. It also offers moderately high electrical resistivity, high initial permeability and low hysteresis loss in both AC and DC currents.

Carpenter's new modified 2½% silicon iron,

Core Iron "B-FM", offers high electrical resistivity, a low hysteresis loss, low residual magnetism in DC currents, and virtual freedom from magnetic aging. Plus . . . greatly improved machinability.

For applications requiring corrosion-resistant properties, Carpenter Stainless 430F (Solenoid Quality) also has excellent machinability. Contact your Carpenter Representative for data and prompt attention to your requirements. The Carpenter Steel Company, Reading, Pennsylvania 19603.

Carpenter steel
IN A WORD, CONFIDENCE

Few surprises at Wescon '68; plastic packaging debate continues

Although fluidics and crime-fighting are new to the program, most of the technical sessions will cover familiar ground; military renews opposition to plastic at packaging meeting

Technical sessions at the 1968 Western Electronic Show and Convention in Los Angeles later this month will trod well-covered grounds. For example, such familiar subjects as linear integrated circuits, testing, nuclear instrumentation, systems engineering, and data communication techniques again lead the topic roster. However, newcomers to the program are sessions on electronic devices for law enforcement applications and fluidics. At the International Electronic Circuit Packaging Symposium being held concurrently with Wescon, the debate on the reliability of plastic-encapsulated semiconductor assemblies will be renewed.

Representatives from Motorola Inc., Texas Instruments Incorporated, and the Signetics Corp., a subsidiary of the Corning Glass Works, will cast affirmative votes for plastic packaging. The lone

nay-sayer at this get-together will be Edward B. Hakim of the Army Electronics Command, Fort Monmouth, N.J., who will report on his organization's tests of small-signal transistors and variable-capacitance diodes. On the basis of his work, which suggests that short-term data does not encourage the use of plastic-encapsulated devices in high-reliability systems, and because of the paucity of long-range information, Hakim feels the military must proceed with caution in this field. He says: "This laboratory has included in SCL-6200 (the component specification for new equipment development) a requirement that only hermetic devices shall be considered hereafter on any proposal. When these (plastic-encapsulated) devices have shown that they are capable of withstanding military environments for sustained periods of time,

Technical sessions at a glance

Subject	Session	When	Where*
Aerospace technology	23	Fri., 9:30	Biltmore Bowl
Civilian applications	D	Fri., 9:30	Biltmore Ballroom
Computers	13	Wed., 2:00	Music Room
	27	Fri., 2:00	Renaissance Room
Controls	14	Wed., 2:00	Galeria Room
	6	Tues., 2:00	Galeria Room
Electro-optics & Displays	4	Tues., 9:30	Galeria Room
	10	Wed., 9:30	Galeria Room
	16	Thurs., 9:30	Music Room
Digital communications	28	Fri., 2:00	Music Room
	12	Wed., 2:00	Renaissance Room
	8	Wed., 9:30	Renaissance Room
Education	3	Tues., 9:30	Music Room
Electromagnetic compatibility	19	Thurs., 2:00	Biltmore Bowl
Fluidics	15	Thurs., 9:30	Biltmore Bowl
Hybrid IC's	1**	Wed., 9:20	Statler Hilton
	2**	Mon., 1:15	Statler Hilton
	2**	Wed., 10:45	Statler Hilton
	3**	Mon., 3:30	Statler Hilton
	3**	Wed., 1:30	Statler Hilton
	4**	Wed., 3:00	Statler Hilton
	5**	Thurs., 9:00	Statler Hilton
	6**	Thurs., 10:00	Statler Hilton

* Sessions at Biltmore Hotel unless noted

Subject	Session	When	Where*
	7**	Thurs., 1:30	Statler Hilton
	8**	Thurs., 3:00	Statler Hilton
Interconnections	4**	Tues., 8:30	Statler Hilton
Monolithic IC's	1	Tues., 9:30	Biltmore Ballroom
	1**	Mon., 9:30	Statler Hilton
	9	Wed., 9:30	Biltmore Bowl
Law enforcement	18	Thurs., 2:00	Biltmore Ballroom
	C	Thurs., 9:30	Biltmore Ballroom
Magnetic devices	17	Thurs., 9:30	Galeria Room
Management	A	Tues., 2:00	Biltmore Ballroom
	B	Wed., 2:00	Biltmore Ballroom
	7	Wed., 9:30	Biltmore Ballroom
Materials	24	Fri., 9:30	Renaissance Room
Medical electronics	11	Wed., 2:00	Biltmore Bowl
Microwaves	5	Tues., 2:00	Renaissance Room
	2	Tues., 9:30	Renaissance Room
Nuclear systems	20	Thurs., 2:00	Renaissance Room
Packaging	5**	Tues., 10:45	Statler Hilton
	4**	Tues., 8:30	Statler Hilton
Pattern recognition	21	Thurs., 2:00	Music Room
	25	Fri., 9:30	Music Room
Power converters	26	Fri., 9:30	Galeria Room
Radar	22	Thurs., 2:00	Galeria Room

** International Electronic Circuit Packaging Symposium

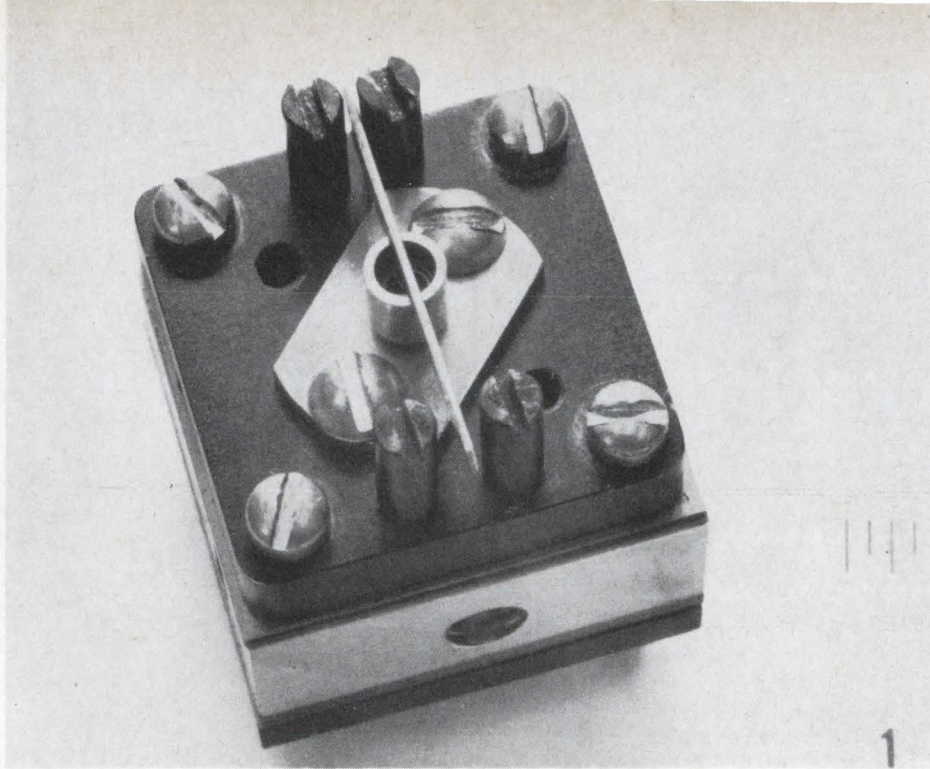

Newcomer. Fluidics is the subject of a Wescon session for the first time this year. One example of the hardware that's becoming commercially available in the field is this miniature mechanical resonator from GE. Unit is designed for use in a governor system where operating temperatures vary over wide range.

then revision of SCL-6200 must be considered."

But for the moment at least, Hakim is convinced that plastic-encapsulated assemblies have a long way to go before the military enlists them for duty. There are many variations in fabrication from the same device manufacturer, he says. Not only is there variation in the basic formation of the package, but there also appears to be considerable variation in the same product categories from week to week.

Transfer molding techniques are generally used to make small-signal devices and epoxy resin is the most popular material, Hakim says. However, he notes, during the course of the lab's test program, it became apparent that such devices just wouldn't do, and a change in fabrication techniques was indicated. The eight semiconductor makers involved in the Fort Monmouth program began scrambling for solutions as tests revealed deficiencies in their wares. One, for example, shifted to a rubbery silicone barrier on the transistor chip, with an epoxy shell surrounding this. Subsequently, this firm substituted phenolic for both the epoxy and silicone. Most of the other manufacturers also opted for a barrier of one sort or another, Hakim reports. Four chose silicone, and another went for silicon nitride. Their efforts, with but two exceptions, proved largely unavailing; failure rates were still high—over 80% in some cases. However, the company using silicon nitride as a barrier had zero failures on 26 devices after 1,055 hours. Another, using epoxy with a barrier, had only one failure on 30 npn and pnp assemblies after 1,104 hours of testing. To determine if hermetically sealed units could survive its standard series of tests, Hakim and his crew checked a dozen typical devices for 1,200 hours and could find no fault.

Test cases

Hakim's organization uses two tests that he considers realistic to check plastic-encapsulated devices. The first is a humidity-temperature cycle with voltage applied to the device. The second is a high-temperature/reverse-bias check. Both have uncovered what Hakim views as serious problems in plastic reliability. In particular, he cites the electrolysis, resulting from moisture penetration, that destroys contact metalization.

Under study at Fort Monmouth is a so-called "pressure cooker" test, a technique that accelerates checks of moisture penetration. Devices are placed in a vessel and suspended above water. Pressure is built up to 15 pounds per square inch in one-half hour. At this pressure, temperature is around 121° C. The devices are tested for seven hours. At the moment, Hakim says, failures can be induced 10 times faster with this test than with standard checks.

Counterattack

In the opposing camp are S.S. Baird and C. Gordon Peattie of TI's quality and reliability assurance department; E. David Metz from Motorola's Semiconductor Products division; and Signetics' R.C. McCoy. As advocates, these men lean on familiar arguments. To wit: plastic-encapsulated semiconductors have proved their mettle in the consumer and industrial fields and are now ready to serve the military in certain applications because of increasing ruggedness and a cost advantage over can-packaged equivalents. But those who have followed the plastics story detect a new note of realism in the case being made by the device makers.

For example, Baird and Peattie of TI—where there is a bias towards injection-molded devices—

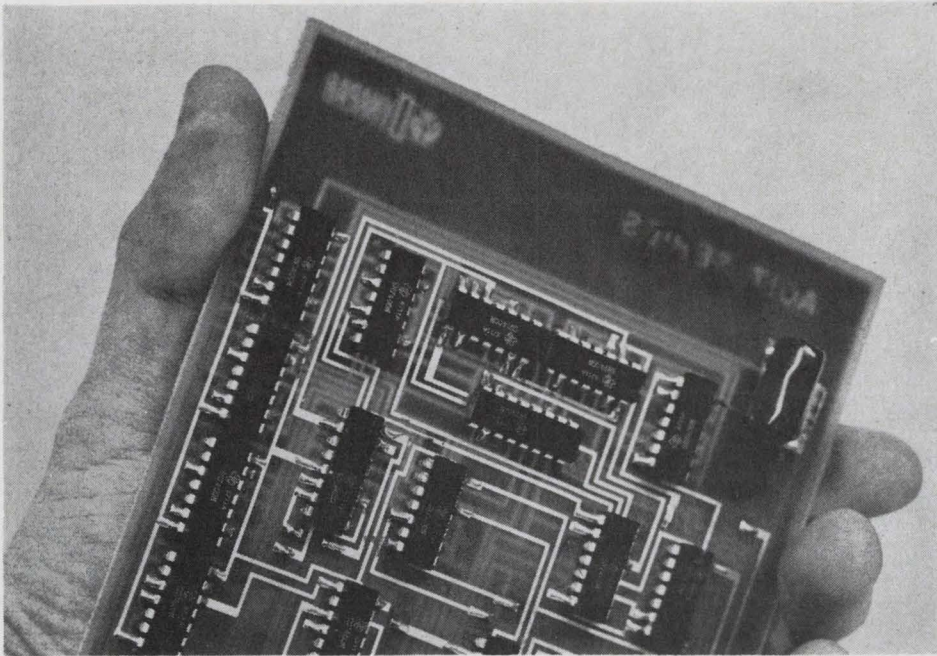

Dirty job. Plug-in card for indicator-computer system used in paper mill features TI IC's packaged in plastic. Semiconductor makers are pushing such assemblies for applications in military systems.

concede that plastic is far from perfect as a packaging material. They single out three areas of technology that are now getting the most attention: improvement of the adhesion of plastic to leads; selection of lead materials that can withstand the corrosive atmosphere involved in the extra humidity testing plastic devices are expected to withstand; and prevention of open connections produced by intermittent operation at maximum rated power.

Essentially, however, the TI paper is a five-part pitch for the use of more plastic-encapsulated

semiconductor devices in military systems:

- If a particular system operates below 65° C and 95% relative humidity and the design derates the devices at least a factor of two on power dissipation, say Baird and Peattie, plastic, rather than metal cans, should be used.

- Plastic-encapsulated devices should be used in preference to those in metal cans when the mechanical environment requires high acceleration, shock, or vibration resistance. The authors believe their point is proved by the widespread—and successful—use of such assemblies in fuzes and anti-personnel mines.

- Plastic encapsulation is well suited for device miniaturization in cases where mechanical integrity is a critical consideration.

- A careful review should be made of those parts of military systems in which plastic-encapsulated devices can be used. Then, test specs should be changed to take into account the less critical system requirements.

- There is a real danger that imposition of unnecessarily tight specs for plastic-encapsulated devices will erase the price differentials between them and their metal-can equivalents.

To illustrate this latter point, Baird and Peattie developed a chart showing semiconductor cost factors over the past eight years. In 1960, proof of performance, they say, accounted for about 20% of total outlays; connections and packaging represented about 30% and active elements the balance. By 1968, when active elements' cost was reduced to around 15% of the total, connection and packaging expenditures were up to 45% and proof of performance to 40%. They conclude that their figures highlight the importance of packaging costs, which could be reduced by going to plastic encapsulation. But they further reason that if plastics

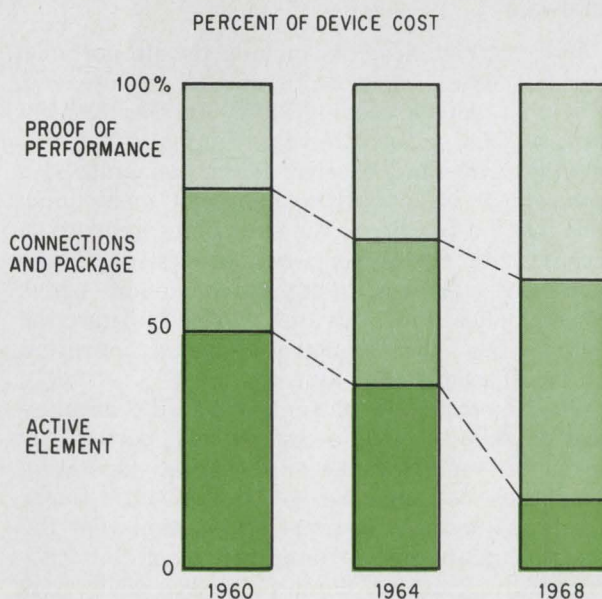

Danger point. Device makers worry about increase in proof of performance costs for plastic-packaged units.

savings are to be significant, the proof of performance percentage will have to remain at near the current level.

Assent

Signetics' McCoy, presenting results of checks run at his company, also concludes that test results show that properly designed and processed silicone-encapsulated IC's meet and even exceed military environmental specifications and should be considered for widespread use—particularly in applications involving high stress levels or mechanical and thermal shock. Regarding the integrity of seals against moisture, McCoy notes: "Presently available long-term data indicates no moisture problems. But due to the lack of a suitable 100% seal integrity screen, additional long-term qualification testing is being undertaken."

Metz, in a somewhat tutorial paper on chemical and mechanical considerations in transfer-molded semiconductor devices states: "By definition plastic-encapsulated devices are not hermetic. However, a complete understanding exists of the limitations of the seals and performance is becoming more predictable in a variety of environments, and performance will continue to improve as more is learned."

Metz points out that a metal can has a seal—in effect a transition region. There is thus no discontinuity. But in a plastic-encapsulated device, the seal is formed by compression forces between the plastic and metal, and there is no true bond in the hermetic sense. This, of course, is at the heart of the problem with plastic-encapsulated devices—moisture creeps up the lead and into the package, where electrolysis can ruin the bonds and cause failure. If the quantity of water is large, hysteresis appears in the reverse characteristic. Further, ionic contaminants can penetrate by being carried up the lead to produce an extra induced charge in the silicon. The charge appears in the reverse characteristic of the p-n junction or in the gain characteristic of the transistor.

Flow chart

The session on fluidics seems tacit admission by Wescon that there are certain applications in which the new technology might replace or complement electronics systems. The four-paper session runs the gamut from analytical exercises to comparisons of fluidic devices with their electronic counterparts. One, on analytical techniques for fluidic analog systems, to be presented by R.R. Clark of I-T-E Imperial Corp., makes the point that fluidic devices can be highly nonlinear. In other words, control systems in which these elements are used may oscillate severely. Having established this, Clark reviews ways of analyzing systems—that should already be well understood by electronics engineers, particularly those working in the control field.

A presentation on the development of a flueric amplifier transfer matrix, by F.M. Manion of the

Army's Harry Diamond Laboratories, appears quite comprehensive. But only the most ardent fluidics engineers—a small but growing group—will appreciate the paper. Electronics engineers will be interested only to the extent that the amplifier is discussed in terms of electronic analogies.

D.F. Jensen and R.R. Schaffer of IBM's Systems Development Laboratories will describe a fluidic digital-diaphragm logic element, developed to interface with data-processing and control systems. The basic device can be packaged to produce such logic functions as NOR and NAND—at low cost, low operating power, and low noise levels. At low frequencies, its performance compares favorably with its electronic equivalent.

Closer to home

Electronics engineers will probably be most comfortable with the paper on a-c fluidics, by C.W. Woodson of the General Electric Co. He notes that for control applications, fluidics engineers are starting to adopt carrier-modulated signals—in much the same way that years ago electronics engineers discovered that a-c signal systems overcame the drawbacks of line losses, drift, and noise of d-c signal systems. By a-c fluidics, Woodson means an oscillatory flow superimposed on a steady flow. Thus, in electronics terms, the fluidic signal always has a d-c component in addition to the a-c signal component.

Woodson's paper effectively discusses some of the applications—turbine speed control, temperature control, and the like—in which fluidics can compete with electronics. He shows how such electronic components as resistors, capacitors, and inductors can be constructed by fluidic means. Then, he puts these passive elements together to make, for example, a tuned resonator which can be used as a frequency reference in modulated carrier systems.

Hardware

Active fluidic elements include the proportional amplifier, which can now be staged, or cascaded, to over-all gains exceeding 2,000. Another element is the rectifier or absolute-value amplifier.

Using active and passive fluidic elements, says Woodson, it is possible to construct many functions that are familiar to the electronics industry. A decoupler, or derivative circuit converts a single-ended pressure to a differential push-pull signal. Other practical functions that can be built are the beat detector, the frequency-to-analog converter, and the phase discriminator.

Woodson expects rapid progress in the development of more a-c fluidic components, particularly for control and sensing applications. Operating frequencies will increase by two or three times, and, he says, there is some speculation that the ultimate high-frequency limit will reach 100 kilohertz. If this happens, fluidics may eventually pick up some significant and substantial portions of electronics' territory.

**This induction motor speed control
can be completed
with a single component...**

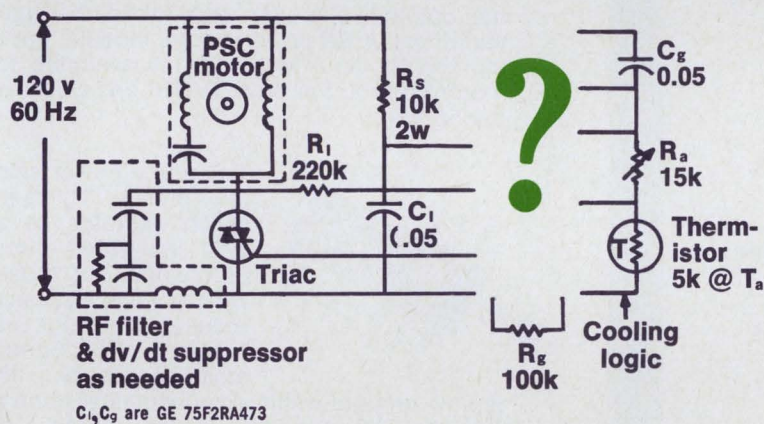

TEMPERATURE CONTROL OF FANS AND BLOWERS

**... General Electric's new PA436
monolithic phase control integrated circuit.
Turn the page for more cost saving ideas from General Electric. ▶**

Control induction motor speed with an integrated circuit . . . General Electric's new PA436 can do it.

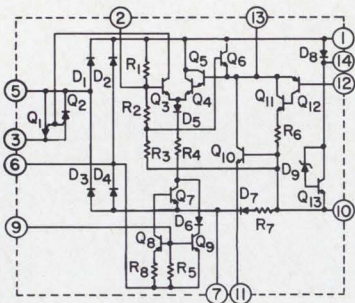

PA436 senses a voltage differential and pulses a triac controlling power to fractional horsepower induction motors. Speed regulation of $\pm 5\%$ is obtainable thru tachometer feedback control. The device is suitable for all lagging power factor motors.

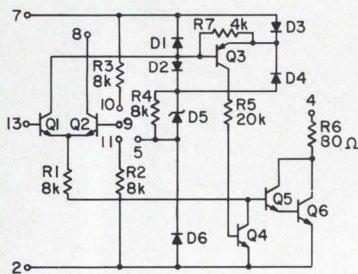

PA424 is industry's first monolithic integrated circuit designed specifically for AC power control. Its prime application is for temperature control of residential and industrial heating units. It can be used to control temperature in kitchen appliances and business machines and can also function as a relay driver, miniature lamp driver, photosensitive control, or DC level sensor.

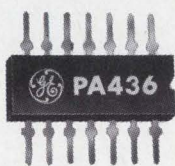

Now you can have all the benefits of integrated circuitry in a major new area. General Electric's new PA436 is the only monolithic integrated circuit on the market designed to control induction motor speed.

It combines the functions of adjustable-gain phase control, inductive load logic, and triac triggering . . . eliminating many external components from your control circuit. Used for fractional horsepower induction motors, PA436 can trigger triacs for loads up to 15 amps and 280 volts RMS. It also can control SCR's handling higher voltages and currents used to drive large motors. Temperature control of fans and blowers is zero to full speed over an adjustable temperature band of 2°C up. The device also allows for external gain adjustment and has internal compensation for ambient temperature and supply voltage variations. A GE power control module, the S300 series incorporating the PA436 and a triac, is available for simplified induction motor control. For more PA436 and S300 information, circle number 500.

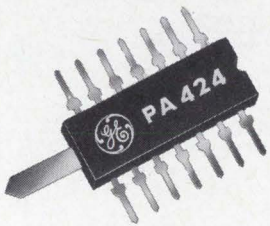

To reduce power switching radio frequency interference, try General Electric's PA424 which operates as a zero-voltage switch. This integrated circuit detects a voltage differential and pulses a triac only at a-c zero voltage crossing . . . it significantly reduces the R.F.I. usually associated with power control. Formerly too expensive for most applications, this switching principle is now brought within an economical price range for the first time. PA424's balanced input allows switching accuracy of $\pm 0.5\%$ of sensor resistance at the control point too. Without trimming, it inherently has $\pm 5\%$ accuracy which is satisfactory in many applications.

Also available from General Electric is a complete power control module—the S200A—that includes the PA424, a triac, and passive elements in a self-contained unit for heater temperature control. For more information on the PA424 and S200A, circle number 501.

Original equipment manufacturers, find out for yourself how General Electric integrated circuits can help you solve your design problems, send for a free sample of either the PA436 or the PA424 . . . or both. Simply tell us the IC you want and your expected application, and send it along with your name, address, title, company, to Product Manager, I.C. Power Control, General Electric Company, Northern Concourse Office Bldg., North Syracuse, N. Y.



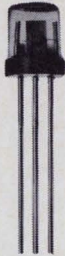

High sensitivity and low-cost makes GE's L14B photosensitive Darlington amplifier a real value

A small scale integrated circuit with a two-transistor amplifier configuration, General Electric's L14B increases collector-to-emitter current as the amount of light falling on it increases.

L14B has high sensitivity because of its high-gain amplifier. Shining a two-cell flashlight on it from a distance of 13 feet generates a one mA collector current.

Packaged in a clear epoxy capsule, L14B accepts light from unusually wide angles. It responds to visible light but is most sensitive to the near infrared. It responds very quickly to a sudden change of light, in comparison with other light detectors.

The unit is low cost, with prices starting at 68¢ for purchases of 1000 units or more. Look into L14B. For more information circle number 502.

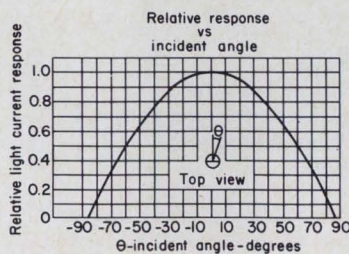

Flexible custom-designed circuit modules solve your power control problems

Quick, economical solutions to your circuit problems are our specialty. GE has designed, built, and delivered over 50 different circuit modules. Each gave some customer exactly the circuit he needed. Some cost less than \$2.00 in quantity.

There are 56 standard GE circuit assemblies with these basic functions:

- basic variable voltage controls
- extended range and combination variable voltage circuits, and AC static switches
- R.F.I. suppressed blower motor speed controls with set low speed
- R.F.I. suppressed basic variable voltage circuits
- monolithic integrated firing circuit controlled power switching for zero-voltage switching and AC phase control induction motor speed.

Whether you need a special temperature control with accuracy to within 1°C, or a standard 10 amp variable voltage control, GE can solve your problem best. Circle number 503.

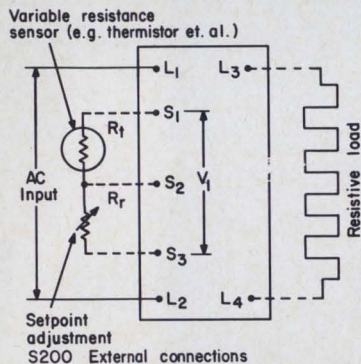

Highest frequency high voltage SCR now available for all these functions

- choppers
- inverters
- induction heaters
- DC to DC converters
- cycloconverters

General Electric's C158/159 is a silicon controlled rectifier designed for power switching at frequencies up to 10k Hz half sine wave current and rectangular current waveshape frequencies up to 5k Hz.

C158/159 offers forward and reverse blocking voltages to 1000V, 40 micro-second maximum turn-off time at severe operating conditions, high di/dt and dv/dt at high frequency, and extremely low switching losses at high frequency.

Find out more about the operating capabilities of this high-speed, high-efficiency SCR. Circle number 504.

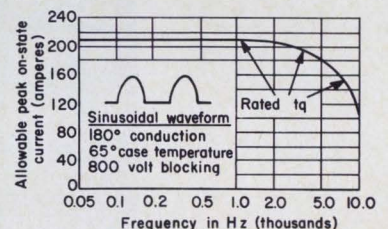

For more information on these and other General Electric semiconductor products, call or write your GE sales engineer or distributor, or write General Electric Company, Section 220-64, 1 River Road, Schenectady, N. Y. 12305. In Canada: Canadian General Electric, 189 Dufferin St., Toronto, Ont. Export: Electronic Component Sales, IGE Export Division, 159 Madison Avenue, New York, N. Y. 10016.

SEMICONDUCTOR PRODUCTS DEPARTMENT

GENERAL ELECTRIC

5 fast, effective ways to stop EMI:

If you want to shield...

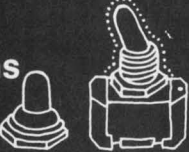
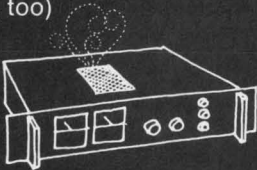
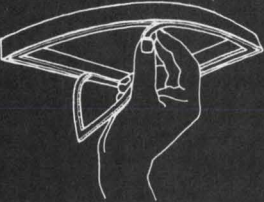
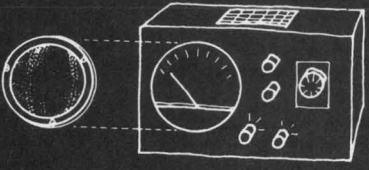
<p>Communications cables</p> 	<p>use</p>	<p>Metex "Zip-Ex"® zip-on metallic sheath. Provides 100% reliable electromagnetic shielding. Knitted mesh sheath zips on any shape before or after installation.</p>
<p>Switches/ push buttons (also keep out moisture)</p> 	<p>use</p>	<p>Metex Flex-Shield shielded rubber boots. Metal mesh, molded in flexible rubber, gives maximum reliability against RFI-EMI.</p>
<p>Electronic equipment (and vent it, too)</p> 	<p>use</p>	<p>Metex Shield-Cell honeycomb panels. It's designed to meet specific attenuation requirements over specified frequency ranges. Many standard sizes and materials are available.</p>
<p>Access doors & lids</p> 	<p>use</p>	<p>Metex Pola-Stick Wire imbedded in silicone. Pressure-sensitive adhesive keeps it securely in place during and after installation.</p>
<p>Viewing windows</p> 	<p>use</p>	<p>Shield-Vu™ Metex Your choice of monel, low carbon steel or etched metal laminated in plexiglass. Any color, size, or shape.</p>
<p>QUICKLY</p>	<p>call</p>	<p>(201) 287-0800 for design engineering service (for your rush rush requirements)</p>

For Free Samples, Prices and Literature on any or all of these EMI shielding materials—or for technical assistance on your particular requirements—write:

METEX Corporation

970 New Durham Road, Edison, N. J. 08817
(201) 287-0800 • TWX 710-998-0578
West Coast: Cal-Metex Corp., 509 Hindry Ave.
Inglewood, Calif. 90301
(213) 674-0650 • TWX 910-328-6100





**That's right. It's a commercial connector.
Our Molex Standard. Millions are finding their
way into some of the most exciting circuitry man
can imagine. For that's our business: creating
connectors that simplify
wiring. Speed produc-
tion. Assembly. Instal-
lation. Servicing.**

**For the men who are
looking for new ideas and
ways to cut costs.**

**In the area of one circuit to sixty
connections or more, Molex has the
product. And the design and engineer-
ing capabilities to solve the most com-
plex wiring and production problems . . .
fast! We'd like to talk to you about it.**

**If you would like a free sample of our
Molex connector, please
write or phone (312)
969-4550. You
can make con-
nections at . . . **molex****



How to use the Singer Model ATS Transfer Standard for 0.01% True RMS Measurements in 15 Seconds

Many precision AC voltage measuring instruments cannot provide accurate RMS measuring unless the AC input is a perfect sine wave. If there is any distortion at all in the wave shape, claimed RMS measuring accuracy will be degraded because of error introduced in the detector circuits.

The Singer Model ATS uses thermoelement techniques accepted by the National Bureau of Standards for high accuracy, True RMS measurements. The Model ATS and your present high accuracy instrumentation permit RMS measurement to better than 0.01% of reading . . . regardless of the wave shape of the input. Any operator can make the measurement in just fifteen seconds, with a procedure so simple it is completely described here.

1.

The Model ATS is the instrument in the center. The signal source at the right is generating an AC voltage whose True RMS value is unknown.

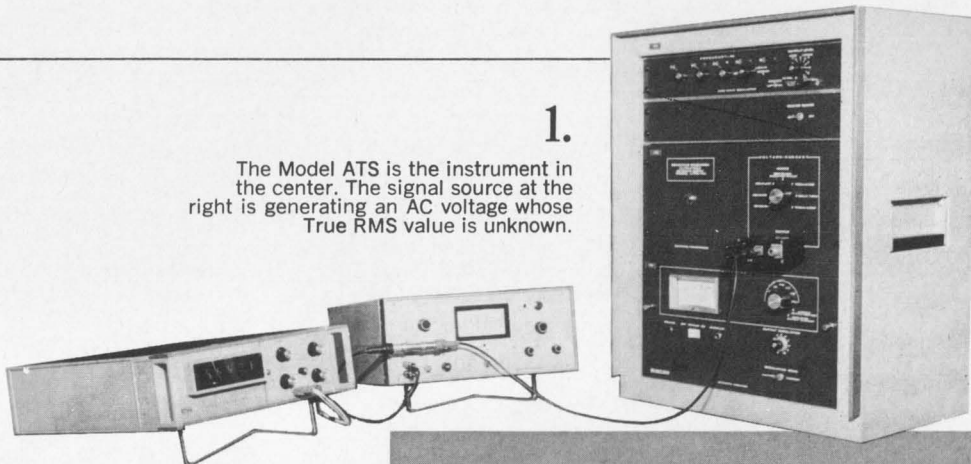

2.

By simply depressing a button on the Model ATS, a DC voltage equal to the True RMS value of the applied unknown AC is automatically developed. The conversion from RMS to DC is within 0.01% of the RMS value of the input.

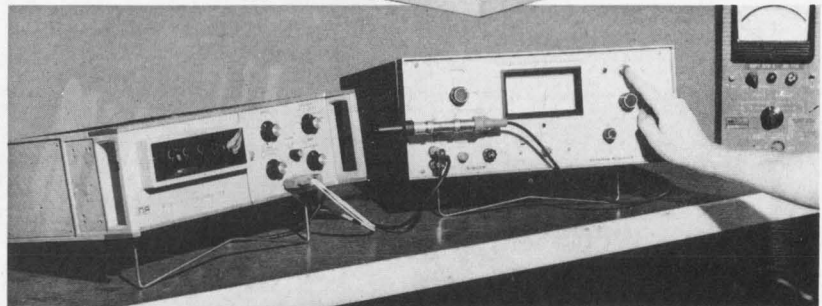

3.

Approximately fifteen seconds after pushing the button, the operator reads the RMS value on the DC voltmeter. Had this measurement been made without the Model ATS — that is, with a conventional AC digital voltmeter (normally, an average-responding device), here is what would have happened: A wave shape with 10% distortion can produce an RMS measurement with an error of more than 3% above the voltmeter's inherent error. In many applications, particularly in the standards lab, such an RMS measurement is inadequate.

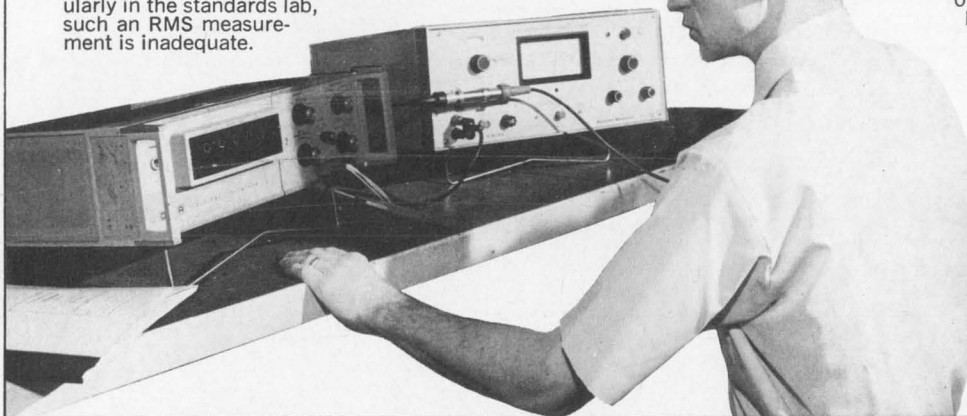

The Singer Model ATS has an overall range of 2 Hz to 30 MHz. It provides accuracies of 0.01% of reading from 0.25 V to 1,000 V, 5 Hz to 20 kHz.

NBS Test Reports on the AC-DC difference may be obtained with uncertainty of measurement of 0.005% or better on all ranges up to 20 kHz; 0.01% at 50 kHz to 500 volts; 0.05% at 100 kHz to 250 Volts and 0.05% at 1 MHz to 16 volts. Model ATS provides ten times better accuracy, over a broader frequency band, than any RMS Digital Voltmeter.

A brochure on the Model ATS is now available. For your copy, please circle the Readers Service Card or write on your letterhead (Att: Fred Rosenthal).



SINGER
INSTRUMENTATION

The Singer Company, Metrics Div., 915 Pembroke Street, Bridgeport, Conn. 06608 (203) 366-3201

SEE SINGER AT WESCON BOOTH 1712-1716

New Mil-Standard 883 specifies "Fluorinert"TM brand electronic liquids for gross leak testing

New Mil-Standard 883, designed specifically for microelectronics, specifies "FLUORINERT" Brand Electronic Liquids for the gross leak testing of microcircuits.

No wonder.

They're compatible with sensitive electronic materials and can be used over a wide temperature range. They drain clean, dry fast and leave no messy residue.

Bring your tests up to "standard". Write today for a copy of Mil-Standard 883, test method 1014.



3M Company, 3M Center Dept. KAX 8-68
St. Paul, Minn. 55101

Please send me a copy of Mil-Standard 883, test method 1014, and more information on "FLUORINERT" Brand Electronic Liquids.

Name _____

Company _____ Title _____

Address _____

City _____ State _____ Zip _____

Chemical Division 3M



Meet the conformist

At GAF, nobody looks down on conformity. After analysis of industrial x-ray problem areas, GAF research came up with SCREEN-PAK™—a convenient, disposable lead screen “package”—that goes out of its way to be a conformist.

SCREEN-PAK conforms easily to curves. While thicker than other disposable screen packages, it bends easily around a small part.

SCREEN-PAK conforms to the need for contrast. Consistently better visualization of structural defects, thanks to superior absorption of scatter radiation by the pure lead foil (.003” thick).

SCREEN-PAK conforms to exposure requirements. Reduced exposure time over the broadest range of radiation energies (120 KV to 1.25 MeV)—but with intensification comparable to that with

conventional lead screens and superior to that with thinner disposables.

Introduced as Industrial “B” Film, new GAF SCREEN-PAK is also available in Industrial “A” and “H-D” on special request.

A call to your x-ray film distributor or GAF Technical Representative will bring full information on SCREEN-PAK and other GAF products for industrial radiography. Or, write: Industrial X-ray Marketing Department

GAF Corporation
(Formerly General Aniline & Film Corp.)
140 West 51 Street, New York, N. Y. 10020

02560—1100

another
fine product **gaf**
from

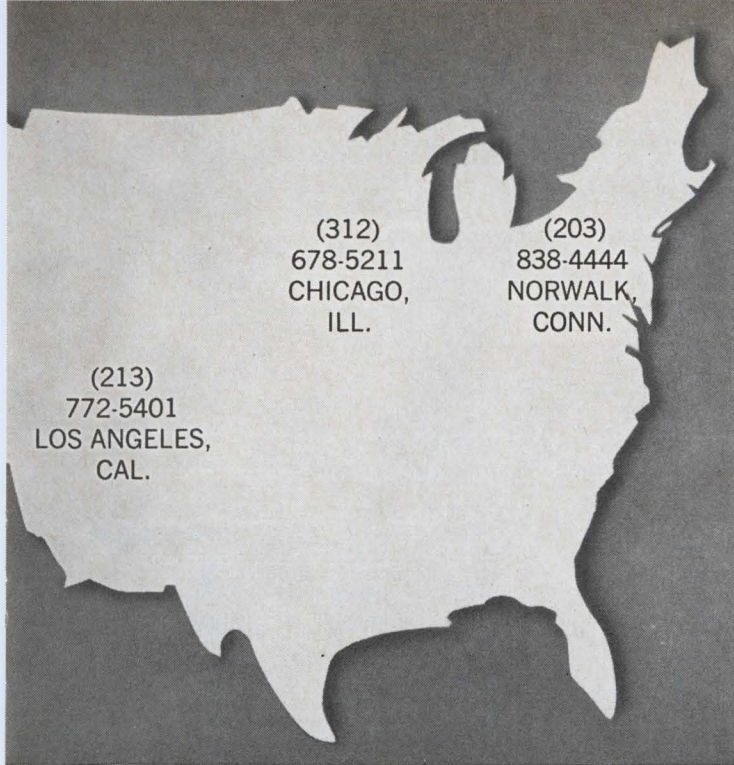

(213)
772-5401
LOS ANGELES,
CAL.

(312)
678-5211
CHICAGO,
ILL.

(203)
838-4444
NORWALK,
CONN.



**This is a Bantam Specialist.
He'll help you on the phone
or on the job.**

**These are our 3 Bantam™
Qik Facility® locations.
There's one near you.**



**This is a girl in one of our
clean rooms. Quality control
is her middle name.**



**And these are our MIL-C-26482
round connectors. They can be
yours fast as you need them.**

Speed isn't the only advantage of ordering MIL-C-26482 from Burndy. Set up to maintain highest military and industry standards, our "clean rooms" are temperature and humidity controlled and all our personnel thoroughly trained and rigidly supervised.

In addition, each location has a staff of engineers who will not only help figure your requirements but assist your installers. So for all variations of miniature round connectors, smooth crimp or solder, and complete cost-cutting installation tooling call

one of the three numbers above. The service will more than please you.



Norwalk, Connecticut

Circle 287 on reader service card

Marketing axiom number 1:

SELL WHERE YOU BUY.

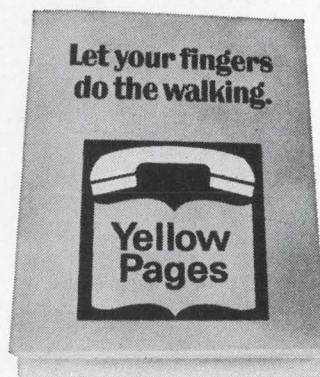

Chances are you or somebody in your company uses the Yellow Pages regularly to buy supplies or services you need to do business. A study of just manufacturing firms alone proved 9 out of 10 buyers do. That's why the Yellow Pages is such a good place to reach business prospects with *your own* advertising. Sell where you buy. It's good business.

Cut it out and paste it on our 3-digit dpm.*

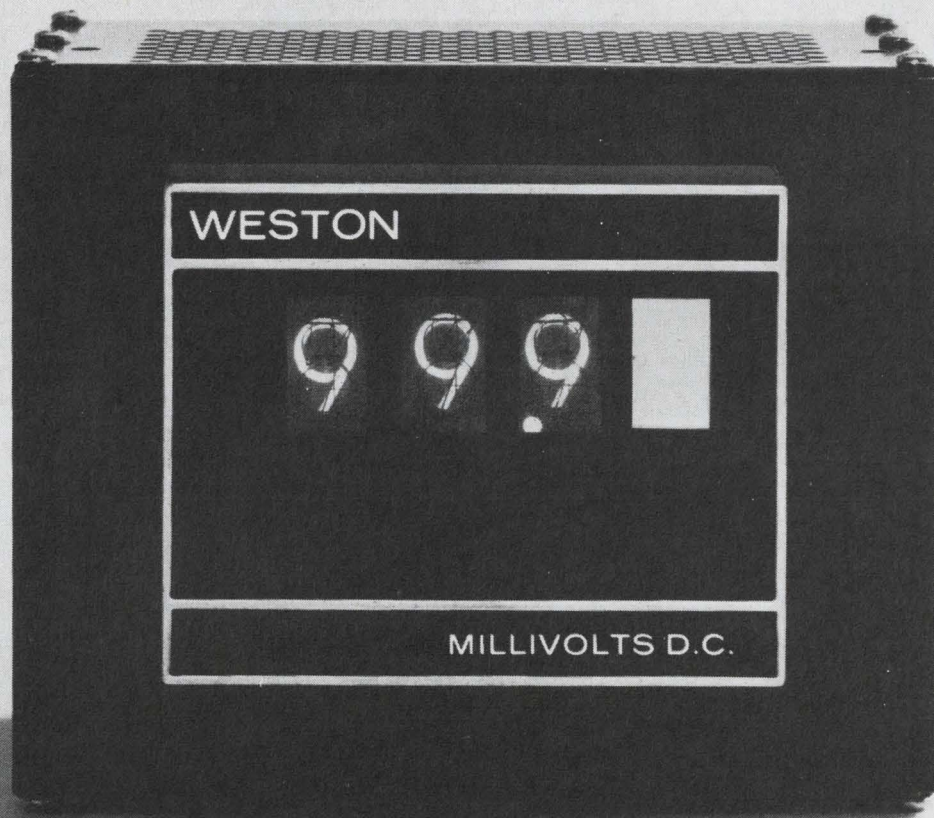

Now you know what our new model looks like.

We introduced the world's first all-electronic *Digital Panel Meter just last fall, and the first AC model in May. Your response has been overwhelming. Now we've taken the same size package—same size panel cut-out—and added a fourth digit. Our new Model 1280 is designed especially for those who

need a full four digit unit with .05% ± 1 digit accuracy, .01% resolution (10 microvolts). But no matter which dpm you wish to order, you'll be getting BCD output, print command, remote command, solid state reliability and digital accuracy in a panel-mount instrument tailored to your needs.

Standard ranges are available from 100 millivolts and up. Write today for information on our complete line of digital panel meters. WESTON INSTRUMENTS DIV., Weston Instruments, Inc., Newark, N.J. 07114. a Schlumberger company

WESTON[®]

Model LAT-100

The \$6,000* Resistor Trimming System

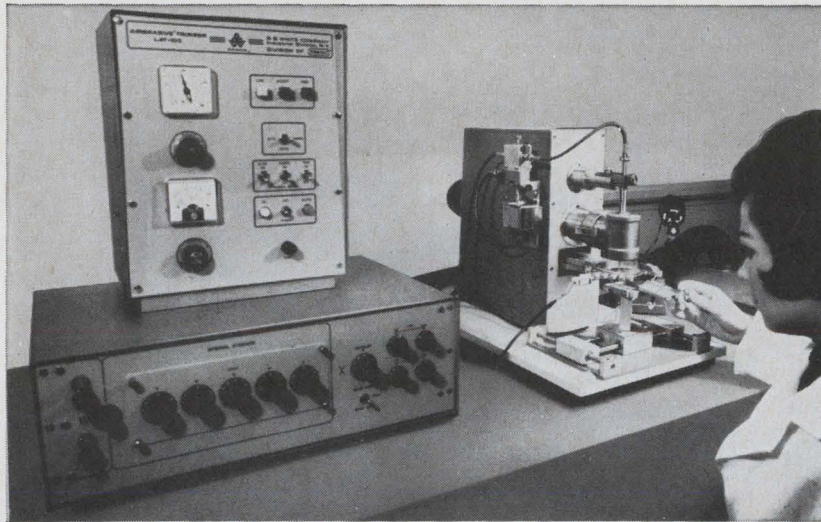

The number to call is 212-661-3320 for a demonstration like this—and you can bring your wife along if you like.

CALL us collect or write to arrange for a demonstration of S. S. White's new LAT-100, the complete, low-cost resistor trimming system for R & D and prototyping.

The LAT-100 automatically trims, monitors, and inspects PAF resistors to tolerances within 1%. That's guaranteed. In tests, 0.5% is often achieved. A precise 4-wire Kelvin bridge is integral to the system, which, with the optional plug-in decade box, permits the system to be programmed through five digits and three multipliers—from 0 to 10K and from 0 to 1M. Tolerances may be programmed from 0 to $\pm 11\%$. Panel controls permit operator to override the automatic cycle at will.

A holding fixture takes substrates up to 2x2 inches. A precise X-Y stage has 4"x4" movement. The trim slide has an automatic fast-return to place it exactly for the start of each trim. Tungsten carbide probes are mounted in a 14-position mounting ring. An efficient dust-removal system permits the LAT-100 to be operated in clean rooms. Installation requires a 110 VAC outlet and a level spot.

*Base price, \$5,950.00 each. With optional decade box, illuminator, foot-switch operation, \$6,350.00.

Without further detail, the LAT-100 does everything its bigger brothers the AT-701 and AT-704 do—a little less accurately, to be sure, and not nearly as fast—but what can you expect for a trifling \$6,000?

A step up from the LAT-100 is the AT-701, a no-nonsense production machine. The AT-701 can produce 600 trims per hour with guaranteed accuracy of 0.5% and attainable accuracy of 0.1% when



Model AT-701 garners accolades at IEEE show—top scientist says "Gee whiz."

things are going your way. The AT-701 with a decent amount of employment (say 1000 hours per year) produces trims at about $\frac{1}{2}\text{¢}$ each—including labor, materials, maintenance, and amortization. How about *that*?

But say you're big. Really big. We've got our big Bertha model for you, otherwise called the AT-704, which produces 4,000 trims per hour with accuracy and cost similar to those of the AT-701.

S. S. White resistor trimming systems are based on the proven Airbrasive® concept, controlled by precision electronics. The Airbrasive method of removing resistance material produces neither heat nor shock, does not alter substrate—yields of 100% can be attained with any of the S. S. White resistor trimming systems at some sacrifice of speed and tolerance. Each of the systems trims and monitors simultaneously and inspects after each trim.

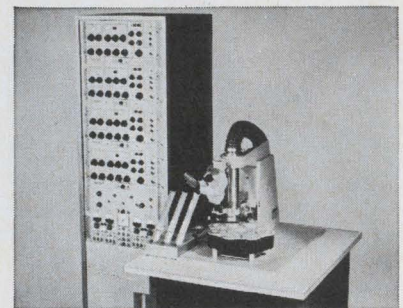

Big Bertha: Model AT 704 trims at 4,000/hour pace for high volume producers.

Up to now we've been able to offer fast delivery on all systems; however the enthusiasm we've encountered over the LAT-100 suggests that you'll be wise to place your order early for this model.

Call us or write to arrange for a demonstration of the LAT-100, the AT-701, or (if you're really big) the AT-704. Or ask for bulletin RT-14—it's great to read on planes.

Inquire, S.S. White Industrial, Dept. R, 201 East 42nd Street, New York, N.Y. 10017. Telephone 212-661-3320.

SEE US AT BOOTH 2412
WESCON SHOW



S. S. WHITE INDUSTRIAL

A DIVISION OF PENNSALT CHEMICALS CORPORATION

A second source you can count on.

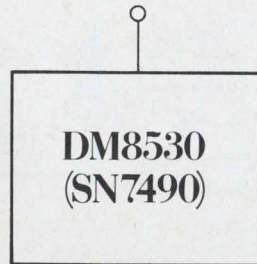

Decade Counter
20 MHz is guaranteed. 0°C to 70°C temp range. Price for 100-999 is \$7.55. Delivery is within 48 hours.

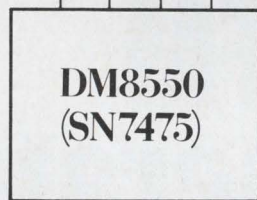

Quad Latch
Diode clamps on the input prevent "ringing." 0°C to 70°C temp range. Price for 100-999 is \$6.90. Delivery is within 48 hours.

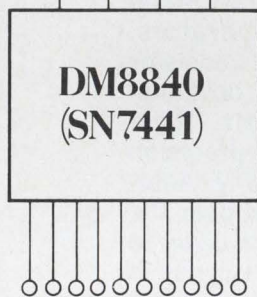

Nixie* Driver
Has overrange decoding capability. There's no oscillation on outputs. Drives STD logic or Nixie tubes and even decodes "excess 3." 0°C to 70°C temp range. Price for 100-999 is \$10.40. Delivery is within 48 hours.

* a trade mark of
The Burroughs Corporation

Our counting kit

Why wait and wait (and wait) when you can get faster delivery from us. Commercial versions are available in both hermetic packages and silicone molded plastic. We're also the new first source you can count on for full-temp versions of the above in hermetic packages. There's the DM 7530 priced at \$14.00 (100-999), the DM 7550 at \$15.30 and the DM 7840 at \$23.10. For data sheets quick, write 2975 San Ysidro Way, Santa Clara, Calif. 95051. Or call (408)245-4320. **National Semiconductor**

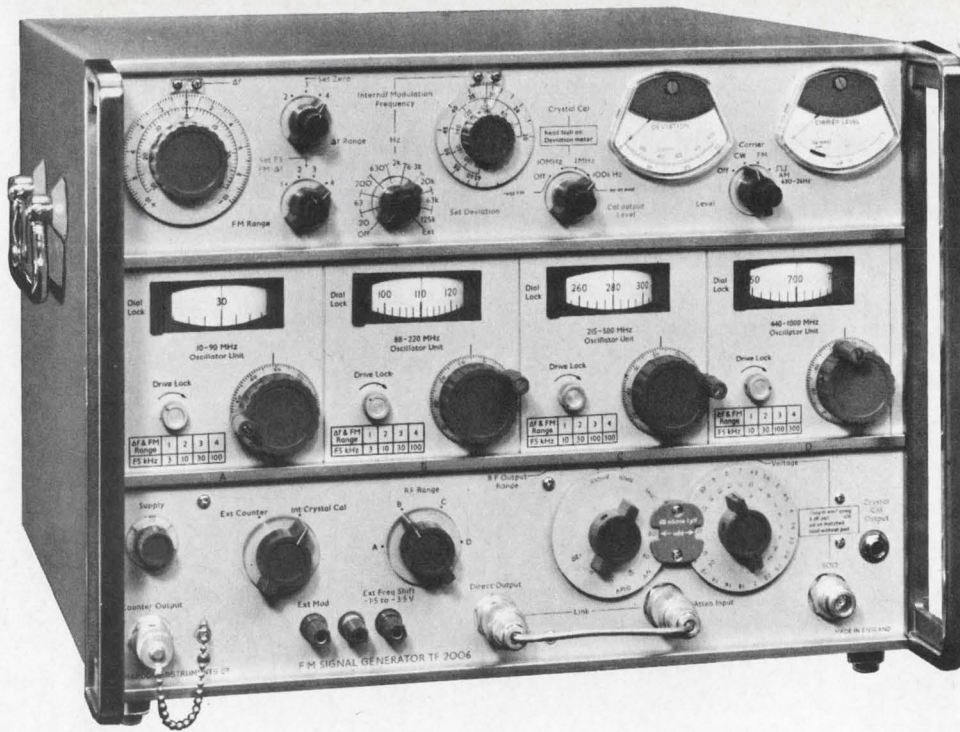

- **Wide Range:**
4-1000 MHz
- **Stability:**
Better than
15 PPM/15 minutes
- **Non-Microphonic**
- **No Range Change
Drift**
- **Fully Solid State**

the clean FM Signal Generator

F.M. Signal Generator TF 2006 is another "first" in the field of wide-range solid-state signal generators. Based on separate high Q resonant-line transistor oscillators, this instrument provides wide deviation f.m. on highly stable carriers up to 1 GHz. Rigid mechanical construction ensures that the precision oscillators have very low drift and microphony. Automatic levelling maintains constant r.f. output over the entire carrier frequency range, which extends down to 4 MHz, and accurate step attenuators offer a dynamic range of 120 db. Electrical fine tuning and f.m. may be simultaneously applied by the drive circuitry. As a result of their electrical relationship within the instrument f.m. as well as the fine tuning may be adjusted to a higher accuracy against the comprehensive crystal calibrator. This oven-controlled calibrator indicates carrier frequencies by meter nulls at 10, 1 or 0.1 MHz intervals and therefore provides almost 10,000 check points of the carrier frequency.

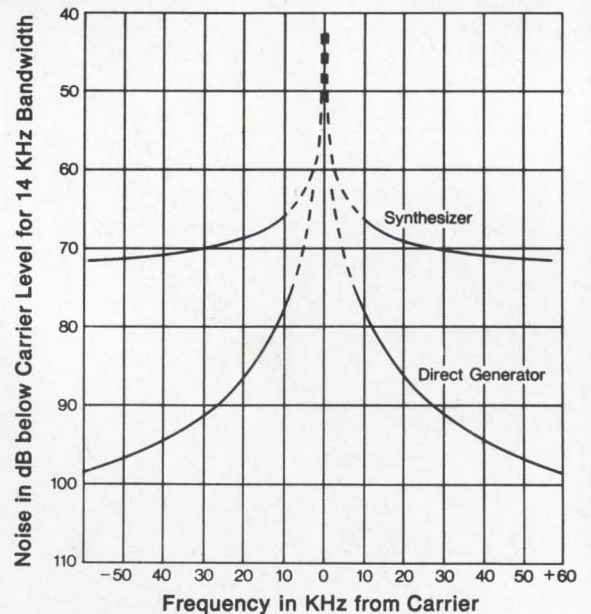

Comparison of Synthesized and Direct Frequency Signal Generator U.H.F. Spectra.

mi **MARCONI**
INSTRUMENTS
DIVISION OF ENGLISH ELECTRIC CORPORATION

111 CEDAR LANE □ ENGLEWOOD, NEW JERSEY 07631
TELEPHONE: (201) 567-0607

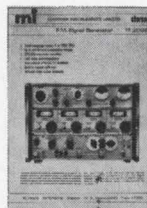

AVAILABLE UPON REQUEST...
Detailed specification brochure including operating principles, mechanical, electrical and environmental specifications.

SEE US AT WESCON BOOTH 1906-7 & 8

Our new LM 106 is the 710 and then some.

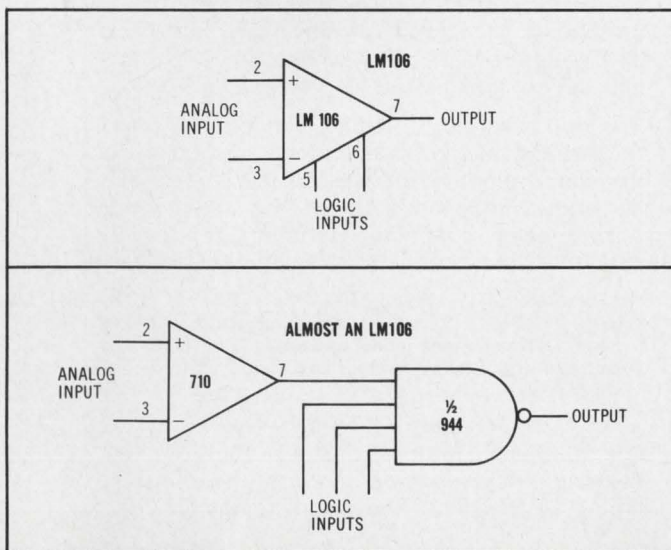

Our LM106 is a clever brute. It's a high-speed voltage comparator that is a direct plug-in replacement for the 710 in practically every application. What's more, on two pins the 710 doesn't even use, the LM106 accepts logic signals to strobe an output that drives up to 10 DTL or TTL loads. Or it switches up to 18V at 100mA to drive relays or lamps directly. The 25,000 gain makes gain error insignificant compared to the 2mV maximum offset. And it operates over a wide range of supply voltages even with symmetrical supplies. In quantities of 100 to 999, the military version LM-106 is \$18.00, the LM206 for instrumentation (-25 to +85°C) is \$11.50, and the LM306 for industrial uses (0 to +70°C) is \$6.80. Write us for other clever things about the LM106. National Semiconductor, 2975 San Ysidro Way, Santa Clara, California 95051. (408) 245-4320.

National Semiconductor

Tektronix

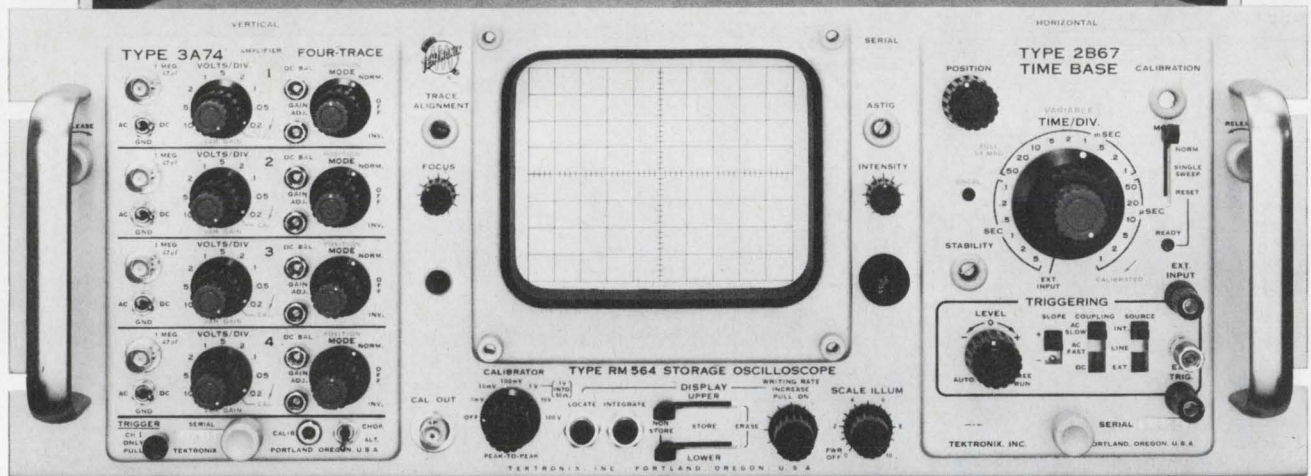
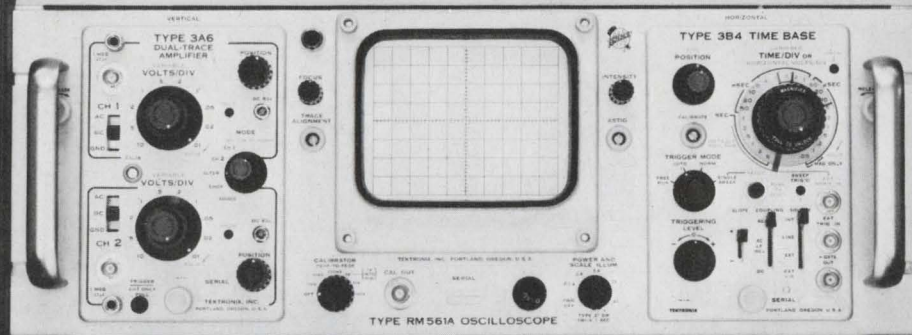

rackmount oscilloscopes

CONVENTIONAL

The Type RM561A 7-inch high rackmount oscilloscope provides conventional oscilloscope performance with measurement capabilities extending from DC through 7 GHz with appropriate plug-in units. It has an 8 by 10-cm CRT with a bright P31 phosphor and an illuminated, internal graticule.

The Type RM561A Oscilloscope has a complete selection of plug-ins including 10 MHz dual-trace plug-ins, 10 μ V/div differential plug-ins, 50-ps sampling plug-ins and spectrum analyzer plug-ins covering the spectrum from 50 Hz to 36 MHz.

Type RM561 A Oscilloscope	\$580
Type RM561A MOD 171A (with side-out tracks)	\$630
Type 3B4 Time Base (50 ns/div to 5 s/div)	\$425
Type 3A6 Dual Trace Amplifier (10 MHz, 35 ns, 10 mV/div)	\$525

SPLIT-SCREEN STORAGE

The Type RM564 split-screen storage oscilloscope uses the same plug-in units as the RM561A and offers the added advantage of split-screen storage. The contrast ratio and brightness of stored displays are constant and independent of viewing time, writing and sweep speeds and signal repetition rates.

The entire screen or either half can be used for storage and/or conventional displays. In the stored mode, either half of the screen can be erased independently of the other half. A rear panel connector permits remote erasure of either or both halves of the display.

Type RM564 Storage Oscilloscope	\$1025
Type RM564 MOD 171A (with slide-out tracks)	\$1075
Type 2B67 Time Base (1 μ s/div to 5 s/div)	\$ 225
Type 3A74 Four-Channel Amplifier (DC-to-2 MHz, 20 mV/div)	\$ 625

U.S. Sales Prices FOB Beaverton, Oregon

For a demonstration, contact your nearby Tektronix field engineer or write: Tektronix, Inc., P.O. Box 500, Beaverton, Oregon 97005.



Tektronix, Inc.

Probing the News

Avionics

Airbus makers go two ways on avionics

Lockheed, which holds an early lead in race for orders, will make supplier a codeveloper of system; Douglas will choose a vendor to work to its specs

By Lawrence Curran

Los Angeles bureau manager

Lockheed Aircraft Corp.'s early lead over the McDonnell Douglas Corp. in winning orders for its entry in the airbus sweepstakes is due in part, some company and airline officials are convinced, to a marked departure from conventional avionics procurement policies. The firm's Lockheed-California Co., which is building the L-1011, will make its eventual recently named supplier a codeveloper rather than a vendor furnishing systems to internally generated specifications.

So far, Lockheed's offbeat approach seems to be working out well; 176 L-1011's had been ordered by five major buyers as against 110 McDonnell Douglas DC-10's; the price tag on each plane is about \$15 million. The airbuses, with seating capacities ranging between 250 and 345, fit between today's Boeing 707 and McDonnell Douglas DC-8 transports and the still abuilding Boeing 747 jumbo jet, which will accommodate nearly 500 passengers. The Douglas Aircraft Division of McDonnell Douglas has DC-10 orders from American Airlines and United Air Lines. The L-1011 buyers are Trans World Airlines, Eastern Airlines, Great Britain's Air Holdings Ltd., Delta Air Lines, and Northeast Airlines.

The race is far from over, though. The next major order is expected to come from Northwest Airlines; Lockheed officials in Burbank, Calif., as well as their Douglas counterparts to the south in Long

Beach, Calif., have been biting their nails for weeks awaiting Northwest's decision, which could come any day now.

Customers' views

John Gorham, assistant division engineer for flight guidance and controls at Lockheed, who acts as division engineer on the L-1011 maintains that his company has been more innovative than Douglas in avionics design. Some airlines officials agree, but others discount the impact of avionics philosophy

on their firm's purchase decision. One who agrees with Gorham is Norman Parmet, vice president for equipment development at TWA: "Lockheed has been willing to go further with us, especially in working toward a Category 3 weather capability for the aircraft." But business considerations, not technical factors, swung United to the DC-10, according to Robert C. Collins, the company's manager of aircraft engineering. "It has been 30 years since United owned a Lockheed airplane. All our maintenance



In depth. Flight simulator is used by Lockheed pilots to check out full-scale flight-station mockups of avionics systems proposed for L-1011 airbus. Terrain image is furnished by a closed-circuit television.

. . . Lockheed hasn't had a new airliner since the turboprop Electra . . .

personnel are oriented to Douglas, and we have a very satisfactory working relationship with that company. There would have had to be a very, very big advantage for us to switch at this point."

On the other hand, Raiford Johnson, Delta's aircraft systems engineering supervisor, says Lockheed's avionics philosophy carried a lot of weight in his company's decision to buy the L-1011. "With an aircraft of this kind it is very important to have a fail-operative automatic landing system," he says. In other words, redundancy is built into the system so that if a failure occurs, the landing won't have to be aborted since a backup is available. "Lockheed offered this capability as part of the package," says Johnson, "but Douglas offered it only as an option."

Me too. Douglas has since announced that an automatic landing system will be part of its avionics package; as a result, both aircraft will be equipped with fail-operative systems. Both planes will be certificated for automatic landings in Category 2 weather conditions, which exist when the pilot must decide whether to land or not at an altitude of only 100 feet and when runway visual range is 1,200 feet. But both planes will be designed to accommodate electronics hardware that will permit automatic landings under Category 3B conditions—as they are presently understood. The

Federal Aviation Administration has not spelled out what these conditions are, but the industry is generally agreed that Category 3B is in effect when a flight crew can't see the runway until touchdown and has only 150 feet of runway visual range.

TWA's Parmet says that while both Lockheed and Douglas can make good aircraft, "John Gorham maintained a dialogue with the airlines and kept an open mind on what they wanted. He's probably more knowledgeable than anyone else about automatic landing, and we're happy to have him leading the program."

Sidestepping the past

Gorham believes Lockheed's design approach to the L-1011's avionics represents a significant departure from past practice in commercial aircraft manufacture. Lockheed hasn't had a new airliner since its ill-starred four-engine turboprop Electra went into production during the late 1950's. Gorham regards this hiatus as an advantage in that the firm is unencumbered by what he views as a tendency to evolve avionics hardware by merely adding to the capabilities of the most recent aircraft a company has built. "We decided we wouldn't simply add extra features to available avionics systems because we don't think such an approach is likely to produce performance su-

perior to what was possible with the older systems, he says. "We don't think avionics systems have worked out well in the past, possibly because the airframe manufacturer designed them and sent the avionics people away to make them without much interface knowledge; and interfacing is one of the biggest problems we have." With an eye to getting around this difficulty, Lockheed chose to have one subcontractor serve as codeveloper of what the company calls the avionics flight-control system, and will conduct a five-phase testing program to minimize avionics interfacing problems.

Keep it flying. "The main objective of the test program is to cut down on equipment removal from the aircraft," Gorham says. Removals have been annoyingly frequent in the past he notes, and in something like two-thirds of such cases, there are no equipment faults even though they have been indicated—a situation incompatible with the fail-operative concept. Such indications could be the result of interface problems, electrical transients in the aircraft, or insufficient testing of the system under operational conditions.

"We'll have the pilot in on all phases of the progressive testing program, and we'll also interface all systems regularly with all other systems," says Gorham. "By keeping the avionics design unfrozen as long as we can, we may lick this problem of failure indications when no fault exists."

Team play

By opting for a codeveloper on the avionics flight-control system design and assistance on integration of subsystems, Lockheed has exposed itself to criticism from certain quarters. Some sources suggest that Lockheed went this route because it lacks the manpower to do the job on its own. Douglas, on the other hand, will have what William P. Yopp, its chief of electrical engineering, calls an integrated flight-guidance system—an autopilot and flight-director computer—in the DC-10. Five firms have been sent invitations to bid on this package; the winner will work to Douglas specifications.

Included in the dual DC-10 autopilot are gyroscopes, vhf omnirange

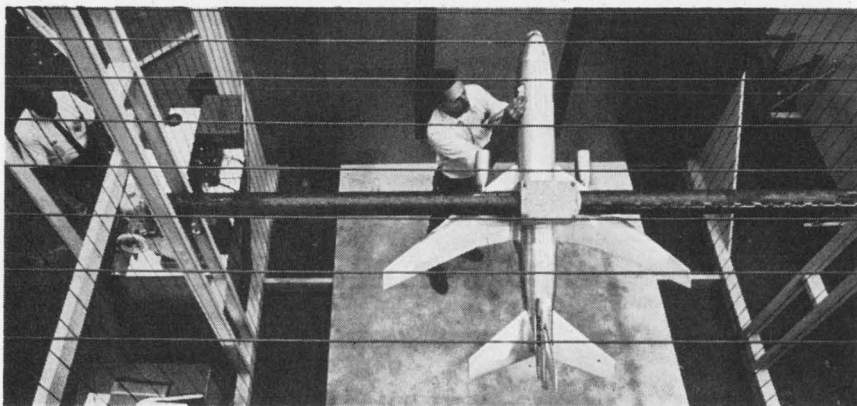

Caged. Technicians use scale model of McDonnell Douglas DC-10 to test proposed communications and navigation antenna systems. The wires are charged to generate a controlled electromagnetic field.

localizer and glide slope receivers, air-data computers to drive altitude and airspeed indicators, accelerometers, a compass to provide heading information, and manual controls so the pilot can select and enter the altitude and heading signals to which he wants the autopilot to steer. The flight director incorporates an integrated attitude indicator and horizontal situation indicator.

A single computer will feed signals to both the autopilot and the flight director indicators. This represents a departure from the DC-8 and DC-9, in which the autopilot and flight director system had separate machines. Douglas chose one computer to provide signals for both systems in the DC-10, says Yopp, to assure compatibility and closer tolerances between the signals given to the autopilot and flight director indicators.

Experienced. Douglas, through simulator work, will exercise technical and systems control over the flight guidance system supplied by the vendor that is chosen. The company will integrate the system's inputs with those from other radio and radar systems. "We feel the continuity of our work in commercial aviation forms a firm foundation for our capability to do this work," says Yopp, referring to the systems integration task.

Clarence Richman, manager of avionics development at American Airlines, a DC-10 buyer says: "It's obvious that Lockheed isn't staffed on a par with Douglas. Douglas has more programs and more people to draw on to do the avionics integration job. You can't enlarge your staff overnight." However, Richman adds that he's not sure whether any one approach—treating the vendor simply as a supplier or treating him as a codeveloper—is inherently superior. Richman would like to see the avionics vendor play a larger role in equipment design, "because he's in a better position to know how to make the hardware than the people who know only airframes."

Partnership. Gorham says this is precisely why Lockheed chose to have the team of Collins Radio, Cedar Rapids, Iowa, and the Astronics division of Lear-Siegler Inc., Santa Monica, Calif., that will supply the flight-control system serve as a co-

developer. Beaten out for the job were: the Navigation and Controls division of the Bendix Corp., Teterboro, N.J.; Elliot Flight Automation, Rochester, England; and Sperry's Flight Systems division, Phoenix Ariz. "Our selected subcontractor will be more a partner," explains Gorham, "and will share a lot of the responsibility if the system doesn't work. It's not a question of having the capability in-house. This is a pretty big part of the aircraft and it would be foolish for us to take it all upon ourselves if we can have the benefit of an avionics specialist."

Big deal

Delta's Johnson maintains that the avionics flight-control system was one of the most important factors in his company's decision to buy the L-1011. He says: "We endorse Lockheed's approach in selecting a single vendor to produce the whole avionics package as a system. We're at the point now with planes of this size and complexity—in which so many systems complement each other—that you just have to put the whole package in the hands of a single manufacturer."

The L-1011 flight-control system is more extensively integrated than the DC-10's flight-guidance package. Besides the fail-operative autopilot and flight-director system, it will include: the aircraft's stability augmentation system (yaw damper) with associated stability augmentation sensors, computers, and rudder servos; the speed-control system, with speed-control computers, throttle servos, and throttle clutch pack; and the primary flight-system electronics, consisting of a stall-warning system, mach-trim system, pilot-trim system, and logic circuitry. In the DC-10, only the fail-operative autopilot and flight-directing equipment are a complete system.

Lockheed's five-step preflight testing will require more than two years; the initial flight test of the L-1011 is scheduled for November 1970. By the time the fourth of five test aircraft is flown-in the autopilot and flight-director system will be optimized for everything but automatic touchdowns; a fifth test craft will concentrate exclusively on automatic landings. Gorham says



we are looking for

For the French and European markets - equipment, sub-assemblies and components for the electronic, electro-mechanical and nuclear fields - the materials to produce them - measuring equipment for laboratories - or the licenses for the above equipment. For example :
 Simulators with medical, scientific or aeronautical applications,
 Data transmission microtelemetry,
 Data processing auxiliary equipment,
 Pressure-change detectors, etc.

we are

a subsidiary of a major international company with subsidiaries in Europe and broad experience in up-to-date marketing, sales and after-sales methods. We are a **young, ambitious and dynamic** team.

you are

a manufacturer already well established in the U.S. market, seeking to promote export sales, or already engaged in export sales but dissatisfied with your sales record in Europe.

in any case you are a manufacturer of **technically up-to-date equipment**, with a successful sales record on the domestic market.

please write to

EUROPAVIA - France
 2 avenue de Messine 75 - Paris 8°
 with details of your company.
 A representative will visit the U.S.
 late 1968 for discussions.



... there is airline and Arinc support for an economical inertial navigator ...

Lockheed should have six to seven months of automatic landings—some 300 flight hours—before the L-1011 gets FAA certification.

Who needs it?

Collins says United is not interested in having a pure inertial navigation system in the DC-10. Both Lockheed and Douglas have asked industry for proposals on an inertial-quality reference system, rather than a pure computer-based inertial navigation system. Present systems meet Aeronautical Radio Inc. (Arinc) characteristic 561 which specifies a navigation error no greater than one nautical mile per hour of flight. But since airbuses are designed primarily for domestic operations with little need to fly over water for long distances—an inertial system meeting Arinc characteristic 561 isn't considered necessary.

Besides, such systems carry price tags of about \$100,000. This cost becomes prohibitive for the airbuses because their navigation data can be updated periodically during flight from enroute VOR and distance-measuring equipment (DME) stations. Such updating is impossible on long over-water flights.

No bluff. Lockheed has asked about 12 firms to bid on an inertial platform that would yield an accuracy of around four nautical miles per hour of flight. Gorham says this is part of a combined corporate and industry effort to cut inertial platform prices to about \$30,000; he expects about half the firms solicited not to bid. "Some of them won't bid because they think we're bluffing," Gorham explains. "They think if we can't stir up enough interest, we'll have to buy the more expensive platforms these firms would rather sell. Our airline customers have asked us to evaluate these proposals, and if they like a proposed system, they may buy it for the L-1011." Gorham anticipates "stretched" versions of the L-1011, which could lead to longer-range, overwater flights. If and when such a plane is made, he says, the inertial platform could be cou-

pled with a loran system to furnish a more sophisticated navigator.

The DC-10 design, like the L-1011, provides instrument panels and rack space for an inertial system. American Airlines has also asked for industry proposals on a "poor man's" system—essentially an inertial reference gyro to provide attitude and heading information. Richman thinks industry is ready to provide such a system, which he says, would have to cost no more than \$30,000 to be economic. He notes that there is Arinc and airline support for the system, although American appears to be spearheading the initial effort.

Self-diagnosis

The DC-10, says Yopp, will be delivered with "certain AIDS provisions, including wiring per Arinc standards." The L-1011 will also include AIDS wiring, and Gorham says the avionics flight-control package will have "latching" fault annunciation. If a fault occurs then disappears, a memory will log the fault and call it out, if required, down to the line replaceable unit level.

Lockheed engineers are studying optimum locations for collision avoidance system antennas atop and on the underside of the fuselage. Rack space and wiring will be provided for associated internal electronics. Yopp says the DC-10 will have a similar collision avoidance system antenna arrangement. "We have some feelings for the size of the antennas and the electronics box, but not enough information yet on how much wiring will be needed," he says.

Douglas has asked for bids on a multiplexed passenger services/entertainment system, including reading lights, stewardess call button, individual stereo music channel and motion picture sound channel selector. More than 20 firms received RFP's, specifying a solid-state system. Although Lockheed hasn't yet asked for bids, the L-1011 will also go the multiplexing route—a move Gorham says will eliminate more than 1,000 pounds of

extra internal wiring.

Douglas is designing a performance monitor to check on the all-weather automatic landing system in the hope of minimizing the number of "nuisance" disconnects. The monitor would enable the pilot to judge whether or not the automatic landing system is going to perform properly even though he has a cockpit indication of a failure somewhere in the system. The hardware being developed for the monitor is proprietary. Neither the DC-8 nor DC-9 production models has an automatic landing system, but Douglas leads Lockheed in this department because it has accumulated considerable Category 3 automatic landing experience in a DC-9 specially equipped with a dual automatic landing system.

Lockheed engineers are studying a Ku-band radar as a possible independent monitor for the L-1011 all-weather automatic landing system. The radar would function without any ground aids and enable the pilot to monitor the aircraft's position in relation to the runway from about 500 feet down to touchdown. The Ku-band looks promising because it would allow better penetration of fog and rain than an X-brand system, says Gorham, while generating a sharper beam with a smaller antenna and requiring less power than an X-brand radar. Gorham anticipates soliciting industry proposals later this year on such a monitoring system after Lockheed's internal evaluation is completed.

Talk with a satellite. Douglas is developing a low-profile antenna in-house for satellite communications. Yopp says a full-scale prototype of this electronically phased array may be ready by the end of the year. The primary aim of this effort is to come up with an aircraft antenna that reduces multipath problems and still deliver good gain, and Yopp says the program is making progress. Lockheed, too, will continue developing a satellite communications antenna in a program begun when the firm was competing for the supersonic transport award. Gorham says no L-1011 buyer has asked for a satellite communications antenna. Nevertheless, both the L-1011 and DC-10 will provide space in the airframes for such a unit.

Series 600-121 for 1/16" Printed Circuit Board—

The most complete line
of printed circuit connectors with
**.100" CENTER-TO-CENTER
CONTACT SPACING**

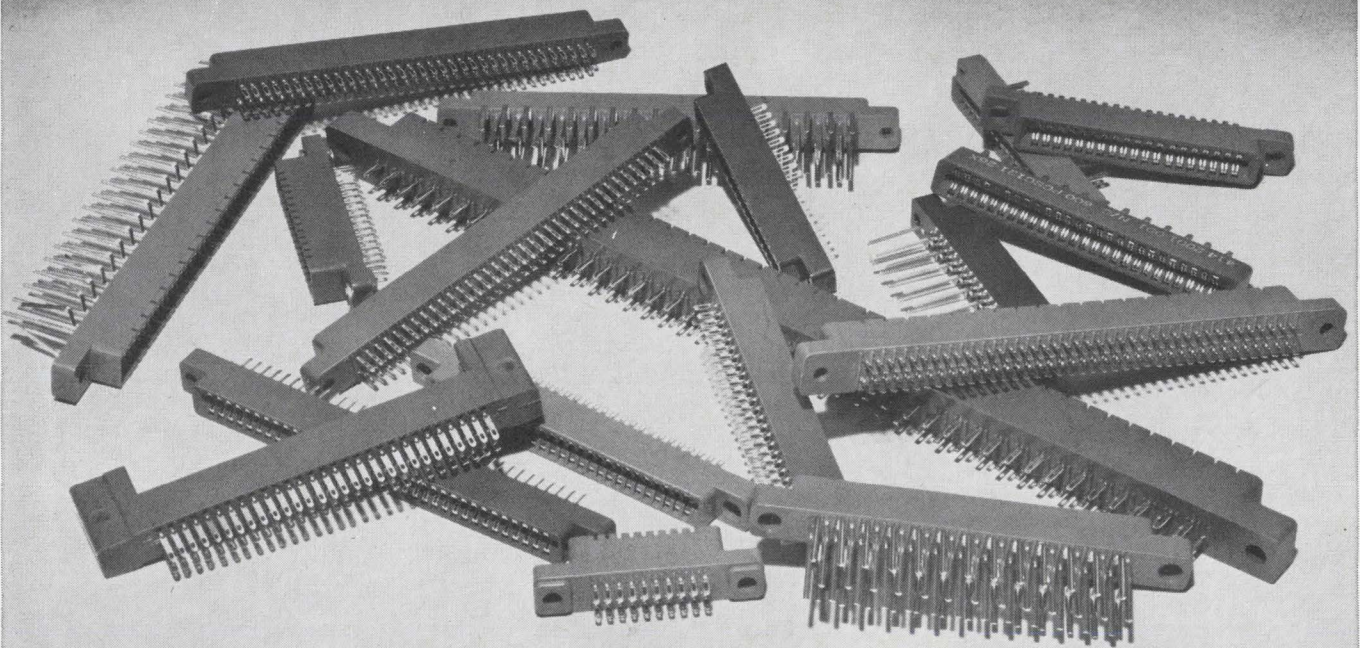

Available with 10, 15, 17, 18, 19, 26, 29, 35, 40 and 86 patented "Bellowform" contacts.

Write for complete specifications or phone sales department at (212) 899-4422 for fast action.

VISIT OUR BOOTHS 618-619 AT WESCON SHOW, HOLLYWOOD PARK

Connect... with a Continental Connector

CONTINENTAL CONNECTORS

CONTINENTAL CONNECTOR CORPORATION ■ WOODSIDE, NEW YORK 11377

For the Sales Representative Nearest You, See Our Listings in EEM and VSMF Directories

CAI edges slowly into the classroom

Computerized teaching fails to fulfill rosy predictions as school administrators find price tag prohibitive

By Howard Wolff

New York bureau manager

Take your choice and call it computer-assisted instruction, computer-based instruction, or computer-managed instruction. Or pick one of these descriptions:

- The first stirrings of a pedagogical revolution—or an idea whose time hasn't come.

- The answer to the nation's classroom and teacher shortage—or a threat to the very foundation of the American way of education.

- The panacea for virtually everything that ails public education—or too expensive, too complex, and too limited.

The one inarguable fact about computer-assisted instruction is that there is some validity in all those characterizations. As to where CAI stands right now, perhaps the best estimate comes from Samuel Feingold of the System Development Corp. A computer systems specialist for the Santa Monica, Calif., firm, Feingold believes that while CAI might be the wave of the future, it's still three to five years away from the big splash predicted for it several years ago.

In other words, CAI hasn't exactly taken the country's educators by storm. Possibly scarred by the "teaching machine" fiasco of the 1950's—when poorly programmed machines were rushed to market only to run headlong into teachers not quite ready to junk the venerable group-education concept—educators have been slow to succumb to the seductive hum of the computer. And local boards of education, with tax-groggy citizens assailing them from one side as equally demanding administrators and faculty bombard from the other, have been more than happy to ignore what to most of them is a mystifyingly technical and far too expensive experi-

ment. Says one New Jersey man, a member of the school board in a community of 50,000 people: "We have enough trouble coming up with the money to keep our buildings from falling down. So when some hot-shot tries to sell us on computers as instructional tools, with a cost of programing for just two classes coming to around \$500,000, we never even bother to ask what the equipment costs."

Cost, then, is the barrier between CAI and hundreds of thousands of pupils; it's the reason that there are only 20 to 30 systems now operating despite the expectations of the Federal government and some companies. And the costliest item is software.

Mixed fractions. The reason is that a computer in a tutorial mode must be branched to handle different programs simultaneously as each student proceeds at his own

pace—time sharing in its purest sense. To develop the heterogeneous software necessary for that kind of operation is difficult and time consuming. The alternative, to standardize programs for a number of school systems, would be an educational heresy tantamount to having a superintendent of schools permit a neighboring system's superintendent hire his teachers.

Still another cost factor are terminals. Each cathode-ray-tube display can cost upwards of \$20,000, and until less expensive ones are developed, they're simply out of the question except for the largest school systems—and then only with massive Federal aid.

But in the city where they wrote the Declaration of Independence—Philadelphia—the attitude is somewhat different. Though mindful that money is an ever-present constraint, a bouncy school official named Syl-



Aides. Curriculum for Philadelphia's CAI system was jointly developed by teachers and programmers at the Philco-Ford Corp.

Who Needs Hertz*...?

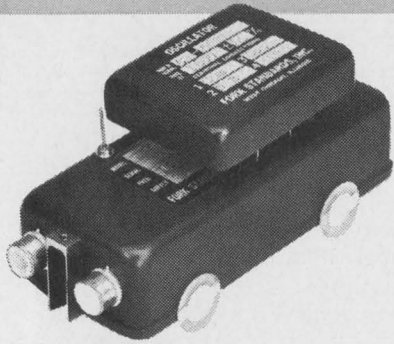

*.1 to 10 Mega-

Let
FORK
STANDARDS
*put you in the
driver's seat!*

Whether you need millihertz, megahertz or in between, Fork Standards builds oscillators to *your* requirements . . . with fast delivery . . . prototype or production quantities.

Precision Oscillators:

- Tuning fork, crystal, or LC controlled
- .1 Hz to 10 MHz
- Sine or square wave
- Standard or custom
- Commercial or MIL Spec
- I C compatible
- Chassis or PC board mounting



FORK
STANDARDS, INC.

211 Main St., West Chicago, Ill. 60185
Telephone Area Code 312-231-3511

via Charp (her title is director of instructional systems), backed by the district's top administrators, is convinced that CAI is a tremendously powerful educational tool. Using \$1.3 million from the U.S. Office of Education, Philadelphia has established a CAI capability at four poverty-pocket schools with a total enrollment of 600 pupils.

All four are tied to a Philco-Ford 211 computer at nearby Willow Grove, Pa. Each school has a Philco-Ford 102 processor and eight keyboard-equipped display terminals; the total can be boosted to 32 without additional processor or computer hardware.

Learning by route. The student answers questions on the keyboard and with a lightpen. His response is passed on to the computer by the processor, which simultaneously gives him further instructions and prepares an analysis of the individual student and the class. That analysis—wrong-right percentages, comparison with other members

of the class, attendance records, scheduling—is printed-out back at the school for use by the instructor.

Going beyond the glowing reports, estimates, and predictions of the school officials' carefully scrubbed statements, though, one finds a certain amount of skepticism on the part of individual instructors.

At the official baptism last spring of the setup at Germantown High School, one biology teacher offered this private estimate of CAI: "It's a very handy thing to have, from the students' viewpoint, because it turns the learning process into a kind of contest between the individual and the machine. Also, that television screen is an old and familiar friend to a generation of kids which cut its teeth on the tube. Equally important is the honor of being selected to participate in the CAI program and the opportunity to get out from under a teacher's thumb for a few hours each day.

"But what happens when a great

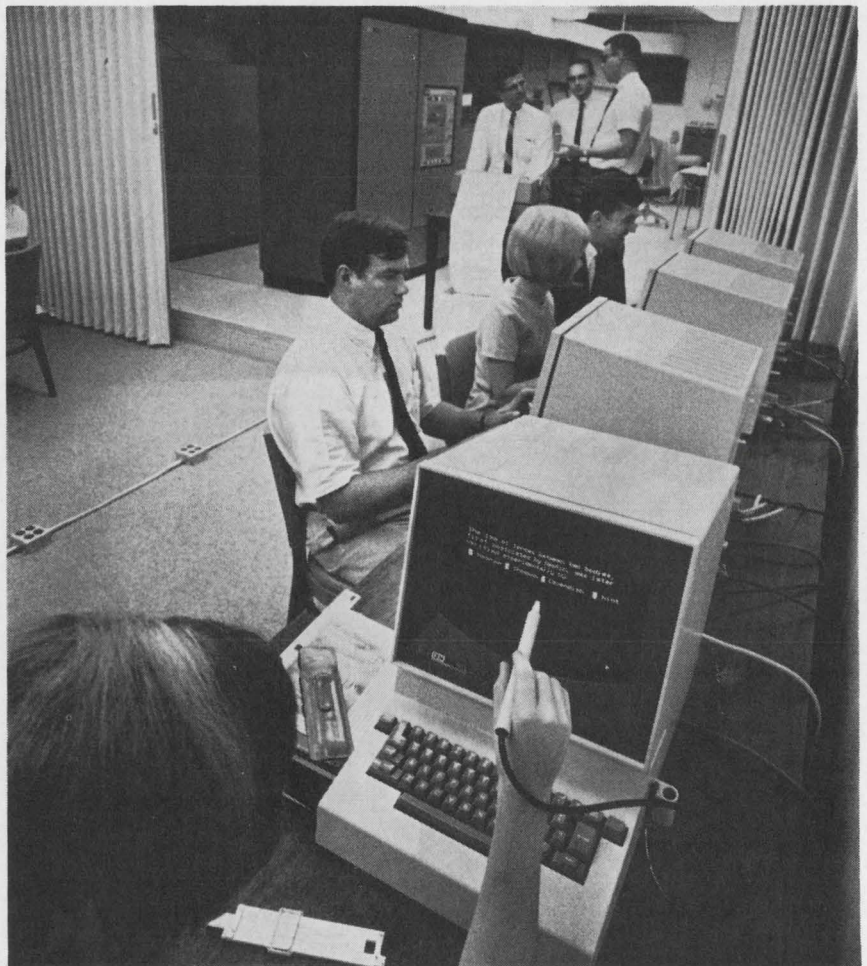

Light touch. CAI system teaches science course at Florida State University; students use sophisticated cathode-ray-tube input/output display consoles.

number of pupils become involved? Goodbye contest, novelty, and honor. What we're left with is a very expensive teaching aid—and no one considers CAI anything but an aid—that isn't 100% reliable, lacks the vital audio interface between student and instructor, and really is frightfully expensive. Each display-keyboard unit costs \$2,000 or \$3,000, a drop in the bucket to Philco or RCA or IBM, but to a schoolteacher making \$8,000, that's a lot of money."

East side, west side

Meanwhile, 90 miles to the north-east, the New York City Board of Education is inching ahead with its program. The system is built around an RCA Spectra 70/45 computer installed on 42nd Street, two blocks from the East River and in the shadow of the United Nations. Not only does the system have a different name than Philadelphia's system, computer-based instruction, and broader scope—15 schools and 6,000 children—but the classroom terminals are also Teletype machines which are slower and less sophisticated than crt displays.

The reason, of course, is money. Teletypes cost less than crt's, and New York is making its \$2.5 million Office of Education grant go as far as possible. The software approach also is different. Philadelphia's programing is controlled by teachers; New York's is farmed out to textbook publishers working with RCA's educational consultants—Patrick Suppes and Richard Atkinson of Stanford University's pioneering Institute for Mathematical Studies in the Social Sciences and Duncan Hansen of Florida State University.

No waiting. Both Philadelphia and New York officials include school housekeeping tasks—payroll, financial and property accounting, textbook ordering, inventory control, census, attendance and grade reporting, and test scoring and analysis—among the duties to be performed by their computers during nonteaching hours.

In contrast to the tantalizingly slow incursion of CAI into the primary and secondary school preserve, great progress has been made at the college level where computers have become relatively common tools. At engineering schools,

for example, they are used for problem solving; they also help teach languages, compile bibliographies, or assist in research projects at numerous seats of higher learning. Among them are Stanford, the State University of New York at Stony Brook, Penn State, the U.S. Naval and Military Academies, the University of Texas, the University of Oklahoma medical school, and the University of California at Irvine.

Down the road

At least one computer maker, the International Business Machines Corp., has always been less sanguine about CAI than the rest of the companies and people active in the area. Shunning extravagant claims, IBM refuses to place a time frame around the process. Says a spokesman: "We have a definite commitment, and R&D is proceeding, but we firmly believe that CAI is only one way that the computer can be used in education." On the primary and secondary levels, IBM divides use into five major areas, only one of which is instructional. The others:

- Administrative tasks
- Education and training in the computer as a subject, both vocationally and as an appreciation of the machine's potential
- Instructional planning
- Information retrieval

IBM believes that too much public attention has been called to the computer's use as the keystone of some miraculous future CAI system; not enough to the more mundane tasks that the machines can perform right now.

View from the capital. At least part of IBM's attitude is echoed by Louis Bright, associate commissioner for research at the Office of Education.

Bright says that the emphasis of his office is shifting from CAI to CMI (computer-managed instruction), which is testing and evaluation rather than teaching. More Federal research money is going to CMI than CAI right now, and he predicts that soon his office will be spending very little of its \$5 million a year research budget in CAI.

"The fact of the matter is most people cannot afford CAI. A student can be accommodated in a CMI system for a tiny fraction of the cost of a CAI system," he says. The Office

TOO BAD

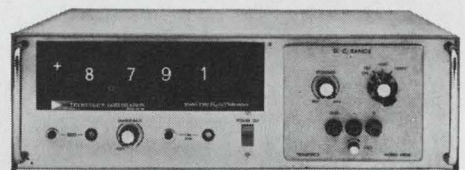

Right now, as you are reading this, someone somewhere is ordering a 3-digit, .05% DVM without stored display for the price of this new Trymetrics .01% 4-digit model. Ouch!

This new Model 4100 is offered with a series of plug-in function heads which provide measurement from 99.99mv to 999.9 volts in 1,3,4 or 5 manual or automatic ranges. \$695 for the basic unit, \$740 with a $\pm 9.999v$ range plug-in.

All units feature automatic polarity and over-scale indication. All have exceptional 0.01% accuracy; all offer a storage register for absolute display stability. With printed output option, DVM 4100 extends its performance to an entirely new series of applications.

If there is no need for stored display, Model 4000 offers the identical features of the Model 4100 but costs only \$595 for the basic unit, \$640 with 103 $\pm 9.999v$ range plug-in head.

We'd like to tell you more; there's much more to tell. It's all in a new catalog. Tell us your name and address and ask to see this .01% 4-digit DVM today.

TRYMETRICS
Corporation
A SUBSIDIARY OF TRYGON ELECTRONICS, INC.
204 Babylon Tpke., Roosevelt, L.I., N.Y.
Phone 516-378-2800 11575

CONTACT!

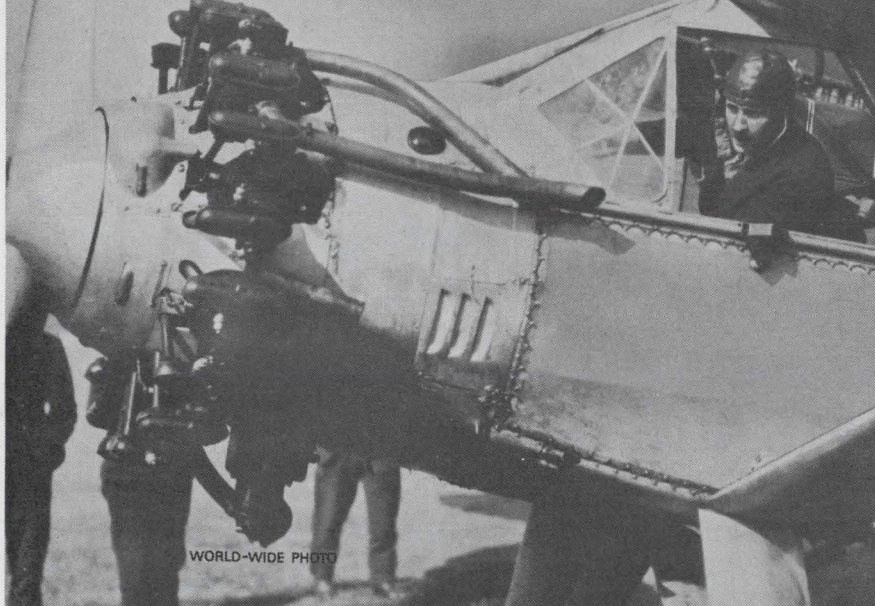

We hope that he's calling* for one of our new ADM series of high frequency coaxial contacts  ... or at least, one of our standard contacts for use in the popular high density D*M or "D-Subminiature"† family of multipin plastic inserts and shells.

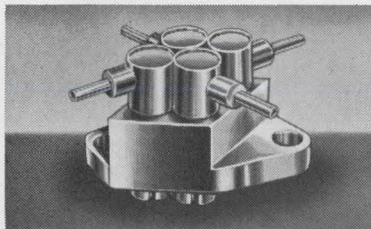

For coaxial applications, the above is a typical example of the metal blocks that can be supplied for simplified "high reliability" custom designs.

*If he calls loud enough, one of our representatives listed below will come to his rescue. If not, he can call the factory for literature and further details.

†D*M, TM ITT CANNON ELECTRIC.
"D-Subminiature" made by CINCH MANUFACTURING CO.
under license agreement with ITT CANNON.

These contacts are designed for miniature multipin applications that can include D.C., low frequency, video, and high frequency, as well as high voltage and high power connection capabilities all in one unit.



automatic
METAL PRODUCTS CORPORATION

315 BERRY STREET, BROOKLYN, N.Y. 11211
TELEPHONE: (212) 388-6057

REPRESENTATIVES: EASTERN. PAUL D. AARON, Phone: (516) 767-8480 • B. and W. ASSOCIATES, Phone: (617) 275-9177
BOWSER and SAPECKY, Phone: (716) 839-4170 (315) 446-5920 • JACK ONORE, Phone: (201) EL 5-0474 • THOMAS ASSOCIATES, Phone: (609) UL 4-3011 • SOUTHERN, KIRKWOOD ASSOCIATES, Phone: (813) 391-8452 • MURPHY and COTA, Phone: (919) 724-0750
WESTERN, ARROWHEAD SALES CORP., Phone: (801) 298-2751 • JAS. J. BACKER CO., Phone: (206) 283-6470 • BELL ELECTRONIC CORP., Phone: (415) 323-9431 • MERCURY ENGINEERING SALES, Phone: (602) 945-1927 • WINTERS and COMPANY, Phone: (213) 879-9045
MIDWESTERN, FRANK J. CAMPISANO, Phone: (513) MO 2-1616 • P. DAVID HALE, Phone: (214) WH 6-7676 • INLAND ASSOCIATES, Phone: (913) EN 2-2366 • R. C. NORDSTROM and Co., Phone: (313) 444-4417 • PGM COMPONENT SALES, Phone: (312) 622-8183 • S.A.R.G.E. INC., Phone: (312) 237-9525 • EXPORT, BEN MANIS ASSOCIATES, 6600 St. Urban Street, Montreal, 10, Que. Phone: (514) 731-7748

of Education is involved with two CMI systems; one is being developed at the Southwest Regional Laboratory in Los Angeles, the other at the N.Y. Institute of Technology on Long Island.

At N.Y.I.T., physics students simply study their lesson, and come in to take tests by marking squares. The computer tells them how they did, grades them, points out deficiencies, and either allows them to go ahead with the next lesson or tells them to repeat the old one. In addition, the computer will also be used to update the subject matter—for example a new discovery in physics can be introduced to the student. Bright says that the system allows the student to get a lot of information at his own pace and takes up very little computer time per student.

Bright feels that CAI and CMI

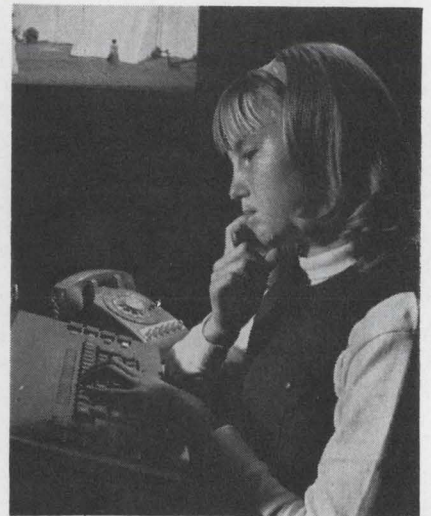

Make believe. Sixth-grader "runs" an ancient kingdom through IBM terminal as part of an educational experiment conducted in Westchester County, N.Y.

will move along for two or three years at a constant rate, and then "the curve will begin to swing up as CMI begins to gain wide acceptance."

People problems. Besides cost, a basic problem clouding the future of computerized instruction is the attitude of teachers. Jealous of their perquisites, they are unwilling to cede their functions to a machine they don't quite understand or trust. Furthermore, some are openly contemptuous of what they consider the electronics engineer's ignorance of the nuances of the art

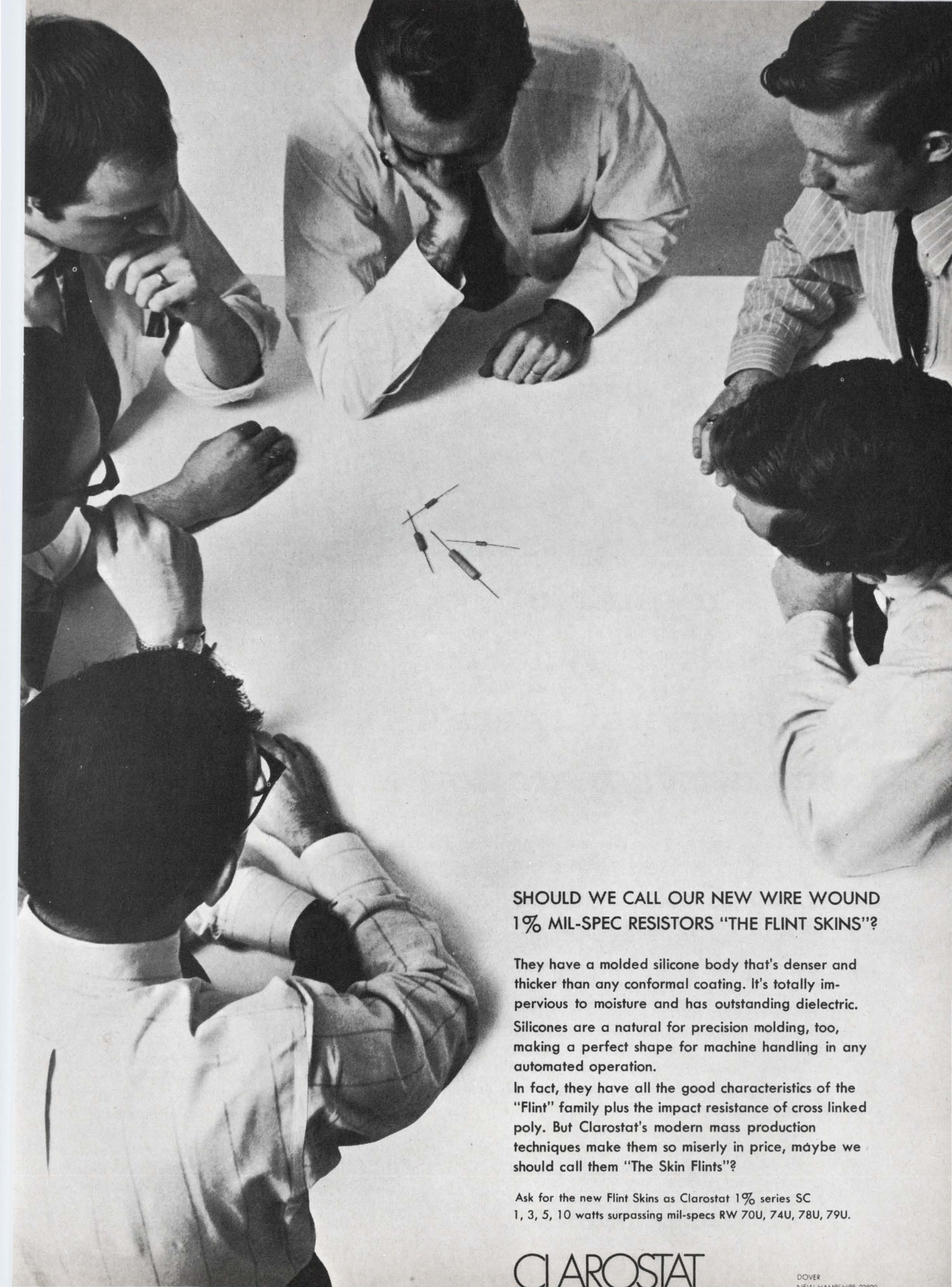

SHOULD WE CALL OUR NEW WIRE WOUND
1% MIL-SPEC RESISTORS "THE FLINT SKINS"?

They have a molded silicone body that's denser and thicker than any conformal coating. It's totally impervious to moisture and has outstanding dielectric. Silicones are a natural for precision molding, too, making a perfect shape for machine handling in any automated operation.

In fact, they have all the good characteristics of the "Flint" family plus the impact resistance of cross linked poly. But Clarostat's modern mass production techniques make them so miserly in price, maybe we should call them "The Skin Flints"?

Ask for the new Flint Skins as Clarostat 1% series SC
1, 3, 5, 10 watts surpassing mil-specs RW 70U, 74U, 78U, 79U.

CLAROSTAT

DOVER
DIGITAL MANUFACTURING CORP.

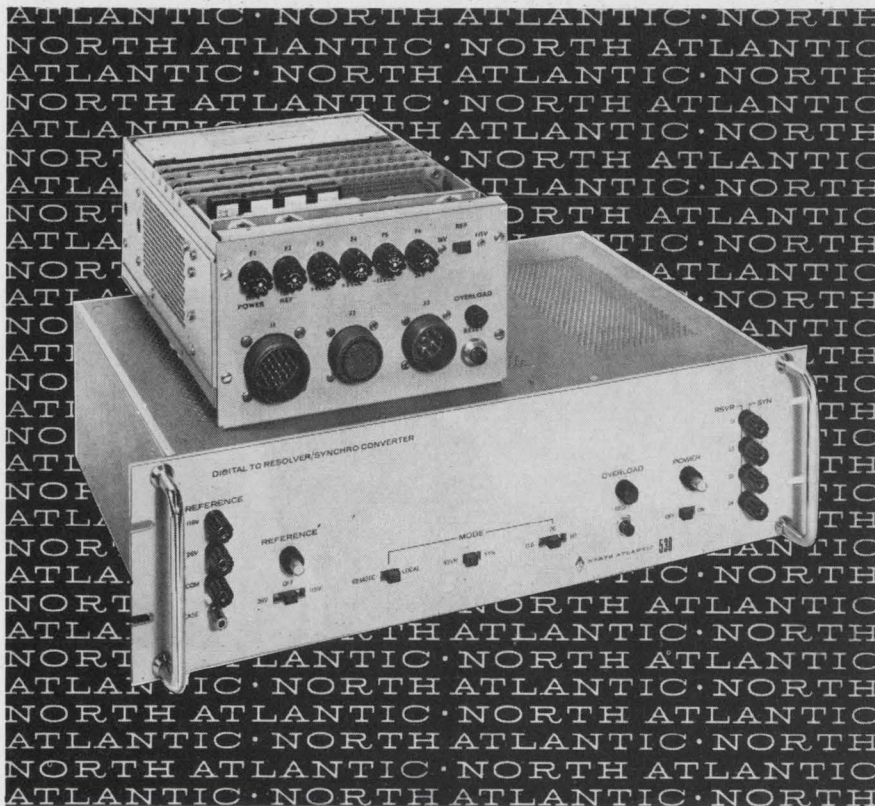

digital to resolver/synchro converters ... here's the next generation!

North Atlantic now brings you a new generation of solid-state digital-to-analog converters. They offer major advances in resolver/synchro conversion accuracy along with drift-free and stable performance unobtainable with currently available resistor/amplifier devices.

Typical of these new instruments are the Model 536 D/R and Model 537 D/S "shoebox" converters (11-13 bit) and the Model 538 D/R-S converter (14-17 bit). Both models use solid-state switched trigonometric transformers and feature input data storage registers thereby saving computer time. Conversion speed exceeds 10 microseconds. Built-in overload and short circuit protection assures trouble-free system integration and reliable on-line performance.

Your North Atlantic representative (see EEM) has complete specifications and application information. He'll be glad to show you how these new converters can be the answer to critical interface problems.



NORTH ATLANTIC industries, inc.
TERMINAL DRIVE, PLAINVIEW, NEW YORK 11803 • 516-681-8600
See us at Wescon—Booths 2325 and 2326 Sports Arena.

... students need simpler computer languages ...

of teaching. One veteran teacher sums up his feelings this way: "We haven't got a movie projector that works—at least none that we can afford. If engineers and industry can't make a rather simple mechanical projector that's been around for so many years, how can they make something as complicated as a computer that teachers can use and that school boards can afford?"

But Richard Nibeck, a Washington official of the National Education Association, is kinder. He believes that industry has been most responsive to educators' needs, pointing out that "educators seem to have difficulty in articulating their needs in a way so that industry can produce for them."

Nibeck goes along with general industry predictions that it will be at least the 1980's before CAI is in general use by public schools.

Changes needed. Nibeck says that CAI will be accepted only when the basic concepts of American education are changed, and that concepts such as "differential staffing" may help accelerate acceptance of CAI. In this concept, one "master teacher," paid a high salary, is assisted by a half-dozen semiprofessional "aides." This staff gets about 200 students, and the cost of the staff is much less than hiring average teachers who babysit for a class of 30 students. The money saved through the new system is invested in audio-visual and other equipment. "Breaking away from lock-step instruction must come before CAI," he says.

Still another deterrent to CAI's growth is the lack of a computer language that isn't too sophisticated for the majority of students. That's the appraisal of Sidney Sharron, a former college mathematics instructor who is now supervisor for secondary mathematics in the instructional planning branch of the Los Angeles City School District. "Usage will not increase until that truly conversational language for CAI is developed," says Sharron. "Fortran and other special computer languages are not ideally suited for teaching math or sciences at lower grade levels and require too much time and effort to master."

By engineering many moving parts out of the Tally photo reader, maintenance has been minimized and performance maximized.



The parts we took out—gears, belts, pulleys, and pinch rollers—put reliability into Tally photo readers.

Tally faced the moving parts dilemma by replacing most of them with three low-inertia servomotors to create a fast, smooth, quiet and more reliable photoelectric tape reader. The motors attach directly to the capstan wheel and the reeling, eliminating all troublesome gears, belts, pulleys and pinch rollers. No adjustments are necessary. Maintenance is greatly reduced and accurate read out over long periods of time can be expected.

Tape movement through the read head is in exact accordance with the rotation of the motor armature. The high speed response of the motor allows a great variety of reading operations by merely controlling the current applied to the motor terminal.

It's fast. Searches at 1,000 characters per second. Reads synchronously at any rate up to 500 char/sec and stops before the next character. Reads asynchronously under

control of external signals at any rate up to 200 char/sec. Runs in either direction in all modes.

It's easy on the tape. The smooth, quiet action of the servo-controlled reels eliminates tape breakage, reduces tape wear and prevents reading errors.

It's offered with many options. Many optional configurations are available, including recessed mount, flush mount, integral reeling, external reeling, and fully militarized construction.

For complete information contact Tally Corporation, 1310 Mercer Street, Seattle, Washington 98109. Phone (206) MA 4-0760. In the U.K. and Europe address Tally Ltd., 6a George Street, Croydon, Surrey, England. Phone: 01-686-6836.

See us at WESCON '68

TALLY

Circle 169 on reader service card

Industry nips at consumers' watchdog

Consumer Union's subjective approach to product testing and limited sampling base are the big bones of contention

By John D. Drummond

Consumer electronics editor

and Frederick Corey

Chicago bureau manager

The Federal Government is now joining the movement to provide the buying public with greater protection by setting product standards in a variety of areas. Meanwhile, the leading private watchdog—Consumers Union—which has been on the job 30-odd years, continues to go it alone. Although industry in general and consumer electronics concerns in particular profess no great love for the nonprofit, tax-exempt group, it is clearly a force to be reckoned with. But a force whose impact depends on: how good a job it does in its testing; how widely it can distribute its data; and the effect its disclosures have on purchasing patterns and manufacturers' quality-control programs.

The most visible—and to industry irritating—evidence of CU's existence is Consumer Reports, an

outspoken monthly that rates some 2,000 products a year for over 2 million fanatically loyal readers. What annoys the organization's severest critics—most of whom will not speak for the record—is CU's subjective approach to rating products and the fact that it is essentially a self-anointed judge and jury.

Says the sales manager at a leading high-fidelity set maker: "CU is often quite vicious in reporting what it considers bad features. Take a set that performs well and has a reasonable price tag. CU will zero in on the shape and size of the knobs; when they get through, only the most intelligent reader will take a second look." On the other hand, the chief engineer at an East Coast consumer electronics firm damns with faint praise. "On balance, Consumers Union is

doing a good job, but there's plenty of room for improvement," he says. This source is particularly disturbed by what he describes as CU's unwillingness to go along with industry test standards. "Yet when we ask them to participate in standards committee work to devise a uniform standard, they refuse our overtures."

Reporting CU

Such harsh judgments tend to obscure the fact that Consumers Union is a small operation, conscientiously trying to do a big job while staying at arms' length from the interests it rates to avoid any suspicion of partiality. Testing is carried out by seven autonomous divisions—electronics, automotive, chemicals, foods, appliances, textiles, and special projects—which are housed in a rambling, elderly brick structure in Mount Vernon, N.Y. The electronics unit is typically compact, having four electrical engineers and two technicians on the staff.

Test case. Makers of color tv sets perhaps are more vocal than any other industry interest group about the efficacy of CU's checks of their wares. This is probably due to the fact that readers of Consumers Reports tend to rely heavily on the magazine's tv recommendations, and bad ratings are often translated into severe sales dips. There is some justice in the set makers' distress since when it comes to color tv, beauty is, to a great extent, in the eye of the beholder. In addition, such factors as broadcast quality—not all stations transmit equivalent signals—

Consuming interest

Increasingly, "consumerism" is becoming a preoccupation of the legislative and executive branches of the Government. Congress, often dilatory about the public's needs in the past, has recently enacted bills covering areas like auto safety and truth-in-packaging. Now, it is turning to legislation involving radiation protection [Electronics, July 22, p. 53]. Earlier, the Congress organized the National Committee on Product Safety. During its two-year life, this group will survey wares ranging from television and radio receivers through garage-door openers and microwave ovens with an eye to determining whether or not self-regulation by industry is effective in preventing injuries. In addition, the commission will study Federal, state, and local safety laws.

And recently President Johnson appointed Betty Furness, an erstwhile tv pitchgirl for Westinghouse, a special assistant for consumer affairs. Far from being the decorative figurehead many observers expected, Miss Furness has plunged into her job with gusto. "The slogan 'let the buyer beware' is as outdated as the crystal radio set," she says bluntly, echoing an Administration view that when industry fails to do an effective policing job on its own, the Government must step in.

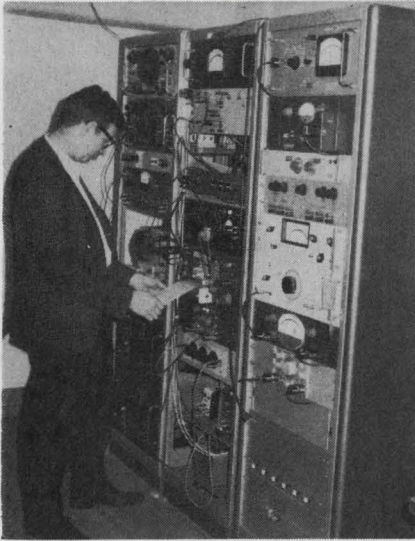

Checkup. Arnold Seligson, an audio specialist watches recorder unit plot bandpass curve of a receiver under test at Consumers Union lab.

type of antenna, set location, and adjustment are legitimate considerations. However, Arnold Seligson, assistant to Karl H. Nagel, who heads the electronics division, says: "It really doesn't make any difference which standards we apply, so long as they are applied uniformly to all the sets we test."

Sets to be tested—usually about 10 at a time—are lined up against a wall, and a signal is applied to their antenna terminals. At first, a test pattern generated in CU's electronics lab is used; the picture on each set is checked against that on a local monitor. Next, the signals are attenuated to discover at

what point the "snow" becomes objectionable; this approach also serves to simulate reception quality at varying distances from a transmitter. Finally, over-the-air signals are piped in and the pictures checked. In cases where a receiver performs particularly well, the CU staff may arrange for further tests in "fringe" areas before submitting a final report.

Independence. Consumers Union also goes its own way in testing hi-fi sets and components, largely ignoring the standard specifications approved by the Institute of High Fidelity's committee. Some observers feel that these procedures permit set makers too much latitude in writing specs. For example, most call out IHF or "music" power rather than root-mean-square (rms) power. Since there are several ways to arrive at a rating, manufacturers can select the method which puts their equipment in the best light. In this way, a 50-watt rms rating could be legitimately converted to a listing of 200 watts peak music power. In choosing an amplifier, the average consumer, as well as many hi-fi buffs, could well fall for the higher—and essentially inaccurate—figure. Says Seligson: "While we respect some of the (power) measurements arrived at in the industry's test methods, we're certainly not married to them."

Many in the electronics trade tax Consumers Union for its supposedly subjective approach to

testing. George Harrigan, who retired from his post as director of electrical engineering at the Admiral Corp. last month, says: "The organization has a job to do, but it tries to be all things to all people. Their standards are idealistic, and their engineers are trying to be objective about purely subjective matters. After all, what is a good tv picture? Tastes vary on this among individuals."

Chad B. Pierce, vice president, engineering at the Wells-Gardner Electronics Corp., a manufacturer of private-label goods, agrees with Harrigan. "Some people like brilliant colors and pink faces on their tv screens. Others don't," he says. "Who's to say what's right and what's wrong?"

Waxing wroth. The sales manager of a leading manufacturer of hi-fi components becomes almost apoplectic when queried on the subject of Consumers Union's subjectivity. "Sure, their intentions are good," he says. "But the road to hell is paved with the very best. It's cold comfort for companies whose reputations have been trampled in the mud."

Own account

Another source at a large Midwestern consumer electronics firm complains that Consumers Union will set its own standards even when no real yardstick is available. "Take speakers; there's no satisfactory way to gauge how they'll sound in someone's home," he says. "Yet a CU engineer will run tests, and then report how they sound to him in the lab. This technique is subjective, unfair, and often inaccurate. We'd like Consumers Union to stick to performance data." The man who has engineering responsibility for the tv and hi-fi lines at a major consumer house believes CU's reports do more harm than good because of their subjectivity. By way of example he cites an amplifier that was downgraded by the organization on the basis of design. "When the unit was redesigned to conform to Consumers Union standards, the result was a poorer operating amplifier," he says.

Dealer's choice. "Consumers Union is trying to be a jack-of-all-trades by rating a wide variety of products. As a result its expertise



Music hath charms. A panel of electrical engineers makes subjective checks of all audio equipment that's rated by the organization for Consumer Reports.

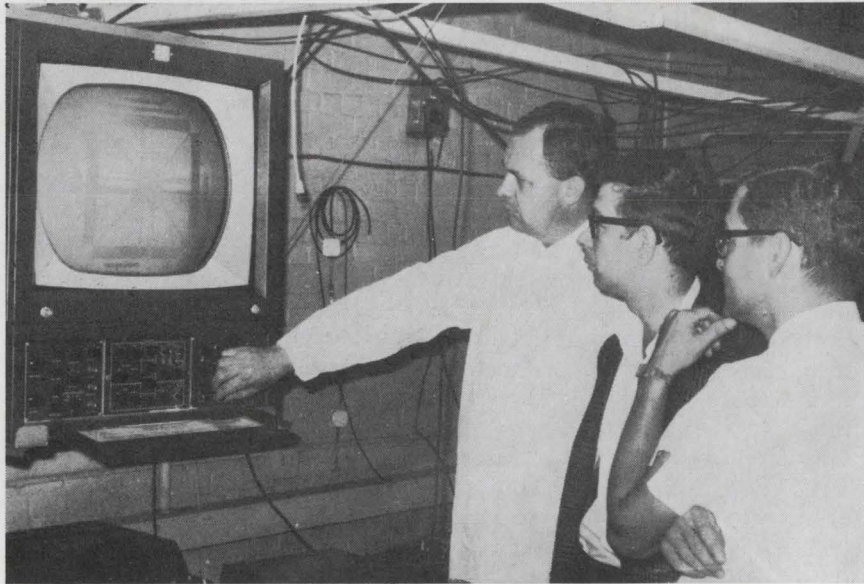

In the picture. Consumers Union engineers adjust test pattern on color monitor so they can compare it to what's produced on sets being checked.

is spread pretty thin," says a senior engineer at a major stereo maker. "Then, there's the problem of criteria. Who decides? When it comes to sight and sound, you enter the realm of subjectivity. And testing engineers are not paragons. Here, we check what we consider five key parameters. But we invariably get into disagreements among ourselves. Is it inconceivable that Consumers Union ratings reflect the taste of the engineer who tested the product?"

Nagel and his group are not particularly upset by such charges, and, in fact, are at some pains to

make their tests as subjective as possible on the grounds that this approach is the only meaningful way to represent the interest of the consumer. "There's a vast gulf between what a person senses or experiences and the numbers on a meter," says Nagel. "We could, for example, plot the finest selectivity curve possible for a receiver, but it may or may not have a significant relationship to what a listener will hear in his home." Likewise, the resolution—and, hence, picture quality—in a tv receiver depends to a great extent on the set's band-pass characteristics. Nagel states

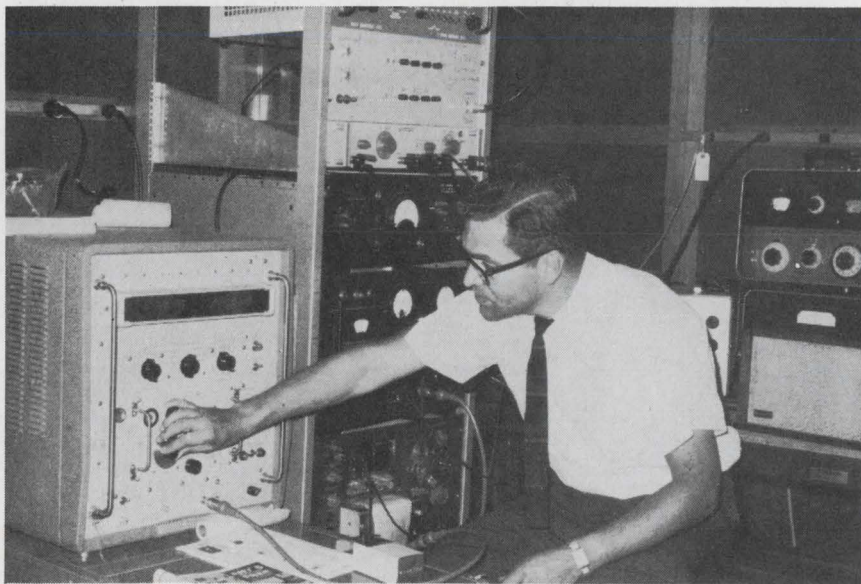

Switchover. To rate speakers, an operator shifts output among several while a record plays so the panel can determine which perform the best.

he's far more concerned about how the intermediate-frequency band-pass affects the picture than about the curve.

Rationale. What CU engineers are attempting to do is get behind and beyond units' theoretical curves to come up with an as close as possible approximation of actual performance. To this end, they put sets through a real wringer. In the case of tuners, for example, Consumers Union engineers will generate interference and apply it to the set to simulate conditions a listener might encounter from another station or noise source.

One advantage of CU's subjective approach lies in the fact that commercially available equipment is, in some cases, unable to furnish qualitative measurements. Distortion analyzers provide a case in point. Although there are a number of sophisticated units on the market, it is virtually impossible to tell from using one how well or how badly a given amplifier performs. Consumers Union has recorded a number of cases where relatively high levels of distortion have been measured in an amplifier. However, when the same unit was checked subjectively by a panel of listeners, no perceptible distortion was discovered. On the other hand, the electronics division has tested amplifiers with theoretically low distortion levels that were almost painful to listen to.

The technical explanation of this apparent paradox centers on the fact that performance depends, to a great extent, on the shape of the transfer curve of the product under test. Commercial equipment can generally provide accurate readings for simple curves. However, these same meters may well be insensitive to the orders of distribution of the harmonic content.

Not everyone, of course, believes that Consumers Union tests—whether or not they are subjective or objective—are uniformly valid. Harrigan, the Admiral retiree, for example, questions the reasonableness of the methods used to downgrade television sets from his company and Packard-Bell this January on the grounds that they were emitting higher levels of X radiation than other receivers in the same test batch. By CU's own ad-

mission, he says, voltage was stepped up to a point no viewer would ever use. "This was certainly reaching pretty far," Harrigan asserts.

Insufficient evidence

One area where Consumer Union's critics appear to have the organization dead to rights is the extremely limited samples on which it bases its test reports. R.W. Sanders, director of the Magnavox Co.'s Consumer Electronics division, says: "Testing one unit or even two is just not enough to get a rating. It's like looking for a needle in a haystack. When Consumers Union tests a set, it could be the best, the worst, or something in between." Harrigan agrees, pointing out that at Admiral a minimum of 50 units are pulled from the production line for rating tests. Additional units are checked in the

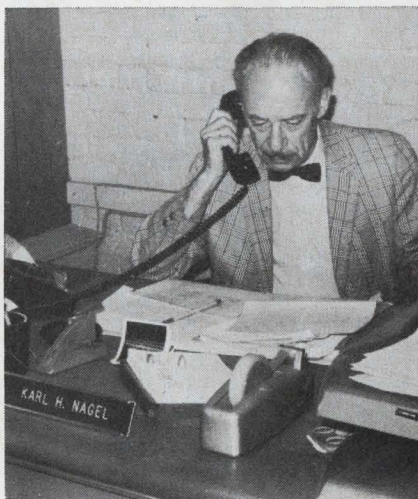

Top man. Karl Nagel, a German-born EE, heads Consumers Union's electronics unit; five staffers assist him.

lab and out in the field.

Al Naegli, a production engineer at Warwick Electronics Inc., a private-label house that sells its total tv output to Sears, Roebuck & Co., also feels that Consumers Union should increase the size of its samples. "Although the organization is open enough about the fact it is reporting on the one set it purchased, consumers definitely get the impression that what's true for this set is true for every other in the model run," he says. "I'd like to see CU go into production plants to make both on-line and off-line tests. They exercise a con-

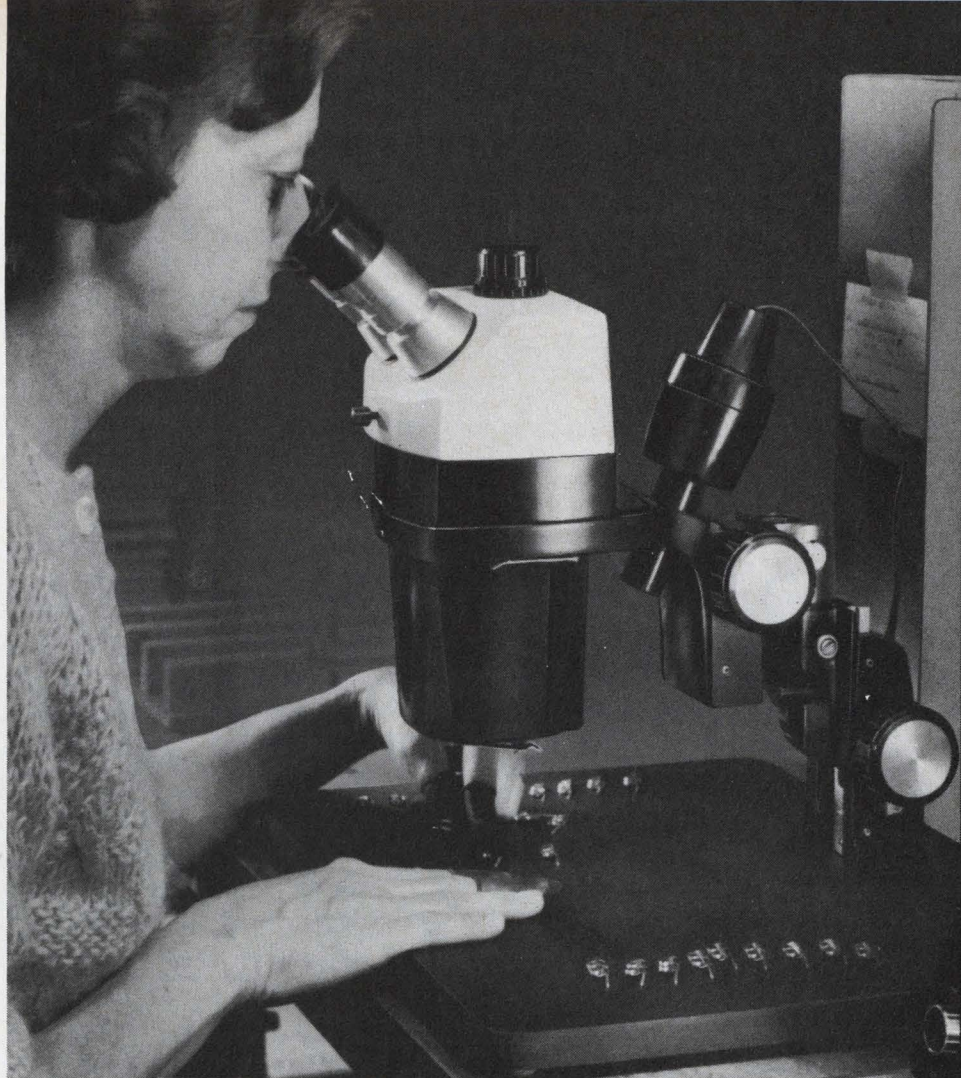

Photo courtesy Electronic Tube Division, Westinghouse Electric Corporation

ALL NEW Bausch & Lomb STEREOZOOM® 7

establishes a new level of performance

We're getting glowing reports of the exceptional performance of StereoZoom 7, latest addition to the matchless line of Bausch & Lomb Stereomicroscopes. Ten years' experience in StereoZoom building is bringing results where it counts the most . . . in actual use.

New StereoZoom 7 offers you the widest zoom range, sharpest images, highest magnification/resolution, simplest photographic setup, plus proven reliability. That's a performance package that can't be equalled anywhere.

But, you be the judge. Write for catalog 31-2185 and our free demonstration offer. Bausch & Lomb, Scientific Instrument Division, 61408 Bausch Street, Rochester, New York 14602.

BAUSCH & LOMB 
SCIENTIFIC INSTRUMENT DIVISION

an-ten'na 1. A wirelike growth on the head of a lobster. 2. An elevated conductor of electrical waves; that which in log-periodic designs Granger has more of than anybody.

az'i-muth The desired direction in which G/A antennas concentrate your signal.

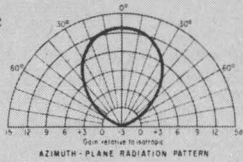

ba'lun 1. An impedance transformer; connects 50 ohm co-ax to open wire lines. 2. A non-porous bag filled with hot air or gas.

cur'tain 1. Opening of a great performance. 2. An ordered arrangement of wires precisely engineered and factory fabricated for easy installation and long life as part of a G/A log-periodic antenna.

dec'i-bel (pronounced dee-bee) A measure of what G/A's h-f products can contribute to your system performance; usually in groups of 40 or 50 in the important characteristics of G/A receivers.

ex-cit'er Any of the new G/A h-f products; specifically, our new solid-state h-f unit with LSB, USB, CW, AM, and with FSK-ability.

fast-switch A rapid change between two pretuned frequencies (e.g. in 50 milliseconds); a characteristic of one of G/A's new transmitters.

gain 1. That which our products contribute to your communications

system's performance. 2. A stage, benefit or profit to be concerned.

h-f 1. Typically the frequency range from 3 to 30 MHz. 2. In G/A equipment the band between 2 and 32 MHz.

im'age A reflection; the antennas use to fullest advantage.

i-on'o-sphere A fictitious layer used to bounce signals back to earth; its erratic behavior can be measured in real time (see *sounder*).

log per-i-od'ic The most versatile, compact precision h-f antenna design; available from Granger in many variations (e.g. rotatable, steerable, transportable, unidirectional).

mode 1. Ice cream on pie. 2. Method of doing (e.g. SSB, ISB, FSK, CW, AM); that which you have a full choice of in our equipment.



mon'o-pole 1. A game wherein you receive \$200 for passing GO. 2. A compact reliable omnidirectional antenna offered by Granger Associates.

om-ni-di-rec'tion-al Going off in all directions; a capability of certain G/A antennas.

po-lar-i-za'tion di-ver'sit-y A combination of vertical and horizontal antennas to overcome fade; a space-saver.

point-to-point From here to there

with no wires; done with ionospheric mirrors.

ra'di-o-tel-e-phone (pronounced TELETRANSCEIVER) A small but mighty G/A device that goes anywhere; specif. the Australian outback, remote Pacific islands, African veldt, etc.

ro-ta'ta-ble Capable of revolving; a new log-periodic antenna from Granger Associates offering reliable performance from 5.5 to 32 MHz.

re-ceive'r A new solid-state G/A unit that selects your message from many others and renders it clearly intelligible.

se-lec-tiv'i-ty The quality of careful discrimination, as in G/A receivers; pert. to elimination of extraneous signals.

sound'er 1. A device used in early telegraphy. 2. A precise instrument for measuring the ionosphere; an efficiency expert in h-f communications.

SSB 1. In aviation, the supersonic balloon. 2. In radio communications, what nearly everyone will be using by 1971; we can help.

trans-mit'ter A microphone-antenna interface device; available from G/A in 1, 3 and 5 kw versions.

VSWR Abbr. for voltage standing wave ratio; less than 2.0:1 in almost all of our antennas.

ze'nith 1. A vertical take-off angle. 2. The name of another famous radio company.



G/A knows h-f from A to Z

Send for complete information to learn how we can spell out solutions to your communications problems.
Granger Associates / 1601 California Avenue, Palo Alto, California 94304 □ Granger Associates Ltd. / Russell House, Molesey Rd., Walton-on-Thames, Surrey, England □ Granger Associates Pty. Ltd./1-3 Dale St., Brookvale, N.S.W., Australia

trolling influence on industry, but could be doing a much better job

Consumers Union concedes that it would like to test a larger number of sets, but says that its budget does not permit this luxury. Monte Florman, the organization's associate technical director, points out that when a big-ticket item like a consumer electronic product or appliance turns in a notably poor performance, CU will buy a second sample—generally in a different retail area—and test again to be sure the first was not simply a lemon. However, Consumers Union maintains, if manufacturers were exercising the kind of quality control they should be, lemons would not be allowed to reach the marketplace.

More equal. The scantiness of Consumers Union's sampling base does lead occasionally to ludicrous situations that can produce lasting bitterness. For example, an engineer at a middling-sized consumer electronics firm that distributes under both its own corporate name and various private labels notes that two identical radio receivers—one bearing the company name, the other the house brand of a mail order house—received disparate ratings from Consumers Union. A similar incident is recounted about two tv sets by the director of engineering at a comparable company. The receivers, each of which carried its own private label, had identical chassis; only the cabinet styling was different. "However," says this source, "Consumer Reports rated each differently, and even called the one a cheap copy of the other."

Sales impact

While Consumers Union disclaims responsibility for any favorable or unfavorable effects its reports may have, the fact remains that enthusiastic comments typically produce a spurt in retail sales. For example, some observers report a tenfold increase in volume for a tape recorder made by a California firm since the unit was endorsed in November 1966. Says the chief engineer at a tv and hi-fi producer: "Consumer Reports' findings are considered gospel by the public. "When a product is check-rated, sales climb; but when an item is downgraded, it just won't



There'll be some changes made. Arnold Seligson, assistant director of electronics division, checks the performance of changer mechanisms.

move. This can have a life-or-death impact on lines." However, a colleague at the same company, who agrees that raves mean bigger business, has adapted his operation to what he considers the realities of the situation. When Consumer Reports rates competitors' products, he takes the findings into account—to the point where he might even order a redesign of certain of his own output, whether or not it was tested.

Party line. A spokesman for RCA's Consumer Electronics division says: "Getting into the best

buy and checkrated categories causes only a brief flurry in sales." Officially, the company maintains that a favorable rating from Consumers Union on a particular product has a little effect because of RCA's broad sales base. "Good ratings help a smaller manufacturer more than a big one," says the spokesman. "Consumers tend to expect high ratings from the bigger concerns. On the other hand, low marks tend to hurt the littler producers in a worse way."

A senior engineer at another diversified consumer electronics

The chosen

In common with the six other testing units comprising Consumers Union, the electronics division checks products selected by a committee of insiders and outside consultants. In addition, the organization will check items that arouse demonstrable readership interest. One such was the Heath Co.'s AR-15 f-m stereo radio; another possible candidate is the same company's GR-295 color television receiver. In general, however, the committee simply tries to spot significant new offerings like KLH's Model Twenty-One f-m radio and Fisher Radio's Model 100 Microceiver [Electronics, Oct. 2, 1967, p. 44].

Better late? But Consumers Union makes no concentrated effort to report on all new products the moment they're unveiled. This policy frequently leads to rating wares that are no longer on the market. For example, the committee may select an item which has been available at retail for six months or more. By the time tests are completed and a report written, there may have been a lapse of a year or so from the time the product was introduced; and in the meantime, the manufacturer may have followed up with a replacement and pulled his original offering out of the marketplace.

Manufacturers soliciting Consumers Union tests can confidently expect to be rebuffed. Even in cases where a company modifies its products to satisfy CU design critiques, there will be no recheck unless the committee decides at a later date that the item involved, for some reason, rates a second look.

THE ELEMENTS ARE ALWAYS RIGHT...

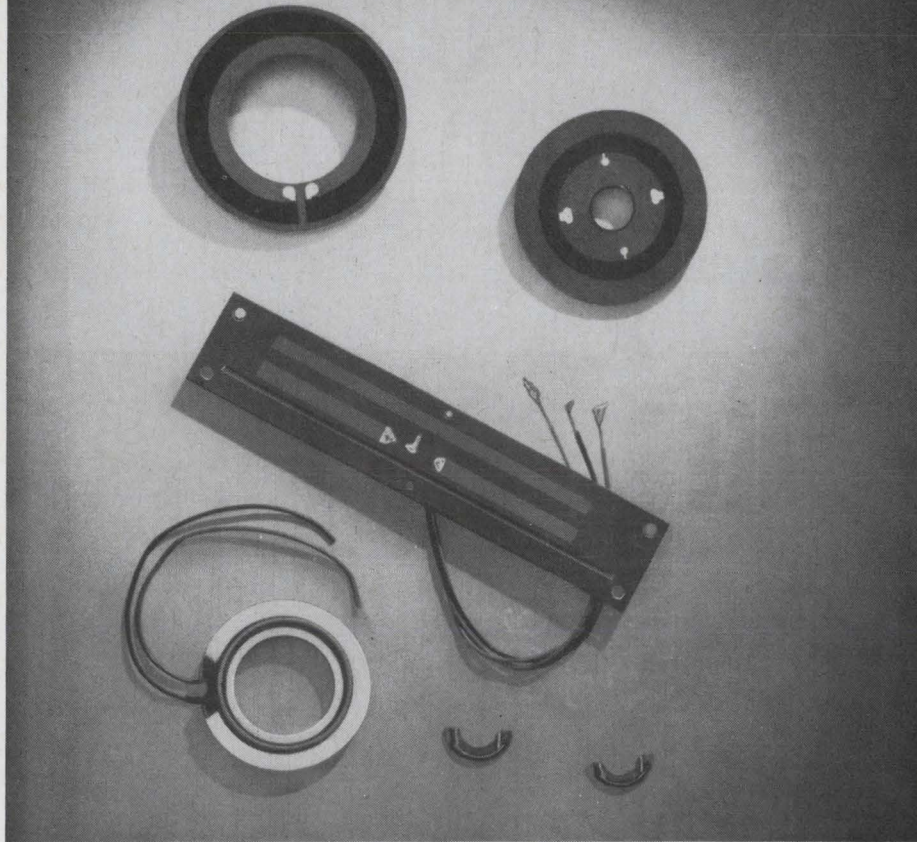

...When they're BLISS-GAMEWELL potentiometer elements

Bliss-Gamewell offers a comprehensive line of conductive plastic or wire wound elements and potentiometers. Available in both translatory and rotary styles. Custom-engineered to fit your exact requirements . . . they're quality-controlled from powder to pot right in our own facilities. Resistance values up to 300 k. ohms. Accuracy as fine as $\pm 0.035\%$. Linear and non-linear functions. Positive control of molecular construction of conductive plastic resistive tracks provides perfect accuracy in high-speed, high-flying avionic equipment — as in the Phantom II now flying in Viet Nam — and in computing and process control systems. Gamewell wire wound precision resistance elements are used in the Army's tank busting guided missile, the Shillelagh, to establish its attitude in flight. Quality and precision come easy at Gamewell—we've been making potentiometers and elements for over twenty-five years. We've learned a lot in this time. Let us put this know-how to work for you, today!

SEND FOR FREE CATALOG

For new information regarding our capabilities and facilities, contact: Bliss-Gamewell, 1238 Chestnut Street, Newton, Mass. 02164. (617) 244-1240.

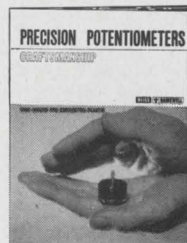

Member of VRCI

FIRST...WHEN PRECISION COUNTS!



A DIVISION OF THE E. W. BLISS COMPANY
A GULF + WESTERN COMPANY

... companies are quiet when their products are okayed . . .

concern, who values Consumer Reports' assessments of such items as tires and household appliances, also discounts the impact of the organization's findings on his operation. "We note little effect on sales," he says. "Any product modifications are based largely on the feedback we get from the field and our customers. Consumers Union findings are taken into consideration only when they parallel such inputs."

Pierce of Wells-Gardner, the private-label house, also professes to be unconcerned by CU ratings—unless they uncover a problem of which he was unaware. Such a finding would lead to modification, he says. Pierce notes that certain of his company's customers are more sensitive than others to ratings in Consumer Reports; Wells-Gardner can usually come up with satisfactory answers to any queries on

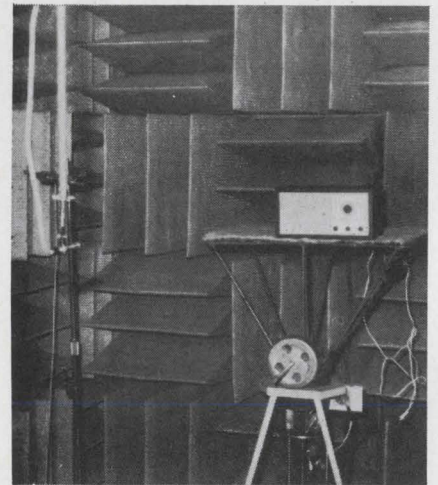

Sounds of silence. Radio receivers are checked out in an anechoic test chamber at electronics division's laboratory.

such subjects, Pierce says, and he can't recall the last time a customer's reaction to a CU rating led to modification of a product. The company hears from its accounts only when a unit is downgraded—and then, only in some cases. There is, Pierce says, no feedback when a consumer's private-label product gets checkrated or lands in the acceptable category in Consumer Reports magazine.

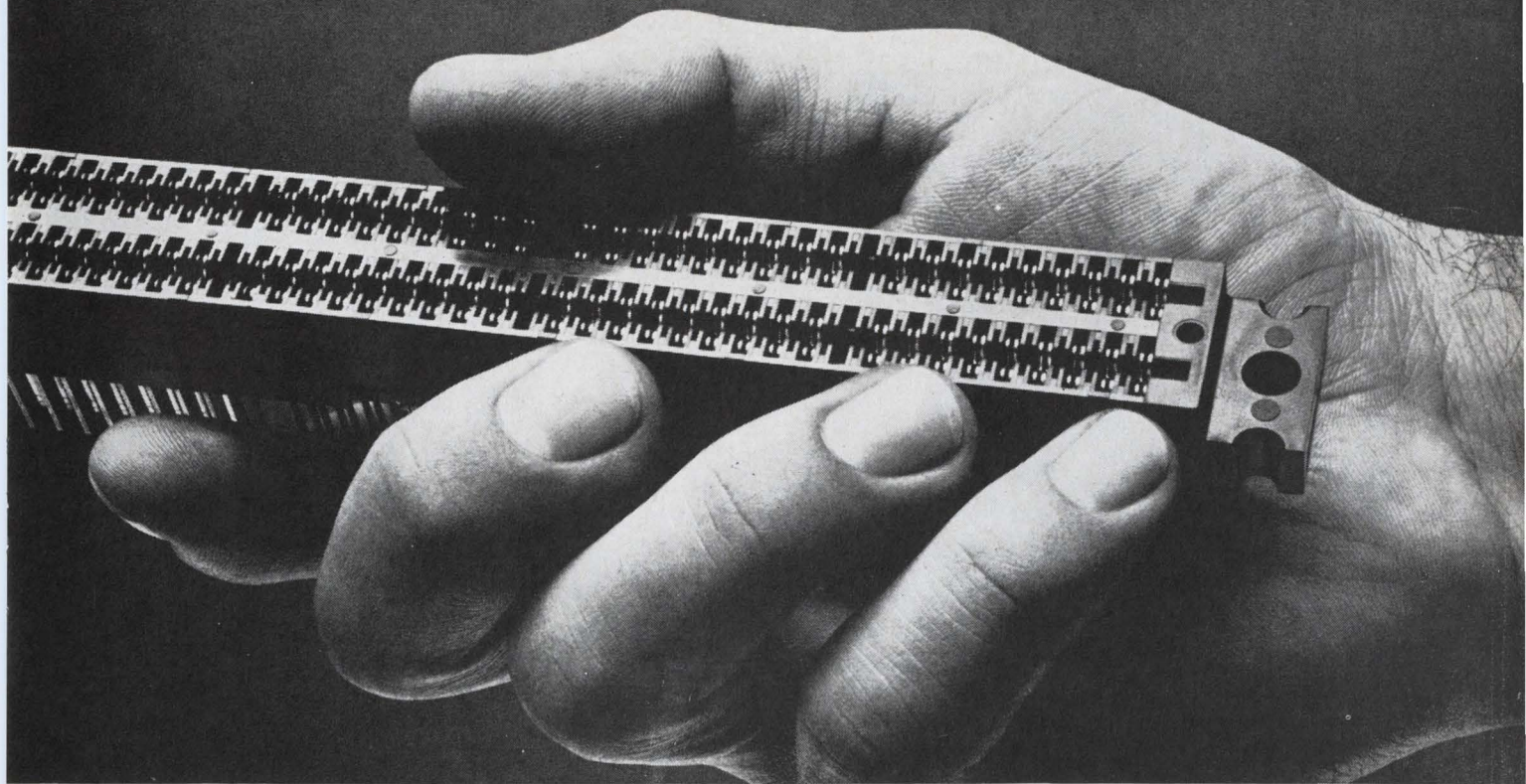

Our connectors are better.

Of course, you have to pay a little less.

Everybody knows that gold makes the best electrical contact.

So we put ten times more gold at the contact area than any plater does.

But everybody knows that gold is expensive.

So, we developed a special welding process that lets us put the gold exactly where you want it. So overall, we use much less gold.

As a result, you get a better, longer-wearing, more reliable connector for

less money.

Sounds simple, but it takes some doing.

It not only calls for advanced technical know-how, but also precise control of all fabricating processes. Well, at Sylvania, we leave nothing to chance—or to outside suppliers.

First, we draw our own wire for the contacts. Then we do our own coining, forming, bending, solder plating, and gold dot welding. Next, we mold our

own plastics bodies to assure precise control of tolerances.

And, finally, we assemble the whole thing ourselves.

And we do it all to your specifications.

So if you want the best connector, and you don't mind paying a little less, give us a call. Sylvania Metals & Chemicals, Parts Division, Warren, Pa. 16365.

SYLVANIA
A DIVISION OF
GENERAL TELEPHONE & ELECTRONICS



A Kokomoan power with mettle of honor.

Type	I_c	V_{CB0}	V_{CE0}	$hFE @ I_c$ amps	$VCE^{(sat)} @ I_c$ Volts @ Amps		
DTS-423	3.5	400	400	30/90 1.0	0.8	1.0	
2N3902	3.5	700*	400	30/90 1.0	0.8	1.0	
JAN 2N3902	3.5	700*	400	30/90 1.0	0.8	1.0	

It started out as the DTS-423. Then, with EIA registration, it became the 2N3902. And now it has JAN approval.

At 700v., 100w., the JAN 2N3902* gives you the full benefit of Delco high energy silicon power: ruggedness, reliability and reduction of circuit weight, size and component cost.

* V_{CEX}

Delco silicon power transistors are serving in high energy circuits including DC to DC converters, ultrasonic power supplies, VLF class C amplifiers, off-line class A audio output and magnetic CRT deflection.

Put this one to work for you.
Just call your local Delco Distributor
or Delco sales office.

*Mil-S 19500/371 (USAF)



DELCO RADIO
DIVISION OF GENERAL MOTORS
KOKOMO, INDIANA



Kokomoans' Regional Headquarters

Union, New Jersey* 07083
Box 1018 Chestnut Station
(201) 687-3770

Chicago, Illinois* 60656
5151 N. Harlem Avenue
(312) 775-5411

Syracuse, New York 13203
1054 James Street
(315) 472-2668

Santa Monica, Calif.* 90401
726 Santa Monica Blvd.
(213) 870-8807

Detroit, Michigan 48202
57 Harper Avenue
(313) 873-6560

Kokomo, Ind. 46901
700 E. Firmin
(317) 459-2175 Home Office

*Office includes field lab and resident engineer for application assistance.

*These are specialized **TRACOR** instruments designed for your specific needs.*

See them at **WESCON68** booths 2030-2031

FREQUENCY STANDARDS

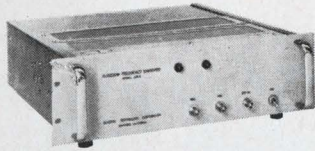

RUBIDIUM FREQUENCY STANDARD
 1×10^{-10} freq
 2×10^{-11} stnd dev/yr
 use Reader Service #315.

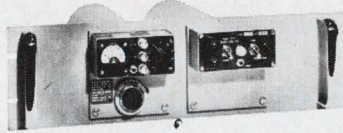

CRYSTAL STANDARDS
 5×10^{-11} /24 hours
 5 to 0.1 MHz
 use Reader Service #316.



LOW COST HOUSE STANDARD
 1×10^7 /24 hours
 use Reader Service #317.

ULTRASTABLE CLOCKS AND DIVIDERS

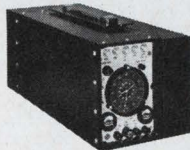

PORTABLE RUBIDIUM ATOMIC CLOCKS
 5×10^{-12} /100 sec avg—37 pounds!
 use Reader Service #318.



CRYSTAL CLOCKS
 2×10^{-6} secs per day
 use Reader Service #319.

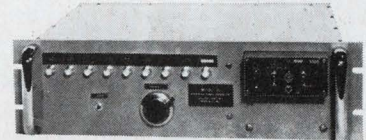

REFERENCE SIGNAL GENERATORS
 200 Hz-6.25 kHz
 use Reader Service #320.

VLF RECEIVERS—FREQUENCY/PHASE COMPARATORS

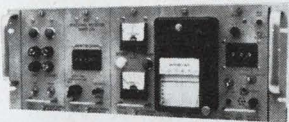

VLF TRACKING RECEIVER/COMPARATORS
 Continuous tuning 3.00 to 99.5 kHz
 use Reader Service #321.

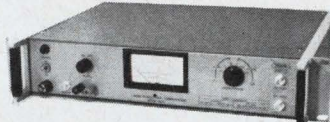

LINEAR PHASE/TIME COMPARATOR
 1 nanosecond time resolution
 0.01 cycle phase resolution
 use Reader Service #322.

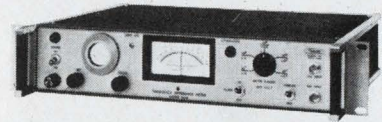

FREQUENCY DIFFERENCE METER
 difference to 1×10^{11} , error multiplied by 10^4 .
 use Reader Service #323.

NOISE ANALYSIS



CONTINUOUSLY-VARIABLE PASSIVE FILTERS 15 Hz-672 kHz
 use Reader Service #324.

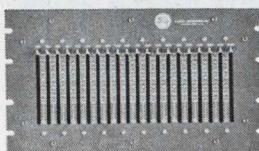

EQUALIZERS/SPECTRUM GENERATORS
 Up to 40 $\frac{1}{3}$ -octave increments
 use Reader Service #325.

OMEGA NAV SYSTEMS

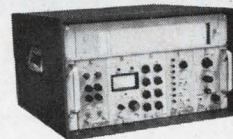

VLF/OMEGA NAVIGATIONAL SYSTEMS
 For broad-area navigation
 use Reader Service #326.

NORTHERN SCIENTIFIC, INC.

ASTRO-SCIENCE CORP.

WESTRONICS INC.

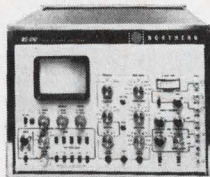

DIGITAL MEMORY OSCILLOSCOPES and Pulse Height Analyzers
 use Reader Service #327.

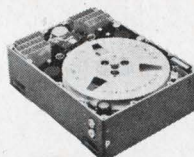

ASTRO-SCIENCE MULTI-CHANNEL AIRBORNE INSTRUMENTATION TAPE RECORDER/REPRODUCERS
 use Reader Service #328.

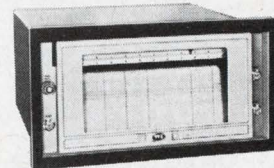

MULTIPOINT AND CONTINUOUS PEN CHART RECORDERS
 use Reader Service #329.

For a short-form catalog of TRACOR instruments, please use Reader Service #330.

Industrial Instruments Division



“WHEN IT COMES TO REED RELAYS,

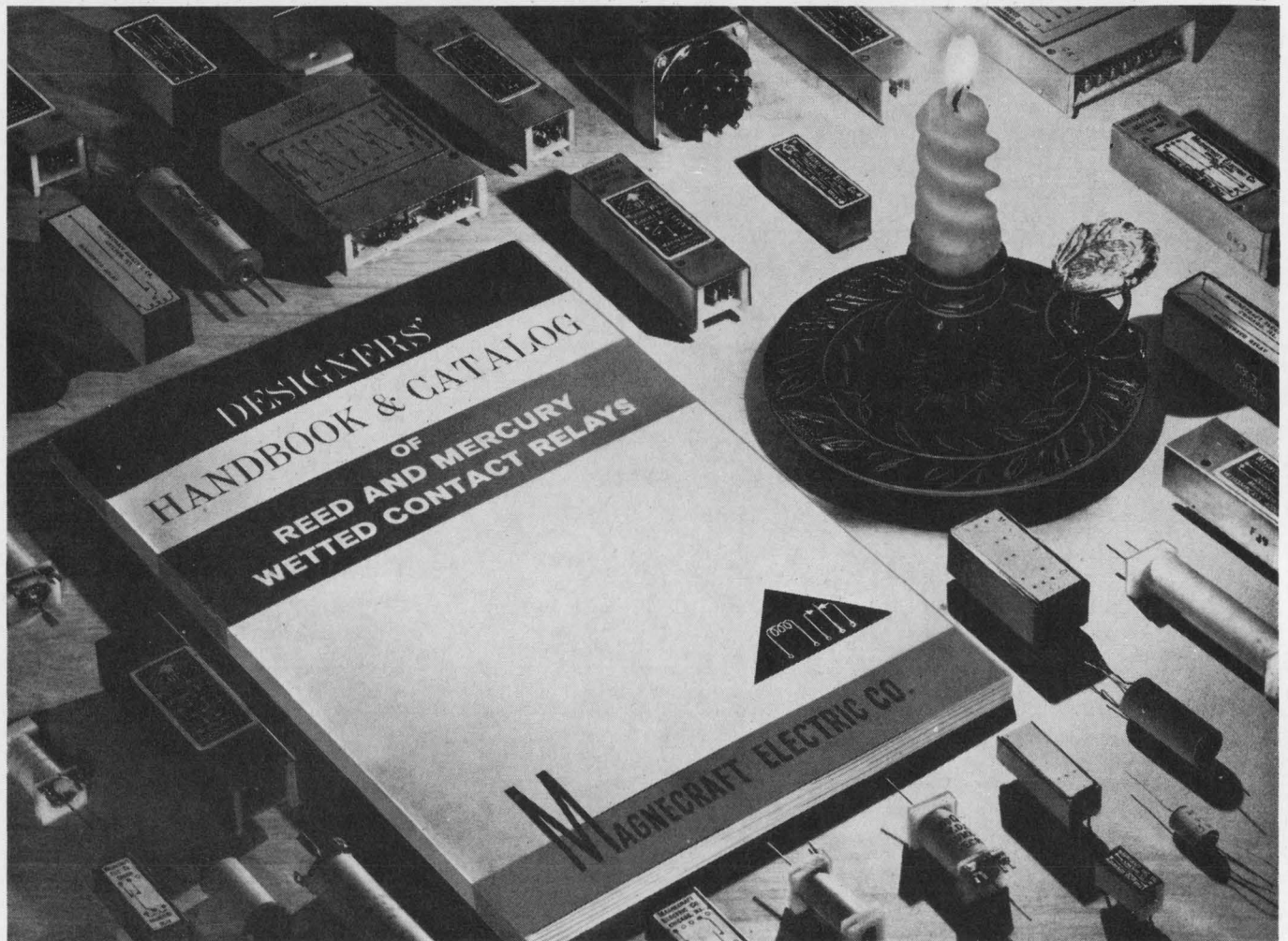

MAGNECRAFT WROTE THE BOOK”!

After developing the largest stock of dry reed and mercury-wetted relays on the market today, we had enough experience to write a book. So, we did! An 80-page handbook, in fact. It starts off with a glossary of terms and carries through to a complete product data section. In addition, there is information on applications and design considerations, how to specify relays, principles of operation and testing procedures.

Free copies are available to qualified circuit designers, engineers and others involved in the electrical or electronic fields. Write for yours. We may never win a Nobel Prize for literature, but if they ever offer one for advancements in reed relay development — well, that's another story.

Manufacturing Stock Relays for Custom Applications

Magnecraft[®] ELECTRIC CO.

5575 NORTH LYNCH AVENUE • CHICAGO, ILLINOIS 60630 • 312 • 282-5500

1,000,000 flashes and still going strong...

that's why you'll find EG&G Xenon Flashtubes and Power Supplies in the new Dennison High Speed Copier

EG&G Xenon Flashtubes and Power Supplies provide the reliable, extremely efficient light output that maintains a consistent level of spectral response . . . flash after flash after flash. Prime considerations for long-lived dependability and fidelity of reproduction in modern office copiers. In addition, EG&G pulsed Xenon Flashtubes and Power Supplies are designed to produce a maximum number of flashes at the least cost per flash.

EG&G capability in this area encompasses the design, development and volume

production of complete Xenon Flashtube systems. This means we can match the flashtube to a compatible electronic flash system to satisfy your total light output requirements.

Through EG&G's continuing program of research and development, the Xenon Flashtube has evolved from a novel device used initially in photographic and stroboscopic applications to an extremely flexible present day tool. Its use in scientific, engineering, industrial and military applications is expanding. You'll find EG&G Xenon

Flashtubes in such diverse applications as laser stimulation, phototypesetting, flash photolysis, warning beacons, oscillograph recorders and microfilm printers.

If you'd like more information on EG&G pulsed Xenon Flashtubes and Systems, or for that matter on any of our products, such as thyratrons, krytrons, spark gaps, transformers, photodiodes, thermoelectric coolers or light instrumentation, write: EG&G, Inc., 166 Brookline Ave., Boston, Mass. 02215. Tel.: 617-267-9700. TWX: 617-262-9317.

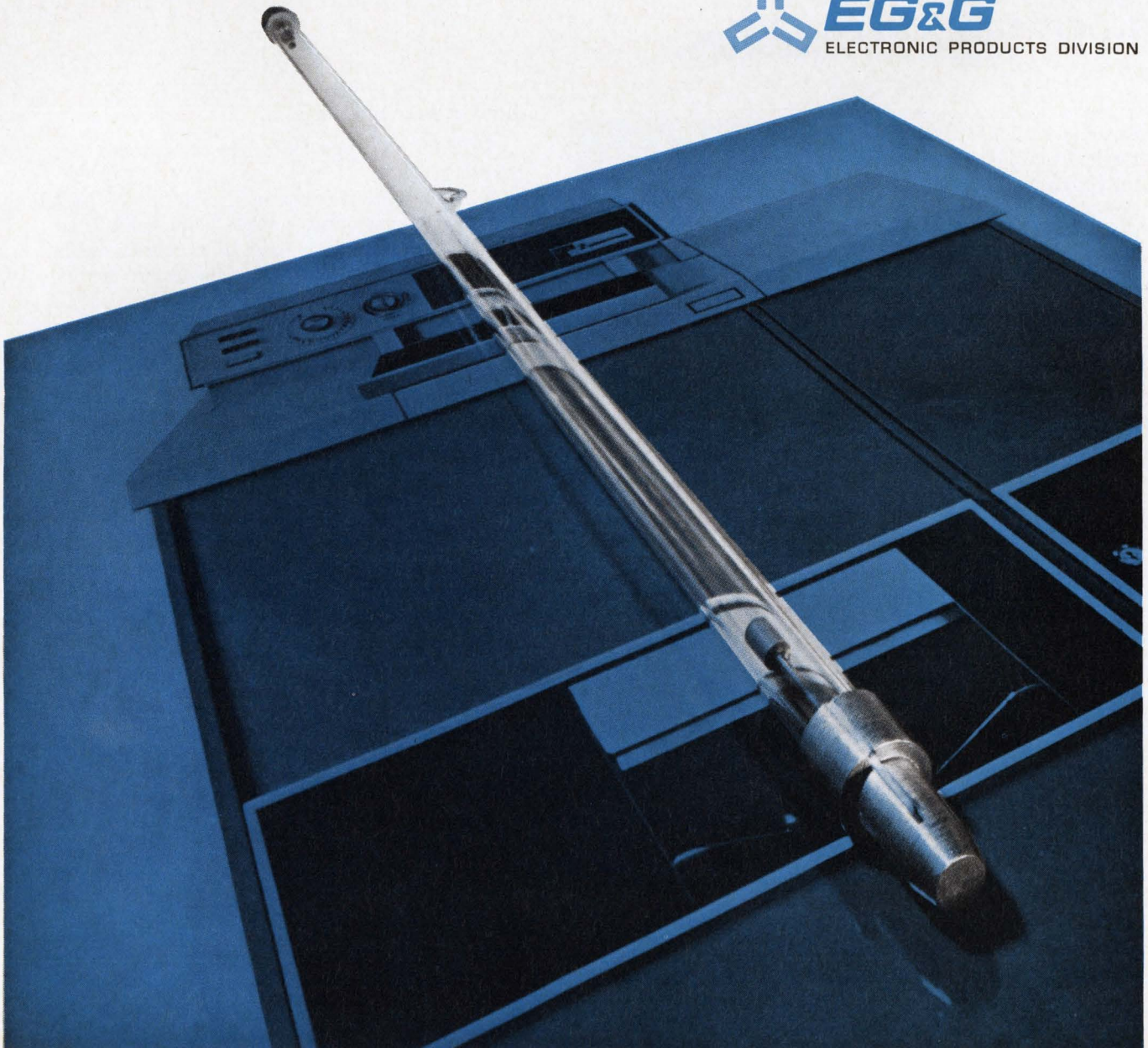

We have something for no-nonsense design engineers

who want to make
the best investment
in IC logic assemblies.

Design with CAMBION® IC Logic Assemblies. You get more for your money . . . more functions on every logic card . . . an exclusive 70-pin input/output that lets you bring more functions through to the outside world.

With this unique connector capability, we've developed both standard and those hard-to-find cards . . . grey code logic, arithmetic logic, counters, decoders, registers, comparators . . . all the odd-ball assemblies you need.

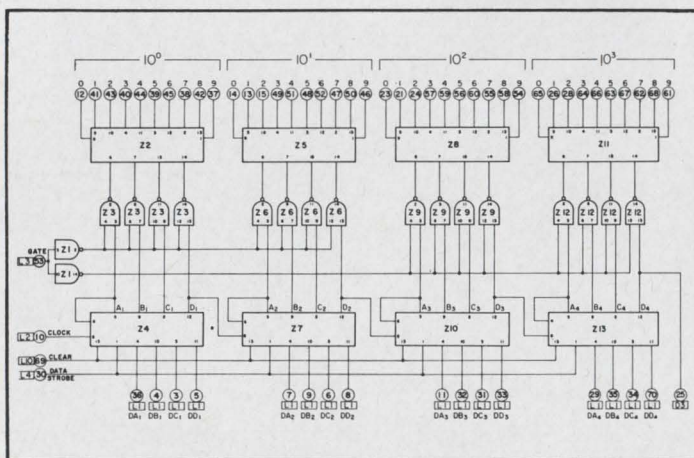
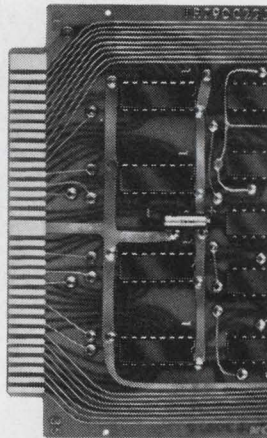

BCD counters with decoder/Nixie drivers

Look at these advantages:

SPEED — IC logic assemblies with speeds to 25 MHz.

NOISE — Exact component location with precision etched interconnections achieve "short-leads" and prevent signal cross-coupling. BCD counters with decoder/Nixie* drivers all on a single card are but one example.

PACKAGE DENSITIES — 70-pin input/output, plus a great array of complex functions and you've got what it takes for highest density packages. (You use fewer cards this way, too.)

VARIETY — Over 250 card types for difficult applications.

DELIVERY — Immediate . . . from stock . . . honestly.

DOCUMENTATION — CAMBION's new logic manual has the data, including application and helpful reference formulas.

NO-NONSENSE — Make the best investment in IC logic assemblies. Send for new manual. Cambridge Thermionic Corporation, 447 Concord Ave., Cambridge, Mass. 02138. Phone: (617) 491-5400. In Los Angeles, 8703 La Tijera Boulevard. Phone: (213) 776-0472.

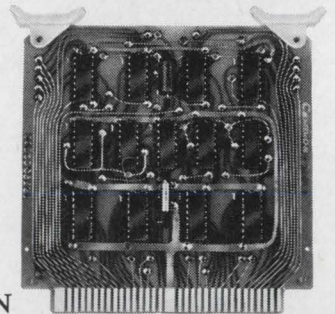

®Reg. U.S. Pat. Off.
*Trademark, Burroughs Corp.

See Us at WESCON
Booth 228

CAMBRIDGE THERMIONIC CORPORATION
CAMBION®

Standardize on CAMBION . . . the guaranteed logic assemblies

STEP UP

**TO WIDER RANGES
GREATER ACCURACY**



Model 630-NA
VOLT-OHM-MILLIAMMETER
PRICE \$93.00

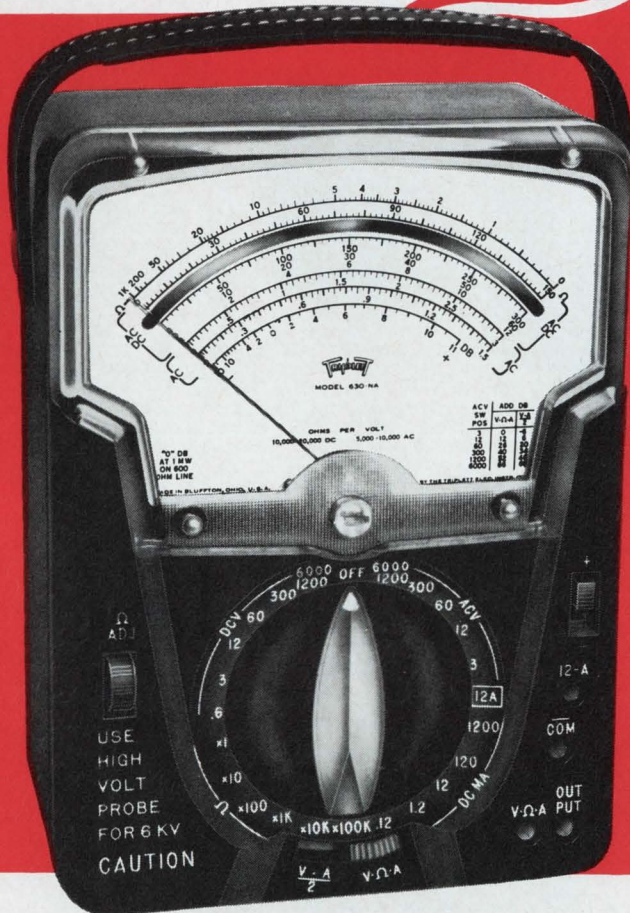

EXTREMELY RUGGED TRIPLET SUSPENSION METER MOVEMENT

- No Pivots, Bearings or Rolling Friction
- Greater Sensitivity
- Greater Repeatability

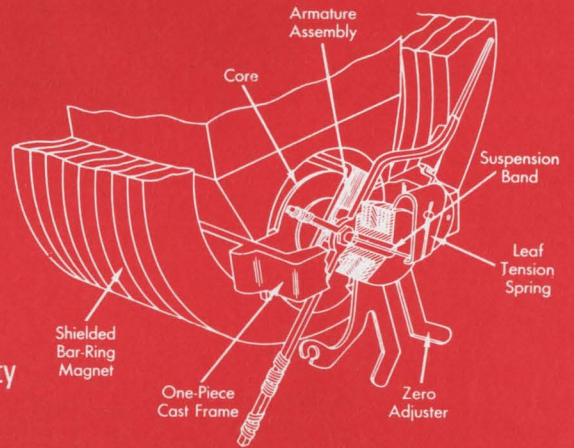

Uses Unlimited:

FIELD ENGINEERS ■ APPLICATION ENGINEERS ■ ELECTRICAL, RADIO, TV, AND APPLIANCE SERVICEMEN ■ ELECTRICAL CONTRACTORS ■ FACTORY MAINTENANCE MEN ■ INDUSTRIAL ELECTRONIC MAINTENANCE TECHNICIANS ■ HOME OWNERS, HOBBYISTS

FACTS MAKE FEATURES:

- 1** ONE SELECTOR SWITCH MINIMIZES CHANCE OF INCORRECT SETTINGS AND BURNOUTS.
- 2** 66 RANGES: 1½% DC ACCURACY ON METER; WITH MIRRORRED SCALE AND DIODE OVERLOAD PROTECTION.
- 3** TEMPERATURE AND FREQUENCY COMPENSATION.

THE TRIPLET ELECTRICAL INSTRUMENT COMPANY, BLUFFTON, OHIO

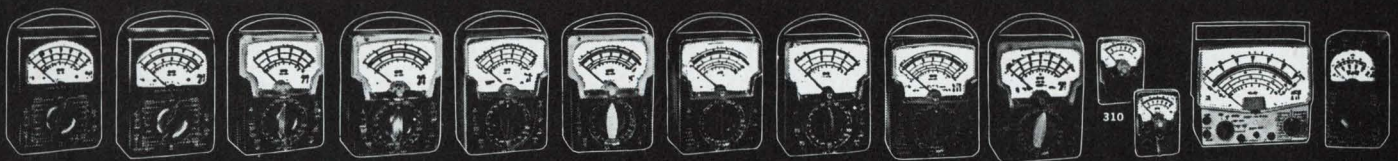

THE WORLD'S MOST COMPLETE LINE OF V-O-M'S. AVAILABLE FROM YOUR TRIPLET DISTRIBUTOR'S STOCK

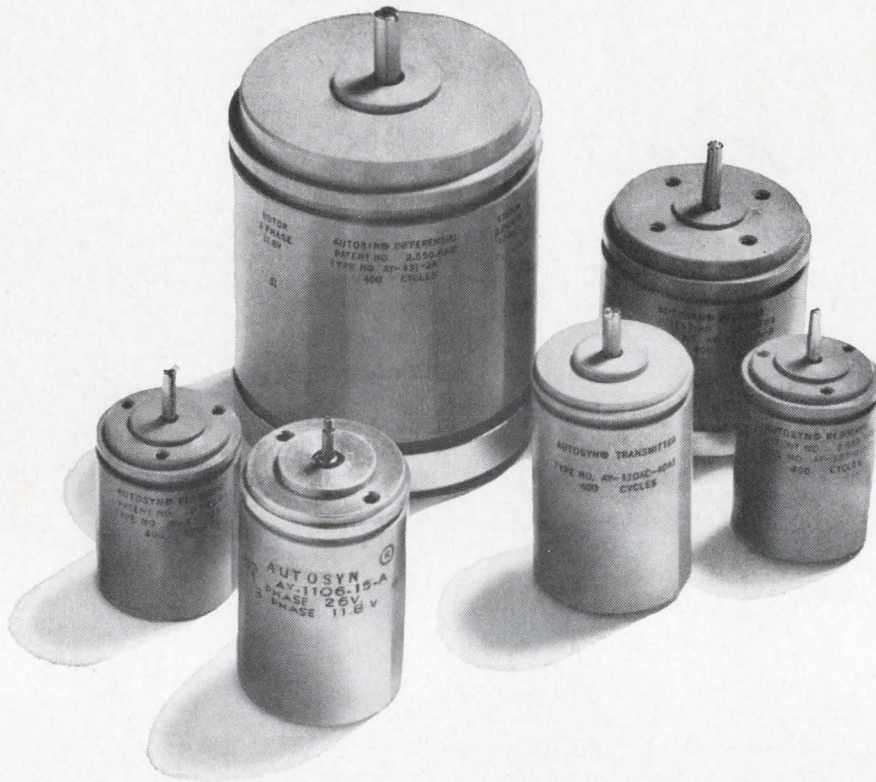

Bendix Autosyn Synchros. Can you afford to buy less?

Not if you need the kind of performance and reliability you get from Bendix® Autosyn® Synchros.

And you have a wealth of types to choose from. Ultrahigh-temperature synchros that perform accurately at sustained temperatures up to 800°F. Ultracompact (size 08), lightweight (1.3-oz.) synchros for critically tight designs. Ultraprecise synchros with tolerances to 50 millionths of an inch. Dependable corrosion- and radiation-

resistant synchros. And there's a complete line of Bendix Mil-Spec synchros, too.

AUTOSYN® SYNCHROS

Size	Max. Diameter (In.)	Typical Weight (Oz.)	No. of Models
08	0.750	1.3	16
10	0.937	1.7	25
11	1.062	3.2	29
15	1.437	4.7	24
22	2.161	18	5

Altogether there are hundreds of types—your largest single source. What's more, our synchro design service can promptly solve your special problems. You can depend on it. As they do at GE, Sperry, RCA, Lear Siegler, Motorola and many other value-conscious firms. Ask for our catalog today. Write: The Bendix Corporation, Flight & Engine Instrument Division, Montrose, Pa. Or phone: (717) 278-1161.

Bendix
Aerospace Products

275 - 2750 MHz to 35 Watts Output

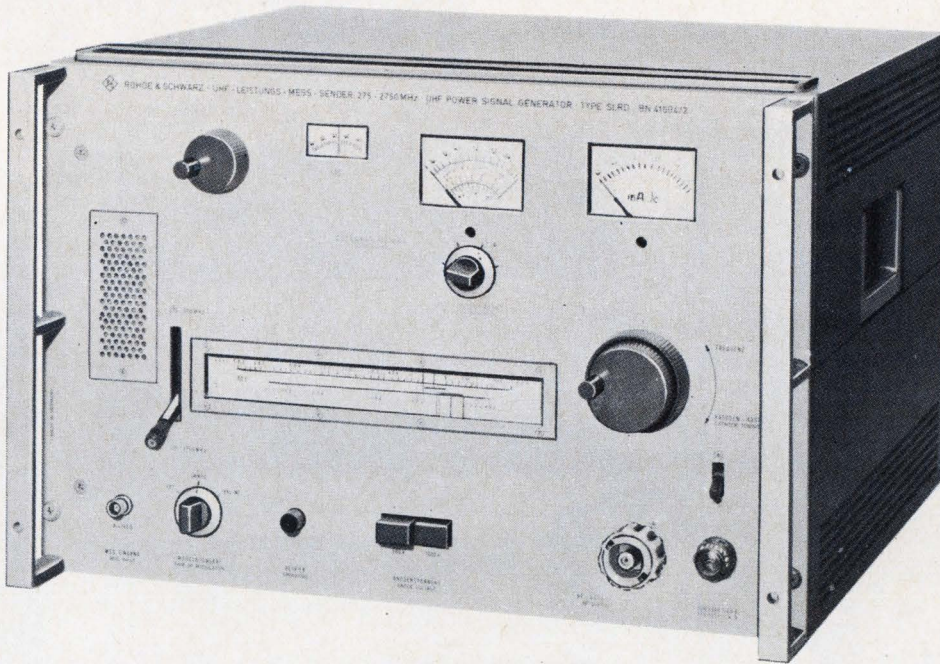

TYPE SLRD

UHF POWER SIGNAL GENERATOR

FEATURES:

- 275-2750 MHz in Two Switchable Ranges; No Cavity Change Required
- Direct Reading in Frequency
- High Output Power: 2.5 W to 35 W
- Built-in Output Attenuator: 0 to 70 dB ($1 \times 10^{-8}W$)
- Built-in Power Meter: +9 to +47 dBm
- Power Limiter Protects Instrument and Test Object
- Int./Ext. Pulse and Squarewave Modulation
- Synchronization Feature Optional

APPLICATIONS

Measure two and four terminal networks, narrow band resonators, microwave systems (especially radar). For antenna ranges: determine propagation and antenna characteristics, absorption, and radiation patterns. For use with slotted lines.

UP TO 35 WATTS OUTPUT

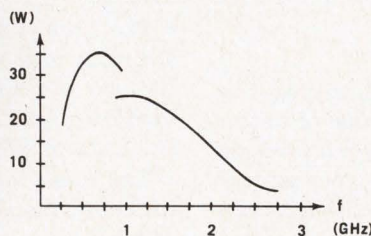

TYPICAL MAX. OUTPUT POWER
INTO 50Ω

The new Type SLRD, BN 41004/2, represents a redesign of our popular UHF Power Signal Generator. Based on the success and experience obtained from its predecessor, this new generator features higher output power, external modulation facility, and a synchronizing option.

Using a disc-sealed triode, max. available power is typically +45 dBm. A precision calibrated attenuator permits continuous power variations to -50 dBm. A high speed pulse modulation, requiring only $3V_{p-p}$ for ext. drive, operates with rise time as low as $0.08 \mu s$.

Combining high power output with a std. signal generator, Type SLRD, has been designed for ease of operation. A level switch permits selecting the desired operating range without having to change cavity elements. Direct reading in frequency eliminates the necessity of "logging" numbers and conversion charts. A max. power circuit breaker is controlled by the power meter f.s.d. and range switch, thereby protecting sensitive test items from overload.

Get The Extra Capability,
Greater Reliability, and
Longer Useful Life Of . . .



ROHDE & SCHWARZ

111 LEXINGTON AVENUE, PASSAIC, N. J. 07055 • 201-773-8010

Inquiries outside the U.S.A. should be made to: Rohde & Schwarz, Muehldorfstrasse 15, Munchen 8, West Germany

The anything recorder.



does anything you want for less than anything else on the market.

The Anything Recorder can't be anything less than the Brush Mark 2300 lightbeam oscillograph... because no other recorder of comparable price has comparable capability. It takes the agony out of recording... in the lab, down in the shop or out in the field.

Here's how:

- It's ready to record when you are. Just plug it in, set the required sensitivity, select any one of sixteen recording speeds, push the button, and go. It produces sharp, clear analog traces of what's happening with an accuracy of 99.5 percent... can handle most any recording job that comes along.
- The 2300 is available with up to 16 analog channels, and offers frequency response from DC to 2 kHz at sensitivities as high as 200 microvolts per chart division. No other recorder has this frequency/sensitivity range in a single package.
- The 2300 has built-in floating and shielded ampli-

fiers which provide full functional control, high input impedance, high common-mode noise rejection. Controls for calibration, attenuation, gain, and trace positioning are right at your fingertips. No need for internal changes.

- The 2300 is portable... (has tilt-up handle)... and ready to go where you go—practically anywhere. It's built to take rough treatment, with all elements fixed on a solid one-piece casting that can't get out of alignment. Weighs only about 65 lbs.

The Brush Mark 2300 recorder. Dollar for dollar, it's better than anything anyone else has come up with yet.

Ask your Brush Sales Engineer for a "show me" demonstration. He'll show you the best all-purpose recorder value on the market. Or write for new 8-page Mark 2300 brochure. Clevite Corporation, Brush Instruments Division, 37th and Perkins, Cleveland, Ohio 44114.

CLEVITE BRUSH

TRW
announces

**THE WORLD'S
FASTEST
SEMICONDUCTOR
POWER SWITCHES.**

For greater payload in missile design

Designing missile and airborne equipment? Save power supply space and weight with these new TRW switching devices. They're 30% faster than anything else available.

Now you can design power inverters and switching regulators to operate through 100 kHz, at current levels from 5 to 40 amps . . . even under spe-

cial environment conditions. The increased efficiency makes more weight and space available for payload.

Sound interesting? Ask about TRW Types 2N5326-31 and IN5409-10. Today.

Contact any TRW Distributor or TRW Semiconductors Inc., 14520 Aviation

Bld., Lawndale, Calif. 90260. Phone: (213) 679-4561. TWX 910-325-6206. TRW Semiconductors Inc. is a subsidiary of TRW INC.

TRW[®]

Trusonic found a better sound at Durez

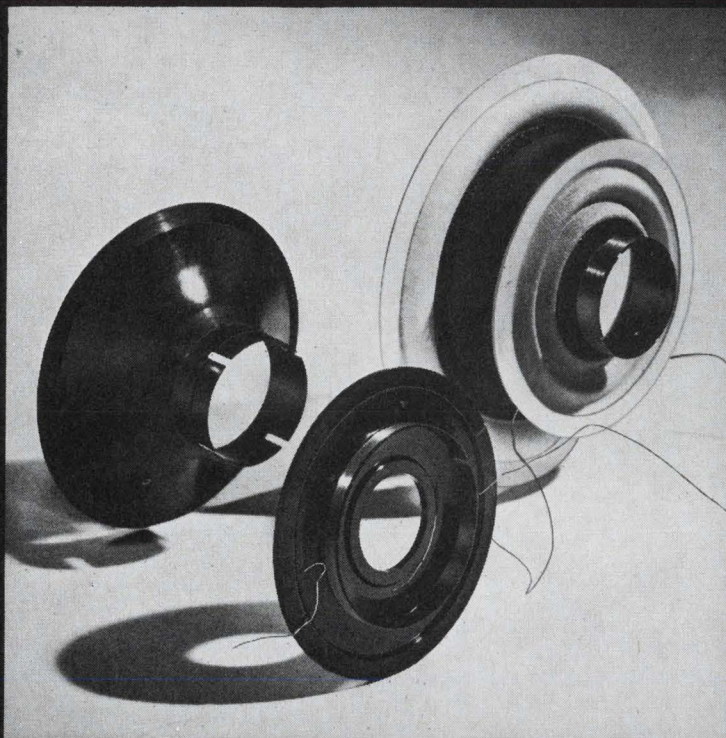

Trusonic builds its new, sophisticated sound systems around speaker cones precision-molded from Durez® phenolics.

Trusonic has found that our phenolics, molded into cones with perimeters as thin as .0065", gave a truer energy transmission than any other material. The added resistance of our phenolics to moisture, shock, and distortion lets Trusonic guarantee its sound systems for 10 years with complete confidence.

Would a tough wafer-thin material with excellent electrical properties improve an idea of yours? Challenge us with your design. Ask your molder for details, or write Durez Division, 9008 Walck Road, North Tonawanda, N.Y. 14120.

 **hooker**
DUREZ DIVISION

Performs more tests with no adjustments than any other IC or discrete op amp tester

Philbrick/Nexus Model 5102 Integrated Circuit Tester performs all tests automatically without calibration or manual programming. The only time you touch a dial is to select the desired test and for a minimum of scale changing for offset voltage and current measurements. Everything else is automatic, including offset zeroing. What's more, it is the only tester that performs CMRR and PSRR tests.

For only \$1400 you get all these additional features in a single instrument: direct reading meter displaying values of all parameters including large signal DC gain, external terminals for displaying IC output, selection of output resistors to match load, oscillation indicator, internal supply of ± 15 VDC programmable for ± 6 VDC — plus many more features. Contact your Philbrick/Nexus sales representative for complete details and specifications. Or write Philbrick/Nexus Research, 22 Allied Drive at Route 128, Dedham, Mass. 02026.

"VISIT US AT WESCON IN BOOTH 1723"



PHILBRICK/NEXUS RESEARCH

A TELEDYNE COMPANY



Voltage Regulator Problems?

- Output voltage changes due to input voltage variations?
- Output voltage changes due to ambient temperature variations?
- Output voltage changes due to reference element voltage/time instability?

Problems Solved!

Use Semcor's Metal Temperature Compensated Reference Elements

Low dynamic impedance — as low as 15 ohms

Controlled temperature coefficient — as low as .0005% / °C

Superior voltage/time stability — to .5mv per year

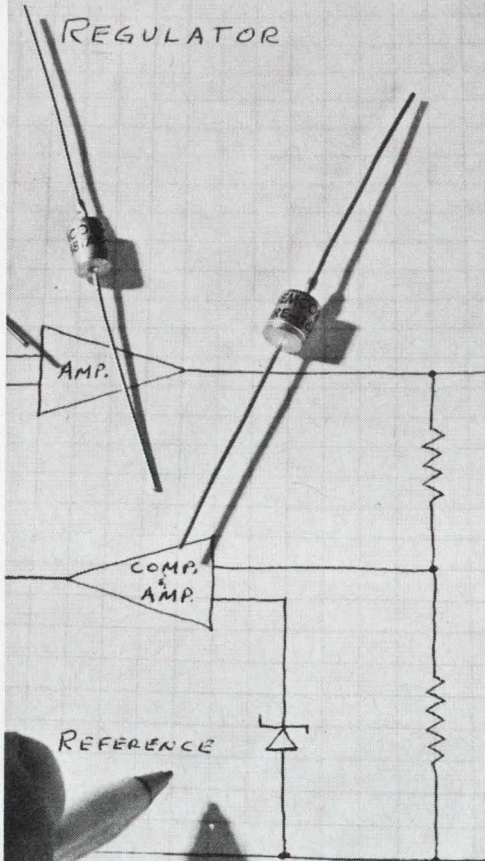

VOLTAGE/TIME STABILITY TEST

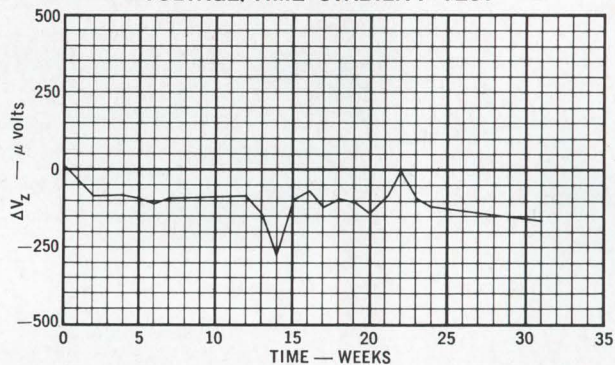

Call Semcor Now!

In stock and at the right price

Metal Temperature Compensated Reference Elements

1N2620 - 1N2624B9.3 Volts	1N3580 - 1N3584B11.7 Volts
1N2163 - 1N2171B9.4 Volts	HRE Series16-96 Volts
SRE Series9.4 Volts		

Also a complete line of Glass and Molded Temperature Compensated Reference Elements



3540 W. OSBORN RD. / PHOENIX, ARIZONA 85019
PHONE 602-272-7671 / TWX 910-951-1381

IC testers, op amps star

Massive engineering efforts to make the automatic testing of integrated circuits less expensive, more adaptable, and more convenient will be evident at the Western Electronic Show and Convention.

Visitors to the four-day show, scheduled for Los Angeles from Aug. 20 to 23, will see an unusual variety of IC test equipment for both digital and linear circuits. Of equal interest will be the significant IC advances in the evolution of the 709-type operational amplifier, including improved slew rate and reduced bias currents.

In the pages that follow are some of the most significant new products to be introduced at Wescon.

New instruments

Fast testing without frills

By cutting out the computer and other expensive "frills," the Birtcher Corp. has produced a flexible, programed automatic integrated circuit tester. It will plug the gap between manual and computer-programed component checkers, according to Rodney Mack, vice president and general manager of Birtcher's instrument division. At a price of \$12,000, his company hopes to tap a so-far unexploited market.

With manual insertion, the unit can test up to 8,000 16-lead devices per day; with an automatic handler, the rate goes up to one device per second—with 30 tests per device. A modular design allows expansion to accommodate more testing steps, more leads, and more performance parameters. Devices with up to 200 leads can be handled by the system and checking rates of 1,200 tests per second are possible with additions to the basic systems at a price still below that of computer-programed automatic testers now on the market, Mack

contends.

Computer techniques are used to program tests. Each system function has a separate addressable memory that can be set to correspond to power supply voltage levels and other test factors. To back up the test system, Birtcher supplies customers with taped programs by teletype on receipt of test information needs. Reaction time for program requests is two minutes at a cost of \$25 per program. This backup service, Mack explains, is possible through use of a time-shared IBM 7040 computer which interprets customers' test limits and conditions and test format to compile a program with the lowest total test time. For customers with their own computers, a software package is also available.

The components for the system include a photoelectric tape reader and controller, voltage- and current-programable power supplies, comparators, a matrix, and resistance decades. The test system matrix allows power-on switching

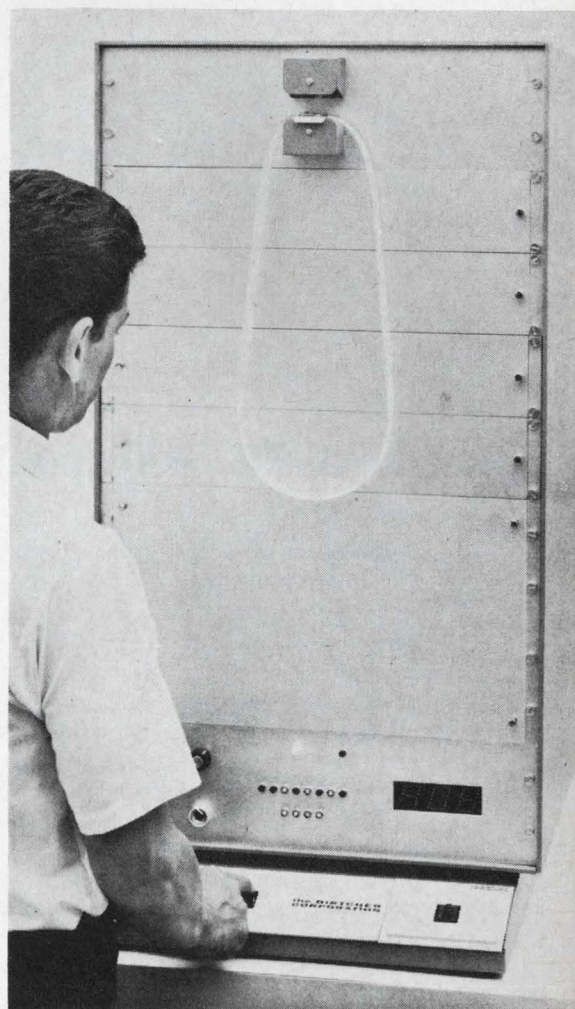

Looped. Tester is programmed with a punched-tape loop and optical reader.

to provide true functional testing of devices. Other automatic testing units for IC's do not permit this, Mack says. Crosspoint switching in the matrix depends on mercury-wetted reed relays with a 2.5 millisecond switching time. Individual printed-circuit cards in the matrix contain addressable switches that can be added as needed. The matrix capability can be expanded at a cost of \$250 per device lead. To keep costs down, Birtcher used epoxy-packaged IC's. There are 24 resistor-transistor logic IC's per card in an epoxy package.

Comparisons of d-c voltage or current can be made. The comparator is programable and it can handle floating or grounded measurements. Birtcher's spec sheet lists comparator current ranges from 10 microamperes to 100 milliamperes in decade steps with 10 nanoampere resolution, and voltage ranges from 1 volt to 100 volts with 1 millivolt resolution. Comparison speed is 10 milliseconds.

Ultra-stable. The programable power supplies for voltage and current use an ultra-stable temperature-compensated zener diode for reference and are designed to provide a source or sink type of application. Voltages with $\pm 0.25\%$ accuracy are delivered in 1-mv steps from 0 to 0.999 volts; 10-mv steps

from 0 to 9.99 volts; 100-mv steps from 0 to 99.9 volts. Short-circuit protection is provided by a 100-ma current limitation. The current supply has an accuracy of 0.25%. It supplies 0 to 9.99 ma in 1- μ a steps; 0 to 9.99 ma in 10- μ a steps and 0 to 99.9 ma in 100- μ a steps.

Program tape for the system is scanned by an eight-channel, 150 character-per-second photoelectric reader. Its interface with the system is a control unit that can handle a data input rate of 1 kilohertz, providing 250 tests per second with a single comparator unit. The system control module is designed so that nearly any data input system could be used.

At present, the Birtcher system is equipped only with a digital display to indicate at which step the go/no-go comparator output has halted the test sequence. However, by the end of the year a digital voltmeter and printer will be offered. Circuitry in the system allows for ready conversion by any customer who doesn't want to wait for the voltmeter-printer accessory, Mack says.

Self-test programs can be used to check operation of the control logic stimuli, comparison levels, and the switching matrix in about two seconds. Another accessory that will soon be available is a tape

cartridge to replace the present tape loop. This will permit sequence programs to be alternated with internal test programs and will make automatic device handling easier. Automatic handling devices cost \$4,000 and \$6,000.

Left out. Comparing the Birtcher system to computer-programed testers, Mack contends that his product can be set up to match the more expensive models in speed and provides a wider range in number of leads and types of tests. However, programable current limitation was left out of the design in the interests of economy, on the theory that a device failure which would allow it to burn up would result in rejection in most cases anyway. Inclusion of programable current limitation in the Birtcher system would add at least \$10,000 to the price.

One of the major design goals was to keep the tester technically alive as long as possible, hence the modular design. Address capability is almost limitless, since a typical system (four voltage supplies, current supply, comparator unit and 18 line matrix) would require 42 addresses, leaving 192 available for future system expansion.

The Birtcher Corp, Instrument Division, Monterey Park, Calif. 91754 [480]

New Instruments

Tester takes to any op amp

A tester for all types of operational amplifiers, the Model 79, automatically runs them through a series of 15 measurements regardless of whether the amp is made as an integrated circuit, or with tubes and solid state components. The instrument is made by Test Equipment Corp., Dallas.

Herman Plott, president, says the 79's capabilities make the instrument comparable to the expensive rigs used by semiconductor houses for on-line production testing.

Each test takes about 100 milliseconds, and all results are displayed by a digital voltmeter.

The 79 measures input offset

voltage, input offset and input bias currents, open loop gain, power supply rejection ratio, maximum output voltage swing, power dissipation, input and output impedance, common mode voltage, and gain bandwidth.

Currents can be measured down to the picoamp range, and voltages in the microvolt region. The accuracy of any test is never poorer than 5%, and most are at 2%.

A sequencer, made with diode-transistor-logic integrated circuits, performs the timing functions during a test and then resets the reed relays in the test matrix so the 79 can perform the next test.

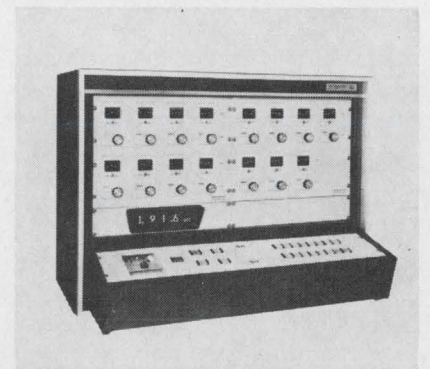

Multi-purpose. System handles IC's, discretes, or tube amplifiers.

The instrument contains seven power supplies, a digital readout with high or low limits, reference voltage supplies, an electrometer, and a multifrequency oscillator.

The 79's price is \$9,800.

Test Equipment Corp. P.O. Box 20215, Dallas, Texas 75220 [481]

Comparing with the best



Programmable. Comparator circuits check IC against program board.

Since early 1967, a fast growing market has opened in low-cost integrated circuit testers. One of the latest entries in the field is the Model 721 from Microdyne Instruments Inc., Waltham, Mass. that sells for \$3,990. The company says its new tester is more accurate and more flexible than competing units that cost \$1,000 more, and is just as fast.

The 721 has a 1.5% overall accuracy, helps spot the difference between a faulty package and a bad test fixture, and rather than just giving a go-no-go indication of IC performance, gives exact measurement of test voltages.

Family way. A selector switch sets up the 721 to test RTL, DTL, TTL, or emitter-coupled-logic circuits. Other testers, even more expensive ones, use "family boards" which are inserted for this function. These printed circuits have the necessary basic input-output connections for the logic type being tested. Such cards can cost several hundred dollars, but the 721 comes with the equivalent of four already built in.

Only one program board is needed for the particular type of IC being tested. This board contains a bogie, a standard IC, against which others of the same type are checked by a bank of 14 dual comparator circuits. Besides the IC, the board holds all additional circuitry needed to perform the comparisons, as well as an analog output for the 721's built-in digital voltmeter.

Since it was designed to work with a high-speed automatic-feed system, the 721 performs a Kelvin-

contact continuity check. Before any current is applied for test, each IC lead is checked for opens, shorts, and contact resistance. If any pin fails, the IC is held over for later test. Microdyne engineers had found that many IC's were being rated no-go because of defects in the test fixture which wore out during repetitive high-speed testing. Now circuits that fail this check can be tested later in a new fixture.

The continuity check takes a millisecond for a 14- or 16-lead package, and since the check precedes testing, a faulty pin won't mean a blownout IC.

The testing speed of the 721 is limited mostly by the rate at which the mechanical handling machines can feed it. According to John H. Gallagher, Microdyne sales manager, 5,000 IC's per hour is a conservative estimate since the individual tests in the 721 take as little as 75 microseconds each, and the 721 can perform a maximum of 1,024 tests per IC.

Automatic handling brings its own disadvantages, and worn test fixtures is only one of them. Sometimes, handling machinery degrades the performance of the tester. To avoid this, Microdyne's engineers have designed the 721 for complete electronic isolation from the handler. "Solenoid-controlled reed relays pass commands between the 721 and handler," says Michael Ferlend, senior design engineer. "We want the IC to change state because we say so, not because of a voltage spike in the handler."

Other factors affect the 72's accuracy—the quality of the tester power supply, tolerance of resistors used on the programing board, and, the resolution and impedance of the 721's comparators.

Microdyne engineers designed 14 separate power supplies into the 721—one for each pin of a 14-lead package. Each supply compensates for factors like contact resistance, which might otherwise bring applied levels below test specifications. Each supply puts out 12 volts

with enough reserve to compensate for a 6-volt drop across the test fixture and pins. If contact resistance is too high, however, the IC is set aside during the Kelvin-contact test.

Microdyne supplies 1% programing-board resistors as standard, with higher tolerances available on special order. For users with exceptionally high requirements, unprogramed boards are available with which users can wire-in test tolerances as tight as necessary.

Compare. The 721 has 28 comparator circuits, two for each of the 14 pins. One of each pair is set to spot high-side deviations and the other to detect below-spec performance. Comparator limits are set on the programing board.

Ferlend says that the comparators can sense a difference of 2 millivolts and trigger the appropriate go-no-go indication in 5 microseconds.

For minimal circuit loading, the comparators use field effect-transistor inputs, bringing their impedance up to about one million megohms—as high as that of some good digital voltmeters.

And, for added flexibility, the 721 includes its own DVM. In contrast to some instruments costing \$1,000 more, the 721 allows the user not only to spot a go-no-go condition, but also to tell how far out of specification the integrated circuit is.

To use the DVM, the operator turns a selector switch to the pin number indicated by a flashing go-no-go lamp. The DVM immediately reads out the signal amplitude at that pin. The operator can compare the readout value to IC data-sheet figures.

Often, an IC may fail a go-no-go test, but be so near the mark that it can be reserved for a non-critical application rather than returned to the vendor. Also, for those IC's which must be returned, a record of failed values helps the vendor find out what went wrong.

Since the 721 uses a comparator-measurement approach and a bogie IC on its program board, it can test

more complex circuits than most similar units. One well-known competitor, for example, is limited to circuits with only four outputs, while the 721 can handle up to 10 inputs or outputs, or as few as four of each. So the 721 can test decoder-driver IC's which have more than four outputs, and such oddball circuits as quad-bistable latches (eight outputs) or seven-segment decoders (seven outputs).

Some more costly competing units simulate the logic functions of the IC under test with DTL circuits. This limits the complexity of the arrays they can test. "Try testing a four-bit adder," says chief engineer Paul Treakle. "It's impossible because that type of machine can't synthesize the adder's operation."

The 721 even has a special clock circuit for use with some Signet-

ics capacitive-input IC's, and is equipped to deal with the delicate transfer function characteristics of ECL and TTL logic circuits.

Finally, for users interested only in go-no-go testing, Microdyne offers the 720—like the 721 in all respects but price, \$3,490, and the lack of a built-in DVM. But the 720 has output jacks for a DVM.

Microdyne Instruments Inc., 225 Crescent St., Waltham, Mass. 02154 [482]

New Instruments

See-as-you-go IC tester

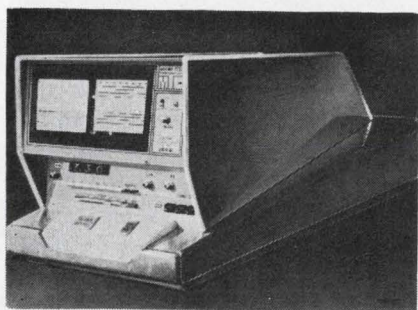

Where and when. After testing a digital IC, the 100-D shows what failed by lighting up points on an error grid.

A double feature is usually one filmed story followed by another, but not at Microtest Inc. To make testing of digital integrated circuits easier and faster, the company's engineers put two stories on the same film strip.

Inside the company's new IC tester, the 100-D, is an 8-millimeter projector. Each frame of a film strip is set aside for a specific type of IC. On the bottom half of the frame the testing sequence is programmed by punching holes that can be read by the instrument's photoelectric decoder. The top half contains test specifications which are displayed on the tester's console, along with the IC's logic diagram, the logic levels at each pin during each test, and an error grid that shows at what pin and during which test a failure occurred.

Andrew Nester, Microtest's director, says the 100-D is aimed squarely at similar systems of three prime competitors—Signetics' 1100,

Teradyne's ACT-1 and Optimized Devices' LT101.

The 100-D can test a wide range of digital IC's and a-c coupled digital devices. A complete d-c test cycle takes less than 16 milliseconds. In this time, Nester explains, a 16-pin device is put through 16 test sequences. An optional feature allows devices with 24 pins to be tested.

"On go-no-go testing we have an accuracy of 1% of the compared value. On current-voltage testing our accuracy is 0.1%," says Nester. "These levels are possible because of our built-in digital voltmeter, that allows measurement of absolute values."

On show. During test, the top half of the film is projected backwards to a small mirror which reflects the image onto the screen on the front of the 100-D. As the tests are made, errors show up as lights on an electroluminescent grid superimposed on the projected display. The tester may be set to stop or pause on fail.

In most IC testers, results are shown as banks of coded flashing lights, says Nester. The operator has to know the code to determine which IC has failed—and how or where. "With the 100-D, this information is rapidly available on the viewing screen. Our tester will show that pin 6 failed on test 5, or whatever it is," he adds.

The test program, which is stored on the bottom half of the film strip and is not projected on

the viewing screen, is a series of holes in the film through which light is projected and then reflected onto a 16-by-20 array of photo-sensitive transistors.

The 100-D is made with more than 200 IC's, plus the discrete components used in the compensating networks and lamp drivers. Diode-transistor logic IC's do the digital functions, and linear devices do the controlling and programming.

The film strip is moved manually. If the framing or focusing is not in line, a warning light goes on and the testing cycle stops.

A bank of 14 potentiometers is used to vary two sets of IC inputs. Each control button actuates one potentiometer that's concerned with one voltage parameter, says Nester, and the DVM shows the value in current or voltage.

Match up. The tester works with wafer probes, handlers and environmental chambers.

Standard equipment includes a film strip that runs tests for 15 types of IC's, and any combination of DTL, transistor-transistor-logic or resistor-transistor-logic can be specified. Additional film strips may be purchased.

The price of the 100-D is \$9,000—somewhat high in comparison to that of other IC testers. But Nester says that extras on some competing equipment are standard on the 100-D.

Microtest, Inc., 8165 Sepulveda Blvd., Van Nuys, Calif. 91402 [483]

New semiconductors

Improving on the 709

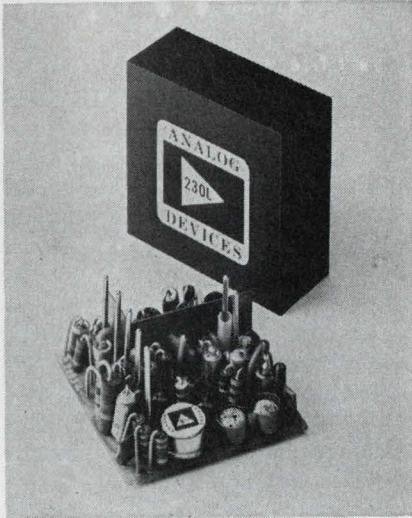

Reducer. IC op amp (foreground) halves volume and price of amplifier.

For all its flaws, the 709 type operational amplifier is anything but a dud in the marketplace. Even discrete-component op amp makers concede that, so far as sales are concerned, the 709 is king. This may explain why Analog Devices Inc., of Cambridge, Mass., has entered the lists with an improved 709 as its first IC product (Electronics, July 22, p. 33). But the improvements are nothing like those performed on Fairchild's 741, National Semiconductor's LM101, or Motorola's MC1539.

Rather than correcting the 709's more obvious flaws (like lack of short circuit protection, its tendency to latch up if overdriven in some applications, its narrow differential voltage range, and its occasional need for complex frequency compensation networks), Analog's engineers decided to reduce input bias current and input offset currents one hundredfold or more.

Thus, says Ray Stata, vice president of Analog, the 709-type op amp for the first time will be able to penetrate applications like high input impedance amplifier circuits, high-accuracy low-level current amplifier circuits, and such

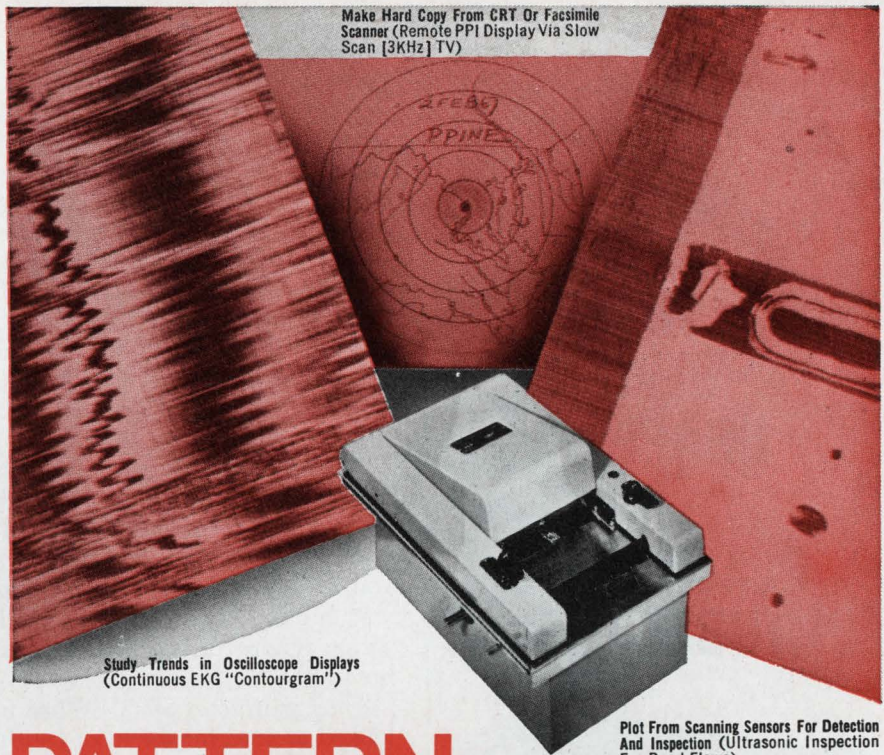

Make Hard Copy From CRT Or Facsimile Scanner (Remote PPI Display Via Slow Scan [3KHz] TV)

Study Trends in Oscilloscope Displays (Continuous EKG "Contourgram")

Plot From Scanning Sensors For Detection And Inspection (Ultrasonic Inspection For Bond Flaws)

PATTERN, PLOT OR PICTURE

Now . . . with a simple instrument . . . you can reproduce electrical phenomena as permanent records in pattern, plot, or picture form where otherwise the data is presented as transient oscilloscope or CRT displays.

The versatile Alden "Flying-Spot" Helix Recorder, used with Alfax Type A electro-sensitive paper, produces permanent graphic images of repetitive or sequential signals with a wealth of detail and information content not approached by other display and recording techniques.

It is a simple matter to synchronize the Alden Recorder with scanning sensor or transducer (sonar, radar, ultrasonic, infra-red detectors, etc.) to provide a continuous "plot" of the information obtained. The recorder sweep speed (horizontal output) can be varied to provide almost any desired rate of presentation. Paper advance rates can readily be changed to provide time expansion or compression for increased detail, or clearer representation of long-term data trends and improved signal-to-noise ratio.

The Alden Recorder can be used with a broad variety of systems (computers, television, medical instrumentation, facsimile, scanning radiometers, etc.) which produce sequential signals on a constant time base, to provide accurate and instantly visible "picture" or "pattern" information. Images are produced with a dynamic, tonal shading directly proportional to signal strength, providing a "third dimension" of information recording.

To satisfy your exact requirements, Alden "Flying-Spot" Component Recorders, in various printing widths from 4" to 48", along with a wide selection of plug-in drives, recording configurations, signal amplifiers, phasing circuits, and synchronizing accessories are available, designed to provide a simple, economical adaptation of Alden instant recording techniques to your instrumentation.

ALDEN ELECTRONICS & IMPULSE RECORDING EQUIPMENT CO., INC., WASHINGTON STREET, WESTBORO, MASSACHUSETTS 01581 — TELEPHONE: (617) 366-8851

For more information on the most versatile data recorders available, write today for complete details.

Dept. E-8

ALDEN ELECTRONICS & IMPULSE RECORDING EQUIPMENT CO., INC., WASHINGTON STREET, WESTBORO, MASSACHUSETTS 01581

GENTLEMEN: I am interested in Alden "Flying-Spot" recording techniques.

I would like to investigate Alden Equipment for use in the following application:

I would like data for possible future reference.

NAME _____ TITLE _____

COMPANY _____

ADDRESS _____

CITY _____ STATE _____ ZIP CODE _____

See us at WESCON, Booth 3062, Sports Arena



THE NEW SHAPE IN PLASTIC TUBING

*may fit
your problem
exactly*

FLEXITE Shrinkdown Plastic Tubing shrinks 50% in diameter upon application of moderate heat to form a tight-fitting sheath around objects of irregular shape. It's being used to solve many different problems . . . like insulating electrical connections; protecting delicate components; strengthening assemblies; binding things together; resisting corrosion, heat or moisture; preventing wear, vibration and noise. What problems do you have that a tight sheath of tough plastic might solve? Markel offers Shrinkdown in three distinct types to meet a broad range of needs. Your call or letterhead request will bring samples and data.



L. FRANK MARKEL & SONS, INC.
Norristown, Pa. 19404 • Phone: 215/272-8960
INSULATING TUBINGS AND SLEEVINGS
HIGH TEMPERATURE WIRE AND CABLE

high-accuracy capacitor-charging circuits as analog to digital converters.

How come? Why build a 709 and change only these current specifications? "Most of the 709's other faults were found quickly and engineers learned to design around them, outboarding resistors or capacitors where necessary—the 709 is a known animal," says Stata. "Also, in reviewing our applications files we found that the 709 was best suited to low-frequency or direct-current applications."

Analog's application files had shown that inverting circuits make up about three-fourths of the 709's applications. "The 709's ± 8 -volt common mode voltage range was broad enough, and we could safely ignore that in our design," he adds.

Thus, continues Stata, "When we looked around for the most fruitful improvements, we picked d-c specs in general and offset current and bias in particular; these were areas that nobody seemed to have paid attention to."

Less bias. Nearly every so-called improved 709 has input bias current and offset current specified at

500 nanoamps. Analog specifies its new 801B at only 2.5 nanoamps bias at 25°C and only one nanoamp input offset. The less expensive 801A has corresponding specifications of 4 and 2 nanoamperes.

"We have improved what we think are meaningful specifications rather than curing faults engineers are accustomed to dealing with," says Stata.

Sacrifice move. Analog sacrificed a little voltage gain to get better current performance; the 801 is rated at 15,000 versus 25,000 absolute gain for the 709 and its successors. But Stata feels that for almost all applications 15,000 is more than enough.

Analog plans to benefit from in-house use of the 801 as well as from sales. Stata feels that the improved current performance offered by the 801 series will make possible refinements in Analog's growing line of functional modules.

Prices for the military-quality 801A are \$18 each in quantities of 100 or more; for the more tightly specified 801B, \$24.

Analog Devices Inc., 221 Fifth St.,
Cambridge, Mass. 02142 [484]

New instruments

A broadband phasemeter

There's been a rush recently among instrument makers to supply a solid state replacement for vacuum tube phasemeters. Wiltron Company's entry is the 355 which makes direct readings for inputs from 10 hertz to 2 megahertz, at levels as low as 1 millivolt, and input ratios up to 2,00:1.

"There's been a clear need for a meter that's sensitive but not loaded down with a lot of range switches, and which can be used as a general purpose instrument," says Duane Dunwoodie, director of product development at Wiltron. "The key to the 355's success is the use of Wiltron's own amplifiers which have a gain of 10,000 over a range from 0.5 hz to 20 Mhz."

Wiltron engineers stabilize the high-gain amplifiers by using a strip-line technique to control the high-frequency feedback. Copper-shielded amplifier circuit boards, says the company, haven't often been used to stabilize amplifiers of this sort but they do contribute to the high stability of the 355. The amplifiers each have four gain stages, three of which are limiters. Field effect transistors in the input stage of each amplifier cut the noise, and also control input capacitance to the point that it's possible to attach a standard oscillator probe to the front of the meter. "With the 355, you can use the probe to compensate the way you would with a scope," says Dunwoodie.



Wide-ranging. Phasemeter covers band from 10 hertz to 2 Mhz. Range makes it useful for measuring response of feedback circuits.

Telling the difference. The 355 has a differential input, the first time one's been available on a phasemeter, according to the company. Dunwoodie points out that with this type of input the 355 can measure the phase between off-ground signals—signals which exist between two ungrounded wires that are each carrying half an input.

All telephone signals, he says, are off-ground, so the telephone companies should be interested in the new meter. The differential input, he adds, makes it possible to take such phase measurements without grounding either side of the input. This, plus the instrument's 1-megohm input impedance permits measurements to be taken without disturbing the lines.

The input can be made single-

ended by just putting a capacitive link between one terminal and ground.

The resolution of the 355 is 0.1° , which the company calls very good for an instrument with such a broad frequency range.

Among the applications Wiltron suggests are 60-cycle tests, and measurement of phase lag in vibration experiments. The increasing popularity of operational amplifiers may also produce a big market. The 355's broad range makes it ideal for measuring feedback response, says Dunwoodie.

The 355 costs \$2,200, and a 50-pin binary data output is offered as a \$150 option. Delivery time is 6 weeks.

Wiltron Co., 930 East Meadow Dr., Palo Alto, Calif. [485]

New instruments

Miniflaws spotted inexpensively

As **electronic** components improve and shrink, flaws become smaller and harder to measure. Capacitor and transistor leakage currents now are measured in picoamperes, and integrated-circuit specifications in the nanoampere range are common. Ten years ago values like

these could only be measured in a laboratory. Now low-level measuring is common throughout industry.

So there's a need for an inexpensive microvoltmeter-nanoammeter with both high accuracy and high sensitivity. The General Ra-

A-to-D Converters

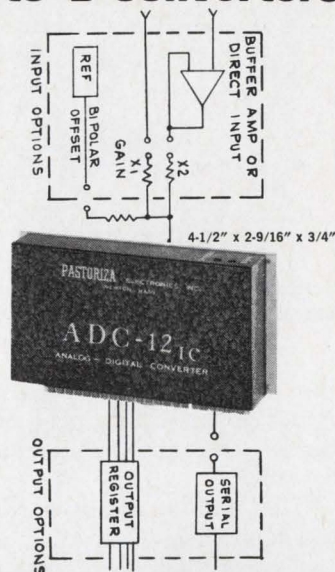

**with more options
at less cost
and delay**

- High-frequency FET input amplifier.
- Bipolar or unipolar input signals of varying ranges.
- Parallel and serial outputs of binary or BCD codes.
- TTL logic for high speed and fanout drive capability.
- Resolution up to one part in 4096 (12 bits).
- Extended temperature capability.

The Model ADC-12_{1C} is a complete, general purpose, integrated circuit A-to-D converter that accepts input voltages on command and converts them to a 12-digit binary code in 25 microseconds. The single card contains an input amplifier, precision reference supply, logic, weighing network, switching, comparison, and internal clock. Only external DC power is needed.

The Model ADC-12_{1C} 12-bit converter is just one of Pastoriza's many competitively priced A-to-D and D-to-A converters. All are available with a variety of different input options, resolutions and output codes, usually in less than thirty days.

Write or call for more information on ADC TTL Series.

PASTORIZA
ELECTRONICS, INC.

385 Elliot St., Newton, Mass. 02164 • 617-332-2131

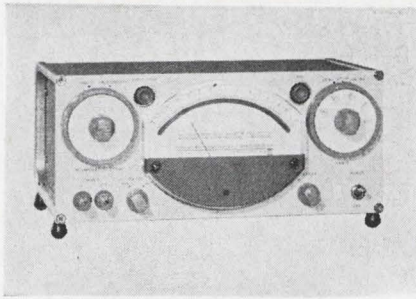

Sensitive. Microvoltmeter-nanoammeter permits low-level measurements.

dio Co., West Concord, Mass., hopes to meet this need with its model 1807 d-c meter that sells for \$665.

The 1807's designer, development engineer George N. Valekdjian, says that while some costlier units reach the 1807's accuracy, none match it in combined accuracy and sensitivity: "The 1807 is about 10 times more accurate than competing units."

How much? On each of its nine current and nine voltage ranges, the 1807 reads to within 0.1%; at the same time, it resolves d-c signals as small as 0.05 picoamp or 0.05 microvolt. Valekdjian says these specs compare with those for digital voltmeters. He designed General Radio's first DVM, introduced last March [Electronics, March 4, p. 192], which sells for about triple the price of the 1807.

Both models use a photochopper input and an input amplifier circuit. The 1807's loop gain of about 300 makes possible a typical input impedance of 1,000 megohms. General Radio conservatively rates the 1807 at only 500 megohms.

With such a high input impedance, loading of external circuitry is vanishingly small and so are the errors.

Getting the most. To maximize accuracy, the 1807 not only reads voltage and current directly, but

also has an interpolator that acts as a range expander to boost resolution and cut error, both by 10.

After a direct reading is taken, the interpolation-offset switch is set to the first significant figure of the direct reading. The switch controls a resistor network which bucks out 90% of the incoming voltage or amperage; meanwhile, gain of the input amplifier goes up 10 times so that the meter reads out the second, third, and fourth significant figures with 0.1% accuracy.

This gets around one of the major flaws of analog measuring instruments, the inaccuracy of the meter itself.

The 1807's other features include optional remote operation, an analog recorder output, and extra input jacks on the back panel for rack mount use.

The General Radio Co., 22 Baker Ave., West Concord, Mass. 07181 [486]

New Subassemblies

Data-gathering in the field

Traditionally, data acquisition systems have been physically large in order to provide large-system capabilities. Now, however, engineers at Non-Linear Systems Inc. have designed a portable, 25-channel data acquisition system mounted in a 10½-inch-high by 19-inch-wide rack.

"We feel we compete favorably with systems four times our size because of portability and price," says marketing manager Leroy Becker. The NLS S-2 sells for \$9,950 with a magnetic tape unit and offers four-digit resolution. A competing system 48 inches high sells for about \$16,000 with the magnetic tape option but offers five-digit resolution.

The S-2 consists of a digital voltmeter with 0.01% accuracy a 25-channel scanner, a serializer to convert parallel output data from the DVM to serial form for entry on the recorder, and the incremental tape unit that records at densities of 200 and 556 bits per inch.

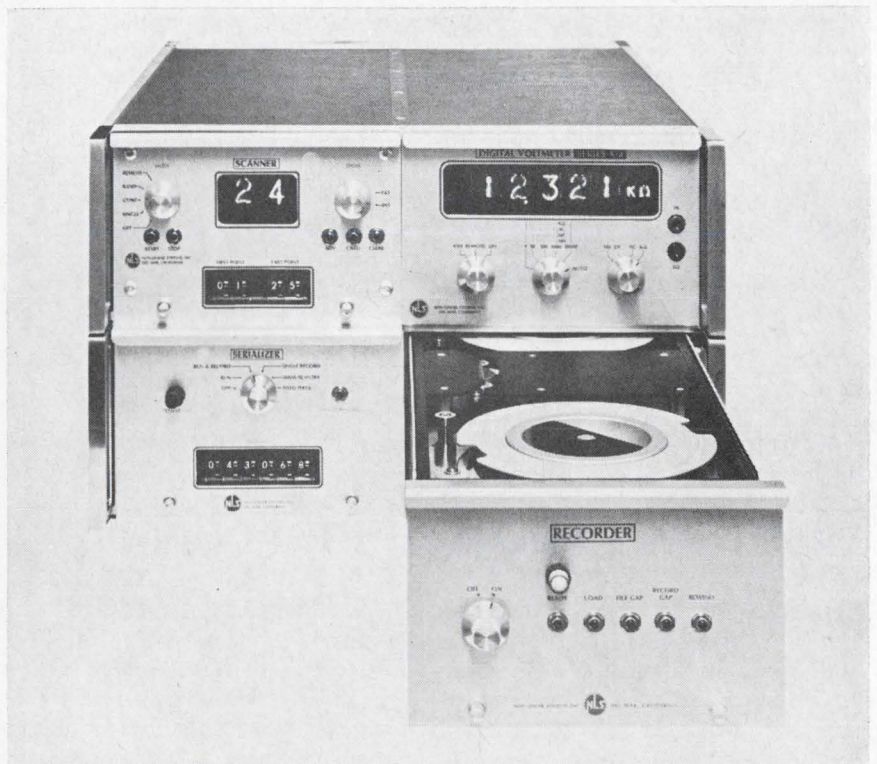

Big little system. Ten-inch high package contains digital voltmeter, scanner, serializer, and magnetic tape unit.

HERE'S HOW...

THE ELECTRONIC INDUSTRY IS USING
THESE FAMOUS ULANO FILMS IN
ULTRAMINIATURE MASK TECHNOLOGY
AND COMPLEX PRINTED CIRCUITRY

Cut a piece of the desired film large enough to cover area to be masked. Tape it down firmly at the top with dull-side up.

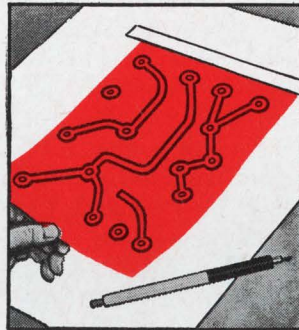

With sharp blade, outline the areas to be masked. Do not cut through the backing sheet. The Ulano Swivel Knife does the job quickly, easily.

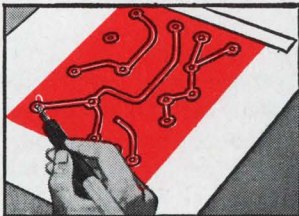

Using the tip of the blade, lift up a corner of the film thus separating it from the backing sheet.

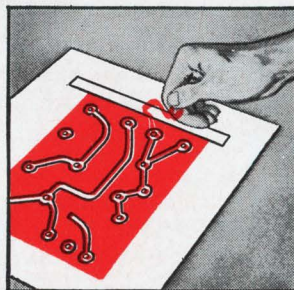

Now carefully peel off the film as outlined leaving a completed mask, positive or negative, that corresponds exactly to the desired pattern.

UlanoTM

RUBYLITHTM AMBERLITHTM

HAND CUT MASKING FILMS FOR THE GRAPHIC ARTS

ULANO RUBYLITH... a revolutionary knife cut red film is laminated to a stable transparent plastic backing sheet. The red film is "light safe" so that when contacted to a sensitized emulsion and exposed to a suitable light source, light passes through the cut-out portions only... not through the red film. ■ The polyester backing is absolutely stable... insures perfect register. ■ Special effects such as crayon tones, paste ups, benday sheets, and opaquing are easily combined with versatile ULANO RUBYLITH.

ULANO AMBERLITH... a companion to Rubyolith serves as a color separation medium used as the master on camera copy board to secure negatives or positives.

A wide variety of Ulano films—
in rolls and sheets—is readily available

Designed FOR YOUR PARTICULAR NEEDS

Ulano offers the most versatile line of hand-cut masking films, including:

.0075—RUBYLITH 75 DR* .005—RUBYLITH 5 DR†

.005—AMBERLITH 5 DA†

Where exact register assures a critical importance, you will find these new, thick, polyester based films the positive answer.

* Available in sheets only, cut to your specifications

† Available in rolls and sheets



WRITE TODAY

on your letterhead for free
special sample kit 1748

"Ulano"—"Rubyolith"—"Amberlith" are registered trade marks of the Ulano Companies.

ulano

610 DEAN STREET, BROOKLYN, N.Y. 11238

In Europe: ULANO A.G., Untere, Heslibachstrasse No. 22, Kusnacht, Zurich, Switzerland

The Material of Unlimited Uses...



SOLDERING "UNSOLDERABLES"

...is but one of the thousands of uses for advanced low-melting-temperature alloys such as Cerroseal® 35. Cerroseal 35 melts between 238 and 260° F., and can be used with ordinary soldering techniques. When soldered with this versatile alloy, "toughies" such as glass-to-metal, ceramic-to-metal and metal-to-metal seals stay tight even in a deep vacuum. Other Cerro® Alloys, including specials made to your individual specs, are perfect for joining ultra-delicate parts like integrated circuits which cannot be heat-sunk during soldering. Low-temperature soldering as cool as 117° F. can also be accomplished with certain Cerro Alloys.

For detailed information contact Cerro Alloy Dept., Cerro Copper & Brass Company, Stamford, Conn. 06907... R. S. Darnell (203) 327-0550.

CERRO®

An average of 2 readings a second can be obtained, Becker says, adding that readings could last as long as a full second or as short as 200 milliseconds. The S-2 is designed to gather data from any type of transducer and will be used principally in university and military research and development.

The scanner is mounted in a half-rack package, has first and last point addresses and the capability of skipping channels. Unused channels are not read, and reed relays are used for switching.

The serializer has manual entry thumbwheel switches mounted on the instrument's front panel. Six decimal digits of information can be entered on the tape. The recording format is compatible with computer inputs, and the recording code may be changed by switching a plug-in module.

Small reels. The recorder is a compact unit using 5½-inch reels. Each reel contains up to 250 feet of tape, and up to seven tracks of data may be recorded. Becker says

some unique packaging techniques were used to bring the recorder to half-rack size (5¼ by 7½ in., 32 pounds), and one of the trade-offs involved going to 5½-inch reels instead of 7½.

If a user has the space, he can get a digital clock and a digital comparator as optional accessories. The clock is used for periodically starting the system and scanning the channels. Readouts are digital in hours, minutes and seconds. The comparator is used for determining if any particular channel is out of its pre-set tolerance.

Will travel. Becker says the S-2 was developed for labs that might not be able to afford more expensive systems and also need portability. The entire unit weighs less than 125 pounds and runs off a 110-volt a-c 60-hz line. For field work, battery packs are furnished; Becker says less than 200 watts are required to run the system.

Delivery time is 60 days.

Non-Linear Systems, Inc., Del Mar, Calif. 92014. [487]

New semiconductors

IC's transfer data at 30 Mhz

Cable connections in digital systems tend to be susceptible to ambient noise and to interference from adjacent cables. In addition, the power dissipation of coupling devices increases with the data transmission rate, limiting data rates to a few megahertz.

Two new monolithic integrated circuits from Radiation Inc.—the RA-245 triple line transmitter and the RA-246 triple line receiver—

promise to alleviate the problems. The T/R provides interfacing between two systems linked by 50-ohm balanced transmission lines. They can transmit data at rates up to 30 Mhz over as much as 10 feet of twisted-shielded-pair cable. For lower transmission rates, it's practical to drive lines of 100 feet or more; the pair can drive capacitances greater than 7500 picofarads at data rates up to 1 Mhz.

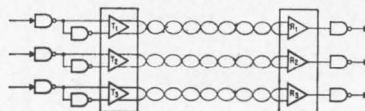

Three channels. T/R pair can transfer data over three twisted pairs, but no power is consumed by an unused pair. Dielectric isolation is used for both transmitter (right) and receiver.

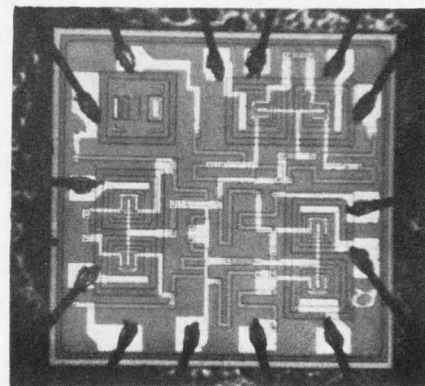

Power dissipation is essentially independent of the data rate—a big improvement over conventional saturated IC line drivers. The RA-245 and RA-246 operate efficiently from d-c to 30 Mhz; they contain three transmitters or three receivers, allowing data to be transferred over one, two, or three cable pairs simultaneously with a maximum total dissipation of 50 milliwatts per channel. No power is consumed in an idle channel.

Constant sum. Radiation, Inc. uses a dielectric isolation technique in the manufacturing process. The low parasitic capacitance characteristic of dielectric-isolated circuits makes the 30 Mhz data rate possible, the company says. The RA-245 and 246 are compatible with all saturated-logic IC's currently on the market, according to William R. Weir, director of marketing for the company's microelectronics division. The transmitter accepts voltage logic information from saturated logic circuits and converts it into a current-mode signal which is fed to the receiver. The algebraic sum of the currents in the transmission line pair is very nearly constant, and instantaneous voltage changes along the line are insignificant. As a result, the power dissipation is independent of the data rate, and there is little electromagnetic interference or susceptibility. The receiver converts the current information back to a voltage level corresponding to that of the original signal. Both circuits will operate properly even with a ± 2 volt ground differential between the two linked systems.

Total propagation delay for both circuits is less than 40 nanoseconds with a duty cycle distortion of less than 15 ns. Maximum current unbalance in the lines is 0.8 milliamperes. The transmitter is provided with continuous short circuit protection.

Doubles. The RA-245 transmitter can double as a high-speed level shifter, operating between +2 volts and -30 volts. There are three level shifters per transmitter or, if the three differential inputs are multiplexed, six shifters per transmitter. The RA-246 receiver has an alternate application, too. It can be used for a threshold detection, with three detectors per package.

The circuits come in TO-84 flat

New Wire Wrap Connectors



*Another
quality
reason for
specifying*

Methode

This new *Methode* series of connectors has been designed to provide reliable, economical connectors capable of satisfying the demands of current military and sophisticated commercial product applications.

Consistent with industry trends, these connectors are readily adaptable to automatic or manual wire wrap or equivalent, with each contact efficiently handling up to three terminations. Available in sizes ranging from 14 to 80 positions, single and dual read-out, these connectors are adaptable to all standard $\frac{1}{16}$ " and $\frac{3}{32}$ " boards. All connectors feature cantilever style bifurcated contacts of phosphor bronze with gold plating over nickel, with contacts formed and polished to provide minimum wear on PC cards. All contacts have radiused mating surfaces to provide lowest contact resistance, highest reliability in use.

Look to *Methode* leadership in quality design and manufacture to resolve your connector problems today. Contact your *Methode* Technical Representative, or write us direct. We invite your inquiry at any time.

Connector Division
Methode Electronics, Inc.
7447 W. Wilson Ave.
Chicago, Illinois 60656 • 312 / 867-9600

New Low Power AC Sources.

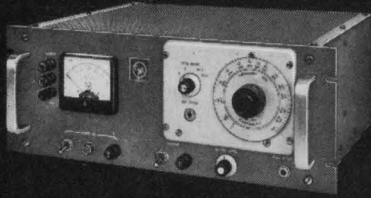

**Prices even
lower.**

175 VA—\$565

350 VA—\$1120

CML has been making the best low power AC sources around. For years. Now low power hits a new low in price. All with interchangeable oscillator modules for fixed or adjustable output frequencies from 45 to 6000 Hz. All feature excellent frequency stability and load regulation, low distortion, and lightning-fast response. Write or call today.

	Model NS175 (175 VA)	Model NS350 (350 VA)
With fixed 400 Hz oscillator	\$565	\$1120
Adjustable 350-450 Hz	685	1225
Adjustable 45-6000 Hz	785	1385

CML, Inc.

A Subsidiary of
Tenney Engineering, Inc.
350 Leland Avenue
Plainfield, N.J. 07062
(201) 754-5502 • TWX 710-997-9529



packs or ceramic dual in-line packages. Radiation says prices for the circuits will be competitive with 2-channel devices manufactured by

Fairchild and National Semiconductor.

Radiation Inc., Melbourne, Fla. 32901
[488]

Typical characteristics

25°C ambient temperature

Circuit parameter each channel	RA-245 Line transmitter $V_{CC} = +5\text{ v}$	RA-246 Line receiver $V_{CC} = +5\text{ v}$ $V_{EE} = -5\text{ v}$
Power dissipation	25 mw	15 mw
Input data current	-1.4 ma	3.0 ma
Output data current	-4.0 ma	20 ma
Short circuit current	-5.0 ma	
Input resistance		50 ohms

Output breakdown	-40 v	6 v
Turn-on delay	3 ns	15 ns
Turn-off delay	3 ns	15 ns

Combined T/R system characteristics

Data current unbalance	0.6 ma
Turn-on propagation delay	18 ns
Turn-off propagation delay	18 ns
Duty cycle distortion	3 ns
Output common-mode noise	10 mv
Transmission rate	30 Mhz
Intra-system noise immunity	$\pm 2\text{v}$

New instruments

Fourth terminal adds new jobs

Ratio measurements are an everyday procedure in an electronics lab. But such measurements have had to be made with three terminals—the reference quantity and the unknown quantity connected to a common ground.

With Hewlett-Packard's model 3450A digital multimeter, true four-terminal ratio measurements can be made. The instrument operates by measuring each input sequentially; the two quantities of the ratio are never connected to the measuring circuits at the same time. As a result, the quantities can be completely isolated from each other. This four-terminal capability makes many new measurements possible, Hewlett-Packard says; it is particularly useful for taking ratios of floating voltages, without the complications that would ordinarily result from the lack of a ground reference for either voltage.

In an unbalanced strain gage bridge, for example, the outputs are proportional to any change in the supply voltage. To measure strain, it's necessary to take the ratio of the d-c voltage across the strain element to the d-c voltage across the reference element—but since the low ends of each of these elements are separated, this measurement can only be made with four terminals.

To calibrate a digital-to-analog

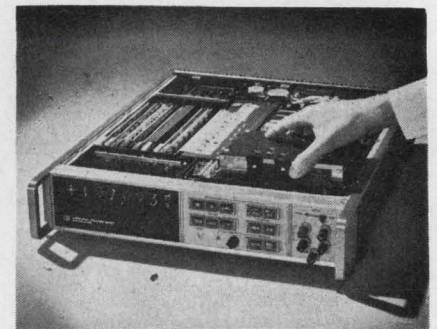

Optional ease. All options are contained within the main frame. They can easily be added to basic meter.

converter resistor assembly, the resistors in each decade have to be compared to a reference resistor. This requires an ohms ratio measurement, and again a four-terminal input is necessary to compare the second decade.

Special task. Hewlett-Packard uses a simple and effective demonstration to illustrate the four-terminal capability of the 3450A. Three resistors are connected in series. The instrument is then used to measure the ratio of the outer two resistors, a job which could not be done with a three-terminal instrument.

The 3450A multimeter provides a five-digit display, with values up to 20% over-range indicated by a sixth digit. It measures d-c voltage on five ranges from ± 100 millivolts to $\pm 1,000$ volts. It has 1-

Meet Our New Baby

Midwestern Instruments' LCR is a portable third-generation, direct-recording, light-beam oscillograph, providing a complete recording system with built-in signal conditioning modules matched to single-unit galvo-magnet structures.

It is the lowest cost unit in its class.

The LCR has been designed with simplified controls and front panel input connectors for ease of operation — even by non-technical personnel.

Principal features include: New single-unit galvo-magnet structures ■ plug-in modular electronics ■ 3, 8 or 14 channels ■ 6-inch chart ■ 8 push button selected speeds ■ and a wide range of options.

You won't have to pamper this "Baby" — even though it's small — because it works just like the big boys.

For all the vital statistics, contact your nearest **Midwestern Instruments Representative** . . . he's handing out cigars.



SEE IT AT WESCON
BOOTH 1709 in the
L.A. Sports Arena

FREE ILLUSTRATED
BROCHURE ON REQUEST

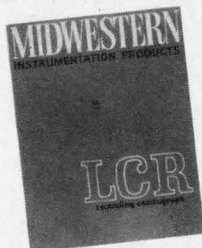

**MIDWESTERN
INSTRUMENTS / TELEX**

DATA SYSTEMS DIVISION

A SUBSIDIARY OF THE TELEX CORPORATION
6422 E. 41st STREET TULSA, OKLAHOMA 74135
PHONE 918 - 627-1111 TWX 918 - 627-6030 TELEX 49-2489

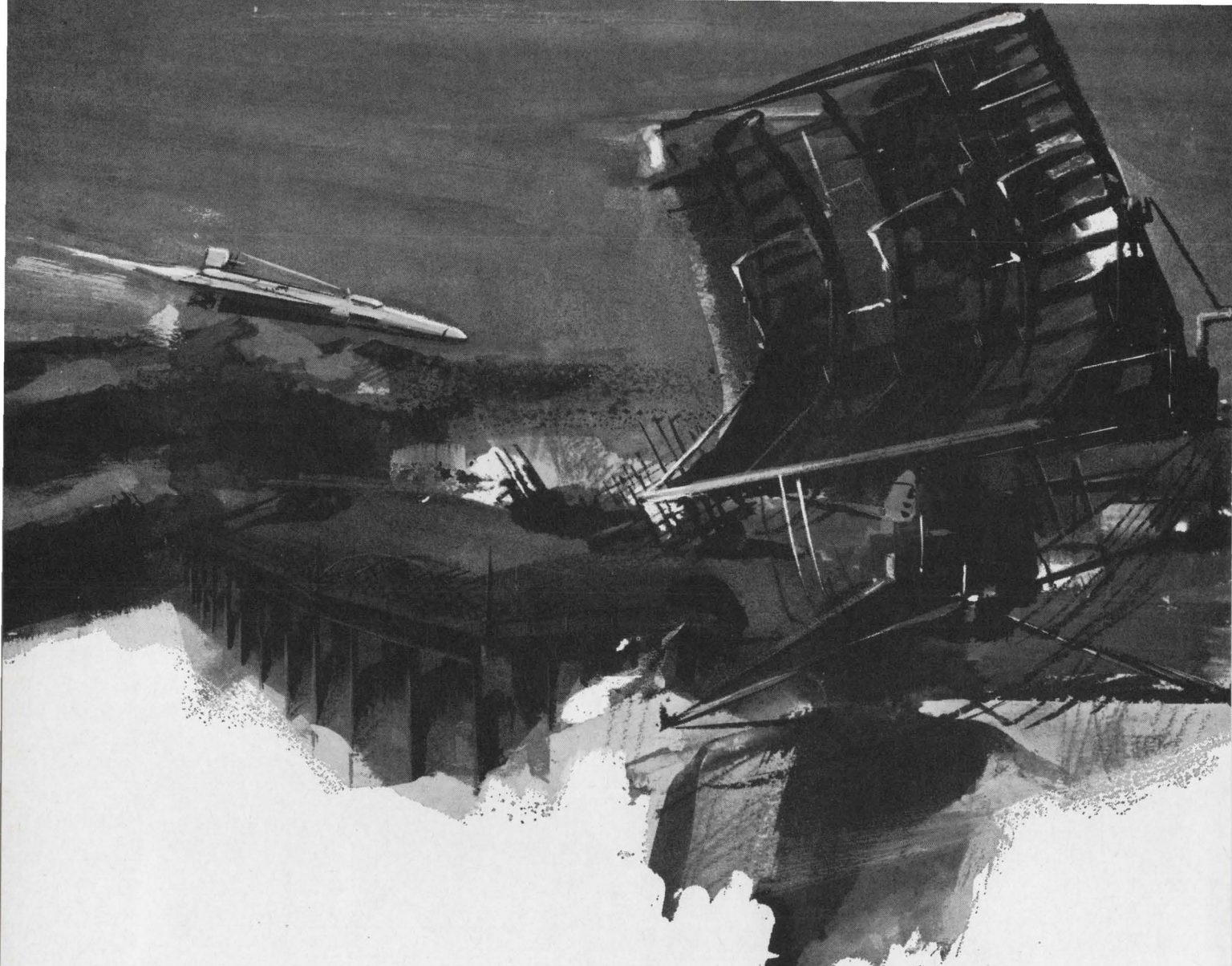

Engineers and Scientists: Diversified opportunities now available on Hughes AGM's

Increasing Air-to-Ground Missile activity at Hughes Aerospace Divisions has created many diversified growth opportunities for qualified Engineers and Scientists. Immediate openings exist at all levels on a variety of interesting projects such as: MAVERICK, Anti-Radiation Missiles, Radar-Guided Missiles and new advanced missile technologies.

Areas of interest include:

Laser	Trajectory Analysis
Radar	Operational Analysis
Infrared	Warheads & Fuzing
Television	Structural Design
Guidance & Control	Thermodynamics
Signal Processing	Aerodynamics
Digital Computer Simulation Studies	

All assignments require accredited, applicable degrees, U.S. citizenship and a minimum of 3 years of related, professional experience.

Please airmail your resume to:

Mr. Robert A. Martin
Head of Employment, Dept. 17
Hughes Aerospace Divisions
11940 W. Jefferson Blvd.
Culver City, Calif. 90230

HUGHES

HUGHES AIRCRAFT COMPANY
AEROSPACE DIVISIONS

An equal opportunity employer

... resistance measured on six ranges ...

microvolt sensitivity at 15 readings per second, and this fast reading rate can be maintained in the presence of noise because dual-slope integration is used to measure d-c voltages. Over a 24-hour period, and with temperature limited to $25 \pm 2^\circ\text{C}$, accuracy is within 0.002% of reading $\pm 0.001\%$ of scale. Input resistance is 10^{10} ohms on the three lowest ranges.

The instrument provides four ranges of d-c ratio, with an extremely wide range of reference levels— ± 100 mv to ± 120 volts.

True rms conversion is used to measure a-c voltages. The converter employs a sampling technique to alternately compare the input and the d-c output through a single thermocouple. This technique provides very high accuracy and frequency range. The frequency range is 45 hz to 1 Mhz, and at 100 khz the accuracy is within 0.12% of reading $\pm 0.03\%$ of full scale. This is four to ten times better than that of competing instruments, Hewlett-Packard claims. There are four a-c ranges—1 volt to 1,000 volts.

True response. A-c ratio measurements have the same reference range and input impedance as the d-c ratios. The 3450A is said to be the first instrument that provides true rms-responding, rather than average-responding, a-c ratio measurements.

Resistance is measured on six ranges, from 100 ohms to 10 meg-ohms. On the 100-ohm range, sensitivity is 1 milliohm. The four-terminal feature eliminates errors caused by lead resistance because it permits sensing at any desired points.

The basic 3450A has d-c volts and d-c ratio capability; price is \$3150. The a-c voltage and a-c ratio capabilities are available in a plug-in module (\$1250), as are the ohms and ohms ratio capabilities (\$400). There are three other optional modules:

- Limit test. This gives a low-go-high indication on the front panel (\$350).
- Remote control, which permits external programming of function and range (\$225).

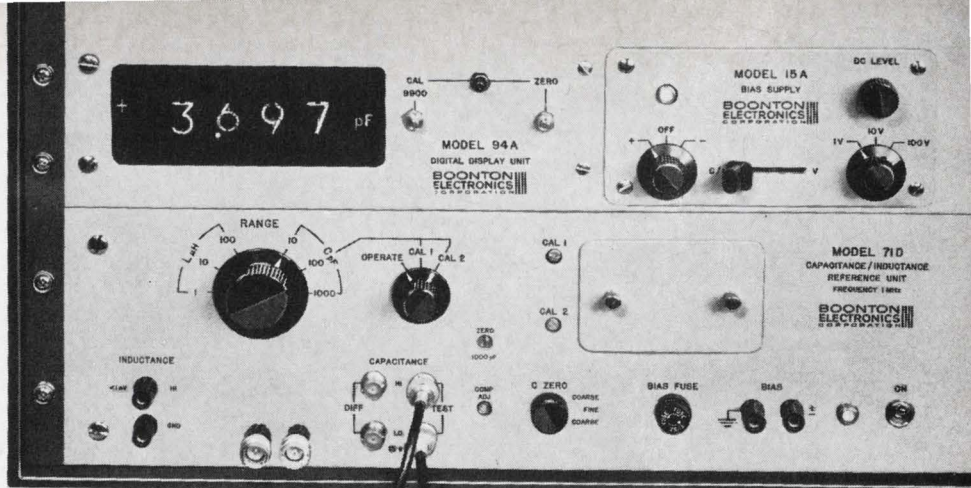

THE MODEL 700A

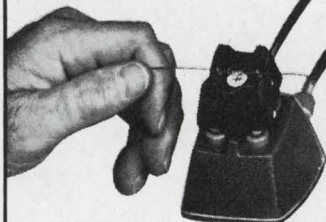

NEW!

The First Digital 1 MHz C/L Meter



It's not surprising that Boonton—No. 1 in 1 MHz capacitance measurements—would bring you a new instrument that provides digital read-out of both C (0 to 1000 pF) and L (0 to 100 μH) with the speed (333 ms) and convenience of a DVM. And it's not surprising that with three C and three L ranges, plus 4-digit read-out and 40% overrange, you get usable .002 pF and .0002 μH resolutions (five times better than the next best capacitance tester).

You'd naturally expect from a leader features like true, 3-terminal capacitance input which uses ground as a shield (unlike inconvenient guarded systems). And you'd expect the ability to make easy, error-free connections to jigs or component handling mechanisms to take full advantage of the $\frac{1}{2}\%$ accuracy. You'd also expect built-in BCD outputs to feed a computer or printer. And digitally-displayed internal or external dc bias.

You'd likely have guessed that the Model 700A's crystal-controlled test frequency and fixed (15 mV rms) test level result in highly stable measurements (not usual with frequency shift systems). And you'd have guessed that it handles a wide range of Q (down to 3 for all capacitance and inductance values). And that it's easily self-checked with a built-in high Q and low Q, 100 pF standard.

But, after all, if you know Boonton, you've known right along that the Model 700A Digital 1 MHz C/L Meter just had to be good.

Price: \$2,500. Full specs on request, of course.

BOONTON
ELECTRONICS
CORPORATION

ROUTE 287
PARSIPPANY, N.J. 07054
Telephone: 201-887-5110
TWX: 710-986-8241

SEE US AT WESCON—BOOTH #1515-1516

Circle 205 on reader service card

- Digital output (\$175).
- Rear input terminals (\$50).

Whatever the function, range changing can be done automatically or manually. The 3450A warms up to full accuracy in less than 45 seconds.

Hewlett-Packard Co., Loveland, Colo. 80537 [489]

New instruments

Ribbon indicator goes all-electric

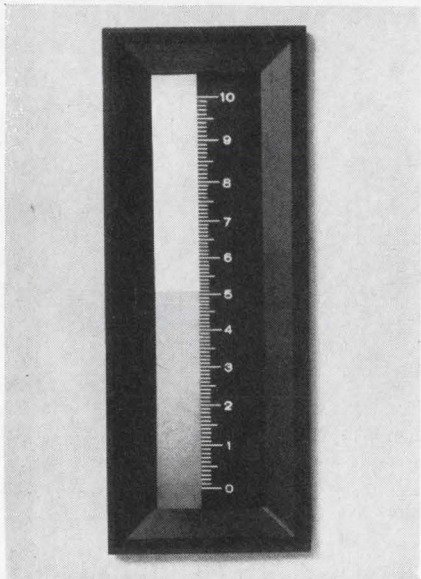

Quick change. The scale can be replaced by just removing two screws.

Ribbon indicators have been popular for a long time in process control systems. As the level of material in a tank or of pressure on a vessel wall changes, the ribbon goes up or down. The indicator is easy to read and can be seen from a distance.

But the people who have grown attached to ribbon indicators are now faced with a problem, says John Harper, product manager at Weston Instruments Division. The indicators use a liquid column or mechanical band that's driven mechanically. But despite the increased use of electric transducers to measure things like liquid levels, when an old meter is used with a new transducer, the electric

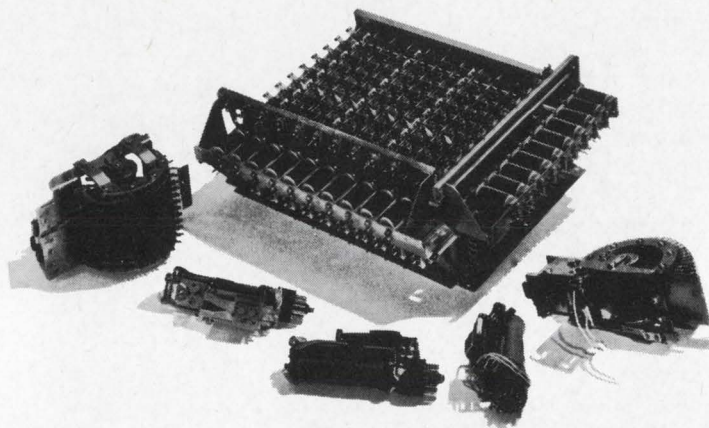

OBSOLETE

The Automatic Electric "K" form 50 contact bar relay on our new DIT-MCO System 660 random access circuit analyzer just made stepping switches, cross-bar relays, and uniselectors obsolete. Give some people an inch and they'll take a mile.

For complete information, photos and spec sheets—write DIT-MCO INTERNATIONAL—A Division of Xebec Corporation—5612 Brighton Terrace—Kansas City, Missouri 64130.

EUROPEAN TECHNICAL REPRESENTATIVE
9, Dartnell Park Road
West Byfleet, Surrey, England
Telephone: Byfleet 45904



Circle 206 on reader service card

Upset stomach?

If you're looking for a remedy and you can't remember the name of a fast-acting brand, just consult the Trade Name Directory in your Electronics Buyers' Guide. You'll have your answer in seconds. EBG also has a Directory of Products and a Directory of Manufacturers and Sales Offices. Use it often.



Electronics Buyers' Guide
A McGraw-Hill Market Directed Publication,
330 West 42nd Street, New York, N.Y. 10036

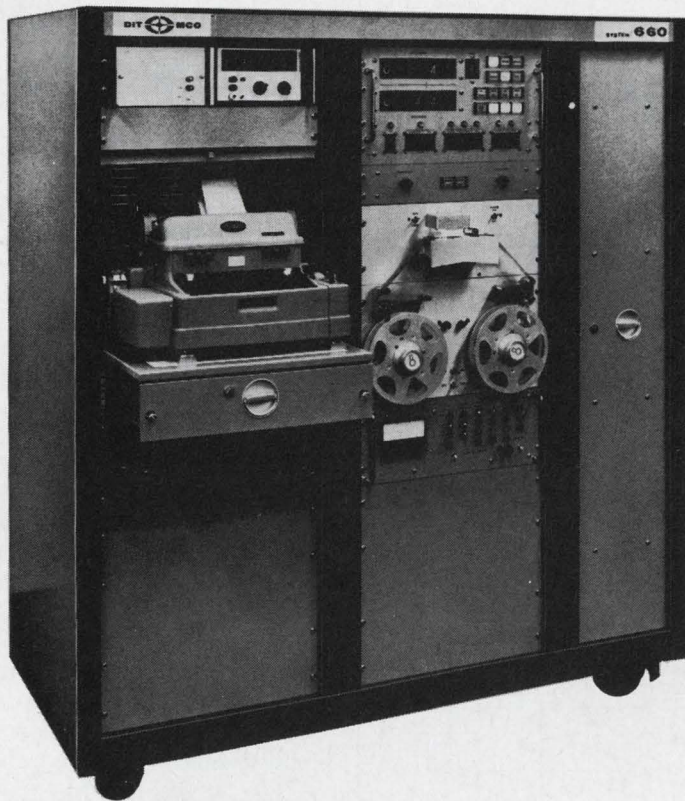

BREAKTHROUGH

Unique bar relay switching makes our DIT-MCO System 660 another in a series of major breakthroughs from the world's leading supplier of circuit testing equipment. Some people have no respect for the status quo.

For complete information, photos and spec sheets—write DIT-MCO INTERNATIONAL—A Division of Xebec Corporation—5612 Brighton Terrace—Kansas City, Missouri 64130.

EUROPEAN TECHNICAL REPRESENTATIVE
9, Dartnell Park Road
West Byfleet, Surrey, England
Telephone: Byfleet 45904



Circle 207 on reader service card

Special ingredients.

Does the laser have the special ingredients your project needs? The names and addresses of laser suppliers are listed alphabetically in the Electronics Buyers' Guide, classified by 5 kinds of lasers, from crystal lasers to ruby lasers.

Electronics Buyers' Guide
A McGraw-Hill Market Directed Publication,
330 West 42nd Street, New York, N.Y. 10036

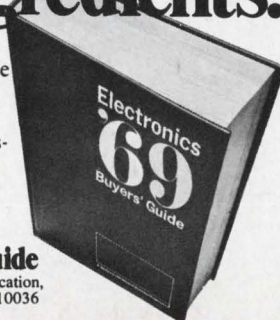

output of the transducer has to be converted into a mechanical form.

To solve the problem, Weston engineers built a ribbon indicator that works directly from an electrical input. Called the Model 1316, the instrument uses an optical projection system to produce the thermometer-like display. Various types of the 1316 will cover a range of inputs from 20 microamps up, and from 1 volt to 500 volts. Harper says that the standard meter will have a response time of about half a second, but slower or faster units can be built.

The 1316's shown at Wescon will have a red indicating band, but the company says meters can be built with any color. According to Harper, the biggest design problem was keeping the band intensity the same at full scale as it is at half scale. He says the intensity change as the bar lengthens is hardly noticeable.

Although designed for process control, uses may be found for the meter in other areas. Harper says interest has already been expressed by people in the machine tool and medical electronics fields. "And it's a natural for displaying temperature," he adds.

The 1316 is 5½-inches long and can be mounted either vertically or horizontally. The scale can be changed quickly.

The price is \$60 and delivery time is 10 weeks.

Weston Instruments Division, 614 Frelinghuysen Ave., Newark, N.J. 07114 [490]

New components

This dielectric keeps its cool

A film-foil capacitor with a new kind of dielectric (a polymer that the manufacturer calls OPD) promises to outperform the conventional polystyrene-dielectric types in operating temperature range, dissipation factor, and dielectric absorption. It's expected to bring new stability and efficiency to integrat-

New Ledex stepping motor has 160 ounce-inches breakaway torque

Our new 18 position Series 50 Stepping Motor has more working torque than any stepping motor we've ever built. Its breakaway torque is 160 ounce-inches . . . and it drives a constant friction load of 64 ounce-inches through a full 20° stroke, accurate to ±1° non-accumulative.

An exclusive new tooth clutch, with positive grip-action drive makes this extra torque possible.

With a **unidirectional** Series 50 you can . . .

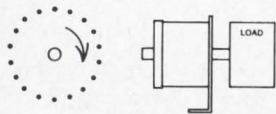

drive your load remotely through a series of short steps and stop at any one of 18 positions



or add a knob for manual re-set in either direction . . .

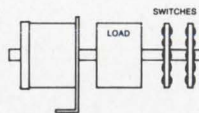

or add rotary switches for a combination power positioning drive and a step or program switch

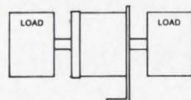

or use shaft extensions on each end to direct-couple two loads and drive them in the same direction at the same time.

With a **bidirectional** Series 50 you can do all this . . . plus *remotely position* loads CW or CCW.

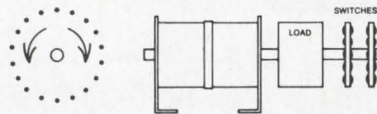

All working parts are completely enclosed. Minimum life is 3 million steps. For bidirectional, 3 million in each direction. And, the Series 50 works on simple square wave input pulses . . . so you don't need expensive logic circuitry.

Here's one of the many ways you can use the Series 50.

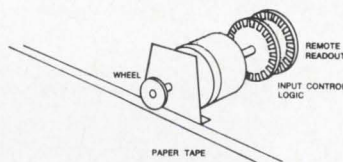

The price gives you a lot of positioning power for your money.

UNIDIRECTIONAL	
1-9 from stock	1000 lots
\$25 to 30	\$10 to 15
BIDIRECTIONAL	
1-9 from stock	1000 lots
\$40 to 45	\$20 to 25

This new stepping motor is ready to solve your remote positioning problems now. For more information, write or call for a copy of our Bulletin 468. Or, send us a description of your application and we'll recommend a solution.

WESCON BOOTH No. 178-80



LEDEX DIVISION, LEDEX INC.

123 Webster Street, Dayton, Ohio 45402 • phone (513) 224-9891

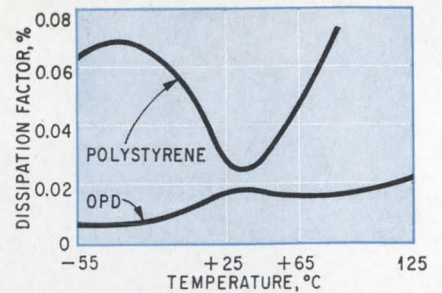

Flatter. Dissipation factor of polymer dielectric is always less than for polystyrene, and it varies less.

ors, differentiators, RC oscillators, Wien bridge oscillators, and other precision circuits. The polymer dielectric is the same material that's used as insulation on low-loss cables.

The capacitors, series 103, are manufactured by International Components Corp. They are packaged in glass-to-metal hermetically sealed tubular metallic cases with axial leads.

A polymer capacitor can operate over a temperature range of -55 to +125°C without voltage derating (polystyrene is good only up to 85°C). Dissipation factor is 0.02% at 25°—two-thirds that of polystyrene—and the polymer capacitor is reported to be much more constant with temperature.

Capacitance values of 0.01 to 1.0 microfarad are available. Size of the smallest is 0.312 inch diameter, 7/8 inch length; the largest is 1.0 inch in diameter and 2 3/8 in length. Voltage rating is 200 volts for all sizes, and the capacitors must withstand 200% of rated voltage at 25°C for two minutes without permanent breakdown. (The test voltage is applied through a resistance of 1 ohm per volt.) Insulation resistance is specified as 1,000,000 megohm-microfarads.

Capacitance decreases at the rate of 1 part per million for each degree Centigrade increase in temperature; capacitance at -55°C is about 1.0% greater than its room temperature value, and at 125°C, it's about 1.3% less.

Meets mil. The series, according to Gerhart Klaiber, president of International Components, meets MIL-C-19978B for temperature cycling, moisture resistance, vibration, and lead strength. Standard leads are solid, bare, and tinned wire. Nickel leads are available

We're selling more Muffin Fans than ever before. Is it because the Muffin is still the best low cost, high performance, low noise solution to your cooling problems?

**YOU BET
IT IS !!!!!**



muffin[®] fan

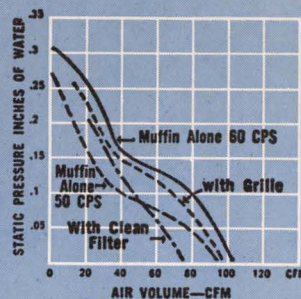
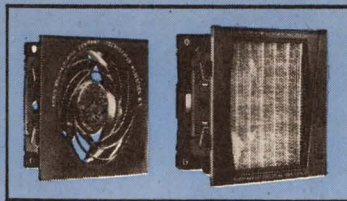

CALL YOUR ROTRON

4-WARD
DISTRIBUTOR

WEST

R. V. WEATHERFORD CO.
GLENDALE, CALIF.
213-849-3451

MIDWEST

ALLIED ELECTRONICS
CHICAGO, ILL.
312-829-9121

SOUTH

HALL-MARK ELECTRONICS CORP.
DALLAS, TEXAS
214-231-6111
ORLANDO, FLORIDA
305-855-4020

EAST

SCHLEY ELECTRONICS CORP.
WATERTOWN, MASS.
617-926-0235
RUTHERFORD, N. J.
201-935-2120



ROTRON MANUFACTURING COMPANY, INC.

WOODSTOCK, NEW YORK • 914-679-2401

West Coast: Rotron/Pacific, Burbank, Calif.
Canada: Aerovox Canada Ltd., Hamilton, Ont.
Rotron Europa N.V. Breda, The Netherlands

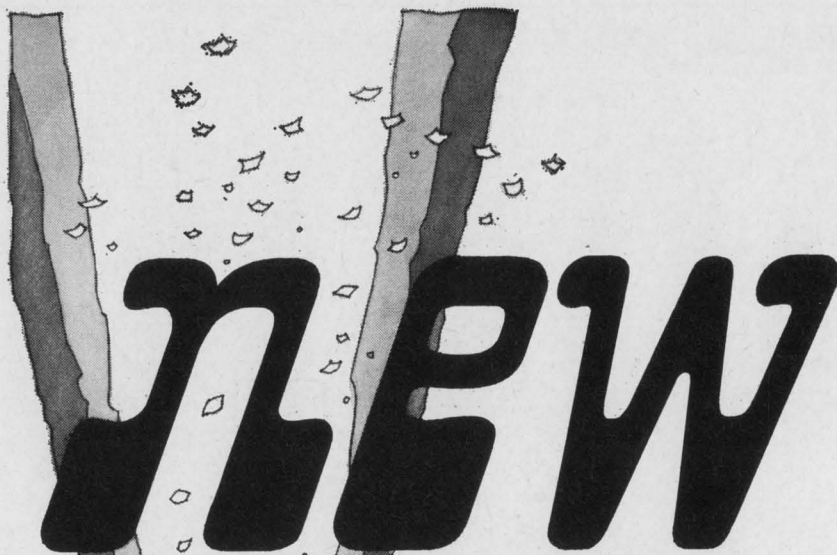

HYSOL moisture resistant compatible semiconductor molding powders

Extensive testing of our new HYFLO® semiconductor grade epoxy molding powders, conducted on actual devices, shows: moisture resistance superior to the requirements of MIL STANDARD 202 method 106B; compatibility with semiconductor materials in virtually all applications ... no corrosion, no ionic contamination.

These dramatic improvements make it possible to have the inherently excellent electrical and physical properties of epoxies, and the production economies of transfer molding, on electronic designs where epoxy molding powders didn't do the job before.

Get the complete information on the 3 new families of HYFLO® semiconductor grade epoxy molding powders now. Write, wire or phone HYSOL, Department EM-88, Olean, N. Y. 14760. Ask for semiconductor molding tech data.

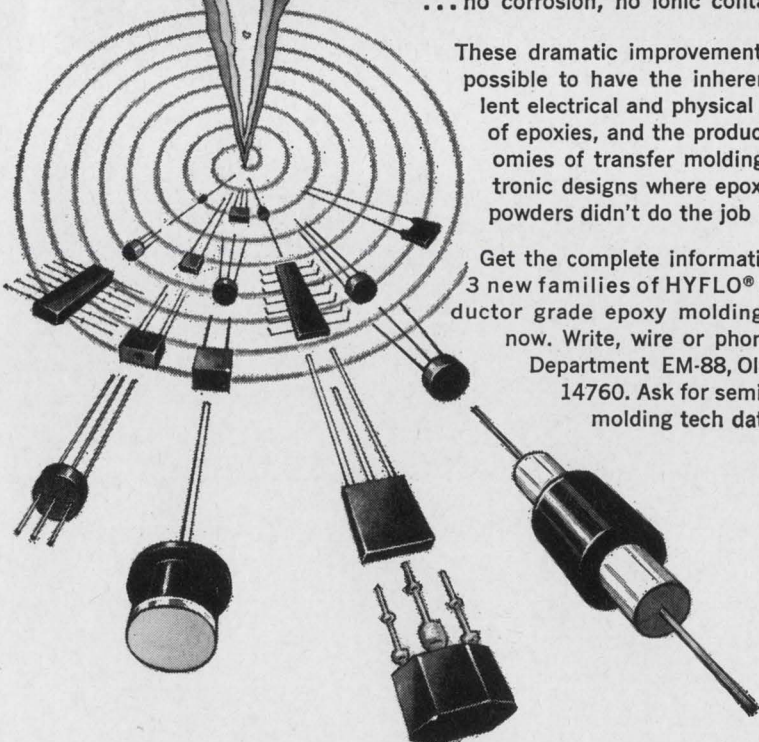

HYSOL HYSOL DIVISION
THE DEXTER CORPORATION

when a high degree of weldability is needed.

Tolerances range from $\pm 5\%$ to $\pm 0.1\%$. Price is identical to equivalent polyester types, Klaiber says. For example, a 10 μf , $\pm 15\%$ unit costs \$1.50 in 500-999 quantities.

International Components Corp., Asbury Park, N.J. 07712 [491]

Digital meter is analog-small

Widespread use of digital voltmeters as panel meters has been hindered by two factors: size and price. Equipment and system designers have tended to choose analog meters, in spite of the DVM advantages of nonambiguity, better resolution, higher accuracy, and computer compatibility.

But Tyco Laboratories will introduce a digital panel meter that is comparable in size and price to high-accuracy analog meters. The manufacturer claims that the DVM meets or exceeds performance of the most expensive 3½-digit DVM's.

The unit will be offered initially at less than \$200 in quantities of 100—this is \$100 to \$150 lower than existing digital panel meters. (High accuracy panel meters are priced from \$90 to \$175.)

Tyco squeezed the complete meter, including power supply, in a package measuring 4½-inch wide by 3-in. high on the face, and 4½-in. by 2¾-in. high by 3-in. deep behind the bezel.

Full-scale voltage of the instrument is 99.9 millivolts, with a resolution of 100 microvolts. Accuracy is 0.1% of reading, plus or minus one digit. It can indicate 60% over-range with full accuracy. Input impedance is greater than 100 megohms. The instrument can make 150 measurements per second, and it has built-in automatic polarity.

Power consumption is 4 watts. The unit operates directly from the power line (50 to 60 hz, 115 or 230 volts a-c).

The manufacturer will supply the meter in sample quantities starting on Sept. 1.

Janus Control Div., Tyco Laboratories Inc., Waltham, Mass. [492]



**Nomex[®], the all-around insulation:
It won't melt at high temperatures,
won't crack when creased or bent and
prevents overload failures.**

And that's not all. Nomex* nylon paper by Du Pont is UL-rated at 220°C, doesn't give you shelf-life problems, conforms to MIL-I-24204 and is relatively unaffected by moisture. "Nomex" can also be punched or die-cut to close tolerances—no rough, uneven edges.

"Nomex" comes in rolls, sheets, tapes, rigid and flexible laminates, creped tapes (plain or pressure-sensitive), tubing, bobbins and other fabricated forms.

So why waste time and money using different insulations? Get everything you need in one material—"Nomex". For more information mail the coupon. In Canada write Du Pont of Canada Ltd. In Europe, Du Pont de Nemours Int. S.A., 81, Route de l'Aire, Geneva, Switzerland.

Du Pont Company, Textile Fibers Dept. J-7
Nomex Marketing
Wilmington, Delaware 19898.
Please send me complete information on
"Nomex". I am interested in its application for

name _____

title _____

company _____

address _____

city _____

state _____ zip _____

*Du Pont registered trademark.





C-r tube WX-5078, with a 3-in.-diameter flat faceplate, is for industrial and military recording and oscillographic use. It has electrostatic deflection and focusing, and features high deflection sensitivity. Maximum line width is 0.020 in. The tube is 9¼ in. long, weighs about 2 lbs, and mounts in any position. Westinghouse Electronic Tube Division, Box 284, Elmira, N.Y. [341]

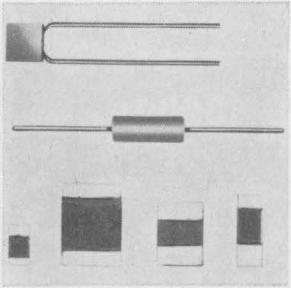

Multilayer redundant capacitors use a floating electrode design. This technique features two capacitors in series within a single multilayer structure, providing a high level of assurance against the short-circuit failure mode. Units are available in radial or axial cases, or in chip configurations. Electro Materials Corp., 11620 Sorrento Valley Road, San Diego, Calif. [345]

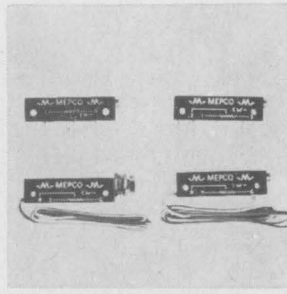

Trimming potentiometers called Accutrim feature an ultrastable film element, with infinite resolution, and a moisture-proof panel mount that permits adjustment of the pot from outside a sealed case. Resistance range is 20 ohms to 1 megohm. Clutching life is in excess of 100,000 cycles. Units exceed requirement of MIL-R-22079C. Mepeco Inc., Columbia Road, Morristown, N.J. [342]

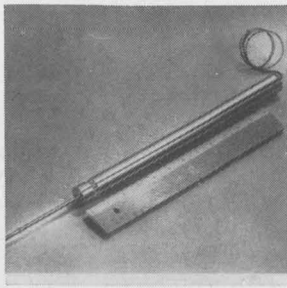

Translatable potentiometer model 16T, encased in a 14 x 1 in. metal tube, is available with conductive plastic or wirewound precision elements in single- or dual-track configurations. Resistive values range from 100 to 40,000 ohms/in. Stroke lengths are from 1 to 12 in. Units meet rugged environments. Gamewell Div., E.W. Bliss Co., 1238 Chestnut St., Newton, Mass. [346]

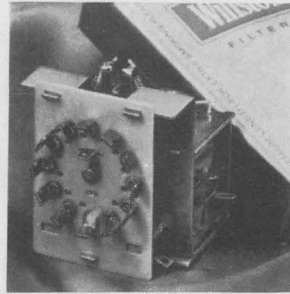

Stepping relays are offered in two models. The contact plate type operates at 2.5w; the wafer switch model, at 4.5 w. Both measure 2.190 x 2.200 x 2.005 in. and weigh 0.40 lb max. They are available in any impedance or will operate up to 150 v. Either can be uni- or bi-directional. Price is \$5.50 each in lots of 100. Dale Electronics Inc., Box 180, Yankton, S.D. [343]

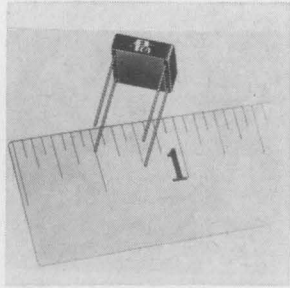

Molded transformers, designed for mounting on p-c boards in computer, process control and related equipment, measure 0.125 x 0.300 x 0.400 in. With a primary inductance of 22 μ h \pm 20%, and a leakage inductance of 0.35 μ h max., units feature an interwinding capacity of 16 pf max. and a turns ratio of 1:1. PCA Electronics Inc., 16799 Schoenborn St., Sepulveda, Calif. [347]



Temperature-compensated crystal oscillator series TCCO features high stability without warm-up time and eliminates oven power consumption. It is supplied at specified frequencies in the 1 to 20 Mhz range. Typical design options include stability \pm 1 ppm or \pm 0.2 ppm over 0° to 50°C ambient temperature range. Biley Electric Co., 200 Union Station Bldg., Erie, Pa. 16512 [344]

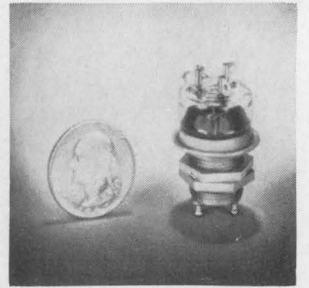

High-voltage relay TCR-1G has a single-pole double-throw (form C) contact configuration, and can switch 4 kv peak in air and 20 kv in oil with a contact rating of 5 amps rms. It measures 1¼ in. long and less than 1 in. in diameter. Uses include switching pulse forming networks, radar and communications. Torr Laboratories Inc., 2228 Cotner Ave., Los Angeles 90064. [348]

New components

Photoresistor coupler switches in 1 ms

Light-emitting diode as source gives high speed; device has isolation greater than 10,000 volts

Optical coupling of an electrical signal is attractive because of the high degree of isolation it affords. Unfortunately, the light source and photoresistor combination that many engineers favor has had rather slow response. A typical incandescent lamp and photoresistor

unit, for example, might take 15 milliseconds to switch from off to on because of the time required for the lamp to heat up.

Monsanto has developed a light-emitting-diode and photoresistor combination that can switch in less than 1 ms. The LED, in fact, is so

much faster than the incandescent lamp—it turns on in only 5 nanoseconds—that the photoresistor becomes the limiting factor on speed.

The LED and photoresistor are optically coupled within an opaque epoxy package about 0.5 inch long and 0.4 inch in diameter.

Although the dark resistance of the photoresistor varies with age and bias conditions, Monsanto guarantees a dark resistance of at least 0.5 megohm that can be driven by the LED to 50 ohms—a range of 5 orders of magnitude from full off to full on. The time required to drive the photoresistor over this range is about 12 ms.

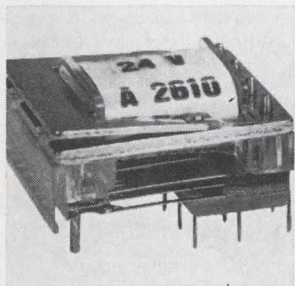

Industrial relay JAEB is for use on p-c boards. It occupies less than $\frac{3}{4}$ cu. in. and weighs $\frac{3}{4}$ oz. Expected life at full rated load is 100,000,000 operations. Four and 6 Form-C arrangements are available. Rated contact load is 0.4 amp at 30 v d-c. Maximum switched power is 12 w. Nominal coil power at 24 v is 0.68 w. ITT Jennings, Box 1278, San Jose, Calif. [349]

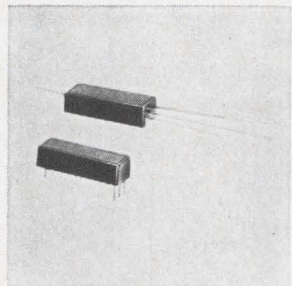

Sealed contact reed relay designated Picoreed is an epoxymolded module measuring 0.781 x 0.187 x 0.250 in. Operate time is 500 μ sec including bounce at nominal coil power. It can operate at a repetition rate of 667 hz and is capable of following 1,000 hz with appropriate coil drive. Contacts are rated from low level to 0.5 amp. C.P. Clare & Co., 3101 W. Pratt Blvd., Chicago. [350]

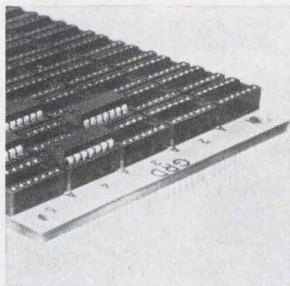

IC connectors with individually replaceable contacts speed wiring, simplify repairs and reduce downtime on automatic wire-wrap machines. The contacts, which accept round, square or rectangular leads, are oriented transverse to the connector axis rather than along it. This design improves reliability of retention. Texas Instruments Inc., 34 Forest St., Attleboro, Mass. 02703. [351]

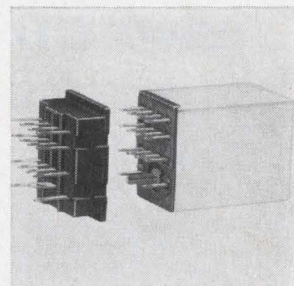

Plug-in relay series 1310 is for computers, data processing, logic systems and business machines. It is available a-c or d-c, plug-in or quick-disconnect, 6 to 115 v a-c and 6 to 110 v d-c. Contact rating is 3 amps at 30 v d-c or 115 v a-c resistive. Expected life is over 100 million operations d-c, 50 million a-c. Guardian Electric Mfg. Co., 1550 W. Carroll Ave., Chicago. [352]

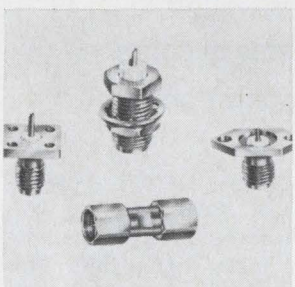

Miniature r-f connectors series SRM conform to MIL-C-39012, series SMA. Vswr is 1.05 ± 0.005 from d-c to 18 Ghz. Units are rated at 500 v rms at 60 hz at sea level and have 5,000 megohms minimum insulation resistance. R-f leakage is 90 db minimum from 6 to 8 Ghz. Contact resistance is 2 mv maximum. Sealectro Corp., 2222 Hoyt St., Mamaroneck, N.Y. [353]

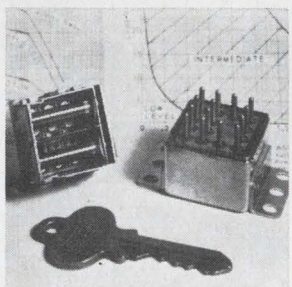

Four-pole, double-throw relay Conelco style 8 is suitable for military and avionics power switching. It measures 1 x 1 x 0.7 in. high and weighs 1.8 oz. Contact rating is 10 amps resistive at 28 v d-c or 115/200 v a-c at 400 hz. Operate time is 15 msec max. Release time is 15 msec. Life is 100,000 operations min. Price Electric Corp., Frederick, Md. [354]

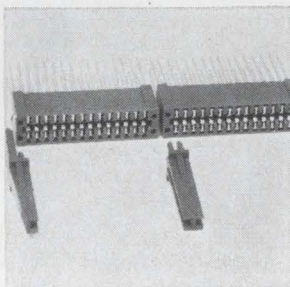

Modular p-c connector series 6028 incorporates 28 dual-read-out wire wrap contacts spaced on 0.100 in. centers. The card-edge receptacle accommodates a 1/16 in. card. The insulator and card guides are molded of glass-filled nylon for resistance to solvents, as well as for ruggedness. Insulation resistance is 25,000 megohms, minimum. Elco Corp., Willow Grove, Pa. 19090. [355]

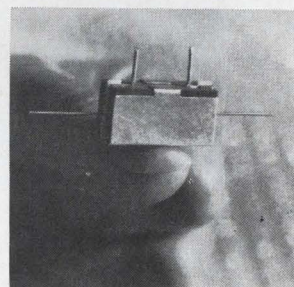

Dry-reed relay series 18 is for single-pole, single-throw, normally open applications requiring high open-circuit resistance of 1×10^{15} minimum. Units weigh less than $\frac{3}{4}$ oz and measure 0.8 x 0.45 x 0.32 in. Coil options are for 6-, 12-, or 24-v ratings at 200-, 1000-, or 3,000-ohms respectively. Price is \$2.50 to \$8, depending on quantity. Compac Engineering Inc., Hollister, Calif. [356]

However, for a smaller resistance change—such as three orders of magnitude—less than 1 ms is required to switch, Monsanto says.

The LED is a III-V semiconductor compound that emits in the infrared region. It operates at 1.4 volts and a maximum current of 150 milliamperes. The photoresistor can dissipate as much as 200 milliwatts, but it is derated to zero at 77°C.

Aside from the speed advantage, the LED had a much longer life than an incandescent bulb. Monsanto claims a minimum life of 100,000 hours for its diode. The company does not specify a life

expectancy for the photoresistor. It should be considerably greater than it has been in the past because it now operates without being subjected to heat from an incandescent lamp.

Monsanto is not committed to its own photoresistor exclusively. According to Dan Grenning, supervisor of infrared device development, the company will "discuss canning any photoresistive device" with its LED.

Isolate and scale. One of the biggest applications for the photoresistor-coupled diode will be in computer input circuitry, Grenning says. In a process control system,

for example, the process signal might range from 0 to 12 volts, whereas the computer requires a 0 to 5 volt range between off and on. By connecting the process signal to the LED through a suitably chosen resistor, the diode can be triggered. With appropriate output circuitry, the signal from the detector can be made to correspond to the 0 to 5 volts required by the process computer. And this scaling is done with no less than 10,000-volt isolation between the emitter and the detector.

Another application is in automatic gain control. By providing a feedback signal to the emitter, it

ALPHANUMERIC, DIGITAL AND SPECIAL READOUTS

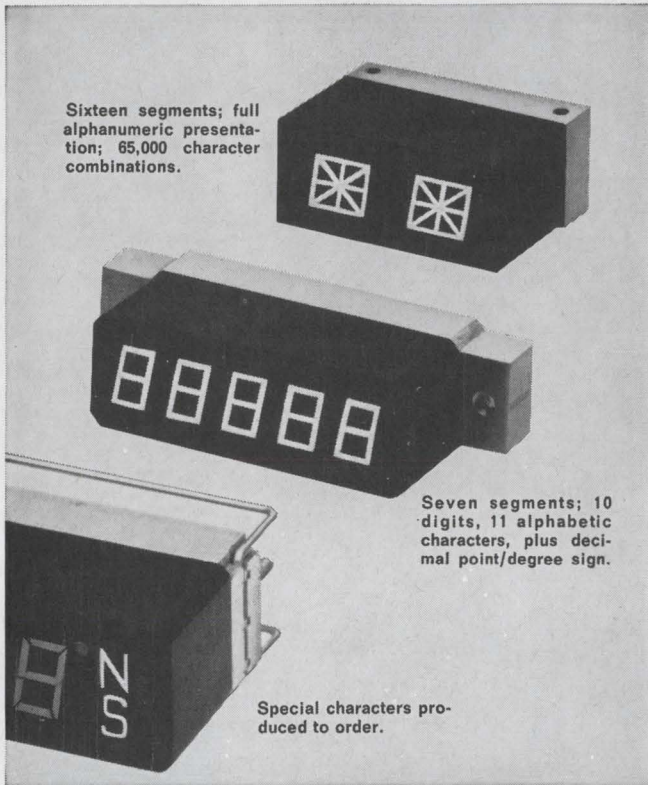

ALL WITH OPTIMUM CONTRAST AND ALL FROM TUNG-SOL

Optimum contrast in Tung-Sol readouts results from the molecularly bonded, flush-surface filter. The use of a new 20 mil lamp sharply reduces the load factor while maintaining good brilliance. Heat is minimized and reliability is substantially improved. Tung-Sol readouts are designed to be inter-mixed. All characters have the same vertical dimension for accurate in-line display. Viewing angle is 150°. Displays can be supplied in color.

MOUNTING FLEXIBILITY

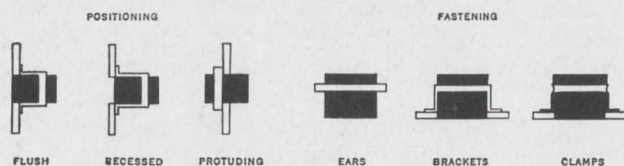

Write for fully explanatory brochure T-431. Tung-Sol Division, Wagner Electric Corporation, One Summer Avenue, Newark, New Jersey 07104.

TUNG-SOL®
**OPTIMUM CONTRAST
READOUTS**

© REG. T.M. WAGNER ELECTRIC CORPORATION

can be triggered at a certain value of gain and thus change the resistance of the detector to limit the gain in the amplifier.

Monsanto is now offering the device in sample quantities. Large quantity orders can be filled in about two months; price will be \$7.50 in quantities of more than 1,000.

Monsanto Electronics, Special Products Group, St. Louis, Mo. [357]

New components

Single-sheet capacitors

Metal is deposited
on both sides of paper
in single operation

Engineers at Matsushita Electric Industrial Co. have found a way to deposit a metallic layer on both sides of a piece of paper. This technique, the company says, means an improved version of its present type of paper capacitor.

The first paper capacitors were made by coating a sheet of paper on one side with lacquer, and then vacuum-depositing a metal layer over the lacquer. Two metallized sheets were then rolled together, and covered with insulation.

Matsushita says that in 1960 it developed a way to deposit a single layer on unlacquered paper. Now the company has taken another step with its new technique; metal layers are vacuum-deposited on each side of a sheet of paper at the same time in one chamber. The metallized paper is then rolled with a sheet of insulating paper to make the capacitor.

Since it's not necessary to bond two strips of paper together, there's less chance of a gap between the electrodes. The company says that a capacitor built with the double-coated paper is superior to older devices in several ways. Electrostatic capacity is 50 to 60% higher, the new unit is smaller and lighter, and its stability is higher.

All paper capacitors are self-

WHAT? A RESISTANCE DECADE BOX USABLE FROM DC TO 100 MHz., WITH AT-THE-TERMINAL ACCURACY TO 0.005%? AND STABILITY, SIZE, PRICE AND USE FEATURES JUST AS UNUSUAL?

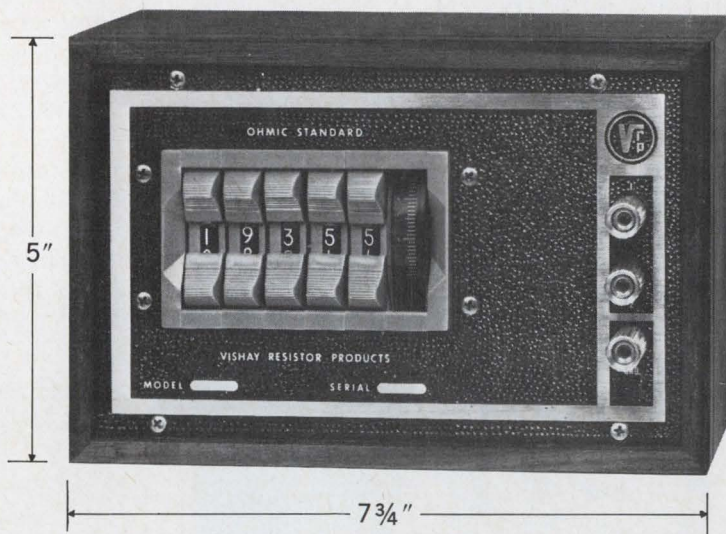

IT MUST BE A VISHAY PRODUCT . . . AND IT IS.
SO SPECIAL WE CALL THEM "OHMIC STANDARDS."

Everything's special about Vishay's new Decade Boxes — performance, versatility, size and price. Let's take them one by one and you'll appreciate how much all these advances can mean. Remember, they're all now in one decade box — and only one — made by Vishay.

PERFORMANCE

No other decade box can approach this standard spec combination:

- Accuracy to $\pm 0.005\%$ at the terminals
- Resistor stability — ± 5 or ± 20 ppm/yr.
- TC tracking — 2 ppm/°C. (0° to $+60^\circ$) for all R values
- Usable from DC to 100MHz.
- Shunt capacitance — 5pf. for all R values

That's right — accuracy at the terminals — because Vishay Decade Boxes are internally compensated for residual resistances. The value you read is the actual value.

That's right — usable from DC to 100MHz. — extending the usable frequency range as much as 10 times that of conventional units—opening com-

pletely new applications areas for resistance decade boxes.

The performance secret, of course, is the use of specially selected Vishay Precision Resistors . . . the "no-trade-off" resistors that are causing an industry revolution.

VERSATILITY

Finding or setting the exact resistance value was never easier, whether you use them as secondary standards, for resistance substitution, as components of bridges, dividers, attenuators or multipliers, as network elements or for op amp feedback circuits.

7-digit models feature infinite resolution setting and readability — in 0.01 ohm divisions from 0.05 to 100,000 ohms. 5-digit models are settable in 1 ohm divisions from 1 to 99,999 ohms.

Both feature high visibility in-line digital readout, and rapid setting with snap-action switches.

SIZE

Only $\frac{1}{3}$ the size of conventional units, Vishay Decade Boxes free valuable lab space. In-case height is only 5", depth $3\frac{1}{8}$ ". Width of 5-digit model is only $5\frac{7}{8}$ ", 7-digit model $7\frac{3}{4}$ ". All models weigh less than 3 pounds.

PRICE

The best news is that — even with all these performance, versatility and size features — 5-digit models begin at \$175.00, 7-digit models at \$250.00.

For more complete specification data, send for your free copy of Bulletin #DB-501-F. We'll send it by return mail, along with the name of the Vishay man in your area. He'll be glad to set up a free demonstration of the new Vishay Decade Box — the first significant improvement in over 25 years. Write today.

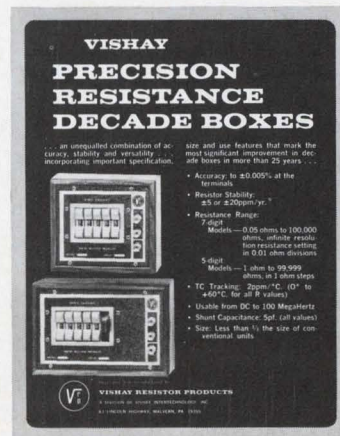

VISHAY RESISTOR PRODUCTS

a division of Vishay Intertechnology, Inc.
63 LINCOLN HIGHWAY
MALVERN, PA. 19355

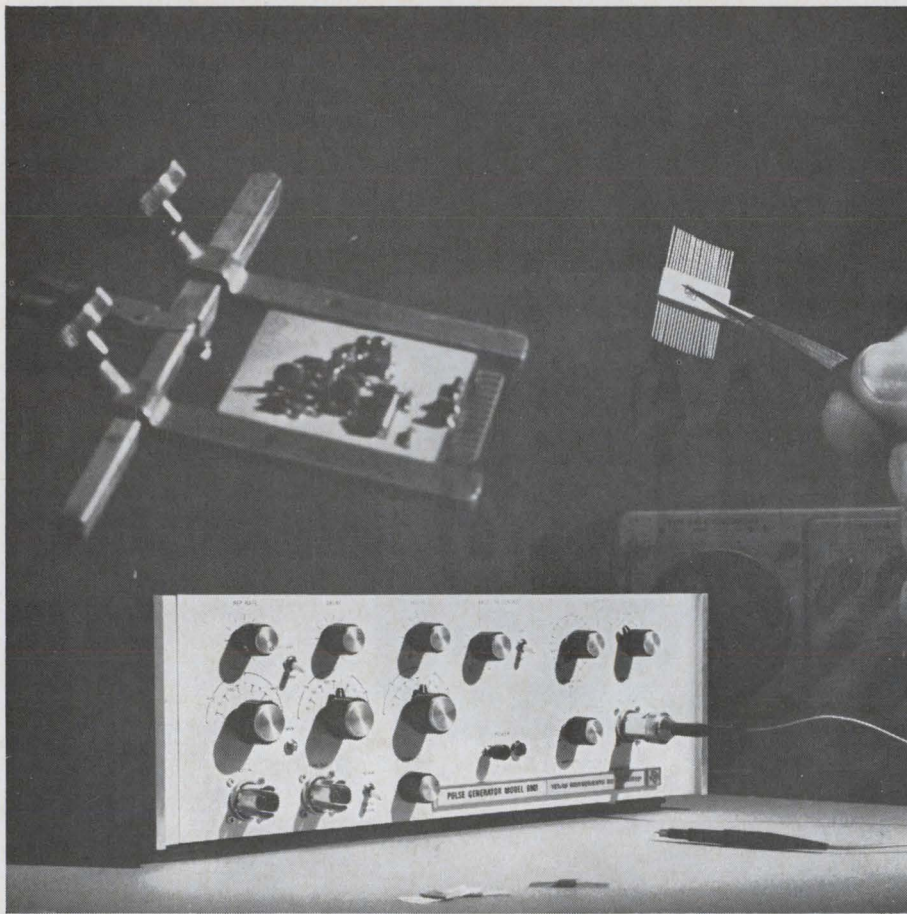

Why You Need a Special Pulse Generator for State of the Art Circuit Design

With high speeds and critical design parameters, you need the best test instruments to be sure your designs will be optimum. The TI Model 6901 Pulse Generator gives outputs from 1 KHz to 0.1 GHz; independent amplitude and baseline controls; jitter less than 0.1% of period + 50 psec; and count-down synchronization output.

The 6901 makes your designing simpler, too. Because the pulse amplitude of the generator can be changed without affecting DC offset, you can use the offset instead of an external bias supply for your circuit.

For additional information, contact your TI Field Office, or the Industrial Products Division, Texas Instruments Incorporated, P. O. Box 66027, Houston, Texas 77006.

TEXAS INSTRUMENTS
INCORPORATED

healing. If too much voltage is applied, the metal burns out at the points where the dielectric breaks down, so there's no shorting. Matsushita says the self-healing time of its new capacitor is shorter than that of older units.

The new capacitors are intended for use in motor-driven home appliances like washers and fans, in distributing lines where they adjust power factors, in fluorescent lamps, and in discharge-type spot welders.

Units are available with capacities between 1 and 600 microfarads, for operation at 50 to 60 hertz between 100 and 300 volts.

Prices have not been set yet. Delivery time is one to three months.

Matsushita Electric Industrial Co.,
Kadoma, Osaka, Japan [358]

New components

Tiny transformer wants tv job

Only 0.12 inch on a side, i-f device is designed for use with IC's

If their promise of smaller, more reliable sets proves true, integrated circuits will be the next big television star [Electronics, July 22, p. 133]. But for IC's to have much effect on the size of tv sets, the size of components used with the circuits has to be reduced also.

Sumida Electric Co. had the television market in mind when it developed its new line of intermediate-frequency transformers which the company says are the smallest available, just 0.12 by 0.12 by 0.12 inch.

Sumida says that a large Japanese maker of television receivers is considering using the small transformers in some prototypes.

Each transformer is a C-shaped ferrite core, 0.08 inch in diameter and 0.06 inch high, wound with a copper coil 0.003 inch in diameter. The core is bonded to a phenol-resin base, and a hole is tapped

827A

Of all DVM's, only Honeywell Digitest gives you five functions (DC Voltage, AC Voltage, DC Current, AC Current, Resistance), a choice of two models, and

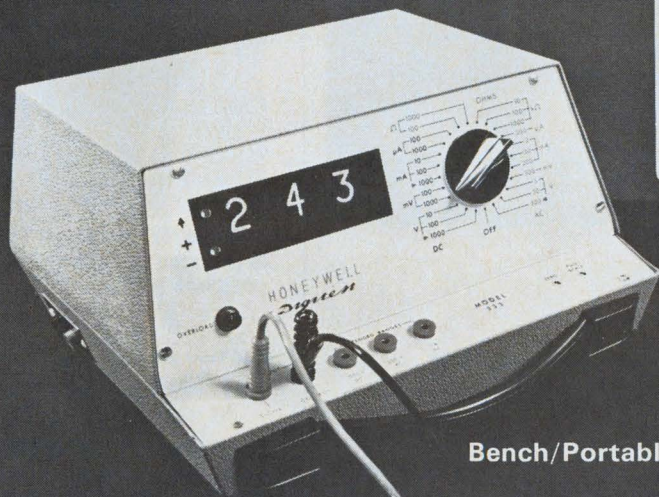

Bench/Portable, Model 333



Bench/Rack, Model 333R

a price tag of only \$395!

With $\pm 0.5\%$ accuracy, $100\mu\text{V}$ resolution, absolutely clear $3\frac{1}{2}$ -digit readout, and simple, foolproof operation, the tough, compact little Digitest makes other low-cost DVM's look overpriced and under-engineered. We won't even mention a comparison with conventional meter-movement instruments.

Both models share the same specs, but Model 333 is completely portable thanks to built-in rechargeable ni-cad battery operation. It operates on AC as well. Both instruments give you $3\frac{1}{2}$ -digit readout, with Model 333R providing an overrange digit while Model 333 employs an overrange indicator.

Compare features, specs, and prices – you'll see that Digitest is your best DVM value. That \$395 price, by the way, is *complete*. There are no shunts or plug-ins to buy, and even leads are furnished. The only option is a set of ni-cad batteries for the portable model at \$33.

Order yours today! Call Ron Craig (collect) at (303) 771-4717, or send your purchase order to Ron at Mail Station 222, Honeywell, Test Instruments Division, P.O. Box 5227, Denver, Colorado 80217. Both models are in stock for immediate delivery, so order now!

Honeywell

Honeywell engineers sell solutions

See us at the WESCON show – Los Angeles Sports Arena, August 20-23. Booths 1501-1503

**NEW
FROM
INTERNATIONAL**

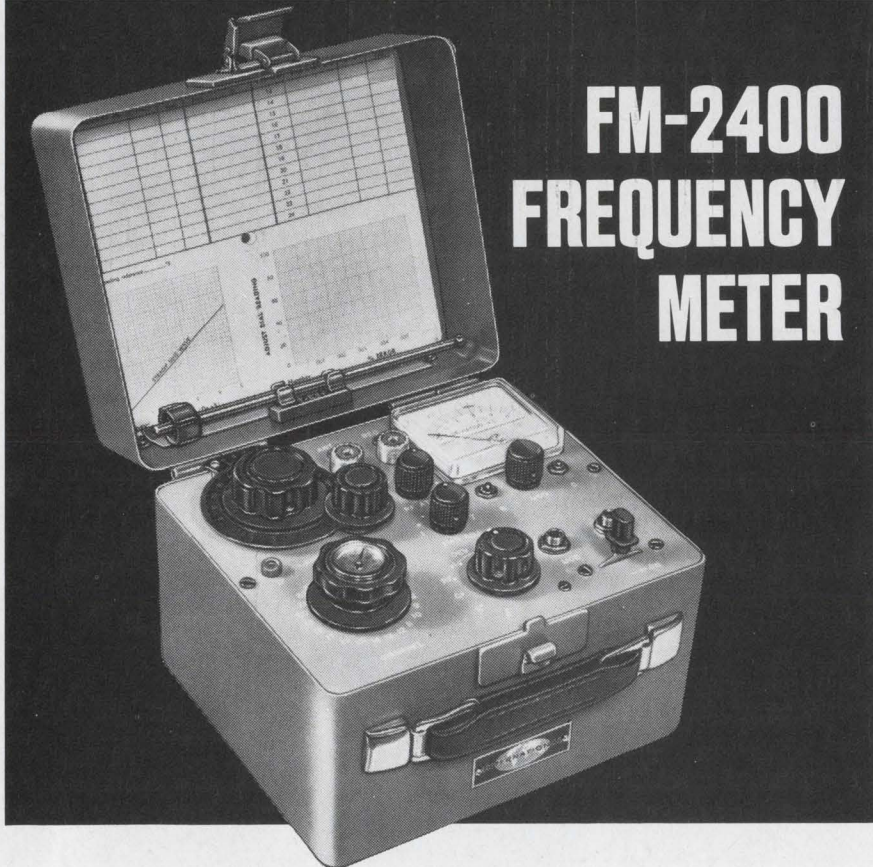

FM-2400 FREQUENCY METER

- For Mobile Or Base Station Use
- Tests Predetermined Frequencies 25 - 470 MHz
- Portable . . . Use It Anywhere

The FM-2400 is designed for testing and adjustment of mobile and base station transmitters and receivers at predetermined frequencies between 25 and 470 MHz. The FM-2400 provides an accurate standard frequency signal to which the transmitter can be compared. This same signal is applied to the associated receiver(s), thereby assuring an accurate frequency adjustment on all parts of the communications system.

Up to 24 crystals may be inserted into the meter for the selection of the frequencies required for testing of the system transmitters and re-

ceivers. The frequencies can be those of the radio frequency channels of operation, and/or of the intermediate frequencies of the receiver between 100 KHz and 100 MHz. Self contained unit. Battery operated.

FM-2400 (meter only).....\$395.00

RF Crystals with temperature run\$23.50 ea.

IF Crystals

200-2,000 KHz.....See Catalog*

2,001-13,000 KHzSee Catalog*

*WRITE FOR FREE CATALOG



CRYSTAL MFG. CO., INC.
10 NO. LEE • OKLA. CITY, OKLA. 73102

**. . . radio transformer can be
tuned down to 455 khz . . .**

through the base at the center of the core. An L-shaped bar, also of resin and attached to the base, is positioned so its broad area hangs over the core. A resin screw fits through this bar and down into the base. Bonded to the underside is a ferrite lug which hangs over the core. When the screw is turned, the lug moves up or down, changing the core's operating frequency.

First to appear in Sumida's line of small i-f transformers will be two 4.5-megahertz units, one for tv's and the other for audio circuits, and a model with a range of 455 kilohertz to 10.7 Mhz intended

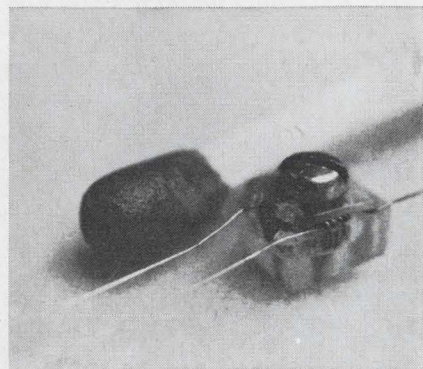

Tunable. Frequency of i-f transformer is changed by turning screw, which positions ferrite lug.

for use in a-m/f-m radios. All three will have a $\pm 5\%$ tolerance.

As the inductance of a tuneable transformer goes up, its Q rises slightly. In a test of a typical a-m/f-m transformer, the Q went from 105 to 120 when the inductance was raised 27%.

Units built now have a 10:1 turns ratio, but Sumida says this can be adjusted for other applications. Intended for use in consumer devices, the transformers operate at 100 volts a-c.

Sumida is taking orders for samples now and will begin shipping them in September. The unit price will be 11 cents.

When the company starts taking volume orders in early 1969, the price will drop to about 5½ cents for the fixed-frequency units, and between 7 and 8½ cents for tuneable transformers.

Sumida Electric Co., Ltd., 2-1279 Kana-machi Katsushika-ku, Tokyo [359]

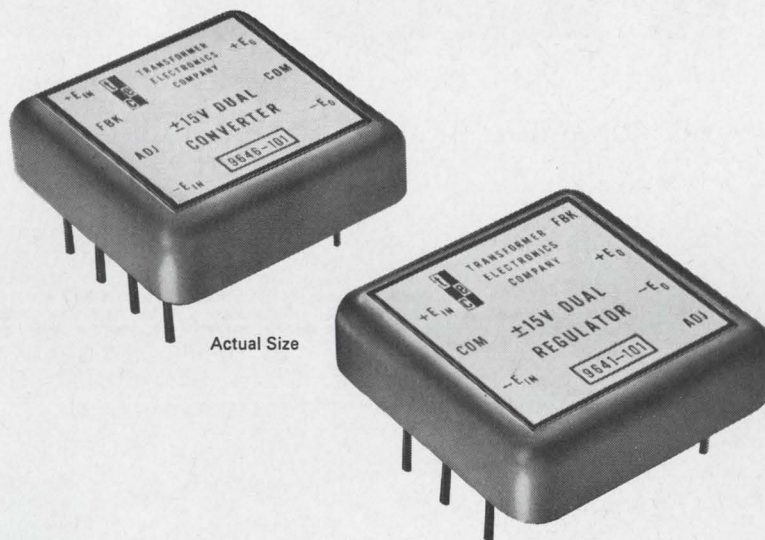

Op Amp Users...Try These!

TEC Dual Converter 9646-101 \$50.00 (100 quan.)

Features: ● input, +24V to +32V ● line regulated ● output adj. $\approx 14V$ to $\approx 21V$ @ $\approx 100MA$ ● single external resistor adjustment ● low temperature coefficient ● input reverse polarity protected ● input-output isolation > 500 megohms ● metal shielded package ● miniature-P.C. mounting ● $-25^{\circ}C$ to $+85^{\circ}C$ operation

TEC Dual Regulator 9641-101 \$50.00 (100 quan.)

Features: ● output, ≈ 15 volts at $\approx 100MA$ ● short circuit proof ● fold back current limiting ● single external resistor adjustment ● voltage ratio regulation ● low temp coefficient ● high ripple reduction—40db ● low output impedance ● metal shielded package ● $-25^{\circ}C$ to $+85^{\circ}C$ operation

(Send for complete technical literature.)



TRANSFORMER ELECTRONICS COMPANY

BOULDER INDUSTRIAL PARK • BOULDER, COLORADO 80302
(303) 442-3837

SEE US AT WESCON BOOTHS 218 and 219

OUR NEW IC TESTER.

(IT'S NOT A TOY FOR ENGINEERS)

The new Signetics Model 1100 Integrated Circuit tester is a production tool. We call it The Producer. It's the most compact, comprehensive, inexpensive, easy to use, production-oriented IC tester in the business. Any device of up to 16 pins can be manually tested at rates of up to 10,000 per shift. And more if auto-loading is used. A series of tests is automatically

performed, including two unique dynamic tests for noise immunity and toggle rate. Operator programming: select and plug in single board. Total training time: one minute. And The Producer stays on line because it's designed for simple, in-field service. It's not a toy for engineers. It's a tool for production men. Get all the facts from your local representative right now.

SIGNETICS CORPORATION
MEASUREMENT/DATA 

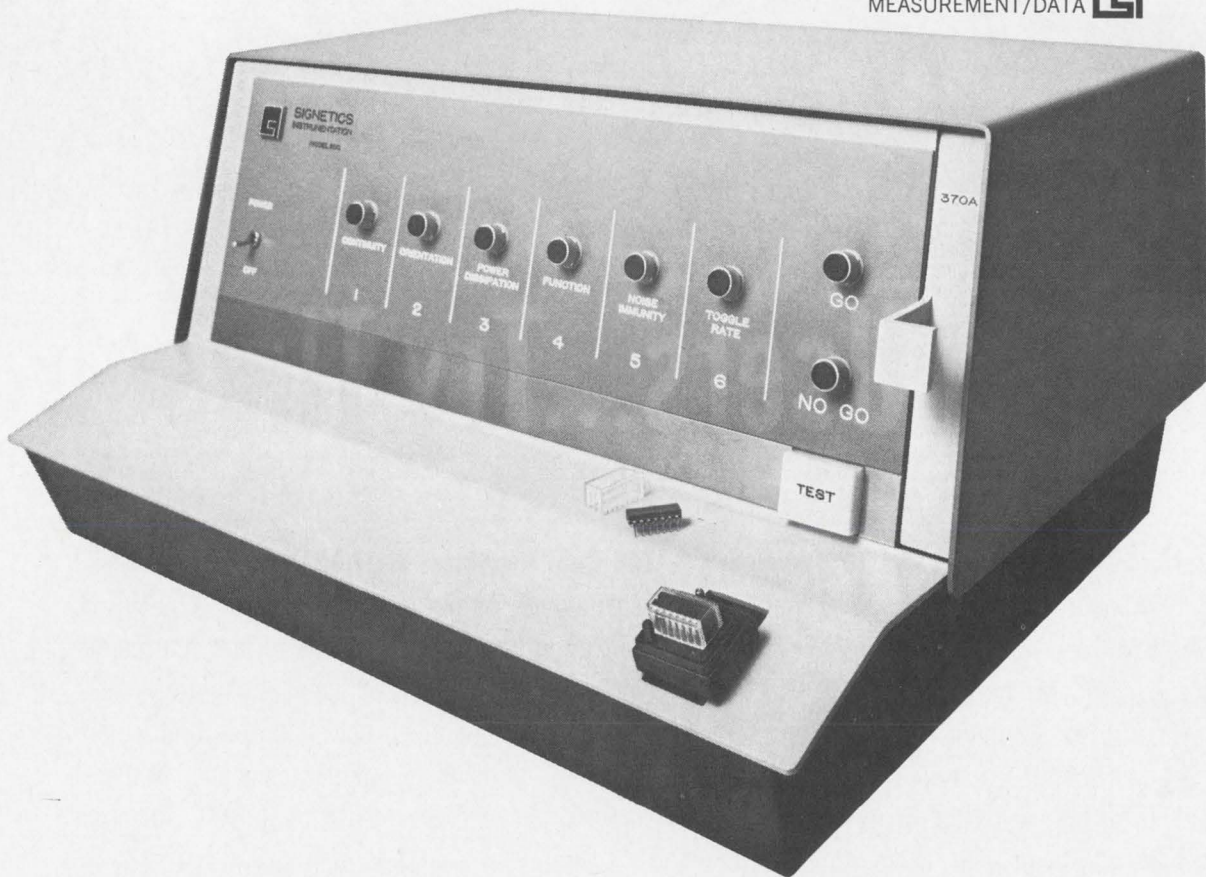

SIGNETICS CORPORATION, 811 EAST ARQUES AVENUE, SUNNYVALE, CALIFORNIA 94086. A SUBSIDIARY OF CORNING GLASS WORKS

AUTHORIZED SIGNETICS REPRESENTATIVES (Measurement/Data) □ Alabama and Tennessee Col-Ins.-Co., Inc., Huntsville (205) 539-1771 □ California L and M Engineering, Inc., Inglewood (213) 678-5409; Santa Clara (408) 243-6661 □ Connecticut Datch Associates, Inc., New Haven (203) 624-7291 □ District of Columbia (see Silver Spring, Maryland) □ Florida Col-Ins.-Co., Inc., Orlando (305) 423-7615 □ Georgia Col-Ins.-Co., Inc., Marietta (404) 422-8327 □ Illinois Carter Electronics, Inc., Chicago (312) 776-1601 □ Indiana Carter Electronics, Inc., Indianapolis (317) 293-0696 □ Maryland QED Electronics, Inc., Silver Spring (301) 588-8134 □ Massachusetts Datch Associates, Inc., Newtonville (617) 527-5394 □ Minnesota Carter Electronics, Inc., Minneapolis (612) 869-3261 □ Mississippi/Louisiana Col-Ins.-Co., Inc., St. Louis (504) 833-1116 □ New Jersey QED Electronics, Inc., Camden (215) 925-8711 □ New York QED Electronics, Inc., Mt. Vernon (914) 968-2200 □ J. A. Reagan Co., Inc., Albany (518) 489-4777; Binghamton (607) 723-9661; Newburgh (914) 561-4510; Syracuse (315) 471-7274; Utica (315) 732-3775; Rochester (716) 473-2115 □ North Carolina Col-Ins.-Co., Inc., Winston-Salem (919) 765-3650 □ Ohio WKM Associates, Inc., Cleveland (216) 885-5616; Dayton (573) 434-7500 □ Pennsylvania WKM Associates, Inc., Pittsburgh (412) 892-2953 □ Michigan WKM Associates, Inc., Detroit (313) 892-2500 □

New Production Equipment Review

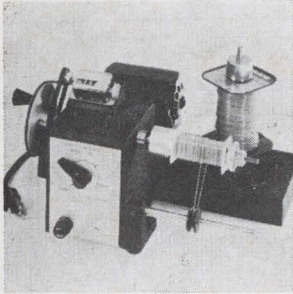

Portable, hand-fed coil winder model 4A has an electronically-controlled motor drive and digital turns counter. It is available with auxiliary foot control and lever-reset turns counter. The universal center assembly takes bobbins from 3/16 in. to 1 1/8 in. i-d, and up to 3 in. long. Set-up for bobbin sizes takes less than 30 sec. Innes Instruments, Box 5216, Pasadena, Calif. [421]

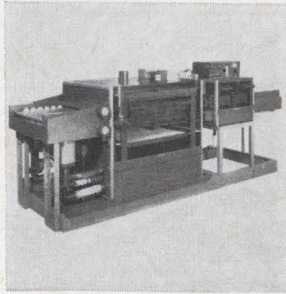

Conveyorized spray etcher model 568 is designed for close-tolerance chemical machining of metal parts and high-volume production of printed circuits, including multilayer types. The 30-in. wide conveyor is driven by an enclosed d-c gear motor, controlled by an SCR drive to provide precise speeds of from 1 to 60 ipm. Chemcut Corp., 500 Science Park, State College, Pa. [422]

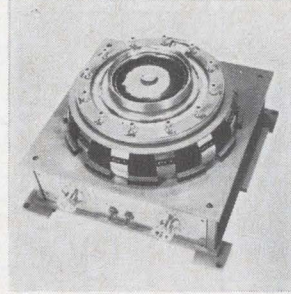

Depending on the size, range and shape of parts being graded, the Vibro-Core-Selector Mark IV will precisely grade ferrite memory cores at rates between 50,000 and 400,000 pieces per hr. Flat, round, square or cube-shaped cores as large as 50 mils and as small as 7 mils can be handled. Selection accuracy is 0.00005 in. Shurtronics Corp., Box 10730, Santa Ana, Calif. 92711. [423]

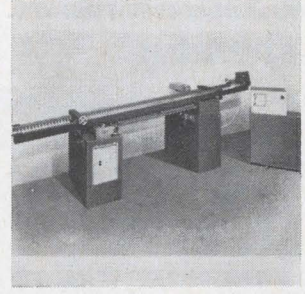

Carrierless conveyor series FC increases loading and unloading speeds in soldering of p-c boards on automatic wave soldering systems. It adjusts for board widths from less than 1 in. to full size of solder wave. The unit illustrated, for series T soldering systems, is about 12 ft long. A platform can be provided for end or top loading. Hollis Engineering Inc., Nashua, N.H. [424]

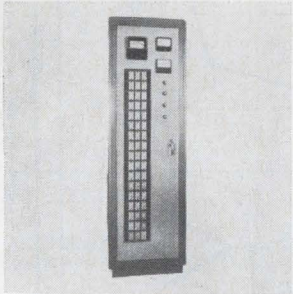

Aging and thermal cycling consoles series LTA provide a new approach to burn-in procedures for semiconductors. They offer an unlimited number of test stations, and interchangeable insulated mounting stations to accept all popular semiconductor case styles. Price per station varies between \$20 and \$80 depending on customer specs. Wakefield Engineering Inc., Wakefield, Mass. [425]



Eyelet machines 230 and 280, designed to insert eyelets and funnelets in circuit board material under critical tolerances, feature a quick disconnect hopper. The operator can change sizes or styles of eyelets or funnelets in less than a minute. Operation of hopper and insertion mechanism is entirely by air. Cimron Div., Lear Siegler Inc., 1152 Morena Blvd., San Diego, Calif. [426]

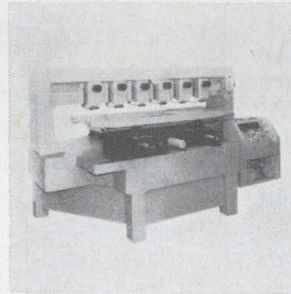

Multiple-spindle, N/C machine series 9000 combines ultrahigh production with extreme accuracy for multilayer and single layer p-c board drilling. The drill is hydraulic, has an infinitely variable feed rate, and production rate of over 150,000 holes an hour. A part program feedback system eliminates drilling errors. Digital Systems Inc., 1078 E. Edna Place, Covina, Calif. [427]

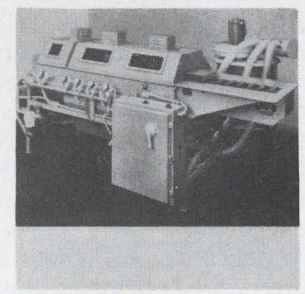

Deflashing machine BLM-CC is for finishing molded dual-in-line IC's as they come from the transfer molding operation. It has 20 finely-controlled, adjustable blast nozzles. Parts are carried through the machine on a dual chain conveyor with a speed variable from 1 to 18 fpm. Deflashing rate is 6,000 pieces/hr. Wells Electronics Inc., 1701 S. Main St., South Bend, Ind. [428]

New production equipment

Infrared camera takes a big picture

System from Sweden will scan a 25° by 12.5° field, take four pictures a second, display image on scope

Building high-speed infrared cameras seems to be a talent peculiar to the Swedes. Two years ago AGA started selling a system [Electronics, July 26, 1965, p. 93] in the U.S. that takes 16 pictures a second and displays thermograms on an oscilloscope. Until now, AGA has

had the high-speed portion of the i-r market to itself. Now another Swedish company is ready to move in.

Engineers at AB Bofors have developed a system, called the T-7, that takes four pictures a second but is able to scan a much broader

field than the AGA unit. This new camera covers a 25° by 12.5° field compared with the 5° by 5° field of the older system, and scans

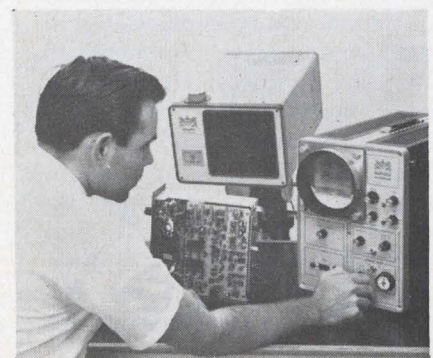

Sweep/Signal Generator



Texscan Corporation,
2446 North Shadeland Ave.,
Indianapolis, Indiana.
Phone: (317) 357-8781.
Price: \$1550.
Delivery: 2 Weeks.

The VS-80, in a single two band instrument, covers the frequency range of 1 to 1200 MHz with up to 400 MHz sweep width. This solid state instrument provides an RF output level of at least 0.5 volts rms over this complete frequency range. This instrument finds wide application as a general lab unit and for field installations where a minimum number of instruments can be maintained. Its wide frequency coverage, wide sweep width capability and excellent CW characteristics result in an instrument that can provide test capabilities usually only available from two or more instruments. The frequency range covered by the VS-80 includes all the normal IF bands, the FM, VHF TV, UHF TV and most communications bands. The instrument can be used for radar and communications RF, IF and video testing. It can be used as a chirp radar simulator and for wide band amplifier testing. Its stability is sufficient for narrow band circuit testing. This instrument could conceivably replace signal generators and sweep generators in repair facilities, thereby reducing the total instrument complement required.

With the addition of the optional 1 kHz amplitude modulation, it is an excellent signal source for use with a slotted line. The variable sweep rates are ideally suited to x-y recorder applications.

... the higher the temperature of a body,
the more i-r energy it gives off ...

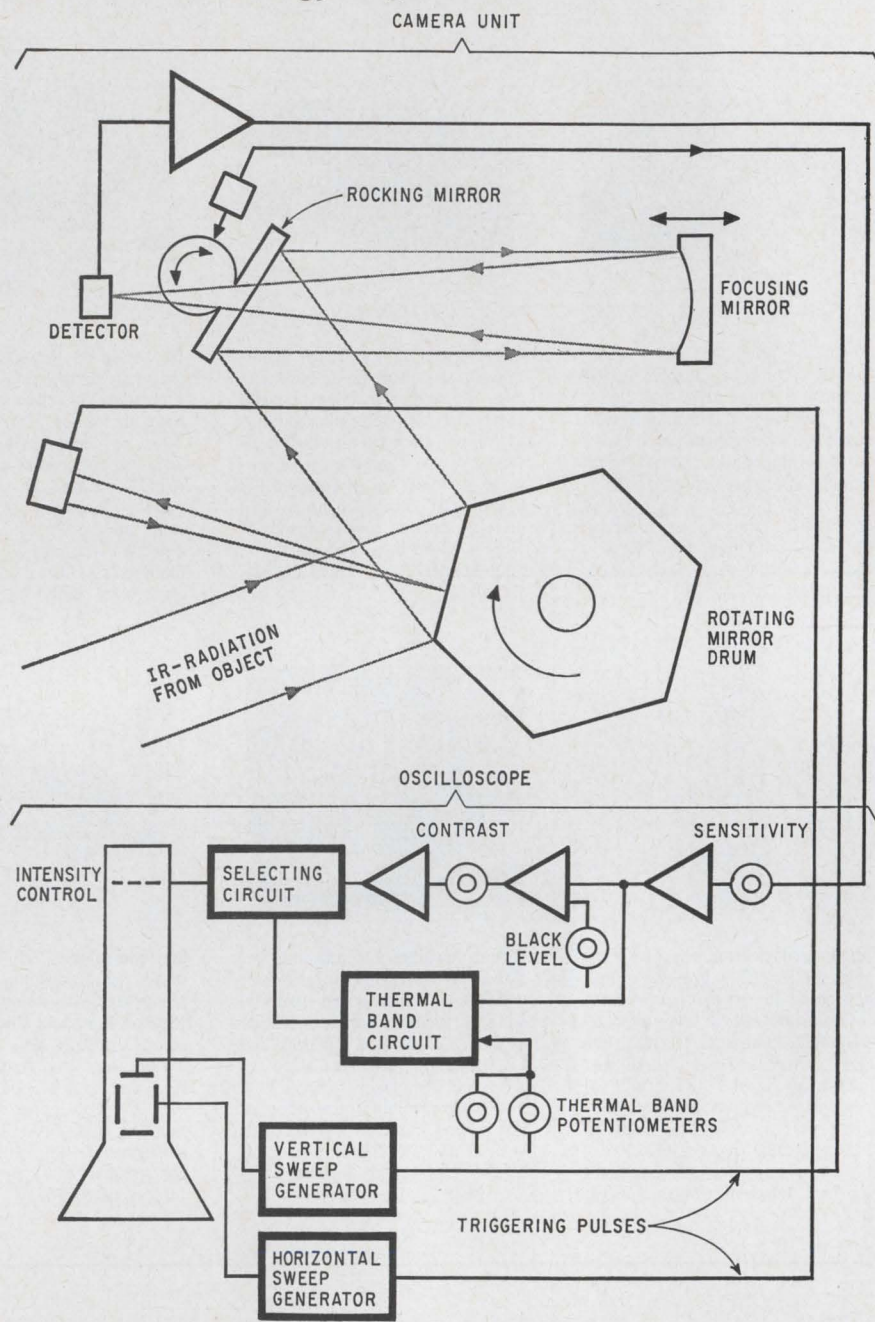

⊙ DENOTES OSCILLOSCOPE PANEL CONTROL

Thermal traces. The rotating drum scans horizontally and the rocking mirror scans vertically. As the amount of energy hitting the detector varies, the trace intensity changes.

125 lines of 250 points compared with a hundred 100-point lines for the AGA camera. The Bofors camera, at \$22,000, will also be about \$5,000 cheaper.

The new system will be sold and serviced in the U.S. by Barnes Engineering Co., itself a long-time maker of i-r cameras. Barnes' best camera, the T-7, takes a picture every three minutes but scans a

hundred and seventy six 350-point lines in a 20° by 10° field, producing resolution that high-speed cameras haven't approached.

The operating principle of the T-7 is the same as that of other thermal cameras. Every object radiates i-r energy, the amount depending on the temperature of the object. The camera's optical system scans a field, collecting the

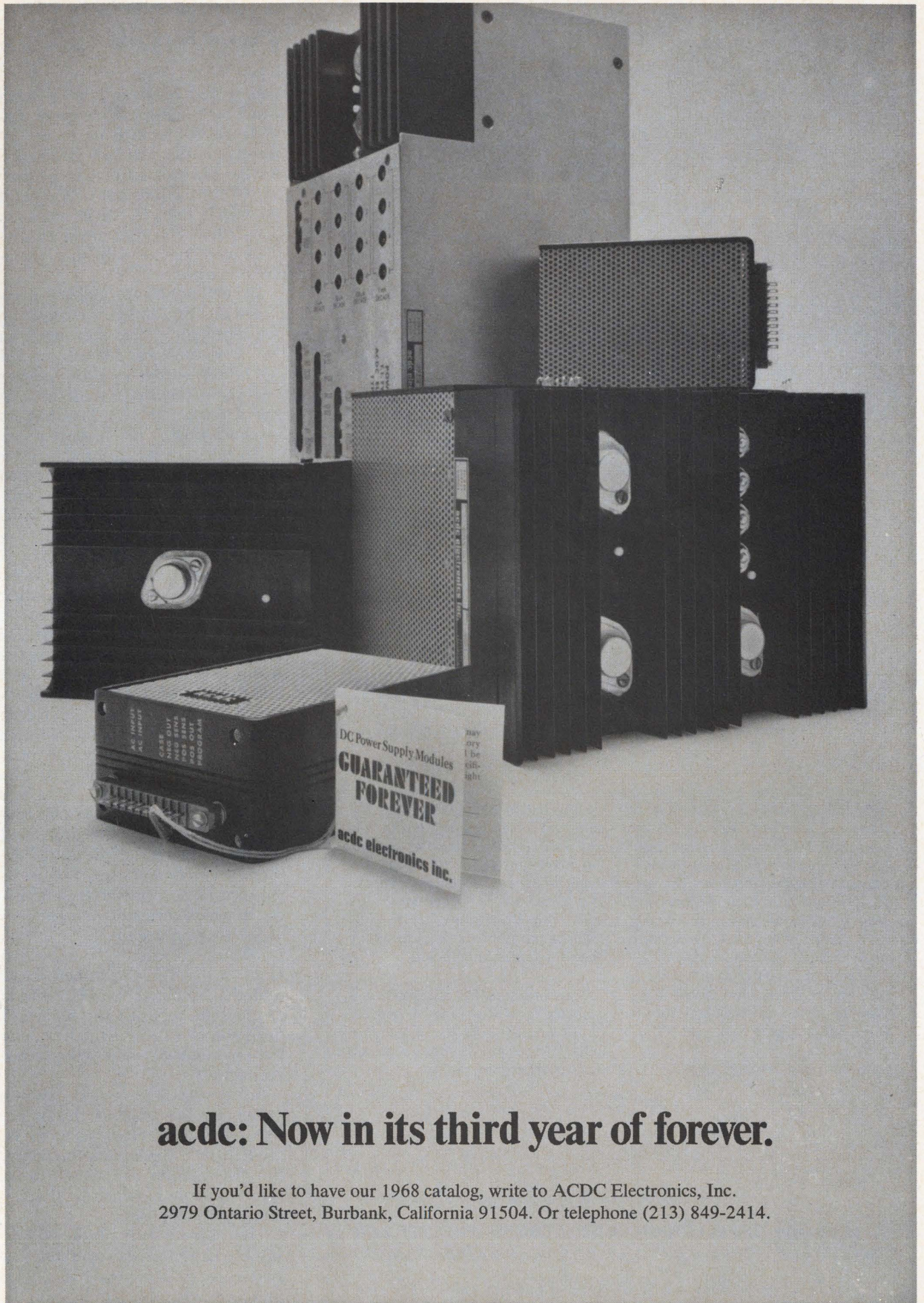

acdc: Now in its third year of forever.

If you'd like to have our 1968 catalog, write to ACDC Electronics, Inc.
2979 Ontario Street, Burbank, California 91504. Or telephone (213) 849-2414.

JFD
MTLC

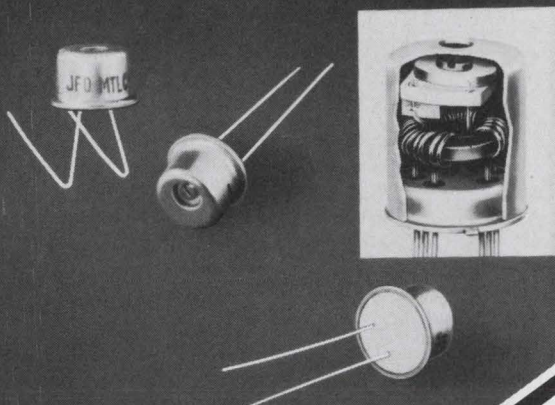

(Illus. 1.25 X actual size)

MICRO-MINIATURE TUNED-CIRCUIT PACKAGE

JFD MTLC TUNERS enable circuit designers to shrink various LC circuits into TO-5 configurations completely compatible with today's miniaturized or hybrid circuitry. The tuning element is a subminiature variable ceramic capacitor measuring: .2 X .28 X .12 in. thick. These variable ceramic capacitors offer high capacitance plus a choice of wide Δ Cs in extra small, ultra stable units. New improved construction makes MTLC more rugged than ever.

Write for bulletin MTLC-67-A.

JFD builds these miniature circuits with high quality ferrite and iron inductor toroidal cores, providing maximum Q for any given frequency. Where necessary, special JFD Uniceram fixed capacitors are used with Modutrim units to yield lower center frequencies or to satisfy special circuit requirements.

Standard tunable LC networks are available for a wide range of applications. Variations of these standard units, or special designs, will satisfy most other requirements.

"TODAY'S COMPONENTS BUILT FOR TOMORROW'S CHALLENGES"

JFD JFD ELECTRONICS CO. / COMPONENTS DIVISION
15th Ave. at 62nd St. • Brooklyn, N.Y. 11219 / Phone 212-331-1000

Offices and subsidiaries in principal cities, world-wide.

... cool detector takes a look at hot spots ...

energy and focusing it on a semiconductor detector, whose impedance is proportional to the intensity of the incident i-r energy. So the detector current is a measure of the temperature of the point on which the camera is focusing. This current is then used to produce an image, usually on a photographic plate.

Drumming it up. Bofors' engineers did two things to speed up their camera. First, they used an indium-antimonide detector, cooled by liquid nitrogen. This detector has about the same sensitivity as the detectors in the T-4, but its response time is much shorter.

To take advantage of the faster detector, Bofors built a high speed horizontal scanner—a six-sided mirrored drum that rotates at 4,500 revolutions per minute.

The AGA camera also has a cooled detector, but the scanning is done by a rotating prism that refracts the incoming radiation.

The i-r energy entering the T-7 reflects off the drum, strikes the rocking vertical-scan mirror, and travels to a third mirror which focuses the energy on the detector. After being amplified, the detector signal goes to the scope where it modulates the intensity of the trace.

A second detector picks off some energy reflected by the drum and sends a triggering pulse to the scope's horizontal scan. The vertical-scan pulse comes from a transducer which measures the position of the rocking mirror.

Like the AGA unit, there are two parts to the T-7, the camera head and the oscilloscope. All controls are in the scope, so the 57-pound head can be put into small or hostile environments and be operated remotely.

Sensitivity is adjusted with a switch on the front of the scope. Normally, the hotter an area is, the lighter it appears on the scope. But the operator can switch to an inverted mode in which light areas represent cold spots.

The normal scan of the T-7 is 25° by 12.5° but the operator can switch to a 12.5° by 12.5° field. In this mode, the middle portion

General Electric introduces the smallest 50mw, 2-amp relay on the market

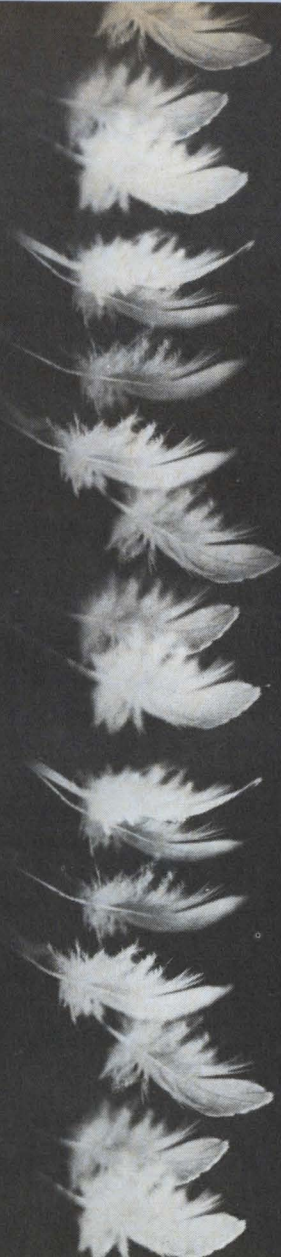

Tiny, powerful
and turned on with the touch of a feather

This extra-small, 2-pole, 2-amp relay needs only the slightest tickle to operate—50 milliwatts. With this impulse, it performs standard high-level output switching from low-level, microelectronic input.

Sizewise, it's only 0.32" high, 0.31" wide, and 0.61" long. And, it meets or exceeds all MIL-Spec environmental and electrical requirements of relays many times larger.

Because of its low operate power and size, this relay is ideally suited for microelectronic applications. Its low profile lets you stack many more circuit boards in the same space.

Like all General Electric 150-grid relays, this new 50mw type is available with a number of options to suit your individual application. You have a choice of coil ratings for a wide range of system voltages, a choice of popular mounting forms and header types.

If this new relay tickles your fancy, contact your General Electric Electronic Components Sales Engineer. Or, write for Bulletin GEA-8589, Section 792-43, General Electric Company, Schenectady, New York 12305.

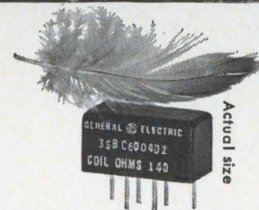

GENERAL  **ELECTRIC**

SPECIALTY CONTROL DEPARTMENT, WAYNESBORO, VIRGINIA

Circle 225 on reader service card

Low cost. High quality.

Douglas Randall series G reed relays offer outstanding benefits in economy and reliability because of simplified design. Rugged bobbin construction features heavy duty, integrally mounted coil terminals. Switch leads are welded to the terminals to increase reliability and eliminate heat stress. Stand-off shoulders are an integral part of these terminals to maintain clearance

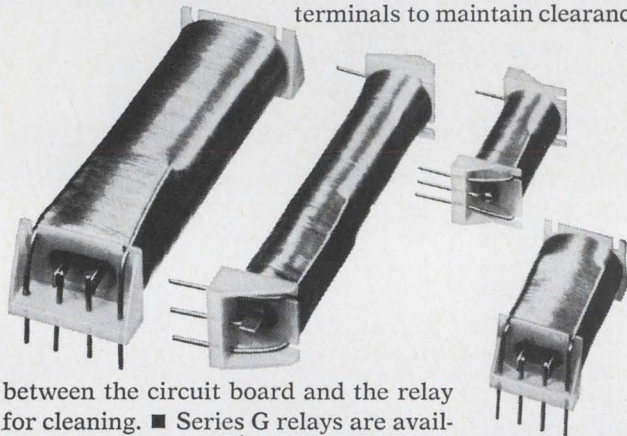

between the circuit board and the relay for cleaning. ■ Series G relays are available in 6-12-24V ratings in addition to other coil voltages. Standard units are stocked for immediate delivery and specials are available to specifications. Either way you get the benefit of Douglas Randall's extensive experience in the manufacture of reed relays to exacting requirements at utmost economy. ■ For information or assistance, contact: Douglas Randall, Inc., 6 Pawcatuck Ave., Westerly, Rhode Island 02891.

Douglas Randall, Inc. 
Division of Walter Kidde & Company, Inc. **Kidde**

Circle 335 on reader service card

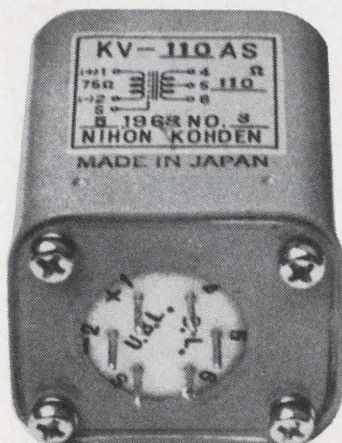

New Video Transformer TYPE KV-110AS for TV Telephone!

This transformer shunts electrostatic induction due to environmental conditions and is the smallest* in size among those that meet the following specifications:

Frequency response: 20 Hz~6 MHz, ± 1.5 db.
Longitudinal current suppressions: 15KHz, 75db or over.
Impedance: Primary 75 Ω , Secondary 110 Ω .
Sag: 5% or less. **Level:** 5 dbm.
*Size: 38 mm(W) x 33 mm(D) x 47 mm(H). **Weight:** 200 g.



NIHON KOHDEN

NIHON KOHDEN KOGYO CO., LTD.
Foreign Dept.: Chiba Bldg., 93, Tsunohazu-2, Shinjuku-ku, Tokyo, Japan
Cable Address: MEKOHEN TOKYO

... thermography used in
factory and hospital ...

of the normal horizontal scan is isolated and expanded.

The T-7 has a digital mode. A triggering circuit permits a trace to appear only when the detector signal is at some preset level. So the trace that appears in this mode is an isothermal line. If the operator traces an isotherm and then tunes away from it with a dial on the front of the scope, he can measure the temperature differences between two points.

The T-7 responds to temperature differences as small as 0.1°C and normally operates over a range from -20°C to +150°. The camera can be built to work over a wider temperature spread.

Checkup. The system is intended for use in two areas—industrial tests and medical applications. The i-r technique has already been established as a reliable means of performing nondestructive tests. I-r cameras screen, among other things, circuit boards, welded structures, and thermal insulation. The high speed of the T-7, compared with the T-4's, not only allows more tests to be performed in a given time but also permits an operator to change test conditions as he goes along. And the broad scan means the camera can look at large objects, like furnaces, cars and vats.

Thermography is also becoming an important medical tool. The coming of real-time scanning is opening the way for i-r cameras to be used to screen large numbers of people in the same way X-ray cameras now help in the early detection of tuberculosis.

Although medical researchers are still finding useful applications for thermography, the technique has already proven itself as the simplest way to detect breast cancer early, and to distinguish between second- and third-degree burns.

According to Barnes, 18 Bofors cameras are being used in Europe, six in industrial applications and 12 in medical areas, including one that's used in a mobile clinic.

Barnes Engineering Co., 40 Commerce Road, Stamford, Conn. 06902 [429]

Just Out! The NEW FALL 1968 BURR-BROWN CATALOG

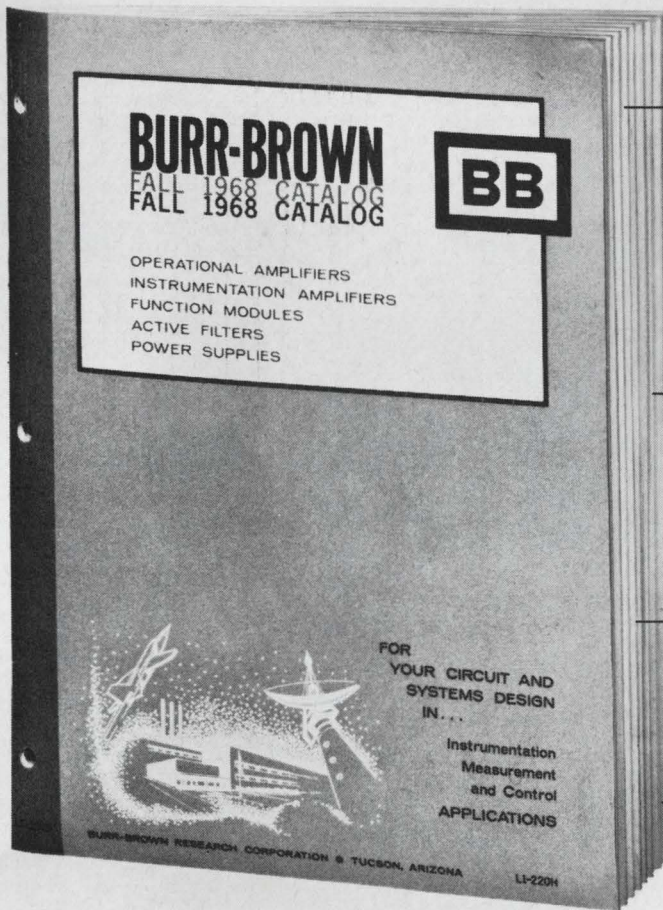

NEW OPERATIONAL AMPLIFIERS

- New low-noise, low-drift chopper stabilized units.
- New low-drift general purpose units . . . plus the industry's broadest line of I.C. and discrete component op amps, many at new low prices.

NEW FUNCTION MODULES

- A/D and D/A Converters
- An encapsulated Diode Function Generator
- Two new low-priced Multipliers
- Sample/Hold Modules
- . . . along with a wide variety of other unique hybrid and analog Function Modules available from Burr-Brown.

NEW INSTRUMENTATION AMPLIFIERS

- . . . high-performance units with prices as low as \$95.00 in single unit quantity.

ACTIVE FILTERS

- . . . the most comprehensive line of encapsulated Active Filters available anywhere.

it's yours for the asking

simply check this publication's reader-service card, contact your Burr-Brown Engineering Representative, or see us at WESCON BOOTH #2327-2328, Sports Arena.

BURR-BROWN
RESEARCH CORPORATION

International Airport Industrial Park • Tucson, Arizona 85706
TELEPHONE: 602-294-1431 • TWX: 910-952-1111 • CABLE: BBRCORP



Operational Amplifiers
Instrumentation Amplifiers
Function Modules
Active Filters
Power Supplies

ENGINEERING REPRESENTATIVES: ALABAMA, HUNTSVILLE (205) 534-1648 / ARIZONA, PHOENIX (602) 254-6085 / CALIF., LOS ANGELES (213) 665-5181, SAN DIEGO (714) 232-2017, SAN FRANCISCO (408) 244-1505 / COLO., DENVER (303) 399-4391 / CONN., EAST HARTFORD (203) 874-9222 / D.C., WASHINGTON (SEE MARYLAND) / FLORIDA, ORLANDO (305) 425-2764 / ILLINOIS, CHICAGO (312) 286-6824 / LA., NEW ORLEANS (504) 888-2266 / MD., SILVER SPRING (301) 588-8134 / MASS., BOSTON (617) 245-4870 / MICH., DETROIT (313) 358-3333 / MINN., MINNEAPOLIS (612) 781-1611 / MO., ST. LOUIS (314) 524-4800 / N.C., GREENSBORO (919) 273-1918 / N.J., CAMDEN (215) 925-8711 / N.M., ALBUQUERQUE (505) 255-1638 / N.Y., ALBANY

(518) 489-4777, BINGHAMTON (607) 723-9661, MT. VERNON (914) 968-2200, NEWBURGH (914) 562-6604, NEW HARTFORD (315) 732-3775, ROCHESTER (716) 473-2115 / OHIO, CINCINNATI (513) 761-5432, CLEVELAND (216) 237-9145, DAYTON (513) 277-8911 / PENN., PHILADELPHIA (SEE CAMDEN, N.J.), PITTSBURGH (412) 243-6655 / TEXAS, DALLAS (214) 357-6451, HOUSTON (713) 774-2568 / UTAH, SALT LAKE CITY (801) 466-8709 / VIRGINIA, (SEE MARYLAND) / WASH., SEATTLE (206) 767-4260 / CANADA, DOWNSVIEW, ONT. (416) 636-4910, MONTREAL, QUE. (514) 739-6776, OTTAWA, ONT. (613) 725-1288, VANCOUVER B.C. (604) 291-7161

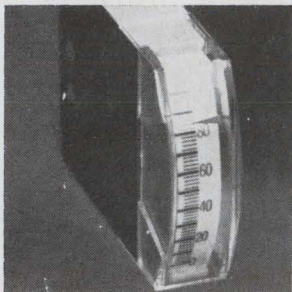

Edgewise panel meter model 1138 combines functions of a monitoring instrument with alarm provisions. Color-coded scale sections are illuminated when the meter pointer reaches one of the predetermined signal levels specified by the customer. Standard ranges are 0-100 μ a to 0-3 amps d-c, and 0.1 v to 0-100 v d-c. International Instruments Inc., Orange, Cor. [361]

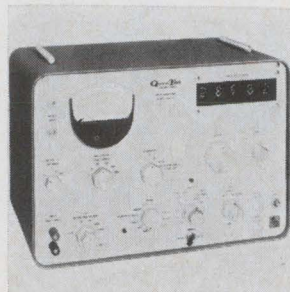

Low frequency (1 hz to 5 khz) tracking wave and spectrum analyzer model 304TD has electronic digital frequency readout. It offers a choice of 3 constant bandwidths: 1, 10 and 100 hz; also broadband 10 hz to 6,500 hz. It also features electronic tuning, AFC, automatic tracking or search and track modes. Quan-Tech Laboratories Inc., 43 S. Jefferson Road, Whippany, N.J. 07981. [362]

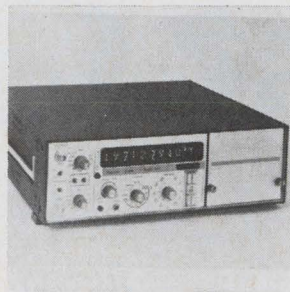

Counter-timer has a main-frame frequency range to 200 Mhz without prescaling, heterodyning, or using special plug-ins. It has 9-decade readout, 10 nsec resolution, gate times from 1 μ sec to 100 sec, and input sensitivity of 10 mv. Converters with ranges to 1.2 and 3.2 Ghz are optional. The cost is under \$2,500. CMC, 12970 Bradley Ave., San Fernando Calif. 91342 [363]

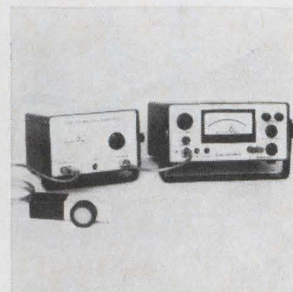

Photometer IL600/IL660 measures extremely low level ultraviolet and visible sources. Typical sensitivities allow full-scale measurements down to 6×10^{-8} ft candles and 4×10^{-6} μ w/cm² (at wavelength of maximum response). Typical applications include study of electroluminescence. Price is \$1,455. International Light Inc., 12 Unicorn St., Newburyport, Mass. [364]



RC-generator/indicator type SUB has single-knob frequency adjustment (50 hz to 50 khz) which insures that the selective indicator is tuned to variations in generator frequency. Logarithmic indication makes sensitivity adjustments unnecessary during bridge measurements. Voltage variations are read from 50 mv to 1 μ v. Ronde & Schwarz, Munich, W. Germany. [365]



Preset scaler-timer model CF-604R utilizes a 1-Mhz crystal oscillator to provide the time base for the counter. It features a space-saving 1 3/4 in. high chassis designed for either rack or bench mounting, easy to read in-line display, and plug-in TTL IC's. Price is \$1,095; delivery, 3 to 4 weeks. Anadex Instruments Inc., 7833 Haskell Ave., Van Nuys, Calif. 91406. [366]

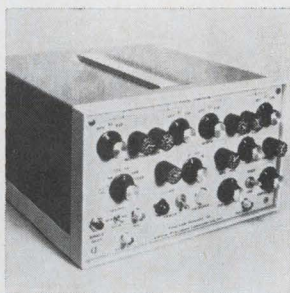

Pulse code generator model 715 can produce up to 5 pulses independently variable. Any one of these pulses may be utilized without the presence of any others. Pulse width is variable from 0.25 to 1,000 μ sec in 4 overlapping ranges. Incorporated is a recovery time feature allowing a coded pulse pair to be delayed from the first pair. Vega Precision Labs, Vienna, Va. [367]



Digital voltmeter 4430 features a 3-pole, noise-rejecting filter that allows the unit to maintain 0.01% accuracy, even when power-line hum and other types of a-c noise reach a level approaching that of the d-c signal itself. Noise rejection is uniformly high across the full frequency range. Starting price is \$1,150. Dana Laboratories Inc., 2401 Campus Dr., Irvine, Calif. [368]

New Instruments

Signal analysis with a 20-hertz bandwidth

German equipment can measure level and frequency of multichannel links with 0.01-db, 1×10^{-6} accuracy

The problem of measuring signal level and frequency is compounded when the signal's neighbors are too near. In multichannel communication links, for example, adjacent signals might be separated by only 80 hertz, and analysis becomes a tricky task.

It will be a lot easier to separate and analyze closely adjacent signals with a combination of equipment offered by Siemens AG, West Germany's biggest electronics company. The equipment can be set to a 3-decibel bandwidth as small as 20 hertz over a frequency range

from 10 kilohertz to 25 megahertz. Signal level can be measured with an absolute accuracy of ± 0.1 db, and relative signal variations of ± 0.01 db are measurable. Frequency accuracy is $\pm 1 \times 10^{-6}$; this means that a 1-Mhz reading, for example, is accurate within 1 hertz. Such accuracy makes a frequency counter unnecessary.

Solid state. H. G. Kolb, sales engineer for measuring instruments at Siemens, long-distance communication division in Munich, says nothing else currently available has such bandwidth and accuracy. Siemens' older set, a vacuum-tube version, has a range of

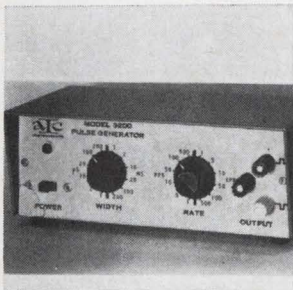

Pulse generator model 3200 has a crystal controlled clock and uses silicon transistors and DTL IC's throughout. Outputs consist of positive-going 0 to 5 v and negative-going 5 to 0 v pulse trains. Pulse width is switch selectable to 12 values from 1 μ sec to 200 msec; pulse rate, in 12 rates from 1 to 500,000 pps. Price is \$149. AIC Instruments, 6214 Royalton St., Houston. [369]

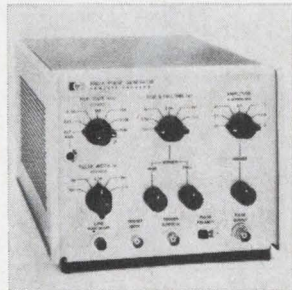

Variable rise- and fall-time pulse generator 8002A offers repetition rates from 0 to 10 Mhz, when controlled by external triggers, or from 0.3 hz to 10 Mhz with internal rate generator. Vernier control sets repetition rate anywhere within 30:1 range on any of the 5 ranges. Prices is \$700; delivery, 4 to 6 weeks. Hewlett-Packard Co., 1501 Page Mill Rd., Palo Alto, Calif. [370]

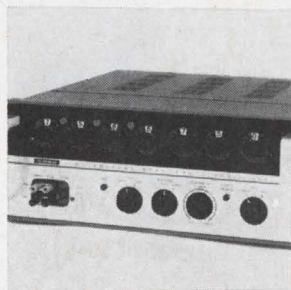

D-c voltage standard model 355 is 0.001% accurate. It has 10 ppm accuracy guaranteed for 30 days at standard reference conditions. Three decade ranges supply voltages from zero to more than 1,000 v with 7-place precision. Output current to 50 ma is available at any voltage setting. Price is \$2,750; delivery, 60 days. Cohu Electronics Inc., Box 623, San Diego, Calif. 92112. [371]

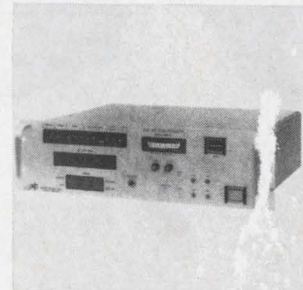

PCM bit synchronizer and detector model 830B is for the optimum recovery of data coded in any IRIG telemetry format. The design combines a second order phase-lock loop with detection circuitry that provides a bit error rate closely approaching the theoretical value for both negative and positive signal-to-noise ratios. Electrac Inc., 1614 Orangethorpe Way, Anaheim, Calif. [372]

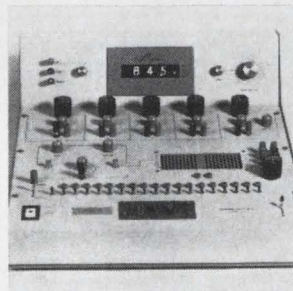

IC tester model 718 measures and displays with 3 decimal readout all important d-c parameters. Test connections and metering are made through a flexible programming matrix and lever switches which speed testing and reduce possibility of error. A built-in square wave generator provides dynamic inputs up to 10 Mhz. Microdyne Instruments Inc., Waltham, Mass. [373]

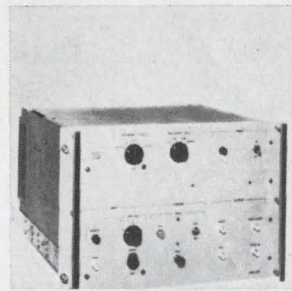

Real-time spectrum analyzer model SAI-21 provides complete capability for on-line analysis of voluminous data. It features an MOS shift register memory that eliminates drift and noise problems. The analyzer covers the frequency range from d-c to 1 Mhz, with 200-line resolution and 42-db dynamic range. Signal Analysis Industries Corp., 12 Di Tomas Court, Copiague, N.Y. [374]

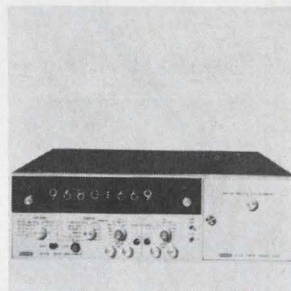

Timing resolution to 10 nsec in period, multiple period and time interval measurements is attainable with the model 625 timer, which is designed as a plug-in for the model 6148. The combination is suited for shock wave analysis, explosive burn timing, ballistics testing, and time delay reflectometry. Beckman Instruments Inc., 2200 Wright Ave., Richmond, Calif. [375]

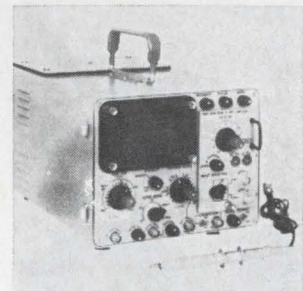

Explosion-proofed oscilloscope model K-106E can be used for on-the-spot check-out of electronic equipment at air fields and aboard ship where the use of high octane gas or the like creates danger of atmosphere ignition from electrical discharges or arcing. The unit is available in 7 or 10 Mhz bandwidth. General Atronics Inc., 1200 E. Mermaid Lane Philadelphia 1118. [376]

10 khz to 17 Mhz. Its smallest bandwidth is 340 hertz and its frequency accuracy is $\pm 2 \times 10^{-5}$.

All four subassemblies in the new system are solid state. A type W2021 signal-level generator and a G2021 frequency generator make up the signal source. The measurement part consists of a D2021 signal-receiving unit and another frequency generator, also type G2021. For measurements in which the transmitter and receiver have identical frequency variations, such as cable or radio-link systems with as many as 3,600 channels, only one G2021 is needed.

Other uses. Set at its 20-hz band-

width, the equipment can also measure Fourier frequencies and carrier leaks. The next highest bandwidth setting, 3 khz, is suitable for noise measurements and for general signal investigations. The third setting, 10 khz, is used for swept-frequency measurements. The setup is particularly valuable for attenuation measurements of four-pole networks.

The level of the transmitted signal is adjustable in 0.1-db steps over an 80-db range. Signal differences as small as 0.01 db are read by using a built-in expander. Suppose, for example, that 23.4 db is indicated; by pushing the

expander button, the operator can get a reading, accurate to the second decimal place.

Frequency can be continuously adjusted over the range of the in-

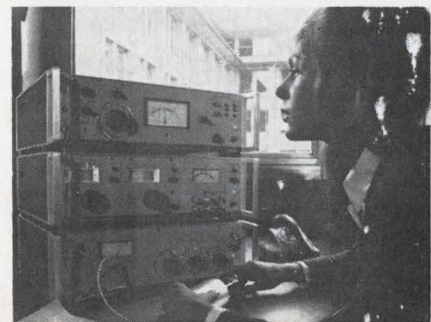

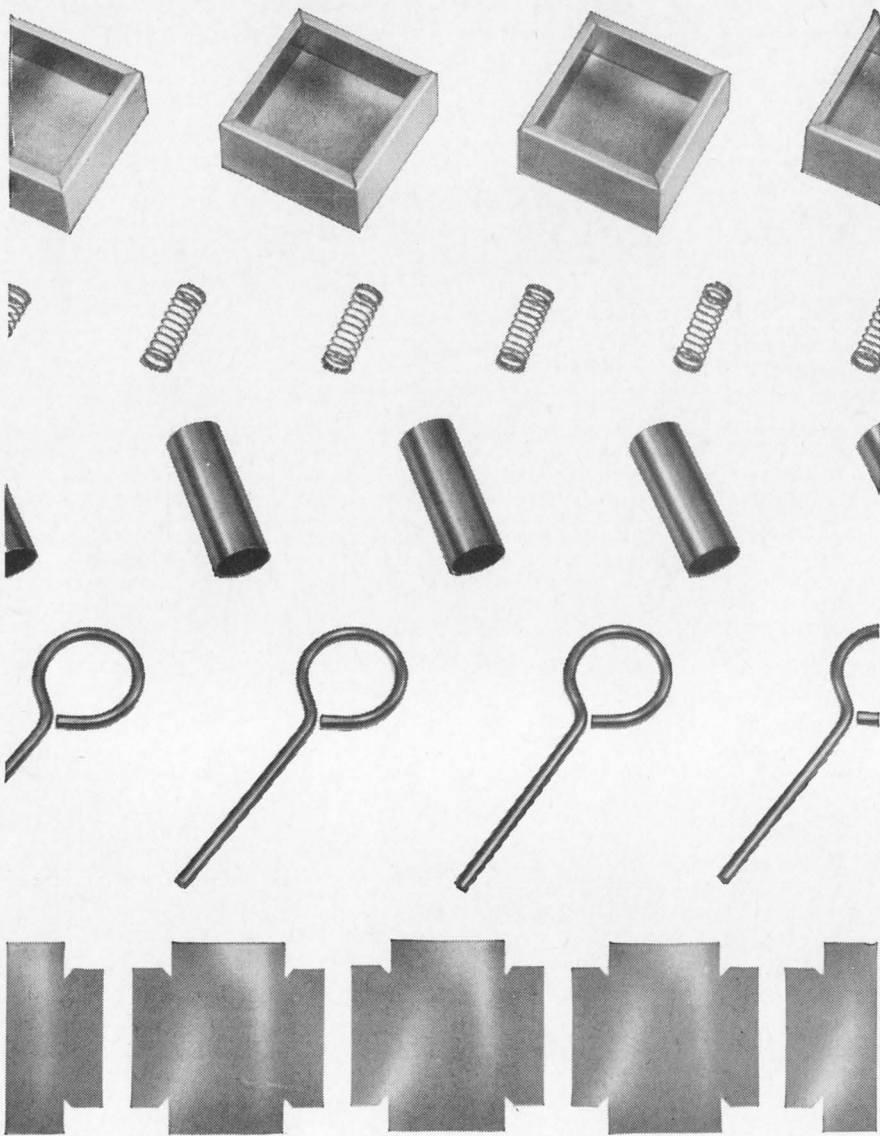

DUPLICATE THESE PARTS AND MORE IN YOUR OWN PLANT WITHOUT DIES!

Here's a way to produce short runs of simple parts quicker than an order can be processed to get them "outside." Versatile Di-Acro "Die-less Duplicating" equipment sets up quickly for cutting stock to size and forming it to die accuracy — without costly dies. Get full information in the new "Die-less Duplicating" catalog. See your distributor or write us.

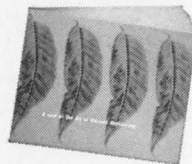

strument, or set and locked in at multiples of 1 khz and 100 khz. The $\pm 1 \times 10^{-6}$ frequency accuracy applies only to the locked-in frequencies, which are generated by crystal oscillators. With continuous coverage, accuracy is ± 20 hz. According to Kolb, the effective length of the frequency scale—that is, the sum of the scale lengths—is about 3,000 meters.

The three-unit combination costs about \$7,500 in the U.S.; delivery takes a month.

Siemens of America Inc., 350 Fifth Ave., New York 10001 [377]

New Instruments

Tremble tester has 3% accuracy

Unit measures amplitude and frequency of surface vibration; cost is \$800

A bad case of the shakes is a sure sign that a piece of industrial equipment isn't working right. Balance Technology Inc., long a manufacturer of instruments that measure machine vibration, is now offering a unit that sells for just about half the price of comparable instruments. Called Vibropac II, the instrument is accurate to within $\pm 3\%$.

The Vibropac measures 4 by 7½ by 9½ inches, is powered by a rechargeable battery, and has a shoulder strap. It's used the same way as other analyzers. All the operator need do is hold the instrument's probe against the machine. Built into the probe is a velocity-sensitive transducer—a stationary coil inside a movable magnet. When the probe touches the vibrating surface, the magnet moves, changing the coil's impedance. The signal from the coil is fed to tuned filters whose output is proportional to the amplitude of the vibration.

The instrument measures amplitude in seven ranges—0.0 to 0.00001 in. up to 0.0 to 0.01 in.—and frequency in four ranges be-

The miniature relay with built-in arc suppression

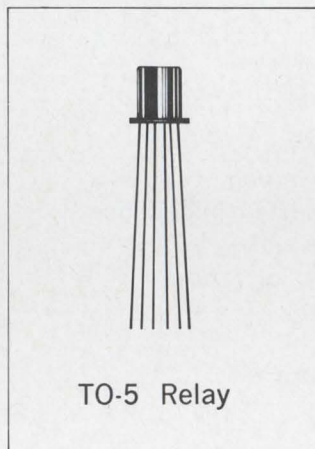

Every time we add to the already enormous capabilities of Teledyne TO-5 Relays we surprise a lot of "relay skeptical" engineers.

Now *all* standard Teledyne Relays are available with internal diode chips for arc suppression. It is no longer necessary for you to add external diodes on your circuit board. Single

or double diodes (for polarity reversal protection), added to our many other performance assets, insures our undisputed leadership in the miniature relay field.

(We have also suppressed the price of the diodes!!! — \$1.00 or less).

Send for complete data:



TELEDYNE RELAYS A TELEDYNE COMPANY

3155 West El Segundo Boulevard • Hawthorne, California
90250 Telephone (213) 679-2205 • 772-4357

Quieter than a whisper

an unheard-of noise level of 17.9 dB SIL*
with an unmatched air delivery of 70 CFM...
only the PAMOTOR model 4800 4½" miniature
all-metal fan can make this claim!

The new Model 4800 fan, 4½" square x 1½" deep, is designed for cooling a variety of OEM equipment such as copying machines, power supplies, sensitive electronic test gear and instruments, and TV cameras and receivers, as well as consumer products such as Hi-Fi/stereo equipment and tape recorders where noiseless performance is a must.

These fans will keep your equipment cool, helping it operate more efficiently and economically. Their hand-fitted broached dual-sleeve bearing system with a large oil reservoir ensures longer, more reliable operation. And their impedance-protected, two-pole, shaded-pole motor offers a life expectancy of 100,000 hrs., continuous duty, at room temperature (25°C), and 20,000 hours at an ambient temperature of 55°C. Extend the life of your equipment . . . cool it with Pamotor . . . with a no-noise Model 4800.

Call us at (415) 863-5440.
Or TWX 910-372-6127.
Or write to 312 Seventh St.,
San Francisco, Calif. 94103.

*Speech Interference Level

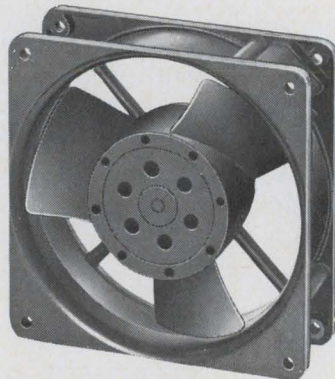

cool it with
PAMOTOR, INC.



Feeling the rumbles. The tip of the probe is held against the machine.

tween 600 and 60,000 cycles per minute. The user can either set the frequency dial at a particular value and read the amplitude, or continuously tune the instrument to determine the frequencies at amplitude peaks.

From tubes to IC's. Balance Technology's older vibration analyzers were made with vacuum tubes. A few years ago, the company decided to build a solid state unit that would sell for under \$1,000. According to Gordon Hines, Balance Technology's president, a transistorized device was designed, built, and all set to be marketed. The price was down where the company wanted it but frequency could only be read to within $\pm 10\%$.

"Then General Electric came out with PA 230 linear amplifiers," says Hines. "By using these IC's we cut the cost of components and at the same time built a more accurate unit."

Vibropac II is priced at \$800. Hines says instruments like the Vibropac are used extensively for safety and performance checks in processing plants, chemical factories, and steel mills.

Balance Technology expects to offer two similar instruments later this year, both priced at \$500. But they will be limited to amplitude measurements. One will be battery operated, and the other a-c operated. The latter will probably be designed for continuous monitoring as part of an alarm or recording system.

Balance Technology Inc., 218 N. Fourth Ave., Ann Arbor, Mich. [378]

See the new little boxes.

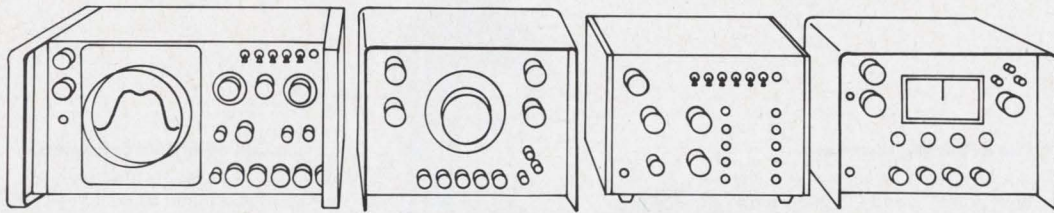

Now see what they can do.

Sweep from two hours to 1GHz.

Measure voltage and frequency.

Generate sine \sim square \square triangle \sim

ramp \wedge tone burst --- trigger \sim sweep ---

sine² \sim phase lock \sim VCG --- plus

complete digital remote control.

See the little boxes work at

Wescon, booth 1710-11.

WAVETEK[®]

8159 Engineer Rd., San Diego, Calif. 92112. Tel. 279-2200
P.O. Box 651, San Diego, Calif. 92112. TWX 910-335-2007

3 ways to get hermetic ICs at epoxy prices.

1. Call a Fairchild Distributor

On July 1, we reduced the price of all our DTL and TTL integrated circuits in hermetic DIPs. Now, they cost the same as competitive epoxy devices. And, you can buy them from any Fairchild distributor.

2. Call a Fairchild Salesman

If you get your samples from one of our salesmen, you might as well get quantity prices from him, too.

Now he can quote on Fairchild ceramic devices from our competitor's epoxy price list.

3. Call Fairchild

Anyone who wants to call Mountain View can get the new ceramic prices directly from Fairchild. Ask for Larry Frankfurt. Dial (415) 962-2103.

FAIRCHILD
SEMICONDUCTOR

Fairchild Semiconductor / A Division of
Fairchild Camera and Instrument Corporation
313 Fairchild Drive, Mountain View Calif 94040
(415) 962-5011 TWX: 910-379-6435

New Microwave Review

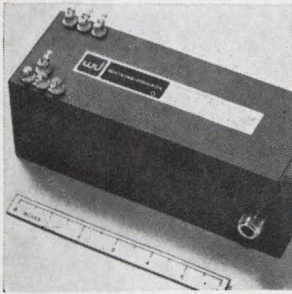

RFI- and magnetically-shielded backward-wave oscillators models WJ-2005, -2006 and -2007 perform under severe military environments. They exhibit a common helix voltage of 1,500 v. They feature max. tube-to-tube tuning curve repeatability. The 2005 covers 4 to 8 Ghz; 2006, 8-12.4 Ghz; and 2007, 12 to 18 Ghz. Watkins-Johnson Co., 3333 Hillview Ave., Palo Alto, Calif. [401]

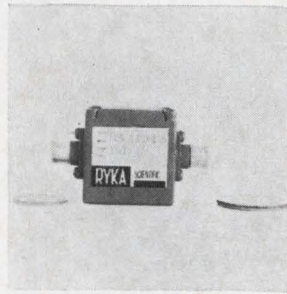

YIG preselector filter RS-411-LS is designed to cover the Tacan frequency range of 960-1225 Mhz. The four-stage unit uses a thermal construction that provides complete specified operation with less than 2 minutes warm-up at -62°C . It measures 1.2 x 1.2 x 1.2 in. and weighs 6.5 oz. Delivery takes 3 to 4 weeks. Ryka Scientific Inc., 2455 E. Middlefield Rd., Mtn. View, Calif. [402]

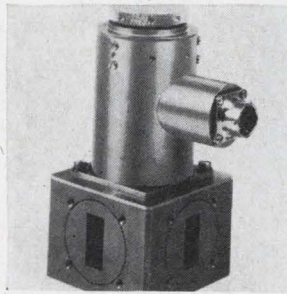

Three-port X-brand waveguide switch AM5177 features 90 db minimum isolation and interchangeable solenoid drive assembly. The unit is provided with a manual override capable of placing the switch in either of its positions in the event of solenoid or power failure. Frequency range is 8.5 to 10.5 Ghz. Alpha Industries Inc., 381 Elliot St., Newton Upper Falls, Mass. [403]

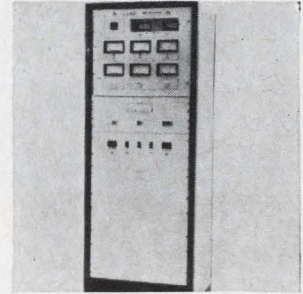

Klystron power amplifiers in a family of 16 span 1.7 to 10.4 Ghz at power levels from 1 to 3 kw c-w. Controlled characteristics include gain, a-m to p-m conversion, intermodulation, harmonic content, noise figure, gain compression, effects of tuning on bandwidth and efficiency, and coherent and noise sidebands. Alto Scientific Co., 4083 Transport St., Palo Alto, Calif. [404]

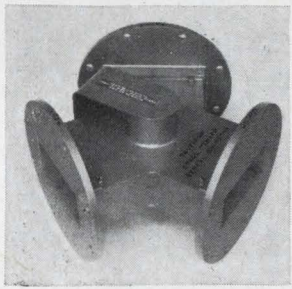

S-band circulator model CSH110 has a c-w powerhandling capability of 1,500 w. The device will handle 200 kw peak power at its design frequency of 3,170 to 3,330 Mhz. Isolation of the unit is 20 db minimum. Insertion loss is 0.3 db maximum; vswr, 1.15 maximum. The unit weighs 4½ lbs and requires no cooling. Raytheon Co., 190 Willow St., Waltham, Mass. 02154. [405]

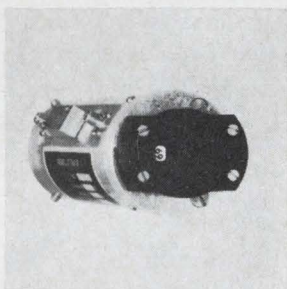

Uhf turret attenuator AT-202 features a range of 0 to 69 db in 1 db steps over a frequency range of d-c to 1 Ghz. It can be used as a laboratory item or incorporated in a system. Accuracy is 2% or 0.5 db; insertion loss, 1 db; vswr, 1.2 (over much of the frequency range). Price is \$225; availability, 4-6 weeks. RLC Electronics Inc., 25 Martin Place, Port Chester, N.Y. [406]

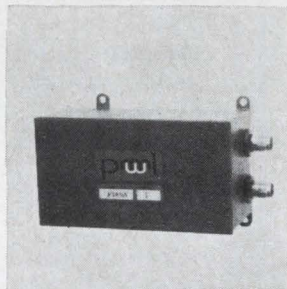

Diplexing filter model F186A operates in the 2.2 to 2.3 Ghz telemetry band. It is used to connect two transmitters to a single antenna. With a center frequency separation of 40 Mhz, the filter provides 35 db isolation with less than 0.7 db insertion loss. Power rating is 10 w per channel. Price is \$500. Peninsula Microwave Laboratories, 855 Maude Ave., Mountain View, Calif. [407]

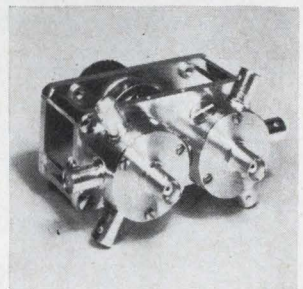

Manually operated coaxial switch model SW-123 features a frequency range of d-c to 2 Ghz, low vswr, low insertion loss, and very low crosstalk. It operates as a manual 2-pole, 3-position break-before-make coaxial switch. Connector types can be either BNC or TNC female. Price is \$300; delivery, 2 to 3 weeks. Texscan Corp., 2446 N. Shadeland Ave., Indianapolis 46226. [408]

New microwave

Amplifier not bothered by 100°C change

Logarithmic device uses feedback loops, matched transistors to keep 80-db gain constant to within ± 1 db

Just shrinking a device to one-fourth its former size and holding the price about the same would be accomplishment enough for some people. But when Ronald Hirsch, president of RHG Electronics Laboratory Inc., talks about his company's new logarithmic amplifier,

he keeps turning the conversation back to the device's stability—output change is less than 1 decibel from -64°C to $+71^{\circ}\text{C}$.

Called the LLT, the new amp is 6 by 1¼ by 1 inches and costs \$825. Hirsch says that RHG's older, larger units sold for anywhere from

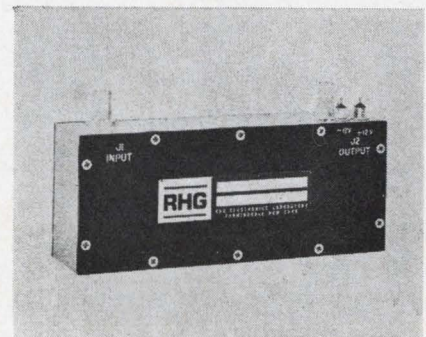

Wide-open input. The LLT's input is broad-band. Selective filters after the input isolate the center frequency.

IC SEALING PROBLEMS SOLVED

WITH WILLIAMS' IMPROVED ALLOYS FOR MICROELECTRONIC DESIGN.

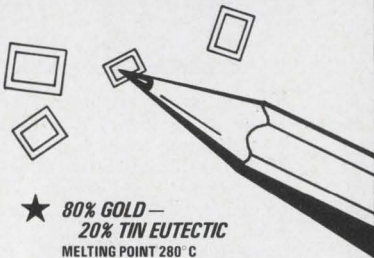

- ★ **80% GOLD — 20% TIN EUTECTIC**
MELTING POINT 280° C
- ★ **88% GOLD — 12% GERMANIUM EUTECTIC**
MELTING POINT 356° C
- ★ **SOLDER PREFORMS FOR SEALING INTEGRATED CIRCUIT PACKAGES**
- ★ **TOOLING AVAILABLE ON MOST STANDARD SIZES**
4 to 6 Weeks Delivery on New Tooling

PARTIAL LIST OF AVAILABLE ALLOYS & SOLDER PREFORMS

88% Gold 12% Germanium (Eutectic Alloy)
Strip and solder preforms in all sizes

80% Gold 20% Tin (Eutectic Alloy)
Strip, wire and solder preforms in all sizes

Gold with .1 to 1.2% Antimony
Wire, strip and solder preforms all sizes

Gold — .05% Min. Phosphorous
Wire, strip and solder preforms all sizes

95% Gold 5% Nickel
Wire, strip and solder preforms all sizes

Gold and up to .5% Arsenic
Strip and solder preforms all sizes

Silver with .1 to 1.2% Antimony
Wire, strip and solder preforms all sizes

Silver — .1% Min. Phosphorous
Wire, strip and solder preforms all sizes

95% Silver 5% Nickel
Wire, strip and solder preforms all sizes

Silver and up to .5% Arsenic
Strip and solder preforms all sizes

Special alloys produced on request at minimum charge.

Precious Metals in 99.9% Pure, 99.99% Pure, and 99.999% Pure.

Modern, up-to-date refining of precious metals and complete spectrographic facilities available.

HIGH PURITY METALS USED ON ALL ALLOYS

WRITE FOR COMPLETE PRECIOUS METALS CATALOG AND SPECIFICATION SHEETS. PHONE 716-834-7204

OVER 50 YEARS OF PRECIOUS METALS EXPERIENCE

WILLIAMS PRECIOUS METALS



2978 MAIN ST. BUFFALO, NEW YORK 14214
Division of Williams Gold Refining Co., Inc.

... amplifier has no inductors so chip version is next ...

\$500 to \$700. Versions of the LLT will be offered with center frequencies of 30, 60, and 70 megahertz with either 10- or 20-Mhz bandwidths. All models will have an 80-db dynamic range.

RHG engineers use a dual-transistor package in each stage of the LLT. One transistor is in the i-f portion of a stage, and the other in the video. They're coupled by a common-emitter resistor.

The dual transistors, which RHG buys, are precisely matched, which accounts for the d-c stability of the amplifier over the wide temperature range. Feedback loops provide the a-c stability.

Hirsch says that no other amplifier in the LLT's price range can match his unit's stability. "In the past we've bid 'no-bid' on some contracts calling for this kind of stability and size because we didn't think it was possible. Any time we wanted this performance before we had to build ovens to keep the transistors at a constant temperature."

The company says it has eliminated transient problems by making the input broadband and using selective filters to determine the center frequency and bandwidth of the amplifier.

A small future. Log amps are used in telemetry devices, communications equipment, and radars. Hirsch feels that as more and more of these systems are built with integrated circuits, there'll be a growing demand for smaller devices like the LLT.

In fact, the company is already thinking ahead to what comes next. Hirsch says that most of the LLT can be put on a chip. "There's plenty of qualified places around where we can send a design and get a chip back. The amplifier doesn't have any inductors so these amps in chip form are possible." RHG engineers could then put the chip on a substrate with appropriate tuning circuits.

The LLT will be introduced at Wescon. Delivery will range from stock to 30 days.

RHG Electronics Laboratory, Inc., 94 Milbar Blvd. Farmingdale, N.Y. 11735 [409]

High Voltage Rectifiers

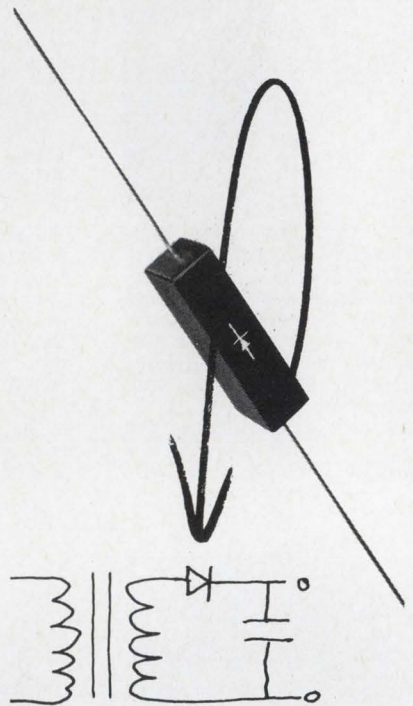

New! From Varo.

Silicon Rectifiers At Selenium Prices!

At last, economical high voltage silicon rectifiers. Ideal for use in all high voltage, low current applications.

- 5,000-40,000 Volts
- 5, 10, 25 milliamp ratings
- Standard and Fast Recovery
- In 1/4" square package.

These are the high voltage rectifiers that make completely solid state television circuits possible. Equally well suited for use in other cathode ray tube applications, electrostatic power supplies and voltage multipliers.

Only \$1.32

10,000V, 5mA rating. Quantity of 1,000. Complete details, applications, and price list available.



SEMICONDUCTOR DIVISION
2203 WALNUT STREET, GARLAND, TEXAS 75040
(214) 272-3561

MATSUSHITA "FIRSTS"—MAXIMUM DESIGN FREEDOM WITH HIGHEST ECONOMY

New generation components now permit unlimited use of these normally high-cost components in your product design, maintaining peak performance.

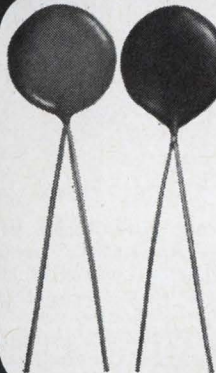

ZENER RESISTORS, ZNR Superior in the α -value (6 to 20)

- Sharp symmetrical characteristic
- Wide voltage range from 300mV to 300V.

Type No.	Resistance			Nonlinearity α	Temperature coefficient	Type of V-I curve
	V ₁	V ₁₀	V ₁₀₀			
ZNR-1	0.3-0.6	0.4-0.8	0.6-1.0	12-20	-0.2%/°C	asymmetry
2	0.6-2.3	0.7-3.0	1.0-4.0	6-10	-0.3%/°C	symmetry
3	4.0-300	5.0-300		8-30	-0.1%/°C	symmetry

PRICES:
ZENER RESISTORS (ZNR 1-2-3)
 Lab Samp/e (1-9) **\$2 ea.**
 Production Quantity **35¢ ea.**

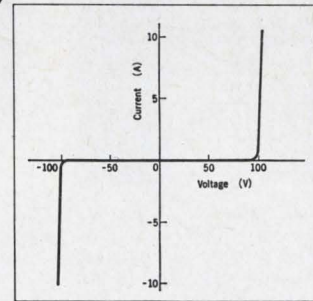

Typical V-I curve of ZNR-3.

VARACTORS A Matsushita development featuring world's highest capacitance ratio of over 14.4 from the hyper abrupt diode.



Reverse Breakdown Voltage.	30V min.: @ 25°C
Maximum Capacitance	250pF±12.5pF @ 1.0V 1 MHZ
Capacitance Change Ratio	14.4:1 @ IV/10V
Q	500 min. @ 1 MH
Leakage Current	MX-1 Less than 0.2μ A

PRICES:
VARACTORS
 Lab Sample (1-9) **\$3**
 Production Quantity **\$1**

Double Matched* \$7.50
Triple Matched* \$12
\$4

*Matched to ± (4% + 2.5 pF) at 250, 100, 60, 40 and 25 pF as standard matching. Please inquire about special matching.

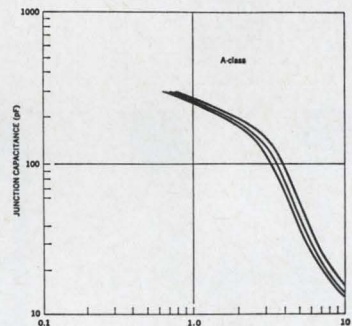

Capacitance vs. Voltage Curve

PTC THERMISTORS Suitable for mass production

- Available in high-wattage ratings
- Small resistance variation with aging.



	Temperature coef. resistance (α) (%/°C)	Linear range (for "A") (for "B" or "H") (°C)	Max. wattage (w)	Max. temp. for PTCR (°C)
A-type 1	2.5	20 to 100	1	150
A-type 2	3.5	-30 to 100	1	150
B- or H-type 2	Max. 13	100	10	260
B- or H-type 3	Max. 15	125	10	280
B- or H-type 5	Max. 10	175	15	320
B- or H-type 6	Max. 10	200	20	340

PRICES:
PTC THERMISTORS (A type)
 Lab Sample (1-9) **\$4 ea.**
 Production Quantity **\$1 or less (depending upon quantity)**

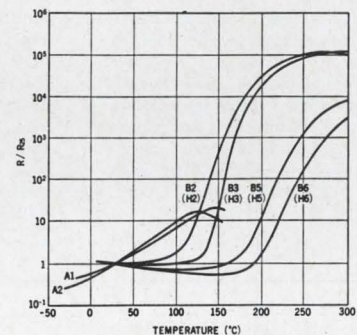

Temperature-logarithmic resistance characteristics of typical PTC-Thermistor.

MATSUSHITA ELECTRIC CORPORATION OF AMERICA

Electronic Components Department, 200 Park Avenue, New York, N. Y. 10017

Gentlemen: Enclosed is our check for \$ _____. Please rush the following components to us.
 Please send technical information immediately.

ZENER RESISTORS Voltage _____ Current _____ Tolerance _____ Quantity _____

PTC THERMISTORS Temperature Characteristic _____ Current _____ Basic Resistance at 25°C _____ Quantity _____

VARIABLE CAPACITANCE DIODE Triple _____ Double _____ Single _____ Quantity _____

Name _____ Title _____

Company _____ Address _____

City _____ State _____ Zip _____ Phone _____ Ext. _____

New Subassemblies Review

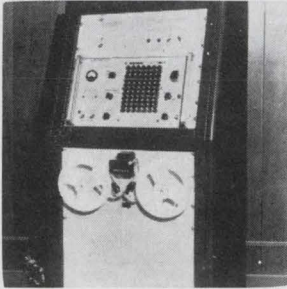

Computer/synthesizer interface system model DCS-1 accepts 24 bit binary data from a computer, converts the data to decimal form, and programs a frequency synthesizer to produce the desired frequency output. Complete conversion/switching time from data input to frequency output is less than 45 μ sec. Curry, McLaughlin & Len Inc., E. Molloy Road, Syracuse, N.Y. 13211. [381]

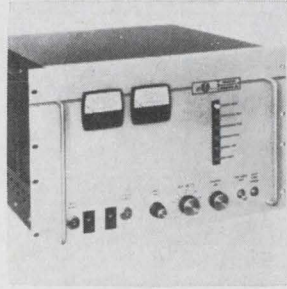

Power supplies in the DCR-1V series have units with d-c voltages up to 6,000, power to 1,500 w, and worst case regulation of $\pm 0.075\%$ for line and load changes combined. Typical resolution is 0.05% of maximum voltage and 0.5% of maximum current. Temperature coefficient is 0.015% of maximum voltage/ $^{\circ}$ C. Raytheon Co., Richards Ave., Norwalk, Conn. 06856. [382]

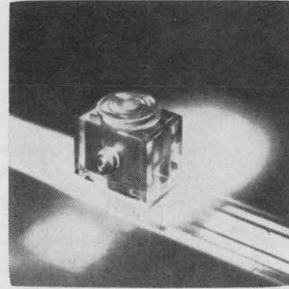

Laser Kerr cells size 25 have been developed for giant pulse laser control operation at the principal ruby wavelength of 6943 angstroms. High power densities of 100 to 250 megawatts can be achieved with pulses ranging from 5 to 20 nsec. Five models have standard apertures of 10, 12.7, 15, 19 and 20 mm. Kappa Scientific Corp., 5780 Thornwood Dr., Goleta, Calif. [383]

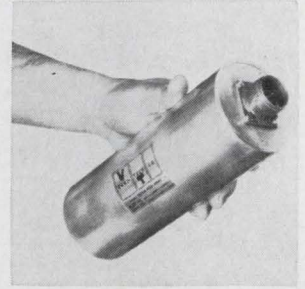

Miniaturized power supply VT-1260 provides automatic starting and continuous operation of low power, cold cathode neon-helium gas lasers. Operating from a standard 12-v acid-lead type automotive battery, it can supply over 7,000 v for automatic ionization of the laser. Initial ionization time is less than 0.1 sec. Vari-Tech Co., 546 Leonard St., Grand Rapids, Mich. [384]

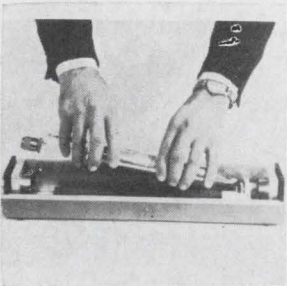

C-w helium-neon laser model 120 provides over 5 mw of power at 6328 angstroms. The plasma tube can be replaced in the field by the user, without the need for mirror alignment adjustments. This is made possible by a design that anchors reflectors and plasma tube rigidly into alignment. Spectra-Physics Inc., 1255 Terra Bella Ave., Mountain View, Calif. 94040. [385]

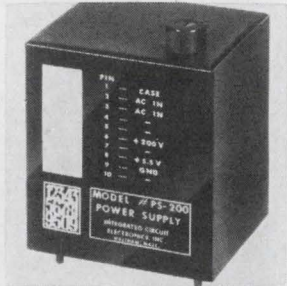

Power supply model PS200 works with display/counter modules using cold cathode display tubes. It provides an unregulated +200 v d-c for readout tubes and regulated 5.5 v for the circuit requirements, with current capabilities to drive 15 decades of decode displays. It measures 3 9/16 x 3 1/16 x 4 3/4 in. Integrated Circuit Electronics Inc., P.O. Box 647, Waltham, Mass. 02154. [386]

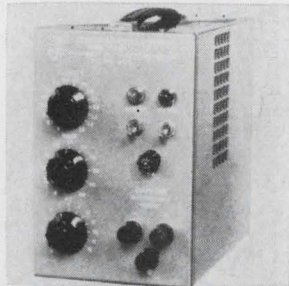

High-voltage power supply model PQE-1601 has a regulation and stability of better than 5 ppm. Long term stability is 0.005%/hr and 0.05%/day. The unit has an output voltage of 0 to 1.6 kv d-c continuously variable in steps of 100 and 10 v in conjunction with a 0 to 12 v vernier. Output current is 0 to 10 ma. Northeast Scientific Corp., 30 Wetherbee St., Acton, Mass. [387]

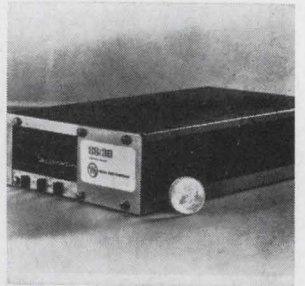

Small store memory SS/30 is a 4-wire coincident current core memory measuring 8 5/8 x 3 1/4 x 13 in. It features 2.4 μ sec full cycle time, storage capacity of 512 or 1,024 words, with word lengths of 8 and 16 bits. It is suited for data storage, time buffering between systems, and code and format conversion. Varian Data Machines, 2722 Michelson Dr., Irvine, Calif. [388]

New subassemblies

Converter handles high-speed-spin signals

Digital-to-synchro device puts out 3,000 $^{\circ}$ /second data with 6-minute accuracy, up to 13-bit resolution

There's a new generation ready to move into synchro and resolver systems, according to North Atlantic Industries Inc. The company now has a line of digital-to-synchro and digital-to-resolver converters that are 10 times as fast and half as big as the company's older con-

verters. To make testing these a-c systems easier, North Atlantic is also introducing a simulator and a bridge that are both broadband.

The 537 converter is just 5 by 8 by 11 inches and puts out positional data at rates up to 3,000 $^{\circ}$ /sec, compared with the 300 $^{\circ}$ speed

of North Atlantic's first-generation converters. To get this kind of speed, the company built solid-state circuits that can switch in 3 microseconds. The company says the extensive use of medium-scale-integration devices and standard integrated circuits is the reason the size is so small.

John Heavyside, North Atlantic's chief engineer, says that by talking to old customers he learned some things that proved useful when it came time to build the 537. "Converters run into trouble in real applications, simply because people tend to make mistakes. There's a lot of disconnecting of

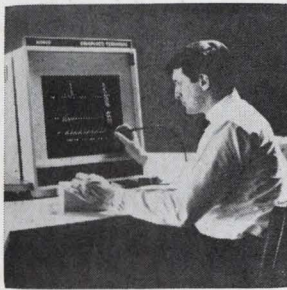

Computer graphics system AGT/10 provides more than 4,500 lines displayed at 40 frames/sec with resolution better than 100 lines/in. It includes hardware to allow for continuous image translation and image sealing; and provides for alphanumeric display with programmatic control of font and size. Price is \$60,000. Adage Inc., 1079 Commonwealth Ave., Boston 02215. [389]

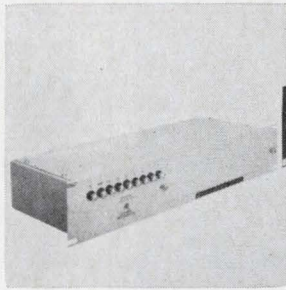

A/D converter 339D222 converts to 9-bit digital words at a rate of 10^6 words/sec. It was designed for such high-speed applications as radar moving target indicators, data collecting and logging, computing systems and other equipment. It measures 19 x $8\frac{1}{2}$ x $3\frac{1}{2}$ in. Temperature range for its p-c cards is -33° to $+62^\circ\text{C}$. Westinghouse Electric Corp., Baltimore, Md. [390]

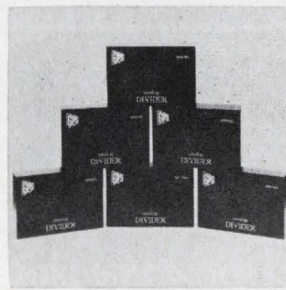

Analog Dividers series DIV 500 consist of six 2-quadrant units featuring wide bandwidth (d-c to 1 Mhz), fast slewing, low drift, accuracy to 0.05% and 20 ma current capability. Prices for the general purpose models are \$99.50 to \$150, and range up to \$750 to \$1,200 for the highest performance devices. GPS Instrument Co., 188 Needham St., Newton, Mass. 02104. [391]

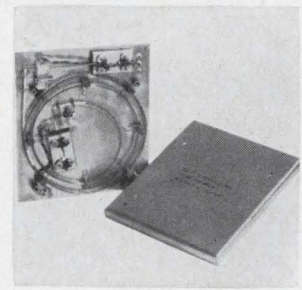

Magnetostrictive delay lines series EX are for low-cost memories in desk-top calculators. They are capable of data storage in any of these standard recording modes: RZ, NRZ, and bipolar with a storage capability of up to 1,500 bits for a 1 msec delay. Price in lots of 1,000 is \$18 each; availability, 2-4 weeks. Delay Devices Corp., 103 Morse St., Watertown, Mass. 02172. [392]



Digital data acquisition system DT-1000 is for multiplexing various input signals at remote locations over phone lines. It will accept data inputs from practically any source, analog, digital and manual. A 6-digit display provides data readout at the receiving terminal. It is computer compatible for automatic polling. Applied Peripheral Systems Inc., 3810 Westheimer, Houston. [393]

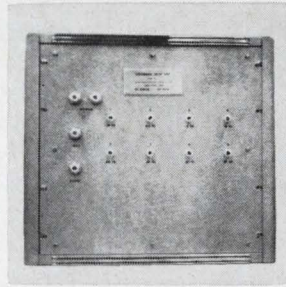

Coaxial cable delay line with 8 front-panel switches provides selection of delays from 1.25 to 160 nsec in 1.25 nsec steps. To compensate for residual loss, a second delay line is included in the package to balance the switchable delay line in a neutral position. The package measures $21\frac{3}{4}$ x $15\frac{1}{4}$ x $19\frac{1}{4}$ in. Phelps Dodge Electronic Products Corp., Box 187, North Haven, Conn. [394]

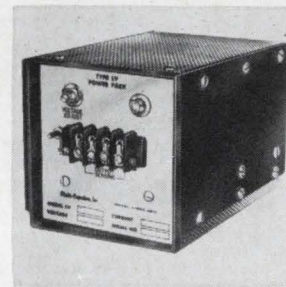

Solid state power packs series LV are available with d-c output voltages of 12, 24, 28, 36, 48, and 100 v with power ratings approximately 25, 50, 100 and 150 w. Line regulation is 0.01% from 105 to 125 v a-c. Load regulation is 0.05% from no load to full load. Ripple and noise are less than 3 mv peak to peak. Plastic Capacitors Inc., 2620 N. Clybourn Ave., Chicago. [395]



Programable digital delay generator model 1399 also serves as a frequency divider. With internal 10-Mhz clock, time delays are from 0.3 μsec to 10 sec in increments of 0.1 μsec . By using an external signal between 100 hz and 13 Mhz, the 1399 acts as a divider, providing frequency ratios of from 3:1 to 99,999,999:1. General Radio Co., West Concord, Mass. [396]

cables, and many times digital inputs are left open."

The 537 is protected against power transients, frequency shifts, overload, and short circuits at the output. The user can leave the digital input open without worrying about electrostatic pickup damaging the instrument. No data is accepted by the 537 unless a 4-microsecond strobe is received.

The converter is available with a resolution of 11, 12, or 13 bits, and an accuracy of 6 minutes. The basic unit, which costs \$2,300, has a reference frequency of 400 hertz, but, as an option, any reference between 60 hz and 10 kilohertz can

be specified.

Spreading out. Converters, like the 537, take digital signals, usually from a computer, and turn them into the synchro or resolver data that position antennas and other rotating devices.

The bridges and simulators that test such positioning systems are used at opposite ends of the system. By balancing the bridge, the user determines through what angle the input data would rotate an antenna. With the simulator the user selects an angle, and the device puts out the synchro or resolver signal equivalent to that angle.

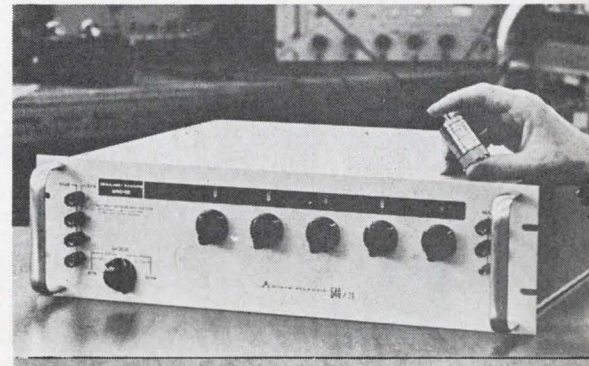

Checking the converter. The bridge, shown above, and the simulator test synchro and resolver systems, like those needing a converter, over a wide frequency band.

When reliability is the rule

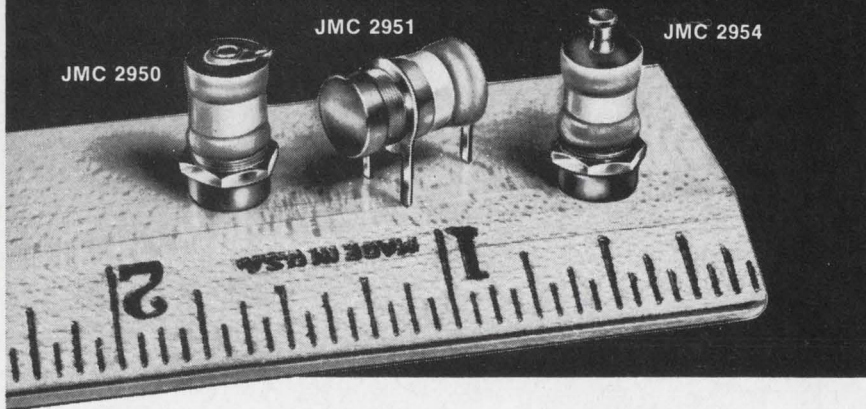

... specify *Johanson*

HIGH Q, HIGH FREQUENCY VARIABLE AIR CAPACITORS

This versatile series provides, in miniature size, exceptionally high Q, superior ruggedness for protection against shock and vibration, -55° to $+125^{\circ}\text{C}$ operating temperature range, protection against fungus, salt spray and humidity ... plus all the other construction and performance features that have made Johanson capacitors the industry standard for excellence.

Specifications

Capacitance Range: 0.8 — 10.0 pF
Dielectric Withstanding Voltage:
 Rating 250 VDC breakdown >500 VDC
Insulation Resistance: $>10^6$, megohms @ 500 VDC
Q: >2000 @ 100 mc
Temperature Coefficient: 0 ± 20 ppm/ $^{\circ}\text{C}$
Rotational Life: >800 revolutions

Write Today for Complete Catalog, Prices.

Johanson MANUFACTURING CORPORATION
 400 Rockaway Valley Rd., Boonton, N.J. 07005, (201) 334-2676
 Electronic Accuracy Through Mechanical Precision

Circle 240 on reader service card

Our little black book has over 100,000 phone numbers.

You never had a black book like it. Over 1,500 pages. And those phone numbers! More than 100,000 telling you who to call/where to go, for the over 4,000 different product categories listed and advertised in the yellow pages of the Electronics Buyers' Guide.

It's the industry's one-stop shopping center that lets you find the products and services you need quickly. You can depend on EBG.

Electronics Buyers' Guide

A McGraw-Hill Market Directed Publication,
 330 West 42nd Street, New York, N.Y. 10036

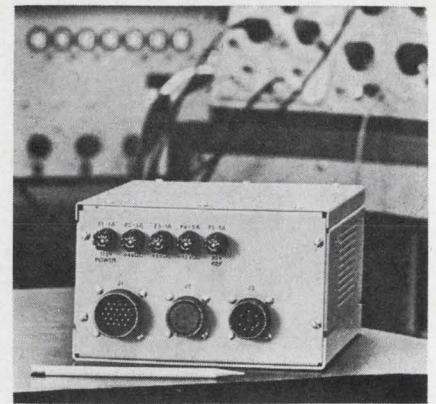
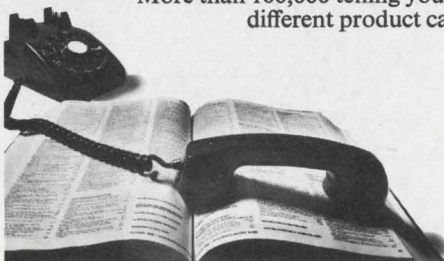

Tight packing. Built with MSI devices, the converter is the size of a shoebox.

North Atlantic's older simulators and bridges worked at just 400 hz. The 530/20 simulator and the 540/20 bridge operate at any frequency from 50 hz to 10 khz. The company feels this added flexibility will be useful to system designers, especially those who are testing the effectiveness of filters.

North Atlantic engineers didn't start out with the idea of making broadband instruments. According to Heaviside, there weren't any bridges or simulators that worked at high frequencies. But the company felt the need was not as great for accurate high-single-frequency units as it was for broadband units even if the accuracy was less.

By using the /20 instruments the user will be giving up some accuracy and some money. The broadband instruments, which cost \$3,300, have an accuracy of 10 seconds at low frequencies and 20 seconds at higher levels. The 400-hz model is accurate to within 2 seconds and sells for \$2,680.

Specifications

537	
Input timing	8.5 usec min to continuously variable
Logic levels	"1" $+5v \pm 0.5$ "0" = 0v to $+1v$
Reference excitation	$26v \pm 10\%$ $400 \text{ hz} \pm 5\%$
Line-line voltage	11.8v
Analog resolution	10.5, 5.3, 2.6 minutes
Analog setting time	100 μsec for MSB input 10 μsec for LSB input
Typical load	100 ohms
Voltage	$115v \pm 10\%$
Power	20 va nominal
530/20	
Angular range	000.000° to 359.999°
Excitation	26v or 115v (400 hz or 10 khz) 115v (60 hz)
Size	$5\frac{1}{4} \times 19 \times 15$ in.

North Atlantic Industries, Inc., Terminal Drive, Plainview, N.Y. [397]

can't get away for evening classes?



here's a practical way to avoid technical obsolescence

Are irregular hours, travel and family obligations keeping you from attending classes—even though you worry about becoming technically obsolescent? Check into the Special Programs in Electronics for Engineers developed by CREI, the Home Study Division of the McGraw-Hill Book Company.

These are not simply courses, but comprehensive programs in advanced electronics offering major electives in such fields as:

Communications Engineering, Aeronautical and Navigational, Television Engineering, Automatic Control Engineering, Missile and Spacecraft Guidance, Radar and Sonar Engineering, Nuclear Instrumentation and Control, Computers.

Industry-recognized CREI Programs make it possible for you to catch up on new developments in electronics through study in your own home, at your own pace,

your own schedule. Free book gives complete information and details of technical material covered. For your copy, mail coupon below or write: CREI, Home Study Division, McGraw-Hill Book Company, Dept. 1830G, 3224 Sixteenth St., N.W., Washington, D.C. 20010.

Founded 1927



Accredited Member of the National Home Study Council



CREI, Home Study Division, McGraw-Hill Book Company
Dept. 1830G, 3224 Sixteenth St., N.W.
Washington, D.C. 20010

Send me free brochure describing CREI Programs in Electronics for Engineers.

NAME _____ AGE _____

ADDRESS _____

CITY _____ STATE _____ ZIP CODE _____

COMPANY _____

TITLE _____

W-I-D-E band RECEIVER



CEI's new 977 VHF Receiver monitors the spectrum from 30 to 300 Mhz . . . AM, FM, CW, pulse signals . . . IF bandwidths: 60 kHz, 300 kHz, 3 MHz . . . Dual-gate MOS FETs in all gain-controlled stages . . . Wide dynamic range . . . Call or write for specifications.



SUBSIDIARY OF WATKINS JOHNSON



COMMUNICATION ELECTRONICS

6006 Executive Blvd., Rockville, Md. 20852 • 301/881-3300 • TWX 710-824-9603

Circle 292 on reader service card

SYNTHESIZER

200Hz to 100MHz
(MG514A/B/C)

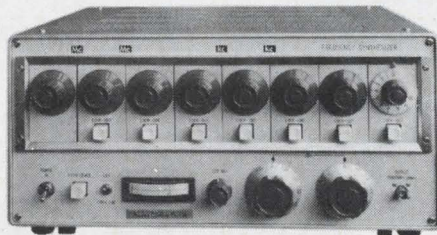

A: 5×10^{-9} /day \$5,900 B: 5×10^{-9} /day \$6,215 C: 2×10^{-9} /day \$6,425

(f.o.b. Yokohama, U.S. \$)

Frequency Range	200Hz~100MHz (2 Range)	
	Normal 0.1~100MHz	$1/10$ 200Hz~10MHz
	Seven decimal dials. Capable of both hand and auto (remotecontrol) operated	
Frequency Selection	10Hz	1Hz
	Continuous variable frequency available for each figure less than 1 MHz by releasing from phase-lock	Continuous variable frequency available for each figure less than 100kHz by releasing from phase-lock
Frequency Switching Time	Less than 2ms	
Output Level	-50 ~ +10dBm, 1dB step	
Output Impedance	75 Ω Unbalanced	
Distortion Factor	≤ -30 dB, both 2nd & 3rd Harmonics	
Spurious	≤ -80 dB	
Frequency Sweep	Maximum sweep width: Frequency range covered by continuous dial.	

For more complete information, write.



Anritsu Electric Co., Ltd.

4-12-20, Minamiazabu, Minato-ku, Tokyo
Phone: Tokyo 442-8171/Telex: 0242-2353
cable address ANRITDENKI TOKYO

New subassemblies

Too-fast converter finds its niche

Digital video, low-light devices
can use 80 db range
and 20 nsec speed capability

By devising a circuit with fast-switching field effect transistors and high-speed tunnel diodes, American Astrionics Inc. has designed a series of analog-to-digital converters faster than most users need. This was not as quixotic as it may seem; the fledgling Palo Alto, Calif., company was founded last fall to build high-speed components for a classified Air Force system. Since then, AAI has been finding some exotic applications for its exotic products.

The top of the line is a 50-megahertz system that has a dynamic range (ratio of highest to lowest input signal) of 80 decibels, or 10,000 to 1. Using logarithmic amplifiers, AAI can even achieve a 70,000 to 1 range. The huge dynamic range is one advantage of the digital system over high-speed analog methods, which use traveling-wave oscilloscopes to make direct traces at gigahertz levels. Besides being bulky and difficult to use, these scopes have typical dynamic ranges of 20 to 1, so that a system measuring 100 volts at peak cannot see less than 5 volts. The scopes must be ganged for more sensitive analysis.

Conventional quantizing methods can digitize signals of 100 kilohertz. These speeds are too low for some of the new applications being investigated by AAI, such as nuclear diagnostic testing, digital video, radar analysis and electronic countermeasures, and low-light-level systems.

AAI itself makes and sells separately, in both discrete and thick-film hybrid form, the video and logarithmic amplifiers in the first stage of its high-speed converters. The large dynamic range is obtained by using four amplifiers in parallel, each responsive to a 20-db

OVER
1,000,000 SIZES
MILITARY CASES

COMBINATION • TRANSIT • INSTRUMENT

MIL-T-945A, T-4734, T-21200, STD-108, C-4150



Choose from over 1,000,000 variations in dimensions, proportions, metals, finishes, and custom accessories. Whatever your need, the MM (multi-measure) method gives you high production savings even on custom runs as low as 25 units. Send your print or requirements. Manufacturers representatives in all major cities.

SEND FOR FREE CATALOG & DIMENSION SPECIFICATION SHEETS.

••MM ELECTRONIC ENCLOSURES, Inc.

111 Bloomingdale Rd., Hicksville, N.Y. 11801 • 516-935-9400

Circle 293 on reader service card

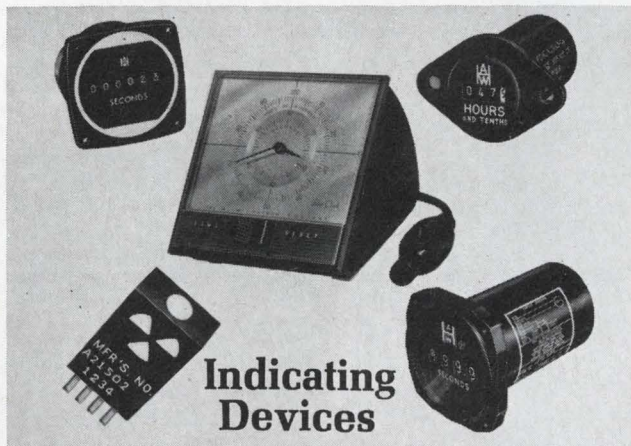

**Indicating
Devices**

Whether your application is industrial or military, you can now choose the indicating devices you need from a complete line offered by The A. W. Haydon Company:

- Microminiature "BITE" (Built-In-Test-Equipment) indicators to monitor circuit or system performance to meet DOD Systems Readiness Requirements.
- Elapsed Time Indicators — microminiature, subminiature, and standard sizes, both reset and nonreset types.
- Microminiature Events Counters, reset and nonreset types.
- Laboratory Stop Clocks for bench use or panel mount, 50 or 60 Hz
- Military Stop Clocks AC and DC, sweep-scale or digital readouts.

Special problems are welcome — send for data now!

AWHAYDON
THE COMPANY

232 North Elm Street
Waterbury, Conn. 06720
4060 Ince Boulevard
Culver City, Calif. 90231

Timing & Stepper Motors • Electromechanical & Electronic Timing Devices & Systems
REPRESENTATIVES THROUGHOUT THE U.S. (SEE EEM) • IN EUROPE CONTACT POLYMOTOR, BRUSSELS.

Circle 294 on reader service card

When Only Excellent is Adequate TURN to Grayhill

**WHAT'S NEW
ABOUT THIS
SWITCH?**

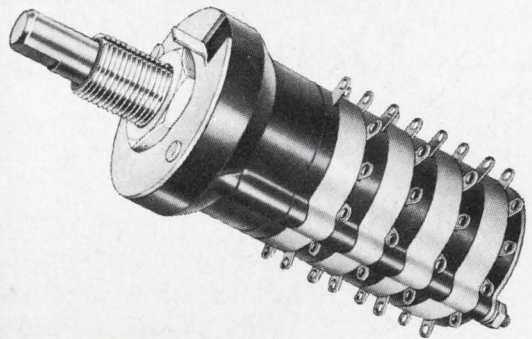

It's NOT Because It

- 1) is explosion proof.
- 2) has up to 12 positions/deck.
- 3) could have up to 6 poles/deck.
- 4) comes in shorting or non-shorting versions.
- 5) is available in sealed, military or standard versions.

NO... These are Standard Grayhill Rotary Switch features.

IT'S NEW BECAUSE

one or more positions may be ISOLATED from normal shaft turning techniques. It has its own built-in shaft turning SAFETY feature.

For details on this
and other Switches
Ask for Catalog G-304-A



Grayhill
INC.

523 Hillgrove Avenue
LaGrange, Illinois 60525
Area Code 312, Phone 354-1040

The Difference Between Excellent and Adequate

Circle 243 on reader service card

243

Don't miss the 24th Annual National Electronics Conference and Exhibition, Conrad Hilton Hotel, Dec. 9-11, Chicago

This friendly reminder
for your annual get-together
has been presented by TWA.
Who also happen to have a
lot of jets going that way.

up up and away 

*Service mark owned exclusively by Trans World Airlines, Inc.

Circle 295 on reader service card



actual size
Model A1-21

Mite-size miniature 7/16" indicator

These tiny indicators are compact, rugged, versatile and easy to read. They feature a microminiature moving coil core magnet mechanism. A1-21 Indicators operate in -55°C to $+85^{\circ}\text{C}$ environments and are sealed against dirt and dust. Choice of pointer or flag display in a wide variety of electrical sensitivities and functions. Size: 7/16" in diameter, 31/32" in length. Weight: 11.5 grams. Write today for complete information.

AMMON

AMMON INSTRUMENTS, INC.
345 Kelley St., Manchester, N.H. 03105

YOUR NO.1 SOURCE FOR ALL MAGNETIC MATERIALS

PERMAG

Complete magnetic material inventory . . . permanent magnets, high permeability, shielding and core materials and ferrites. Full fabrication facilities. Skilled engineering staff. 24-hour delivery.

PERMAG PACIFIC CORP.

5441 WEST 104th ST., LOS ANGELES, CALIFORNIA 90045
Telephone Area Code (213) 776-5656 TWX [910] 328-6547

PERMAG CENTRAL CORP.

5301-D OTTO AVE., ROSEMONT, ILL. 60018
Telephone Area Code (312) 678-1120

PERMAG MAGNETICS CORP.

formerly EMPIRE MAGNETICS
3130 SOUTH AVENUE, TOLEDO, OHIO 43609
Telephone Area Code (419) 385-4621

PERMAG NORTHEAST CORP.

50 THAYER ROAD, WALTHAM, MASSACHUSETTS 02154
Telephone Area Code (617) 484-0550

PERMAG CORP.

88-06 VAN WYCK EXPRESSWAY, JAMAICA, N.Y. 11418
Telephone Area Code (212) 657-1818 TWX [710] 582-2952

. . . taking the data when
the time is short . . .

part of the input. An input video signal is sampled and fed to the four amplifiers successively after brief time delays until a tunnel-diode sense amplifier turns one on; this signal then provides the most significant two bits of the conversion.

Summed. The split signal is then reconstituted in a summing amplifier and fed to special circuitry for the rest of the conversion. To accept data fast enough for such high-speed conversion, the system uses fast (1 nanosecond) switching FET's in the input amplifiers of the device.

The company is exploring the use of such converters to take data in extremely short bursts, where analog methods may be impractical. Instruments that are supposed to measure underground nuclear tests, for instance, are saturated by a huge common-mode voltage, on the order of 100 to 300 volts, for the first 20 microseconds after detonation.

The Atomic Energy Commission suspects that this voltage may last for only 1 μsec or so downhole, and previous nuclear tests have indicated that the most interesting data may come in the first few μsecs after the blast.

The Sandia Corp. will therefore use some AAI amplifiers, with tunnel-diode threshold detectors, to clamp off this voltage for 1,5, and 25 μsec , sensing when the voltage is once again at a reasonable level for data taking.

Hot storage. High-speed digital data is like a hot potato; the receiver has to do something with it fast or drop it. AAI has developed a hybrid transistor-transistor-logic metal-oxide-semiconductor recirculating memory into which the data can be placed for storage; it can be taken out with a clock pulse as slow as 10 khz and put on magnetic tape. The memory, too, came from the classified contract and is for sale.

"We want to keep developing new products under our systems contracts," explains company president Jerry Frascilla.

With random-access memories [Electronics, June 24, p. 49] as well

DO YOU WANT TO SELL IN THE UNITED KINGDOM AND EUROPE?

LEONARD WADSWORTH & COMPANY LIMITED, the well known U.K. importers and distributors of materials for the electronics industry, have set up a new facility specifically to handle U.S. manufactured components and equipment.

They wish to make contact with American producers who need a lively and technically oriented organization to sell their products in the U.K. and possibly other countries in Europe. Specific suggestions are:

1. Capacitors, preferably for specialized applications.
2. Equipment for manufacture and test of Capacitors.
3. Connectors particularly for printed wiring.
4. Accessories and hardware for integrated circuits.
5. Instruments and control equipment for electrochemical industry.
6. Wires and cables for very high temperature application.
7. Switches of unique or special design.
8. Other components and equipment of advanced design.

Managing Director of parent Company will visit the U.S. in September to discuss arrangements.

Please contact us at:

Leonard Wadsworth & Co. Ltd.
Broadway House, Broadway
London S.W. 19. England.

Cables: Exwad London. Telephone: 01 542 4258. Telex: 264028.

Circle 296 on reader service card

Transistor Life Test Assemblies with close temperature control

Unlimited number of modules can be tested or broken in . . . with air or liquid (house water or closed system coolant) cooling. Electrically insulated interchangeable mounting stations to accept all popular case styles. Individual cell temperature control with 5°C max. variation between devices. Each cell functions as an individual test facility with control of temperature and power dissipation. Supplied complete or ready to accept your power supplies and circuitry.

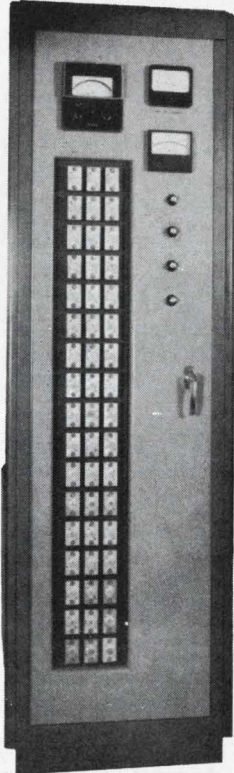

Write for BULLETIN NO. LTA.

WAKEFIELD ENGINEERING, INC.

WAKEFIELD, MASS. 01880 (617) 245-5900 • TWX 617-245-9213

Visit WESCON Booth No. 734, Hollywood Park

Circle 297 on reader service card

Big performance in small space

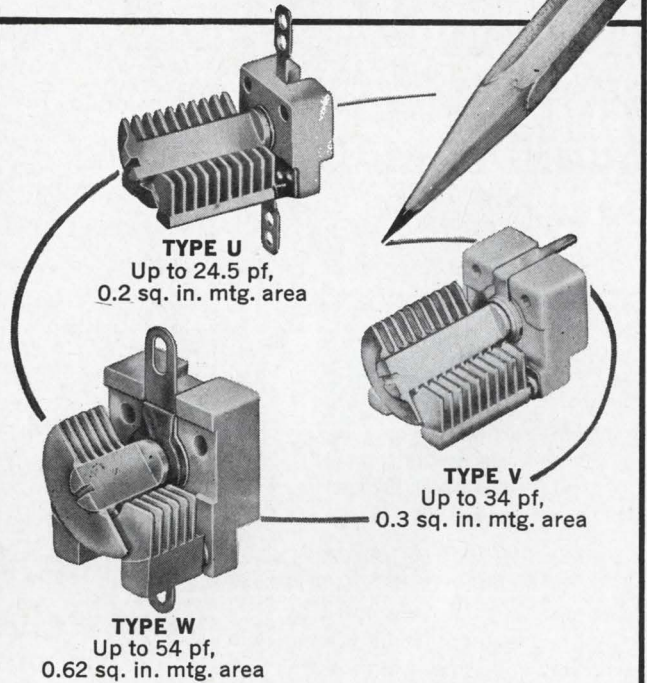

CUT COSTS . . . IMPROVE PERFORMANCE . . . SAVE SPACE

Sub-miniature Type U capacitors now provide 28% more capacitance in the same compact package that takes less than 0.2 square inches of mounting area. Type V miniature and Type W capacitors, available in higher capacities, are also unusually compact.

Unique Johnson milling technique permits machining each rotor and stator from a single piece of solid brass. This provides exceptional uniformity and stability, both mechanically and electrically. "Q" is greater than 1500 at 1 MHz. Temperature coefficients are typically plus 45 ± 15 PPM/°C. Breakdown ratings 650 volts DC.

Johnson Type U, V, and W Machined Plate Capacitors are made to solve design engineers' problems! Unusually compact, these air dielectric capacitors give increased capacitance, yet require as little as 0.2 square inch mounting area.

FREE CATALOG includes complete information on these and other Johnson quality electronic components. See your Johnson representative or write for your copy today.



E. F. JOHNSON COMPANY

3054 Tenth Ave. S.W., Waseca, Minnesota 56093

Providing nearly a half-century of communications leadership

Circle 245 on reader service card

245

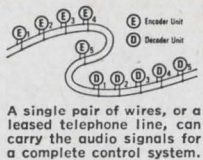

A single pair of wires, or a leased telephone line, can carry the audio signals for a complete control system.

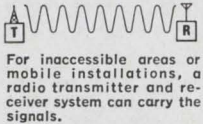

For inaccessible areas or mobile installations, a radio transmitter and receiver system can carry the signals.

REMOTE CONTROL SWITCHING WITH AUDIO SIGNALS

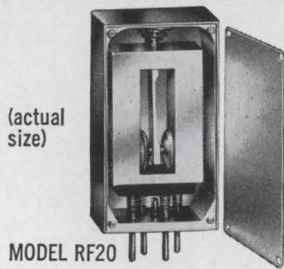

(actual size)

MODEL RF20
contactless resonant reed encoder/decoder
.395 x .620 x 1.100

An audio tone can be generated by an electronic oscillator or resonant reed encoder circuit, then transmitted by wire or radio. The tone activates a resonant reed relay to perform a control function.

Bramco reeds permit over 100 selective control frequencies within the 67 to 3000 Hz. spectrum. This is assured by: (1) the narrow response band-width of about 1% for decoders and (2) the high accuracy of Bramco reed encoders (1/10 of 1% of design frequency).

A big advantage of reeds in control switching is that they are ideally suited for simultaneous and sequential coded tone systems. The actual number of control functions possible in such a system is virtually unlimited. For example, over 3300 individual control functions are possible with only 16 frequencies coded sequentially in groups of three.

Compared to other types of tone filters, resonant reeds are small and inexpensive. They give more control functions per spectrum, per size, per dollar.

If you work with controls that select, command, regulate, or indicate, you should know how it can be done with audio signals. We custom design and stock a broad line of encoder/decoder components and modules. Bramco also custom designs LC filters from 0 to 200 KHz.

For literature write Bramco Controls Division, Ledex Inc., College and South Streets, Piqua, Ohio, or call 513-773-8271.



WESCON BOOTH NO. 178-80

BRAMCO CONTROLS DIVISION
LEDEX INC.

College and South Streets, Piqua, Ohio 45356

as sequential memories, plus the video and log amplifiers—some of which have been used in the F-111 simulator built by the Dalmo-Victor Corp.—AAI clearly has components. The converters indicate a systems capability as well.

The converters come in four versions: AD-100, 8- through 12-bit resolution, 1-Mhz word rate (\$3,750); AD-1000, 6- through 10-bit resolution, 10-Mhz word rate (\$10,500); AD-2500, 5- through 8-bit resolution, 25-Mhz word rate (\$14,750); AD-5000, 5- through 7-bit resolution including sign, 50-Mhz word rate (\$17,500). All have continuous sampling.

American Astrionics, Inc., Palo Alto, Calif. [398]

New subassemblies

Servocontrol dons civvies

Motor-tachometer system, made for industrial use, delivers 30 w, costs \$390

Servocontrols make good soldiers but often find it difficult to enter civilian life. At least that's the feeling of George Attura, chief engineer at Industrial Control Co., a long-time maker of mil-spec servos.

"Industrialists have been slow to adopt servocontrols in their factories and shops because of a natural resistance to change. Then too, most of the servos around have been designed for military environments and are expensive. Now, with

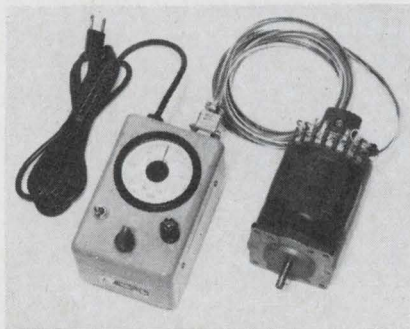

Back and forth. Speed is continuously adjustable over a \pm 3,000-rpm range.

NEW

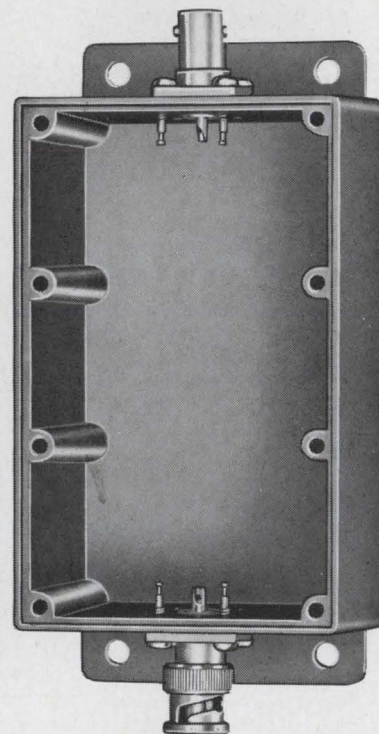

MODEL 2903
Shown $\frac{2}{3}$ Actual Size

LARGER SHIELDED "BLACK BOXES"

Useable inside space: 4" long x 2" wide x 1½" deep. Large enough to permanently protect and shield custom test circuits. Six models, with four connector combinations. Rugged die-cast aluminum boxes supplied with aluminum cover.

Featured in our 1968 general catalog. Write for your free copy.

POMONA

ELECTRONICS CO., INC.
1500 E. Ninth Street, Pomona, Calif. 91766

di/dt capability
10 times industry's best
EVEN WITH LOW POWER GATE DRIVE

**NATIONAL® INVENTS
 THE REGENERATIVE
 GATE* SCR**

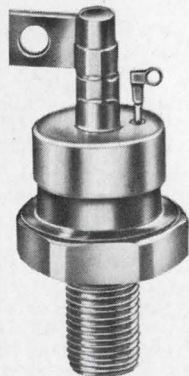

NATIONAL ELECTRONICS, INC. regenerative gate SCR is the only SCR that will give 600 amps/ μ sec. when tested according to JEDEC SUGGESTED STANDARD NO. 7 Section 5.1.2.4. This is a di/dt rating at three times the peak on-state current and $\frac{1}{2}$ the switching loss of any SCR now on the market. No sacrifice is required in gate drive, turn-on time, turn-off time or any other characteristic. Now available in 55 and 110 amps.

*Patent Pending

NATIONAL REQUEST
 ELECTRONICS, INC. BULLETIN

a varian subsidiary
 PHONE: (312) 232-4300 • GENEVA, ILLINOIS 60134

Circle 300 on reader service card

Reticles

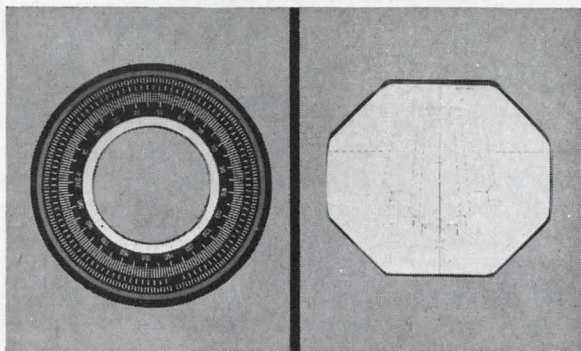

Precision etching of glass reticles, scales and other critical tolerance items is a specialty at Buckbee-Mears. We etch polished or water white plate, crown or flint glass to $\pm .0001$ " with lines filled permanently with a choice of compounds if required. We etch flat, concave or convex surfaces.

May we tell you more? See your Buckbee-Mears technical representative, or call or write Bill Amundson, our industrial sales manager.

**BUCKBEE-MEARS
 COMPANY**



245 E. 6th St., St. Paul, Minn. 55101 / (612) 227-6371

Circle 301 on reader service card

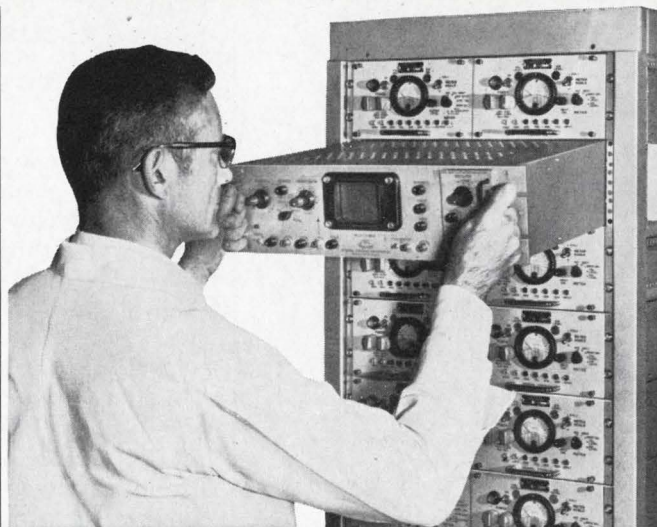

JUST SLIDE IT IN AND TURN IT ON

MIL Spec Scope K-106 (AN/USM-117)

a ready-made answer to military system display. Mil Spec requirements for scope ruggedization — performance — documentation — are all met in one 18 lb. fully transistorized oscilloscope. This is a stock instrument QPL'd and thoroughly job tested for more than 5 years by the Military.

Bandwidths range from 6 to 10 MHz. The cathode ray tubes are our own ETC brand, delivering the utmost clarity in data display. Accessories and plug-ins assure non-obsolescence.

For something a little special — wider bandwidths, unusual form factors, front panel variations, or somewhat different performance characteristics, let us know and we'll modify to your specs.

Facts, figures, specs, diagrams and photos—all the information you need to make the decision—are yours on call. Write Electronic Instrument Division, General Atronics, Phila., Pa. 19118, or phone (215) 248-3700.



GENERAL ATRONICS

Circle 247 on reader service card

247

FREE SAMPLE
ECCOSPHERES[®]
 Glass Microballoons[®]

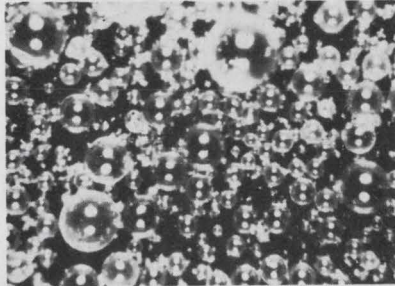

Micron sized hollow particles look like fine sand. Under the microscope they appear as in photo. The ideal filler for low weight and high strength. Excellent electrically and mechanically.

Circle 508 on reader service card

**LOW DENSITY
 HIGH STRENGTH
 MATERIALS**



Eccosyn Syntactic Plastics are unique in the world of materials! Provide low density, high strength-to-weight; ideal for aerospace, hydrospace and structural uses. Casting resins, pack-in materials, adhesives and other are described in new literature.

Circle 509 on reader service card

ECCOCOAT[®]
 SURFACE COATINGS
 FREE WALL CHART



Epoxies, urethanes, alkyds, phenolics. Clear and in colors. Some are electrically conductive. Some are in aerosol cans. Electrical and physical properties and application notes are included.

Circle 510 on reader service card

Emerson & Cuming, Inc.



CANTON, MASS.
 GARDENA, CALIF.
 NORTHBROOK, ILL.
 Sales Offices
 in Principal Cities

EMERSON & CUMING EUROPE N.V., Oevel, Belgium

... add a battery and pots,
 it's a position servo ...

labor costs going up," says Attura, "things are changing."

Getting ready for that change, Industrial Controls developed the Model 923-A, which Attura calls "the first real industrial servo." It consists of a solid state amplifier and a motor-tachometer package. Motor speed is continuously adjustable between 3,000 revolutions per minute clockwise and 3,000 rpm counterclockwise, and the maximum shaft output is 30 watts at 2,000 rpm. The 923-A costs \$390, and Attura says that's half the cost of an equivalent military unit.

Triple play. The unit can be used as a motor-speed control, a velocity servo, or a positional servo. The user needs only drive belts or a gearing unit to connect the servomotor to the load. When plugged into a 117-volt, 60-hertz line, the speed can be adjusted by a dial on the front panel of the amplifier.

To use the unit as a velocity servo, a d-c source—adjustable between -10 and +10 volts—is attached at the servo's terminal board. The motor speed and direction of rotation are then dependent on the magnitude and polarity of this voltage. At 10 volts input, the 923-A draws 20 milliamps.

To convert this velocity servo into a positional control unit, the wiper of a potentiometer is connected to the motor shaft. When 40 v d-c is put across the pot, the system compares the wiper voltage with the command voltage and uses the error signal to position the load.

In both the positional and velocity modes, a line transformer is used in front of the input to isolate the system from the a-c line.

The 923-A has a minimum stall torque of 40 ounce-inches. If the motor is running at full speed and no load, the speed drops 250 rpm when the maximum load is connected.

According to Attura the device is intended for small-shop owners, hurt by rising labor costs but unable to afford expensive numerical control tools. Buyers can use the 923-A to control tool speed and table position, or operate textile shuttles and batch mixers.

FREE! FROM BISHOP!



NEW 28-PAGE CATALOG
 for electronic engineers, designers, draftsmen

Illustrating Bishop's complete line of multi-pad configuration PreKut StikOn electronic drafting symbols for integrated circuits, printed circuits, micrologics, welded modules, flatpacks, transistors, plus hundreds of pads, elbows, corners, tees, ells, tapes, connector strips, reference numbers, letters and schematic symbols. All individually die cut with a pressure sensitive adhesive. In opaque black, transparent red, and transparent blue.

All new from Bishop... your prime source for a complete line of PreKut Drafting Aid symbols. Whatever your needs, check Bishop first.

Send today for your free catalog and sample pack.

Bishop Industries Corporation
 11728 Vose St., N. Hollywood, California 91605
 Phone (213) 982-2000

Circle 303 on reader service card

ECONOMICAL Thin Film!

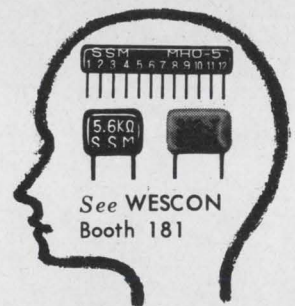

See WESCON
 Booth 181

What's needed for memory system is everlasting high accuracy. SSM's components are the very ones satisfying superior reliability.

- Plate-ohm: evaporated metal film resistor
- Pla-module: thin film modulated C-R circuit
- Pla-con: organic thin film capacitor by plasma reaction

SUSUMU INDUSTRIAL CO., LTD.

Minami Bldg. 1-12 Ebisuminami
 Shibuya-ku, Tokyo, Japan
 TEL: Tokyo (03) 712-5990
 TELEX: No. 246-6270

Circle 304 on reader service card

A New Waterproof Series

MINIATURE

TOGGLE SWITCHES

New case design with double high voltage barriers, and low-loss, high impact, high temperature materials. Wide silver contacts. Waterproof 'O' rings and sealed terminals. Available in One, Two, Three and Four Pole configurations all in compact unitized bodies. 6 Amps @ 125 VAC.



SPECIFY THE NEW "E" SERIES BY

FREE
PRODUCT
PLANNING
CATALOG

ALCOSWITCH

DIV. OF ALCO ELECTRONIC PRODUCTS INC. LAWRENCE, MASS.

Reliable — Reed

KEYBOARD

SWITCH BANKS

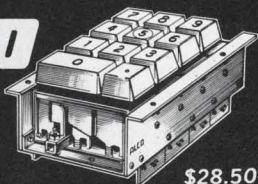

\$28.50

FIRST time available for researchers or customer manufacturers, a reliable keyboard using highly efficient open circuit reed switches. Short strokes provide smooth operation of the switch plunger. Designed for light pressure, operator's convenience, and positive input of data with long-life under heavy use. Buttons have an industry standard 0.9 marking and placement along with a period. Size $3\frac{3}{8}'' \times 2\frac{1}{16}'' \times 1\frac{1}{8}''$ depth below the panel. Quantity quotations on specials, on request.

FREE
12-PAGE
CATALOG
WRITE!

ALCOSWITCH

DIV. OF ALCO ELECTRONIC PRODUCTS INC., LAWRENCE, MASS.

Circle 302 on reader service card

THE MINI-COMPACT CALCULATOR THAT CARRIES LIGHT AND WORKS LIKE THE DEVIL



Model CS-22A

*14 digits, 6 decimal places
*Memory register *Rounding-off device *Double-set protection keys *4kg (8.8 lbs.)

Our CS-22A is instant, silent and dependable. It's dyna-convenient, too! 82 MOS ICs helped us drastically reduce overall size, yet improve performance. Calculations up to 14 digits and 6 decimal places. Even has a memory register to store intermediate answers for continued calculations. Rounding-off device, overflow error lamp, and double-set protection keys—everything to assist the beginner and accommodate the professional.

For the man who wants IC electronic calculator convenience on a smaller budget, we made the CS-17B. Its 12 digit, 6 decimal capacity takes care of practically every calculating task.

Choose a little devil to go to work on your calculating problems.



Model CS-17B

*12 digits, 6 decimal places
*Double-set protection keys
*4kg (8.8 lbs.)

 **SHARP**

HAYAKAWA ELECTRIC CO., LTD. Osaka, Japan

U.S. Subsidiary: SHARP ELECTRONICS CORP. 178 Commerce Road Carlstadt, New Jersey

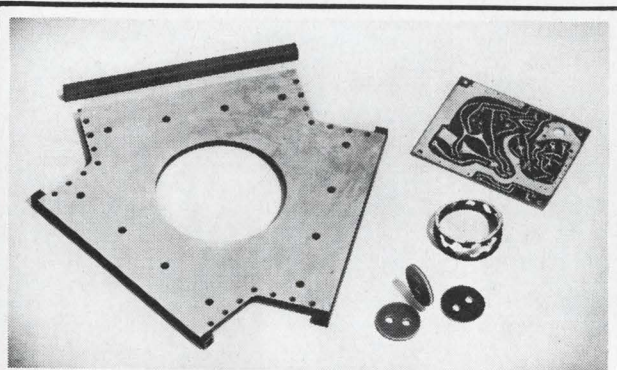

New design ideas possible with "sandwich" materials

Synthane laminated plastic sheets are available in "sandwich" combination with many other materials.

The other materials—listed below—may be bonded to one or both sides of Synthane or incorporated within the Synthane sheet during manufacture.

Mylar	Nickel
Acetate	Kovar
Copper or Brass Screen	Cork
Aluminum	Rubber, synthetic or natural
Stainless Steel	Fish Paper

By combining Synthane laminates with other materials, it is possible to obtain properties not supplied by any one material. Write for information about Synthane combined with other materials today. Synthane Corporation, 36 River Road, Oaks, Pa. 19456

SYNTHANE

CORPORATION  OAKS, PA. 19456

Laminated Plastic Sheets, Rods, Tubes, and Fabricated Parts

Circle 305 on reader service card

Circle 249 on reader service card

249

NEW

**ultra
miniature**

**I/C POWER
SUPPLY**

**80%
SMALLER!**

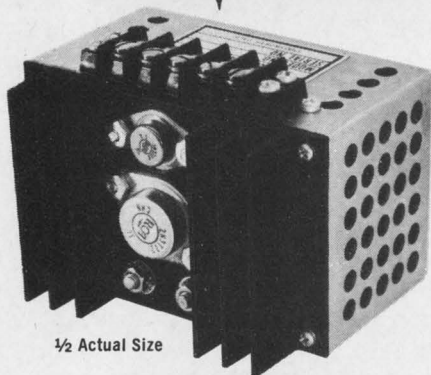

1/2 Actual Size

Powertec's new, ultra-miniature power supply is only 4"x3"x2 5/8" including heatsink.

POWERTEC 9-D SERIES power supplies are specifically designed for use in light weight chassis with IC or other digital logic. Output voltages are available from 3 to 30 volts with .05% regulation.

INPUT: 115 VOLTS 47-440HZ

TYPICAL OUTPUTS:

3 V at 6 A

5 V at 5 A

15 V at 2 A

THE POWERTEC 9-D SERIES is currently available from stock. Detailed specifications and price are available upon request.

CUSTOM POWER SYSTEMS

Powertec's experts are capable of solving your most difficult power conversion requirements.



POWERTEC DIVISION

9168 DeSoto Street
Chatsworth, California 91311

... precise control in
the physiology lab ...

Monkey see. Maybe the 923-A will find a home in machine shops, but the first unit is being used in a neurophysiology laboratory. Dr. Bernard Cohen, assistant professor of neurology at New York's Mount Sinai Hospital, is studying the eye movements of monkeys and needs a simple way to control moving charts and platforms.

In his experiments, two thin electrodes are placed near the monkey's eyes, one on each side of his head. This pair of electrodes measures a potential that changes as the monkey looks at a moving object. Dr. Cohen puts the monkey in a chair, clamps the monkey's head so it can't move, and then shows the monkey a moving strip of paper with equally-spaced black lines on

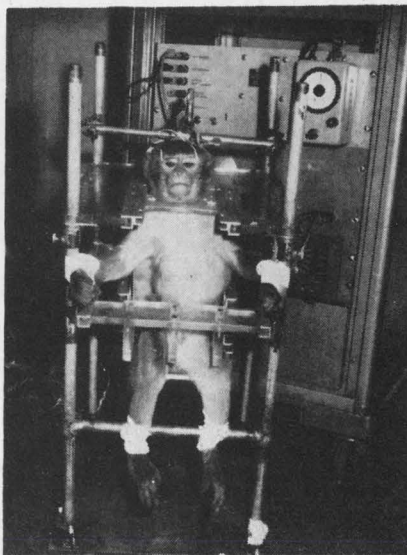

Servo for simians. The 923-A controls charts that move in front of the monkey during experiments.

it. Dr. Cohen correlates the signals from the electrodes with the position and velocity of the lines.

Experiments of this type have been conducted for over 10 years at Mount Sinai, but with the new servo more varied and precise tests can be performed. Dr. Cohen uses his unit in all three modes, switching from one to the other in a matter of minutes.

The 923-A is in production and delivery time is 6 weeks.

Industrial Control Co., Central Ave.,
Farmingdale, L.I., 11735 [399]

MICO

**NEW MODEL 885
SEVEN RATIO
WIDE-RANGE ENGRAVER**

NO. 885

FOR LONG AND
MULTI-LINE WORK

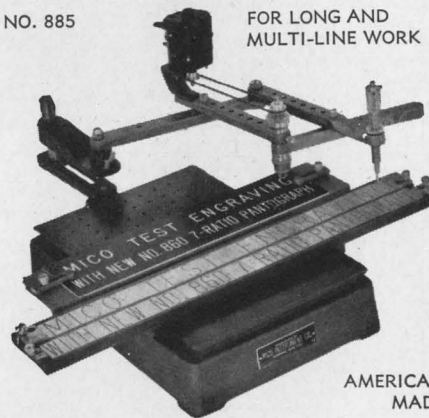

AMERICAN
MADE

- A time-saver for large plate work
- Engraves 3" x 19" area in one set-up.
- Seven pantograph ratios—from 1:5:1 to 6:1.
- Choice of 3-ball-bearing spindle assemblies for 1/8", 3/16" or taper-shank cutters.
- HSS, COBALT and Solid Carbide Cutters.
- Single and multi-line copy carriers for holding, blanks 3/4" to 3 1/2" high.
- Accommodates Mico standard accessories.

Send for bulletins and prices

MICO INSTRUMENT CO.

77 Trowbridge St. Cambridge, Mass. 02138

Circle 306 readers service card

NORTON Magnetic Tape Heads

2008 1" Tape

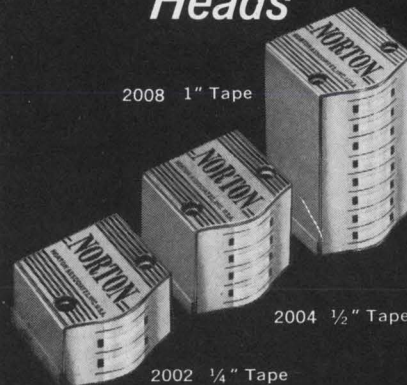

2004 1/2" Tape

2002 1/4" Tape

SERIES 2000

Crosstalk—60 DB
+75°C Temperature Operation

Send now for complete technical literature.

NORTON

ASSOCIATES, INC.

10 Di Tomas Court, Copiague, N.Y. 11726
Phone: 516 598-1600

Circle 307 readers service card

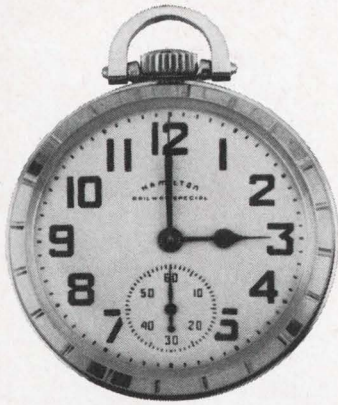

actual size



NEW Series 270

...time to go DIGI/EC

with the smallest, lowest cost, all solid state digital panel meter

- Size: 2 1/16" x 4 1/2" x 7 7/8"
- Accuracy 0.1%
- D.C. Ranges from 200MV and 20 μ A
- Non-blinking display
- High Input Z 100M Ω
- 100 μ V/digit resolution
- Fast sample rate
- Completely self-contained
- Reading retention
- B.C.D. option

\$279
list

GENEROUS
QUANTITY DISCOUNTS
AVAILABLE



See us at
Booth 1309-1310

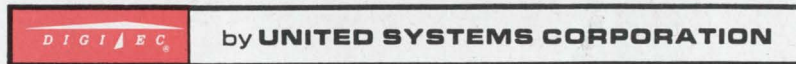

918 Woodley Road • Dayton, Ohio 45403 • (513) 254-6251

Circle 308 on reader service card

Yes, there is
a Birnbach
Brand Rex*
distributor
in your area

And he does
carry the
approved line
of Brand Rex
electronic
wire & cable

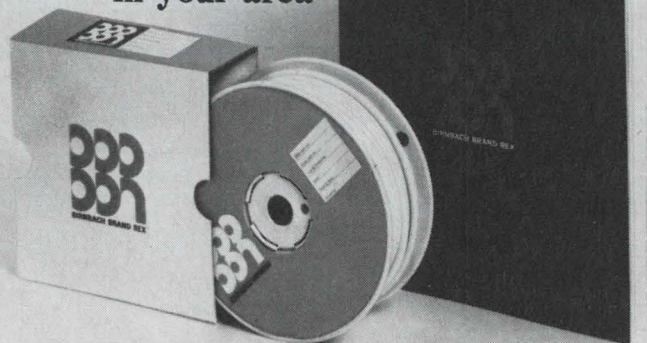

*Brand Rex wire marketed by Birnbach

And he will
supply you in
any quantity
you need...
quickly

This catalog
is for those who
won't believe it
until they see it.
Just ask for it.

Birnbach Brand-Rex, 435 Hudson Street, New York, 10014 Phone: 212-255-6600

A FET FOR UHF

The 2N5397 has guaranteed 450 MHz performance
...Power gain 15 dB min...NF 3.5 dB max.

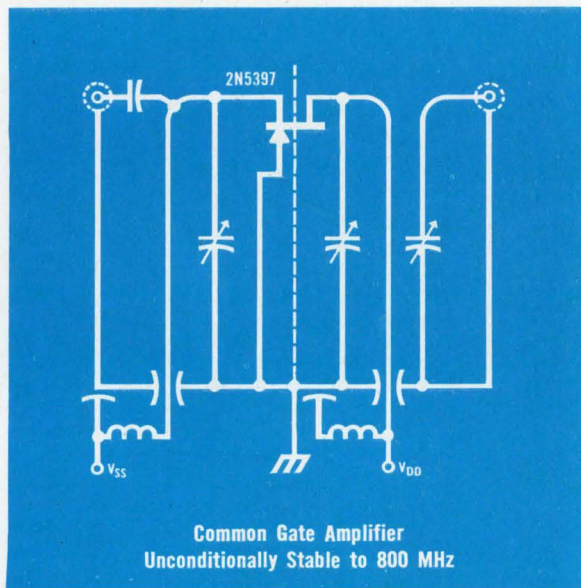
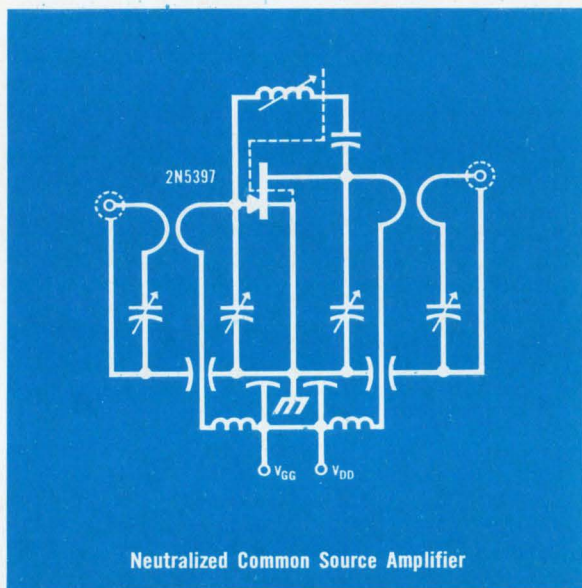

High g_m — 6000 μmho min — and low C_{rss} — 1.2 pF max — combine to give these results in a neutralized common source amplifier. But if you're against neutralizer twiddling then design a common gate circuit. With the 2N5397 it'll be unconditionally stable up to 800 MHz and, at 450 MHz, still have 13 dB power gain with NF less than 4 dB. Used either way — CS or CG — the FET's "square law" character reduces inter- and cross-

mod products... better than any other active device.

We also make other RF FETs... 2N3823; 2N4220-24; 2N4416... some industrial types and a power FET or two. We've crammed all this data plus more detailed specs on these two CS and CG circuits into an "RF FET Data Packet"... write for it.



FET TESTER
For $BV - V_{GS} - I_D - g_{fs} - I_{GSS}$ (to less than 100 pA). Write for specs.
S1200 Main Chassis . . . \$ 960.00
S1201 FET Test Module . 1,335.00

 **Siliconix incorporated**
1140 W. Evelyn Ave. • Sunnyvale, CA 94086
Phone (408) 245-1000 • TWX: 910-339-9216

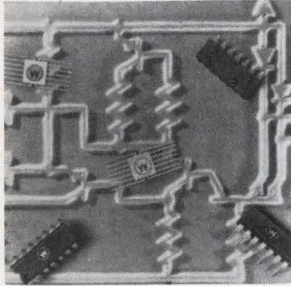

A separate clock, no reset dual J-K flip-flop with negative edge clock, the MC3062 is a member of the MTTL III line of transistor-transistor logic. It eliminates the need for stringent control of the clock pulse width and the restrictive timing rules common to system use of charge control or master-slave devices. Motorola Semiconductor Products Inc., Box 20924, Phoenix. [436]

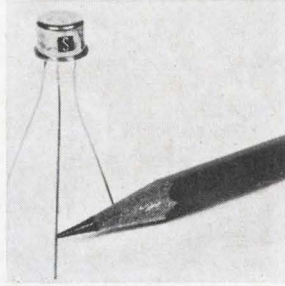

Silicon planar transistors 2N5237 and 2N5238 come in TO-5 cases and meet MIL-S-19500. They are designed for medium current switches, power supplies, regulators and amplifiers requiring high density packaging. Both have power ratings of 5 w at 100°C. Gains are 40 to 120 at 5 amps and 10 at 10 amps. Hughes Semiconductors, 500 Superior Ave., Newport Beach, Calif. [437]

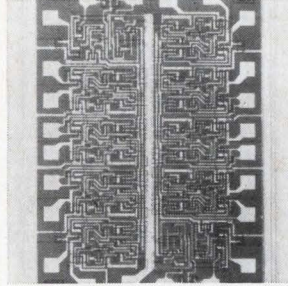

Dual 4-bit latch 9308 is for use in military, computer and industrial digital systems requiring high speed performance. The monolithic circuit features a latch time of 25 nsec. It is available in a 24-lead dual in-line package and flatpack. Price is from \$13.40 to \$44 depending on quantity and temperature range. Fairchild Semiconductor, 313 Fairchild Dr., Mtn. View, Calif. [438]

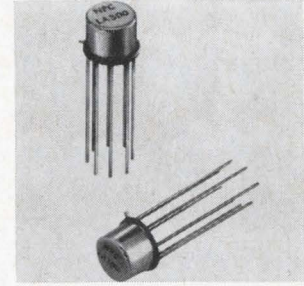

Integrated circuit voltage regulators are offered in an 8-lead TO-5 package with monolithic chip. Output voltage is adjustable from 2 to 30 v. Input voltage range is 35 to 40 v. Line regulation is as low as 0.05%; load regulation, as low as 0.1%. Output currents in excess of 5 amps are possible with external components. Nucleonic Products Co., E. 12th St., Los Angeles. [439]

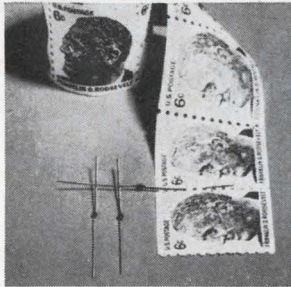

Microminiature, single junction silicon diodes, series MR, supply 100 ma maximum continuous forward current with 20 na maximum reverse current at the rated piv. They operate with piv ratings from 400 to 1,500 v and maximum power dissipation of 200 mw. Operating temperature range is -65° to +100°C. Atlantic Semiconductor Inc., 905 Mattison Ave., Asbury Park, N.J. [440]

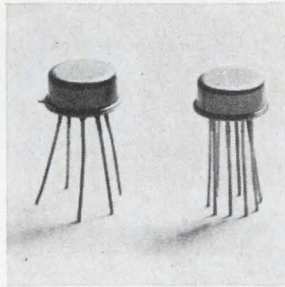

Wideband, monolithic operational amplifiers models 9300 (5 lead) and 9302 (8 lead) are housed in TO-5 packages. The 9300 provides up to 20 Mhz closed loop bandwidth. The 9302 provides ±10 v swing up to 100 khz at unity gain. Both are priced at \$22 each in sample quantities and \$17 each at the 100 level. Optical Electronics Inc., P.O. Box 11140, Tucson, Ariz. [441]

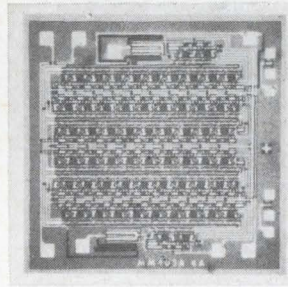

Dual 32-bit MOS static register MM405 operates from d-c to 1 Mhz. It is designed with low threshold transistors permitting operation with a drain supply of -10 v; a clock amplitude and gate supply of less than 16 v. It features low power consumption of 1.7 mw per bit and output impedance of 500 ohms. National Semiconductor Corp., 2950 San Ysidro Way, Santa Clara, Calif. [442]

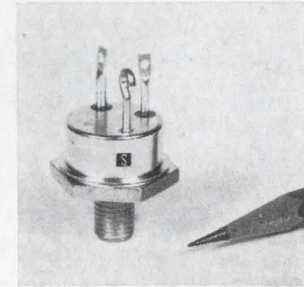

Silicon NPN planar power transistor 2N5218 comes in a TO-61 package. It is capable of collector to emitter sustaining voltages of 200 v, with 10 amp gain of 5 and a beta of 15 to 120 at 5 amps. The gain curve is virtually flat from 10 ma to 1 amp. Switching times are in the microsecond range. Solitron Devices Inc., 1177 Blue Heron Blvd., Riviera Beach, Fla. 33404. [443]

New semiconductors

Dual 100-bit register stores indefinitely

Static device, built on 91-by-140-mil chip, is an MOS IC; unit has 200-bit capacity and no minimum clock rate

Static shift registers have a big advantage over dynamic ones: they can operate at very low clock rates, all the way down to d-c. This means that they can store data indefinitely between clock pulses. Dynamic shift registers, on the other hand, have a minimum limit

on their clock rate, usually between 20 and 50 khz.

And the greater the bit capacity that is squeezed into a static register, the longer the storage time will be at a given clock rate. This has spurred IC manufacturers to increase the bit capacity of their

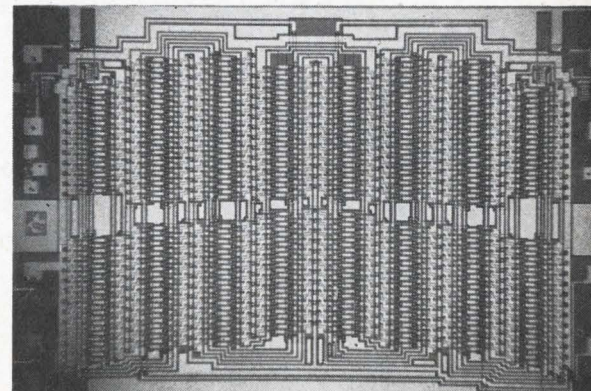

Old friend. Designers like static MOS registers because the workings of its flip-flops are familiar.

component testing from -100° to $+400^{\circ}$ F with maximum gradient of 1° F

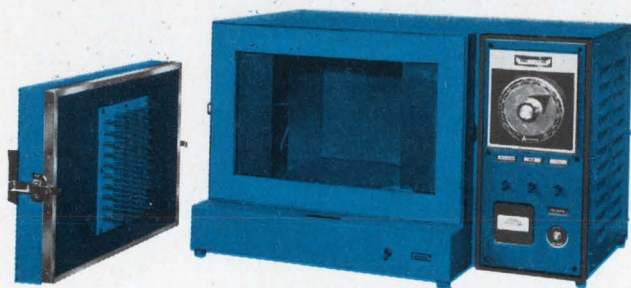

Only Associated Gives You This Test Capability At This Down-To-Earth Price!

Designed specifically for rapid, accurate incoming and production test of transistors, diodes, integrated circuits and other small components, Model TP-1100 Component Test Chamber has a working capacity of 0.5 cubic foot, permits simultaneous testing of up to 50 components at temperatures from -100° to $+400^{\circ}$ F...with maximum gradient of 1° F across the test tray.

Besides its exceptional low-gradient specifications — proven out in rigorous on-the-line service in Associated's own laboratory — the TP-1100 offers these outstanding features:

- Fast CO₂ refrigeration
- All Kelvin wiring standard on transistor trays
- All Kelvin wiring available for diodes and axial lead components
- 10¹² ohms pin-to-pin insulation resistance
- Bidirectional on/off time proportional controller
- Temperature control stability $\pm 1/4^{\circ}$ F
- Internal defrost system; no connector-pin shorts
- High temperature fail safe
- CO₂ scrubber with replaceable cartridge

Prices of the TP-1100 start at \$1000—a dollar-for-dollar value that can't be equalled for versatility, efficiency and performance. Complete data are yours for the asking—simply write or call.

Write today for new M-7 catalog of environmental test chambers.

ASSOCIATED TESTING LABORATORIES INC.

See us at Wescon—Booths 3161 and 3162 Sports Arena



We are able to manufacture more ferromagnetic pot cores than anybody else . . .



because . . .

1. No one can match the variety of materials at our disposal—many unique because we developed them ourselves. (Our F series 2001~4 demonstrate drastically improved temperature coefficient for this reason.)
2. We use the most modern technology in the world, both domestic and imported.
3. Our factories are second to none in scale and up-to-dateness.
4. Our 3,000 highly skilled employees, advanced research laboratory, and 30 years' experience back up every product.

If your telecommunications equipment calls for high-performance pot cores of guaranteed uniformity, send us your specs. We'll do the rest. Also, we'll be happy to send you detailed technical literature on request.

WESCON68
Eight great shows in one!

If you plan to visit the WESCON, don't miss our pot cores and other representative products at Booth No. 560.

Tokin

Tohoku Metal Industries, Ltd.

4, 7-chome, Ginza-Higashi, Chuo-ku, Tokyo, Japan
Telephone: Tokyo 542-6171 Cable Address: TOHOKUMETAL TOKYO

Main Products: Ferrite Cores, Memory Cores, Memory Matrices, Ferrite Magnetostrictive Vibrators, Pulse Transformers, Permanent Magnets (Cast, Ferrite), Tape Wound Cores, Bobbin Cores, Magnetic Laminations, Fe-Co Alloys, Sandust Cores



Model 79 Linear IC Tester

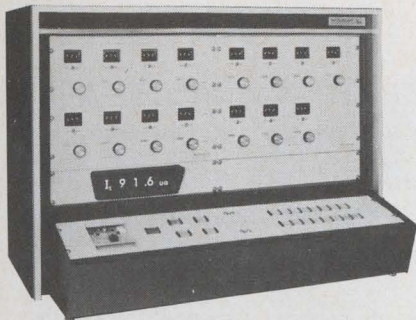

New automatic Linear IC Tester offers simple, preprogrammed operation

The simple operation of the new automatic Model 79 Linear Integrated Circuit (LIC) Tester from Test Equipment Corporation virtually eliminates costly operator training. This savings, combined with its low initial cost, makes the Model 79 an excellent buy for production, engineering and quality control applications.

TEC's Model 79 "LIC" Tester is completely automatic with the exception of test limits and range selections and is preprogrammed on performance boards (inset)

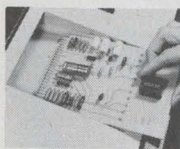

for up to 15 different test measurements. It provides five dc and eight dynamic tests. In addition, two auxiliary positions are available for customer-specified tests.

The Model 79 features low current measurements to 99.9 pa full scale, low voltage measurements to 99.9 μ v full scale, and high speed typically 100 ms or less per test. It accepts all IC package configurations.

Write today for full technical and pricing information on the new TEC Model 79 "LIC" Tester.

Test Equipment

CORPORATION
P.O. BOX 20215, DALLAS, TEXAS 75220 • 214/357-6271

shift registers. Texas Instruments Inc., for example, started its series of shift registers with the introduction of a dual 16-bit unit, and later added dual 25-, 32-, and 50-bit circuits. With its 7C3003, TI now has a dual 100-bit circuit—a total of 200 bits in a single package. It's the longest static shift register commercially available, TI says.

The two registers are constructed on a single monolithic silicon chip by thick-oxide techniques to form metal oxide semiconductor p-channel enhancement mode transistors. TI uses a king-size silicon chip measuring 91 by 140 mils.

Like the others in the family, the dual 100-bit register consists of cross-coupled flip-flops, each implementing one bit of delay. The use of flip-flops is another advantage of static registers, TI claims, because equipment designers are more familiar with their operation than they are with the RC storage used in dynamic MOS registers.

The two 100-bit registers in the 3003 have independent input and output terminals and common clock, power, and ground terminals. Two power supplies and two external clocks are required for operation; a third clock is generated internally. The two registers in the circuit can be connected to two parallel registers, or the output of one register can be connected to the input of the other.

Data is transferred into the register when clock 1 is at a logic 1. Data is shifted when clock 1 is momentarily pulsed to a logic 1 and clock 2 is pulsed to a logic 0. For long term data storage, clock 1 must be held at logic 0 and clock 2 must be held at logic 1.

Suggestions. TI suggests clock pulse levels of -28 volts for a logic 1 and no greater than -2 volts for a logic 0. The clock pulses should be at least 0.4-microseconds wide. Maximum clock repetition rate is 1 Mhz.

Data input levels of -10 volts minimum for logic 1 and -2 volts maximum for logic 0 are recommended. Typically, output logic levels are -13 volts for 1 and -0.3 volts for 0, and output logic response time is 300 nanoseconds.

Price is \$30 in 100-999 quantities.

Texas Instruments Inc., Dallas, Texas 75222 [444]

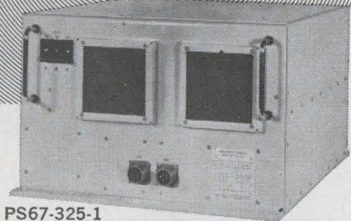
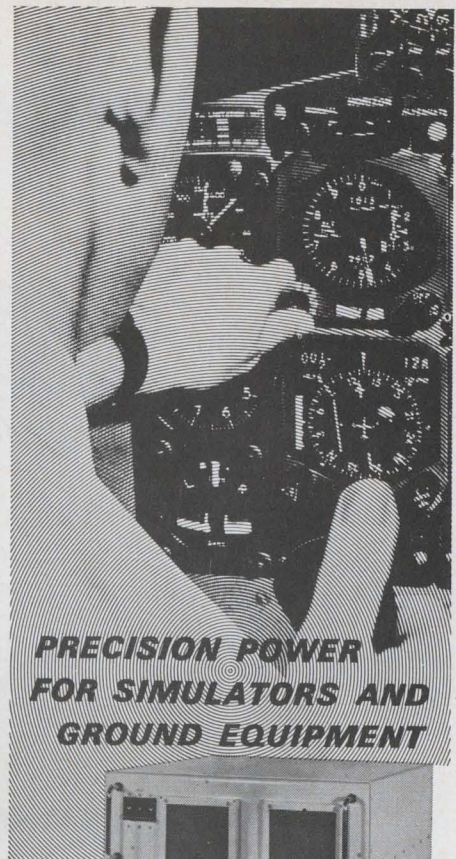

MODEL PS67-325-1

UNITRON FREQUENCY CONVERTER 60 Hz to 400 Hz 2 KVA Sine Wave Output

Completely protected — INPUT: Over/undervoltage, phase loss, overcurrent. OUTPUT: Overload and short circuit

- Stable frequency and voltage regulation
- Designed to meet applicable RFI specifications

One of several all-silicon solid-state converters providing precision 400 Hz, 2 KVA power from a 50/60 Hz source, with virtually no audible noise. A stable output is assured by complete frequency and voltage regulation. This and similar 2.5 KVA unit will handle severe surge currents. A separate 28 VDC, 350 W output is optional, and a rack-mount, fully-metered configuration is available. Typical applications are flight simulators, and testing and ground support equipment. Other units with 1 and 8 KVA outputs.

Write for complete information.

UNITRON

Division of Electric Machinery Mfg. Company
1624 N. FIRST ST.
GARLAND, TEXAS 75040 (214) 276-8591

SPECIAL COSMICAR[®] LENSES

COSMICAR lenses have improved in quality as CCTV cameras have improved.

There is no problem whether your cameras are with a built-in EE mechanism or a viewfinder mechanism.

COSMICAR will make whatever new lenses you need for your CCTV cameras to satisfy your every CCTV purpose.



FOR YOUR SPECIAL CCTV CAMERAS

For example, COSMICAR lenses can be adopted to automatic or rear control system by one hand.

Superb lenses of proven ability from 12.5mm to 1,000mm and Zoom lenses are on sale.

For further details, write to:



COSMICAR OPTICAL CO., LTD.

(Former name: ICHIZUKA OPTICAL CO., LTD.)

568, Shimoochiai, 2-chome, Shinjuku-ku, Tokyo Cable Address: "MOVIEKINO TOKYO"

Circle 311 on reader service card

intellux has flipped and gone dip

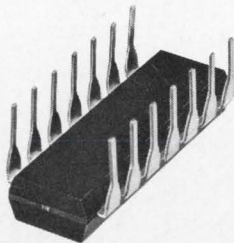

Our 1st . . . is a 100 mA hex driver for lamps or relays with diode suppression, driven directly from DTL or TTL.

Flip chip semiconductors are mounted on thin film multilayer substrates . . . all in a 16 pin dual-in-line package.

We can ship the hex driver to you tomorrow, or this technique can be applied to your special.

Try us.

intellux

SUBSIDIARY — HARVEY RADIO CO., INC.

26 COROMAR DRIVE ■ GOLETA, CALIFORNIA 93017

256

Circle 256 on reader service card

Speed-up
Wire
Marking
with a
KINGSLEY
Wire & Tube
Marking Machine
right in your plant!



Write
for
Details

Now you can *permanently* mark wire or tubing directly on the insulation... quickly... economically... right in your own plant!

Cut costs and speed production with the same machine that has consistently proven so successful in the aircraft/missile field.

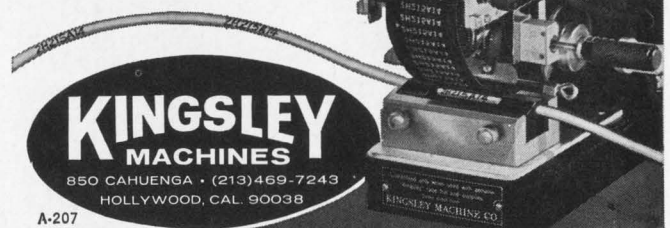

KINGSLEY
MACHINES

850 CAHUENGA • (213) 469-7243
HOLLYWOOD, CAL. 90038

A-207

Circle 312 on reader service card

New Books

Intuitive light

Gas Lasers
A.L. Bloom
John Wiley & Sons
172 pp., \$8.50

This well conceived, readable, technically sound work will be useful to anyone interested in the subject, from the newcomer in the field to the old hand. It is a result of the best of two related efforts by the author: a short course on lasers given at the University of California and a review article in a joint issue of Applied Optics and the Proceedings of the IEEE. The short course was intended to reach a wide audience of varied backgrounds, while the review articles were intended for more sophisticated readers who needed to be brought up to date.

In writing a smooth-flowing account of the gas laser's history, background physics, technical properties and applications, the author did not ignore the subtleties and complications of applied physics. Though he deals with the fine points in a less than rigorous fashion, he provides substantial insight, making an appeal to the reader's intuition even where mathematical arguments are used.

The first chapter, on basic principles, is a somewhat historical introduction to the subject. Unfortunately, he uses Bloch equations to describe the interaction of the photon fields with the atomic population inversions. The more usual rate equations are just as arbitrary a starting point, but at least they involve more intuitively understandable quantities.

The later chapters cover characteristics of practical gas lasers, such as frequency, power and efficiency, modes and resonators, and noise and coherence. The main text ends with a terse discussion of laser safety in addition to brief coverage of interferometry, holography, data processing, and coherent scattering.

A good, but incomplete, bibliography is included.

Charles B. Zarowin
International Business Machines
Thomas J. Watson Research Center
Yorktown Heights, N. Y.

HIGH RELIABILITY MINIATURES WITH HYPERTAC™ CONTACTS

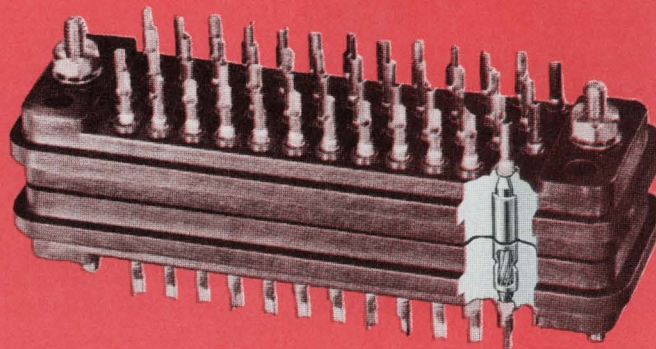
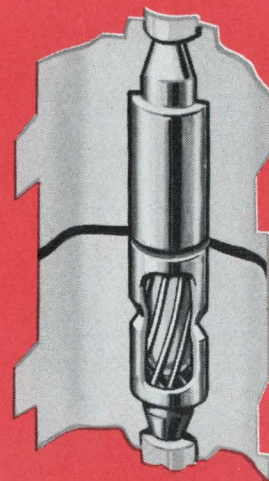

For maximum performance and complete interconnection reliability you can't beat IEH's Series HTM Miniature Connectors. The reason is HYPERTAC™—a patented hyperbolic design that's functional perfection in a connector contact. Series HTM connector contacts maintain their high performance characteristics without any noticeable deterioration after over 100,000 operating cycles—surpassing anything in today's state-of-the-art. Their low insertion/extraction forces and low, low contact resistance are a particular plus for critical design applications. Add closed entry construction, low signal/noise ratio under shock or vibration, pre-assembly plating for uniform thickness of finishes, easy manual insertion of high density connectors plus many other features, and it's easy to see you get more for your money. Series HTM connectors are available in standard 7, 14, 18, 20, 26, 34, 50 and 75 pin models. Customized units can also be made for any of your high performance military or industrial applications.

In addition to miniature connectors, the HYPERTAC™ contact is applicable to sub-miniature, micro-miniature, power, coaxial and printed circuit connectors. So, for connectors to meet—or exceed—all your performance requirements, see your local IEH sales representative or contact:

INDUSTRIAL ELECTRONIC HARDWARE CORPORATION

109 PRINCE STREET, NEW YORK, N. Y. 10012 (212) 677-1881

Distribution direct from factory.

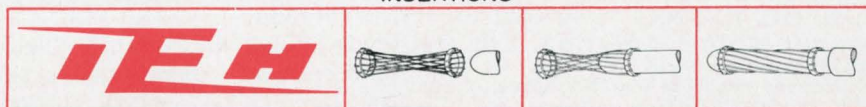
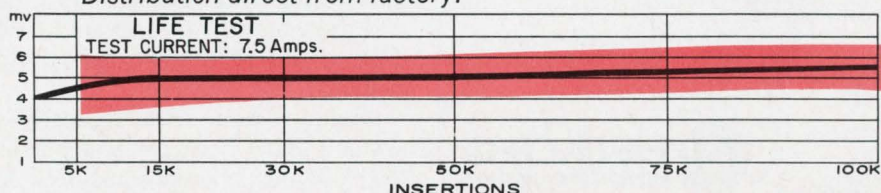

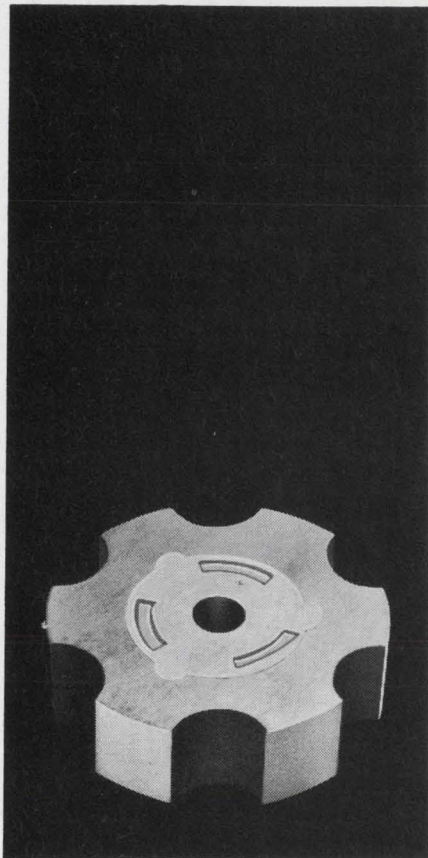

**For
Extra Meter
Precision
and Consistency
Specify
Hitachi Magnets**

To create these extremely stable magnets Hitachi developed its own processes for the compounding and heat-treatment of fine alloys. The result is a range of cast magnets for metering that are precisely finished to unusually close tolerances, are more compact, and yet retain magnetic stability and uniformity. You can get a fast supply of Hitachi meter magnets with properties to suit your particular application. Each one has guaranteed characteristics. Full information on types for your application can be quickly mailed.

Products:

Meter Magnets:

For Speedometer, Tachometer, Amperemeter

Motor Magnets:

For Micro Motor, Hysteresis Motor, Wiper Motor, Blower Motor

Generator Magnets:

For A.C. Generator, Flywheel



Head Office

Chiyoda Bldg., Marunouchi, Tokyo, Japan

Hitachi Metals America, Ltd.

Magnet Materials Sect.

437, Madison Ave., New York, N.Y. 10022,
U.S.A. Tel. 212-758-5255

Technical Abstracts

Data in the air

Air-ground digital communication for commercial air lines

James L. Whitaker
Bendix Avionics Division
Ft. Lauderdale, Fla.

It hasn't been economically feasible till now for the airlines to implement an air-to-ground digital data communications system. But such a system, used to make an airline's flight operations more efficient, is closer than ever because of several new factors. These include:

- Satellite relay systems which will overcome the spotty nature of present vhf and hf communications and offer reliable communications for high-speed transoceanic traffic.

- The high cost of owning and operating such giant aircraft as the Boeing 747 or the supersonic transport will dictate better methods for communicating the aircraft's operational and engineering status. With digital communications, this could be done automatically while the aircraft is still in the air, heading for its destination and adjustments could be begun as soon as the plane lands.

- The increasing complexity of the various systems in an aircraft makes it all the more important to get information about what may be malfunctioning to the expert who's able to repair it. Such trouble-shooting-at-a-distance, with engine and system performance data radioed ahead while the plane is still in flight, would be possible with digital communications.

- Airlines are setting up their own computer-based data communications and processing networks on the ground for reasons other than air traffic control—for ticketing, for example, and for automating maintenance records and procedures. Air-to-ground data links could readily fit into these systems.

Digital data communications systems have been tested by Bendix Avionics aboard trans-oceanic jets for more than two years. Extended-range vhf circuits are being tried on North Atlantic routes, and via the ATS-1 communications

satellite on trans-Pacific routes. The system transmits two messages: a flight operational message that includes the aircraft's position, and a flight engineering message that contains information about the aircraft's engine parameters.

Initially, such data will not be available automatically; it will be keyed in by push buttons or switches. Also keyed in will be fixed information identifying the aircraft and its destination. It will be possible to add alphanumeric and plain language information at the ground terminal.

With even a rudimentary system such as this, it will be possible to gain experience in aspects of air-to-ground digital data exchange that include selective signaling, message assembly, speed, code and format conversion, interfacing with existing ground computer facilities and with airborne systems involving sensors for engine and flight-control parameters, navigation aids, and airborne integrated data systems.

When it does become operational aboard an aircraft, the data link will, at first, probably use the existing vhf a-m communications system. The digital data will probably be interspersed with voice on the same r-f channel. Data modulation will be a form of audio sub-carrier keying.

The extent of the system will, of course, be determined by the individual airlines and their decisions on how much and what type of information they will want to deal with. But in any case, the center of the airborne terminal will be the modem/control unit that will connect to the radio communications system. The unit will generate the data modulation signal for the transmitter, demodulate the data signal from the receiver and include the control logic to compile messages originating within the aircraft. It will also distribute incoming messages to output devices such as cathode-ray-tube displays, hard copy printers, and annunciators.

1968 IEEE International Conference on Communications, Philadelphia, June 12-14

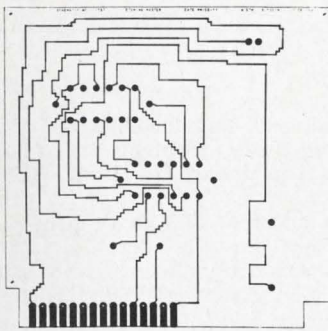

Figure D-14. Etching Master, Side 1

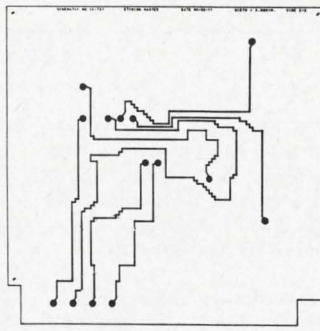

Figure D-15. Etching Master, Side 2

ACCEL—Capable of producing the design information in printed-circuit fabrication, this program provides outputs in the form of:

- 1) A SCHEMATIC DRAWING
- 2) AN ASSEMBLY DRAWING
- 3) MASKS FOR ETCHING CIRCUIT BOARD LAYERS
- 4) A HOLE DRILLING COORDINATE LIST
- 5) A PARTS LIST

This program may be run on a IBM 7090/7094 computer with a SC-4020 plotter.

COMPUTER PROGRAMS IN ELECTRONICS

COSMIC (Computer Software Management and Information Center) disseminates the computer programs that have been developed as a result of the numerous projects of the National Aeronautics and Space Administration, Atomic Energy Commission and the Department of Defense. The COSMIC library contains over 300 scientific and engineering programs, some

To receive the publications, send \$10.00 to:

COSMIC

Barrow Hall

University of Georgia

Athens, Georgia 30601

developed at costs of millions of dollars and years of work, now available for a small percentage of the development costs.

A catalogue, with subsequent supplements, of all available programs is obtainable for the annual subscription rate of \$10.00; however, this fee is not necessary to order programs. Upon request, a search by the COSMIC technical staff will be initiated to locate and suggest programs that will be applicable in the specified areas.

For further information or assistance, contact:

Ralph E. McMorris

Telephone: (404) 542-3265

Circle 313 on reader service card

\$740

is the full price of Tenney's new bench type, high-low SST Temperature chamber

This sturdy new "Hermeticool" mechanically refrigerated chamber now available at a great low price. Check these features:

Range: -95° F to +350° F, ±1/2° F control

Chamber Dimensions: 16" wide x 11" deep x 12" high

Heatup: To 350° F in 35 minutes

Pulldown: From ambient to -95° F within 55 minutes

Power: 110 volts

Temperature indicator

Available from stock

Write or call today for complete details on Tenney Model SST

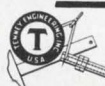
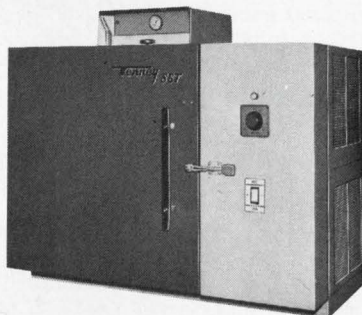

Tenney
ENGINEERING, INC.

1090 Springfield Rd., Union, N.J. 07083 • (201) 686-7870

Western Division: 15721 Texaco St., Paramount, Calif. 90723

515

TDK CORE

The high-performance ferrite cores that made possible many breakthroughs in Japan's electronics technology

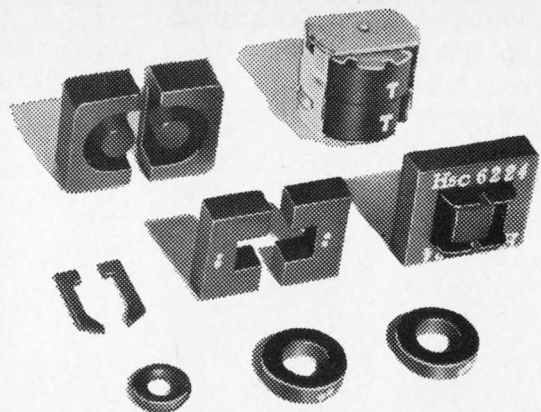

Write to MH&W for full technical data and information applications



Representative in U.S.A. & Canada for Ferrite Core for Communications

MH&W INTERNATIONAL CORPORATION

280 Midland Avenue, Saddle Brook, N.J. 07662

Phone: Area Code 201-791-6277

N.Y. Phone: Area Code 212-244-0695



TDK ELECTRONICS CO., LTD.

2-14-6 Uchikauda, Chiyoda-ku, Tokyo Japan.

Circle 314 on reader service card

Circle 259 on reader service card

259

MATSUO

Highly Reliable Capacitors

POLYESTER FILM CAPACITORS.

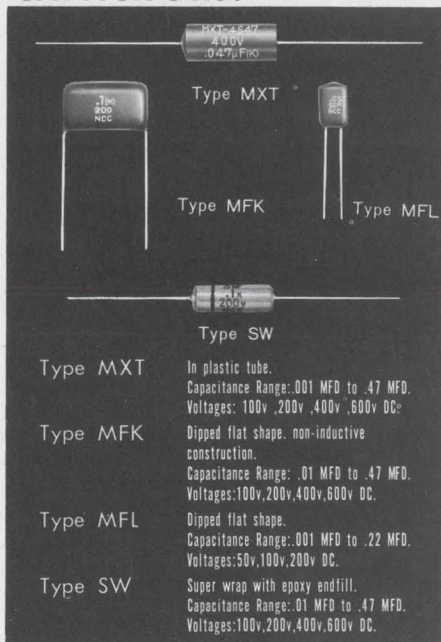

Type MXT
In plastic tube.
Capacitance Range: .001 MFD to .47 MFD.
Voltages: 100v, 200v, 400v, 600v DC.

Type MFK
Dipped flat shape, non-inductive construction.
Capacitance Range: .01 MFD to .47 MFD.
Voltages: 100v, 200v, 400v, 600v DC.

Type MFL
Dipped flat shape.
Capacitance Range: .001 MFD to .22 MFD.
Voltages: 50v, 100v, 200v DC.

Type SW
Super wrap with epoxy endfill.
Capacitance Range: .01 MFD to .47 MFD.
Voltages: 100v, 200v, 400v, 600v DC.

METALLIZED POLYESTER FILM CAPACITORS.



Type FNX-H Mylar wrapped semioval with epoxy end seal.
Capacitance Range: 1 MFD to 10 MFD
Voltages: 100v, 200v, 400v, 600v DC.

SOLID TANTALUM CAPACITORS.

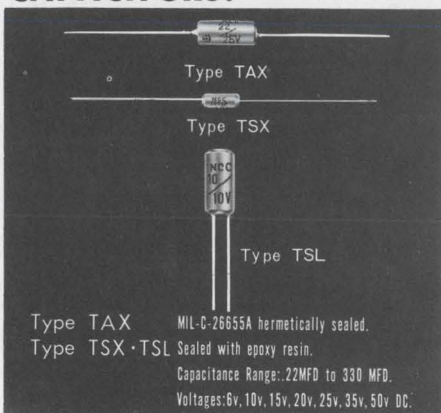

Type TAX MIL-C-26655A hermetically sealed.

Type TSX · TSL Sealed with epoxy resin.
Capacitance Range: .22 MFD to 330 MFD.
Voltages: 6v, 10v, 15v, 20v, 25v, 35v, 50v DC.

for further details, contact:

MATSUO ELECTRIC CO., LTD.

3-chome, Sennari-cho, Toyonaka-shi, Osaka, Japan
Cable Address **NCC MATSUO OSAKA**
TWX-523 4164 OSA.

New Literature

Power supplies. Spellman High Voltage Electronics Corp., 1930 Adee Ave., New York, N.Y. 10469. A six-page short-form catalog covers a diversified line of high-voltage power supplies. Circle 446 on reader service card.

Torque measurement. Vibrac Corp., Alpha Industrial Park, Chelmsford, Mass. 01824. A 17-page application note discusses principles of four different torque-measuring transducers [447]

Operational amplifier. Analog Devices Inc., 221 Fifth St., Cambridge, Mass. 02142. Model 501 hybrid IC operational amplifier is described in a two-page data sheet. [448]

Metal film resistors. Pyrofilm Resistor Co., 77 Route 46, Lodi, N.J. 07644, has available a data sheet on a family of four miniature, high-value metal film resistors. [449]

D-c motor. Electro-Mechanical Group, American Electronics Inc., 1600 E. Valencia Dr., Fullerton, Calif. 92634, has released a technical bulletin covering its size 9 permanent-magnet d-c motor. [450]

Core memory systems. Standard Memories Inc., 15130 Ventura Blvd., Sherman Oaks, Calif. 91403, offers four-page bulletin TB402B on a new series of high-speed, low-cost core memory systems featuring expandable capacities from 1,024 words to 16,384 words of up to 36 bits each. [451]

Solid tantalum capacitors. Union Carbide Corp., 30-20 Thomson Ave., Long Island City, N.Y. 11101, has published an engineering application note for Kemet E-series, dipped solid tantalum capacitors. [452]

Tape-wound cores. Magnetic Metals Co., Hayes Ave. at 21st St., Camden, N.J. 08101. A manual and catalog provides complete technical information for the engineer concerned with the design of components involving the use of tape-wound cores. [453]

Frequency sensor. G-V Controls Inc., Okner Parkway, Livingston, N.J. 07039, has issued an engineering bulletin on the series 905, a solid state 400-hertz frequency sensor. [454]

Process control components. Brooks Instrument Division, Emerson Electric Co., Hatfield, Pa. 19440. A 12-page brochure describes a line of precision process control components for analytic instrumentation. [455]

BITE indicators. Minelco, 600 South St., Holbrook, Mass. 02343, offers data sheets describing the electrical, me-

chanical, and environmental specifications of six new go/no-go BITE (Built-In Test Equipment) indicators. [456]

Analog dividers. GPS Instrument Co., 188 Needham St., Newton, Mass. 02164. A brochure contains complete information on the DIV500 series of solid state, fully encapsulated analog dividers. [457]

Delay lines. Columbia Components Corp., 60 Madison Ave., Hempstead, N.Y. 11550, has published a catalog dealing with the selection and application of delay lines. [458]

Frequency synthesizers. Monsanto Electronics Technical Center, 620 Passaic Ave., West Caldwell, N.J. 07006. A comprehensive review of frequency synthesizer techniques, performance, and applications is provided in bulletin 74-1625. [459]

Thermistors. Victory Engineering Corp., 128 Springfield Ave., Springfield, N.J. 07081. Product bulletin MDRW031 describes a complete line of general purpose disk, rod, and washer thermistors. [460]

Servo control components. McMaster Products Corp., 4200 W. Victoria Ave., Chicago 60646. An eight-page catalog contains design data, in tabulated form, on precision servomotors, motor tachometers, and synchronous motors. [461]

Directional couplers. I-Tel Inc., 10504 Wheatley St., Kensington, Md. 20795. Bulletin 1929-19 gives preliminary data on two new series of directional couplers. [462]

Holding coils. Master Specialties Co., 1640 Monrovia, Costa Mesa, Calif. 92627. Supplement sheet 4032A describes a line of snap-on magnetic holding coils for pushbutton switches. [463]

Gas lasers. University Laboratories Inc., 733 Allston Way, Berkeley, Calif. 94710, has available a four-page brochure on continuous gas lasers and accessories. [464]

Communication equipment. Altec Lansing, a division of LTV Ling Altec Inc., 1515 S. Manchester Ave., Anaheim, Calif. 92803. Composite product catalog AL-1712 covers sound and communication equipment for all types of installations. [465]

IC testers. Microdyne Instruments Inc., 225 Crescent St., Waltham, Mass. 02154. An eight-page brochure provides complete operating specifications for five models of IC testers and related accessories. [466]



It's never too early to start saving their hearts

Help your children form good health habits now to reduce risk of heart attack later:

- Encourage normal weight; obesity in youth may persist throughout life;
- Build body health through regular physical activity;
- Serve them foods low in saturated fats;
- Teach them that cigarette smoking is hazardous to health;
- Make medical check-ups a family routine.

Set a good example. Follow the rules yourself and guard *your* heart, too.

GIVE...
so more will live
HEART FUND

Contributed by the Publisher



J.A.E.

The Best Electronic Equipment
and Parts Manufacturer
For Aircraft and Commercial Use.

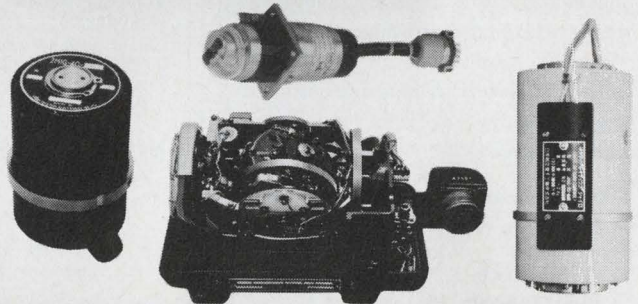
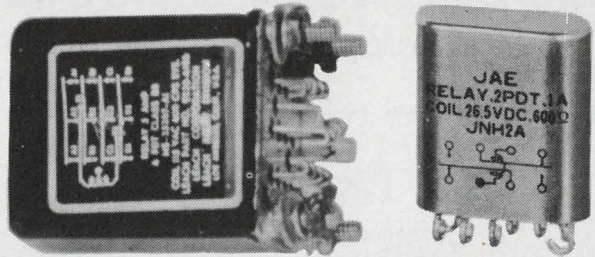

You can count on our electronic equipment for any job you have to do. We will stand behind each and every one of our products with confidence. Confidence born out of superior technology. No matter what you are doing, if it has to do with electronics, it has to do with us. Give us a call!

OUR MAIN PRODUCTS INCLUDE: Every kind of Electrical Connector, Automatic Flight control systems (A. F. C. S.), High Precision Gyros, Fuel Quantity Gauging Systems, Proximity Switches and Relays, including top quality Miniature Relays, Circuit Breakers, and the Nikko Light (Portable Searchlight).

Tokyu-Skyline Building
32 Nampo-dai-cho
Shibuya-ku Tokyo Japan

Cable Address: AVIONICS TOKYO

JAE Japan Aviation Electronics Industry, Limited



EMPLOYMENT OPPORTUNITIES

THE MARKET-PLACE
FOR ALL YOUR
EMPLOYMENT NEEDS

Closing Date Information: September 2nd Issue Closes August 12th
New Ads or Inquiries: Send to Classified Advertising Department
Electronics: Post Office Box 12, New York, N. Y. 10036

COPY PRO FOR ELECTRONICS ACCOUNTS

General Electric is on the look-out for a professional copywriter to work on an established electronics account.

The kind of man we have in mind should have 3 to 5 years agency experience writing for a major industrial electronics account or an engineering degree in electronics plus demonstrated writing ability, maybe for one of the business press.

Submit resume and salary requirements in confidence to:

J. W. Lovell
Bldg. 6 Room 231
General Electric Co.
Schenectady, New York 12305

GENERAL  ELECTRIC

An equal opportunity employer

CIRCLE 966 ON READER SERVICE CARD

The Scientists and Engineers served by Corcoran in the last year have found the difference between "a job" and "the job."

- Nationwide. Fee paid.
- Please airmail background to:

JOSEPH P. CORCORAN
Personnel Consultants
505B Germantown Pike
Lafayette Hill, Pa. 19444
Member IEEE

CIRCLE 967 ON READER SERVICE CARD

• EMPLOYMENT SERVICES

Florida/Nationwide EE's ME's IE's needed Electronics fields. Aerospace, Industrial Manufacturing. \$9—18,000. Tech. Div., Brodeur Personnel Service Inc., 3947 Blvd. Center Dr., Jacksonville, Fla. 32207.

GRADUATE ELECTRONIC ENGINEER

With the equivalent of approximately two years calibration experience in micro-wave parameters (frequency ranges 2 GHz to 18 GHz).

Familiarity with NBS calibration techniques and traceability processes and coaxial experience preferred with understanding of wave guide to coaxial conversion techniques.

The engineer will have opportunity to perform other assigned R & D functions and activities relating to sonic, mass, optical, mechanical and electronic measurement and calibration systems.

All activities will be an integral part of all assigned functions performed in metrology laboratories.

Liberal benefit program including vacation, group insurance, sick leave, retirement plans.

For further information call or write to:

R. B. Joiner

**MASON & HANGER-SILAS MASON CO.,
INC.**

P. O. Box 647

Amarillo, Texas 79105

Telephone: A.C. 806 DI9-1581

An Equal Opportunity Employer

CIRCLE 968 ON READER SERVICE CARD

What is *your* problem?

Competent men for your staff? . . . employment? . . . or are you looking for—or offering—a business opportunity of special interest to readers of this publication? You can get their attention—through an advertisement in the Employment Section of Electronics.

Send New Ads to:

ELECTRONICS

Class. Adv. Dept., P.O. Box 12,
N. Y., N. Y. 10036

EMPLOYMENT OPPORTUNITIES

The advertisements in this section include all employment opportunities—executive, management, technical, selling, office, skilled, manual, etc.

Look in the forward section of the magazine for additional Employment Opportunities advertising.

— RATES —

DISPLAYED: The advertising rate is \$71.00 per inch for all advertising appearing on other than a contract basis. Contract rates quoted on request.

An advertising inch is measured $\frac{7}{8}$ " vertically on a column—3 columns—30 inches to a page.

Subject to Agency Commission.

UNDISPLAYED: \$3.30 per line, minimum 3 lines. To figure advance payment count 5 average words as a line. Box numbers—count as 1 line.

Discount of 10% if full payment is made in advance for 4 consecutive insertions.

Not subject to Agency Commission.

Send new ads to:

ELECTRONICS

Class. Adv. Dept.,

P. O. Box 12, N. Y., N. Y. 10036

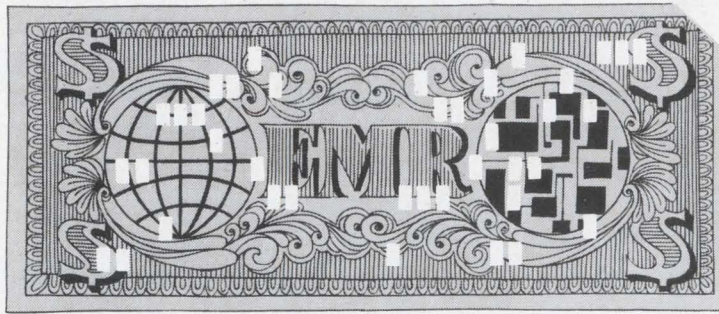

The cost of all this to you? Absolutely nothing. No fees or charges at any time.

Other advantages of EMR:

- Your resume is sent only to those companies that have a genuine requirement for your particular skills.
 - There is no general "broadcasting" in the hope "someone will be interested."
 - Your identity is protected because your name is released only according to your prior instructions. Your name can be deleted on request.
 - EMR's service is nationwide. You may be considered for job opportunities anywhere in the U.S.
- The Electronics Manpower Register is a powerful tool and should be considered when you are seriously seek-

ing a new position. And, although you may be reasonably happy in your present position, chances are that you might have that ideal job in mind.

This is why EMR makes good sense for you. If that job does turn up, you'll be there.

To get your name in the EMR file, just fill out the resume form and return to:

Electronics Manpower Register
330 West 42nd Street
New York, N. Y. 10036

Please enclose a copy of your resume if you have one. A detailed brochure further describing EMR will be sent to you.

⚙️ Electronics Manpower Register

A computerized employment opportunity service

CONTINUED FROM OTHER SIDE				
Previous Position	Employer	City/State	From	To
Duties and accomplishments				
Previous Position	Employer	City/State	From	To
Duties and accomplishments				
GENERAL INFORMATION				
(Summarize your over-all qualifications and experience in your field. List any pertinent information not included above.)				
Current annual base salary	Total years of experience	Date available	U.S. Citizen <input type="checkbox"/> Non U.S. Citizen <input type="checkbox"/>	
My identity may be released to:	Any employer <input type="checkbox"/>	All but my present employer	Have you security clearance?	Yes <input type="checkbox"/> No <input type="checkbox"/> If yes, What level
Mail (with a copy of your resume, if you have one) to:				
Electronics Manpower Register 330 West 42nd Street, New York, N. Y. 10036			NO FEES OR CHARGES	

In electronics it's Electronics magazine to sell used equipment!

Your advertisement will produce Results in Electronics. Engineers turn to Electronics magazine for the latest technical developments — and for the latest buying information. You can reach them inexpensively in Electronics Searchlight Section.

For information:
Searchlight Section
Classified Advertising Division
Post Office Box 12
New York 10036

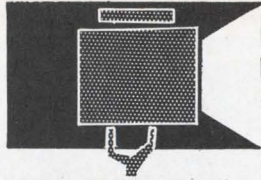

SEARCHLIGHT SECTION

- CLASSIFIED ADVERTISING • BUSINESS OPPORTUNITIES
- USED OR SURPLUS EQUIPMENT

AUTOTRACK ANTENNA MOUNT



360 degree azimuth, 210 degree elevation sweep with better than 1 mil. accuracy. Missile velocity acceleration and slewing rates. Amplidyne and servo control. Will handle up to 20 ft. dish. Supplied complete with control chassis. In stock—immediate delivery. Used world over by NASA, USAF, MP-61-B. Type SCR-584. Nike Ajax mounts also in stock.

PULSE MODULATORS

MIT MODEL 9 PULSER 1 MW—HARD TUBE

Output 25kv 40 amp., 30kv 40 amp. max. Duty cy .002. .25 to 2 microsec. Also .5 to 5 microsec. and .1 to .5 microsec. Uses 6C21. Input 115v 60 cycle A.C. Mfg. GE. Complete with driver and high voltage power supply. Ref: MIT Rad. Lab. Series, Vol. 5, p. 152.

2 MEGAWATT PULSER

Output 30 kv at 70 amp. Duty cycle .001. Rep rates. 1 microsec 600 pps. 1 or 2 msec 300 pps. Uses 5948 hydrogen thyratron. Input 120/208 VAC 60 cycle. Mfr. GE. Complete with high voltage power supply.

250 KW HARD TUBE PULSER

Output 16 kv 18 amp. Duty cycle .002. Pulses can be coded. Uses 5D21, 715C or 4PR60A. Input 115 v 60 cy. AC \$1200 ea.

18 MEGAWATT PULSER

Output 150KV at 120 amps. Rep rate: 50-500 PPS. Pulse length: 5 msec. 15KV 120 amp. into pulse transformer. Rise time 1.5 msec. Filament supply 5V 80 amp. incl. 17.5KV 1.5 amp DC power supply. Input: 220V 60 cy AC.

INDICATOR CONSOLES

AN/SPA-4A, PPI 10", range to 300 mi.
VJ-1 PPI 12", Range to 200 mi.
VL-1 RHI 12" to 200 mi. 60K ft.

HIGH VOLTAGE POWER SUPPLIES

100KV, 200MA, DC, \$5500; 27 KV, 100MA, DC, \$2200; 15KV, 2 amp. DC, \$3800; 12KV, 1200MA, DC, \$1400; 8KV, 800MA, DC, \$975.

SCR 584 AUTOTRACK RADARS

Our 584s in like new condition, ready to go, and in stock for immediate delivery. Ideal for telemetry research and development, missile tracking, satellite tracking Fully Desc. MIT Rad Lab Series, Vol. 1, pps. 207-210, 228, 284-286. Comp. Inst. Bk available \$25.00 each.

VOLT SENSOR

VOLTAGE SENSITIVE RELAY DRIVER



- 100 K Input Impedance
- 25 Microsecond Response
- +/—20 Volt Trip Range
- \$38 ea., \$26.60 at 100 pcs.
- Accuracy 0.01%

Send today for full specifications

CALIF. ELECTRONIC MFG. CO.
P.O. Box 555, Alamo, Calif. 94507

CIRCLE 970 ON READER SERVICE CARD

SURPLUS IBM EQUIPMENT

28 page catalog of powers supplies, light & switch panels, semiconductors, test equipment, IC's, optics, etc.

GADGETEERS SURPLUS ELECTRONICS, Inc.
5300 Vine St. Cincinnati, Ohio 45217

CIRCLE 972 ON READER SERVICE CARD

SONAR SYSTEMS IN STOCK

AN/FQS-1A, AN/UQS-1B, QHBa scanning sonars. Rochelle salt hydrophones 6 ft.

MICROWAVE SYSTEMS

200-2400 mc. RF PKG

Continuous coverage, 30 watts CW nominal output. Uses 2C39A. Price \$575.

L BAND RF PKG.

20 KW peak 990 to 1040 MC. Pulse width .7 to 1.2 micro sec. Rep. rate 180 to 420 pps. Input 115 vac incl. Receiver \$1200

200-225 mc RADAR SYSTEM

1 Megawatt output. 200 nautical mile range for long range detection of medium and high altitude jet aircraft as well as general search. AN/TPS-28.

SURVEILLANCE DRONE RADAR SYSTEM

X-Band tracking system with plotting boards. Type AN/MPQ-29. Drone also in stock.

5 MEGAWATT C-BAND

Klystron RF package delivering nominal 5 megawatt pulse RF. Complete with pulser and power supply.

500 KW L BAND RADAR

500 kw 1220-1359 msc. 160 nautical mile search range P.P.I. and A scopes. MTL thyratron mod 5J26 magnetron. Complete system.

AN/GPG-1 SKY-

SWEEP TRACKER

3 cm. automatic tracking radar system. Complete package with indicator system. Full target acquisition and automatic tracking. Input 115 volts 60 cycle New. In stock for immediate delivery. Entire System 6' long, 3' wide, 10' high. Ideal for Infrared Tracker. Drone Tracker, Missile Tracker, R. & D.

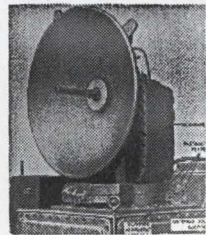

500KW S BAND RADAR

250 miles search 115V 60 cy A.C. Mfg. G.E.

RADAR SYSTEMS GROUND AND AIRBORNE. AUTOMATIC TRACKING ANTENNA SYSTEMS. NIKE AJAX. NIKE HERCULES. M-33. MSQ-1A. MPS-19. MPS-9. SCR 584. TPS-1D. TPS-28. FAA-ASR-2. AIRBORNE SYSTEMS. APN-84. APN-102. APS-20. APS-27. APS-45. DPN-19. DIGITAL COMPUTERS. IBM 650. IBM 704

LARGEST INVENTORY OF RADAR AND MICROWAVE EQUIPMENT IN THE WORLD.

RADIO RESEARCH INSTRUMENT CO.

45 WEST 45TH ST. N. Y. 10036 212-JU 6-4691

CIRCLE 969 ON READER SERVICE CARD

Minifuid DISPENSER

for miniature potting and encapsulating

Available in 3 sizes
6cc - 12cc - 30cc



PHILIP FISHMAN COMPANY
7 CAMERON ST., WELLESLEY, MASSACHUSETTS 02181

CIRCLE 971 ON READER SERVICE CARD

ELECTRON TUBES

KLYSTRONS • ATR & TR • MAGNETRONS
SUBMINIATURES • C.R.T. • T.W.T. • 5000-

6000 SERIES

• SEND FOR NEW CATALOG A2 •

A & A ELECTRONICS CORP.

1063 PERRY ANNEX
WHITTIER, CALIF.
696-7544

CIRCLE 973 ON READER SERVICE CARD

Mr. Used Equipment Dealer:

When you advertise in the Searchlight Section . . . You have hired your most persuasive salesman:

He's efficient . . . He thrives on long hours . . . His territory is the entire nation . . . and overseas . . . He doesn't see buyers of used and new surplus equipment: They see him—regularly. They depend on him.

He is Searchlight—The section of this publication where wise dealers advertise and list their stocks for sale.

SEARCHLIGHT SECTION

Classified Advertising Division

Post Office Box 12 • New York, N. Y. 10036

Signal Generator Versatility + Synthesizer Accuracy + Programming and Sweep Flexibility + IC Economy = LORCH-ADRET SIGNAL GENERATOR-SYNTHESIZERS

Models to 100KHz,
2MHz and 60 MHz

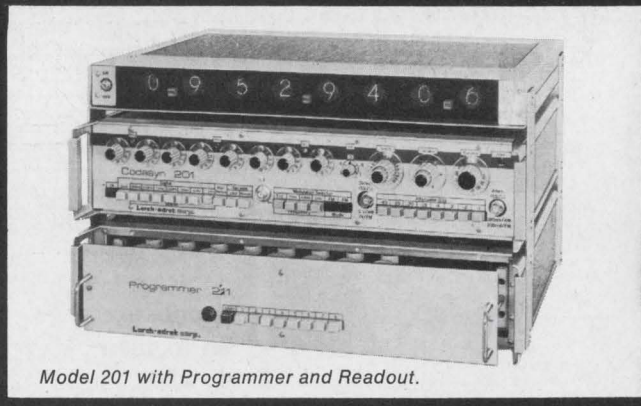

Model 201 with Programmer and Readout.

- Digital Frequency Selection YES
- Excellent Frequency
and Amplitude Stability YES
- Coherent Output YES
- High Spectral Purity YES
- Built-In Digital Attenuator YES
- BCD Programmable Frequency
and Attenuation YES
- Programmable Search Oscillator YES
- AM and FM Internal
and External Modulation YES
- Sweep: Narrow Band
and Wide Band YES
- IC Design using MSI Devices YES
- Small Size YES
- Attractive Price YES

SPECIFICATIONS

Model	301 100 KHz	201 2 MHz	202 60 MHz
Frequency Stability	3×10^{-5} / week	1×10^{-7} / day (2×10^{-9} / day optional)	
Digital Decades	4	8	8
Resolution (with vernier)	0.1 Hz	0.001 Hz	0.001 Hz
Modulation AM	none	0 - 100%	0 - 100%
Deviation FM	100 KHz (external only)	2 MHz	10 MHz
Sweep Range	100 KHz	2 MHz	12 MHz
Output Level	+21 dbm	+13 dbm	+13 dbm
Attenuator	continuous	0 - 100 db	0 - 60 db
Spurious Output (nonharmonic)	- 60 db	- 70 db	- 80 db
Signal to Phase Noise	60 db	70 db	70 db
Rack Panel Height	$3\frac{1}{2}$ " ($\frac{1}{2}$ rack)	$3\frac{1}{2}$ "	$5\frac{1}{4}$ "
Price	\$2150.00	\$3800.00	\$6900.00

Also available: BCD Programmable DC Voltage Standard (6 digit); Remote Displays; Remote Programmers; Programmable Attenuators; IRIG Programmers and Comb Generators.

See us at WESCON

Lorch-adret corp.

105 Cedar Lane, Englewood, N.J. 07631 • 201-569-8282

Newsletter from Abroad

August 5, 1968

Litton nails Concorde deal . . .

The inertial navigators aboard the third and fourth Concorde supersonic transports—and probably the production models to follow—will be Litton LTN-51's. They'll be made under license by Sagem (Societe d'Applications Generales d'Electricite et de Mecanique).

For the first two Concordes, navigators are being made jointly by Sagem and Britain's Ferranti. But while those systems have more than met performance requirements in tests, Sagem's half (the platform) doesn't meet Arinc specs. Since there isn't enough time for the company to engineer a whole new system, it's trying to keep at least part of the business for post-prototype planes by buying U.S. technology. Ferranti is expected to retain its share in the system—the chart display and related components.

. . . as flight date continues to slip

Even as Concorde's inertial navigators were being selected, it became clear that the maiden flight of the French prototype will be even later than expected. Originally scheduled for the end of February, the test was pushed back to October. Now, say observers, even that is too optimistic—November is more like it.

The dating game being played by Sud Aviation, builder of the first Concorde, has industry sources conceding that the company blundered when it announced the Feb. 28 deadline to the world. Sud's thinking was that announcement of the precise date would wring a top priority effort from its many subcontractors.

Instead, when the date passed quietly, the press—especially the British press—went sniffing around for reasons and flushed out a few. Engines were late in reaching the Toulouse assembly site, for example, and there were delays with the electrical and hydraulic systems. In addition, the strikes of May and June hit Toulouse severely. But now the plant is working overtime and will keep operating through August, when most French plants close for vacation.

British take step toward optic cable

The British Post Office's program to develop a laser communication system using optical glass-fiber cables to complement metal coaxial cable and microwave links has passed its first major hurdle. British Titan Products, working under a Post Office contract, has developed methods of making oxides of aluminum, silicon, sodium, and calcium pure enough for the glass from which the fibers are made.

Barr & Stroud of Glasgow will now try to develop for the Post Office a technique of making glass and drawing fibers that won't contaminate the materials. The Post Office regards the work as long-term research and thinks it may be 10 years or more before optical glass-fiber cables are in use.

The Post Office is thinking of fibers about 0.1 millimeter in outside diameter, with a central core a few microns in diameter. In the first experimental systems, the information will probably be transmitted by pulse-code modulation of a wave generated by a gallium arsenide laser; wavelength would be about 0.9 micron. Repeaters, a bit more than half a mile apart, will probably be entirely solid state low-power devices, made up mainly of silicon avalanche photo-diode optical signal receivers,

Newsletter from Abroad

high-speed integrated-circuit signal regenerative amplifiers, and low-power gallium arsenide laser optical signal transmitters.

Standard Telecommunication Laboratories Ltd., which originated studies in Britain of wave transmission along glass fibers, is responsible for development of methods of launching, propagating, and detecting the wave.

The club is dead —long live the club

The British Government's decision to buy telecommunications hardware outside the General Post Office's "suppliers' club" [Electronics, Feb. 19, p. 234] apparently was something less than a death blow to the five-company group. Now, Postmaster General John Stonehouse says that the club will still be guaranteed 50% of the business "to allow for continuity of production."

There is a catch, though. The five (Standard Telephones & Cables, General Electric Co., Associated Electrical Industries, Automatic Telephone & Electric, and Ericsson Telephones) will have to compete for that 50% rather than share it almost equally as has been the case. The remaining half will be subject to open bidding, with the members of the club eligible.

Computer makers in Japan coordinate parts purchases

To prevent duplication of computer marketing and production efforts, three Japanese companies—Oki Electric Industry, Hitachi Ltd., and the Mitsubishi Electric Corp.—have agreed to buy and sell components and hardware from each other. The Ministry of International Trade and Industry, which has complained repeatedly about lack of coordination among Japan's seven computer builders, is backing the plan.

The arrangement, still not in final form, calls for Oki to supply line printers, teletypewriters, and some other peripherals, while buying semiconductors and integrated circuits from the other two exclusively. In return, Hitachi and Mitsubishi will stop developing and making peripherals.

Tv export drop worries Yugoslavs

Yugoslavia's electronics industry is fretting over declining exports of television receivers. Sales abroad dropped to about 14,000 last year from 28,000 in 1966. And the situation is far worse this year; so far, exports total only about 1,000.

The introduction of color tv in some West European countries is held responsible for the decline; Yugoslavia doesn't make color sets. Formerly, West Germany and the Netherlands were the biggest buyers of Yugoslav sets.

Production of sets fell to 252,400 last year from 286,370 in 1966, and this trend continued for the first three months of 1968. And with color production still not in sight, Yugoslav industry sources are predicting more lean years to come.

Addendum

Although the West German aerospace industry has a long way to go before it can be considered competition for American, British, or French companies, it has ambitious plans to capture at least a portion of the world market. To push those plans, representatives of the industry, with the active aid of the Economics Ministry, have agreed to form an association to work out a long-term program [Electronics, July 8, p. 212].

Japan

Oriental etchings

An etch, figures Hitachi Ltd., will give Japanese semiconductor producers an edge over their U.S. and European competitors.

The etch is a kingpin step in Hitachi's new silicon transistor production process. It strips off the silicon oxide that normally forms on a diffused wafer and readies the surface for three-layer passivation laid down at relatively low temperatures. The etching acid also carries away the impurities and the thermal defect layer that cut yields on conventional production lines, where successive coatings of protective oxide are grown at temperatures of about 1,200°C.

Down with royalties. End result, Hitachi says, is transistors with improved noise figures, higher gain, and higher reverse breakdown voltage. What's more, Hitachi officials claim the process skirts the planar-technique patents held by the Fairchild Camera & Instrument Corp. Over the past year, Hitachi paid some \$280,000 in royalties for the right to use Fairchild's planar patents while the Japanese semiconductor industry as a whole paid an estimated \$840,000.

Hitachi researcher Takashi Tokuyama worked out the multilayer passivation scheme and a team of engineers headed by Masayuki Yamamoto scaled it up for production. The company has spent \$1 million for facilities to turn out low-temperature-passivation transistors and currently produces about 4 million monthly. The line comprises 15 types of transistors; among them are low-noise preamplifiers, video amplifiers, display tube drivers, and switching transistors.

Glassy. Like conventional fabrication techniques, Hitachi's starts by putting down an epitaxial n-ma-

terial layer on a silicon substrate. Then the collector, base, and emitter regions are diffused successively into the wafer through windows in a silicon-dioxide protective layer.

After that, Hitachi departs from the usual technique and strips away the oxide—normally left on—using hydrofluoric acid. A first layer of silicon dioxide glass is put atop the etched surface by vapor deposition of tetraethoxysilane. Next comes a layer of glass containing alumina, lead oxide, and phosphorous oxide. A second layer of silicon dioxide completes the passivation. The temperatures at which the glass-forming elements are oxidized run about 740°C.

Italy

Gassed up

Adjusting the gas flow through more than 3,720 miles of trunk lines to match supply and demand in a network that feeds about 600 Italian towns is no pencil and paper job. The gas—some 353 billion

cubic feet yearly—pours in from 22 input points and goes out at 70 main delivery outlets. Flow and pressure are matched to the demand by four compressor stations, 20 pressure-reduction substations and 40 sectioning valves.

It's a job for a computer and that's just what Società Nazionale Metanodotti S.p.A. (SNAM) is using for its transmission network. But rather than a digital computer programmed with an elaborate mathematical model of the system, SNAM develops its control data with a \$225,000 analog computer.

Parallels. Analog simulation, SNAM engineers say, is the slicker way to check out the interaction of changes in the network. Relatively simple electrical circuits act much the same as gas pipelines do: voltage changes resemble pressure changes, current variations parallel gas flow. What's more, because the circuits are plug-in modules, the analog computer can be easily adapted to reflect additions to the network itself.

All told, the computer uses 366 electrical analogs. The bulk of them—210—represent the major trunk lines in the network. Each basic module consists of two

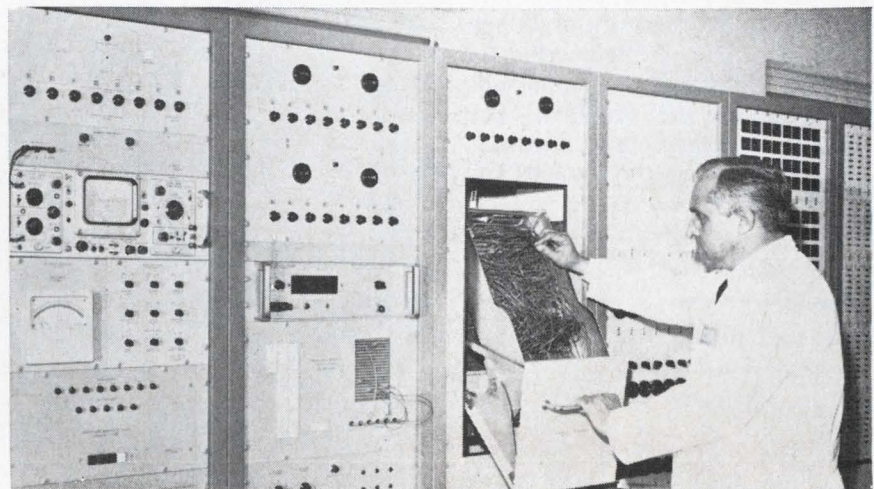

Sono buoni. Analog computer simulates what goes on in Italy's gas transmission network when the country's housewives attend to their spaghetti.

strings of resistors in series; with the strings connected in parallel through diodes that are polarized by an operational amplifier. The op amp, in turn, is controlled by a booster amplifier. A pair of condensers in the circuit represents the capacity for the associated segment of pipeline.

In and out. These basic analog modules are hooked together to represent a network—existing or proposed—and energized with current generators, one for each of the 22 inlet terminals. Each is set to deliver a current that corresponds to the flow from a natural gas field, a tank storage farm, or a tanker terminal. The voltage level is adjusted by the computer operator to match the pressure at the inlet points.

The modules for the four compressor stations boost the voltage according to the laws of physics relating gas pressure to gas flow. At each station, individual compressors can be harnessed in parallel or in series and the analogs allow the operator to simulate any possible combination.

As for the 70 delivery points, their analogs can be programmed to take into account both short-term and long-term variations in demand. The program breaks up take-off volume into segments representing 3 hours in real time. On the simulator, though, the segment requires only 3 seconds to run.

Teamwork. SNAM, a subsidiary of the government fossil-fuel monopoly Ente Nazionale Idrocarburi, turned to the University of Bologna's department of engineering for help in designing the vacuum-tube prototypes for the simulator. The final version, completely transistorized, was built by the Paoletti Co. of Florence.

West Germany

Ghost chaser

Broadcasters in West Germany have high hopes for a high tower in the center of Munich. Crowning the 951-foot structure is a televi-

sion antenna, slated to go into service later this summer, that will have a unique radiation pattern. To give nearby receivers a ghost-free signal, the antenna array is phased to cause a dip in the pattern. The dip, however, has no effect on the long-range aspect of the pattern; the coverage extends about 30 miles from the tower.

Nicely stacked. Engineers of Rohde & Schwarz, a Munich-based firm, devised the method that results in a cosecant-shaped pattern. Essentially, it depends on slight differences in phase and amplitude of the radio-frequency energy fed to the 72 radiating elements that make up the antenna. These differences bend the lower edge of the beam downward.

The tv antenna makes up the top 72 feet of the tower. It consists of a stack of 18 arrays, each carrying four interconnected radiators. The high number of radiators is necessary to meet the power requirements for the antenna—450 to 500 kilowatts of radiated power for each of the two channels that will be broadcast from it.

The bends. Since the four radiators in each array project from the corners of a square box-like support, the radiation pattern is omnidirectional in the horizontal



View from the top. Stack of 18 arrays with four radiators each makes up tv antenna inside cylindrical shield at top of Munich tower.

plane. Because the radiators of adjacent arrays are closely stacked one atop the other, the radiation would be concentrated into a beam in the vertical plane if all of them were energized in phase.

By varying the lengths of feed cables to the radiators, Rohde & Schwarz gets a phase shift between neighboring elements. The differences in amplitude levels come from the differences in attenuation between cables. The company's antenna engineers worked out empirically the amount of phase shift needed for the pattern they wanted in field tests.

The antenna system, including a cylindrical weather shield, cost \$185,000.

France

The right address

Computerized telegraph transmission systems brook no slipup in message addresses and automatically reject them if there are even minor errors.

Since operators can err when tapping out addresses on a keyboard, the Société de Constructions Electromécaniques Jeumont-Schneider has developed equipment that generates call letters and symbols identifying the sending and receiving stations, the transmission channel, and the message number. The gear also generates the characters that identify the closing sequence.

One way. Jean Huet, a Jeumont-Schneider engineer, says that for the moment the equipment is aimed at a well-defined market—air navigation and national weather services, airports, airlines, and the like—where several outlying stations all serve a common control facility. For that reason the equipment doesn't have the elaborate memory that would be needed for a machine that could send messages to several destinations. But the company says it will develop a multiple-address model when it decides to go after a bigger market.

Actually, Jeumont-Schneider de-

veloped an address generator several years ago. But the original version—bulky and expensive—made little impact on the market. It weighed roughly 100 pounds and was priced at about \$3,200. By contrast, the present generator, built around integrated circuits, is packed into a 19- by 11.5- by 8-inch box and it will sell for \$1,300 after volume production gets under way early next year.

Many characters. The address generator can handle a maximum of 64 characters and symbols—many more than are required for normal address and message closing sequences. A typical message would carry a 24-character-and-symbol address.

The address sequence runs off automatically when transmission begins. When the opening sequence ends, the generator signals the tape equipment to start sending the message punched out earlier by the operator. At the end of the text the generator produces the closing sequence, 14 characters and symbols. Thus coded, the opening and closing sequences use a total of 38 characters and symbols.

Variable speeds. The address generator uses about 70 transistor-transistor-logic IC's for all digital functions and for message counting. The unit uses a quartz oscillator that permits transmissions at speeds from 50 to 400 bauds. Another type of quartz crystal could boost the speed to 600 bauds.

Great Britain

Changing stations

Right now there's no question about the best way to run a nuclear power station in Britain—flat out. That's because uranium is the cheapest fuel there and the 11 nuclear stations already in service can be run steadily at full capacity to handle the base load.

With another seven atomic power plants in the works, and more coming, Britain's Central Electricity Generating Board has to get ready for the time when reactors will pick

up peak loads as well and thus have to vary their outputs.

Fast giant. To work out its reactor-control tactics, the generating board will have an impressive tool, a \$2.5 million hybrid computer, one of the largest ever built. It's coming from Electronics Associates, Inc. of Long Branch, N.J. and it's the biggest single computer order so far for the company.

The British agency says it went for the simulator because the complex behavior of a gas-cooled reactor simply can't be analyzed adequately by a digital computer alone. Three EAI 8800 analog computers will handle the computations needed to simulate reactor characteristics like neutron flux and temperature changes in fuel and the carbon-dioxide cooling gas. Similarly, there'll be analog handling of most boiler and turbine characteristics.

The digital computer in the setup, an EAI 8400 machine with a 32,000 word internal store, will simulate slowly changing reactor functions. And the 8400 will store the steam tables and other reference data, feeding it to the analog sections through the simulator's interface. But the main job of the digital computer will be to sequence the simulation runs and later analyze them.

Shining example

Word in late May that U.S. defense officials had declassified the Army's "see-in-the-dark" telescopes provoked a relatively rapid response from Britain's military establishment. Late last month, the British released for civilian use their own intensifier tube, the crucial component for night viewers that work without infrared illumination of the scene under scrutiny.

The British tube was developed by Mullard Ltd., a subsidiary of Philips' Gloeilampenfabrieken, and it's startlingly similar to the U.S. one.

Asked to point out the main differences between the two, a Mullard engineer said they weren't worth mentioning. He explained that Mullard had a research group—headed by Daphne Lampport, one



Good looking. Mullard's Daphne Lamport checks the scene with a demonstration night-viewer built around a recently declassified image intensifier tube. Early development of the tube was performed by a team headed by Miss Lamport.

of the prettiest project leaders ever—at work on an image intensifier tube but when it learned that the U.S. Army had one in the works Mullard built its intensifier to U.S. specifications. These call for three stages with an electron-acceleration potential of 15 kilovolts for each to make low-level light images 40,000 times brighter.

Like the U.S. producers of the night-viewers, Mullard can trot out a long list of potential civilian uses including navigation, aerial mapping, astronomy, and police work. Mullard, though, can't figure on making much headway in the U.S. market. It will price the tube alone at about \$1,700. U.S. companies in the field are shooting at a \$1,000 price tag for complete viewers.

Minding the store

So far, the Wilson government's effort to forge a strong computer industry has concentrated on putting together a giant British computer company. Now that International Computers Ltd. (ICL) has started operations, a campaign to better British computer technology is emerging.

Out of the campaign will come the technological guidelines for the first generation of ICL computers,

to be marketed in the mid-1970's. (Until then, ICL will sell the machines of two of the companies that are part of the combine—International Computers and Tabulators Ltd. and the English Electric Co.)

ICL's machine, quite likely, will have an associative memory. And at the Fourth Congress of the International Federation of Information Processing at Edinburgh this week, a research team from the University of Manchester will describe an integrated-circuit associative memory element being developed with government backing.

The right word. David Aspinall, David Kinniment and David Edwards say their bipolar IC works both as an associative and a word-organized memory element. With it, then, an interrogation word fed to the computer leads to the required stored word. In today's computers, addresses showing the location of words in the memory have to be used.

Along with making life easier for computer programmers, the associative memory will make for faster computing over-all. The memories will work at arithmetic-unit speeds, says Aspinall. This is possible because word-finding sequences can overlap. While a word is being read out of the conventional half of the memory, a new interrogate

word can be fed to the associative half.

The Manchester trio, whose monolithic IC designs have been produced in small batches by Ferranti Ltd., feels that the best chip size would be .060-inch square, with eight bit circuits on each chip. A combined associative and word-organized store of 64 words would have a total cycle time of 110 nanoseconds, Aspinall predicts. This estimate is based on a test run with an array of 4-bit chips. Each word would have 30 bits for the associative function and 24 bits for the word proper. The cost would run about \$7 per bit, he figures.

Matchmaker. Each bit circuit is based on two dual-emitter transistors connected as a flip-flop, to provide storage. The transistors are connected across two digit wires and have a common connection to a single word wire running at right angles to the digit wires. In the circuit's simplest form, the word wire is normally held slightly positive with respect to the digit wires so that no current flows into the word wire. If one digit wire is made more positive than the word wire, and one transistor is saturated, the current flowing in this digit wire is diverted into the word wire. If the other transistor is saturated, though, no current will flow into the word wire. The presence or absence of current indicates match or no-match of the stored bit with an interrogate on bit.

Entries. To write in a bit, one digit line is raised to a high potential and the other kept low, while the word-line potential is raised. If sufficient potential difference exists between the two digit lines, the transistor corresponding to the lower digit line becomes saturated and stays that way when the potential on the word line is lowered.

The Manchester memory men limited the circuitry on the chip to the storage matrix. The sense-write drive circuits were not included because eight of them would have been necessary, each as complex as a single bit circuit. In order to keep the initial chips relatively easy to manufacture, the drive circuits are built around discrete components at the moment.



nimo™
10-Gun CRT Display
unretouched

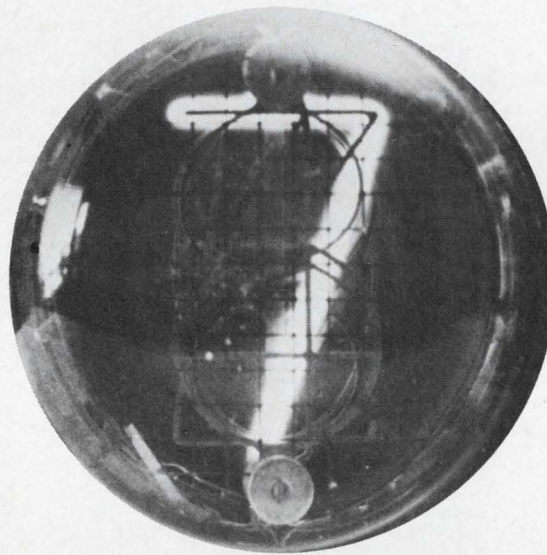

Gas Discharge Tube
unretouched

The difference is clear.

Until now, tube readouts left something to be desired. The multi-plane gas discharge display tube is a real eyestrainer, particularly under high ambient light or at a wide viewing angle.

Now we have the **nimo™** 10-gun CRT display. Now, every character or message can be displayed on the same sharp, clear plane. No feedback...no image ambiguity...no external focusing...no ambient light worries.

IEE put eight years of Research and Development into **nimo™**. Thousands of tests in every possible environment achieved an uncommon *clarity* with noticeable hardware savings.

We came up with plenty more. A Cathode Ray Tube display controlled by a 10-volt swing at 0 current which produces a base operating brightness of 100 FL. Unequalled viewing power, even under direct sunlight. All images

displayed equally near the tip of the tube, with unmatched wide-angle viewing.

In all, there are 12 clear advantages to the new **nimo™** 10-gun CRT.

Why not arrange with IEE for an eye-opening comparison? Phone...or drop us a line; you'll get an immediate response. Industrial Electronic Engineers, Inc., 7720 Lemona Avenue, Van Nuys, Calif. (213) 787-0311.



The uncommon readout.

Electronics advertisers

Aug. 5, 1968

A C D C Electronics Faust/Day, Inc. Adv.	223	Communications Electronics, Inc. William C. Estler—Public Relations	242	General Electric Co., Electronic Components Sales Operation Robert S. Cragin, Inc.	32
Acopian Corp. Mort Barish Associates	14	Connecticut Hard Rubber Co. Chirurg & Cairns, Inc.	26	General Electric Co., Semiconductor Products Div.	141, 142, 143
Airtronics, Inc., Powertec Div. Frost, Shaffer, Gauthier	250	Continental Connector Corp. Dunwoodie Associates	162	General Electric Co., Specialty Control Div. Robert S. Cragin, Inc.	225
Alco Electronic Products, Inc. Marketronics Advertising	249	Cornell-Dubilier Electronics Daniel & Charles, Inc.	161	General Radio Co. Horton, Church & Goff, Inc.	2nd Cover
Alden Electronics Larcom Randall Adv., Inc.	195	COSMIC	259	Granger Associates West Associates	174
Allen-Bradley Co. Fensholt Adv. Agcy.	67	Cosmicar Optical Co., Ltd. Matsushita, Inc.	256	Grayhill, Inc. Merchandising Adv., Inc.	243
American Telephone & Telegraph Co. Cunningham & Walsh, Inc. Adv.	150	CREI, Home Study Div. of the McGraw-Hill Book Co. Henry J. Kaufman & Associates	241		
Ammon Instruments, Inc. Culver Adv., Inc.	244				
Amperex Electronics Corp., North American Phillips Co. Div. Sam Groden, Inc.	57	Delco Radio Div. of General Motors Corp. Campbell-Ewald Co.	178	Hayakawa Electronics Co., Ltd. Dai-ichi International, Inc.	249
Andrew Corp. Fensholt Adv., Inc.	72	Deringer Metallurgical Corp. R. B. Advertising	61	Haydon Co., A. W. Chambers, Wiswell & Moore, Inc.	243
Anritsu Electric Co., Ltd. Diamond Agcy. Co., Ltd.	242	Di-Acro Corp., Div. of Houdaille Industries, Inc. Charles E. Brown Adv. Agcy.	230	Heath Co., Sub. of Schlumberger, Ltd. Advance Advertising Service	82, 83
Associated Testing Laboratories, Inc. Murray Heyert Associates	254	Digilog Electronics Corp. Pollock & Loth, Inc.	8	Hewlett Packard, Frequency & Time Division Lennen & Newell, Inc.	3rd Cover
Augat, Inc. Horton, Church & Goff, Inc.	103	Dit-Mco International Div. of Xebec Corp. Martin Fromm & Assoc., Inc.	206, 207	Hewlett Packard, Microwave Div. Lennen & Newell, Inc.	2
A. U. Sales of Encino, California Stadler/Cowman Advertising	55	Douglas Randall, Inc. MacManus, John & Adams, Inc.	226	Hewlett Packard, Palo Alto Div. Lennen & Newell, Inc.	1
Automatic Metal Products Corp. Davon Service Corp.	166	Duncan Electronics, Inc., Sub. of Systron Donner Corp. Helme Assoc., Inc.	63	HI-G, Incorporated Marketing Assistance, Inc.	59
		DuPont de Nemours Co., Industrial Fibers Nomex Batten, Barton, Durstine & Osborn, Inc.	211	Hitachi Metals, Ltd. Standard Adv., Inc.	258
Bausch & Lomb, Inc. Wolff Assoc., Inc.	173	DuPont de Nemours Co., Mylar Div. Batten, Barton, Durstine & Osborn, Inc.	66	Honeywell, Test Instruments Div. Campbell Mithun, Inc.	217
Beckman Instruments, Inc., Helipot Div. Hixson & Jorgensen, Inc.	90	DuPont de Nemours Co., Teflon Div. Batten, Barton, Durstine & Osborn, Inc.	47	Hooker Chemical Corp., Durez Div. Rumrill-Hoyt, Inc.	188
Bell, Inc., F.W. Wheeler, Kight & Gainey, Inc.	60			Hughes Aircraft Co. Foote, Cone & Belding	204
Bendix Corp., Flight & Engine Instruments Div. MacManus, John & Adams, Inc.	184	Eagle Signal, Div. of E. W. Bliss Co. Feeley & Wheeler, Inc.	35	Hurst Mfg. Corp. Hathaway Adv. Agcy.	46
Bendix Corp., Semiconductor Products Div. MacManus, John & Adams, Inc.	25	E G & G, Incorporated Culver Adv., Inc.	181	Hysol Corp. Barber & Drullard, Inc.	210
Bendix Corp., Vacuum Div. MacManus, John & Adams, Inc.	68	Emerson & Cuming, Inc. Edwin F. Hall	248		
Birnbach Co. Kornazagraphic	251	Europavia Dumesnil Publicite	159	Industrial Electronic Engineers Van Der Boom, McCarron, Inc., Adv.	273
Bishop Industries Corp. Eastman Adv. Agcy.	248	Exact Electronics Hugh Dwight Adv., Inc.	16	Industrial Electronic Hardware A.D. Adams Adv., Inc.	257
Bliss Gamewell, Div. of E. W. Bliss Co. Feeley & Wheeler, Inc.	176			Intellux, Inc. Palmer/Larson Communications	256
Boonton Electronics Corp. The Creative Group	205	Fairchild Semi- conductor, Inc. Faust/Day, Inc.	10, 11, 18, 19, 88, 89, 234	International Crystal Mfg. Co. Robert V. Freeland & Associates	218
Brush Instruments, Div. of Clevite Corp. Carr Liggett Adv., Inc.	186	Farinon Electric Jack Herrick Adv., Inc.	7	International Electronic Research Corp. Van Der Boom, McCarron, Inc., Adv.	12, 13
Buckbee-Mears Co. Midland Assoc., Inc.	247	Fluke Manufacturing Co., John Bonfield Associates	27		
Bulova Watch Co., Electronics Div. Levy Adv. Assoc.	22	Fork Standards, Inc. Consultek	164	Japan Aviation Electronics Industry, Ltd. Diamond Agency Co., Ltd.	261
Burndy Corp. Don Kemper Co., Inc.	149			J F D Electronics Co., Components Div. Delphi Adv., Inc.	224
Burr Brown Research Corp. N.A. Winter Adv. Agcy.	227	G A F Corp. L.W. Frohlich & Co/ Intercon International, Inc.	148	Johanson Mfg. Co. Josephson, Cuffari & Co.	240
Bussmann Mfg. Div. of McGraw Edison Co. Henderson Adv. Co.	42	Gamma Scientific, Inc. Barnes-Champ/Advertising	58	Johnson Co., E. F. Midland Associates	245
		Gardner-Denver Co. Buchen Adv., Inc.	28, 29		
Cambridge Thermionic Corp. Chirurg & Cairns, Inc.	182	General Atronics Corp. Garceau Hallahan & McCullough, Inc.	247	Kepeco, Inc. Weiss Advertising	62
Carpenter Steel Co., The Beaumont, Heller & Sperling, Inc.	136	General Cable Corp. Hicks & Greist, Inc.	36, 37	Kings Electronics Co., Inc. Caroe Marketing, Inc.	24
Centralab Div. of Globe-Union, Inc. The Brady Co.	44	General Electric Chemical Materials Dept. Ross Roy of New York, Inc.	71	Kingsley Machine Co., Aero Space Div. Brown, Clark & Elkins, Inc.	256
Cerro Copper & Brass Co. Feeley & Wheeler, Inc.	200				
Cherry Electrical Products Corp. K & A, Incorporated	70				
Cimron Div. of Lear Siegler, Inc. Phillips-Ramsey, Inc.	49				
Clarostat Manufacturing Co. Horton, Church & Goff, Inc.	167				
CML, Div. of Tenny Engineering Co. Keyes, Martin & Co.	202				

■ Leach Corp. Jay Chiat & Associates	84, 85
■ Ledex, Inc. Yeck & Yeck, Inc.	208
■ Ledex, Inc., Bramco Controls Div. Yeck & Yeck, Inc.	246
Lorch-Adret Corp. Herbert Lindauer Associates	266
■ Machlett Laboratories, Div. of Raytheon Co.	15
Fuller & Smith & Ross, Inc.	
Magnecraft Electric Co. Mills, Fife & Mac Donald, Inc.	180
Marconi Instruments McCarthy, Scelba & DiBiasi Adv. Agcy., Inc.	154
■ Markel & Sons, L. Frank George Moll Adv., Inc.	196
Markem Corporation Creamer Trowbridge Case & Basford, Inc.	6
■ Matsuo Electric Co., Ltd. Daiyusha, Inc. Adv.	260
■ Matsushita Electric Corp. of America, Panasonic Div. Dentsu Corp. of America	237
Metex Corp. Keyes, Martin & Co.	144
Methode Electronics, Inc. Sander Rodkin Adv. Agcy., Ltd.	201
Mico Instrument Co.	250
Microdot, Inc. Gumpertz, Bentley & Dolan Adv.	86, 87
■ Micro Switch Div. of Honeywell Batten, Barton, Durstine & Osborn, Inc.	104
■ Microwave Cavity Laboratories, Inc. Art Brown Writing Service	276
Midtex/Aemco Chuck Ruhr Assoc. Adv.	38
■ Midwestern Instruments White Adv. Agcy., Inc.	203
Minnesota Mining & Manufacturing Co., Chemical Div. Young & Rubicam, Inc.	147
Minnesota Mining & Manufacturing Co., Scotchpar Div. Young & Rubicam, Inc.	76
M M Electronic Enclosures, Inc. Berin/Pecor, Inc.	243
Molex Products Co. Fensholt Adv., Inc.	145
Monsanto Co. Foote, Cone & Belding	39
Monsanto Co. Michel-Cather, Inc.	41
Motorola Semiconductor Products, Inc. Lane & Bird Adv., Inc.	109
■ National Electronics, Inc. Conner-Sager Associates	247
National Semiconductor Corp. Jay Chiat & Associates	153, 155
■ Nihon Kohden Kogyo Co., Ltd. Overseas Catalog Specialists, Inc.	226
■ North Atlantic Industries, Inc. Murray Heyert Associates	168
■ Norton Associates, Inc. J. J. Coppo Co.	250
Pamotor, Inc. Harry P. Bridge Co.	232
Pastoriza Electronics Co. L. K. Frank Co., Inc.	197
■ Permag Corp. Schneider, Allen, Walsh, Inc.	244
■ Philbrick/Nexus Research Culver Adv., Inc.	189
Philco Ford Corp. Sierra Electronics Operation Hal Lawrence, Inc.	23
Pomona Electronics Co. Buxton Adv. Agcy.	246
■ Potter & Brumfield Div., American Machine & Foundry Corp. Grant, Schwenck & Baker, Inc.	65

Radiation, Inc. W. M. Zemp & Assoc., Inc.	77 to 81
Radio Corporation of America Al Paul Lefton Co.	4th Cover
■ Raytheon Co., Industrial Components Div. Fuller & Smith & Ross, Inc.	45
Rohde & Schwarz Fletcher-Walker-Gessell, Inc.	185
Rotron Manufacturing Co. Lescarboursa Adv., Inc.	209
Scientific Data Systems Doyle, Dane, Bernbach, Inc.	50
Semcor Division Components, Inc. Marketing & Corporate Communications, Inc.	190
Signetics Corp. Sub. Corning Glass Works Cunningham & Walsh, Inc.	40, 220
■ Siliconix, Inc. Graphics West	252
Singer Co., The, Metrics Div. The Stanley Schwartz Co.	146
■ Sorensen Operation, Raytheon Co. Urrutia & Hayes, Inc.	75
Sprague Electric Co., The Harry P. Bridge Co.	5, 9
■ Susumu Industrial Co., Ltd. Sanko Sha Adv. Agcy. Co., Ltd.	248
Sylvania Electric Products, Inc. Parts Div. Doyle, Dane, Bernbach, Inc.	177
Synthane Corp. Arndt, Preston, Chapin, Lamb & Keen, Inc.	249
Tally Corp. Bonfield Assoc., Inc.	169
■ TDK Electronics Co., Ltd. Fuji Agency	259
■ Tektronix, Inc. Hugh Dwight Adv., Inc.	156
Teledyne Relays Co. S. Michelson Advertising	231
Temescal, Div. of Aircro Allen, Dorward and Scroggin, Inc.	64
Tempress Research Co., Inc. Hal Lawrence, Inc.	17
Tenney Engineering, Inc. Keyes, Martin & Co.	259
Teradyne, Inc. Quinn & Johnson Adv., Inc.	30
Test Equipment Corp. Dean & Bain Adv. Inc.	255
Texas Instruments Incorporated Components Group Don L. Baxter, Div. of Albert Frank Guenther Law, Inc.	48
Texas Instruments Incorporated Industrial Products Group Robinson-Gerrard	216
Texscan Corp. Burton Browne Advertising	222
■ Tohoku Metal Industries, Ltd. Hakuhodo, Inc.	254
Torrington Mfg. Co., Air Moving Div. Wilson, Haight & Welch, Inc.	43
■ Tracor, Inc., Industrial Instruments Div. Winn-McLane Assoc., Inc.	179
■ Transformer Electronics Co. Dacey, Wolff & Weir	219
Transistor Automation—A Teledyne Co. Weston Assoc., Inc.	69
Transitron Electronic Corp. Larcom Randall Adv., Inc.	117
Trans World Airlines, Inc. Foote, Cone & Belding	244
Triplet Electrical Instrument Co. Burton Browne Advertising	183
TRW Semiconductors, Inc. Fuller & Smith & Ross, Inc.	187
■ Trygon Electronics, Inc. Kameny Associates, Inc.	56
Trymetrics Corp. Kameny Assoc., Inc.	165
■ Tung-Sol Div., Wagner Electric Corp. Feeley & Wheeler, Inc.	214, 276



Ulano Graphic Arts Supplies, Inc. Lory Roston Associates	199
■ United Systems Corp. Advertising & Merchandising, Inc.	251
Unitron, Div. of Electric Machinery Mfg. Co. Warren Associates	255
Varian Associates Electron Tube & Device Group Botsford, Constantine & McCarty, Inc.	20, 21
■ Varo, Inc. Tracy-Locke Co., Inc.	236
Vishay Instruments, Inc. Alpern Communications	215
Wadsworth & Co., Ltd., Leonard	245
Wakefield Engineering, Inc. Sales Promotion Services, Inc.	245
Wavetek Chapman, McQuiston Michetti Advertising	233
■ Weston Instruments, Inc., Newark Div. Arndt, Preston, Chapin, Lamb & Keen, Inc.	151
■ White Co., S.S., Resistor Trimmer Div. W.L. Towne Co., Inc.	152
Williams Gold Refining Co., Inc., Precious Metal Div. Stahlka, Faller & Klenk, Inc.	236

Classified Advertising

F.J. Eberle, Manager

EMPLOYMENT OPPORTUNITIES

Corcoran, J. P.	262
General Electric Co., Ind. Sales Div.	262
Mason & Hanger Silas Mason	262

EQUIPMENT (Used or Surplus New) For Sale

A & A Electronics Corp.	265
Calif., Elec. Mfg. Co.	265
Fishman Company, P.	265
Gadgetters Electronics Inc.	265
Radio Research Instrument Company	265

■ For more information on complete product line see advertisement in the latest Electronics Buyer's Guide

Electronics Buyers' Guide

George F. Werner, General Manager
[212] 971-2310
Ray Smyth, Eastern Regional Manager
[212] 971-6538
Robert M. Denmead,
Midwest Regional Manager
[312] MO 4-5800
Regina Hera, Directory Manager
[212] 971-2544
Thomas M. Egan, Production Manager
[212] 971-3140

Circulation Department

Isaaca Siegel, Manager [212] 971-6057

Research Department

David Strassler, Manager [212] 971-6058
Chloe D. Glover, Research Associate
[212] 971-6057

Precise dimensional accuracy, one step, ceramic-to-glass-to-metal thermo-bonding and Mil-spec quality standards, provide optimum performance and maximum design freedom in microcircuit packaging.

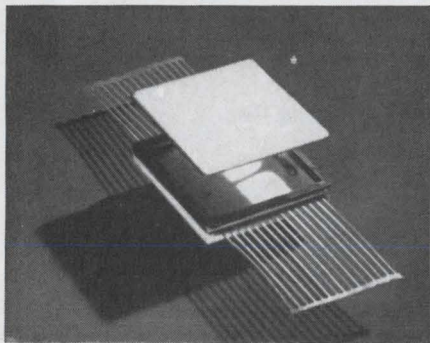

TYPICAL CONFIGURATIONS

Available in closed and "see-through" types.

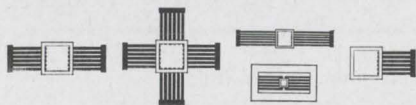

WRITE FOR "MICROCIRCUIT PACKAGES"



This brochure tells the Tung-Sol Flat Pack story in eight fully detailed pages.
TUNG-SOL DIVISION,
 Wagner Electric Corporation, One Summer Avenue, Newark, N.J. 07104.

TUNG-SOL "FLAT PACKS"
 MICROCIRCUIT PACKAGES

Advertising Sales Staff

Frank E. LeBeau [212] 971-6464
 Advertising Sales Manager

Wallis Clarke [212] 971-2187
 Assistant to sales manager

Donald J. Austermann [212] 971-3139
 Promotion Manager

Warren H. Gardner [215] LO 8-6161
 Eastern Advertising Sales Manager

Atlanta, Ga. 30309: Michael H. Miller, 1375 Peachtree St., N.E.
 [404] 892-2868

Boston, Mass. 02116: William S. Hodgkinson
 McGraw-Hill Building, Copley Square
 [617] CO 2-1160

Cleveland, Ohio 44113: William J. Boyle, 55 Public Square, [216] SU 1-7000

New York, N.Y. 10036
 500 Fifth Avenue
 James R. Pierce [212] 971-3616
 John A. Garland [212] 971-3617

Philadelphia, Pa. 19103:
 Jeffrey M. Preston
 Warren H. Gardner,
 6 Penn Center Plaza,
 [215] LO 8-6161

Pittsburgh, Pa. 15222: Warren H. Gardner,
 4 Gateway Center, [412] 391-1314

Rochester, N.Y. 14534: William J. Boyle,
 9 Greylock Ridge, Pittsford, N.Y.
 [716] 586-5040

Donald R. Furth (312) MO 4-5800
 Midwest Advertising Sales Manager

Chicago, Ill. 60611: Kenneth E. Nicklas
 Ralph Hanning, 645 North Michigan Avenue,
 [312] MO 4-5800

Dallas, Texas 75201: Richard P. Poole, 1800 Republic National Bank Tower,
 [214] RI 7-9721

Houston, Texas 77002: Robert Wallin,
 2270 Humble Bldg. [713] CA 4-8381

Detroit, Michigan 48226: Ralph Hanning,
 856 Penobscot Building
 [313] 962-1793

Minneapolis, Minn. 55402: 1104 Northstar Center [612] 332-7425

St. Louis, Mo. 63105: Kenneth E. Nicklas,
 The Clayton Tower, 7751 Carondelet Ave.
 [314] PA 5-7285

James T. Hauptli [415] DO 2-4600
 Western Advertising Sales Manager

Denver, Colo. 80202: Joseph C. Page, David M. Watson, Tower Bldg., 1700 Broadway
 [303] 255-5484

Los Angeles, Calif. 90017: Ian C. Hill,
 John G. Zisch, 1125 W. 6th St.,
 [213] HU 2-5450

Portland, Ore. 97204: James T. Hauptli,
 Thomas McElhinny, 218 Mohawk Building,
 222 S.W. Morrison Street,
 Phone [503] 223-5118

San Francisco, Calif. 94111: James T. Hauptli,
 Thomas McElhinny, 255 California Street,
 [415] DO 2-4600

Pierre Braude Tel: 225 85 88: Paris
 European Director

Paris: Ken Davey
 88-90 Avenue Des Champs-Elysees, Paris 8

United Kingdom and Scandinavia
Brian Bowes Tel: Hyde Park 1451
 34 Dover Street,
 London W1

Milan: Robert Saidel
 1 via Baracchini Phone 86-90-656

Brussels: F.I.H. Huntjens
 27 Rue Ducale Tel: 136503

Frankfurt/Main: Hans Haller
 Elsa-Brandstroem Str. 2
 Phone 72 01 81

Geneva: Ken Davey
 1, rue du Temple Phone: 31 95 60

Tokyo: Takeji Kinoshita
 Shiba, Minato-Ku [502] 0656

Osaka: Ryoji Kobayashi 163, Umegae-cho
 Kita-ku [362] 8771

Business Department

Wallace C. Carmichael, Manager
 [212] 971-3191

Stephen R. Weiss, Production Manager
 [212] 971-2044

Thomas M. Egan,
 Assistant Production Manager [212] 971-3140

Dorothy Carmesin, Contracts and Billings
 [212] 971-2908

Frances Vallone, Reader Service Manager
 [212] 971-2865

**MICROWAVE
 Oscillators And
 Amplifiers**

With the **MCL**
 "Dynamic
 Disciplines" Approach

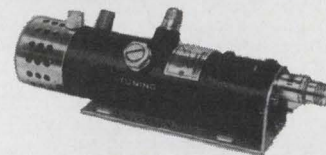

CAPABILITIES

- DC TO 10 GHZ
- MICROWATTS TO MEGAWATTS

Custom Design, Engineering,
 Manufacturing to Industrial,
 Commercial, Scientific and
 Government Requirements.

- HIGH POWER RF CW AND PULSE AMPLIFIERS AND SYSTEMS
- LARGE STOCK VARIETY OF TRIODE AND TETRODE CAVITIES (Covers 200 to 6000 MHZ)
- CW, PULSE OSCILLATORS
- CW MULTIPLIERS
- PULSE MODULATORS
- SOLID STATE COMPONENTS
- TEST EQUIPMENT
- ACCESSORIES



See Our Spread in 1968 Electronics Buyers' Guide. Write for MCL Catalog.

**MICROWAVE CAVITY
 LABORATORIES, Inc.**

MCL 10 North Beach Avenue
 La Grange, Illinois 60525
 Phone: (312) 354-4350
 Western Union Telex 25-3608

Let's play tag.



You win. Because one look at the price tags of Hewlett-Packard's low-cost integrated circuit counters tells you the name of our game is performance-for-cost. We started the game with the first 10 MHz counter for \$350.

The HP 5321A Counter—\$350—is a 5 Hz-to-10 MHz counter with four-digit readout and power line time base. It is perfect for measuring frequency, simple time intervals, or for totalizing in electrical, electronic or mechanical applications. The 5321B, at \$700, adds BCD output, 5-digit readout, additional gate times and crystal time base.

The HP 5221A/B Counters are the same as the above counters in every way but size. These counters offer a different form factor—taller, slimmer and not as deep. These, too, are \$350 and \$700.

If you need more capabilities, consider the HP 5216A Counter at just \$925. With it, you can totalize, measure frequency period, multiple period averages, frequency ratio, multiple ratios and time interval. It has a 7-digit readout, gate times of 0.01, 0.1, 1.0 and 10 secs. Frequency range is 3 Hz to 12.5 MHz, and input sensitivity 10 mV.

And the HP 5325A Counter, at \$1200, is a universal counter that does almost everything a counter can do without plug-in accessories. This versatile 0-12.5 MHz

counter is particularly useful for simple or complex time interval measurements from 100 nanoseconds to 10^8 seconds. Marker outputs indicate measured intervals on an oscilloscope display of the input waveform.

All these counters have other advantages that add to their performance-for-cost value: Zero-blanking suppresses unwanted zeros. Readout storage increases measuring speed by holding the displayed value while the next measurement is in progress.

So if you're looking for the exact counter you need at the exact price you can afford, check the HP performance-for-cost game. It's rigged in your favor.

Call your local HP field engineer for details, or write Hewlett-Packard, Palo Alto, California 94304; Europe: 54 Route des Acacias, Geneva.

HEWLETT  PACKARD

ELECTRONIC COUNTERS

RCA CD2300 DTL Family

direct replacements for 830 and 930 series

45 types / 3 package styles / 2 Temperature Ranges
Gates / Expanders / Flip-Flops / Inverters
2K Ω and 6K Ω Output Pull-Up Options

• For Your Military Applications:

CD2300 Series—15 circuits in RCA's Unique
Ceramic Flat Package.

CD2300D Series—15 circuits in RCA's Unique Ceramic
Dual In-Line Package.

• For Industrial and Commercial Applications:

CD2300E Series—15 circuits in RCA's Dual In-Line
Silicone Package.

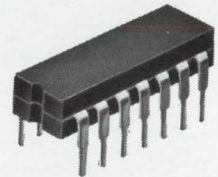
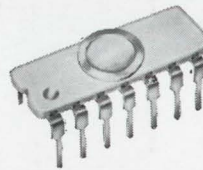
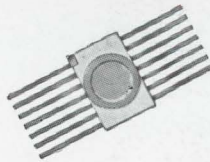

Circuit and Pull-up Option	-55°C to +125°C Operation				0°C to +75°C Operation	
	14-Lead Ceramic Flat Pack	Price (1000 Units)	14-Lead Ceramic Dual In-Line Package	Price (1000 Units)	14-Lead Dual In-Line Silicone Package	Price (1000 Units)
NAND Gates						
Dual-4 Expandable (6K Ω)	CD2300/930	\$2.50	CD2300D/930	\$2.50	CD2300E/830	\$1.05
Dual-4 Expandable (2K Ω)	CD2301/961	\$2.50	CD2301D/961	\$2.50	CD2301E/861	\$1.05
Dual-4 High Fanout, Expandable (transistor output pull-up)	CD2306/932	\$2.75	CD2306D/932	\$2.75	CD2306E/832	\$1.15
Dual-4 High Fanout Expandable (no output pull-up)	CD2307/944	\$2.75	CD2307D/944	\$2.75	CD2307E/844	\$1.15
Triple-3 Input (6K Ω)	CD2308/962	\$2.75	CD2308D/962	\$2.75	CD2308E/862	\$1.15
Triple-3 Input (2K Ω)	CD2309/963	\$2.75	CD2309D/963	\$2.75	CD2309E/863	\$1.15
Quadruple-2 Input (6K Ω)	CD2302/946	\$2.75	CD2302D/946	\$2.75	CD2302E/846	\$1.15
Quadruple-2 Input (2K Ω)	CD2303/949	\$2.75	CD2303D/949	\$2.75	CD2303E/849	\$1.15
Hex Inverters						
Diode Input (6K Ω)	CD2310/936	\$2.90	CD2310D/936	\$2.90	CD2310E/836	\$1.45
Diode Input (2K Ω)	CD2311/937	\$2.90	CD2311D/937	\$2.90	CD2311E/837	\$1.45
Expandable Input (6K Ω)	CD2312	\$2.90	CD2312D	\$2.90	CD2312E	\$1.45
Expandable Input (2K Ω)	CD2313	\$2.90	CD2313D	\$2.90	CD2313E	\$1.45
Flip-Flops						
Clocked RS with JK Capability (6K Ω)	CD2304/945	\$3.00	CD2304D/945	\$3.00	CD2304E/845	\$1.90
Clocked RS with JK Capability (2K Ω)	CD2305/948	\$3.00	CD2305D/948	\$3.00	CD2305E/848	\$1.90
Input Expander						
Dual 4-Diode	CD2314/933	\$2.25	CD2314D/933	\$2.25	CD2314E/833	\$.90

Ask your RCA Representative for details. See your RCA Distributor for his price and delivery. For technical information, write RCA Electronic Components, Commercial Engineering, Section IC-N-8-1, Harrison, N.J. 07029.

RCA
Integrated
Circuits