

Electronics[®]

Charts simplify pulse analysis: page 62

Negative-impedance converters: page 82

Phased-array radar on the horizon: page 94

September 2, 1968

\$1.00

A McGraw-Hill Publication

Below: Decoders drive arrays of light-emitting diodes, page 74

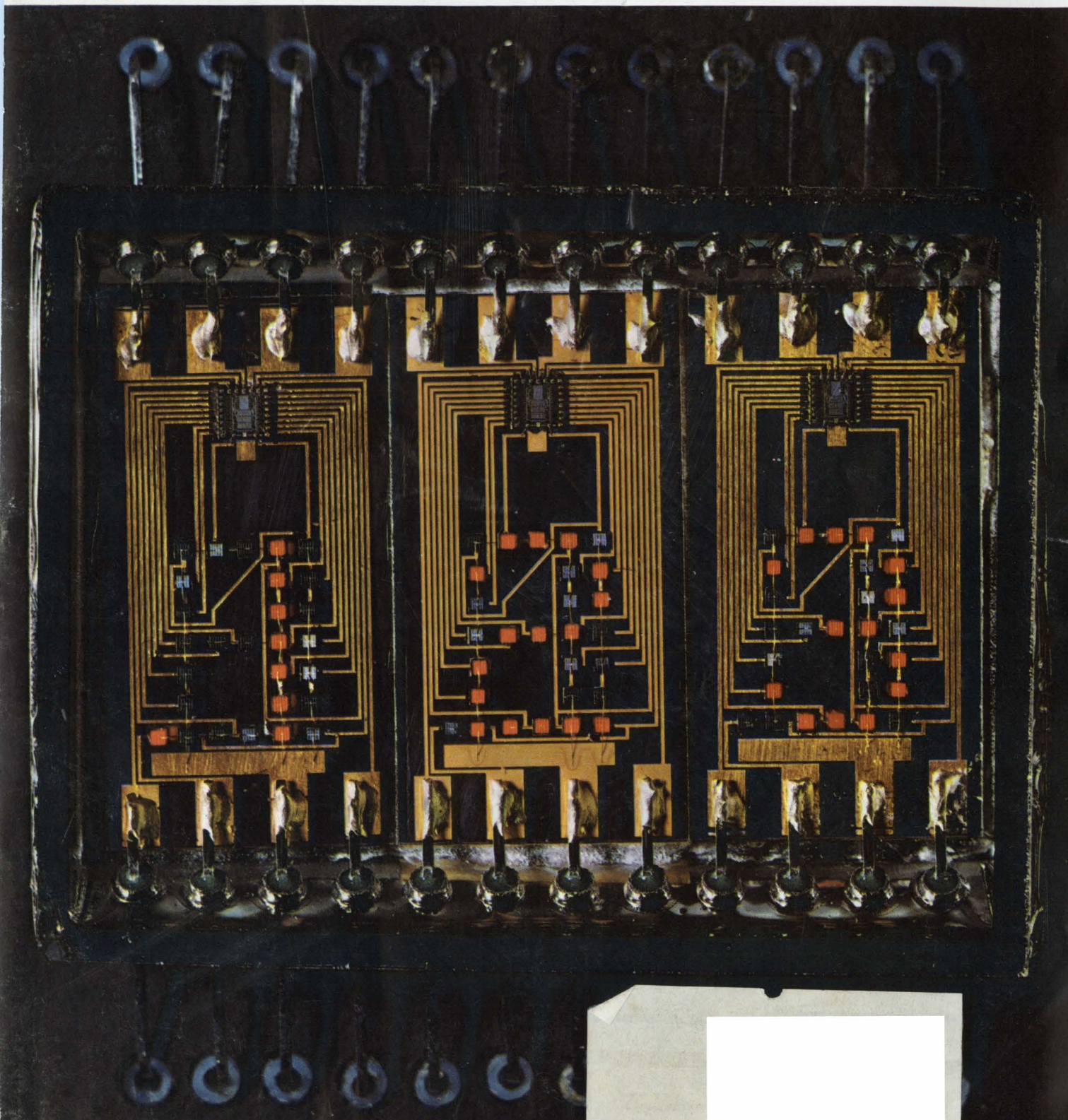



The world's most versatile synthesizer

You buy a frequency synthesizer because you need its accuracy, resolution, resettability, or stability. General Radio synthesizers afford all these advantages and more. Up to the 70-MHz frequency limit, the GR 1160-series synthesizers are virtually tunable frequency standards. For example, at 50 MHz the rms fractional frequency deviation of an 1164 synthesizer is less than 3×10^{-11} with a 1-s averaging time, and spurious signals are down at least 60 dB. Nine significant figures can easily be set on in-line, easy-to-read dials. Eighty different models are available, differing mainly in degree of resolution, programmability, and sweepability. Prices range from \$3640 to \$7515.

In addition to offering a complete line of synthesizers, General Radio also offers a line of accessories to enhance greatly the usefulness of these instruments. You don't spend thousands of dollars and then have to build your own breadboard to sweep or to program. GR's synthesizer accessories enable you to perform those functions easier and better.

Sweep The 1160-P2 Sweep and Marker Generator (\$495) transforms any GR synthesizer containing the continuously adjustable decade module into an ultra-precise sweep generator with sweep excursions of <1 Hz to 1.2 MHz. The instrument provides a choice of automatic sweep speeds as well as manual sweeping, a calibrated, crystal-controlled frequency marker, accurate, adjustable side markers, and a convenient means of expanding the frequency excursion without changing the display width and without affecting the center frequency. These features are just what you need for testing crystal filters or other high-Q devices on the production line or in the laboratory.

Program Where fast, repetitive, and error-free selection of frequencies is required, the new 1160-P1 Preset-Frequency-Program Unit fills the need. This instrument converts the single-contact closure of a mechanical or electronic switch into multiple closures required to set up all seven digits of a selected frequency. And now with the new 1164-RDI-3 decade module, you can preprogram frequencies all the way up to 70 MHz. The 40-channel model of the 1160-P1 costs \$1825, the 20-channel model costs \$1000. Interconnecting

cables (1 required for each synthesizer decade) are \$75 each.

High-Stability Oscillators Other accessories enable you to lock the synthesizer's internal crystal oscillator for improved long-term stability. The 1160-P3 Standard-Frequency Oscillator sells for \$525, and it reduces drift to 3×10^{-9} per day after warmup. For even greater stability, the 1115-C Standard-Frequency Oscillator (\$1800) further improves deviation to 5×10^{-10} per day.

Of course, you don't have to buy any of these accessories when you order a GR synthesizer, but because they're available as standard items, they make the most versatile synthesizers on the market even more versatile.

For complete information or a demonstration, call your nearest GR office or write General Radio Company, West Concord, Massachusetts 01781; telephone (617) 369-4400. In Europe Postfach 124, Ch 8034, Zurich 34, Switzerland.

GENERAL RADIO

Prices apply only in U.S.A.

Circle 900 on reader service card

For Quantity and Quality Calibration:

SIX INSTRUMENTS IN ONE!

For true versatility in your calibration laboratory, production or design areas, get the hp 741B AC/DC Differential Voltmeter/DC Standard. You'll be getting six instruments in one! The hp 741B is a dc standard, an ac differential voltmeter, a dc differential voltmeter, a floating ac voltmeter, a floating dc voltmeter, and a power amplifier—all with a 90-day calibration cycle.

DC Standard. The hp 741B is a stable, $\pm 0.01\%$ dc standard with output voltage to 1000 V—with 5-digit resolution. It is designed for accurate calibration of digital voltmeters, differential voltmeters, and

for general calibration lab applications.

AC Differential Voltmeter. The hp 741B measures ac voltages with $\pm 0.03\%$ midband accuracy. It maintains a low input capacitance of < 5 pF. This unique feature reduces loading error—and makes the 741B ideal for circuit measurements where added capacitance might cause circuit instabilities.

DC Differential Voltmeter. The hp 741B measures dc voltages to 1000 V in four ranges with $\pm 0.02\%$ accu-

racy. Input impedance is $> 10^9 \Omega$ on all ranges—*independent of null*. This extremely high impedance makes the 741B ideal for drift measurements where null conditions cannot be maintained.

Floating DC Voltmeter. The hp 741B measures dc voltages from 1 mV to 1000 V. It has an input impedance of $> 10^9 \Omega$ on all ranges.

Floating AC Voltmeter. The hp 741B measures ac voltage from 1 mV to 1000 V. The low capacity ac probe provides an input impedance of 1 M Ω shunted by < 5 pF on all ranges.

Power Amplifier. As a $\pm 0.02\%$ power amplifier, the hp 741B provides unity voltage gain and up to 20 mA output. Use it as an impedance converter.

Check on how this six-in-one versatility can simplify your calibration measurement needs. Look at your Hewlett-Packard Instrumentation Catalog and call your hp field engineer. Or, write to Hewlett-Packard, Palo Alto, California 94304. Europe: 54 Route des Acacias, Geneva. Price: 741B, \$1875.

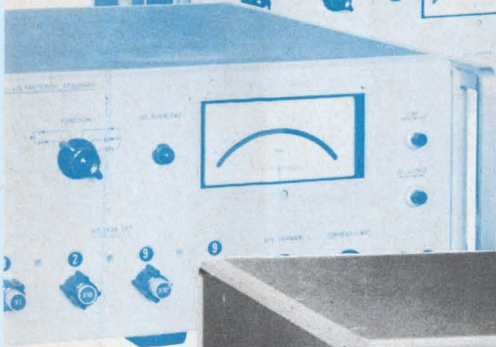
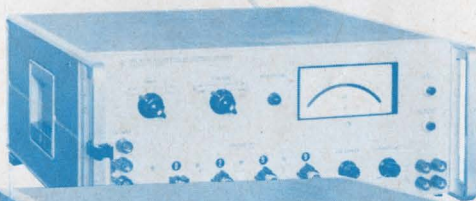
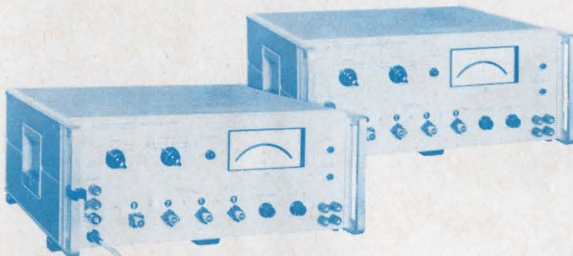

HEWLETT  PACKARD

WORKING STANDARDS

098/19

Circle 1 on reader service card

ONE WILL GET YOU TEN...

10 Hz OR 10 MHz

One hp test oscillator—the hp 652A—will get you 10 Hz or 10 MHz—or anywhere between—with an expandable output monitor for amplitude control to 0.25% across the band.

Use the solid-state capacitance-tuned model 652A for test quality signals in your laboratory production area or systems checkout. Set and monitor output with ease. Readings on the uppermost scale of the X20 expanded scale monitor are in percent for quick reading of frequency response measurements.

With the 652A you get attenuator accuracy of

± 0.075 dB, amplitude stability of $\pm 2\%$ per month. Two output impedances are available from the front panel providing 200 mW into 50Ω or 16 mW into 600Ω .

Another test oscillator, the hp 651B, has all the performance features of the 652A except the expandable output monitor. Get full specifications on these two broad-range oscillators from your nearest hp field engineer. Or, write to Hewlett-Packard, Palo Alto, California 94304. Europe: 54 Route des Acacias, Geneva. Price: hp 652A, \$725; hp 651B, \$590.

098/B

HEWLETT  PACKARD
SIGNAL SOURCES

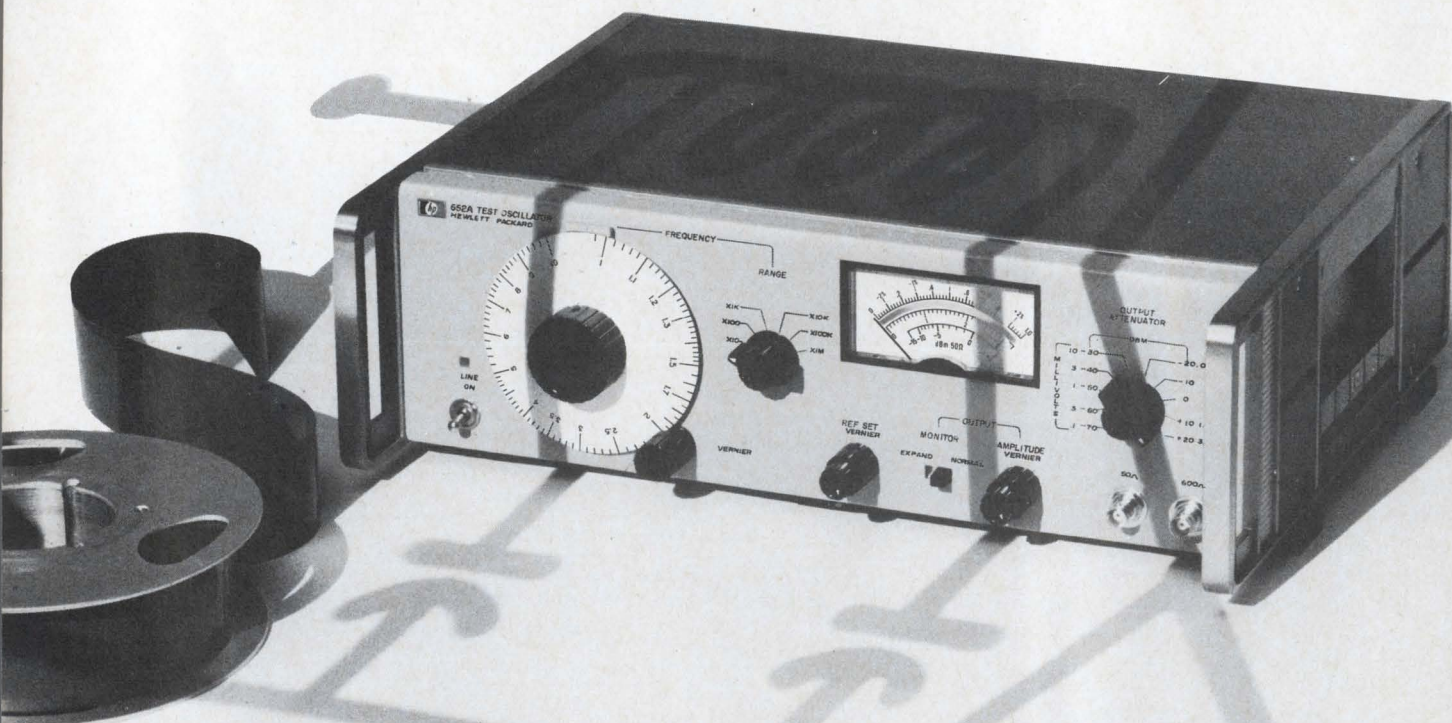

News Features

Probing the News

- 111 **Avionics:** Air traffic control: the waiting game
117 **Electronics abroad:** India bids for self-sufficiency

Electronics Review

- 39 **Advanced technology:** Gunn diodes in series
40 **Companies:** Fairchild, Act Two
41 **Instrumentation:** Tuning a laser over 50 gigahertz
42 **Oceanology:** Underwater guide
42 **Integrated electronics:** More gates per circuit
44 **Space electronics:** Aeronautical services satellite
46 **Medical electronics:** Monitoring the heart
46 **For the record**

Electronics Abroad

- 169 **Japan:** Ultrasonic tv; real-time X-ray crystallography; photoelectric phonograph cartridge
170 **Great Britain:** Thin-silicon holds high promise; Gunn diodes generate pcm pulses
172 **West Germany:** Short-haul jet a new market for avionics companies
173 **The Netherlands:** Monolithic circuit computes exposure time for automatic cameras
173 **Around the world**

New Products

- 125 **Police fight eavesdropping**
133 **Components review**
133 Frequency switch averages input
136 Cell sees ultraviolet radiation
141 **Instruments review**
141 Counter + extender = synthesizer
142 Meter teamed with solid state relay
145 **Subassemblies review**
145 Logic trainer's circuits plug in
149 **Microwave review**
149 Paramp built with planar diode
153 **Semiconductor review**
153 IC regulates negative voltage

Technical Articles

- Applied design** 62 **Charts simplify prediction of noise from periodic pulses**
Families of broadband spectra for six common pulse shapes make it easy to determine high-frequency interference
Robert B. Cowdell
Genisco Technology Corp.
- Circuit design** 70 **Designer's casebook**
▪ Inexpensive comparator reacts in 100 nanoseconds
▪ One capacitor makes IC a pulse-width modulator
▪ Bridge and amplifier monitor d-c level
▪ Feedback keeps motor torque constant
- Displays** 74 **Solid state module makes for light reading**
Bright, distinct numerals are displayed by a small, inexpensive unit that uses a large-scale integrated circuit to decode binary commands and drive a matrix of gallium-arsenide-phosphide light-emitting diodes
Members of the technical staff, Solid-State Laboratory, Hewlett-Packard Co.
- Design theory** 82 **Active filters: part 3 Negative-impedance converters**
These two-port devices are being used to produce transfer functions without inductors, and with greater simplicity than is possible with other active-filter elements
Louis de Pian and Arnold Meltzer
George Washington University
- Avionics** 94 **Potential of phased-array radar spurs increasing R&D activity**
More experimental models are due soon, but operational versions of these multifunction systems are still several years away
Alfred Rosenblatt
Avionics and space editor

Departments

- | | | | |
|----|--------------------------|-----|------------------------|
| 4 | Readers Comment | 40 | Index of Activity |
| 8 | Who's who in this issue | 53 | Washington Newsletter |
| 14 | Who's who in electronics | 156 | New Books |
| 22 | Meetings | 159 | Technical Abstracts |
| 31 | Editorial Comment | 161 | New Literature |
| 39 | Electronics Newsletter | 167 | Newsletter from Abroad |

Electronics

Editor-in-Chief: Donald Christiansen

Associate managing editors

Technical: Stephen E. Scrupski
News: Robert Henkel
Copy: Sally Powell

Senior associate editors

Joseph Mittleman, Harry R. Karp

Department editors

Avionics & Space: Alfred Rosenblatt
Computers: Wallace B. Riley
Communications: William Bucci
Components: George Watson
Consumer electronics: John D. Drummond
Design theory: Joseph Mittleman
Industrial electronics: Harry R. Karp
Military electronics: Richard Gundlach

Domestic bureaus

Boston: James Brinton, manager
Chicago: Frederick Corey, manager
Los Angeles: Lawrence Curran, manager; Burton Bell
New York: Howard Wolff, manager
San Francisco: Walter Barney, manager; Peter Vogel
Washington: Robert Skole, manager; Paul Dickson, William F. Arnold

Foreign bureaus

Bonn: John Gosch
London: Michael Payne
Tokyo: Charles Cohen

Copy editors

James Chang, Larry Miller

Graphic design

Art director: Gerald Ferguson
Assistant art directors: Valerie Betz, Susan Hurlburt
Production editor: Arthur C. Miller

Editorial research:

Kay Fontana
Editorial secretaries: Lorraine Longo, Claire Goodlin, Patricia Gardner, Barbara Razulis, Stina Colombo

McGraw-Hill News Service

Director: Arthur L. Moore; **Atlanta:** Fran Ridgway; **Chicago:** Robert E. Lee
Cleveland: Arthur Zimmerman; **Dallas:** Marvin Reid
Detroit: James Wargo; **Los Angeles:** Michael Murphy
Pittsburgh: Louis Gomolak
San Francisco: Margaret Drossel
Seattle: Ray Bloomberg; **Washington:** Charles Gardner, Daniel B. Moskowitz, Herbert W. Cheshire, Seth Payne, Warren Burkett, William Small, William D. Hickman

McGraw-Hill World News Service

Bonn: Robert Dorang; **Brussels:** James Smith; **Hong Kong:** Wes Perry;
London: John Shinn; **Mexico City:** Gerald Parkinson; **Milan:** Ronald Taggiasco, Jack Star;
Moscow: Jack Winkler; **Paris:** Robert E. Farrell, Stewart Toy
Rio de Janeiro: Leslie Warren; **Tokyo:** Marvin Petal

Reprints: Susan Nugent

Circulation: Isaaca Siegel

Publisher: Gordon Jones

Electronics: September 2, 1968, Vol. 41, No. 18

Published every other Monday by McGraw-Hill, Inc. Founder: James H. McGraw 1860-1948.

Publication office 99 North Broadway, Albany, N.Y. 12202; second class postage paid at Albany, N.Y.

Executive, editorial, circulation and advertising addresses: McGraw-Hill Building, 330 W. 42nd Street New York, N.Y. 10036. Telephone (212) 971-3333. Teletype TWX N.Y. 710-581-4235. Cable address: MCGRAWHILL N.Y.

Subscriptions solicited only from those professionally engaged in electronics technology. Subscription rates: qualified subscribers in the United States and possessions and Canada, \$8.00 one year, \$12.00 two years, \$16.00 three years; all other countries \$25.00 one year. Non-qualified subscribers in the U.S. and possessions and Canada, \$25.00 one year; all other countries \$50.00. Air freight service to Japan \$50.00 one year. Single copies: United States and possessions and Canada, \$1.00; all other countries, \$1.75.

Officers of McGraw-Hill Publications: Joseph H. Allen, President; J. Elton Tuohig, Executive Vice President; David J. McGrath, Senior Vice President-Operations; Vice Presidents: John R. Callahan, Editorial; Paul F. Cowie, Circulation; John R. Emery, Administration; John M. Holden, Marketing; David G. Jensen, Manufacturing; Jerome D. Luntz, Planning & Development; Robert M. Wilhelm, Controller.

Officers of the Corporation: Shelton Fisher, President and Chief Executive Officer; John L. McGraw, Chairman; Robert E. Slaughter, Executive Vice President; Daniel F. Crowley, Donald C. McGraw, Jr., Bayard E. Sawyer, Senior Vice Presidents; John J. Cooke, Vice President & Secretary; Gordon W. McKinley, Vice President & Treasurer.

Title © registered in U.S. Patent Office; © Copyright 1968 by McGraw-Hill, Inc. All rights reserved. The contents of this publication may not be reproduced either in whole or in part without the consent of copyright owner.

Subscribers: The publisher, upon written request to our New York office from any subscriber, agrees to refund that part of the subscription price applying to copies not yet mailed. Please send change of address notices or complaints to Fulfillment Manager; subscription orders to Circulation Manager, Electronics at address below. Change of address notices should provide old as well as new address, including postal zip code number. If possible, attach address label from recent issue. Allow one month for change to become effective.

Postmaster: Please send form 3579 to Fulfillment Manager, Electronics, P.O. Box 430, Hightstown, New Jersey 08520

Readers Comment

Voicing the case for ssb

To the Editor:

It is difficult to comprehend why a natural resource like spectrum space is wasted by the proliferation of f-m voice communication. Man, as he harnesses the higher frequencies, finds progressively more inefficient methods of using them.

I don't argue against f-m and other noise-improvement techniques, such as pcm, for data transmission or high-quality broadcast, but they have no place in the transmission of voice information. Voice does not require transmission over a redundant media for the exchange of intelligence. Both a-m and single-sideband techniques provide more reliable communications per watt of power than f-m, which provides a higher signal-to-noise ratio only for an already strong signal that does not require it for syllable intelligibility.

Two arguments are usually presented against ssb for the higher vhf ranges: complexity and the existence of Doppler and path a-m.

The complexity argument is weak. It has been shown that ssb results in smaller and less expensive units than a-m sets of equivalent range. The low power required for vhf and uhf sets using ssb could result in equally small and inexpensive units. Frequency stability required is little better than 10^{-7} , which is within easy reach of elementary crystal oscillators even for the 450-Mhz band.

Doppler shift between two cars going at the legal limit in opposite directions amounts to no more than 100 hertz at the 450-Mhz band. But ssb can tolerate this amount for voice work without affecting intelligibility very much, and fine frequency control (also called "clarifiers" on h-f sets) or a pilot carrier can correct the situation.

Anybody who listens to f-m broadcasts while driving far from the transmitter or in mountainous terrain can testify to the deficiency of f-m under marginal conditions. It is true that near the transmitter, f-m quality is excellent and ssb would always suffer from some small amount of flutter. However,

Obviously from Sprague Electric!

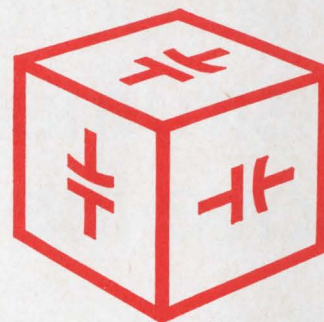

**Higher CV product per cubic inch
than any other solid tantalum capacitor!**



Red Top® Miniature Solid-Electrolyte Tantalex® Capacitors

Red Top® Capacitors are TOPS when your circuit design calls for reliable, low-cost, commercial/industrial solid tantalums for printed wiring boards, packaged circuit modules, and other applications where miniaturization is a must.

Their special construction employs a metal case and plastic resin end seal, providing the price advantages but eliminating the mechanical disadvantages often associated with molded capacitors, such as "off-center" units with consequent "thin" walls, secondary cathode connection prior to molding, and limited humidity resistance.

Red Top® Capacitors are ideally suited for today's circuit design requirements which demand filtering at specific locations. Their small size permits "salting" or "sprinkling" wherever needed.

With capacitance values that range from 68 μF to .016 μF in voltage ratings from 2 to 100 WVDC, Sprague Red Top® Capacitors are available with axial or "single-ended" leads.

For complete technical data, write for Engineering Bulletin 3536A to Technical Literature Service, Sprague Electric Company, 35 Marshall Street, North Adams, Massachusetts 01247.

SPRAGUE COMPONENTS

CAPACITORS
TRANSISTORS
RESISTORS
INTEGRATED CIRCUITS
THIN-FILM MICROCIRCUITS

PULSE TRANSFORMERS
INTERFERENCE FILTERS
PULSE-FORMING NETWORKS
TOROIDAL INDUCTORS
ELECTRIC WAVE FILTERS

CERAMIC-BASE PRINTED NETWORKS
PACKAGED COMPONENT ASSEMBLIES
BOBBIN and TAPE WOUND MAGNETIC CORES
SILICON RECTIFIER GATE CONTROLS
FUNCTIONAL DIGITAL CIRCUITS



Sprague® and '®' are registered trademarks of the Sprague Electric Co.

We build 847 instruments to be sure we have the exact 1 you need.

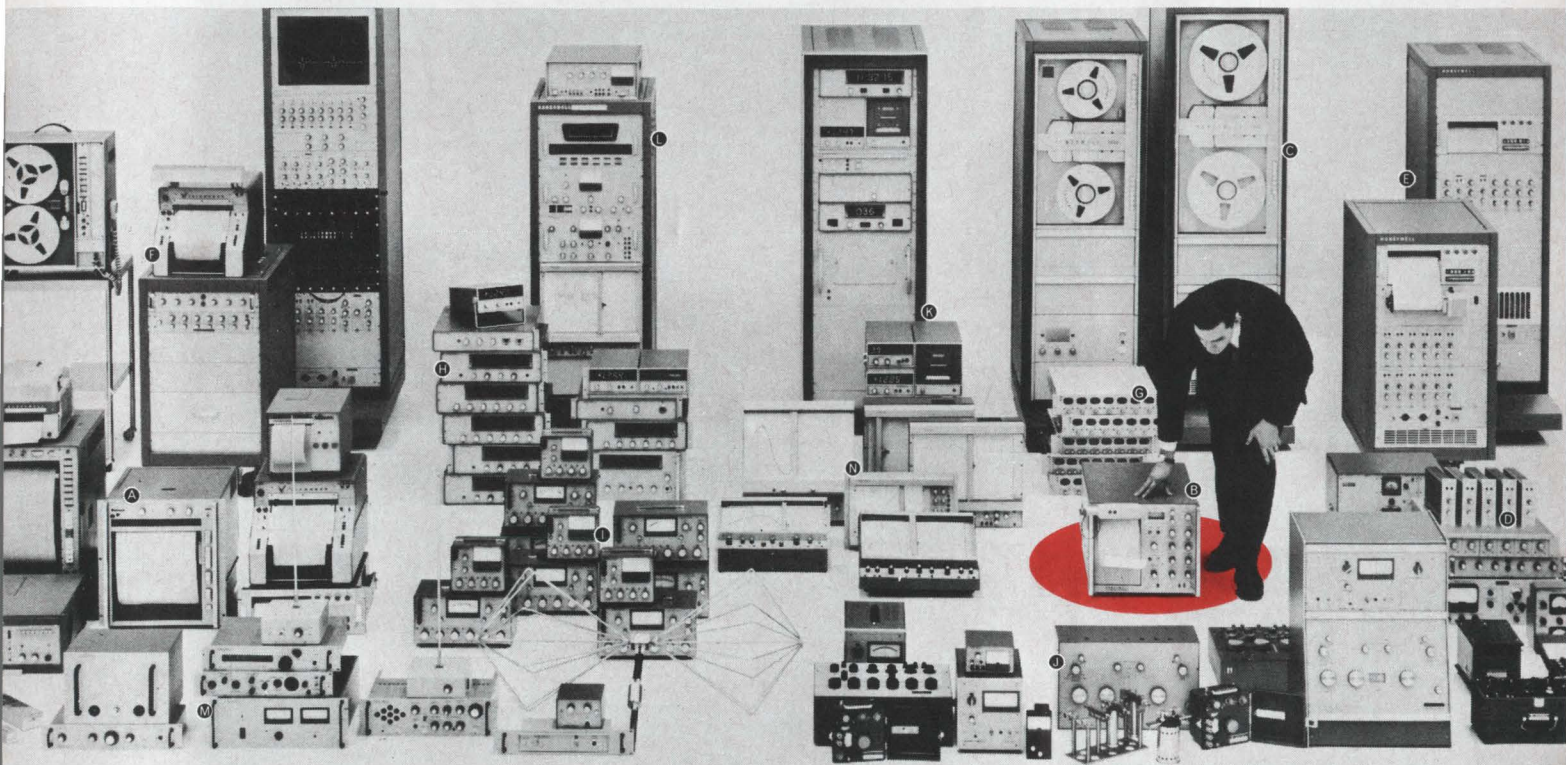

Here's just part of the full Honeywell line, which includes: **A** 117 Visicorder direct-recording oscillographs in 6", 8", and 12" models; **B** 2 Model 1806 fiber-optics CRT Visicorder oscillographs; **C** 26 magnetic tape systems, including the 7600 Series in 10½" and 15" reel versions; **D** 84 amplifiers and other signal-conditioning units; **E** 78 analog recording systems; **F** 46 electronic medical systems; **G** 14 oscilloscopes; **H** 37 digital multimeters; **I** 29 differential voltmeters; **J** 179 precision laboratory standards and test instruments; **K** 128 data loggers; **L** 9 analysis systems; **M** 61 EMI products; **N** 37 X-Y graphic recorders.

Your Honeywell sales engineer can zero in on the *precise* solution to your instrumentation problems. Quickly and efficiently. You won't have to settle for "almost" what you need because the Honeywell sales engineer isn't handicapped by a limited line. He can choose from 847 basic instruments whose combinations and permutations approach the infinite.

The solution might be a Visicorder recording oscillograph. Or one of our modular magnetic tape systems. Or an X-Y recorder, a digital multimeter, or a portable potentiometer. But whether

it's a single instrument or a complete data system, you can be sure the solution will be the right one, carefully thought out with your future requirements considered as well as your current needs. Local service and nationwide metrology facilities back up your Honeywell instrument or system. And, we can even provide factory training courses for *your* operating personnel. For the full story on how Honeywell can help you, call your local sales engineer or write: Honeywell, Test Instruments Division, Denver, Colorado 80217. **Honeywell**

Honeywell engineers sell solutions

Readers Comment

when it comes to transmitting intelligence by means of voice, flutter is preferable to the typical dropouts and locks on other stations so typical of f-m. Ssb offers approximately 10 times more channels per megacycle than f-m. It gives a minimum of interference because of the intermittent nature of the mode. At least 200,000 radio amateurs operating ssb in no more than 2 Mhz of spectrum space on the h-f bands can testify to the very high load factor possible with ssb.

In view of the limited amount of spectrum space available, I'd urge that both a-m and f-m be phased out for all person-to-person voice transmission. The technology to do this is here.

Peter Laakmann

Hughes Aircraft Co.
Culver City
Calif.

That's the law

To the editor:

As a patent attorney, I was dismayed to read some of the statements in your article "Focus on CO₂" [Aug. 5, p. 51], which reported the award of the CO₂ laser patent to R.C. Vickery et al. after an interference with C.K.N. Patel. The article said that "many scientists and engineers expressed surprise that Patel lost the bid because he is well known in the field," and that one CO₂ laser scientist called the award a "gross injustice" because "Patel worked for years on

this, and he's probably responsible for bringing the art to its present level."

For your information, in a U.S. patent interference, the patent is awarded to the inventor who was first to "reduce the invention to practice" (i.e., build and test the invention or file a patent application thereon) unless the other inventor conceived the idea first and was diligent in reducing it to practice. In most other countries, the patent is awarded to the first to file a patent application on the invention. No country awards a patent to the one who is best known in the field or who is most responsible for developing the art. It's hard enough in a patent interference to determine the first inventor without making the proceeding a popularity contest.

David R. Pressman

Philadelphia

What's in a name?

To the Editor:

As the manufacturer of the low temperature dry asher pictured in the article "Cool stripper" we would like to protest the omission of our name [July 8, pp. 56-58].

T.J. Gallagher

Tracerlab
Richmond, Calif.

Readers' letters should be addressed:
To the Editor,
Electronics,
330 West 42nd Street, New York,
N.Y. 10036

SUBSCRIPTION SERVICE

Please include an Electronics Magazine address label to insure prompt service whenever you write us about your subscription.

Mail to: Fulfillment Manager
Electronics
P.O. Box 430
Hightstown, N.J. 08520

To subscribe mail this form with your payment and check new subscription renew my present subscription

Subscription rates: qualified subscribers in the U.S.: 1 year \$8; two years, \$12; three years, \$16. Non-qualified: 1 year \$25. Subscription rates for foreign countries available on request.

CHANGE OF ADDRESS

ATTACH LABEL HERE

If you are moving, please let us know five weeks before changing your address. Place magazine address label here, print your new address below.

name _____

address _____

city _____

state _____

zip code _____

IC SEALING PROBLEMS SOLVED

WITH WILLIAMS' IMPROVED ALLOYS FOR MICROELECTRONIC DESIGN.

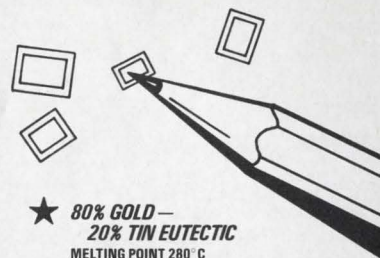

★ 80% GOLD — 20% TIN EUTECTIC
MELTING POINT 280° C

★ 88% GOLD — 12% GERMANIUM EUTECTIC
MELTING POINT 356° C

★ SOLDER PREFORMS FOR SEALING INTEGRATED CIRCUIT PACKAGES

★ TOOLING AVAILABLE ON MOST STANDARD SIZES
4 to 6 Weeks Delivery on New Tooling

PARTIAL LIST OF AVAILABLE ALLOYS & SOLDER PREFORMS

88% Gold 12% Germanium (Eutectic Alloy)
Strip and solder preforms in all sizes

80% Gold 20% Tin (Eutectic Alloy)
Strip, wire and solder preforms in all sizes

Gold with .1 to 1.2% Antimony
Wire, strip and solder preforms all sizes

Gold — .05% Min. Phosphorus
Wire, strip and solder preforms all sizes

95% Gold 5% Nickel
Wire, strip and solder preforms all sizes

Gold and up to .5% Arsenic
Strip and solder preforms all sizes

Silver with .1 to 1.2% Antimony
Wire, strip and solder preforms all sizes

Silver — .1% Min. Phosphorus
Wire, strip and solder preforms all sizes

95% Silver 5% Nickel
Wire, strip and solder preforms all sizes

Silver and up to .5% Arsenic
Strip and solder preforms all sizes

Special alloys produced on request at minimum charge.

Precious Metals in 99.9% Pure, 99.99% Pure, and 99.999% Pure.

Modern, up-to-date refining of precious metals and complete spectrographic facilities available.

HIGH PURITY METALS USED ON ALL ALLOYS

WRITE FOR COMPLETE PRECIOUS METALS CATALOG AND SPECIFICATION SHEETS. PHONE 716-834-7204

OVER 50 YEARS OF PRECIOUS METALS EXPERIENCE

WILLIAMS PRECIOUS METALS



2978 MAIN ST. BUFFALO, NEW YORK 14214
Division of Williams Gold Refining Co., Inc.

Bulova forks solve low frequency problems

Let the experience behind 300,000 forks per year help you!



American Time Products forks are now available up to 25 kc, thanks to years of experience plus new design techniques developed by Bulova. (Including the tiny forks for Accutron® electronic timepieces, Bulova made 300,000 last year alone!)

Result: ATP units provide lower cost, smaller size, lighter weight and greater long term stability in such applications, as Computers, Navigation Systems, Doppler Radar, Motor Drives, Encoders and Timers. Accuracies of up to 0.001% are available.

Bulova fork oscillators offer the added advantage of simplicity of design and circuitry. Fewer components mean greater reliability. Finally, Bulova fork products are uniquely capable of withstanding severe shock and vibration environments.

No wonder Bulova sold 300,000 last year!

FS-11 FORK FREQUENCY STANDARD

Standard Frequencies: Up to 10,000 cps

Accuracy: Up to $\pm 0.001\%$

Input: 28V DC (others on request)

Output: 5 volts p-to-p min. into 10K ohms
Temperature Range: As low as -55°C to as high as $+85^{\circ}\text{C}$

Size: $1\frac{1}{2}$ in. sq. x $\frac{3}{8}$ "



SUB-MINIATURE TF-500 TUNING FORK

Standard Frequencies: Up to 2400 cps

Accuracy: Up to $\pm 0.001\%$ at 25°C

Input: 28V DC (others on request)

Output: Up to 5V rms into 20K ohms

Temperature Range: As low as -55°C to as high as $+85^{\circ}\text{C}$

Size: $\frac{3}{8}$ " x $\frac{3}{4}$ " x $1\frac{1}{2}$ " max.

Write or call for specifications on Bulova's complete line of tuning fork products. Address: Dept. E-16.

BULOVA

AMERICAN TIME PRODUCTS

ELECTRONICS DIVISION OF BULOVA WATCH COMPANY, INC.

61-20 WOODSIDE AVENUE WOODSIDE, N.Y. 11377, (212) DE 5-6000

Who's Who in this issue

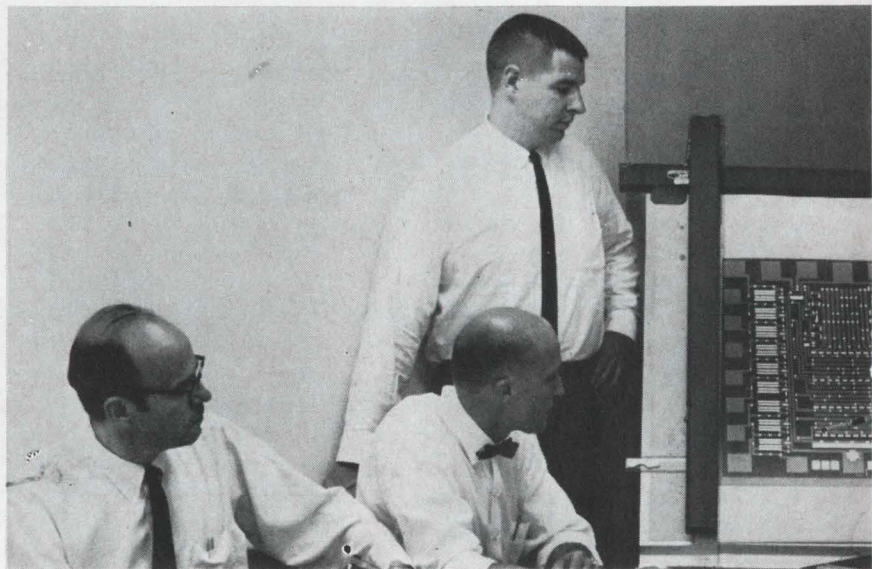

Like the engineering development it describes, the article on the light-emitting diode display, page 74, was a team effort. M.M. Atalla, director of Hewlett-Packard's Solid State Laboratory, guided an array of talent so diverse that, as one member of the team put it, "you wouldn't normally expect us to be able to talk coherently together, much less work all at once on the same device."

Atalla is shown in the photo with some of the contributors. Seated left to right are Robert J. Archer, Paul E. Greene, and John E. Price; standing left to right are Robert A. Burmeister, Atalla, Gerald P. Pighini, and Egon E. Loebner.

Solid state physicists defined the design parameters that would yield useful light emission. Materials scientists and metallurgical engineers devised an efficient method of producing the tricky gallium-arsenide-phosphide alloy. Psychophysics—the science relating physical phenomena to human responses—was a factor in the decision on the tradeoff between light wavelength and efficiency. And specialists in hybrid and monolithic integrated circuits, optics, and even vacuum-tube manufacturing (for the final glass-to-metal hermetic seal) made their contribution.

"The number of those who contributed content, correction, and clarification to the article could hardly be contained on a believable byline," Atalla says. "Even the list on the title page is not complete."

"Failure to comply with performance specs has become all too common," says Robert B. Cowdell, author of the article on pulse analysis [p. 62]. The noise spectrum created by waveforms in a system, he notes, reveals the amount and type of isolation (filtering or shielding) required to guarantee inter- and intra-system compatibility.



Cowdell

Cowdell has designed digital and communications systems as a consultant for Philco, General Dynamics, RCA, Autonetics, Control Data, and Collins Radio. He is now manager of systems engineering for the Genisco Technology Corp.'s consulting and research operation.

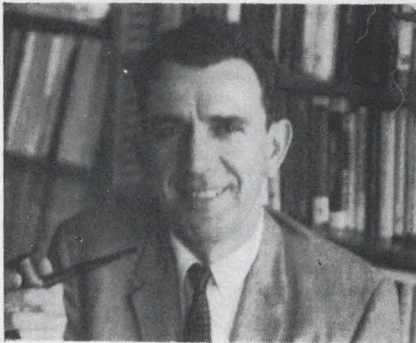

de Pian

Active-filter design isn't new to either Louis de Pian or Arnold Meltzer [p. 82]. De Pian is chairman of the electrical engineering department at George Washington University and published a book, "Linear Active Network Theory."

Meltzer did research on active filters for his doctorate from George Washington, where he is now teaching.

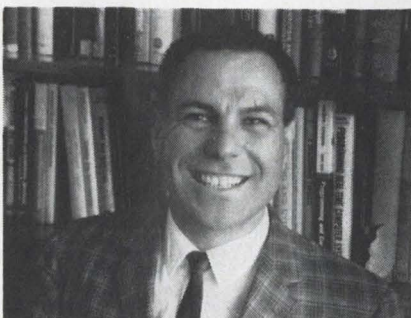

Meltzer

Your custom pulse transformer is a *standard* DST* transformer

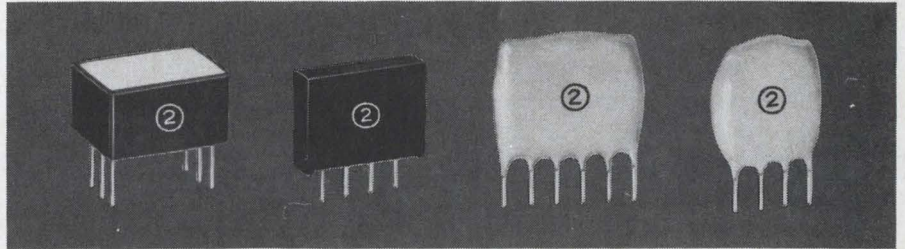

Some of the case styles in which Sprague DST Pulse Transformers are available. Note the in-line leads.

You can select the transformer design you need from the new Sprague DST Family, a fully-characterized series of Designer Specified Transformers which Sprague Electric has pioneered. It's easy. Start with the two basic parameters dictated by your circuit requirements: primary (magnetizing) inductance and volt-second capacity.

New Sprague engineering data gives basic information from which all nominal sine wave parameters are derived. This data allows you to specify the one transformer from thousands of possibilities which will optimize performance in your application.

Design Style A minimizes magnetizing inductance change as a function of temperature. Typically it's $< \pm 10\%$ change from 0 to 60 C; $< \pm 30\%$ from -55 to +85 C.

Design Style B and C give you broad bandpass characteristics, and still keep magnetizing inductance change $< \pm 15\%$ from 0 to 60 C.

Design Style D is *fast*. Associated leakage inductance and coupling capacitance are kept at a minimum. This style is just what you need for interstage and coupling devices in computer drive circuits.

The Sprague DST Series packs a lot of transformer into minimum volume packages — epoxy dipped for minimum cost, or pre-molded. The 100 mil in-line lead spacing is compatible with integrated circuit mounting dimensions on printed wiring boards.

To solve your pulse transformer design, start now. Write for Engineering Bulletin 40,350 to the Technical Literature Service, Sprague Electric Company, 35 Marshall St., North Adams, Mass. 01247.

*Trademark

SPRAGUE COMPONENTS

PULSE TRANSFORMERS
CAPACITORS
TRANSISTORS
RESISTORS
THIN-FILM MICROCIRCUITS
INTEGRATED CIRCUITS







INTERFERENCE FILTERS
PACKAGED COMPONENT ASSEMBLIES
FUNCTIONAL DIGITAL CIRCUITS
MAGNETIC COMPONENTS
CERAMIC-BASE PRINTED NETWORKS
PULSE-FORMING NETWORKS

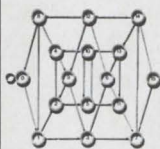
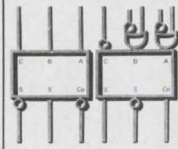
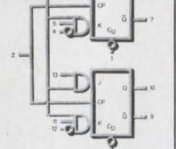
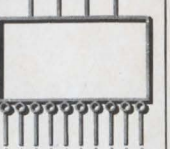
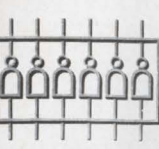
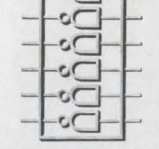
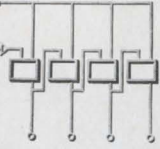
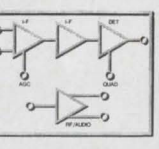

Sprague and '2' are registered trademarks of the Sprague Electric Co.

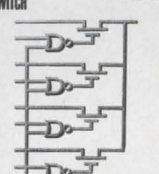
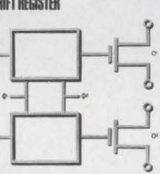
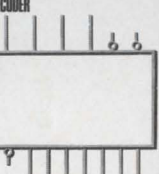
Fairchild has introduced 48 new products in the last 48 weeks.

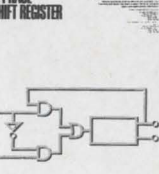
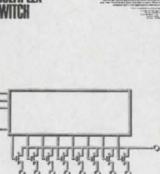
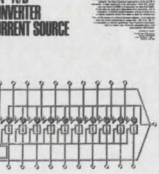
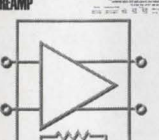
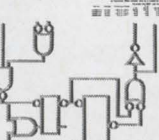
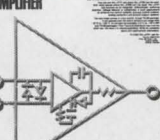
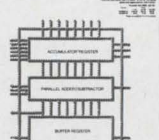
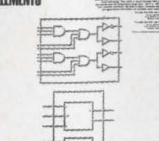
Our goal is fifty-two new integrated circuits in fifty-two weeks. To obtain the Reader Service number for any product announcement ad, simply add 100 to the new product number. For example, New Product No. 3 is Reader Service No. 103.

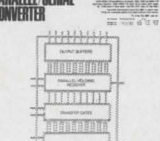
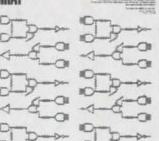
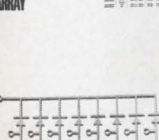
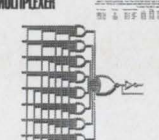
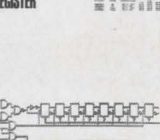
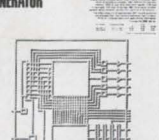
<p>9300 FOUR-BIT UNIVERSAL REGISTER</p> 	<p>9304 DUAL FULL ADDER</p> 	<p>9620 DUAL J-KR FLIP-FLOP</p> 	<p>9301 ONE-OF-TEN DECODER</p> 
<p>9109 HIGH LEVEL HEX CONVERTER</p> 	<p>9112 HIGH LEVEL HEX CONVERTER</p> 	<p>9589 FOUR-BIT BINARY COUNTER</p> 	<p>μA719 HIGH FREQUENCY COMMUNICATIONS SYSTEM</p> 
<p>3102 MOS THREE-INPUT GATE</p> 	<p>3700 FOUR-CHANNEL MULTIPLEX SWITCH</p> 	<p>3303 DUAL 25-BIT DYNAMIC SHIFT REGISTER</p> 	<p>9307 BCD TO SEVEN-SEGMENT DECODER</p> 
<p>4500 BIPOLAR MICROMATRIX ARRAY</p> 	<p>3320 MOS 64-BIT, 4-PHASE SHIFT REGISTER</p> 	<p>3705 8-CHANNEL MOS MULTIPLEX SWITCH</p> 	<p>μA722 PROGRAMMABLE D/A-A/D CONVERTER CURRENT SOURCE</p> 
<p>μA727 TEMPERATURE-CONTROLLED DIFFERENTIAL PREAMP</p> 	<p>9601 RETRIGGERABLE MONOSTABLE MULTIVIBRATOR</p> 	<p>μA781 FREQUENCY COMPENSATED OPERATIONAL AMPLIFIER</p> 	<p>3800 EIGHT-BIT MOS LSI PARALLEL ACCUMULATOR</p> 
<p>3100/3101 MOS FUNDAMENTAL ELEMENTS</p> 	<p>μA737 COLOR TV CHROMA DEMODULATOR</p> 	<p>3801 MOS 10-BIT SERIAL-PARALLEL PARALLEL-SERIAL CONVERTER</p> 	<p>4600 7x7 MICROMATRIX ARRAY</p> 
<p>F5A 2500 MONOLITHIC CORE DRIVER ARRAY</p> 	<p>9312 MOS 8-BIT DIGITAL MULTIPLEXER</p> 	<p>9320 MOS DUAL 8-BIT SHIFT REGISTER</p> 	<p>3750 MOS NUMERIC CHARACTER GENERATOR</p> 
<p>September 9, 1968</p>	<p>September 16, 1968</p>	<p>September 23, 1968</p>	<p>September 30, 1968</p>

More about:

Starting October 6, 1981, Fairchild Corporation
will be publishing a new series of
Applications Notes.

43.

**μA723
PRECISION
VOLTAGE
REGULATOR**

The μA723 is a versatile, second-generation linear integrated circuit. It can be used as a series regulator, switching regulator, shunt regulator, floating high-voltage regulator, or a regulated current source. It can be used for both positive and negative supplies. It can be used with an external PNP or NPN pass element when higher output currents are required. And, it provides output current up to 150mA without external pass transistors.

This low-cost linear features excellent line and load regulation of 0.01% of V_{out} ; remote shutdown capability; adjustable current limit with or without foldback; standby current drain of only 2mA; output voltage from 2 to 37V; and a temperature coefficient of .002%/°C. The following applications exhibit the excellent performance and broad versatility of the μA723:

Positive Switching Regulator
Negative Switching Regulator
Shunt Regulator
High-Voltage Regulator
Regulated Current Source

To order the μA723, see the
 Fairchild Semiconductor Catalog, 1981 Edition, page 100.

Low-cost switching voltage regulators

The μA723 is a highly versatile, Second-Generation Linear Integrated Circuit. It can be used as a series regulator, switching regulator, shunt regulator, floating high-voltage regulator, or a regulated current source. It can be used for both positive and negative supplies. It can be used with an external PNP or NPN pass element when higher output currents are required. And, it provides output current up to 150mA without external pass transistors.

This low-cost linear features excellent line and load regulation of 0.01% of V_{out} ; remote shutdown capability; adjustable current limit with or without foldback; standby current drain of only 2mA; output voltage from 2 to 37V; and a temperature coefficient of .002%/°C. The following applications exhibit the excellent performance and broad versatility of the μA723:

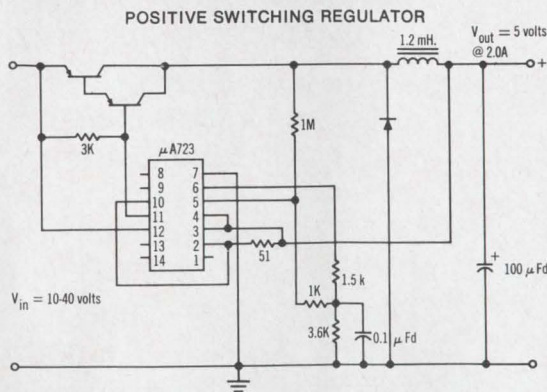

Efficiency: 86%
 Output Current: 1 Amp
 Regulation: 0.05%

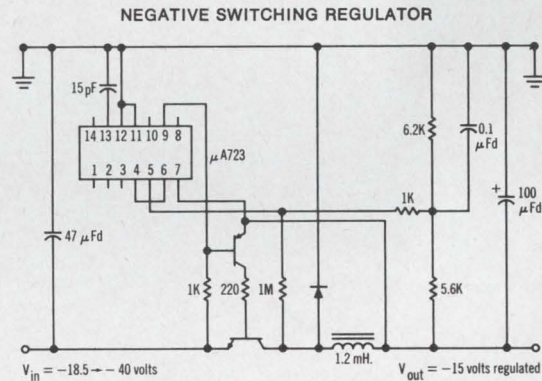

Efficiency: 86%
 Output Current: 1 Amp
 Regulation: 0.05%

If you'd like more applications data,
 use the coupon below.

Please send me the μA723 Applications Notes.

Name _____

Company _____

Mailing Address _____

FAIRCHILD
 SEMICONDUCTOR

Fairchild Semiconductor A Division
 of Fairchild Camera and Instrument
 Corporation 313 Fairchild Drive,
 Mountain View, California 94040
 (415) 962-5011 TWX: 910-379-6435

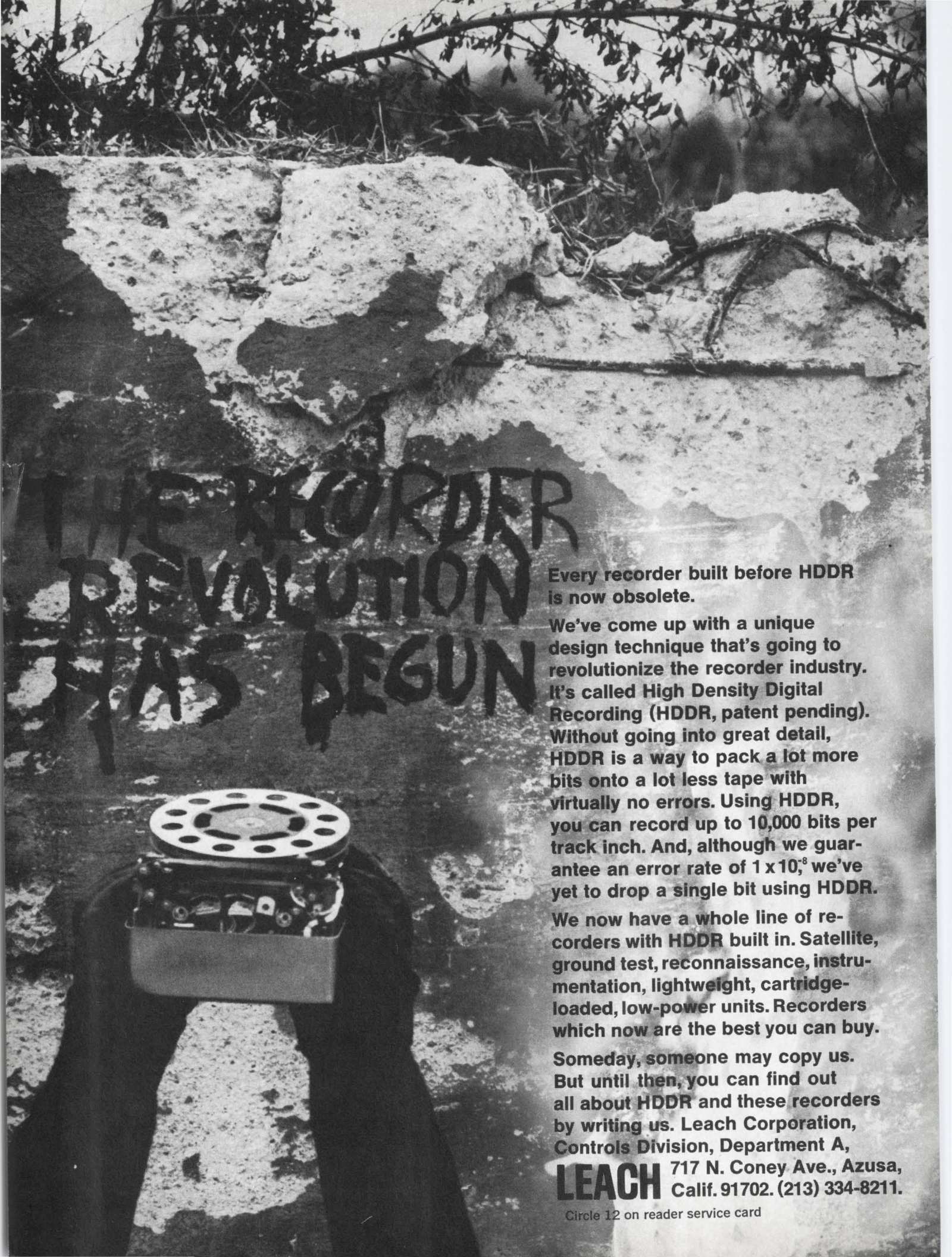

THE RECORDER REVOLUTION HAS BEGUN

Every recorder built before HDDR is now obsolete.

We've come up with a unique design technique that's going to revolutionize the recorder industry. It's called High Density Digital Recording (HDDR, patent pending). Without going into great detail, HDDR is a way to pack a lot more bits onto a lot less tape with virtually no errors. Using HDDR, you can record up to 10,000 bits per track inch. And, although we guarantee an error rate of 1×10^{-8} , we've yet to drop a single bit using HDDR.

We now have a whole line of recorders with HDDR built in. Satellite, ground test, reconnaissance, instrumentation, lightweight, cartridge-loaded, low-power units. Recorders which now are the best you can buy.

Someday, someone may copy us. But until then, you can find out all about HDDR and these recorders by writing us. Leach Corporation, Controls Division, Department A,

LEACH 717 N. Coney Ave., Azusa,
Calif. 91702. (213) 334-8211.

Circle 12 on reader service card



IN JUST

3

DAYS

ACOPIAN WILL SHIP ANY OF 62,000 DIFFERENT POWER SUPPLIES

This catalog lists 62,000 models of AC to DC plug-in power supplies available for shipment in just three days. Choose the exact outputs you need. Singles or duals, regulated or unregulated. Write or phone for your free copy.

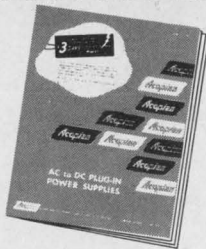

Name _____
Title _____
Company _____
City _____
State _____ Zip _____



Acopian Corp., Easton, Penna. 18042
Phone: (215) 258-5441

Who's who in electronics

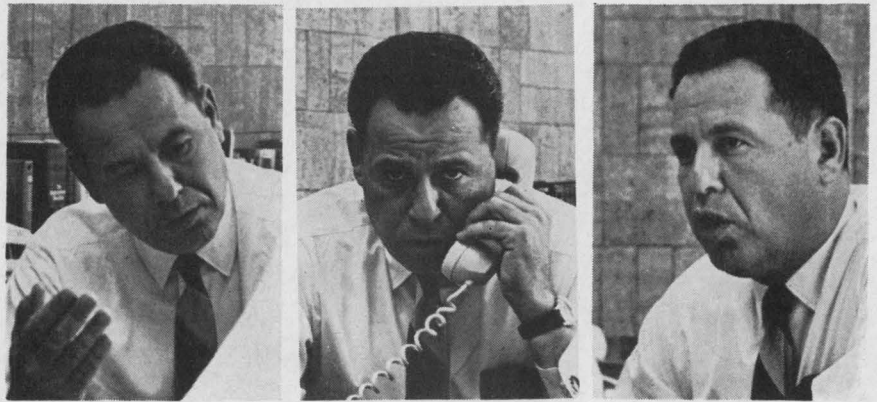

Stephen Levy of Motorola: "I don't think our ability to compete has been harmed because some of the talent left. . . . We are stronger than we were before. . . . If we're not No. 1 this year, we'll be so close it will be insignificant"

How well the Semiconductor Products division of Motorola Inc. can survive the greatest raid in electronics corporate history will depend on the men who replaced C. Lester Hogan and the group that accompanied him to Fairchild Semiconductor [see story on p 40]. Each man was replaced by the assistant he had selected as backup man for emergencies. "And in at least one respect," said Stephen L. Levy, 47, Hogan's successor as general manager, "we are stronger than we were before: we have John Welty back."

Welty, 46, had already been scheduled to return to Motorola from the Philco-Ford Corp., whose Microelectronics division he had headed for seven months. Levy says Welty's presence in Phoenix gave him much more flexibility in reorganizing than he might otherwise have had.

Move up. Levy's other chief lieutenant will be John C. Haenichen, who moved up from group operations manager to become director of operations, with essentially the same responsibilities as those borne by Leo Dwork before Dwork departed for Mountain View, Calif.

Welty wasn't replaced when he left Motorola; his duties were divided among Dwork, Levy, and George Scalise when Scalise was manager of support operations. As a corporate vice president, Welty now has most of his old responsibilities back, with some of Dwork's.

Specifically, he will be in charge of product reliability and quality assurance, equipment and plant operations, materials, facilities, and administrative areas.

Haenichen, 33, cedes some administrative functions to Welty, but retains Dwork's responsibilities for thyristor, zener, varactor, trigger, and optoelectronic product groups and for central research and development. He had all of those groups, except R&D, when he reported to Dwork.

Motorola has two other manufacturing segments besides Haenichen's. Patrick D. Lynch, 35, has taken over the discrete silicon product group previously headed by Wilfred Corrigan, and Robert H. Lyon, 34, has been named director of integrated-circuits operations, replacing Eugene Blanchette. Lynch moves up from the direction of Motorola's very productive plastic transistor operations. Lyon was previously operations manager for current-mode products and linear circuits.

Levy also named Richard P. Abraham, 38, to be director of advanced IC programs, in which capacity he will keep responsibility for Motorola's Sentinel program; Joseph Flood, 42, to be director of reliability and quality assurance, a job he previously handled for IC's only; and Harry J. Geyer, 39, to be manager of equipment and plant operations. Geyer had been manager of mechanical equipment engineering and maintenance for



The ML-EE64Y is the smallest 10 kv (peak) switch tube—and the smallest 10 kv (peak) regulator tube you can buy. ML-EE64Y gives you up to 36 free cubic inches per tube, and doesn't require a socket. It offers you a 12 amp peak current, high signal sensitivity, and a simple BeO heat sink with no other cooling required. The ML-EE64Y provides tabs for simple, low-cost connection. For complete data, write to Machlett—the tube specialist most responsive to customer needs—today. The Machlett Laboratories, Inc., 1063 Hope Street, Stamford, Connecticut 06907.

Why use this tube...for high voltage switching or voltage regulation...when this one is better?

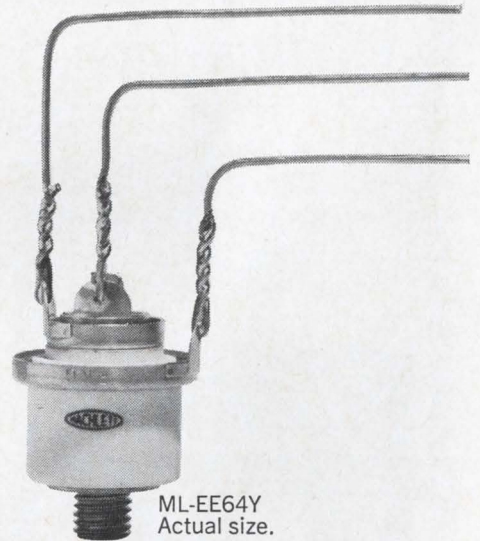
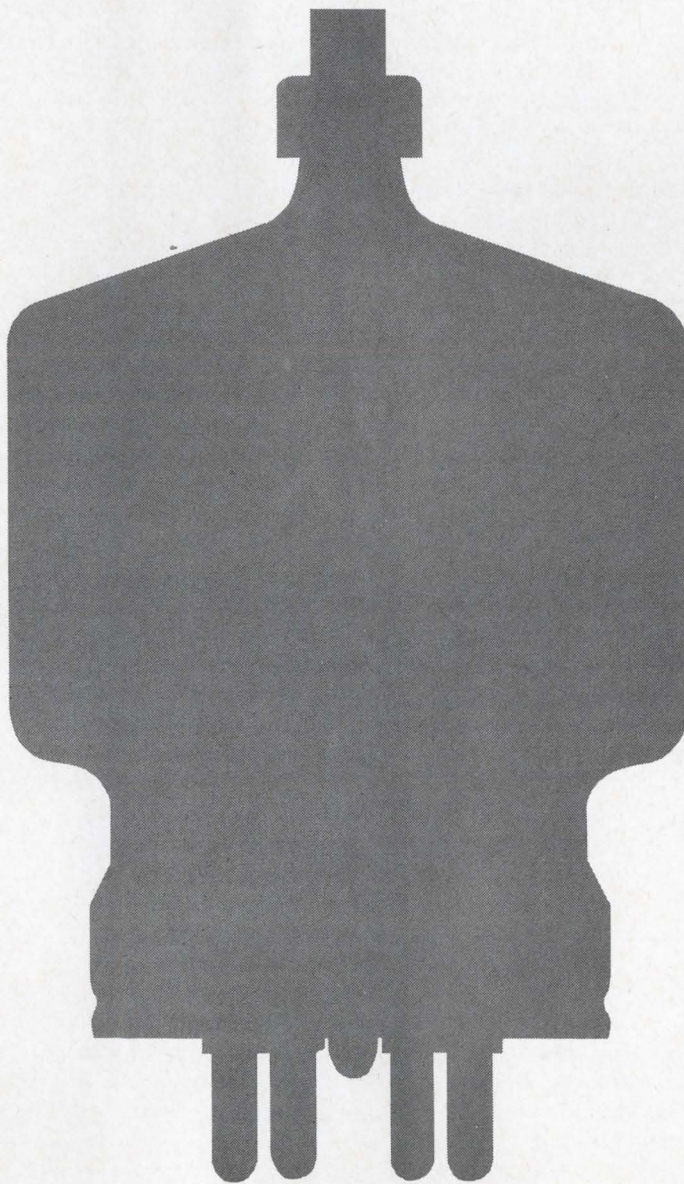

ML-EE64Y
Actual size.

RAYTHEON

THE MACHLETT LABORATORIES, INC.

A SUBSIDIARY OF RAYTHEON COMPANY

NEW SOLID STATE POWER PACKS

for
regulated
low voltage
applications
from

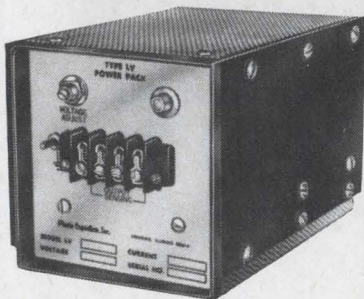

Plastic Capacitor's new LV Series Power Packs, ranging from 12 to 100 volts DC, offer an improved solution to today's system requirements. Models available with DC output voltages of 12, 24, 28, 36, 48, and 100 volts with power ratings of approximately 25, 50, 100 & 150 watts.

FEATURES INCLUDE:

- 0.01% LINE REGULATION
- 0.05% LOAD REGULATION
- 3MV PEAK TO PEAK RIPPLE AND NOISE
- NEGATIVE 0.015%/°C TEMPERATURE COEFFICIENT
- LESS THAN 0.2 OHMS OUTPUT IMPEDANCE
- TEMPERATURE OPERATING RANGE OF 0°C TO 55°C

For positive proof that good things come in small packages . . . check your power pack needs with Plastic Capacitors. Write for full engineering data today.

Plastic Capacitors

INC.

2620 N. Clybourn Chicago, Ill. 60614

Who's who in electronics

integrated circuits.

First big loss. "You can see that these people had the same responsibilities, but over a narrower base, before the defections," says Levy. "I don't think our ability to compete has been harmed because some of our top people left. This is the first time that we lost any significant group of people, and consequently we have a great depth of management talent in the company."

Levy's own promotion, from assistant general manager to general manager, was probably merely moved ahead by Hogan's departure. Since Levy joined the division four years ago as product marketing manager for IC's, his rise at Motorola has been swift and seemingly inexorable. His appointment as assistant general manager in April made the outside world sure that when Hogan became president of Motorola, Levy would take over the Semiconductor Products division.

Levy is credited with carrying out Hogan's plans for expansion in the IC market so well that the company threatened to pass Fairchild this year. Hogan's departure may delay that event, but Levy says that Fairchild's own predictions indicate that "if we're not No. 1 this year, we'll be so close that it will be insignificant."

Company strategy to capture that top spot is unchanged; Levy isn't impressed with talk of medium- and large-scale integration today. "Some day you will sell a system on a chip," he says, "but there are a lot of problems to solve between now and then. If you can't show an economic advantage, LSI is a myth. The question is, when is it real, and at what level. I think some manufacturers have tried to put over a compressed timetable."

Change of plans. Levy's reliance on Welty during the stress period must have made the latter's return to Phoenix a pleasant one after a sojourn at Philco that can only have been disappointing. A corporate decision to cut losses in Philco's Microelectronics division made Welty's plans for it seems ir-

relevant to some. Yet he left the corporation on good terms and showed no signs of bitterness. Seemingly unflappable, he picked up at Motorola almost where he left off, and was in close consultation with Levy on the new executive lineup.

Welty made no effort to minimize the effect of the Fairchild raid, but at the same time he left no doubt that Motorola expected to survive. "The question is academic: of course we've been hurt," he said. "But there's a hell of a lot of self-confidence here; that's Hogan's heritage. He convinced the organization that it could do things that it didn't believe it could. Now Hogan is gone, but the organization is here."

Where it's at. Haenichen, an engineer turned into a manager, partly by Motorola's policy of paying more for administrative talent, is perhaps best known outside Motorola for his work in developing annular structures to prevent channeling in high-voltage, high-power pnp transistors. But he says that a young engineer at Motorola soon discovers that production is where the action is; Haenichen himself displays no nostalgia for the laboratory.

It is in his areas that Fairchild is weakest, and Haenichen expects to maintain Motorola's advantage. "They just don't have a broad line," Haenichen notes. "In discrete, we only see them in silicon transistors. But it took us a long time to build our product line; in nine years we've just encircled them in silicon controlled rectifiers, thyristors, germanium devices, power, and so forth. Right now they're not fighting me anywhere."

Lynch echoes Haenichen's belief in the effect of Motorola's long head start in some areas. "We're so far ahead now that he can't catch up," Lynch says of his old boss, Corrigan. Lynch even asserts that where the old management team built Motorola into some leadership positions, the new one may be better suited to keep it there. "All you can say right now," he says, "is that it's different."

Charlie Straightarrow was dazzled digitally. Don't let it happen to you!

Charlie Straightarrow is a good engineer. He's been at it for about ten years now. Like a lot of us, Charlie's bought his share of scopes, counters, voltmeters and other assorted test and measurement equipment during that time.

And also like a lot of us, Charlie has been impressed with the digital instrumentation he's seen on the market lately. (So are we, especially since we make the only true RMS digital voltmeters. But back to our story.) In fact, for awhile this winter Charlie was dazzled digitally. Everything he bought had to be digital. Recently, Charlie was looking for a digital scope when, quite by accident, he stumbled across our little pamphlet, **Differential or digital, the unvarnished truth about precision voltmeters.**

Charlie got perspective after that. Charlie found out that the most accurate digital voltmeter on the market today costs upwards of \$4,000. He also found several Fluke differential voltmeters with twice the accuracy of the best digital and ten times the resolution for far less money. Lowest price units are less than \$1,000. Highest, only \$1,535 and that includes AC capability as well. Or, put another way. Is analog dead?

So as Charlie reasonably decided, the problem of choosing a voltmeter comes down to application. A Fluke differential such as our 895A should be your choice in laboratory applications where the ultimate in precision

measurement without ambiguity is required. Accuracy of the Model 895A is 25 parts per million. The best digital is always limited by its parts per million accuracy and plus or minus 1 digit. Resolution of the Model 895A is 1 ppm compared to 10 ppm for the best digital.

It's in systems applications that the digital voltmeter offers the most promise. If your problem involves making a great number of measurements using relatively untrained personnel and if accuracy demands are modest, then the digital voltmeter is usually the best answer. But if you need accuracies better than even 100 ppm, then the dollar-performance bias is in favor of the differential voltmeter.

If you would like to stop "digital dazzle" too, write for the same pamphlet Charlie read. We'll even send one to digital design engineers. Please address Frank Peep for your free copy.

(P. S. our readout is digital, too!)

The Fluke Model 895A solid state differential voltmeter is

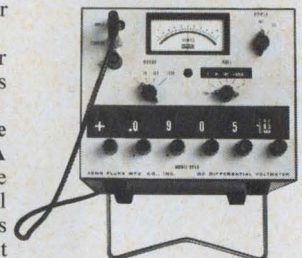

but one of more than 150 precision voltmeters, calibrators, power supplies, and frequency and time instruments. Components for Fluke instruments are tested and checked out in one of the best standards labs anywhere (the only lab more complete is operated by the NBS). Fluke instruments are guaranteed to work in your environment. Or put another way, if the Fluke instrument doesn't work there, you can't live there.

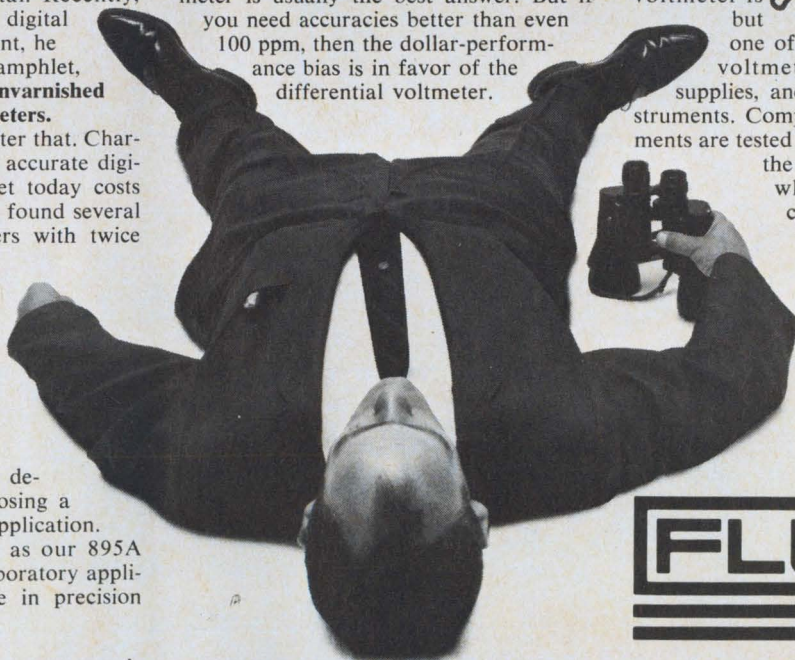

FLUKE

Fluke, Box 7428, Seattle, Washington 98133. Phone: (206) 774-2211. TWX: (910) 449-2850. In Europe, address Fluke International Corporation, P.O. Box 5053 Ledeborstraat 27, Tilburg, Holland. Telex: 844-50237 In U.K., address Fluke International Corporation, P.O. Box 102, Watford Herts, England.

See the latest in precision instruments from Fluke at the Instrument Fair, Washington, D.C. Sept. 25 & 26, 1968.

**Reliability is six things we do
that nobody else does.**

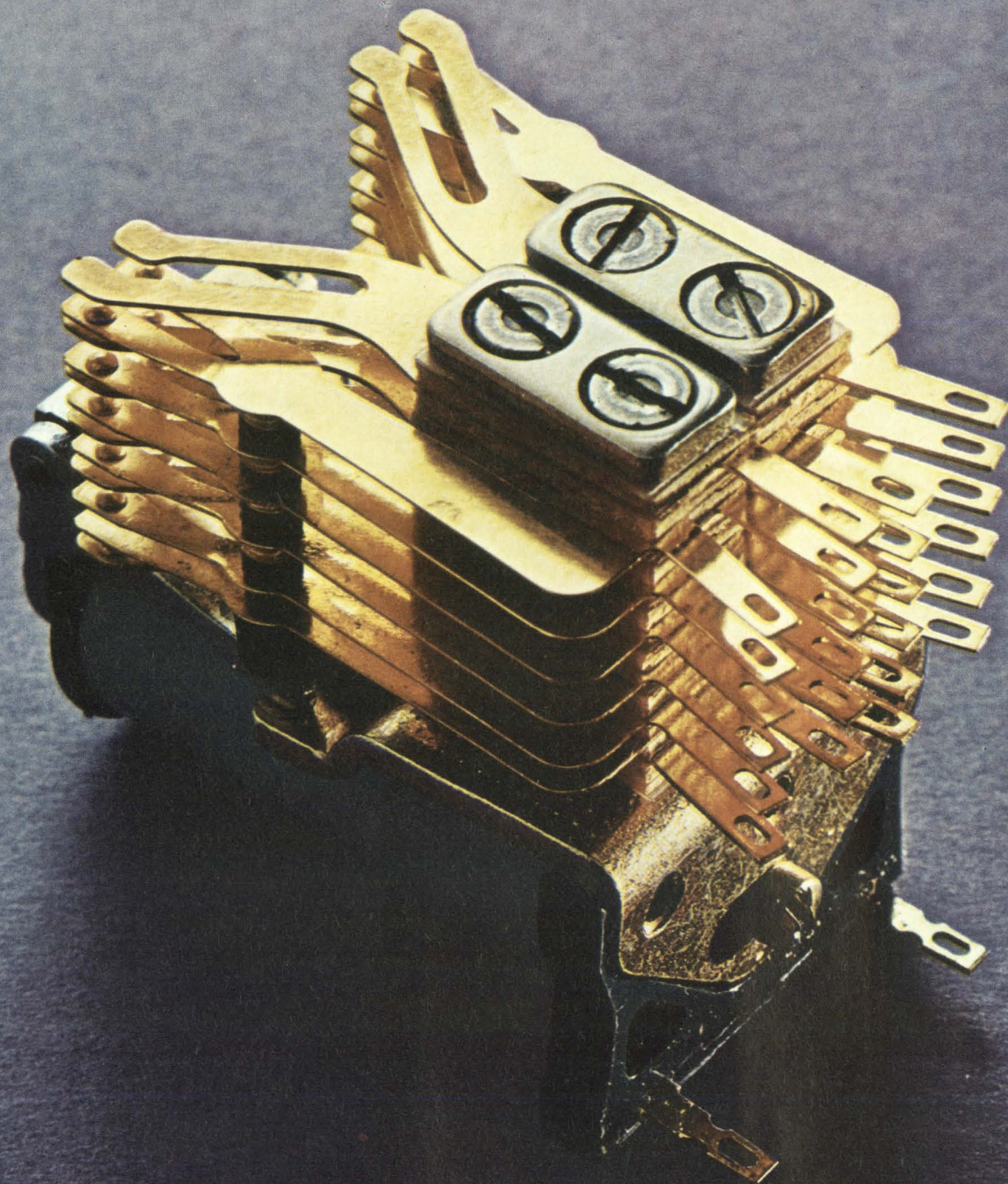

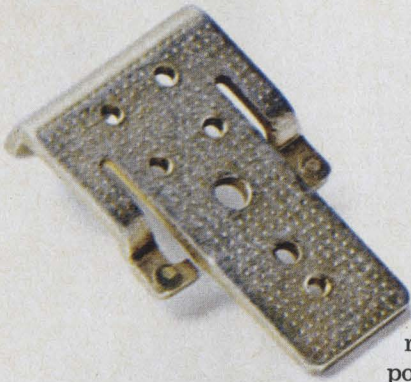

We're fanatics.

We build our relays stronger than we have to. That way, they last lots longer than they ever have to. Our Class E relay (shown on the opposite page) is a good example of our way of thinking.

The industry's strongest heelpiece.

We make the strongest heelpiece in the industry. A gigantic machine bangs them out extra fat and extra flat.

Extra fat to carry a maximum of flux. To handle big loads. Extra flat so that once an AE relay is adjusted, it stays adjusted.

Since our backstop is part of the heelpiece, it's just as thick and flat. But, tough as it is, the slightest wear here would throw the entire contact assembly out of whack. So, to be safe, we weld two tiny, non-magnetic pads where the armature arms meet the backstop. You might say we created the no-stop backstop.

Three parts that'll wear like crazy.

When you build a relay like a small tank, you have to think of everything. We try. Right down to the tiniest part. For example, we make our armature arms and bearing yoke extra thick.



Thicker than years of testing and use say they have to be. Then, to make sure they don't cause wear problems, we insert a hardened shim between the hinge pin and the frame. The pin rides on the shim, instead of wearing into the heelpiece. (You can forget the bearing, it's permanently lubricated.)

Buffers with lots of muscle.

We make our buffers of a special tough phenolic material that lasts. And lasts. And lasts. All without wear or distortion. Another reason why our relays stay in whack.

To make sure our buffers stay in place, we weld the buffer cups to the armature arms. We weld, instead of using rivets, because our lab found that rivets have a habit of falling out.

For the very same reason, we weld buffer cups to the contact springs. And also use the same special tough phenolic buffers.

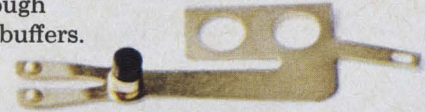

No, we didn't forget the contact springs.

We have some strong feelings as to what makes a contact spring reliable. Our sentiment is that two contacts are better than one. So, we bifurcate all the springs, not just the make and break. This slotting and the addition of another contact to each spring means you get a completed circuit every time.

We make each set of contact points self-cleaning. The bad stuff doesn't have a chance to build up.

Now, what's different about our bobbin?

Our bobbin is one piece—molded of glass-filled nylon. This provides the maximum in insulation resistance.

Because our bobbin is nylon, we don't have to impregnate with varnish. Moisture and humidity have no effect on the stubborn nylon material. No effect means no malfunctions for you to worry about.



What all this means to you.

What this all adds up to is reliability. The kind of toughness no one else can give you. It means an AE relay works when it's supposed to, longer than it has to.

Isn't this the kind of reliability you really need? Automatic Electric Company, Northlake, Ill. 60164.

AUTOMATIC ELECTRIC
SUBSIDIARY OF GENERAL TELEPHONE & ELECTRONICS

**THE
TOMORROW
MOSFETS.**

The Tomorrow MOSFETs are a different kind of animal.

They run on 2 volts instead of the ordinary 6.

So they turn on with a lower drive voltage.

And they have lower channel resistance.

And the lowest 1/f noise going.

The advantages of the Tomorrow MOSFETs are obvious.

First, your gate drive can be lower than with any other MOSFET.

Which means lower power consumption.

And more power available for other devices.

And less heat dissipation.

And faster operating speeds.

Second, they're flexible. You can use them in higher voltage applications if you want.

Third, they're compatible. They end the need for level translators.

Which means less money and less space and less power for extra hardware.

So there's not as much interference and clutter to burden your system.

Fourth, they last longer.

Today, Hughes makes 23 Tomorrow MOSFETs. All standard.

During the next 6 months, we'll be introducing 20 more.

How do you find out more about the Tomorrow MOSFETs?

Mail the coupon. Today.



HERE TODAY.

Hughes Aircraft Company
Hughes MOSFET Devices
500 Superior Avenue, Newport Beach, Calif. 92663.
Please send me complete information on Hughes
Tomorrow MOSFETs.

Name _____

Title _____

Company _____ Dept. _____

Address _____

City _____ State _____ Zip _____

Circle 21 on reader service card

ATTENUATORS

FIXED, Coaxial
Complete coverage
0-10 Gc/s
Rugged and reliable

VSWR: 1.20 Max.
Polarity: Bi-Directional
(Jack is Input)
Peak Power: 3 KW
Environmental: Per
Mil-E-5272B

D5033



VSWR: 1.25 Max.
Polarity:
Bi-Directional
Peak Power: 2 KW
Environmental:
Per Mil-E-5272B
Connectors:
Type N Plug/Jack

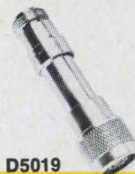

VARIABLE, Coaxial
Low VSWR
Economically priced



D5165

Frequency: 2-12 GHz
Insertion Loss: 0.5 db Max. to
10.0 GHz
Impedance: 50 OHMS
VSWR: 1.33 (1.15 Typical)
Connectors Available: OSM, N,
TNC, Plugs and/or Jacks
Readout: Turns, counting dial-
100 div/turn
Body Size: 5 5/8" x 3 7/8" x 1 1/8"
Weight: 2 lbs., 8 oz.
Finish: Gray enamel or black
and gray wrinkle
Power: 5 Watts Avg.
Rack mounting holes available
on request



D1196

Insertion Loss:
0.3 db Max. 0-500 MHz
0.8 db Max. 0-1000 MHz
VSWR: 1.5 Max. (Calib. Range)
Power: 3 Watts Avg. (2 KW Peak)
Impedance: 50 OHMS (75 and 90
OHMS available)
Accuracy: (10 db model) 0.85 db
(20 db model) 1.0 db
Body Size: 6 1/8" x 3 3/4" x 1 1/8"
Weight: 2/25 lbs.
Finish: Gray epoxy enamel

Send for complete information . . .



**RADAR DESIGN
CORPORATION**
510 PICKARD DR. ■ SYRACUSE, N. Y. 13211
PHONE: 315-454-4418

Meetings

Electrochemical Society: Materially significant

The trend in electronics is clearly toward a materials-oriented science, and the Electrochemical Society meeting in Montreal, Oct. 6 to 11, is one of the best places to find out who's doing what with what materials.

Sandwiched among the papers on batteries, fuel cells and corrosion are several papers of immediate interest to electronics engineers who are looking ahead to better semiconductor devices. The semiconductor papers will cover such topics as ohmic contacts, epitaxial compounds and phosphors, metal-insulator devices, and photosensitive materials for electronics applications.

From the lab. Though these papers are coming from the research labs, the semiconductor industry's record of bringing techniques from the laboratory onto the production floor quickly is well known.

Two papers on ohmic contacts are aimed at further improving a device that is, itself, just now moving out of the research lab: the Gunn-type oscillator. In one, Ronald H. Cox and Turner E. Hasty, researchers at Texas Instruments, Dallas, will discuss the metallurgy of alloyed ohmic contacts for the

gallium-arsenide oscillator.

Cox and Hasty will point out that alloyed contacts made directly to the device's active n-region form a thin high-resistance region that can produce a nonuniform electric field in the device, which in turn, limits output power and efficiency. They'll discuss ways to reduce the dislocation density at the contact-gallium arsenide interface, the main result of the poor contacts. They say that the bad effects of alloy contacts can be largely avoided by using an n⁺ n⁻ n⁺ gallium arsenide structure, with the top n⁺ layer made either by vapor-phase or solution-regrowth epitaxy. The defects formed by alloying are then formed in the n⁺ layer, not the active n⁻ layer, and thus don't affect device behavior.

In the second paper on ohmic contacts to gallium arsenide, two Bell Telephone Laboratories researchers, Carl Paola and Stephen Knight of the Murray Hill, N.J., facility, will discuss such contact alloys as indium-gold, tin-gold, and germanium-gold, as well as such pure elements as indium, gold, silver and tin.

For additional information write Charles Moore, Electrochemical Society, 30 E. 42 St., New York 10017.

Calendar

Electronics and Aerospace Systems Conference, IEEE; Sheraton Park Hotel, Washington, Sept. 9-11.

Meeting of the Union Radio Scientific International; Hotel Somerset, Boston, Sept. 9-12.

Group on Antennas & Propagation International Symposium, IEEE; Northeastern University, Boston, Sept. 9-12.

International Conference on Microwave and Optical Generation and Amplification, IEEE; and the University of Hamburg; University of Hamburg, West Germany, Sept. 16-20.

Cedar Rapids Conference on Communications, IEEE; Veteran's Memorial Coliseum, Cedar Rapids, Iowa, Sept. 19-21.

Aerodynamic Deceleration Systems Conference, American Institute of Aeronautics and Astronautics; El Centro, Calif., Sept. 23-25.

Conference on Electronics Design, Institution of Electrical Engineers, Institution of Electronics and Radio Engineers, IEEE; Cambridge University, England, Sept. 23-27.

Symposium on Physics & Nondestructive Testing, Gordon & Breach Science Publishers; O'Hare International Inn, Schiller Park, Ill., Sept. 24-26.

Instrumentation Fair, IEEE; Sheraton Park Hotel, Washington, Sept. 25-26.

(Continued on page 24)

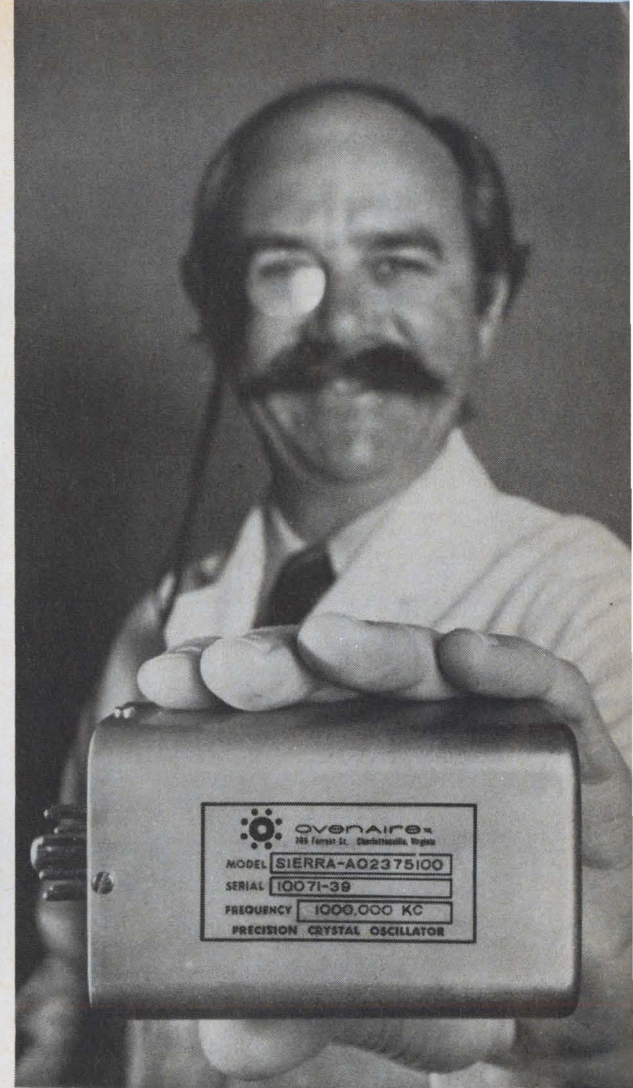
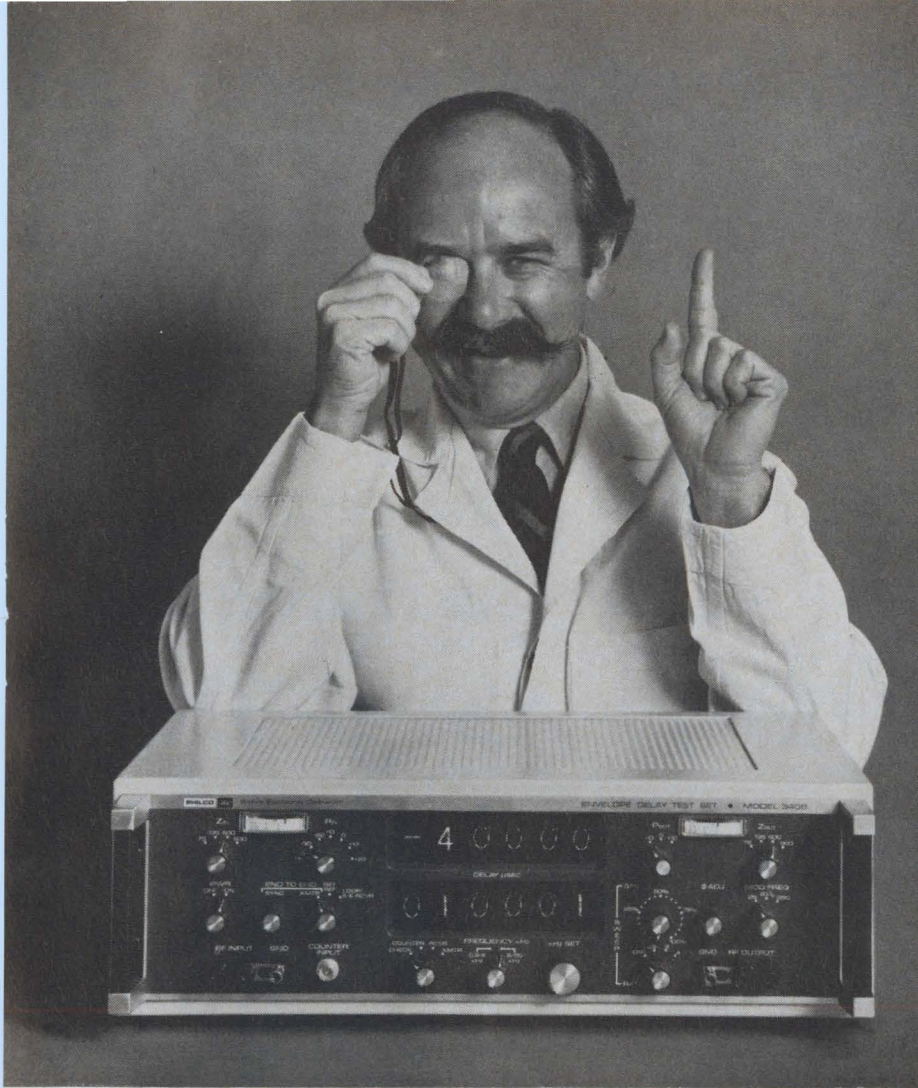

Precise! (resolves envelope delay to 0.1 μ sec)

Bright digital displays pinpoint relative delay and indicate carrier frequency to the nearest 10 Hz on Sierra's solid-state Model 340B Envelope Delay Test Set. Range of 300 Hz to 110 kHz spans both voice (4 kHz) and group (60-108 kHz) frequencies. A three-position switch sets you up for end-to-end, end-to-end with return reference path, or loop-back operation. Another selects your modulation frequency (25, 83 $\frac{1}{3}$, and 250 Hz now standard).

Accurate end-to-end delay measurements without a separate reference circuit are assured by the stability of Model 340B's precision internal master clock. To compensate for slight long-term frequency drift, a high-resolution, multiturn potentiometer helps keep the two clock oscillators synchronized.

Each modulation frequency has a single delay range: $\pm 20,000$ μ sec at 25 Hz, ± 6000 μ sec at 83 $\frac{1}{3}$ Hz, ± 2000 μ sec at 250 Hz. The 10V analog outputs for frequency and delay, with internal electronic scan, allow you to record a delay contour in seconds, then tune to any number of discrete points for closer analysis. Optional: A third analog output to record levels of received signals.

Among the numerous other features a Model 340B has to offer: Built-in transformers for balanced or unbalanced 135-, 600-, and 900-ohm, as well as 75-ohm circuits; built-in 1-MHz frequency counter with digital readouts accurate to 1 Hz.

Your signal will produce a product bulletin without delay. Write Sierra/Philco-Ford, 3885 Bohannon Drive, Menlo Park, California 94025. Or call (415) 322-7222, ext. 328.

... stability guaranteed by this oven-controlled master clock oscillator



PHILCO-FORD CORPORATION
Sierra Electronic Operation
Menlo Park, California • 94025

Circle 23 on reader service card

from Gertsch... an all solid state phase angle voltmeter



that goes all the way to...

true broadband



Single Frequency
Multiple Frequency
30-10 KHz

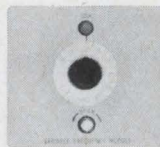

Variable
Frequency
300-10 KHz

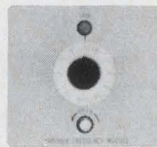

Variable
Frequency
10 KHz-300 KHz

Plug-In Modules provide complete frequency coverage with:

- Filtering at all frequencies — both signal and reference inputs
- Isolation at all frequencies available — both signal and reference units
- Programmable frequency control
- 1 VDC single-ended output for computer interface.

The variable frequency modules shown above use a unique heterodyne system to provide phase-locked tracking of any selected frequency. These modules are ideal for transfer function analysis, filter analysis — any test that requires broad band coverage in a phase angle voltmeter (gain and phase shift displayed simultaneously on the front panel).

Additional modules, that cover right down to 30Hz, are available for production tests of servo systems and components. These modules provide single frequency or multiple frequency control and eliminate operator calibration.

Our four-page brochure is available now.

Gertsch SINGER
INSTRUMENTATION

THE SINGER COMPANY — Panoramic/Sensitive Research/Empire/EMC
3211 S. LaCienega Blvd., Los Angeles, Calif. 90016 Phone (213) 870-2761

Meetings

(Continued from p. 22)

Ultrasonics Symposium, IEEE; Statler Hilton Hotel, New York, Sept. 25-27.

International Fair for Electronics, Automation, and Instruments; Copenhagen, Sept. 27-Oct. 4.

Engineering Management Conference, IEEE; Marriott Motor Hotel, Philadelphia, Sept. 30-Oct. 1.

Government Microcircuit Application Conference, Department of the Army; Washington, Oct. 1-3.

Allerton Conference on Circuit and System Theory, IEEE; Allerton House, Monticello, Ill., Oct. 2-4.

Symposium on Multivariable Control Systems, International Federation of Automatic Control; Duesseldorf, West Germany, Oct. 7-8.

International Telemetering Conference, Foundation for Telemetering, IEEE; Ambassador Hotel, Los Angeles, Oct. 8-11.

Joint Engineering Management Conference, American Society of Mechanical Engineers, Instrument Society of America, American Institute of Aeronautics and Astronautics, IEEE; Jack Tar Hotel, San Francisco, Oct. 9-10.

Symposium on Applications of Ferroelectrics, IEEE; Catholic University, Washington, Oct. 10-11.

International Astronautical Congress, American Institute of Aeronautics and Astronautics; Waldorf Astoria Hotel, N.Y., Oct. 13-19.

System Science and Cybernetics Conference, IEEE; Towne House, San Francisco, Oct. 14-16.

Annual Symposium on Switching and Automata Theory, IEEE; Schenectady, N.Y., Oct. 15-18.

Symposium of Reliability in Electronics, Hungarian Academy of Sciences; Budapest, Oct. 15-18.

Conference on Electrical Insulation and Dielectric Phenomena, National Academy of Sciences—National Research Council; The Inn, Buck Hill Falls, Pa., Oct. 20-23.

Meeting and Technical Display, American Institute of Aeronautics and Astronautics; Philadelphia Civic Center, Philadelphia, Oct. 21-25.

Shock and Vibration Symposium, Naval Research Laboratory; Asilomar Conference Grounds, Pacific Grove, Calif., Oct. 22-24.

(Continued on p. 26)

whatever direction
your design takes...

Allen-Bradley thick film networks will put you out front in...

Packaging—Advanced manufacturing capability covers virtually every type and every configuration of resistive and/or capacitive networks—single or dual in-line, as well as flat-packs, with or without hermetic sealing.

Characteristics—Exclusive and patented formulations enable A-B to provide resistance values from 1 ohm to 5.0 megohm. Ratings to 20 watts/in² at 85°C. Capacitance values from 10 pfd to 0.5 mfd with voltage ratings to 50 volts. Applications include precision tuned circuits.

Performance—Standard resistance tolerance $\pm 10\%$. For critical circuitry, tolerances to $\pm 0.1\%$ can be furnished—with resistances and TC's matched. Temperature coefficient less than 250 ppm in all cases. Special units to 100 ppm or less. Load life stability of 1% in 10,000 hours can be achieved.

Reliability—Allen-Bradley has precise control over all raw materials and manufactures all basic components—glasses, organic materials, and substrates. Special machines—designed and built by A-B—assure uniform product quality—at a competitive price.

Timing—Allen-Bradley has unique in-plant ceramic facilities. Prototype networks—with or without holes—can be prepared to meet your specific needs. Quickly. Economically.

For more details, write Henry G. Rosenkranz,
Allen-Bradley Co., 1315 S. First St., Milwaukee,
Wis. 53204. In Canada: Allen-Bradley
Canada Ltd. Export Office: 630
Third Ave., New York, N. Y.,
U.S.A. 10017.

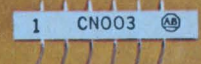
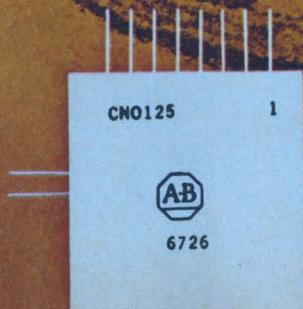
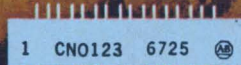
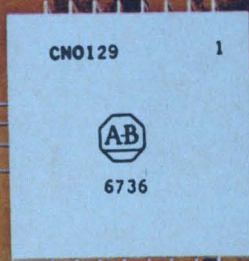
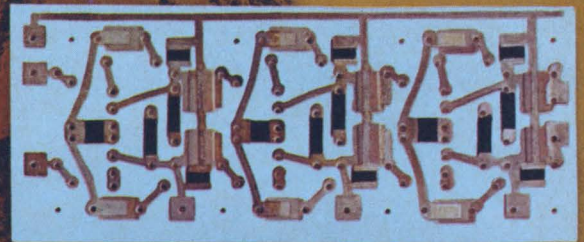

ALLEN-BRADLEY
QUALITY ELECTRONIC COMPONENTS



Our steps in aerospace

direct our control on the ground.

The new line of SCR's: Designed by SSPI to maximize performance, reliability, and price to give you maximum value for your Industrial Control applications. Now you can map out your own application directions. How? By taking these steps:

Step 1: Use these new SCR's by SSPI in all your Industrial Control applications. They're versatile. They have a Forward and Reverse Blocking voltage to 400 volts!

Step 2: Use these new SCR's by SSPI to directly control AC Power, or for sure-fire triggering of high powered SCR's in motor control systems.

Step 3: Use these new SCR's by SSPI for quick response and precise triggering in overload protection circuitry. Gate Trigger voltage, 0.4 to 0.8 volts.

Step 4: Now, use these new SCR's by SSPI to design your own stable, long-life system.

They're available in TO-18, TO-5 and $\frac{7}{16}$ studs.

We can recommend these steps because we've already taken them in hi-rel areas of mil/aerospace.

For more information on SSPI's SCR's for Industrial Control, the ID 100, 200, and 300 Series, steer your inquiries to John Kelly at:

SOLID STATE PRODUCTS 
DIVISION OF UNITRODC CORPORATION
 ONE PINGREE STREET SALEM, MASSACHUSETTS 01970 PHONE: 617-745-2900

Meetings

(Continued from p. 24)

International Electron Devices Meeting, IEEE; Sheraton Park Hotel, Washington, Oct. 23-25.

Nuclear Science Symposium, IEEE and United States Atomic Energy Commission and Atomic Energy Commission of Canada; Bonaventure Hotel, Montreal, Canada, Oct. 23-25.

Seminar in Depth—Image Information Recovery, Society of Photo-Optical Instrumentation Engineers; Benjamin Franklin Hotel, Philadelphia, Oct. 24-25.

Call for papers

Electronic Components Conference, IEEE; Washington, April 30-May 2. **Nov. 1** is deadline for submission of summaries to James A. O'Connell, technical program chairman, Electronic Components Conference, ITT, 320 Park Ave., New York, N.Y. 10022.

International Communications Conference, University of Colorado and IEEE; University of Colorado, Boulder, June 9-11. **Jan. 1** is deadline for submission of abstracts and papers to Dr. Martin Nesenbergs, Environmental Science Services Administration, Institute for Telecommunications Sciences, R614, Boulder, Colo. 80302.

Joint Automatic Control Conference, American Institute of Aeronautics and Astronautics, American Institute of Chemical Engineers, American Society of Mechanical Engineers, Fluid Power Society, IEEE Automatic Control Group, Instrument Society of America, and Simulation Councils; University of Colorado, Boulder, Aug. 5-7. **Nov. 15** is deadline for submission of papers to W.E. Schiesser, program chairman, 1969 JACC, Department of Chemical Engineering, Lehigh University, Bethlehem, Pa., and five copies for review to J.B. Lewis, department of electrical engineering, Pennsylvania State University, University Park, Pa. 16802.

Short courses

Avionics systems engineering, University of California, Los Angeles, Sept. 9-20; \$375 fee.

Fundamentals of nondestructive testing, Ohio State University, Columbus, Sept. 9-20; \$350 fee.

Process dynamics and control, Purdue University's Schools of Engineering and Laboratory for Applied Industrial Control, Lafayette, Ind., Oct. 28-Nov. 2; \$150 fee.

ALLEN-BRADLEY
Metal-Grid resistor networks
combine a new measure of

precision, stability and performance in a sealed, compact package



Precision Metal-Grid resistor network shown
approximately 1½ times actual size

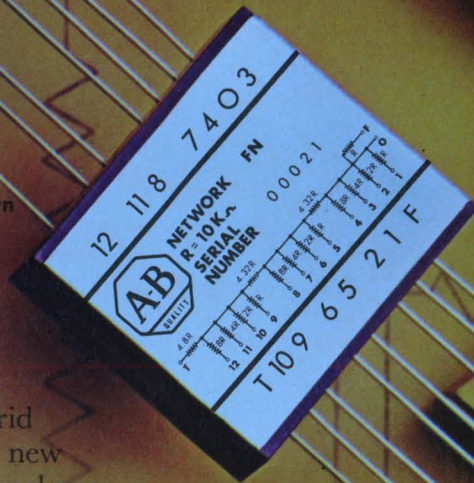

The advanced capabilities—developed from years of manufacturing Allen-Bradley Metal-Grid resistors—are now applied to a new line of resistor networks. This technology enables the production of complex resistive networks on a single substrate.

Allen-Bradley's exclusive simultaneous deposition method is used to obtain the best resistance tolerance and temperature coefficient matching. The reliability of interconnections on the common resistance plane is incomparable. Uniformity and quality are inherent in A-B networks. To illustrate, 2 PPM temperature tracking is normal.

A-B Metal-Grid networks offer a wide range of values—with individual resistances as low as 25 ohms and as high as 2.0 megohms. Both the inductance and capacitance are low, permitting efficient operation at high frequencies.

A-B engineers will be pleased to cooperate in developing networks for your specific need. For additional details, please write to Henry G. Rosenkranz, Allen-Bradley Co., 1315 S. First Street, Milwaukee, Wisconsin 53204. In Canada: Allen-Bradley Canada Ltd. Export Office: 630 Third Avenue, New York, N. Y., U.S.A. 10017.

BRIEF SPECIFICATIONS

Resistor Networks

Tolerances: $\pm 1.0\%$ to $\pm 0.01\%$
Resistance Matching: to 0.005%
Temperature Range: -65°C to $+175^{\circ}\text{C}$
Temp. Coef.: to ± 5 ppm/ $^{\circ}\text{C}$
Load Life (Full load for 1000 hr @ 125°C): 0.2% maximum change

Ladder Networks

Full Scale Accuracy: 10 bits or less, better than $\pm 1/4$ least significant bit. More than 10 bits, better than $\pm 1/2$ least significant bit.
Frequency Response: Less than 100 nanosecond rise time or settling time
Temp. Coef.: Less than 10 ppm/ $^{\circ}\text{C}$
Temperature Range: -65°C to $+175^{\circ}\text{C}$

ALLEN-BRADLEY
QUALITY ELECTRONIC COMPONENTS

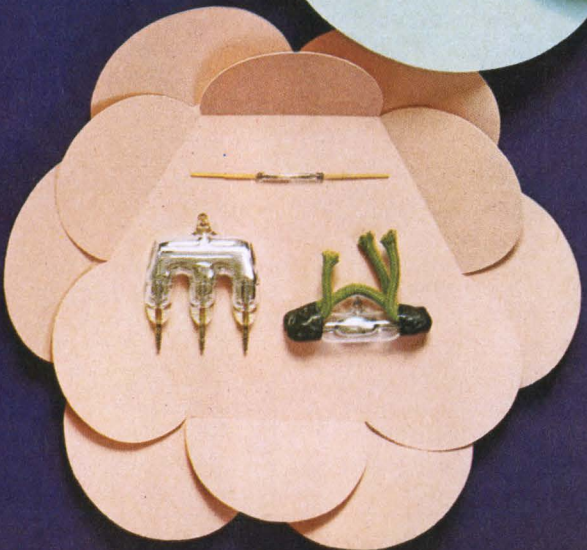
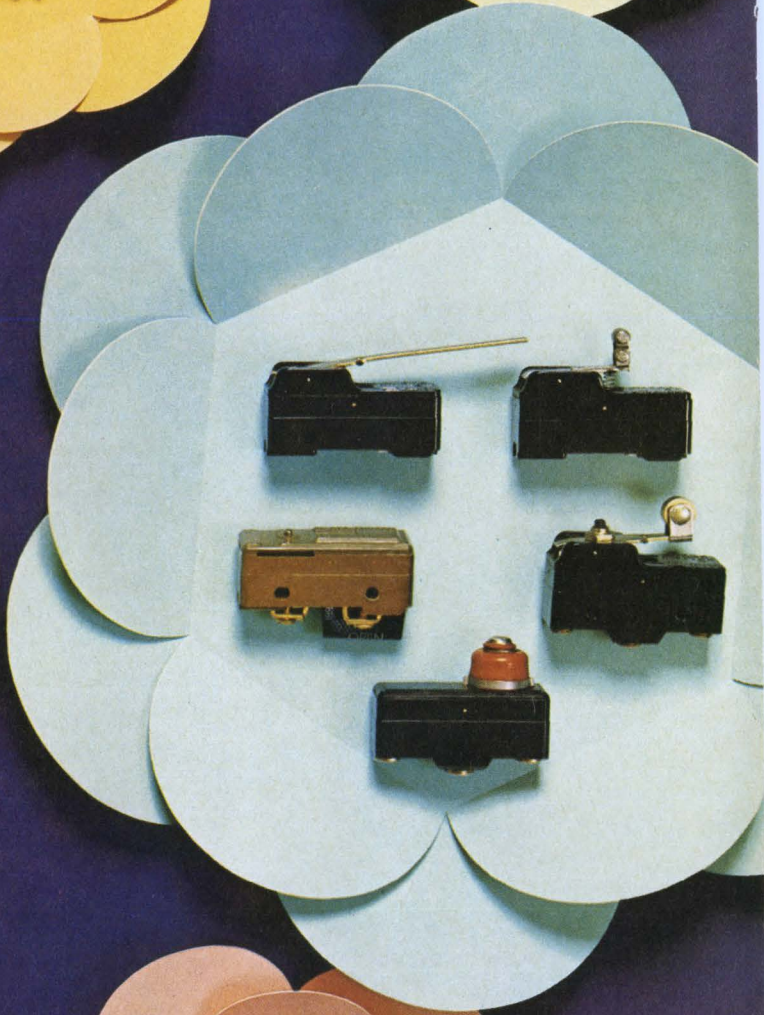
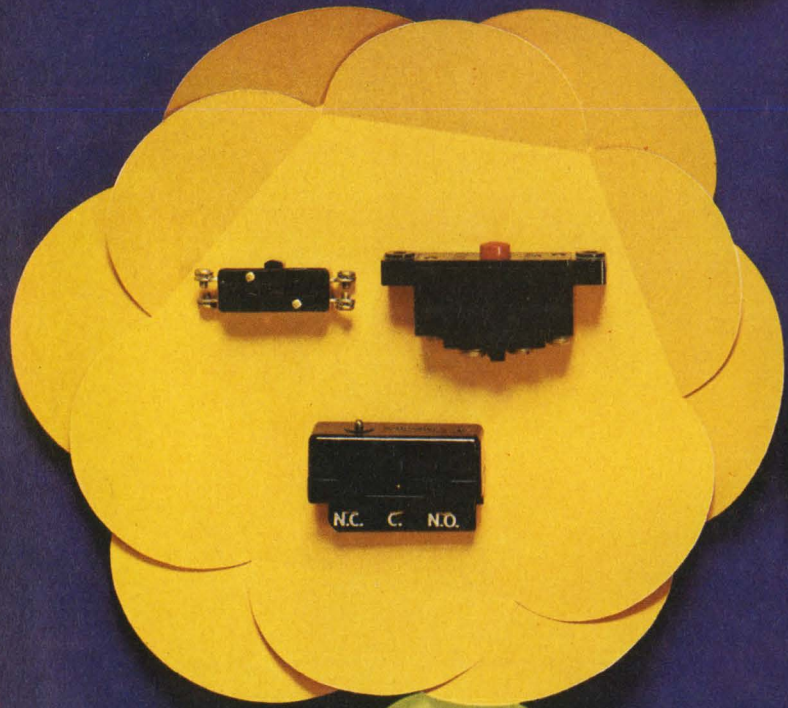
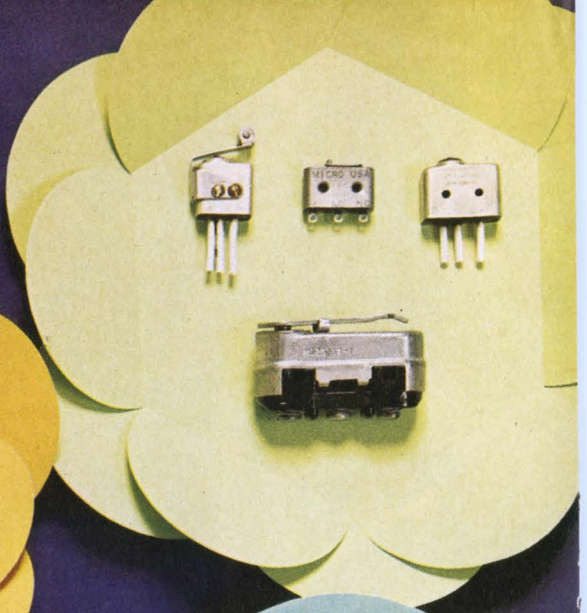
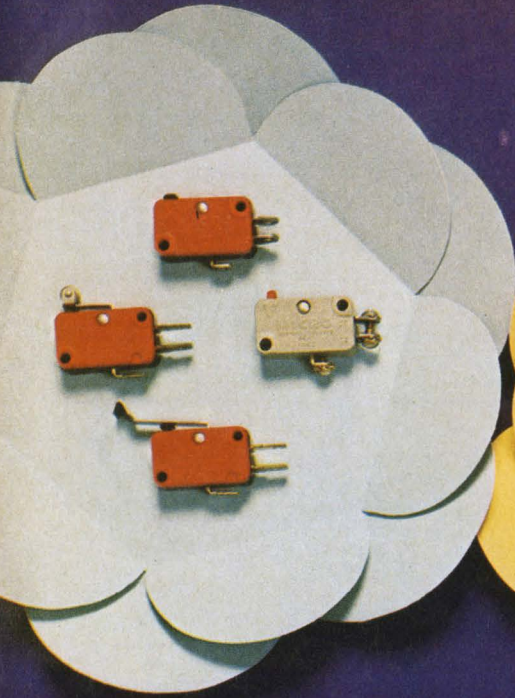

Basic Switches?

Go where you can pick from the whole blooming family.

You won't miss out on the latest in basic switches when you come to MICRO SWITCH. Here you can make your selection from the world's largest family. Thousands of subtle variations help you meet any combination of requirements—size, weight, circuitry, electrical capacity, actuation, termination and environmental resistance.

For example, there are switches especially sealed to do the job in highly contaminated environments; switches that operate efficiently at temperatures as severe as +1000° or -320°F; electrical loads from milliamp to 25 amps, 125 vac, or 10 amps, 125 vdc. A large number meet military specifications.

But you can expect much more when you come to MICRO SWITCH. For instance, extra assurance of consistent quality throughout a large quantity run. Or

the certainty that a switch will deliver precise operating characteristics throughout a long life. Perhaps what's essential to you is the convenience of local distributors with complete selections on the shelf—or, on the other hand, world-wide availability! If on-time deliveries are critical to you, you'll be interested in our computer-controlled ordering, inventory and production control system. Finally, should you have special design problems, our engineering field service—the largest in the industry—specializes in coming up with the right solutions.

Shown at left and described below are just a few members of our ever-blooming family of basic switches. For additional information, call a Branch Office or Distributor (Yellow Pages, "Switches, Electric"). Or write for Catalogs 50 and 52.

A. Type V3 Basic Switches—Small, versatile precision switches. Over 500 standard designs, including many actuator and terminal variations. Operating force as low as 10 grams, differential travel as small as .002 inch. Rating up to 15 amps 125 vac. SPDT, SPNO or SPNC. Temperature range up to 600° F. Military listed. Case size 1.09 x .62 x .40 inch.

B. Subminiature Basic Switches—Precision operation with minimum space and weight. Variety of actuators, terminals and characteristics. Silver or gold contacts, and bifurcated contact design for reliable low energy operation. Military listed. Type SM: Case size .78 x .35 x .25 inch, up to 10 amps 125 vac. Type ISX: Case size .50 x .35 x .20 inch, 7 amps 125 vac.

C. Sealed Basic Switches—Small switches for reliable military/aerospace use and other applications requiring environmental protection. Types XE and SE are classed watertight (Symbol 3, MIL-S-8805), with a corrosion-resistant metal housing, molded silicone rubber plunger seal, and terminals encased in epoxy resin. Types HM and HS feature true hermetic sealing (Symbol 5, MIL-S-8805), with metal-to-metal and glass-to-metal fusion. Solder or leadwire termination.

D. Special Circuitry Basic Switches—Simplify circuit design and eliminate extra wiring. Type "DT": DPDT. Type TB: 2-Ckt and 4-Ckt Double-Break. Type MN: 2-Ckt Double-Break. Also dual SPDT assemblies, make-before-break, pulse operation, and sequential action types.

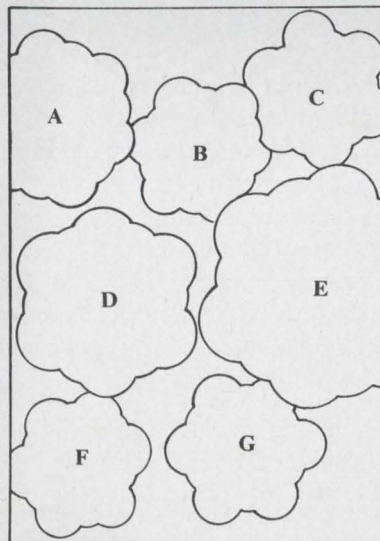

E. Standard Basic Switches—The maximum in precise operation, accurate repeatability, long life and high electrical capacity. Thousands of proven designs available. Variety of actuators and terminals. Case size: 1.94 x .95 x .68 inch. SPDT, SPNO or SPNC. Momentary or maintained contact. Type Z: 15 amps; Type A: 20 amps; Type M: 22 amps; Type E: 25 amps; each at 125 vac. Type MT: 10 amps 125 vdc.

F. High Temperature Basic Switches—Type HT switches withstand +1,000°F and -321°F. Available with panel-mount push-plunger or roller-plunger, or side-mount with auxiliary actuators. Corrosion and shock resistant.

G. Glass-Enclosed Switches—Hermetically sealed contacts for extra reliability and long life. Modern automatic equipment assures product uniformity in large quantity production. Type AS mercury switches: low force, tilt operation; SPST, SPDT, or 2-Ckt; rating up to 70 amps 30 vac; variety of operating characteristics. Type CS miniature reed switches: Form A or Form C; outstanding long life/high capacity combination—up to 100,000,000 cycles at 10 watts; and high reliability on micro-volt or micro-ampere circuits.

MICRO SWITCH

FREEPORT, ILLINOIS 61032

A DIVISION OF HONEYWELL

HONEYWELL INTERNATIONAL: Sales and service offices in all principal cities of the world. Manufacturing in United States, United Kingdom, Canada, Netherlands, Germany, France, Japan.

Sticky RFI problems?

sticky **fingers**[®]

attach with self-adhesive, shield RFI better than anything else!

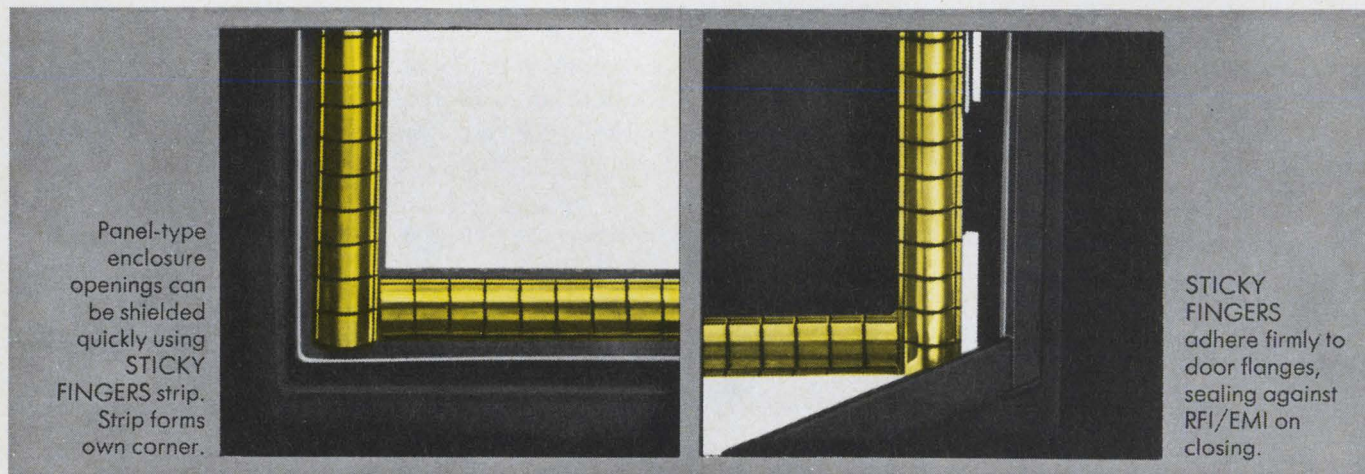

At last you can get superior RFI/EMI shielding with a beryllium copper finger strip that requires no soldering, screws, clips, or other fasteners. A unique adhesive, developed especially for new STICKY FINGERS, provides an extremely tight instant bond that "cures" and strengthens with age . . . won't creep or crawl even with thousands of closings.

And new STICKY FINGERS meet MIL Specs on salt spray, shock and humidity cycle tests and is unaffected by temperatures from -65°F to 160°F !

What's more, shielding effectiveness is greater than 108 dB at 10 GHz, and 70 dB at 200 kHz magnetic!

New STICKY FINGERS are available in a variety of surface finishes. Write today for complete information plus a free sample.

Address: Dept. E-53

Easy to install!

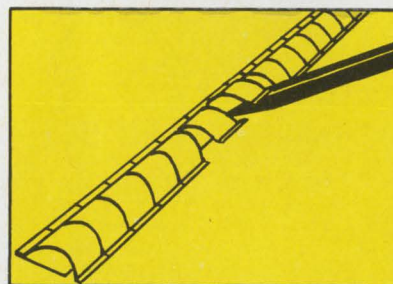

Simply remove adhesive backing and rub a pen or small screwdriver under the fingers, assuring complete contact.



INSTRUMENT SPECIALTIES CO., INC.
Little Falls, New Jersey
Phone 201-256-3500

Editorial comment

A case of self-deception

The electronics industry is perennially hopeful of converting the technology and management techniques learned while working on military and space contracts to civilian programs in such fields of public interest as rapid transit, air and water pollution, urban renewal, and air and ground traffic control. But though defense programs such as the missile development effort are unsurpassed in size and funding, the transfer of benefits to civilian areas has been less than overwhelming and often downright disappointing.

Sometimes the relationship between successful Government-sponsored projects and civilian fallout is tenuous indeed. Critics of the frustrating pace of technology diffusion argue that Japan, West Germany, and Sweden have accomplished as much in some civilian sectors as the U.S. without benefit of our vast aerospace programs.

In truth we are deceiving ourselves to expect the rapid and efficient diffusion of electronics/aerospace technology to broad civilian areas. Some technology just doesn't "transfer" well. When the Battelle Memorial Institute studied the attempts of aerospace businesses to diversify, it found that shifting into nonmilitary Government markets was generally much easier for such firms than tackling commercial-industrial or consumer markets.

The hardware needed for military gear and the hardware applicable to consumer products often differ so radically that the direct transfer of technology becomes an exercise in futility. Moreover, the technological content of some civilian programs seems so small that neither project managers nor vendors will invest in developing the possibilities.

Further complications stem from a poor understanding of the mechanisms of technology transfer and diffusion. Karl Harr Jr., president of the Aerospace Industries Association, emphasizes the years of lag time between the use of a new idea in advanced systems and its appearance in products on the commercial market. Even for those technological developments that seem eminently transferable, lag time is a limitation. The Air Force is proposing the use of synchronous satellites for communications, navigation, and identification [Electronics, Aug. 19, p. 33] and is aiming to get such a system

in operation in five to 10 years. Could such a system be extended to handle commercial air traffic control? One Air Force official thinks it could, but that it might take up to 20 years.

The transfer of software has been more successful than the transfer of hardware, so that lists of conversions stress projects involving systems engineering and managerial methodology rather than devices, circuits, and systems. A good many of these projects involve systems modeling by computer. For example, TRW uses computer programs to weigh such factors as vehicle configurations, route selections, terminal locations, and system costs in its studies of transportation requirements for the Northeast Corridor. Aerojet-General has simulated the criminal justice system for the State of California, and North American Rockwell proposes the development of simulation models to continue its study of California's transportation problems.

Fortunately, there are cases in which hardware-oriented technology that's been nurtured by Government dollars can be directly applied to civilian needs. Those that come immediately to mind are in the field of medicine. For example, North American Rockwell is developing remote patient-monitoring systems that use IC's in transmitters (an outgrowth of the Apollo program). Hamilton Standard has developed a way to relay electrocardiogram data in real time by telephone, and Martin-Marietta is applying lasers to surgery and diagnostics.

Ultimately, the payoff from Government-supported R&D should come in the greater transfer of hardware, or at least in the development of new hardware based on "hard" technology. We applaud studies by private research groups—the Rand Corp. and the Brookings Institution, for example—aimed at pinning down the factors involved in the transfer of technology. With better definition, the process might be speeded up, and, more important, extended to fields that don't currently benefit.

As of right now, though, there's little basis for optimism in the electronics industry about direct technological transfers.

The Standard of Excellence

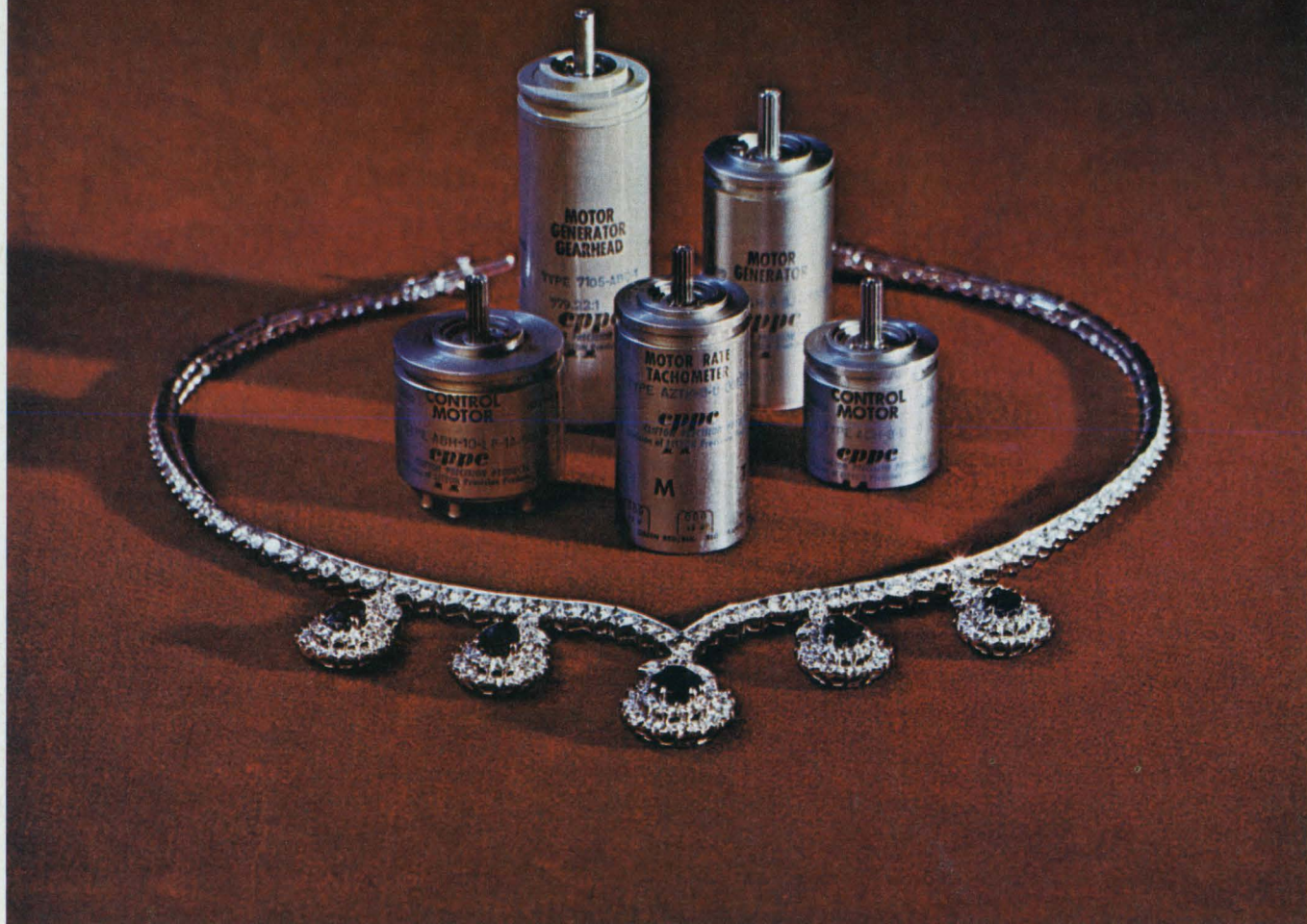

Diamond and Sapphire Necklace by J. E. CALDWELL Co., Philadelphia—\$15,500.

Servo Motors, Generators and Tachometers by CLIFTON

When we talk about Clifton QUALITY in our servo motors, what do we mean?

Things like this.

Extra care in manufacture by a crew which has specialized in rotating components for 20 years.

Increased reliability due to hand inserted windings.

All internal connections welded, not soldered.

Pinion Rockwell C hardness of 36 to 42 for the most critical part of your gear train.

All units will perform in an ambient of 125°C. Insulation system for 200°C applications is available.

You expect more from Clifton in all their rotating components. Why take less?

Call your local Clifton Sales Office, or telephone 215 622-1000.

CLIFTON 
DIVISION OF LITTON INDUSTRIES

Electronics Newsletter

September 2, 1968

Air Force seeks most powerful pulse radar ever

The world's most powerful short-pulse radar is the goal of a \$713,853 Air Force contract awarded to the Eimac division of Varian Associates, San Carlos, Calif. The ultrahigh power sought—perhaps 600 to 700 megawatts—and the ultrashort pulses—possibly only a few nanoseconds long—would boost range and target resolution far beyond today's levels.

Industry sources say development of the classified system will require major advances in both tube and power-supply designs. If the new designs succeed, the system will begin to push the bounds set by the theory of relativity. Though the tube will embody klystron design principles, its electrons will be accelerated at such speeds that they will gain significant mass as they near the speed of light.

A subcontractor, Ion Physics of Burlington, Mass., will develop a pulser capable of delivering several kiloampere pulses per second at potentials far above a megavolt. Such powers have never before been achieved in such short pulses.

The Air Force's Rome Air Development Center says the system should be operating by 1970-71 at the center's Floyd, N.Y., test facility.

LSI may get job in SST computer

Large-scale integration may find its way into the flight-control computer for the supersonic transport being built by Boeing. General Electric's Avionic Controls division, which is competing with Sperry Rand for the computer order, is buying 250-gate LSI circuits from Fairchild Semiconductor. The devices, which can perform a series of combinational logic functions, are in a MOS configuration on 80-by-80-mil chips.

GE paid Fairchild \$12,000 to develop the arrays; it will pay \$60 a chip for the first 100 and about \$44 thereafter.

This purchase follows news that GE is negotiating with Fairchild to acquire medium-scale integrated devices for the electronic controls of the swiveling gunner's station in the Air Force's Cheyenne helicopter [Electronics, Aug. 5, p. 33].

Watkins-Johnson begins microwave transistor R&D

Watkins-Johnson, one of the major producers of traveling-wave tubes, has started in-house research on transistors for microwave amplifiers. Apparently the Palo Alto, Calif., firm sees the handwriting on the wall: except for very high-power needs, twt's will eventually be replaced by solid state components.

Although the R&D work is extensive, it's not far enough advanced to determine when or what commercial products will be available.

Navy sharpens new ship checkout

The Navy's going to write a new inspection procedure into future contracts for surface vessels. Under the scheme, tried for the first time on the aircraft carrier John F. Kennedy, crews will be installed aboard long before the ships are commissioned. This early exposure of operators to equipment makes for a more effective checkout, says the Navy, and improves equipment performance—including that of electronic gear—in builders' trials and acceptance tests.

Shipbuilders and electronics firms are generally less enthusiastic. They feel that these early shakedown will force them to make many more revisions and adjustments than before, and will thus narrow profits.

Electronics Newsletter

Capital, technology get marriage broker

The latest to join a new trend in the electronics industry—the formation of companies specializing in marrying technology to capital—is Richard Petritz, former director of technology at the components group of Texas Instruments. He has joined Richard Hanschen to found a firm called New Business Resources in Dallas. Hanschen, a former marketing director and vice president at the TI group, will remain associated with the investment firm of Burnham & Co.

As Theodore Maiman has done in Los Angeles with Maiman Associates, the founders of New Business Resources plan to devote most of their efforts to helping people with sound technology find financial backing in return for a share of the resulting business. The company's officials will also act as consultants during the formative stages.

Maiman, inventor of the ruby laser and founder of the Korad Corp., left to form Maiman Associates when Korad was absorbed by Union Carbide. Petritz was director of TI's semiconductor research and development laboratory (a line function) for six years, before he was shifted to the technology directorship (a staff function).

He says the new firm was launched because he and Hanschen want to help bring about the fourth generation in electronics—the move to medium- and large-scale integration.

Philips wins FAA order

North American Philips is planning heavier marketing efforts in the U.S. for computerized message-switching equipment manufactured by Philips Telecommunications Industries of the Netherlands. The firm received a good start last month with the award by the FAA of a \$5 million contract for a five-computer complex to handle weather and forecasting data at the Kansas City message-switching center. Last year, Philips got a \$1.7 million contract for air traffic control message-switching equipment at the same facility.

To avoid the "buy American" act provisions, the Dutch firm will buy at least 51% of the equipment and labor in the United States, including much of the peripheral equipment, assembly and programing.

Motorola pushes memory work

Officials at Motorola's Semiconductor Products division have ambitious plans for their fledgling semiconductor memory efforts. Wally Raisanen, newly named operations manager for metal oxide semiconductor and memory operations, says his group is working on a 4,000-bit memory module for main frame computer memories using hybrid large-scale integrated devices that will be faster (100-nanosecond cycle time) and cheaper (two to three cents per bit by the late 1970's) than magnetic memories. Motorola is working with two computer manufacturers now, and Raisanen foresees memories evolving into a \$50 million per year business for the division in the 1970's.

Addenda

Corts (Conversion of Range Telemetry System) is finally on the way. An \$11.5 million Air Force contract has been awarded to Service Technology, a subsidiary of LTV Aerospace, for the first phase, which runs to July 1969. The changeover, scheduled for completion by January 1970, will shift missile telemetry from the 225-260-megahertz vhf band to the 1,435-1,540-Mhz and 2,200-2,300-Mhz regions of the uhf band. . . . The Navy Systems Command is looking for companies to build and equip a satellite system for low-frequency air-to-ground communications.

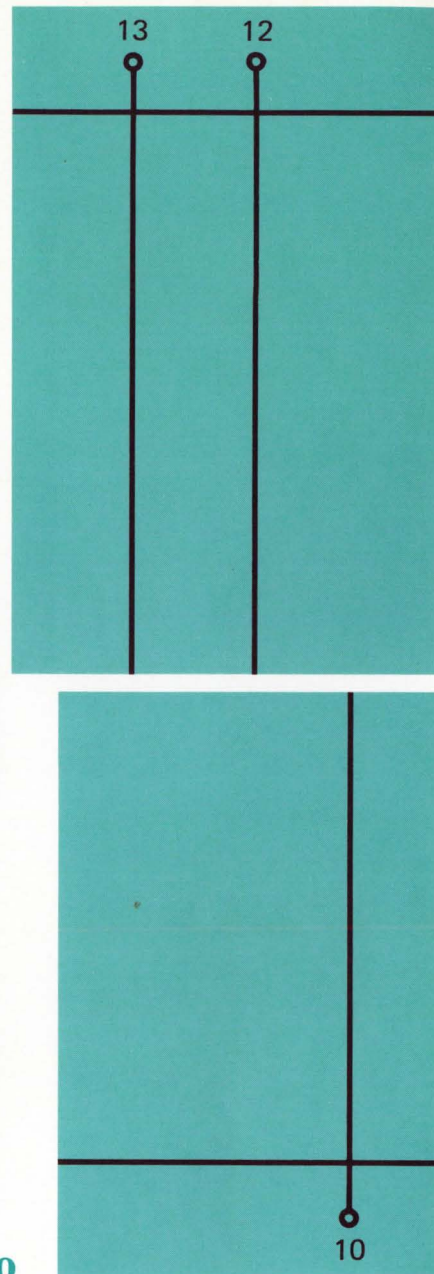
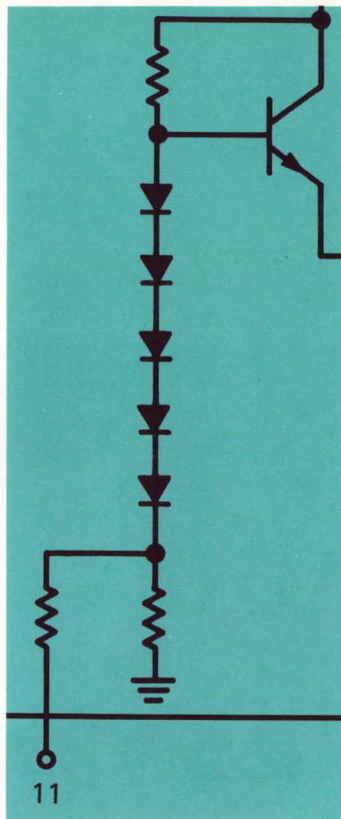
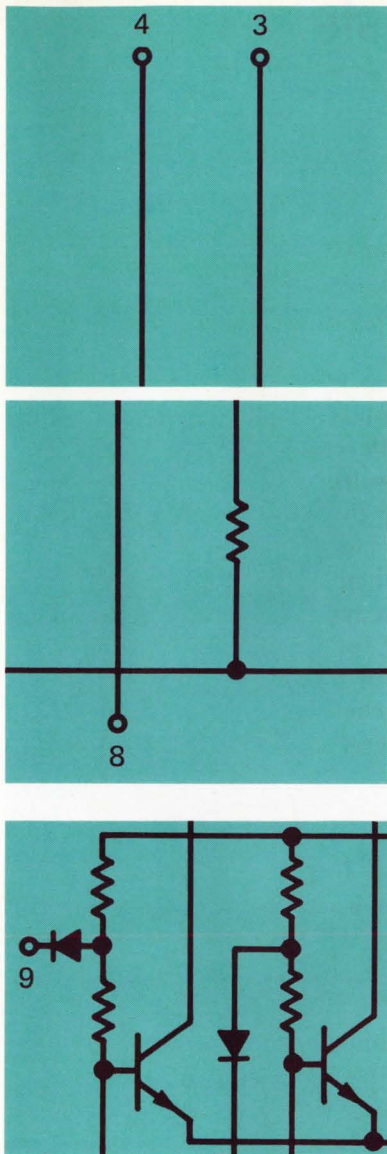

1/2 μ sec Memories With 1/2 The I/Cs

Dual-Channel Sense Amp, MC1541, Also Offers Six Performance Improvements

Two input channels on the new MC1541F make it possible to reduce by as much as one-half the number of I/C sense amp packages required for 0.5 μ sec core memory applications. Basically, a dual-gated sense amplifier (with differential input amplifiers), the MC1541 also features these unusual performance features:

1. Either one of the two input amplifiers can be gated "on" to provide signal detection without interference from unwanted signals.
2. Precise threshold voltage is obtained without the designer having to provide a precision external reference.
3. Pins 12 and 13 let the

designer look at the amplified pulse after the gain stage to accurately set strobe pulse position.

4. The two input channels drive a single DTL output stage. Each of the two channels and the strobe input can be gated with DTL and TTL levels.
5. For greater accuracy, the MC1541 provides an extremely tight threshold range with a 6 mV maximum spread.
6. Latch capability, with

improved performance, is available by using two external cross-coupled gates.

In addition to the full-temperature-range ceramic flat pack, competitively-priced at \$18.00 (100-up), this new circuit will soon be available also in the dual in-line ceramic package. Later, 0 to +75° versions will be available in ceramic flat and dual in-line packages.

For more complete details, turn page:



MOTOROLA
Semiconductor Products Inc.

- where the priceless ingredient is care!

Here's detailed data for the MC1541F

Check the specs . . . to see how you can design 1/2 μsec core memories — With 1/2 The Sense Amp I/Cs



MC1541F DUAL-CHANNEL CORE MEMORY SENSE AMPLIFIER INTEGRATED CIRCUIT

MONOLITHIC SILICON
EPITAXIAL PASSIVATED
MAY 1968 - DS 9008



TO 98
CASE 83



MONOLITHIC SILICON
EPITAXIAL PASSIVATED

TO 98
CASE 83

MONOLITHIC SILICON
EPITAXIAL PASSIVATED

MONOLITHIC SENSE AMPLIFIER

Dual-channel gated sense amplifier with separate wideband differential input amplifiers. Either input can be gated on from saturated logic levels. The sense amplifier features adjustable threshold, saturated logic output levels, and a strobe input that accommodates saturated logic levels. Designed to detect bipolar signals from either of two sense lines. Operates with core memory cycle times less than 0.5 μs.

- Nominal Threshold — 17 mV
- Input Offset Voltage — 1.0 mV typical
- Propagation Delay
Input to Gate Output — 20 ns
Input to Amplifier Output — 10 ns
Gate Response Time — 15 ns
Strobe Response Time — 15 ns
- Common Mode Input Range — 1.5 Volts
- Differential Mode Input Range
With Gate On — 600 mV
With Gate Off — 1.5 Volts
- Power Dissipation — 140 mW typical

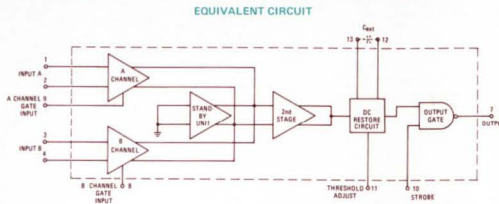
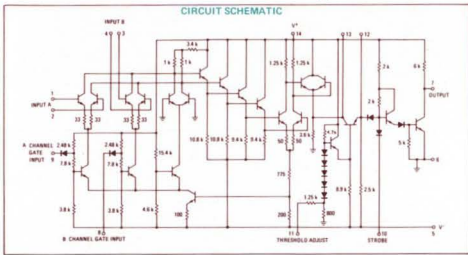
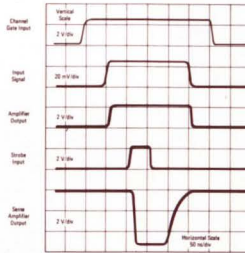

FIGURE 1 — TYPICAL OPERATION



Rating	Symbol	Value	Unit
Power Supply Voltage	V ⁺	+10	Vdc
	V ⁻	-10	Vdc
Differential Input Signal	V _{diff}	x5	Vdc
Common Mode Input Voltage	CMV _{in}	x5	Vdc
Load Current	I _L	25	mA
Power Dissipation (Package Limitation)	P _D	500	mW
		2.3	mW/°C
Operating Temperature Range	T _A	-55 to +125	°C
Storage Temperature Range	T _{stg}	-65 to +150	°C

ELECTRICAL CHARACTERISTICS

Characteristic	Fig. No.	Symbol	Min.	Typ.	Max.	Unit
Input Threshold Voltage (V _A = +25°C)	8	V _{th}	14	17	20	mV
Input Offset Voltage (-55°C < T _A < +125°C)	8	V _{off}	-	1.0	6.0	mV
Input Bias Current (V ₁ = V ₂ = V ₃ = V ₄ = 0)	9	I _b	-	5.0	35	μA
Input Offset Current (V ₁ = V ₂ = V ₃ = V ₄ = 0, T _A = +25°C)	9	I _{off}	-	1.0	2.0	μA
Output Voltage High (V ₁ = V ₂ = V ₃ = V ₄ = 0)	10	V _{OH}	6.9	-	-	Vdc
Output Voltage Low (V ₁ = V ₂ = V ₃ = V ₄ = 0, V ₁₂ = +5.0 Vdc, I _L = 10 mAdc)	10	V _{OL}	-	-	350	mVdc
Stroke Load Current (V ₁₂ = +5.0 Vdc, I _L = 10 mAdc, T _A = +125°C)		I _L	-	-	1.2	mAdc
Stroke Reverse Current (V ₁₂ = +5.0 Vdc)		I _{SR}	-	-	2.0	μAdc
Input Gate Voltage Low (V ₁ = V ₂ = 25 mVdc, V ₃ = V ₄ = 0)	11	V _{GL}	-	0.7	-	Vdc
Input Gate Voltage High (V ₁ = V ₂ = 25 mVdc, V ₃ = V ₄ = 0)	11	V _{GH}	-	1.6	-	Vdc
Input Gate Load Current (V ₁ or V ₂ = 0)		I _{GL}	-	-	2.5	mAdc
Input Gate Reverse Current (V ₁ or V ₂ = 5.0 Vdc) (T _A = +25°C)		I _{GR}	-	-	2.0	μAdc
Common Mode Range Input Gate High Input Gate Low	13	V _{CM}	+1.5	-	-	Vdc
Differential Mode Range Input Gate High Input Gate Low	14	V _{DM}	+600	-	-	mVdc
Power Dissipation		P _D	-	140	180	mW

SWITCHING CHARACTERISTICS

Characteristic	Fig. No.	Symbol	Min.	Typ.	Max.	Unit
Propagation Delay Input to Amplifier Output (V ₁ = 25 mV pulse, V ₁₂ = -2.0 Vdc)	8	t _{1A}	-	10	15	ns
Input to Output (V ₁ = 25 mV pulse, V ₁₂ = -2.0 Vdc)	8	t _{1O}	-	20	30	ns
Strobe to Output (V ₁ = V ₂ = V ₃ = V ₄ = 0, V ₁₂ = -2.0 V pulse)	12	t _{1S}	-	15	30	ns
Gate Input to Amplifier Input (V ₁ = 25 mV pulse, V ₃ = 2.0 V pulse)	11	t _{1G}	-	10	15	ns
Gate Input to Amplifier Output (V ₁ = 25 mV pulse, V ₃ = 2.0 V pulse)	11	t _{1G}	-	30	35	ns
Recovery Time Differential Mode Input Gate High V ₁ or V ₂ = 600 mV pulse Input Gate Low	14	t _{1R}	-	30	50	ns
Common Mode Input Gate High V ₁ or V ₂ = 1.5 V pulse Input Gate Low	13	t _{1CM}	-	15	30	ns

FIGURE 2 — TYPICAL INPUT THRESHOLD versus TEMPERATURE

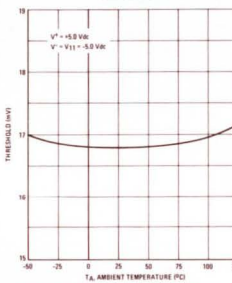

FIGURE 4 — TYPICAL INPUT THRESHOLD versus V⁻

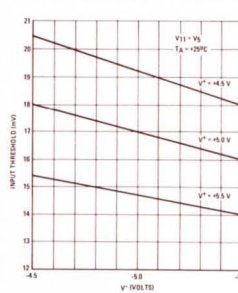

FIGURE 3 — TYPICAL THRESHOLD versus THRESHOLD VOLTAGE ADJUST

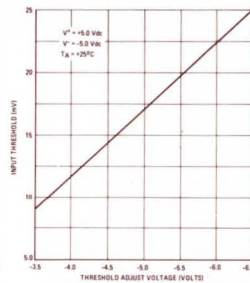
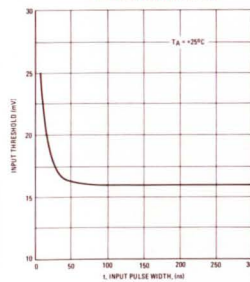

FIGURE 5 — TYPICAL INPUT THRESHOLD versus INPUT PULSE WIDTH



Your nearest franchised Motorola Semiconductor distributor has evaluation units now . . . just \$18.00 each (100-up quantities). For further information, write:



MOTOROLA Semiconductor Products Inc.

P. O. Box 20912, Phoenix, Arizona 85036

**FAST WARM UP IN A
PRECISION CRYSTAL
STANDARD IMPORTANT?**

***Sulzer Labs' new 5C does 5 parts in 10¹⁰
within 12 hours!***

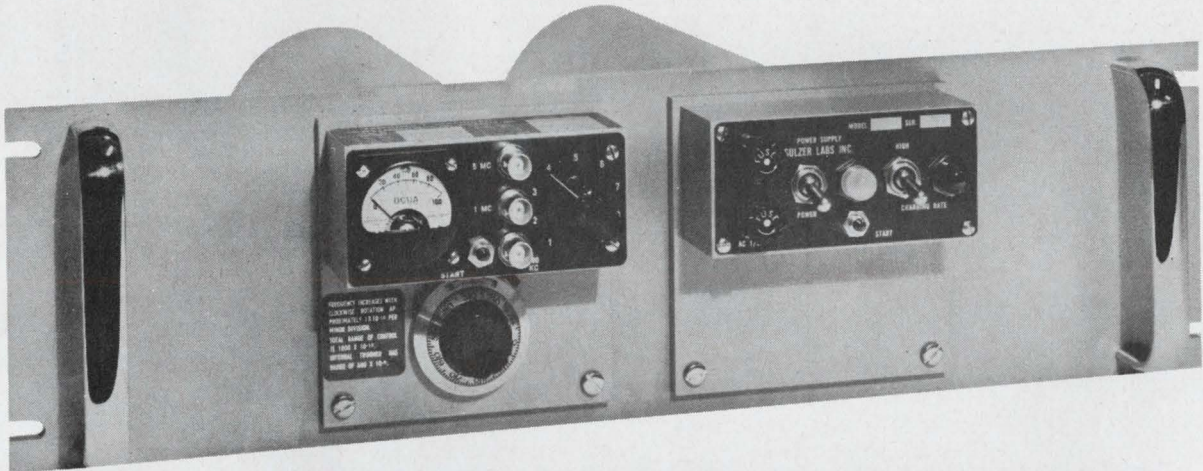

Temperature stability — better than
1 part in 10¹¹ per degree centigrade.

Typical ultimate aging rate — 1 part
in 10¹⁰.

. . . plus all of the features that you
need in a quality crystal standard.

*Write for additional information on
the Sulzer Labs 5C Crystal Standard.
TRACOR, Inc., 6500 Tracor Lane,
Austin, Texas 78721 • 512-926-2800.*

IA-116

Specialized instruments from  to meet your specific needs



It's the fastest. It's the most accurate.

The MD51 is a high-level 64 channel multiplexer, a sample and hold amplifier and a 15-bit A to D converter, all in a single chassis. It has a total sample and conversion time of 10 microsec-

onds max. and an accuracy of 0.01%. And it sells for under \$10,000. If that doesn't say it all, write for the rest.

SDS

Scientific Data Systems,
Santa Monica, California

Electronics Review

Volume 41

Number 18

Advanced technology

First of a series

In the five years since J.B. Gunn of IBM demonstrated that a chunk of gallium arsenide could directly generate milliwatts of microwave energy, output of such diodes has inched up steadily. Most recently, Gunn diodes in the limited space-charge accumulation mode have generated about 100 watts. But researchers have generally given up hope of substantially boosting the output of a single Gunn device much beyond that. And practical efforts to cascade the devices met with little success: parallel operation resulted in too sharp a drop in impedance and series operation

just wasn't found to be practical.

However, in a private showing in June, three scientists at General Electric's research center in Schenectady, N.Y., startled their colleagues with the disclosure that they could link four diodes in series.

No limit? "And if we can do it with four diodes, we can probably do it with hundreds," says one of the three scientists, Paul J. Shaver. The others on the GE team are SePuan Yu and Wirojana Tantraporn.

This means there's a distinct possibility of building solid state microwave transmitters that generate thousands of watts—and maybe even more.

Naturally, the trio had to do more than just bond the four diodes

to get them to operate in series. Until now, microwave scientists have generally agreed that the reason series operation was impossible was that one member of the chain tended to capture most of the applied voltage, leaving but a trickle for the rest. And although connecting them in parallel was not difficult, the resultant impedance drop left the circuit nearly useless as a transmitter.

Last year, however, a British researcher, J.E. Carroll, showed that there was a way—albeit very complex and cumbersome—to connect the diodes in series. By connecting the Gunn diodes one-half wavelength apart he could get them to contribute equally to the total output. But the spacings—from a fraction of an inch to several

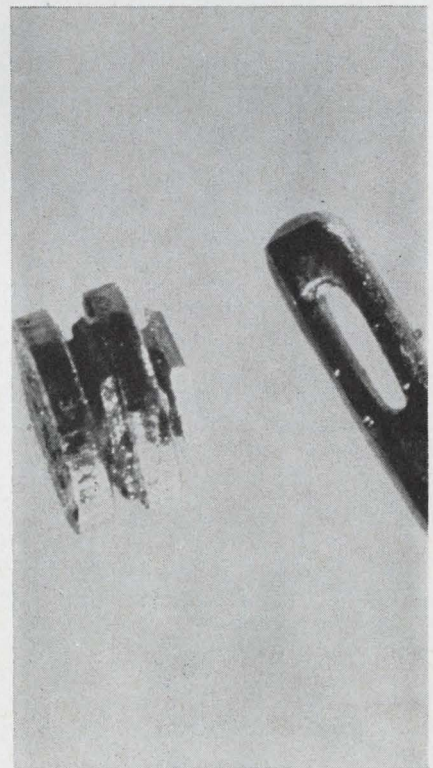
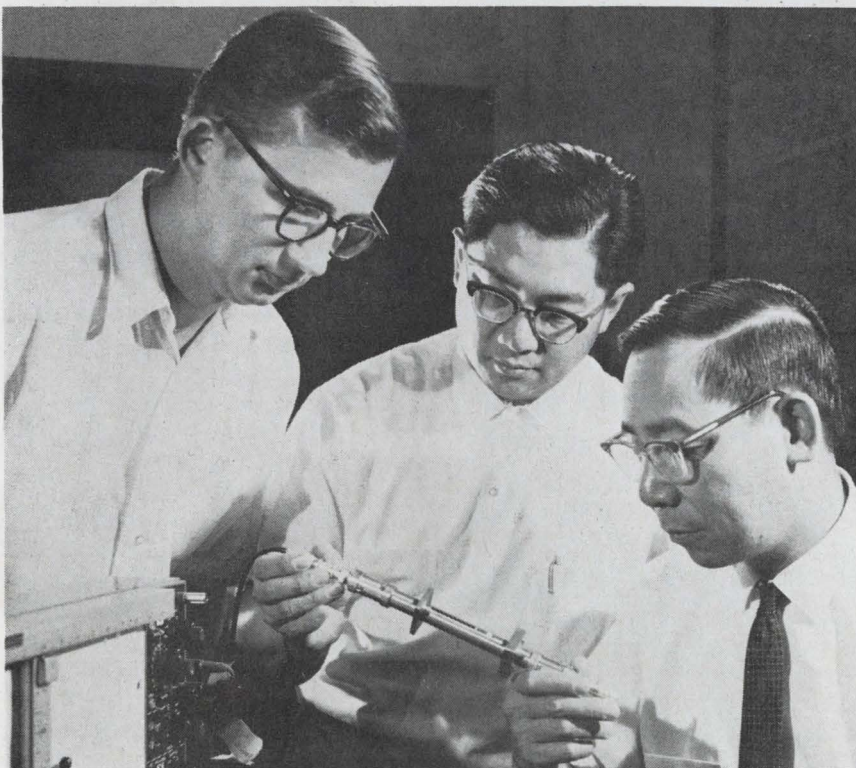

Together. Gunn-effect diodes (right) are linked in series to produce high-power microwave signals. GE developers, from left, Paul J. Shaver, Wirojana Tantraporn, and SePuan Yu, have already linked as many as four diodes.

inches—made the microwave component impractical as a piece of hardware.

Computer help. The GE team turned to a computer for help in understanding the voltage-capturing mechanism. By simulating the details of the electron-transporting properties of cascaded diodes, they could manipulate several variables in both the composition of the diodes and the geometry in which they were connected.

They found that three conditions were necessary to get the diodes to work together:

- The diodes must be similar in doping content to within 20%—relatively easy to control in manufacturing.

- The operating frequency of the microwave circuit must be some-

what higher than the Gunn frequency.

- The impedance of the circuit must exceed a certain minimum. “What makes the direct series connection particularly attractive,” explains Shaver, “is that the characteristics of the group of diodes are fundamentally the same as a single diode.”

Further, he says, it’s possible to tailor the combination to the needs of the circuit. For example, the demonstration model contains four diodes; two are arranged in parallel in combination with two in series. “In this way,” notes Shaver, “we were able to select our impedance.”

The GE team does acknowledge an inherent limit to the size of a diode series chain: it can be no

longer than the wavelength of the microwave signal it produces. “But,” cautions Shaver, “we’ve yet to hook up more than four diodes. We’re still looking for the problems.”

By November the team expects to link as many as 12 diodes in series.

Companies

The dust settles

Act Two of the Motorola-Fairchild management switch took place mostly behind the scenes. The Semiconductor Products division of Motorola, stunned at first by the departure of general manager C. Lester Hogan and seven other key executives [Electronics, Aug. 19, p. 45], reacted like a man who was hit by a truck but found to his surprise that he could get up and walk away from the accident. The Fairchild Semiconductor division, on the other hand, was like a mail-order bride discovering that married life doesn’t necessarily begin with a honeymoon.

Although Motorola leaked word that the whole package had been sealed and delivered on the Friday afternoon that Hogan announced his resignation, no one at Fairchild expected to see such a large contingent from Phoenix quite so soon. Hogan and his team arrived in Mountain View, Calif., the following Monday morning (Aug. 12), and by that night, to no one’s surprise, Fairchild general manager Thomas H. Bay had resigned.

Takeover. “Hogan is bringing in his own boys; I can understand his reasons, but I can’t be a part of it,” Bay said. “He doesn’t know if any of our guys are any good or not, but he’s replacing them anyway.” Bay was referring to Hogan’s immediate assumption of the role of acting general manager of the Semiconductor division (in addition to the presidency of the parent corporation), and the appointment of his Motorola colleagues as “group directors” in charge of Fairchild’s various manufacturing and support

Electronics Index of Activity

September 2, 1968

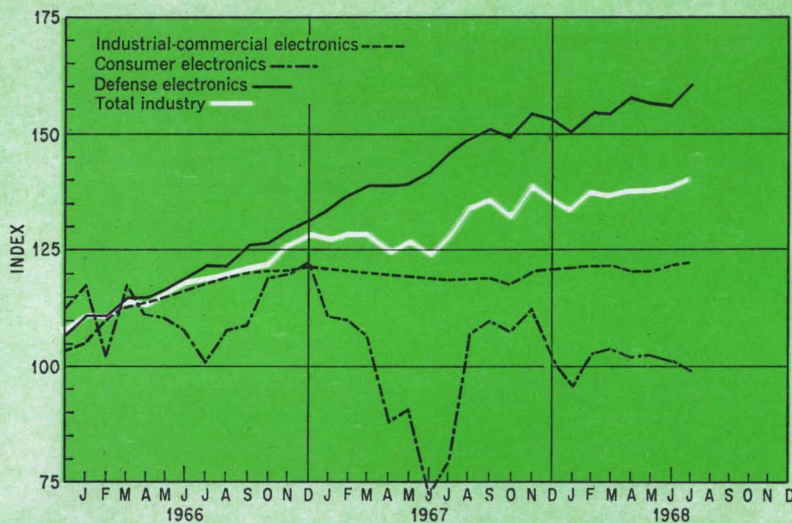

Segment Of Industry	July 1968	June 1968*	July 1967
Consumer electronics	99.7	102.0	79.5
Defense electronics	160.4	156.1	145.2
Industrial-commercial electronics	122.8	122.5	118.9
Total industry	139.0	137.1	126.2

Electronics production rose in July to 139.0, up 1.9 points from June and 12.8 points from the year-earlier level. The defense index posted the sharpest gain, advancing 4.3 points in the month and 15.2 points in the year. Industrial-commercial output inched 0.3 point ahead of the June figure and 3.9 points ahead of July 1967. The only decline was recorded in the consumer index, which slipped 2.3 points from the previous month. However, it was up 20.2 points from a year before.

Indexes chart pace of production volume for total industry and each segment. The base period, equal to 100, is the average of 1965 monthly output for each of the three parts of the industry. Index numbers are expressed as a percentage of the base period. Data is seasonally adjusted.
*Revised

operations. In effect, Hogan inserted a whole layer of top management between himself and the previous top echelon.

The only survivor of the reorganization was Jerry Sanders, who cut short a Hawaiian vacation and confounded the experts by emerging from a conference with Hogan as group director of marketing, with a raise in pay. Otherwise, John Sentous, who had been in charge of discrete devices, found himself reporting to newcomer Wilfred Corrigan; and John Megarian, the integrated-circuit manager, was placed under Eugene Blanchette. Of the other newcomers, Leo F. Dwork became corporate director of research and development, with direct responsibility for L. John Kabell's semiconductor R&D facility; Thomas Hinkelman became a corporate planning director; George Scalise took over as head of manufacturing services; Andrew Procasini became group director of quality assurance and reliability; and William Lehner, who designed and built Motorola's automated assembly lines, was named head of equipment engineering and facilities.

Mixed reception. Reaction to the shakeup was mixed. Marketing men seemed delighted at the prospect of new manufacturing vigor, but at the same time they were sympathetic about their colleagues' plight. On the manufacturing side, there was some resentment at the swiftness of the takeover. No one, apparently, was mad enough to leave immediately, however.

In Phoenix, meanwhile, there was bitterness toward Hogan for taking so many top executives with him, but also expressions of confidence in the new team (see story on p. 14).

Motorola leaked the claim that Fairchild had made a fantastic offer to Hogan: an interest-free loan to buy 90,000 shares of Fairchild stock at \$60 a share and another huge block at \$10 a share, plus \$250,000 in cash for "moving expenses." The others who left reportedly got interest-free loans to buy 12,000 to 15,000 shares at \$60 each. Hogan's Fairchild salary was reported to be \$120,000, and his aides' \$50,000 to \$60,000. "They've

set a new pay scale," said one observer.

Motorola also denied rumors that Hogan had been locked out of his office after resigning.

No secrets. Everyone was painfully aware that Hogan and his colleagues knew every detail of Motorola's manufacturing techniques, profit rates, yields, and marketing plans. Officially, however, this factor was discounted. "That only serves to calibrate them as to how far behind Fairchild is," said Motorola's new general manager, Stephen L. Levy. But neither he nor any other Motorola executive would comment on the possibility of a damage suit against Fairchild.

To stop further "defections" (the term is Motorola's) after Hogan's move, the company immediately raised some salaries and offered promises of bonuses. To stop rumors and avert panic, it took quick action to inform its employees, down to the production-worker level, of exactly what had happened. To allay customers' fears (and get a line on customer reaction), it called its major ones; and Levy went on a special trip to address a distributors' meeting in California.

Initial results were heartening. As expected, there were a few resignations—Fairchild picked up two production people, including transistor specialist Gregory Rayes, Signetics lured away at least two employees, and Walter Seelbach, integrated-circuit R&D manager, resigned—but in general the precautionary moves apparently held the line.

No retreat. Customer reaction was so good that Thomas H. Connors, Motorola's vice president in charge of marketing, was positively jaunty. "We haven't reset our goals," he said. "My first inclination was to pull back, and that was Steve Levy's, too. But Fairchild has an empty wagon, across the board. If they don't have quality problems they have low yields, both in transistors and IC's." (One outsider says that Motorola's yields are four times higher than Fairchild's.)

As far as orders, Connors says:

"I don't see any dent in the bookings curve, and as far as I can see, we'll have a record fourth quarter. From a bookings standpoint, the year is already over."

One of Hogan's first moves at Fairchild will be to try to fill that "empty wagon" by reversing a recent company decision to cut back on power transistors and silicon controlled rectifiers for the industrial-commercial market. The next step may affect processing; one source says a couple of minor adjustments in Fairchild procedures—improved wafer cleaning and the use of a glass layer to protect metalization—would quadruple yields immediately.

Hogan won't comment on that, but he does say that he expects quick results. "We have the technology, facilities, backlog, and personnel, to make a dramatic improvement in the next six to 12 months, and I'm fully confident that we will," he says.

Instrumentation

Light tuner

A diode laser that can be electronically tuned over 50 gigahertz has been developed by a team at the Massachusetts Institute of Technology. The diode's center frequency can be shifted from 6.5 microns (red) to 28 (infrared) by altering its chemical makeup. Because of the device's wide range and frequency stability—better than three parts in a billion—the MIT team believes the diode laser will have wide application in instrumentation.

The developers, E. David Hinkley, Theodore C. Harman, and Charles Freed, say the laser is made of single crystals of the mixed semiconductor lead-tin telluride, formed by vapor deposition from lead telluride and tin telluride seed crystals. The proportion of the two seed crystals determines the energy gap of the diode—or the center frequency.

Frequency finding. The diode is

tuned by varying the current through it. A few thousandths of a second are required for an output frequency shift of several gigahertz, but the tuning rate can be speeded somewhat by placing a magnetic solenoid around the diode.

In one application, the diode laser can be used to accurately measure the output frequency of another laser. The outputs of the known and unknown lasers are mixed, and the diode laser is tuned until a measurable heterodyne signal is obtained. The wavelength of the unknown laser can then be easily calculated by measuring the tuning current, because the current is related to the diode laser's output frequency.

Such a measurement can be particularly handy in tracking a satellite with a laser. Since the satellite's motion will cause a doppler shift in the laser's frequency, the diode laser could be used as a local oscillator, analogous to superheterodyne radio receivers.

Oceanology

Underwater guide

Since radio beacons situated near or between airports help planes fix their position through triangulation, why couldn't a similar system aid submarines? The increasing number of commercial and oceanographic subs navigating along or above the continental shelf has created a need for an underwater

equivalent of the omni beacon—a need the Submarine Signal division of the Raytheon Co. hopes to fill.

The division has developed a system that can give a submarine commander his bearing and range, and without triangulation; only a single benchmark beacon is needed to navigate accurately within an area several miles in diameter.

Tests of a breadboard model were to have begun late last month in Rhode Island's Narragansett Bay. This initial model will have a three-mile range, but later versions should be able to supply range and bearing data from as far away as 10 miles, says Gilbert N. Fain, designer of the system.

Clocking the run. A battery-powered bottom beacon will ping every 3 seconds at about 8.33 kilohertz. The timing of the pings is closely controlled by a low-drift crystal oscillator clock. Aboard the sub there will be an oscillator synchronized to the one at the beacon, making it possible to measure the travel time of the ping's sound wave as it moves at about a mile per second from beacon to ship. So accurate are the two oscillator clocks that range error should be only about 5 feet, according to Raytheon.

To determine bearing, a cylindrical piezoelectric transducer with four electrodes inside and a common electrode outside will be mounted aboard the sub. The two pair of electrodes are arbitrarily designated north-south and east-west, and the sensitivity pattern of each pair is shaped like a figure eight, with maximum receptivity

along one axis and almost a total null for signals at right angles to this axis.

Full sweep. Fixing a submarine's position thus involves simply rotating the pairs of acoustic rabbit ears to find the direction from which the pings are coming.

Units will probably first be tested aboard research subs and then be installed on geophysical research and exploration vessels—perhaps to aid in the search for underwater natural resources such as oil.

Integrated electronics

Opening the gates

Fairchild Semiconductor made a big splash with its 96-gate large-scale integrated circuit when it introduced it this summer [Electronics, July 22, p. 121]. But the record for the commercially available circuit with the most gates won't stay with Fairchild long. Both Westinghouse's Molecular Electronics division and Texas Instruments are getting into the act, with 120- and 174-gate LSI circuits, respectively.

Westinghouse has a series of semicustom bipolar transistor-transistor-logic arrays, the largest of which will have 120 gates. And TI has delivered TTL bipolar arrays with 174 equivalent gates to two West Coast firms and says it can now deliver similar customized arrays to others on two months' notice.

More to come. TI's arrays which use discretionary-wiring techniques, consist of flip-flops plus one-, three-, five-, and seven-input TTL gates in TI's standard series 54 logic configurations. The propagation delay at the gate is 15 nanoseconds, and the power dissipation is 10 milliwatts per gate.

The array is on a single 1.25-inch silicon wafer. The 174 gates are interconnected with three layers of metalization separated by insulating layers of silicon dioxide.

Glenn Penisten, a vice president, said TI expects to produce within 18 months LSI devices using 2-inch

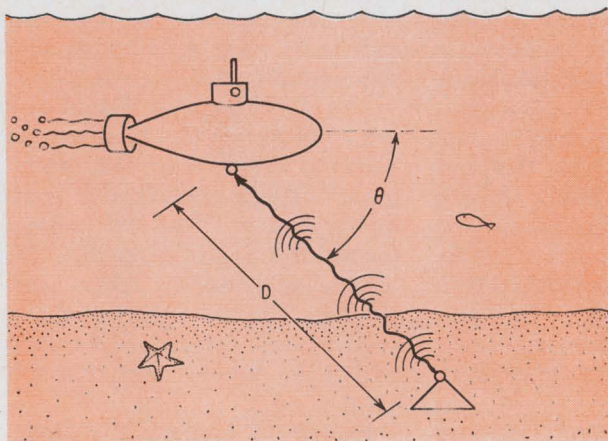

Beep. Single underwater beacon can provide navigation data to submarine. Unit gives range and bearing data without triangulation. Range of present design is three miles, and plans are to extend that to 10 miles.

**Why couldn't all the king's horses
and all the king's men put humpty dumpty together
again?**

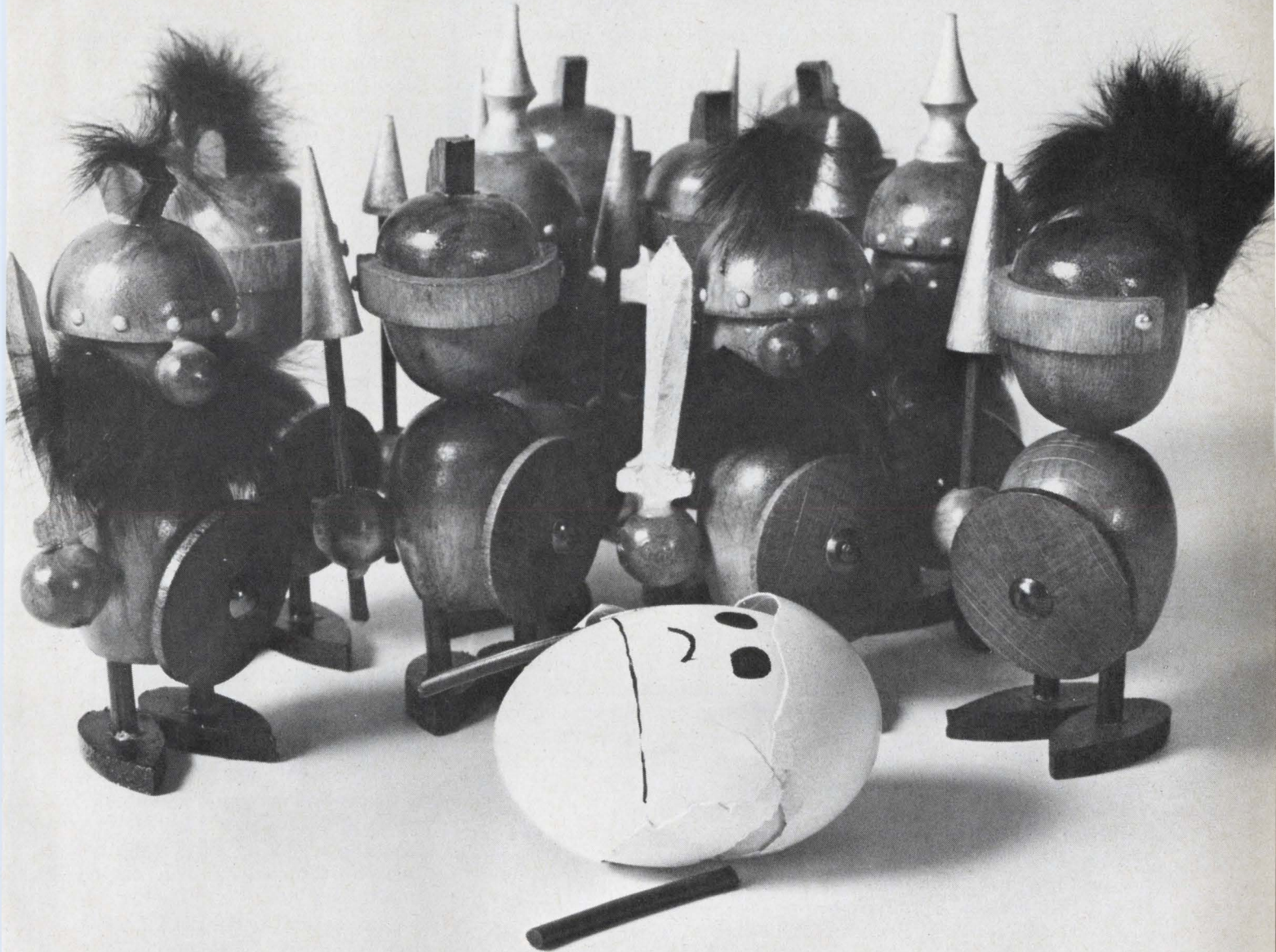

They couldn't fix a scrambled egg.

Or, integrating the whole (egg in this case) was their problem. But we've licked that problem. We put together fragments of your industrial operation that waste time, money, and materials, and integrate them into a totally efficient whole. We've been developing our compatible, versatile logic card capabilities for a long time. Now, we have the systems' design know how to build equipment to control your equipment. For you this means a process control system you can use in data terminal equipment, or in rolling mills, or in printing press control, or in . . . You name it. We're programmed to fix a scrambled egg. For more information, write or call:

 **CONTROL LOGIC, INC.** 3 Strathmore Road, Natick, Massachusetts 01760
Tel: 617 / 235-1865

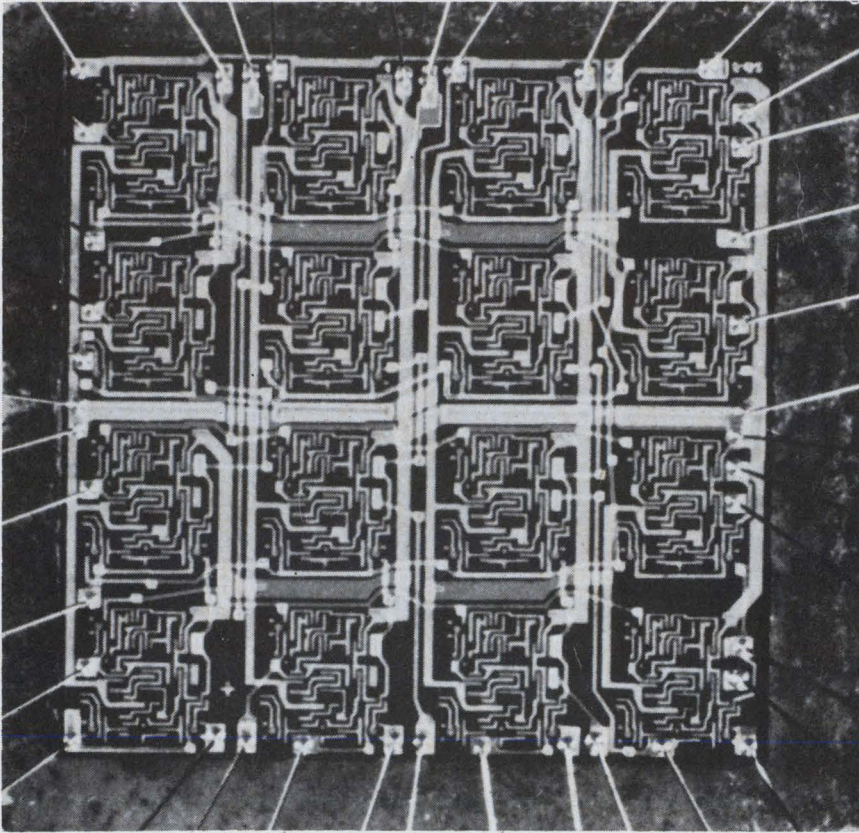

Upward. Record for the largest number of gates on a commercially available chip, held since this summer by Fairchild with a 96-gate device, went briefly to Westinghouse with a 120-gate device, above. Now Texas Instruments has a 174-gate circuit.

silicon wafers that will reach the level of 500 equivalent gates.

Also, he said, emitter-coupled logic circuits are now being designed into the cell library.

Made to order. Developed originally under a proprietary contract with a computer house, the Westinghouse WM500 series will soon be introduced for adder circuits, storage registers, and other applications. The basic unit of the series is a cell with three to five gates whose intraconnections can be made to order. The series will come in any combination, from three-by-three to four-by-six cell variations, with a five-by-five (125-gate) array coming later.

Regardless of size, the same basic cell diffusion pattern prevails. Westinghouse chooses to partially customize the circuit on the first layer of the two-layer metalization process. An interconnect pattern is superimposed on the photographic plate along with the standard cell pattern. The second-layer metalization, over dielectric glass, com-

pletes the customization.

Westinghouse uses the fixed-pattern master slice method—excluding redundancy in production and discretionary-wiring problems—which puts 800 standard cells on a single silicon wafer. This would give 40 four-by-four arrays, assuming a 100% yield. For any one such array to be good, however, all 16 grouped cells have to be functional.

“To make LSI pay you have to have high yields,” comments O. Robert Ryerson, an engineer on the project. “Our way is to have somewhat loose tolerances to ensure a high yield at the photochemistry steps.”

Consequently, Westinghouse uses large dies, which it believes don't slow up the circuit with TTL logic. The basic cell is 37 mils square, making the four-by-six array 148 by 222 mils (Fairchild's 96-gate 4700 measures 145 mils square). Right now, the division figures that's as large as it can go before silicon defects begin to reduce the yield measurably.

Space electronics

Speculative proposal

In the solemn jargon of the Pentagon and the space agency, an RFP, or request for proposal, announces an intention to buy equipment or services based on competitive bidding. Recently the Communications Satellite Corp., acting for the International Telecommunications Consortium, issued a long-awaited RFP for an aeronautical services satellite—but the RFP included a monumental catch.

It read: “The issuance of this RFP should not be understood as implying a decision by the ICSC (Interim Committee for Satellite Communications) to proceed with an aeronautical communications satellite program.”

No one is happy with this state of affairs except, of course, Comsat. One FAA official said the situation was clearly an imposition on bidders who might have to lay out as much as half a million dollars to develop a proposal. He added that “privately” the potential bidders were upset with the arrangement.

No comment. Of the four potential bidders, Philco-Ford and Hughes Aircraft, plan to bid, while the Space Vehicles division of TRW Systems intends to go in as a subcontractor with another company, and Lockheed Missiles and Space won't bid at all. All four refused to comment publicly on the unorthodox RFP.

The reason for the disclaimer is lack of cash. Says an insider: “We're still not exactly sure how attractive this concept is to potential users and we are still not sure how the bill will be paid.”

Heading the list of potential users are the airlines, which are represented by the Air Transport Association. Frank C. White, manager of communications and data processing for the ATA, says, “Comsat tells us that the cost of the satellite could go as low as a million dollars per channel per year.”

Again no comment. He explains

The **ONE** low-price pulser which wraps up everything you want:

- 50V into 50 ohms amplitude
- 5Hz to 3.5 MHz rep rate
- risetime of 12 ns variable to 100 ns
- clean waveform

E-H doesn't save all its revolutionary ideas for big-ticket pulsers. For instance, here's a low-priced general purpose pulser — Model 132A — with a unique E-H development, latched output circuitry. This feature assures "no-droop" pulses. It eliminates all waveform adjustment control,

makes sure the pulse is clean and fast under all conditions — without "trimming up." (You can slow the rise time for special applications with a front panel control.) Check the EH 132A against other pulsers in the low-priced field. You'll find it's top man on the totem in specs, and low man in price. Just \$715°



E-H RESEARCH LABORATORIES, INC.

515 11th Street • Box 1289, Oakland, California 94604 • (415) 834-3030 • TWX 910-366-7258

In Europe: E-H Research Laboratories (Ned) N.V., Box 1018, Eindhoven, The Netherlands, Telex 51116

In Japan: Iwatsu Electric Co., Ltd., No. 710, 2-Chome Kugayama Suginami-Ku, Tokyo, Japan

that in earlier talks about such a satellite with Comsat, the costs estimated were in the neighborhood of \$4 million to \$5 million per channel per year. Meanwhile, Comsat refuses to comment on the cost of the satellite, indicating only that it would be less than \$4 million.

As proposed, either two or three satellites would be purchased. The craft would be a very-high-frequency communications satellite with four channels. Eventually the satellite would also provide navigational services. It would be spin-stabilized and in a synchronous equatorial orbit. The technical variations in the bids will be examined closely but the future of the satellite rests on the ability of Philco-Ford and Hughes to keep the cost down.

Medical electronics

Heart watch

Although effective in monitoring heart activity, the electrocardiogram can't measure the amount of blood pumped by the muscle. About the only way to take such a measurement is to implant catheters into the heart—a potentially dangerous procedure with critically ill patients. A physiology professor with an undergraduate degree in electrical engineering, however, has developed an electronic technique to measure the blood flow.

Can't say why. The professor, Dr. William G. Kubicek of the University of Minnesota Medical School, passes a small current through the patient's body and then measures the slight drop in impedance of the current each time the heart pumps. It's this change in impedance, Kubicek has discovered, that's related to the amount of blood flow. But just why this is so, the doctor is unsure.

This month Kubicek will deliver one of his instruments to Dr. Christian Barnard, the South African heart transplant specialist. A decline in the blood flow, Kubicek notes, is early evidence of a heart-

rejection reaction by the body.

Developed under Air Force and NASA contracts, the impedance cardiograph is also being tested at 12 medical centers across the country. Four instruments miniaturized to the size of two cigarette packages by Space Labs of Van Nuys, Calif., have been delivered to NASA.

The experimental instrument measures the drop in resistance between two external electrodes while 4 to 5 milliamperes of 100-kilohertz current are sent through the body. The 25-ohm body resistance fluctuates about 0.1 ohm with the action of the left ventricle. And the amount of blood the heart is pumping can be derived from this small change.

Four strips. To take a reading, four Mylar-aluminum strips are taped to the patient. Two are placed on the neck and two on the body, one about five inches below the armpit and the fourth just above the waist. The top and bottom electrodes receive the current; the others are pickup electrodes connected to amplifiers.

Since such factors as the current and the distance between the electrodes are known, the change in impedance in the thoracic cavity between the middle electrodes can be measured.

Kubicek's instrument is a bulky 12-inch, 16-pound cube containing a differentiator, a digital voltmeter, and detector circuits designed by Robert Patterson, an electronics engineer on Kubicek's staff.

For the record

Firepower. The Navy's Poseidon ballistic missile and the Air Force's Minuteman 3 were successfully test-fired from Cape Kennedy last month. Both the two-stage Poseidon and the three-stage Minuteman are designed to carry the "multiple individually targetable re-entry vehicles" that contain up to 10 nuclear bombs in each warhead. This makes each missile essentially a missile bomber.

High power. By laminating two transistor wafers in a way that allows heat sinking from both the collector and emitter sides, RCA has pushed the power of an experimental silicon transistor to 800 watts at 1 megahertz. RCA officials say that they know of no other companies using the laminating process and that they are studying the process for application to other devices.

The device, which delivers about 400 watts more than the best present power transistors, is still about two years away from production. Officials foresee its use in equipment requiring 1 to 5 kilowatts, including sonar systems and radio broadcast transmitters.

Helping hand. A new data service promises to make such circuit-design computer programs as Circus, NET-1, and Sceptre more efficient and perhaps less expensive to use. For a fixed fee, Dynetics Inc. of Seattle will supply semiconductor information in either Ebers-Moll or change-control formats and on either punched cards or magnetic tape. Prices range from \$1,800 for data on four devices to \$9,500 for a 60-device data library. Both prices include specialized information furnished by the customer.

According to Dynetics, its data is more accurate than could be obtained in-house, and saves the customer money in test equipment and personnel. The firm also plans to offer design and analysis software, plus data on device and radiation effects.

Computer program club. For an annual fee of \$5,000, a firm or organization can become a member of the Franklin Institute's new Center for Computer-Aided Analysis. Membership privileges will include access to a \$1 million library of computer programs, as well as consultation services on how to use the program.

For those who don't want to become members, the Philadelphia center will also sell individual programs or develop them on a contractual basis. The association needs at least 25 members to begin operations.

Pick the
BEST IC
for the job

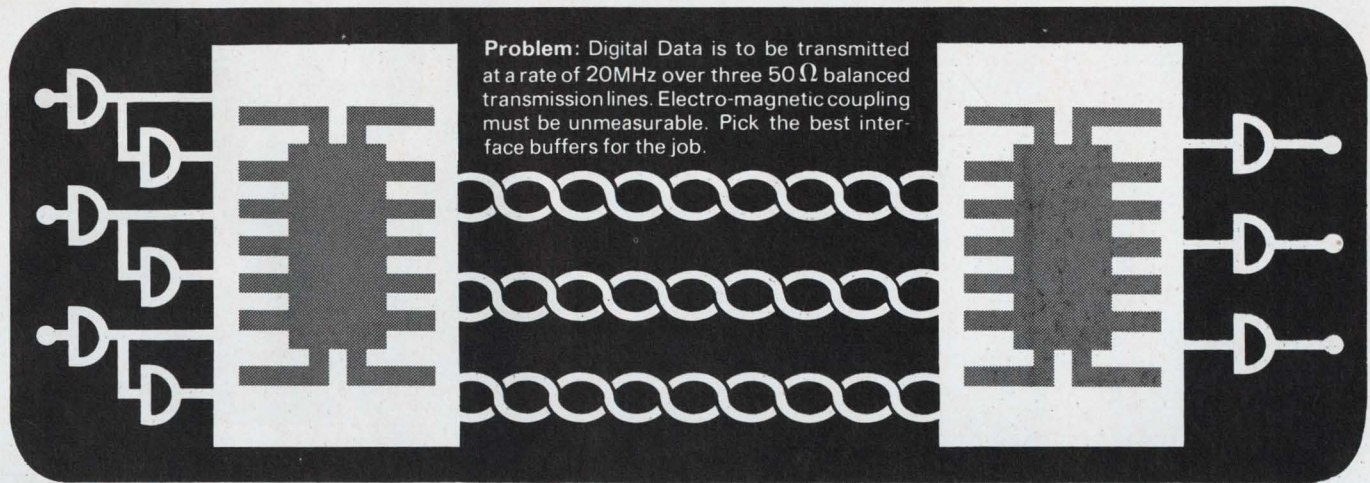

the **BEST** Solution:

THE NEW RA-245 LINE TRANSMITTER

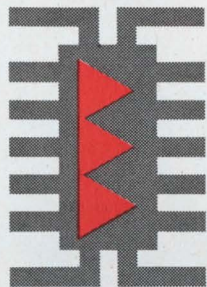

The best IC to use at the sending end is Radiation's dielectrically isolated RA-245. This line transmitter converts digital voltage pulses to current pulses. The high speed CML circuits assure data transfer rates in excess of 30MHz. Power dissipation is a constant, independent of data rate. The balanced system virtually eliminates the adverse effects of line capacity. Electro-magnetic coupling and susceptibility is greatly reduced. RA-245 is available in both the TO-84 flatpack and the ceramic dual inline package. Three voltage-to-current converters are in each package. Power dissipation is negligible when converters are not being used. So use only one or all three. RA-245 is the Best IC for the job.

THE NEW RA-246 LINE RECEIVER

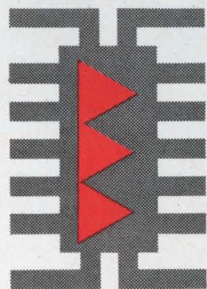

For best results, use Radiation's dielectrically isolated RA-246 at the receiving end. This 3-element buffer faithfully restores the current pulses to digital voltage pulses. The RA-246 current-to-voltage converter has built-in input terminations for balanced 50Ω lines. Outputs from each element are suitable to drive all standard saturated logic circuits (such as DTL, TTL, etc.).

Like the RA-245, the RA-246 is available in both the TO-84 flatpack and the ceramic dual inline package. And you can use any or all of the converters. The Best IC for the job.

Contact your nearest Radiation sales office for further information. Ask how the RA-245 can be used as a level shifter. And how to use the RA-246 as a threshold detector. We will help you pick the Best IC for the job.

WE MAKE THE **BEST** IC FOR THE JOB



RADIATION
INCORPORATED
SUBSIDIARY OF HARRIS-INTERTYPE CORPORATION
MICROELECTRONICS DIVISION

RADIATION SALES OFFICES: P.O. Box 476, Lexington, Mass. 02173, (617) 682-1055 • 600 Old Country Road, Garden City, N.Y. 11530, (516) 747-3730 • 2600 Virginia Avenue N.W., Washington, D.C. 20037, (202) 337-4914 • 6151 W. Century Boulevard, Los Angeles, California 90045, (213) 670-5432 • P.O. Box 37, Melbourne, Florida 32901, (305) 727-5430 • International Sales: Marketing Department, P.O. Box 37, Melbourne, Florida 32901, (305) 727-5412

at
\$1.22*

*you have
no choice of
color...*

black



MODEL
3305P

also black



MODEL
3305W

... but they're Stocked In Depth by BOURNS Distributors!

the specs are better than "those other makes" that cost more! The Model 3305 TRIMPOT® potentiometer has been designed from the ground up as a **commercial**.

Here are the facts on the 3305 . . . besides the price, that is!

The unit is sealed to prevent contamination from fluxing, soldering, and cleaning . . . in addition our pins can be used on boards using 0.1" grid spacing. This small $\frac{5}{16}$ " dia. unit has a resistance range of 50Ω to $25K\Omega$, with standard resistance tolerance $\pm 5\%$. Being a wirewound unit, it provides plus features such as low temperature coefficient . . . better resistance tolerance . . . and superior noise characteristics. Operating range is -55°C to $+125^\circ\text{C}$. . . temperature coefficient is only ± 70 PPM/ $^\circ\text{C}$. . . power rating $\frac{1}{2}$ watt and noise is negligible at 100 ENR.

*500 piece price

Check into our one color—basic black—Model 3305 for the best . . . at a low-low price. For complete technical data contact your nearest Bourns office, representative, or stocking distributor.

FREE

Exploded-view drawing and new informative specification comparison chart



BOURNS, INC., TRIMPOT DIVISION • 1200 COLUMBIA AVE., RIVERSIDE, CALIF.
TELEPHONE (714) 684-1700 • TWX: 910 332-1252 • CABLE: BOURNSINC.

TRIMPOT® and Precision Potentiometers - Miniature Relays - Electronic Modules - Microcomponents.

SOLVE YOUR HIGH FREQUENCY RF SWITCHING PROBLEMS WITH THESE QUALITY COAXIAL RELAYS

Hi-G provides the most complete line of *miniature* coaxial relays that meet or exceed the applicable portions of MIL-R-5757/D . . . and at competitive prices. These hermetically sealed coaxial relays have been specifically designed for high frequency RF switching applications. Their trouble free performance characteristics are a result of Hi-G's long experience in the design and manufacture of sophisticated switching devices. All Hi-G relays are built to withstand extremely tough environmental conditions.

Dice Cube

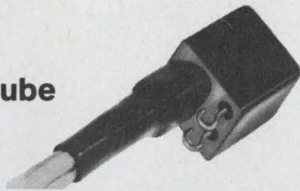

Relay Type	RFC
Size	0.5-Inch Cube
Rated Contact Current	1 Ampere RF
Maximum Weight	0.3 Ounce (without terminations)

Half Size Crystal-Can

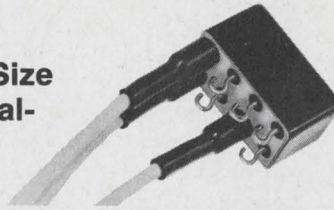

Relay Type	RFK
Size	.4 x .8 x .4 inch
Rated Contact Current	1.5 Amperes RF
Maximum Weight	0.37 Ounce (without terminations)

Crystal-Can

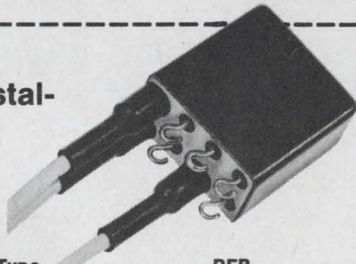

Relay Type	RFB
Size	.875 x .800 x .400
Rated Contact Current	1.5 Amperes RF
Maximum Weight	0.95 Ounce (without terminations)

High Sensitivity

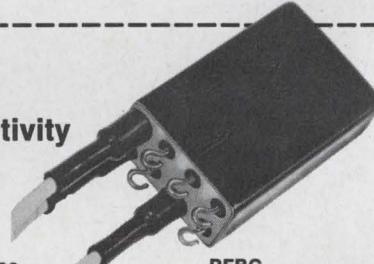

Relay Type	RFBC
Size	1.275 x .800 x .400
Rated Contact Current	1.5 Amperes RF
Maximum Weight	1.0 Ounce (without terminations)

RADIO FREQUENCY CHARACTERISTICS

Frequency Range	0-500 MHz*
Voltage Standing Wave Ratio (VSWR)	<1.1:1 typical
Insertion Loss	0.16DB typical
Characteristic Impedance	-50 Ohms†
Crosstalk	-50DB typical

* Usable to 1000 MHz with reduced R.F. Characteristics

† Other impedances available on special order

Standard input and output connections from R.F. contacts are RG-196/U Teflon insulated coaxial cable, 6" in length, unterminated. Other lengths, types of cable, or coaxial connector terminations available on special order.

Call, write, or check the reader service card for your copy of Hi-G Product Bulletin 155. Hi-G relays are available from Hi-G Distributors. For applications engineering assistance, an experienced Hi-G representative awaits your call. Telephone 202-623-2481



SPRING STREET & ROUTE 75 / WINDSOR LOCKS, CONNECTICUT 06096

SERIES RF Relays are available at the following DISTRIBUTORS

Angus, Incorporated, Pleasant Valley Avenue, Moorestown, N.J. 08057 TEL: 609-235-1900

Federal Electronics, P.O. Box 1208, Vestel Parkway E., Binghamton, New York 13903 TEL: 607-748-8211

Hall-Mark Electronics, 2805 Governors Drive, SW, Huntsville, Alabama 35805 TEL: 205-536-9627

Hall-Mark Electronics, 1290 West Oakland Park Blvd., Fort Lauderdale, Florida 33307 TEL: 305-563-3271

Hall-Mark Electronics, 7233 Lake Ellenor Drive, Orlando, Florida 32809 TEL: 305-855-4020

Hall-Mark Electronics, 701 Georgetown Road, Raleigh, N.C. 27508 TEL: 919-828-0991

Harvey Radio Company, Inc., 60 Crossways Park West, Woodbury, New York 11797 TEL: 516-921-8700

Lectronix, Incorporated, 214 North 2nd Street, P.O. Box 188, St. Charles, Missouri 63301 TEL: 314-723-1122

Moulton Electronics Distributors, Inc., 1058 Terminal Way, San Carlos, California 97078 TEL: 415-591-8292

Moulton Electronics, c/o Banks Sales Corp., 2785 N. Speer Blvd., Denver, Colorado 80211 TEL: 303-433-5455

Tomelco/Moulton, 531 N. Brown Avenue, Scottsdale, Arizona 85251 TEL: 602-945-5030

Tomelco/Moulton, 15846 Pacific Highway South, Seattle, Washington 98188 TEL: 206-246-1727

Radio Products Sales, Inc., 1501 South Hill Street, Los Angeles, California 90015 TEL: 213-748-1271

R & D Electronics, Inc., 71 Pearl Street, Cambridge, Mass. 02139 TEL: 617-864-0400 and 8401; ENterprise 7135 in Major Cities

Solid State Electronics Co. of Texas, 2643 Manana, P.O. Box 20299, Dallas, Texas 75220 TEL: 214-352-2601

Westates Electronics Corp., 20151 Bahama Street, Chatsworth, California 91311 TEL: 213-341-4411

KNOWING WHAT YOU'LL NEED IN STATE-OF-THE-ART UNIUNCTION TRANSISTOR PERFORMANCE TOMORROW

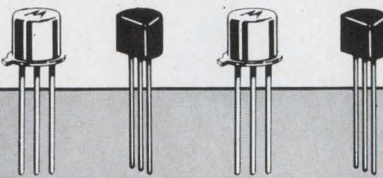

			Peak Point Current @ V_{B2B1} μA (Max)	Intrinsic Standoff Ratio (η)		Emitter Reverse Current nA (Max)
				Min	Max	
Renowned for Minutes-To-Microseconds Timing Capability	February, 1967	2N4851	2.0	0.56	0.75	100
		2N4852	2.0	0.70	0.85	100
		2N4853	0.4	0.70	0.85	50
			@ 25 V			
Outstanding for Ultra-Accurate Industrial/Military Timing	May, 1967	2N3980	2.0	0.68	0.82	10
			@ 25 V			
Popular for 43-cent* Plastic Versatility	August, 1967	2N4870 2N4871	5.0 5.0	0.56 0.70	0.75 0.85	1.0‡
			@ 25 V			
Distinguished† For Reliable Timing, Triggering, Sensing Capability	November, 1967	2N4948 (JAN2N4948) 2N4949 (JAN2N4949)	2.0 1.0	0.55 0.74	0.82 0.86	10
			@ 25 V			
Specified For Wide Spec Choice At Low Cost	March, 1968	MU4891 MU4892 MU4893 MU4894	5.0 2.0 2.0 1.0	0.55 0.51 0.55 0.74	0.82 0.69 0.82 0.86	10
			@ 25 V			
Discovered for Lower-Than-Ever Voltage Operation in Long-Time-Delay Circuits	August, 1968	2N5431	4.0	0.72	0.80	10
			@ 4 V			

*1,000-Up
†Meets MIL-S-19500/388
‡#A

HAS MADE THESE WHAT THEY ARE TODAY!

We try to look ahead to your unijunction transistor circuit design needs . . . that's why these units have become integral parts of so many advanced, new-design systems — and why we continue to introduce you to the newest and best in this semiconductor field.

For example, the just-announced 2N5431, like its teammates, features all the fast-response, long-time-delay advantages of Annular* technology. What's unique is inter-base voltage is spec'd at only 4.0 volts . . . you can design it into low-voltage applications and still realize low-leakage, low-peak-point characteristics permitting accurate, reliable operation in a variety of timing, triggering and sensing designs.

To help you remember why these well-known UJT's became true design standards, your Motorola distributor is offering a free Unijunction Design/Sampler Kit containing a 2N4852 unit, data sheet, Thyristor Selector Guide and "Theory & Characteristics of the UJT," "UJT Timers & Oscillators," and "UJT Triggers for Thyristor Circuits." Contact him for a free kit today.

Send for data sheets on the above devices: Box 20912, Phoenix, Arizona 85036.

Then you'll know what we know.

*Annular semiconductors patented by Motorola Inc.

-where the priceless ingredient is care!



MOTOROLA
Semiconductor Products Inc.

Speed reading for status seekers.*

You've never seen an indicator quite like this before. Only the exclusive optical meter capability of Weston could offer it to you now. The new Weston Model 1316 Optical Ribbon Indicator lets you scan the status of many parameters at a quick glance. Parallax problems are eliminated by optical projection, and the unique design allows the flat scale to be changed as often as desired without expos-

ing the mechanism. It's ideal for displaying temperature, making inspection histograms, or gauging liquid or material levels. The flat, self-shielded mechanism also permits side-by-side mounting where group display is required. So you can use multiple units as a medical patient/station monitor, for example, or to monitor temperature profiles or a roomful of lathes. Accuracy is $\pm 1\%$, and the instru-

ment is available in all popular ranges—including suppressed zero for process control applications. Priced under \$60 in quantity. Write today for complete details on this latest Weston advance in optical meters. **WESTON INSTRUMENTS DIV.**, Weston Instruments, Inc., Newark, N.J. 07114, a Schlumberger company.

WESTON[®]

*The Weston Optical Ribbon Indicator

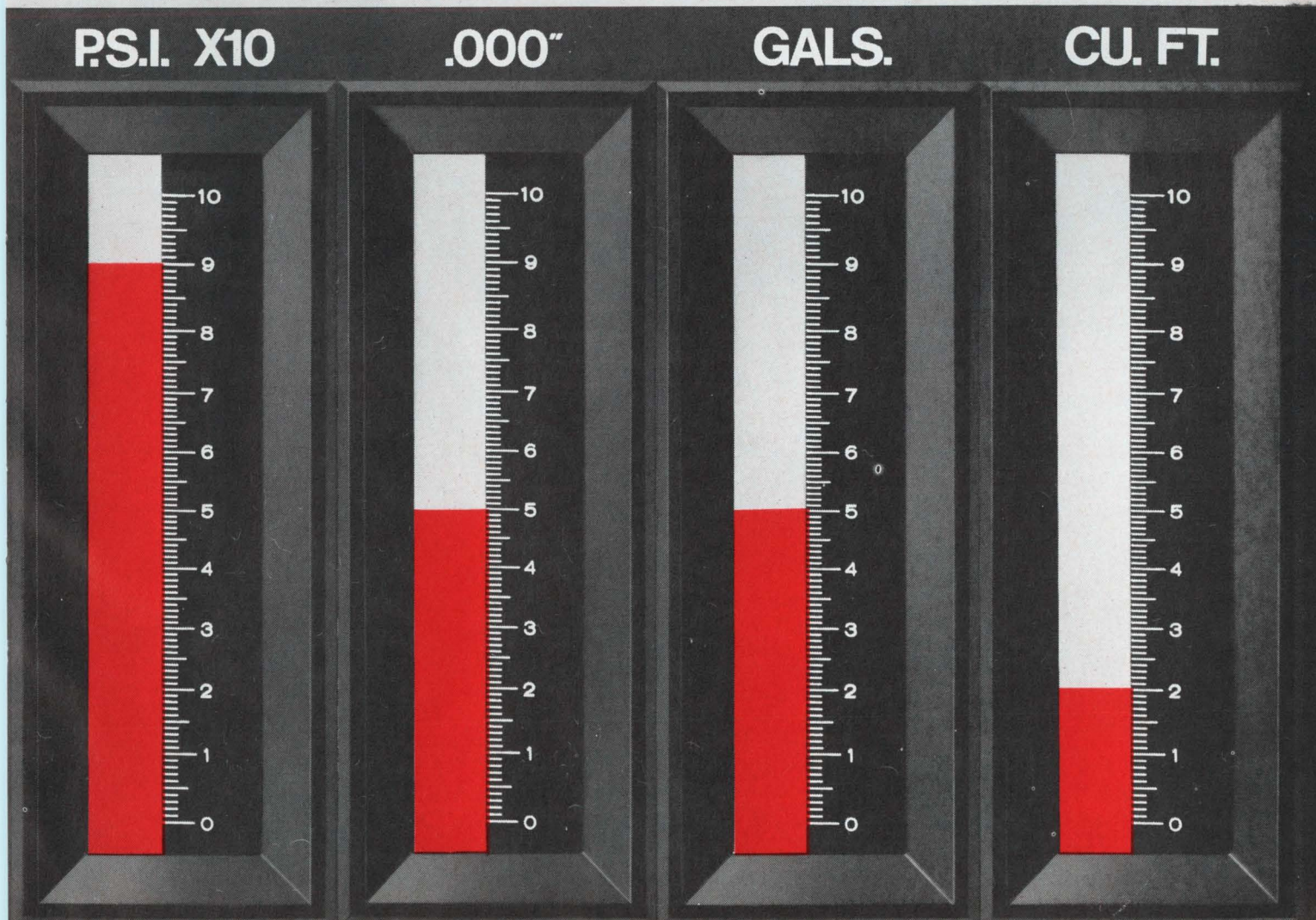



now in 9 sizes HELIAX[®] elliptical waveguide covers the microwave spectrum

With the addition of two new sizes, flexible HELIAX elliptical waveguide is available for all microwave communication bands from 1.7 to 13.2 GHz. The continuous single lengths of HELIAX waveguide assure reliable system performance, with electrical characteristics better than conventional rigid

waveguides at less cost. ■ Investigate HELIAX Elliptical Waveguides for your next microwave system whether it be for a short haul installation or a long high density system. ■ Write for specifications—Andrew Corporation, 10500 W. 153rd Street, Orland Park, Illinois 60462.

2-67

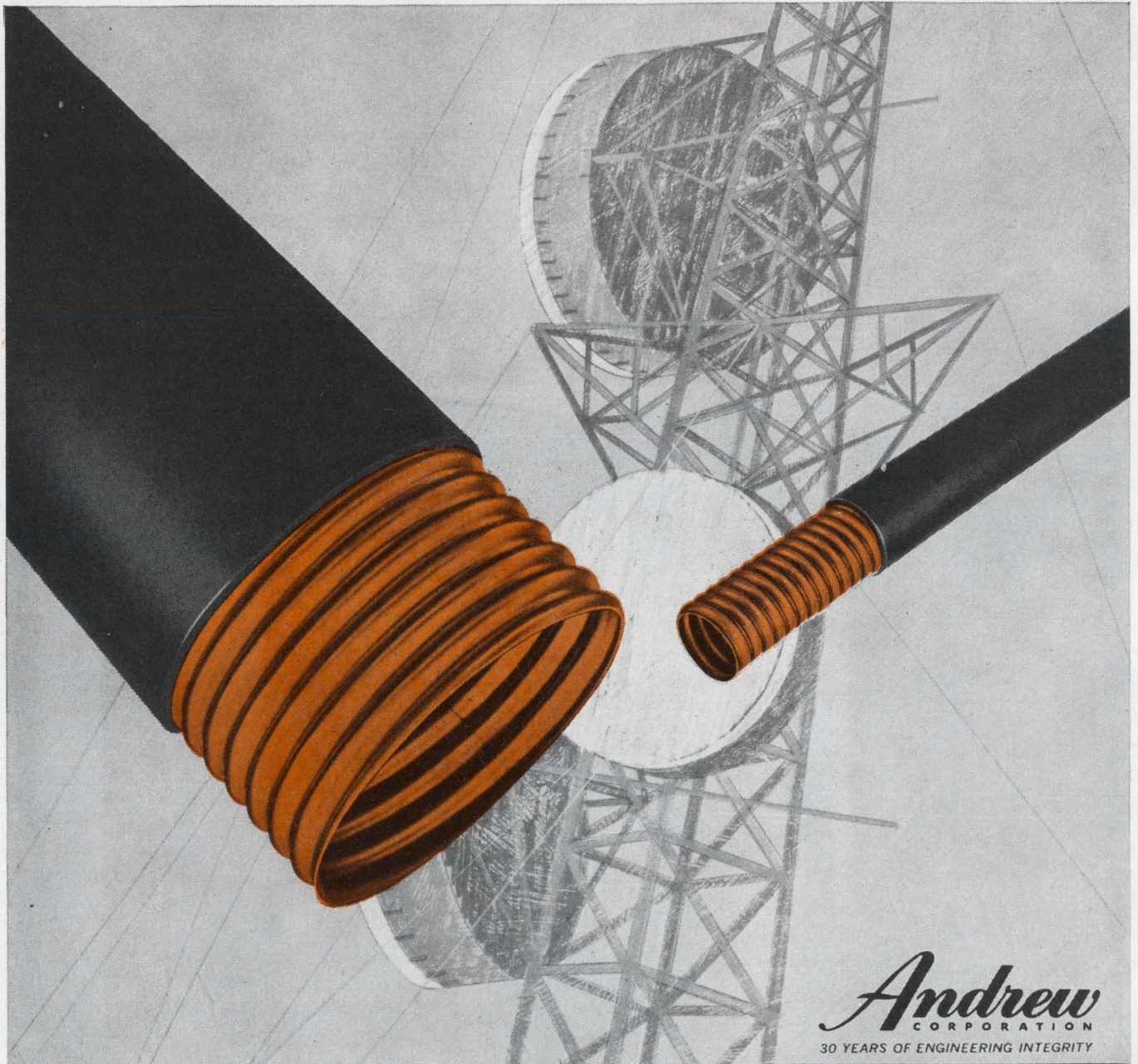

Andrew
CORPORATION
30 YEARS OF ENGINEERING INTEGRITY

9 SIZES OF ELLIPTICAL WAVEGUIDE

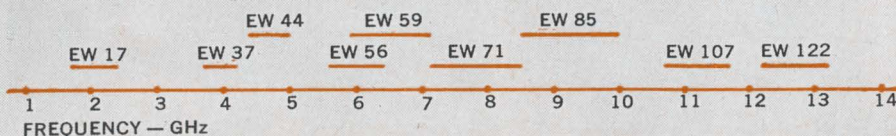

Standard or Tuned Connectors to Fit Standard Waveguide Flanges.

Washington Newsletter

September 2, 1968

Missile sites to get new computer setup

The Air Force is planning to equip its Minuteman ICBM system with a new set of command and control computers. Details on the digital machines, which would be modular building blocks capable of handling several functions, will be spelled out at a bidders' briefing Sept. 5. On Oct. 21, the Space and Missile Systems Organization will issue a request for industry proposals for the initial phase of the program—the development of six prototype units. A production run of 1,080 machines over three years is planned.

To be located in the missile silos, these advanced computers wouldn't replace any equipment currently used in the Minuteman system. "There's nothing like it now," says a program official. **The machines would monitor all the Minuteman systems and interlock the entire complex.**

Among the specifications the Air Force will ask: a mean time between failure of 25,000 hours; a 32,000-bit, electrically alterable, random-access permanent memory with a 4,000-word temporary storage; access times of less than 500 nanoseconds to the permanent memory storage and no more than 2 microseconds to the temporary storage; and bi-directional serial data channels with a capacity of up to 100,000 bits per second.

The development contract is scheduled to be awarded next February, with delivery of the prototypes set for the following October.

FAA approves color for radar displays

The FAA is finally convinced that color-phosphor technology is here—for its air traffic control radar displays. The agency has set Sept. 3 as the date for industry proposals on a two-part development contract for prototype color-phosphor tubes. The contract would be awarded in November and tests might begin this winter.

About three years ago the FAA ruled out color radar displays—using a single layer and a triple electron gun—for lack of accuracy. But, even if accuracy had been adequate, the costs would have been prohibitive. **Now the agency is convinced that the single gun, multilayer phosphor approach will work.** Color-coded information on radar scopes would separate vital data from radar clutter and ease the job of the controllers.

First phase of the development effort will be experiments to prove feasibility. With feasibility established—and the FAA has no doubt about it—the contractor would build six prototype tubes for installation at the FAA's Atlantic City center and possibly at its Atlanta center. **If the tests go well, color displays may be in all major terminals within two years.** The rest of the FAA's 700 enroute and terminal radar displays would get the color tubes as the agency obtained funding.

NASA, FAA seek low-cost detectors to complement CAS

With work finally moving ahead towards flight tests next year of five competing collision-avoidance systems [Electronics, Aug. 5, p. 34], NASA and the FAA are now pressing for development of a complementary pilot warning indicator that would cost less than \$2,000. Collision-avoidance systems (CAS) are expected to cost \$40,000 to \$50,000 and will be used en route by high-altitude, high-speed craft. The pilot warning indicator would be carried by slower planes flying at lower altitudes—general-aviation craft, feeder airlines' planes and the like—but it would also be used by jet airliners in terminal areas. Its range would be five miles.

Washington Newsletter

NASA's Electronics Research Center has asked for industry proposals for a prototype infrared sensor that could detect a plane's xenon strobe lights. And the agency's Langley Research Center is working on a radio-frequency doppler device.

The FAA—though it hasn't had the money to let a contract—has persuaded several companies to work in-house on pilot warning indicators. Two approaches are being studied—infrared detectors and lasers. In the latter scheme, all aircraft would carry laser-signal reflectors. **Out of all this work could come a decision standardizing on a single technique.**

NASA juggles funds; hopes 1970 budget will justify the risk

The space agency is playing a dangerous game with its fiscal 1969 budget. In shifting money away from some long-term programs to keep the more immediate ones fully funded, NASA is gambling that it will get enough money next year to put the neglected projects back on schedule. "There's a calculated risk in this kind of thing," concedes one NASA official. "It means we're going to have to really fight in the next budget to get the long-term programs going again."

An early case in point: the Mariner Mars 1973 program, originally down for \$20 million this year, will now receive only \$4 million to \$6 million. The two spacecraft with their planet landers will be held to their present schedule, but unless there's a lot more money for the program in fiscal 1970, they'll have to go, at best, with far less sophisticated lander sensors than are now planned. On the other hand, NASA intends to allocate to the Mariner Mars 1971 project the full \$18 million slated.

It's expected that this kind of budget juggling will be applied to other projects as NASA puts into effect its "interim operating plan" [Electronics, Aug. 19, p. 59].

Research cash asked for solid state

The latest addition to the litany of complaints about decreasing Government support for basic research will be in a report to be issued later this month by the National Academy of Sciences' solid state sciences group.

The report will warn that the level of Government support in solid state research "is actually critical with respect to both manpower and technology." Specifically, says the committee, research is most needed in ferromagnetism, superconductivity, dislocation theory, low-temperature physics, high-field transport phenomena, plasmas, and lattice dynamics.

ATS-E launch may be delayed

Launching of the fifth Applications Technology Satellite (ATS-E)—presently scheduled for next May—would be delayed several months if the addition of a number of experiment packages is approved.

Because ATS-D failed to achieve proper orbit last month, project officials would like to add some of the ATS-D experiments to ATS-E. One of them is the image orthicon camera with steerable optics.

Project officials are also awaiting approval to add an L-band transponder [Electronics, July 22, p. 53]. Also being considered is a piggyback satellite called Camsat. The outlook for adding the L-band transponder is still bright, but somewhat dimmer for Camsat, a Hughes Aircraft proposal that would cost as much as \$10 million. It would carry three cameras—black and white, infrared, and color—capable of simultaneous transmission. A final decision will be made on Camsat and the L-band transponder in the next few weeks, while the go-ahead on adding ATS-D experiments is expected shortly.

WELDPOWER®



For High-Precision, High-Energy Welding

Yes, the Model 225C Mark I welder and the R-Series welding heads do form an impressive production system! The 225C Mark I is a power-packed AC-to-DC energy storer which is calibrated in both watt-seconds and charging voltage (0-1500 Vdc). Unaffected by input line variations, the welder has a peak output of 8,000 amperes and offers selectable pulse durations of approximately 4, 8, 17 and 33 milliseconds. New features include simplified operation (only a single operation control!) and, for those polarity-sensitive materials and oxides, a polarity reversal system.

The new R-Series welding heads, ideal companions for the 225C Mark I, offer adjustable electrode forces from 2 to 60 pounds, high acceleration for high-speed production and repeatability proven

through thousands of hours of endurance testing. Additional features include a firing indicator, adjustable external override and a precisely calibrated pressure indicator.

Raytheon's coherent design concept provides wide-range flexibility for both the Mark I and the R-Series. For example, the 225C Mark I is not only compatible with R-Series heads but with other Raytheon heads as well (Q-, O-, J and JA Series, to name a few).

For more information on these products and Raytheon's full spectrum of welding systems and services, call or write Raytheon Company, Richards Ave., Norwalk Conn. 06856 TWX 710-468-2940.



And for solutions to your welding problems... **Call Raytheon: 203-838-6571**

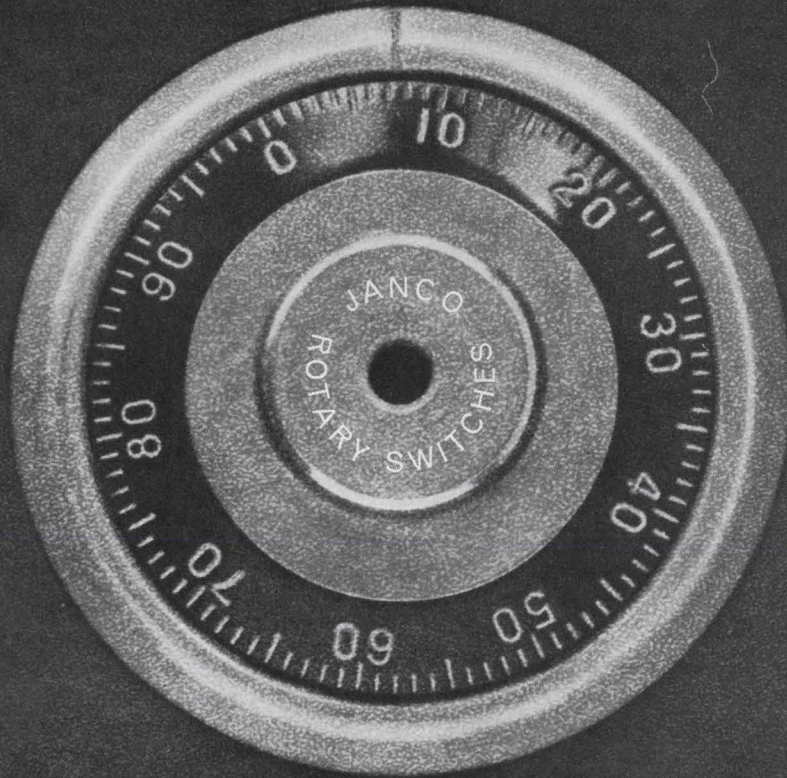

WHAT IS THE RIGHT COMBINATION FOR YOU?

Janco Corporation's ability to build a quality, totally enclosed rotary switch stems from a concern to offer you the right combination.

It is this philosophy which permeates Janco's products, management, and customer relations. It is a credo which states that we owe the best combination of talents and materials to you and ourselves, and the end result is peace of mind for both of us. Peace of mind in knowing that the product we built, and you bought, will consistently perform to your requirements.

The right combination starts with the right materials... top quality materials. All Janco rotary switches are

insulated with glass filled alkyd for superior mechanical and electrical characteristics. Current conduction is handled by Beryllium copper and solid silver alloy contacts.

The finest materials in the world and the finest manufacturing techniques and equipment are worthless without the added combination of quality control... tight quality control. Janco has that control because all manufacturing steps are performed within its own plant. Tooling, investment casting, die stamping, component machining, plating and furnace brazing are all performed at Janco by specialists.

Another important ingredient that makes up the right combination for you, is customer service. Janco's data processing center keeps tabs on your order from development to delivery... on time delivery. A technically oriented rotary switch specialist is located in your area to service your requirements.

Remember, Janco builds a quality rotary switch... a switch that might cost a little more than the one you used yesterday, but it is the cost of quality that takes the problems out of tomorrow and gives the builder and the buyer peace of mind. Now, isn't that the right combination for you?

JANCO

CORPORATION

3111 Winona Avenue
Burbank, California 91504

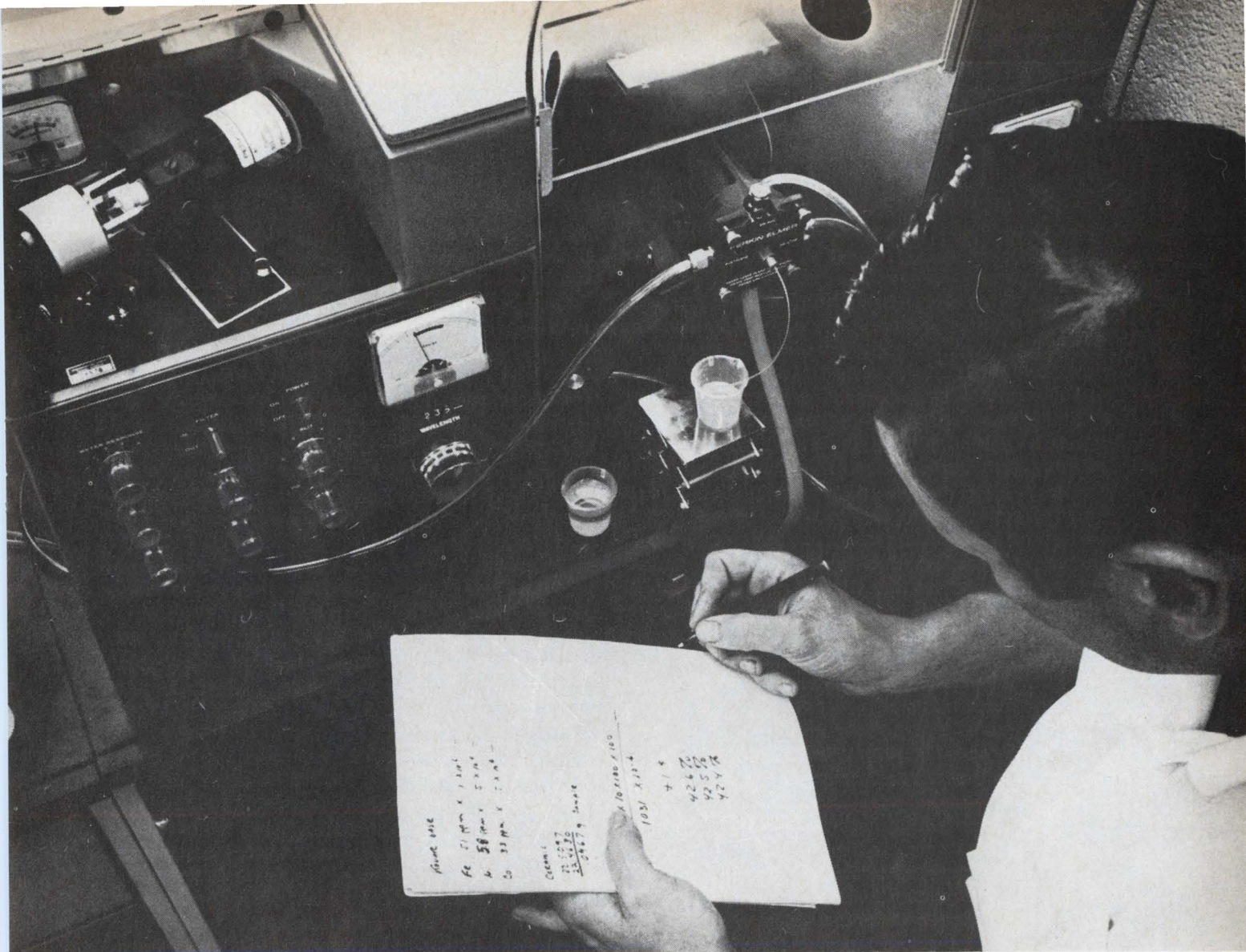

We solve problems you never knew you had.

Any good custom fabricator can solve problems he can see.

It's the ones you can't see that cause all the trouble.

Like parts that stick in the mold.

Or too much flash on the edges.

Or production delays and extra charges for special die changes.

Well, at Sylvania, we don't take chances. When you turn out 50 million precision parts a day, you have to solve problems before they exist.

So the first thing we do is analyze your part's design and its function in the finished product. You'd be surprised at how many

problems we solve here.

Then our diemakers look into it. They know what a tool can and can't do. They solve problems you never knew existed.

Finally, our production engineers get into the act. It's one thing to design a part; it's another to produce it economically. Sometimes, this means designing a whole new piece of equipment. Other times, it calls for modifying your design.

Either way, it means you get the parts you want, the way you want them, when you want them—probably at lower cost than you could do it for yourself.

And we've got nine plants, the most

advanced equipment and the best diemakers and engineers around. We've been doing it for 17 years. On transistor leads, computer memory core frames, connectors, pen caps, aerosol spray tips, razor blade dispensers, integrated circuit frames. You name it.

So the next time you need a custom fabricated precision part, let us solve your problems. Especially the ones you don't even know you have.

Sylvania Metals & Chemicals, Parts Div., Warren, Pa. 16365.

SYLVANIA
A SUBSIDIARY OF
GENERAL TELEPHONE & ELECTRONICS

CHOOSE THE SURE THINGS: FIELD-PROVEN Telemetry Products from DEI

Why gamble with uncertainties? Late deliveries?
Or pay unnecessary R/D costs?
Here today is the quality line of DEI/Nems-Clarke telemetry receivers
and RF auxiliary products for
S and L-Band data acquisition systems.

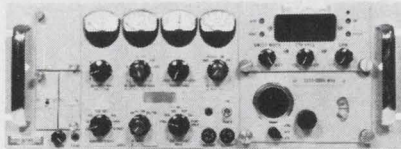

R-1074A-11 . . . 55-2300 mHz tuning ranges. Switch selectable IF filters and demodulators. Suitable for telemetry data reception and conical scan tracking. Automatic AFC reset carrier-operated relays.

Designed with sufficient space to allow installation of five or more additional modules. Options include predetection up/down converters, phase tracking demodulators, adjacent channel filters, and conical scan tracking filters. Completely solid-state and modular in construction. RF tuners, IF filter and demodulators used are quick-change, front panel plug-in assemblies.

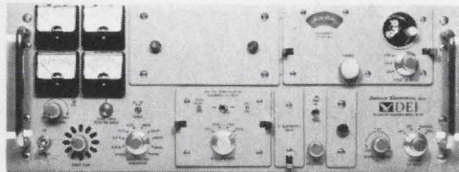

TR-711 . . . 55-2300 mHz tuning ranges. Solid state with switch selectable IF filters. All IRIG bandwidths. Plug-in record/playback converters, spectrum analyzer and oscilloscope.

Offers an order of magnitude improvement in strong signal handling capability and reduction of spurious responses common in previously available solid state receivers. Unit has extremely linear AGC for accurate signal strength recording and matched AGC performance curves for optimum diversity combiner operation. Multisection tunable preselectors are provided ahead of the first RF amplifier or mixer stages for maximum intermodulation and adjacent channel interference rejection.

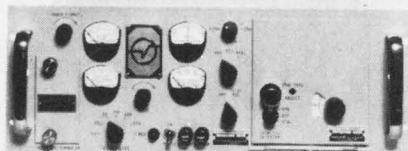

1037-G . . . 55-2300 mHz tuning range. Solid state with nuvistor and stripline tuners. Matched IF filter/demodulators. All IRIG bandwidths. Optional SDU and up/down converters.

A multi-range universal receiver designed for the reception of all known or projected telemetry formats. RF tuning range, bandwidth, and demodulation capability are all determined by plug-in modules providing the receiver with a high degree of flexibility. Twelve RF tuners, from 55 to 2300 mHz, are available. Options include front panel spectrum display unit, internal plug-in pre-D record and playback converters, and adjacent channel filters.



TPA-70 and TPA-73 S and L-Band Preamp amplifiers. S-band: 6 db. Maximum noise: 20 db. Minimum Gain/ L-Band: 5 db. Maximum Noise: 20 db. Minimum Gain/ No Parametric Oscillation with Signal Overloads/ High immunity to strong signal burnouts/ Power output for 1 db Amplitude Compression: -5 db minimum.

These solid state preamplifiers have been developed to provide compact, economical, high performance, low noise, broadband, stable, rugged lightweight preamplifiers with excellent dynamic range and increased immunity to large signal burnout, damage or instability to meet the increasing operational requirements resulting from expanded activities at S and L-Bands.

For further information on these and other field-proven products and systems, contact the DEI sales office nearest you.

Defense Electronics, Inc.

PRODUCERS OF
DEI AND NEMS-CLARKE
EQUIPMENT



DEI
RESEARCH
DEVELOPMENT
MANUFACTURING

ROCKVILLE, MARYLAND (301) 762-5700; TWX: 710-828-9783; TELEX: 089602 • LOS ANGELES, CALIFORNIA (213) 670-4815
INTERNATIONAL: ROCKVILLE, MARYLAND • CABLE: DEIUSA; INTELEX: 64102

Sales Representatives: Rome, Italy • London, England • Madrid, Spain • Tel Aviv, Israel • Bromma, Sweden • Rijswijk, Holland • Köln, Germany
• Paris, France • Zurich, Switzerland • Oslo, Norway

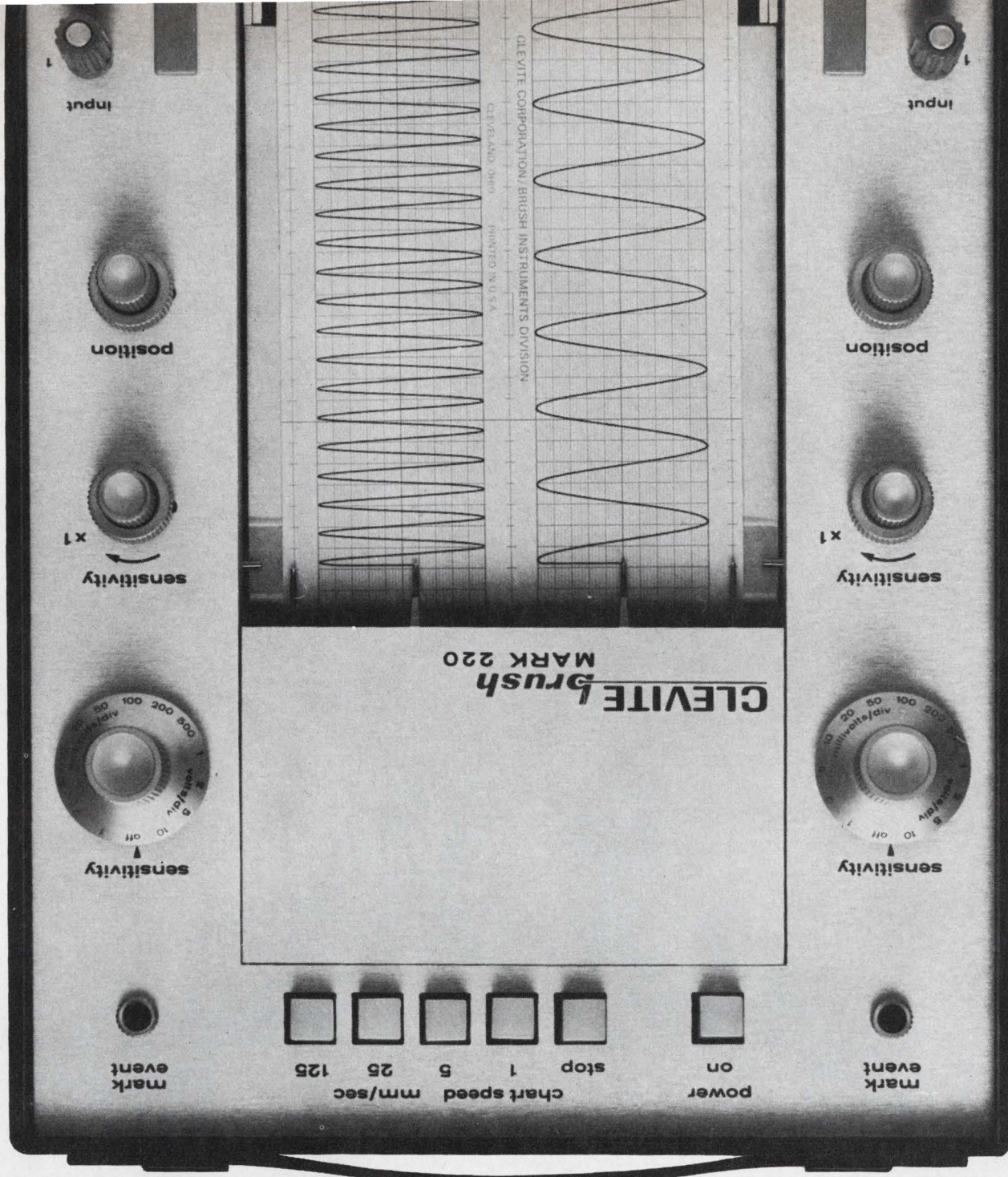

Write-side up?

Why not? New Mark 220 by Brush features pressurized-ink writing. Puts trace into the paper . . . not just on it. And you can see you don't have to pamper it! Now, anyone can take this remarkable new 25 lb. portable *anyplace*, plug it in . . . and put it in writing. And what writing! Fine, sharp traces you can read at a distance—99½% accurate! Rectilinear writing, of course, on two easy-to-read 40mm analog channels plus left and right-hand event markers. And there's enough ink in the throw-

away ink cartridge to last for about a thousand miles. There's more. Rugged, reliable solid state electronics to give you position feedback pen control . . . no springs, no strings. Pushbutton choice of chart speeds. Frequency response that's flat ($\pm 2\%$) from d-c to 40 cps at 50 div, or from d-c to 100 cps at 10 divisions. The price? Less than \$1700. For a portable chart recorder the likes of which you've never seen! Bulletin 942-1 has all the details. Call or write: Clevite Corporation, Brush Instruments Division, 37th & Perkins, Cleveland, Ohio 44114.

CLEVITE
—brush INSTRUMENTS DIVISION



The Compatibles

NEW Helipot Model 841 Miniature 4-bit Ladder Switches feature:

- unipolar or direct bipolar operation
- 350 nanosecond rise and fall time
- 0 to 2 millivolt switch offsets (at 25°C)
- 5 (± 3) ohms "on" resistance
- 0 to 5 milliamps output current
- small size (1" x 1" x 0.170" high)
- cermet thick film construction
- list price, \$100.00
- available from stock

Helipot Series 811 Precision, High Speed Binary Ladder Networks feature:

- up to $\frac{1}{2}$ bit accuracy in 12 bits from -55° to $+125^\circ\text{C}$ or from -20° to $+80^\circ\text{C}$
- 50 nanosecond settling time
- 1 ppm/ $^\circ\text{C}$ tracking
- small size (1" x 1" x 0.1" high)
- cermet thick film construction (assuring ultrastability and minimum change in performance with time)
- list prices from \$27.00
- available from stock

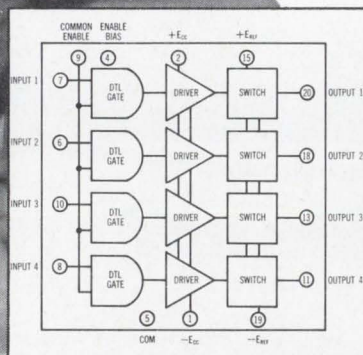
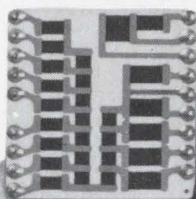
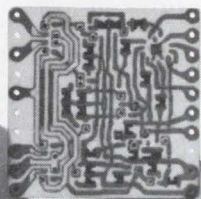

Model 841 Ladder Switch Block Diagram

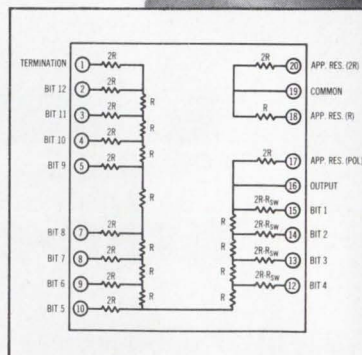

Series 811 Ladder Network Schematic

The Helipot Compatibles are designed to give you—pre-engineered and pre-packaged—a ladder system with the combination of economy, sophistication, small size, and flexibility you can't get anywhere else. ■ Check out The Compatibles from Helipot—for complete specifications, ask your local Helipot sales representative or circle the reader service number.

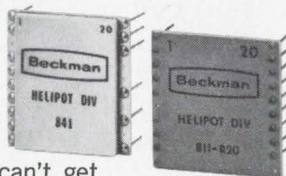

Beckman

INSTRUMENTS, INC.
HELIPOT DIVISION
FULLERTON, CALIFORNIA • 92634

INTERNATIONAL SUBSIDIARIES: GENEVA; MUNICH; GLENROTHES, SCOTLAND; TOKYO; PARIS; CAPE TOWN; LONDON; MEXICO CITY

Technical Articles

**Charts simplify
Fourier analysis**
page 62

A Fourier analysis of a pulse train can help determine where high-frequency noise is coming from, but such analysis takes a long time. Some relief can be found in handbooks that contain equations defining the characteristics of common pulse shapes, but using these equations isn't a simple analytical method. However, the need for very detailed Fourier analysis can be eliminated by using generalized charts. By listing actual values for a given pulse, the charts provide a straight-line approximation of an equivalent broadband spectrum.

**Solid state
diode display**
page 74

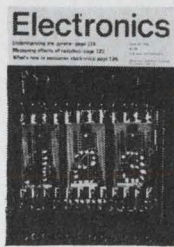

A practical version of the solid state display—more convenient and longer lasting than phosphor-type electroluminescent lamps—has emerged in the form of an array of gallium-arsenide-phosphide light-emitting diodes. Not only is this numerical display compatible with integrated circuits, but the decoding and driving circuit, an LSI chip, is packaged in the same compact module

as are the diodes, 28 of which form each matrix.

Active filters
part 3
page 82

Negative-impedance converters can be used to design active filters that have a smaller spread of capacitance values and fewer network elements than active filters made with a gyrator. They offer the engineer many design alternatives for synthesizing a network from its transfer equations. Only a few transistors are needed to build an NIC, which can give filters very high Q's at very low frequencies.

**A look at
phased-array radar**
page 94

Any system that promises to handle more than one job, especially in an aircraft, is sure to be the object of heavy R&D activity; such is the case with phased-array radar. As this survey indicates, the pace of present efforts points to the development in the near future of airborne systems that will search, track, and map with a single antenna.

Coming

High-power lasers

The kickoff of a series on new laser applications and advances in laser capabilities will feature an article on generating short-duration pulses and another on the use of narrow-pulse lasers in an optical communications terminal.

Charts simplify prediction of noise from periodic pulses

Families of broadband spectra for six common pulse shapes make it easy to determine high-frequency interference by eliminating the need for Fourier calculations

By Robert B. Cowdell

Genisco Technology Corp., Compton, Calif.

Experienced engineers know that pulses with a low repetition rate can generate high-frequency interference, but circuit designers who aren't familiar with this phenomenon might be baffled until they recall their hours in school studying Fourier analysis. What such analysis offers, of course, is a way to convert waveshapes stated as a function of time (pulses) to waveshapes stated as a function of frequency (spectra).

Specifically, engineers will recall that by using Fourier analysis any periodic nonsinusoidal waveform can be represented by an infinite series of sinusoidal spectral lines at harmonic multiples of the pulse frequency. Spectral lines at high frequency and with enough energy can cause interference in related or nearby circuits by conduction or radiation coupling.

However, Fourier analysis of a pulse takes more time than most engineers can spare. Some relief can be found in handbooks that contain equations defining the frequency characteristics of common pulse shapes. But these equations aren't quite adequate either as simple analytical methods or as explanations of how a pulse's parameters affect harmonic content.

The need for Fourier analysis can be eliminated, however, by using the generalized charts on pages 64, 65, and 66. These charts make it easy to find the broadband spectrum for six pulse shapes—trapezoid wave, full- and half-wave rectified sine wave, Gaussian wave, clipped sawtooth, sawtooth, and fractional sine wave. Only values of pulse parameters—such as amplitude, rate, width, and rise—are needed. The charts cover a wide range of these parameters, so using actual values for a given pulse

can very rapidly yield the straight-line approximation of an equivalent broadband spectrum.

Noisy trapezoid

To see how these charts were obtained, consider the so-called square wave. Actually, this pulse is shaped like a trapezoid, because of the finite rise (and fall) time of the pulse. The rise time must be considered in a Fourier analysis because it creates the higher harmonics in the frequency spectrum. In this trapezoidal pulse, of amplitude A ,

$$T \geq 2(t + t')$$

where T is the pulse repetition rate, t the pulse width, and t' the rise time.

By Fourier analysis, the amplitude at the frequency of the n th harmonic, A_n , of the trapezoidal pulse is

$$A_n = \frac{2A(t + t')}{T} \cdot \frac{\sin[\pi f(t + t')]}{\pi f(t + t')} \cdot \frac{\sin \pi f t'}{\pi f t'}$$



Trapezoidal pulse. A steep rise time, t' , creates high harmonics with large amplitudes.

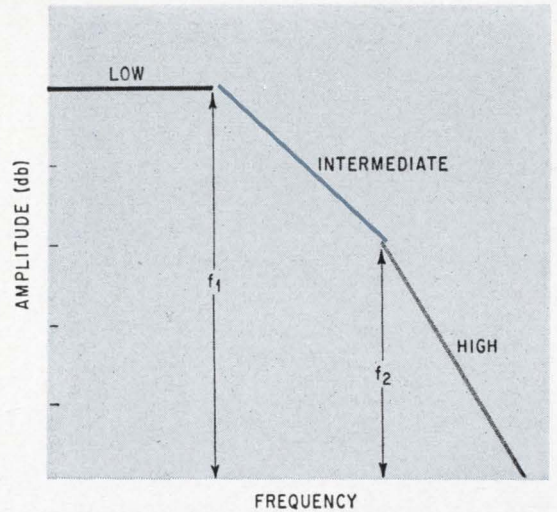
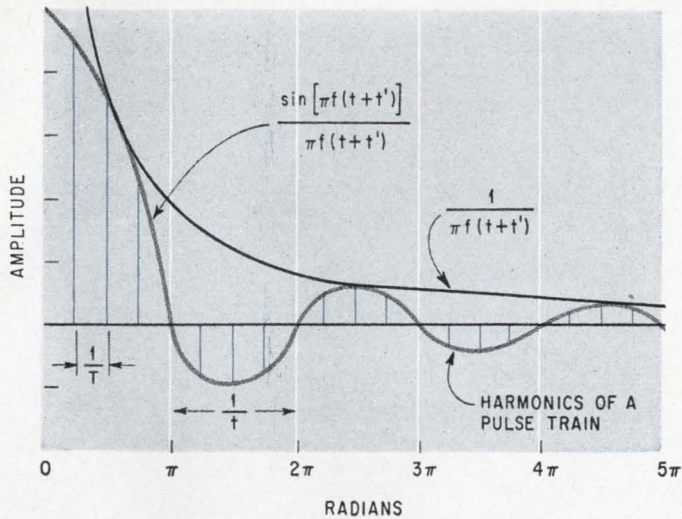

Spectral to broadband. The envelope of the maximum spectral lines, color, define the broadband spectrum, the black line. For convenience, the spectrum—approximated by three straight-line segments—is replotted in decibels and log frequency, right.

where $f = n/T$ is the frequency of the n th harmonic. The figure above, at the left, shows one way of looking at the spectral response of the trapezoidal pulse. The colored vertical lines represent the harmonics of the pulse repetition rate. The amplitude of each such spectral line depends on the pulse shape; some lines, grouped in cusps, have negative amplitude.

If the frequency spectrum resulting from the pulse were scanned with a narrowband tunable receiver, the receiver would indeed show a peak output at each harmonic and no output at frequencies in between.

Broadband spectrum

The gray curve in the figure forms the envelope of the amplitude of the harmonics of the pulse train, including the harmonics that have negative amplitudes. The envelope of the maximum amplitudes of the harmonics, however, is more useful. To get this curve, shown in solid black in the figure, the cusps of the negative-amplitude harmonics are inverted to make them positive. This can be done with impunity; the receiver's detection circuit does the same thing anyway.

The black envelope yields more understanding of broadband characteristics of the frequency spectrum generated by a pulse. From a design and interpretation viewpoint, however, such an envelope is difficult to use and is somewhat unrelated to the physical significance of the broadband concept. It's more useful to plot amplitude and frequency on a logarithmic basis.

Accordingly, replotting the black curve results in a broadband spectrum like that shown at the right of the above figure.

The characteristics of the broadband spectrum can be developed mathematically. The number of harmonic spectral lines falling within a finite band-

width is equal to the bandwidth (Δf) divided by the spacing, F , of the lines, where $F = 1/T$. The total interference, $V(\Delta f)$, falling in this bandwidth and caused by the "square" wave's harmonics, is equal to the average amplitude of the lines, A_n , times the number of lines within the bandwidth, $(\Delta f/F)$, where V and A are in volts. Thus, for the trapezoidal pulse

$$\begin{aligned}
 V(\Delta f) &= A_n (\Delta f/F) \\
 &= \frac{2A(t+t')}{T} \cdot \frac{\sin[\pi f(t+t')]\Delta f}{\pi f(t+t')F} \\
 &\quad \cdot \frac{\sin \pi f t'}{\pi f t'}
 \end{aligned}$$

Conventionally, the interference is specified relative to microvolts above 1 μ volt per megahertz. Thus, the preceding equation is divided by the bandwidth, so that

$$\begin{aligned}
 \frac{V(\Delta f)}{\Delta f} &= 2 \times 10^6 A(t+t') \\
 &\quad \cdot \frac{\sin[\pi f(t+t')]}{\pi f(t+t')} \\
 &\quad \cdot \frac{\sin \pi f t'}{\pi f t'} \frac{\mu V}{\text{Mhz}}
 \end{aligned}$$

where A is volts, t and t' microseconds, and f megahertz.

The governing equation

For convenience, however, this equation is converted so it's given in decibels above 1 μ volt per megahertz. Taking 20 times the logarithm results in

BROADBAND CONDUCTED

Trapezoidal pulse

Legend: A in volts; t and t' in microseconds; f in megahertz.

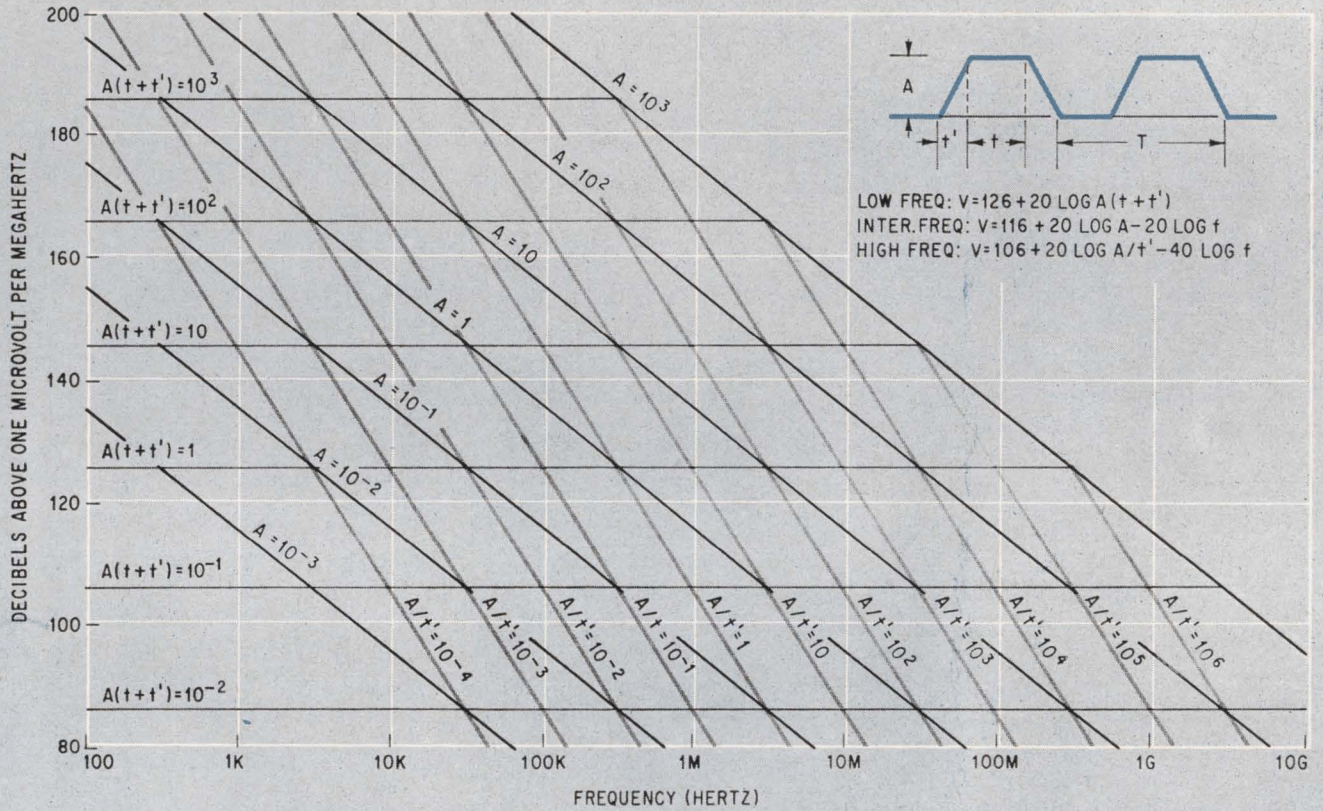

Full- or half-wave rectified sine wave

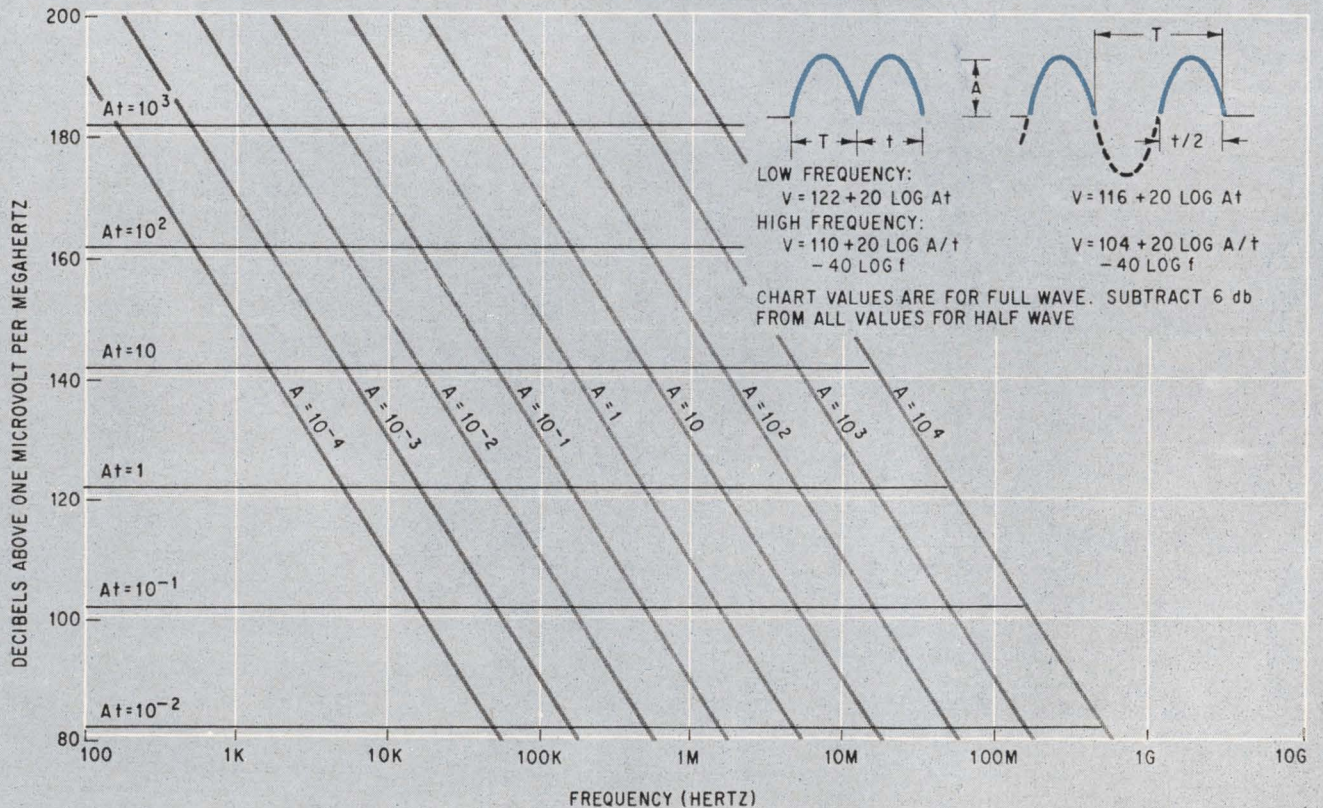

$$\begin{aligned}
 V \text{ (db above } 1\mu\text{V/Mhz)} & \\
 &= 126 + 20 \log A (t + t') \\
 &+ 20 \log \frac{\sin [\pi f (t + t')]}{\pi f (t + t')} \\
 &+ 20 \log \frac{\sin \pi f t'}{\pi f t'}
 \end{aligned}$$

This equation can be used to plot the broadband spectrum of a trapezoidal pulse train directly from knowledge of the time characteristics of the pulse.

The amplitude can be calculated at each harmonic, but such a tedious procedure isn't necessary. An excellent approximation of the broadband spectrum can be made simply by developing three straight-line segments to represent the spectrum, as shown in the right figure on page 63. Indeed, taking the asymptotic linearization of the actual response is common engineering practice in frequency-response analysis.

One segment is for the low-frequency region, another the intermediate-frequency region, and the third the high-frequency region.

At low frequencies, ($f < 100$ hertz)

$$\sin [\pi f (t + t')] = \pi f (t + t')$$

and

$$\sin \pi f t' = \pi f t'$$

so the last two terms in the governing equation equal zero. Thus the low-frequency line segment, which is horizontal, is given by

$$\begin{aligned}
 V \text{ (db above } 1\mu\text{V/Mhz)} & \\
 &= 126 + 20 \log A (t + t')
 \end{aligned}$$

and extends out to the first break frequency

$$f_1 = \frac{1}{\pi (t + t')}$$

At intermediate frequencies, $\sin \pi f t'$ still equals $\pi f t'$ because of the small value of t' . Therefore, the last term of the governing equation drops out. At these frequencies, however,

$$\sin [\pi f t (t + t')]$$

can be set equal to 1; this is valid because only the maximum harmonic in each cusp is of interest in determining the broadband spectrum. Therefore, at middle frequencies, the governing equation reduces to

$$\begin{aligned}
 V \text{ (db above } 1\mu\text{V/Mhz)} & \\
 &= 116 + 20 \log A - 20 \log f
 \end{aligned}$$

This second line segment starts at the first break frequency and slopes off at -20 decibels per decade to the second break frequency

$$f_2 = \frac{1}{\pi t'}$$

At high frequencies, $\sin \pi f t'$ can be set equal to 1, so the equation becomes

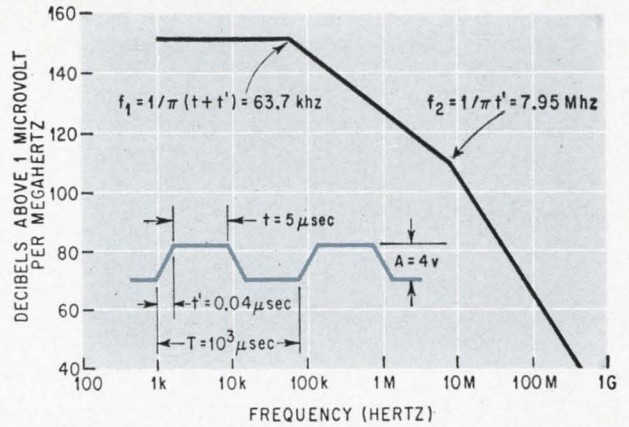

For example. Spectrum of a specified pulse, above, can be found rapidly using the trapezoid chart on page 64.

$$\begin{aligned}
 V \text{ (db above } 1\mu\text{V/Mhz)} & \\
 &= 106 + 20 \log (A/t') - 40 \log f
 \end{aligned}$$

That is, the third line segment starts at the second break frequency and slopes off at -40 db per decade.

The first break frequency is found by setting the right-hand terms of the low- and intermediate-frequency equations equal to each other and solving for f_1 . Similarly, f_2 is found by equating the intermediate- and high-frequency equations.

Using the equations for each region and a range of values for each parameter, line segments can be plotted to make a general chart that can be used to obtain the broadband spectrum of any trapezoidal pulse. Such a chart appears at the top of page 64. Procedures similar to those for analyzing the trapezoidal pulse result in charts for other types of pulse shapes. These procedures aren't carried out here, but the useful results for five other pulse shapes are charted on pages 64, 65, and 66.

Sketching a spectrum

Use of the charts is simple and can be demonstrated by drawing the broadband spectrum, shown above, for a typical trapezoidal pulse. Consider a 1,000-hertz (2,000-baud) "square wave" used for data transmission. It has an amplitude, A , of 4 volts, a repetition rate, T , of 1,000 μ seconds, a pulse width, t , of 5 μ sec and a rise time, t' , of 0.04 μ sec. The three segments defining the spectrum in the chart on the top of page 64 are $A (t + t')$, A , and A/t' . For this example, the values are

$$\begin{aligned}
 A &= 4 \\
 A (t + t') &= 4 (5 + 0.04) = 20.16 \\
 A/t' &= 4/0.04 = 100
 \end{aligned}$$

Enter the chart at the db value corresponding to 20.16. The db value for $A (t + t') = 10$ is already plotted as 146 db. Then the value for $A (t + t') = 20.16$ can be found from $20 \log (20.16/10) = 6$ db, so the 6 db are added to 146. Thus the chart is

COMMON PULSE SHAPES

Clipped sawtooth waveform

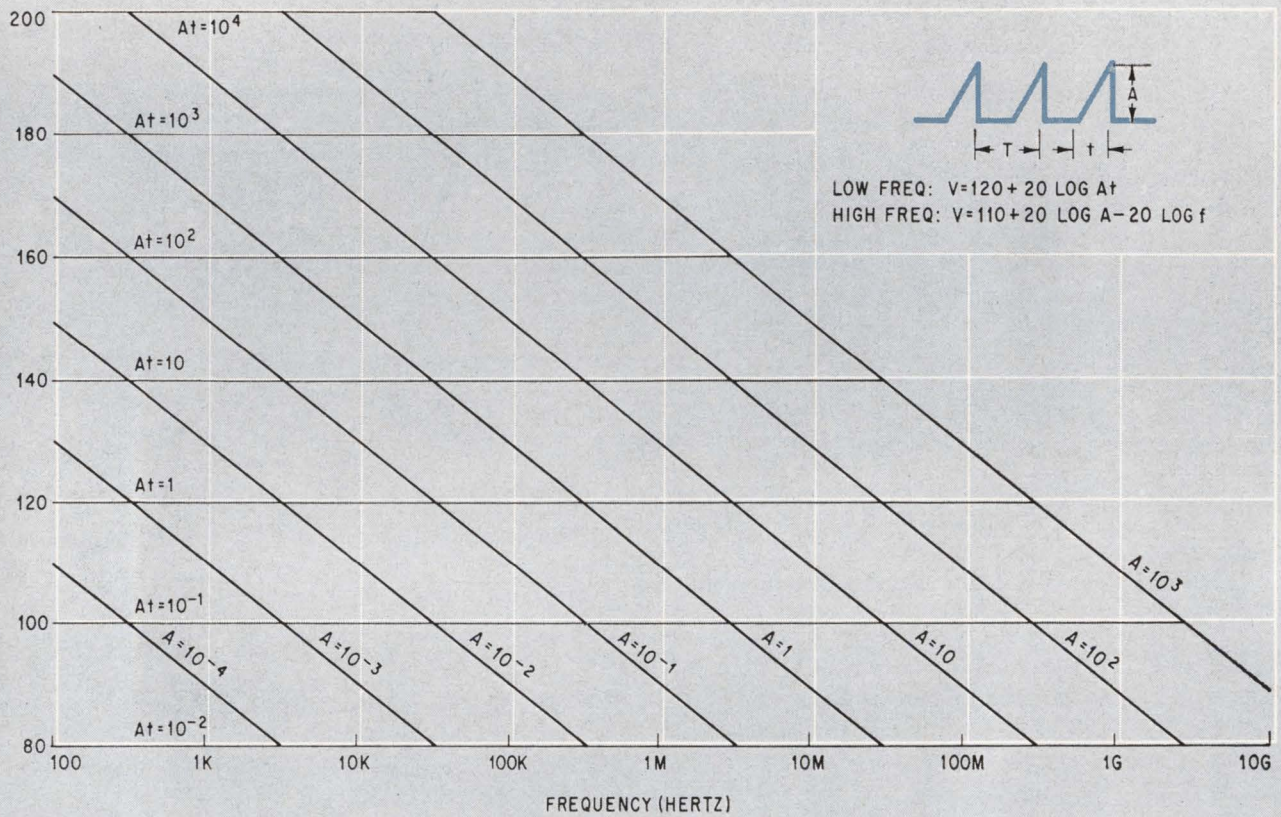

Sawtooth waveform

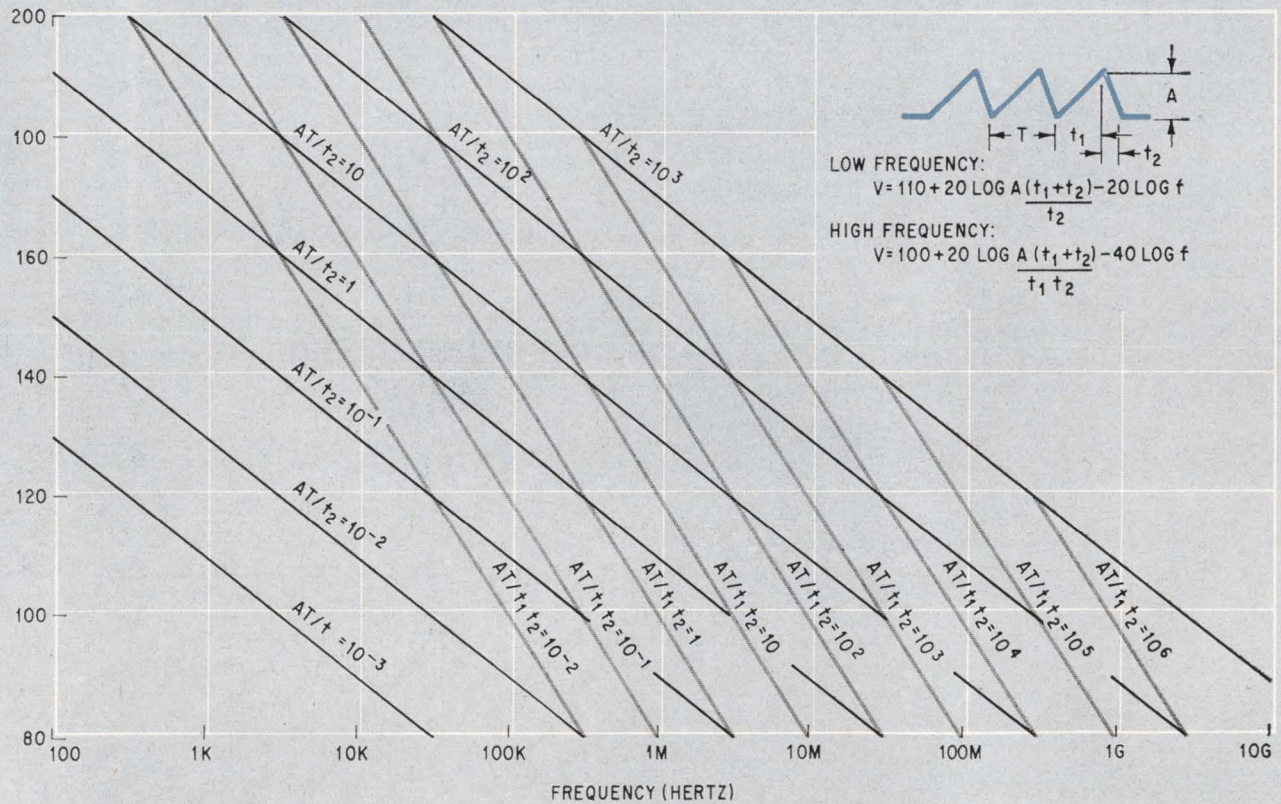

INTERFERENCE VOLTAGES FROM SIX

Gaussian waveform

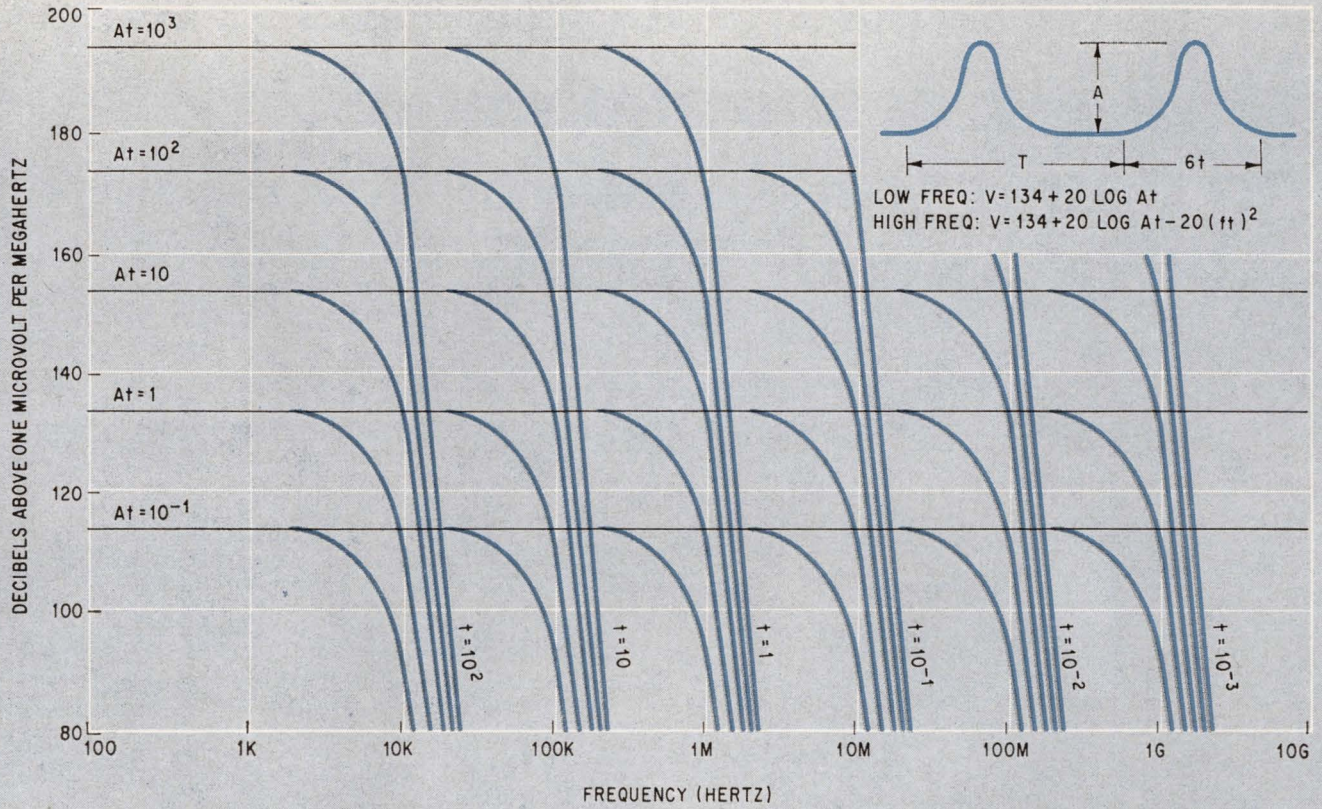

Fractional sine wave

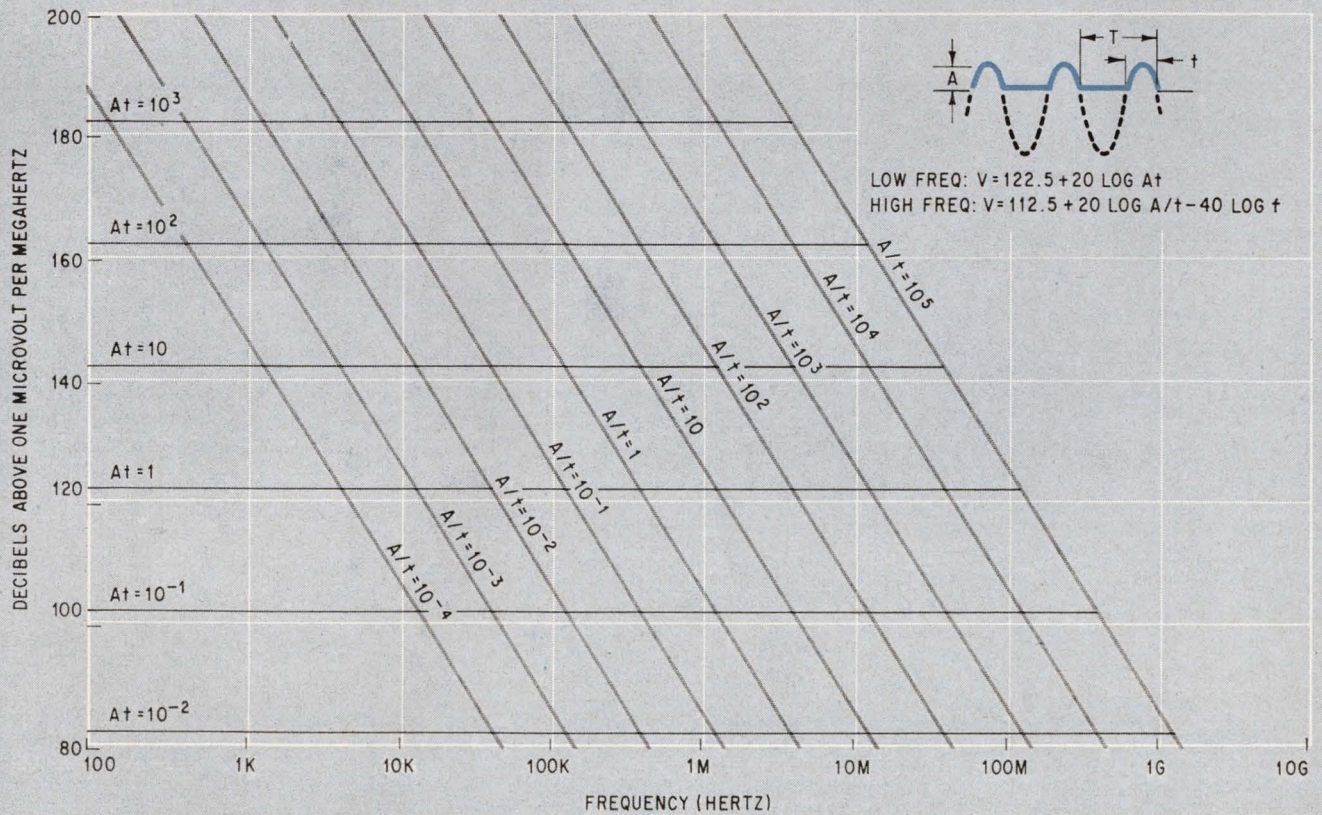

Uncanny solutions to power transistor cost problems from your TI Distributor

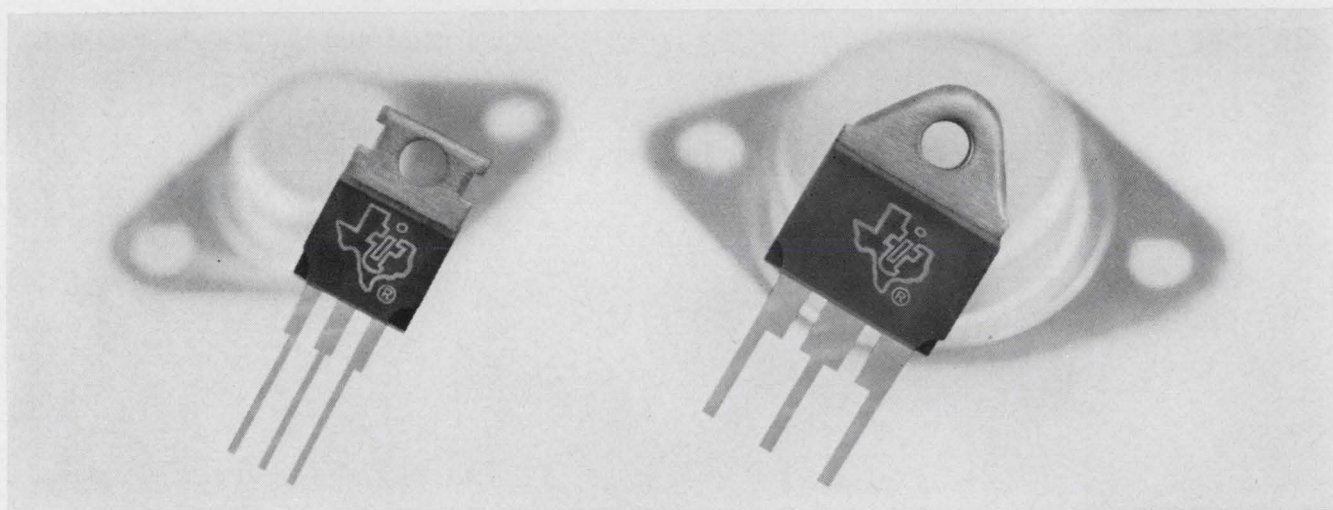

Replacing metal cans with economical plastic packages is one way to make high costs disappear like magic...and TI's new line of NPN/PNP complementary power transistors will help you make it happen!

Only Texas Instruments now offers complementary pairs in plastic from 1 to 25 amps with power dissipations up to 90 watts.

And these brand new, versatile plastic packages will fit virtually any mounting arrangement you have in mind. They'll even plug into old TO-3 or TO-66 metal can sockets—with just one screw and *without* extra adapter hardware.

Reliability of the new devices is well documented—including three-

cycle "pressure cooker" tests (125°C, 15 PSIA) with *no* hermetic or electrical failures.

So when you need the "uncanny" savings inherent in plastic design, call your TI distributor. There'll be nothing spooky about the way you

get on-time delivery!

To help *you* take the mystery out of reducing power circuitry costs, circle Reader Service No. 295 for comprehensive data sheets, detailed applications, information, and reliability report.

NPN	PNP	BV_{CEO}	I_C	PACKAGE TYPE	$H_{FE}@I_C$	$P_T@25^\circ C$ Case
TIP29	TIP30	40	1	TO-66	40-200 @ 200mA	30W
TIP29A	TIP30A	60	1	TO-66	40-200 @ 200mA	30W
TIP31	TIP32	40	3	TO-66	20-100 @ 1A	40W
TIP31A	TIP32A	60	3	TO-66	20-100 @ 1A	40W
TIP33	TIP34	40	10	TO-3	12-125 @ 3A	80W
TIP33A	TIP34A	60	10	TO-3	12-125 @ 3A	80W
TIP35	TIP36	40	25	TO-3	10-100 @ 15A	90W
TIP35A	TIP36A	60	25	TO-3	10-100 @ 15A	90W

TEXAS INSTRUMENTS INCORPORATED

entered at 152 db, and a horizontal line is drawn out until the first break frequency

$$f_1 = \frac{1}{\pi(t+t')} = \frac{1}{3.14 \times (5.04)} = 63.7 \text{ kHz}$$

The second segment ($A = 4$) then slopes off at -20 db per decade according to the intermediate-frequency equation until it intersects with the second break frequency

$$f_2 = \frac{1}{\pi t'} = \frac{1}{3.14 \times 0.04} = 7.95 \text{ MHz}$$

The third segment slopes off from this break frequency at -40 db per decade according to the high-frequency equation.

Slower and shorter

The chart at the top of page 64 shows how pulse parameters affect frequency content. A change in the signal amplitude shifts the amplitude of the entire envelope by a factor of $20 \log A$. A change in pulse width, t , affects only the lower-frequency harmonics by a factor of $20 \log t$. A change in the repetition rate, T , does not affect the envelope's shape, but determines where the spectrum begins and succeeding harmonics. A change in rise time, t' , affects only higher-frequency harmonics by a factor of $-20 \log t'$. That is, making the rise time 10 times slower reduces the high-frequency interference by a factor of 20 db.

To sum up: the lower the pulse amplitude, the lower all harmonic amplitudes; the slower the rise time, the lower the high-frequency amplitudes; the shorter the pulse width, the lower the low-frequency amplitudes.

Narrow look

So far, only the broadband aspects of interference generated by pulses have been considered. If a receiver is to measure harmonics, its bandwidth determines whether the narrowband or broadband results are obtained. Narrowband means that only one harmonic is being measured at a time; broadband means that more than one harmonic is included and that the amplitude reading will therefore be the sum of the harmonics within the receiver bandwidth. Thus the bandwidth capabilities of a receiver, as well as its frequency range, must be taken into account when measuring interference.

A narrowband spectrum can be obtained easily; simply subtract $20 \log T$ db from the entire broadband spectrum developed according to the previous procedures.

The two line segments in the figure above show just the intermediate- and high-frequency regions for a trapezoidal pulse obtained with the aid of the chart at the top of page 64. The dots represent measurements made with a narrowband receiver, one whose bandwidth is less than $F = 1/T$, where T is the pulse repetition rate. The black dots are measurements of maximum amplitude harmonics in each cusp, as noted in the figure on page

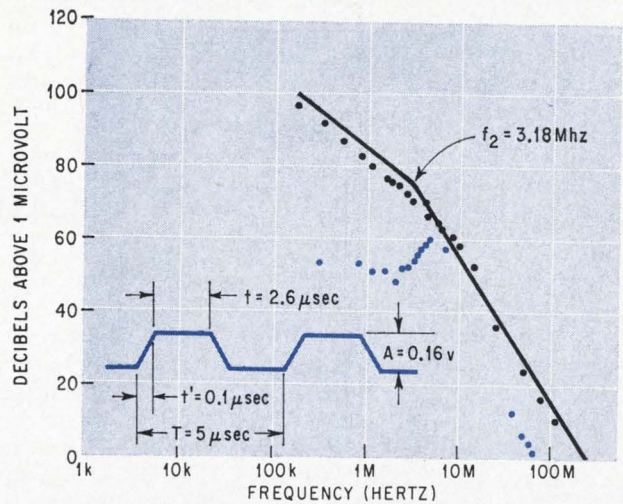

Narrowband spectrum. Harmonics for this pulse occur at 200-kHz intervals. Line is calculated maximum-amplitude envelope; black dots show measured values. Colored dots are measured nonmaximum harmonics.

63. The colored dots are nonmaximum harmonics that exist when

$$\sin[\pi f(t + t')] = 0$$

is not zero.

Field intensity

The six charts on pages 64, 65, and 66 apply to conducted interference. A very good estimate of radiation levels a foot from a circuit carrying the pulse waveform can be obtained by reducing the conducted levels by a factor of 22 db. This gives the electric field intensity levels in db above 1 μ volt per meter for narrowband signals and 1 μ volt per meter per megahertz for broadband signals. To obtain electric field levels at other distances, subtract an additional $20 \log$ (distance in feet). Thus, at three feet, the level is $(-22 - 20 \log 3) = -33$ db.

Finally, while the charts are given in voltage amplitudes, they apply just as well to current amplitudes. The amplitude is then interpreted as db above 1 μ ampere per megahertz.

To obtain the magnetic field strength generated by a small loop of current, first compute the current spectrum and add to it the factor

$$20 \log(NA/4\pi r^3)$$

where N is the number of loop turns, A the loop area in square meters, and r the distance from the loop in meters. This procedure will yield the decibels above 1 μ ampere-turn per megahertz per meter.

Reprints of this article available at 50 cents each. Order from Electronics Reprint Department, 330 West 42nd Street, New York, N.Y. 10036.
© copyright 1968, Electronics®
A McGraw-Hill Publication

Designer's casebook

Inexpensive comparator reacts in 100 nanoseconds

By Richard Becker

University of Vermont

Inexpensive fast comparators are rare. But costs can be kept down by using heat sinks and emitter-follower configurations instead of such extra components as zener diodes.

A comparator built in this way can detect and react to input changes in as little as 100 nanoseconds. Its output can be switched from logic 0 to 1 by less than 63 nanoamperes, and it's stable to less than 2 nanoamperes per degree C. It can be driven with a clock pulse for synchronous comparison when it becomes necessary.

With the input base at zero volts, each transistor in the differential amplifier draws 50 microamperes of collector current. In this output state of the pair, Q_1 's collector rests at +3.6 volts and the emitter-follower output at +3 volts. Because these +3 volts are also the base of the output transistor,

Q_4 , it is turned off, thus providing a 0 signal. When Q_1 's base goes negative, Q_2 's collector goes to 0 and the emitter follower to -0.6 volt. This voltage saturates Q_4 , providing a 1 signal. A 1-volt shift in the 3-volt supply causes less than 1.5% error in the comparison levels.

The differential-amplifier transistors, Q_1 and Q_2 , are mounted on the same heat sink so temperature changes will affect the sensitive base-emitter voltages of the transistors equally. Q_3 and Q_4 don't have to be matched for beta. Their base-emitter voltages oppose each other, consequently, temperature changes which cause the V_{be} of Q_3 to change are nullified by an equal V_{be} change in Q_4 of opposite polarity. This is a fail-safe method of eliminating temperature caused errors.

Because of the comparator function of the transistors in the differential amplifier, their base-emitter voltages should be within a millivolt of each other. And to preserve linearity, their betas shouldn't vary more than 10% when the collector current is 50 microamperes.

To prevent loading of the amplifier, Q_3 is connected in an emitter-follower configuration. This also enables the driver stage, Q_4 , to operate an integrated-circuit gate.

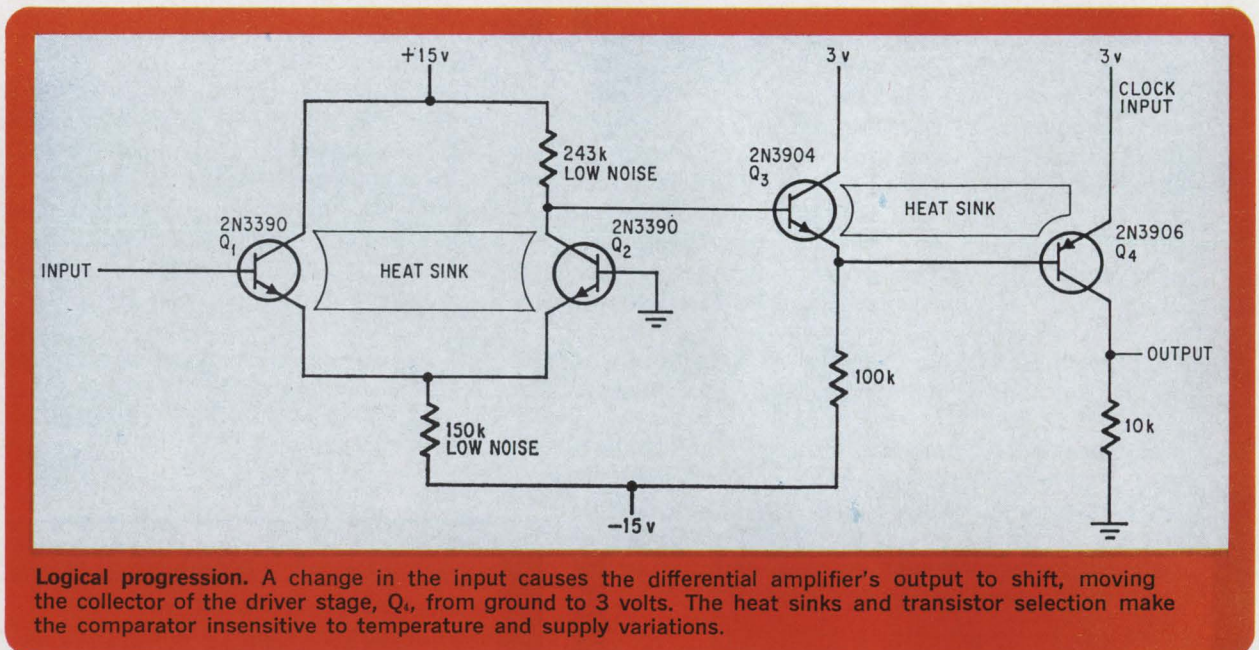

One capacitor makes IC a pulse-width modulator

By Otto Baade

Standard Telephones & Cables Ltd., London

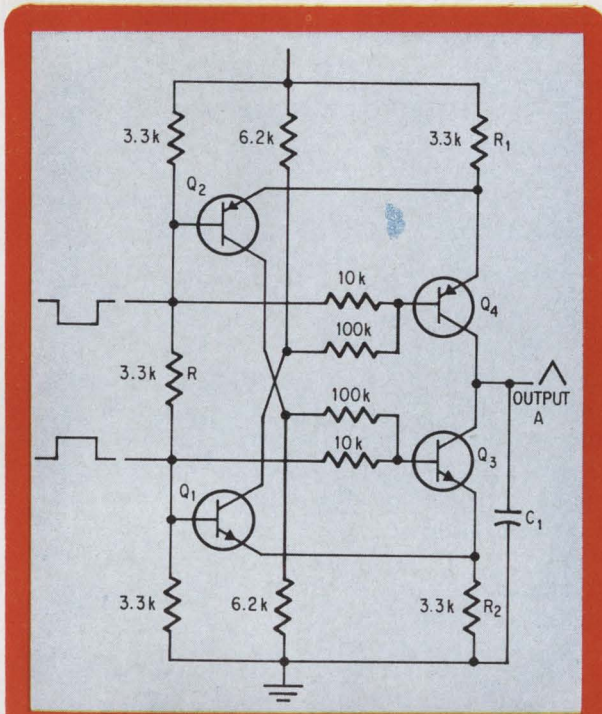

Sawtooth. Changing of capacitor C_1 by Q_4 's collector current forms the leading edge of the sawtooth.

Triangular-wave generators can be used for pulse-width modulation in audio amplifiers to provide greater output than conventional amplifiers. And integrated circuits can make this technique economical. Because it's difficult to put capacitors in IC's, a way to make an IC generator with only one capacitor should get an enthusiastic welcome. The generator described here produces two square waves in addition to the triangular ones.

With transistor Q_1 conducting, the voltage at the base of transistor Q_4 is more negative than that at Q_2 's base, so Q_4 conducts. The constant collector of Q_4 charges capacitor C_1 . The base voltage of Q_3 is more negative than that of Q_1 , which conducts until Q_4 becomes saturated.

The current through resistor R_1 then flows through Q_2 instead of Q_4 , causing Q_2 and Q_3 to conduct instead of Q_1 and Q_4 . Capacitor C_1 is discharged by Q_3 's collector current until Q_3 is saturated. The current is then switched back to Q_1 and Q_4 .

Bridge and amplifier monitor d-c level

By John P. Budlong

Bedford Institute of Oceanography
Dartmouth, Nova Scotia

Small d-c signals with high source impedance can be difficult to measure, especially when the signals can vary either way from zero.

A circuit consisting of an operational amplifier, milliammeter, and bridge rectifier provides high input impedance and high sensitivity. The meter reads up-scale regardless of the input polarity, and calibration depends on only one component.

The circuit provides a sensitivity of 1 volt full scale. Assume a +1 volt signal applied to the amplifier's (+) input. Since the offset voltage between the amplifier's (+) and (-) inputs is very small (usually assumed to be zero), the voltage on the (-) input must also be +1 volt. The amplifier generates this voltage across R_2 by driving 1 milliampere through D_1 , the meter, D_2 , R_1 , and R_2 .

Resistor R_2 determines the calibration; its value is calculated by

$$R_2 = \frac{1 \text{ v}}{1 \text{ ma}} = 1 \text{ kilohm}$$

R_1 provides meter protection and overload will not exceed 5%. To accurately measure a millivolt

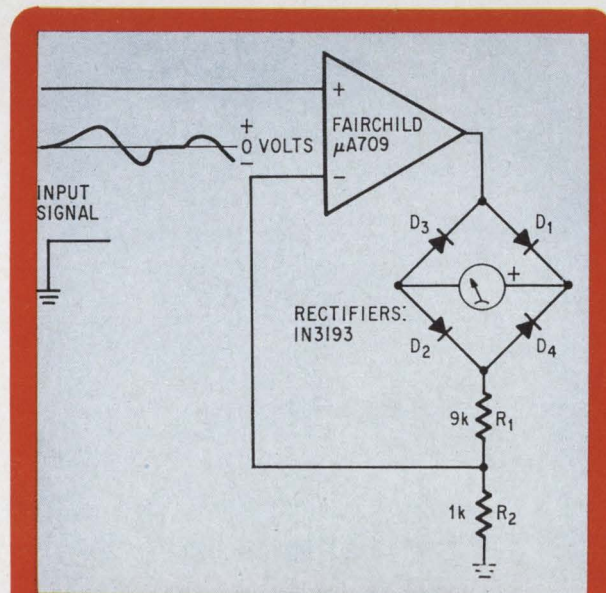

Accurate both ways. Variations in a voltage level are given meter-driven capability by the operational amplifier

**Four-digit counter.
Significant digit display
without extra digits:
\$350.**

Fairchild's 8040 counter provides a unique time base with five gate times in the frequency mode: 1msec through 10 sec. It's the only instrument in its price range that allows you to display the most significant digit for any frequency without buying extra digits. The 8040 time base is 60Hz line frequency with 0.1% stability. It offers 1 Megohm input. Its range is 10Hz to 2MHz. A fifth digit is optional. If you need a more sophisticated counter, we also have a five-digit, 30MHz instrument. It's called the 8050. It costs \$695. It does a lot more than the 8040. Call for specs on both. Dial **FAIRCHILD** (408) 735-5201. Ask for Don Greening.
INSTRUMENTATION

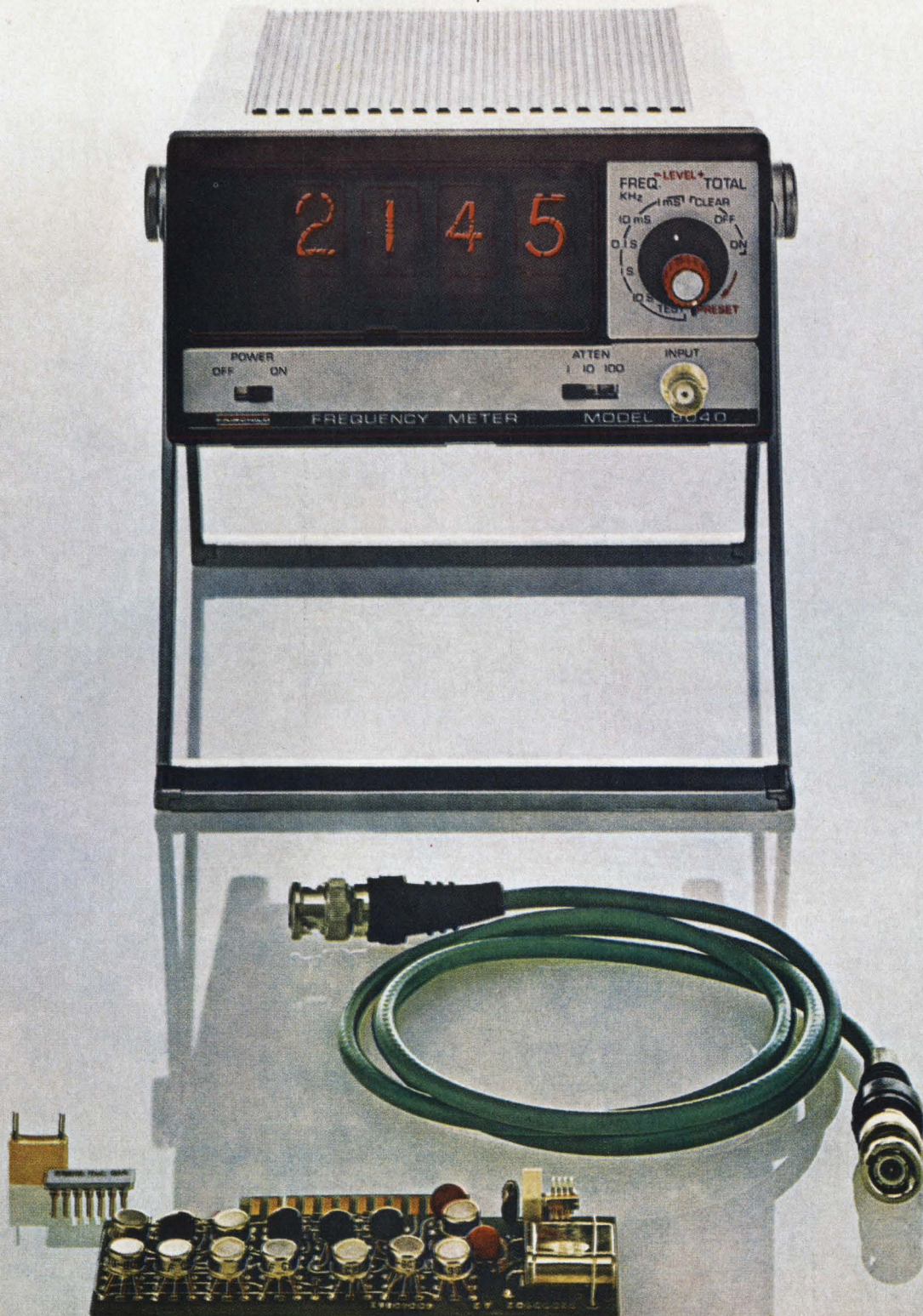

Solid state module makes for light reading

Bright, distinct numerals are displayed by this small, inexpensive unit, which uses a large-scale integrated circuit to decode binary commands and drive a matrix of light-emitting gallium-arsenide-phosphide diodes

By members of the technical staff

Solid State Laboratory, Hewlett-Packard Co., Palo Alto, Calif.

The need for a solid state display has been apparent for a long time. Phosphor-type electroluminescent devices were once thought to be the answer, but they've proven short-lived and dim, and require an awkward high-voltage and audiofrequency power supply. What's really needed is a semiconductor diode display compatible with integrated circuits.

It's now possible to build such displays—mass produce them, in fact—as a result of work at the Hewlett-Packard Co. on gallium-arsenide light emitters and large-scale IC's.

The display module is inexpensive and small and consumes little power. And it can directly translate, in less than a microsecond, internal machine states into intelligible symbols. The characters are readable in direct sunlight, and their brightness is adjustable; there's no parallax, flicker, or loss of definition.

One of the first uses of the solid state display will probably be in avionics equipment. The advantages of its employment in aircraft, spacecraft, and related ground support equipment are substantial—small size, readability, thinness, adjustable brightness, and electrical compatibility with IC's. Life span is important here, too—the half-life of

the solid state display (the time required for a 50% drop in brightness) is apparently about 10,000 hours.

The new display is also suitable for commercial equipment. It can function as a readout for instruments or data-processing gear, for example. With its compactness and high image definition, the display is particularly suited to present telemetered or computer-generated data on situation status boards. And with its variable-intensity red light, it should find applications in darkrooms and in working areas where the personnel have to be dark-vision-adapted.

Efficiency's the thing

If there's a single key to Hewlett-Packard's solid state display, it's the ability to make a diode emit visible light efficiently. Although the integrated-circuit portion of the display is certainly state of the art—it contains some 400 circuit elements—it's the diode portion that's of special interest. The over-all display appears to be the first such to become commercially available [Electronics, July 22, p. 95].

Most of the research, development, and design work was financed by the company, but several important tasks were supported by outside organizations. Prominent among these are the Navy's former Bureau of Ships, now part of the Naval Electronic Systems Command, and the Tv Products division of the Corning Glass Works.

Efforts to increase the efficiency of light emitters started many years ago. By 1960, research on phosphor-dielectric-type electroluminescent devices had reached a plateau with three major problems still unsolved: light output was insufficient, operational life was limited, and there was no economical and

The interdisciplinary nature of the development of the solid state display is reflected in the contributors to this article. The materials aspects are explained by P. E. Greene and R. A. Burmeister, devices by R. J. Archer, E. E. Loebner, and D. Kerps, IC's by J. D. Barrett and J. E. Price, and engineering and manufacturing by H. D. Borden and G. B. Pighini. M. M. Atalla is director of the laboratory.

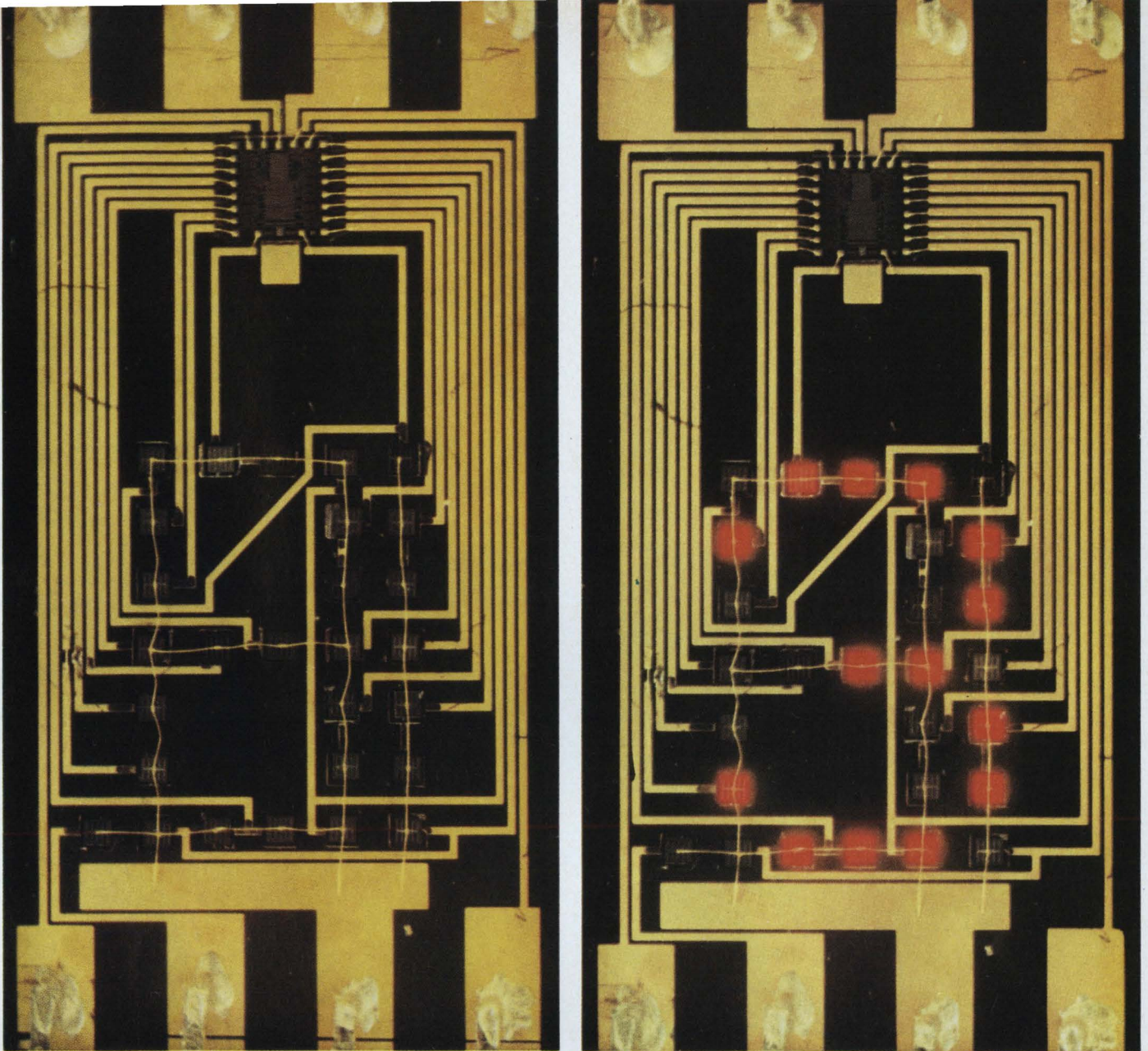

Bottoms up. Signals from a large-scale integrated circuit are conducted by photolithographically formed metal strips to the bottoms of the 28 light-emitting diodes. Wire at top of the diodes provides a common anode. IC determines which diodes light up by decoding the binary-coded-decimal input to the module.



Sharp definition. With a red glass cover, the IC and the metalization are not visible, and the diode display appears to float in space.

fast means of switching and addressing that was compatible with the high a-c voltages required by the devices. Theory was—and still is—vague and qualitative;^{1,2} solvable problems couldn't be isolated. And as a result, progress had to be left to chance.

Hewlett-Packard then turned its attention to an older kind of electroluminescent device, the semiconductor injection diode. The theory of this device, which was moderately well understood even at that time, promised high efficiency and very high outputs. It also appeared possible to operate this device at the sort of low voltages compatible with semiconductor switching circuitry.³

But experiments had shown an extremely low efficiency at room temperature. Fortunately, it turned out that this inefficiency was only an apparent one, in gallium arsenide at least.⁴ Photons were generated plentifully at room temperature, but they were absorbed by the material on their way from the diode junction to the surface. The inefficiency at room temperature was therefore a problem that could be overcome by improved design and better selection of materials.

Actually, there are three efficiencies that are useful in describing the performance of light-emitting diodes.

- External quantum efficiency—the number of photons emitted from the device for each electron.
- Internal quantum efficiency—the number of photons generated inside the device for each electron. This is computed from the external efficiency by accounting for all the optical absorption and scattering losses.
- Electroluminescent yield—the number of lumens emitted per unit current, expressed in foot-lamberts per unit current density.

The physics of electroluminescent diodes is complex. In the case of the H-P display, the desired effect—photons emitted at energies compatible with the characteristics of the human eye—is only one of many possible injected carrier transitions, as shown at right. The quest for efficiency is thus a problem of channeling the sequence of physical events so that the strong near-edge luminescence branch of this family tree is favored.

Briefly, the sequence of events goes something like this:

- Externally applied energy is stored in excited electrons and holes in and around a p-n junction.
- This energy is disposed of by radiation of photons and other processes.
- The photons pass through the device and into the surrounding medium.

Where the transitions take place in the diode influences the number of photons generated and the quantity that escape from the device. For maximum efficiency, of course, both quantities should be as high as possible. In general, the transitions can take place on both sides of the p-n junction, in the space charge region, and at the electrodes.

The H-P diodes are designed to generate photons predominantly on the p side of the junction. Here

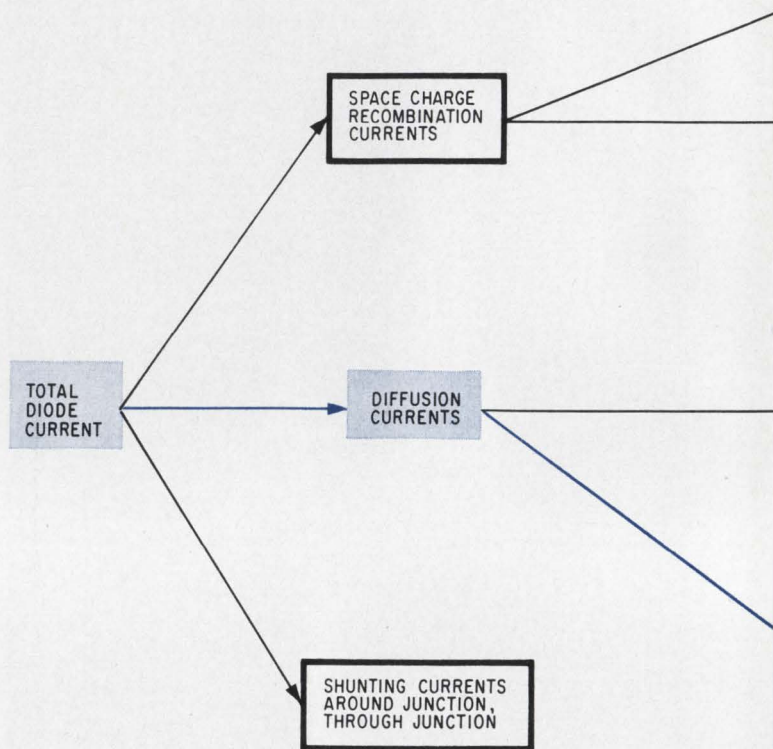

Genealogy of a photon. Many transitions of the injected carriers possible, but only one chain of them leads to the desired strong near-edge luminescence.

electrons, which have much higher mobility than holes, are injected more plentifully and tend to generate near-edge photons (that is, photons whose energy is near the band-gap energy).

Near-edge rather than deep-level luminescence was selected for the Hewlett-Packard diodes because its efficiency—power and luminous—is greater, it provides better definition, and it doesn't change color as the current varies.

The current density through the diode must be greater than 1 milliamperere per square millimeter if a large fraction of the total diode current is to contribute to light emission. At a lower current density, the fraction of tunneling and space-charge recombination currents increases, and the current shunting the p-n junction entirely may become appreciable.

Optimizing the injection of electrons into the p side—by selecting the dopants and their profiles—is the main task in fabricating the diodes. If the

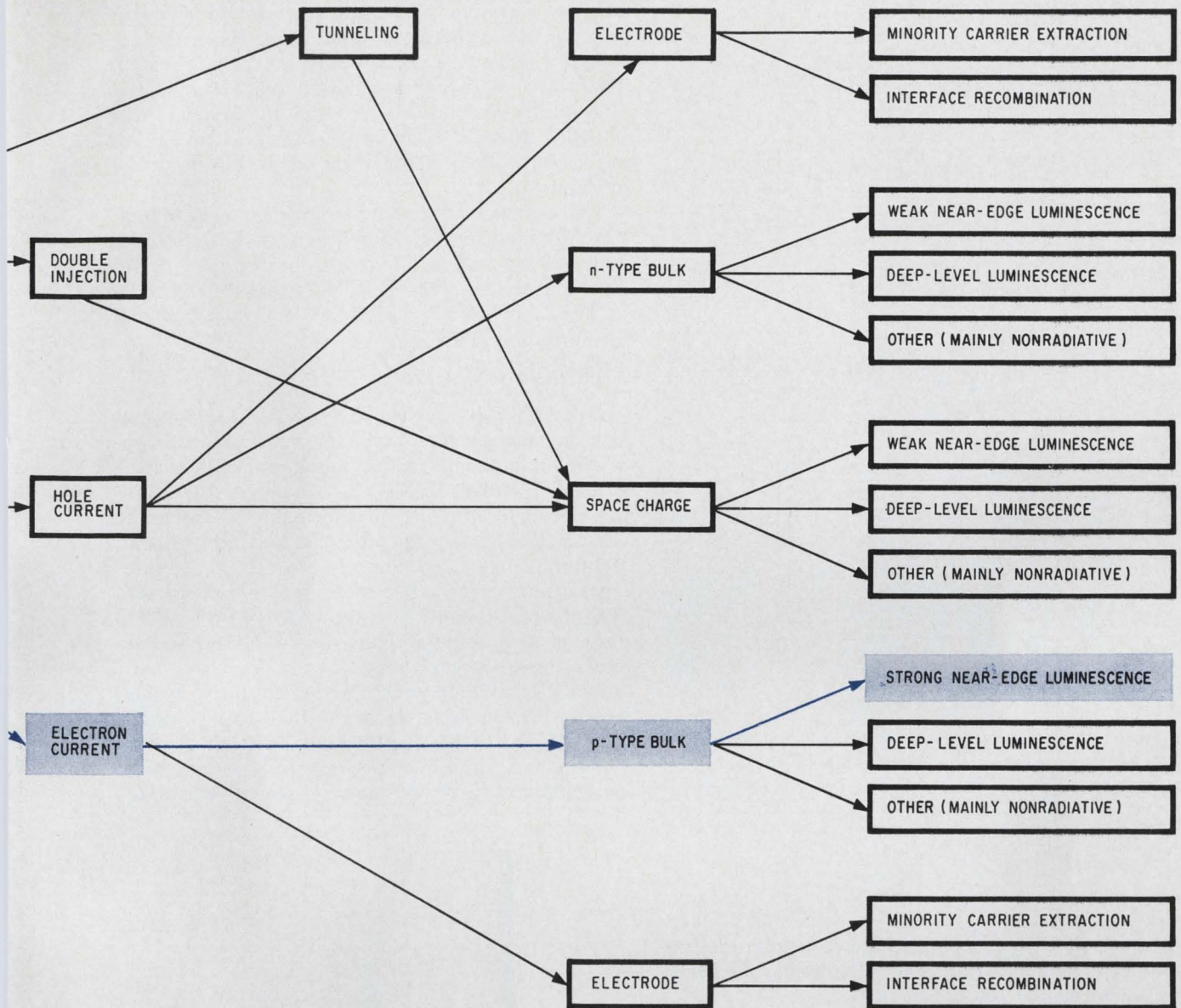

p-type dopant gradient is too steep, for example, or if the p-side electrode is too close, the electron may not suffer a shining termination of its existence, and efficiency may be too low.

Material questions

The choice of a semiconductor material for the diode hinges upon how closely the doping profile can be controlled—in other words, how carefully the positions of the various recombination zones can be controlled—and upon how strong the near-edge recombination is in comparison with all the other competing recombination mechanisms such as deep-level or nonradiative recombination.

Another important factor concerns whether the energy bandgap is larger than 1.85 electron volts, so that the radiation is sufficiently visible. There's only one practical material that satisfies these requirements now—a gallium-arsenide-phosphide [Ga(As,P)] alloy [Electronics, March 4, p. 105].

Gallium arsenide is amenable to device fabrication, but it emits in the infrared region. Gallium phosphide, though it can emit near-edge green light efficiently,⁵ hasn't yet progressed to the manufacturing stage, technically or economically.

Gallium-arsenide-phosphide alloys have the formula $\text{GaAs}_{1-x}\text{P}_x$, where x can have any value from 0 to 1. These alloys have two conduction bands, described as Γ and X^6 in the Γ band, electrons are highly mobile and are characteristic of pure GaAs ($x = 0$). Electrons in the X band have a lower mobility and are characteristic of pure GaP ($x = 1$).

Hewlett-Packard researchers found that the luminous efficiency at room temperature is highest in an alloy composition in which the preponderance of electrons is in the X rather than Γ band. They developed methods of controlled synthesis for optimum material composition, and even more important, they developed a means of independently

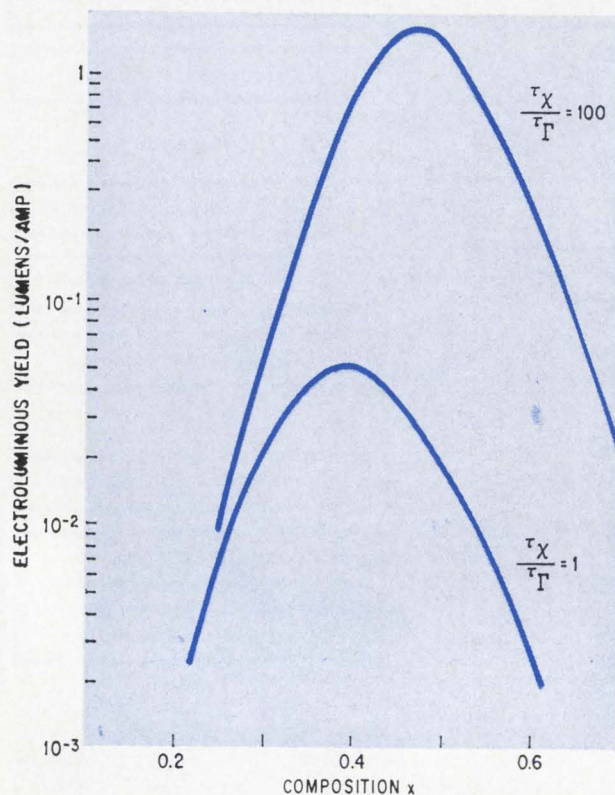

Brighter, longer life. Increasing the lifetime τ of the X-type electrons boosts the electroluminescent efficiency for a given proportion of phosphorus. Composition x of 0.4 corresponds to 20% of phosphorus.

increasing the lifetime of the dominant X electrons.^{7,8} (For equal composition x , a long-lifetime alloy has much higher electroluminescent efficiency, as shown at the top of the page).

The net result is that efficiency became a parameter subject to control during the synthesis of the diode material. This achievement is partly due to advances in the technology of growing materials, but also rests to a great extent on analytical and experimental work on the complex tradeoffs involved in electroluminescent p-n junctions.

H-P's manufacturing facility is equipped to make almost all the parts in the module. Initial production capacity is 1.5 million electroluminescent-diode elements a year. The company designed and built a vertical flow, r-f heated dual reactor system that can grow Ga(As,P) wafers up to 2 inches in diameter. This cold-wall vapor epitaxial system permits control of the phosphorus-to-arsenic ratio to within 1% throughout the epitaxial layer, and of the thickness to within a micron.⁹ Because of this degree of control, the entire wafer is of sufficient quality for diode fabrication.

The net result of all the analysis, design, and development is a simple mesa structure, shown at right, in which a forward bias reduces the potential barrier between the n and p regions, allowing current

to flow. Electrons are injected from the n region into the space charge layer and into the p region; there's a similar injection of holes from the p region. These excess carriers recombine, with as much as 10% of the recombination resulting in near-edge photons. Most of them are generated in a region only about a half-micron wide on the p side of the junction.

The nearness of the anode surface ensures high transmittance through the p region, but even so, about 98% of the photons are lost because of internal reflection—a result of the great difference in index of refraction between the semiconductor and the surrounding medium.

A bit more

Although only four bits are needed to represent a decimal in machine language, or six bits to represent an alphanumeric symbol, humans need a greater quantity of bits to recognize the number. Because of this, the formats of electronic numeric planar displays produced by various manufacturers range from seven segments in a figure-eight arrangement to the more general matrix with 100 picture elements. This redundancy isn't wasted however. It makes the display easy to read and reduces the chance of error.

The electroluminescent diodes in H-P's system number 27, enough to make the display easily readable and to preclude ambiguity if one or two don't light. Further, they're compatible with the conventional five-by-seven matrix used in the ASCII

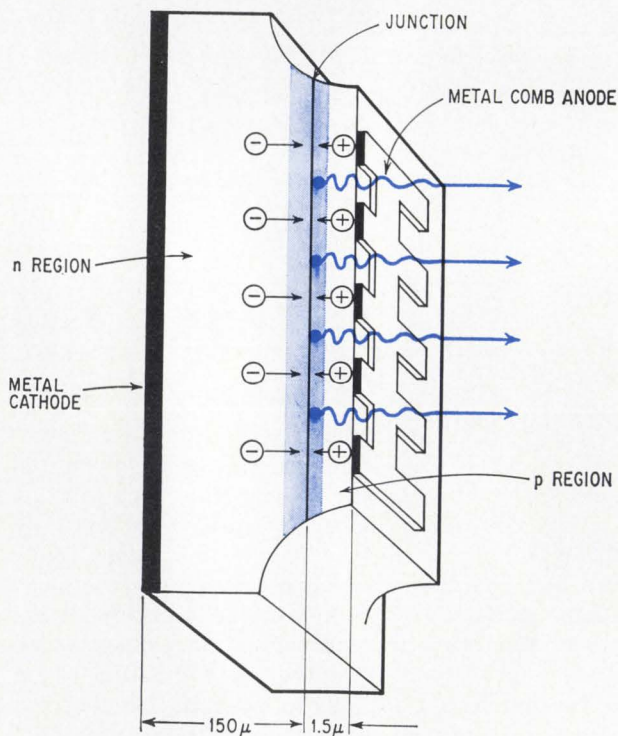

Anatomy of a diode. Each light emitter is a mesa diode. The light-emitting region (shaded) is a sheet approximately 0.5 to 1 micron thick and predominantly on the p side of the junction.

From bits to photons

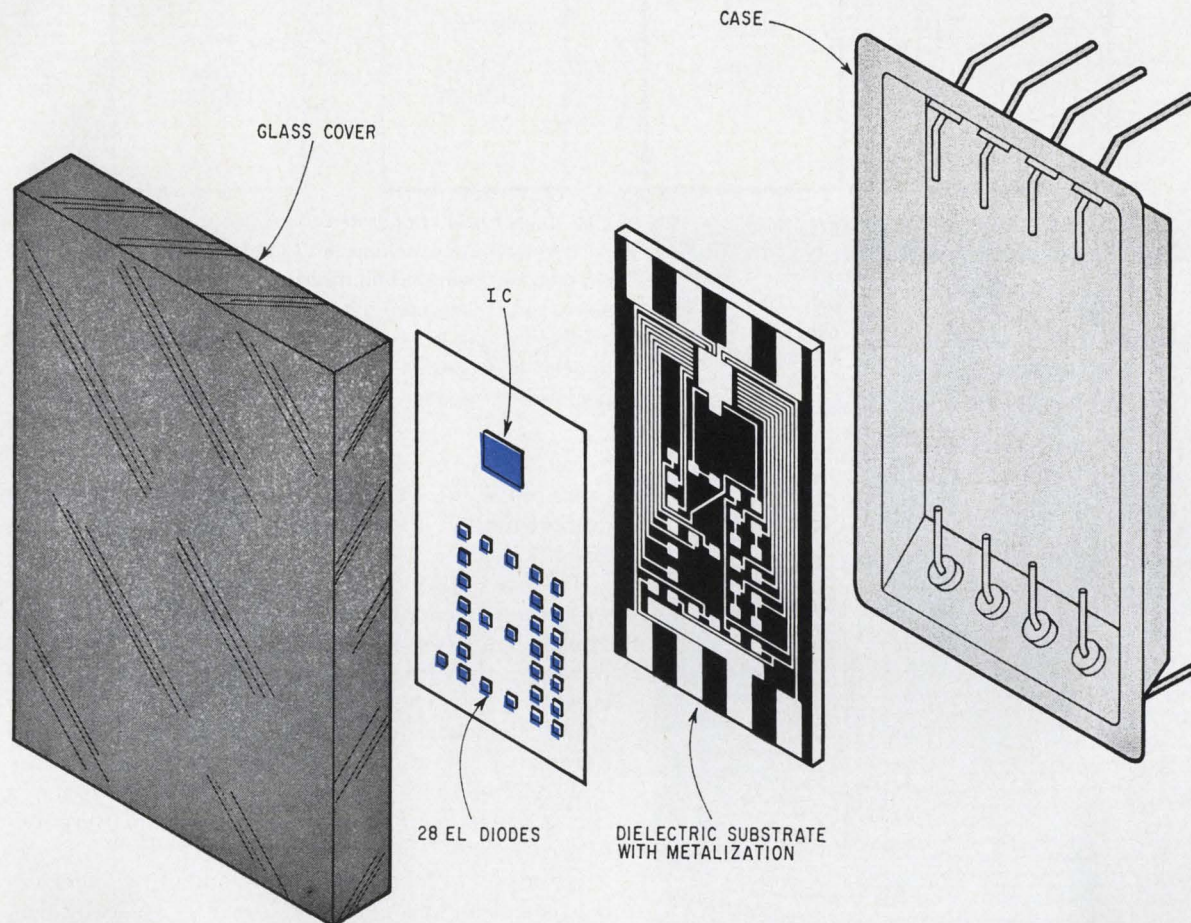

Assembly. The diodes and IC are mounted on a substrate containing metalized conductive paths, placed in a metal case, and hermetically sealed with a glass cover.

H-P's new solid state display consists of 28 red-light-emitting, gallium-arsenide-phosphide diode chips and a monolithic silicon integrated circuit. These are assembled on a dielectric substrate in a flat package with a glass top. A metal-film pattern connects the IC to the diodes, and as many as three diode-IC modules have been incorporated in a single package, as shown on the cover.

The 28 diodes are arrayed in a five-by-seven matrix (not all positions are occupied by diodes). The characters 0 through 9 are generated by combinations of 27 diodes, while the remaining diode is used to indicate the decimal point. The cathode side of each diode is bonded to the substrate metalization. Light exits from the opposite side, which has a common anode connection. The metallic thin-film anode on the chip is digitated to

assure uniform current density across the junction, and it's small in area to hold the loss of brightness to less than 25%.

The IC translates a machine-language input to drive the appropriate diode elements in the display. The input signals must be in standard 8-4-2-1 binary-coded-decimal logic at transistor-transistor-logic voltage levels (0 to 0.8 volt for binary 1, 2 to 5 volts for binary 0). A fifth input signal drives the decimal-point diode directly.

There are two power-supply connections—5 volts for the IC and a variable voltage to adjust the diodes' light output. Typical power dissipation is 150 milliwatts for the logic and 500 mw for the combined IC driver stages and electroluminescent diodes at the 50-foot-lambert output level.

The luminous emittance of the diodes is adjustable between 5 and

50 foot-lamberts. Hue is of high purity and has a dominant wavelength to which the human eye is rather sensitive. The diodes have a response time of less than 1 microsecond.

The display can be viewed from an angle as much as 60° off the axis horizontally and from an even wider angle above and below. The numerical character is a quarter-inch in height but is subject to an interesting and unexplained effect: it appears bigger than it is. Most people estimate the height at $\frac{5}{8}$ inch and no has guessed under 0.4 inch.

The package for a one-digit display is slightly more than 1 inch high, and is 0.57 inch wide and 0.162 inch thick. Density is 275 characters per square foot.

Hewlett-Packard estimates the initial cost of a one-digit display module at \$50.

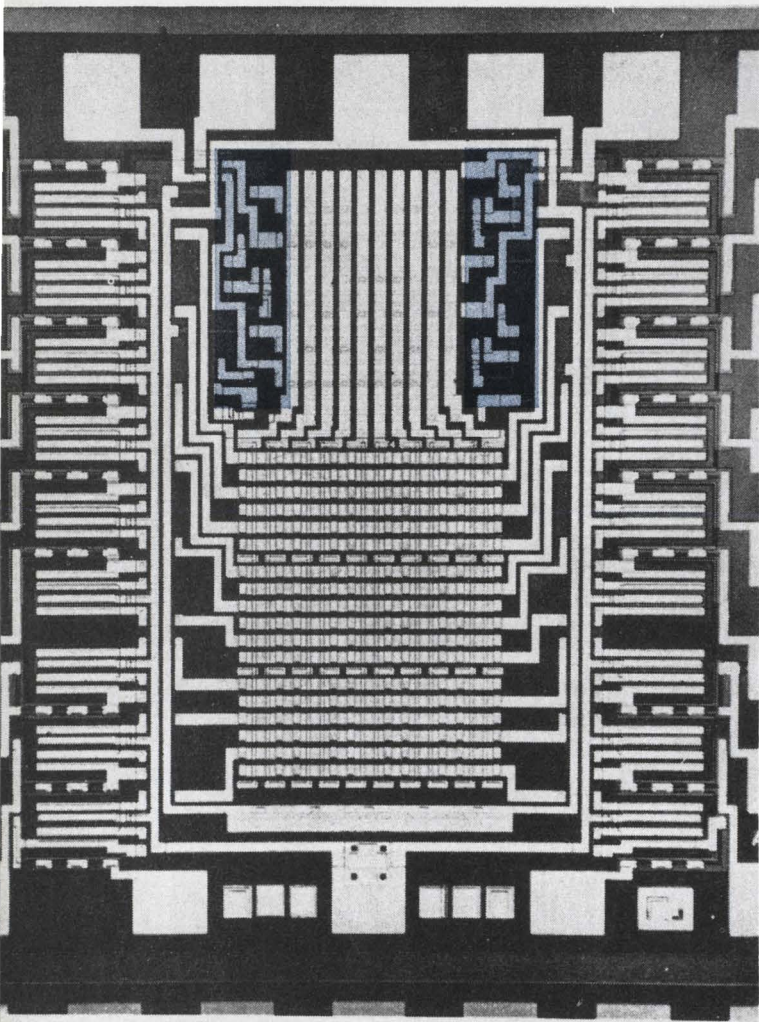
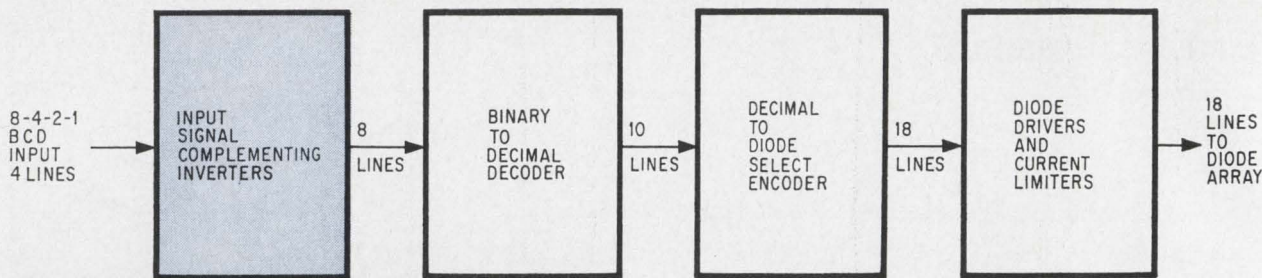

Two steps. The IC generates the appropriate display pattern by first decoding the BCD input to decimal signals, and then putting them into an 18-line diode-select code. The tinted regions on the IC indicate the complementing inverters. Between them is the binary-to-decimal decoder, and below this is the decimal-to-diode-select encoder. Diode drivers are on both sides.

- Amplifying the 18 output signals by means of current-limited drivers matched to the light-emitting diodes.

The use of a two-step translation—binary to decimal, then decimal to the eighteen-set code—may appear unnecessary at first glance. Why not translate directly from BCD to the diode-select code? Well, the two-step process does require more active elements on the chip, but it was adopted because it allows easy changes in machine code and symbol font; all that's necessary for such a change is to alter the interconnection pattern between the logic elements.

Each of the four input complementing inverters consists of an npn emitter follower coupled by way of a resistor network to the base of an inverting transistor with a grounded emitter. For the worst case, the input threshold is between 0.8 and 2 volts, a range compatible with transistor-transistor logic.

The binary-to-decimal decoder consists of 10 four-input common-collector pnp transistor AND gates. The eight input lines are low resistivity n⁺ diffused stripes insulated from the 10 decoder aluminum lines by a layer of silicon dioxide. Since only the base current of the pnp transistors flows through these diffused stripes, the voltage drop is at a minimum.

The decimal-to-driver-select encoder consists of 18 common-collector npn emitter-follower OR gates fabricated within a single isolation area. To minimize the voltage drop in the encoder base regions, n⁺ stripes were diffused into (and shorted to) the base in several places. The decode and encode logic matrices are fabricated by selective etching through the silicon dioxide; unused transistors are left floating and don't participate in switching.

The 18 drivers are made up of resistor-divider input networks followed by common emitter npn inverters that drive pnp emitter followers (whose currents are routed through the substrate) in series with output-current-limiting resistors. The resistor values are so closely matched in an IC that the brightness of the individual diodes is also matched closely.

alphanumeric code. The 27 diodes don't operate independently. Rather, they are grouped in 18 independently switchable sets to minimize the complexity of the decoder-driver circuit.

The IC chip performs four basic functions:

- Generating the complements of the four binary-coded-decimal inputs by sending the signals through inverter stages for a total of eight signals for the decoding stage.

- Decoding the original and complemented BCD signals into 10 mutually exclusive line signals. The output from this stage is a decimal version of the input to the module.

- Encoding the 10 signals into 18 output signals for diode groups to form the numerals 0 through 9.



Handy. Small size of solid state unit can be a convenience, as in this experimental probe display, which puts measurement data at the operator's fingertips.

A significant departure in the IC's from industry practice is the use of a low-resistivity (p^+) substrate with a p-type epitaxial layer. This substrate can conduct the sum of the output currents and minimizes the current density in the aluminum metalization.

Glowing future

An early extension of the present technology will be the addition of alphabetic characters. Hewlett-Packard plans to introduce upper- and lower-case letter symbols—both Greek and English—to identify measuring units.

One of the most promising areas of development is that in which small display size is a distinct advantage. Solid state displays could be incorporated, for example, in such manual instruments as probes and micrometers, as shown above. Head-mounted displays are another good possibility; they could keep data within the field of vision regardless of where the observer is.

H-P expects a density of 50,000 to 250,000 characters per square foot in these future displays. With cost reductions limited only by the size of the

market, and size reductions limited only by the human side of the man-machine interface, a glowing future seems in store for these displays.

References

1. H.K. Henisch, "Electroluminescence," Pergamon Press, New York, 1962.
2. P.R. Thornton, "The Physics of Electroluminescent Devices," E.&F.N. Spon Ltd., London, 1967.
3. E. Mroz, "Some Aspects of Integrated Circuit Technology," Microwave Journal, July 1964.
4. D.H. Lowndes, E.E. Loebner, T.L. Larsen, and R.W. Soshea, "Extrinsic and Intrinsic Optoelectronic Effects in GaAs," IEEE Trans. Elec. Devices, vol. 10, p. 333, 1963.
5. E.E. Loebner and E.W. Poor Jr., "Bimolecular Electroluminescent Transitions in GaP," Phys. Rev. Lett., vol. 3, p. 23, 1959.
6. R.A. Burmeister and W.B. Hewlett, "Two-Band Conduction in the $GaAs_{1-x}P_x$ System," Bull. Amer. Phys. Soc., series II, vol. 12, p. 1120, 1967.
7. T.L. Larsen, E.E. Loebner, and R.J. Archer, "Relative Strength of Direct and Indirect Radiative Transitions in $GaAs_{1-x}P_x$ Alloys," Bull. Amer. Phys. Soc., series II, vol. 10, p. 388, 1965.
8. T.L. Larsen, R.J. Archer, and E.E. Loebner, "Indirect Energy Bandgap Topology Injection Electroluminescent Light Source," U.S. Patent No. 3,398,310, 1968.
9. R.A. Burmeister, Jr., G.P. Pighini, and P.E. Greene, "Large Area Epitaxial Growth of $GaAs_{1-x}P_x$ for Display Applications," Conf. on Preparation and Properties of Electronic Materials, the Metal Society of AIME, 1968.

Active filters: part 3

Negative-impedance converters

These two-port devices are being used to produce transfer functions without inductors, and their strong advantages over gyrators include greater simplicity of network design and use

By Louis de Pian and Arnold Meltzer

George Washington University, Washington

Given a transfer function, an engineer can apply classical synthesis techniques and develop a passive RLC combination that produces this equation. But ask him to achieve the same result without inductors, and he will have to rely on active-circuit devices. Two such devices are the gyrator [Electronics, June 10, p. 114] and the negative-impedance converter, or NIC.

An NIC is a two-port device operating on the principle that any impedance placed across one of its ports will appear as the negative of that impedance at the other port. For example, if the load were a resistor it would behave as a negative resistor at the input port.

This means that resistor-capacitor circuits coupled to NIC's can be built in integrated-circuit form and achieve Q's at low frequencies far greater than those possible with inductors.

The NIC has several advantages over the gyrator. It can be used to design filters with a smaller spread of capacitance values and fewer network elements.

There are more design procedures for NIC's. With simple networks, the poles and zeros can be shifted easily by adjusting the circuit components without any interaction. Thus, an exact transfer function is obtained simply by trimming the individual components. Finally, an NIC can be built with fewer transistors and with a wider bandwidth than is possible for a gyrator.

Understanding NIC properties

Because an NIC's input impedance is the negative of an impedance placed at its output terminals, its transfer matrix can be defined as

$$\begin{bmatrix} E_1 \\ I_1 \end{bmatrix} = \begin{bmatrix} A & B \\ C & D \end{bmatrix} \begin{bmatrix} E_2 \\ -I_2 \end{bmatrix} \quad (1)$$

If a load Z_o is placed at the output, the input impedance is

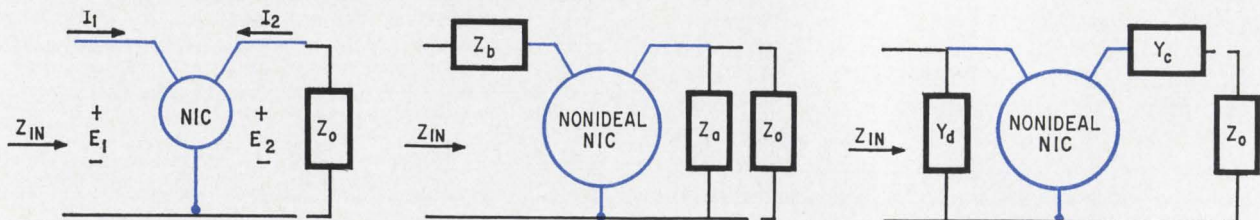

Negative-impedance converters. By definition Z_{in} equals $-Z_o$ for an ideal NIC (left). When the negative-impedance converter is nonideal (center and right) impedances and admittances can be added to adjust the over-all behavior of the NIC, causing it to react as an ideal device. The added impedances Z_a and Z_b , and added admittances Y_c and Y_d cause the matrix element on the main diagonal of the G and H matrix to be zero.

$$Z_{in} = \frac{AZ_0 + B}{CZ_0 + D} \quad (2)$$

For Z_{in} to be equal to $-kZ_0$, B and C must be zero. Thus,

$$A = -Dk \quad (3)$$

This result is achieved with either of the following transfer matrices

$$[F] = \begin{bmatrix} -k & 0 \\ 0 & 1 \end{bmatrix} \quad (4a)$$

$$[F] = \begin{bmatrix} 1 & 0 \\ 0 & -1/k \end{bmatrix} \quad (4b)$$

Both of these yield

$$Z_{in} = -kZ_0 \quad (5)$$

If an impedance transformation is realized from port 1 to port 2, the reciprocal impedance transformation is achieved from port 2 to port 1. Thus the designer can proceed once he is given the transfer impedance Z_{12} or Z_{21} .

For an ideal NIC, in which the input impedance is exactly the negative of the load impedance, k should be unity. Because equation 4a yields $E_2 = -(E_1) 1/k$, and $I_2 = -I_1$, the NIC for this system is said to invert the voltage while leaving the normal direction of current unchanged.

Alternate case

Conversely, because equation 4b produces $E_2 = E_1$, and $I_2 = k I_1$, this NIC inverts current; it reverses the current flow at one of the ports with respect to the flow that would normally be encountered in a purely passive device. For both types of NIC's, k is a positive constant that is called the gain of the NIC network.

In terms of the H and G matrix notations, the NIC can be expressed as

$$[H] = \begin{bmatrix} 0 & -k \\ -1 & 0 \end{bmatrix} \text{ voltage inversion} \quad (6a)$$

$$[H] = \begin{bmatrix} 0 & 1 \\ k & 0 \end{bmatrix} \text{ current inversion} \quad (6b)$$

$$[G] = \begin{bmatrix} 0 & -1 \\ -1/k & 0 \end{bmatrix} \text{ voltage inversion} \quad (7a)$$

$$[G] = \begin{bmatrix} 0 & 1/k \\ 1 & 0 \end{bmatrix} \text{ current inversion} \quad (7b)$$

The zero matrix element in equations 4, 6, and 7 is sometimes difficult to achieve. However, this requirement can be relaxed by adding input and output impedances, Z_b and Z_a , respectively, to an NIC that isn't ideal. Such a device will have G_{11}

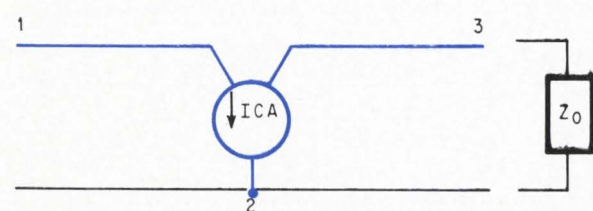
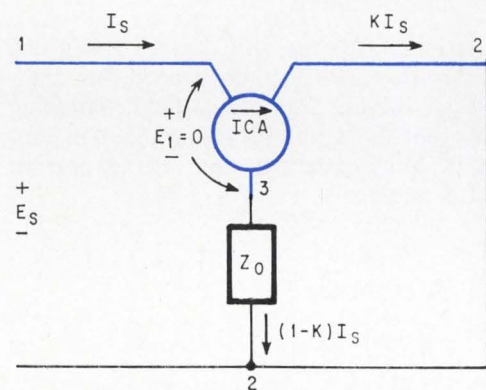
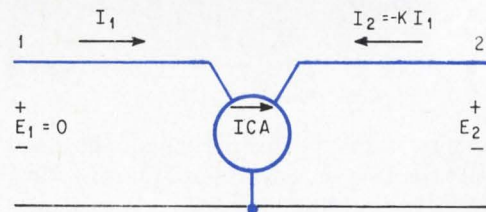
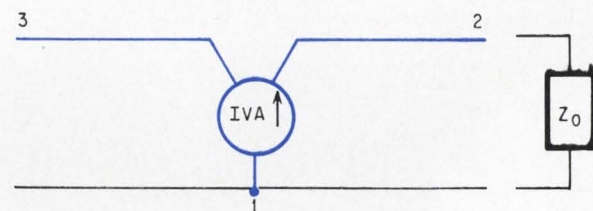
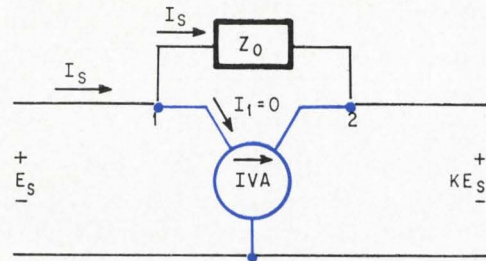
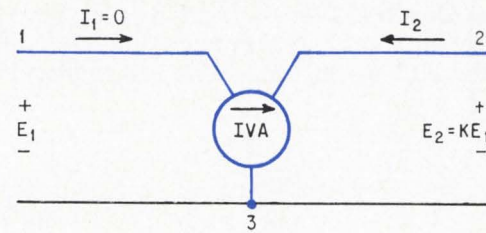

Rotation helps. In the second and fourth drawings the load appears between terminals of an ideal voltage and current amplifier, IVA and ICA, respectively, without a common ground. Rotating the device as in the third and last drawings provides a common ground and doesn't change the NIC effect.

$\neq 0$, $G_{22} \neq 0$, and $G_{12}G_{21} \neq 1/k$. However, properly choosing Z_a and Z_b , can produce the effect of an ideal NIC. To have $Z_{in} = -k Z_o$ it is sufficient to have

$$Z_a = \frac{a}{G_{11}} \quad (8)$$

$$Z_b = b G_{22} \quad (9)$$

$$ab = 1 \quad (10)$$

$$G_{12} G_{21} = a + G_{11} G_{22} \quad (11)$$

$$a = \frac{1}{2k} + \sqrt{G_{11} G_{22} + \frac{1}{4k^2}} \quad (12)$$

If $G_{11} = 0$, $G_{22} = 0$ then $a = 1/b = 1/k$, $Z_a = \infty$, $Z_b = 0$, and $G_{12} G_{21} = 1/k$, thus satisfying equation 7.

Another possibility can be described with admittances. Here it is sufficient to set

$$Y_o = \frac{c}{H_{11}} \quad (13)$$

$$Y_d = d H_{22} \quad (14)$$

$$cd = 1 \quad (15)$$

$$H_{12} H_{21} = c + H_{11} H_{22} \quad (16)$$

$$c = \frac{1}{2k} + \sqrt{H_{11} H_{22} + \frac{1}{4k^2}} \quad (17)$$

The simplicity with which an NIC can be used to compensate for its own deviations from the ideal adds even more to its attractiveness.

Some simple configurations

The properties of voltage and current NIC's can be illustrated with an ideal voltage amplifier characterized by an infinite input impedance—making the input current I_1 equal to 0—and a constant voltage gain K independent of the output current I_2 . Its transfer matrix is

$$[F] = \begin{bmatrix} \frac{1}{K} & 0 \\ 0 & 0 \end{bmatrix} \quad (18)$$

If an impedance Z_o is placed between the output and input terminals, the input impedance will be

$$Z_{in} = \frac{E_s}{I_s} = \frac{E_s}{\frac{E_s(1-K)}{Z_o}} = \frac{Z_o}{1-K} \quad (19)$$

This indeed represents a voltage NIC with

$$k = \frac{1}{K-1} \quad (20)$$

If this ideal voltage amplifier is rotated clockwise by 90° , its new transfer matrix will be

$$[F] = \begin{bmatrix} \frac{-1}{(K-1)} & 0 \\ 0 & 1 \end{bmatrix} \quad (21)$$

which again characterizes a voltage NIC.

A similar result can be obtained with an ideal current amplifier whose characteristics are a zero input impedance—making $E_1 = 0$ —and a constant current gain K independent of E_2 . Its transfer matrix is

$$[F] = \begin{bmatrix} 0 & 0 \\ 0 & \frac{1}{K} \end{bmatrix} \quad (22)$$

If an impedance Z_o is inserted in one leg, the input impedance will be

$$Z_{in} = \frac{E_s}{I_s} = \frac{(1-K) I_s Z_o}{I_s} = (1-K) Z_o \quad (23)$$

This is a current NIC with

$$k = K - 1 \quad (24)$$

Moreover, if the ideal current amplifier is rotated clockwise by 90° its new transfer is

$$[F] = \begin{bmatrix} 1 & 0 \\ 0 & \frac{-1}{(K-1)} \end{bmatrix} \quad (25)$$

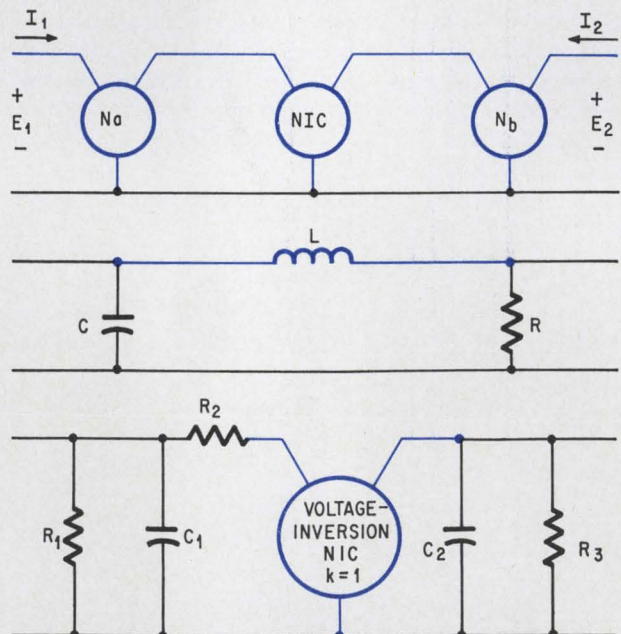

Cascade. To design a low-pass filter using the Linvill technique, the engineer assumes an ideal NIC is flanked by an RC network N_a and N_b . Such a configuration, detailed in the bottom drawing, has the same effect as the RLC network, center, but without requiring an inductor. Cutoff frequency is approximately 20 kilohertz with the values in the text.

which again characterizes a current NIC.

Designing inductorless filters

In passive-network synthesis, all transfer functions are produced with specific combinations of resistors, capacitors, and inductors. In active-network synthesis, an active element replaces the inductor, and the transfer function is produced by a combination of R's, C's, and active elements, such as the NIC. Several engineers have developed design techniques for synthesizing a particular transfer function using NIC's. Three such techniques were developed by John G. Linvill, executive head of the electrical engineering department at Stanford University, T. Yanagisawa, and Jack M. Sipress supervisor at the Bell Telephone Laboratories. Features of these techniques are compared in the table on page 90. These techniques use only one NIC in combination with several RC networks.

In the Linvill technique, the engineer produces the transfer function with an RC network, N_a , in cascade with an NIC and another RC network, N_b . Either a voltage or current NIC can be used. With the voltage type, the over-all open-circuit transfer relationship is

$$Z_{21} = \left. \frac{E_2}{I_1} \right|_{I_2=0} = \frac{Z_{21a} Z_{21b}}{Z_{22a} - kZ_{11b}} \quad (26)$$

where the subscripts a and b refer to networks N_a and N_b , and k is defined in equation 4 for the NIC. With a current-type NIC, the corresponding relationship is

$$Z_{21} = \frac{k Z_{21a} Z_{21b}}{k Z_{11b} - Z_{22a}} \quad (27)$$

Either equation 26 or 27 may be used to design the filter network; the procedure is the same. As an example, consider the transfer impedance, Z_{21} , for a low-pass network:

$$\begin{aligned} Z_{21}(s) &= \frac{K_0}{s^2 + K_1 s + K_2} \\ &= \frac{Z_{21a} Z_{21b}}{Z_{22a} - k Z_{11b}} = \frac{P/q}{Q/q} \end{aligned}$$

where $P = K_0$, $Q = s^2 + K_1 s + K_2$, and the values of the K coefficients are $K_0 = 10^{12}$ ohms-sec⁻², $K_1 = 10^5$ sec⁻¹ and $K_2 = 10^{10}$ sec⁻².

If this transfer function were to be produced with passive elements, the design would be an LC network loaded with a resistor, R, having the following parameters: $C = K_1/K_0$, $L = K_0/K_1 K_2$, $R = K_0/K_2$. For the numerical values given, $C = 0.1$ μ f, $L = 1$ mh, and $R = 100$ ohms. With the Linvill technique the effect of the inductor is replaced as follows:

Step 1. Divide both numerator and denominator with an arbitrary polynomial q—as shown for Z_{21} —

whose roots must be simple, real and negative, and whose order must equal that of P(s) and Q(s), whichever is higher.

$$q = M (s + \alpha_1) (s + \alpha_2)$$

where M, α_1 , α_2 are arbitrary.

Step 2. Compare the result obtained in step 1 with equation 27 and set

$$Z_{21a} Z_{21b} = \frac{K_0}{M (s + \alpha_1) (s + \alpha_2)} = \frac{P}{q}$$

and

$$Z_{22a} - k Z_{11b} = \frac{s^2 + K_1 s + K_2}{M (s + \alpha_1) (s + \alpha_2)} = \frac{Q}{q}$$

Step 3. Expand Q/q into partial fractions. Thus,

$$\frac{s^2 + K_1 s + K_2}{M (s + \alpha_1) (s + \alpha_2)} = A_0 + \frac{A_1}{s + \alpha_1} + \frac{A_2}{s + \alpha_2}$$

where

$$A_0 = \frac{1}{M}$$

$$A_1 = \frac{1}{M} \frac{\alpha_1^2 - K_1 \alpha_1 + K_2}{\alpha_2 - \alpha_1}$$

$$A_2 = -\frac{1}{M} \frac{\alpha_2^2 - K_1 \alpha_2 + K_2}{\alpha_2 - \alpha_1}$$

Assume that the numerical values assigned to α_1 and α_2 make A_1 positive and A_2 negative. Assign the positive ones to Z_{22a} and the negative ones to $-kZ_{11b}$. Thus

$$Z_{22a} = A_0 + \frac{A_1}{s + \alpha_1}$$

$$-k Z_{11b} = \frac{A_2}{s + \alpha_2}$$

Step 4. Split P, which in this case is K_0 , in a convenient manner to produce possible RC networks for N_a and N_b . Such a split gives

$$Z_{21a} = -K_0 \frac{A_0}{A_2} \frac{1}{s + \alpha_1}, \quad Z_{21b} = K_0 \frac{A_0}{A_1} \frac{1}{s + \alpha_2}$$

and

$$A_0 = -\frac{A_1 A_2}{K_0}$$

Step 5. Having determined Z_{21a} , Z_{22a} for N_a and Z_{21b} , Z_{11b} for N_b , proceed with the conventional RC synthesis which will yield the network shown on

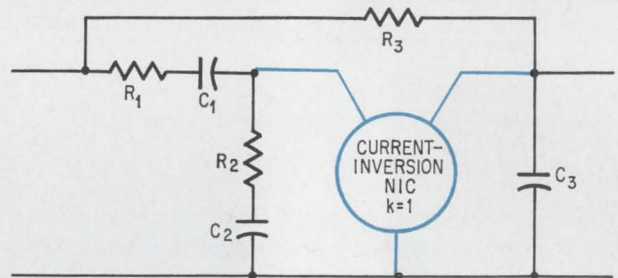
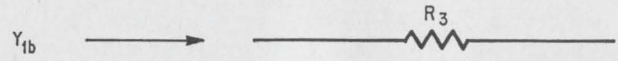
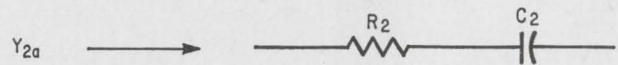
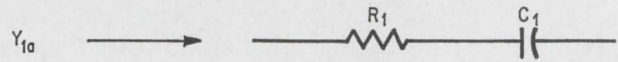
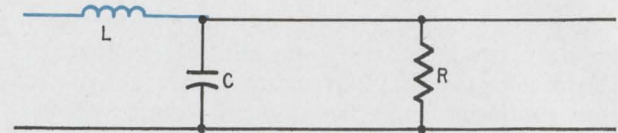
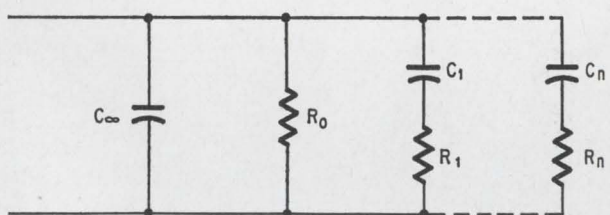
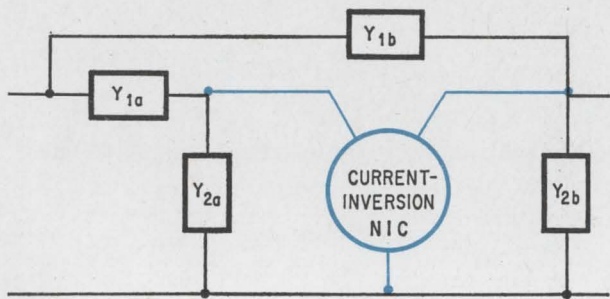
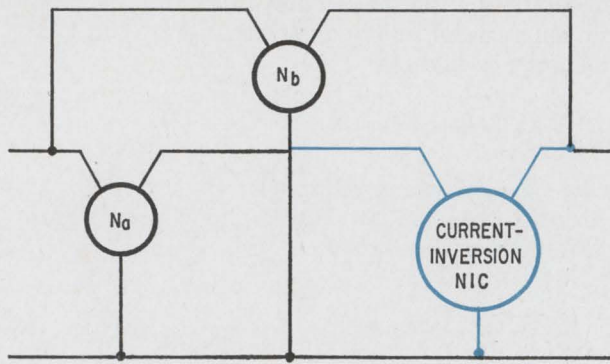

Bridging. A low-pass filter, designed by the Yanagisawa technique, has an RC network N_a cascaded to a current-inversion NIC and a bridged T, N_b . Networks N_a and N_b are replaced by admittances Y_{1a} , Y_{1b} , Y_{2a} , and Y_{2b} , which are achieved by RC combinations, bottom left and center right. Low-pass networks can be achieved with an RLC circuit but the inductor is undesirable since it can't be built in integrated-circuit form, has a low Q , and is bulky. Final design, bottom right, has a cutoff frequency of about 20 kilohertz.

page 84. For simplicity, the value of k for the NIC is set equal to unity. The element values are

$$R_3 = \frac{10}{1.10} \text{ ohms} \quad k = 1$$

$$R_1 = -\frac{K_o}{\alpha_1} \frac{A_o}{A_2}$$

$$R_2 = -K_o \frac{A_o}{A_1} \frac{A_o}{A_2} \quad C_1 = -\frac{1}{K_o} \frac{A_2}{A_o}$$

$$R_3 = \frac{K_o}{\alpha_2} \frac{A_o}{A_1} \quad C_2 = \frac{1}{K_o} \frac{A_1}{A_o}$$

For numerical simplicity assign $\alpha_1 = 10^5$ and $\alpha_2 = 1.1 \times 10^5$. This yields $A_1/A_o = 10^6$ and $A_2/A_o = -1.11 \times 10^6$, with

$$R_1 = \frac{10}{1.11} \text{ ohms} \quad C_1 = 1.11 \mu\text{f}$$

$$R_2 = \frac{1}{1.11} \text{ ohm} \quad C_2 = 1 \mu\text{f}$$

The Yanagisawa technique

In Yanagisawa's method, the NIC is cascaded with an RC network; N_a , and the combination of N_a and NIC is parallel with an RC network N_b .

In this method, the product of two impedances isn't required, as it is in Linvill's technique (see equation 26). Moreover, Yanagisawa's technique is simpler because the resulting RC networks can be designed with one-ports rather than two-port networks. However, to apply this method the designer must use a current-inversion NIC.

The basic circuit is shown above at the top left, where both networks N_a and N_b consist of only RC elements. The over-all open-circuit voltage transfer function is

$$T = -\frac{Y_{21b} - k Y_{21a}}{Y_{22b} - k Y_{22a}}$$

If N_a and N_b are pi networks with the left shunt element missing, the over-all network takes the form shown in the drawing on page 86.

$$\begin{aligned} Y_{21a} &= -Y_{1a} \\ Y_{22a} &= Y_{1a} + Y_{2a} \\ Y_{21b} &= -Y_{1b} \\ Y_{22b} &= Y_{1b} + Y_{2b} \end{aligned}$$

Now T can be written in the form

$$T = \frac{Y_{1b} - k Y_{1a}}{Y_{1b} - k Y_{1a} + Y_{2b} - k Y_{2a}} = \frac{P}{Q}$$

The Yanagisawa design procedure can be demonstrated with the transfer function for the following low-pass network.

$$T(s) = \frac{K_o}{s^2 + K_1s + K_o}$$

where $P = K_o$, $Q = s^2 + K_1s + K_o$, and the K values are $K_o = 10^{10} \text{ sec}^{-2}$ and $K_1 = 10^5 \text{ sec}^{-1}$. The classical passive synthesis can be achieved with an LC network loaded with R and having the following parameters

$L = R K_1/K_o$, and $C = (1/R) 1/K_1$ with R arbitrary. This selection of values makes $R = 100 \text{ ohms}$, $L = 1 \text{ mh}$, and $C = 0.1 \mu\text{f}$. The inductor is replaced as follows:

Step 1. Arbitrarily choose a polynomial q as outlined in the Linvill method, and divide numerator and denominator by q . Thus, $q = M(s + \alpha)$ where M and α are arbitrary.

Step 2. Set

$$Y_{1b} - k Y_{1a} = \frac{K_o}{M(s + \alpha)}$$

$$Y_{2b} - k Y_{2a} = \frac{s^2 + K_1s}{M(s + \alpha)}$$

Step 3. Expand P/q and $(Q-P)/q$ into partial fractions. Thus,

$$\frac{K_o}{M(s + \alpha)} = A_o + \frac{A_1s}{s + \alpha}$$

$$\frac{s^2 + K_1s}{M(s + \alpha)} = B_\infty s + \frac{B_1s}{s + \alpha}$$

where

$$A_o = \frac{K_o}{\alpha M}, \quad A_1 = -\frac{K_o}{\alpha M}$$

$$B_\infty = \frac{1}{M}, \quad B_1 = -\frac{\alpha - K_1}{M}$$

which gives (setting $k=1$ for simplicity)

$$Y_{1b} = A_o, \quad Y_{1a} = -\frac{A_1s}{s + \alpha}$$

$$Y_{2b} = B_\infty s, \quad Y_{2a} = -\frac{B_1s}{s + \alpha}$$

Step 4. The realizations of Y_{1b} , Y_{1a} , Y_{2b} , Y_{1b} are as shown on page 86, with the following parameters

$$R_1 = \frac{\alpha M}{K_o}$$

$$C_1 = \frac{K_o}{\alpha^2 M}$$

$$R_2 = \frac{M}{\alpha - K_1}$$

$$C_2 = \frac{1}{\alpha} \frac{\alpha - K_1}{M}$$

$$R_3 = \frac{\alpha M}{K_o}$$

$$C_3 = \frac{1}{M}$$

The over-all network is shown 1234567890. For numerical values, assume $\alpha = 1.1 \times 10^5 \text{ sec}^{-1}$ and $M = 10^6 \text{ ohm-sec}^{-1}$.

This gives

$$R_1 = 11 \text{ ohms} \quad C_1 = 1/1.21 \mu\text{f}$$

$$R_2 = 100 \text{ ohms} \quad C_2 = 1/11 \mu\text{f}$$

$$R_3 = 11 \text{ ohms} \quad C_3 = 1 \mu\text{f}$$

The Sipress technique

When two of a network's four short-circuit admittance parameters are specified—for example, Y_{11} and Y_{12} or Y_{12} and Y_{21} —the engineer can use the Sipress technique to design his network. If Y_{11} and Y_{12} are known, a voltage-inversion NIC must be used; if Y_{12} and Y_{21} are specified, a current-inversion NIC is used. For all cases, the basic circuit is the same, and the NIC is either of the voltage or current type, and N_a , N_b , N_c , and N_d are all RC networks.

To design an inductorless filter for this network, the y -admittance parameters of the over-all circuit must be known in terms of the individual RC components. These are as follows:

$$Y_{11} = Y_{11a} + Y_{11b} - \frac{(Y_{12a} + Y_{12b})(Y_{12b} - k Y_{12a})}{Y_{22b} + Y_{11d} - k Y_{22a} - k Y_{11c}}$$

$$Y_{22} = Y_{22c} + Y_{22d} - \frac{(Y_{12c} + Y_{12d})(Y_{12d} - k Y_{12c})}{Y_{22b} + Y_{11d} - k Y_{22a} - k Y_{11c}}$$

$$Y_{12} = -\frac{(Y_{12c} + Y_{12d})(Y_{12b} - k Y_{12a})}{Y_{22b} + Y_{11d} - k Y_{22a} - k Y_{11c}} = Y_{21}$$

$$Y_{21} = -\frac{(Y_{12a} + Y_{12b})(Y_{12d} - k Y_{12c})}{Y_{22b} + Y_{11d} - k Y_{22a} - k Y_{11c}} = Y_{12}$$

The left-hand side of Y_{12} and Y_{21} applies for voltage-inversion NIC's and the right-hand side for

current types indicate by V and I

When Y_{21} is specified, the basic circuit can be simplified in the form shown at center right. This gives

$$Y_{11c} = -Y_{12c} = Y_{22c} = Y_c$$

$$Y_{11d} = -Y_{12d} = Y_{22d} = Y_d$$

and Y_{11} and Y_{21} are:

$$Y_{11} = Y_{11a} + Y_{11b} - \frac{(Y_{12a} + Y_{12b})(Y_{12b} - kY_{12a})}{Y_{22b} + Y_d - kY_{22a} - kY_c}$$

$$Y_{21} = -\frac{(Y_{12a} + Y_{12b})(kY_c - Y_d)}{Y_{22b} + Y_d - kY_{22a} - kY_c}$$

A further modification of the circuit appears at bottom right. Here networks N_a and N_b are split into N'_a and N'_b , with Y_a and Y_b at their output terminals. This means

$$Y_{22a} = Y_{22a'} + Y_a$$

$$Y_{22b} = Y_{22b'} + Y_b$$

The design procedure is as follows, given:

$$Y_{11} = \frac{K_1}{s} = \frac{P_1}{Q}$$

$$Y_{21} = \frac{K_1}{\omega_0} \frac{(s - \omega_0)}{s} = \frac{P_2}{Q}$$

Find the network. Here, Y_{11} and Y_{21} have the same denominator polynomial, Q . The denominators of the given Y_{11} and Y_{21} can be made the same, if necessary, by multiplying with suitable surplus factors; for example, if $Y_{11} = P_1'/Q'$ and $Y_{21} = P_2''/Q''$, write

$$Y_{11} = P_1' F_1 / Q' F_1, \quad Y_{21} = P_2'' F_2 / Q'' F_2$$

such that

$$P_1 = P_1' F_1, \quad P_2 = P_2'' F_2, \quad Q = Q' F_1 = Q'' F_2$$

To simplify the calculation, let $K_0 = K_1/\omega_0$ and $s = \omega_0 p$, which yields $Y_{11} = K_0/p$, $Y_{21} = K_0(p-1)/p$. This means that if the admittance of a capacitive element is found to be $Y = Kp = K_s/\omega_0$, the value of the capacitance is K/ω_0 . The dimensionless variable p is used rather than s .

By inspection:

$$\begin{aligned} P_1 &= K_0 \\ P_2 &= K_0(p-1) \\ Q &= p \end{aligned}$$

Step 1. Choose an RC admittance

$$Y_{RC}(s) = N_1 \frac{r(s)}{q(s)}$$

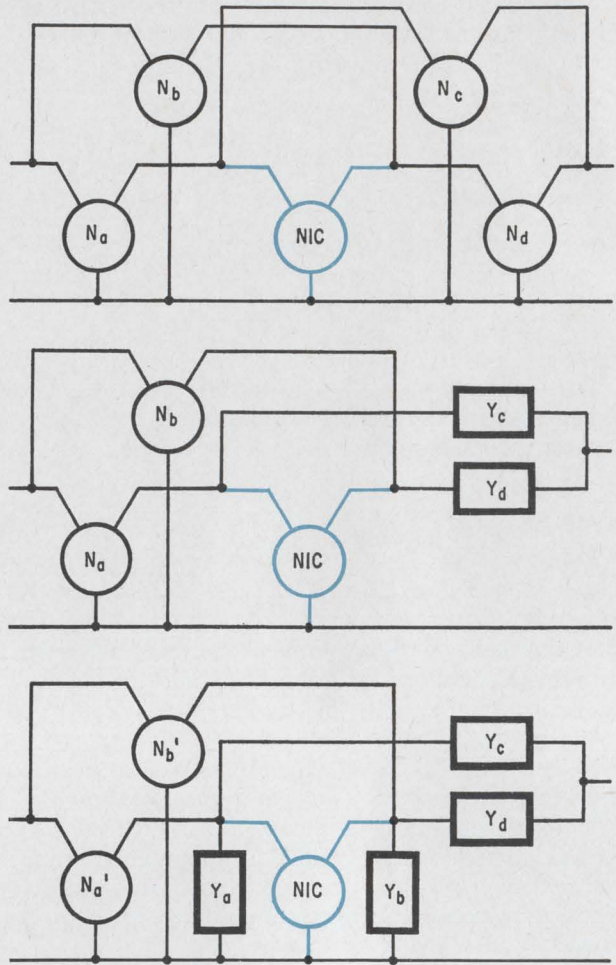

Combining. In the Sipress technique, a basic Linvill configuration is combined with two bridged-T networks, N_b and N_c . Networks N_b and N_c are RC admittances Y_c and Y_d . Networks N_a and N_b are partially represented by RC admittances Y_a and Y_b and RC networks N'_a and N'_b .

The only restrictions here are that the order m of Y_{RC} must be equal to or larger than the degree of P_1 , P_2 , or Q , whichever is larger, and that $r(0) \neq 0$. N_1 is a constant. Thus,

$$\begin{aligned} m &= 1 \\ r(p) &= p + \beta_1 \\ q(p) &= p + \beta_2 \end{aligned}$$

If $\beta_1 < \beta_2$ then r/q can be produced by an RC admittance. Let $\beta_1 = 1$, $\beta_2 = 4$ so that

$$\begin{aligned} r(p) &= p + 1 \\ q(p) &= p + 4 \end{aligned}$$

Step 2. Choose two polynomials $U(s)$ and $V(s)$ such that $U(s)$ has a degree m

$$U(s) = M_0 (s + a_1) (s + a_2) \dots (s + a_m)$$

where a_1, a_2, \dots, a_m are all distinct, real and positive, and M_0 is any positive constant. The polynomial $V(s)$ must be either the same degree as

m or one less. Also choose a real constant M_1 such that

$$M_1 N_1 r Q - q P_1 = UV$$

Thus,

$$M_1 N_1 (p + 1) p - (p + 4) K_o = M_1 N_1 p^2 + (M_1 N_1 - K_o) p - 4 K_o$$

Choose $M_1 N_1 = K_o$, giving

$$M_1 = \frac{K_o}{N_1}$$

so that

$$M_1 N_1 r Q - p P_1 = K_o (p + 2) (p - 2)$$

and therefore

$$U = K_o (p + 2)$$

$$V = (p - 2)$$

Step 3. Let

$$Y_{11a} + Y_{11b} = M_1 Y_{RC}$$

$$= M_1 N_1 \frac{r}{q} = \frac{K_o (p + 1)}{(p + 4)}$$

Step 4. Separate Y_{11a} and Y_{11b} as follows:

$$Y_{11a} = M_a N_{1a} \frac{r_a}{q}$$

$$Y_{11b} = M_b N_{1b} \frac{r_b}{q}$$

The separation must be such that Y_{11a} and Y_{11b} are RC admittances and

$$M_a N_{1a} r_a + M_b N_{1b} r_b = M_1 N_1 r$$

$$M_a N_{1a} r_a + M_b N_{1b} r_b = K_o (p + 1)$$

$$r_a = p \quad r_b = (p + \gamma_1)$$

Thus,

$$\gamma_1 > \beta_1, \quad \gamma_1 < \beta_2. \quad \text{Let } \gamma_1 = 2, \quad \text{so that}$$

$$r_a = p \quad r_b = (p + 2)$$

and

$$M_a N_{1a} p + M_b N_{1b} (p + 2) = K_o (p + 1)$$

or, equating equal powers of p ,

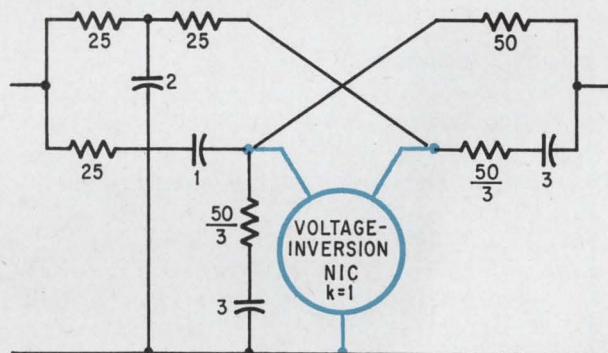
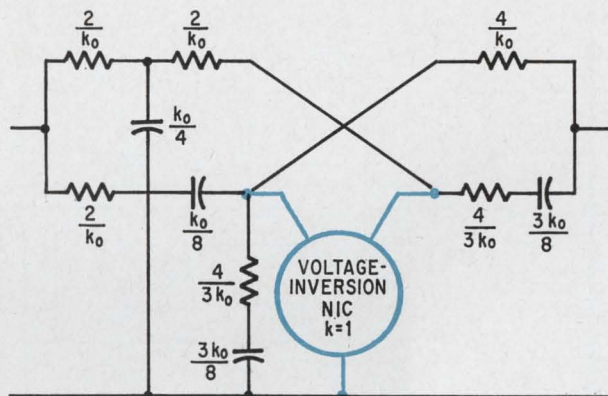
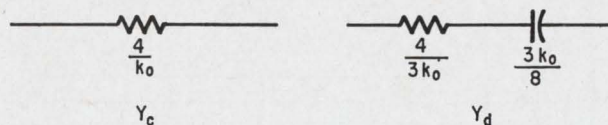
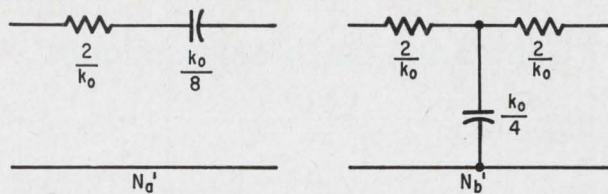

High-pass network. Two-port parameters for a high-pass, short-circuit current gain, $I_2/I_1 = Y_{21}/Y_{11}$ are used to design this NIC network. Values in center drawing are given in terms of k_o , final numerical values appear in bottom drawing.

$$M_a N_{1a} = \frac{K_o}{2}$$

$$M_b N_{1b} = \frac{K_o}{2}$$

giving

$$Y_{11a} = \frac{K_o}{2} \frac{p}{(p + 4)}$$

$$Y_{11b} = \frac{K_o}{2} \frac{(p + 2)}{(p + 4)}$$

Comparing the three techniques

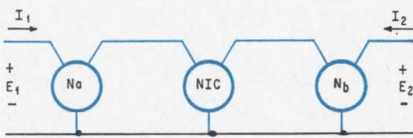
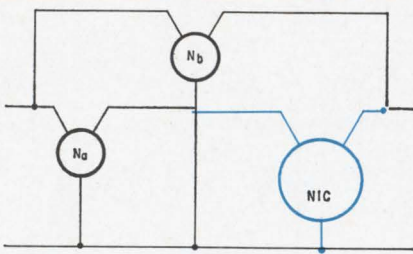
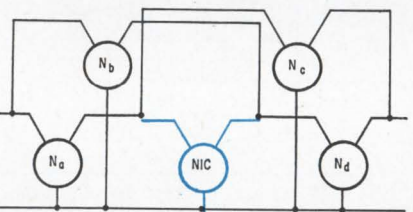
Basic circuit	Applicable NIC's	Applicable transfer function	Networks needed with NIC	Ease of Synthesis
Linvill 	INIC or VNIC	Open-circuited impedance transfer functions	2 RC two-ports	Fair
Yanagisawa 	INIC	Open-circuited voltage transfer functions	2 RC one-ports	Good
Sipress 	INIC or VNIC	Resistance-terminated and open-circuited impedance-admittance, and voltage-transfer functions	2 RC two-ports and 2 RC one-ports	Poor

Linville technique

$$\text{Given: } Z_{21}(s) = \frac{P(s)}{Q(s)}$$

Step 1. Divide Z_{21} by a polynomial $q(s)$.

$$Z_{21} = \frac{Z_{21a} Z_{21b}}{Z_{22a} - kZ_{11b}} = \frac{P/q}{Q/q}$$

Step 2. Set $Z_{21a} Z_{21b} = P/q$

$$Z_{22a} - kZ_{11b} = Q/q$$

Step 3. Expand Q/q into partial fractions.

Step 4. Assign the positive terms to Z_{22} and the negative to $-kZ_{11b}$.

Step 5. Divide P into two factors, one for Z_{21a} and the other for Z_{21b} .

Step 6. Synthesize networks N_a and N_b .

Yanagisawa technique

$$\text{Given: } T(s) = \frac{P(s)}{Q(s)}$$

Step 1. Divide $T(s)$ by a polynomial $q(s)$.

$$T = \frac{Y_{1b} - kY_{1a}}{Y_{1b} - kY_{1a} + Y_{2b} - kY_{2a}} = \frac{P/q}{Q/q}$$

Step 2. Set $Y_{1b} - kY_{1a} = P/q$, and

$$Y_{2b} - kY_{2a} = (Q - P)/q$$

Step 3. Expand P/q and $(Q-P)/q$.

Step 4. Synthesize N_a and N_b .

Sipress technique

$$\text{Given: } Y_{11} = \frac{P_1}{Q}, \quad Y_{21} = \frac{P_2}{Q}$$

Step 1. Choose an RC admittance

$$Y_{RC} = N_1 \frac{r(s)}{q(s)}$$

Step 2. Choose two polynomials $U(s)$ and $V(s)$

$$U(s) = M_o (s + \alpha_1) (s + \alpha_2) \dots (s + \alpha_m)$$

$$V(s) = (M_1 N_1 r Q - q P_1) / U$$

Step 3. Let $Y_{11a} + Y_{11b} = M_1 Y_{RC} = M_1 N_1 r / q$

Step 4. Separate $Y_{11a} = M_a N_{1a} r_a / q$

$$Y_{11b} = M_b N_{1b} r_b / q; \quad M_a N_{1a} r_a + M_b N_{1b} r_b = M_1 N_1 r$$

Step 5. Define $U_a = \frac{M_2 U + kV}{1 + k}$

$$U_b = \frac{kM_2 U - V}{1 + k}; \quad Y_{12a} = M_3 U_c / q$$

Step 6. Form $Y_d - kY_c = M_3 k P_2 / U$

Step 7. Expand $Y_d - kY_c$ into partial fractions.

Step 8. Assign positive A 's to Y_d and negative ones to $-kY_c$.

Step 9. Form

$$kY_a - Y_b = kM_3 (M_2 M_3 Q / q + P_2 / U) - kY_{22a}' + Y_{22b}'$$

Step 10. Synthesize the networks

Step 5. Define

$$U_a = \frac{M_2 U + k V}{(1 + k)}$$

$$U_b = k \frac{M_2 U - V}{(1 + k)}$$

and subsequently

$$Y_{12a} = -M_3 \frac{U_a}{q}$$

$$Y_{12b} = -M_3 \frac{U_b}{q}$$

The choice of the constants M_2 and M_3 is arbitrary. If M_2 is large enough, networks N_a and N_b can be designed with ladder networks. For simplicity, let $k = 1$; Thus,

$$U_a = \frac{1}{2} (M_2 K_o + 1) p + (M_2 K_o - 1)$$

$$U_b = \frac{1}{2} (M_2 K_o - 1) p + (M_2 K_o + 1)$$

and therefore,

$$Y_{12a} = -\frac{M_3}{2} \frac{(M_2 K_o + 1) p + 2 (M_2 K_o - 1)}{(p + 4)}$$

$$Y_{12b} = -\frac{M_3}{2} \frac{(M_2 K_o - 1) p + 2 (M_2 K_o + 1)}{(p + 4)}$$

Choose

$$M_2 = 1/K_o$$

so that

$$Y_{12a} = -M_3 \frac{p}{(p + 4)}$$

$$Y_{12b} = -M_3 \frac{2}{(p + 4)}$$

now

$$M_3 = \frac{K_o}{2}$$

Thus,

$$Y_{11a} = \frac{K_o}{2} \frac{p}{(p + 4)}, \quad Y_{12a} = -\frac{K_o}{2} \frac{p}{(p + 4)}$$

$$Y_{11b} = \frac{K_o}{2} \frac{(p + 2)}{(p + 4)}, \quad Y_{12b} = -K_o \frac{1}{(p + 4)}$$

Networks N_a' and N_b' can now be designed by conventional synthesis and $Y_{22'a}$ and $Y_{22'b}'$ deter-

mined. The result is given in the top drawings on page 89. From these networks

$$Y_{22a}' = Y_{11a} = \frac{K_o}{2} \frac{p}{(p + 4)}$$

$$Y_{22b}' = Y_{11b} = \frac{K_o}{2} \frac{(p + 2)}{(p + 4)}$$

Step 6. Find $Y_d - Y_c$.

$$Y_d - Y_c = \frac{K_o}{2} \frac{(p - 1)}{(p + 2)} M_3 k \frac{P_2}{U}$$

Step 7. Expand $Y_d - Y_c$ into partial fractions, and assign the positive A'_s to Y_d and the negative A'_s to $-kY_c$. Y_c and Y_d are determined in this fashion. Thus,

$$Y_d - Y_c = \frac{K_o}{2} \frac{(p - 1)}{(p + 2)} = \frac{K_o}{2} \left(A_\infty p + A_o + \frac{A_1 p}{(p + 2)} \right)$$

with

$$A_\infty = 0$$

$$A_o = -\frac{1}{2}$$

$$A_1 = \frac{3}{2}$$

so that

$$Y_c = \frac{K_o}{4}$$

$$Y_d = \frac{3K_o}{4} \frac{p}{(p + 2)}$$

Their realization is on page 89, center drawing.

Step 8. Find Y_a , Y_b , and Y_d .

$$kY_a - Y_b = kM_3 \left(M_2 M_3 \frac{Q}{q} + \frac{p^2}{U} \right) - kY_{22a}' + Y_{22b}'$$

which can now be expanded in a manner similar to that of step 7, with the positive terms assigned to kY_a and the negative to $-Y_b$. In this fashion the complete network can be designed in this way. Thus,

$$Y_a - Y_b = \frac{K_o}{4} + \frac{K_o}{2} \frac{(p - 1)}{(p + 2)} = \frac{3K_o}{4} \frac{p}{(p + 2)}$$

which gives

$$Y_a = \frac{3K_o}{4} \frac{p}{(p + 2)}$$

$$Y_b = 0$$

Thus, Y_a is the same as Y_d , and Y_b is an open circuit. The final network is on page 89, bottom

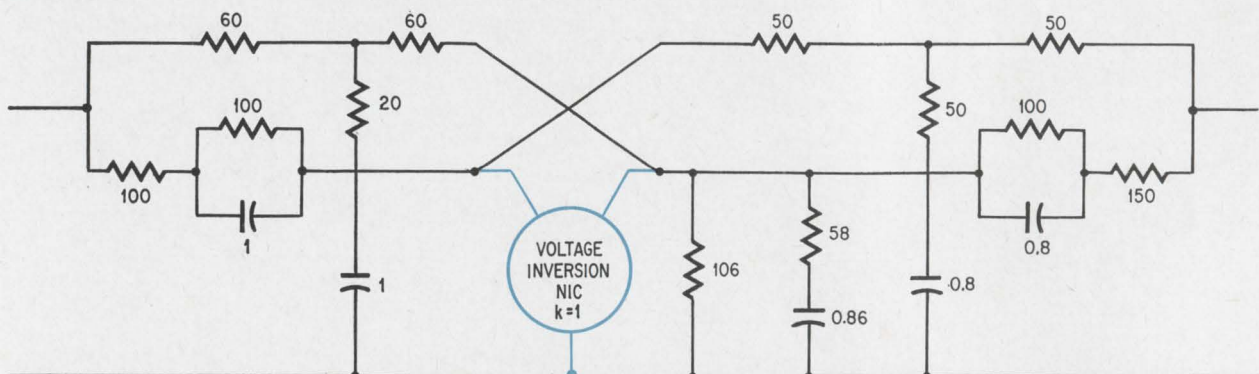
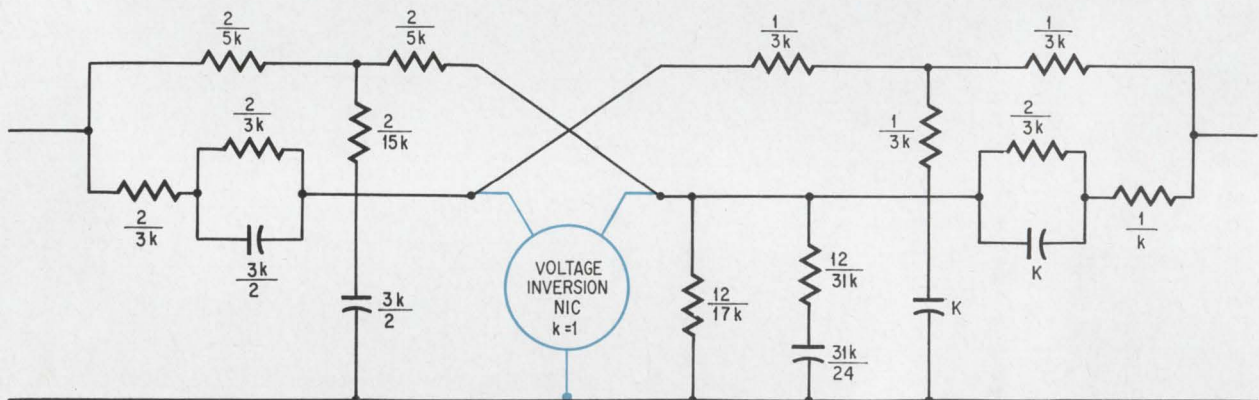
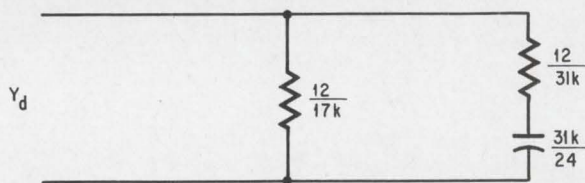
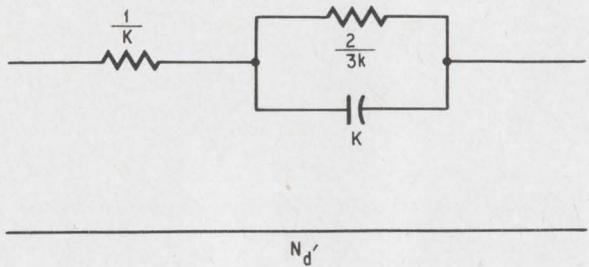
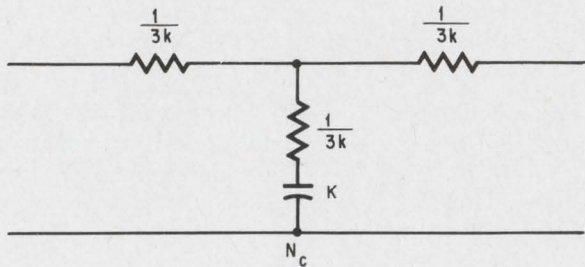
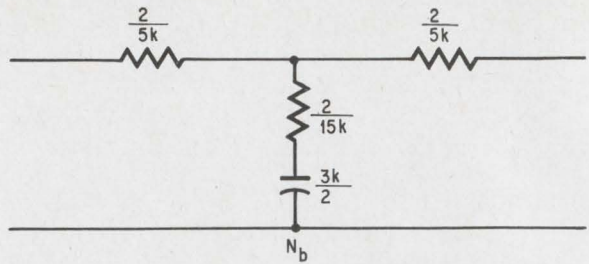
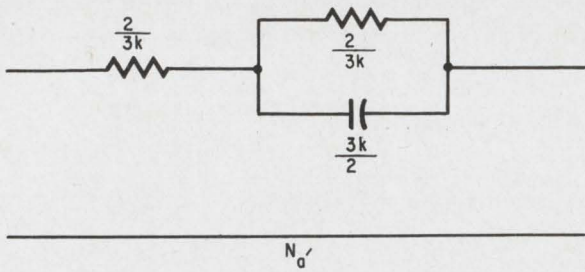

Alternate case. When parameters Y_{12} and Y_{21} are specified, the designer must use a voltage inversion NIC. Network is based on the example on the opposite page and all numerical values appear in bottom drawing.

drawing. Numerically $K_o = 8 \times 10^{-2}$ ohms $^{-1}$ and $\omega_o = 10^4$ sec $^{-1}$.

When Y_{12} and Y_{21} are specified, a current NIC will be used and the circuit will be that shown on page 92.

To simplify the calculations, let $s = \omega_o p$ so that

$$Y_{12} = \frac{P_1}{Q} = \frac{k(s-w_o)}{(s+w_o)}$$

$$Y_{21} = \frac{P_2}{Q} + \frac{2kw_o}{(s+w_o)} \quad (126)$$

Let m be the degree of P_1 , P_2 , or Q , whichever is greatest. If the parameters happen not to have the same denominator, surplus factors can be used as explained in the example for a voltage NIC.

By inspection,

$$Y_{12} = \frac{K(p-1)}{p+1}$$

$$Y_{21} = 2K \frac{1}{p+1}$$

Step 1. Choose a polynomial $q(s)$ of degree m , with real, negative, distinct roots of the form

$$P_1 = K(p-1)$$

$$P_2 = 2K$$

$$Q = (p+1)$$

with M_1 a positive constant. Thus,

$$q = M_1(s + \alpha_1)(s + \alpha_2) \cdots (s + \alpha_m)$$

$$q = (p+2)$$

Step 2. Choose an arbitrary constant M_2 (if M_2 is large enough, the RC networks will be of the ladder type) and define the following polynomials:

$$U_a = \frac{M_2q + P_1}{(1+k)} \quad U_b = \frac{kM_2q - P_1}{(1+k)}$$

$$U_c = \frac{M_2q + P_2}{(1+k)} \quad U_d = \frac{kM_2q - P_2}{(1+k)}$$

For simplicity, let $k = 1$ and choose

$$M_2 = 2K$$

Thus,

$$U_a = \frac{3K}{2}(p+1) \quad U_b = \frac{K}{2}(p+5)$$

$$U_c = K(p+3) \quad U_d = K(p+1)$$

Step 3. Set

$$Y_{12a} = -\frac{U_a}{q} \quad Y_{12b} = -\frac{U_b}{q}$$

$$Y_{12c} = -\frac{U_c}{q} \quad Y_{12d} = -\frac{U_d}{q}$$

Thus,

$$Y_{12a} = -\frac{3K}{2} \frac{(p+1)}{(p+2)} \quad Y_{12b} = -\frac{K}{2} \frac{(p+5)}{(p+2)}$$

$$Y_{12c} = -K \frac{(p+3)}{(p+2)} \quad Y_{12d} = -K \frac{(p+1)}{(p+2)}$$

$$Y_{22b} + Y_{11d} - Y_{22a} - Y_{11c} = 2K \frac{(p+1)}{(p+2)}$$

Step 4. Networks N_a' , N_b , N_c , N_d' are synthesized from the transfer admittances Y_{12} .

Step 5. The driving-point admittances are calculated from these networks as:

$$Y_{22a'} = \frac{3K}{2} \frac{(p+1)}{(p+2)} \quad Y_{22b} = 2K \frac{(p+5/4)}{(p+2)}$$

$$Y_{11c} = 2K \frac{(p+2/3)}{(p+2)} \quad Y_{11d'} = \frac{3K}{2} \frac{(p+1)}{(p+2)}$$

Step 6. From the networks N_a and N_d by adding the admittance Y_a to the output of N_a' and Y_d to the input of N_d' . This makes

$$Y_{22a} = Y_{22a'} + Y_a$$

$$Y_{11d} = Y_{11d'} + Y_d$$

$$Y_d - kY_a = M_2 \frac{Q}{q} - Y_{22b} - Y_{11d'} + kY_{22a'} + kY_{11c}$$

$$\text{yielding, } Y_d - Y_a = 4K \frac{(p+17/24)}{(p+2)}$$

Step 7. Expand $Y_d - Y_a$ into partial fractions, so that

and assign the positive A 's to Y_d and the negative A 's to $-kY_a$. Y_d and Y_a can then be determined. For this example,

$$Y_d - Y_a = \frac{17K}{2} + \frac{31K}{2} \frac{p}{(p+2)}$$

which makes

$$Y_a = 0 \quad Y_d = \frac{17K}{2} + \frac{31K}{2} \frac{p}{(p+2)}$$

References

- John G. Linvill, "A New RC Filter Employing Active Elements," Proc. National Electronics Conference, vol. 9, September 1953, pp 342-352, and "RC Active Filters", IRE, vol. 42, March 1954, pp 555-564.
- T. Yanagisawa, "RC Active Networks Using Current-Inversion Type Negative Impedance Converters," IRE Trans. on circuit theory, vol. CT-4, No. 3, September 1967, pp. 140-144.
- Jack M. Sipress, "Synthesis of Active RC Networks," IRE Trans. on circuit theory, vol. CT-8, September 1961, pp. 260-269.

Potential of phased-array radar spurs increasing R&D activity

More experimental models are due soon, but operational versions of these multifunction systems are still several years away; further in the future are arrays of solid state modules

By Alfred Rosenblatt

Avionics and space editor

"It's only a matter of time before antenna gimbals are placed in the Smithsonian," says Robert San Souci, president of the Emerson Electric Co.'s Electronics and Space division. His prediction of impending obsolescence for the bearings used to mechanically rotate radar antennas is based on the increasing pace of efforts—both military- and company-funded—to apply phased-array techniques to airborne radars.

About half a dozen phased-array systems will be turned on between now and early next year. And at least one is already being test-flown. However, problems involving weight and cost have yet to be overcome, and present estimates put the application of phased arrays at least four years away.

The prime advantage of this kind of antenna is its ability to perform a combination of tasks. With a multimode capability, a phased-array system could replace two or more conventional radars with dishes, and could handle such jobs as

- Air-to-air search, with tracking of multiple targets
- Air-to-air and air-to-ground weapons delivery
- Ground mapping
- Terrain following and avoidance
- Identification of aircraft and ground-beacon tracking

In a phased-array setup, the radar beam is shaped, positioned, and scanned electronically. Instead of a mechanically rotated dish, there's a flat array of electronically steerable radiating elements; the signal applied to each element is phase-shifted to shape the beam and position it in space. Scanning rates are fantastically high—up into the megahertz range.

Such electronic beam handling also lends itself

to the development of radar systems capable of adapting to changes in mission conditions. It should be possible, for example, to vary the character of the signal that's transmitted—changing its pulse width, compression ratio, or power level—to match the threats faced by an aircraft. Such an array could also provide electronic countermeasures. Once energy from an enemy's radar was sensed, a high burst of jamming energy could be immediately pulsed in his direction.

And as tiny, all-solid state microwave integrated circuits are perfected, conformal arrays may replace the planar arrangement. Such arrays would be fitted to the contours of an aircraft, becoming part of its aerodynamic structure.

The latest military aircraft being designed—the Navy's VFX and Air Force's FX fighters—will probably move into the inventory faster than new radars can be developed, but phased-array systems are being considered for later models of the planes.

Phased-array antennas continue to be studied for use in early-warning surveillance systems such as AWACS (Airborne Warning and Control System), and they're also said to figure in plans for the Air Force's Advanced Manned Strategic Aircraft (AMSA). Such radars could well help this plane penetrate hostile territory at low levels and defend itself with its on-board missiles.

Arrays could also be used for missile guidance. With its elements built conformally into the front of the weapon, such a system wouldn't have the heat problems that plague ordinary radomes at hypersonic speeds. And in space vehicles and satellites, the use of phased-array radars would avoid the motion reaction caused by moving dishes.

But the technology goes beyond radar applica-

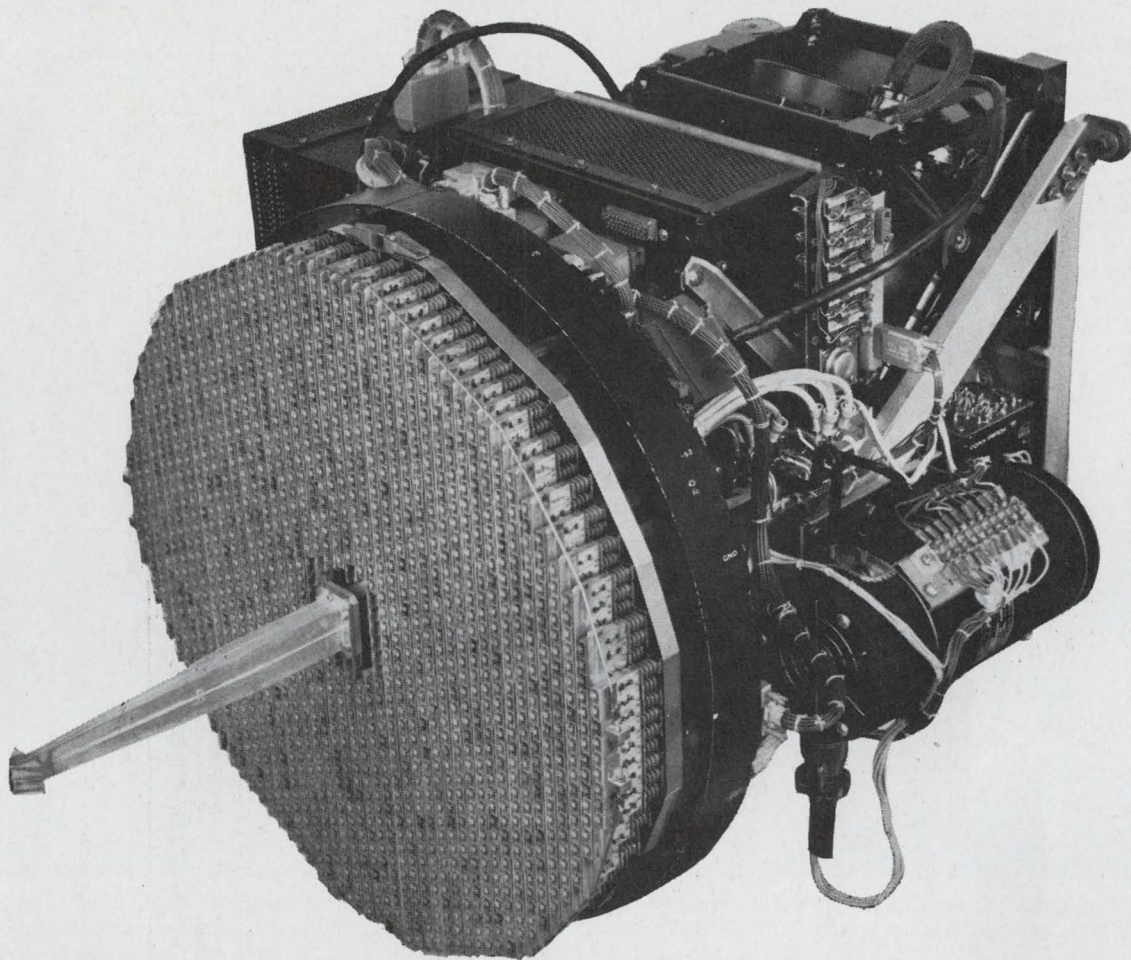

Flying model. Demonstration Ku-band phased-array antenna built for the Navy by Maxson Electronics has 1,500 diode phase-shifting elements and is being test-flown aboard an A-6 Intruder.

tions. "With the progress being made in developing solid state array modules, we're able to tackle the total r-f systems problem aboard an aircraft, instead of treating it as a series of separate radar, navigation, or communications tasks," declares Dwaine E. Hunt, an engineer at Texas Instruments' equipment group.

In a paper to be presented at next week's Electronics and Aerospace Systems Convention (Eascon) in Washington, Hunt predicts the development within the next decade of all-solid state arrays that will not only perform several functions but will operate over several frequency bands. TI has experimented with a common-aperture receive array in which "we interspersed simple L- and S-band dipoles at half-wavelength intervals," Hunt says. "There was some shadowing effect when we went pretty far off boresight, but we proved we could get good electrical isolation between the bands while doing simultaneous—not time-shared—operations."

Employment of such a common aperture would

reduce the prime power requirements, cost, and weight of the total system, Hunt continues, and the individual subsystems might operate more effectively. The large number of separate antennas needed on an aircraft would also be reduced.

Current projects

Several military-funded projects are aimed at simply replacing the moving dish of a conventional radar with a stationary, electronically steerable array. Receiving and power generating would be handled by conventional radar subsystems.

Ku-band arrays are receiving considerable attention in this regard. Among the arrays of this type are:

- A 1,500-element reflecting antenna (shown above) built by the Maxson Electronics Corp. An experimental version is being flight-tested in a Navy A-6 Intruder. Phase-shifting is done by p-i-n diodes.

- Antennas being developed for a program called RARF (for Radome, Antenna, and Radio-Frequency circuitry) under the sponsorship of the Air Force

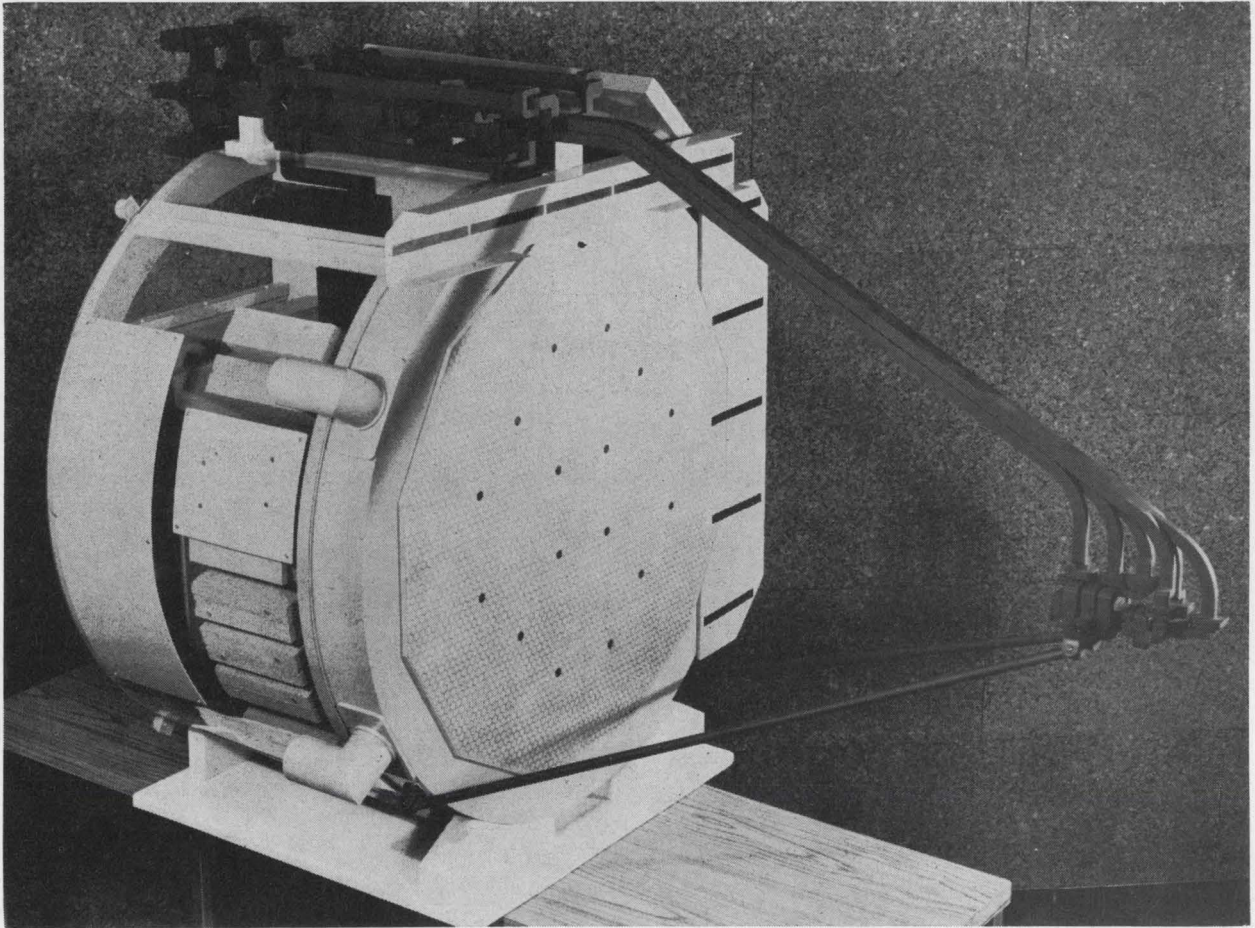

Reflective array. Wooden model of the Ku-band antenna Raytheon is proposing for the Air Force's RARF program. Actual array will contain more than 4,000 ferrite phase shifters; tests of completed system should begin later this year.

Systems Command's avionics laboratory at Wright-Patterson Air Force Base.

Two different approaches are being followed here. The Raytheon Co.'s Missile Systems division is working on a technique in which energy is beamed from feed horns to an array of more than 4,000 antenna elements, shown above, each of which phase shifts the energy by a prescribed amount and reflects it back into space. The other contractor, the Electronics and Space division of Emerson Electric, is building the transmission-lens setup shown on the next page. In this arrangement, energy is beamed from behind and through the individual phase-shifting and antenna elements and then radiated into space. Both companies should have models ready for testing by the end of the year.

- A 144-element reflecting array being jointly developed for the Air Force Systems Command by Microwave Associates and the Bendix Corp. This system employs p-i-n diode phase-shifters instead of the ferrite shifters used in the RARF program.

Other companies developing similar types of arrays with their own or military funds include the Hughes Aircraft Co., Autonetics, the General Electric Co., and the Lockheed Electronics Co.

But the greatest departure from current radar designs will come with the development of solid state transmitter-receiver modules incorporating phase-shifting and antenna elements. Pioneer work on this type of configuration began four years ago at Texas Instruments, which at that time undertook the development, under Air Force sponsorship, of a microwave integrated-circuit module. Some 604 of these Molecular Electronic Radar Application (MERA) modules will be combined later this year into a complete radar system.

Other projects directed at solid state arrays include:

- The Navy's MAIR program, a design study of an X-band system undertaken by two teams of contractors. The Westinghouse Electric Corp. is developing a MERA-type system, with TI supplying the microwave IC modules. Raytheon, with Microwave Associates working on the diode phase shifters, is developing a reflective X-band equivalent of its RARF array. However, the latter two companies are considering the use of a new type of solid state power source to drive the array.

- The Boeing Co.'s in-house development of S-band IC modules that would be applicable to airborne surveillance radars. Boeing has in mind

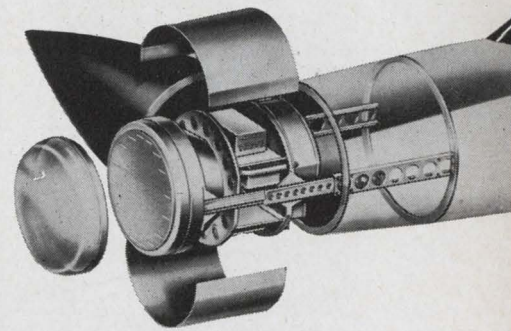
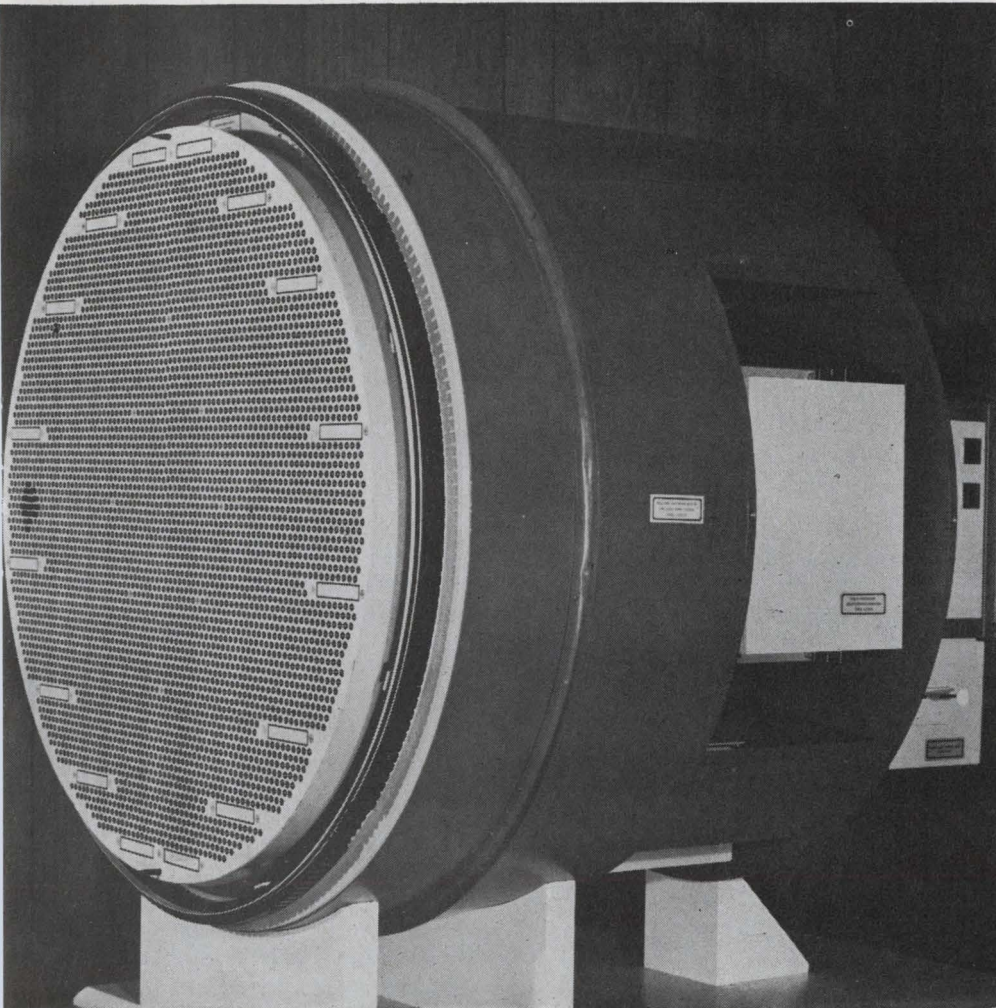

Fast service. Installed in the nose of an aircraft, Emerson's RARF antenna, with its transmitter-receiver package, could be mounted on slide rails to ease flight-line maintenance.

Clear view. Space-fed transmission lens is used in Emerson Electric's version of RARF antenna. Feedhorns can't be seen in this mockup because they're behind the phase shifters, eliminating the blockage problems that plague reflective arrays.

applications in advanced early-warning systems.

- The Ryan Aeronautical Co.'s work, with NASA support, on C- and S-band microwave IC modules capable of controlling phase without conventional phase-shifting devices. This approach could lead to radically new designs for solid state arrays.

- The Lockheed Electronics Co.'s effort to develop solid state modules operating at L and S bands.

- RCA's Blue Chip program, which aims at a whole family of microwave IC's applicable to various radar designs [Electronics, March 20, 1967, p. 112].

Long-range views

Many firms are counting on the solid state approach, with the use of transistors and frequency multiplication if necessary, to make phased arrays pay off.

"A lens configuration that replaces the dish antenna will only be an interim solution," declares R.E. Pickens, manager of advanced systems at Bendix' Communications division. "The ultimate solution will be an active element per module."

"Transistors will be the route to highly efficient and low-cost arrays for airborne and electronic-

countermeasures equipment," says Ronald Rosenzweig, president of the newly formed Microwave Semiconductor Corp. "We'll soon have power levels of 3 to 5 watts at 4 Ghz, and simple combining techniques could be used to increase the output power from each antenna module."

However, Malcolm Vosburgh of the Institute of Defense Analysis in Washington notes that though transistors have been around for quite some time, not much data has been accumulated on their behavior and life span in the microwave radar region. "We do know that it's tough to operate transistors at high peak powers for the short periods required in a radar," he says. "We don't really know what the cost per watt for transistor power would be."

And Carl Blake of MIT's Lincoln Laboratory points out that over-all systems costs must be considered when deciding how to steer a phased-array radar beam. Lossy steering at high power levels, as in a MAIR reflective array, boosts the cost of the power supply, phase-shifter drivers, and cooling equipment. Steering at low power levels, as in a MERA system, requires many little amplifiers, and thus complex—and inefficient—modules. Over-all operation might be more reliable, however.

"But," says Vosburgh, "the name of the game is

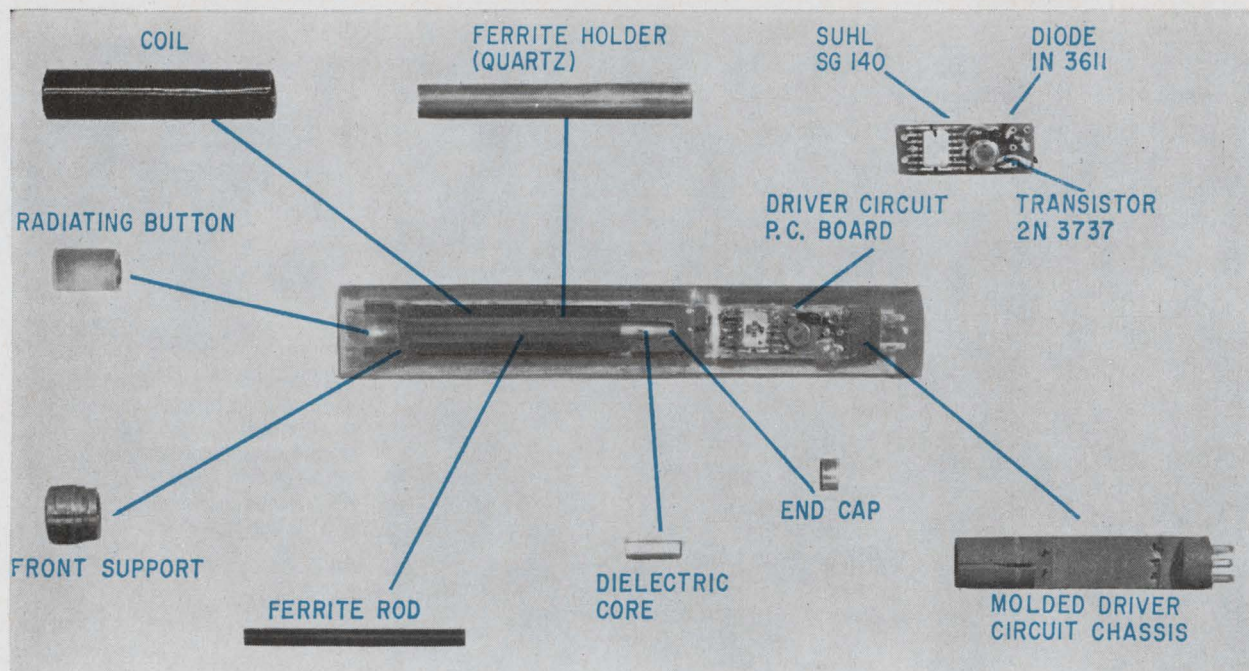

Piece by piece. Four-inch-long ferrite phase shifter for Raytheon's RARF antenna contains its own driver circuit and plugs into the face of the array.

not solid state versus tubes; it's microwave integrated circuitry. If phased arrays are carried to their logical conclusion, they will be made up of repetitive devices designed for automated production. Waveguides, choke joints, test benches and machining will be replaced by a printed-circuit-board type of line. Solid state fits this prescription like a glove; tubes do not."

Opinion is divided on the possibility of using recently developed semiconductor devices to generate power in the modules. Some say the Gunn-effect or limited-space-charge-accumulation-mode devices being made from gallium arsenide won't be ready for the job—so far as efficiency is concerned—for another five years or more. But others point out that all-solid state radar arrays won't be operational for quite some time either, and that the GaAs devices may be ready when the arrays are finally applied.

While most industry officials expect operational phased arrays no sooner than four years from now, the waiting time for all-solid state transmitter-receiver modules is estimated at eight years or more. As noted earlier, a major problem in either case is to reduce the weight and expense of the components. Another factor that could further slow development in this area is the present cutback in military spending for projects unrelated to the Vietnam war.

Adjusting parameters

Beyond solving the problems of cost and of designing electronically steerable elements, the concept of adaptability to changing mission conditions must be investigated.

If a radar is looking at a single target in the clear,

there's little noise to contaminate the signal returns and it's relatively simple to specify the pulse width, pulse repetition frequency (prf), and desired accuracy.

But if there's clutter or several targets in the beam, the signal processing and targeting may have to be modified, with conventional pulse processing being replaced by moving-target-indicator processing. Pulse-compression techniques might be needed to increase resolution. But these techniques should be used only when they're needed; continuous operation in a multitarget mode would contribute unnecessarily to system losses.

The answer is to adapt such parameters as pulse width, prf, bandwidth, and transmitted power to specific situations. This can be done in conventional radars but much more control is available with phased arrays. And besides main-beam sharpening or broadening, the side lobe levels can be adjusted.

The requirements for a system whose operating characteristics can be varied over a broad range can be seen in an examination of an all-digital multimode radar being developed in-house by Raytheon. A. Michael Briana, technical director for avionics systems at the firm's Missile Systems division, calls it an extremely flexible transmitter-receiver section, and says it's the first of its class to be put under real-time digital control.

The system is designed to handle air-to-air and air-to-ground situations, he says, and will eventually be hooked up to the company's RARF antenna. The demonstration model will turn out 200 watts of average power.

Both prf and duty cycle will be variable over a wide range. Long-term duty cycles will run from

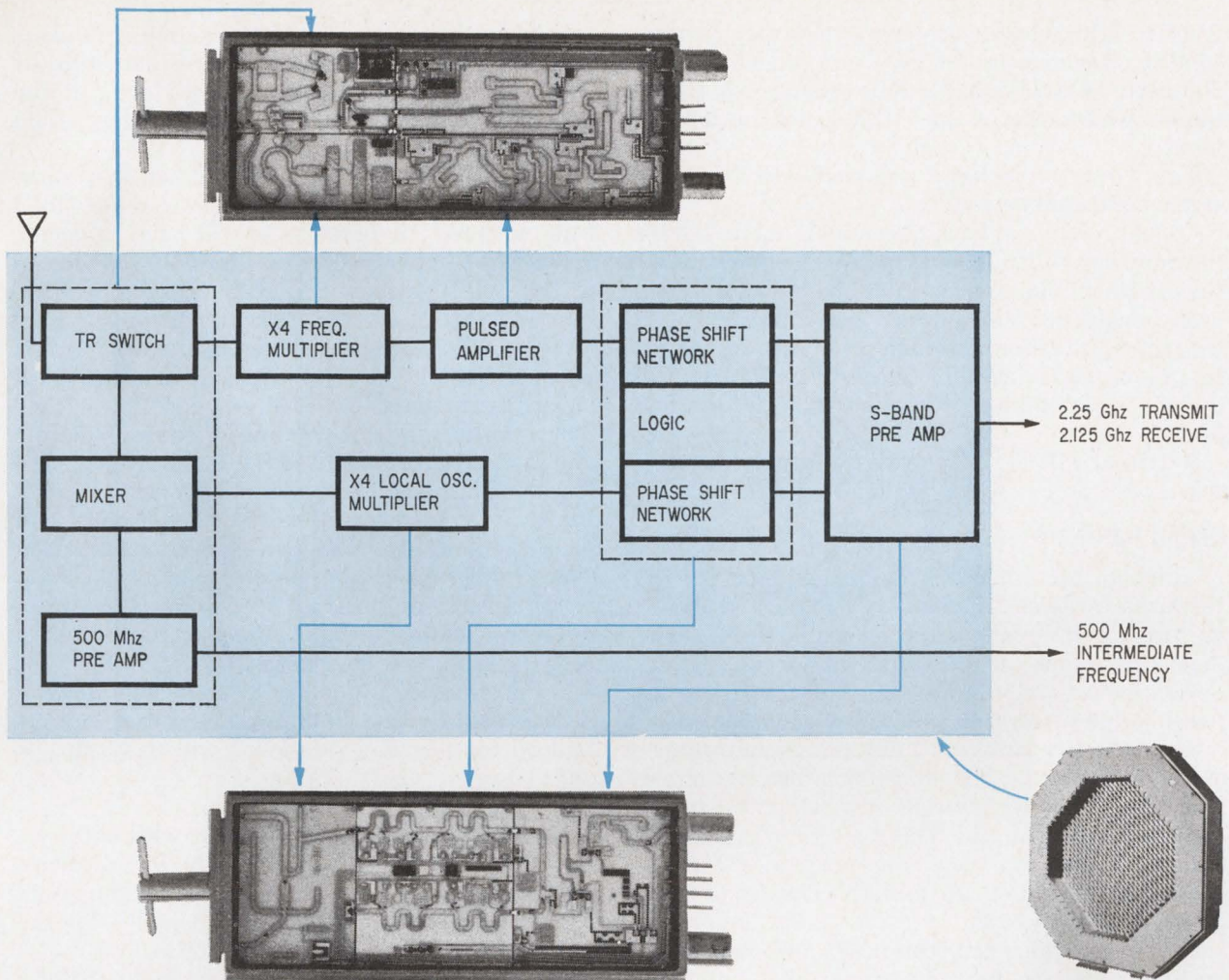

Solid state. Functions of a complete radar set are built into TI's X-band MERA module. Signal-distributing manifold will hold 604 of these modules in the complete system.

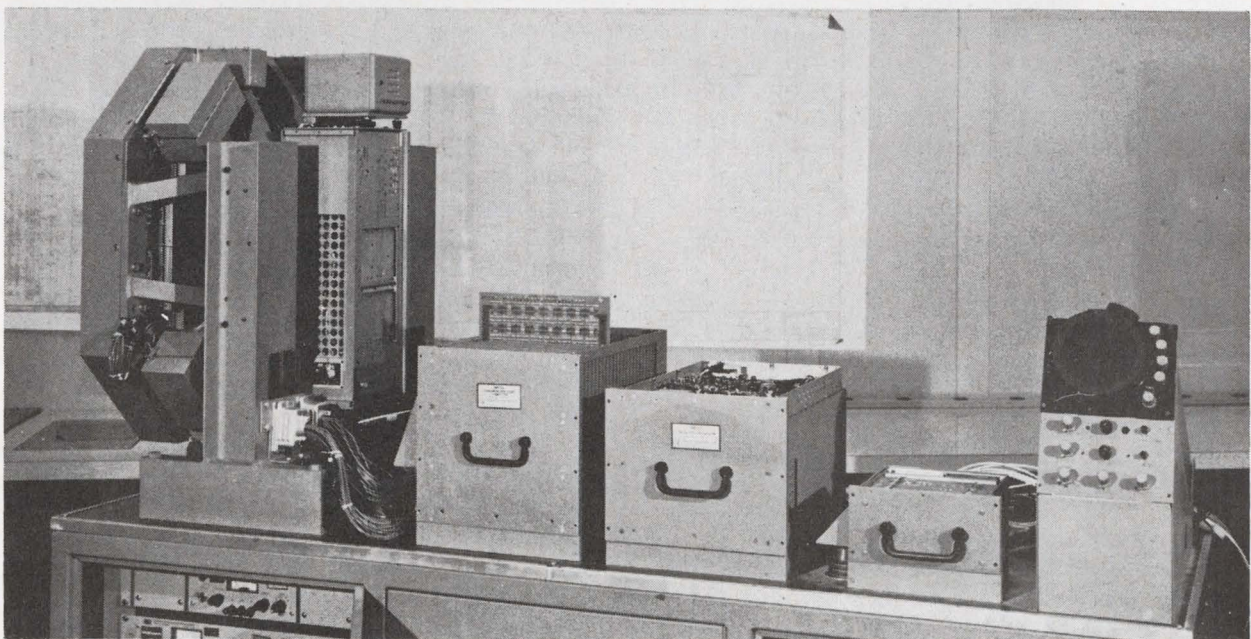

Full lineup. From the left, the antenna manifold and signal generator of the MERA system are joined by the beam-steering computer, receiver-processor, terrain-following computer, and radar indicator.

0.001 to 0.16, while short-term cycles may vary up to 40%, Briana says. Prf may vary anywhere from 200 hertz to 400 kilohertz. Pulse-compression techniques with ratios of up to 100:1 will be the key here.

Fast Fourier transforms will deal with the digital signals in the processor.

"Such a processor hasn't been built before but it's the only way to handle both the high and low prf's," says Briana. "The processor will have to be able to interchange range and velocity bins depending upon the tactical situation. For high prf operation, there'll be a lot of filters and a few range bins. Low prf will call for a lot of range bins backed by just a few filters."

Raytheon will use a Honeywell Alert computer as the central processor for the demonstration model.

Flying hardware

Although the antenna Maxson has built for the Naval Air Systems Command is being tested aboard an aircraft, it's really more an exploratory model than a prototype for an operational design. It was developed primarily to see how a phased-array antenna would perform in an airborne environment.

The reflective array of 1,500 phase-shifting elements is arranged within an 18-inch-diameter circle. It is putting out 50 kilowatts of peak power in the Navy tests, where it's being used in automatic tracking, search, and elevation scan modes. Maxson has, however, gotten up to 125 kilowatts of peak power in its own tests.

The beam, which can scan $\pm 60^\circ$ off boresight, is positioned by one-bit p-i-n diode phase shifters. Phase shifter, driver, and open-ended-waveguide radiating element are each less than 4 inches long and plug into a printed-circuit board. The model also includes a beam-steering computer and power supply.

Operational hardware could be ready in three years, according to Edward J. Shubel, deputy director of engineering at Maxson. It would be a more sophisticated system, he says, with some 6,000 elements in a 36-inch aperture to give a narrower beamwidth and greater pointing accuracy. Two-bit diode phase shifters would be used, along with more advanced silicon monolithic IC's than were available when design of the experimental unit began 2½ years ago.

Shubel estimates that the operational antenna will weigh about 172 pounds, and adds that this would be lighter than any comparable mechanical system or even phased-array antenna he knows about.

Cost of a complete 6,000-element array, including beam-steering electronics and power supply, is estimated at \$150,000, based on a high-volume price of \$20 each for the phase-shifting elements.

As many as 20% of the elements in such an array could fail and the antenna would still function adequately, according to John McLaughlin, Maxson's vice president for research and development. "It's very difficult to determine if just a few elements

have failed," he says. "The deterioration is gradual. We've had hundreds of hours of test time with the array we've built and it's operated perfectly. If any of the elements have failed, we don't know about it yet."

Raytheon's reflective array and Emerson's transmission-lens approach represent two routes to a RARF antenna. Air Force tests will have to decide which is the better path.

"Our reflective array fits nicely into the nose radome of a tactical aircraft," says Raytheon's Briana. "You have blockage because the feed mechanism is out in front, but we've always had blockage with conventional radars."

But the fact that there's no aperture blockage with the transmission lens gives that arrangement a decided advantage, according to L. Bruce Long, director of research at Emerson's Electronics and Space division. Side lobe levels can be more easily controlled because of this, he says, and also because it's possible to use a larger feed-horn assembly to give more illumination taper. Emerson has a 12-horn feed; Raytheon uses four horns.

Raytheon expects its array to have side lobes of 24 decibels down and 19 to 20 db up. Emerson says its downward-looking side lobes will be 30 db.

Ferrite phase shifters

One of the most difficult problems with both systems was the design of lightweight ferrite phase shifters that are polarization insensitive and operate over the broad temperature range spelled out in the environmental specification Mil-E-5400.

Raytheon has already built almost 4,000 of these ferrite phase shifters, according to Briana. About this number, placed in a circle 32 inches in diameter, will produce a pattern around a solid cone of $\pm 60^\circ$, he says, a pattern that can be stepped as little as a milliradian at a time. The phase shifter, shown on page 98, can handle up to 200 watts peak power and 6 or 7 watts average. It's 4 inches long, weighs 0.9 ounce, and has a six-pin connector. The driver, designed to minimize drive power and complexity, is built into the phase shifter. It consists of an IC flip-flop, an output transistor, and a diode, and it uses a pulse-width-modulating scheme that gives the output transistor a 90% operating efficiency.

The phase shifters plug into Mu-metal tubes spaced 0.43 inch apart center to center on a triangular grid, Briana explains. The metal shields one element from the next and also closes the magnetic path within the phase shifter. The tubes are spot-welded together and held within a cast aluminum frame. Air blown around the tubes cools them.

The connectors on the end of the phase shifter are picked up by a multilayer printed-circuit board. This is inherently a simpler way to do things; with a transmission setup, wires have to be led carefully between the elements because there is high power r-f energy on both sides of the array.

The ferrite rod itself is roughly ½ inch in diameter and 1⅝ inches long. Waveguide surfaces are silver-plated in a vacuum evaporation chamber,

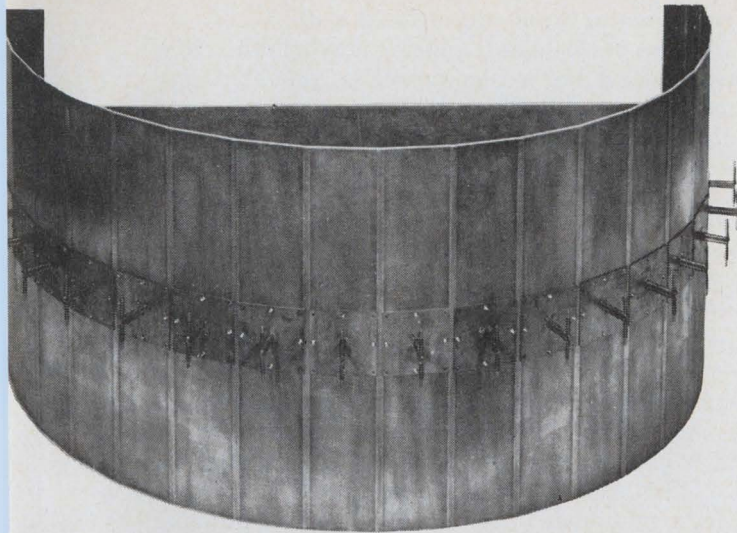

Made to fit. Techniques for controlling this semicircular array of dipoles are being studied at TI as part of a program that could lead to conformal radars.

and each end is dielectrically loaded with a round quartz button to match the impedance of the guide to that of free space.

Energy from the feed enters the circular waveguide, passes through the ferrite rod, is reflected by a short-circuit back through the rod and out into space. Because it shifts the phase of the energy twice in its round trip, the Raytheon shifter can be shorter than Emerson's, which acts on the energy only once.

The Raytheon shifters are reciprocal analog devices that use the equivalent of five-bit input signals to set and maintain a d-c current level. Unlike the Emerson units, they aren't latching; they require holding power all the time. This is not a disadvantage, though, if you're going to jump the beam around hundreds of times each second, Briana states.

For its version of RARF, Emerson has developed a reciprocal ferrite phase shifter that's about 7 inches long, and has its IC driver circuitry built into one end. The amount of phase shift is determined by the width of the driving pulse. The shifter handles about 3 kilowatts of peak power and almost 10 watts average, according to Paul Safran, chief of the Electronics and Space division's microwave branch.

The phase shifter has a circular radiating element at each end, one to pick up the high power coming from the feed horns, the other to radiate it into space. Dielectric caps on the radiators match their characteristics to that of free space.

Emerson believes it has developed some proprietary techniques for producing low-cost phase shifters, including new ways to grind the ferrite and to deposit a conductive coating on the surfaces to act as the waveguide walls. Large-scale production costs could go as low as \$10 to \$15 per unit, Safran says.

In addition to the 12-horn feed cluster, the

antenna has 16 slot radiating elements in the face of the array for identifying other aircraft (IFF), and a separate horn to supply 3 kilowatts of continuous-wave power for missile illumination.

Slimming down

Emerson is working on a minimum-depth array that could reduce the distance required between the feed horns and the phase-shifting elements. Involved here is a space feeding technique for deriving the monopulse signals, but the feed mechanism is put right up against the phase shifters. This could reduce the array's depth by 75%, according to the company.

Another part of the RARF project is a special-purpose beam-steering computer that activates the individual phase shifters. This computer, which loads the array and forms the beam in less than 200 microseconds, will take information from the general-purpose processor that selects the operating modes and translate it into signals for the phase shifters. A complete RARF system, including a transmitter-receiver and signal processor will weigh about 600 pounds.

Bendix's 144-element Ku-band reflecting array is circular and roughly 8 inches in diameter. This project is entering the second year of a two-year development contract.

"The problems here," says Pickens, "are to apply microwave integrated circuitry and diode phase shifters at this extremely high frequency, and to come up with good antenna gain and aperture efficiency, plus low side lobe levels.

"Our unit is a demonstration model to show the accuracy and power levels that can be achieved," Pickens continues. "Ultimately, the design could be part of an antenna system having anywhere from 2,500 to 3,000 elements. Power in the demonstration unit should reach 15 kilowatts peak and 750 watts average.

Another goal of the project is to perfect techniques for lightening the array and reducing its cost, Pickens observes. Each antenna element, or cartridge, will be only 3 inches deep and will contain the diode phase shifter and driver circuit. The cartridges will plug into a supporting manifold much like Raytheon's RARF grid.

A rectangular open waveguide at the head of the cartridge receives energy from the feed horn. Instead of a short-circuit at the far end, the element has a four-bit reflecting diode phase shifter. Microwave Associates, which, interestingly, is the prime contractor for the project, is delivering the shifters to Bendix.

"The circular aperture of our array will produce a 5° pencil beam," Pickens says. "Right now, the trick is to design an efficient feed that's virtually transparent to r-f energy. We're still working on several approaches to minimize the blockage problem that's present in any reflective antenna."

Under wraps

But perhaps the most unusual development in

the phased-array field may be coming from Ryan Aeronautical. The company says it has developed a beam-steering technique that eliminates phase shifters.

"We're building a four-by-four array at C band, with each element consisting of a solid state transmitter and receiver," says John Aasted, program manager at the advanced systems group in Ryan's Electronic and Space Systems division.

Ryan will reveal no specific details about its phase-shifting technique at present, but it's believed that phase is adjusted smoothly and continuously as power is generated. The company may be using a gallium-arsenide power-generating device employing the Gunn effect or LSA.

Space radar

Ryan's work is being done under a NASA contract to develop a general-purpose space radar called the Combined Acquisition and Tracking radar. Functional units are put together on 1-inch-square ceramic substrates, and a receive-only array would be but 2 inches thick, according to Aasted. Adding a transmit function would double the size.

"Simplifying the design of the modules as we've done should open up many new applications for phased-array techniques," Aasted declares. "The high cost of the modules has always been a problem. The combination of our simplification with new techniques for mounting microwave integrated circuits could bring costs down significantly."

Ryan is also applying its secret phase-shifting principle to an S-band antenna being built for NASA. Separate transmitting and receiving elements have already been built, says Aasted, but they have yet to be combined in a single module.

The feasibility of building a complete radar system with microwave integrated circuits was demonstrated by Texas Instruments' development of the MERA module. To show this feasibility was the basic goal of the program when it was launched by the Air Force in 1964.

"MERA as such will never be an operational radar," says Virgil L. Simmons, microwave products manager at TI's Semiconductor Components division. "Its purpose was to develop techniques suitable for a solid state radar. The work that follows MERA will be directed at systems problems, at specific applications."

The MERA module measures 3 by 1 by 0.5 inches and consists of a transmitter-receiver, the equivalent of four-bit diode phase shifters, and a dipole radiator, as shown on page 99. It plugs into a manifold that distributes the master signal power through a stripline power divider. Peak output power of an element is 0.7 watts (down from an originally projected 1 watt) at 9 Ghz, making the array's total output roughly 423 watts. However, 100:1 pulse-compression techniques give the 604-element array an effective radiated power of 42 kilowatts.

TI says the modules could be produced in quantity for about \$100 apiece. The company is

now aiming to boost output to 10 watts.

Because of the high frequency at which the radar must operate, the master power is generated at S band (2 mw at 2.25 Ghz is fed to each module), and a times-four varactor multiplier is used to convert the signal to X band. A separate times-four multiplier handles the received signal out of a mixer.

TI is turning out some 10 modules a day and should have enough for a complete array by the end of this month, Simmons says. Final design of the module was actually frozen last February, he says, but "silly problems" like reversed or out-of-registration masks kept popping up.

The complete radar, shown at the bottom of page 99, should be put together by the end of this year, and TI plans to fly it in a company plane early next year. This test, in which the radar will be used in at least two modes—terrain following and ranging—should go a long way toward changing MERA's "laboratory curiosity" image.

A MERA radar system would operate for an average of 10,000 hours between overhauls, TI estimates, compared with as little as 300 hours with many conventional airborne systems.

The full system will include the array, a master signal generator, a beam-steering computer, a receiver-processor, a terrain-following computer, and an indicator modified from an APQ-110 radar. The feasibility of building a beam-steering computer with large-scale integrated components is being studied, but no real effort has been made to reduce the weight of the system, which should reach 400 pounds.

Fallout

But TI expects to reap greater rewards for its MERA work than simply the right to point to the world's first solid state radar. The company sees great commercial potential in the high-frequency transistors and microwave IC's it has developed for the project.

"MERA-developed transistors will be the basis for a new product line we'll have by the end of the year to cover the 500-Mhz-to-3-Ghz spectrum," confides Simmons. "For example, we expect to offer 3 watts of pulsed power at around 3 Ghz, compared with the 400 to 100 mw at 4 Ghz we're selling now."

And MERA-type components such as voltage-tunable oscillators, wideband and pulse-dispersion amplifiers, and mixers may well turn up in other firms' radar systems. TI has won contracts to supply microwave IC's for other solid state radar programs, and it's teaming with Westinghouse on the Navy's MAIR project.

The two teams of contractors studying MAIR (Molecular Airborne Intercept Radar) have each received a modest \$70,000 since completing initial studies last fall.

Westinghouse and TI, applying the MERA concept, are studying active transmitter-receiver modules. Raytheon, on the other hand, is approaching the problem from the direction of its Ku-band

RARF work for the Air Force. Teamed with Microwave Associates, Raytheon has in mind a reflective array of passive modules containing only phase-shifting and associated elements.

Although the latter approach requires a higher power level for phase shifting, and thus involves higher losses, Raytheon's Briana feels it will probably be easier to make all the elements alike if they're passive. "It's hard to cover the temperature and environmental range with active elements to worry about," he says. "And as the phase tolerances go up, the main beam gain degrades and the side lobe levels increase."

Raytheon is working with Microwave Associates to develop polarization-insensitive diode phase shifters for the array. This unit could weigh as little as $\frac{1}{3}$ ounce and have a 1.7-db insertion loss, Briana says, so that the over-all antenna could be very light. Briana expects it to weigh no more than the dish and gimbals of current airborne intercept radars—about 150 pounds.

But the most unusual design departure Raytheon and Microwave Associates are considering involves the generation of X-band power.

"The antenna element isn't the logical place to generate the power," says M. E. Hines, Microwave Associates' vice president for research. "We'd like to keep these elements—which occur thousands of times in the system—as simple as possible, containing just a phase shifter and radiator. The more complex the element, the harder it is to maintain uniformity in production. Yield goes down and costs go up.

"Also, by designing your system around power sources that are available now," Hines continues, "you may be cutting yourself off from possible future sources such as Gunn-effect, LSA, or Impatt devices."

Microwave Associates is studying a new type of transmitter that would act like a solid state version of a traveling-wave tube—a "black box transmitter" is the way Raytheon describes it. Raytheon's attitude towards this device is: if it works, fine. If it doesn't, we'll still be able to use a conventional source to power the array.

Microwave Associates isn't describing exactly what it has in mind. The transmitter could involve a lot of amplifying devices, possibly of gallium arsenide, spread out along a waveguide wall; each would add a bit of gain as a wavefront propagated down the guide. In any case, Hines looks for a kilowatt of average solid state power three to five years from now.

Standing guard

As indicated before, airborne early-warning systems are also candidates for phased-array radars. Instead of carrying its prime surveillance sensor in a rotodome, an AWACS plane might have it fitted into its fuselage. Four companies—Hughes Aircraft, Autonetics, Sedco Inc., and Sylvania—completed studies along these lines last year for the Air Force, but the service didn't choose to follow up, perhaps

because of a lack of funds.

Phased arrays on an early-warning craft would provide other advantages beside eliminating the aerodynamically troublesome rotodome atop the fuselage. "We'd be able to get better side lobe control—some 10 db better—than we could with a mechanically scanned radar," says Wayne Diehl, a Sylvania marketing manager. "This is extremely important when dealing with the intense clutter problem the AWACS planes must face. Also, we could handle a multiplicity of high-speed targets with the inertialess scan, something not possible with a mechanical one."

Sylvania proposed the use of four separate arrays to give the required 360° of coverage around the aircraft. These, it said, could be built into two V-shaped antennas, one to go in the nose, the other in the tail.

Sylvania, like Emerson, has been working on narrowing the distance between the feed horns and the array elements. Sylvania wants an antenna that would be less than a foot thick at S band and half that size at X band. Power, supplied by conventional megawatt sources, would be emitted from open-ended waveguide. The company is now building a scale model containing 200 to 300 elements with its own funds.

Boeing, which is in the running with McDonnell-Douglas for the over-all AWACS prime contract, is also considering phased arrays for an advanced version of the system it has proposed. With its own funds, the company for almost a year has been working on solid state MERA-type modules containing a transmitter-receiver, a diode phase shifter, and a radiator. Glenn Coughlan, manager of the airborne surveillance radar program at Boeing's Missile and Information Systems division, says the goal is peak r-f power of 20 watts and average power of 2 watts at S band.

Each module would fit into a cylinder $1\frac{3}{4}$ inches in diameter and 4 inches long—about the size of a frozen juice can, Coughlan says. With its module, a cylinder would weigh about 3.2 ounces. The complete antenna would fit into a cylindrical pod built into the airframe.

Boeing is working with thin-film hybrid circuits on alumina substrates. "We're building our own devices—varactor doublers, transistors, diodes—because we can't get them properly packaged for installation on microstrip," says Coughlan. "The commercially available devices give us too many parasitics."

However, it isn't likely that Boeing will ever manufacture its own modules.

"Building the devices ourselves is the only way to really understand the problems," says Kenneth Hammerle, Boeing's chief of radar technology. "We've found in the past that we couldn't go to vendors, tell them we wanted something, and then sit back. We'll now be in a much better position to understand what our vendors tell us, to evaluate and even guide their work, and to monitor their production once they begin fabrication."

Believe it or not...

THIS SIGNAL WAS

LOST IN THIS NOISE

Recovered by...

MODEL 304TD

RANGE: 1Hz to 5kHz

AUTOMATIC TRACKING

DIGITAL READOUT

ELECTRONIC TUNING

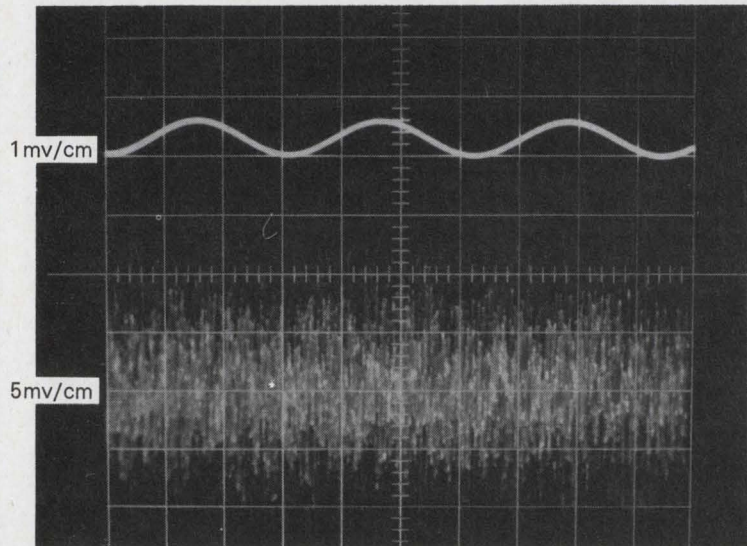

UNRETOUCHED PHOTO FROM SCOPE



No matter where, within its frequency range, that elusive signal is hiding, even under noise 20 times greater than itself, Quan-Tech's new Model 304TD will search for it; lock onto it and give you clear visual electronic display of its frequency and amplitude.

The 304TD features automatic tracking which enables it to lock onto, and track the fundamental or harmonics of a signal whose frequency is varying over narrow or wide limits, without requiring an external pilot or reference frequency.

Electronic, digital readout provides instant frequency determination of the tracked signal, or in manual operation, the frequency to which the analyzer is tuned. The 304TD offers a choice of three constant bandwidths: 1, 10 and 100Hz; also broadband 10Hz to 6500Hz. The unit also features electronic tuning (manual, internal automatic sweep or external) AFC, automatic tracking or search and track modes. Two Models 304TD may be connected together without modification to form a multi-channel, phase locked, master slave analyzer system suitable for mechanical impedance and transfer function analysis. Price: \$3250.

WRITE FOR COMPLETE TECHNICAL DATA

15

Quan-Tech LABORATORIES, INC. • 43 South Jefferson Rd., Whippany, N.J. 07981
QUAN-TECH® Phone (201) 887-5508 TWX 710-986-8251

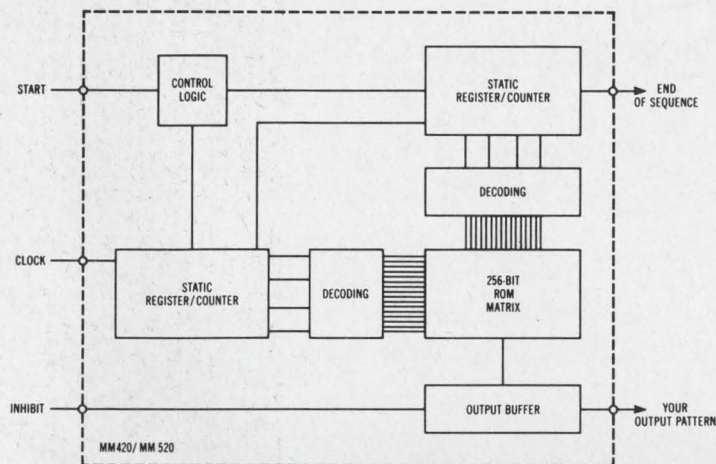

**For a paltry \$38* each
you can get a complete
read-only memory
system on a chip
(made to your specs
and delivered 4
weeks from next Tues.)**

*Buy a hundred of the MM520 commercial version at \$38 each.
Or, better yet, buy more.

National Semiconductor

National Semiconductor, 2975 San Ysidro Way, Santa Clara, California 95051. (408) 245-4320.

What is small, has stripes, and shrinks boards?

New CORNING®
C3 Resistor.

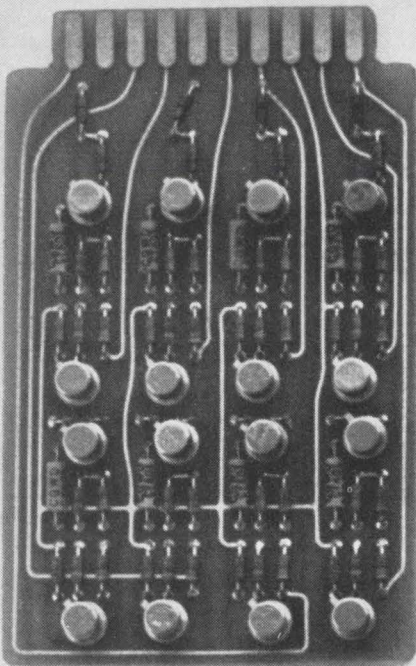

16 transistors
8 capacitors
52 C3 resistors
Actual size

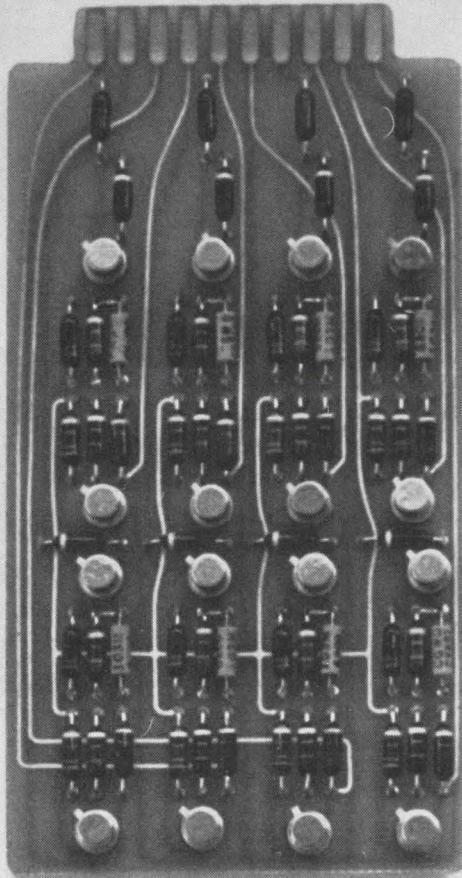

16 transistors
8 capacitors
52 RL07 resistors
Actual size

Now you can get 1/8 watt in a clean lead length of .150" and diameter of .066" maximum. That means a 35% reduction in board size for these eight Schmitt trigger circuits. Plus the proven stability of glass tin oxide film construction.

Put more circuit in the same space.
Or put the same circuit on a smaller board.

For specs and samples, write to Corning Glass Works,
Electronic Products Division, Corning, N. Y. 14830.

CORNING
ELECTRONICS

Good old Hirschfeld.

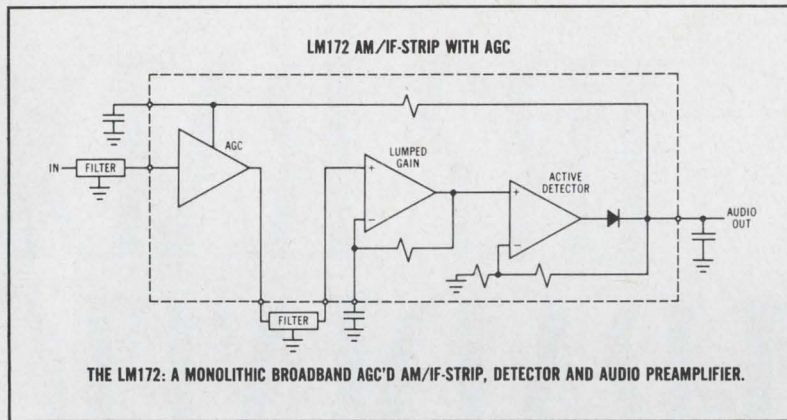

He put all this on a chip.

When Bob Hirschfeld came up with a monolithic IC that replaced a lot of transistors, coils and other things, we were whelmed. It's an AGC'd AM/IF-strip at any center frequency up to 2 MHz. Or, if you prefer, it's a complete TRF receiver for the AM broadcast band or for getting a fix on any of the aeronautical/navigational frequencies below 2 MHz. Its full mil temperature range and extremely low power dissipation make today's conglomerations of cans and gadgetry look pretty old fashioned.

Now that it's on all our distributors' shelves at \$12.95 for the mil temperature range LM172 and \$4.95 for the commercial communications LM272 (100 quantities), we're a bit more blasé. But still impressed. Call or write for the full impression. Bob will like that.

National Semiconductor, 2975 San Ysidro Way, Santa Clara, California 95051. (408) 245-4320.

National Semiconductor

Engineers & Scientists:
What's your line in AGM's?

IR? RADAR? ANTI-RADIATION? CORRELATION? LASER? T.V.?

Rapid expansion of Air-to-Ground Missile activities at Hughes Aerospace Divisions in Southern California has created unusual growth opportunities for qualified Engineers and Scientists. Immediate openings exist at all levels on a variety of interesting projects such as: MAVERICK, anti-radiation missiles, radar-guided missiles and new advanced missile technologies. Areas of interest include:

Laser	Guidance	Structural Design
Radar	Aerodynamics	Warheads & Fuzing
Infrared	Signal Processing	Operations Analysis
Television	Digital Computer	Simulation Studies
Control	Thermodynamics	Trajectory Analysis

All assignments require accredited, applicable degrees, U.S. citizenship and a minimum of 3 years of related, professional experience. Please airmail your resume to:

Mr. Robert A. Martin
Head of Employment
Dept. 27
Hughes Aerospace Divisions
11940 W. Jefferson Blvd.
Culver City, Calif. 90230

HUGHES
HUGHES AIRCRAFT COMPANY
AEROSPACE DIVISIONS
An equal opportunity employer.



NEW 25-ps SAMPLING

35-ps TDR, 18-GHz TRIGGERING and MORE!

NEW



NEW



NEW



NEW



Type S-4 25-ps RISETIME

The new Type S-4 Sampling Head features a 25-ps risetime, DC-to-14 GHz bandwidth, and a 50- Ω input impedance. This step-ahead measurement capability gives increased detail and resolution when making fast pulse measurements. Type S-4 Sampling Head \$750

Type S-50 25-ps PULSE GENERATOR

The new Type S-50 Pulse Generator Head has a 25-ps risetime, +400 mV amplitude and a pulse duration of 100 ns. The Type S-50 and Type S-4 feature high resolution, 35-ps TDR measurements. Type S-50 Pulse Generator Head \$450

Type S-51 18-GHz TRIGGERING

The new Type S-51, 1-to-18 GHz Trigger Countdown Head provides stable oscilloscope triggering to 18 GHz and displays to 14 GHz and above with the Type S-4 Sampling Head. Type S-51 Trigger Countdown Head . . \$425

Type S-3 SAMPLING PROBE HEAD

The new Type S-3 Sampling Probe Head has a 350-ps risetime and an input impedance of 100 k Ω paralleled by 2.3 pF. The Type S-3 is designed to measure high impedance signal sources and is easy to use when probing into miniature circuits. Type S-3 Sampling Probe Head \$375

Type S-2 50-ps RISETIME

The Type S-2 Sampling Head features a 50-ps risetime with a terminated 50- Ω input impedance and standard GR874 input connectors. Type S-2 Sampling Head \$300

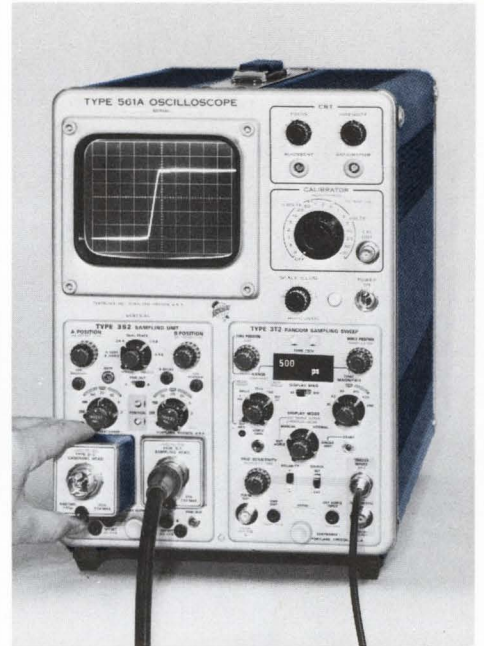

The Tektronix Type 561A Oscilloscope with the Type 3T2 Random Sampling Sweep and the Type 3S2 Dual-Trace Sampling Unit features new measurement capabilities with plug-in and extendable Sampling Heads. Six Sampling Heads are presently available offering a step ahead in measurement performance, designed to meet your changing measurement needs.

Type S-1 350-ps RISETIME

The Type S-1 Sampling Head is a 350-ps risetime, 50- Ω unit that features low displayed noise and an unexcelled transient response. Type S-1 Sampling Head \$250



please turn page for additional information

Making the Measurement . . . TEKTRONIX 25-ps Sampling Oscilloscope

NEW! 25-ps Risetime

The Type S-4 offers for the first time 25-ps measurement capabilities in an oscilloscope. This state-of-the-art measurement performance provides increased detail and resolution of your fast pulse displays. The photograph shows the same pulse displayed with the 25-ps Type S-4 (upper trace) and a 350-ps unit (lower trace). Note the difference in detail of the pulse characteristics displayed by the Type S-4 with its 25-ps risetime performance.

NEW! 14-GHz Displays

For the first time, you can see displays to 14 GHz on an oscilloscope. Using the Type S-4, DC-to-14 GHz Sampling Head with the Type S-51, 1-to-18 GHz Trigger Countdown you can see how your circuit is really performing. Two Type S-4 Sampling Heads used in the Type 3S2 (XY mode) let you measure phase shift to 14 GHz. The photograph shows the loss due to a 3-ft coaxial cable transmitting a 15-GHz signal. Sampling Heads can be used at your signal source eliminating losses due to cables.

NEW! 35-ps TDR System

The Type S-4, 25-ps Sampling Head and the Type S-50, 25-ps Pulse Generator provide a high resolution 35-ps TDR system. The double exposure photograph shows a comparison of a 100-ps TDR System (upper trace) and the new 35-ps TDR System (lower trace). Note the better resolution with the 35-ps Type S-4/S-50 TDR System.

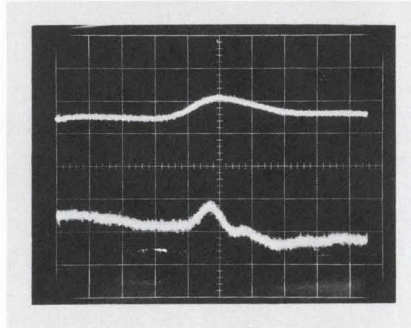
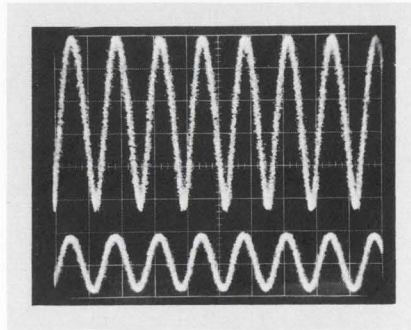
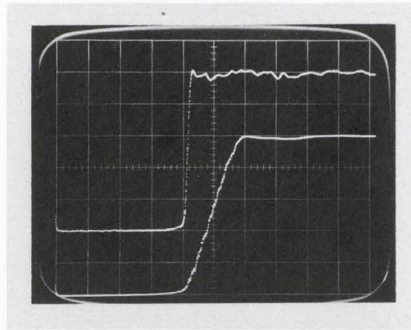

Mix or Match!

Sampling Heads may be mixed or matched. High frequency signals and fast risetime pulses must be generated and transmitted in low impedance circuits. The Type S-1, S-2 and S-4 Sampling Heads have a terminated 50- Ω input providing excellent termination for your fast risetime pulses and a choice of risetime capabilities. Add the Type S-3 Sampling Probe Head with its 100-k Ω , 2.3 pF input impedance when it is necessary to measure high impedance signal sources.

For a demonstration, call your local Tektronix field engineer or write: Tektronix, Inc., P. O. Box 500, Beaverton, Oregon 97005.

A Choice of Oscilloscopes

Tektronix offers a choice of sampling oscilloscopes designed to satisfy your measurement needs. Select the Type 561A Oscilloscope with an 8 x 10-cm CRT and illuminated internal graticule for conventional displays. The Type 564 Storage Oscilloscope offers the added advantage of split-screen storage. Storage is especially useful when sampling low repetition rate signals, making TDR measurements and for signal comparison. The Type 568/230 Digital Readout Oscilloscope provides digital readout of measurements without operator interpretation or error. Measurements include voltage, risetime, delay time, pulse width and many other specific measurements, readout directly in four-digit resolution.

Random Sampling

Type 3T2 Random Sampling Sweep provides all the measurement capabilities of a conventional (sequential) sampling sweep, plus it features the added advantage of random sampling operation. When used in the random sampling mode, the triggering event may be displayed on screen without the use of delay lines or a pretrigger. The Type 3T2 has a calibrated sweep range from 100 μ s/div to 200 ps/div, extending to 20 ps/div with the X10 magnifier.

Plug-ins for a Plug-in

The Type 3S2 Dual-Trace Sampling Unit features a choice of six Sampling Heads that provide new convenience and versatility when making fast pulse measurements. The Sampling Heads can be plugged into the Type 3S2 or used remotely, eliminating losses due to cables. An interchannel delay control compensates for signal cables or other external delays between channels. Select the performance you need today and update your measurement capabilities with new Sampling Heads in the future.

Type 561A Oscilloscope \$530
Type 564 Storage Oscilloscope . . \$925
Type 568/230 Digital Oscilloscope \$3840
Type 3T2 Random Sampling Sweep \$990
Type 3S2 Sampling Unit \$800
Type 285 Power Supply \$150
(powers one S-50 or S-51)

U.S. Sales Price FOB Beaverton, Oregon

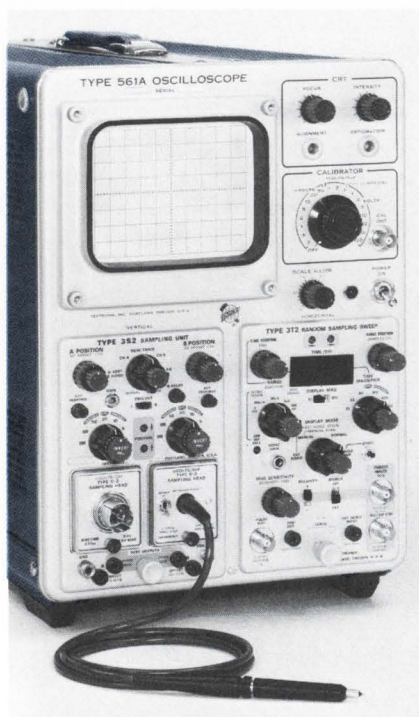

Tektronix, Inc.

committed to progress in waveform measurement

Probing the News

Avionics

Air traffic control: the waiting game

Passengers wait in holding patterns while the FAA waits for money and manpower; meanwhile, the controllers themselves wait for a bigger voice in equipment selection

Sins of omission, rather than commission, on the part of the Federal Aviation Administration are at the root of this summer's jet jams around East Coast airports. And unfortunately, improved hardware appears to be only a partial solution to the current difficulties.

The latest crisis was precipitated when harried air traffic controllers, "in the interests of safety," began operating strictly by the book—a development that led to massive stack-ups at terminals and arrival delays of as much as six hours. Blame for this fiasco must fall largely on the FAA, which, despite its own high-flying projections of future air travel, has failed to press for adequate airport capacity to handle the anticipated traffic. Moreover, since 1963 the agency has made only token additions to its force of air traffic controllers and has failed to sell Congress on the need for substantial investment in advanced equipment concepts.

But the airlines are far from blameless; the carriers' predilection for high-density routes and rush-hour operations have exacerbated the traffic jams on key routes.

Up, up and away

By any standards, the growth of both commercial and general aviation has been, and will continue to be, dizzying. At the moment, the domestic airlines have about 2,000 craft, most of which are jets. Within less than a decade, the number is expected to grow to around 3,500, with most of the added planes being jumbo and supersonic jets. In addition, the general-aviation fleet, now around

104,000 planes is expected to increase to 180,000; a healthy percentage of this total will be business jets.

FAA controllers now handle upwards of 50 million takeoffs and landings a year, but, based on the agency's own data, this load will rise in 10 years to 140 million. Beset by an already overburdened control system, the FAA is making serious efforts to automate procedures at the nation's airports.

At the top of the agency's list of priorities is installation of National Airspace System (NAS) equipment at 20 en route traffic control centers. The system displays luminous blocks of data

furnished by transponders carried aboard aircraft flying between U.S. cities. The blocks, called alphanumeric tags and displayed on controllers' radar scopes, automatically follow the correct blips until planes are through the area covered by the center. The system is built around an IBM 9020 computer—a modified 360/50 with modular memory—plus Burroughs Corp. digitizers to convert radar signals into computer data, and computer display channel gear from the Raytheon Co.

The en route center in Jacksonville, Fla., is scheduled to become the first operational NAS facility next July. Installation of centers in

Sunpapers—Richard Stacks

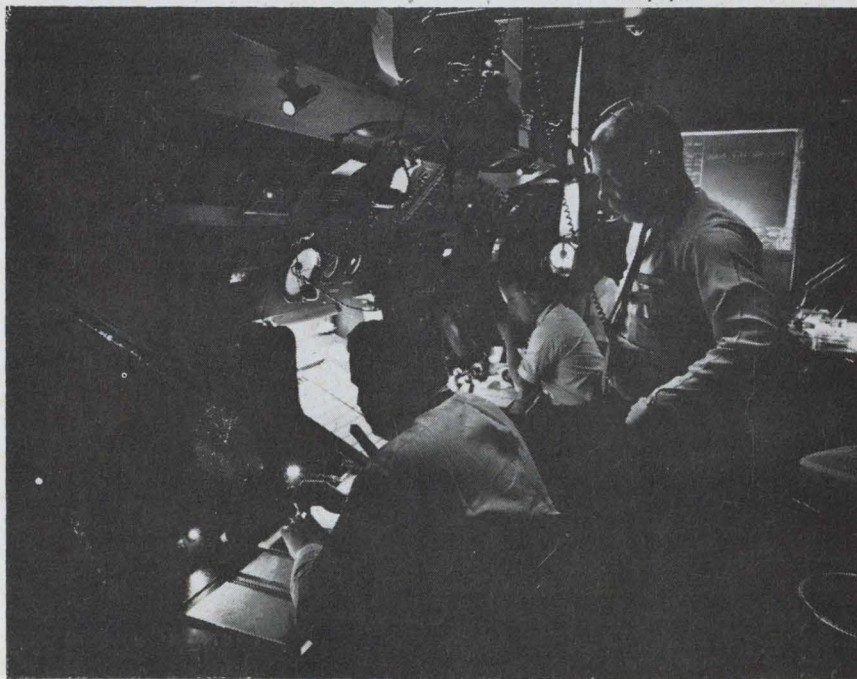

Undermanned. Air traffic control crews like this one at Friendship Airport in Baltimore are continually overworked because of personnel shortages.

... controllers are more than dubious about alphanumeric techniques ...

Cleveland, Washington, Los Angeles, and Chicago is also well along; the whole project is to be completed by mid-1973.

Pragmatism. NAS work is proceeding at a faster pace than the Advanced Radar Traffic System (ARTS), a terminal control project, although research on both programs was undertaken at about the same time. "En route problems proved easier to solve," explains J.W. Rabb, chief of the systems division in the NAS program office.

As yet, the FAA has not codified its plans for NAS much beyond setting a completion date. Rabb does note, however, that such features as collision avoidance, improved sequencing, and better scheduling are being considered. "At one time, we intended to take a giant step into Stage B, but we now think functions can be added gradually—once we get smart enough to perfect them," he says.

Plans now call for 64 airports around the U.S. to be equipped with terminal radar control (Tracon) equipment over the next three years. Tested for several years in Atlanta, Ga., as part of ARTS, Tracon will bring to terminal control the same kind of automated alphanumeric identification used in NAS. The package, designated Tracon C, is hooked up to existing

terminal radars to display an aircraft's identification number, range, altitude, and speed. Typically, a system includes a video digitizer to accept data from a plane and convert it into alphanumeric characters written on bright radar displays. A computer processor stores flight plan information and calculates aircraft speed. Initially, the FAA will buy 17 complete Tracon C systems, including a training setup and one for the agency's National Aviation Facilities Experimental Center.

From all sides. Despite such efforts as NAS and Tracon C, the FAA is still drawing a full quota of fire from its many critics. For one thing, the Air Transport Association feels the agency isn't moving fast enough. "We're way ahead of the FAA in implementing an alphanumeric system," says a spokesman for this airlines' trade organization. "By 1970, 69% of the airlines' planes will be able to furnish identity and altitude data, and 80% will be able to send identification signals. However, the FAA will have only 30% of its centers ready by then."

On top of this criticism, air traffic controllers are more than dubious about the efficacy of alphanumeric techniques. "When beacons cross, the alphanumeric tend to jump from one block to an-

other," complains Frank Havlin, a controller in the common instrument flight rules room at New York's Kennedy Airport. "Beacon readings are supposed to be separated by discrete codes." And Frank Kane, chief controller at Baltimore's Friendship Airport, notes that when two landing aircraft get near the field at altitudes around 2,000 feet, the alphanumeric signatures tend to get switched. But by then, each controller would know which blip was which, he says with the air of a man who dislikes such switching.

But even beyond specific quibbles about such matters as alphanumeric signatures, New York controllers are bitter about not being consulted by the FAA on equipment decisions. In particular, they complain about the setup in the common IFR room, which is supposed to handle all traffic control for the area's three principal airports—Kennedy, LaGuardia, and Newark—from one central location when it becomes completely operational next year. John Meehan, vice chairman of the militant Professional Air Traffic Controllers Organization (Patco), dismisses the system as failure-prone and unworkable because of human factors. "It's not humanly possible for our people to cope with the amount of data provided," he says. "And the primary radar is at least 90% unusable. The last time the Vice President's plane flew into Kennedy, it was lost twice because of outages."

Lost horizons. His colleague Havlin agrees, noting that the information blocks, which are 7 inches long, tend to converge on display boards during rush hours. "But these problems were well known in 1966 when we went to Nafec for an eight-week course," he says. "The FAA just didn't listen to us."

Havlin is also critical of the new airport surveillance radar, claiming that storms cause white spots, that make target tracking impossible. "With the old system, you could turn the equipment down and almost eliminate storm cells," he says. "Furthermore, displays are now projected through a radar bright scan converter. And somewhere in the process, something's been lost."

Rebutting such charges, John

Sunpapers—Frank Gardina

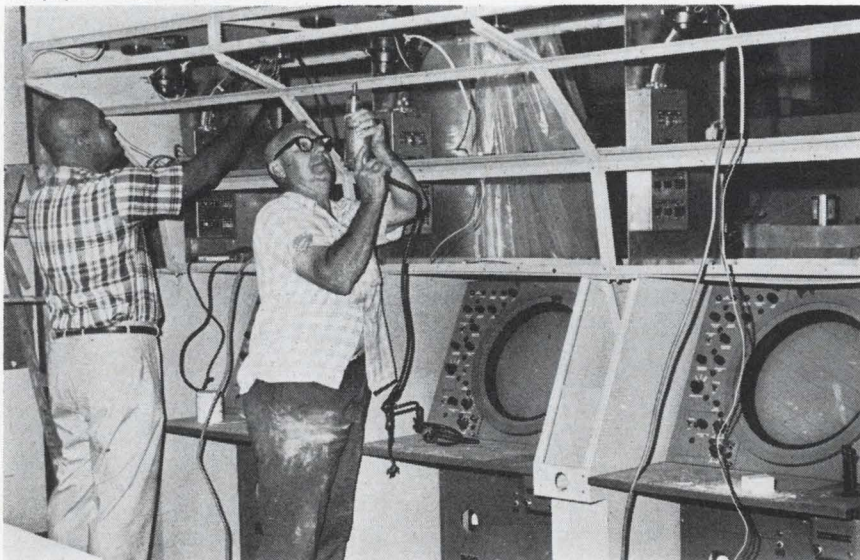

New deal. Baltimore's Friendship Airport is getting a new instrument flight rules room with bigger radar scopes and a transponder system.

Fitzgerald, a specialist in air traffic control with the FAA's Eastern office, says: "Traffic controllers are the most narrow-minded people in the world. I should know—I used to be one. The fact is, the equipment at Kennedy is new and they're just not used to it." Fitzgerald recalls that when radar was introduced at LaGuardia in 1947, the controllers wanted no part of it. "Eventually the bugs were ironed out, and we couldn't have done without it," he says. Fitzgerald concedes that controllers' beefs about having to call in for wind and runway visibility information are legitimate, but he points out that steps are being taken to include such data in the system.

Company man. Outside the FAA circle, there are, of course, other critics. Edward J. Shubel, deputy director of engineering at the Maxson Electronics Corp., takes the agency to task for selecting an approach involving transponder beacons. "If the FAA had opted for three-dimensional radar when the project was being evaluated, all the problems of the common IFR room could have been avoided," he says. Maxson has built 3-D systems.

Along the same lines, John Fling, a section chief working on ATC systems at ITT Gilfillan Inc., a subsidiary of the International Telephone & Telegraph Corp., believes continuous primary radar surveillance of all air traffic will be the solution. "Beacons are a good step, but not a final solution," he says. "The FAA did well to specify the mode C altitude-reporting feature. But this device isn't yet mandatory." Fling says, the agency, has been forced to rely on two-dimensional equipment because of the original high cost of 3-D radar. Unfortunately, he points out, office buildings and high-rise motels have been springing up around major airports, limiting coverage and inhibiting the effectiveness of such systems.

On the other side of the fence are men like Marvin Slevin, marketing manager for the Technical Products division of the Whitaker Corp. From his point of view, the use of limited-range transponders with a beacon system is an excellent approach. "Beacon systems are less apt to be a prob-

lem during bad weather," he says. "And 3-D radar is useful only in controlling aircraft not equipped with transponders. Besides, 3-D systems are expensive." Whitaker is working with the FAA on a beacon-like system known as DAIR, for direct altitude and identity readout [Electronics, July 24, 1967, p. 145]. As yet, however, the agency has not booked an order with the company.

Concrete proposals

Behind the air traffic control mess are deficiencies in facilities and manpower. Allan Horning, chief of airways facilities in the FAA's Los Angeles regional office, decries the lack of runways and taxiways. And automobile parking lots are encroaching on real estate needed for getting around the airport on the ground, he says. Another annoyance, according to Horning, is flight scheduling. "If the FAA were allowed to draw up the timetables, you could handle traffic control on the back of a dirty old envelope without all this sophisticated equipment," he says. "Without major changes in scheduling policies, no advances in systems will solve the problems faced by the nation's major airports."

The Airline Pilots Association, a trade union representing about 25,000 men, stated in recent testimony before the House subcommittee on government activities: "Immediate relief can be obtained by scheduling carriers' aircraft so as not to exceed the IFR capability of a particular airport and its environs, as well as by attracting general aviation to satellite facilities." A union spokesman notes that airports simply don't have enough runways and gates to handle traffic at peak hours. Baltimore's Kane agrees: "Most of the congestion is on the runways; it builds and backs up. There's no real problem in the airways."

Chain reaction. Fling of ITT Gilfillan also makes a pitch for satellite facilities to handle the air traffic overflow. "By trying to cram all aircraft into a limited area, we get nothing but jam-ups," he says. At Chicago's O'Hare and Midway airports, for example, it's not unusual to see 20 or 30 planes lined up waiting to take off during peak hours. However, the cause of this

TRYGON HAS THE POWER

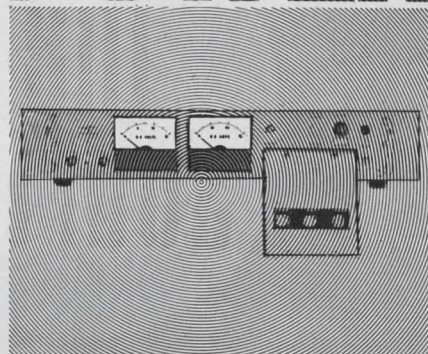

to deliver wide slot range performance in ratings to fit every system... from \$119.

- Rack mounted and modular.
- Meter and control options, integral.
- All silicon design—precision performance.
- Adjustable current limiting—optional overvoltage protection.
- Remote sensing and programming.

LIBERATORS from TRYGON... the ultimate in IC and transistor system power in minimum size at lowest possible cost. Specs like 0.5mV ripple, 3mV P-P noise, MIL Spec. performance and overvoltage protection.

FULL-RACK MODELS: voltages to 160V; output currents up to 40 A (3½") and 70 A (5¼"), 0.005% regulation and 0.01% stability, plus load share automatic paralleling.

SUB-RACK MODULAR MODELS: voltages to 160VDC, output currents from .25 A to 25 amps, 0.01% regulation and 0.03% stability. Write today.



TRYGON POWER SUPPLIES

111 Pleasant Avenue, Roosevelt, L.I., N.Y. 11575
 Trygon GmbH 8 Munchen 60, Haidelweg 20, Germany
 Write for Trygon 1968 Power Supply Handbook.
 Prices slightly higher in Europe.

TOROIDS Over 150 sizes (most with center-tap) available from stock include Permalloy, Ferrite and Powdered iron types.
Inductance tolerance $\pm 2\%$

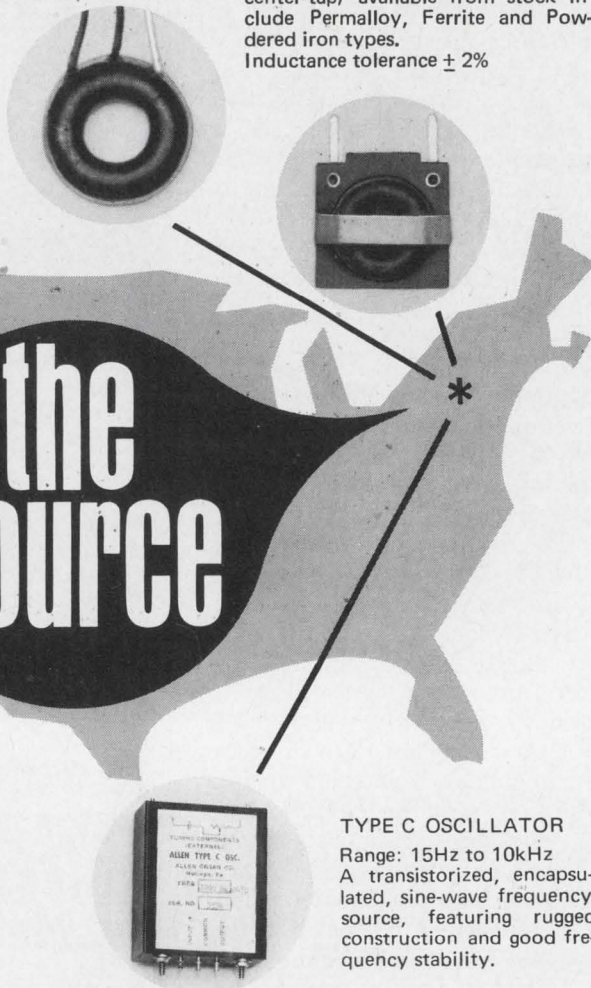

the
source

TYPE C OSCILLATOR

Range: 15Hz to 10kHz
A transistorized, encapsulated, sine-wave frequency source, featuring rugged construction and good frequency stability.

THAT'S ALLEN ELECTRONICS DIVISION.

Your source for toroids, oscillators and other components that combine quality and reliability, with low price and immediate delivery.

HOW?

We manufacture these components in quantity, for use in the world's finest electronic organs. For this use, we constantly maintain a complete inventory—a part of which we make immediately available to users of electronic components at far below competitive prices.

All Allen components are made under the most rigid quality controls, including thorough inspection and testing, at our own plant—one of the finest and most modern in the country.

So when your need is immediate for quality components in general, and toroids and oscillators in particular, look to where quality, low price, and fast shipment begin. At "The Source."

Write for catalog sheets with complete details on all Allen components.

ALLEN electronics division



Dept. E 968, Macungie, Pa. 18062

... the FAA miscalculated its manpower requirements ...

is not necessarily local. As a rule, the nose-to-tail trains of airliners on Windy City ramps result from stack-ups over metropolitan areas along the Eastern seaboard.

Fling also notes another problem area—the limited approach and departure patterns set up around big airports by the FAA for noise abatement. "Highly confined spaces inevitably lead to queues," he says. "And such narrow streets produce bottlenecks." Nor, in Fling's opinion, will the jumbo jets and SST's of tomorrow prove a panacea. "They'll simply put more people into the air more often; there won't be a reduction in traffic."

Help wanted. Another aspect of the control problem is rooted in the fact that the FAA, by its own admission, "seriously underestimated" its manpower needs. The agency's recently initiated program to hire more air controllers is at best a long-range solution. It takes from two to four years to train a competent controller, and though recruitment has been intensified, attrition continues to be a problem.

The situation at Chicago's O'Hare—the world's busiest commercial airport—is fairly typical of what's going on around the country. There, five-day work weeks have turned into six- and even seven-day propositions. And of every 10 prospects hired, six leave within a year. Some simply can't stand the pace while others wash out because of deficiencies. As a result of this turnover, there's a constant influx of trainees. At present, fully half the complement of control-tower personnel at O'Hare falls into this category.

Working conditions are much the same in Baltimore where, Kane says, his men get only one 15-minute break during an eight-hour shift. As a result, he can't train his new controllers to man every slot in the IFR room. But he bristles at the suggestion that such procedures might be risky. "There's nothing unsafe about what we're doing. When we get additional equipment, our operation won't be safer—just more efficient."

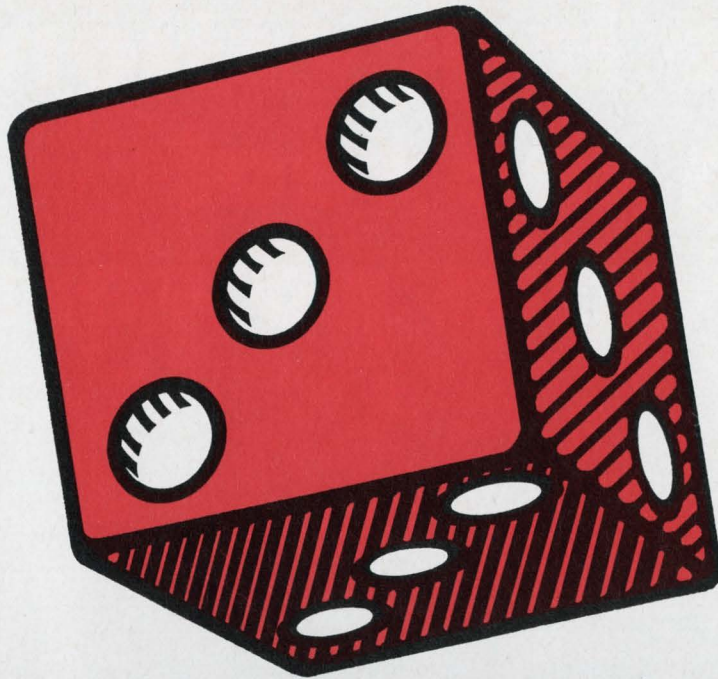

LIKE A SURE THING?

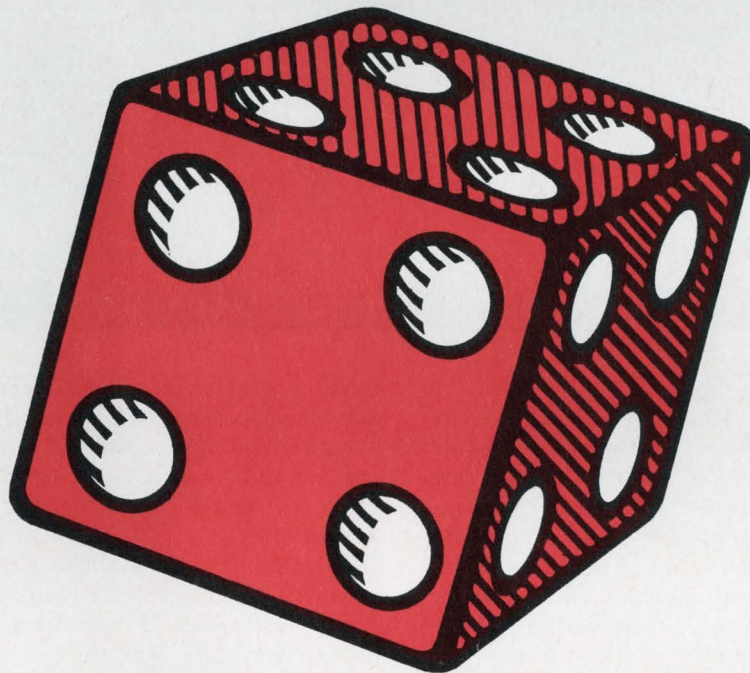

THE ODDS ARE 36,000 TO ONE COHU HAS THE RIGHT TV SYSTEM FOR YOU! A pioneer in TV, Cohu today is the largest producer of standard, off-the-shelf TV systems in the industry. Take the standard lenses, camera controls, pick-up tubes (both vidicons and Plumbicons®) and video monitors—put these together with Cohu's various camera housings, remote controls and lens drives and you have over 36,000 possible TV system combinations. And this does not include Cohu's wide variety of quality TV accessories and switching systems.

ONE IS RIGHT FOR YOU! Whether your needs be industrial, educational or military, one of Cohu's TV combinations is right for you. Let Cohu engineering know-how design for you a custom TV system from standard, off-the-shelf components.

For details on the industry's most complete TV line, contact your nearest Cohu representative or call Bob Boulio direct at 714-277-6700 in San Diego. The odds are in your favor.

® Reg. TM N. V. Philips Co. Holland
Box 623, San Diego, California 92112. TWX 910-335-1244.



More innovation from the real power in power:

More-advanced power hybrid IC's.

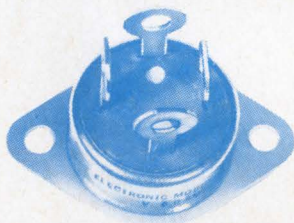

Actual Size

power semiconductor know-how?

It's obvious what this means in power hybrid IC's. Greater flexibility to build more into a circuit to start with. Plus quality from raw materials to finished power function, all under one roof. Immediate off-the-shelf delivery. And attractive prices.

Take our new, thick-film, 10-amp, integrated bridge rectifier for power supplies, AC/DC converters and motor controls. Customers tell us it's the most advanced power hybrid of its type on the market. Because it combines Bendix hybrid fabrication techniques with plastic encap-

It figures.

Who is better equipped than Bendix to make the most advanced power hybrid integrated circuits? Who has spent more time working with your kind of power circuit requirements? And who has more "in-house" access to

sulation in a standard TO-3 package. Because it matches functional specs to your needs: 10-amp average DC output current at 65°C; up to 600 volts Peak Reverse Voltage per leg; and 70- to 420-volt RMS voltage range. And because it gives the design engineer a universal circuit at a low price.

Yet, this unit is just a taste of things to come in Bendix power hybrid integrated circuits: Power audio amplifiers. Power darlingtonts. Power-driver modules. Voltage regulators. And more. Much more.

Looking for the most advanced power hybrid IC's? Look up the real power in power—Bendix. Contact your nearest sales office or write the Power Specialists: Semiconductor Division, The Bendix Corporation, Holmdel, New Jersey 07733.

Bendix **Electronics**

Chicago—(312) 637-6929; Dallas—(214) 357-1972; Detroit—(313) 548-2120; East Northport, N.Y.—Harry Friedman Co. (516) 692-2839; Great Neck, N.Y.—H. V. Sales Co. (516) HU 7-1142; Greenwich, Conn.—(203) 869-7797; Holmdel, N.J.—(201) 946-9400; Lexington, Mass.—(617) 861-8350; Los Angeles—(213) 776-4100; Minneapolis—(612) 926-4633; Orlando, Fla.—(304) 241-6559; Rochester, N.Y.—(716) 266-5550; Runnemede, N.J.—(609) 933-2550; Seattle—Ray Johnston Co., Inc. (206) LA 4-5170; Export—Cable: "Bendixint," 605 Third Avenue, New York, (212) 973-2121; Ottawa, Ont.—Computing Devices of Canada, P.O. Box 508 (613) 829-1800; San Juan, Puerto Rico—Southern International Sales Co. 723-3879.

India bids for self-sufficiency

But country's plan to boost production of electronic equipment and components continues to be hobbled by limited resources and unique sociological problems

By Bidyut Sarkar

New Delhi correspondent

By 1975, India should be turning out more than \$400 million worth of electronic equipment a year, according to its government's official estimates. Since most of the capacity to produce this output has yet to be built, the country faces an enormous task. Current annual volume is less than \$70 million, and, notes A.S. Rao, director of the electronics division of India's Atomic Energy Commission, about \$65 million of this output depends on the collaboration of foreign interests.

India's plan for a self-sufficient electronics industry was codified two years ago when a government committee headed by the late Homi Bhabha (then chairman of India's AEC) issued a report on the subject. The committee put the country's required electronic-equipment production at around \$3 billion over the 10 years through 1975, and identified consumer goods, data processing systems, instrumentation, radio communications gear, and components as the principal areas of involvement. Professing to see a silver lining in the Indian industry's backwardness and small size, the committee noted: "India is in the fortunate position of bypassing the stage-by-stage development in other countries and of planning the industry on the basis of the latest ideas and techniques."

On paper this sounds fine, but putting it into practice in an underdeveloped country of the size and sociological complexity of India is something else again. Thus the nation's technological goals, while modest by Western standards, may be hard to reach.

For example, the computer—now an accepted servant in industrialized societies—is proving a bone

of contention in India. A month or so ago, employers and trade union representatives met in New Delhi at a special session of the standing labor committee to discuss the problem of automation. The unions criticized the increasing use of computers and other electronic equipment in offices and factories, expressing the fear that workers would lose their jobs. S.A. Dange, a Communist leader, says the country, in its present state of social development, does not require automation. Employers counter that automation would, in fact, accelerate economic development and create additional jobs for white-collar workers.

But the debate continues to be inconclusive; characteristically, a subcommittee is being set up to study the problem further and recommend guidelines for a national policy on automation. Meanwhile, the chairman of the government-owned Life Insurance Corp. announced that the company would soon put a machine in its Calcutta offices. Unionists have promised to resist such a move with "all their might," which appears to be considerable since a recent computer installation for Eastern Railways in that city had to be carried out under a heavy police guard.

Count. There are only 70 systems in the entire country, but their impact has been far out of proportion to their number. Among the first to order these machines were such public-service institutions as state banks, national railways, and other official organizations that have traditionally provided sinecures for a large segment of India's white-collar middle class. Opposition to computers is largely concentrated in this restive, vocal group.

The group's position is not without a certain reasonableness. Of the nation's 14 million jobless, a substantial number are educated. And many who support automation feel that perhaps the starting point has been ill-chosen. For example, a Bombay financial daily recently noted: "Babu (the educated clerk) is the cheapest and most surplus commodity in the country." The paper went on to argue that it would be impolitic to provoke him by eliminating desk jobs so long as the existing educational system was largely geared to producing more of his kind.

Unwelcome return. If the stakes were not so high, the computer situation would be somewhat laughable. Last month, for example, employees of the Indian Statistical Institute in Calcutta sought an audience with Prime Minister Indira Gandhi to protest against the introduction of computers at their organization. Ironically enough, the institute, which exists to utilize statistics as a key to unlock modern technology, collaborated with Jadavpur University in designing and building an Indian computer. In addition, the institute is the country's foremost data-collection and analysis agency.

Industrial applications of computers and electronic controls have so far been relatively limited in India. But many planners recommend a policy of selected introduction in export-oriented fields with well-defined growth potential; the steel, petroleum, petrochemicals, and fertilizer industries are cited. After computers have proved their worth and contributed to the general well-being in these areas, these planners reason, the machines will be more enthusiastically received

... a debate is also raging over the role of television in India ...

in other sectors of the economy.

Notwithstanding the problems involved, the Bhabha committee predicted that India would need more than 5,500 digital computers by the mid-1970's; an estimated 90% of this total falls in the small-machine category. But many observers jeer at such projections, dismissing them as little more than wishful thinking. Economists and planners in India point to such problems as runaway population, insufficient agricultural output, a critical foreign exchange position, large-scale unemployment, labor agitation, and a chaotic political situation. There is, they say, a paucity of resources and conflicting demands for what's available.

Bright side

Skepticism is, however, by no means universal. For example, International Computers (India), a subsidiary of Britain's International Computers Ltd., last month began to expand its manufacturing plant in India. Asked if he's surveyed the local market, H.G. Treverton,

managing director, says: "A country with population of over 500 million doesn't need a market study. It's so vast that even a small share of the pie can be very profitable."

Partnership. ICI will make its 1900 series of machines in collaboration with Bharat Electronics Ltd., a government-owned venture operating out of Bangalore where the bulk of India's infant industry is concentrated. The BEL facility will turn out semiconductor devices and electronic subassemblies for the ICI plant in Poona. In turn, ICI will set up a training school and test facility in Bangalore.

The first machine is due off the lines next May. Within the next four years, the joint venture is expected to produce some 300 computers. "We're going to start at the bottom and work up to larger models," says Treverton. Among the concerns that have booked orders for the ICI-BEL machines are Binnys, a textiles house in Madras, and the General Electric Co. of Calcutta; eventually, it's hoped, computers will be exported.

Consuming interest

India's vaulting ambitions for various industries have an unhappy tendency to fall short of the mark despite a succession of five-year plans and government regulation of production, distribution, and prices. The country's mediocre record thus far clouds its grandiose plans for self-sufficiency in electronics.

For example, the Bhabha report, which charts the country's technological path through the mid-1970's, bases many of its projections on the assumption that Indians should spend some \$900 million on radio receivers and other consumer goods during the decade through 1975. Clearly, that sort of spending would require a sharp rise in the nation's standard of living. And since the average Indian still needs every rupee he can lay his hands on to fend off starvation, outlays for radio sets would seem frivolous.

Even if famine is eventually conquered—and the most optimistic official estimate defers self-sufficiency in agriculture to 1972—the electronics industry must still contend with unfavorable consumer attitudes. Traditionally, Indians have hoarded their savings—in gold or personal possessions. Manufacturers may get around the fact that most rural villages lack electricity by turning out battery-operated transistor sets. But it will take some time to overcome the predilection of the poorer people to save whatever money they accumulate.

If radio has problems coming of age in India, television is barely born. The Indian government has made only a token provision for the medium in its fourth five-year plan. And it shows no inclination to make the massive investments in programing, studios, and transmission and relay equipment that will be needed to extend broadcasting beyond its single experimental base in New Delhi.

Right now, ICI has only one major sales and manufacturing rival, albeit a formidable one. IBM, which brought the first second-generation computers into the country in 1960, is turning out a full line of data processing equipment, including key punches, at its Bombay plant. And last year the company was the second largest exporter of light engineering goods from India, selling them in about 40 countries.

Generation gap. IBM recently produced its first made-in-India computer, a machine from the 1401 series. The unit was built largely with imported components, but the company, along with ICI, plans to increase the indigenous content of locally made machines. IBM will soon be making System/360 computers in India; the only third-generation machine now operating there is a Control Data Corp. 3600 that was installed at the Tata Institute of Fundamental Research in Bombay with the aid of a U.S. grant.

Honeywell Inc., though it doesn't have a manufacturing or sales facility in India, is still a major supplier of computers thanks to a special agreement with the government. Ten H-400 units are being installed to satisfy the data processing requirements of official agencies, among them the AEC in Bombay, Hindustan Aeronautics Ltd. in Bangalore, the Defense Research and Development Establishments in Poona, and the Joint Cipher Bureau in New Delhi.

Fuzzy picture

A debate is also raging about the role of television. Some ministers believe the medium should be primarily instructional, educating the Indian people in a variety of problems—national integration, food production, family planning, and the like. But others fear that such programs would draw the same response as the government-sponsored documentaries shown in movie houses—audiences frequently leave the hall for a smoke when they go on. They suggest that tv have a strong entertainment base to hold an audience and attract advertisers.

At the moment, India has only one tv station; located in New Delhi, it was established primarily for school broadcasts, which still

MOLY-PERMALLOY POWDER CORES

16 standard sizes with ID's from .110" to 1.40", and OD's from .250" to 2.25". Guaranteed $\pm 8\%$ inductance limits on toroids with permeabilities of 14, 26, 60, 125, 200, 300 and 550. Available either stabilized or unstabilized with temperature.

TAPE WOUND CORES

Made from nickel, silicon, or cobalt irons. We supply all AIEE standards plus special sizes in thicknesses from $\frac{1}{2}$ through 14 mils. All sizes boxed in phenolic or plastic, aluminum or GVB-coated aluminum boxes.

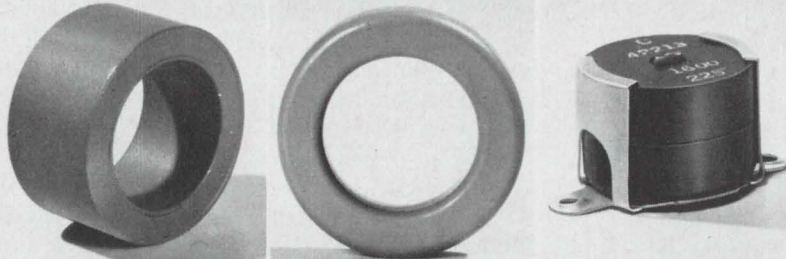

FERRITES

Guaranteed linear temperature coefficients on 750, 1400 and 2000 perm materials. Flat temperature coefficient on 2300 perm material also guaranteed. A total of 175 part numbers to choose from.

BOBBIN CORES

Made from Permalloy 80 and Orthonol[®] strip .000125" to .001" thick and .023" to .250" wide. Diameters range to less than .050", with flux capacities as low as several maxwells.

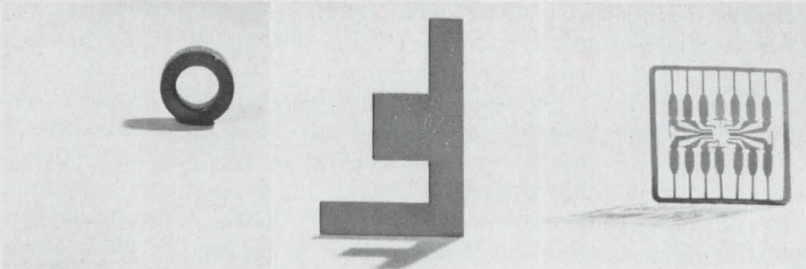

PHOTOFAB[®] PARTS

Precision flat components chemically milled from almost any magnetic or specialty alloy. Thickness tolerances range from $\pm 5\%$ to $\pm 10\%$, depending on thickness and type of material.

MAGNETIC LAMINATIONS

Nickel-iron materials in thicknesses of .004", .006" and .014". 38 standard shapes in sizes from DU-87 and EI-12 down to EI-093, EE-30-31 and F-094.

Magnetics Inc. gives you total quality control and single-source responsibility on every component

At Magnetics Inc., we're particular about what the finished component does for you. So particular that we maintain up-tight control right from the start. On ferrites and powder cores, we begin with the exact blending of powders. Our metal strip products also evolve from closely controlled custom blending and composition. This emphasis on precision, from start to finish, results in product uniformity—you get optimum characteristics and full-measure performance every time. That's what we mean by single-source responsibility. For additional information on any of our products, mail coupon today.

Magnetics Inc.
Dept. EL-103, Butler, Pa. 16001

Please send me additional information on:

- Tape Wound Cores Bobbin Cores Moly-Permalloy Powder Cores Ferrite Cores Magnetic Laminations Photofab Parts Specialty Metals

Name _____

Title _____

Company _____

Street _____

City _____

State _____

Zip _____



Tape, Powder, Bobbin, Ferrite Cores • Laminations • Photo-etched Parts • Specialty Metals • Engineered Control Systems

... prices for components have been cut by one-third since the start of 1968 ...

make up the bulk of its fare. Most—343 of 392—of the higher secondary schools in the city have receivers. But there's no real agreement as to how effective the medium is for such applications. "It's like fitting radar to a bicycle," says a teacher referring to the ill-equipped and overcrowded schools where tv tutoring looks out of place.

Ambitious advice. In a recent report on radio and tv, a government-appointed committee recommended "countrywide coverage by a television network over a period of about seven years." But the government—mainly because of a lack of funds—is thinking of establishing television services during the 1969-74 period only in metropolitan centers like Calcutta, Bombay, Madras, and Kanpur. The only definite expansion of television now on the schedule is the establishment of a station at Srinagar, the capital of Jammu and Kashmir State, by early 1970. About 2,500 sets will be installed in the Kashmir valley for community viewing, a move that's expected to facilitate national integration.

Two private companies, J.K. Electronics in Kanpur, and Telerad in Bombay, have each been licensed by the government to manufacture 10,000 sets, and a consortium of small concerns will make another 10,000. The first receivers are expected out of factory by the end of this year; the price tag on a 23-inch set will be around \$250.

Ceiling

The government hasn't agreed so far to the requests of the licensed manufacturers to boost production to 100,000 sets to reduce unit costs. It has also not responded favorably to the suggestion that other companies be allowed in the field to produce sets at more competitive prices, possibly by using imported designs and components. Still, the consensus is that an annual output of 30,000 sets is woefully inadequate. K.K. Shah, minister of information and broadcasting, concedes that "Bombay alone could account for 100,000 sets in no time."

Though tv has "iffy" production prospects, radio does not. At the moment, the manufacture of radio receivers represents the biggest chunk of the Indian electronics industry. The number of sets is now estimated at around 10 million. In a country of over 500 millions, this is a small fraction, but this year another 2 million sets will be made.

The Bhabha committee estimated that India would require 14 million sets, including replacements, during the 10-year period through 1975. However, the panel also pointed out that cheaper sets would have to be produced; the cost of a locally made receiver is 50% higher than that of imports.

The high cost of components is largely responsible for pushing prices up. The committee found that the cost of locally made components needed to build a low-cost receiver would be about \$8 in India, as against \$4.75 in Japan.

The government-owned BEL plant in Bangalore, which supplies all of the country's requirements for receiving tubes and shares the manufacturing responsibility for transistors and related components with Semi-Conductors in Poona and Continental Devices in New Delhi, recently responded to the radio industry's clamor for lower-cost parts. Since the beginning of the year, BEL has slashed prices on transistors, diodes, and related parts by an average of one-third. Additional cuts are considered likely when and if new production facilities are brought on stream.

Foreign markets. O.V. Soskuty, a member of the United Nations mission on export production, says the principal obstacles to increased exports of Indian components and electronic equipment are high prices stemming from small-scale production and obsolete manufacturing methods. At present, the output of parts, including semiconductors, is running at an annual average of only about \$8 million. But Soskuty feels this is the first segment of the Indian electronics industry in a position to make a dent in world markets—once it modernizes. "Handwork is a price-

less ingredient in the efforts of artisans," he says. "But it has no place in situations requiring mass-production techniques."

According to the Bhabha committee, after domestic radio receivers and other consumer products, communications systems, radar, and navigational equipment will constitute major fields of future development for India's electronics industry. It's estimated that India's defense services alone will account for about \$700 million worth of equipment during the decade through 1975.

Defense requirements are largely met by BEL, which proposes to establish another factory to manufacture radar equipment; magnetrons will be produced by the company next year. The company is also setting up an industrial park next to its Bangalore plant. Here, small businessmen will run specialized assembly shops, producing electronic goods and components for BEL under close supervision. The company plans to double its dollar volume—now running at an annual rate of \$21 million—by 1971.

In addition to defense equipment and components for the entertainment industry, BEL produces a widening range of industrial and medical electronic wares. It's also looking for export markets.

Salesman. Col. V.M. Bhide, who manages the company's business operations, visited Southeast Asia earlier this year on a sales mission. He reports that the BEL catalog came as a surprise to many who didn't realize that such a variety of equipment is produced in India. Trade delegations from Malaysia and the Philippines have since visited the BEL plant, and orders have been booked in a number of countries. Bhide's next sales mission will be to the Middle East later this year.

Another government-owned company in Bangalore, Indian Telephone Industries, produces equipment for Indian Posts and Telegraphs and other government agencies. ITI now makes more than \$5 million worth of electronic equipment a year, and a new factory is expected to triple production in two years' time. Among ITI's prospective projects are entry into digital electronics and development of electronic exchanges.

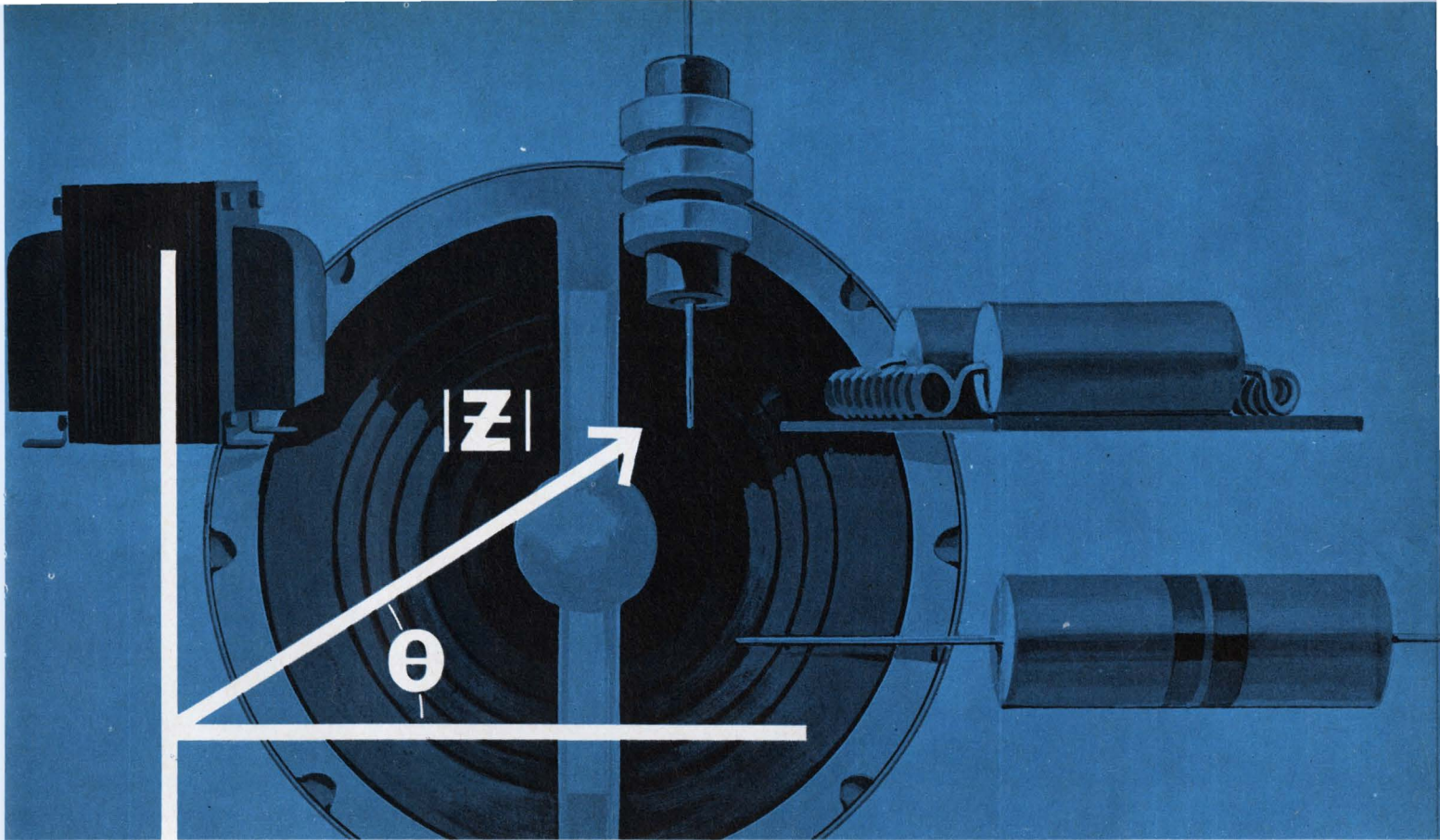

Check phase and impedance as fast as you read voltage

The Hewlett-Packard 4800A Vector Impedance Meter quickly evaluates the impedance characteristics of any passive device or circuit. It covers a range of 5 Hz to 500 kHz. Meter operation is simple. There's no nulling or balancing — no calculations to make. Just select the impedance range, set the desired frequency and read out impedance and phase directly. Analog outputs of frequency, impedance and phase are provided for X-Y recording.

Application Note 86 describes many applications of the 4800A Vector Impedance Meter (5 Hz to 500 kHz) and the 4815A RF Vector Impedance Meter which operates in the 500 kHz to 108 MHz range. For your copy and complete specifications, contact your local Hewlett-Packard field engineer or write:
Hewlett-Packard, Rockaway Division,
Green Pond Road, Rockaway, N. J. 07866.

Pertinent Specifications:

Frequency Range: 5 Hz to 500 kHz, continuous.
Impedance Range: 1 ohm to 10 megohms.
Phase Range: 0 to $\pm 90^\circ$.
Price: \$1650.

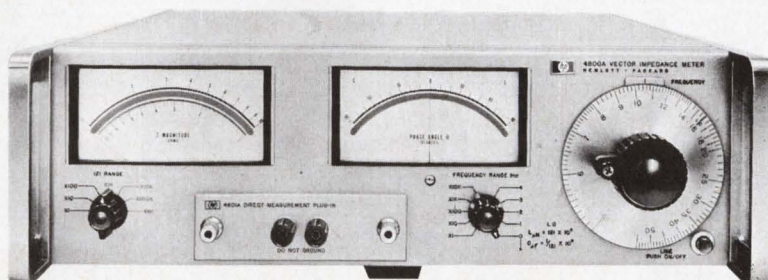

HEWLETT  PACKARD
IMPEDANCE INSTRUMENTS

YOU'RE LOOKING AT THE BANK ACCOUNT OF A \$25,000 ENGINEER



IT'S HIS INFORMATION BANK

(You can open an account today)

Further your own career by joining the *Electronics and Control Engineers' Book Club*... and save money on every book you buy!

TAKE ANY
ONE FOR \$1
ONLY
with your first club selection

Values from \$8.00 to \$29.50

#171. **Engineers' Relay Handbook** by the National Association of Relay Manufacturers. Comprehensive information on operating principles, properties, performance characteristics, application requirements, specifications, and testing.
Pub. Price, \$11.95 **Club Price, \$10.15**

#381. **Pulse, Digital, and Switching Waveforms** by J. Millman and H. Taub. Working descriptions of active and passive devices and circuit configurations for the generation and processing of pulse-type signals.
Pub. Price, \$18.00 **Club Price, \$15.30**

#290. **Antenna Engineering Handbook** by Henry Jasik. Provides a vast storehouse of data on antenna design for commercial and military applications.
Pub. Price, \$26.50 **Club Price, \$18.95**

#850. **Mathematics for Electronics with Applications** by H. M. Nodelman. Offers the working engineer practical, time-saving mathematical techniques.
Pub. Price, \$8.00 **Club Price, \$6.80**

#509. **Electronic and Radio Engineering** by F. E. Terman. Helps you solve problems in FM, TV, pulse techniques, and higher parts of the radio spectrum.
Pub. Price, \$17.50 **Club Price, \$14.95**

#737. **Transistor Circuit Design** by the Engineering Staff of Texas Instruments, Inc. Tested solutions to a wide range of today's basic circuit problems.
Pub. Price, \$15.00 **Club Price, \$12.75**

#371. **System Engineering Handbook** edited by R. E. Machol. Covers system environments, system components, theory, techniques, and useful mathematics associated with system engineering.
Pub. Price, \$29.50 **Club Price, \$25.00**

#240. **Radio Transmitters** by L. Gray and R. Graham. Gives a detailed analysis of transmitter components with design information on amplifiers, coupling circuits, frequency control units, power supplies, cooling equipment, and control circuits.
Pub. Price, \$14.00 **Club Price, \$11.90**

#530. **Project Engineering** by Victor Hajek. How to plan and execute a technical program efficiently and profitably, with recent advances in project monitoring, including PERT.
Pub. Price, \$8.50 **Club Price, \$7.25**

There are no more powerful tools than *books* in building a successful engineering career. Here's a professional Club Plan that assures you of getting the most needed and practical books in your field—at an average savings of 15% from publishers' prices.

HOW THE CLUB OPERATES. Basic to the Club's service is its publication, the *Electronics and Control Engineers' Book Club Bulletin*, which brings you news of books in your field. Sent to members without cost, it announces and describes in detail the Club's featured book of the month as well as alternate selections which are available at special members' prices.

When you want to examine the Club's feature of the month, you do nothing. The book will be mailed to you as a regular part of your Club service. If you prefer one of the alternate selections—or if you want no book at all for that month—you notify the Club by returning the convenient card enclosed with each *Bulletin*.

As a Club member, you agree only to the purchase of four books over a two-year period. Considering the many books published annually in your field, there will surely be at least four that you would want to own anyway. By joining the Club, you save both money and the trouble of searching for the best books.

MAIL THIS COUPON TODAY

electronics and control engineers' book club
582 PRINCETON ROAD, HIGHTSTOWN, N. J. 08520

Please enroll me as a member of the Electronics and Control Engineers' Book Club and send me the two books indicated below. You will bill me for my first selection at the special Club price and \$1 for my new membership book, plus local tax where applicable, and a few additional cents for delivery costs. These books are to be shipped on approval, and I may return them both without cost or further obligation. If I decide to keep the books, I agree to purchase as few as four additional books during the next two years at special Club prices (approximately 15% below list).

Write Code # of your \$1 bonus book Write Code # of your first selection

NAME

ADDRESS

CITY STATE ZIP

COMPANY

(This offer good in United States and Canada) E33064

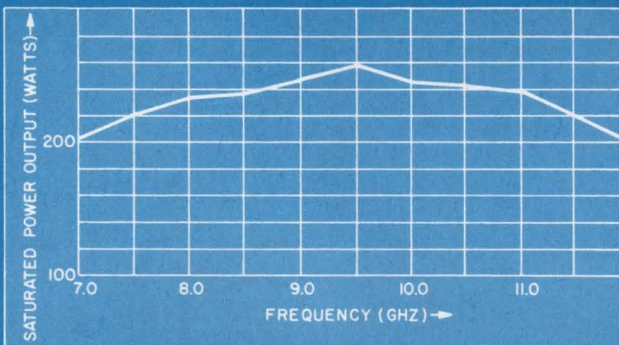
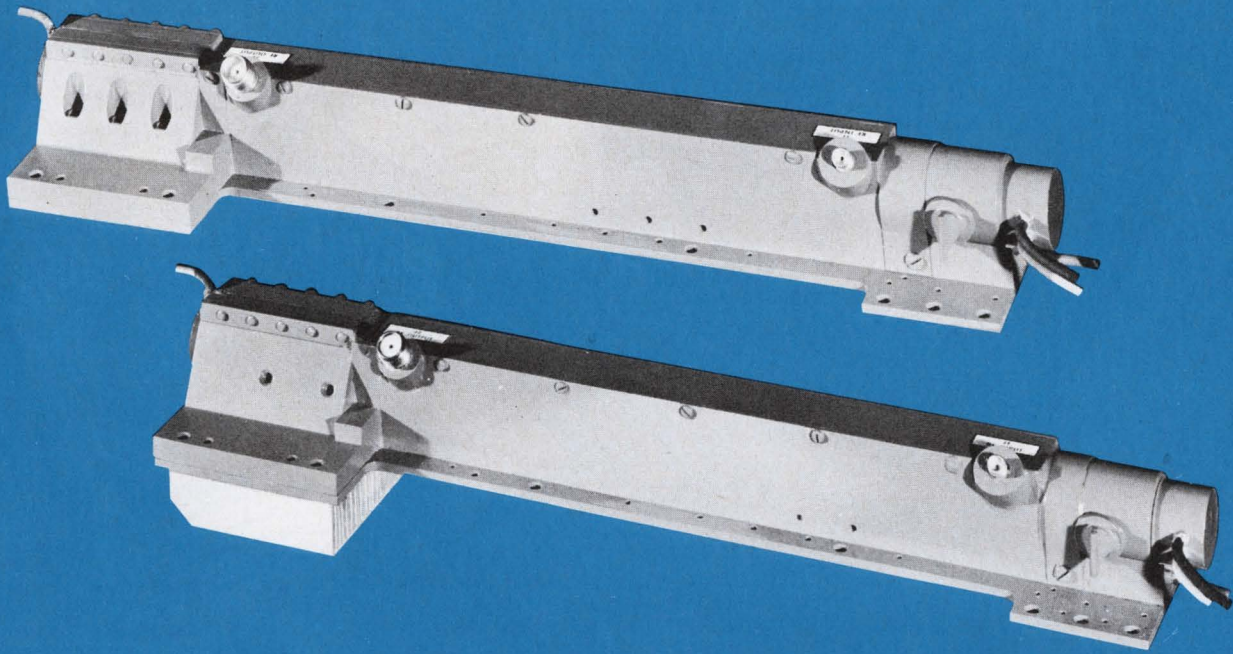

TYPICAL SATURATED OUTPUT POWER VS FREQUENCY, STX-5220

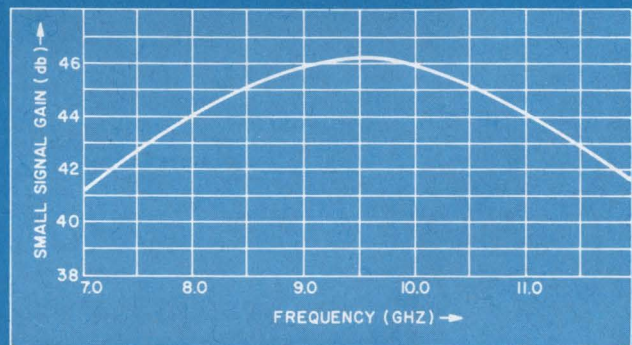

TYPICAL SMALL SIGNAL GAIN VS FREQUENCY, STX-5220

SPERRY OFFERS WIDE BAND, 200 WATT, CW TWTS AT C AND X BANDS

Sperry has news for system designers who need high power broadband performance in commercial or military communication satellite ground terminals, airborne radars, augmentors or ECM applications. In X band, it's the STX-5220, a PPM focused tube that delivers a minimum 200 watts of power from 7 to 11 GHz. Typical small signal gain is 40 db.

The STX-5220 is also available with a matched power supply and a wide selection of input voltages. The tube can be provided for either forced air or conduction cooling. This compact, rugged, high power device is only 15 $\frac{1}{8}$ " long and weighs 6 pounds.

Sperry also offers a C band (4 to 7 GHz) version of the 200 watt CW tube, designated the STC-5210. This tube offers the same advantages as its X band counterpart. Contact Cain and Co., or write Sperry Electronic Tube Division, Gainesville, Fla., for full details on either model.

SPERRY
ELECTRONIC TUBE DIVISION
GAINESVILLE, FLORIDA

MICROWAVE PROS - Tell us about your engineering degree(s) and your five or more years of microwave tube experience. Let us tell you about exciting work, educational opportunity and pleasant living in one of America's most attractive university cities. Resume, please, to Walt Thomas, Director of Industrial Relations. (An equal opportunity employer, M&F.)

TRON RECTIFIER FUSES

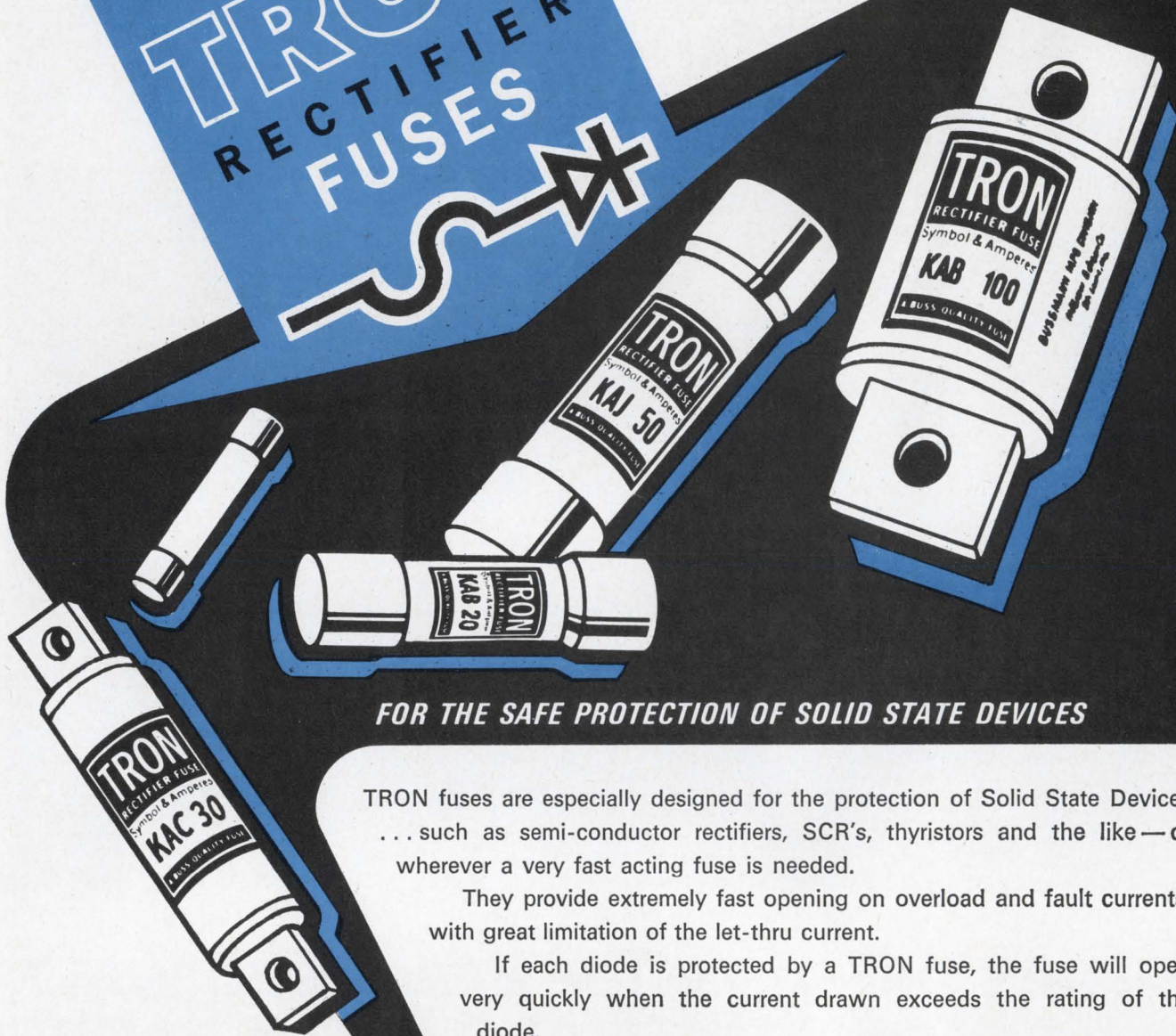

FOR THE SAFE PROTECTION OF SOLID STATE DEVICES

TRON fuses are especially designed for the protection of Solid State Devices ... such as semi-conductor rectifiers, SCR's, thyristors and the like—or wherever a very fast acting fuse is needed.

They provide extremely fast opening on overload and fault currents, with great limitation of the let-thru current.

If each diode is protected by a TRON fuse, the fuse will open very quickly when the current drawn exceeds the rating of the diode.

Thus when a short-circuit occurs in a diode the fuse opens and takes that diode out of the circuit. This protects other good diodes in the rectifier which might otherwise be damaged.

TRON fuses are available in a wide range of physical dimensions and in sizes from ½ to 1000 amperes in voltage ratings up to 1500.

For full information and time-current characteristic charts, ask for BUSS Bulletin HLS.

BUSSMANN MFG. DIVISION, McGraw-Edison Co., St. Louis, Mo. 63107

For fuses and fuseholders of unquestioned high quality for every protection need ...

Supplied the Economical Way
... Thru Distributors

BUSS QUALITY

FUSES

New Products

Communications

“Car 54, wgbfr akl yih?”

Scrambling and encoding devices can help police fight eavesdropping, but high costs and disagreement over methods are producing real static

Almost all policemen say they need communications privacy, but there's little agreement on how much is required or the best way to get it.

There is some consensus on the main problem. Systems with the desired features cost more than most departments can afford. This difficulty is illustrated by two new products: a device that can operate on as many as 1,024 codes but costs \$2,500 in single units, and a scrambler that costs less than \$300 but is conceded by its maker to be far from ideal.

On most matters, however, even officials in the same city sometimes disagree widely. In Los Angeles, for example, Anthony Gains, chief of the city's electronics division, says the traditional technique of frequency inversion is simple, effective, and reasonably priced. But Noel McQuown, the city's deputy police chief, says, “We have a man who can ‘read’ scrambled or inverted voice transmissions—without equipment—as well as our officers can understand regular transmissions. Voice inverters are not satisfactory. We're using this technique on one of our frequencies and we're convinced it's not the answer. It's a simple system and can easily be compromised.”

And Walter Key, director of communications for the Chicago police, feels the same way: “It doesn't take much to unscramble a frequency-inverted message by someone who puts a little effort into it.”

But many manufacturers believe

frequency inversion fills the bill for most of today's needs. This adequacy—and the method's low cost—mean that voice-inversion devices are emphasized even though few in industry or public safety believe this technique is the ultimate solution to the eavesdropping problem.

No Federal grants

Some authorities doubt the need for voice privacy. Studies of crime list “no stated need” for scramblers, says Robert Emerich of the office of law enforcement assistance at

the Justice Department. Emerich, one of the men in charge of Federal grants to police departments for testing of new devices, says that no money has been awarded for scrambler tests and that the department is looking to teleprinters and digital communications to provide security [Electronics, Aug. 19, p. 34].

But Robert Brookings, communications engineer for Burbank, Calif. says there's a definite need for simple, inexpensive scramblers. “You can go into any radio shop and for



**NEW KH ALL-SILICON
DIGITALLY TUNED
VARIABLE FILTER
FEATURES
ULTRA LOW FREQUENCY
96 DB/OCTAVE SLOPE**

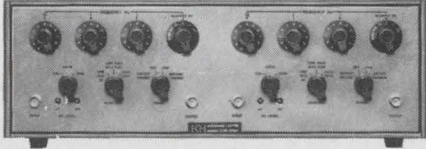

MODEL 3342 DUAL-CHANNEL, MULTI-FUNCTION FILTER provides low-pass and high-pass operation with 96 db attenuation slope or 48 db slopes as band pass or band reject filter. The digital frequency control provides cut-off frequencies from 0.001 Hz to 100 kHz with 2% calibration accuracy and excellent resettability. Size: 5 1/4" H x 19" W x 16 1/2" D.

The new Krohn-Hite Series 3300 operates on either line or batteries, with 0.1% distortion and provides gain of 20 db.

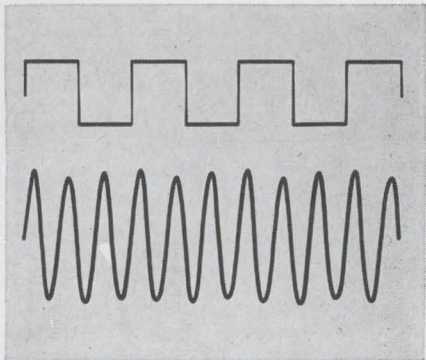

RECORDING ILLUSTRATES gain and selective response of Model 3342, in minimum band-pass operation, to a 0.01 Hz square wave. Output consists primarily of third harmonic component of input.

This kind of low-frequency performance is backed by other important specifications. Examples are:

Filter Characteristics: Either 4 or 8-pole Butterworth (maximally flat) and RC for transient-free operation.

Digital Tuning: Six bands, 3 digits; rotary switches.

Maximum Attenuation: 80 db.

Dynamic Range: 80 db.

Input Impedance: 10 megohms.

Output Impedance: 50 ohms.

Write for Data

KH KROHN-HITE CORPORATION
580 Massachusetts Avenue, Cambridge, Mass. 02139
Telephone: 617/491-3211

\$19.95 buy a device to monitor police transmissions," says Brookings. "The need for systems to prevent this on a daily basis is apparent, and these scramblers are most useful during civil insurrection or riots." Brookings is also chairman of the national planning commission for the Associated Public-safety Communications Officers Inc. (APCO).

First-step device. When Motorola Inc. introduced a frequency-inversion device at the APCO convention last month in Palm Springs, Calif.,

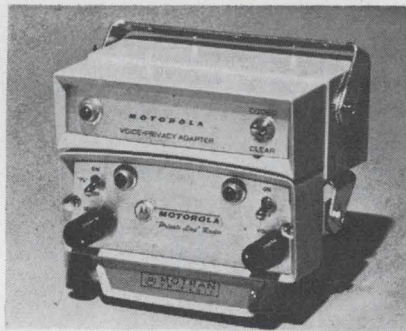

Private line. Adapter for two-way radio inverts signal to foil eavesdroppers.

the company stressed that the scrambler wasn't the ultimate answer. John F. Mitchell, Motorola's vice president for communications products, told the police officials not to consider the adapter a total communications device. "That would require a vast number of codes," he said, "so that even a listener with the same device would not likely find the right code before it was changed."

Audio information is received at the microphone terminals of Motorola's equipment and converted into double-sideband suppressed carrier information in a balanced modulator. Low-pass filtering then eliminates the upper sideband, resulting in a scrambled signal that's a frequency-inverted image of the original information.

In the receiver, audio from the discriminator is fed into the scrambler, where an identical frequency conversion occurs, transforming the audio signal to its original makeup. A clear or code-selector switch turns the scrambler on or off. The unit sells for less than \$300.

"The usual echo or 'rain barrel' effects encountered with this type

of scrambler have been eliminated through the use of fast rise-time computer switching techniques," Mitchell says.

Where are you? Chicago's Key was at the convention and pointed out a drawback of such single-code scrambling devices by asking: "What's to stop someone from stealing a squad car and stripping it of its scrambler?" Indeed, thefts of police cars just to get at their radios aren't uncommon, particularly in the big cities.

A number of police officials have long opted for car teleprinter systems that can automatically record both messages and the output of a computer. And they've sought to increase security even more by getting a system that would route the message to only the car or cars being called.

Motorola, in effect taking both sides of the voice-vs.-printer issue, also showed such a system at the convention. The VP-100, whose price hasn't been disclosed, prints 100 characters a minute. An array of 35 dots in a 5-by-7 matrix forms each character. Impulses bend six piezoelectric ceramic crystals, which deflect the printing bar. The bar forms each character's pattern of dots and spaces on paper containing a self-marking material.

Codified conversation

For those who want more privacy than frequency inversion allows, Technical Communications Corp., a small Lexington, Mass., company, has developed a voice device [Electronics, Sept. 4, 1967, p. 25] whose codes can be changed at any time by resetting one or more of 10 switches; the number of possible code combinations is so large that the chances of timely deciphering are remote.

"The device gives you safety in numbers," says Arnold M. McCalmont, president of the company. "The likelihood of a stolen unit being set to the correct code is close to zero." Units can be equipped to operate on any one of 128, 256, or even 1,024 codes.

The method of encoding, McCalmont says, "is a hybrid technique, part digital, part analog. This keeps the price down to under \$800 in quantity." The \$800 price is for orders between 100 and 1,000; a single unit costs \$2,500.

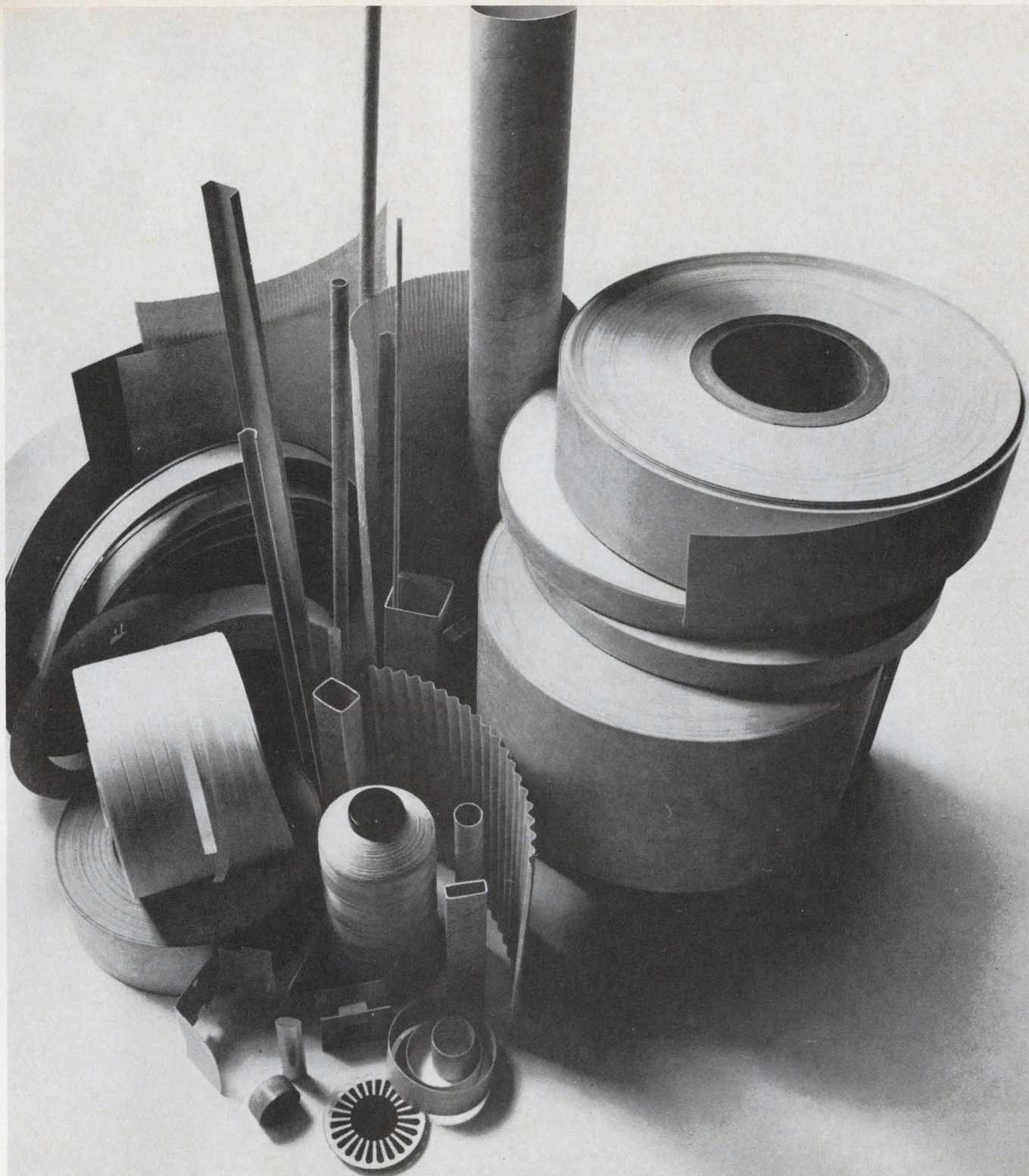

Throw away your insulation handbook. All you need is Nomex.[®]

Nomex[®] nylon paper is the one insulation you can use for just about every application. It won't melt or support combustion—it's UL-rated at 220°C. and it complies with MIL-I-24204. Durable "Nomex" paper won't crack when creased or bent and does not flake. It can be easily slit or punched for close tolerance and can be used in automated operations.

*Du Pont registered trademark.

"Nomex" is compatible with all major resins, varnishes and enamels. It is relatively unaffected by moisture, and there are no shelf-life problems.

"Nomex" is available in a wide variety of fabricated forms designed to fit any application. So look to one material—"Nomex"—for all your insulation needs.

To get more information, write:

Du Pont Company, Nomex Marketing,
Room J-8, Wilmington, Delaware
19898. In Canada, write Du Pont of
Canada Ltd. In Europe, Du Pont de
Nemours Int., S.A., 81, Route de l'Aire,
Geneva, Switzerland.

DU PONT **NOMEX**[®]
REG. U.S. PAT. OFF. **NYLON**

NEW Model 28G5P

LIGHT As Little as 15 Lbs.

SMALL 10 $\frac{1}{4}$ " L. x 5" Dia. (25 amps)

**BUT BIG
ON POWER**

Up to 200 amps at 28 VDC

...AND ONLY THE FAN MOVES!

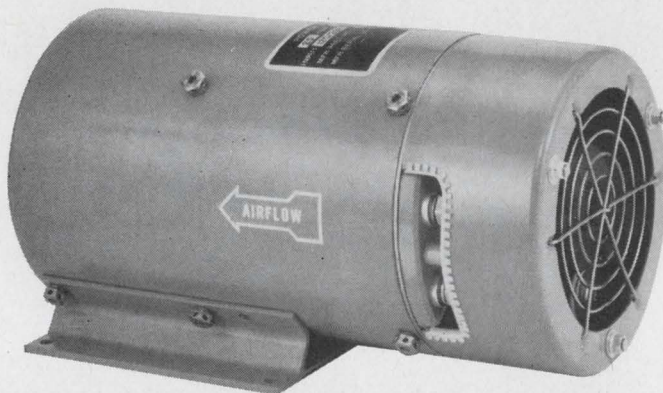

Tung-Sol's new high-efficiency miniaturized supplies pack a potent and powerful punch. They operate off conventional 3-phase, 120/208 VAC mains of 47-65 Hz and are available in four models with outputs of 25, 50, 100 or 200 amps at 28 VDC. The typical 50-amp unit weighs but 25 lbs. and is 12" L. with a 6" dia. At 200 amps, units weigh only 65 lbs. and are but 16 $\frac{1}{2}$ " L. with an 8" dia.

How did we cut size and weight? By using an exclusive circular Class H double Delta-Wye transformer which is electrically and magnetically symmetrical. Special aircraft-type silicon diodes manufactured by us to rigid specs assure operational dependability. These units supply clean 28 VDC with 1.5 V maximum peak ripple and can be mounted in any attitude. Internal noise-filtering networks meet MIL-E-55301. Units withstand transient overloads of 150% without damage.

Write for full specs on these fan-cooled static supplies. By the way, they're perfect for process control, communications systems, truck-mounted gear, and air transportable systems. Think smaller and lighter...think Tung-Sol 28G5P power supplies! Tung-Sol Division, Wagner Electric Corporation, 630 W. Mt. Pleasant Ave., Livingston, N. J. 07039. LED-101

TUNG-SOL®

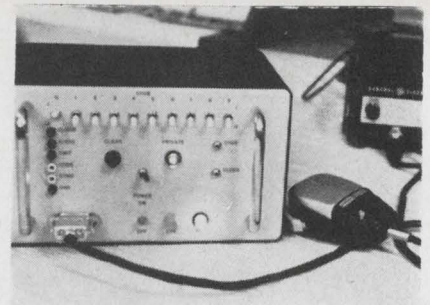

Cryptic. Changeable code makes gibberish out of audio signal.

McCalmont adds that privacy is enhanced by the way the device is attached to the radio's circuitry. "Even with the device and a police radio, a thief would still get gibberish unless the little black box were properly connected," he says. Regarding the coding technique, McCalmont will say only that after encoding, "the radio's output signal no longer looks like a voice-modulated carrier, but rather like random noise centered on the carrier frequency."

Inversion plus. Another device demonstrated at the APCO convention was the Tele-Signal Corp.'s \$750 programable scrambler, called the Codavox 2193M. Up to 450 codes are available.

Built specifically for mobile radio units, the plug-in device requires no adaptation of the basic set, according to Russell A. Popp, project director at Tele-Signal, a subsidiary of the General Precision Equipment Corp. The device splits the voice signal into five 500-hertz bands, which pass through a switching matrix. This displaces and inverts them in accordance with a variable code. The code is set with thumb-wheel switches or a plastic card plugged and locked into the system. "Patrolmen could be issued a card each day with the day's code on it," says Popp.

"A secure system is what the police chiefs all over the country want and need," Popp notes. "I can buy a \$20 receiver plus a couple of dollars worth of components and decode signals from the \$300 voice-inversion scramblers. We sell these scramblers—I tell the police chiefs we sell them and then I tell them they don't want these scramblers. Any police official who knows the communications business would throw me out if I talked about voice inversion alone."

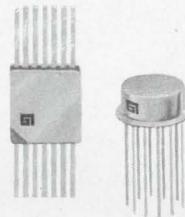

General Instrument, the “#1 Power” in hybrid microcircuitry adds the NC/PC-260 Hybrid Power Amplifier to the industry’s original and broadest line of hybrid ICs. The NC/PC-260 does more and costs less* than any other hybrid power amplifier.

The NC/PC-260 Hybrid Linear/Pulse Power Amplifier is a complementary symmetrical current amplifier exhibiting exceptional linearity in the entire output voltage range without crossover distortions; power efficiency approaching theoretical maximum; high output current; high input impedance; low output impedance and wide bandwidth. This unique combination of performance characteristics is made possible by the V_{BE} pairing and thermal feedback of the four transistors which keep the bias current constant, thereby preventing thermal runaway.

The NC/PC-260s are designed for use as linear, T²L, and MOS buffers. They are immediately available from your authorized General Instrument distributor in TO-5 (NC-260) and $\frac{3}{8}$ " square flat packs (PC-260).

TYPICAL CIRCUIT PERFORMANCE RATINGS:

$V_{CC} = V_{EE} = 12V$, $R_L = R_S = 1K$
 $T_{OP} = -55^{\circ}C$ to $+125^{\circ}C$

Voltage Gain	0.99
Bandwidth (3 dB), $R_S = 100\Omega$, $V_{IN} = 1V_{PP,DC}$ to	40 MHz
Input Resistance	1 M Ω
Output Impedance	12 Ω
Total Harmonic Distortion $V_{in}(1-5 V_{rms})$	0.2 %
Power Efficiency ($R_L = 240\Omega$, 18V _{PP} Swing)	53%

*at quantities 1-24, NC-260 @ \$17.50 ea.; PC-260 @ \$20.30 ea.

Write for complete information. (In Europe write: General Instrument Europe, Via Turati 28, Milano, Italy)



GENERAL INSTRUMENT CORPORATION • 600 WEST JOHN STREET, HICKSVILLE, L. I., NEW YORK

Crisp Bacon in 90 Seconds

with INTERNATIONAL'S
MICROWAVE OVEN



The culinary wonder of space age cooking moves to your kitchen with this new International countertop oven that cooks with radar-spawned microwave power.

People on the go will welcome an oven that makes cooking chores a pleasure. Imagine a "piping hot" TV dinner (frozen) in 3½ minutes* instead of 20 to 50 minutes. Bake a potato in 5 minutes instead of 60 minutes. Warm a chilled baby bottle in 60 seconds. Fry crisp bacon in 90 seconds on a paper plate. Great for those leftovers.

International Microwave Oven is truly remarkable. No more waiting for the oven to reach cooking temperature.

Countertop designed for the home, mobile home, or the galley on your boat. No special wiring required. Works on 115 vac house circuit. Comes in baked vinyl white with attractive trim. **\$545.00**

Available direct from International or through your local appliance dealer.

*Times listed are approximate and vary with size of item.

Write for folder



CRYSTAL MFG. CO., INC.
10 NO. LEE • OKLA. CITY, OKLA. 73102

... simple plug-in device
sought for privacy ...

Cost remains the main barrier to extensive use of scramblers. "A lot of chiefs want to buy scramblers but just don't have the money," says Everett R. Sarratt, president of Mico Inc., which makes an inversion scrambler with a twist—the transmitting and receiving frequencies can be changed independently. This not only makes it harder to intercept a conversation but also makes it almost impossible to listen to both sides without sophisticated frequency sweepers. The system sells for \$3000, and even Sarratt concedes that the price is still too high for extensive police use in the nation's cities.

New York, which has used some scramblers, is installing a computer-based police dispatch system. Data from a message coming into headquarters will be typed into the computer, which will relay it to selected squad cars for printout. The system is expected to be completely operational within two years.

Even after this goes into effect, New York's finest will still need scramblers for their voice channels. Stephen Walsh, a deputy inspector, says the police want scramblers even though interception of police broadcasts isn't a big problem. He says the devices tested so far have been plagued by drift, making daily tuning necessary.

Incompatibility. These scramblers were the speech-inversion type, and all were in the \$300 range. Walsh says that for a reliable system the police would probably go to \$500 or \$600, "but we are not willing to spend \$3,000 each for sophisticated scramblers."

Jules Beckley, a shop foreman who maintains the San Francisco police network, says the city experimented a couple of years ago with a scrambler. It worked well, but it was too expensive and wasn't compatible with existing units.

"It cost \$400 per unit plus \$800 for the base station," Beckley says. "We have 265 patrol cars; to outfit them all would have been impossible. I don't get \$15,000 a year to maintain the entire fleet."

"What's needed," he says, "is a simple plug-in adapter for under \$100."

MORE ALSIMAG[®] CERAMICS

to Close Tolerances "As Fired"

PARTS SHOWN APPROXIMATELY ACTUAL SIZE

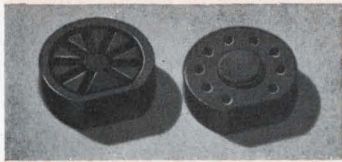

Holes $.043 \pm .001$

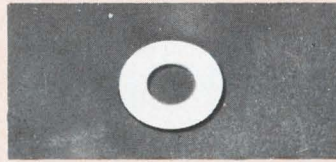

Metallized on O. D. I. D. $.250 \pm .003$
Thickness $.018 \pm .001$



Cavity Depth $.005 \pm .001$

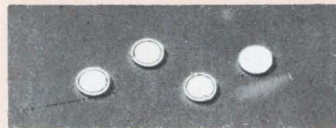

Cavity Diameter $.150 + .004$
 $- .000$

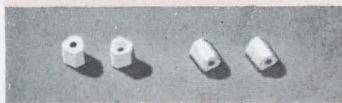

O. D. $.126 \pm .001$
Hole $.0425 \pm .001$



O. D. $.279 \pm .0025$
Holes $.022 \pm .003$

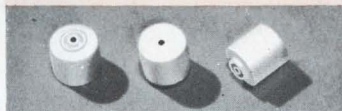

Shank Length $.021 \pm .001$
Shank O. D. $.1315 \pm .0015$
Hole $.032 \pm .001$



Flat Within $.002$
Cavity Depth $.008 + .003$
 $- .000$

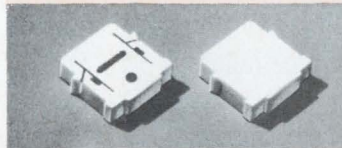

Width $.420 \pm .003$
Slot Width $.015 \pm .003$
Hole $.021 \pm .001$
Hole Spacing $.372 \pm .002$

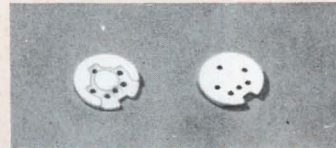

O. D. $.367 \pm .003$
Holes $.041 \pm .002$
Flat Within $.002$

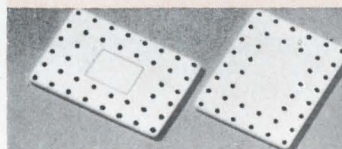

40 Holes $.025 + .005$
 $- .000$
Thickness $.035 \pm .002$
Camber $.003$



Ceramic $\pm .002$
.007 Pattern Separation

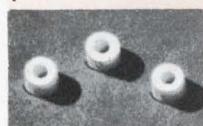

O. D. $.048 \pm .0015$
Hole $.020 \pm .002$

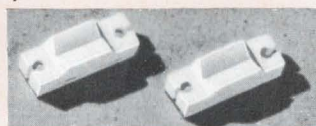

Hole $.020 \pm .002$
Slot Width $.010 \pm .002$

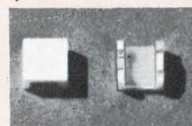

.064 Square with Critical
Dimensions $\pm .002$

*THESE PARTS SHOWN ENLARGED APPROXIMATELY 4 TIMES SIZE

PROGRESS REPORT

More and more AlSiMag ceramic compositions are available to close tolerances "as fired". This precision was pioneered by American Lava on alumina ceramics. AlSiMag beryllia ceramics conduct heat about like aluminum and have the favorable electrical characteristics of alumina ceramics. Beryllia was for many years considered impractical for close tolerance work. Today small AlSiMag beryllia ceramics are also regularly produced to close tolerances "as fired".

Certain AlSiMag steatite compositions have been famed for their excellent electrical performance. Their mechanical strength is adequate for a broad range of applications. Their cost is, in most instances, quite favorable. This is especially true where large volume is involved. These accurately controlled AlSiMag steatite compositions are now generally available in "as fired" precision tolerances. In some instances they offer equal or superior performance at substantial cost savings.

American Lava has developed a highly satisfactory dark colored alumina ceramic as well as a dark colored steatite and brought them under close dimensional control. They are produced regularly and in volume for applications where the dark color is an advantage or where opaque ceramics are required.

Precision Metallizing

Precision metallizing techniques have paralleled the advances in "as fired" precision ceramics. This includes the most modern precision drafting equipment, cameras, step-and-repeat, screening and inspection facilities as well as specialized plating facilities.

Single source responsibility with integrated production of precision ceramic and precision metallizing can result in greatly improved reliability and quality, faster deliveries and lower over-all cost.

American Lava offers the industry's widest range of ceramic compositions. For economy, dimensional tolerances always should be as broad as the application permits. But if you require close "as fired" tolerances on any ceramic composition, we have broad experience and are ready to work with you. Send blueprints and outline requirements and let us make suggestions.

CODE IDENT. NO. 70371

PHONE 615 265-3411, CHATTANOOGA, TENN. 37405

American Lava Corporation **3M** COMPANY

A SUBSIDIARY OF

For service, contact American Lava representatives in Offices of Minnesota Mining and Manufacturing Company in these cities (see your local telephone directory): Boston: Needham Heights, Mass. • Chicago: Elmhurst, Ill. • Dallas, Texas • Chagrin Falls, Ohio • Harvard, Mass. • Laurens, S. C. • Los Angeles, Calif. • Metropolitan New York: Ridgefield, N. J. • Up-State New York and Canada: Phoenix, N. Y. • Orange, Conn. • Philadelphia, Penn. • Roanoke, Va. • St. Louis: Lee's Summit, Mo. So. San Francisco, Calif. • 3M International: c/o American Lava Corporation, Chattanooga, Tenn. 37405, U.S.A., 615/265-3411.

67th
YEAR
OF
CERAMIC
LEADERSHIP

Circle 200 on reader service card

"We don't want our customers to be surprised by what we deliver in integrated circuits—just satisfied that they got what we both know will meet tomorrow's competition."

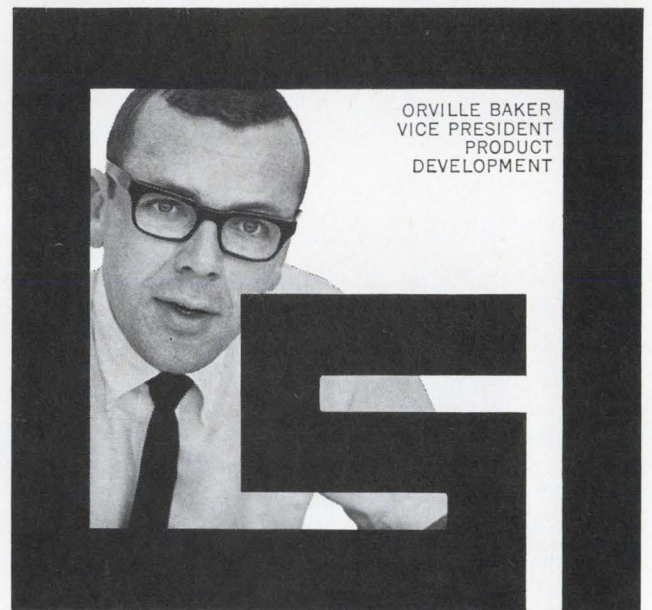

SIGNETICS INTEGRATED CIRCUITS

SIGNETICS CORPORATION
THE RESPONSE/ABILITY COMPANY

New Components Review

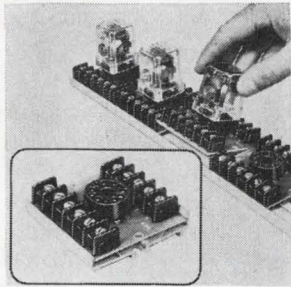

Track-mounted socket assemblies hold 11-pin 3pdt relays. Sockets have recessed center post chamber, which allows rocking out relays without danger of fracturing off center post. Prepunched vinyl track allows fast mounting of up to 16 sockets on 46 in. length, with only 2 or 3 mounting screws instead of 2 per socket. Curtis Development & Mfg. Co., 3250 N. 33 St., Milwaukee. [341]

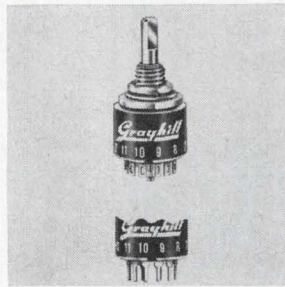

Rotary switch is available with 1-, 2- or 4-pole circuitry in less than 0.7 in. behind panel and diameter of 0.562 in. It is offered with p-c or solder-type lug terminals, military or commercial styles, shorting or nonshorting contacts, and adjustable or pre-set stops. Life expectancy for a 50 ma current level is 25,000 cycles. Gary-hill Inc., 523 Hillgrove Ave., La-Grange, Ill. [342]

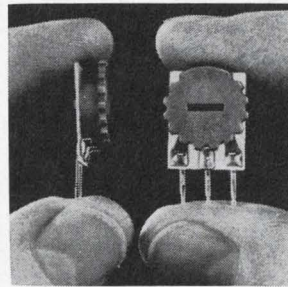

Cermet trimmer resistors called Centrims are for commercial, military and industrial applications where component space is limited. Units for commercial use are rated at $\frac{3}{4}$ w per section at 70°C, derated to zero at 125°C; those for industrial use, $\frac{3}{4}$ w per section at 85°C derated to zero at 175°C. Centralab Div. of Globe-Union Inc., 5757 N. Green Bay Ave., Milwaukee. [343].

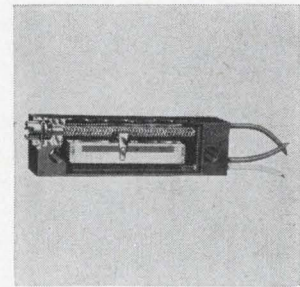

Rectangular metal film trimmer 2851 is a $\frac{1}{4}$ -in. device featuring infinite resolution and low noise. It will operate at ambient temperatures up to 175°C and is humidity-proof. Temperature coefficient is 100 ppm/°C max. Resistance values available range from 10 ohms to 10,000 ohms. Amphenol Controls Div., Bunker Ramo Corp., 120 S. Main St., Janesville, Wis. [344]

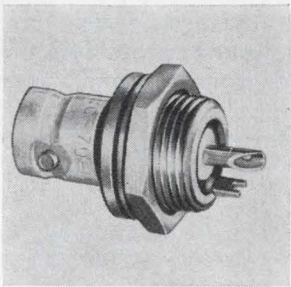

BNC receptacle KC 79-67 has a Teflon insulated ground lug to isolate r-f from the equipment panel. It is designed to be mounted in a $\frac{1}{2}$ in. diameter hole, on a $\frac{3}{8}$ in. thick panel. A bayonet coupling type for use with r-f cables, it is protectively coated with TR-5 tarnish-resistant finish. Price is \$1.43 each in quantity. Kings Electronics Co., 40 Marble-dale Road, Tuckahoe, N.Y. [345]

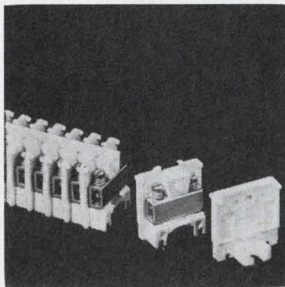

Polypropylene miniature 300-v sectional terminal block, with $\frac{1}{4}$ -in. center-to-center spacing, handles a wire range up to No. 12 Awg and eliminates lugging. Contact sections are $\frac{1}{8}$ in. high and $\frac{7}{8}$ in. wide. Each 12-in. length can handle 48 circuits. The contact sections can be snapped off or added as needed. Buchanan Electrical Products Corp., Union, N.J. [346]

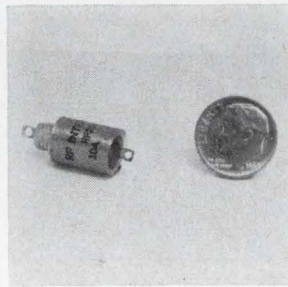

Subminiature filters series 2500 for feed-through mounting are housed in $\frac{3}{8}$ in. cylindrical cases. Six "Pi" and "T" types are rated 0.25 to 5 amps, with voltage ratings of 50 v d-c at 85°C to 30 v d-c at 125°C. Six "L" types have current ratings of 60 ma to 10 amps, with the same voltage ratings as in "Pi" and "T" types. RF Interionics Inc., 100 Pine Aire Drive, Bay Shore, N.Y. [347]

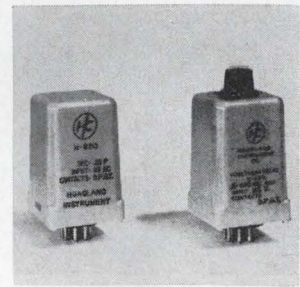

Time delay relay with a de-energize circuit improves both the reset time and reliability of industrial time delays. The timing section is activated only during the actual timing cycle. Reset time is as low as 0.025 sec. Rated life is in excess of 10 million cycles. Price is \$10 to \$30 depending on specification. Hoagland Instrument Co., 65 Chestnut St., Red Bank, N.J. [348]

New components

Frequency switch resists noise

Device said to be cheaper, smaller, faster than its counterparts averages the input

Nobody likes being chased around by a runaway motor, let alone paying to repair one. This is one reason why most pieces of rotating machinery are watched over by frequency-sensitive switches, ready to turn off when rotational velocity reaches the danger point.

G.I.D. Ltd., London, has built a switch, the Z-Trip, that can be tripped by a change as small as 0.1% of a set frequency. The company says the Z-Trip is cheaper, smaller, and faster than similar devices with the same switching differential. Besides, says G.I.D., the

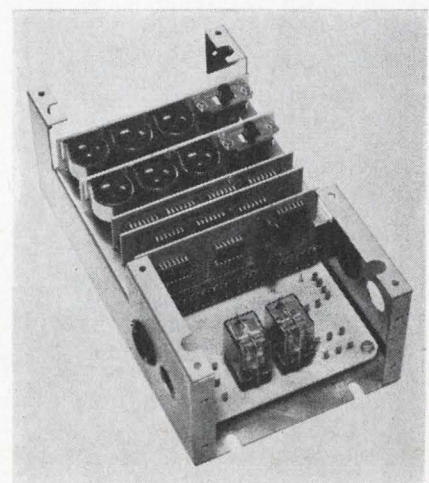

Shaping up. The Z-Trip works with any wave shape over a wide range.

A New X-Y Recorder...

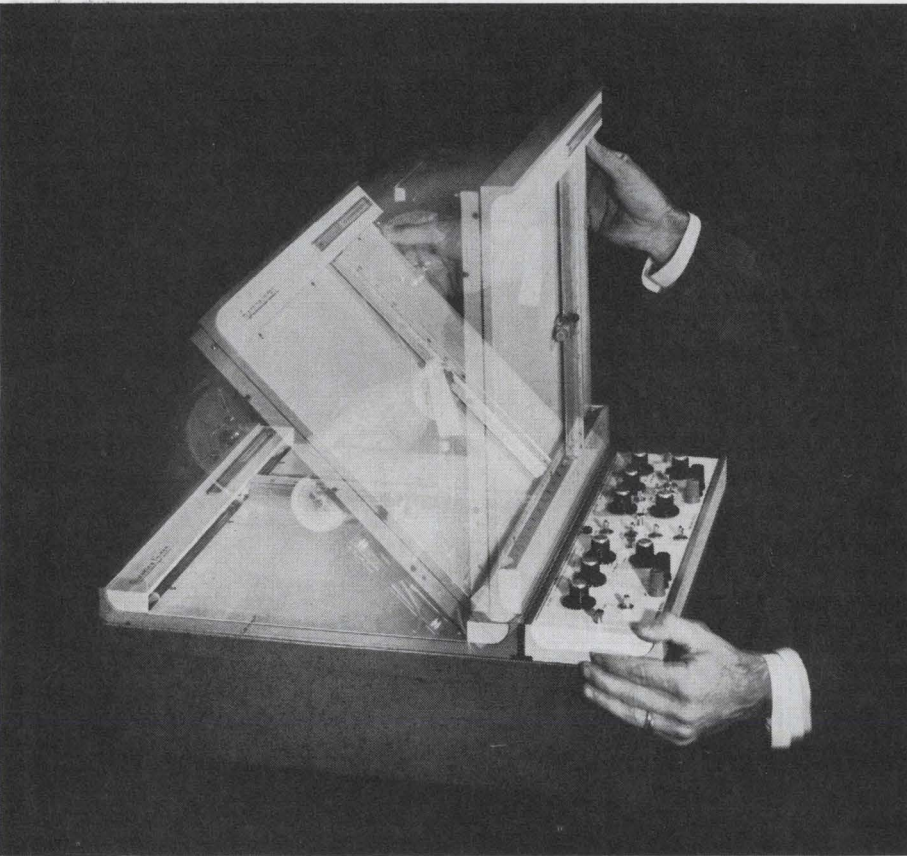

That's Easier To Operate

Easier to operate... easier to position... and meets top performance requirements. The *function/riter** recorder is more convenient than other X-Y plotters. You can operate this new TI recorder in five different positions to suit any application. Mount it in a 19-inch rack without adapters, stand it upright on a benchtop or position it flat with the writing surface horizontal, at a 45° or 90° tilt angle so you see the plot, even when you're sitting.

It's easy to change applications too. Three types of plug-in "function modules" allow you to plot inputs from 100 μ v to 50v, with time sweeps from 0.1 second/inch to 100 seconds/inch. All modules are interchangeable between X and Y axes. *Signal Input* module permits single-range millivolt recording. *Signal Control*

module offers 16 calibrated scale factors. *Time Base* module gives 10 time or voltage factors.

For more than four years, the servo system of the *function/riter* recorder has been use-proved in thousands of other TI instruments. Quieter operation of the vacuum hold down (for either 8½ x 11-inch or 11 x 17-inch paper), solid-state electronics, 20 inches/second slewing speed and accuracy of 0.2% of full scale are some of the other features that make this X-Y recorder an outstanding instrument to solve your plotting problems.

There's more to the story too. Find out by asking for complete data or a demonstration from your TI representative or the Industrial Products Division, P. O. Box 66027, Houston, Texas 77006 (713-349-2171).

*Trademark of Texas Instruments

TEXAS INSTRUMENTS
INCORPORATED

... available with either
d-c or relay output ...

Z-Trip isn't easily fooled by noise.

According to the company, other frequency-sensitive switches use either digital-counting or analog-integration techniques. The Z-Trip compares the duration of the average input wave with a reference pulse. It's this averaging, usually done over eight cycles, that enables the device to ignore most random noise. The trip frequency is set by adjusting a potentiometer to change the pulse width.

Two routes. The Z-Trip works with inputs from d-c to 20 kilohertz, and the trip point can be set from 10 hertz to 12 khz. Trip frequency can be approached from either above or below.

The switch has two reset modes. It automatically resets itself when the frequency moves away from the trip point, or it stays tripped until reset by hand.

The output change is either a shift from 0 to 6 volts d-c or a relay closure.

When fitted with its optional integrator, the switch's output voltage is directly proportional to the frequency of the input.

In Britain, the Z-Trip's price ranges from \$48 for a d-c output switch to \$75 for a relay-output model that can switch a-c signals.

The switch is packed into a metal frame, 228 by 125 by 89 millimeters, and the whole package weighs 3 pounds. It's also available in a weatherproof housing that brings the weight up to 8 pounds.

In a couple of months, G.I.D. will bring out a Z-Trip that switches when the input frequency moves out of a preset band. The British price for this model will be around \$170.

Specifications

Input	0.5 to 150 v, waveform unimportant
Input impedance	200 kohms
Set-point stability	0.015%/°C, typical
Switching differential	0.1% of set point (fixed), 1% to 10% (variable)
Response time (1% / sec rate of change through set point)	0.08 sec at 100 hz 0.008 sec at 1,000 hz Figures halved if rate of change greater than 50%/sec
Temperature	-10°C to +60°C

G.I.D. Ltd., 142/146 Old St., London [349]



**we
know
the
game**

The Electronics Group of The Bank of New York has only full time industry specialists.

If your needs involve financing, corporate or product development, mergers, acquisitions, stockholder relations, options, pensions or other considerations, no one is better equipped than our full time "electronics bankers" to assist you in finding the solutions for continued growth and increasing profits.

On a comprehensive, first-hand level, the officers in our Electronics Group, Special Industry Banking Division, have a unique ability to give your company the most experienced attention in the field.

Ask yourself if you can afford to have your financial needs handled by other than a banker who concentrates exclusively in Electronics.

... a specialist from The Bank of New York

Write for our new Electronics Group booklet.

**THE
BANK
OF
NEW YORK**

ELECTRONICS GROUP

Special Industry Banking Division
48 Wall Street • New York, New York

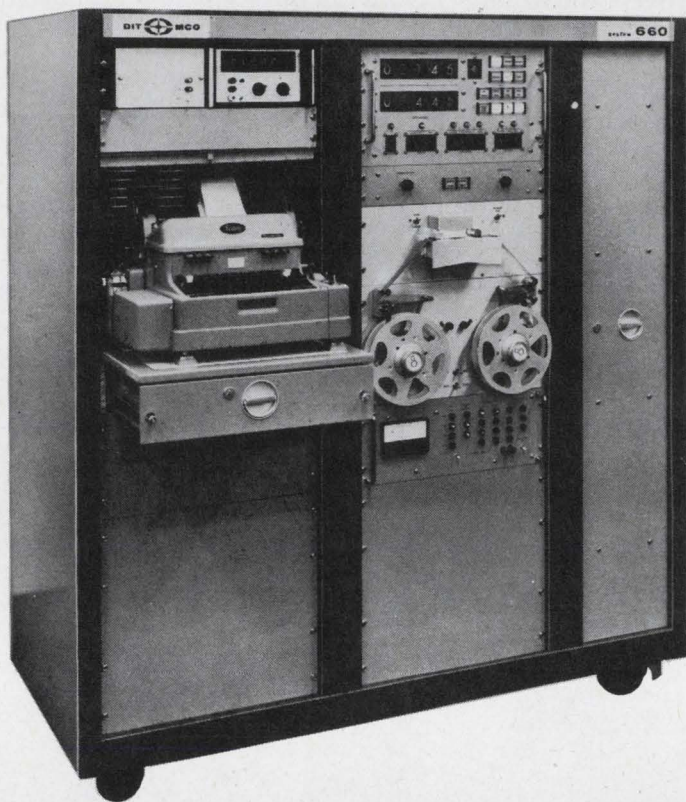

BREAKTHROUGH

Unique bar relay switching makes our DIT-MCO System 660 another in a series of major breakthroughs from the world's leading supplier of circuit testing equipment. Some people have no respect for the status quo.

For complete information, photos and spec sheets—write DIT-MCO INTERNATIONAL—A Division of Xebec Corporation—5612 Brighton Terrace—Kansas City, Missouri 64130.

EUROPEAN TECHNICAL REPRESENTATIVE
9, Dartnell Park Road
West Byfleet, Surrey, England
Telephone: Byfleet 45904



Circle 204 on reader service card

Upset stomach?

If you're looking for a remedy and you can't remember the name of a fast-acting brand, just consult the Trade Name Directory in your Electronics Buyers' Guide. You'll have your answer in seconds. EBG also has a Directory of Products and a Directory of Manufacturers and Sales Offices. Use it often.

Electronics Buyers' Guide
A McGraw-Hill Market Directed Publication,
330 West 42nd Street, New York, N.Y. 10036

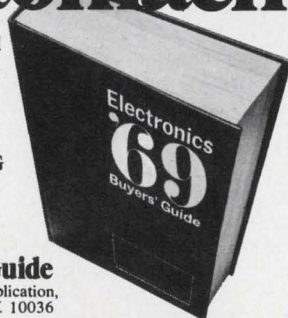

New components

Another photocell senses ultraviolet

Using a phosphor to detect radiation, this British device follows U.S. unit to market

A couple of months ago, Clairex Corp. introduced the first photoreistor sensitive to ultraviolet radiation (*Electronics*, June 24, p. 163). Now there's another on the market, this one made by England's Hird-Brown Ltd.

But this British cell, the UVS, isn't a me-too device. Its peak sensitivity is at a lower wavelength than that of the Clairex device, and it senses ultraviolet radiation with a phosphor rather than with zinc sulfide.

Hird-Brown hasn't yet set a U.S. price, but it's offering the UVS in Britain for \$30. Clairex is selling

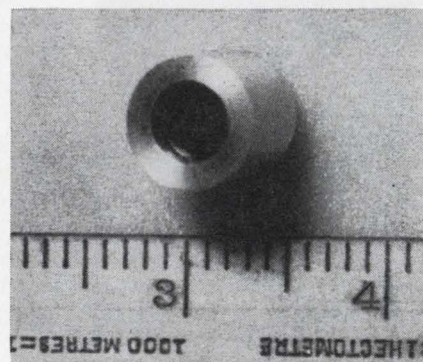

Falling off. The cell's resistance drops two orders of magnitude when u-v intensity goes from $1\mu\text{w}$ to $100\mu\text{w}/\text{cm}^2$.

its device in sample quantities in the U.S. at between \$10 and \$20.

So the U.S. customer will probably have to pay more for the British cell than he would for the one from Clairex. However, for the extra money he'll get a device that's less likely to be fooled by visible violet light. The Clairex cell's greatest sensitivity is at 3,700 angstroms, the fringe of the ultraviolet region (200 Å to 3,800 Å); the UVS's response curve peaks at 2,537 Å and falls away to mini-

Both a universal counter and a DVM

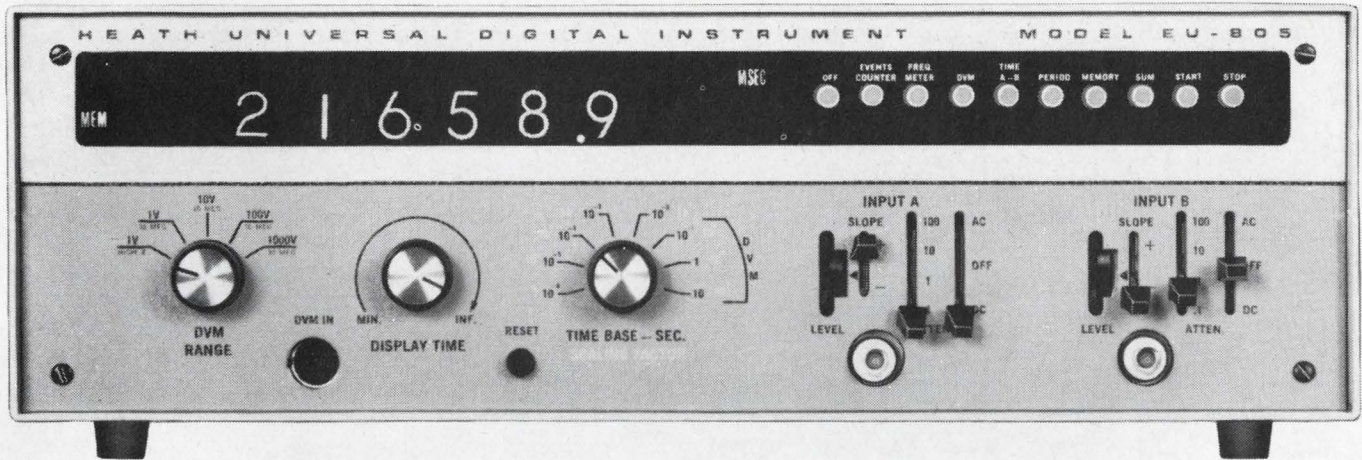

Heath Universal Digital Instrument only . . . \$1250

Now you need only one instrument, the Heath EU-805A to make any digital measurement you want. The UDI will measure all these functions: Frequency, Period, Ratio, Time-Interval, Events Count, Integrating DVM and Voltage Integrator. Combining in one standard rack package a DC-12.5 MHz Multi-Purpose Counter/Timer with a 0.05% accuracy Digital Voltmeter, the new Heath/Malmstadt-Enke EU-805A offers compactness on your bench and unmatched versatility. An original modular design based on plug-in cards with TTL IC's — cards stay in place for all 7 functions. And you can add new cards for other functions and protect the instrument from obsolescence.

The UDI features convenient fast cycling on slow time bases, unique summing function for continuous summation without display reset, memory starts new count scaling before previous count has cleared, variable display time from 0.1 s to 30 s, 6 digit read-out plus over-range.

The two identical high-sensitivity (10 mV) input comparators provide 1 MΩ impedance, complete range of trigger controls (including Automatic Mode), oscilloscope monitoring of triggering point and

four levels of input attenuation to accept up to 500 V. Input pulse resolution is better than 50 ns. Time base stability is better than 5 in 10^9 (short term) & 1 ppm (long term). Time bases range from 1 us to 10 s. Accuracy is ± 1 count.

DVM section has Automatic Polarity Indication, 5×10^9 ohm input impedance on separate 1 V range (10 MΩ on the others) four ranges from 1 to 1000 V, 10 uV resolution, 0.1 second to 10 second integrating time and V-F output available at rear panel.

The EU-805A is obviously the instrument you need . . . and it is obviously priced right: \$1250. Less DVM order EU-805D at \$940. DVM conversion pack costs \$340.

The UDI is part of the Heath Modular Digital System. Many of its cards may be used in the Heath/Malmstadt-Enke Analog Digital Designer EU-801:

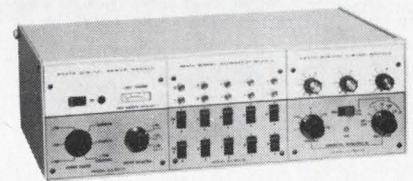

The ADD permits investigation and design of various analog and digital circuits and instruments, by plugging-in circuit cards to its power, binary and timing modules. Connections are made with ordinary wire and component leads.

<p>For more information send for the NEW HEATH Scientific Instrumentation Catalog</p>		<p>HEATH COMPANY, Dept. 580-04 Benton Harbor, Michigan 49022</p>
	<p><input type="checkbox"/> Please Send Free EU-805 UDI Spec. Sheet <input type="checkbox"/> Please Send Free EU-801 ADD Spec. Sheet <input type="checkbox"/> Please Send Free New Scientific Instrumentation Catalog</p> <p>Name _____ Company _____ City _____ State _____ Zip _____ (prices & specifications subject to change without notice) EK-253</p>	

LENS AND OPTICAL INSTRUMENT PROTOTYPES

DESIGNED AND FABRICATED

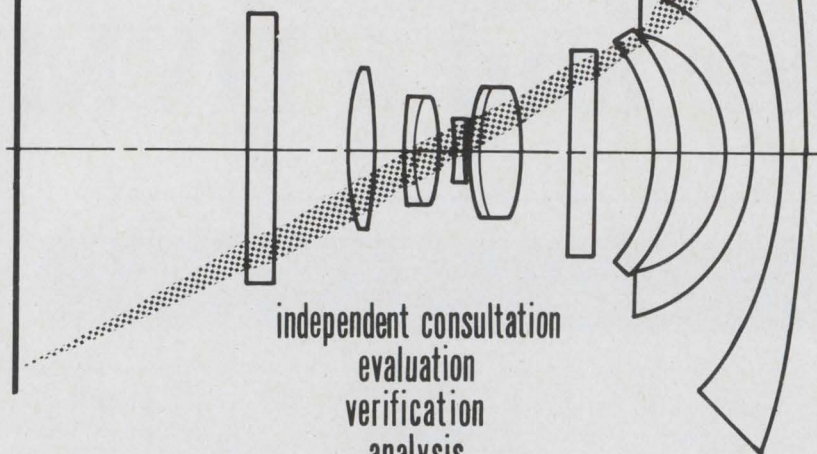

independent consultation
evaluation
verification
analysis
of existing designs



517 SOUTH CARROLLTON
NEW ORLEANS La. 79118
Ph. (504) 861-3688

OPTICS

Lewis Epstein will be pleased to discuss your needs and requirements in detail

Circle 207 on reader service card

How'd you like to
drill carbon plates
6 times faster?
Pinpoint accuracy—
even for unskilled
operators with the
new multi-spindle

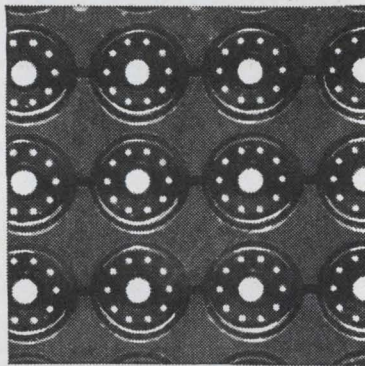

Engravograph[®]

Speed transistor mounting! Now anyone can drill six carbon plates in one operation from one template with registration and depth of hole controlled to a plus-or-minus .001" tolerance.

Drill up to 1600 holes per minute. Save time, labor... and especially costs.

For details write: Dept. 175.

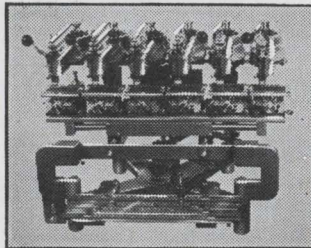

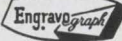
new hermes engraving machine corp. 

20 Cooper Sq., N.Y., N.Y. 10003 • Chicago, Atlanta, Los Angeles, Dallas, Montreal, Toronto, Mexico City

... resistance drops from
27 kilohms to 1 kilohm ...

mums at 2,300 Å and 2,650 Å.

Tough case. Hird-Brown engineers pack their cell in a stainless-steel case 15.8 millimeters in diameter and 16.6 mm high. Inside the case, which has a window of quartz-based glass, there's a phosphor that's excited by radiation and a detector that's sensitive to the light emitted by the phosphor.

In one model of the new cell, the UVS-254-53, resistance slides from 220 to 3.25 kilohms when the intensity of 2,537-Å radiation moves from 1 to 100 microwatts per square centimeter. The UVS-254-54 goes from 27 kilohms to 1 with a change of the same intensity.

Since the resistance-versus-intensity plot is logarithmic, the cell can easily be adapted to measure ultraviolet radiation as well as detect it.

Afterglow. Hird-Brown hasn't measured response times, but it puts rise time at 15 milliseconds and estimates that decay time is probably a lot longer because of phosphor afterglow.

The company had no specific application in mind when it built the cell; it says the UVS can be used any place vacuum tubes and barrier-layer detectors work. The device can be employed in hospitals to check a room's sterility by measuring the ultraviolet level, and in photography labs to detect those amounts of ultraviolet radiation that could distort colors.

A UVS handles up to 70 volts a-c or d-c, dissipates up to 0.5 watt, and works at from -40° to +70° C. The temperature coefficient goes from 1% to 1.8% per degree centigrade when intensity drops from 100 μ W to 1 μ W per square centimeter.

The cell was intentionally designed so that it can be easily fitted with a constant-temperature oven for increased stability.

Delivery time is one week for small quantities and six weeks for lots of more than 1,000 units. For two to five devices the price in Britain is \$26.40, and in quantities to 10, the price is \$24. For more than 10 cells, price is by quotation.

Hird-Brown Ltd., Bolton, England [350]

A CLARE
EXCLUSIVE!

What do you require
in a military-type relay?

Clare meets your needs
...exactly!

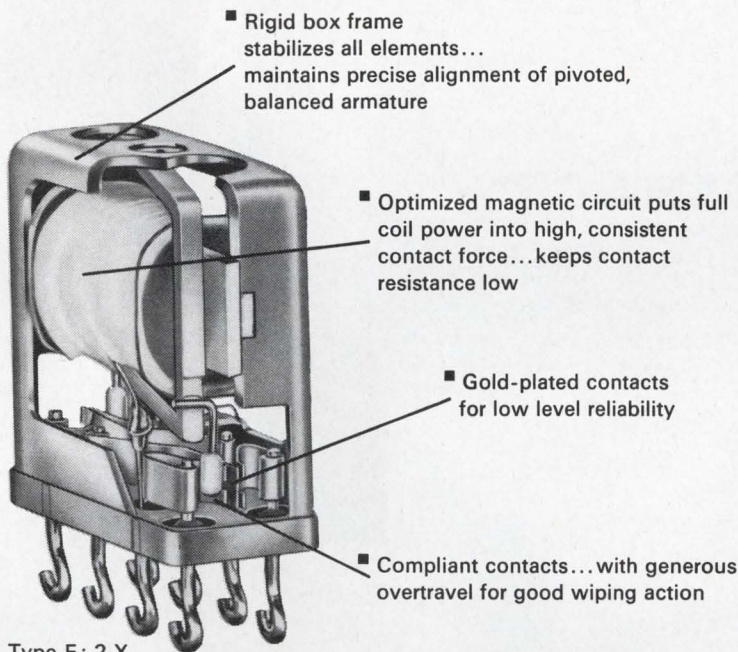

Type F: 2 X

Only Clare provides the range of performance characteristics...in crystal can to subminiature sizes...to meet military, industrial, and commercial relay applications without compromise.

The simple, precision construction of the Clare F relay (left) is the proven performance base of all Clare military relays—tough, dependable, built-for-action.

For overall switching reliability, every Clare military relay meets appropriate MIL-R-5757D requirements. All serve throughout a temperature range of -65°C to $+125^{\circ}\text{C}$. Shock capabilities range to 100G...vibration to 30G. Hermetically sealed, welded cases eliminate contamination.

Versatility in application is further extended by a broad range of mounting styles.

For complete information, circle Reader Service Number—or ask for data on the relay of your choice... Write Group 9N7.

C. P. Clare & Co., Chicago, Ill. 60645
... and worldwide



a GENERAL INSTRUMENT company

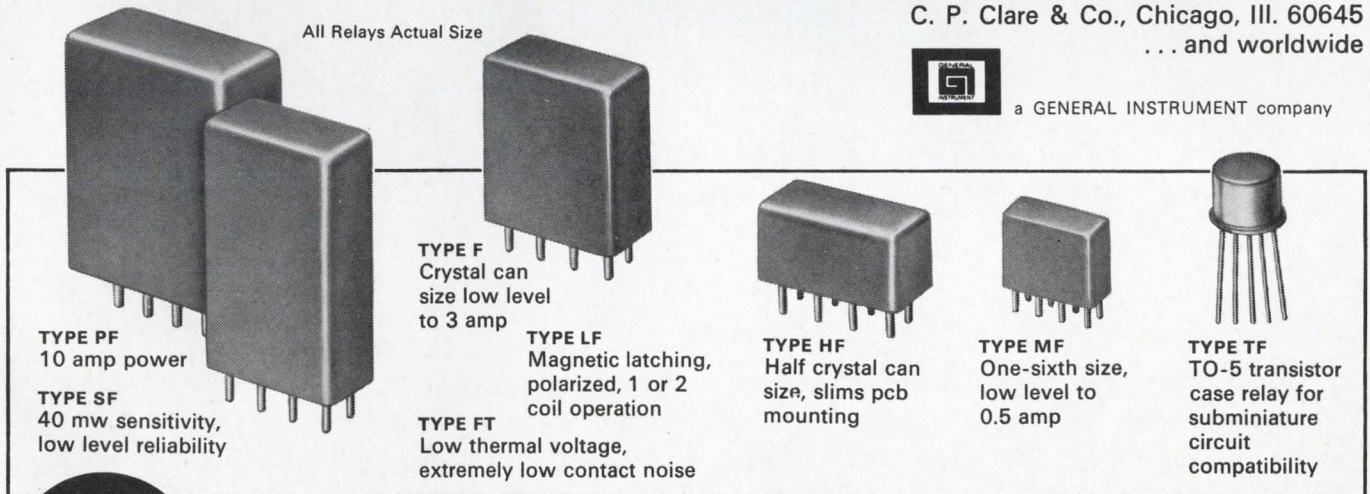

CLARE MILITARY-TYPE RELAYS

for airborne, aerospace, and ground support equipment,
communications, and industrial and commercial control systems

TWO NEW CERAMAG® 90° COLOR YOKE CORES FROM STACKPOLE

THE COMPACT

(Part No's 52-437, 52-506)

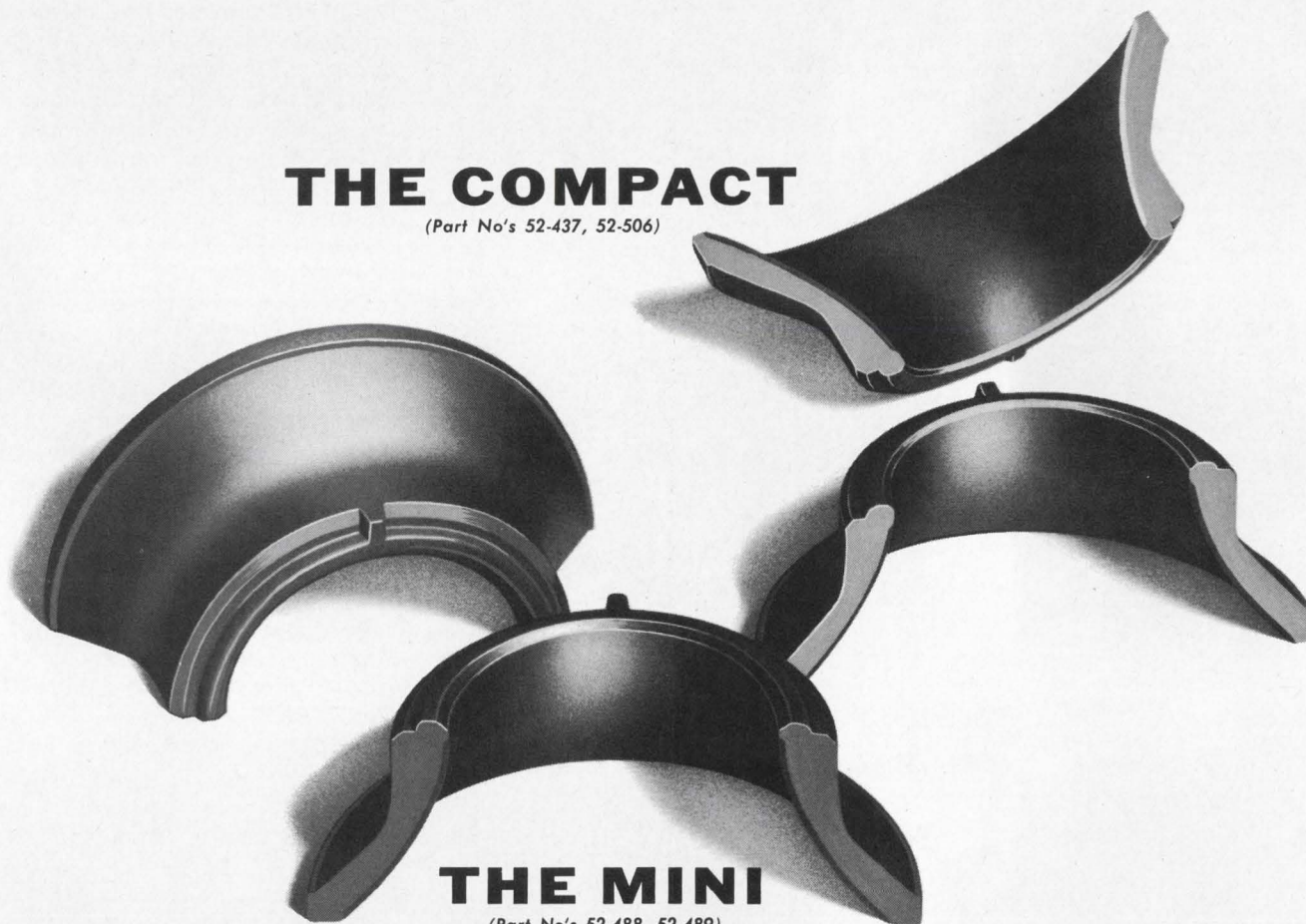

THE MINI

(Part No's 52-488, 52-489)

With deflection yoke cores that are 25% smaller, consider the savings in copper, hardware, labor and shipping costs, too. Both the Compact and Mini yoke cores are moulded from Stackpole's standard 7B ferrite material. Even though you benefit from smaller, more compact yoke size and appreciably lower prices, there is no sacrifice of nickel content with Ceramag® 7B. Curie is 160°C. $\pm 10^\circ\text{C}$. For specifications, samples, prices and delivery, call: D. L. Almquist, Electronic Components Division, Stackpole Carbon Company, St. Marys, Pa. 15857. Phone: 814-781-8521. TWX: 510-693-4511.



STACKPOLE
ELECTRONIC COMPONENTS DIVISION

ALSO A LEADER IN THE MANUFACTURE OF QUALITY FIXED COMPOSITION RESISTORS

New Instruments Review

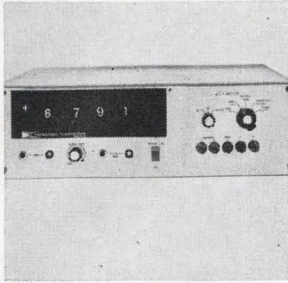

Digital multimeter 4243 measures d-c and a-c voltages and resistance to an accuracy of 0.01%. The solid state unit is for systems as well as bench-type uses. D-c and a-c voltage ranges are 0.9999 v d-c, 9.999 v d-c, 99.99 v d-c, and 9999.9 v d-c, and resistance is measured from 999.9 ohms to 9.999 megohms. Price is \$850. Trymetrics Corp., 204 Babylon Turnpike, Roosevelt, N.Y. [361]

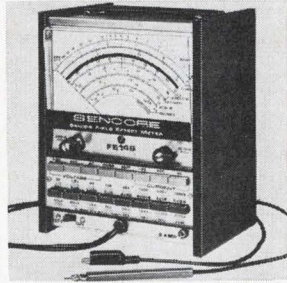

Field effect meter model FE149 features simplified operation with push-button design. With accuracy of 1.5% on d-c and 3% on a-c, plus a 7-in. meter and mirrored scale to prevent reading errors due to parallax, extremely accurate tests are assured. The unit provides 8 d-c voltage ranges to 1,500 v; 8 resistance ranges to 6,000 megohms. Price is \$149. Sencore Inc., Addison, Ill. [362]

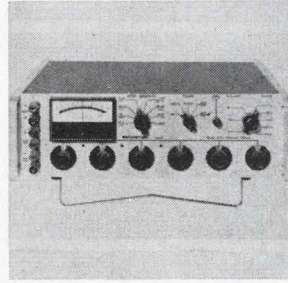

Differential voltmeter model A-72 features $\pm 0.002\%$ accuracy and 2 ppm/day stability. Short term stability is such that a 1/10 ppm or 0.1 μv voltage change can be detected. The instrument has 6 readout dials and 5 ranges from 110 mv to 1,100 v full scale. Price is \$1,125; availability, 10 days. Medistor Instrument Co., 4503 8th Ave. NW, Seattle Wash. 98107. [363]

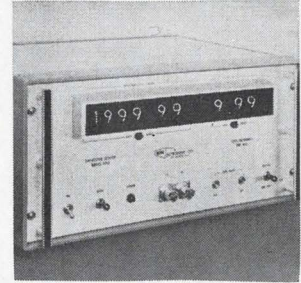

Capacitance tester 1212 provides 1 Mhz digital display of dissipation factor. Capacitance is read from 0 to 1999.99 pf with basic 6-digit in-line readout accuracy of $\pm 1/2\%$ of reading, ± 3 digits. Dissipation factor is read on the 3 in-line readouts from 0 to 9.99% with accuracy of $\pm 1\%$ of reading, ± 3 digits. Micro Instrument Co., Crenshaw Blvd., Hawthorne, Calif. [364]



A-c/d-c transfer standard model ATS converts a d-c digital voltmeter, potentiometer, or any d-c measuring system to a true rms measuring system. Its rated accuracy, 0.01% of reading, covers the range of 0.25 to 1,000 v and 5 khz to 20 khz. The unit sells for \$3,500 and is available from stock. Singer Co., Metrics Division, 915 Pembroke St., Bridgeport, Conn. [365]

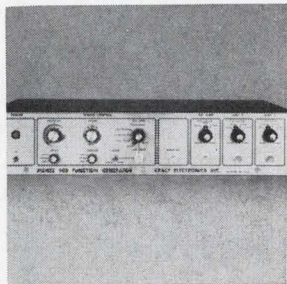

Function generator model 503 uses 3 independent amplifiers to provide 3 simultaneous and separate outputs at frequencies from 0.0001 hz to 1 Mhz. All three output signals can be varied from zero to approximately 25 v peak-to-peak into 600 ohms. Units measure 16 3/4 x 3 1/2 x 14 3/4 in. Price is \$525; availability, stock to 3 weeks. Exact Electronics Inc., Box 160, Hillsboro, Ore. [366]

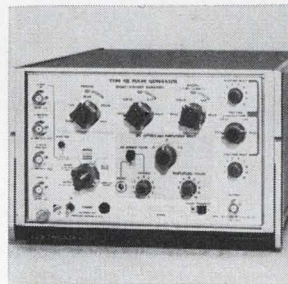

Pulse generator type 115 is a 10-Mhz, 10-v unit for use where a variety of pulse amplitudes, polarities, and shapes are required. Risetimes and falltimes are continuously variable from 10 nsec to 100 μsec and periods variable from 100 nsec to -0 msec. Pulse widths are variable from 50 nsec to 500 μsec with duty factors to 75%. Tektronix Inc., Box 500, Beaverton, Ore. [367]



Solid state noise generator model 602A-1390 provides a random output. Three output ranges of 5 hz to 20 khz, 5 hz to 500 khz, and 5 hz to 5 Mhz are selectable by a front panel range switch. Output level is continuously adjustable from 0 to 3, 0 to 2, 0 to 1 v rms on the 3 ranges respectively. Price is \$330. Elenco Inc., 1550 Euclid St., Santa Monica, Calif. [368]

New instruments

Frequency counter extended into uhf

Basic digital readout for receiver plus companion unit make up a low-cost synthesizer covering 30 to 1,000 Mhz

By pairing its \$2,800 DRO-302A digital-readout counter with its new \$1,750 DRX-1000 digital-readout extender, Communication Electronics Inc. has developed an instrument that displays tuned receiver frequencies from 30 to 1,000 megahertz.

"They make a poor man's synthesizer," says the firm's engineering manager, Peter S. Pao, since comparable units, designed strictly for laboratory use, cost about \$15,000. Although CEI's system isn't quite as accurate as the more expensive models (the duo will stabi-

lize a receiver to within ± 1 kilohertz), it's not only cheaper but operates over a wider range than the synthesizers, which usually cover up to 150 Mhz.

Steering the tandem is the DRO-

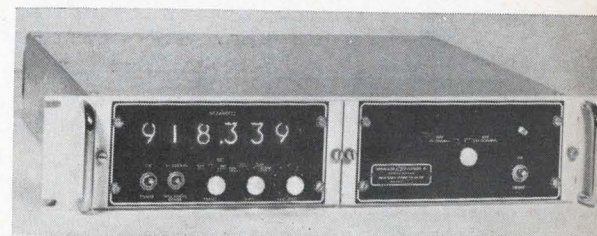

Stretchout. Extender, at right, pushes counter's range up another 700 Mhz.

We just took a great step backwards



(with three new, forward-looking unitized DVMs)

Trymetrics' new 4243 Digital Multimeter with AC, DC and OHM readings—auto polarity—full four digit—.01% (\$850) . . . a tremendous step backwards. And so are the 4240 DVM (\$695) and 4230 DVM (\$595).

We started with our Model 4100: stored display—precision .01%, four-digit DVM and its full range of plug-ins for the price of an ordinary 3-digit job—just \$740 with the ± 9.999 v DC head; \$1045 with a complete multimeter head; and eight other plug-ins to choose from. For an encore, the only way to go was down.

Down \$195 to \$850 for the versatile 4243 Digital Multimeter: DC-AC-OHMS .01% — auto polarity ± 999.9 mv to ± 999.9 v. Same 4-digit stored display—no plug-ins. Sorry—unless you don't need plug-ins.

Down again, \$155, to \$695, for the 4240 DVM. Same high accuracy, same stored display, same ± 999.9 mv DC to ± 999.9 v DC 4-digit measurements. But, no AC or OHMS—unless, of course you don't need AC or OHMS.

Once more, down, to \$595 for the Trymetrics 4230 DVM. Still the same precise 4-digit unit with readings ± 9.999 v DC to ± 999.9 v DC. Don't buy this one if you need to measure in the low millivolts.

You don't need true 4-digit readout with .01% accuracy at a 3-digit, .05% price? Sorry—but we can't keep backtracking forever. May we send you our new catalog that shows ALL our models, all our plug-in versatility, all our reasons for going backwards?

PRICES SLIGHTLY HIGHER IN EUROPE.

TRYMETRICS
Corporation
A SUBSIDIARY OF TRYGON ELECTRONICS, INC.
204 Babylon Tpke., Roosevelt, L.I., N.Y.
Phone 516-378-2800 11575

302A counter introduced earlier this year. Used alone, it can indicate the tuned frequency of a receiver with a 21.4-Mhz. intermediate frequency over a range of 30 to 300 Mhz. And it can display the tuned frequency of high-frequency receivers down to 10 khz.

The solid state DRX-1000 extends these capabilities another 700 Mhz, into ultrahigh-frequency bands. Receivers or tuners can be locked to any desired frequency in the 30-1,000-Mhz range in 1-khz increments; the frequency is indicated on a Nixie-tube display.

The extender's only operating control is a range switch that selects input frequencies in the 30-to-300 Mhz or 235-to-1,000 Mhz ranges. If the first is selected, the local oscillator signal is routed directly into the counter. In the case of the 235-to-1,000-Mhz range, the input signal is beat with the signal from a crystal-controlled transfer oscillator in a double balanced mixer to produce an output signal within the range of the associated counter.

Together, the DRX-1000 and the DRO-302A fill a standard 19-inch rack. The duo operate on 115 or 230 volts a-c and 50-to-400 hertz power. A minimum local oscillator input of 50 millivolts is needed over the full frequency range.

Each unit, Pao notes, is designed to be used with other manufacturers' devices. CEI will eventually put a common faceplate on the two devices and sell them as a single item.

Communication Electronics Inc., 6006 Executive Blvd., Rockville, Md. 20852 [369]

New instruments

Relay won't wait for a reading

IC switch and a meter
are put in one package
but act independently

The **Ultimeter** is both a reporter and a traffic cop. Built by the API Instruments Co., the device is a re-

lay-meter that measures d-c signals in ranges down to 0 to 1 micro-ampere and 0 to 1 microvolt.

The user may find the meter fast, but the relay's a good deal faster. Built with integrated circuits, the relay has a 50-millisecond response time. As soon as the input reaches a set point, the relay trips. It doesn't wait for the pointer to move to the correct value, and will work even if the meter is broken.

API says the Ultimeter can be almost any type of measuring instrument—ammeter, voltmeter, pyrometer, and so forth. All it needs is a d-c input.

Any additional control circuitry can be supplied in an optional module, or API engineers will pack this circuitry into the Ultimeter's case, which is 3¼ by 4½ by 5½ inches.

Too fast. In one way, the Ultimeter is too fast for its own good. Al-

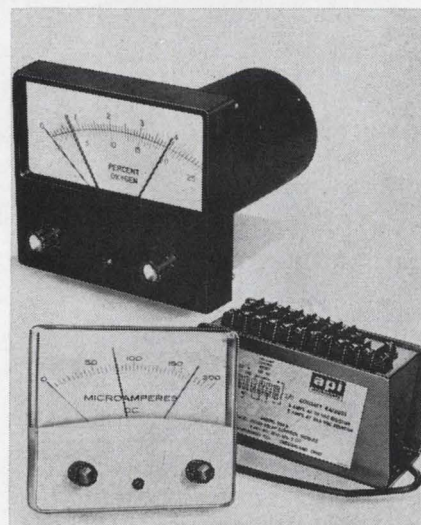

In or out. Control circuitry can be built into the Ultimeter or supplied in a separate module.

though generally interchangeable with existing meter-relays, the Ultimeter can't just be plugged into a line where there's a lot of noise. API points out that mechanical relays smother noise just by being slow. But the Ultimeter needs external filters to keep out high-frequency interference.

API will begin deliveries in November, and by the first of next year expects to have a model that controls temperature-regulating devices. The price ranges from \$100 to \$200.

API Instruments Co., 7100 Wilson Mills Rd., Chesterland, Ohio [370]

LINEAR INTEGRATED CIRCUIT PRICES

TUMBLE!

You may flip when you see them. One has been reduced 85% . . . to \$.75 (100-up). It's just like getting resistors, assembly and wiring FREE . . . compared to discrete componentry. (Active Components — \$.09 each). Best of all, they're in hermetically-sealed packages. Here's the list of "tumblers":

Device Type	Description	Old Price (100-Up)	New Price (100-Up)	% Reduction
MC1433G	Operational Amplifier	\$5.50	\$1.95	64%
MC1437L	Dual Operational Amplifier	8.50	3.25	62%
MC1439G	Operational Amplifier	7.50	1.80	76%
MC1440G	Sense Amplifier	8.00	1.50	81%
MC1550G	High Frequency Amplifier	4.85	.75	85%
MC1709CG	Operational Amplifier	5.50	1.95	64%
MC1710CG	Sense Amplifier	4.00	1.95	51%
MC1711CG	Dual Differential Amplifier	6.50	1.95	70%
MC1712CG	Operational Amplifier	2.95	1.95	34%

Call your nearby Motorola Semiconductor distributor. He'll tumble over with an evaluation unit, pronto! For complete data and volume pricing, contact the Motorola sales office nearest you.

- where the priceless ingredient is care!



MOTOROLA
Integrated Circuits

P. O. Box 20912 / Phoenix, Arizona 85036

an-ten'na 1. A wirelike growth on the head of a lobster. 2. An elevated conductor of electrical waves; that which in log-periodic designs Granger has more of than anybody.

az'i-muth The desired direction in which G/A antennas concentrate your signal.

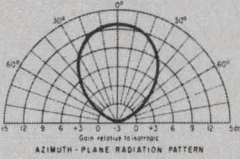

ba'lun 1. An impedance transformer; connects 50 ohm co-ax to open wire lines. 2. A non-porous bag filled with hot air or gas.

cur'tain 1. Opening of a great performance. 2. An ordered arrangement of wires precisely engineered and factory fabricated for easy installation and long life as part of a G/A log-periodic antenna.

dec'i-bel (pronounced dee-bee) A measure of what G/A's h-f products can contribute to your system performance; usually in groups of 40 or 50 in the important characteristics of G/A receivers.

ex-cit'er Any of the new G/A h-f products; specifically, our new solid-state h-f unit with LSB, USB, CW, AM, and with FSK-ability.

fast-switch A rapid change between two pretuned frequencies (e.g. in 50 milliseconds); a characteristic of one of G/A's new transmitters.

gain 1. That which our products contribute to your communications

system's performance. 2. A tag, benefit or profit to be concerned.

h-f 1. Typically the frequency from 3 to 30 MHz. 2. In G/A equipment the band between 2 and 32 MHz.

im'age A reflection; the receivers don't have; the antennas use to fullest.

i-on'o-sphere A fictitious layer used to bounce signals back to earth; its erratic behavior can be measured in real time (see *sounder*).

log per-i-od'ic The most versatile, compact precision h-f antenna design; available from Granger in many variations (e.g. rotatable, steerable, transportable, unidirectional).

mode 1. Ice cream on pie. 2. Method of doing (e.g. SSB, ISB, FSK, CW, AM); that which you have a full choice of in our equipment.



mon'o-pole 1. A game wherein you receive \$200 for passing GO. 2. A compact reliable omnidirectional antenna offered by Granger Associates.

om-ni-di-rec'tion-al Going off in all directions; a capability of certain G/A antennas.

po-lar-i-za'tion di-ver'sit-y A combination of vertical and horizontal antennas to overcome fade; a space-saver.

point-to-point From here to there

with no wires; done with ionospheric mirrors.

ra'di-o-tel-e-phone (pronounced TELETRANSCEIVER) A small but mighty G/A device that goes anywhere; specif. the Australian outback, remote Pacific islands, African veldt, etc.

ro-ta'ta-ble Capable of revolving; a new log-periodic antenna from Granger Associates offering reliable performance from 5.5 to 32 MHz.

re-ceiv'er A new solid-state G/A unit that selects your message from many others and renders it clearly intelligible.

se-lec-tiv'i-ty The quality of careful discrimination, as in G/A receivers; pert. to elimination of extraneous signals.

sound'er 1. A device used in early telegraphy. 2. A precise instrument for measuring the ionosphere; an efficiency expert in h-f communications.

SSB 1. In aviation, the supersonic balloon. 2. In radio communications, what nearly everyone will be using by 1971; we can help.

trans-mit'ter A microphone-antenna interface device; available from G/A in 1, 3 and 5 kw versions.

VSWR Abbr. for voltage standing wave ratio; less than 2.0:1 in almost all of our antennas.

ze'nith 1. A vertical take-off angle. 2. The name of another famous radio company.

G/A knows h-f from A to Z

Send for complete information to learn how we can spell out solutions to your communications problems.

Granger Associates / 1601 California Avenue, Palo Alto, California 94304 □ Granger Associates Ltd. / Russell House, Molesey Rd., Walton-on-Thames, Surrey, England □ Granger Associates Pty. Ltd. / 1-3 Dale St., Brookvale, N.S.W., Australia

New Subassemblies Review

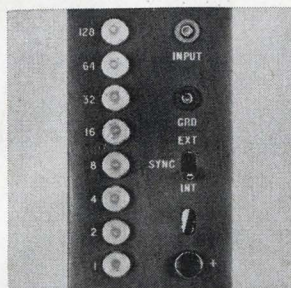

Analog-to-digital converter model DCM-1 has a 2.8 in. panel height and allows 14 converters to be installed in a 3½ x 19 in. rack adapter. Visual display of binary output is provided by 8 miniature lamps on the front panel. Output is 8 bits parallel in a natural binary code. Word conversion time is 256 μ sec max., 1 μ sec minimum. Defense Electronics Inc., Rockville, Md. [381]

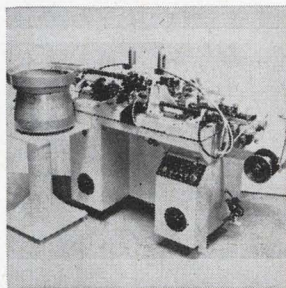

Digital count-printer is for recording count totals and time intervals. Solenoid actuated, it continuously registers sequential input pulses up to 600 per minute, and will print the accumulated total when desired. Models are available in either 1 or 2 channels, printing in-line on a single 3-in. paper tape. Mechanics For Electronics Inc., 152 Sixth St., Cambridge, Mass. [382]

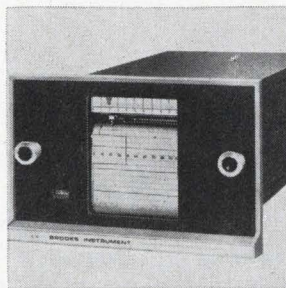

Solid state, wideband air-to-air relay link features a deviation capability of ± 24 Mhz and a video baseband of 20 Mhz. The relay link consists of a model FMR 9.6 receiver (illustrated) and model FMT transmitter and meets MIL specs for airborne equipment. Typical uses are in reconnaissance and surveillance. RHG Electronics Laboratory Inc., Farmingdale, N.Y. [383]

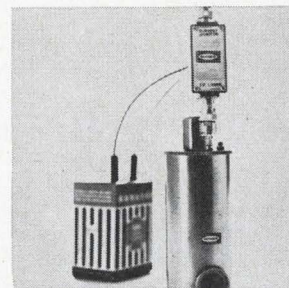

Indium-arsenide laser model IAL-6, with an output at 3.18 microns, can be used for wavelength calibration, as a radiation source for detector response-time measurements, or for general i-r illumination, replacing more costly and complex illuminators. I-r detector rise time as short as 60 nsec can be measured. The system costs \$940. Raytheon Co., Foundry Ave., Waltham, Mass. [384]

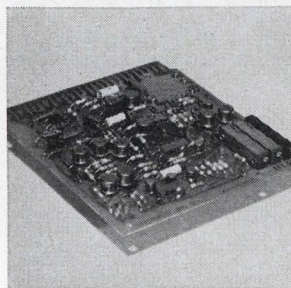

Universal operational amplifier HT58 can be used single-ended or differential, or as a buffer with variable gain. Accuracy is 0.01% to cover almost all requirements. Output of ± 40 ma at ± 10 v full scale will drive large capacitance loads. Slew rate is 10 v/ μ sec. Common mode rejection is 100 db at d-c. Scientific Data Systems, 1649 17th St., Santa Monica, Calif. [385]

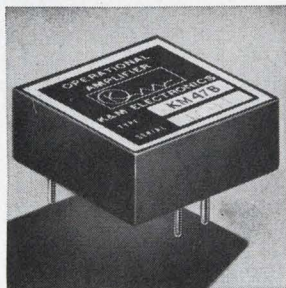

FET power amplifier model KM-47B exhibits a 200-ma output at ± 10 v and typical input impedance of 10^{12} ohms. Bias current is 10 pa max. The internally compensated device is suited for integrators and buffers in instrumentation, control and computation applications. Price (1 to 9) is \$50 each. K&M Electronics Corp., 102 Hobart St., Hackensack, N.J. [386]

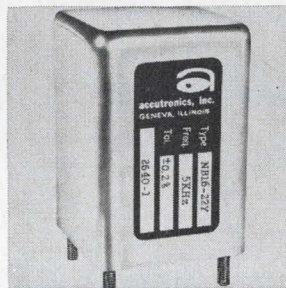

RC voltage controlled oscillator series NB provides frequencies between 1 khz and 40 khz as specified with frequency tolerances of less than $\pm 0.2\%$ over a temperature range of -20° to $+50^\circ$ C. Frequency deviation of $\pm 10\%$ with linearity better than $\pm 0.1\%$ is standard. Price ranges from \$235 to \$385. Accutronics Inc., 628 North St., Geneva, Ill. 60134. [387]

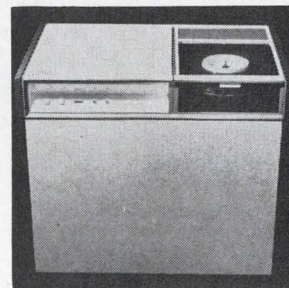

Disk storage drive M2500, completely interchangeable with IBM's 2311 unit, has average random access time of 48 msec and error rate of less than 1 part in ten billion. It offers a direct-seek actuator for positioning heads in a single mechanical action, eliminating errors. Price is \$19,750. Marshall Laboratories, 3530 Torrance Blvd., Torrance, Calif. 90500. [388]

New subassemblies

Logic trainer has movable modules

Student can set up simple or complex digital systems with plug-in circuits on device's pegboard

Pegboards aren't new to engineering schools or in-plant training sections, but usually they're part of a crosspatching arrangement. On the pegboard of a new training aid, the circuits themselves, not just patchcords, are moved around.

In using the device, built by

Adtech Inc. for teaching the basics of logic-circuit design, the student engineer plugs in block-shaped modules, each of which performs a specific logic function.

Called the 401 Logic Laboratory, the device is for both the student with homework headaches and the

designer with breadboarding problems. A user usually starts out with a logic diagram of a circuit. He selects the modules, called logic-cubes, that correspond to the digital circuits called for by the diagram. There are 44 types of logic-cubes, ranging from a simple gate up to a counter complete with decoder, driver, and Nixie display.

After selecting the cubes, the user plugs them into the 401's 32-by-18-inch pegboard, orienting them in the same way—forwards, backwards, up, or down—as the logic symbols are oriented in the diagram. He then connects the cubes with patchcords; up to 100

The PARKER model ER 35

will
really

TURN YOU ON . . . or OFF,

OR ON OFF ON, OR OFF ON OFF, OR WHATEVER YOUR
MOOD AND APPLICATION MAY BE !

- Completely Self-Contained Indicating and Control Meter.
- See it at ISA SHOW BOOTH 2825



PARKER INSTRUMENT CORP.

200 HARVARD AVE. STAMFORD, CONN. 06904 tel-203 325-4361 TWX 710-474-2277

Circle 215 on reader service card

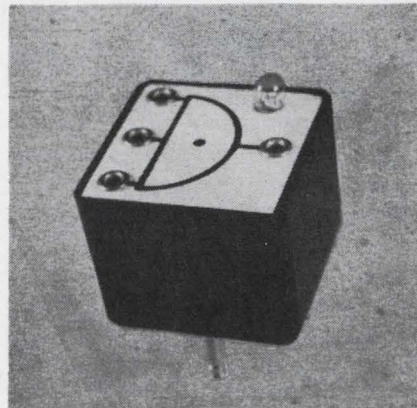
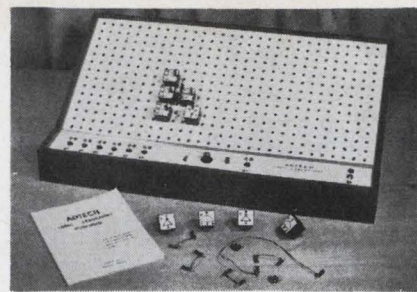
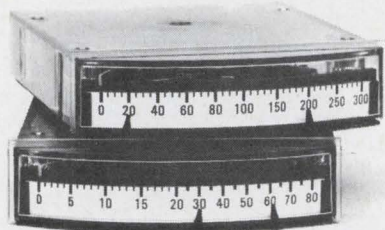

Warning. The light in the cube's upper right-hand corner indicates whether the cube is working.

cubes fit onto the 401's board.

Two advantages. Many competitive logic trainers have fixed-position modules. Adtech says the 401 is superior to this type for two reasons. First, it doesn't have a lot of wires obscuring the circuit. And the 401 makes it easier to learn what's going on in a digital system, because the layout on the board looks exactly like the logic diagram.

Most of the cubes are 1½ by 1½ by 1¼ inches; the ones that perform the more complex functions are 2½ by 2½ by 1¼ inches. On the top of each cube are digital input and output terminals, the appropriate logic symbol, and an indicator light that's on when the output is 1. Input-power and ground leads are on the bottom.

Prices of basic modules like gates and flip-flops are around \$15; more complex functions can cost as much as \$85.

A set of 26 cubes, enough to set up most basic circuits, costs \$324.

Six logic sources, three clocks—1, 5, and 60 hertz—and, a 5-volt d-c, 4-amp supply are part of the 401. It's 32 by 18 by 12 inches, weighs 30 pounds, and costs \$596.

Adtech Inc., P.O. Box 10415, Honolulu, Hawaii 96816 [389]

NEW

50 AMP SCR

POWER SUPPLY **\$649**



CHRISTIE
SINCE 1929

Technological advances enable CHRISTIE to offer an economical 50 amp SCR power supply with improved performance and reliability.

CHRISTIE ELECTRIC CORP.
3412N West 67th Street
Los Angeles, Calif. 90043
Phone (213) 750-1151

- 1.5-37 VDC, 0-50 AMPS
- ± 0.25% voltage regulation
- ± 1.5 amp current regulation
- 1% rms ripple
- 25/100 msec response

Other SCR power supplies up to 135 volt or 600 amps

**TRANSIENTS
IN THE AC INPUT LINE
WON'T HURT YOUR PRODUCT
DESIGNS IF YOU SPECIFY
JOSLYN AC PROTECTORS**

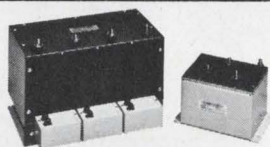

For ultra fast precision response clamping at extremely low levels any kva rating with line voltages up to 650 v rms max. life expectancy that exceeds that of your product no power interruption and no line insertion loss (exc. 1201-02).

Call or write now for full information on 1200 single-phase, 1400 three-phase 60-cycle Series Protectors. Just two of many surge arrester lines.



JOSLYN
ELECTRONIC SYSTEMS

Division of Joslyn Mfg. & Supply Co.
SANTA BARBARA RESEARCH PARK
P.O. BOX 817, GOLETA, CALIFORNIA 93017
Tel. (805) 968-3551.

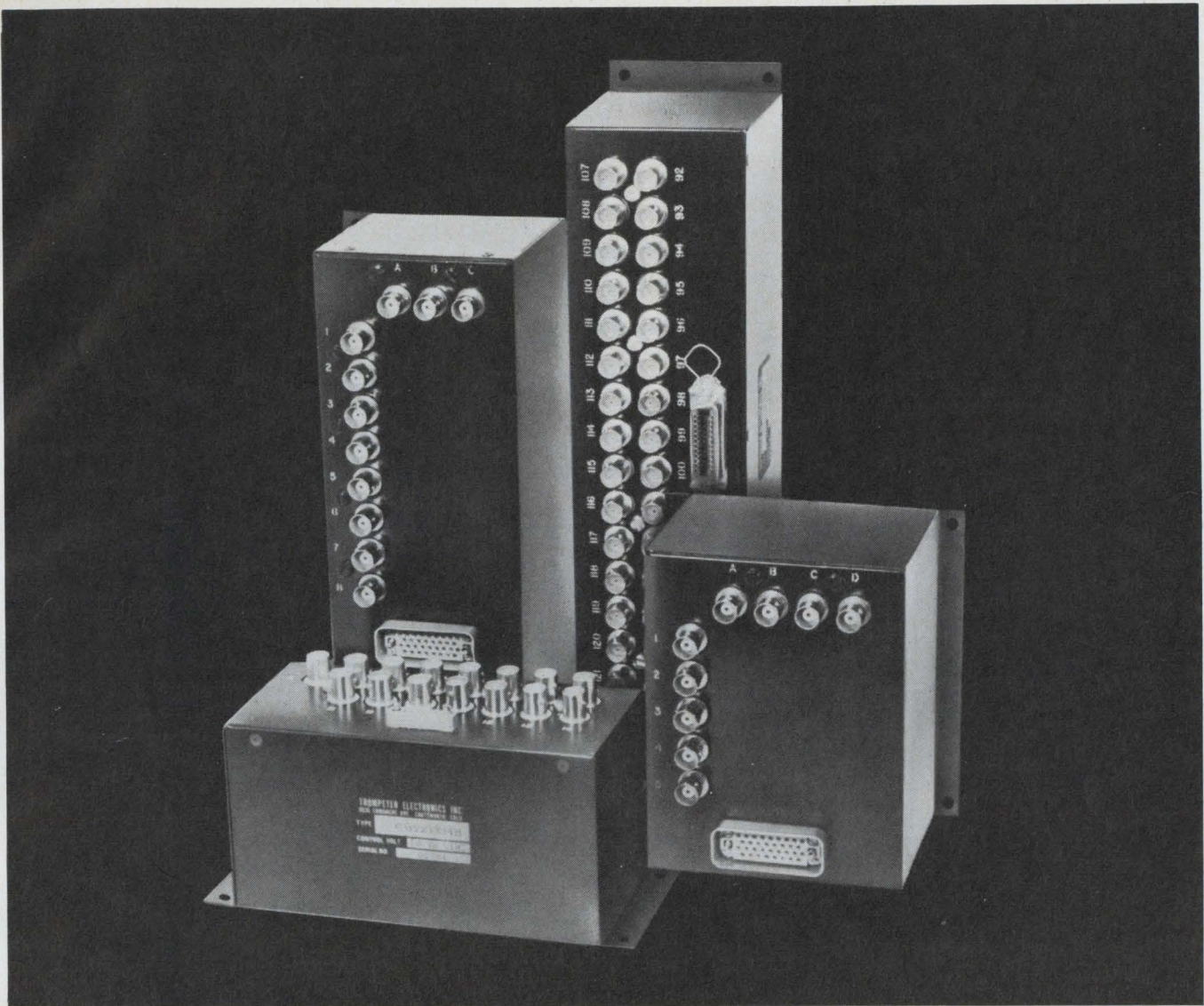

Instant Switch

...Just plug in and start switching... We don't give you a handful of parts to strap together! Trompeter Matrices and Switches come to you as a completely assembled system that has been carefully tested to meet your specifications. Available in twinax or coax configurations, they are pre-programmable, electrically activated systems configured as cross point matrices (crossbar), featuring low cross talk, high isolation, hermetically sealed contacts, fast activation time, excellent high frequency and pulse responses and excellent electro-magnetic shielding. As video data and switching matrices, systems are available in either X,Y plane, or X,Y,Z and multi-level formats with isolation up to 110db at 60MHz. Switches are available in multi-pole, multi-throw formats up to 20 poles, 20 throws in both coax and twinax.

Now, if you still want to use the modular approach... Okay! We have a building block matrix system also available that helps to eliminate a lot of the usual fuss and high cost of assembling such a system. And incidentally, we'll even take on the system's responsibility! ... Ask for our new catalogue M-5.

TROMPETER ELECTRONICS, INC.

8936 Comanche Avenue. □ Chatsworth, California 91311 □ Telephone (213) 882-1020

$$\begin{array}{r} 1 \\ + 1 \\ \hline 2 \end{array}$$

Two for the Price of One . . . New Dual Op Amp from Amelco

COMPARISON GUIDE

THE AMELCO 810CJ \$5.90

The 810 consists of two complete, overvoltage and short circuit proof amplifiers on a single monolithic chip in a 14 lead dual in-line package. It is pin interchangeable with the dual 709. Typical specs for each amplifier are

Gain: 40,000	CMR: ± 13 V
Offset: 1 mV	CMRR: 90 db
100 nA	Input Current: 500 nA
Tracking: $10 \mu\text{V}/^\circ\text{C}$	Input Impedance: 200 K Ω
1 nA/ $^\circ\text{C}$	

Compensation: single component with no power supply by pass necessary

Brand F	($\mu\text{A}709\text{C}$)	2 x 5.95	11.90
Brand N	(LM201)	2 x 8.80	17.60

Competitive prices based on best information available to us—quantity 100 pieces. Ask about our 811CE offering the performance above in the 709 pin configuration.



Amelco Semiconductor, 1300 Terra Bella Ave. • Mountain View, Calif. 94040, Phone (415) 968-9241

Circle 217 on reader service card

New Microwave Review

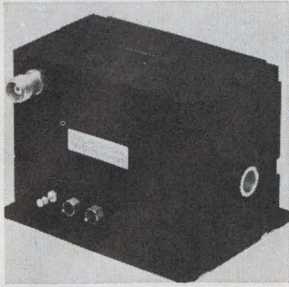

C-band, crystal controlled, phase locked oscillator is a 10-mw unit for telecommunications applications. It offers a guaranteed stability of $\pm 0.005\%$ from -30° to $+60^\circ$ C over the 5.855 to 6.455 Ghz band. Residual f-m is less than 10 hz in a 1 khz bandwidth from 10 khz to 5 Mhz. Power output is 10 dbm. California Microwave, 1188 Elko Drive, Sunnyvale, Calif. [401]

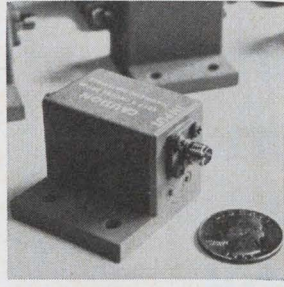

Miniature X-band coaxial isolator has 1.1 Ghz bandwidth (8.5 to 9.6 Ghz). Isolation is 60 db minimum; insertion loss, 0.5 db max.; and vswr, 1.25 max. The unit is $1\frac{1}{2} \times 1\frac{1}{8} \times \frac{3}{4}$ in., weighs 3 oz, has OSM connectors, can withstand extreme shock and vibration, and is temperature-stabilized over a wide thermal range. Micromega, Del Ray Ave., Venice, Calif. [402]

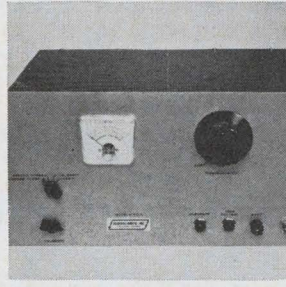

R-f power generator series HV is for research applications. Power output is adjustable to 100 w at 2,450 Mhz. Built for continuous output monitoring, the unit includes forced-air cooling, time delay relay to allow magnetron warm-up, and protection against "no-load" damage. Price is \$975. Scintillonics Inc., 600 Fort Collins Industrial Park, Fort Collins, Colo. 80521. [403]

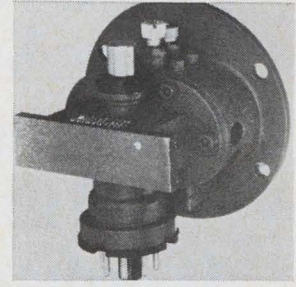

Reflex klystron oscillator has 1.5-w output from 6.575 to 6.875 Ghz. Full range tuning is with screw adjustment, and a 30-Mhz band can be tuned electrically. Tube is $2.34 \times 3.5 \times 2.2$ in. and weighs 22 oz. Cooling is by conduction or vapor. Input connector is a small-wafer octal plug; output flange mates with UG-344/U flange. Varian, 611 Hansen Way, Palo Alto, Calif. [404]

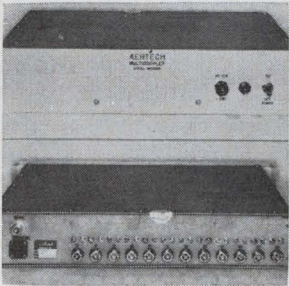

Multicoupler model M5804H operates over the 2.2 to 2.3 Ghz range. It features 12 outputs with an output-to-output isolation figure of 70 db. Intermodulation product is $+3$ dbm at intercept point. Gain is 1 to 5 db with an output, 1 db compression point of -10 dbm. Noise figure (ambient temperature) is 8 db maximum. Aertech, 815 Stewart Drive, Sunnyvale, Calif. [405]

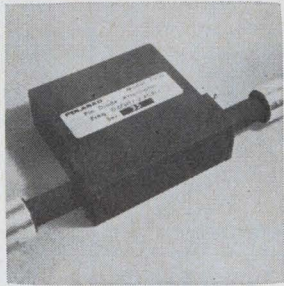

L-band pin attenuator model 7950 has a dynamic range of 20 db and a max. vswr from min. to max. attenuation of less than 1.5 db. Frequency range of the $1 \times 3 \times 7$ in. unit is 0.6 to 2.4 Ghz. Typical rise time when driven by appropriate pulse modulator is less than 200 nsec. Price is \$250 in quantities of 1-9. Polarad Electronic Inst., Long Island City, N.Y. [406]

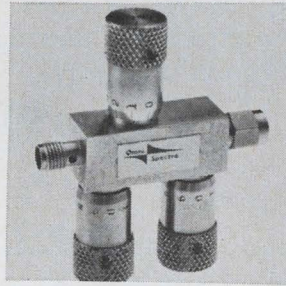

Triple stub coaxial tuner model 20360 is designed to match out reflections from connectors, adapters, coaxial terminations and measuring instruments. The match produced is frequency insensitive. Designed for the 2 to 10 Ghz range, the tuner may be used up to 26 Ghz. Dimensions are $2.3 \times 2 \times 0.5$ in. Omni Spectra Inc., 24600 Hallwood Ct., Farmington, Mich. [407]

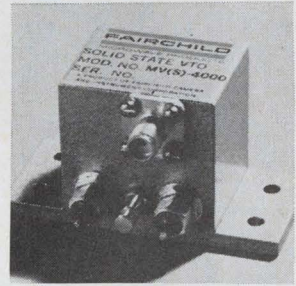

Voltage tuned fundamental oscillators come in 4 models. Two cover the 0.5 to 1 Ghz band; and one each cover the 1 to 2 and 2 to 4 Ghz bands. They offer power outputs from 50 to 200 mw depending on octave range over a -30° to $+60^\circ$ C temperature range. Harmonic content is more than 20 db below the output. Fairchild Microwave Products, Mtn. View, Calif. [408]

New microwave

30-Ghz amplifier has 600-Mhz bandwidth

Parametric device with 15-db gain, 3-db noise figure is built with a planar Schottky-barrier diode

When radio astronomers listen to stars, they need special hearing aids. One, for example, is the parametric amplifier that handles the high-frequency wideband signals received by a radio telescope, before the signals are heterodyned. If the signals weren't amplified,

they'd be swamped with noise.

How good a parametric amplifier is depends on its bandwidth, gain, and noise figure. Engineers at the Advanced Technology Corp. are now building amplifiers with operating frequencies of around 30 gigahertz, 600-megahertz band-

width, a 3-decibel noise figure, and a 15-db gain. "Nobody building 30-Ghz sets can come close to us in bandwidth and noise figure," asserts Allan Tucker, the company's contract manager.

The National Radio Astronomy Observatory in Green Bank, W. Va., got the first of these high-performance devices, a 31.4-Ghz unit, for test. It was more a breadboard than a finished product, and it was never used in any on-line receiver. A second 31.4-Ghz amplifier, smaller than the first and completely packaged, is being readied now by Adtec for use in NRAO's antenna on Kitt Peak in Arizona.

Don't miss the 24th Annual National Electronics Conference and Exhibition, Conrad Hilton Hotel, Dec. 9-11, Chicago

This friendly reminder
for your annual get-together
has been presented by TWA.
Who also happen to have a
lot of jets going that way.

up up and away 

*Service mark owned exclusively by Trans World Airlines, Inc.

Circle 220 on reader service card

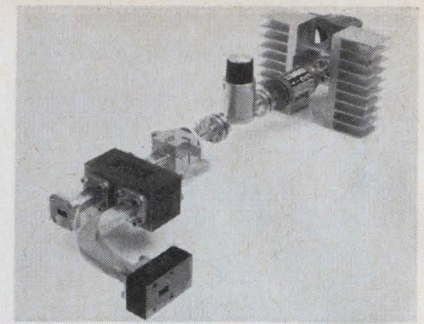

Minus. Output frequency is difference between pump, input frequencies.

Also in the works are a 33.6-GHz model for the Naval Research Laboratories in Corona, Calif., a 35.5-GHz unit for the Air Force Cambridge Research Laboratories, and a 24-GHz model for NASA.

Adtec's amplifier is degenerative—output frequency is a submultiple of pump frequency—and similar in layout to other parametric amps. A pump signal whose frequency is double that of the operating signal goes through an attenuator, an isolator, and a varactor to a circulator where it's mixed with the input signal. The result is a signal 15 db stronger than the input, whose frequency equals the difference between the pump and input frequency.

The key component in this setup is the varactor, which is made with a planar Schottky-barrier diode whose cutoff at -2 volts bias is 600 Ghz.

According to Adtec, 35 Ghz was the highest operating frequency anyone could give a parametric amplifier at the time it started to design its unit. The diodes used previously were point-contact types with low cutoff frequencies; efficiency at a given operating frequency declines with cutoff.

So Adtec engineers decided to use planar diodes, which they made by putting silicon dioxide on gallium arsenide and then etching and depositing anode material.

Tucker says there's no reason why Adtec can't build parametric amplifiers with operating frequencies as high as 100 Ghz, and he predicts that the bandwidth will be 1 Ghz within a year.

Cost depends on the operating frequency. The 24-GHz model, for example, costs \$27,000.

Advanced Technology Corp., 1830 York Rd., Timonium, Md. [409]

FASTENERS FROM

GRC

DIE CAST
ZINC ALLOY

NOW . . .
Widest Range of
Styles & Sizes in

WING NUTS

DIE CAST ZINC ALLOY



Wing Nuts



Cap Nuts



Thumb Nuts



Thumb & Wing Screws



Screws



Hex Nuts



Washers



Screw Insulators



- Hundreds of stock sizes
- Thousands of blank and thread combinations up to 3/8"
- Exclusive recessed finger grip
- Smooth acting washer bases
- Bright Corrosion-resistant finish
- Modern, attractive appearance to help sell your product

Write, wire, phone for samples, prices.
GRC's NEW
INDUSTRIAL
FASTENER
CATALOG.

GRIES

GRIES REPRODUCER CO.
Division of Coats & Clark Inc.
151 Beechwood Ave.
New Rochelle, N.Y. 10802
(914) 633-8600

World's Foremost
Producers of Small
Die Castings and
Plastic Moldings

offset and scaling simultaneously!



NUS

MODEL 3020 OFFSET/SCALING COUNTER

Now, for the first time, the NUS Model 3020 makes it possible to offset and scale frequency variant signals SIMULTANEOUSLY. The end result is precise data, clearly displayed in the engineering units required. The units' BCD output may be recorded for computer processing of the data.

Employs Nixie readout with display storage . . . Accepts a wide variety of signal inputs . . . Features broad-data acquisition applications . . . Integrated circuitry assures reliability . . . Counting periods up to 100 seconds, for high resolution. For further information and specifications, please contact:



NUS Corporation
Electronic Systems Division

9 Keystone Place Paramus, N. J. 07652
Phone: (201) 265-2400

Mullard calls this a Vinkor*...^c

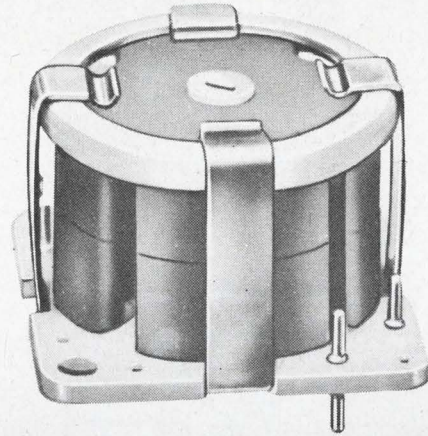

... part of a range of adjustable pot cores with Q factors from 100 to 1200, for frequencies from 400Hz to 15MHz

This is the Vinkor I.E.C. Range (LA3000)

Sizes: Diameter	14	18	22	26	30	36	mm
Height	8	11	13	16	19	22	mm

Inductance Adjustment A unique self-tapping screw in a plastic sleeve gives, in the majority of cases, $\pm 7\%$ inductance adjustment without backlash.

Permeabilities From $A_L 25$ to $A_L 400$.

Choice of Housings Standard metal nut-and-bush mountings or clip-and-board assemblies.

Precise Inductance without core grinding, to an accuracy of $\pm 0.02\%$. Long-term stability 0.1%.

Every designer should obtain the Mullard Literature on Vinkor adjustable pot cores. Also ask to be put on the mailing list of the Mullard Bulletin—a regular publication

which gives details of new components and applications . . . the result of extensive research and development programmes in the Mullard laboratories in England. Mullard employs 1,000 qualified scientists and engineers, and has six major plants with over 3 million square feet of floor space.

Write today for information on Mullard Vinkor pot cores, and for the name of your local Distributor.

Mullard Limited, Mullard House, Torrington Place, London WC1, England.

U.S.A. enquiries to Mullard Inc., 100 Finn Court, Farmingdale, Long Island, New York 11735, U.S.A. Telephone: (516) 694 8989 Telex: 961455

*registered trade mark of Mullard Limited, one of the world's leading suppliers of pot cores.

Mullard

MOL 51

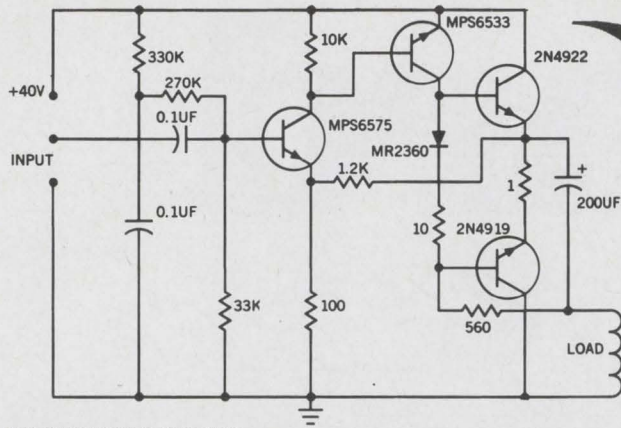

UNLESS OTHERWISE SPECIFIED
RESISTANCE VALUES ARE IN
OHMS. CAPACITANCE VALUES
ARE IN PICOFARADS.

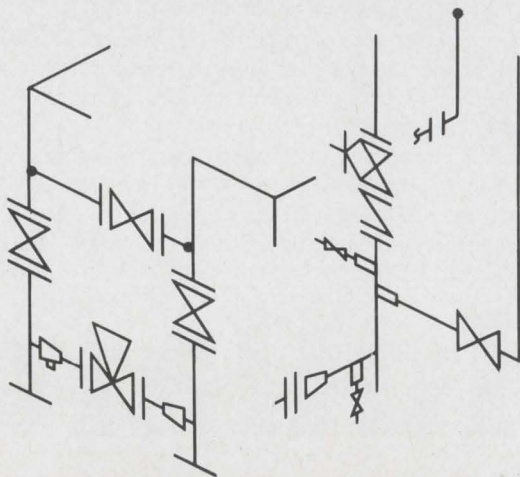
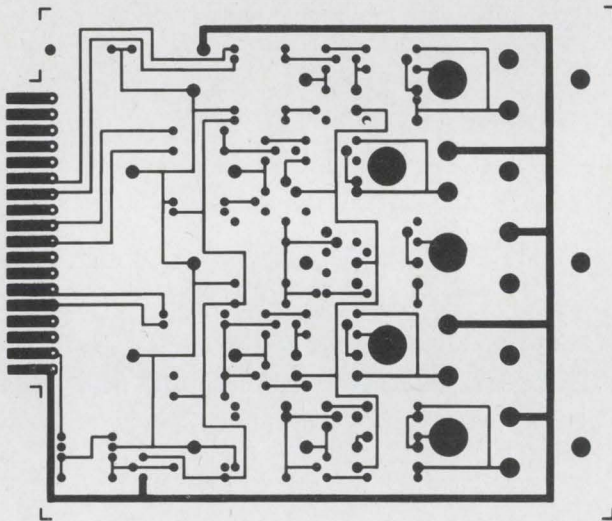

If your top draftsman can't produce all four drawings in 26 minutes, he's probably wasting your time—and money. Before you call your personnel manager, please understand that these drawings were produced on a Mergenthaler DIAGRAMMER—an automated drafting system, that will permit a semi-skilled operator to push-button produce high quality (better than MIL-SPEC) drawings on stable polyester film, 3 to 4 times faster than your best and most versatile draftsman. The rate is 30 times faster when drawings have been prepared in digitized form, as all these drawings were; the DIAGRAMMER, under control of an 8-level paper tape, produced all four drawings in 26 minutes!

drafting time: 26 minutes

The same tape that is used to produce precision drawings in the DIAGRAMMER can be reprocessed in the digitizing/computer equipment to produce N/C tape for subsequent machining operations, as in the case of multilayered circuit boards.

Expensive? Not when DIAGRAMMER users have experienced payback periods of less than 18 months.

Mergenthaler—the total graphic arts company—through agreements with allied equipment manufacturers, will recommend the optimum system approach for all automated drafting room equipment—digitizers, computers, software, DIAGRAMMER, through processors, assuring that all components will be functionally compatible.

For details, write or call, Automated Drafting Systems, Mergenthaler Linotype Co., a division of ELTRA Corp., 300 E. 42 Street, New York, N. Y. 10017; Tel.: 212-661-5615; TWX: 710-581-3385.

Mergenthaler the
total
graphic arts
company

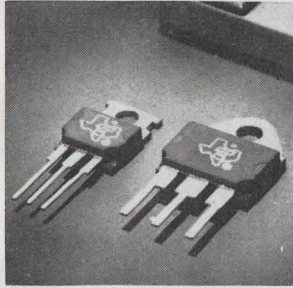

Plastic-encapsulated, single-diffused power transistors help designers lower equipment costs by replacing more expensive equivalent devices in T0-3 and T0-66 metal cans. Rated at 30 to 90 w, they meet a wide range of power and polarity requirements at 40 and 60 v. Prices (100 to 999) range from 70 cents to \$6. Texas Instruments Inc., N. Central Expressway, Dallas. [436]

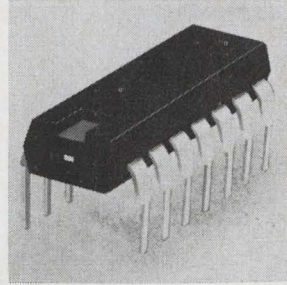

Fully compensated FET operational amplifier model 830 comes in a dual-in-line epoxy package. The device is short-circuit proof. Key specifications include: voltage gain of 300,000; $20 \mu\text{V}/^\circ\text{C}$ drift; input bias current of 15 pa; $6 \text{ v}/\mu\text{sec}$ slew rate; 10 v common mode voltage; and output of 10 v at 5 ma. Availability is immediate. Zeltex Inc., Concord, Calif. [437]

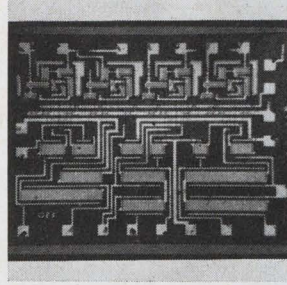

Monolithic MOSFET array HRM-2302 consists of 4 type D flip-flop and 12 switches. It is designed for d/a and a/d applications, and is capable of performing 12-bit conversions at rates of approximately 100 μsec . The 0.55×0.072 in. chip consists of 52 MOSFET devices. Price is \$28 in lots of 1,000. Hughes Aircraft Co., 500 Superior Ave., Newport Beach, Calif. [438]

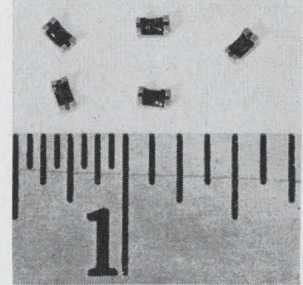

Lid packaged silicon transistors for thin/thick film and stripline circuit use are intended for uhf/vhf and microwave hybrid circuit applications. They are for low noise amplifier applications over the 60- to 2,000-Mhz range. The oscillator types range from 10 mw minimum at 2 Ghz to 30 mw at 2.5 Ghz. KMC Semiconductor Corp., Parker Road, Long Valley, N.J. [439]

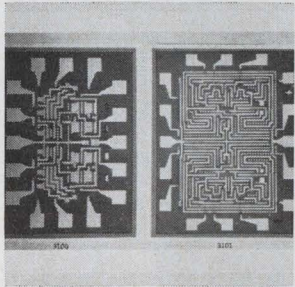

Dual 5-input gate 3100 and dual J-K flip-flop 3101 are MOS building blocks for interconnecting large block functions of MOS systems and serving as timing, decoding or random control. They come in a 16-lead dual-in-line package and in an operating temperature range of -55° to $+85^\circ$ C. Price is in the \$6 to \$12 range. Fairchild Semiconductor, Mtn. View, Calif. [440]

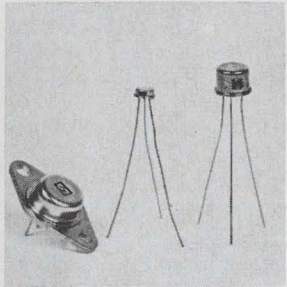

Silicon medium power transistors are 2-amp devices available in T0-46, T0-5 and T0-66 packages. They have voltages to 300 v, leakages as low as 0.5 na, saturation voltages less than 0.1 v, uniform current gain from 10 ma up to 500 ma, and a typical gain bandwidth of 85 Mhz. Units are available from stock. Solitron Devices Inc., Riviera Beach, Fla. [441]

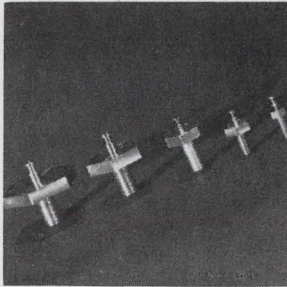

Ion-implanted diodes called Iso-diodes are offered in package sizes ranging from 0.500 amp to 30 amps. Features include fast power, short recovery time, low turn-on voltages, high current-carrying capability and good peak reverse voltage. Units are useful in applications such as voltage supplies and regulators. Isofilm International, 20131 Bahama St., Chatsworth, Calif. [442]

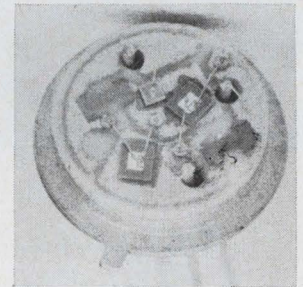

Solid state a-c switch, available in a hermetic T0-5 package, is for high-frequency operation from 0 to 20,000 hz and has sensitivity of 2 ma max. gate trigger current. The switch operates in both direct and proportional modes and requires only 1.5 ma load current. It has application in low level control uses. Solid State Products, 1 Pingree St., Salem, Mass. 01970. [443]

New semiconductors

IC regulates negative voltages

Monolithic device works without bias in most circuits; with a bias, though, it can handle high voltages

A voltage regulator built with discrete components can be switched from positive to negative simply by replacing npn transistors with pnp's. With monolithic integrated circuits, however, the trick isn't so easy. There are several ways of making a positive regulator see

negative potential, but most of these involve some sacrifice of performance. Merely reversing the output and ground terminals, for example, will reverse polarity, but the user will then not be able to ground his input.

The first commercial IC that regu-

lates negative voltages has just been introduced by the National Semiconductor Corp. Called the LM104, the IC is the brainchild of Robert J. Widlar, whose first design for National was a positive regulator, the LM100. The LM104, in fact, is intended to complement the LM100 and its stablemate, the LM105.

Op amp. Central to the LM104 is an internal operational amplifier that acts as an error amplifier to deliver a constant output. The reference voltage is derived from a temperature-compensated current source, I_{ref} [p. 154], feeding the op amp through a 7.5-kilohm resistor.

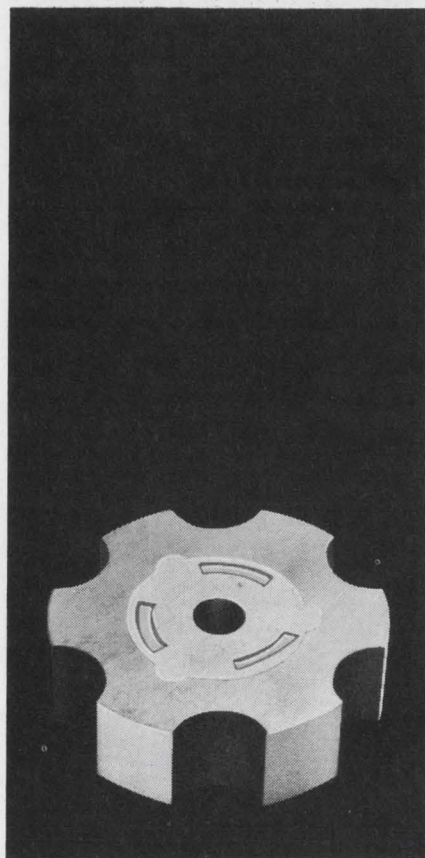

For Extra Meter Precision and Consistency Specify Hitachi Magnets

To create these extremely stable magnets Hitachi developed its own processes for the compounding and heat-treatment of fine alloys. The result is a range of cast magnets for metering that are precisely finished to unusually close tolerances, are more compact, and yet retain magnetic stability and uniformity. You can get a fast supply of Hitachi meter magnets with properties to suit your particular application. Each one has guaranteed characteristics. Full information on types for your application can be quickly mailed.

Products:

Meter Magnets:

For Speedometer, Tachometer, Amperemeter

Motor Magnets:

For Micro Motor, Hysteresis Motor, Wiper Motor, Blower Motor

Generator Magnets:

For A.C. Generator, Flywheel



Head Office
Chiyoda Bldg., Marunouchi, Tokyo, Japan
Hitachi Metals America, Ltd.
Magnet Materials Sect.
437, Madison Ave., New York, N.Y. 10022,
U.S.A. Tel. 212-758-5255

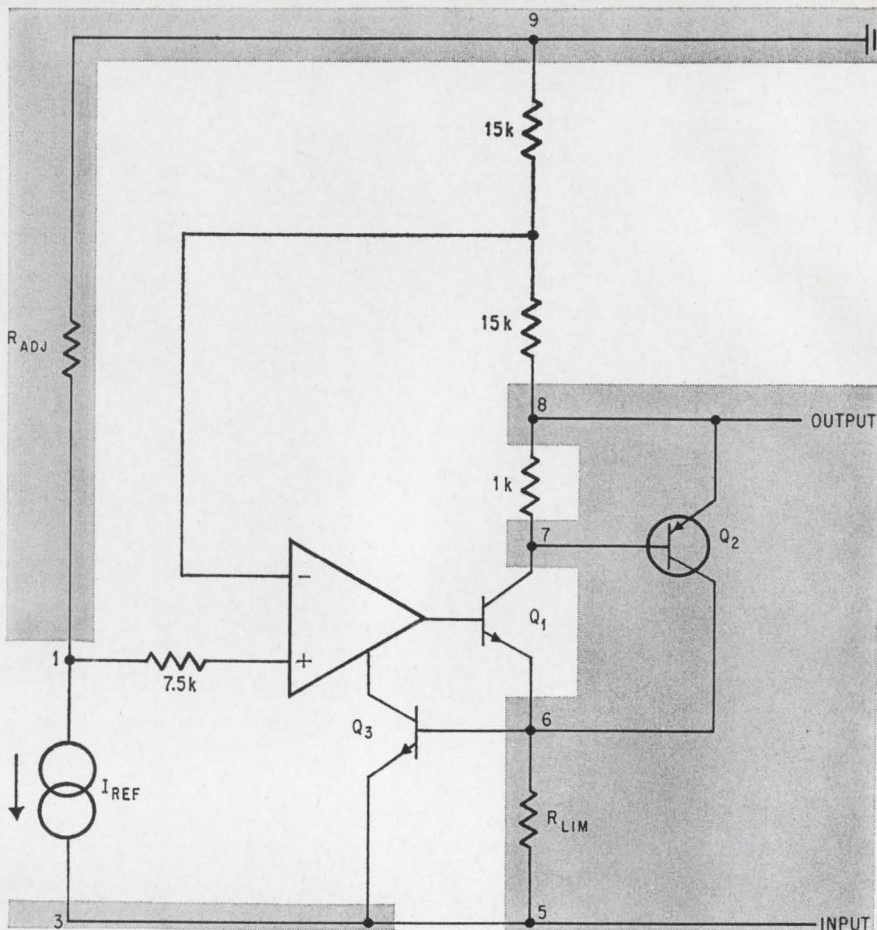

Negative approach. The external components used with the negative-voltage regulator are shaded. The IC itself delivers 25 ma, and Q_2 increases output capability. Q_3 and R_{LIM} provide short-circuit protection.

A supply voltage proportional to an external programming resistor, R_{adj} , is also fed to the amplifier.

Since the amplifier has very high gain, very low output voltage will turn the output transistor on more strongly. If the output is too high, the amplifier saturates its output transistor less fully.

The amplifier drives an internal transistor, Q_1 , which supplies an output voltage that's twice the voltage across R_{adj} .

Quick drop. Because the output is proportional to this programming resistor, the circuit's output can be reduced to zero merely by removing R_{adj} . Normally, regulators can't drop to a value below that of the reference voltage without using a bias power supply.

The LM104, however, works with a bias supply to regulate high-voltage circuits. In series with an external transistor, the device can regulate high voltages while seeing only 10 volts internally.

The circuit, National says, can be used as a switching or current

regulator as well as a linear series regulator, its prime application. In complementing the LM100 and LM105, it should find use in systems requiring regulated voltages that have a common ground with the supply. Most linear equipment has both positive and negative power supplies, Widlar notes, and current-mode logic and complementary transistor logic use negative voltage supplies.

The LM104's, which operate from -55° to $+125^\circ\text{C}$, cost \$30 each in quantities of up to 24, \$24 in lots of up to 99 units, and \$20 in quantities of over 100. A limited-temperature-range version, the LM204, costs \$21, \$16.80, and \$14 in similar-size lots.

Specifications

Input voltage	50 v max
Input-output voltage differential	50 v max
Power dissipation	500 mw
Storage temperature	-65°C to 150°C
Lead temperature (soldering, 60 sec.)	300°C

National Semiconductor Corp., Santa Clara, Calif. [444]

SYNCHRO-TO-DIGITAL

• 20,000°/second tracking • .01°/15 bit accuracy • binary or BCD

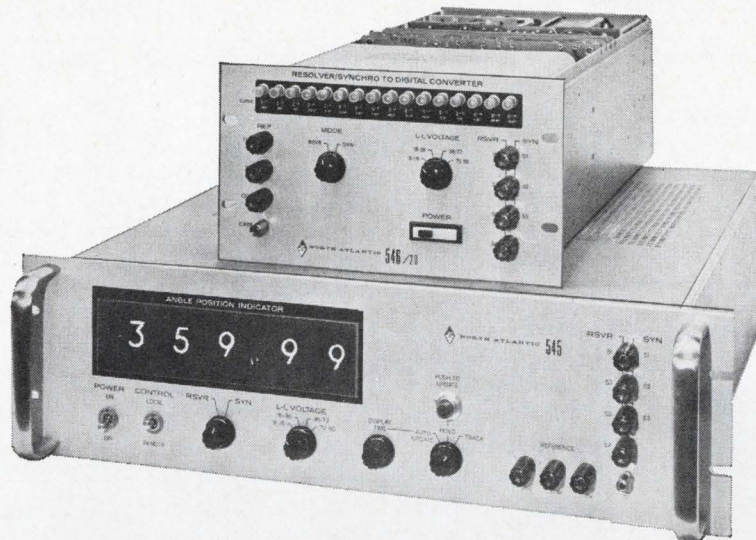

DIGITAL-TO-SYNCHRO

• 11 to 16 bits • accuracy to 30 arc seconds • 4 μ s data strobe

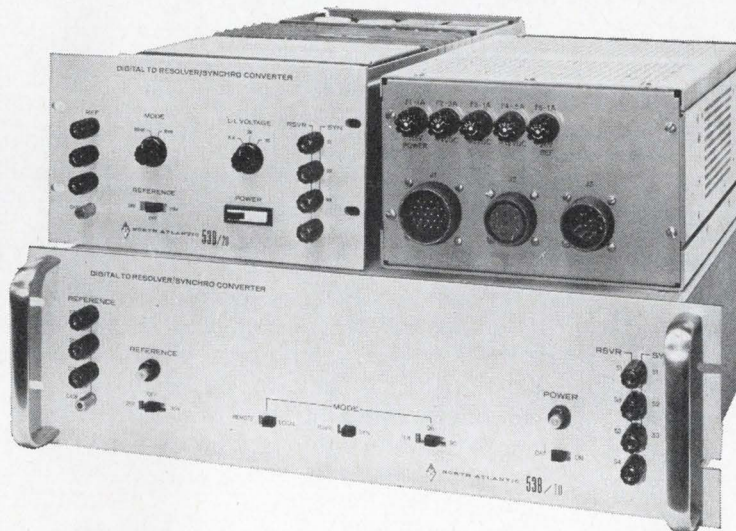

- low cost • all solid-state designs
- precision trigonometric transformers



NORTH ATLANTIC industries, inc. TERMINAL DRIVE, PLAINVIEW, NEW YORK • (516) 681-8600

ECCOFOAM®

PLASTICS/CERAMICS FOAM CHART

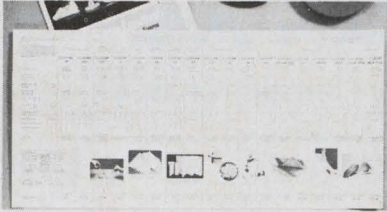

Complete physical and electrical data are displayed for eighteen foams—liquids, powders, sheet stock—plastics, ceramics and even artificial dielectrics. Fold-out chart in full color for notebook or wall mounting is yours.

Circle 516 on reader service card

THERMAL CONDUCTIVE DIELECTRICS

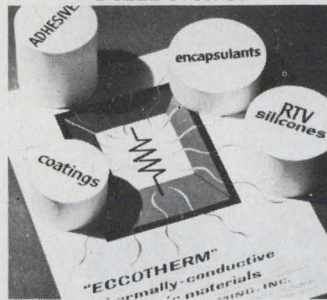

Electrically insulating, thermally conductive . . . for bonding, encapsulating, coating or sealing heat sinks, components or cryogenic devices where rapid heat transfer is desired. New four-page folder describes materials and applications.

Circle 517 on reader service card

ECCOAMP

ELECTRICALLY CONDUCTIVE ADHESIVES & COATINGS



New four page folder describes materials from 0.0001 to 100 ohm-cm. Adhesive pastes to replace hot solder, thin liquids, silver lacquer in aerosol spray, lossy coatings, etc.

Circle 518 on reader service card

Emerson & Cuming, Inc.



CANTON, MASS.
GARDENA, CALIF.
NORTHBROOK, ILL.
Sales Offices
in Principal Cities

EMERSON & CUMING EUROPE N.V., Oevel, Belgium

New Books

Heavy on theory

Finite-State Models for
Logical Machines
Frederick C. Hennie
John Wiley & Sons
466 pp., \$18.50

Some books are written to introduce engineers to complex subjects in a simple way. These books often emphasize the "what" at the expense of the "why." But other books go very deeply into theory and leave the engineer who wants a little practical advice floundering.

Hennie's book, unfortunately, is an example of the latter. Though the circuit forms and computational models discussed by Hennie relate to the design of working hardware, references to these relationships are scarce and the book just about manages to ignore the real world.

The clue is in the preface, where the author warns that his purpose is to provide "specific techniques for the logic designer" and to "develop useful ways of thinking about a broad class of problems."

That's good. Nevertheless, it would have been better if a few links with actual hardware had been included. One may be somewhat put off, for instance, to be told that a truth table "is" a machine, when it more precisely represents a sequential circuit that could be built with any of several kinds of components; these would actually "be" the machine.

With these brickbats out of the way, one very large bouquet is in order. The book is very well written; the style is an easy, informal one rarely found in treatises on such abstruse subjects as this. Yet the arguments are precise and rigorous.

Because this informal presentation takes up more space than would a formal text full of equations and symbols, the author feels impelled, unnecessarily, to apologize for it in his preface.

Hennie also states: "When formalism does not contribute to understanding, its proper place would seem to come after a good intuitive understanding has been achieved." O that more technical writers would recognize the distinction between formalism and understanding!

Thought-provoking

Sophisticated Signals and the
Uncertainty Principle in Radar
D.E. Vakman
Translated from the Russian by
K.N. Trilogoff
Springer-Verlag New York Inc.
253 pp., \$14.80

The emphasis in radar is shifting from hardware to the signal itself as the limits of practical transmitter power and receiver sensitivity are approached. Increasing the sophistication of the signal and its processing is now of paramount importance in enhancing the effectiveness of radar and widening its range of application.

This well-written book, which draws upon the work of both Western and Soviet scientists, is notable for its summary of modern radar theory. As one would expect from a Russian text, the presentation is rigorous, with the central premise of each contribution subjected to thorough analysis and mathematical proof. Organization of the material is logical and the development of the essential arguments is sequential and easy to follow. Although the subject matter is both complex and abstruse, the thoughtful reader should have no difficulty in understanding it.

The book is organized into four parts: the theory and practical effects of pulse compression signals and signal processing; the uncertainty principle of Heisenberg as compared to the bandwidth-time relation in radar; the ambiguity function in the radar statistical problem; and the synthesis of signals to meet the criteria of the ambiguity function.

While the author has made an interesting contribution to the growing field of advanced radar theory, credit is also due K.N. Trilogoff for a concise and readable translation. The book is highly recommended both as a thought-provoking text for anyone interested in advanced electromagnetic radiation and as a useful reference for the radar engineer and scientist.

D.L. Kratzer
RCA Missile and Surface Radar Division
Moorestown, N.J.

business trips rule out evening classes?



here's a practical way to update your knowl- edge of electronics

Are irregular hours, travel and family obligations keeping you from attending classes—even though you worry about becoming technically obsolescent? Check into the Special Programs in Electronics for Engineers developed by CREI, the Home Study Division of the McGraw-Hill Book Company.

These are not simply courses, but comprehensive programs in advanced electronics offering major electives in such fields as :

Communications Engineering, Aeronautical and Navigational, Television Engineering, Automatic Control Engineering, Missile and Spacecraft Guidance, Radar and Sonar Engineering, Nuclear Instrumentation and Control, Computers.

Industry-recognized CREI Programs make it possible for you to catch up on new developments in electronics through study in your own home, at your own pace,

your own schedule. Free book gives complete information and details of technical material covered. For your copy, mail coupon below or write : CREI, Home Study Division, McGraw-Hill Book Company, Dept. 1834-G, 3224 Sixteenth St., N.W., Washington, D.C. 20010.

Founded 1927



Accredited Member of the National Home Study Council



CREI, Home Study Division, McGraw-Hill Book Company
Dept. 1834-G, 3224 Sixteenth St., N.W.
Washington, D.C. 20010

Send me free brochure describing CREI Programs in Electronics for Engineers.

NAME _____ AGE _____

ADDRESS _____

CITY _____ STATE _____ ZIP CODE _____

COMPANY _____

TITLE _____

We have quite a thing about transmission capacity. 108 50-baud channels. Like RECTIPLEX.

This new carrier telegraph system commenced service between Tokyo (KDD) and San Francisco (RCA) June 1968 and revolutionized transmission capacity and transmission rates.

The development of this brilliant innovation posed quite a few problems. We had to increase speed and capacity, and, at the same time, battle the high costs of for-hire cables and new-cable installation. In cooperation with K.D.D. we found the answer: RECTIPLEX, in which

a unique phase-modulation transmits 108 standard telegraph channels over a single voice band. The resulting transmission capacity is five times that of conventional multiplex systems, and combines economical capacity expansion with faster data transmission.

RECTIPLEX I lived up to the highest expectations. So will RECTIPLEX II, when it revolutionizes cable transmission between Tokyo (KDD) and New York (ITT) this September.

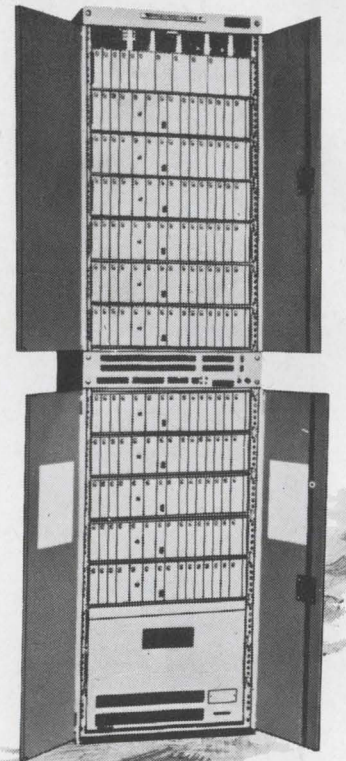

FUJITSU LIMITED

Communications and Electronics

Marunouchi, Tokyo, Japan

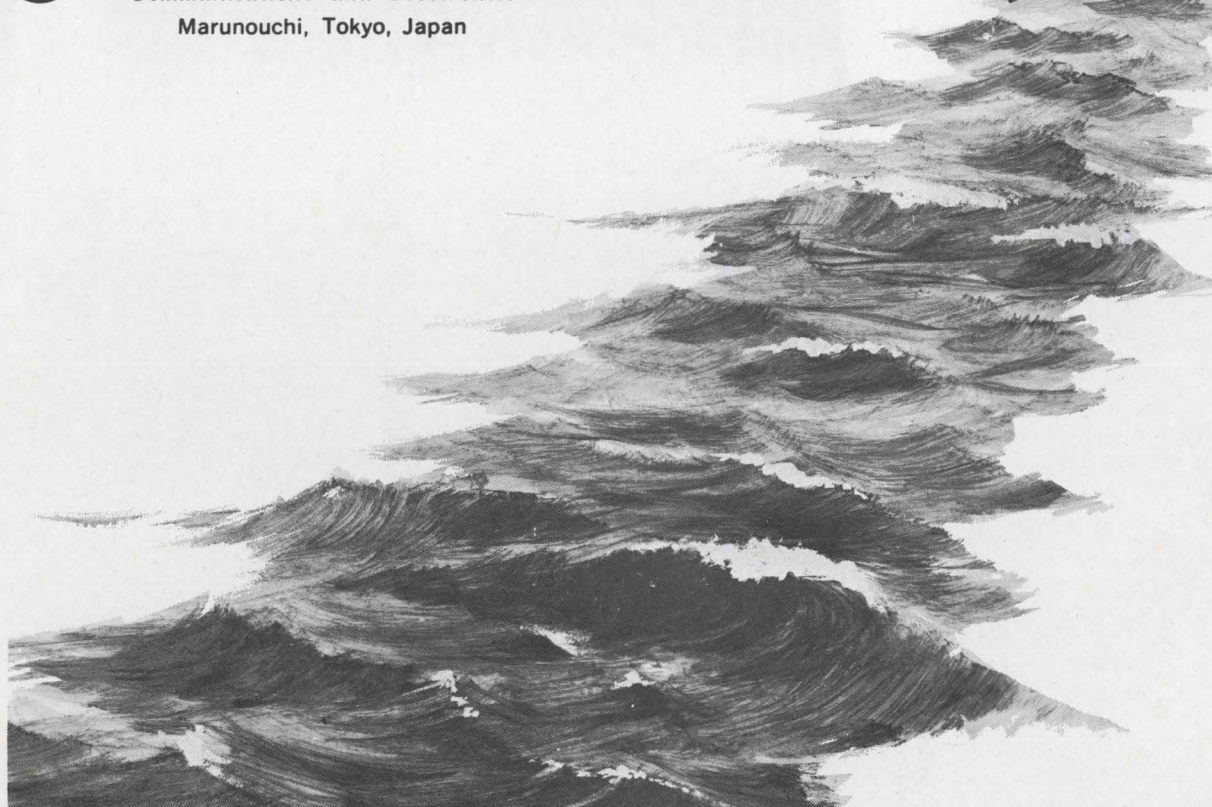

Main Products: Telephone Exchange Equipment Telephone Sets Carrier Transmission Equipment Radio Communication Equipment Space Electronics Equipment Data Communication Equipment Telemetry and Remote Control Equipment Computers (FACOM) and Peripheral Equipment Automatic Control Equipment (FANUC) Electric Indicators Electronic Components and Semiconductor Devices.

Technical Abstracts

MIC's and matches

New microwave integrated circuit modules
Wesley G. Matthei and William Crowe
Micro State Electronics
Raytheon Co.
Murray Hill, N.J.

To serve as the key elements in an experimental solid state microwave receiver, several microwave-integrated-circuit hybrid modules were developed—a tunnel-diode amplifier, a balanced mixer using gallium arsenide Schottky-barrier diodes, and a GaAs avalanche diode to act as the local oscillator. The circuits were designed for operation in C band—about 5.5-gigahertz—and provided about 15 decibels gain over a 400-megahertz bandwidth with a 7-db noise figure.

The tunnel-diode amplifier used a circulator as a coupler to maintain stability in the face of variations in input and output impedance, and to provide good impedance matching and low voltage standing-wave ratio. The tunnel diode itself was a germanium unit mounted in a standard package to ease the problems of connection to the microstrip transmission line; one end of the package was connected to the ground plane through a hole in the alumina substrate while the other was connected to the microstrip conductor.

The passive components for a tunnel-diode biasing network were also built separately and attached to the basic substrate. The resistor was a film-type element deposited on an alumina substrate and then inserted in the microstrip circuit, and the d-c blocking capacitor was of a small, 20-picofarad chip type. The band-reject filter was a quarter-wave open-circuited line that placed an r-f short across the bias resistor at the 5.5-GHz operating frequency.

The avalanche-diode oscillators were made tunable by adding a varactor at the end of the half-wavelength microstrip resonator. Variations of 30 volts in the bias on the varactor tuned the output frequency from about 6 GHz down to about 5.66 GHz.

Presented at Wescon, Los Angeles, Aug. 20-23.

Gunning for avalanches

Avalanche and Gunn diode oscillators
Meyer Gilden, Charles D. Buntschuh,
T.B. Ramachandran, and J.C. Collinet
Microwave Associates, Inc.
Burlington, Mass.

Both avalanche and Gunn diodes develop negative resistances over certain frequency ranges because of nonlinear processes under certain bias conditions.

The negative resistance of the avalanche diode is a transit-time effect resulting from the travel of bunched carriers across the depletion zone. The avalanche diode has a current-controlled negative resistance.

The negative resistance of the Gunn diode stems from the transfer of high-energy electrons from a high- to a low-mobility conduction band when the applied electric field exceeds approximately 3,000 volts per centimeter. The Gunn diode has a voltage-controlled negative resistance.

For circuit design, the active region of either type of diode can be treated as a series or parallel circuit consisting of the negative resistance and a capacitance. For the avalanche diode, the capacitance can be taken as the value at breakdown. For the Gunn diode in the parallel mode, the negative resistance is about 400 ohms.

As a local oscillator, the Gunn device is equivalent to a klystron in noise performance and electronic tuning. The noise performance of the avalanche diode oscillator in a high-Q cavity and a system using a balanced mixer will also compare favorably with that of a klystron. A 30-gigahertz avalanche diode used to pump an X-band parametric amplifier resulted in an amplifier with a 2-decibel noise figure. In a simple police speed-radar system, the avalanche diode oscillator, used as the transmitter, provided good performance. However, for more sophisticated Doppler radar transmitter applications, where the noise close to the carrier frequency is important, the avalanche diode doesn't yet appear to be adequate.

Presented at Wescon, Los Angeles, Aug. 20-23.

Need a custom TCXO fast?

For airborne or manpack communications? For a computer clock, or a data handling system? T²L compatible?

call Varo.



This 2.5-ounce TCXO has a half-inch maximum profile, zero warm-up time, stability to 3×10^{-7} over the temperature range, and produces any frequency from 2.7 MHz to 20 MHz. We'll adapt this TCXO to meet your specs. Or we'll build you one that does.

Varo answers fast.

Because our business is oscillators. Not oscillators and ovens and crystals and etc. But oscillators, period. Tell us what you need. We'll tell you how and when. Like we've done for GM, RCA, Hughes, Sylvania, and others. Try us for speed.



TIME & FREQUENCY PRODUCTS
402 GUTIERREZ STREET
SANTA BARBARA, CALIF. 93101
TELEPHONE (805) 963-2055
TWX 805-4497200

NEW LOW PRICE! **\$9²⁰*** ELAPSED TIME INDICATORS



Now, at low cost, you can get an indication of the operating time of any electronic or electrical equipment. Here are rugged, accurate, elapsed time indicators that tell you when lubrication, overhaul, adjustment or replacement of components is due on machine tools, computers, industrial machinery and test equipment or complete processing systems. Six-digit displays read either "hours and tenths", "minutes and tenths", or "seconds". Three different types of mounting are available as shown. All models have synchronous motors; nominal power requirement is 2.5 watts. Both bezel mountings are to standard NEMA dimensions.

* 1-3 units . . . volume prices even lower

THE AWHAYDON COMPANY

232 North Elm Street
Waterbury, Conn. 06720
4060 Ince Boulevard
Culver City, Calif. 90231

REPRESENTATIVES THROUGHOUT THE U.S. (SEE EEM). IN EUROPE CONTACT POLYMOTOR, BRUSSELS.
Circle 223 on reader service card

Free control knob catalog

Broadest selection of commercial and military knobs: colorful new PANELRAMA series, self-locking types, aluminum-cap and designer series, MIL-spec, custom knobs of all shapes and colors. Send reader service card or write: Raytheon Company, Components Division, Fourth Avenue, Burlington, Mass. 01803.

RAYTHEON

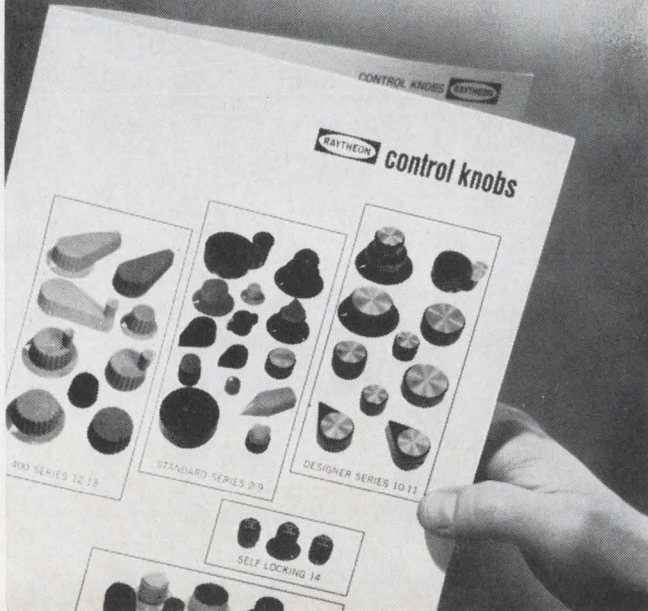

160 Circle 160 on reader service card



It's never too early to start saving their hearts

Help your children form good health habits now to reduce risk of heart attack later:

- Encourage normal weight; obesity in youth may persist throughout life;
- Build body health through regular physical activity;
- Serve them foods low in saturated fats;
- Teach them that cigarette smoking is hazardous to health;
- Make medical check-ups a family routine.

Set a good example. Follow the rules yourself and guard *your* heart, too.

GIVE...
so more will live
HEART FUND



Contributed by the Publisher

Electronics | September 2, 1968

New Literature

Tv camera system. Westinghouse Electric Corp., P.O. Box 8606, Pittsburgh, Pa. 15221. A two-piece secondary electron conduction tv camera system, for low-light-level viewing of transient and stationary images, is described in bulletin DB95-154.
Circle **446** on reader service card.

Heat sinks. George Risk Industries Inc., 672 15th Ave., Columbus, Neb. 68601, offers a catalog covering 21 different models of heat sinks. **[447]**

H-element crystals. Reeves-Hoffman, Division of DCA, 400 W. North St., Carlisle, Pa. 17013. Technical information on H-element crystals is supplied in a two-color sheet. **[448]**

Electrolytic transducers. Hamlin Inc., Lake & Grove Streets, Lake Mills, Wis. 53551, has available a four-page brochure featuring its complete EP family of gravity-sensing electrolytic transducers. **[449]**

Frequency multipliers. Kevlin Mfg. Co., 26 Conn St., Woburn, Mass. 01801. A technical bulletin describes a series of single stage and cascaded frequency multipliers using strip transmission line techniques. **[450]**

Precision counters. Melland Gear & Instrument Co., 84 Sylvester St., Westbury, N.Y. 11590, has available an illustrated catalog of precision counters designed for instrument applications. **[451]**

Semiconductor heat dissipators. International Electronic Research Corp., 135 W. Magnolia Blvd., Burbank, Calif. 91502, offers a short form catalog covering its line of heat dissipators for metal and plastic case transistors and diodes. **[452]**

High-stability oscillators. Motorola Communications and Electronics Inc., 4900 W. Flournoy, Chicago 60644. Brochure TIC-3315 contains complete information on three precision, high-stability oscillators. **[453]**

Rear projection readouts. Shelly Associates Inc., 111 Eucalyptus Drive, El Segundo, Calif. 90246. A four-page brochure describes a line of binary to decimal rear projection readouts featuring IC electronics. **[454]**

MOS products. National Semiconductor Corp., 2950 San Ysidro Way, Santa Clara, Calif. 95051, has issued a report describing quality and reliability programs including recent test results on its MOS products. **[455]**

High power terminations. Weinschel Engineering, Gaithersburg, Md., has published a data sheet on the model 569A precision high-power terminations

that operate over a d-c to 3 Ghz frequency range. **[456]**

Precision resistors. Airco Speer Electronic Components, Du Bois, Pa. 15801, has issued a catalog describing the Jeffers JC series of low-cost industrial precision resistors. **[457]**

Data processing system. Varian, Instrument Group, 611 Hansen Way, Palo Alto, Calif. 94303, offers a 16-page brochure describing its SpectroSystem 100, one of several data processing options available as part of the company's SpectroPlan. **[458]**

Multilayer p-c boards. Lockheed Electronics Co., 6201 E. Randolph St., Los Angeles 90022. Basic design criteria and tolerances for multilayer p-c boards are discussed in a 16-page, two-color booklet. **[459]**

Ultrasonic transducers. Nortec, 3001 George Washington Way, Richland, Wash. 99352. A catalog consisting of 12 data sheets contains vital information on more than 25 ultrasonic transducer models. **[460]**

Digital potentiometer. Honeywell Inc., Industrial Division, Fort Washington, Pa. 19034, has issued a four-page specification on the series 40011 digital potentiometer, which precisely measures and converts low-level analog input signals to digital displays. **[461]**

Audio amplifier. Bendix Corp., Semiconductor Division, South St., Holmdel, N.J. 07733. A four-page engineering data sheet describes a 2-w audio amplifier featuring thick-film fabrication. **[462]**

Insertion loss test set. Maury Microwave Corp., 10373 Mills Ave., Montclair, Calif. 91763. A four-page brochure covers the MT-100A dual channel, d-c comparator, insertion loss test set designed for extremely accurate measurements. **[463]**

Opto-electronic components. Sigma Instruments Inc., 170 Pearl St., Braintree, Mass. 02185. An eight-page brochure describes the range of opto-electronic components and controls offered by the company. **[464]**

Wire and cable. Harbour Industries Inc., Wire Division, Shelburne, Vt. 05482, has produced a comprehensive pocket manual on high temperature wire and cable technology. **[465]**

Automation control devices. Sensor Corp., 97 Indian Field Road, Greenwich, Conn. 06830. A brochure on electronic controls for automated machinery includes devices for sensing, counting, positioning, gaging, and sorting. **[466]**

High Voltage Rectifiers

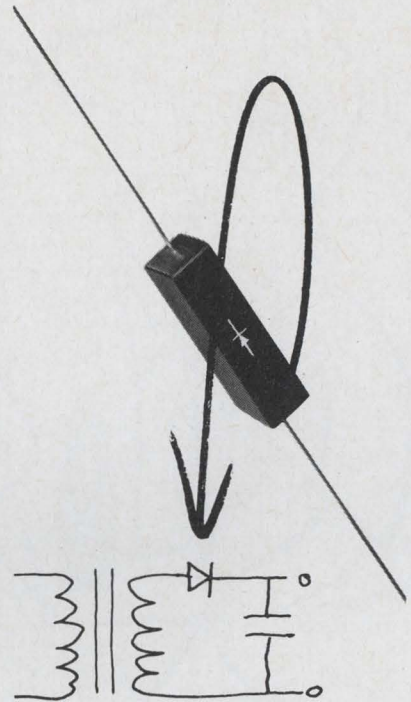

New! From Varo.

Silicon Rectifiers At Selenium Prices!

At last, economical high voltage silicon rectifiers. Ideal for use in all high voltage, low current applications.

- 5,000-40,000 Volts
- 5, 10, 25 milliamp ratings
- Standard and Fast Recovery
- In 1/4" square package.

These are the high voltage rectifiers that make completely solid state television circuits possible. Equally well suited for use in other cathode ray tube applications, electrostatic power supplies and voltage multipliers.

Only \$1.32

10,000V, 5mA rating. Quantity of 1,000. Complete details, applications, and price list available.



SEMICONDUCTOR DIVISION
2203 WALNUT STREET, GARLAND, TEXAS 75040
(214) 272-3561

THINK SHRINK!



Motorola's growing leadership in state-of-the-art miniaturization of electronic fuzes is advancing the science of detonating explosives.

Fuzes designed and produced by Motorola — for the U.S. Army, Navy and Air Force — span the entire spectrum from small explosive packages to large missile systems — including free-fall devices and highly sophisticated surface-to-air, air-to-air, and air-to-surface systems.

To help us maintain our pace-setting competence in this vitally important field, Motorola needs Electronics Engineers with fuze experience. Ours is an engineering-oriented company where you'll be given freedom to exercise your own initiative — and by helping us "think shrink" about fuzes, you can make it big professionally. Send us your resume.

Opportunities in Fuzing & Guidance:

Electronics & Mechanical Design ■ Integrated Electronics ■ Advanced RF & Microwave Techniques ■ Antennas & Propagation ■ Fuzing ■ Missile Guidance ■ Checkout Systems ■ Reliability & Components ■ **OTHER OPPORTUNITIES:** Space Communications ■ Radar Systems ■ Tracking & Telemetry ■ Digital Data Transmission ■ ECM & Elint ■ Coherent Transponders ■ Radar Transponders

in PHOENIX  **MOTOROLA**

Government Electronics Division · Aerospace Center

Write: Paul Ahler, Recruitment Mgr., Dept. 65, Box 1417, Scottsdale, Arizona

MOTOROLA ALSO OFFERS OPPORTUNITIES AT CHICAGO, ILLINOIS — AN EQUAL OPPORTUNITY EMPLOYER

CIRCLE 966 ON READER SERVICE CARD

**DO YOU SELL
EFFICIENCY IN EUROPE?**

Scandinavian electronic engineer with several years experience in sale and sales management of industrial, scientific and medical equipment, offers his assistance for start and management of your Scandinavian department. Your own limited company, one sales engineer, administration, stock and service facilities: Invest \$8000. Yearly cost \$13,000. Send information on your products to MRA 6339, Electronics Class. Adv. Dept., P. O. Box 12, N. Y., N. Y. 10036, and it will be a pleasure to send you further information and a short market-valuation.

CIRCLE 967 ON READER SERVICE CARD

Leading instrument manufacturer has an opening for an aggressive engineer interested in the

**DEVELOPMENT
and DESIGN**

of process instrumentation. Requirements: B.S. degree, strong background in electronics.

Attractive salary, benefits, profit sharing, paid relocation expenses.

Reply to: Hubert Dreckmann

THE HAYS CORPORATION

742 E. 8th St. Michigan City, Ind. 46360

CIRCLE 968 ON READER SERVICE CARD

EMPLOYMENT SERVICES

Florida/Nationwide EE's ME's IE's needed Electronics fields. Aerospace, Industrial Manufacturing. \$9—18,000. Tech. Div., Brodeur Personnel Service Inc., 3947 Blvd. Center Dr., Jacksonville, Fla. 32207.

*"Put Yourself in the
Other Fellow's Place"*

TO EMPLOYERS

TO EMPLOYEES

Letters written offering Employment or applying for same are written with the hope of satisfying a current need. An answer, regardless of whether it is favorable or not, is usually expected.

MR. EMPLOYER, won't you remove the mystery about the status of an employee's application by acknowledging all applicants and not just the promising candidates.

MR. EMPLOYEE you, too, can help by acknowledging applications and job offers. This would encourage more companies to answer position wanted ads in this section.

We make this suggestion in a spirit of helpful cooperation between employers and employees.

This section will be the more useful to all as a result of this consideration.

Classified Advertising Dept.

McGraw-Hill Inc.

330 West 42nd St., New York, N. Y. 10036

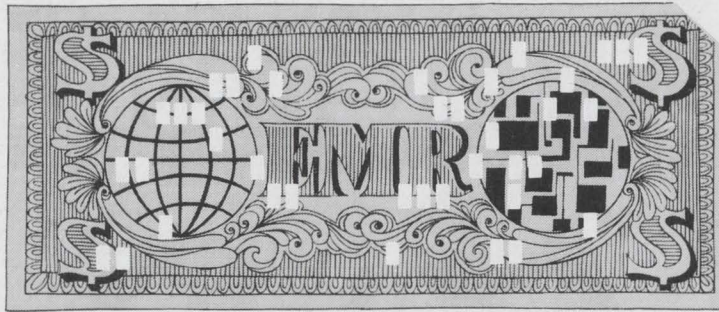

The cost of all this to you? Absolutely nothing. No fees or charges at any time.

Other advantages of EMR:

- Your resume is sent only to those companies that have a genuine requirement for your particular skills.
- There is no general "broadcasting" in the hope "someone will be interested."
- Your identity is protected because your name is released only according to your prior instructions. Your name can be deleted on request.
- EMR's service is nationwide. You may be considered for job opportunities anywhere in the U.S.

The Electronics Manpower Register is a powerful tool and should be considered when you are seriously seek-

ing a new position. And, although you may be reasonably happy in your present position, chances are that you might have that ideal job in mind.

This is why EMR makes good sense for you. If that job does turn up, you'll be there.

To get your name in the EMR file, just fill out the resume form and return to:

Electronics Manpower Register
330 West 42nd Street
New York, N. Y. 10036

Please enclose a copy of your resume if you have one. A detailed brochure further describing EMR will be sent to you.

Electronics Manpower Register A computerized employment opportunity service

CONTINUED FROM OTHER SIDE			
Previous Position	Employer	City/State	From To
Duties and accomplishments			
Previous Position	Employer	City/State	From To
Duties and accomplishments			
GENERAL INFORMATION			
(Summarize your over-all qualifications and experience in your field. List any pertinent information not included above.)			
Current annual base salary	Total years of experience	Date available	U.S. Citizen <input type="checkbox"/> Non U.S. Citizen <input type="checkbox"/>
My identity may be released to: employer <input type="checkbox"/>	All but my present employer	Have you security clearance?	Yes <input type="checkbox"/> No <input type="checkbox"/> If yes, What level
Mail (with a copy of your resume, if you have one) to:			
Electronics Manpower Register		NO FEES	
330 West 42nd Street,		OR	
New York, N. Y. 10036		CHARGES	
			EMR-3

In electronics it's Electronics magazine to sell used equipment!

Your advertisement will produce Results in Electronics. Engineers turn to Electronics magazine for the latest technical developments — and for the latest buying information. You can reach them inexpensively in Electronics Searchlight Section.

For information:
Searchlight Section
Classified Advertising Dept.
Post Office Box 12
New York 10036

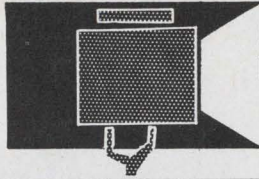

SEARCHLIGHT SECTION

- CLASSIFIED ADVERTISING • BUSINESS OPPORTUNITIES
- USED OR SURPLUS EQUIPMENT

AUTOTRACK ANTENNA MOUNT

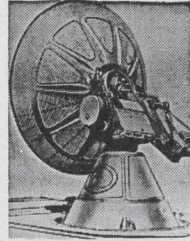

360 degree azimuth, 210 degree elevation sweep with better than 1 mil. accuracy. Missile velocity acceleration and slewing rates. Amplidyne and servo control. Will handle up to 20 ft. dish. Supplied complete with control chassis. In stock—immediate delivery. Used world over by NASA, USAF, MP-61-B, Type SCR-584. Nike Ajax mounts also in stock.

PULSE MODULATORS

MIT MODEL 9 PULSER 1 MW—HARD TUBE
Output 25kv 40 amp., 30kv 40 amp. max. Duty cy .002. 25 to 2 microsec. Also 5 to 5 microsec. and 1 to .5 microsec. Uses 6CZ1. Input 115v 60 cycle AC. Mfg. GE. Complete with driver and high voltage power supply. Ref: MIT Rad. Lab. Series, Vol. 5, p. 152.

2 MEGAWATT PULSER
Output 30 kv at 70 amp. Duty cycle .001. Rep rates. 1 microsec 600 pps. 1 or 2 msec 300 pps. Uses 5948 hydrogen thyratron. Input 120/208 VAC 60 cycle. Mfr. GE. Complete with high voltage power supply.

250 KW HARD TUBE PULSER
Output 16 kv 16 amp. Duty cycle .002. Pulses can be coded. Uses 5D21, 715C or 4PR60A. Input 115 v 60 cy. AC \$1200 ea.

18 MEGAWATT PULSER
Output 150KV at 120 amps. Rep rate: 50-500 PPS. Pulse length: 5 msec. 15KV 120 amp. into pulse transformer Rise time 1.5 msec. Filament supply 5V 80 amp. incl. 17.5KV 1.5 amp DC power supply. Input 220V 60 cy AC.

INDICATOR CONSOLES

AN/SPA-4A, PPI 10", range to 300 mi.
VJ-1 PPI 12", Range to 200 mi.
VL-1 RHI 12" to 200 mi. 60K ft.

HIGH VOLTAGE POWER SUPPLIES

100KV, 200MA, DC, \$5500; 27 KV, 100MA, DC, \$2200; 15KV, 2 amp. DC, \$3800; 12KV, 1200MA, DC, \$1400; 8KV, 800MA, DC, \$975.

SCR 584 AUTOTRACK RADARS

Our 584s in like new condition ready to go, and in stock for immediate delivery. Ideal for telemetry research and development, missile tracking, satellite tracking. Fully Desc. MIT Rad Lab Series Vol. 1, pps. 207-210, 228, 284-286. Comp. Inst. Bk available \$25.00 each.

ELECTRON TUBES

KLYSTRONS • ATR & TR • MAGNETRONS
SUBMINIATURES • C.R.T. • T.W.T. • 5000-
6000 SERIES
• SEND FOR NEW CATALOG A2 •
A & A ELECTRONICS CORP.
1063 PERRY ANNEX
WHITTIER, CALIF.
696-7544

CIRCLE 972 ON READER SERVICE CARD

*If there is anything you want
that other readers can supply
OR . . . something you don't want—
that other readers can use—
Advertise it in the
SEARCHLIGHT SECTION*

SONAR SYSTEMS IN STOCK

AN/FQS-1A, AN/UQS-1B, QIBa scanning sonars. Rochelle salt hydrophones 6 ft.

MICROWAVE SYSTEMS

200-2400 mc. RF PKG

Continuous coverage, 30 watts CW nominal output. Uses 2C39A. Price \$575.

L BAND RF PKG.

20 KW peak 990 to 1040 MC. Pulse width .7 to 1.2 micro sec. Rep. rate 180 to 420 pps. Input 115 vac incl. Receiver \$1200

200-225 mc RADAR SYSTEM

1 Megawatt output. 200 nautical mile range for long range detection of medium and high altitude jet aircraft as well as general search. AN/TFS-28.

SURVEILLANCE DRONE RADAR SYSTEM

X-Band tracking system with plotting boards. Type AN/MPQ-29. Drone also in stock.

5 MEGAWATT C-BAND

Klystron RF package delivering nominal 5 megawatt pulse RF. Complete with pulser and power supply.

500 KW L BAND RADAR

500 kw 1220-1359 msc. 160 nautical mile search range P.P.I. and A scopes. MTI. thyratron mod 5J26 magnetron. Complete system

AN/GPG-1 SKY-SWEEP TRACKER

3 cm. automatic tracking radar system. Complete package with indicator system. Full target acquisition and automatic tracking. Input 115 volts 60 cycle New. In stock for immediate delivery. Entire System 8' long, 9' wide, 10' high. Ideal for Infrared Tracker. Drone Tracker. Missile Tracker. R. & D.

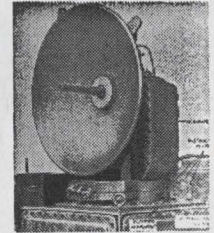

500KW S BAND RADAR

250 miles search 115V 60 cy AC. Mfg. G.E.

RADAR SYSTEMS GROUND AND AIRBORNE. AUTOMATIC TRACKING ANTENNA SYSTEMS. NIKE AJAX NIKE HERCULES M-33 M50-1A MPS-10. MPS-9. SCR 584. TFS-10 TFS-28. FA-ASR-2. AIRBORNE SYSTEMS APN-84. APN-102. APS-23. APS-27. APS-45. DPN-19. DIGITAL COMPUTERS. IBM 650. IBM 704.

LARGEST INVENTORY OF RADAR AND MICROWAVE EQUIPMENT IN THE WORLD.
RADIO RESEARCH INSTRUMENT CO.
45 WEST 45TH ST. N. Y. 10036 212-JU 6-4691

CIRCLE 969 ON READER SERVICE CARD

NEED LESS THAN \$1,000,000?

Then, we can help. We are a poor but honest finance firm, willing to lease anything to anyone for up to five years. Inquire.

EQUITY LEASING CORP.

40 W. 15 St., N. Y. C. 10011 212-234-1316

CIRCLE 970 ON READER SERVICE CARD

Minifluid DISPENSER
AIR OPERATED

for miniature potting and encapsulating

Available in 3 sizes
6cc - 12cc - 30cc

\$34.00
UP

PHILIP FISHMAN COMPANY
7 CAMERON ST., WELLESLEY, MASSACHUSETTS 02181

CIRCLE 971 ON READER SERVICE CARD

Mr. Used Equipment Dealer:

When you advertise in the Searchlight Section . . . You have hired your most persuasive salesman:

He's efficient . . . He thrives on long hours . . . His territory is the entire nation . . . and overseas . . . He doesn't see buyers of used and new surplus equipment: They see him—regularly. They depend on him.

He is Searchlight—The section of this publication where wise dealers advertise and list their stocks for sale.

SEARCHLIGHT SECTION

Classified Advertising Dept.
Post Office Box 12 • New York, N. Y. 10036

We sell choice in solid state.

Our newly formed Solid State Microwave Project brings you the world's widest choice of high quality solid state microwave signal sources, control devices, diodes and complex components.

Our line speaks for itself. Gunn effect diodes and oscillators that work from -54° to $+95^{\circ}\text{C}$. Impatt diodes and oscillators with 100 mW output at 16.0 GHz. Varactors with cutoff above 500 GHz. Harmonic generators stable to 1 part in 10^9 . Not to mention high power microwave switches, limiters, mixers, modulators, solid state generators and more.

One man sells the works. Our Varian Marketing Engineer isn't wedded to any single approach, so he offers you the single best answer to your design problem. Talk to him at the more than 30 Varian Electron Tube and Device Group Sales Offices throughout the world, or call our Solid State Microwave Project, Beverly, Massachusetts. Send for complete product-line data now.



varian
solid state
microwave
project

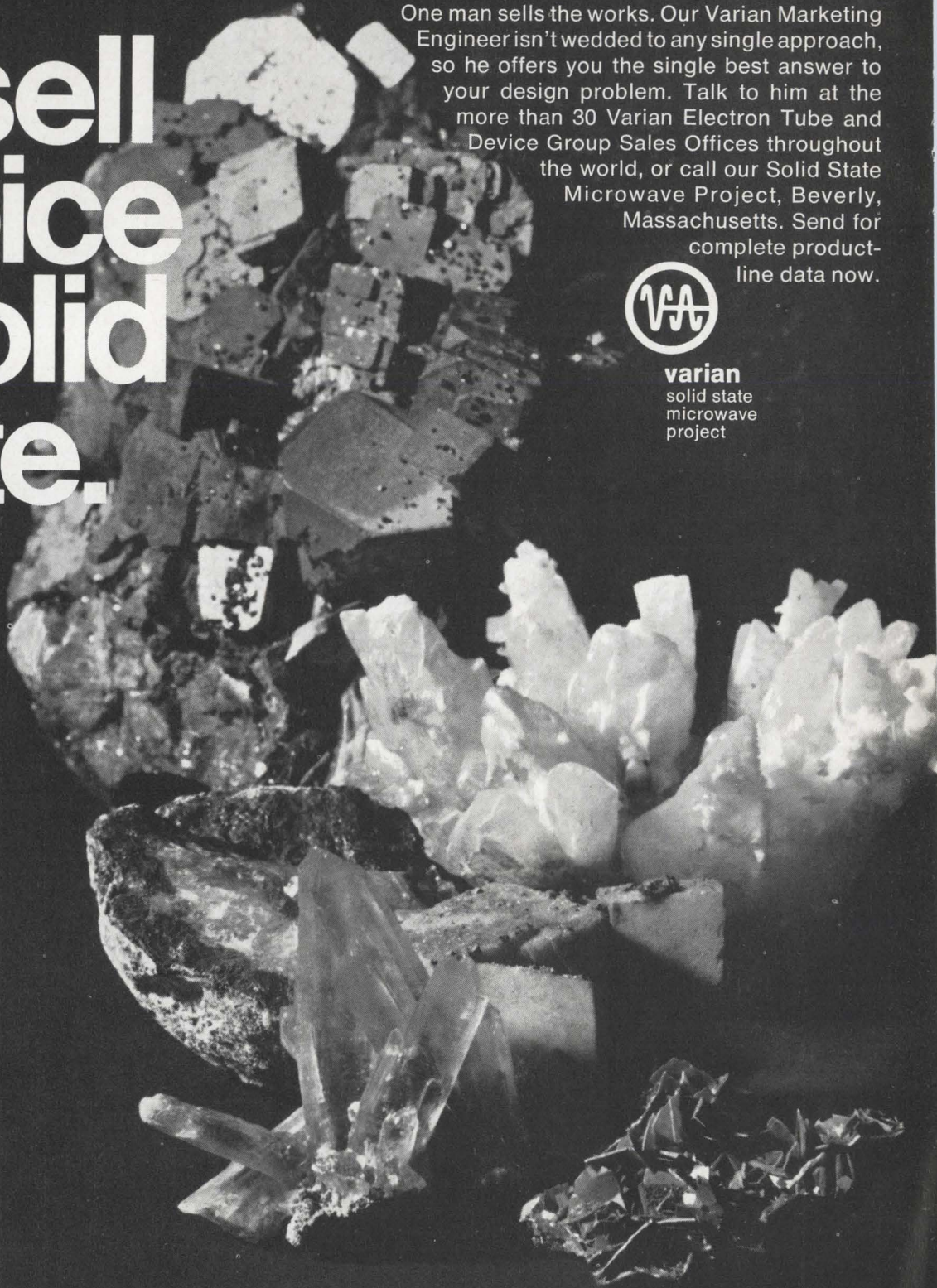

Newsletter from Abroad

September 2, 1968

Red tanks burst comsat bubble . . .

The Russians' invasion of Czechoslovakia appears to have doomed their plan to launch Intersputnik, a Communist-bloc communications satellite consortium designed to rival Intelsat.

The plan had been branded a propaganda ploy by Western experts when it was introduced last month in Vienna at the U.N. space conference. For one thing, the U.S. pointed out, Moscow hasn't got a stationary-satellite system on the drawing boards; for another, the Russians placed **great emphasis on Intersputnik's one-nation-one-vote character as opposed to Intelsat's weighted voting arrangement** under which the U.S. has about 53% of the voting shares.

But even the propaganda value of Intersputnik's one-vote feature seems to have disappeared in the dust kicked up by Russian tanks in Czechoslovakia as Moscow's partners—the Czechs among them—wonder how much weight their votes would have against the might of Russian displeasure. **Moreover, when the 62 nations in Intelsat sit down within a year to negotiate final arrangements for their consortium, the U.S. will take a smaller share and thereby further erode the Soviet position.**

. . . but Bull-GE sure Czech deal is on

Officials at Bull-GE feel confident that Czechoslovakia's political turmoil won't wreck the deal they worked out to have the French-designed Gamma 140 computer built under license in Czechoslovakia by the government-owned organization, Tesla.

Although the five-year agreement was signed by the liberal Dubcek government, it was actually negotiated with the conservative Novotny regime. **So Bull-GE thinks the computer pact will stand no matter what the country's ultimate political coloration.**

A team of Bull-GE technicians had just finished installing a first Gamma 140 in Czechoslovakia when Warsaw Pact troops moved into the country. After stability returns, so will Bull-GE teams.

Computer ambitions spur Plessey's bid for English Electric

British insiders now believe that ambitions in the computer field rather than a simple desire to expand led the Plessey Co. to bid late last month to take over the much larger English Electric Co. If its move succeeds, Plessey would add English Electric's 18% holding in International Computers Ltd. to its own 18% share. **This would make it the largest corporate stockholder in the British computer giant and put it in a position to take over that firm as well.**

Plessey management offered \$630 million for English Electric's equity and apparently stands a chance of convincing the company's shareholders that the price is right. If Plessey does, the British nonconsumer electrical-electronics industry will be dominated by Plessey-English Electric and the group put together by the British General Electric Co. (not connected with its U.S. namesake) after it took control of Associated Electrical Industries. **The Plessey combine would be the larger of the two with some \$1.4 billion in revenue, and would rank among the top half-dozen electrical-electronics companies in the world.**

But though Plessey's and English Electric's electronics operations dovetail reasonably well over-all, the prime motive behind Plessey's move appears to be the company's belief that computers and communications add up to the most promising growth field in electronics.

Newsletter from Abroad

Japanese squabble over vtr patents

The leading video tape recorder producers in Japan may be in for an intramural hassle over patents. At issue: the rights to two crucial techniques for low-cost vtr's—skipped-field recording, and the "Omega" tape wrap around the drum of two-head recorders.

Sony and Victor Co. of Japan are the main contenders in the skipped-field-recording patent fight. Victor obtained a design patent on the technique early this year. (With it, only one field of each frame is recorded—permitting a narrow tape—and then the field is played back twice to get adequate brightness.) Sony nonetheless still has in the works a regular patent covering a skipped-field home video recorder it put on the market nearly four years ago.

Victor says it will file objections to Sony's application before the mid-September deadline and presumably will have the backing of other manufacturers, who want to avoid having to work out license arrangements with two patent holders.

Victor's allies in the skipped-field controversy, though, figure to be on the other side in the squabble over who first invented the "Omega" wrap. Sony, Toshiba, Nippon Electric, Sanyo, and Shiba all have filed counterclaims to Victor's patent application.

22-inch color sets in offing for U.K.

Color television sets with 22-inch screens should be on the British market by next spring.

Mullard Ltd. is readying to mass-produce the 22-inch tubes and a sister company of the Philips' Gloeilampenfabrieken group, Philips Electrical Ltd., will use them in a single-standard receiver. Most color sets on the market now are bistandard—625 lines for the British Broadcasting Corp.'s second network and 405 lines for BBC-1, which broadcasts only black-and-white tv programs.

Philips figures that the 22-inch size gets around the common complaint that current 25-inch sets are too big for many British living rooms. At the same time, the compromise size avoids the "too small" label that has plagued 19-inch sets.

Mullard expects several set makers will hit the market with 22-inch receivers about the same time as its sister company. If the sets sell well—they'll be ticketed about 10% below 25-inch sets—the two other U.K. picture-tube makers presumably would follow Mullard's lead. Then, British set makers would almost surely build 22-inch sets exclusively.

German set makers color it rosy . . .

A fall spurt in color television sales now seems certain in West Germany. The country's set makers are confident that the Olympic games—which will be broadcast in color by the German network—will send buyers flocking to retailers.

Along with the games, there's a general upturn in the economy that's buoying sales. As a result, sales for the year should run about 220,000 sets. Early in the year, that figure would have seemed very optimistic.

. . . and so does AEG-Telefunken

The West German phase-alternation-line (PAL) color-tv system continues to annex territory. In Asia, Thailand and Hong Kong have adopted PAL. In two or three years, says its developer Telefunken, PAL most likely will be introduced in Finland, Sweden, Denmark, and Norway. This would make Northern Europe solid PAL territory except for France, where the competing Secam system was developed.

Japan

Sound vision

Sometimes, the best way to "see" something inside something else is to play an ultrasonic beam on it and pick up the image that's formed. Like X rays, ultrasonic waves go right through many objects that won't pass light, but the sound waves don't entail any radiation hazard.

The trick, of course, is converting the ultrasonic image into a visual one. The Tokyo Shibaura Electric Co. has found a slick way to do it—replace the photoconductive target of a 1-inch vidicon television camera tube with a quartz piezoelectric plate.

Toshiba had its ultrasonic system on hand at the Sixth International Congress on Acoustics at Tokyo last week and will probably be the first to put one on the market. Other such systems built so far have been too complex to get out of the laboratory, but Toshiba's uses a modified industrial tv camera.

Differences. In the image converter, a difference in potential is set up at points on the quartz plate where acoustic waves impinge. This difference causes a change in the number of secondary electrons generated when the tube's scanning electron beam hits "illuminated" points. Thus, there's a varying current flow through a resistor connected between ground and the conductive electrode on the face of the plate. The voltage drop across this resistor is the tube's output signal.

Internally, the ultrasonic tube is much like the usual vidicon. But because the ultrasonic image converter depends on the generation of secondary electrons, its scanning beam has to pack more energy—several hundred electron-volts in-

stead of the several tens for a vidicon. The potential difference across the quartz plate has to be several volts for the change in the number of secondary electrons to produce a usable video signal.

Tanked. Toshiba's demonstration unit pairs the ultrasonic pickup tube, at one end of a small tank of water, with a 4-megahertz transducer at the other end. Between the two lie the object being looked at and an acoustic lens that focuses the image on the tube through a diaphragm.

The resolution for the 1-inch tube is several tens of lines. For sharper images, larger tubes would be needed. Toshiba concedes that this would be difficult. The quartz plates are a half-wave thick—0.7 millimeter—and diameters larger than 1 inch would be hard to produce, but the company's researchers insist it could be done. Despite the low resolution, though, the standard 525-line scan is used.

Looking in. Toshiba sees non-

destructive testing of light-opaque materials as the first industrial use for the ultrasonic system. Doctors one day may use it to check internal organs. And Toshiba researchers say the system is a natural for inspecting construction jobs going on in turbid waters.

If the ultrasonic tv doesn't catch on, Toshiba has another development to fall back on—cells filled with aluminum flakes suspended in liquid. Where ultrasonic waves hit the cell, the flakes line up and the cell appears bright; elsewhere, it's dark. At present, resolution is better than in the tv system, but the flake-filled cell is hard to use and the persistence is too long for viewing moving objects.

Crystal clear

It's not only the research crew at Toshiba (see story above) that's putting strange scenes on its television monitor screens. The solid

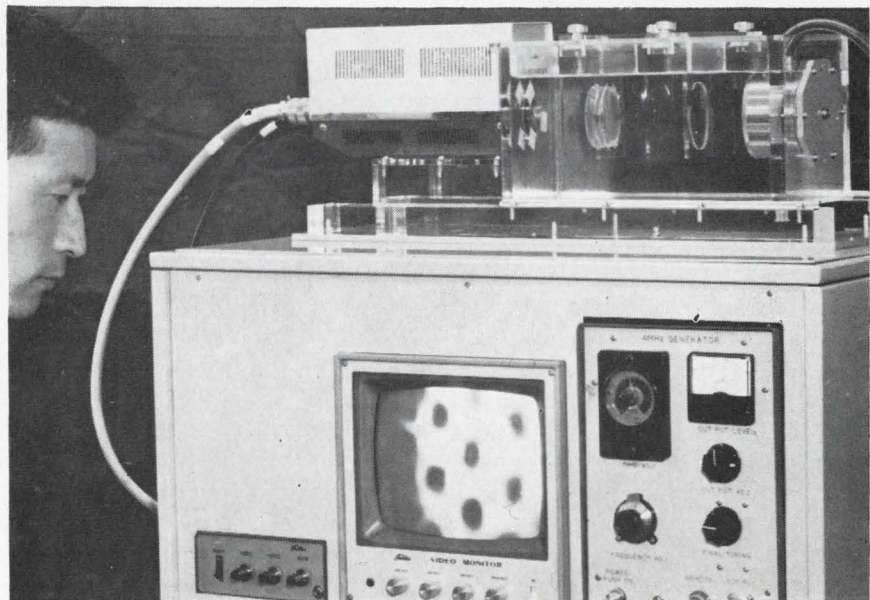

Screen test. Small perforated iron plate about 0.8-inch square in tank looms large on monitor of Toshiba's ultrasonic tv system.

state group at the Broadcasting Science Research Laboratories of Nippon Hoso Kyokai has found a way to show what's happening inside crystals while it's happening.

NHK, a nonprofit public-service corporation whose main business is running broadcast stations, says its researchers are the first to see crystal structures "live" on a picture tube. The secret behind their success: a very powerful source of X rays and an X-ray vidicon.

Run-of-the-mill crystallography requires about 12 hours to get a series of diffracted X-ray images showing defects in crystal structures—defects that make all the difference in the characteristics of semiconductors. The slowness stems, essentially, from the low-intensity X rays put out by the industrial generators generally used for diffraction studies.

In a minute. Three years ago, NHK's solid state group started work on a generator that could develop X rays 100 times more intense than those of conventional generators. Early this summer, the group completed an experimental version that bombards a rotating target with a 60,000-volt, 1/2-ampere electron beam. As a result, films can be exposed in only about 1 minute.

The new X-ray source also makes possible electronic viewing at the standard frame rate of 30 per second. To transform the X-ray diffraction pattern into a video signal, NHK developed a special vidicon. Its window is beryllium—transparent to X rays—and its target is lead oxide. The oxide's characteristics are tailored to get maximum sensitivity to the soft X rays produced by diffraction.

Good tip

High-fidelity addicts in Japan will have a new issue to take sides on this fall—the merits of a light-modulating, lightweight stereo phonograph cartridge.

The Tokyo Shibaura Electric Co. plans to start selling the cartridge in its home market in October. The \$78 price includes both a preamplifier that carries the power source

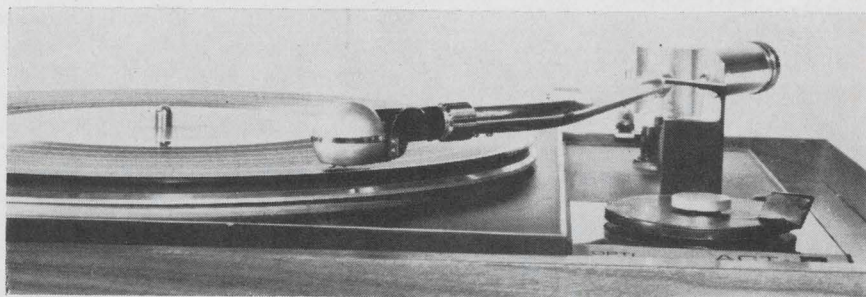
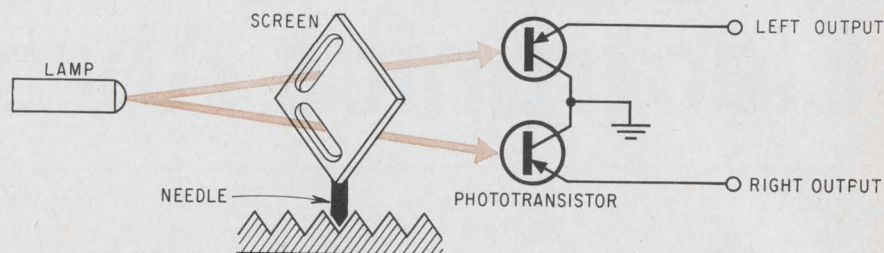

Light fantastic. Special germanium phototransistors and a low-mass screen are chief ingredients in Toshiba's recipe for low-distortion phonograph pickup.

for the light and—according to Toshiba—the lowest harmonic distortion anyone offers. Toshiba will export the cartridge, but hasn't decided when.

Groovy. The cartridge itself has a miniature lamp, a screen jiggled by the needle, and a pair of special germanium phototransistors. As the screen moves it modulates the light falling on the transistors according to what's in the grooves.

Because the needle moves only the screen, the moving mass of the pickup cartridge is a mere 0.3 milligram. Coil pickups have masses of about 0.4 mg and other types—moving magnet, ceramic, or crystal—have to push about 1 mg. Like most top-drawer pickups, Toshiba's has a 1 gram tracking force.

The phototransistors were designed for very high linearity, and they make for a frequency response over a range from 20 hertz to 40 kilohertz. Under standard distortion-measuring conditions—1 khz and tracking velocity of 5 centimeters per second—harmonic distortion is 0.65%, exceptionally low. At the same 1-khz frequency, the channel separation is 32 decibels.

The direct audio output of the cartridge is 75 millivolts. The preamplifier, which contains equalizing circuits for the two channels, boosts the output to 200 millivolts.

Light-headed. Toshiba also has something new in cartridges for consumers who'd rather buy a phonograph than put components together. The company's high-priced consoles are going to get an integrated-circuit cartridge that's just slightly larger in diameter than a kitchen match.

The small size, Toshiba says, stems from the IC's field-effect transistors. Because of them, the output from the piezoelectric elements driven by the needle can be very low—several millivolts. The cantilever rods attached to the needle can be shorter and lighter because the piezoelectric elements need not be deformed as much as in conventional cartridges. Since the cartridge is so small that a conventional plug wouldn't make sense, Toshiba does not plan to sell it as a component.

Great Britain

Thin slices

Ask a semiconductor expert why silicon slices are almost always more than 100 microns thick and he'll probably start explaining how anything thinner than that is too

brittle to be of any real use.

Not so, say three researchers at Standard Telecommunication Laboratories, one of the British units of the International Telephone and Telegraph Corp. Like everybody else, they found that silicon wafers do become brittle at first when thinned down below the presumed 100-micron limit. But, partly by accident, the trio also discovered that the brittleness practically vanishes when slices are 10 microns thick or less.

The three researchers, Derek Mash, Gordon Henshall, and Brian Eales, say that a 5-micron slice can be folded almost double before it cracks, like a piece of celluloid. At the Second Conference on Solid State Devices at the University of Manchester later this week, they intend to double over some slices and discuss what very thin silicon might lead to.

Lapped. The trio's discovery was an offshoot of its work on a high-slope varactor, one with a much-higher-than-usual change in capacitance. One of the ideas was to lap down the back side of a slice all the way through the substrate and into the diffused region, turning the p-n junction into a ring. The result was a slice less than 10 microns thick. Much to the trio's surprise, the wafer—so thin it was transparent—didn't disintegrate when it was picked up.

Mash says his team can make 5-micron wafers up to 1 inch in diameter and can hold thickness variations to ± 0.2 micron. To fabricate the thin slices, Mash laps down ordinary 100- or 200-micron wafers, using alumina slurry. The transparency makes the thickness easy to measure optically. The lapping is sometimes followed by a chemical etch to clean off work damage, but Mash doesn't think this step would be necessary in full-fledged production. It takes about four hours to polish a slice down to 10 microns.

Junction rings in the thin slices have about the same electrical properties as junctions in ordinary slices. Breakdown voltage, particularly, is comparable for the two. The team currently is checking out in detail

the properties of 5-micron slices. From results obtained so far, Mash predicts that devices with a capacitance of 0.1 picofarad could be easily made.

Up with power. The thin slices, Mash thinks, will lead to higher power outputs for high-frequency devices; the thinner the slice, the better its thermal conduction to a copper heat sink. Perhaps the first device to come will be a varactor diode for harmonic generation.

A high-slope varactor also looks like an early thin-slice device. It would have a diffused area whose outline would look like that of a daisy. At low voltages, the depletion layer is narrow and would closely outline the serrations around the junction ring. At higher voltages, the depletion layer gets larger and thus would tend to fill in the serrations. In other words, the area of the outer wall of the depletion layer is reduced—compared to the inner wall's area—as voltage increases. This results in a greater capacitance change than in an ordinary varactor.

Still another class of thin-slice devices would have metalization on both sides. An obvious example, Mash points out, would be a decimal-to-binary converter. It would comprise a matrix of diffused regions connected in horizontal rows on one side and in vertical rows on the other. The device could be made in four steps: diffusion, thinning, metalization on one face, and metalization on the other face.

Gunned-up pulses

Add pulse-code-modulation transmission to the fast-growing list of potential applications for Gunn diodes. The devices, report two researchers at the University of Sheffield, should perform admirably as generators and regenerators of very fast pulses—with durations from 1.4 to 6 nanoseconds.

The two, Hans Hartnagel and Touraj Izadpanah, work with ordinary gallium arsenide crystals made into diodes from 140 to 600 microns long. They've recorded power gains from 8 to 11 decibels. That's high

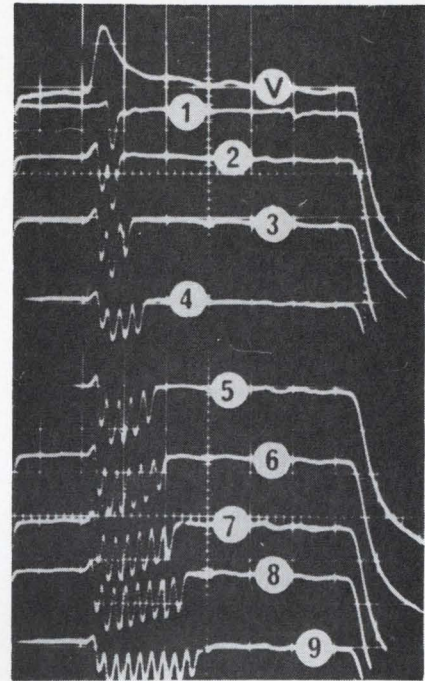

Fast count. The output pulses of a Gunn diode give a digital readout of analog voltage. An analog input pulse lasting 12 nanoseconds triggers the "9" reading at bottom.

enough, Hartnagel figures, to make possible production of pulse regenerators built around Gunn diodes. There's still a heat dissipation problem, but Hartnagel thinks the solution is diodes with cross sections 100 microns by 100 microns or smaller. In their experimental work, Hartnagel and Izadpanah have skirted the heat problem by using pulses to bias their diodes.

Domains. In a Gunn diode, high-field domains move through the crystal one at a time when it's biased above a threshold value. As each domain forms, the resulting current drop can be transformed into a voltage pulse by putting a load resistance—50 ohms in this case—in the circuit.

As pulse regenerators, the diodes work best biased at just below the threshold for domain formation. The pulse output from one diode triggers a domain in the next. Once a domain forms, though, it will continue to pass through the crystal even though the pulse that launched it has ended, because the bias voltage exceeds the extinction level.

The load resistor can be in series

with the diode or in parallel with it, but Hartnagel and Izadpanah found the series arrangement best over-all. Parallel circuitry, with a current source for bias, gave greater gain than the series arrangement, but suffered from reflection effects. There isn't any reflection in the series configuration, because the input and output pulses have opposite polarities.

Converter. Hartnagel and Izadpanah also see the Gunn diode as the basis for a very fast analog-to-digital converter. Their scheme: use a trapezoidal diode to trigger a conventional one biased, like the pulse regenerator, just below the threshold for domain formation.

The trapezoidal diode generates a triangular pulse that's fed to the second Gunn diode, whose bias is set so that with a low-input analog voltage the domain threshold is reached only at the apex of the triangular pulse. This triggers a single pulse from the output diode.

As the analog voltage increases, more of the triangular pulse lies above the threshold level and there's time for more than a single domain to move across the output diodes. The number of output pulses thus depends on the input voltage level. The pulses have amplitudes between 3 and 4 volts; a digital count of "9" requires an input pulse of 12 nanoseconds.

Hartnagel and Izadpanah are scheduled to talk about their work later this week at the University of Manchester solid state meeting.

West Germany

Back in the air

West German avionics producers long have counted on a big military program—replacements for the Luftwaffe's aging F-104 Starfighters—to airlift them off their current low sales plateau. The order for the next batch of military planes is still to come, but a ripple of optimism went through the industry late last month as the government announced it would back develop-

ment of a short-haul jet.

The 36-passenger plane—the first commercial jet to be built by West Germany's once high-flying aviation industry—will come off the production lines of Vereinigte Flugtechnische Werke GmbH at Bremen.

Loaded. Rolf Stuessel, who will run the program, says the prototype will fly by 1971. The sales target for the jet, called the VFW 614, is 375 planes. At an average \$1.9 million apiece, that would mean something like \$712 million in sales for VFW and the other companies participating in the project.

If VFW's sales plans pan out, West German avionics producers stand to pick up a good part of the estimated \$32.8 million in electronics hardware the jets would need. Standard systems for the plane include four very-high-frequency radio sets, two direction finders, two compass systems, a flight-control system, an autopilot, distance-measuring equipment, a transponder, weather radar, and a flight-data recorder. An automatic landing system will be among the options.

The Netherlands

Right-light chip

Japan's Yashica Co. stole a march on its competitors early this summer when it marketed an electronic camera with an integrated circuit that shows when the shutter speed and aperture setting are right [Electronics, July 8, p. 221].

But like many a technological pioneer, Yashica may soon find itself with an obsolescent product. Philips' Gloeilampenfabrieken has developed a monolithic IC for electronic cameras, and it's a good bet that some camera maker will snap it up before too long. The Philips IC develops an output that operates a shutter-closing solenoid. Yashica's circuit, manufactured by the Nippon Electric Co., is a thick-chip hybrid that controls lamps.

Wide range. The Dutch IC, developed at Philips' Eindhoven research facility, has on the chip all

the key components for an exposure meter, including a photodiode. Its output voltage is measured, with very little current consumption, by a differential amplifier.

When the shutter opens, the circuit starts integrating the difference current. The integration continues until the amount of light that has passed through the lens is right for the aperture setting and the film rating. Then, the voltage across the integrating capacitor is high enough to switch a trigger circuit that controls the shutter solenoid.

The circuit, Philips says, can handle a wide range of camera settings—apertures from f2 to f16, shutter speeds from 1/1,000 to 20 seconds, and film ratings from ASA 25 to ASA 2,800. Philips has kept details of the circuit to itself but will report on it at the Solid State Sensors and Transducers Symposium in Minneapolis next week.

Around the world

Australia. Down Under electronics producers will turn out about \$224 million worth of hardware this year, the government estimates. The figure for 1968 is up \$22 million from last year's output and is split about equally between consumer goods and heavy equipment.

Japan. The Ministry of Transportation expects to have a nationwide data-transmission network ready by 1971 to handle auto registrations. The system will link the ministry's 63 regional offices to a Nippon Electric NEAC 2200 Model 500 computer in Tokyo. Last year the ministry handled 20 million registration transactions. The figure is expected to reach 100 million in the next five years.

Great Britain. The Marconi Co. has landed a contract to supply some \$2.4 million of television transmitters to the British Broadcasting Corp. between now and 1971. The order covers five 40-kilowatt, two 25-kw, and nine 10-kw transmitters. All are uhf units.

TRW ANNOUNCES NEW MILITARY MYLARS



Up to 72% smaller than MIL-C-25C paper capacitors!

MIL-C-19978B/2 reduces capacitor size drastically—down to .125" diameter by 1/2" long. At the same time electrical characteristics are upgraded sharply.

MIL-C-19978B/2 hermetically sealed mylar* capacitors are available now from TRW with immediate delivery in production quantities.

- **REDUCED SIZE**—35% to 72% smaller than MIL-C-25C.
- **VOLTAGE CHOICE**—30V, 50V, 100V, 200V, 600V, 1000V.
- **CAPACITANCE CHOICE**—.001 mfd through 10.0 mfd.
- **TOLERANCE CHOICE**—±10%, ±5%, ±2%, ±1%.

Product information is available from TRW Capacitor Division, TRW INC., Box 1000, Ogallala, Nebraska. Phone (308) 284-3611. TWX: 910-620-0321.

*Du Pont registered trademark

TRW[®]

Circle 173 on reader service card

173



■ Acopian Corp. Mort Barish Associates	14	■ Hewlett Packard, Colorado Springs Div.	3rd Cover	■ Tektronix, Inc.	109, 110
Allen-Bradley Co. Fensholt Adv. Agcy.	25, 27	■ Hewlett Packard, Loveland Div. Tallant/Yates Adv., Inc.	1, 2	■ Texas Instruments Incorporated Components Group	68
Allen Electronics Div., Allen Organ Co. Rex Reichert Assoc., Inc.	114	■ Hewlett Packard, Rockaway Div. Culver Adv., Inc.	121	■ Texas Instruments Incorporated Industrial Products Group	134
■ Amelco Semiconductor Serra Associates	148	■ HI-G, Inc. Marketing Assistance, Inc.	49	■ Tracor, Inc.	37
American Lava Corp. Sub. of Minnesota Mining & Mfg. Co. Designers, Inc.	131	■ Hitachi Metals, Ltd. Standard Advertising, Inc.	154	■ Weekley & Valenti, Inc.	150
Andrew Corp. Fensholt Adv., Inc.	52	■ Honeywell, Test Instruments Div. Campbell Mithun, Inc.	6	■ Trans World Airlines, Inc. Foote, Cone & Belding	147
Automatic Electric Co. Sub. of General Telephone & Electronics Corp. Marsteller, Inc.	18, 19	■ Hughes Aircraft Co. Foote, Cone & Belding	20, 21, 108	■ Trompeter Electronics Jansson Advertising	173
Bank of New York, The, Special Industries Group	135	■ Instrument Specialties Co., Inc. Levy Adv. Assoc., Inc.	30	■ TRW Electronics, Capacitors Div. Fuller & Smith & Ross, Inc.	113
Evans Marketing Communications, Inc.	138	■ International Crystal Mfg. Co. Robert V. Freeland & Associates	130	■ Trygon Electronics, Inc. Kameny Assoc., Inc.	142
Baus Optics, Inc.	60	■ Janco Corp. Eastman Adv. Agcy.	56	■ Trymetrics Corp. Kameny Assoc., Inc.	128
■ Beckman Instruments, Inc., Helipot Div. Hixson & Jorgensen, Inc.	60	■ Joslyn, Inc. Chace Company	146	■ Tung-Sol Div., Wagner Electric Corp. Feeley & Wheeler, Inc.	175
Bendix Corp., Semiconductor Products Div. MacManus, John & Adams, Inc.	116	■ Krohn-Hite Corp. L.K. Frank Co., Inc.	126	■ University Laboratories, Inc. West Associates	175
Bendix Corp., Vacuum Div. MacManus, John & Adams, Inc.	176	■ Leach Corp. Jay Chiat & Associates	12, 13	■ Varian Associates—Solid State Microwave Project	166
Bourns, Inc., Trimpot Div. Lester Company, The	48	■ Machlett Laboratories, Div. of Raytheon Co. Fuller & Smith & Ross, Inc.	15	■ Botsford, Constantine & McCarty, Inc.	159, 161
Brush Instruments Division of Clevite Corp. Carr Liggett Adv., Inc.	59	■ Magnetics, Inc. Lando Adv. Agcy., Inc.	119	■ Varo, Inc. Tracy-Locke Co., Inc.	151
■ Bulova Watch Co., Electronics Div. Levy Adv. Assoc.	8	■ Mergenthaler Linotype Co. Merlin Advertising	152	■ Weston Instruments, Inc., Newark Div. Arndt, Preston, Chapin, Lamb & Keen, Inc.	51
■ Bussmann Mfg. Div. of McGraw Edison Co. Henderson Adv. Co.	124	■ Micro Switch Div. of Honeywell Batten, Barton, Durstine & Osborn, Inc.	28, 29	■ Williams Gold Refining Co., Inc., Precious Metal Div. Stahlka, Faller & Klenk, Inc.	7
Christie Electric Corp. Len Woolf Co. Advertising	146	■ Motorola Semiconductor Products, Inc. Lane & Bird Adv., Inc.	35, 36, 50, 143		
Clare & Co., C.P. Reincke, Meyer & Finn Adv., Inc.	139	■ Mullard, Ltd. Parker-Rumrill International, Inc.	151		
■ Clifton Precision Products Co., Div. of Litton Industries Ivey Adv., Inc.	32	■ National Semiconductor Corp. Jay Chiat & Associates	105, 107		
Cohu Electronics, Inc. Erwin Wasey, Inc.	115	■ New Hermes Engraving Machine Corp. Lester Harrison Adv., Inc.	138		
Control—Logic, Inc. Van Christo Assoc., Inc.	43	■ North Atlantic Industries, Inc. Murray Heyert Associates	155		
Corning Glass Works Electronic Div.— Resistors Rumrill Hovt Co., Inc.	106	■ Nus Corp., Electronic Systems Div. Graphic Associates	150		
CREI, Home Study Div. of the McGraw-Hill Book Co. Henry J. Kaufman & Associates	157	■ Parker Instrument Corp. Philco Ford Corp.	146		
Defense Electronics, Inc. Harry I. Clarkson Associates	58	■ Sierra Electronics Operation Hal Lawrence, Inc.	23		
Dit-Mco International Div. of Xebec Corp. Martin Fromm & Assoc., Inc.	136	■ Plastic Capacitors, Inc. Sander Rodkin Adv. Agcy., Ltd.	16		
DuPont de Nemours Co., Industrial Fibers Nomex Batten, Barton, Durstine & Osborn, Inc.	127	■ Quan-Tech Laboratories Kniep Associates	104		
E-H Research Laboratories, Inc. Steedman, Cooper and Busse Advertising	45	■ Radar Design Barlow-Johnson, Inc.	22		
Electronics and Control Engineers' Book Club	122	■ Radiation, Inc. W.M. Zemp & Assoc., Inc.	47		
Emerson & Cuming, Inc. Edwin F. Hall	156	■ Radio Corporation of America Al Paul Lefton Co.	4th Cover		
Fairchild Instrumentation Faust/Day, Inc.	73	■ Raytheon Co., Industrial Components Div. Fuller & Smith & Ross, Inc.	160		
■ Fairchild Semiconductor, Inc. Faust/Day, Inc.	10, 11	■ Scientific Data Systems Doyle, Dane, Bernbach, Inc.	38		
Fluke Manufacturing Co., John Bonfield Associates	17	■ Signetics Corp. Sub. Corning Glass Works Cunningham & Walsh, Inc.	132		
Fujitsu Ltd. Asian Advertisers, Inc.	158	■ Solid State Products Van Christo Assoc., Inc.	26		
■ General Instrument Corp., Semiconductor Products Div. Norman Allen Associates	129	■ Sorenson Operation, Raytheon Company Urrutia & Hayes, Inc.	55		
General Radio Co. Horton, Church & Goff, Inc.	2nd Cover	■ Sperry Rand Corp., Sperry Electronic Tube Div. Neals & Hickok, Inc.	123		
Gertsch/Division of the Singer Co. Marylyn Ritchie and Associates	24	■ Sprague Electric Co., The Harry P. Bridge Co.	5, 9		
Granger Associates West Associates	144	■ Stackpole Carbon Co., Electronic Components Div. Meek & Thomas, Inc.	140		
Gries Reproducer Co. Harold Marshall Adv.	150	■ Sylvania Electric Products, Inc., Parts Div. Doyle, Dane, Bernbach, Inc.	57		
Haydon Co., A.W. Chambers, Wiswell & Moore, Inc.	160				
■ Heath Co., Sub. of Schlumberger, Ltd. Advance Advertising Service	137				

Classified Advertising

F.J. Eberle, Manager

EMPLOYMENT OPPORTUNITIES

The Hays Corporation	162
Motorola Aerospace Center	162

EQUIPMENT (Used or Surplus New) For Sale

A&A Electronics Corp.	165
Equity Leasing Corp.	165
Fishman, P., Co.	165
Radio Research Instrument Co.	165

■ For more information on complete product line see advertisement in the latest Electronics Buyer's Guide

Electronics Buyers' Guide

George F. Werner, General Manager
[212] 971-2310
Robert M. Denmead,
Midwest Regional Manager
[312] MO 4-5800
Regina Hera, Directory Manager
[212] 971-2544
Thomas M. Egan, Production Manager
[212] 971-3140

Circulation Department

Isaaca Siegel, Manager [212] 971-6057

Research Department

David Strasser, Manager [212] 971-6058
Chloe D. Glover, Research Associate
[212] 971-6057

Advertising Sales Staff

Frank E. LeBeau [212] 971-6464
Advertising Sales Manager

Wallis Clarke [212] 971-2187
Assistant to sales manager

Donald J. Austermann [212] 971-3139
Promotion Manager

Warren H. Gardner [215] LO 8-6161
Eastern Advertising Sales Manager

Atlanta, Ga. 30309: Michael H. Miller, 1375
Peachtree St., N.E.
[404] 892-2868

Boston, Mass. 02116: William S. Hodgkinson
McGraw-Hill Building, Copley Square
[617] CO 2-1160

Cleveland, Ohio 44113: William J. Boyle, 55
Public Square, [216] SU 1-7000

New York, N.Y. 10036
500 Fifth Avenue
James R. Pierce [212] 971-3616
John A. Garland [212] 971-3617

Philadelphia, Pa. 19103:
Jeffrey M. Preston
Warren H. Gardner,
6 Penn Center Plaza,
[215] LO 8-6161

Pittsburgh, Pa. 15222: Warren H. Gardner,
4 Gateway Center, [412] 391-1314

Rochester, N.Y. 14534: William J. Boyle,
9 Greylock Ridge, Pittsford, N.Y.
[716] 586-5040

Donald R. Furth (312) MO 4-5800
Midwest Advertising Sales Manager

Chicago, Ill. 60611: Kenneth E. Nicklas
Ralph Hanning, 645 North Michigan Avenue,
[312] MO 4-5800

Dallas, Texas 75201: Richard P. Poole, 1800
Republic National Bank Tower,
[214] RI 7-9721

Houston, Texas 77002: Robert Wallin,
2270 Humble Bldg. [713] CA 4-8381

Detroit, Michigan 48226: Ralph Hanning,
856 Penobscot Building
[313] 962-1793

Minneapolis, Minn. 55402: 1104 Northstar
Center [612] 332-7425

St. Louis, Mo. 63105: Kenneth E. Nicklas,
The Clayton Tower, 7751 Carondelet Ave.
[314] PA 5-7285

James T. Hauptli [415] DO 2-4600
Western Advertising Sales Manager

Denver, Colo. 80202: Joseph C. Page, David
M. Watson, Tower Bldg., 1700 Broadway
[303] 255-5484

Los Angeles, Calif. 90017: Ian C. Hill,
John G. Zisch, 1125 W. 6th St.,
[213] HU 2-5450

Portland, Ore. 97204: James T. Hauptli,
Thomas McElhinny, 218 Mohawk Building,
222 S.W. Morrison Street,
Phone [503] 223-5118

San Francisco, Calif. 94111: James T. Hauptli,
Thomas McElhinny, 255 California Street,
[415] DO 2-4600

Pierre Braude Tel: 225 85 88: Paris
European Director

Paris: Ken Davey
88-90 Avenue Des Champs-Elysees, Paris 8
United Kingdom and Scandinavia

Brian Bowes Tel: Hyde Park 1451
34 Dover Street,
London W1

Milan: Robert Saidel
1 via Baracchini Phone 86-90-656

Brussels: F.I.H. Huntjens
27 Rue Ducale Tel: 136503

Frankfurt/Main: Hans Haller
Elsa-Brandstroem Str. 2
Phone 72 01 81

Geneva: Ken Davey
1, rue du Temple Phone: 31 95 60

Tokyo: Takeji Kinoshita 1 Kotohiracho
Shiba, Minato-Ku Tokyo [502] 0656

Osaka: Ryoji Kobayashi 163, Umegae-cho
Kita-ku [362] 8771

Business Department

Wallace C. Carmichael, Manager
[212] 971-3191

Stephen R. Weiss, Production Manager
[212] 971-2044

Thomas M. Egan,
Assistant Production Manager [212] 971-3140

Dorothy Carmesin, Contracts and Billings
[212] 971-2908

Frances Vallone, Reader Service Manager
[212] 971-2865

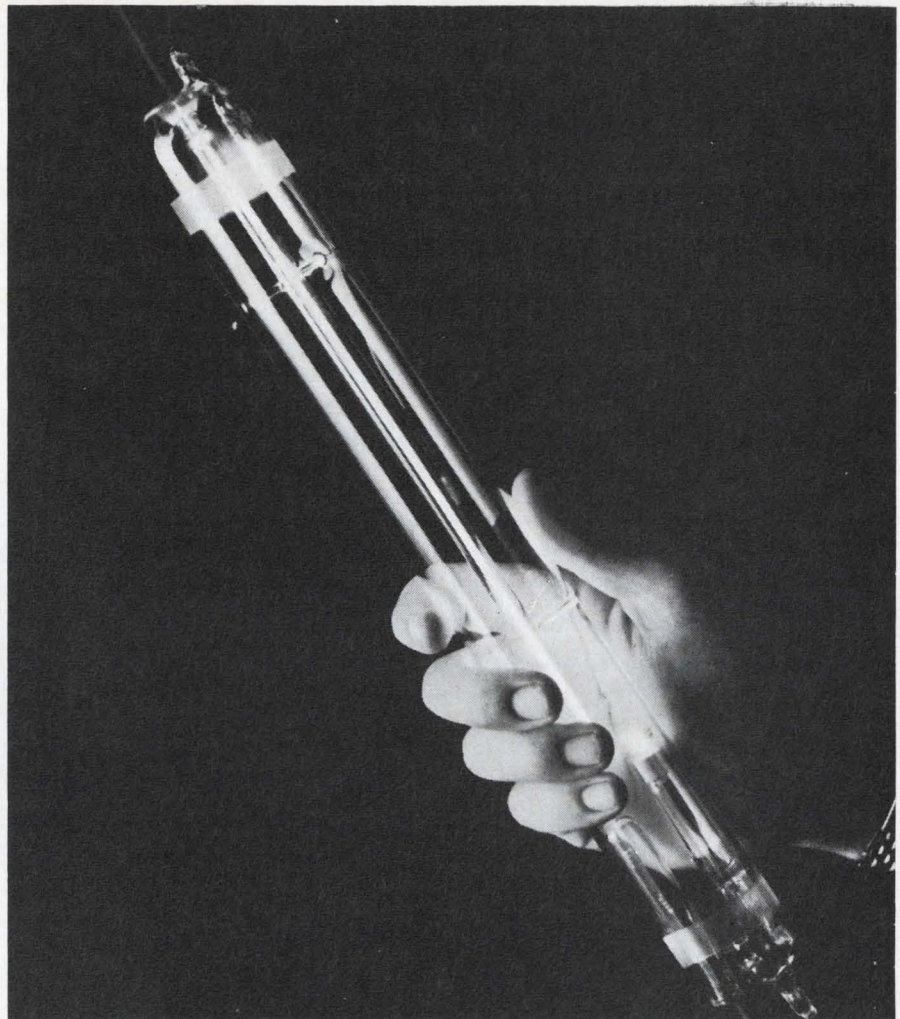

The coherent lightbulb

A new concept in He-Ne continuous gas lasers for systems and OEM users.

The Lasertron™ He-Ne plasma tube is a lightbulb. A coherent one. Operate it without a housing. Even under water. And it is available as an individual component or as a complete laser instrument with a separate, detachable, low-ripple solid-state power supply.

The Lasertron tube needs no adjustment, alignment, or maintenance. Simply switch it on and off. Nothing more. Its resonator mirrors are permanently aligned inside a rigid coaxial pyrex envelope. Collimation is built in; alignment stability is guaranteed. Dust, humidity, vibration, temperature extremes, and ageing will not affect it.

Lasertron tubes are available in a variety of geometries for systems and OEM users. Power outputs range from 10 mW to 0.6 mW in TEM₀₀ mode, at a wavelength of 6328 Angstroms.

Lasertron tubes and complete instruments are guaranteed for one full year, with no restriction on operating hours.

For applications assistance and product literature, please return coupon or contact University Laboratories, 733 Allston Way, Berkeley, California 94710 (415) 848-0491.

University Laboratories

733 ALLSTON WAY, BERKELEY, CALIF. 94710

Please send new brochure with complete specifications on He-Ne laser instruments and accessories.

Please send information on Lasertron™ Plasma Tubes.
My interest is current for future reference.

Name _____

Organization _____

Dept., Mail Station _____

Address _____

City, State, Zip _____

HERE'S THE LATEST INFORMATION ON THIN-FILM DEPOSITION...

Five CVC PlasmaVac® Low-energy Sputtering Systems — to handle thin-film applications from laboratory to production line.

Sputtering thin films with a CVC PlasmaVac® system lets you deposit almost any material on almost any surface—with excellent control over film composition, purity, and thickness. You'll increase efficiency, quality, and yields over any other thin-film

deposition method. Please write for full details on any or all of the PlasmaVac Systems described below. Vacuum Division, The Bendix Corporation, 1775 Mt. Read Blvd., Rochester, N.Y. 14603.

	PLASMAVAC 100	PLASMAVAC 200	PLASMAVAC 300	PLASMAVAC 400	PLASMAVAC 501
GENERAL	DC triode sputtering. Metals, conductors.	RF triode sputtering. Conductors, semi-conductors, non-conductors.	RF diode sputtering.	Production-type system with DC Crossfire™ and RF capability on in-line basis with air to air substrate transport.	DC Crossfire™ with rotary work holder, multiple targets.
APPLICATIONS	Laboratory and limited production. Ideal with CV-18 vacuum system.	Laboratory and limited production when used with PlasmaVac 100.	Sophisticated research applications. Reactive sputtering, sputter etching, semi-conductors, dielectrics, etc.	Bridges the laboratory/production interface. Modular concept so process can be developed, then scaled up to meet production needs.	Batch-type production unit for pilot plant operation.
Deposit Metals	Yes	Yes	Yes	Yes	Yes
Deposit Dielectrics	No	Yes	Yes	Yes	Yes*
Deposit Semiconductors	Some	Yes	Yes	Yes	Yes*
Deposit Cermets	No	Some	Yes	Yes	Yes*
Deposit Alloys	Yes	Yes	Yes	Yes	Yes
Deposit Organics	No	No	Some	Some	No
Water Cooled Target (for use of thermally sensitive materials)	No	No	Yes	Yes	Yes
Water Cooled Substrate	No	No	Yes	Yes	No
Reactive Sputtering	No	Some	Yes	Yes	Some
Bias Sputtering	Yes	Some	No	No	No
Sputter Etching	Few	Some	Yes	Yes	No
Type of Chamber	Bell Jar	Bell Jar	Bell Jar	Production-type modular chamber	Low profile metal chamber
Multiple Target Sputtering	Yes	Yes, with PlasmaVac 100	No	Yes	Yes

*Available on special order.

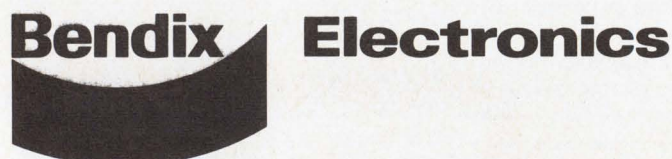

New All-Solid-State hp 1200 Scope System Sets New Standards of Performance for Your dc-500 kHz Measurements

Now you can upgrade your low frequency measurements with the new hp 1200 scope system for better performance, greater sensitivity and improved accuracy in the dc to 500 kHz range.

The hp 1200 scope system has an all-new design from the inside out to provide all-solid-state reliability and stability. Drift has essentially been eliminated to allow accurate measurements—even in the 100 μ V dc area. Controls on the front panel have been grouped to give faster measurements, quicker set-up, direct dial readout even when using the magnifier.

Choose from four models to get single or dual trace 100 μ V/cm sensitivity, or single or dual trace 5 mV/cm sensitivity. The 100 μ V scopes have 17 calibrated ranges in 1-2-5 sequence with vernier for continual adjustment between ranges. (The 5 mV scopes have 12 calibrated ranges.) All four

models have large 8 x 10 cm internal graticule CRT's, single-ended or differential input on all ranges, complete triggering versatility, external horizontal input, dc-coupled Z-axis, beam-finder—many of the features you normally associate only with high frequency scopes.

All four models are available as lightweight (< 25 pounds) cabinet or 5 $\frac{1}{4}$ " high rack mounts. Power consumption of 33 watts eliminates need for cooling fans.

For details on how you can increase your measurement confidence and your measurement accuracy in the low frequency range, contact your nearest hp field engineer. Ask him about the new hp 1200 scope system. Or, write to Hewlett-Packard, Palo Alto, California 94304. In Europe: 54 Route des Acacias, Geneva.

Circle 901 on reader service card

	1200A/AR*	1202A/AR*	1205A/AR*	1206A/AR*
Number of Channels	2	1	2	1
Maximum Vertical Sensitivity	100 μ V/cm	100 μ V/cm	5 mV/cm	5 mV/cm
Common Mode Rejection (Differential)	100 dB	100 dB	50 dB	50 dB
X-Y Capability	Identical Amplifiers (17 ranges)	17 vertical vs. 4 horizontal ranges	Identical Amplifiers (12 ranges)	12 vertical vs. 4 horizontal ranges
Price	\$990	\$790	\$875	\$715

* AR indicates 5 $\frac{1}{4}$ " rack mount model

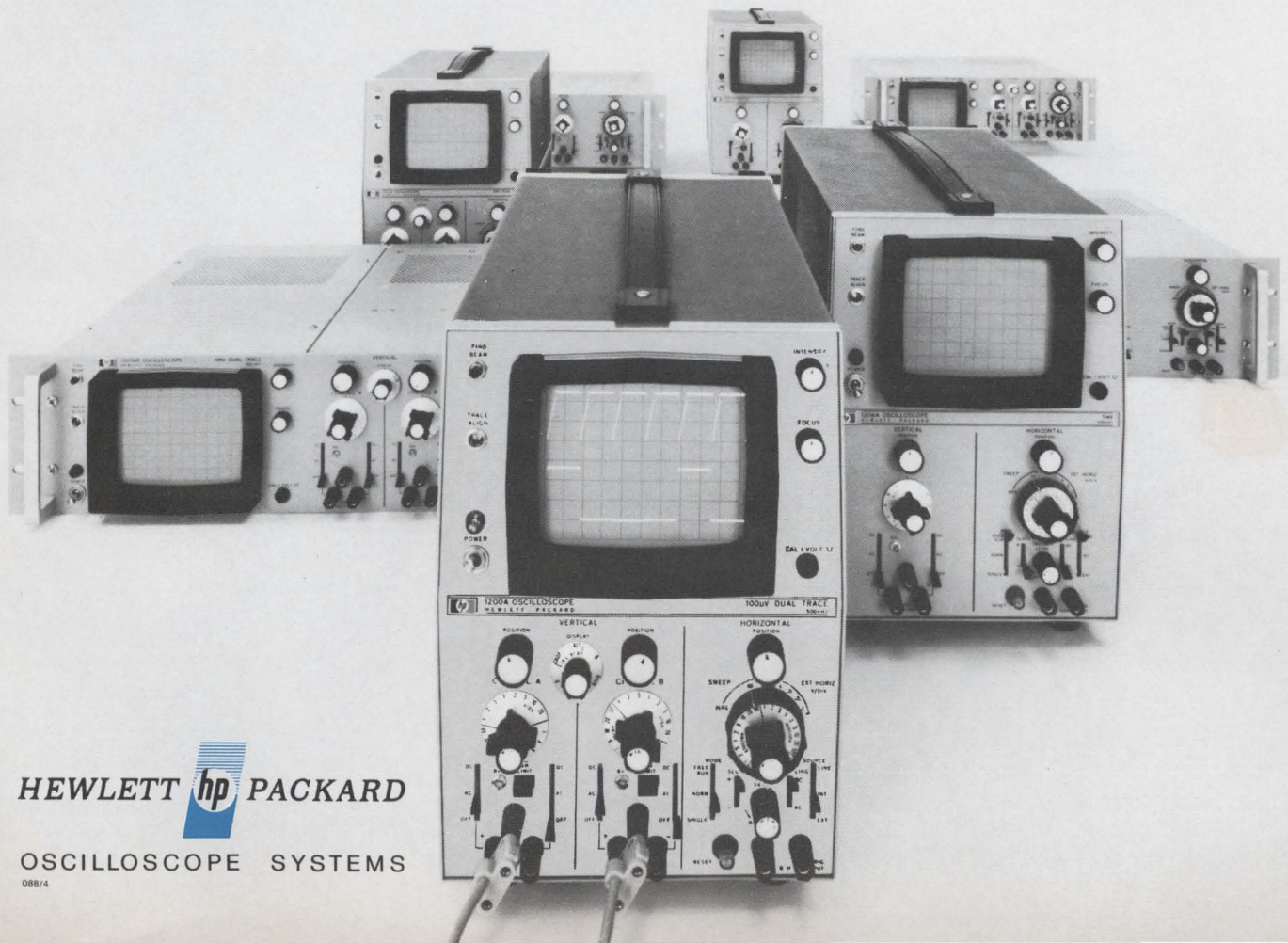

HEWLETT  PACKARD

OSCILLOSCOPE SYSTEMS

088/4

Power for any socket... new or old

There's a wide selection of RCA Power Tube types — all meeting the challenge of modern, high-power RF design — all with the same built-in reliability — all made to the same exacting standards.

You already know the RCA-6146 "family." Its new RCA-6146B type sets new marks for reliability and performance. Like all RCA RF power tube types, it's built for service. Carefully-shielded getters reduce RF losses. Grid side rods are high dissipation copper. Plates? Pure nickel inside the low-loss lead-glass bulb. Regular life tests at full rated RF input and frequency prove our point — RCA-6146B — and every other RCA power tube — will give you and your customer maximum reliability and RF performance in new or old equipments.

Now meet the RCA-8794 — latest example of RCA Power Tube innovation in design. A 10-kW tube, designed and priced for HF, FM and VHF-TV sockets, it is capable of full performance throughout the military UHF band! This 400-MHz capability makes it a cinch to operate in lower frequency and linear applications, and the high-gain CERMOLOX[®] tube construction pays off in performance and reliability wherever you use the RCA-8794.

See your RCA Representative or your RCA Distributor for more information on the more than 100 RCA Power Tube Types to meet your exact requirements. For technical data on specific RCA Power Tube types, write RCA Electronic Components, Commercial Engineering, Section I-19-Q-1, Harrison, N. J. 07029.

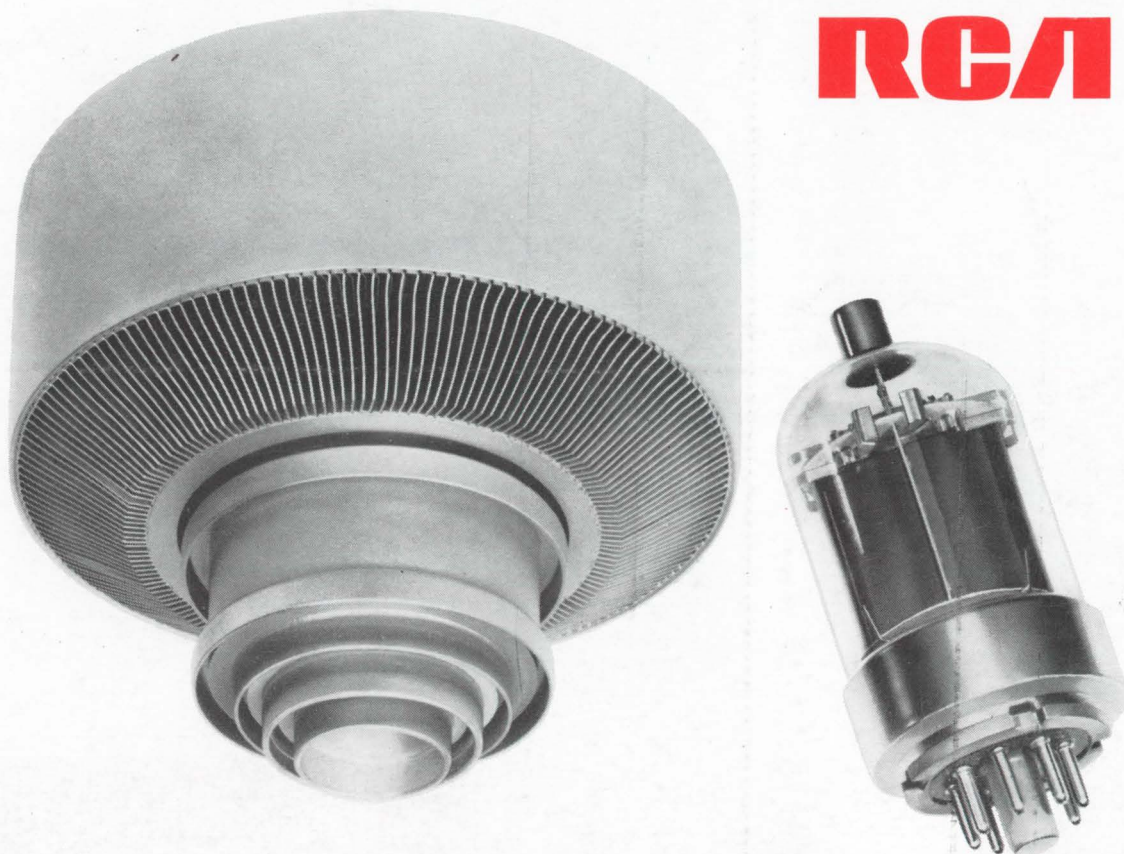

RCA