

# Electronics<sup>®</sup>

**Small computer with big capacity: page 92**

**Achieving negative impedance: page 105**

**Picosecond laser pulses: page 112**

September 16, 1968

\$1.00

A McGraw-Hill Publication

Below: The many paths  
of the laser, page 110

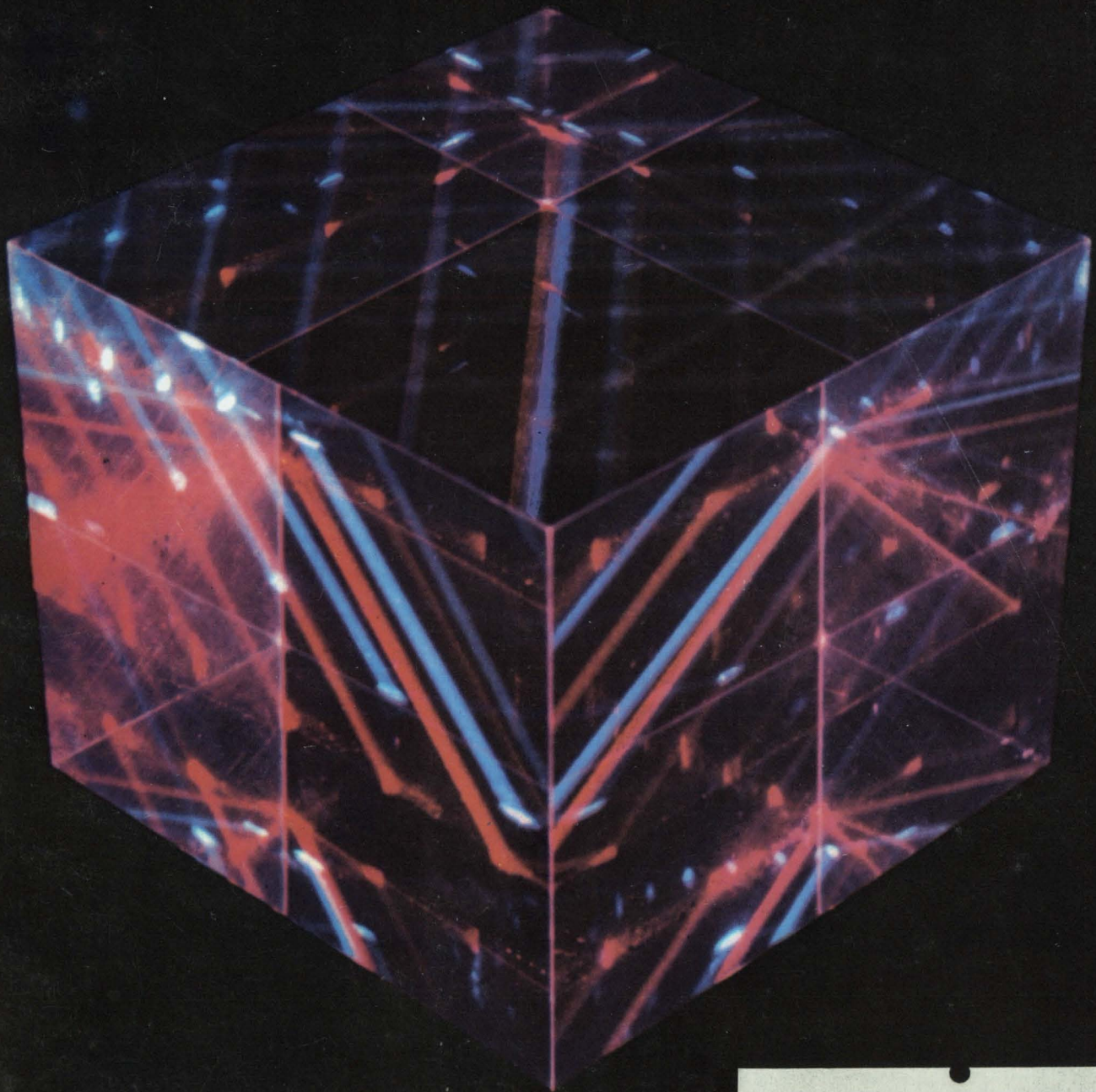



# They're on our shelf



## The "special" audio transformers you need are "standard" at UTC.

When you're ready to specify transformers and inductors, before you turn to costly specials, check UTC. Chances are there's a standard unit that fits your special electrical and mechanical requirements exactly.

UTC has over 500 audio types in stock, ready for immediate delivery. And UTC engineers are constantly adding to the line. Microwatts to kilowatts. Less than  $\frac{1}{4}$  Hz to greater than 1 MHz. MIL-T-27 or industrial. Metal-encased or open frame. Input, output, mixing, match-

ing, modulating, phase shifting, hybrid, baluns, ring modulator. All in continuous production for sample or high-volume requirements.

If the specific unit you need isn't on our shelf, we'll tailor a standard unit to your special requirements—saving the time and costs of starting from scratch. For catalog, write: United Transformer Company, Division of TRW INC., 150 Varick Street, New York, N.Y. 10013.

**TRW**<sup>®</sup>

UNITED TRANSFORMER COMPANY



# How do you make the best power meter better?



## Automatic zero setting, for one thing.

The new Hewlett-Packard 432A Power Meter offers even more performance and convenience than the well-known HP 431C. For one thing, you simply press a toggle switch on the front panel and the meter balances to zero automatically.

For another thing, the 432A offers  $\pm 1\%$  of full scale accuracy over an even broader power and temperature range. This accuracy holds for all seven power ranges, from 10 mW (+10 dBm) down to 10  $\mu$ W (-20 dBm)—and over the temperature range from 0°C to 55°C. Frequency coverage is 10 MHz to 40 GHz with interchangeable thermistor mounts.

Improved "zero carryover" adds still more convenience. With the HP 432A Power Meter, zero set shifts

less than  $\frac{1}{4}\%$  for a range change. And because the 432A is dc biased exclusively, the thermistor mount cable can be flexed without affecting the zero set.

The new power meter operates with the same thermistor mounts used with the 431C. And its Calibration Factor control lets you normalize the meter reading, using the mount efficiency data supplied with each HP temperature-compensated thermistor mount. This assures highest overall power measurement accuracy. Price: \$495 (add \$100 for optional rechargeable battery pack).

Call your HP field engineer for more details, or write Hewlett-Packard, Palo Alto, California 94304; Europe: 54 Route des Acacias, Geneva.

HEWLETT  PACKARD

MICROWAVE TEST EQUIPMENT

04812



# The best swept frequency measurements between 100 kHz and 40GHz start here:

REFLECTOMETRY

GAIN/ATTENUATION

NETWORK ANALYSIS

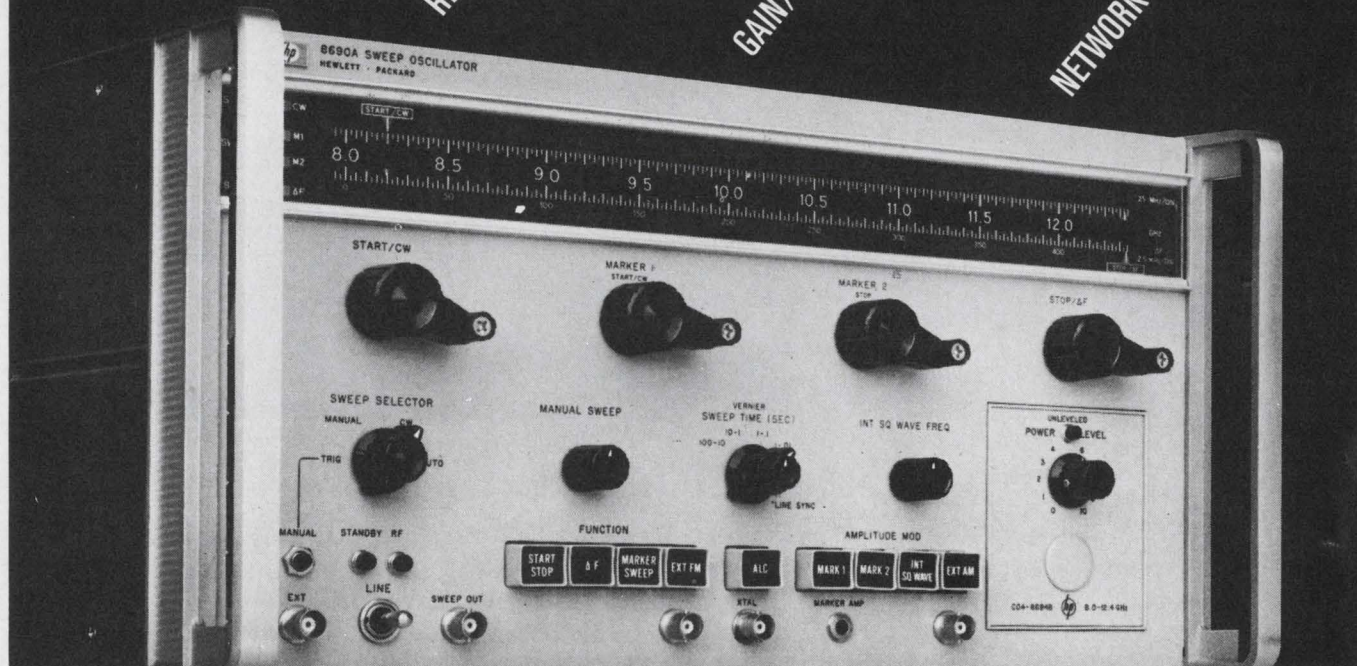

The measurements you get out of a circuit are only as good as the signals you put in. Consequently, the HP 8690B Sweep Oscillator—and each of its RF plug-ins—are designed to give excellent frequency accuracy and linearity with low residual FM. The result is superior overall performance. And you can be sure the measurements you get represent the device you're testing.

In addition, controls on the 8690 are designed to eliminate human error. Pushbuttons select the desired function and modulation. Start and Stop pointers set end points for sweeping, up or down, anywhere in the band. Two independent frequency markers, also set anywhere in the band, expand a sweep segment or establish a second sweep range. You can switch to a calibrated narrow-band sweep symmetrical about a center frequency.

The HP 8690B mainframe costs \$1600. Plug-in RF Units range from \$1150 to \$4300, depending on the frequency range. The 8690 is also the starting point for multiband and phase-locked systems used in production and systems applications. For complete information, call your HP field engineer. Or write Hewlett-Packard, Palo Alto, California 94304; Europe: 54 Route des Acacias, Geneva.

HEWLETT  PACKARD  
SWEEP OSCILLATORS



## News Features

### Probing the News

- 153 **Military electronics:** Defense Department slates reform of systems engineering management
- 159 **Air defense:** Air Force gets new, economy Buic
- 165 **Avionics:** Designers up in air over specs

### Electronics Review

- 53 **Solid state:** Taking a new cut at silicon
- 54 **Electro-optics:** Improving night vision
- 55 **Advanced technology:** Plastic laser
- 55 **Communications:** Ma Bell and the foreign attachments
- 56 **Military electronics:** Guaranteed results
- 57 **Commercial electronics:** Unlocking memories; Green light, red faces
- 58 **Manufacturing:** Spider bonding
- 60 **Companies:** Motorola vs. Fairchild
- 62 **Computers:** Linking machines
- 62 **Avionics:** Altitude alert
- 64 **Space electronics:** Race for the Olympics
- 64 **For the record**

### Electronics Abroad

- 235 **Japan:** Two phone conversations on one line; woven memories for Univac machines
- 237 **Australia:** Measuring speed and direction of ionosphere
- 237 **Italy:** Raytheon-Elsi decision near
- 238 **Great Britain:** Etched coils for scanning deflection
- 239 **Canada:** Domestic satellite ruffles feathers

### New Products

- 169 Hall generators trigger IC's in keyboard priced at \$100
- 172 Heat sensors are ISA show feature
- 176 **Components review**
- 176 Hybrid crowbar guards circuits
- 180 Thick-film paste fires fast
- 183 **Instruments review**
- 183 Digital meter sells for \$230
- 186 Thermocouple display goes digital
- 189 **Subassemblies review**
- 189 Tape recorder is C-5A spinoff
- 193 IC's help halve clock price
- 194 SCR regulates power supply
- 198 IC's control tiny d-c source
- 200 **Production equipment review**
- 200 P-c board eases layout tasks
- 202 Infrared camera costs \$10,000
- 207 **Semiconductor review**
- 207 IC package permits batch-handling
- 208 Hybrid circuit controls appliances
- 210 MOS gate does its own decoding
- 213 **Industrial electronics review**
- 213 System monitors auto lights

## Technical Articles

### Computers 92

#### PDP-8/I: bigger on the inside yet smaller on the outside

Updating a proven computer design with IC's made room for many options inside the machine and paid extra dividends in increased capability

James F. O'Loughlin  
Digital Equipment Corp.

### Circuit design 99

#### Designer's casebook

- Operational amplifier simulates inductance
- Transistor increases zener's power capacity
- SCS outperforms UJT in relaxation oscillator
- Tester measures resistance of multilayer p-c boards
- Simple logic configuration compares eight-bit binary numbers
- Parallel-T bandpass filter produces voltage gain

### Design theory 105

#### Active filters: part 4

##### Approaching the ideal NIC

Several proposed circuits yield negative-impedance converters with the characteristics required to produce accurate transfer functions

Louis de Pian and Arnold Meltzer  
George Washington University

### Lasers I 110

#### Laser research takes a practical turn

New emphasis on jobs for lasers may give electrical techniques a run for their money

William Bucci  
Communications editor

### Lasers II 112

#### Mode locking opens door to picosecond pulses

Bursts of light with hundreds of gigawatts of peak power are generated by Q-switched lasers with phase-locked frequencies

A.J. DeMaria  
United Aircraft Research Laboratories

### Lasers III 123

#### Light wave of the future: optical pcm

Digital light terminals use mode-locked lasers, time multiplexing, and state-of-the-art components to increase information capacity

T.S. Kinsel  
Bell Telephone Laboratories

## Departments

- |     |                          |     |                        |
|-----|--------------------------|-----|------------------------|
| 4   | Readers Comment          | 33  | Electronics Newsletter |
| 8   | Who's who in this issue  | 67  | Washington Newsletter  |
| 14  | Who's who in electronics | 216 | New Books              |
| 22  | Meetings                 | 218 | Technical Abstracts    |
| 31  | Editorial Comment        | 222 | New Literature         |
| 233 | Newsletter from Abroad   |     |                        |



# Electronics

Editor-in-Chief: Donald Christiansen

## Associate managing editors

Technical: Stephen E. Scrupski  
News: Robert Henkel  
Copy: Sally Powell

## Senior associate editors

Joseph Mittleman, Harry R. Karp

## Department editors

Avionics & Space: Alfred Rosenblatt  
Computers: Wallace B. Riley  
Communications: William Buccu  
Components: George Watson  
Consumer electronics: John D. Drummond  
Design theory: Joseph Mittleman  
Industrial electronics: Harry R. Karp  
Military electronics: Richard Gundlach

## Senior staff editor

Samuel Weber

## Section editors

Electronics abroad: Arthur Erikson  
Electronics review: Stanley Zarowin  
New Products: H. Thomas Maguire,  
William P. O'Brien  
Probing the news: Eric Aiken

## Assistant editors

Stephen Wm. Fields, Peter Schuyten,  
Owen Doyle

## Domestic bureaus

Boston: James Brinton, manager  
Chicago: Frederick Corey, manager  
Los Angeles: Lawrence Curran, manager; Burton Bell  
New York: Howard Wolff, manager  
San Francisco: Walter Barney, manager; Peter Vogel  
Washington: Robert Skole, manager; Paul Dickson, William F. Arnold

## Foreign bureaus

Bonn: John Gosch  
London: Michael Payne  
Tokyo: Charles Cohen

## Copy editors

James Chang, Larry Miller

## Graphic design

Art director: Gerald Ferguson  
Assistant art directors: Valerie Betz, Susan Hurlburt  
Production editor: Arthur C. Miller

## Editorial research: Kay Fontana

Editorial secretaries: Lorraine Longo, Claire Goodlin,  
Patricia Gardner, Barbara Razulis, Stina Colombo

## McGraw-Hill News Service

Director: Arthur L. Moore; Atlanta: Fran Ridgway; Chicago: Robert E. Lee  
Cleveland: Arthur Zimmerman; Dallas: Marvin Reid  
Detroit: James Wargo; Los Angeles: Michael Murphy  
Pittsburgh: Louis Gomolak

## San Francisco: Margaret Drossel

Seattle: Ray Bloomberg; Washington: Charles Gardner, Daniel B. Moskowitz,  
Herbert W. Cheshire, Seth Payne, Warren Burkett, William Small, William D. Hickman

## McGraw-Hill World News Service

Bonn: Robert Dorang; Brussels: James Smith; Hong Kong: Wes Perry;  
London: John Shinn; Mexico City: Gerald Parkinson; Milan: Ronald Taggiasco, Jack Star;  
Moscow: Jack Winkler; Paris: Robert E. Farrell, Stewart Toy  
Rio de Janeiro: Leslie Warren; Tokyo: Marvin Petal

Reprints: Susan Nugent

Circulation: Isaaca Siegel

## Publisher: Gordon Jones

Electronics: September 16, 1968, Vol. 41, No. 19

Published every other Monday by McGraw-Hill, Inc. Founder: James H. McGraw 1860-1948.

Publication office 99 North Broadway, Albany, N.Y. 12202: second class postage paid at Albany, N.Y.

Executive, editorial, circulation and advertising addresses: McGraw-Hill Building, 330 W. 42nd Street  
New York, N.Y. 10036, Telephone (212) 971-3333, Teletype TWX N.Y. 710-581-4235, Cable address:  
MCGRAWHILL N.Y.

Subscriptions solicited only from those professionally engaged in electronics technology. Subscription rates:  
qualified subscribers in the United States and possessions and Canada, \$8.00 one year, \$12.00 two years,  
\$16.00 three years; all other countries \$25.00 one year. Non-qualified subscribers in the U.S. and  
possessions and Canada, \$25.00 one year; all other countries \$50.00. Air freight service to Japan \$50.00  
one year. Single copies: United States and possessions and Canada, \$1.00; all other countries, \$1.75.

Officers of McGraw-Hill Publications: Joseph H. Allen, President; J. Elton Tuohig, Executive Vice President;  
David J. McGrath, Senior Vice President-Operations; Vice Presidents: John R. Callahan, Editorial; Paul F. Cowie,  
Circulation; John R. Emery, Administration; John M. Holden, Marketing; David G. Jensen, Manufacturing;  
Jerome D. Luntz, Planning & Development; Robert M. Wilhelmy, Controller.

Officers of the Corporation: Shelton Fisher, President and Chief Executive Officer; John L. McGraw, Chairman;  
Robert E. Slaughter, Executive Vice President; Daniel F. Crowley, Donald C. McGraw, Jr., Bayard E. Sawyer, Senior  
Vice Presidents; John J. Cooke, Vice President & Secretary; Gordon W. McKinley, Vice President & Treasurer.

Title © registered in U.S. Patent Office; © Copyright 1968 by McGraw-Hill, Inc. All rights reserved. The contents  
of this publication may not be reproduced either in whole or in part without the consent of copyright owner.

Subscribers: The publisher, upon written request to our New York office from any subscriber,  
agrees to refund that part of the subscription price applying to copies not yet mailed.  
Please send change of address notices or complaints to Fulfillment Manager; subscription  
orders to Circulation Manager, Electronics at address below. Change of address notices  
should provide old as well as new address, including postal zip code number. If possible,  
attach address label from recent issue. Allow one month for change to become effective.

Postmaster: Please send form 3579 to Fulfillment Manager, Electronics,  
P.O. Box 430, Hightstown, New Jersey 08520

## Readers Comment

### In defense

To the Editor:

Messrs. Drummond and Corey's excellent article on the Consumers Union [Aug. 5, p. 170] quotes a critic of that organization who calls it a "self-anointed judge and jury" . . . but judges and juries have legal power. Consumers Union does not.

It is OK to print opinion (so long as it is not libelous) about actors, athletes, politicians, and artists. Why not about industrial products? Personally, I have never found magazines such as Consumers Reports to be of much use except for straight factual data, such as weights and dimensions of automobiles; nevertheless, the statement attributed to Voltaire should apply: "I disapprove of what you say, but I will defend to the death your right to say it."

Lawrence Fleming

President

Innes Instruments  
Pasadena, Calif.

### Those dedicated airlines

To the Editor:

In regard to your editorial, "Systems engineering for the airlines" [Aug. 5, p. 31], how Electronics could fail to recognize the fundamental of airline economics—that passengers will only travel when they have confidence in the safety of the flight, the crew, and the airline—is a puzzle. Equating the search for new routes and bigger payloads with passenger safety is like saying that Electronics doesn't give a damn about its readers because it clutters up its articles with all those pages of advertisements.

As for automatic check-in and loading, it is a worthy objective but is not needed if all you have to do is walk aboard the airplane—which is the case in some air-travel markets today. Where the check-in does require the passenger to pass by the agent who lifts his ticket, we anticipate improvements soon.

When Electronics says that the airlines "have not exploited electronics in controlling traffic safely and efficiently," it is just plain wrong. While the responsibility for



# Add Sprague Series 7400A to your prints for Series 74N TTL circuits. They're pin-for-pin identical.

SERIES 74N	FUNCTION	SPRAGUE PART NO.
SN7400N	Quad 2-Input NAND	USN-7400A
SN7401N	Quad 2-Input NAND (No Collector Load)	USN-7401A
SN7402N	Quad 2-Input NOR	USN-7402A
SN7410N	Triple 3-Input NAND	USN-7410A
SN7420N	Dual 4-Input NAND	USN-7420A
SN7430N	Single 8-Input NAND	USN-7430A
SN7440N	Dual 4-Input NAND Buffer	USN-7440A
SN7450N	2-Wide 2-Input Expandable AND-OR-INVERT	USN-7450A
SN7451N	2-Wide 2-Input AND-OR-INVERT	USN-7451A
SN7453N	4-Wide 2-Input Expandable AND-OR-INVERT	USN-7453A
SN7454N	4-Wide 2-Input AND-OR-INVERT	USN-7454A
SN7460N	Dual 4-Input Expander	USN-7460A
SN7470N	D-C Clocked J-K Flip Flop	USN-7470A
SN7472N	J-K Master Slave Flip Flop	USN-7472A
SN7473N	Dual J-K Master Slave Flip Flop:	
—	Single chip, pin 11 GND	USN-7473A
—	Single chip, pin 7 GND	USN-74107A
SN7474N	Dual D-Type Edge-Triggered Flip Flop	USN-7474A
—	Dual AC Clocked J-K Flip Flop	USN-7479A

Series 5400, full-temperature-range equivalents in 14 pin flat-packs, are also available for rapid delivery from Sprague.

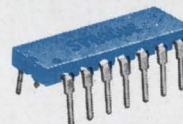

## And coming soon: Series 54/74 Complex-Function circuits.

For complete technical data on Series 5400 and 7400A circuits, write to Technical Literature Service, Sprague Electric Co., 35 Marshall St., North Adams, Mass. 01247

SPRAGUE WORCESTER...the world's finest microcircuit facility



'Sprague' and '®' are registered trademarks of the Sprague Electric Co.



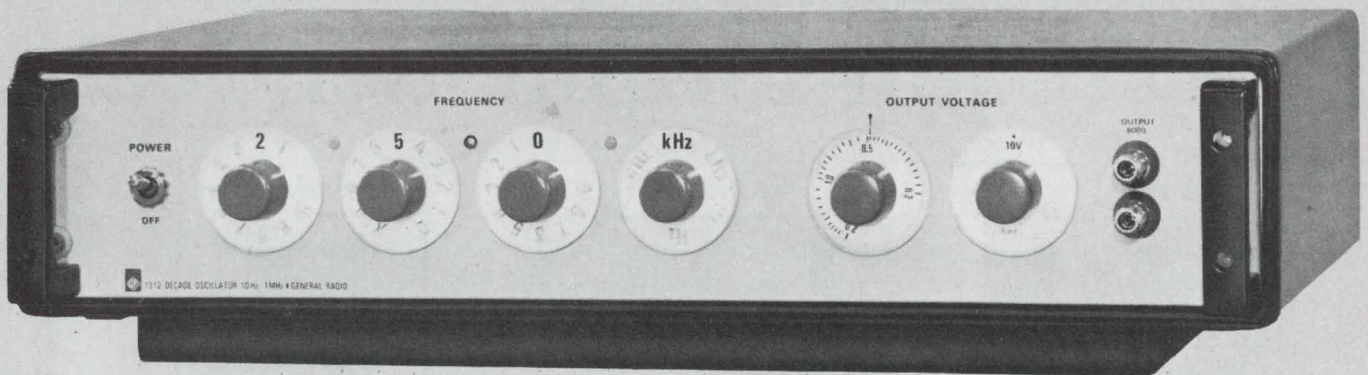

## Simple to set ... impossible to misread

For people who must constantly change and repeat oscillator-frequency settings, quick and accurate resettability is one of the most important features of an oscillator. With GR's new general-purpose 1312 Decade Oscillator, you can reset in a jiffy any frequency in the oscillator's 10 Hz-to-1 MHz range. Resettability is better than 0.005%, and it's virtually impossible to misread the in-line readout. The first two frequency digits are set with step decades; the third, with a detented continuously adjustable dial. One more control sets the decimal point and indicates the frequency unit, also in-line. Basic accuracy is  $\pm 1\%$  of the setting.

Up to 20 volts is available both at the front-panel OUTPUT terminals and at a rear-panel connector. Output is flat within  $\pm 2\%$  from 10 Hz to 100 kHz, and you can even short the output without clipping the waveform. The 1312 has a 100-dB output range, provided by a 20-dB continuously adjustable attenuator and an 80-dB step attenuator calibrated in 20-dB steps.

Output impedance is 600 ohms at all voltage levels, including the four intermediate zero-volt positions of the attenuator that allow you to reduce output to zero without touching the adjustable attenuator.

A sync jack at the rear provides an isolated signal to trigger a counter or scope. Through this sync jack, the frequency of the 1312 can also be phase-locked to an external signal for extreme stability.

With excellent performance characteristics, ease of use even by unskilled operators, and a price of only \$415, the 1312 Decade Oscillator is ideal for any lab or production test station. Ask to see one in your own plant. Call your nearest GR Sales Office or write General Radio Company, W. Concord, Massachusetts 01781.

**GENERAL RADIO**



## Readers Comment

exploiting electronics in the control of air traffic clearly rests with the Federal Government, by act of Congress, nearly all of the electronic innovations of the past 20 years have been speeded by dedicated airline effort.

For example, the airlines have constantly prodded the CAA and FAA to speed up the use of secondary radar, with identity and automatic altitude reporting. The airlines pioneered the application of communications satellite technology to air-ground communication.

Over FAA objections some years ago, the airlines persisted in working towards an air-ground data link and now have FAA cooperation in efforts to standardize a digital communications system. The transformation of new time-frequency technology into a long-sought collision avoidance system is being led by the airlines.

William G. Osmun  
Technical Information Services  
Air Transport Association  
Washington

### Making gains

To the Editor:

A boxed insert in Robert W. Henkel's "Intelsat 4 countdown nears zero" [June 24, p. 139] contains inaccuracies which make a successful design and development story appear as a near failure.

Sylvania satisfied the gain specifications of TRW and Comsat as far back as July, 1967. An earlier story, which dealt with our Intelsat 3 despun antenna progress illustrated

gain curves at the edge of earth at least 1 db. above specifications [April 1, p. 71]. Moreover, since that report, we have measured the gain of two prototypes and three flight models. All measurements are above specification by at least 1.5 db.

The author refers also to an unspecified new material and claims that Sylvania is "very excited about it." The article incorrectly infers that this new material has improved the gain performance whereas it is actually part of the over-all antenna thermal design.

R. G. Evans

Program manager  
Sylvania Electronic Systems  
Waltham, Mass.

### Routine

To the Editor:

The article entitled "Air Force plans new weather monitor" [June 24, p. 151] was read with interest.

It is noted, however, that the statement "Awards will mark the first time a dew-point sensor has been flown in an operational weather aircraft or dropsonde, says Shunk" is in error. Cambridge dew-point sensors have been flown routinely in Navy WC-121 aircraft assigned to Airborne Early Warning Squadron One (Typhoon Trackers) for five months and Weather Reconnaissance Squadron Four (Hurricane Hunters) for two years.

E. T. Harding

Capt., USN  
Naval Weather Service Command  
Washington

Application For

# FET SWITCHES

**PROBLEM:** Drive 5-volt logic from MOS shift register.

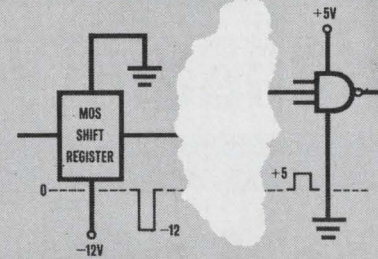

**REQUIRED:** Change negative MOS output to positive signal suitable for bipolar logic.

**GIVEN:**

- MOS output ...
- 0 to -12 V
- Bipolar Input ...
- Logic 0—0.3 V max
- Logic 1—+5 V max
- Fan out ... 15
- Temperature range ...
- 55 to +125°C

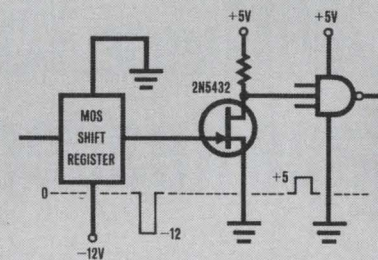

**SOLUTION:** Apply the output of the MOS to the gate of a common source n-channel junction FET ... 0 V will turn it ON and -12 V will turn it OFF. For maximum fan out use the 2N5432 ... it's got 5Ω  $r_{ds(on)}$  max. Need tight packaging density? We can put up to four in a flat pack.

Your MOS still underground? Signal us ... we'll give you applications assistance and send our "FET SWITCH DATA PACKET."



**Siliconix incorporated**

1140 W. Evelyn Ave. • Sunnyvale, CA 94086  
Phone (408) 245-1000 • TWX: 910-339-9216

## SUBSCRIPTION SERVICE

Please include an Electronics Magazine address label to insure prompt service whenever you write us about your subscription.

**Mail to:** Fulfillment Manager  
Electronics  
P.O. Box 430  
Hightstown, N.J. 08520

To subscribe mail this form with your payment and check  new subscription  renew my present subscription

**Subscription rates:** qualified subscribers in the U.S.: 1 year \$8; two years, \$12; three years, \$16. Non-qualified: 1 year \$25. Subscription rates for foreign countries available on request.

## CHANGE OF ADDRESS

**ATTACH LABEL HERE**

If you are moving, please let us know five weeks before changing your address. Place magazine address label here, print your new address below.

name \_\_\_\_\_

address \_\_\_\_\_

city \_\_\_\_\_

state \_\_\_\_\_

zip code \_\_\_\_\_



# Economy

ONLY \$180

# Simplicity

VALUE ENGINEERED

# Reliability

EXCEEDS 100 MILLION CYCLES

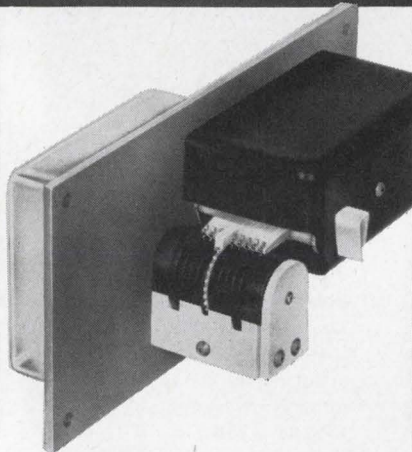

## CMC MODEL 18 Tape Reader

This simple unit reads tape uni-directionally . . . at 30 characters per second. **Starwheels sense holes**; output is in the form of contact closures.

Model 18 Tape Reader provides control equivalent to that of far more costly units **without complex circuitry or timing**. As easy to use as a relay.

Priced at only \$180 F.O.B.

**COMPUTER  
MECHANISMS  
CORPORATION**

290 Huyler St., S. Hackensack,  
N.J. 07606 (201) 487-1970

## Who's who in this issue



O'Loughlin

No newcomer to digital system design is Jim O'Loughlin, author of the article on the PDP-8/I computer on page 92. He has been with the Digital Equipment Corp. for two years, working on computer typesetting systems and test equipment as well as the S/I. Before joining DEC, he worked for six years on circuit design and logic design for the Nike-X system at the Raytheon Co.

O'Loughlin has a master's degree from Northeastern University in Boston, and has done additional graduate work both at Northeastern and MIT. He's a member of the computer group of IEEE, and of Tau Beta Pi and Eta Kappa Nu, engineering honor societies.



DeMaria

Although working on the generation of picosecond pulses only since 1965, Anthony J. DeMaria has been involved with lasers since the very beginning of the technology. Joining United Aircraft's research laboratories in 1958, he worked along with others to build the first laser but was beaten out by Theodore Maiman at Hughes Aircraft. Now the principal scientist in the quantum physics group at United's labs, DeMaria, author of the article on page 112, is currently devising an experiment to make use of picosecond pulses in the measurement of continental drift between cliffs. DeMaria holds a Ph.D. in physics and electrical engineering from the University of Connecticut.



**Now from Sprague!**

QUALITY  
STABILITY  
RELIABILITY  
SMALL SIZE

## All the advantages of tantalum in one **LOW COST** capacitor!

### EPOXY-DIPPED TANTALEX® CAPACITORS . . .

For industrial, commercial, and entertainment electronic applications where tantalum capacitors were previously too expensive!

— Type 196D Solid-electrolyte Tantalum Capacitors have special epoxy-dip coating which keeps costs down without sacrifice in dependability. Positively seals capacitor section while providing excellent electrical insulation. Protects against mechanical damage in handling.

— Radial lead design for plug-in mounting on printed wiring boards. The .250" lead spacing will fit standard .125" grids.

— High stability—very little capacitance change, even at outer limits of operating temperature range.

— Low dissipation factor of these capacitors permits higher ripple currents.

— Meet environmental test conditions of Military Specification MIL-C-26655B.

— Prime capacitance and voltage ratings. Based on rating popularity of other types of solid tantalum capacitors.

— Designed for continuous operation at temperatures from -55 C to +85 C.

For complete technical data, write for Engineering Bulletin 3545 to Technical Literature Service, Sprague Electric Company, 35 Marshall Street, North Adams, Massachusetts 01247.

**Now available for fast delivery  
from your Sprague Industrial Distributor**

#### SPRAGUE COMPONENTS

CAPACITORS  
TRANSISTORS  
RESISTORS  
INTEGRATED CIRCUITS  
THIN-FILM MICROCIRCUITS  
INTERFERENCE FILTERS

PACKAGED COMPONENT ASSEMBLIES  
FUNCTIONAL DIGITAL CIRCUITS  
MAGNETIC COMPONENTS  
PULSE TRANSFORMERS  
CERAMIC-BASE PRINTED NETWORKS  
PULSE-FORMING NETWORKS

**SPRAGUE®**  
THE MARK OF RELIABILITY

® Sprague and ® are registered trademarks of the Sprague Electric Co.



Kinsel

Using light in various ways has interested Tracy S. Kinsel for most of his professional career. For instance, from 1957 to 1962 he used light at RCA to investigate the non-equilibrium properties of semiconductors. Joining Bell Telephone Laboratories in 1963, he began by making optical measurements of the recombining and trapping properties of insulating semiconductors. He then switched to the work on optical pcm terminals described in the article on page 123.

Away from the job, one of Kinsel's hobbies is modeling artistic forms with coherent light. He holds bachelor's and master's degrees in physics from the University of Chicago and a Ph.D. from Rutgers.

Louis de Pian and Arnold Meltzer last visited these pages on Sept. 2. Their article on active filters begins on page 105.



# microtopics

product news from Philco-Ford Microelectronics

## The New Look in Linear IC's — Low Cost, High Reliability CERDIP Packaging!

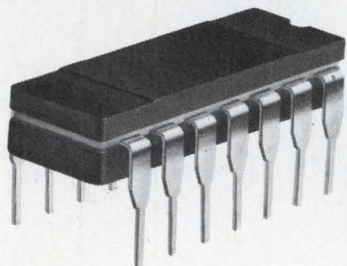

Treat yourself to the proven hermeticity of ceramic dual in-line linear integrated circuits by Philco-Ford—the people who know ceramic packaging. Treat yourself to the simple handling, economical wave-solder connection of DIP packages.

If you're the kind of guy who wants linear IC performance at high reliability *without* premium price, we've got the line for you. The four circuits listed below are now available in CERDIP packages from our distributors. And there'll be more soon.

- PA 7709 high performance operational amplifier \$4.05\*
  - PA 7710 high speed differential comparator \$3.85\*
  - PA 7711 dual voltage comparator \$4.45\*
  - PA 7712 wide band amplifier \$3.25\*
- \*100-999

CIRCLE 321 ON READER SERVICE CARD

## Immediate Delivery Arrives For T<sup>2</sup>L

Series 9620 T<sup>2</sup>L gates, expanders, and flip-flops are now immediately available from Philco Distributors. This family includes a wide selection of compatible monolithic silicon integrated circuits that feature 6 ns propagation delay, pin interchangeable with SUHL\* II, 20 mW per gate, prime and standard fanouts. The circuits are available in both MIL and Industrial temperature ratings.

\*Trademark of Sylvania Electric Products, Inc.

CIRCLE 322 ON READER SERVICE CARD

## New Low Prices For High Sensitivity IR Detectors

Philco indium antimonide photovoltaic detectors similar to those supplied for advanced defense projects are now available at a price that makes them attractive for industrial applications. Just \$125.00 each for the ISC-363 Detector.



Performance more than meets the most demanding measurement, security, or communication problem. Minimum detectivity:  $D^*$  (peak  $5\mu$ ) is  $8 \times 10^{10}$  cm Hz per  $1\frac{1}{2}$  watt. The ISC-363 is packaged in style 10, high-vacuum glass Dewar for use in liquid nitrogen, in cryostat assembly or liquid transfer system.

CIRCLE 320 ON READER SERVICE CARD

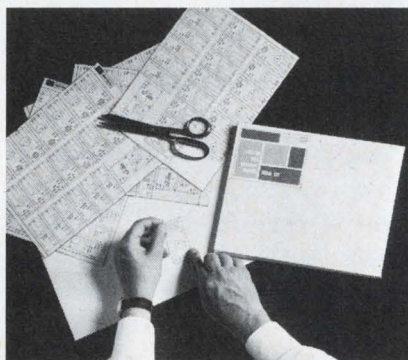

Paste up decals

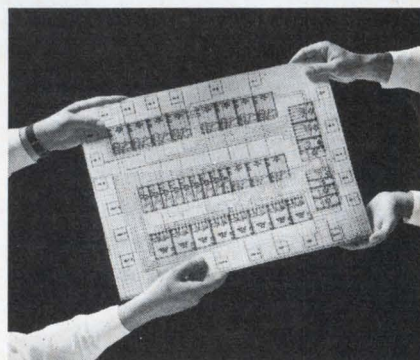

Turn your layout over to us

## Design Your Own Large-Scale MOS Arrays

We've taken the mystery out of MOS IC's. With the new Philco Building Block Program, you can easily design and partition your own custom arrays. We supply all the materials and assistance you need; comprehensive handbook, adhesive-backed decals, and help from Philco specialists to optimize the economics.

The procedure is simple. Just follow the instructions detailed in the handbook. Partition the system by using the scaled replicas (250 times actual

size) of proved digital functions, lay the decals on scaled paper representing the chip, and draw interconnections. Then, after determining power requirements, turn your layout over to us. We'll evaluate and optimize your layout for economic use of chip area.

You end up with a proprietary design, short turn around time, and cost savings.

CIRCLE 323 ON READER SERVICE CARD



### OUTPUT VOLTAGE VS. INPUT VOLTAGE

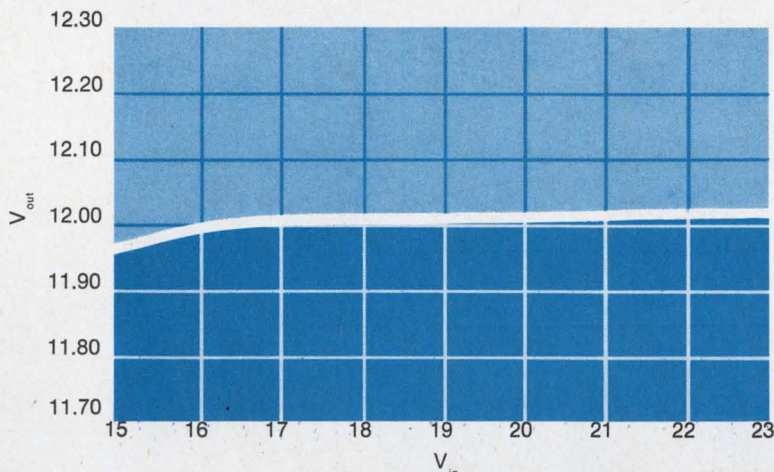

Output voltage vs. input voltage, 12-volt regulator

## Hybrid Voltage Regulator Delivers 100 Milliamps at 0.2% Regulation

The Philco PH5200 series of hybrid voltage regulators will give you performance to match your toughest assignments. They're packaged in a TO-5 case, small enough to fit anywhere. And they're rated for full military temperature duty, from  $-55^{\circ}\text{C}$  to  $+125^{\circ}\text{C}$ . A single 100 pf capacitor is the only external component needed for outputs up to 100 ma.

Standard models have factory-preset output of +5, -5, +12, -12, +28 or -28 volts. For a slight premium, you can specify any custom output voltage from  $\pm 4$  to  $\pm 32$  volts.

Add an external potentiometer, and

you can vary output voltage manually. A 40K pot will permit variation of output from 7 to 35 volts, for example. Add a power transistor, and you can extend current capability to 4 amperes.

The PH5200 series is available immediately. Standard models are priced \$28.00 each in lots of 100 and up.

CIRCLE 324 ON READER SERVICE CARD

## New Schottky Diodes Break the Noise Barrier

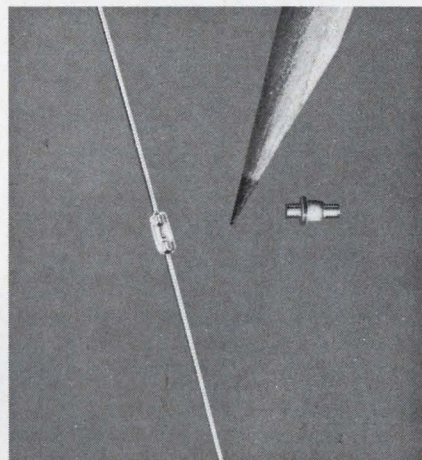

Over-all receiver noise figures of less than 5.5 db are now available with the L8200 Series of silicon Schottky-Barrier Diodes. The result of Philco's extensive experience in manufacturing microwave mixers and detectors, these units are especially designed for use as low noise mixer diodes in S and X bands, and offer significant improvements in dynamic range, burnout, and reliability over conventional diodes. Both pill prong and axial-lead glass package configurations are available.

CIRCLE 325 ON READER SERVICE CARD

## MOS High Speed Dynamic Shift Registers With 256, 250 and 128 Bits Capacity

This family of shift registers offers the highest speeds commercially available. Standard frequencies are 2 and 5 MHz, selectable to 8 MHz.

The pL5R256 is a single 256 bit shift register without recirculation; and the pL5R250 is similar except its capacity is 250 bits.

The pL5R128 is a dual 64 bit register with recirculation on each register.

Each half is configured as shown in the diagram.

Power dissipation is 0.2 milliwatt

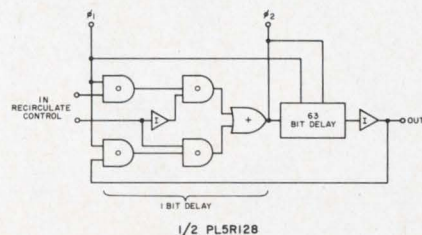

per bit per MHz. Each basic type is available in either commercial ( $0^{\circ}$  to  $70^{\circ}\text{C}$ ) or military ( $-55^{\circ}$  to  $+125^{\circ}\text{C}$ ) temperature rating, in TO-5 packages.

CIRCLE 326 ON READER SERVICE CARD

### Specifications: 12-volt regulator

Max input	40 VDC
Load regulation	
0-50 ma.	.1% max.
0-100 ma.	.2% max.
Line regulation:	
20-40V <sub>in</sub>	.5% max.
Ripple suppression,	
10 Hz-10 KHz	60 db min.
Transient recovery	
time	4 $\mu\text{sec}$
Output impedance	0.1 ohm max.
Standby current	
(V <sub>in</sub> = 20V)	4.0 ma. max.



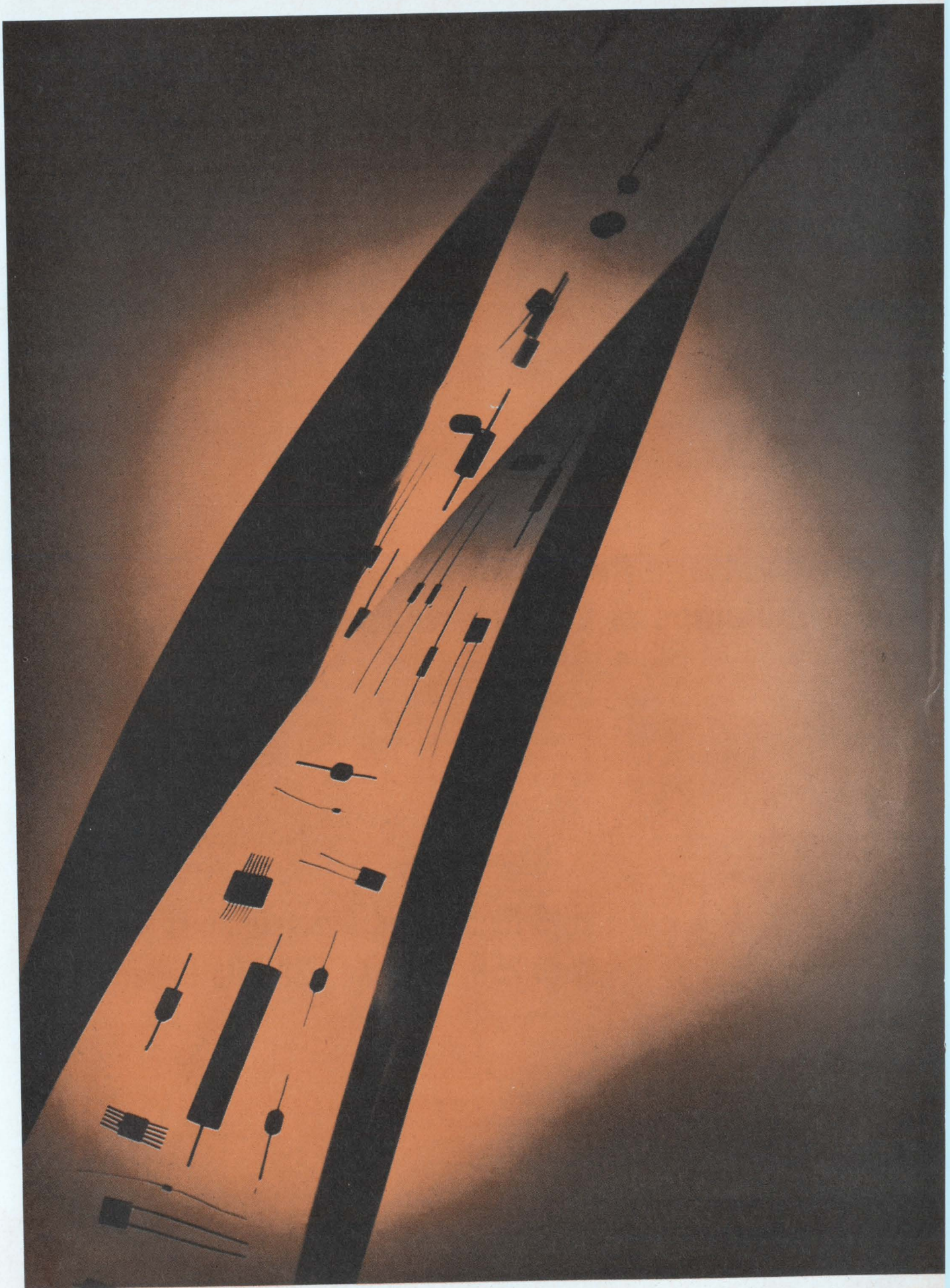



# For environmental protection... silicone encapsulating resins

Whatever the operating conditions — heat, cold, moisture, or other harsh environments... there's a Dow Corning silicone encapsulating resin to provide protection for your electronic equipment.

Sylgard® brand encapsulating resins from Dow Corning are ideally suited for filling, potting, coating, impregnating and embedding. Processing flexibilities include room

temperature cure, heat accelerated cure, one-part and two-part systems. All provide these unique properties:

- cure in thick section without reversion
- no damaging exotherm during cure
- are self-extinguishing
- provide excellent dielectric strength
- have excellent resistance to moisture, ozone and oxygen

- maintain constant physical and electrical properties from —65 to 200 C or better
- excellent thermal shock resistance

Regardless of your encapsulating protection problems... Dow Corning offers a silicone resin to meet your needs. Find out by writing Dept. E-8474, Dow Corning Corporation, Midland, Michigan 48640, or call 517-636-8940.

## DOW CORNING

DOW CORNING

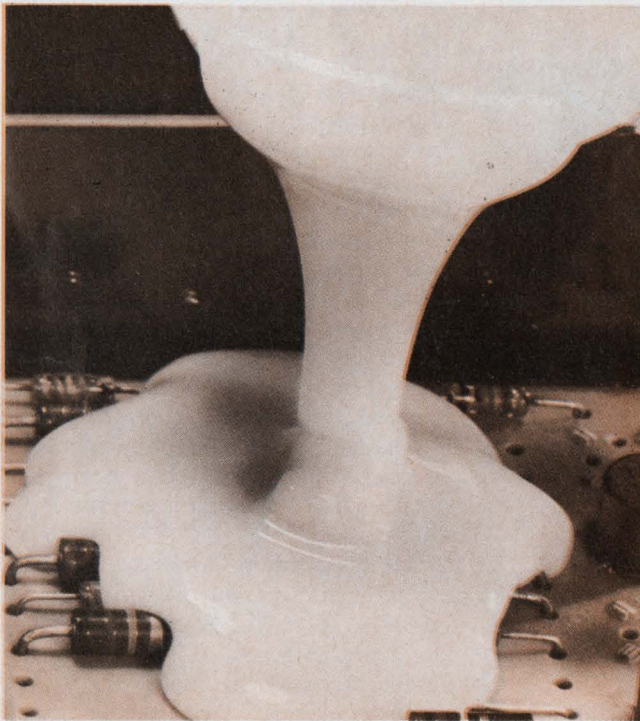

*New premixed, ready-to-use white Sylgard silicone encapsulating resin flows freely around components and provides virtually unlimited working time at room temperature... cures in one hour at 135 C and in two hours at 100 C... no post cure required... no reversion... low water absorption... self-extinguishing.*

*New shock absorbing Sylgard silicone resins are ideal encapsulants for delicate electronic equipment subject to high G shock loads and continuous vibration. These low bayshore materials dampen out external forces with little internal reaction... available in either clear or black... deep section cure without reversion.*





# AMPERITE

## GLASS ENCLOSED Thermostatic DELAY RELAYS

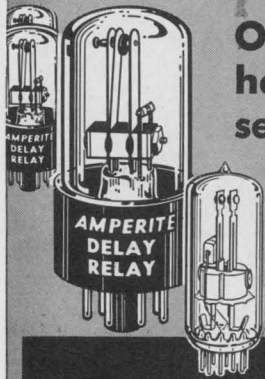

Offer true  
hermetic  
sealing—

— assure  
maximum  
stability  
and life!

### Delays: 2 to 180 seconds

Actuated by a heater, they operate on A.C., D.C., or Pulsating Current... Being hermetically sealed, they are not affected by altitude, moisture, or climate changes... SPST only — normally open or normally closed... Compensated for ambient temperature changes from  $-55^{\circ}$  to  $+80^{\circ}$ C... Heaters consume approximately 2 W. and may be operated continuously. The units are rugged, explosion-proof, long-lived, and inexpensive!  
TYPES: Standard Radio Octal and 9-Pin Miniature... List Price, \$4.00  
PROBLEM? Send for Bulletin No. TR-81.

# AMPERITE

## BALLAST REGULATORS

Hermetically sealed, they are not affected by changes in altitude, ambient temperature ( $-50^{\circ}$  to  $+70^{\circ}$  C.), or humidity... Rugged, light, compact, most inexpensive.

List Price, \$3.00

Write for  
4-page  
Technical  
Bulletin  
No. AB-51

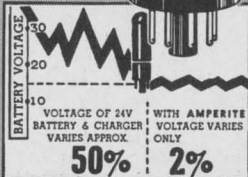

# AMPERITE

600 PALISADE AVE., UNION CITY, N.J.  
Telephone: 201 UNion 4-9503  
In Canada: Atlas Radio Corp., Ltd.,  
50 Wingold Ave., Toronto 10

## Who's who in electronics

The computer industry faces a manpower crisis: as more and more machines are sold, programmers get harder and harder to find. And the future looks even bleaker. But an IBM engineer, J.D. Aron, believes he and his team can do something about it. Aron, 41, manager of the Federal Systems Center's programming laboratory, is looking at a variety of interim and long-range approaches.

One attack is to find a way to make sure that virtually identical programs, such as those for payrolls, aren't rewritten time and time again—a frequent waste of manpower.

**Stitch in time.** Aron believes that an idea still in its experimental stage will eventually lead to "computer-based development support systems" in the next decade; time-

tage is that he is able with the computer to check his work as he goes along—a process Aron calls "conversation debugging."

Aron explains, "Normally it would take a man 24 hours to write part of a program and then check it out in actual operation. Using the computer as we are in Boston, the man checks the program as he writes it. It's the most important aspect of the system."

Among other advantages, Aron points out, is that at the Boston center as many as eight men have worked on a program in the computer at the same time, thus completing the debugging quickly and efficiently. Soon, he adds, CS-1 will allow expert programmers from various areas to collaborate on programs; early next year the Boston center will be connected to the IBM programming center in Gaithersburg, Md.

**Off the team.** Aron thinks that eventually CS-1 can be modified to catch mistakes and ferret out unnecessary statements automatically. He also envisions storing information on existing programs in the system to prevent parts or whole programs from being written twice. And he foresees greater development of plain-language compilers to increase the programmer's efficiency.

Aron feels that the problem hasn't yet received the attention it deserves and that his group is challenging existing programming and concepts.

He illustrates: "One man came to me and told me that he could replace 10 or more programmers if he were allowed to write a program his way. It looks like he's going to do it." Aron recalls that the man challenged the idea of a "team" working on a program, which means duplication of effort and the need for supervision. He took complete charge of the program, occasionally using consultants as he needed them.

Aron points out that just that type of simple organizational change may be the answer to a lot of the problems facing the electronics industry.



Aron

sharing would be the equalizer allowing the programmer greater speed, flexibility, and also improve efficiency.

At the IBM Programming Center in Boston, a program called CS-1 (for Computer Service-1) is in its early stages of operation. Aron explains that a programmer at a console goes into the computer and identifies his program. He may begin by asking for a readout of what has been accomplished on the program, as a refresher, and then he starts writing. He types in statements and continues writing the program. One immediate advan-



# The deflection plate aligner

LOW CURRENTS:

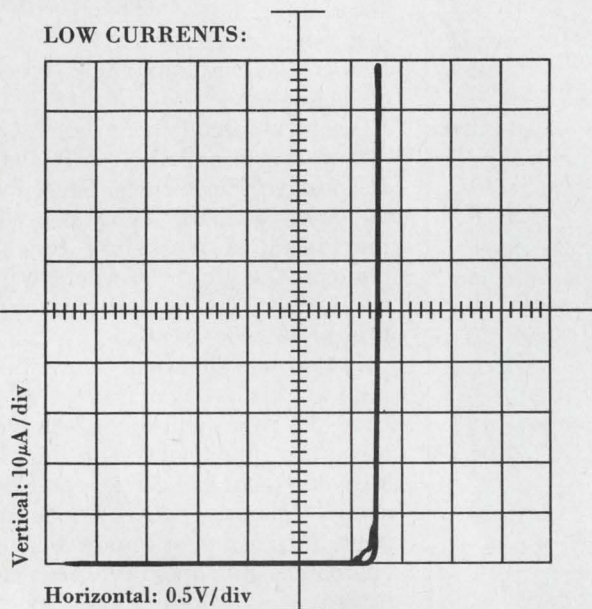

MEDIUM CURRENTS:

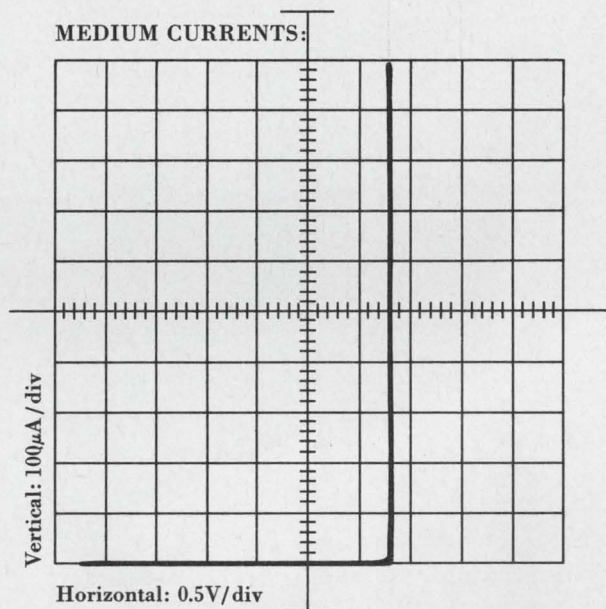

HIGH CURRENTS:

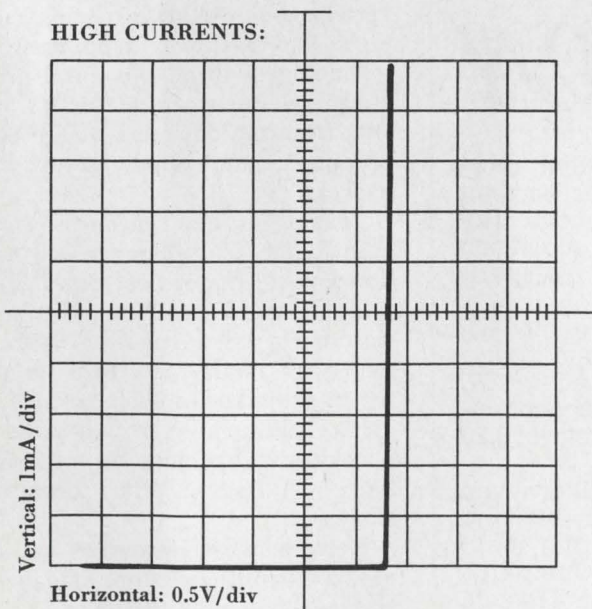

\$4.50 buys you the only zener that can give you these traces. At any of ten voltages from 5.6V down to 2.4V. Or all the way down to 2.2V, 2.0V and 1.8V if you insist. And the voltage you choose will typically vary 15mV from  $100\mu\text{A}$  to 1mA (or 125mV over its full  $10\mu\text{A}$  to 10mA range).

Ask for it by name—the LM103.

**National Semiconductor**

2975 San Ysidro Way, Santa Clara, California 95051. (408) 245-4320.



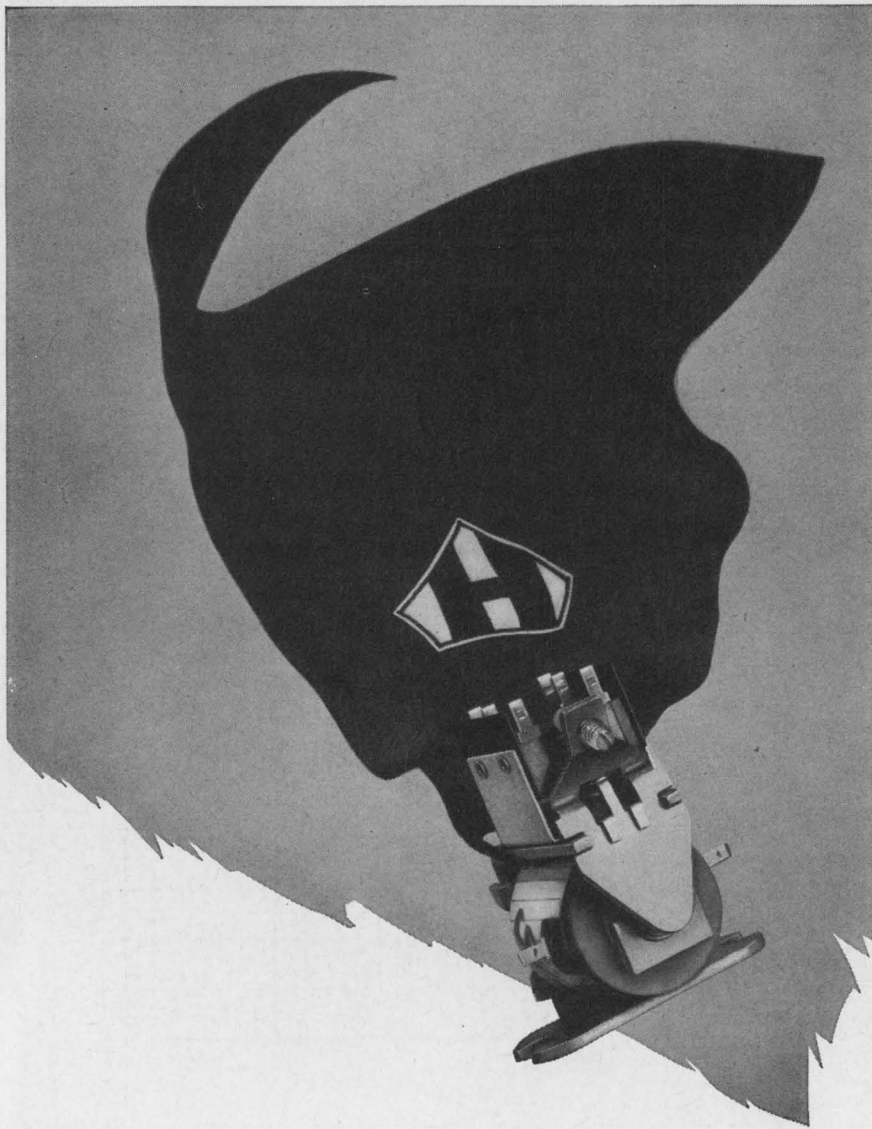

# SUPER RELAY!

## Heinemann time-delay relays lead a double life.

Most time-delay relays give you a pause for your money. And that's it. Our hydraulic-magnetic time-delay relays go a good bit further. They can double as their own load relays.

This is possible because the relays have continuous-duty coils. They can remain energized indefinitely after actuation. If you can get by with a contact capacity of up to 5 amps (125vac, resistive) you can have a simpler, less expensive product to put on the market.

There are some other advantages worth noting. Non-thermal actuation, for one. It avoids the problem of heat-loading effect

when you have frequent recycling. It also minimizes ambient temperature complications. Recycling time is shorter, too; it can be as brief as 15% of the specified delay period.

We offer a diversity of models, ranging from open frame to hermetically sealed, for AC or DC operation. Switching can be either SPDT or DPDT. Delays: 0.25 to 120 seconds.

Our Bulletin 5006 will give you full data. Drop us a line and we'll put a copy in the mail. Heinemann Electric Company, 2600 Brunswick Pike, Trenton, N.J. 08602.



**HEINEMANN**

4018

## Who's who in electronics

For several years, Richard F. Petritz, 45, had been helping spawn new business within the components group at Texas Instruments. He was director of the semiconductor research and development laboratory from 1961 until late last year, when he became the company's director of technology.



Petritz

Last month, Petritz left TI to set up a firm called New Business Resources [Electronics, Sept. 2, p. 34] with Richard Hanschen, former head of marketing for TI's components group, who left to join the Dallas office of the investment firm of Burnham & Co.

**Providing direction.** New Business Resources won't make products. Its role will be to provide resources—financial help, market analysis, technical advice, and personnel planning—to help launch new businesses or guide existing companies into lucrative new ventures.

Hanschen will remain with Burnham & Co.; Petritz is president, and he believes Hanschen's contacts and his own reputation in technology will enable the firm to attract venture capital for its clients from mutual funds, large corporations, and small groups of backers.

"Taking a new business from zero to the \$5 million or \$10 million level is the critical time," Petritz observes, so New Business Resources will furnish a "venture manager" to the new firm for six to 12 months to help establish goals. Additionally, it will provide checks and balances on planning and spending in the formative stages.

New Business Resources will be paid a fee for the venture manager's services, and will also own 5% to 10% of the new venture.

But Petritz emphasizes that the firm wants the key managers in the client company to own 50% of it in three to five years.





## Put time on your tape for \$1495 ...and read it too!

New Model 8350 generates and reads serial time code with unprecedented economy. Enables you to find recorded data at search speeds up to 250 times the recording speed. Displays real time when recording and recorded time when searching. Takes only half the rack space usually occupied by generator/readers.

Tapes containing high noise or flutter can be searched reliably, because Model 8350 will disregard as many as three consecutive garbled time frames and will compensate for brief signal drop-outs.

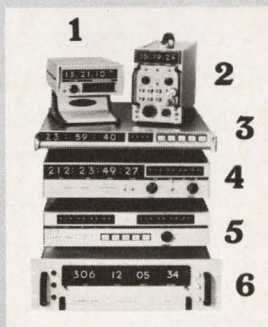

Systron-Donner produces a complete line of time code equipment built with modern integrated circuits. Shown in the photo at left are: 1. Digital clock with BCD output and time stability of 2 parts in  $10^6$  per month. 2. Battery-powered time code generator for field use. 3. Model 8350 described above. 4. Generator/reader with switch selection of six different codes. 5. Bi-directional tape search control for automatic data location. 6. Precision generator with time stability of 5 parts in  $10^9$  per day.

**Send for catalog.**

**SYSTRON  DONNER**

888 Galindo Street, Concord, California 94520. Telephone (415) 682-6161



# Guess how many different JT connectors Bendix makes.

Guess again. It's closer to 1,000,000 in all—and increasing every day. Bendix makes crimp, solder, grommeted, potted and hermetic versions. In eight different shell types and nine shell sizes—8 through 24. You can choose from 40 different insert patterns in 16-, 20-, 22- and 22M-contact sizes, that will accept a wire range of 16- through 28-gage. And they feature temperature capabilities that range to 392°F. continuous operation.

Somewhere in all that, there's bound to be the Bendix® JT connector that's right for you. (Especially if you're concerned with aircraft, rockets, missiles, submarines, torpedoes or ground support equipment.)

Why the wide acceptance of Bendix JT connectors? They cut weight up to 60%, length up to 50%. They're the smallest, lightest of their type in the industry. They're readily available from our jobbers or the plant. They're loaded with the latest connector innovations, many of which are sure to become industry standards.

Like more information?

Contact: The Bendix Corporation, Electrical Components Division, Sidney, New York 13838.

**Bendix**  
  
**Electronics**



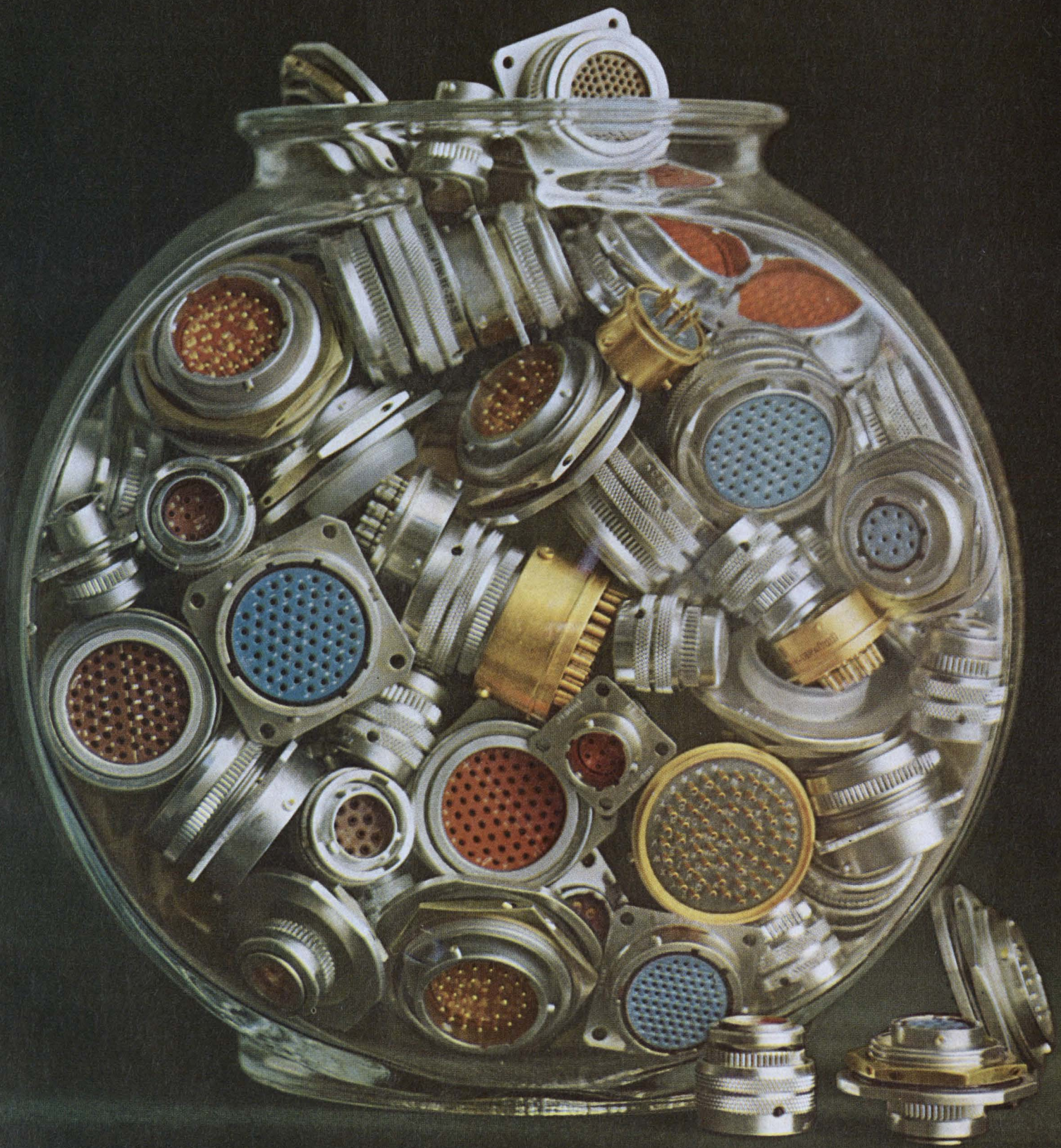





The accuracy is a "first" in DVM design. 0.0025%. Stability is too. .0065% for a full year over a temperature range of +12° to +40°C. Nor do the "firsts" stop here.

There's a speed you've never seen. 18 milliseconds for dc, and 45 milliseconds for ac.

There's no other unit more of a stranger to noise. It has the now famous "3-pole, active filter." This outshines an integrator or a notch filter anytime. You can even choose the amount of noise rejection by either programming or manually selecting the filter position.

And since the unit is a box-within-a-box, it's immune from common mode noise.

There's a flexibility you've never heard of before. Four dc, four ac, and four dc/dc ratio ranges, three dc millivolt ranges, and five kilohm ranges.





## The Dana 5700 DVM is not just another pretty face.

There's no instrument more compatible.

Both the digital output and programming are completely isolated. No grounding problems.

There's nothing easier to calibrate. No adjustments, just a single point calibration. Once a year.

There's nothing easier to maintain. All the plug-in boards can be slipped in and out from the front.

Which brings us to that pretty face business. If you're the finest DVM in the world, you've got to have more to offer than just good looks.

*Speaking of handsome, we have a brand new brochure with all the specs on the 5700 and every other Dana instrument. Own one. Write Dana Laboratories, Inc., 2401 Campus Drive, Irvine, Calif. 92664.*

**DANA**

Circle 21 on reader service card



# CRYSTAL FILTERS

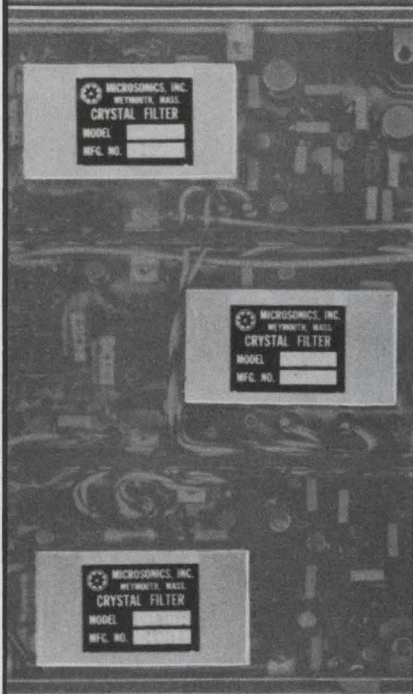

Microsonics, Inc. has designed and developed phase tracking crystal filters, in which the phase between filters will track within close tolerances, over wide temperature ranges, without temperature control. Any one of the standard multi-pole filters such as Butterworth, Tchebycheff, Bessel, etc. may be obtained with phase tracking requirements. In the event of tight tracking requirements, the filters are produced in matched sets according to the customer's requirements.

The set of 3 filters shown above have been produced in production quantities and the specifications are shown below.

## SPECIFICATIONS

### Center

frequencies: .....5MC  $\pm$ 150 cps  
Bandwidth 3db: .....1KC  $\pm$ 100 cps  
Shape-factor 60/3db: .....5:1  
Ultimate rejection: .....70db min.  
Initial phase off-set: .....1°  
Phase tracking across the  
3db bandwidth: .....5° max.  
Operating  
temperature: -35°C to +75°C

Send for Microsonics' Brochure No. 4350



**MICROSONICS, INC.**

60 Winter Street  
Weymouth, Mass. 02188  
Tel: 617 337-4200

A subsidiary of the Sangamo Electric Company

## Meetings

### Electronic devices: emphasis on materials

In China it's the year of the monkey, but in electronics it's the year of materials [Electronics, Sept. 2, p. 22]. One indication of this trend is evident at the International Electron Devices Meeting, which is devoting this year's keynote session to papers on materials. The conference, scheduled for Washington, Oct. 23 to 25, will hold 24 sessions, in addition to the keynote meeting, with as many as five parallel sessions at a time.

At the keynote session, Carl D. Thurmond, an engineer with the Bell Telephone Laboratories, will focus on the preparation of electro-optic materials such as barium sodium niobate, lithium niobate, and barium titanate and their uses in modulating and tuning coherent light in the red and near-infrared regions.

Other papers on materials include an evaluation of today's silicon device technology by Gordon Moore, late of Fairchild Semiconductor and now vice president of Intel Corp. John Moll, a member of the engineering faculty at Stanford University, will discuss new developments in III-V compounds.

In a materials-related paper, R.B. Robrock, also with Bell Labs, will

describe his work in simulating domain propagation in nonuniformly doped gallium-arsenide bulk-effect devices. Given the doping profile of a GaAs bulk device, Robrock can predict the behavior of the structure with the aid of computer simulation, which determines electric field and carrier distribution, a technique that aids in the design of such devices.

Two years ago, at the 1966 Electron Devices Meeting, B.A. Dhaka, a researcher at IBM's Components division reported on a silicon planar double-diffused narrow-gauge transistor with a cut-off frequency of 7.15 gigahertz and a switching time of 400 picoseconds. Dhaka, and a colleague from IBM, A.S. Oberai, are coming back this year to report an improvement in performance up to 12.6 Ghz and 300 psecs. Two years ago the collector and emitter base junction capacitance of the transistor were 0.58 and 0.28 picofarads, respectively. The improved device has a collector base capacitance of 0.08 pf and an emitter base capacitance of 0.045 pf.

For more information write L.M. Jeffers Jr., 1968 International Electron Devices Meeting, Sylvania Electronic Systems, P.O. Box 188, Mountain View, Calif. 94040.

## Calendar

**International Conference on Microwave and Optical Generation and Amplification**, IEEE; and the University of Hamburg; University of Hamburg, West Germany, **Sept. 16-20.**

**Cedar Rapids Conference on Communications**, IEEE; Veteran's Memorial Coliseum, Cedar Rapids, Iowa, **Sept. 19-21.**

**Aerodynamic Deceleration Systems Conference**, American Institute of Aeronautics and Astronautics; El Centro, Calif., **Sept. 23-25.**

**Conference on Electronics Design**, Institution of Electrical Engineers, Institution of Electronics and Radio Engineers, IEEE; Cambridge University, England, **Sept. 23-27.**

**Symposium on Physics & Nondestructive Testing**, Gordon &

Breach Science Publishers; O'Hare International Inn, Schiller Park, Ill., **Sept. 24-26.**

**Instrumentation Fair**, IEEE; Sheraton Park Hotel, Washington, **Sept. 25-26.**

**Ultrasonics Symposium**, IEEE; Statler Hilton Hotel, New York, **Sept. 25-27.**

**International Fair for Electronics, Automation, and Instruments**; Copenhagen, **Sept. 27-Oct. 4.**

**Engineering Management Conference**, IEEE; Marriott Motor Hotel, Philadelphia, **Sept. 30-Oct. 1.**

**Government Microcircuit Application Conference**, Department of the Army; Washington, **Oct. 1-3.**

(Continued on page 24)





HONEYWELL

SERIES 16

**Tomorrow computer systems today...**

**that you'll want to live with a long,  
long time**

Some computers come and go. And when they go, you're out of luck if you own one and want to extend the system to keep pace with your expanding needs.

No problem when you own a member of the Honeywell Series 16 family of real-time integrated-circuit computer systems. This prolific brood includes standard computer mainframes like the DDP-516 and DDP-416, many peripherals, a mature and expanding software library plus support services tailored to stretch the life of your investment. Special systems, functional application packages and new configurations like our Ruggedized and Ruggedized/EMI suppressed models give you even greater flexibility. No wonder Series 16 systems are being used so much in applications

like communications, research, medicine, industrial control and flight simulation.

And Honeywell's Series 16 family will continue to grow — investment today in time, money and effort will not go down the drain because of sudden obsolescence tomorrow.

For more information about the Series 16 family and some of the ways Honeywell computers are being used, write:  
Honeywell, Computer Control Division, Framingham, Massachusetts 01701.

**Honeywell**  
**COMPUTER CONTROL**  
DIVISION



1/8" Shank  
Solid Carbide  
Circuit Board Drill

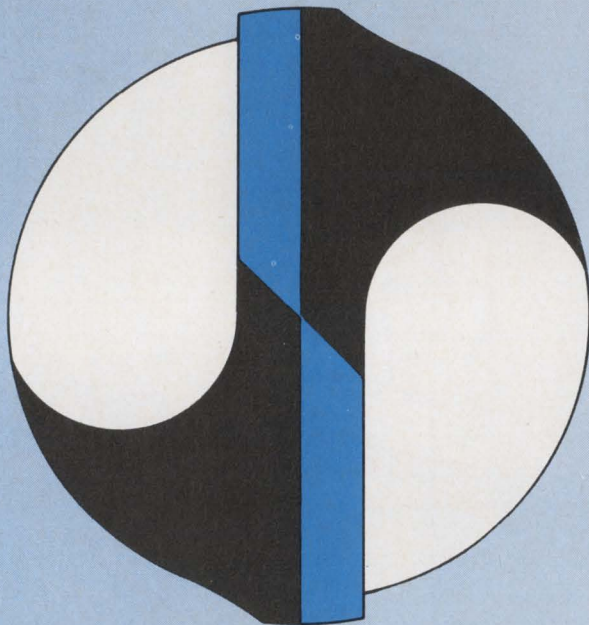

**4 FACET POINT**

for bur-free  
no smear holes

••• any questions?



**THE METAL REMOVAL COMPANY**

1859 W. Columbia Avenue • Chicago, Illinois 60626  
Plants located in CHICAGO / LOS ANGELES / SAN JUAN

MASTER TOOL AND WHEEL MAKERS FOR THE WORLD  
END MILLS / DRILLS / REAMERS / BURS / SPECIAL TOOLING

## Meetings

(Continued from p. 22)

**Allerton Conference on Circuit and System Theory**, IEEE; Allerton House, Monticello, Ill., **Oct. 2-4.**

**Symposium on Multivariable Control Systems**, International Federation of Automatic Control; Duesseldorf, West Germany, **Oct. 7-8.**

**International Telemetry Conference**, Foundation for Telemetry; Ambassador Hotel, Los Angeles, **Oct. 8-11.**

**Joint Engineering Management Conference**, American Society of Mechanical Engineers, Instrument Society of America, American Institute of Aeronautics and Astronautics, IEEE; Jack Tar Hotel, San Francisco, **Oct. 9-10.**

**Symposium on Applications of Ferroelectrics**, IEEE; Catholic University, Washington, **Oct. 10-11.**

**International Astronautical Congress**, American Institute of Aeronautics and Astronautics; Waldorf Astoria Hotel, N.Y., **Oct. 13-19.**

**System Science and Cybernetics Conference**, IEEE; Towne House, San Francisco, **Oct. 14-16.**

**Annual Symposium on Switching and Automata Theory**, IEEE; Schenectady, N.Y., **Oct. 15-18.**

**Symposium of Reliability in Electronics**, Hungarian Academy of Sciences; Budapest, **Oct. 15-18.**

**Conference on Electrical Insulation and Dielectric Phenomena**, National Academy of Sciences—National Research Council; The Inn, Buck Hill Falls, Pa., **Oct. 20-23.**

**Meeting and Technical Display**, American Institute of Aeronautics and Astronautics; Philadelphia Civic Center, Philadelphia, **Oct. 21-25.**

**Shock and Vibration Symposium**, Naval Research Laboratory; Asilomar Conference Grounds, Pacific Grove, Calif., **Oct. 22-24.**

**International Electron Devices Meeting**, IEEE; Sheraton Park Hotel, Washington, **Oct. 23-25.**

**Nuclear Science Symposium**, IEEE and United States Atomic Energy Commission and Atomic Energy Commission of Canada; Bonaventure Hotel, Montreal, Canada, **Oct. 23-25.**

**Seminar in Depth—Image Information Recovery**, Society of Photo-Optical Instrumentation Engineers; Benjamin Franklin Hotel, Philadelphia, **Oct. 24-25.**

(Continued on p. 26)



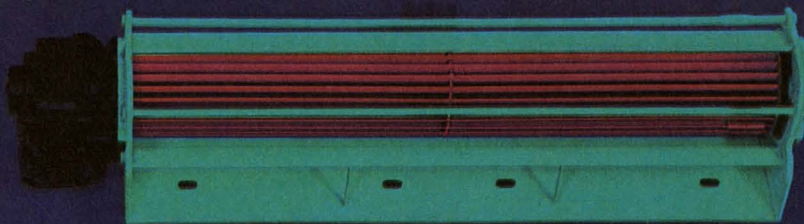
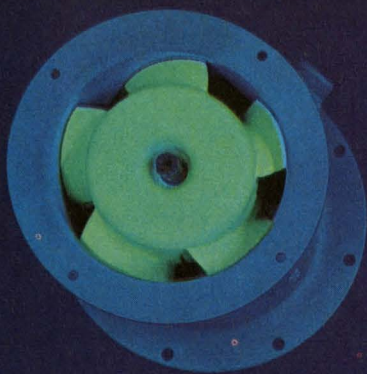

**Torrington**

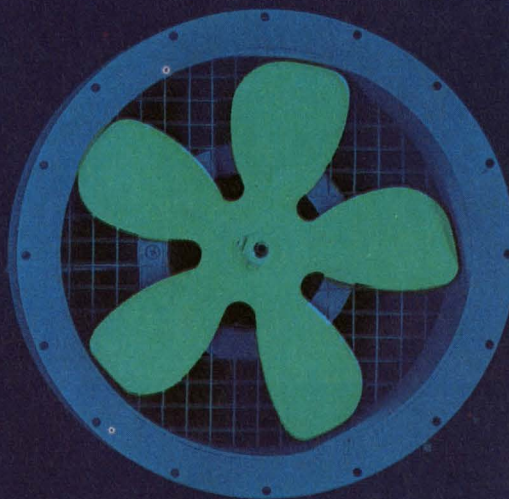
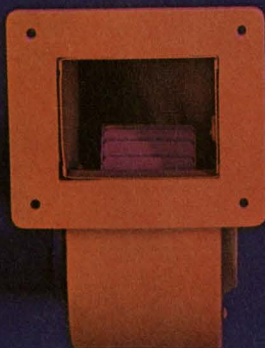
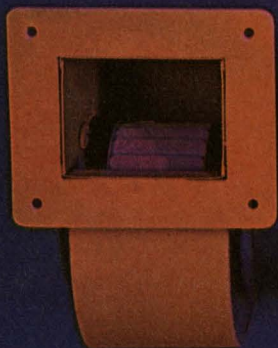

**makes a few colorful claims**

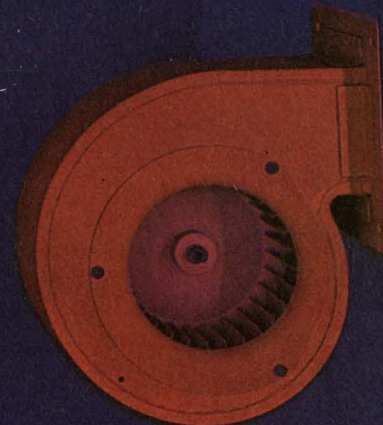
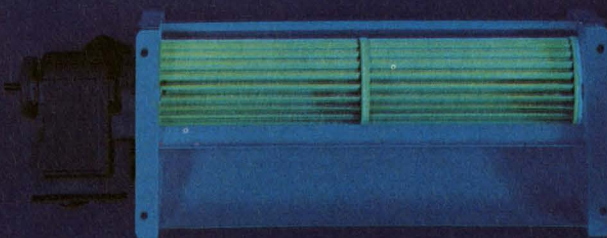

**for its blower line.**

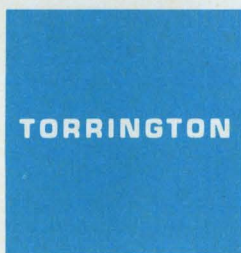

We've painted these Torrington blowers to illustrate some points. Torrington makes about as many different types of blowers as there are colors in the spectrum. Backward and forward curved, single or dual centrifugal units, tube axials, vane axials, single or multi-staged turbine-driven units, Crossflo's® and you-name-it-we'll-make-it units.

We'll not only produce any type you require (many standard in our line), but we'll make them in an almost endless range of sizes to meet your application needs. Between Torrington's vast productive capabilities at home and abroad and the technological know-how of its engineers, no problem's too big or too small.

Like a more detailed account of what modern blowers can do for you? Send for our 24-page reprint from a major industrial publication. Profusely illustrated with charts, drawings and photographs, it shows and describes every type of blower made.

Write today, to The Torrington Manufacturing Company, Torrington, Connecticut.

Circle 25 on reader service card

**TORRINGTON MANUFACTURING COMPANY**

**United States:** Torrington, Connecticut/VanNuys, California/Rochester, Indiana **Canada:** Oakville, Ontario **England:** Swindon, Wilts **Belgium:** Nivelles **Australia:** Sydney

25 F 86





**\$295 BUYS A LOT OF DVM**

- 3+ DIGITS ▪ 100 READINGS/SEC ▪ 1mV RESOLUTION
- ±0.1% ACCURACY ▪ CONTINUOUS TRACKING
- SWITCHABLE FILTER ▪ AUTOMATIC POLARITY

X-MOD 722A is the lowest-cost, fastest-reading, 3+ digit, straight-dc box in town. The latest in Preston's quality line of source, control and measurement modules, it's loaded with IC's, all-silicon semiconductors and plug-in p.c. boards... internal and external triggers... neon-edgellighted indicators. And \$15 per decade buys you positive true output logic levels and true bipolar BCD output code.

\$485 BUYS 4+ DIGITS! X-Mod 723A, with 0.1 mV resolution, ±0.01% accuracy, offers the same fine features, same six-month calibration guarantee.

To get the most DVM for your dollar, get in touch with us today.

PRESTON



SCIENTIFIC INCORPORATED  
805 EAST CERRITOS AVENUE  
ANAHEIM, CALIFORNIA 92805  
TELEPHONE (714) 776-6400

## Meetings

(Continued from p. 24)

**Instrument Automation Conference and Exhibition**, Instrument Society of America, Hilton Hotel; New York Coliseum, N.Y., **Oct. 28-31.**

**Machine Tools Industry Technical Conference**, IEEE; Wagon Wheel Lodge, Rockford, Ill., **Oct. 28-30.**

**Applied Superconductivity Conference and Exhibition**, Oak Ridge National Laboratory; IEEE and American Physical Society, Gatlinburg, Tenn., **Oct. 28-30.**

**Symposium of the American Vacuum Society**; Pittsburgh Hilton Hotel, **Oct. 30-Nov. 1.**

**Northeast Research and Engineering Meeting**, IEEE; Sheraton-Boston Hotel, Boston, **Nov. 1-3.**

**Product Assurance Conference and Technical Exhibit on Reliability, Standard Maintainability and Parts-Materials Packaging**, IEEE & Standards Engineers Society; Waldorf-Astoria Hotel, New York, **Nov. 2-3**

**American Institute of Ultrasonics in Medicine**; Monteleone Hotel, New Orleans, **Nov. 4-7.**

## Call for papers

**Numerical Control Society Annual Meeting and Technical Conference**; Stouffer's Cincinnati Inn, April 1-3. **Oct. 15** is deadline for submission of abstracts to Peter Senkiw, program chairman, Advanced Computer Systems Inc., 2185 S. Dixie Ave., Dayton, Ohio 45409

**International Conference on Magnetics**, IEEE and the Nederlandse Natuurkundige Vereniging, and the Division T.W.O. of the Koninklijk Instituut van Ingenieurs; Amsterdam, the Netherlands, April 15-18. **Dec. 1** is deadline for submission of abstracts to Dr. U. F. Gianola, Bell Telephone Laboratories, Mountain Ave., Murray Hill, N.J. 07974

**Conference on Trunk Telecommunications by Guided Waves**, The Institution of Electrical Engineers, the Institute of Electronic and Radio Engineers, and IEEE; London, Sept. 15-17, 1969. **Jan. 5** is deadline for submission of abstracts to Conference Department, the Institution of Electrical Engineers, Savoy Place, London, W.C. 2.

**Symposium on Information Processing**, Purdue University's School of Electrical Engineering; Memorial Center, Purdue University, Lafayette, Ind., April 28-30. **Jan. 15** is deadline for submission of abstract to John C. Hancock, symposium chairman, School of Electrical Engineering, Purdue University.



Allen-Bradley's experience in resistor production reaches...

to the moon and back!

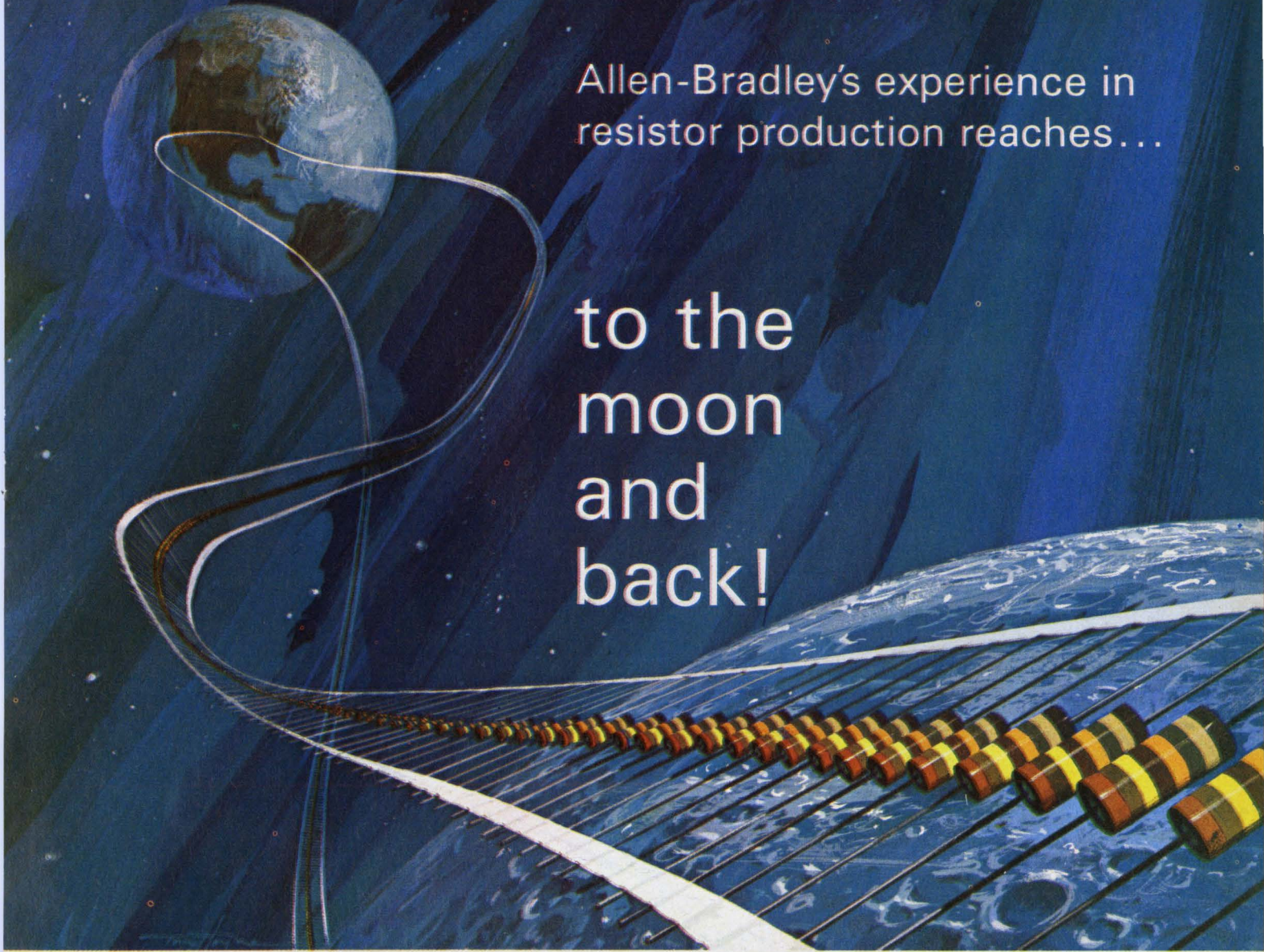

TYPE BB 1/8 WATT

TYPE EB 1/2 WATT

TYPE HB 2 WATTS

TYPE CB 1/4 WATT

TYPE GB 1 WATT

A-B hot-molded fixed resistors are available in all standard resistance values and tolerances, plus values above and below standard limits. **A-B hot-molded resistors meet or exceed all applicable military specifications including the new Established Reliability Specification at the S level.** Shown actual size.

After more than three decades and untold billions of hot-molded resistors, Allen-Bradley has accumulated manufacturing "know-how" which cannot be approached by anyone else. The fact that the resistors made by A-B over the years—if placed side by side—would more than reach to the moon and back, may be impressive. But "how" they are made is the key.

Allen-Bradley resistors are produced by an exclusive hot-molding technique—developed by A-B. They're made by completely automatic machines—also developed, built, and used only by Allen-Bradley. The human element of error is removed. Uniformity is so precise from one resistor to the next—year in and year out—that long-term resistor performance can be closely predicted.

And there has been no known incident of catastrophic failure of an A-B hot-molded resistor.

The reputation for quality and performance established by Allen-Bradley hot-molded resistors is reflected in the fact that they have been an integral part of virtually every U.S. space probe. And they are "on" the moon. No other resistor applications demand a higher measure of reliability.

For detailed specifications on this superior line of hot-molded resistors, please write Henry G. Rosenkranz and request a copy of Technical Bulletin 5000: Allen-Bradley Co., 1201 South Second Street, Milwaukee, Wisconsin 53204. Export Office: 630 Third Ave., New York, N.Y., U.S.A. 10017. In Canada: Allen-Bradley Canada Limited.

EC 6815

QUALITY ELECTRONIC COMPONENTS



ALLEN-BRADLEY







# Dense, hand mated, and very tolerant.

Maintainable contact on .075" centers. Solder, weld or wrap. Unique elliptical spring contact design. Only four-ounce insertion, one-ounce extraction per contact. Vibration-proof continuity. Forgives misalignment. Two-piece in-line (10 to 180 contacts), two-piece right angle (up to 77 contacts). No guides, no hardware, no sweat. Designed for airborne navigation and radio black boxes, computers, ground support equipment. Ask about it.

**AMP**  
INCORPORATED  
Harrisburg, Pennsylvania



# New ITT C-7 COAX offers GREATER FLEX-LIFE

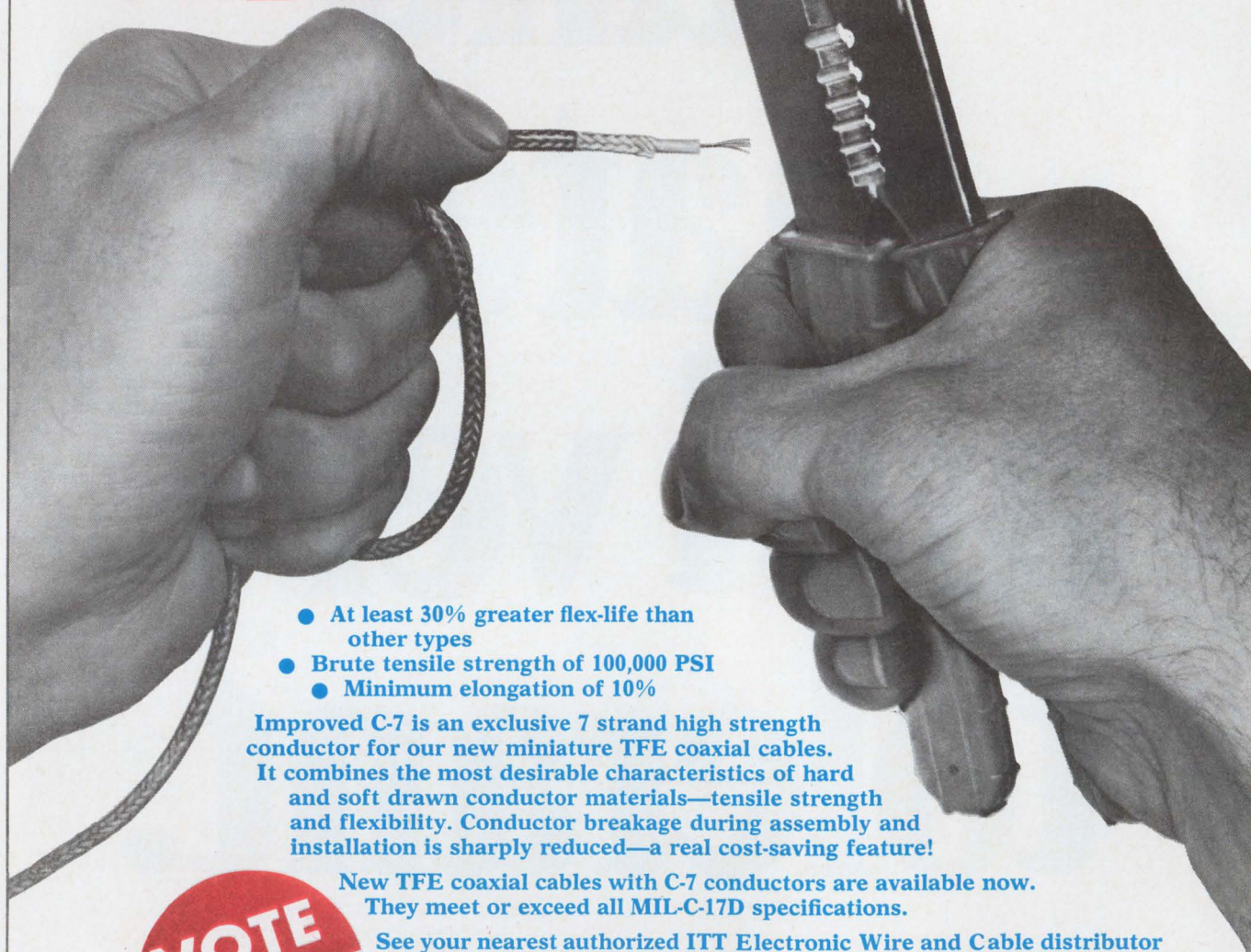

- At least 30% greater flex-life than other types
- Brute tensile strength of 100,000 PSI
- Minimum elongation of 10%

Improved C-7 is an exclusive 7 strand high strength conductor for our new miniature TFE coaxial cables. It combines the most desirable characteristics of hard and soft drawn conductor materials—tensile strength and flexibility. Conductor breakage during assembly and installation is sharply reduced—a real cost-saving feature!

New TFE coaxial cables with C-7 conductors are available now. They meet or exceed all MIL-C-17D specifications.



See your nearest authorized ITT Electronic Wire and Cable distributor or contact ITT Wire and Cable, Division of International Telephone and Telegraph Corporation, Clinton, Massachusetts 01510.  
IN CANADA: ITT WIRE AND CABLE, Cooksville, Ontario.  
IN EUROPE: ITT WIRE AND CABLE, Lister Road, Basingstokes, Hants, England.

WIRE AND CABLE **ITT**



---

**Editorial comment**

---

## Survival kit

**Product planning** in an industry whose technology is highly stable, someone wryly observed, can be done on the back of an envelope. It's not that simple for the electronics industry. New developments come so fast that industry has to run hard just to keep abreast of them. As for technological forecasting, forget about that envelope—even if you use both sides. The industry needs all the help it can get from tools it has itself developed, to do so critical and hazardous a job. Forecasting technology by computer techniques is one of the most promising methods.

Back in 1965, TRW conducted an experiment that produced a top secret company report entitled "Probe of the future—the next twenty years." In it, a panel of TRW experts listed 400 technical events that could occur by 1975. One of them, for example, was 3-D color movies using holography. The panel thought that development would be technically feasible by 1972. It also developed a "technological road map" that itemized interim developments that had to precede the final development, and added to that map some branch roads—those developments that were likely to occur as fallout.

While such techniques are valuable to long-range planners, they don't go far enough for the men who must develop the technology that is translated into marketable products. So TRW has embarked on an extension of its probe which will solicit the answers to more detailed questions. Panelists will weigh possible new products against their desirability to the customer and their ease of manufacture. Judgment of the latter will reflect an estimate of the technical difficulty that might be encountered in meeting prerequisite developments.

An important part of the study, expected to yield about 1,500 technical events, is a timetable. For example, an event might be expected between 1979 and 1990, but the most probable date would be 1985.

TRW is already using computers to print questionnaires for the second phase of its studies. What's more, it will probably take a computer-based approach to the technological road maps. Without computer aid, planners might abandon the whole idea as too formidable.

The end result of any systematic approach to product planning (such as TRW's) should be clear identification of an unfulfilled need for a new product or service. But the proposed development must fit into corporate strategy and resources. Strategies common

in the electronics industry were described by Phillip Myers, manager of control systems for the Electronic Specialty Co. at a Wescon panel session last month. They include the state-of-the-art leader, the second-in-product exploiter, the premium-quality leader, the broad-line producer, the specialist, the bargain-basement house, the service-oriented firm, and the acquirer of new business.

The choice of strategy is, or should be, dictated by the company's capabilities and personnel. The state-of-the-art leader, for example, must have a good research and development staff. Its products will tend to be sophisticated, costly, and production volume will be small. The bargain-basement strategy is quite the opposite, usually working best late in a product's life cycle when volume is high and standardization and interchangeability are important.

Acquisition-minded North American Aviation (it has a new name now) undertook one of the most ambitious planning projects yet. It developed an input-output model of the U.S. economy to help forecast annual sales for major industries through 1980. The computer program covered some 8,000 markets in 93 industries, and considered changes in technology, growth in the labor force, changes in productivity, personal spending, and capital equipment needs. North American used the forecasts generated by this computer program to zero in on potential candidates for merger; the program played an important role in North American's decision to merge with Rockwell-Standard Corp. last September.

Renamed North American Rockwell, the company is now supporting—along with other companies—improvement of the input-output forecasting model at the University of Maryland, and will continue to run the program on its own computers. It is also updating its data bank of prospective acquisitions, and studying the possibility of growth through internal diversification. Among the areas of opportunity, North American Rockwell sees nuclear energy, medical technology, integrated electronics, oceanography, education, pollution control, and systems management.

With the emphasis on formal, and costly, planned strategy in the electronics industry, the entrepreneur who relies on intuition and experience might seem out of it. Would Texas Instruments have entered the semiconductor business if it had made a large-scale formal study of the proposition? Perhaps not.

I. Gordon Odell, executive director of corporate development for North American Rockwell, insists that emphasis on a planned strategy does not muffle opportunity's knock on the door. Sound planning, he says, cultivates opportunity and provides a basis for rapidly evaluating its significance when it does appear.

Good planning in today's electronics industry is necessary not only for growth, but for survival.





## To solve some sticky ferrite problems, we're pressing tubes and rods up to 20 inches.

The old way of making large ferrite parts is simple: epoxy or glue small ferrites together. But the resulting problems aren't so simple. Magnetic characteristics suffer. Costs are high. And delivery schedules are excessive.

Now, new pressing and firing techniques let Indiana General make single piece large parts. Up to 35 lbs. And in giant sizes, like 10" sq. x 2" plates, 3" dia. x 20" rods, and 6" O.D. x 4" I.D. x 20" tubes.

Our large ferrite parts have opened

up new design opportunities in oceanography. VLF communications applications, in the 10 to 80 kc range, need large ferrite parts for higher power. And our new sizes, in Ferramic® O-5, deliver the massive "brute wave forces" to penetrate denser-than-air media with none of the problems of epoxied ferrite assemblies. O-5's high permeability results in higher sensitivity in antennas where signal strength dissipates rapidly.

So instead of looking high and low for high power, low frequency antenna ferrites, look to Indiana General. Where we keep magnetic problems from making you come unglued. For technical information on our new large ferrite parts capability, write Mr. K. S. Talbot, Manager of Sales, Indiana General Corporation, Electronics Division/Ferrites, Keasbey, New Jersey.



**INDIANA GENERAL**  
Making Magnetics Work.



---

# Electronics Newsletter

---

September 16, 1968

## TI gears up for ECL IC's

Texas Instruments has decided to make a major thrust into the market for emitter-coupled logic IC's. The company has elaborately equipped its Sherman facility near Dallas with processing and test equipment and is already producing ECL devices with 2 to 12 gates per package.

Gene McFarland, manager of ECL product marketing, says TI will introduce a catalog ECL product line by the end of this year. The devices, with propagation delays of 2 to 3 nanoseconds, will compete with Motorola's just-introduced MECL 3 line [see p. 64], which has a typical propagation delay of 1 nanosecond. Motorola's established MECL 2 line operates in the 4-to-6-nanosecond range.

TI recognizes that saturated-type logic—primarily TTL—will dominate the digital IC market for some time to come. But McFarland foresees a fast-growing demand for the faster ECL because of the influx of very large, high-performance computers in the class of Illiac 4, Burroughs' 8500 series, Control Data's 6600 line, or IBM's 360/85 series. He also anticipates growth of ECL in military specialty computers and commercial high-frequency instrumentation.

TI plans to apply its ECL know-how toward medium- and large-scale integrated products too. MSI functions based on ECL with 12 to 80 gates per package are already being designed.

## Software patent confuses everyone

The award of the first patent on computer software has thrown not only the industry but also the Patent Office itself into a dither. Universal confusion has followed a decision by patent examiners earlier this summer to give Applied Data Research a patent on a program for sorting. The confusion arises because patent officials themselves are at a loss to explain this deviation from their policy that computer programs aren't patentable but are the province of the Copyright Office.

Copyright protection is much weaker than that provided by a patent; minor variations on a work usually don't infringe on a copyright, but patents often protect an entire concept.

A Patent Office spokesman says that officials are still working on the old principle that software can't be patented and that there hasn't been any clarification. He couldn't, however, offer anything to reduce the confusion.

## FCC gives AT&T a busy signal

AT&T appears to have gotten tangled in its own appeals. Immediately after the FCC's historic ruling this summer on the Carterphone case, allowing "foreign attachments," AT&T appealed to the FCC to reconsider the issue. Last month, AT&T asked permission to file tariffs, effective Nov. 1, that would require a black box unit, renting for less than \$2 a month, between "foreign attachments" and Bell lines [See "Mother of circumvention," p. 55]. Now, the FCC has, in effect, told AT&T to keep its shirt on; the commission wants to dispose of AT&T's Carterphone appeal first and then take up the black-box proposal. Although couched in the best of bureaucratic legalese, the notice clearly indicates that the FCC is not in a mood to accept without question the AT&T "compromise" proposal for the black box.



---

# Electronics Newsletter

---

## Firms pool talents to manufacture a-c/d-c IC tester

E-H Research Laboratories Inc., an Oakland, Calif., maker of a-c testers for integrated circuits, and Teradyne Inc., a Boston-based producer of comparable d-c equipment, have undertaken a joint venture. **The new company, as yet unnamed, will develop and manufacture computer-controlled a-c/d-c IC testers.**

At the moment, **only semiconductor houses are making such instruments.** An E-H spokesman says prospective buyers had asked the two companies to make a joint quote; the eventual result was formation of the subsidiary.

According to John C. Hubbs, E-H's president, the system "could be on the market by March or April." **The hybrid system will be designed to test logic modules and complex arrays, as well as conventional IC's, with the appropriate software.** Production will be handled at E-H facilities, and both companies will market the equipment.

## FAA to order radar with two added horns

**The FAA will soon let a contract for the development of ground radar antennas employing the "passive horn" technique.** A working model of the antenna is called for within 12 months after the award.

The technique employs dual feed horns plugged into a conventional single-horn system. One of these horns is aimed low to get long range while the other is aimed high to minimize ground clutter. By microsecond switching of the feed horns, the FAA hopes to get the best of both worlds—a long range look without ground clutter.

If the passive horn arrangement works out, the FAA plans to apply it to antennas at those airports with the most ground clutter.

## Talent flight goes with DEC success in small computers

Now that the Digital Equipment Corp. has proven that small general-purpose computers can be best sellers, **many of the men hired by the Maynard, Mass., firm to develop the PDP-5 and PDP-8 lines are leaving.** The most recent defector is Michael A. Ford, product manager for the company's PDP-8 and PDP-8 I. He's formed a company that will make production control systems and related equipment, built around the kind of small computers he once sold. Ford's departure was amicable, says a spokesman, and the company expects him to be a customer.

Last April was also a tough month for DEC because of the departure of Edson D. de Castro, then head of small computer design—and the man some consider the father of the small general-purpose machine at the company. **He and two other DEC officials have since formed the Data General Corp., an avowed competitor of their former employer.**

Observers point to a number of reasons for the exodus. For one thing, the young, aggressive men hired to get small computers off the ground now want more of the action. For another, their success has made venture capital easier to come by.

## Addenda

As expected, ITT's Joseph Van Poppelen has joined C. Lester Hogan's team at Fairchild. Van Poppelen, who used to be Hogan's sales manager at Motorola Semiconductor Products, will become corporate director of marketing at Fairchild. He's expected to be elected a vice-president of the corporation at the next board meeting this month. . . . In the continuing game of musical chairs, Richard Hodgson, Fairchild vice chairman, will join ITT as "senior executive." **It's generally believed that Hodgson will take over ITT's electronics operations.**



# Integrated Circuit

# IDEAS

FROM SYLVANIA

**The biggest problem in LSI,  
and how MSI can help you solve it.**

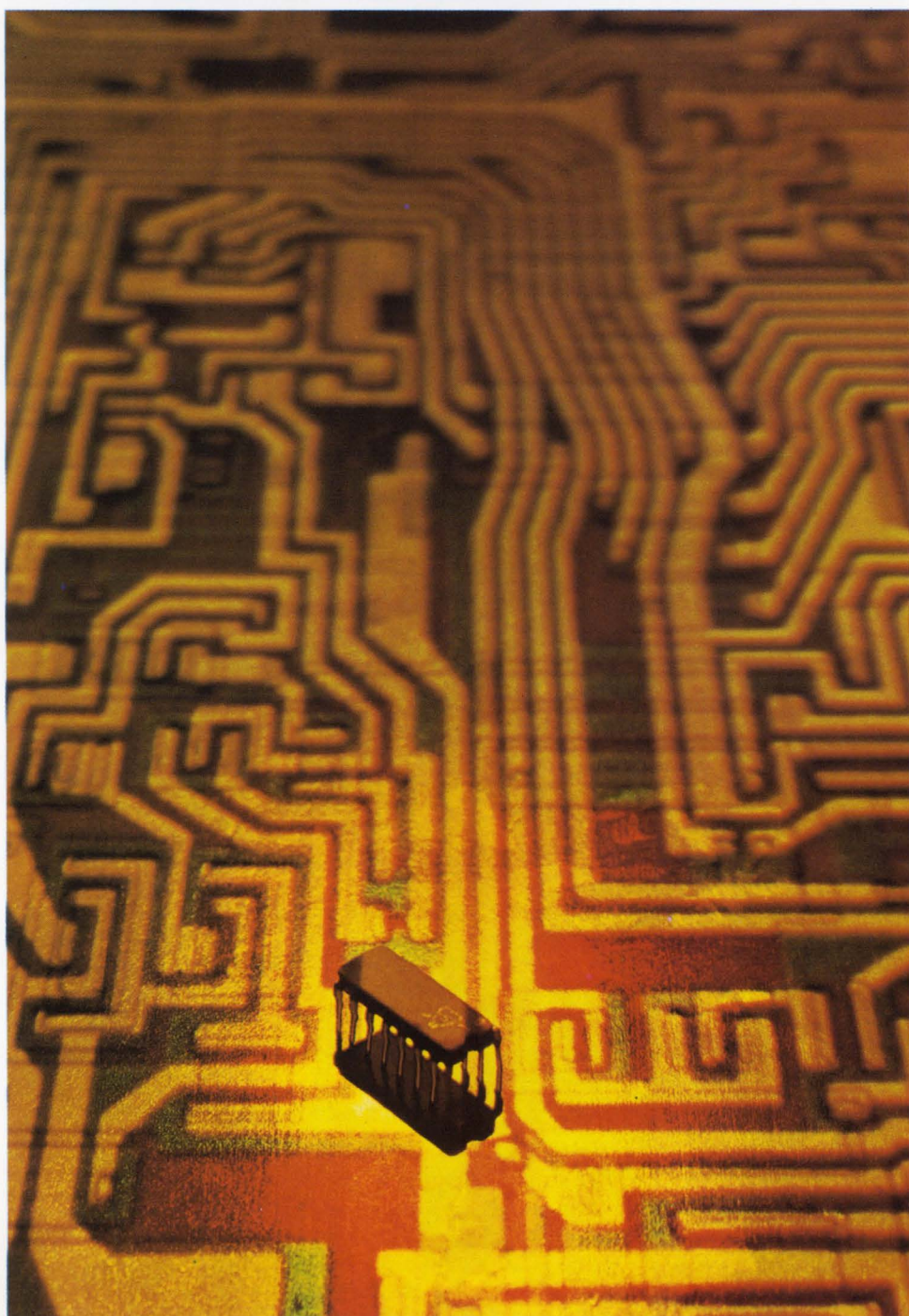

Testing large-scale integrated circuits can be the big stumbling block in working with these complex circuits. Here is a solution using Sylvania MSI.

The key to simplified LSI testing is Sylvania's SM-130 comparator shown in Fig. 1. This functional array is designed to accomplish logic functions that would normally require 10 separate NAND gates. Putting the entire circuit on a single monolithic chip provides advantages in speed, power dissipation, reliability and ease of circuit design. In addition, the SM-130 comparator incorporates SUHL input and output circuits and is, therefore, completely compatible with other circuits in Sylvania's SUHL family.

Each SM-130 comparator is capable of comparing up to four bits from two separate sources and provides an output for both coincident and non-coincident conditions. A unique expansion feature allows comparison of words up to 36 bits in length with a data delay of less than 50 ns.

The SM-130 (Fig. 2) makes an ideal tester for go/no-go testing of large-scale integrated circuits,

*continued on next page*

## **This issue in capsule**

### **Programmable Dividers**

MSI single-chip circuit simplifies frequency synthesizer design.

### **MSI Preview**

A quick look at some new and exciting devices to come.

### **IC Types**

A handy guide to Sylvania's SUHL I and II families and functional arrays.

### **IC Applications**

How SUHL II helps detect weak signals from space.

### **Parity Generator/Checker**

Single-chip MSI circuit takes the work out of systems design problems.

### **Manager's Corner**

Let's get LSI out of the clouds.



## Programmable dividers in MSI make frequency synthesis a cinch.

Single chip binary and decade dividers offer high system speed, lower power and fewer packages for designers of frequency synthesizers and signal generators.

By putting the translator and decoding gate circuits on the same chip with a programmable divider, Sylvania has simplified the task of designing frequency synthesizers, signal generators, multiplexers and other systems where precise division of frequency is required. Sylvania's SM-140 (binary) and SM-150 (decade) programmable dividers will accept a direct binary or binary coded decimal input for control of the division process. The output is decoded internally and requires no further processing. Result... system power reductions of as great as 4 to 1 can be achieved over conventional approaches.

The logic circuit of the SM-150 decade divider is shown in Fig. 1. The circuit consists of four triggerable flip-flops, a four-input clock gate, a decoder gate, four set gates, a decoder enable gate and a clear line. The flip-flops are connected as a synchronous down counter operating according to the truth table shown. The circuit and operation of the SM-140 binary divider is similar to that of the decade counter except that all of the sixteen possible states are allowed.

In operation, the divisor is set in bcd on  $D_1$  through  $D_4$ , setting the flip-flops to that number. Each clock pulse will decrease the stored number by one until the flip-flops reach the 0000 state. When this state is reached the decoder logic produces an output pulse. If the output pulse is tied back to the preset line, the cycle will be repeated.

The four-input clock gate allows you to take advantage of the higher operating speed of synchronous counting circuit in multiple-stage counters. The three-stage synchronous counter in Fig. 2 is capable of operating at counting rates up to 25 MHz. This system can handle any integral divisor from 1 to 999.

To see how the system operates, assume that the divisor is 16. This number is inserted into the divider as follows: divider #3-0000, divider #2-1000, divider #1-0110. Divider #1 starts to count down from 6.

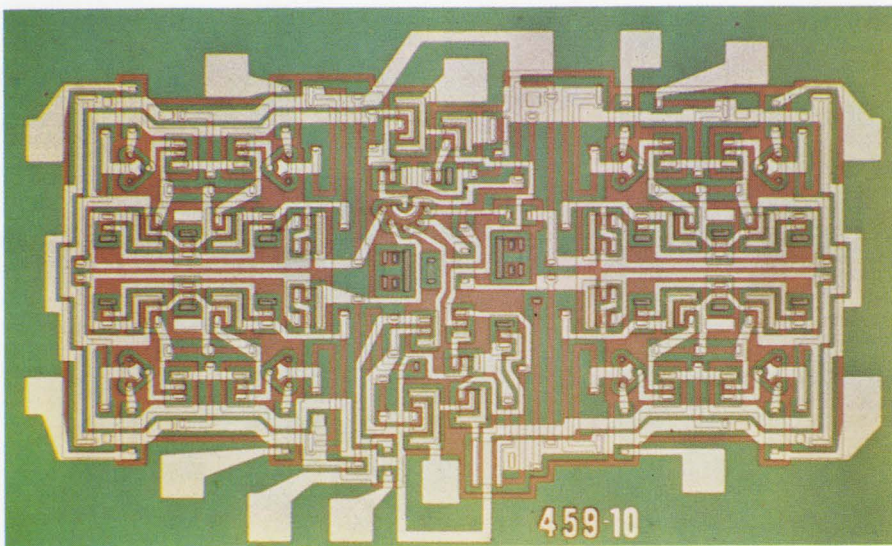

SM-130 comparator

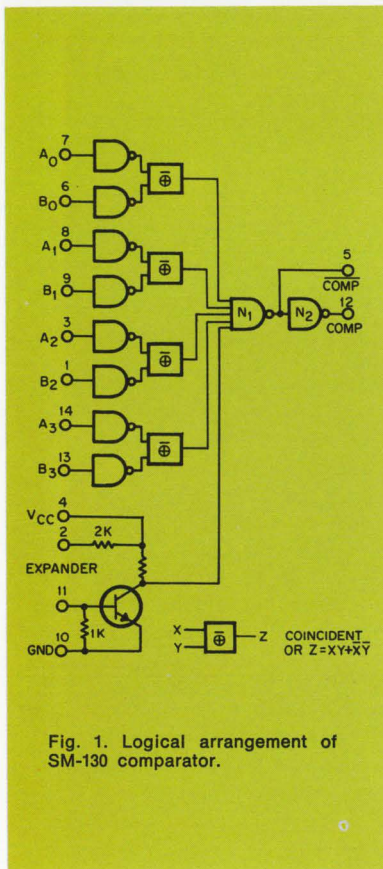

Fig. 1. Logical arrangement of SM-130 comparator.

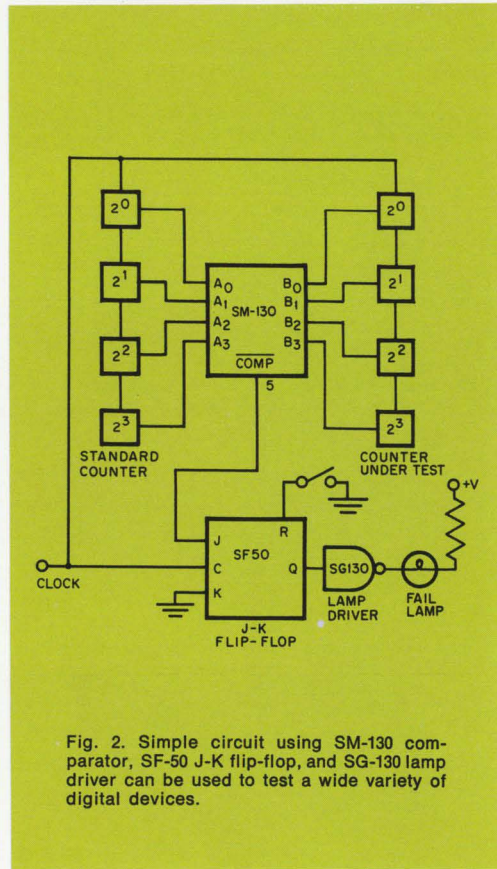

Fig. 2. Simple circuit using SM-130 comparator, SF-50 J-K flip-flop, and SG-130 lamp driver can be used to test a wide variety of digital devices.

including gate arrays, flip-flops, adders, shift registers and other digital circuits. In operation, one set of inputs is connected to a standard circuit (this can be a circuit with known characteristics on a breadboard). The second set of inputs is connected to the device under test.

Both the unit under test and the standard circuit are driven from an identical source. Test operation is initiated by momentarily grounding the reset terminal of the SF-50 flip-flop which sets the Q output in the low state.

As long as the outputs of the device under test and the standard circuit compare, the flip-flop remains in the low state. If the device under test miscounts, the non-coincident output goes high and toggles the flip-flop, switching Q to the high state. This pulls the SG-130 lamp driver low, drawing current through the lamp. The lamp will continue to glow, indicating a failure, until the flip-flop is reset.

In similar applications, the SM-130 comparator can be used to compare the input sections of repeaters and other stations in digital data transmission links to detect spurious and missing pulses; it can also be used to insure equality of words in computers and other data processing systems. The SM-130 is available in either 14-lead ceramic flat packs or in-line plug-in packages.

CIRCLE NUMBER 300



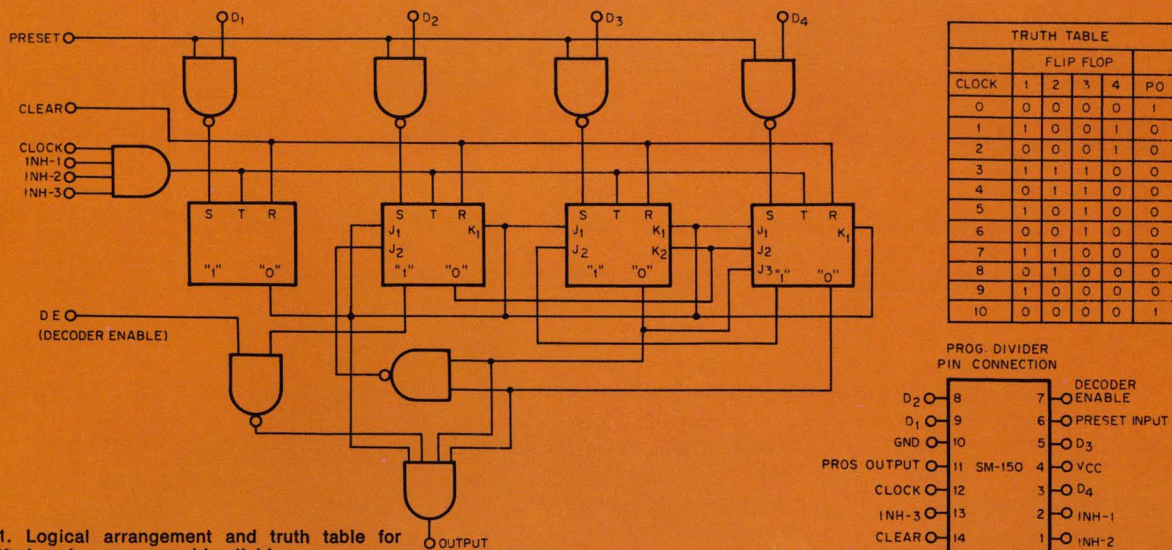

Fig. 1. Logical arrangement and truth table for SM-150 decade programmable divider.

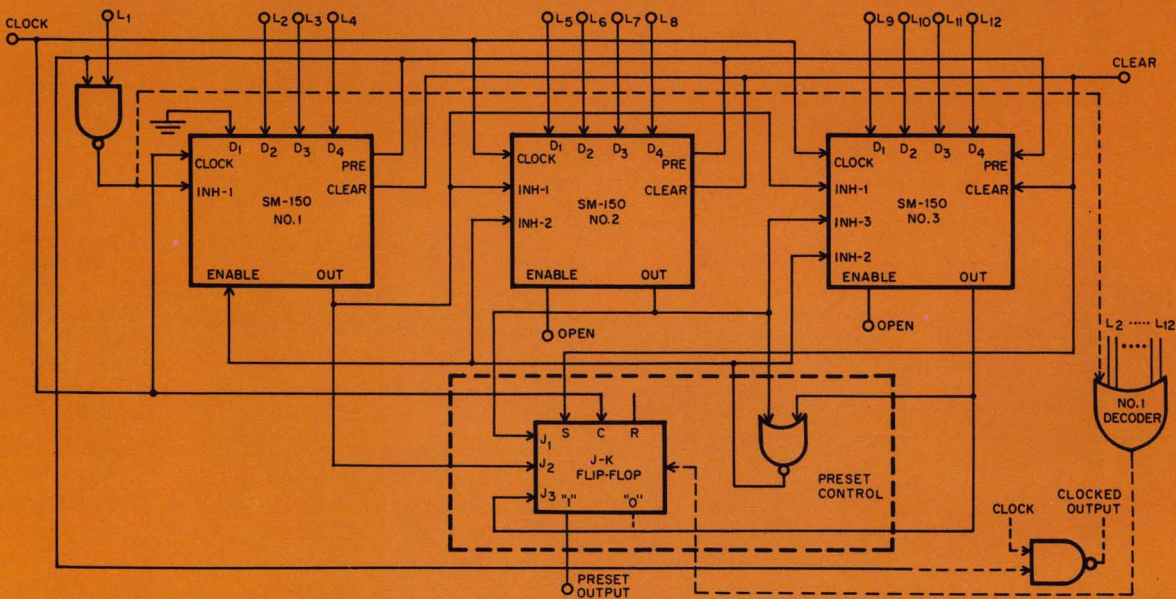
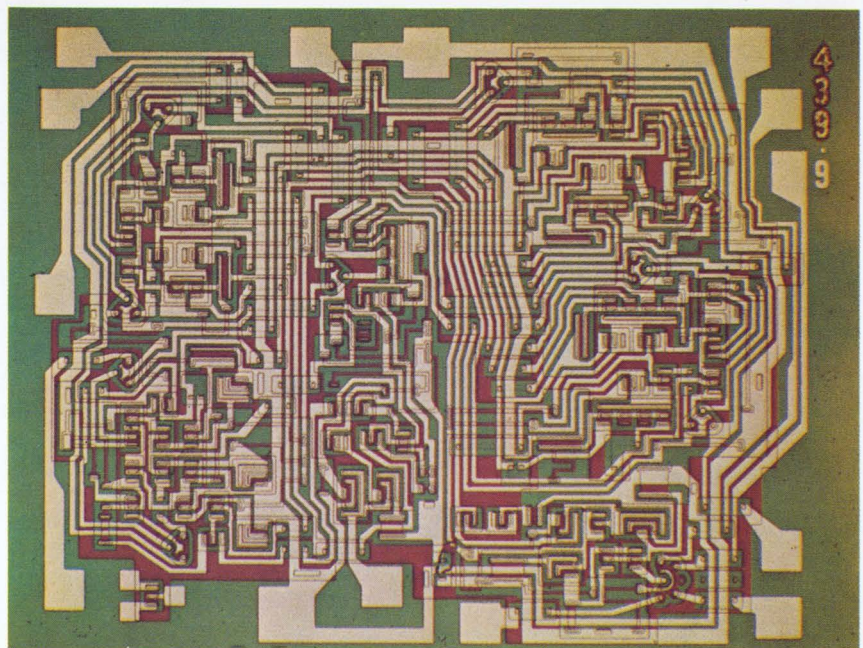

Fig. 2. 3-digit programmable divider.

When 0000 is reached, a logic "1" output is fed to divider #2. Divider #2 now counts down from 1000 and provides a logic "1" output at 0000. Divider #3 was set at 0000 and therefore is at the logic "1" level.

The logic "1" outputs from dividers #2 and #3 change the output of the external NAND gate from a logic "1" to a logic "0". This output inhibits #2 and #3 from further counting but enables #1 to continue. The outputs of #2 and #3 also prime the external J-K preset flip-flop. Divider #1 continues to count down (from 10 in this cycle). When #1 reaches 0000 again, its logic "1" output, combined with the existing logic "1"s from #2 and #3, triggers the J-K flip-flop and produces an output pulse. The preset output pulse restores the divisor number (or a new number) and the cycle repeats.



SM-150 programmable decade divider



## ...and there's many more MSI circuits coming your way.

Sylvania's family of functional arrays is expanding rapidly, and we will soon be in production with a number of new medium-scale integrated circuits. Here's a sneak preview of things to come.

Binary and digital counters are a natural for single-chip integration and we have four devices coming that will bring your counter can count down to a single package. Soon to be available are Sylvania's SM-160 binary counter and SM-170 decade counter. Both units are capable of operating at speeds up to 20 MHz and are completely compatible with Sylvania's popular SUHL logic family.

Not satisfied to offer you single-chip unidirectional counters, we have their bidirectional counterparts off the drawing board and well along the way to production. These units, the SM-180 (binary) and SM-190 (decade) counters are the up/down versions of the SM-160 and SM-170. Both units have a 20 MHz counting rate with the added flexibility of bidirectional operation.

A fifth new circuit, soon to be available, is the SM-200 driver for seven-segment displays. This unit, designed for use with a wide variety of readouts, is capable of driving high-voltage transistors, SCRs, or miniature incandescent lamps, directly.

Keep your eye on the Sylvania IDEAS pages for announcement of availability of these new circuits.

CIRCLE NUMBER 302

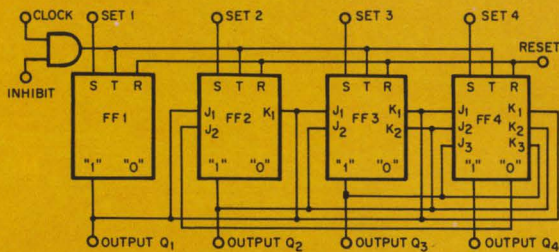

SM-160 4-bit binary counter.

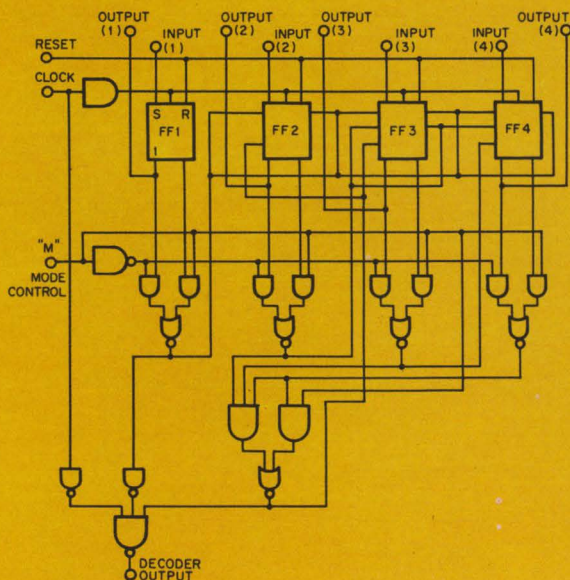

SM-190 decade up-down counter.

## The growing SUHL families —added types for added flexibility.

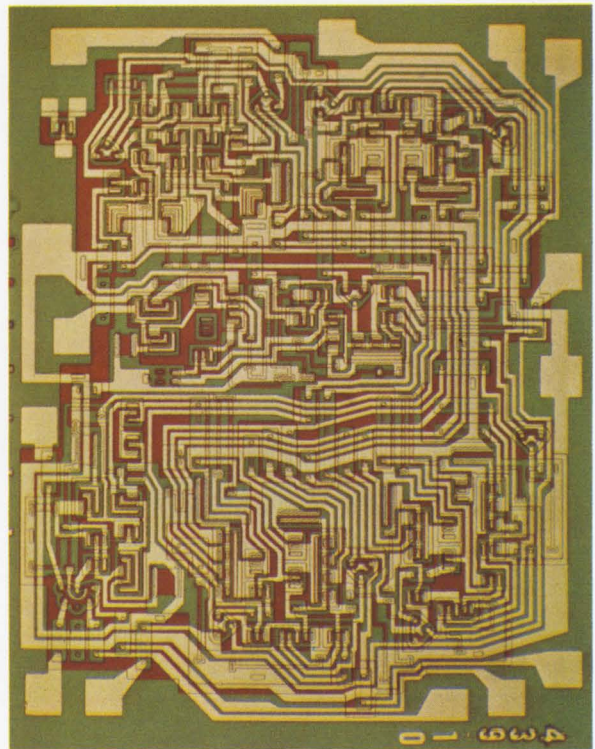

SM-140 programmable binary divider

You get more types to do more jobs faster and better with Sylvania's line of integrated circuits. Now functional arrays pack more functions into a single can.

The table on the facing page gives you a handy checklist of Sylvania's popular SUHL I and II families and our growing line of complex functional arrays.

All of these units give you the well-known advantages of Sylvania's high-level TTL logic design —the design other manufacturers admit to copying. But, why use copies when you get the original.

When you select the originals, you get flip-flops that can switch at a 50 MHz rate, gates with propagation delays as low as 6 ns and, of course, the extremely high noise immunity that is inherent in all SUHL circuits.

In addition, SUHL devices are designed to maintain waveform integrity despite varying load and temperature conditions.

All Sylvania SUHL units are fully and automatically tested on our specially designed Multiple Rapid Automatic Test of Monolithic Integrated Circuits (MR. ATOMIC) equipment to assure that you get the performance you pay for every time. Tests are performed at four different temperatures ( $-55^{\circ}\text{C}$ ,  $0^{\circ}\text{C}$ ,  $+75^{\circ}\text{C}$  and  $+125^{\circ}\text{C}$ ). An additional test at  $25^{\circ}\text{C}$  provides "worst case" testing of switching performance.

All units are available in 14-lead flat-pack style or dual in-line plug-in packages.

CIRCLE NUMBER 303



SUHL I TYPICAL CHARACTERISTICS (+25°C, +5.0 Volts)										
Function	Type Nos.	t <sub>pd</sub> (nsec)	Avg. Power (mw)	Noise Immunity +(volts)-	**Military (-55°C to +125°C) Prime FO Std. FO		**Industrial (0°C to +75°C) Prime FO Std. FO			
<b>NAND/NOR Gates</b>										
Dual 4-Input NAND/NOR Gate	SG-40, SG-41, SG-42, SG-43	10	15	1.1	1.5	15	7	12	6	
Single 8-Input NAND/NOR Gate	SG-60, SG-61, SG-62, SG-63	12	15	1.1	1.5	15	7	12	6	
Expandable Single 8-Input NAND/NOR Gate	SG-120, SG-121, SG-122, SG-123	18	15	1.1	1.5	15	7	12	6	
Dual 4-Input Line Driver	SG-130, SG-131, SG-132, SG-133	25	30	1.1	1.5	30	15	24	12	
Quad 2-Input NAND/NOR Gate	SG-140, SG-141, SG-142, SG-143	10	15	1.1	1.5	15	7	12	6	
Triple 2-Input Bus Driver	SG-160, SG-161, SG-162, SG-163	15	15	1.1	1.5	15	7	12	6	
Triple 3-Input NAND/NOR Gate	SG-190, SG-191, SG-192, SG-193	10	15	1.1	1.5	15	7	12	6	
<b>AND-NOR Gates</b>										
Expandable Quad 2-Input OR Gate	SG-50, SG-51, SG-52, SG-53	12	30	1.1	1.5	15	7	12	6	
Expandable Dual Output, Dual 2-Input OR Gate	SG-70, SG-71, SG-72, SG-73	12	20/gate	1.1	1.5	15	7	12	6	
Exclusive-OR with Complement	SG-90, SG-91, SG-92, SG-93	11	35	1.1	1.5	15	7	12	6	
Expandable Triple 3-Input OR Gate	SG-100, SG-101, SG-102, SG-103	12	25	1.1	1.5	15	7	12	6	
Expandable Dual 4-Input OR Gate	SG-110, SG-111, SG-112, SG-113	12	20	1.1	1.5	15	7	12	6	
<b>Non-Inverting Gates</b>										
Dual Pulse Shaper/Delay-AND Gate	SG-80, SG-81, SG-82, SG-83	11	30/gate	1.1	1.5	15	7	12	6	
Dual 4-Input AND/OR Gate	SG-280, SG-281, SG-282, SG-283	11	38/gate	1.0	1.5	10	5	8	4	
<b>AND Expanders</b>										
Dual 4-Input AND Expander	SG-180, SG-181, SG-182, SG-183	< 1	0.9/gate	1.1	1.5					
Dual 2 + 3 Input AND/OR Expander	SG-290, SG-291, SG-292, SG-293	7	15/gate	1.0	1.5					
<b>OR Expanders</b>										
Quad 2-Input OR Expander	SG-150, SG-151, SG-152, SG-153	4	20	1.1	1.5					
Dual 4-Input OR Expander	SG-170, SG-171, SG-172, SG-173	3	5	1.1	1.5					
<b>Flip-Flops</b>										
Set-Reset Flip-Flop	SF-10, SF-11, SF-12, SF-13	20MHz*	30	1.1	1.5	15	7	12	6	
Two Phase SR Clocked Flip-Flop	SF-20, SF-21, SF-22, SF-23	20MHz*	30	1.1	1.5	15	7	12	6	
Single Phase SRT Flip-Flop	SF-30, SF-31, SF-32, SF-33	15MHz*	30	1.1	1.5	15	7	12	6	
J-K Flip-Flop (AND Inputs)	SF-50, SF-51, SF-52, SF-53	20MHz*	50	1.1	1.5	15	7	12	6	
J-K Flip-Flop (OR Inputs)	SF-60, SF-61, SF-62, SF-63	20MHz*	55	1.1	1.5	15	7	12	6	
Dual 35MHz J-K Flip-Flop (Separate Clock)	SF-100, SF-101, SF-102, SF-103	35MHz*	55/FF	1.0	1.5	11	6	9	5	
Dual 35MHz J-K Flip-Flop (Common Clock)	SF-110, SF-111, SF-112, SF-113	35MHz*	55/FF	1.0	1.5	11	6	9	5	
<b>SUHL II TYPICAL CHARACTERISTICS (+25°C, +5.0 Volts)</b>										
<b>NAND/NOR Gates</b>										
Expandable Single 8-Input NAND/NOR Gate	SG-200, SG-201, SG-202, SG-203	8	22	1.0	1.5	11	6	9	5	
Quad 2-Input NAND/NOR Gate	SG-220, SG-221, SG-222, SG-223	6	22	1.0	1.5	11	6	9	5	
Dual 4-Input NAND/NOR Gate	SG-240, SG-241, SG-242, SG-243	6	22	1.0	1.5	11	6	9	5	
Single 8-Input NAND/NOR Gate	SG-260, SG-261, SG-262, SG-263	8	22	1.0	1.5	11	6	9	5	
Triple 3-Input NAND/NOR Gate	SG-320, SG-321, SG-322, SG-323	6	22	1.0	1.5	11	6	9	5	
<b>AND-NOR Gates</b>										
Expandable Dual 4-Input OR Gate	SG-210, SG-211, SG-212, SG-213	7	30	1.0	1.5	11	6	9	5	
Expandable Quad 2-Input OR Gate	SG-250, SG-251, SG-252, SG-253	7.5	43	1.0	1.5	11	6	9	5	
Expandable Triple 3-Input OR Gate	SG-300, SG-301, SG-302, SG-303	7	36	1.0	1.5	11	6	9	5	
Expandable Dual Output Dual 2-Input OR Gate	SG-310, SG-311, SG-312, SG-313	7	30/gate	1.0	1.5	11	6	9	5	
<b>AND Expanders</b>										
Dual 4-Input AND Expander	SG-180, SG-181, SG-182, SG-183	< 1	0.9/gate	1.1	1.5					
<b>OR Expanders</b>										
Quad 2-Input OR Expander	SG-230, SG-231, SG-232, SG-233	2	28	1.0						
Dual 4-Input OR Expander	SG-270, SG-271, SG-272, SG-273	2	6.7	1.0	1.5					
<b>Flip-Flops</b>										
Dual 50MHz J-K Flip-Flop (Separate Clock)	SF-120, SF-121, SF-122, SF-123	50MHz*	55/FF	1.0	1.5	11	6	9	5	
Dual 50MHz J-K Flip-Flop (Common Clock)	SF-130, SF-131, SF-132, SF-133	50MHz*	55/FF	1.0	1.5	11	6	9	5	
50MHz J-K Flip-Flop (AND Inputs)	SF-200, SF-201, SF-202, SF-203	50MHz*	55	1.0	1.5	11	6	9	5	
50MHz J-K Flip-Flop (OR Inputs)	SF-210, SF-211, SF-212, SF-213	50MHz*	55	1.0	1.5	11	6	9	5	
<b>Lamp Driver</b>										
Quad 2-Input Lamp Driver	SG-350 series	10	37	1.0	1.5	22	12	18	10	

FUNCTIONAL ARRAYS, TYPICAL CHARACTERISTICS (+25°C, +5.0 Volts)										
Function	Type Nos.	t <sub>pd</sub> (nsec)	Avg. Power (mw)	Noise Immunity +(volts)-	Fanout					
Full Adder	SM-10 series	sum 22 carry 10	90	1.0	1.0					
Dependent Carry Fast Adder	SM-20 series	sum 22 carry 10	125	1.0	1.0					
Independent Carry Fast Adder	SM-30 series	sum 22 carry 10	125	1.0	1.0					
Carry Decoder	SM-40 series	2	25	1.0	1.0					
Four Bit Storage Register Bus Transfer Output	SM-60 series	20	30/bit	1.0	1.0					
Four Bit Storage Register Cascade Pullup Output	SM-70 series	20	30/bit	1.0	1.0					
16-Bit Scratch Pad Memory	SM-80 series	25	250	1.0	1.0					
Decade Frequency Divider	SM-90 series	35MHz	85	1.0	1.0					
Four-Bit Shift Register	SM-110 series	25MHz	120	1.0	1.0					
Parity Generator/Checker	SM-120 series	22	125	1.0	1.0					
Comparator	SM-130 series	17	120	1.0	1.0					
Programmable Binary Divider	SM-140 series	25MHz	150	1.0	1.0					
Programmable Decade Divider	SM-150 series	25MHz	150	1.0	1.0					

\*Minimum toggle frequency \*\*Minimum fan-out

Available  
in fanouts  
up to 15.  
Completely  
compatible  
with SUHL I  
and SUHL II  
lines.



## How SUHL II helps detect weak signals from space.

Autocorrelation receiver for radio astronomy uses high-speed SUHL II circuits to build up extraterrestrial signals buried in noise.

The weakness of radio-frequency signals from radiation sources in interstellar space makes their detection, amplification and analysis a challenging task for even the most sophisticated scientific instrumentation.

Sylvania's SUHL II 6-ns integrated circuits are helping to meet this challenge at the National Radio Astronomy Observatory\* in Green Bank, West Virginia. Over 2,000 SUHL II circuits are being used in a complex, deep space observation system.

At the heart of the observation system is NRAO's 413-channel, 10-MHz bandwidth, digital autocorrelation receiver. The autocorrelation technique consists of filtering out a selected bandwidth centering on a desired frequency and heterodyning it down to a video signal with one side of the bandpass being zero frequency.

The signal is then clipped to provide a rectangular waveshape of fixed amplitude. The clipped signal is then sampled at twice the bandwidth and the sampled data is used to generate two autocorrelation functions of 29 and 384 sample points, respectively.

Since the receiver's bandwidth is 10 MHz, sampling rates of 20 MHz are required—a rate not easily achieved with conventional ICs. This is where Sylvania's high-speed SUHL II integrated circuits come into the picture. SUHL II circuits are capable of providing noise free operation up to 50 MHz. Over 2,000 SUHL II circuits, mostly J-K flip flops, are used in the autocorrelator. Of these circuits, about 1,000 flip-flops and 350 gates are clocked at 20 MHz. The

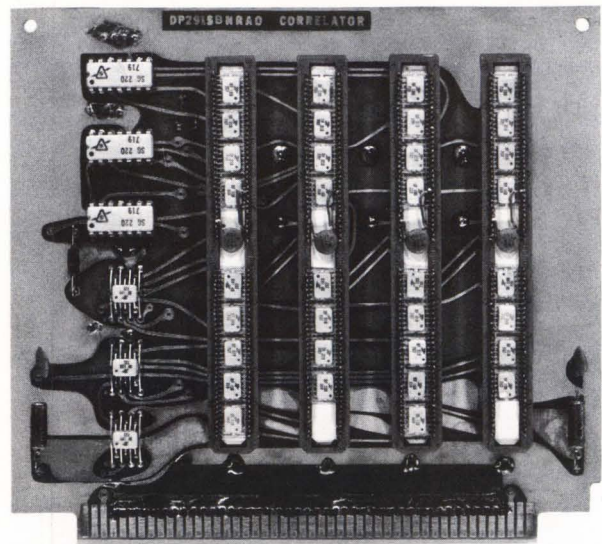

One of the 161 logic boards used in the National Radio Astronomy Observatory autocorrelation receiver. All high-speed processing is done using Sylvania SUHL II integrated circuits.

gates are used only as clock drivers, and all logic is handled by the J-K flip flops.

After processing through the SUHL circuitry, the integrated autocorrelation function is passed to an on-line computer. The computer performs a Fourier transform to generate a power spectrum. Output of the computer is available as a graphic plot on a storage oscilloscope and as a magnetic tape which can be used for further processing by an off-line computer.

Sylvania SUHL II circuits used in the autocorrelator system include: SF-133 dual 50-MHz J-K flip-flop (common clock), SF-120 dual 50-MHz J-K flip-flop (separate clock), SF-213 50-MHz J-K flip-flop (OR input), SF-103 dual 35-MHz flip-flop (separate clock), SG-132 dual four-input line driver, and SG-220 quad two-input NAND/NOR gate. All of these units are available in military ( $-55^{\circ}\text{C}$  to  $+125^{\circ}\text{C}$ ) and industrial ( $0^{\circ}\text{C}$  to  $+75^{\circ}\text{C}$ ) temperature ranges. They share the high noise immunity and low power consumption characteristics of the entire SUHL family.



Weak signals from outer space are gathered in by a 140-foot polar-mounted radio telescope for processing in autocorrelator using Sylvania SUHL II high speed logic circuits.

\*The National Radio Astronomy Observatory is operated by Associated Universities, Inc., under contract with the National Science Foundation.



# Single-chip parity generator/checker simplifies system design.

Putting NAND gates together to make a parity generator/checker is a thing of the past. Sylvania has done all the hooking-up for you, and we've done it on a single MSI chip.

Our new SM-120 functional array (Fig. 1) takes the place of multiple NAND gates in parity generator/checker circuits to simplify your systems design task. In addition, it brings you other advantages of monolithic construction including low overall power dissipation, reduced delay time per gate, and higher reliability because of a reduced number of interconnections.

At the systems level, the SM-120 increases predictability of delay times through simplified design, and offers faster system speed through elimination of many worst-case limit summations.

The SM-120 is valuable in any system where you want to insure error-free transmission of digital data. When used as a generator, the SM-120 will generate a redundant bit as needed to insure that each word contains an even number of ones. As the data is moved through the computer, the SM-120 can be used at key points as a checker to insure that none of the ones have been lost during transmission.

A typical set-up for a 24-bit parity generator/checker is shown in Fig. 2. Four SM-120s are used. Propagation delay is only two parity generator delays, or about 50 ns  $T_{on}$ , 60 ns  $T_{off}$ . Through its unique expansion capability this circuit can be expanded to 64 bits. Specific applications for the SM-120 include identification of errors in word transfer from input to memory, memory to control, control to arithmetic section, recorders to magnetic tape drum to input sections, tape to readers and other areas involving data transfer.

The SM-120 is completely compatible with other members of Sylvania's SUHL family of integrated circuits and arrays, and is available in either flatback or plug-in 14-lead ceramic packages. It will accept up to eight input bits and can be used in conjunction with other similar devices to check or generate parity for many-bit words.

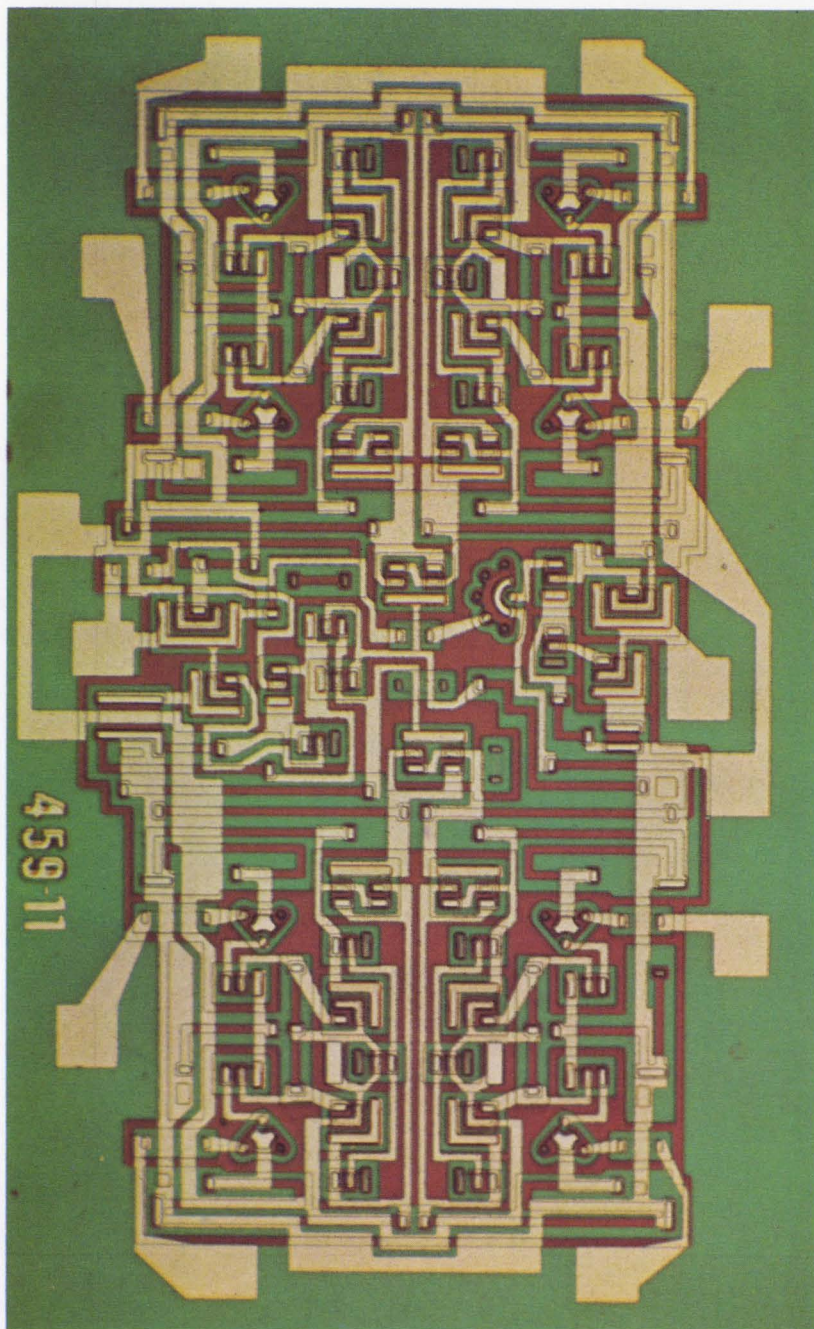

SM-120 parity generator/checker

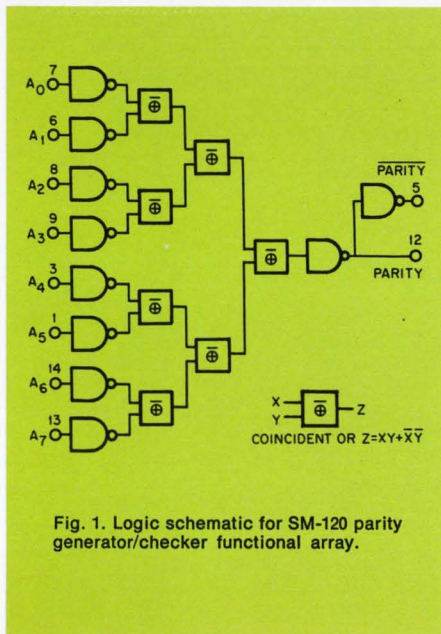

Fig. 1. Logic schematic for SM-120 parity generator/checker functional array.

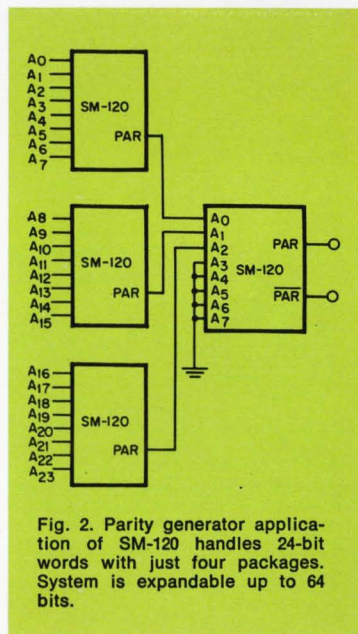

Fig. 2. Parity generator application of SM-120 handles 24-bit words with just four packages. System is expandable up to 64 bits.



## Let's get LSI out of the clouds.

The glamour and mysticism surrounding the term LSI often obscures the fact that LSI will have to compete under the rules of the marketplace.

When you come right down to it, LSI is only definable in terms of a physical product. The product is an electronic circuit and is subject to the same ground rules applied to other electronic circuits.

Price, availability and reliability are the standard criteria used by systems manufacturers in making "buy" decisions. If LSI is to compete with other components to form a system, they must eventually be judged against these three factors. At the present time, LSI circuits are being used only in prototype systems and normal standards are not being applied. LSI prices are generally high, availability is limited and reliability is relatively unproven. For an LSI circuit to become a competitive and practical product, all of these factors must be changed. This is where the major difficulties come in.

The first and most obvious difficulty in changing these factors lies in the very thing that makes LSI exciting to consider in the first place—complexity. The larger the area of silicon required to produce the function, the fewer circuits per wafer. The greater the complexity and number of layers of interconnect required to connect the elements, the lower the yield. Fewer circuits and lower yield to the manufacturer means higher cost, which results in higher prices to the user. But how high is high?

If the component manufacturer can offer an array containing 100 logic gates already interconnected in a single package at a cost to the user of \$1/gate, is that high? It may be considered high if board layout, assembly and testing costs are neglected. The cost may not seem high if these factors are considered. Thus, there is no hard and fast reply to this question.

This same complexity factor also presents difficult problems in testing and guaranteeing electrical per-

formance of the array. There is no tester on the market today that can adequately exercise an LSI array to guarantee its switching and DC performance. There are, however, array testers in the advanced design stages that will overcome the DC testing difficulty. But, AC propagation delay performance testing presents a problem which has not been adequately defined, let alone solved.

The second major source of difficulty lies in the increasing level of specialization designed into arrays. A resistor that performs the  $E=IR$  function, or a NAND gate that performs the  $A=B \cdot C \cdot D \cdot E$  function has a widespread applicability. As the market for these devices broadened and volume increased, the cost of masks, development engineering, test programming and product debugging became an insignificant portion of the total cost of the product.

But what of the LSI array designed for a specific customer which might have a total production life of only 1,000 units? The start-up costs can now become the primary cost of manufacture.

As a result, the industry is increasingly turning toward one of the creatures it helped spawn, the computer, for an answer to this problem. Computer-aided design, layout and mask generation will reduce the probability of errors and decrease turn-around time. Computer-controlled array test facilities with standardized format entry are required. On-line computers for operator and process control, overall scheduling, costing, estimating and inventory control are essential to maintain efficiency of operation.

Arrays are now being produced, yields are improving, computer equipment is being installed and integrated into array operations. Systems manufacturers for their part are looking at different ways of organizing systems to make more extensive use of more highly repetitive complex components. The problems of producing arrays will be solved and LSI arrays will be just another family of IC circuits having high component density, good reliability and availability at an attractive price.

R. Bohn  
Supervisor  
Product Engineering



This information in Sylvania Ideas is furnished without assuming any obligations.

# SYLVANIA

A SUBSIDIARY OF  
GENERAL TELEPHONE & ELECTRONICS

NEW CAPABILITIES IN: ELECTRONIC TUBES • SEMICONDUCTORS • MICROWAVE DEVICES • SPECIAL COMPONENTS • DISPLAY DEVICES

## Need IC information in a hurry?

You can get full information on any integrated circuit or application shown in this special issue of Sylvania IDEAS.

The quickest way is to drop us a line at the address shown here. Be sure to give us your name, title, company, address, and tell us the names of the products on which you'd like to

receive more information. And if you have a particular design problem, just let us know. We'll rush you full particulars. Please write to:

Dept. No. C 77  
Sylvania Electronic Components Group  
1100 Main Street  
Buffalo, New York 14209

You can also get information using the publication's card elsewhere in this issue.

Select the items you're most interested in and circle the appropriate reader service numbers.



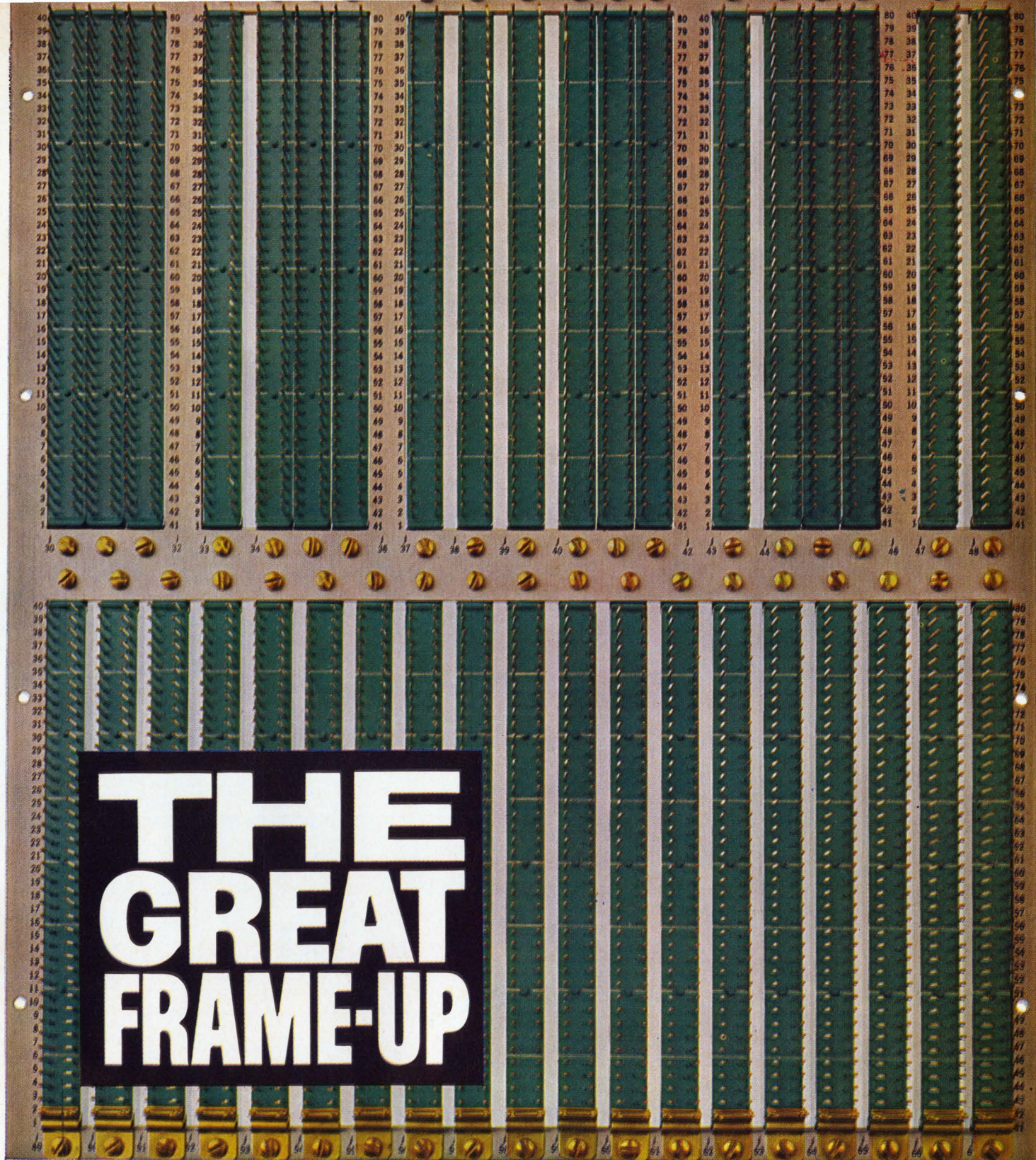

# THE GREAT FRAME-UP

**We call it AccurFrame.  
And it can save you more than 1¢ per contact.**

Our new AccurFrame takes the fuss and bother out of wire-wrapping. It's easy, fast and error-free. And very simple to use.

Here's why. Our HW Series Wire-Wrap\* connectors have two polarized alignment holes in the card insertion side of the block. These fit over accurately positioned pins on the alignment tool. There's no chance of a connector being placed wrong-end-to.

With connectors in perfect position, our frame is placed over the assembly; connectors are quickly attached with machine screws. The frame and connectors lift off—ready for automatic wire-wrapping.

Winchester's long experience has made the whole thing so sure, simple and *fast* that most users are saving 1¢ per contact over other methods. And those pennies add up.

You'll like our Wire-Wrap connectors, too. They're available in sizes ranging from 22 to 50 contact positions. Designed for automatic equipment, high-strip force retention, bifurcated spring contacts for superior interfacing. We integral-mold them in diallyl phthalate SDG-F. Contacts are easily removed. Retained by a 90° twist.

Get all the profitable facts about the Great Frame-Up from your District Sales Office. Or from Winchester Electronics, Main Street & Hillside Avenue, Oakville, Connecticut 06779.

**WINCHESTER ELECTRONICS**  
LITTON INDUSTRIES 

\*Trademark-Gardner Denver Company



# now...Clare-Quality in TO-5 Relays!

- Only .275" high by .370" maximum diameter
- Rigid frame keeps elements stable . . . balanced armature precisely aligned
- High, consistent contact force . . . low contact resistance
- Form C and 2 Form C contacts
- Speeds to 2 ms
- 1,000,000 operations at low level . . . 100,000 at rated load
- Pressurized, hermetically-sealed welded case



New Clare TF Military-Type Relays provide true reliability in subminiature relay operation . . . new compatibility in pcb design—backed by the simple, precision construction in eight types of Clare military relays.

Optimized magnetic circuitry assures maximum contact pressure. Balanced armature design. Withstands shock to 80G . . . vibration to 30G, without false operation. Serves over temperature range from  $-65^{\circ}\text{C}$  to  $+125^{\circ}\text{C}$ . All welded construction. Pressurized nitrogen atmosphere minimizes arcing, extends contact life.

Design dependable new capabilities for interface, input/output isolation, and buffering into subminiature circuits. Circle Reader Service Number— or ask Clare for Data Sheet 758 . . . Write Group 9N7.

C. P. Clare & Co., Chicago, Ill. 60645 . . . and worldwide



a GENERAL INSTRUMENT company

## TYPE TF RELAY CONTACT ARRANGEMENTS

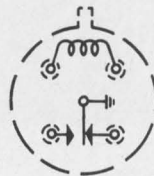

1 Form C,  
movable contact  
connected to case

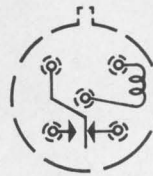

1 Form C,  
all contacts  
insulated from case

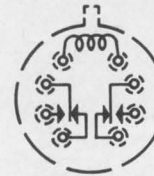

2 Form C,  
all contacts  
insulated from case



## CLARE SUBMINIATURE MILITARY-TYPE RELAYS

for airborne, aerospace, and ground support  
equipment, industrial, and commercial control systems



# Latest in the line of Monsanto IC counter/timers.

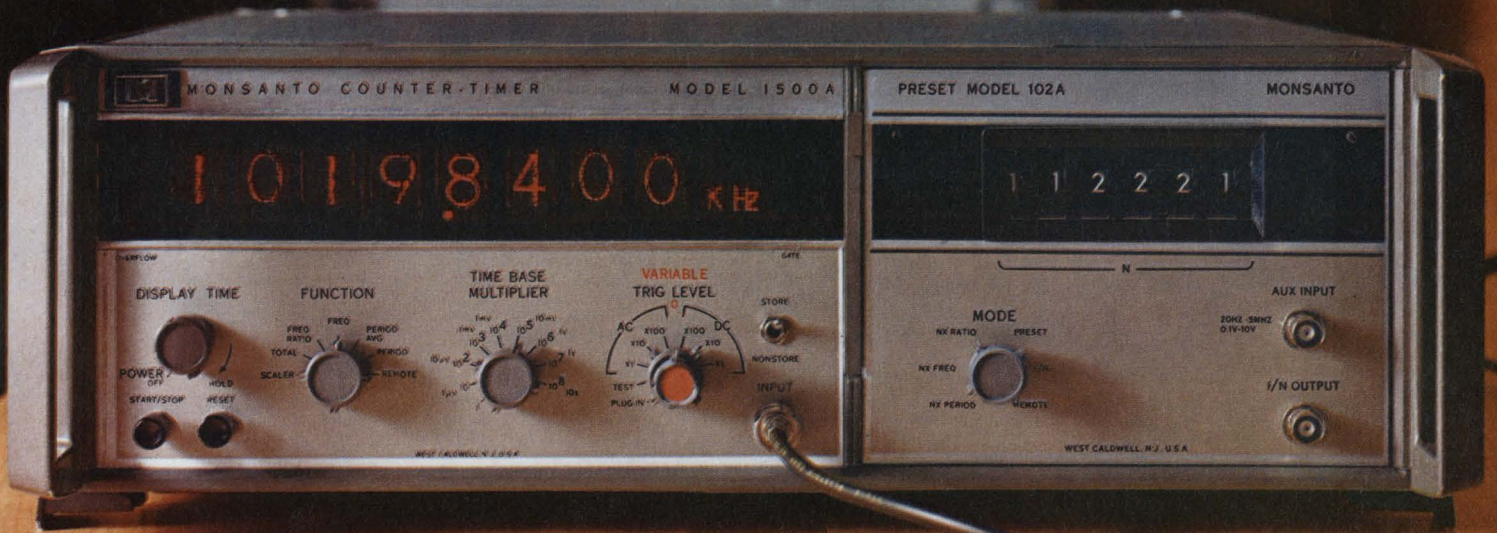

AVAILABLE PLUG-INS: TWO FREQUENCY CONVERTERS (50 MHz TO 500 MHz, 100 MHz TO 3 GHz); PRESCALER (dc TO 1 GHz); PRESET UNIT (20 Hz TO BEYOND 10 MHz); VIDEO AMPLIFIER (1 mV SENSITIVITY, 10 Hz TO 200 MHz); TIME INTERVAL UNIT (100 ns RESOLUTION); NON-COMMITTED PLUG-IN.

**With 90% integrated circuit construction this new "4th generation" instrument is the most advanced plug-in counter/timer yet.**

Our new model 1500A takes full advantage of IC capabilities to bring you: main-frame counting range from dc to over 125 MHz; to 3 GHz with a single plug-in. Remote programmability by either contact closure or voltage level. Provision for external time base up to 10 MHz. And nat-

urally, the inherent stability and reliability of integrated circuit construction, as indicated by our two-year warranty. All this for only \$2,850\*. Call our field engineering representative in your area for full technical details, or contact us directly at: Monsanto Electronics

Technical Center, 620 Passaic Avenue, West Caldwell, N. J. 07006. Phone: (201) 228-3800; TWX 710-734-4334. \*U. S. Price, FOB West Caldwell, N. J.



**ELECTRONICS**

Circle 45 on reader service card



# LOOKING FOR LOW-COST AUTOMATION?

Here's a **NEW** way:

**Eagle's all-solid-state count controls**

**100% Accurate up to 1200 Counts per minute\***

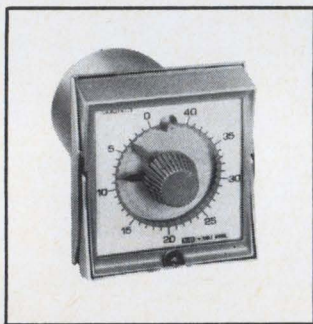
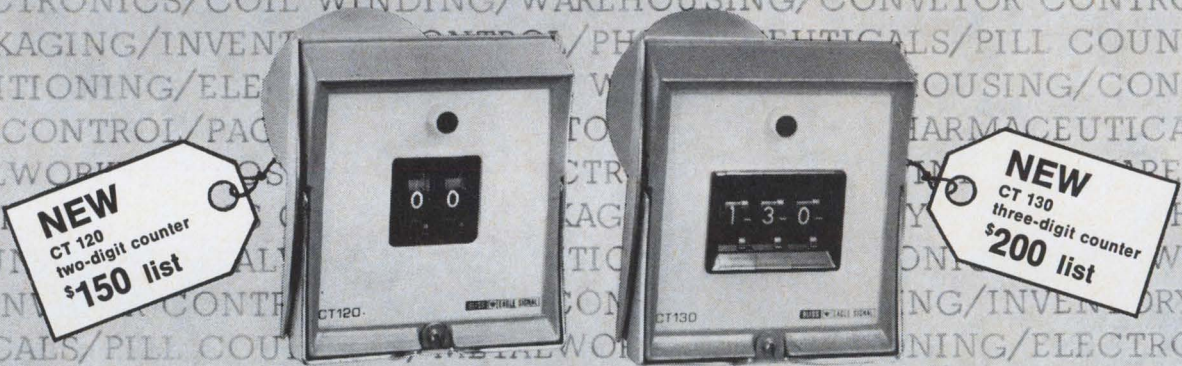

HZ170 PREDETERMINING COUNTER



HZ760 CONTINUOUS BATCH COUNTER

Eagle continues to expand its reliable count-control products . . . always compatible with its complete line of proven solid-state or electromechanical time controls. Our two, new transient-protected integrated circuit counters above offer 100% accuracy from a wide variety of inputs of specified voltages and frequency . . . at low cost. With flexible solid-state control output, easy-to-set binary thumbwheels and easy-to-see integral indicator lights, these counters are particularly well suited for machine tool and process control duty. Eagle's famous Cycl-Flex® plug-in feature cuts down time . . . unit can be replaced without tools in 5 seconds or less.

Eagle solid-state count controls are also available in electromechanical models, as those shown at the left.

*\*Count speed based on counter input from electromechanical sources. Higher counts to 30,000 per second limited only by input accuracy.*

## For complete information

on these new counters and all 56 basic types of Eagle time/count controls, circle the number below on the Reader Service Card. Or write: Eagle Signal Division, E. W. Bliss Company, 736 Federal St. Davenport, Iowa 52808.



In Canada: Eagle Signal Division,  
E. W. Bliss Company  
(Canada) Ltd.



A GULF + WESTERN COMPANY



ERIE

TECHNOLOGICAL

PRODUCTS, INC.



LOOK FIRST TO ERIE FOR...

# CUSTOM *Hybrid* INTEGRATED CIRCUITS

*When choosing your Custom HYBRID Circuit Source...  
Check ERIE'S "Total Package" In-Plant Capability*

There are very specific reasons why ERIE is becoming a preferred source for Custom Hybrid Integrated Circuits. Our distinctly superior *resistor technology* is unique in the industry, as is our in-depth *capacitor technology*. We produce our own *precious metal formulations*, our own *substrates*, *semiconductors* and the best *protective encapsulant* available. Result? Economy, greater reliability, excellent quality control and delivery to meet your schedules. Prototypes available in about two-weeks with production quantities in about six weeks.

Look first to ERIE as *Your Custom Hybrid source*. Our total in-plant capability and expERIENCE are unparalleled in the industry.

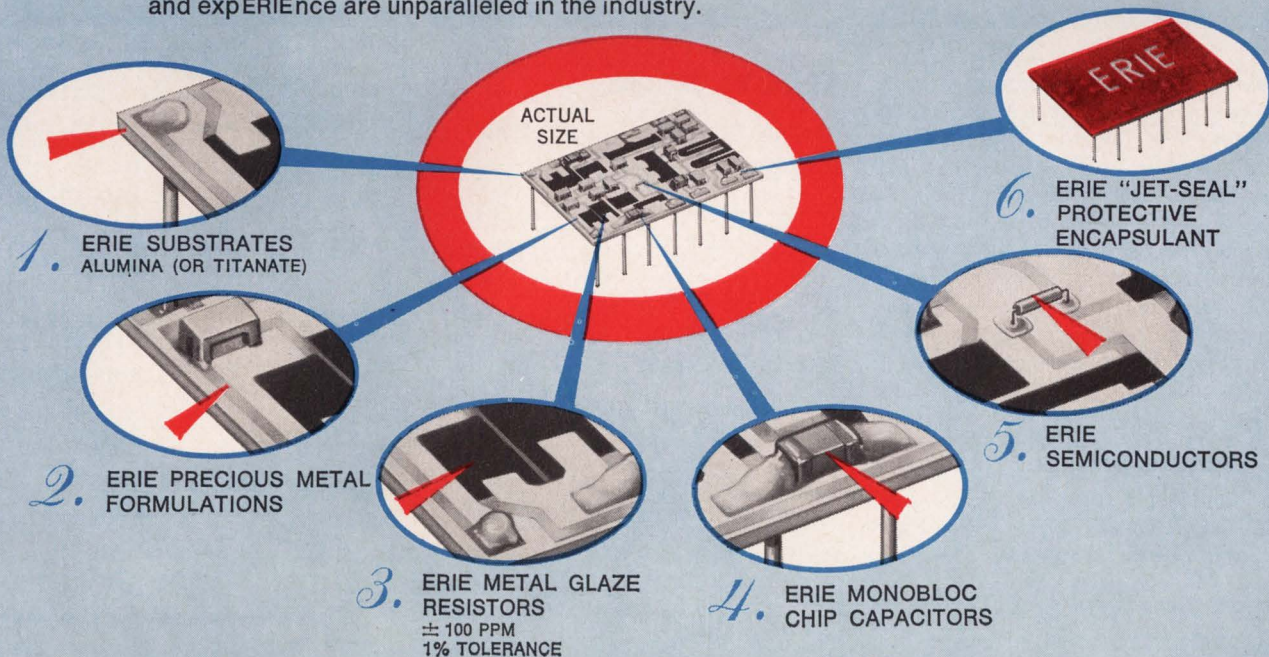

Write today for ERIE "Custom Hybrid I/C" Brochure...



ERIE TECHNOLOGICAL PRODUCTS, INC. • 644 West 12th St. • Erie, Pa. 16512 • Phone (814) 456-8592



**4**

**ONLY  
ITT  
SELLS  
DIODES  
FOR**

**¢**

**Standard Silicon  
DO-35 double-plugs  
or Germanium DO-7's;  
500,000 or more**

Here's a major breakthrough in diode pricing—made possible by ITT's technological leadership. Popular types are available at only 4¢ each in 500,000 quantities, when ordered for delivery in one year or less. ITT diodes are designed to meet all the JAN mechanical and environmental specs.

Don't give away reliability — buy these American-made diodes and be sure. Buy from the largest supplier of diodes and get tomorrow's prices today. For more information, call your local ITT Sales Office. ITT Semiconductors is a division of International Telephone and Telegraph Corporation, 3301 Electronics Way, West Palm Beach, Florida, 305/842-2411

**ITT SALES OFFICES**

Phoenix, Arizona .....602/264-2778  
 Long Beach, California....213/774-4820  
 Winter Park, Florida\* .....305/645-3790  
 Palo Alto, California.....415/964-3400  
 North Palm Beach,  
 Florida\* .....305/848-4617  
 Chicago, Illinois .....312/282-4777  
 Kansas City, Missouri .....816/444-1781  
 Wakefield,  
 Massachusetts .....617/245-8350  
 Minneapolis, Minnesota...612/920-2943  
 Poughkeepsie, N.Y. ....914/452-0800

Dayton, Ohio .....513/434-6121  
 Seattle, Washington.....206/282-9150  
 Willowdale, Ontario,  
 Canada\* .....416/225-7494  
 Towson, Maryland .....301/828-4616  
 Southfield, Michigan .....313/353-0880  
 Bloomfield, New Jersey...201/743-9613  
 Syracuse, New York.....315/463-6677  
 Bala Cynwyd,  
 Pennsylvania .....215/667-4596  
 Pierrefonds, Quebec,  
 Canada\* .....514/626-6511

\*ITT Representative

**semiconductors ITT**

FACTORIES IN FLORIDA • CALIFORNIA • MASSACHUSETTS • ENGLAND • FRANCE • GERMANY • PORTUGAL • AUSTRALIA



# We Androids absolutely demand Guardian Steppers

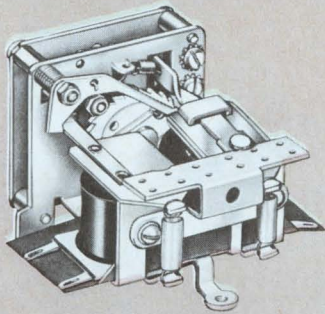

If there's one thing a robot hates it's that embarrassing maintenance check! That's why we want long-life components built for dependable operation. Like Guardian stepping relays (some humans call them rotary stepping switches). They average over five million operations on the life-test rack.

Then, too, Guardian steppers are compact . . . replace relays in series or banks of multiple circuitry . . . so we keep slim.

If you don't want a fat, broken-down android on your hands, specify Guardian steppers. Lots of types available . . . sequence selecting, automatic resetting, pulse multiplying, slave and master, etc., etc. Up to 52 contacts per deck . . . up to 8 undivided circuits. Write for Bulletin F32.

## **GUARDIAN<sup>®</sup>**

GUARDIAN ELECTRIC MANUFACTURING COMPANY

1550 W. Carroll Ave. • Chicago, Ill. 60607







# The F-111's Defense Penetration System

has some  
nerve.

## Ours.

No ordinary coaxial cable can handle the black box-to-antenna (nose-to-tail) interconnect for this incredible avionics marvel. Ordinary coaxial cable is too lossy and too heavy, won't hold high input powers above 60,000 feet and 350° F, and exhibits a large VSWR change with temperature cycling. And it can't be bent on a 2½" radius without a large VSWR increase. Ordinary connectors are too large, too heavy and create too much VSWR. Ordinary assemblies aren't pressure tight, and here the pressure really is on—to 15 psig. Obviously, the F-111 is an extraordinary aircraft. Obviously its Enemy Defense Penetration System needed extraordinary cables and connectors.

Times developed and manufactured a complete ship set of prebent, and terminated interconnecting assemblies, each sweep-tested for VSWR and insertion loss across its bandwidth. We used High Temperature, Light Weight Alumispline® (seamless aluminum sheath) with a longitudinally extruded dielectric. And, despite one bend per foot needed to meet configurations of the aircraft, we achieve negligible motion of the cable axis and change in size during bending by a unique method developed for this type of cable.

For each F-111 we are now furnishing 45 assemblies, of cable lengths from 2 to 14 feet, joined by selected connectors and our own specially-designed low-profile Timatch® Type-N connectors (minimum VSWR and minimum space). Each assembly is completely terminated, three-dimensionally fit checked, and electrically tested, so all General Dynamics has to do is put them in. That makes field maintenance simple, too.

Have you a tough cable interconnect problem? Times has the nerve to solve it. Times Wire & Cable, Wallingford, Connecticut 06492. Phone (203) 269-3381. Contact the Engineering Services Department.

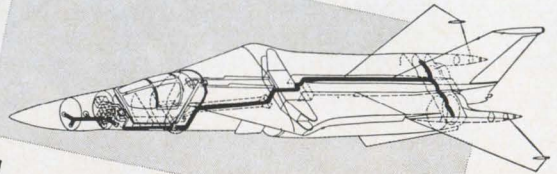

**TIMES**  
**WIRE & CABLE**  
DIVISION OF THE INTERNATIONAL SILVER CO.



# Switch High Voltage In Nanoseconds With PNP Silicon Power!

Take a silicon power transistor that operates to 300 volts . . . switches in nanoseconds . . . and exhibits saturation voltages well under  $\frac{1}{2}$  volt — *with PNP polarity*, too — and you have a device that provides a whole new perspective in the art of power switching and amplifier circuit design!

Motorola's new silicon PNP 2N5344-45, 250 and 300-volt power switches allow you to employ circuitry directly from high-voltage "plus" supplies. You can put them to work in dc to dc converters, relay and hammer drivers, motor controls, servo and pulse amplifiers. And, their high-voltage ratings permit direct-line operation, eliminating the need for step-down componentry.

Switching capability of these state-of-the-art devices is ultra-nimble, too . . . less than 900 nanoseconds maximum total switching time at 500 mA and 100 volts. And efficient, low-power-loss, low-distortion performance is ensured due to collector-emitter saturation voltages typically 0.38 volts at 500 mA.

Packaged in the space-saving, thermally efficient, TO-66 hermetic case, the 2N5344-45 transistors have excellent safe operating areas, such as 1 A dc at 30 V — while at 300 volts and 100 microsecond pulse widths, the 2N5345 can switch up to 50 mA.

The new units' operating temperature range extends from  $-65^{\circ}$  to  $200^{\circ}\text{C}$ , making them ideal replacements of germanium types in today's demanding systems.

Scan these specs — then switch your high-energy circuit designs to Motorola high-voltage, PNP, silicon power!

Parameter Highlights	2N5344	2N5345
Polarity	PNP	
High $V_{CEO}$ Ratings	250 V	300 V
Fast Switching — Total Switching Time @ 500 mA/100 V	900 ns (max)	
High $h_{FE}$ @ $I_C = 500$ mA $V_{CE} = 5$ V	25-100	
Low $V_{CE(sat)}$ @ $I_C = 500$ mA $I_B = 50$ mA	0.38 V (typ)	
High $f_T$ @ $I_C = 100$ mA	60 MHz (Min)	
High $P_D$ @ $T_C = 25^{\circ}\text{C}$	40 W	

A complete line of PNP silicon power transistors is available from your franchised Motorola distributor or the factory. Send for data sheets today on all of them: Box 20912, Phoenix, Arizona 85036.



## MOTOROLA

Semiconductor Products Inc.

— where the priceless ingredient is care!

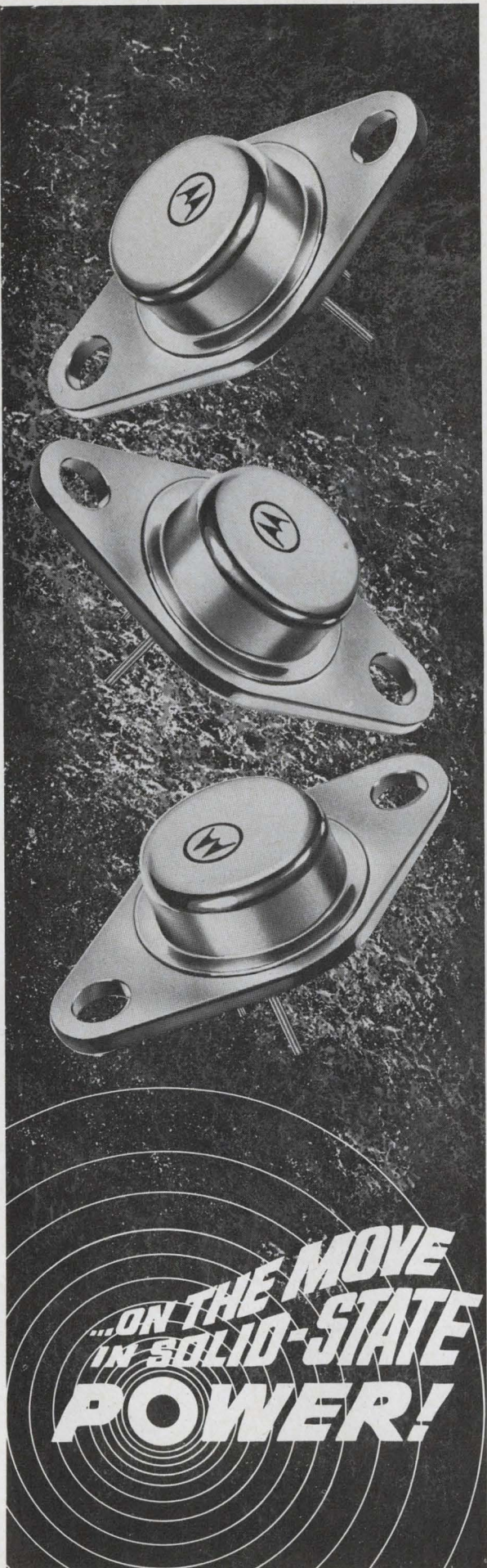



# NOISY SIGNAL PROBLEMS?

Look to **PAR**  
for a solution,  
because...

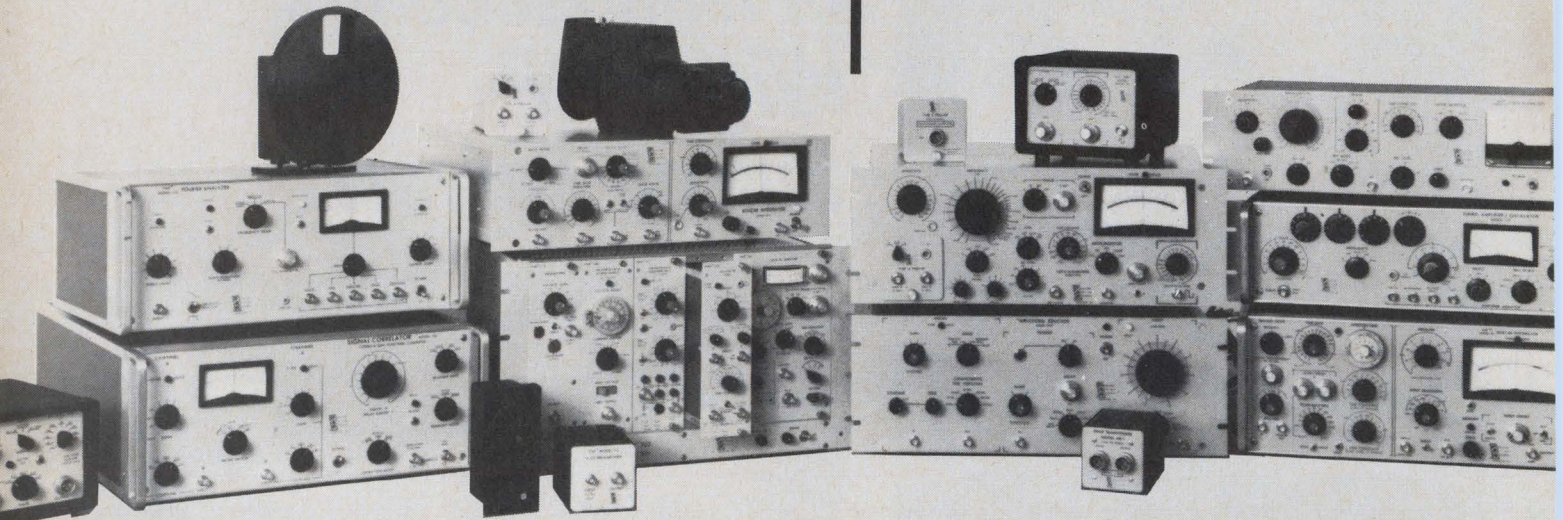

You can select from over 50 signal processing instruments, including Lock-In Amplifiers, Signal Averagers, Correlators, and compatible accessory equipment.

You can draw upon the longest and broadest experience in low-level signal recovery instrumentation, documented by technical reports available for the asking. Chances are we have already encountered a problem similar to yours.

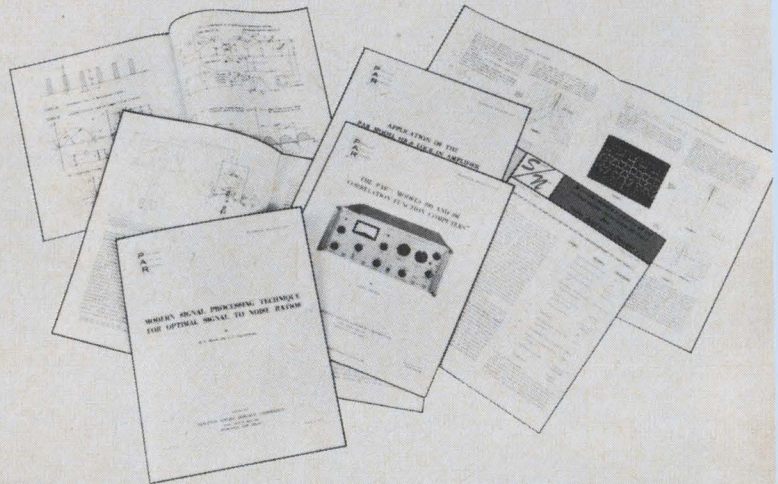

You can talk to PAR application engineers for advice on the selection of equipment and its use in your experiment. Our technical staff includes instrumentation specialists with broad research experience in physics, chemistry, biomedics, geophysics, optics. . . .

If your experimentation involves the recovery of signals from noise call Princeton Applied Research for assistance at 609-924-6835 and ask for our Applications Department, or write Princeton Applied Research Corporation, P. O. Box 565, Princeton, New Jersey 08540.



PRINCETON APPLIED RESEARCH CORPORATION



## Solid state

### Squaring off at Motorola

For years, semiconductor makers have been slicing their silicon ingots as they would a salami, producing a pile of round wafers. But with wafer diameters getting bigger—to help boost yields—engineers at Motorola's Semiconductor Products division have discovered that by cutting ingots the long way, like a French bread, and squaring off the edges, they get 30% more dice from the rectangular slice than from the round wafer, and labor costs are reduced by a third.

Motorola has been using the process for more than two months in the production of 2N4918 plastic-packaged silicon power transistors, devices used as output amplifiers in stereo radios and phonographs.

The ingots from which the slabs are sliced are produced like conventional silicon but have a different—and proprietary—crystallographic structure. The slabs themselves, measuring 2 by 6 inches, are cut 18 mils thick with an ordinary diamond band saw. They're then polished to a 12-mil thickness and finally lapped down to 5 or 6 mils.

**Same masks.** Savings in labor costs stem from the fact that standard square masks for 2-inch-diameter wafers (produced for more than two years by Motorola) can be used. "We take this mask and step it to get three square wafers on the rectangular slab," explains Joe A. Bailey, manager of silicon power devices. Bailey says 196 operations are performed on an epitaxial wafer between the stages of initial oxidation and electrical probing, and each requires manual handling of the wafer.

"In the KMER (Kodak Metal Etch

Resist) operation," he notes, "you have to spin the KMER on, bake it, inspect it, expose it, develop it, expose it again, etch away the oxide where it was, and then remove it." By putting three wafers on the slab, manual handling at the wafer stage is cut by two-thirds.

Bailey believes this advance makes silicon more attractive than germanium for power devices. Silicon is cheaper than germanium in raw form but requires far more processing steps.

Motorola is making dice ranging from 60 to 400 mils square on the three-in-one slab wafer. "As the die size increases," observes Bailey,

"say 300 to 400 mils, you lose a considerable number of dice because of edge effect on round wafers." With a 200-square-mil die on a 2-inch-diameter round wafer, Motorola gets 63 potentially usable dice, but it gets 81 on each of the three square die areas of the slab wafer.

**Same gear.** Motorola had to buy new equipment to handle the two-inch-diameter round wafer when the division converted from smaller sizes about two years ago, but officials say this same equipment can accommodate the 2-by-6-inch slabs with little modification.

The boats used to cradle round

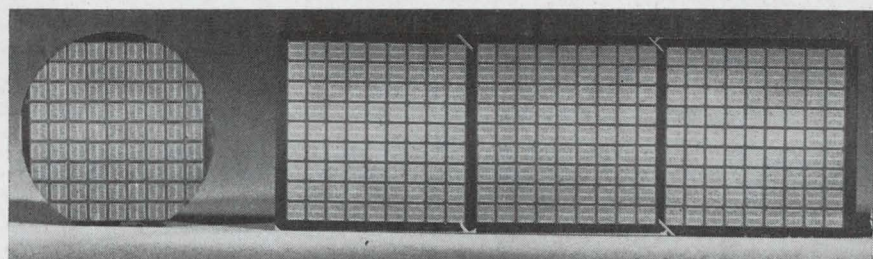
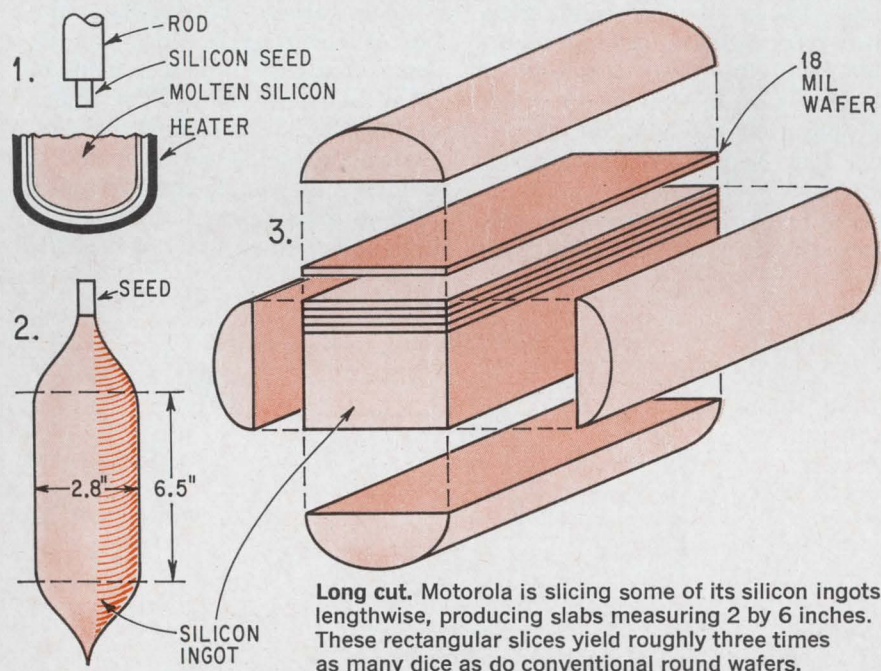



wafers in the diffusion furnaces can handle the slabs, and with less wasted space. Motorola says Teflon etch baskets may eventually be required in the processing of the slab, but it finds existing scribing equipment suitable because the three die areas laid down on the slab are cut apart before normal scribing.

The company sees a process for growing rectangular single-crystal silicon slabs as the next step in this field, a step that will probably come in about two years.

## Electro-optics

### Improving night vision

A glass disk resembling a thin fiber-optics plate with the cores etched out will make the second generation of night-vision instruments smaller, simpler, lighter, and less expensive than the present devices. Placed in an image intensifier tube, the disk, called a microchannel plate (MCP), exhibits an electron gain that enables a single amplification stage to do the job that now requires three stages in low-light-level devices.

The first contract for second-generation devices, a \$4.8 million Army

order, was awarded in late July to the ITT Industrial Laboratories in San Fernando, Calif. ITT is to deliver 650 sets of night-vision goggles plus 700 replacement tubes; the contract is classified, but the tubes are reportedly the size of a small coin. Robert Ferraez, project manager at ITT, will say only that the goggles will replace the 18-ounce AN/PAS-5 types, which are a little more than 3 inches long and operate with infrared light.

**Big gains.** The resemblance of the MCP's to fiber-optics plates is only structural. Electronically, microchannel plates behave like an array of single-channel multiplier tubes shrunken to microscopic size. These glass multiplier tubes, used in satellites to detect radiation, are about 40 mils in diameter and a few inches long, and have an electrode at each end. A field-gradient voltage creates a longitudinal electric field that pulls electrons down the tube, knocking loose secondary electrons from the walls as they go. The swelled number of electrons reaching the far end of the tube produces gains of from 10,000 to 10 million. Gains of the MCP's are comparable.

Developmental work directed at reducing the single-channel multiplier to a microscopic array 1 to 3 millimeters thick has taken nearly

seven years. But now at least three companies—the Rauland division of Zenith Radio, the Mosaic Fabrications division of Bendix Corp., and the Palo Alto Tube division of Varian Associates—have succeeded in making the plates on a production basis. Varian is a comparative newcomer to the field, having started its work in April 1967. Bendix had R&D efforts of its own in this field until it bought out Mosaic.

In a practical night-vision device, the MCP will be placed between the photocathode and the phosphor screen. Electrons knocked off the photocathode will be multiplied in the MCP and accelerated by an electrostatic field to excite the phosphor. With many more electrons hitting the phosphor in this arrangement than in first-generation devices, only a single stage is needed to magnify light some 40,000 times.

**Rough estimate.** Because each tube in the array delivers, in effect, a bundle of electrons to the phosphor, tube diameter determines the resolution of a device made with an MCP. For this reason, the hole size and the length-diameter ratio (which determines gain) are classified. Loosely, hole size is comparable to that of a single optical fiber, and the ratio is comparable to that of a single-channel multiplier. There are more than a million holes in a 1-inch-diameter plate with a surface area of more than 850 square centimeters.

Dominic Ruggieri, MCP manager at Varian, describes the first stages of array manufacturing as similar to those used in the fabrication of fiber-optics plates. A glass core is inserted into a tube about an inch in diameter; the tube and core have the same index of expansion so that together they can be heated and drawn out into a small rod. The rods are chopped off in 1-foot lengths, then bundled together and drawn out again. Lengths from the second drawing are also bundled and heated into a boule from which the plates are sliced.

Here, says Ruggieri, the MCP and fiber-optics processes part company. The core of a fiber-optics plate is used to transmit light; in

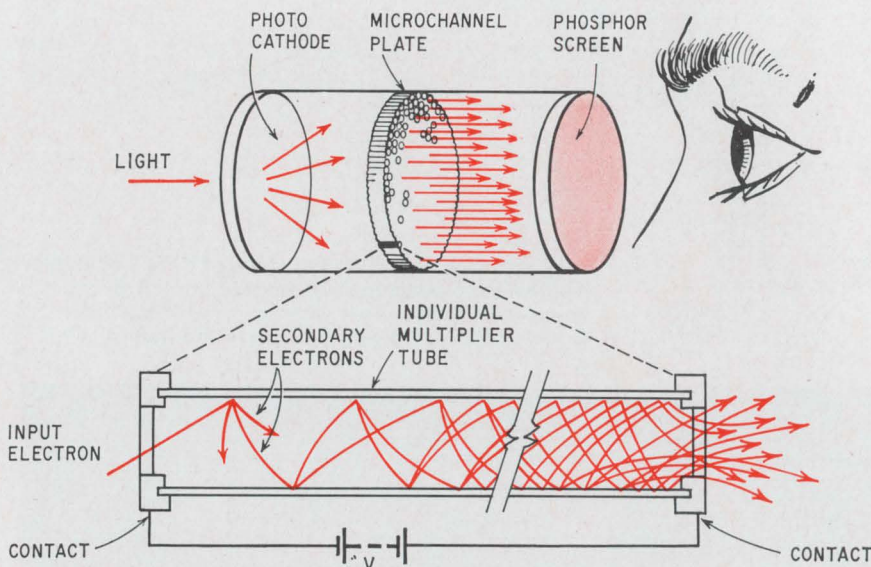

**Through a glass brightly.** Tiny microchannel plate, used in new-generation night-vision instruments, sharply boosts brightness of image.



an MCP, it merely keeps the tube from collapsing during the drawings and is therefore etched away at this point.

**Touchy job.** Then, in the most sensitive part of the operation, the insides of the tubes are coated with a few angstroms of dielectric oxide. This coating, the source of the secondary electrons, also serves to keep the electrons moving down the tube by varying the electric field. Metal contacts are then evaporated over the faces of the disk.

Varian expects the industry next year to sell 3,000 to 6,000 MCP's at a price of \$100 to \$150 per plate, all to the military. From 1970 to 1975, the company puts the military market at some 300,000 plates, but it also sees civilian use of MCP's in X-ray image intensifiers (to reduce the amount of X radiation required) and in some new chemical-filtration and electronic-display applications.

In some fast-writing cathode-ray tubes, Ruggieri notes, a single-shot scan doesn't deliver enough current per unit time to activate the phosphor. Though an MCP could increase the number of electrons hitting the screen, present plates have such high resistance that they couldn't take the heat. Ruggieri suggests that what's needed for this application and for chemical filtration are ceramic plates fabricated with entirely new techniques involving micro-drilling.

---

## Advanced technology

---

### Getting a glow on

Dayglow colors—those bright, vivid reds, greens, and oranges—have been around for years. The military uses dayglow paint to make aircraft more visible and dayglow dyes to make the uniforms of downed airmen easier to spot. On the homefront, dayglow ink appears on almost every bumper sticker, and dayglow plastic signs tout everything from beer to bras.

Now, two Raytheon Co. scientists have built a dayglow plastic

laser that may presage devices that would be the cheapest lasers yet and would require little input energy to lase.

Michael N. Bass and Thomas F. Deutsch, research scientists at Raytheon's laser advanced development center in Waltham, Mass., hit upon the idea in the course of work on liquid, or dye, lasers. They had tried mixing fluorescing dyes in plastics to see if they would work as well as they had in solution, but without much luck. They did notice, though, that the color of dayglow red acrylic plastic almost exactly matched one of the dyes used in their liquid laser experiments, Rhodamine B.

So they invested \$4 in an 18-inch-by-4-foot sheet of quarter-inch plastic, cut off a corner, and, using light from another laser as a pump, tried to make it lase. It did—very well, in fact.

**Flash of light.** They then cut from their slab of plastic a laser "rod"  $\frac{1}{4}$  by  $\frac{1}{4}$  by 4 inches. Its end faces were only roughly parallel and it was hand-polished at that, but when it was pumped with a quick-rise-time flash of light it worked like a charm.

Their discovery is so new they haven't had a chance to make accurate measurements, but Bass and Deutsch estimate the rod's gain at about 15% per inch. This compares well with the figure for the far more common—and costlier—ruby laser rod. And the pump energy needed to trigger lasing is only about 6 joules; an equivalent ruby rod would require about 100 joules, the researchers say.

But best of all, the plastic laser is inexpensive. The two scientists estimate that the 4-inch rod drew no more than 3 cents out of Raytheon's research fund. With a basic material this cheap, they feel it might be possible to build solid state lasers at as little cost as gas lasers. But even if it was only competitive in price, the plastic laser would probably be more rugged than the delicate glass helium-neon lasers, and could carve a place for itself in the small but growing market for laser alignment tools. It might also find use in battlefield

communication systems or range finders.

**Puzzlers.** But some problems must be solved before plastic devices can challenge other types of lasers. For one thing, commercially available plastic is of poor optical quality and can't generate the kind of finely collimated beam produced by crystal or gas systems. More importantly, there's a problem in getting plastic that will lase dependably; the amount of fluorescent dye in commercially available acrylics varies from lot to lot, and sometimes there isn't enough for laser action.

And for some unknown reasons, commercial plastic rod stock doesn't lase at all, though its dye concentration appears to be about the same as that of sheet stock.

It would be ironic in an age in which dayglow colors brighten everything from billboards to costume jewelry, but Raytheon may have to invest in a chemical facility of its own to overcome these problems. The plastics industry is geared to volume sales, not custom jobs. Bass and Deutsch have even had trouble getting single sheets of stock items, and they've often had to content themselves with leftovers from warehouse lots.

But they haven't been squelched by this. Instead, they've begun searching for other new laser materials which, like dayglow, may have been under their noses for many years.

---

## Communications

---

### Mother of circumvention

When the FCC handed down the so-called Carterphone decision, permitting the attachment of nontelephone-company equipment to phone lines, Ma Bell began having nightmares about lost revenue. The company figured that large numbers of customers would go elsewhere for their terminal equipment. But things aren't always as bad as they seem; AT&T may



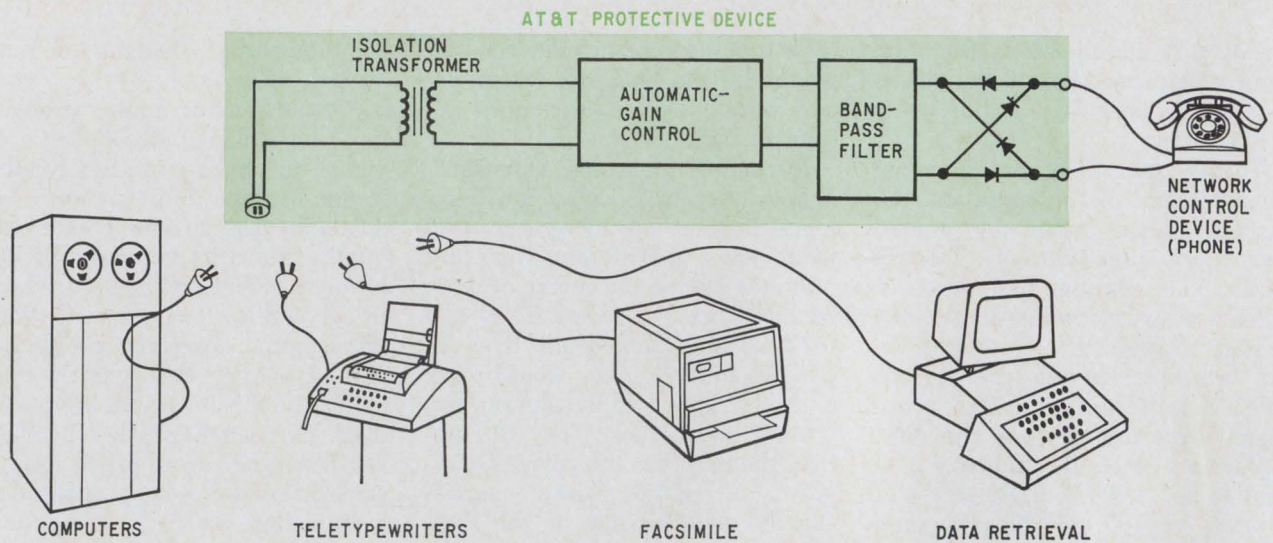

**Ma Bell's answer.** AT&T has asked the FCC to require the use of a protective device between non-Bell equipment and phone lines. The equipment would have to have its own modulating and demodulating circuitry. The device would rent for under \$2 a month.

have a way to satisfy the letter of the FCC ruling while partially circumventing its spirit.

Like most clever solutions, this one is simplicity itself. The telephone company has asked the commission to require that subscribers with foreign attachments (other than phones) use a network protection device—essentially a simple black box between the line and their equipment. Further, AT&T has requested that it be the sole supplier of the device, which it would rent to its customers for no more than \$2 a month.

**Holding the line.** The prototype device consists of a full-wave bridge to prevent a reverse-polarity connection to the line, a band-pass filter to restrict the frequency of the signal that's put on the line, an automatic gain control, and an isolation transformer.

Observers in Washington see AT&T's petition as an alternative to a legal action that would seek to set aside the Carterphone decision. As a compromise, the plan would effectively modify some of the more far-reaching implications of the Carterphone decision.

For example, by giving the customer the option of buying terminal equipment outright from a non-Bell System supplier instead of renting it on a monthly basis, the FCC has effected a change in the whole AT&T

rate structure, which depends as much upon guaranteed revenues from rentals as it does from line-service charges. With the proposed new tariff, the phone company would become the sole supplier of a piece of required interface equipment, and would have the right to rent, rather than sell, that equipment to the customer.

**Restriction.** Also, the black box could be used to limit the frequency, and hence the speed, at which data is transmitted over a given line, regardless of the line's capacity. It would thus tend to inhibit the sale of transmission-line wave analyzers—devices that check the bandwidth of telephone lines.

Further, the absence of a Bell System Dataphone at a computer center, for instance, would mean that the plugged-in equipment would have to have its own modulation and demodulation circuitry.

Sources inside the FCC are betting that the commission will allow the tariff to go into effect on Nov. 1, as requested by AT&T. However, these same sources say the FCC will probably hold a full hearing on the matter later on, reasoning that the principle of requiring a customer to rent rather than buy a simple piece of equipment from only the phone company was one of the reasons for the Carterphone decision.

At present the commission is still studying the technical language in the petition filed by the telephone company.

## Military electronics

### Guaranteed results

The defense industry is trying to shoot down a Defense Department proposal to require a warranty on "technical data packages" furnished to the Pentagon under research and development contracts.

Technical data packages contain the design approaches, reports, engineering drawings, and specifications a company uses to produce a prototype system or hardware. The Pentagon turns these packages over to other companies to create competitive bidding on procurement contracts.

The Pentagon proposes that contractors guarantee that the data and specifications they used to complete a development contract are so complete and accurate that other companies could use them to make the product during a procurement or reprocurement contract. Also under consideration by the Armed Services Procurement Regulations (ASPR) committee,



whose decisions are usually binding on the services, is a requirement that the initial contractor be liable for compensatory damages if the insufficiency of data keeps another company from making the product using the same specifications.

Objecting strongly, the Council of Defense and Space Industry Associations calls the proposal "improper" and argues that it will lead only to "controversy and confusion."

Says Franz O. Ohlson, director of aerospace procurement services for the Aerospace Industries Association: "It's unrealistic to expect company B to exactly manufacture a part designed by company A. It's a question of know-how. How do you transfer the know-how of one company's production line of thin-film integrated circuits, for example?"

**Keeping a secret.** Sometimes these packages are incomplete or inaccurate, either through oversight or, some service officials allege, because the company doesn't want to give away proprietary ideas. Occasionally the packages are just too large to go through before the contract is completed.

That's why there's strong pressure within the Pentagon to impose the warranty. Some ASPR committee members feel there's no "black magic" in a technical data package, so any company should be able to match its results.

But there is some disagreement even within the ASPR committee: some of the staff think that small companies without the expertise may bid on a contract. "You can't take RCA's data and expect Podunk Tool and Dye to make it," says one staff member. With a warranty, he says, "all we're buying is a right of action against a contractor. But we don't want to sue our contractors; we just want a complete technical data package."

The council, noting that private industry uses no such warranties, suggests that the Pentagon increase its ability to check over the packages. If ASPR imposes the warranty, the council wants it to require only that the contractor cor-

rect and complete his package.

Congress, however, has already strongly endorsed the warranty idea. Both the House Appropriations Committee and the General Accounting Office have urged warranty provisions in Pentagon contracts. This puts ASPR right in the middle.

## Commercial electronics

### Unlocking memories

"Bombs away" and "charge it, please" are miles apart in meaning. But Litton Industries Inc. has made these miles mini-inches with a ceramic disk memory. Developed for use as an ordnance timer, it's now set for new applications in credit cards, door keys, and industrial security.

The memory, composed of ferroelectric material, is a half-inch in diameter and is built by Litton's Advanced Research Directorate [Electronics, Feb. 5, p. 98]. Litton has licensed a Los Angeles company, Diginetics Inc., to use the memory in commercial systems, and Diginetics has put the device into what it calls a Uni-Key.

A Uni-Key is a matchbook-sized plastic rectangle (1¼ inches by 1¼ inches) with the memory encapsulated in it. When inserted into a terminal, the Uni-Key could serve as a universal credit card, a means of entry into a security area, or a room key in a hotel.

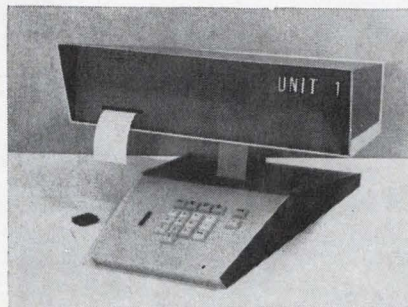

**Charge it.** Ceramically encoded credit cards—difficult to forge and impossible to alter—are expected to open new markets for readout devices like this terminal.

The memory, which costs about a dollar, can store 16, 32, or 52 bits. It is built of a polycrystalline material, such as lead zirconate titanate, on which electrodes have been vacuum-deposited. In operation, a stepped d-c voltage is applied to the address line to activate the ceramic material. A positive or negative voltage is then applied to the bit pins to load information into the key and generate a bit output of positive or negative polarity.

**Double duty.** The key's electrodes are activated when it's inserted into the readout terminal, and the memory is addressed. The memory—consisting of a pair of word-oriented 20-bit ceramic elements—is mounted on a tiny printed-circuit board. The numerical data stored on the memory can be changed an infinite number of times, eliminating the necessity for replacement.

The electronic readout terminal is dubbed Unit-1, for universal numerical interchange terminal. It can interface with a remote computer and, when it's not handling a key input, can double as a desktop calculator.

Duplication of the key would be extremely difficult if not impossible, according to Carl Budde, Diginetics president. All the bit pins are identical electrically, he points out, so a person trying to duplicate the key would have to determine the precise electrical output of each and the exact composition of the memory itself. "Even the Mafia would probably be stymied," Budde says.

The basic Uni-Key system (keys and terminal) will initially be marketed on a lease basis, says Budde.

### Green light, red faces

When officials of Card Key Systems learned that a New Hampshire delegate to the Democratic National Convention in Chicago inserted his Dartmouth College identification card into the security entrance terminal, turning on the green light, their faces turned red.

The delegate charged the machine was a fraud and that the convention was being packed. He



was later arrested and shortly thereafter released.

But investigation disclosed that failure of a microswitch, which pushes a lever backward to a locked position to trigger the green light, caused the lock to remain in position and the light glowed green when any card was inserted. This is the explanation Bruce Sedley, general manager of the Security Controls division of Card Key Systems offers for what went wrong with the system at the convention.

The firm, a subsidiary of Liquidonics Industries, won the contract to install the magnetic card security apparatus after it built and demonstrated a prototype system for the Democratic National Committee earlier this summer. Sedley says his Burbank, Calif., company has been supplying magnetic card security systems for more than 20 years. The system supplied to the Democrats was completed and installed in only five weeks and Sedley concedes quality control was not as tight as it should have been.

## Manufacturing

### Spider approach

One of the tools Motorola is relying on to speed its transistor-transistor-logic production to meet the expected higher demand is its new spider bonding technique [Electronics, May 13, p. 26], which is up to 20 times faster than the conventional wire bonding.

Reliable estimates give the firm's Semiconductor Products division about 4.5% of the TTL market now, but officials are trying to boost that share to 20% within six months.

Robert Helda, mechanization manager for the division, designed the two automatic machines used in the process. One is the mechanized spider bonder. It ultrasonically bonds semiconductor dice to their spider-like leads (which replace conventional wire leads) in a continuous operation. The second machine automatically welds the spider-bonded dice and leads to the lead frame or header strip.

Both machines have been turning out integrated circuits since the first quarter of the year. They handled diode-transistor logic initially, then were committed to all the division's dual in-line 14-lead plastic-packaged TTL's. A third machine to automatically encapsulate the spider-bonded parts is expected to be in production by the second quarter of next year. It will handle the output of the existing spider-bonding equipment plus that of a second spider bonder and resistance welder that will swing into operation earlier next year.

**Sandwich.** The spider bonder has an input reel and an output reel. The former contains from 10,000 to 25,000 spider piece parts stamped out of a continuous aluminum strip one to three mils thick; the latter is a take-up reel containing the bonded "sandwich." In addition to the die and spider lead strip, a ceramic pad to facilitate handling completes this sandwich.

As the spider lead strip is fed through the bonder, guided by pins that nest in locating holes in the

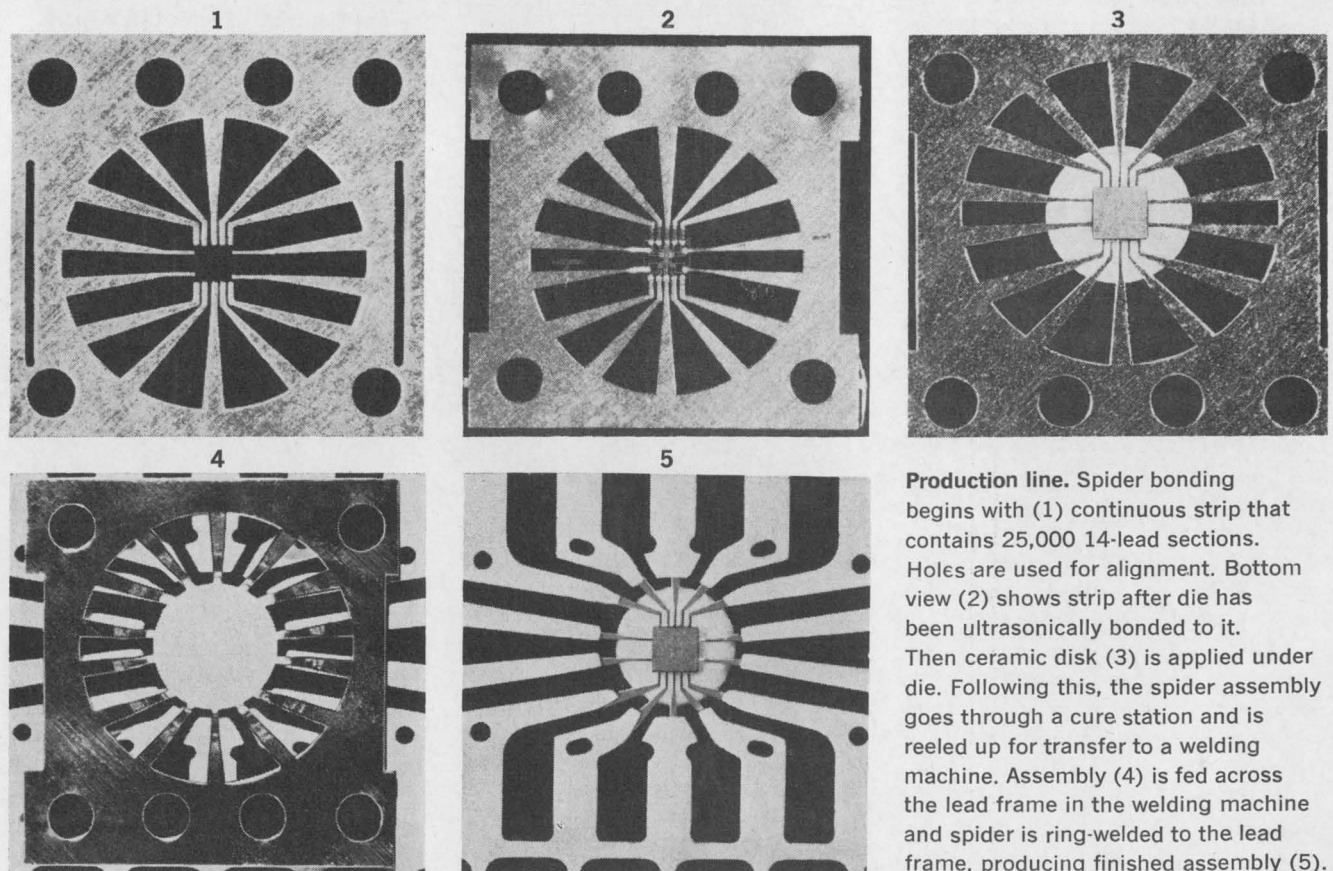

**Production line.** Spider bonding begins with (1) continuous strip that contains 25,000 14-lead sections. Holes are used for alignment. Bottom view (2) shows strip after die has been ultrasonically bonded to it. Then ceramic disk (3) is applied under die. Following this, the spider assembly goes through a cure station and is reeled up for transfer to a welding machine. Assembly (4) is fed across the lead frame in the welding machine and spider is ring-welded to the lead frame, producing finished assembly (5).



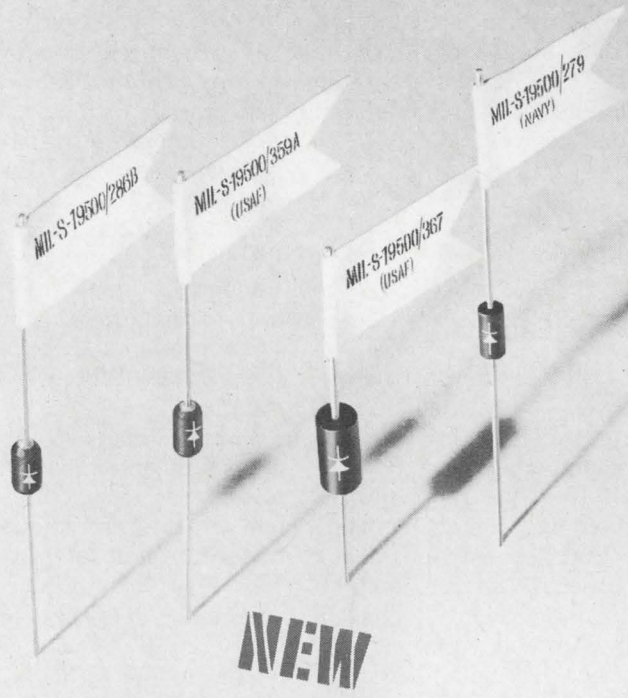
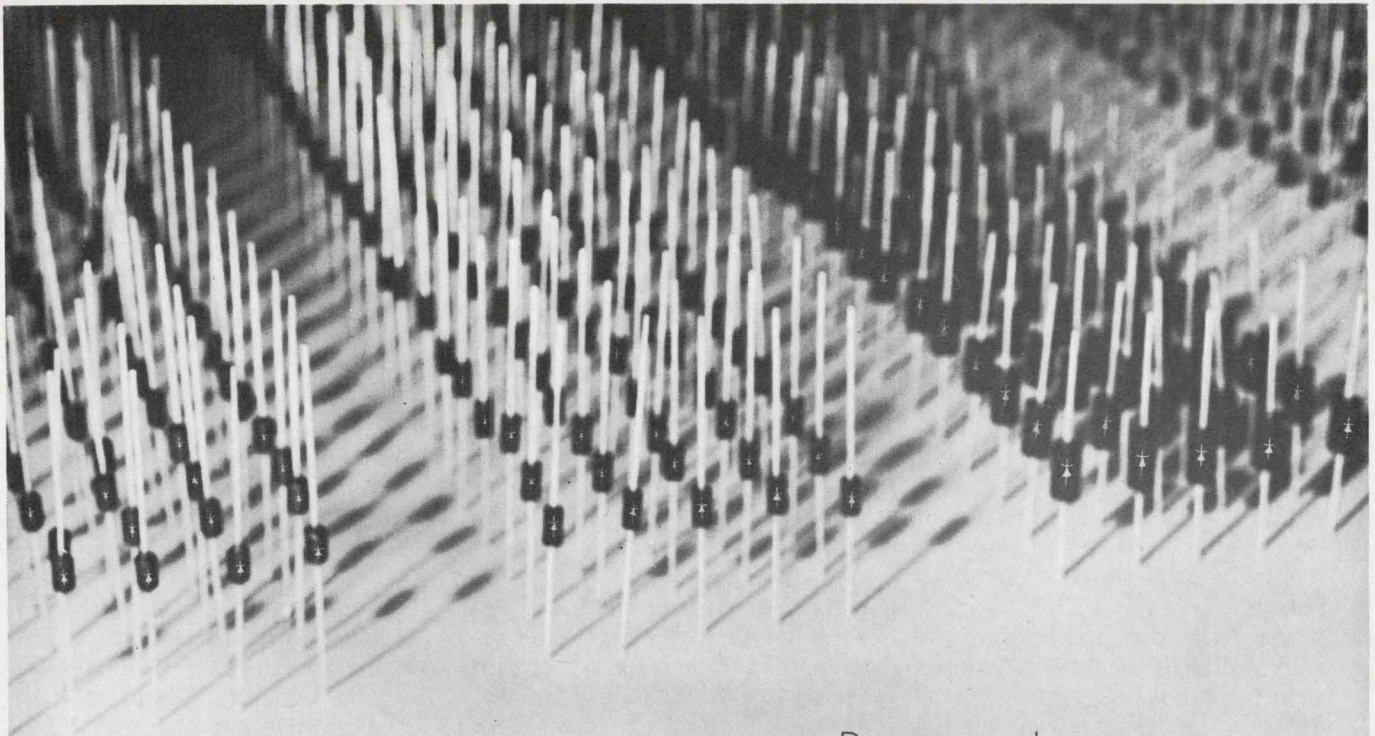

Do you need  
**MIL Type Rectifiers?**  
(JAN or JANTX Types)

1 amp Fast Recovery Rectifiers  
MIL-S-19500/359A (USAF)  
1N4942, 1N4944, 1N4946,  
1N4947 and 1N4948

1 amp General Purpose Rectifiers  
MIL-S-19500/286B  
1N4245, 1N4246, 1N4247,  
1N4248 and 1N4249

3 amp General Purpose Rectifiers  
MIL-S-19500/367 (USAF)  
1N5197, 1N5198, 1N5199,  
1N5200 and 1N5201

High Voltage Sub-miniature Rectifiers  
MIL-S-19500/279 (NAVY)  
1N3644, 1N3645, 1N3646  
and 1N3647

Semtech has extensive environmental and power burn-in facilities available to process your military and high reliability requirements.

Contact your local representative for immediate delivery —

**San Francisco** — 941 E. Charleston, Suite 10, Palo Alto, California 94303  
(415) 328-8025  
**Chicago** — 140 N. La Grange Road, La Grange, Illinois 60525  
(312) 352-3227 / TWX: 910-683-1896  
**Dallas** — 402 Irving Bank Tower, Irving, Texas 75060 / (214) 253-7644  
**New York** — 116-55 Queens Blvd., Forest Hills, New York 11375  
(212) 263-3115 / TWX: 710-582-2959  
**European Sales** — Bournes A. G., Alpenstrasse 1, Zug, Switzerland  
(042) 4 82 72/73



**SEMTECH™**  
CORPORATION

652 Mitchell Road, Newbury Park, California 91320  
(805) 498-2111, (213) 628-5392 / TWX: 910-336-1264



strip, an operator feeds in dice at the machine's first work station. Helda says the operator is required for gross location of the die in an aperture slightly larger than the die. Then a novel optical and servo system takes over to precisely align the die over the spider strip. This system consists of a flying spot scanner that looks at a negative of a master die of the type being bonded, then looks at the die nested in the aperture by the operator. The servo system moves the nested die in three axes until its image is superimposed over the master.

The face-down die is ultrasonically bonded to the spider lead strip by a tool that comes up from beneath the spider strip, bonding all 14 leads at once as an anvil comes down to hold the die in place. The mated spider and die then move to a station at which an epoxy is applied from beneath the spider lead strip, the epoxy is cured, and a small ceramic disc is placed on the strip, forming the bottom of the sandwich. This ceramic pad distributes the load on the spider lead strip so that the strongest parts absorb the greatest stresses in succeeding steps.

After the ceramic pad is cured, the bonded assembly is fed to the take-up reel, from which it is manually carried to the resistance welder. This second machine also has two reels, one of which feeds blank plug-in lead frames (header strips) from left to right—just as the spider lead strip is fed in the bonding machine—but the bonded spider sandwich is fed perpendicular to the plug-in lead frame.

**More reliable.** At the first station in the welding machine, the bonded spider leads and die are cut from the spider strip into individual assemblies and transferred to the plug-in lead frame, then indexed to the welding station where the spider leads are ring-welded to the plug-in lead frame. Finally, after indexing to the right again, the scrap from the aluminum spider is trimmed away automatically, and the bonded and welded assembly is reeled up to await encapsulation.

Besides the two functioning au-

tomatic machines, Motorola is using manual spider bonders and welders, but even these are 3 to 15 times faster than conventional wire bonding, Helda says. He adds that the spider strip costs the same as conventional wire lead frames, but it will eventually be cut to half price.

Peter Robinson, staff assistant to the operations manager for TTL devices, says he likes spider bonding because it produces more reliable devices than conventional wire bonding. "The process gives us about five times the cross section in the spider lead compared with wire bonding. We've tripled pull strengths on the leads, which is reflected in fewer handling losses in the line," Robinson notes. "We have complete environmental and life test data on the devices," he continues, "and in every test the units have been more reliable than wire-bonded devices."

---

## Companies

---

### Motorola vs. Fairchild

Motorola's suit to prevent the executives who went to Fairchild from using trade secrets tells almost as much about the relative position of the two companies as it does about the complaint itself.

The exhaustive 38-page document lists the functions of each of the defendants, showing how each can harm Motorola's competitive position vis-à-vis Fairchild. Significantly, the complaint devotes far more space to Leo Dwork's duties than to those of C. Lester Hogan, the new president of the Fairchild Camera & Instrument Corp.

Dwork was a vice president and director of certain product and operations groups at Motorola. In delineating his duties, the complaint points out that Motorola's "pre-eminent position in the semiconductor field is significantly influenced by its proven competence in high-speed, low-cost assembly of semiconductor products, which is dependent to a large degree on manufacturing and test equipment."

**Discrete fear.** This suggests that Motorola is particularly anxious about protecting its generally conceded lead over Fairchild in manufacturing know-how. The complaint further points out that of the product lines under Dwork while he was at Motorola—zener diodes, thyristors, germanium transistors, tuning diodes, unijunction, bilateral trigger devices, and optical semiconductors—Fairchild is making optical semiconductors only.

The suggestion, underscored in sections of the complaint devoted to Wilfred Corrigan and William Lehner, is that Motorola isn't eager to have Fairchild come on strong and quickly in discrete devices—an area in which Motorola now has little competition from the Mountain View, Calif., firm.

Corrigan, as director of product groups at Motorola, was also chiefly concerned with discrete-product development and related manufacturing operations. The complaint maintains that any substantial transfer of the trade secrets he knows "would enable Fairchild to wrongfully enter into new fields, and to manufacture new or additional products . . . currently manufactured by Motorola but not by Fairchild."

Lehner, manager of equipment and plant operations while at Motorola, was responsible for designing and building all special manufacturing and testing equipment. This equipment, according to the complaint, "contributed as importantly as any other manufacturing factor to Motorola's success in semiconductors. . . ." The contention is that transfer of the trade secrets he knows would be valuable to Fairchild Semiconductor in its operations and could also be used by Fairchild Instrumentation, which makes and sells semiconductor manufacturing equipment.

**Shift of focus.** The legal focus of the struggle, meanwhile, has shifted back to Phoenix, Ariz., where Hogan and the seven key managers he took with him from Motorola [Electronics, Aug. 19, p. 33] have been ordered to appear in U.S. District Court Sept. 26 to answer charges made by Motorola.





**Two bits  
says  
you've  
never seen  
a 1.5 amp  
bridge  
this small with**

- 75 nanosecond recovery
- 25 amp surge rating
- PIV's to 600V
- Controlled avalanche
- Wired or board mounted
- Made entirely with individually fused-in-glass diodes
- Reasonably priced

Now that you *have* seen it, don't you want to know more? First of all, you can get our data sheet, just packed with all kinds of specs and charts too detailed to put in this ad. Just circle the reply card now.

Second . . . if you send us your circuit requirements, we'll see to it you get the right sample for the job.

And . . . if it's fast action you want, why not call Fred Swymer collect at (617) 926-0404.

580 Pleasant St., Watertown, Mass. 02172, (617) 926-0404

**UNITRODE** 

**STANDARD RECOVERY**  
PIV to 600V  
Rating 1.5A  
Surge 25A

**FAST RECOVERY (500 nsec)**  
PIV to 600V  
Rating 1.0A  
Surge 20A

**ULTRA-FAST RECOVERY (75 nsec)**  
PIV to 200V  
Rating 1.0A  
Surge 20A

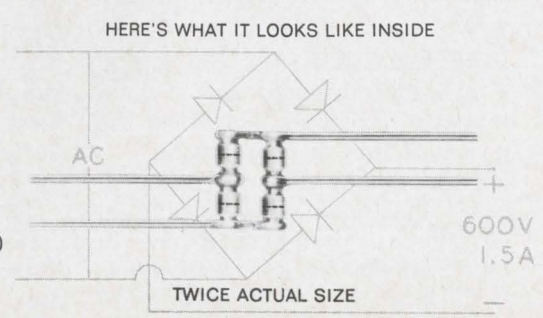



The seven besides Dwork, Lehner, and Corrigan are Eugene Blanchette, George Scalise, Andrew Procassini, and Thomas Hinkelman. The injunction Motorola seeks would:

- Prevent the defendants from further recruiting Motorola employees and Fairchild from employing them.

- Prevent the defendants from disclosing or using Motorola trade secrets in their jobs at Fairchild and prevent Fairchild from trying to extract such information from the defendants.

- Grant whatever additional injunctions may be needed to protect the confidential nature of Motorola trade secrets and trade secrets of Motorola customers.

- Prevent the defendants and their wives from using the financial gains they realized in joining Fairchild. Motorola maintains that these gains are illicit and should be held by the defendants and their wives (also named as defendants) in trust for Motorola, to be ultimately paid "as the price for breaching their employment and fiduciary obligations to Motorola. . . ."

The suit also seeks compensatory and exemplary damages.

However, Fairchild apparently isn't worried about the suit. Last week it hired eight more engineers from Motorola. Five of them will work for Lehner in equipment design; the other three will work under Corrigan in discrete devices. Also, Walter Seelbach, who recently resigned as head of IC R&D at Motorola, has joined Fairchild.

---

## Computers

---

### Incompatibles engaged

The first time-sharing network using incompatible computers has come a big step closer to reality. The project, announced last year, now has a timetable and is ready to buy hardware, says Lawrence G. Roberts, assistant to the director of information processing at the Pentagon's Advanced Research

Projects Agency.

In the ARPA network, a user of one computer will have access to programs in all other machines, even if those programs won't run on the computer to which he's directly connected.

The plan is to link more than 20 incompatible computer systems maintained by ARPA's research contractors. Computers at Lincoln Lab, the Rand Corp., the Stanford Research Institute, the Systems Development Corp., Dartmouth College, and others in 11 cities will be linked. A total of 35 computers and about 1,500 remote consoles will be tied together to allow researchers access to programs at remote centers.

**Bids made.** Last Monday, bids were received for interface message processors, and Roberts says ARPA plans to let contracts within the next two months. The processors will provide store-and-forward switching for messages between computers.

In addition, interconnection software will be developed to make incompatible computers compatible enough to interact. Roberts says that the first part of the net, or a "subnet," will be operating by next summer. It will be quickly evaluated, then the other centers will be tied in, and the basic net will be completed in 1970.

After that, ARPA's plans are indefinite, but Roberts points out that once the network has been in operation for a year, the Pentagon will consider bringing in other cities and computers.

By permitting researchers to use each other's programs and findings, the network will eliminate research duplication, Roberts says. He also points out that the network will be able to work quickly, transmitting at 100 to 200 kilobits a second. A user can expect delays of no more than half a second in getting a message through, and beyond that can expect no more than the normal delays of time sharing.

**How much?** Roberts acknowledges that much work remains to be done and that there'll have to be exhaustive work on software.

He is a bit cautious in describ-

ing the cost of the project. He declines to give a total figure, but does say that the added cost to ARPA over the cost of the present independent setup will be about 10% a year.

---

## Avionics

---

### Altitude alert

Airlines don't like to talk of such things, but one of the problems of flying is that pilots occasionally aren't aware of their exact altitude. And with jets descending and ascending at ever-increasing speeds, the problem gets that much more serious.

Without too much fanfare, and with the approval of the airlines, the Federal Aviation Administration has ruled that all U.S. civilian jets must have altitude-alerting systems in operation after Feb. 28, 1971.

No specific approved FAA standards for the equipment have been set. The FAA hopes to have the standards ready in six months—which will give roughly 18 months for development of devices by firms not already in the business and for marketing and installation.

The FAA ruling is expected to mean a nice chunk of business for firms in this field. There will probably be about 3,000 civilian jets in operation in 1971 in the U.S.—and alerting devices are expected to sell for around \$2,000 each.

The equipment will provide two warnings: aural and visual. Pilots will set the device to sound and flash warnings at certain altitudes or at increments in altitude.

**First purchase.** One instrument maker, Aero Mechanisms of Van Nuys, Calif., got a good lead in this field by winning a contract to supply the entire jet fleet of Northwest Orient Airlines with alerting devices. Northwest has gone ahead on its own to buy them.

The Aero Mechanisms device operates with a barometric pressure sensor. An electronic unit, which uses integrated circuitry, controls



# THIS NEW ADD-ON...

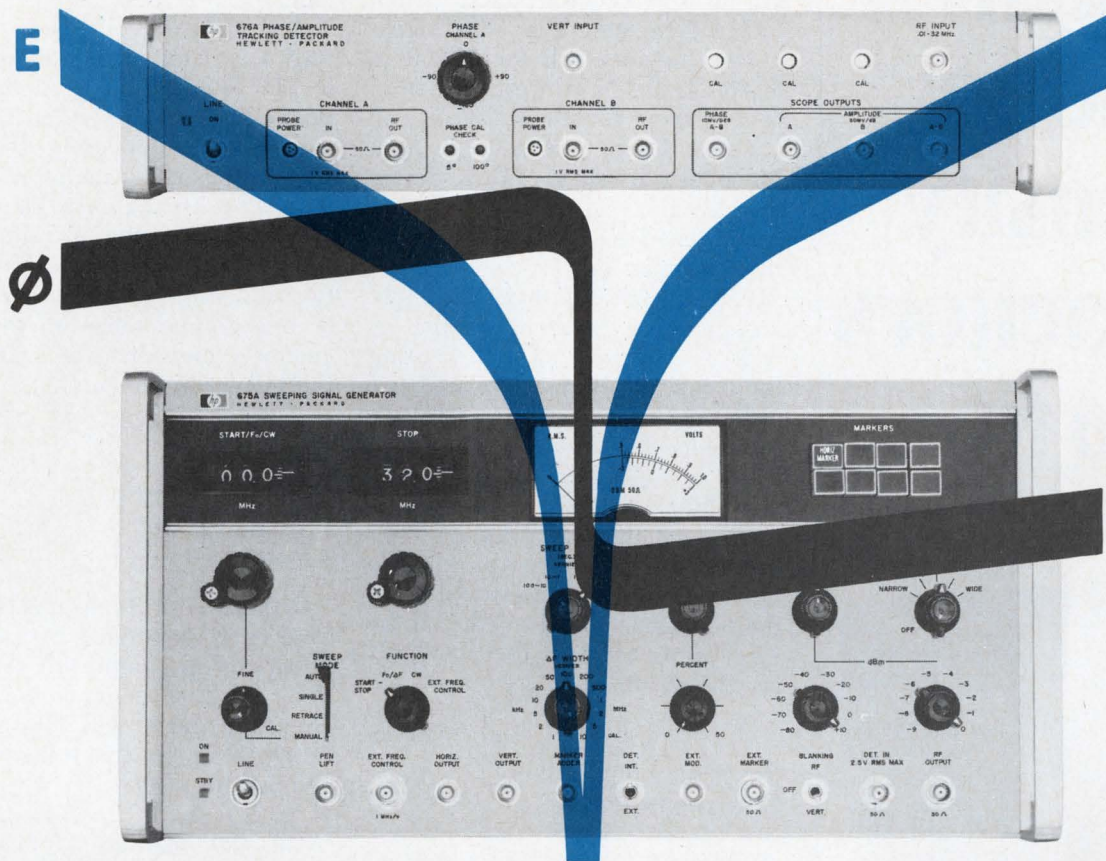

## MAKES THE HP 675A SWEEPER A NETWORK ANALYZER... Simultaneously display phase and amplitude!

Now you have *both* phase and amplitude information on a swept basis to 32 MHz. You save hours of time, see changes in phase and amplitude responses immediately as you make adjustments. This combination of instruments is oriented toward production and lab testing.

The 675A Sweeping Signal Generator has a 10 kHz to 32 MHz range with settings anywhere in this range for single or continuous sweep. The 676A Phase/Amplitude Tracking Detector adds a full 360° phase measurement capability and an 80 dB dynamic amplitude range. Combination is programmable for automatic or computerized testing.

Channel A and B outputs of the 676A provide simul-

taneous amplitude measurements of two devices for comparison. Amplitude A-B and PHASE A-B make difference measurements easy. Outputs can be easily calibrated in linear dB and linear phase on a low frequency oscilloscope or X-Y recorder. New active probe (100 k $\Omega$ , 3.5 pF) augments 50  $\Omega$  input for high impedance measurements.

Check your design and production areas for the savings you can make with the new network analyzer—the combination that makes point-to-point plotting passé. Call your local HP field engineer for complete information. Or, write Hewlett-Packard, Palo Alto, California 94304. Europe: 54 Route des Acacias, Geneva. Price: 675A, \$2250; 676A, \$1275.

HEWLETT  PACKARD  
SIGNAL ANALYZERS



# We design high energy density capacitors to fit.

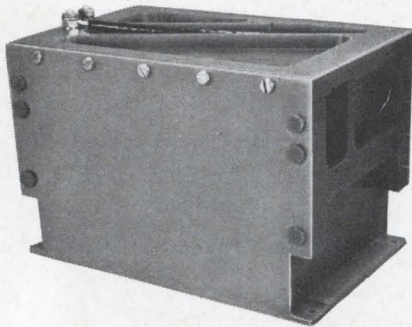

A typical AMPLIFILM\* capacitor assembly. Even un-encapsulated, the exclusive dielectric construction provides moisture resistance meeting MIL-STD-202 (Method 106), making possible an energy efficiency greater than 0.6 joules per cubic inch without the encumbrance of a metal case.

- Capacitance:  $0.1 \mu\text{f} \pm 5\%$
- Voltage rating: 40,000 volts DC
- Power factor: 0.5% max.
- Temperature Range:  $-55^{\circ}\text{C}$  to  $+100^{\circ}\text{C}$
- Size:  $4\frac{1}{2}'' \times 4\frac{1}{2}'' \times 6\frac{1}{2}''$  max.
- Weight:  $9\frac{1}{2}$  lbs.

We can supply units rated from 4,000 to 60,000 Volts DC with capacitances from 100 pf to 1.0  $\mu\text{f}$  and higher. Ask us to build you a high-energy-density capacitor that makes the best use of your available space. Call or write, today.

\*Trademark of AMP Incorporated

## AMP INCORPORATED

### CAPITRON DIVISION

155 Park Street • Elizabethtown, Pa.  
717-367-1105 • TWX: 510-675-4561

## Electronics Review

the warning device, which can be set for warnings anywhere from sea level to 40,000 feet and in 100-foot increments. The Aero Mechanisms devices sell for \$1,800 to \$2,600 each. Northwest has been testing them for about a year.

James Carp, president of Aero Mechanisms, says, "This device was the first one we ever built that was defined by the pilots—and not the engineers."

FAA officials say that they might accept a voice warning system as well as a buzzer or bell warning for the aural alert. Such devices—ordinarily using a woman's voice—are found on military aircraft to warn of mechanical failures. The Aero Mechanisms unit uses a bell. Carp says that the warning light might be coupled into an altitude display light, but this would make the unit more complicated, and the FAA wants to keep the standards for the devices simple.

## Space electronics

### Photo finish

Comsat, which is slated to provide the television relay for the Olympic Games, is involved in a race against time to get Intelsat 3 in operation before the games begin in Mexico City on Oct. 12th.

The margin for error is slight, the timing is close, and there is no second-string satellite ready in reserve.

Late last week the situation was this: the launch was scheduled from Cape Kennedy for Sept. 18 at the earliest. Once the satellite is aloft, Comsat officials predict, it should take about 36 hours to get the attitude corrected, then a week to check it out in synchronous orbit and another week to position it over the equator at  $31^{\circ}$  west longitude.

**Space race.** If the launch is made on the 18th, the satellite could be ready with 10 days grace. However, any delay—either on the ground or in the air—adding up to 10 days could cost Comsat the Olympic communications relays.

The satellite itself was delivered to the Cape from TRW Systems, the

prime contractor, far later than the originally scheduled June target date.

According to Nelson Pixley, TRW's assistant program manager for the satellite, International Telephone & Telegraph's Federal Labs was late in delivering the communications subsystem. Pixley says that the subsystem was plagued by cross-talk and the traveling-wave tube had to be isolated from the two transmitter diplexers to get rid of background noise on the voice channels and disturbing lines on the television channels.

## For the record

**Civvies.** Texas Instruments' MERA (molecular electronics for radar applications) program will soon produce its first commercial fallout. By year's end TI will offer a family of hybrid microwave transistors developed for MERA.

**On the market.** Motorola announced that it is introducing the first devices in its subnanosecond, third-generation, emitter-coupled-logic line—MECL 3 [Electronics, April 15, p. 46]. The circuits are a dual four-input OR/NOR gate, a quad two-input NOR gate, and a single-phase type D flip-flop, which uses two layers of metalization. The MECL 3 family may eventually encompass 14 device types: six gates, six flip-flops, and two varieties of an eight-bit full adder. The adder will be a large-scale integrated device.

**Another direction.** In a move seemingly contrary to the market, General Electric is raising the prices of some of its devices an average of 7%.

Included are low-current silicon rectifiers, germanium and silicon rectifier stacks, germanium rate grown and alloy transistors, silicon-mesa power transistors, selected tunnel diodes, medium-current silicon controlled rectifiers, and some of the selenium and copper oxide products.



# More innovation from the real power in power:

## More-advanced power hybrid IC's.

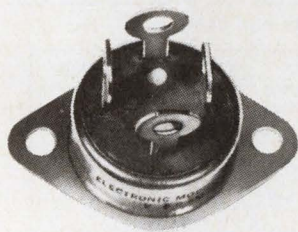

Actual Size

power semiconductor know-how?

It's obvious what this means in power hybrid IC's. Greater flexibility to build more into a circuit to start with. Plus quality from raw materials to finished power function, all under one roof. Immediate off-the-shelf delivery. And attractive prices.

Take our new, thick-film, 10-amp, integrated bridge rectifier for power supplies, AC/DC converters and motor controls. Customers tell us it's the most advanced power hybrid of its type on the market. Because it combines Bendix hybrid fabrication techniques with plastic encap-

It figures.

Who is better equipped than Bendix to make the most advanced power hybrid integrated circuits? Who has spent more time working with your kind of power circuit requirements? And who has more "in-house" access to

sulation in a standard TO-3 package. Because it matches functional specs to your needs: 10-amp average DC output current at 65°C; up to 600 volts Peak Reverse Voltage per leg; and 70- to 420-volt RMS voltage range. And because it gives the design engineer a universal circuit at a low price.

Yet, this unit is just a taste of things to come in Bendix power hybrid integrated circuits: Power audio amplifiers. Power darlington. Power-driver modules. Voltage regulators. And more. Much more.

Looking for the most advanced power hybrid IC's? Look up the real power in power—Bendix. Contact your nearest sales office or write the Power Specialists: Semiconductor Division, The Bendix Corporation, Holmdel, New Jersey 07733.

**Bendix** **Electronics**

Chicago—(312) 637-6929; Dallas—(214) 357-1972; Detroit—(313) 548-2120; East Northport, N.Y.—Harry Friedman Co. (516) 692-2839; Great Neck, N.Y.—H. V. Sales Co. (516) HU 7-1142; Greenwich, Conn.—(203) 869-7797; Holmdel, N.J.—(201) 946-9400; Lexington, Mass.—(617) 861-8350; Los Angeles—(213) 776-4100; Minneapolis—(612) 926-4633; Orlando, Fla.—(304) 241-6559; Rochester, N.Y.—(716) 266-5550; Runnemede, N.J.—(609) 933-2550; Seattle—Ray Johnston Co., Inc. (206) LA 4-5170; Export—Cable: "Bendixint," 605 Third Avenue, New York, (212) 973-2121; Ottawa, Ont.—Computing Devices of Canada, P.O. Box 508 (613) 829-1800; San Juan, Puerto Rico—Southern International Sales Co. 723-3879.



# Skillful substrate handling improves microstrip circuit performance for PACT program

Very early in Sperry's PACT (Progress in Advanced Component Technology) Program, scientists and engineers involved in the effort concluded that materials selection and fabrication for substrates would be critical to their success. As a result, much of the early PACT work concentrated on substrate technology. Today's operating microstrip devices attest to the success of that endeavor.

Considerable work has been done with various dielectric and ferrimagnetic materials, as well as with substrates combining both materials. Much of the PACT activity has been concentrated in the development and utilization of ferrimagnetic substrates.

PACT has benefited significantly from Sperry's extensive in-house production capability for ferrimagnetic materials. The availability of 400 different ferrite and 500 different garnet compositions freed development engineers from dependence on commercially available ferrites and enabled them to use optimum material characteristics rather than working inside restrictions imposed by the material.

As reported earlier (Progress Report #2) PACT personnel proved that a thicker substrate contributed materially to lower insertion losses. This led to the adoption of 55 mils as the PACT standard for ferrite substrates instead of the more familiar 25 mil configuration.

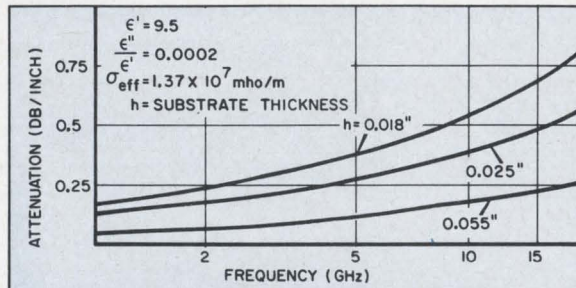

ATTENUATION VS FREQUENCY  
FOR 50 OHM MICROSTRIP LINE  
ON VARIOUS SUBSTRATE THICKNESSES

Similar progress has been made in the understanding and control of substrate microstructure, surface finishing, ground plane spacing, strip width, conductor dimensional tolerances and impedance matching for minimum losses in microstrip transmission lines.

In the area of ferrimagnetic substrate fabrication, PACT has explored two methods: dry pressing substrates to size and a highly automated wafering technique. In the latter process, acceptable surface finishes have been achieved with minimum labor, materials waste has been minimized, and excellent process controls have been developed.

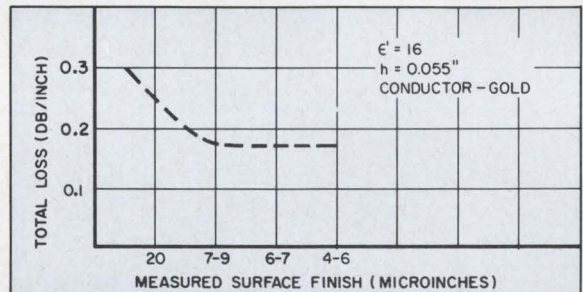

TOTAL LOSS — VS — SURFACE FINISH OF SUBSTRATE

In summary, Sperry efforts have been directed at placing substrates in their proper perspective. The objective is to let circuit requirements dictate substrate characteristics rather than letting substrate limitations force circuit compromises. These efforts included close attention to manufacturability, and they have resulted in products which offer the best practical combination of performance, availability and cost.

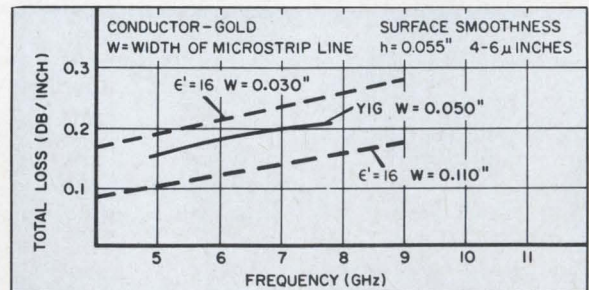

TOTAL LOSS — VS — FREQUENCY  
FOR VARIOUS STRIP WIDTHS

If you would like more information about PACT progress in substrate technology and about microwave integrated circuits that use it, contact your Cain & Co. representative or write Sperry Microwave Electronics Division, Sperry Rand Corporation, Clearwater, Florida.

*For faster microwave progress,  
make a PACT with people  
who know microwaves.*

**SPERRY**  
MICROWAVE ELECTRONICS DIVISION  
CLEARWATER, FLORIDA



---

# Washington Newsletter

---

September 16, 1968

## Long wait ends; Pentagon will okay Awacs for Air Force

The Pentagon finally is about to give the Air Force an okay to proceed with project definition of the 411L airborne warning and control system (Awacs). Everyone connected with the program has been waiting impatiently for this approval for the past eight months. A top official for the Director of Defense Research and Engineering says **the problems have been solved and Awacs should clear DDR&E in a week or two.** He estimates it will take the Air Force another month to award the phase-1 contracts to McDonnell Douglas and Boeing, which are expected to split the estimated \$35 million authorized in fiscal 1969 [Electronics, July 22, p. 46].

“Getting a complete understanding between the office of the Secretary of Defense and the Air Force on the best way to proceed” was the reason for the delay, the Pentagon official said. For example, the Air Force had only one system demonstration—category-2 flight testing—but the DDR&E wanted more check points along the way. It took a lot of time to write things like this into the Awacs plan. The official denied that **the big delay on the program was in deciding whether the overland radar was developed to a point where Awacs could move into project definition.**

## Air pollution agency may advise industry of equipment needs

The National Air Pollution Control Administration may try to duplicate the Post Office's success in interesting industry in its equipment needs. **The year-old agency, disappointed in the surveillance and control gear now available, is expected to schedule an industry briefing on surveillance devices soon.**

Faced with a similar problem last year, the Post Office's research and engineering bureau held a meeting at which it told industry just what it was looking for. The response was enthusiastic, and **at least 300 companies now plan to attend a second briefing in Washington, Oct. 17-18.** Air pollution officials feel that if the new agency can attract as much interest, it will be on its way to obtaining the kind of equipment it requires—simple, accurate, precise, and stable devices that can be operated remotely and don't require the constant care of an electronics engineer.

**The air pollution unit won't have as much money to spend as the Post Office;** total funds available for surveillance equipment in fiscal 1969, including local money, is estimated at only around \$6 million to \$7 million. The Post Office bureau gets its entire budget through Congress without any cuts; **it has some \$35 million for research and engineering this year, up from about \$23 million in fiscal 1968.**

## Task force report slips to October

Latest word on the President's task force on telecommunications is that its report won't be ready until October at the earliest. **And the White House is not expected to make the complex study public until late November or early December—after the elections.** Earlier there was a chance [Electronics, Aug. 5, p. 73] that the report would reach President Johnson not too long after the originally scheduled mid-August date. But, among other things, the panel decided it needed more time to integrate several outside studies into its findings. The report, whatever the conclusions, will generate controversy among users and equipment makers and be a headache to the next President. He'll be the one to face



---

# Washington Newsletter

---

the difficult job of acting on the recommendations made by the task force.

## Justice briefing may set trend . . .

An industry briefing on Oct. 8 by the Justice Department on its electronics equipment needs is expected to be the first of many by Federal agencies to be sponsored by the Electronic Industries Association. **Next departments on the list will probably be Transportation and Health, Education and Welfare.** The Pentagon and NASA have made it a practice in recent years to brief industry; now the EIA's industrial electronics division is urging other agencies to do the same. **The Justice meeting will be the department's first with an industry group.**

## . . . in outlining an agency's needs

The briefing in San Francisco should give the electronics industry its first clear view of the growing market in crime-control equipment. Justice officials will explain how companies can get into the crime-control business and what hardware is needed. The crime and safe streets law provides \$36 million for fiscal 1969, \$300 million next year, and up to a billion dollars annually by the 1970's. The Justice briefing also will give industry a chance to lobby for a big chunk of the money. Over the past three years, \$20.6 million has been spent in Federal grants with a large share of it going to electronics equipment.

## Navy seeks top spot in oceanology effort

A struggle is shaping up over who will run the nation's oceanology program—something expected to soon grow into a full-fledged national effort to exploit the sea's resources. **Navy brass are now pushing quietly to win Pentagon approval of a new 12-year oceanography program before the President's special commission on oceanology makes its report on Jan. 9.** Other Government agencies with programs of their own are worried that the Navy may steal the thunder from the White House commission's report and grab the top position in the field—a role many of them covet.

The Navy project, estimated to cost \$3.5 billion, is now on the desk of Navy Secretary Paul R. Ignatius, and the service soon hopes to get Defense Secretary Clifford's approval. Although details of the Navy's plan are being kept secret, **one insider says the program "has a tremendous shopping list—just about everything you can imagine."**

The commission's report is expected to blueprint Federal funding for oceanology over the next several years, and to set the goals and name the Government agencies in charge.

## Addenda

The Defense Communications Agency will turn its millimeter-wave-transmission test results over to the Air Force for use in studies on designing equipment to fit user requirements. **The DCA tests proved the feasibility of sending up to 50 megabits of data per second over five- and 20-mile paths.** Conducted in an urban area in all types of weather, the tests were run at frequencies between 28 and 40 gigahertz [Electronics, May 13, p. 60] . . . The Senate Labor Committee is expected to report the radiation protection bill out this week, but it's still not likely to get through Congress this session [Electronics, July 22, p. 53]. With industry pressure building to knock out the Administration's callback and in-house inspection provisions in the Senate version, **it will be difficult for the House-Senate committee conference to hammer out a compromise bill.**



# Sorensen modular power supplies

**± 0.005% regulation** **\$89<sup>00</sup>**

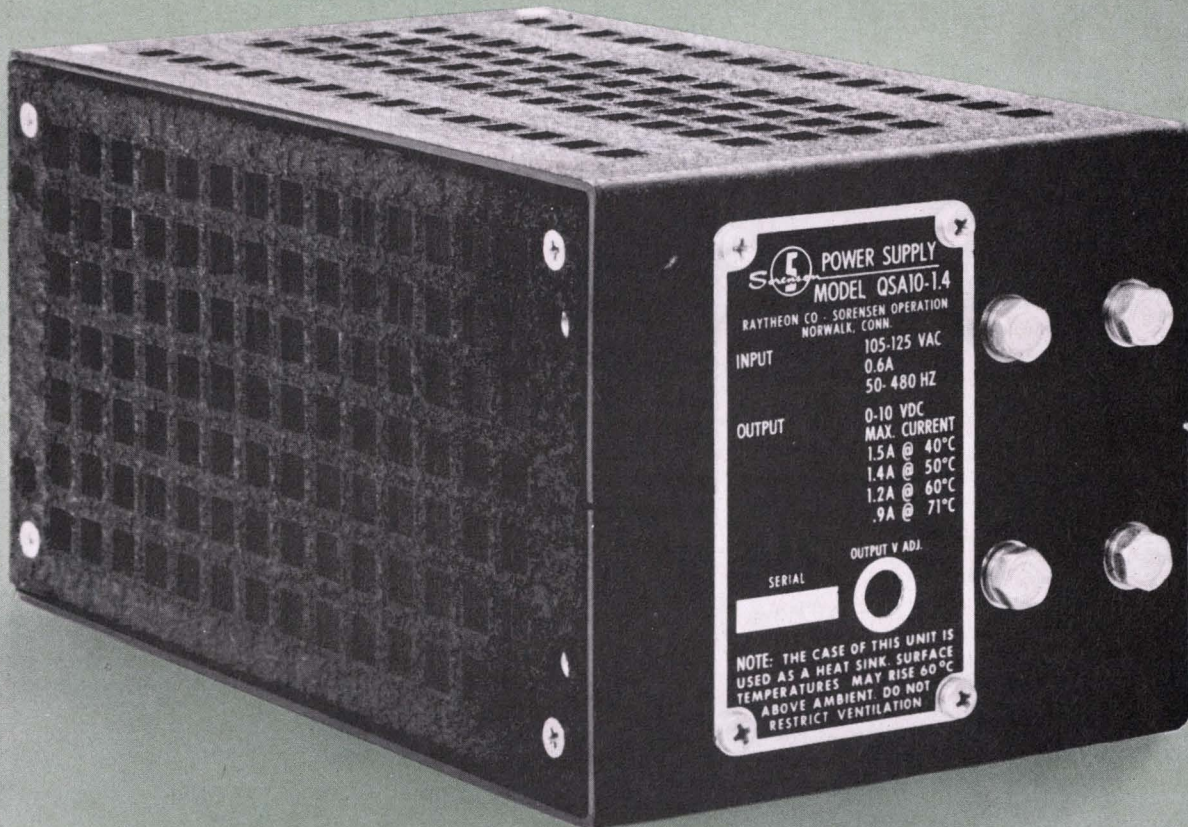

- Optional 10 $\mu$  sec. overvoltage protection.
- Requires no external heat sink in ambients to 71° C.
- 29 models—voltages to 330 Vdc at power levels to 300 watts.
- Remote programming—remote sensing—series/parallel operation.
- Overload and short circuit protection.
- Meets military specifications.

Model QSA 10-1.4, shown actual size, illustrates the compactness of the Sorensen QSA Series. These laboratory-grade, precision power sources are designed for OEM or system applications and utilize the latest solid-state regulating technology to provide a high degree of regulation and stability.

Sorensen produces 29 wide-range models, each with optional overvoltage protection. Other manufacturers require more than 100 models to cover the same area. By producing and stocking fewer models, Sorensen is able to provide better specifications, higher reliability, lower prices and "same-day shipments."

For more information: contact your local Sorensen representative or: Raytheon Company, Sorensen Operation, Richards Ave., Norwalk, Conn. 06856. Tel.: 203-838-6571; TWX: 710-468-2940; TELEX: 96-5953.

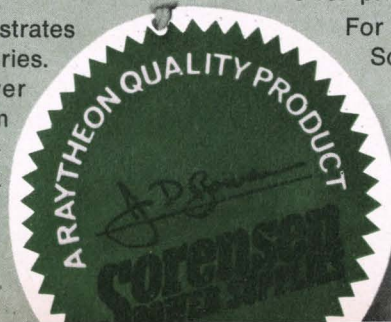



**...and another MTOS first!**

# 2048 BIT ROM

READ ONLY MEMORY

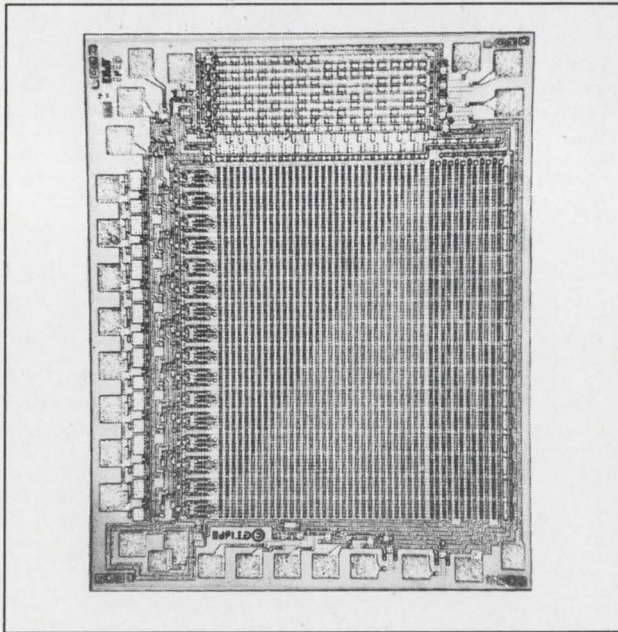

**Now, for the first time — off-the-shelf customized LSI memory chips organized for low-cost, quick-turn-around, mass production . . . available only from General Instrument.**

- Outputs can drive TTL, DTL or MOS without interface hardware
- Up to 11 bit decoding matrix
- Expandable to 2048 x 8 ROM modules without additional hardware
- Power Dissipation 120 mW @ 1MHz
- 1 microsecond access time
- Non-volatile, non-destructive memory

General Instrument's exclusive 2048 bit ROM (Read Only Memory) cell is a four phase M<sub>I</sub>OS array consisting of 11 bits of two dimensional addressing (5 and 6 bits respectively) and 8 outputs. It permanently stores 2048 bits of information in a 64 bit x 32 bit matrix positioned into 8 segments, each of which contains an 8 bit x 32 bit matrix and an output stage. The ROM chip outputs have internal "wire-or" capability which allows the formation of ROM modules without any other component



# < 1 PER BIT\*

**ROM ORGANIZATION CHART**

No. of Outputs Per Chip	No. of Bits of Addressing Used Per Chip	No. of Bits Available For Chip Select	No. of Bits Per Word	No. of Words Per Chip	No. of Chips Per Module	Total Bits Per Module
1	11	—	1	2048	1	2048
2	10	1	2	1024	2	4096
4	9	2	4	512	4	8192
8	8	3	8	256	8	16384

additions. This organization permits an extremely wide range of operating variations with a modular capability applicable to virtually all ROM systems.

Since any and all changes to the ROM chip, both data pattern and "chip-select," are made by alteration to a single mask only, low cost, quick-turnaround time is guaranteed for customized ROM circuits.

**EXAMPLE OF MODULE (2048 x 2)**

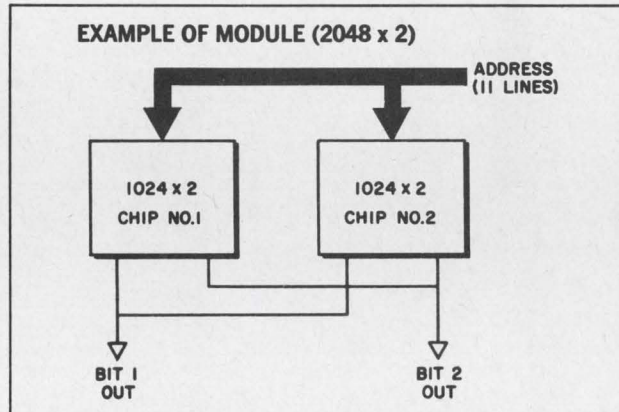

General Instrument's 2048 bit ROM cells are designed to undercost and outperform cores, drums, delay lines and complex logic functions, while providing dramatic savings in space and weight.

Write for full information. (In Europe, to: General Instrument Europe, Via Turati 28, Milano, Italy.)

\*At quantities in excess of 25,000 ROMs



GENERAL INSTRUMENT CORPORATION • 600 WEST JOHN STREET, HICKSVILLE, L. I., NEW YORK



# IBM<sup>®</sup> Circuit Design and Packaging Topics

## Reed switches give remote control reliability in 2-mile long ionospheric antenna switching network.

Automated Measurements Corporation, Los Gatos, California, makers of RF switching equipment, depends on IBM miniature dry reed switches as components in a number of products where trouble-free, remote control reliability is critical for performance.

One example where IBM's reed reliability is particularly important is Automated Measurement's switching relays used in Stanford University's new 1.6-mile-long antenna for precision study of the ionosphere.

The antenna installation, resting on a 9000-foot earth-work strip near Los Banos, California, is remotely controlled from a central command trailer. Because it is stationary, "steering" is achieved by

centrally controlling reception of signals coming from the ionosphere.

The antenna itself is composed of an array of 256 18-foot-high whip antennas, much like those on automobiles. To monitor the ionospheric waves, signals must be precisely delayed for simultaneous addition along the entire length of the long array.

Because multi-switching presents special problems in RF ranges, several design approaches were examined prior to selection of the reed-based coaxial switch.

Mechanical switches were considered too slow and cumbersome for this remote control application. Diode switching, while capable of handling this function involved excessive forward impedance over such distances.

AMC's coaxial switch utilizing IBM reeds offers optimum characteristics for the job demands: long life, rapid programming, minimum crosstalk and maximum bandwidth.

AMC switches similar to Type 43 shown in exploded view are used extensively in the Stanford project. These SPDT switches offer 200 picosecond risetime with each single-pole, double-throw section operating independently. The switches present a nominal impedance of 50 ohms. The above characteristics allow maximum flexibility in applications that require matched propagation delays, termination of unused signal lines, low noise and low crosstalk.

The IBM miniature dry reed switches designed into the AMC matrices are selected for uniform sensitivity, low contact resistance and long, adjustment free life.

To measure the IBM reed's reliability,

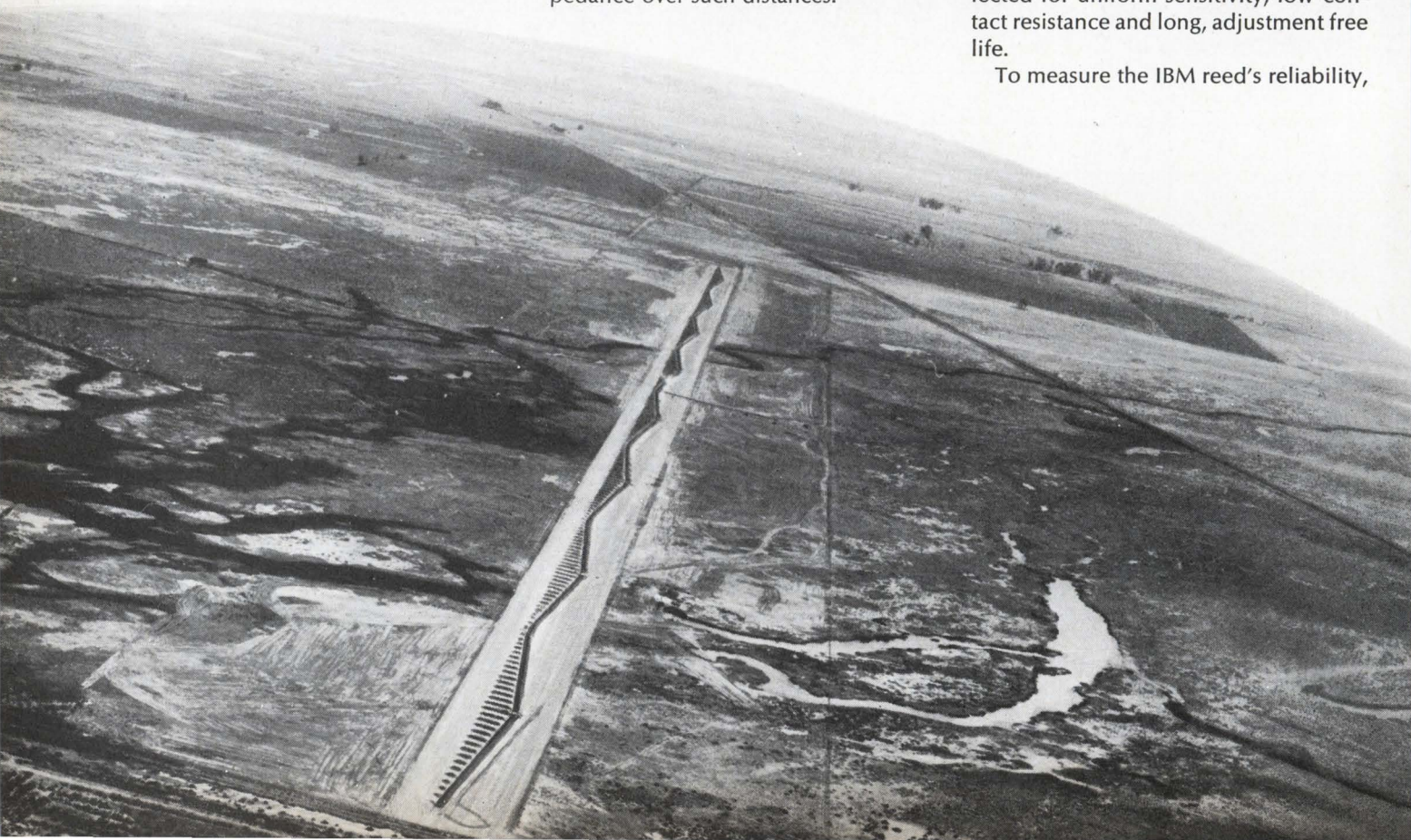



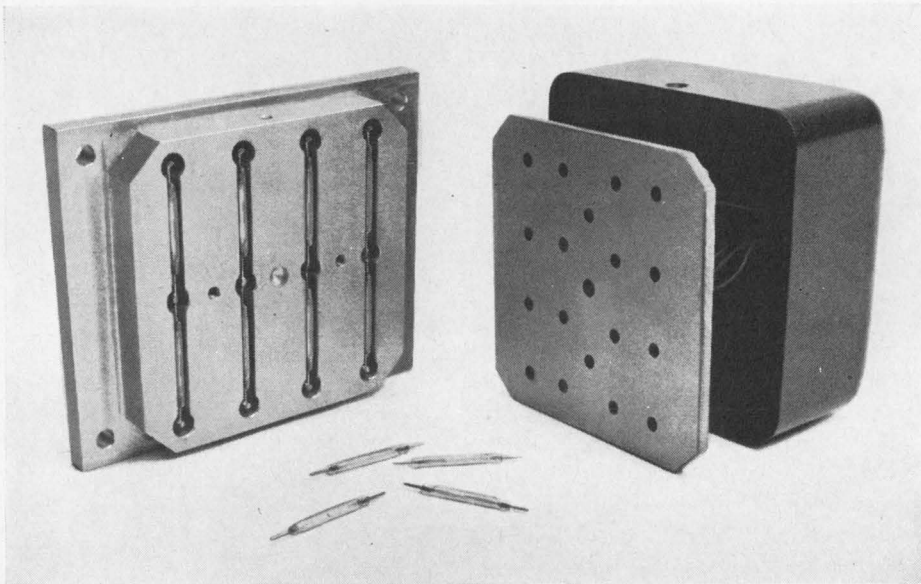

Exploded view of Automated Measurement's Type 43 remotely programmable coaxial switch similar to the type used in ionospheric antenna. IBM reed switches displayed in foreground can also be seen installed inside assembly.

the Stanford group conducted its own tests. These findings add further evidence to the IBM quality story.

IBM components and packaging assistance can help designers in timing control, digital logic testing, telemetering, process or numerical control. See for yourself. Send in the coupon.

Stanford's new 1.6-mile-long ionospheric antenna near Los Banos, California trains its sensitive ear by use of vast reed switch network that controls reception of signals.

**IBM Industrial Products Marketing Dept. E916  
1271 Avenue of the Americas  
New York, New York 10020**

**Please send information on the IBM reed switch.**

name \_\_\_\_\_

position \_\_\_\_\_

company \_\_\_\_\_

address \_\_\_\_\_

city \_\_\_\_\_ state \_\_\_\_\_ zip \_\_\_\_\_

**IBM**<sup>®</sup>  
INDUSTRIAL  
PRODUCTS



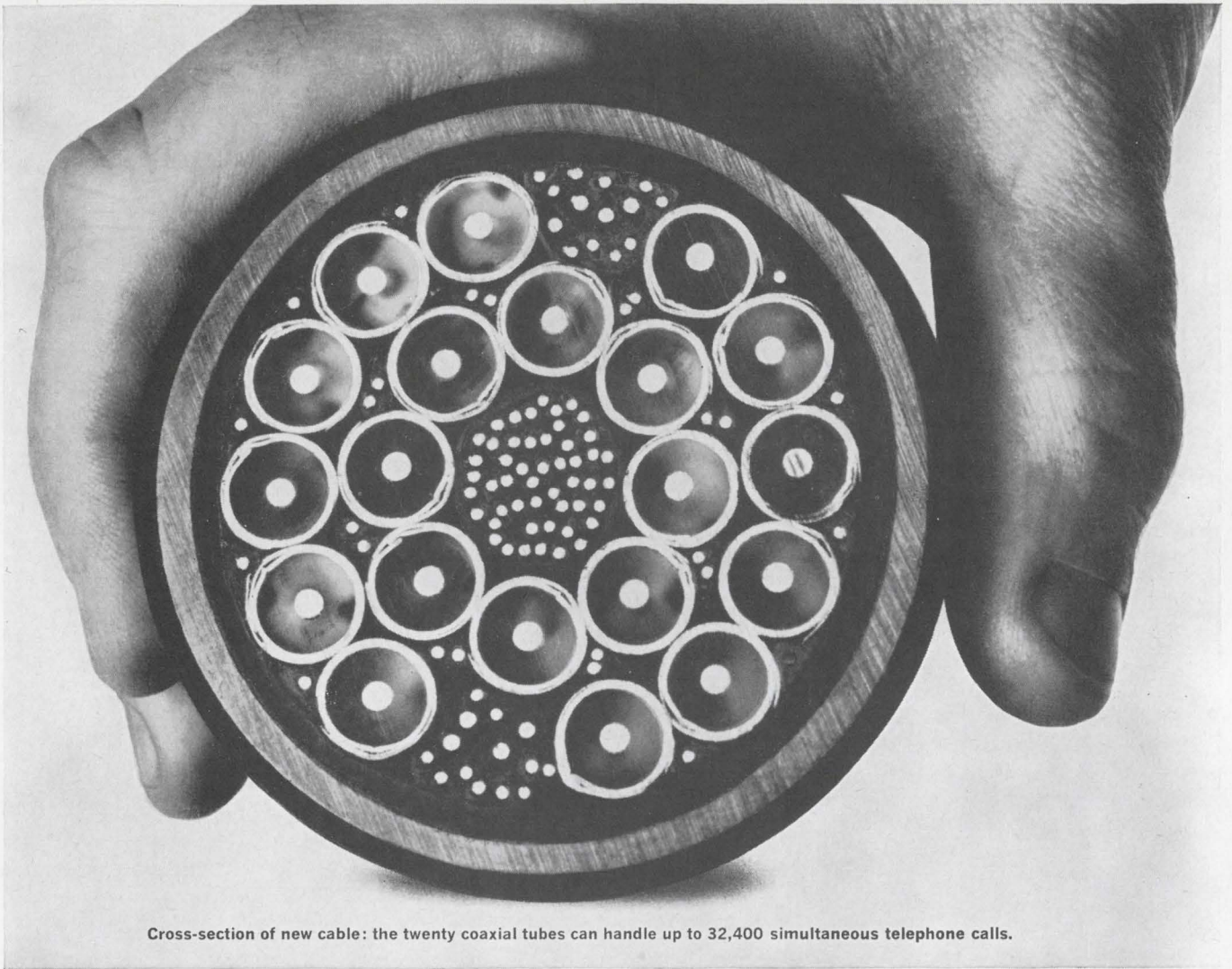

Cross-section of new cable: the twenty coaxial tubes can handle up to 32,400 simultaneous telephone calls.

# Development of a transmission system



The Long Lines Department of the AT&T Co. recently announced that a new coaxial cable system was placed in service between Washington, D.C., and Miami, Florida, and that the system would later be extended to Boston.

Behind this simple statement lie decades of research and development, millions in investment, years of planning and of efficient manufacture... and the constant desire to improve telephone service.

Service, in fact, is the beginning of the story. The demand for communications along the east coast has risen by about 2500 new circuits per year. More important, forecasts warned that this rise would continue, and at an even greater rate.

Why not, then, merely install additional systems of the types already developed? The answer is that communications technology has advanced greatly in the fifteen years since Bell Laboratories developed a major new coaxial system. Here was a chance to use this new technology for better service and lower cost.

But what type of system? Why not microwave radio, so important in modern telephony? Coaxial cable systems require a high initial investment. Cable, rights-of-way, and installation add up to large sums of money, even though only part of the cable may be used at first. Microwave radio also requires heavy investment, but with the difference that some expenditures may be deferred until service is needed.

In other words, you don't use coaxial unless you have a reasonable expectation of "rapid fill"—the rapid use of communications circuits to justify the expense of making them available.

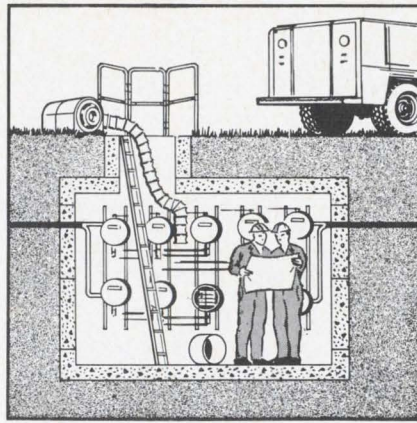

**Underground "repeater" or amplifier hut of the new system. Reliable transistors and related devices, plus new designs, let advanced electronic equipment work in such environments without excessive maintenance.**

But if you can expect this rapid use, as on the east coast route, coaxial cable becomes very attractive. It is not inherently limited by frequency space. And coaxial cable is "exploitable": new systems, when developed, can be added to in-place cable.

So the problem reduced to developing the right coaxial system at the right time to meet the rising needs for service at a reasonable cost.

The "right" coaxial cable system was an all-solid-state system. For several years transistors and related devices had been available. They had the desired bandwidth but had neither the required linearity nor the power-handling ability for amplifiers that could transmit several thousand voice signals.

The technical problem, then, was to improve transistors, to design efficient circuits, and to organize circuits and

subsystems into a working whole... that is, to plan and develop a large communications system.

The new system had to be—and is—better than older coaxial systems. Cost per channel mile has come down. Noise has been reduced (required because better telephone instruments are now used and because of very long, continental, and even intercontinental, circuits). A high degree of monitoring and control is built in; adjustments that once required a trip to a remote amplifier site can now be made from a main station. Maintenance visits to amplifier stations along the route are to average one per year or less.

New prefabricated "manhole" structures house the amplifiers. These are much easier to construct and install—and are more secure against damage—than the previous above-ground "huts."

In all, the new system typifies the complex, essential jobs that are the reason for Bell Laboratories... research, development and systems engineering organization of the Bell System.

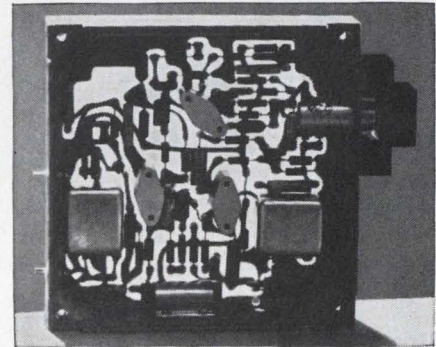

**Basic solid-state amplifier of the new transmission system.**

**The new transmission system between Washington and Miami. The cable contains ten pairs of coaxials; one pair is reserved for emergency service. Each pair can carry 3600 telephone channels; nine pairs can carry up to 32,400 simultaneous telephone calls, or the equivalent in mixed telephone, data, telephoto, and other services. About every two miles, there is an amplifier whose basic solid-state circuit handles the very wide range of 0.564 MHz to 17.548 MHz. The circuit's amplification characteristic is carefully shaped to give more gain at the high-frequency end of the band, where cable loss is greater. Most amplifiers are of this simple type, with fixed gain. Others incorporate the basic circuit but also include more complicated circuits to compensate for temperature and other effects on transmission. Main stations (major terminals from which remote adjustments can be made) are used about every 150 miles along the route. In addition to self-regulation, the new system includes fault-locating equipment to identify any failed repeater. These and other sophisticated design techniques give stable and reliable transmission. Noise is 4 dB less than in earlier coax systems.**



**Bell Telephone Laboratories**  
Research and Development Unit of the Bell System



**Sealok™**  
**new Burndy micromodular  
interconnection system  
is ultra-reliable**  
**withstands**  
**temperature, vibration,**  
**shocks, wire training,**  
**moisture and most**  
**fluids and gases.**  
**Whew!**

Developed to provide density for critical applications, the new Burndy Sealok system eliminates current intermittencies and variations in millivolt drop.

Designed so that they are unaffected by severe training of wires, modules are protected by a rigid outer shell. Exclusive with Burndy, this protects the sealing grommet and other internal components and provides a guide for proper insertion and extraction of contacts. The inner

construction (illustrated far right) insures that every contact is held firmly against the bus bar.

Sealok modules and contacts are available in sizes 20, 16 and 12, with one hybrid module which accommodates both 16 and 20. Contacts cover a wire range of 24 thru 12 and are easily and quickly installed with standard tooling. Sealing plugs for unused positions are also available. Write for catalog giving full details.

 **BURNDY**  
Norwalk, Connecticut

INTERNATIONAL SALES HEADQUARTERS AND MANUFACTURING FACILITIES:  
CANADA: Scarborough, Ontario / ENGLAND: St. Helens, Lancs. / BELGIUM: Mechelen / MEXICO: Naucalpan de Juarez / BRAZIL: Sao Paulo / JAPAN: Tokyo / Sales Offices in Other Major Cities





Extruded aluminum track is available in 6-foot lengths or to specification. End clamps keep modules in track and provide mechanical rigidity.

(below) Plan view of Sealok modules shows clear identification of contacts and bussing arrangements. Different bussing arrangements available in each module size.

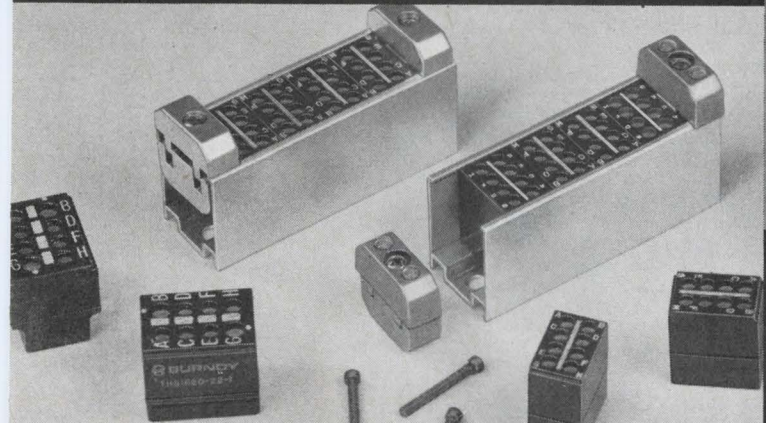
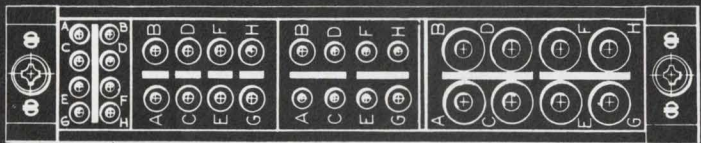

Track features recessed mounting hardware so there is no interference with removal of modules. Two-piece end clamp construction permits insertion from ends or top anywhere along track.



Modules can be easily inserted and removed with inexpensive stainless steel tool.

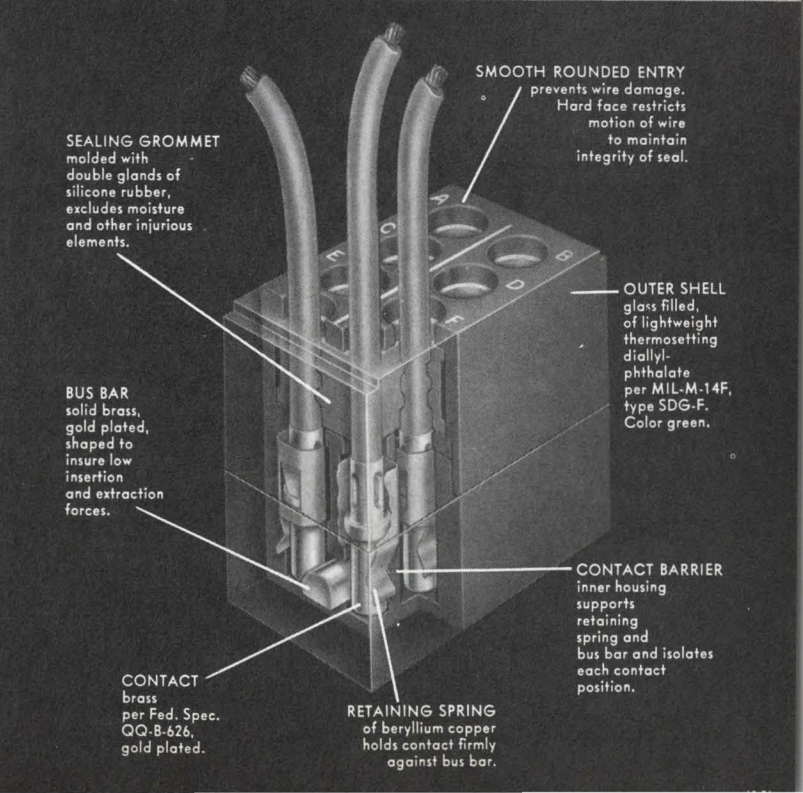
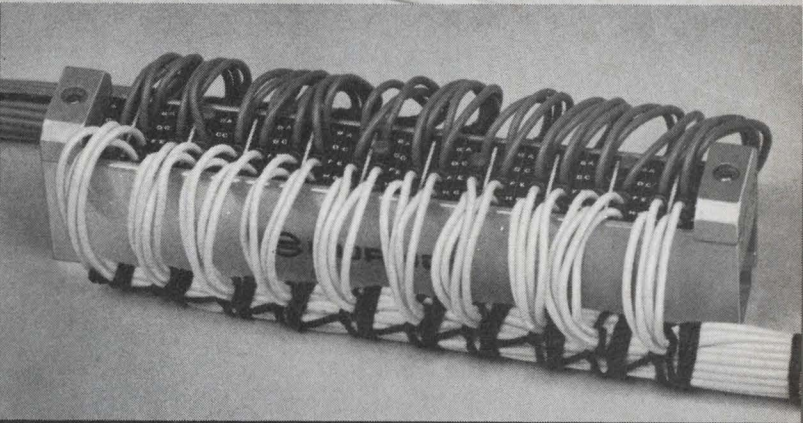

SEALING GROMMET molded with double glands of silicone rubber, excludes moisture and other injurious elements.

SMOOTH ROUNDED ENTRY prevents wire damage. Hard face restricts motion of wire to maintain integrity of seal.

OUTER SHELL glass filled, of lightweight thermosetting diallyl-phthalate per MIL-M-14F, type SDG-F. Color green.

BUS BAR solid brass, gold plated, shaped to insure low insertion and extraction forces.

CONTACT BARRIER inner housing supports retaining spring and bus bar and isolates each contact position.

CONTACT brass per Fed. Spec. QQ-B-626, gold plated.

RETAINING SPRING of beryllium copper holds contact firmly against bus bar.



# SYNCHRO-TO-DIGITAL

• 20,000°/second tracking • .01°/15 bit accuracy • binary or BCD

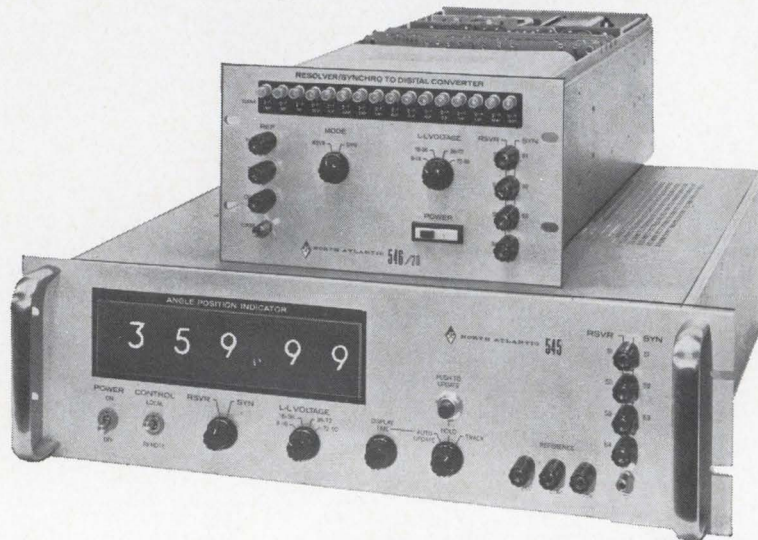

# DIGITAL-TO-SYNCHRO

• 11 to 16 bits • accuracy to 30 arc seconds • 4 $\mu$ s data strobe

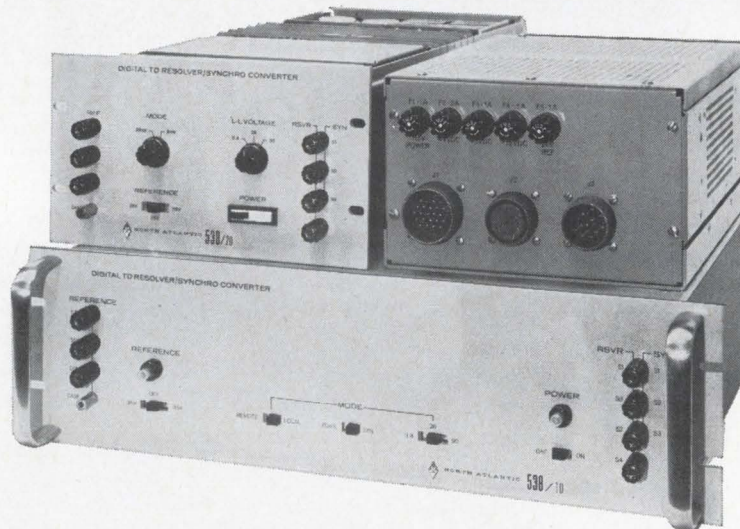

- low cost • all solid-state designs
- precision trigonometric transformers



**NORTH ATLANTIC industries, inc.** TERMINAL DRIVE, PLAINVIEW, NEW YORK • (516) 681-8600





## Rumor has it that CDE's Sprint Program deals only with standardized electronic components.

## Read on and help quash a rumor.

CDE started its Sprint Program 4 years ago in the hope of standardizing as many electronic components as technically feasible. In that time it has become enormously successful. But somehow a lot of you have been led to believe Sprint meant only standard, stocked electronic components. Well, in part, it does. But it also deals with specialized items.

The Sprint concept was designed to give you the most economical Business/Engineering evaluation for your specific requirements, taking into account all economic factors.

If, after the evaluation, you need a standard component, we recommend it. If you need a specialized one, we recommend that. Then design, manufacture and deliver it.

What our Sprint Program is trying to accomplish is to do away with

unnecessary, over-specialized items. And in turn cut down on delivery times, production costs, inventory and purchasing costs to you. A standardized component, whose parameters and characteristics cover a maximum series of specified devices, will achieve this goal. These components are stocked in depth by our Authorized Industrial Distributors.

We do away with the problem of over-specialization which has been harassing the industry for years.

Standard components where they're best for you. Specialized components where they're best. That's Cornell-Dubilier's Sprint in a nutshell. To learn more about it send for your free copy of CDE's Component Selector. Over 180,000 people already have. Write CDE, 50 Paris Street, Newark, N.J. 07101. And now that you know the truth about Sprint, please spread it.



Circle 79 on reader service card





# OLYMPUS CORPORATION OF AMERICA

PRECISION INSTRUMENT DIV. DEPT. E-9  
2 Nevada Drive, Lake Success  
(N.H.P.-P.O.) New York 11040

Send information on Olympus stereo microscopes, including  JM,  XL-4,  SZ-III,  X-TR and  microscope cameras,  X,  VT-II,  VA-II,  MTX. My applications include:

Name \_\_\_\_\_  
Title \_\_\_\_\_  
Address \_\_\_\_\_  
City \_\_\_\_\_  
State \_\_\_\_\_ Zip \_\_\_\_\_

# The Olympus stereo microscope line.

## It puts things in perspective.

We now offer a stereo microscope for almost every purpose. Which may give you a new perspective on us, if you've known Olympus only for our metallurgical microscopes, our metallographs, or our medical and research instruments.

A closer look will reveal some surprising features: working distances to 18", dark-field illumination, and the only trinocular optical system (for simultaneous viewing and photography) in the stereo field. And you can see their quality even before you look through precision optics.

Olympus stereos fit your budget as easily as they fit your applications. Tell us what those applications are. We'll give you the full perspective on the Olympus microscope that suits them.

- A. Model JM dark-field zoom.
- B. Model XL-4 long (8 1/2") working distance (shown on VS-V universal arm stand).
- C. Model SZ-III extra-long (5.7:1) zoom range (shown on VS-IV universal arm stand).
- D. Model X-TR Trinocular for viewing and photography (shown with PM-7 camera).
- E. Model X with convenient turret magnification selector (shown on transilluminating stand).
- F. Models VT-II, VA-II priced for use throughout your plant. (VT-11 shown with LSG epi-illuminator).
- G. Model MTX (not shown) with 18" working distance. Camera accessories available.



Circle 80 on reader service card





# The Best Of ECL And T<sup>2</sup>L Circuit Design Are Combined To Make This The World's Fastest 16-Bit Coincident Memory!

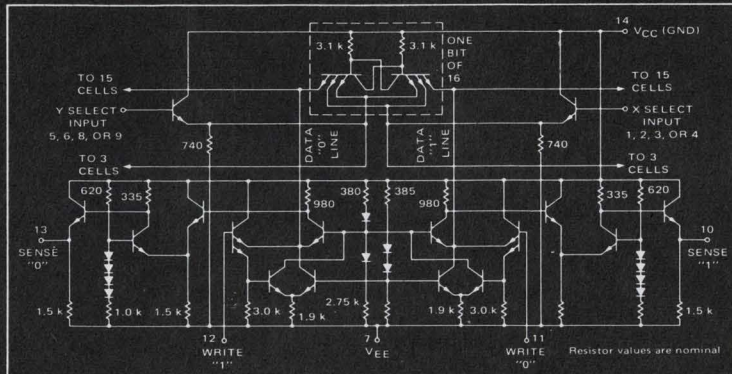

**(MECL II MAKES IT POSSIBLE!)**

Combining area-saving saturated logic MTTL\* with high-speed unsaturated logic MECL\*, Motorola has successfully blended — on a single monolithic die — the most desirable features of both circuit forms to produce the MC1036L/MC1037L 16-bit coincident memory I/Cs. The storage cells are considered TTL in nature while the amplifiers and drivers provide ECL input and output characteristics for the memory.

Capable of operating in systems with cycle times as low as 50 ns, the MC1036L/MC1037L consist of 16 multiple-emitter flip-flops, eight-input emitter followers and two non-saturating complementary Sense/Write circuits. The flip-flops form an addressable 4 by 4 memory matrix that exhibits non-destructive readout for all 16 bits. The emitter-coupled sense-amplifier outputs permit wired-OR operation so that word expansion is easily accomplished. Both units are identical except that emitter follower pulldown resistors are omitted in the MC1037L.

These memories are used primarily where information is temporarily stored and retrieved quickly —

such as in “scratchpad” applications; or, where information needs to be reprogrammed for reference throughout the problem that is under consideration.

Priced at \$12.00 in 1,000-up quantities, they come in the 14-pin dual in-line ceramic package (0 to +75°C). Read time is just 17 ns. Power dissipation is 250 mW (typ); and, the circuits will perform over the temperature range with power supply variations of ±%.

See your franchised Motorola Semiconductor distributor for units for immediate evaluation. For data sheets and applications information, circle the reader service number or write us on your company letterhead.

\*Trademark of Motorola Inc.



— where the priceless ingredient is care!

**MOTOROLA**  
Semiconductor Products Inc.

Box 20912 / Phoenix, Arizona 85036



# Cut control clutter and cost ...with S-D plug-in relays and modules

One basic heavy-duty Struthers-Dunn socket fits dozens of Dunco relay types, or plug-in modules containing your own sub-assembly circuitry or control devices.

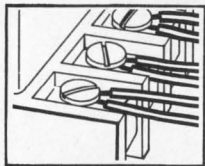
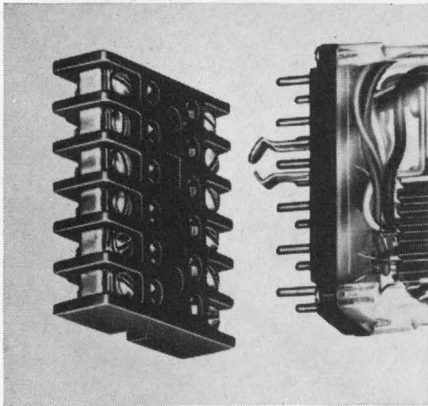

All wiring is on one plane, consistently  $\frac{5}{8}$ " above mounting surface. No complex multiple level wiring! Every terminal is instantly accessible for fast, easy wiring and convenient check-out from front of panel.

Sockets mount level, end to end, for full length of panel. Pre-wiring is as simple as terminal strip wiring. Control panel at upper right shows why Duncontrol plug-in design has been used for years by manufacturers of some of America's most famous brand-name industrial equipment.

Check appropriate Reader Service Card numbers for data listed at the right.

You get trim, symmetrical, compact panels that cut assembly and service time and costs . . . panels that reflect superior engineering of systems and machines.

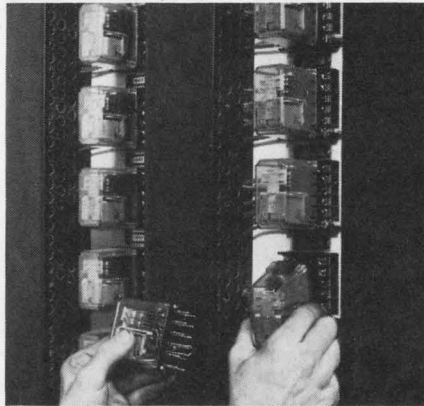

Sockets can be used with all our Duncontrol general purpose, latch, time delay, sequence and alarm relays. Also with any of our vast line-up of special relays with such optional features as indicating lamps and manual actuators.

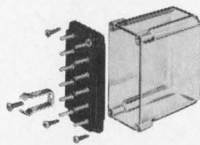

Money-saving idea! Modularize your special circuitry by combining your components and

controls into pre-wired and tested sub-assembly modules. Use Struthers-Dunn plug-in enclosures, available separately as Module Kits. Enclosures are furnished disassembled in two sizes, complete with all hardware.

For a bigger choice of plug-in relays, start where you find the most

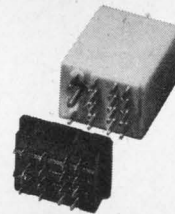

**Miniature Industrial**  
Wire direct, or use sockets with choice of P/C or lug terminals. 3-Amp, 4P-DT, gold-flashed contacts. AC or DC coils. Nylon cover. Over 50,000,000 high speed operations.

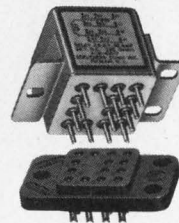

**Aerospace**  
At only 1 cubic inch, here is one of the smallest 4P-DT, 10-amp relays made to MIL-R-6106. Available with solder hook terminals, or as plug-in with socket in 3 terminal designs.



**Mercury wetted**  
High speed, long life relays with one- and two-switch Form D bridging and sensitive Form C non-bridging contacts. Use with standard octal or 11-pin sockets. P/C mounting styles available.

Get data on items mentioned!  
Check numbers on Reader Service Card for more information on any or all of these plug-in relays.

- # 502 General purpose relays
- # 503 Latch relays
- # 504 Time delay relays
- # 505 Sequence relays
- # 506 Alarm relays
- # 507 Plug-in options and modules
- # 508 Miniature industrial
- # 509 Cubic-inch aerospace
- # 510 Mercury wetted



## STRUTHERS-DUNN, INC.

PITMAN, NEW JERSEY 08071

Canada: Struthers-Dunn Relay Div., Renfrew Electric Co., Ltd.



# From The Antenna Men at TRG...

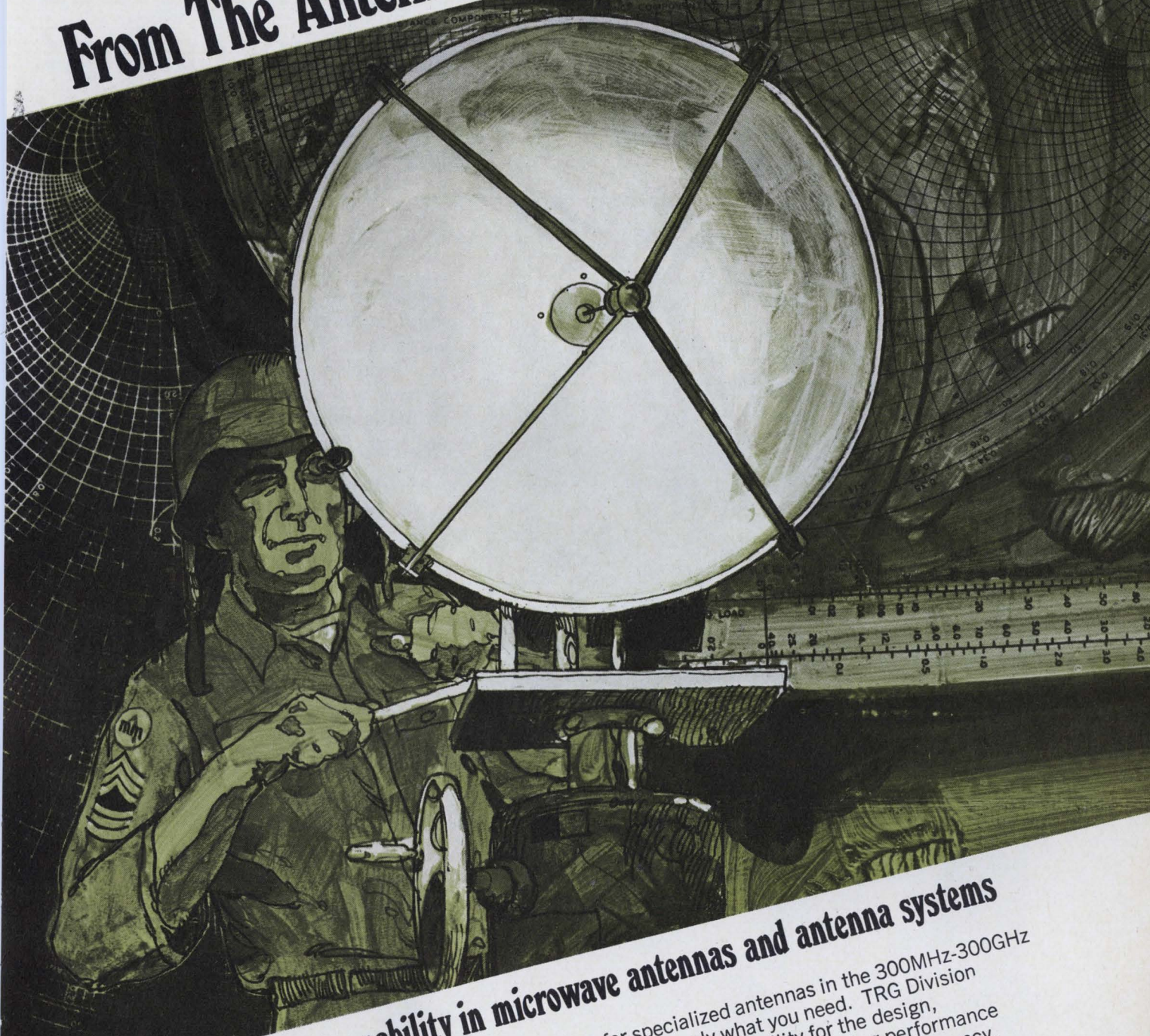

## ...a comprehensive capability in microwave antennas and antenna systems

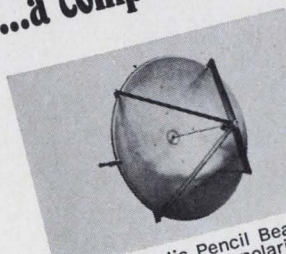

TRG Parabolic Pencil Beam Antenna, a linearly polarized type, operates over the full waveguide band of 26.5 to 40 GHz. Has unique scalar feed for broadband operation without adjustment. Send for bulletin.

If your microwave system calls for specialized antennas in the 300MHz-300GHz range, The Antenna Men at TRG can supply what you need. TRG Division of Control Data Corporation offers in-depth capability for the design, development, and production of antennas that meet exacting performance specifications. They are available with linear, dual frequency, circular, or multiple mode polarization and are fabricated to quality standards required for the most sophisticated communications, radar, radiometry, telemetry, countermeasure, or surveillance systems. TRG specialists are also uniquely qualified to design complete antenna systems for you or to assemble systems to your specifications. If specialized antenna procurement poses problems for you, contact The Antenna Men, TRG Division, Control Data Corporation, 404 Border Street, East Boston, Mass. 02128. Tel: 617-569-2110.





# Got a hot idea for data processing?

## We'd like to have a part in it.

Relays, connectors, resistors, you name it—if it requires precision stampings, chances are we're in it. Our winning combination of exacting tolerances plus high volume, on-time delivery and competitive prices have made us the leaders in electronic stampings for 30 years.

We'd like to have a part in your next project. A challenging part that will tax our unique engineering service, diemaking skills and production techniques. Write or call Volkert Stampings, Inc., Subsidiary of The Stanley Works, 222-35 96th Avenue, Queens Village, L. I., N. Y. 11429. Tel.: 212-464-8400.

***Volkert*** STAMPINGS, INC.





# TTL Trends

from Texas Instruments

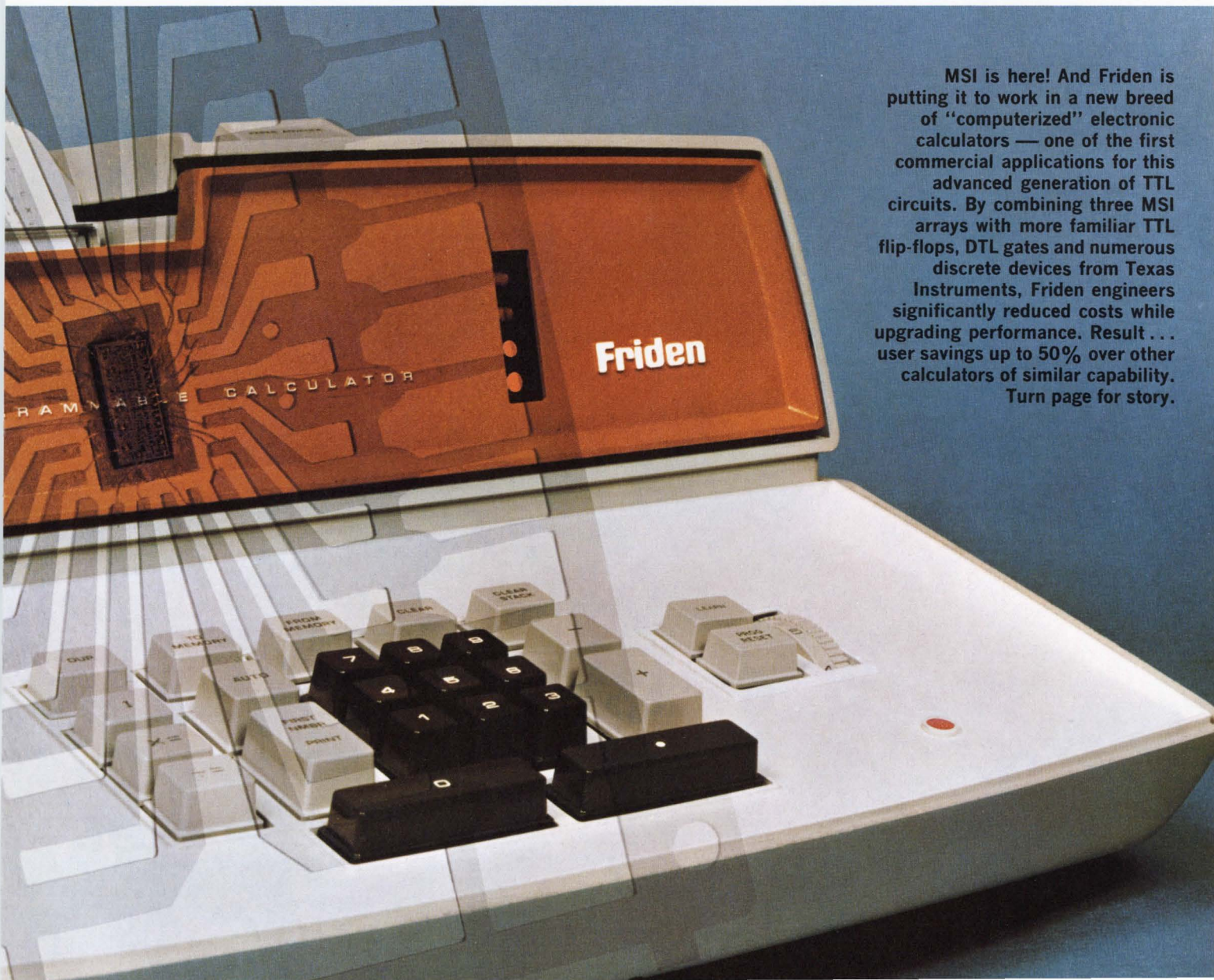

MSI is here! And Friden is putting it to work in a new breed of "computerized" electronic calculators — one of the first commercial applications for this advanced generation of TTL circuits. By combining three MSI arrays with more familiar TTL flip-flops, DTL gates and numerous discrete devices from Texas Instruments, Friden engineers significantly reduced costs while upgrading performance. Result . . . user savings up to 50% over other calculators of similar capability.

Turn page for story.



# MSI from TI helps Friden cut costs of "computerized" calculators

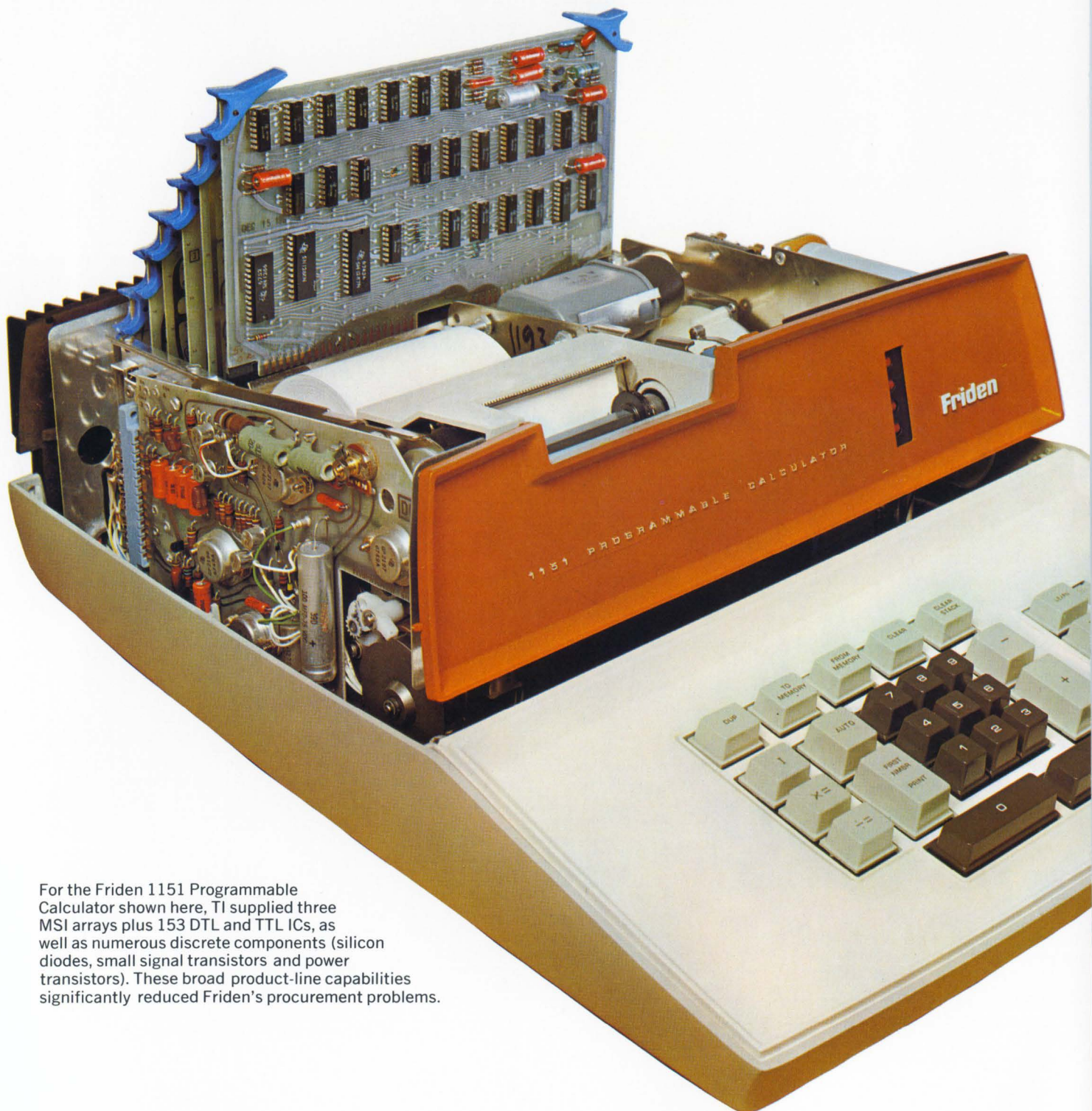

For the Friden 1151 Programmable Calculator shown here, TI supplied three MSI arrays plus 153 DTL and TTL ICs, as well as numerous discrete components (silicon diodes, small signal transistors and power transistors). These broad product-line capabilities significantly reduced Friden's procurement problems.



TI combined the equivalent of 93 gates in just three 24-lead MSI arrays to help Friden engineers reduce package count, circuit boards and overall costs of their new 1150 and 1151 electronic printing calculators.

Three custom TTL ring counters form the heart of Friden's sophisticated "computerized" calculators. These MSI units recirculate all arithmetic and memory information handled by the machines. Since June of 1966, they have been making possible substantial reductions in both costs and complexity.

Friden engineers took advantage of TI's broad IC capability to develop a low-cost, single-chassis design combining both electronics and printer in a single unit. They packed up to 662 gates on only six compact circuit boards by selecting optimum combinations of multiple-gate DTL and complex-function TTL integrated circuits. This single-chassis design not only means lower manufacturing costs, but also greater reliability and convenience for the user.

The high noise-immunity of TI circuits also provided an unexpected bonus. With both printer and electronics combined in a single chassis, Friden engineers were concerned with possible noise problems...but none developed. Expensive noise-suppressing design techniques were therefore unnecessary, and further cost reductions were realized.

As a result of these cost (and space) economies, Friden engineers were able to upgrade performance without corresponding



Smaller circuit boards, made possible by MSI and multiple-gate ICs, enabled Friden engineers to develop high-performance low-cost calculators, with both electronics and printer in a single chassis. Here, R. A. Ragen, Friden's Director of Engineering compares a new MSI/IC circuit board with one of the larger functional equivalents required in an earlier all-discrete-component model. In the pre-assembly checkout area (background), an 1151 Calculator performs final screening of hundreds of circuit boards each day.

price premiums. Here are two cases in point: The "stacking" feature, which allows retention of intermediate answers; and the floating decimal point, which permits the user to preselect desired accuracy. In addition, the 1151 is a programmable machine capable of "learning" up to 30 mathematical steps.

*All this performance...at user savings up to 50 percent over machines of similar capability!*

In these and other ways, Friden's new breed of calculators help close the gap between computers and office machines. They reduce the time required for complex calculations and minimize operator errors...yet they are priced far below today's least expensive computers.

Reliability is another bonus. The marriage of an all-IC logic design with a mechanical printer of unique simplicity dramatically reduces maintenance.

Finally, broad total semiconductor availability—in volume—were key considerations in Friden's design and procurement decisions. For example, gates are Series 15 830 DTL and flip-flops are Series 74 because this combination promised optimum performance/cost ratios. And inspection of TI manufacturing facilities indicated capacity sufficient to meet Friden's high-volume production requirements.

Cost...performance...size...availability...reliability...product saleability. These are some of the ways Friden benefited by using TI integrated circuits in their new computerized calculator line.

You can benefit, too. Join the growing list of OEMs that are improving their profits and building for the future. Include TI integrated circuits in your new equipment designs...today.



**TEXAS INSTRUMENTS**  
INCORPORATED



# Nine new TTL decoders expand complex-function line

**SN5442/SN7442**  
BCD-to-decimal decoder.

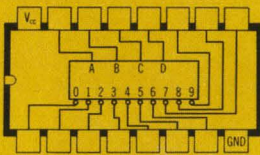

Active-low outputs. Fully compatible with all popular DTL and TTL logic.

**SN5443/SN7443**  
Excess 3-to-decimal decoder.

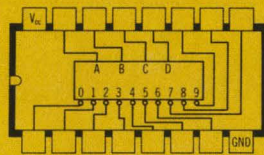

Active-low outputs. Fully compatible with all popular DTL and TTL logic.

**SN5444/SN7444**  
Excess 3 gray-to-decimal decoder.

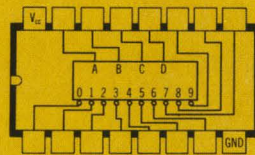

Active-low outputs. Fully compatible with all popular DTL and TTL logic.

**SN5445/SN7445**  
BCD-to-decimal decoder-driver.

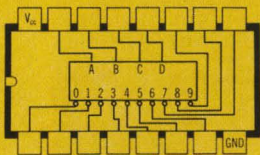

Active-low high-performance outputs. 30V breakdown, 80 mA sink-current capability for lamps, relays or memories.

**SN54145/SN74145**  
BCD-to-decimal decoder-driver.

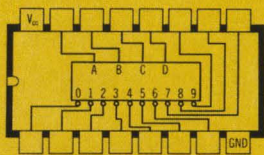

Active-low high-performance outputs. 15V breakdown, 80 mA sink-current capability for lamps, relays or memories.

**SN5446/SN7446**  
BCD-to-seven segment decoder-driver.

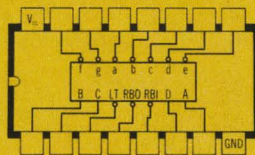

Active-low, open-collector outputs. 30V breakdown, 20 mA sink-current capability to drive indicator segments.

**SN5447/SN7447**  
BCD-to-seven segment decoder-driver.

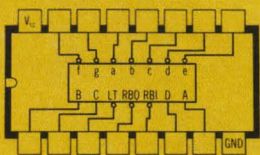

Active-low, open-collector outputs. 15V breakdown, 20 mA sink-current capability to drive indicator segments.

**SN5448/SN7448**  
BCD-to-seven segment decoder-driver.

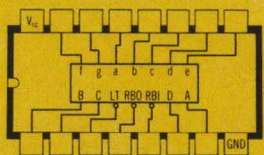

Active-high, passive pull-up outputs. For current-sourcing applications to drive logic circuits or power transistors.

**SN5449/SN7449**  
BCD-to-seven segment decoder-driver.

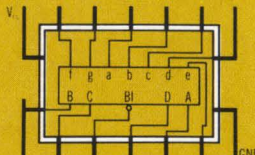

Active-high, open-collector outputs. For current sourcing applications to drive logic circuits or power transistors.

These new monolithic decoders give design engineers new opportunities to reduce costs and improve performance of logic and display systems. They couple the high speed and high noise immunity of TTL with the overall economies of complex functions for a host of new applications.

Four basic logic forms are offered: BCD-to-decimal, excess 3-to-decimal, excess 3 gray-to-decimal, and BCD-to-seven segment. Active-high and active-low logic configurations are available.

All decoders have buffered inputs to reduce fan-in requirements to a standard TTL load.

A choice of output configurations are offered. Three of the decimal decoders (SN7442-44) employ familiar totem-pole outputs for high capacitive drive capability while two others (SN7445 and SN74145) have high-performance open-collector outputs to drive display lamps or relays. Two of the seven-segment decoders (SN7446-47) can drive display lamps directly while two others (SN7448-49) are designed to drive large displays through external power transistors.

Two temperature ranges are offered...full military (Series 54) and industrial (Series 74).

All decoders except the SN7449 are available in either of TI's 16-pin dual in-line packages...the low-cost plastic or the ceramic hermetic. For space-critical applications, the SN7449 is offered in the hermetic 14-lead flat package.

For data sheets on any or all these new decoders, write on your letterhead to Texas Instruments Incorporated, P.O. Box 5012, M.S. 980, Dallas, Texas 75222.





Of all DVM's, only  
 Honeywell Digitest gives  
 you five functions (DC Voltage,  
 AC Voltage,  
 DC Current,  
 AC Current,  
 Resistance),  
 a choice of two models, and



Bench/Portable, Model 333



Bench Rack, Model 333R

a price tag of only \$395!

With  $\pm 0.5\%$  accuracy,  $100\mu\text{V}$  resolution, absolutely clear  $3\frac{1}{2}$ -digit readout, and simple, foolproof operation, the tough, compact little Digitest makes other low-cost DVM's look overpriced and under-engineered. We won't even mention a comparison with conventional meter-movement instruments.

Both models share the same specs, but Model 333 is completely portable thanks to built-in rechargeable ni-cad battery operation. It operates on AC as well. Both instruments give you  $3\frac{1}{2}$ -digit readout, with Model 333R providing an overrange digit while Model 333 employs an overrange indicator.

Compare features, specs, and prices — you'll see that Digitest is your best DVM value. That \$395 price, by the way, is *complete*. There are no shunts or plug-ins to buy, and even leads are furnished. The only option is a set of ni-cad batteries for the portable model at \$33.

**Order yours today!** Call Ron Craig (collect) at (303) 771-4717, or send your purchase order to Ron at Mail Station 222, Honeywell, Test Instruments Division, P.O. Box 5227, Denver, Colorado 80217. Both models are in stock for immediate delivery, **Honeywell** so order now!

Honeywell engineers sell solutions



**NEW**

# high-brightness NIXIE<sup>®</sup> tubes. designed for tomorrow, delivered today.

## TYPE B-5750

**LOW COST:**  
\$3.95 each in 1000 quantities.

**HIGH BRIGHTNESS:**  
time sharing up to 12 digits,  
or for DC operation.

**TUBE SIZE:**  
0.53" diameter; 1.5" height.



## TYPE B-5855

**LOW COST:**  
\$4.35 each in 1000 quantities.

**ULTRA-HIGH BRIGHTNESS:**  
time sharing more than 12  
digits, or for DC operation.

**MINI TUBE SIZE:**  
0.51" diameter; 1.35" height.



TUBES SHOWN ACTUAL SIZE

### TIME-SHARING OPERATION:

like numerals can be driven in parallel, reducing driver costs, and without sacrifice of brightness.

### IC-COMPATIBLE PIN CONFIGURATION:

dual-inline layout designed for IC decoder/drivers.

### OPTIONAL PIN CONFIGURATION:

conventional plug-in type for socket mounting, or flying leads for direct soldering.

### COMBO PIN SPACER/LEAD STRAIGHTENER:

simplifies PC-board and/or socket insertion.

### DECIMAL POINTS:

positioned left and right, independently operable.

### CHARACTER HEIGHT: 0.5"

### MINI-SIZE, LOW-COST SOCKETS:

for DC or time-sharing operation.

### ULTRA-RELIABLE:

like all ultra-long-life NIXIE tubes.

### LONGEST STATIC LIFE:

for demanding applications.

### SPECIAL-CHARACTER TUBES:

+/- tubes available from stock. Alpha/special-character tubes made to order.

### MOST COMPLETE HARDWARE BACK-UP:

low-cost IC decoder/drivers available off-shelf. Custom assemblies at production costs through modular design.

### MOST COMPLETE APPLICATIONS BACK-UP:

design and applications assistance of the kind available only from Burroughs, the originator of NIXIE tubes. For a demonstration, application notes and full information call or write Burroughs Corporation, Electronic Components Division, Dept. N-17, P.O. Box 1226, Plainfield, New Jersey 07061  
TEL: (201) 757-5000.

**Burroughs** 



# Technical Articles

---

**Small computer  
thinks big  
page 92**

A proven computer design has been brought up to date with integrated circuits, yielding a machine that costs less, executes the same programs, and uses the same input-output gear as its discrete parent. And the much smaller IC machine has room internally for options that had to be externally connected to the earlier version.

**Active filters:  
part 4  
page 105**

Inductorless filters can produce a desired transfer function when they incorporate a negative-impedance converter connected to external RC networks. But many engineers who are familiar with this idea are not as familiar with what the ideal NIC circuit should look like. Here are several circuits that do the job defined for the practical NIC.

**Laser R&D comes  
down to earth  
page 110**



Commercial applications of lasers are getting closer as engineers realize that coherent light is better than electrical circuits for doing some jobs and the only way to do others. Work under way includes efforts to perfect techniques for tuning over a wide band of frequencies and to improve optical modulators. The cover photograph, taken at Bell Labs, highlights the start of an Electronics' series on lasers; the first two articles are described below, and the cover is discussed on page 111.

**Picosecond  
laser pulses  
page 112**

Pulses of coherent light less than a picosecond long with hundreds of gigawatts of peak power may find use in such applications as ranging, controlled thermonuclear fusion, optical information processing, and high-speed photography. These pulses are produced by locking in phase the many frequencies emitted by Q-switched lasers, either by using an externally modulated crystal or a dye cell in the laser cavity.

**Optical pcm:  
the light way  
page 123**

One way around the bandwidth limitations of available optical modulators is to use mode-locked laser pulses, binary pulse-code modulation, a modulator gate, and optical multiplexing techniques. Data-handling terminals have been built that could transmit  $2 \times 10^{14}$  bits per second of information through a shielded pipe.

---

## Coming

**Hybrid computers**

When engineers want thorough analyses of complex projects, they can simulate their problems on a hybrid computer. A new series looks at the roles and types of hybrid systems and how they are developed from analog and digital computers.



# PDP-8/I: bigger on the inside yet smaller on the outside

Updating a proven computer design with integrated circuits made room for many options inside the machine and paid extra dividends in increased capability

By James F. O'Loughlin

Digital Equipment Corp., Maynard, Mass.

**Redesigning** a small scientific computer to replace its discrete components with integrated circuits will, obviously, reduce size and costs. But IC's also make possible the inclusion of many optional circuit assemblies that had to be packaged outside the main frame of the original machine.

The principles of redesigning for IC's that the Digital Equipment Corp. used for the computer can also be used for any kind of IC system for process control, data acquisition, or instrumentation. And the test procedure DEC established for the IC's and their modules, which was vital to the redesigning, could also find widespread applications.

Even though DEC's PDP-8/I (I for integrated circuits) is smaller and has more circuitry than the PDP-8 and PDP-5, it's hardware- and software-compatible with them.

## Father and son

Both the PDP-8 and its offspring are single-address parallel computers. Each has a 1.5-microsecond memory containing 4,096 words of 12 bits each. The same programs can run on either machine, and the same input and output equipment can be connected to either. The diagram on page 97, bottom left, compares the vital statistics of the two machines.

The PDP-8/I has much more internal space for optional logic than the PDP-8. But in both computers, major options, such as extended memory control or extended arithmetic, require many modules.

Extended memory in both expands the basic 4,096 words to as many as 32,768; extended memory

control consists of several three-bit registers that extend addresses from the basic 12 bits to 15 ( $2^{12} = 4,096$ ;  $2^{15} = 32,768$ ). Adding the first increment of extended memory requires installation of the control circuits for all increments and one 4,096-word stack—the ferrite-core storage elements and their associated drivers and sense amplifiers. The first stack goes outside the main frame of the 8 but inside the 8/I. Successive increments require only additional stacks, which go outside both machines.

Extended arithmetic permits both computers to multiply and divide directly, making step-by-step programming unnecessary for these operations. Parity-checking circuits are a third option, and circuits to protect an operating program if the power fails are also available.

These four options take up all the available space in the PDP-8, but in the PDP-8/I there is still space for control logic for a high-speed paper-tape reader and punch, a card reader, a plotter, one of two display units, a light pen or vector capability for the displays, and a real-time clock. And even with all these installed, space is still left for further expansion.

Yet the basic price of the 8/I is 29% less than that of the 8. The major options are also priced proportionately lower for the 8/I.

## Two changes

The transition to monolithic IC's required two major changes: shifting from diode-transistor logic (DTL) to transistor-transistor logic (TTL), and expanding an already extensive testing procedure to ensure IC reliability.



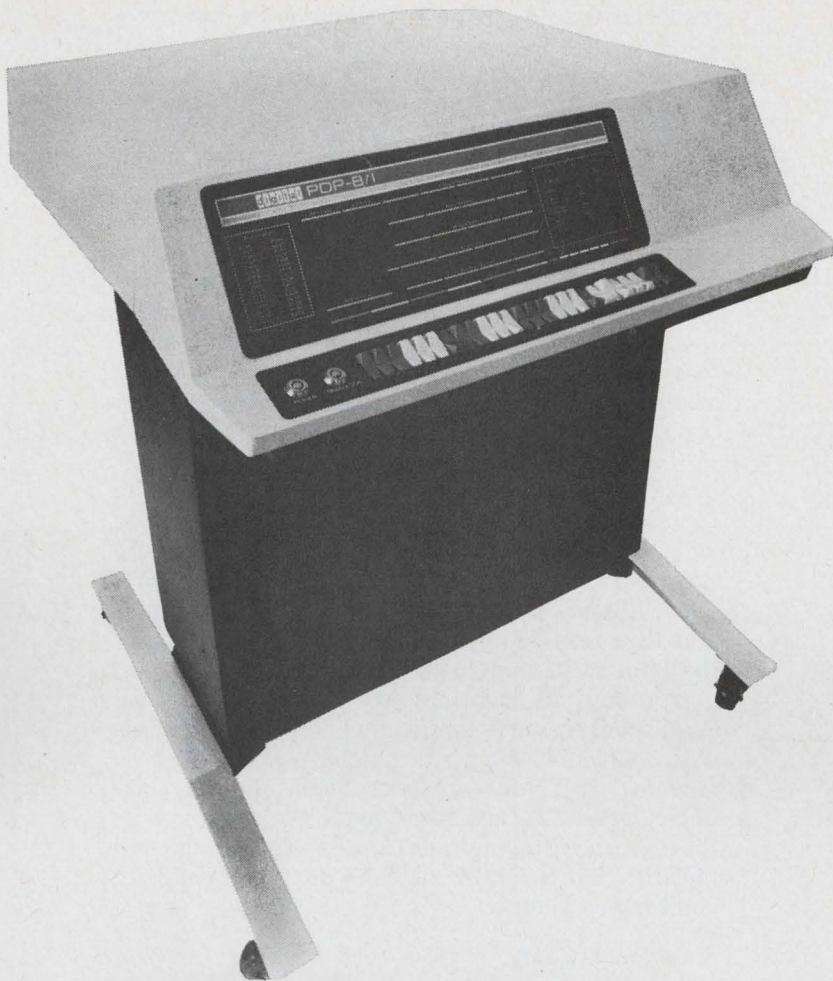

**Little giant.** This computer, the all-IC PDP-8/I, can be more powerful than the discrete version because it has room inside for several optional features. It's small enough for a desk top.

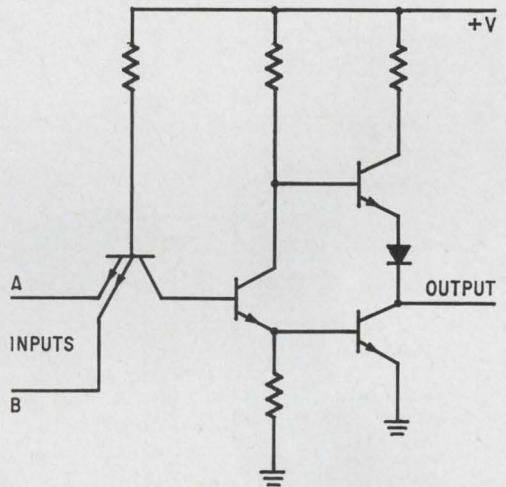
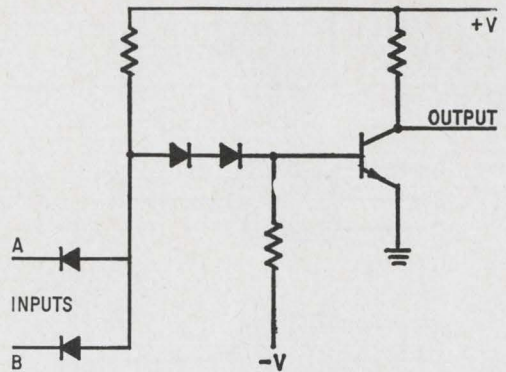

**Old and new.** Diode-transistor-logic circuit (top), used in older PDP-series computers, has been superseded by transistor-transistor logic—faster, less sensitive to noise, and cooler.

Of course, the TTL circuit, at right above, has several advantages over the DTL circuit, such as quicker switching and a propagation delay only about half as long.

The switching time is less because the multiple-emitter transistor at the IC's input has less chip area and capacitance than the diodes. The two output transistors make the waveform's rise time very nearly the same as its fall time, and it's this characteristic, combined with the quicker switching, that cuts the propagation delay to about 12 nanoseconds from about 25 in DTL. The "totem-pole" output also makes TTL less sensitive to capacitively coupled noise. Finally, the TTL circuit requires only one supply voltage, not two, and it draws only 10 milliwatts from the supply, compared to 80 or more for DTL.

The DTL does have one advantage. DEC's R series DTL gates have a load capability of 18 gates, but the TTL circuits in the PDP-8/I can drive only 10 gates. The TTL driving ability, however, is adequate. Both types of circuits have logic thresholds of about 1.4 volts, and the load-driving ability of

both is determined by how much current can pass through the output transistor to ground.

### Logic types

Other types of logic are also superior to DTL, but TTL was chosen because it's available in quantity from several IC manufacturers, in the many different logic forms needed for computer design. For example, a NAND-gate family, shown on page 94, must have circuits with from one to eight inputs so they can be used as inverters and for general logic and decoding.

Two or more gates can have electrically common outputs, giving an OR function at no cost in circuitry, but all the common gates must share a single collector resistor. In this configuration, the usual TTL totem-pole output can't be used; a variation with only the bottom transistor takes its place. These circuits are somewhat slower than the standard TTL circuits, because, as in DTL, the line capacitance must discharge through the common collector resistor.

Where speed is essential, this "wired OR" can-



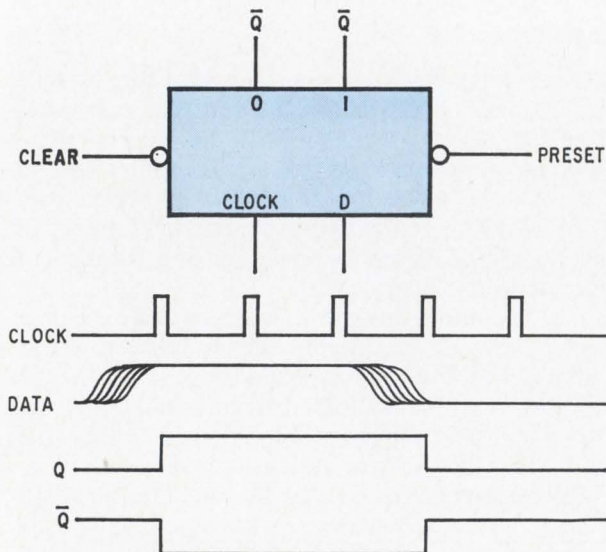
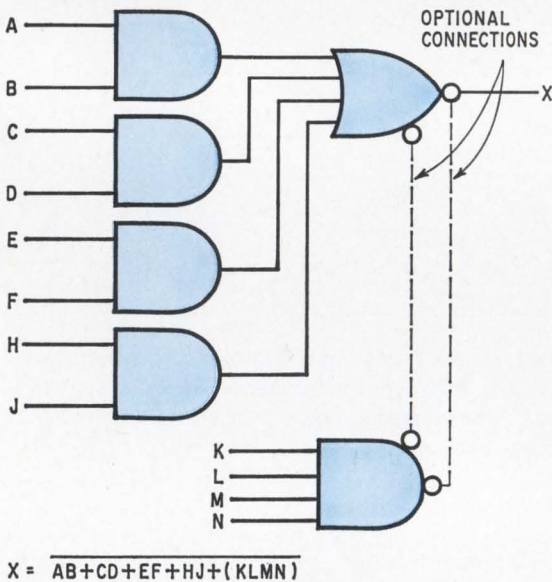
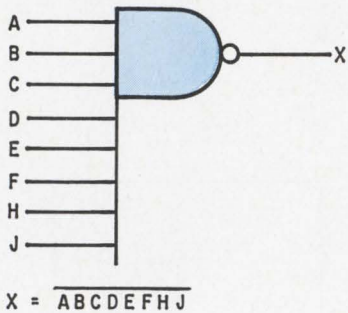
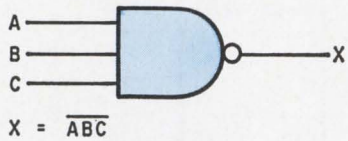
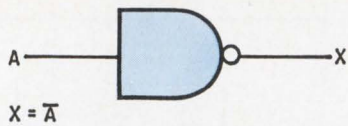

**Logic configurations.** All these gate forms are available in TTL circuits.

not be used. An AND-OR INVERT logic gate is a suitable substitute; it's available with an extender element for additional inputs.

A flip-flop circuit is necessary for single-bit storage functions, both in control applications and as a building block for registers in the data path. In the PDP-8/I, a single-input flip-flop controlled by a clock signal performs this function in both applications.

Where a single signal must drive a great many loads, as is often the case with timing or general reset signals, a power driver is needed. Finally, more complex logic assemblies can be used if their cost and the number of circuits per machine justify them. In the PDP-8/I, for example, two full adders in a single package were chosen over less costly multichip devices because 12 adders are used in each machine. Two single chips, with associated logic, are included on a single module that also contains two bits of each of four registers. On the other hand, a part needed only once in each machine—and then only as an option—would hardly justify the extra cost of single-chip design.

DEC buys its logic circuits for the 8/I in dual in-line packages and mounts them on module boards with contacts on both sides along one edge. These modules plug into connector blocks in the computer panel. The boards are made the same size as those in the 8 to capitalize on existing production facilities, but the older machine uses modules with single-sided contacts.

### Shrunken memory

Although IC's were primarily responsible for the reduced size of the PDP-8/I, its memory is an excellent example of how careful design can pay dividends without extensive use of IC's. The memory's capacity and functional design are the same as in the PDP-8, but the packaging drastically reduced the size.

The new memory has only three core planes, each containing four bits of the 4,096 words. These planes are sandwiched between two end boards carrying selection diodes, shown at right, top. The boards are the same size as double-height modules, and each plugs into a pair of back-panel connectors. The entire sandwich assembly covers three pairs of back-panel connectors; the memory planes, between the end boards, cover one pair but don't plug into it. Short cables connect the assembly with related circuitry packaged on modules that plug into nearby connectors. The reduction in size is illustrated in the photos directly opposite.

Another design technique that saved space was a new type of switch that does away with the need for baluns (pulse transformers that are necessarily discrete components). All 3-D or 2½-D memories require circuitry to drive current in either direction through the memory windings—one way for reading, the other for writing. This current is routed through a configuration that resembles a balanced transmission line. Because the read-write current controls usually drive an unbalanced line, most



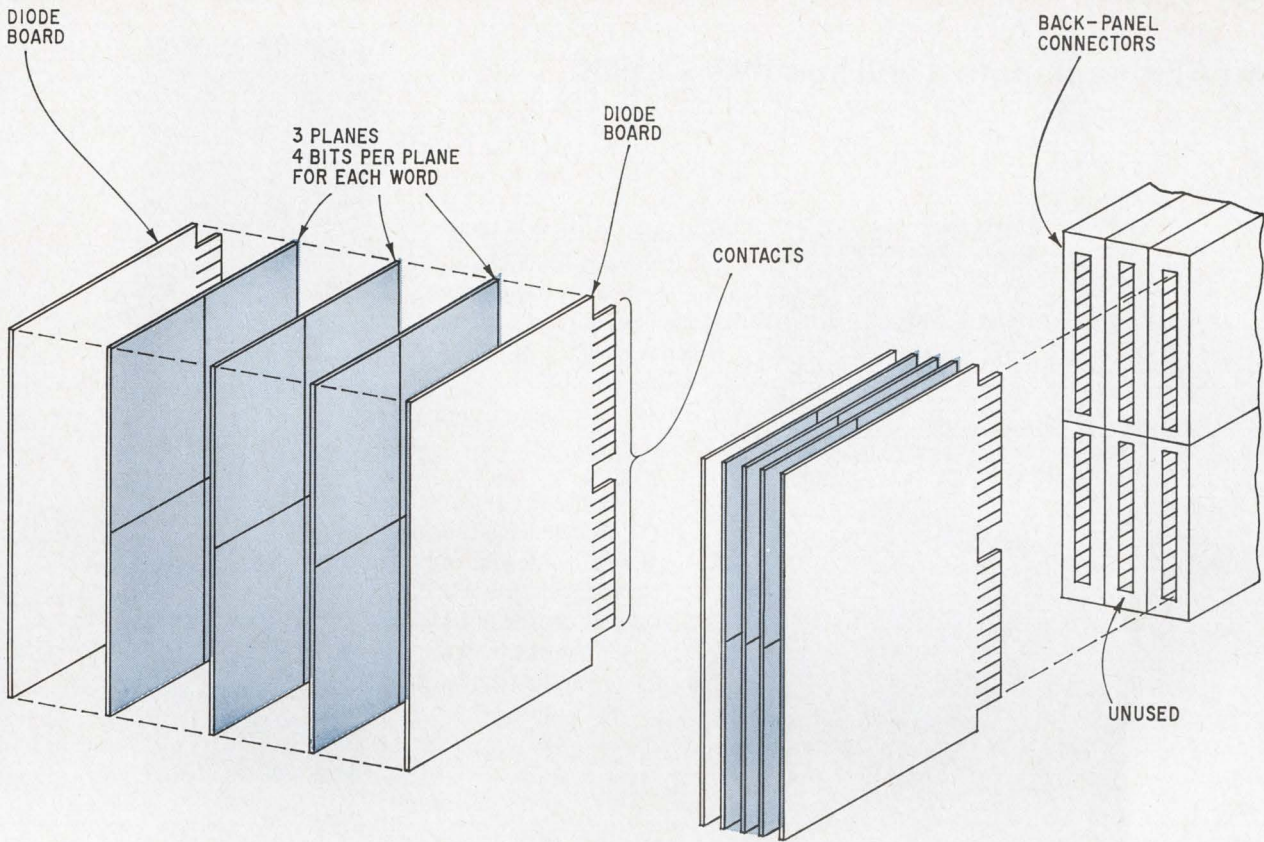

EXPLODED VIEW

ASSEMBLED VIEW

**Midget memory.** Only three core planes, sandwiched between two diode boards, make up a memory that holds as much as one requiring 12 planes and several cards full of other components.

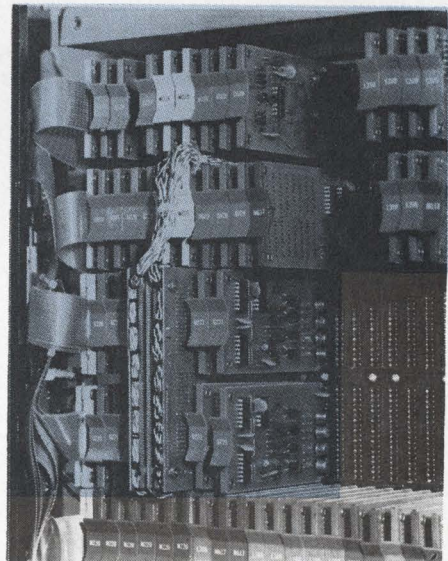
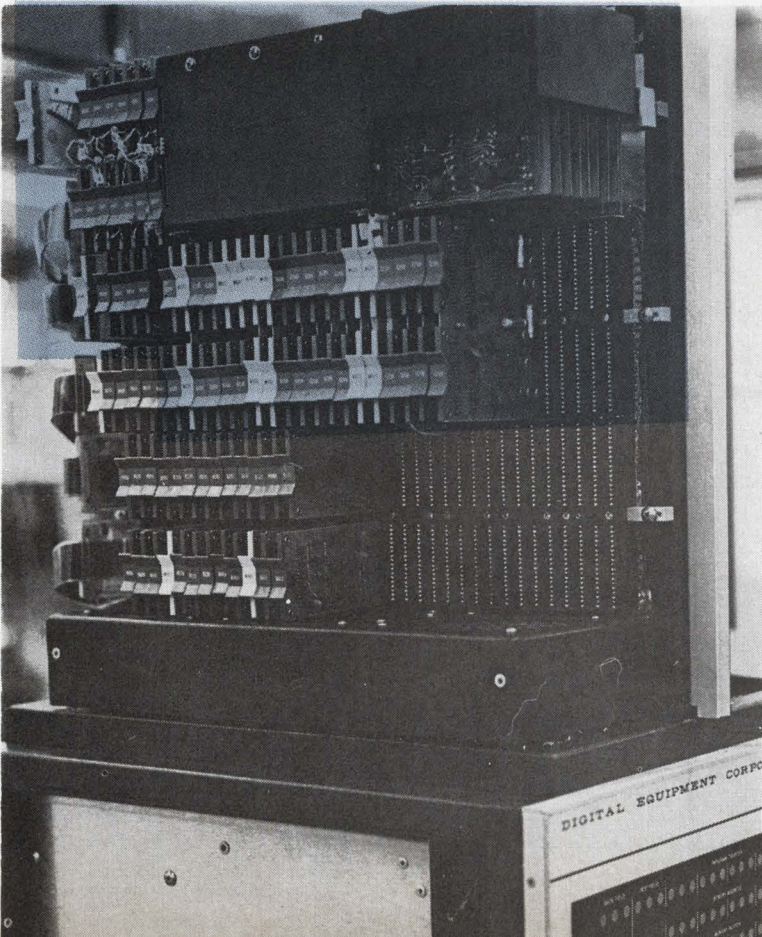

**Before and after.** The big black box is the memory assembly for the old PDP-8. The small assembly above stores just as much data and makes it accessible just as fast.



## Three little computers and how they shrank

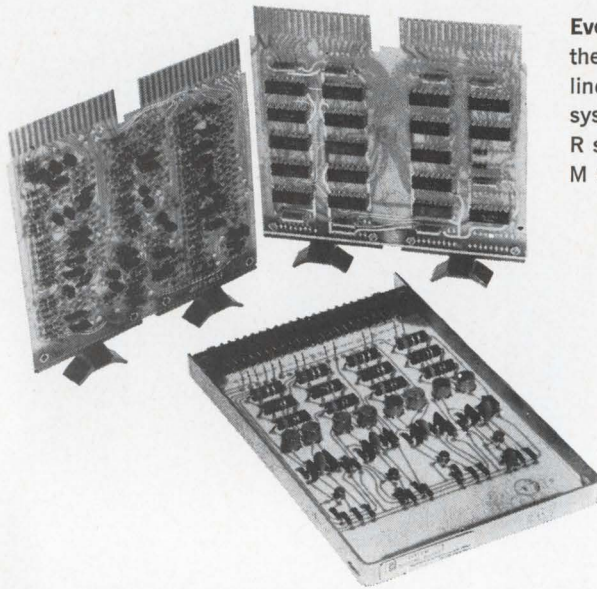

**Evolution.** Three stages in the development of DEC's line of circuit modules; the system modules at bottom, R series at left, and new M series at right.

**Granddaddy.** Digital Equipment's first small computer, the PDP-5, was introduced in 1963.

It was built with system modules.

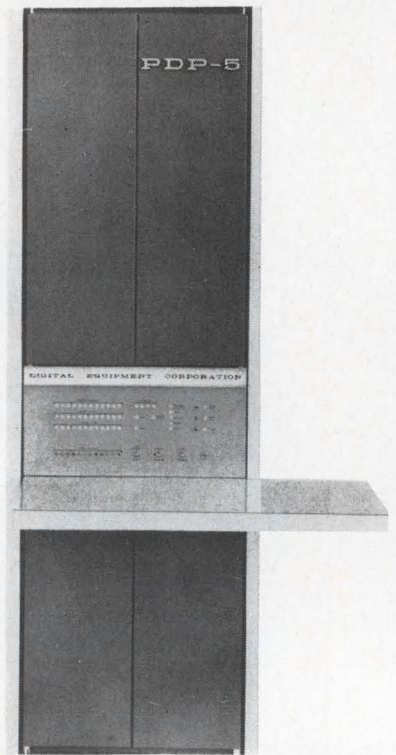

The evolution of modules from the earliest discrete solid state circuits to monolithic integrated circuits is illustrated by those shown above, used by Digital Equipment in its machines.

At the bottom of the photo is a typical system module, made with germanium transistors. These modules are large and rigidly supported so they can withstand extended experimentation. They were also used in DEC's PDP-5 computer, introduced in 1963. The computer is no longer in production, but the modules are; they're still being sold as replacement parts and for experiments and instruction.

The smaller R- and S-series modules, carrying DEC's trade name "Flip-Chip," are made with silicon transistors. The typical double-height module at the left has 36 pins on its connector edge; a single-height module would have only 18. The double-height modules are less rigidly built because most of them are used either by DEC in its own computers—such as PDP-8—or by customers in their own systems; the modules, once plugged into the systems, aren't very likely to be changed.

The M-series modules, with monolithic IC's, are used in the PDP-8/1. They have more logic and more kinds of logic than the earlier versions.

The three computers are program-compatible, so they illustrate the size reductions and increased capability made possible by module evolution. The PDP-5, above right, occupies a whole rack; it stands on the floor and is as tall as a man. The PDP-8, at the right, is a tabletop machine, but most people would have to stand on tiptoe to see over it. The PDP-8/1 is also a tabletop computer, but the operator can see over it while sitting down. The 8/1 is also available in a rack-mounted version that has plenty of extra space for external options or associated instruments.

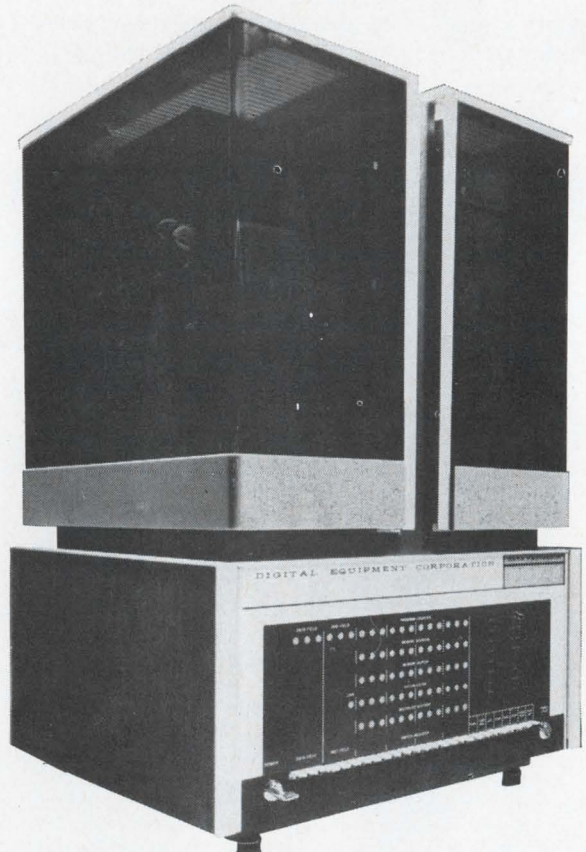

**Daddy.** The three-year-old PDP-8 has been used as a subassembly in many instrumentation and process-control systems.



memory systems use baluns to connect the two lines.

But in the PDP-8/I, a switch consisting of four diodes and one discrete transistor, shown at right, replaces the bulky and expensive balun. What's more, two of the diodes are "free" because they would be required even with baluns. Thirty-two of these switches are used; they select one of two sets of 64 wires threading the cores in the memory. Each wire passes through 64 cores—each threaded by a different wire in the other set—in a single plane, and passes through all 12 planes, for a total of 768 cores.

### Testing cuts costs

DEC, which regularly tests all the components it buys, developed a special test procedure for IC's as part of the PDP-8/I project. Defects are found and eliminated before assembly is started.

Forty static tests and 16 dynamic tests, performed in slightly more than one second, measure minimum and maximum voltage and current levels at the circuit inputs, propagation times—using worst-case waveforms of minimum amplitude—and, in general, all the manufacturer's specifications.

The more complicated IC's, of course, take longer to test; the gated full adder, for example, has so many specifications that its computer-controlled testing takes 30 seconds.

The modules are tested both before and after the IC's are inserted. The back-panel wiring is tested before the modules are inserted, and the complete computer is also tested. All these checks

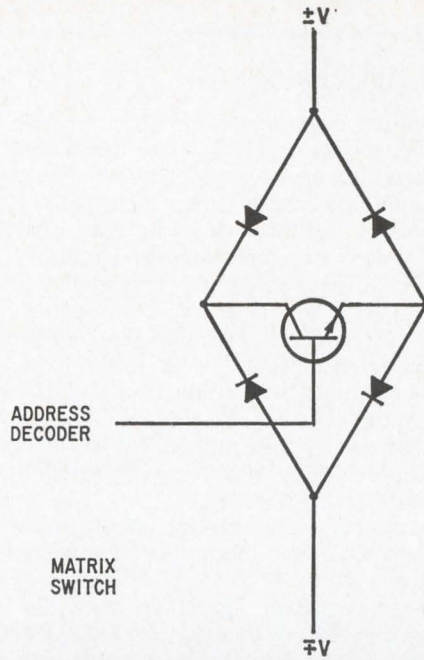

### TYPICAL APPLICATION

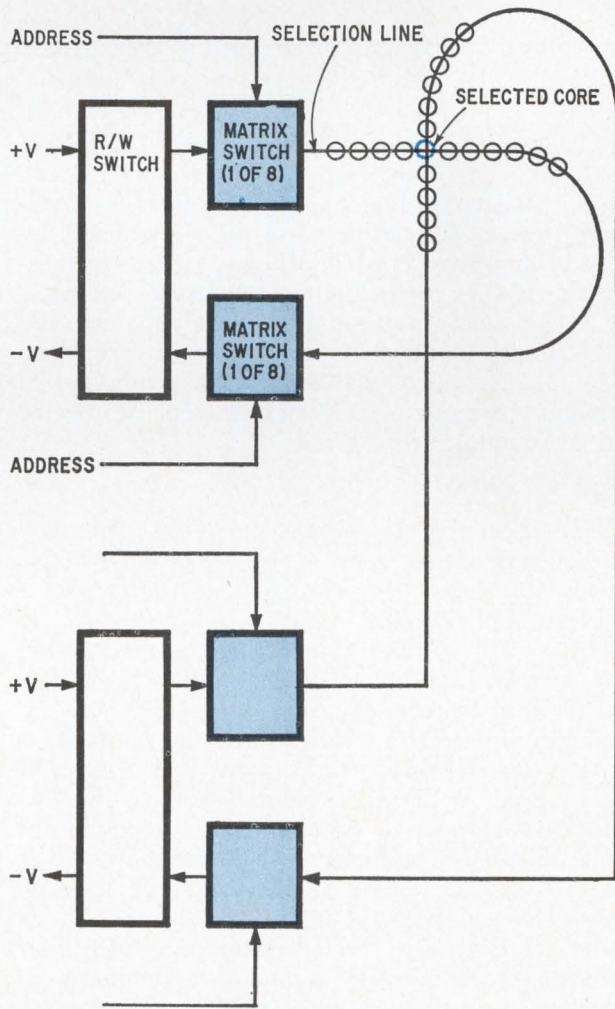

**Matrix switch.** Four diodes and a transistor replace a pulse transformer, helping to reduce the size of the PDP-8/I memory.

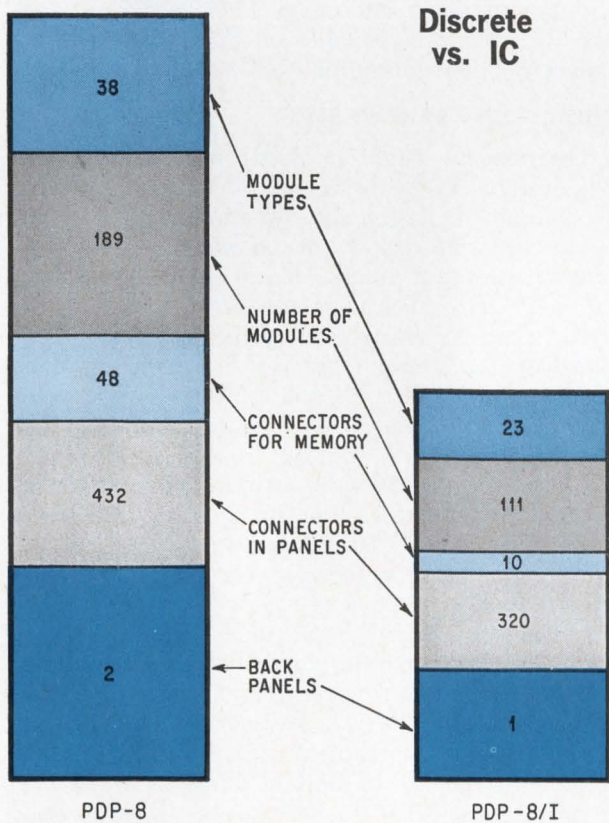



## The PDP-8 is still kicking

A new computer that can run any program written for an older model, connect to all the same peripheral devices, fit in much less space, and still cost almost a third less might be expected to wipe out the market for the older machine. But this hasn't happened with the PDP-8 and 8/I, nor with other pairs of compatible machines that Digital Equipment has marketed.

Most of DEC's sales are to makers of equipment that use a small computer as a subassembly. These manufacturers buy the machines in relatively large quantities, and redesigning their products around the new computer would require a major retooling at great expense. It's much more economical—at least for the time being—to stay with the older model, even though it costs more per unit.

Another fountain of youth for the older model is that introduction of a less costly new one often entices prospective customers to start thinking seriously of computerizing their operation; they discover advantages they hadn't thought of previously. But when deliveries of the new machines won't start for several months or even a year, sales of the old machines actually increase for a short period.

The 8/I has been so well received in the few months since its first shipments that its production



**Going strong.** This computerized typesetting system is only one of many current products built around the PDP-8 (left).

rate is three to four times that of the 8. However, the latter will never be completely discontinued, although it will probably be phased out of full-scale production before too long.

are made under worst-case conditions.

Detection is a special problem in modules containing sequential logic instead of purely combinational forms. The outputs of a sequential-logic device at any given time depend on its previous inputs as well as on its inputs at that time; examples of such devices are counters, shift registers, and even simple flip-flops. On these modules, test points permit detection of signals ordinarily not needed outside the module and establishment of specific initial conditions for testing.

### Optional extras

The logic for the optional features described earlier may use standard modules like those in the central processor or special modules designed for specific applications.

For example, the extended memory control and the extended arithmetic use modules essentially identical to those in the basic machine. These are complex options and would require several modules even if special ones were designed. But some of the simpler options can have all their controls packaged on a single special-purpose module. For example, an electromechanical device may require an initial delay while the device starts moving; this delay can be incorporated in the control circuitry through the time constant of a capacitor and resistor mounted on a module containing both discrete components and IC's. The PDP-8/I contains several kinds of such hybrid modules as well as the IC variety. These special-purpose modules are simple to install and make it easy to change

from one option to another very quickly.

Other special modules include those for the real-time clock option available for the PDP-8/I. The option comprises one double-height module and two single-height modules, all of which are plugged into the machine internally. They provide a capability that was available on the PDP-8 only by connecting an external rack containing 12 modules.

### Where do we go from here?

The machine might be made even smaller and less costly through the use of serial techniques or of medium- or large-scale integration. Serial computers are quite slow, of course, because they process one bit at a time. In any event, the outlook for these approaches seems doubtful.

DEC brought out a serial computer, the PDP-8/S, shortly before introducing the 8/I. The existence of the 8/S—the first computer with a price less than \$10,000—might at first glance indicate that a serial IC machine would be feasible and economical. However, the PDP-8/L, a kind of stripped-down 8/I that nevertheless remains a fully parallel 12-bit machine, costs only \$8,500 and seems to serve the same market that a serial IC computer would be aimed at.

MSI or LSI wouldn't be of much value unless the entire machine were designed that way, especially with a different circuit form, such as metal oxide semiconductor. When LSI is partially used, it generally appears in features, such as scratch-pad memories, that are of limited value in small machines.



# Designer's casebook

## Operational amplifier simulates inductance

By Anthony C. Caggiano  
Ridge, N.Y.

**Although inductance** isn't physically realizable in integrated circuits, designers can achieve its effects by manipulating the parameters of solid state amplifiers. High Q, good stability, and versatility are possible in an inductance simulator when the input and feedback resistors of an op amp are properly selected.

Input impedance of the operational amplifier is expressed by

$$Z_{in} = \frac{R_1 + sR_1R_2C_1}{sC_1(R_1 + R_2 - AR_1) + 1}$$

When  $R_1$  and  $R_2$  are selected so that

$$\frac{R_1}{R_2} = \frac{1}{A-1}$$

the first equation then reduces to

$$Z_{in} = R_1 + sC_1R_1R_2$$

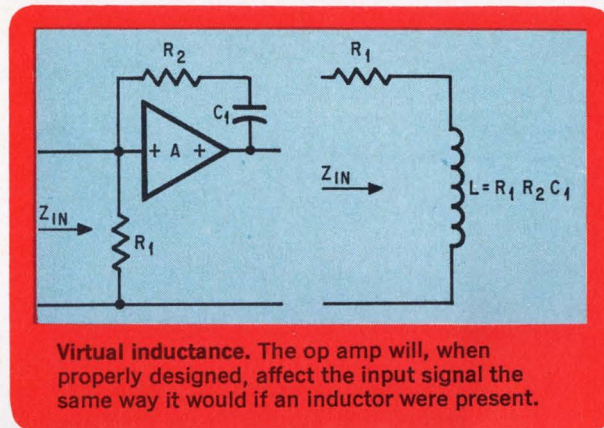

**Virtual inductance.** The op amp will, when properly designed, affect the input signal the same way it would if an inductor were present.

because the term

$$sC_1(R_1 + R_2 - AR_1)$$

becomes zero.

Thus,

$$Z_{in} \pm R_1 + sC_1R_1R_2$$

A resistance in series with an inductance is the circuit this equation represents. At an input frequency of 20 kilohertz, the Q of the circuit is 10. By decreasing the value of  $R_1$ , the stability of the circuit increases along with the Q.

## Transistor increases zener's power capability

By John O. Schroeder  
RCA Laboratories, Princeton, N.J.

**A low-current zener** controlling a transistor can be used to establish a voltage level in a high-power circuit. Such a circuit costs several times less than the power zener that would otherwise be required.

A positive voltage of less than 24 volts at the zener's anode and at the transistor's collector causes no current flow in either device. As the supply reaches 24 volts it causes the zener to conduct, so a voltage is developed across the 1-kilohm resistor. This voltage biases the transistor on, and

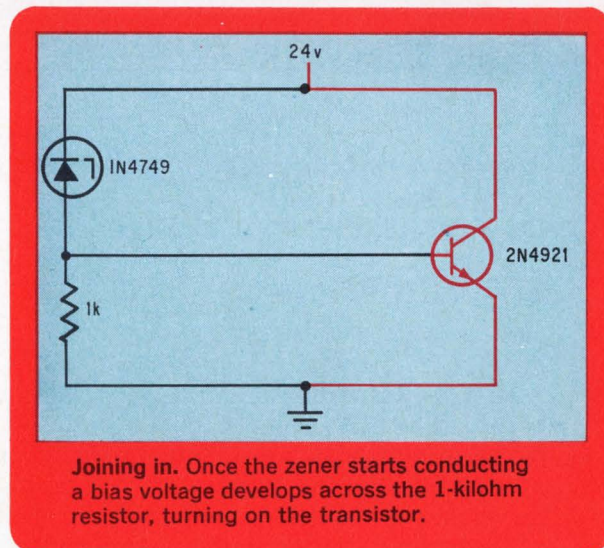

**Joining in.** Once the zener starts conducting a bias voltage develops across the 1-kilohm resistor, turning on the transistor.



most of the supply current flows between collector and emitter; the saturated transistor has a lower resistance than the zener. To keep the transistor in conduction, the zener must supply a small base current equal to the collector current divided by

the d-c current gain.

With judicious selection of devices, an extremely wide latitude of voltage and current requirements can be handled with this simple zener-transistor circuit.

## SCS outperforms UJT in relaxation oscillator

By Joseph S. Hayhurst

National Cash Register Co., Cambridge, Ohio

**Silicon controlled switches** can replace the conventional unijunction transistor in relaxation oscillators,

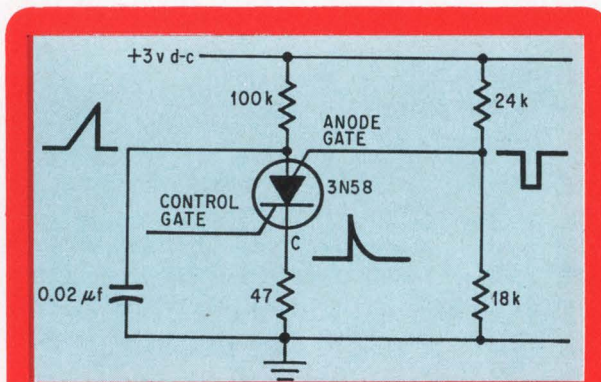

**Switching oscillator.** Compared with UJT versions, the SCS, with its simpler construction and lower dynamic resistance, yields a more efficient oscillator.

tors, timing generators, and delay timers. In these applications, the SCS consumes less power than the UJT, generates a more powerful output pulse, and sharpens both the leading and falling edges of the pulse.

With the addition of high external resistor values, the SCS oscillator dissipates about 10 times less power than the UJT version while producing the same waveforms. Due to the lower dynamic resistance of the SCS itself, rise times are faster and pulse power greater than the unijunction oscillator can provide.

The firing point of the SCS can be conveniently controlled by varying the ratio of the anode gate resistors. The cathode gate provides a means of external control by which timing intervals and clock pulses can be initiated.

Another advantage of the SCS oscillator is its ability to operate at extremely low voltage levels; satisfactory performance has been achieved at as low as 2 volts.

Replacing the cathode resistor with a suitable lamp or relay will produce a circuit combining timing and load-driver functions.

Frequency of oscillation of the circuit shown is approximately 1 kilohertz with the component values shown. Pulse rise times are on the order of 60 nanoseconds.

## Tester measures resistance of multilayer p-c boards

By Douglas Haggan

Burroughs Corp., Plainfield, N.J.

**During the inspection** of multilayer printed circuit boards, the resistance of certain critical runs must be measured. A go-no-go tester built around an operational amplifier can do the job faster than the digital ohmmeter method presently used.

The current source forces a regulated current

through the unknown resistance, and the voltage developed is applied to the input of the integrated-circuit operational amplifier. Coaxial leads probe the unknown resistance; the outside braid carries the current to the unknown resistance, and the inside conductor is used for one of the operational amplifier's sensing leads. The operational amplifier is adjusted for a voltage gain of 100. This produces 6 volts at the output of the op amp—also at the base of  $Q_1$ —when 200 milliamperes are forced through a resistance of 0.3 ohm. When the unknown resistance exceeds 0.3 ohm by approximately 0.01 ohm, the lamp in the detector circuit goes out, indicating a high resistance condition.



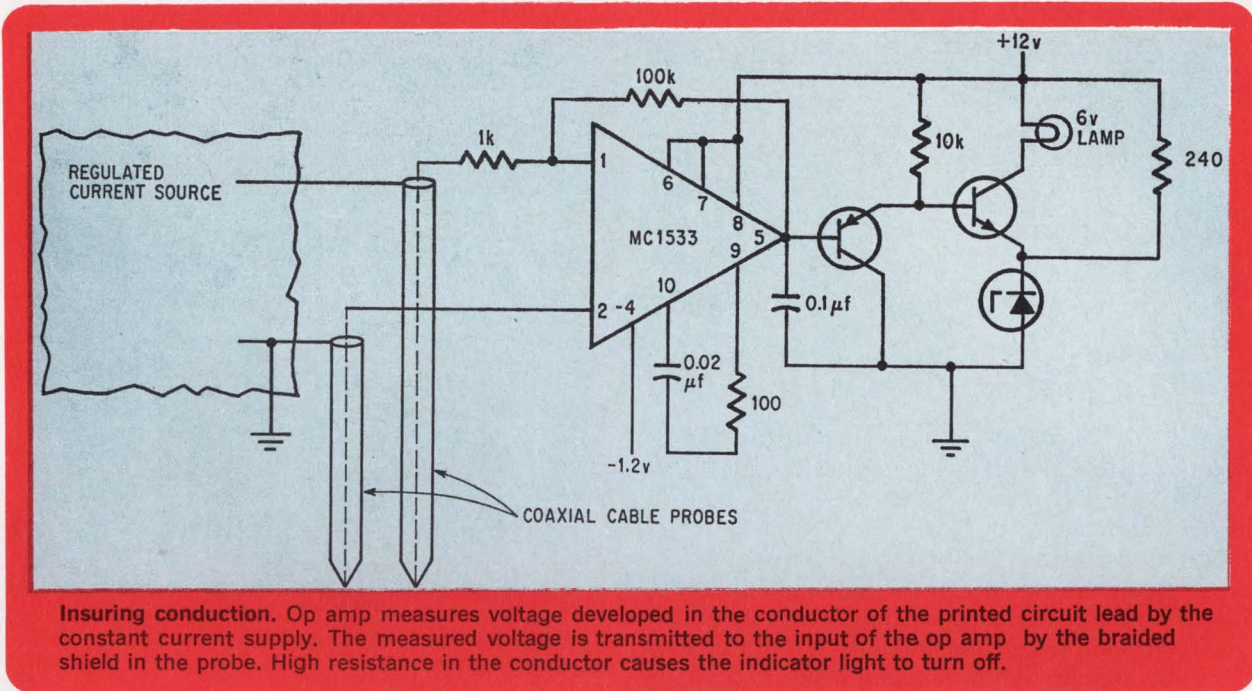

The detector circuit composed of transistors  $Q_1$  and  $Q_2$  and zener reference  $D_1$  compares the voltage at the base of  $Q_1$  to the reference voltage,  $D_1$ . When the voltage at the base of  $Q_1$  is less than the refer-

ence voltage, transistor  $Q_2$  is turned off and the lamp is out. Conversely, when the voltage at the base of  $Q_1$  exceeds the reference voltage, transistor  $Q_2$  is turned on.

## Simple logic configuration compares 8-bit numbers

By Gregory M. Cinque  
CBS Laboratories, Stamford, Conn.

In digital arithmetic units with fast parallel adders, it's frequently necessary to determine if one binary number is larger than another. A fast all-parallel method, capable of comparing numbers with as many as 8 bits, can be used. If fan-in and fan-out requirements are considered, this method can be used for larger numbers since it is always possible to subdivide larger numbers into 8-bit blocks and examine the higher order bits first.

The relationship between two 2-bit numbers—here designated  $A_1A_2$  and  $B_1B_2$ —can be examined on a Karnaugh map. For example when  $A_1A_2$  is 01 and  $B_1B_2$  is 00— $A_1A_2$  larger than  $B_1B_2$ —then a 1 is placed in the appropriate box. Other comparisons

result in the Karnaugh map as shown. From the Karnaugh map we get

$$A > B = A_1\bar{B}_1 + A_1A_2\bar{B}_2 + A_2\bar{B}_1\bar{B}_2$$

This may be simplified to read

$$A > B = A_1B_1 + (\bar{B}_1\bar{A}_1)A_2\bar{B}_2$$

For any two bit positions  $A_1, B_1$

$A_1$	$B_1$	
0	0	
0	1	$B_1\bar{A}_1 = B_1 > A_1$
1	0	$A_1\bar{B}_1 = A_1 > B_1$
1	1	

Therefore, in the above example we have

$$A > B = (A_1 > B_1) + (\bar{B}_1 > \bar{A}_1)(A_2 > B_2)$$

which says: A is greater than B if  $A_1$  is greater than



$B_1$  or if  $B_1$  is not greater than  $A_1$  and  $A_2$  is greater than  $B_2$ .

The equation may be expanded for any length number as shown below:

$$A > B = A_1 > B_1 + (\overline{B_1 > A_1}) (A_2 > B_2) + (\overline{B_1 > A_1}) (\overline{B_2 > A_2}) (A_3 > B_3) + \dots (\overline{B_1 > A_1}) (\overline{B_2 > A_2}) \dots (\overline{B_{N-1} > A_{N-1}}) (A_N > B_N)$$

where for any bit position

$$\begin{aligned} A_i > B_i &= A_i \overline{B_i} \\ \overline{B_i > A_i} &= \overline{B_i} \overline{A_i} \end{aligned}$$

An all parallel logic implementation for two 4-bit numbers is shown below where NAND/NAND positive logic is used since NAND/NAND is equivalent to AND/OR.

Very large binary numbers, such as one 64-bits long, can be broken up into eight 8-bit numbers. Each 8-bit block is compared and the results of this first level comparison are put into a second level of similar logic to obtain the final result as a single output.

Often it is necessary to determine if  $A \geq B$ . At first it may seem that the question of equivalency will impose the requirement of the use of a separate comparator. This, however, is not the case. If the question is restated as is  $A > B$  the problem is simplified for if  $A$  is not greater than  $B$ , then  $B$

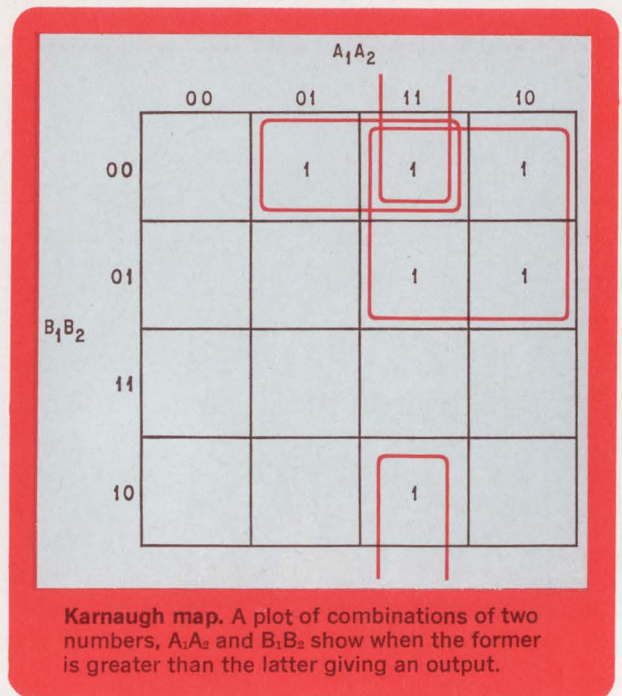

**Karnaugh map.** A plot of combinations of two numbers,  $A_1A_2$  and  $B_1B_2$  show when the former is greater than the latter giving an output.

is greater than or equal to  $A$ . Hence all that is required is an extra inverter since

$$\overline{A > B} = B \geq A$$

If one of the numbers in the comparison is known,

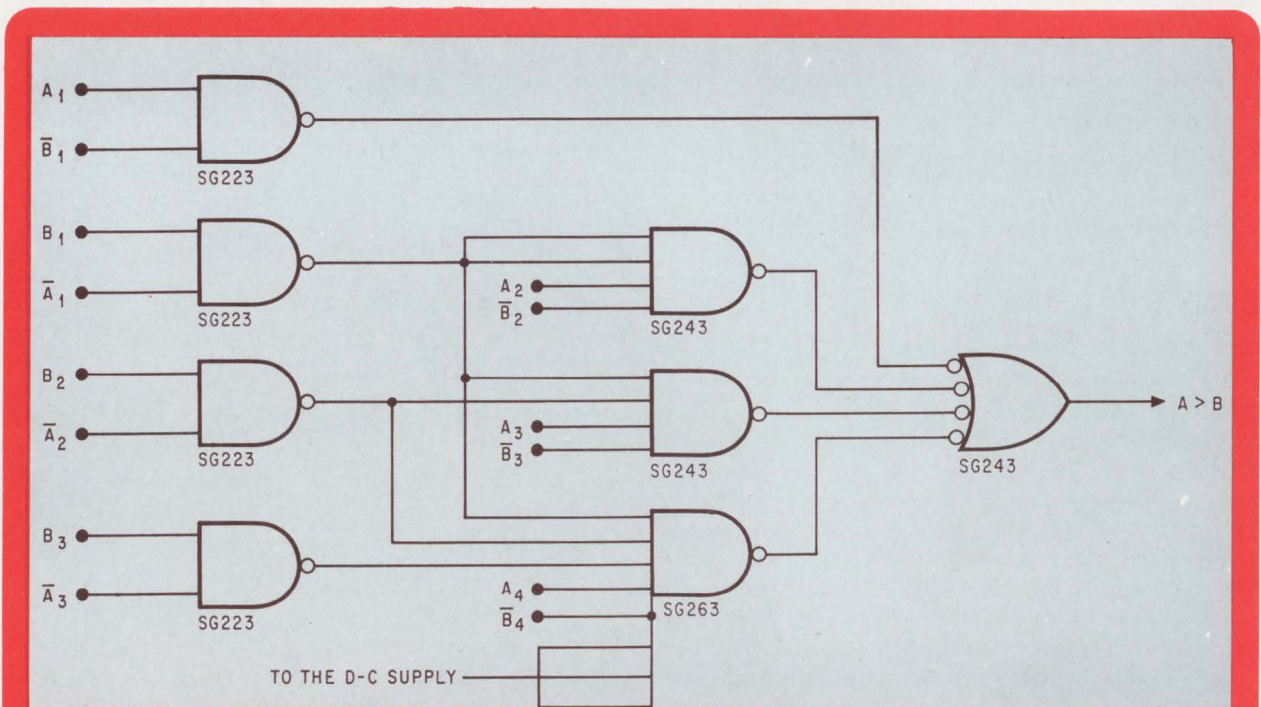

**Basic principle.** Any number, digitally represented, can be compared with any other number by using a circuit made up of NAND gates. Actually, the configuration is NAND/NAND which performs AND/OR operations. This circuit will compare two 4-bit numbers and deliver an output when the number  $A$  is larger than the number  $B$ .



the problem is simplified. In a recent arithmetic calculation it was required to know if  $X > 492$ . The two numbers are shown below.

$$492 = 1\ 1\ 1\ 1\ 0\ 1\ 1\ 0\ 0$$

$$X = X_1 X_2 X_3 X_4 X_5 X_6 X_7 X_8 X_9$$

Logic was used to determine if  $492 > X$ .

Then

$$\overline{492 > X} = X \geq 492$$

Using the equations derived for  $A > B$  where  $A = 492$  and  $B = X$  we obtain

$$492 > X = \bar{X}_1 + \bar{X}_2 + \bar{X}_3 + \bar{X}_4 + \bar{X}_5 + \bar{X}_6 + \bar{X}_7$$

Converting to NAND/NAND we obtain

$$\overline{492 > X} = X \geq 492$$

$$= X_1 X_2 X_3 X_4 (\bar{X}_5 \bar{X}_6) (\bar{X}_5 \bar{X}_7)$$

The logic is shown below.

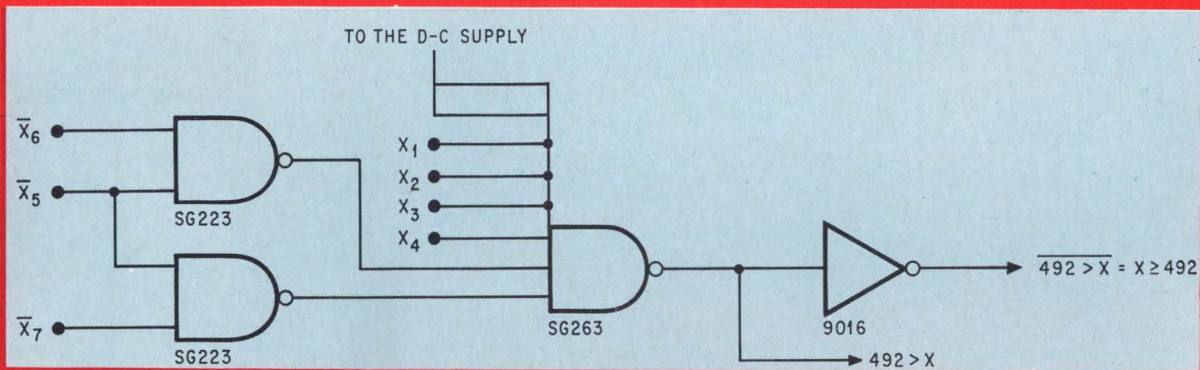

**Practical comparison.** In comparing the number 492 with any other number, two NAND gates and an inverter are used. This circuit is far simpler than the more general one shown because one of the numbers, 492 in this case, is known, and hence some decisions can be designed into the circuit.

## Parallel-T bandpass filter produces voltage gain

By James J. Murphy

Mountain View, Calif.

The simple interchange of a resistor and a capacitor in a parallel-T, band-rejection filter gives the filter a bandpass characteristic. The bandpass filter can be designed to have zero attenuation at its center frequency and can also be designed to exhibit voltage gain at mid-band. The interchange is between resistor  $R_1$  and capacitor  $C_2$ .

The circuit is designed using values for  $C_1 = C$  and  $R_3 = R$ , where  $1/RC = 2\pi f_0$ , with  $f_0$  the center frequency. The other components are related to  $R$  and  $C$  through arbitrary constants  $b$  and  $k$  as follows:  $R_1 = kR$ ;  $R_2 = bR$ ;  $C_2 = C/k$  and  $C_3 = C/b$ .

The condition for zero attenuation at the center frequency,  $f_0$ , is  $b = k/k - 1$ , while the condition for a maximum transfer function—voltage gain greater

than 1—at  $f_0$  is  $b = (k/k - 1) (1 + (2k/k + 1)^2)$ .

The output of the filter is in phase with the input at the center frequency. Absolute maximum gain occurs when  $k$  approaches infinity and  $b$  is 1.207. As a practical matter,  $k$  need not be any greater than 100. The gain will be 1.2.

One application is in an oscillator where the filter output supplies its own input through a buffer to prevent loading.

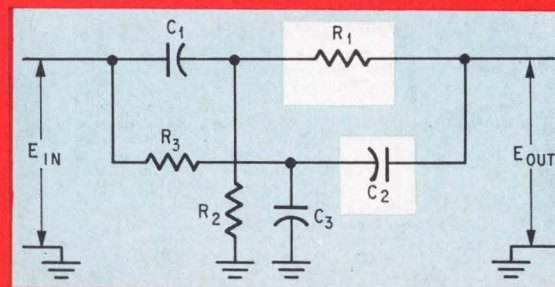

**Bandpass RC filter.** Components  $R_1$  and  $C_2$ , change places in a band rejection filter to give a bandpass characteristic.



# INTRODUCING



## THE SERIES 6000 DIGITAL COMPUTER SYSTEM

The SERIES 6000 COMPUTER SYSTEM is the newest, fastest, most powerful 24-bit digital computing system available and is ideally suited for real-time simulation, process control and scientific applications.

A desk or rack mountable basic DC 6024 computer, including five 24-bit general purpose registers, a 4096-word memory, hardware multiply/divide/square root, four true levels of priority interrupt and an ASR-33 typewriter sells for \$49,500.

For additional specifications and pricing information, call or write Datacraft today. P.O. Box 23550, Fort Lauderdale, Florida 33307. Phone (305) 565-9441.

### FEATURES:

Full Cycle Time .....	600 Nanoseconds
Full Word Fixed Point Execution Times	
Add/Subtract .....	1.2 Microseconds
Multiply .....	4.8 Microseconds
Divide .....	9.0 Microseconds
Square Root .....	8.4 Microseconds
Fourth Generation Hardware	
65K Word Storage	
80 True Levels of Priority Interrupts	
Hardware Square Root	
Full Word, Byte and Operand Manipulation	
Automatic Data Transfer	
Memory Area Protect	

*Datacraft  
Corporation*

776 N.E. 40th Court P.O. Box 23550 Ft. Lauderdale, Fla. 33307 Phone (305) 565-9441



# Active filters: part 4

## Approaching the ideal NIC

Several proposed circuits yield negative-impedance converters with the characteristics required to produce accurate transfer functions

By Louis de Pian and Arnold Meltzer

George Washington University, Washington

**Techniques for designing** filters from transfer functions produced by negative-impedance converters connected to RC networks usually assume an ideal NIC. That assumption isn't so far-fetched; there are several configurations in which NIC's have near-ideal characteristics for the job.

The NIC is a two-port device whose input impedance is—ideally—the negative of the impedance at its output terminals. This effect stems from either current or voltage inversion.

When it inverts current flow in a direction opposite to the normal one in a passive resistor-capacitor network, the NIC does so without disturbing the polarity of the input and output voltages. For example, if a current,  $I_2$ , flows out of port two in a network with a load impedance,  $Z_0$ , an engineer expects a current,  $I_1$ , to flow into port one—if the output and input voltages,  $E_2$  and  $E_1$ , have the same polarity. If the two-port device somehow inverts one of these currents,  $E_1$  causes a current flow in an opposite direction and opposes the applied voltage. The input impedance is therefore negative, and

$$E_1 = E_2; I_1 = kI_2$$

These equations define an ideal current-inversion negative-impedance converter, INIC. The constant,  $k$ , is the device's gain, and the input impedance,  $Z_{in}$ , equals

$$E_1/I_1 = Z_0/k$$

The input impedance is  $1/k$  times the negative load impedance,  $Z_0$ , so the magnitude of this negative impedance can be varied by changing  $k$ .

Similarly, if impedance  $Z_1$  is connected across the input, the output impedance  $Z_{out}$  equals

$$E_2/I_2 = -kZ_1$$

In this case, the INIC gives the same result in both directions when  $k$  equals unity.

When the voltage is inverted, the direction of current flow through the device remains unchanged. The ideal voltage-inversion negative-impedance converter, VNIC, is defined by

$$I_1 = -I_2; E_1 = kE_2$$

### Voltage inversions

In 1953, John Linvill<sup>1</sup> designed the first transistorized NICs. This circuit, which was a-c coupled and operated in the voltage-inversion mode, is shown on page 106 without biasing elements. Neglecting the coupling capacitors and assuming audio-frequency operation so that the transistors' collector capacitance can be ignored, the low-frequency  $g$  parameters can be calculated as

$$g_{11} = \frac{1 - \alpha_2}{R_1 + r_{e2} + r_{b2}(1 - \alpha_2)}$$

$$g_{12} = -\alpha_1$$

$$g_{21} = \frac{-\alpha_2 R_2}{R_1 + r_{e2} + r_{b2}(1 - \alpha_2)}$$

$$g_{22} = r_{e1} + (r_{b1} + R_2)(1 - \alpha_1)$$

If we make  $R_1 \gg r_{e2} + r_{b2}(1 - \alpha_2)$

then the product  $g_{12} g_{21}$  is

$$g_{12} g_{21} \approx \alpha_1 \alpha_2 \frac{R_2}{R_1}$$

If  $R_1 = R_2$  and  $\alpha_1 = \alpha_2 \approx 1$ , the circuit

approximates an ideal voltage inversion NIC.



# Lundry

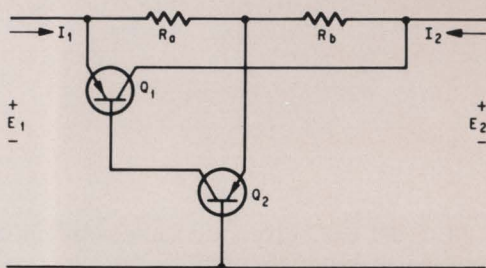
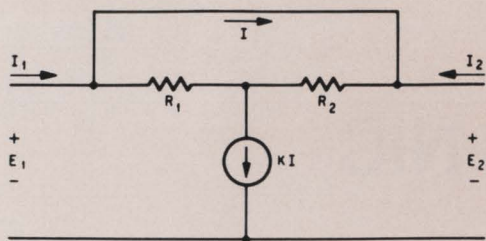

**Practical  
NIC's  
provide  
efficient  
low-pass  
filters**

# Larky

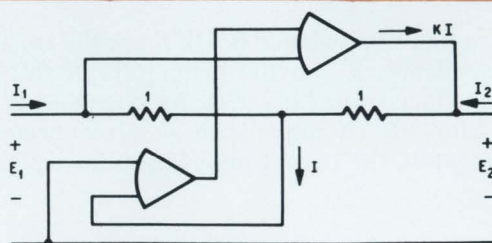
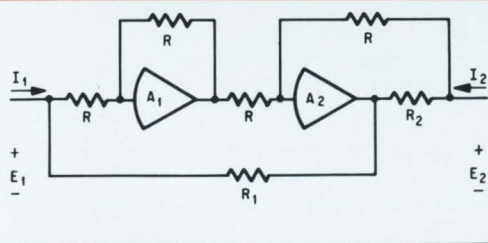
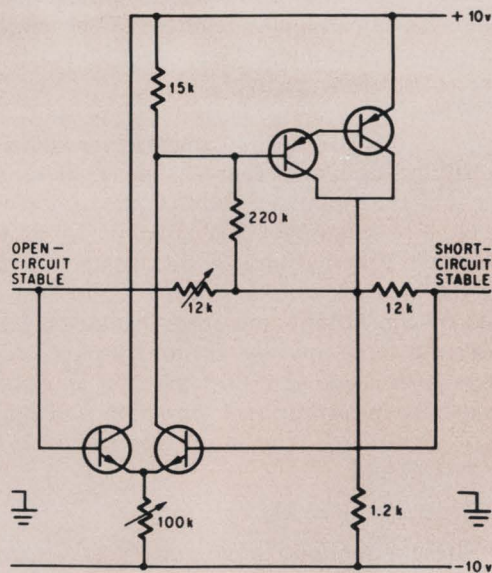
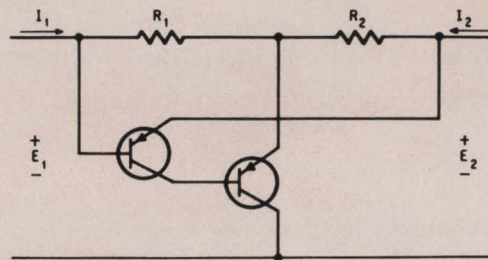
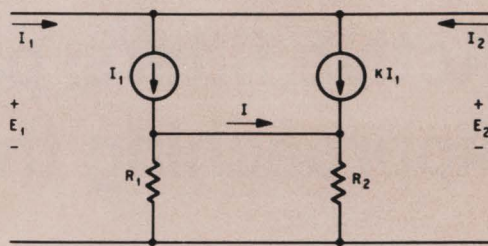



Since the gain of this circuit is linearly dependent on both  $\alpha_1$  and  $\alpha_2$ , a Darlington pair is usually used in place of each of the transistors to achieve low sensitivity. A complete circuit developed by Linvill with Darlington pairs is shown on page 106.

Another voltage-inversion NIC, this one proposed by W.R. Lundry in 1957,<sup>2</sup> can be understood by considering the arrangement at the top of the third column. Here the generator is a current-controlled current source. If  $k$  is made very large, the transfer matrix of the circuit approaches

$$[F] = \begin{bmatrix} -\frac{R_a}{R_b} & 0 \\ 0 & 1 \end{bmatrix}$$

If  $R_a = R_b$ , this is the transfer matrix of an ideal voltage-inversion NIC. A transistorized version of this circuit is shown without biasing components; it's d-c coupled and works well at low frequencies.

An INIC proposed by A.I. Larky in 1957<sup>3</sup> is based on the circuit at the top of the fourth column, where KI is a current-controlled source whose current gain approaches infinity. Under such conditions the  $g$  parameters of the circuit approach

$$g_{11} = g_{22} = 0, \quad g_{21} = 1, \quad g_{12} = \frac{R_1}{R_2}$$

A current-inversion NIC with unity gain ( $k=1$ ) results when  $R_1 = R_2$ .

Approximated without biasing elements, the circuit is d-c coupled and is less sensitive than the Linvill circuit to variations in transistor current gain. The Larky INIC is similar in structure to the Lundry VNIC and can use the same current source.

A transistorized INIC of the Larky type was developed in 1965 by D.P. Franklin.<sup>4</sup> Direct-coupled, it uses an emitter-coupled pair in place of a single input transistor, and a Darlington pair in place of the output transistor.

A circuit proposed by T. Yanagisawa yields yet another INIC.<sup>5</sup> For the network at the top of the second column,

$$E_1 = E_2 \quad \text{and} \quad \frac{I_1}{I_2} = \frac{KR_1}{(K+1)R_2 + R_1}$$

Thus, for a large value of  $K$ , or over-all gain,

$$\frac{I_1}{I_2} \approx \frac{R_1}{R_2}$$

and if  $R_1 = R_2$ , the circuit behaves as a negative-impedance converter with unity gain.

A transistorized circuit that approximates this network is shown with the biasing elements omitted. The small-signal equivalent of this circuit can be approximated as shown at the bottom of the second column if the collector resistors are ignored.

If  $r_c$  and  $r_b$  of the transistors are small compared

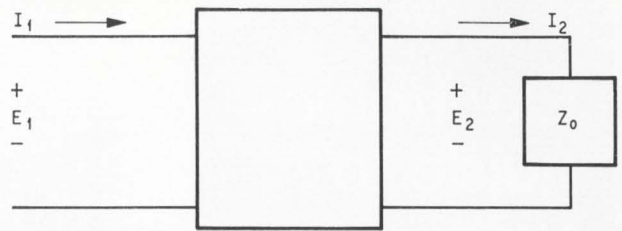

**Basic NIC.** By definition, the NIC has an input impedance,  $Z_{in}$ , that is equal to the negative of the output,  $Z_o$ .

to  $R_1$  and  $R_2$ , and if the transistors'  $\beta$  is large ( $\beta \gg 1$ ), the circuit approximates the ideal.

A complete negative-impedance converter of the Yanagisawa type, including biasing elements and provisions for adjusting the offset currents at the ports and maintaining the proper conversion ratio, was developed by A.J. Drew and J. Gorski-Popiel in 1964.<sup>6</sup> Their circuit is shown at the bottom of the second column.

All the circuits discussed here are practical and manufacturable. If the transistorized versions have any drawback, though, it would be their relative frequency instability. This problem has been solved by the advent of integrated-circuit operational amplifiers with their high input impedance and low output impedance.

Of the several op-amp circuits that have been proposed as negative-impedance converters, three are shown here. In these configurations, when  $R_1 = R_2$ ,

$$g_{11} \approx \frac{(R + R_1)^2}{R_1 R^2 G_2}, \quad g_{12} \approx 1 - \frac{R_1 (R + R_1)}{R_1 R G_2}$$

$$g_{21} \approx 1 - \frac{(R + R_1)}{R G_2}, \quad g_{22} \approx \frac{R_1}{G_2}$$

where  $G_2$  is the voltage gain of operational amplifier  $A_2$ ;  $G_2 \rightarrow \infty$  is then used to obtain:

$$g_{11} \rightarrow 0, \quad g_{22} \rightarrow 0, \quad g_{12} = g_{21} = 1.$$

## References

1. J.G. Linvill, "A New RC Filter Employing Active Elements," Proc. National Electronics Conference, vol. 9, September 1953, pp. 342-352.
2. W.R. Lundry, "Negative Impedance Circuits—Some Basic Relations and Limitations," IRE Trans. Circuit Theory, vol. CT-4, No. 3, September 1957, pp. 132-139.
3. A.I. Larky, "Negative Impedance Converters," *ibid*, pp. 124-131.
4. D.P. Franklin, "Direct-Coupled Negative-Impedance Converter," Electronic Letters, vol. 1, No. 1, March 1965.
5. T. Yanagisawa, "RC Active Networks Using Current-Inversion-Type Negative-Impedance Converters," IRE Trans. Circuit Theory, vol. CT-4, No. 3, September 1967, pp. 140-144.
6. A.J. Drew and J. Gorski-Popiel, "Directly Coupled Negative-Impedance Converter," Proceedings IEEE, vol. 111, No. 7, July

## Bibliography

- L.P. Huelsman, "Theory and Design of Active RC Circuits," McGraw-Hill Book Co., 1968, p. 1282-1283.



# Electronics' guide to NIC's

## Basic idea

### Yanagisawa

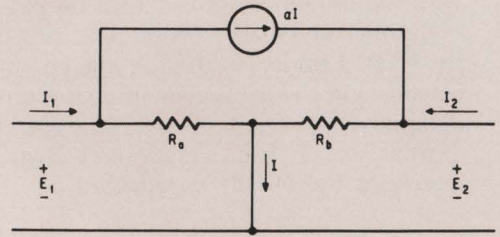

### Linville

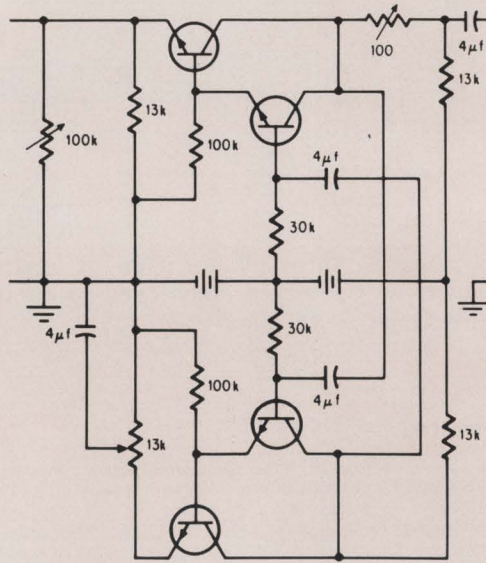
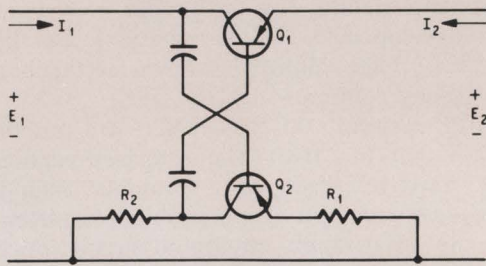

## NIC's without biasing

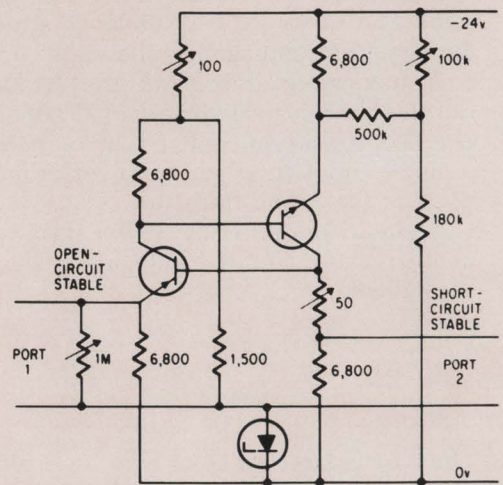

## NIC's achieved with operational amplifiers

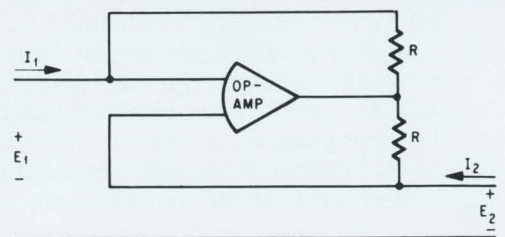



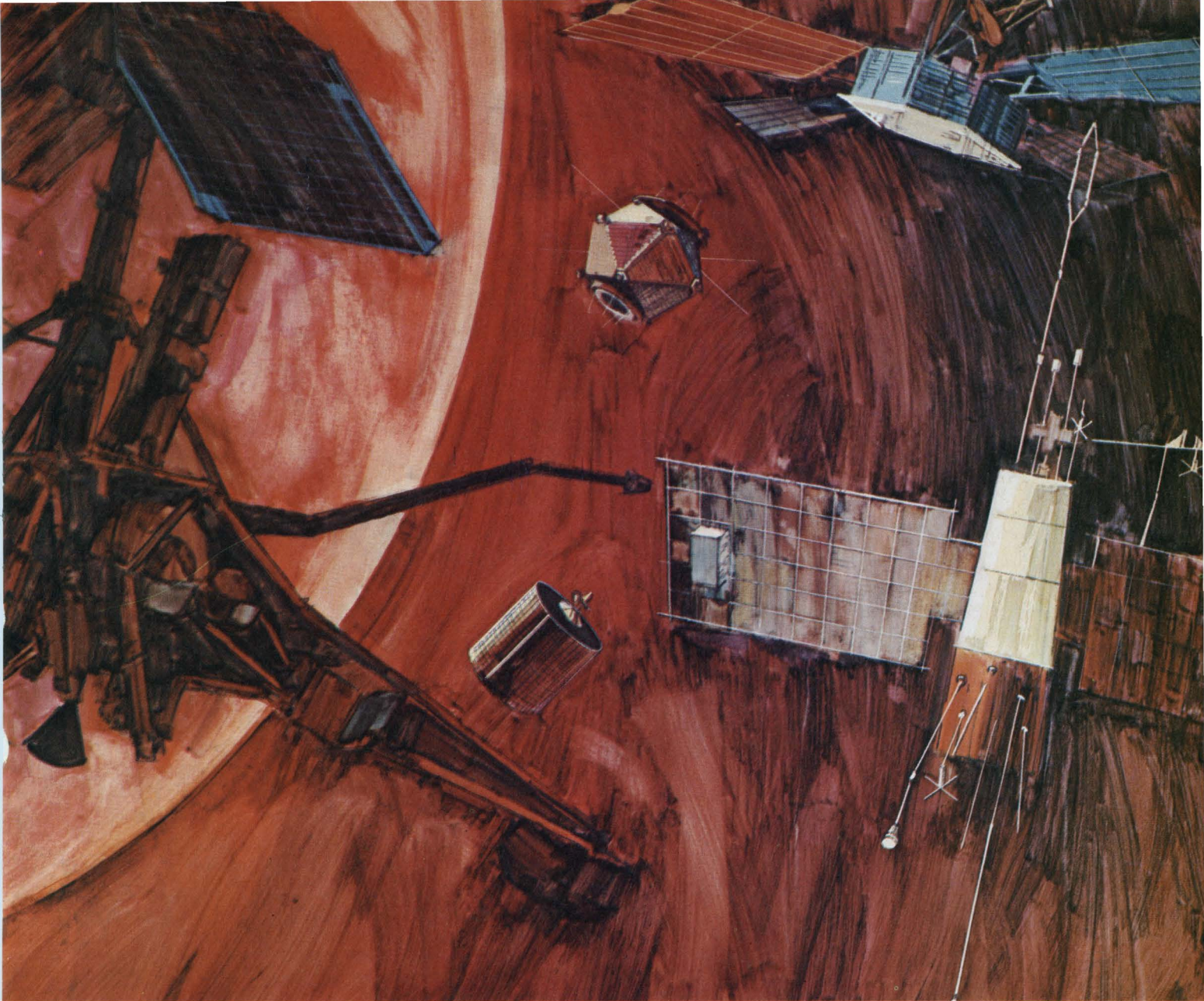

## CINCH AEROSPACE CONNECTORS GO BEYOND MIL SPECIFICATIONS

Since 1963 Cinch has been a major source for these ultimate performance rack and panel connectors. America's major space and defense spacecraft use these Cinch connectors in space and on the moon...TRW's Intelsat III, OGO, Pioneer and VELA spacecraft and JPL's Mariner satellites.

Their production involves complex quality control procedures beginning with raw material selection through every stage of fabrication and "clean room" assembly. Plating QC alone involves 119 lab measurements for 4 different characteristics, on the pre-assembled contacts. The completed connector must have a maximum residual magnetism of less than 20 gamma at the magnetometer probe and be free of visible contamination under 25x microscopic examination.

Do your connector requirements involve unusual design or production problems? Cinch can help you. For more information on Cinch aerospace connectors and the Cinch capabilities available to you, write Cinch Manufacturing Company, 1501 Morse Avenue, Elk Grove Village, Illinois 60007.

C-6810

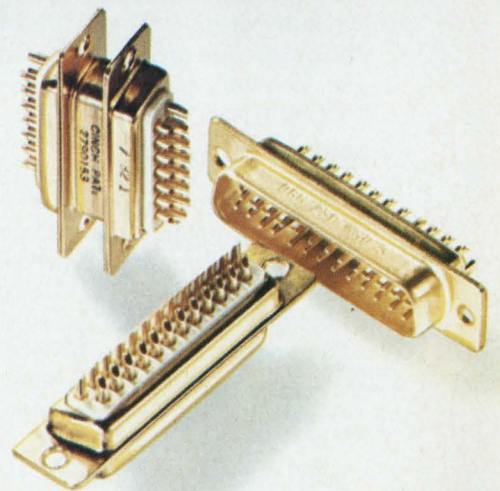

**CINCH**

DIVISION OF UNITED-CARR

MEMBER



CONSISTING OF CINCH MANUFACTURING COMPANY, CINCH-GRAPHIK, CINCH-MONADNOCK, CINCH-NULINE, UCINITE (ELECTRONICS) AND PLAXIAL CABLE DEPT

Circle 109 on reader service card



# Laser research takes a practical turn

A new emphasis on finding jobs for the laser may give electrical techniques a run for their money

by William Bucci

Communications Editor

**Those youthful days** when physicists vied to design lasers that emitted still another frequency of the highest spectral purity are over. Older but still healthy after years of unrealized promises, laser research has shifted its emphasis. Now it's concentrating on doing jobs that can't be done any other way or doing them better than other methods can.

As a result, extensive work under way now includes efforts to develop better light modulators, pack more energy into light pulses, stabilize pulse trains, improve laser efficiency, and perfect techniques for tuning the laser.

Nevertheless, lasers still haven't found their niche in industry, and those who assert that they have are more prophets than reporters. The developments of most significance to the laser market are taking place now in the world's research laboratories.

There are exceptions, of course. Laser drilling and machining is catching on to some extent. Western Electric now resizes worn dies used for drawing wire by drilling them with a laser beam. And some hospitals are performing surgery with lasers. But applications such as these are hardly taking industry by storm.

## Photon engineers

But there's cause for optimism on the part of marketing people. Electrical engineers are starting to rid themselves of preconceived notions—that they should stick with electronics as much as possible because it's worked so well for so many years. They're realizing that to take full advantage of the laser's potential it's necessary to develop a new technology and design new optical components. Many think engineers of the future will be as schooled in laser physics and diffraction laws as they now are in basic electronics.

"Mode locking opens door to picosecond pulses" on page 112 is the first article of a series on some of the significant work being done in laser research

—work that's already making its impact on industry, although on a very limited scale at the moment.

One of the most volatile areas is that of narrow, high-peak power pulses. Already it's borne fruit in a number of laboratory applications. As the mode-locking article shows, the very narrow pulses were formed by applying the Fourier principle—that a periodic pulse train could be formed from a wide bandwidth of regularly spaced frequencies. The first mode-locking technique to be developed uses external modulating circuits; the latest uses the quantum properties of a dye. Today's engineers are as concerned with photons as they are with electrons.

As their work progresses, applications, such as high-speed photography and thermonuclear fusion, are coming closer to reality. But there's still a long way to go in understanding basic phenomena and being able to measure results. In fact, some scientists today are questioning the techniques used to measure picosecond light pulses.

Another area seeing a flurry of activity—lasers in communications—is discussed in "Light wave of the future: optical pen" on page 123. The laser's potential for carrying large amounts of information was recognized from the beginning, but it's still far from being tapped. One approach to overcoming the problems of modulating information onto a coherent light beam is to use mode-locked lasers and pulse-code modulation. Engineers seem to agree that pcm is the way to go optically for links that can carry a high rate of information, but they're far from agreed on the optimum laser communications system. But when the need develops for such a system, there's a good chance that terminals like those described in this issue will be used.

## Changing views

These terminals illustrate the trend in laser systems toward using more optical components at the



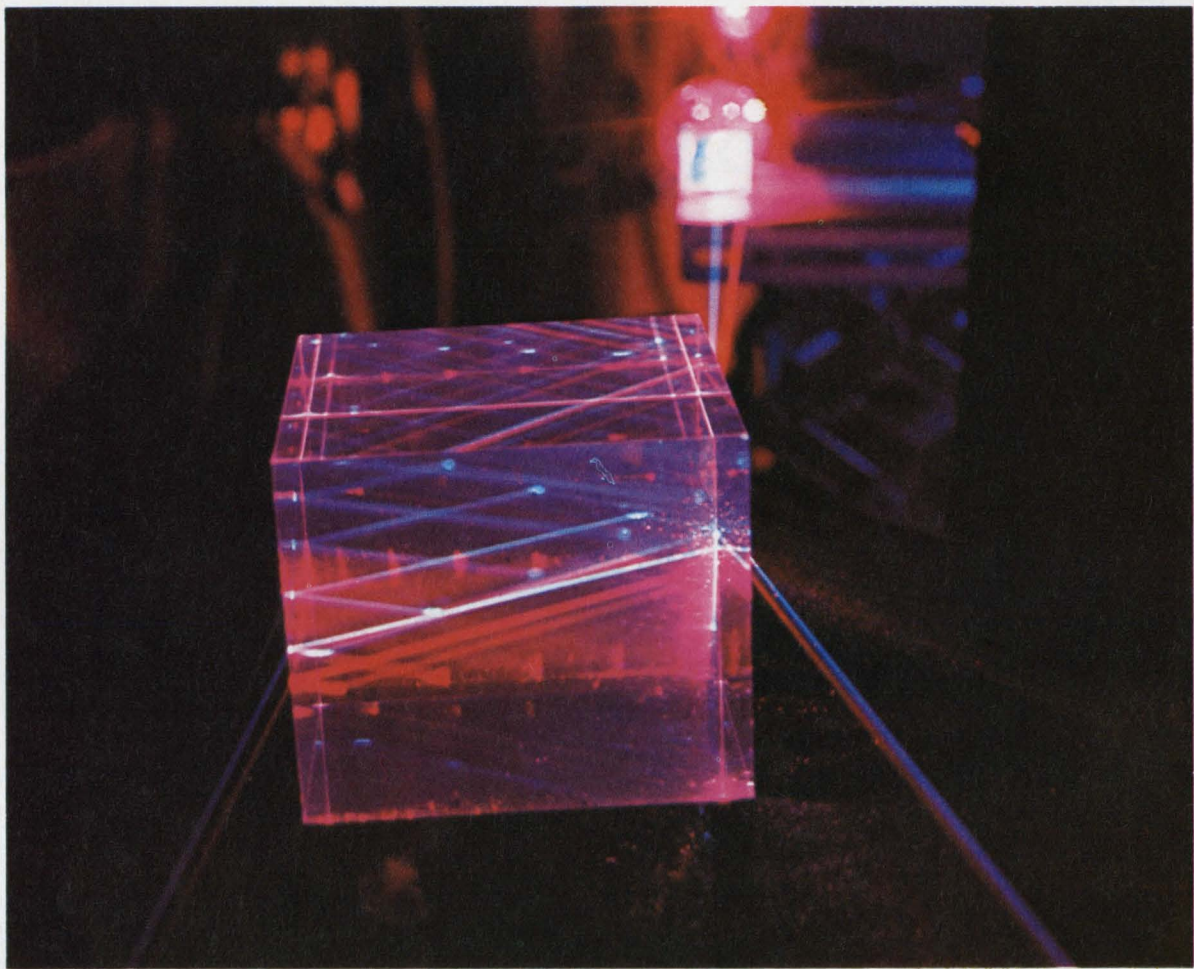

Cover and above photo by Murray Diutz

### The laser: pattern for the future

Its coherence and collimation allow the laser beam to be focused to an intense spot. This property is useful in such applications as display and recording and retrieval systems. The intensity of laser light is demonstrated here in this setup prepared by Bell Telephone Laboratories technicians M.A. Karr, J.R. Potopowicz, and P.C. Tietze. Using several reflecting mirrors, they passed a blue beam from an argon laser and red beam from a helium-neon laser

through a polished lucite crystal. As the beams hit the sides of the crystal they bounce back and forth, making many passes through before they exit. The number of passes can be controlled by moving the platform on which the crystal is mounted. No other light source is intense enough to make so many passes through the crystal. In the upper part of the photograph a part of one laser and the pattern from the reflecting mirrors can be seen.

expense of electrical components.

In another trend to be covered later in the series, research engineers focus on one type of laser that has the advantages of efficiency, wide bandwidth, and ease of pumping, and try to develop techniques for tuning it. Engineers realize that it's more practical to develop and market only a few different types of lasers that can be made to emit a wide range of center frequencies. One of the most popular types—the neodymium-doped laser—and a promising tuning technique using parametric interaction—will be described in a future article.

Other researchers, concerned about the expense

of solid state lasers and the difficulty of producing the active medium, are turning to liquids. Another article will describe their success in getting both organic and inorganic liquids to emit coherent light.

The use of Q-switched lasers to extend vision underwater will also be discussed. In this application, high-peak powers and narrow pulses can do what no other light source can—enable men to see underwater objects as distant as 10 meters.

Also featured in the series will be wide-bandwidth data recorders using photographic film and laser beams, laser display systems, and laser-acoustic variable delay lines.



# Mode locking opens door to picosecond pulses

Bursts of light with hundreds of gigawatts of peak power are generated by Q-switched lasers with phase-locked frequencies; applications include ranging, data processing, and high-speed photography

By A.J. DeMaria

United Aircraft Research Laboratories, East Hartford, Conn.

**Ultrashort pulses** of coherent light with dramatically high peak powers are now being produced by lasers, a development that opens the way to a host of new applications. Devices of this type can be used in controlled thermonuclear fusion, ranging, topographical mapping, high-speed photography, and the measurement of wide-bandwidth electronic systems. Short-pulse lasers are being employed in scientific experiments right now to study the nonlinear optical properties of materials and to measure the transient response of quantum systems.

Only two years ago, the narrowest high-peak-power pulses produced by lasers lasted 5 to 10 nanoseconds and had peak powers of several hundred megawatts. Now lasers are generating optical pulses less than a picosecond long at hundreds of gigawatts of peak power.

The key to this impressive progress is the development of mode locking, a technique that locks in phase the many frequencies emitted by lasers. Constructive and destructive interference then produces a train of narrow pulses with widths inversely related to the bandwidth of their component frequencies.

Perhaps the most significant of the mode-locking techniques uses a saturable dye to simultaneously Q-switch the laser; this results in the narrowest pulses with the highest peak powers. Automatic and simple, this "passive" mode-locking method causes the laser to generate "chirped" pulses whose duration can be compressed to fractions of picoseconds.

## First step

Mode locking, in a sense, represents the second generation in this field. The first big advance in

reducing pulse duration came in 1961 when R.W. Hellwarth of the Hughes Aircraft Co.'s research laboratories developed Q-switching, a technique requiring a laser medium with a long storage lifetime and a shutter in the feedback cavity. Closing the shutter prevents the laser from oscillating, thereby creating overpopulation of the upper energy level. Opening the shutter when this overpopulation is at a maximum causes energy within the feedback cavity (the Fabry-Perot interferometer) to build up rapidly, generating the enormous output pulse.

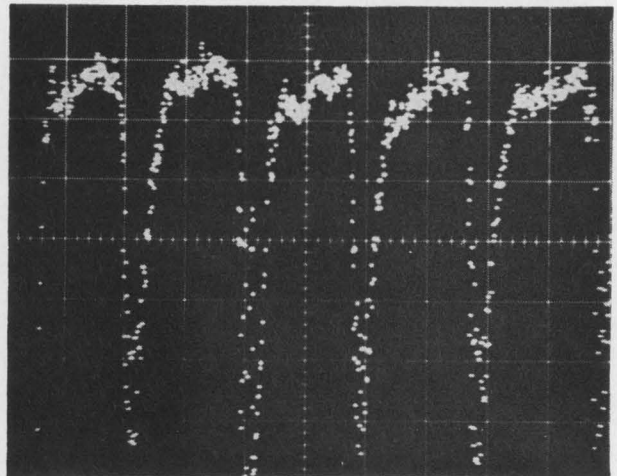

**Pulse train.** Oscilloscope displays mode-locked laser output received by a detector with a  $0.1$  to  $0.2 \times 10^{-9}$  sec rise time. The oscilloscope has a sweep speed of  $1 \times 10^{-9}$  sec/div and a rise time of  $0.1 \times 10^{-9}$  sec.



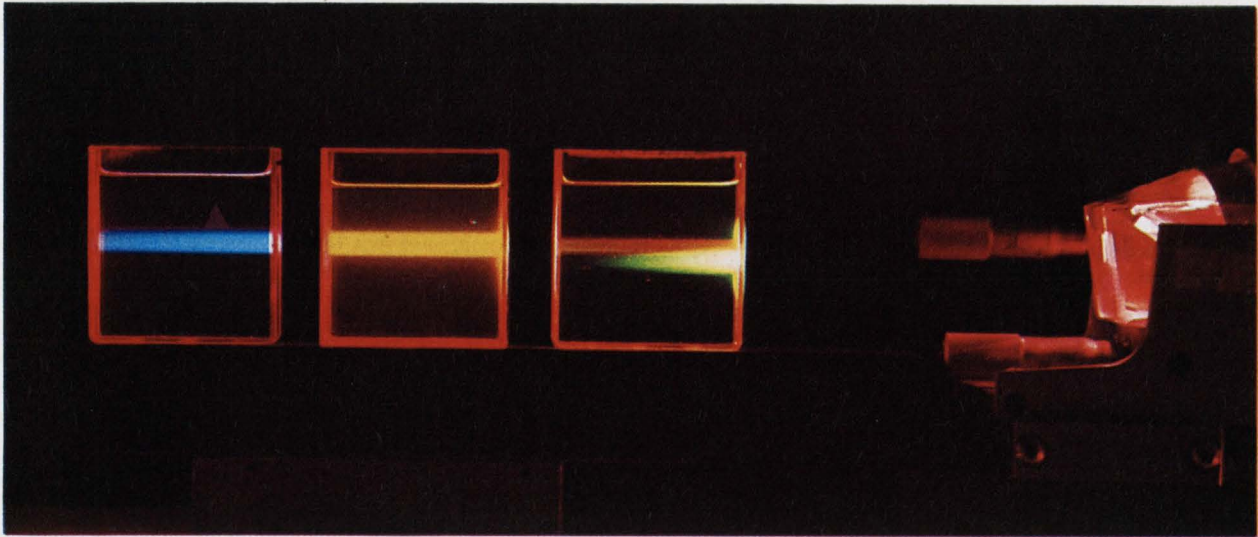

**Colored pulses.** Pumped by mode-locked pulses, these dyes, which can be used as the active medium in liquid lasers, fluoresce in different colors. It's possible to get picosecond pulses throughout visible spectrum.

Using such shutters as Kerr cells, rotating mirrors, and ultrasonic diffraction liquids, researchers obtained pulses of  $10^{-8}$  seconds duration with peak powers of  $5 \times 10^8$  watts. Generating narrower pulses was difficult because the pulse had to make several passes through the laser medium to build amplitude once the shutter opened.

Nevertheless, the availability of Q-switched lasers marked a turning point in laser research. It led to many experiments, some of which can now be done with normally running continuous-wave lasers. Among these are optical frequency doubling, plasma generation, optical electrostriction, and stimulated Raman, Brillouin, and Rayleigh scattering.

### Narrower yet

Potential applications of short pulses were extended when the author and two colleagues reported a technique for the generation of picosecond pulses with 1 gigawatt peak powers at the 1966 Quantum Electronics Conference in Phoenix, Ariz. These pulses could be applied in such fields as:

- Radar and ranging. Light travels only 0.03 centimeters per picosecond. Thus, picosecond laser pulses could measure distances from many kilometers to fractions of millimeters.

- Controlled thermonuclear studies. Nuclear fusion requires a hot plasma. But the high power used to produce the necessary temperatures damaged optical components. Since damage is less likely with narrower laser pulses, however, more power can be applied and thermonuclear neutron emission temperatures can be reached. It's thus possible to get a plasma hot enough for ejection into a thermonuclear machine.

- Optical information processing. Shorter pulses are needed to increase the speed of binary logic operations in computers. Picosecond light pulses

generated at microwave repetition rates could be used to perform the operations orders of magnitude faster than is now possible with electronic devices.

- High-speed photography. An object would only move a distance of about one optical wave-length in a picosecond if it were traveling at 1/10th the velocity of light. Thus it's evident that high-power picosecond pulses can capture high-speed motion.

- Ultrashort, high-voltage electrical pulses. Fast photoelectric diodes used with picosecond laser pulses have generated electrical pulses with rise times of less than  $10^{-10}$  seconds, amplitudes of 60 to 100 volts across a 125-ohm load, and repetition rates of more than 1.5 nanoseconds. Such pulses could be used to determine the location and severity of internal reflections in wide-bandwidth electrical transmission systems, for example, or for propagation studies or bandwidth measurements.

- Ultrashort acoustic pulses. High-peak-power picosecond light pulses will be extensively used to generate acoustic shock waves with harmonic components well into the microwave region.

### Two keys to locking

Mode locking causes a laser to oscillate with its wide band of frequencies in a fixed phase relationship. The commonest way of achieving this effect is to modulate the amplitude of these frequencies, or modes, to produce sidebands in phase with the modulated frequencies. Since the individual modes have about the same amplitude, the periodic pulse train produced consists of sharp pulses whose narrowness derives from the many phase-locked frequency components.

Mode locking was first achieved with helium-neon and argon lasers, both of which have relatively narrow bandwidths of about  $10^{10}$  hertz; pulse widths were therefore limited to about  $10^{-10}$  seconds. Narrower pulses resulted when ruby, neodymium-doped glass, or neodymium-doped yttrium alumi-



num garnet were used. Since the glass laser has a bandwidth of 100 to 200 angstroms at a center wavelength of 1.06 microns, it is theoretically possible to generate pulses lasting only  $2 \times 10^{-13}$  seconds. However, it's only recently that such narrow pulses have been produced, mostly because the understanding of mode locking has increased.

The first mode-locking experiments were performed at Bell Telephone Laboratories by L.E. Hargrove, R.L. Fork, and M.A. Pollack, who used an ultrasonic diffraction modulator driven by an external electrical signal to mode lock a helium-neon laser operating at 6,328 Å.

Since then, various types of "active" modulators—potassium-dihydrogen-phosphate Pockels cells, for instance—have been used on wider-bandwidth lasers. The yag laser, for example, has been actively mode locked to produce a train of pulses between  $10^{-12}$  and  $10^{-11}$  seconds long with peak powers in excess of 4 watts.

Active mode locking is still the preferred technique when a continuous train of very stable pulses at relatively high repetition rates is required. But this method requires very careful adjustment of mirror spacing and selection of modulating frequency, and results in wider pulses than those possible with the "passive" method.

### Double blessing

Around the middle of 1965, the author, D.A. Stetser, and H.A. Heynau of United Aircraft developed this passive technique after they found that certain dyes could act both as Q-switches and automatic amplitude modulators. There's one disadvantage, though, at least for some applications. It's impossible to mode lock without simultaneously Q-switching, so the pulse train isn't continuous. However, most applications require only a few pulses—or even a single one.

And the advantages more than offset that drawback. Simultaneous Q-switching and mode locking have boosted peak powers. It's no longer necessary to make adjustments or depend on the stability of an external modulation circuit. And the high non-linearity of the dye results in more high-amplitude harmonics or sidebands and, therefore, narrower pulses.

The saturable absorber, as the dye is called, must have an absorption line at the laser's center frequency, a bandwidth equal to or broader than the laser's, and a recovery time shorter than the round-trip time of a pulse circulating between the two mirrors forming the laser cavity.

In the passive modulator, the dye is enclosed in a transparent container and placed within the laser cavity. When two or more laser modes begin oscillating, their interference with each other causes a periodic amplitude fluctuation at a frequency equal to the spacing between the axial modes,  $\Delta f$ .

The passage of this initial sinusoidal amplitude fluctuation in the dye becomes distorted because the dye's absorption isn't linear with respect to

input intensity. The net result is that the amplitude of the peak-to-peak variation of the transmitted pulse increases. As in r-f amplitude modulation, this adds energy to the sidebands and also adds other sidebands to the frequency spectrum of the pulse.

In an optical cavity of length  $L=c/2\Delta f$ , this process develops very rapidly as the light reflects back and forth between the mirrors placed on either side of the dye container. The intensity of modulation continues to increase until the pulse reaches its minimum width. The laser gain compensates for losses from the dye and cavity mirrors.

### Side effect

Since the dye pumps energy from  $\nu_0$ , the laser center frequency, into the sidebands, in one sense it can be thought of as a new type of optical amplifier. For while the laser is amplifying the sidebands, so is the dye. United Aircraft researchers have coined the acronym LAISA—light amplification (in saturable absorbers—for this effect, and have boosted the power of a weak optical pulse traveling through the dye with the mode-locked pulse. One of the group, M.E. Mack, has achieved power gains as high as 13 decibels with a mode-locked ruby laser and a dye cell only 1 centimeter long.

There's another way to think of the dye's modulating action. If the dye atoms can exist in either of two energy states and the difference between these states equals the photon energy of the pulse, then the following process occurs. As the pulse enters the dye, its leading edge is heavily absorbed, pumping the dye atoms into the upper state. As more and more atoms are excited, the dye becomes saturated, absorption decreases, and the higher amplitudes aren't absorbed as much as the lower amplitudes. The pulse's leading edge is thus sharpened, and as the pulse continues through the dye, the atoms drop to the lower state by radiationless transitions.

As the pulse reflects back and forth in the laser cavity, the edge continues to sharpen until the dye no longer absorbs energy. At that point, its harmonic content equals the bandwidth of the laser medium. The dye thus acts as a shutter that automatically adjusts its modulating frequency to the spacing between modes—the cavity round trip time.

### Wider than theory

Ideally, the product of the pulse width and gain bandwidth should equal unity, but United Aircraft researchers instead found products from 15 to 20. These unexpectedly wide pulses obtained from neodymium-doped glass lasers led them to suspect that the dye mode-locked pulse was being chirped. Part of this suspicion was based on the existence of a similar phenomenon in an electronic regenerative pulse generator designed by C.C. Cutler of Bell Labs.

Cutler's microwave device shortens an electrical pulse circulating within a feedback loop until the



width reaches the minimum allowed by the circuit's frequency response. Corresponding to the components in the generator's feedback loop are the laser's active medium, the combination of cavity and atomic resonances, the round-trip time in the cavity, and the dye modulator.

Analyzing Cutler's system sheds some light on why chirping occurs in passively mode-locked lasers. This analysis involves Fourier transforms, the frequency or amplitude characteristics of each circuit element, and the equating of the characteristics of the returning signal to the characteristics of the assumed initial signal.

In the passive mode-locked laser, the refraction index,  $n$ , of the laser medium can be expressed as

$$n = n_o + \frac{dn_o}{dv} (\nu - \nu_o) + \frac{d^2 n_o}{d\nu^2} (\nu - \nu_o)^2 + \dots$$

where the first and second derivatives are evaluated at the laser center frequency  $\nu_o$ . The phase of the light propagating in a medium of length  $L$  is

$$\phi = \frac{2\pi L n}{c}$$

Substitution then yields an equation showing how the phase shift of the closed loop varies with frequency:

$$\phi = \alpha + \beta (\nu - \nu_o) + \gamma (\nu - \nu_o)^2 + \dots$$

Cutler concluded that a quadratic nonlinearity of phase with frequency in the feedback loop causes the pulse's instantaneous frequency to change. The second power-phase-versus-frequency characteristic results in a linear frequency sweep of the pulse carrier. Whether this "chirp" increases or decreases in frequency depends on the sign of  $\gamma$ , the constant of the quadratic frequency term of the closed loop's phase-versus-frequency characteristic.

With this knowledge, United Aircraft researchers postulated that the nonlinear phase-frequency characteristic of the optical feedback loop was responsible for the wider-than-expected optical pulses. They also postulated that the chirping was positive, that is, the frequency swept from low to high. Their problem was to devise a way of compressing the pulses in a manner analogous to that used in radar.

### Compression

A member of the group, E.B. Treacy, devised such a technique and proved that passively mode-locked glass lasers increase their carrier frequency with time. Their large oscillating bandwidth,  $5 \times 10^{12}$  hertz, accounts for the wide frequency sweep. Using two cascaded optical diffraction gratings, Treacy compressed the pulses into subpicoseconds.

To date, the shortest pulse generated by this technique is  $4 \times 10^{-13}$  seconds. At a wavelength of 1.06 microns, this pulse width consists of approximately 100 optical cycles and corresponds to a linear sweep over a bandwidth of 100 Å, or 2 to 5 terahertz.

In the various experiments performed with mode-locked lasers, dye concentration, optical pumping

intensity, and mirror reflectivity could be adjusted to obtain long pulse trains with corresponding lower pulse amplitudes, short pulse trains with higher amplitudes, or single or multiple Q-switched mode-locked pulses.

And Steve Schwarz of the University of California at Berkeley recently mode locked and Q-switched a CO<sub>2</sub> laser using sulphahexifluoride as the saturable absorber. By varying the gas pressure in the laser he was able to generate—for the first time—a continuous train of Q-switched, passively mode-locked pulses. Unfortunately, the pulses have had widths of 10 to 20 nanoseconds due to the small—60 Mhz—bandwidth of the CO<sub>2</sub> laser. The highest Q-switched repetition rate so far—100,000 pulses a second—has been achieved by David Smith of United Aircraft.

In the glass-laser experiments, rods measuring from 12.2 to 100 cm long were shaped to Brewster angles at their ends, thereby eliminating back reflection. Typical dye-cell lengths were 1 to 0.1 cm, and the best results were obtained by placing the dye cell at a Brewster angle with the dye contacting one of the mirrors. To guarantee long dye life, ultraviolet glass filters were placed on the cell window. Practically all the dyes useful in generating ultrashort laser pulses decompose when exposed to this portion of the spectrum.

Researchers used Eastman 9740 or 9860 in their glass-laser work and cryptocyanine dissolved in methanol or alcohol in their ruby experiments. Eastman 9740 has a relaxation time of 25 to 35 psec, an order of magnitude slower than that of 9860.

Of the commonly used dyes for Q-switching ruby lasers, only cryptocyanine has a relaxation time shorter than the round-trip transit time of a light pulse in a cavity of reasonable length. By using acetone as a solvent to dissolve this dye in methanol, researcher Mack substantially improved the consistency of operation. In methanol, the absorption peak of the dye is 7060 Å; it's shifted by 120 Å in acetone to coincide with the ruby laser's resonance peak. Unfortunately, this highly desirable dye-solvent combination has a useful lifetime of only one or two hours.

Using the very short pulses generated by mode locking and a fast photo-detector, Heynau and A.W. Penny of United Aircraft have evaluated the impulse response of RG-63B/U and RG-8 coaxial cables. The combination of short light pulse and fast detector provides a simple method for calculating the impulse response to large-amplitude pulses of electrical networks.

Short laser-generated electrical pulses may also be used to evaluate detectors and detector systems, evaluate and optimize such active networks as wideband amplifiers and oscilloscopes, evaluate the performance of coincidence and anticoincidence networks, provide extremely narrow sampling-gate pulses, and develop new wideband electronic components and systems.

For example, when picosecond pulses from a glass laser are detected by an F4014 photodiode,



the narrow electrical pulses generated—less than 0.1 nsec—make a standard 1-gigahertz traveling-wave oscilloscope ring. The impulse response of the instrument can thus be studied.

One of the United Aircraft experiments involved the simultaneous mode locking and Q-switching of a glass laser to produce six pulses with a total energy output of 44 Joules. The glass rod measured 75 cm long and 1.8 cm in diameter, and the 1-cm dye cell contained 16 cubic centimeters of solvent and 5 cc of Eastman 9740 dye.

First measurements showed each pulse to have a duration of about 2 nsec and an average of 7 joules of energy. However, nonlinear optical measurements revealed that each nanosecond pulse actually consisted of a group of picosecond pulses with a repetition period much shorter than the 0.5-nsec response time of the oscilloscope and detector.

There are many applications where much longer time intervals between pulses—possibly hundreds of nanoseconds—are desirable. One way of achieving this is to make cavity lengths of hundreds of feet, but a more practical means was developed by Stetser, W.H. Glenn, and the author. The team used a spherical-mirror optical delay line to “fold” the long cavity into a practical length. Because the curved mirrors periodically focus the pulse, diffraction losses are very low.

Pulses separated by 71.5 nsec were obtained in preliminary experiments with this arrangement. One of the delay-line mirrors might also be used as the output element for an automatic, nonmechanical digital scan of the pulse train.

### One from many

For some applications, such as plasma research or high-speed still photography, it's desirable to select only one of the picosecond pulses in the Q-switched envelope. Penny and Heynau managed to do this by combining passive mode locking with a special Q-switching technique developed by A.A. Vuylsteke, then at the General Motors Corp.

In Vuylsteke's method, called the pulse transmission mode, or PTM, energy is stored in the laser cavity as well as in the laser active medium. At the peak of the pulse, the output mirror is switched rapidly from 100% reflectivity to zero reflectivity, and the optical energy stored is discharged as the light completes a round trip in the cavity.

The United Aircraft technique, which combines the mode locking of a glass laser in a bleachable dye with the PTM method, has yielded the highest peak power and shortest duration for one optical pulse of all experimental methods so far reported.

At first, the researchers were forced to make the laser feedback cavity long—about 2.5 meters—so that they could successfully select a single output pulse about 70% of the time using standard electronics for the Q-switching. The problem arises from the fact that the rise time of the high voltage pulse applied to the optical switch must be shorter than the time required for the optical pulse to make the trip from one cavity mirror to the other.

However, United Aircraft researchers were later able to get single picosecond light pulses with hundreds of megawatts of peak power using feedback cavities less than 70 cm long. After amplification, the single selected pulse had about 2 joules of energy and peak power slightly under 200 gigawatts.

Some two years later, N.G. Basov and others at the Lebedev Physical Institute of Russia's Academy of Science got 30 Joules output and a peak power of some  $3 \times 10^{12}$  watts in a laser pulse  $10^{-11}$  seconds long. Four out of 14 times they observed neutron emission when they focused the pulse on a lithium deuteride surface. They've calculated that this number of emissions is 20 times higher than could be attributed to accidental coincidence.

In experiments at United Aircraft's Labs, a Brewster-ended glass rod, a dye cell, a Glan prism polarizer, and a Kerr cell were placed in a 70-cm feedback cavity. With the Glan prism adjusted for maximum transmission, most of the light passed through the Kerr cell and was reflected by the cavity mirror. Some of the pulse energy, however, was focused onto a Marx-Bank pulse generator, an opto-electric device that includes a series of spark gaps and fast-discharge condensers.

When the laser pulse built to a critical amplitude—determined by setting the gap and the voltage across the gap—the first gap broke down. The resulting high voltage triggered the breakdown of the remaining gaps, effectively placing in series capacitors that were initially in parallel and finally opening the Kerr cell shutter. The Marx-Bank generator can produce tens to hundreds of thousands of voltages only some 20 nsec after the initial gap breakdown and with jitter times of a nanosecond or less.

Energizing the cell changes the polarization of the propagating pulse by  $90^\circ$  in a round trip. At this polarization, the Glan prism stops the pulse from circulating in the cavity, redirecting it instead to the output port. In effect, the cavity's high reflectivity suddenly changes to low reflectivity so that the stored energy is “dumped.”

More recent experiments have substituted Pockels cells for optical shutters and have replaced spark gaps in the Marx-Bank generator with avalanche transistors. A photodetector triggers the avalanche transistor chain, which finally breaks down one gap in series with the shutter. This technique offers the advantage of easy adjustment of the Marx-Bank initiation voltage.

### Shorter rulers

Optical pulses traditionally are measured by displaying the output of a photodetector on an oscilloscope. Though the large bandwidth of sampling scopes is attractive when considering ways to measure picosecond pulses, these scopes can't sample fast enough to keep up with the pulse trains emitted by simultaneously Q-switched and mode-locked lasers. These trains last from about 50 to 150 nanoseconds, making it necessary to use travel-



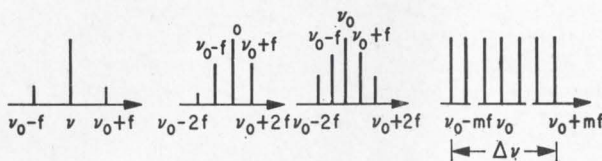
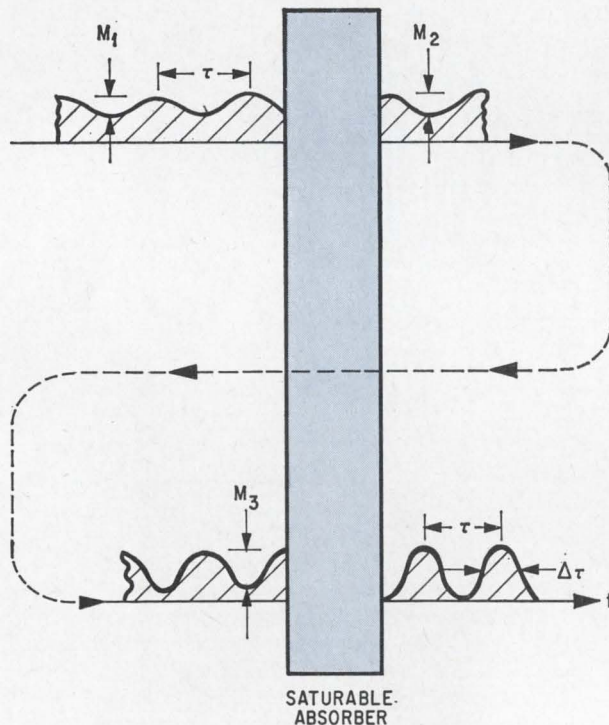
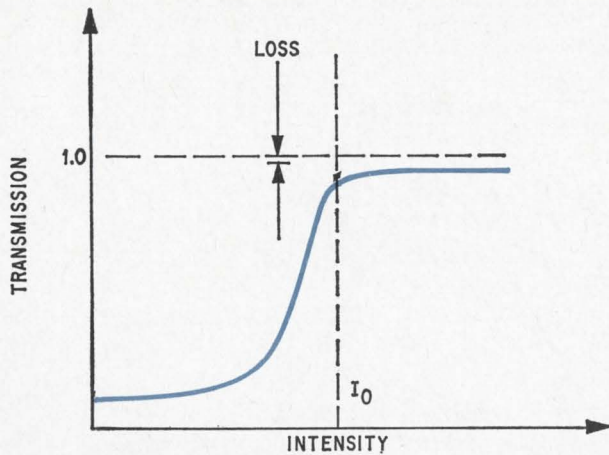

**Passive modulation.** As two modes begin oscillating in the laser they interfere with each other, causing a periodic amplitude fluctuation. When these frequencies pass through the dye, their fluctuation becomes distorted because the dye's absorption is nonlinear with respect to input intensity. This increases amplitude modulation, causing sidebands to grow.

ing-wave scopes, which, fortunately, have narrower bandwidths and require large signal inputs.

Nevertheless, a modified version of a traveling-wave scope has been used to obtain a direct measurement of a simultaneously Q-switched and mode-locked pulse with a rise time comparable to those measured with sampling oscilloscopes. By computing the scope's 0.13-nsec rise time out of the 0.15-nsec measurement, a pulse width of less than 90 psec was obtained.

This points up the inadequacy of conventional techniques, a situation that has spurred efforts in recent years to develop other methods for measuring picosecond light pulses. Since the minimum obtainable pulse width depends on the pulse bandwidth, it can be determined by measuring the spectral content of the pulses. When these measurements were made at United Aircraft in 1966, the spectral content was found to be 180Å, a bandwidth sufficient for a pulse rise time of  $2 \times 10^{-13}$  seconds.

Measurements of each individual pulse in the train showed the bandwidth to be 120 Å, enough for the generation of pulses having a rise time of  $3 \times 10^{-13}$  seconds. But since it's also possible to generate such bandwidth with amplitude or frequency variations in the carrier frequency of pulses whose duration is much longer than this specified minimum, this technique isn't suited to determining the actual widths of picosecond pulses.

Another way to find minimum possible pulse width is to pass the pulse through a Michelson interferometer having legs of equal lengths. Film placed at the interferometer exit records the interference fringe pattern formed. When one of the interferometer's legs is lengthened or shortened, the recorded fringe pattern decreases until it "vanishes." This happens when the length change,  $\Delta L$ , equals

$$\frac{c\Delta\tau}{2} = \frac{c}{2\Delta\nu}$$

where  $\Delta L$  is the pulse duration and  $\Delta\nu$  the spectral width.

Thus, the interference pattern is the pulse's amplitude correlation function and  $\Delta L$  is the coherence length of the pulse. It's important to note that though the coherence length of a c-w white-noise source is very short, no one would attribute the spectral width of the source to amplitude and phase fluctuations. The coherence length is therefore an indication of the minimum possible pulse width.

Experiments show that with  $\Delta L$  variations from 0 to  $4 \times 10^{-13}$  cm, the fringe patterns are very clear. With variations from 4 to  $8 \times 10^{-13}$  cm, the patterns aren't as easy to see, and with variations greater than  $8 \times 10^{-13}$  cm, they disappear. These results put the minimum pulse width for the mode-locked glass laser at  $5 \times 10^{-13}$  seconds, a figure fairly close to the one given by the diffraction grating measurements.

This is to be expected, because the Michelson interferometer measures the amplitude autocor-



## Primer on phase locking

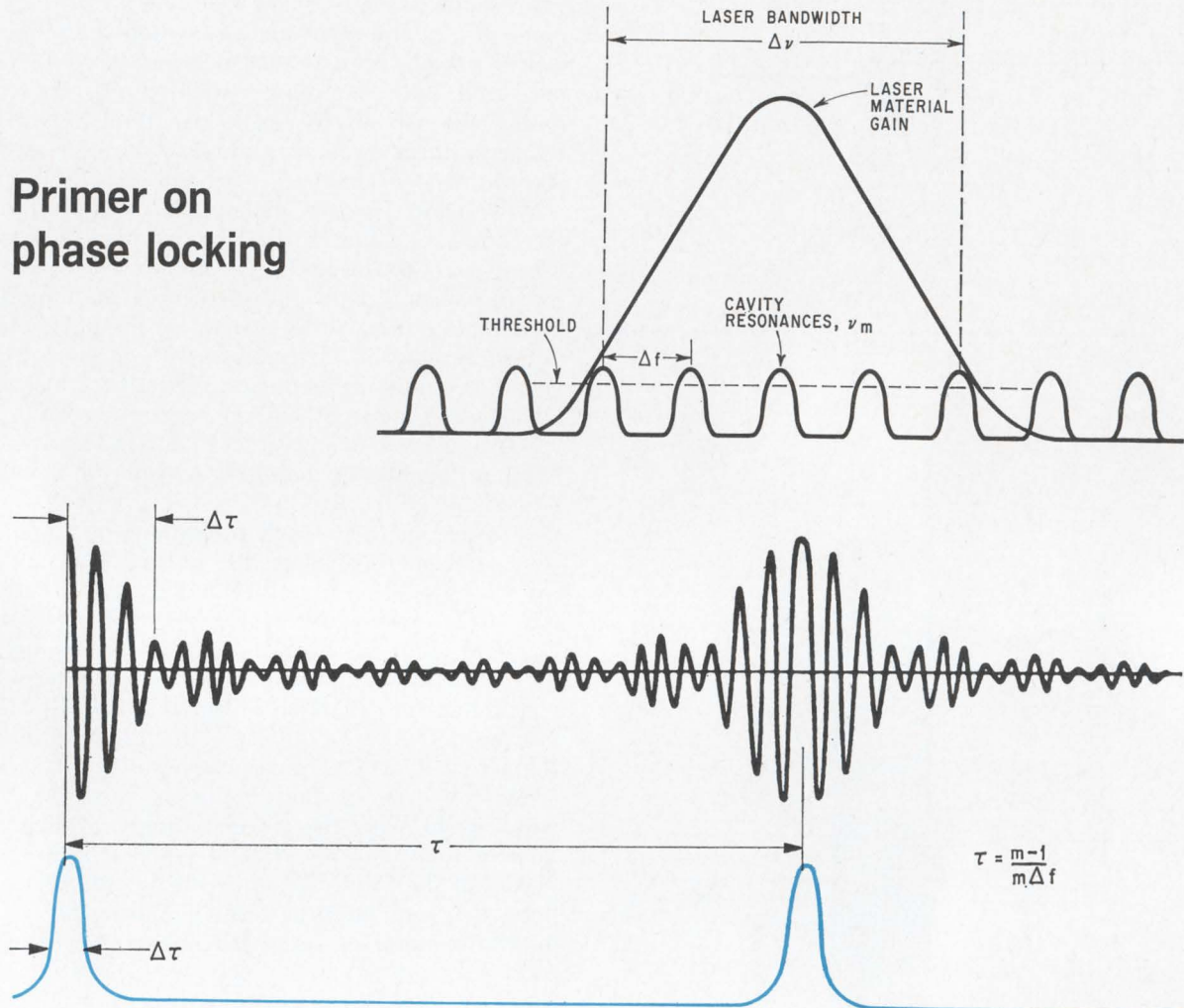

Though it's often thought of as a single-frequency source, the laser actually produces many frequencies. This property is put to use in the mode-locked devices. In fact, the wider its bandwidth, the better the laser is for mode locking. Bandwidth depends upon the atomic resonances of the laser material and the number of half-wavelengths of the resonant frequencies between the two cavity mirrors.

The separation between closely spaced modes,  $\Delta f$ , is equal to the velocity of light,  $c$ , divided by the product of the cavity length,  $L$ , and the laser material's index of refraction,  $n$ , while the feedback-cavity resonant frequencies are each equal to  $mc/2Ln$ , where  $m$  is the number of modes.

To take advantage of the total bandwidth, an amplitude or phase modulator is used at a modulating frequency,  $f$ , that's equal to  $\Delta f$ , the frequency spacing between modes.

As the laser is pumped, the frequency,  $\nu_n$ , nearest the peak of its atomic resonances begins to oscillate first, and is therefore amplitude modulated first.

Since  $f$  has been chosen so that it equals the fre-

quency spacing between the axial modes, the frequencies of the upper ( $\nu_m + \Delta f$ ) and lower ( $\nu_m - \Delta f$ ) sidebands are exactly equal to those of the adjacent resonances and start in-phase oscillations. These sidebands are amplitude modulated in turn, producing other sidebands equal to adjacent resonances and also in phase with the first oscillating frequency and its sidebands.

**Fourier series.** The amplitudes of the phase-locked frequencies add and subtract from each other to form a repetitive pulse train that can be analyzed by the Fourier theorem. Such a train, with a fixed period,  $\tau$ , can thus be represented by a series of sinusoidal waves with harmonically related frequencies,—all multiples of  $1/\tau$ —and fixed phase relationships:

$$E(t) = \frac{E_0}{2} + \sum_{m=1}^{\infty} \left[ E_m \cos\left(\frac{2\pi mt}{\tau}\right) + E'_m \sin\left(\frac{2\pi mt}{\tau}\right) \right]$$



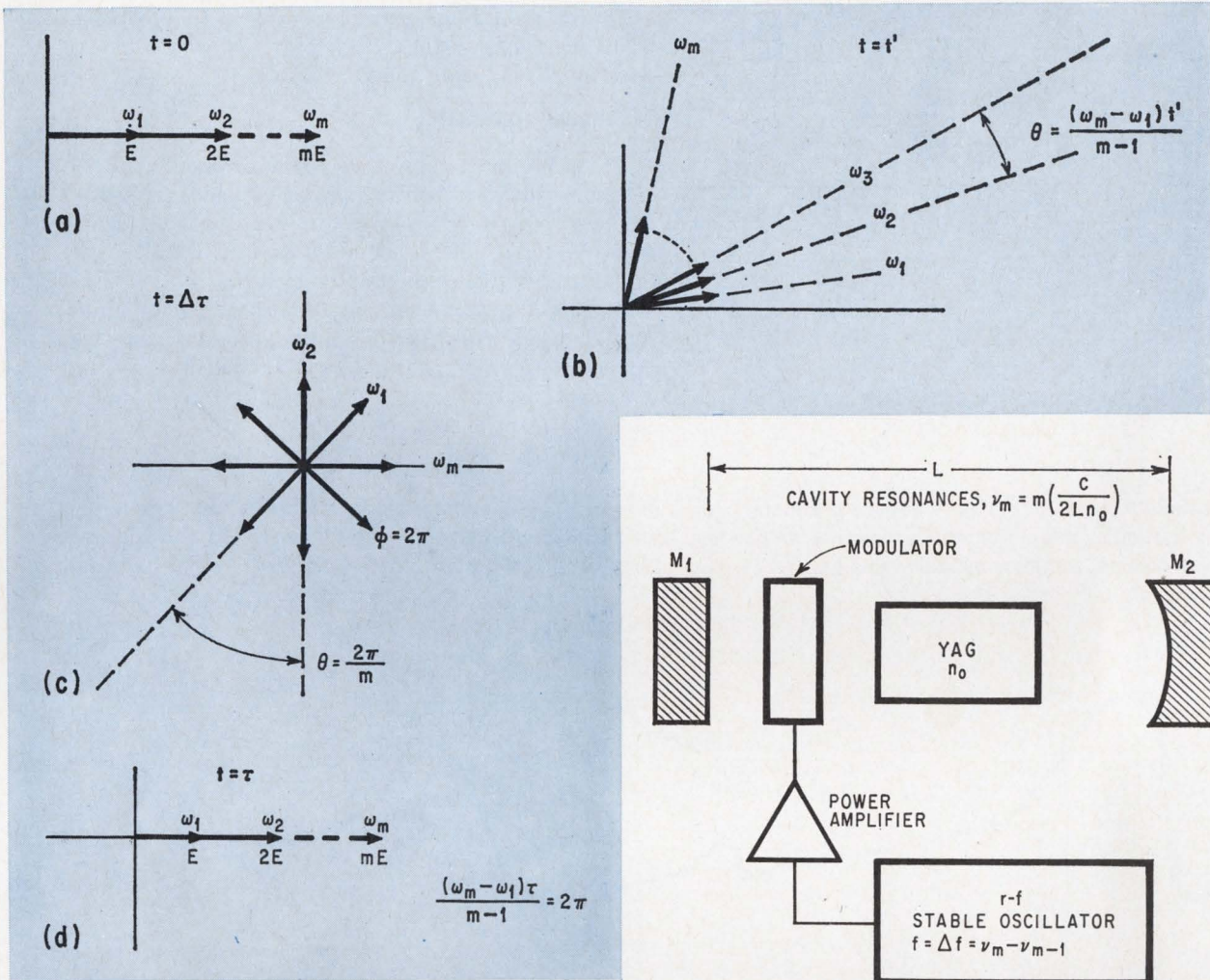

The wider the bandwidth of these frequencies, the narrower the pulse width,  $\Delta\tau$ . A train of ideal impulse functions, for example, can be formed by an infinite number of sine waves of equal amplitude, integrally related frequencies, and fixed phase relationships.

A phasor diagram helps indicate how these frequencies combine constructively and destructively. There is one time,  $t$ , when all the sinusoidal components,  $m$ , of amplitude  $E$  and angular frequencies  $\omega_1, \omega_2 \dots \omega_m$  are in phase. Thus, they're all aligned on the  $x$  axis of the phasor diagram, and the resultant,  $R$ , of their optical fields ( $E$ ) is equal to  $mE$ .

But at a later time,  $T'$ , the frequencies have all rotated at an angle  $\alpha = \omega_m t'$  from the  $x$  axis. And the angle,  $\theta$  between  $\omega_m$  and its adjacent frequency—or between any two adjacent frequencies—is equal to  $(t) (\omega_m - \omega_1) / M - 1$ .

Finally, when  $t = \Delta\tau$ , the angle  $\theta$  is  $2\pi/m$  and the phasors are symmetrically arranged about the origin and cancel out for full destructive interference.

At a later time,  $\tau$ , the phasors will have returned

to their original in-phase positions and again will have added for full constructive interference. For wide bandwidths, when the number of laser modes is much greater than 1, the pulse period is approximately equal to the reciprocal of the mode spacing,  $\Delta f$ . Thus, with a mode spacing—and modulating frequency—of 250 megahertz, the pulse period will be about 1/250 Mhz, or about 4 nanoseconds.

**Seen as power.** Mode-locked laser pulses are actually wave packets oscillating at about  $10^{14}$  to  $10^{15}$  hertz. But since all optical detectors are square-law devices, these pulses, like microwave pulses, are detected as power.

When a large number of modes are present, phase locking results in pulses with very high peak powers. This is true because although the average power of the total unlocked, equal-amplitude, and equally spaced modes is proportional to  $mE^2$ , the peak power of these modes when they're phase locked is proportional to  $(mE)^2$  or  $M(P_{av})$ . The maximum number of axial modes possible within a gain bandwidth,  $\Delta\nu$ , is expressed by  $M = 2L\Delta\nu/\lambda_m$ .



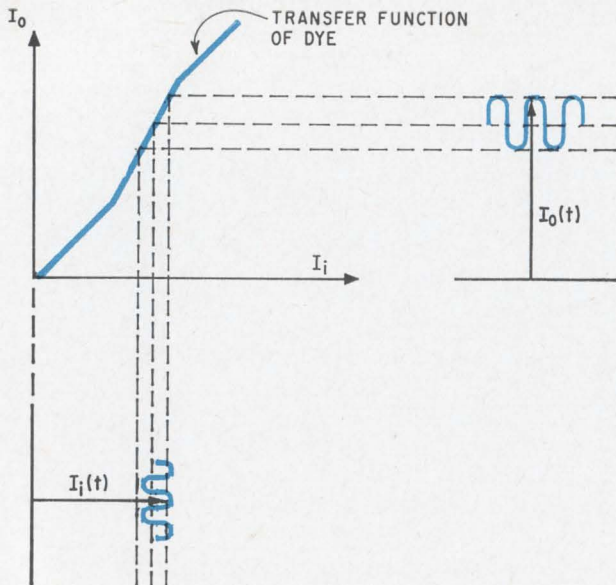

**Amplification.** Because of the dye's nonlinear transfer function, it pumps energy from the laser center frequency into the sidebands, acting as optical amplifier.

relation function and the grating spectrometer measures the power-density spectrum. Since the amplitude auto-correlation and the power-density spectrum are a Fourier transform pair, they contain equivalent information. Both parameters are measured by linear optical instruments.

### Nonlinear approach

But a nonlinear optical instrument is needed to measure the width of an optical picosecond pulse. In one experiment along this line, a Michelson interferometer splits a pulse into two pulses of equal amplitude separated in time,  $\tau$ , by  $2 \Delta L/c$  when the legs of the interferometer are of unequal length. Each pulse is then first passed through a second-harmonic-generator crystal that doubles the pulse carrier frequency, and then through a photodetector. The crystal output,  $E_{2\omega}(t)$ , is given by

$$E_{2\omega}(t) = \gamma [E(t) + E(t - \tau)]^2$$

where  $\gamma$  is a constant that denotes the efficiency of the second-harmonic conversion. As the legs of the interferometer are adjusted so that  $L_1$

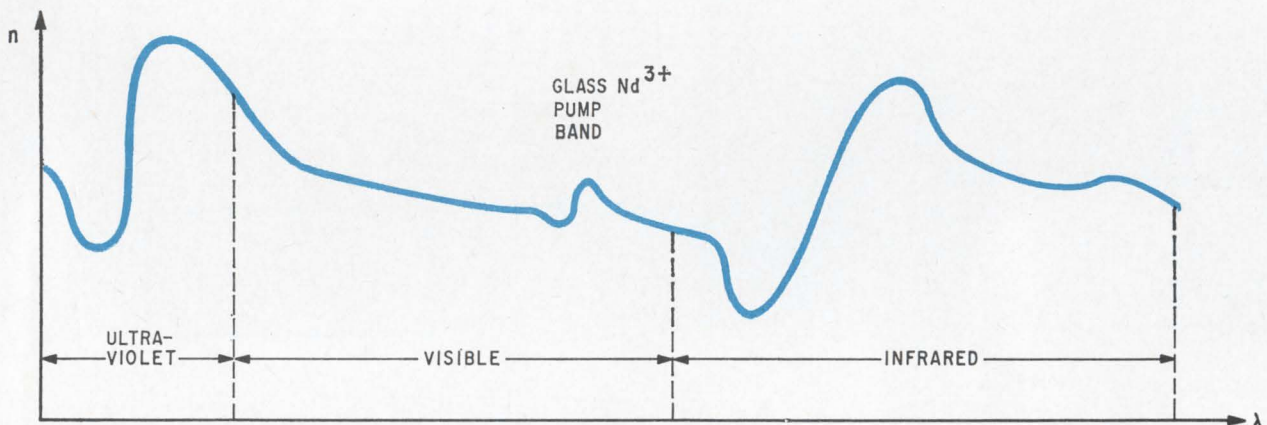

**Chirping.** A quadratic nonlinearity of phase with frequency in the feedback loop of the mode-locked laser causes the pulse's instantaneous frequency to sweep linearly from a low to a high frequency.

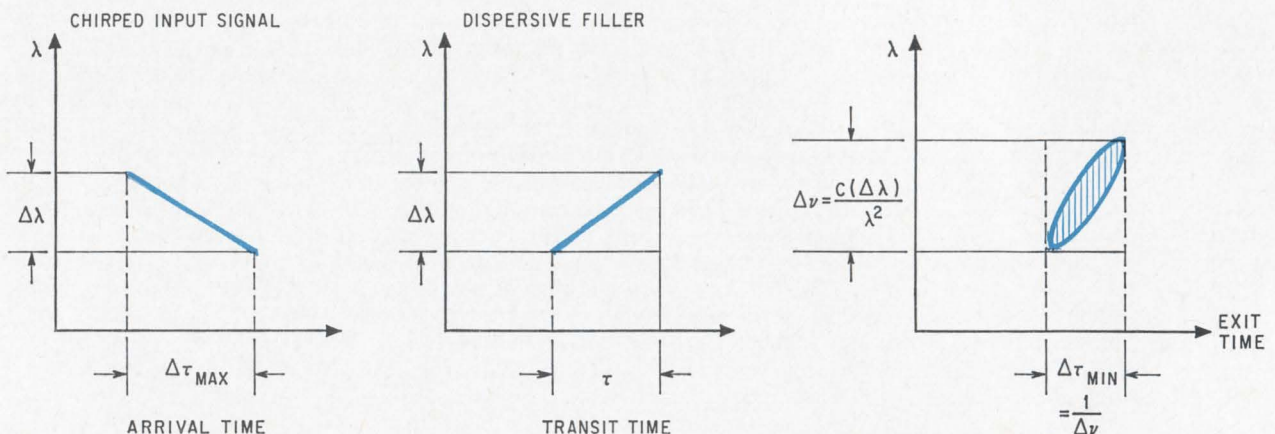

**Time compression.** Pulse width of the dispersed signal is maximum because of chirping effect. Dispersive filter at output delays frequencies selectively—as in radar—so that pulse width is reduced to reciprocal of bandwidth.



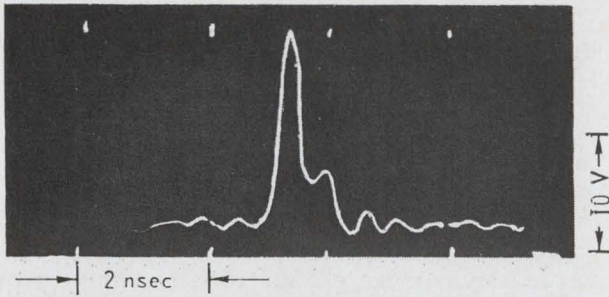

**Ringling.** A 1-GHz traveling-wave scope had this impulse response to a laser-generated electrical pulse.

approaches  $L_2$ , the pulses begin to overlap and the second-harmonic intensity and photo-detector output increase.

The output signal,  $S(\tau)$ , from the photodetector is given by

$$S(\tau) = \int_{-\infty}^{\infty} |E_{2\omega}(t)|^2 dt = \alpha \gamma^2 W_{2\omega} [1 + 2I(\tau)]$$

where  $W_{2\omega}$  is the energy of one of the second-harmonic pulses,  $I(\tau)$  is the correlation function of pulse intensity, and  $\alpha$  a detector constant.

The  $I(\tau)$  obtained with a nonlinear optical instrument contains more information than the correlation function of the pulse amplitude obtained with a linear instrument, and this additional information makes it possible to determine the actual pulse width instead of simply the minimum possible width. When the interferometer's legs are equal, the ratio of the detector output to second-harmonic energy is maximum because the pulses overlap. The maximum value of the ratio in this situation is 3. But when the legs are unequal, the ratio drops to unity when the separation of the legs is larger than the pulse width. The contrast ratio is thus 3:1.

In this measurement technique, the pulse width is approximately equal to  $2\Delta L/c$ . Pulses of a picosecond or less are automatically measured when the periodic change in the length of one interferometer leg is displayed along the horizontal axis of an oscilloscope and the output of the photo-detector is displayed along the vertical—a setup that's an optical analog of an electronic sampling scope.

J.A. Giordmaine and others at Bell Labs recently reported a "two-photon absorption" technique for measuring picosecond laser pulses. The simplicity of this technique—also an intensity-correlation method—is its major advantage over the second-

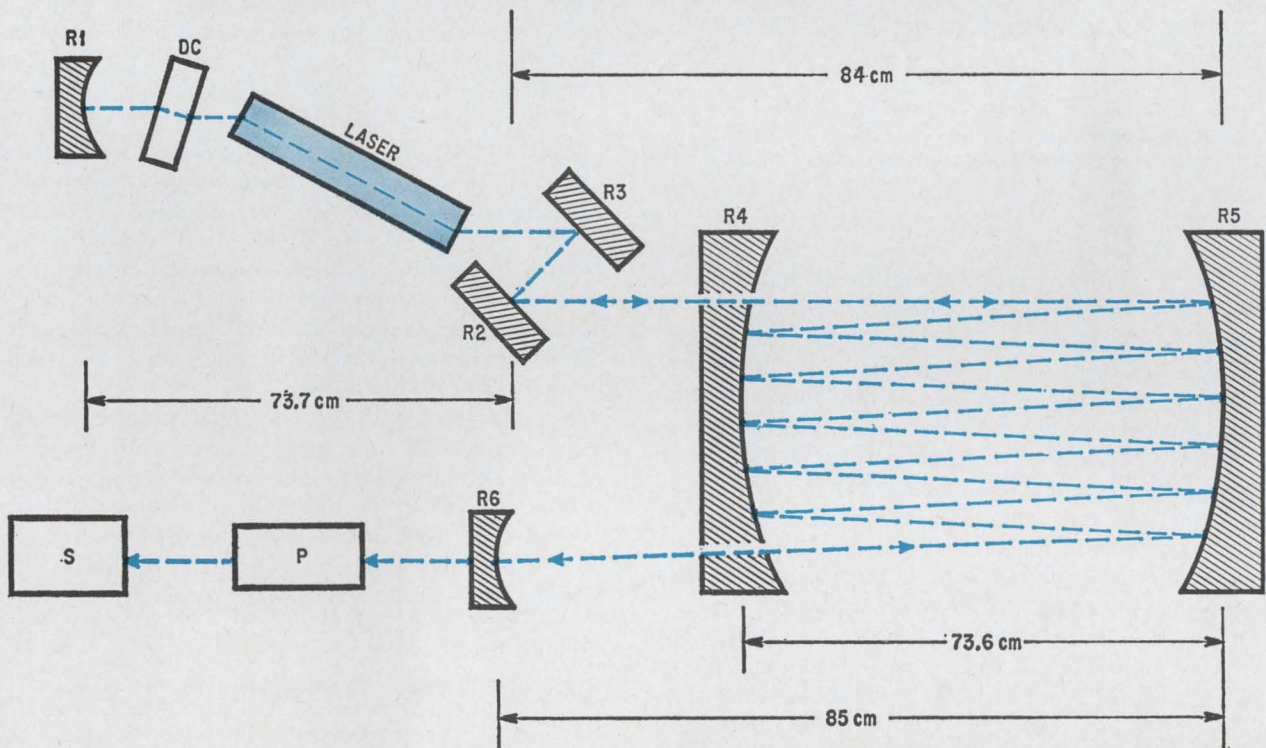

**Welcome delay.** To obtain long intervals between pulses, the cavity of the laser was folded to a practical length by the delay line shown above. Curved mirrors focus pulses, keeping diffraction losses very low. Train in scope photo is shown on 20 nsec/div scale.

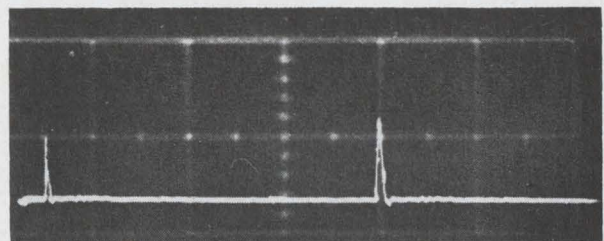



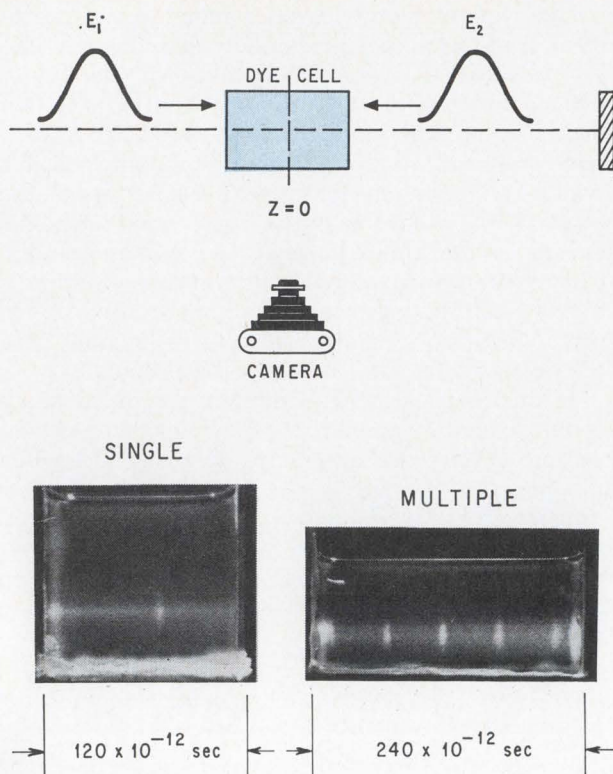

**Two-photon method.** Two pulses enter dye cell, which absorbs energy at twice their frequency. Bright spots are intense fluorescence from overlapping light pulses.

harmonic system.

With the two-photon method, two pulses of the same frequency approach each other from opposite directions and enter a liquid that absorbs energy at twice their frequency. The fluorescent intensity,  $I_f$ , of the liquid is proportional to the square of the intensity of the laser pulses,  $I_w$ , because of the square-power-law dependence of the process.

Each pulse traveling through the liquid leaves a fluorescent trail behind it. As the pulses overlap, the optical electric field increases because of constructive interference; there's a bright spot at the point of overlap. A camera records  $I_f$ , averaging it out in time and space. The bright spot on the film has a width  $\Delta L$ , that's equal to  $\Delta\tau c/2n$  where  $\Delta\tau$  is the pulse duration,  $c$  is the velocity of light, and  $n$  is the refractive index of the dye.

The maximum contrast ratio of the bright spot to the background fluorescence is 3 for coherent pulses and 1.5 for incoherent light. Moving either the reflecting mirror or the dye cell causes the bright spot to move a corresponding distance in the cell, thereby confirming that the spot is caused by the overlapping of the pulses.

### Absorption lines.

Researchers at United Aircraft also experimented with photon absorption. M. J. Brienza, Glenn, and the author used Rhodamine 6G dye in an ethanol solution in this work because the dye's primary absorption peak is close to the 5300-Å second

harmonic of the glass laser. This dye also has another strong absorption line that peaks close to the second harmonic of the ruby laser.

Rhodamine 6G exhibits considerably more fluorescence efficiency at both these wavelengths than does 1,2,5,6-dibenzanthracene dye first used by the Bell Labs group for their two-photon method. In addition, one can measure the fundamental wavelength directly, rather than going to the second harmonic wavelength as is necessary with the dibenzanthracene dye.

In applying this technique, the relatively long time that it takes for axial modes to build up in the Q-switched, passively locked laser must be taken into consideration. These modes undoubtedly affect the contrast-ratio measurement, and it has recently been pointed out by H. P. Weber of the University of Berne that one cannot conclude that the output of Q-switched wide-bandwidth free-running lasers usually consists of picosecond pulses solely on the basis of data obtained by the two-photon technique. Such conclusions were made in the past without regard to the contrast ratio.

The proper interpretation of the data depends on the contrast ratio on the photographic film. It turns out that modes of equal amplitude, and frequency separation, and with random phase relationships, yield a maximum ratio value of 1.5. But when the modes are locked in phase, the contrast ratio value increases to 3. It was recently reported by the Bell Labs group that a contrast ratio of 2 is obtained with mode-locked lasers—an interesting and as yet unexplained result.

Still another way of measuring picosecond pulses employs a nonlinear interferometer and two pulses polarized orthogonally to one another. The harmonic generator crystal is oriented to double the frequency of both pulses. A maximum signal is obtained when the pulses coincide; when they don't coincide, the second-harmonic signal disappears. Since the contrast ratio is infinite here, this technique is preferred to others.

For all these advances the field of picosecond-pulse generation and measurement remains confined to the laboratory. There has been no breakthrough to date in the practical application of these "bullets" of light, but the potential in such areas as information processing, ranging, and high-speed photography continues to spur research.

### Bibliography

- C.C. Cutler, "The Regenerative Pulse Generator," IRE Proc., February 1955, pp. 140-148.
- M.H. Crowell, "Characteristics of Mode-Coupled Lasers," IEEE Journal of Quantum Electronics, April 1965, pp. 12-20.
- J.A. Armstrong, "Measurement of Picosecond Laser Pulse Width," Applied Physics Letters, January 1967.
- W.H. Glenn and M.J. Brienza, "Time Evolution of Picosecond Optical Pulses," Applied Physics Letters, April 1967, pp. 221-223.
- A.J. DeMaria, R. Gagosz, H.A. Heynau, A.W. Penney, and G. Wisner, "Generation and Amplification of a Subnanosecond Laser Pulse," Journal of Applied Physics, May 1967, pp. 2693-2695.
- A.J. DeMaria, D.A. Stetser, and W.H. Glenn, "Ultrashort Light Pulses," Science, June 23, 1967, pp. 1557-1568.
- J.A. Giordmaine, P.M. Rentzepis, S.L. Shapiro, and K.W. Wecht, "Two-Photon Excitation of Fluorescence by Picosecond Light Pulses," Applied Physics Letters, October 1967, pp. 216-218.



# Light wave of the future: optical pcm

Digital light terminals use mode-locked lasers, time multiplexing, and state-of-the-art components to increase information capacity

By T.S. Kinsel

Bell Telephone Laboratories, Murray Hill, N.J.

**Bandwidth limitations** of available optical modulators have been the stumbling block in exploiting the laser's potential for handling huge amounts of information. But there's a way to get around the obstacle. Bell Telephone Laboratories has built optical transmitting and receiving terminals and successfully tested an approach that has these four key elements:

- Mode-locking the laser to form very narrow but relatively low-repetition-rate light pulses.
- Selecting a binary pulse-code modulation format.
- Requiring that the modulator only block or pass pulses at a rate well within its capacity.
- Optically combining these pulses into a very high-speed stream.

The success of its early experiments, which will be described later, encourages Bell Labs to believe its approach is feasible and worth further investigation. As a result, a new experiment is now being set up in which a neodymium-doped yttrium aluminum garnet laser is mode locked at a frequency of 280 megahertz—the timing frequency of the electrical input pcm signal. Then, beam splitters divide the optical pulse stream into several identical optical streams.

Separate electro-optic crystals—driven by individual 280 megabit/sec electrical signals—modulate each of these subdivided streams. Next, a series of delay lines and polarization switches combine the coded (modulated) streams by assigning each to different time slots, thereby forming a very high repetition rate digital signal that is transmitted to the receiving terminal.

At the receiver, similar delay lines and polarization switches separate the stream into individual 280 megabit/sec optical signals. Avalanche photodiode detectors finally convert each stream into a correspondingly coded electrical stream. Since each photodiode detects only the low repetition rate signal, it operates well within its bandwidth limits.

Simply stated, Bell researchers hope to demonstrate that maximum signal processing with optical techniques produces the highest information capacity.

Because the electronics-optical interface is near the front of the transmitter, at the array of optical modulators, and the optical-electronics interface is near the back of the receiver, at the array of photodetectors, all multiplexing and demultiplexing is handled optically. The goal is the design of very high capacity terminals using either commercially available or state-of-the-art devices. Such terminals might someday operate with an enclosed optical transmission line.

Using time, polarization, frequency, and spatial multiplexing, terminals of this type could, theoretically, transmit  $2 \times 10^{14}$  bits/second of information through a shielded pipe. Losses in the transmission line and losses from optical processing would require the use of repeaters about every 80 miles. That's quite an improvement over the repeater spacings of 1.5 miles now used, for example, in commercial electrical pcm systems handling 1.5 megabits/sec.

In the successful initial experiments two pcm pulse streams were time-multiplexed using the 0.6-nanosecond pulses generated by a mode-locked helium-neon laser. The new tests should demonstrate the feasibility of time-multiplexing 24 channels using the 25- to 100-picosecond-wide pulses generated by a mode-locked yag laser. Although this experiment will multiplex only two channels, they will be separated by only  $\frac{1}{24}$ th of the pulse repetition rate to allow meaningful crosstalk and other measurements to be made.

## Building block

The basic transmission terminal contains the electrical information input, the mode-locked laser, and the optical modulator. In an optical communication terminal, the output of the mode-locked laser must be a highly stable pulse train with a relatively high



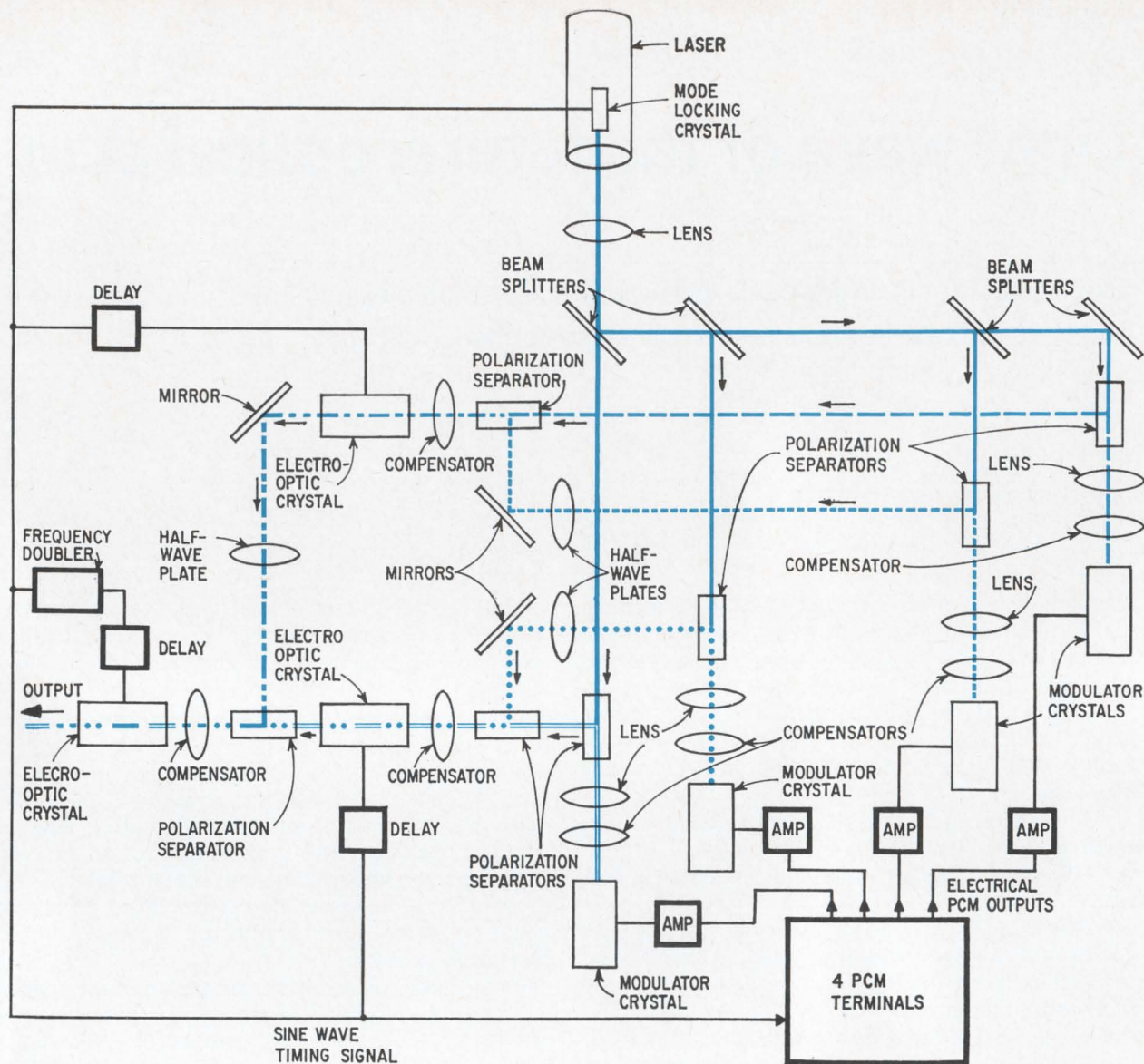

**Multiplexing.** At the experimental optical terminal electrical input pcm streams are first converted to pcm streams of light, then combined into the high-speed signal that would be transmitted in a shielded pipe. In this example of the multiplexing of four pcm signals, the mode-locked output of a laser is divided by beam splitters. Each stream is modulated by a separate crystal, focused, and routed along its path by a polarization separator. The beams are eventually combined by half-wave plates, reflecting mirrors, and other optical components.

repetition rate that never varies. This rules out passive mode locking.

The active intracavity modulator used—a crystal of potassium dihydrogen phosphate (KDP)—operates at the timing frequency of the pcm signal. For mode locking, the laser's cavity length must be adjusted so that the frequency spacing of the axial modes equals the timing frequency.

With a pcm format, light pulses of equal amplitude are transmitted, and the modulator codes the signal merely by allowing the pulse to occupy a time slot or by rejecting it. Similarly, the detector need only recognize the presence of a pulse in a time slot. Thus, both components needn't be highly linear as would be required, for example, in a multi-

level digital format where pulses could have any of several amplitudes. Another reason for picking binary pcm was the existence of pcm terminals, operating at 280 megabits per second. Bell had built these terminals as part of a development program for a commercial high-speed system.

Of the several possible types of modulators—magneto-optic, acousto-optic, or electro-optic—the author and colleagues chose the latter. Electro-optic materials, such as the lithium tantalate crystals used, change the polarization of light passing through them when they're driven by an applied voltage. They do so because their indexes of refraction along the crystalline axes differ for various polarizations. These materials are cut in rectangular



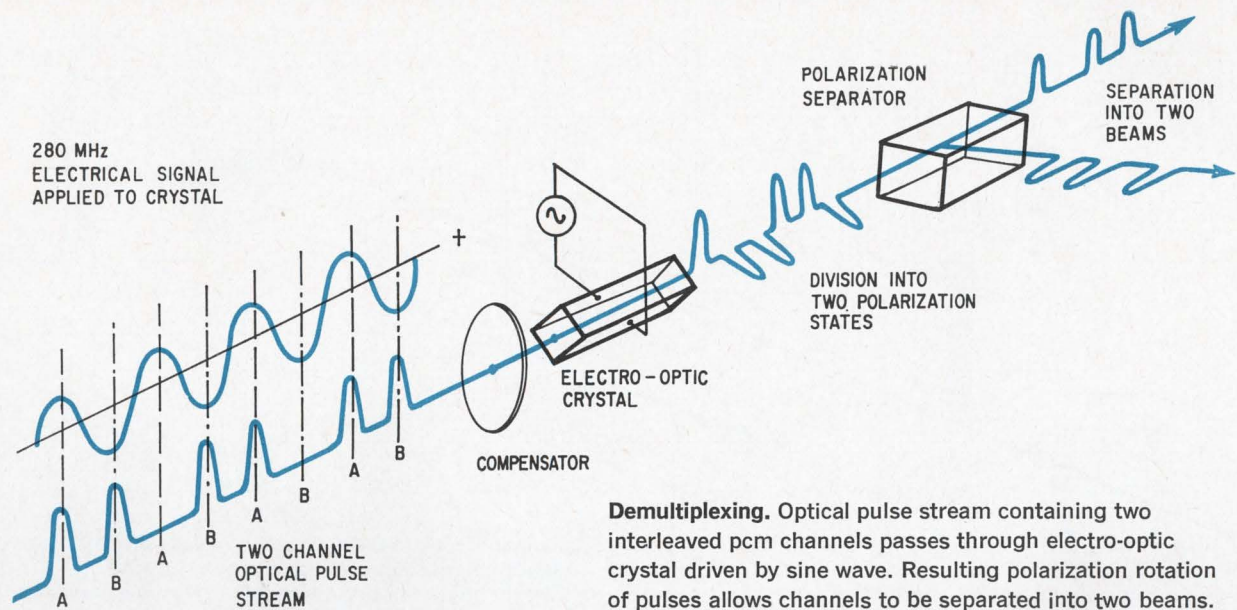

shapes with their crystal axes aligned along the edges.

Light propagating in a crystal can be thought of as having two polarization components along the crystalline axes. The two components are equal if the light is linearly polarized at  $45^\circ$  to one of them. But their indexes of refraction respond differently to the application of an electric field. When that happens, the two components get out of phase and recombine at the end of the crystal, forming an elliptically polarized beam. The amount of phase shift increases with crystal length and applied voltage.

An output polarizer passes the component of the elliptically polarized light that lies along its axis. If this polarizer is oriented at  $90^\circ$  to the input polarizer which precedes the modulator, and no voltage has been applied to the crystal, it blocks light. But it will pass all the light if enough voltage has been applied to develop a phase difference of  $\pi$  radians between the two components. This critical "half-wave voltage,"  $V_\pi$ , depends on the material, the ratio of its width to length, and the wavelength of the propagating light.

The amount of drive power supplied to the crystal to achieve a voltage of  $V_\pi$  across the terminals is proportional to the ratio of the cross-sectional area of the crystal to its length. Thus, the amount of drive power can be reduced by making this ratio as small as possible. However, since an optical beam must be focused through the crystal, the smallest ratio is determined by the diffraction laws of light. There's another limitation—fabricating the long thin crystals.

In the Bell Laboratories lithium tantalate modulator, the 0.025 by 0.025 by 1.0 centimeter dimensions are about a safety factor of 10 above the diffraction limit. The lithium tantalate crystal has a  $V_\pi$  of 60 volts and a capacitance of about 6 pf. Other materials, such as strontium barium niobate and barium

sodium niobate, promise modulators with low drive requirements but it's difficult to consistently fabricate crystals with the desired properties.

### Double take

To cut down on the amount of drive power required in the modulator used in the optical transmitting terminal, the crystal was coated at one end with a dielectric mirror. Thus, light passes through the crystal, reflects off the mirror, and travels back to the input. This double pass halves  $V_\pi$  to 30 volts with no increase in capacitance because it optically doubles the crystal length. But it also makes it necessary to modify the input-output polarizers.

A polarization separator preceding the modulator allows a reflected pulse to pass through it if its polarization hasn't been rotated. If it has, the separator deflects the pulse to the transmission line (or multiplexer). This passive device therefore functions as an input and output polarizer.

However, the reflected pulses that haven't been rotated can't be allowed to travel back to the laser. Mode-locked lasers become unstable with such feedback. So it's necessary to misalign the modulator crystal slightly, hurting its performance somewhat. Plans are to use a Faraday-type optical isolator in the new terminals to avoid this problem.

Even in the absence of an applied voltage there's a phase shift between the two components of light in the lithium tantalate crystal because the light isn't propagated along the crystal's major axis. As a result, drive power can be lowered, but you have to add a compensator to cancel the phase shift. There's a further complication. The modulator crystal has to go into a temperature controlled oven because the phase shift varies with temperature.

Associated with the crystal is the driver amplifier, a specially designed, seven-transistor circuit that uses a current routing pair at the output to provide the required 30-volt pulses. Since the width



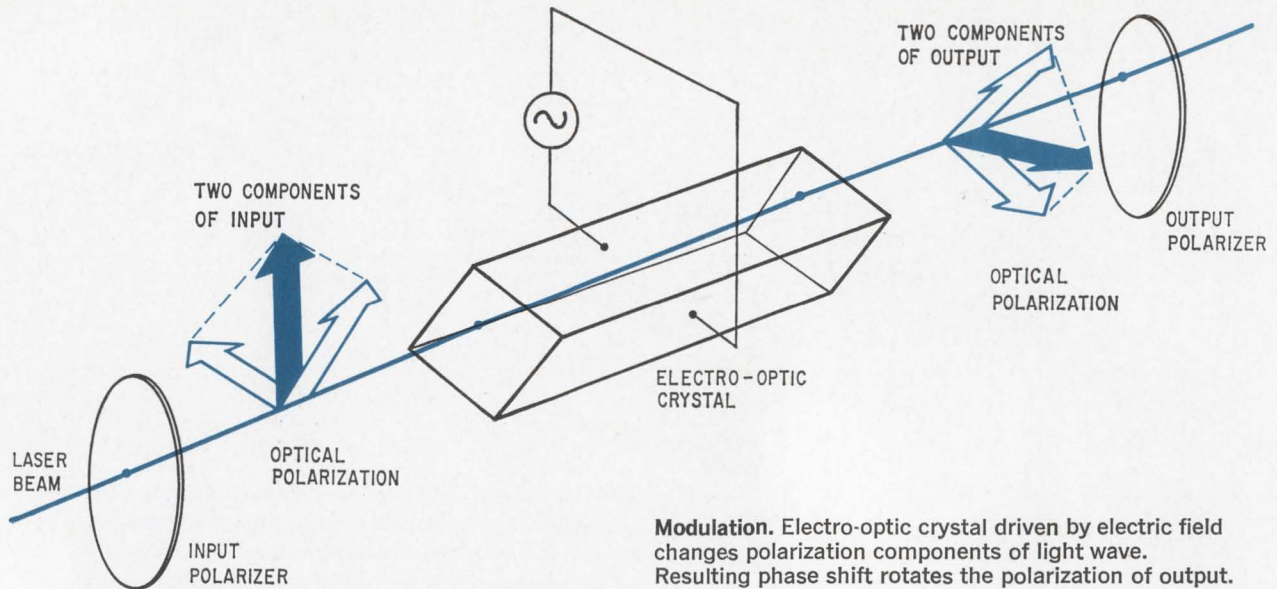

**Modulation.** Electro-optic crystal driven by electric field changes polarization components of light wave. Resulting phase shift rotates the polarization of output.

of the optical pulses is so much shorter than the period between them, the drive voltage need be present on the crystal only for a short time. Requirements are that the rise and fall times of the amplifier need be no longer than the period between pulses. Thus, the amplifier bandwidth can be reduced to 140 Mhz.

A coded sequence of 1 volt pulses feeds into the amplifier from a pcm word generator. The generator also provides the 280-Mhz timing signal used to mode-lock the laser. Between the generator and the modulator a variable delay line insures that the voltage pulse is driving the crystal at the same time a light pulse is propagating through it.

Either superheterodyne or direct detection techniques could have been used in the receiving termi-

nal. But even though the former performs better at low signal-to-noise ratios, it has several disadvantages for a pulsed communication link. For one thing, it's sensitive to mode conversion and spatial drift in the optical beam. For another, the design of i-f stages would be difficult because the pulses are equivalent to a multifrequency carrier.

So the present terminal uses a silicon avalanche photodiode to directly convert the light into electrical pulses. This diode is the solid-state analog of a photomultiplier and has a gain-bandwidth product of several gigahertz.

The receiver also contains a timed regenerator—a decision circuit that determines whether a particular time slot contains a 0 or a 1.

In the experimental single-channel transmitter and receiver terminal built with a mode-locked He-Ne laser and a lithium tantalate modulator, the modulator's ability to discriminate between a pulse and no pulse exceeded 20 decibels. And pulses propagating through the optical gate to the transmission line were attenuated about 1 db. Now in operation over two years with an actual electrical pcm terminal, the optical set-up has proved to be almost error-free for long periods of time.

### Finding a slot

Because the optical pulses forming the digitally coded light beam are so narrow, a number of independent pcm channels can be interleaved in time, that is, time multiplexed. Theoretically, a multiplexed optical pulse stream can have a maximum repetition rate equal to half the laser's bandwidth. However, interference between channels may reduce the number that can be placed in the stream.

In the Bell Labs approach, pulses are multiplexed and demultiplexed into a high speed stream by means of a "sinusoidal polarization switch," which consists of a compensator, an electro-optic crystal, and a polarization separator.

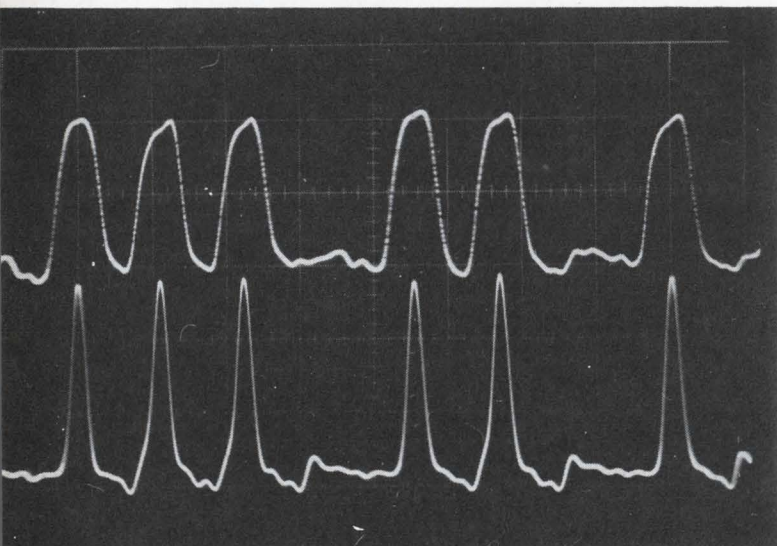

**Conversion.** Input electrical (224 megabit/sec) pulse stream codes output optical pulse stream.



To see how this switch works, it's best to follow the demultiplexing of, say, a pulse stream with a rate of 560 megabit/sec. This pulse stream, composed of two separate, interleaved pcm channels, passes through the compensator and then through a lithium tantalate crystal, driven by a 280-Mhz sinusoidal electrical signal. The phase of this signal is adjusted so that the time slots for one channel travel through the crystal at its peaks while the time slots for the other channel travel through at its valleys.

If the peak-to-peak voltage of the electrical signal equals  $V_{\pi}$ , then the optical pulses from the two pcm channels will be divided into two orthogonal linearly polarized states. The polarization separator then divides the channels into two pulse streams. Several other ways of operating the polarization switch using sine waves of harmonically related frequencies and different amplitudes, have been suggested but the best results are expected from the scheme just described.

Peaks of the 280-Mhz sinusoidal signal don't last long enough to rotate the polarization of the entire pulse, and some energy spills over into other channels, resulting in crosstalk. A pulse regenerator at the receiving terminal, however, can significantly reduce this interference. In the experimental two-channel terminal, crosstalk was close to that predicted by theory—22 decibels.

The sinusoidal polarization switch can be operated in inverse fashion to multiplex properly phased, orthogonally polarized channels into a single beam. With a sinusoidal signal, drive requirements can be reduced by resonating the crystal.

Handling more than two channels requires a binary tree arrangement. For example, four channels would be multiplexed and demultiplexed this way: A series of beam splitters would divide the pulse stream from the mode-locked laser into four streams, each of which would be modulated sepa-

## Capacity of an optical pcm system

Type of Multiplexing	Number of channels	Bits per sec	Number of video signals
None	1	$2.80 \times 10^3$	3
Time—multiplexed Nd: YAG (both polarization states)	64	$\approx 2 \times 10^{10}$	192
Frequency—multiplexed (100 carriers)	6,400	$\approx 2 \times 10^{12}$	19,200
Spatially—multiplexed (100 beams)	640,000	$\approx 2 \times 10^{14}$	1,920,000

rately. The four streams are combined by a series of half-wave plates that rotate their polarization by  $90^\circ$ , polarization switches, and mirrors. As the drawing on page 124 shows, the end result is to delay the pulses by appropriate amounts so that they are interleaved in time and combined into a single beam. Such a multiplexed stream would contain four channels at a rate of 1.12 gigabit/sec.

At the receiving terminal, demultiplexing would be handled similarly by sinusoidal polarization switches. Then each pulse stream would go to its own photodiode.

### Upward, then onward

Once time-multiplexing is accomplished, there's a possibility of using both linear states of polarization of the high-speed pulse stream, thereby doubling the information capacity. Furthermore, other types of multiplexing—frequency and spatial—might also be used in an actual communications system. Of course, these techniques are equally applicable in analog systems but they're worth considering in

**Two passes.** Mode-locked pulses travel through modulating crystal and are reflected back to polarization separator. This increases the crystal's optical length.

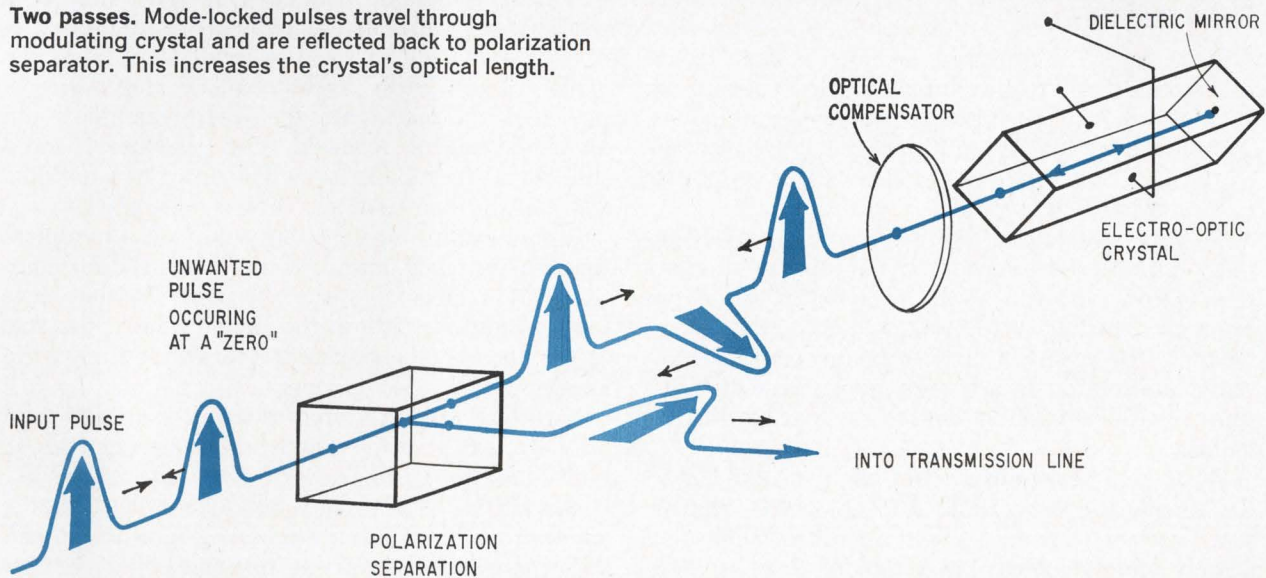



## SIGNAL-TO-NOISE MARGINS FOR AN OPTICAL PCM SYSTEM

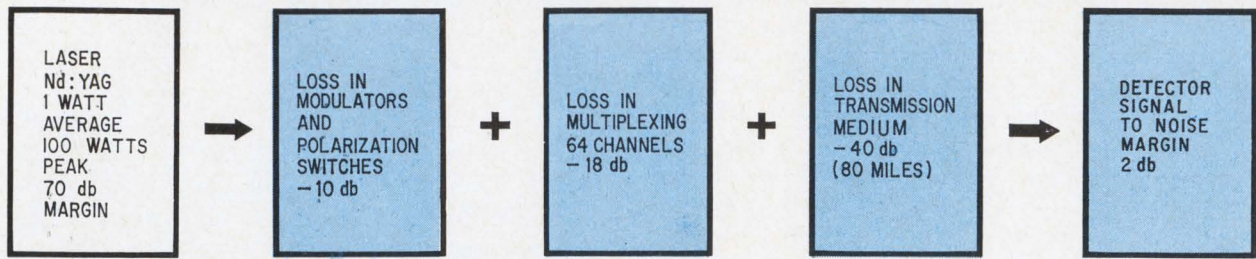

the light of currently available or state-of-the-art components to get a feel for the capacity of an optical communications system carrying pcm signals.

In frequency multiplexing, other individual time-multiplexed pulse streams would be transmitted at different carrier frequencies. There are three stipulations: the other carrier frequencies must be obtainable; the transmission medium must not distort the composite wideband signal, and the receiver must be able to separate the carriers.

Different lasers will certainly produce different carrier frequencies—but will they all have sufficient bandwidth to form pulses of the required width? Will they require complicated pumping?

Another possibility is to build a tunable laser with parametric techniques. Bell Labs has made some progress in this area using a barium sodium niobate crystal to tune a continuous-wave yag laser over nearly 2,000 angstroms.

Now, the transmission medium. Assuming that a hollow pipe with glass lenses were used, the frequency-multiplexed signal would be expected to arrive at the receiver virtually undistorted.

Finally, the selectivity of optical filters dictates the minimum separation between carrier frequencies. Presently available, high-quality, interference-type filters can separate optical wavelengths spaced by about 10 angstroms. In the case of a parametric-tuned laser, this indicates the possibility of 200 different carriers.

### Room to expand

In an enclosed transmission line, capacity could be increased still further by launching beams of the same frequency in different transmission modes. This so-called spatial multiplexing takes advantage of the fact that a number of beams can propagate in a multimode waveguide.

The maximum number of beams that can be spatially multiplexed depends on the number of spots that can be resolved at the receiver. However, in practice, crosstalk would reduce this number somewhat. It's been shown that 300 beams could be spatially multiplexed in a beam waveguide with a radius of 10 centimeters and lens spacing of 100 meters.

What kind of terminal could one get by using all the techniques described? The answer is impressive. Such a terminal could transmit 640,000 pcm signals simultaneously at a rate of  $2 \times 10^{14}$ —the

equivalent of 1,920,000 video signals. This calculation is based on time-multiplexing 32 channels, using both polarization states, generating 100 separate carriers, and spatially multiplexing 100 beams.

### Lost light

In such a high-capacity terminal not all of the laser's output goes into the transmission of information. There are losses along the way. Estimations based on measurements made with the helium-neon laser terminals are promising. With about 1 milliwatt of peak power, the earlier terminal had a 20 db signal-to-noise margin. Since it's expected that a mode-locked yag laser can provide 100 watts of peak power, signal to noise margin will be increased to 70 db.

Therefore, if this laser's output were divided into 64 beams (32 time-multiplexed channels in both polarization states), the loss would be 18 db. This would be caused primarily by the reduction of beam power by division.

Each of the 64 beams would then go through one modulator and several polarization switches. Lumping the losses from multiplexing, demultiplexing, and modulation gives 10 db of loss for each beam.

Studies of enclosed transmission media with glass lenses have shown optical losses as low as 0.5 db per mile. In 80 miles, then, the multiplexed optical signals would be attenuated by 40 db, resulting in a net signal-to-noise ratio of 2 db. At this spacing a repeater might be needed. One advantage of a pcm system is that, in principle, an infinite number of repeaters can be used without increasing the signal-to-noise ratio. Right now, no single optical device could regenerate the highly complex and wideband signal received, and repeaters would probably demultiplex the signals down to individual 280 megabit/sec channels before regeneration.

It's interesting to note that with some modification the terminals described could be used for communication links in space missions. In that case range would depend on the laser's power, the size of the beam at the transmitter, and the size of the receiving optical components.

Naturally, such a system doesn't exist now, and it's not clear at this point whether it ever will be built along the guidelines we now have. As wider bandwidth devices, such as bulk-effect components, are improved and better modulators are developed, the present concept of multiplexing could change.



# Something for nothing

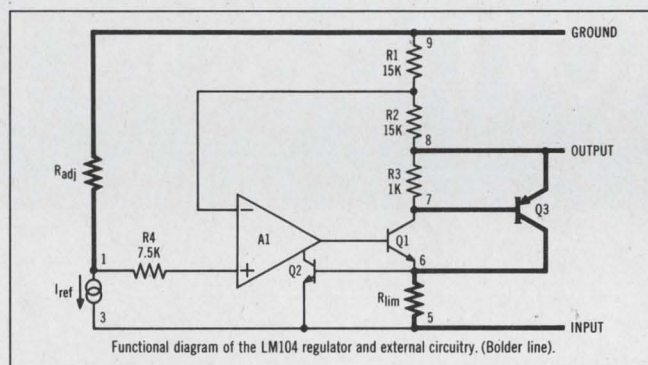

0V on the output terminals of your monolithic voltage regulator no longer means that it's not working. Our latest linear device, the LM104, is a precision *negative* voltage regulator that can be programmed by a single resistor to supply any voltage from -40V to 0V. And that's with a single unregulated supply. You get up to 25mA out with 1mV regulation no-load to full-load, 0.01%/V line regulation, and temperature stability of 0.3% over the full military temperature range. Adding an external pass transistor boosts the current capability; adding a separate floating bias supply provides 0.01% regulation at any voltage, limited only by the breakdown of the external pass transistors.

Who needs it? The same engineers buying our LM100 and LM105 positive regulators—the LM104 is their complement. Like our positive regulators, the LM104 can be used for linear, series, switching or current regulation.

At \$20 each in 100 quantities, they're not free, but still a good deal. We also have the LM204 (-25°C to 85°C) for \$14 and the LM304 (0°C to 70°C) for \$5.60. Write for complete specifications. Or just go out and buy one; it's really something.

National Semiconductor Corporation, 2975 San Ysidro Way, Santa Clara, Calif. 95051 • (408) 245-4320.

## National Semiconductor





# The Kokomoans' power

Thanks to our Delco distributors. They stand ready to deliver power fast. From 32 offices all over the country, with one near you. Each distributor is hand-picked for his organization, experience and ability to provide quality service. So he can give you what you need in power semiconductors: silicon or germanium power transistors; silicon power rectifiers and diodes. Anything in the Delco line. If you're still in the design stage, he's got up-to-date specs, prices and applications information. And sample quantities\* when you need them. Just give him a call. He'll show you why the Kokomoans are in power.

*\*From 1 to 4,999 pieces.*



MARK OF EXCELLENCE

**DELCO RADIO**  
DIVISION OF GENERAL MOTORS  
**KOKOMO, INDIANA**

**Kokomoans' Regional Headquarters**

Union, New Jersey\* 07083  
Box 1018 Chestnut Station  
(201) 687-3770

Chicago, Illinois\* 60656  
5151 N. Harlem Avenue  
(312) 775-5411

Syracuse, New York 13203  
1054 James Street  
(315) 472-2668

Santa Monica, Calif.\* 90401  
726 Santa Monica Blvd.  
(213) 870-8807

Detroit, Michigan 48202  
57 Harper Avenue  
(313) 873-6560

Kokomo, Ind. 46901  
700 E. Firmin  
(317) 459-2175 Home Office

\*Office includes field lab and resident engineer for application assistance.



# is everywhere.

## IN THE EAST

**BALTIMORE, MD. 21201**  
Radio Electric Service Co.  
5 North Howard Street  
(301)-539-3835

**BINGHAMTON, N.Y. 13902**  
Federal Electronics, Inc.  
P. O. Box 1208  
(607)-748-8211

**CLIFTON, N.J. 07015**  
Eastern Radio Corporation  
312 Clifton Avenue  
(201)-471-6600

**NEWTON, MASS. 02195**  
The Greene Shaw Co., Inc.  
341-347 Watertown St.  
(617)-969-8900

**NEW YORK, NEW YORK 10036**  
Harvey Radio Co., Inc.  
2 West 45th St.  
(212)-582-2590

**PHILADELPHIA, PENN. 19123**  
Almo Industrial Electronics, Inc.  
412 North 6th Street  
(215)-922-5918

**PITTSBURGH, PENN. 15206**  
Radio Parts Company, Inc.  
6401 Penn Ave.  
(412)-361-4600

**WOODBURY, L.I., N.Y. 11797**  
Harvey Radio Company, Inc.  
60 Crossways Park West  
(516)-921-8700

## IN THE SOUTH

**BIRMINGHAM, ALA. 35233**  
Forbes Distributing Company, Inc.  
1416 Fourth Ave., South  
(205)-251-4104

**MIAMI, FLORIDA 33142**  
Mountain Electronics  
Division of Mountain National Co.  
3730 Northwest 36th St.  
(305)-634-4556

**RICHMOND, VA. 23220**  
Meridian Electronics, Inc.  
1001 West Broad Street  
(703)-353-6648

**WEST PALM BEACH, FLA. 33402**  
Mountain Electronics  
Division of Mountain National Co.  
1000 N. Dixie Highway  
(305)-833-5701

## IN THE MIDWEST

**CINCINNATI, OHIO 45237**  
United Radio, Inc.  
7713 Reinhold Drive  
(513)-761-4030

**CLEVELAND, OHIO 44125**  
The W. M. Pattison Supply Co.  
Industrial Electronics Division  
4550 Willow Parkway  
(216)-441-3000

**INDIANAPOLIS, IND. 46225**  
Graham Electronics Supply, Inc.  
122 South Senate Avenue  
(317)-634-8486

**KALAMAZOO, MICH. 49005**  
Electronic Supply Corp.  
P. O. Box 831  
(616)-381-4626

**KANSAS CITY, MO. 64111**  
Walters Radio Supply, Inc.  
3635 Main Street  
(816)-531-7015

**MINNEAPOLIS, MINNESOTA 55401**  
Stark Electronics Supply Co.  
112 3rd Ave., North  
(612)-332-1325

**SKOKIE, ILL. 60076**  
Merquip Electronics, Inc.  
7701 N. Austin Ave.  
(312)-282-5400

**ST. LOUIS, MO. 63144**  
Electronic Components for Industry Co.  
2605 South Hanley Road  
(314)-647-5505

## IN THE WEST

**ALBUQUERQUE, N. M. 87103**  
Sterling Electronics, Inc.  
1712 Lomas Blvd., N. E.  
(505)-247-2486

**DALLAS, TEXAS 75201**  
Adleta Electronics Company  
1907 McKinney Ave.  
(214)-742-8257

**DENVER, COLO. 80219**  
L. B. Walker Radio Company  
300 Bryant Street  
(303)-935-2406

**HOUSTON, TEXAS 77001**  
Harrison Equipment Co., Inc.  
1422 San Jacinto Street  
(713)-224-9131

**LOS ANGELES, CAL. 90015**  
Radio Products Sales, Inc.  
1501 South Hill Street  
(213)-748-1271

**LOS ANGELES, CAL. 90022**  
Kierulff Electronics, Inc.  
2585 Commerce Way  
(213)-685-5511

**OKLAHOMA CITY, OKLAHOMA 73102**  
Radio, Inc.  
903 North Hudson  
(405)-235-1551

**PALO ALTO, CAL. 94303**  
Kierulff Electronics, Inc.  
3969 East Bayshore Road  
(415)-968-6292

**PHOENIX, ARIZ. 85005**  
Sterling Electronics, Inc.  
1930 North 22nd Ave.  
(602)-258-4531

**SAN DIEGO, CAL. 92101**  
Milo of California, Inc.  
2060 India Street, Box 2710  
(714)-232-8951

**SEATTLE, WASH. 98108**  
Kierulff Electronics, Inc.  
5940 6th Ave., South  
(206)-763-1550

**TACOMA, WASH. 98402**  
C & G Electronics Company  
2502 Jefferson Ave.  
(206)-272-3181

**TULSA, OKLAHOMA 74119**  
Radio, Inc.  
1000 South Main Street  
(918)-587-9124

## IN CANADA

**SCARBOROUGH, ONTARIO**  
Lake Engineering Co., Ltd.  
123 Manville Rd.  
(416)-751-5980





Positive Air Pressure Tape Loop  
(Patented)

Dual Inertia Drive  
(Patented)

Capstan Design  
(Patented)

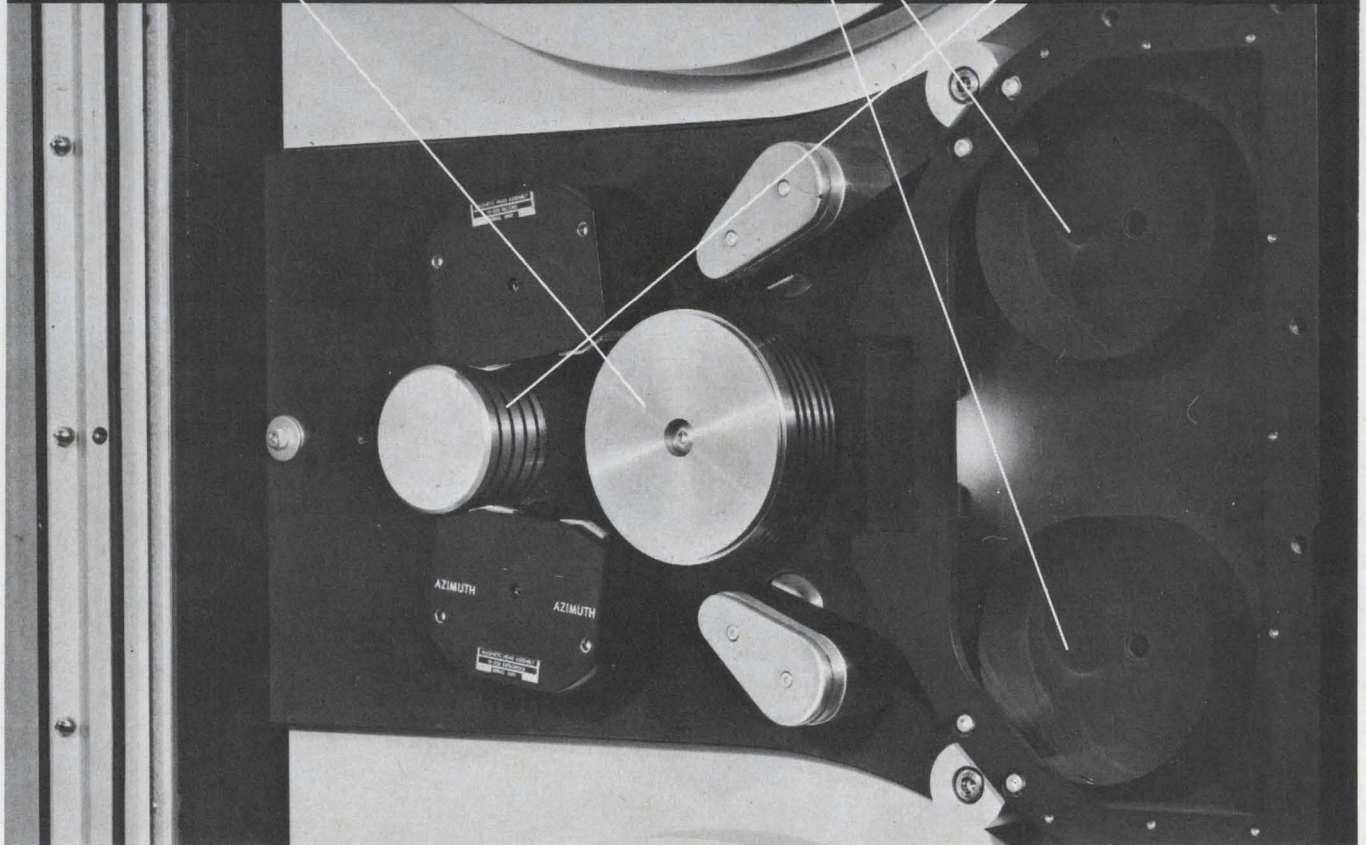

## Patently your best recorder

We're referring, of course, to the new VR 5000.

Today, instrumentation recorders have reached such a degree of efficiency that a single, patentable improvement is considered a "break-through". So you can imagine what happened to the state-of-the-art when CEC achieved *three* patentable improvements with *one* recorder.

And here are the three advances that did it:

**1. DUAL INERTIA DRIVE**—which provides high mass recording and low mass reproduce. Result: a flutter correction capability *demonstrably* more efficient than that of the next best recorder now available.



**2. POSITIVE AIR PRESSURE TAPE LOOP**—which assures reel perturbation isolation and eliminates the chronic problems of vacuum buffers and pinch rollers.

**3. CAPSTAN DESIGN WITH EXCLUSIVE O-RING SURFACE**—which produces tracking superior to any other recorder yet tested.

**NOW ADD ANOTHER ADVANTAGE**, a time base error of  $\pm 200$  nanoseconds. Which means that the ultimate in real-time restoration of data is now possible. And tapes made on data acquisition recorders under severe environmental conditions can be successfully reduced with correct time base restored.

For a complete performance report on the VR 5000—and all the facts—call your nearest CEC Field Office. Or write

Consolidated Electroynamics, Pasadena, California 91109. A subsidiary of Bell & Howell. Ask for Bulletin VR 5000-X4.

CEC also offers a complete line of other DATATAPE® recorders for mobile, laboratory and aerospace use.

CEC/DATA INSTRUMENTS DIVISION



**BELL & HOWELL**



# Who can make your precision resistors take up less space?

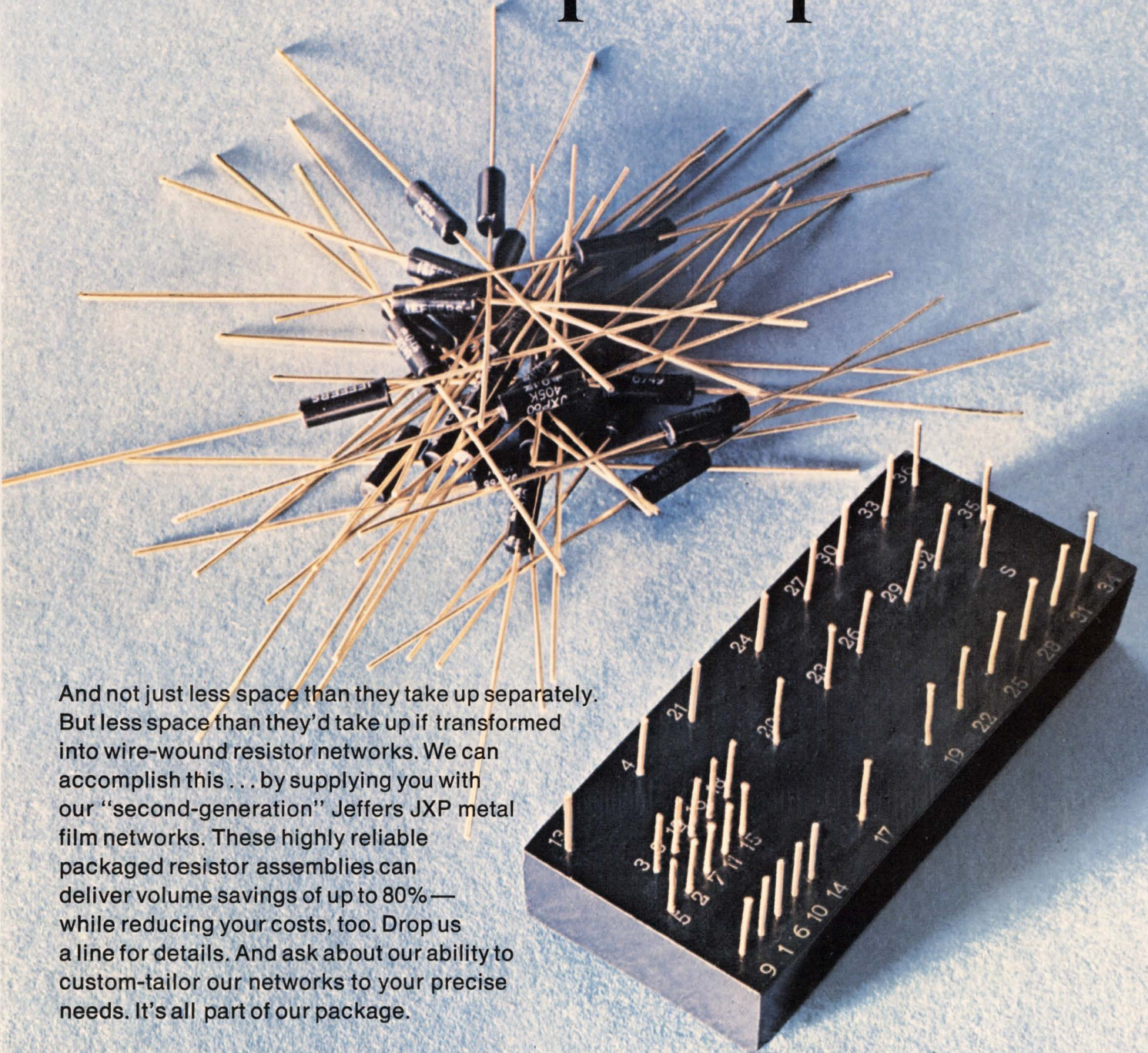

And not just less space than they take up separately. But less space than they'd take up if transformed into wire-wound resistor networks. We can accomplish this . . . by supplying you with our "second-generation" Jeffers JXP metal film networks. These highly reliable packaged resistor assemblies can deliver volume savings of up to 80%—while reducing your costs, too. Drop us a line for details. And ask about our ability to custom-tailor our networks to your precise needs. It's all part of our package.

## The passive innovators at Airco Speer.

**AIRCO Speer Electronic Components** include Speer resistors, Jeffers JC precision resistors, Jeffers JXP precision resistors and networks, Jeffers inductors and capacitors and PEC variable resistors and trimmer potentiometers.  
St. Marys, Pa. 15857 • Bradford, Pa. 16701 • DuBois, Pa. 15801 • Toronto 15, Ontario.



97 Projects. No Waiting.



The name of our company is MITRE.  
We're in the business of designing, developing,  
verifying large computer-based systems  
for the Government. Under both civil  
and defense contracts.

Right now we're in communications, military command  
and control, air traffic control, transportation,  
medical information, education, urban planning.

We have openings for systems engineers,  
electronic engineers, systems analysts, mathematicians.

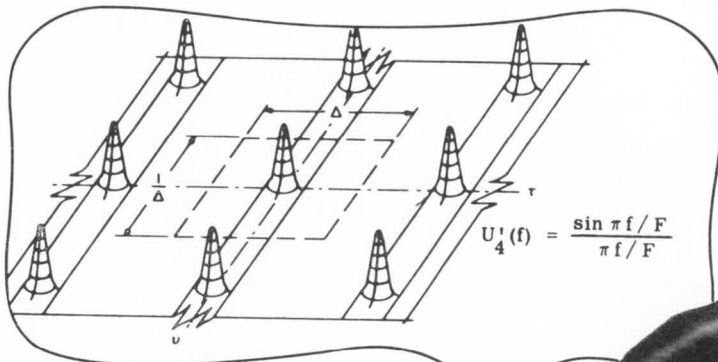

For more information write to

THE  
**MITRE**  
CORPORATION  
An Equal Opportunity Employer

in Bedford.  
Or Washington.

Address Mr. Richard Seamans, 3909 Middlesex Turnpike, Bedford, Mass., 01730  
In Washington: Mr. Robert Knotts, P. O. Box 1202BC, Bailey's Crossroads, Va., 22041

## MITRE HAS IMMEDIATE OPENINGS IN BOSTON AND WASHINGTON

### ■ Communications Engineers

MITRE's responsibility in Bedford includes technical direction on such current communications systems as 490L Overseas Autovon, TACSATCOM, and Integrated Communication Navigation and Identification (ICNI). There are also openings for communications engineers on 407L, Tactical Air Control System, and related tactical communications projects.

Interest and background are desired in systems analysis; design, installation and checkout of communications networks; modulation and signal processing techniques; switching systems; voice and data transmission and satellite communications and associated airborne and ground terminal hardware.

### ■ National Airspace System

MITRE is currently augmenting its top-flight team of systems men in the suburban Washington, D.C. and Atlantic City, N.J. areas where FAA's prototype Air Traffic Control systems are now under development. Their mission: to provide the system engineering to the Federal Aviation Administration on the new National Airspace System — an air traffic control system for the 1970's. Their job encompasses such technical areas as broad level system analysis, computer program analysis, system specifications, system logical design and system test planning for design verification.

On this project you would have the opportunity to: translate system operational objectives into technical requirements for the system's subsystems; synthesize the technical characteristics of equipment subsystems of balanced reliability, and analyze alternatives; review and analyze, at the logic level, the design submissions of system hardware contractors; conduct design optimization studies with respect to cost, reliability, and technical suitability; or to synthesize software designs for a multi-processing computer environment.

### ■ National Range Support Systems Development

MITRE needs scientists and engineers in Washington to assist the Air Force Systems Command in its development of the future systems requirements and instrumentation plans for the Eastern and Western Test Ranges. Systems-oriented planning and research activities include studies of range functional subsystems categories: radar, telemetry, optics, communications, and data processing.



# Tools of the drafting trade.

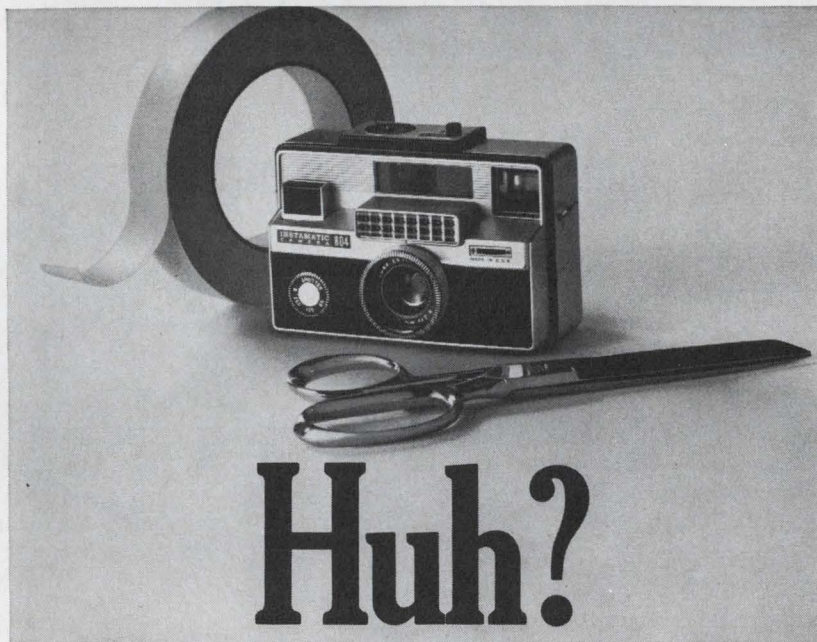

Strange looking drafting tools? When you know how to use them with KODAGRAPH ESTAR Base Films, you can save hours of creative drafting time.

Take the camera. With it and ESTAR Base Film you can make a photodrawing. As the name implies, a photodrawing is simply a combination of a photograph and a drawing. You just photograph an existing part, assembly, model—no matter how complicated—and combine the photo with drawings on ESTAR Base Film. Extra detail, such as connecting lines, can be added easily on the outstanding matte drafting surface of the film.

Tape and scissors? "Scissors drafting," of course. With KODAGRAPH ESTAR Base Films you can de-

lete and add components of a drawing by cutting and taping—not redrafting the whole job.

This is only the beginning. Your Kodak Technical Sales Representative will be happy to show you something about photodrawings and "scissors drafting"—as well as some other uses of the tools of the trade that will save you time and money. In the meantime, for your free copy of a special booklet detailing the many uses and variations of photodrawings, "scissors drafting," and other techniques, just write: Eastman Kodak Company, Business Systems Markets Division, Rochester, N.Y. 14650.

**Kodak**

**DRAWING REPRODUCTION SYSTEMS BY KODAK**



# MIL-T-713 calls for 22% to 32% wax coating on LACING TAPE.

- But what really is the right amount for trouble-free, tight-knot lacing?
- **GUDEBROD KNOWS.** They make yard after yard after yard exactly right!
- **GUDEBROD TAPE** cuts harness costs!

- Send for a sample.

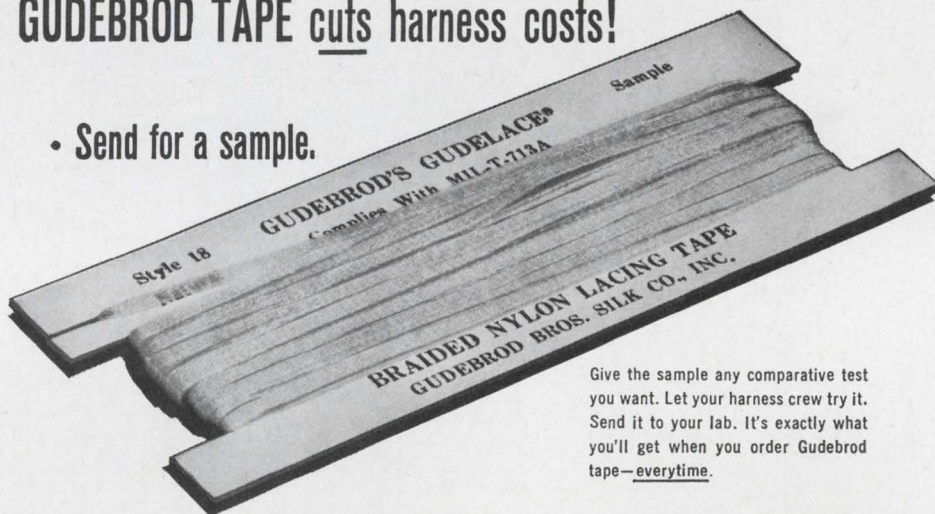

Give the sample any comparative test you want. Let your harness crew try it. Send it to your lab. It's exactly what you'll get when you order Gudebrod tape—everytime.

You are often required to lace with tape that meets MIL-T Specs—with a specified range of wax content. But that's no assurance that you are using a tape that ties tight, holds tight, that probably won't be rejected—unless, of course, you have Gudebrod Gudelace. Like all Gudebrod Lacing Tapes it's manufactured under strict quality control including the wax coating. Every yard of Gudelace is impregnated exactly the same, exactly right. You can count on that—and on speedier, easier, better harnessing. That's where you save real money. Want to know more? Get in touch with Gudebrod.

#### GUDEBROD CABLE-LACER

The first hand tool engineered for wire harnessing. Handle holds bobbins, feeds tape as needed, grips tape for knotting. Speeds, eases harnessing. Pays for itself in time saving.



Area Code 215, WA 2-1122



## GUDEBROD BROS. SILK CO., INC.

FOUNDED IN 1870

*Electronics Division*

12 SOUTH 12th STREET, PHILADELPHIA, PENNSYLVANIA 19107



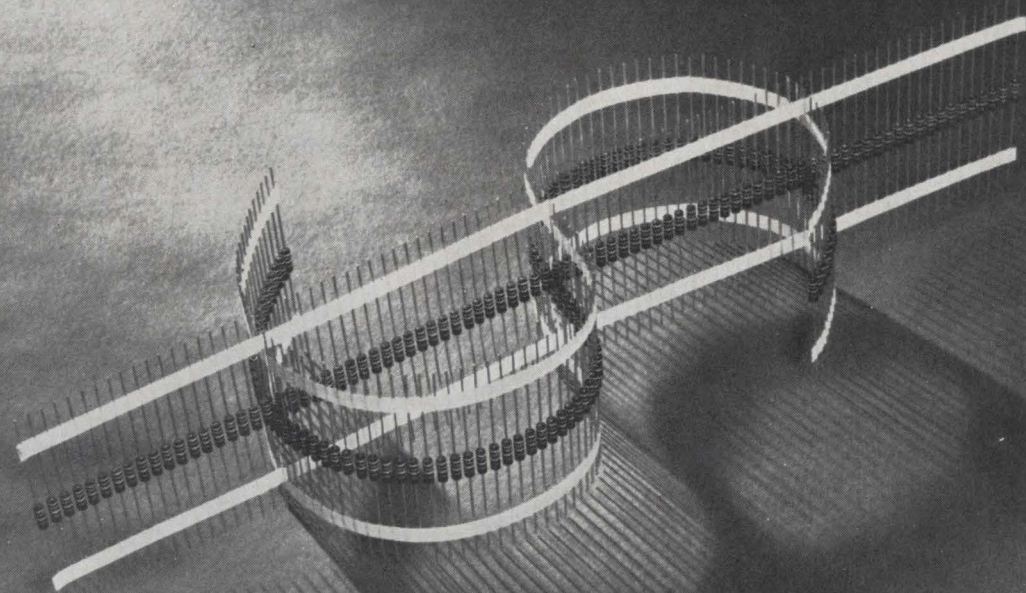

## Why buy price at any cost

To pay too little is to obviously speculate. To spend too much is to be foolishly extravagant. The real value of any purchase is determined in performance, not price. Resistors are like this also.

For years, Stackpole fixed composition resistors have been the standard of value for many leading manufacturers of electrical and electronic equipment. Engineers have become familiar with the testing and evaluation that go into each Stackpole resistor order. Purchasing people know they can expect prompt delivery. And management is assured of complete, in-depth service backed by sixty years of experience.

It's for reasons like these that Stackpole resistors are selected to maintain top performance on so many established products and on a growing number of brand new ones. Such confidence and loyalty cannot be based on price alone, but instead come from the kind of dependability that builds a reputation for your product.

Uniformity is a known characteristic of Stackpole resistors. Unique production methods coupled with thorough testing assure you absolute performance. You can rest assured that the Stackpole resistors you order today will be identical in every way, order after order.

Are you getting what you pay for in a resistor? Why not investigate the value Stackpole resistors can give you. Quality, economically priced and backed by the recognized name . . . Stackpole. There are four sizes to choose from: 2, 1, 1/2 and 1/4 watts.

For samples or a copy of our new booklet, "How to spot a quality resistor", write: Stackpole Carbon Company, Electronic Components Division, Kane, Pa. 16735. Phone: 814-837-7000 — TWX: 510-695-8404.



**STACKPOLE**

ELECTRONIC COMPONENTS DIVISION



# More THYRISTORS from Transitron...

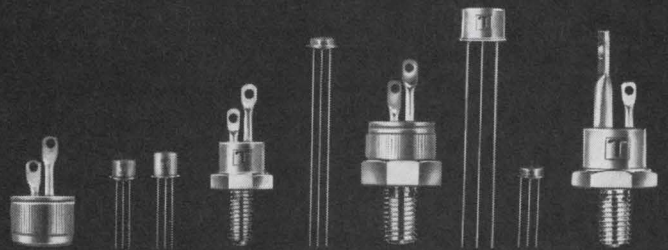

**MORE TYPES.....MORE RATINGS.....MORE STOCK**

## ALL THESE...

Current Rating (RMS)	SILICON CONTROLLED RECTIFIERS (SCR's)										TRIACS				GTO's		LASCR's	
	320mA		400mA		1.6 AMP		8.0 AMP		25 AMP		1-3 AMP	3-10 AMP	3-15 AMP	6-25 AMP	400mA	800mA	400mA	
	IG-115	TO-46	TO-52	TO-18	TO-5	TO-5 (Isolated)	TO-64	TO-66	IG-111	TO-48	IG-114	TO-5	TO-66	IG-111	IG-114	TO-18	TO-5	
BLOCKING VOLTAGE (V <sub>RRM</sub> , V <sub>ROV</sub> )	15V	■	■	■	■	■	■	■	■	■	■	■	■	■	■	■	■	■
30V	■	■	■	■	■	■	■	■	■	■	■	■	■	■	■	■	■	■
50V	■	■	■	■	■	■	■	■	■	■	■	■	■	■	■	■	■	■
60V	■	■	■	■	■	■	■	■	■	■	■	■	■	■	■	■	■	■
100V	■	■	■	■	■	■	■	■	■	■	■	■	■	■	■	■	■	■
150V	■	■	■	■	■	■	■	■	■	■	■	■	■	■	■	■	■	■
200V	■	■	■	■	■	■	■	■	■	■	■	■	■	■	■	■	■	■
250V	■	■	■	■	■	■	■	■	■	■	■	■	■	■	■	■	■	■
300V	■	■	■	■	■	■	■	■	■	■	■	■	■	■	■	■	■	■
350V	■	■	■	■	■	■	■	■	■	■	■	■	■	■	■	■	■	■
400V	■	■	■	■	■	■	■	■	■	■	■	■	■	■	■	■	■	■
500V	■	■	■	■	■	■	■	■	■	■	■	■	■	■	■	■	■	■
600V	■	■	■	■	■	■	■	■	■	■	■	■	■	■	■	■	■	■

...AND MANY MORE

For a complete listing of available devices, send for your copy of the new Transitron Thyristor Selection Guide.



**Transitron**  
electronic corporation  
168 Albion Street Wakefield, Massachusetts 01880



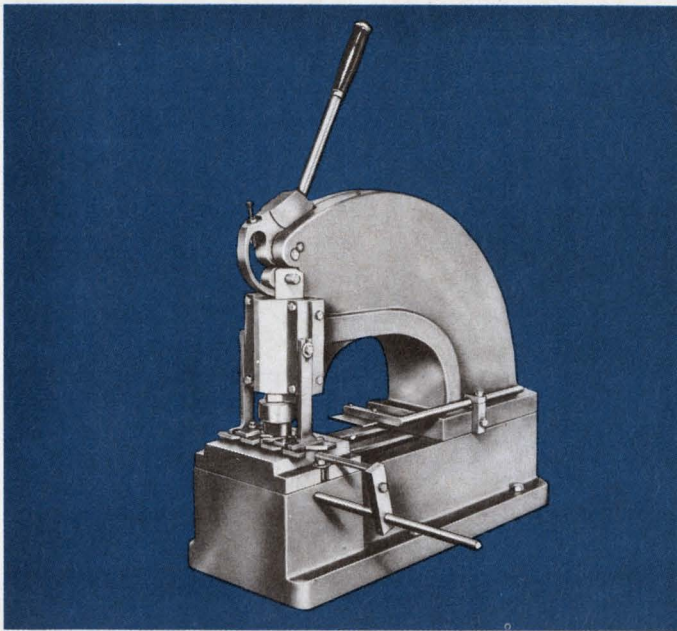

Back when some of our friends needed a few holes, we supplied them with hand operated Di-Acro Punch Presses.

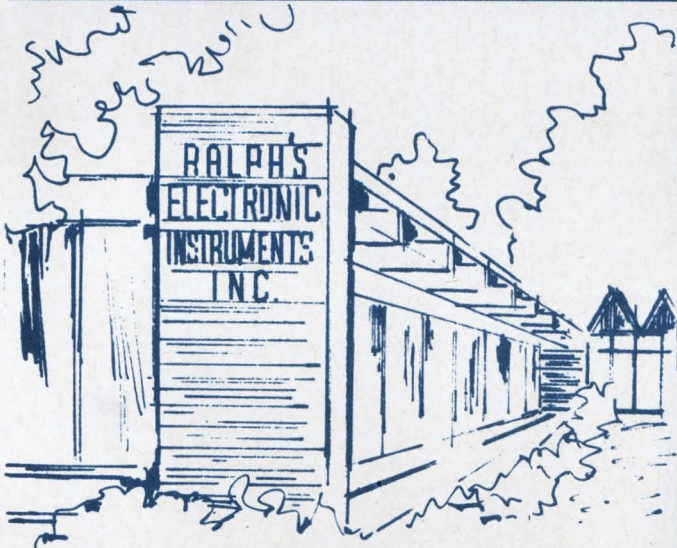

Today those good friends are positioning and punching holes galore with Di-Acro Stylus Operated Turret Punch Presses, now even with N/C!

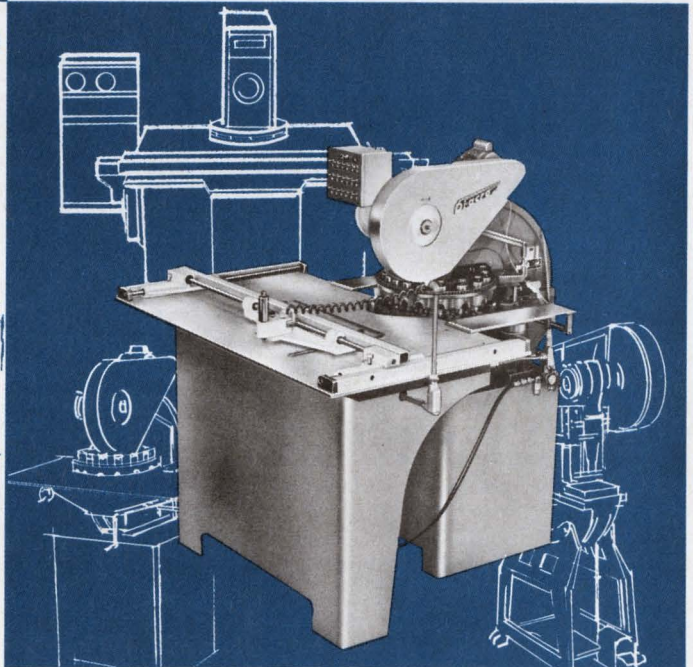

## DI-ACRO ALWAYS DID KEEP UP WITH THE TIMES!

Back when the young men coming home from World War II were exploring the possibilities of starting businesses in electronics, Di-Acro hand operated machines were there to help them. And what machines they were!

The hand operated Di-Acro Punch Press changed dies in a matter of moments for any size and shape of hole up to a three-inch diameter circle or its equivalent.

It positioned holes with assembly line precision. Four tons of cam actuated punching power pierced up to 16 gauge steel. And the quality was such that anyone could run it without danger to himself or the machine.

Now those young men are a generation older. Many of them are meeting multiplied production demands with the power operated Di-Acro Stylus Punch Press.

It changes dies automatically and punches a complete blank as fast as the operator can trace a template. Some of them are automating the operation even more with Di-Acro's new N/C unit.

A constant eye on current technology makes today's Di-Acro Punch Press better than ever — single station or turret models — operated by hand, power, stylus or numerical control. Ask your Di-Acro distributor for our "Art Of Punching" book, or write us.





# Leave the relay driving to us!

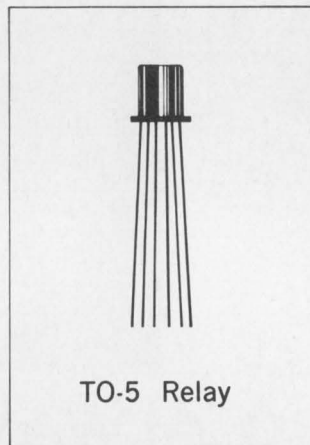

Teledyne Relays has put the Driver where it belongs — in the Driver's Seat. Neatly enclosed in the relay package, it: • suppresses coil transients • increases reliability • reduces design time • reduces relay package size more than 50% • cuts production costs. Don't wait! Our new T Series TO-5 Relays, with



Driver enclosed, are in full production—available off-the-shelf. Driver cost? Less than \$3. Learn how Teledyne is qualified to meet your specific relay requirements — current or future.

Send for complete data on our T Series TO-5 Relays:



## TELEDYNE RELAYS A TELEDYNE COMPANY

3155 West El Segundo Boulevard • Hawthorne, California  
90250 Telephone: (213) 679-2205



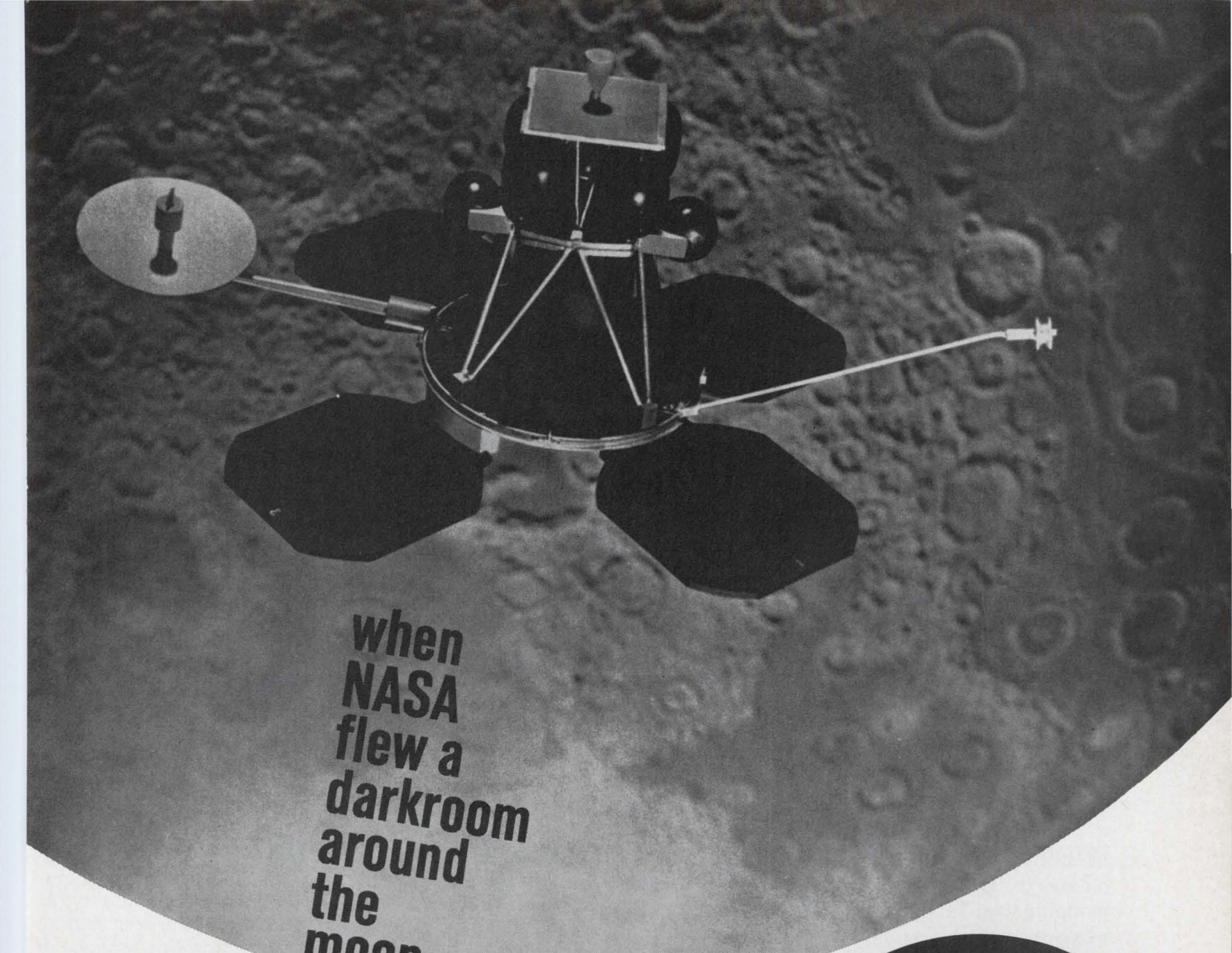

when  
NASA  
flew a  
darkroom  
around  
the  
moon

## Keystone thermistors kept thermal controls on the beam!

On Lunar Orbiter's historic photographic mission encircling the moon, Keystone thermistors were on the job—sensing and controlling temperatures of lenses and film processing laboratory.

With outer temperatures ranging from  $-200^{\circ}\text{C}$ . in the moon's shadow to  $+200^{\circ}\text{C}$ . in full sunlight, Orbiter's temperature balancing systems performed beautifully . . . holding temperatures in the spacecraft to within  $\pm 4^{\circ}\text{C}$ . of required figures.

A dramatic instance of Keystone thermistor ability to perform as specified on very tough applications. Is yours a problem? Write us.

KEYSTONE CARBON COMPANY, St. Marys, Pa. 15857

**Keystone**  
leads  
in versatile thermistor design

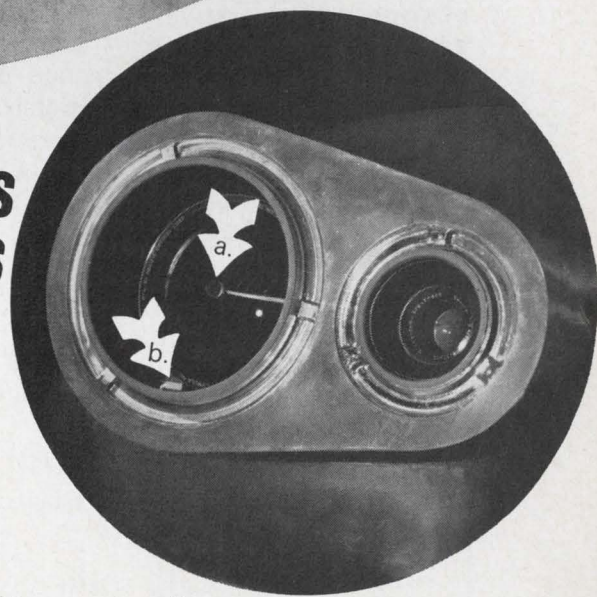

Uniform temperature is a must for stable lens focus. a. Keystone thermistor monitors temperature at lens center. b. Another is placed between lens and outer cover.

Circle 141 on reader service card



# Two new tachometers with hardly a ripple

*By adding a printed armature tachometer to a printed armature servo motor, PMI has created two unique designs that provide low ripple velocity feedback.*

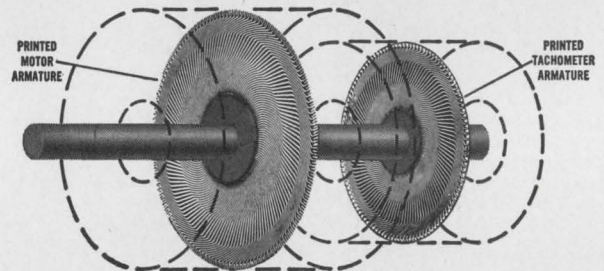
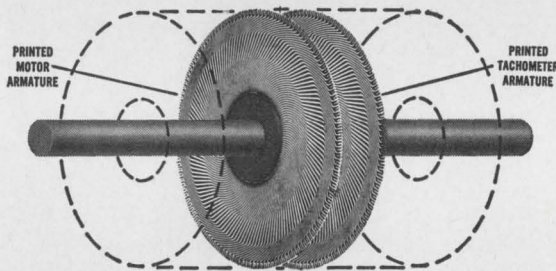

**INTEGRAL TACHOMETER** — Adds a superior tachometer to standard printed motors **with no increase in motor size**. Tach features include low ripple (5% peak-to-peak at 100 rpm; below 2% over 1000 rpm), excellent linearity and elimination of mechanical coupling and torsional resonance problems. The printed tachometer armature typically has the equivalent of over 100 commutator bars raising the frequency of output ripple far beyond that attainable with conventional tachometers. Ideal for wide speed range velocity servos.

**LOW INERTIA TACHOMETER** — Designed for high performance incrementing servos where low ripple, low inertia and minimum torsional resonance are necessary. Built as an integral part of the rear shaft extension of any standard PMI motor, this tachometer has a lower ripple output than any comparable tach available today... 1.5% peak-to-peak at 50 rpm. Inertia added by the tachometer is only .0006 oz.-in.-sec.<sup>2</sup>. Couplings and mounting hardware are eliminated by this design and accidental damage to the tach is minimized by housing it in a rugged 1/4" aluminum casting.

Mail this coupon — for information and literature on these exciting new tachometer developments.



**PRINTED MOTORS, INC.**

GLEN COVE, NEW YORK 11542

Engineering, Manufacturing and Sales by:  
PHOTOCIRCUITS CORPORATION  
GLEN COVE, NEW YORK

**PRINTED MOTORS, INC.**

33 Sea Cliff Avenue, Glen Cove, N. Y. 11542

Dear Sirs: Please send me information on your new printed armature tachometers.

Integral Tachometer

Low Inertia Tachometer

NAME \_\_\_\_\_ TITLE \_\_\_\_\_

COMPANY \_\_\_\_\_

ADDRESS \_\_\_\_\_

CITY \_\_\_\_\_ STATE/ZIP \_\_\_\_\_



JEDEC  
Registered

# PNP

## SILICON POWER TRANSISTORS



TO-61  
Isolated

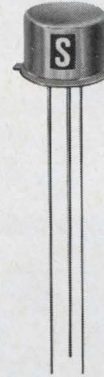

TO-5



TO-111  
Isolated

All devices have **100% Hi-Rel processing**, including High Temperature Vacuum Bake, Temperature Cycle ( $-65^{\circ}\text{C}$  to  $+200^{\circ}\text{C}$ ), High Temperature aging (100 hours) and Fine and Gross Leakage Tests. JEDEC registered, these high reliability PNP transistors and their complements are immediately available from Solitron.

20  
AMP  
Series

Type Number TO-61 Isolated	MAXIMUM RATINGS			PRIMARY ELECTRICAL CHARACTERISTICS ( $T_C = 25^{\circ}\text{C}$ )					
	$V_{CEX}$ Volts	$V_{CEO}$ Volts	$V_{EBO}$ Volts	$h_{FE}$		$V_{CE(sat)}$ Volts	$V_{BE(sat)}$ Volts	$I_{CEX}$ $\mu\text{A}$	$f_T$ MHz
				$I_C = 20\text{A}$ $V_{CE} = -5\text{V}$	$I_C = 10\text{A}$ $V_{CE} = -5\text{V}$	$I_C = 10\text{A}$ $I_B = 1.0\text{A}$	$I_C = 10\text{A}$ $I_B = 1.0\text{A}$	$V_{CE} =$ Rated $V_{CEX}$	$I_C = 1.0\text{A}$ $V_{CE} = -10\text{V}$
				Min.	Range	Max.	Max.	Max.	Min.
2N5312	-80	-80	-6	5	30-90	-1.5	-1.5	10	30
2N5314	-100	-100	-6	5	30-90	-1.5	-1.5	10	30

10  
AMP  
Series

Type Number TO-61 Isolated	MAXIMUM RATINGS			PRIMARY ELECTRICAL CHARACTERISTICS ( $T_C = 25^{\circ}\text{C}$ )					
	$V_{CEX}$ Volts	$V_{CEO}$ Volts	$V_{EBO}$ Volts	$h_{FE}$		$V_{CE(sat)}$ Volts	$V_{BE(sat)}$ Volts	$I_{CEX}$ $\mu\text{A}$	$f_T$ MHz
				$I_C = 10\text{A}$ $V_{CE} = -5\text{V}$	$I_C = 5\text{A}$ $V_{CE} = -5\text{V}$	$I_C = 5\text{A}$ $I_B = 0.5\text{A}$	$I_C = 5\text{A}$ $I_B = 0.5\text{A}$	$V_{CE} =$ Rated $V_{CEX}$	$I_C = 1.0\text{A}$ $V_{CE} = -10\text{V}$
				Min.	Range	Max.	Max.	Max.	Min.
2N5316	-80	-80	-6	10	30-90	-0.6	-1.2	10	30
2N5318	-100	-100	-6	10	30-90	-0.6	-1.2	10	30

5  
AMP  
Series

Type Number TO-5	Type Number TO-111 Isolated	MAXIMUM RATINGS			PRIMARY ELECTRICAL CHARACTERISTICS ( $T_C = 25^{\circ}\text{C}$ )					
		$V_{CEX}$ Volts	$V_{CEO}$ Volts	$V_{EBO}$ Volts	$h_{FE}$		$V_{CE(sat)}$ Volts	$V_{BE(sat)}$ Volts	$I_{CEX}$ $\mu\text{A}$	$f_T$ MHz
					$I_C = 5.0\text{A}$ $V_{CE} = -5\text{V}$	$I_C = 2.0\text{A}$ $V_{CE} = -5\text{V}$	$I_C = 2.0\text{A}$ $I_B = 0.2\text{A}$	$I_C = 2.0\text{A}$ $I_B = 0.2\text{A}$	$V_{CE} =$ Rated $V_{CEX}$	$I_C = 0.2\text{A}$ $V_{CE} = -10\text{V}$
					Min.	Range	Max.	Max.	Max.	Min.
2N5404	2N5408	-80	-80	-6	5	20-60	-0.6	-1.2	10	40
2N5405	2N5409	-100	-100	-6	5	20-60	-0.6	-1.2	10	40
2N5406	2N5410	-80	-80	-6	10	40-120	-0.6	-1.2	10	40
2N5407	2N5411	-100	-100	-6	10	40-120	-0.6	-1.2	10	40

Dial 1-800-327-3243 for a "No Charge" telephone call and further information

**Solitron** DEVICES, INC.

1177 BLUE HERON BLVD. / RIVIERA BEACH, FLA / (305) 848-4311 / TWX: (510) 952-6676



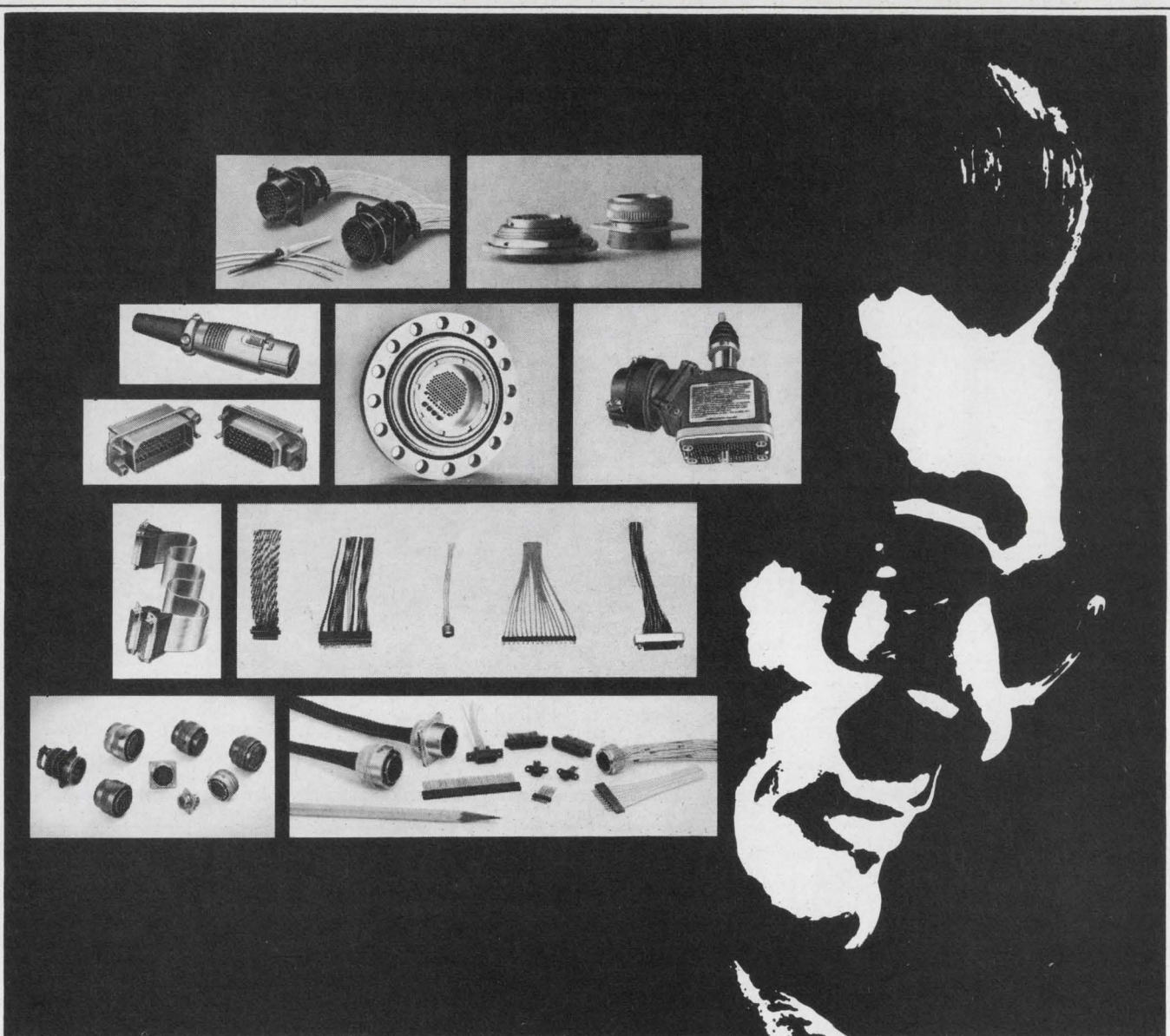

## What you can imagine...ITT Cannon provides.

### We've pioneered every important stage in connector design.

Imaginative engineering that's unmatched in the industry distinguishes ITT Cannon connectors as the standard for reliability in space vehicles, ground support equipment, or any application where highly engineered connectors are paramount requirements.

Backed by a rigorous reliability program, including identification and traceability when required, ITT Cannon offers the widest

selection of connectors available — for every application and environment — microminiature, subminiature, miniature, and standard to solve every conceivable connector problem such as hermetic sealing, heat, radiation, shock, vibration, non-outgassing.

ITT Cannon is also the foremost supplier of special, highly engineered connectors for missiles and space vehicles, including breakaway-umbilicals, interstage disconnects, harnesses,

and associated equipment. If you have a special requirement, contact ITT Cannon, the world's most experienced and imaginative manufacturer of electrical connectors.

Write for our "Connector Selection Guide." ITT Cannon Electric, 3208 Humboldt Street, Los Angeles, California 90031. A division of International Telephone and Telegraph Corporation.



# CANNON ITT



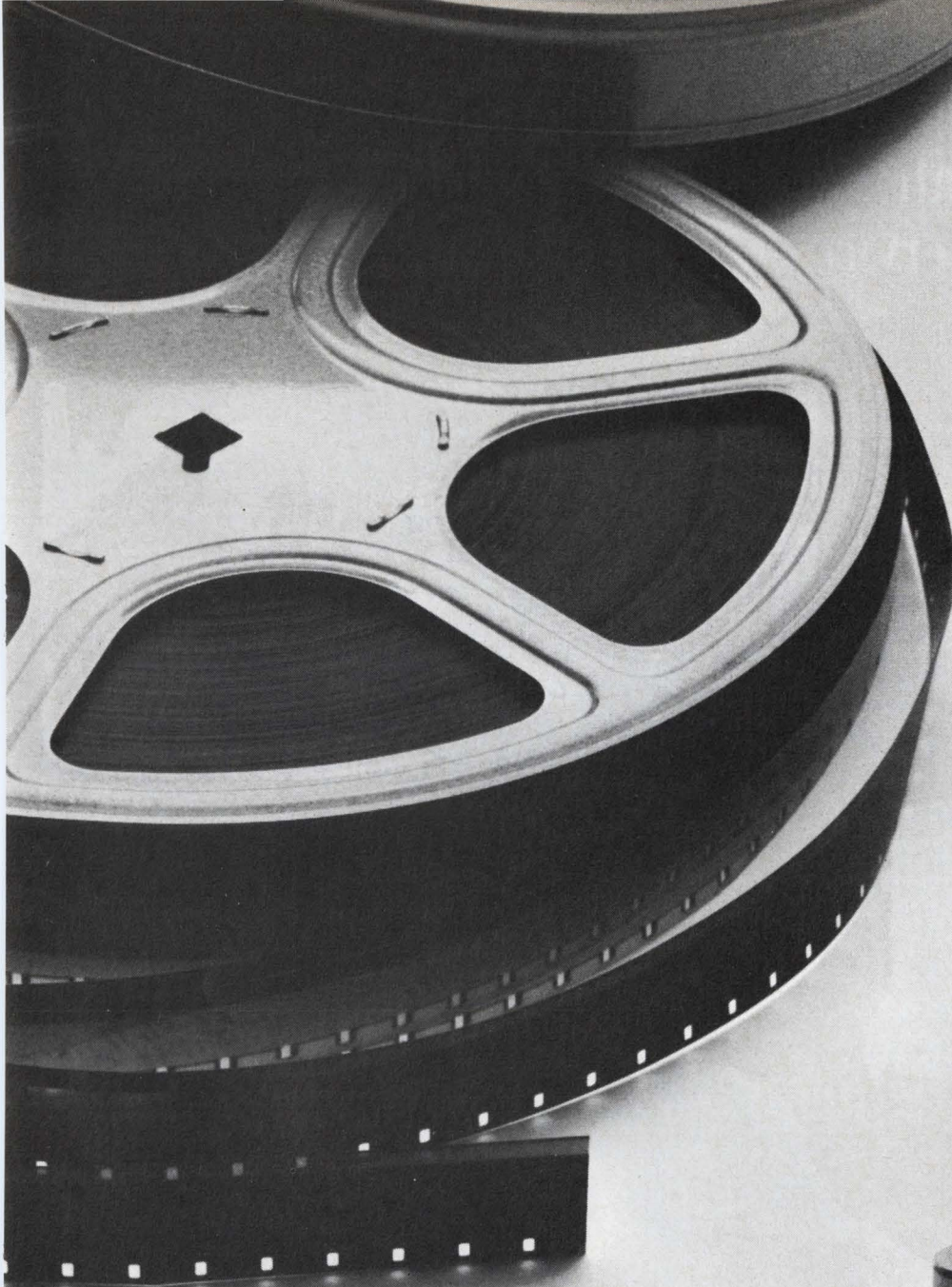

#### THE QUIET ONE IS A MOVIE STAR

The film shown above proves that the Quiet One has more than twice the linearity of any other potentiometer anywhere near its low price.

The proof was so dramatic we made a 15 minute color movie about it. The picture also shows the Quiet One is twice as electrically quiet and has many times the cycle life of any other pot in its class.

We'd like you to see it.

Your Clarostat representative will be pleased to arrange a viewing.

Or write directly to us.  
Dept. 101  
Dover, N.H. 03820

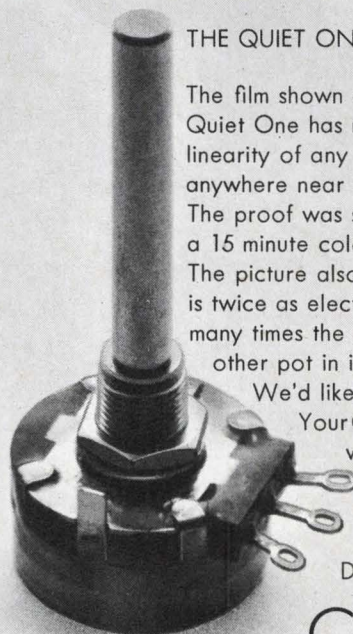

# CLAROSTAT



# How to use the Singer Model NF-105 to make Noise and Field Intensity Measurements to meet the Tri-Service Specs

The Singer Model NF-105 has plug-in tuning units for specific bands of frequency. You can buy just the heads you need, add others as you need them. Rarely will contractual requirements for RFI testing make it necessary to purchase instrumentation that covers the entire spectrum — 14kHz to 1 GHz. This time-proven instrument, the most widely used in the world for RFI testing performs its measurements simply, accurately and quickly.

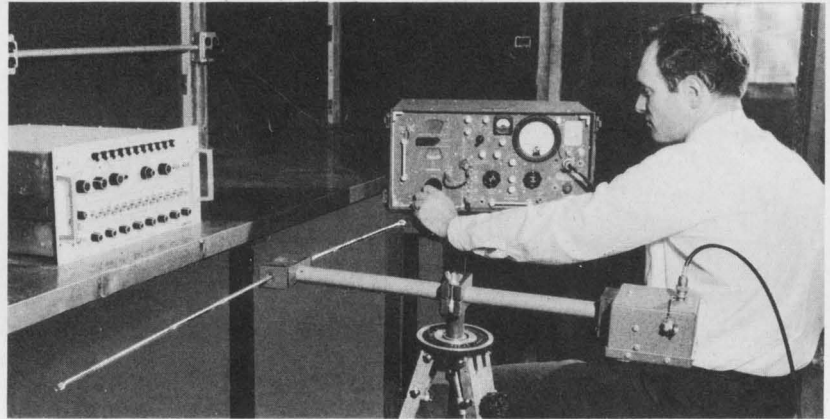

1.

In this standard noise and field intensity measurement, a Singer dipole antenna is placed in front of the instrument under test. The operator first tunes through the frequency band on the Model NF-105 to determine quickly what signals — if any — the instrument under test is emitting.

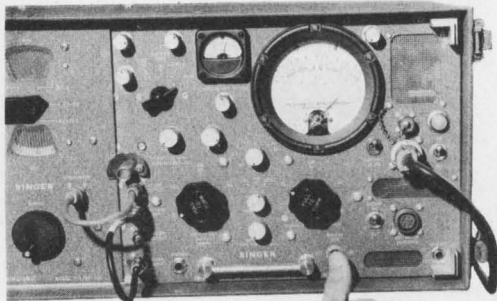

2.

When a signal is detected, the antenna is disconnected, and the output from an internal impulse generator is connected to the receiver's antenna input. Depressing this push-button activates the generator for self-calibration of the receiver. The generator produces a broadband highly stable signal at a predetermined amplitude for calibration.

A brochure on the Model NF-105 is now available. For your copy, please circle the Readers Service Card or write on your letterhead.

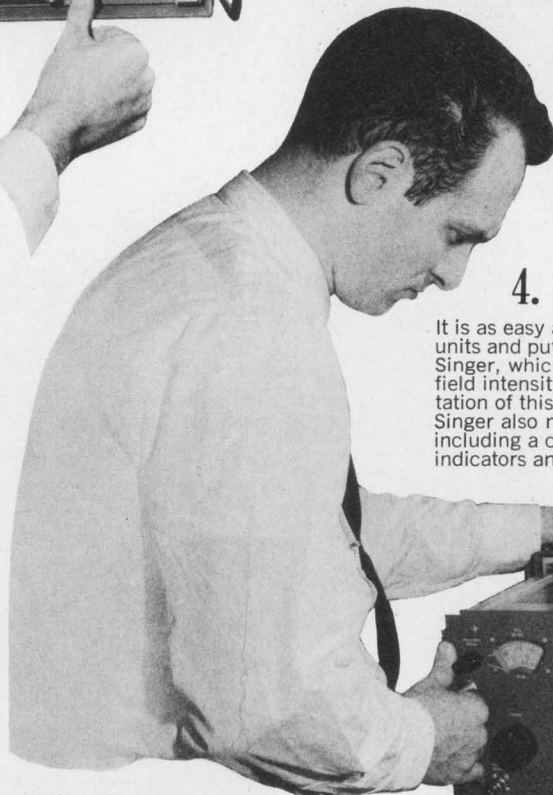

3.

After the receiver has been calibrated, the operator re-connects the antenna to the antenna input jack and reads the result directly on the front panel meter. The meter is calibrated in dB above one microvolt. Calibrated internal attenuators extend the effective dynamic range of the meter to 100 dB.

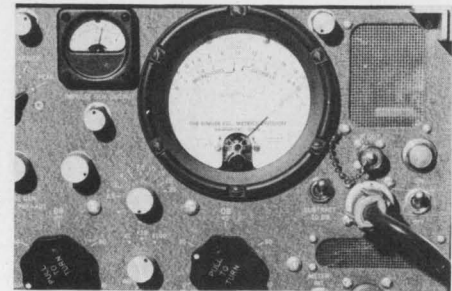

4.

It is as easy and as fast as this to pull out the plug-in tuning units and put in others to cover additional frequency bands. Singer, which has been setting the standard for noise and field intensity measurements for 15 years, makes instrumentation of this type to cover the range of 20 Hz to 26.5 GHz. Singer also makes a complete line of accessory equipment, including a comprehensive set of antennas, probes, remote indicators and other equipment.

**EMPIRE SINGER**  
INSTRUMENTATION

The Singer Company, Metrics Div., 915 Pembroke Street, Bridgeport, Conn. 06608 (203) 366-3201



# Wherever you go, Amphenol connectors go, too.



Immersion-proof connector has  
Poke-Home® shielded contacts.

On the ocean floor, aboard ship or on off-shore oil rigs. For pressures to 5000 psi, our 171 Series hull connectors tolerate severe corrosion, abrasion, temperature and flexing conditions.

For connections on awash decks or in shallow water, our 89 Series connectors take the punishment heat, cold, corrosion and high humidity give.

For conditions when standard connections aren't right, we'll design one. For pressures to 15,000 psi. Or for suspending heavy instruments.

Sealed cable assemblies for tough environments are being designed and produced by Amphenol right now.

To find out where we can join you undersea, write for our Oceanographic Products Guide, Amphenol Space and Missile Systems, 9201 Independence Ave., Chatsworth, California 91311.



**AMPHENOL CONNECTOR DIVISION**

THE BUNKER-RAMO CORPORATION

Specify Amphenol electronic components... produced in Canada, England, France, Japan, Mexico, United States, West Germany.

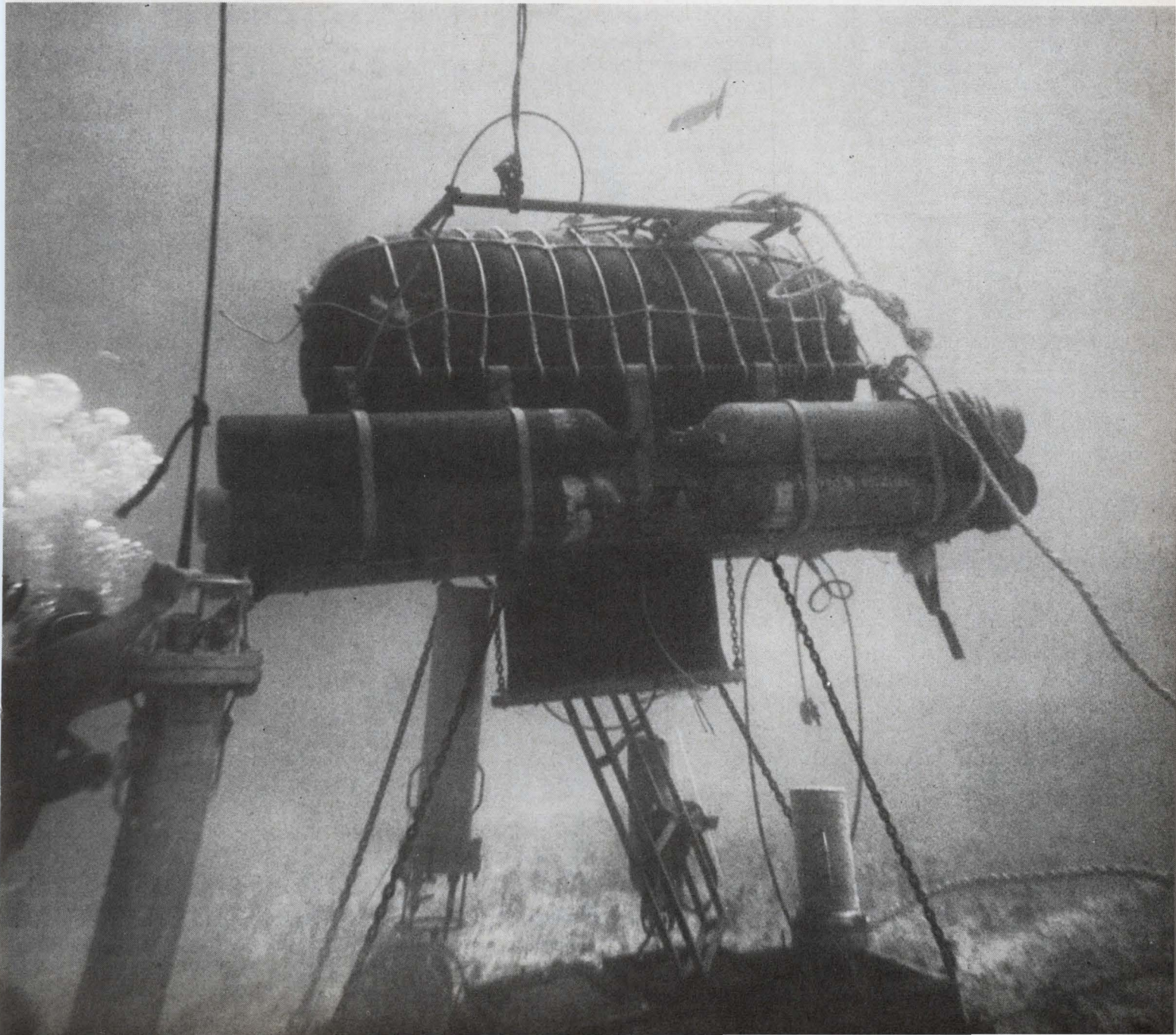



# EIMAC

has a rugged 500 watt tetrode that is ready to talk before you are.

We knew you weren't satisfied with ordinary push-to-talk mobile and airborne UHF/VHF communications systems. Why? They took up to 60 seconds to warm-up. You needed more power and you needed it with "instant talk" speed.

The EIMAC metal ceramic X2099B is the only tetrode combining 500 watts of plate dissipation with instant warm-up. The quick-heat cathode in the X2099B takes only 250 milliseconds to warm up to half power or 70% of peak current. You can drive the X2099B with low level solid state, and you can air cool it.

The X2099B is available only at EIMAC. We're ready to talk whenever you are. (415) 592-1221.

Contact your nearest distributor or Varian Field Office for further information. Offices are located in 16 major cities. Ask information for Varian Electron Tube and Device Group.

TYPICAL OPERATING CHARACTERISTICS  
Class AB<sub>1</sub> Radio Frequency Linear Power Amplifier

	DC Plate Voltage		V
	1600	2600	
DC Screen Voltage . . . . .	200	250	V
DC Grid Voltage . . . . .	-24	-34	V
Zero-Signal Plate Current . . . . .	250	225	mA
Max Signal DC Plate Current . . . . .	455	370	mA
PEP or CW Plate Output Power . . . . .	400	500	W
Third Order Intermodulation Distortion . . . . .	-36	-38	dB
Fifth Order Intermodulation Distortion . . . . .	-54	-46	dB
Filament Voltage . . . . .	2.5	2.5	V
Filament Current . . . . .	10.0	10.0	A
Warm-up Time (to half power) . . . . .	250	-	ms

**EIMAC**  
Division of Varian  
San Carlos, California 94070

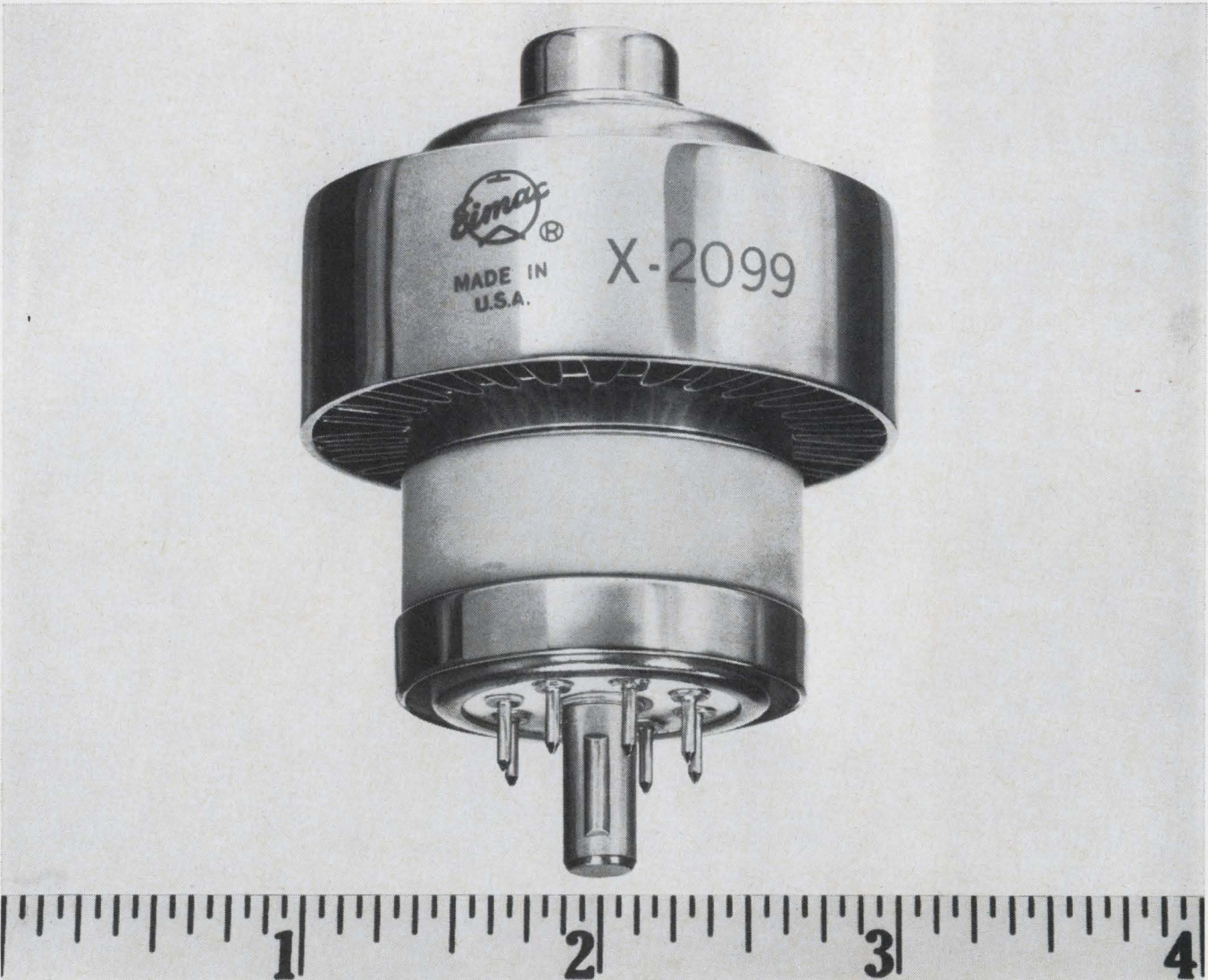



# How do most companies move a lightning-fast, long-memory, high-capacity computer?



They choose an on-time, precision-planning, big-capacity van line.

Allied Van Lines safely moves more computers (with long memories) than any other mover.

Call the confident Allied Agent in your area.

Circle 149 on reader service card

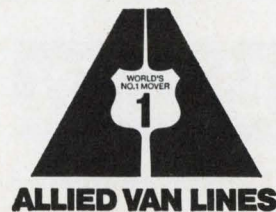



# You don't have to go overseas for a 9¢ electrolytic

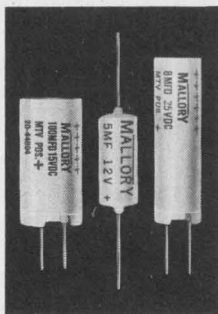

Go to Mallory, instead. Mallory MTA and MTV are the first molded case aluminum electrolytic capacitors that have U.S. made quality at prices competitive with foreign imports.

What's in it for you? Excellent stability and long life. Exclusive one-piece molded case that prevents electrolytic leakage. More reliability data than ever before gathered on a capacitor of this class.

Imagine all this . . . at a price as low as 9¢ in production lots. And no more worries about custom red tape, snarled up make-goods on field failures, lack of nearby technical assistance. All you'll be missing is a lot of headaches. All you'll be getting is today's biggest bargain in capacitor performance. Standard Mallory capacitors are also available from authorized Mallory distributors throughout the United States.

## MALLORY

### MALLORY CAPACITOR COMPANY

a division of P. R. MALLORY & CO. INC.  
3029 E. Washington St., Indianapolis, Indiana 46206;

Electrical and electronic components; sequence timers; metallurgical products; batteries





# 150 MHz, 2.4 ns Portable Oscilloscope

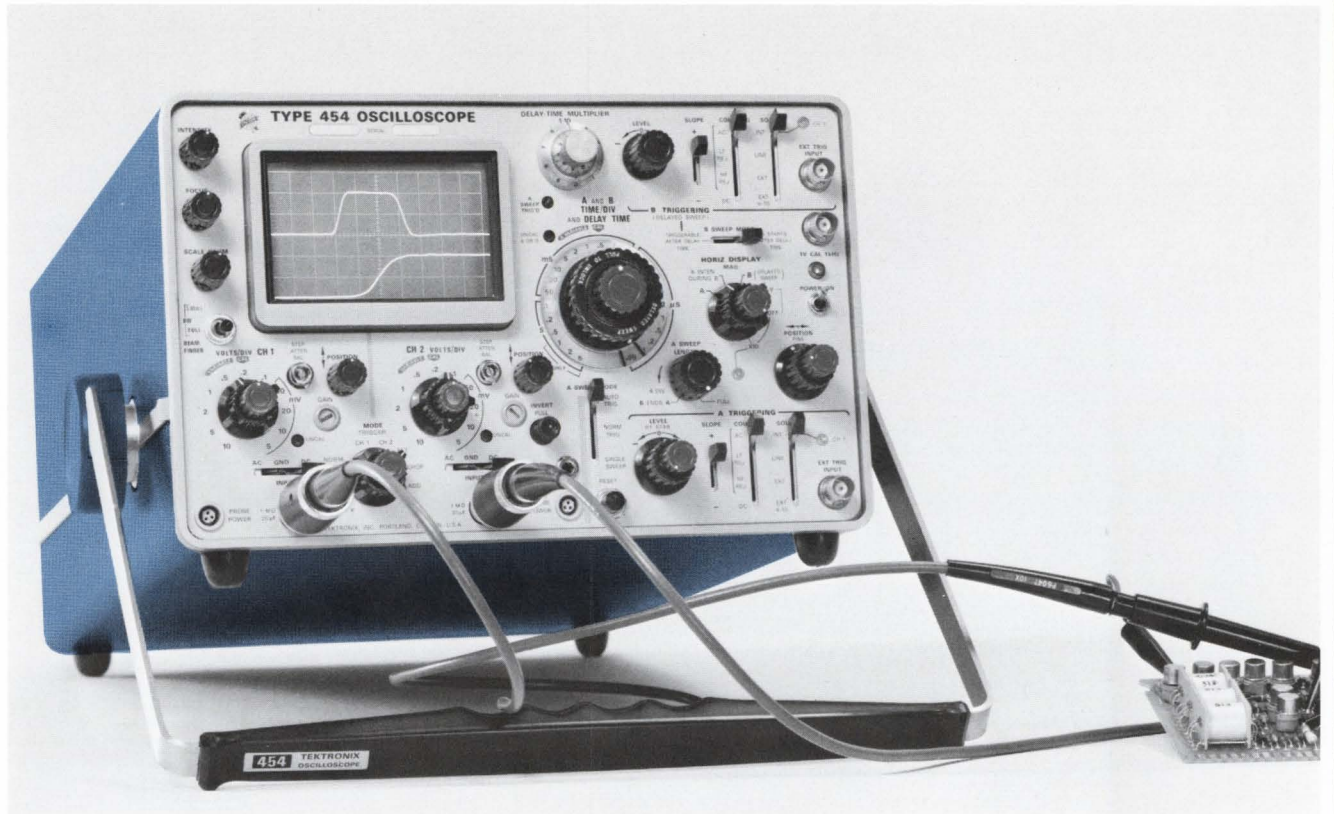

## PERFORMANCE

The Tektronix Type 454 is an advanced design portable oscilloscope providing measurement of fast-rise pulses and high-frequency signals beyond the capability of most conventional real-time oscilloscopes. New miniature 10X probes permit specifying the 150-MHz bandwidth, 2.4-ns risetime performance at the probe tip—where you need it!

The Type 454 is a complete instrument package with dual-trace displays at 5 mV/div deflection factor, triggering to above 150 MHz internally or externally and 5 ns/div normal or delayed sweep. Full bandwidth measurements (150 MHz) are provided at 20 mV/div deflection factor. For low-level applications the Type 454 provides single channel 1 mV/div at 33-MHz bandwidth. Full-sensitivity X-Y operation (CH 1 drives the horizontal, CH 2 drives the vertical) is also provided with phase difference between X and Y not exceeding 3° from DC to 2 MHz. An illuminated, parallax-free graticule defines the 6 x 10 div display area and a bright P31 phosphor contributes to sharp, clear waveform displays even under marginal conditions.

For single-shot applications a photographic writing speed of 3200 div/ $\mu$ s (>2500 cm/ $\mu$ s) is provided by the Type 454 Oscilloscope, C-31 Camera and 10,000 ASA film . . . without employing film fogging techniques!

## PORTABILITY

The Type 454 is mechanically designed to be easily carried. It meets temperature, humidity, vibration and shock tests which simulate environments "portable" instruments may encounter. A dust-tight front cover protects the panel and serves as a convenient storage compartment for accessories. The handle may be rotated to several positions to serve as a tilt stand or adjusted for convenient carrying. All these features and more are packaged in a rugged 31-pound instrument.

## RELIABILITY

Advanced design concepts and the use of solid-state components insures long-term stable performance and permits operation within specifications over an ambient temperature range of -15° to +55°.

Your Tektronix field engineer will demonstrate the Type 454 performance capabilities in your application, at your convenience. Please call him or write Tektronix, Inc., P.O. Box 500, Beaverton, Oregon 97005.

Type 454 (Complete with probes and accessories) . .	\$2600
Type R454 (Rackmount) . . . . .	\$2685

U.S. Sales Price FOB Beaverton, Oregon

*please turn page for additional information* →

TEKTRONIX PRODUCT REPORT — PORTABLES



# Making the Measurement . . . with the Tektronix Type 454

## Portable Oscilloscope



454/P6046

### DIFFERENTIAL MEASUREMENTS

A 50-mV pulse with 1-volt, 50-MHz common mode signal displayed on the Type 454 using a P6046 Differential Probe and Amplifier. The 1000:1 CMRR of the P6046 Probe and Amplifier at 50 MHz rejects all but 1 mV of the unwanted signal. This same Probe/Amplifier/Oscilloscope combination provides 1-mV/div deflection factor at  $\approx 70$  MHz bandwidth!

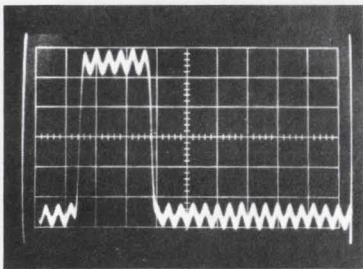

Vertical - 1 mV/div; Horizontal - 50 ns/div

### X-Y

The Type 454 converts to a calibrated X-Y Oscilloscope with a flick of two front panel switches. Phase difference between X and Y is less than  $3^\circ$  from DC to 2 MHz. The upper display is a 150-MHz signal that is 50% modulated by a 2-kHz signal. The lower display is an X-Y trapezoidal modulation pattern showing the 150-MHz AM signal vertically (Y) and the 2-kHz modulation signal horizontally (X). The straight vertical line to the right of the photo represents the unmodulated carrier amplitude. Multiple exposure.

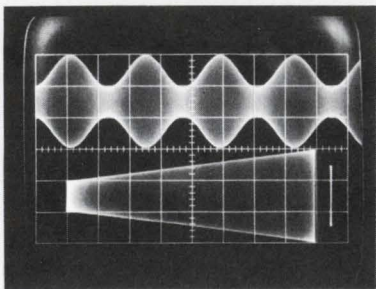

*The total value an instrument provides its user is related to its ease of application in making practical measurements. Compatible accessory items such as voltage and current probes, special purpose probes, cameras, Scope-Mobile® Carts, etc. contribute significantly to a total measurement capability and are essential if the user is to utilize instrument performance to full advantage.*

### MEASURING CURRENT

The new P6042 Current Probe provides measurements from DC to 50 MHz with sensitivity to 1 mA/div. Other Tektronix AC current probes are available and provide measurements from 8 Hz to 200 MHz.



P6042

### PULSE FIDELITY

The miniature 10X passive probes that are supplied with the Type 454 Oscilloscope permit easy access to subminiature or compact circuitry while preserving full bandwidth/risetime performance. The double-exposure photograph shows the same 12-ns wide pulse displayed by the Tektronix Type 454 (upper trace) and by a 7-ns, 50-MHz Oscilloscope (lower trace). Note the difference in detail of the pulse characteristics displayed by the Type 454 with its 2.4-ns risetime performance.

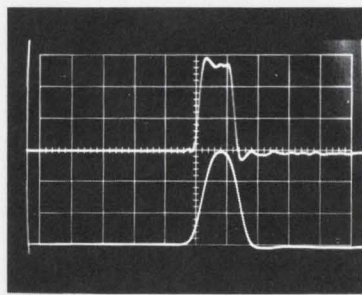

### PHOTOGRAPHIC WRITING SPEED

The Tektronix Type 454 Oscilloscope, C-31 Camera, 10,000 ASA film and P11 CRT phosphor provide a minimum photographic writing speed of 3200 div/ $\mu$ s ( $>2500$  cm/ $\mu$ s) without employing film fogging techniques. This writing speed is in excess of that required to record a single-shot pulse at the risetime and screen height limits of the Type 454 . . . the important extra margin of performance a high-frequency oscilloscope should have.

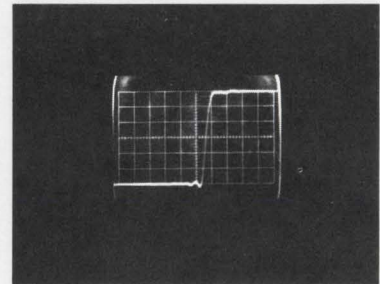

5 ns/div



454/C-31

**Your Tektronix Field Engineer will demonstrate the Type 454 in your application at your convenience. Please call him, or write: Tektronix, Inc., P.O. Box 500, Beaverton, Oregon 97005.**

Type 454	.....	\$2600
Type R454 (Rackmount)	.....	\$2685
C-31 Camera	.....	\$ 550
P6046 Differential Probe and Amplifier	.....	\$ 690
P6042 Current Probe	.....	\$ 600
P6045 DC-to-230 MHz 1X Voltage Probe	.....	\$ 275
Type 200-1 Scope-Mobile Cart	.....	\$ 75

U.S. Sales Price FOB Beaverton, Oregon



## Tektronix, Inc.

committed to progress in waveform measurement



# Probing the News

Military electronics

## Defense Department slates reform of systems engineering management

Contractor complaints about how-to specifications and excessive documentation have led to Pentagon reappraisal; the eventual goal is a flexible triservice standard

By William Arnold

Washington regional editor

**Systems engineering** management is more than one of those phrases that fall trippingly from the tongues of Pentagon planners. It's supposed to be an orderly way of handling all the procedures—including the documentation required to justify engineering decisions—that are involved in producing complex military equipment such as missiles and aircraft. Unfortunately, in the course of producing all this complex documentation and justification, a number of defense contractors have found themselves engulfed in a flood of exasperating paper work. Recently, however, reform-minded officials both in and out of the Government have mounted a counterattack that promises to streamline this aspect of procurement practices and lead eventually to a flexible triservice format.

As it happens, systems engineering management (SEM) is but one element of the 1,100-odd manage-

ment control systems established by the armed forces and their various commands to lower costs, enhance efficiency, and reduce turnaround times on large projects. There are, in the main, no strenuous objections by contractors to periodic progress reports and record keeping, but industry resists being told just how it should go about reaching specified objectives, and bitterly resents what it considers excessive documentation requirements.

Along these lines, a bemused observer cites the case of a proposed standard requiring that a contractor's human factors group submit written recommendations to the design department and duplicates to the service program office. Should the designers turn down the advice of their colleagues, an additional report detailing the reasons for the decision would have to be sent to the program office.

### New Deal

Partly as a result of pressure from electronics and aerospace firms, but also because of the high cost of processing documentation, the Defense Department, along with the Council of Defense and Space Industry Associations (Codisia), is now examining a series of proposals aimed at unifying management control procedures. "We're going to put in a series of filters

**At sea.** Defense contractors often find their engineers are awash in paper work required to justify design and systems decisions.

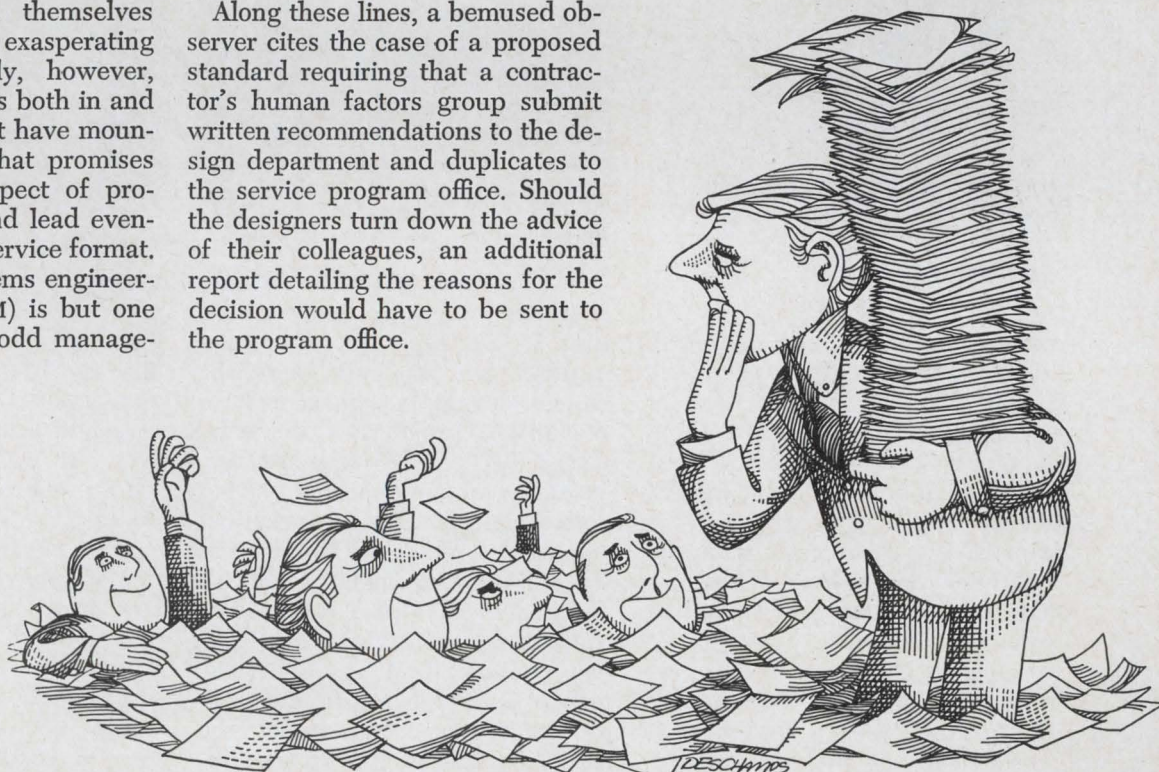



## . . . the Air Force took a hard line on applying specs in the C-5A . . .

to reduce spurious signals," says Edward J. Engoron, deputy assistant director of engineering management in the Office of the Director of Defense Research and Engineering. "Our plan will eliminate or reduce the proliferation of new management control systems."

Scheduled for introduction within three years, the new procedures will be output, rather than input,



**Reticence.** Engineers are shy about exposing their thinking processes.

oriented, according to Engoron. In other words, a service will simply specify what it wants instead of how it wants its things done. Contractors will be largely left to their own devices in filling in the blanks, though they will continue to be responsive to service program officers. Felicitous features of the new plan are screening provisions that will:

- prevent duplications of intent or function by cross-indexing approved systems on a master list
- forestall new proposals that re-

peat existing procedures

- assure that control procedures are used to assist in project management and don't become an end in themselves.

**Ways to go.** Some observers believe that for all these straight-forward intentions, the Pentagon faces an enormous winnowing job. Herman E. Shipley, technical director of the Aerospace Industries Association of America and a member of the Codsia committee, estimates that thousands of specifications and standards will have to be revised to arrive at simpler SEM procedures. In this regard, he recalls that it took years to reduce a 5-inch-thick triservice MCS to an eight-page cost schedule control system.

Contractors who have to live with SEM may fondly recall the days when one group of engineers could design and build an airplane from the ground up. Today, the same sort of group would figure to handle little more than a small piece of the action.

As military hardware became more expensive and more complex over the years, the services sought ways to coordinate the work of the thousands of specialists who might work on a program. Over the past decade the armed forces applied—and retained—quality-control and systems-integration methods before graduating to systems engineering management techniques. In the process, many companies were taken by surprise.

### Shock value

"At Raytheon we at first thought SEM was gimmicky, but after we tried it, we approved; it brought results," says Stanley N. Bernstein, director of systems management for the SAM-D program at the company's Missile Systems division. "SEM, for example, helped us spot a potential flaw in our launcher design before things got to the point where it would cost a lot of money."

Bernstein also praises SEM documentation: "Most of the 40,000 pages on the central processing system for SAM-D deal with either engineering or cost tradeoffs," he says. "By breaking down descrip-

tions into a series of required functions and subfunctions, and then plotting the relationships, you can get a good idea of just what parts are going to be needed and just how they'll fit together. During the process, engineers may find themselves inventing hardware they hadn't figured on, or eliminating unnecessary items."

SEM techniques also save money, Bernstein says. "Once you reach the hardware level, it's possible to loop back and determine the effect of changes on performance or function. In this way you can avoid incompatible retrofits or failure-producing 'improvements.'"

However, the use of SEM is not for the inexperienced or unwary. Most procedures lean heavily on computer analyses and routines. But data processing equipment is a notorious producer of paper, so novice practitioners can be overwhelmed in very short order.

**Object lesson.** When the Air Force Systems Command wrote its tough 375-5 SEM into the C-5A air transport contract, the service did more than catch the Lockheed-Georgia Co. by surprise. The firm's experience has been so painful that it still won't discuss the matter. However, other sources have shown no such reticence.

George F. Romano, director of advanced programs at the Data Systems division of Litton Industries Inc., which became involved with Lockheed shortly after the C-5A program began, says: "I've never seen such confusion. Lockheed personnel knew they had something new, but they weren't sure how to handle it."

Richard De Lauer, vice president and general manager of TRW Inc.'s systems group feels the paperwork problems Lockheed experienced on the C-5A were not wholly attributable to 375-5. "It was the asinine applications of the specs at the time that caused the problem," he says. "It was unnecessary to get that complex during contract definition. The Air Force could have made a decision on who the contractor was going to be and could have had a good idea of the total cost without going into the detail it did on every conceivable phase of the system."

**Too much too soon.** De Lauer says that what appalled industry



about 375-5's application in the C-5A program was that the Air Force had two contractors taking the identical development approach during the definition phase. "How can the customer expect any difference in performance if he specifies the same requirements for both competitors?" he asks.

According to Lt. Col. James R. Barton, former chief of the Air Force Systems Command's engineering policy division, there was a great deal of misunderstanding on both sides. The upshot was that Lockheed set up two new departments just to handle the documentation it felt was required. Ironically, the Lockheed Missiles & Space Co. in Sunnyvale, Calif., has had no particular problems in using 375-5 on other projects, according to Robert S. McCarthy, manager of the division's space systems department.

Lockheed's C-5A experience, however, produced enough alarm throughout the industry to create pressure for not only the joint Pentagon-Codsia effort but also for a new and less rigorous version of 375-5, which the Air Force is now drafting [Electronics, Aug. 5, p. 74].

### Second guessing

One-third more paperwork is required with 375-5 than with BSD (for ballistic systems division) exhibit 6262A of the Air Force's Space and Military Systems Organization, according to Raymond S. Alexander,

deputy manager and technical director of the Minuteman program at Sylvania Electronics Systems. As an SEM-procedure 375-5 is too detailed, Alexander says, "There's too much to it; you've got to decide which parts you're going to comply with, and then decide how." Alexander prefers 6262A; he says it's more explicit than 375-5 and requires less interpretation.

He also notes that "while 6262A doesn't hamstring the contractor with specified report formats, it does make clear just what data is supposed to go into each form."

Sylvania has adopted its own procedures for the more detailed portions of systems engineering. Alexander cites the Minuteman's control-center message processor system as an example: "The way we handle SEM within the confines of those four racks is our concern—6262A treats them as one black box."

**Practice makes perfect.** Experience with SEM—even 375-5—can reduce the paper work, according to Litton's Romano. When the company won the 407L tactical air control contract, the Air Force specified that 375-5 be used. The procedures weren't welcomed, Romano says, principally because the concept was new. And for a while it appeared that documentation was obscuring the goals of the project. The contract definition phase of the program alone produced 18,000

### Battling the paper dragon

The proliferation of controls and reporting requirements applied by the military on systems contracts has been an official source of concern since 1966 when the DOD-Codsia (for Department of Defense-Council of Defense and Space Industry Associations) advisory committee was set up. However, a progress report on efforts in this area by the Air Force's Col. Albert Buesking, director of management systems control in the Office of the Assistant Secretary of Defense, is not particularly encouraging.

In many cases, he finds, management systems documents do not fit together in an efficient whole. All too often, they duplicate and conflict with one another. At the root of these difficulties are overly broad statements on objectives, variant definitions of identical terms, and nonuniform implementation of standards.

At bottom, Buesking, concludes, the success of the projected control program will depend on the efforts of those who must live with it. Pentagon managers must invest time and trouble in deciding on the adequacy of available procedures before developing new and different forms. "What's needed is simply a way to assure that people do the best they can with what they have at hand," he says.



## THE NEW SHAPE IN PLASTIC TUBING

*may fit your problem exactly*

FLEXITE Shrinkdown Plastic Tubing shrinks 50% in diameter upon application of moderate heat to form a tight-fitting sheath around objects of irregular shape. It's being used to solve many different problems . . . like insulating electrical connections; protecting delicate components; strengthening assemblies; binding things together; resisting corrosion, heat or moisture; preventing wear, vibration and noise. What problems do you have that a tight sheath of tough plastic might solve? Markel offers Shrinkdown in three distinct types to meet a broad range of needs. Your call or letterhead request will bring samples and data.



**L. FRANK MARKEL & SONS, INC.**  
Norristown, Pa. 19404 • Phone: 215/272-8960  
INSULATING TUBINGS AND SLEEVINGS  
HIGH TEMPERATURE WIRE AND CABLE



SETTING

A *trend*

in  
electronic  
instrument  
enclosures...

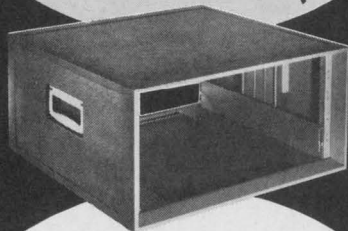

CLASSIC  
CABINETS



The cabinet often is a key that opens the door to sales. What the eye conveys to the user is a basis of his first impression of quality and performance. That's why, year after year, Bud Sheet Metal Enclosures are the overwhelming choice of engineers who design and build both simple and sophisticated systems.

Classic Cabinets have the clean lines and exclusive construction that enhance the value of the contents. Some exclusive features include sturdy aluminum extrusions that form the framework; the patterned aluminum panels; the vinyl texture finish and the manner of supporting the contents.

Creators of electronic equipment will find that these Classic Cabinets offer an attractive as well as a practical solution to most of their housing problems. Ask your authorized Bud Distributor to demonstrate the advantages of these and other Bud enclosures. Our catalog is available upon request.



**BUD RADIO, INC.**  
Willoughby, Ohio

your product  
*Belongs* in a BUD cabinet

## ... systems engineering management strengthens internal communications ...

pages of results and proposals.

A year later, Litton got another more complicated contract specifying 373-5; it was able to handle it in less than 12,000 pages. Romano says the company benefitted in this case from an analysis of the "paper-work impact" on the 407L program and from a concentration on the real needs of the service.

And SEM documentation can im-

of exposing their thinking processes, engineers would write up their procedures in detail for their own notebooks. But when SEM forms were passed around, they felt this exposed them to a lot of potential criticism."

Bernstein and Sylvania's Alexander say it took 18 months to acclimate their men to SEM practices. Raytheon used a "seed bed" ap-

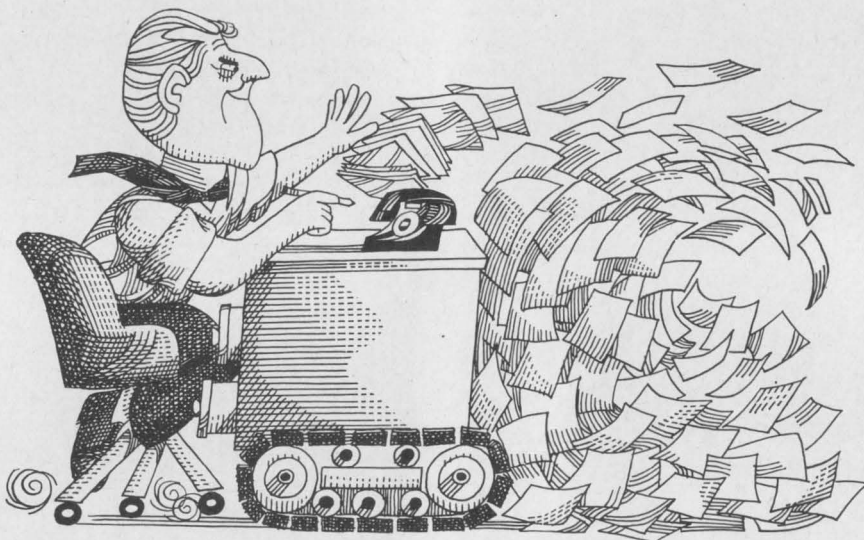

**Pushover.** With experience, defense contractors can reduce the burden of paper work on projects where systems engineering management is used.

prove a company's procedures, according to a source at a large air-frame concern. "It's forced the establishment of a stronger line of internal communication," he says. "Now the logistics people have to speak to the engineers, and if aero wants to change the shape of the tail, they have to talk with the hangar people. In other words, the specialists must now tell the rest of the world what they're up to."

Lockheed's McCarthy agrees: "Since documentation requires that engineers' detail their decisions, we have their rationale," he says. "They move around among departments and companies so often, it would be difficult to reconstruct decision-making if it weren't for our reporting requirements."

Raytheon's Bernstein, however, says: "Paper, forms, and the like scared our engineers. Generally shy

proach, spotting engineers familiar with SEM techniques around in different groups. As the other engineer saw their SEM-oriented colleagues solving problems faster and more accurately, they wanted to learn, says Alexander.

**Right idea.** Most companies approve the premise of SEM. "There are no drawbacks whatsoever," declares TRW's De Lauer, "but the specifications should depend on the system's complexity." Raytheon's Bernstein agrees: SEM's detractors tend to be those ignorant of its value—sensationalists who scream about paper work or administrators who have a fixation about documentation."

But De Lauer cautions against too much detail in SEM procedures. "You don't need three forms to tell you how to put your pants on as you optimize the procedure," he



says. "Systems engineering is nothing but a way of doing things in optimum fashion."

Many criticize SEM because they misinterpret the intent, says a source at an aerospace firm. "They have a tendency to think you can't accept what has already been proven, but we accept the premise that wings at the front and a tail at the end of an aircraft are pretty good design procedures. If you aren't willing to take anything from past experience, then SEM will produce an incredible and intolerable amount of work on any given project."

**Two different worlds.** This observer notes that the way SEM is applied depends on whether a company is working for a commercial or a military customer. Commercial business requires less documentation because the buyers are less interested in the way behind a design than are the services. On the other hand, a commercial contract requires greater equipment redundancy.

Also, the company working on a commercial project must consider the needs of a variety of customers. And in the case of the armed forces, the procuring and the certifying agency are the same, this source points out. "But with commercial aircraft, for instance, you're dealing with the Federal Aviation Administration on safety and airworthiness, and with the airlines on the profit-making potential."

### Schools of thought

In the case of military, contracts, the application and intent of SEM depend on the bias of the special projects officer. There are two kinds, says E.B. Carne, a vice-president of LTV ElectroSystems Inc. "One group is all for SEM and wants the defense contractor to follow procedures like 375-5 step by step and to the letter. The second group, however, doesn't much care for the idea and this is where we encounter most of our problems. These officers often want to modify procedures or apply only bits and pieces and we often wind up having arguments."

In general, Carne approves of systems engineering management—especially when it's uniformly applied. "But when zealous types get involved, watch out," he says.

**ANY  
WAY  
YOU  
LOOK  
AT  
IT**

**SERIES SIXTY CONVERTIBLES**

*provide the right  
angle for your  
viewing comfort*

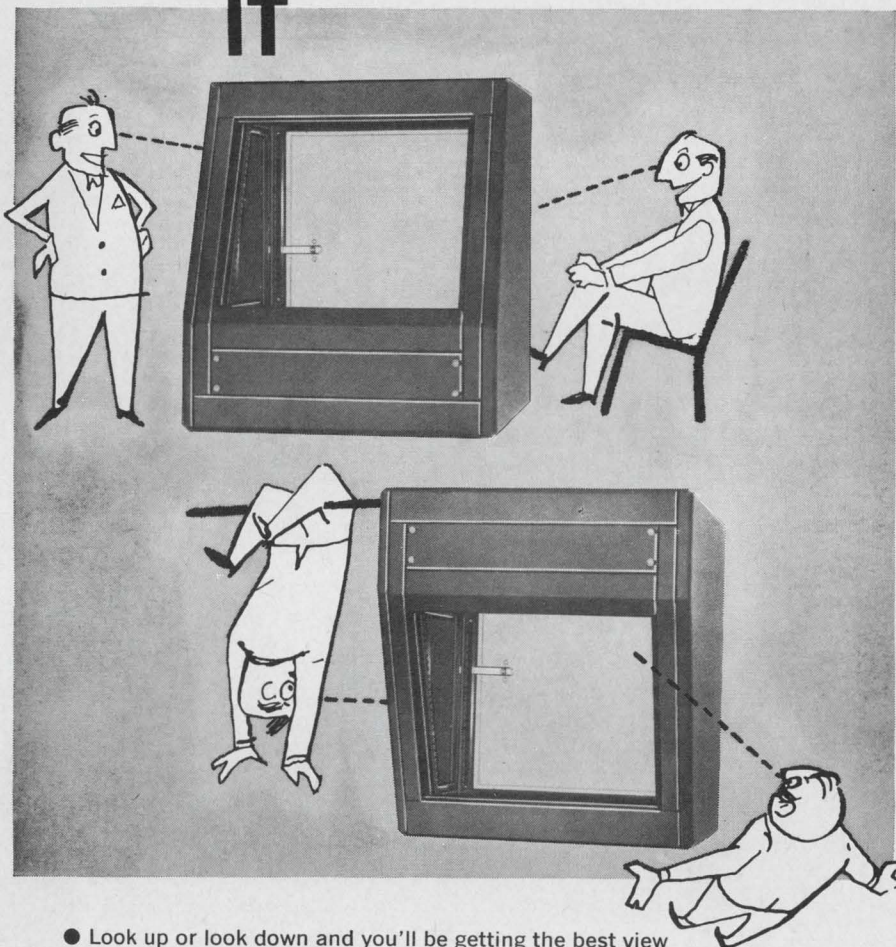

● Look up or look down and you'll be getting the best view of the meters, read-outs, dials, etc. on the sloping panel of the Convertible. It's extremely useful on a table or bench or placed on top of a tall cabinet.

The Convertible is built along the same structural lines as other Bud Series Sixty Cabinets. It is an extremely rugged enclosure for delicate instruments and systems. Maximum access to interior for installation of components or service is provided. Standard 19" panels are used.

See these practical new enclosures at your authorized Bud Distributors. Comprehensive literature is available.

**BUD Series Sixty . . . The Growth Line**



**BUD RADIO, INC.**

Willoughby, Ohio

**your product** *Belongs* **in a BUD cabinet.**





## Helipot's new, economy dc voltage regulators are only \$10<sup>80</sup> (100 piece quantity)

Helipot's new *positive* (Model 809) and *negative* (Model 859) self-contained hybrid *cermet* units are designed to give you high performance at budget prices.

- 5 to 28 volts fixed outputs
- 0.003%/ma maximum load regulation
- 2 volt minimum  $\Delta V$  across regulator
- 750 ma load capability
- 34 db ripple attenuation to 100 kHz
- $-55^{\circ}$  to  $+125^{\circ}\text{C}$  operating temperature range
- Add-on capabilities include: short circuit protection with an external transistor, loads over 5 amps with an external pass transistor, and adjustable outputs with an external resistor.

These regulators are small (1" x 0.5" x 0.170" high), fully sealed ( $1 \times 10^{-7}$ ) and compatible with flat pack and dual in-line packaging. And, they're available from local stock. For more information, call your local Helipot sales representative or circle the reader service number.

**Beckman**

INSTRUMENTS, INC.

HELIPOT DIVISION

FULLERTON, CALIFORNIA • 92634

INTERNATIONAL SUBSIDIARIES: GENEVA; MUNICH; GLENROTHES, SCOTLAND;  
TOKYO; PARIS; CAPE TOWN; LONDON; MEXICO CITY; STOCKHOLM; VIENNA



# Air Force gets new, economy Buic

Third version of the backup interceptor control system has about double the air defense capabilities of predecessor network, costs but \$35 million

By James Brinton  
Boston bureau manager

**U.S. air defenses** will get a lift later this fall when the Aerospace Defense Command takes delivery of the first of 15 improved Buic—backup interceptor control—systems at North Truro on Cape Cod, Mass. The price of Buic 3 is comparatively modest by the standards of military procurement—around \$35 million. But the system, which has considerably greater capabilities than its predecessors, is considered good enough to rate as a potential successor to the Sage—semiautomatic ground environment—air defense system, which will be phased out in the 1970's. Buic 3's technical excellence is all the more welcome in light of the fact that Pentagon planners have continually sliced funds from the program since it was first set up during the early 1960's.

**Too close for comfort.** Sage centers, which began going operational in 1958, were originally intended for defense against manned bombers and air-breathing missiles, and are located in or near the areas they're supposed to protect. With the development of intercontinental ballistic missiles carrying nuclear payloads, it became apparent that an enemy could wipe out with a single shot not only a key target area but its air defense system as well.

Accordingly, the Air Force began casting about for alternatives. Eventually, the service went for the Buic program, which locates control centers at long-range-radar sites located well away from important targets.

The first Buic system, deployed in 33 locations, was an interim, manual setup. But Buic 2, which was developed under the manage-

ment of the Air Force Electronics Systems division (ESD) at Hanscom Field in Bedford, Mass., was designed to be an austere replica of the sophisticated Sage.

## Facilities

A Buic 2 center uses Sage radars, but it has its own solid state data processing equipment, built around the Burroughs Corp.'s D-825 general-purpose military computer. Five operator consoles with fast cathode-ray-tube displays are linked to the computer by communications lines.

Each center can manage an air battle over an adjacent Sage sector, as well as above its own terrain. Operators get a visual display of data stored by the computer, along with a continuous flow of new information from farflung airborne, shipboard, or ground-based sensors. The consoles are push-button controlled and of modular construc-

tion to facilitate interchanges in case of breakdowns. Each unit is fully capable of air surveillance, weapons control, direction of air battles, and simulated training exercises.

**Scramble.** When Sage radars pick up a target, the Buic 2 center accepts the inputs from the sensors, generates tracking information, and displays the data on the operator consoles. The system can check regional weapons availability and determine whether interception is possible. Once prelaunch and firing commands have been issued, the system can calculate and transmit guidance data to interceptors, whether aircraft or missiles.

Though a technical success, Buic 2 got caught in the switches of a Pentagon economy drive. So, after \$140 million had been invested in hardware, the number of installations was frozen at 13. However,

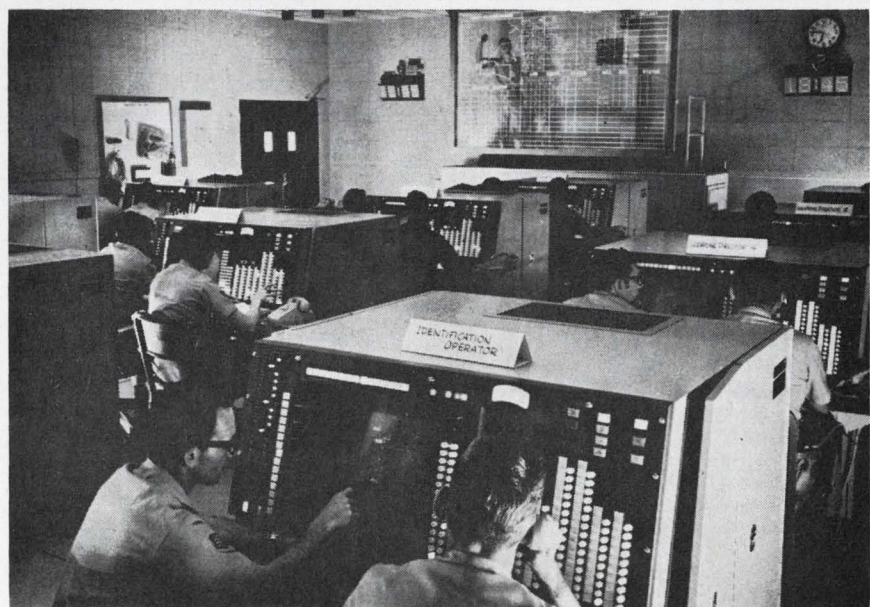

**Overview.** In a dry run, console operators scan Buic 3's tv-like displays for track and intercept data, as well as the status of retaliatory forces.





**New**  
**MINIDAC**  
**High-Speed D-to-A**  
**Converter in a**  
**small package**

- 3/4" x 3/4" x 1 1/2"
- No Switching Transients
- Low Price

MINIDAC is an extremely versatile, UHF Digital-to-Analog converter module designed for driving into 100 ohm matching impedance. It may also be used with Operational Amplifiers for greater voltage ranges. These modules accept RTL, DTL or TTL input signals, include reference, switching, resistors, and provide currents of up to 10 ma. into resistive load.

Output voltage time constant is less than 30 nanoseconds and will settle to 0.1% in 200 nanoseconds. An external threshold adjustment permits user to adjust the actual switching threshold minimizing the variations in rise and fall times in his logic. Feed through of switching signals has been eliminated.

**APPLICATIONS**

- High Speed Scope Deflection Systems
- Time Compression
- High Speed A/D Converters
- Precision High Speed Test Circuits

MINIDAC units are available in up to 12 bits Binary or BCD input codes, and current output ranges of 4 and 10 ma. Maximum output voltage without amplifier is 2 volts. Custom designed D/A Converters including Buffer Storage and special output Amplifiers are available upon request.

**PASTORIZA**  
**ELECTRONICS, INC.**

385 Elliot St., Newton, Mass. 02164 • 617-332-2131

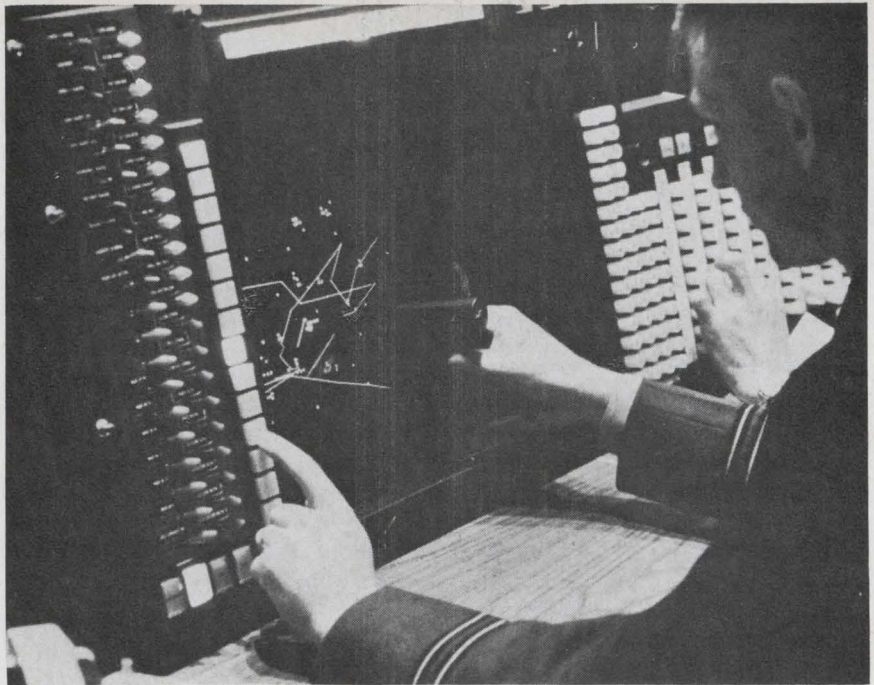

**Test case.** An officer practices air-defense routines at display console of Air Force's Buic 3 system; first facility goes operational this year.

during 1964 and 1965, before the first Buic 2 site had been activated, the whole program got a thorough going-over. Eventually, defense officials sent ESD and the Mitre Corp., which was doing the systems engineering work, back to their drawing boards to get more mileage out of the hardware that had been bought. As a result, a lot of engineers were wearing two hats, performing acceptance tests on Buic 2 and drawing up design specifications for a follow-on system.

**Added attractions**

When Mitre and ESD finished their specifications on Buic 3—amid a crescendo of groans from project managers over further cutbacks and a lack of manpower, sympathy, and the like—a number of additions had been made. There are, for example, more operator consoles (making a total of 11 at some sites, 10 at others), another message processor, another tape unit, eight core memories instead of six and an additional drum memory.

"With more memory, more consoles, and a greater capacity to communicate, Buic 3 can handle two or more times the number of tracks, as well as manage twice as much weaponry," says Capt. Joseph F. Elefritz, ESD's project manager.

James C. Naylor, Mitre's Buic 3

project leader, believes the console changes are more significant than those made in the data processing gear. "At least they took more effort and resulted in a noticeable enlargement of the system's capabilities," he says.

**Wider choice.** Almost all of the logic in the consoles has been modified in some way, according to David B. Fleury, an assistant site engineer from Burroughs. But probably the most important change is the use of 49 categories of incoming information rather than 15, as in Buic 2 units. Operators can now call up more information on displayed features or geographical references, targets, and the like.

Information written on a drum for relay consoles is tagged with a nine-bit identification code. Throwing the console's category selector switches filters some data out and passes some through to the display. Some information is sent to a console with a specific mission, say, weapons director, because of the computer program, but category switches give the operator some discretion as to what he observes. There's an "only" position for each category that keeps all other data off the screen.

In addition, says Fleury, there are new console address switches that can send information to a display that isn't programed for it.



Two group switches make it possible to select large numbers of categories at will.

**Enhancement.** The display is refreshed by repeated reading of the continuously spinning drum memory. Only a few delay lines are used to prevent jitter or other visible defects. "There isn't any memory capability to speak of in the consoles," says Naylor. "And because we serve 11 consoles from our drums, we refresh less often than in Buic 2. Thus our display flickers a little."

This flicker problem was a thorny one for a while, Naylor explains, because Buic 3 uses a light sensor gun to discriminate among various displayed features and to help initiate action against a "hostile." The pulse code used to distinguish the various types of data is transmitted to the gun by flashing phosphor.

"So we were stuck," Naylor says. "On the one hand, we needed a phosphor with long persistence for low flicker, and on the other, we wanted a fast rise time to get the code pulses on the screen clearly enough for the logic behind the light gun to decipher them. Eventually we came up with a mixture of P-12 phosphor, for persistence, and P-16, for rise time. We still get a little flicker, but the data codes come through clearly."

**Gun shy.** Naylor notes that only certain information can be handled with a light gun—a situation that tends to cut the number of operator

errors. For example, if an operator tries to dispatch an interceptor to shoot down a geographical boundary, rather than a hostile aircraft, the computer refuses to transmit the order and informs the operator of his error on a small cathode-ray tube to the right of the large display.

In addition, the computer can reject such goofs as committing weapons to a track (target) already being shot down by another operator. The machine can also tell the operator if the interceptor has too little fuel or lacks the speed to reach the target, or if the target is actually a friendly airplane. All this information appears in flashing letters on the message crt, along with instructions about how to rectify errors.

Naylor points out that Buic 3 consoles have feature selection switches that put track data on the display crt in alphanumeric form. This information includes the course, speed, and altitude of a target, notice of the dispatch of weapons to deal with the track, and symbols indicating when track is about to become the responsibility of an adjacent center. Buic 2 lacked this latter feature.

#### Next best

Outside the operator consoles, Naylor feels that the status display console in the data processing section is the most important new feature of the Buic 3. In the Buic 2,

## The Material of Unlimited Uses...

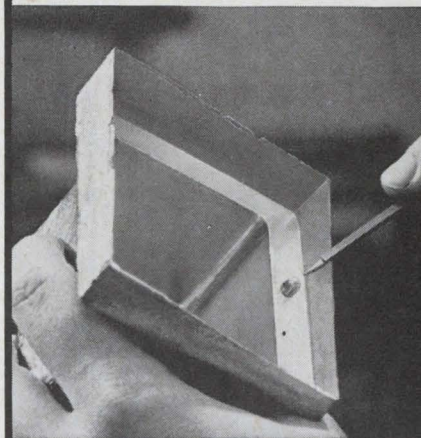

## INSTANT DIP-A-MOLD

In seconds, you can make perfect molds, like this one, for potting any encapsulation, and make them economically, with low-melting CERRO® Alloys. Just dip the master in molten alloy. A thin coating of alloy clings to the pattern. Withdraw the pattern, and you have a perfect high fidelity mold. When the encapsulating plastic cures, simply remove the CERRO Alloy. Use it over and over again, almost without limit.

This particular alloy—CERROTRU®—does not shrink, slips easily from the pattern without parting or contaminating compounds or coatings. Because of its low melting point, it is safe and easy to handle.

You can reproduce such unusual details as positioning lugs for transformer cases, as shown above, without the use of cores, inserts or secondary operations.

Instant molding is just one of the many uses for CERRO Alloys. To find out more, contact Cerro Copper & Brass Co., Cerro Alloy Dept., Stamford, Conn. 06907... R. S. Darnell (203) 327-0550.

# CERRO®

### Survival of the fittest

In the budget message and five-year program, presented to the Senate Armed Services Committee last January, Robert McNamara, then Defense Secretary, forecast that much of the U.S. air surveillance, warning, and control network could be phased out during the 1970's when Awacs (airborne warning and control system) and over-the-horizon radar become available. On the "to-go" list would be all but one of the Sage combat centers, all of the Sage direction centers and about half the search radars, all of the gap-filler and DEW (distant early warning) line radars, and all of the AEW/ALRI (airborne early warning/airborne long-range input) aircraft. Retained would be the Norad (North American Air Defense Command) combat operations center, a manually operated combat center in Alaska, 10 Buic stations, and some of the search radars and fire-control centers at Nike-Hercules batteries.

When Buic 3, which has twice the data processing, tracking, and display capacity of its predecessor system, got a green light in 1966, McNamara recommended that Sage be all but eliminated. Under the original plans, two Buic 3 systems would have been deployed in each of eight Sage sectors along U.S. borders; in addition, three other Sage sectors were to get one Buic system apiece. Subsequently, however, the total number of Buic sites was cut back to 15.



DAFC



## CEI's New Type DRO-302A COUNTER Offers MAXIMUM VERSATILITY

DIGITAL AUTOMATIC FREQUENCY CONTROL lets you "LOCK IN" a CEI receiver to a selected frequency with stability approaching that of the counter's internal reference source. Extensive use of integrated circuits has permitted design of a counter that is simple to use and in a compact half-rack size. It will not produce RFI in the associated receiver.

The 302A has been designed for use with CEI VHF receivers to indicate the tuned frequency over the range of 10 MHz to 300 MHz or it can be used as a laboratory counter for direct counting frequencies up to 300 MHz. It may be combined with CEI's DRX-1000 Digital Readout Extender to indicate the tuned frequency of CEI receiving equipment up to 1000 MHz. In the DAFC mode the 302A controls the local oscillator of the receiver to hold a desired frequency and, in effect, gives results similar to a frequency synthesizer.

The unit has an internal preset for receivers with a 21.4 MHz IF. Other presets are available as options. BCD output plus print and inhibit commands for printers such as the CMC-410A also are available. Call or write for details.



SUBSIDIARY OF WATKINS JOHNSON



COMMUNICATION ELECTRONICS

6006 Executive Blvd., Rockville, Md. 20852 • 301/881-3300 • TWX 710-824-9603



**Check point.** Status display console rides herd on communications and data processing portions of the Buic 3; system serves as maintenance monitor.

information on how the computer was running and what was going wrong came to the facility maintenance monitor via Flexowriter. Now there's a board full of lighted buttons that not only indicates the status of the equipment at a glance but also allows the site personnel to conduct tests and simulate defense operations without having to use punched cards or keyboard instructions.

The new setup will speed repairs, Naylor observes. "The use of a utility computer program with simplified trouble printouts on the status display console helps the men find an error to within 13 to 15 circuit cards that can be pulled en masse and replaced," he says. "While all this is going on, the computer will switch over to some of the redundant components in the system."

But Buic 3 isn't home free so far as maintenance, Naylor feels. "It uses the relatively new and untried concept of error detection and recovery; this might be a big chunk of technology to digest immediately," he says. "I'm sure a computer expert could quickly learn how to work with the system, but the airmen have only 19 weeks of training in maintenance."

### Progress report

Naylor maintains that the programs used with the D-825 are the



best possible for such a processor. There were software problems, though, growing out of the fact that the computer is a transistorized second-generation machine. In addition, the computer has to service more consoles, record and relay more data, and perform more data analyses, than it had had to in Buic 2 operations. The exact nature of the new software developed by the Systems Development Corp. is classified, but Naylor does state that "SDC solved a problem that there was no money left to solve, and in doing so pushed the D-825 to the limit of its capabilities."

**Overcoming adversity.** If Buic 3 had been properly funded, says Naylor returning to a favorite theme, the programing problem could have been solved more easily. Withal, the program's shortage of men and money forced two other innovations, he says. The first was an adaptation of existing Bell System modems that permits the transmission of double the amount of data per second than was previously possible. Since the extra speed really isn't as important as money in this case, the Aerospace Defense Command is switching some of its communications links from duplex to simplex lines. Naylor believes that when the change over is finished, the ADC will be saving approximately \$6 million a year.

The other innovation is the application of systems engineering management techniques to the procurement of computer programs. Says Naylor: "In the late 1950's, software producers weren't required to meet performance standards. Now with SEM spec 3751 and ESD's Exhibit EST-1, software makers must show and tell just like the hardware people."

EST-1 includes a statement of test procedures and makes some tests the responsibility of the contractor, Naylor continues. "It's no longer a case of the software contractor writing a program and letting the buyer debug it; with EST-1 documentation, there are fewer bugs in the first place, and test instructions are included as a further protection to the customer." In reference to Buic 3, he says that "the use of EST-1 helped us escape several problems long before the scheme went into operation."

If you need a relay to meet these specifications:

# MS 27245 MS 27247 MIL-R5757/23

Specify this:

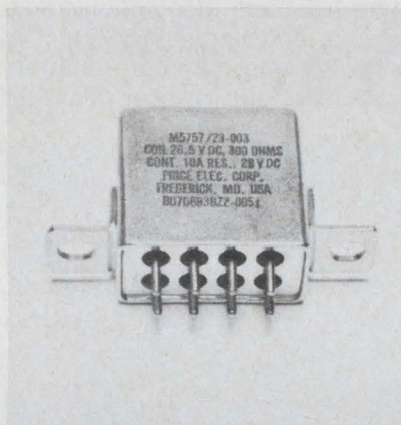

Conelco Style 7 Relay DPDT 10 amp military

You can't get a better 10 amp relay for your money than the Conelco Style 7. It was developed specifically for the aerospace industry.

So it's durable and dependable. For 3-phase AC requirements, an arc chamber is used to assure trouble free operation to 100,000 times, minimum. And all welded construction makes it absolutely reliable for the most stringent avionic applications. Independent tests have proven that the Style 7 Relay stands up against the effects of altitude, vibration and temperature extremes.

We've got a Style 7 Relay designed specifically for your needs. Send for our exclusive Select and Specify Chart.

**FEATURES:**

All welded construction for positive contamination control.  
20% smaller than similar relays.  
Arc chamber: -10 amp AC rating 115 volts single and three phase with case grounded.

**CHARACTERISTICS:**

DPDT 10AMP 28VDC/115VAC res.  
Coil: 565 MW typical: 26.5VDC 300 ohms  
Ambient temp: -65 to +125 C  
Vibr: 20G up to 2000 Hz  
Shock: 50G 11msec  
Mil-Spec: MS 27245 MS 27247 MIL-R 5757/23



Price Electric Corporation, Frederick, Maryland 21701, 301/663-5141, TWX: 710/862-0901, subsidiary of Consolidated Electronics Industries Corp.



# THREE NEW BROADBAND QUADRATURE HYBRIDS

Merrimac's new lineup of broadband quadrature hybrids are unsurpassed in performance, quality and price. The QH-7-17 covers the full bandwidth over 2-to-32 MHz with 23 db minimum isolation. This four-port hybrid network exhibits less than 0.75 db insertion loss and output equality of 0.5 db. Phase quadrature is  $90^\circ \pm 3^\circ$ . Other new broadband quadrature hybrids include the QH-4-53 covering 30-to-76 MHz and the QH-5-30 covering 10-to-50 MHz. Their low prices will surprise you! These broadband networks are extremely useful for imageless mixing, single sideband modulation, radio direction finding, phasing of antenna systems, and homing systems. Also available are a variety of reduced bandwidth and miniature quadrature hybrids from audio to microwave. For more details, write or phone Merrimac.

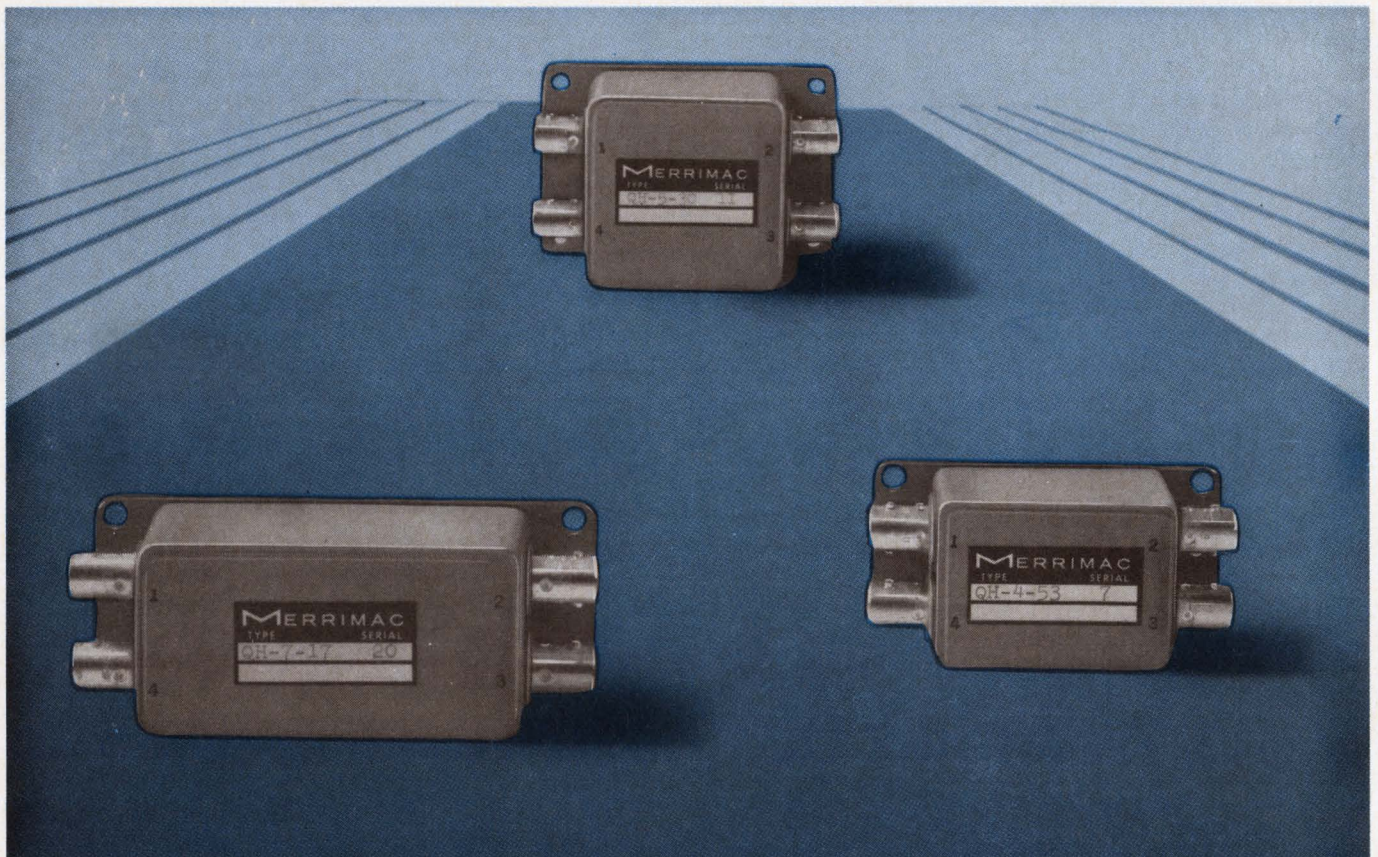

The image shows three Merrimac quadrature hybrids. The top one is a small, square device with four ports, labeled 'MERRIMAC TYPE SERIAL QH-7-17 20'. The bottom left one is a larger, rectangular device with four ports, labeled 'MERRIMAC TYPE SERIAL QH-5-30 20'. The bottom right one is a medium-sized, square device with four ports, labeled 'MERRIMAC TYPE SERIAL QH-4-53 7'. They are set against a blue background with perspective lines.

 **MERRIMAC RESEARCH AND DEVELOPMENT, INC.**  
41 FAIRFIELD PLACE, WEST CALDWELL, N. J. 07006 • 201-228-3890



# Designers up in air over specs

Discrepancies between two military standards on electromagnetic compatibility crop up during testing of avionics equipment for the Air Force's C-5A transport

By Lawrence Curran

Los Angeles bureau manager

**Occasionally**, a few of the thousands of standards and specifications issued by the Pentagon work at cross purposes. When this happens, the contractor's program manager has to sit down with the service's project officer and thrash out an interim solution. In the meantime, of course, designers are left hanging.

A recent case in point involves Military Standard 704, which has been around since 1959 and covers, among other things, avionics hardware. Until the Air Force got to work in the C-5A transport, this standard wasn't rigidly enforced, so no one paid much attention to it. Since then, however, the standard, along with a revision—704A—has been causing headaches for suppliers of avionics equipment because the Air Force is insisting on strict compliance. At first glance, this might not seem to be too great a burden, but contractors say certain key provisions are too vague.

**Stumbling block.** Specifically at issue is the question of electromagnetic compatibility (EMC) in aircraft—a major problem for designers of avionics gear. Wendell Wood, an engineer in the EMC group at the Lockheed-Georgia Co., which is building the C-5A, complains that only about 1% of the 704 document deals with the voltage transients that cause EMC problems. "It isn't clear that this is an EMC susceptibility standard for black boxes," he says. And EMC is definitely a problem, he says, particularly since pulse-operated digital equipment generates a host of high-frequency spikes. In the C-5A and other advanced aircraft, electrical transients can trip equipment or cause it to burn out.

Nor is it clear, says Wood,

whether the standard requires the testing of negative voltage transients. Other engineers familiar with standard 704 describe it variously as ambiguous or downright incomprehensible. There's agreement on one point, though: the specs as written leave testers a lot of room for interpretation.

**At odds.** An Air Force spokesman, familiar with the situation, readily concedes that spike suppression has been a problem "for ages." But the real difficulties cropped up only when the service began enforcing 704, he says. This is because there were already two standards—461 and 462—dealing specifically with EMC. These documents, put together by working electrical engineers, specify suppression of only 100-volt transient spikes. 704 and its follow-on appear to call for suppression of 600-volt spikes. So designers of avionics equipment can have a hard time deciding which master to serve.

What it boils down to, says the Air Force source, is a matter of what size spikes must be suppressed and how it's to be done. There are several schools of thought on these questions within the service. Some, for example, suggest using a busbar. In the case of 600 volts, however, this works out to a unit three feet long—hardly a handy size for aircraft. Missile engineers are strong for diodes, but avionics designers point out that it's difficult to determine when such devices are burnt out. Because of the general dissatisfaction and shifting currents of opinion, the Air Force has set up a committee under the auspices of the Society of Automotive-Engineers to resolve the situation. A report is due in a year or so.

## Going it alone

But until 704 and 704A are revised, buyers and sellers of avionics gear must make do. As a result, Lockheed-Georgia, following the

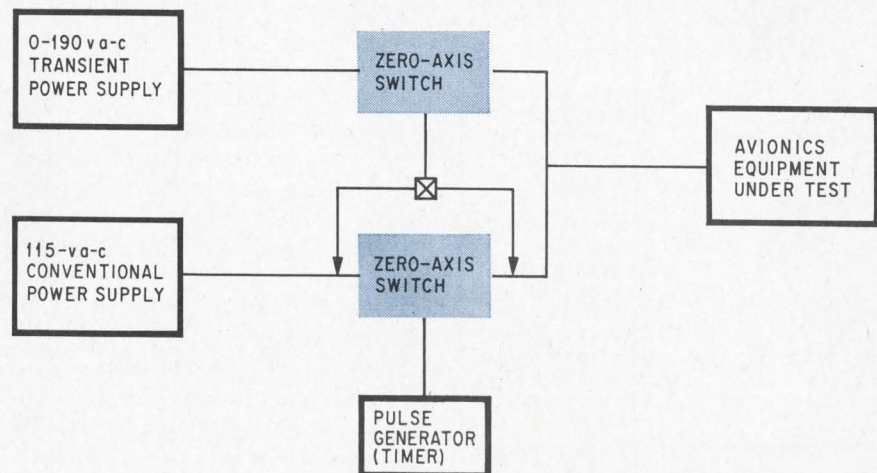

**Soft touch.** Genisco's a-c transient generator features zero-axis switches that protect equipment under test from damage by large spikes of voltage.



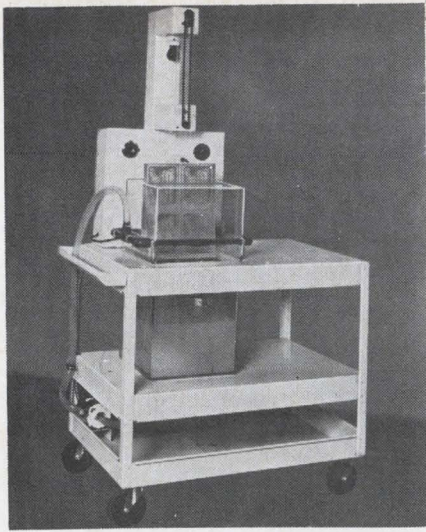

## "fine line" etcher

for prototypes—limited runs

Model No. 201 (illus.), etches two  
11" x 14" one-sided  
boards or one 11" x 14"  
two-sided board: **\$795**  
Pat. applied for

**ETCH YOUR OWN  
P C BOARDS  
AUTOMATICALLY**  
(in less than 5 minutes)

from this →  
to 11" x 14"

Shown Actual Size



- No cooling or venting required!
- Etches as fine as .001"!
- Cuts costs in half—saves time!
- Complete photo processing instructions!
- Work is illuminated while etching!
- No patterning . . . minimum undercutting!

### NOW IN USE BY:

AMP, Inc.  
Ampex Corp.  
Atomic Energy Com.  
Bendix  
Charles Bruning  
Esso Research  
General Dynamics  
General Electric  
IBM  
ITT  
Lear Siegler  
Magnavox  
Micro Switch  
NASA  
Owens-Illinois

Sprague Electric  
Union Carbide  
U.S. Air Force  
Western Electric  
Whirlpool  
M.I.T.  
Oklahoma State U.  
Purdue Univ.  
Washington Univ.  
Univ. of Calif.  
Univ. of Chicago  
Univ. of Colorado  
Univ. of Georgia  
Univ. of Hawaii  
Univ. of Penn.

## CYCLO-TRONICS, INC.

3858 N. CICERO — CHICAGO, ILL. 60641  
TELEPHONE: (312)-282-6141

## . . . the controversy over standards has helped one West Coast firm . . .

lead of the Airlines Electronic Engineering Committee (AEEC) of Aeronautical Radio Inc., extended the range of EMC susceptibility voltage levels for the C-5A beyond the d-c specs outlined in 704. Under the company's scheme, d-c transient tests run from -600 volts for 10 microseconds to +600 volts for 10  $\mu$ sec. These limits were partially incorporated in 704A. Wood of Lockheed says the AEEC was the first to tackle the transient susceptibility problem after airlines representatives complained that overvoltages from "utilization equipment"—such as percolators—were causing problems with avionics gear.

Because the test levels for a-c transients are the same in both 704 and 704A, Lockheed went along with them. Specific voltages and durations are: 0 volts for 3 seconds; 90 volts for 5 seconds; 137 volts for 5 seconds; 160 volts for 0.8 second; and 190 volts for 0.1 second.

### Will it start?

The check at 0 volts is attributable to several possibilities; power supplies can skip a beat and a-c lines can be shorted, thereby reducing the load to zero. In addition, the power being supplied to equipment under test may be switched from one source to another. As a result, it's necessary to test whether the equipment will start up again once a short is removed or power reapplied.

Lockheed also set an internal impedance level of 10 ohms simply to have a standard to work with when performing tests.

Wood says 10 ohms isn't ideal. But neither is, say, 50 ohms, because nobody really knows the impedance of a power-line bus in an aircraft. The level can vary from 0 to 10,000 ohms. However, it is generally recognized that the d-c impedance of buses is pretty low—about 0.1 ohm for a power line capable of handling 280 amps. But as the length of the line in an aircraft is increased, the impedance will vary with different transients—depending on the distance from the

transient source. However, the lower the level of specified impedance, the larger the test equipment required to generate the transients. Lockheed settled on 10 ohms as a level that wouldn't impose harsh cost penalties on makers of test equipment for C-5A program applications.

### Beneficiary

For all the controversy, 704 and 704A have helped one West Coast firm. The Genisco Technology Corp. is offering to test C-5A avionics equipment for the suppliers. Genisco has taken an all-solid state approach in the d-c and a-c transient generators it has developed for the tests.

Lockheed-Georgia is also designing and building transient generators, as are some other C-5A avionics suppliers, including the Northrop Corp.'s Nortronics division and the Garrett Corp.'s AiResearch Manufacturing Co. Joseph Tobin, an EMC engineer at AiResearch in Los Angeles, says that the firm's generator is 95% complete but that it's now having its d-c testing done by Genisco in nearby Compton.

Lockheed's Wood says his company's d-c and a-c generator uses silicon controlled rectifiers to switch current from a bank of capacitors to a power line. The SCR's are shorted to ground to control the amplitude and duration of the pulse; Lockheed says a patent is pending on this control circuitry. The unit also employs wave-shaping techniques to get a controlled transient. The resultant waveform is almost flat-topped, controlling both the voltage level and duration of the transient spike.

**Added bounce.** Lockheed is using a relay to switch power from the d-c line to the equipment being tested. But Robert Shepard, director of computer services in Genisco's Electronics Components division, says this sort of arrangement can introduce "contact bounce" during switching. Such bouncing may require about 20 milliseconds to settle, says Shepard, and five or six transients can be fed to the test



specimen when only a single input is desired.

The solid state switch Genisco is using eliminates contact bounce and limits pulse current to 14 amperes under all condition. A relay switch, says Shepard, may allow inrush currents much higher than 14 amps, which can damage or destroy equipment under test. Current limiting in the Genisco generator is handled by two 400-volt, 15-amp power transistors in the switch; these devices are made by Motorola Inc.'s Semiconductor Products division.

### Proud parents

Genisco engineers believe their a-c transient generator is also unique—primarily for its zero-axis switching features. Stephen Jensen, who recently left Genisco to form his own company but who had a lot to do with the generator's design, explains the equipment's operation this way:

Two power supplies—one putting out a normal 115 volts, the other transients from 0 to 190 volts—are used. In addition, the Genisco system has two zero-axis switches and a programable pulse generator, or timer. The timer unit is set up to actuate the switch controlling the transient power supply only when the amplitude of the sine wave of the voltage from the conventional supply is at 0. Both the duration and level of the spike are externally controllable.

**On and off.** In effect, the first switch "asks" if there's any line voltage. When there isn't, the zero-axis switch in series with the transient power supply goes into action. The equipment under test is then zapped at, say, 190 volts for 0.1 millisecond, at which point the pulse generator senses that the proper amount of time has elapsed. The transient is ended by again activating the first zero-axis switch, putting the test equipment back on the normal 115-volt supply.

Jensen says this method provides waveform continuity and prevents the kind of inordinate spikes of voltage that might be a problem with mechanical relay switches. But he adds that Genisco's test still satisfies the specifications calling for abrupt changes in the voltages applied to a given piece of avionics equipment.

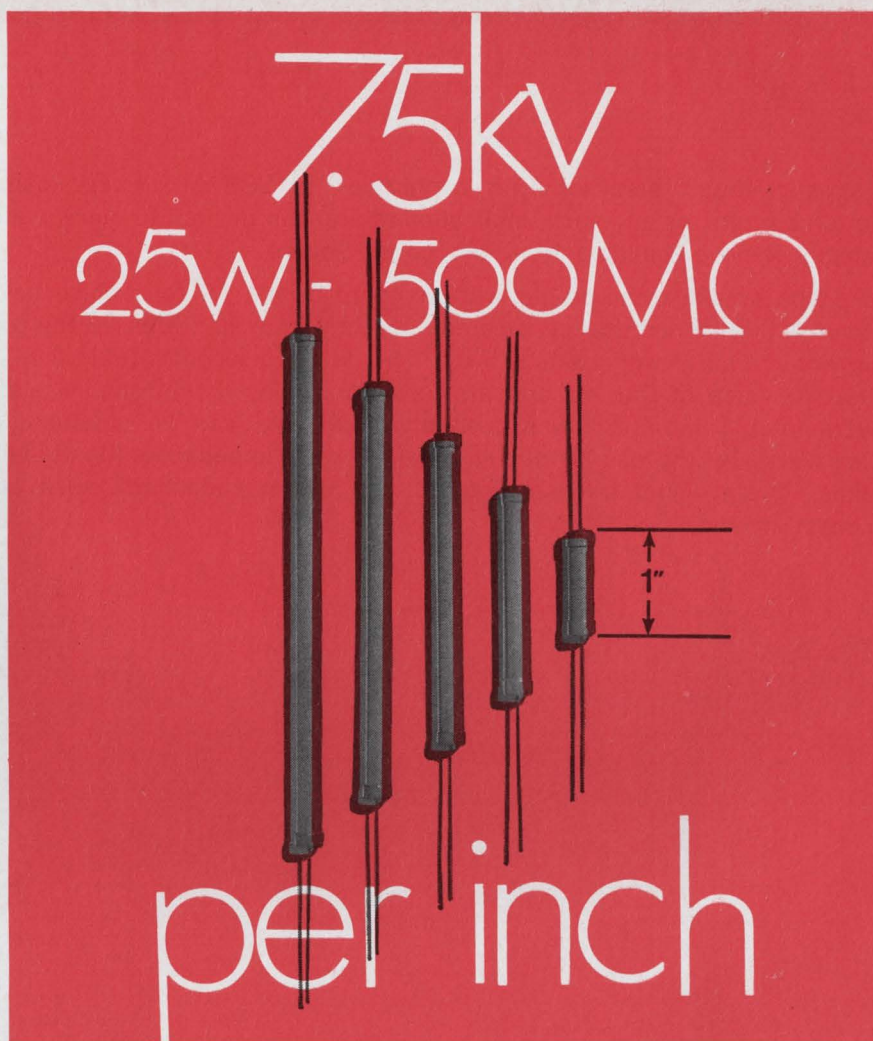

## New Victoreen MOX Resistors Now values to 2500 megohms in a compact package only 1/4 OD x 5" long

Now — by specifying new Victoreen metal oxide glaze resistors — you can buy resistance by the inch.

Based on our standard 1/4" OD size, Victoreen Series MOX resistors, per inch of lineal length, give up to 7.5 kv ratings . . . 500 megohms resistance . . . 2.5 watts power dissipation. Tolerances are  $\pm 2\%$  or  $\pm 5\%$  right across the board up to the 5" size . . .  $\pm 1\%$  and  $\pm 0.5\%$  in some sizes. Stability is exceptional, too — less than 1% full-load drift in 2000 hours . . . shelf life drift less than 0.1% per year.

Victoreen MOX Resistors are available right now in sizes and ratings that make them near-perfect — for HV probes with DVMs, meter multipliers, HV plate load resistors and similar circuits. And still more new sizes and ratings are on the way, too.

A-1962

**VICTOREEN INSTRUMENT DIVISION**  
10101 WOODLAND AVENUE • CLEVELAND, OHIO 44104  
IN EUROPE: GROVE HOUSE, LONDON RD., ISLEWORTH, MIDDLESEX, ENGLAND





# DUMP CIRCUITS

Magnetic circuit breakers lend themselves to SCRAM circuits, panic button circuits, or any such application where it is desired to quickly and reliably remove the load from the power source.

APL type breakers can be had with standard 50 ma AC coils which have about 420 ohms impedance. Operated directly from 115 volts AC the coil current of Pole B will reach 275 ma for a few milliseconds. (Pole A is in the other side of the line and provides time delayed protection against overloads.) Somewhat lower pushbutton currents can be obtained, if necessary, by the use of circuit breakers with impedances up to 11K ohms. These would be non-standard, but our non-standard costs are modest indeed.

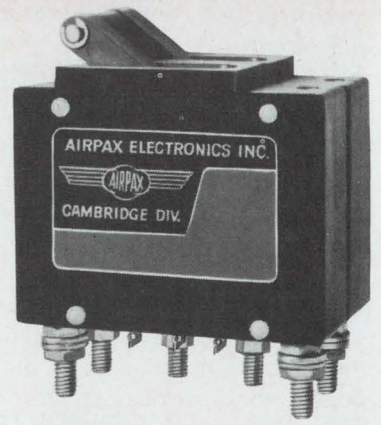

**APL  
MAGNETIC  
CIRCUIT BREAKER**  
Double Pole with  
auxiliary signal contacts

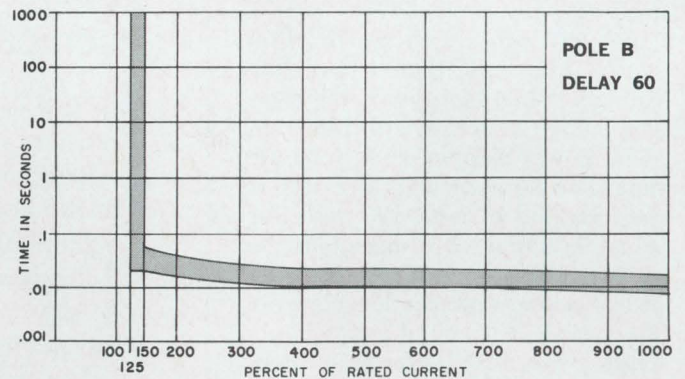
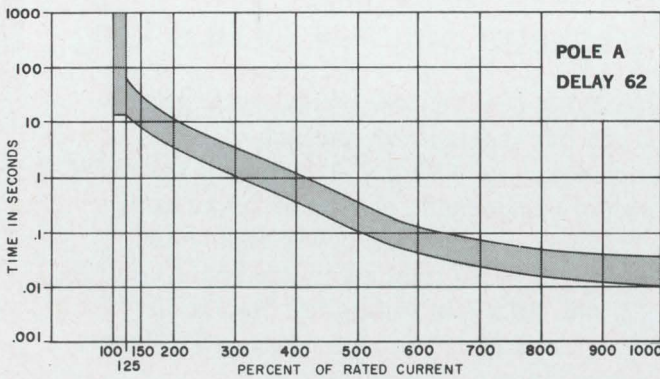
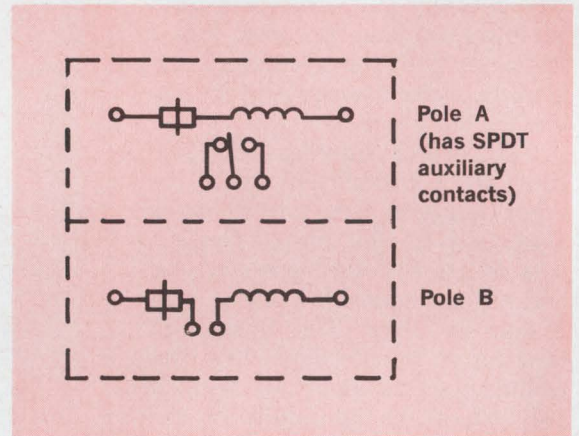
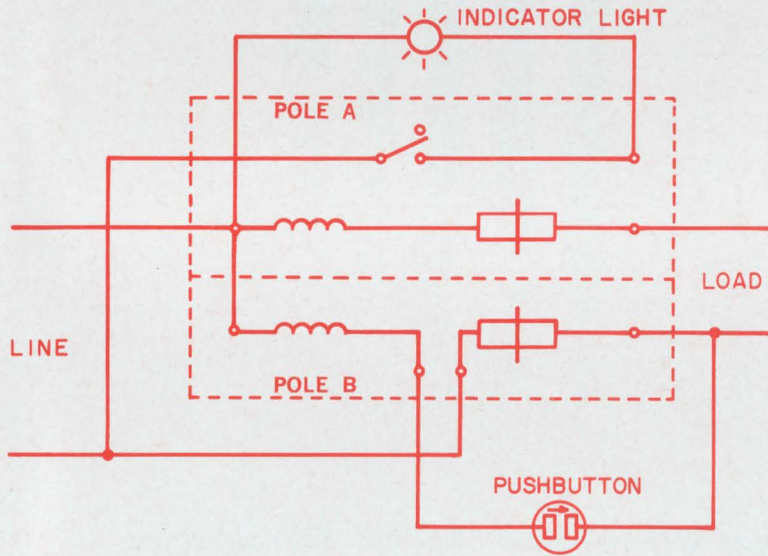

## AIRPAX ELECTRONICS

CAMBRIDGE DIVISION, CAMBRIDGE, MARYLAND 21613

Phone (301) 228-4600

TWX 710 865-9655

TELEX 8-7715



# New Products

## Subassemblies

### IC operation keyed to Hall effect

Solid state keyboard for computer input terminals tagged at \$100 is half the price of comparable electromechanical units

A magnet-actuated integrated circuit is the heart of a solid state keyboard developed by the Micro Switch division of Honeywell Inc.

"To the best of our knowledge, this is the first time that mechanical control of an IC has been accomplished economically in the industry," says James S. Locke, division general manager and a Honeywell vice president.

Locke emphasizes "economically." The basic price of the new keyboard is about \$100, approximately half that of most electromechanical types. Honeywell hopes to carve out a sizable share of the mushrooming market projected for remote terminals and desk-top computers in the 1970's. The company has started making the keyboards, and is gearing up for full production starting early in 1969.

Each key on the board has its own IC chip. When a key is depressed, a magnet is lowered around the chip and the circuit is actuated. The only mechanical portions are the key itself and its associated spring mechanism.

The IC was the brainchild of Everett A. Vorthmann of the division's advanced engineering department and Joseph Maupin of Honeywell's Solid State Electronics Center in Minneapolis. The circuit includes a Hall generator, a trigger and an amplifier.

**Surrounded by field.** The circuit's operation depends on the Hall effect—the development of a

voltage between the two edges of a current-carrying metal strip whose faces are perpendicular to a magnetic field. As the key is depressed, the magnetic field surrounds a metallic epitaxial layer on a chip of p-type silicon, which carries a current perpendicular to the field. The Hall voltage is developed in a direction perpendicular to both the current and the field. It is very small—in microvolts; it is amplified, and the amplifier output flips the trigger, which switches the amplifier's output to the proper lines to represent the binary code for the depressed key.

Four bonded wires connect the terminal of the chip to a lead frame, which is fastened to a single-side, glass epoxy printed-circuit terminal board. A comb, soldered just above the top switch row, provides the jumpers or connections for all of the negative inputs in each column of switches. A second p-c board, for the encoding, is mounted below the terminal board and is two-sided.

One side of the encoding board has two vertical columns of conductors for each key, and the reverse side is made up of 32 horizontal rows of conductors. These, in effect, are two separate grid systems. With 16 possible combinations of a four-bit binary code—four 0's through four 1's—and each system utilizing a four-bit code, two grid outputs can be combined to yield an eight-bit code.

The net result: a specific eight-bit code for each key.

Because the keyboard was designed to meet the American Standard Code for Information Interchange (ASCII) requirements, two separate codes, one each for the shifted and unshifted modes, are assigned to each key. The codes differ by only a single bit so that

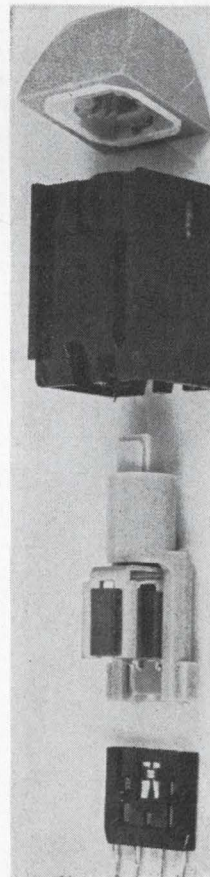

**Button action.** Lead frame with four terminals, at bottom, has IC mounted near top edge. Just above it is plunger with magnet which surrounds chip and actuates circuit. At top are key button and, under it, the switch housing.





# IMAGINE!

**A current regulator that makes no compromise with the voltage mode!**

Kepeco's new CC line, six models from 0-200 mA to 0-2 amperes, with load ratings of 0-100V to 0-7V, all made in a 1/6th rack plug-in configuration.

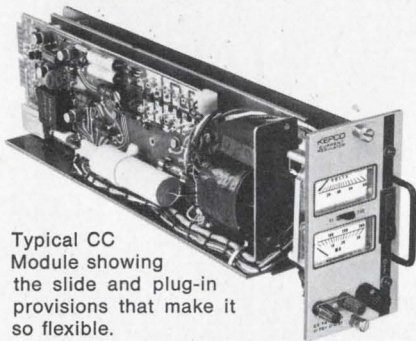

Typical CC Module showing the slide and plug-in provisions that make it so flexible.

Special linear IC's control the regulator (0.01%) and isolate the dual metering circuit (no loading). The ammeter and the 10-turn current control are switched over a 10:1 range for enhanced set-and-read resolution at the low end.

Recovery is at an amazing 2  $\mu$ sec per volt (except 4  $\mu$ sec/V for the 2A-7V model) made possible by a special capacitorless output filter (no unwanted stored energy) that yields a modest 0.02% ripple and noise figure.

MODEL	VOLTS	AMPS	PRICE
CC 7-2M	0-7	0-2	195.00
CC 15-1.5M	0-15	0-1.5	195.00
CC 21-1M	0-21	0-1	195.00
CC 40-0.5M	0-40	0-0.5	195.00
CC 72-0.3M	0-72	0-0.3	195.00
CC 100-0.2M	0-100	0-0.2	195.00

The Kepeco CC current sources are FAST, ACCURATE and SMALL. Mount 1, 2, 3 or 6 of them in available housings.

For full story write Dept. AL-14



131-38 SANFORD AVE. • FLUSHING, N.Y. 11352  
(212) 461-7000 • TWX # 710-582-2631

## ... solid state design eliminates need for special circuits to combat bounce ...

shift—such as between upper and lower case—can be accomplished by the inversion of the single bit. Besides ASCII, however, the keyboards can also be coded in extended binary coded decimal interchange code (EBCDIC) often used in IBM equipment.

**Switch to DTL.** Despite the mounting interest by computer makers in transistor-transistor logic for their newer machines, Micro Switch has chosen to go with diode-transistor logic. "We started out with resistor-transistor logic,"

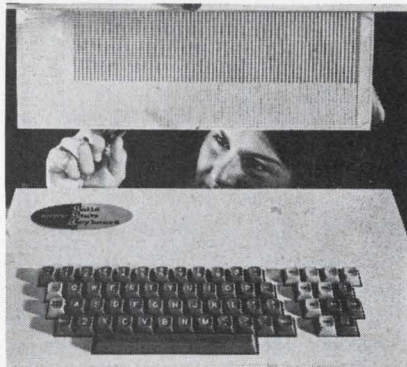

**Design grid.** Printed-circuit board fits under keys, provides coding.

says Vorthmann, "but from the point of view of cost and speed, we decided to move up to DTL. Since cost for both RTL and DTL is fast becoming comparable, it would have been foolish not to take advantage of the speedier DTL."

"As for TTL," he points out, "it isn't worth the premium we would have to pay for a speed advantage that is only marginal right now." Clearly, Vorthmann isn't ruling out TTL in the future.

Honeywell makes the IC used in the Micro Switch keyboard, but outside vendors supply the logic circuits. "Rather than be dependent on a single vendor," says Vorthmann, "we use the type 830 DTL, common enough today to be manufactured by several companies."

Micro Switch claims six benefits of the solid state approach to keyboards: low cost; no bounce; long life and high reliability; and compatibility; electrical repeatability.

**No bounce.** "Reed switches," designer Vorthmann points out,

"require two diodes per key, which is costly in itself. But the bigger problem there is bounce, caused by the two leaf springs. This means that the engineer has to design around the bounce period." Usually, this calls for bounce-gate and delay circuits. "Photoelectric keyboards are too slow," says Vorthmann, "and are prone to degradation. Mechanical approaches, like those used in teleprinter systems, require a great deal of maintenance."

Because the solid state approach has no bounce, the need for bounce-gate and delay circuits is eliminated.

Electromechanical switches have lifetimes measured in the millions of keystrokes, but there is still no yardstick for IC switches. At the minimum, say Honeywell engineers, the lifetime will be measured in the billions of strokes. The voltage and current levels of the IC switch match those of most other logic devices.

Micro Switch launched its keyboard program four years ago with the introduction of a mechanical code generator called the KB switch. In 1966, the KB was modified by substituting a reed switch for the mechanical contacts. But it wasn't until last year that the Honeywell division started deliveries of keyboards. These employed the mechanical KB switch. Phase II keyboards, using KB reed switches, p-c boards and IC's for termination and encoding, made their bow earlier this year.

The basic keyboard of the new Phase III line consists of four 17-unit rows that provide up to a 69-key array, including the space bar. A second version, with a 14-unit row that will provide up to 57 keys, is expected to be ready by early 1969. Micro Switch is making the keyboards available in two configurations, sloped or stepped; the latter is similar to the keyboards of standard typewriters. These configurations, say company officials, will ease the human transition from the everyday typewriter keyboard to a remote-terminal or a desk-top calculator keyboard.

Micro Switch, Freeport, Ill. 61032 [338]





Over 80% of current magnetic shield designs originated at MSD. Some were pretty simple . . . and some were pretty complicated. Each was so successful that they have made MSD the world recognized standard in magnetic shield design and fabricating.

Whether your specific shield problem requires a complicated

or simple solution, MSD's vast design, engineering and fabricating experience is available to you.

Write for EMC Engineering and Procurement Catalog.

**AT  
MSD,  
THE  
UNUSUAL  
IS A WAY  
OF LIFE**

**MAGNETIC SHIELD DIVISION**

*Originators of permanently effective non-shock sensitive shielding alloys*

**West Coast Stocking Reps**

Tech Rep Distributor Co.  
10606 W. Pico Blvd.  
Los Angeles, Calif. 90064  
213, 836-6806 213, 871-0055

Frauman Associates  
P.O. Box 969  
Menlo Park, Calif. 94026  
415, 322-8461

Perfection Mica Company • 1322 N. Elston Avenue, Chicago, Illinois 60622 • Phone: 312, EV 4-2122 • TWX 910 221-0105





## KEPCO ANNOUNCES AN OLD DEVELOPMENT

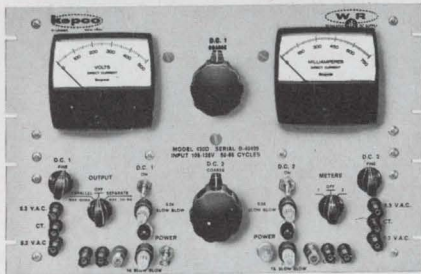

Model 430D — \$725.00

Ancient history, really, (they use vacuum tubes\*) power supplies that have survived the test of time and are still as useful in the electronics lab as ever. You can get a multi-output supply like the Model 800B (dual 0–600V, 0–200 mA sections that can be seriesed or paralleled at will . . . PLUS two 6.3V ac, 10A outputs) or a single output 0–2000V, 0–500mA bomb, Model HB 2050!

OR, maybe you'd like a small, low-cost dual 0–300V supply with adjustable bias and a filament output . . . our Model 103

The eleven models in the venerable Kepeco WR (wide range) grouping have amassed hundreds of thousands of trouble-free operating hours over the past 20 years of production and are assembled today with the same care and attention to detail that has always distinguished a "Kepeco."

We're proud of our oldies. If you'd like to know what we have in your range, drop a line to Dept. AK-14

*\*you remember vacuum tubes . . . They're those glass-enclosed NPN devices with the built-in pilot light.*



131-38 SANFORD AVE. • FLUSHING, N.Y. 11352  
(212) 461-7000 • TWX # 710-582-2631

## New industrial electronics

# ISA preview: the heat is on

A sampling of the new instruments to be shown at the annual Instrument Society of America Exhibit indicates that electronic techniques for sensing, measuring, and displaying temperatures will be featured. Attendees will also see more digital circuits to perform traditionally analog functions.

The ISA show, to be held in New York, Oct. 28-31, will reflect the continuing—if somewhat slow—penetration of electronics technology into instrumentation applications that have traditionally used pneumatic and mechanical equipment and systems.

### No bathing or baking

A cold junction compensator developed by Omega Engineering Inc., Stamford, Conn., supplies a reference voltage without bathing or baking an extra thermocouple.

Conventionally, a thermocouple is put in the test area and another is put in an ice bath, or a constant-

temperature oven. The reference voltage from the second thermocouple is compared with the voltage from the test probe; the difference between the two is proportional to the temperature difference between the two thermocouples.

The Omega-CJ cold junction compensator, powered by a mercury battery, supplies a reference voltage without bathing or baking the extra thermocouple. Inside the fist-size CJ is a bridge, a thermistor in one arm. The test thermocouple plugs into the CJ, either directly or through a temperature-compensated cable, and the CJ, in turn, plugs into the potentiometer, recorder, or other measuring device. The reference, generated by the compensator is the voltage that would be produced by the test thermocouple at 0°C. So the bridge output is proportional to temperature in the test area.

Price ranges between \$85 and

### . . . and now there are 13

Last year, London's chamber of commerce tried an experiment. It sponsored exhibits by a dozen British instrument companies at the ISA Show in Chicago. Fourteen firms signed up for the 1968 show, but one has since withdrawn and only four are repeats.

"The show last year was hopeless," says Tom Jermyn, director of Jermyn Industries, one of the repeats. But he says he has been advised that this was due, in part at least, to the Chicago location. "I have better hopes for New York this year," he adds.

Jermyn will show transistor and integrated-circuit accessories.

Another British repeat, A.M. Lock & Co., credits the 1967 show with increasing U.S. sales of its system for testing the accuracy of gas chromatographs. This year, it will exhibit an instrument for detecting unwanted particles of metal in food, tobacco, or textiles during processing. The solid-state detector can be maintained by unskilled personnel.

A coil at the center of the sensing head's aperture transmits a high-frequency field to receiving coils at each side of the aperture. If no metal is present in the products scanned, the signals received will be identical and will balance out. But metal will distort the field and unbalance the signals. Prices in England start at \$700.

Alma Components, a newcomer to the show, will display its Unislector, a ring of sealed reed switches designed for use as a counter or scanner in industrial applications. Each switch is turned on by a single 24-volt pulse through an energizing coil and off by a pulse through a demagnetizing coil. Input pulses are fed in parallel to the deenergizing coil of the switch that's on and to the energizing coil of the next switch in line, so that break and make are simultaneous.

The input pulse is put through a capacitor that discharges into the reed line a minimum pulse of 10 milliamps for 2 milliseconds.

The Unislector will be priced in the U.S. at less than \$50 per decade.



# Now get IC Op Amp power...

with high gain and high voltage

RCA has these two monolithic OP AMP units for you—ready to meet your design requirements for high input impedance, high gain and high power output. Only the price isn't high! Ask your RCA Distributor for his price and delivery. Write RCA Electronic Components, Commercial Engineering Section, ICN-92, Harrison, New Jersey 07029 for Data Sheet.

All characteristics below are typical

Power output (8% THD)  
Output swing voltage (P-P)  
Input impedance  
Open-loop Gain  
Input Offset Voltage  
Input Offset Current  
Input Bias Current  
Noise Figure  
Slew Rate

RCA-CA3033  
for  $\pm 12V$  Supply

122 mW  
21V  
1.5 M $\Omega$   
90 dB  
2.6 mV  
5 nA  
83 nA  
—  
1.2V/us

RCA-CA3033A  
for  $\pm 18V$  Supply

255 mW  
32V  
1 M $\Omega$   
96 dB  
2.9 mV  
9 nA  
103 nA  
16 dB  
2.5V/us

\$3.95 (1000 units)

\$4.95 (1000 units)

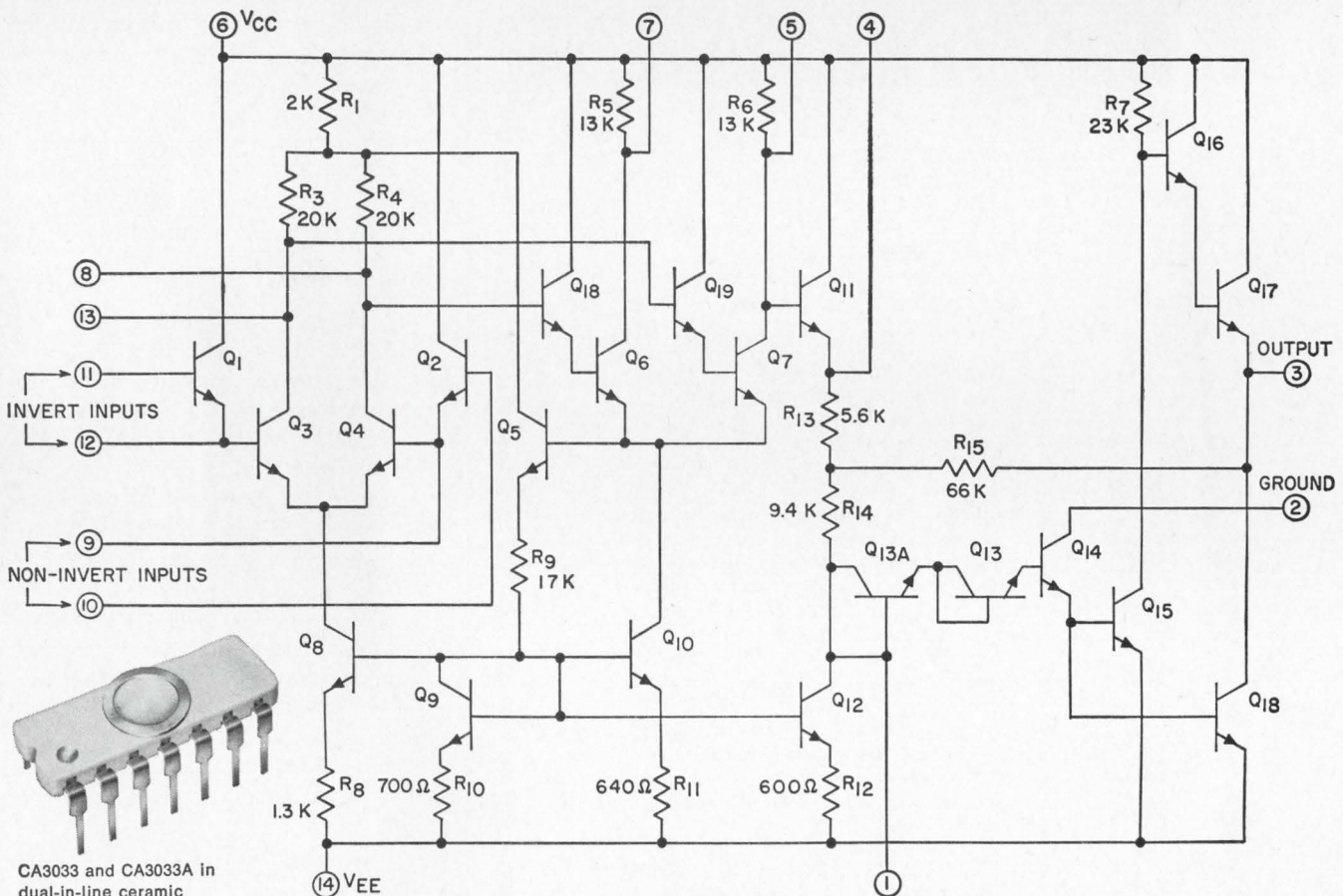

CA3033 and CA3033A in dual-in-line ceramic package ( $-55^{\circ}$  to  $+125^{\circ}C$  operating temperatures)

CA3033 now available in dual-in-line plastic as CA3047 at \$1.95 (1000 units)

**RCA** Integrated Circuits



# Why settle for Mylar® when you can get Metallized Polycarbonate Film Capacitors at the same low price?

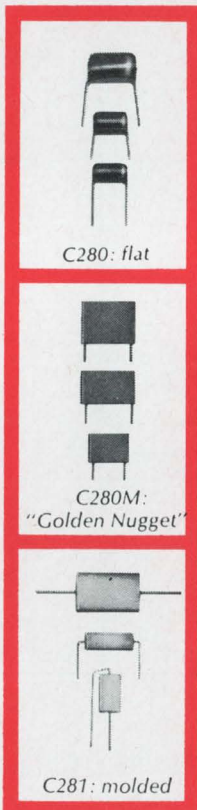

We don't know of a single application, professional or entertainment, where metallized polycarbonate film capacitors cannot replace metallized Mylar®... without changes in production setup... and do a better job, all around.

The advantages offered by Amperex metallized polycarbonate film capacitors over metallized Mylar® include: stability, lower leakage, no voltage derating to 125°C and negligible capacitance change over the operating temperature range.

Volume production efficiencies have sharply reduced the price of Amperex metallized polycarbonate capacitors so that they are now competitive with metallized Mylar®.

In the rectangular "Golden Nugget" style, Amperex C280M series capacitors offer values from 0.01 to 6.8  $\mu\text{f}$ , mount rigidly on printed circuit boards and are especially easy to identify with their high-visibility embossed markings. The C281 molded axial-lead types in values to 6.8  $\mu\text{f}$  are ideal for consumer and professional applications.

For detailed data and samples of Amperex fixed film capacitors or Amperex variable capacitors (with ceramic or film dielectrics), write: Amperex Electronic Corporation, Component Div., Hauppauge, L.I., N.Y. 11787.

**Amperex®**  
TOMORROW'S THINKING IN TODAY'S PRODUCTS

®: A DuPont trademark.

\$95, and delivery time is 3 weeks.

## Temperature controller adapts

A two-mode temperature controller that requires no adjustments for widely varying operating conditions will be exhibited by API Instrument Co., Chesterland, Ohio. Model 227 has automatic reset and a wide fixed proportioning band. Because of its high input resistance, thermocouple wire of differing lengths and gauges can be used without compensation. Thermocouple break protection is automatic. The unit offers 25 standard temperature ranges, and minimum spans of 50°F or 25°C are available as options.

**Adjustable in field.** The prevailing temperature is displayed on a meter, which is isolated from the solid-state control circuitry so that control will continue even if the meter fails. Both reset and proportioning band can be adjusted in the field. The operating voltage (120 or 240 volts a-c) can also be converted in the field.

Various options are available: process control voltage or current, on-off control with a load relay, SCR drive, a single controller with several set-point assemblies.

## Built-in sweep

A digital oscillator which includes a sweep generator as built-in, standard equipment will be introduced by the Data Technology Instrument Corp. of Mountain View, Calif.

Marketing manager Arnie Mandel, says the 0-2 Mhz instrument will be the least expensive of comparable digital oscillators on the market. Including the sweep generator and standard remote control, binary-coded-decimal programming capabilities, the DT 120 will sell for \$2,495.

**IC's lower costs.** According to the instrument's designer, the costs have been cut by using low-cost digital integrated circuits for analog functions.

The instrument has seven variable sweep steps from a base of one hertz to the full 1.999999 Mhz range; each individual decade may be automatically swept through its frequency range.

Initial shipments of the DT 120 will begin in October. Delivery time will be about 30 days.



# NOW, MAKE YOUR OWN VISHAY PRECISION RESISTORS . . . IN YOUR PLANT . . .

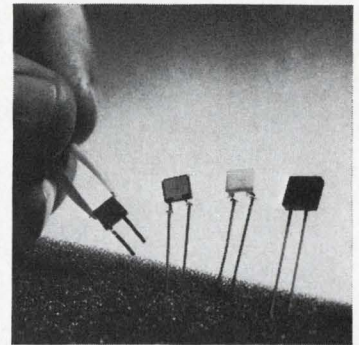

## ... low-cost "instant-resistor" installation gives you prototype and internal production flexibility

Here's the quick, uncomplicated, do-it-yourself way to have the ultra-precise, stable, no-trade-off Vishay resistors you need for: • prototype • breadboarding • final system adjustment • trimmer replacement (in "set and forget" applications) • and for spares and repairs. Make them in your own plant!!

Just follow these 4 steps . . . after setting up the proper equipment (you probably have most of it already) and easy-to-comprehend training by Vishay:

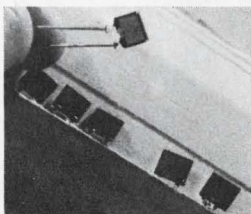

1) Select the right pre-value resistor chip (only 17 image patterns cover the entire 10Ω to 30KΩ range). All chips are supplied on substrate, with ribbon leads already attached (also available complete with external leads). No large stocks of finished resistors necessary . . . No time-consuming selection or screening.

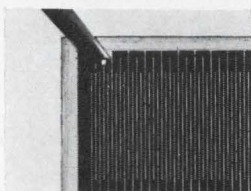

2) Adjust to exact value you need, by merely scribing thru etched resistance paths and watching a null detector.

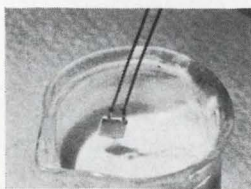

3) Coat with silicone rubber.



4) Encapsulate, in provided cases, with epoxy.

With very little practice, your operators will produce reliable resistors equalling the unusual Vishay "spec package":

- Tolerance to 0.005%
- Shelf stability — 25ppm/yr. (50/3 yrs.)
- Load stability — <0.02% max. (0.15wa. @ 125°C., 2000 hrs.)
- TC — 0±1ppm/°C. (0° to +60°C.)
- Response — 1ns., without ringing (non-inductive)
- Non-measurable noise



Vishay's proven adjustment method is quick, clean, easy to grasp, low in cost and accurate every time.

Find out how easily and inexpensively your plant can produce Vishay resistors "instantly." Write for full details today.

### END OF THE "SET-AND-FORGET" TRIMMER?

When you can't (or shouldn't) use trimmers because of reliability, use Vishay adjustables for final adjustment . . . and save money, too. Reduce overall cost by loosening specs on other circuit components. Then, just determine the right R value, make and install your home-grown Vishay resistor . . . far more stable and reliable than any trimmer made. You get better circuit performance at lower cost.

VISHAY  
RESISTOR  
PRODUCTS



a division of Vishay Intertechnology, Inc.

63 LINCOLN HIGHWAY ■ MALVERN, PA. 19355



## New Components Review

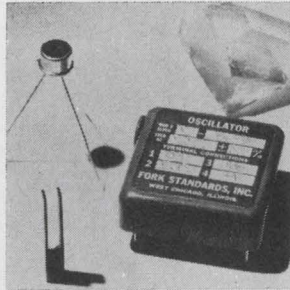

Miniature crystal oscillator model UQ is available with output frequencies from 10 Mhz down to less than 50 hz, with frequencies below the natural resonance of the controlling crystal reached through the use of micrologic dividers. Accuracy to 0.001% over a temperature range of 15° to 35°C without an oven is available. Fork Standards Inc., 211 Main St., West Chicago. [341]

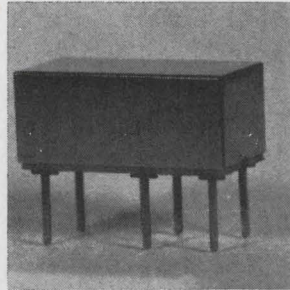

Bistable Form C relay series 8120 realizes a latching capability from the surface tension forces of its mercury film contacts. It requires no holding power. A 2-msec pulse operates or releases the relay. The unit measures 0.65 x 0.265 x 0.3 in. Production quantities sell for less than \$12 net each; delivery, 4 to 6 weeks. Fifth Dimension Inc., P.O. Box 483, Princeton, N.J. [342]

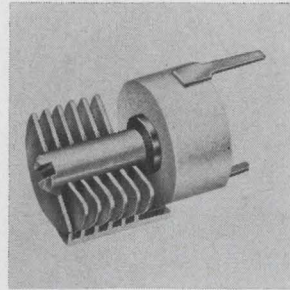

Subminiature type T air dielectric trimmer capacitor is designed for vhf and uhf circuit applications where small size (0.310 in. diameter), high Q (greater than 1,500 at 1 Mhz), low temperature coefficient, and low-cost are important. Nominal capacitance is 1.5 pf min., 10 pf max. Peak voltage breakdown is 250 v d-c. E.F. Johnson Co., Waseca, Minn. 56093. [343]



High-reliability Mark 4 Muffin fan comes in 4 models delivering 100 cfm of cooling air. It will operate for up to 10 years at room temperature with a 90% survival rate. A built-in aluminum heat sink lowers motor winding temperature. Units are available with 115 v or 230 v a-c, 50/60 hz single phase motors that draw 15 w or less. Rotron Mfg. Co., Woodstock, N.Y. [344]

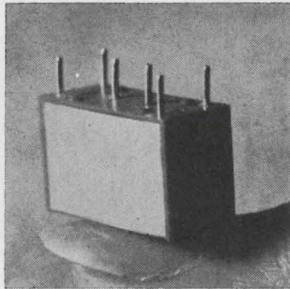

Dry-circuit reed relay series 10-DR is built in half crystal-can size (0.75 x 0.45 x 0.30 in.). It has 40 milliohms initial and 100 milliohms max. contact resistance after 50 million operations with zero open circuit voltage. The unit can switch 250 v d-c and carry 2 amps at a rating of 7 w. Compac Engineering Inc., 810 East St., Hollister, Calif. [345]

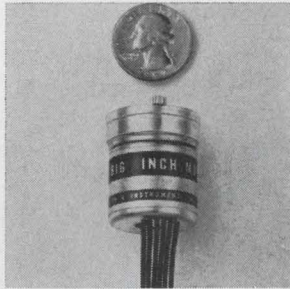

Reversible step servo motor 31600 measures  $1\frac{1}{8}$  in. diameter by  $1\frac{1}{4}$  in. long. It provides a variable speed drive for strip chart recorders and other devices requiring a 200:1 speed range or higher. It will operate with rated load up to 50 hz, or 200 changes of state/sec, each resulting in a 90° step. Haydon Switch & Instrument Inc., 1500 Meriden Rd., Waterbury, Conn. [346]

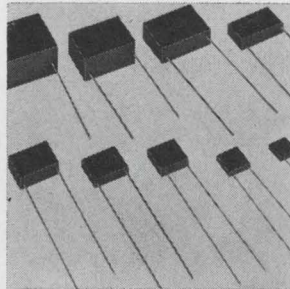

Metalized polycarbonate capacitors type 630A feature rectangular shape, radial leads, and epoxy encasement for high packaging density and environmental protection. They come in voltage ranges of 100, 200, 300, 400 and 600 v d-c, with capacitances from 0.001 to 10  $\mu$ f, and tolerances from 1% to 20%. Electro Cube Inc., 1710 S. Del Mar Ave., San Gabriel, Calif. [347]



Rotary switch JSR 170 withstands vibration requirements of MIL-S-3786 and breakdown voltages of over 1,000 v a-c. A ceramic wafer, 0.63 in. in diameter, offers insulation resistance greater than  $10^{12}$  ohms. Solid silver contacts, pressured by a long life coil spring, insure low contact resistance of 0.066 ohm. ITT Jennings Division of ITT Corp., Box 1278, San Jose, Calif. [348]

### New components

## Thick-film crowbar guards logic circuits

Overvoltage protector fires silicon controlled rectifier to short terminals when potential exceeds threshold

As digital and linear systems become more complex—and more expensive—designers must protect them against overvoltages, which can destroy hundred or thousands of dollars worth of integrated circuits that may be driven by a single source. Systems designers often

find it necessary to make their own overvoltage protectors, using discrete components.

Aware of the dangers of surges in logic systems, and alert to the fact that few overvoltage protection devices are available, engineers in the microcircuits operation of Beckman

Instruments Inc.'s Helipot Division have applied their thick-film capability to what they believe is the first hybrid overvoltage protector, or "crowbar", complete in one package.

Model 826 offers a range from 8 to 40 volts; model 827 covers 5- to 10-volt systems. These ranges make the model 826 crowbar suitable for use with diode-transistor and transistor-transistor logic systems, with their typical operating levels of about 8 volts, and for linear systems in the 10- to 20-volt range. "We feel the model 826 is also good for metal-oxide-semiconductor devices," says George Smith, super-



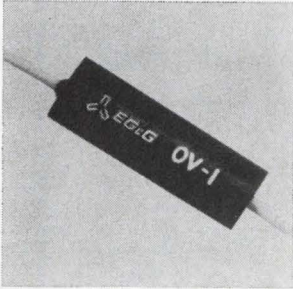

Miniature overvoltage gap OV-1 provides reliable breakdown characteristics under all dynamic conditions from d-c overvoltage to fast rise time pulses. It has a switching time of 40 nsec and is available throughout the voltage range from 450 to 4,000 v d-c breakdown. Unit features rugged ceramic-metal construction. EG&G Inc., 160 Brookline Ave., Boston, Mass. 02215. [349]



High-voltage, glass reed relay series 3029 has a pressurized switch, contacts of gold alloy, and is available in 1, 2, 3, 4 and 5 poles. The switch is replaceable without removal of the relay from the p-c board. The relay has initial contact resistance of 0.070 ohm and will provide  $10 \times 10^6$  operations at 15 w. Wheelock Signals Inc., 273 Branchport Ave., Long Branch, N.J. 07740. [350]

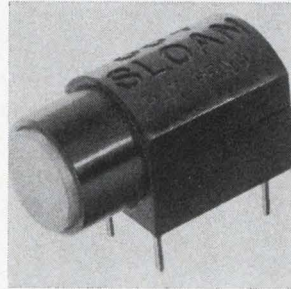

Designed for p-c board mounting, model 864 Pee Cee replaceable lamp indicator light eliminates hand mounting and soldering. It can be used with or without front panel. The 4-pin unit is mounted by inserting the terminals directly into the circuit. Lamps are replaceable from the front by removing the lens. The Sloan Co., P.O. Box 367, Sun Valley, Calif. 91353. [351]

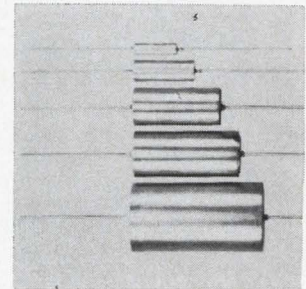

Micro capacitors series 102 are metalized polycarbonate units combining dielectric materials 2 microns thin with a conductive metalization of 50 angstroms. Glass-to-metal hermetic sealing insures satisfactory operation within all specified environmental conditions. Units operate from  $-55^\circ$  to  $+125^\circ$  C. International Components Corp., Asbury Ave., Asbury Park, N.J. [352]

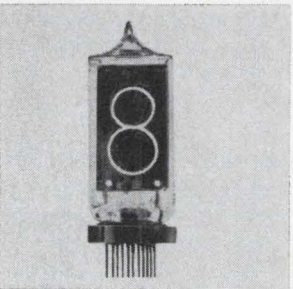

High brightness Nixie tubes, for both time sharing and d-c applications, are suited for demanding use where one digit may be continually displayed. Pin configuration is designed for use with IC decoder/drivers. Tube is available with short leads (B-5855S) for plug-in, or flying leads (B-5855) for direct soldering. Burroughs Corp., Box 1226, Plainfield, N.J. [353]

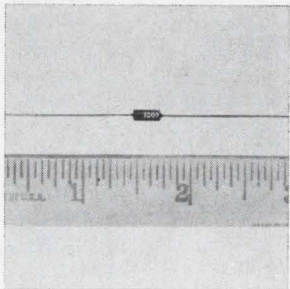

R-f shielded inductor designated Nano-Red is a  $\frac{1}{4}$ -w unit that measures  $\frac{1}{10}$  in. in diameter by  $\frac{1}{4}$  in. long and weighs no more than 0.28 gram. It is available, off the shelf, in inductance values from 0.10  $\mu$ h to 1,000  $\mu$ h  $\pm 10\%$ . Higher values may be obtained by special order. The unit is designed to meet MIL-C-15305C. Lenox-Fugle Electronics, 475 Watchung Ave., Watchung, N.J. [354]

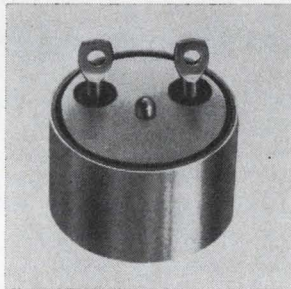

Snap-acting thermal switch series S features all-welded construction which provides a hermetic seal and eliminates contamination caused by solder fluxes. Temperature set points range from  $-65^\circ$  to  $+500^\circ$  F with set point tolerances from  $\pm 2^\circ$  F and differentials from  $5^\circ$  F. Switch handles resistive loads of 5 amps. Standard Controls, 2401 S. Bayview St., Seattle 98144. [355]

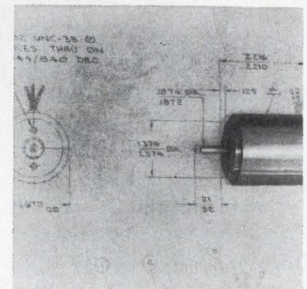

An 18 Frame (1.670-in. o-d) fractional h-p, squirrel cage induction motor is for powering blowers and fans that cool electronics equipment in aircraft and on board ship. Only 2.215 in. long, it can supply up to 5 oz-in. of stall torque at 115 v, 400 hz and up to 3 oz-in. at 10,000 rpm. Temperature range is  $-55^\circ$  to  $+85^\circ$  C. Indiana General Corp., Walnut St., Oglesby, Ill. [356]

visor of product design in the microcircuits section. Smith says MOS systems operating from 0 to  $-27$  volts are becoming very popular, "and if you pay \$800 for an array, you'll be glad to pay \$12.50 to make sure it doesn't disappear in smoke." That's the price of the 826.

"The 827 will catch the resistor-transistor logic market," notes Smith, "in which 4, 5, or 6 volts is the typical level."

**Guardian.** The crowbar senses the voltage between two terminals. When it exceeds a preset threshold, the crowbar fires a silicon-controlled rectifier that shorts the two terminals. The device is in series

with a fuse or circuit breaker, Smith explains, "so that if the power supply fails and the voltage goes high (the typical failure), or a big transient on the input to the power supply gets through the voltage regulator, the crowbar shorts the terminals and blows the fuse before the overvoltage can damage the following IC's or power transistors."

The Beckman crowbars can handle a 10-ampere surge, independent of temperature, if its duration is short enough. They can tolerate a similar surge for 8 milliseconds at  $25^\circ$  C. The crowbars are made to function as fast as is possible with hybrid thick-film technology—a 5-

microsecond switching time. "But we've given the user the freedom to slow them down by adding an external capacitor if he wants to loosen the spec a bit," notes Smith.

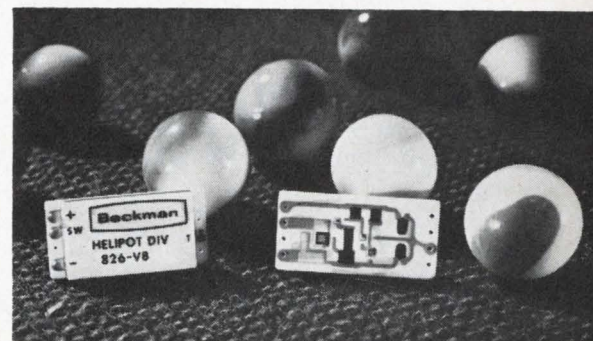



# The state of our art in solid state lamps.

## ...a report from General Electric

Since the wedding of silicon and carbide produced our first solid state lamp a year and a half ago, our SSL family's grown fast.

Today, GE solid state offspring total eight. More are in the embryonic stage. All have an exceptionally long life expectancy. An outstanding feature is their reliability of performance under shock and vibration.

SSL's permit fast switching, from 10,000 to 1,000,000 cycles per second. They are tiny, no taller than 1/4 inch. And operate at a low 6 volts or less.

**There the family resemblance ends.**

Three SSL's combine silicon and car-

bide, and emit a visible yellow light. Four are gallium arsenide infrared sources. Another converts invisible infrared radiation into visible green light, thanks to a newly developed GE phosphor powder.

**Their jobs differ, too.**

The visible sources have hundreds of applications, as indicators and photocell drivers, in computers, missiles, telephone equipment and aircraft. Infrared SSL's operate in counting devices, machine controls, card and tape readers, and photo-electric applications. Meanwhile, hundreds of users are busily experimenting with new innovations.

### Here's a technical profile of the family.

GE Lamp No.	SSL-1	SSL-3	SSL-4	SSL-5A	SSL-5B	SSL-5C	SSL-6	SSL-11
Color	Yellow	Green	Infrared	Infrared	Infrared	Infrared	Yellow	Yellow
Output	25-65 Ft. L.	100 Ft. L.	.3 mw	.6 mw	1.5 mw	2.3 mw	25-65 Ft. L.	75-100 Ft. L.
Operating Voltage	2.5-5.1v	1.1-1.7v	1.1-1.5v	1.1-1.7v	1.1-1.7v	1.1-1.7v	2.5-5.1v	2.5-6.0v
Operating Current	50ma	100ma	100ma	100ma	100ma	100ma	50ma	100ma

General Electric SSL lamps save space and improve performance. Their reliability and long life (no theoretical failure if operated within ratings) promise much lower maintenance costs. All this from a nickel lamp? Of course

not. GE SSL's are priced between \$4 and \$32 apiece.

For a detailed technical album on the entire SSL family, write: General Electric Co., Miniature Lamp Dept. E-8, Nela Park, Cleveland, Ohio 44112.

Miniature Lamp Department

**GENERAL**  **ELECTRIC**

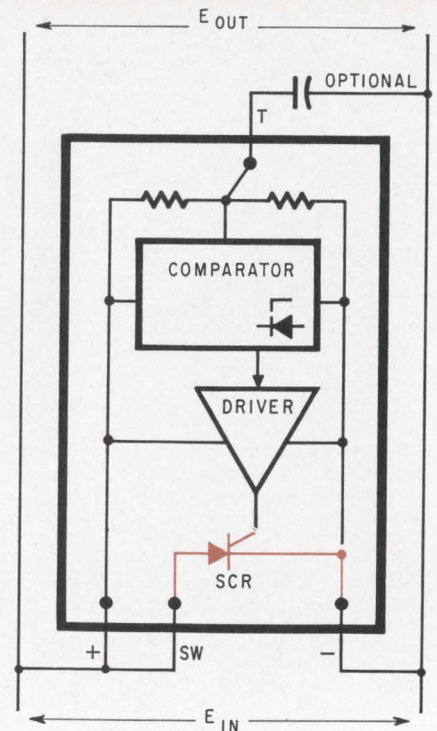

**Protection.** The thick-film crowbar is made for inputs up to 40 volts.

In the model 826 range are discrete levels of 8, 14, 18, 30, and 40 volts; the 827's discrete levels are 5, 6 and 7 volts. But John Ypma, senior applications engineer, notes that the devices can be tailored to have trip points in 1-volt increments anywhere in their ranges.

The model 826 contains four chips in Beckman's standard 1/2 by 1-inch cermet package with four leads. There are an SCR, a zener reference diode and two transistors that act as an amplifier in the package, which is compatible with standard heat sinks.

**Mostly discrete.** Smith says there are only two or three other firms making small crowbars and these are made of discrete devices, one of them in a potted module. He says most of these discrete devices sell for about \$28 in quantities of 100.

"Most people buy voltage dividers and SCR's to make their own crowbars. We save them that work. Someone might want to build this kind of device in monolithic form, but the economics mitigate against it," Smith adds.

Operating temperatures for Models 826 and 827 are  $-55^{\circ}\text{C}$  to  $+125^{\circ}\text{C}$ .

Helipot Division, Beckman Instruments Inc., Fullerton, Calif. 92634 [357]



## HERE'S HOW...

THE ELECTRONIC INDUSTRY IS USING THESE FAMOUS ULANO FILMS IN ULTRAMINIATURE MASK TECHNOLOGY AND COMPLEX PRINTED CIRCUITRY

Cut a piece of the desired film large enough to cover area to be masked. Tape it down firmly at the top with *dull-side up*.

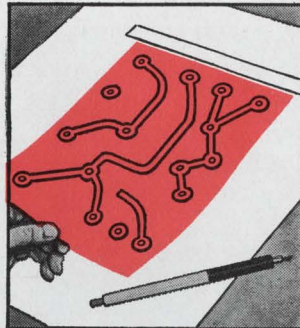

With sharp blade, outline the areas to be masked. *Do not cut through the backing sheet.* The Ulano Swivel Knife does the job quickly, easily.

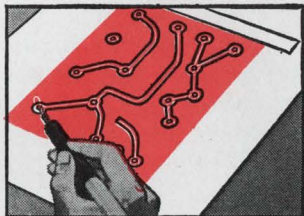

Using the tip of the blade, lift up a corner of the film thus separating it from the backing sheet.

Now carefully peel off the film as outlined leaving a completed mask, positive or negative, that corresponds exactly to the desired pattern.

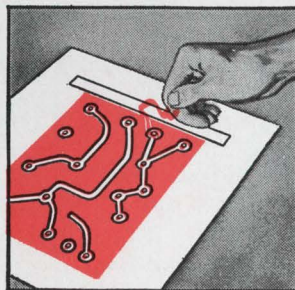

# Ulano<sup>TM</sup>

## RUBYLITH<sup>TM</sup> AMBERLITH<sup>TM</sup>

HAND CUT MASKING FILMS FOR THE GRAPHIC ARTS

**ULANO RUBYLITH**... a revolutionary knife cut red film is laminated to a stable transparent plastic backing sheet. The red film is "light safe" so that when contacted to a sensitized emulsion and exposed to a suitable light source, light passes through the cut-out portions only... not through the red film. ■ The polyester backing is absolutely stable... insures perfect register. ■ Special effects such as crayon tones, paste ups, benday sheets, and opaquing are easily combined with versatile ULANO RUBYLITH.

**ULANO AMBERLITH**... a companion to Rubylith serves as a color separation medium used as the master on camera copy board to secure negatives or positives.

*A wide variety of Ulano films—  
in rolls and sheets—is readily available*

## Designed FOR YOUR PARTICULAR NEEDS

Ulano offers the most versatile line of hand-cut masking films, including:

**.0075—RUBYLITH 75 DR\*** **.005—RUBYLITH 5 DR†**  
**.005—AMBERLITH 5 DA†**

Where exact register assures a critical importance, you will find these new, thick, polyester based films the positive answer.

*\* Available in sheets only, cut to your specifications*

*† Available in rolls and sheets*



**WRITE TODAY**  
*on your letterhead for free  
special sample kit 1748*

"Ulano"—"Rubylith"—"Amberlith" are registered trade marks of the Ulano Companies.

# ulano

610 DEAN STREET, BROOKLYN, N.Y. 11238

In Europe: ULANO A.G., Untere, Heslibachstrasse No. 22, Kusnacht, Zurich, Switzerland



# the niagara frontier is hot all year long...

YOUR  
FUTURE  
IS HERE  
ON THE NIAGARA FRONTIER

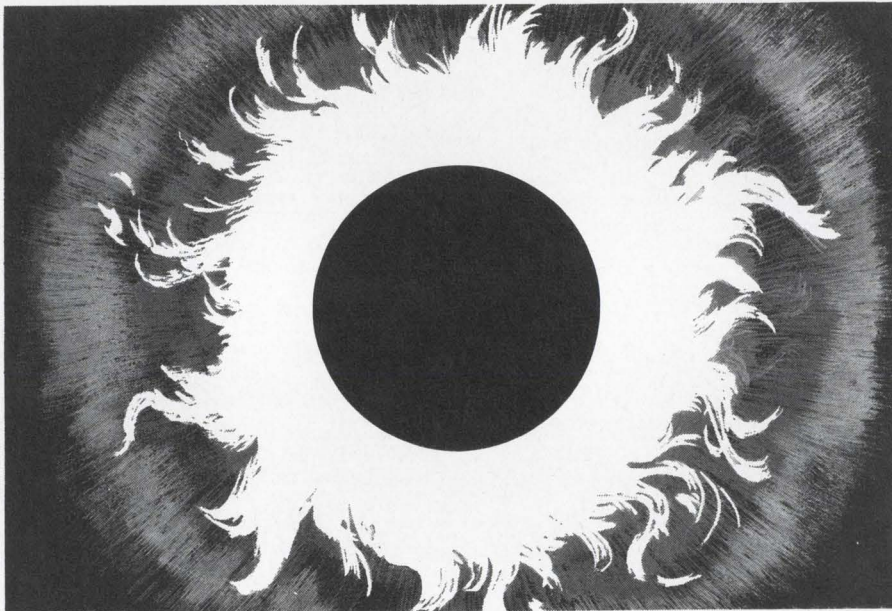

Mr. Edward Rath  
Erie County Executive  
Erie County Hall, Dept. E-28  
Buffalo, N. Y.

O.K. Mr. Rath. Send me your new book that tells why the Niagara Frontier (Buffalo and Erie County, N. Y.) is a profitable spot for our plant.

Name \_\_\_\_\_

Title \_\_\_\_\_

Company \_\_\_\_\_

Address \_\_\_\_\_

City \_\_\_\_\_

State \_\_\_\_\_ Zip \_\_\_\_\_

Check if you want convention information.

## ... FOR YOU!

It's a new frontier with plenty of Pizzazz. The attitude is right and the heat of building a new frontier is intense. If you haven't been to Buffalo, New York recently, stop off and see the exciting new look.

Main Place is now rising in the heart of downtown. It's an all new city complex of office and shopping areas, that has lit the fire to do things differently.

The Niagara Frontier is "hot for you" all year long. Its leaders say, "Give industry what they want." ... Its people agree.

These same people enjoy a pleasing change of seasons. They have fun out-of-doors all year long. There's skiing, camping, boating, fishing, hunting, swimming, racing, golf, riding ... you name it and the frontier has got it.

If an area is "hot for you" ... it's got to be good for you ... your people ... your business ... Look us up soon!

New components

## A non-precious thick-film paste

Thallium-oxide compound fires faster than silver, is less temperature-sensitive

Turn in your silver. That's the advice the Aircor Speer division of the Air Reduction Co. is giving to makers of thick-film circuits.

Aircor scientists have developed a thallium-oxide paste that the company says is better in many ways than the palladium-silver pastes for thick-film resistors.

Since no precious metals are used in making it, the thallium paste is a few dollars cheaper per ounce. In small quantities, the price per ounce is \$11.50; in volume, \$8.25 an ounce.

The absence of precious metals also means there's nothing in the Aircor paste that will settle out. So a user can just take the paste off the shelf and starting using it. He doesn't have to mix or thin it.

**In the oven.** Aircor also says its thallium paste behaves better in the oven. It takes only nine minutes to fire it, compared with 30 minutes for silver pastes. And oven temperature can change by as much as 10°C without affecting the paste. Silver pastes require a much closer control over temperature.

Two problems confront Aircor. First, the silver pastes have been around for 10 years and many circuit makers have become accustomed to using them, particularly the ones made by Dupont. Secondly, thallium salts are very toxic, so there has been a reluctance to use thallium compounds of any sort.

Two types of paste are available, TGF for use with forsterite and titanates, and TGA for use with alumina substrates. TGF is made with resistivities of 0.3, 5, 20, 100, or 1,000 kilohms-mil, and TGA with resistivities of 0.1, 1, 10, 100, and 1,000 kilohms-mil. The firing temperature for both is 570°C.

Aircor Speer, St. Marys, Pa. 15857  
[358]



At ECI in St. Petersburg, Florida . . .  
Digital Communications Opportunities

## For a special breed of engineer

If you're one of that special breed of communication engineers who finds a challenge in projects beginning with applied research and advanced development and continuing through prototype and product design, you may well be the kind of person we're looking for

Check this partial list of digital engineering activities at ECI. If you'd like to help push the state-of-the-art in any of these or other areas in communications, send us your resume. You'll design systems and equipment for satellite communications, multiplexing, electronic switching, command and control and advanced radio communications for some of the nation's major defense and space programs.

### Digital Communication Engineering Activities:

- Frequency Synthesis
- MODEM Technology
- Microelectronic Applications
- Error Control Coding
- Electronic Switching
- Time Division Multiplexing
- Reliability Techniques

### CHALLENGE, GROWTH . . . and LOCATION TOO!

At ECI your job will be challenging. At ECI you'll find real opportunity for growth instead of just another confining groove — two-thirds of all advanced development is done in regular engineering development areas. And, at ECI you'll like where you're living just as much as you'll like your job. We'll match subtropical, sunny St. Petersburg against any location in the U. S. for stimulating, comfortable living.

SEND YOUR RESUME TODAY — in confidence — to K. E. Nipper, Supervisor of Professional Placement, Electronic Communications, Inc., P. O. Box 12248, St. Petersburg, Florida 33733.  
(An equal opportunity employer, M & F.)



ELECTRONIC COMMUNICATIONS, INC.  
ST. PETERSBURG DIVISION

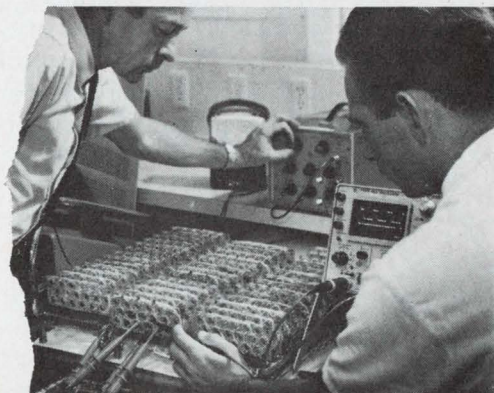
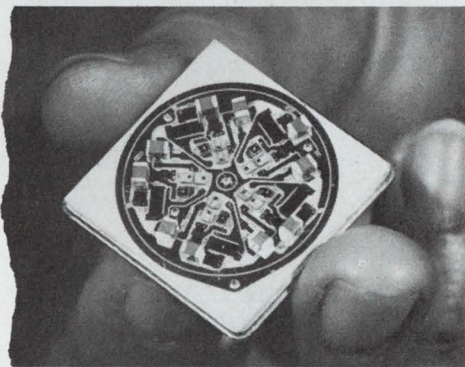
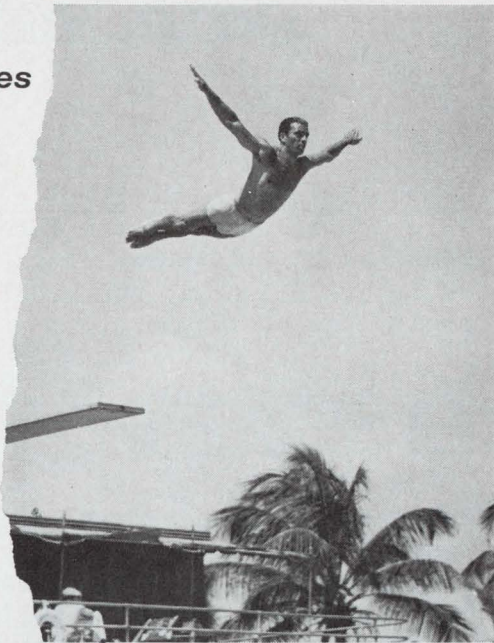



# SCIENCE / SCOPE

Communications capacity of a new satellite proposed to the Communications Satellite Corporation for the International Communications Satellite Consortium would be 25 times that of the Early Bird and Intelsat II satellites. It could relay 6,000 two-way phone calls or 12 color TV programs, is designed for an orbit life of 10 years.

Giant satellite can concentrate its power into two "spotlight beams" and point them at heavily populated areas. It was designed by Hughes scientists, who have developed all the commercial satellites now in service.

3-D reflection holograms of objects in action (such as a light bulb being smashed) are now being made at exposures of about 40 billionths of a second by Hughes scientists. Definition and resolution are of photographic quality. High-speed holography in reflected light, using the giant-pulsed laser, was first demonstrated at Hughes Research Laboratories in 1965. Work is also proceeding on a system for making high-speed holograms in rapid sequence, using transmitted instead of reflected light.

A \$95-million Air Force contract to develop the Maverick air-to-ground, non-nuclear missile has been awarded to Hughes. New missile is a highly accurate, TV-guided weapon designed to knock out enemy tanks, armored vehicles, and field fortifications.

A spatial-frequency analyzer developed recently at Hughes identifies patterns by extracting their spatial-frequency content. Using a wide-angle defocused lens and diffuse white light, it examines the entire image in parallel. Uses include recognition of textures, sea states, and patterns with strong periodicity, such as orchards or grids of city streets.

Two easy-to-operate argon lasers now being offered by Hughes include a 22-lb., 30-inch, "get your feet wet" pulsed model (3042H) and a three-watt continuous-wave model with Hughes' Select-A-Wavelength as standard equipment (3055H). Its fiberglass laser head weighs only 70 pounds and its compact power supply is on wheels. Model 3042H costs only \$1945.95; Model 3055H less than \$22,000.

A \$10.5-million contract has been awarded to the Bath Iron Works-Hughes Aircraft team for a nine-month contract definition study of the Navy's multi-function DX destroyer. The Bath-Hughes team was one of three chosen from among six contenders. The DX program is intended primarily to produce a new class of surface ships that will provide antisubmarine warfare and anti-aircraft support.

The first laser fire-control system for tanks -- now undergoing field trials on a Belgian Mark 47 tank -- will, in the opinion of foreign military experts, make all other tank fire-control systems obsolete. It is achieving its principal objectives in the current tests: improved accuracy against fixed and moving targets, greater speed in finding and engaging targets, and minimal training time for the operator.

*Creating a new world with electronics*

**HUGHES**

HUGHES AIRCRAFT COMPANY



## New Instruments Review

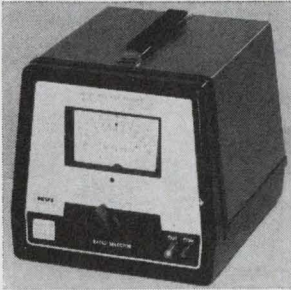

Voltage divider HVI 20-1, for use up to 20 kv d-c, has a division ratio accuracy of 0.1% and a max. current drain of 100  $\mu$ a. Back-panel input taps are also available for 10 kv and 5 kv d-c. A built-in monitoring meter indicates polarity and approximate magnitude of h-v input. Three output ranges are available on the front panel. AMP Inc., 155 Park St., Elizabethtown, Pa. [361]

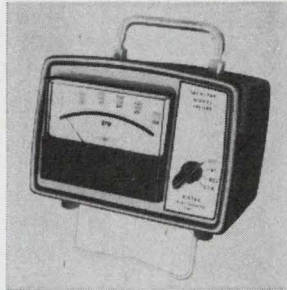

Tach-Pak style G is a portable electronic tachometer powered from 115 v a-c, 50-400 hz, 1 w max. The front panel includes a 4 1/2-in. rectangular meter and a function switch. Any frequency range up to 100,000 hz full scale is available. Input signal for standard sensitivity units is from 0.25 to 5 v RMS. Airpax Electronics, P.O. Box 8488, Fort Lauderdale, Fla. 33310. [362]



Microvolt DVM DS-100 solves instrument drift and repeatability problems, particularly those involved in process control and other low level instrumentation. This is accomplished by the Auto Zero double slope, true integrating measurement technique used. Sensitivity is 1  $\mu$ v even at speeds of 20 readings/sec. Doric Scientific Corp., 7969 Engineer Road, San Diego, Calif. [363]

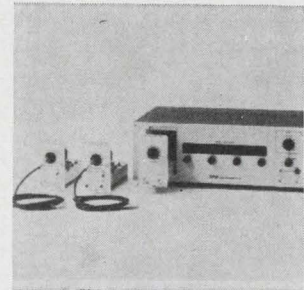

High-voltage pulse generator 89A provides pulse widths of 10 nsec to 100  $\mu$ sec. The 1,000-v positive pulse generator also features 10-nsec to 10- $\mu$ sec pulse delay with rise and fall time of 10 nsec. Internal delay is 40 nsec. The internal oscillator provides 0.1 to 15 pps, stepped and vernier. Price, under \$4,000. TRW Instruments, 139 Illinois St., El Segundo, Calif. [364]

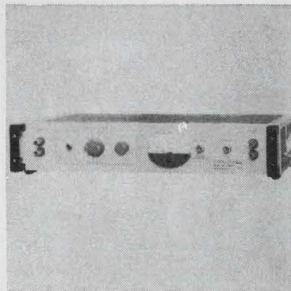

Automatic acoustic-energy level regulator type 1569 is for maintaining a constant signal level in swept frequency sound and vibration tests. It operates at frequencies from 2 hz to 100 khz. It features a control range of 50 db. Regulation is such that a level variation of 25 db is compressed to less than 1 db. Price is \$485. General Radio Co., West Concord, Mass. 01781. [365]



Inductance meter type LRT uses a resonance circuit technique for measuring inductance, resonant frequency, self capacitance and Q. It has 7 ranges which provide for  $\pm 1\%$  accuracy measurements of inductors from 0.1  $\mu$ h to 1 henry. Self capacitance of coils from 0 to 200 pf can be measured with  $\pm 3\%$  accuracy. Rohde & Schwarz, 111 Lexington Ave., Passaic, N.J. [366]

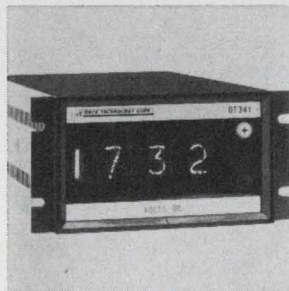

Bipolar digital panel meter DT341 is for electronic control equipment and systems. It features zero and full scale calibration by way of front panel access, plus isolated analog and digital ground. It has 5 d-c volt ranges, 7 current ranges, and 6 ohm ranges. Weight is under 30 oz. Price is \$365. Data Technology Instrument Corp., 2370 Charleston Rd., Mtn. View, Calif. [367]

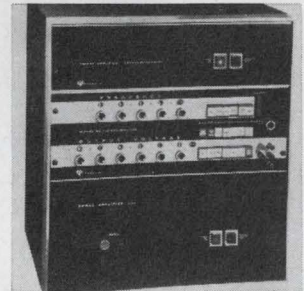

Programmable a-c calibration source AC-110 has a precision output of 0 to 110 v over 1 hz to 1 Mhz. Accuracy is 0.02% over most of the range. The a-c output can be fully programmed over 7 voltage ranges and 4 frequency ranges. Price is \$5,000 to \$25,000 depending upon programing and digital readout options. Optimization Inc., 9421 Telfair Ave., Sun Valley, Calif. [368]

### New instruments

## Digital panel meters narrow price gap

Three entries compete with top-of-line analog types; binary-coded-decimal feature for computer input is optional

The gap between prices on low-cost digital panel meters and top-of-the-line analog meters is getting very narrow. Integrated-circuit digital counters containing input amplifiers, analog-to-digital converters, decade counters, storage units, and Nixie tubes have been introduced

by a half-dozen manufacturers at prices just above the \$200 level.

Latest entry in the field is the Fairchild Camera & Instrument Corp. Its Instrumentation division is offering three digital panel meters that are cousins to the low-priced multimeter introduced by

the firm earlier this year.

Designed mainly for original-equipment and systems applications, these meters are the three-digit model 7020 with single polarity, the three-digit model 7030 with dual polarity, and the four-digit,

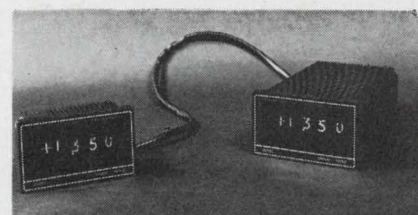

Coming down. Prices for this line of panel meters start at \$230.



# Lapp Entrance Insulators

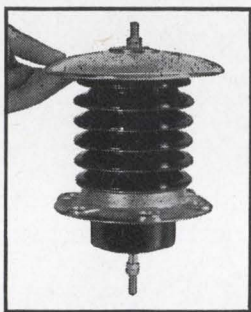

The sizes vary...  
But our skills are always large.

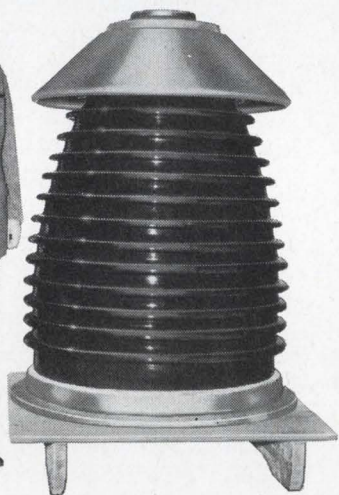

Lapp skill in designing and building entrance insulators goes back over 43 years. We're big on design knowledge, ingenuity and ability to deliver the job . . . right to your requirements.

Standard designs, or special types, Lapp can produce entrance insulators for almost every electrical and mechanical requirement. Save your company time, money and searching . . . call in Lapp when your projects require entrance insulators, or antenna, or tower insulators.

Put Lapp skills to work for you . . . from design to delivery. Lapp Insulator Co., Inc., LeRoy, N. Y.

## Lapp

. . . temperature-compensated amplifier is the input . . .

dual-polarity model 7040. The company is also offering a satellite remote readout for the 7030 and 7040.

The 7020 is priced from \$230 to \$245 depending on the quantity ordered, the 7030 at \$251 to \$291, and the 7040 at \$435 to \$495.

**Bigger package.** In their black aluminum cases, the Fairchild units are somewhat larger and heavier than their competition. Richard Thornton, an engineering manager at Fairchild, concedes that this can be a handicap, but he asserts that the greater amount of space inside the boxes makes the new units easier to produce and more reliable. Also, the Fairchild meters are shielded against electromagnetic interference.

Like most of their competitors, the Fairchild meters employ dual-slope detection in a-d conversion. "You get most for your money that way," Thornton says, "though it's slower than the successive approximation method."

A comparatively new circuit from the Fairchild Semiconductor division—the 727, a temperature-compensated successor to the 709—is used for the input amplifier. Otherwise, the circuitry is routine: a 958 decade counter, a 959 buffer storage unit, and a 960 Nixie driver.

Buyers can also get, as an optional feature, print and hold lines to provide binary-coded-decimal information from the back panel. Other manufacturers have made much of this feature, which enables a user to put process data, for instance, directly into a computer. But Fairchild feels that while BCD outputs are potentially valuable, not too many customers are now prepared to use them.

Input isolation with respect to ground is 500 volts for all the new Fairchild models. For the 7020, full-scale input voltage is 1.5 volts, resolution is 1 millivolt, and accuracy is  $\pm(0.1\%$  of reading  $+0.1\%$  of full scale). The other models offer improved specs. Supply voltage is 115 volts at 50 to 400 hertz for all models, but higher levels are available at no extra charge.

Fairchild Instruments, 475 Ellis St., Mountain View, Calif. 94040 [369]



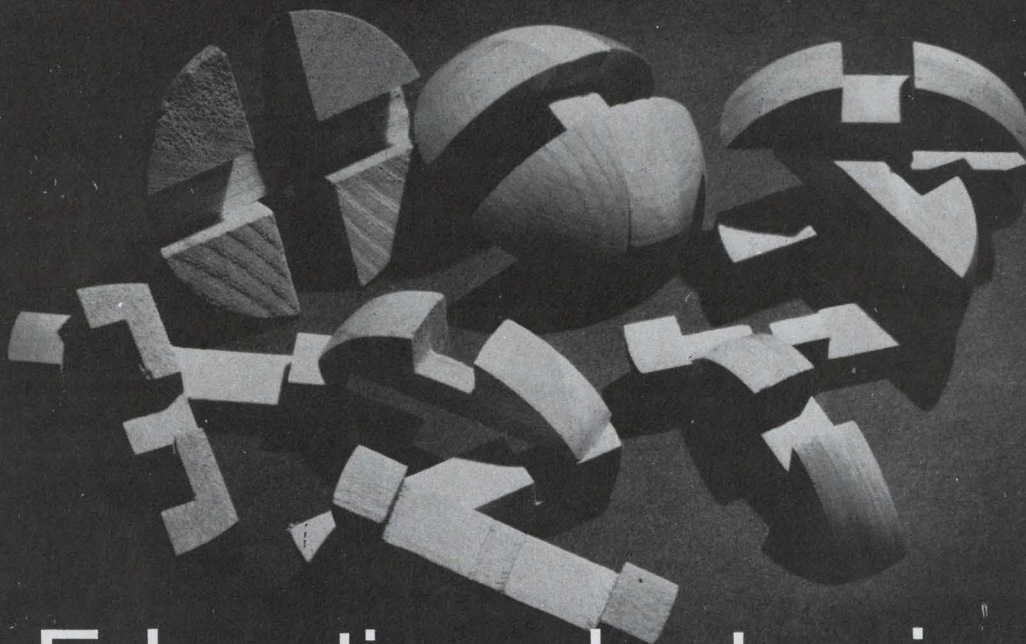

# Educating electronics personnel is too big a problem to have only one solution.

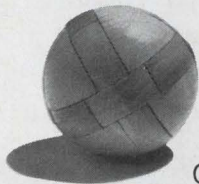

Of course, you're sold on the importance of providing continuing education for your electronics personnel. So rapidly do new developments take place in electronics that knowledge begins to lose its value almost as soon as it is acquired. Valuable men can become outmoded and unproductive almost overnight. And the shortage of technical manpower at both the professional and supporting levels makes it imperative that you utilize fully every man you have.

Perhaps your company conducts in-plant programs of instruction. Or pays all or part of the cost

of evening classes in nearby technical institutes, colleges and universities. Whatever your educational program, we believe it will be more flexible and more effective if you supplement it with CREI Home Study Programs in Electronics.

We've prepared a brochure that tells how CREI Programs can help you update, upgrade and reorient electronics personnel. Use coupon below to send for a copy today.

Founded 1927



Accredited Member of the National Home Study Council



#### CREI, Home Study Division, McGraw-Hill Book Company

Dept. 1836-G, 3224 Sixteenth Street, N.W.  
Washington, D.C. 20010

I want more information on CREI Programs in Electronics and how they can supplement our educational program for electronics personnel. Please send me, without obligation, your descriptive brochure.

Name \_\_\_\_\_

Title \_\_\_\_\_

Firm Name \_\_\_\_\_

Address \_\_\_\_\_

City \_\_\_\_\_ State \_\_\_\_\_ Zip \_\_\_\_\_





**With the Vent-Rak 5050 you get design and functional strength... *the girl is ours!***

Beneath the attractive, modular styling of this Vent-Rak 5050 Series Cabinet lies a reinforced 12-gauge steel frame. Highly versatile, the 5050 Cabinet will meet wide requirements for single or multiple installations. The 5050 Writing Surface is a functional, though rugged accessory.

Economy, accessibility, interchangeable steel components, and ease of assembly make the 5050 Series ideal for your complete electronic packaging, or to supplement your present installation.

For complete information, write:

**VENT-RAK, INC.**  
**525 South Webster Ave.**  
**Indianapolis, Indiana 46219**



New instruments

## Thermocouple data digitized

Indicator can display thousands of degrees for process monitoring

**Even measurements** with old reliable thermocouples have gone digital. Instead of using analog meters to indicate temperature, process-control and monitoring systems can display data digitally with a thermocouple indicator that Iacon Data Systems will introduce next month at the Instrument Society of America show in New York.

The indicator is available in versions calibrated for ISA thermocouple types J, K, R, S, or T (the range for type R, for example, is from 1,000 to 3,100°F), and centigrade or Fahrenheit models are available. Designed for panel mounting, the instrument can show polarity and decimal point.

The input is floating and guarded, and it can be used whether the thermocouple instal-

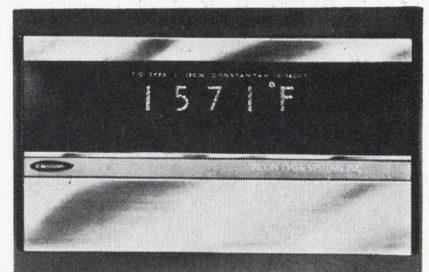

lation is isolated, grounded, or operating at high stray potentials.

The display automatically compensates for cold junction temperatures, and its accuracy is better than that of standard thermocouple wire. Accuracy depends on the model, but a maximum error of 0.1% of reading, +3°, is representative over an ambient temperature range of 60° to 95°F.

Base price is \$1,150.

Iacon Data Systems Inc., 207 Lawrencewood Center, Niles, Ill. 60648 [370]



# CHOOSE THE SURE THINGS: FIELD-PROVEN Telemetry Products from DEI

Why gamble with uncertainties? Late deliveries?  
Or pay unnecessary R/D costs?  
Here today is the quality line of DEI/Nems-Clarke telemetry receivers  
and RF auxiliary products for  
S and L-Band data acquisition systems.

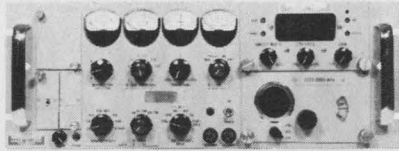

R-1074A-11 . . . 55-2300 mHz tuning ranges. Switch selectable IF filters and demodulators. Suitable for telemetry data reception and conical scan tracking. Automatic AFC reset carrier-operated relays.

Designed with sufficient space to allow installation of five or more additional modules. Options include predetection up/down converters, phase tracking demodulators, adjacent channel filters, and conical scan tracking filters. Completely solid-state and modular in construction. RF tuners, IF filter and demodulators used are quick-change, front panel plug-in assemblies.

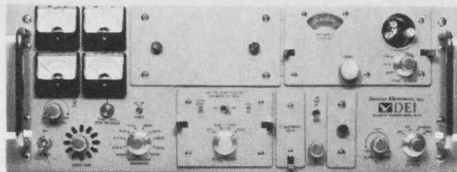

TR-711 . . . 55-2300 mHz tuning ranges. Solid state with switch selectable IF filters. All IRIG bandwidths. Plug-in record/playback converters, spectrum analyzer and oscilloscope.

Offers an order of magnitude improvement in strong signal handling capability and reduction of spurious responses common in previously available solid state receivers. Unit has extremely linear AGC for accurate signal strength recording and matched AGC performance curves for optimum diversity combiner operation. Multisection tunable preselectors are provided ahead of the first RF amplifier or mixer stages for maximum intermodulation and adjacent channel interference rejection.

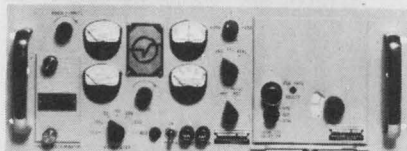

1037-G . . . 55-2300 mHz tuning range. Solid state with nuvistor and stripline tuners. Matched IF filter/demodulators. All IRIG bandwidths. Optional SDU and up/down converters.

A multi-range universal receiver designed for the reception of all known or projected telemetry formats. RF tuning range, bandwidth, and demodulation capability are all determined by plug-in modules providing the receiver with a high degree of flexibility. Twelve RF tuners, from 55 to 2300 mHz, are available. Options include front panel spectrum display unit, internal plug-in pre-D record and playback converters, and adjacent channel filters.



TPA-70 and TPA-73 S and L-Band Preamp amplifiers. S-band: 6 db. Maximum noise: 20 db. Minimum Gain/ L-Band: 5 db. Maximum Noise: 20 db. Minimum Gain/ No Parametric Oscillation with Signal Overloads/ High immunity to strong signal burnouts/ Power output for 1 db Amplitude Compression: -5 db minimum.

These solid state preamplifiers have been developed to provide compact, economical, high performance, low noise, broadband, stable, rugged lightweight preamplifiers with excellent dynamic range and increased immunity to large signal burnout, damage or instability to meet the increasing operational requirements resulting from expanded activities at S and L-Bands.

For further information on these and other field-proven products and systems, contact the DEI sales office nearest you.

**Defense Electronics, Inc.**

PRODUCERS OF  
**DEI AND NEMS-CLARKE**  
EQUIPMENT



**DEI**  
RESEARCH  
DEVELOPMENT  
MANUFACTURING

ROCKVILLE, MARYLAND (301) 762-5700; TWX: 710-828-9783; TELEX: 089602 • LOS ANGELES, CALIFORNIA (213) 670-4815  
INTERNATIONAL: ROCKVILLE, MARYLAND • CABLE: DEIUSA; INTELEX: 64102

Sales Representatives: Rome, Italy • London, England • Madrid, Spain • Tel Aviv, Israel • Bromma, Sweden • Rijswijk, Holland • Koln, Germany  
• Paris, France • Zurich, Switzerland • Oslo, Norway



# our subminiature relay line:

## If you make electronic things (to MIL-R-5757), this is your group

**SERIES D** (10 amp, 2 pdt)—Most compact welded relay for use where size and performance are critical. 50g shock, 20g vibration.

**SERIES CL** (10 amp, 2 pdt)—Magnetic latch, all-welded relay. 50g shock, 20g vibration.

**SERIES E** (2 amp, 2 pdt)—All-welded half size relay for dry circuit/low level and 2 amp switching. 100g shock, 30g vibration.

**SERIES G** (2 amp, 2 pole)—All-welded, 150 grid relay only 0.32" x 0.310" x 0.610". 100g shock, 30g vibration.

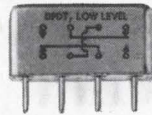
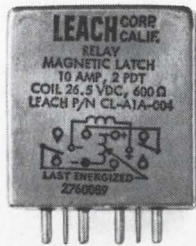
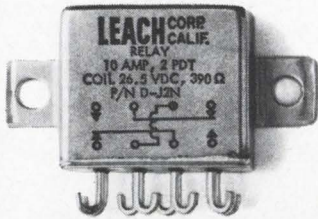

SERIES G quantities available October 1st.

## If you make electrical things (to MIL-R-6106), this is your group

**SERIES J** (10 amp, 2 pdt)—Balanced-Force\* relay for DC current. 100g shock, 30g vibration.

**SERIES JA** (10 amp, 2 pdt)—Balanced-Force\* relay for AC current. 100g shock, 30g vibration.

**SERIES K** (10 amp, 4 pdt)—Balanced-Force\* relay for DC current. 100g shock, 30g vibration.

**SERIES C** (10 amp, 2 pdt)—50g shock, 20g vibration.

**SERIES KA** (10 amp, 4 pdt)—Balanced-Force\* relay for AC current. 100g shock, 30g vibration.

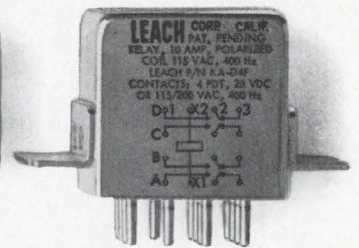
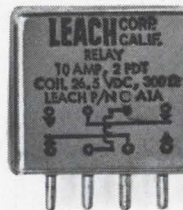
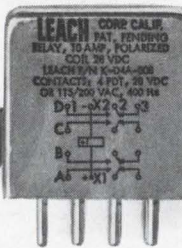
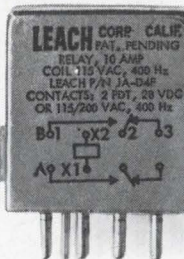
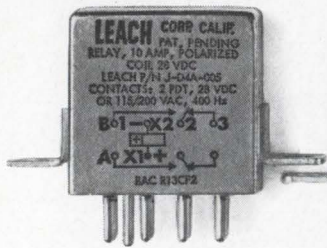

\*Patent Pending.

Complete specs are yours for the asking. Write Leach Corporation, Relay Division, 5915 Avalon Boulevard, Los Angeles, California 90003. Telephone: (213) 232-8221.

# LEACH



## New Subassemblies Review



Fixed frequency oscillator FFO-244A is a 1,000 khz unit that uses a crystal with a Q in excess of 1/2 million to provide excellent short term stability. It has a long term stability of better than 1 part in 10<sup>9</sup> per day. To insure long term performance, the crystal is gold plated and vacuum sealed in a glass enclosure. Hallicrafters Co., 600 Hicks Road, Rolling Meadows, Ill. [381]

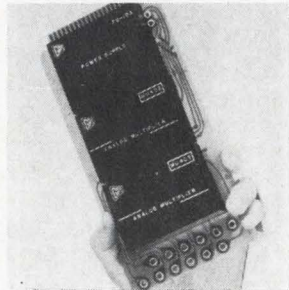

Solid state analog multipliers operate in all four quadrants. All have  $\pm 10$  v input and output levels and do not require external amplifiers. All models operate at d-c. An upper range to 5 Mhz is spanned by 12 models. A special p-c board complete with 2 model 401 multipliers and a model 101 power supply costs \$385. GPS Instrument Co., 188 Needham St., Newton, Mass. [382]

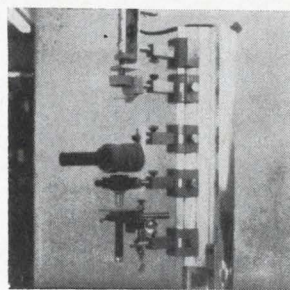

Micro laser for industry and laboratories is easily mounted on a system or optical rail. It is operable in any position, vertically, horizontally, or at any angle. Output is 250 millijoules at a pulse rate of once per minute. Price is \$1,200. For a faster rate with same output, air cooling is supplied for an extra \$90. Laser Nuclear Inc., 123 Moody St., Waltham, Mass. [383]

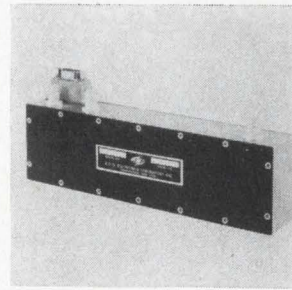

Solid state i-f amplifiers series EST/LD contains a wide range linear video detector and feature instantaneous linear-detected ranges of over 30 db with  $\pm 0.5$  db accuracy. Video output capability is 5 v into 93 ohms. Unit also features i-f outputs to  $\pm 13$  dbm with less than 1 db of compression. RHG Electronics Laboratory Inc., 94 Milbar Blvd., Farmingdale, N.Y. [384]

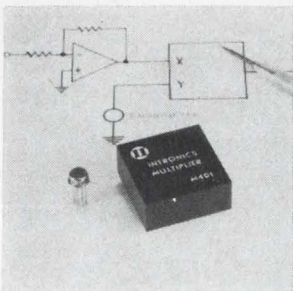

Analog multiplier M401 linearity is 0.5% over the full  $\pm 10$  v range. Offsets and gain errors may be externally adjusted. Full power response bandwidth is 20 khz along with a small signal bandwidth of 100 khz. Inputs have an impedance greater than 10 kilohms. Units measure 1.5 x 1.5 x 0.625 in. Price is \$75 at the 100 level. Intronic Inc., 57 Chapel St., Newton, Mass. [385]

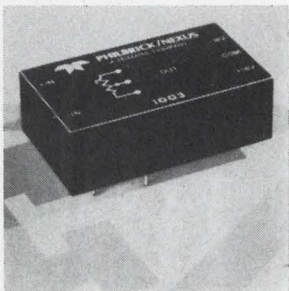

Operational amplifiers 1003 and 100301 have FET-transistor input and low thermal drift. Common-mode rejection is greater than 110 db. Each unit is trimmed internally at manufacture to below  $\pm 300$   $\mu$ v offset voltage with  $\pm 50$   $\mu$ v as typical. Input impedances are above 10<sup>11</sup> ohms. Operating temperature is 55° to +125° C. Philbrick/Nexus Research, Allied Dr., Dedham, Mass. [386]

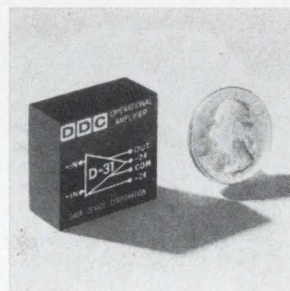

Operational amplifier D-31 has a minimum output of  $\pm 20$  v at 150 ma peak. Frequency for unity gain is 1.5 Mhz; voltage drift, 15  $\mu$ v/° C. The unit is designed for use in servo/resolver systems and solenoid drivers. Case size is 1.115 x 1.115 x 0.515 in. high. Price (1-9) is \$95; availability, stock to 2 weeks. Data Device Corp., 240 Old Country Road, Hicksville, N.Y. [387]

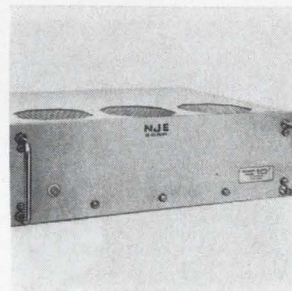

High power rack supplies series SP offer current output ranging from 20 to 100 amps. Voltages range from 10-32 to 30-52. Line regulation is 50 mv for 10 v line change. Load regulation is 100 mv for full load current change. Ripple is 35 mv RMS. Operating temperature range is 0° to 50° C. Prices range from \$525 to \$1,450. NJE Corp., 20 Boright Ave., Kenilworth, N.J. [388]

### New subassemblies

## C-5A recorder ready for other jobs

Built for giant plane's check-out system, incremental unit is being offered as an all-purpose instrumentation recorder

One of the first products to spin off the C-5A is a light and rugged incremental tape recorder. As part of the big plane's built-in check-out system, this digital recorder stores performance data during flight. But Lockheed Electronics Corp., which developed the re-

recorder for its sister division, Lockheed-Georgia Co., feels the unit has a big future as a general-purpose instrumentation recorder. "There's nothing of comparable weight and versatility that can work in military environments," says Elmer Anderson, the Lock-

heed program manager who designed the unit.

Anderson points out many other places, besides aircraft, where the recorder, called the ADR 445, can be used. "Because we built it to meet mil-specs," says Anderson, "you can put it out somewhere and leave it for almost as long as you want. It's incremental, so running out of tape is not a big problem. And when it's locked up, nothing can get at it. Water, salt spray, sand—you name it."

The capstan motor in the ADR 445 advances the tape in 0.0018-inch steps, corresponding to the



They can help you see right through it. And they do it with invisible IR radiation from a pulsed gallium-arsenide device when they are coupled with a gated image converter tube. RCA TA2930 is the solid-state laser diode array. And it offers at 30 A peak pulse forward current 50-watts output at room temperature. In illumination applications, the TA2930 offers a maximum forward threshold current equal to 15 A and a wave length of peak emission of  $9050 \pm 50 \text{ \AA}$ . It is also an excellent

device for long distance communications, fuse designs, illumination ranging and guidance systems, instrumentation and control, and missile guidance.

For more information on Developmental Types TA2930 and TA2628—a 1-watt single laser diode, and 40598 IR Emitting Diode, see your RCA Representative.

For comprehensive technical data sheets, write: RCA Electronic Components, Commercial Engineering, Section SN-92, Harrison, N.J. 07029.

## RCA Lasers and IR Emitting Diodes make spectacles of themselves in thick fog

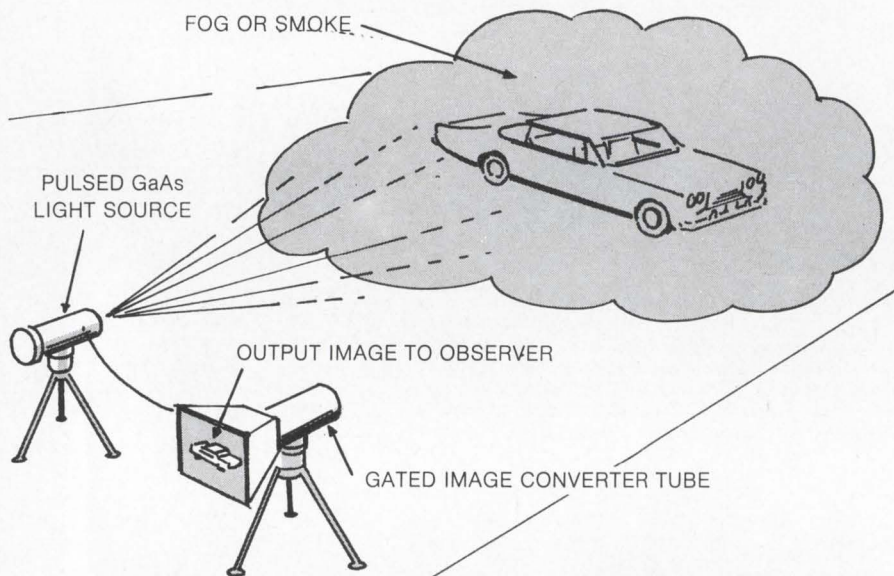

# RCA

Circle 190 on reader service card

## Upset stomach?

If you're looking for a remedy and you can't remember the name of a fast-acting brand, just consult the Trade Name Directory in your Electronics Buyers' Guide. You'll have your answer in seconds. EBG also has a Directory of Products and a Directory of Manufacturers and Sales Offices. Use it often.

**Electronics Buyers' Guide**  
A McGraw-Hill Market Directed Publication,  
330 West 42nd Street, New York, N.Y. 10036



## ... open a hatch and there are p-c card test points ...

standard 556 characters per inch. Speed is adjustable from 1 to 400 steps per second. Running continuously at maximum speed, the recorder takes 11 hours to use up a 10½-in. reel. Lockheed predicts the recorder will be used in remote weather stations, in mine shafts, and on buoys.

**Compatible.** The ½-inch tape used by the ADR 445 has seven channels—six for data and one for on/off commands. Input levels are 5 volts d-c  $\pm 10\%$  for logical 1, and 0 v  $+0.45$  v for logical 0. According to the company, the recorder works with all standard computers. "We've run it with all the big-name models, including IBM's and Burroughs'," says Anderson.

The unit is guaranteed for 4,000 hours of operation or 20 years of shelf life. It has its own check-out system which looks at write error, spool-motor temperature, power supply levels, tape speed, power-on reset, and tells when the tape ends and whether the case is closed and locked. It would be stupid to spend the money for a mil-spec recorder, set it out in the middle of the ocean, and forget to button it up.

"Since it was built to be the central point in a complex monitoring system, we give the recorder the ability to look out for itself," says Anderson.

The ADR 445 was built for easy repair. The deck, on which most mechanical parts are mounted, can be lifted right out of the case. Most circuits are on printed-circuit cards that have test points lined up on the ends that face the front of the recorder. If something goes wrong, a maintenance man opens a hatch, goes down the check points with a meter probe till he locates the bad card, and then replaces it.

**Quick load.** Anderson claims the ADR 445 is the only 10½-inch incremental recorder that's cassette-loaded. "A couple others have elaborate guide mechanisms in their cassettes, but ours just holds the tape."

In loading, a user puts the cassette on the recorder, locks the cassette with four snaps, pulls down each of the reel locks, and pushes



in the tape-head lock—15 seconds for the whole operation.

Measuring 22 by 14 by 7 inches, the recorder weighs 36 pounds, including tape. By making the deck with honeycombed aluminum and reinforcing the mounting holes with solid aluminum, Lockheed kept the weight down.

The other weight-saver is the magnesium case, which Anderson describes as state of the art. "We have the case built for us, and our supplier is the only one who can do the job. It takes a lot of skill to handle magnesium and to plate on it the metal layers needed to make the case strong, weather-proof, and impervious to electrical interference."

According to Anderson, the recorder would have weighed as much as 50 pounds had these two techniques not been used.

The hinged top of the recorder contains an inspection window for visual monitoring of tape, and the packaging design includes radio-frequency-interference shielding at all connecting surfaces. A blower provides induced draft cooling. Intake and exhaust ports are covered with filters for dust protection and rfi shielding.

Most of the circuits are integrated. "But where discretes can do a better job, we use them," says Anderson. "We started the design project about two years ago when IC's couldn't do a lot of things they do today, particularly where high current amplification is involved."

**Pull.** Tape tension is kept constant without servoamplifiers and positional potentiometers. Each spool has its own drive motor and own spring-loaded tension arm that looks like any other tension arm. The difference is under the deck where two reed switches are mounted and a magnet is attached to the arm. As the tape moves, the arm pivots, moving the magnet. One reed closes, turning off the drive motor. Tension on the arm decreases, so it pivots back, opening one reed and closing the other, which turns the drive motor back on.

It would have been possible to control the motor directly with just one reed but with two reeds there's control of the inputs to a flip-flop which, in turn, works the motor so that motor control is not limited

## Choose from 44 styles of film capacitors... There's one to meet your exacting requirements

### HERMETICALLY-SEALED METAL CASE TUBULAR CAPACITORS



#### BARE METAL CASE

Style LP8, metallized polycarbonate film  
Style LM8, metallized PETP-polyester film  
Style LS8, metallized polystyrene film  
Style AP8, polycarbonate film  
Style AM8, PETP-polyester film  
Style AS8, polystyrene film  
Style AF8, PTFE-fluorocarbon film

#### METAL CASE WITH INSULATING SLEEVE

Style LP9, metallized polycarbonate film  
Style LM9, metallized PETP-polyester film  
Style LS9, metallized polystyrene film  
Style AP9, polycarbonate film  
Style AM9, PETP-polyester film  
Style AS9, polystyrene film  
Style AF9, PTFE-fluorocarbon film

CIRCLE 511 READER SERVICE CARD

### EPOXY-CASE RECTANGULAR CAPACITORS

#### AXIAL-LEAD



Style LP7A, metallized polycarbonate film  
Style LM7A, metallized PETP-polyester film  
Style LS7A, metallized polystyrene film  
Style AP7A, polycarbonate film  
Style AM7A, PETP-polyester film  
Style AS7A, polystyrene film

#### RADIAL-LEAD

Style LP7S, metallized polycarbonate film  
Style LM7S, metallized PETP-polyester film  
Style LS7S, metallized polystyrene film  
Style AP7S, polycarbonate film  
Style AM7S, PETP-polyester film  
Style AS7S, polystyrene film



CIRCLE 512 READER SERVICE CARD

### WRAP-AND-FILL ROUND TUBULAR CAPACITORS



Style LP66, metallized polycarbonate film  
Style LM66, metallized PETP-polyester film  
Style LS66, metallized polystyrene film  
Style AP66, polycarbonate film  
Style AM66, PETP-polyester film  
Style AS66, polystyrene film

CIRCLE 513 READER SERVICE CARD

### WRAP-AND-FILL OVAL TUBULAR CAPACITORS



Style LP77, metallized polycarbonate film  
Style LM77, metallized PETP-polyester film  
Style LS77, metallized polystyrene film  
Style AP77, polycarbonate film  
Style AM77, PETP-polyester film  
Style AS77, polystyrene film

CIRCLE 514 READER SERVICE CARD

### HERMETICALLY-SEALED METAL CASE RECTANGULAR CAPACITORS



Style CML, high voltage paper/PETP-polyester film, inserted tab construction.

CIRCLE 515 READER SERVICE CARD

### HERMETICALLY-SEALED CERAMIC CASE TUBULAR CAPACITORS



Style SML, high voltage paper/PETP-polyester film, inserted tab construction.  
Style SMLE, high voltage paper/PETP-polyester film, extended foil construction.

CIRCLE 516 READER SERVICE CARD

### HERMETICALLY-SEALED GLASS CASE TUBULAR CAPACITORS



Style GML, high voltage paper/PETP-polyester film, 85 C  
Style GTL, high voltage paper/PETP-polyester film, 125 C

CIRCLE 517 READER SERVICE CARD

### EPOXY CASE RECTANGULAR CAPACITORS



Style EFX, high voltage paper/PETP-polyester film.

CIRCLE 518 READER SERVICE CARD

For engineering bulletins on the capacitor styles in which you are interested, write to Dearborn Electronics, Inc., Box 530, Orlando, Fla. 32802.

# Dearborn Electronics, Inc.

(a subsidiary of the Sprague Electric Company)

FOREMOST IN FILM CAPACITORS

1D-8100





## By George... Captor sure makes small EMC Filters!

Captor subminiature EMC filters are the industry's smallest . . . 25% to 37% more compact than other popular miniatures. Volumes and weights are correspondingly reduced . . . as light as 4.9 grams for many units. Captor EMC filters maintain high published performance over full temperature range to 125° C. Their performance is equal to or better than the competition's, yet they truthfully cost less! Let Captor bid on your next EMC filter or filter assembly requirement, by George! Write for Catalog F-104 and prices today.

**Captor Corporation manufactures miniature filters . . . communications and security filters . . . custom-design filters, and other electronic components.**

**CAPTOR CORPORATION**

APPLICATION ENGINEERING DEPT.

5040 Dixie Highway, Tipp City, Ohio 45371

by switch characteristics, like bounce.

The stepping motor which advances the tape is a harmonic drive unit. Lockheed also buys this from an outside supplier.

**Airborne.** The recorder gets its first ride in a C-5A this month. Built into each of these planes is a system called Madar—malfunction detection, analysis, and recording [Electronics, April 29, p. 81]. It includes more than 1,000 test stations that keep watch over the performance of the C-5A's systems. Data from these stations is analyzed by an on-board computer, and failures are reported on the plane's console.

Data also goes to the recorder. When the plane lands, the tape is removed and played into an on-ground computer.

Lockheed Electronics predicts

ture, thrust, and gas consumption. These profiles change as an engine ages, and it should be possible to tell when overhaul is needed by studying the profiles."

The third advantage is the reduced time for preflight checks. Instead of going through long lists of tedious checks, maintenance crews would go right to the faulty equipment pointed out by the tape. "If we used a standard checklist, it would take 15 hours to get a C-5A off the ground," says Anderson.

**Playback.** Lockheed hasn't yet decided on a price, but says it will start taking orders this month and expects to have an inventory built up by December.

Meanwhile, Anderson goes on designing the basic recorder. His goals now are a nonmilitary version for industrial use and a model with

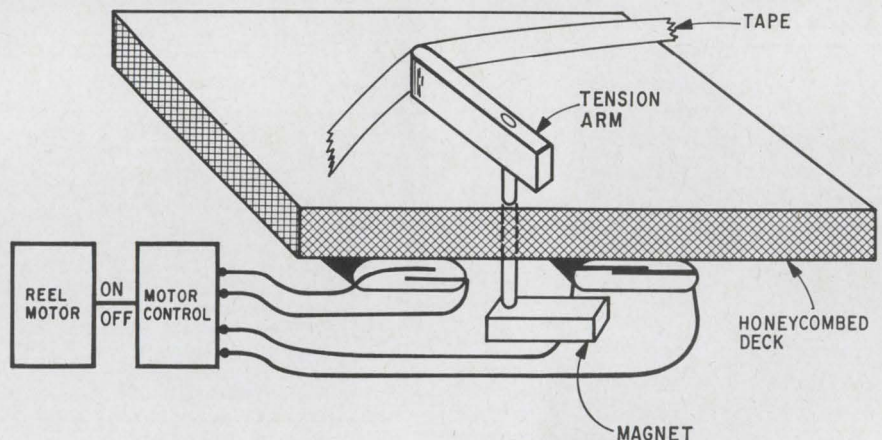

**Steady pull.** As the tape is pulled to the left, the tension arm pivots and the magnet swings to the right. The reed switch on the right closes, turning off the motor. Tape backs up and the tension arm pivots back. The reed on the left closes, starting the motor.

that in-flight data storage will be the rule for future aircraft. This is another reason the division is optimistic about the commercial possibilities of the ADR 445.

**Some reasons.** Anderson points out three advantages of in-flight storage. First, and most obvious, is that the data points a finger at malfunctioning equipment, and in many cases, tells why the equipment went bad. The second boon is more efficient long-range maintenance programs.

"Now, engines get torn down every so many hundred hours whether they need overhaul or not," says Anderson. "There's just no way to know. By storing in-flight information we can build up performance profiles of things like tempera-

playback capability.

For now, Anderson feels that most users won't need playback capability. "When these things are used in remote areas, the engineer just goes out to the site, picks up the tape, and plays it back in his lab."

### Specifications

Operating temperature	-34°C to +55°C
Nonoperating temperature	-54°C to +92°C
Humidity	Mil-E-5400 Class 1A
Altitude	50,000 ft.
Vibration	Mil-E-5400
Input format	Digital RZ
Recording format	Digital NRZ (MARK) IBM 729 or 360 compatible
Packing density	556 or 800 bits/inch
Power	115 v, 400 hz, 3 phase

Lockheed Electronics Co., U.S. Route 22, Plainfield, N.J. 07061 [389]



New subassemblies

## Clockmaker counts on IC's

Use of these devices helps it halve prices on time references

**Experience** and integrated circuits are the factors Chrono-log Corp. engineers cite when explaining how they were able to halve the prices on their digital clocks.

The company has been selling these devices, which provide time references for data processors and other digital systems, for \$1,000 and up. Deliveries can take months because of the design time needed to meet a customer's specific requirements. But a typical clock from Chrono-log's new line, called the 30,000 series, sells for \$500, and delivery time ranges from stock to two weeks.

The older units were built with discrete components mounted on nine printed-circuit cards; a 30,-

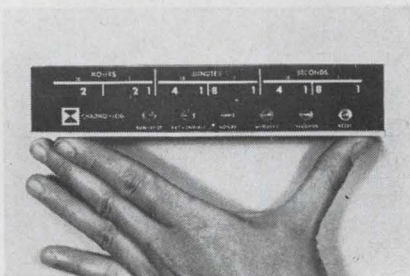

**Little time.** The 1 $\frac{3}{4}$ -inch high clock shows that an experiment has been running 23 hr., 59 min. and 59 sec.

000 clock is made entirely of IC's and has only one p-c card.

"Our parts costs are a little less," says Saul Meyer, Chrono-log's vice president for engineering. "The big savings come in those vague areas usually listed as overhead. A large part of the cost of our old clocks went for interconnecting the cards. Since there's just one card and a lot fewer components, we save quite a bit in areas such as supervision, quality control, and documentation."

Meyer says the company,

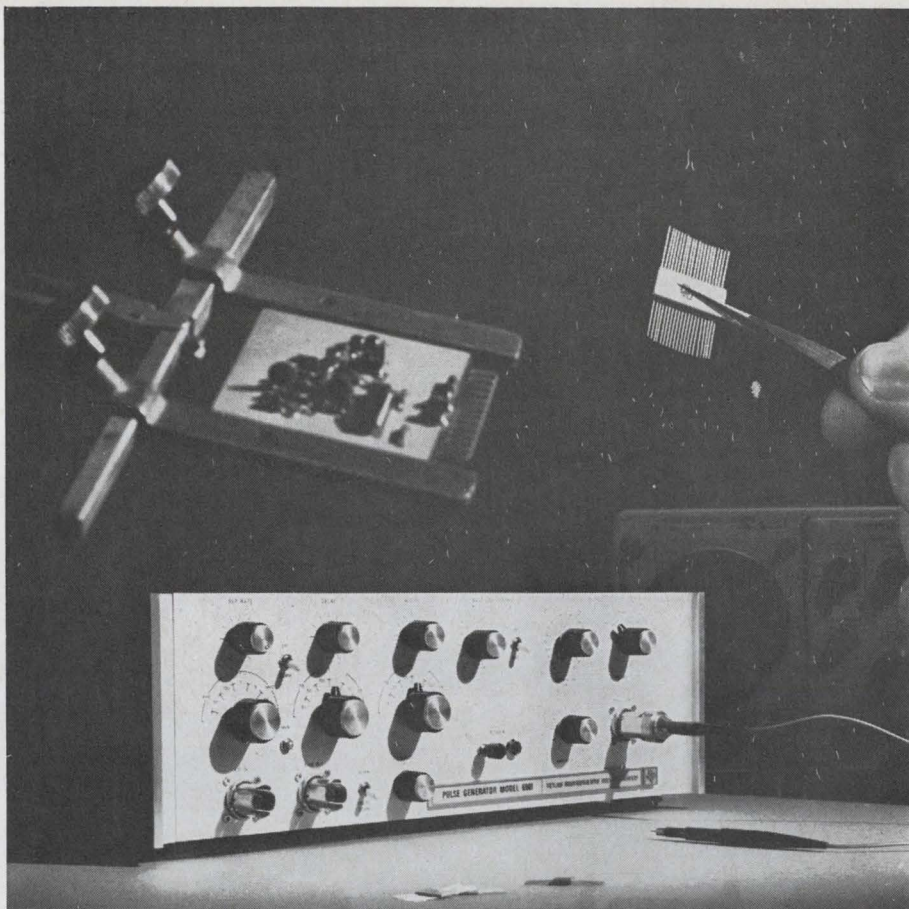

## Why You Need a Special Pulse Generator for State of the Art Circuit Design

With high speeds and critical design parameters, you need the best test instruments to be sure your designs will be optimum. The TI Model 6901 Pulse Generator gives outputs from 1 KHz to 0.1 GHz; independent amplitude and baseline controls; jitter less than 0.1% of period + 50 psec; and count-down synchronization output.

The 6901 makes your designing simpler, too. Because the pulse amplitude of the generator can be changed without affecting DC offset, you can use the offset instead of an external bias supply for your circuit.

For additional information, contact your TI Field Office, or the Industrial Products Division, Texas Instruments Incorporated, P. O. Box 66027, Houston, Texas 77006.

**TEXAS INSTRUMENTS**  
INCORPORATED



**This new PDM  
miniature microwave  
straight plug is:  
  
reusable,  
shipped complete,  
and has no snap ring!**

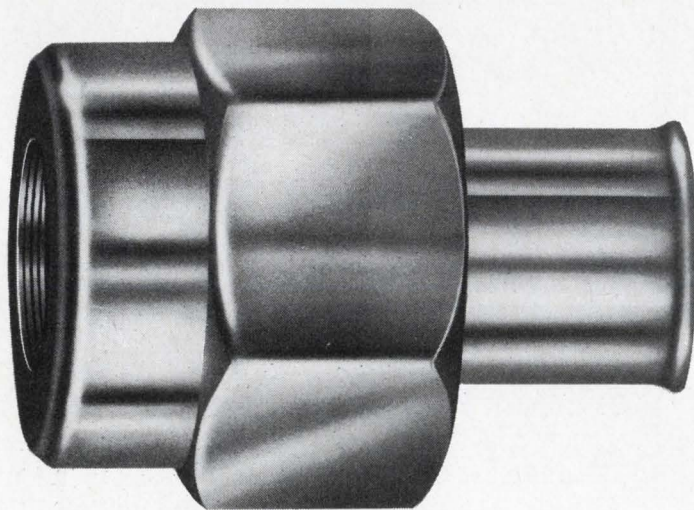

The new PDM straight plug is one of four new types of connectors which, we believe, represent a significant breakthrough in the miniature microwave field. The basic design concept represents a radical departure from conventional techniques because a snap ring is no longer used to attach the coupling nut to the body.

The net result of this new approach is a straight plug which uses a tube for the body with a very simple straight machined shoulder. The coupling nut which fits over the back will withstand torque up to 20 inch pounds without pull-off or distortion. And, this same coupling nut may be slid away making it possible to unsolder the connector and resolder it to the same or another section of cable.

So, there you are. A brand new connector with no snap ring, com-

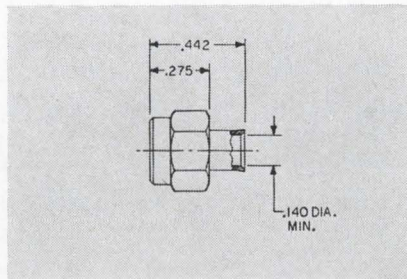

pletely reusable, and one which will arrive at your plant completely assembled.

*There's a lot more we can tell you, if you'll give us the chance. Write for full details on PDM Miniature Microwave Straight Plugs, Right Angle Plugs, Straight Jacks and Bulkhead Receptacles. Phelps Dodge Electronic Products Corporation, 60 Dodge Avenue, P. O. Box 187, North Haven, Connecticut 06473.*

through experience, knows what options are asked for most. So the basic 30,000 clock can be converted by Chrono-log technicians into one of 6,000 models by changing a few connections on the p-c card.

**Another cut.** Size has been reduced almost as much as price. The older Chrono-log clocks are 5¼ by 19 by 12 inches; one of the 30,000 series is 1¾ by 12 by 9½ inches. It counts up to 24 hours and displays time in seconds; hours, minutes, and seconds; hours, minutes, and fractions of a minute; or hours and fractions of an hour. Readout is either decimal or binary-coded decimal.

Besides telling time, the calendar-clock, which is 19 inches wide, displays day of the month or the day of the year numerically. For example, March 17 would be either 03-17 or 0076 (0077 in a leap year).

Meyer says the new clocks work with any standard logic family. Input levels are 2.0 volts minimum for up and 0.8 volt maximum for down, while output signals are 3.4 volts for up and 0.35 volt for down at currents up to 6.4 milliamps. Output can be either serial or parallel.

Reference input for the 30,000 is either a 60- or 50- hertz signal, and power can be supplied by 5-volt d-c, 115-volt a-c, or 230-volt a-c sources.

Customers also have a choice of temperature ranges: -20° to +70°C or -55° to +70°C.

Chrono-log Corp., 2583 West Chester Pike, Broomall, Pa. 19008 [390]

New subassemblies

## SCR permits d-c compromise

3% regulation provided  
in low-cost supply  
for computer circuits

**Designers** of computer power and communications systems are faced with a hard choice when buying d-c power supplies. As Sola Basic

**PHELPS DODGE** ELECTRONIC PRODUCTS CORPORATION 



**When it comes to making discoveries...**



## **Colorado is choice country** **for a growing boy.... or a growing business**

Finding something new broadens a boy's horizons. That goes for a business, too.

Over 100 organizations conducting basic and applied research make a wealth of information available to businesses in Colorado. Thousands of specialized personnel under the direction of more than 3,500 graduate scientists study everything from uranium to UFO's. Colorado's scientific and academic community attracts and stimulates high caliber scientists, engineers, and technical administrators. The State ranks in the top three nationally for percentage of scientists in its population.

Along these lines, Colorado is a great place. Kids have

a field day in wide open spaces filled with wonderful things to learn about. Like all kinds of trees and flowers and rocks. There are horses to ride, streams to wade, mountains to climb. And, of course, libraries, museums and zoos throughout the State add to the choice of new things to do.

If you want to know more about a state that's enthusiastic about making discoveries, we'll send you a complimentary copy of our 66 page "Industrial Colorado." Address inquiries to Dwight E. Neill, Director, Division of Commerce and Development, 1030 State Services Building, Denver, Colorado 80203.

## **Make Industrial Colorado Your Choice**



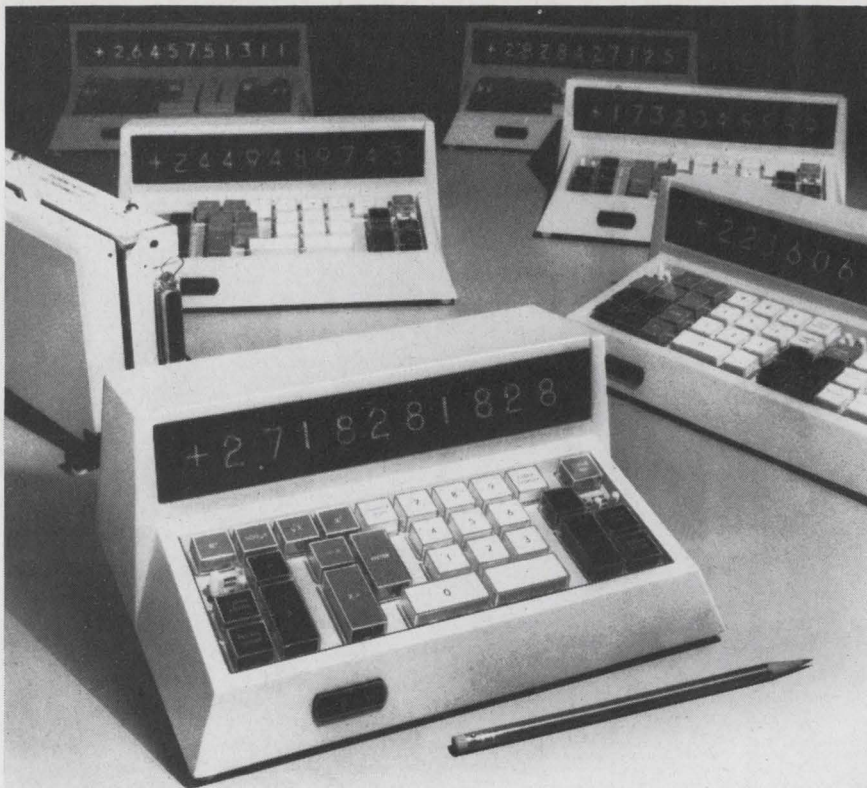

## Why companies standardize on Wang electronic calculators

A truly functional, basic calculator design, the Wang 300 Series, fills the needs of most company operations. Each calculator consists of: a briefcase-size electronics processor and a compact, telephone-size keyboard. Up to four keyboards, each tailored to individual requirements, can operate simultaneously from the electronic package. Wang's unique multiple keyboard approach results in far greater versatility and less cost per operator than any comparable electronic calculator. (One leading company reports a saving of \$73,000 four months after installing Wang calculators.)

As simple to learn and operate as a 10-key adding machine, Wang calculators are powerful and versatile enough to solve, at

your desk, everything from the usual arithmetic calculations to complex equations and programmed computations which otherwise require the use of computers.

You can begin as simply as budget and requirements dictate. As your needs grow, simply add compatible Wang plug-in modules such as an 80-step card programmer, an automatic output writer, etc. (Wang offers more optional capabilities than all other calculator manufacturers combined.)

Over 10,000 Wang users have already discovered the advantages of standardization without built-in obsolescence. Call your nearest Wang office for an immediate demonstration.



Dept. 9H, 836 North St., Tewksbury, Massachusetts 01876 • Tel. 617 851-7311

### Call today for immediate trial:

(201) 241-0250	(215) 642-4321	(309) 674-8931	(412) 366-1906	(601) 982-1721	(714) 234-5651
(203) 223-7588	(216) 333-6611	(312) 889-2254	(415) 454-4140	(602) 265-8747	(716) 381-5440
(203) 288-8481	(301) 588-3711	(313) 278-4744	(415) 692-0584	(608) 244-9261	(717) 397-3212
(205) 595-0694	(301) 821-8212	(314) 727-0256	(504) 729-6858	(612) 881-5324	(805) 962-6112
(206) 622-2466	(303) 364-7361	(317) 631-0909	(505) 255-9042	(615) 588-5731	(816) 421-0890
(212) 682-5921	(304) 344-9431	(402) 341-6042	(512) 454-4324	(616) 454-4212	(817) 834-1433
(213) 278-3232	(305) 564-3785	(404) 457-6441	(513) 531-2729	(617) 851-7311	(901) 272-7488
(214) 361-4351	(305) 841-3691	(405) 842-7882	(517) 835-7300	(702) 322-4692	(916) 489-7326
			(518) 463-8877	(703) 877-5535	
			(601) 234-7631	(713) 668-0275	(919) 288-1695

Industries sees it, units regulated by constant-voltage transformers are inexpensive, but their 8%-and-higher regulation is a big minus. On the other hand, solid state supplies can have regulation under 1%, but they're too costly.

Sola is trying to resolve this dilemma by offering a compromise. Its new line of supplies, called SCRDC's, have 3% regulation and are priced, the firm says, no more than 20% above supplies with constant-voltage transformers.

A silicon controlled rectifier handles the regulation. The supply's input passes from an isolation transformer through a full-wave rectifier to the SCR, which is fired by an error signal that's fed back

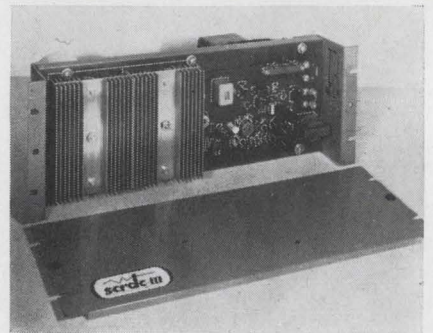

**Checking out.** The SCR's gate is fired by an error signal fed back from the power supply's output.

from the output and amplified in a control loop.

SCRDC's with outputs of 4.5, 6, 12, 24, or 48 volts are available. Sola will also adjust a supply to deliver some other voltage.

The buyer can also pick his current. There are 10-, 20- and 40-amp models in each voltage category. And current-limiting circuitry before the SCRDC's output prevents a short across the output terminals from damaging the device.

Changes in line frequency don't bother the supply; it operates over a range from 48 to 62 hertz.

The supply operates with convection cooling from 0°C to 50°C. In this range, a temperature shift changes output voltage by no more than 0.05%.

Ripple is less than 1% and, following an input change, the supply settles within 250 microseconds.

Sola Electric Division, Sola Basic Industries, Elk Grove Village, Ill. [391]



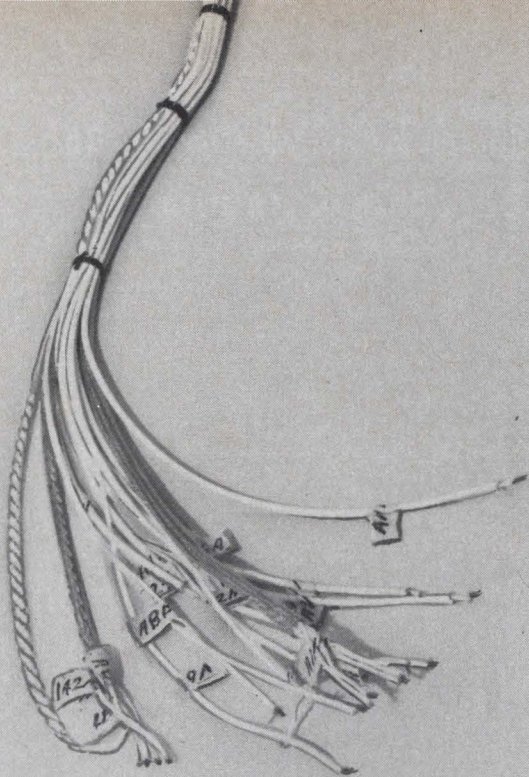

**If you're still wiring circuits like this . . .**

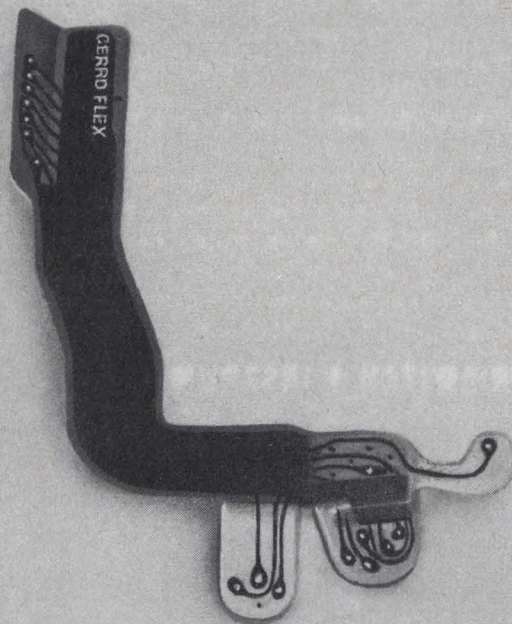

**you've left a lot of room for improvement.**

The modern way to package electronic circuits is with Cerro-Flex® flexible cables and printed wiring.

They can save installation time and cost, weight and volume. And, even more important, they improve the reliability and consistency of your electronic equipment.

Cerro-Flex® Products can provide continuous flat flexible cables and custom-designed printed circuitry in a wide variety of plastic film insulations. A Cerro-Flex® Technical Man can also give you design assistance for your particular application.

Send today for a copy of the Cerro-Flex® Flat Cables and Circuits Catalog.

**Cerro-Flex Products, Cerro Wire & Cable Co.**  
**330 Boston Post Road, Old Saybrook, Conn. 06475**



Gentlemen:

Please send me a copy of "Cerro-Flex Flat Cables and Circuits."

Please have a Cerro-Flex Technical Man call.

Name .....

Title .....

Company .....

Address .....

**CERRO**  
 WIRE & CABLE



**The BIG INCH Series 31000 3-Wire Stepper . . .** Unique principle drives rotor 360° for each pulse cycle. Other step angles available through integral gear reduction. An economical solution whenever compact unidirectional stepper drives are needed.

**The BIG INCH Series 31600 Reversible Step Servo . . .** Bi-directional operation is obtained by energizing four coils in sequence or can be driven by simple logic circuitry up to 200 steps per second. Ideal for instrument drives.

**The HSI BIG INCH™ line is truly revolutionary.** No brushes, commutators or ratchets to limit life; an almost infinite variety of ways to actuate and drive. Send for catalog with complete details on features, applications and circuitry.

## **HAYDON SWITCH & INSTRUMENT, INC.**

1500 Meriden Rd., Waterbury, Ct. 06720 Tel: (203) 756-7441

**Two  
great new  
steppers  
from H-S-I**

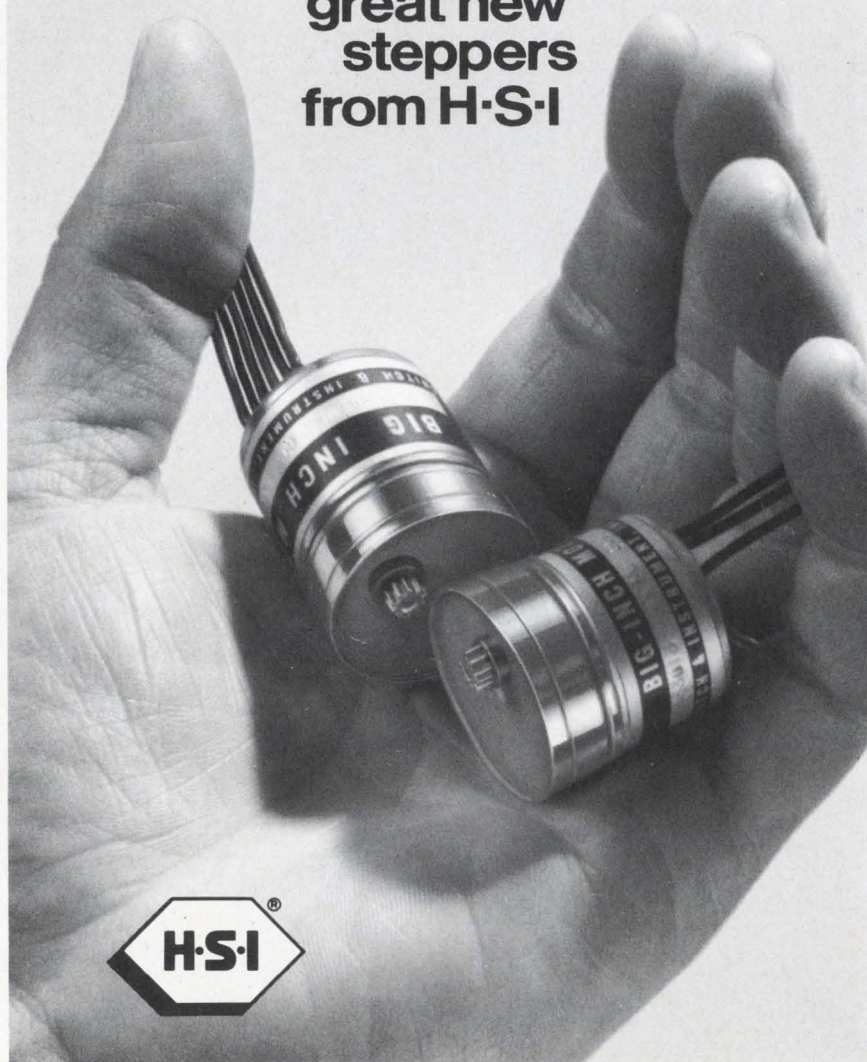

New subassemblies

## **Small supply has an IC regulator**

D-c source, 1½ inches high,  
pre-packed into systems;  
regulation is within 0.01%

**The small size** of a new d-c power supply from the Lambda Electronics Corp. is attributed by company engineers mostly to integrated circuits. Just 1½ by 3 by 3 inches, the Com-pak Mark II is billed by Lambda as the smallest supply in its performance class.

The IC's show up in the Com-pak's regulator, which keeps the supply's output constant to within 0.01% + 1 millivolt. Ripple is 250 microvolts rms, noise is 1 mv peak-to-peak, and temperature coefficient is 0.01% + 300  $\mu$ v per degree centigrade.

When ordering the Com-pak, the customer specifies output voltage—0 to 7, 18, 32, 60, or 120 volts—and the temperature-rated current—14 to 300 milliamps at 40°, 50°, 60°, or 70°C. The supply works with inputs from 105 to 132 volts.

Lambda is also offering the Com-pak in a ¾-inch cube for mounting in a ½-inch rack. There's a dual-output model, too, but it's available right now only in the larger size. Prices on the Com-pak start at \$85 for the single-output model and at \$150 for the dual.

Best customer for the Com-pak may turn out to be Lambda itself. The company is using the new supplies in its first integrated power system. Mounted in a rack 19 inches long and ¼ inches high, the system can have as many as eight Com-paks, eight overvoltage protectors, and eight power-control panels, plus a metering panel.

By offering the Com-pak as a module and by interconnecting power systems at its plant, Lambda feels it can cut the customer's design time and its own delivery time for customized power systems. The company expects the systems to be used to power computer subsystems and instruments.

Lambda Electronics Corp., Route 110,  
Melville, N.Y. 11746 [392]



# missile engineers

## Launch your new career at HUGHES Missile Systems Division.

The Missile Systems Division combines the technical and business functions associated with missile analysis, design, engineering, fabrication and checkout. Located at Canoga Park in Southern California on an 85-acre, campus-like complex, the new Division is responsible for all phases of missile development—from advanced conceptual studies through systems analysis, systems engineering, hardware design, prototype construction and testing of a wide variety of air-to-air, air-to-ground and tactical missiles. Current programs include Walleye, TOW, Maverick and Phoenix.

The Missile Systems Division now employs more than 1400 engineers, scientists, technicians and administrative personnel. New and expanding programs have created hundreds of openings for additional experienced people. Now is the ideal time to launch your new career with a dynamically expanding new organization.

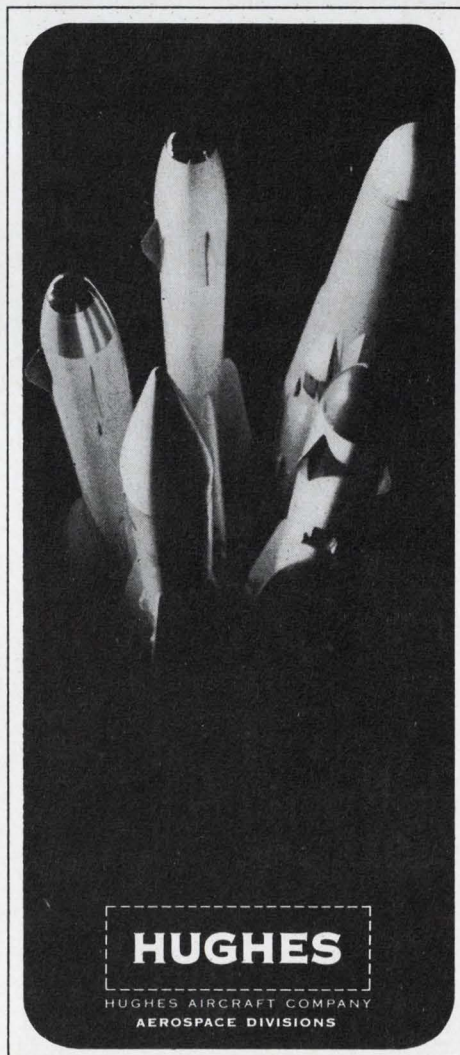

Some of our openings include:

Stress Analysts  
Test Engineers  
Systems Engineers  
Preliminary Design Engineers  
Guidance Systems Engineers  
Circuit Design Engineers  
Mechanical Product Design Engineers  
Electronic Product Design Engineers  
Aerodynamic Engineers  
Servo Systems Design Engineers

Most assignments require accredited Engineering or Scientific degrees and applicable professional experience. Some openings are available for recent engineering graduates. U.S. citizenship is required.

For prompt consideration, please airmail your resume to:

**Mr. Robert A. Martin**  
Head of Employment  
Dept. 31.

Hughes Aerospace Divisions  
11940 W. Jefferson Blvd.,  
Culver City, Calif. 90230

An equal opportunity employer



## New Production Equipment Review

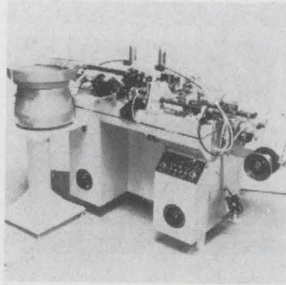

Lead attachment machine series 600 is for automatic welding of axial or radial leads to capacitors. It handles 1800 units/hr from 6 in. spools of tinned copper, copper weld or other material in wire diameters from 0.020 in. to 0.032 in. The machine operates on 110 v a-c 50/60 hz. Midland Engineering & Machine Co., 9630 W. Allen Ave., Rosemont, Ill. [410]



Four-spindle, numerically controlled p-c board drilling machine model 404 drills up to 72,000 holes an hour with high accuracy. It features quick-change drill bit, an IC numerical controller and an X-Y mechanism that moves the overhead spindle assembly in the Y axis and the work table in the X axis. Digital Systems Inc., 1078 E. Edna Pl., Covina, Cal. [411]

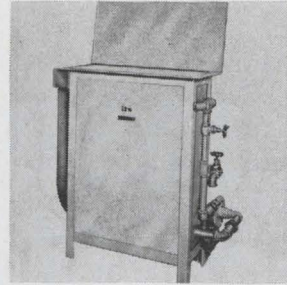

Manual flood developer provides rapid, even development of photoresists on p-c boards and metal flats in low output operations. It assures full flow of fluid over both sides of the work and washes away all unpolymerized resist. Over-all tank size is 46 x 28 x 35 in. with a sump capacity of 6 gallons. Maximum work size is 24 x 24 in. Infra-Red Systems Inc., Riverdale, N.J. [412]

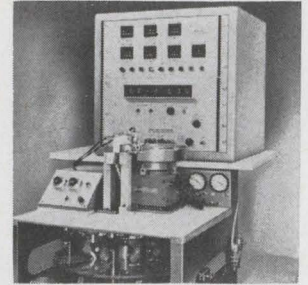

Ceramic chip capacitor test system model 5321 tests and sorts capacitor chips from 125 pf to 12.5 uf with  $\pm 0.25\%$  accuracy at a rate of 3600 measurements/hr. It mechanically feeds ceramic chips to the test clips where electrical measurements are performed. Prices start at \$13,000; delivery, 90 days. Micro Instrument Co., 12901 Crenshaw Blvd., Hawthorne, Calif. [413]

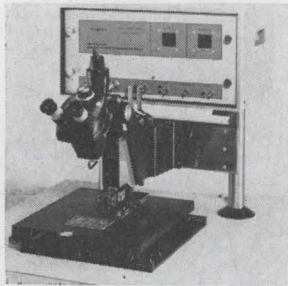

Semiautomatic reflow soldering system HPS-120 is for "all-lead" soldering of IC packages. It uses loading "nests" for positioning IC package under heater bars. After being positioned, the device is held in place by a vacuum pickup. System features a desolder cycle for removing defective devices from the p-c board. Hughes Welders, Oceanside Blvd., Oceanside, Calif. [414]



Ultrasonic wire bonder model 1350, with a dual channel selection that follows two independent schedules of ultrasonic power and time duration, is for bonding dissimilar materials to surfaces in any sequence. A search area in X and Y permits a bond to be made anywhere within a 3-in. circle. Hugle Industries Inc., 750 N. Pastoria Ave., Sunnyvale, Calif. 94086. [415]

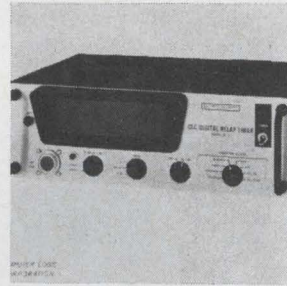

High-speed digital relay timer model RT-1 enables measuring relay bounce for better than 200 units per hour. It features a simplified control panel with a 3-digit readout display to facilitate operation by nontechnical personnel. Measurements are displayed in milliseconds. Price is \$2,950; delivery, 30 days. Computer Logic Corp., 1528 20th St. Santa Monica, Calif. [416]

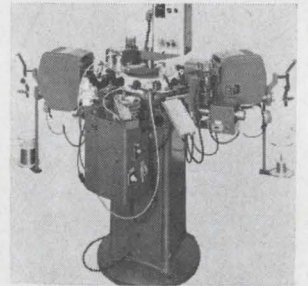

Versatile coil winding machine model BGO-2 automatically loads, winds, taps, cuts leads, solders, waxes, tapes and unloads. The standard machine has a 12-position turret, which rotates in either direction, and will handle practically any kind of coil on any form configuration. Winding speed is 400 to 4,000 turns per minute. Leesona Corp., 1313 West St., Danbury, Conn. 06810. [471]

### New production equipment

## Easing the circuit designer's job

Three-section p-c board for layouts and testing of IC's accepts 18-pin dual in-line packages

**Offer an off-the-shelf** printed-circuit board for integrated circuits, one that lets the engineer work out his own circuitry. Make the board so that it accepts 16-pin dual in-line packages (up to 48 per three-section board) where most competitors take only 12-pin versions. Price it

as low as \$35 per three-section board. Presto! You have a product that could well become the keystone of a four-month-old company.

That's the approach—and the hope—of the Computer Circuits Corp. Founded by a chemical engineer, an electrical engineer and a

veteran p-c board maker, Computer Circuits is tailoring its line to compete directly with the in-house operations of large systems companies. Says sales manager Don Goldberg, an EE formerly with Electronic Devices Inc. and the General Instruments Corp.: "We aim to deliver custom and off-the-shelf boards faster and at a lower price than the in-house setups. And we believe there's a demand for that kind of service. We just got a proprietary-circuit order, for instance, from one of the biggest computer makers in the country."

**Across the board.** About the board for dual in-line packages,



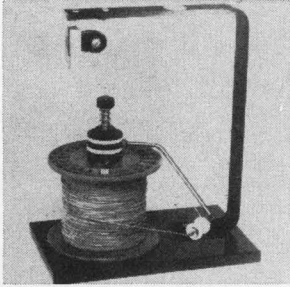

Combination dereeler and tensioner Mark 2 is for use on any type of coil-winding machine. It features a tensioning device that keeps the wire away from the spool flange. This eliminates kinking during dereeling. Constant positive action is easily adjustable for tension and wear. Price is \$34.50. Excelsior Electronics Co., 7448 Deering Ave., Canoga Park, Calif. 91303. [418]

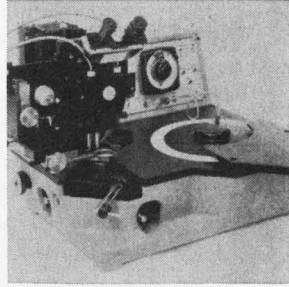

Optical mask alignment systems use fiber-optic light guides. Alignment of a semiconductor wafer to a mask and exposure of the wafer's photoresist coating are done semiautomatically in model 510 and manually in model 360. Both have lamp power of 200 w; UV reflectance of dichroic mirror, 98% or more at 4,000 angstroms. Electroglas Inc., 150 Constitution Drive, Menlo Park, Calif. [419]

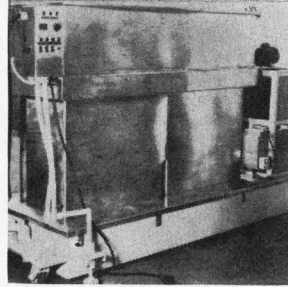

Variable, multistage cleaning operations now can be performed in a single, heavy-duty machine. Vapor degreasing, immersion ultrasonic cleaning, spray and vapor rinsing are all provided in the Apec-Acoustica. Units come in 6 standard sizes, with ultrasonic cleaning tank capacities ranging from 3 to 50 gallons. American Process Equipment Corp., 5331 W. 104 St., Los Angeles. [420]

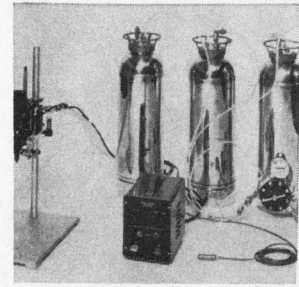

Processing equipment pots and encapsulates circuitry with foams, elastomers and solid resins. Output is up to 500 g/min. under continuous operation and 15 g/shot for single-cycle. Metering accuracy is better than 1% and ratio of components may be varied from 1:1 to 20:1 with max. viscosity of 20,000 centipoises. CBS Industries Inc., 2415 Campbell St., Oakland, Calif. [421]

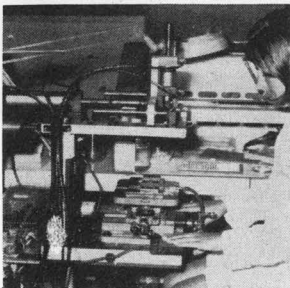

Bench model automatic screen printer, designated Accu-Coat model 3100, permits fine line metalizing (down to 0.004 in. line widths) using etched metal masks. The machine can be used for contact printing IC's. It accommodates masks or screens as large as 8 x 10 in. Price is \$2,250; delivery, about 3 weeks. Aremco Products Inc., P.O. Box 145, Briarcliff Manor, N.Y. [422]

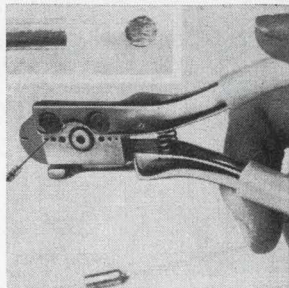

Wire and ribbon cutter called Square-Kut performs with equal efficiency on wire or tubing up to 0.0734 in. in diameter or on metal ribbon up to 0.025 in. thick and 0.125 in. wide. The smooth, flat-cut ends provided by the tool eliminate the need for secondary finishing on wires that are to be butt-welded or soldered. Henes Mfg. Co., 4301 East Madison, Phoenix, Ariz. [423]

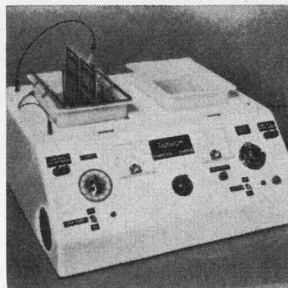
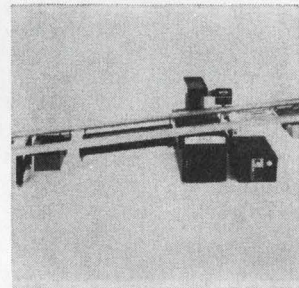

Table-top electroplating units provide precision plating for electronic applications. The Technilab II and Technilab IV have 2 and 4 electroplating tanks, respectively. The polyethylene tanks come in 2 sizes: 11 x 6 $\frac{3}{8}$  x 5 in. deep for rack or still plating, and 11 x 7 x 11 in. deep for barrel or rack plating. Prices are \$500 and \$700. Technic Inc., Box 965, Providence, R.I. 02901 [424]



Wave soldering system handles any size p-c board and soldering circuit patterns from highly intricate to large ground areas without icicling or bridging. It includes a 10-ft anodized aluminum conveyor, a foam flux applicator, a pumping system that produces an infinitely variable solder wave from  $\frac{1}{8}$  to  $\frac{5}{8}$  in. high. Gale Systems Inc., 50 Main St., North Reading, Mass. [425]

Goldberg says, "so far as we know, there's only one comparable product on the market and it doesn't offer the sophisticated features of ours." These include double-sided construction with established ground plane, a feature affording maximum in-out configuration. Also, the p-c board accepts vector-type T-28 terminals, allowing wiring from either side. And to give as much circuit versatility as possible, the power-supply leads aren't connected.

Phil Altebrando, Computer Circuits' president and a former senior process engineer at the Solitron Corp. and product manager at Gen-

eral Instruments, says there's a need right now for just such a test and design tool. "What our new board replaces," he explains, "is the hole-filled plastic vector board that has to be wired. You can imagine what that looks like with a handful of 16-pin DIP's wired to it."

The board itself is built of General Electric's G-10 material, a glass epoxy. It is tin-lead soldered and has nickel-gold fingers. Made in three-section cards, it can be cut into single sections for card cages with dual 28-pin connectors.

**Circuit saver.** The board's primary application is in the designing and production testing of

circuits using DIP's. With an optional mounting socket, the board eliminates the need to solder each package when laying out a circuit. Since the soldering operation itself can blow an IC, the result is fewer discarded circuits in the design stage.

Adds Goldberg: "It's difficult to overemphasize that no-soldering feature. You have no idea just how many expensive IC's can be killed during the design stage of even a simple circuit; multiply that by the number that must go into a complex circuit—that of a computer, for example—and the costs can really add up.



# LIFE ASSURANCE!

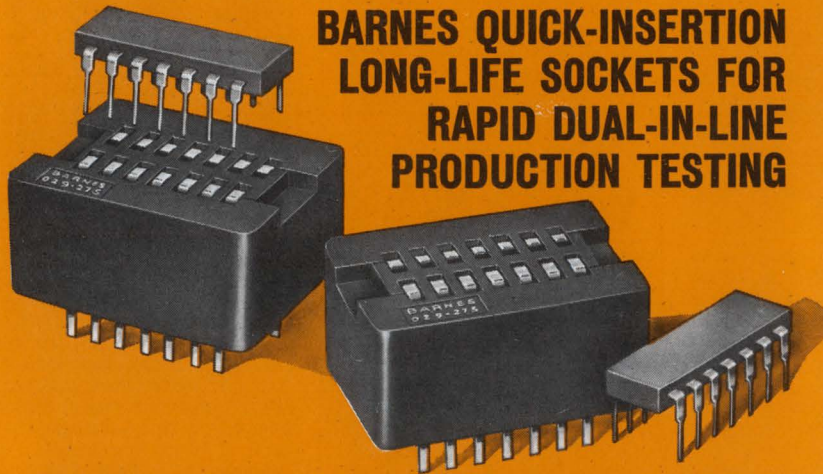

## BARNES QUICK-INSERTION LONG-LIFE SOCKETS FOR RAPID DUAL-IN-LINE PRODUCTION TESTING

Faced with having to check out large quantities of DIP's . . . quickly and reliably? No problem! The large tapered lead entrances and highly flexible contacts in Barnes 029-275 sockets permit fast and easy device insertion and withdrawal for a typical life of 50,000 to 100,000 cycles. No deformation of lead taper . . . yet reliable electrical contact is maintained for round or flat leads. Available for 14 or 16 lead DIP's, and with Kelvin contacts. Write for data.



Lansdowne, Pa. 19050 • 215/MA2-1525

**barnes** / THE FIRST WORD IN CARRIERS, CONTACTORS AND SOCKETS FOR I.C.'S

Circle 245 on reader service card

"And if an engineer at a big systems house should try to get his own p-c board people to give him a board like ours, he might just cool his heels for six weeks waiting for delivery. All we need is a phone call and we'll get the boards out the same day."

Ideally, the buyer will first decide on his circuit design and then bring the board back to Computer Circuits for manufacture of the custom version.

The three-section p-c board costs \$35 in quantities up to 25; single sections are priced at \$14. The price on the three-section board with T-28 terminals and mounting socket is \$150 in quantities up to 25, while single sections cost \$65 each.

Computer Circuits Corp., 174 Marine St., Farmingdale, N.Y. [426]

New production equipment

## Infrared camera costs but \$10,000

Thermographs are taken in 30 seconds on Polaroid film; color model available

**Thermal photography** is still too expensive to be anyone's hobby, but the cost is coming down. For example, an infrared camera from the Barnes Engineering Co., the T-6, costs less than \$10,000 compared with \$15,000 and up for similar cameras. Its optical system weighs only 25 pounds and its i-r detector doesn't have to be cooled, so one man can tote the T-6 around and set it up.

Scan time is 30 seconds and thermographs are taken on Polaroid film. And a \$14,000 version of the T-6 takes color thermographs, also on Polaroid film.

Instead of the usual infrared-sensitive resistor, the T-6 has what Barnes calls a pyroelectric detector, a wafer of crystalline triglycine sulfate with metal electrodes deposited on its two broad parallel faces. When i-r energy shines on this detector, a voltage appears across the electrodes; the more intense the i-r

## Chart-Pak® short cuts get printed circuit masters off the board fast!

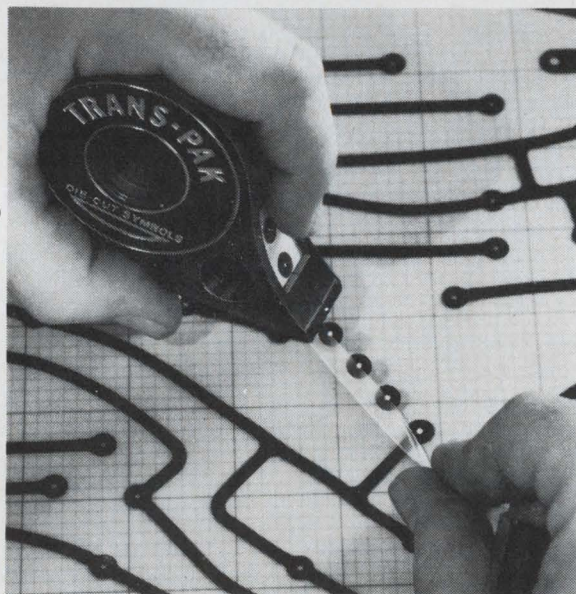

- Trans-Pak die-cut symbols and Chart-Pak pressure sensitive tapes cut time, cut cost.
  - Trans-Pak's unique patented "position, press and peel" method permits fast application of distortion-free symbols.
  - Chart-Pak crepe paper tapes precision-slit guaranteed to  $\pm .002$ " accuracy.
  - Finished masters reproduce with maximum sharpness . . . require minimum opaquing.
  - Chart-Pak's Precision Grids guarantee master accuracy.
- Using is believing . . . write for free catalog showing complete line of printed circuit materials.



**CHARTPAK ROTEX**

A Division of Avery Products Corp.  
1461 River Road, Leeds, Mass. 01053

Look In The Yellow Pages under Charts/ Business, Drafting Supplies, Tapes or Art Supplies for your dealer's name.



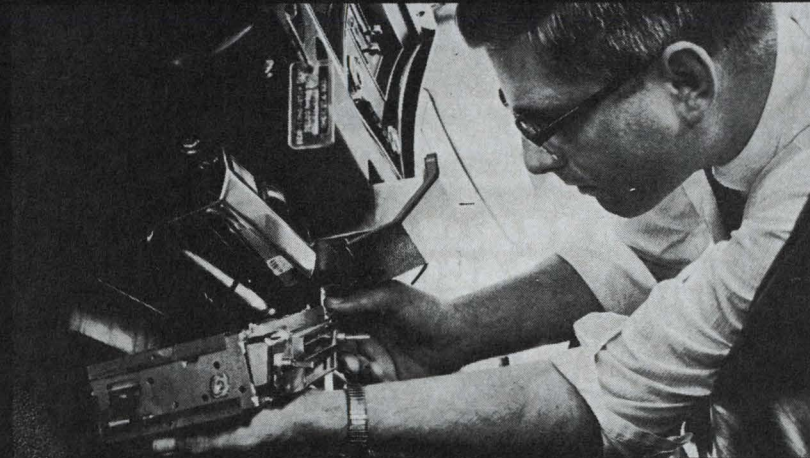

## Mondays never look the same to Bob Byse

When you're breaking ground on a new idea at Delco, you don't see a lot of your own desk. For Bob Byse, design engineering means work with two dozen solid professionals . . . people whose specialties range from microelectronics to model making to production. Wherever the project leads, Bob Byse is on his way. And every skill is at his disposal. Right through full production. And beyond. If there's trouble shooting under dealer warranty three years from now, Bob Byse is still the man we'll call for. That's why no two Mondays ever look alike to Bob Byse and his colleagues at Delco. The question is . . . can you say the same? Take a good hard look at how your responsibility shapes up, compared with Bob's. In fact, why not discuss it with us. By letter or telephone. Collect. Area Code 317/459-2808. Contact: Mr. C. D. Longshore, Supervisor, Salaried Employment, Dept. 304, Delco Radio Division of General Motors, Kokomo, Indiana.

**DELCO  
RADIO**



AN EQUAL OPPORTUNITY EMPLOYER  
DIVISION OF GENERAL MOTORS  
KOKOMO, INDIANA



**When  
reliability  
is the rule**

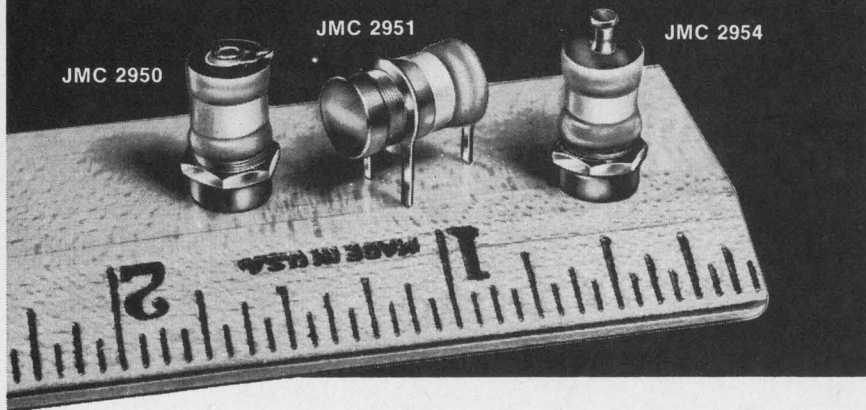

**... specify** *Johanson*

**HIGH Q, HIGH FREQUENCY  
VARIABLE AIR CAPACITORS**

This versatile series provides, in miniature size, exceptionally high Q, superior ruggedness for protection against shock and vibration, -55° to +125°C operating temperature range, protection against fungus, salt spray and humidity . . . plus all the other construction and performance features that have made Johanson capacitors the industry standard for excellence.

**Specifications**

- Capacitance Range:** 0.8 — 10.0 pF
- Dielectric Withstanding Voltage:**  
Rating 250 VDC breakdown >500 VDC
- Insulation Resistance:** >10<sup>6</sup>,  
megohms @ 500 VDC
- Q:** >2000 @ 100 mc
- Temperature Coefficient:** 0 ± 20 ppm/°C
- Rotational Life:** >800 revolutions

*Write Today for Complete Catalog, Prices.*

*Johanson* **MANUFACTURING CORPORATION**  
400 Rockaway Valley Rd., Boonton, N.J. 07005, (201) 334-2676

Electronic Accuracy Through Mechanical Precision

Circle 204 on reader service card

**Our little black book has  
over 100,000 phone numbers.**

You never had a black book like it. Over 1,500 pages. And those phone numbers! More than 100,000 telling you who to call/where to go, for the over 4,000 different product categories listed and advertised in the yellow pages of the Electronics Buyers' Guide.

It's the industry's one-stop shopping center that lets you find the products and services you need quickly. You can depend on EBG.

**Electronics Buyers' Guide**

A McGraw-Hill Market Directed Publication,  
330 West 42nd Street, New York, N.Y. 10036

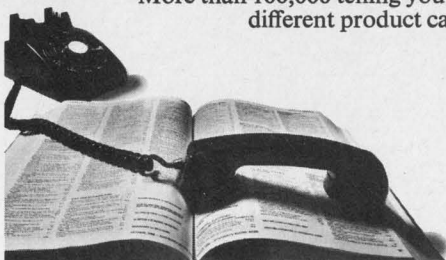

energy, the higher the voltage.

This voltage passes through a field-effect-transistor amplifier and modulates a beam of light that's focused onto the film. The detector works at room temperature, so the T-6 doesn't need any Dewar flasks and the operator doesn't have to carry around a thermos of liquid nitrogen.

In the color version, the modulated light passes through a filter on the way to the film. There's a group of filters in the T-6, each of which passes a specific color. Which one the light strikes de-



**Broad outlook.** The T-6 scans a 10° by 10° field covering 10,000 points.

pends upon the intensity of the received i-r energy. Instead of modulating the light, the infrared-generated signal rotates a mirror galvanometer that directs the light to a specific filter.

Both the color and black-and-white models have an electric control unit measuring 9½ by 5 by 9½ inches and weighing 15 pounds. One switch on this unit's panel selects the threshold of the camera—the minimum intensity of i-r energy that will produce a gray trace on a black-and-white picture or a black trace on the color shot. Anything below the threshold comes out white on a color picture and black on a black-and-white.

The other control on the panel determines the display's temperature bandwidth, which can be as narrow as 2.5°C.

The T-6 scans 10° by 10° and looks at 100 lines of 100 points each in that field.

Barnes feels the camera will find applications in areas where i-r photography has already proved itself, [Electronics, Aug. 5, p. 221] such as nondestructive testing, quality control, and medical screening.

Barnes Engineering Co., 30 Commerce Rd., Stamford, Conn. 06902 [427]



# HeNe GAS LASERS

Together with extreme reliability and low cost, ENL Models LS-30 and LS-32 feature:

- Advanced coaxial plasma tube design
- Compact, lightweight laser head for easy mounting
- Simple to operate
- Mechanically rugged design for industrial, laboratory, and classroom applications
- Needs no adjustment, except in the case of multimode operation
- Requires no alignment or maintenance
- Excellent output stability, exceptionally long life
- Fast delivery from stock

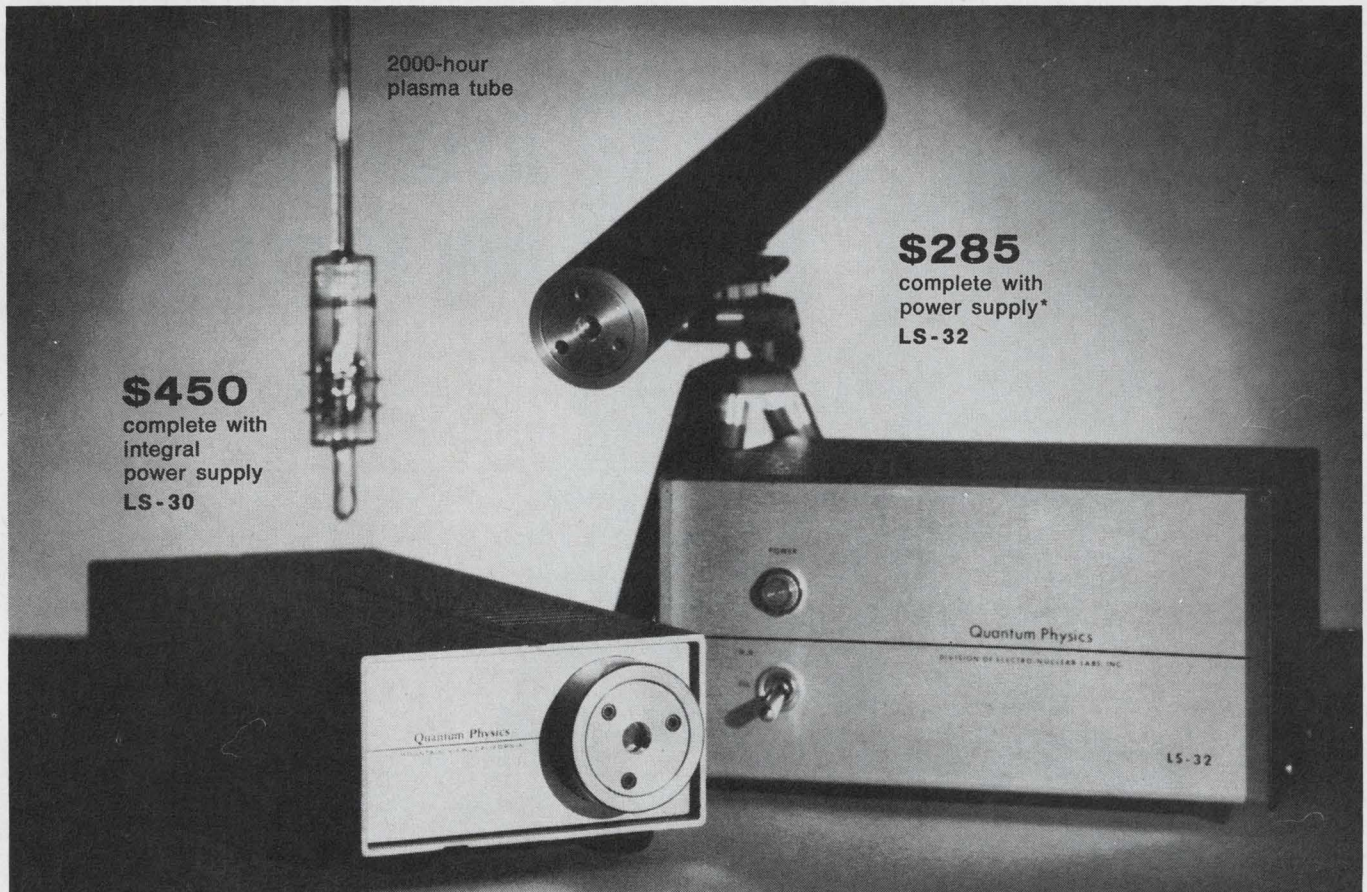

**\$450**  
complete with  
integral  
power supply  
LS-30

2000-hour  
plasma tube

**\$285**  
complete with  
power supply\*  
LS-32

\*Tripod extra

**LASER MODEL LS-30** Extremely compact, low noise CW gas laser with 1% regulated integral power supply. Portable, easy to operate. Features, in common with the entire Quantum Physics laser line, sealed interferometer mounts that require no adjustment, but have the capability for tuning all of the Fabry-Perot interferometer modes. Optical power at 6328 Å, single mode 2.0 mw.

**LASER MODEL LS-32** Educational / laboratory HeNe gas laser of exceptional quality and performance at minimal cost. A complete laser system (including 2% regulated dc power supply). Designed for ease of operation, mounting, stability, ruggedness, and long life. Serves as an excellent source of highly collimated optical radiation at 6328 Å. Output power, single mode 1.5 mw.

**Guaranteed operating life, both models, 2000 hours or one year shelf life.**  
**Ask also for information about ENL's ultra-fast laser and infrared detectors.**  
**Literature available on request.**



**QUANTUM PHYSICS DIVISION**  
**ELECTRO-NUCLEAR LABORATORIES, INC.**

115 Independence Drive, Menlo Park, California 94025 • (415) 322-8451



## The biggest little \$3.97 precision 10-turn wirewound pot in the world!

The Duncan "PIXIEPOT" potentiometer gives you the big features at a little price. It is the one and only precision 10-turn miniature pot for under \$4 that has all these features: □ Length: ONLY 3/4" □ Diameter: ONLY 7/8" □ Linearity: ±0.25% □ Resistance Range: 100 ohms to 100K ohms □ Power Rating: 2 watts @ +20°C □ Temperature Range: -25°C to +85°C □ Resolution: Better than ANY wirewound pot TWICE its size □ Slotted Stainless Steel Shaft/C ring □ Now you can save big dollars on your instrument and system requirements. Specify Model 3253

"PIXIEPOT" for as low as \$3.97 each in production quantities and only \$5.95 each for 1-24 units. In-stock delivery, of course. Call, write or wire Duncan today for complete specifications.



**DUNCAN electronics, inc.**

A DIVISION OF SYSTRON-DONNER CORPORATION  
2865 FAIRVIEW ROAD,  
COSTA MESA, CALIFORNIA 92626  
Phone: (714) 545-8261

# "PIXIEPOT"™

## little price, big features

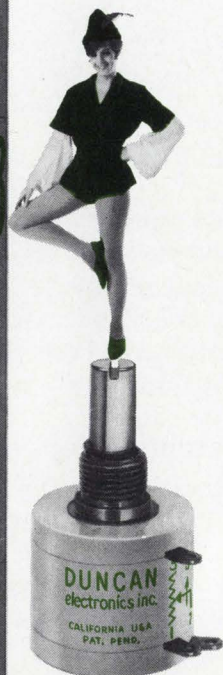



## New Semiconductors Review

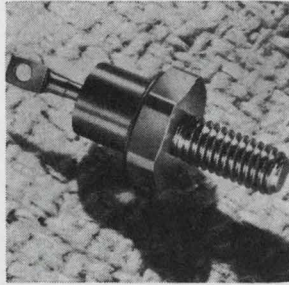

JEDEC D0-4 style 12-amp silicon power rectifiers now encompass types 1N1199A, -RA through 1N4506, -R. They have peak reverse voltages from 50 to 1,200 v. Units have surge-overload current ratings to 240 amps. They mount in any position by means of a 10-32 stud. Price ranges from 99 cents to \$3.45. Tung-Sol Div., Wagner Electric Corp., 1 Summer Ave., Newark, N.J. [436]

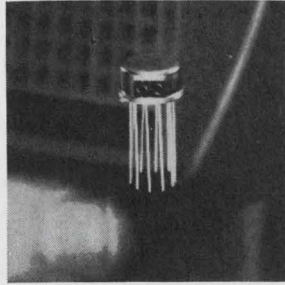

Monolithic AGC/squelch amplifier LM170 contains the preamplifier, variable gain circuit and sensitive squelch threshold detection on the same chip. It features large gain control of 80 db; differential inputs, with common-mode input range; dissipates 18 mw from +4.5 v supply. National Semiconductor Corp., 2950 San Ysidro Way, Santa Clara, Calif. 95051. [437]

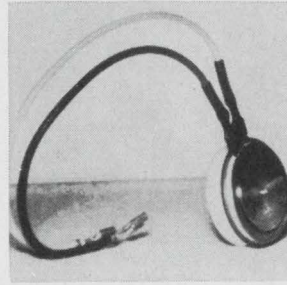

Flatpack thyristor type 272 is suited for use in motor controllers, welding applications, and primary control power systems. It is rated at 300 amps half-wave average, with forward blocking voltage to 1,500 v. Units have a forward-or-reverse-polarity mounting capability. Westinghouse Semiconductor Division, Youngwood, Pa. 15697. [438]

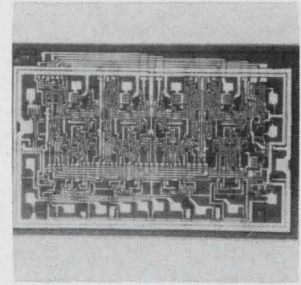

IC TTL 9306 is a monolithic up/down synchronous decade counter that performs with speeds greater than 15 Mhz and possesses excellent noise immunity characteristics. It can be used in any digital system where counting is required. Prices range from \$21.10 to \$69.30 according to quantity and operating temperature. Fairchild Semiconductor, 313 Fairchild Dr., Mtn. View, Calif. [439]

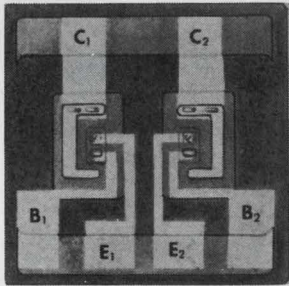

Dual transistors, the type most often used in differential amplifier circuits, are produced on a single 20 x 20 mil chip. Types K4044, K4045 and K4046 offer a  $V_{CE0}$  (at a collector current of 1 ma) of 60 v, 45 v and 30 v minimum. Prices for the chips start at \$1 and orders can be fulfilled on a 10-day basis. Industro Transistor Corp., 35-10 36th Ave., Long Island City, N.Y. [440]

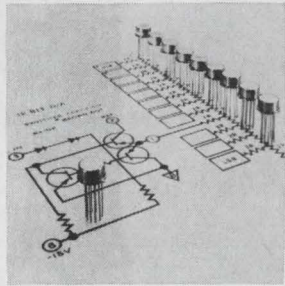

D-to-A ladder switches series CDA1 are usually used with a ladder network of 20,000 and 10,000 ohms. The theoretical variation of "on" resistance represents 0.25% of the 20K value. On this basis, the standard series hybrids will build a 10-bit system that is accurate to 1/2 bit. Price of a 12-bit system is \$528. Crystalonics, 147 Sherman St., Cambridge, Mass. 02139. [441]

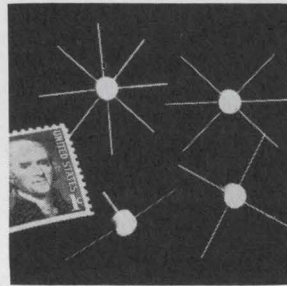

Multithrow, broadband PIN and varactor diodes, the D5109 "spiders", offer up to 8 ribbon radial leads with a common center lead. Breakdown voltage is 200 v at 10  $\mu$ a; junction capacitance, 0.2 pf at -50 v; series resistance, 2.5 ohms at 100 ma and 1 khz; switching time, 20 nsec; peak power handling capability, 700 w. Sylvania Electric Products Inc., Woburn, Mass. [442]

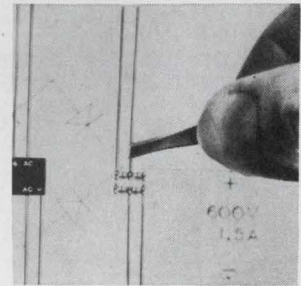

Miniature, single-phase bridges with universal application consist of 4 ultrahigh reliability, fused-in-glass, controlled avalanche diodes that are furnace brazed together. They have current ratings to 1.5 amp, surge ratings to 25 amps, piv's from 50 to 600 v, and recovery times of 2  $\mu$ sec, 500 nsec and 50 nsec, typical. Unitrode Corp., 580 Pleasant St., Watertown, Mass. [443]

## New semiconductors

### IC package permits unit or batch handling

Low-cost technique developed for hybrid assembly competes with flatpacks and transistor cans

A packaging design for integrated circuits which makes possible batch-packaging, testing, and assembly at reduced costs compared to conventional flatpacks and TO-5 cans has been developed by Varo Inc.'s Special Products division.

The technique involves a matrix,

called Versipak, which has as a base a single piece of 20-mil Kovar material so designed that up to 140 packages can be handled as a unit during production.

Varo developed the technique for its own hybrid assembly work. "A real good package didn't exist,"

says Jim Moore, manager of the Special Products division. "We wanted a package that would permit resistance welding without having to go to the transistor cans."

With development out of the way, the small Dallas-area firm plans to market the packages either in matrix strips or individually. It will also license its process to others for large production operations.

Moore says the price of Versipaks at this stage runs between 20 and 25 cents per package. This compares, he adds, with existing ceramic-type (flatpacks, TO-5 can) prices between 35 and 40 cents. With increased production, Moore



Ferrite Shielded Air Core Yoke C5380. Designed for high speed precision character displays (nanosecond writing speeds). Undesirable magnetic coupling and stray fields eliminated by unique shield design.



# DESIGN DEVELOPMENT FROM *syntronic* THE YOKE SPECIALISTS

Syntronic engineers and manufactures the most extensive line of deflection yokes available . . . and continually develops new designs to satisfy the ever increasing requirements of the display industry. For large production or custom applications get the engineering control and production experience that only SYNTRONIC, the yoke specialists, can provide.

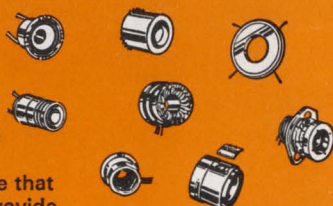

*syntronic*

**INSTRUMENTS, INC.**  
100 Industrial Rd., Addison, Ill. 60101  
phone 312-543-6444

Circle 208 on reader service card

estimates, the Versipak price will drop to about 10 cents. Varo plans to sell the packages in both the U.S. and overseas. Delivery time is two to four weeks.

**Gold plated.** Starting with the 20-mil Kovar material as a base, the Versipak sheet matrix is designed so that leads emerge at right angles from the bottom of the matrix. The bonding posts are these axial Kovar leads that project above the base where they have been sealed with glass. The entire matrix is plated with high-purity gold and the tops of the posts can be aluminized if aluminum wire leads are to be bonded to them.

Moore says that packages in the matrix can be handled as a single unit during circuit die bonding, lead welding, sealing and testing. The matrix can then be diced at the plant or shipped intact.

Packages can be as small as one-quarter by one-eighth inch. Varo is offering six standard sizes but can make the packages in various sizes with up to 70 leads.

The company cites several versatile mounting possibilities and other features. For example, the matrix can increase circuit package density on a printed-circuit board because of the axial-lead construction and shielded, all-metal design.

Varo Inc., 1500 Dallas North Parkway, Plano, Texas [444]

New semiconductors

## A-c up to 100 watts is controlled by IC

Japanese hybrid device  
regulates motor speed  
in fans, air conditioners

"Just for makers of consumer equipment" won't be stamped on the new hybrid integrated circuit developed by Japan's Origin Electric Co., although it was for use in such products as fans and blenders that Origin built the IC. Called the F87-01, the device is a medium-power-output circuit that can act as either an a-c phase controller or an a-c

## NORTON Magnetic Tape Heads

5218 1" Tape



5209 1/2" Tape

### SERIES 5200

Crosstalk—40 DB  
+75°C Temperature Operation

Send now for complete technical literature.

**NORTON**

ASSOCIATES, INC.

10 Di Tomas Court, Copiague, N.Y. 11726  
Phone: 516 598-1600

Cartoon by Whitney Darrow, Jr.

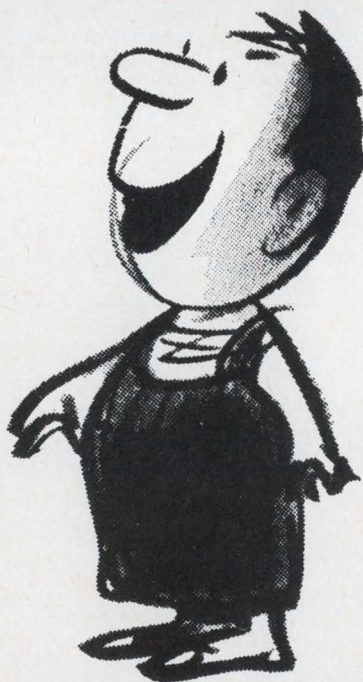

## Be a buddy!

One gift works many wonders  
**THE UNITED WAY**



switch, and can be used to regulate motors of any kind.

In the IC are a silicon controlled rectifier, a triggering element for the SCR's gate, and a diode, all bonded to a metal base and packed in epoxy. There are three leads, two for main current and one for the gate.

Normal input is 100 volts at 50 to 60 hertz, and the maximum output over a range from 10 to 68 volts is 100 watts. Though made for low-frequency jobs, the IC can be run, in some applications, at up to 5 kilohertz.

Origin estimates that a manufacturer can save up to 30% of his costs by switching from discrete components to the F87. Labor costs go down since there are fewer connections to make. Besides, says Origin, there's no danger of burning

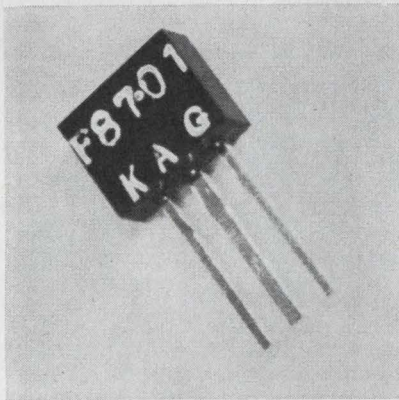

**Threesome.** Packed inside the IC's epoxy case are a silicon controlled rectifier, a trigger, and a diode.

out diodes with a soldering iron during fabrication.

Some applications suggested by Origin are motor controls in air conditioners, electric fans, sewing machines, and refrigerators, and temperature controls in toasters, heaters, and fans. The company says the device should also find uses in automobile voltage stabilizers and ignition systems.

The circuit is priced at \$1.10 in Japan. U.S. prices haven't been set yet, and Origin will probably insist that overseas orders be for lots of at least 10,000 units. Origin will be ready to market the device in October; it says delivery to overseas customers will take two months.

Origin Electric Co., 1-18 Takada, Toshimaku, Tokyo [445]

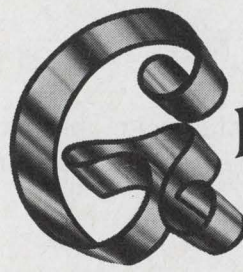

## GET THE SAME CRITICAL PROPERTIES TIME AFTER TIME BY USING HAMILTON STRIP AND FOIL

A step-by-step precise record of each operation in processing every order is kept in our files. This record is used as the standard for processing each subsequent order for the same material from the same customer. This method of manufacture insures the repetition of the same critical properties in each lot of the same material and eliminates "trial and error" processing in your plant.

Every lot of Hamilton strip and foil is produced under rigid control of mechanical properties through alloy analysis, annealing and heat-treating; the closest dimensional control by means of X-Ray and Beta-Ray gages; superior surface finish through the use of diamond lapped work rolls and process cleanliness.

This same technical "know-how" goes into the processing of every one of our 7 proprietary metals, 12 pure metals and 112 commercial alloys rolled in thicknesses from 0.060" down to 0.000070" in widths up to 12" and continuous coils to 1000 lbs.

Write, wire or phone giving us the material you desire and the properties you need. We'll tell you how fast we can get it to you—in quantity! Or, write for our latest catalog containing our capabilities and engineering data on all our materials.



### HAMILTON PRECISION METALS

Division of Hamilton Watch Company, Lancaster, Pa. 17604  
Telephone 717-394-7161 TWX 717-560-4417





## Shapes, shows, and stores sound spectra like no single instrument should.

By rights, no bandpass filter set should be able to do what B & K's Model 123 does.

But here it is doing it. Shaping sound spectra by dividing input into 36 one-third octave bands. What other instrument shapes it so fine?

Then vertical attenuators, mounted in two rows on the front panel, form a visual configuration of the set-in spectrum shape. What other instrument shows it so clearly?

And finally, a detachable memory bar recreates any previously recorded spectrum in seconds. What other instrument stores it for recall so easily?

See? The 123 shouldn't exist. But it does. Maybe you can find a use for it in the lab, sound studio, or classroom.

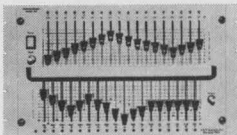

Write today. We'll send you the vital statistics. Judge for yourself whether we've created a monster or a miracle.

**B & K INSTRUMENTS, INC.**  
 Bruel & Kjaer Precision Instruments  
 5111 West 164th Street • Cleveland, Ohio 44142  
 Telephone (216) 267-4800 • TWX (810) 421-8266

## New semiconductors

### Decoding job built into IC

MOS gate driver compatible with both low-power and standard DTL or TTL

By adding an AND gate to the input stage, Siliconix, Inc., has incorporated the decoding function into the latest member of its family of metal-oxide-semiconductor gate switches and drivers. A binary counter must be decoded into four or eight lines, or however many switches are in the user's system. Ordinarily, external gates are required. But Siliconix's D129 quad driver for MOS switches has a 3-input AND gate to decode a binary counter to four lines, thus eliminating one level of logic for the user.

The additional circuitry makes the D129 the most complex of the two dozen or so IC's in the line, with a chip size of 50 by 75 mils. What IC Design Supervisor Jerry Parker describes as "evolutionary" advances in processing has also extended the usefulness of the device: the D129 has a maximum  $I_f$  (input forward current) of 200 microamps, making the input fully compatible with low-power DTL or TTL circuits as well as the standard power series of both logic families.

Siliconix's MOS switches have a self-contained field effect transistor that acts as a load resistor for the gate. Since the decoder/driver is intended for use with these switches, the driver chip contains no pullup resistor. If it is used with other switches, the user will have to provide an external resistor.

With 36-kilohm resistors in the input AND gate, the circuit has a low standby power of 1 milliwatt when the gates are turned off by the common inhibit line. Siliconix says that the design makes the circuit easy to use directly with conventional binary counters in multiplexers, time sharing systems, digital/analog converters, and other analog switching systems.

Siliconix Inc., Sunnyvale, Calif. [487]

# YOUR FREE COPY IS READY!

## NEW 1969 NEWARK INDUSTRIAL ELECTRONICS CATALOG

- ★ The one-source buying guide
- ★ Over 70,000 items—500 major brand lines
- ★ 700 pages

★ Over \$7,000,000 industrial electronic inventory  
 NEWARK HAS IT NOW, THE COMPLETE LINE OF



Low-drain, accurate voltage sensors at practical prices. Adjustable pick-up and drop-out type or factory set pick-up and adjustable drop-out. Both for 24V DC or 120V AC operation.

**Contacts**—Two Form C (DPDT), rated 3 amps at 28V DC or 120V AC; **Max. current drain**—30 ma, after sensing; **Sensing current drain**—3 ma, max.; **Operating temp.**—40°C to +55°C; **Accuracy**—1%; **Rated life**—100,000 operations; **Termination**—Standard octal plug.

Immediate delivery from stock—factory OEM prices  
 —fast efficient service from 11 Newark warehouses.



### New Main Office & Warehouse

**NEWARK ELECTRONICS CORPORATION**

500 North Pulaski Chicago, Illinois 60624  
 (312) 638-4411

- AUTHORIZED P & B WAREHOUSES IN**
- ★ Minneapolis, Minn. (612) 331-6350
  - ★ Cincinnati, Ohio (513) 421-5282
  - ★ Denver, Colorado (303) 757-3351
  - ★ New York City (212) 255-4600
  - ★ Dallas, Texas (214) BR 2-3571
  - ★ Detroit, Michigan (313) 548-0250
  - ★ Los Angeles Area (213) OR 8-0441
  - ★ Grand Rapids, Michigan (616) 452-1411
  - ★ New Orleans, Louisiana (504) 834-9470
  - ★ Houston, Texas (713) 782-4800



## PROFESSIONAL ENVIRONMENT

The Fort Worth Division of General Dynamics strongly urges and encourages all personnel to take advantage of the excellent educational facilities in and near Fort Worth to further their professional development through participation in graduate and undergraduate degree programs at five area universities and colleges. Full tuition refund is provided by General Dynamics for successfully completed, job-related courses.

A graduate study program of exceptional merit is offered by University of Texas at Arlington, located within 15 minutes' drive

of Fort Worth, with evening classes leading to the Master of Science degree in Electrical Engineering, Engineering Mechanics, and other fields.

Southern Methodist University and Texas Christian University, jointly, offer evening classes in Fort Worth leading to the Master of Science degree in five fields of engineering—electrical, mechanical, civil, and industrial engineering, and engineering mechanics. In addition, the Institute of Technology at Southern Methodist now offers "The Texas Twelve"—a new program of Cooperative Graduate Fellowships.

Short courses and seminars may be selectively attended at leading universities across the United States, and industry-

education liaison programs with Caltech, MIT, and the University of Texas facilitate a continuing exchange of ideas and knowledge.

Assistance and P. E. registration are provided for all qualified engineers, and membership is encouraged in professional societies.

Informal in-plant courses relating to current projects are conducted during working hours, with periodic after-hours courses with voluntary enrollment provided in response to employee interest. Membership is also available to all professional and technical staff members in the General Dynamics Management Association of Fort Worth, which provides a broad spectrum of knowledge-heightening programs.



Engineering and scientific action is required to solve the intriguing problems posed by aerospace projects in research, development, design, test and evaluation now in progress at the Fort Worth Division of General Dynamics. If your creative background and education qualify you for advanced assignments, you'll find room to satisfy your potential. You'll enjoy action living, too, in smog-free Fort Worth, where residential areas are easily reached via uncrowded freeways . . .

and where a broad range of cultural, recreational and upper level educational facilities is at hand.

A mild climate and low living costs make an added contribution to your career satisfaction. Call Collect—817-732-4811, Extension 3551; or send a résumé of your education and experience to Mr. J. B. Ellis, Industrial Relations Administrator-Engineering, General Dynamics, Fort Worth Division, P.O. Box 748E, Fort Worth, Texas 76101. An equal opportunity employer.

## **GENERAL DYNAMICS**

### *Fort Worth Division*

Of primary interest in the Fort Worth Division's current \$37 million facility expansion program is the new \$8 million Engineering and Office Building, encompassing 581,400 square feet and covering 12 acres.

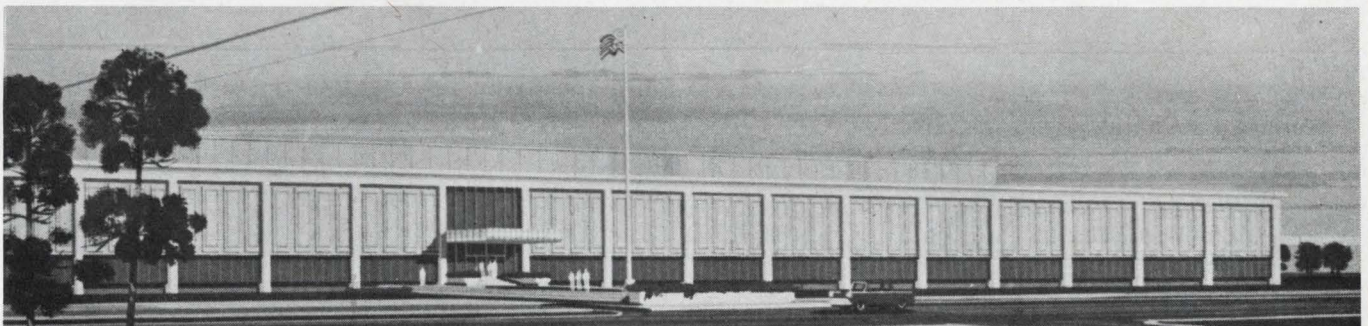



# If you thought all Daystrom pots were squares

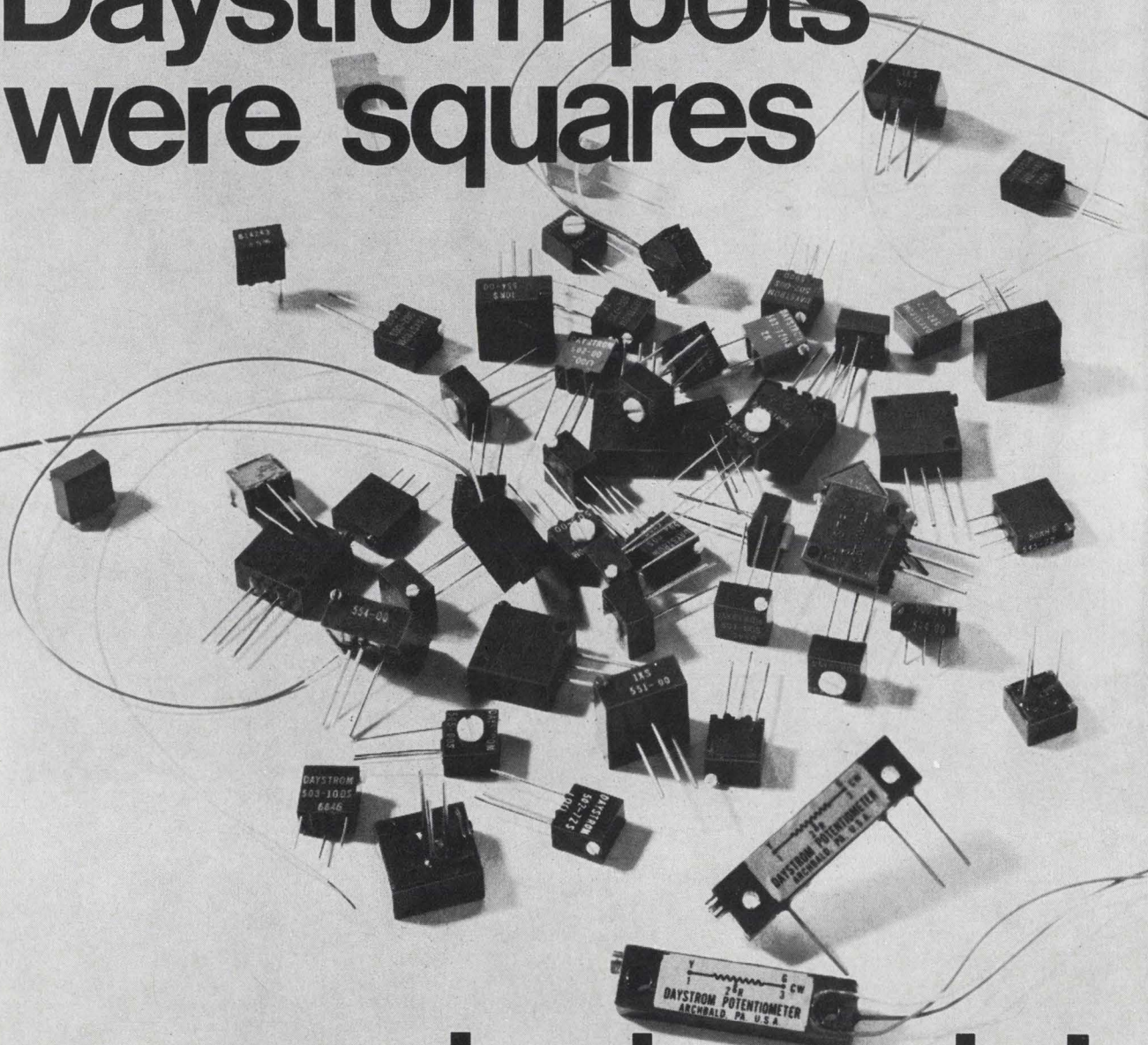

## ...look again!

Rectilinear components are still a necessary requirement in many circuit applications. That's why Weston has rounded out its high-performance potentiometer line with two new rectilinear models. RT-12 styles 534 and 535 are designed for both general-purpose and military applications. They feature the same  $\pm 5\%$  tolerance, 10 ohm to 50K range, and slip clutch stop protection that are standard with Daystrom Squaretrim® units, plus 24-turn adjustability and

humidity proofing. Also new this year . . . models 553 half-inch and 543 three-eighth-inch Squaretrim potentiometers in military and commercial versions. Save board space as well as money with our field proven 501 Series multi-turn and 504 Series single-turn  $\frac{1}{16}$ " Squaretrims offering values to 20K in a 0.02 cubic inch case. All Squaretrim Diallyl-Phthalate cased pots give you Weston's patented "wire in the groove" construction and your choice of flexible leads,

pin and screw configurations. Whether your trimmer needs are military, industrial or commercial, you'll find the answer in this complete new low-cost line. Write today for data sheets and evaluation samples. DAYSTROM potentiometers are another product of WESTON COMPONENTS DIV., Archbald, Pennsylvania 18403, Weston Instruments, Inc., a Schlumberger company

**WESTON®**



## New Industrial Electronics Review

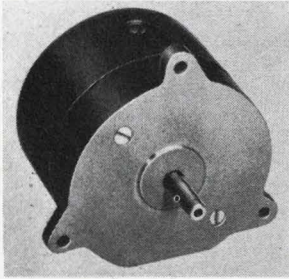

Torque motor model NT-2173A is designed for commercial applications in positioning and rate control for computer peripheral devices, magnetic tape or wire drives, and camera drives. It develops 54 oz-in. torque for 58 w input power. The unit is 2½ in. in axial length, 3½ in. in o-d. Price is under \$60 in quantities. Inland Motor Corp., 501 First St., Radford, Va. [401]

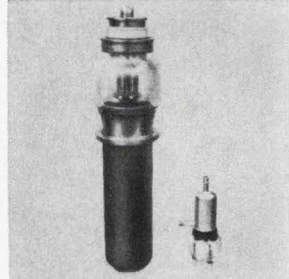

Two control diodes, capable of controlling up to 30 kw (WL-23178) and 360 kw (WL-23454), are for industrial control applications ranging from machine tools to dielectric heating. The former has a max. forward voltage of 15,000 v; and the latter, 20,000 v. Both have a control time of 0.2 sec. Westinghouse Electronic Tube Division, P.O. Box 284, Elmira, N.Y. 14902. [402]

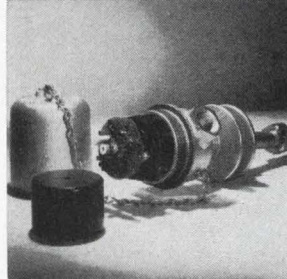

Two-wire thermocouple-to-current transmitter is a solid state unit that eliminates intermediate transducer. Output signal and input are carried on 2 copper wires, making thermocouple extension wire unnecessary. The device is said to be immune to extreme ambient temperature changes and corrosive atmospheres. Price is \$295. Honeywell Inc., Fort Washington, Pa. [403]

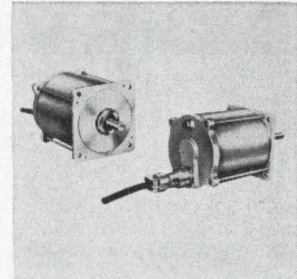

Slo-Syn precision d-c stepping motor type HS50D is internally viscous damped to minimize shaft overshoot. It makes 200 precise steps per shaft revolution. Each step of 1.8° is accurate within ±3% noncumulative. Speeds faster than 500 steps/sec are possible using accelerating and decelerating circuits. Superior Electric Co., Bristol, Conn. 06010. [404]

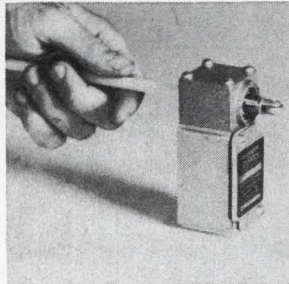

Limit switch model C2-JA529, a roller-activated, plunger-type manual reset unit, includes a plunger rod that is pushed out when trouble occurs, overload or fault loads are encountered, or some other abnormal operation of the machine or process develops. The nylon rod (8 in. long) can be cut to any suitable length. R.B. Denison Inc. 103 Broadway, Bedford, Ohio. [405]

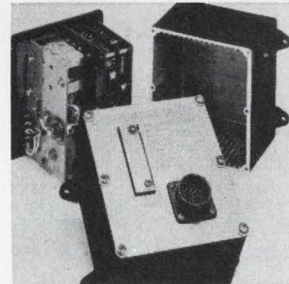

Solid state turbine speed switches and turbine temperature switches use IC's to minimize size and maximize reliability and performance. Speed switches feature 1% accuracy. Temperature switches feature ±10° F accuracy, 50 msec response, and up to 6 adjustable outputs from 0 to 1,500° F. Crydom Controls, 3115 W. Warner Ave., Santa Ana, Calif. 92704. [406]

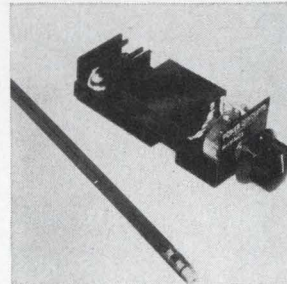

D-c motor speed controller MC3 has infinitely variable speeds and makes available true linear output speed as a function of the control setting with stable performance down to zero RPM. The unit shown is 4 in. deep, with 1½ x 1½ in. front panel space required. The 1/50th h-p controller costs less than \$10 in large lots. Power Concepts Corp., Box 684, Binghamton, N.Y. [407]

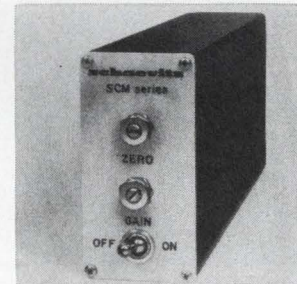

Transducer signal conditioner series SCM is suited for use in indicating, recording and controlling systems in a wide variety of industries. Specifications include linearity of ±0.25% of full scale, frequency response with 3 db to 250 hz, and temperature stability of ±2% of full range output from 32° to 120° F. Price is \$250. Schaevitz Engineering, Box 505, Camden, N.J. [408]

### New industrial electronics

## Monitor warns of car light that fails

Reed-relay system glows green when lights are working, red if any burn out; use in some 1969 autos is predicted

"Doesn't that fool know his brake lights are out?" Probably not. Short of getting shouted at by a passing motorist, a driver has no way of knowing if a car light isn't working. But the Federal Government may change this by requiring that new cars carry a light monitor.

The Gordos Corp., a maker of reed switches, has such a device ready now. Called the Essential Light Monitor, the Gordos system has two parts. One, a package the size of a small flashlight, is connected on one side to the car lights and on the other to the battery

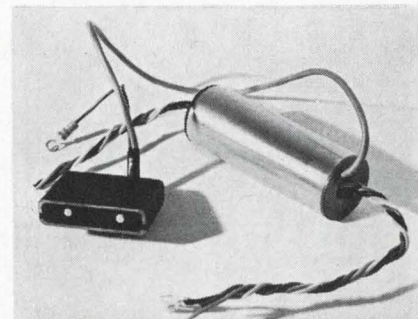

**Sentry.** A reed switch in the cylindrical package closes when a light fails, and the red panel light comes on.



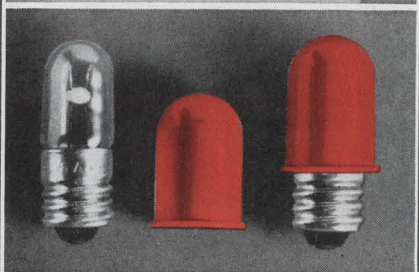
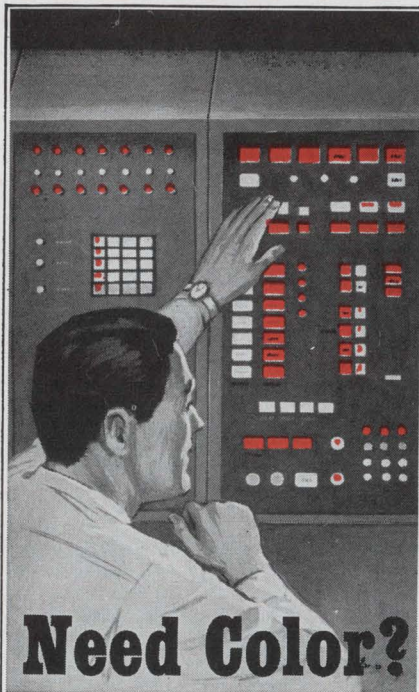

# Silikrome<sup>®</sup>

## + Lamp = Color

Just snap a SILIKROME color filter over a clear miniature lamp. That's all! No need to worry about special fittings, coated bulbs that fade or plastic filters that melt. SILIKROMES are made of silicon rubber, will never fade, can withstand 500°F for over 1,000 hours. They come in any color; are interchangeable, unbreakable, reusable, act as shock mounts. Want proof? Return the coupon below and we'll send you some of our fabulous SILIKROMES.

**APM** HEXSEAL CORPORATION  
44 HONECK ST., ENGLEWOOD, N.J.



APM-HEXSEAL CORP.  
DEPT. E-89  
44 Honeck St., Englewood, N.J.

- Please send free samples and full details on commercial and military applications of SILIKROMES.
- Please have a representative call.

Name \_\_\_\_\_  
 Title \_\_\_\_\_  
 Company \_\_\_\_\_  
 Address \_\_\_\_\_  
 City \_\_\_\_\_  
 State \_\_\_\_\_ Zip \_\_\_\_\_

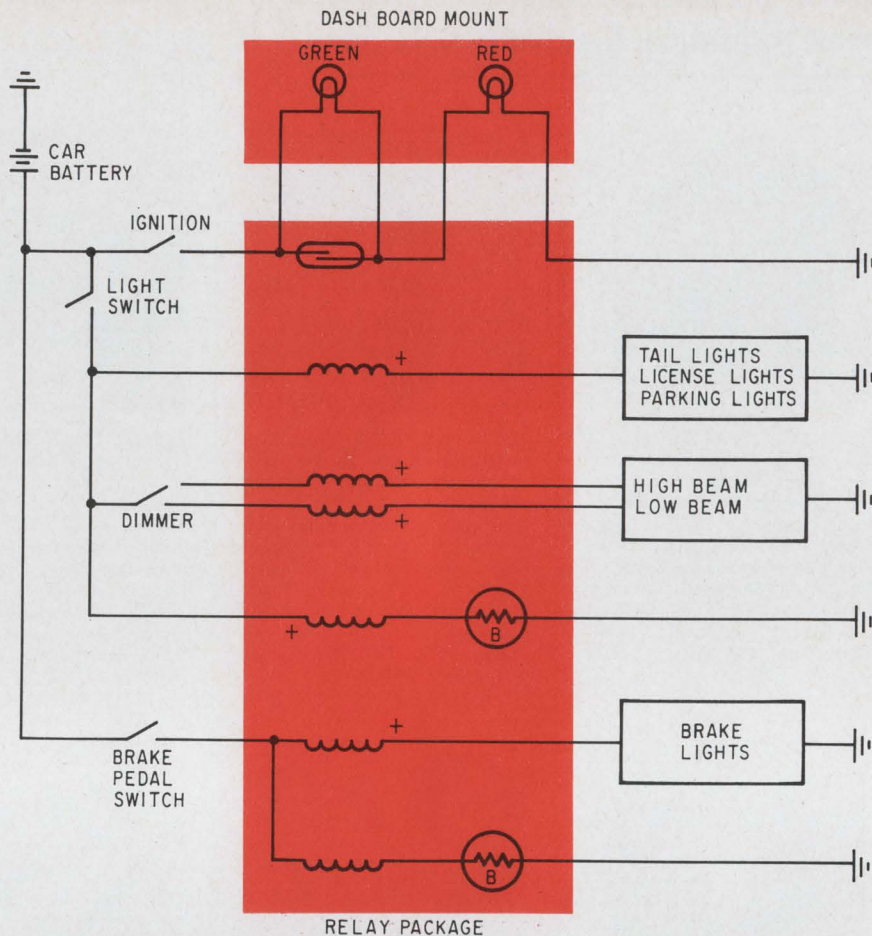

**Light lookout.** As long as all car lights are working, the magnetic field of the light coils is equal and opposite to the field of the ballast coils. When a light fails, a net field appears and the reed closes. The green lamp goes out and the red one glows.

through the dashboard switches. Inside the package are coils, ballast lamps, and a reed switch.

The other part, a 3-by-1½-inch panel containing a red and a green lamp, fits on the dashboard. The green lamp is in parallel with the reed switch, and both are in series with the red lamp.

Although Gordos is concentrating on the auto makers now, the company feels it can eventually go after a much broader market. For example, the system could keep watch on the lights on a highway or runway, or might be adapted for use as a short-circuit detector.

When the monitor is installed in a car, some of its coils are in series with the battery and the lights, while the others are between the battery and the ballast lamps. They're arranged so that the ballast coils' field is opposed by the magnetic field caused by current flowing in the light coils.

As for the lamps, a green light in-

dicates that all lights supposed to be on are on; a red light means that either a light's out or the monitor isn't working.

The reed is open when a driver switches on the ignition, so current flows through both the green and red lamps. Only the green one glows, however, because the red lamp requires a great deal more current to light it up.

If the driver turns on his lights, current flowing through coils to the lights sets up a magnetic field in the package. This field is canceled by one set up by current flowing at the same time through the ballast circuits. The reed feels no magnetic pull and remains open, and the driver sees the green lamp glowing.

**Seeing red.** Failure of a light causes a current change in its coil. A field appears in the cylinder and the reed closes, taking the green lamp out of the system. Current in the red lamp therefore increases,



# WE MAY ALREADY HAVE DESIGNED THE SILICON RECTIFIER ASSEMBLY YOU WANT

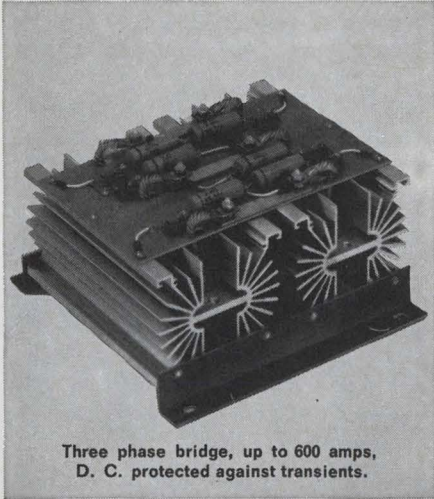

Three phase bridge, up to 600 amps.  
D. C. protected against transients.

Tung-Sol packages a lot of performance into silicon rectifier stacks. Thorough experience in heat sink configuration, control of transients and the manufacture of solid state devices, assures highest efficiency in units that require only minimum space. Power capability is extremely broad.

Write for descriptive literature. Describe your requirements and we will offer specific suggestions. Tung-Sol Division, Wagner Electric Corporation, One Summer Ave., Newark, N.J. 07104.

Controlled avalanche assembly, to 150KV at 12 amps, single phase, half-wave rating.

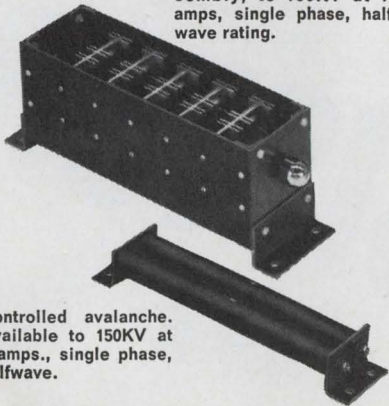

Controlled avalanche. Available to 150KV at 3 amps., single phase, halfwave.

## TUNG-SOL®

### SILICON RECTIFIER ASSEMBLIES

© REG. T.M. WAGNER ELECTRIC CORPORATION

Circle 248 on reader service card

## ... a third lamp tells if brake lights are on ...

and that light starts to glow.

There's usually one ballast loop for brake lights and one for the rest of the lights. The total number of loops required depends on the number of lights being monitored and the tolerances of those lights' current ratings. The closer the tolerances and the fewer the lights, the fewer loops are needed.

The system keeps a close watch on itself. If a coil goes bad, the field changes and the red light comes on. If the reed is working properly, the red light comes on briefly when the dimmer switch is pushed.

**Looking blue.** John Dieth, Gordos' sales manager, says the ballast lamps can be mounted outside the case and used as external lights. He also notes that Gordos is considering adding a third indicator lamp, possibly blue, that would be in series with the brake lights.

Dieth explains that when the driver hits the brakes, the brake light switch closes; current flows to the lights through their coil and also through the brake light's ballast loop. It's possible that when the driver releases the brakes, the switch will stick and the lights will stay on. The blue lamp would alert the driver to this condition.

A few cars now have a fiber-optic system that tells specifically what light fails. But Dieth says the Gordos system is a lot easier to install on the assembly line.

Gordos has shown the system to Detroit's Big Three, and says all have shown interest. In fact, Dieth predicts that the Essential Light Monitor will be available in some 1969 cars. Gordos' price to auto-makers will be under \$10.

**Endorsement.** The system has road experience. Connecticut's John Fitch & Co., which customizes standard models, has been offering the monitor as an option and has installed it in many of the company's Corvair Sprints, Toronto Phantoms, and Fitch Firebirds. John Fitch, the company's president and a former racing driver, describes the system as "very satisfactory".

Gordos Corp., 250 Glenwood Ave., Bloomfield, N.J. 07003 [409]

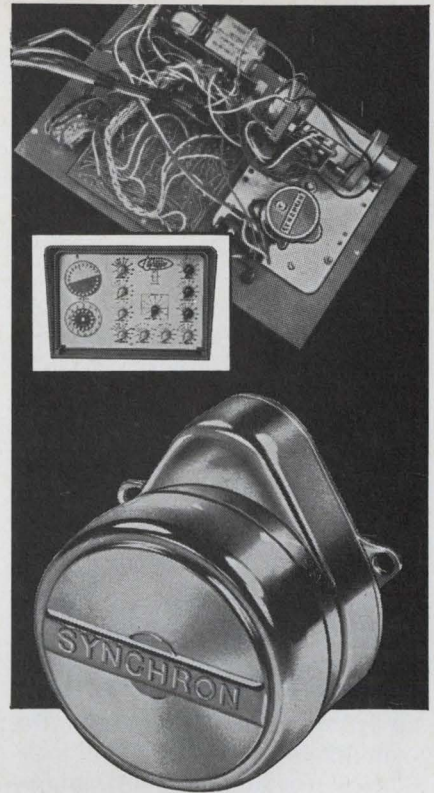

## HOW SYNCHRON® MOTORS control this specialized TIME-DELAY RELAY

In this special design timer a Hansen SYNCHRON Motor drives the cam-type sequence timer for an electronic time-delay relay. When power is applied, SYNCHRON runs through the first three sequences; starts the time-delay relay, then stops. Relay performs a panel-adjustable delay period of 180-240 seconds, then returns power to the motor to complete the sequence. Special applications are easy to design, using SYNCHRON Motors. How about yours? Call or write Hansen, or your SYNCHRON representative, for brochure and all the facts.

**SYNCHRON timing and control motors; 168 different speeds. Right, left or reversible rotations. 8, 20 or 30 oz.-in. torques; 220, 110 or 24 volts; 60, 50 or 25 cycles.**

Visit Booth No. 1726, ISA Exhibit

## HANSEN

Manufacturing Co., Inc., Princeton, Ind. 47570

HANSEN REPRESENTATIVES: CAREY & ASSOCIATES, Houston and Dallas, Texas; R. S. HOPKINS CO., Sherman Oaks, Calif.; MELCHIOR ASSOCIATES, INC., San Carlos, Calif.; THE FROMM CO., Elmwood Park, Ill.; JOHN ORR ASSOCIATES, Grand Rapids, Mich.; H. C. JOHNSON AGENCY, INC., Rochester, N.Y.; WINSLOW ELECTRIC CO., Essex, Conn., Narberth, Pa., and New York, N.Y.  
EXPORT DEPARTMENT: 64-14 Woodside Ave., Woodside, N.Y.

Circle 215 on reader service card

215



## New Books

### Talking to the machine

Applied Linear Programming  
J. Ronald Frazer  
Prentice-Hall, Inc.  
174 pp., \$7.95

Despite a few shortcomings, Frazer's book is a welcome addition to a computer user's library.

After defining linear programming—a technique for finding the best of several possible solutions to a problem—Frazer outlines a simple graphical solution and then moves to the simplex method, a means of arriving at tabular solutions of problems too complex to handle graphically. Although hand calculations can be applied to the simplex method, the amount of work can be enormous. Here's where the computer comes in.

Frazer's coding for a Fortran program for the simplex method, a list of instructions reproduced from a computer printout, is liberally interspersed with comments, and he

devotes an entire chapter to a description of the program and how it works.

The remainder of the book deals with setting up the problem in tabular form, establishing variable costs, assigning facilities to tasks, and deciding whether a problem should be stated to maximize profits or minimize costs.

Among the book's shortcomings is the Fortran listing; the author assumes that the reader is familiar with the language. But a simple Fortran listing isn't self-explanatory, even with the many interspersed comments in the listing and the accompanying textual description.

The listing also includes an uncomprehensive output table, though the author says, "The form and accuracy of the output can readily be checked by comparing with the hand solution given previously." A flow-chart would have been better, either in addition to the Fortran

listing or instead of it.

Less important, but still irritating, is the fact that references to previously discussed material are often unclear. More serious is the omission of a bibliography. Knowing where to turn for further study would be of great value to the interested reader.

### Mathematical approach

Introduction to Distributed Parameter Networks With Application to Integrated Circuits  
Mohammed S. Ghauri and John J. Kelly  
Holt, Rinehart, & Winston  
352 pp., \$11.95

Both the academic and industrial communities should be interested in this book. The subject of distributed-parameter networks is treated at a level suitable for a graduate course, and the mathematical methods of analysis are constantly stressed.

The reader is introduced to distributed-parameter structures by being asked to consider the familiar RLC transmission-line problem, and the application of the pole-zero

### CTS series 750 cermet resistor networks with snap-in formed leads . . .

for either automatic insertion or hand mounting.

- Available in 4 sizes and an infinite number of circuit combinations.
- Extremely good environmental specifications.
- 5 lbs. pull strength on leads.
- Available with or without active devices.

**Delivery:** 2 weeks for prototypes; 4-6 weeks for production quantities.

**Order from:** CTS of Berne, Inc., Berne, Indiana 46711. (219) 589-3111.

### CTS CORPORATION

Founded 1896

Series 750	2-pin 1 resistor	4-pin 3 resistors	6-pin 5 resistors	8-pin 7 resistors
1,000 piece price	31.6c ea.	29.6c ea.	40.6c ea.	50.9c ea.
10,000 piece price	15.8c ea.	15.5c ea. (5.2c/ resistor)	21.0c ea. (4.2c/ resistor)	26.1c ea. (3.7c/ resistor)

These prices are based on  $\pm 5\%$  tolerance,  $\pm 300\text{ppm}/^\circ\text{C}$  standard TC, and 50 ohms thru 100K ohms resistance range with all resistance values being within a 10:1 ratio per side.

# CERMET RESISTOR

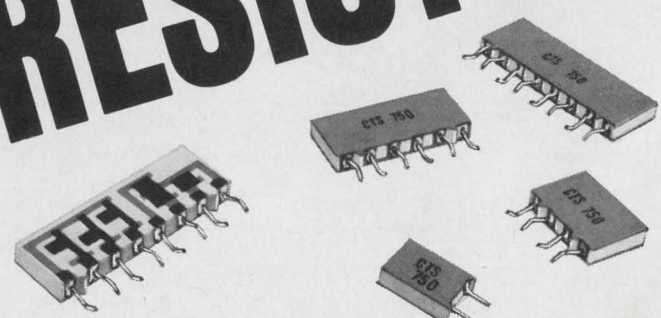



concept makes the treatment interesting. Properties of the two-port networks are then developed and presented in terms of basic-set solutions of the transmission-line equations.

This is followed by the treatment of a wide range of topics, including frequency and transient response, network tapering, discrete and distributed terminations, generalization of root-locus techniques and stability tests, and the synthesis of distributed-parameter networks. There's also an extensive bibliography and several appendices devoted to particular mathematical methods.

The central theme of the book is the applications of mathematical techniques to distributed-parameter networks. Of the wide variety of analysis methods covered, some have been familiar in mathematical circles for a long time while the rest, the result of research by the authors and others, are new. All are carefully presented, with the authors noting any new or novel material and placing developments within the context of an existing

body of literature. The authors also point out areas in which there are unsolved problems of particular interest.

The many examples included will be of special interest to the practicing engineer.

John J. Golembeski  
Bell Telephone Laboratories  
Murray Hill, N.J.

### Problems and diagrams

Detection, Estimation and Modulation Theory, part 1  
H.L. Van Trees  
John Wiley & sons  
697 pp., \$20

The first of a two-volume set, this book develops and organizes the concepts of detection and estimation theory. The framework is such that specific problems in either field can be approached in a logical and orderly fashion. The book is basically organized into three sections, the first discussing the background to classical theory and the representation of random processes, and the other two sections handling

the major areas of detection and estimation.

The book is written in an extremely fluid and easy style that almost lulls one into a false sense of security; this work is not intended for casual reading. It was written for, and is clearly aimed at second-year graduate students. An unusual feature is the inclusion of an appendix outlining the material covered in the form of a 32-lecture series.

Two features make this volume particularly attractive. First of all, it makes generous use of problems as illustrative examples—120 pages are devoted to problems. Solutions to about a third of them will be published in paperback edition this fall.

Secondly, block diagrams and performance curves abound. And so-called "optimum receivers" are derived not only in the rigorous mathematical formulation, but are reduced to the functional block diagrams familiar to engineers.

Gino J. Coviello  
Sylvania Electronic Systems  
Williamsville, N.Y.

# NETWORKS

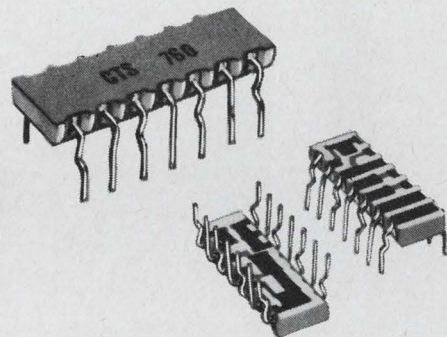

**CTS Series 760 cermet resistor network or thick film hybrid circuit is mechanically compatible with standard 14 lead dual-in-line package . . . simplifying automatic insertion**

and reducing assembly costs accordingly. The networks can also be easily hand mounted.

#### Series 760 provides:

- Up to 13 resistors per module with an infinite number of circuit combinations.
- Extremely good environmental specifications.
- 5 lbs. pull strength on leads.

**Delivery:** 2 weeks for prototypes; 4-6 weeks for production quantities.

**Order from:** CTS of Berne, Inc., Berne, Indiana 46711. (219) 589-3111.

Series 760	9 resistors	11 resistors	13 resistors
1,000 piece price	82c ea.	86c ea.	90c ea.
10,000 piece price	41c ea. (4.5c/resistor)	43c ea. (4c/resistor)	45c ea. (3.5c/resistor)

Prices shown are based on  $\pm 5\%$  tolerance,  $\pm 300\text{ppm}/^\circ\text{C}$  standard TC, and 50 ohms through 100K ohms resistance range with all resistance values within a 5:1 ratio per side.

# CTS CORPORATION





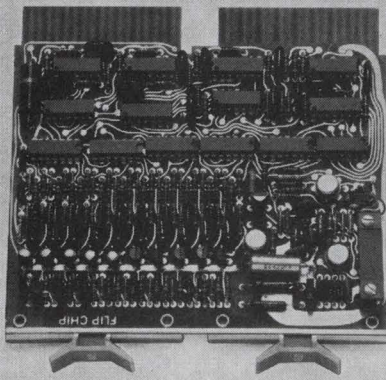

## Complete High Speed A to D Converter: ~~\$750~~ \$450

An analog to digital converter complete on one module and just 5 by 5 by 1/2 inch, including the control logic, digital register, comparator and internal precision reference supply, converts 100,000 samples per second with an accuracy of 0.1%.

The A801 converter, part of our A Series module line, is designed for industrial and scientific instrumentation applications with DIGITAL's range of small computers. It features the reliability, space savings and speed of the latest TTL integrated circuits coupled with the economies of mass production and machine assembly.

DIGITAL is the world's leading producer of logic modules. Our dominance in this area, and our experience with interfacing between measuring systems and computing systems, resulted in the development of this converter.

Other converters, interfacing modules, modules for computer-speed instrumentation and industrial control modules are all described in our Industrial Control and Logic Handbooks. Write for free copies.

### A801 A to D Converter

#### Specifications

**Input:** Uni-polar

Voltage 0 to +10v

Impedance 1000 ohms

**Output Format:** Parallel Binary  
Uni-polar

**Digital Output:** Logical "0" + 0.4v max.  
Logical "1" + 2.4v min.

**Resolution:** 10 bits

**Accuracy:** 0.1% of full scale

**Conversion rate:** 100 kHz max.

**digital**  
MODULES · COMPUTERS

Maynard, Mass. Tele: (617) 897-8821

## Technical Abstracts

### Medical Market

The electronic medical instrumentation market from a hospital administrator's point of view, Seymour Schulman  
Los Robles Hospital  
Thousand Oaks, Calif.

Hospitals today constitute a \$200 million-to-\$300 million electronic medical instrumentation market—one that should increase by 1977 to \$1.5 billion. An additional 25,000 beds are needed right now for the intensive care of coronary patients in the nation's 6,500 hospitals. This represents an immediate potential market in patient monitoring equipment alone of \$125 million.

At the present time, it's estimated that hospitals spend between \$400 million to \$500 million dollars a year, or approximately 3% of their current plant asset value, for capital equipment needs. About half this amount goes for electronic medical equipment such as pacemakers; defibrillators; oscilloscopes; ekg, eeg, and emg gear; cauteries; ultrasonic washers; X-ray diagnostic, fluoroscopic, and therapy units; radioisotope scanners, and scalers; autoanalyzers; ballisto-cardiographs; and blood-volume and electro-phoresis equipment.

The total health industry by 1977 should represent a market of \$3 billion to \$3.5 billion. The stream of electronic instrumentation flowing into medical research laboratories and hospitals is transforming medicine from an art to a science.

The establishment of intensive-care and coronary-care units should stimulate the science of patient monitoring. Eventually, all acutely ill patients will be monitored, as well as such ambulatory patients as those with a high-risk "coronary profile." The equipment and know-how exists today. It is just a matter of how much and how fast the medical profession and hospitals want to assume that much wider role of being the sentinel and guardian of the community's health—rather than just its doctor and its place of treatment.

The extension of telemetry to outpatients connected through private or pay station dataphones to

preset computers in the hospital could alert the patient, the doctor, and the hospital to danger.

Presented at Wescon, Los Angeles, Aug. 20-23.

### Blast protector

Nuclear-electromagnetic-pulse protection for communications facilities and equipment  
Don B. Clark and Homer A. Lasitter  
U.S. Naval Civil Engineering Laboratory  
Port Hueneme, California

The electromagnetic energy produced by a nuclear explosion poses a real threat to communications. Generally, the broadband power density resulting from a nuclear explosion can couple damaging voltages and currents into a system by two routes.

The first, direct radiation, gives rise to strong electromagnetic fields in the immediate vicinity of sensitive equipment. This type of coupling is best reduced by surrounding the equipment with solid metal shields.

But damaging surges can also be carried in by commercial power lines, exposed telephone and signal cables, and other penetrations. The combination of high- and low-level surge protectors with hybrid protector filters on incoming lines will reduce such surges to a level below the susceptibility point of most operating equipment.

The Naval Civil Engineering Laboratory is now providing handbook design information on protective measures for both existing facilities and those still in the planning and construction stages.

Magnetic fields can be reduced on the order of 30:1 within communications shelters by designing reinforcing steels in the concrete construction. Further reductions can be made by using high-quality commercial shielded enclosures to house sensitive equipment.

The installation of suitable surge arresters and protectors at the entrances of power and signal lines, plus the use of a low impedance grounding system for protector connections will protect facilities already in use.

Presented at Wescon, Los Angeles, Aug. 20-23.



## THE MINI-COMPACT CALCULATOR THAT CARRIES LIGHT AND WORKS LIKE THE DEVIL

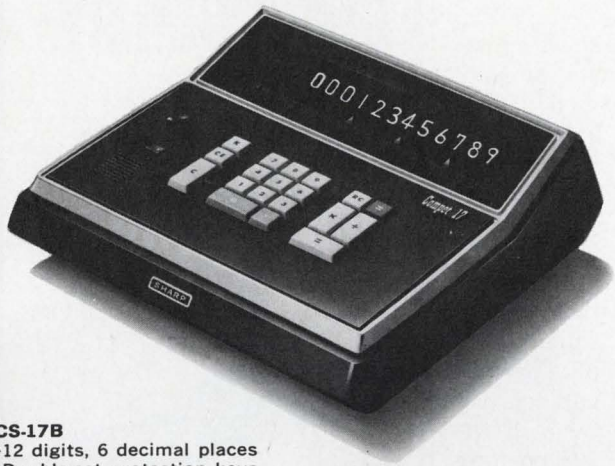

**CS-17B**  
 \*12 digits, 6 decimal places  
 \*Double-set protection keys  
 \*4kg. (8.8 lbs.)

Our CS-17B is instant, silent and dependable. It's dyna-convenient, too. 56 MOS ICs helped us drastically reduce overall size, yet improve performance. Handles calculations up to 12 digits and 6 decimal places with amazing ease. Has a rounding-off device and double-set protection keys—features designed to assist the beginner and accommodate the professional.

The CS-22A packs even more punch into the same space. 14 digit capacity, memory register and overflow error check lamp are added features which put it right out in front.

Choose the little devil that's just right for your calculating problems.



**CS-22A**  
 \*14 digits, 6 decimal places  
 \*Memory register \*Round-  
 ing-off device \*Double-set  
 protection keys \*4 kg. (8.8  
 lbs.)

 **SHARP**

HAYAKAWA ELECTRIC CO., LTD. Osaka, Japan

U.S. Subsidiary: SHARP ELECTRONICS CORP. 178 Commerce Road Carlsbad, New Jersey

Circle 249 on reader service card

## New, smaller air variable capacitor

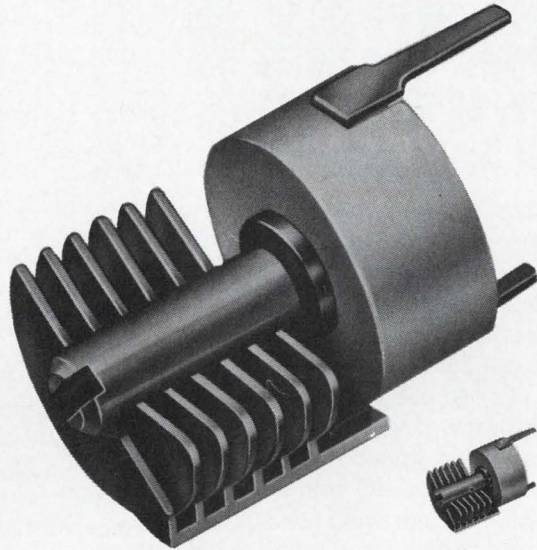

**ACTUAL SIZE**

### 1.7 to 11 pf machined plate capacitor for PC mounting is only .310" in diameter

This new, sub-miniature Type "T" air dielectric trimmer capacitor from E. F. Johnson fits the limited space requirements of modern design. It is designed for VHF and UHF applications where small size (.310" diameter), high Q (greater than 1500 at 1MHz), low TC and low cost are important considerations.

The Type "T" mounts interchangeably with widely used 3/8" printed-circuit-type ceramic disc trimmers in two .050" diameter holes on .300" centers.

Nominal capacity is 1.7 pf minimum, 11.0 pf maximum. Peak voltage breakdown is 250 VDC. End frame is 95% alumina, grade L624 or better, DC200 treated. Metal parts are silver plated and Iridited.

Johnson machined plate construction provides exceptional stability, including minimum drift over extremes of temperature and humidity.

**MAY WE TELL YOU MORE?** Write for detailed specs and prices on Type "T" capacitors. And ask for Components Catalog 701 covering the entire E. F. Johnson component line.



**E. F. JOHNSON COMPANY**

3078 Tenth Ave. S.W., Waseca, Minnesota 56093

Providing nearly a half-century of communications leadership

Circle 219 on reader service card

219



# Rent INSTRUMENTS FOR ANY EMERGENCY Rent INSTRUMENTS TO SAVE CAPITAL

You can save time and money and satisfy your short term equipment requirements by renting almost any kind of electronic instrument or small computer from Rentronix. Our rates are low . . . Our service is fast and easy to use. You simply select the instrument you want from our complete catalog, confirm its availability by a collect phone call or quotation request, and send us your purchase order for 30 days rental or more.

Your calibrated, fully maintained instrument will be on its way to you, transportation prepaid, anywhere in the United States within hours.

Get full information now at no obligation. Fill out the coupon or call collect, (301) 933-6655 for even faster service.

## Rentronix

A DIVISION OF INMARK, INC.

11501 Huff Court  
Kensington, Maryland 20795

Send me full information   
I would like to rent a Model \_\_\_\_\_

from you for \_\_\_\_\_ months.  
How much would it cost?

Name \_\_\_\_\_ Title \_\_\_\_\_

Company \_\_\_\_\_

Address \_\_\_\_\_

City & State \_\_\_\_\_ Zip \_\_\_\_\_

# R Rentronix

## Technical Abstracts

### In good voice

Predictive coding of speech signals  
B.S. Atal and M. R. Schroeder  
Bell Telephone Laboratories  
Murray Hill, N.J.

Voice coding techniques all aim at reducing the channel capacity needed to transmit a signal. This is done, in many cases, by transmitting only nonredundant information. By using an adaptive predictive coding technique, Bell Labs is now producing high-quality voice signals at low bit rates.

Predictive coding subtracts from the signal that part of it that can be predicted from a preceding part. In effect, the transmitter and receiver estimate the present value of the signal by linearly extrapolating from the value of the last segment.

The difference between this estimate and the true value of the signal is quantized, coded, and transmitted to the receiver. At the receiver the decoded difference signal is added to the predicted signal to reproduce the input signal.

Bell's technique goes beyond simple linear prediction, though, because it's adaptive. The company periodically adjusts the predictor parameters to match the characteristics of the speech. A fixed predictor can't perform efficiently at all times because the period of the speech varies with time.

Bell recalculates the predictor parameters, made up of 10 different coefficients related to the signal spectrum, every 5 milliseconds. The result is a difference signal representing that part of the speech signal that can't be predicted linearly.

The quality of the reproduced signal at the receiver has been evaluated by simulating the system on a digital computer. Listening tests have indicated only slight, often imperceptible, degradation in the quality of the reproduced speech. In addition, calculations suggest that the binary difference signal and the predictor parameters together can be transmitted at rates of less than 10 kilobits per second—several times slower than the bit rate required for pulse-code-modulation encoding with comparable speech quality.

Presented at Wescon, Los Angeles, Aug. 20-23.



# continuously variable broadband

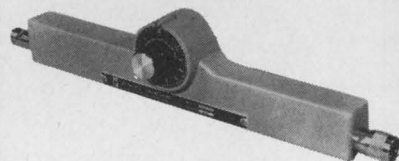

## attenuators

Each Model in  $\Psi$  Series 953 and 973 operates in frequency ranges up to 3½ octaves wide with only small changes in characteristics.

MODEL	RANGE FREQ. (GHz)	RANGE IN dB
953-3	1-11	3
953-10	2.5-11	10
953-20	4-11	20
973-10	1.3-11	10
973-20	2.5-11	20
973-40	4-11	40

They are available as either level set or calibrated units. The direct reading insertion loss scales are individually calibrated. They also feature . . .

- Non-contacting control device
- Stainless steel connectors
- Small phase shift
- High stability
- Optional panel mounting versions

Using the simple control, insertion loss is continuously variable, and the scale is almost linear in dB.

Designers and  
Manufacturers of Precision  
Microwave Equipment  
**WEINSCHEL  
ENGINEERING**  
Galthersburg, Maryland



# Tech labs 2A\* Tap Switch YOU CAN'T BUY

- MORE PRECISION
- LOWER CONTACT RESISTANCE
- HIGHER CURRENT CARRYING CAPACITY
- LONGER LIFE

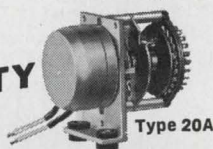
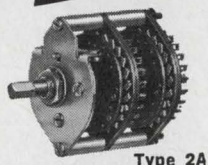

# FOR THE PRICE

\* Available in remote controlled versions, open or hermetically sealed. SEND FOR FREE CATALOG.

**TECH LABORATORIES, INC.**  
Palisades Park, New Jersey

Circle 250 on reader service card

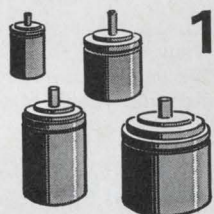

## 1001 uses for STEPPER MOTORS

Because their output is in discrete increments, Cedar stepper motors have many advantages over conventional motors for precise positioning applications. They are bi-directional and have high torque output. They can be run at high stepping rates or as slow as you wish. Because shaft rotation is incremental, damping is not required.

Some of the applications for which stepper motors have been used are: replace motor-tachometers in servo systems, control missile ailerons, shutter control on high-speed cameras, open loop positioner in checkout systems, high-speed counter in such applications as rapid firing weapons, replace ultra low-speed dc motors, incremental tape handlers, and digital-to-analog and analog-to-digital conversion equipment.

The uses for stepper motors are as unlimited as your imagination. New applications are constantly being discovered. What new use will you next make of stepper motors? Let us know about your ideas; we'll be happy to work with you.

Cedar Stepper Motors are available in sizes 5, 8, 11 and 15 in both permanent magnet and variable reluctance types, and with a wide variety of stepping angles. All meet the full requirements of MIL-E-5272. For free booklets on stepper motor application ideas, write or call:

**CEDAR**  
ENGINEERING DIVISION

**CONTROL DATA**  
CORPORATION

5806 West 36th Street, Minneapolis 16, Minnesota. Phone 929-1681

Circle 251 on reader service card

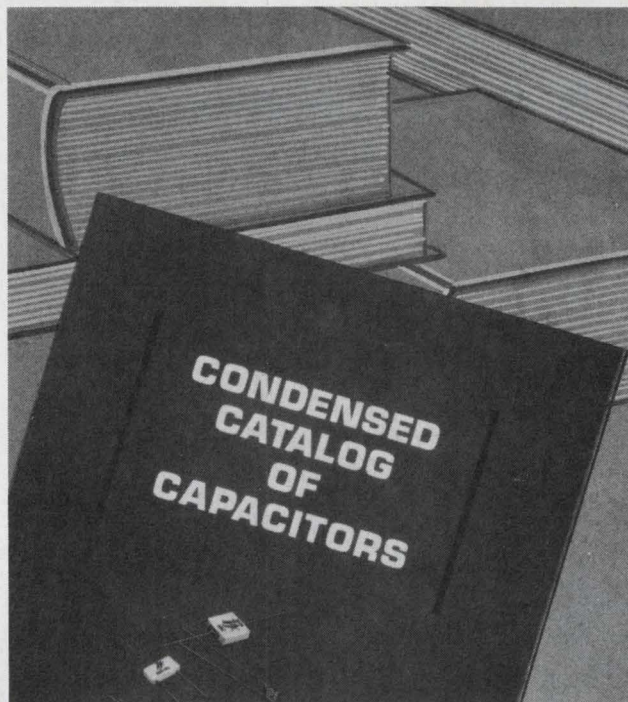

## The Book on Ceramic Capacitors (Vitramon® wrote it.)

In fact, Vitramon, Inc. has been re-writing this book since we first introduced the ceramic capacitor series in 1959.

Now, you can obtain these unique capacitors in over 20 styles.

In values ranging from 10 pf to 1.0 mfd.

In chip, wafer, axial and radial forms.

Even NPO dielectrics.

What's more, all established ceramic series display a low failure rate of less than 1% per 1000 hours.

If you haven't been able to find the right ceramic capacitor to meet your exact needs, perhaps you've been reading the wrong books. Request our condensed catalog — you'll see why our customers consider our capacitors as classics.

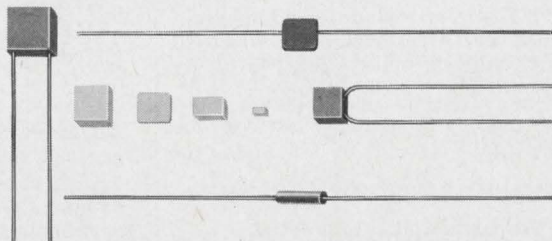

**Vitramon®**

VITRAMON, INCORPORATED  
BOX 544  
BRIDGEPORT, CONN. 06601

Circle 221 on reader service card

221



# NEW MAGNETIC RELAY plugs into your PC board!

NO Springs, NO Wiring,  
NO Sockets, NO Soldering,  
NO Mechanical Linkage

# Printact®

Standard Series G  
Latching Series LS/LD

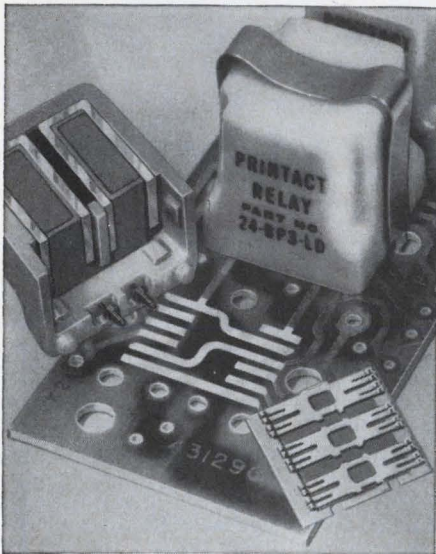

(actual size)

## Plated Conductors on Your PC Board are the Fixed Contacts

Save SPACE, MONEY and MANHOURS with these new small, lightweight, highly reliable Standard and Latching PRINTACT Relays.

Available with Bifurcated Palladium or Gold Alloy contacts for more than 10 million cycle 2 to 4\* pole switching. Handles up to 2 amp. res. loads. Coils for 6, 12, 24 and 48 vdc at 500 mw. Operating temperature  $-30^{\circ}\text{C}$  to  $+95^{\circ}\text{C}$ . Operate time 7 ms. The little gem is an 0.8 oz.  $\frac{7}{8}$ " cube.

Quality features include: double-break contacts; balanced armature, enclosed housing, plug-in application; encapsulated coil; self-wiping contacts and inherent snap-action — saves sockets soldering, and wiring and the cost is lower than you think!

\*Switches up to 4 form A plus B, or 4 form C.

For data and prices write or call:  
212-EX2-4800

## Executone

PRINTACT RELAY DIVISION  
47-37 Austell Place  
Long Island City, N.Y. 11101

## New Literature

**Ultrasonic cleaning.** Branson Instruments Co., Progress Dr., Stamford, Conn. 06904. Bulletin S-898 describes the principle of ultrasonic cleaning and outlines the application of two newly designed ultrasonic generators. Circle 446 on reader service card.

**Coaxial switching matrices.** Trompeter Electronics Inc., 8936 Comanche Ave., Chatsworth, Calif. 91311. Catalog M-5 covers a complete line of coaxial switching matrices for use in video, telemetry, data and r-f switching systems. [447]

**Power amplifier.** Ampex Corp., 401 Broadway, Redwood City, Calif. 94063, offers a data sheet listing features and specifications of the model AA-80 power amplifier. [448]

**Microwave filters.** Varian Associates, 611 Hansen Way, Palo Alto, Calif. 94303. Design and performance characteristics of reflective, absorptive, and special filters are outlined in a 16-page brochure. [449]

**Communications transmission measurement.** Sierra Electronic Operations of Philco-Ford Corp., 3885 Bohannon Dr., Menlo Park, Calif. 94025, has published an eight-page brochure on the model 305/360 communications transmission measurement system. [450]

**Diode selector.** Transatron Electronic Corp., 168 Albion St., Wakefield, Mass. 01881, has available a selection guide for users of zener and reference diodes. [451]

**Microwave components.** Premier Microwave Corp., 114 Wilkins Ave., Port Chester, N.Y. 10573. Ferrite circulators, isolators and waveguide windows, and plumbing are just a few of the many microwave components featured in a 50-page catalog. [452]

**Ferrite cores.** Magnetics Inc., Butler, Pa. 16001, has released a ferrite cores catalog to help engineers evaluate quickly the available materials, cores, and inductances. A copy may be obtained by writing on company letterhead.

**Sealed switches.** Micro Switch, a division of Honeywell Inc., Freeport, Ill. 61032. Brochure 84-02003-0 covers a complete line of switches for critical environment applications. [453]

**Real time analyzer.** Federal Scientific Corp., 615 W. 131 St., New York 10027. Bulletin 600 describes the Ubiq, a real time analyzer for processing underwater signals, noise and vibration data, and radar doppler signals. [454]

**Slow-scan vidicons.** Westinghouse Electric Corp., P.O. Box 284, Elmira, N.Y. 14902. Bulletin TD-86-855 gives application information and operating characteristics for slow-scan vidicon camera tubes. [455]

**Microwave anechoic chambers.** Emerson & Cuming Inc., Canton, Mass. 02021. Two four-page folders describe some of the latest advances in the design and construction of Eccosorb anechoic chambers and r-f shielded chambers. [456]

**Sweep generators.** Telonic Instruments, 60 N. First Ave., Beech Grove, Ind. 46107. A 28-page catalog covers a complete line of sweep generators for testing tv tuners and circuits in the i-f, vhf, and uhf regions. [457]

**Silicon power rectifiers.** Edal Industries Inc., 4 Short Beach Rd., East Haven, Conn. 06512, has published a catalog sheet on the series E4 power rectifiers in the stud-mounted DO4 package. [458]

**D-c voltage regulators.** Beckman Instruments Inc., 2500 Harbor Blvd., Fullerton, Calif. 92634. Data sheet 68667 describes the miniature hybrid cermet thick-film series 855 d-c voltage regulators. [459]

**Impulse counters.** Landis & Gyr Inc., 45 W. 45th St., New York 10036. Four-page bulletin 501 covers the Sodeco series Ti remote indicating impulse counters. [460]

**Power supplies.** Lambda Electronics Corp., 515 Broad Hollow Rd., Melville, N.Y. 11803, has issued a 40-page general catalog of all-silicon, convection-cooled power supplies for systems, laboratory, and test equipment and OEM applications. [461]

**Metal-film capacitors.** Sprague Electric Co., 35 Marshall St., North Adams, Mass. 01247, has published engineering bulletin 2445A on new and smaller sized metalized polyester-film capacitors in wrap-and-fill construction. [462]

**Analog multiplier.** Analog Devices Inc., 221 Fifth St., Cambridge, Mass. 02142. A four-page data sheet describes low-cost, wideband analog multiplier model 420. [463]

**Microwave integrated components.** Micro State Electronics, 152 Floral Ave., Murray Hill, N.J. 07974, has prepared a flyer describing its line of integrated-circuit microwave components. [464]

**Forced air coolers.** George Risk Industries, 672 15th Ave., Columbus, Neb. 68601, has issued a catalog de-



# X LINE

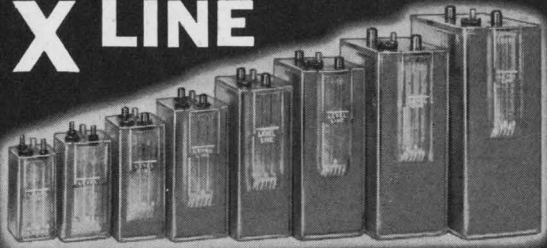

## STORAGE BATTERIES

**X Line**— Offers the portability of dry cells, plus the stable voltage, high-rate discharge capability, reliability and economy of lead-acid storage batteries.

**Versatile**— Eight sizes, ranging from 2.5 to 60 ampere hours, provide compact, lightweight power for a wide variety of applications. Available in multiples of 2 volt units.

**Spill-Proof**— Operate in any attitude with minimum loss in output and change in center of gravity.

**Mil-Types**— Include BB-236/U through BB-243/U.

**Safe**— Critical control of charge and discharge is not required.

**Charge Indicator**— Built-in, gravity-ball type shows full charge and when to recharge.

**Pricing**— Favorable for mass-market applications.

FOR COMPLETE INFORMATION WRITE:

**WISCO**  
DIVISION

**ESB INCORPORATED**   
1222 — 18th Street, Racine, Wis. 53403

Circle 252 on reader service card

# WANTED: ELECTRONICS MANUFACTURER

who desires to fill a  
dependable supply of  
government contracts

Excellent opportunity for growth-minded electronics manufacturer to locate in Texas and help meet the needs of the government and the third fastest-growing state. Stable, productive labor. Incomparable tax advantages. Lowest living costs. For 1968 Texas Fact Book, write or call the:

**TEXAS INDUSTRIAL COMMISSION**  
Central Information Source for all of Texas  
Box JJ-E, Capitol Station  
Austin, Texas 78711  
Telephone 512/475-4331

Circle 253 on reader service card

## How Small is Big Enough?

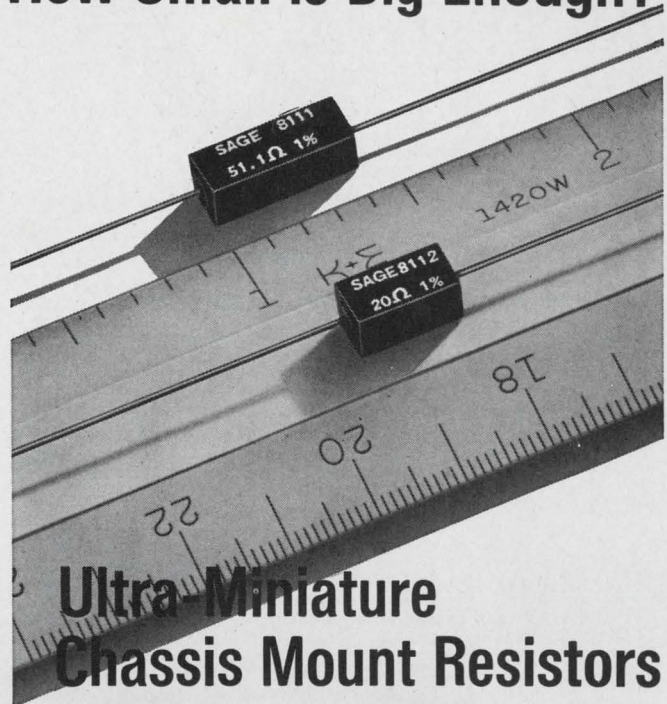

## Ultra-Miniature Chassis Mount Resistors NEW from SAGE!

**PROBLEM:** To produce, for aerospace application, out-board resistive components for use with hybrid and/or integrated circuits which combine minimum size with maximum efficiency and reliability; also to provide mounting ease and flexibility using component clips, clamps or high temperature epoxy bonding materials

**SOLUTION:** The new Sage Ultra-Miniature Chassis Mount Resistors shown here!

**STYLE 8111:** 7 WATTS CHASSIS MOUNTED—3.5 WATTS FREE AIR—LESS THAN 0.015 IN<sup>3</sup> VOLUME

**STYLE 8112:** 5 WATTS CHASSIS MOUNTED—2.5 WATTS FREE AIR—LESS THAN 0.009 IN<sup>3</sup> VOLUME

Part	Length	Width	Height	Standard Ranges Resistance
8111	0.430" ± 0.015"	0.156" ± 0.005"	0.165" Max.	.05Ω-13KΩ
8112	0.305" ± 0.015"	0.156" ± 0.005"	0.165" Max.	.05Ω-6KΩ

**ACCURACY:** Tolerance to ± 0.05%

**PERFORMANCE:** Meet or exceed all applicable requirements of MIL-R-18546

Free air rating is based on maximum surface hot spot temperature of 275° C.

Chassis mount power rating is based on maximum surface hot spot temperature of 150° C when mounted on 4" x 4" x 0.040" aluminum chassis.

For complete engineering data on these new Sage achievements in miniaturized electronic products, write



SEE OUR SPECIFICATIONS IN  
**VSMF**  
THE MICROFILM CATALOG FILE

**SAGE**

**SAGE ELECTRONICS CORP.**

Subsidiary of Gulton Industries, Inc.

BOX 3926 ROCHESTER, N. Y. 14610

Phone: (716) 586-8010

Circle 223 on reader service card

223



**CUT CONSTRUCTION DELAY**

with pre-punched  
**VECTORBORD,\***  
**PLUGBORDS** and  
**Push-in TERMINALS**

Make circuits the fast, easy way . . . simply insert Vector push-in terminals (wide variety available) and component wires into pre-punched Vectorbord, or use punched copper clad for do-it-yourself etching; and, for production, we're geared to omit the holes not required and assemble terminals, eyelets, etc. to your specifications. Eleven patterns available with .025", .040", .062", .093" holes in XXXP phenolic, glass silicone, glass or paper epoxy and copper clad. Plugbords supplied in many sizes with etched pads, .040" dia. Edge-Pins or Elco Varicon\* contacts.

**Save time — Save work — Save money!**

\*TRADE MARK

Send for complete literature  
**VECTOR ELECTRONIC CO., INC.**  
 1100 Flower St., Glendale, Calif. 91201 Area 213 Phone 245-8971  
 Circle 254 on reader service card

## New Literature

scribing modular forced air coolers that offer maximum heat transfer in minimum size and weight. [465]

**Telemetry modules.** Solid State Electronics Corp., 15321 Rayen St., Sepulveda, Calif. 91343, offers a 52-page catalog describing its line of f-m/f-m telemetering modules. [466]

**Epoxy adhesives.** Amicon Corp., 25 Hartwell Ave., Lexington, Mass. 02173. Low-temperature cure, one-component epoxy-based adhesives and insulating compounds are described in a recently published folder. [467]

**Rotary switches.** Chicago Dynamic Industries, 1725 Diversey Blvd., Chicago 60614. A sealed and a plug-in rotary switch are technically described and illustrated in a two-page catalog. [468]

**Electronic counters.** Anadex Instruments Inc., 7833 Haskell Ave., Van Nuys, Calif. 91406, offers a wall chart, measuring approximately 2 by 3 feet, on its complete line of electronic solid state counters. [469]

**Accelerometers.** Gulton Industries Inc., 1644 Whittier Ave., Costa Mesa, Calif. 92627. Assistance in selecting the right piezoelectric accelerometer or microphone for specific applications is provided in a 17-page condensed catalog. [470]

**Transistor mounting.** Bishop Industries Corp., 11728 Vose St., North Hollywood, Calif. 91605, has available a six-page flyer featuring a technical summary of transistor mounting techniques. [471]

**Relays.** Babcock Electronics Corp., 3501 Harbor Blvd., Costa Mesa, Calif. A six-page catalog contains basic data on the firm's complete line of electro-mechanical and mercury-wetted relays. [472]

**Synchro/resolver bridges.** Theta Instrument Corp., 22 Spielman Rd., Fairfield, N.J. 07006. Bulletin 4-20 explains and illustrates the company's line of synchro and resolver bridges. [473]

**Electronic wire and cable.** International Telephone and Telegraph Corp., Pawtucket, R.I. 02862, has issued a 52-page catalog to assist in selecting wires and cables for specific electronic applications. [474]

**Leadless inverted devices.** Ampere Electronic Corp., Providence Pike, Slatersville, R.I. 02876, offers a brochure containing complete listings of its entire line of semiconductors available in the microminiature LID pack-

**NTK**

**HIGH RELIABILITY CAPACITORS**

All "NTK" products are carefully manufactured and strictly quality-tested on the basis of **50 years** experience and technique, to meet the world's highest standards of excellence.

**MAIN PRODUCTS:**

- All-welded Construction Miniature Aluminum Electrolytic Capacitors — S (Radial Type) & W (Axial Lead Type)
- "MD" Metallized Polyester Film Capacitors (Epoxy Resin Sealed Type)
- Paper Capacitors (High Voltage Encased Glass Tube)
- Wide Band Noise Suppressors (500Kc — 1000Mc, 200VAC)
- TELEPHONES (AUTOMATIC ANSWERING TELEPHONE, AUTOMATIC DIALING DEVICE, ETC.)

**Nitsuko Ltd.**

260 Kitamikata, Kawasaki, Japan Tel. 044-82-5131  
 Cable: NITSUKO KAWASAKI Telex: 3842-177 NITSUKO KAW



# Free! Latest data on our electronic products.

New Catalog 52 gives you comprehensive, up-to-date information on Superior Electronic Products. Includes data on cathode designs, materials and chemical composition, physical properties, and special features. Also describes the major characteristics of each cathode material. And Superior's capability in fabricating tubular parts for electronic applications.

Write for your free copy. It will help you evaluate and select the best cathode design and material for your specific application. Or fabricated parts. Superior Tube Company, Electronic Sales Department, 2500 Germantown Avenue, Norristown, Pa. 19404.

 **Superior Tube**  
Norristown, Pa. 19404

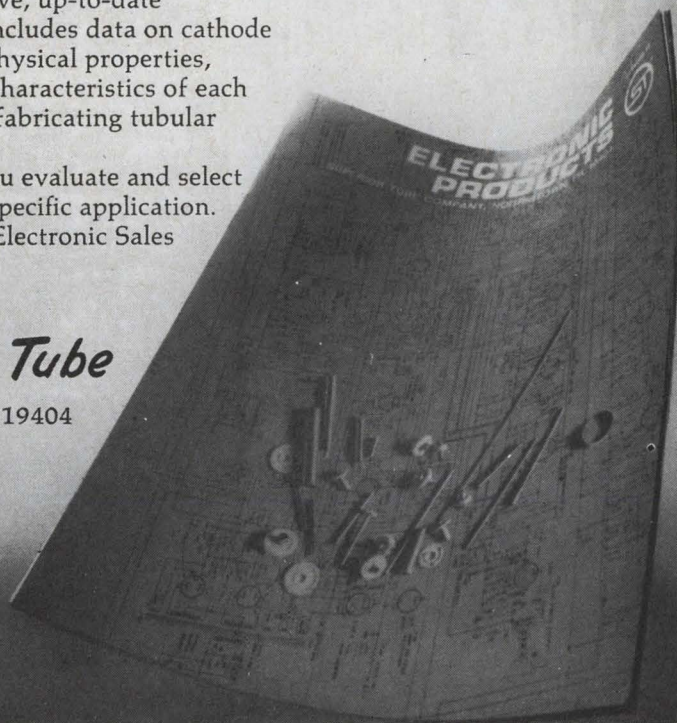

Circle 255 on reader service card

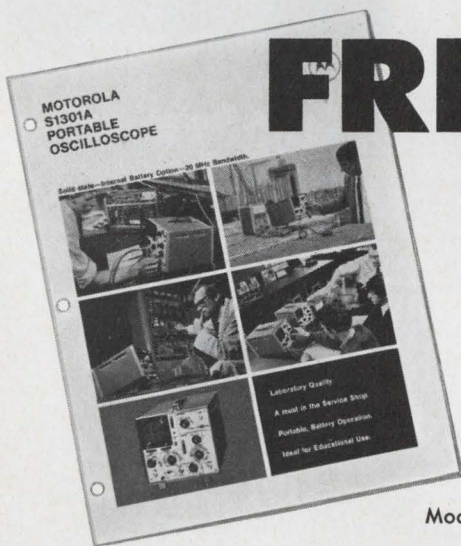

# FREE

Model S1301A

Get technical literature on the only *totally* portable, solid state oscilloscope. Operates from optional internal battery or from 110/220 vac, 50 to 400 Hz line voltage. Features include: 20 MHz bandwidth; 17 nsec rise time; 18 ranges of calibrated sweep speeds; internal voltage calibrator; and triggering stability in excess of 30 MHz.

Write for Bulletin TIC 3316 to Motorola Communications & Electronics Inc., 4501 W. Augusta Blvd., Chicago, Ill. 60651



**MOTOROLA**  
Precision Instrument Products

Circle 256 on reader service card

# NEW

## TWO LOW COST LOW RIPPLE REGULATED DC POWER SUPPLIES



These new low cost ELECTRO power supplies offer excellent load (.01%) and line (0.01 + 2mV) regulation, and only 100 microvolts RMS max. ripple.

Features all solid state circuitry with regulation through Zener diodes and integrated circuit components. Automatic current limiting. Lightweight—only 7 lbs.

Ideal for transistor circuit design, development and experimental use, also as a general purpose laboratory supply, as a bias supply or battery substitute.

**PSR-12-25** output 0 to 25 VDC 0 to 500 mA

**PSR-12-50** output 0 to 50 VDC 0 to 250 mA

Input: 105-125 VAC, 60 HZ  
Rack-mount accessory for up to 4 units available.

Write for specifications.

Sold exclusively through Electronic Distributors.



**ELECTRO**  
POWER SUPPLIES

**ELECTRO PRODUCTS LABORATORIES, INC.**  
6125-Y Howard St., Chicago, Illinois 60648 • 312/775-8744

Circle 225 on reader service card

225



# why Maryland

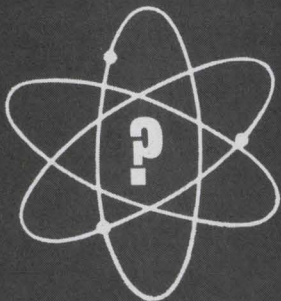

Proximity to federal agencies in Washington, D.C. affords the unique advantage of constant personal contact with government officials working with science-oriented industry. Such contact is an increasingly important locational criterion.

No other state is as convenient to as many Federal agencies as Maryland. For example, Maryland's major government scientific installations include NASA, AEC, NIH, the National Bureau of Standards, plus some 20 others.

Are there other reasons why R&D and science-oriented industries should locate in MARYLAND?

Yes... emphatically!

There are almost 30,000 scientists and over 25,000 engineers living and working in Maryland and the District of Columbia. Graduate and post-doctoral programs considered most significant to research and science industry are available.

## Locate in a big state like Maryland

We could write a book about why you should locate in Maryland... and we did. Send for it.

Contact:

Maryland Department of  
Economic Development

DIVISION E-8

State Office Bldg.  
Annapolis, Md. 21404

## New Literature

age with their primary electrical characteristics. [475]

**Neon lamps.** Signalite Inc., 1933 Heck Ave., Neptune, N.J. 07753. An illustrated single-page bulletin discusses the replacement characteristics of neon glow lamps for digital readout tubes. [476]

**Mass spectrometer selector.** Varian Associates, 611 Hansen Way, Palo Alto, Calif. 94303. A one-page mass spectrometer selector quickly summarizes the operating parameters of a wide range of low-, medium-, and high-resolution instruments. [477]

**Paper-dielectric capacitors.** Sprague Electric Co., 35 Marshall St., North Adams, Mass. 01247. Engineering bulletin 2142A describes type 234P/235P Clorinol T paper-dielectric capacitors for d-c applications. [478]

**Thermoplastic insulations.** Tensolite Insulated Wire Co., West Main St., Tarrytown, N.Y. 10591, has available bulletin 109, "Thermoplastic Insulated Wire and Cable." [479]

**Zero speed switches.** Airpax Electronics Inc., P.O. Box 8488, Fort Lauderdale, Fla. 33310. A four-page instruction manual describes the company's line of zero speed switches. [480]

**Disk file systems.** Bryant Computer Products, 850 Ladd Rd., Walled Lake, Mich. 48088, offers a four-page brochure featuring its on-line disk file systems for mass data storage. [481]

**Heat sinks.** Astrodyne Inc., 207 Cambridge St., Burlington, Mass. 01803. A series of transistor heat sinks designed for printed-circuit, computer, and other applications are described in technical bulletin NC-701. [482]

**Altitude reporting encoder.** Collectron Corp., 304 E. 45th St., New York 10017. A technical data sheet details an altitude reporting encoder that complies with ARINC characteristic No. 532D specification. [483]

**Time delay relays.** Relay Specialties Inc., 3 Godwin Ave., Fair Lawn, N.J. 07410, has prepared a 12-page brochure on its solid state, electronic and thermal time-delay relays. [484]

**Volt-ohm-milliammeter.** Triplett Electrical Instrument Co., Bluffton, Ohio 45817. Data sheet 42068 covers the battery-operated model 601 V-O-M with FET circuitry. [485]

**Operational amplifiers.** Analog Devices Inc., 221 Fifth St., Cambridge, Mass. 02142. A six-page foldout data sheet describes models 148 and 149 high-speed operational amplifiers. [486]

THIS SPACE CONTRIBUTED BY THE PUBLISHER

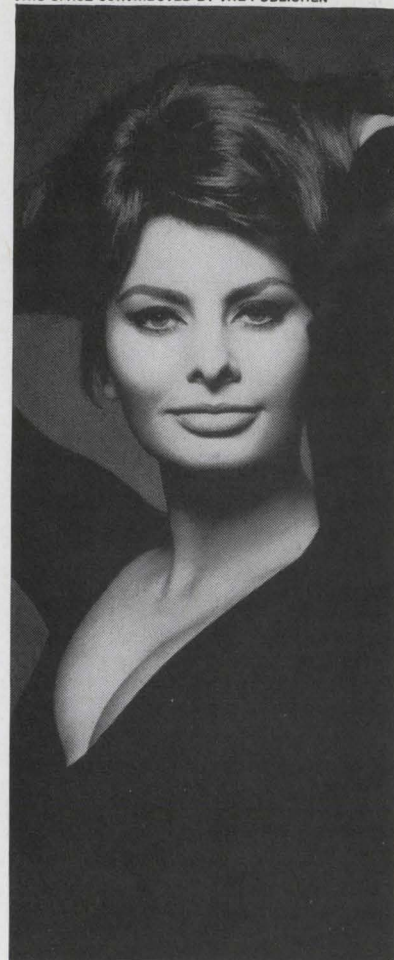

Avedon

Miss Sophia Loren

Learn the seven  
warning  
signals of  
cancer.  
You'll be in  
good company.

1. Unusual bleeding or discharge.
2. A lump or thickening in the breast or elsewhere.
3. A sore that does not heal.
4. Change in bowel or bladder habits.
5. Hoarseness or cough.
6. Indigestion or difficulty in swallowing.
7. Change in a wart or mole.

If a signal lasts longer than two weeks, see your doctor without delay.

It makes sense to know the seven warning signals of cancer.

It makes sense to give to the American Cancer Society.



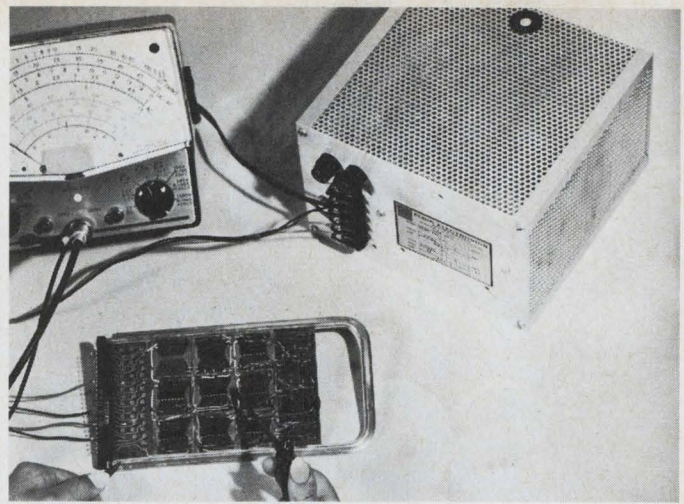
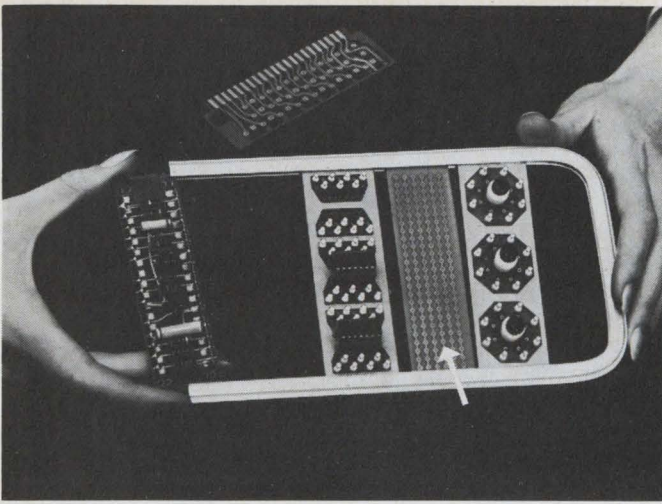

## PICK A CARD ... THEN POWER UP

with Elgin's New Integrid® Cards and Low Voltage Power Supplies

"Mix and match" with Elgin's Integrid Cards. Couple 8 and 10-pin T.O. 5's with 14 and 16-pin dual-in-line I.C.'s. Then add Elgin's patented "strip pack" to link I.C.'s with discrete components, and Econo-Grid® for additional bussing.

Finally, complete the cycle with one of Elgin's nine new, off-the-shelf Low Voltage (5V) Power Supplies for precision sources. They feature exclusive over-current and over-voltage protection (patents pending). Elgin's solid state units are available in three basic sizes, with three standard output currents of 4, 8 and 16 amps—at a *fraction* of the cost you'd

expect. Regulation—less than 0.05%, load regulation—less than 0.1% for 0-100% load change. Combined regulation—less than  $\pm 0.25\%$ !

AND YOU GET AN ELGIN BONUS—*GUARANTEED PROMPT DELIVERY.*

For literature and prices on Integrid Cards or Power Supplies, write Elgin Electronics Incorporated, P. O. Box 1318, Erie, Pennsylvania 16512, or phone 814-452-6773.

**ELGIN ELECTRONICS INCORPORATED**  
Subsidiary of Basic Incorporated

Circle 257 on reader service card

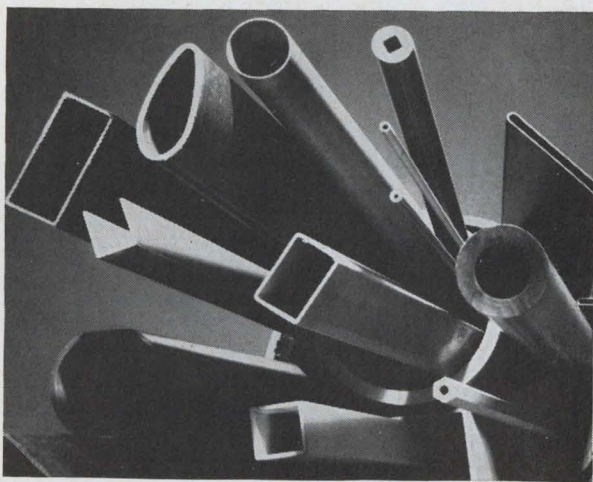

### New Design Opportunities With Laminated Plastic Tube Shapes

Why be restricted to the use of round laminated plastic tubes? We make them in a wide variety of inside and outside contours—square, oval, hex, rectangular, and in angles and channels, even multi-cavity tubes. Wide range of grades, diameters and lengths. Complete fabrication facilities. Write for further information. Synthane Corporation 30 River Road, Oaks, Pa. 19456—or call (215) 666-5011.

**SYTHANE**  
CORPORATION  OAKS, PA. 19456

Laminated Plastic Sheets, Rods, Tubes and Fabricated Parts

**NEW**  
**NL-950**

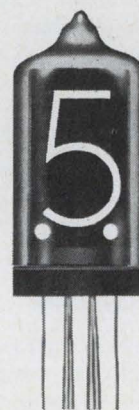

1.350"

### NATIONAL® shortened the NL-5750 to save space

- maximum overall height 1.350"
- made in Geneva, Illinois U.S.A.
- \$3.95 in 1000 quantity

**NATIONAL**  
ELECTRONICS, INC.

a varian subsidiary

PHONE: (312) 232-4300 • GENEVA, ILLINOIS 60134



# we're in solid...

## at Western Electric

Advanced solid state circuitry, that is! New and exciting things are happening NOW at Western Electric, the manufacturing and supply unit for the Bell System. We are seeking electronic engineers for assignment to specific projects concerning the development of test and systems circuitry and methods required in the manufacture and installation of electronic central office switching systems associated with tele-communications. Become involved in a forward-looking professional environment that emphasizes individual initiative and competence. Projects will be carried to completion with a minimum of supervision.

Positions require a minimum of a B.S.E.E. and experience in solid state electronics is helpful. Assignments are open at the Indian Hill Bell Telephone Laboratory facility near Naperville, Illinois (35 miles west of Chicago), and the Hawthorne facility in Chicago, Illinois.

Be where the current things are happening.

Professional environment, development and personal advancement are provided. Western Electric has very competitive salaries and liberal employee benefit programs. For a confidential discussion of your qualifications for these positions, call collect:

**Bob Smick (312) 494-5067**

If unable to call during business hours, send resume in confidence to Mr. Robert Smick, Engineering Dept. 2013-E, Western Electric, Hawthorne Station, Chicago, Ill. 60623



## Western Electric

MANUFACTURING AND SUPPLY UNIT OF THE BELL SYSTEM

AN EQUAL OPPORTUNITY EMPLOYER

## FOR INFORMATION

*about  
classified advertising,  
contact the McGraw-Hill  
office nearest you*

**ATLANTA, 30309**  
1375 Peachtree St., N.E.  
404-875-0523

**BOSTON, 02116**  
607 Boylston St.  
617-262-1160

**CHICAGO, 60611**  
645 No. Michigan Avenue  
312-664-5800

**CLEVELAND, 44113**  
55 Public Square  
216-781-7000

**DALLAS, 75201**  
1800 Republic Nat'l, Bank  
Tower  
214-747-9721

**DENVER, 80202**  
1700 Broadway, Tower Bldg  
303-255-5483

**DETROIT, 48226**  
856 Penobscot Building  
313-962-1793

**HOUSTON, 77002**  
2270 Humble Bldg.  
713-224-8381

**LOS ANGELES, 90017**  
1125 West Sixth Street  
213-482-5450

**NEW YORK, 10036**  
500 Fifth Avenue  
212-971-3594

**PHILADELPHIA, 19103**  
Six Penn Center Plaza  
215-568-6161

**PITTSBURGH, 15222**  
4 Gateway Center  
412-391-1314

**ST. LOUIS, 63105**  
7751 Carondelet Avenue  
314-725-7285

**SAN FRANCISCO, 94111**  
255 California Street  
415-362-4600



# Looking for a better job?

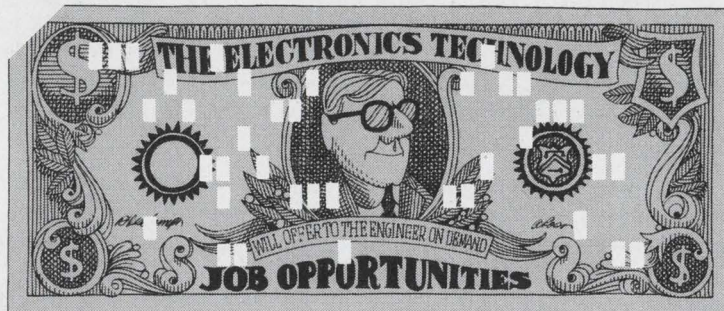

## Ask Electronics' computer all about it

Electronics magazine feels an obligation to help its readers find positions in the electronics technology which will make the greatest contribution to their profession and to society — jobs in which electronics men themselves will be happiest.

Electronics has joined with a nation-wide talent search company—National Manpower Register, Inc.—to form the computerized Electronics Manpower Register.

Your qualifications and job requirements will be pro-

grammed into a GE 265 computer, direct-linked to the Manpower Register's offices in New York. The computer, once your resume form (bottom of page and following page) is received, will continuously compare all your data with the specific manpower needs of electronics companies. When a match is made, you will be contacted directly or through an affiliated agency. The company and you will be brought together on a confidential basis.

*Continued on next page*

### Electronics Manpower Register

It is important that your information be complete and that you type or print legibly

IDENTITY		PRESENT OR MOST RECENT EMPLOYER	
Name	Date	Parent company	
Home address		Your division or subsidiary	
City	State	Zip	Location (City/State)
Home phone	Do you subscribe to Electronics <input type="checkbox"/>		or see a library or pass-along copy <input type="checkbox"/>
<b>GEOGRAPHICAL PREFERENCE (Check appropriate boxes and complete all blanks)</b>			
Depends on opportunity <input type="checkbox"/>	East coast <input type="checkbox"/>	West Coast <input type="checkbox"/>	Mid-west <input type="checkbox"/>
South <input type="checkbox"/>	FOR OFFICE USE ONLY		
Other (state)	Would you consider any other location? Yes <input type="checkbox"/>	No <input type="checkbox"/>	<input type="checkbox"/>
<b>EDUCATION</b>		REGISTRATION NUMBER	INITIAL OF LAST NAME
Degree	Major field	Year	College or University
<b>EMPLOYMENT INFORMATION</b>			
Position desired			
Present <input type="checkbox"/>	or most recent <input type="checkbox"/>	position	
From	To	Title	
Duties and accomplishments			

CONTINUED ON OTHER SIDE



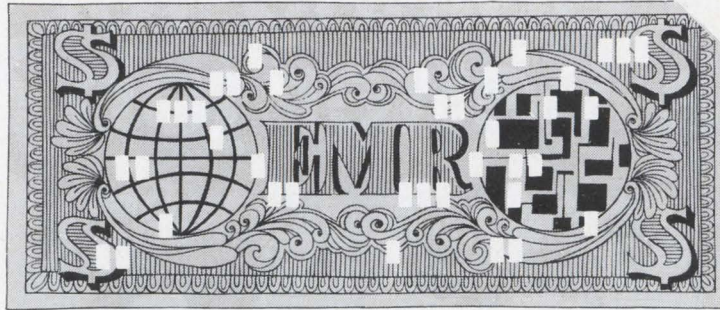

The cost of all this to you? Absolutely nothing. No fees or charges at any time.

Other advantages of EMR:

- Your resume is sent only to those companies that have a genuine requirement for your particular skills.
- There is no general "broadcasting" in the hope "someone will be interested."
- Your identity is protected because your name is released only according to your prior instructions. Your name can be deleted on request.
- EMR's service is nationwide. You may be considered for job opportunities anywhere in the U.S.

The Electronics Manpower Register is a powerful tool and should be considered when you are seriously seek-

ing a new position. And, although you may be reasonably happy in your present position, chances are that you might have that ideal job in mind.

This is why EMR makes good sense for you. If that job does turn up, you'll be there.

To get your name in the EMR file, just fill out the resume form and return to:

Electronics Manpower Register  
330 West 42nd Street  
New York, N. Y. 10036

Please enclose a copy of your resume if you have one. A detailed brochure further describing EMR will be sent to you.

## **Electronics Manpower Register** A computerized employment opportunity service

CONTINUED FROM OTHER SIDE					
Previous Position	Employer	City/State	From	To	
Duties and accomplishments					
Previous Position	Employer	City/State	From	To	
Duties and accomplishments					
<b>GENERAL INFORMATION</b>					
(Summarize your over-all qualifications and experience in your field. List any pertinent information not included above.)					
Current annual base salary	Total years of experience	Date available	U.S. Citizen <input type="checkbox"/> Non U.S. Citizen <input type="checkbox"/>		
My identity may be released to:	Any employer <input type="checkbox"/>	All but my present employer	Have you security clearance?	Yes <input type="checkbox"/> No <input type="checkbox"/>	If yes, What level
Mail (with a copy of your resume, if you have one) to:					
<b>Electronics Manpower Register</b>			<b>NO FEES</b>		
<b>330 West 42nd Street,</b>			<b>OR</b>		
<b>New York, N. Y. 10036</b>			<b>CHARGES</b>		
			EMR-4		



## TOP-NOTCH ENGINEER

40, with PHD in automation, having created and directed a French company specialising in application of automation to industry (data loggers and process control), wishes to contact US Company wanting to establish operations in France or Europe. Strong personality, good organiser and manager, can handle large-scale operations.

Write to:

**BOX 21 - Electronics**  
90 Avenue des Champs-Elysees  
PARIS (75) FRANCE

WHEN

*Answering Advertisements*

**P**LEASE do not send original letters, certificates or photographs. We cannot be responsible for their return. Please send photostat or carbon copies.

## STAND TALLER IN YOUR JOB!

If you're an Electronic Engineer with 2-10 years experience in Infrared, Solid State Design, Digital or Analog Design and who feels shorted in your present position, stand a bit taller at Hallicrafters.

Assume an important role on a crack team of engineering professionals exploring new developments and techniques leading to the next generation of highly sophisticated ECM and electronic communications equipment. This fast-moving team emphasizes practical and immediate results and your chances for personal and professional growth have never been greater.

If you're a professional who thrives on this concept of challenge and creativity, you'll find your work, your leisure, your family life a good deal more satisfying—when you stand a bit taller in your job—at Hallicrafters, in Illinois, the Tall State. Please submit your resume in confidence to: Mr. Roy Anderson, Professional Placement.

*the hallicrafters co.*

A Subsidiary of Northrop Corporation

**Engineering & Administrative Center**

600 Hicks Road, Rolling Meadows, Illinois 60008

An Equal Opportunity Employer



CIRCLE 968 ON READER SERVICE CARD

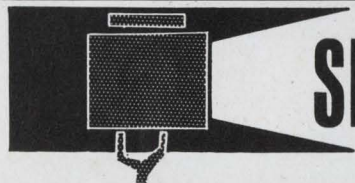

## SEARCHLIGHT SECTION

- CLASSIFIED ADVERTISING
- BUSINESS OPPORTUNITIES
- USED OR SURPLUS EQUIPMENT

## MR. USED EQUIPMENT DEALER:

When you advertise in the Searchlight Section . . . You have hired your most persuasive salesman:

He's efficient . . . He thrives on long hours . . . His territory is the entire nation . . . and overseas . . . He doesn't see buyers of used and new surplus equipment: They see him—regularly. They depend on him.

He is Searchlight—The section of this publication where wise dealers advertise and list their stocks for sale.

## SEARCHLIGHT SECTION

CLASSIFIED ADVERTISING DEPT.

POST OFFICE BOX 12 • NEW YORK, N. Y. 10036

### free catalog

**POTTING APPLICATORS**  
MANUAL AND DISPOSABLE

6cc 12cc 30cc

FOR POTTING, ENCAPSULATING, AND SEALING OF MINIATURE COMPONENTS

PHILIP FISHMAN COMPANY  
7 CAMERON ST., WELLESLEY 81, MASSACHUSETTS

CIRCLE 969 ON READER SERVICE CARD

### NEW ENGINEERING COURSES STUDY AT HOME!

University-tested engineering correspondence courses in logic design, digital computer design, feedback control systems and circuitry. Send for free catalog.

**EDUCATION FOR CAREER ADVANCEMENT**

P.O. Box 31, Mineola, N.Y., 11501  
(licensed as a correspondence school by the N.Y. State Education Dept.)

CIRCLE 970 ON READER SERVICE CARD

### Want to buy

**Small Electronic Manufacturing Business**

Interested in land, buildings, over the counter stock. Would be interested in manufacture of small switch arresters, etc. Mass., Conn. area. Possibly Me., N.H.

Exclude business manufacture computers and electronic measuring devices.

**Shawmut Real Estate & Investment**

294 Washington St., Rm. 428, Boston, Mass. 02114  
Mr. Wm. G. Riley

CIRCLE 971 ON READER SERVICE CARD

RADAR SYSTEMS GROUND AND AIRBORNE AUTOMATIC TRACKING ANTENNA SYSTEMS NIKE AJAX NIKE HERCULES M-33 MSQ-1A MPS-19 MPS-9 SCR 584 TPS-1D TPS-28 FAA-ASR-2 AIRBORNE SYSTEMS APN-84 APN-102 APS-23 APS-27 APS-45 DPN-19 DIGITAL COMPUTERS IBM 650 IBM 704



LARGEST INVENTORY OF RADAR AND MICROWAVE EQUIPMENT IN THE WORLD.  
**RADIO RESEARCH INSTRUMENT CO.**

45 WEST 45TH ST. N. Y. 10036 212-JU 6-4691

CIRCLE 972 ON READER SERVICE CARD



# Acopian will ship this power supply in only 3 DAYS

## and any of the other 61,999 too.

Next time you need power supplies in a hurry, contact Acopian and request a copy of our latest catalog. It lists 62,000 different AC to DC plug-in power supplies, any of which will be shipped to you in **just three days!** Choose the exact DC output you need. Singles or duals. Regulated or unregulated. Whether you need one power supply or several, your order will be shipped in just three days! That's our promise. For particulars, contact your local Acopian rep, call us at (215) 258-5441, or write to Acopian Corp., Easton, Penna. 18042.

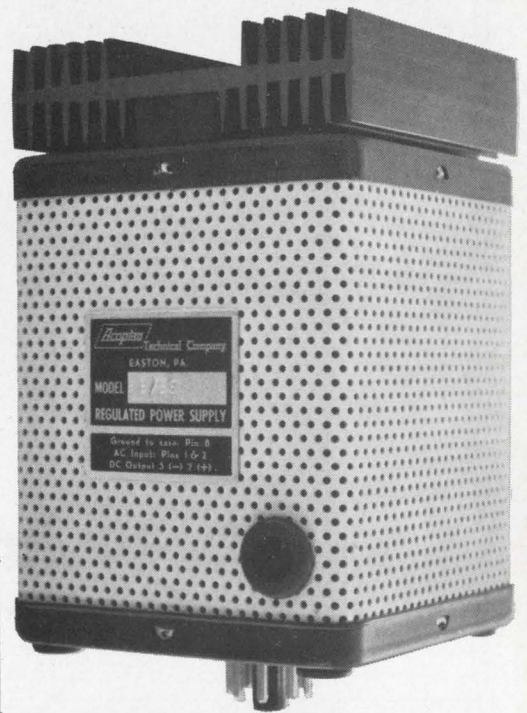

### SINGLE OUTPUT SOLID STATE REGULATED POWER SUPPLIES

Ambient temperature rating 0 to 55 C.

Model	Nominal Output Voltage	Adjustment - Volts	Output Current Range	REGULATION			Ripple mV RMS	Price	Model	Size
				Load - %	Line - %	Line - %				
34	1	1	100	.5	.5	5	\$ 60	34A10	AAA	
34	1	1	100	.05	.05	5	65	34B10	AAA	
34	1	1	200	.05	.05	5	70	34B20	AAA	
34	1	1	300	.05	.05	5	75	34D30	AAU	
34	1	1	500	.1	.05	5	85	34D50	AAU	
34	1	1	600	.1	.05	5	95	34D60	AAU	
34	1	1	800	.15	.05	5	105	34D80	AAU	
34	1	1	1.5	.3	.05	5	175	34B150	AAU	
35	1	1	100	.5	.5	5	60	35A10	AAA	
35	1	1	100	.05	.05	5	65	35B10	AAA	
35	1	1	200	.05	.05	5	70	35B20	AAA	
35	1	1	300	.05	.05	5	75	35D30	AAU	
35	1	1	500	.1	.05	5	85	35D50	AAU	
35	1	1	600	.1	.05	5	95	35D60	AAU	
35	1	1	800	.15	.05	5	105	35D80	AAU	
36	1	1	100	.5	.5	5	60	36A10	AAA	
36	1	1	100	.05	.05	5	65	36B10	AAA	
36	1	1	200	.05	.05	5	70	36B20	AAA	
36	1	1	300	.05	.05	5	75	36D30	AAU	
36	1	1	500	.1	.05	5	85	36D50	AAU	
36	1	1	600	.1	.05	5	95	36D60	AAU	
36	1	1	800	.15	.05	5	105	36D80	AAU	
36	1	1	1.5	.3	.05	5	175	36B150	AAU	
37	1	1	100	.5	.5	5	60	37F10	AAA	
37	1	1	100	.05	.05	5	65	37D10	AAA	
37	1	1	200	.05	.05	5	70	37D20	AAA	
37	1	1	300	.05	.05	5	75	37D30	AAA	
37	1	1	500	.1	.05	5	85	37D50	AAU	
37	1	1	600	.1	.05	5	95	37D60	AAU	
37	1	1	800	.15	.05	5	105	37D80	AAU	
38	1	1	100	.5	.5	5	60	38F10	AAA	
38	1	1	100	.05	.05	5	65	38D10	AAA	
38	1	1	200	.05	.05	5	70	38D20	AAA	
38	1	1	300	.05	.05	5	75	38D30	AAA	
38	1	1	500	.1	.05	5	85	38D50	AAU	
38	1	1	600	.1	.05	5	95	38D60	AAU	
38	1	1	800	.15	.05	5	105	38D80	AAU	
39	1	1	100	.5	.5	5	60	39F10	AAA	
39	1	1	100	.05	.05	5	65	39D10	AAA	
39	1	1	200	.05	.05	5	70	39D20	AAA	
39	1	1	300	.05	.05	5	75	39D30	AAA	
39	1	1	500	.1	.05	5	85	39D50	AAU	
39	1	1	600	.1	.05	5	95	39D60	AAU	
39	1	1	800	.15	.05	5	105	39D80	AAU	
40	1	1	100	.5	.5	5	60	40F10	AAA	
40	1	1	100	.05	.05	5	65	40D10	AAA	
40	1	1	200	.05	.05	5	70	40D20	AAA	
40	1	1	300	.05	.05	5	75	40D30	AAA	
40	1	1	500	.1	.05	5	85	40D40	AAU	
40	1	1	600	.1	.05	5	95	40D60	AAU	
41	1	1	100	.5	.5	5	60	41F10	AAA	
41	1	1	100	.05	.05	5	65	41D10	AAA	
41	1	1	200	.05	.05	5	70	41D20	AAA	
41	1	1	400	.1	.05	5	95	41D40	AAU	
42	1	1	100	.5	.5	5	60	42F10	AAA	
42	1	1	100	.05	.05	5	65	42D10	AAA	
42	1	1	200	.05	.05	5	70	42D20	AAA	
42	1	1	300	.05	.05	5	75	42D30	AAA	
42	1	1	400	.1	.05	5	85	42D40	AAU	
42	1	1	600	.15	.05	5	115	42D60	AAU	
43	1	1	100	.5	.5	5	60	43F10	AAA	
43	1	1	100	.05	.05	5	65	43D10	AAA	
43	1	1	200	.05	.05	5	70	43D20	AAA	
43	1	1	300	.05	.05	5	75	43D30	AAA	
44	1	1	100	.5	.5	5	60	44F10	AAA	
44	1	1	100	.05	.05	5	65	44D10	AAA	
44	1	1	200	.05	.05	5	70	44D20	AAA	
44	1	1	300	.05	.05	5	75	44D30	AAA	
44	1	1	400	.1	.05	5	85	44D40	AAU	
44	1	1	600	.15	.05	5	120	44D60	AAU	



---

# Newsletter from Abroad

---

September 16, 1968

## Plessey takeover appears doomed

It appears that the Plessey Co.'s bid to take over the much larger English Electric Co. [Electronics, Sept. 2, p. 167] is going to backfire. **Although the matter is still in the hands of EE's stockholders, the betting is that EE's strategy of undercutting Plessey by agreeing to a merger with the British General Electric Co.-Associated Electrical Industries combine will work.** One hurdle: the influential Industrial Reorganisation Corp., an independent agency set up by the government to push more efficient regroupings, still must give its blessing.

When Plessey made its move, EE's board was alarmed at the prospect of allowing its large heavy-electrical and diesel interests to come under the control of men whose experience was confined largely to electronics, automation, and telecommunications. On the other hand, a union with GEC-AEI and its parallel product line offers stockholders the **additional incentive of having their company run by Arnold Weinstock of GEC-AEI, considered by many one of the best managers in Britain.**

The new giant would combine EE's \$1 billion in sales (about 36% in electronics and telecommunications) with GEC-AEI's \$1.2 billion (about 25% in electronics and telecommunications). The combine would have sales about equal to those of Philips Gloeilampenfabrieken of Holland and Siemens of Germany, and rank among the top electronics-electrical firms outside the U.S.

## Plan Calcul has first model ready

A prototype computer, the first fruit of France's government-subsidized Plan Calcul, will be shown in Paris on Sept. 19 at the Office Equipment Salon [Electronics, April 1, p. 143]. Officials are keeping details secret, but informed sources indicate that **the machine will be on the order of IBM's 360/40: a medium-sized computer with a top capacity of 250,000 bits.** Memory cores are made of lithium ferrite, and integrated circuits are said to be used throughout.

Compagnie Internationale pour l'Informatique (CII), maker of the computer, has no firm orders for the new machine but says it has several prospects lined up. **The price will be about the same as for the 360/40—around \$500,000—but clients may also make lease deals.** Orders will presumably come first from agencies of the government, which has put about \$200 million into its dream of a national computer industry free of dependence on American firms. **Still, this first Plan Calcul computer relies heavily on U.S. components because Plan Composants, which aims to emancipate the French electronics industry from dependence on foreign components, has yet to catch up with the computer effort.**

With production to start early in 1969 and delivery due the second half of the year, France's other computer makers (all of them either U.S. controlled or licensed) aren't overly fearful of the new competitor. Says a Bull-GE spokesman: "All the Plan Calcul publicity has made the French more aware of the possibilities of computers—it's developing a new market for us. And CII itself is a market for our peripherals."

## All-uhf in Japan a decade away . . .

The announcement that uhf television broadcasting will completely replace vhf in 10 years has been met with both delight and dismay in Japan. **Manufacturers of tv sets and transmitting equipment are delighted because they foresee sharply rising sales; broadcasters are dismayed by the**



---

# Newsletter from Abroad

---

## prospect of having to replace expensive equipment.

The decision to go all-uhf was triggered by the need for more channels; the vhf frequency is all used up. As for the two largest cities, there are seven channels in Tokyo and six in Osaka. Other areas have two or three. A preliminary step in the switchover was the assignment of 23 uhf channels in 19 districts last fall; **14 additional allocations are expected next month.**

The 70 megahertz to be vacated in the vhf band will be given to additional mobile stations, probably covering public safety, security, and utilities—everything from the police to taxis. Applications are being received at a rate of about 5,000 a month. To provide more channels, **some-time next year the 40-kilohertz bandwidth used by mobile vhf services will be halved.**

Set makers hope the new plan will pull sales out of the doldrums. Monthly domestic sales are about 300,000 black and white, 140,000 color sets. It's estimated that by year's end 70,000 will be all-channel—priced \$10 or \$15 more a set. And there should be brisk sales of uhf converters for old sets (there are 27 million of them) at \$20 to \$30 apiece.

## ... as observers predict \$11 billion industry by '75

An optimistic forecast of an \$11 billion electronics industry by 1975 has been issued by the Japan Electronic Industry Development Association. This compares with the association's forecast for 1968 of \$4.6 billion in sales. **However, U.S. industry experts point out that the Japanese include components as a separate item in their tabulations and final total without subtracting them from such classifications as computers and consumer electronics, as is the U.S. practice.**

The association says growth has averaged 23.9% in the past 10 years. Total size in 1967 was \$3.9 billion. But Electronics magazine, allowing for the double count of components, estimates the 1968 figure will be only about \$4 billion.

By comparison, the 1968 prediction for the U.S. industry is \$23.6 billion and a growth rate of 6.7% [Electronics, Jan. 8, p. 105].

## Britain getting faster data links

If large, fast computers fail to catch on in Britain, no one will be able to blame the Post Office. **That agency, which controls the commercial telecommunications network, plans to install 48,000-bits-per-second data links between industrial centers.**

At present, only one company—Rolls-Royce—regularly transmits operations data at high speeds. It uses U.S. equipment operating at the standard U.S. 40,800-bits-per-second rate, and an exclusive rented line. Now the Post Office will open a switchable line, available to all, linking London, Birmingham, and Manchester—a distance of about 200 miles—by the end of 1969.

## Japanese balk at added royalty

Japanese manufacturers using Western Electric's field effect transistors are grumbling at WE's efforts to have them pay royalties on complete circuits. They say that since WE already collects patent royalties from Japanese semiconductor houses that make the FET's, the additional fee is uncalled for.

**But Western Electric points out that the manufacturers are using the FET's in patented circuits and that the second levy would merely compensate WE for those patents.**



## Japan

### Double talk

If necessity is the mother of invention, then it must also be the step-mother of mind-numbing repetition—as illustrated by the communications industry's "more signal in less bandwidth" refrain. But repetition or not, the very real need is there; work goes on in the continuous drive to pack more communications into less space.

Another step toward that end has been taken by the Kokusai Denshin Denwa Co., which operates Japan's overseas radio and cable system. Researchers there are perfecting a technique to transmit two telephone conversations over a single voice-grade telephone line. The method could also be used to advantage on radio and other circuits to transmit a single conversation over a narrower bandwidth than at present.

**Squeeze.** The bandwidth of a normal telephone channel is on the order of 0.3 to 3.4 kilohertz. The new transmission scheme consists basically of transmitting roughly the lower half of the band—that is, frequencies between 0.3 and 1.85 khz—and then synthesis of the higher half of the band at the receiving end.

Higher frequencies are synthesized by generating harmonics of the transmitted signal with a diode rectifier, filtering out the lower fundamental frequencies, and then equalizing the higher frequency spectrum so its frequency-energy spectrum is similar to that of speech. This synthesized higher-frequency component is mixed with the transmitted lower frequencies to form a reconstituted speech signal.

The diode harmonic generator must be teamed with a compandor (a compressor and expander). In-

coming signals are amplified and compressed to reduce the dynamic range of signals applied to the harmonic generator, harmonics are generated, and then the signal is expanded to restore dynamic range to a close approximation of the original signal's. Suitable compandor characteristics are extremely important in obtaining proper operation of the harmonic generator.

**P's and Q's.** Reconstituted vowel sounds are fairly accurate reproductions. Reconstituted consonant sounds are less accurate but much preferable to those in narrow-band speech that don't have synthesized higher frequencies reinserted.

### How it all started

The bandwidth reduction innovation—permitting two conversations over a single voice-grade line—is an outgrowth of Kokusai Denshin Denwa's Rectiplex system. Rectiplex, now in commercial use on trans-Pacific teletypewriter circuits operated by RCA, will soon be used on ITT's circuits. It squeezes 108 teletypewriter circuits into a single voice telephone channel, where only about 20 would fit using conventional pulse-modulation techniques with frequency-division multiplexing.

The system will transmit one telephone conversation in half the normal bandwidth. To transmit two conversations over one normal channel slight refinements are needed.

The first conversation is carried as described. This leaves the part of the channel between 1.85 and 3.4 khz empty. The second conversation is inserted into that empty higher frequency sector of the channel after being filtered to remove frequencies above 1.85 khz, and then translated and inverted in a ring modulator so it occupies the 1.85 to 3.4 khz sector.

At the receiving end, signals for the second conversation are translated and inverted to their original values. Then higher frequencies are synthesized and reinserted in the same way as those for the first conversation.

**It works.** Syllable articulation normally runs about 90% over ordinary telephone lines. Tests of the new system showed that if the signal with a highest frequency of only 1.85 khz was transmitted with no higher frequency synthesis and reinsertion, articulation ran about 80% and naturalness of speech suffered greatly. With high-frequency synthesis and reinsertion, articulation went up to about 85% and naturalness improved markedly.

Those tests were conducted over telephone lines with a good signal-to-noise ratio. For use over high-frequency radio, the new system may be even more attractive. High-frequency radio suffers generally from a poor signal-to-noise ratio, interference from other signals (crosstalk), and frequency-selective fading that may change the relative strength of signals differing by as little as 400 hertz.

Although this system's greatest failure is its inability to achieve complete accuracy for reconstituted consonant sounds, consonant sounds lost in noise are even worse in conventional systems. Transmission of this narrower band signal at the same energy—and thus a higher level—and with sharper tuning at the receiver can thus be preferable from the point of view of intelligibility to transmitting the original signal. Results are similar when one considers interfering signals—restriction of bandwidth permits reduction in interference. And frequency selective fading is reduced for the narrower bandwidth. These considerations would appear to give similar results regardless of the type of modulation—ordinary a-m single-sideband usually used



on overseas phone lines, f-m, or whatever. Conclusive tests, though, still must be made.

### Finished goods

Five years of development work on woven plated-wire thin-film memories have finally begun to pay off for Toko Inc. Toko and Oki Univac Kaisha Ltd. plan to use Toko memory planes as main memories in Oki Univac's OUK 9200 and OUK 9300 computers, currently in production, and in the planned OUK 9400. Oki Univac, a joint venture of Oki Electric Industry Co. and the Sperry Rand Corp., says it plans to ship the first computers with the Toko memories at the end of October.

Toko has been supplying high-speed scratch-pad memories to Hitachi and Fujitsu for their computers, and to the Electrotechnical Laboratory for experimental computers. But memory production, in bits, has been small; there wasn't enough business for Toko to recover its large investment in R&D and production equipment. Talks with Univac started last August. The negotiations, prototype fabrication, and tests of planes culminated in Oki Univac's decision to use Toko's planes—said to be the

first plated memory to be produced in Japan as the main memory for a computer.

**Better.** Advantages claimed for the woven plated-wire memory over cores include high speed, small size, lower cost because production processes can be mechanized, lower driving power consumption, and easier maintenance.

Toko will supply the memory plane, including a matrix of selection diodes, and Oki Univac will fabricate peripheral circuits needed to complete the memory. It will be mechanically interchangeable with old Univac units, which for the 9300 have a capacity of 16,000 to 32,000 bytes, and for the 9400 a capacity of 24,000 to 134,000 bytes. Peripheral circuits are modified.

Oki Univac officials say that the characteristics of the memories fabricated with Toko planes and those fabricated with imported Univac planes are identical. Initially, the cost to Oki Univac will be about the same, but as production at Toko picks up the officials expect the domestic units to cost much less than the imported ones. And delivery and other problems will be simplified. The executives are discussing with Univac officials the possibility of export to the U.S.

**Growing.** Toko is expanding its production facilities and expects to

be able to produce planes with a total of about 1.8 million bits of memory capacity per month this autumn, and about 4.5 million to 5.5 million bits per month by next spring. Oki Univac refuses to disclose the cost of the memory, but says it sells to the Japan Electronic Computer Co.—a government-sponsored leasing outlet of Japan's six domestic computer manufacturers—an 8,000-byte memory, with 10 bits per byte, for about \$11,000.

Toko may sell its planes to other computer makers, but this particular design is exclusive for Univac, and Toko is committed to deliver the 1.8 million to 4.5 million bits to Univac before it can supply memory planes to others.

The new design differs slightly from present memory configurations. Between the word lines are magnetic keeper lines of fine-gauge drawn permalloy instead of the copper spacer lines of previous designs. The magnetic lines provide a closed magnetic circuit and permit a reduction in driving currents to about 80% of those previously needed; they also give a slightly better signal-to-noise ratio because interference between adjacent word lines is reduced. The improvement is admittedly slight, but it doesn't add cost, since spacer wire must be woven in anyway and permalloy

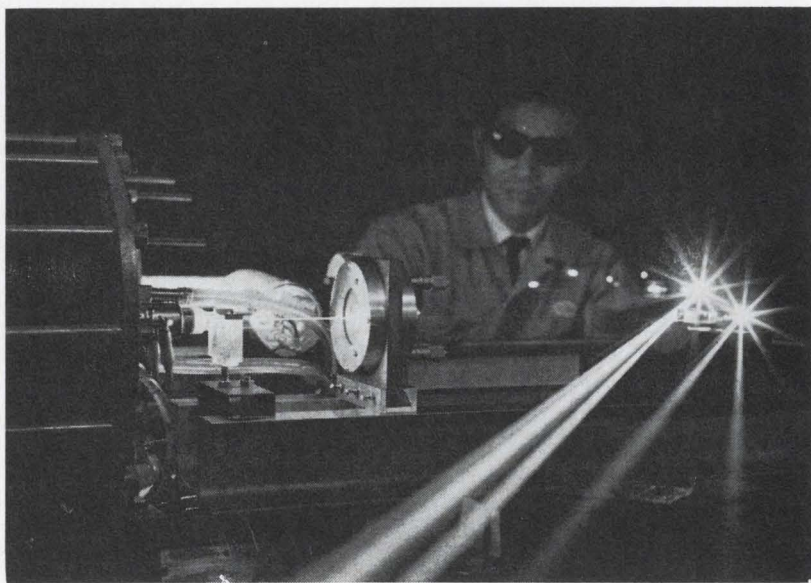

**Turned on.** A technician checks multicolored rays emitted by what Japan's Tokyo Shibaura Electric Co. says is the first long-life, high-output argon and krypton lasers made in Japan. They can oscillate over 11 wavelengths from blue to green; total output is one watt. Beryllium ceramics, rather than quartz, are used for the tubes.



isn't expensive.

The digit-sense line of the new planes consists of 0.13 millimeter conducting wire with an electroplated thin film of nickel-iron alloy about 700 millimicrons thick. The word lines woven at right angles to the digit-sense lines are insulated copper wires with a diameter of about 0.08 mm. Spacing between word lines is 1 mm, with magnetic keeper halfway between. The access time of the memory in which the plane is used is 600 nanoseconds, and the readout is nondestructive.

The speed of Toko's plane is about twice that of ordinary core memories, but the potential speed of this type of woven plated-wire thin-film memory is thought to be about 10 times that of cores. Engineers say they held back rather than worked for speed, because they wanted a unit compatible with those using imported memory planes.

## Australia

### Written on the wind

It's important for engineers, as well as meteorologists and space scientists, to know just how fast the ionosphere moves. Those ionized layers of upper atmosphere are not only known to reflect radio waves but are also believed to interact with the earth's magnetic field and to play a vital role in the perturbation and resulting decay of satellite orbits. And by learning more about ionospheric movement, engineers will be able to predict more accurately the behavior of radio waves.

Up to now, the ionosphere's high-speed movement has been measured largely by rocket probes. But these probes provide only small, isolated samplings.

**Looking up.** However, a team of scientists from the physics department of Australia's University of Adelaide has just put into operation a radar setup that promises to give more comprehensive and accurate

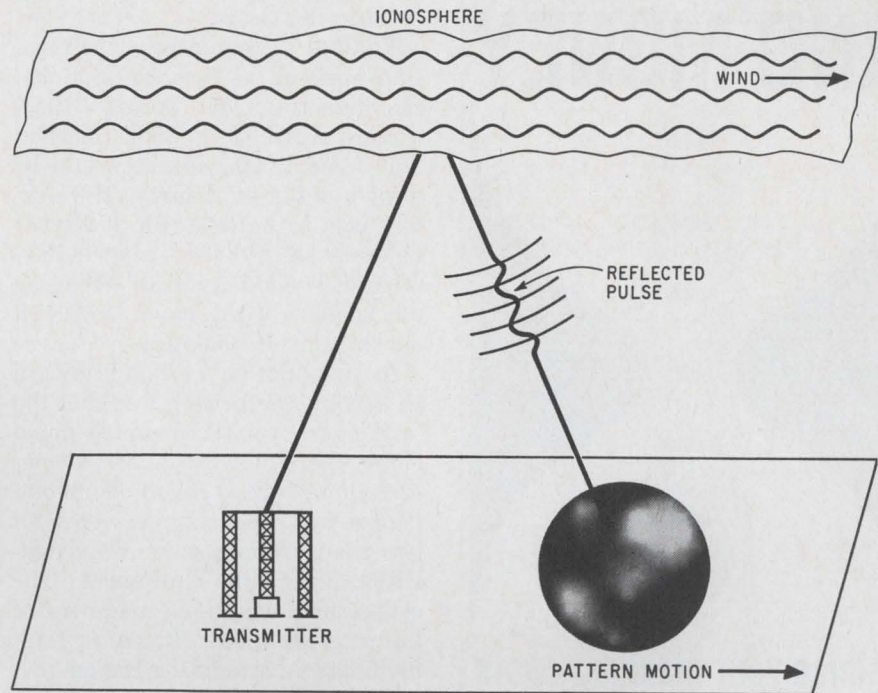

**Light from above.** The Australian system of measuring the speed and direction of the ionosphere's movement gives a visual picture when reflected pulse varies brightness of a light on the ground.

data on ionospheric speed and movement. Working with funds from the U.S. Air Force Office of Scientific Research and Australia's Research Grants Committee, Radio Research Board, and the university itself, the team has assembled a transmitter and 89 antennas spread out over an area three-quarters of a mile in diameter.

Pulses of 100 microseconds are bounced off the ionosphere, and the echoes are picked up by the array of antennas, each of which is connected to a receiver. Because the ionosphere has a bumpy surface, the amplitude of the echo is different at different points on the ground. The antennas sample this random pattern as the ionosphere moves; the speed as measured on the ground is twice the ionosphere's actual speed.

**Two pictures.** The team, headed by B. H. Briggs and W. G. Elford, has developed two ways to record speed and direction. In the visual method, each of the 89 receivers controls the brightness of a light in proportion to the strength of the echo it receives. The lights are arranged in a pattern identical to that of the antennas; smoothing of the

light pattern by a piece of ground glass reproduces the radio wave pattern. The moving light pattern can be filmed and played back at a more realistic speed.

In the second method, receiver outputs are recorded digitally on magnetic tape, which is processed by a Control Data Corp. CDC 6400 computer.

## Italy

### End of the road

The book is ready to close on the complicated Raytheon-Elsi affair after months of litigation, negotiation, and machinations by Sicilian politicians and Italian industrialists.

A subsidiary of the Raytheon Co., Raytheon-Elsi is a Palermo-based manufacturer of electronic components. After a series of losses—Raytheon-Elsi had built up a tidy export business for itself but had no luck in cracking the Italian domestic market—Raytheon decided



# SAVE TIME AND MONEY

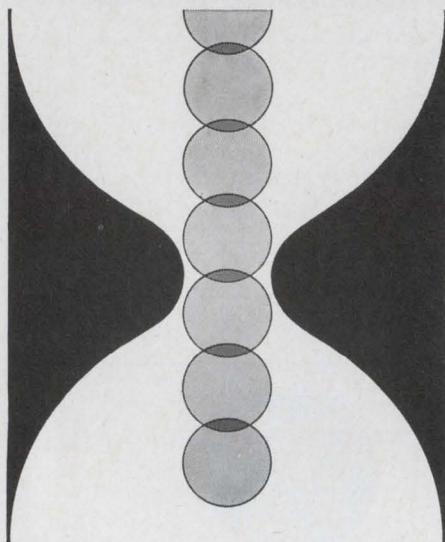

Reduce your masking costs  
Increase your production

with  
**BY-BUK**  
**KWIKY-DOTS**<sup>®</sup>  
OVERLAPPING MASKING DISCS

Connected strings of several discs can be used for faster application, no adhesive transfer. High heat resistance, size from 1/8" dia. up.

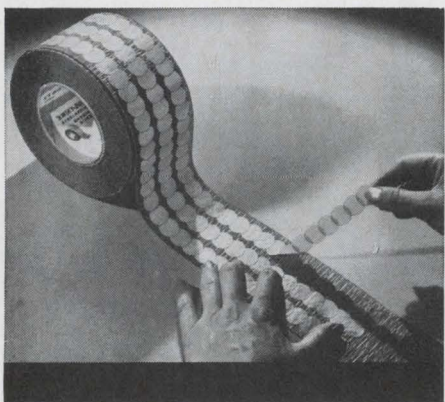

Also, masking tape cut to special widths 1/32" to 6". Pre-cut spray masks, die-cut masks, caps, plugs and other masking aids.

Write for FREE catalog and samples

**BY-BUK**  
COMPANY

4326 W. Pico Blvd.  
Los Angeles, Calif. 90019  
Area Code (213), 937-3511

## Electronics Abroad

to close the doors.

**Timing.** Unfortunately, the decision came at the height of national electioneering last spring [Electronics, April 15, p. 268]. Shocked that some 1,000 workers would be thrown out of work just as the election was to be held, the mayor of Palermo seized the plant. Raytheon-Elsi filed a suit challenging the legality of the move, and then declared itself bankrupt.

As negotiations ground toward an accord, the betting was that the settlement would be pretty much along the following lines. A consortium of Italian government companies will offer the receiver a bit less than \$9 million for Raytheon-Elsi's plant and equipment. The consortium would be made up of Istituto Mobiliare Italiano (IMI), the financial arm of the Italian government; Ente Siciliano per lo Sviluppo Industriale (ESPI), a Sicilian regional development group; and Istituto per la Ricostruzione Industriale (IRI), the Italian state holding company. Ownership in the consortium would be 45% for IMI and ESPI, 10% for IRI.

Moreover, General Instruments Europe is interested in running the Palermo facility for the consortium. Arno Nash, president of GI's European division, says he has made a bid to run the Raytheon-Elsi plant. He will not disclose the terms of his bid, adding that his company would rent rather than buy the machinery.

Barring any unforeseen circumstances, the consortium purchase and General Instruments' entry into the picture is considered to have a good chance of winning final approval.

---

### Great Britain

---

#### Mortal coils

Wire coils as used for scanning deflection in television camera and picture tubes may have remained unchanged longer than any other component in electronics. But now EMI Electronics Ltd., one of the three major producers of color tele-

vision studio equipment in Britain, is in pilot production with etched scanning coils for its four-Plumbicon color camera. Eric Bull, of the company's research laboratories, explained the reasons for the change and described construction of the etched coil at the International Broadcasting Convention in London last week.

As pictures get larger, wound coils have to be made with greater precision to maintain proper geometry, whether the picture is monochrome or color. With color, the rasters have to register perfectly or there is loss of resolution, which pushes up the precision requirement still further. What's more, assembling coils on the tube neck so that they're properly in line with no mutual coupling is a tedious job dependent to a large extent on the skill, care, and patience of the assembler.

**Masked.** To obtain the basic component from which his coils are made, Bull uses established mask and etching techniques on strips of copper-covered flexible insulating material. Because finished etchings are identical, it's relatively simple to make finished coils identical; the skilled labor effort is confined to the production of the master transparency. And since a pair of coils is set down together using a single mask, identical performance and accurate alignment is provided at the masking stage and follows almost automatically when the coil unit is fitted to the tube. Bull says that he has made several types of coil assemblies and that the errors are usually less than those in the camera tube on which they're to be mounted.

The copper remaining on the substrate after etching is in the form of a spiral strip conductor with up to 20 parallel paths in the spiral. The spiral is rectangular, with the two ends of the strip along one of the short sides. The long sides follow a square wave path, with the outer flat "peaks" of the square waves of one side 180° out of phase with those of the other side.

A sheet of insulation is inserted between the copper faces to pre-



vent contact. The folded strip is then wound on a cylindrical form of such a diameter that the square waves along each side lie exactly on each other. Since the outer peaks of one side are 180° out of phase with those on the other side, one set of superimposed waves is exactly opposite the other providing two diametrically opposite coils. The number of square waves in an etching strip, and the number of parallel conductor paths in the spiral, can be varied according to the coil characteristics required, as in an ordinary coil.

**In line.** To ensure that each square wave exactly matches its companions during the winding process, a longitudinal strip of copper is left along each outer edge of the etching, and each side of the center line. The four strips are punched with small holes at predetermined intervals. The winding jig has small pins extending radially from its mandrel, which engage with these holes and keep everything in line. A strip of flexible insulating material is interleaved to prevent contact between adjacent turns. During winding the radius increases progressively, and the spacing of the square waves and the positioning holes has to be progressively increased accordingly. This is taken care of in the mask design. The coils for both coordinates of deflection are normally set down on the same strip, and the complete system is wound in a single operation. After winding the complete unit is vacuum-impregnated with epoxy resin.

## Canada

### Vox politics

As engineers assigned to develop communication satellites discover early in the game, politics plays as large a role in their task as technology. The history of such projects as Intelsat and Symphonie is studded with tradeoffs dictated as much by ruffled national pride as by electronics.

Now it's the turn of Canadian industry to learn about this phenomenon firsthand. Probably as the result of a misunderstanding, the Northern Electric Co. and the RCA Victor Co. are being forced to go to great lengths to explain that they aren't selling out Canada's electronics industry in favor of southern California's.

**Study money.** It all started April 1 with the government's announcement that Canada would create a domestic communications satellite and a corporation to operate it. The announcement included the innocent statement that "Canada already possesses to a large degree the essential technology to determine the design and construction of its own system." This, assumed many Canadians, meant work would be done entirely at home.

But the award of study contracts this month was another story. Totalling \$550,600, the contracts went to Northern Electric (\$276,600) and RCA Victor (\$274,000)—with each subcontracting a piece of the work to California firms. Northern Electric is going to the Hughes Aircraft Co., RCA Victor to TRW Inc. Canadian newspapers carried articles insisting that the satellite system was to have been all Canadian.

**Not so.** As a Northern Electric spokesman pointed out, that was never the case. "We originally made our bid after we linked up with Hughes," he says, adding: "Both firms [Northern Electric and RCA Victor] could do the job on their own without a shadow of a doubt. But the job would take longer—more R&D would be required—and cost more. Why not cut in the experts like Hughes and TRW to act as consultants? And while it isn't clear yet just how much the U.S. subcontracts will be worth, we do know that the figure will be less than 30% of the total cost. Incidentally, it will be to our advantage to keep that figure as low as possible to make marks with the government."

Naturally, adds the spokesman, it's to be presumed that that same percentage of follow-on contracts would go to whichever U.S. subcontractor is lined up with the winning Canadian subcontractor.

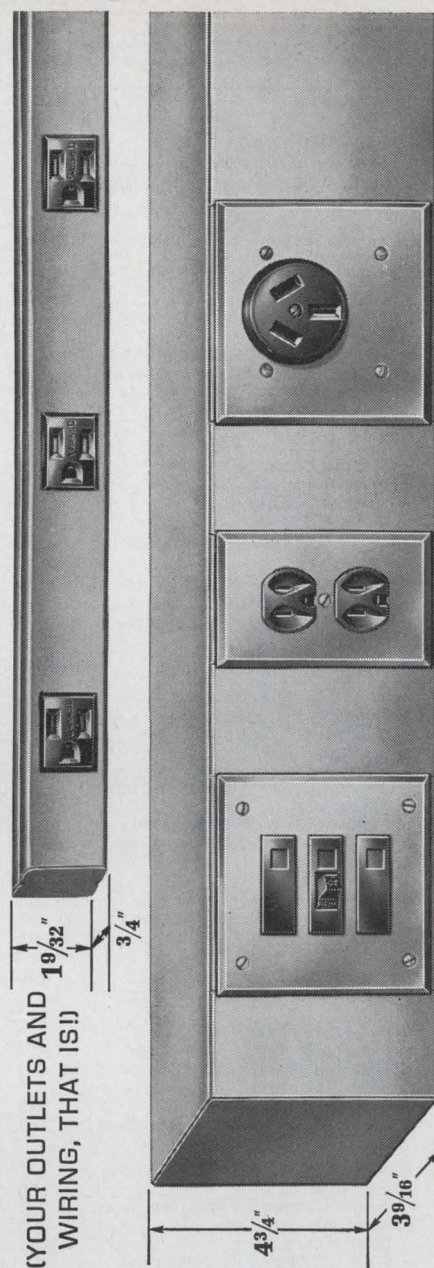

# ORGANIZE!

**PLUGMOLD® MULTIOUTLET SYSTEMS** offer a versatile efficient way to organize electrical wiring and devices of all kinds. Build Plugmold into the products you design. Use it in lab and production areas.

Rugged, attractive Plugmold—in a variety of sizes—accommodates 14 to 2/0 AWG wire, devices to 60A, circuit breakers to 100A. U.L. listed. Send for bulletin.



**WIREMOLD**

THE WIREMOLD COMPANY / HARTFORD, CONNECTICUT 06110



# Electronics advertisers

September 16, 1968

■ Acopian Corp. Mort Barish Associates	232	■ Dale Electronics, Inc., Sub. of Lionel Corp.	3rd Cover	Hughes Aircraft Co. Foote, Cone & Belding	182, 199
Airco Speer Electronic Components Hazard Adv. Co., Inc.	133	Swanson, Sinkey, Ellis, Inc.		□ Hull Corporation The Michener Co.	OAS 8
Airpax Electronics, Inc. Welch, Mirabile & Co., Inc.	168	Dana Laboratories, Inc. Jay Chiat & Assoc., Inc.	20, 21		
Allen-Bradley Co. Fensholt Adv. Agcy.	27	Datacraft Corp. Advertising Art Services	104		
Allied Van Lines, Inc. Young & Rubicam, Inc.	149	Dearborn Electronics, Inc., Sprague Electric Co. Div. Harry P. Bridge Co.	191	IBM Corp., Systems Development Div. Marsteller, Inc.	72, 73
■ AMP, Inc. Garceau, Hallahan & McCullough, Inc.	28, 29, 64	Defense Electronics, Inc. Harry I. Clarkson Associates	187	Indiana General Corp., Ferrites Div. Griswold & Eshleman	32
■ Amperex Electronics Corp., Div. of North American Philips Co. Sam Groden, Inc.	174	Delco Radio Div. of General Motors Corp. Campbell-Ewald Co.	130, 131	■ ITT Cannon Electric MacManus, John & Adams, Inc.	144
Amperite Co. H.J. Gold Co.	14	Delco Radio Div. of General Motors Corp. Macbill/Ross, Inc.	203	ITT Semiconductors Div. Neals & Hickok, Inc.	48
■ Amphenol Corp. Marsteller, Inc.	147	Di-Acro Corp., Div. of Houdaille Industries, Inc. Charles E. Brown Adv. Agcy.	139	ITT Wire & Cable MacManus, John & Adams, Inc.	30
APM-Hexseal Corp. Mohr & Co., Inc.	214	Digital Equipment Corp. Kalb & Schneider, Inc.	218	■ Johanson Mfg. Co. Josephson, Cuffari & Co.	204
■ Barnes Corp. Industrial Public Relations, Inc.	202	Dow Corning Corp., Engineering Products Div. Church & Gusewite Advertising	12, 13	Johnson Co., E.F. Midland Associates	219
Basic, Inc.—Elgin Electronics Div. Carr Liggett Adv., Inc.	227	□ Dow Chemical Europe S.A. MacManus, John & Adams S.A.	OAS 7	■ Kepco, Incorporated Weiss Advertising	170, 172
■ Beckman Instruments, Inc., Helipot Div. Hixson & Jorgensen, Inc.	158	Duncan Electronics, Inc., Sub. of Systron Donner Corp. Enyart & Rose Adv., Inc.	206	Keystone Carbon Co. Downing Industrial Adv., Inc.	141
Bell Telephone Laboratories N.W. Ayer & Son, Inc.	74, 75	□ Dynamco, Ltd. Nicholas Daniels Associates	OAS 17	■ Lapp Insulator Co. Wolff Associates	184
Bendix Corp., Electrical Components Div. MacManus, John & Adams, Inc.	18, 19	Eagle Signal Div. of E.W. Bliss Co. Feeley & Wheeler, Inc.	46	■ Leach Corp. Jay Chiat & Associates	188
Bendix Corp., Semiconductor Products Div. MacManus, John & Adams, Inc.	65	Eastman Kodak Co., Business Systems Markets Div. J. Walter Thompson Co.	135	Litton Industries, Inc., Winchester Electronics Div. MacManus, John & Adams, Inc.	43
□ Bernard Golay S.A. Claude Langel	OAS 14	Elco Corp. Fien and Schwerin, Inc.	242	□ LTT Promotion-Vente-Publicite	OAS 2
B & K Instruments, Inc. The Jayme Organization, Inc.	210	Electronic Communications, Inc. Neals & Hickok, Inc.	181	■ Magnetic Shield Div., Perfection Mica Co. Burton Browne Adv.	171
Bud Radio, Inc. Allied Adv. Agcy., Inc.	156, 157	Electro-Nuclear Laboratories Hal Lawrence, Inc.	205	■ Mallory & Co., P.R., Mfg. Div. Aitkin-Kynett Co.	150
Buffalo & Erie County N.Y. Barber & Drullard, Inc.	180	Electro Products Laboratories, Inc., Transducer Div. Grant, Schwenck & Baker, Inc.	225	□ Marconi-Co., Ltd. Line Edition Comm. Mars Hampshire House, Ltd.	OAS 11
■ Burndy Corp. Don Kemper Co., Inc.	76, 77	Erie Technological Products Co., Inc. Altman-Hall Associates	47	■ Markel & Sons, L. Frank George Moll Adv., Inc.	155
■ Burroughs Corp., Electronic Components Div. Conti Adv. Agcy., Inc.	90	Executone, Inc., Printact Relay Div. J.A. Richards	222	Maryland Dept. of Economic Development The Robert Goodman Agcy., Inc.	226
By-Buk Company Albert Frank Guenther Law Adv., Inc.	238	□ Fieldtech, Ltd. Crane, Norman, Craig & Kummel, Ltd.	OAS 10	Merrimac Research and Development, Inc. Fletcher-Walker-Gessell, Inc.	164
Captor Corp. Weber, Geiger & Kalat, Inc.	192	General Dynamics Corp., Electronics Div. Knoth and Meads Co.	211	Metal Removal Co., The Advertising Producers Associates	24
Cedar Engineering Div., Control Data Corp. Colle & McVoy Adv. Agcy., Inc.	221	■ General Electric Co., Miniature Lamp Div. Batten, Barton, Durstine & Osborn, Inc.	178	□ Micro Dumesnil Publicite	OAS 19, OAS 20
Cerro Copper & Brass Co. Feeley & Wheeler, Inc.	161	■ General Instruments Corp., Semiconductor Products Div. Norman Allen Associates	70, 71	■ Microsonics, Inc. S. Gunnar Myrbeck & Co.	22
Cerroflex Products, Cerro Wire and Cable Co. Rochford, Inc.	197	General Radio Co. Horton, Church & Goff, Inc.	6	Mitre Corp. The Bresnick Co.	134
Chartpak Rotex Hoag & Provandie, Inc.	202	□ Globe Union, Inc., International Div. The Brady Company	OAS 15	Monsanto Co. Foote, Cone & Belding	45
■ Cinch Manufacturing Co. Stral Adv. Co., Inc.	109	■ Guardian Electric Mfg. Co. K & A Advertising	49	Motorola Communications & Electronics, Inc. The Griswold-Eshleman Co.	225
Clare & Co., C.P. Reincke, Meyer & Finn Adv., Inc.	44	■ Gudebrod Brothers Silk Co., Electronics Div. Ramsdell-Buckley & Co.	136	Motorola Semiconductor Products, Inc. Lane & Bird Adv., Inc.	51, 81
Clarostat Manufacturing Co. Horton, Church & Goff, Inc.	145	Hamilton Watch Co. Beaumont, Heller & Sperling, Inc.	209	■ National Electronics, Inc. Connor-Sager Associates	227
Colorado State of, Industrial Development Div. Buchen Adv., Inc.	195	Hansen Mfg. Co. Kelley-Crescent Co.	215	National Semiconductor Corp. Jay Chiat & Associates	15, 129
Communication Electronics, Inc. William C. Estler—Public Relations	162	Hayakawa Electronics Co., Ltd. Dai-ichi International, Inc.	219	■ Newark Electronics Corp. Stral Adv. Co.	210
Computer Mechanisms Corp. Hammel, Bomar Co.	8	■ Haydon Switch & Instrument, Inc. Reynolds & Foster, Inc.	198	■ Nitsuko, Ltd. General Adv. Agcy., Inc.	224
Consolidated Electrodynamics Corp., Sub. of Bell & Howell Hixson & Jorgensen, Inc.	132	Heinemann Electric Co. Thomas R. Sundheim, Inc.	16	■ North Atlantic Industries, Inc. Murray Heyert Associates	78
□ Contelec Werbegraphik	OAS 16	■ Hewlett Packard, Loveland Div. Tallant/Yates Adv., Inc.	63	■ Norton Associates, Inc. J.J. Coppo Co.	208
■ Cornell-Dubilier Electronics Daniel & Charles, Inc.	79	■ Hewlett Packard, Microwave Div. Lennen & Newell, Inc.	1, 2	Olympus Corp. Kameny Assoc., Inc.	80
CREI, Home Study Div. of the McGraw-Hill Book Co. Henry J. Kaufman & Associates	185	Honeywell, Computer Control Div. Franklin P. Folts, Inc.	23	Pastoriza Electronics Co. L.K. Frank Co., Inc.	160
□ CSF GTE S P I Agency	OAS 12	■ Honeywell, Test Instruments Div. Campbell Mithun, Inc.	89		
■ CTS Corporation Burton Browne Advertising	216, 217				
Cyclo-Tronics, Inc. Bernard J. Hahn & Associates	166				





Helps Dodge Electronics Products Corp. Smith, Dorian & Burman, Inc.	194
Philco Ford Co., Microelectronics Div. The Aitkin-Kynett Co., Inc.	10, 11
Philips Eindhoven N.V. T.A.G. De La Mar	OAS 1
Photocircuits Corp. Duncan Brooks, Inc.	142
Preston Scientific Donald S. Smith Associates	26
Price Electric Corp. H.W. Buddemeier Co., Inc.	163
Princeton Applied Research Corp. Mort Barish Assoc., Inc.	52
Radio Corporation of America Al Paul Lefton Co.	4th Cover, 173, 190
Rentronix Bonfield Assoc., Inc.	220
Rotron Mfg. Co. Lescarboua Adv., Inc.	OAS 9, OAS 18
Sage Electronics Corp. Mathison Adv., Inc.	223
Schlumberger A.C.B. Industrie et Publicite	OAS 3
Semtech Corp. Burress Advertising	59
Sesco Maurice Ridant, Editions Techniques & Publicite de Firmes	OAS 5
Siliconix, Inc. Graphics West	7
Singer Co., The, Metrics Div. The Stanley Schwartz Co.	146
Sogie Etudes et Creations Publicitaire	OAS 6
Solitron Devices, Inc., Transistor Div. Haselmire Pearson Adv., Inc.	143
Sorensen Operation, Raytheon Company Urrutia & Hayes, Inc.	69
S.P. Elettronica Publicitas SPA	OAS 4
Sperry Rand Corp., Sperry Microwave Electronics Div. Neals & Hickok, Inc.	66
Sprague Electric Co., The Harry P. Bridge Co.	5, 9
Stackpole Carbon Co., Electronic Components Div. Meek & Thomas, Inc.	137
Struthers-Dunn, Inc. Harry P. Bridge Co.	82
Superior Tube Co. Gray & Rogers, Inc.	225
Sylvania Electric Products, Inc., Electronic Components Group Doyle, Dane, Bernbach, Inc.	35 to 42
Synthane Corp. Arndt, Preston, Chapin, Lamb & Keen, Inc.	227
Syntronic Instruments, Inc. Burton Browne Advertising	208
Systron-Donner-Corp. Bonfield Assoc., Inc.	17
Tech Laboratories, Inc. Lewis Adv. Agcy.	221
Technique et Produits Ste de Publicite de Films et de Documentaires	OAS 13
Tektronix, Inc. Hugh Dwight Adv., Inc.	151, 152
Teledyne Relays Co. S. Michelson Adv.	140
Texas Industrial Commission The Pitluk Group	223
Texas Instruments Incorporated Components Group Don L. Baxter, Div. of Albert Frank-Guenther Law, Inc.	85, 86, 87, 88
Texas Instruments Incorporated Industrial Products Group Robinson-Gerrard	193
Times Wire & Cable Div., International Silver Co. Mohr & Co., Inc.	50
Torrington Mfg. Co., Air Moving Div. Wilson, Haight & Welch, Inc.	25

Transitron Electronic Corp. Larcom Randall Adv., Inc.	138
TRG, Inc., Div. of Control Data Corp. Culver Adv., Inc.	83
Tung-Sol Div., Wagner Electric Corp. Feeley & Wheeler, Inc.	215
Ujano Graphic Arts Supplies, Inc. Lory Roston Associates	179
United Transformer Co., Div. of TRW, Inc. Fuller & Smith & Ross, Inc.	2nd Cover
Unitrode Corp. Silton Brothers, Inc.	61
Varian Assoc., Eimac Div. Botsford, Constantine & McCarty, Inc.	148
Vector Electronic Co., Inc. Packard Adv., Inc.	224
Vent-Rak Quinlan Keene Peck & McShay, Inc.	186
Victoreen Instrument Co. Palm & Peterson, Inc.	167
Vishay Instruments, Inc. Alpern Communications	175
Vitramon, Inc. Ted Sommers, Inc.	221
Volkert Stampings Fred Wittner Co., Inc.	84
Wang Laboratories Impact Adv., Inc.	196
Weinschel Engineering, Co. E.G. White Adv., Inc.	220
Weston Instruments, Inc., Archbald Div. Arndt, Preston, Chapin, Lamb & Keen, Inc.	212
Wiremold Co., The The Charles Brunelle Co.	239
Wisco Division, ESB, Inc. E.L. Speer Adv. Agcy.	223

### Classified Advertising

F.J. Eberle, Manager

### EMPLOYMENT OPPORTUNITIES

Hallicrafters Co. ....	228
Western Electric .....	228

### EQUIPMENT (Used or Surplus New) For Sale

Education For Career Advancement.....	231
Fishman, Philip Co.....	231
Radio Research Instrument Co.....	231
Shawmut Real Estate & Investment.....	231

■ For more information on complete product line see advertisement in the latest Electronics Buyer's Guide

□ Advertisers in Overseas Advertising Section following Newsletter from Abroad

### Electronics Buyers' Guide

George F. Werner, General Manager [212] 971-2310  
 Robert M. Denmead, Midwest Regional Manager [312] MO 4-5800  
 Regina Hera, Directory Manager [212] 971-2544  
 Thomas M. Egan, Production Manager [212] 971-3140

### Circulation Department

Isaaca Siegel, Manager [212] 971-6057

### Research Department

David Strassler, Manager [212] 971-6058  
 Chloe D. Glover, Research Associate [212] 971-6057

## Advertising Sales Staff

Frank E. LeBeau [212] 971-6464  
 Advertising Sales Manager

Wallis Clarke [212] 971-2187  
 Assistant to sales manager

Donald J. Austermann [212] 971-3139  
 Promotion Manager

Warren H. Gardner [215] LO 8-6161  
 Eastern Advertising Sales Manager

Atlanta, Ga. 30309: Michael H. Miller, 1375 Peachtree St., N.E. [404] 892-2868

Boston, Mass. 02116: William S. Hodgkinson McGraw-Hill Building, Copley Square [617] CO 2-1160

Cleveland, Ohio 44113: William J. Boyle, 55 Public Square, [216] SU 1-7000

New York, N.Y. 10036  
 500 Fifth Avenue  
 James R. Pierce [212] 971-3616  
 John A. Garland [212] 971-3617

Philadelphia, Pa. 19103:

Jeffrey M. Preston  
 Warren H. Gardner,  
 6 Penn Center Plaza,  
 [215] LO 8-6161

Pittsburgh, Pa. 15222: Warren H. Gardner,  
 4 Gateway Center, [412] 391-1314

Rochester, N.Y. 14534: William J. Boyle,  
 9 Greylock Ridge, Pittsford, N.Y. [716] 586-5040

Donald R. Furth (312) MO 4-5800  
 Midwest Advertising Sales Manager

Chicago, Ill. 60611: Kenneth E. Nicklas  
 Ralph Hanning, 645 North Michigan Avenue,  
 [312] MO 4-5800

Dallas, Texas 75201: Richard P. Poole, 1800 Republic National Bank Tower,  
 [214] RI 7-9721

Houston, Texas 77002: Robert Wallin,  
 2270 Humble Bldg. [713] CA 4-8381

Detroit, Michigan 48226: Ralph Hanning,  
 856 Penobscot Building  
 [313] 962-1793

Minneapolis, Minn. 55402: 1104 Northstar Center [612] 332-7425

St. Louis, Mo. 63105: Kenneth E. Nicklas,  
 The Clayton Tower, 7751 Carondelet Ave.  
 [314] PA 5-7285

James T. Hauptli [415] DO 2-4600  
 Western Advertising Sales Manager

Denver, Colo. 80202: Joseph C. Page, David M. Watson, Tower Bldg., 1700 Broadway [303] 255-5484

Los Angeles, Calif. 90017: Ian C. Hill,  
 John G. Zisch, 1125 W. 6th St., [213] HU 2-5450

Portland, Ore. 97204: James T. Hauptli,  
 Thomas McElhinny, 218 Mohawk Building,  
 222 S.W. Morrison Street,  
 Phone [503] 223-5118

San Francisco, Calif. 94111: James T. Hauptli,  
 Thomas McElhinny, 255 California Street,  
 [415] DO 2-4600

Pierre Braude Tel: 225 85 88: Paris

### European Director

Paris: Ken Davey  
 88-90 Avenue Des Champs-Elysees, Paris 8

United Kingdom and Scandinavia

Brian Bowes Tel: Hyde Park 1451  
 34 Dover Street,  
 London W1

Milan: Robert Saidel  
 1 via Baracchini Phone 86-90-656

Brussels: F.I.H. Huntjens  
 27 Rue Ducale Tel: 136503

Frankfurt/Main: Hans Haller  
 Elsa-Brandstroem Str. 2  
 Phone 72 01 81

Geneva: Ken Davey  
 1, rue du Temple Phone: 31 95 60

Tokyo: Takeji Kinoshita 1 Kotohiracho  
 Shiba, Minato-Ku Tokyo [502] 0656

Osaka: Ryoji Kobayashi 163, Umegae-cho  
 Kita-ku [362] 8771

### Business Department

Wallace C. Carmichael, Manager  
 [212] 971-3191

Stephen R. Weiss, Production Manager  
 [212] 971-2044

Thomas M. Egan,  
 Assistant Production Manager [212] 971-3140

Dorothy Carmesin, Contracts and Billings  
 [212] 971-2908

Frances Vallone, Reader Service Manager  
 [212] 971-2865



# We're not afraid to say it out loud:

## Delivery OF ELCO CARD-EDGE CONNECTORS FROM OUR STOCKING DISTRIBUTORS IN 24 HOURS. PERIOD.

Why wait? And wait?? And wait??? When you can not only get delivery in a day, but the Card-Edge Connectors that meet your exact requirements. At competitive prices. MIL-Spec designs. 6 to 100 bifurcated or non-bifurcated contacts at .100" to .200" spacing. Single or dual readout. For wire wrap and other terminations. Insulators with or without extended p. c. card guides. Even a new Series with single-cantilever contacts, with noses pre-loaded for maximum performance. Down with down-time. And up to your nearest Distributor listed here. Or write, call, wire or TWX us for Card-Edge Connector Guide and complete data. Elco Corporation, Willow Grove, Pa. 19090; 215-659-7000; TWX 510-665-5573.

P.S.—FREE SAMPLE? Let us know after you read our literature. We'll be delighted to send you one.



#### EAST COAST

**CAROLINA RADIO SUPPLY COMPANY**  
838 Huffman St., Greensboro, N.C.  
27405; Phone: 919-273-8669

**CONNECTOR CORPORATION**  
137 Hamilton St., New Haven, Conn.  
06510; Phone: 203-624-0127

**D.R.W. ELECTRONICS**  
100 Milbar Blvd., Farmingdale, L. I.,  
N. Y. 11735; Phone: 516-249-2660

**HAMMOND ELECTRONICS**  
911 W. Central Blvd., Orlando, Fla.  
32805; Phone: 305-241-6601

**POWELL/FLORIDA**  
2049 W. Central Blvd., Orlando, Fla.  
32805; Phone: 305-423-8586

**POWELL/HUNTSVILLE**  
Huntsville Highway, Fayetteville,  
Tenn. 37334; Phone: 615-433-5737

**POWELL/PHILADELPHIA**  
Island and Enterprise Rds., Phila.,  
Pa. 19101; Phone: 215-724-1900

**POWELL/WASHINGTON**  
10728 Hanna St., Beltsville, Md.  
20705; Phone: 301-474-1030

**PYTRONICS/BALTIMORE**  
2035 Worcester St., Baltimore, Md.  
21230; Phone: 301-539-6525

**PYTRONICS/MONTGOMERYVILLE**  
Bldg. 2-Stump Rd., Montgomeryville,  
Pa. 18936; Phone: 215-643-2850

**RADIO SHACK**  
920 Main Street, Waltham, Mass.  
02154; Phone: 617-891-8700

**SAGER ELECTRICAL SUPPLY COMPANY**  
172 High St., Boston, Mass. 02107  
Phone: 617-542-2281

**STERLING/ATLAS ELECTRONICS**  
774 Pfeiffer Blvd., Perth Amboy,  
N.J. 08861; Phone: 201-442-8000

**SUMMIT DISTRIBUTORS**  
916 Main St., Buffalo, N.Y. 14202  
Phone: 716-884-3450

**TERMINAL-HUDSON ELECTRONICS**  
236 W. 17th St., New York, N.Y.  
10011; Phone: 212-243-5200

#### MID-WEST

**ALLIED RADIO CORPORATION**  
111 N. Campbell Ave., Chicago, Ill.  
60680; Phone: 312-421-6800

**HAMILTON ELECTRO SALES OF TEXAS**  
1216 W. Clay St., Houston, Tex.  
77019; Phone: 713-526-4661

**CONTACT ELECTRONICS**  
2403 Farrington St., Dallas, Tex.  
75207; Phone: 214-638-2850

**D. F. COUNTRYMAN & COMPANY**  
1955 University Ave., St. Paul,  
Minn. 55104; Phone: 612-645-9151

**ELECTRONIC EXPEDITORS, INC.**  
6045 N. Green Bay Ave., Milwaukee,  
Wis. 53209; Phone: 414-374-6666

**ELECTRONIX, INC.**  
214 N. Second St., St. Charles, Mo.  
63301; Phone: 314-723-1122

**PIONEER-STANDARD ELECT. SUPPLY CO.**  
5403 Prospect Ave., Cleveland, Ohio  
44103; Phone: 216-432-0010

**SREPCO, INC.**  
314 Leo St., Dayton, Ohio 45404  
Phone: 513-224-0871

#### WEST COAST

**ALMAC/STROUM ELECTRONICS**  
5811-Sixth Ave., S., Seattle, Wash.  
98108; Phone: 206-763-2300

**ELECTRO-SONIC COMPONENTS**  
14126 Lemoli Ave., Hawthorne, Cal.  
90250; Phone: 213-679-9781

**HOLLYWOOD RADIO**  
5250 Hollywood Blvd., Hollywood,  
Cal. 90027; Phone: 213-466-3181

**KIERULFF/DENVER**  
10890 E. 47th St., Denver, Colo.  
80239; Phone: 303-343-7090

**KIERULFF/LOS ANGELES**  
2585 Commerce Way, Los Angeles,  
Cal. 90022; Phone: 213-685-5511

**KIERULFF/PALO ALTO**  
3969 E. Bayshore Rd., Palo Alto,  
Cal. 94303; Phone: 415-968-6292

**KIERULFF/SAN DIEGO**  
8797 Balboa Ave., San Diego, Cal.  
92123; Phone: 714-278-2112

**RICHEY ELECTRONICS**  
5505 Riverton Ave., N. Hollywood,  
Cal. 91601; Phone: 213-761-6133

**WEATHERBIE INDUSTRIAL  
ELECTRONICS**  
1280 N. Fourth St., San Jose, Cal.  
95112; Phone: 408-297-9550





**sealed!**

## You can do more with Dale 1" Commercial Trimmers

New 2300 Econo-Trim Series available sealed or unsealed... from 97 cents.

Dale's 2300 Econo-Trim matches your needs for a low-price, high-performance commercial trimmer. Sold unsealed at 97 cents (1,000 lots), it can be automatically soldered and provides excellent protection against dust and dirt contamination. For just pennies more, it can be fully sealed to withstand cleaning, fluxing and automatic soldering processes. Inside either style, Dale uses Mil-type construction to give you excellent electrical performance—plus stay-put wiper settings that won't unbalance your circuit by shifting due to shock or vibration.

Four models in the 2300 Series are ready for you right now. Check the specifications at right, then... CALL DALE AT 402-564-3131.

### FOUR MODELS—SEALED OR UNSEALED

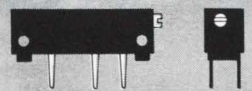

Printed Circuit Terminals  
Model 2317 (sealed)  
Model 2387 (unsealed)

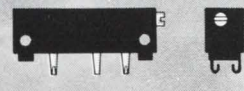

Hook-type Lugs  
Model 2319 (sealed)  
Model 2389 (unsealed)

### SPECIFICATIONS

Standard Resistance Range: 10 ohms to 50K ohms

Resistance Tolerance:  $\pm 10\%$  standard

Resolution: 1.82% to .18%

Power Rating: 0.5 watt at room temperature to 0 watt at 105° C

Operating Temperature Range: -55° C to 105° C

Mechanical Adjustment: 15 turns nominal

Mechanical Stops: None. Clutch mechanism permits overtravel without damage

Dimensions: 1.0" L x .36" H x .28" W

Terminals: P.C. terminals (Model 2387 unsealed), (Model 2317 sealed)  
Hook-type solder lugs (Model 2389 unsealed), (Model 2319 sealed)



**DALE ELECTRONICS, INC.**

1300 28th Ave., Columbus, Nebr. 68601  
In Canada, Dale Electronics Canada, Ltd.



# Name RCA's PPP\*

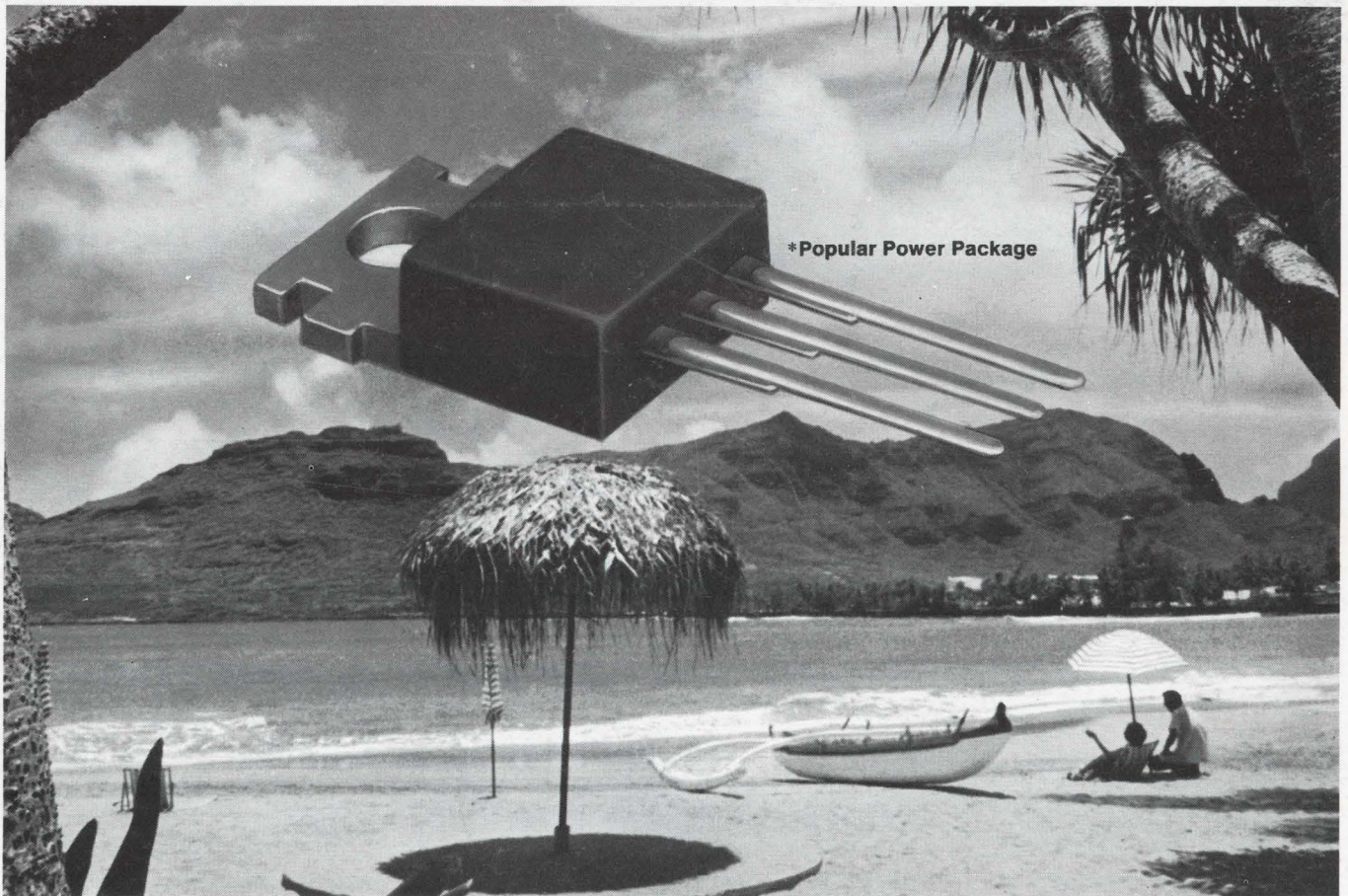

## It may get you to Hawaii

We've decided to run a contest. Why? Because your tremendous acceptance of this RCA "plastic TO-66 package" merits naming it. Just come up with a name for it...and you may be the lucky winner of a 10-day round-trip vacation for two to HAWAII! The trip includes a fabulous first-class jet flight, right from your nearest U. S. airport...deluxe hotel accommodations on full American plan!

Some power transistor features to inspire you:

- ruggedness • versatile configuration • high power density

And to expand your design capabilities...

### RCA Announces the 2N5490 through 2N5497

This new 2N5496 family (formerly the TA7311) extends your ability to design by giving you good gain in applications up to 3.5 A... power dissipations to 50 watts.

The chart below provides easy reference for type selections according to your needs.

See your RCA Representative or RCA Distributor for further information. For technical data, write to RCA Electronic Components, Commercial Engineering, Section IN-92, Harrison, N. J. 07029.

**To Enter the Contest**...submit all the names you wish (each must be on a separate postcard or letter). Entries must be postmarked no later than midnight November 15, 1968. There is nothing to buy or submit with your entry. Decision of the judges is final. In case of duplications of names, the entry with the earliest postmark is the winner. In case of duplicate postmarks, the winner will be picked by drawing. All entries become the property of RCA. Only employees of RCA and their families are ineligible. This contest is void where prohibited by law.

Mail your entry, along with your name, title, company, and address to: Manager, Power Transistor Marketing, RCA Electronic Components, Somerville, N. J. 08776.

# RCA

TYPE	V <sub>CER</sub> (sus)**	h <sub>FE</sub>	TYPE	V <sub>CER</sub> (sus)**	h <sub>FE</sub>
2N5293† 2N5294†	75 V	30-120 @ I <sub>C</sub> = 0.5 A, V <sub>CE</sub> = 4 V	2N5492* 2N5493*	65 V	20-100 @ I <sub>C</sub> = 2.5 A, V <sub>CE</sub> = 4 V
2N5295† 2N5296†	50 V	30-120 @ I <sub>C</sub> = 1 A, V <sub>CE</sub> = 4 V	2N5494* 2N5495*	50 V	20-100 @ I <sub>C</sub> = 3 A, V <sub>CE</sub> = 4 V
2N5297† 2N5298†	70 V	20-80 @ I <sub>C</sub> = 1.5 A, V <sub>CE</sub> = 4 V	2N5496* 2N5497*	80 V	20-100 @ I <sub>C</sub> = 3.5 A, V <sub>CE</sub> = 4 V
2N5490* 2N5491*	50 V	20-100 @ I <sub>C</sub> = 2.0 A, V <sub>CE</sub> = 4 V	†θ <sub>J,C</sub> 3.5 °C/W max.      *θ <sub>J,C</sub> 2.5 °C/W max.      **R <sub>BE</sub> = 100 ohms		